

BYTE

OCTOBER 1981 Vol. 6, No. 10

\$7.50 in USA/\$2.95 in Canada

A McGraw-Hill Publication

the small systems world

LOCAL NETWORKS

ROBERT
ST. TINNEY



A new small computer that won't limit you tomorrow



New Cromemco System One shown with our
high-capability terminal and printer.

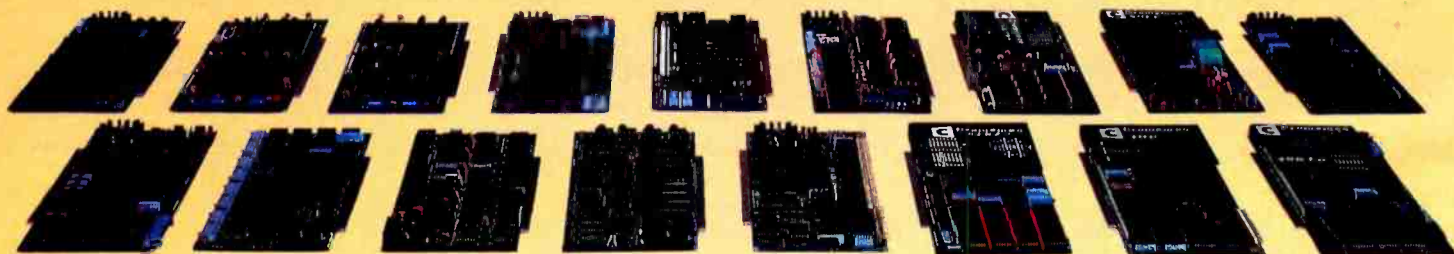

Expandability

Here's a low-priced computer that won't run out of memory capacity or expandability halfway through your project.

Typically, computer usage tends to grow, requiring more capability, more memory, more storage. Without a lot of capability and expandability, your computer can be obsolete from the start.

The new System One is a real building-block machine. It has capability and expandability by the carload.

Look at these features:

- **Z80-A processor**
- **64K of RAM**
- **780K of disk storage**
- **CRT and printer interfaces**
- **Eight S-100 card slots, allowing expansion with**
 - **color graphics**
 - **additional memory**
 - **additional interfaces for telecommunications, data acquisition, etc.**
- **Small size**

GENEROUS DISK STORAGE

The 780K of disk storage in the System One Model CS-1 is much greater than what is typically available in small computers. But here, too, you have a choice since a second version, Model CS-1H, has a 5" Winchester drive that gives you 5 megabytes of disk storage.

MULTI-USER, MULTI-TASKING CAPABILITY

Believe it or not, this new computer even offers multi-user capability when used with our advanced CROMIX* operating system option. Not only does this outstanding O/S support multiple users on this computer but does so with powerful features like multi-

ple directories, file protection and record level lock. CROMIX lets you run multiple jobs as well.

In addition to our highly-acclaimed CROMIX, there is our CDOS*. This is an enhanced CP/M† type system designed for single-user applications. CP/M and a wealth of CP/M-compatible software are also available for the new System One through third-party vendors.

COLOR GRAPHICS/WORD PROCESSING

This small computer even gives you the option of outstanding high-resolution color graphics with our Model SDI interface and two-port RAM cards.

Then there's our tremendously wide range of Cromemco software including packages for word processing, business, and much more, all usable with the new System One.

ANTI-OBSOLESCENCE/LOW-PRICED

As you can see, the new One offers you a lot of performance. It's obviously designed with anti-obsolescence in mind.

What's more, it's priced at only \$3,995. That's considerably less than many machines with much less capability. And it's not that much more than many machines that have little or nothing in the way of expandability.

Physically, the One is small — 7" high. And it's all-metal in construction. It's only 14½" wide, ideal for desk top use. A rack mount option is also available.

CONTACT YOUR REP NOW

Get all the details on this important building-block computer. Get in touch with your Cromemco rep now. He'll show you how the new System One can grow with your task.

*CROMIX and CDOS are trademarks of Cromemco Inc.
†CP/M is a trademark of Digital Research



Cromemco™
i n c o r p o r a t e d

280 BERNARDO AVE., MOUNTAIN VIEW, CA 94040 • (415) 984-7400
Tomorrow's computers today

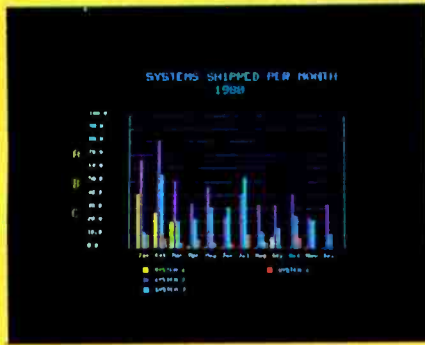

Management Information Display

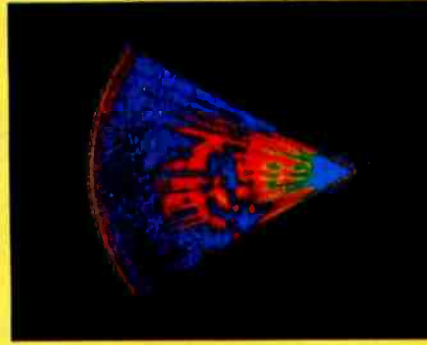

Ultrasonic heart sector scan

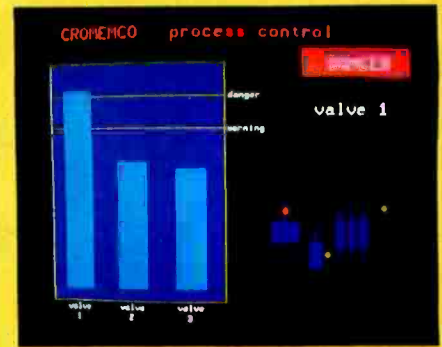

Process Control

Get the professional color display that has BASIC/FORTRAN simplicity

LOW-PRICED, TOO

Here's a color display that has everything: professional-level resolution, enormous color range, easy software, NTSC conformance, and low price.

Basically, this new Cromemco Model SDI* is a two-board interface that plugs into any Cromemco computer.

The SDI then maps computer display memory content onto a convenient color monitor to give high-quality, high-resolution displays (756 H x 482 V pixels).

When we say the SDI results in a high-quality professional display, we mean you can't get higher resolution than this system offers in an NTSC-conforming display.

The resolution surpasses that of a color TV picture.

BASIC/FORTRAN programming

Besides its high resolution and low price, the new SDI lets you control with optional Cromemco software packages that use simple BASIC- and FORTRAN-like commands.

Pick any of 16 colors (from a 4096-color palette) with instructions like DEFCLR (c, R, G, B). Or obtain a circle of specified size, location, and color with XCIRC (x, y, r, c).

*U.S. Pat. No. 4121283

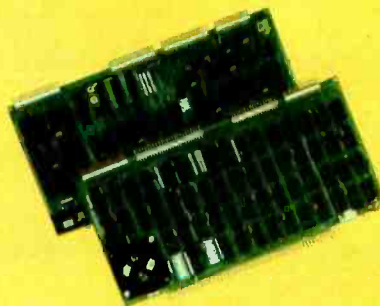

Model SDI High-Resolution Color Graphics Interface

HIGH RESOLUTION

The SDI's high resolution gives a professional-quality display that strictly meets NTSC requirements. You get 756 pixels on every visible line of the NTSC standard display of 482 image lines. Vertical line spacing is 1 pixel.

To achieve the high-quality display, a separate output signal is produced for each of the three component colors (red, green, blue). This yields a sharper image than is possible using an NTSC-composite video signal and color TV set. Full image quality is readily realized with our high-quality RGB Monitor or any conventional red/green/blue monitor common in TV work.

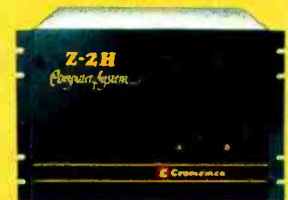

Model SDI plugs into Z-2H 11-megabyte hard disk computer or any Cromemco computer

DISPLAY MEMORY

Along with the SDI we also offer an optional fast and novel two-port memory that gives independent high-speed access to the computer memory. The two-port memory stores one full display, permitting fast computer operation even during display.

CONTACT YOUR REP NOW

The Model SDI has been used in scientific work, engineering, business, TV, color graphics, and other areas. It's a good example of how Cromemco keeps computers in the field up to date, since it turns any Cromemco computer into an up-to-date color display computer.

The SDI has still more features that you should be informed about. So contact your Cromemco representative now and see all that the SDI will do for you.

 **Cromemco**
incorporated
280 BERNARDO AVE., MOUNTAIN VIEW, CA 94040 • (415) 964-7400
Tomorrow's computers today

Features

- 26 The IBM Personal Computer: First Impressions** by Phil Lemmons / The computer giant embraces software compatibility and support for independent peripheral manufacturers.
- 36 Build an Intelligent EPROM Programmer** by Steve Ciarcia / With a Z8-BASIC Microcomputer, you can easily put together a versatile programmer for 2716 EPROMs.
- 50 Ultra-Low-Cost Network for Personal Computers** by Ken Clements and Dave Daugherty / The age of communication for personal computers has arrived; don't be left behind.
- 70 The Atari Tutorial, Part 2: Graphics Indirection** by Chris Crawford / Graphics indirection lets you quickly change the colors used in the video display and redefine the Atari character set.
- 92 Local-Area Networks, Possibilities for Personal Computers** by Dr Harry J Saal / The "one person, one computer" concept is improved with communications.
- 114 Prepare Your Program for Publication** by C A Johnson / A checklist of professional touches that can make software sell.
- 126 Software Protection In the United Kingdom** by Martin Hayman / A London conference confronts the problem of software piracy.
- 140 Network Tools, Ideas for Intelligent Network Software** by Peter B Reintjes / A set of general modules provides a basis for networking.
- 176 A Simple Implementation of Multitasking** by Wendell Brown / A little SLEEP can go a long way.
- 195 Tree Searching, Part 2: Heuristic Techniques** by Gregg Williams / Admissible algorithms allow you to find an optimal solution without an exhaustive search of the state-space tree.
- 214 Drawing with UCSD Pascal and the Hiplot Plotter** by Dr James Stork / Some UCSD plotting routines that can be linked to any Pascal program.
- 250 Evaluate Your Home's Energy Efficiency, Conserve Energy with Your Computer** by Kimball Beasley / Use your computer to lower those budget-breaking heat bills.
- 264 Bridging the 10-Percent Gap** by Paul T Brady / Software problems can hold back a small-business data-processing explosion.
- 284 Graphics Fundamentals** by Kathleen Bresnahan Sandifur / A company logo is the vehicle for understanding windows and scaling.
- 400 Build a Versatile Keyboard Interface for the S-100** by David R Richards / A device that lets you communicate with your microcomputer.
- 407 PERT Organization** by W Douglas Maurer / A mathematical method used by computer programmers to determine the relative importance of the tasks under their supervision.
- 413 Should the DO Loop Become an Assembly-Language Construct?** by Glenn L Williams / Innovative instructions can forestall the "software crisis."

- 430 Multiple Regression for the TRS-80** by Douglas William Madron / On converting the mathematics of linear regression into a general-purpose BASIC program.
- 448 Bits and Bytes In Pascal, and Other Binary Wonders** by David Casseres / Put UCSD Pascal through its paces to ease programming and have fun.
- 458 Apple Analog-to-Digital Conversion in 27 Microseconds** by Michael A Seeds / Build this high-speed, 10-bit analog-to-digital converter for your Apple for less than \$100.
- 462 PS—A FORTH-Like Threaded Language, Part 1** by Valo G Motalygo / PS allows assembly-language code and high-level code to be mixed.

Reviews

- 86** Atari's Telelink I by Glen Flint
- 378** Integral Data's Paper Tiger 460 by Eliakim Willner
- 383** The Mauro Proac Plotter by Mark Dahmke
- 385** The Radio Shack FORTRAN Package by Tim Daneliuk

Nucleus

- 6** Editorial
- 10** Letters
- 122, 278, 334, 354, 467** System Notes: List Pager; Discover the Machine Beneath the Machine. A Z80 Monitor Program; A Closer Look at the TRS-80 Color Computer; Two Short Graphics Programs for the OSI C-1P; Recursive Procedures for the 6502 Microprocessor
- 302** Software Received
- 304** Books Received
- 306** BYTELINES
- 316** Ask BYTE
- 324** Event Queue
- 332** Clubs and Newsletters
- 332, 375** BYTE's Bits
- 342** Book Reviews: Four Roads to Understanding Radio Shack's TRS-80
- 356, 376, 419** Programming Quickies: Memory Manipulator, Eliminate Hex-a-Phobia: A Fast, Ancient Method for Multiplication; Apple Pascal Cross-Reference
- 366, 391, 394** Technical Forums: Use a Relative Subroutine Call for Relocatable Z80 Programs; The Variable-Duty-Cycle Algorithm; Dynamic Simulation in BASIC
- 372** Languages Forum: BASIC, Pascal, or Tiny-c? A Simple Benchmarking Comparison
- 471** What's New?
- 526** Unclassified Ads
- 527** Reader Service
- 528** BOMB, BOMB Results

BYTE



Page 36



Page 70

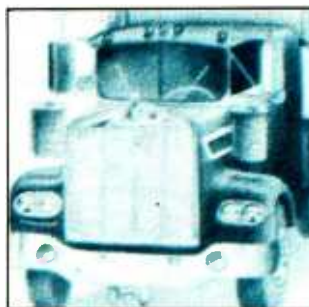

Page 264

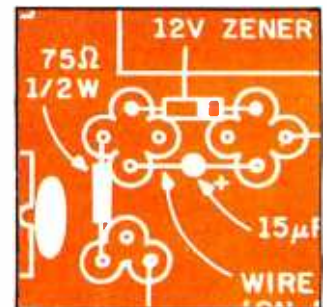

Page 400



Editor in Chief
Christopher Morgan

Managing Editor
Mark Haas

Technical Editors
Gregg Williams, Senior Editor;
Richard S Shuford; Curtis P Feigel;
George Stewart; Arthur Little;
Stanley Wszola; Charles Freiberg;
New Products Editor: Steve Ciarcia.
Mark Dahmke, Philip Lemmons,
Consulting Editors: Jon Swanson,
Draftsman

Copy Editors
Beverly Cronin, Chief; Faith Hanson;
Warren Williamson; Anthony J Lockwood;
Ann Graves; Jane Harrigan;
David R Anderson

Assistants
Faith Ferry; Debe Wheeler;
Karen A Cilley; Susan Ferber

Production
Nancy Estle, Director; Christine Destrempe.
Asst Director; Jonathan M Graves, Creative
Consultant; Wai Chiu Li; Patrice Scribner;
Karen Labaugh; Damien Henriques;
Jan Muller; Sherry McCarthy,
Chief Typographer;
Debi Fredericks; Donna Sweeney;
Valerie Horn

Advertising
Thomas Harvey, Director; Marion Carlson;
Rob Hannings; Marilyn Williams;
Deborah Porter; Vicki Reynolds;
Barbara Hoy; Jacqueline Earnshaw,
Reader Service Coordinator

Circulation
Gregory Spitzfaden, Manager;
Andrew Jackson, Asst Manager;
Agnes E Perry; Barbara Varnum;
Louise Menegus; Pinky Krulis;
James Bingham, Dealer Sales;
Carol Baniecki, Asst.

Controller's Office
Daniel Rodrigues, Controller;
Mary E Fluhr, Acct. & D/P Mgr; Karen Burgess;
Jeanne Cilley; Mary Beth Ireland; Linda Fluhr

Traffic
N Scott Gagnon; Michael Bacon;
Cynthia Damato

Receptionist
Joanne Colburn

Publishers
Virginia Londoner; Gordon R Williamson;
John E Hayes, Associate Publisher;
Cheryl A Hurd, Publisher's Assistant;

Officers of McGraw-Hill Publications Company: Paul F McPherson, President; Executive Vice Presidents: James E Boddorf, Gene W Simpson; Group Vice President: Daniel A McMillan; Senior Vice President-Editorial: Ralph R Schulz; Vice Presidents: Kemp Anderson, Business Systems Development; Robert B Doll, Circulation; James E Hackett, Controller; Eric B Herr, Planning and Development; H John Sweger, Marketing.

Officers of the Corporation: Harold W McGraw Jr, Chairman and Chief Executive Officer; Joseph L Dionne, President and Chief Operating Officer; Robert N Landes, Senior Vice President and Secretary; Ralph J Webb, Treasurer.

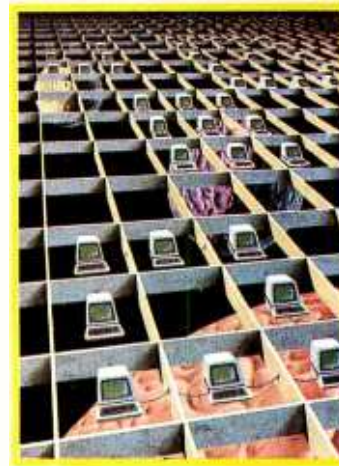

In This Issue

Local-area networks are a means of sharing information and resources among many personal computers located within a relatively short distance of each other. As Robert Tinney's cover illustrates, each station in the network is linked physically to the others, but each also can operate independently. The local networks themselves need not operate in a void; gateways can link them with other networks thousands of miles away.

To expand on this month's theme, we present an assortment of articles, including "Local-Area Networks: Possibilities for Personal Computers," "Ultra-Low-Cost Network for Personal Computers," and "Network Tools—Ideas for Intelligent Network Software."

In addition, Steve Ciarcia helps you "Build an Intelligent EPROM Programmer," and Martin Hayman discusses "Software Protection in the United Kingdom." We have "The Atari Tutorial, Part 2: Graphics Indirection," and C A Johnson advises on how to "Prepare Your Program for Publication." Of course, you can also enjoy our regular features and much more.

BYTE is published monthly by BYTE Publications Inc, 70 Main St, Peterborough NH 03458, phone (603) 924-9281, a wholly-owned subsidiary of McGraw-Hill, Inc. Address subscriptions, change of address, USPS Form 3579, and fulfillment questions to BYTE Subscriptions, POB 590, Martinsville NJ 08836. Controlled circulation postage paid at Waseca, Minnesota 56093 - USPS Publication No. 528890 (ISSN 0360-5280). Canadian second class registration number 9321. Subscriptions are \$19 for one year, \$34 for two years, and \$49 for three years in the USA and its possessions. In Canada and Mexico, \$21 for one year, \$38 for two years, \$55 for three years. \$43 for one year air delivery to Europe, \$35 surface delivery elsewhere. Air delivery to selected areas at additional rates upon request. Single copy price is \$2.50 in the USA and its possessions, \$2.95 in Canada and Mexico, \$4.00 in Europe, and \$4.50 elsewhere. Foreign subscriptions and sales should be remitted in United States funds drawn on a US bank. Printed in United States of America.

Address all editorial correspondence to the editor at BYTE, POB 372, Hancock NH 03449. Unacceptable manuscripts will be returned if accompanied by sufficient first class postage. Not responsible for lost manuscripts or photos. Opinions expressed by the authors are not necessarily those of BYTE. Entire contents copyright © 1981 by BYTE Publications Inc. All rights reserved. Where necessary, permission is granted by the copyright owner for libraries and others registered with the Copyright Clearance Center (CCC) to photocopy any article herein for the base fee of \$1.00 per copy of the article or item plus 25 cents per page. Payment should be sent directly to the CCC, 21 Congress St, Salem MA 01970. Copying done for other than personal or internal reference use without the permission of McGraw-Hill is prohibited. Requests for special permission or bulk orders should be addressed to the publisher.

BYTE® is available in microform from University Microfilms International, 300 N Zeeb Rd, Dept PR, Ann Arbor MI 48106 USA or 18 Bedford Row, Dept PR, London WC1R 4EJ England.



Subscription WATS Line: (800) 258-5485

Office hours: Mon-Thur 8:30 AM - 4:30 PM, Friday 8:30 AM - Noon, Eastern Time

NATIONAL ADVERTISING SALES REPRESENTATIVES:

NORTHEAST (617) 444-3946
Hajar Associates
280 Hillside Ave
Needham Heights MA 02194

MIDWEST (312) 966-0160
Hajar Associates
5225 Old Orchard Dr
Skokie IL 60076

MID ATLANTIC (212) 682-5844
Hajar Associates
521 Fifth Ave
New York NY 10017

NORTHWEST (415) 964-0706
Hajar Associates
1000 Elwell Ct, Suite 227
Palo Alto CA 94303

SOUTHWEST (714) 540-3554
Hajar Associates
3303 Harbor Blvd
Suite K-4
Costa Mesa CA 92626

SOUTHEAST (305) 886-7210
Hajar Associates
1220 Prairie Lane
Apopka FL 32703

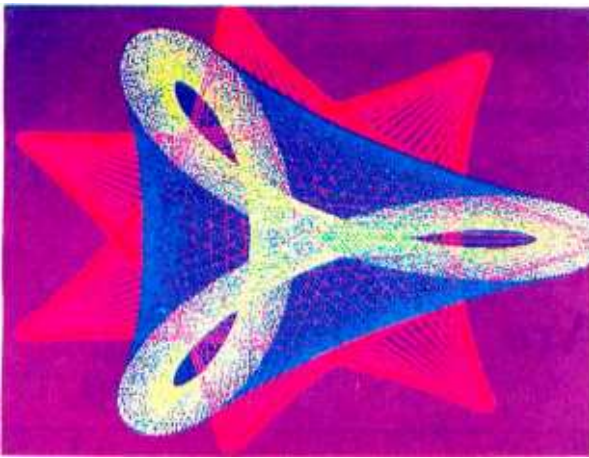

"...stands well above other S-100 graphics displays in its price and performance range."

BYTE, Product Review



"...better monochromatic display..."

ELECTRONIC DESIGN,
1981 Technology Forecast

MICROANGELO

HIGH RESOLUTION GRAPHICS SINGLE BOARD COMPUTER
512 x 480 resolution black and white and vivid color displays

RS-170 composite or direct drive output

Local or external sync generation

4 Mhz Z80 microprocessor

60 hertz real-time clock

8 level interrupt tie-in

IEEE S100 bus compatible

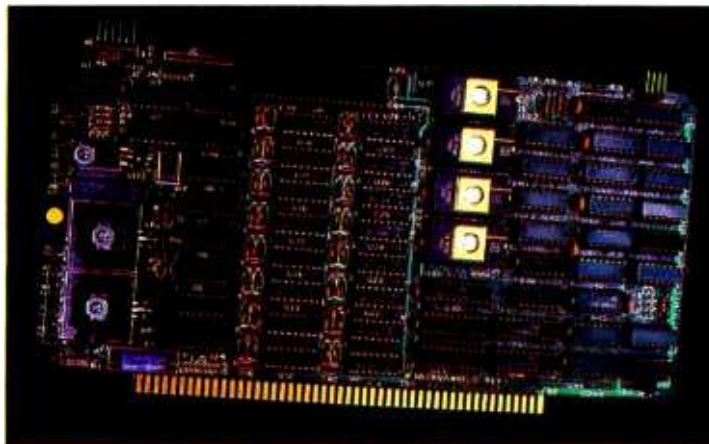

Light pen interface

Time multiplexed refresh

4K resident Screenware™ Pak I operating system

32K RAM isolated from host address space

High speed communications over parallel bus ports

Screenware™ Pak I

A 4K byte operating system resident in PROM on MicroAngelo™. Pak I emulates an 85 character by 40 line graphics terminal and provides over 40 graphics commands. Provisions exist for user defined character sets and directly callable user extensions to Screenware™ Pak I.

Screenware™ Pak II

An optional software superset of Pak I which adds circle generation, polygon flood, programmable split screen for separate graphics and terminal I/O, relative coordinates, faster vector and character plotting, a macro facility, full UCSD Pascal compatibility, and more.

And now... COLOR!!

The new MicroAngelo™ Palette board treats from 2 to 8 MicroAngelos as "bit planes" at a full 512 x 480 resolution. Up to 256 colors may be chosen from 16.8 million through the programmable color lookup table. Overlays, bit plane precedence, fade-in, fade-out, gray levels, blinking bit plane, and a highly visual color editor are standard.

SCION

Circle 328 on Inquiry card.

12310 Pinecrest Road • Reston, VA 22091 • (703) 476-6100 • TWX: 710-833-0684

PLAN80™

A powerful tool for planning and analysis

Version 2.0 featuring Graphic Analysis

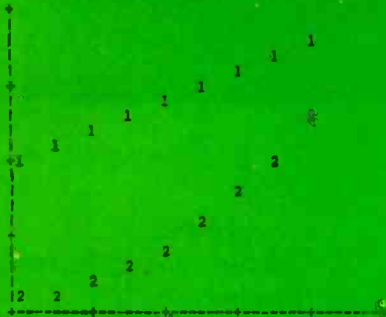

PLAN80 is a modeling system for desktop computers... Easy to use yet capable of handling most timesharing applications.

With any familiar word processor you can create models in terms that make it easy to review assumptions and methods with others. Anyone can create budgets, project sales, analyze cash flow or build a system of inter-related plans.

PLAN80 has the power of big computer modeling systems and lets you

- Produce both tables and graphs from same data
- Change assumptions and recalculate results in seconds
- Prepare reports exactly to your specifications
- Consolidate any part of one model into another
- Create models having up to 4,000 cells
- Compute depreciation, internal rate of return, or step functions using table lookup.

PLAN80 requires 56K, CP/M and a Z80 or 8080 micro. Also available for CP/M-86. Price is \$295. Manual alone \$30.

SOFTWARE SOFTWARE DIGITAL MARKETING DIGITAL MARKETING

2670 Cherry Lane • Walnut Creek • CA 94596 (415) 938-2880 Telex 17-1852 (DIGMKTG WNCK)

CP/M & CP/M-86 trademarks Digital Research

Editorial

Local Networks Are Buzzing

by Chris Morgan, Editor in Chief

Buzzwords are a way of life in the computer industry, and the latest buzzword (or, to be more correct, buzz-phrase) among computer cognoscenti is the local network. Networks in one form or another have been with us for some time. IBM's SNA network and the X25 public network from ISO (International Standards Organization), used by Tymenet and Telenet, are systems designed to transmit huge amounts of data over long distances. But recently a whole new industry has sprung up to serve personal computer owners who want to send electronic mail or share the other resources of a local network.

This month we present several articles about local networks, including one written by Harry J Saal, President of Nestar Systems Inc, called "Local-Area Networks: Possibilities for Personal Computers." It's an excellent overview of local networks, their history, and the current state of the art. Much of the impetus behind the blossoming local-network field comes from Ethernet, Xerox's high-end local network system that can transmit up to 10 megabits per second (Mbps) of information between users. You may have seen the recent television advertisements for the Ethernet system.

Although Ethernet works well for large-scale systems employing minicomputers or mainframes, it's a case of overkill for microcomputers, which have inherent speed limitations. Two local network schemes, both patterned in one way or another after Ethernet, now exist to serve the microcomputer market. One such network, made by Nestar, is described in detail by Dr. Saal. The other is a relative newcomer — Corvus's Omninet.

Comparing Two Systems

While the Nestar system, officially called the Cluster/One Model A, is designed exclusively for use with Apple II computers, the Omninet system allows users to mix and match such computers as the Apple II, Radio Shack's TRS-80, the Onyx, and computers using the LSI-11 processor and the S-100 bus.

The data-transfer rate of the Omninet system is 1 Mbps, compared with Nestar's 240 kbps. Although Omninet is technically four times faster than the Nestar system, the numbers can be misleading because the actual amount of time spent transmitting or receiving data to and from the network usually represents only a fraction of the total computing time. Recent tests by Xerox of the Ethernet system bear out these results.

Of more importance to the average user is the network's reliability and how easy it is to use. The Nestar system has been around for more than two years and has earned high marks for reliability and sophistication. It's particularly well suited to classroom use, and I have seen the system at work in many schools around the country. The Omninet system is just beginning to appear on the market, and we plan to review it in detail in a future issue of BYTE. Aside from its ability to handle a variety of computers, Omninet also offers the attraction of low price. The hardware cards for the Apple II, TRS-80, and

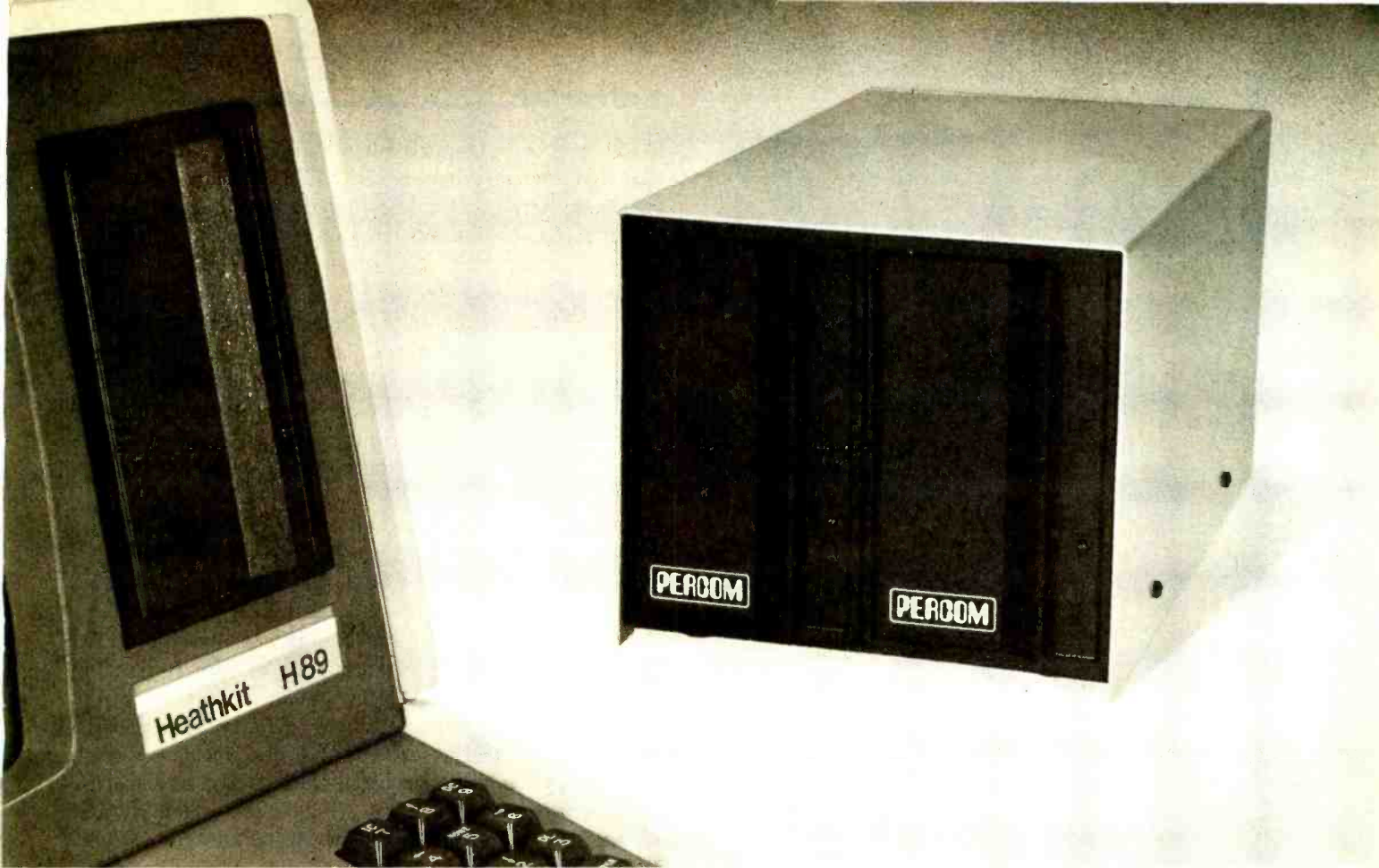

New! Z Controller and Z Drives . . . Expect more from Percom. You won't be disappointed.

Percom's double-density Z Controller for the H-89 is now available.

Check its many outstanding features.

And keep in mind its from Percom, a company that introduced its first disk system in 1977.

- Controls up to four single- or double-headed mini-disk drives.
- Handles 35-, 40-, 77- and 80-track drives, and other standard track densities.
- Formatted data storage capacity of 80-track diskettes is over 368 Kbytes. Forty-track diskettes store over 184 Kbytes. Capacities for other track densities are proportional. A Z system with four double-headed, 80-track drives provides almost 3 megabytes of on-line data.
- The Z Controller co-resides with your H-89 disk drive controller. Your software can select either, and you don't have to move drives around when switching between systems.
- The Z Controller includes Percom's proven digital data separator circuit and a dependable write-precompensation circuit. Expect reliable disk operation for a long, long time under 'Z' control.
- The Percom Z Controller is priced at only \$249.95, complete with HDOS-compatible disk drivers on diskette, internal interconnecting cable and comprehensive users manual.

System requirements – H-89 Computer with 24 Kbytes memory (min). Replacement ROM Kit H-88-7 and HDOS 2.0.



PERCOM DATA COMPANY, INC.
211 N. KIRBY GARLAND, TEXAS 75042
(214) 272-3421

Toll-Free Order Number: **1-800-527-1592**

© 1981 PERCOM DATA COMPANY, Inc.
PERCOM, ZFD-40 and ZFD-80 are trademarks of Percom Data Company.
CP/M is a trademark of Digital Research Corporation.

Add-On Z Drives for H-89, H-8 Computers

- Forty- and eighty-track densities in either 1- or 2-drive modules.
- All drives are rated for single- and double-density operation. With a Z Controller, an 80-track drive can store over 364 Kbytes (formatted, one-side), a 40-track drive can store over 184 Kbytes.
- Some models permit "flippy" storage, letting you flip a diskette and store files on the second side.
- Z drives are fully tested, including a 48-hour operating burn-in to prevent shipment of drives with latent defects.
- Assembled and tested one-drive units from only \$399, two-drive units from only \$795.

System requirements – H-89 or H-8 computer with 16-Kbyte RAM, Heath first-drive floppy disk system, HDOS and drives interconnecting cable. (Two-drive interconnecting cable optionally available from Percom)

PRICES AND SPECIFICATIONS SUBJECT TO CHANGE WITHOUT NOTICE.

Watch for announcement of 'Z' CP/M.

Yes . . . I'd like to know more about Percom Z drives and the Z Controller. Rush me free literature.

Send to
PERCOM DATA COMPANY, Inc., Dept. 26 -B02
211 N. Kirby St. Garland TX 75042

name

street

city

state

zip

phone number

MAIL TODAY!

Pascal/Z

NEW 4.0

SYMBOLIC DEBUGGER

This fourth generation version of our reliable, Z-80 native code compiler adds the two features professionals ask for:

- ◆ **SWAT™**—an interactive symbolic Pascal debugger that allows easy error detection.
- ◆ **Overlays**—that allow larger programs to run in limited memory.

A compiler for Professional programmers

Pascal/Z is a true Pascal. It closely follows the Jensen and Wirth standard with a minimum of extensions designed to aid the serious program developer in producing extremely compact, bug-free code that runs FAST.

Pascal/Z generates Z-80 native code that is ROMable and Re-entrant. Permits separate compilation, direct file access, external routines and includes a relocating macro assembler and Microsoft compatible linker.

And code written for Pascal/Z is fully compatible with I-PAS 8000, our new native code Pascal compiler for Z-8000, to guarantee graceful migration to 16 bit operation.

Get "The FACTS about Pascal"

Confused about which Pascal to buy? Pseudo-code... Native code... M, MT or Z? Compare the *unbiased* benchmarks in our new booklet. **Don't buy a Pascal compiler until you've read it.**



The FACTS about



Call us for a free copy:

800-847-2088

(outside NYS)

or **607-257-0190**

And ask your local full-service computer dealer about our Pascal/Z demo package.

InterSystems™

Ithaca Intersystems Inc.

Micros for bigger ideas.

Ithaca Intersystems Inc.

1650 Hanshaw Rd • Ithaca, NY 14850 • TWX 510 255-4346

U.K. Distributor:

Ithaca Intersystems (U.K.) Ltd.

Coleridge Road London N8 8ED Phone: 01-341 2447 Telex: 299568

Editorial

S-100-type computers cost less than \$500 each, meaning that two interested networkers could assemble a minimal two-node network for less than \$1000. The only additional cost is for the twisted-pair wiring used to connect the two computers. No central control computer is needed to run the network.

Data is transmitted on the Omninet in blocks of ASCII characters using software tools called pipes, reminiscent of the pipes used in the UNIX operating system but operating in a different manner. In this way, machines having incompatible operating systems (such as CP/M and UCSD Pascal) can communicate, albeit with some limitations.

Comparing Nestar and Omninet is like comparing the proverbial apples and oranges (pun intended). Omninet is attractive for entry-level users, and it's the only choice if you want to combine various brands of computers. Although rumor has it that Nestar is expressing an interest in other brands of computers besides Apple, the company has made no official statement on the subject.

Nestar has its own advantages, including its excellent track record. The file server used in the Nestar system is actually an Apple II computer, which can act as a spare if needed in the system. Also, Nestar offers extensive and well-documented software. The Nestar system requires 16-conductor ribbon cable for computer interconnection, compared with twisted-pair wire for the Omninet — a cost saving for the Omninet user.

Corvus is actively promoting Omninet as an industry standard for microcomputers. Onyx already has bought an Omninet license, and the Japanese are reportedly interested in the network. (I recently saw a very interesting hobbyist-designed local network system at the offices of ASCII magazine in Japan. We hope to tell you about that in a future issue.)

* * *

Siggraph '81

As I write this, the '81 conference of Siggraph (the ACM's special interest group for computer graphics) is in full swing in Dallas, and it's a winner all the way. Ken Livingston (who, with Mark Dahmke, reviewed Siggraph '80 for us last year) is on hand again, and his full report will appear later this year in BYTE. Without trying to steal Ken's thunder, I must say that never before have I seen such exciting portents for the future of computer graphics as I've seen in the last few days at this conference. The demonstrations of the latest computer animation left all previous efforts in their wake.

The roster of attendees includes just about everyone doing meaningful work in the computer graphics field. I wish continued success to Siggraph, and I hope many of our readers can attend Siggraph '82, to be held in Boston next summer. For more information, write to Elaine Sonderegger, Siggraph '82 General Chairman, at POB 353, Derby CT 06418. ■

Circle 185 on inquiry card.



**RUN CP/M
2 to 4 TIMES FASTER!**

The ultimate single user machine

The PDS-80™ with Cache BIOS™ is a professional system designed for the most rigorous single user CP/M* environments... in business, software development, scientific, educational and industrial research... where speed and program space are critical factors.

SymBIOSis quadruples speed

No matter what high-level language you use... Cobol, Basic, Fortran, PL/1, or Pascal... PDS-80 offers more speed, power and reliability than any other floppy based CP/M system currently on the market. The InterSystems Cache BIOS fully exploits the advanced DMA and interrupt features of our reliable Series II hardware to buffer whole tracks in extended memory so most operations run two to four times faster than on other floppy based systems... actually equals the speed of many small hard disk systems. And Cache BIOS also provides many sophisticated system test and protection features to assure reliable operation.

An advanced CP/M application system

PDS-80 has all you need for commercial systems integration and applications software development... including a choice of the industry's only integral 8 bit front panel. Best of all, PDS-80 allows the systems integrator or applications developer addressing a vertical market to develop on the same components he configures for resale. The highly expandable modular design with

20slot S-100 mainframe allows almost unlimited options to suit any end use environment... including a choice of tabletop or rackmount design.

InterSystems will work with you at whatever level is appropriate to configure the target system you need... right up to fully assembled and tested systems with floppy and Winchester disk drives.

Full software support

In addition to InterSystems' Cache BIOS and the CP/M operating system, models of PDS-80 can include Pascal/Z,

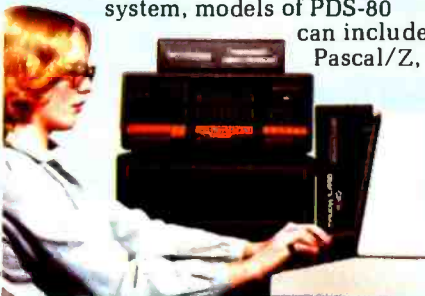

our highly acclaimed Z-80® native code Pascal compiler, and InterPak 80™, a special set of utilities including a powerful screen editor and versatile spelling editor to assist in the rapid editing, proofing and documentation of your code. These powerful programming aids are also available as standalone products.

It's upgradeable!

Both hardware and software are designed to provide for upgrade to 16 bit operation. Programs written for Pascal/Z are fully compatible with I-Pas 8000™, our Z-8000® native code compiler, and all PDS-80 systems are upgradeable to our 16 bit multi-user DPS-8000.

We build micros for bigger ideas.

Your big ideas. We're dedicated to providing the computer professional... Systems Integrators, commercial program developers, scientific and industrial programmers... with professional hardware and software tools. And we support our customers to the fullest, with complete, professional documentation, application engineering consultation, and prompt, responsive service both from the factory and through factory-authorized service centers.

Call us toll free: 800-847-2088

for complete information on any of our 8 or 16 bit systems and software products.



Distributor
Inquiries
Invited

InterSystems™
Ithaca InterSystems Inc.

Circle 185 on Inquiry card.

Micros for bigger ideas.

Ithaca InterSystems Inc. • 1650 Hanshaw Road • Ithaca, NY 14850 • Phone (607) 257-0190 • TWX: 510 255 4346
U.K. Distributor Ithaca InterSystems (U.K.) Ltd. Coleridge Road London N8 8ED Phone: 01-341 2447 Telex: 299568

*Z-80 and Z-8000 are registered trademarks of Zilog, Inc. **Trademarks of Ithaca InterSystems Inc. *Registered trademark of Digital Research

Clearing Waveforms

I enjoyed reading Robin Moore's article "Mountain Computer's MusicSystem" (July 1981 BYTE, page 60). There may be some confusion, however, about the way the Casheab synthesizer handles waveform storage. With the Casheab synthesizer, waveforms are stored on the synthesizer cards and not in the host memory. This was done for three reasons:

- The Casheab synthesizer uses 1024 words by 12 bits for each of its 16 waveforms. This requires 25 K bytes of memory, which would be a considerable chunk of memory space if the waveforms were stored in the host's memory space.
- When the waveforms are stored in the host's memory, processor time is going to be required to transfer them to the synthesizer. The MusicSystem uses DMA (direct memory access), which is probably the most efficient way to make the transfer. However, this effectively slows the Apple's processor from 1 MHz to 500 kHz.
- It is much easier to add more channels to a system by adding another synthesizer card set when the waveform tables are not in the host memory.

Cesar Castro
Casheab
5737 Avenida Sanchez
San Diego CA 92124

Unsung Marketer

While I thoroughly enjoyed the recent article entitled "The Japanese Computer Invasion," I would like to go on the record to correct some misleading information that appeared in the section regarding Hitachi on page 212, beginning with the third paragraph. (See the August 1981 BYTE.)

Mr Miastkowski is correct in stating that there is no Hitachi marketing organization in the US (for large-scale computers, that is, a qualification that should have been included) nor any movement toward developing one. However, to call this a "major problem" totally ignores Hitachi's satisfaction with the job being done by National Advanced Systems (NAS). "Lack of a US organization" has not "hurt" sales of the AS/9000. Indeed, NAS has doubled the sales rate of its

predecessor and is progressing very well in AS/9000 penetration.

Mr Miastkowski also states that Hitachi introduced the AS/9000. This is incorrect. NAS introduced the AS/9000, its redesign of the Hitachi M200H.

It is also incorrect to characterize NAS as a company "with (merely) a large amount of small-computer experience." In the 303X class and upward, NAS has 276 systems installed, hardly a lack of experience. If one includes MVS-class machines (which are generally considered not to be "small" systems), the number goes to about 600! And, in the "H" class, the subject of the paragraph, we have more experience than either IBM or Amdahl (i.e., we're shipping and they aren't)!

Lastly, Miastkowski refers to the "strange bug" which occurred at Lockheed Dialog and implies that service is a major problem. This is absolutely untrue. Specifically, a problem arose in the channel check logic in which the software was unable to recover from a channel check. Investigation revealed that, while the AS/9000 channel interfaces were designed to published IBM specification documents, IBM had subsequently changed (in this case, loosened) the parameters governing the timing of the counting of parallel bits. We immediately applied an EC retiming the parameters and retrofitted all other AS/9000s. The incident, in fact, illustrated the expertise of our engineers in solving a problem we did not even create and in solving it in record time.

David Goldsmith
Director—Sales Support
National Advanced Systems
800 E Middlefield Rd,
Mountain View CA 94043

On Old Ad Age

As a mechanical engineer, I have had BYTE save my neck by letting me know what to expect from the "Silicon Wonders" before other engineers. But I would like to share some observations about BYTE that I have made over the last five years.

BYTE has evolved from a magazine of "hobbyists" into a leading and respected technical journal. As such, the reader is assumed to have sufficient technical expertise to read and assimilate the infor-

mation presented. To my knowledge, this assumption has turned off a number of potential subscribers. It shouldn't be too difficult to publish a yearly "Beginner's Intro" issue of BYTE which could be included with every new subscription. It could educate and entice new subscribers, while the "old-timers" shouldn't object too strenuously to a yearly review of basics (who knows, it might even help). It would definitely help overcome the shock to a neophyte who wants to learn about the nitty-gritty of computers and picks up a BYTE only to be deluged with "computerese" and articles that go over his or her head in the first paragraph.

A good portion of each BYTE is devoted to advertisement. I am not complaining. In fact, I have learned almost as much about computers from the ads as from the articles. But I currently have about 30 inches of bookshelf devoted to BYTE and, if the advertisements could be removed, that could be cut down to 20 inches or less! An advertisement that's a year or more old is of little value to me, but articles that age are very valuable to me. What I suggest is to bind the articles in one group that can be removed for filing. They could be preceded by the "prestige" ads and followed by the bulk ads. I doubt that this change in format would reduce the effect of advertising in BYTE since most of BYTE readers that I know either read every ad in each issue or ignore them. It would reduce the space required to archive back issues considerably. (I'd like to see this idea catch on because I currently have over 15 feet of bookshelf dedicated to my technical journals and it's growing daily!)

Lew Merrick
19217-28th Ave W
Lynnwood WA 98036

Our "potential subscribers" who are turned off by our technical level should take a look at our new sister publication, Popular Computing. . . . MH

Legal Arguments

As an attorney, computer enthusiast, and coauthor of a recently published booklet entitled "The Copyright Kit—How to Copyright Your Computer Software," I feel I must clarify two points raised by Stephen Becker in his article

A Busload from SSM.

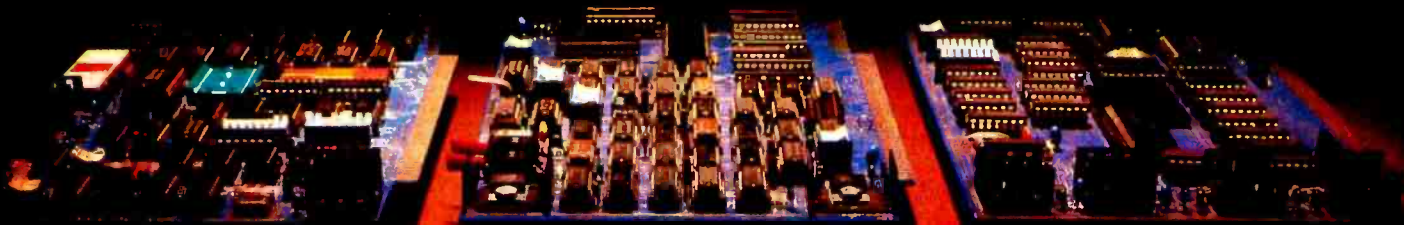

80 Character Video

With 80 characters per line our VB3 is the perfect video interface for word processing. It produces a standard 80x24 display of upper and lower case characters or as much as 80x50 for a full page of text. The matrix for graphic display goes up to 160x200. And with optional EPROM, as many as 256 user programmed characters or symbols can be produced.

VB3 is memory mapped for rapid screen updating. But it occupies memory only when activated. So one or more VB3s can be located at the same address with a full 65K of memory still available to the user.

It generates both U.S. and European TV rates and meets IEEE 696.1 standard. Other features include keyboard input, black on white or white on black, one level of grey, underline, strike thru, blinking char., blank-out char., and programmable cursor. Software includes a CP/M compatible driver and a powerful terminal simulator.

Z-80 CPU

We spent over a year designing the CB2 to assure that it is the most fully S-100 compatible Z-80 CPU on the market.

It operates at 2MHz or 4MHz by DIP switch selection and includes two sockets for 2716/2732 EPROMs or 2K RAMs. Memory sockets can be disabled. Separate run/stop and single step switches allow system evaluation without the benefit of a front panel.

CB2 also features an MWRITE signal, firmware vector jump, and an output port to control 8 extended address lines (allowing use of more than 65K of memory). Jumper options generate the new IEEE 696.1 signals.

8080-CPU

Our CB1A is identical to our popular CB1 with the exception that the on-board RAM has been increased from 256 bytes to a full 1K.

It also features an optional 2K of 2708 EPROMs, power-on/reset vector jump. MWRITE, parallel input port with status and DIP switch addressing.

Our S-100 line includes CPU, Video, I/O, 8 and 16 Bit RAM, EPROM, EPROM Programmer, Prototyping, Terminator, Extender, and Mother boards. Available assembled or as kits.

New SSM Products.

Please call for all the latest details on our newest products:

- **MB 64** 64Kb static RAM memory.
- **I05** two parallel, two serial input/output ports, with complete RS-232 protocol.
- **I08** multiple RS-232 serial I/Os.



SSM Microcomputer Products, Inc.

2190 Paragon Drive, San Jose, CA 95131, (408) 946-7400 Telex: 171171, TWX: 910-338-2077

Reddy Chirra improves his vision with an Apple.

Reddy is an optical engineer who's used to working for big companies and using big mainframes.

But when he started his own consulting business, he soon learned how costly mainframe time can be. So he bought himself a 48K Apple II Personal Computer.

And, like thousands of other engineers and scientists, quickly learned the pleasures of



cutting down on shared time
own tamper-proof data base.

His Apple can handle
formulas with up to 80 vari-
ables and test parameters on
250 different optical glasses.



and having his

He can even use BASIC, FORTRAN,
Pascal and Assembly languages.

And Apple's HI-RES graphics come in
handy for design.

Reddy looked at other microcomputers, but
chose Apple for its in-depth documentation,
reliability and expandability.

You can get up to 64K RAM in an Apple II.
Up to 128K RAM in our new Apple III. And
there's a whole family of compatible peripherals,
including an IEEE-488 bus for laboratory
instrument control.

Visit your authorized Apple dealer to find
out how far an Apple can go with scientific/
technical applications.

It'll change the way you see things.

The personal computer.



"Legal Protection for Computer Hardware and Software." (See the May 1981 BYTE, page 140.)

Mr Becker tells us that he does not recommend that his clients copyright (i.e., register) their software until an infringement suit is contemplated. My advice would be just the opposite.

Section 412 of the 1976 Copyright Act specifically disallows statutory damages and attorneys' fees for any infringement of copyright commenced after first publication of the computer program if it was not registered within three months after the first publication of the work. This means that by not registering a computer program within three months of publication, you lose possibly important damages for infringement. For \$10 (the cost of registration), I feel a computer program should be registered at the earliest possible moment.

Mr Becker also states that two copies of a computer program must be filed with the Copyright Office along with form TX for registration. In fact, the Rules and Regulations of the Copyright Office (Section 202.20 (c) (2) (vii) Code of Federal Regulations) provide that for a computer program published only in the form of machine-readable copies (such as magnetic tape, disk, punch card, or the like) from which the work cannot ordinarily be perceived except with the aid of a machine, the deposit need only consist of one copy of the first and last 25 pages of the program printout together with the page where the copyright notice appears.

I hope these corrections, in part, clarify for BYTE readers a complex area of the law.

Noel D Adler
14 Longacre Ct
Port Jefferson NY 11777

Stephen Becker Replies

I stand by my advice. Mr Adler's statement that "Section 412 of the 1976 Copyright Act specifically disallows statutory damages and attorneys' fees for any infringement . . ." tells only part of the story. In fact, the 1976 Copyright Act specifically provides for statutory infringement occurring after registration, whether or not registration occurs within three months after first publication of the work.

Ideally, each program should be registered as soon as possible. Copyright registration of a program is neither as com-

plex nor expensive as patenting. It can, however, be burdensome to register each program, particularly if you are developing a substantial amount of new software. Each registration requires, besides the \$10 registration fee and attorney's fees (if one is retained), deposit of a copy of the first and last 25 pages of the program printout together with the page where the copyright notice appears if the program is published only in machine-readable form, as Mr Adler notes; otherwise, two complete copies of the program must be deposited.

As a practical matter, however, the software supplier will probably become aware of any infringement fairly soon after it occurs. The infringer will be liable for statutory damages and attorneys' fees for all infringements following registration. If the registration occurs within three months from the first publication date, the infringer will be liable even during the three-month intervening time period. Even before registration, the courts have the discretion to allow recovery of the infringer's profits to the software developer and may even require that royalties be paid.

BYTE's Guide Praised

My wife and I wish to thank BYTE for including Mister McGiddies Creations Ltd in "The BYTE Guide: NCC Chicago." (See the April 1981 BYTE, page 64.) It is nice to be recognized for all the work we have done to promote the best in Bluegrass music in Chicago, while serving high-quality food at a good price.

McGiddies is now computerized by a 48 K-byte Radio Shack TRS-80 Model I with multiple disk drives, Scripsit, and the Paper Tiger 460 printer. Without a publication like BYTE, the information that I would need to learn how to use a computer in small business would not be available. I can actually say the computer has put some fun back into paperwork, and, of course, the games are always fun.

Thank you, BYTE. Keep up the good work.

Hal and Sharon Berger
President and Vice President
Mister McGiddies Creations Ltd
2423 N Lincoln Ave
Chicago IL 60614



Quality Percom products are available from the following authorized Percom retailers. If a retailer is not listed for your area, call Percom toll free at 1-800-527-1592 for the address of a nearby retailer, or to order directly from Percom.

| | | | |
|-------------------------------|----------------------------------|----------------|--|
| | ARKANSAS | | |
| MICROCOMPUTER SYSTEMS, INC. | Hot Springs | (501) 623-5209 | |
| | ARIZONA | | |
| SIMUTEK | Tucson | (602) 886-5880 | |
| | CALIFORNIA | | |
| ALPHA BYTE STORES | Calabasas | (213) 883-8594 | |
| BERKELEY MICRO COMPUTERS | Berkeley | (415) 848-7122 | |
| COMPUTER INFORMATION EXCHANGE | | | |
| | San Luis Rey | (714) 757-4849 | |
| COMPUTER SERVICE CENTER | Hollywood | (213) 851-3434 | |
| DESMAR ELECTRONICS | Santa Clara | (408) 988-2208 | |
| HOBBYWORLD | Northridge | (213) 886-9200 | |
| WHOLESALE TECHNOLOGY | Santa Ana | (714) 979-1700 | |
| | COLORADO | | |
| MICROCOMPUTER APPLICATIONS | Denver | (303) 922-6410 | |
| | DISTRICT OF COLUMBIA | | |
| THE PROGRAM STORE | Washington | (202) 337-4691 | |
| | FLORIDA | | |
| EN-TRON, INC. | Largo | (813) 586-5012 | |
| MICROCOMPUTER CONSULTANTS | | | |
| | Ormond Beach | (904) 673-5787 | |
| MICROSYSTEMS SOFTWARE, INC. | | | |
| | Hollywood | (305) 983-3390 | |
| | GEORGIA | | |
| DAVIS SYSTEMS, INC. | Atlanta | (404) 634-2300 | |
| | HAWAII | | |
| COMPUTER CENTER | Honolulu | (808) 488-2171 | |
| | IDAHO | | |
| OFFICE MAGIC COMPUTERS | Boise | (208) 376-4613 | |
| | ILLINOIS | | |
| GARCIA & ASSOCIATES | Chicago | (312) 782-9750 | |
| | KANSAS | | |
| BESCO ELECTRONICS | Shawnee | (913) 268-7633 | |
| CARDENS, INC. | Hutchinson | (316) 669-8261 | |
| | MASSACHUSETTS | | |
| OMNITEK | Teuksbury | (617) 851-4580 | |
| | MARYLAND | | |
| DAMASCUS RADIO SHACK | Damascus | (301) 253-2101 | |
| | MICHIGAN | | |
| ALTERNATE SOURCE | Lansing | (517) 487-3358 | |
| | MINNESOTA | | |
| THE CODE ROOM | Eden Prairie | (612) 934-1826 | |
| | MISSOURI | | |
| LEMBERGER CO. | Vienna | (314) 422-3353 | |
| SOFTWARE CENTER | Florissant | (314) 838-7755 | |
| | NEW HAMPSHIRE | | |
| HARDSIDE | Milford | (800) 258-1790 | |
| | NEW JERSEY | | |
| CHANNEL 1 RADIO SHACK | Medford | (609) 654-7454 | |
| | NEW MEXICO | | |
| AUTEL ELECTRONICS | Albuquerque | (505) 255-6451 | |
| | NEVADA | | |
| PCS COMPUTER | Las Vegas | (702) 870-4138 | |
| | NEW YORK | | |
| H & E COMPUTRONICS | Spring Valley | (914) 425-1535 | |
| 80 MICRO COMPUTER SERVICES | Cohoes | (518) 235-9007 | |
| MICRO 80 SYSTEMS | Brooklyn | (212) 748-3236 | |
| STONY CLOVE | New York City | (212) 391-8337 | |
| | OHIO | | |
| FELDMAN ENTERPRISES | Akron | (216) 724-5583 | |
| JERRY'S COMPUTER | Cleveland | (216) 641-6719 | |
| MPS | Wadsworth | (216) 336-2771 | |
| | PENNSYLVANIA | | |
| ADVANCED MECHANIZATION | Loyland | (215) 672-9000 | |
| COMPUTER ANALYSTS | New Brighton | (412) 846-9323 | |
| | TENNESSEE | | |
| COMPUTER WORLD, INC. | Nashville | (615) 255-8330 | |
| MARKETING COMMUNICATIONS | Memphis | (901) 794-8677 | |
| | TEXAS | | |
| ACCESS UNLIMITED | Richardson | (800) 527-3475 | |
| | | (214) 690-0206 | |
| COMPUTEX | Webster | (713) 488-8022 | |
| QUALITY SOFTWARE | Dallas | (214) 484-2976 | |
| TEXAS COMPUTER SYSTEMS | Brady | (915) 577-2931 | |
| | UTAH | | |
| MICRO MNEMONICS | Sunset | (801) 298-6809 | |
| | WISCONSIN | | |
| BYTE SHOP MILWAUKEE | Greenfield | (414) 281-7004 | |
| | FOREIGN DEALERS | | |
| | AUSTRALIA | | |
| DICK SMITH ELECTRONICS | P.O. Box 321 North Tyde NSW 2113 | | |
| | CANADA | | |
| VALERIOE AND ASSOC. | Guelph Ontario | (519) 824-7041 | |
| DVR ELECTRONICS | Surrey B.C. | (604) 576-1045 | |
| | MEXICO | | |
| CIBERMATIC, S.A. | Mexico | (905) 592-3433 | |
| COMPUTADORAS Y ASESORAMIENTO | | | |
| | Rto Panvco 14 Mexico 5 D.F. | | |
| | DOMINICAN REPUBLIC | | |
| RADIO SHACK | Santo Domingo | (809) 565-9121 | |



Introducing the **Z** Line . . .

Now! Percom Drives for Heath Computers.

Percom's now making add-on drives for your H-89 and H-8.

Complete drive systems will be available soon.

If your immediate need is for add-on storage, check the features of our fully compatible Z drives.

If you plan to add a complete disk system, watch for the imminent announcement of our double-density Z Controller.

Given a choice, we think you'll choose from the Percom Z line.

Add-On Z Drives

- Available in 40- and 80-track densities, in 1- and 2-drive color-compatible modules.
- All drives are rated for single- and **double-density** operation.
- Some models accommodate **flippy storage**, allowing you to flip a diskette and store files on the second side.
- Fully tested both electrically and mechanically. Plus, all Z drives receive a 48-hour **operating burn-in** to uncover latent defects. Look for the signed quality assurance slip.



PERCOM DATA COMPANY, INC.
211 N. KIRBY GARLAND, TEXAS 75042
(214) 272-3421

Toll-Free Order Number: **1-800-527-1592**

- Low prices: Fully assembled and tested, one-drive units start at only \$399, two-drive units from only \$795.

Z DRIVES FROM PERCOM: THE BEST ONES FOR YOUR ALL-IN-ONE

| Model | Number Tracks one side | Formatted Strg. Cap. | | Features |
|----------|------------------------|----------------------|------|----------------------------|
| | | SD | DD | |
| ZFD-40™ | 40 | 102K | 180K | Low price, fast step time |
| ZFD-80™ | 80 | 205K | 364K | Max. stg., fast step time |
| ZFD-100™ | 40 | 102K | 180K | Flip-side diskette storage |

SYSTEM REQUIREMENTS: H-89 or H-8 computer with 16 Kbytes of RAM, Heath first-drive floppy disk system, Heath disk-operating system and drives interconnecting cable. (Two-drive interconnecting cable optionally available from Percom). ZFD-80 drives include a program patch on diskette to modify HDOS for 80-track operation.

PRICES AND SPECIFICATIONS SUBJECT TO CHANGE WITHOUT NOTICE.

Available Soon!

Percom's Low-Cost Double-Density Z Controller.

Yes . . . I'd like to know more about Percom Z drives and the Z Controller. Rush me free literature.

Send to
PERCOM DATA COMPANY, Inc., Dept. 26
211 N. Kirby St. Garland TX 75042

name _____

street _____

city _____ state _____

zip _____ phone number _____

MAIL TODAY! B01

TWELVE STRONG HEATH/ZENITH YOUR

Pick a strong partner

A computer purchase is the beginning of a long term partnership between you and the people you buy from. Your ongoing need for software and accessories requires a partner who will stand by you with a growing line of products. And nowhere will you find a more complete line of hardware, software and accessories than at your Heathkit Electronic Center. Here are twelve strong reasons to make Heath/Zenith your partner.

1. The All-In-One Computer

The heart of the Heath/Zenith line is the stand-alone *89 Computer*. It's a complete system with built-in 5¼-inch floppy disk drive, professional keyboard and keypad, smart video terminal, two Z80 microprocessors, and two RS-232C serial I/O ports. It comes with 16K RAM, expandable to 64K.

2. Peripherals

These include the popular *Heath/Zenith 19 Smart Video Terminal*, loaded with professional features. And the *14 Line Printer*, priced as low as \$495. Other printer brands are on display, including high-speed, typewriter-quality printers.

3. Software

Word processing, includes reliable, easy-to-use Zenith Electronic Typing and powerful, full-featured WORDSTAR.

Small Business Programs, feature General Ledger and Inventory Control.

HUG, Heath Users' Group, offers members a library of over 500 low-cost programs for home, work or play.

4. Programming Languages



For your own custom programs, Microsoft languages are available in BASIC (compiler and interpreter), FORTRAN and COBOL.

5. Operating Systems

Three versatile systems give you the capability to perform your specific tasks.

CP/M by Digital Research makes your system compatible with thousands of popular CP/M programs.

UCSD P-System with Pascal is a complete program development and execution environment.

HDOS, Heath Disk Operating System gives you a sophisticated, flexible environment for program construction, storage and editing.

6. Utility Software

Expand the performance range of your computer with a broad selection of utility tools, including the best of *Digital Research* and the complete line of innovative *Softstuff* products.

7. Disk Systems

The 8-inch Heath/Zenith 47 Dual Disk System adds over 2 megabytes of storage to your



89 Computer. Diskettes are

standard IBM 3740 format, double-sided, double-density.



The 5¼-inch 87 Dual Disk System adds 200K bytes of storage to your 89. Both disk systems feature read/write protection and easy plug-in adaptability.

8. Self-Study Courses

Learn at your own pace with *Programming Courses* that teach you to write and run your own programs in Assembly, BASIC, Pascal or COBOL.

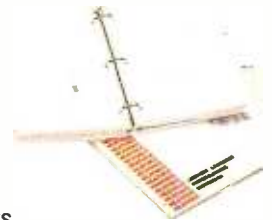

A course on *Computer Concepts for Small Business* gives you the understanding to evaluate the ways a computer can benefit your business.

Personal Computing is a complete introduction to the fundamentals for the novice. Every Heathkit/Zenith course is professionally designed for easy, step-by-step learning.



All Heath/Zenith Computer Products are available completely assembled and tested for commercial use. Or in easy-to-build, money-saving kits.

REASONS TO MAKE COMPUTER PARTNER

9. Expansion Options

Communicate with the outside world through a *Three-port EIA RS-232C Serial Interface*.

Expand RAM to 64K with easy-to-install *expansion chips*.

10. Accessories



Your Heathkit Electronic Center has the latest in modems, black-and-white and color video monitors, computer furniture and a full line of supplies, accessories, books and parts.

11. Service

No one stands by you like Heath/Zenith. We help you get your system up and running smoothly. Service is available from trained technicians, over the phone or at one of 56 Heathkit Electronic Centers.



12. Value

Your money buys you more because Heath/Zenith prices are among the industry's most competitive. Make your own comparison and find out how much you can save.

Complete, integrated computer hardware and software, designed to serve you and to grow with you — that's what to look for in a strong partner. And with Heath/Zenith you get it all under one roof.

All at your Heathkit Electronic Center

Pick the store nearest you from the list at right. And stop in today for a demonstration of the Heath/Zenith 89 Computer System. If you can't get to a store, send \$1.00 for the latest Heathkit® Catalog and the new Zenith Data Systems Catalog of assembled commercial computers. Write to Heath Co., Dept. 334-827, Benton Harbor, MI 49022.

Visit Your Heathkit Electronic Center*

where Heath/Zenith Products are displayed, sold and serviced.

- | | | |
|--|--|---|
| PHOENIX, AZ 2727 W. Indian School Rd. 602-279-6247 | MISSION, KS 5960 Lamar Ave. 913-362-4486 | CLEVELAND, OH 28100 Chagrin Blvd. 216-292-7553 |
| ANAHEIM, CA 330 E. Ball Rd. 714-776-9420 | LOUISVILLE, KY 12401 Shelbyville Rd. 502-245-7811 | COLUMBUS, OH 2500 Morse Rd. 614-475-7200 |
| CAMPBELL, CA 2350 S. Bascom Ave. 408-377-8920 | KENNER, LA 1900 Veterans Memorial Hwy. 504-467-6321 | TOLEDO, OH 48 S. Byrne Rd. 419-537-1887 |
| EL CERRITO, CA 6000 Potrero Ave. 415-236-8870 | BALTIMORE, MD 1713 E. Joppa Rd. 301-661-4446 | WOODLAWN, OH 10133 Springfield Pike 513-771-8850 |
| LA MESA, CA 8363 Center Dr. 714-461-0110 | ROCKVILLE, MD 5542 Nicholson Lane 301-881-5420 | OKLAHOMA CITY, OK 2727 Northwest Expressway 405-848-7593 |
| LOS ANGELES, CA 2309 S. Flower St. 213-749-0261 | PEABODY, MA 242 Andover St. 617-531-9330 | FRAZER, PA 630 Lancaster Pike (Rt. 30) 215-647-5555 |
| POMONA, CA 1555 N. Orange Grove Ave. 714-623-3543 | WELLESLEY, MA 165 Worcester Ave. 617-237-1510 | PHILADELPHIA, PA 6318 Roosevelt Blvd. 215-288-0180 |
| REDWOOD CITY, CA 2001 Middlefield Rd. 415-365-8155 | DETROIT, MI 18645 W. Eight Mile Rd. 313-535-6480 | PITTSBURGH, PA 3482 Wm. Penn Hwy. 412-824-3564 |
| SACRAMENTO, CA 1860 Fulton Ave. 916-486-1575 | E. DETROIT, MI 18149 E. Eight Mile Rd. 313-772-0416 | WARWICK, RI 558 Greenwich Ave. 401-738-5150 |
| WOODLAND HILLS, CA 22504 Ventura Blvd. 213-883-0531 | HOPKINS, MN 101 Shady Oak Rd. 612-938-6371 | DALLAS, TX 2715 Ross Ave. 214-826-4053 |
| DENVER, CO 5940 W. 38th Ave. 303-422-3408 | ST. PAUL, MN 1645 White Bear Ave. 612-778-1211 | HOUSTON, TX 1704 W. Loop N. 713-869-5263 |
| AVON, CT 395 W. Main St. (Rt. 44) 203-678-0323 | BRIDGETON, MO 3794 McKelvey Rd. 314-291-1850 | SAN ANTONIO, TX 7111 Blanco Road 512-341-8876 |
| HIALEAH, FL 4705 W. 16th Ave. 305-823-2280 | OMAHA, NE 9207 Maple St. 402-391-2071 | MIDVALE, UT 58 East 7200 South 801-566-4626 |
| PLANTATION, FL 7173 W. Broward Blvd. 305-791-7300 | ASBURY PARK, NJ 1013 State Hwy. 35 201-775-1231 | ALEXANDRIA, VA 6201 Richmond Hwy. 703-765-5515 |
| TAMPA, FL 4019 W. Hillsborough Ave. 813-886-2541 | FAIR LAWN, NJ 35-07 Broadway (Rt. 4) 201-791-6935 | VIRGINIA BEACH, VA 1055 Independence Blvd. 804-460-0997 |
| ATLANTA, GA 5285 Roswell Rd. 404-252-4341 | AMHERST, NY 3476 Sheridan Dr. 716-835-3090 | SEATTLE, WA 505 8th Ave. N. 206-682-2172 |
| CHICAGO, IL 3462-66 W. Devon Ave. 312-583-3920 | JERICHO, L.I. NY 15 Jericho Turnpike 516-334-8181 | TUKWILA, WA 15439 53rd Ave. S. 206-246-5358 |
| DOWNERS GROVE, IL 224 Ogden Ave. 312-852-1304 | ROCHESTER, NY 937 Jefferson Rd. 716-424-2560 | MILWAUKEE, WI 5215 W. Fond du Lac 414-873-8250 |
| INDIANAPOLIS, IN 2112 E. 62nd St. 317-257-4321 | N. WHITE PLAINS, NY 7 Reservoir Rd. 914-761-7690 | *Units of Veritechnology Electronics Corporation in the U.S. |

Prices and specifications subject to change without notice.

HEATH/ZENITH

Your strong partner

Comments on VIC

I recently evaluated the specifications of various personal microcomputers now on the market, so I noticed a couple of errors in Gregg Williams's comparison of Commodore's new VIC 20 to other microcomputers. (See "The Commodore VIC 20 Microcomputer," May 1981 BYTE, page 46.)

Mr Williams stated that the VIC is the only machine in which "the background color can change independently of the character color." This is untrue. If the Atari is used in graphics mode 1 or 17, its normal text display is reduced to 24 rows by 20 columns (similar to the VIC's 23

rows by 22 columns) and the background color becomes separately adjustable to any of 16 colors. Mr Williams also incorrectly stated that the Atari's normal text display is "16 rows by 32 columns"; actually it is 24 rows by 40 columns, which means it can display 25% more text than any of the other computers he surveyed. It also can be expanded to a full 32 K bytes of memory by installing one of the new 32 K-byte "RamCram" boards made by Axlon (Sunnyvale, California).

On the whole, BYTE should make more of an effort in the future to standardize comparison tables. For example, the cost of each system with a fully extended BASIC in ROM (read-only memory) and

16 K of programmable memory could be given. The graphics capabilities should be compared in some way to show the trade-off between high-resolution and multi-color capabilities, such as the maximum resolution available if you want the ability to display four colors simultaneously with individual color control over each pixel. I would be interested to know how the VIC with the Super Expander Cartridge would compare with the other machines reviewed according to this criterion. If the advertised 176 by 176 pixels are individually assignable to any of four (or more) colors, then the graphics capabilities of the VIC 20 would lie between those of the Apple (280 by 192) and the Atari (160 by 96), being approximately equivalent to the Radio Shack Color Computer (128 by 192).

Finally, Mr Williams mentioned that the VIC 20 uses the 6502A microprocessor instead of the 6502. What's the difference? Also, is it possible to replace the 6502 with a 6502A?

George Fergus
1810 Hemlock Pl #204
Schaumburg IL 60195

Gregg Williams Replies

Mr Fergus's two points about the Atari are correct—my apologies for the errors. His comments on the fairness of the comparison chart point up the difficulty of comparing several microcomputers fully. Anyone buying a microcomputer should learn everything he or she can about the different brands (just as Mr Fergus did). Such an evaluation was beyond the scope of the article I wrote, so I chose representative configurations of the different microcomputers.

The only difference between the 6502 and the 6502A is the higher system-clock frequency of 2 MHz for the 6502A. However, a 6502A microprocessor would offer no improvement in an existing microcomputer system without similarly upgrading the access time of the memory and increasing the speed of the system clock (which may have harmful side effects).

APL Pals

I read Gregg Williams's article "Three Versions of APL" with great interest. (See the April 1981 BYTE, page 188.) His conclusion that Vanguard APL/V80 is the fullest and fastest implementation is one that we agreed with two years ago when

THE WORLD IS YOURS



Data communications can open up a whole new world to you and your computer. A world of the future. Now. A world full of information resources, time-sharing computer systems, and electronic "bulletin boards." All you need for admission to this world is your CP/M-based computer, a modem, and the proper software. That's where we come in. We have the proper software. CROSSTALK,™ our smart terminal & file transfer program for CP/M, allows you to call into thousands of dial-up computer systems around the world, and communicate with them. REMOTE,™ our CP/M remote console program, allows you to operate your CP/M system from a remote terminal, giving your computer added flexibility and usefulness.

CROSSTALK

- Allows your computer and modem to communicate with other computers, including other CROSSTALK systems, public-access "bulletin board" systems, main frame computers, subscription "information utilities" such as THE SOURCE,™ and much more
- Simple, easy to use "plain English" command structure makes CROSSTALK easy to learn, yet provides a powerful tool for exchanging files, capturing data, and controlling modem parameters
- Concurrent printer and video allows you to print data while viewing it on the CRT
- Fully error-checked file transfers using 16 bit CRC protocol. Protocol transfers allow exchanging files which are larger than the system's memory.
- Built in "DIR" command.
- Data capture allows saving received data onto your disk.
- Auto-dial, redial, and auto-answer (if supported by modem)

Available for the following modems. Hayes 80-103a
Hayes Smartmodem™
Hayes Micromodem 100™
PMMI Communications MM-103
Hayes Micromodem II™ for the Apple II™
Any RS-232 modem, including 1200 baud modems

REMOTE

- Allows remote use of your computer from a remote terminal location.
- May be called as a subroutine from BASIC, PASCAL, or any other program to allow answering under program control.
- Provides nulls if needed for printing terminals.
- Uses less than 1k of memory space
- Automatically selects proper baud rate
- Available for S-100 modems (Hayes and PMMI) only.

For details, see your computer retailer, or contact us directly.



Microstuf, Inc.
Box 33337
Decatur, Georgia 30033
(404) 491-3787 (voice)
(404) 939-1520 (demo system)

Smartmodem™ and Micromodem™ are trademarks of Hayes Microcomputer Products, Inc. / Apple is a registered trademark of Apple Computers, Inc. CROSSTALK is a trademark of Microstuf, Inc. CP/M is a registered trademark of Digital Research, Inc.

DEALER INQUIRIES WELCOME

Mountain Computer CPS MultiFunction Card™

The Only Interface Card You Need!

Connecting a Parallel Printer?

Epson® Centronics®, IDS Paper Tiger®, CP- handles all these printers and others with on-board intelligence to provide paging and other features found on no other card.

Connecting a Serial Printer?

Inable®, Quume®, NEC®, TI 800 Series® CPS handles these printers and others with standard RS-232 interface providing selection of baud rates, handshakes, paging, and more.

Connecting a Modem or Terminal?

Haves Smartmodem®, Novation CAT®, M & R Perry's basic CPS handles these and others with full/half duplex operation, baud rate selection, and even a transparent terminal mode which includes a dual mode feature that permits printing of text to parallel printers while 'on-line' eliminating the need for special terminal software—and more.

Connecting with the Time?

The on-board calendar/clock provides real time and date information including day of week, day, month, year, hours, minutes, and seconds for any application requiring a time stamp—battery backed-up for over two years!

Connecting with The Source?

Used with a modem, CPS provides the connection to information utilities, such as The Source®, Dow Jones, and others. Additionally, CPS provides the connection to big-time electronic mail with programs such as Micro Courier® and Micro Telegram®, and other data transfer programs.

Connect with Easy Use!

CPS has no switches to set. All functions on the card are set from a user program. Menu driven screens set up your choice of all facilities on CPS and store them on-board in CMOS RAM—battery backed-up (including the clock) for over two years! To change parameters, run the set-up program again—or use special commands from your keyboard. Furthermore, most existing software programs are immediately usable with CPS. *Phantom Slot Capability* permits assignment of CPS functions to your software's pre-defined slots.

Connect with Your Apple® Dealer

Drop by your Apple dealer and see how the CPS MultiFunction Card provides the most comprehensive capabilities for RS-232C serial interface, parallel output, and real-time calendar/clock of any card available today—all on *one card*—at one low price—competitive with *any one* of the three or more single function cards that it replaces.



Mountain Computer
INCORPORATED

300 El Pueblo Road, Scotts Valley, CA 95066
408/438-6650 TWX:910 598-4504

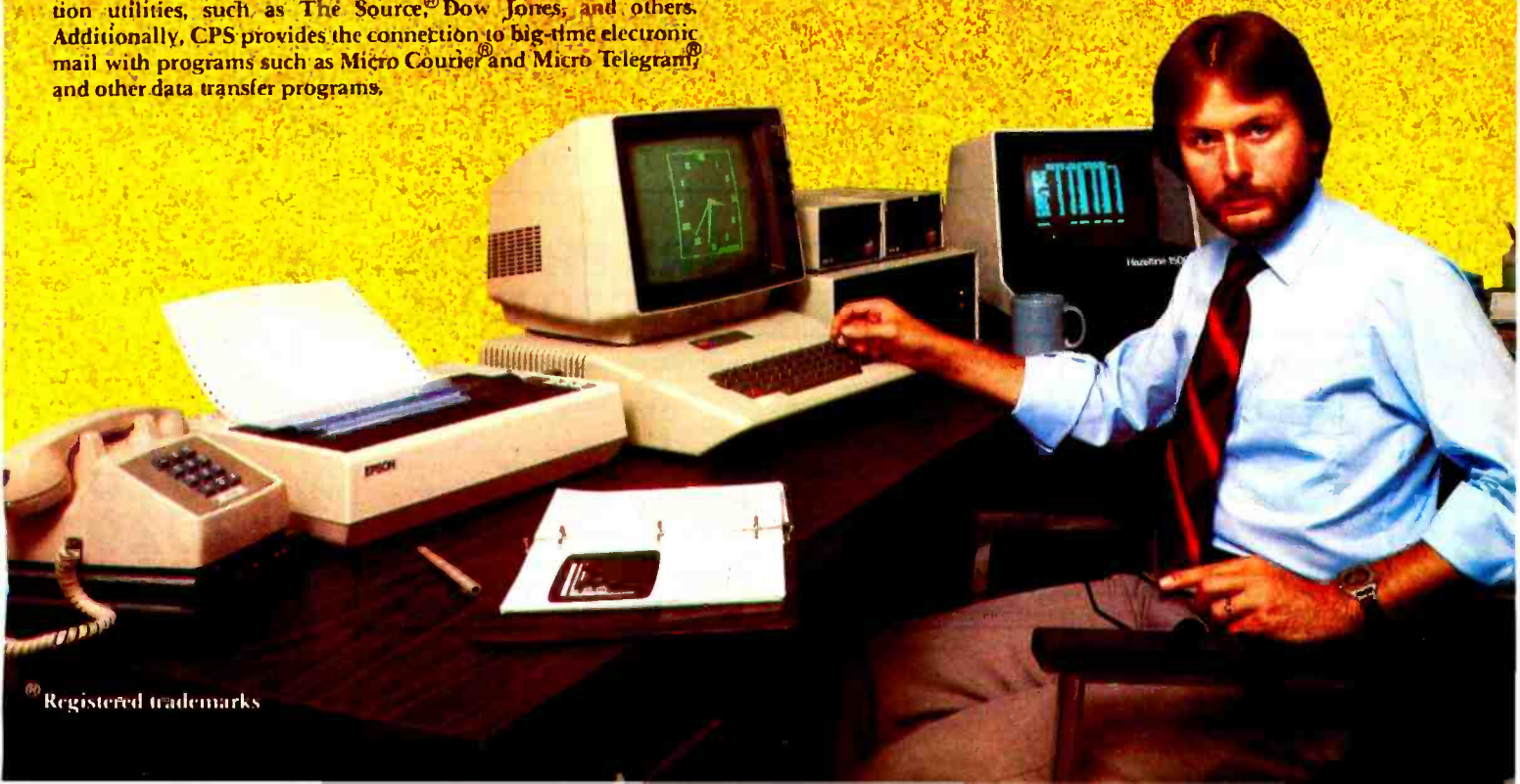

Letters

we made our own evaluation.

Since then, we have modified and enhanced Vanguard APL extensively. MicroAPL's own APL 4.0 release is now packed with goodies for the APL enthusiast. These include fast auxiliary processors for text search, character-set translation, laboratory instrument input/output; MicroTASK utility for project development, documentation, and screen handling; MicroFILE software for four different types of file access; MicroPLOT drivers for Tektronix, Hewlett-Packard, Qume, Diablo, and A-J plotters; MicroLINK workspaces for online timesharing links and CP/M file interchange; and MicroSPAN, a complete computer-aided instruction package for APL neophytes.

I hope BYTE will include us in its next language review. There are some exciting projects in the pipeline for 16-bit APL systems. APL is very popular in Europe, so in the meantime, we hope European readers will feel free to contact us if they're interested in further details.

Robert Bittlestone
MicroAPL Ltd
19 Catherine Pl
Victoria, London, SW1E 6DX, England

Roots Fair and Square

Steve Able's statement that any 10-digit calculator that accurately yields $(\sqrt{2})^2 = 2$ "... is either doing "funny arithmetic" or else is not telling you everything it knows" aroused my curiosity. (See "Letters," April 1981 BYTE, page 16.) My rather ancient Texas Instruments SR-51A does, in fact, yield $(\sqrt{2})^2 = 2$. So I wondered if it was performing "funny

arithmetic" or was hiding information from me.

The SR-51A does calculate $\sqrt{2}$ to 13-digit accuracy as does HP-41C, then displays the result rounded to 10 digits. The difference is that the SR-51A does not then proceed to forget the additional three digits. These are still retained in the register and are used in any subsequent operations.

The $\sqrt{2}$ operation produces a displayed result of 1.414213562, but the internal memory has 1.414213562373. Squaring correctly produces a rounded result of 2. The other functions also produce 13-digit accuracy rounded to 10 digits for the display.

In the words of Mr Abel, my SR-51A "is not telling me everything it knows." But, why should the accuracy of the machine be limited to the size of the display? Because it does not forget the extra three digits it calculated, the outdated, middle-line SR-51A performs with greater accuracy than the new, top-line, very expensive HP-41C.

In addition, my SR-51A, with a little trickery, will tell me "everything it knows." Entering $\sqrt{2}$ yields a display of 1.414213562. First, I multiply this by 100, which produces 141.4213562; then I subtract 141, producing a display of 0.4213562373. There are the three extra digits.

For π , the displayed result is 3.141592654. Multiply this by 100, then subtract 314, and the result 0.159265359 is displayed. This would be accurate for the 14-digit value of $\pi = 3.1415926535897$ rounded to 13 digits. The trailing 0 is suppressed in the LED (light-emitting-diode) display to conserve the batteries.

It is also possible to enter 13 digits with an appropriate trick. To enter

1.414213562373, first enter 3.73 EE-10, then add 1.414213562. This will result in the register containing 1.414213562373, and squaring this will produce the rounded answer of 2.

Apparently, this accuracy cannot be achieved with "the world's fanciest calculator."

James E Kitchen
Director
Chapman College
Residence Education Center
General Delivery
Beale AFB CA 95903

Talking DVMs

In Steve Ciarci's "Build a Low-Cost Speech-Synthesizer Interface" (June 1981 BYTE, page 46), he describes an encounter with a disbelieving clerk "at a local electronics store" after asking if they carried "any DVMs (digital volt ohmmeters) that talked." Steve implies that today none exist, but someday they will be very common. Well, at least one does exist.

I recently came across a reference to a "talking DVM" in the March 1981 *Journal of Chemical Education* (page 231). It's available from Sabtronics International Inc, 13426 Floyd Cr, Dallas TX 75243 (product number DMM 2010A).

Charles J Spillner
4054 Shona Ct
San Jose CA 95124

The Franklin Institute Research Laboratory also has a talking voltmeter available. Contact the company at Benjamin Franklin Pky, Philadelphia PA 19103, (215) 448-1340. . . .

GET THE LATEST SOFTWARE PRODUCTS NOW... ...CHECK OUT OUR 2020 RANGE

THE FIRST IN A SERIES OF ADVANCED MICROCOMPUTER SOFTWARE PRODUCTS FROM OUR 2020 RANGE IS THE WP2020 WORD PROCESSOR SYSTEM.

DESIGNED FOR THE HEATH/ZENITH Z89 COMPUTER RUNNING UNDER CP/M* 2.2. IT OFFERS MORE FACILITIES THAN MOST OTHER MICROCOMPUTER WP SYSTEMS. CHECK THESE.

- ALL THE STANDARD FEATURES YOU WOULD EXPECT FROM AN ADVANCED WORD PROCESSOR SUCH AS MARGINS, TABS, PAGINATION, GLOBAL SEARCH AND REPLACE, PROPORTIONAL SPACING ETC
- EASY TO FOLLOW FIRST TIME USER DOCUMENTATION
- SPELLING CHECKER AND MERGE DOCUMENT MODULES BUILT IN AS STANDARD - NO ADDITIONAL PROGRAMS TO RUN
- COMMUNICATIONS MODULE ALLOWS THE SYSTEM TO ACT AS A TERMINAL TO A MAIN FRAME OR LINK UP TO ANOTHER WP2020 SYSTEM

- SPECIAL SET OF COLOURED FUNCTION KEYPADS SUPPLIED AS STANDARD.
- MENU DRIVEN SYSTEM DESIGNED FOR TYPISTS AND SECRETARIES - THERE ARE NO COMPLICATED CONTROL CODES TO REMEMBER
- NO CONFIGURATION REQUIRED - PRINTER DRIVERS ARE ALL BUILT IN - YOU CAN BE PRODUCING REPORTS AND LETTERS WITHIN MINUTES OF INSTALLATION
- SUPPORTS BACKGROUND PRINTING WHILE WORKING ON OTHER DOCUMENTS
- HAS ITS OWN FILING SYSTEM WITH DOCUMENT NAMES UP TO 72 CHARACTERS LONG

OTHER IN SERIES INCLUDE: FP2020 FINANCIAL PLANNER CH2020 CONFIGURABLE MANAGER
SPECIFY 8" OR 5 1/4" S/S/D Z89 WHEN ORDERING. SYSTEM REQUIRES MINIMUM OF 2 DISKS AND 48K MEMORY
*CP/M REGISTERED TM DIGITAL RESEARCH WP2020 REGISTERED TM GRAFFCOM PRICE: £220.00



CALL US TODAY
FOR IMMEDIATE SHIPMENT
DEALER ENQUIRIES WELCOME



GRAFFCOM GRAFFCOM SYSTEMS GROUP 102 FORTLAND ROAD LONDON W11 4LX TEL 01-727-5561

WP2020
WP2020
WP2020
WP2020
WP2020
WP2020
WP2020



State-of-the-art hardware demands state-of-the-art software

Operating Systems & Support Software from Technical Systems Consultants

To perform to its fullest capabilities, your hardware demands software designed to meet the specialized requirements of today's microprocessors. State-of-the-art software from Technical Systems Consultants keeps pace with the rapid advancements in computer technology so your hardware can live up to its full potential. Our complete line of state-of-the-art software includes:

The UniFLEX™ Operating System

UniFLEX, a true multi-user, multi-tasking system for the 6809 and 68000 microprocessors, supports such features as:

- hierarchical file systems
- device independent I/O
- four Gigabyte disk capacities
- full file protection
- inter-task communication via pipes
- I/O redirection
- task swapping
- full random-access files
- comprehensive shell command language

UniFLEX, structured for large-scale microprocessor systems, will not run with minimal systems and thus has avoided design compromise. (Off-the-shelf versions and OEM licenses are available.)

The FLEX™ Operating System

FLEX, a powerful, easy-to-use operating system designed for the 6800 and 6809 microprocessors, includes:

- dynamic filespace allocation
- random files
- batch job entry
- automatic space compression
- English error messages
- user environment control
- disk resident commands
- flexible device I/O
- printer spooling

Plus, FLEX can accommodate hard disks as well as floppies. The System is available off-the-shelf for a variety of systems and in a field-adaptable version. (OEM licenses available.)

FLEX and UniFLEX are trademarks of Technical Systems Consultants, Inc.

Support Software

Technical Systems Consultants offers a full line of state-of-the-art support software compatible to FLEX and UniFLEX, some of which are:

- native C and Pascal compilers for advanced programming
- extended BASIC for business and educational applications
- text editing and processing software
- sort/merge package for business applications
- variety of absolute and relocatable assemblers
- debug and diagnostic packages

... and more. Write or call today for our brochures describing our complete product line.

 **technical systems
consultants, inc.**

Box 2570, 1208 Kent Avenue
West Lafayette, Indiana 47906
(317) 463-2502 Telex: 27-6143

Sculpture by Joann Chaney



BUILD

YOUR OWN 68000 SYSTEM THE EASY WAY

FULLY ASSEMBLED BOARDS PROVIDE COMPLETE 68000 CAPABILITY. AND ALL BOARDS CAN BE INTEGRATED INTO YOUR OWN SYSTEM.

MC68000 MULTIBUS™ BASED MICROCOMPUTER

This board provides a full speed MC68000 as the CPU for your Multibus™ based system. 256 kilobytes of on-board RAM permit the MC68000 to execute code at full speed (8-MHz clock with no wait states). The board is compatible with the proposed IEEE P796 bus at a compliance level of D16M20I16V02L. Edge connectors for a logic analyzer are provided to ease debugging. Bus timeout protection, simple memory protection and interrupt type selection are also provided.

MAIN PERIPHERAL BOARD

- Up to 32K Bytes of PROM
- Triple Interval Timer
- Two Programmable USARTS
- Polynomial Generator and Checker
- Three Parallel Interface Chips
- Keyboard Interface
- Baud Rate Generator for USARTS
- Priority Interrupt Controller

VIDEO BOARD

- 32K Bytes of RAM
- Programmable Video Controller
- Programmable DMA Controller
- PROM Character Sets—Up to 256 Characters
- Enhancements: Reverse Video, Understrike, Intensify, Blink, Suppress
- Interrupt Level Options

An I/O board with up to 5 serial I/O ports is also available; other Multibus™ compatible boards will be available in the near future. Multibus is a trademark of Intel Corporation.

For further information, write or call:

TSD Display Products, Inc. 35 Orville Drive, Bohemia, New York 11716. Tel. 516-589-6800

TSD

Letters

BDS C Update

Thank you, BYTE, for the "printf" technical note and the larger article on BDS C, by Chris Kern. (See "Printf for the C Function Library," May 1981 BYTE page 430, and "The BDS C Compiler," June 1981 BYTE, page 356.) Unfortunately, the items have fallen victim to some time-warp distortion, and several points regarding the package were out of date.

In the printf article, reference is made to a clumsy method of passing formal parameters to C functions in which the parameters are copied into absolute locations in memory by the caller and accessed from there by the subordinate function. The parameter-passing mechanism of BDS C has been totally revamped since those days. Currently, all parameters are passed on the stack, and all local (automatic) variables also reside on the stack. Also, a printf that is functionally equivalent to Chris Kern's is now a standard part of the package.

The June review was completely accurate in all technical details, except for the statement that "it's a shame the BDS compiler doesn't go one step further and provide redirected input and output. . . ." Actually, the current version of BDS C does include a special-function library for performing both directed I/O (input/output) and pipes in the standard UNIX-like manner. This is a recent addition to the package, and it has the advantage of not wasting any memory if it isn't used, because it's merely a simple set of library functions (written in C, of course).

BDS C users may be interested to know that the compiler has recently been run under the MARC operating system (a UNIX-like system) and that the combined package will be available soon from Vortex Technology. MARC furthers BD Software's tradition of translating the "best" of UNIX onto 8080- and Z80-based systems. BDS C finally has an operating system it can appreciate, rather than battle.

Leor Zolman
BD Software
33 Lothrop St
Brighton MA 02135

Stop playing games and get organized.

You spent up to \$2,500 on computer hardware to make your personal life easier. You didn't spend it just for fun.

Now there's GUARDIAN — the first microcomputer software program that can truly organize your life with ultimate ease and speed.

GUARDIAN is the only program that lets you make a single one-line data entry to remind you... for the rest of your life... of birthdays, oil changes, appointments and any other recurring events. Once an item and its frequency of recurrence is entered, you'll never have to worry about remembering again. Each morning you flip a switch, enter your personal code, and get an instant readout of everything you need to accomplish that day.

Plainly speaking, there's no need for special codes or computer language with GUARDIAN... you talk to it, and it talks right back in plain English. GUARDIAN even tells you how to enter data and correct errors with step-by-step on-line instruction through its built-in video display manual. The printed manual that comes with GUARDIAN is also complete and easy-to-understand.

Years Ahead

GUARDIAN lets you organize everything you need to do today for years to come. The single-line entries are easy to make, and can even be set to flag you several days in advance of the event.

Advance To Go

GUARDIAN is programmed to automatically advance and schedule appointments, PTA meetings, vacation schedules, tax deadlines and other activities indefinitely, until you cancel the entry. GUARDIAN's internal calendar adjusts itself from year to year.



Protects Your Interests

GUARDIAN is as easy to use as pencil and paper, but its memory can't be lost or erased by accident. System failure and operator error are protected by automatic file closure. Password protection keeps your files confidential.

GUARDIAN's disk has the storage capacity to organize up to 2,000 separate events for 200 people at the same time.

Yes... I want to put GUARDIAN to work for me, to receive maximum efficiency and ease in organizing my personal life with my microcomputer.

NAME _____

ADDRESS _____

CITY _____ STATE _____ ZIP _____

I have enclosed \$119.95 to avoid delays and handling charges.

Check Money Order Price includes tax, handling and shipping (except C.O.D. Orders).

C.O.D. (If delivery address is different than above, please specify)

Please specify one: 5 1/4-inch disk 8-inch disk 10A1

Please specify one: CP/M* Operating System TRSDOS** Operating System

The GUARDIAN program is recommended for use with any soft disk drive system with 48k memory or more, and operates on any CP/M*-based system or the TRS 80** (Model I, II or III). Programs are available on standard 5 1/4- or 8-inch disk, with storage sleeve. **\$119.95.**

GUARDIAN is available directly from Time Management Software, and is not sold through any store, catalog or other source. To order GUARDIAN call one of our toll-free numbers or return the order blank below.

Call now toll free to order (Ask for operator 601)

1-800-824-7888 (nationwide, except California, Alaska and Hawaii)

1-800-852-7777 (in California)

1-800-824-7919 (in Alaska and Hawaii)



TIME MANAGEMENT SOFTWARE™

123 E. Broadway
P.O. Box 727
Cushing, Oklahoma 74023

* Registered Trademark of Digital Research, Inc. ** Registered Trademark of Tandy Corp.

Did you know
that with
the new

UCSD*

P-SYSTEM VERSION IV

you can write
programs in



and run them on

ALTOS, APPLE, COMMO—
DORE, CROMEMCO, DEC,
INTERTEC, PHILIPS, OHIO
SCIENTIFIC, RADIO SHACK,
TERAK, TEXAS INSTRU—
MENTS, VECTOR GRAPHIC,
ZENITH, and many more...

without change!

(Think about that next time
you want a larger market)

We support systems
software and applica—
tions ready-to-run on

APPLE, DEC LSI-II, RADIO
SHACK MODEL II $\frac{1}{2}$ and AL—
TOS.

PCD SYSTEMS

P. O. Box 143
Penn Yan, NY 14527
315-536-3734

IBM Digital Equipment
STM of Tandy Corp.
*TM U. of California

Letters

Points on Printers

In connection with the review "The Epson MX-80 and MX-70 Printers" (see the May 1981 BYTE, page 22), the following specific comments may be of interest:

- The MX-80 offers four rather than three character densities. The fourth is the double-width reduced character. It is produced by an SO (shift-out) code when an SI (shift-in) code is in effect. The resulting density is 3.25 characters per cm (8¼ per inch).
- A fourth character style can be obtained by transmitting codes for both boldface and emphasized. The result is a character heavier in both horizontal and vertical lines.
- Line spacings of less than ½ of an inch on the MX-80 are overridden when graphic characters are present. In our experience, even a single graphic character in a line will cause the line feed to default to ½ of an inch. (This phenomenon is not covered in the user's manual.)
- The annoying buzzer on the MX-80 can be turned off by use of internal switch 1-6.
- The MX-70 (even though its character matrix is 5 by 7) produces a graphic matrix of 480 by 8 pixels per line.

As for the Apple II interface, which does not transmit the high bit and, hence, the graphic characters, the peculiarity lies in the Epson-designed interface, rather than the Apple's memory. Our company produces and distributes an interface for the Apple II and the Epson printers that transmits all bits and all characters. We also produce a firmware printer-support card for the Apple II. In conjunction with our interface, this card will (in addition to many other functions) produce a low-resolution graphic dump on the MX-80 using the graphic characters and a high-resolution graphic dump on the MX-70, which is printed as eight graphic lines on each pass.

Amnon Katz
President
Inverted—A Inc
401 Forrest Hill Ln
Grand Prairie TX 75051

I have just purchased the MX-70 version of Epson's printer, and I would like to make two comments on the May 1981 BYTE article.

First, the MX-70 can print with eight

points, not seven, which means that with special software it is possible to print lowercase descenders by utilizing the graphics mode.

Second, the Epson interface card for the Apple II computer has a link option for the most-significant bit that must be changed to allow this bit to get to the printer. The graphics mode requires a true 16-bit (2-byte) argument to instruct the printer as to how many bytes are to be interpreted as points on the print head. Also, a complete byte is required to define which print hammer is to strike. Before I discovered this, I had some weird effects every time I tried the graphics mode.

I think the graphics mode is the most significant part of the MX-70 because it allows a large number of extra features to be defined by the user:

- special-character sets
- proportional spaces between characters
- proportional spaces between words
- overstrike, and
- underlining

Bruce Piggott
725 Flower City Pk
Rochester NY 14615

Changing Names

Gary Stotts's Apple Name-Address program is so useful that I made a modification for my own purpose. (See the April 1981 BYTE, page 32.) Although there is a way to change the address and telephone number of a person listed on the file, there is no way of changing a person's name. There may be reason to change the person's name: marriage, for example. I have added a few lines to the program to do just that. (See listing 1).

Gino J Piazza
49 Browndale Pl
Port Chester NY 10573

Listing 1

```
1172 PRINT : PRINT "OLD: ";NS(I)
1175 PRINT : INPUT "NEW: ";NS(I)
1177 IF LEN(NS(I)) < 1 THEN 1175 ■
```

Credit Due

We inadvertently omitted the credit line for the photographer responsible for the photographs in "A Look at NCC '81" (September 1981 BYTE). We apologize to Richard Faverty.

Announcing the WICAT 68000 Microcomputer System 150.

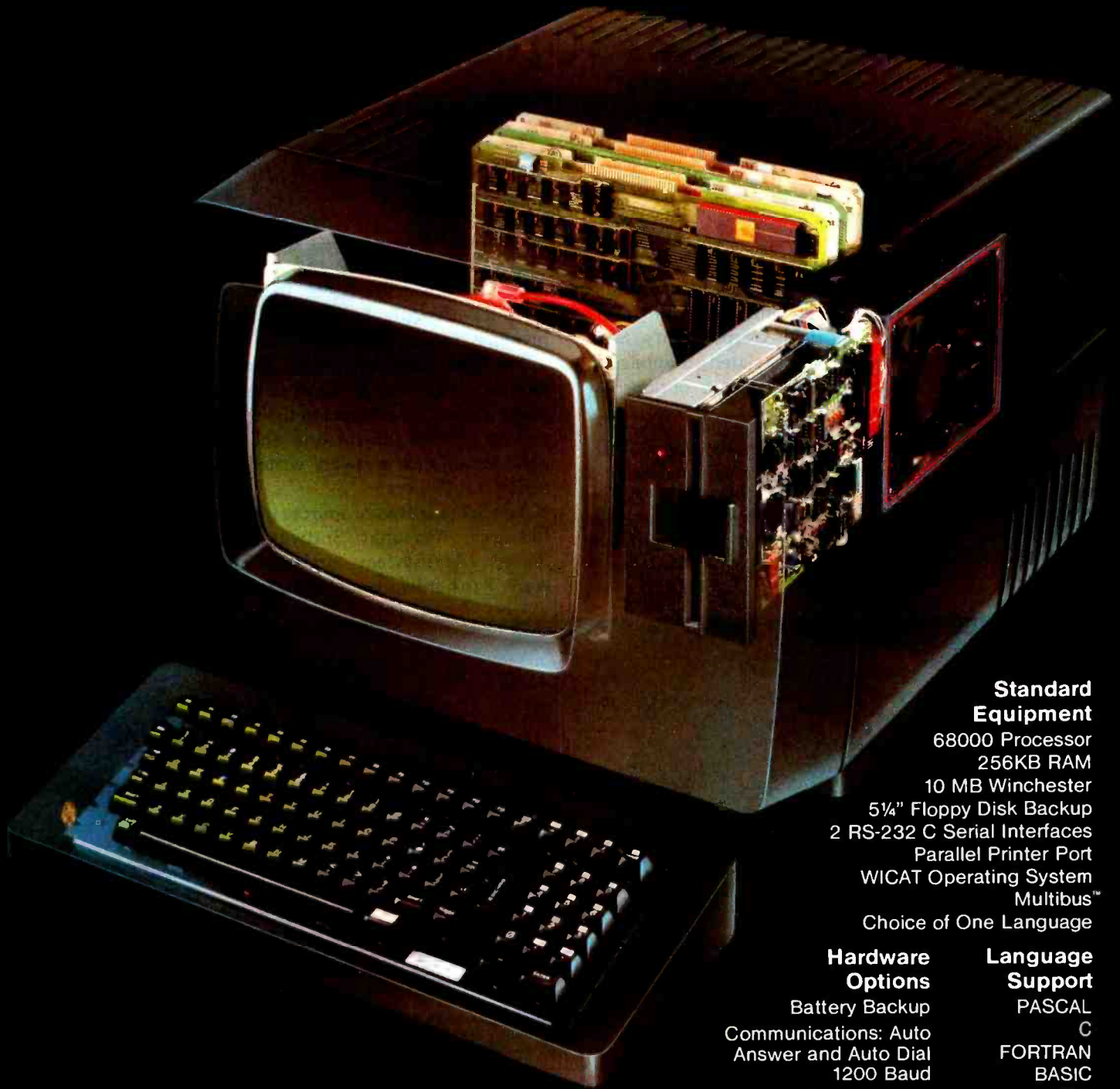

Standard Equipment

68000 Processor
256KB RAM
10 MB Winchester
5¼" Floppy Disk Backup
2 RS-232 C Serial Interfaces
Parallel Printer Port
WICAT Operating System
Multibus™
Choice of One Language

Hardware Options

Battery Backup
Communications: Auto
Answer and Auto Dial
1200 Baud
Graphics CRT
Videodisc Interface

Language Support

PASCAL
C
FORTRAN
BASIC
APL
COBOL
ADA
LISP
Assembler

Software Options

UNIX™/V7
CPM Emulator

Call or write WICAT Systems
for additional information.

WICATsystems

P.O. Box 539 1875 South State Street Orem, Utah 84057 801/224-6400

Circle 409 on Inquiry card.

UNIX is a trademark of Bell Labs. Multibus is a trademark of INTEL

The IBM Personal Computer

First Impressions

Phil Lemmons
89 Remsen St
Brooklyn NY 11201

IBM (International Business Machines Corporation) has at last introduced the keenly anticipated IBM Personal Computer. Based on Intel Corporation's 8088 microprocessor, the new machine is slated to appear in stores this month, with various hardware options, at

Photo 1: The new IBM Personal Computer is based on the Intel 8088 microprocessor and will be supported by software from well-known, independent sources. Shown here are the System Unit with two built-in 5-inch floppy-disk drives, the black-and-white video monitor, the adjustable keyboard, and an Epson MX-80 printer bearing the IBM label, all of which sells for \$4385.

prices ranging from \$1565 to more than \$5000. Color graphics are built in, and up to 256 K bytes of user memory may be installed.

The hardware is impressive, but even more striking are two decisions made by IBM: to use outside software suppliers already established in the microcomputer industry, and to provide information and assistance to independent, small-scale software writers and manufacturers of peripheral devices.

The list of software sources includes Microsoft, Digital Research, Personal Software, Peachtree Software, Softech Microsystems, and Information Unlimited Software. For hardware configurations including floppy-disk



See us at Comdex '81 in Las Vegas, Booth #774.

The BOS M System: The Universal Donor

Type "O" Positive

The BOS M Card is the heart of the M System. It is designed to be IEEE S-100 bus compatible for universal system use. Virtually all elements of a computer mainframe now reside on one S-100 card — Z-80A CPU, 64k of 200ns RAM (no wait states), 4k 250ns EPROM, Winchester Disk I/O port, two RS-232 serial ports, system port, floating point processor, and parallel I/O. The same M Card can be used in single-user, multi-user, or even multi-processor systems.

Second Generation Multi-Processor. With the BOS M Card, multi-processing is finally free of the Master/Slave and handshaking parameters so prevalent in first generation multiprocessors. Inter-system communications are FIFO buffered; the old "Master" is now a slave to the user, and the system functions without "S-100 bus overrun" or system generated wait states.

The Universal Processor is now a reality! As a single-user system, the BOS M is unmatched in performance (up to ten times the speed of other microcomputers). As a multi-user system, this power can be translated into a low cost multi-terminal capability. As a multi-processor, the system leaves the realm of "microcomputer" and competes in performance with a minicomputer! You can start with a single user computer and expand to a multi-user/multi-processor computer system when needed.



The Universal Product. BOS has what you need — anything from a single M Card to a complete turnkey computer system. Diskette, rigid-disk, tape and telecommunications sub-systems are all available. Compatible software includes CP/M*, MP/M*, CP/NET*, BOS/TURBODOS, complete monitor, languages, application packages, and more!

Dealer and OEM Inquiries Welcome

BOS

Bus based Operating Systems, Inc.
2835 East Platte Avenue
Colorado Springs, Colorado 80909
In Colorado Call: (303) 634-1541
Toll Free Number: 1-800-525-3898

Circle 49 on inquiry card.

The BOS M System does what a Universal Donor must do — it provides high performance for all system types; single-user, multi-user, and multi-processor. M Systems start as less than \$5,000.00 for a single-user computer with dual 8" double-density diskette drives.

*Registered Trademark
of Digital Research
TURBODOS is
a product of
Software 2000

drives, IBM will sell three different disk operating systems: CP/M-86 from Digital Research, the UCSD p-System from Softech Microsystems, and IBM Personal Computer DOS, developed by Microsoft in imitation of CP/M. IBM isn't trying to force the world to choose between the IBM DOS and other popular operating systems. The published documentation of IBM Personal Computer DOS will include the source-code listing of the BIOS (basic input/output system), and of the diagnostic programs executed automatically when the computer is turned on.

The hardware uses an interconnection scheme different from the industry-standard S-100 bus, but IBM doesn't want to exclude anyone from developing plug-compatible printed-circuit boards for installation in any of the vacant expansion slots inside the chassis. In fact, the company plans to publish a hardware manual with drawings and industry-standard specifications. IBM's attitude toward support for independent hardware and software efforts was summarized by Don Estridge, Director of Entry Systems Business for the IBM Personal Computer. "IBM will provide information for the existing cottage industry to design boards," Estridge said. "We're open to any software proposals."

General System Characteristics

The entry-level version of the IBM Personal Computer consists of the System Unit, which contains the 8088 microprocessor, a 40 K-byte built-in ROM (read-only memory) containing the extended version of Microsoft BASIC, a built-in speaker that can be programmed to play music, a power-on automatic self-test of system components, 16 K bytes of user memory in the form of semiconductor RAM (random-access read/write memory), a combination video-monitor and printer adapter, and empty space for two 5-inch floppy-disk drives. In this minimal configuration, the system uses an audio-cassette recorder for mass storage and an ordinary television set as a video monitor.

Not including the cassette recorder and monitor, the minimal system will sell for \$1565. With a single 5-inch, 160 K-byte floppy-disk drive and 64 K bytes of user RAM, the price increases to \$3005. An expanded business system with powerful color graphics, two floppy-disk drives, and an IBM-labeled Epson MX-80 dot-matrix printer costs \$4500. In addition to the 40 K-byte ROM, the system has a 16 K-byte RAM buffer for graphics operations. None of the user memory is required by the system software.

DATAFACE GRQ SERIES INTERFACE

URNS YOUR ELECTRONIC TYPEWRITER INTO A PRINTER/TYPEWRITER

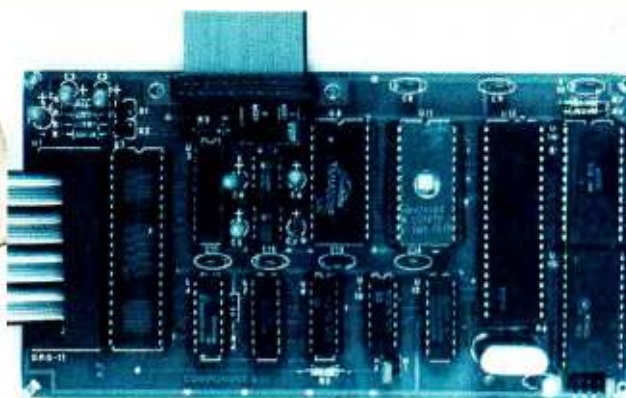

The Dataface GRQ-11 Interface expands your Olympia ES Series electronic typewriter into a letter press quality printer for your personal or business computer. And, you still have a fully featured electronic typewriter—two machines in one.

The GRQ Series Interface features:

1. Standard EIA RS-233-C Serial Interface and Parallel (Centronics compatible).
2. Standard asynchronous ASC11 code, 7 bit data; 1 start bit; accommodates 1 or 2 stop bits automatically; accommodates odd, even or absence of parity bit.
3. Fifty thru 9600 Baud data rate options.
4. Two K buffer; supports X-on, X-off protocol as well as RTS signals.

5. Circuit board is installed inside typewriter back panel along side logic board. The connection between boards accomplished by 40 pin jumper cable using existing socket. No soldering required. Power is provided to the GRQ thru two pins of the 40 lead cable. Installation in 10 minutes.

End user, Dealer, Distributor and OEM inquiries are welcome. For additional details, specifications and computer compatibility contact:

DATAFACE INC.

2372 A WALSH AVE., SANTA CLARA, CA 95050
(408) 727-6704

THE DAWN OF A NEW AGE

The 2nd Generation™ is here!

MEASUREMENT systems & controls proudly introduces its new and exciting "2nd Generation" family of S-100* compatible products. Each has been specifically designed for use with multi-user and network operating systems such as MPM, CP/NET, and OASIS. Every product is fully tested and burned-in, comes with a 1 year guarantee, and offers you features not currently available from any other source.

Z80 PROCESSOR BOARD — The most powerful CPU board available today. Outstanding features include 4MHz operation, high-speed serial and parallel I/O utilizing DMA or programmed control, eight vectored priority interrupts, and a real time clock.

MULTI-USER SERIAL I/O BOARD — For use in expanded systems requiring up to eight additional serial I/O ports. Features include: 16 maskable

vectored priority interrupts, RS-232C interfaces with full handshake, asynchronous or synchronous operation with asynchronous baud rates to 19,200. Available in four or eight channel versions.

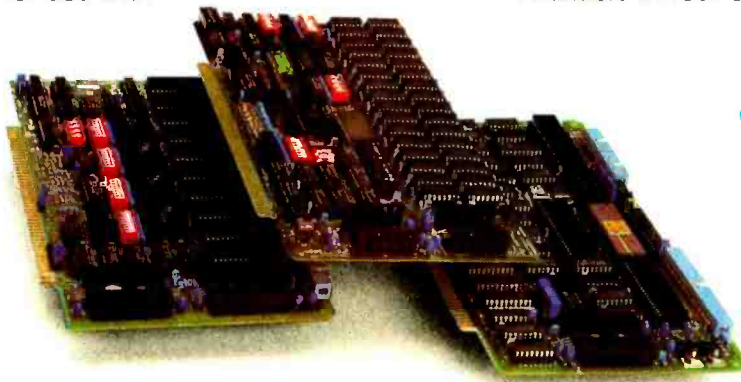

DOUBLE DENSITY FLOPPY DISK CONTROLLER BOARD — controls up to four 5¼-inch or 8-inch disk drives using IBM soft sector formats. It features 1K of on-board buffering, DMA controlled data transfers and the performance characteristics of the superior NEC 765 chip.

64K BANK SELECTABLE MEMORY BOARD — Features include I/O port addressing for bank select with 256 switch selectable I/O ports for the memory bank addressing. The memory is configured as four totally independent 16K software-selectable banks, with each bank addressable on any 16K boundary.

*All products meet the new IEEE standards.

"Attractive Dealer & OEM Prices"

See your nearest computer dealer, or contact us for the complete story on The 2nd Generation.

Systems Group

A Division of MEASUREMENT systems & controls
incorporated

1601 Orangewood Ave., Orange, CA 92668
TWX/TELEX: 910 593 1350 SYSTEMGRP ORGE

Plug-in circuit cards of user RAM are available in three denominations: 16 K bytes (\$90), 32 K bytes (\$325), and 64 K bytes (\$540). The user can increase the memory capacity to 256 K bytes using the available IBM boards and slots. (Outside companies could make a single memory board containing 256 K bytes of RAM, or expansion boards that contain even more.) All user memory is 9-bit, with one bit devoted to parity check. An edge connector on the back of the System Unit looks as if it is longing for a hard-disk drive, but IBM is mum on that possibility.

The 8088 processor communicates with memory and peripheral devices through an 8-bit data bus, but it conducts its internal affairs using the 16-bit instruction set of Intel's 8086 microprocessor. In the IBM Personal Computer, the 8088 operates at 4.77 MHz, with a cycle time for main storage of 410 nanoseconds; for access, the cycle time is 250 nanoseconds.

Together, the System Unit, keyboard, and a monitor make a very smart, full-feature terminal. A six-foot coiled cable connects the separate keyboard to the System Unit. You can adjust the keyboard's tilt toward you when it rests on a desktop, or you can hold it in your lap. The system supports both uppercase and lowercase characters, and all 83 keys have automatic repeat. Ten keys on the right side are for a numeric keypad and cursor controls, and ten special-function keys can be used for editing. The keyboard provides access to 256 characters, including all the ASCII (American Standard Code for Information Interchange) characters and many other characters useful for producing virtually any sort of graphics display.

IBM sells an 11½-inch green-phosphor video monitor for \$345. The monitor displays 25 lines of 80 characters each. You can adjust brightness and contrast or use soft-

COMPUTERS

IMPORTS



EPSON MX-80's/100's

Call for prices!

Okidata M-80 \$374.00

Okidata M-82A \$589.00

Okidata M-83A \$765.00



NORTHSTAR

Burned and tested - backed by fast warranty service. Exclusive Sail® CP/M® increases drive capacity. Octals and Winchester available. Our Northstars are better than "factory sealed" - call us - we'll tell you why. (free games disk).

Horizon II 64K DD \$2895.00

Horizon II
64K Quad \$3245.00

NEW



Televideo 910 \$589

Hazeltine Esprit \$589

ADD5 Viewpoint \$559

Sorec IQ 130 \$589

HIGH SPEED



Anadex

9500/9501 \$1274.00

Datascout - 180

New CP-Graphics coll

TI 810 Basic \$1295.00



ALTOS

Single user 8000-2 includes dual 8" double density drives (1 Mg. capacity), two serial ports, two parallel ports, and CP/M®.

Call for other Altos prices.

ACS8000-2 w/ CP/M \$2995.00

ATARI 800 \$739.00 / ONYX SYSTEMS CALL

TELEVIDEO



ZENITH

The all-in-one computer that's backed by your local Zenith/Heath service center. Green Phosphor screen and CP/M included.

Z89 w/48K 2510's \$2144

PAPER TIGERS



445G \$749

460G \$895

560G \$1129



Scottsdale Systems Ltd.

6730 E. McDowell Road, Suite 110, Scottsdale, Arizona 85257

(602) 941-5856

Call 8-5 Mon.-Fri.

(We Expon) TWX 910-950-0082 (IMEC SCOT)

TELEVIDEO



Televideo 912 \$710

Televideo 920 \$759

Televideo 950 \$949

MORE PRINTERS

Centronics 737 \$719.00

Mallbu

Dual Mode 200 \$2395.00

DEC LA 34AA \$1049.00

Mannesmann-Tally

MT-1802 \$2095.00

ORDERING

MAIL ORDER ONLY

2% cash discount included/charge cards add 2%. Prices subject to change. Product subject to availability. Arizona residents add 5% F.O.B. point of shipment Scottsdale. 0.20% restocking fee for returned merchandise. Warranties included on all products. Personal checks take 3 week to clear.

TERMINALS



Ampex D80 \$925

D80 Amber \$969

Mime Act 5A \$799

ADM - 3A \$775

Soroc 120 \$674

MORE PRINTERS

* NEC 5510 \$2689.00

* Diablo 630 \$2295.00

C.Itoh Starwriter..... \$1370.00

Qume

Sprint 9/45 \$2095.00

*Tractors included in price

SYSTEM 2800

nothing

A MAJOR BREAKTHROUGH!



20 MByte Winchester Hard Disk with Tape Backup

The SYSTEM 2800, designed for business, industrial and educational applications, is now available with a 20 MByte Winchester Hard Disk and a 20 MByte Tape Drive for disk backup. Created to be innovative and competitive, the SYSTEM 2800 utilizes our existing line of field-proven and dependable "2nd Generation" S-100 Memory, Z80 Processors, Disk Controllers and Serial I/O boards.

As a family of expandable microcomputers intended for single and multi-user applications based on CP/M*, MP/M* and OASIS**, the SYSTEM 2800 contains many big system features. Outstanding characteristics such as FAST operation make it a clear market leader. In fact, the SYSTEM 2800 is one of the fastest Z80-based systems recently benchmarked by Interface Age magazine.

*CP/M and MP/M are Registered Trademarks of Digital Research

**OASIS is a Trademark of Phase One System, Inc.



Other features include the capability to BOOT from any drive including the hard disk, and extensive error recovery. The error recovery prompts the user with detailed error messages and prevents system lock up, all too common to many other systems.

Designed for easy service, the SYSTEM 2800 comes with two 8-inch drives: a choice of single or double sided, double density floppies with up to 2.52 MBytes of formatted storage; 10 or 20 MByte Winchester hard disk; and 20 MByte tape drive for disk backup.

These enhanced features result in a highly reliable, quality built, state-of-

the-art microcomputer that gives you the cost/performance edge you need to be a leader in your field.

Dealers, OEM's and System Integrators share many common needs. Not the least of these is dependable products. That's why we back our SYSTEM 2800 with our established reputation for high quality, superior support, prompt and courteous service, an inclusive one-year warranty and comprehensive dealer support program.

Take the next logical step. See your nearest computer dealer, or contact us for the complete story on our S-100 family of board products and enhanced systems.

Systems Group

A Division of MEASUREMENT systems & controls Incorporated

1601 Orangewood Avenue
Orange, Calif. 92668 (714) 633-4460
TWX/TELEX: 010 592 1350 SYSTEMGRP ORGE

ware to activate underlining, high-intensity blinking characters, and reverse video.

With a color monitor, the IBM Personal Computer will support 16 foreground and eight background colors. In the medium-resolution graphics mode, screen resolution is 320 pixels (picture elements) across by 200 down. In the high-resolution graphics mode, resolution is 640 by 200 pixels. Text and graphics can be mixed, allowing you to label items in a graphics display.

One Centronics-compatible parallel printer port and one RS-232C serial I/O (input/output) port are standard. An asynchronous communications adapter (\$150) enables you to connect a modem to the serial port.

IBM is even offering a Game Control Adapter (\$55) that permits connection of user-supplied joysticks and paddles to the IBM Personal Computer.

Sales and Service

IBM's sales and service strategies show the computer giant's determination to develop quickly into a major force in the microcomputer market. Beginning this

month, the company is marketing the Personal Computer nationwide in four ways:

- through Computerland retail stores
- through Sears, Roebuck and Company's new business-machine stores (IBM will train the Sears sales personnel)
- through a special sales unit in the IBM Data Processing Division (for high-volume sales)
- through IBM Product Centers, which will make provisions for installment purchases

Only four Product Centers exist now, but IBM has selected many more cities around the country as sites for future centers. "In the course of the next two years," said C B Rogers, Jr, IBM vice president and group executive of the General Business Group, "we expect to be fairly well represented."

IBM will offer a 5 percent discount on sales of 20 to 49 units, 10 percent on sales of 49 to 150 units, and 15 percent on sales of 151 units or more. Educational institutions will also receive discounts.

At a Glance

Product Name

The IBM Personal Computer

Manufacturer

International Business Machines Corporation
Information Systems Division
Entry Systems Business
POB 1328
Boca Raton FL 33432

When Available

October 1981

Where Available

Sears, Roebuck and Company's business-machines stores
Computerland stores
IBM Product Centers
IBM Data Processing Division (volume sales)

Components

System Unit

Size: width 20 inches, depth 16 inches, height 5.5 inches;
weight (without disk drives) 21 pounds, (with two disk
drives) 28 pounds

Electrical needs: 120 VAC

Processor: Intel 8088

Cycle Time: main storage, 410 nanoseconds; access,
250 nanoseconds

Memory: 40 K bytes of built-in ROM (read-only memory),
16 K bytes of user RAM (random-access read/
write memory); expandable to 256 K bytes

Standard: keyboard for data and text entry; audio-cassette
recorder connector; five expansion slots for
memory, display, printer, communications, and
game adapters; built-in speaker for music program-
ming; power-on automatic self-test of system com-
ponents; BASIC-language interpreter; 16 K bytes
of user RAM (all user RAM is 9-bit parity
memory)

Keyboard: 83 keys for data and text entry, 10 keys for
numeric entry and cursor control, 10 special func-
tion keys, and ASCII characters and special
graphics characters (total 256 characters);
automatic repeat on all keys; adjustable typing
angle; detachable six-foot coil cable

Disk drives: up to two 5-inch floppy-disk drives, 160 K bytes
each

Operating Systems

IBM Personal Computer DOS (Microsoft)
CP/M-86 (Digital Research)
UCSD p-System (Softech Microsystems)

Software Available for IBM Personal Computer DOS

BASIC interpreter (Microsoft) standard; extended BASIC inter-
preter (Microsoft) \$40; Pascal compiler (Microsoft) \$300; VisiCalc
(Personal Software) \$200; Easywriter (Information Unlimited Soft-
ware) \$175; General Ledger, Accounts Receivable, Accounts
Payable (Peachtree Software) \$595 each; asynchronous com-
munications support \$40; Adventure (Microsoft) \$30

Hardware Prices

| | |
|---|--------|
| System Unit, 16 K-byte RAM, keyboard | \$1265 |
| System Unit, 48 K-byte RAM, keyboard | |
| single floppy-disk drive, disk-drive adapter | 2235 |
| Monochrome video display | 345 |
| Combination monochrome-display adapter and printer adapter | 335 |
| Color-graphics-monitor adapter | 300 |
| 16 K-byte memory-expansion kit | 90 |
| 32 K-byte memory-expansion kit | 325 |
| 64 K-byte memory-expansion kit | 540 |
| Disk-drive adapter | 220 |
| Disk drive (5-inch floppy disks) | 570 |
| Asynchronous communications adapter | 150 |
| Game-control adapter | 55 |
| Keyboard | 270 |

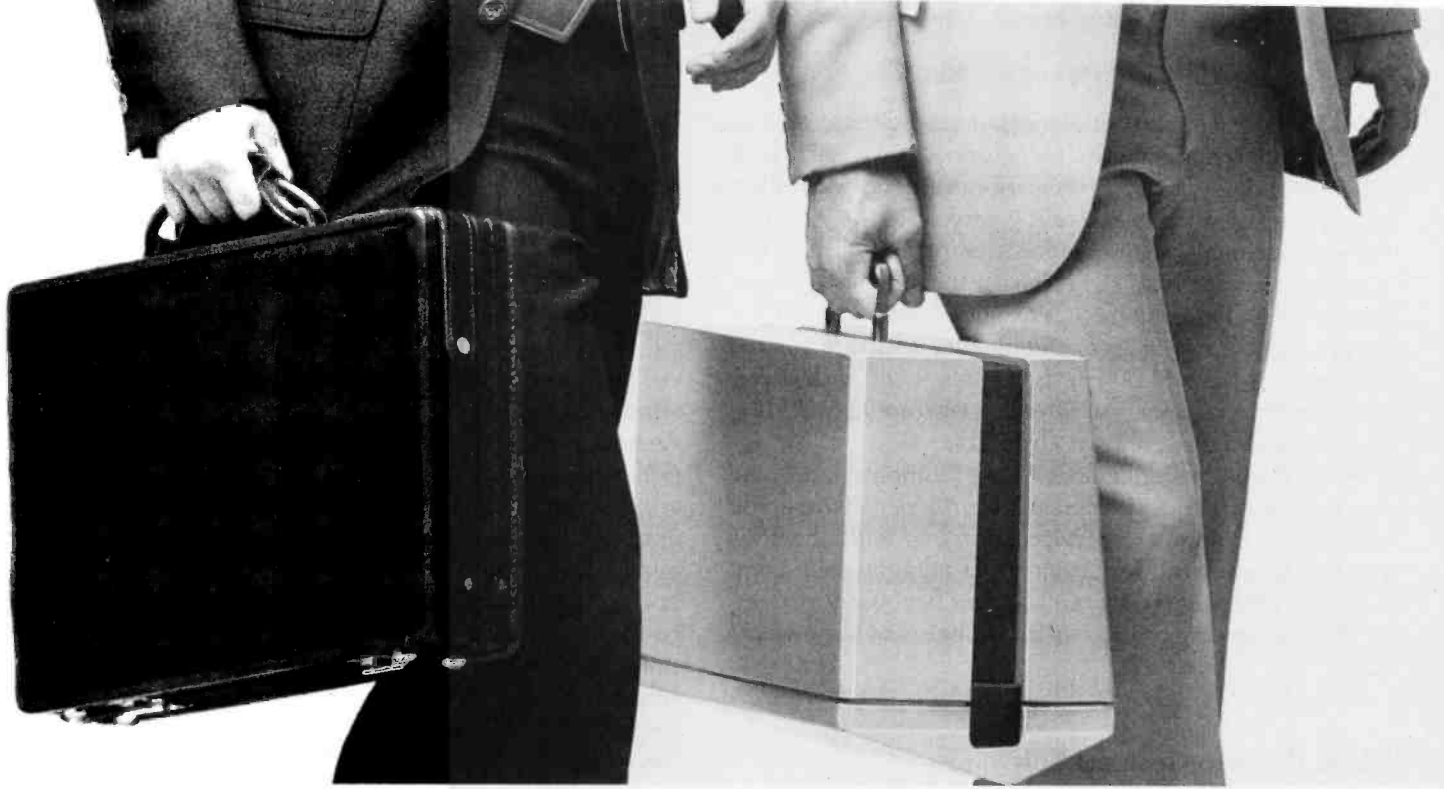

The guy on the left doesn't stand a chance.

The guy on the left has two file folders, a news magazine, and a sandwich.

The guy on the right has the OSBORNE 1®, a fully functional computer system in a portable package the size of a briefcase. Also in the case are the equivalent of over 1600 typed pages, stored on floppy diskettes.

The owner of the OSBORNE 1 is going to get more work done—and *better* work done—in less time, and with less effort.

Unfold it, plug it in, and go to work like you've never worked before. . . .

Go to work with WORDSTAR® word processing, so your correspondence, reports, and memos take less time to produce, and say more of what you wanted to say. And with MAILMERGE®—the mailing system that turns out personalized mass mailings in the time you'd spend on a rough draft.

Go to work with SUPERCALC®, the electronic spreadsheet package that handles complex projections, financial planning, statistics, and "what if" questions instantly. For the more technically minded, SUPERCALC will process scientific data and calculate results.

Go to work with powerful BASIC language tools—the CBASIC-2® business BASIC, or the Microsoft BASIC® interpreter.

That's standard equipment.

Options include about a thousand different software packages from a host of vendors designed to run on the CP/M® computer system.

Go to work at the office, at home, or in the field.

Or anywhere. Optional battery packs and telephone

transmission couplers mean you need never work without the capabilities of the OSBORNE 1. That's good, because you won't want to work again without it.

All for \$1795. It's inevitable.

The OSBORNE 1 is the productivity machine that's changing the way people work. Put simply, the machine delivers a significant productivity edge—day in and day out—to virtually anyone who deals with words or numbers. Or both.

Since the entire system is only \$1795, it won't be too long before the guy on the left has an OSBORNE 1 of his own. The same probably goes for the person reading this ad. In fact, we think it's inevitable.

The OSBORNE 1 includes a Z80A® CPU, 64K bytes of RAM memory, two 100 kilobyte floppy disk drives, a business keyboard, built-in monitor, IEEE 488 and RS232 interfaces for printers and other things that get connected to computers, plus CP/M, CBASIC-2, Microsoft BASIC, WORDSTAR, and SUPERCALC. The system is available from computer retailers nationally.

\$1795. It's inevitable.



OSBORNE
COMPUTER CORPORATION

26500 Corporate Avenue Hayward, California 94545
Phone (415) 887-8080 TWX (910) 383-2021

IBM's service plans should meet or exceed those offered by other microcomputer manufacturers. For a start, IBM offers a 90-day warranty. Owners can extend warranties to a full year for between 7 and 9 percent of the purchase price of various system components, or buy annual service contracts for 10 to 15 percent of the purchase price of components. For example, an extended warranty for the System Unit costs \$88; a maintenance contract for the System Unit costs \$112. For the System Unit, disk drive, and disk-drive adapter, an extended warranty costs \$154, and a maintenance contract costs \$196.

Service will be available at Sears, Computerland, and from the IBM Product Centers, regardless of where you bought the computer. Service contracts with the IBM Product Centers call for exchange of major system components. IBM will send a replacement keyboard, printer, or System Unit by courier within 48 hours of the owner's call.

Three Ways to Generate Software

Recognizing the advantage that an existing broad software base gives to CP/M-compatible, Radio Shack, and Apple computers, IBM plans to meet the problem head-on with a three-part strategy.

First, when the Personal Computer reaches stores this month, it will be accompanied by a software offer including some application programs ready to run with IBM DOS. Here's a quick look at what IBM is offering:

- IBM Personal Computer DOS. This CP/M look-alike from Microsoft offers the familiar "A>" prompt character along with features for copying files and disks, comparing files and disks, initializing disks, displaying a directory, renaming files, and other housekeeping chores. Although it has a debugger and a line editor, IBM DOS does not yet have an assembler. It seems safe to speculate that Microsoft is hard at work on that.
- a cassette-level enhanced Microsoft BASIC interpreter that supports input/output instructions, use of the keyboard, display, light pen, and printer, and many editing and mathematical functions.
- a disk-level Microsoft BASIC that provides extensions including more powerful graphics, date and time-of-day functions, and communication capabilities; the enhanced graphics include such features as point, circle, and get/put display, and increased light-pen support for design work (\$40)
- a Pascal compiler, also from Microsoft (\$300)
- VisiCalc, the electronic-worksheet program from Personal Software
- Easywriter, the word-processing program from Information Unlimited Software (\$175)
- an asynchronous communications program (\$40) (This is written in BASIC and is menu-driven; the menu includes an option for the Dow Jones Information Services, another for The Source, and another for teletypewriter-like communications. IBM soon will also offer a full subset of Model 3270 emulation capabilities so that the

Personal Computer can appear to larger IBM systems as an IBM 3270 terminal.)

- general-ledger, accounts-payable, and accounts-receivable packages, from Peachtree Software, but with color and other enhancements for ease of use (\$595 each)
- Adventure, the fantasy-simulation game, from Microsoft (\$30)

The second part of IBM's software-development strategy is to offer Digital Research's CP/M-86 operating system and Softech Microsystem's UCSD p-System (which includes UCSD Pascal). Purchasers of these operating systems will have access to many third-party programs as they become available. IBM says it expects the availability of these operating systems to provide the opportunity for many current applications to be transferred to the IBM Personal Computer with minimal modifications. This approach will enable owners of the IBM Personal Computer to use a tremendous amount of software originally written for other common machines. Users can have everything that IBM offers without giving up software for the other two operating systems.

The third part of the IBM software strategy is to establish its own Personal Computer Software Publishing Department. The new department will solicit software from outside authors, both professional and amateur. IBM will send software-submission information packets to anyone who writes to IBM Personal Computer Software Submissions, Dept 765, Armonk NY 10504. IBM will also encourage its employees to write software for the personal computer (on the employees' own time). Authors will receive quarterly royalties based on actual sales.

A Shaking Out?

For those of us who dislike giants, the IBM Personal Computer comes as a shock. I expected that the giant would stumble by overestimating or underestimating the capabilities the public wants and stubbornly insisting on incompatibility with the rest of the microcomputer world.

But IBM didn't stumble at all; instead, the giant jumped leagues in front of the competition. Although the IBM Personal Computer has not (as of this writing) reached store shelves, it already seems to hold a firm position in the field. Its prices seem to compare favorably with available 16-bit S-100 systems. Furthermore, the cost of an IBM Personal Computer configured for word processing is not much more than that of an Apple II Plus, an Intertec Superbrain, or most other 8-bit machines fully equipped for word processing. A superior machine from the start, the IBM Personal Computer should grow in capability as outside vendors begin producing peripheral devices and add-on hardware for special applications.

In fact, the only disappointment about the IBM Personal Computer is its dull name. One rumor claimed that IBM referred to this computer internally as the Acorn. To me, it looks more like a Mighty Oak. ■

STRUCTURED SYSTEMS FINANCIAL SOFTWARE.

ANYTHING LESS IS CHEATING YOUR OWN BUSINESS.



Penny wise and software foolish. One of the best ways to cheat your business is to waste a whole lot of time on solutions that don't work, or that can't grow with your business. And frankly, we get phone calls every day from computer users who've tried to get by on "bargain" software, and found that "bargain" software is the most expensive kind a business can own.

Here's a fact: if you have a real need for a computer in any of these areas:

- General Ledger
- Accounts Receivable
- Accounts Payable
- Order Entry
- Inventory Control
- Payroll,

any business software less than Structured Systems Financial Software is cheating your business. You'll cheat yourself out of lots of time. Time spent with

systems which aren't designed for high volume use. You'll cheat yourself out of reliable audit controls and reliable error prevention features. Out of the training you invest in a system you outgrow when you need to add more disk storage, more customers, more data. You'll be cheating yourself out of a software bargain in the truest sense of the word—the greatest value for your dollar.

CP/M® microcomputer systems can do the job of minicomputers. Structured Systems software makes that potential a reality. Right now, hundreds of businesses are profiting from the financial controls and operating efficiency of SSG financial software. So can yours.



**Take it easy on yourself.
But sentence your computer
to hard labor.**

Please send more information on your

- General Ledger Accounts Receivable Order Entry
 Accounts Payable Payroll Inventory Control

Name _____
Company _____
Address _____
City State Zip _____
Telephone () _____

CP/M is a registered trademark of Digital Research.

Structured Systems Group

5204 Claremont, Oakland, California 94618 (415) 547 1567

INCORPORATED

Build an Intelligent EPROM Programmer

Steve Ciarcia
POB 582
Glastonbury CT 06033

Longtime followers of the activities in Ciarcia's Circuit Cellar may remember an incident I wrote about a few years ago. My friend Jerry needed to program an EPROM (erasable programmable read-only memory) device in a hurry for a demonstration

Copyright ©1981 by Steven A Ciarcia. All rights reserved.

at his computer club. The EPROM-programming arrangement we devised gave me the idea for the article "Program Your Next EROM in BASIC" (March 1978 BYTE, page 84), in which I presented a design for an inexpensive programming circuit and told how to drive it with software written in a high-level language.

EPROM technology has advanced considerably since then. In 1978, the

type-2708 EPROM chip, which requires a three-voltage power supply, was just becoming established, replacing the hard-to-program type-1702 EPROM device. Not only was the 2708 easier to program, it also held more data: 1 K (1024) 8-bit words, compared to 256 8-bit words stored by the 1702 EPROM.

The 2708 EPROM has been replaced in most new designs by the single-voltage type-2758 EPROM, and a number of higher-capacity devices that require only a single-voltage power supply have been developed and made available by several manufacturers. These are the type-2716 (2 K 8-bit words, or 16 K bits), type-2732 (4 K 8-bit words), and type-2764 (8 K 8-bit words) EPROMs. The 2716 has become especially popular, partly because its 2 K bytes are sufficient memory space for storing most bootstrap loaders, command monitors, and simple utility programs; and partly because the 2716 is usually priced under \$10.

The 2758, 2716, and 2732 EPROMs are members of the same family of components, sharing a common pinout specification. With only minor modifications to the wiring, a designer can allow different-capacity memory devices to be plugged into the same socket on a circuit board. This versatility also means the same basic circuit can serve in several applications.

My previous article on EPROMs suggested using an interpreted BASIC

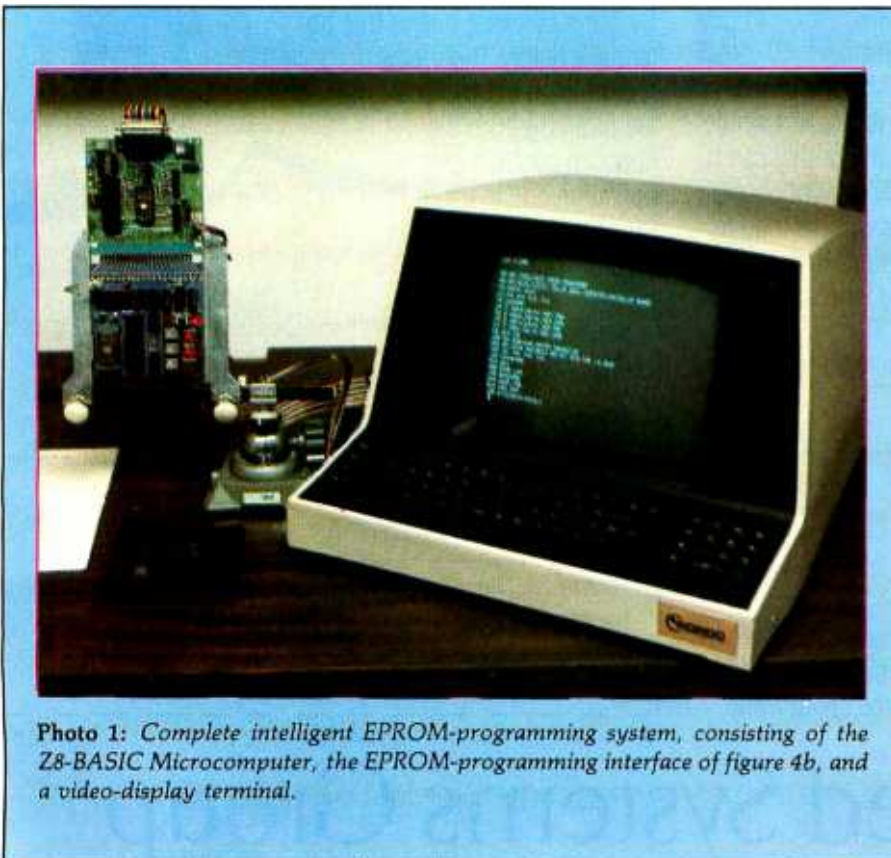

Photo 1: Complete intelligent EPROM-programming system, consisting of the Z8-BASIC Microcomputer, the EPROM-programming interface of figure 4b, and a video-display terminal.

program to drive the EPROM-programming circuit. This idea did work, but it took a long time to program a 2708 EPROM. If you wanted to program more than a few 2708s, you would have been wise to pack a box lunch for the occasion. The BASIC program demonstrated the algorithm for programming an EPROM, but a machine-language driver program was needed for practical large-scale EPROM programming.

The slow speed for programming, or "burning," 2708s this way results from the need to iterate the write pulse 100 times for each byte location. Each byte in the 2708 must be written for at least 100 ms (milliseconds) to assure stability of the stored data. However, this 100 ms duration must consist of 100 separate, pulsed write sequences, each lasting only 1 ms. All 1024 byte locations must be addressed in sequence while a +25 V programming pulse is applied for 1 ms for each address. The cycle is then repeated 100 times.

The 2716, on the other hand, requires only one loop through all the addresses, instead of 100 loops. While each location is being addressed, a 50 ms programming pulse is applied, usually timed by a one-shot (monostable multivibrator). The 50 ms, single-loop programming conditions fall well within the speed capabilities of BASIC, and no machine-language driver routine need be written for serious use.

Using a program essentially the same as the one presented in the original article (running under an 8 K BASIC interpreter on a Z80 microprocessor with a 2.5 MHz clock rate), a 2716 can be completely burned in 154 seconds, requiring 75 ms per location. The minimum time required with a machine-language driver is 103 seconds, or 50 ms per location. The difference is hardly noticeable.

Because EPROMs are so widely used, I thought it was about time to write another article on them, featuring the 2716. First, I'll discuss why EPROMs are used and how they work, and then I'll describe the design

of my new EPROM-programming circuit.

What is different about this new circuit? I decided to "unbundle" the system and design the EPROM programmer as a stand-alone, intelligent unit. By incorporating the Z8-BASIC Microcomputer (my July-August Circuit Cellar project), we can easily put together a stand-alone 2716 programmer with capabilities that rival those of units costing ten times as much. (See "Build a Z8-Based Control Computer with BASIC, Part 1," July 1981 BYTE, page 38, and "Part 2," August 1981 BYTE, page 50.)

Whys and Wherefores of EPROM

A personal computer, even in its minimum configuration, always contains some user-programmable memory or RAM (random-access read/write memory), usually in the form of semiconductor memory integrated circuits. This memory can contain both programs and data. Any machine-word-level storage element within the memory can be individual-

ly read or modified (written) as needed.

Any of several kinds of electronic components can function as bit-storage elements in this kind of memory. TTL (transistor-transistor logic) type-7474 flip-flops, bistable relays, or tiny ferrite toroids (memory cores) are suitable, but all cost too much, are hard to use, and have other disadvantages.

In personal-computer and other microprocessor-based applications, the most cost-effective memory is made from MOS (metal-oxide semiconductor) integrated circuits. Unfortunately, data stored in these semiconductor RAMs is volatile. When the power is turned off, the data is lost. Many ways of dealing with this problem have been devised, with essential programs and data usually stored in some nonvolatile medium.

In most computer systems, some data or programs are stored in non-volatile ROM (read-only memory). A semiconductor ROM can be random-

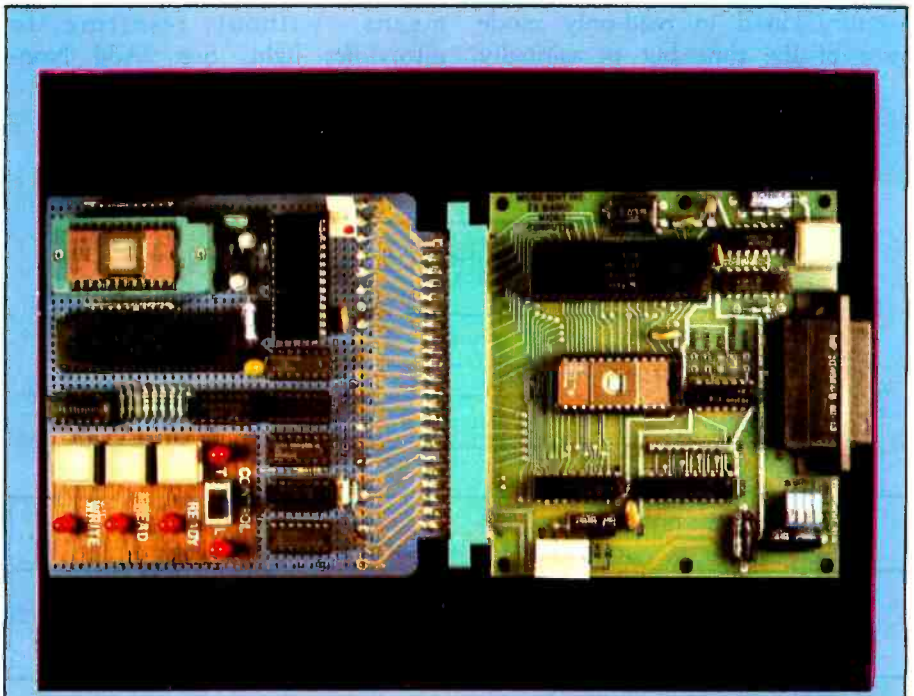

Photo 2: Closeup of the EPROM programmer. On the right is the Z8-BASIC Microcomputer circuit board with the program-controller software resident in the onboard EPROM. On the left is the prototype type-2716 EPROM programming interface. It includes a control panel, an operator display (LEDs), a zero-insertion-force EPROM socket, and a 4 K-byte buffer memory.

ly accessed for reading in the same manner as the volatile memory, but the data in the ROM is permanent. In a mask-programmed ROM, the data that can be read is determined during the manufacturing process. Whenever power is supplied to the ROM, this permanent data (or program) is available. In small computer systems, ROM is chiefly used to contain operating systems and/or BASIC interpreters—programs that don't need to be changed.

Another type of ROM is the PROM (programmable read-only memory). A PROM component is delivered from the factory containing no data. The user decides what data he wants it to contain, and permanently programs it with a special programming device. Once initially programmed, PROMs exhibit the characteristics of mask-programmed ROMs. You might label such PROMs as "write-once" memories.

The ultraviolet-light-erasable EPROM is a compromise between the "write-once" kind of PROM and the volatile memory. You can think of the EPROM as a "read-mostly" memory, used in read-only mode most of the time but occasionally

| Pins Mode | \overline{CE}/PGM (18) | \overline{OE} (20) | V_{PP} (21) | V_{CC} (24) | Outputs (9-11,13-17) |
|-----------------|-----------------------------|----------------------|---------------|---------------|----------------------|
| Read | V_{IL} | V_{IL} | +5 | +5 | D_{out} |
| Standby | V_{IH} | Don't care | +5 | +5 | High impedance |
| Program | Pulsed V_{IL} to V_{IH} | V_{IH} | +25 | +5 | D_{in} |
| Program Verify | V_{IL} | V_{IL} | +25 | +5 | D_{out} |
| Program Inhibit | V_{IL} | V_{IH} | +25 | +5 | High impedance |

Table 1: Voltages present at specified pins of the 2716 during the five modes of operation. V_{IL} must be in the range -0.1 V to $+0.8$ V; V_{IH} must be in the range $+2.0$ V to $V_{CC} + 1$.

erased and reprogrammed as necessary. The EPROM is erased by exposing the silicon chip to ultraviolet light at a wavelength of 2537 angstroms. Conveniently, most EPROM chips are packaged in an enclosure with a transparent quartz window. (I once wrote about a different kind of "read-mostly" memory, the EAROM: electrically alterable read-only memory. An EAROM is erased by purely electrical means, without resorting to ultraviolet light. See "Add Non-

volatile Memory to Your Computer," December 1979 BYTE, page 36.)

How the EPROM Works

EPROMs made by Intel Corporation and several other manufacturers store data bits in cells formed from stored-charge FAMOS (floating-gate avalanche-injection metal-oxide semiconductor) transistors. Such transistors are similar to positive-channel silicon-gate field-effect transistors, but with two gates, as shown in figure 1a. The lower, or "floating," gate is completely surrounded by an insulator layer of silicon dioxide, and the upper "control" or "select" gate is connected to external circuitry.

The amount of electric charge

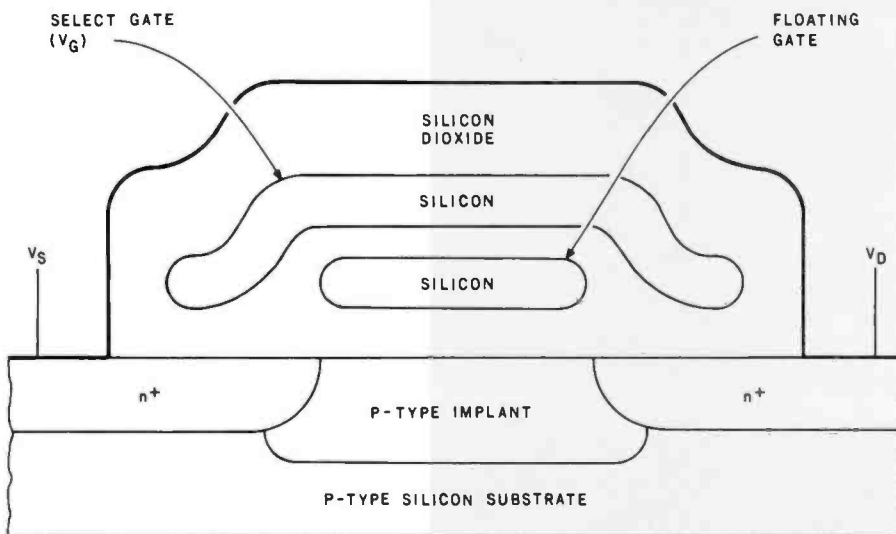

Figure 1a: Physical structure of one bit-storage cell in a 2716 EPROM. The cell consists of a FAMOS (floating-gate avalanche-injection metal-oxide semiconductor) field-effect transistor manufactured in a stacked-gate configuration. During programming, a voltage placed on the select gate creates an electric field within the structure. The field raises the energy levels of electrons passing through the channel from drain to source enough that some of the electrons are able to tunnel through the silicon-dioxide insulator and accumulate on the floating gate.

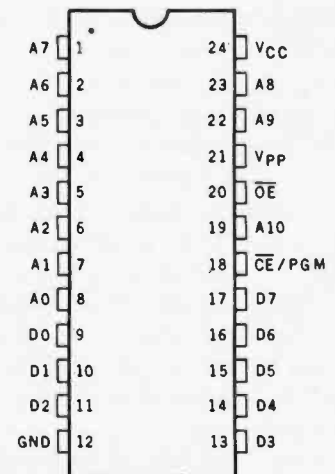

Figure 1b: Pinout specification of the type-2716 EPROM (erasable programmable read-only memory) integrated-circuit package.

stored on the floating gate determines whether the bit cell contains a 1 or a 0. Charged cells are read as 0s; uncharged cells are read as 1s. When the EPROM chip comes from the factory, all bit locations are cleared of charge and are read as logic 1s; each byte contains hexadecimal FF.

When a given bit cell is to be burned from a 1 to a 0, a current is passed through the transistor's channel from the source to the gate. (The electrons, of course, move the opposite way.) At the same time, a relatively high-voltage potential is placed on the transistor's upper select gate, creating a strong electric field within the layers of semiconductor material. (This is the function of the +25 V charging potential applied to the 2716.) In the presence of this strong electric field, some of the electrons passing through the source-drain channel gain enough energy to tunnel through the insulating layer that normally isolates the floating gate. As the tunneling electrons accumulate on the floating gate, the gate takes on a negative charge, which makes the cell contain a 0.

When data is to be erased from the chip, it is exposed to ultraviolet light, which contains photons of relatively high energy. The incident photons excite the electrons on the floating gate to sufficiently high energy states that they can tunnel back through the in-

sulating layer, removing the charge from the gate and returning the cell to the 1 state.

Programming the 2716

The 2716 EPROM contains 16,384 (16 K) bit-storage cells configured as 2048 individually addressable bytes. This organization is often called "2 K by 8." The completely static operation of the device requires no clock signals.

The pinout specification of the 2716 is shown in figure 1b, and a block diagram of its internal structure is shown in figure 1c.

The 2716 has five different operating modes, for which the input-voltage requirements are shown in table 1. The read, standby, and program modes are the ones I'll discuss in detail, since the program-inhibit and program-verify modes are important primarily in high-volume applications.

In the *read* mode, two control inputs are used to select the chip after the processor has selected the memory address. The \overline{OE} (output enable) line is provided mainly as a means of jointly selecting a bank of several 2716s, perhaps by a connection to the memory-read line on the system bus. The $\overline{CE/PGM}$ (chip enable/program) input is decoded and used as the primary device-selecting line.

After the logic level present on the $\overline{CE/PGM}$ pin has been brought low, the \overline{OE} input should also be brought low. Then 120 ns (nanoseconds) elapse before the addressed data is available on the data-output pins. This is sufficiently fast to be compatible with other types of memory devices in most systems, allowing direct connection of the 2716 to the system bus for reading data, as shown in figure 2a on page 40.

The 2716 can be placed in the static *standby* mode to reduce the power consumption without increasing the access time once it is addressed. With a TTL high level applied to $\overline{CE/PGM}$, the output lines assume a high-impedance condition. It doesn't matter what voltage is present on \overline{OE} .

In the *program* mode, particular bit cells are induced to contain 0 values. Both 1s and 0s are present in the data word presented on the data lines of the 2716, but only the presence of a 0 causes action to take place.

When the V_{PP} power-supply input is placed at a potential of +25 V and the \overline{OE} input is at a high level (V_{IH}), the TTL-level data to be programmed for a specific address is set up on the 2716's data lines, and the address is set up on the address lines A0 through A10. After a setup time of at least 2 μ s (microseconds), a high TTL-level programming pulse 50 ms long is applied to the $\overline{CE/PGM}$ input. Addresses to be programmed may be specified in any order.

The 50 ms programming pulse must be applied once for each location to be programmed. Under no circumstances should a constant high level be applied to the $\overline{CE/PGM}$ input in the program mode. Repeated 50 ms pulses to the same location are acceptable, but any pulse width greater than 55 ms might destroy the chip. (The minimum pulse width is 45 ms.) Using a nonretriggerable one-shot (monostable multivibrator) to generate the pulse is one simple protective measure.

A Simple EPROM Programmer

As we have previously seen, in the read mode the 2716 may be connected

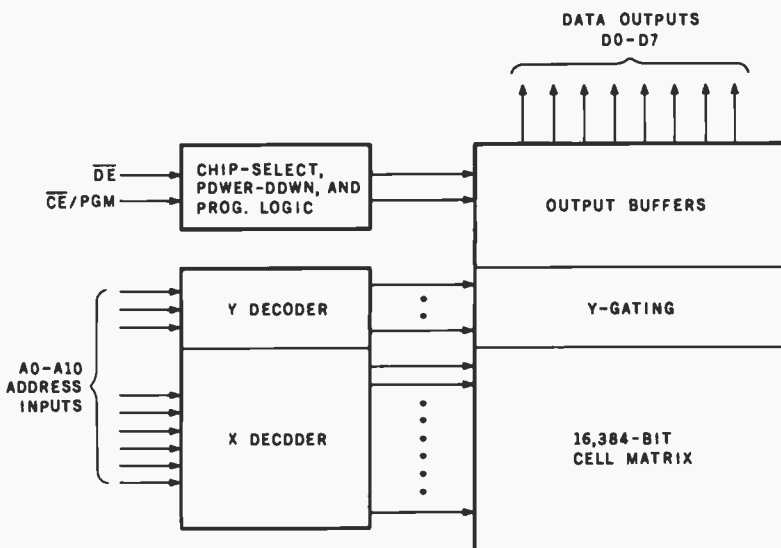

Figure 1c: Block diagram of the internal structure of the type-2716 EPROM.

directly to the system's address and data buses. It's not so easy, however, in the program mode.

Because of the setup-time interval that must elapse after the address data are presented, the programming pulse must come at an instant that doesn't fit too well within the synchronous operating constraints of the typical computer system bus. This limitation is most easily overcome by using three parallel output ports to communicate with the EPROM. The address and the data can be held constant while the programming pulse is applied. Figure 2b shows a block diagram of this scheme, and figure 3 shows the schematic diagram of an

actual circuit that uses this principle, which can be used with almost any personal computer.

The simple EPROM-programming circuit uses two integrated circuits besides the EPROM: the Intel 8255 PPI (Programmable Peripheral Interface) and a type-74121 one-shot. The 40-pin 8255 contains three separate I/O (input/output) ports. Twenty-four I/O lines can be programmed for various input, output, and control functions. (For more information on the 8255 PPI, see "Interfacing the S-100 Bus With the Intel 8255," by David L Condra, October 1979 BYTE, page 124, or the Intel *Component Data Catalog*.)

In this application, I set up the 8255 to operate in two different configurations. When programming, ports B and C contain the address, and port A contains the data. All three ports are set up for output. When verifying the contents (in read mode) after programming, ports B and C again contain the address, but port A is set for input to read output data from the 2716.

The 8255 is relatively simple to use. Its four internal registers for ports and control are accessed just like any other I/O device. Using a combination of chip-select and address-decoding logic, particular combinations of logic levels on the A0 and A1 lines designate the specific register being addressed, as shown in table 2. The data word written into the mode-control register configures the particular functions of the 24 I/O bits.

Setting all three ports for output is accomplished by writing hexadecimal 80 into the mode-control register. The other combination, B and C set for output with A set for input, is arranged by loading hexadecimal 90 into the mode-control register. These two control codes are the only ones required.

The EPROM interface in figure 3 requires the operator to select the read or program mode by the position of a toggle switch. In the read mode, the V_{pp} power input will be at +5 V, and $\overline{CE/PGM}$ and \overline{OE} will be at logic 0. In the program mode, with the switch closed, V_{pp} will be at +25 V, \overline{OE} will be at logic 1, and the one-shot will be strobed for each successive location. The driver program which coordinates this effort

WRITE / PROGRAM

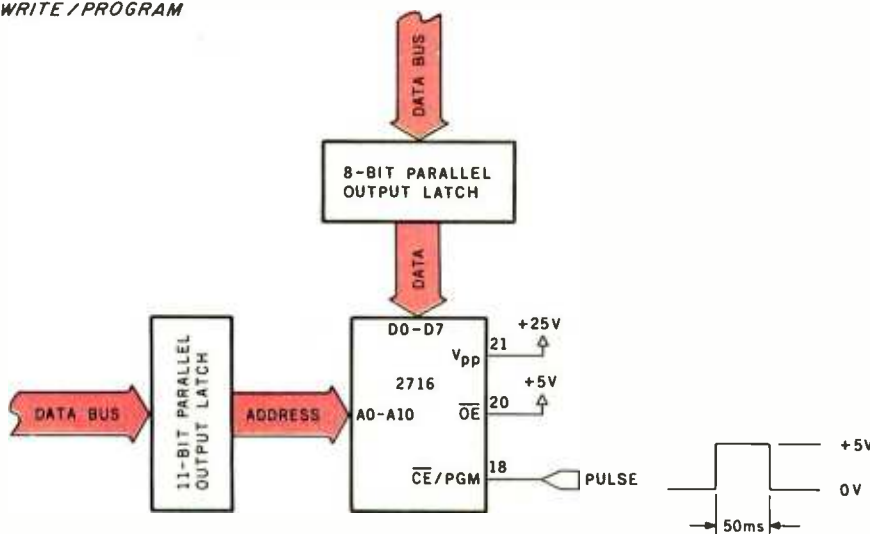

Figure 2a: For read-mode operation, the 2716 EPROM is fast enough that it can be directly connected to the address and data buses of most microcomputer systems. The \overline{OE} (output enable) line is usually used as a means of jointly selecting a bank of 2716s, while the $\overline{CE/PGM}$ (chip enable/program) line is used to select the particular integrated circuit that is to be addressed.

READ

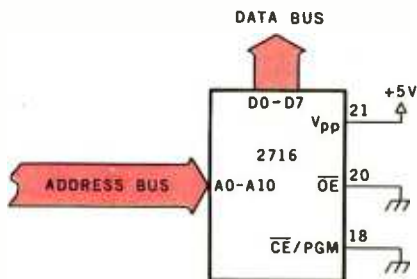

Figure 2b: In the write-program mode, the need for an asynchronous programming pulse necessitates the use of external data latches, driven by the output ports of the controlling computer system.

| Register | Address Bits | |
|-----------------------|--------------|----|
| | A0 | A1 |
| Port A | 0 | 0 |
| Port B | 0 | 1 |
| Port C | 1 | 0 |
| Mode-Control Register | 1 | 1 |

Table 2: Addressing of port and mode-control registers in the Intel 8255 Programmable Peripheral Interface.

will be essentially the same as that for the more sophisticated EPROM programmer yet to be described.

An Intelligent Programmer

The 2-chip EPROM programmer previously described is an *interface* designed to be attached to a program-development-type computer system. It can do just as much as the one I am about to discuss. However, what I have in mind is better than a mere EPROM-programming interface: an intelligent EPROM programmer, a stand-alone device that functions only as a programmer.

In my opinion, such a programmer should be able to perform the following tasks: accept raw input data by various means and store this data in a buffer memory, read a previously programmed EPROM and store the contents in the buffer, write the con-

tents of the buffer into another EPROM, and compare the contents of the same or a different EPROM chip to the buffer. In essence, these are standard load, program, and verify functions consistent with any reasonably useful 2716 programmer.

Photo 1 on page 36 shows the prototype of such a device. The intelligence for this programmer is supplied by a Z8-BASIC Microcomputer, a single-board computer specifically configured for use as a controller in dedicated applications. Using this Z8-based controller board, I was able to program and test the driver software directly and easily.

The final configuration consists of the Z8 board, 4 K bytes of expansion memory, the EPROM-programming circuit of figure 3, three pushbutton switches, and some LEDs (light-emitting diodes) added to com-

municate with the operator. The pushbuttons L, V, and W activate the load, verify, and write functions, respectively. The three LEDs next to them are labeled Read, Write, and Ready. Two more LEDs, labeled T and L (for terminal and local) are placed adjacent to the Control slide switch. I'll explain them later.

The intelligent EPROM programmer has two operating modes. With the Control switch in the L (local) position, the programmer receives all its commands through the pushbutton switches. With the Control switch in the T (terminal) position, the programmer expects to receive commands from a video terminal or teletypewriter connected to the Z8-BASIC Microcomputer's RS-232C connector. In this terminal mode, you can examine the buffer contents, directly change or introduce new

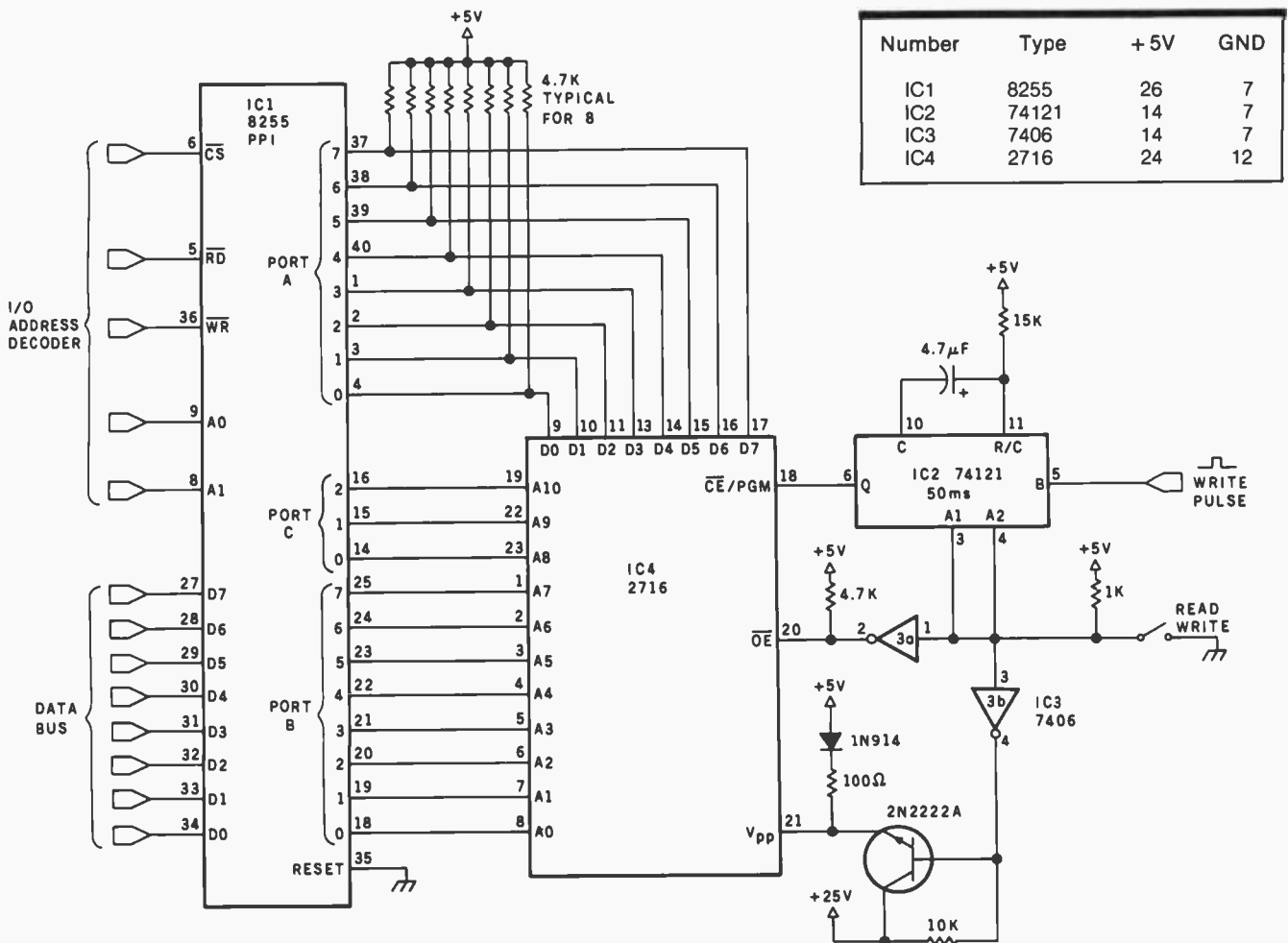

Figure 3: Schematic diagram of a simple EPROM-programming circuit that is intended to be driven from an external large (program-development-type) computer system.

data, and execute the standard read, write, and verify functions by keyboard commands. In addition, this mode facilitates serial entry of data directly into the buffer.

The local mode emulates the pushbutton operation of typical commercial EPROM programmers. Pressing L (load) will cause the device to read an EPROM inserted into the ZIF (zero insertion force) integrated-circuit socket and store the data in 2 K bytes of the 4 K-byte read/write-memory buffer. (The buffer has enough capacity to store all the data in a type-2732 EPROM, making possible yet more versatility.) Pressing W (write) will make the device program the 2 K bytes of data from the memory buffer into an erased EPROM inserted into the ZIF socket. Pressing V (verify) will cause the Z8 program device to compare the contents of the buffer to the EPROM. The LEDs indicate the current status and inform the operator when a function has been completed. All these operations and control assignments are under program control. Their meanings and functions can easily be changed in software to meet your specific requirements.

Programmer Hardware

The EPROM-programming hardware consists of two basic sections: memory expansion for the Z8-BASIC Microcomputer (shown in figure 4a), and the EPROM-interface section (shown in figure 4b).

After the EPROM-programming software has been written and debugged (which is done using the BASIC interpreter), it can itself be placed into an EPROM, which can then be plugged into the Z8 board's

Z6132 memory socket. With the on-board read/write memory removed to accommodate the EPROM, a separate buffer memory must be added to the Z8 board to hold the data read from or written into the 2716 being processed. This can be provided by the original or another Z6132 quasi-static 32 K-bit memory device and two other chips. IC1 in figure 4a is the Z6132, and IC2 and IC3 func-

tion as address decoders. As configured, the 4 K-byte expansion memory resides at hexadecimal addresses 8000 through 8FFF.

The EPROM-interface hardware shown in figure 4b is essentially the same as that in figure 3, with a few more "bells and whistles." As previously described, the 8255 PPI is attached to provide three parallel ports. Instead of using four incremen-

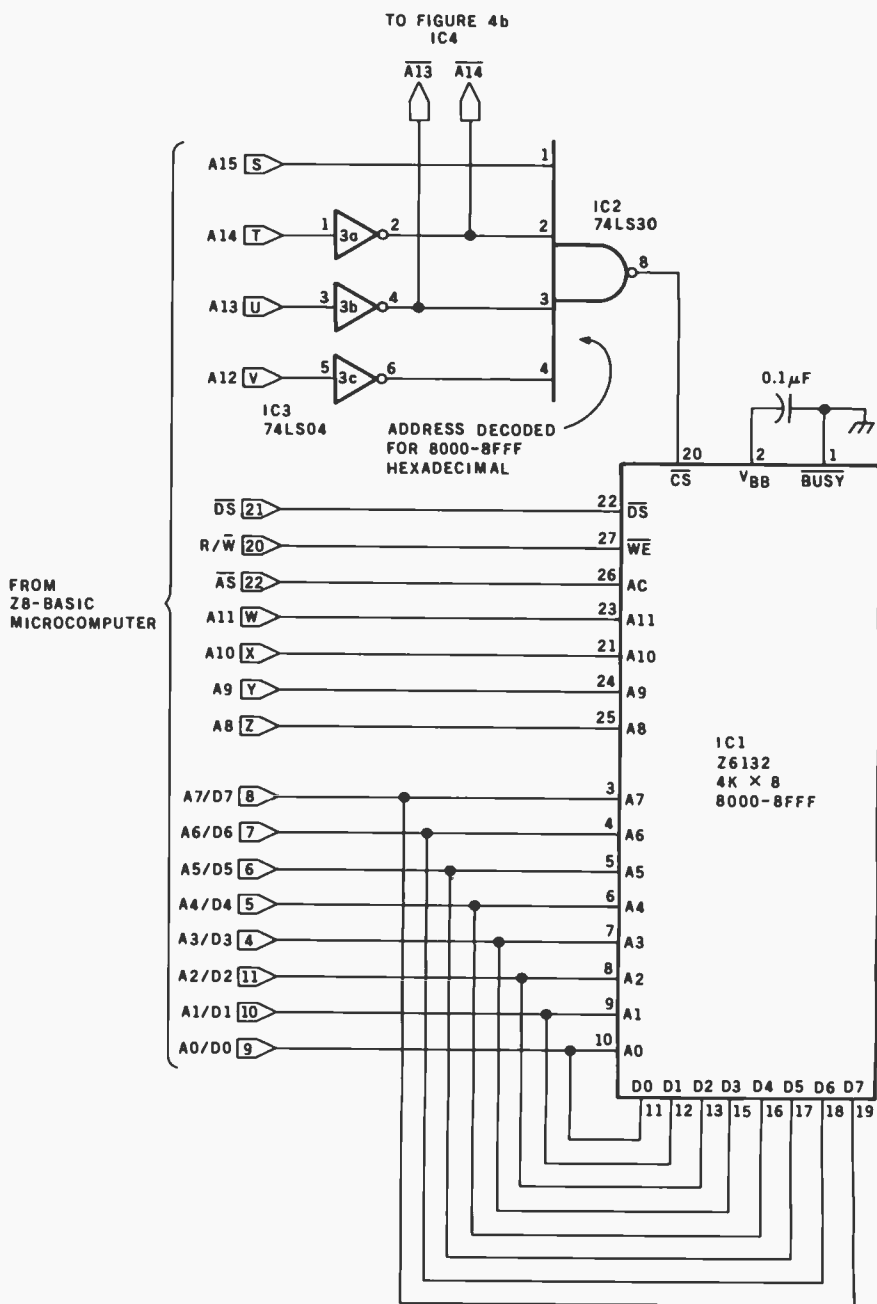

Figure 4a: Schematic diagram of the buffer-memory section of the intelligent EPROM programmer. This circuit expands the read/write memory capacity of the Z8-BASIC Microcomputer, and it may be used independently of the EPROM-programming interface.

| Number | Type | +5V | GND |
|--------|--------|-----------------------|-----|
| IC1 | Z6132 | 28 | 14 |
| IC2 | 74LS30 | 14 | 7 |
| IC3 | 74LS04 | 14 | 7 |
| IC4 | 74LS30 | 14 | 7 |
| IC5 | 74121 | 14 | 7 |
| IC6 | 7406 | 14 | 7 |
| IC7 | 74LS04 | 14 | 7 |
| IC8 | 8255 | 26 | 7 |
| IC9 | 2716 | see schematic diagram | |

tally adjacent addresses to designate the mode-control-register and port locations, I conserved hardware and addressed the four ports as follows: hexadecimal 9000, port A; hexadecimal 9100, port B; hexadecimal 9200, port C; and hexadecimal 9300, mode control.

Other differences in the circuit include computer control of the read/write function and the supply of power to the EPROM. Rather than making you manually turn off the power to insert or extract a 2716, the EPROM programmer controls the power through a relay. The READY LED indicates when the power is off (the LED will be lit). The three control signals come from output port 2 provided on the controller board. Bit 0 is the power control (0 = off, 1 = on), bit 1 is the read/write control (0 = read, 1 = write), and bit 7 provides the program pulse to the

one-shot (a transition from low to high and back to low). The Control switch and the three pushbutton switches are read as bits 4 through 7 of an I/O port memory-mapped to hexadecimal address FDE8 (decimal 65000). This input port is also provided on the Z8 board.

The intelligence for the EPROM programmer is supplied by a Z8-BASIC Microcomputer.

Software Control

The driver program for the programmer is written in tiny BASIC and resides in EPROM on the controlling Z8 board. The routine is very straightforward and can easily be rewritten to run on another BASIC interpreter, should you care to con-

nect the EPROM interface to a different computer. The entire program is too complex to cover in this article; it includes a lot of code necessary merely for screen formatting and operator interaction in the terminal mode. Let's confine our attention to the less involved routines which allow automatic programming control in the local mode.

The code for the local-mode control routines is given in listing 1 on page 47. Flowcharts of the constituent parts of the listing are shown in figures 5 through 8. Essentially, the program consists of a supervisory input scanner and four subroutines. The supervisor reads the pushbutton and slide switch inputs and transfers control to the appropriate subroutine to execute the corresponding function. The functions include reading the EPROM and storing the data values in the buffer, writing the buf-

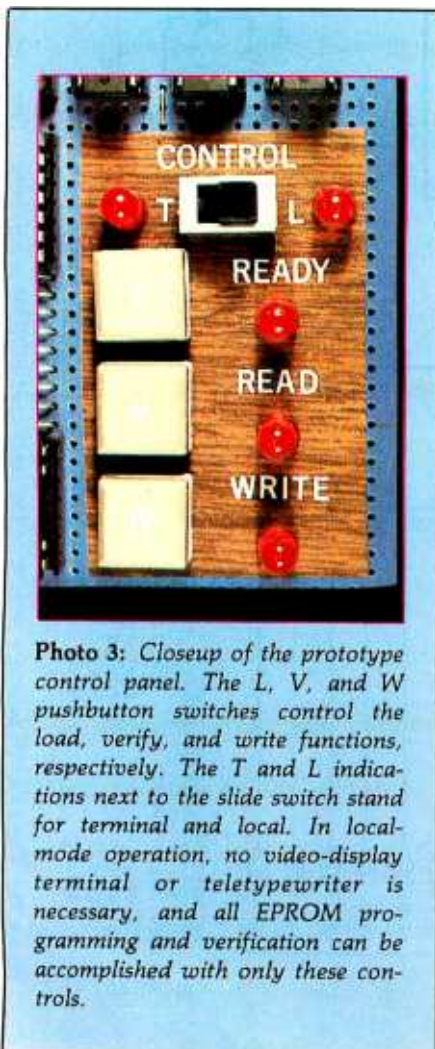

Photo 3: Closeup of the prototype control panel. The L, V, and W pushbutton switches control the load, verify, and write functions, respectively. The T and L indications next to the slide switch stand for terminal and local. In local-mode operation, no video-display terminal or teletypewriter is necessary, and all EPROM programming and verification can be accomplished with only these controls.

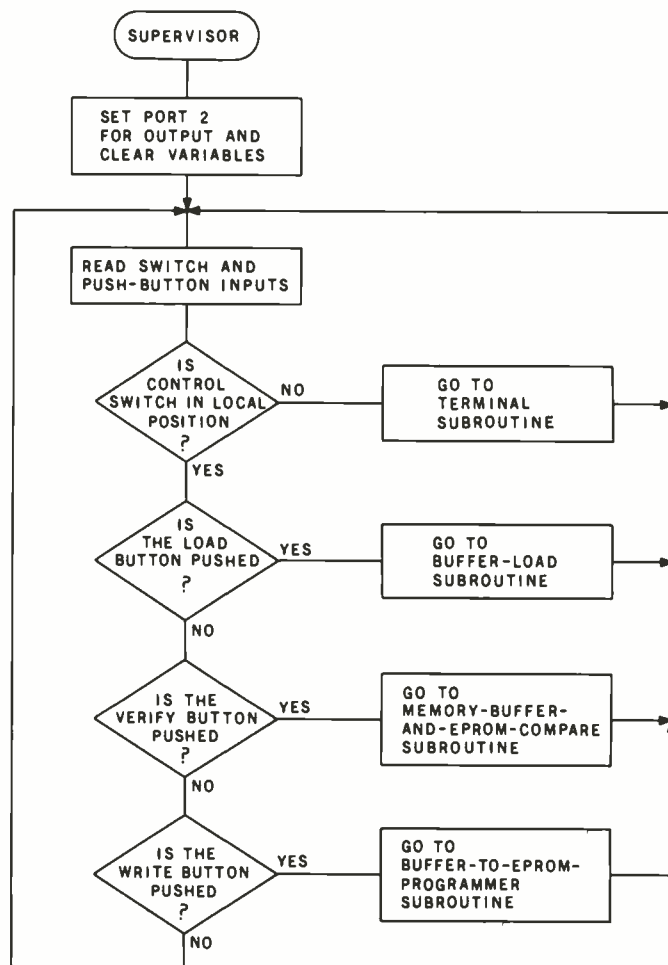

Figure 5: Flowchart of the command-input, user-interface section of the EPROM-programming software, as shown in listing 1.

fer contents to the EPROM, comparing the buffer and EPROM values, and transferring control to an interactive routine that communicates with the operator through a keyboard and display (terminal mode). The flowcharts indicate the sequence.

Conclusion

As the technology of EPROM manufacturing continues to be developed, I will keep a close eye on the possible need for circuits to use new components. Perhaps in another few years I'll be writing about interfacing and programming 1-megabyte EPROM chips.

I shall also be investigating other projects using the Z8-BASIC Microcomputer as a component that can give additional flexibility and

Text continued on page 48

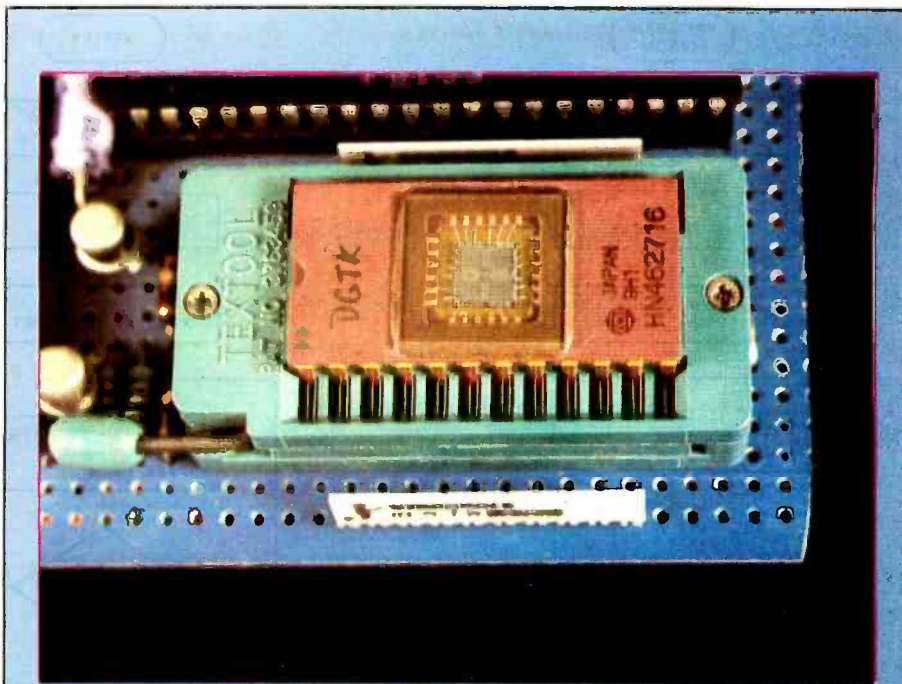

Photo 4: Closeup of ZIF (zero insertion force) socket. When the lever on the lower left is in the vertical position, the two metal contacts touching each IC (integrated circuit) pin are spread far apart. The IC therefore requires no (zero) extra effort to separate the contacts during insertion or removal. When the lever is down, as shown, the two contacts are clamped against each IC pin, and the IC is held fast with good electrical contact.

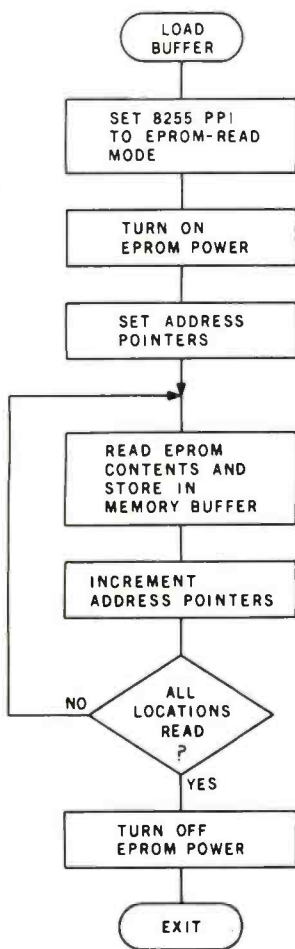

Figure 6: Flowchart of the subroutine to load the EPROM programmer's buffer memory from a previously programmed EPROM chip.

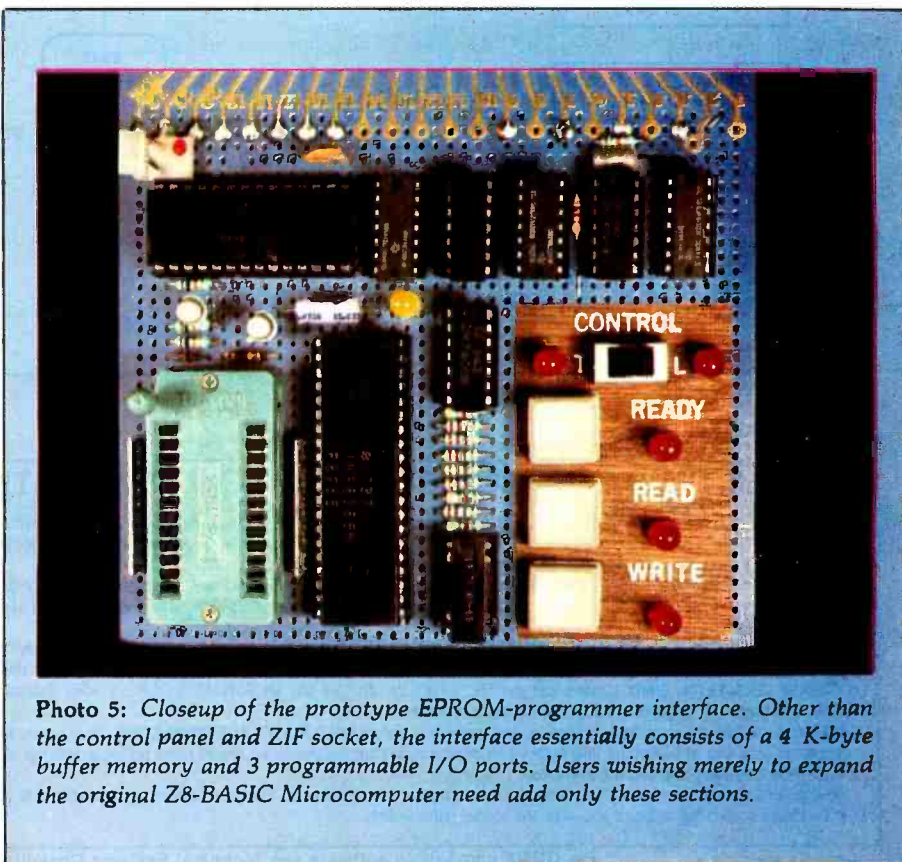

Photo 5: Closeup of the prototype EPROM-programmer interface. Other than the control panel and ZIF socket, the interface essentially consists of a 4 K-byte buffer memory and 3 programmable I/O ports. Users wishing merely to expand the original Z8-BASIC Microcomputer need add only these sections.

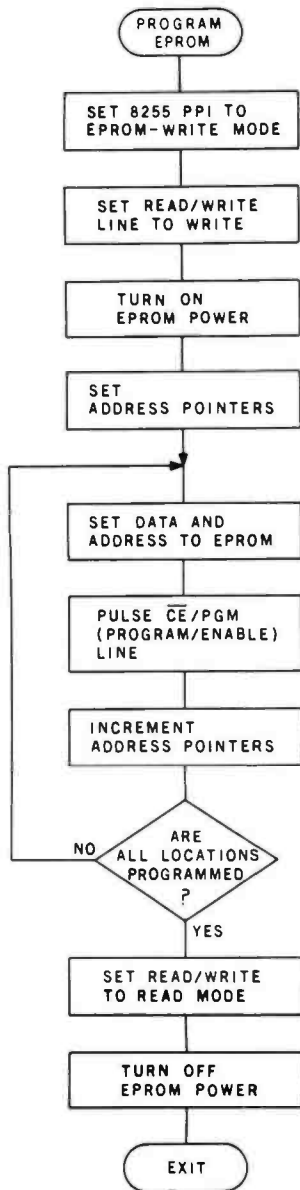

Figure 7: Flowchart of the routine to write data from the buffer into a new or erased 2716 EPROM chip.

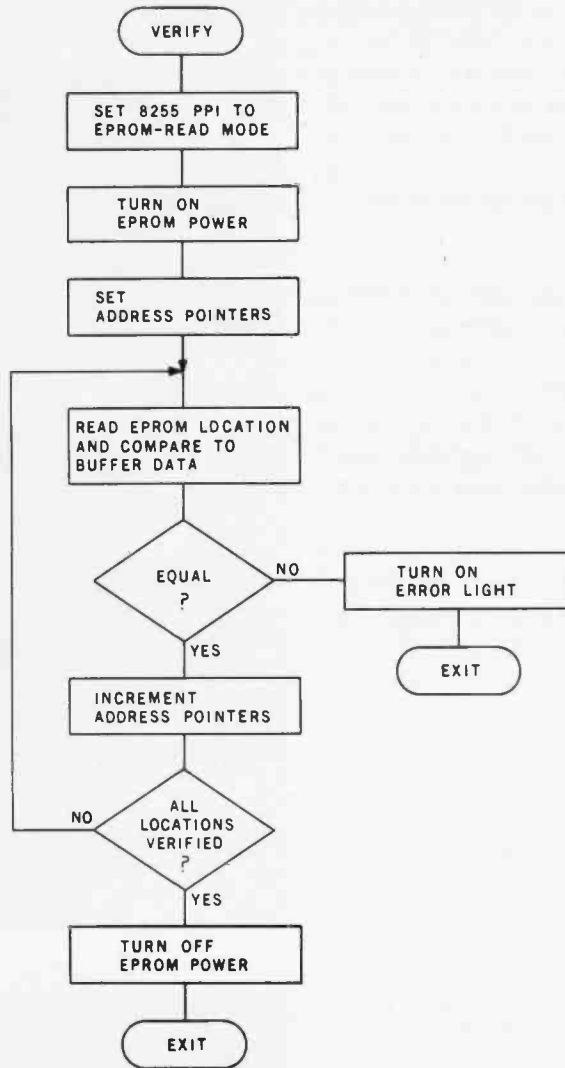

Figure 8: Flowchart of the routine that verifies correct programming of the EPROM.

6809 SYSTEMS

Featuring the **GIMIX** mainframe with 30 amp C.V. ferro-resonant power supply; fifteen 50 pin and eight 30 pin slot Mother Board; 2 Mhz CPU with time of day clock & battery back-up, 1K RAM, 6840 programmable timer, provisions for 9511A or 9512 Arithmetic processors, and 4 PROM/ROM/RAM sockets that can hold up to 32KB of monitor or user software.

VARIETY: you can have 32KB, 56KB, 128KB and up of static RAM. You can use 5" and/or 8" disk drives, single or double density, single or double sided, and single or double tracking with **GIMIX** disk controllers. You have a wide choice of serial or parallel I/O cards.

EXPANDABILITY: You can add memory, I/Os, Video or Graphics cards, Arithmetic processors, additional drive capacity, and other hardware now or in the future to this SS50 bus structured system from **GIMIX** or other SS50 bus compatible manufacturers.

SOFTWARE VERSATILITY: **GIMIX** systems can use TSC's FLEX or UNIFLEX and MICROWARE'S OS-9 operating systems. A wide variety of software and languages is available for these systems.

QUALITY: All boards are assembled, burned-in, and tested and feature **GOLD PLATED BUS CONNECTORS**. Only top quality components are used and all boards are fully buffered for maximum system expansion. All boards come complete with bus connectors and all necessary instruction and documentation.

GIMIX designs, manufactures and tests, in-house, their complete line of products. Complete systems are available to fit your needs. Please contact the factory if you have any special requirements.

For further information, pricing and brochures, contact:



GIMIX inc.
The Company that delivers
Quality Electronic products since 1975.

1337 WEST 37th PLACE, CHICAGO, IL 60609
(312) 927-5510 • TWX 910-221-4055

GIMIX and **GHOST** are registered trademarks of **GIMIX inc.**
Flex and Uniflex are trademarks of Technical Systems Consultants Inc. OS9 is a trademark of Microware Inc. See their ads for other **GIMIX** compatible software.

For **GIMIX** compatible software see Technical Systems Consultants ad page 21.

Listing 1: Program routines to control various functions of the intelligent EPROM programmer, written for the BASIC/Debug interpreter of the Zilog Z8671 single-chip micromputer found in the Z8-BASIC Micromputer.

```
100 REM INTELLIGENT EPROM PROGRAMMER
102 REM USING CIRCUIT CELLAR BASIC COMPUTER/CONTROLLER BOARD
103 REM CLEAR VARIABLES AND CHECK KEYPAD ENTRIES
105 @246=0 :@2=0
110 A=0 :B=0 :X=0 :Y=0
130 A=@65000
135 REM B7-TERM/LOCAL,B6-LOAD,B5-WRITE,B4-VERIFY
140 IF AND(A,%80)=0 THEN 5000
150 IF AND(A,%40)=0 THEN 1000
160 IF AND(A,%20)=0 THEN 2000
170 IF AND(A,%10)=0 THEN 3000
200 GOTO 130
1000 REM READ/LOAD BUFFER SUBROUTINE
1005 REM CLEAR VARIABLES AND SET 8255 FOR I/O READ
1010 X=0 :Y=0 :A=0 :B=0
1020 @%9300=%90
1025 REM MEMORY BUFFER STARTS AT 8000 HEX
1030 @2=1
1040 GOSUB 1100
1050 @B=@%9000
1060 GOSUB 1300
1070 GOTO 1040
1100 B=(32768+X+(Y*256))
1110 @%9100=X :X=X+1 :GOSUB 1200
1120 @%9200=Y
1130 RETURN
1200 IF X=256 THEN Y=Y+1 :X=0
1210 RETURN
1300 IF B=34815 THEN @2=0 :GOTO 130
1310 RETURN
2000 REM WRITE CONTENTS OF MEMORY BUFFER INTO EPROM
2010 X=0 :Y=0 :A=0 :B=0
2015 REM SET PROGRAMMER TO WRITE MODE AND TURN ON EPROM POWER
2020 @2=3
2030 @%9300=%80
2040 GOSUB 1100
2045 REM SET DATA AND ADDRESS ON 8255 AND PULSE WRITE STROBE
2050 @%9000=@B
2060 @2=131 :@2=3
2070 GOSUB 1300
2080 GOTO 2040
3000 REM VERIFY CONTENTS OF EPROM TO MEMORY BUFFER
3020 X=0 :Y=0 :A=0 :B=0
3025 REM SET PROGRAMMER TO READ MODE AND TURN ON EPROM POWER
3030 @%9300=%90
3040 @2=1
3050 GOSUB 1100
3055 REM COMPARE EPROM AND MEMORY -- IF WRONG, TURN ON ERROR LIGHT
3060 IF @%9000<>@B THEN @2=128 :GOTO 130
3070 GOSUB 1300
3080 GOTO 3050
5000 REM ENTER TERMINAL EXERCISOR PROGRAM HERE
5010 GOTO 130
:
```

RCA's remarkable new VP-3303 Interactive Data Terminal turns any home TV into a videotex display unit.

Now you can connect your family to the whole informative and entertaining world of CompuServe, The Source, Dow Jones News/Retrieval and other time-sharing and data-base networks.

All you need is our VP-3303, a modem and a modem cable, a telephone and your home TV.

You can get instant access to regional newspapers and newsletters ... weather reports and sports results ... computer games and more. You can use the VP-3303 to make airline reservations ... find restaurant recommendations in cities around the world. Plus stock market and corporate data. Or access your school or business computer. You can even send electronic mail and buy products.

What you have working for you is a versatile, feature-packed interactive data terminal which can be worth far more to you than its low price. Its unique color-locking circuitry gives you sharp color graphics and rainbow free characters. You get 20- and 40-character formats in one of eight colors and separate color backgrounds. The spill-proof, easy-to-clean keyboard is highly suitable for hostile environments. And the light touch

membrane keyboard switches give you a natural feel. With reverse video, you can emphasize certain letters, words or sentences. A built-in tone generator ... plus a white noise generator ... let you create everything from the sound of explosions to the sound of music.

The RCA VP-3303 is complete with both RS232C and 20mA current loop interfaces. It has six baud rates, eight data formats and ASCII encoding ... versatility that allows you to connect directly to a computer, as well as time-share.

The RCA VP-3303 is truly a fine videotex terminal. And don't forget, it's made by RCA ... the first name in television ... now the foremost name in videotex terminals.

See a demonstration of the new RCA VP-3303 at your local computer or electronics dealer, or order direct from RCA, toll free or by mail.

Order now ... only \$389.00 (Suggested user price.) For more information call toll free. **800-233-0094**. In Pennsylvania, call 717-393-0446. Visa or MasterCard holders may order by phone. Or send a check including \$3 delivery charge per unit plus your local sales tax.

PRIME TIME-SHARING.



RCA

New Holland Avenue, Lancaster, PA 17602

Text continued from page 45:

capability to an otherwise simple project.

Next Month:

If you've wanted to use a switching-type power supply in your projects but didn't know how to go about it, you will have an opportunity to find out as I explore this topic in November. ■

References

1. Ciarcia, Steve. "Add Nonvolatile Memory to Your Computer," December 1979 BYTE, page 36. Reprinted in *Ciarcia's Circuit Cellar, Volume II*. Peterborough NH: BYTE Books, 1981, page 129.
2. Ciarcia, Steve. "Build a Z8-Based Control Computer with BASIC, Part 1," July 1981 BYTE, page 38.
3. Ciarcia, Steve. "Build a Z8-Based Control Computer with BASIC, Part 2," August 1981 BYTE, page 50.
4. Ciarcia, Steve. "Program Your Next EROM in BASIC," March 1978 BYTE, page 84. Reprinted in *Ciarcia's Circuit Cellar, Volume I*. Peterborough NH: BYTE Books, 1979, page 39.
5. *Component Data Catalog*. Santa Clara CA: Intel Corporation, 1980.
6. Condra, David L. "Interfacing the S-100 Bus With the Intel 8255," October 1979 BYTE, page 124.
7. Gable, G H. "Zapper: A Computer-Driven EROM Programmer," December 1978 BYTE, page 100.
8. Greene, Robert, George Perlegos, Phillip Salisbury, and William Morgan. "The Biggest Erasable PROM Yet Puts 16,384 Bits on a Chip," *Electronics*, March 3, 1977, page 108.
9. Greene, Robert, and Frank Louie. "EPROM Doubles Bit Density Without Adding a Pin," *Electronics*, August 16, 1979, page 126.
10. Lewin, Douglas. *Theory and Design of Digital Computer Systems*, second edition. New York: Halsted Press, a Division of John Wiley, 1980.
11. Smith, Roger L. "More Information on PROMs," May 1976 BYTE, page 28.

Editor's Note: Steve often refers to previous *Circuit Cellar* articles as reference material for the articles he presents each month. These articles are available in reprint books from BYTE Books, 70 Main St, Peterborough NH 03458. *Ciarcia's Circuit Cellar* covers articles appearing in *BYTE* from September 1977 through November 1978. *Ciarcia's Circuit Cellar, Volume II* presents articles from December 1978 through June 1980.

To receive a complete list of *Ciarcia Circuit Cellar* kits available from the MicroMint, circle 100 on the inquiry card.

New from HIPLØT™

6-pen plotting for as little as \$1480*.



FCC class B tested.
UL listed.

The Houston way

And you can retrofit your present single pen HIPLØT for only \$395.

The new HIPLØT DMP Series 6-pen option makes high performance multi-pen plotting affordable. It's available on the DMP-2, 3 or 4 models in the HIPLØT family so you can enjoy the advantages of multi-colored plots on surfaces of 8½" × 11" (DIN A4) or 11" × 17" (DIN A3). Of course, you also get the standard HIPLØT range of capabilities such as intelligence, controls, interfaces and resolutions. There's a model for virtually every plotting application.



Big Performance in a Small Plotter
Since its introduction, the HIPLØT DMP Series has been recognized as the innovative plotter

line which made low-cost, high performance digital plotting a reality.

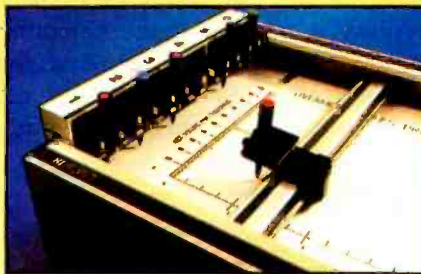

Now, with our new 6-pen option, there's an exciting new dimension in the DMP Series' versatility. Imagine standard models with RS-232-C and parallel interfaces, intelligent models with RS-232-C or Centronics® compatible interfaces, a choice of controls, resolutions, and pen speeds. Add to this the ability to plot with 6-pens on paper, vellum or Mylar (ideal for overhead projectors) and you have the ultimate plotter price/performance combination — the perfect choice for the user or OEM.

Easily Retrofitted to Existing HIPLØT Models

If you already have a single pen DMP-2, 3 or 4, don't despair. For as little as \$395* you can upgrade these models with our 6-pen conversion kit. It's simple to do . . . and the complete change can be made by the user in only six minutes.

So why wait? Let us send you complete information on this breakthrough in affordable, multi-pen plotting. Contact Houston Instrument, One Houston Square, Austin, Texas 78753. (512) 837-2820. For rush literature requests, outside Texas, call toll free 1-800-531-5205. For technical information ask for operator #5. In Europe contact Houston Instrument, Rochesterlaan 6, 8240 Gistel, Belgium. Phone 059/27-74-45.

houston instrument

GRAPHICS DIVISION OF

BAUSCH & LOMB



TM Trademark of Houston Instrument.
* U.S. Suggested retail prices.
Centronics® registered trademark of Centronics Data Computer Corp.

Ultra-Low-Cost Network for Personal Computers

Ken Clements and Dave Daugherty
Pacific Polytechnical Corp
POB 2780
Santa Cruz CA 95063

Ten years ago, computer "hackers" listened with glee to predictions that technological advances would soon allow them to buy their very own computers. Indeed, the seers predicted, the computers of the future would fit into a spare bedroom or basement and wouldn't even require air conditioning. The word went out: start saving \$100,000 to be ready when that great time came.

The time came with a vengeance. Today you can hardly take twenty paces around a technical organization, school, or office without bumping into or being addressed by yet another computer.

One of the sad outcomes of this exponential growth was creation of the computer junkie, the unfortunate soul who went out and bought each of the newest computers he or she

could afford. The junkie ended up with a basement full of equipment and a computer habit that could be satisfied only by more spending.

Just when the future was looking grim for these computer junkies, salvation took form and appeared on college campuses. Perhaps the best explanation came from a recruiter from the giant Xmumblex Corp, who took a young graduate aside and whispered, "I have just one word for you: *networks*."

The big-computer companies and an army of computer scientists apparently will be going network crazy for the next ten years. This development thrills the computer junkies because it provides more computer "stuff" to get excited about. And, the junkies calculate, if they could get their own personal networks going,

they might be able to string together all the "coldware" collecting dust in their basements.

What stops most people from going ahead with their own networks is complexity, both in terms of cost and technical considerations. A typical coaxial network "box" may be as difficult to build and interface as was the computer you wanted to network. This stumbling block is particularly large for the computer junkie who owns no two pieces of hardware that are the same. He must come up with a new interface for each one.

But almost all those pieces of hardware have at least one RS-232 serial port. RS-232 was designed to provide point-to-point communication, and it requires some central manager "box" to produce a network. But with as little as one diode per port, two resistors for the ends, and a -12-volt (V) source, you can turn RS-232 into ULCNET, the Ultra-Low-Cost Network.

Simple Technique

The primary technique for this transformation is shown in figure 1. It is amazingly simple: just connect a diode in series with the transmit line, then connect the receive line and the diode to your cable. At the ends of the cable you will need resistors to "pull down" the line to -12 V and to help soak up reflections. Serial communications via RS-232 are usually not too fast, so the type of cable and exact terminations are not critical.

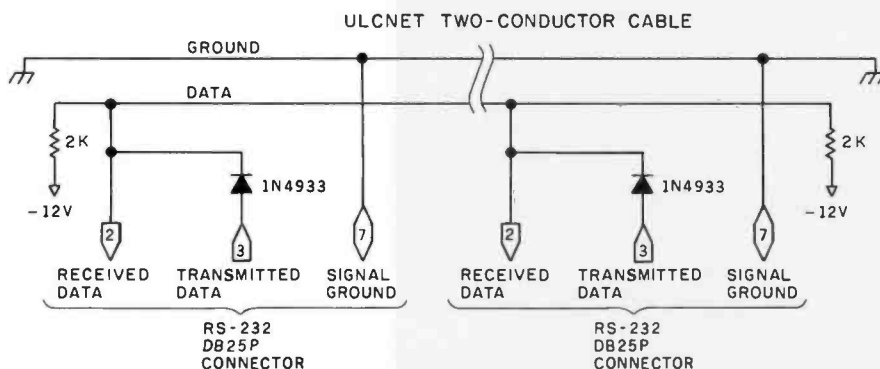

Figure 1: Simplest version of ULCNET. The addition of a diode, cable, and terminating resistors converts RS-232 ports into a basic network for personal computers.

Please call (213) 883-8594.

Our Epson prices are so low, we're not allowed to print them.

EPSON MX-80\$CALL

80 cps/9x9 matrix/Lower case with true descenders/Bi-directional & Logic seeking/Adjustable tractor/Expanded printing/Block graphics/Forms control/Compressed printing/Double-strike printing/Correspondence quality/Emphasized printing mode/Standard parallel interface

EPSON MX-80 F/T\$CALL

Same features as the MX-80 plus Friction Feed. Adjustable removable tractor is standard for ease of handling forms and single sheets.

EPSON MX-100 F/T\$CALL

Same features as the MX-80 & MX-80 F/T but on 15½ inch carriage for printing 132 columns with standard 10 cpi font or 232 columns in the compressed character font. The MX-100 is complete with Dot Resolution Graphics

EPSON INTERFACES & OPTIONS

| | | | |
|-----------------------------------|--------|-------------------------------------|--------|
| TRS-80 MODEL I III CABLE | \$ 30 | SERIAL INTERFACE (2K BUFFER) | \$ 149 |
| TRS-80 MODEL I Keyboard Interface | \$ 95 | SERIAL CABLE Male to Male | \$ 30 |
| TRS-80 MODEL II CABLE | \$ 30 | DOT RESOLUTION GRAPHICS | \$ 90 |
| APPLE INTERFACE & CABLE | \$ 100 | REPLACEMENT RIBBON | \$ 13 |
| IEEE 488 INTERFACE | \$ 60 | REPLACEMENT PRINT HEAD (Quiet type) | \$ 40 |
| SERIAL INTERFACE | \$ 70 | EPSON SERVICE MANUAL | \$ 40 |

Alpha Byte STORES

We built a reputation on our prices and your satisfaction.

We guarantee everything we sell for 30 days. If anything is wrong, just return the item and we'll make it right. And, of course, we'll pay the shipping charges.

We accept Visa and Master Card on all orders. COD accepted up to \$300.00. We also accept school purchase orders.

Please add \$2.00 for standard UPS shipping and handling on orders under 50 pounds, delivered in the continental U.S. Call us for shipping charges on items that weigh more than 50 pounds. Foreign, FPO and APO orders please add 15% for shipping. California residents add 6% sales tax.

31245 La Baya Drive, Westlake Village, California 91362

ULCNET SHIELDED, TWISTED-PAIR CABLE

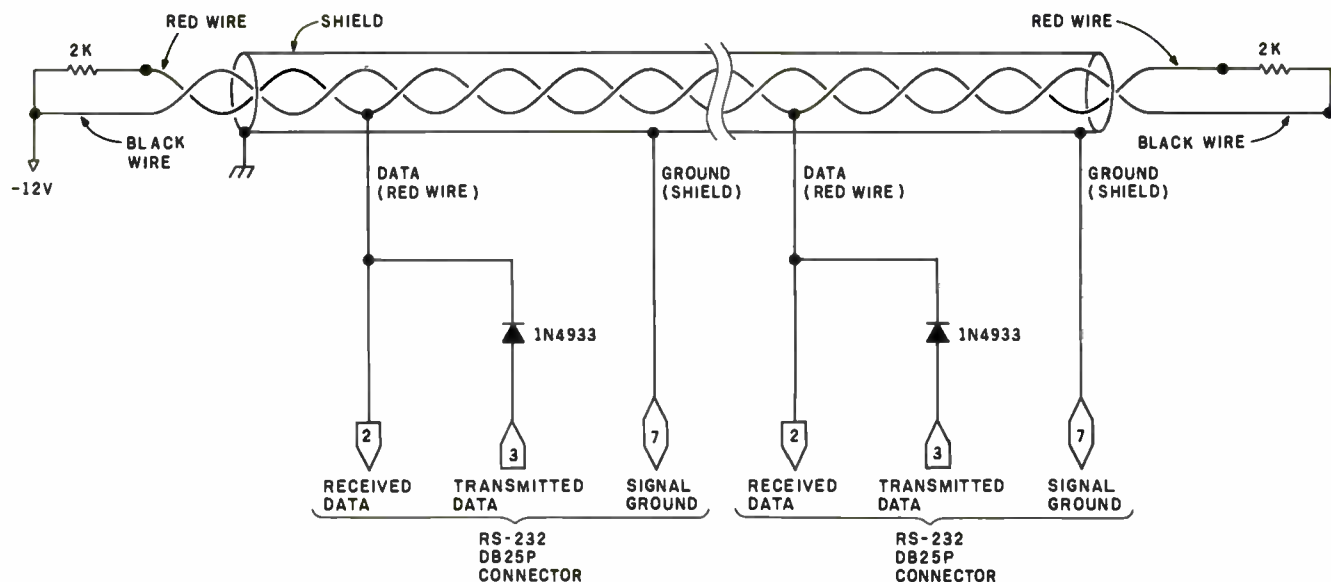

Figure 2: ULCNET for two-wire shielded cable. In this version, a single -12 V power supply is specified, and power is transmitted to the pull-up resistors via one conductor of the cable.

For most applications, it is easy to use shielded twisted-pair cable for the net. This allows one of the wires in the pair to carry the -12 V needed by the termination resistors at the end of

the cable. An example of wiring the termination is shown in figure 2. This technique assumes that somewhere along the line, the black wire in the pair is connected to -12 V and the

shield is grounded.

When characters are sent through an ULCNET port, they are received at all the ports on the net, including the port that did the sending. However, if two or more ports send different messages at the same time, the transmitting ports will each receive something other than what they sent: the logical OR of the two messages. This allows an extremely important property, namely *collision detection* (a property also used in Xerox's Ethernet).

The ULCNET uses the fact that an RS-232 port holds its transmit line at negative voltage when not transmitting, and then pulses the transmit line positive at the start of a character. The RS-232 standard defines a positive level as a transmitted 0 and a negative level as a binary 1. In other words, a character starts with a 0, followed by a byte of code transmitted low-order bit first. At least one binary 1 is inserted after each byte-long character, and it is called the stop bit.

The termination resistors on the ULCNET provide the negative level, and each port may "pull" the line to a positive level by the start pulse of a character. In terms of bits, the resistors supply the 1s, and the ports supply the 0s.

VT 100 Owners:
THE KEY TO FAST AND EASY EDITING
(OF YOUR KED EDITOR)

INTRODUCING VT 100 KEYS FOR THE KED EDITOR...These quality 3-color keys will make editing faster and simpler. They're easy to install—no overlays—just pull out the old keys and push in a new set with the KED functions clearly stated. A set of 18 3-color keys — \$40.

SynTronics 4 Frost St./Cambridge, MA 02140
 (617) 739-7710

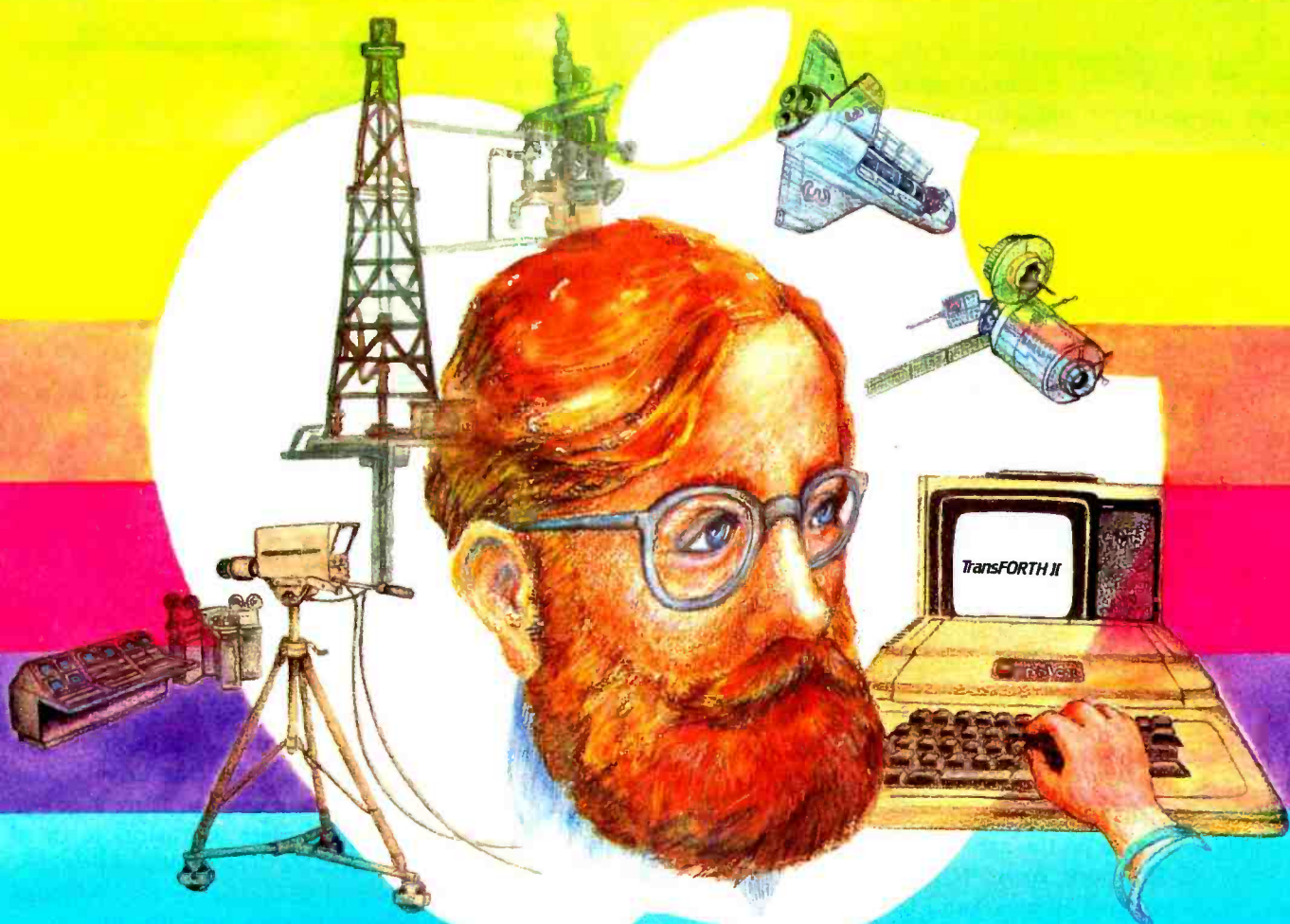

In Language Lies The Future.

Paul Lutus creates language. Language for the future. From him we have Apple Writer, Apple World and MusiComp. His software was used by the Viking Mars Lander team and other advanced space programs.

For the past three years he has applied himself to the development of more efficient and powerful computer languages to help him with his work. These new languages of the future are now available for your use exclusively from Insoft.

See the new world of programming from Insoft at your Apple dealer.



The languages of the future. The tools of today.

259 Barnett Rd. / Unit 3 / Medford, Or 97501 / (503) 779-2465



Each package introductory price \$125.00

Apple is a registered trademark of Apple Computer, Inc.

TransFORTH II

The final "word" in Apple programming. A brilliant extension of FORTH.

- Fully compiled
- Floating point
- Transcendental functions
- Strings and arrays
- Hires, Lores and Turtlegraphics
- Music

Far more compact and approachable than Pascal, TransFORTH II is both recursive and structured and easier to use than BASIC.

Over three years in development, this high level language enables you to program in English with far greater speed and convenience than ever before possible.

TransFORTH II. A transformation in computer programming. Available today.

ALD System II

The Assembly Language Development System. Already the preferred assembler for professional software developers.

- Object files to 18K
- Source files to 37K
- Cursor based screen editor
- Upper and lower case text entry
- Nested macro instructions
- Local, global and universal labels
- Comprehensive error trapping

The enormous file capacity of ALD System II assures you of the ability to develop virtually any imaginable software system. And you can do so with ease since ALD System II edits with the simplicity of a word processor.

ALD System II. Powerful yet convenient. The first choice of professionals.

The best comes last. Both new programs are available for the Apple II or Apple III.

The speed and distance limits of the ULCNET come from a combination of the drive-current limitations of an RS-232 port and the load each receiver puts on the net. The limits lead to a three-way trade-off of distance, speed, and number of receivers. For example, you might use the ULCNET at 19,200 bps (bits per second) for six devices separated by 20 feet, or you might connect three devices with two miles of wire and run at 300 bps.

Improvements

Some simple modifications can be made to expand the network capability. The first modification gets the number of receivers out of the trade-off equation. Figure 3 shows an alternate ULCNET connection in which an op amp (operational amplifier) is used to buffer the incoming signal. This reduces to almost nothing the load each node places on the network, thereby allowing as many connections as desired on the net.

Some RS-232 ports have +12 V and -12 V supplied on pins 9 and 10 of their DB25 connector (these can be used to power the op amp). Most,

however, do not, so the user will need to run a pair of wires to the power supply of the computer. If some other power source is used, the user must be sure its ground reference is the same as pin 7 of the RS-232 port.

Figure 3 also shows a circuit that drives the DTR (data terminal ready) input of the RS-232 port. This circuit is used to detect activity on the net, and it will assert (pull high) DTR if the net is busy. The circuit works by charging C1, a 0.1 μ F capacitor during the start bit of a character. The capacitor will then discharge through the 330-kilohm (k Ω) resistor R1 when characters are no longer being transmitted. The choice of values for these two components is set by the slowest data rate to be used on the net. The choice shown was picked for 1200 bps operation. If 2400 bps is desired as the lowest rate, then halve R1's value. The resistor can be scaled in this manner for the lowest transfer rate desired. Table 1 suggests resistor values for various data rates, but plan to experiment.

The purpose of the *busy flag* circuit shown in figure 3 is to relieve the software of checking the condition of the

| Data Rate (bps) | Size of R ₁ (k Ω) |
|-----------------|--------------------------------------|
| 1200 | 330 |
| 2400 | 160 |
| 4800 | 82 |
| 9600 | 39 |
| 19.2 k | 22 |
| 38.4 k | 10 |
| 76.8 k | 5.1 |
| 153.6 k | 2.2 |

Table 1: Suggested resistor values for running ULCNET at various speeds. Experimentation is suggested.

net, and to provide a signal that can be used with an interrupt-driven system. (These techniques are discussed later.)

Aiming for Speed

Figure 4 is included for those who crave speed. Here, the drive limitation is overcome by using a power FET (field-effect transistor) to drive coaxial cable. The cable can be either standard 50- Ω coax, or the 75- Ω coax commonly used in cable TV operations. Whichever you choose, you *must* use a matching resistor (50 Ω or 75 Ω) on *each* end of the cable.

In this form of the ULCNET, the logical 0 is represented by a +12 V level, and the logical 1 is at 0 V. The same busy-detect circuit is used, and all of the network techniques will remain the same. This version of ULCNET is included for those who have very fast controller devices on their ports and want to operate in the 50 kbps to 1 Mbps range.

To make this fast version work, it is important to have a very solid source of +12 V that can put out about one amp for a very short time. The fuse included in figure 4 is meant to shut down the connection if the computer turns on the power FET and leaves it on. If not corrected, this error condition would cause the entire net to halt.

One way to set up a network is shown in figure 5. This setup would allow all the computers to share the hard disk and the printer. The computer directly connected to the hard disk and printer would be partially

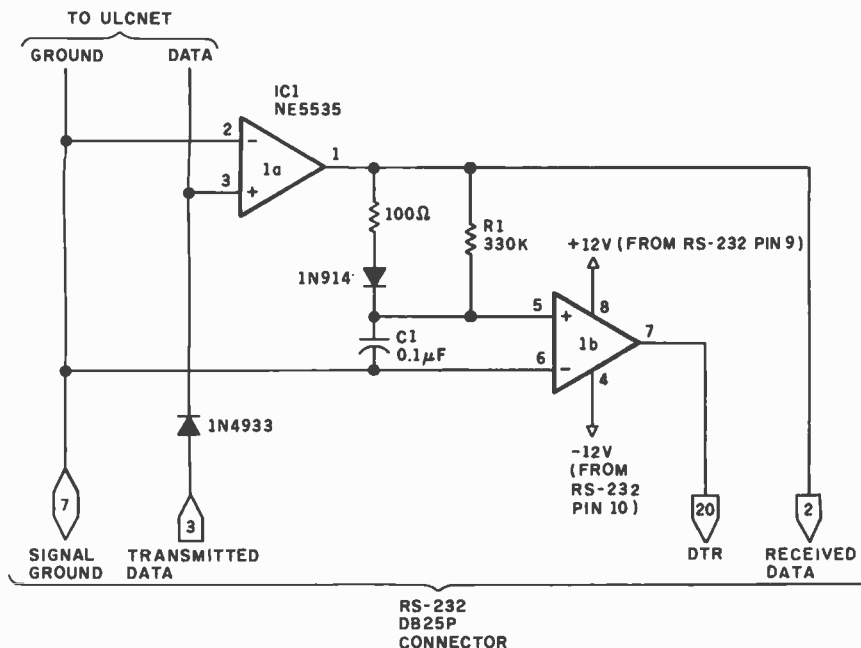

Figure 3: Simple modifications expand network capacity. An operational amplifier reduces the load placed on the net by each node, so that a virtually unlimited number of nodes can be used. Resistor R1 and capacitor C1 control the op-amp comparator to signal that the network is busy. The components shown can be used with speeds as low as 1200 bps; see table 1 for alternate selections.

NEW!

THE B810 RAM

engineered for excellence

256K Byte/128K Word Dynamic Memory

FEATURES

- Byte or Word width operation
- Extended Addressing or Port Select
- 150 ns Access, 270 ns Cycle (B Version)
- 200 ns Access, 335 ns Cycle (A Version)
- Full DMA capability with transparent refresh
- Precise memory timing module
- Low Power
- Meets IEEE 696 specifications
- Four-layer board

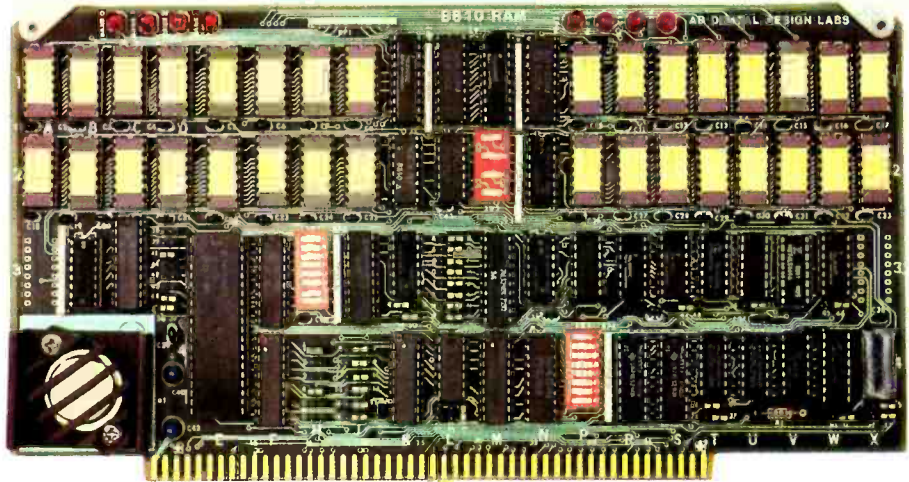

\$1249.* Assembled & Tested with 1 Year Warranty
*Introductory Price valid through 30 Sept., 1981

The B810 RAM represents one of the best solutions for applications requiring compact design and speed for remarkably low cost. Suitable for a wide range of commercial applications, the B810 RAM is form, fit and functionally compatible with the proposed IEEE 696 (S-100) bus standard. It automatically provides byte or word width access using the sXTRQ* signal. It features the AMD 2964 Dynamic Memory Controller and a new memory timing module designed for the B810 by Engineered Components Corp. for precise timing. Its four layer board with full ground and power planes provides noiseless operation. As an integral part of the AB Digital B800-series, the B810 RAM provides full DMA capability. Designed to be as universal as possible, the B810A RAM will work with most S-100 cards using a Z80 or Z8000, and the B810B (with optional byte parity), works with Alpha Micro, Cromemco, Northstar, and all S100 CPU cards.

Available through California Digital (toll-free orders only 800-421-5041) and other fine distributors, or direct. Specification sheets on request. Manuals may be purchased separately for \$25.00 refundable on order.

COMING NEXT MONTH: THE B880 80ns 64K/32K STATIC RAM

The **B800 series** of 8-bit cards provides the OEM with a complete line of 6 MHz computer cards. All peripheral controllers are intelligent. This series includes the B800 CPU; the B820 SCC Serial Communications Controller; the B830 HDC Hard Disk Controller; the B840 FDC Floppy Disk Controller, and others which will be announced.

The **B8000 series** provides a complete line of 16-bit 4 and 6 MHz cards in three formats: double-height S100, MultiBus and the new Zilog ZBI bus. As with the B800 series, all peripheral controllers are intelligent with their own processors and memory. The B8000 series includes the B8000 CPU (Z8001-based); the 1 Megabyte B8100 RAM with optional EDC; the B8200 SCC Serial Communications Controller; the B8300 HDC Hard Disk Controller; the B8400 WDC Winchester Disk Subsystem; and others to be announced.

AB Digital Design Labs products are designed to provide technological leadership and industrial-grade quality with unexcelled performance. Before you buy any computer product, we invite you to examine our spec sheets and manuals. We think the choice will be clear.



DIGITAL DESIGN LABS

109 Cuyama Road Shell Beach, CA 93449

(805) 773-1731

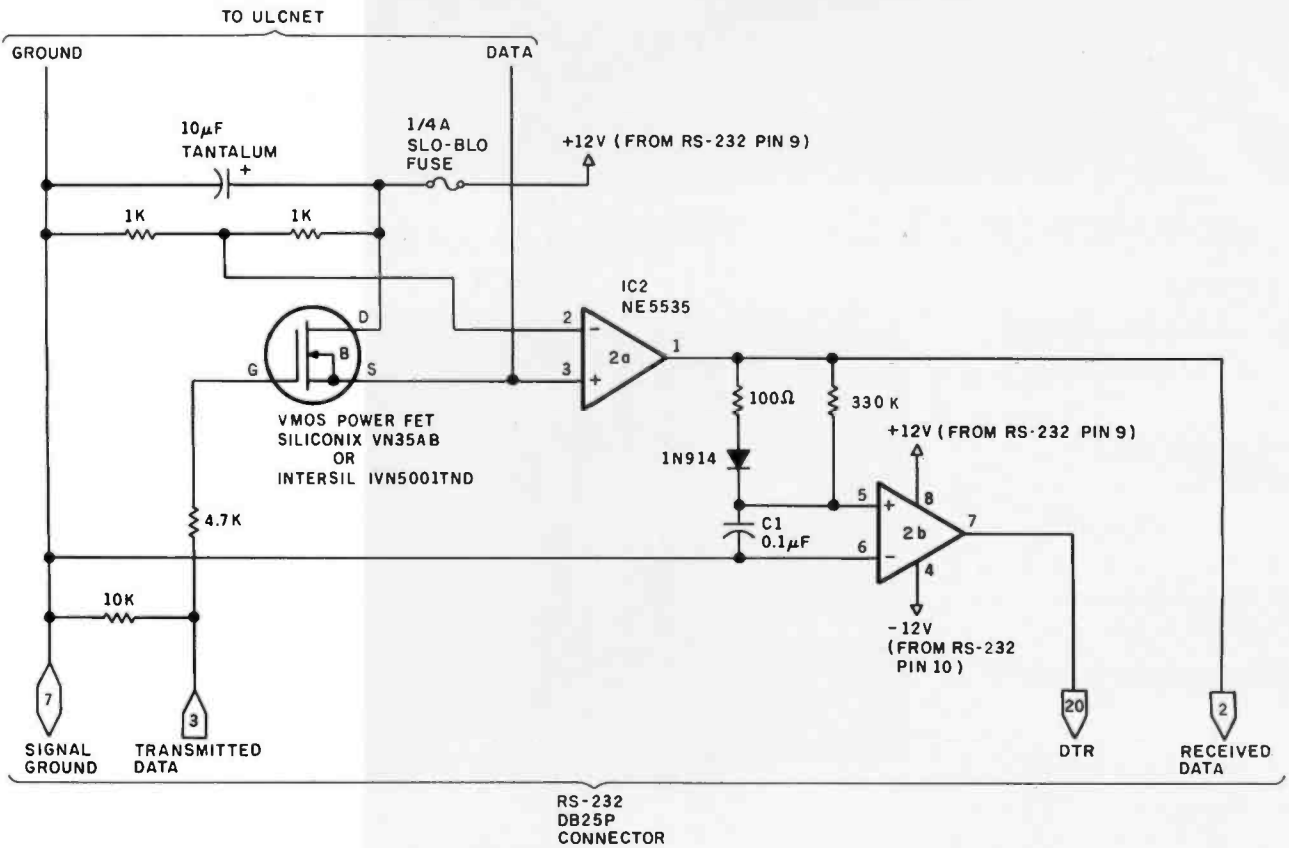

Figure 4: Fast version of ULCNET. The primary limitation of driving power is overcome by installing an output transistor at each port. The transmitter shown may draw as much as 1 A from the -12 V supply, for short periods.

dedicated to servicing the requests for these resources.

Design Issues

Now that we've discussed the hardware for the ULCNET, let's look at some of the issues involved in designing software for the network. These issues are: node-addressing concepts, message formats, task layering, low-level transmission and reception, communication protocols and error recovery, dialogue pipes, special types of networking communica-

tions, and networking under multi-tasking operating systems.

First let's define a node as any device connected to the ULCNET that has the ability to transmit information, receive information, or both.

If there are more than two nodes on a net, some mechanism is needed to uniquely specify the destination of transmitted information. This need is fulfilled by assigning to each node a unique numeric address. A single digit may be sufficient to specify the node for which a message is intended.

Many mechanisms can be used to inform the node's software of its particular address. The possibilities include establishing a switch setting on an input port, including the information in the software for each node (but each node would then need a unique version of the network software), or having the software query the user for an address during initialization.

An address does not necessarily have to be a number, as long as it can be uniquely recognized. It could be a character string such as EVA or SHIRLEY, but you must be willing to pay the cost of pattern matching in order to adopt this scheme.

A nameserver mechanism allows the nicety of character strings for addresses without sacrificing the advantage of number matching for decoding addresses. The nameserver consists of a file and a program on a node with mass storage that associates an ASCII (American Standard Code for Information Interchange) string with an address number. The nameserver

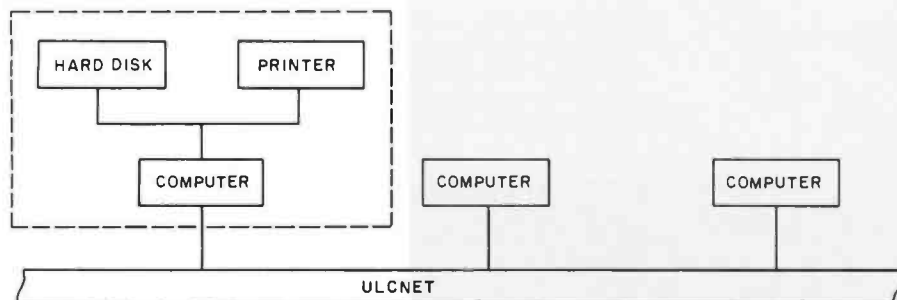

Figure 5: One possible ULCNET configuration. In this example, the mass storage and printer on one computer system can be shared by several other systems.

**Radio Shack, The Leader in Small Business Computers
Also Has Computers for Your Home!**

Introducing the Lowest Cost Color Disk System Ever— Radio Shack's TRS-80

Radio Shack now offers disk drives for our popular TRS-80 Color Computer. Now you can have superb high-resolution color graphics and fast, "on-line" access to large amounts of data.

Only \$1198. Our new \$599 disk kit makes our TRS-80 Color Computer with 16,000 characters (16K) of internal memory and Extended Color BASIC language a versatile, low-cost computing system that's ready to attach to any TV (not included).

Stores 156,000 Characters! Just plug in the Program Pak™ controller to add disk storage to the Color Computer. The Disk Operating System—an enhanced version of the Color Computer's Extended Color BASIC language—is completely contained in the Program Pak, so you get a full 156K-bytes of on-line storage.

Easy to Use. The 16K TRS-80 Color Computer lets you create sophisticated color diagrams, business charts and even simple animation—using just a few simple one-line commands! This gives experienced programmers incredible power, yet makes it easy for beginners, too. We take you from the ground up with over 500 pages of easy-to-read documentation.

Instant Fun and Games. And just for fun, you can plug in any of our game cartridges. Battle starships in outer space, conquer dinosaurs from a prehistoric world, or just brush up on your chess.

Fully expandable. Your TRS-80 Color Computer Disk System can expand with up to four drives for over 626,000 characters of storage! And the additional drives are only \$399 each. Add up to 16K more memory, a printer and other accessories anytime.

Radio Shack's TRS-80—The Best-Supported Microcomputer in the World!

The TRS-80 line of computers is backed with a wide selection of accessories, software, and service. We can even show you how to get up-to-the-minute news, current stock market reports and even electronic mail using your TRS-80! It's all available today at over 8000 Radio Shack stores and dealers, and at 185 Computer Centers nationwide.

\$ 1198

**16K-1 Disk
System
(TV not included)**

Stop by your nearest Radio Shack and see what's really new in personal computers. Or write: Radio Shack, Department 82-A-123, 1300 One Tandy Center, Fort Worth, Texas 76102

Radio Shack

The biggest name in little computers™

A DIVISION OF TANDY CORPORATION

Retail prices may vary at individual stores and dealers



| SOT | TO ADDRESS | FROM ADDRESS | MESSAGE NUMBER | BYTE COUNT | MESSAGE ID | DATA | CHECKSUM |
|-----|------------|--------------|----------------|------------|------------|------|----------|
|-----|------------|--------------|----------------|------------|------------|------|----------|

Figure 6: Proposed message format. Various fields are included in each message to help the network software ensure reliability of the system.

accepts requests for registration, deregistration, and name queries.

Special *generic addresses* also can be set aside for special purposes. For instance, the nameserver could be assigned a generic address to be used by all nameserver-related messages, making it unnecessary to know which node the nameserver is actually on.

Another generic address could be set aside to represent a *broadcast* message—one that all nodes on the network would want to receive. A typical use of a broadcast message is sending a company-wide memo to all employees on the network. The generic address eliminates the need to address the same memo to each person on the net.

Special types of nodes such as mass-storage nodes or printers can have their own addresses. For exam-

ple, the address M might be reserved for the printer node. If there is only one printer on your net, M would mean that printer. If there is more than one printer on the net, an additional field called the logical printer number could be used to specify the printer for which the message is destined.

Message Formats

A message is a predetermined sequence of fields by which two nodes communicate. A message normally consists of several parts: the header, the body, and some kind of error-checking mechanism, such as checksum, at the end.

The structure allows for much variation. The basic component for constructing a message usually is a byte. A field is defined as one or more

bytes that designate a particular section of a message. Typical fields in a message are shown in figure 6 and explained below.

●**SOT:** start of transmission. This byte is useful for informing all receivers that the beginning of a message is now on the net and that the next byte will be the address byte. Obviously, the byte must not be confused with bytes in the middle of a message.

●**To Address:** the address of the intended receiver.

●**From Address:** the address of the node that transmitted the message. As will be shown later, this field is important for sending acknowledgments back to the transmitter.

●**Message Number:** a unique number that distinguishes one message from the next. The usefulness of this field will be illustrated in the sections of this article dealing with duplicate messages.

●**Bytecount:** tells a receiver how many bytes to expect in the message body. It can be used as a receive loop counter, to be decremented each time a byte is received. When the counter equals zero, the user knows the checksum byte will follow immediately.

●**Message ID:** distinguishes three types of messages within a network system. The *data message* contains the essential information to be transmitted from one node to another. The *message acknowledgment* acknowledges a data message, and the third type of message, **ACKACK**, acknowledges a message acknowledgment.

●**Data:** zero or more bytes of information that follow the Message ID.

●**Checksum:** the error-checking byte, computed as the *n*-bit sum of all the bytes in the message (except the SOT byte and the checksum itself). The transmitter sums up all the bytes in its transmitted message and "ships out" the lower *n* bits of that sum as the last byte of the message. Meanwhile, the receiver does the analogous operation on the message it receives. If all the characters were received correctly, the receiver's lower *n*-bit sum should match the transmitter's checksum.

NEW! Speech synthesis using the Votrax SC-01 with the **ads SYNCHETALKER!**

- 64 PHONEMES AND 4 INFLECTIONS PROVIDE AN UNLIMITED VOCABULARY THAT IS USER PROGRAMMABLE
- PROGRAMMABLE OSCILLATOR FOR PITCH CONTROL GIVES YOU MORE NATURAL SPEECH OR MULTIPLE VOICES
- EXTENDED DEVICE OPTION
- UP TO TWO WAIT STATES
- EASILY PROGRAMMED IN BASIC!

Write or call for complete details
Ackerman Digital Systems, Inc.
 110 No. York Rd., Suite 208
 Elmhurst, IL 60126
 (312) 530-8992

*Votrax is a trademark of Federal Screw Works

NEW

The World's First MacroComputer[®]



The **Parallel Processing[®] System/48[®]** is the world's first **MacroComputer[®]**, an elegantly powerful and modular multi-user computer for business and industry. It was designed from the start to out-perform other computer systems at three or more times its price. The operating system software is so friendly, versatile and fast that it's called **MAGIC[®]**.

In addition to outstanding new capabilities, **MAGIC'S** interface translator allows instant access to a large number of standard languages and applications for GL, AR, AP, PR, Inventory, Financial Planning, Fixed Assets, Property Management, Prospect Management, Order Entry, Word Processing and a host of others. **DataMagic II[®]** is provided with the **System/48**, for comprehensive database management . . . and it makes new application programming a simple joy.

Whether it's 2 or 3 users, or 128, **MAGIC** exhibits exceptional performance with transactional disk back-up to cartridge or 9-track tape; full access security; logical partitioning of tasks and users; fast Multi-Key ISAM access to multiple disks in each node (10-250 Mbytes); 1-16 Workstations and Task Processors in each node; up to 16 nodes; local and central printers for both word and data processing; remote Workstations and nodes; communications; real-time calendar and clock; and exceptional reliability because of its modularity and redundancy of software and hardware. Circle 361 on inquiry card.

And that's the whole point! You can get exactly the performance and configuration needed now and it can expand easily to meet future needs, taking advantage of the technology revolution. Large or small, real-time, batch or mixed, there's a **System/48** that's just right for the job.

If you haven't seen our **Parallel Processing System/48 MacroComputer** in **ACTION**, then seeing is believing! See your local dealer today for the full story. Or call Jim Knepton now at (713) 738-2300 and he'll explain how you can have your own private showing . . . and how easy and profitable it can be for you and your business.

TEI has 14 years of experience in manufacturing it **RIGHT!**
OEM and Dealer inquiries invited — come **GROW WITH US!**



System/48[®]

5075 S. LOOP EAST, HOUSTON, TX. 77033
(713) 738-2300 TWX. 910-881-3639

© COPYRIGHT TEI, INC. 1981
® REG TM OF TEI, INC. 1981

68000 μ P on the S-100 Bus?

YES, AVAILABLE NOW FROM DUAL SYSTEMS!

- 8 MHz 68000 microprocessor.
- 16-megabyte direct addressing.
- 32-bit internal arithmetic.
- Minicomputer type instructions including MULTIPLY.
- FULL IEEE-696 S-100 compliance. Runs with all 4 MHz S-100 boards and automatically runs faster when accessing Dual Systems memory boards, for FULL SPEED OPERATION OF THE 68000.
- Powerful vectored interrupts. 7 Vectored interrupts, including NMI, as well as alternate mode having up to 256 interrupts.
- On board monitor ROM for immediate use.
- Connector for future addition of memory management unit for multi-user operating systems.
- Built to the highest industrial standards with 200 hour burn-in.

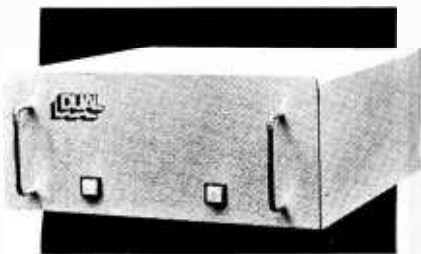

CPU/68000 CPU board.... \$1195
 32K-byte 8/16-bit NONVOLATILE RAM board, for secure storage of programs you are developing. Allows FULL SPEED CPU operation. CMEM-32K, per 32K-bytes .. \$895
 32K-byte 8/16-bit EPROM board, EPROM-32K \$395
 Serial I/O board, SIO-2 \$285
 All of the above with cabinet, power supply and backplane..... \$3685

OEM and Dealer pricing is available.

Sales representatives in most metropolitan areas.



system reliability/system integrity

**DUAL SYSTEMS
 CONTROL CORPORATION**

1825 Eastshore Hwy., Berkeley 94710
 (415) 549-3854 • TWX 910 366-2035

Layering the Tasks

The network software can be broken up into three separate layers for implementation (see figure 7). These layers are the basic transmitter and receiver subroutines, the protocol layer, and the application program. Breaking up the network software in this manner is useful because it allows the implementer to concentrate on a subset of network functions without having to give much consideration to the rest of the functions. As an added benefit, the layered structure limits the software modifications needed in order to bring up networking capability for particular network tasks and particular machines.

As an example, let's say network software is to be brought up on two of the same type of microcomputers, each having a different serial interface. Subroutines in the transmitter/receiver layer that specifically deal with the serial interface are the only parts of the network software that need changing. On the other end, a printer-application program and a disk-write program should be able to use the same protocol layer and transmitter/receiver layer.

The Transmitter

A buffer and a byte count are the necessary parameters this routine needs from the protocol layer. The transmitter should neither know nor care what type of message is in the buffer. First, the transmitter will need to know if anyone else is currently using the network. In an interrupt environment, this can be determined by a flag set when a character is received and reset when a carrier-detect interrupt occurs. If the flag is reset, therefore, it shows that the network is not in use.

If the transmitter is to be implemented without the aid of interrupts, it will be necessary to wait the length of time needed to receive one character (based on the data-transfer rate). If no characters are received in this time, it is assumed no one is in the middle of transmission.

Once it has been determined the network is not busy, the transmitter must send out the SOT field. A

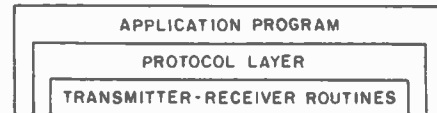

Figure 7: Network protocol is based on the layer concept. Applications programs deal at a high level by letting the underlying layers do the "dirty work."

potential "race" problem resulting in a collision could occur at this point, since two transmitters could conceivably start this transmission simultaneously.

Because the network is set up so that transmitters receive what they transmit, the received character should always be compared to the character that was just transmitted. If the two characters do not match, a collision has occurred. Later, we will decide how to recover from such a collision.

Assuming the transmitter received what it transmitted, it continues to send out bytes until all, including the checksum, have been sent. If the transmitter is interrupt-driven, it may want to set a flag to inform the protocol layer that transmission was successful. For a transmitter running without interrupts, this information could be returned as a parameter to the routine that called the transmitter.

The Receiver

A receiver activated by interrupts will be able to synchronize with the beginning of a message by the carrier-detect interrupt that occurs after the end of any message. Receivers without interrupts or latched carrier-detect pulses must repeatedly wait until a whole character time has gone by without receiving anything. The next field to be received should be the SOT field. If it is not, it will be necessary to go back to the previous step until an SOT is detected.

Once the SOT is detected, the next field should be the Destination Address. When this field is received, it should be compared with the receiver's own address to determine whether the message is intended for this receiver. If your network supports broadcast messages, all

THE GRAPHIC DIFFERENCE

BETWEEN ATARI® COMPUTERS AND ALL OTHERS.

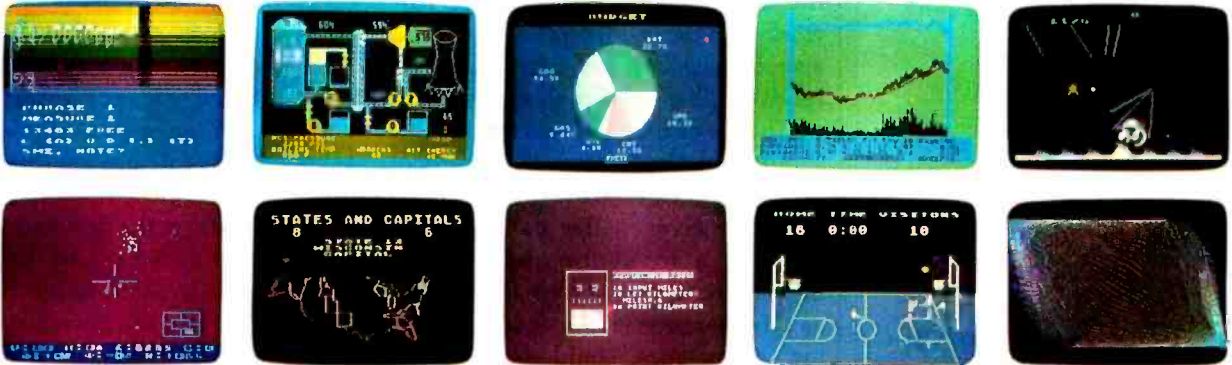

3.7 million reasons why the ATARI Personal Computer is something to see.

The display screen used with our computers is composed of 192 horizontal lines, each containing 320 dots. Delivering color and luminosity instructions to each dot for a second requires 3.7 million cycles... a lot of work for the normal 6502 processor.

That's why the ATARI computer has equipped its 6502 with its own electronic assistant. It's called ANTIC, and it handles all the display work, leaving the 6502 free to handle the rest. What this means to you is uncompromisingly spectacular display capabilities without loss of computer power needed to carry out the demands of your program.

That's a quality you just don't find in ordinary personal computers. And it's one of the reasons some computer experts say that ATARI computers are so far ahead of their time.

There's more... which is what you'd expect from ATARI.

Language. The ATARI Personal Computer uses several programming languages to give the user maximum control of its extraordinary capabilities. PILOT, Microsoft BASIC,* and ATARI BASIC are understood and spoken by the ATARI computer. You'll also find our Assembler Editor cartridge indispensable for



machine language programming.

Sound. An ATARI computer has four sound generators, or voices, activated by a separate microchip. This leaves the principal microprocessor chips free to perform other tasks. And you can take full advantage of this capability which is designed for easy programming.

Change. ATARI Personal Computers have been designed to make change and expansion easy. The ATARI computer has a modular operating system* that can be easily replaced as new technology develops. If you need it, memory expansion requires no more than inserting additional RAM modules.* And the ATARI ROM cartridge system also makes it easy to change languages. In short, your ATARI computer won't be obsolete by future developments... *because it already incorporates the future.*

Sharing. To learn more about the amazing capabilities of ATARI computers, visit your local computer store for a demonstration. Or send for our Technical User's Notes, intended for the serious programmer. They are only \$27 and contain a lot more information about our computers' special capabilities than most companies could tell. See your ATARI dealer, or send \$30 (\$27 plus \$3 postage and handling), payable to ATARI, to Technical User's Notes, c/o ATARI Customer Service, 1340 Bordeaux Avenue, Sunnyvale, CA. 94086.

*ATARI 800™ computer only.

ATARI®

Computers for people.™

©1981 Atari, Inc.

A Warner Communications Company

Circle 35 on inquiry card.

The Ultimate IEEE S-100 Memory Would...

- BE NONVOLATILE** holding data for up to eight years with the power off.
- RUN AT 6 MHZ** without wait states.
- RUN IN 8 OR 16-BIT** systems with 8 or 16-bit wide data paths.
- HAVE EXTENDED 24-BIT ADDRESSING** and bank select.
- HAVE DYNAMICALLY MOVABLE WRITE PROTECT AREAS** to prevent accidental erasure of programs and critical data.
- GENERATE POWER-FAIL** interrupts for orderly system shutdown & power failure recovery.

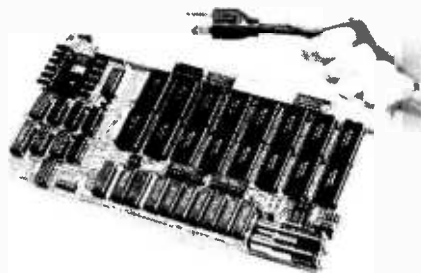

...Available Now from Dual Systems

The Dual Systems CMEM memory boards combine high-speed CMOS memories with new 5-10 year lithium batteries to give you the nonvolatility of an EPROM board while retaining the instant writability of a high-speed read/write RAM. These industrial grade boards are ruggedly built and are burned-in for 200 hours.

- CMEM-32K, 32K-bytes ... \$895
- CMEM-16K, 16K-bytes.... \$795
- CMEM-8K, 8K-bytes..... \$695

OEM and Dealer pricing is available.

Sales representatives in most metropolitan areas



system reliability/system integrity

**DUAL SYSTEMS
CONTROL CORPORATION**

1825 Eastshore Hwy., Berkeley 94710
(415) 549-3854 · TWX 910 366-2035

receivers must check to see if the message is a broadcast message. Additionally, printer and disk storage nodes must also check to see if the destination address is their generic address. If no address match exists, the receiver should go back to hunting for an SOT field (unless this receiver is a gossip monger).

If the message is addressed to a particular receiver, the address and all subsequent bytes should be received and summed together for comparison with the checksum byte at the end of the message. If your particular network uses parity, the message should also be checked for each character received. The receiver should not care what type of message was received; it should simply inform the protocol layer of receipt. With an interrupt-driven receiver, a flag can be set at completion to inform the protocol layer. Additional information, such as whether any errors occurred during the message, could also be communicated to the protocol layer via common memory. If the receiver is not interrupt-driven, this information can be passed back as parameters to the protocol layer.

The Protocol Layer

For the following discussion, *source* will be defined as the node that transmitted the original message, and *destination* as the node to which the message was addressed.

When computer A sends a message to computer B, there is no guarantee that computer B will receive it. Many things could go wrong. There might be a loose connection somewhere. Computer B might not be running, or it might not be listening to the net. Computer C could start transmitting at the same time as computer A.

Protocol schemes detect and correct such situations. Protocol is basically a conversation between a source and a destination, trying to ensure that what the source transmitted was actually received by the destination.

The simplest protocol is one in which the source sends a message to a specific destination and assumes the message arrived. If your network is in good working order and you know

that a particular destination is running properly, this protocol will be sufficient most of the time. You probably would want to use this protocol, for example, when you are sending messages to your friend Carol, who is using computer B. If she is there, she will probably send a message back, thereby acknowledging that she received your message. You'd also use this protocol for broadcast messages, to prevent the net from getting jammed by everyone trying to send acknowledgments at the same time.

When you are doing things on your net, such as writing a file to a disk, assuming the file got there is not enough. You need some real acknowledgment that the file got to the disk. If no acknowledgment comes back from the destination, or if the destination returns to the source an acknowledgment stating that the disk is full, the source will have to take some error-recovery measures. These are discussed later.

What happens if the destination receives a correct message and sends back an acknowledgment that is not received by the source? In this case, the source thinks its original message did not get through, but it actually did. To avoid this situation, an acknowledgment of an acknowledgment received (ACKACK) can be added to the protocol. If after sending an acknowledgment, the destination does not receive the ACKACK, it will have to take some kind of error-recovery action.

What happens if the source receives the acknowledgment and sends the ACKACK, but the destination does not receive the ACKACK? Somebody has got to have the last word, and there can be no guarantee that a message and all its associated protocol are transmitted and received successfully. Especially on a low-speed network, the criterion for deciding how much protocol to use is "as little as possible for a particular application." An intelligent system might provide all three types of protocol (ie: message, message-ACK, and message-ACK-ACKACK) and allow the application program to decide which one to use.

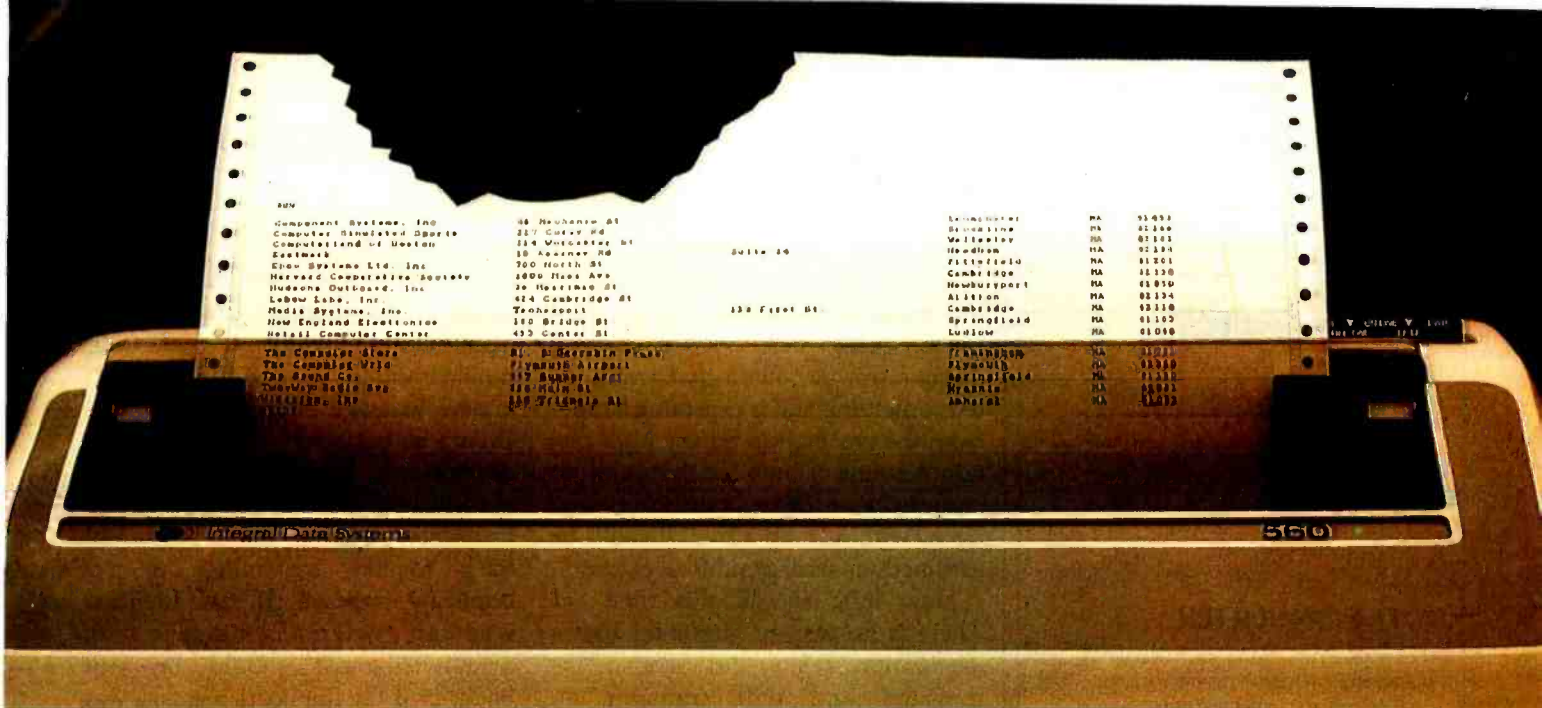

Meet the Tiger with a bigger bite.

Introducing the remarkable 132-column Paper Tiger™ 560. The first full-width matrix printer to give you fully formed characters for a low \$1394.*

The new 560 features a staggered nine-wire ballistic type print head that overlaps dots in both horizontal and vertical planes. It bi-directionally prints up to 150 dense, text quality characters per second.

The 560 also features a reliable cartridge ribbon that lasts up to four times as long

presents a breakthrough in matrix printing, offering the user excellent print quality with the use of a matrix printer. Employing a unique "red column" head manufactured by Integral Data Systems, Inc., the 560 creates high quality printouts by overlapping dots in both horizontal and vertical planes.

Paper Tiger 560 Print Sample

as spool and cassette ribbons, separate heavy-duty stepper motors to drive the print head and advance the paper, plus true tractor feed.

And famous Paper Tiger performance comes with every new 560. Like fixed or proportionately spaced text, programmable tabbing and business forms control, automatic text justification, print formats to 220

columns, parallel and serial interfaces, self-diagnostics, and more. All inside the most compact printer of its kind.

Need more stripes? Dotplot™, our high-resolution raster graphics package, is standard on every 560.

For data processing, word processing and small business applications, this is your Tiger. The business-sized Paper Tiger™ 560.

It's a Tiger you can count on.

Call TOLL FREE 800-258-1386 (In New Hampshire, Alaska and Hawaii, call 603-673-9100.) Or write: Integral Data Systems, Inc., Milford, NH 03055.



Paper Tiger 560

 Integral Data Systems, Inc.

Toughest Boards in Town... IEEE 696/S-100

NON-STOP CLOCK

Keeps time with power off. Our industrial clock utilizes a new lithium battery for 3-9 years use. Easiest clock to program you'll ever see. Runs in all S-100 systems.

- Year, date, hrs, mins, secs, msec.
- Uses new LSI CMOS chip.
- Vectored interrupts.
- CLK-24 \$250

A/D CONVERTER

IEEE696/S-100 AIM-12 industrial standard module designed for industrial analog-to-digital use.

- Runs in all S-100 systems.
- 32-channel, 16-differential 12-bit resolution/accuracy. 25-microsecond conversions.
- Instrumentation amplifier.
- BASIC program provided. AIM-12, S695 or S785 w/1-1000 gain transducer amplifier.

D/A CONVERTER

AOM-12 IEEE696/S-100 industrial level digital-to-analog (D/A) converter.

- 12-bit $\pm 1/2$ L.S.B. accuracy over full 0-70°C temperature range.
- Outputs 0-10, ± 5 , or ± 10 volts.
- Short circuit protection, all outputs.
- Switch-programmable for multiple boards.
- AOM-12, S575

VIC 4-20

Standard output for industrial control 4-20 mA D/A converter. Used in conjunction with the D/A board.

VIC4-20, S445.

DUAL 77 Data Acquisition and Control System-

Built to industrial standards; designed for severe environments. BASIC language makes programming easy. Access to hundreds of sensors. Expandability to meet your increased needs. Nonvolatile memory. Power interruption recovery with automatic restart. DUAL 77 is economical; S5985 & up.



system reliability/system integrity

**DUAL SYSTEMS
CONTROL CORPORATION**

1825 Eastshore Hwy., Berkeley 94710
(415) 549-3854 · TWX 910 366-2035

Error Recovery

What should be done when a message was sent and no acknowledgment came back? Or when an acknowledgment was sent but no ACKACK came back? Both these cases call for a timing mechanism. A source that transmitted something and is expecting a reply from the destination must wait a certain amount of time for that reply to come back. If the reply does not come back within that time, it will be assumed an error condition exists.

How long should this time be? There is no way to guarantee that a destination really did receive the message and will transmit an acknowledgment within the time the source has set. The waiting time, then, should be more than long enough to cover any reasonable situation.

Once the source has waited a set amount of time without receiving a reply, a reasonable action would be to retransmit the original message at least once more, and again wait the specified amount of time for a reply. The same strategy could be used by the destination when it sends acknowledgments and waits for an ACKACK. If you are doing your network without the aid of a hardware timer, you will need a time-counting subroutine that continually checks to see if a reply was received, and decrements the counter. If the counter reaches 0 before a reply is received, then a *timeout error* exists. If your software has access to a hardware timer, you can use it to set an interrupt.

If no reply is received after repeated attempts to transmit a message, there is nothing to do but give up and report the problem to the program that initiated the network call.

This retransmission scheme introduces another problem. Suppose the source sends a message that is received by the destination, but the destination sends back an acknowledgment that is never received by the source. After timing out, therefore, the source retransmits the original message, and the destina-

tion receives it a second time. The Message Number field, along with the From Address field, can be used to correct such situations.

All receivers should keep a list of the last *n* messages received. The list need contain only the message number and the From Address. When a new message is received, the list should be examined for a match. If a duplicate is detected, the message should be "dumped," but the appropriate response should be sent back to the transmitter of the duplicate message. If the duplicate was an original message, an acknowledgment should be sent back, or if the duplicate message was an acknowledgment, an ACKACK should be sent back.

Collisions are another issue. Assuming that all transmitters check the state of the network before starting transmission, collisions can happen only when two or more transmitters start their transmissions within one character time of each other. When collisions happen, all transmitters involved should immediately stop transmitting and allow the network to return to the "not busy" condition.

Now some kind of mechanism is needed to tell colliding transmitters when they can start transmitting again. If they all wait an equal amount of time, they will collide again. Therefore, they must all wait different lengths of time.

One way to ensure this setup is to establish a priority order based on node address. If a node with the address of 1 collides with a node with the address of 3, then node 1 will wait one unit of time before attempting retransmission, while node 3 will wait three units of time. One problem with this scheme is that under heavy load conditions where collisions are more frequent, nodes with high address numbers may never be able to get a message through because they must wait so long after each collision.

A fairer scheme would be one in which each node has a random-number generator guaranteed to create a unique sequence of random numbers. All nodes would then have

equal priority in retransmissions after collisions.

A Typical Application Program

As an example of a typical application program, let's consider a request to a filing system on a hard-disk node.

The "save" request would first want to send to the filing system a message containing the file name and the number of sectors to be saved. The request probably would ask the protocol layer to expect an acknowledgment and allow the protocol layer to take care of retransmissions if necessary. Along with the acknowledgment would come information from the filing system indicating whether or not the request can be accommodated. If it cannot be accommodated, the request program must report the failure to its caller.

If the request can be accommodated, the save request program must break up the file to be saved into convenient blocks (probably a disk sector). When errors occur during transmission, it is more economical to retransmit small blocks than large ones. In either case, the save request should send an ACKACK to the filing system to say it agrees to what the filing system considers the state of the request.

Once the file has been partitioned into blocks, the save request should hand them in sequence to its protocol layer for transmission to the filing system. The request should ask its protocol layer to expect an acknowledgment for each block transmitted. Each block should have

a unique number that can be checked by the filing system against block numbers already received. In this manner, duplicate blocks can be dumped.

By the value of the last block number, both parties know when the file transfer is completed. If implementation is done in a straightforward manner, the last block number should equal the corresponding field in the original request message.

The save request should ask the protocol layer to send an ACKACK to the filing system when it submits the last block for transfer. Upon receipt of this ACKACK, the filing system can be sure it will not be getting a retransmission of the last block, and it can close the file and forget about the request.

When extended conversations are taking place between two nodes on the net (as in the previous file transfer examples), the network can be made to appear constantly busy by never allowing more than a character time to elapse between messages. In this way, no other user on the network can interfere with the conversation.

If the data rate is controlled by software on the two conversing nodes, you might consider increasing the rate after the initial conversational link has been established. The rate could be increased beyond what's normally acceptable to every node on the network, but it must be changed back after the conversation is completed. While the process is going on, every other node on the network should recognize it as a network-error condition. Because the nodes have

not seen a transition from a busy net to a nonbusy net, they will not be looking for an SOT field anyway. This scheme can get a little tricky when attempting to end a conversation, especially if the last acknowledgment or ACKACK did not get through but the data rate on one node has already been reduced to its former value.

Multitasking Environments

Networking in multitasking environments raises many issues that cannot be considered here, but a few obvious ones should be pointed out.

The protocol layer probably should be set up as a process by introducing another parameter to indicate whether the application program will "go to sleep" waiting for a reply or acknowledgment. The protocol layer would then have to give the application program a "wake up" by indicating whether the message got through to the receiving process.

Since messages could in this way be addressed to one of several processes on a node, the address fields for To and From addresses would need to be extended to include a Process ID number.

The software design presented in this article reflects only one of many possibilities. For more information, or for software if you don't want to write your own, contact Cheshire Software, POB 2780, Santa Cruz CA 95063.

Now that you have a taste of what networking is all about, you can experiment and enjoy implementing your own ULCNET. ■

| | | | |
|--|--|--|-----------------------------------|
| AMS | ADVANCED MICRO SYSTEMS • 26188 ADAMOR ROAD • CALABASAS, CA 91302 | | OFFER EXPIRES Oct. 31, 1981 |
| | MORROW DESIGNS PRODUCTS AT LOW LOW PRICES! | Tel.: (213) 880-4670 | |
| *HARD DISK SUBSYSTEMS | ADDITIONAL HARD DISK | FLOPPY DISK SUBSYSTEMS | TWO DRIVE SUBSYSTEMS |
| M-26 DISCUS M26 \$3397.00 | A-26 DISCUS M26 \$3037.00 | F-1118 DISCUS 1 \$ 816.00 | F-1128 DISCUS 1 \$1389.00 |
| M-20 DISCUS M20 \$3553.00 | A-20 DISCUS M20 \$3193.00 | F-1218 DISCUS 2D \$ 888.00 | F-1228 DISCUS 2D \$1450.00 |
| M-10 DISCUS M10 \$2760.00 | A-10 DISCUS M10 \$2400.00 | F-2218 DISCUS 2 + 2 \$1105.00 | F-2228 DISCUS 2 + 2 \$1896.00 |
| DISK CONTROLLERS (A & T) | STATIC MEMORY (A & T) | *DECISION I BASIC UNIT \$1342.00 | |
| DJ-M26 M26 HARD DISK \$720.00 | 16K SUPERAM \$248.00 | NOTE: 1. The disk subsystems include Digital Research CP/M 2.2 and Microsoft Basic V5.2 | |
| DJ-M20 M20 HARD DISK \$720.00 | 16K MEMORY MASTER \$284.00 | | |
| DJ-M10 M10 HARD DISK \$720.00 | 24K MEMORY MASTER \$378.00 | 2. If you own a MITS controller and disc drive, we have the interface to run them with our new subsystems, and a reformatter for your Petic drives and software to translate your Milt's files to your new operating system. | |
| DJ-2208 DOUBLE DENSITY FLOPPY \$349.00 | 32K SUPERAM \$450.00 | | |
| DJ-1108 SINGLE DENSITY FLOPPY \$219.00 | 65K STATIC RAM \$870.00 | | |
| I/O CONTROLLERS (A & T) | I.E.E. S-100 BUS (A & T) | | |
| SB-2411 SWITCHBOARD I/O \$219.00 | WB-0800 8 SLOT MOTHER BRD. \$109.00 | | |
| SB-2411-4K 4K RAM OPTION \$ 80.00 | WB-1200 12 SLOT MOTHER BRD. \$129.00 | | |
| MB-3200 MULT I/O BOARD \$309.00 | WB-2000 20 SLOT MOTHER BRD. \$173.00 | | |
| All shipments FOB Calabasas — 90 days warranty on all products | | Prices, Terms, Specifications subject to change without notice. | |

Announcing
The Table Top Computer
That Can't Be Topped.



The 5000 SX with:

Capacity: 5.5 MB Winchester Plus Two Mini Floppies

If you know our Series 5000 table top computer line, you know that *good* things come in small packages.

Now, with the introduction of the 5000 SX, *big* things come in small packages.

One integrated package can contain two double sided, double track density floppies plus a 5.5 megabyte Winchester drive.

Speed: Load 20K in Less Than a Second

Not only does our high performance Winchester subsystem include error detection with automatic error correction, its extreme speed is comparable to that of large main frame hard disk systems.

A 20K program loads in less than one second, about 10 to 12 times as fast as a floppy.

We invite comparison with our competitors' Winchester implementation so you can see how a truly engineered solution speeds up your application programs.

Extras: You'll Be Glad You Have Them

The 5000 SX comes standard with lots of extras, starting with a fully terminated S100 mother board. Add to that 64K dynamic RAM modules, with parity, of course, and receptacles for your CRT and Printer that turn on with the main power switch.

Plus, convenient up front reset switch, incoming power line filter and much more.

Software:

Operating Systems: CPM, MPM, TurboDOS

Languages: BASIC, FORTRAN, COBOL

Application Packages: FMS-80, WORDSTAR, Accounting Plus, all tailored to operate on the 5000 SX.

Quality: So Good, It's Warranted 2 Years

There isn't room on this page to even scratch the surface of the IMS International story.

However, our 2-year warranty is a dead giveaway that we produce rugged, top quality, professional equipment. We do things right the first time so they don't come back to us.

The truth is, we have fewer returns within our 2-year warranty period than other manufacturers have within their 90-day warranty periods.

For full details and the location of your nearby IMS International dealer, call us today at (714) 978-6966. Or write:

IMS
INTERNATIONAL

We Build Computers As If Your Business Depended On Them.

2800 Lockheed Way, Carson City, NV 89701
Telex: 810-395-6051

CP/m & MP/m, TM of Digital Research • TurboDOS, TM of Software 2000 • FMS-80, TM of DJR Associates • WORDSTAR, TM of MICROPRO • ACCOUNTING PLUS, TM of SYSTEMS PLUS

Circle 426 on inquiry card.

New Software from CompuView



MicroCraft Systems, Inc. Apple Software Development Tools

MicroCraft offers the Apple user a flexible set of development tools. This includes a low-cost full screen editor, the most powerful 6502 Macro Assembler available, and a compiled graphics language optimized for real-time applications. Each package compliments any Apple system and together they offer unequaled power and versatility.

RGL Real-time Graphics Language

Do real-time animation • Similar to 'C' • Display, move and rotate 3D objects • Compiles text files to 'BRUN'able binary object files. **\$75 / \$25 Until 10/31/81**

MacroLink Complete 6502 Assembler

Disk Assembler • Text to binary object • Standard 6502 mnemonics • Recursive macros with up to 10 arguments • Nestable conditional assembly • Links source or object code • Nestable file includes • Unlimited source file size • Editor provided **\$125 / \$20**

SuperEdit Full Screen Editor

Horizontal scrolling allows 80 columns • Uses standard text files • Move cursor by character, line or page • Find, search and replace • Block move and copy • Use with RGL or MacroLink • 80 column video board versions also available. **\$75 / \$20**

DiskScreen Disk Utility

Displays a complete disk sector in hex and ASCII, using high-res screen • Edit sector by typing over display **\$40 / \$10**

Complete Assembler System [MacroLink, SuperEdit, DiskScreen] \$200 / \$40

Complete Graphics System [RGL, SuperEdit] \$120 / \$40

Systems available to utilize extra 16K or 32K expansion boards Please inquire

Note: All programs require a single disk drive and 48K. When ordering please specify configuration.

Circle 412 on Inquiry card.

Telephone (313) 996-1297

Circle 413 on Inquiry card.

CompuView is proud to carry the MicroCraft Systems, Inc. quality software for the Apple II.

CompuView Products Inc.

618 Louise, Ann Arbor, Michigan 48103 • Telephone (313) 996-1299

8086 Software

- VEDIT full screen editor for CP/M-86.
- Contact us for availability of VEDIT for SCP 86-DOS and IBM 8088 computer.
- CP/M-86 BIOS for popular S-100 disk controllers. Source code \$185

V-COM Disassembler

Finally a Z-80 disassembler for CP/M which produces easy to read code, a cross reference table, and handles INTEL and ZILOG mnemonics. V-COM is exceptionally fast and produces a .ASM file directly from a .COM file. V-COM can accept a user-created file containing assignments of labels to 8 and 16 bit values. A second file can specify the location of tables and ASCII strings. **\$80**

FASTSCREEN CRT emulation and Command Line Editor

Memory mapped displays offer over ten times the speed of the fastest CRT terminal but are usually not supported by application software. This is where FASTSCREEN fits in. FASTSCREEN provides a fast and highly compatible emulation of several popular CRT terminals for most memory mapped displays. It also provides editing and re-entry of any line on the screen, paging, and includes interrupt driven keyboard routines. (FASTSCREEN is provided as source code on a CP/M compatible diskette and requires assembly language modifications for installation.) **\$85**

PIICEON 24 x 80 S100 Video Board

The PIICEON V-100 is the heart of a high speed alternative to a CRT terminal. Being I/O mapped, it uses no memory space, yet runs at full processor speed. FASTSCREEN is the perfect software driver for the V-100. Fully assembled and tested by PIICEON, the company known by OEMs for reliability.

PIICEON with FASTSCREEN \$510
PIICEON board only \$475

Customizable

*The Unique Difference that Sets
VEDIT Apart in Full Screen Editors*

Total user customizability is a predominate reason that over a thousand users find VEDIT the easiest to use full screen editor. It makes VEDIT the only editing package which allows you to determine your own keyboard layout and use the cursor and special function keys on any terminal having them. And only VEDIT fully supports all of the newly available terminals. It may come as a surprise to you, that with any other editor or word processor, you will have to memorize obscure control characters or multi-character sequences, while your terminal's extra keys and editing functions go unused. The customization extends to setting the default tab positions, scrolling methods and much more. It's almost like designing your own editor for your system, applications and preferences. And all of this is easily done with the setup program which requires no programming knowledge or 'patches', but simply prompts you to press a key or enter a parameter.

Unequaled Hardware Support

The CRT version supports all terminals by allowing you to select during setup which terminal VEDIT will run on. Features such as line insert and delete, reverse scroll, status line and reverse video are used on 'smart' terminals. All screen sizes are supported, including large ones such as the 60 X 80 format on the Ann Arbor Ambassador terminal. Special function keys on terminals such as the Heath H19, Televideo 920C and IBM 3101, and keyboards producing 8 bit codes are all supported. The memory mapped version is extremely flexible and supports bank select and hardware cursors such as on the SSM VB3. With this level of customizability and hardware support, you will feel for the first time that the software was optimally designed for your system.

Fully Compatible Replacement for Ed

Since VEDIT creates and edits standard text files of up to one diskette in length, it serves as a replacement for the CP/M

standard editor ED. Of course, you benefit from the fastest and easiest to use 'What you see is what you get' type full screen editing available, fast disk access and an editor which takes up only 12K of your valuable memory space. With VEDIT you will never again need or want to use the slow and tedious ED.

Special Features

VEDIT is more than just a full screen editing replacement for ED, it gives you many new editing capabilities, such as a scratchpad buffer for moving and rearranging sections of text, complete file handling on multiple drives and iteration macros. Among its special features you will find automatic indenting for use with structured programming languages such as Pascal and PL/I, and other special facilities for Assembler and COBOL. A real time saver is the ability to insert a specified line range of another file anywhere in the text. Unlike most software, VEDIT will even tolerate your mistakes. For example, one key will 'Undo' the changes you mistakenly made to a screen line, and the disk write error recovery lets you delete files or insert another disk should you run out of disk space.

Ordering

Many dealers carry VEDIT, or you may contact us for fast delivery. Specify the CRT version, your video board or microcomputer, the 8080, Z80 or 8086 code version, and disk format required.

VEDIT for 8080 or Z80: Disk and manual \$130
VEDIT for CP/M-86: Disk and manual (NEW) \$185
Manual: Price refunded with software purchase \$15

VISA or MASTERCARD Welcomed

CP/M and MP/M are registered trademarks of Digital Research. Inc. Apple II is a registered trademark of Apple Computer, Inc. SoftCard is a trademark of Microsoft. TRS-80 is a trademark of Tandy Corp.

• North Star • Cromemco • Heath H8/H89 • SuperBrain • Apple II Softcard • TRS-80 Model II & Model I
Most other CP/M Systems with CRT or Memory Mapped Displays • MP/M • CP/M-86



CompuView Products Inc.

618 Louise, Ann Arbor, Michigan 48103 • Telephone (313) 996-1299

Circle 98 on inquiry card.

The Atari Tutorial

Part 2: Graphics Indirection

Chris Crawford
Atari Inc
1265 Borregas Ave
POB 427
Sunnyvale CA 94086

Indirection is a powerful concept in computing, but a difficult one for the beginning programmer to appreciate. In 6502 assembly language, there are three levels of indirection in referring to numbers. The first and most direct level is the immediate addressing mode, in which the number itself is directly stated:

```
LDA #$F4
```

The second level of indirection is reached when the program refers to a memory location that holds the number:

```
LDA $0602
```

The third and highest level of indirection is attained when the program refers to a pair of memory locations that together contain the address of the memory location holding the number. In the 6502, this indirection is complicated by the addition of an index:

```
LDA ($D0),Y
```

Indirection provides a greater degree of generality and power to the programmer. Instead of trucking out the same old numbers every time something needs to be done, the programmer can simply point to them.

By changing the pointer, the behavior of the program can be changed. Indirection is an important capability.

Graphics indirection is built into the Atari Personal Computer system in two ways: with color registers and character sets. Programmers using this computer after programming other systems often think in terms of direct colors. A color register is a more complex beast than a color. A color specifies a permanent value. A color register is indirect; it holds any color value. The difference between the two is analogous to the difference between a box-end wrench and a socket wrench. The box-end wrench comes in one size only, but a socket wrench holds almost any size socket. A socket wrench is more flexible, but takes a little more skill to use properly. Similarly, a color register is more flexible than a color, but takes more skill to use effectively.

Color-Register Indirection

The Atari 400/800 has nine color registers; four are for player-missile graphics and will be discussed in a later article in this series. The remaining five are not always used. Depending on the graphics mode used, as few as two registers, or as many as five, will show up on the screen. In BASIC mode 0, only one and one-half

registers are used because the hue value of the characters is ignored. Characters take the same hue as playfield register 2, but take their luminance from register 1. The color registers are in CTIA (one of the Atari custom integrated circuits) at hexadecimal addresses D016 through D01A. They are "shadowed" (ie: copied) from certain RAM (random access read/write memory) locations in the Atari OS (operating system) into CTIA during the vertical blank interrupt of the video display. Table 1 gives color-register shadow and hardware addresses.

For most purposes, the user controls the color registers by writing to the shadow locations. There are only two cases in which the programmer writes directly to the CTIA addresses. The first and most common is the display-list interrupt, which will be covered in a later article in this series. The second case arises when the user disables the OS vertical-blank interrupt routines, which move the shadow values from the OS into CTIA.

Colors are encoded in a color register by a simple formula. The upper nybble gives the hue value, which is identical to the second parameter of the BASIC SETCOLOR command. Table 9.3 of the *Atari BASIC*

THE WAR ON BUGS

C O N T I N U E S

with

CRTFORM™

CRTFORM™ is a comprehensive package for creating interactive programs.

Good programming starts with clear specifications. CRTFORM saves time by gathering those specifications with a field-oriented editor. The editor can be used to manipulate and modify input and system fields, as well as to assert any of a complete group of input specifications.

A forms manager maintains the specifications. It allows the analyst to create and modify random access files of forms. The form files contain the field attributes of forms as well as author, comment, and revision information.

System analysts can easily produce documentation by using CRTFORM to print field attributes and images of forms. In addition, a special Test mode allows the end user to test and verify the forms before any code is produced.

CRTFORM's code generator produces the Pascal, BASIC, COBOL, FORTRAN, PL/1, Z-80, or Ada source text necessary to interface to the runtime module.

The runtime module assures the user of consistent interaction with the com-

pleted application program. This reduces training time, and eliminates the frustration common in the use of many large programs.

The package automatically produces documentation and provides capabilities for runtime enhancements. The programmer can dynamically lock and unlock displays, erase, skip, and reset fields. In addition, the system provides for redirection of field access and enables the programmer to send specialized error and comment messages.

The system is terminal independent. This means that forms created for one terminal can be used on a terminal requiring different control sequences. Function keys can be configured for special applications.

CRTFORM is intended for use by system houses, program developers and OEMs. It is available under the CP/M, UCSD, Apple Pascal, RT-11, and RSX-11M operating systems.*

Statcom is a corporation specializing in software development tools and techniques. In addition to CRTFORM, we offer an end user oriented report generation package. Please call or write for further information.



PROGRAMS THAT WRITE PROGRAMS

STATCOM

CORPORATION

5766 BALCONES SLITE 202
AUSTIN TEXAS 78731
PHONE 512/451-0221

Reference Manual lists hue values. The lower nybble in the color register gives the luminance value of the color. It is the same as the third parameter in the BASIC SETCOLOR command. The lowest-order bit of this nybble is not significant. Thus, there are eight luminances for each hue. This gives a total of 128 colors from which to choose (eight luminances times sixteen hues). In this series of articles, the term *color* denotes a hue-luminance combination.

Once a color is encoded into a color register, it is mapped onto the screen by referring to the color register that holds it. In map-display modes that support four color registers, the screen data specify which color register is to be mapped onto the screen. Since there are four color registers, it takes only 2 bits to encode one pixel. Thus, each screen-data byte holds data for four pixels. The value in each pair of bits specifies which color register provides the color for that pixel.

In color-text display modes

(BASIC's graphics modes 1 and 2), the selection of color registers is made by the top 2 bits of the character code. This leaves only 6 bits for defining the character, which is why these two modes have only 64 characters available.

Color-register indirection gives the programmer four special capabilities. First, the programmer can choose from 128 different colors for displays.

Second, the programmer can manipulate the color registers in real

time to produce pretty effects. The simplest version of this is demonstrated by the following BASIC line:

```
FOR I=0 TO 254 STEP 2:POKE 712,I:NEXT I
```

This line cycles the border color through all possible colors. The effect is quite pleasing and certainly grabs attention. The fundamental technique can be extended in a variety of ways. A special variation of this is to create

| Image Controlled | Hardware | | Operating System Shadow | |
|------------------|----------|---------------------|-------------------------|---------------------|
| | Label | Hexadecimal Address | Label | Hexadecimal Address |
| player 0 | COLPM0 | D012 | PCOLOR0 | 2C0 |
| player 1 | COLPM1 | D013 | PCOLOR1 | 2C1 |
| player 2 | COLPM2 | D014 | PCOLOR2 | 2C2 |
| player 3 | COLPM3 | D015 | PCOLOR3 | 2C3 |
| playfield 0 | COLPF0 | D016 | COLOR0 | 2C4 |
| playfield 1 | COLPF1 | D017 | COLOR1 | 2C5 |
| playfield 2 | COLPF2 | D018 | COLOR2 | 2C6 |
| playfield 3 | COLPF3 | D019 | COLOR3 | 2C7 |
| background | COLBK | D01A | COLOR4 | 2C8 |

Table 1: Names and addresses of color registers used by the Atari 400/800.

"I have recently used Spellguard and I can only echo the evaluations of a recent Infoworld review: excellent all the way."

Mark Garetz
Infoworld 25
May 1981

"Spellguard is an example of the new standard—fully professional microcomputer software."

Bill Burns
Infoworld 30 March
1981

"... Spellguard was given the manuscript from my first book. This version had been corrected after several (human) proofreaders thoroughly reviewed it. I therefore expected it to be relatively error free. Not so. Spellguard was

able to discover numerous typographical errors ..."

Allan Miller
Interface Age
June 1981

"This easy to use, operator-oriented program has saved me

countless hours of proofreading, and from the embarrassment of submitting a manuscript with typos. Unlike most spelling test programs, Spellguard is fast ..."

Tony Dowden
Microcomputing
May 1981

EXPERTS AGREE

SPELLGUARD™ IS THE FASTEST EASIEST TO USE MOST POWERFUL AND RELIABLE SPELLING CHECKER YOU CAN BUY

InfoWorld
Software Report Card

SpELLGUARD

| | Poor | Fair | Good | Excellent |
|----------------|--------------------------|--------------------------|--------------------------|-------------------------------------|
| Usefulness | <input type="checkbox"/> | <input type="checkbox"/> | <input type="checkbox"/> | <input checked="" type="checkbox"/> |
| Documentation | <input type="checkbox"/> | <input type="checkbox"/> | <input type="checkbox"/> | <input checked="" type="checkbox"/> |
| Ease of Use | <input type="checkbox"/> | <input type="checkbox"/> | <input type="checkbox"/> | <input checked="" type="checkbox"/> |
| Error Handling | <input type="checkbox"/> | <input type="checkbox"/> | <input type="checkbox"/> | <input checked="" type="checkbox"/> |

System Requirements

- CP/M (1.4 or later)
- 32 K bytes of memory
- One or two disk drives

Price: \$295

ISA

INNOVATIVE SOFTWARE APPLICATIONS
260 Sheridan Avenue, Suite 300
Palo Alto, CA 94306
P.O. Box 2797 Menlo Park, CA 94025
(415) 326-0805

TELEVIDEO 950

List Price: \$1195.00

Microhouse Price: \$975.00

TELEVIDEO 910 Terminal

List Price: \$699.00

Microhouse Price: \$595.00

Zenith 289 Computer

Z80 CPU, 48K RAM, two serial I/O ports, 2msec realtime clock. Includes Z19 CRT and one built-in 5 1/4 inch disk drive (100K storage).

List Price: \$2895.00

Microhouse Price: \$2399.00

Anadex DP9500

List Price: \$1650.00

Microhouse Price: \$1350.00

Anadex DP9501

List Price: \$1650.00

Microhouse Price: \$1350.00

C ITOH STARWRITER I

Letter-quality printer uses Diablo plastic printwheels and ribbons. 25 cps bidirectional, logic-seeking. Parallel interface.

List Price: \$1895.00

Microhouse Price: \$1431.00

C ITOH STARWRITER II

Serial Version

List Price: \$1960.00

Microhouse Price: \$1502.00

C. Itoh Comet I

80 column dot matrix printer. 125 CPS, high resolution 9x7 dot matrix. Compressed print, 10 cpi, 16 cpi. Parallel or RS 232C interfaces.

List Price: \$495.00

Microhouse Price: \$425.00

IDS 560G

List Price: \$1695.00

Microhouse Price: \$1464.00

IDS 460G

List Price: \$1394.00

Microhouse Price: \$1150.00

MORROW DISCUS 2D

8 inch single-sided double-density floppy disk drive subsystem. Includes CP/M* and MBASIC.

List Price: \$1199.00

Microhouse Price: \$995.00

MORROW HARD DISK SUBSYSTEM

10 Megabyte. Includes S-100 controller card, CP/M*, and enclosure.

List Price: \$3695.00

Microhouse Price: \$3059.00

Novation D Cat Modem

List Price: \$199.00

Microhouse Price: \$156.00

MICROSOFT APPLE SOFTCARD

Regular Microhouse price \$305.00. Save when purchased with MicroPro's WordStar for Apple or TCS/Atlanta Accounting System. Includes CPM* and MBASIC.

List Price: \$349.00

Microhouse Price: \$290.00

VIDEX VIDEOTERM SPECIAL!

Converts your Apple screen to 80x24 upper and lower case. Purchase VIDEOTERM with WordStar and save! Regular Microhouse price \$290.

List Price: \$345.00

Microhouse Price: \$270.00

VIDEX Keyboard Enhancer

Use the keyboard to its fullest advantage! Allows use of shift key and control key for keyboard lock.

List Price: \$129.00

Microhouse Price: \$105.00

dBASE II

Written in assembly language (no host language required), dBASE can handle up to 65,000 records of 32 fields and 1000 bytes each. Reads existing ASCII files. Can be run interactively or can be programmed to produce reports.

List Price: \$700.00

Microhouse Price: \$628.00/\$50.00

WORDSTAR™

New version 3.0 features horizontal scrolling and column moves.

List Price: \$495.00

Microhouse Price: \$319.00/\$40.00

SPELLSTAR™

New option for WordStar. Compares words in your text to its 20,000 word compressed dictionary. Then returns to WordStar for correction of errors. Expandable dictionary. Requires WordStar Version 3.0 (if you have another version, call for details on updates.)

List Price: \$250.00

Microhouse Price: \$165.00

MAILMERGE™

Option for WordStar. (Requires current version of WordStar. Call for details)

List Price: \$150.00

Microhouse Price: \$105.00/\$25.00

SUPERSORT™ I

List Price: \$250.00

Microhouse Price: \$170.00/\$40.00

Datastar™

List Price: \$350.00

Microhouse Price: \$245.00/\$40.00

WORDSTAR™ for Apple.

List Price: \$375.00

Microhouse Price: \$245.00/\$40.00

WORDSTAR™ CUSTOMIZATION

Package includes diskette and manual. Specify disk format.

List Price: \$150.00

Microhouse Price: \$95.00

APPLESOFT™ COMPILER

List Price: \$200.00

Microhouse Price: \$167.50

SUPERSORT™ for APPLE

List Price: \$200.00

Microhouse Price: \$130.00/\$40.00

MICROSOFT BASIC COMPILER

List Price: \$395.00

Microhouse Price: \$325.00/\$30.00

VISICALC II for APPLE

New version II.

List Price: \$169.95

Microhouse Price: \$155.00

VISITREND/VISIPILOT

Allows you to perform sophisticated business math operations or production figures. Operations include multiple linear regression

List Price: \$259.95

Microhouse Price: \$219.00

VISIPILOT

Creates high resolution graphs and charts. Visualize data in 6 formats and 6 colors.

List Price: \$179.95

Microhouse Price: \$149.00

VISIDEX for Apple

Gives instant access to lists, memos, and short reports. Reference the information with key words or numbers. Then information can be referenced on demand.

List Price: \$99.95

Microhouse Price: \$159.00

Software & Manual/Manual Only

PRICES AND SPECIFICATIONS SUBJECT TO CHANGE WITHOUT NOTICE

CP/M is a registered trademark of Digital Research. APPLE is a registered trademark of Apple Computers.

WORDSTAR, DATASTAR, MAILMERGE,

SPELLSTAR, and SUPERSORT are registered

trademarks of MicroPro International.

SHIPPING: Add \$5 per manual or software package. Add \$2.50 for COD orders. Call for shipping charges on other items. Pennsylvania residents add 6 per cent sales tax.

P.O. Box 498
Bethlehem, PA 18016
(215) 868-9219**GET THIS!**
TeleVideo 910
List Price: \$699 \$595**Super Special:**
dBASE II
List Price: \$700
\$628**Microhouse™**
Circle 226 on inquiry card. SAVINGS FOR YOU!

simple cyclic animation by drawing a figure in four colors, and then cycling the colors through the color registers, rather than redrawing the figure. The program in listing 1 illustrates the idea.

The third application of color registers is to logically key colors to situations. For example, a paged-menu system can be made more understandable by changing the background color or the border color for each page in the menu. Perhaps the screen could flash red when an illegal key is pressed. The use of the color characters available in BASIC graphics modes 1 and 2 can greatly extend the impact of textual material. An account sum could be shown in red if the account is in the red, or black if the account is in the black. Words or phrases of import can be emphasized in special colors. The use of colors in map modes (no text) can also improve the utility of such graphics. A single graphics image (a monster, a boat, or whatever) could be presented in several different colors to represent several versions of the same thing. It costs a great deal of RAM to store an image, but it costs very little to change the color of an existing image. For example, it is much easier to show three different boats by presenting one boat shape in three different colors than three different boat shapes.

The fourth and most important application of color registers is used with display-list interrupts. A single

color register can be used to put up to 128 colors onto a single screen. This important capability will be discussed in part 4 of this series.

Character Sets

Graphics indirection is also provided through the redefinable character set. A standard character set is provided in ROM (read-only memory), but there is no reason why this particular character set must be used. The user can create and display any character set desired. There are three steps necessary to use a redefined character set. First, the programmer must define the character set. This is the most time-consuming step. Each character is displayed on the screen on an 8 by 8 grid, which is encoded in memory as an 8-byte table. Table 2 depicts the encoding arrangement.

A full character set has 128 characters in it, each with a normal and inverse video incarnation. Such a character set needs 1024 bytes of space and must start on a 1 K-byte boundary. Character sets for BASIC modes 1 and 2 have only 64 distinct characters. These require only 512 bytes and must start on a ½ K-byte boundary. The first 8 bytes define the zeroth character, the next 8 bytes define the first character, and so on. Each group of 8 bytes is termed a *character definition*; the index that designates such a group (FIRST character, FIFTH character, etc) is called the *character name*. Obviously, defining a new character set is a big job. Fortunately, there are software

packages to make this job easier.

Once the character set is defined and placed into RAM, the second step is to tell ANTIC (another custom integrated circuit on the Atari 400/800) where it can find the character set. This is done by poking the page number of the beginning of the character table into hexadecimal location D409 (decimal 54281). The OS shadow location, the location normally used, is called CHBAS and resides at hexadecimal 2F4 (decimal 756). The third step in using character sets is to print the character wanted onto the screen. This can be done directly from BASIC with simple PRINTs or by writing numbers directly into the screen memory.

A special capability of the system not supported in BASIC is the four-color, character-set option. BASIC graphics modes 1 and 2 support five colors, but each character in these modes is really a two-color character; each one has a foreground color and a background color. The foreground color can be any of four single colors, but only one color at a time can be shown within a single character. This can be a serious hindrance when using character graphics.

There are two other text modes designed especially for character graphics, ANTIC modes 4 and 5. Each character in these modes is only four pixels wide, but each pixel can have four colors (counting background). The characters are defined like BASIC graphics mode 0 characters, except that each pixel is twice as wide and has 2 bits assigned to it to

Listing 1: A short graphics program demonstrating the illusion of movement by changing color-register assignments.

```

10 GRAPHICS 23
20 FOR X=0 TO 39
30 FOR I=0 TO 3
40 COLOR I
50 PLOT 4*X+1,0
60 DRAWTO 4*X+1,95
70 NEXT I
80 NEXT X
90 A=PEEK(712)
100 POKE 712,PEEK(710)
110 POKE 710,PEEK(709)
120 POKE 709,PEEK(708)
130 POKE 708,A
140 GOTO 90

```

| CHARACTER IMAGE | BINARY REPRESENTATION | HEXADECIMAL REPRESENTATION |
|-----------------|-----------------------|----------------------------|
| | 0 0 0 0 0 0 0 0 | 0 0 |
| | 0 0 0 1 1 0 0 0 | 1 8 |
| | 0 0 1 1 1 1 0 0 | 3 C |
| | 0 1 1 0 0 1 1 0 | 6 6 |
| | 0 1 1 0 0 1 1 0 | 6 6 |
| | 0 1 1 1 1 1 1 0 | 7 E |
| | 0 1 1 0 0 1 1 0 | 6 6 |
| | 0 0 0 0 0 0 0 0 | 0 0 |

Table 2: Internal representation of a character in memory. One character needs 8 bytes to represent it. Although the standard character set is in ROM, the pointer to the beginning of the character set can be changed to point to other memory locations, allowing the user to create a modified or completely new character set.



enjoy the problem-solving power of APL language on your Apple computer

Solve engineering, scientific, or business problems easily--write finished applications software in a fraction of the time you'd take to write similar programs in BASIC, FORTRAN, or COBOL. . . and do it all with your Apple® right at your desk.

Test your language against APL

To compare APL/V80's clear concise code with the language you're now using to solve problems, take this short programming test. Here are three common problems, showing the APL/V80 solution for each. Program your best effort for each problem in the language you use now. Now compare the number of lines and keystrokes needed to achieve a solution in your language to the APL solution. Keep in mind the APL/V80 solution shown contains not only the computation commands, but also every instruction needed to input required data, as well as all the commands to print out the results.

Problem 1:

Write a program to input a list of values (List "A"), sort the list from lowest to highest values, then print all the values in list A in ascending order.

APL/V80 solution:

`A[ΔA+□]`

Solution in your present language:

(Hint: Usually this takes two loops and 15 to 20 statements.)

Problem 2:

Write a program to input a list of values (List "X") and compute the standard deviation for the list values.

APL/V80 solution:

`((+/X-(+/X)÷N)*2)÷N+√1+ρX+□)*.5`

Solution in your present language:

(Hint: This takes at least one loop and about 16 statements.)

Problem 3:

Write a program which will compress adjacent spaces to a single space, with possible multiple occurrences, in a string of characters called TEXT.

APL/V80 solution:

`(1.(~1+T)~1+T+ ' '=TEXT)/TEXT+□`

Solution in your present language:

?

APL is the most concise, powerful programming language available to develop computer solutions for scientific and business problems. Developed in the early 1960's, APL has been used to program large mainframe computers for years. Because APL has so many functions and operators built in, only very large computers could run APL programs until 1977. In 1977, we at Vanguard changed that by introducing APL/V80™, a version of APL for Z80-based microcomputers. We've revised and extended this software now to run on your Apple®.

APL/V80™ for Apples is easy to learn, quick to write. It's a language proven easier to program in than BASIC, COBOL, FORTRAN, or even PASCAL. Because APL can apply a function to a whole array of data, when you store a list of values in an array, a single symbol in APL/V80 can do the work of an entire "DO" or "FOR" loop in other languages. This is programming power!

Concise code saves thinking time

Compactness is part of the reason you can solve your problems so much more quickly using APL/V80 than by using other languages. With far fewer lines of code required, APL/V80 lets you develop functional software, and debug it, in about one-fifth the time you'd need to program your problem in other languages. With APL/V80, you can truly focus your attention on problem-solving, rather than having to worry so much about the details of coding a program to compute your solution.

Finished programs easier to understand

Because APL/V80 programs are so much shorter than programs doing equivalent work in other languages, APL/V80 programs are easier to read and understand, and they require less documentation. When you look at the APL/V80 solutions shown in the box with our language comparison test, don't let the unusual symbols worry you. They may be unfamiliar to you now, but so were the commands in your present language until you learned them. . . and APL is far easier to learn. APL/V80 uses the common mathematical practice of using a single symbol to represent a function, but there are so many functions built into APL there aren't enough

common symbols to represent them all. So APL uses additional symbols to represent those functions which go beyond the familiar mathematical operations. After you learn any language, you use as many abbreviations as you can to save time. APL/V80 lets you use "abbreviations" from your first efforts, saving memory space both in your head and in your Apple. Solve your problems faster

Whether you're an engineer, scientist, educator, or businessman, now you can solve problems faster than ever using your Apple computer. With APL/V80 from Vanguard Systems Corporation, you can search for solutions in a fraction of the time you thought

possible. APL/V80 makes your programs easier to understand, easier to write, easier to explain to others, and easier to modify.

A whole new world of convenience

APL/V80 is more than a language. . . it's a whole new world of convenience for you and your Apple. Included with our APL interpreter are 6 new auxiliary processors to make your life easier. The Utility Processor provides 6502 memory access and 6502 processor calls so you can use routines stored in Apple system ROMs and 6502-dependent peripherals. An Input Stack Processor lets you stack input commands for later execution. Our Communications Processor, when combined with an appropriate modem, lets your Apple communicate with another computer. The Graphics Processor gives you full access to Apple's high resolution graphics. An APL File Processor gives you an indexed file system. Our CP/M** Input File Processor lets you read any CP/M and use it with APL/V80.

Hardware required

APL/V80 for the Apple requires the following hardware for proper use: a 48k Apple II or Apple II+, one disk drive, a Z-80 SoftCard***, and either the Language Card***, or RamCard***, or other compatible 16k memory extension card.

To learn more, act now

No matter how you use your Apple to solve problems, APL/V80™ can help you solve them faster, with fewer errors. If you'd like to know more, send us the coupon below. In the English language, we can hardly begin to tell you in just one page all the ways APL/V80 can help. Ah, if only we could write this in APL/V80 itself. But send us the coupon, and we'll happily send you additional information (in English).

Note: Specifications subject to change without notice.

*Apple design, Apple II, Apple II+, & Language

Card are trademarks of Apple Computer, Inc.

**CP/M is a trademark of Digital Research

***SoftCard and RamCard are trademarks of Microsoft

Contact your local Apple dealer for a demonstration of APL/V80 and get your copy today. If you don't have a local dealer, use this coupon to order direct from us now: Please rush the items ordered below. I understand all items are normally in stock and available for immediate shipment:

- More information about APL/V80 for Apple
- APL/V80™ User's Manual - Enclosed is \$30.
- Complete APL/V80 - Apple Software Package Enclosed is \$500. Please send me an end-user license, object code disk, documentation manual, and special APL character generator.
- Software PLUS RamCard - Enclosed is \$675.
- Software PLUS Z-80 SoftCard - Enclosed is \$850
- Software PLUS Z-80 SoftCard PLUS RamCard Enclosed is \$995
- Complete Hardware - Software system - APL/V80 - Apple Software PLUS Apple II+ 48k computer with APL character generation card already installed PLUS Apple Disk Drive, PLUS NEC 12" video screen PLUS SoftCard PLUS RamCard. Enclosed is \$3195.
- As above with second Disk Drive - Enclosed is \$3695.

Enclosed is my check for \$ _____ Card # _____ exp. date _____

OR Charge to: MasterCard Visa Signature _____

Ship to: Name _____

Address _____ Phone _____

City _____ State _____ Zip _____

VANGUARD SYSTEMS Corp.

6901 Blanco Road
San Antonio, Texas 78216
(512) 340-1978

Check the Osborne Books You

INTRODUCTORY BOOKS

Business System Buyer's Guide

by Adam Osborne and Steven Cook
Purchasing a computer for any business is a complex process, but this book will help. Before you buy any computer, read this book. You'll never make a better investment. #47-0, \$7.95 □

An Introduction to Microcomputers

Volume 0:
The Beginner's Book
by Adam Osborne

Here's the book to start with if you know nothing about microcomputers but wish to learn. Provides the concepts you'll need to understand this technology. #26-8, \$4.95 □

An Introduction to Microcomputers

Volume I: Basic Concepts
by Adam Osborne

The world's best selling textbook on microcomputers uses concepts that are common to all microprocessor systems. Shows what a microcomputer can do, and how it does what it does. This edition is the most comprehensive and up-to-date introduction to microprocessor systems available anywhere. #34-9, \$12.99 □

Running Wild-The Next Industrial Revolution

by Adam Osborne
An insider's look at the microelectronics revolution. Will the coming years prove to be a dream or a nightmare? Running Wild tells the story. #28-4, \$3.95 □

GUIDES

Apple II™ User's Guide

by Lon Poole, Martin McNiff and Steven Cook
Complements your Apple II owners manual. Our guide will tell you more about your Apple II or Apple II plus computer than any other single source. This guide is a complete BASIC programming tool. It covers all the special features of the Apple computer. #46-2, \$15.00 □

PET/CBM™ Personal Computer Guide

by Adam Osborne and Carroll Donahue
A step-by-step guide which takes you from the "on" switch to assembly language subroutines for your Commodore system. It's a BASIC tutorial and covers many recent CBM products. #55-1, \$15.00 □

PROGRAMMING BOOKS

NEW

Science and Engineering BASIC Programs

ed. by John Heilborn
An important collection of the most valuable programs for scientists and engineers. Easily used on most popular microcomputers. #63-2, \$15.99 □

Some Common BASIC Programs

by Lon Poole and Mary Borchers
76 well designed and brilliantly documented programs that solve a variety of problems in statistics, finance, and math.

Generalized BASIC Edition

#06-3, \$14.99 □

PET/CBM™ Edition

#40-3, \$14.99 □

NEW

TRS-80™ Level II Edition

#54-3, \$14.99 □

NEW

Atari™ Edition

#53-5, \$14.99 □

All 76 programs ready to run on:
PET/CBM™ floppy disk
#33-0, \$22.50 □

PET/CBM™ cassette
#25-X, \$15.00 □

TRS-80™ Level II cassette
#32-2, \$15.00 □

Practical BASIC Programs

Here are 40 useful and fully documented programs designed to run on most microcomputers. Especially useful in small business and household applications. (Generalized BASIC) #38-1, \$15.99 □

NEW

Osborne CP/M™ User Guide

by Thom Hogan
The most complete and up-to-date CP/M book you can find. It will make your first use of CP/M easy. If you already own CP/M, it will help you modify your system. #44-6, \$12.99 □

NEW

CBASIC™ User's Guide

by Adam Osborne, Gordon Eubanks and Martin McNiff
Co-authored by Gordon Eubanks, the creator of CBASIC, this is more than a self-teaching textbook, it is the definitive reference of the CBASIC language. #61-6, \$15.00 □

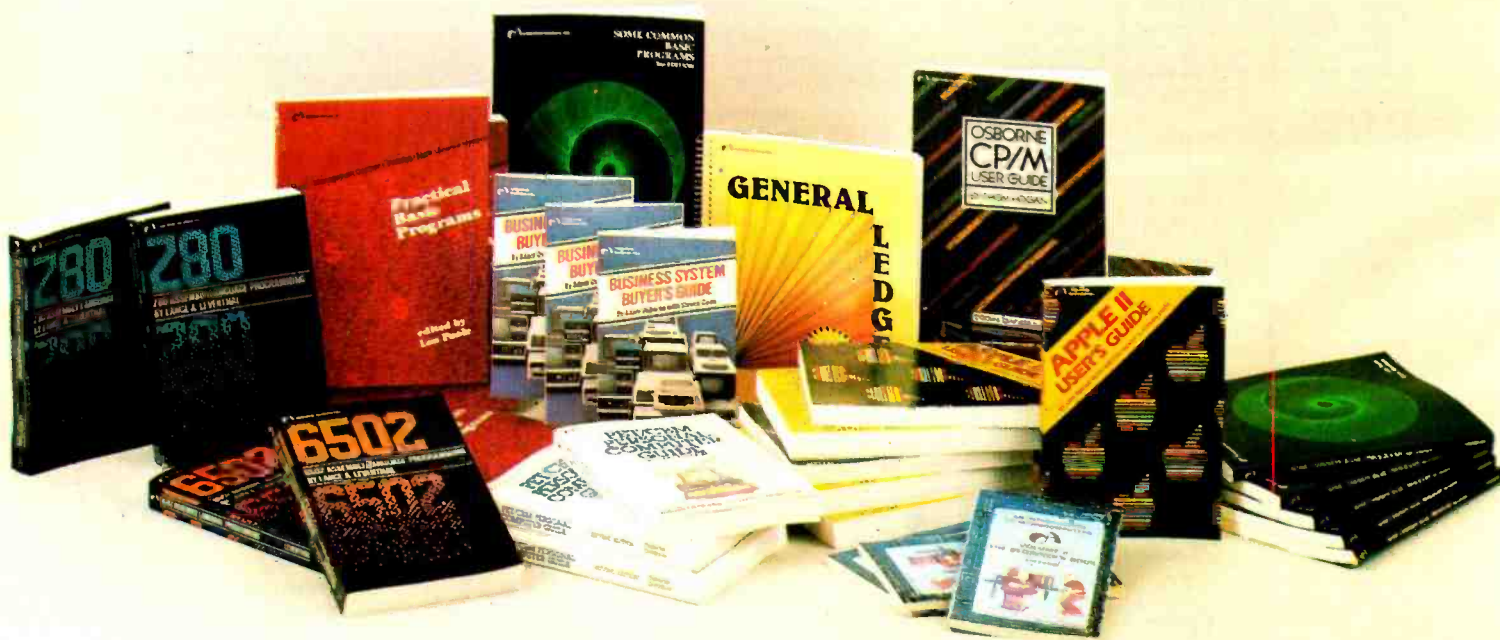

Want

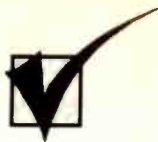

BUSINESS BOOKS

by Lon Poole and co-authors

Osborne's three business systems are renowned for excellence in design and documentation. Our books explain in detail how to use the programs. They contain complete program listings, supporting technical documentation, and specific information on changing and installing the programs.

Payroll with Cost Accounting
#22-5, \$20.00 □

Accounts Payable and Accounts Receivable
#23-3, \$20.00 □

General Ledger
#24-1, \$20.00 □

ASSEMBLY LANGUAGE PROGRAM SERIES

by Lance Leventhal and co-authors

You needn't know anything about assembly language to use these books. Each one is a straightforward, self-teaching textbook that is both precise and easy to understand.

68000 #62-4, \$16.99 □

6809 #35-7, \$16.99 □

6502 #27-6, \$16.99 □

Z80 #21-7, \$16.99 □

Z8000 #36-5, \$19.99 □

6800 #12-8, \$15.99 □

8080A/8085 #10-1, \$15.99 □

The 8086 Book

by Russell Rector and George Alexy

Part assembly language text and part hardware reference, this book covers all of the 8086's most important features.

#29-2, \$16.99 □

NEW INTERFACE

Interfacing to S-100 (IEEE 696) Microcomputers

by Sol Libes and Mark Garetz

Describes the S-100 Bus with unmatched precision. Covers mechanical and electrical design, logical and electrical relationships, bus interconnections, and much more.

#37-3, \$15.00 □



PET and the IEEE 488 Bus (GPIB)

by E. Fisher and C.W. Jensen

Provides chapters on all aspects of the General Purpose Interface Bus. Includes lines, signals, specifications, and much more.

#31-4, \$15.99 □

NEW

Microprocessors for Measurement and Control

by D.M. Auslander and P. Sagues

Learn to design mechanical and process equipment using microprocessor based "real-time" computer systems. This book allows readers (even those unfamiliar with machine or assembly language) to initiate projects.

#57-8, \$15.99 □

MICRO-ELECTRONIC REFERENCES

Osborne 4 & 8 Bit Microprocessor Handbook

by Adam Osborne and Gerry Kane

The one source for complete, objective and accurate informa-

tion on 4 and 8 bit microprocessors. This book describes virtually every 4 and 8 bit microprocessor on the market today and allows you to evaluate any device or combination of devices.

#42-X, \$19.95 □

Osborne 16-Bit Microprocessor Handbook

by Gerry Kane and Adam Osborne

A total reference book on virtually every 16-Bit microprocessor, this book permits objective evaluation and comparison of these new devices.

#43-8, \$19.95 □

An Introduction to Microcomputers: Volume 3 - Some Real Support Devices

by Gerry Kane and Adam Osborne

Available with or without 3-ring binder or updates. Each device is described in detail, including an analysis of the best uses for that device.

Book - #18-7, \$15.00 □
Binder - #19-5, \$6.99 □
Six Updates - #98, \$25.00 □

HANDBOOKS

68000 Microprocessor Handbook

by Gerry Kane

This handbook offers more information about the 68000 than the manufacturer's data sheets.

#41-1, \$6.99 □

CRT Controller Handbook

by Gerry Kane

Describes five devices in the same thorough detail you'll find in Volume 3. Contains 13 tables and 149 separate illustrations.

#45-4, \$6.99 □

8089 I/O Processor Handbook

by Adam Osborne

A complete presentation of the 8089. The 8289 Bus Arbiter is also described with the same careful attention to design and application.

#39-X, \$6.99 □

ORDER FORM

Book Title, Book #, Price

Osborne/McGraw-Hill Dept. B20
630 Bancroft Way, Berkeley, CA 94710

Call Toll Free: 800-227-2895
in California (415) 548-2805



Name _____

Address _____

City/State/Zip _____

Plus: .75/item 4th class \$1.50/item UPS \$2.50/item Air Mail \$10.00/item Overseas
(California residents add applicable tax.)

Total amount enclosed \$ _____ or charge my Visa Mastercharge
Card # _____ Exp. Date _____

GOOD IDEA!

You can save buying wholesale with our buying service. As your agent we will buy computer equipment on the wholesale market for you. Our fee is one fourth of what we save you off list price. Access to over 500 manufacturers. Minimum fee of \$100. Call for present wholesale market conditions.

Examples of total prices paid by our clients (including our fee) are:

COMPUTERS

| | |
|------------------------|----------|
| Alpha Micro 10 MEG | \$12,046 |
| Altos 8000-02 | 2,810 |
| Altos 8000-10 | 6,395 |
| Altos 8000-15 | 4,600 |
| Archive Model 1 | 4,798 |
| Calif. Comp. 64K 1 MEG | 4,414 |
| Compustar Model 30 | 3,820 |
| Cromemco System 3 | 5,990 |
| Ithaca System 2A | 2,790 |
| NEC PC 8001A | 1,010 |
| North Star HRZ2 DD64K | 2,875 |
| North Star HRZ2 QD64K | 3,150 |
| Televideo System 1 | 2,949 |

CRT'S

| | |
|-----------------|-----|
| ADDS View Point | 555 |
| Televideo 910 | 575 |
| Televideo 920C | 720 |
| Televideo 950C | 945 |

DISC DRIVE

| | |
|-------------|-------|
| Morrow M-26 | 3,850 |
|-------------|-------|

PRINTERS

| | |
|-----------------------------------|-------|
| Anadex 9500/9501 | 1,260 |
| C. Itoh Starwriter 125 CPS Serial | 1,450 |
| C. Itoh Starwriter 125 CPS Par. | 1,400 |
| C. Itoh Starwriter 140 CPS Serial | 1,600 |
| Centronics 737 | 710 |
| Diablo 630/RO | 1,945 |
| Malibu 165 | 1,895 |
| NEC 5510 | 2,375 |
| Qume 5/45 RO | 2,465 |
| TI 810 Basic | 1,302 |

Prices subject to change without notice.
15% cancellation fee.

We are buying agents for overseas computer dealers. Export services available.

International Telex 470851

The Purchasing Agent

1635 School Street, Suite 101
Moraga, CA 94556

(415) 376-9020

specify the color register used. Unlike ANTIC modes 6 and 7 (BASIC modes 1 and 2), color-register selection is not made by the character-name byte, but instead by the defined character set. Each byte in the character table is broken into four bit pairs, each of which selects the color for a pixel. (This is why there are only four horizontal pixels per character.) The highest bit (D7) of the character-name byte modifies the color register used. Color-register selection is made according to table 3.

Using these text modes, multicolored graphics characters can be put onto the screen.

Another interesting ANTIC character mode is the lowercase-descenders mode (ANTIC mode 3). This mode displays ten scan lines per mode line, but since characters use

only 8 bytes vertically, the lower two scan lines are normally left empty. If a character in the last quarter of the character set is displayed, the top two scan lines of the character will be left empty. The data that should have been displayed there will be shown on the bottom two lines (see figure 1). This allows the user to create lowercase characters with descenders.

Modified Character Sets

Many interesting and useful application possibilities spring from character-set indirection. The obvious application is the modified font. A different font can give a program a unique appearance. It is possible to have Greek, Cyrillic, or other special character sets. Going one step further, graphics fonts can be created. The Energy Czar computer program

| Bit Pair In Character Definition | Color Register Selected | |
|----------------------------------|-------------------------|--------|
| | D7 = 0 | D7 = 1 |
| 00 | COLBAK | COLBAK |
| 01 | PF0 | PF0 |
| 10 | PF1 | PF1 |
| 11 | PF2 | PF3 |

Table 3: Use of color registers in character definition during ANTIC graphics modes 4 and 5. See the text for details.



Photo 1: A bar chart made using character graphics. Even though each character is eight pixels wide, the horizontal bars can be any number of pixels wide by using redefined characters representing bars of varying width.

OPTIMUM™

BROADEN YOUR HORIZONS

UVEON proudly announces OPTIMUM.™ OPTIMUM is an easy to use, total concept data management program for CP/M® and MP/M™ systems. Breaking through traditional DMS barriers, OPTIMUM provides large scale data management capability to broaden your computer horizons. Developed for individual computer users and applications builders, OPTIMUM supports user-defined forms and files, dictionaries, powerful reporting, storage efficiency, speed and unique cross-referencing. Everything you want in data management is now complete in one system.

USER-DEFINED FORMS AND FILES

With OPTIMUM, implementing an application is simple. The user defines screen forms to fit the data and describes how the data is to be stored. Once this is complete, data entry may begin. Input editing, validation and cross-referencing during data entry extend OPTIMUM's range. If the need exists, OPTIMUM can handle complex or multiple screen forms for the same file. Screen forms may be modified and expanded as needed.

DICTIONARIES

OPTIMUM maintains a dictionary of terms for each file. This dictionary contains information on each data element in the file and describes operations to be performed. Alterations and additions to the dictionary may be made as required.

MICRO-ENGLISH™ REPORTING

OPTIMUM Micro-ENGLISH lets the user request standard or custom reports from the OPTIMUM files. Sophisticated selecting and sorting capability give Micro-ENGLISH all the power of a large scale interactive inquiry processor. A dictionary based vocabulary keeps the user interface simple.

OPTIMUM STORAGE EFFICIENCY AND SPEED

OPTIMUM stores all information in a compact variable-length format. OPTIMUM files are designed for interactive speed; a single file item may be retrieved from among hundreds in an instant.

OPTIMUM DATA CROSS-REFERENCING

A unique feature of the OPTIMUM system allows a user to cross-reference data elements. Once information is entered, it may be retrieved using key words in the data.

From simple applications to complex systems, OPTIMUM manages it all. Broaden your horizons using the total concept data management system with the power of such industry forerunners as Prime Information, Honeywell Ultimate and Microdata Reality. Call or write UVEON today for more information on OPTIMUM. 1-800-525-1637.

CP/M and MP/M are trademarks of Digital Research, Inc.
OPTIMUM and Micro-ENGLISH are trademarks of UVEON Computer Systems, Inc.

UVEON

The Future in Software.

UVEON Computer Systems, Inc.
899 Logan Street
Denver, Colorado 80203



Photo 2: Two views of a war-game map made totally from character graphics. The map is several times larger than the video display, and a player can use a joystick to view different parts of the map. Even though character-sized graphics are used, the scrolling appears to be smooth due to some advanced Atari display techniques.

(sold by Atari) uses a redefined character set for bar graphs. A character occupies eight pixels. This means that bar charts implemented with standard characters have a resolution of eight pixels, a rather poor resolution. Energy Czar uses a special character set in which some of the less useful text symbols (ampersands, pound signs, etc) have been replaced with special bar-chart characters. One character is a one-pixel bar, another is a two-pixel bar, and so on to the full eight-pixel bar. The program can thus draw detailed

bar charts with resolution of a single pixel. Photo 1 shows a typical display from this program. The mix of text with map graphics is only apparent; the entire display is constructed with characters.

In many applications, character sets can be created that show special images. For example, by defining a terrain graphics character set with river characters, forest characters, mountain characters, and so forth, it is possible to make a terrain map of any country. With imagination, a terrain map of a different planet can just

8086 Pascal MT+[®] AVAILABLE NOW

If what you need is more of you...



Pascal/MT+®

With our exclusive SpeedProgramming™ Package

Do you ever wish that you had more good people like yourself when you really have to produce? Pascal/MT+ and the SpeedProgramming™ Package makes you feel like you have an army of workers who know just what to do. With all of the tools we provide you for editing, checking, compiling, debugging and documenting your programs you are able to produce working programs in an amazingly short time. With Pascal/MT+ and SpeedProgramming™ you will never feel short-handed again!

Pascal/MT+ is a total programming system including our native machine code compiler, linker, Pascal-level debugger, disassembler, run-time subroutine library and the exclusive SpeedProgramming™ Package. Used by thousands of companies worldwide, our customers have told us that the Pascal/MT+ system, with its built-in mini-assembler and language extensions, all but eliminates the need for any assembly language programming. The efficient machine code produced by the ISO Standard Pascal/MT+ compiler combined with our extensions to the Pascal language for bit/byte manipulation, I/O port handling, business arithmetic, hardware floating point support along with our exclusive interrupt procedures allow construction of programs ranging from ROM based controllers and operating systems to extensive data base applications.

The Pascal/MT+ System:

- Compiler: Generates ROMable Native Code
- Complete ISO Standard (superset of Jensen & Wirth)
- Powerful Extensions Include:
 - Modular Compilation
 - Direct production of binary relocatable modules
 - Dynamic strings

- Chaining
- Powerful Overlay system
- Address and Size returning functions
- Bit manipulation (test, set, clear, shifts)
- Byte manipulation (high, low, swap)
- Imbedded assembly language
- Easy linkage to external assembly language
- Full NEW and DISPOSE procedures
- Direct access to I/O ports
- Fast floating point, both software and AMD 9511
- Accurate 18 digit BCD (fixed point, 14.4)
- Include files
- Hex literal numbers
- And more...

Linker

- Combines relocatable modules into executable files
- Can generate Hex format for use with PROM programming

Interactive Symbolic Debugger

- Variable display
- High-level breakpoints by procedure/function name
- Tracing/single step by Pascal statement
- Procedure/function entry and exit trace available

FOR: 8080/8085/Z80/8086/68000

Disassembler

- Combines a relocatable module with its listing file to produce interleaved Pascal and approximate assembly language code.

The SpeedProgramming Package™

The SpeedProgramming Package is an integrated set of tools which allows you to create Pascal/MT+ programs, check them for correct syntax and undefined identifiers, format them to display flow of control, and do this all within the editing environment before you ever invoke the compiler. Programmers like SpeedProgramming because it frees them from the time consuming chore of repeated compilations to correct simple syntactic and typing errors. Managers find that SpeedProgramming improves productivity, thereby reducing development costs. SpeedProgramming combined with our field tested Pascal/MT+ package gives you a comfortable, powerful, interactive programming environment in which to create your professional quality software. Your products demand production quality tools. Order Pascal/MT+ with SpeedProgramming today!

Screen Editor

- User configurable
- Standard random cursor movement, file access, search and replace, insert, delete, exchange, etc.
- Structured language editing features such as automatic indent, line adjustment, reading from and writing to a file, block text insertion and duplication.
- Requires: 24 X 80 CRT (or larger), ASCII Keyboard (7 bit data), random cursor addressing.

Interactive Syntax Scanner

- Finds syntax errors in text being edited
- Enters SPEED, puts cursor at error, prints error text

Variable Checker

- Catches undefined and mis-spelled variables before the compiler is invoked

On-Line Reformatter

- Beautify programs in seconds
- Clearly show structure and program flow

Source Code Management Tools

- Automatic Modification Log and Backup utility program

PRICING

Prices and Specifications subject to change without notice

Available Now

- 8080/8085/Z80 Price \$475
- 56K Min CP/M-80
- Compiler requires 150K bytes disk storage
- SpeedProgramming Package™ requires 110K bytes disk storage
- 8086/8088 Requires 128K CP/M-86, MP/M-86 or 86-DOS SYSTEM (116K user area)
- Compiler, Linker, utilities alone Price \$600
- Compiler, etc. with SpeedProgramming Package Price \$800

Coming soon

- 68000 Price (to be announced)
- Initially cross compiler
- Resident compiler to follow
- Available on 8" (3740) single-density Contact distributors for other formats.

OEM INQUIRIES INVITED

MT Micro SYSTEMS

1562 Kings Cross Drive
Cardiff, California 92007 (714) 755-1366



If you have anything to do with small computers, you should be reading the Carl Helmers **PERSONAL COMPUTER LETTER** every month!

You won't want to miss a single issue of the new Personal Computer Letter... a monthly publication of comprehensive studies on issues affecting design, implementation, and applications of small computer systems. The Personal Computer Letter is a journal compiled and edited by Carl Helmers, co-founder and first editor of *Byte Magazine*. Here is valuable information in professionally prepared format about small computers, software, peripherals, trends in the industry, and new ideas. We accept no advertising, and the information provided is available nowhere else. Written for executives, decision-makers, market strategists, product designers and authors in the small computer field, each 12 to 16-page issue contains analysis and design studies by many of the personal computer industry's foremost experts. For example, the current issue covers: **A Voice In The Wilderness:** *Some first reactions to experiments with voice-aided interactive programs.*

Subscribe today. Mail the coupon with your check for \$200 for the next 12 monthly issues. Sample issues at \$25 per copy, applicable to a full year's subscription.



NORTH AMERICAN TECHNOLOGY, INC.

Strand Building
174 Concord St.,
Peterborough, NH 03458
(603) 924-6048

- Enclosed is my \$200 check or money order for the next 12 issues of the Personal Computer Letter.
- Enclosed is my \$25 check or money order for a sample issue, applicable to subscription price.

NAME _____
ADDRESS _____
CITY _____
STATE _____ ZIP _____

as easily be done. When doing this, it is best to define five to eight characters for each terrain type. Each variation of a single type should be positioned slightly differently in the character pixel. By mixing the different characters together, it is possible to avoid the monotonous look characteristic of primitive character graphics. Most people won't realize that the resulting map uses character graphics until they study the map closely. Photo 2 shows two views of a terrain map created with character-set graphics.

You could create an electronics character set with transistor characters, diode characters, wire characters, and so forth to produce an electronics schematics program. Or you could create an architectural character set with doorway characters, wall characters, corner characters, and so on to make an architectural blueprint program.

Characters can be turned upside down by POKEing a 4 into decimal location 755. One possible applica-

tion of this feature might be for displaying playing cards (as in a blackjack game). The upper half of the card can be shown right-side up; with a display-list interrupt, the characters can be turned upside down for the lower half of the card. This feature might also be useful in displaying images with mirror reflections (reflection pools, lakes, etc).

Even more exciting possibilities spring to mind when it is realized that it is practical to change character sets while the program is running. A character set costs either 512 bytes or 1024 bytes; in either case, it is inexpensive to keep multiple character sets in memory and flip between them during program execution. There are three time regimes for such character-set multiplexing: human slow (more than 1 second), human fast (1/60 second to 1 second), and machine fast (faster than 1/60 second).

Human-slow character-set multiplexing is useful for *change of scenery* work. For example, a space-travel program might use one graphics

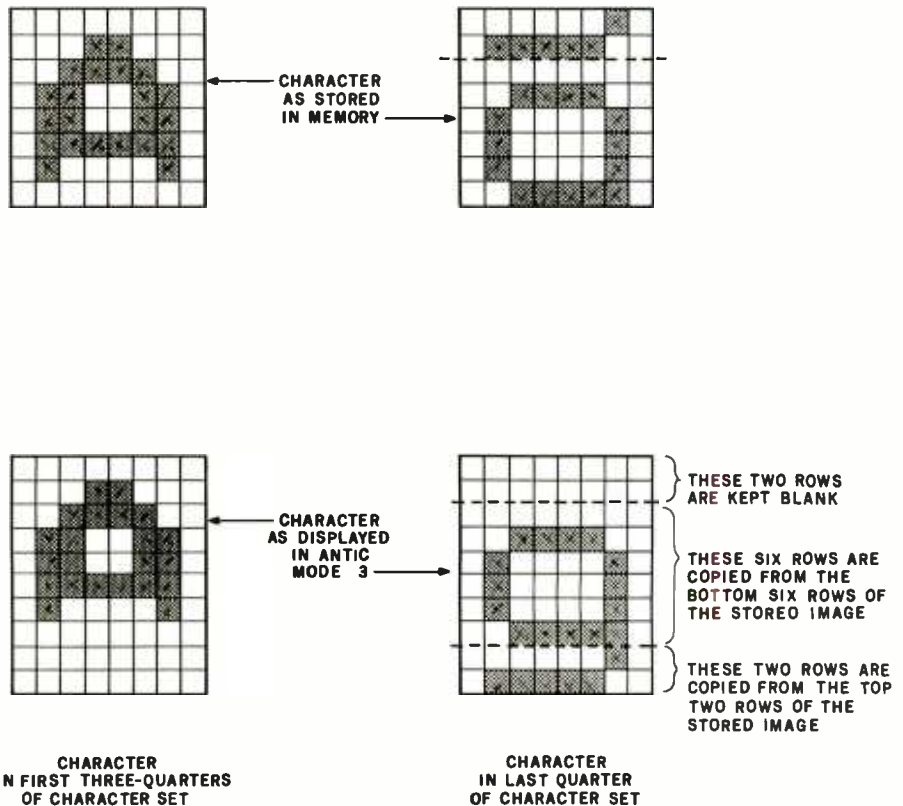

Figure 1: Lowercase descenders in ANTIC mode 3. Using the method shown here, the Atari 400/800 can display characters in an 8 by 10 matrix, even though their internal representation is an 8 by 8 matrix.

SuperSoft's Optimizing



for CP/M

The SuperSoft "C" compiler supports most of version 7 Unix standard "C". Several special and widely desired features are supported, including:

- Macro expansions via the #define statement.
- Include files using the #include statement.
- Inline assembly code is supported with the #asm and #endasm.
- The object code may be ROMed.
- Programs may be ORGed for any location.
- Completely dynamic memory allocation is supported, both by the compiler and in user programs. (That is, the functions 'alloc' and 'free' are provided with the compiler.)

SuperSoft "C" is a two pass compiler. The first pass of the compiler produces an intermediate code (U-code, for Universal code). Pass two contains both the translator and the optimizer. The intermediate code is optimized and assembly code is output to file.

The optimizer typically results in 40% code reduction. This means that compiled object code will run nearly as fast as that which was written in assembler.

An important feature of the compiler is that assembly code is produced. This means that "hand optimization" of critical sections is possible. Also, the inline coder allows easy insertion of assembly language routines.

With the compiler comes the complete source code to the I/O libraries. These libraries are equal to or better than any that exist for the 8080/Z80 computer system.

Functions Included:

| | | | |
|------|-------|-------|--------|
| open | close | read | write |
| seek | tell | fopen | create |
| putc | getc | flush | |

The Seek command supports absolute, relative from front, and relative from end of file. Fopen includes fcreat. Also included with the compiler are numerous sample programs and a complete library of useful functions.

Compile time options include listing file, console output, syntax checking and others.

Requires: 48K CP/M, (more recommended)

"C" compiler: \$200.00

Manual only: \$ 20.00

Z8000 cross-compiler: \$500.00

(CP/M to Z8000 code, requires Z8000 assembler)

Source code for in-house use only: \$5,000.00

CP/M Formats: 8" soft sectored, 5" Northstar, 5" Micropolls Mod II, Vector MZ, Superbrain DD/QD, Apple II+

All Orders and General Information:
SUPERSOFT ASSOCIATES
P.O. BOX 1628
CHAMPAIGN, IL 61820
(217) 359-2112

Technical Hot Line: (217) 359-2691

(answered only when technician is available)

*CP/M registered trademark Digital Research

*Unix registered trademark Bell Laboratories



SuperSoft

First in Software Technology

character set for one planet, another set for space, and a third set for another planet. As the traveler changes locations, the program changes the character set to give exotic new scenery. An adventure-type program might change character sets as the player changes locales.

Human-fast character-set multiplexing is primarily of value for animation. This can be done in two ways: changing characters within a single character set, and changing whole character sets. The Space Invaders game on the Atari 400/800 uses the former technique. The invaders are actually *characters*. By rapidly changing the characters, the programmer was able to animate them. This was easy because there are only six different monsters, each with four different incarnations. High-speed cyclic animation of an entire screen is possible by setting up a number of character sets, drawing the screen image, and then cycling through the character sets. If each character has a slightly different in-

carnation in each of the character sets, that character will go through an animated sequence as the character sets are changed. In this way, a screen full of objects could be made to cyclically move with a simple loop. Once the character-set data are in place and the screen has been drawn, the code to animate the screen would be this simple:

```
1000 FOR I=1 TO 10
1010 POKE 756,CHARBASE(I)
1020 NEXT I
1030 GOTO 1000
```

Computer-fast character-set animation is used to put multiple character sets onto a single screen. This makes use of the display-list interrupt capability of the computer. This topic will be addressed further in a later article in this series.

The use of character sets for graphics and animation has many advantages and some limitations. The biggest advantage is that it costs little RAM to produce detailed displays. A

graphics display using BASIC mode 2 characters (such as the ones in photo 2) can give as much detail and one more color than a BASIC mode 7 display. Yet, the character image will cost 200 bytes, while the map image will cost 4000 bytes. The RAM cost for multiple character sets is only 512 bytes per set, so it is inexpensive to have multiple character sets. Screen manipulations with character graphics are much faster because you have less data to manipulate. However, character graphics are not as flexible as map graphics. You cannot put anything you want anywhere on the screen. This limitation precludes the use of character graphics in some applications. However, many graphics applications remain for which the program need display only a limited number of predefined shapes in fixed locations. In these cases, character graphics provide great utility. ■

This article appears in slightly different form in De Re Atari, published by Atari, Inc, and is reproduced with its express permission.

3 ALTERNATIVE INTERFACES FOR THE TRS-80

COMM-80

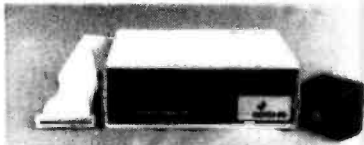

Featured in May/June '80 BYTE

- RS-232-C port (50-19.2K baud) software/hardware selectable
- Centronics printer port 8-bit
- connects to keyboard or E. I.
- chain up to 16 units
- use with E. I. for 2nd printer
- includes terminal software
- only \$179.95 complete

ALL INTERFACES ARE RADIO SHACK HARDWARE AND SOFTWARE COMPATIBLE AND CARRY A 60 DAY WARRANTY INCLUDING PARTS AND LABOR. ALL UNITS INCLUDE USER'S MANUAL, POWER SUPPLY & AUXILIARY TRS-BUS CONNECTOR FOR FUTURE EXPANSION.

DISK-80



Featured in March '81 BYTE

- disk controller (4 drives)
- hardware data separator
- includes 16K of RAM provision for additional 16K
- buffered TRS-bus connector
- real-time clock
- printer port (optional)

ASSEMBLED & TESTED
with 16K of RAM . . . \$329.95
Centronics Printer
Port add . . . \$ 50.00
with 32K RAM add . . . \$ 50.00
DISK-80 pc board . . . \$ 48.00
Printer/Power Supply
pc board . . . \$ 16.00
Complete Kit with 16K
RAM and Printer Port . \$275.00

Dealer inquiries invited.

16S 80 is a trademark of Tandy Corp.

CHATTERBOX

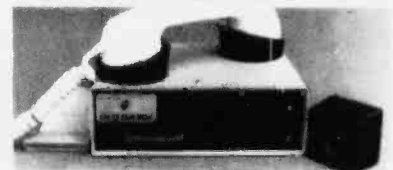

Featured in Aug. '80 BYTE

- 300 baud originate modem
- Centronics printer port 8-bit
- RS-232-C port (50-19.2K baud)
- connects to keyboard or E. I.
- received data automatically routed to printer ports
- includes terminal software
- only \$279.95 complete

Call 1-800-645-3479, in N.Y. 1-516-374-6793

or write: The MicroMint Inc.
917 Midway
Woodmere, NY 11598





**THE NEW
FLIP/FLOPPY™ DISK
with twice the byte**

OMNI is pleased to bring you a **reversible** 5¼" mini diskette...the FLIP/FLOPPY DISK. Now you can record on both sides for twice the storage capacity of a single sided disk. And you'll be able to do it far more economically, too!

Each OMNI FLIP/FLOPPY DISK incorporates all of the quality features you'd expect from the very best single sided disk.

- Two recording surfaces
- Two sets of WRITE ENABLE notches
- Two index holes
- Reinforced **HUB RINGS**
- Certified error-free operation at more than twice the error threshold of disk drives
- Over 12 million rated passes without disk related errors or significant wear, for extra long life operation
- Available in Soft or Hard sector
- Compatible with most 5¼" disk drives including APPLE, TRS-80, PET, OHIO SCIENTIFIC, ZENITH, NORTH STAR, and many more.

OMNI Resources

4 Oak Pond Avenue • Millbury, MA 01527 • 617-799-0197

**Call TOLL-FREE: In Mass. 1-800-252-8770
Nationwide 1-800-343-7620**

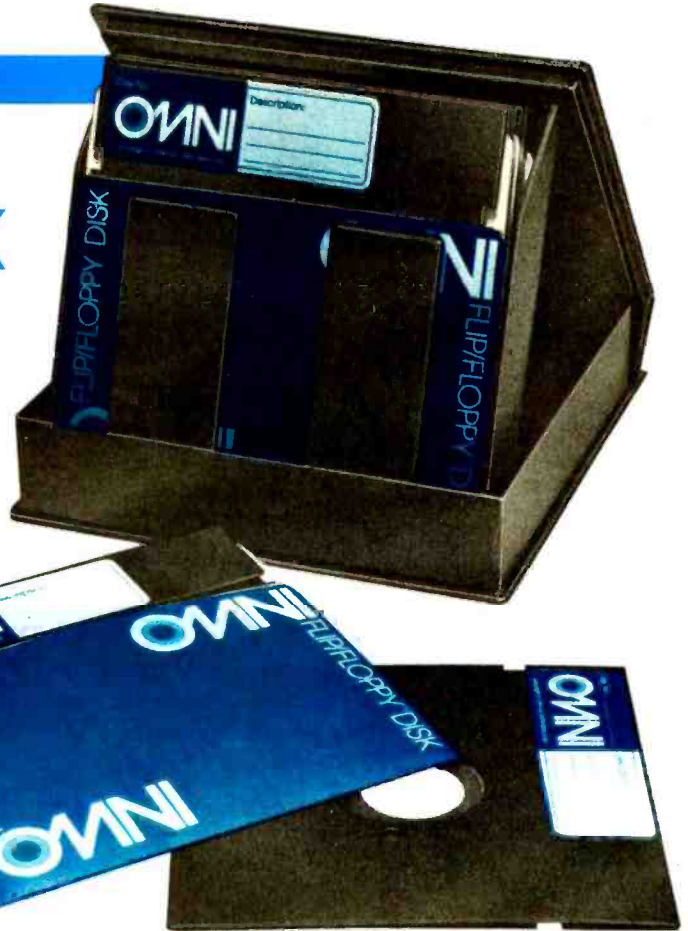

INTRODUCTORY OFFER

Order the OMNI FLIP/FLOPPY DISK at this special introductory price:

Five Pack...\$21.00

Equivalent to ten single-sided disks.

Ten Pack....\$40.00

Equivalent to twenty single-sided disks.

Circle 277 on inquiry card.

Please send me the following OMNI FLIP/FLOPPY DISK(s)

_____ Five Pack(s) @ \$21.00 each = \$ _____
 _____ Ten Pack(s) @ \$40.00 each = \$ _____
 _____ Library Case(s) @ \$3.00 each = \$ _____
 Shipping and handling \$ 1.50
 TOTAL \$ _____

Check made payable to OMNI RESOURCES C.O.D.
 Mastercard
 Account Number _____
 VISA/BankAmericard
 Account Number _____
 Credit Card Expiration Date ___/___/___

Name _____
 Address _____
 City _____
 State _____ Zip _____
 Phone Number (____) _____

Authorized Signature _____

Massachusetts residents add 5% sales tax

Money back guarantee if not completely satisfied

Atari's Telelink I

Glen Flint
14219 Pierce Pl #41
Omaha NE 68144

Telelink I is a program cartridge for the Atari 400 or 800 personal-computer system that lets you access data bases, electronic mail, and other services offered by information utilities such as The Source and CompuServe. You must have the Atari 850 interface module and an Atari 830 modem, or the equivalent, to use Telelink I. One of Atari's printers, Atari 820, Atari 822, or Atari 825, may be used.

Telelink I comes with a well-prepared five-page manual explaining the use of the cartridge. Following a general introduction, the manual explains how to hook up the modem, telephone, and printers. It also describes some of the options for controlling the printers, the width of the screen, and the word or the character mode (which will be explained later). There are lists of what will be transmitted by each of the keys on the keyboard. Some

special control-character combinations send ASCII (American Standard Code for Information Interchange) characters not available on the Atari 400 and 800 keyboards. (For example, a Control-[sends a {.) A list of definitions of several data-communications terms is also included. Finally, the manual lists the ASCII character set with the decimal and hexadecimal values of each character. The meanings of the ASCII control characters are also given.

An offer to sign up with CompuServe and receive one hour of free time on Micronet is included when you buy Telelink I. Micronet has several services that may be of interest to the Atari user: one is the monthly Atari newsletter. Another service is a CB (citizen's band) radio simulator. Users can enter the CB simulator and talk with computer users across the country.

At a Glance

Name
Telelink I

Type
Communications utility

Manufacturer
Atari Inc
1346 Bordeaux Dr
Sunnyvale CA 94086
(800) 538-8547; in California
(800) 672-1404

Price
\$19.95

Format
Computer program cartridge
(read-only memory)

Language
6502 assembly language

Computer
Atari 400 or 800 computer
with an Atari 850 interface
module and an Atari 830
modem (or equivalent)

Documentation
5 pages, 8½ by 11 inches

Audience
Individuals wishing to use
information utilities and
timesharing networks

Control Features

Pressing Control-8 changes the width of the screen from 38 characters to 40 characters. Control-0 toggles between word mode and character mode. The character mode splits words at the edge of the screen; the word mode, which moves a word to the next line rather than splitting it, improves the readability of the text on the screen. This is also known as word wrap.

Atari's printers can be used with Telelink I to provide hard copy of a terminal session. Telelink I reserves a 1.5 K-byte buffer for the printer. This buffer can be printed automatically or under direct user control with the Select key. In the automatic mode, 1 K bytes of data are collected in the buffer, then an ASCII XOFF is transmitted to the sender. (XOFF is an ASCII control character meaning "stop sending data.") At this point, Telelink I stops looking for data from the modem and begins printing the information stored in the buffer. When the buffer

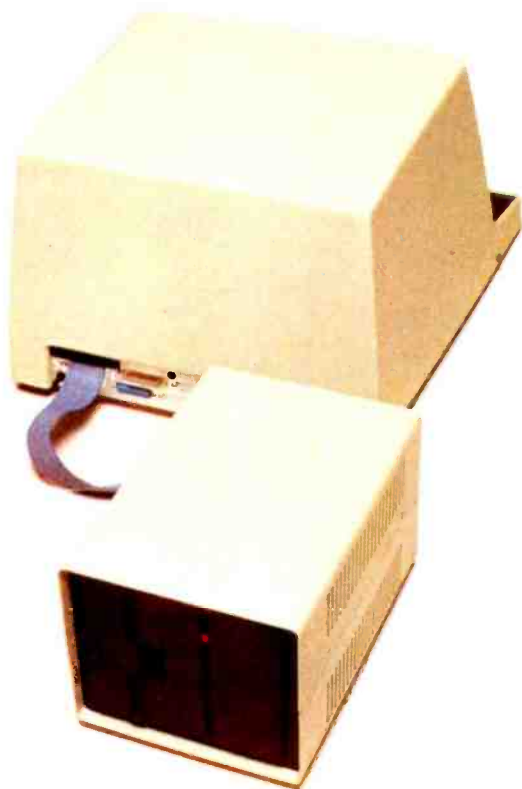

**"And in conclusion,
I'll only use
my exceptional powers
for the good of mankind."**

"That's a vow all we Vector 3005s make. And it's not one we make lightly.

"After all, being the only product on the market with a Vector 3 terminal, a 5¼" floppy, and a 5¼" Winchester rigid disk drive that provides 5 megabytes of storage is quite a responsibility. It used to take 20 floppies to give you that kind of capacity.

"Our powers don't stop there, however. Each 3005 also comes with a 32-bit error-correcting code — the first time sophisticated IBM-style technology has been available on a small business system. This lets us detect and correct errors, and almost completely eliminates data loss on disks due to dirt, wear, or damage.

"All this makes us pretty awesome, all right. But there's more. When coupled with Vector's MEMORITE III and EXECUPLAN software packages, we give you a 30,000 word dictionary, the ability to create your own phrase library, a teaching manual right on the screen, pass word security, plus a host of other word processing capabilities as well as financial planning, forecasting and basic accounting.

"And we're reliable. Our powers won't diminish, our abilities won't fade, and dedication to mankind won't weaken.

"For more information and your nearest dealer, call Vector at 800-423-5857. In California, call 800-382-3367. Or write to them at 31364 Via Colinas, Westlake Village, CA 91362.

"Thank you all for coming today. And I hope we'll have the chance to do business together in the future."

VECTOR
VECTOR GRAPHIC INC.

COMPUTERS FOR THE ADVANCEMENT OF SOCIETY.

ALTOS BUSINESS C



**Now—A four station,
hard disk business computer
with letter quality printer,
terminals and get-rolling
software for less
than \$15 a day.***

Introducing the Altos Business Computer Special. The most powerful, reliable, easy-to-use system in its price range. And Altos now offers on-site, nationwide service.

The hardworking engine of our system is the Altos ACS8000-10 computer. It can cost-effectively hook-up with from one to four stations, as your needs demand. Its rapid access, 10 MByte Winchester hard disk is capable of storing a 3,000 page load.

*Price approximate and may vary in your area. Daily lease based on: \$17,000 principal, 20% annual interest, 5-year term. Includes: Altos ACS8000-10 computer, letter quality printer, four precision terminals and get-rolling software. Does not include tax, installation, training and maintenance.

COMPUTER SPECIAL



Our get rolling business software package includes multi-user systems software, Wordstar™ for word processing and Microplan™ for business analysis. And when you need more, your local Altos representative can route you through to hundreds of other business and accounting programs, to meet virtually any requirement. Plus Altos also lets you communicate with other computers, mainframes, and even allows networking.

Get on the right track! Join thousands of professionals, institutions and businesses who rely on Altos computer systems. Call our toll free number or write today for the Altos sales and service depot nearest you.

All aboard!

**Packed with
fresh ideas
for business**

ALTOS
COMPUTER SYSTEMS

2360 Bering Drive
San Jose, California 95131

800-538-7872
(In Calif. 800-662-6265)

Wordstar is a trademark of MicroPro International Corp.
Microplan is a trademark of Chang Laboratories, Inc.
© 1981 Altos Computer Systems

Circle 17 on inquiry card.

Buy with Confidence from the best

GREAT PRICES, GREAT SERVICE, GUARANTEED
COMPUTERS, PRINTERS, TERMINALS

Apple
IEEE-488
card now
available

CALL TOLL FREE: 1 800 421-1520
In Calif. 213 320-4772

COMPUTERS



Apple Computers
Disk drives, accessories
software, graphics tablets.
CALL FOR BEST PRICES



**HEWLETT
PACKARD**

Whether you want their great
computer or a wide selection of
computer calculators-we have them
HP-85 - Retail \$3250
Only \$2475

Call us for great prices:
**Altos, Atari, NEC,
Zenith and other
computers**

PRINTERS - MONITORS

MONITORS
BMC & NEC Green Screen
NOW IN STOCK

EDUCATORS
We have the CORVUS
systems to hook up several
Apple computers at once!

NEC & DIABLO PRINTERS
Anadex, Paper
Tiger. CALL
for latest prices



NEW
MX 100 &
MX 80 F/T



The new 136
column Epson
printer with graphics and the
Friction/tractor MX 80 are in
stock. WE HAVE THE GRAPHIC
PACKAGE FOR MX 80. call.

SILENTYPE PRINTER
ONLY \$284.00

Computer furniture too

ACCESSORIES - SOFTWARE

SOFTWARE

Amazing Mountain Hardware
CPS Multi-function card
ALL IN ONE:
Parallel/Serial/Clock/Calen

Visicalc 3.3 \$175/Reg. \$199
BPI GL/INV/AR/etc 299/Reg. 399
Tax Preparer by Howardsoft ... 79/Reg. 99
Real Estate Analyzer,Howardsoft 125/Reg. 150
Creative Financing, Howardsoft 125/Reg. 150
ASCII Express II by SDS..... 55/Reg. 65
Z-TERM (CPM) (16 sector) 85/Reg. 100
TRS 80 & ATARI SOFTWARE TOO

PLOTTERS
Bausch&Lomb plotters
for your computer by
Houston Instruments...
CALL!

MICROSOFT 16K
Ramcard \$155

CALL TOLL FREE

1(800)421-1520
in Cal (213)3204772



104/1
5 1/4" Disks only 3.95

Visit our retail store:
Net Profit Computers
521 W. Chapman Ave
Anaheim, Cal. 92802
714 750-7318

Mail orders ONLY:
NET PROFIT COMPUTERS
2908 Oregon Court, Bld G1
Torrance, Ca 90503
1(800)421-1520
in Cal: 213 320-4772



Cal residents add 6% sales tax. Minimum shipping and handling charges are \$3.00. Mstch, Visa, Amex prices slightly higher on sale items. Store prices differ

is empty, Telelink I transmits an XON to the sender. (XON is an ASCII control character meaning "start sending data.") Once the buffer has been filled, this process is repeated. All this is automatic and is handy for copying information to the printer when no user interaction is required.

In the nonautomatic mode, data is received until 1 K bytes of data have been stored in the buffer. At this point, the keyboard begins to make a clicking noise, signaling that the buffer is nearly full. The user must do whatever is required by the communications protocol currently in use to stop the transmission of data. (Due to the serial data transmission on the Atari 400 and 800 peripheral bus, the Atari 850 interface module cannot share the bus with any other peripheral device, including the printer.) To print data, the Atari 850 must not be attempting to transmit or receive data. Telelink I causes the Atari 850 interface to cease monitoring the communication link for incoming data while printing the contents of the buffer. If the transfer of data is not stopped, the data that was received during printing will be lost.

Once the transfer has been stopped, the Select key may be pressed, and the contents of the buffer will be printed. When the contents of the buffer have been printed, the user should send the character(s) required to resume transmission of data. Another buffer will be filled and can be printed by repeating the procedure.

The options provide means to configure Telelink I to your needs. Pressing System Reset will set all of the options back to their default values. Although the automatic printer feature would be convenient, the two networks I tried, Compuserve (through Tymnet) and HDR Systems Inc (in Omaha, Nebraska), didn't respond to the XON and XOFF control characters. The nonautomatic mode will have to be used in cases where the host computer does not recognize XON and XOFF.

When an option is changed, the change is printed on the screen. Perhaps it would have been more helpful to reserve one line of the screen to show all the status information continuously. This would make it easy to determine exactly what mode the printer is in at any time. Another helpful feature Atari could have added is the ability to select local echo of keyboard input, rather than depending on the host computer to send back each character it receives.

Conclusions

- The Telelink I cartridge provides an easy way to turn your Atari 400 or 800 computer into a terminal for dialing into information utilities and timesharing networks such as The Source and Compuserve.
- The printer-control features make the cartridge valuable for an Atari system with a printer. The ability to get a hard copy of a terminal session is a definite plus.
- For an Atari system without a printer, the decision may be harder. A simple program to emulate a terminal using GET and PUT (in Atari BASIC) was given in the February 1981 *Compute*. The word mode is a nice feature and probably makes the cartridge worth the extra expense. ■

SYSTEMS KICKER.

Reliability, price, and a performance kicker that leaves other 8-bit systems far behind. Real-time hardware vectored interrupts and the DASIS multi-user OS for an economical system that rivals 16-bit performance. CP/M is included. Floppy disk and hard disk subsystems, terminals, printers, board-level modules — all part of CCS full S-100 product line. A product line brochure is yours for the asking.

CP/M is a trademark of Digital Research.
DASIS is a trademark of Power One Systems.



California Computer Systems

250 Camobear Drive
Sunnyvale, California 94086
(408) 734-5811
Telex 171059 CCS SUVL

MAKING MINK OUT OF MICROS.

Local-Area Networks

Possibilities for Personal Computers

Dr Harry J Saal
Nestar Systems Inc
2585 E Bayshore Rd
Palo Alto CA 94303

Today's technical press is filled with announcements of "local-area network" products and "personal computers." New technologies from billion-dollar corporations are being rivaled by products from small firms, in a field no more than a few years old. This article provides an overview of local-area networks and how they relate to personal computers.

Defining local-area network is every bit as difficult as defining personal computer. Features, prices, and technology are distributed across a broad spectrum. Thus, we will try to describe the distinguishing characteristics of a local-area network—how to know one when you see one—and discuss some related system designs that are not local networks, but address many of the same requirements.

Personal Computers and the Group

The revolution in computer systems began with dramatic advances in silicon technology that greatly reduced the cost of the "computing" part of a computer system. Before this, CPU (central processing unit) cycles were a valuable and scarce resource; whole industries grew up developing hardware and software techniques to squeeze out

the last bits of efficiency from big mainframes. Learned papers on how to salvage another two percent of processing time dominated computer conferences. People gathered in computer centers (hospital-like environments with air conditioning, raised white floors, and observation galleries). Then, suddenly, all that changed.

The cost of the CPU is no longer the dominant concern. Instead, electromechanical devices such as disks, printers, terminals, and cables generally cost more than the entire central processor. As the prices of these peripheral components drop, the time people spend using the systems becomes more important. We need rapid access to information; we need to review alternatives "on-line" to make decisions quickly. Our computer systems must respond to our needs and schedules, not the other way around.

The personal computer is dedicated to providing this environment. It is ready for work when we want to use it. It is typically dedicated to one person (or task) and not shared with other people. Although timesharing systems attempted to give the user the illusion of a dedicated computer, they failed because inevitably the load

presented by numerous users slowed them down. A personal computer, on the other hand, responds equally well at any time of day. We no longer need to worry about the "wasted cycles" if we simply leave it on our desks just blinking its cursor. The hallmark of the personal computer is this "one person, one computer" approach.

While having to share a central processor may not be justified for many of today's computing needs, information sharing is as important as ever. Once two or more people begin to work cooperatively, they need to communicate and exchange information, whether the impetus be the joint development of a large program, several people checking on information in a common data base, or the implementation of an electronic mail system.

Sharing of larger and more reliable peripheral devices is equally important in all but the smallest computer applications. We can't all have our own letter-quality printer in our office, though we may need access to one. Large libraries of programs or extensive data bases require larger disks than those normally connected to personal computers. Their cost (and reliability) is much higher than

SuperSoft's Gallery of CP/M Masterworks



| | |
|------------------------------|------------------|
| Programming Languages | Disk/Manual Only |
| "C" | \$200/20 |
| FORTH | \$200/25 |
| FORTRAN IV | \$250/25 |
| RATFOR | \$100/NA |
| BASIC | \$200/25 |
| 'TINY' PASCAL | \$ 85/10 |
| System Maintenance | |
| Diagnostics II | \$100/15 |
| Diagnostics I | \$ 75/15 |
| DISK DOCTOR | \$100/15 |
| Utilities | |
| Utility Pack #1 | \$ 60/NA |
| Utility Pack #2 | \$ 60/NA |
| Text Processing | |
| TFS | \$ 85/15 |
| Super-M-List | \$ 75/10 |
| Software Security | |
| Encode/Decode II | \$100/20 |
| Encode/Decode I | \$ 50/20 |
| Intercommunications | |
| TERM | \$150/15 |
| TERM II | \$200/15 |
| Entertainment | |
| ANALIZA | \$ 35/NA |
| NEMESIS | \$ 40/NA |
| Dungeon Master | \$ 35/NA |
| (For use with Nemesis) | |
| Miscellaneous | |
| Z8000 Cross-Assembler | \$500/25 |
| "C" Cross-Compiler | \$500/25 |
| (Z8000 Target) | |

TERM

A Complete Networking/Intercommunications Package

TERM allows the CP/M user to communicate with other CP/M based systems or with remote timesharing computers. TERM supports file transfers between both timesharing systems and between CP/M systems.

TERM equals or exceeds comparable programs in power and flexibility, but costs less, delivers more and *source code* is provided on discette!

With TERM you can send and receive ASCII, HEX and COM files. You also have a conversational mode, and a timesharing terminal emulator. Below is a partial list of features:

- Engage/disengage printer
- auto error checking with re-try
- conversational mode
- send files
- terminal emulator
- receive files

requires 32K CP/M and a minimal knowledge of assembly language programming.

TERM is supplied with source and user manual: \$150.00
Manual only: \$15.00

TERM

Many programs include SuperSoft's online "HELP" system!

SUPERDISKS FOR SALE!

SuperSoft Has Great Prices on Blank Discettes

SuperSoft sought out and found a discette that met our high standards. In the software distribution business we needed a discette that was reliable, sturdy, durable, and inexpensive. We wanted no data errors on any discette that we shipped.

- **Guaranteed**
- **Data density in excess of 3200 b.p.i.**
- **Approved by Shugart, Persci, Qume, Remex, others**
- **Operating temperature: 50-120 degrees Fahrenheit**

| | |
|---------------|---------------|
| Discette type | price per box |
|---------------|---------------|

| | |
|-------------------------------------|---------|
| <u>Single Sided Single Density:</u> | |
| Soft sectored IBM compatible 8" | \$30.00 |
| 10 hard sectors 5 1/4" | \$30.00 |
| 16 hard sectors 5 1/4" | \$30.00 |

| | |
|-------------------------------------|---------|
| <u>Single Sided Double Density:</u> | |
| Soft sectored IBM compatible 8" | \$35.00 |
| 10 hard sector 5 1/4" | \$35.00 |
| 16 hard sector 5 1/4" | \$35.00 |

* Add \$15.00 for Double Sided Discettes
Illinois residents add 5%
Add \$1.00 shipping per box

All SUPERDISKS are sold only in lots of 10. Each comes with jackets and box. All orders must be prepaid or C.O.D. Generally we ship from stock with arrival times running about 8-10 days.

For complete information on these and all other SuperSoft products, please write for our free catalogue.

All software can be supplied on the following media:
CP/M formats . . . 8" sft sectored, 5" Northstar,
5" Micropolis Mod II, Vector MZ, Superbrain DD/QD,
Apple II+



All Orders and General Information:
SUPERSOFT ASSOCIATES
P.O. BOX 1628
CHAMPAIGN, IL 61820
(217) 359-2112
Technical Hot Line: (217) 359-2691
(answered only when technician is available)

*CP/M REGISTERED TRADEMARK DIGITAL RESEARCH
SSS FORTRAN is the copyright of Small Systems Services, Urbana, Illinois

24 hour express service available!

SuperSoft

First in Software Technology

Prices subject to change without notice

The Converter that transforms your electronic typewriter into a computer printer.



- ▶ No modifications to the typewriter
- ▶ Does not affect normal typewriter functions
- ▶ All typewriter functions accessible by computer
- ▶ RS232C, IEEE and parallel interfaces available
- ▶ KSR version turns typewriter into a computer terminal
- ▶ Fully assembled, tested and burned in

NEW! NOW AVAILABLE

OLIVETTI PRAXIS 35
TYPEWRITER
+
CONVERTER TP35 =
DAISY WHEEL PRINTER
FOR LESS THAN \$1000.

Prices start as low as \$275.
CONTACT YOUR LOCAL
OFFICE EQUIPMENT DEALER
OR
VERTICAL DATA SYSTEMS INC.
FOR FURTHER DETAILS.



Vertical Data Systems Inc.
1215 Meyerside Dr., Unit 2A,
Mississauga, Ontario,
Canada L5T 1H3
(416) 671-1752

Dealer inquiries invited

the stripped-down "consumer" variety offered by most personal computers.

Multiuser Systems

Personal computer networks preserve the independence of each computer work station while offering the possibility of sharing information and devices among the individuals on the network. Networks are useful in almost all situations where several people need to work together and share information, but still want the attractive features of the dedicated personal computer.

Of course, we can satisfy the multiuser requirements in a more traditional way, too. A number of companies offer shared multiuser systems based on a single microprocessor. Digital Research's MP/M system permits up to sixteen users to share a common microprocessor and its peripherals. MP/M is a derivative of the popular CP/M operating system that permits applications written for that environment to function for multiple users. Onyx's C8000 is a multiuser system based on the Zilog Z8000 microprocessor running the Western Electric UNIX operating system.

Multiuser systems are fundamentally similar to timesharing systems of the past. Users may be happy with the performance as long as the demands on the single processor are low, but they share one of the great weaknesses of central computer systems in that if the processor should fail, everyone loses his work and has to wait until the system is repaired or restarted. And because of the statistical nature of the sharing of the processor, things we take for granted in personal computers, such as real-time graphics and instantaneous response to keystrokes, are sacrificed.

Networks, Networks, Networks

Until five years ago, a computer-communications network generally meant a connection of a large number of terminals, geographically distributed throughout a company or across the country, to one or more central computers.

Anyone using The Source or Com-

puserve (Micronet) uses such a network. The terminal is connected by telephone to a nearby communications processor, which takes the fairly low-speed information (30 to 120 characters per second) going to or from your home and merges it with the data of other local users. These communications processors are connected together by much higher speed lines from city to city. The data are put into groups, called *packets*, with routing information and error-detecting fields appended, and sent from site to site until the packets arrive at a processor connected to a large time-sharing system. (Western Union's Telex and TWX services are other examples of international low-speed networks.) These networks process information at speeds appropriate for humans typing or reading data from a screen. Loading a 16 K-byte program or operating system takes over nine minutes at 300 bps (bits per second); the same load would take under one second from a local floppy disk.

Some networks are used to connect computers rather than terminals. They run at much higher speeds and transmit large files, documents, and electronic mail between systems. But even these nets don't have the bandwidth required to allow modern storage devices to operate at full speed, and are not acceptable for the interactive transmission of program and data files in real time.

Device Sharing

There are a number of systems on the market that permit each user to have his own dedicated computer and share disks or printers, but which are not truly computer networks. Several recent products permit numerous independent microprocessor boards and separate memory to be installed in one chassis. One of these boards is generally reserved for shared access to one central disk subsystem or printer. A terminal is attached to each processor, so each user on the system actually has a dedicated microprocessor.

Such a system is quite attractive, but certain inherent disadvantages still remain. The chassis is large, needs a big power supply and large

Easy on your eyes and your budget.

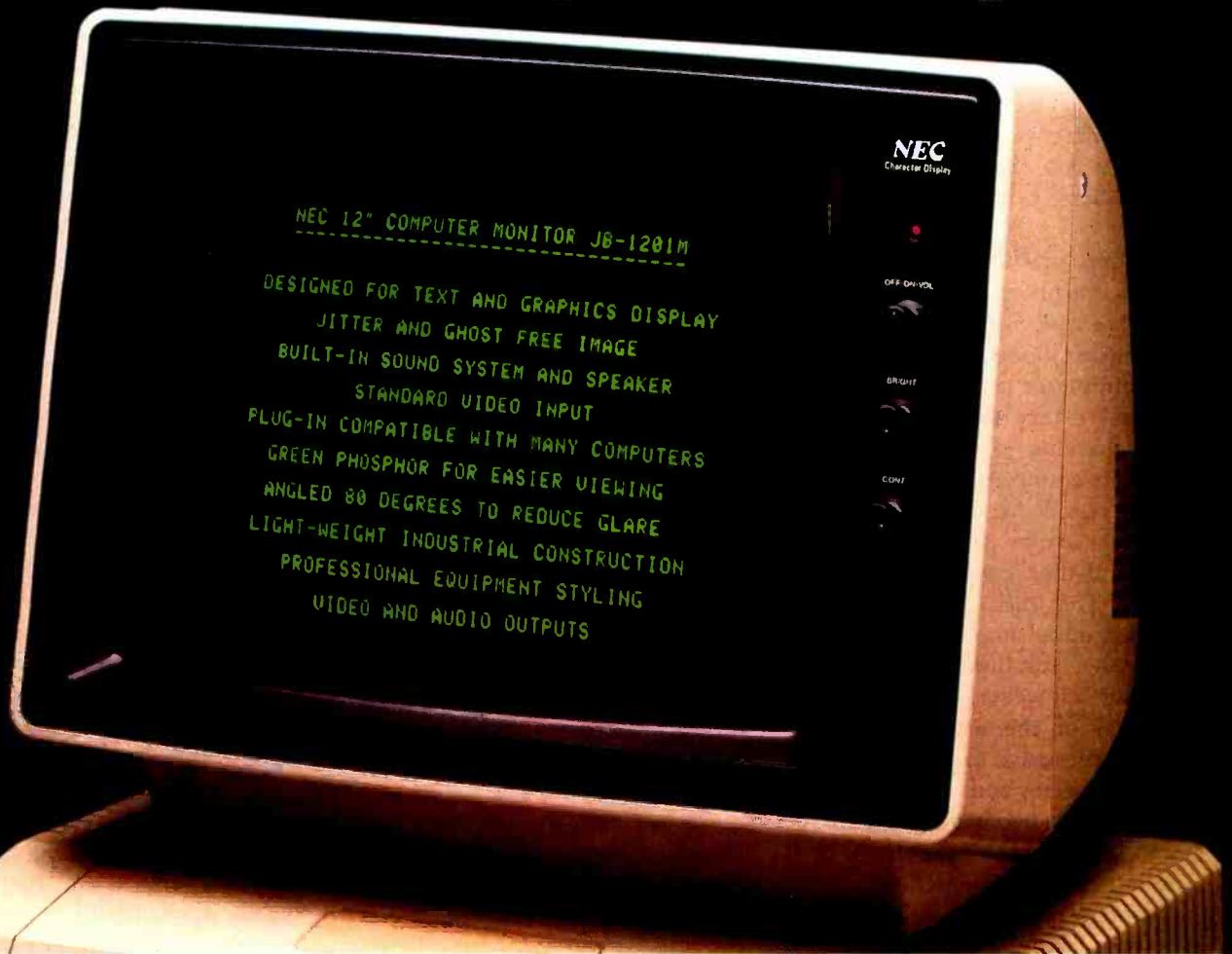

NEC 12" COMPUTER MONITOR J6-1201M
DESIGNED FOR TEXT AND GRAPHICS DISPLAY
JITTER AND GHOST FREE IMAGE
BUILT-IN SOUND SYSTEM AND SPEAKER
STANDARD VIDEO INPUT
PLUG-IN COMPATIBLE WITH MANY COMPUTERS
GREEN PHOSPHOR FOR EASIER VIEWING
ANGLED 80 DEGREES TO REDUCE GLARE
LIGHT-WEIGHT INDUSTRIAL CONSTRUCTION
PROFESSIONAL EQUIPMENT STYLING
VIDEO AND AUDIO OUTPUTS



This high quality professional computer monitor provides sharp, clear display of up to 80 characters by 25 lines of text, making it ideal for word processing as well as standard business applications.

Lightweight industrial grade construction gives maximum portability with reliable operation.

Color monitor also available for Apple®, Atari® and other popular computers. See your authorized NEC America Dealer.

Apple is a registered trademark of Apple Computer, Inc.
Atari is a registered trademark of Atari Inc.

80 character display makes it ideal for word processing and scientific applications.

NEC

NEC America, Inc.

1401 Estes Avenue
Elk Grove Village, IL 60007

cooling capacity, and if any module fails, the entire system, generally, is down. There is no way to add more stations while the system is running, and the terminals can't be located very far from the main processor unit. Each processor must communicate with the others through the common-service processor. They cannot directly exchange information, nor can they have their own private disks, printers, modems, and the like.

Another product for multiuser, independent-processor sharing of a disk is the *disk multiplexer* (the Corvus Constellation is an example). A disk multiplexer can be likened to a very fast rotary switch that cycles around looking to see if any of the computers connected to it wish to do a disk access. When it finds a request, it reads or writes the particular disk sector and then goes on to the next station. The disk multiplexer approach is quite simple and can be an inexpensive solution for many applications. However, due to the very low level of the requests that are typically presented to the multiplexer (eg: read a sector and write a sector) it is generally limited in dealing with the more sophisticated problems that arise in multiuser interactions.

A more sophisticated interface with a powerful software base is needed for complex applications. Like the

multiprocessor systems previously described, there is no way for separate stations to communicate directly. They must send their information to the multiplexer, where it goes to disk, or may be temporarily buffered in memory. If the central disk or multiplexer fails, all work comes to a halt.

Networks Without Software

One of the central themes of a computer network is communications. A large number of companies now offer computer networks that provide the ability to transmit data from station to station, but do not address the questions of the necessary operating system, programming language, and applications software needed to make use of these networks. Basically, these units are peripherals with low-level drivers that permit data exchange. While they are suitable for those installations that have the necessary system-programming talent to design, modify, and implement the changes needed to take advantage of this facility, we will be focusing on integrated computer-network systems. Very few vendors are willing to step up to the complex software tasks inherent in blending these technologies into a coherent system design.

Both Digital Research and 3COM provide software without a network. Digital Research's CP/NET system

permits up to sixteen stations on a host. These stations share the data and devices on that central host. CP/NET is written without any particular network communication devices in mind. Each hardware vendor may select a particular technology and protocol to connect the work stations to the host. But although CP/NET provides a framework for multiuser software based on the familiar CP/M environment, due to the lack of support for applications in the languages and systems running under CP/NET, many companies have chosen to develop their own variant of CP/M with their own sharing protocols.

3COM's UNET is a package written for the UNIX environment. It is a software implementation of a government-standard intercomputer protocol, called TCP; it, too, leaves open the question of how the computers are actually connected, and application programs must explicitly deal with the network in a nontransparent fashion.

Attributes of a Local Network

A local-area network can be described as a communications network that covers a limited geographical area. Just what "limited" means varies substantially, from 0.1 km (approximately 328 feet) to 10 km (approximately 6.2 miles). Data rates on

APPLESCOPE

Interface for the Apple II Computer

The APPLESCOPE system combines two high speed analog to digital converters and a digital control board with the high resolution graphics capabilities of the Apple II computer to create a digital storage oscilloscope. Signal trace parameters are entered through the keyboard to operational software provided in PROM on the DI control board.

- DC to 3.5 Mhz sample rate with 1024 byte buffer memory
- Pretrigger Viewing up to 1020 Samples
- Programmable Scale Select
- Continuous and Single Sweep Modes
- Single or Dual Channel Trace
- Greater than or less than trigger threshold detection

Price for the two board Applescope system \$595

*Dealer Inquiries Invited

For further information contact:

RC Electronics Inc.
7265 Tuolumne Street
Goleta, CA 93117
(805) 968-6614

Circle 316 on inquiry card.

DIGITAL STORAGE OSCILLOSCOPE INTERFACES

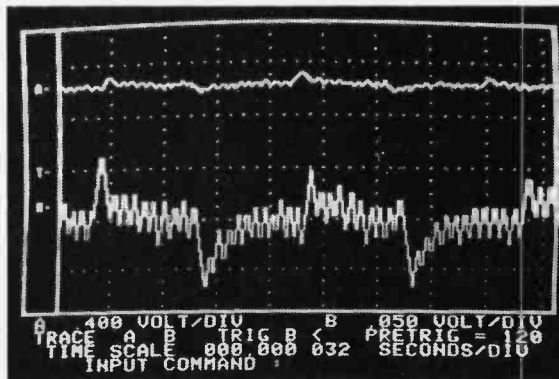

Combine an Apple II or S100 based computer system with our interface circuit boards to create a digital storage oscilloscope at a fraction of the cost of other storage scopes.

The S100 interface provides an additional 1024 bytes of buffer memory in place of the PROM. The user must supply the graphics display and driving software. Price of the single board is \$495.

The SCOPEDRIVER is an advanced software package for the Applescope system. It provides expanded waveform manipulation and digital signal conditioning. The SCOPEDRIVER is available on 5 1/4" floppy disks for \$49.

Start talking business

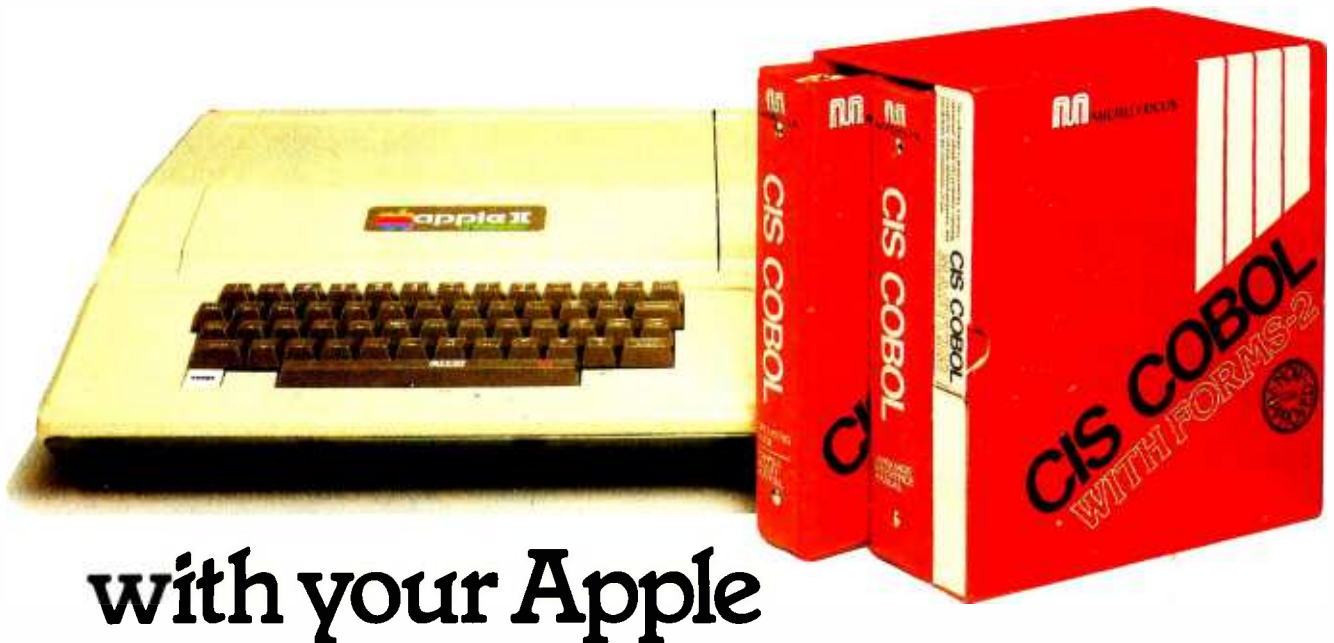

with your Apple

COBOL is the most effective business language. Apple II is the most friendly business computer. CIS COBOL with FORMS-2 brings together the best features of COBOL and Apple to enable you to deliver the most effective, user-friendly applications.

Business Programmers: Take the COBOL expertise you have acquired on big business mainframes, and use it on Apple II to create friendly applications that will talk directly to your users — where it suits them best, on their own desks.

CIS COBOL's dynamic module loading gives you big application capability and the FORMS-2 source generator lets you build and modify conversational programs from visual screen formats, creating much of the code automatically.

Application vendors: CIS COBOL with FORMS-2 steps up the pace for your development of the high quality professional application packages needed today. And creating them in COBOL makes them more maintainable.

Over half the Apple II's now being sold are going to business or professional users so demand for quality applications is growing fast, creating big business opportunities for you.

Stability proven by the US Government.

CIS COBOL has been tested and approved for two consecutive years by the US General Services Administration as conforming to the ANSI '74 COBOL Standard. Apple II under CP/M is included in CIS COBOL's 1981 GSA Certificate of Validation (at Low-Intermediate Federal Standard plus Indexed I-O and Level 2 Inter-Program Communication).

Get your hands on CIS COBOL at your Apple dealer.

Talk business with him now!

Micro Focus Inc., 1601 Civic Center Drive
Santa Clara, CA 95050. Phone: (408) 248-3982.



MICRO FOCUS

CIS COBOL with FORMS-2 for use on the Apple II with CP/M is an Apple Distributed Product. CIS COBOL and FORMS-2 are trademarks of Micro Focus. CP/M is a trademark of Digital Research. Apple II is a trademark of Apple Computer.

Save \$2500⁰⁰

Are you faced with having to spend \$3000 and up for a letter-quality printer?

Mediamix offers an alternative.



For only \$500 the **Mediamix ETI²** lets you connect IBM Electronic Typewriter Models 50, 60, or 75 to **any** computer. Why invest in two separate machines? Your office typewriter can do both jobs, yielding better type quality, a consistent corporate image and renowned IBM service.



The **ETI²** is no simple black box, either. It is a sophisticated micro-computer with 2000 characters of memory, over 39 special commands and the option of doing typesetting on the IBM Model 50.

Write or Call

MEDIAMIX

P.O. Box 67B57
Los Angeles, California 90067
(213)475-9949
Dealer Inquiries Invited

a local network also vary over orders of magnitude, from 100 K bps to 10 M bps, and higher. But these boundaries are far from sufficient to characterize the meaning of "local network" today.

Compared to terminal-like devices, a local network generally has an inexpensive communications medium and high data rates. Every node on the network can communicate with every other node, and the network requires no central node or processor. Messages are "broadcast" over the communications medium, with a destination address included. Only the intended receiver is expected to respond, although other stations have the capability of "listening in." Thus, a high level of security, such as found in point-to-point networks, is not present unless cryptographic techniques are used. Local networks are meant to be highly reliable, so that any failing station will simply be unavailable, without interrupting the communications between the remaining stations. Similarly, it is possible to add new stations without disrupting the ongoing communications flow.

Due to the limited-distance nature of local networks, another standard feature is the ability to connect multiple networks. This internetwork link, called a *gateway*, may be a high-speed link for networks that are close to each other, or it may depend on a more conventional telecommunications network for reliably transmitting data from city to city, or around the world. Because of the multiplicity of emerging network technology, and the variety of communications protocols in use, gateways must be provided to permit stations on one type of network to exchange information with others on a different type or speed of network. Both electrical and software protocols must be converted when passing data through these gateways.

Origins of Local-Area Networks

Local-area networks evolved from the large-scale telecommunications networks developed in the 1960s. As universities and research labs began

to install computers, the need arose to permit the flow of information among them. The underlying communications protocols (packet transmission) came from the long-distance networks. The communications media (twisted pair or coaxial cable) were developed to support very high speed direct coupling between computers.

One experiment significantly affected the nature of modern local-area networks: the University of Hawaii wanted to connect terminals all over the Hawaiian islands to a local computer and communications processor, and from there to other networks. They developed a system called ALOHA, a packet radio-transmission system. No wires were used to connect each station to the others, so techniques such as polling could not be used.

The scheme was elegant, and operated in a manner very similar to the way that telephone party lines work. Each station would first listen to see if anyone else was transmitting (in radio jargon, this was called "carrier sense"). If not, the station would transmit its message, including error-detection bits. As long as the total fraction of available transmission time used was low, everyone got a turn—eventually. If two stations found the channel clear and started transmitting simultaneously, the two packets would *collide*. This collision would scramble the information, but the error-detection logic would throw away the bad data. If the stations didn't receive an acknowledgment by a certain time, they would simply send the packet again.

Studies of this scheme quickly revealed a number of problems, one of the more serious being that as the number of messages grew, many collided, and only a small fraction of the true communications bandwidth was used for valid data. Far more serious was the fact that if enough stations tried to transmit, less and less data got through, and the result was continuous collisions!

The Ethernet Network

Numerous refinements to the basic

C ~~AND~~ Pascal

Efficiency ~~AND~~ Portability

Flexibility ~~AND~~ Strong Typing

Now you don't have to compromise!

Whitesmiths Ltd. now offers portable language development systems for four families of computers. Approximately one thousand installations use our software.

We support complete versions of both C and Pascal, as compilers and cross-compilers. You get C automatically when you license Pascal, and you get native support with each cross-compiler. Test the software on your VAX before burning PROMs for your 68000 or 8080.

Whitesmiths Ltd. offers a variety of licensing arrangements, the simplest being a binary license for use on a single CPU. The full source code is available with internal documentation. Maintenance, training and sublicensing rights may also be obtained.

Call or write for more information.

| Source Operating Systems | Target Machines | | | |
|--|-----------------------------|---------------------------|---------------------------|-----------------------------|
| | 8080/Z80 | LSI-11/PDP-11 | VAX-11 | M68000 |
| 8080/Z80 CP/M | C: \$750 Pascal: \$950 | * | * | * |
| LSI-11/PDP-11: Idris, Unix, RT11, RSX-11/M, RSTS/E, IAS | C: \$1350 Pascal: \$1550 | C: \$750 Pascal: \$950 | * | C: \$1350 Pascal: \$1550 |
| VAX-11 Unix/V32 VMS | C: \$1350 Pascal: \$1550 | * | C: \$750 Pascal: \$950 | C: \$1350 Pascal: \$1550 |
| M68000 VERSAdos | * | * | * | C: \$750 Pascal: \$950 |

Idris is a trademark of Whitesmiths, Ltd. ■ Unix is a trademark of Bell Laboratories ■ CP/M is a trademark of Digital Research Company ■ VMS, RSX-11/M, RSTS/E, LSI-11, VAX, are trademarks of Digital Equipment Corporation ■ VERSAdos is a trademark of Motorola Corporation

* Special Order

Protect your software investment.

Whitesmiths, Ltd.

P.O. Box 1132 Ansonia Station New York, N.Y. 10023 (212) 799-1200 Telex 645 592

Distributors: **Australia**
Fawnray Pty Ltd.
Hurstville, NSW
02 570 6100

Japan
Advance Industries
Chiyoda-ku, Tokyo
03-258-0839

United Kingdom
Real Time Systems
Newcastle upon Tyne
0632 733131

Starwriter

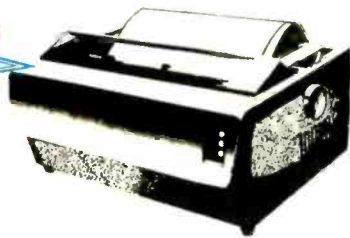

**PRINTERS,
MONITORS,
DISKS**

| | |
|--------------------------------------|------|
| Daisy Wheel Printer by C. Itoh | 1750 |
| Paper Tiger 445G | 725 |
| Paper Tiger 460G | 1194 |
| Paper Tiger 560G | 1495 |
| Qume (shipped FREIGHT COLLECT) | 2499 |
| Silentype w/interface | 349 |
| Amdek Color Monitor | 349 |
| Amdek Green Screen | 169 |
| Amdek/Leedex B/W 12" Monitor | 129 |
| NEC 12" Green Screen | 239 |
| Sanyo 9" B/W Monitor | 169 |
| Sanyo 12" B/W Monitor | 255 |
| Sanyo Green Screen | 309 |
| Dysan Disks (pkg. 10) | 50 |
| Memorex Disks (pkg. 10) | 40 |
| Opus Disks (pkg. 10) | 30 |
| Verbatim "Gold" (pkg. 10) | 35 |



ATARI 800
PERSONAL COMPUTER SYSTEM

\$789

IF
ATARI[®]
MAKES
IT, WE
SELL IT

| | |
|----------------------------------|-----|
| Atari 400 8K Computer | 419 |
| Atari 800 16K Computer | 789 |
| Atari 410 Program Recorder | 69 |
| Atari 810 Disk Drive | 499 |
| Atari 820 Printer | 429 |
| Atari 825 Printer | 695 |
| Atari 850 Interface | 169 |
| 16K RAM by Microtek | 99 |
| 32K RAM by Microtek | 189 |
| Assembler/Editor | 45 |
| Atari Joysticks | 18 |
| Atari Paddles | 18 |
| Basketball | 30 |
| Computer Chess | 30 |
| Invitation to Programming | 17 |
| Music Composer | 45 |
| Star Raiders | 39 |
| Super Breakout | 30 |
| 3-D Tic-Tac-Toe | 30 |
| Video Easel | 30 |
| Visicalc | 180 |

SSM A10 \$149

*** MONTHLY *
SPECIALS**

**VERSA-WRITER
DIGITIZER \$239**

LIST 645
CALL

The Epson
80-Column Dot Matrix Printer

MX-80

- Full 96-character ASCII with descenders
- Adjustable tractor-type pin feed

• Interfaces —

Standard — Centronics-style 8-bit Parallel

Optional — RS232, IEEE488
Buffer Size — one line

Available for immediate shipment

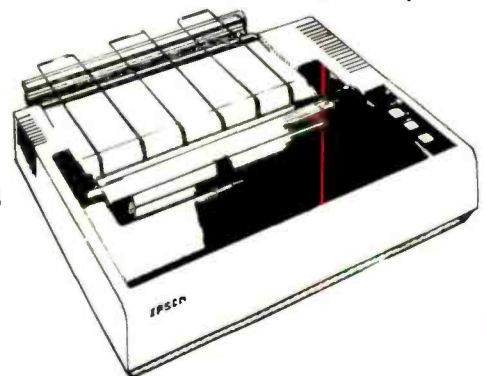

TO ORDER: Phone orders invited using Visa, Mastercard or bank wire transfers. Visa and MC service charge of 2%. Mail orders may send charge card number (include expiration date), cashiers check, money order, or personal check (allow 10 business days for personal or company checks to clear). Please add 3% (\$5.00 minimum) for UPS shipping, handling, and insurance. APO and FPO include 5% (\$7.00 minimum) for postage. Calif. residents add 6% sales tax. Please include phone number on all orders.

FOREIGN ORDERS include 1% handling — shipped air FREIGHT COLLECT only. Credit cards not accepted on foreign orders. All equipment is in factory cartons with manufacturer warranty. Opened products not returnable. Restocking fee for returned merchandise. Equipment subject to price change and availability. Retail prices differ from mail order prices. WE SHIP THE SAME DAY ON MOST ORDERS!



(714) 579-0330 • MAIL TO: 1251 BROADWAY, EL CAJON, CA. 92021

AUTHORIZED
APPLE
SALES &
SERVICE

COMPUTER



SPECIALTIES

DIV OF
COMPUTER
METRICS
INC

EXCITING DISCOUNTS

apple II
16K computer

DISK with CONTROLLER
 NEW DOS 3.3 \$529
 without . . . \$445
 Nearly Everything
 for Apple



**WE WILL
 MEET OR BEAT
 ANY ADVERTISED PRICES
 ON MOST ITEMS IF MERCHANDISE
 IN STOCK**

**APPLE II 48K
 \$1095**

APPLE SOFTWARE

| | | | |
|---|------|---|-----|
| ABM by Muse | 19 | Pool 1.5 | 29 |
| Adventure by Microsoft | 27 | Pulsar II | 25 |
| Alien Rain by Broderbund | 19 | Raster Blaster | 24 |
| Apple PIE | 119 | Robot War by Muse | 31 |
| Apple Pilot | 129 | Sabotage | 21 |
| Apple-oids | 25 | Sargon II Chess Game | 29 |
| Appleplot by Apple | 59 | Snoggle/Puckman by Broderbund | 24 |
| Applepost Mailing List System | 44 | Space Game Album by Budgeco | 39 |
| Applewriter Word Processor | 65 | Space Eggs | 25 |
| Asteroid Field by Cavalier | 19 | Space Invaders/Cosmos Mission | 19 |
| CCA Data Mgmt | 84 | Space Raiders by USA | 25 |
| Data Factory by Microlab | 129 | Star Cruiser | 24 |
| Desktop Plan II | 159 | Sub-Logic FS-1 Flight Simulator | 34 |
| DB Master II by Stoneware | 199 | Super Single Disk Copy Routine | 35 |
| DOS Tool Kit | 65 | Super Stellar Trek | 33 |
| DOS 3.3 Upgrade | 49 | Supertext II by Muse | 129 |
| Dow Jones Portfolio Evaluator | 45 | Ultima | 35 |
| Fortran by Apple | 159 | Visicalc II | 159 |
| Hi-Res Football | 33 | Visilist | 24 |
| Head-On | 21 | Visitrend/Visiplot | 219 |
| Integer Basic Cassette Demos | 29 | Wizard and the Princess | 32 |
| Orbitron | 25 | Zork | 34 |
| PASCAL Language System | 425 | | |
| Peachtree Bus. Pkgs | CALL | | |
| Personal Filing System | 84 | | |
| Phantoms Five | 29 | | |

**LARGE SELECTION OF
 SOFTWARE IN STOCK —
 CALL FOR FREE BROCHURE —**

**APPLE COMPUTER
 INTERFACE CARDS**

| | |
|---|-----|
| Applesoft II Firmware Card | 149 |
| CCS Asynchronous 7710A | 129 |
| CCS Parallel Print Cd. 7720A | 155 |
| Centronics Interface Cd. | 179 |
| Comm. Cd. & DB25 Cable | 179 |
| CPS Multifunction by Mtn. Comp. | 199 |
| Expansion Chassis by Mtn. Comp. | 555 |
| HiSpeed Serial Int. Cd. | 155 |
| Integer Basic Firmware Cd. | 149 |
| ROMPLUS | 135 |
| SSm AIO Serial/Parallel I/O Assembled & Tested | 149 |

ACCESSORIES

| | |
|--|-----|
| A/D D/A Board by Mtn. Comp | 319 |
| Andromeda 16K Ramcard | 179 |
| Apple Game Paddles | 25 |
| Arith. Processor 7811 A or B | 339 |
| COPYROM by Mtn. Comp | 51 |
| Dan Paymar L.C. Kit 1 or 2 | 55 |
| Extender Board | 27 |
| GPIO IEEE 488 Card | 259 |
| Graphics Input Tablet | 639 |
| Hayes Micromodem | 299 |
| Introl X-10 Remote Control Sys | 239 |
| Joystick for the Apple | 47 |
| Keyboard Filter ROM chip | 49 |
| Lazer Lower Case Plus+ | 49 |
| M & R Sup-R-Term 80-col-bd | 319 |
| Music System by Mtn. Comp | 479 |
| Programmable Timer CCS 7440A | 159 |
| Prototyping Hobby Card | 22 |
| ROMWRITER by Mtn. Comp | 149 |
| SuperTalker Speech Synthesizer | 239 |
| Thunderclock | 129 |
| Versa-Writer Digitizer Drawing Sys | 239 |
| Videx Keyboard Enhancer | 115 |
| Videx Videoterm 80-col-cd | 319 |
| Z-80 SOFTCARD by Microsoft | 319 |



CALL 1-800-854-2833
PHONE ORDERS
MON. - SAT. 8 to 6 P.S.T.

Circle 88 on inquiry card.

MEMBER CHAMBER OF COMMERCE

AUTHORIZED
 APPLE
 SALES &
 SERVICE

COMPUTER



SPECIALTIES

DIV OF
 COMPUTER
 METRICS
 INC

ALOHA scheme were developed, but the most significant were developed at the Xerox Palo Alto Research Center as part of an experimental project, called Ethernet, started in the mid 1970s. (It was once thought that a universal medium called "luminiferous ether" was the carrier of electromagnetic waves. Xerox decided to build its "ether" out of coaxial cable.)

The Ethernet scheme could detect a collision in progress by reading back the state of the cable *as data were being transmitted*. Thus, a station could sense when another station was sending data and stop transmitting, instead of continuing until the end of its packet. (To guarantee that all such stations recognized the collision, a burst of noise was sent prior to quitting.) A randomized delay function was added so that each station would wait a different amount of time, instead of beginning to transmit immediately after a previous transmission was complete. This avoided causing a collision each time two or more stations had something to send. The delays would get progressively longer as the channel became busier.

Using these modifications, an Ethernet-style local network could use essentially all the bandwidth of the communication medium. Even as stations began sending ten times as much information as the channel could handle, things no longer came to a halt.

The Ethernet algorithms were designed to be simple. Every station on the network manages its use independently, so there is no need for a master to control access. Simplicity was important to ensure minimal building costs and reliability. Other schemes are considerably more complex, which makes them either difficult or expensive to include in each node's interface.

Network Topology

Most early local networks used a *star* topology (see figure 1): a central node was connected via a radial cable to each of the other stations. Unfortunately, this system suffers from the consequences of a central failure. The entire system goes down if the center fails. But there are still many reasons to use a star network.

Telephone exchanges are organized as star networks, and many companies already have PBXs (private-branch exchanges). By using the PBX as a local-area network for data as well as voice communication, companies can take advantage of the already existing wiring: this is most suitable for low-data-rate information, such as video terminals.

A *ring* (or *loop*) topology connects its stations in a closed network. Messages circulate in one direction, often being amplified and repeated at each node they pass through. Again, a station failure can interrupt the entire message flow, but in some cases two alternate parallel loops are provided for reasons of reliability. Rings often use a form of control strategy called a *token*. A token is a special message that gives the receiving station permission to transmit. When a free token comes by a station that wants to transmit, the token is removed and replaced by the message. Generally, the same station removes this message when it comes around again and reinserts the token.

Rings are most popular in process-control applications (eg: controlling equipment in manufacturing environments). When dealing with the equipment being controlled, it is important to be able to guarantee the worst-case maximum time necessary to send a message to some station, say to close a valve. Token systems can provide a solution to this problem. The random nature of the Ethernet scheme might prevent a station from sending a critical message in time. (Actually this is a bit misleading. Ethernet can be used to build token-like control that requires stations to avoid sending a message just because they see the net is free; they have to wait to receive the control token first.)

Much of the ring approach has been developed in England, particularly at Cambridge University, where numerous computers and terminals have been interconnected using a simple but high-speed interface. Several British companies are now developing commercial versions of the Cambridge Ring interface unit.

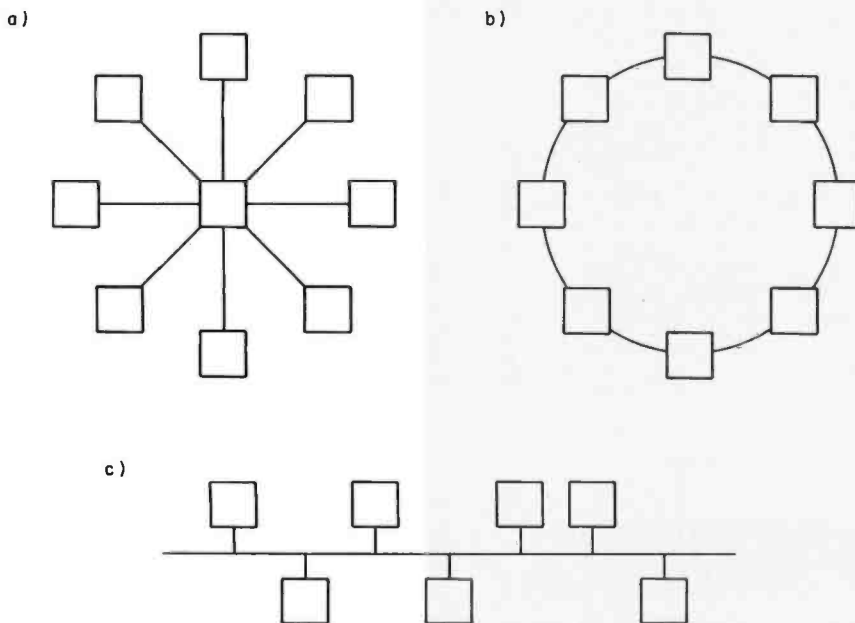

Figure 1: Popular network topologies. The star network (1a) is the most common of the early network types (such as the telephone system), and relies on the central node for control of operations. The ring network (1b) circulates all messages in one direction, and may employ tokens to specify which node may transmit; a failure of any node may interrupt network operation. Bus configuration (1c), as used on the Ethernet and by cable television, allows nodes to be added or removed without impairing the network.



The next generation of business software

WHAT'S IN A NAME?

We've changed the name of our product line. Originally, we called our products "Phoenix" because we saw the phoenix as an appropriate symbol of quality. Unfortunately, a lot of other companies chose Phoenix as well, and there was some concern that the market place would become confused.

Our new name, PALANTIR™ (pronounced pal'anteer), is not a new name for us since it's our corporate name. It comes from J.R.R. Tolkien's *The Lord of the Rings* and describes a black crystal ball, a "seeing stone", used to see things at a distance.

Whatever the name on the package, the software in the package hasn't changed. It is still the highest quality business software you can buy for your microcomputer.

WORD PROCESSING

We know word processing. A year-and-a-half ago the owners of Designer Software™ wrote a well-known word processor for another company. In the last 18 months we've learned about other features you want in a word processing package. PALANTIR™ Word Processing reflects our experience. It is more powerful than other word processing packages you can buy and can compete, feature for feature, with expensive dedicated word processors.

Many people have remarked that the user's manual we wrote earlier was the best ever for microcomputer software. Even so, we felt that we could have made it more accessible to the non-technical user. With PALANTIR™

Word Processing we have a separate Training Manual with beginning, intermediate and advanced levels. By allowing you to work at your own level, we have made the learning process easier and less intimidating.

ACCOUNTING

All five PALANTIR™ general accounting packages (General Ledger, Accounts Receivable and Payable, Payroll and Inventory) were designed by CPA's based on similar packages from mini and mainframe computers. The programs are COBOL with an integral assembly-language data base. They are integrated to allow automated posting to the General Ledger. An internal screen handler permits full-screen data entry for speed and ease of use. Although we made cosmetic enhancements prior to distribution, the basic programs have been user-tested for at least eighteen months.

PALANTIR™ Accounting also includes a growing number of specific application packages. We have completed or scheduled for completion Fixed Assets, Tenant Processing, Mail Management, Financial Projections and Time/Billing. Each package stands alone, but many also work in conjunction with other PALANTIR™ packages. For example, Mail Management will work very well by itself, but we also designed it to fit in easily with the merging capabilities of Word Processing.

With all PALANTIR™ Accounting we have given special attention to documentation. Not being content to describe which buttons to push, we have taken the time to explain the accounting principles behind the programs and how each package helps to automate your office.

Designer Software™

HOUSTON

If you want to know what PALANTIR™ Word Processing and accounting can do for your business, call, write, telex or use The Source to request more information.

**3400 Montrose Blvd • Suite 718 • Houston, Texas 77006
(713) 520-8221 • Telex 790510 • Source TCU671**

Designer Software and Palantir are trademarks of Palantir, Inc.



COMPUDIAL, INC.

"The Link Between Technology & People"

Cherry Hill Industrial Center
2 Keystone Avenue / Cherry Hill, N.J. 08003

TELEPHONE

(609) 424-4700 • (215) 629-1289

**The Leading Intertec Dealer
In The Northeast**
Dealer and OEM Inquires Invited
**Special Discounts on
SUPERBRAINS**

SUPERBRAIN™

Intelligent Video Terminal Systems
350K or 700K of Disk Storage

w/64K Double Density, List \$3495
w/64K Quad Density, List \$3995

CompuStar™

**MAINFRAME PERFORMANCE AT
MICROCOMPUTER PRICES
MULTI TASKING - MULTI USER**

No networking degradation experienced as with single CPU systems. A business system priced comparable to the TRS 80.



*Government and International
Inquiries Invited*

PRINTERS

Nec Spinwriter
Data South
Microline

MODEMS

Racal-Vadic

SOFTWARE FOR SUPERBRAIN AND COMPUSTAR

Accounts Payable
Payroll
Accounts Receivable
Word Processing
Many Others

FAST RELIABLE

Hardware Service On Our Premises
Or In Our Area

**For Information Or
To order call (609) 424-4700**

Bus topology is quite simple, being merely a long length of cable that runs past each station. Stations are connected to it at the nearest point, and can be added or removed without affecting any other station. A station can be added in two ways: the bus can be split, temporarily disrupting communications, and a new station inserted, or, more commonly, *taps* (devices developed by the cable TV industry that literally pierce the cable from the outside, making contact to the inner conductor and the outer shield) can be installed while stations are transmitting. Even temporary shorts will only garble some packets, and they will be retransmitted once the short is removed. The Ethernet uses this form of interconnection.

What Frequency, What Wire?

Another significant parameter in the description of a local-area network is the particular medium used to send the information between stations. Local networks have used twisted pair, multiconductor flat cable, coaxial cable, optical fibers, and even infrared light transmitted through the atmosphere. Within each of these categories, numerous choices abound in the frequency used for transmission and the details of the modulation technique.

The most fundamental split in technology revolves around frequencies used on coaxial cable. You can think of coaxial cable as a simple wire. If someone wants to send information, the wire can be left at 0 V or raised to some nonzero voltage. Another station can detect the changes in voltage and decode the information. This is generally referred to as *baseband transmission*, since the frequency spectrum generated starts at 0 Hz (direct current) and goes up from there.

Television transmission is sent at very high frequencies (typically 50 MHz to 100 MHz). A central carrier-frequency is modulated up and down to transmit the information. At these frequencies, the cable has far less attenuation than in the baseband region, so a transmitter can broadcast over miles of cable instead of being

limited to several thousand feet. And the blossoming cable-TV industry can provide the necessary devices at a very low cost due to the large volumes they are expected to produce for standard television reception. RF (radio-frequency)-modulated systems can also provide much higher bandwidths than baseband, so the cable can, in principle, be shared along with voice- and video-transmission systems.

RF systems (also known as *broadband*), while very attractive, do require a central retransmitter to receive the data sent from each station and rebroadcast it, much amplified, at a different frequency that each station is expected to listen on. The required unit is expensive, even for the smallest system, and if that unit fails, the network is unavailable until the retransmitter is back in service.

Local-Area Network Standards

Numerous local-area network products have already been announced, and new entries are made daily. In almost every case, the manufacturers have developed their own hardware and software protocols. These, naturally, are incompatible with everyone else's!

The exception to the above incompatibility is the Ethernet specification released in November 1980 by DEC (Digital Equipment Corporation), Intel, and Xerox Corporation. Based on years of actual experience with an experimental version of Ethernet communications, the "tri-company standard" was provided, with every detail of the electrical and low-level communications protocols defined. These companies are trying to encourage the adoption of this scheme among computer and peripheral manufacturers; indeed, many large and small companies have publicly announced their adoption of the DIX Ethernet system, and are busy designing and building products.

The DIX Ethernet system uses a baseband-transmission scheme, with a 10 Mbps data rate. It provides for the use of a large number of stations and packet formats, with 48 bits allocated for a unique world-wide

No business is too small for a NORTH STAR



The economical business computer that does it all.

Bookkeeping. Mailing Lists. Word processing. Running your business is a lot more complex than running a lemonade stand. But it doesn't have to be. Sure, you may already know you could use a computer. But did you know that the North Star HORIZON® can do the job better than many bigger computers? For much less money?

The North Star HORIZON is easy to install and operate. As you grow, add programs, work stations, and memory. Today, more than 22,000 HORIZONS are in operation worldwide.

HORIZON is a registered trademark of North Star Computers, Inc.

And our sales and service support is there to help you.

So look at the HORIZON before you buy a computer. You owe it to yourself. And to your business.

For the dealer in your area, call toll-free (800) 447-4700.

In Illinois (800) 322-4400.

In Alaska and Hawaii (800) 447-0890. Or write

North Star Computers, Inc.,
14440 Catalina Street,
San Leandro, CA 94577.

Phone (415) 357-8500.

TWX/Telex (910) 366-7001.



FOLLOW THE STAR

NorthStar 

station address that is not duplicated anywhere, and it has a large (32-bit) checksum on each packet to detect errors.

This scheme pushes the technological requirements by operating at such high speeds and using the particular packet format and checksums adopted. Without specially designed VLSI (very large scale integration) devices to handle the network interface, it is expensive to build an Ethernet interface. For example, Intel has announced a Multibus Ethernet interface (the iSBC-550) that costs about \$4000. To that you must add several hundred dollars for an analog interface (the transceiver unit) to connect between the interface board and the physical cable. It is expected that volume production of the needed components will begin within the next two years and prices will drop dramatically.

One means of lowering the effective cost is to share the Ethernet interface among several stations. A number of companies (such as Xerox,

and Ungermann-Bass) offer a microcomputer-based Ethernet interface with four to eight ports for connecting terminals or other microcomputers. The effective cost per station can be reduced to between \$500 and \$1000 for a fully loaded system.

Standards Organizations

While product activity continues, several committees are attempting to develop an industry-wide standard for local-area networks. The IEEE (Institute of Electrical and Electronics Engineers) Computer Society Local-Network Committee (Project 802) has been meeting for over a year to try to establish a viable standard, and the standard is still in a state of flux. Fierce battles have been raging among the committee members representing different local-network interests. The IEEE standard has been evolving in a manner that attempts to accommodate many diverse application areas and functional requirements.

The framework for defining a communications network is based on a

highly layered series of protocols developed by the ISO (International Standards Organization), called the OSI (Open System Interconnection) protocols. The OSI architecture defines seven layers of communications.

Layer 7, the Application layer, provides for the identification of users and services, and is responsible for initiation and reliability of data transfers, as well as general network access, flow control and recovery. Utility programs may perform network file-transfers, terminal-to-network support, etc.

Layer 6, the Presentation layer, is primarily responsible for making data available to the Application layer in a meaningful fashion. The Presentation layer takes care of protocol conversion, data unpacking, translation, or encryption.

Layer 5, the Session layer, is used to set up and break communications paths across the network and manage the exchange of data. It is responsible for multiplexing and demultiplexing

DISCOUNT PRINTER RIBBONS

Brand New, Top Quality, Exact Replacement Ribbons & Cartridges. These Ribbons Produce Super Jet Black Impressions and Ultra Reliable Print Life. They Are Delivered to Your Door Promptly for Much Less Than Most Retail Stores

★SPECIAL! BUY 10 and GET ONE FREE!

| YOUR PRINTER | PACK SIZE | RETAIL LIST** | YOUR WHOLESALE PRICE | | SIZE | COMMENTS | CAT. ORDER # |
|---|-----------|---------------|------------------------|------------|----------------------|-----------------------------------|--------------|
| RADIO SHACK LP11, LPV | one/pk | 13.95/cart | 8.95/Reload rib. only | (8.95 ea) | .500" x 45' | Nylon Incl Instr | R-T3 |
| RADIO SHACK LP11, LP1V | 3/pk | 18.95/3 pk | 11.95/3 pk | (3.98 ea) | .563" x 45' | Nylon Jet Blk | C-700 |
| CENTRONICS, MOOS 700 to 703 | 3/pk | 18.95/3 pk | 11.95/3 pk | (3.98 ea) | .563" x 45' | Nylon Jet Blk | C-700 |
| CENTRONICS 100, 101A, 102, 103, 300, 301, 306, 308, 330, 358, 398, 500, 501, 503, 508, 588, 620, 820. | 3/pk | 26.33/3 pk | 17.55/3 pk | (5.85 ea) | 1" x 108" | Nylon Jet Blk 5 mil High Speed | C-100 |
| CENTRONICS 704-705 | 1/pk | 16.95 ea | 13.95/Giant Cart | (13.95 ea) | 5/16" x 210' | Giant Cart | C-7045 |
| IBM - "SILVER DOLLAR" Sys. 34, Sys. 32 MDLA, Series IMDL4974, 5258, 3287, 3770, 3771-3774, 4974, 5100, 5103, 5110, 5228, 5258, 5320MDLA | 5/pk | 5.80 ea | 14.90/5 pk | (2.98 ea) | 9/16" x 30' | Nylon Jet Blk | R-300 |
| IBM - HARMONICA 1/2". SERIES I. MOD 4973/II, 3200, 3289, MOD 2. | 3/pk | 9.42 ea | 20.85/3 pk | (6.95 ea) | 1/2" x 108" | Nylon Jet Blk | C-350 |
| TELETYPE MOD 33, 28, 35, 37, 38, 88. | 10/pk | 2.40 ea | 13.90/10 pk | (1.39 ea) | 1/2" x 38" | Nylon Jet Blk | R-450 |
| DIABLO HYTYPE II (M/S BLK) HI YIELD. FITS 70 PRINTERS! | 1/pk | 9.31 ea | 6.87 ea | (6.87 ea) | 5/16" x "High Yield" | 300,000 plus imp. | C-511 |
| QUME (FITS 80 PRINTER MOOS) | 3/pk | 18.00/3 pk | 13.95/3 pk | (4.65 ea) | 1/4" x 310' | Multistrike Film | C-525 |
| WANG M/S. 5541W, WC, 5581, WD, 8581W, 2281W | 1/pk | 6.85 ea | 5.95 ea | (5.95 ea) | 5/16" x 393' | Multistrike Film | C-550 |
| DEC 1/2 x 40YD. | 3/pk | 17.77/3 pk | 12.95/3 pk | (4.32 ea) | 1/2" x 120' | Double Spools | R-800 |
| DEC 1/2 x 60YD. | 3/pk | 20.12/3 pk | 14.25/3 pk | (4.75 ea) | 1/2" x 180' | Double Spools | R-644 |
| NEC SPINWRITER | 4/pk | 23.40/3 cart | 23.80/4 pk. rb. reload | (5.90 ea) | 1/2" x 51' | Nylon/Ex Lng Life | R-400 |



40%

OFF!!
OR MORE!

TERMS:

MINIMUM PURCHASE - \$20

PAYMENT BY: C.O.D. (UPS), CHECK, MASTER CARD, OR VISA CHARGE CARD.

VOLUME DISCOUNTS:

20 - 50 PACKS 10%

51 - 100 PACKS 15%

*UNDER \$20, ADD \$5 HANDLING.

**APPROX. RETAIL. PRICE VARIES.

ANCIE LABORATORIES

9204 Baltimore Blvd. 301-345-6000 (Wash. D.C. Local)

College Park, MD 20740 301-792-2060 (Balto. MD Local)

800-638-0987 (National)

| | | | | |
|--|--|-------------|------------|--|
| NAME _____ | QTY _____ | CAT.# _____ | AMT. _____ | <input type="checkbox"/> Check Enclosed <input type="checkbox"/> C.O.D. <input type="checkbox"/> VISA <input type="checkbox"/> MASTER CHARGE ACCT. # _____ EXP. DATE _____ MIN. ORDER \$20 PRICES SUBJECT TO CHANGE |
| ADDRESS _____ | _____ | | | |
| CITY _____ STATE _____ ZIP _____ | _____ | | | |
| ANCIE Laboratories 9204 Baltimore Blvd. College Park, MD 20740 | 301-345-6000 (Wash. D.C. Local) 301-792-2060 (Balto. MD Local) 800-638-0987 (National) | | | |

Is it possible you haven't heard of American Computers & Engineers?

Not anymore.

Get to know the company that's been quietly making changes in the business computer marketplace. With a very impressive reputation for service, fair prices, and technical know-how.

Whether you need a network of office systems installed locally or a single diskette rush-shipped to Zurich, all orders receive immediate attention.

- Cromemco's extensive line of micro-computers, accessories and peripherals fully stocked.
- DEC systems configured and integrated.
- Color Graphics.
- Complete selection of software packages plus customizing.

Los Angeles Headquarters: 2001 So. Barrington
Los Angeles, CA 90025 • (213) 477-6751

Berkeley: 2855 Telegraph Ave.
Berkeley, CA 94705 • (415) 849-0177

Newport Beach: 4141 MacArthur Blvd.
Newport Beach, CA 92660 • (714) 851-8700

Canada: 6715 Eighth St. North East
Calgary, Alberta T2E7H7 • (403) 275-5871

France: 55 Rue de Rivoli • 75001 Paris, France
Tel. 236-94-95



**Maxi-performance
on Minis and Micros.**

messages, managing the sequencing and priority of these messages, and providing the needed buffers.

Layer 4, the Transport layer, provides another level of connections between network entities. This layer manages the connections and segments messages into smaller pieces that the network can support. It may also be involved in error and flow control, as well as additional multiplexing activities.

Layer 3, the Network layer, is the level that actually determines how to get a message from one network to another (since many paths may exist). The Network level may use several intermediate hops to get information to its ultimate destination and, thus, needs to know how to route packets through the network. It, too, may be involved in sequencing and error- and flow-control activities.

Layer 2, the Data-Link layer, is where the actual packet formats are established, along with the particular access control mechanism used to regulate use of the physical network.

Data is encapsulated in packets that contain physical addressing information, error-detecting checksums, etc.

Layer 1, the Physical layer, defines the electrical and mechanical interfaces to the network. The Physical layer specifies the particular signaling means (baseband vs RF, for instance), the modulation technique adopted, station-identification addresses, etc.

The current activity of the IEEE 802 committee is focused on specifying Layers 1 and 2, the Link and Physical levels. Similarly, the DEC/Intel/Xerox Ethernet specification addresses only these two levels of protocol.

It appears that the 802 Committee is converging on a standard that offers many alternatives within one framework. Even the issue of data rate (specified by Ethernet as 10 M bps) appears to be an optional value (such as 1, 5, 10, or 20 M bps). The error detection used may be either a 16- or 32-bit CRC (cyclic redundancy check) code, and the access method may be either a token-like scheme or

a CSMA/CD (carrier-sense, multiple access with collision detect) scheme resembling (but not identical to) the Ethernet system. While the 802 Committee deliberates, manufacturers continue to develop their own systems. It is possible that some may modify their products once standards activities are resolved.

Recently, attention has been given to the higher levels of protocols. The National Bureau of Standards is proposing a series of Transport and higher-level protocols. It is unfortunate that the work on the higher-level protocols does not precede the lowest-level issues. The advantage of layered protocols is that the underlying levels can be changed in ways transparent to the higher levels, while the converse is not true, but the standards activities are not moving in that direction.

Servers and Clients

The most significant contribution in the local-area network field is not the communications aspect, but the development of a whole new way of building computer systems. The fundamental organization described by Xerox assumes a fully distributed control mechanism (see figure 2). There is no master-slave relationship among stations; they all communicate and cooperate with one another. Any number of stations (called *servers*) on a local network may provide services to other stations (called *clients*). Typical server functions are: mass-storage file system, printer support, time-of-day clock, translation of symbolic names into physical addresses, data-base management support, gateways to other networks or computers, and other specialized hardware support. Servers may also be clients of other servers on the network. For instance, the printer server may be a client of the file-system server in the course of serving its own clients.

Servers are distinguished on the network merely by the software they run and any special hardware they contain. A station that is willing to listen to requests from other stations (using a higher-level protocol they

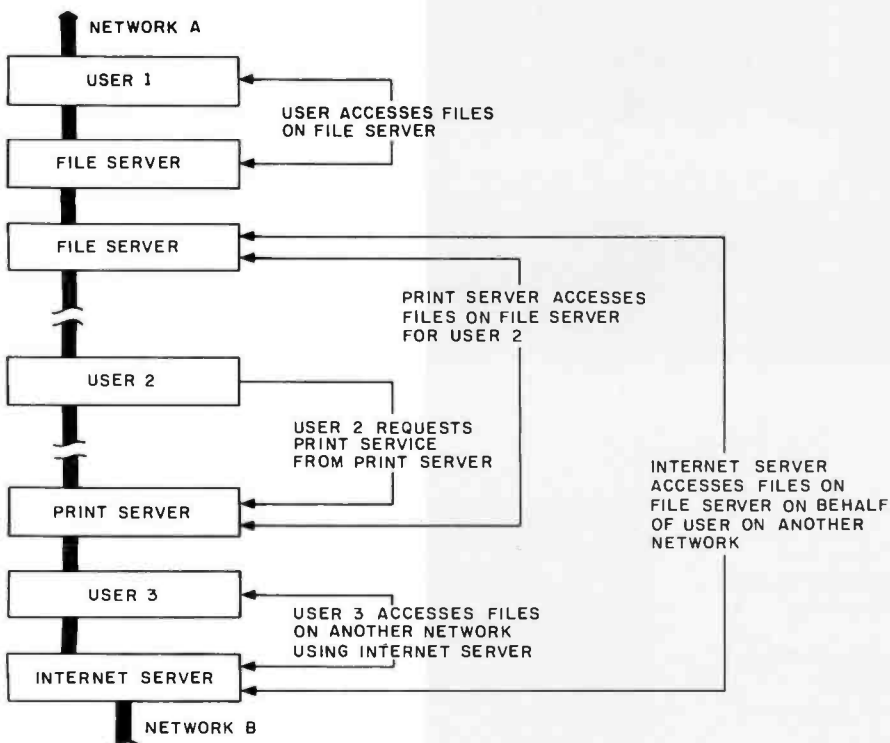

Figure 2: The server/client relationship on local networks. Perhaps the most significant advance in communications is that, under this scheme, the computer system is fully distributed; there is no master node, so each node can call on others when resources are needed. Some nodes are dedicated to special functions, such as controlling hard-disk mass-storage devices, or printing.

MDBS, Incorporated

*proudly
announces*

MDBS III

a new generation
in data base
management technology

not limited
to relational, tabular,
flat-file structures

not limited
to hierarchical structures

not limited
to CODASYL network
structures

The structures above are mere subsets of the capabilities of MDBS III.
Far beyond these, MDBS III provides valuable innovations available in no other system!

Unprecedented POWER! FLEXIBILITY! PORTABILITY!

For serious application development, MDBS III offers major advantages in these seven key areas:

Extraordinary data structuring

Unmatched flexibility for relating records to each other with ease.

Automatic data *compression* where desired.

Up to 255 record types per schema.

High-level query language

Automatically generates desired report or data file with a *single statement*.

Language is *English-like, non-procedural*, and has report writing capabilities.

Extensive performance control

Gives application designer extensive control over record placement. . . includes automatic *clustering* and *CALC* features.

For highest performance, a streamlined DML . . . over 20 *host language* interfaces available.

All processing is *data-dictionary driven*.

Data security and integrity

User *passwords* and optional data *encryption*.

Comprehensive *access code facility* for automatic security enforcement.

Automatic *range checking*.

Available for Minis and Micros

Availability for numerous *8* and *16-bit micros*, as well as for *minis*, provides standardized approach to data handling.

Allows extensive portability of application systems. . . from the *Z-80* to the *PDP-11*.

True multi-user capabilities

Supports multiple *concurrent* users of the same data base.

Supports both active and passive locking.

Automatic transaction logging

Automatically logs all transactions after last back-up.

Selective restoration of data base in event of a crash.

Allows surveillance of user activities.

For the full story about the finest application development tool existing in the mini-micro world. . . , call, write, or TWX us today!

Setting standards of excellence for data base software . . . worldwide.

Micro Data Base Systems, inc.

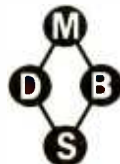

Box 248
Lafayette, Indiana 47902
317-448-1616/TWX 810-342-1881

Dealer/distributor/OEM inquiries invited.

- Yes, please send me a copy of the MDBS III brochure.
- Please send me the complete MDBS III manual set including manuals for MDBS III, RTL, QRS, and DMU plus tutorial materials. Check for \$75.00 enclosed. (Indiana residents please add \$3.00 for Indiana tax.)

Name _____ Title _____
(Please print)

Company _____

Address _____

City _____ (State) _____ (Zip) _____

Phone _____

MAIL TO: Micro Data Base Systems, Inc.
P.O. Box 248-B
Lafayette, IN 47902

agree on) can perform a server function.

In order to maintain a high level of reliability, the logical functions of the servers are usually implemented using separate physical computers. One could merge all of the above services into one larger computer, but in doing so would end up with something resembling a conventional central computer system.

Putting It All Together

Clearly, the local-area network field is too broad to cover in great depth. Most of the attention has focused on nonpersonal computer systems, such as large mainframes or terminals. We will describe the Nestar Cluster/One Model A system.

The Cluster/One Model A is a local-area network system based on the Ethernet principles, but its implementation has been optimized for the connection of low-cost Apple II personal computers. The system was first announced in January 1980 and has been used around the world for almost two years. It includes integrated software and hardware features needed to provide a comprehensive data-processing and data-communications facility, and the system permits either independent operation of individual stations, with a full complement of local peripherals, or a share in the larger, more reliable peripherals via the local network. The work station in question costs between \$1000 and \$2000, so cost constraints differ from those applied to networking work stations in the \$10,000 to \$20,000 price range. Nestar chose to implement many network functions via simple programmable hardware, and assigned many functions to software. Another decision influenced by these cost factors involves network speed. The speed of the Cluster/One was decided by the reasonable cost for a personal computer network interface and the bandwidth requirements needed for the work typically done by these personal computer work stations.

The Model A network operates at 240 kbps—almost a thousand times faster than a 300-bps telephone link,

and 40 times slower than the Xerox Ethernet system. This was the fastest rate that could be supported by network-interface software running on the 6502 host processor of the Apple II computer and still allow data checksums to be performed on the message packets.

The choice of the network medium was also influenced by the basic cost goal. Rather than taking 8-bit data from the Apple memory and then serializing and deserializing it, it was decided to transmit the data in an 8-bit-wide parallel fashion, which not only reduced the interface cost, but increased the inter-bit transition time. This has the effect of permitting essentially arbitrary interconnection topology for the Nestar network, something not found in any other system. The Nestar network is not restricted to a linear-bus topology, but can be wired as suits the particular installation requirements.

Network Design

The overall system design resembles the Ethernet scheme. No single critical component must function for network communication to take place. All station-to-station communication is direct, with a carrier-sense algorithm executing in the ROM- (read-only memory) based protocols in each station interface. The interface is passive, so stations may be added or removed from the network during operation. Stations not in use may be turned off until needed.

In the Model A network, the carrier-detect function is implemented using a dedicated control line, which indicates the bus is busy. Stations do not transmit until they see that this line is available. The electronics of the bus interface permit reading of data just written. However, it is not necessary to perform full collision detection. At the start of a packet transmission the address of the station attempting to send is first put on the bus, and then read back. If two stations do this simultaneously, at least one will not read back its own address and will detect a conflict. Even this is rare, since each station

has a random waiting algorithm that avoids most collisions that would occur at the end of a previous transmission. Once this initial collision detection has been passed, the carrier signal has been established and further collision detection is not necessary. The rest of the packet is sent, like ALOHA, without collision detection. After the initial check, later collisions can result only from erroneous stations, and not under normal conditions.

Each packet of data contains initial header information, followed by up to 256 bytes of data and a 16-bit checksum. Once the packet is transmitted, the receiving station immediately acknowledges the receipt of the packet (if the checksum matches the data) or else requests a retransmission. This error-control algorithm is completely contained in the ROM-based protocols on the Nestar interface, and permits higher levels of software to work with reliable and correctly sequenced data. The ROM protocols are also responsible for taking messages longer than the 256-byte packet size and splitting them into multiple packets, each with its own checksum. Thus the four lowest layers of the OSI protocols are supplied as part of the logic on board the Nestar network interface.

The Model A network also includes a variety of network servers and the software needed to make their use literally transparent to current applications. The Nestar Network File Server runs on an Apple II microcomputer interfaced to the network. It can support a variety of devices, ranging from two 8-inch double-sided floppy disks, to 66 megabytes of hard-disk storage. Larger capacity is available by using more than one file server. The network software allows multiple file servers on one local network, thus giving essentially unlimited online storage capacity. The data on these reliable, sealed Winchester disks can be "backed up" using Nestar's compact cartridge-tape streamer drive. A single cartridge can write and check over 20 megabytes of data in twelve minutes.

The Network File Server can also

The Landlord™



Apartment Management Software

Keeping track of apartment availabilities, rent payments, security deposits, leases, and other administrative functions consumes a great deal of time and attention for apartment owners and managers. You and your staff probably spend countless hours dealing with the paperwork necessary to manage your property.

With the Landlord™ apartment management software and an Apple II* computer, file cabinets full of paperwork and the frustrations of cumbersome bookkeeping procedures can be eliminated. The clerical work for your apartments can be accomplished with greater accuracy in a fraction of the time you presently spend. The Landlord™ will keep up-to-date files on apartments and residents as well as detailed records of property income and expenses.

You'll be able to enter, change, or delete information by following the simple English instructions that appear on the screen of the Apple II*. The Landlord™ will automatically organize and store your data and make it available for your review at any time. With the Landlord™, your resident manager can instantly determine where apartment vacancies exist and when additional units will become available for rental. The Landlord™ also keeps track of resident payments, letting

you see at a glance who is behind on rent or other payments. Property and tax analysis reports are printed automatically each month and allow you to monitor the profitability of your apartments.

The Landlord™ apartment management software and the necessary Apple II* equipment are available for less than the cost of a new sub-compact car. If you own or manage an apartment property with no more than 400 units, visit your nearest computer dealer for a demonstration.

BY1081

Please return this coupon for more information about the Landlord™ and the name of the dealer nearest you.

Name _____

Company _____

Address _____

City/State _____ Zip _____



MIN MICROCOMPUTER SOFTWARE, INC.
5835-A Peachtree Corners East
Norcross, Ga. 30092

*Apple II is a registered trademark of Apple Computer, Inc.
The Landlord is a trademark of MIN Microcomputer Software, Inc.

contain a real-time clock/calendar, which stations can interrogate. This facility is used to *timestamp* the creation, access, modification, and backup times of network files. Files are organized with a tree-structured system similar to a UNIX directory; they can be password-protected in a variety of ways to ensure that only authorized users can create, modify, or otherwise access network data.

The software provided makes the use of this data straightforward from any Apple II work station on the network. All of Apple's current operating systems (DOS 3.2, DOS 3.3, Pascal 1.0, and Pascal 1.1) can be directly loaded over the network. Modifications are made during this process so that stations can logically connect to virtual disks on the network shared disks (either from keyboard commands or from programs). These disks need not have the same capacity as 5-inch floppy disks, but may be much larger or smaller. Each storage area is allocated the appropriate size for the application;

users may be executing programs in any set of languages or operating systems at the same time.

Network Applications

The Cluster/One network has been used in a variety of applications that include general office-automation environments, engineering and software development sites, educational and entertainment uses, and special turn-key applications, such as travel-agency and real-estate systems.

To support this variety of uses, Nestar provides a number of general-purpose computing products. Other servers, such as print servers supporting a multiplicity of printers, are available. Communications servers support internetwork activity. Application programs for general database access, interoffice electronic mail, and teleconferencing, have been developed by Nestar, either in-house or in conjunction with the suppliers of popular packages for the Apple II. The collection of hardware and software capabilities makes this network

attractive for a wide range of application areas.

What's Next?

There seems to be little doubt that the current interest in local-area networks and personal computer work stations will continue to grow over the next few years. As stations become more powerful and sophisticated in both systems software and applications programming, they will replace an even larger fraction of conventional minicomputer systems. As manufacturers provide fully integrated VLSI components designed for very high performance networks, they will be incorporated into the personal computer local-area network interfaces. Whether or not the standards activities will stem the proliferation of de facto standards remains to be seen. The emergence of networks of personal computers has opened up a whole new set of challenges for programmers in developing real-time, multiuser, interactive systems. ■

MARYMAC INDUSTRIES, INC.

In Texas Orders
Questions & Answers
1-713-392-0747

21969 Katy Freeway
Katy (Houston) Texas 77450

To Order
1-800-231-3680
800-231-3681

SAVE BIG DOLLARS ON ALL TRS-80® HARDWARE & SOFTWARE

TRS-80® BY RADIO SHACK. Brand new in cartons delivered. Save state sales tax. Texas residents add only 5% sales tax. Open Mon.-Sat. 9-6. We pay freight and insurance. Come by and see us. Call us for a reference in or near your city. Ref: Farmers State Bank, Brookshire, Texas.

WE OFFER ON REQUEST

Federal Express (Overnight Delivery)

Houston Intercontinental
Airport Delivery (Same Day)

U.P.S. BLUE (Every Day)

References from people who have
bought computers from us probably
in your city

Telex 77-4132 (Fleks Hou)

* TRS-80 is a Registered Trademark of Tandy Corp

ED McMANUS

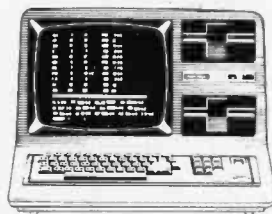

In stock TRS-80 Model
II and III

No Tax on Out of Texas Shipments!

Save
10% 15%
OR MORE

We Specialize In Overseas Shipments

Telex 77-4132 (Fleks Hou)

WE ALWAYS OFFER

NO extra charge for Master Card
or Visa

We use Direct Freight Lines. No
long waits.

We always pay the freight and
insurance

Toll free order number

Our capability to go to the giant
TRS-80® Computer warehouse 5
hours away, in Ft. Worth, Texas,
to keep *you* in stock.

JOE McMANUS



MicroMed™ and MicroDent™ make your practice perfect.™

Simply the best!

They're the real solution to the problems confronting every physician's and dentist's office. Each is a unique package, developed through years of work in close conjunction with doctors and dentists. They'll help you treat your patients more efficiently and accurately, while saving you time and money in the process.

Versatility.

Whether you are in private practice or a member of a busy group, there's sufficient capacity to handle your needs. Thousands of patients can be accommodated on floppies, and even more on hard disk. MicroMed and MicroDent can easily handle everything in your practice from billing to patient records to complex insurance forms. With millions of hours of actual use in medical and dental offices throughout the country, they stand alone at the top, in a class by themselves.

Solutions, not more problems.

We know you're after solutions, not more problems. Our menus are simplicity itself, and are designed for your convenience (not our programmers'). The computer displays your options at every step. What could be simpler? Your own office staff can easily take care of the routine so that you can devote your valuable time to your patients.

You are the boss.

Forget about problems with outside billing services or manual record-keeping. You exercise absolute control over your billing procedures. Finger-tip patient recall lets you know instantly whose accounts are due and what services were performed. Account aging is automatic, and past-due notices or statements are printed and addressed, ready for mailing. All types of reports may be requested to help you better understand your finances and cash flow. Daily backups are created automatically.

Multiple Insurance Forms.

Many patients have several different types of insurance coverage. With MicroMed and MicroDent you can enter almost any form, keep track of which patients it applies to, and get it processed and ready for mailing. When new forms come out (as we all know they will) you don't have to pay for custom programming, you can modify the form print format yourself. With our exclusive Formulator™ system it takes just minutes.

Economic Sense.

The biggest surprise of all is that MicroMed and MicroDent are just \$1500 each. Plus, having your own office computer provides you with great tax advantages. If you like what you see, contact your nearest computer store. They can provide you with MicroMed or MicroDent on any CP/M® based computer for an amazingly economical price. Or, if you already have a computer, a demo disk and manual set is available for just \$75, and allows you to run the entire program. The manual separately is \$50. Send for one today, and make your practice perfect!

Features:

- Automatic billing for any patient load
- Handles practices with up to 20 doctors
- Accepts all insurance forms
- Exclusive "Formulator" form system
- Multiple insurance coverage
- Insurance preauthorization
- Automatic statements with aging
- Instant access to patient records
- Full transaction and treatment details
- Cumulative totals by doctor
- Profitability analysis reports
- Mailing list maintenance
- Can be linked to word-processing
- Appointment recall with reminders
- Maintains hospital and lab codes
- Keeps track of referring doctor codes

Demo disk and manual set \$75!

Dealerships are available to established computer vendors on a territorial basis.

™MicroMed, MicroDent, and Formulator are trademarks of SoftwareHowz
©CP/M is a registered trademark of Digital Research
Copyright ©1981, SoftwareHowz

SOFTWARE HOWZ

P.O. Box 36275, Los Angeles, CA 90036

(213) 731-0876 • TWX: 910-321-2378

Prepare Your Program for Publication

C A Johnson
3619 Sugarhill Dr
San Antonio TX 78230

"When I get my personal computer, I'm going to make it pay for itself. I have some ideas for programs that everyone will want to buy." Such dreams are shared by many prospective microcomputer buyers, some armed with a college programming course, others with experience writing programs for business.

What these aspiring software authors usually don't know is how to prepare a program with the best possible chances of being accepted, published, and marketed. As a result, they enter the highly competitive software market with a disadvantage that may even guarantee failure.

But programmers' pipe dreams can have happy endings. If you want to write software for publication, consider these steps toward success.

Look at the Market

The first step in writing a marketable program is to conduct your own market analysis before choosing your subject. If the market is already cluttered with programs similar to the one you're considering, yours won't stand a chance unless it includes a special feature that will grab the attention of potential buyers.

Games and simulations have enjoyed great popularity since the beginning of the microcomputer age, and they probably always will. But the universe can hold only so many versions of *Star Trek*, and any microcomputer used for game playing already has at least one. The game is still fun, but the market has worn thin.

Star Trek is only one example of a game that has been programmed to death. Dozens of versions of Nim, Slot Machine, Guess the Number, Dice, and many other games are stacked knee-deep in the marketplace at giveaway prices. Chess might be an exception because of its perennial appeal, but a new chess program won't attract attention without a record of strong tournament play. New versions of old games assail software publishers like

so many attackers on the video screen. But publishers can make unlimited use of the ultimate weapon: the rejection slip.

Finding a Subject

Adventure games and sword-and-sorcery games are the most popular simulations now. They bring the excitement of storytelling and role playing into computer entertainment.

Games that spring from your own imagination hold more promise than rehashes. Literary classics can also inspire games. Stories like *Gulliver's Travels* and *The Voyages of Sinbad* contain excellent dramatic situations that can serve as the basis for games with wide appeal. So do *1984*, *Animal Farm*, and many romantic classics. Don't overlook game and puzzle books; they often contain the seeds of intriguing situations.

When you choose a game situation, make sure it challenges the player. To offer a challenge, the game must encompass a complex and variable winning strategy for the player. If the winning strategy is fixed, the player will soon discover it, and the game will cease to be fun. Although you can create difficult games by arranging for a high-probability random function to "kill" the player, such games are more frustrating than challenging. The player shouldn't get "killed" in the middle of the game unless he uses faulty strategy or makes some other mistake. If the player plays with care and uses an intelligent strategy, he should win.

Lively graphics add appeal and enjoyment to both simulations and games. Try to dream up striking visual effects that advance the story line of your program.

Use Your Own Interests

Your best and most marketable program may well spring from your own interests and experiences. If you

Finding the best software on the market can take you weeks.

Reading this ad takes 31.7 seconds and gives you the same results!



The Westico Software Review Committee is easy to recognize. It's their red-rimmed eyes. You get that way checking through an endless parade of software programs. And they do it so that you don't have to. But selecting good software is only part of what makes Westico one of the fastest growing companies in the software industry. Having experts on staff who really understand both software and hardware is another. But Westico offers more than quality products and

support. We offer our unique 24-hour service overnight! Westico. We're working hard to be your software company.

The Westico 24-Hour Computer Hotline (300 baud) (203) 853-0816 for detailed program information and quick access ordering.

- A full range of professional software.
- Support for a wide variety of CP/M® and other computer systems, including: TRS-80 Model II, Apple, Vector Graphic, Cromemco, North Star, Micropolls, Ohio Scientific, Altos, Dynabyte, SuperBrain, Xerox, Zenith and more.

TWO MORE GREAT PROGRAMS FROM WESTICO

Job Cost Control

This system can track and control costs of jobs in progress and monitor job profitability. It detects cost overruns and allows for corrective action. It can control the job's Accounts Receivable and provide information on employee performance for use in profit-sharing plans.

Features:

- Automatically apportions firm overhead expenses to jobs in progress
- Provides early detection of potential budget overruns
- Monitors profitability of jobs in progress
- Helps identify most profitable services
- Monitors employee performance across all jobs
- Tracks job-related costs and reimbursable expenses.

Reports Include:

- Job status report
- Job update register
- Performance report
- Office income report
- Employee hour summary
- Job accounts receivable register

System & documentation — \$595
Documentation alone — \$20

Inventory Control for Manufacturers

This system includes standard inventory control functions such as maintaining and reporting on the status of the inventory stock as well as maintaining records of all transactions made against part numbers in stock. In addition, it supports multi-level bills of materials (BOM's), the creation of multiple part number transactions for jobs based on those BOM's, the tracking of jobs through work-in-progress, the generation of material requirements reports based on manufacturing schedules.

Reports include:

- Full inventory listing with valuation
- Inventory listing by category
- Costing bill of materials
- Material requirements report
- Assembly listing
- Job issue listing
- Job status report
- Part number usage report

System & documentation — \$995
Documentation alone — \$20

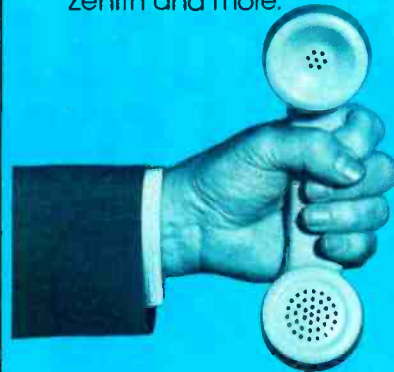

4 Ways to Order

- Write Westico, Inc., 25 Van Zant Street, Norwalk, CT 06855.
- Call (203) 853-6880.
- Telex 643-788.
- Dial-up our 24-hour computer (300 baud) (203) 853-0816.

COD, MasterCard and VISA accepted. Prices do not include shipping and are subject to change. In CT add 7.25% sales tax. All sales final.

Manual price may be credited toward purchase of software

Dealer Inquiries Invited. Copyright © 1981 Westico, Inc.

WES-38

WESTICO

The Software Express Service

25 Van Zant Street • Norwalk, Connecticut 06855
(203) 853-6880 • Telex 643-788

Send for FREE catalog.

golf, bowl, or play tennis, perhaps you could write a program for computing players' handicaps or for scheduling and managing tournaments. Tournament directors would be a natural market.

Depending on your interests, you could consider writing programs that manage stock portfolios, catalog stamp collections, or make an inventory of personal property. Other possibilities are programs that record progress in training activities or dieting and then display the data graphically. Hobbies and club activities such as scouting offer dozens of possibilities.

If you have trouble coming up with a good program idea, get some friends together for a brainstorming session. To stimulate everyone's imagination, choose a field in which you feel reasonably competent, then describe in general terms some program that's been thoroughly exploited. Think of a few variations on that program.

The most important thing to remember about brainstorming is never to reject or belittle a suggestion, no matter how trivial or ridiculous it may seem. Don't risk turning off anyone's imagination. Once the session gets rolling, it will have its own momentum. Write down every suggestion, or better still, tape record the session. One brainstorming session with a few intelligent people will yield enough material to keep you busy writing code for years.

Remember the Hardware

When choosing the subject of your program, another thing to keep in mind is the capacity of the computer on which the program will run. The most popular computers obviously offer the biggest market. If at all possible, scale the program for a popular machine.

Once you've selected your subject, you can start writing the program. It's important to write readable code. Readability not only makes the program easier for you to debug, it also endears you to customers who need to adapt the program to their particular systems or tastes.

Not So Fast!

When the program is finished, debugged, and running perfectly, stop! Don't send it to a publisher yet. Now is the time to add those finishing touches that make the difference between a good program and one that is really commercial and marketable.

Study your program with a critical eye. Ask yourself, "Does my program contain all the instructions the user will need?" Make sure the instructions are thorough, clear, correct, and free of misspellings and grammatical errors.

Then ask, "Does my program lead the user through it? Is it conversational and personal?" A game, for example, doesn't pit just any anonymous soul against the villain.

BAR CODE FOR YOUR SMALL COMPUTER.



New in-depth report tells you how-at savings of up to \$40,000

"Contemporary Applications of Optical Bar Code Technology" is a new, comprehensive report from North American Technology that can save you thousands of dollars in research and development

time when programming and equipping your small computer for bar code.

Written by the originators of Byte Magazine's experiments with publication of software in printed form, Walter Banks and Carl Helmers, this report is the only complete presentation of materials on keyless data entry using modern bar code technology. It will enable you to:

- Read HP-41C calculator formats into your Apple, or other suitable computer.
- Prepare and deliver machine readable printed software to your customers.
- Read a UPC code into your personal computer.
- Print Code 39 manufacturing inventory tags with your formed character or dot matrix printer.

Here, in clear, concise, understandable language is all you need to know about bar code history, software engineering requirements, complete machine independent Pascal software in source listing form. There is software

to generate and read all major formats from Code 39 to HP-41C, and UPC to the new NATI text software publication format. You get information you can use to program your small computer for bar code without detail processing by a human operator. This method speeds the operation, eliminates translation and entry errors and, where desirable, permits the use of unskilled personnel for the entry function. You save thousands of dollars as a result. The \$500 purchase price of the report includes license for the commercial modification and use of all software contained therein.

For detailed information, send for our brochure. There is no cost or obligation. Mail the coupon today.



NORTH AMERICAN TECHNOLOGY, INC.

Strand Building
174 Concord St.,
Peterborough, NH 03458
(603) 924-6048

Please send me your **FREE** brochure on "Contemporary Applications of Optical Bar Code Technology."

NAME _____
ADDRESS _____
CITY _____
STATE _____ ZIP _____

Maxi Manager

The finest
Data Base
Manager
Available

DATA MANAGEMENT PROGRAM COMPARISON CHART

| FILE CAPACITY & FORMAT | CCA DATA MANAGER | AUG III With CALS | MAXI MANAGER | RADEX 10 | PROFILE |
|---|------------------|-------------------|--------------|----------|---------|
| Maximum # of disks per file | 1 | 1 | 4 | 31 | 4 |
| Maximum # of records per file | 2450 | Note 1 | 32,767 | 10,199 | 65,535 |
| Maximum record length | 249 | 254 | 800 | 255 | 255 |
| Maximum # of characters per field | 249 | 254 | 40 | 254 | 255 |
| Maximum # of fields | 24 | 20 | 20 | 127 | 153 |
| Maximum # of characters per field label | 15 | 10 | 19 | 12 | 765 |
| Variable length records (pack sectors) | No | Note 2 | Yes | No | No |

FIELD TYPES

| | | | | | |
|-----------------------------|--------|--------|-----|-----|-----|
| Alphanumeric | Yes | Yes | Yes | Yes | Yes |
| Numeric | Yes | Yes | Yes | Yes | No |
| Fixed decimal numeric | Note 4 | Yes | Yes | No | No |
| Date (MM/DD/YY) | Yes | No | Yes | No | No |
| Extended date (MM/DD, YYYY) | No | No | Yes | No | No |
| Calculated equation | Note 5 | Note 6 | Yes | No | No |
| Permanent fields | Yes | No | No | No | No |

SORTING

| | | | | | |
|-------------------------------------|-----|-----|---------|--------|-----|
| Machine language assisted | No | Yes | Yes | Note 7 | Yes |
| Sort by any field | Yes | Yes | Yes | | Yes |
| Number of Sort Key files | 1 | 1 | 5 | | 1 |
| Numeric sort | Yes | Yes | Yes | | No |
| Ascending sort | Yes | Yes | Yes | | Yes |
| Descending sort | Yes | Yes | Note 11 | | Yes |
| Sort within a selected range | No | No | Yes | | No |
| Sort multiple fields simultaneously | Yes | Yes | No | | No |

FILE MAINTENANCE

| | | | | | |
|--|-----|-----|-----|-----|-----|
| Fixed length input fields | Yes | Yes | Yes | Yes | Yes |
| Single key entry of common data | No | No | Yes | No | No |
| Single field EDIT selection | Yes | Yes | Yes | Yes | Yes |
| Skip record (next or previous) | Yes | Yes | Yes | No | Yes |
| Search & EDIT record | No | Yes | Yes | No | Yes |
| Search & DELETE record | No | Yes | Yes | No | No |
| Auto rejection of alphanumeric data in numeric field | Yes | No | Yes | No | No |

RECORD SELECTION TECHNIQUES

| | | | | | |
|--------------------------------|-----|-----|-----|-----|----|
| Record number | Yes | Yes | Yes | Yes | No |
| Binary search (high speed) | No | No | Yes | No | No |
| Maximum # of simultaneous keys | 1 | 4 | 10 | 31 | 1 |

RELATIONAL COMPARISONS

| | | | | | |
|-------------------|-----|-----|-----|-----|-----|
| Equal | No | Yes | Yes | Yes | Yes |
| Not equal | No | Yes | Yes | No | Yes |
| Greater than | No | Yes | Yes | Yes | Yes |
| Less than | No | Yes | Yes | Yes | Yes |
| Instoring | Yes | No | Yes | Yes | No |
| AND / OR | No | No | Yes | Yes | No |
| Wild card masking | No | No | Yes | No | No |

PRINTING

| | | | | | |
|--|--------|-----|-----|-----|---------|
| User specified page title | Note 8 | Yes | Yes | No | Note 10 |
| User specified column headings | No | No | Yes | No | Yes |
| Automatic page numbering | Yes | Yes | Yes | Yes | Yes |
| Right justification | No | Yes | Yes | No | No |
| User defined column widths | Yes | No | Yes | Yes | Yes |
| User defined column separators | No | No | Yes | No | No |
| Keyboard entered column values | No | No | Yes | No | No |
| Merge data into form letters | No | No | Yes | No | No |
| Form filling applications | No | No | Yes | No | No |
| Columnar totals | Yes | Yes | Yes | No | No |
| Columnar subtotals generated upon change in a specific field | Yes | Yes | Yes | No | No |
| Built in screen print | No | No | Yes | No | No |

MISCELLANEOUS

| | \$75.00 | \$94.90 | \$99.95 | \$99.00 | \$79.95 |
|--|---------|---------|---------|---------|---------|
| Punctuation allowed within data fields | Yes | ? | Yes | Yes | Yes |
| Upper / Lower case | Note 3 | Note 3 | Yes | Note 3 | Note 3 |
| Built in RS-232-C driver | Note 3 | Note 3 | Yes | Note 3 | Note 3 |
| Built-in TRS-232 driver | Note 3 | Note 3 | Yes | Note 3 | Note 3 |
| Programmer's interface | Note 9 | Note 9 | Yes | No | Note 9 |
| Sample DATA disk | No | No | Yes | No | No |
| Documentation (# of pages) | ? | ? | 120 | 38 | 29 |

NOTE 1: File size is dependent on memory size.
NOTE 2: Sequential files only.
NOTE 3: User must supply own driver routine.
NOTE 4: Hard copy print out only.
NOTE 5: Four functions (e.g. /) only.
NOTE 6: Same as note #5 with a maximum of two calculated fields.
NOTE 7: Available as a separate program for \$99.95.
NOTE 8: 120 character maximum.
NOTE 9: Data structures defined in manual.
NOTE 10: 132 characters maximum.
NOTE 11: User option (files can be read from ascending or descending order).

The jury is in and the verdict is . . . "outstanding!" Reviews from all of you who purchased MAXI MANAGER (not to mention raves by many top microcomputing magazines) have heralded it as the definitive data base managing system. We knew that business owners and hobbyists demanded the finest data base managing system available. To all of you who praised us for MAXI MANAGER, we extend our thanks. And to those of you who have yet to try MAXI MANAGER, we invite you to experience this incredible system today. But don't take our word for it (or our jury's). Judge for yourself.

JUST CHECK SOME OF THESE FEATURES

- Supports six different relational search techniques.
- Comes with programmer's interface.
- Over 120 pages of documentation.
- Supports up to 20 user defined fields of 40 characters each.
- Record length up to 800 characters.
- Files can be up to four disks in length.
- Compatible 35, 40, 77 & 80 track drives with proper operating system.
- Has calculated equation fields.
- Complete report generator.
- Works hand in hand with any word processor.

MODEL 1 version requires TRSDOS 2.3 and is compatible with NEWDOS 2.1 & NEWDOS 80

MODEL 3 version comes on TDOS, a special version of the DOSPLUS operating system.

Requires 48K of RAM and one disk drive minimum.

For the TRS-80 Model 1 & 3
Order No. 012-0096

\$99.95

A Division of Scott Adams, Inc.
Adventure International • Box 3435 • Longwood, FL 32750
TOLL-FREE ORDER NUMBER: (800) 327-7172
IN FLORIDA (305) 882-8917
SHIPPING AND HANDLING CHARGES ARE EXTRA
PRICES ARE SUBJECT TO CHANGE WITHOUT NOTICE

ai

The player who faces all the dangers your program holds has a name. Your program should ask the user's name and call him by it frequently.

Now ask, "How does my program treat the user?" Cute messages are okay if used sparingly and in good taste, but never be condescending or insulting to the user. Remember that the user bought your program to perform some task or to have a good time. If he enters a response that isn't in the accepted input range, don't tell him he's an idiot. Tell him what the accepted input range is.

There is nothing so discouraging as running a program and finding yourself facing a prompt without knowing what kind of input is expected, or seeing attackers swarming across the screen when you don't know how you're supposed to defend yourself. If the program doesn't make clear at all times what input it expects, then you owe the user the courtesy of a way to ask for help.

Remember that the user is also your customer. If you treat him with respect, he'll consider buying your next program. These finishing touches are just as important to the program as the most intricate code.

Don't Forget Testing

Is the program ready to go to the publisher now? No, not until it's been tested. Bring in a friend and give him the program to load and run. Don't give him any help. Watch every detail as he works his way through the program. Make notes both for changes in the program and

for anything that seems appropriate to put in the user's guide.

If your friend has trouble with the mechanics of the program (not in developing a game strategy), review the game later to see if ambiguous or inadequate instructions caused the problems. If your friend gets hopelessly stuck and you are forced to help him, you must face the fact that you have either a flawed program or a less-than-brilliant friend. You'll probably feel better if you blame the program and go back to work on it.

After correcting problems discovered in the first test run, bring in a different friend and repeat the usability test. This isn't because you're no longer speaking to the first friend, but because you need another naive user. If the second friend can use and enjoy the program, you may be ready to write the documentation. If the second friend has problems, you'll have to revise the program and find a third friend. If you run out of friends, you'll probably find that enemies are better at testing software anyway.

You can't test a program too much. Once you're satisfied that the program is usable, you can begin writing the documentation.

Before you started work on the program, did you write down the things you wanted it to do? If so, you may be able to modify your notes as a starting point for the user's guide. You should also use your notes from all the test runs.

A user's guide should be written in the simplest words possible. Don't try to show off your vocabulary or prove how ingenious you were in writing the program. Invite a friend to read the first draft and offer criticism. Insist that he point out any places where the user's guide is unclear, ambiguous, or overwritten. Don't be upset if the first draft requires extensive changes. After you make the revisions, type or print a fresh copy on good paper. Include a title page, a copyright notice, and a table of contents. Then place the user's guide in a binder that looks good and makes turning the pages easy.

Now Is the Time

Now, finally, you're ready to submit your program to a publisher. The user-friendly program and the professional-looking user's guide will greatly increase the likelihood of acceptance. The user's guide may also provide the basis for advertising copy when your program goes to publication.

Amateurs are writing many of the programs submitted for publication today, and the lack of professionalism often shows. It shows in programs that have bugs, poor instructions, incorrect spelling and grammar, and shoddy or incomplete documentation. Most of all, it shows in the choice of unsalable subject matter.

Take the time and effort to make your program look and perform as if a professional had written it. At the very least, you'll be proud to run the program on your own system. And there's a good chance your effort will pay off in more sales and hard cash. ■

And You Thought You Didn't Have A Choice

Now you can have another one of those little extras that makes you feel good about your computer...

...a complete packet of the most attractive stock forms on the market. From the people whose only business is the small computer user.

CALL NOW TOLL FREE
For free packets for the following systems:

- Systems Plus • TCS • Structured Systems Group •
- Vector • Peachtree • Radio Shack • Osborne •
- Alpha Micro • Durango • Wares • Cado •
- VECTOR • BPI • Honey/MacInte
- SHASTA • IBM • & MANY MORE •

NATIONWIDE 800-854-2750

Checks To-Go

IN CALIFORNIA 800-552-8817

The Alternative You Deserve

Cameo Makes Your Micro Big Enough for Big Business



When you want a data base for your micro that will grow as fast as you do — look to Cameo. Whether your business is commercial, educational or institutional — for large inventories, massive mail lists, extensive accounts receivable and effective cash management — Cameo has the system to meet your needs.

Cameo's Cartridge Disk Subsystem provides reliable mass storage for most popular micros*. The Cameo subsystem gives you up to 100 times the storage capacity of floppies, while retaining the same flexibility that floppy media provide. With Cameo's system you can remove, copy and back-up massive amounts of data quickly and easily. And, byte-for-byte, cartridge disk mass storage is more economical than floppy disks. Even today's new technologies cannot give you the reliability, flexibility and back-up capability that Cameo provides.

Installation and start-up is simple. Cameo's subsystem is compatible with most operating systems, eliminating the need for additional complex programming. Make Cameo your micro mass storage connection. Call today for the location of the dealer nearest you.

*Apple, TRS-80 Model I & II, Heath H89 and most S-100's

Cameo Electronics, Inc.
1626 Clementine Street
Anaheim, CA 92802
(714) 535-1682
See us at Comdex
European Distributor
Cameo Electronic Vertriebs-GmbH
Escherstrasse 3, D-8121 Eberfing
West Germany
Tel: 8802-8363 TELEX: 59903



CAMEO
Sculptured Brilliance
in Mass Storage

PRINTERS

**10 DAY
FREE RETURN**

EPSON MX-80
Now in stock!

The MX-80 dot matrix printer. Unequaled Epson reliability. Has all the features of the MX-70 plus more power and extra functions.

C-ITOH STARWRITER: LETTER QUALITY PRINTING FOR UNDER \$2000! This daisywheel printer gives high quality at a low price. 25 cps. Parallel and serial interfaces available.

NEC SPINWRITER FROM THE FIRST NAME IN LETTER QUALITY PRINTERS/ Compumart offers beautiful print quality with NEC Spinwriter Terminals. We carry all models from RO THRU KSR WITH NUMERIC KEYPAD—5510-5530. All versions give unsurpassed hard copy output!

NEW INTEGRAL DATA'S 560 PRINTER/ All the exciting features of the 400 series plus 14 1/2" paper capacity. 132 col. graphics printer. **IDS 445.** Priced lower than the 440 and equipped with a better print head. With & w/o graphics. **IDS 460.** Features include correspondence quality printing, high resolution graphics.



Spinwriter 5520

**CENTRONICS PRINTERS
3 SERIAL MODEL 737**

The closest thing to letter quality print for under \$1000.
List \$1045 **SPECIAL \$795.**

737-1 Parallel Interface
List \$995 **SALE PRICE \$695.**
PLUS EXCITING REBATE OFFER ON CENTRONICS PRINTERS.

OMNI 810 PRINTER FROM TEXAS INSTRUMENTS CALL US

The 820 RO PACKAGE includes machine mounted paper tray and cable. A compressed print option and device forms control are standard features.

THE 820 KSR PACKAGE includes fully ASCII Keyboard plus all of the features of the RO.

**MONITORS
TERMINALS**

**CONFIGURATION
HELP**

CLEARANCE ZENITH COLOR VIDEO MONITOR \$349.

SUPER SELLING TERMINALS FROM LEAR SIGLER/ We have the following Lear Siegler terminals in stock at prices too low to print! Call for quotes.

ADM-3A/ Industry's favorite dumb terminal for some very smart reasons/
ADM-3A + NEW from Lear Siegler. **CALL!**

IT IS HERE! It is the new Intermediate Terminal from Lear Siegler.

SANYO MONITORS AT LOW COMPUMART PRICES/ Sanyo's new line of CRT data display monitors are designed for the display of alphanumeric or graphic data.

- 9" SANYO B/W \$169.
- 12" SANYO B/W
- 12" SANYO W/ GREEN SCREEN
- 13" SANYO COLOR



Sanyo 13" Color Monitor

NEC COLOR MONITOR/RECEIVER HIGH RESOLUTION/

Composite video using BNC connectors. 8-Pin connector for VCR/VTR video loop In/Out and television reception.

Visit our giant

ANN ARBOR STORE

1250 North Main Street
Ann Arbor, Michigan

FREE CATALOGS

MICRO

The original and most complete catalog of micro-computers, accessories and peripherals.

DEC PDP/LSI-11

Systems configured and integrated with other manufacturers compatibles. The first, best DEC based systems catalog.

Send for them!

**CALCULATORS
MISC**

**TOLL FREE
ORDERING**

HP-41C CALCULATORS MEMORY MODULES for storing programs of up to 2000 lines of program memory.

"EXTRA SMART" CARD READER. Records programs and data back onto blank magcards.

THE PRINTER. Upper and lower case. High resolution plotting. Portable thermal operation.

APPLICATION MODULES

NEW SUPER 41-CV SYSTEMS with Quad RAMS built-in. Maximum memory on-board leaves slots open for Application Pacs and peripherals.

+ CARD READER + CARD READER + PRINTER QUAD RAMS equivalent to four Memory Modules all packed into one.

MATROX PRODUCTS/ Compumart stocks the complete line.

DEC LSI-11/ Compumart now offers the entire product line **CALL FOR PRICES AND DELIVERY**

NOVATION CAT ACOUSTIC MODEM Answer Originate.

NEW! D-CAT Direct Connect Modem from Novation.



Giltronix Switch

NEW! GILTRONIX RS 232 SWITCH/ The ultimate in flexibility. You can connect three peripherals to one computer or three computers to one peripheral. Switches the eight most important RS 232 signals.

DYSAN DISKETTES/ Single side, single density. Hard or Soft Sector **\$5. ea.**

MEMOREX 3401's/ 5 1/4" disks **\$3.25.** /with hub ring for Apple **\$3.50.**

MEMORY INTEGRATED CIRCUITS/ Call for quantity discounts when ordering over 50 units.

MOTOROLA 4116 (200 Nano-second Plastic) \$4.50

**SYSTEMS
SOFTWARE**

RM EXPANSION ACCESSORIES FOR AIM— CALL SPECS AND PRICES

APPLE III IS IN STOCK/ Apple III Information Analyst Package—128K Apple III. Black and White Monitor 12", and information analyst software.

TOP SOFTWARE PACKAGES FROM COMPUMART

VISICALC/ FOR APPLE/ FOR HP/ FOR COMMODORE/ FOR ATARI

SOFTWARE FROM APPLE/ Apple Plot (the perfect graphic complement for Visicalc/Dow Jones News & Quotes/Apple Fortrom/Apple Writer/Pascal Language System/Controller Business System

PERSONAL SOFTWARE/ Visidex/ VisiTrend/VisiPlot/VisiTerm MUSE/Super Text



Apple Software

MOUNTAIN COMPUTER/

Expansion accessories for Apple/ Super Talker/The Music System/ ROM plus board with Keyboard filter/ROM Writer/Clock Calendar/AtOD and DtoA Converter/ Clock for Apple/CPS Multifunction Board

VIDEX/ Video Term (80 col. x 24 line. 7x9 Matrix plug in compatible board for Apple II) w/wo graphics EPROM/SSM Serial & Parallel. Apple Interface/ABT's Numeric Key Plan/California Microcomputer Keyboard

NEW!

VIC 20 PERSONAL COMPUTER FROM COMMODORE

\$299

SEE US AT THE NORTHEAST COMPUTER SHOW, OCTOBER 15-18, 1981, BOOTH #608

IMPORTANT ORDERING INFORMATION

CALL: 800 343-5504, in Massachusetts (617) 491-2700, phones open from 8:30 a.m. to 7:00 p.m. Mon-Fri. 11:00 a.m. to 4:00 p.m. Sat. P.O.'s. Accepted from Dun & Bradstreet rated companies—shipment

contingent upon receipts of signed purchase order.

SALE PRICES: Valid for month of magazine date only—all prices subject to change without notice. Our Ann Arbor retail store is open 11:00 a.m. to 7:00 p.m. Tues-Fri. 10:00 a.m. to 5:00 p.m. on Saturdays

SYSTEMS

APPLE II STARTER

\$1895

SAVE OVER \$200 ON OUR BEST SELLING APPLE SYSTEM/ System includes a 48K Apple II, Apple Disk, DOS 3.3 and Controller and a Sup R MOD RF Modulator.

List \$2209.

EXCLUSIVE FOR THE APPLE: Magic Wand, Videx, Z-80 softcard (Requires 48K Apple and disk).

COMPLETE SUB-SYSTEM \$925.

APPLE ACCESSORIES

CHOOSE FROM: Silenotype Printer w/x face/Light Pen/Easy Writer (80 col. need a Videx)/Clock for Apple.

FROM MICROSOFT: 16K RAM Board/FORTLAN.

FROM COMPUTER STATION: Hi-Res Dump for 460 Printer.

OUR APPLE INVENTORY IS COMPLETE. WE'VE GOT IT ALL—



apple computer
Authorized Dealer
Accept No Less

SYSTEMS

COMMODORE WORD CRAFT 80

\$4695

CRISP LETTER QUALITY OUTPUT UNSURPASSED EASE OF OPERATION

This Compumart/Commodore system includes a **COMMODORE 8032 32K CPU**, a **4040 DUAL DISK**, a **C-ITOH PRINTER** and x/face and **WORD PRO 4 PLUS** (all cables included). List \$5685.

EDUCATORS: COMMODORE HAS EXTENDED ITS 3 FOR 2 DEAL

A COMPLETE SYSTEM: includes a **DUAL DISK DRIVE/TRACTOR PRINTER** and an **80 COLUMN 32K CPU**. No interfaces needed. Cables included. List \$3985.

COMPUMART \$3635.

SAVE \$200 ON COMMODORE ACCESSORIES WITH PURCHASE OF A 32K PET—SAVE \$100 WITH A 16K PET.

CHOOSE FROM:

Visicalc/Word Pro 4/Wordcraft 80/Ozz the Information Wizard/Dow Jones Portfolio Mgmt System/Assembler Development Package



commodore
Authorized Dealer
Accept No Less

Systems
Customized

SYSTEMS

HP 85 BASIC

\$3250

This Basic 16k BYTE system (expandable to 32k) includes: **CRT DISPLAY, THERMAL PRINTER, MAGNETIC TAPE CARTRIDGE, 6 ROM CAPACITY VIA ROM DRAWER, 4 IO PORTS. COMMUNICATION—HPIB, RS232**

PLUS

YOUR CHOICE OF 4 SOFTWARE PACS OR TWO OF OUR "BEST SELLERS"—(VISICALC, GRAPHICS PRESENTATION, INFORMATION MANAGEMENT) SAVE \$400

HP-83 SYSTEM

This Basic System from Hewlett-Packard includes **HP-83/ROM DRAWER/MASS STORAGE ROM/ 5 1/4" SINGLE MASTER FLEXIBLE DISK DRIVE/HP-1B INTERFACE MODULE/2 METER HP-1B CABLE. COMPLETE SYSTEM \$4249.**



hp HEWLETT PACKARD
Authorized Dealer
Accept No Less

SYSTEMS

AIM 65 STARTER

\$795

FROM ROCKWELL

Our AIM Starter System for Educational & Laboratory use includes **4K AIM/BASIC & ROM/ASSEMBLER & ROM/POWER SUPPLY EGI ENCLOSURE/CRAIG TAPE RECORDER.**

ACCESSORIES FOR AIM STARTER: PL 65 High Level Language/Paper for the Aim (roll)/Rockwell's 4 slot Motherboard/

WE ALSO CARRY RM EXPANSION ACCESSORIES FOR THE AIM-65.



Rockwell International
Authorized Dealer
Accept No Less



800-343-5504

IN MASS CALL 617-491-2700

COMPUMART

65 Bent Street, Dept 110

PO Box 568, Cambridge, MA 02139

From THE LEADER...

We just might be the largest independent small systems dealer in the country. Here's why: COMPUMART has been serving the computer needs of industry since 1971.

We stock, for immediate shipment, only those products from the finest micro-computer manufacturers.

And any product, except software, can be returned within 10 days for a full refund—even if you just change your mind. We also honor all manufacturers' warranties. Our expert technicians will service any product we sell.

Call us for more information on products, product configuration and service. Our phones are open Monday thru Friday, 8:30 a.m. to 7:00 p.m. and Saturday 11:00 a.m. to 4:00 p.m.

We have a staff of highly knowledgeable sales people waiting to hear from you, and to help. Because service is what we're all about.

Circle 76 on inquiry card.

List Pager

Allan Lovett, 20024 N 18th Dr, Phoenix AZ 85027

List Pager, shown in listing 1, is a simple program for the Apple II or Apple II Plus computer. The program prints out listings, one page at a time, with a title on the first page and a number on each of the following pages. It will not split statements between pages but will instead automatically produce line feeds to move to the next page. You can choose either a full 80-column format or 60 columns with margins on each side. List Pager is written in Applesoft BASIC, is set up for a Centronics 730 printer, and requires one floppy-disk drive.

To use List Pager, the program to be listed must first be captured as a text file. This can be done using a program such as Capture, which is found on page 76 of the *Apple DOS* manual. When List Pager is run, it will ask for the

title of the program, the name of the text file, and if an offset (60-column format) for hole punching is desired. After this information is entered, it will print the listing.

This program greatly improves the readability of a listing over that of continuously printed listings, which always seem to have an important line written on the perforations between pages. ■

Listing 1: The List Pager program printed in a 60-column format with 10-column margins. The List Pager can also list programs in full 80-column format. List Pager places a title on the first page of a listing and numbers on subsequent pages. The program is written in Applesoft floating-point BASIC for the Apple II or II Plus computer with one disk drive and a Centronics 730 printer.

C Compiler only \$75

We have re-written Small-C as published by Ron Cain in the May, 1980 issue of *Dr. Dobbs*. The Code Works C compiler (CW/C) includes these additional features:

- Structures and unions
- For, switch/case, do-while
- Multidimensional arrays
- Conditional compilation (#ifdef, etc.)
- Assignment operators, e.g. x += 10;
- Can declare complex types, e.g. int (*fp)[5];
- User supplied I/O buffers of any size
- Dynamic storage allocation (alloc and free)
- Command line arguments using argv and argc
- Improved error handling

CW/C is a proper subset of the full C language. We do not have: float, double, long, unsigned or short data types; static; initializers; sizeof; typedef; "?:"; casts; bit fields; goto; #undef, #if, #line.

CW/C generates assembly language source code that is then assembled using ASM or MAC. CW/C supports inline assembly language with the #asm ... #endasm preprocessor commands. Requires 56K 8080 or Z80 CP/M system. Distributed on single-density 8" disk or Northstar double density CP/M 5" disk. Includes an excellent User Manual, the executable CW/C compiler, runtime library, and several useful example programs written in C.

**THE CODE
WORKS**

CW/C is \$75, including shipping in the US and Canada.
CA residents add 6% tax. Visa and MasterCard welcome.
CP/M is a registered trademark of Digital Research.

Box 550, Goleta, CA 93116 805-683-1585

```
100 D$ = CHR$(4):T$ = CHR$(1): ONERR GOTO 390
110 RO = 0:LM = 1
120 HOME : HTAB (15): PRINT "LIST PAGER": PRINT : PRINT
130 INPUT "TITLE IS ? ":TITLES$: PRINT : PRINT
140 PG = 2
150 INPUT "TEXT FILE IS ? ":TF$: PRINT
160 LW = 80
170 PRINT "OFFSET FOR HOLE PUNCH ? (Y/N) ": GET AN$: PRINT
    T$:AN$
180 IF AN$ = "Y" THEN LW = 60:LM = 10
190 HOME : PRINT D$:"PR#1"
200 PRINT CHR$(9):"80N"
210 OS = ((80 - LEN (TITLE$)) / 2): HTAB (OS): PRINT TITLE$
    : PRINT CHR$(10): PRINT CHR$(10)
220 PRINT D$:"OPEN ":TF$
230 PRINT D$:"READ ":TF$
240 FL = 4
250 PRINT CHR$(9):"80N"
260 LN$ = "":L1$ = ""
270 GET A$: IF LEN (LN$) < 240 THEN LN$ = LN$ + A$: GOTO 2
    80
275 IF LEN (LN$) = 240 THEN L1$ = L1$ + A$
280 IF LN$ = CHR$(13) THEN GOTO 260
290 IF A$ = CHR$(13) THEN GOTO 310
300 GOTO 270
310 PRINT T$:LE = 1
320 LH = LEN (LN$) + LEN (L1$):LE = 1: FOR I = 1 TO 10: IF
    LH > (LW * I) THEN LE = I + 1: NEXT I
330 FOR I = 1 TO LE: IF I * LW < 241 THEN L$(I) = MID$(LN
    $,((I - 1) * LW + 1),LW)
335 IF I * LW > 240 THEN L$(I) = MID$(L1$,((I - 1) * LW
    + 1) - 240),LW)
339 NEXT I
340 FL = FL + LE
350 IF FL > 60 THEN FL = FL - LE: FOR I = 1 TO 66 - FL: PRI
    NT CHR$(10): NEXT :RO = 1: GOTO 380
360 FOR I = 1 TO LE: HTAB (LM): PRINT L$(I): NEXT
370 GOTO 250
380 PRINT CHR$(10): PRINT TAB(60):"PAGE ":PG:PG = PG +
    1: PRINT CHR$(10): PRINT CHR$(10):FL = 4: IF RO = 1 THEN
    LE = LE: FOR I = 1 TO LE: HTAB (LM): PRINT L$(I): NEXT :FL
    = FL + LE: GOTO 250
390 PRINT T$
400 PRINT D$:"CLOSE"
410 FOR I = 1 TO 67 - FL: PRINT CHR$(10): NEXT
420 PRINT D$:"PR#0": HOME : END
```

COMPUTER WAREHOUSE

CALL TOLL FREE **1-800-528-1054**

ATARI

| | |
|--|--------------|
| Special 32K 800 System | |
| 800 w/32K. recorder. star raiders. joysticks. | \$930 |
| Above w/48K. | \$990 |
| 800 (16K) | \$744 |
| 400 | Call |
| 810 Disk Drive | \$440 |
| 825 Printer | \$575 |
| 850 Interface | \$120 |
| 410 Recorder | \$70 |
| 830 Modem | \$140 |
| 16K Memory | \$75 |
| 32K Memory | \$150 |

DISK DRIVES

| | |
|-----------------------|--------------|
| Lobo | |
| Apple 1st Drive | \$490 |
| Apple 2nd Drive | \$410 |

MODEMS

| | |
|--------------------|--------------|
| Novation | |
| CAT | \$155 |
| D-CAT | \$155 |
| Apple Cat II | \$349 |
| Auto Cat | \$235 |

PRINTERS

| | |
|------------------------|---------------|
| C. Itoh | |
| 25CPS - Serial | \$1380 |
| 25CPS - Parallel | \$1325 |
| 40CPS - Serial | \$1825 |
| 45CPS - Parallel | \$1710 |

| | |
|------------------|---------------|
| Datasouth | |
| DS 180 | \$1275 |

| | |
|-------------------|---------------|
| Diablo | |
| 630 RO | |
| w/Tractors | \$2295 |
| 630 RO | |
| wo/Tractors | \$2100 |
| 1640 RO | |
| w/Tractors | \$2485 |
| 1640 KSR | |
| w/Tractors | \$2740 |
| 1650 RO | |
| w/Tractors | \$2985 |
| 1650 KSR | |
| w/Tractors | \$2885 |

| | |
|---------------------------------|-------------|
| Epson | |
| MX-80 | Call |
| MX-80 F/T | Call |
| MX-100 | Call |
| Fric. Feed Opt. for MX-80 | \$50 |

| | |
|------------------|---------------|
| NEC | |
| PC-8023A | Call |
| 5510 RO | |
| w/Tractors | \$2662 |
| 5520 KSR | |
| w/Tractors | \$2995 |

| | |
|----------------------|---------------|
| Okidata | |
| Microline 80 | \$375 |
| Microline 82-A | \$535 |
| Microline 83-A | \$790 |
| Microline 84 | \$1115 |

| | |
|----------------|---------------|
| Qantex | |
| Serial | \$1150 |
| Parallel | \$1125 |

| | |
|--------------------------|---------------|
| Texas Instruments | |
| 810 Basic | \$1250 |
| 810 Loaded | \$1450 |

ATARI®

Novation

ZENITH data systems

NorthStar

SOROC TECHNOLOGY, INC.

TeleVideo™

3M TEXAS INSTRUMENTS

EPSON EPSON AMERICA, INC.

OKIDATA

California Computer Systems

VIDEO TERMINALS

| | |
|------------------|--------------|
| Adds | |
| Viewpoint | Call |
| Soroc | |
| IQ 120 | Call |
| IQ 130 | Call |
| IQ 135 | Call |
| IQ 140 | Call |
| Televideo | |
| 910 C | \$589 |
| 912 C | \$694 |
| 920 C | \$744 |
| 950 C | \$935 |
| Zenith | |
| Z-19 | \$769 |

DISKETTS

| | |
|--------------------------------------|--------------|
| Scotch | |
| 5¼" 0, 10, 16 Sector (Qty 100) | \$250 |
| 8" 0, 32 Sector (Qty 100) | \$260 |

COMPUTERS

| | |
|-------------------------|---------------|
| Altos | |
| ACS 8000-15 | Call |
| ACS 8000-2 w/CPM | Call |
| Northstar | |
| Horizon II 64K DD | \$2875 |
| Horizon II 64K QD | \$3150 |
| Zenith | |
| Z-89 48K w/CPM | \$2200 |

MONITORS

| | |
|------------------|--------------|
| Panasonic | |
| 9" B&W | \$150 |
| Sanyo | |
| 9" B&W | \$150 |
| 12" Green | \$240 |

CALIFORNIA COMPUTER SYSTEMS

| | |
|---------------------------|--------------|
| 64K Dynamic Memory | \$500 |
| 16K Static Memory | \$255 |
| Floppy Disk Cont. | \$285 |
| Serial Asynch Board | \$110 |

Prices & availability subject to change without notice Personal checks will delay shipping two weeks



2222 E. Indian School Rd. • Phoenix, Arizona 85016
Order Line: 1-800-528-1054

Other Information: 602-954-6109



Store Hours: Tues.-Fri. 10-5 MST Saturday 10-3 MST

Prices reflect 3% cash discount. Product shipped in factory cartons with manufacturers warranty. Add 2%, a minimum of \$5, for shipping and handling.

If you can beat these prices, you must have a brother-in-law in the business.

16 K RAM KITS

NEC 4116 200 ns 17.95

DISKETTES

MD 525-01.10.16 26.50
 MD 550-01.10.16 44.50
 MD 577-01.10.16 34.80
 MD 557-01.10.16 45.60
 FD 32 OR 34 -9000 36.00
 FD 32 OR 34 -8000 45.60
 FD 34-4001 48.60

DISKETTE STORAGE

5 1/4" PLASTIC LIBRARY CASE 2.50
 8" PLASTIC LIBRARY CASE 3.50
 PLASTIC STORAGE BINDER WITH INSERTS 9.95
 PROTECTOR 5 1/4" 24.95
 PROTECTOR 8" 29.95

INTEGRATED COMPUTER SYSTEMS

ITHACA INTERSYSTEMS CALL
 ALTOS CALL
 ZENITH Z89 CALL
 CALIF. COMPUTER SYSTEMS CALL
 MORROW DESIGNS CALL

PRINTERS

ANADEx DP 9500 1295.00
 ANADEx DP 9501 1295.00
 CENTRONICS 739 765.00
 C-ITOH 25 CPS PARALLEL 1440.00
 C-ITOH 25 CPS SERIAL 1495.00
 C-ITOH 45 CPS PARALLEL 1770.00
 C-ITOH 40 CPS SERIAL 1870.00
 C-ITOH TRACTOR OPTION 195.00
 EPSON MX-80 \$CALL
 EPSON MX-80 F/T \$CALL
 EPSON MX-100 GRAPHIC \$CALL
 EPSON GRAPHICS ROM 90.00
 IDS-445G PAPER TIGER 779.00
 IDS-460G PAPER TIGER 945.00
 IDS-560G PAPER TIGER 1195.00
 INFOSCRIBE 500 9X9, 150 CPS 1495.00
 MALIBU 200 DUAL MODE 2995.00
 NEC SPINWRITER 3510 SERIAL RO 2099.00
 NEC SPINWRITER 3530 PARALLEL RO 2099.00
 NEC SPINWRITER 7710 SERIAL RO 2595.00
 NEC SPINWRITER 7730 PARALLEL RO 2595.00
 NEC SPINWRITER 7700 D SELLUM OPTION 2795.00
 NEC SPINWRITER 3500 SELLUM OPTION 2295.00
 OKIDATA MICROLINE 80 399.00
 OKIDATA MICROLINE 82A 599.00
 OKIDATA MICROLINE 83A 899.00
 OKIDATA MICROLINE 84 1199.00

MODEMS

NOVATION CAT ACOUSTIC MODEM 145.00
 NOVATION D-CAT DIRECT CONNECT MODEM 155.00
 NOVATION AUTO-CAT AUTO
 ANSWER MODEM 219.00
 NOVATION APPLE-CAT 349.00
 UDS 103 LP DIRECT CONNECT MODEM 175.00
 UDS 103 JLP DIRECT CONNECT/AUTO
 ANSWER 209.00
 D.C. HAYES MICROMODEM II (Apple) 299.00
 D.C. HAYES 100 MODEM (S-100) 325.00
 D.C. HAYES STACK Smart Modem (RS 232) 249.00
 LEXICON LX-11 MODEM 115.00

APPLE HARDWARE

VERSA WRITER DIGITIZER 219.00
 ABT APPLE KEYPAD 119.00
 MICROSOFT Z-80 SOFTCARD 299.00
 MICROSOFT RAMCARD 170.00
 ANDROMEDA 16K CARD 170.00
 VIDEX 80 X 24 VIDEO CARD 299.00
 VIDEX KEYBOARD ENHANCER 99.00
 M & R SUPERTERM 80 X 24 VIDEO BOARD 315.00
 NEC 12" GREEN MONITOR 235.00
 SANYO 12" MONITOR (B & W) 249.00
 SANYO 12" MONITOR (Green) 279.00
 SANYO 13" COLOR MONITOR 469.00
 TEECO 12" HIGH RES GREEN MONITOR 169.00
 SSM AIO BOARD (INTERFACE) A&T 165.00
 SSM AIO BOARD (INTERFACE) KIT 135.00
 SSM IEEE 488 INTERFACE 369.00

MOUNTAIN HARDWARE

| | |
|------------------------------|--------|
| CPS MULTIFUNCTION BOARD | 209 00 |
| SUPERTALKER SD200 | 259 00 |
| ROMPLUS WITH KEYBOARD FILTER | 179 00 |
| ROMPLUS W/O KEYBOARD FILTER | 130 00 |
| KEYBOARD FILTER ROM | 49 00 |
| COPYROM | 49 00 |
| MUSIC SYSTEM | 459 00 |
| ROMWRITER | 149 00 |
| APPLE CLOCK | 252 00 |
| A/D + D/A | 299 00 |
| EXPANSION CHASSIS | 575 00 |

VISTA COMPUTER CO.

| | |
|--|--------|
| APPLE 40 Track Drive A40 (163 K Bytes) | 389 00 |
| APPLE 80 Track Drive A80 (326 K Bytes) | 549 00 |
| APPLE 160 Track Drive A160 (652 K Bytes) | 799 00 |
| APPLE 80 Column Card | 329 00 |
| APPLE 8 Inch Disk Drive Controller | 549 00 |

CALIF. COMPUTER SYSTEMS

S-100 BOARDS

| | |
|------------------------------------|--------|
| 2200A MAINFRAME | 349 00 |
| 2032A 32K STATIC RAM | 599 00 |
| 2065C 64K DYNAMIC RAM | 499 00 |
| 2422 FLOPPY DISK CONTROLLER & CP/M | 339 00 |
| 2710 FOUR SERIAL I/O | 249 00 |
| 2718 2 SERIAL / 2 PARALLEL I/O | 269 00 |
| 2720 FOUR PARALLEL I/O | 199 00 |
| 2810 Z-80 CPU | 249 00 |

APPLE BOARDS

| | |
|---------------------------------------|--------|
| 7710A/D ASYNCHRONOUS SERIAL INTERFACE | 139 00 |
| 7712A SYNCHRONOUS SERIAL INTERFACE | 149 00 |
| 7424A CALENDAR/CLOCK | 99 00 |
| 7728A CENTRONICS PRINTER INTERFACE | 99 00 |

APPLE SOFTWARE

| | |
|-------------------------------------|--------|
| MAGIC WINDOW WORDPROCESSOR | 89 00 |
| MAGIC WAND | 275 00 |
| WORDSTAR—APPLE | 259 00 |
| MAILMERGE—APPLE (REQUIRES WORDSTAR) | 90 00 |
| SPELLSTAR—APPLE (REQUIRES WORDSTAR) | 169 00 |
| DATASTAR | 199 00 |
| EXPEDITER II APPLESOFT COMPILER | 89 00 |
| PFS: PERSONAL FILING SYSTEM | 79 00 |
| PFS: REPORT GENERATOR | 79 00 |
| ASCII EXPRESS TERMINAL PROGRAM | 59 95 |
| Z—TERM COMMUNICATIONS SOFTWARE | 89 95 |
| MICROSOFT FORTRAN | 165 00 |
| MICROSOFT COBOL | 550 00 |
| DB MASTER 2.4 | 179 00 |
| VISICALC 3.3 | 169 00 |
| VISIPL0T | 149 00 |
| VISIDEX | 169 00 |
| CCA DATA BASE MANAGER | 99 00 |
| A-STAT COMPREHENSIVE STATISTICS PKG | 119 00 |

APPLE GAME SOFTWARE

| | |
|----------------|-------|
| SPACE EGGS | 24 95 |
| POOL 1.5 | 29 95 |
| RASTER BLASTER | 24 95 |
| GORGON | 32 95 |
| APPLE PANIC | 24 95 |

CP/M SOFTWARE

| | |
|------------------------------------|--------|
| MICROSOFT BASIC-80 | 299 00 |
| MICROSOFT BASIC COMPILER | 319 00 |
| MICROSOFT FORTRAN-80 | 399 00 |
| PEACHTREE SYSTEMS | CALL |
| MAGIC WAND (REQUIRES CP/M) | 275 00 |
| WORDSTAR (REQUIRES CP/M) | 325 00 |
| MAILMERGE (REQUIRES WORDSTAR) | 110 00 |
| SPELLSTAR (REQUIRES WORDSTAR) | 199 00 |
| DATASTAR | 249 00 |
| SPELLGUARD | 239 00 |
| CP/M PICKLES & TROUT FOR TRS-80 II | 175 00 |

MORROW DESIGNS

FLOPPY DISK SYSTEMS

| | |
|--|---------|
| Controller, P.S., Cables, Microsoft Basic, CP/M, A&T | |
| DISCUS I (Single Drive—250 K) | 799 00 |
| DISCUS I (Dual Drive—500 K) | 1429 00 |
| DISCUS 2D (Single Drive—500 K) | 869 00 |
| DISCUS 2D (Dual Drive—1 MEG) | 1499 00 |
| DISCUS 2 + 2 (Single Drive—1 MEG) | 1099 00 |
| DISCUS 2 + 2 (Dual Drive—2 MEG) | 1999 00 |

HARD DISK SYSTEMS

| | |
|--|---------|
| Controller, P.S., Microsoft Basic, CP/M, A&T | |
| DISCUS M10 (10 Megabytes) | 2949 00 |
| DISCUS M20 (20 Megabytes) | 3829 00 |
| DISCUS M26 (26 Megabytes) | 3949 00 |

DECISION 1 COMPUTER

| | |
|--|------|
| Z-80A, CP/M, NIX (UNIX Identical), 32 to 1 MEG of memory | |
| Floppy and/or Hard Disk | CALL |

SD SYSTEMS

S-100 BOARDS

| | |
|------------------------|--------|
| VERSAFLOPPY II A&T | 389 00 |
| VERSAFLOPPY II KIT | 329 00 |
| SBC 200 (Z-80 CPU) A&T | 369 00 |
| SBC 200 (Z-80 CPU) KIT | 299 00 |
| Z-80 STARTER KIT | 289 00 |
| EXPANDORAM II KIT (0K) | 220 00 |

We built a reputation on our prices and your satisfaction.

Alpha Byte STORES

(213) 883-8594

31245 LA BAYA DRIVE, WESTLAKE VILLAGE, CALIFORNIA 91362

TRS-80 MOD I HARDWARE

| | |
|-------------------------------|--------|
| PERCOM DATA SEPARATOR | 27 00 |
| PERCOM DOUBLER II | 159 00 |
| DOUBLE ZAP II/80 | 45 95 |
| TANDON 80 TRACK DISK DRIVE | 429 00 |
| TANDON 40 TRACK DISK DRIVE | 299 00 |
| LNW DOUBLER WITH DOSPLUS 3.3D | 169 00 |

TRS-80 SOFTWARE

| | |
|------------------------------------|--------|
| NEWDOS/80 2.0 MOD I | 139 00 |
| LAZY WRITER MOD I | 125 00 |
| PROSOFT NEWSOFT MOD I.III | 99 00 |
| SPECIAL DELIVERY MOD I.III | 119 00 |
| X-TRA SPECIAL DELIVERY MOD I.III | 199 00 |
| TRACKCESS MOD I | 24 95 |
| OMNITERM SMART TERMINAL MOD I.III | 89 95 |
| MICROSOFT BASIC COMPILER FOR MOD I | 165 00 |

CORVUS

FOR S-100, APPLE OR TRS-80 MOD I,II

| | |
|--|---------|
| Controller, Case/P.S., Operating System, A&T | |
| 5 Megabytes | 3095 00 |
| 10 Megabytes | 4495 00 |
| 20 Megabytes | 5395 00 |
| MIRROR BACK-UP | 700 00 |

SUPPLIES

AVERY TABULABLES

| | |
|---------------------|-------|
| 1,000 3 1/2 X 1 1/8 | 8.49 |
| 3,000 3 1/2 X 1 1/8 | 14.95 |
| 5,000 3 1/2 X 1 1/8 | 19.95 |

UARCO PAPER (Prices F.O.B. S.P.)

| | |
|-------------------------|-------|
| 9 1/2 X 11 18 lb white | 29 00 |
| 14 1/4 X 11 18 lb white | 39 00 |

We stock a complete line of computer covers, printer ribbons, print wheels & NEC thumbles—CALL US FOR YOUR NEEDS

We guarantee everything we sell for 30 days. If anything is wrong, just return the item and we'll make it right. And, of course, we'll pay the shipping charges.

We accept Visa and Master Card on all orders. COD orders accepted up to \$300.00. We also accept school purchase orders.

Please add \$2.00 for standard UPS shipping and handling on orders under 50 pounds, delivered in the continental U.S. Call us for shipping charges on items that weigh more than 50 pounds. Foreign, FPO and APO orders please add 15% for shipping. California residents add 6% sales tax.

The prices quoted are only valid for stock on hand and all prices are subject to change without notice.

Software Protection in the United Kingdom

Martin Hayman
Science Writers
80 Paxton Rd
London W4 2QX England

The first conference on software protection in the United Kingdom started with a joke and ended with a joke. In between, there was little to laugh about. In opening the conference, Alistair Kelman, a leading software copyright lawyer, told an old music-hall joke about an Englishman who asked an Irishman how to get to County Derry. The Irishman replied, "If I wanted to get to County Derry, I wouldn't start from here." In other words, Kelman suggested, if we had a choice in the matter of software protection, we would not set out from the point at which we find ourselves: ensnared by a tangled and thorny copyright law whose concepts spring from the days when the computer was little more than a fancy abacus in the mind of Charles Babbage.

The conference's closing joke came from retired software dealer and industry pundit Julian Allason, who proposed a "final solution" to the piracy problem: give the pirates free rein! Allason told how the American software house OEM is offering a "nonexclusive" licensing deal. For \$460, OEM sells a complete line of programs, which the purchaser can dispose of as he wishes—for his own use, for copying, or for modification

and resale. According to Allason, OEM intends its programs as "blueprints" that the purchaser can modify to meet his needs. But even so, an unnamed mail-order firm has already pirated OEM's products, offering the complete OEM line for a mere \$260.

Held in March at the Waldorf Hotel in London, the Computer Software Protection Conference was subtitled "How to Beat the Pirates." The conference offered many suggestions on how to deal with the worldwide problem now reaching epidemic proportions in the UK. But the general conclusion was that the pirates can be beaten only by spending lots of time and money and retaining a knowledgeable lawyer from the outset.

The Backup Problem

Software theft has only recently become a problem in the UK. Hardware releases usually reach the UK about a year after introduction in the United States. In the one-year interval, Americans do a great deal of software development for the new machine. Because a question always exists about how and by whom the American software will be brought to the UK, the situation seems to offer great possibilities for software

thieves.

Perhaps we should be surprised that VisiCalc, the world's best-selling program, was not copied here until late in 1980. VisiCalc retails in the UK at £125 (\$290) and is distributed by Applied Computer Techniques (ACT) of Birmingham, the same firm that sells the Commodore PET, Britain's best-selling microcomputer. In December 1980, ACT discovered that a mail-order firm run by David Bolton was marketing what it called a "backup disk" for VisiCalc. The "backup disk" didn't contain a copy of VisiCalc but was preformatted in a way that enabled the user to defeat VisiCalc's protection routines and make a backup copy of the original disk from ACT. Bolton's backup disks sold like hotcakes, partly because ACT itself still will not give a registered user of VisiCalc a backup copy.

ACT promptly retained Alistair Kelman to apply to the High Court for an injunction to stop Bolton from selling the "backup disk," which ACT claimed was effectively a copy or an invitation to copy, and hence a breach of copyright relating to "artistic or literary works." After requiring ACT to get US suppliers Personal Software and Software Arts as

the supreme command

We're Offering You Our Company Secret.

It's a brand new American-designed program generator that can eliminate the need to spend thousands of dollars on specialty programs.

And, It's Available Today.

It's the microcomputer program that Time Management Software is using to write its own professional software packages. And now, you can use it to write all the programs you'll ever need. We call it *GENESIS*. You'll call it incredible, because we have yet to find a program on the market that *GENESIS* can't create.

GENESIS is the next generation.

Designed by a team of doctoral-level programmers, *GENESIS* runs on all CP/M* 2.XX systems, using compiled PL/1-80*.

The code generated by *GENESIS* is fast and efficient, and this new product's capacity to code difficult algorithms is virtually unlimited.

The speed of code generation itself is literally awesome. Preliminary tests have indicated an ability to generate efficient code at a rate well in excess of four lines per second. Clearly, *GENESIS* can write months of code in a matter of minutes.

With You As Architect, Genesis Is The Ultimate Master Builder.

Word processing, accounting procedures, statistical analysis, time management studies... *GENESIS* can write any functions you could possibly need. Naturally, complete program changes are quickly and easily made.

You speak plain American English to *GENESIS* — no code, no difficult introductory language to memorize. The only time you spend with *GENESIS* is in deciding the specifications of your program.

Simply Stated, Genesis Is The Best Microcomputer Program Generator In The World. Period.

Genesis comes with on-line documentation, as well as a complete concise printed manual, written by a professional manual writer.

Due to its sophistication, we recommend this program for use with any disk system with 48k or more, using CP/M* 2.XX. The code which is generated is CBASIC*.

(Note: Even though *GENESIS* runs in compiled PL/1-80* it is not necessary to have PL/1-80* in order to run the program.)

The program comes on standard 5¼- or 8-inch disk, with storage sleeve. The program that will allow maximum use of your hardware... an introductory price of \$500.

GENESIS is available now directly from Time Management Software, and is

not sold through any other outlet. Time Management Software will send free updates of new material and products to *GENESIS* owners as they develop, to make sure you've got everything you need.

Order the most advanced program generator system on the market today, by calling one of the toll-free numbers or by returning the order blank below.

Call now toll-free to order. (Ask for operator 603.)

1-800-824-7888 (Nationwide, except California, Alaska and Hawaii)

1-800-852-7777 (In California)

1-800-824-7919 (In Alaska and Hawaii)



YES... I need *GENESIS* to develop the ultimate program and to take fullest advantage of my hardware. 10A1

NAME _____

ADDRESS _____

CITY _____ STATE _____ ZIP _____

I have enclosed \$500 to avoid delays, shipping and handling charges.

Check Money Order C.O.D. (If delivery address is different than above, please specify.)

Please specify one: 5¼-inch disk 8-inch disk

Price includes tax, handling and shipping (except C.O.D. orders.)

**TIME
MANAGEMENT
SOFTWARE™**

123 E. Broadway
P.O. Box 727
Cushing, Oklahoma 74023

*Registered Trademarks of Digital Research Inc.



How To Start Your Own



Successful Computer Business

Projections for the computer industry indicate astronomical growth during the coming years. Sales of microprocessors alone are expected to exceed a staggering 2 billion dollars by 1983! This comprehensive manual will show you how to use your expertise to cash in on the exploding computer marketplace.

This manual covers virtually every aspect of starting or buying a computer business. It contains over 300 pages that are filled with valuable information and facts to put you on your path to success. A path that you tailor to your personal goals, preferences, background, strengths, and resources. With this manual you will explore and evaluate opportunities such as an independent software vendor, systems house, consultant, distributor, retail store, and more.

"How to Start Your Own Successful Computer Business" will help you get the best return on your investment. It is comprehensive and easy to use. This manual provides the planning checklists and sample forms needed to get your business started successfully. It includes step-by-step guides for preparing your business plan, financial plan, and customer contracts, to name a few. You will learn how to avoid costly mistakes and save your precious dollars in such areas as advertising and software development.

This manual is filled with priceless tips gained from many years of experience on how to succeed in the computer marketplace. If you are considering starting a part-time or full-time computer business, then you cannot afford to pass up this valuable resource.

ORDER YOUR COPY NOW
PRICE \$75.00
15-DAY REFUND GUARANTEE

InfoSource Inc.

6087 Buford Hwy., Suite B106
Norcross, Georgia 30071

Please send me my copy of
"How to Start Your Own
Successful Computer Business"

Enclosed is check money order
for \$75.00.

I prefer to use my VISA
 MASTERCARD

Card No. _____

Exp. _____

NAME _____

ADDRESS _____

CITY _____

STATE, ZIP _____

For faster shipment on credit card orders
call (404) 447-7889

co-applicants in the injunction, the court found no reason to stop Bolton from selling his "backup disk."

Instead, the court simply passed a motion requiring Bolton to record all sales of the disk until some future day when the matter would come to trial. In the event of a trial, the motion would become the basis of any legal award for compensation. But even if Bolton paid up, the cost of recovery would far outweigh the damages themselves. The legal process is extremely slow in the UK, and the backup disk is still being sold. Furthermore, practice at the UK Bar forbids a lawyer from taking a case on a speculative basis. Counsel's fee for pleading is payable whether or not damages are recovered. This makes "test cases" such as this one a rather Quixotic exercise.

Oblique Threat

In the Bolton case, an apparent attempt to persuade Bolton to desist may have undermined the position of the plaintiffs. On the morning of his appearance in court, Bolton received by mail a trade-newspaper clipping describing the somewhat similar case of Vincent Cohen. London police arrested Cohen in connection with the alleged theft and dishonest handling of source code belonging to the American firm Graham-Dorian Software. Detectives interviewed Cohen and were thought to be considering a charge of conspiracy. (By a quirk of English law, one need not actually conspire to do anything illegal in order to be charged with conspiracy.)

The Cohen case has now been settled out of court, but the case was very much alive when someone sent Bolton the clipping with the word "arrested" underlined. Clearly the sender of the clipping knew the date of Bolton's hearing, and that suggests the sender was an interested party. As Alistair Kelman pointed out, if a judge learned that a plaintiff had indulged in this sort of oblique threat, the plaintiff's case could only suffer.

Cohen, incidentally, appeared at the piracy conference looking unabashed.

To Be a Pirate

Against this background, Julian Allason's opening remarks are understandable. "If I were to start again in the software business," he said, "I would be a pirate. It's the quickest way to make money with the least risk that there is in Britain today. I would buy a wide range of programs, copy them and resell them by mail-order. Then if things went well, which they would, I would get bold and make the programs available to dealers. If the programs were so well known as to be obviously recognized, then I would describe them as 'backup copies.'"

Although Allason said additional precautions would probably be unnecessary, the aspiring pirate could put aside any fears by following American practice: change a few program lines, renumber the program, remove the serial numbers, advertise under a bland trade name, or buy a "cut-out" license from a company that has either gone out of business or bought its license from another dubious and short-lived company. The result is a "deck of cards" in which each company must be sued in turn. This wrinkle is a recent migrant to the UK, first making its appearance in the case of a backwoods outfit called Kansas City Systems.

Level IV, Anyone?

Despite its name, Kansas City Systems is literally a backwoods operation. Its premises are a shack in a forest near Chesterfield, in the north of England. One of the British distributors of Level III BASIC and an associated monitor, the Eastbourne software house A J Harding (Molimerx), took Kansas City Systems to court for pirating Level III and reselling it as Level IV. Kansas City Systems' chief, Tom Crossley, argued that he had bought the software from one Sorrell B Chapman, whom he met at a microcomputer show in Britain in 1979. According to Crossley, Chapman claimed to be legitimately selling the software on behalf of the now defunct GRT Corporation.

Clearly there is no way for an

Take a look at our EPROM blaster for your Apple™ or TRS-80™

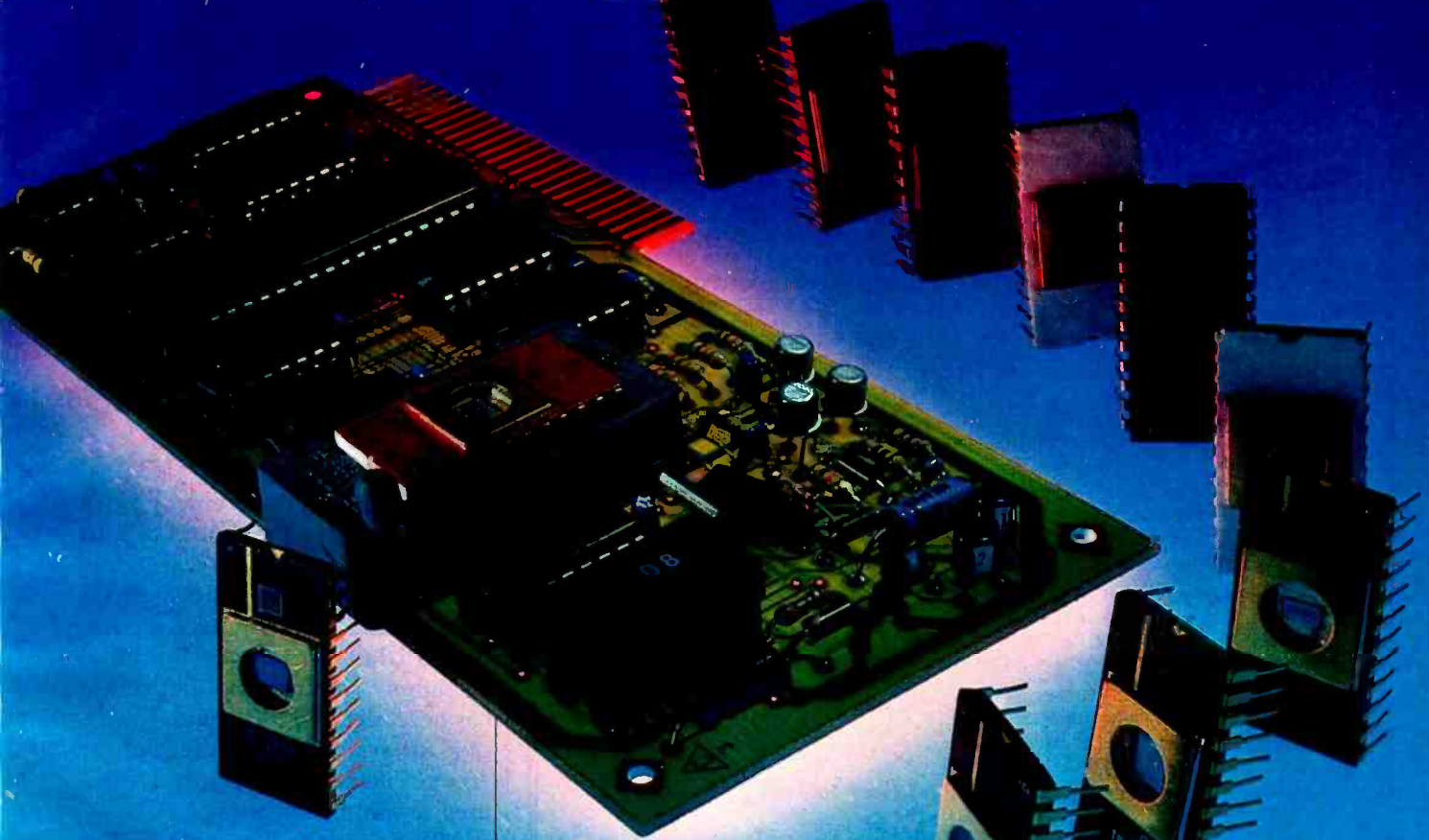

Apparat announces the most versatile EPROM burner available today for your TRS-80 model I and III or Apple computer . . . the Apparatus PROM Blasting system (A.P.B.). Most EPROM burners will program only one type of EPROM. The A.P.B. system will program all commonly used 24 pin EPROMs by using special personality modules that adapt the unit to the EPROM. The following EPROMs are programmable: 2704, 2708, 2716, (3-volt) & (5-volt), 2732, 2508, 2516 and 2532.

The versatility and power of the A.P.B. system means you're getting a PROM burning package with extensive capabilities. The price, \$149.00, insures you're getting the most cost-effective PROM burner on the market today.

With a unique combination of personality modules and

sophisticated software, A.P.B. will perform many operations impossible with conventional PROM burners. Here's a brief list of some of A.P.B.'s capabilities:

- Verify ROM is erased
- Read ROM
- Copy ROM
- Copy between different ROM types
- Program ROM
- Partial programming and copies
- Verify programming
- Read or save ROM data on disk or cassette (Apple only)
- Program directly from computer memory
- Examine and/or modify working memory
- Preset working memory

The A.P.B. system is the most flexible PROM burner available. The A.P.B. system package consists of an interface card that plugs directly into an expansion slot*, a complete set

of personality modules, software on disk and a detailed instruction manual. The software will run under NEWDOS/80, or TRSDOS™ for the TRS-80, and APPLE DOS™ or APEX for the Apple.

If you're looking for a powerful, versatile and cost efficient EPROM burner, call APPARAT today. Dealer inquiries welcome.

(303) 741-1778

*TRS-80 version requires the TRS-80 bus extender (Cat. # 1-025) or a separate user provided power supply and cable. TRS-80, and Apple are trademarks of Tandy Corp. and Apple Computer.



Apparat, Inc.

4401 So. Tamara Parkway, Denver, CO 80237 (303) 741-1778

"ON GOING SUPPORT FOR MICROCOMPUTERS"



Professional Quality 80 Column Dot Matrix Printers for Business or Personal Computers

C. ITOH Model 8510 offers 8 character sizes, 5 different alphabets (upper and lower case descenders), character generator and high resolution graphics (144x144 dots per inch). The 9xN Matrix (9 pin printhead) produces exceptional quality printing combined with proportional spacing, if desired. Throughput can be more than 150 lpm and 100 CPS with logic seeking bidirectional and quick cancel printing technique. The printhead is designed with air cooled fins for a long useful life. Paper can be cut stock or punched and can be fed by built in Friction or Tractor. Cut off is within 1 inch of the print line.

Vertical and horizontal tabbing is automatic. The manual functions included are Select, Line Feed, Top of Form and Power On, combined with Paper Empty LED indicator.

Using industry standard parallel or serial (RS232-C) or Apple II Computer interface with Buffer Memory and the popular protocols including X-ON and X-OFF features for easy match to your systems.

Print Features:

| | |
|-------------------|---|
| Number of Columns | 136 col. max. |
| Print Speed | 100 CPS |
| Print Direction | Single-directional and Bidirectional. Switch Selectable |
| Throughput Speed | From 44 to 152 lpm |
| Line Spacing | Variable to 1/144" |
| Print Width | 203 mm (8") max. |

Forms Type: Fan Fold Roll or Cut Sheet

| | |
|------------------|------------------------------------|
| Width | 113 mm to 254 mm (4.5" to 10.0") |
| Total Thickness | 0.05 to 0.28 mm (0.002" to 0.011") |
| Number of Copies | Original + 3 copies nominal |

Form Feed:

| | |
|--------------|---------------------|
| Method | Tractor or Friction |
| Form Loading | Either rear or top |

Power:

| | |
|-----------------|--|
| 115V ±10% 60 Hz | Operating 180 Watts (max.) Idle 16 Watts |
|-----------------|--|

Also in stock —
EPSON MX-80
With parallel or serial (RS232-C)
or Apple Computer interface.

ORDER NOW

Please send me the following printer:

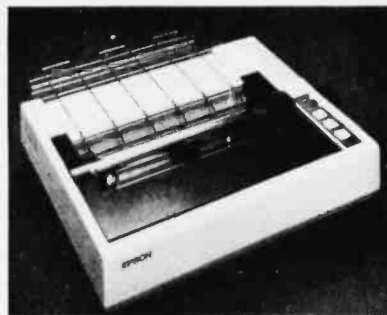

| | |
|---|---|
| C. ITOH 8510 with (list price \$825.00) | EPSON MX-80 with |
| <input type="checkbox"/> Parallel interface \$595.00 | <input type="checkbox"/> Parallel interface \$479.00 |
| <input type="checkbox"/> RS232-C interface 695.00 | <input type="checkbox"/> RS232-C interface 629.00 |
| <input type="checkbox"/> Apple II Computer interface 665.00 | <input type="checkbox"/> Apple II Computer interface 549.00 |

California residents, please add 6% sales tax. All unit prices are f.o.b. Mt. View, California.

Print Name _____ Signature _____

Address _____ City _____

State _____ Zip _____ Phone _____

Charge to my Mastercharge VISA Check enclosed.

Acct. No. _____ Exp. date _____



English court to test the validity of the American "cut-out" license, but in this instance the plaintiffs won a qualified victory. Using an unusual legal instrument called the Anton Pillar order, the plaintiffs got hold of disks, documentation, and correspondence belonging to Kansas City Systems. The Anton Pillar order empowers the plaintiff's legal representative to act as an officer of the court in cases of suspected copyright infringement. The plaintiff's lawyer can require the defendant, without notice, to open his premises to a search and to let the plaintiff's representative take away any relevant documents. If the defendant refuses, he is in contempt of court.

The Knock at Night

Will the Anton Pillar order play an important role in the control of software piracy in the UK? Will pirates fear the knock in the middle of the night? Alistair Kelman calls the Anton Pillar order a "judicial invention," noting that Parliament has never debated this unusual provision for search and seizure. But the Anton Pillar order has already been used several hundred times.

Although most commonly applied in piracy cases involving phonograph records and music tapes, the order was first invoked in a case of computer piracy. Its namesake, Anton Pillar, was a German manufacturer of an emulator utility for IBM equipment. British distributors of the utility, however, started making unlicensed copies and selling them at cut rates. When Pillar found out, he sought an injunction to stop the pirates, and he successfully argued that the evidence needed to prove infringement could only be seized by a search that took the offenders by surprise.

Kelman noted that at the top end of the market, much business can be lost through organized software piracy. "There is now a risk from organized crime—the big sharks who will be a real menace as the market develops," he warned. But so far, little evidence of organized crime involvement has surfaced. In typical piracy cases,

ADS ANTEX DATA SYSTEMS
A Division of International Antex, Inc.

2630 California Street
Mountain View, California 94040
(415) 941-7914
Telex via TWX 910-373-8500
"INTERAX PTV"

Phenomenal!



STAR-EDIT

FOR CP/M

From Supersoft, a phenomenon in screen editors/word processors. Star-Edit is a completely tested, "no surprises" screen editor suitable for any text processing task, including program writing and word processing. Its features compare with the highly acclaimed "EMACS" editor. Even though Star-Edit is at least as powerful as any other screen editor, it can be learned easily and quickly by both programmers and non-programmers. Star-Edit includes:

- Multiple file editing capabilities. The user may edit several files simultaneously.
- Split screen option for viewing different files or pieces of the same file.
- The user has free and unrestricted access to all the file at any time, regardless of whether or not the file will fit in RAM. This means that the user may edit the first page, then the last page, then the first, and so on, without rereading. This is accomplished through the use of "virtual memory" residing on disk file.
- Optional "no return mode" (fill between left and right margin) allows text to be entered without the use of carriage returns.
- Complete user manual and tutorial.
- Ability to enter ANY typeable character into the file

- Includes menu driven terminal configurator with simple selection for the 16 or so most popular terminals and video boards. Also allows customization for most other terminals.

Someone familiar with an ordinary typewriter should have no trouble learning and using Star-Edit. The novice need learn only a few commands to make immediate use of the editor; the experienced user will find that Star-Edit has a complete set of text manipulation commands (nearly one hundred).

Requires: 32K CP/M system with
cursor-addressable terminal

Star-Edit: \$225.00
Manual only: \$ 10.00

CP/M formats: 8" soft sectored, 5" Northstar,
5" Micropolis Mod II, Vector MZ, Superbrain
DD/OD, Apple II+

All orders and general information:
SUPERSOFT ASSOCIATES
P.O. BOX 1628
CHAMPAIGN, IL 61820
(217)-359-2112
Technical Hot Line: (217)-359-2691
(answered only when technician is
available)

U.K. and Europe:
DIGITAL DEVICES
134 LONDON ROAD
SOUTHBOROUGH KENT
TUNBRIDGE WELLS
TN4 0PL
ENGLAND
Japan:
ASR CORPORATION INTERNATIONAL
1-2-8, SHIBA-DAIMON
TOKYO 105
JAPAN
Tel.: (03)-437-3901 Telex: 242-3296

SuperSoft

First in Software Technology

POWER FOR YOUR APPLE



APPLESOFT: 30.3 MIN.
MICROSPEED: 3.9 MIN.

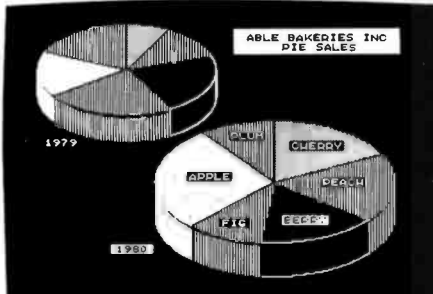

FASTEST: SIX TO SIXTY TIMES FASTER THAN APPLESOFT

MOST POWERFUL: MORE POWER THAN BASIC PASCAL OR FORTRAN

EXPANDABLE: LANGUAGE BASED ON FORTH

CREATIVE: GROW YOUR OWN LANGUAGE

USER-FRIENDLY: EASIEST FOR YOU TO LEARN

SPEED II
LANGUAGE SYSTEM

REQUIRES
48K APPLE II or II+ SINGLE DISK
SEE YOUR DEALER OR CONTACT:

applied analytics incorporated
8910 Brookridge Dr., Suite 604 Upper Marlboro, Md. 20870
(301) 627-6650

I'm Interested: Please Send
 160 Page Manual \$35.00
 Detailed Information

Name _____
 Address _____
 City _____
 State _____ Zip _____

dealers supply a "complimentary" copy of one disk instead of a discount on another; or a service engineer "just happens to have" a word-processor program that he can get the customer for a cash discount—say of 90 percent.

Only Amateurs

Home copiers, as distinguished from professional bootleggers, drew sharp words from Allason. Claiming that amateurs account for 99 percent of illicitly copied programs, Allason revealed the results of a confidential survey of PET users in the UK. For every program bought from a legitimate source, Allason found, two and a half copies were made without permission. The UK trade paper *Computer Weekly* confirms Allason's figures. Commodore says its software cassette market has slumped to only 40 percent of what it was a year ago. Even with many PET users changing to disk, such a decline in cassette sales puts an intolerable strain on the market.

Is copying in the home less pernicious than professional bootlegging? From the amateur's point of view, illicit copying might seem a good thing. Certainly the surroundings are innocent enough; this sort of copying takes place mainly among friends, at schools, and in user groups.

But amateurs confront software publishers with a dilemma: if publishers take no steps to protect their programs, making a copy becomes the easiest thing in the world. On the other hand, if publishers use protection routines, making a copy is for many amateurs the most enjoyable thing in the world. Unlike semiprofessional users of software, amateurs have both the time and the enthusiasm needed to defeat protective measures. Peter Laurie, editor of *Practical Computing*, confirmed Allason's view by saying, "Any intelligent teenager will make it (overcoming copy-protection measures) his first task of the day."

The case of Microchess shows how severely amateur copying can damage software sales. Before the In-

ternational PET Users' Group published a method of copying Microchess, the game program had sold more than 100,000 copies. After publication of the copy method, sales dried up. By contrast, the semi-professional program Wordcraft enjoyed a dramatic increase in sales when the protection routine known as the "Dongle" was incorporated.

The Price of Free Copies

The amateur's own long-term interests are actually damaged by copying software at home, according to Allason. As royalties decline, both authors and publishers become reluctant to publish. Until recently, ACT published 200 titles; its list has now dwindled to 20. The company no longer finds it worthwhile to publish, document, and support a long list of marginal sellers. Instead, ACT leaves programs with a small market to smaller firms that skimp on documentation and support, or to bootleggers who provide no support and who would never consider providing documentation. Because documentation is clearly a written work, it is subject to the provisions of the Copyright Act.

Allason named some programs whose publication stands in jeopardy because of pervasive software piracy. Among them are a financial modeling program called Nebula, produced at a cost of \$600,000; Micromodeler, which was to have sold for \$900; and Dr Michael Brinson's elegant and useful AC Circuit Analysis, withdrawn from the marketplace.

In brief, Allason said amateur piracy will have five consequences for the average software buyer. It will reduce the range of software available, raise prices, and make companies reluctant to invest in software development. He said piracy also leads to lack of support and maintenance, and discourages development of software by cottage industries which cannot afford to go to court to protect their interests.

Allason disagreed with those who claim the solution to piracy is to reduce prices paid by consumers. He cited a survey showing that programs

PRIME SOURCE DISTRIBUTING



Z-90 MICRO COMPUTER

- Complete standalone Desktop System.
- Dual Z80 Microprocessor control.
- 64K RAM, Twin Serial I/O Ports.
- Special Graphics for Business Presentation.
- Disk Storage from 800K Internal to over 11 Megabytes optional.
- Full Line of Business Software and Programming Languages provided by Zenith.
- Proven Zenith Reliability.
- Nationwide Service Centers.



DEALERSHIPS AVAILABLE NOW!

Zenith is building a National Network of Dealers to Market their growing line of field-proven Microcomputer systems. Zenith is in Business Microcomputers all the way. For over 60 years Zenith has specialized in building reliable, economical products. Their proven experience in marketing through the local dealer assures that the Zenith Computer Dealer will enjoy a long and profitable relationship.

Check these support pluses:

- Support comes from three parallel sources: The local distributor, the local factory representative, and the local service center.
- A Flooring Plan takes the Cash Flow Risk out of Start-up.
- Software Demonstration Packages enables you to learn and sell the software without a large cash commitment.
- The Zenith name is recognized by your customer.

Special "Show and Sell" Advantages are available to those dealers who get started now. Don't delay, call right now.

RIGHT NOW!

BECAUSE:

PRIME SOURCE Delivers computer systems that work. We carry a complete line of microcomputers and peripherals backed by in-house technical expertise. Pretested and Preconfigured systems available.

PRIME SOURCE is a stocking distributor with product ready ship.

PRIME SOURCE Supports the dealer with extras such as flooring plans, demonstration software packages, sales leads from national advertising, and advertising funds for local advertising.

PRIME SOURCE sells to Dealers, Manufacturers, Systems Houses, and Independent Software Vendors. We do not sell to end users.

PRIME SOURCE DISTRIBUTING

18380 Enterprise Lane
Huntington Beach, CA 92648
714/842-2208 213/592-4201
Outside California 800/854-6451

Buy
Direct from

CPI



An Authorized
Direct HP
Dealer

HUGE SAVINGS ON CALCULATORS AND COMPUTERS

Call 800-682-9250 in California • 800-538-9580 in all other states including Alaska and Hawaii

408-624-0822 outside USA • Telex 172532 • TWX 9103605000

BI-Lingual Operators Available/GERMAN/JAPANESE/FRENCH

Hours: 7:00-6:00 (PST) Monday-Friday



HEWLETT PACKARD

COMPUTERS

| | |
|--|-----------|
| HP-85 Built In Printer/Tape SYS/CRT | \$2600.00 |
| HP-83 Built In CRT | 1800.00 |
| HP 7225B Plotter | 1960.00 |
| HP 2631B OPT 885 Printer | 3160.00 |
| 5¼ Dual Master Flex Drive | 2000.00 |
| 5¼ Single Master Flex Drive | 1200.00 |
| 8" Dual Master Flex Drive | Call |
| 8" Single Master Flex Drive | Call |
| 16K Memory | 245.00 |
| Adv PROG ROM | 118.00 |

NEW! 82905A HP 80 Column Printer
W/Graphics 756.00

CALL ON
HP-125 Computer

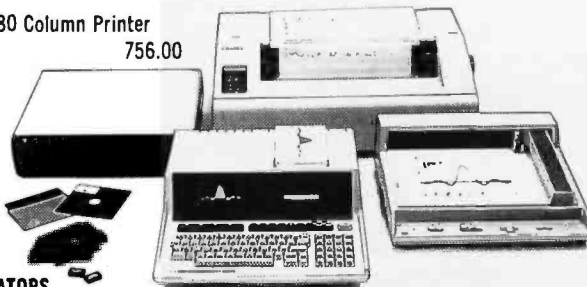

CALCULATORS

| | |
|---|---------|
| HP-32E ADV SCI W/STAT | 44.00 |
| HP-33C PROG SCI | 72.00 |
| HP-34C ADV PROG SCI | 120.00 |
| HP-37E BUSINESS | 60.00 |
| HP-38C ADV FIN | 120.00 |
| HP-41C ALPHANUMERIC FULL PERFORMANCE | 200.00 |
| HP-41CV ALPHANUMERIC FULL PERFORMANCE QUAD MEM | 265.00 |
| PRINTER | 308.000 |
| CARD READER | 172.00 |
| QUAD MEMORY | 76.00 |

PERIPHERALS & SOFTWARE

| | |
|------------------------|--------|
| VisiCalc™ PLUS | 170.00 |
| Graphic Presentations | 170.00 |
| Surveying | 170.00 |
| Basic Training | 80.00 |
| Financial Decisions | 80.00 |
| Information Management | 170.00 |

HP-41C SOFTWARE

| | |
|---------------------|-------|
| Financial Decisions | 27.00 |
| Securities | 27.00 |
| Statistics | 27.00 |
| Home Management | 27.00 |
| Real Estate | 40.00 |

OTHER PRODUCTS

| | |
|-----------------------|--------|
| Epson Printer MX-80FT | 599.00 |
| Epson Printer MX-100 | 796.00 |

Prices subject to change without notice • Prices do not reflect shipping and handling charges

CPI — P.O. Box 22530 — Carmel, CA 93922 • 3785 Via Nona Marie

Call for items not shown in this ad

are copied whether they're priced at \$7 or \$400.

Few Are Innocent

Consultant Ian Litterick approached software piracy with an honesty that refreshed some and horrified others. Stepping up to speak on "Why I Am a Software Thief," Litterick asked, "Which of you can say, hand on heart, that you have never made a copy, or used one knowingly?" Fewer than five people raised their hands.

Buoyed by this mass confession, Litterick assuaged everyone's guilt by arguing that bootleg copies are indispensable for software evaluation. In the hectic and hyped atmosphere of a store, he said, real evaluation is impossible. Authors of good software have nothing to fear from unauthorized copies, according to Litterick. "If it's a good package," he claimed, "then there are compelling reasons why I should go on to buy it in the conventional way."

Litterick's speech implied that the unseen "customer" actually plays a vital role in the development of software. With the help of the amateur pirate, poor programs are gradually winnowed out, leaving the kernel—the 100-percent debugged, easy-to-run, and magnificently documented software—selling for a song. If only authors and publishers would show a little more gratitude!

A great many amateurs would probably endorse Litterick's second point: a single-disk user *must* have a backup copy, especially if he has both data and program on the one disk. What's more, Litterick said defiantly, what can any of the manufacturers do if the determined thief goes for bit-by-bit copying?

Countermeasures

The conference raised many ideas for fighting software piracy. Some are new and theoretical, but most are already familiar to Americans. Allason ran down a list of anti-pirate weapons that he thinks should be brandished immediately:

• "Megabuck" lawsuits—the cost-attrition weapon.



SuperCalc™ and the Answer Key.

Answers. As a decision maker that's what you're after when you use an "electronic worksheet" to analyze problems in management, finance, marketing, sales, and engineering. However, a lot of time and energy can be spent just trying to figure out how your program works. That's why we've invented The SuperCalc[†] Answer Key.

As a new SuperCalc user you want answers on program operation fast...as your questions

arise. As an experienced user you want a complete description of all your options at your fingertips.

From formatting printed reports to merging sheets, the SuperCalc Answer Key gently guides you every step of the way. And included with the SuperCalc Software Package is a comprehensive tutorial and reference guide which introduces you to the full power of the electronic spreadsheet.

The SuperCalc Answer Key. Invented so you can move on to answering the questions that really count.

SuperCalc is available now for your CP/M* computer. Contact us today for the name and address of your local dealer.

SuperCalc™
 **SORCIM**

405 Aldo Avenue Santa Clara, CA 95050
(408) 727-7634

† SuperCalc and The Answer Key are trademarks of Sorcim Corporation

*CP/M is a trademark of Digital Research

●The embarrassment factor. Perhaps saying "You know that I know" will be more effective in the UK's smaller, more centralized economy than in the US.

●Induced dependence, a strategy used by mainframe manufacturers who claim that only they can give customers the documentation and backup they need.

●Licensing of users, generally considered the most effective weapon against piracy.

Laurie believes licensing is the *only* effective way to combat pirates. Although amateurs are too numerous and energetic to be stopped from

making illicit copies, vendors can stop real pirates by using existing provisions of law to secure agreements at the point of sale. If the supplier's name is visibly coded in at the beginning of a program, and invisibly coded in elsewhere, there is a legal basis for enforcing the original license agreement. The visible trademark establishes a breach of contract; the invisible, if the illicit copier expunges it, establishes a breach of copyright.

When programs are intended for the mass-market microcomputer, Laurie sees a contradiction in trying to discourage copying by making the programs hard to use. Software is made to be used; in fact, a license

should permit the licensed user to make the modifications he needs. Tying software to a specific machine or implementing a turnkey system would be self-defeating.

The Case of ChessBall

Alistair Kelman gave the conference a detailed and analytic look at the state of the legal theory of software protection. In both British and American law, the most desirable form of protection for a computer program is a patent, which confers a monopoly on the owner. Unfortunately, in the UK the Patent Act of 1977 specifically excludes computer

Computers may simplify your business, but it isn't always simple to choose one.

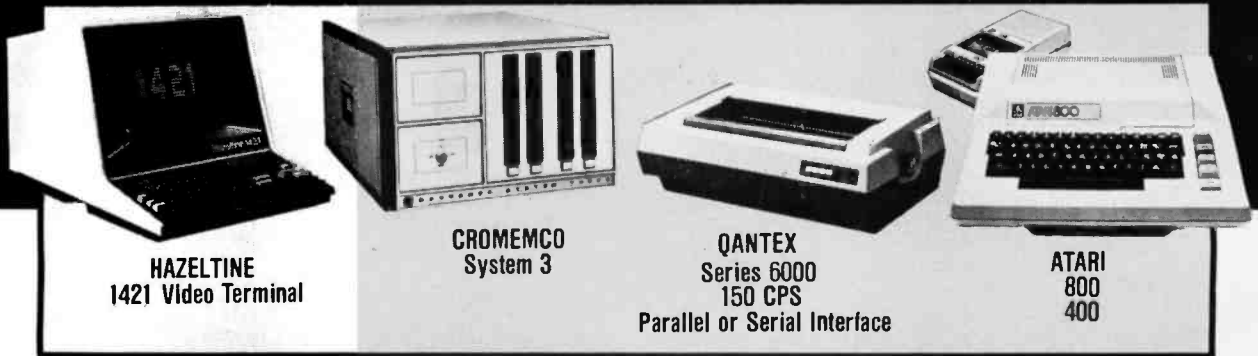

As your computer company, Synchro-Sound International will not only offer you a large selection of computer models at discount prices, we'll offer expert guidance on how to choose one.

We'll help you determine which computer system will best suit your individual business needs. Whether it's a micro-computer, a printer, a video display terminal, accessories, or even a complete turn-key operation. We'll design it. Configure it. Guarantee it. We also offer a wide range of easy-to-understand software.

What's more, we have all the answers after you purchase your computer, too. We'll give you fast delivery. And we have a staff of computer specialists who'll respond quickly to any service you may require.

Which all adds up to why we've grown to be one of the largest computer companies in the New York area over the past seven years.

So when you decide you need a computer, decide on Synchro-Sound. Our guidance could be almost as priceless as your business.



SYNCHRO-SOUND INTERNATIONAL, INC.

Where the computers are cold and calculating. But the people aren't.

1550 NORTHERN BOULEVARD, MANHASSET, N.Y. 11030 TWX 510-220-0021
For orders or more information, call: (516) 484-1852 Toll-free: 800-645-3820

Meet HP Series 80: Hewlett-Packard's new one-on-one computing systems for professionals.

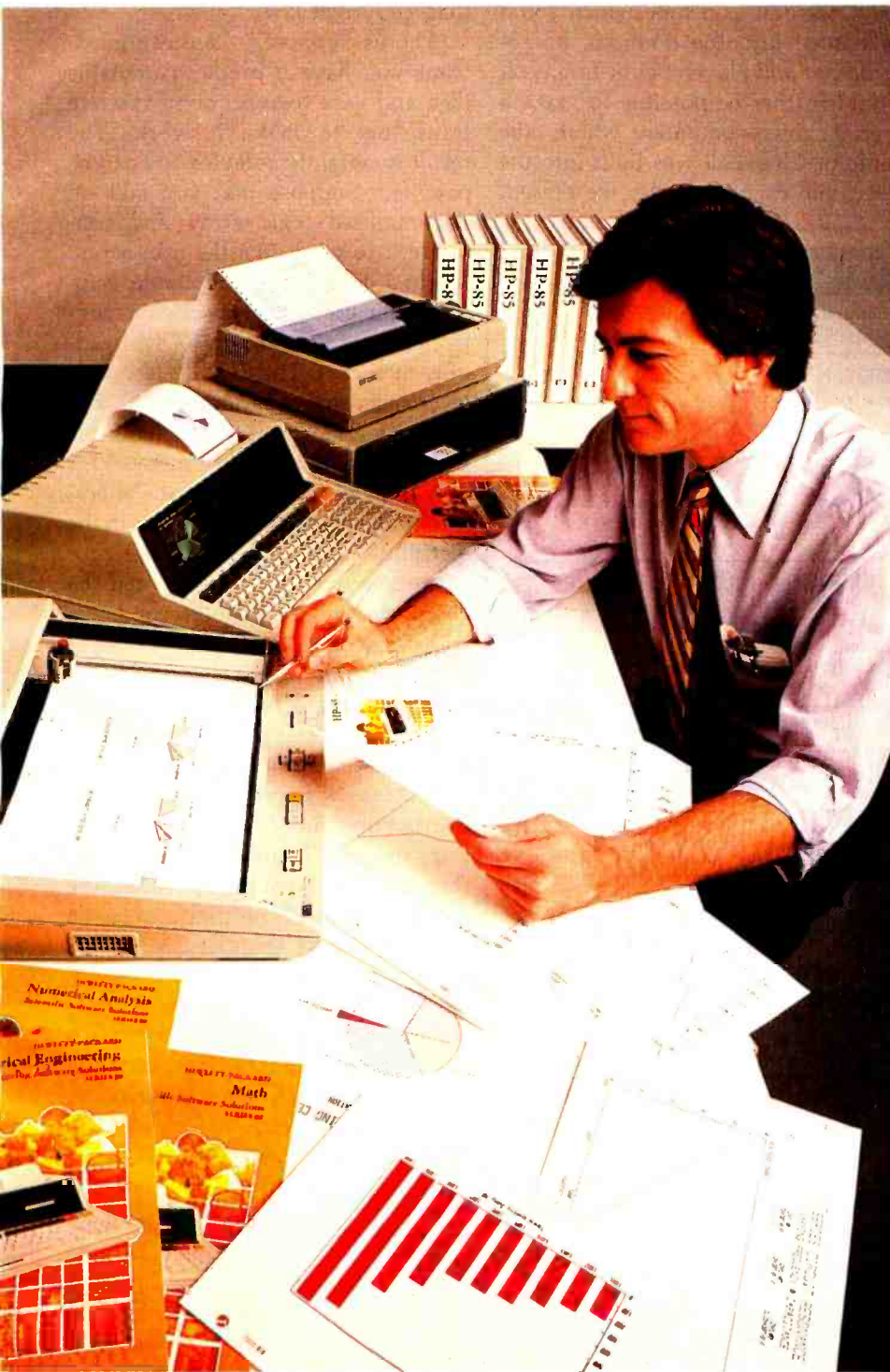

Together, You can Analyze Technical Problems and Evaluate Solutions. Rapidly and Accurately.

HP Series 80 personal computing systems provide the technical solutions you require. Quickly! Easily! Inexpensively! Analysis techniques that were formerly difficult and often impossible become part of your everyday work routine. You can evaluate functional behavior, select variable alternatives, perform cost analysis... and more... all with greater accuracy and using more variables than you thought possible.

Series 80, VisiCalc™ PLUS And You

HP's VisiCalc PLUS is a major new software tool. It's an electronic worksheet that instantly recalculates results as you change the variables. You ask the *what-if* questions and immediately see their effects on your solution. No programming is necessary... you can become proficient with VisiCalc PLUS in a few hours... and then watch your horizons broaden. VisiCalc PLUS features many powerful functions including statistical analysis tools and the entire HP Series 80 BASIC math set. Plus graphics! Create professional presentations with curve-fitting plots, stacked or clustered bar graphs, exploded pie charts and line graphs, all in up to four colors, on paper or transparencies.

ONLY FROM HEWLETT-PACKARD

HP Series 80 personal computing systems are part of a forty-year tradition of electronic products built to uncompromising standards of excellence. Additionally, HP Series 80 products are serviced by HP technicians and on-site service contracts are now available. We urge you to judge for yourself with a hands-on, one-on-one demonstration at your HP dealer. For locations, call TOLL-FREE 800-547-3400, Dept. 276F, except Alaska/Hawaii. In Oregon call 758-1010. Or write Hewlett-Packard, Corvallis, Oregon 97330, Dept. 276F.

611/04

HP Series 80 Personal Computers for Professionals: HP-85 (\$3250*) and HP-83 (\$2250*) specifications: 16K RAM expands to 32K, 32K ROM expands to 80K; CRT with integrated graphics; (HP-85 only); built-in thermal printer, cassette tape unit. Software includes VisiCalc PLUS, Information Management, Graphics Presentations, Surveying, Data Communications (Fall '81), Statistics, Regression Analysis, Math, Linear Programming, Waveform & Circuit Analysis, BASIC Training. HP peripherals include flexible disc drives, printers and plotters. VisiCalc™ is a trademark of Personal Software, Inc.

*Suggested retail price excluding applicable state and local taxes—Continental U.S.A., Alaska & Hawaii.

Circle 168 on inquiry card.



**HEWLETT
PACKARD**

software. But Kelman showed how, in the realm of computers, the artificial distinction between copyright and patent can make a monkey of the law.

Kelman described a game called ChessBall, invented by patent agent Paul Cole. A board game combining chess and football, ChessBall is played by two teams of three players—a Knight, a Queen, and a Bishop. The ball is on a grid and reacts to the arrival of a player in one of the surrounding squares according to a complex set of rules. Goalposts

stand where the King and Queen are situated on a normal chessboard. The object of the game is to score as many goals as possible in a set period.

"It is possible to sell ChessBall as a board game, and it might be possible to obtain a patent for it," Kelman said. "However, it is also possible to sell ChessBall as a tape which could be loaded into the domestic micro-computer and played by the family. It would further be possible to make a special microcomputer where the game of ChessBall was built into the electronic circuits. Under the present

law, the game on tape is not patentable but the designated micro might well be."

These ideas were elaborated upon by Laurie, who advanced the idea that a "device" is patentable and hence enjoys the protection of patent law, which is far more bulletproof than copyright law.

"Let us suppose," Laurie argued, "that you have a bright, patentable idea and wire together some discrete transistors to make it work. The result is certainly a device and can be patented. Suppose that you take an uncommitted logic array and configure it to work like the transistors. Again a device, and patentable. Suppose you use a microprocessor controlled by a program in ROM (read-only memory). The ROM is physically changed by programming it. The same program in EPROM (erasable programmable read-only memory) is also a device, even though the alteration to the basic structure is just in the distribution of charge." If the program is in dynamic memory and the charge lasts only a millisecond, it's still a device, he said.

By a quirk of the British Patent Law of 1977, a person can commit "contributory infringement" of a patent if he helps someone else infringe the patent by, for example, providing instructions about how to do it. By this means, Laurie argued, it is theoretically possible to catch the software pirate. The pirate may, he said, be giving "instructions" in the form of software which, once loaded, becomes a patent infringement under the terms of the Act. This approach may or may not work; certainly nobody in the UK has had the nerve to put it to the test.

New Concepts

In the process of trying to overhaul the Copyright Act of 1956, Kelman has suggested some new concepts that may help clarify legal thinking about the intellectual property called software. One important concept is that of "transitory reproduction."

According to Kelman, a transitory reproduction occurs when, for example, a program is read into memory

★ ★ ★ WRITE OR CALL FOR FREE CATALOG ★ ★ ★

We test all systems thoroughly before shipping. We integrate the CRT, printer, modem & other peripherals. Every system purchased from us is ready for plug-in operation when you receive it.

CALIFORNIA COMPUTER SYSTEMS 2210A: HIGH QUALITY, LOW PRICE
Z80A CPU with 1 serial port; 12 slot S-100 mainframe, disk controller, 64K dynamic RAM.
CP/M 2.2 \$1,750.
We can add additional I/O capability, drives, CRT, printer.

IMS 5000 and 8000 SYSTEMS

Outstanding long term reliability. Features Z80A CPU, S-100 bus; double density drives (single or double sided), DMA disk controller, 64K RAM, 2 serial, 1 parallel port. We stock IMS boards. Hard disk, multi-user systems available.

MULTI-USER SYSTEMS FEATURING TURBODOS & MUSYS

TURBODOS: Spectacular CP/M® compatible operating system. Z80 code, interrupt driven. Up to 6X faster than CP/M®; up to 35% increased disk capacity. We have configured many multi-user IMS systems using Turbodos and Musys single card computers allowing each user his own CPU, 64K RAM and I/O. Turbodos Single user \$250.
Multi-user \$750. Musys single card computer \$1,300.

MAX BOX Mfg by John D. Owens Assoc. 8" dual drive cabinet w/regulated power supply, fan, complete internal cabling. Will hold Qumes, Shugarts or Siemens, horizontally mounted. Excellent design & engineering. 17 1/4" x 5 1/2" x 22 \$325.
With 2 Shugart 801 R \$1,275. With 2 Qume double sided drives \$1,680.

PER SCI—THE KING AND QUEEN OF DRIVES

Model 299B \$2,300. Model 277 \$1,245. Slim line cabinet \$325.

ITHACA INTERSYSTEMS Inventory sale on boards and systems.

MARINCHIP 9900 uses TI 9900 16 bit CPU. Full S-100, IEEE compatibility. Extensive software. Boards from \$550; Systems from \$4,995.

★ ★ ★ GRAPHICS EQUIPMENT ★ ★ ★

MICROANGELO GRAPHICS SUBSYSTEM from Scion \$2,295.
Screenware Pak II \$350. S-100 Graphics card \$985.

HIPAD DIGITIZER from Houston Instruments \$755.

INTERACTIVE GRAPHICS SOFTWARE on line, real time. For use in design of PC boards, IC Masks, Architectural drawings, etc. To be used with MicroAngelo \$1,000.

CAT 100 Full Color Graphics. Digital Graphics complete S-100 color imaging system with high performance video Frame/Grabber. Extensive options available \$1,875.

MAURO MP-250B Proac Plotter. Uses standard paper, choice of pen colors and line widths, resolution is 200 steps per inch; .005" tracking error. RS232 \$895.

WE EXPORT: Overseas Callers: TWX 710 588 2844
Phone 212 448-6298 or Cable: OWENSASSOC

JOHN D. OWENS Associates, Inc.

12 Schubert Street, Staten Island, New York 10305

212 448-6283 212 448-2913 212 448-6298

and used to perform a particular task. Although the program itself may be a copyright work, no blame is attached to using and reproducing the program for the brief period of its appearance on the video display terminal. Nor does the use of the copyright work dilute in any way the copyright of any material which the transitorily reproduced program has processed.

Kelman has proposed a new concept called "transmutation" to describe any computing whose final effect is to steal one person's program and render it in another form. He defines the term as the automatic conversion of a source work into an object code by electronic, mechanical, or similar techniques. Transmutation is intended to cover such familiar words as "compile," "assemble," and "interpret," which already have specific meanings in law and computer science.

British courts already have groped with the concept of transmutation, but the current copyright law has shown itself unable to cope with the new concept. A notable instance is a recent case in which Sinclair Electronics sought an injunction against Compshop, which Sinclair alleged had copied the design of Sinclair's ZX80 pocket computer kit and introduced the copy in the US. Kelman bemoaned Justice Megarry's position that information held in ROM could not be copyright "because he couldn't see it." Kelman asked whether the rights to the Justice's own work, *Manual of Real Property*, would disintegrate if the manual were entered into the memory of a computer as a code, and then accessed by someone asking questions in "computer language."

International Complications

Although Kelman's concept of transmutation has found some favor with European lawmakers trying to draft a harmonized copyright law for Europe in the 1980s, important differences exist between Continental and Anglo-Saxon laws on intellectual property. These differences may complicate international software protection. The Continental concept of

"moral right" to intellectual property is an example. In the US and the UK, an author sells intellectual property in much the same way as he would sell a piece of furniture. The author gets money in exchange for rights to the property. According to Continental tradition, however, the author retains the right to have his name associated with his work, and to stop unauthorized versions of his work from appearing, *whether or not* he has sold, given away, or otherwise disposed of his *pecuniary* rights with respect to the work.

Will Continental programmers be able to wield the concept of "moral right" in defense of their creations? If so, could the Anglo-Saxon world borrow the concept? Will North American and British programmers be able to defend their rights by pressing the important distinction between "transitory reproduction" and "transmutation"? Until these questions are answered, software authors and publishers can only hope to enforce license agreements signed at the point of sale. The laws on software piracy are all buckle and no swash. ■

★★★ GREETINGS TO OUR FRIENDS IN WEST GERMANY ★★★

| | |
|--|--|
| <p>SD SYSTEMS KITS</p> <p>Z80 STARTER KIT: single board computer with RAM/ROM, I/O, display, keyboard, kluge area\$360.</p> <p>VFII: double density floppy controller kit, with software\$390.</p> <p>CPU Z80A, 4 Mhz, serial & parallel I/O IK on-board RAM, Z80 CTC.....\$345.</p> <p>EXPANDORAM II including high quality 4116s 64K.....\$540.</p> <p>Complete SD line available.</p> <p>HAZELTINE 1500\$ 925.</p> <p>1510\$1,030.</p> <p>1520\$1,265.</p> <p>220 volt models, add \$100</p> <p>IBM 3101 CRT Model 10\$1,295.</p> <p>Model 20\$1,495.</p> <p>TELEVIDEO CRTs</p> <p>912..\$780. 920..\$850. 950..\$1,050.</p> <p>TEXAS INSTRUMENTS Printers</p> <p>10% off list price on entire TI printer line.</p> <p>EPSON MX80\$560.</p> <p>MX100\$830.</p> <p>RS 232 Interface\$ 70.</p> <p>TELETYPE</p> <p>Model 4320 AAK\$1,140.</p> <p>Model 43ASR, 8 level, 1" tape...\$2,595.</p> <p>3M SCOTCH® Diskettes</p> <p>5 box minimum, price per box</p> <p>740, 8" single sided, single density...\$27.</p> <p>741, 8" single sided, double density...\$35.</p> <p>743, 8" double sided, double density...\$43.</p> <p>744-0, 5¼" soft sectored, single sided</p> <p>744-10, 5¼", hard sectored, single sided.....\$27.</p> <p>TEI MAINFRAMES, S-100</p> <p>We are proud to announce that we are now a TEI stocking distributor. For the best in mainframes....TEI!!</p> <p>TARBELL</p> <p>Double density controller\$435.</p> <p>Z80 CPU\$395.</p> | <p>★★★ SOFTWARE★★★</p> <p>ESQ-1: Legal Time & Billing System</p> <p>PROMOT: Professional Time & Billing System</p> <p>SCHEDULER: Docket/Calendar & Control System</p> <p>TAXEXEC: Individual Income Tax Return Preparation System</p> <p>JOBSHOP: Job Cost & Profitability Reporting System</p> <p>MAGIC QUILL: Bookkeeping and Accounting System</p> <p>Six easy-to-use, flexible packages from Micro Information Systems.....\$1,500 each</p> <p>THE FORMULA</p> <p>A new concept in report generation. Uses a unique full screen editor to visually describe format of reports. Multiple file access, algorithmic calculations & conditional printing. Includes CBS. From Dynamic Microprocessor Assoc. .\$.595.</p> <p>dBASE II</p> <p>Brings power of mainframe database software to a microcomputer. Manual and demo software:\$ 50.</p> <p>Complete package with money back guarantee:\$625.</p> <p>COMMUNICATIONS SOFTWARE</p> <p>Enables communications from a micro to a terminal or to another micro, mini or maxi computer. Source code:\$250.</p> <p>MICROSOFT</p> <p>BASIC-80 (interpreter)\$335.</p> <p>BASIC COMPILER:.....\$360.</p> <p>COBOL-80\$710.</p> <p>FORTRAN-80.....\$435.</p> <p>X-MACRO-86:.....\$275.</p> <p>muLISP/muSIMP:.....\$190.</p> <p>MICROPRO</p> <p>WORDSTAR:.....\$425.</p> <p>MAIL MERGE:.....\$125.</p> <p>All Microsoft and Micropro software available on 8", IBM compatible, single sided media. Write or call for prices on other Micropro and Microsoft products.</p> |
|--|--|

Prices subject to change without notice

JOHN D. OWENS Associates, Inc.
SEE OUR AD ON FACING PAGE

Network Tools

Ideas for Intelligent Network Software

Peter B Reintjes
Rte 3 Box 85
Morehead City NC 28557

Some people foresee electronic information as the currency of the future: those who have it will use it to get more, and those who don't have it will be exploited. Actually, money probably will continue to be the currency for years to come, but the computer will be the primary tool for controlling its flow. The key to this flow lies in computer networks. With the price of individual computers dropping, more people are solving their problems with computer networks, rather than with a single large computer.

Networks are more than just connections between computers. The physical connection—be it a twisted-wire pair, phone line, or satellite transmission—is of little consequence compared with the software that *uses* the connection.

Personal Computer Networks

Most network software developments aim to define protocols with sufficient generality to last a decade or more. ARPAnet, X25, and Ethernet, all primarily computer-to-computer networks, are now the focus of computer vendors' attention.

But another group of networks uses computer-human interfaces to provide interactive services. News and mail systems, shopping marts for software releases, and bulletin boards all fall into this category.

In these networks, information clearly is not currency but instead the *commodity* being paid for. (You may become painfully aware of this upon

receiving monthly bills from the telephone company and the "information utilities.")

As a personal computerist, you have special needs that should be taken into consideration by the networking software. Ideally, your home computer should become an intelligent node on the network, making the network connection process invisible to you. Under such a system, your computer can call up the information service at night, when rates are lowest and the network response time is probably at its best.

An intelligent node system has another valuable application: a set of files on one computer can be transferred automatically to another node on the system. Each night when the network is activated, system A calls system B to determine which one has the latest version of each file. The updated file is then copied over the outdated one. You can spend all day Friday editing your resume on system A at work or school, then get up Saturday morning to find the edited version in your home computer's file, ready for further use or revision. A similar procedure could be used to send revisions of operating systems and even the network programs themselves. The command to activate the network can be executed at any time if a transaction is required before the usual late-night activation.

An Intelligent Node Program

With the needs of the personal

computerist in mind, I have designed a set of modules that provide a basis for networking. I tried to make the modules very general, as well as compact and efficient enough for use in an actual networking system. In any event, the modules should prove useful in trying out new protocols and adapting quickly to different network interfaces.

Designing a network from the ground up provides the advantages of control over the planning and regulation of protocols and transactions. James Martin's book *Systems Analysis for Telecommunications* is recommended to anyone interested in designing a network. Another valuable book is *Software Tools* by Kernighan and Plaugher, from whom I have borrowed the idea of presenting modular programs as a set of tools. In this case the tools are for developing a network system.

Desirable as it may be in some ways, designing your own network creates the immediate problem of interfacing with all other information services. For the microcomputer owner, a more realistic goal would be designing a general-purpose interface to converse with other machines on the network, and then designing a local protocol to "ride on top" of the interface. The designers of the X25 network architecture anticipated this problem when they specified X25 in several distinct layers. Only the lowest level is in contact with the network. The higher levels behave as if they were sending and receiving data

PRIME SOURCE DISTRIBUTING

NorthStarTM

INCREASES THE HORIZON ADVANTAGE



THE POPULAR HORIZON COMPUTER SYSTEM GOES MULTI-USER

- Up to 5 users—DOS and CP/M® in one System
- 5 or 18 MegaByte Hard Disks with Tape Back-up
- Famous North Star Speed, Reliability, and Price
- Full Line of Integrated Applications Software
- Earlier Horizons are fully Upgradeable

THE NEW NORTHSTAR ADVANTAGE

AN INTEGRATED DESK-TOP GRAPHICS COMPUTER SYSTEM

- 12" Green Screen with Bit-Mapped graphics
- Dual processors: 64K Z80 and 20K 8035
- Dual Quad Capacity 5 inch Drives
- 87 Key Sculptured, Selectric-like Keyboard
- Graphics DOS and Graphics Basic Included, Graphics CP/M® Available

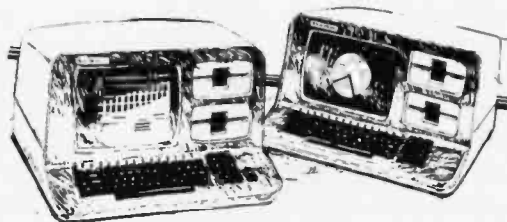

List \$3999

SPECIAL ADVANTAGES FOR DEALERS WHO SIGN EARLY

RIGHT NOW!

BECAUSE:

PRIME SOURCE Delivers computer systems that work. We carry a complete line of microcomputers and peripherals backed by in-house technical expertise. Pretested and Preconfigured systems available.

PRIME SOURCE is a stocking distributor with product ready ship.

PRIME SOURCE Supports the dealer with extras such as flooring plans, demonstration software packages, sales leads from national advertising, and advertising funds for local advertising.

PRIME SOURCE sells to Dealers, Manufacturers, Systems Houses, and Independent Software Vendors. We do not sell to end users.

CP/M® is a licensed product supplied by Digital Research, Inc.

PRIME SOURCE DISTRIBUTING

Circle 303 on inquiry card.

18380 Enterprise Lane
Huntington Beach, CA 92648
714/842-2208 213/592-4201
Outside California 800/854-6451

across the network in a more abstract way.

The lowest (physical) level of any network can be implemented with my proposed networking modules. The user level could be fashioned to appear the same as X25 or the ARPAnet.

The following specifications describe software modules needed for a basic network capability. The source codes for five of the functions—DIALER, PROMPT, CONVERSE, TRANSLUCID, and TRANSACT—are given after the specifications. These functions can be implemented in whatever language is available, and under any operating system or monitor the user chooses. Once the functions are available, the environment will be reasonably independent of the operating system, and future utilities designed for this environment will be easier to install. The functions can make the network protocol easier to implement and put the transaction processing on a high level.

WATCHDOG and ALARM

Networking, a real-time process, is slow and has a wide tolerance for speed fluctuations. But because protocols still must be executed in the proper sequence and in a consistent time frame, interrupt handling is needed for timing functions as well as for input and output.

Many large networking computers have multiprocessing operating systems. They can have several tasks running at once, trading off central processing unit (CPU) cycles, and each task can be doing part of the job. The most important tasks are the ALARM and WATCHDOG functions, and I have included them among the modules. ALARM tells the system when it is time for a transaction, or when certain services are available on the network. WATCHDOG watches the network traffic and steps in if a conversation gets bogged down in protocol.

In networking, perhaps more than anywhere else, error recovery is crucial. When two computers are

talking over a voice-grade line at 4:00 in the morning, they could easily get out of step on a bad byte. In this case, you would at least want to make sure a telephone connection is broken, and you probably would like the computers to settle their differences without waking someone up or having to start from scratch the next night. This level of error recovery may sound formidable, but a few strategies can solve most common problems while enabling your computer to decide when it is hopeless to continue trying.

The WATCHDOG and ALARM functions can also be implemented on the typical personal computer system without multiprocessing. A timer with interrupt capability is required, and a real-time clock with interrupt alarms would be best.

Both the WATCHDOG and ALARM functions can be implemented in the same timer-interrupt routine with a global flag to signify whether the normal ALARM mode or the WATCHDOG mode is active. In using the ALARM function, a pointer in the AGENDA (a file specifying the transactions that need to be performed) shows what the next activity is and when it is scheduled. The timer is then set for activation, and the process goes into a wait state. When the interrupt occurs, the interrupt handler notes that it is in the alarm mode and jumps to a routine which starts up the desired activity.

If you are starting a process which may get hung (meaning you may wait forever for a transaction to be completed), set the TIMER function to WATCHDOG, start the timer and start the process. If the process is not finished before the timer causes an interrupt, the handler will see that it was activated as a WATCHDOG, and it will look around for an incomplete transaction. Then it can clean up the failed action, closing or removing any files the transaction used and incrementing a counter to keep track of the number of failures. If this counter exceeds a certain threshold, the transaction will be removed from the agenda and

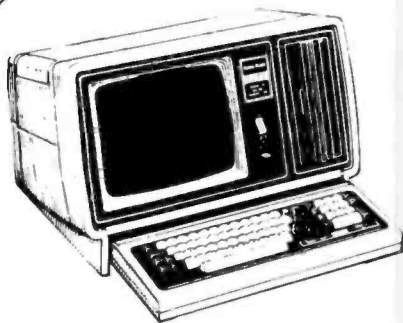

96K CP/M®

(For your TRS-80* Model II)

Multiple Job Executive

Add a whole new dimension to your TRS-80 Model II. Let it work while you work!!

ATON's unique JobStream™ CP/M 2.2, along with additional RAM memory, allows you to **simultaneously** compile, assemble, or link in one 64K background partition (62K TPA) while you edit files, **and** spool to the printer, **and** communicate with another computer in up to four 32K foreground partitions (28K TPA).

As you expand your memory beyond 32K, you can also enter the amazing world of TrackMode BIOS™ which not only **multiplies diskette speed up to five times**, but also automatically performs read after write checks for the ultimate in data reliability.

- Gain hard disk performance for a fraction of the cost—and no backup problems!!!
- Works in 32K, add RAM memory to 256K using standard Radio Shack memory boards.
- Supports two sided expansion disk drives (1.2 megabytes per diskette).

| | |
|---|-------|
| JobStream CP/M 2.2 (with Z-80** Debugger) | \$235 |
| Video Text Editor | \$130 |
| Z-80 Debugger Source Code | \$ 50 |
| Package of above (a \$415 value) | \$295 |

"Software with Service"



Aton
International, Inc.

Prepaid, Visa, MasterCard or COD.
Shipping and handling extra.
California residents add 6% sales tax.

CP/M® Digital Research, Inc.
*Tandy Corp. **Zilog Corp.
JobStream, TrackMode BIOS™ ATON Intl.

260 Brooklyn Avenue, San Jose, CA 95128
(408) 286-4078

JUST LAUNCHED! VOYAGE OF THE VALKYRIE

BY LEO CHRISTOPHERSON

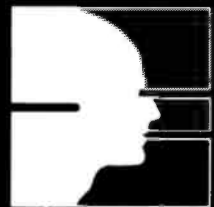

**ADVANCED
OPERATING
SYSTEMS**

450 St. John Road
Michigan City,
Indiana 46360

The ancient Norse lords bravely sailed their ships across new waters in search of adventure. No obstacle was too great to overcome nor any force powerful enough to prevent their mighty advance. ■ Now you're in command. You are the pilot of the attack ship Valkyrie. Your mission: to wrestle the island Fugloy from the grasp of an army of laser-wielding war birds and secure the golden treasures hidden within the walls of the island castles. Success of the mission depends solely upon you. The castle Drage appears on the horizon when suddenly the air is alive with the flutter of giant wings. Your prize is in sight . . . do you dare accept the challenge and go on? ■ You can put yourself at the controls of the Valkyrie thanks to the genius of Leo Christopherson and the versatility of the *TRS-80 microcomputer. As absolutely flickerless birds sail smoothly across the screen, strains of Wagner's "Ride of the Valkyries" are heard. The game offers 10 levels of difficulty which provide a challenge for players of all ages and skills. The game also provides one of the finest examples of computer cartoon-graphics presently available. Accept the challenge of the Voyage of the Valkyrie . . . available now at leading software retailers.

reported as a failure.

The flow of control when the timer interrupt occurs is shown in figure 1. The timer-interrupt handler provides the synchronization. When the system has finished its nightly transactions, it may print a status report similar to the one in figure 2.

TIMER

Set the timer to wait for a specified time. It can be set in seconds, minutes, or until an actual hour if a real-time clock is available. When the time is up, the interrupt routine will

be activated, either in the WATCH-DOG or ALARM mode.

DIALER

DIALER is a procedure for dialing the phone number of the remote computer. This software (see listing 1), plus a simple relay driven from an output port, can substitute for an expensive auto-dialer. Because telephone service supports pulse dialing even in areas with Touch Tone service, this procedure is a very cost-effective way for your computer to make phone calls. The phone number

is represented as an array of 20 characters. The only valid characters are the digits 0 through 9 and a dash (-). The dash is interpreted as a pause in the dialing sequence.

PROMPT

This routine, shown in listing 2, is called with a sample prompt string and a pointer to a buffer of text. It determines whether the prompt occurs in the text, returns the offset into the buffer, or returns a negative number if the prompt is not found.

When you are conversing with a remote host system, a prompt from the host signals that the system is waiting for a command. On IBM's OS-360, it might be the word READY and a new line; on the UNIX operating system it is usually a percent sign followed by a space. Your system needs to recognize the prompt coming from the remote system and respond to it appropriately. This recognition is especially useful during the log-on procedure, when the system may have a status message of indeterminate length.

An alternate scheme for recognizing a prompt in the input stream is detailed in the TRANSACT procedure.

CONVERSE

The CONVERSE function in listing 3 attempts to carry on the dialog con-

Text continued on page 154

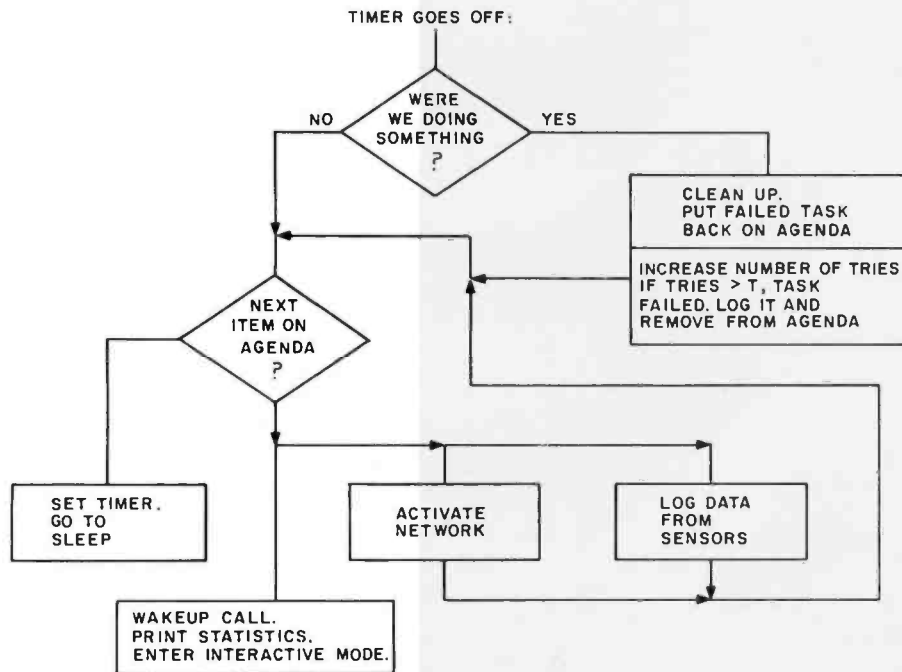

Figure 1: Flow of control when the timer goes off.

Good Morning

Nocturnal Network Summary 8:02 May 19, 1981

| Successful Transactions | Time on | Time off | # | tries |
|---------------------------|---------|----------|----------|-------|
| MAIL; NEWS | 2:03 | 2:18 | 666-6666 | 1 |
| FILE x from remote | 2:19 | 2:40 | 777-7777 | 2 |
| FILE y to remote | | | | |
| MAIL; NEWS | | | | |
| NEWS | 3:10 | 3:20 | 888-8888 | 1 |
| Unsuccessful Transactions | | | | |
| FILE n to remote | 3:45 | 3:50 | 111-1111 | 4 |
| MAIL | 3:55 | 4:10 | 222-2222 | 4 |

Figure 2: A sample report summarizing the activities of the preceding night.

THE HARD EDGE

AND STILL THE LEADING EDGE . . .
IN SYSTEM PERFORMANCE

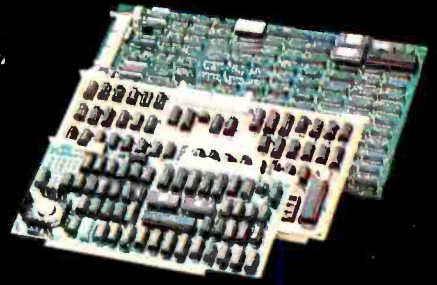
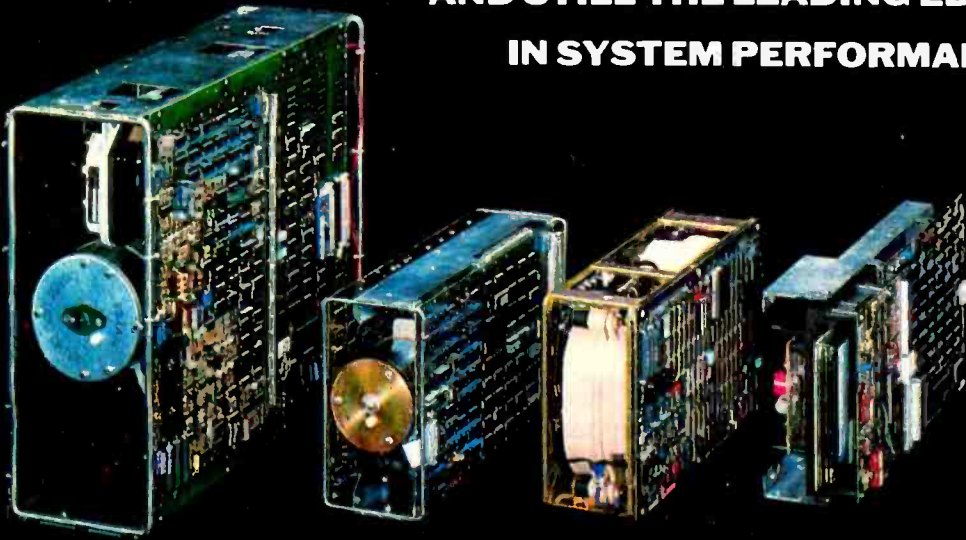

Hard Disk and Streaming Tape

reliability and versatility that can't be beat

OEM CONTROLLERS

- Multibus
- General Purpose
- S100



S33

- 31 or 62 MByte formatted
- Lowest cost/MByte from any manufacturer
- CP/M* compatible "drop in" BIOS
- Single S100 card controller
- Fully expandable up to four drives, 8" or 14"
- Reliable high performance Primam Winchester Disks
- Immediate delivery



S10



SYSTEM 8

- 8" Winchester 10 or 32 MByte formatted
- Integrated streaming cartridge backup
- Streaming backup at 5 MB/min
- Selective file backup under CP/M
- Versatile parallel I/O or DMA interface

ADES

ADAPTIVE DATA & ENERGY SYSTEMS

2627 Pomona Boulevard • Pomona, CA 91768

Phone: (714) 594-5858

*CP/M is a trademark of Digital Research Corp.

Listing 1: The module for dialing a telephone number using a simple relay to create pulses.

```

module dialer;
  (*****
  (*
  (* Dialer is a function which alternately opens and closes *)
  (* a relay on a phone's hook switch to 'dial' the number of *)
  (* the remote computer. *)
  (*
  (* Copyright 1981 by Peter Reintjes *)
  (*
  (*****

type
  phone_number = ARRAY [1..20] OF CHAR;

const
  HMASK = 100; (* bit in register for relay *)
  PAUSE = 10000; (* constant for pause *)
  HI_DC = 400; (* These two numbers set the *)
  LO_DC = 600; (* duty-cycle of the relay *)

var
  i, j, n: INTEGER;
  c : CHAR;
  exit : BOOLEAN;

external assembly procedure relay( data : INTEGER);

procedure high;
  var
    i : integer;
  begin
    (* relay is an assembly language routine to set the *)
    (* output port for the dialer to the value HMASK *)
    relay(HMASK); (* turn bit on *)
    for i:=0 to HI_DC do ; (* relay on *)
  end;

procedure low;
  var
    i : integer;
  begin
    relay(-HMASK-1); (* this inverts HMASK *)
    for i:=0 to LO_DC do ; (* relay off *)
  end;

entry procedure dialer (telenum: phone_number);
  (* telenum is at most 20 chars, terminated with a null *)

begin
  (* begin dialer *)
  (* null char is after the last digit in the array *)

  for i:=1 to 20 do begin
    c := telenum[i];
    case c of

```

Listing 1 continued on page 150

New Dimensions in Software Technology

At General Electric developing new generations of software is just part of our commitment to advancing the state of computer technology. Our technical environment includes the very latest in computer hardware (3033, 3081, VAX 11/780, JES 2, ACF/NCP, ADABAS and MVS) as well as technical support unsurpassed within the industry.

Among our current projects is the development of large scale, distributed information processing systems. In developing these systems GE software professionals have utilized some of the most innovative design approaches seen in industry today. Presently we have positions available for individuals looking to advance their career in one of the world's most sophisticated hardware/software computer environments.

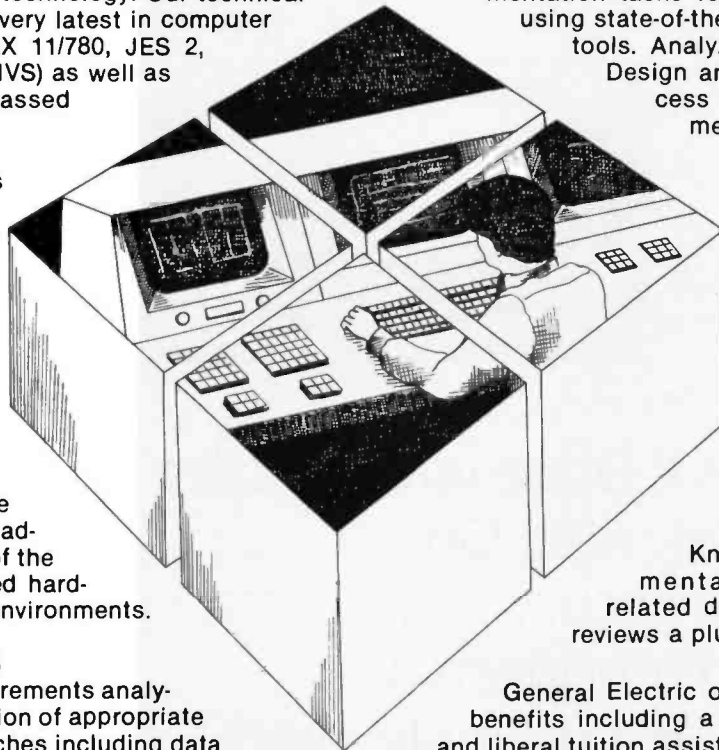

DATA BASE ANALYSTS

Responsible for data requirements analysis and subsequent selection of appropriate data management approaches including data base management systems evaluation.

COMPUTER SYSTEMS ARCHITECTS

Responsible for requirements analysis in the design of large scale Computer Systems to support on-line information management applications. Duties include selection and specifications of:

- Computer Hardware • Operating Systems
- Data Management Systems
- Telecommunications Systems

MVS SYSTEMS PROGRAMMERS

Perform SYSGENS, maintain and tune MVS. Select and install program products. Develop MVS enhancement, H/W-S/W-interfaces, and 3705 telecommunications applications.

DATA BASE DESIGNERS/ADMINISTRATORS

Perform data base design administration and implementation tasks for large scale data systems using state-of-the-art data base management tools. Analyze data base requirements. Design and select file structures, access methods and data management techniques. Install, maintain and tune vendor supplied data base management packages. Provide data base support and technical interface for data base design, query and update utilities.

SCIENTIFIC PROGRAMMER/ANALYSTS

Develop design approaches and implement state-of-the-art, high technology programs. Knowledge of structured implementation environment with related documentations and design reviews a plus.

General Electric offers excellent salaries and benefits including a comprehensive dental plan and liberal tuition assistance. And our relocation for eligible senior level professionals includes:

- Rapid cash payment for your current home • Closing costs on both current and new home • Attorney's fees • Mortgage origination fees or points.

Our facility, located in suburban Philadelphia (Valley Forge), provides easy access to seashore and mountain resorts as well as some of the nation's leading educational and cultural facilities.

General Electric is looking forward to discussing your future... and ours. For confidential consideration forward your resume in complete confidence to: **Mr. William E. Sarno, GENERAL ELECTRIC, Space Systems Division, Department BY-40, P.O. Box 8555, Philadelphia, Pa. 19101.** An Equal Opportunity Employer, M/F.

consumer computers mail order

This is just a sample of our everyday low prices.

APPLE II PLUS

64K*
ONLY
\$1249



16K for only
\$1025
48K for only
\$1089

*48 K Apple II Plus with 16K Ram Card

- Apple Disk II Drive w/controller **\$499**
- Disk II Drive, Add-On **\$439**
- Silentype Printer **\$349**
- Hayes Micromodem II **\$299**
- Epson MX-80 w/apple card **CALL**

VIDEX
VIDEOTERM
\$269

16K
RAM CARD
\$130

FREE!

1982 Catalog

In order to keep our phone lines clear for your orders,
please mail this coupon to receive a free catalog.

NAME _____

ADDRESS _____

CITY _____ STATE _____ ZIP _____

MICROSOFT
z-80 SOFTCARD
\$299

ZENITH 12 INCH
GREEN SCREEN
VIDEO MONITOR
\$149

TOLL FREE ORDER LINE 800-854-6654
*in California or outside
the continental U.S. (714) 698-8088*

See pages 503 and 371 for more discount prices and order information.

ANNOUNCING A NEW ERA OF LOWER PRICES

We're in the business of saving you money.

Let's Face It. When you order anything through the mails you never really know who you are dealing with. We at Consumer Computers realize this every time we talk to you or receive a letter from you. We do our darndest to see that you not only get the information and help you need to intelligently place your order, but also that the price we give you is the best you can get anywhere.

We've been around. Consumer Computers has been actively serving people's computer needs in the San Diego area for 5 years now. We will still be here tomorrow, and the next day, too. So when you deal with Consumer Comput-

ers, you can rest assured that you're dealing with people that are thoroughly familiar with the business of selling computers. We pledge to see that any order placed with us is handled with the utmost efficiency and care, from the time the order is placed until it arrives at your doorstep. And if you have a problem, we think you will find that the expertise of our Service Department is unmatched for the quality of their work, and the speed that they have your equipment back into your hands where it belongs.

That's our promise. That's Consumer Computers.

**consumer
computers** *mail order*

See our advertisement on previous page

Listing 1 continued:

```
        '<0>': exit := true; (* null character *)

        '1','2','3','4','5',
        '6','7','8','9','0': begin
(* integer value of digit *) n := ord(c) - 48;
        if (n=0) then n:=10;
        for j:=0 to n do begin
            high;
            (* toggle relay *) low;
        end;
        end;

        '-': for j:=1 to PAUSE do; (*pause*)

        otherwise begin
            writeln('error: bad digit ',c);
            exit := true;
        end;
        end; (* end of case *)
        if (exit) then exitloop;
    end;
end;
```

Listing 2: The module to recognize a prompt from the host computer and take appropriate action.

```
module prompt;

(*****)
(* Prompt is a function which searches a text buffer for an *)
(* occurrence of the 'prompt' a string specified in the array *)
(* pmt[]. It is called prompt because it will most often be *)
(* used to wade through extraneous system chatter to determine *)
(* if the remote system came back with a 'prompt'. *)
(* *)
(* Copyright 1981 by Peter Reintjes *)
(* *)
(*****)
type
    buffer = ARRAY [0..2047] OF CHAR;
    buf = @buffer;
    prom = STRING 50;

entry function prompt(pmt: prom; bptr: buf; off,len:INTEGER):INTEGER;

var
    c : CHAR; (* temporary character *)
    i,p : INTEGER;
    lpmt : INTEGER;
    found : BOOLEAN; (* boolean true when prompt is matched *)

begin
    found := false;
    lpmt := length(pmt);
    p := 0; (* pointer in text buffer *)
    c := bptr@[p+off]; (* c gets first character *)

    while( NOT(found) AND (p<len-lpmt) ) do begin
```

Listing 2 continued on page 154

MULTIUSER

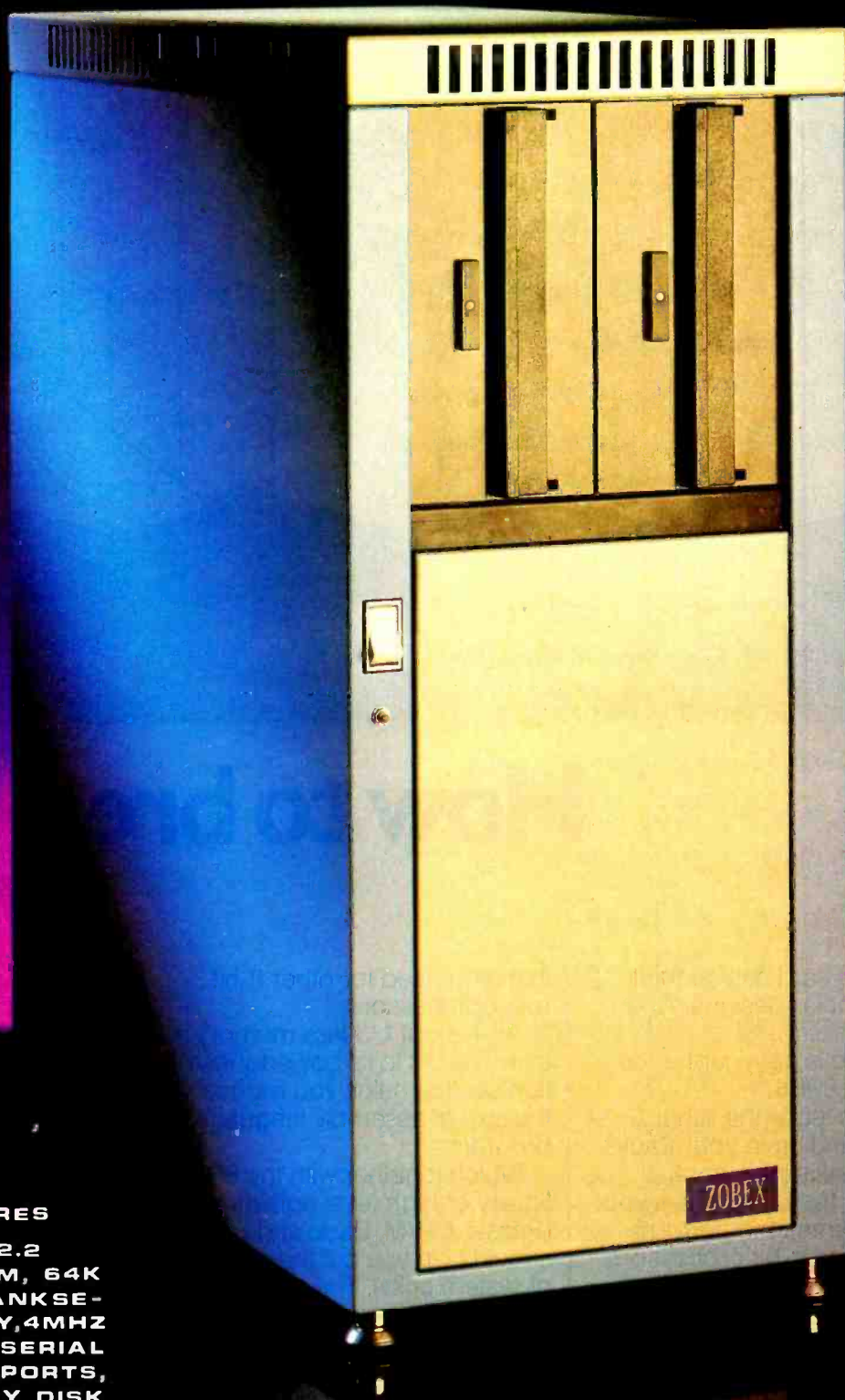

**COMPUTER
ON S-100 BUS
DESIGNED TO
SATISFY A WIDE
VARIETY OF
APPLICATIONS.**

**STANDARD FEATURES
INCLUDE: CP/M 2.2
OPERATING SYSTEM, 64K
EXPANDABLE, BANKSE-
LECTABLE MEMORY, 4MHZ
Z80A CPU WITH 4 SERIAL
AND 3 PARALLEL PORTS,
RELIABLE 8" FLOPPY DISK
DRIVES IN A STURDY ALL
METAL CABINET.**

\$ 4900

MP/M OPTIONAL.

CP/M AND MP/M REGISTERED TRADE MARKS OF DIGITAL RESEARCH

ZOBEX[®]

P.O. BOX 1847 SAN DIEGO, CA. 92112

7343-J RONSON RD, SAN DIEGO, CA. 92111

(714) 571-6971

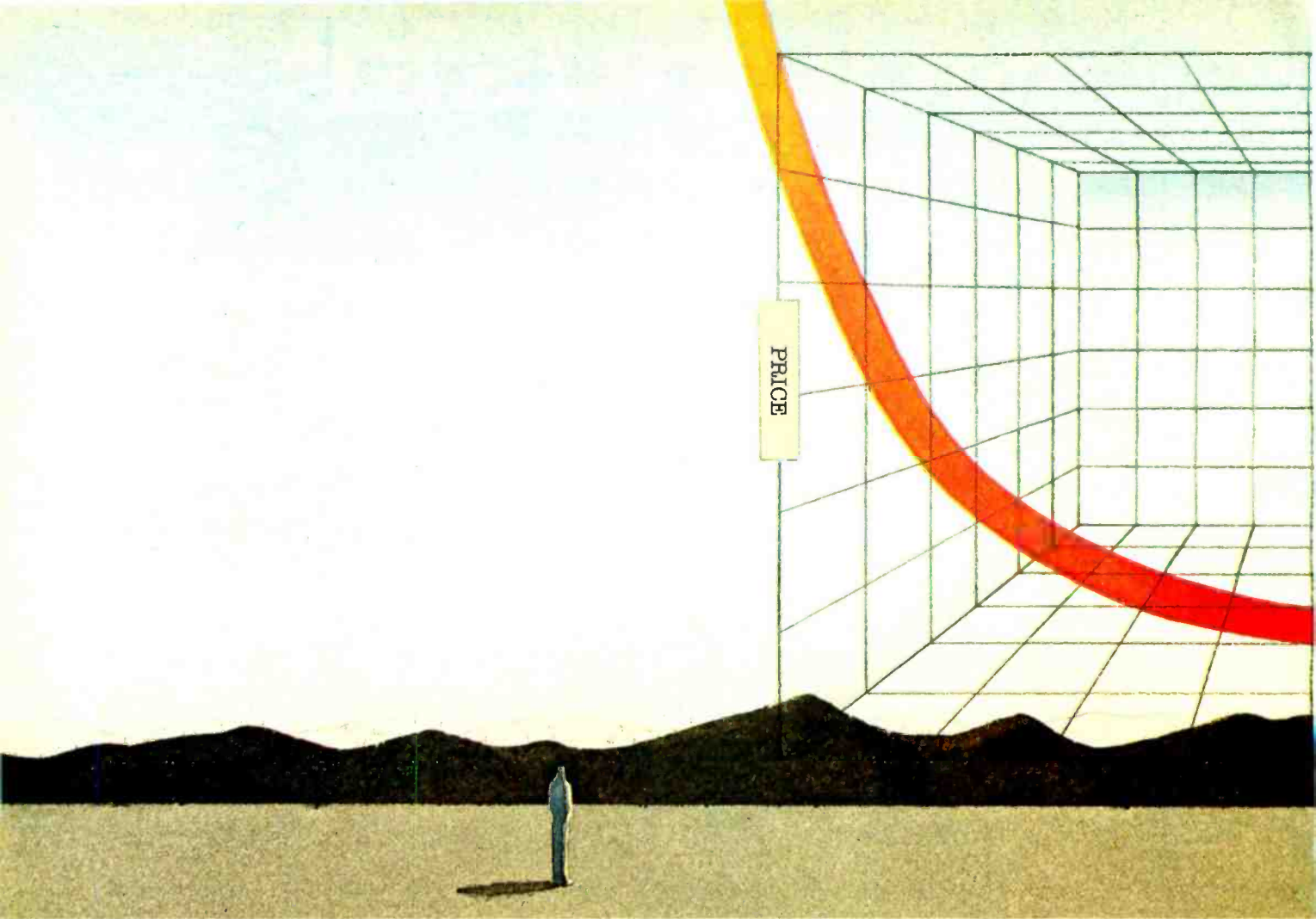

How to break the 8-bit without

It's not as hard as you think. Forget complex designs. And two-year waits.

All you do is get your hands on the Intel 8088.

And then leave the other 8-bit systems standing in your tracks. Without breaking the bank.

Because the 8088 gives you two to five times the performance of other 8-bit processors. For a whole lot less.

In fact, at \$14.10 for 100 pieces, 75% less than last year. (Because high volume shipments are already pushing the 8088 down a super fast price curve.)

And about 20% less than you'd pay for a Z80 or MC6809 system. For some simple reasons.

The 8088 runs at full speed with slower speed memories

than you need for other 8-bit microprocessors.

And about 1/3 less memory at that. Thanks to its powerful instruction set that helps you reduce the size of assembly language programs.

Which together with the 8088's library of high level software (Pascal, CP/M, Basic and Fortran) should help you cut the other part of system costs. The part that's larger than hardware.

But even though you're paying less, you'll be getting more.

Like 1-megabyte addressing. Extra power for 16-bit number crunching.

And faster string processing.

Fact is, our recent benchmarks show the 8088 runs circles around a Z80A, Z80B or MC6809

when it comes to terminal and small business applications.

But don't think you have to stop there. With any of our iAPX 88 multiprocessor configurations, you can give performance an added boost—and still keep the cost and simplicity of an 8-bit system.

For 100 times the throughput on number crunching, just choose the iAPX 88/20 system.

Relative Performance

| | Intel 8088 (5 MHz) | Zilog Z80B (6 MHz) | Motorola MC6809 (2MHz) |
|-------------------|--------------------------|--------------------------|------------------------------|
| Computer Graphics | 1.0 | 0.1 | 0.05 |
| 16-bit Multiply | 1.0 | 0.17 | 0.5 |
| Block Move | 1.0 | 0.75 | 0.49 |

Full details of these benchmarks available in the iAPX 88 Book.

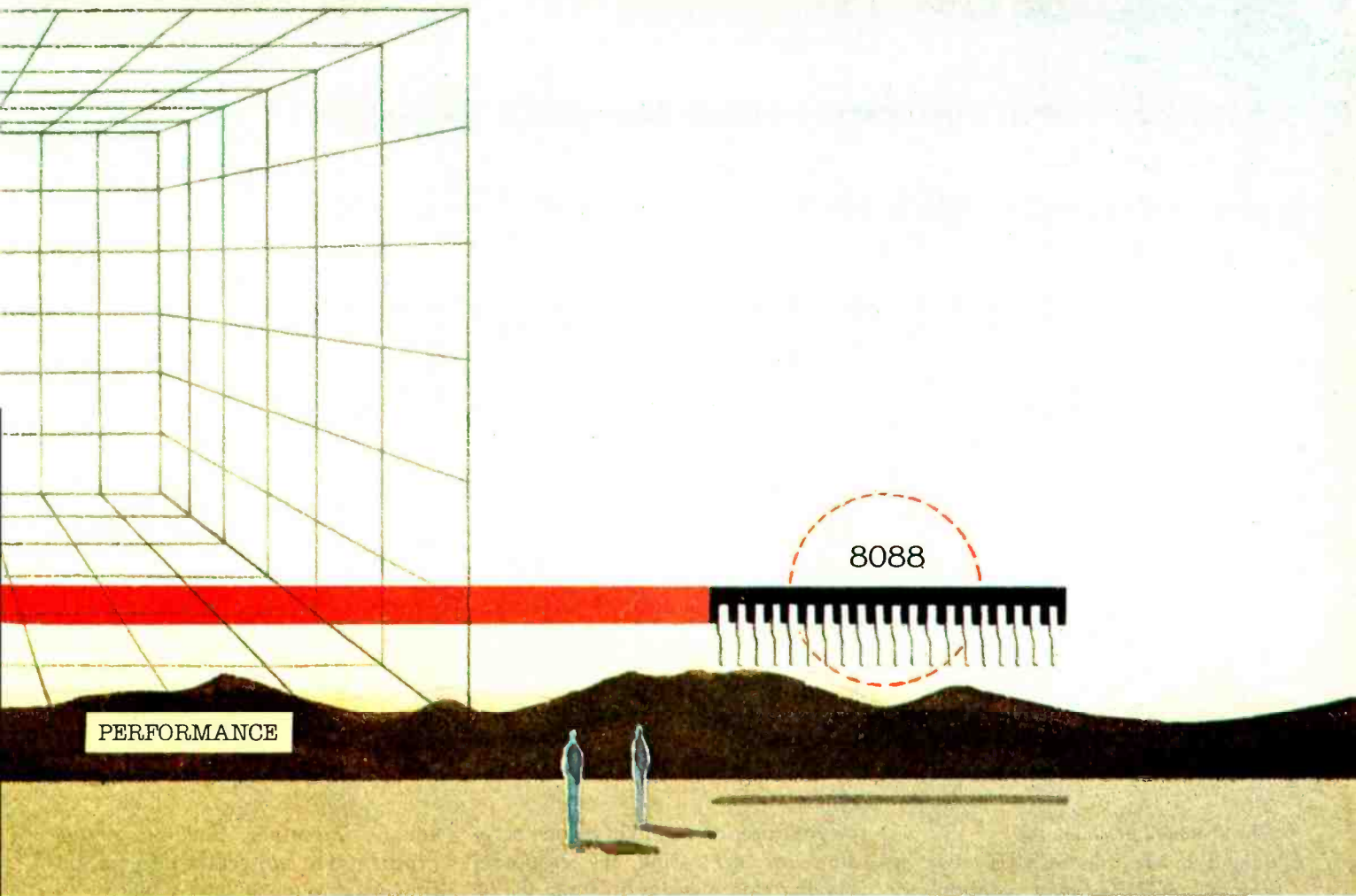

PERFORMANCE

bit performance barrier going broke.

It combines the power of the 8088 with our 8087 numeric coprocessor.

Or if you're worried about getting bound up in I/O. Don't. Select our iAPX 88/11 system that speeds I/O processing three to five times by putting an 8088 together with an 8089 I/O processor.

Then there's the fact if you ever decide to make the jump to 16 bits, you won't have to jump. The 8088 is 100% software compatible with our 8086.

Because we don't think you should have to sell out your future to get the best deal on price/performance today.

And to put you in the right frame of mind, we're ready to make you an offer.

Just clip this coupon and send it with \$5 to Intel Corporation, Literature Department, 3065 Bowers Avenue, Santa Clara, CA 95051. (Or call 408-987-8080.) We'll send you the book on

how to design iAPX 88 systems and a coupon good for one free 8088.

Everything you need to start breaking through barriers—without going broke.

Circle 405 on inquiry card.

Name _____
 Title _____
 Company _____
 Address _____
 City _____
 State/Zip _____

Europe: Intel International, Brussels, Belgium.
 Japan: Intel Japan, Tokyo. United States and Canadian distributors: Alliance, Almac/Strom, Arrow Electronics, Avnet Electronics, Component Specialties, Hamilton/Avnet, Hamilton/Electro Sales, Harvey, Industrial Components, Pioneer, L.A. Varah, Wyle Distribution Group, Zentronics.

intel® delivers solutions

Limit one per person.

Listing 2 continued:

```
    i := 1;
    while( (c=pmt<<i>>) AND (i<=lpmt) ) do begin
        i := i + 1;
        p := p + 1;
        c := bptr@[p+off];
        end;
        (* while c matches next char in pmt*)

    (* if entire prompt recognized, i will equal lpmt+1 *)
    (* if part of pmt was seen, we must move p back *)

        if ( i <= lpmt ) then begin
            p := p - (i-1);
            end;

        if ( i = lpmt+1) then found := true;
    end;

    (* if found, offset of prompt into text buffer passed *)

        if found then prompt := p
            else prompt := -1;

end;
```

Text continued from page 144.

tained in the file SCRIPT. For instance, SCRIPT may contain the dialog necessary to log on to the remote system. This function will be invoked after the number has been dialed and the remote system has answered. If CONVERSE does not get the response it expects at any point in the conversation, it can drop back to an earlier part of the conversation and try to pick up the thread. However, if it continues to find errors and can't get through, it will give up and tell the transaction processor to try again later.

CONVERSE allows the system to log on to interactive services designed for a human interface, and to give the local system access to these services without operator intervention. It also lets you test new protocols by providing a table-driven protocol handler.

If the remote system has a response used to indicate an incorrect sequence (for example, INCORRECT USER NAME—TRY AGAIN), that response should be included in the model of a normal dialog. Giving the remote system an empty line instead

of your user name might be one occasion for generating the response. Having this message in your dialog will give you a recovery point. If something happens later in the dialog and the system responds with INCORRECT USER NAME—TRY AGAIN, you will be able to pick up the conversation at the appropriate point.

CLEANUP

If the WATCHDOG wakes up and sees that a specified transaction was active, it calls the CLEANUP function to shut it down. If the number of tries for this transaction exceeds a predetermined limit, it is taken off the AGENDA.

TRANSLUCID

This is a shell, or command-line, program which interacts with the user at the keyboard. The primary function of TRANSLUCID, shown in listing 4, is to make the local computer look like a terminal, passing information from the user's keyboard to the network and sending the data from the network to the local video display or printer. A secondary, and

equally important, function of this program is to redirect the information flowing through it into a file, or to use files as the source of text to be substituted for the keyboard. Using the "transparent" monitor to conduct transactions manually will show you the dialogs which must take place between the computers.

The GETC and PUTC functions handle character input and output from the user terminal or files designated by the redirection commands. GETREMOTE and PUTREMOTE serve the same function on the network (modem) side. The first parameter to these routines specifies the channel over which the data is received or sent. The channels in my examples are the terminal input (STDIN), the output channel to the terminal screen (STDOUT), the output to the modem (NETOUT) and the return data from the modem (NETIN). All other channels in the programs are to files on the local system.

The second parameter is the character variable, and the third (GET functions only) is the WAIT/

Text continued on page 163

Listing 3: The input/output module, CONVERSE.

```

module converse;

(*****)
(*)
(*) Converse is a function which alternately transmits lines of (*)
(*) text and receives them from the remote unit. It monitors this (*)
(*) conversation as it proceeds, attempting to recover if it (*)
(*) gets out of step. It then returns 0 if the conversation was (*)
(*) successful and a -1 if it failed. (*)
(*)
(*) Copyright 1981 by Peter Reintjes (*)
(*)
(*****)

external procedure putremote ( c : CHAR );
external function getremote ( var c : CHAR; wflag : BOOLEAN ):INTEGER;
entry function converse(fname: STRING 20) :INTEGER;

    (* fname is a file of text strings terminated by NULL. *)
    (* Every other string starting with the first one is *)
    (* what the local unit sends, the next line is what we *)
    (* expect to get back. The file starts with a NULL and *)
    (* is terminated by two or more NULLs. *)

const
    NULL = '<0>'; (* reference character *)
    ATTN = '<12>'; (* interrupt remote computer *)
    HOLD = 100; (* max time delay for each *)
            (* character from the net *)
    wait = true;
    nowait = false; (* options for getremote call *)

var
    c, cn : CHAR;
    i : INTEGER;
    errors : INTEGER;
    error : INTEGER;
    done : BOOLEAN;
    giveup : BOOLEAN;

procedure recover; (* call this as many times as you want *)

var
    reply : STRING 180; (* longest response from remote *)
    found : BOOLEAN;
    error,i,time : INTEGER;

begin
    if ( c <> NULL ) then begin (* error recovery *)
        errors := errors + 1;

        putremote(ATTN); (* get remote's attention *)

        reply := ''; (* null string for response *)
        time := 0; (* wait for the response *)
        while ( time < HOLD ) do begin
            error := getremote(c, nowait);

```

Listing 3 continued on page 156

Listing 3 continued:

```
        if (error = 0) then begin (* we got one *)
            append(reply,c);
            time := 0;
            end;
        time := time + 1;
    end;

    (* If we waited long enough, the response is in reply *)
    (* if there's no reply then the remote system is dead *)
    if (length(reply)=0) then giveup := true;
    if (giveup) then exitloop;

    (* now we search the file for the system's response *)

    reset(infile,fname);
    read(infile,c);
    found := false;
    while ( NOT found AND NOT EOF(infile)) do begin
        read(infile,c);          (* read past NULL *)
        if EOF(infile) then exitloop; (* being cautious *)

        (* read past local part of conversation *)
        while ( c <> NULL ) do read(infile,c);
        read(infile,c);          (* read past NULL *)
        if EOF(infile) then exitloop;

        i := 1;
        while((i <= length(reply))AND(c = reply<<i>>)) do begin
            read(infile,c);
            if EOF(infile) then exitloop;
            i := i + 1;
        end;
        if EOF(infile) then exitloop;
        if((i>length(reply))AND(c=NULL))then found := true;
        while ( c <> NULL ) do read(infile,c);
        if EOF(infile) then exitloop;
    end;

    if ((c<>NULL) OR EOF(infile) OR (errors>10)) then giveup := true;
end; (* end of error recovery *)

        (* Main procedure CONVERSE *)

begin
    errors := 0; (* keep track of error recovery attempts *)
    done := false; (* we've only just begun *)

    reset(infile, fname); (* open script file *)

    read(infile,c);
    while ( NOT EOF(infile) AND NOT done ) do begin
        while( c <> NULL ) do begin
            write(netout,c);
            read(infile,c);
        end;

        read(infile,c);

        while (c <> NULL) do begin
            read(infile,c);
```

Listing 3 continued on page 158

NEED A PRINTER?

UP TO 25% DISCOUNTS! — SAME DAY SHIPMENT!

NEW

CENTRONICS 739 (RADIO SHACK LINE PRINTER IV)

With Graphics and Word Processing Print Quality



- 18 x 9 dot matrix; suitable for word processing • Underlining • proportional spacing • right margin justification • serif typeface • 80/100 CPS • 9½" Pin Feed/Friction feed • Reverse Platen • 80/132 columns • Top of form

CENTRONICS 739-1 (Parallel) (List \$995) \$765
 CENTRONICS 739-3 (Serial) (List \$1045) 815
 GRAPPLER™ Apple graphics interface \$165

ANADEX

Dot Graphics, Wide Carriage



- 11 x 9 dot matrix; lower case descenders • Dot resolution graphics • Bi-directional, logic seeking • Up to 200 CPS • RS 232 Serial & Parallel • Forms control • X-ON/X-OFF • Up to 6 part copy.

ANADEX 9501 (List \$1650) \$ Call
 GRAPPLER™ Apple graphics Interface \$165

VISTA — C. ITOH STARWRITER

Daisy Wheel Letter Quality



- 25 CPS (Optional 45 CPS) • Typewriter quality • Centronics parallel • RS 232 Serial (Optional) • Proportional spacing • Bidirectional • Programmable VFU • Self test • Diablo compatible • Friction feed (Optional tractors) • 136 printable columns • Manufactured by C. ITOH.

VISTA V300 (C. ITOH) STARWRITER (List \$1895) \$1575

IDS PAPER TIGERS

Dot Resolution Graphics, quality print, speed



- 9 wire printhead (460) with lower case descenders • Over 150 CPS • bi-directional, logic seeking • 8 character sizes; 80-132 columns • Adjustable tractors • High-resolution dot graphics • Proportional spacing & text justification

IDS 460G 9 wire printhead, graphics (List \$1094) \$ Call
 IDS 560G wide carriage, graphics (List \$1394) \$ Call
 GRAPPLER™ Apple graphics interface \$165

EPSON MX80/MX70/MX100

Low-Priced Professional Print Quality



- 9 x 9 dot matrix • Lower case descenders • 80 CPS • Bidirectional, Logic seeking • 40, 66, 80, 132 columns per line • 64 special graphic characters: TRS-80 Compatible • Forms handling • Multi-pass printing • Adjustable tractors

We also carry a full line of Epson Accessories.

EPSON MX80 (& MX80FT) (List \$645) \$ Call
 EPSON MX70 Dot graphics, 5 x 7 matrix (List \$450) \$ Call
 EPSON MX100 wide carriage, graphics (List \$945) \$ Call
 GRAPPLER™ Apple Graphics Interface \$165
 GRAFTRAX 80 - MX80 Dot Graphics \$ 95

MX80/70 FRICTION FEED KIT

User installable kit for single sheets.

Easy 30 minute installation \$ 75

ANACOM

Low Cost, High Speed, Wide Carriage

- 9 x 9 dot matrix • Lower case descenders • Wide carriage • Adjustable tractors to 16" • 150 CPS, Bidirectional, Logic Seeking

ANACOM 150 (List \$1350) \$995

NEC SPINWRITER

High Speed Letter Quality

- 55 CPS • Typewriter quality • Bidirectional • Plotting • proportional spacing.

5510 RO, Serial (List \$3055) \$2575
 5530 RO, Parallel (List \$3055) \$2575

TELEVIDEO CRT'S

AT DISCOUNT PRICES!



TVI 910 } Please Call Toll Free
 TVI 912C } Prices are too low to
 TVI 920C } advertise
 TVI 950 }

QUANTITY PRICING AVAILABLE

CRT'S

ADDS VIEWPOINT (List \$698) \$600

PRINTERS

MALIBU 165 wide carriage, graphics, letter quality .. (List \$1975) \$1325
 QUME 5/45 typewriter quality (List \$2905) \$2559
 DIABLO 630 \$ Call

INTERFACE EQUIPMENT

EPSON ACCESSORIES \$ Call
 ORANGE INTERFACE for Apple II parallel interface board & cable \$ 110
 MICROTROINCS Atari parallel interface \$ 69
 TRS-80 CABLES to keyboard or Exp. interface \$ Call
 NOVATION D-CAT direct connect modem \$ 180

CALL FOR INFORMATION & CATALOG

(800) 854-8275

CA, AK, HI (714) 630-3322

RETAIL PRINTER STORES:

Store #1 3150 E. La Palma, #I, Anaheim, CA (714) 630-3622
 Store #2 13604 Ventura Bl., Sherman Oaks, CA (213) 501-3486

Store Hours: M-F 10-6 Sat. 10-4



Orange Micro inc.

3150 E. LaPalma, Suite G, Anaheim, CA 92806



Phone order WELCOME; same day shipment. Free use of VISA & MASTER-CARD. COD's accepted. Manufacturer's warranty included on all equipment. Prices subject to revision.

Listing 3 continued:

```
        i := 0;
        while ( i < HOLD ) do begin
            error := getremote(cn, nowait);
            if ( error = 0 ) then i := HOLD;
            i := i + 1;
        end;
        if ( c <> cn ) then exitloop;
    end;

    (* c should now be at the NULL before the local *)
    (* system's next statement. *)
    (* If c <> NULL at this point then there was an error *)

    (* try to pick up conversation *)
    while ((c <> NULL)AND(NOT giveup)) do recover;

    if (NOT giveup) then begin
        read(infile,c);
        if ( c = NULL ) then done := true; (* two NULLs in a row *)
    end;

end; (* conversation complete *)

    if (done) then converse := 0 (* worked *)
        else converse := -1; (* failed *)
end;
```

Listing 4: The command processor "shell" program, TRANSLUCID.

```
program TRANSLUCID(input,output);

const    ENDOF      =    -1;
         NL         =    '<012>';
         ESC        =    '<176>';
         wait       =    true;
         nowait     =    false;

type
    cfile = FILE OF CHAR;

var
    network: TEXT;          (* Fake network data source *)
    netout  : TEXT;          (* Fake network data sink *)
    auxfile: TEXT;          (* One file may be opened for aux output *)
                                (* Up to 9 files may be opened for *)
                                (* input. *)
    macfile: ARRAY [0..9] OF cfile; (* array of file descriptors *)
    level  : INTEGER;
    done   : BOOLEAN;
    c      : CHAR;
    error  : INTEGER;      (* error flag back from get and put calls *)
    aux,app: BOOLEAN;      (* true if we have an auxillary file open *)
    fname  : STRING 20;    (* Filename for rewrite or reset calls *)

external function getc(fdesc : FILE OF TEXT;
                    var c :CHAR;
                    wflag :BOOLEAN) : INTEGER;

external procedure putc( fdesc: FILE OF TEXT; c :CHAR);
```

Listing 4 continued on page 160

datasouth announces... THE TOTAL PRINTER PACKAGE!

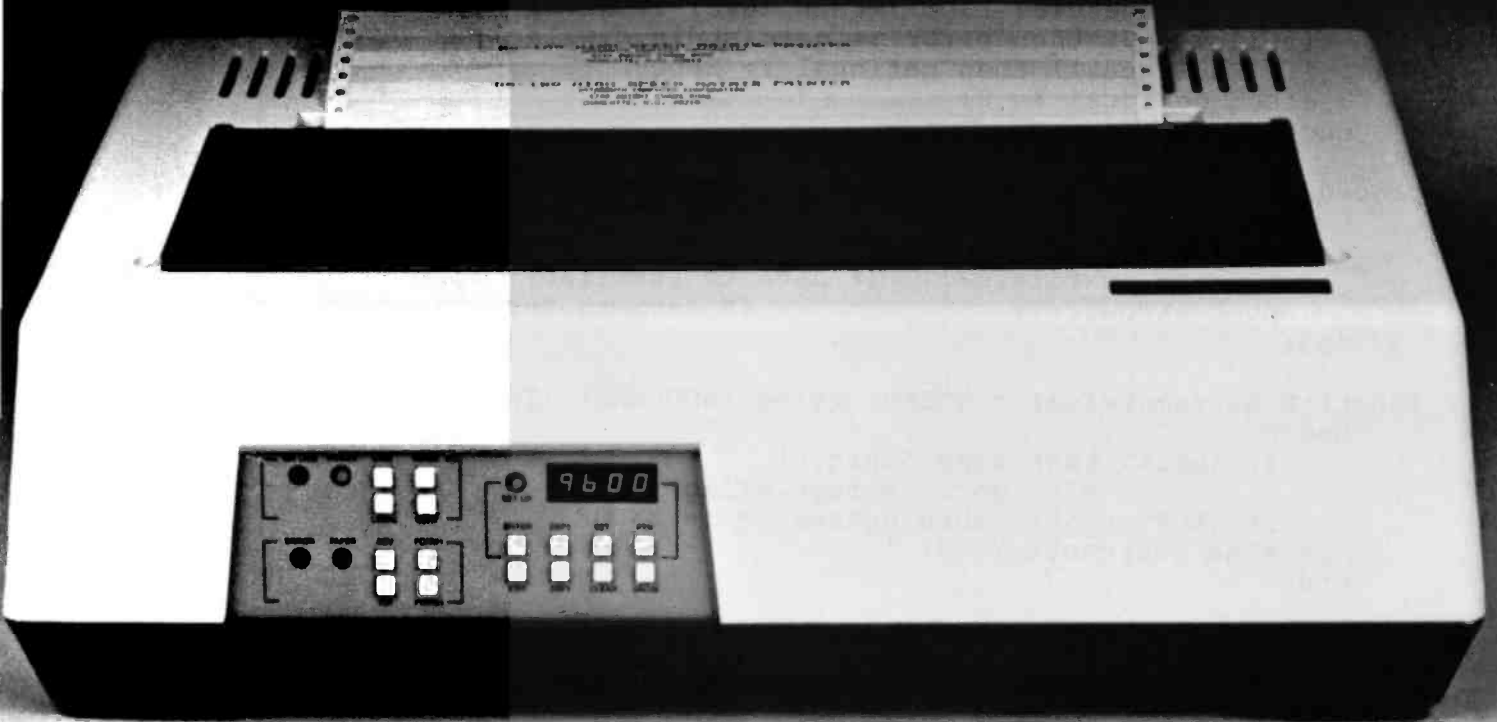

With so many matrix printers on the market today, it may seem tough to find exactly the right one for your application. Some models may offer the speed you need, others the communications flexibility and still others the forms handling capability. But no printer offers all the features you need... until now.

The DS180 matrix printer provides the total package of performance features and reliability required for applications such as CRT slave copy, remote terminal networks and small to mid-range systems. Not a "hobby-grade" printer, the DS180 is a real work-horse designed to handle your most demanding printer requirements. And pricing on the DS180 is hundreds of dollars below competitive units.

High Speed Printing—Bidirectional, logic-seeking printing at 180 cps offers throughput of over 200 lpm on average text. A 9-wire printhead life-tested at 650 million characters generates a 9x7 matrix with true lower case descenders and underlining.

Non-volatile Format Retention—a unique programming keypad featuring a non-volatile memory allows the user to configure the DS180 for virtually any application. Top of form, horizontal and vertical tabs, perforation skipover, communications parameters

and many other features may be programmed and stored from the keypad. When your system is powered down, the format is retained in memory. The DS180 even remembers the line where you stopped printing. There is no need to reset the top of form, margins, baud rate, etc... it's all stored in the memory. If you need to reconfigure for another application, simply load a new format into the memory.

Communications Versatility—The DS180 offers three interfaces including RS232, current loop and 8-bit parallel. Baud rates from 110-9600 may be selected. A 1K buffer and X-on, X-off handshaking ensure optimum throughput.

Forms Handling Flexibility—Adjustable tractors accommodate forms from 3"-15". The adjustable head can print 6-part forms crisply and clearly making the DS180 ideal for printing multipart invoices and shipping documents. Forms can be fed from the front or the bottom.

If you would like more information on how the DS180's low-cost total printer package can fill your application, give us a call at Datasouth. The DS180 is available for 30-day delivery from our sales/service distributors throughout the U.S.

Circle 112 on Inquiry card.

datasouth
computer corporation

4740 Dwight Evans Road • Charlotte, North Carolina 28210 • 704/523-8500

```

function fgetc(var c :CHAR) :INTEGER;
  (* file-get keeps track of the multiple inputs *)
  (* like the include facility of most languages *)
begin
  read(macfile[level],c);
  if(EOF(macfile[level])) then fgetc := ENDOF
  else fgetc := 0;
end;

function getlocal(var c : CHAR; wflag :BOOLEAN) :INTEGER;
begin
  while (level<>0) do
    if (fgetc(c)=ENDOF) then level := level -1;
  if (level=0) then error := getc(stdin,c,wflag);
  if (EOF(input)) then getlocal := ENDOF
  else getlocal := 0;
end;

procedure putlocal(c : CHAR);
begin
  if (aux) then
    write(auxfile,c);  (* data to auxillary file *)
  putc(stdout,c);      (* data to terminal screen *)
end;

function getremote(var c :CHAR; wflag :BOOLEAN) :INTEGER;
begin
  if (wait) then read(netin,c)
  else getc(netin,c,wflag);
  if (EOF(netin)) then getremote := ENDOF
  else getremote := 0;
end;

procedure putremote( c :CHAR);
begin
  write(netout,c);
end;

begin
  level := 0;          (* level counter for redirected input *)
  while (NOT done) do begin
    error := getlocal(c,nowait);
    if (error <> ENDOF) then begin
      if( c=ESC) then begin  (* enter command mode *)
        error := getlocal(c,wait);
        case c of
          ESC: putremote(c); (* pass special character *)

          (* take input from *) '<': begin (* increase macro level *)
            (* a new file *)      fname := '';
            error := getlocal(c,wait);
          (* get filename into fname *) while(c<>NL) do begin
            error := getlocal(c,wait);
            append(fname,c);
            end;
            level := level + 1;
            (* open new file *) reset(macfile[level],fname);
          end;
        end;
      end;
    end;
  end;
end;

```

At Hayes, we don't believe in second best. Or planned obsolescence. We believe in taking the state of the art to the limit. Our new Smartmodem, for example, is the most sophisticated 300-baud originate/answer modem you can buy. And yet, it is perhaps the easiest-to-use modem ever.

RS-232C Compatible. Smartmodem lets any RS-232C compatible computer or terminal communicate by phone with other computers and time-sharing systems located *anywhere in North America*. You get full and half-duplex operation with both Touch-Tone® and pulse dialing.

Auto-Answer/Dial/Repeat. Smartmodem can answer the phone, dial a number, receive and transmit data, and then hang up the phone—automatically! If desired, Smartmodem will even repeat the last command. You can depend on Smartmodem for completely unattended operation.

Completely Programmable. Smartmodem can be controlled using

Hayes Stack™

Microcomputer Component Systems

any programming language. Over 30 different commands can be written into your programs or entered directly from your keyboard.

Smartmodem also includes several switch-selectable features that let you tailor performance to your exact needs. You can "set it and forget it" for the ultimate in convenience.

Built-in Audio Monitor. Thanks to an internal speaker, you can actually listen to your connection being made. You'll know immediately if the line is busy or if you reached a wrong number—

and you don't even need a phone!

Status at a Glance. Seven LED's indicate Smartmodem's current operating mode: auto-answer, carrier detect, off hook, receive data, send data, terminal ready and modem ready. You're never left in the dark!

Direct-Connect Design. Smartmodem is FCC registered for direct connection to any modular phone jack—there's no acoustic coupler to cause signal loss and distortion.

Smartmodem, Smart Buy. Professional quality features. Versatile performance. A full two-year limited warranty. A suggested retail price of only \$279.

What more could you want? Perhaps the matching Hayes Stack Chronograph, an RS-232C compatible calendar/clock system.

Check out the Smartmodem wherever fine computer products are sold. And don't settle for anything less than Hayes.



Smartmodem.
The ultimate concept in modems
is now a reality.

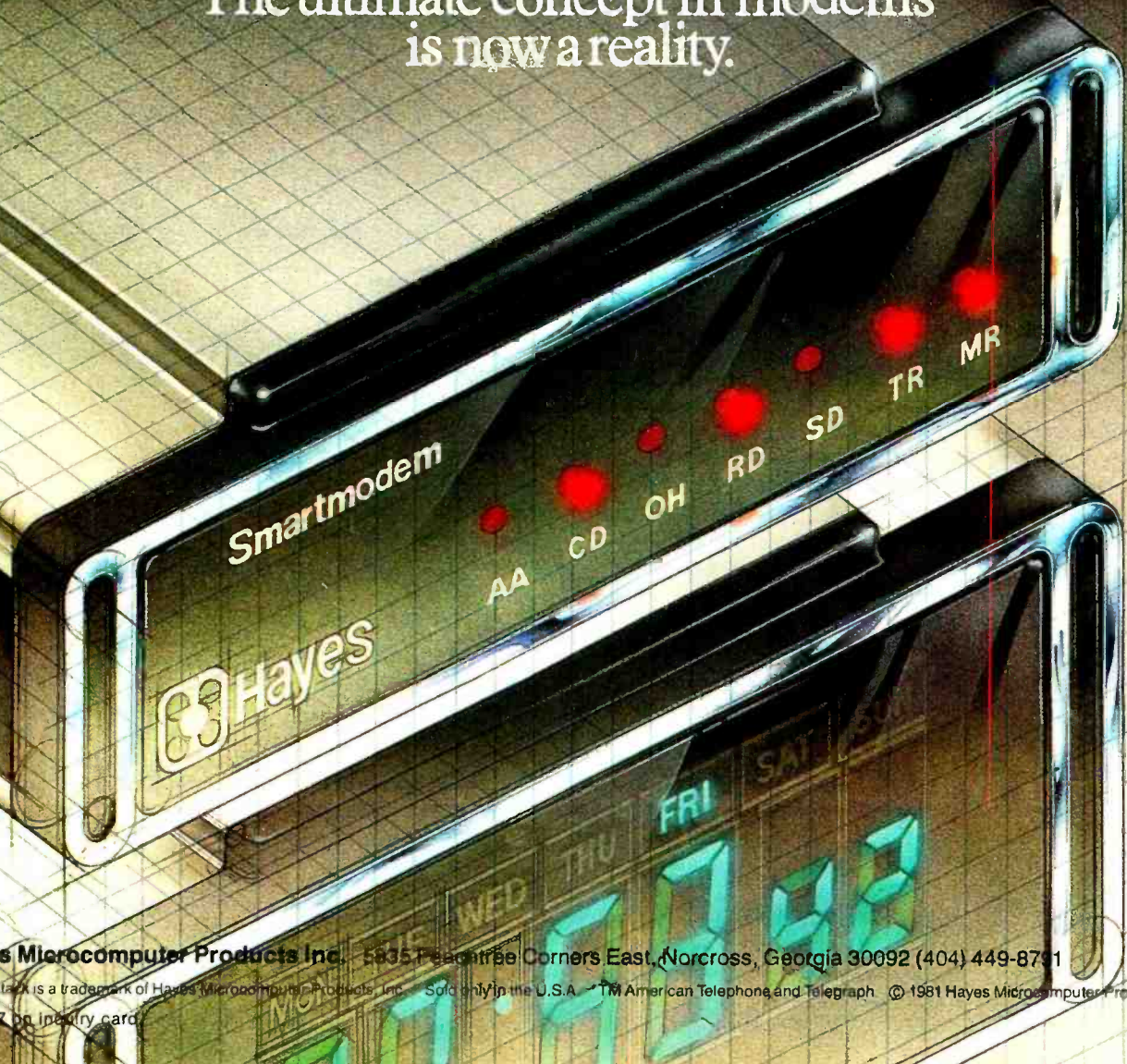

Hayes Microcomputer Products Inc., 5835 Peachtree Corners East, Norcross, Georgia 30092 (404) 449-8731

Hayes Stack is a trademark of Hayes Microcomputer Products, Inc. Sold only in the U.S.A. TM American Telephone and Telegraph. © 1981 Hayes Microcomputer Products, Inc. Circle 107 on inquiry card.

Amdek

From picture perfect.

To letter perfect.

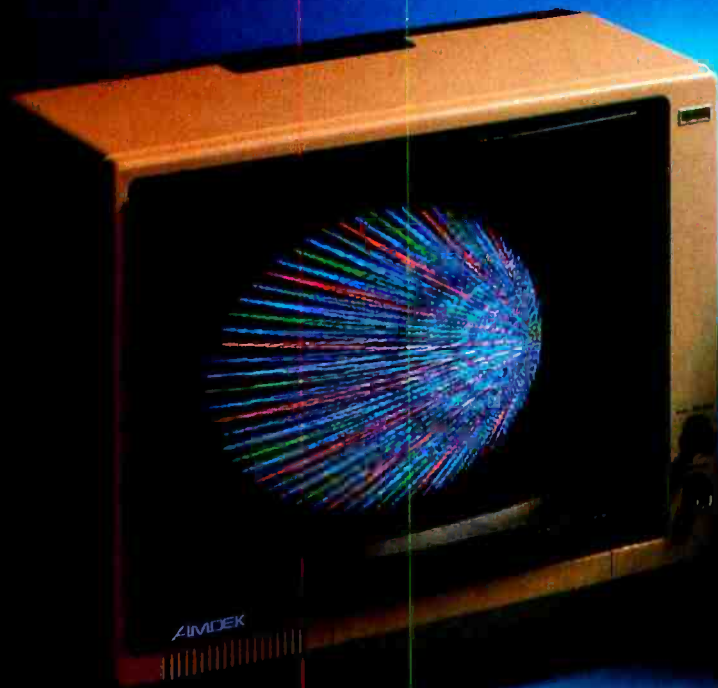

Amdek
Color-I
FCC/UL approved



Amdek
Video-300

At Amdek, we make monitors for people who demand state-of-the-art color. And for people who know that crisp, clear text display is an art in itself.

Our versatile Color-I 13" video monitor features standard NTSC composite input, front-mounted controls and a built-in speaker with audio circuit. Our popular Video-300 12" Green Phosphor monitor has an easy-to-read, non-glare screen, 18 MHZ band width and 80 x 24 character display.

Both offer easy portability, with lightweight cabinetry and molded-in handles. And both are fully

compatible with most computer and word processing systems. So compare our performance with other monitors. Then compare prices. For quality and value, you'll choose Amdek.

NEW THIS FALL: our advanced high resolution Color-II monitor with interface board for Apple II compatibility. Color-II features RGB, TTL input and 560(H) x 260(V) resolution for crisp 80 x 24 character display and exceptionally sharp color graphics. Ask your dealer about an Amdek Color-II, Color-I, or Video-300 monitor today.

AMDEK

2420 E. Oakton Street, Suite "E" Arlington Heights, Illinois 60005 (312) 364-1180 TLX: 25-4786

Come see our complete line of color, green phosphor and black/white monitors at the COMDEX Show (Booth 386-8) in Las Vegas, November 19-21.

```

'>': begin (* put output into file *)
    if (aux) then
        writeln('error: file already open.')
    else begin
        aux := true;
        error := getlocal(c,wait);
        if (c = '>') then begin
            app := true;
            error := getlocal(c,wait);
            end;
        fname := '';
        (* get filename into fname *) while(c<>NL) do begin
            append(fname,c);
            error :=getlocal(c,wait);
            end;
        (* open new file or *) if(NOT app) then rewrite(auxfile,fname)
        (* append to old file *) else fileappend(auxfile,fname);
        end;
    end;

'|': begin (* close file opened by > or >> *)
    app := false;
    aux := false;
    close(auxfile);
    end;

'.': (* terminate connection *)
    done := true;
    end; (* inner case *)
    end (* end command mode *)
    else putremote(c);
    end; (* ENDOF error check block around case *)
    error := getremote(c,nowait); (* characters from network *)
    if (error = 0) then putlocal(c); (* go unchanged to local *)
end; (* while *)
end.

```

Text continued from page 154:

NOWAIT directive to control input flow. If GETC(STDIN,C,NOWAIT) is specified, the function will come back immediately even if no character was available from the console. GETC(STDIN,C,WAIT) will wait until the user produces the needed character before returning. The integer returned by the function will show if a valid character, no character, or an end-of-file was received.

The internal designs of the GET and PUT functions depend on the system and are not shown here. Your own GETC can buffer an entire line from the terminal to allow for backspacing and editing the line before it is sent.

Some of these commands may cause a great deal of data to come

back across the network. Routines which manage the system buffers will need to control the I/O, sending stop and start codes to the network as needed to prevent buffer overflow. When the input buffer is full, the host must send a pause (Control-S) to the remote to stop any more data flow until the buffer is emptied. Then it sends a resume (Control-Q) to the remote unit for more data.

The program continually looks for data going in either direction and passes it through. The only exception comes when the user types the escape character (represented as ESC), thus activating the command processor. The command processor stays active until a carriage return is received, indicating the end of the command. The following commands are supported

by my TRANSLUCID module:

- ESC<filename (carriage return). Take input characters from filename instead of the console. When all the characters in filename have been read, return control to the console. The sequence ECS<filename (carriage return) can occur inside a file as well as from the keyboard. The version in this article will support ten levels of nesting and can be easily modified for any number of levels.
- ESC>filename (carriage return). Send output from the network to the file specified by filename as well as to the terminal screen.
- ESC>>filename (carriage return). Append output from the network to filename as above.
- ESC| (carriage return). Close out-

put file specified by previous > or >> command. Note that only one output file can be opened at a time.

- ESC . Terminate the program. If TRANSLUCID is used as a procedure, this will return to the next highest level.

Any character can be used for the ESC or escape sequence by changing the constant declaration at the beginning of TRANSLUCID. This character can be passed to the network by typing it twice (only one copy gets through). I used the character ESC (hexadecimal 1B).

TRANSACTION

The program to conduct the transaction is directed by a data structure which describes the transaction. For all transactions, the program will determine what is to be done from this structure and execute commands on the remote and local system. It will move, copy, or delete files across the link. The data structure is shown in figure 3.

The number of data types determines the number of pending transactions a system can have. Following is a description of the variables in TRAN_TYPE:

- ACTION: one of five ACTIONS supported for moving files between systems and executing commands on the remote system. These are detailed in the TRANSACTION source code.

- SYSTEM_ID: an integer identifying the remote unit.

- T_PACKET: the name of the file which contains the packet. The packet consists of commands to the transaction processor, commands to the local and remote system, and data (or the names of files containing data).

- ACTIVE: a flag set if this transaction is the currently active one. The flag is checked by the WATCHDOG timer to see if a transaction was active and timed out.

This data structure will be used by the three main routines: AGENDA, which sets up the transaction; TRANSACTION, the transaction processor which carries out the actual work; and WATCHDOG.

TRANSACTION (see listing 5) needs the primitive commands — OPEN, CLOSE, DELETE, PRINT, and APPEND — for each remote system with which it will communicate. When the transaction processor wants to read a file on the remote system, it must look in a file called COMMANDS for the command to PRINT a file on that system. The proper command is extracted from this file by specifying which command is desired and the system identifier. The algorithm appears in the procedure COMMAND of TRANSACTION.

The execution of an arbitrary command on the remote system is handled by case five in TRANSACTION. This routine uses another scheme for synchronizing with the prompt. When a character is received from the network, it is put in a string called CBUFFER. When CBUFFER is the same length as the expected prompt and a new character is received, CBUFFER is sent along to the output, and the new character becomes the first one in the buffer. If the network stops sending characters, the routine will time out. The last thing in

```

tran_type = RECORD
    action      : INTEGER;
    system_id   : INTEGER;
    t_packet    : file_name;
    active      : BOOLEAN;
END;

var tran_table : ARRAY[20] OF tran_type;

```

Figure 3: Definition of the transaction table, represented in Pascal.

ADA™

A NEW BEGINNING

```

pragma ___ ; type ___ is ___ ; subtype ___ is ___ ; raise ___ ; abort ___ ;
case ___ is ___ when ___ = ___ end case; access ___ ; with ___ use ___ ;
return ___ ; record ___ end record; exit ___ when ___ ; when ___ = ___ ;
if ___ then ___ elseif ___ else ___ end if; case ___ is when ___ ; delay ___ ;
for ___ in reverse ___ loop ___ end loop; while ___ loop ___ ; entry ___ ;
procedure ___ in out ___ is ___ begin ___ exception ___ end; return ___ ;
function ___ in out ___ return; select ___ else ___ end select; loop ___ ;
accept ___ do ___ end; task body ___ is ___ begin ___ exception ___ end;
select accept ___ or delay ___ end select; task ___ is ___ end ___ ;
package ___ is ___ private ___ end; for ___ use record ___ end record;

```

- ADA/M - Compiles ADA program for Host system execution. Excellent for learning ADA and converting existing programs. Includes ADA Compiler and Compiler ADA Programming Support Environment (CAPSE) \$495.
- ADA/C - Compiler and Kernal APSE (KAPSE) for CP/M® \$995.
- ADA Programmers Manual \$25.
- ADA Syntax Reference Card \$6.

Specify exact configuration and operating system. Courses are available for compiler customers to learn the most powerful and complex software language, ADA.

Credit for purchase of ADA/M will be given toward purchase of larger ALS. Royalty will be paid to customers who convert existing programs into ADA for inclusion in the ALS, ADA Language System library.

DIGITAL ELECTRONIC SYSTEMS, INC.
Box 5252, Torrance, California 90510
213/539-6239



ADA is a registered trademark of Dept. of Defense CPM is a registered trademark of Digital Research

Text continued on page 174

The COMPUTER FACTORY

TO ORDER CALL (212) 687-5000

SUPERBRAIN™

INTERTEC
DATA
SYSTEMS
64K
ONLY
\$2495



More than an intelligent terminal, the SuperBrain outperforms many other systems costing three to five times as much. Endowed with a hefty amount of available software (BASIC, FORTRAN, COBOL), the SuperBrain is ready to take on your toughest assignment. You name it! General Ledger, Accounts Receivable, Payroll, Inventory or Word Processing... the SuperBrain handles all of them with ease.

FEATURES INCLUDE:

- 2 dual-density minifloppies with 360K bytes of disk storage
- A CP/M Disk Operating System with a high-powered text editor, assembler and debugger

Model QD

720K Bytes disk storage
and 64K RAM
\$2995

SUPER BRAIN HARD DISKS

| | |
|----------------------------|--------------------------|
| 10 Megabyte List \$4995 | 16 Fixed-16 Removable |
| \$4495 | \$9995 |

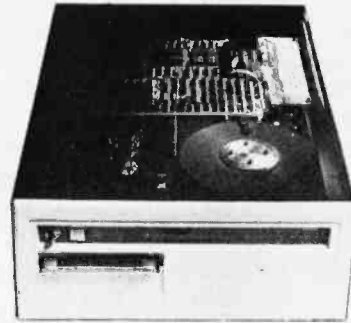

WINCHESTER DISK & TAPE BACK-UP— FLOPPIES ARE NOW OBSOLETE!

- By using extremely advanced Winchester Disk Technology the ONYX system can now support up to 8 users simultaneously!
- Disk capacities available in increments of 6.1, 10, 20, 40 megabytes—up to 4 disks per system (160 megabyte total!)
- Choice of 2 systems:
Z80A/OASIS® Z8002/UNIX®
- Memory from 64K to 1 megabyte!
- Languages available include:
COBOL, BASIC, PASCAL, & FORTRAN
- A choice of very sophisticated software that formerly was only available to larger machine users! (ACCOUNTING, RELATIONAL DATABASES, WORD PROCESSING, INSURANCE, CONSTRUCTION, ETC.)
- Systems start at under \$9500

ONYX COMES EAST

THE COMPUTER FACTORY NOW STOCKS THE MOST POWERFUL AND COST-EFFECTIVE COMPUTER ON THE MARKET!

INTRODUCING A NEW ERA IN COMPUTING



NEW CORVUS
5 MEG
ONLY \$3750



APPLE II PLUS for price

A complete self-contained computer system with APPLESOFT floating point BASIC in ROM, full ASCII keyboard in a light weight molded carrying case.

Features Include:

- auto-start ROM
- Hi-Res graphics and 15 color video output
- Expandable to 48K

| | | | |
|-------------------------|-------|---------------------------|-------|
| Supertalker | \$279 | Micromodem | \$379 |
| Disk | 645 | Superterm (24 x 80) | 395 |
| Add-on Disk | 525 | Speechlab | 229 |
| Pascal Card | 495 | Communication Card | 225 |
| Business Software | 625 | Modem | 200 |
| Monitor | 159 | Graphics Printer | 595 |
| Printer Card | 180 | Graphics Tablet | 795 |

apple III
IS FINALLY HERE
128K RAM!!



FOR BEST DELIVERY AND SUPPORT SEE IT AT THE COMPUTER FACTORY

NEW STORES Grand Opening Specials

LONG ISLAND, NY 1301 Franklin Ave.,
Garden City, Opposite Saks (516) 248-6700

FOREST HILLS, NY 100-17 Queens Blvd.
At 67th Road (212) 896-0700

YONKERS, NY 2361 Central Ave.,
Opposite Caldors (914) 793-1300

PRINTERS

EPSON

MX-70
MX-80
MX-80FT
MX-100FT
Call for Prices

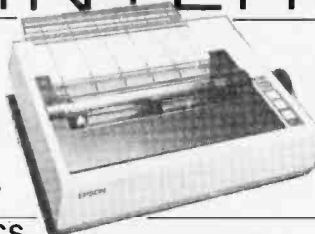

CENTRONICS

700-9
\$1195



- 180 cps Bi-Directional • Up to 15 Paper Width • 9 x 9 Matrix
- Upper/Lower Case
- Tractor Feed
- RS-232 Serial Interface

704
\$1695

- 60 cps • Up to 15" paper width
- Tractor Feed • Parallel Interface for Apple & TRS-80 • 2 channel vertical forms! • Top of Form!

737 Parallel \$895

ANDERSON JACOBSON



841 I/O Terminal Ideal for word processing and small businesses.

- ASCII Code
- 15 CPS Printout
- High Quality Electric Printing
- Reliable heavy duty mechanism
- Completely Refurbished by A.J.

Serial
\$895

• Delivered FREE to nearest service center

HAZELTINE ESPIRIT

NEW!

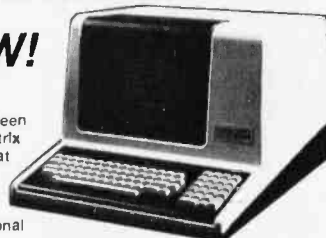

- 24 x 80
- Green Screen
- 7 x 11 Matrix
- Full Format Editing Controls

- Bi-Directional Aux-Port

INCREDIBLY
ONLY \$695

DEALER INQUIRIES
INVITED ON DIABLO,
CENTRONICS,
SUPERBRAIN



DIABLO
630 Special \$2495

On Site Warranty List \$2755



Min. Credit Card Order \$75

- N.Y. residents add 8% sales tax
- Same day shipment on prepaid and credit card orders

TO ORDER CALL (212) 687-5000

The COMPUTER FACTORY®

485 Lexington Ave., New York, NY 10017 (46th St. Lobby)

Foreign order desk — Telex 640055

Open
Mon-Fri. 10-6 Sat. 11-5

Listing 5: The module that determines the overall behavior of the network node, according to "instructions" contained in a transaction table data base.

```

module transact;
  (*****)
  (*                                           *)
  (* Transact is the transaction processor. Given a record of *)
  (* a tran_type, it executes the specified transaction.      *)
  (* The following actions are possible:                *)
  (* 1  move a new file to the remote system            *)
  (* 2  copy over a file on the remote system           *)
  (* 3  move a new file from the remote system          *)
  (* 4  copy over a file from the remote system        *)
  (* 5  execute an arbitrary command on the remote system *)
  (*                                           *)
  (* Basic commands executable on remote system are      *)
  (* 1: OPEN FILE   2: CLOSE FILE   3: DELETE FILE      *)
  (* 4: PRINT FILE  5: APPEND TO FILE                   *)
  (*                                           *)
  (*           Copyright 1981 by Peter Reintjes        *)
  (*                                           *)
  (*****)

type
  file_name      = ARRAY [1..20] OF CHAR;

  tran_type      = RECORD
                    action          : INTEGER;
                    system_id       : INTEGER;
                    t_packet        : file_name;
                    active           : BOOLEAN;
                END;

  buffer         = ARRAY [0..2047] OF CHAR;
  buf            = @buffer;
  prom           = STRING 50;

external function getremote(channel: CHARS;
                           var c :CHAR;
                           wflag :BOOLEAN):  INTEGER;
external procedure prompt( pmt : prom;
                          bptr: buf;
                          off, len : INTEGER): INTEGER;

const
  wait          = true;
  nowait        = false;
  TIMEOUT      = 500;

var
  i, j, n      : INTEGER;
  c            : CHAR;
  cbuffer      : STRING 100;
  time, error  : INTEGER;
  exit         : BOOLEAN;
  failed       : BOOLEAN;
  command_file : FILE OF CHAR;
  tran         : tran_type;
localname, remotename : file_name;
  tempname, newname : file_name;

function command( system, cmd : INTEGER) : STRING 100;

var

```

Listing 5 continued on page 168

**This
Single
Board...**

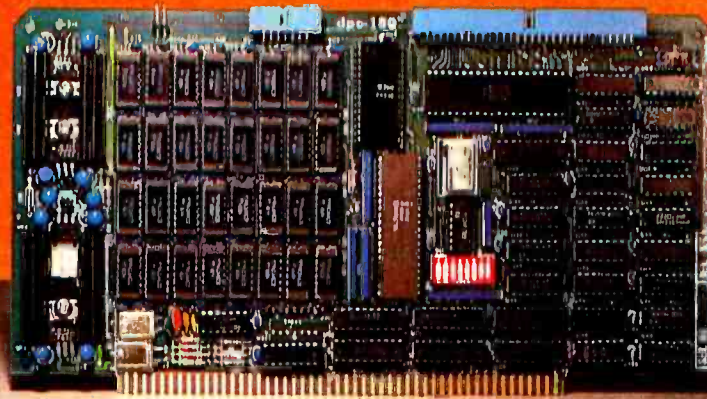

**...is the Heart
of the
Microprocessor
World's
Best Multi-User
System ...**

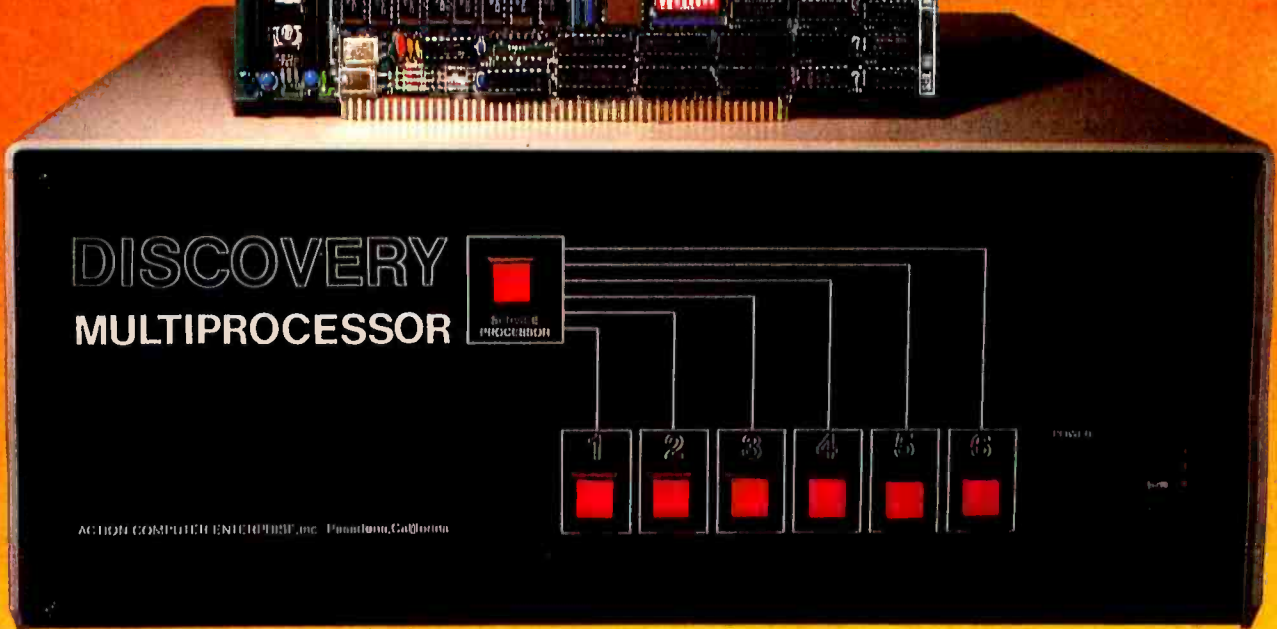

THE DISCOVERY MULTIPROCESSOR

The dedicated power of this complete single board computer is provided to each user, making the DISCOVERY MULTIPROCESSOR unique among multi-user systems. With the power and expandability of distributed processing ● With the economy of shared peripherals ● With the flexibility of shared and public files ● And all of this with full CP/M* and S-100 compatibility.

Multiprocessing Software Multiprocessing Hardware

Our Distributed Processing Operating System, **dpc/os**[®], resides in the Service Processor, establishing a CP/M environment for each user and managing access to the shared system resources. Multiuser facilities are provided for print spooling, for interprocessor communication and for private, public and shared-update files. Several processors can be employed concurrently by a single user via the enhanced batch submit facilities. And with **DISCOVERY** all CP/M compatible programs will execute without modification, thus protecting your software investment.

The ACE 64K Distributed Processing Single Board Computer, the **dpc-180**[™] gives the **DISCOVERY MULTIPROCESSOR** its own unique architecture. One DPC is dedicated to each user providing exclusive use of the onboard Z-80, 64K ram and serial I/O. Access to the shared resources is provided by an expanded DPC used as a Service Processor. Additional users can be added at any time by simply inserting additional DPC's, into the standard S-100 bus — up to a total of sixteen user processors in a single chassis!

*CP/M is a registered TM of Digital Research, Inc.

DISCOVERY has been proven in installations throughout the World. If you need the Power of Multiprocessing... it's time you discovered us!

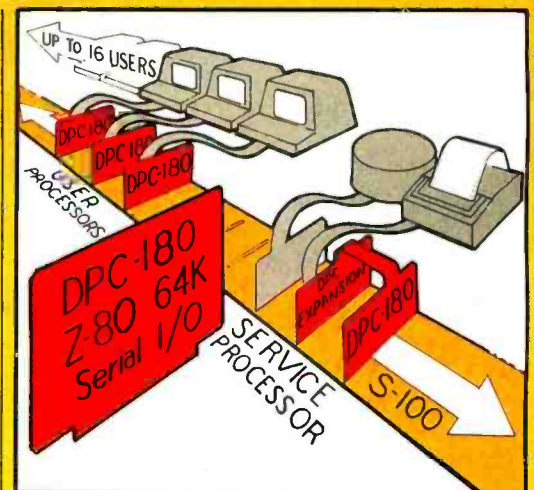

The ACE **DISCOVERY MULTIPROCESSOR** dedicates a complete 64K Z-80 Distributed Processing single board Computer, the **dpc-180**[™] to each user. An expanded DPC coordinates all of the system activities.

Multiuser mainframes with 192K ram start at under \$6000. The 64K **dpc-180**[™] is priced at \$1395. Immediate delivery. A complete line of standard peripherals including a 26M byte hard disk subsystem can be supplied on request. Dealer and OEM inquiries are invited.

Action Computer Enterprise, Inc.
The Multiprocessing Company

55 West Del Mar Boulevard, Pasadena, California 91105 USA ● Cable ACEPAS Pasadena ● (213) 793-2440

Listing 5 continued:

```
        i, n      : INTEGER;
        cstring  : STRING 100;

begin
    (* The file contains the system name and five commands *)
    (* for each system. If we want the third command for the *)
    (* fourth system we need to get the 22nd line of the file *)
    (* ( system # - 1 ) * 6 + command # + 1 *)

    n := (system - 1) * 6 + cmd + 1 ;

    for i := 1 to n do read(command_file, cstring);
    command := cstring;
end;

(***** MOVERL *****)
(* move a file from the remote system to local *)

function moverl( r_name, l_name :file_name ): INTEGER;

var
    lf : FILE OF CHAR;
    result : INTEGER;

begin
    rewrite(lf,l_name); (* create local file *)

    (* get command to print a file from the remote *)
    (* write out the command followed by the filename *)
    write(network, command, r_name);

    while ( time < TIMEOUT ) do begin
        error := getremote(c,nowait);
        if (error = 0) then time := 0;
        write(lf,c);
    end;

    result := prompt(pmt,bufptr,offset-length(pmt),length);
    (* the prompt should be the last thing in the buffer *)
    if ( result = offset + length ) then moverl := 0
    else moverl := -1;
end;

(***** MOVELR *****)
(* move a file from the local system to the remote *)

function movelr( l_name, r_name :file_name; sid :INTEGER): INTEGER;

var
    cstring : STRING 100;
    lf      : FILE OF CHAR;
    result  : INTEGER;

begin
    reset(lf,l_name); (* open local file *)

    (* get command for opening a file on remote *)
    cstring := command(sid,l);
    write(network, cstring, r_name);
```

Listing 5 continued on page 170

CASH FLOW PROBLEMS?



IT'S NICE TO KNOW SOMEONE WHO HAS THE SOLUTION.



MicroAge is your Solution Store . . . that means at MicroAge Computer Stores we have a wide selection of time-saving computerized business systems designed specifically to solve the daily cash flow problems every businessman faces.

MicroAge has computerized business systems that quickly and affordably allow you to regain control of your critical accounts receivable . . . at last making it possible for you to carry out effective collection procedures on a consistent basis. MicroAge has accounts receivable program packages to automatically display and update account information; prepare trial balance including a balance-due and delinquency aging

report, and take care of dozens of other tasks that eat into your time and profit!

Computerized business systems from the MicroAge Computer Store are available in the \$5,000 to \$15,000 range, to suit the individual budget of your small business or professional practice. MicroAge backs up every system with personalized service, warranty service and repair, installation, systems consulting, even customer training. Visit the MicroAge Computer Store in your area soon with your business problems, and let us help you with the solution.

MicroAge
COMPUTER STORE
"The Solution Store" SM

Circle 220 on inquiry card.

VISIT THE STORE IN YOUR AREA:

El Paso, Texas
(915) 591-3349
Rockville, Maryland
(301) 762-7585
Tucson, Arizona
(602) 790-8959
Albuquerque, New Mexico
(505) 883-0955
61 Chilpancingo Pkwy,
Pleasant Hill, California

Aurora, Colorado
(303) 696-6950
Rochester, New York
(716) 244-9000
Hurst, Texas
(817) 284-3413
Sallina, Kansas
(913) 825-7596
8752 W. 159th Street
Orland Park, Illinois

Milwaukee, Wisconsin
(414) 257-1100
Mountain View, California
(415) 964-7063
Scottsdale, Arizona
(602) 941-8794
Anchorage, Alaska
(907) 279-6688
4620 Convoy Street
San Diego, California

Richardson, Texas
(214) 234-5955
Minneapolis, Minnesota
(612) 338-1777
Omaha, Nebraska
(402) 339-7441
Phoenix, Arizona
(602) 265-0065
Columbus, Ohio
(614) 868-1550

Indianapolis, Indiana
(317) 849-5161
Portland, Oregon
(503) 256-4713
Norwalk, Connecticut
(203) 846-0851
St. Louis, Missouri
(314) 567-7644

COMING SOON TO:

Houston, Texas
Palm Beach, Florida
Spokane, Washington
Panama City, Panama
Toronto, Canada
Boston, Massachusetts
Oklahoma City, Oklahoma
Chicago, Illinois
Washington, D.C.
Allentown, Pennsylvania

FOR FRANCHISE OPPORTUNITY INFORMATION CALL (602) 968-3168

```

    while (NOT EOF(lf)) do begin
        read(lf,c);
        write(netout,c);
    end;
    (* get command for closing file on remote *)
    cstring := command(sid,2);
    write(network,cstring);

    (* after network has settled, check for a normal system prompt *)
    (* Note we haven't read characters from the input buffer yet *)
    (* These are global variables. *)

    result := prompt(pmt,bufptr,off,len);

    (* the prompt should be the last thing in the buffer *)
    if ( result = off + len ) then movelr := 0
    else movelr := -1;
end;

entry function transact (var transaction:tran_type):INTEGER;
begin
    reset(command_file,'commands');

    with transaction do begin
        active := true;
        reset(packet, t_packet); (* open instruction file *)

        case action of
            1: begin (* move a new file to remote *)

                read(packet,localname); (* name of local file *)
                read(packet,remotename);(* name of file on remote *)
                error := movelr(localname,remotename);
                if (error <> 0) then begin
                    rem_delete(remotename);
                    failed := true;
                end;
            end;

            2: begin (* copy already existing file to remote *)
                read(packet,localname); (* name of local file *)
                read(packet,remotename);(* name of file on remote *)
                tempname := remotename;
                append(tempname,'.temp');
                error := movelr(localname,tempname,system_id);
                if (error = 0) then begin
                    rem_delete(remotename);
                    rem_rename(tempname,remotename);
                end
                else begin
                    rem_delete(tempname);
                    failed := true;
                end;
            end;
        end;
    end;
end;

```

PL/I-80™: Not for beginners*

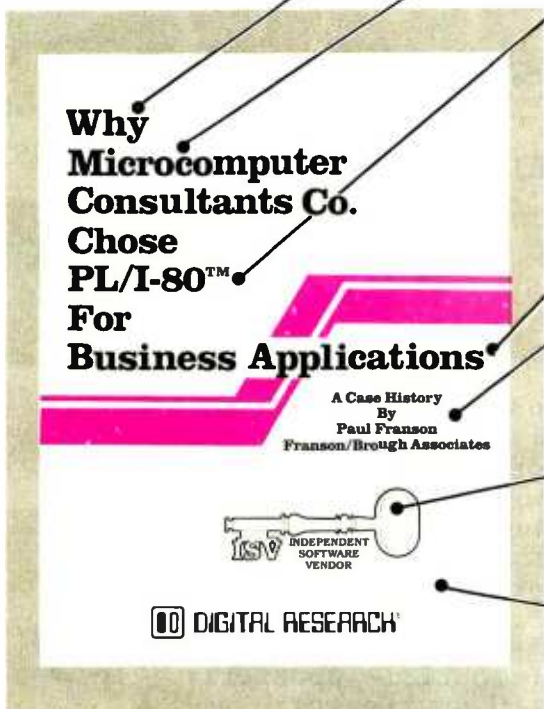

- **For internal savings**, product capabilities, code speed and upward compatibility – How PL/I-80 meets these criteria is making software news.
- **MC is a successful company** selling business applications to first time users.
- **MC switched** from a popular but less efficient language. MC benefits from these PL/I-80 (ANSI Subset G) features. • *Fast design* with picture specifications for output. • *Easy data retrieval* with BT-80™ file manager. • *Improved performance* with LINK-80™ loading of disk resident overlays. • *Small, fast programs* with optimized object code and no interpreter.
- **Specific examples** of PL/I-80's speed, memory conservation, error checking, and control in the business environment are cited.
- **In a candid interview**, Mr. Charles Russell, MC's president, discusses his professional programming needs.
- * *Mr. Russell distinguishes. "PL/I-80 isn't a panacea. It's a programmer's language, ideal for the experienced programmer. Just as PASCAL and BASIC are good for beginners."*
- **Worldwide market exposure** of your products and company through your listing in our CP/M® Compatible Software Catalog; news affecting your business in a free subscription to ISV FORUM; plus comprehensive seminars comprise our ISV Support Plan for those who write applications under CP/M.

Yours free. See why MC switched. Then compare your language.

Limited quantity. Respond now and receive a bonus book, *PL/I-80 Command Summary*, a quick reference to 343 PL/I-80 commands and error messages.

I'd like to analyze PL/I-80 features. Send your Brochure & Bonus Book to:



Name: _____
 Title: _____
 Company: _____
 Address: _____

DIGITAL RESEARCH®
 P.O. Box 579D, Pacific Grove, CA 93950

Europe: Vector, Intl., Leuven, Belgium, 32(16)202496
 Far East: Microsoftware Assoc., Tokyo, Japan, 03-403-2120
CP/M is a registered trademark of Digital Research, Inc. PL/I-80, BT 80 and LINK-80 are trademarks of Digital Research, Inc.
 © Copyright 1981, Digital Research, Inc.

```

3: begin (* move a new file from remote *)
    read(packet,newname); (* name of local file *)
    read(packet,remotename); (* name of file on remote *)
    error := moverl(remotename,newname,system_id);
    if (error <> 0) then begin
        delete(newname);
        failed := true;
    end;
end;

4: begin (* copy over local file from remote *)
    read(packet,localname); (* name of local file *)
    read(packet,remotename); (* name of file on remote *)
    tempname := localname ;
    append(tempname,'.temp');
    error := moverl(remotename,tempname);
    if (error = 0) then begin
        delete(localname);
        rename(tempname,localname);
    end
    else begin
        delete(tempname);
        failed := true;
    end;
end;

5: begin (* execute a command on the remote *)
    rewrite(outfile,'cmd.temp');
    read(packet,command); (* get command from packet *)
    write(netout,command); (* write it out to network *)
    while (time < TIMEOUT) do begin
        error := getremote(c,nowait);
        if (error = 0) then begin
            time := 0; (* reset clock *)
            if (length(cbuffer)=length(pmt)) then begin
(* we buffer a string *)          write(outfile,cbuffer);
(* the length of prompt *)      append(cbuffer,c);
                                end;
(* do we see the prompt?*)
                                if (cbuffer=pmt) then failed := false
                                    else failed := true;
                                end
                                else time := time + 1;
        end;
    end;

    (* Timed out in the middle of the transfer *)
    if (failed) then transact := -1
    (* If the last thing we saw was the prompt *)
    (* then it worked ok. *)
    else transact := 0;

    end; (* of case 5 *)
end (* of case *)

end;

```

Get on the right **trak**TM in floppies with new

trak 5¼" & 8" disk drives

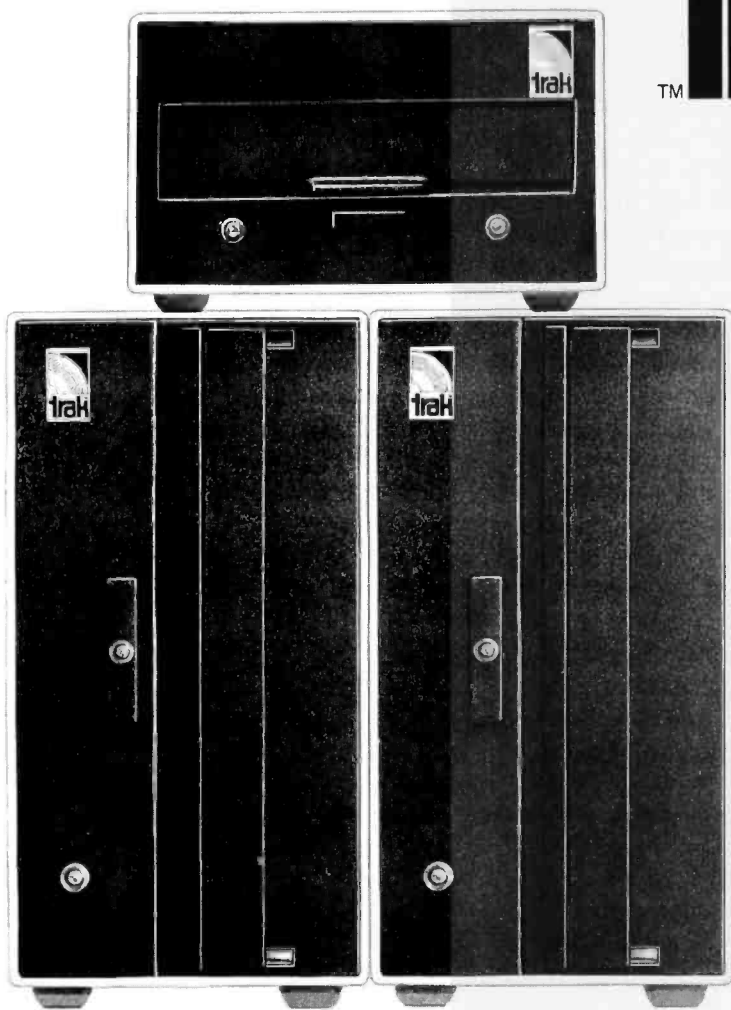

5¼" from \$399 list
8" from \$899 list

TRAK — the way to go — in floppy disk drives. Whether you are just setting up your computer system, expanding it, or re-equipping — make it TRAK.

With TRAK you get the finest of industry-standard disk drives, custom electronics and custom cabinetry. In your choice of office beige or silver gray. And other options like door locks, front bezels, write-protect switch, extender card and more.

Drives with the industry's fastest access time — from 3 to 5 ms. With up to 9200 hours MTBF. 40, 77, 80 track. Single or double density. Single or double sided. Up to 1.6 Mega-Byte capacity. Single, dual or triple cabinets. With or without power supplies. And a TRAK exclusive — dual LED panel indicators for Power-On and In-Use. Convenient — as you know if you've ever left things "on" for long periods without realizing it. Compatible with TRS-80®, Heath/Zenith, Northstar, Apple II® and most S-100 based systems.

Custom electronics — custom transformers — for 110VAC or 220VAC, 50 or 60 Hz. Fused for protection. With regulation for low ripple and constant output even with input variation. Quiet convection cooling through vents on all cabinet sides without the need of noisy, bothersome fans.

Low prices. Complete 5¼" drives list as low as \$399, complete 8" drives as low as \$899 list. And your TRAK dealer gives you the best of everything — in price and service, in or out of warranty. Standard TRAK warranty is 90 days; 12 month extension available at extra cost. Check your dealer now for the right TRAK in disk drives — TRAK.

For the name of your nearest dealer and full details, Call Toll-Free 1-800-323-4853

or write:

International inquiries invited.
Dealerships available.

trak microcomputer corp.

1511 Ogden Ave., Downers Grove, IL 60515

® TRS-80 is a registered trademark of Radio Shack, a Tandy Company
® Apple II is a registered trademark of the Apple Computer Company

| | | |
|---|--|------|
| \$25 | INTRODUCTORY FACTORY REBATE | \$25 |
| Buy from your TRAK dealer, then mail copy of sales receipt with TRAK serial number and this coupon to TRAK. We will rebate \$25 direct to you as our way of welcoming you to the TRAK drive family. | | |
| Name _____ | | |
| Address _____ | | |
| City _____ State _____ Zip _____ | | |
| Offer expires Nov. 30, 1981. Limit one rebate per customer. Offer void where prohibited. | | |

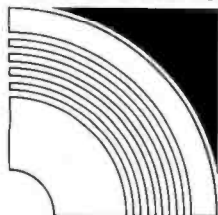

Text continued from page 164:

CBUFFER after the routine times out should be the prompt from the system indicating that the operation is complete. You do not usually want the prompt passed along to the output file because it is not really part of the network's response to your command.

Possible Enhancements

Several other functions may be needed on the local processor, including:

- Monitor space usage on the local system, and terminate network activity if the local storage is dwindling.
- Buffer input and output to keep track of data moving in all directions and control its flow. The goal is to avoid any loss of data because of speed differential or overflow in the interface.
- Archive data to keep track of the large amount of data (and storage) available on the network. You will probably need some form of off-line storage, either local or out in the network. Systems frequently run out of file space a few months after a mail or news system is installed.

Both the high-level user interface and the low-level system interface have been sketched briefly here. These are user- and system-dependent and therefore not portable, but they will help you develop a protocol-free network on most systems.

Some preprocessing of files can cut down on the network interaction

time. It is important to order the transactions by SYSTEM_ID so that all transactions for a given system will be made on the same phone call. If there is no system response for the first transaction, the others should not be attempted. A Huffman encoding can compress text files by as much as two-thirds and random data by 20 to 30 percent. If you are sending large files over long distance, this could mean significant savings.

Making the files self-loading would be an improvement. This can be done by a separate utility; the actual transaction processor could then be much simpler than the one I described.

Breaking up large files into standard packet sizes and adding checksums can reduce the amount of retransmission due to a dropped bit; the optimal packet size will depend on the modem speed and the quality of the connection. Other forms of preprocessing can further enhance your network system. With the proper set of tools, these variations can be explored with much less effort.

The problems of conversations between computers are greatly simplified if you install programs on both systems which support the same protocol. However, my proposed system is sufficiently general to be used when you have little or no control over the software running on the remote computer, and your machine must log on and behave like a human user.

Even if every remote site has computer-protocol facilities, they are not likely to support the same protocol. Modules like the ones I have

presented allow you to build a generalized system to converse with all such services.

Future Network Developments

Some trends that will make a flexible network philosophy important in the future already are evident today.

The telephone, for example, will offer increased bandwidth, possibly at less expense. Modem-based networks will be at least as important as hardwired configurations. Greater processing power and storage will be available on a network node as more powerful CPUs and memory systems are developed. More network services with a wide variety of protocols will be available, and we have no reason to be optimistic about standardization.

The possibilities for a system not tied to a specific protocol are almost endless. High-level programs can be built for a mail or source management system. You can write utilities that do everything from answering your electronic mail while you're away, to synchronizing the system clock with a weekly call to a computer at the National Bureau of Standards.

In addition, the modularity I've encouraged will allow you to make enhancements without losing your investment in previous software. This characteristic could mean the difference between a networking system which withstands (or changes to meet) the test of time, and one that will be abandoned in the next generation of hardware and software. ■



THE 488+3 IEEE 488 TO S-100 INTERFACE

IEEE-488



S-100

- Handles all IEEE-488 1975/78 functions
- IEEE 696 (S-100) compatible
- MBASIC subroutines supplied; no BIOS mods required
- 3 parallel ports (8255A-5)
- Industrial quality; burned in and tested
- \$375

(Dealer inquiries invited)

D&W DIGITAL

1524 REDWOOD DRIVE
LOS ALTOS, CA 94022 (415) 966-1460

COMPUSTAR™

INTERTEC'S INCREDIBLE 255 USER SMALL BUSINESS COMPUTER

At last, there's a multi-user micro-computer system designed and built the way it should be. The CompuStar™. Our new, low-cost "shared-disk" multi-user system with mainframe performance.

Unlike any other system, our new CompuStar offers what we believe to be the most practical approach to almost any multi-user application. Data entry. Distributed processing. Small business. Scientific. Whatever! And never before has such powerful performance been available at such modest cost. Here's how we did it . . .

The system architecture of the CompuStar is based on four types of video display terminals, each of which can be connected into an auxiliary hard disk storage system. Up to 255 terminals can be connected into a single network! Each terminal (called a Video Processing Unit) contains its own microprocessor and 64K of dynamic RAM. The result? Lightning fast program execution! Even when all users are on-line performing different tasks! A special "multiplexor" in the CompuStar Disk Storage System ties all external users together to "share" the system's disk resources. So, no single user ever need wait on another. An exciting concept . . . with some awesome application possibilities!

CompuStar™ user stations can be configured in almost as many ways as you can imagine. The wide variety of terminals offered gives you the flexibility and versatility you've always wanted (but never had) in a multi-user system. The CompuStar Model 10 is a program-mable, intelligent terminal with 64K of RAM. It's a real workhorse if your requirement is a data entry

or inquiry/response application. And if your terminal needs are more sophisticated, select either the CompuStar Model 20, 30 or 40. Each can be used as either a stand-alone workstation or tied into a multi-user network. The Model 20 incorporates all of the features of the Model 10 with the addition of two, double-density mini-floppies built right in. And it boasts over 350,000 bytes of local, off-line user storage. The Model 30 also features a dual drive system but offers over 700,000 bytes of disk storage. And, the Model 40 boasts nearly 1½ million bytes of dual disk storage. But no matter which model you select, you'll enjoy unparalleled versatility in configuring your multi-user network.

Add as many terminals as you like - at prices starting at less than \$2500. Now that's truly incredible!

No matter what your application, the CompuStar can handle it! Three disk storage options are available. A tabletop 10 megabyte 8" winchester-type drive complete with power supply and our special controller and multiplexor costs just \$4995. Or, if your disk storage needs are more demanding, select either a 32 or 96 megabyte Control Data CMD drive with a 16 megabyte removable, top loading cartridge. Plus, there's no fuss in getting a CompuStar system up and running. Just plug in a Video Processing Unit and you're ready to go . . . with up to 254 more terminals in the network by simply connecting them together in a "daisy-chain" fashion. CompuStar's special parallel interface allows for system cable lengths of up to one mile . . . with data transfer rates of 1.6 million BPS!

Software costs are low, too.

CompuStar's disk operating system is the industry standard CP/M*. With an impressive array of application software already available and several communication packages offered, the CompuStar can tackle even your most difficult programming tasks.

Compare for yourself. Of all the microcomputer-based multi-user systems available today, we know of only one which offers exactly what you need and should expect. Exceptional value and upward growth capability. The CompuStar™. A true price and performance leader!

**INTERTEC
DATA
SYSTEMS®**

2300 Broad River Rd. Columbia, SC 29210
(803) 798-9100 TWX: 810-666-2115

Circle 183 on Inquiry card.



A Simple Implementation of Multitasking

Wendell Brown
8 Reynolds St
Oneonta NY 13820

Multitasking software makes multiuser systems possible and permits the division of complex programs into smaller segments. Writing such software requires an understanding of the basic principles of synchronization (ie: executing the right program or using the right stack at the right time) and a knowledge of resource sharing (using such computer resources as printers, keyboards, memory, and central processing units).

This article explains how to write multitasking software for microprocessors. I will first discuss the theory of multitasking, then give a simple example of one of the better implementations, called SLEEP (originated by APh Technological Consulting, a firm located in Pasadena, California).

Multitasking has many possible applications. A few examples are: handling communications between a computer and more than one terminal; programming devices like thermostats, burglar alarms, and light controllers; having your computer play your favorite adventure game and regulate room temperature at the same time; and connecting two terminals to your computer so that each can run a different BASIC program at the same time.

The last example is, of course, timesharing—a well-known and

About the Author

Wendell Brown, a Hughes Aircraft Company Bachelor of Science scholar, is studying Computer Science at Cornell University. Among his interests are robotics, computer graphics, and speech.

complex variety of multitasking.

Not all programs can or should use multitasking, but many applications are naturals for this approach. Keyboard polling (watching the keyboard to see if a key is pressed) and printer driving (telling a printer to do something) can each be written as a closed loop, and then, during execution, made to seem as if they are running simultaneously.

In addition to making your computer more versatile and useful, learning to write multitasking software has other benefits. For one thing, it forces you to organize your programs. For another, the multitasking approach lets you break large programs into smaller, more manageable pieces. You can then assign the writing to several different persons, and the author of one piece will not need to know how the other pieces work. Of course, each writer must know the bounds of his or her assignment, and must understand the relationships between the pieces. Dividing programs this way not only helps you complete a large project faster, but also simplifies debugging, as it is much easier to debug small pieces of code than one large program.

Methods of Multitasking

Though simple in theory, several of the methods of achieving multitasking are tough to implement. Others

Acknowledgments

I would like to thank Paul Mosier, of Cornell University's low-temperature group, for helping me write the HPIB software.

can be implemented by means of straightforward programming. Let's examine a few methods, choose one, and focus on it.

Perhaps the most familiar way to complete a series of tasks is to simply line them up and perform them in succession. In BASIC we could do this by writing a set of subroutines, and then have a master loop to call each of the subroutines in turn (sometimes called the "hen-and-piglets" method, see listing 1). A similar structure can also be used in a machine-code program.

One problem with the hen-and-piglets method is that subroutines are not closed; there is no guarantee that the piglet will ever run to completion. Thus, each subroutine must have a RETURN statement at the end. While this does not pose a difficulty for simple routines, it can be cumbersome in larger programs where we might want to use a routine written by someone else. In that case we might have trouble adding the RETURN statement in the proper place.

Another problem with this method is that each routine cannot have its own stack. Although it isn't a problem in BASIC, it can be a big problem in machine code; sometimes a routine needs its own stack, or the stack is too short, or we don't want to disturb the data far up on the stack.

But the hen-and-piglets method does work well for simple programs. The method requires no programming overhead, and, furthermore, it is easy to add another routine in the loop. To do so, simply insert a CALL statement in the control loop where

Tiny BASIC MICROCOMPUTER

K-8073

The Computer That Recaptures Simplicity

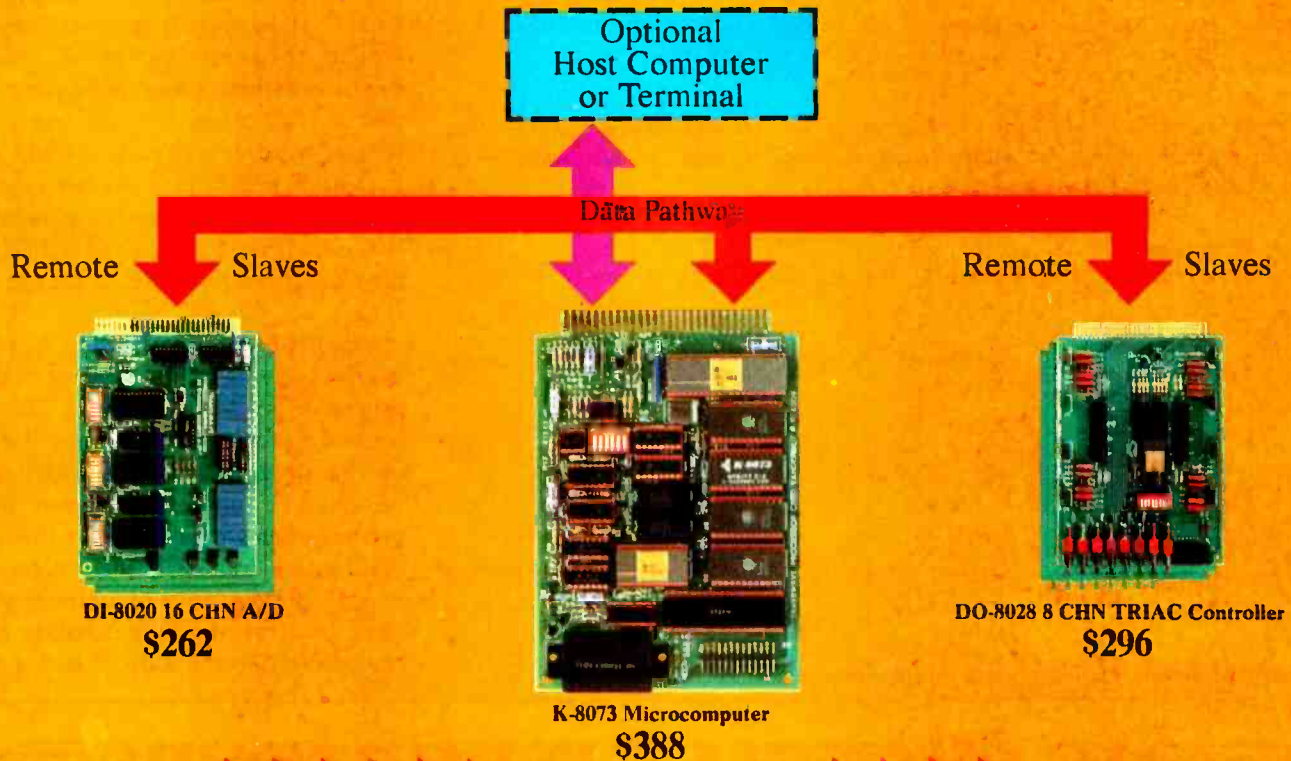

INPUT ►►►►► DECISION ►►►►► OUTPUT

TODAY'S NEEDS

How many times have you thought about designing or purchasing the ultimate intelligent control system but were discouraged by the R&D time or price? Transwave took the initiative of designing one for you. Combining versatility with low cost, the K-8073 Tiny BASIC Microcomputer has already taken the lead in the process control market. Programming is reduced to mere hours because of the on-chip Tiny BASIC Microinterpreter. I/O is extended to previously unheard of limits because of the on-board ART/RC (Asynchronous Receiver Transmitter/Remote Controller).

This processor-like chip provides bi-directional serial communication between the K-8073 and its remotely located peripheral I/O devices. In addition, the K-8073 can operate in a stand-alone, satellite, or host mode. When interfaced thru RS-232, you can utilize your host computer, large or small, for polling, editing and mass data storage.

INPUT

The DI-8020 is a 20 channel A/D input module designed to collect data from remote sensors monitoring temperature, humidity, light, pressure, etc. Each A/D module is capable of monitoring 16 analog and 4 digital signals. Remarkably versatile, the DI-8020 is adaptable to any environment.

In addition to an extensive input range, this A/D module eliminates the usual installation hassles because of the unique ART/RC communications route. A single twisted pair or coaxial wire serves as the bi-directional DPW (Data Pathway) between the DI-8020 and the K-8073 Tiny BASIC Microcomputer.



PS-5/25 Development Station \$195

DECISION

After receiving data, the K-8073 executes from your EPROM based Tiny BASIC program. This decision making process is augmented by these State-of-the-Art features:

- 1K Byte Local RAM
- 8K Byte Operating EPROM Space
- 2K Byte of Firmware Utilities
- RS-232, 110-4800 Baud Selectable
- Real-Time/Date Clock (Even Calculates Leap Year)

- 24 Lines Programmable Parallel I/O (PPI)
- Single Wire Serial I/O for 128 Remote Slave Stations (ART/RC)
- On-Board EPROM Programming
- Autostart EPROM (Power-on Boot)
- 2 Sense Interrupts
- 3 Flag Outputs
- +5 Volt Operation

OUTPUT

Completing the cycle of I→D→O is the DO-8028: an 8 channel TRIAC Control Module. This board features 8 optically isolated TRIACS with a maximum rating of up to 300 Watts AC control per channel. Receiving commands from the K-8073 via the full duplex DPW, you can daisy chain as many as 128 of these "slave" stations.

STAND ALONE SIMPLICITY

Whether you free your mainframe, free your mini or start from scratch, you can let closed loop control be the minimum configuration it should be. These cards are exactly the fundamental pieces needed for today's control applications. To order your K-8073 or for further information on the Vanderbilt Series 8000 Product Line, write or call: TRANSWAVE CORPORATION, Cedar Valley Building, Vanderbilt, PA 15486 Phone: (412) 628-6370.

TRANSWAVE
COMPUTER DIVISION OF UTSC

POWER-ONE D.C. POWER SUPPLIES

Our customers select their favorite models









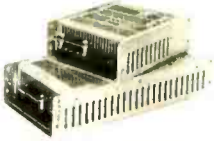
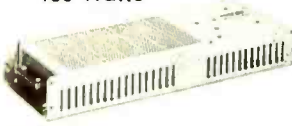

The choice wasn't easy. Not with 105 open frame linears and a full switcher line to choose from. Still, the top models of the past year — proudly pictured below — have been named.

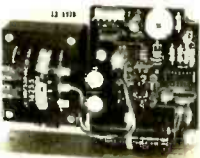
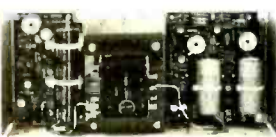
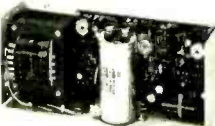
Actually, this is a statement of Power-One's most popular D.C. power supplies — as determined by our customers. Obviously, applications vary widely, from

small floppies and micro-computers to large main-frame systems.

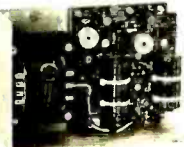
But one thing they all have in common. They're built by Power-One. Which means the most reliable power supplies available, at the lowest cost possible.

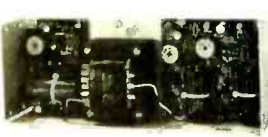
So take a look at our entire line. Send for our new 1981 Catalog and Facilities Brochure for details.

| | | | |
|---|--|--|---|
| <p>Switchers</p> <ul style="list-style-type: none"> • Hi-Tech Design • High Efficiency - 75% min. • Compact/Light Weight • 115/230 VAC Input • 20 msec Hold-up • Totally Enclosed Packaging • Two Year Warrantee • 24 Hour Burn-in | <p>SINGLE OUTPUT</p>  <p>5V to 24V Models</p> <p>SD, 60W : \$115.00 SF, 100W : \$170.00 SK, 200W : \$250.00</p> | <p>MULTIPLE OUTPUT 150 Watts</p>  <p>5V @ 20A -12V @ 3A 12V @ 5A 5V to 24V @ 3.5A User Selectable</p> <p>SHQ-150W : \$295.00</p> | <p>QUME PRINTER SUPPLY</p>  <p>5V @ 10A ± 15V @ 4.5A/16A Peak</p> <p>SP305 : \$345.00</p> |
| <p>Disk-Drive</p> <ul style="list-style-type: none"> • Powers Most Popular Drives • 7 "Off the Shelf" Models • Powers Drives & Controller • UL & CSA Recognized • 115/230 VAC Input | <p>5 1/4" FLOPPY SUPPLIES</p>  <p>CP340, 1 Drive : \$44.95 CP323, Up to 4 Drivers : \$74.95</p> | <p>8.0" FLOPPY SUPPLIES</p>  <p>CP205, 1 Drive : \$69.95 CP206, 2 Drives : \$91.95 CP162, Up to 4 Drives : \$120.00</p> | <p>WINCHESTER SUPPLIES 2 Models to Power any Manufacturer's Drive</p>  <p>CP379, CP384 : \$120.00</p> |
| <p>Open-Frame Linear</p> <ul style="list-style-type: none"> • Industry Standard Packages • 115/230 VAC Input • ± .05% Regulation • Two Year Warrantee • UL & CSA Recognized • Industry's Best Power/Cost Ratio | <p>SINGLE OUTPUT</p>  <p>5V @ 3A 24V @ 1.2A 12V @ 1.7A 28V @ 1.0A 15V @ 1.5A 250V @ 0.1A</p> <p>HB Series : \$24.95</p> | <p>SINGLE OUTPUT</p>  <p>5V @ 6A 24V @ 2.4A 12V @ 3.4A 28V @ 2.0A 15V @ 3.0A 48V @ 1.0A</p> <p>HC Series : \$44.95 to \$49.95</p> | <p>DUAL OUTPUT</p>  <p>± 12V @ 1.0A or ± 15V @ 0.8A</p> <p>HAA15-0.8 : \$39.95</p> |
| <p>DUAL OUTPUT</p>  <p>± 12V @ 1.7A or ± 15V @ 1.5A</p> <p>HBB15-1.5 : \$49.95</p> | <p>TRIPLE OUTPUT</p>  <p>5V @ 2A ± 9V to ± 15V @ 0.4A</p> <p>HTAA-16W : \$49.95</p> | <p>TRIPLE OUTPUT</p>  <p>5V @ 3A ± 12V @ 1A or ± 15V @ 0.8A</p> <p>HBAA-40W : \$69.95</p> | <p>POWER FAIL MONITORS</p>  <ul style="list-style-type: none"> • Indicates pending system power loss. • Monitors AC line and DC outputs. • Allows for orderly data-save procedures <p>PFM-1 : \$24.95 PFM-2 : \$39.95</p> |



NEW '81 CATALOG & FACILITIES BROCHURE

Get your free copies now!

Phone or write us direct, or circle the reader service number

POWER-ONE
D.C. POWER SUPPLIES



Power One Drive • Camarillo, CA 93010 • (805) 484-2806 • (805) 987-3891 • TWX 910-336-1297

Circle 301 on inquiry card.

| Balance Sheet for COMPANY, Inc. | |
|--|---------------|
| ASSETS | |
| Cash | 125957 |
| Accounts Receivable | 125950 |
| Inventories | 112280 |
| Equipment at Cost | 152690 |
| accumulated Depreciation | 28755 |
| Incorporation Expenses, Less Amortization | 34473 |
| TOTAL ASSETS | 588021 |
| LIABILITIES | |
| Accounts Payable | 82694 |
| TOTAL LIABILITIES | 82694 |
| SHAREHOLDERS' EQUITY | |
| Common Stock Issued | 300000 |
| Retained Earnings | 197327 |
| TOTAL SHAREHOLDERS' EQUITY | 497327 |
| TOTAL LIABILITIES + SE | 588021 |

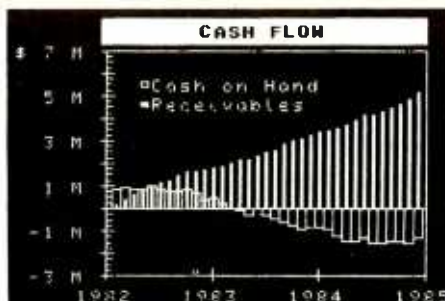

01/22/83 COMPANY Word Processing Services, Inc. Page 27

| MODEL | Medium Growth | STARTING 09/82 | ACTUALS 03/83 |
|--------------------------|---------------------|----------------|---------------------------------|
| ID | Project Name | UNITS | EXPENSE INCOME CASH W/C |
| MONTH 14: September 1982 | | | |
| -11 | Oper Expense | 1 0 | "Phone" |
| -72 | Rental | 1 0 | "Delivery Van" |
| 10 | General Overhead | 0 | 2057 0 |
| -85 | Purchase | 2 0 | "Electric Typewriter" |
| -23 | Hire | 2 0 | "Tupost II" |
| 20 | Typing Service | 4403 | 3275 |
| +80 | New Product/Service | | "Individually Targeted Resumes" |
| 38 | Resumes Writing | 8472 | 13289 |
| 40 | Printing | 23245 | 34674 |
| TOTAL | | 38177 | 55156 45231 62210 |



- FLOW OF FUNDS REPORT OPTIONS**
- A Inhibit month names
 - B Breakdown numbers by project
 - C Total monthly expenses/incomes
 - D List critical events
 - E Subtract income taxes
 - F Store financial statement data
 - G Show accounts payable/receivable
 - H Show all operating expense items
 - I Show all income related expenses
 - J Show all income items
 - K Show all cash flow items
 - L Print a single month per page
 - M Pause after each month
 - N Pause at end of each page
- LETTER toggles option RETURN prints

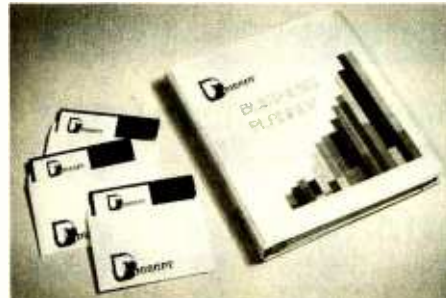

BUSINESS PLANNER™ – Duosoft's Real World Business Plan Modeling System

You've been wanting to start your own business for quite some time, but just haven't been able to do so. You've got a money-making idea—but how can you get bankers and investors to listen?

Here's how! We've come up with the first business modeler designed for entrepreneurs. It turns your ideas into dollars and cents language that hard-headed businessmen understand. It does your talking for you.

- Customized reports
- Graphical projections
- Standard financial statements
- Password protected data
- Moving time window
- Sample business data
- Tutorial documentation
- Projections updated by actuals

PROJECT ORIENTED

BUSINESS PLANNER enables you to group employees, equipment, and

BUSINESS PLANNER is a trademark of Duosoft Corporation. APPLE and Apple Pascal are trademarks of Apple Computer, Incorporated. UCSD Pascal is a trademark of the Regents of the University of California.

other costs into an income producing project.

Projects can be combined together in a model to show the net result, or examined independently. By starting projects at different times, you can make crucial timing decisions.

As your business grows, models may be combined into larger models. Each new venture can be brought under the master plan. BUSINESS PLANNER can continue working for you.

HANDLES ACTUALS

Planning your business is only part of the problem. BUSINESS PLANNER compares actual results against the model in order to focus attention on problems that may affect future performance. "What If?" scenarios can be developed to help you plan for the unexpected.

CUSTOMER SERVICE

Duosoft backs its software by a full service guarantee that protects your investment. Updates are free for the first year. Extra backup copies are available at a nominal cost.

You'll receive our newsletter free of charge. It features tips for new businesses, user comments, product descriptions, and announcements of version updates.

AVAILABLE FOR THE APPLE II

BUSINESS PLANNER is now available for the Apple II, and will be released JAN 1982 for the Apple III. Versions for all major machines are currently being developed.

Written in UCSD Pascal with extensions in Apple Pascal, 48K of memory and at least one disk drive is required. The Language Card is not necessary since we supply special system software.

PLANNING FOR YOUR FUTURE

BUSINESS PLANNER helps provide the financial proof you've needed to fund that new business. What is knowledge like that worth to you?

Yet it costs only a low \$295, a small business expense.

You need to put all this power to work for you right now. Unless you really like working for somebody else.



Circle 133 on inquiry card.

DUOSOFT
CORPORATION
Box 1827, Champaign, IL 61820

If your dealer doesn't have BUSINESS PLANNER, call us—(217) 356-7542.

DISCOUNT HARDWARE

Division of System Interface Consultants, Inc.

IEEE 696/S-100 Standard Boards



STATE OF THE ART CPU BOARDS

DUAL CPU 8/16 bit..... \$349
Z-80 CPU..... \$249

FAST RELIABLE STATIC MEMORY

16K..... \$299 32K... \$499... \$549
48K... \$749... \$799 64K... \$749... \$999

SYSTEM AUGMENTATION

I/O-I or I/O-II \$199
DISK-1 DMA Disk Cont. \$399
SUPPORT-1 Multifunction \$299

DISCOUNT HARDWARE

Division of System Interface Consultants, Inc.
17440 Revello Drive
Pacific Palisades, CA 90272

Enclosed is \$ _____
Please express the following assembled,
tested, and warranted IEEE 696/S-100
boards:

Name _____

Address _____

Phone () _____

Add \$25 to each order for express shipping, handling
and insurance. California residents add 6% tax. Allow
2 weeks for personal checks. Prices subject to change

CONSULTANTS

CALL FOR INFORMATION AND PRICES ON



The business computer that's

HERE TODAY and HERE TOMORROW

avoid obsolescence 8 & 16 bit

(213) 454-2100

System Interface Consultants, Inc.

Computer Specialists

Established 1969

Listing 2 continued:

;AND NOW THE THREE PROGRAMS

```
HUEY:  LDA    # "H"                ;PROGRAM HUEY
        JSR    TTYOUT              ;PRINT A "H" AT THE TERMINAL
        JSR    SLEEP
        JMP    HUEY
```

```
DUEY:  LDA    # "D"                ;PROGRAM DUEY
        JSR    TTYOUT              ;PRINT A "D" AT THE TERMINAL
        JSR    SLEEP
        JMP    DUEY
```

```
LUEY:  LDA    # "L"                ;PROGRAM LUEY
        JSR    TTYOUT              ;PRINT A "L" AT THE TERMINAL
        JSR    SLEEP
        JMP    LUEY
```

```
SLEEP:  TSX
        LDY    CURJOB              ;ROUTINE TO "PUT TO SLEEP" THE
        STX    SPTABLE,Y          ;CURRENT JOB, AND "AWAKEN" THE NEXT
        INY                          ;JOB. SLEEP CAN BE PLACED ANYWHERE.
```

```
        CPY    # JOBS              ;IF REACHED THE LAST JOB, THEN START
        BNE    NOZERO             ;EXECUTING THE FIRST JOB AGAIN
```

```
        LDY    # 0
        STY    CURJOB
        LDX    SPTABLE,Y
        TXS
        RTS
```

; IF YOU WANT TO SAVE YOUR CPU REGISTERS BEFORE A PROGRAM IS PUT TO SLEEP,
; THEN CALL SLEEPR INSTEAD OF SLEEP.

```
SLEEPR:  PHP
        PHA
        TXA
        PHA
        TYA
        PHA
        JSR    SLEEP              ;SLEEP NOW THAT REGISTERS ARE SAVED
        PLA
        TAY
        PLA
        TAX
        PLA
        PLP
        RTS
        ;AWAKEN. RECALL REGISTERS FROM STACK
```

Example: Using SLEEP

Let's look at the program SNOOZE (see listing 2). Written in 6502 assembly language, SNOOZE is a simple example of SLEEP that shows how to multitask the three functions Huey, Duey, and Luey. SNOOZE can be broken down into three main areas: initialization; the sub-programs Huey, Duey, and Luey; and SLEEP.

Although in this example the initialization segment is larger than the program segment, this is not always the case. The purpose of initialization is to set up the stack areas for the three subprograms. We'll follow the initialization segment from the top down.

The ZSECT merely tells the assembler to place the following code in page zero (bytes 0 to 255). With the 6502 microprocessor, the stack

pointer can point to memory only within the first page. TTYOUT is a routine (not shown) which prints the contents of the accumulator to the terminal. This routine varies from one computer system to the next.

JOBS signifies the number of jobs that we want to multitask; in this case, there are three (Huey, Duey, and Luey). STACKLEN signifies the length of each program's stack. SPTABLE is a table of length JOBS, to be used exactly like a stack pointer. Each job has its own stack pointer, which is stored in the table when one particular job is asleep. CURJOB contains the number of the job currently running. In this example, CURJOB may have only the values 0 (which means Huey is running), 1 (Luey), or 2 (Duey).

STACKAREA is JOBS × STACKLEN bytes long (3 × 20 = 60 in this

The Multi-User Computer With The MmmOST®*

The TeleVideo family of multi-user business computer systems brings you the highest job throughput . . . every user controls a private computer while sharing a common data base!!! The CP/M®† operating system

†CP/M® is a Registered Trademark of Digital Research, Inc.
*MmmOST® is a Registered Trademark of TeleVideo Systems, Inc.

*Multi-user, Multi-task, Multi-processor Operating System Technology
opens the window to the largest array of business applications available for microcomputers.

TeleVideo Systems provides the computing solution!

Nationwide service by General Electric Company's Instrumentation and Communication Equipment Service Centers.



TeleVideo® Systems

TeleVideo Systems, Inc., 1170 Morse Avenue, Sunnyvale, CA 94086
408/745-7760; 800/538-8725 (toll-free outside California)

DECIS

Minicomputer performance in

Multi-user. Multi Tasking. Decision I™ memory management hardware includes a memory map that is similar to the IBM 360® and IBM 370®. It supports up to 16 tasks or 15 users and a supervisor without swapping. And, more with swapping. Each task or user enjoys complete memory protection and dynamic memory allocation. One task may be delegated as a supervisor to privileged system functions forbidden to ordinary tasks or users. Such functions (I/O calls, unauthorized memory access, etc.), will trap to the supervisor. If supervisory functions are not required the system can be configured for turnkey multi-user operation.

Multi-purpose IEEE696/S-100. Decision I utilizes the Morrow Designs IEEE Standard S-100 Wunderbuss®. That means you can configure it to your specific applications. Add a floating point processor, add memory (to a full megabyte), add I/O, add controllers...add boards from dozens of manufacturers. And S-100 has a major advantage over single-board computers: If a board goes down, you simply replace it. And keep running. If you want to expand your system. Add boards and terminals.

An unmatched software base. Decision I runs on the M/OS™ operating system. M/OS supports all system calls source

compatibly with UNIX®. Thus, UNIX programs will compile directly and UNIX documentation is almost totally applicable. Morrow CP/M® has been configured to run under M/OS and communicate with both CP/M and UNIX standard media for maximum portability. Languages available include BASIC, COBOL, FORTRAN, RATFOR, Pascal and C. That means Decision I offers you a software base unmatched in its price/performance arena.

The OEM machine. A basic multi-user system at \$5,225 includes the Decision I, 4 Mhz Z80A-based CPU, sophisticated memory

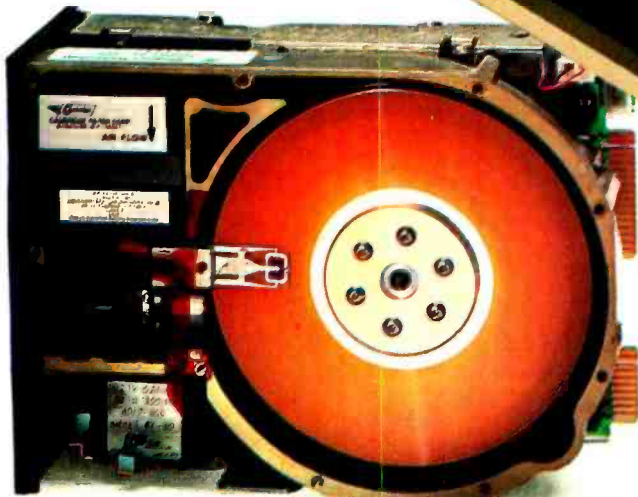

IBM 360 and 370 are trademarks of IBM Corp.
Wunderbuss is a registered trademark of Morrow Designs
Decision I and M/OS are trademarks of Morrow Designs
UNIX is a trademark of Bell Laboratories, Inc.
CP/M is a trademark of Digital Research Corp.

ION I

a multi-user Microcomputer.



management hardware, CP/M 2.2, M/BASIC 5.2, 3 serial and 2 parallel I/O ports, 14 I/O slots with S-100 connectors, supervisor control in both hardware and software, 128K of RAM and two quad-density disk drives (800K) with DMA controller. Plus, cabinet (either desk-top or rack-mount), and power supply. The same system with 8" floppies and a full Megabyte of formatted storage costs \$5,659. And, we offer OEM pricing.

A better microcomputer. Whether you're building a single or multi-user system, the Decision I offers you a hardware/software combination unmatched in the field. Decision I is not simply an improved 8-bit microcomputer. It's a breakthrough. In both computing power and price.

Systems your way. Morrow Designs' full range of hard and floppy disk memory, add-in memory boards, I/O

boards, controllers and software allow you to configure your system your way... through a single supplier.

The decision is yours. Compare the Decision I, feature-for-feature with mini or microcomputers on the market today. Compare capabilities. Compare flexibility. Compare utility. Then, compare price. We think Decision I will change the way you think about microcomputer systems.

Complete information? See your computer dealer. Or, write Morrow Designs.

LOOK TO MORROW FOR ANSWERS.

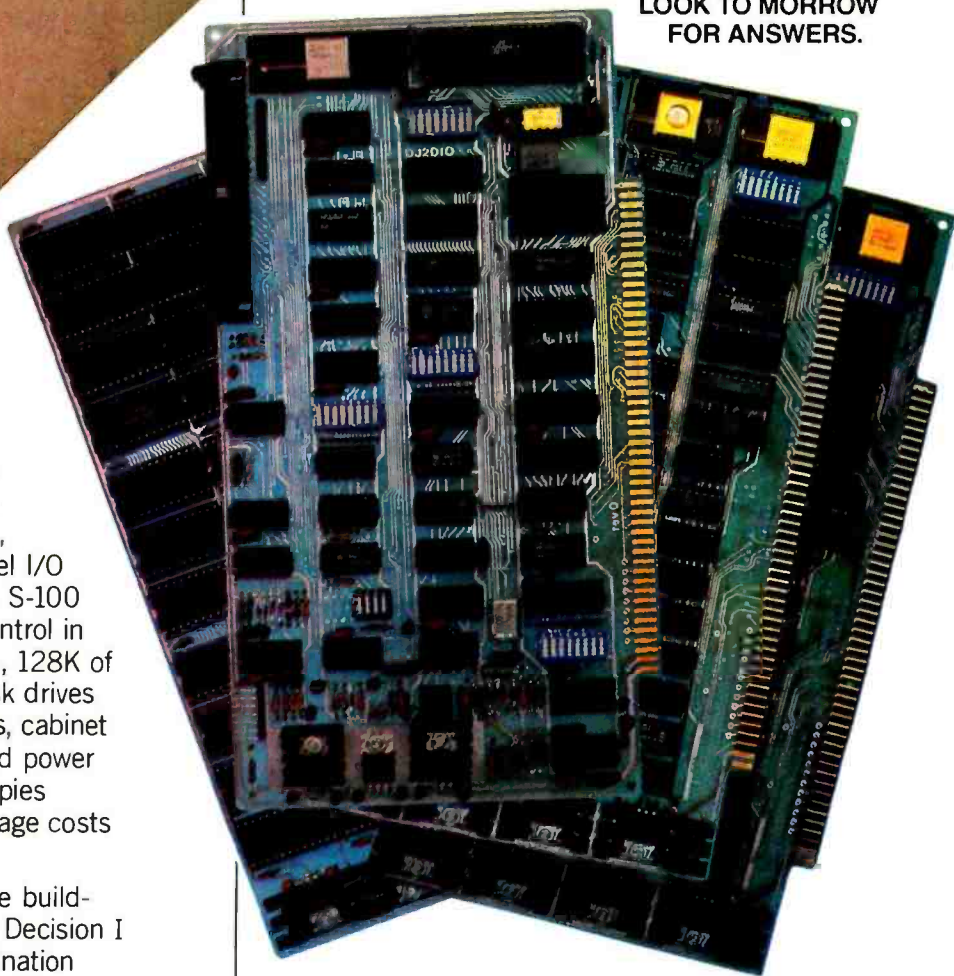

MORROW DESIGNS

5221 Central Avenue, Richmond, CA 94804
(415) 524-2101



example), and houses the actual stack for each program. Since in the 6502 the stack "grow" upward (toward page zero), each program's stack has a label pointing to the bottom of the stack. As a stack is used, the pointer

steps along the stack.

Now that we have defined variables and stacks in page zero, we must fill those variables with meaningful values. PSECT tells the assembler that the following is program code, to be placed somewhere other than page zero. Label START-UP is the place we'll branch to in order to begin the programs.

Before Huey, Duey, and Luey run, however, we must complete initialization. SEI disables the 6502 interrupts—just a precaution in case we forget to disable interrupts after the last program. CLD clears the 6502 decimal mode, and is another general precaution, rather than a unique requirement of multitasking.

The next twenty instructions lead to one goal: to fill the bottom two bytes of each stack with the starting address of the program so that we can

Figure 1: Saving a return address in the stack during execution of the SNOOZE program (shown in listing 2). Whenever a machine-level subroutine is called, the microprocessor forces the return address onto the stack. Later, when an RTS (return) instruction is executed, the microprocessor retrieves the return address from the stack and puts it into the program counter. As a result, executing an RTS instruction causes the microprocessor to branch to the start of the subroutine.

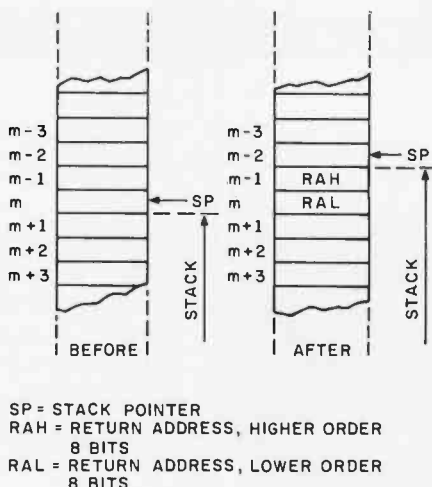

New! MIZ' SPELL™

FOR TRSDOS
OR CP/M

Picture the fastest, most accurate schoolteacher you ever had, pointing out all your spelling errors so you can correct them instantly. This new spelling checker for Electric Pencil and Scripsit files is modeled after her: it's virtually impossible to misspell with MIZ SPELL!

Unlike other spelling checking programs:

MIZ SPELL will operate on one or more disc drives. (Some others require a minimum of two.)

MIZ SPELL will work with words of any length. (Others have limits on maximum word length.)

MIZ SPELL is interactive; you can correct mistakes as they are pointed out. (Some require multiple, time-consuming passes.)

Check these features vs. other spelling checkers:

MIZ SPELL maintains separate dictionaries for specialized vocabularies, each with a 27,000 word capacity. (18,000 included.)

MIZ SPELL learns new words from your text files as it checks for spelling errors. (Words can also be deleted from the dictionary—but not accidentally, as with some other programs.)

MIZ SPELL offers such options as: ignore word in text, delete word in text, change word in text, add all remaining words, etc.

MIZ SPELL permits user configuration of system, including specification of default extensions for original and corrected text file.

TRS-80 Model I **\$5995** CP/M 8" **\$7995**
48K Disk Single Density

TRS-80 and TRSDOS are registered trademarks of Tandy Radio Shack Corp.
CP/M is a registered trademark of Digital Research.

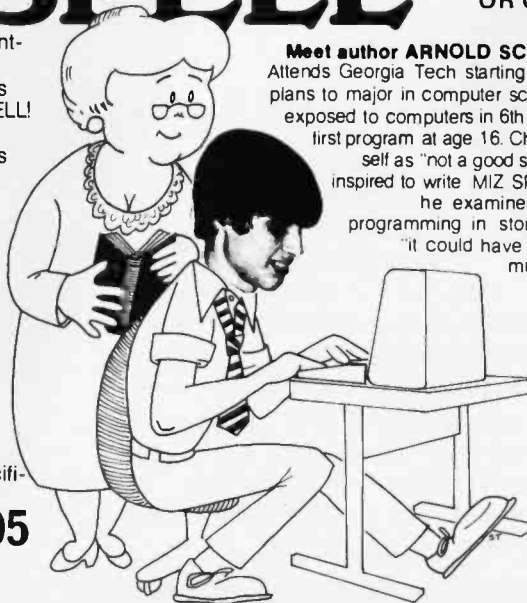

Meet author ARNOLD SCHAEFFER

Attends Georgia Tech starting Fall, 1981; plans to major in computer science. First exposed to computers in 6th grade; sold first program at age 16. Characterizes self as "not a good speller"; was inspired to write MIZ SPELL when he examined available programming in store. Decided "it could have been done much better."

HOW TO ORDER:

CALL TOLL FREE: (800) 645-6038 (except NY*)

COMPUTER TO COMPUTER: (516) 334-3134

WRITE: Dept. 881b, Box 265, Jericho, NY 11753

Add \$1.00 for postage and handling.
NY Residents add sales tax.

FULL GUARANTEE

If for any reason dissatisfied with any purchase from PROGRAMS UNLIMITED, return merchandise in original condition and packaging for prompt, full refund.



PROGRAMS UNLIMITED™

Visa, Master Card, American Express.

*NY State residents call 516-997-8668

DOS, DOS/VS, DOS/VSE, EDOS Systems Programmers . . .



A good career fit is often hard to find . . . and definitely worth looking for.

If you're an IBM DOS, DOS/VS, DOS/VSE, or EDOS operating systems professional, your search is over. Nixdorf Computer Software Company, Richmond, VA, is the company tailor-made for your talents and ambitions.

NCSC: Small company informality. Big company resources.

As a wholly-owned subsidiary of Nixdorf Computer Corporation, Waltham, MA, NCSC offers the perfect environment for your personal and professional growth. You'll work with other talented professionals in small project teams at the leading edge of operating systems development technology. Our atmosphere encourages and rewards creativity and innovation. And it's all backed by Nixdorf Computer's international reputation.

Our simple philosophy: Challenged and happy people produce the best work.

At NCSC, we're firmly committed to state-of-the-art technological excellence—placing us on the Datapro software honor roll for 3 consecutive years. So your talent will be challenged and stimulated to grow and mature. Our creative environment, professional attitude, and friendly atmosphere blend to provide a truly enriching career experience.

What about the benefits?

They're outstanding. Health, major medical, life, dental, prescription drugs, short-term and long-term disability, vacations and holidays, sav-

ings and investment plan, direct pay deposit, 100% tuition reimbursement, in-house training and education programs, and more. Sounds great? You're right.

Nationwide Locations.

NCSC has regional offices in some of the most desirable cities in the U.S. Several opportunities are available in Dallas and Chicago, with the majority of positions open at NCSC headquarters in Richmond, Virginia.

In Richmond, the emphasis is outdoors.

Golf in January. Enjoy your favorite outdoor activities 9 to 10 months a year. Sensibly-priced homes on family-sized building sites. You'll like living in Virginia's state capital, with its cosmopolitan, professional ambience, 600,000 metro population, within 2 hours from Washington, D.C., the Blue Ridge Mountains, or the seashore. And your very competitive NCSC salary goes a lot farther with Richmond's low cost of living.

Our Current Opportunities:

For all these positions, you should have at least 2 years IBM DOS, DOS/VS, DOS/VSE or EDOS operating system experience and be proficient in Assembly language programming. Teleprocessing, networking, RJE, VSAM, BTAM, VTAM and CICS would be valuable.

Operating Systems Programmer.

Design and develop from ground floor a complete software system, including operating systems and communications software.

Software Support Representative.

Provide customer support for Nixdorf operating system software. Customer contact and troubleshooting experience essential.

Systems Programmer.

Provide program fixes, implement enhancements, and assist customer support efforts.

Support Systems Programmer.

Perform systems generation, maintenance, and other software support functions for in-house development, support and production.

Technical Instructor.

Conduct in-house and customer education for our operating system products; travel involved. Instruction proficiency essential.

Technical Writer.

Provide internal documentation development programs. We seek a professional whose talents combine systems programming experience with strong technical writing skills.

If you're interested and feel you're the right fit for one of our opportunities, please forward your resume, stating your area of interest and including your salary history, to Employment Manager, Dept. B, Nixdorf Computer Software Company, 6517 Everglades Dr., Richmond, VA 23225. Or call — outside of Virginia — TOLL FREE 800-446-9900. In Virginia, 804-276-9200. We are an equal opportunity employer m/f/h.

Committed to Success.

NIXDORF COMPUTER SOFTWARE COMPANY

NIXDORF
COMPUTER

THE MOST POWERFUL SMALL BUSINESS COMPUTER IN THE WORLD

The IBC ENSIGN business computer was designed from the ground up to run MP/M, multi-user OASIS, MVT-FAMOS, and other multi-user Z-80 operating systems faster than any other computer in the world.

Consider these features:

- Up to 16 users
- Up to 768K byte memory
- Up to 150M bytes/disk drive
- 17M byte tape cartridge
- 46M byte 9 track tape
- 6 MHz Z-80B CPU

But it takes more than a lot of I/O ports, memory, and disk storage to make a super multi-user computer. The ENSIGN has what it takes.

MULTIPE MICROPROCESSORS: The ENSIGN has two separate Z-80's and 32K byte memory buffer to handle all I/O between CRT's and printers at baud rates up to 19,200 baud.

A third Z-80 handles all disk and tape I/O. Commands from the main CPU are totally supervised by the disk slave Z-80.

And the main CPU is the new 6 MHz Z-80B running at full speed with 120 nsec memory.

PERIPHERALS: The ENSIGN supports the tape and winchester disk family from Kennedy Co. These drives, tape cartridges, and 9 track tape drives are the premier of the industry. Yet prices are low on the ENSIGN.

SOFTWARE: If you are running MP/M, OASIS, or MVT-FAMOS you will run better on an ENSIGN. And if you're not already tied to one of these systems you may want to try IBC-SUPERDOS. SUPERDOS is very powerful and very very fast.

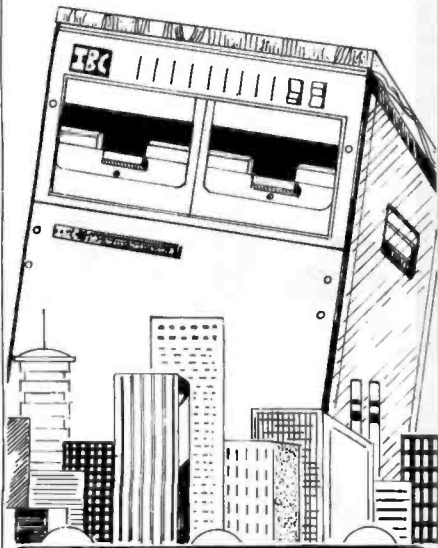

For dealership information contact:
IBC / Integrated Business Computers

22010 S. Wilmington Avenue, Suite 306
Carson, CA 90745 • Call (213) 518-4245

The following have registered trademarks: Z 80, Z8000, MP/M, DIGITAL RESEARCH, OASIS, PHASE ONE SYSTEMS, MVT/FAMOS, MVT MICROCOMPUTER SYSTEMS

fake a jump instruction with a return instruction. When we call a machine-level subroutine, the microprocessor forces the return address onto the stack, and jumps to the subroutine (see figure 1). The opposite (popping the stack, and jumping to the return address of the function which originally called the subroutine) occurs when the microprocessor executes a return from the subroutine (RTS in 6502 assembly language).

Thus, if we put the starting address of the program on the stack, then execute an RTS, the microprocessor branches to the start of the program. The entire operation is simple, but lets us perform several clever tricks.

Starting at STKINIT, we initialize the stack areas. #LSB is an assembler function that extracts the LSB (least-significant byte) from the value in parentheses. TXS transfers the value from the X register (which contains

Luey's stack pointer) to the stack-pointer register. Similar to #LSB, #MSB is an assembler function that extracts the MSB (most-significant byte).

In the next several instructions, we will place two bytes, which are the starting address of program Luey, on the stack. PHA pushes the value of the accumulator onto the stack. We then store the value of the stack-pointer register into the SPTABLE array offset by 1 (remember how CURJOB's value of 1 means Luey is running?). Next, we initialize Huey's stack exactly as we did Luey's, except at the end we store the stack pointer into SPTABLE with an offset of 2 instead of 1. We now set the stack-pointer register to Huey's stack area, since Huey will run first (see figure 2). We must also set CURJOB to signify that Huey will be running (CURJOB=0). Finally, we jump to Huey,

STACKAREA:

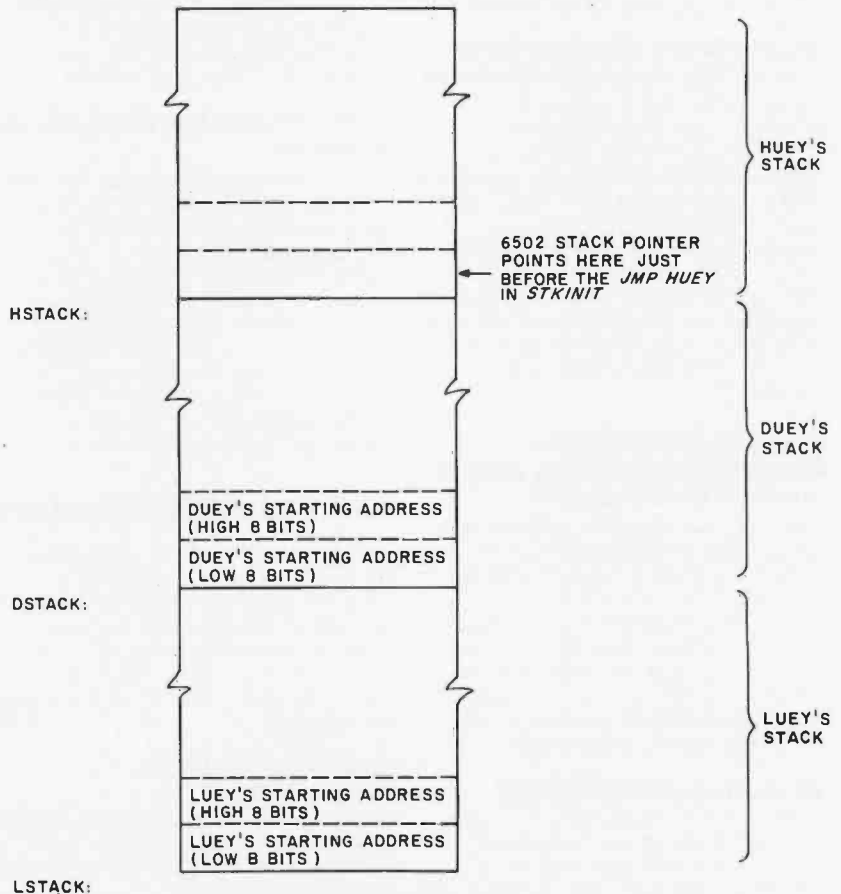
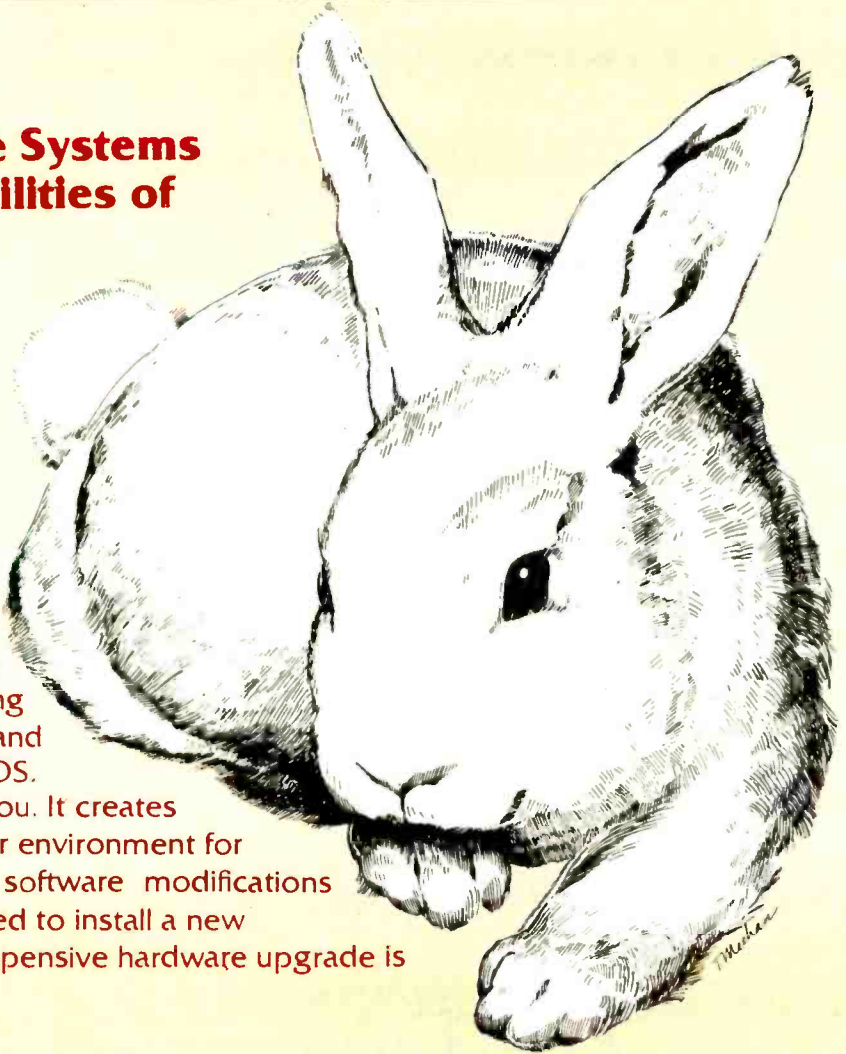

Figure 2: The state of the stack area immediately before the JMP HUEY instruction in the STKINIT subroutine of the SNOOZE program (see listing 2). STKINIT initializes the stack areas. Since the stack-pointer register is now pointing to Huey's stack area, Huey will run before the subroutines Duey and Luey.

Wild Hare Software Systems Multiply the Capabilities of Data General's

**RDOS
INFOS®
ICOS
DOS**



Wild Hare gives Data General users a choice when upgrading to a multi-user environment and eliminates the need to use AOS. Wild Hare makes it easy for you. It creates a true multi-lingual, multi-user environment for your current system. No user software modifications are necessary. There is no need to install a new operating system. And, no expensive hardware upgrade is required.

Features

- Each user is totally independent of all other users.
- Each user may run all standard Data General software.
- Each user may independently edit, compile, execute and debug programs written in any language supported by RDOS, INFOS®, ICOS and DOS.
- Standard languages supported include: Fortran IV, Fortran V, COBOL, ALGOL, RPG, DG/L™, BASIC, PASCAL, MAC, etc.
- All NOVA's® and ECLIPSE's® are supported.
- Wild Hare guarantees its software systems on a money back basis.

**Wild Hare's Software
Gives Data General Users
A Choice!**

WILD HARE COMPUTER
SYSTEMS INC.

P.O. Box 3581, Boulder, Colorado 80307
(303) 494-0221

NOVA, ECLIPSE and INFOS are registered trademarks of Data General Corporation.



Turn your Apple into the world's most versatile personal computer.

The SoftCard™ Solution. SoftCard turns your Apple into two computers. A Z-80 and a 6502. By adding a Z-80 microprocessor and CP/M to your Apple, SoftCard turns your Apple into a CP/M based machine. That means you can access the single largest body of microcomputer software in existence. Two computers in one. And, the advantages of both.

Plug and go. The SoftCard system starts with a Z-80 based circuit card. Just plug it into any slot (except 0) of your Apple. No modifications required. SoftCard supports most of your Apple peripherals, and, in 6502-mode, your Apple is still your Apple.

CP/M for your Apple. You get CP/M on disk with the SoftCard package. It's a powerful and simple-to-use operating system. It supports more software than any other microcomputer operating system. And that's the key to the versatility of the SoftCard/Apple.

BASIC included. A powerful tool, BASIC-80 is included in the SoftCard package. Running under CP/M, ANSI Standard BASIC-80 is the most powerful microcomputer BASIC available. It includes extensive disk I/O statements, error trapping, integer variables, 16-digit precision, extensive EDIT commands and string functions, high and low-res Apple graphics, PRINT USING, CHAIN and COMMON, plus many additional commands. And, it's a BASIC you can compile with Microsoft's BASIC Compiler.

More languages. With SoftCard and CP/M, you can add Microsoft's ANSI Standard COBOL, and FORTRAN, or

Basic Compiler and Assembly Language Development System. All, more powerful tools for your Apple.

Seeing is believing. See the SoftCard in operation at your Microsoft or Apple dealer. We think you'll agree that the SoftCard turns your Apple into the world's most versatile personal computer.

Complete information? It's at your dealer's now. Or, we'll send it to you and include a dealer list. Write us. Call us. Or, circle the reader service card number below.

SoftCard is a trademark of Microsoft. Apple II and Apple II Plus are registered trademarks of Apple Computer. Z-80 is a registered trademark of Zilog, Inc. CP/M is a registered trademark of Digital Research, Inc.

MICROSOFT

CONSUMER PRODUCTS

Microsoft Consumer Products, 400 108th Ave. N.E.,
Bellevue, WA 98004. (206) 454-1315

printer), keyboard polling, and floppy-disk management, to their own multitasked programs. Music synthesizers could produce multiple tones from software designed for single tones.

At Cornell University's low-temperature physics group, we have written multitasking software for the 6502 that implements the HPIB functions (Hewlett-Packard Instrument Bus, also known as IEEE standard 1978-488). This standardized bus is used not only in laboratory instruments, but also in the Commodore PET computer as a peripheral port. While it is possible to program all these routines using other software techniques, the use of SLEEP may simplify conception and implementation.

Let's take a closer look at how we might multiprogram a standard BASIC. First, we must have enough free memory in our system to hold at least two different BASIC programs. The best method of multitasking BASICs involves updating BASICs pointers to the start of the program

memory, variable areas, etc. However, this method is complex and you must know where these pointers reside in memory for your particular BASIC. Let's consider a simpler but less efficient method.

The general scheme is to swap out the BASIC program, variables, and line counter (the value indicating the next BASIC line to be executed), and then swap in the next program's program, variables, and line counter. The addresses vary depending on which BASIC we use. Since most computers have only one keyboard and display, we must have a way to indicate which program we wish to communicate with at any given time. To accomplish this, we must choose a specific keyboard command. Finally, we must decide how often we want the computer to swap the programs in and out. We could do this in software, similar to SNOOZE, by calling SWAP occasionally. Or we could force swapping by pulling a hardware interrupt.

A hardware interrupt is, basically, a method of forcing the execution of

specific software when the proper signal is sent on the interrupt line. We could connect a timing device to the interrupt line, forcing a SWAP routine to swap BASIC programs at every clock period of our timer. SNOOZE could also be implemented using this interrupt approach. However, the requirement of such interrupt hardware is a slight disadvantage.

Now that you have seen the structure of the SLEEP method of multitasking, you may want to try writing your own multitasking software. For the small-computer owner who thinks he is outgrowing his system, the convenience and added power of resource sharing can be a strong incentive to implement multitasking. All too often, our first reaction to a strain on resources is to buy a new system. But a better reaction might be to write such software. The SLEEP method may help your present computer system perform beyond your expectations. If your system seems overburdened and worn out, maybe it just needs a little SLEEP. ■

Radio Shack

**TRS-80TM
COMPUTERS**

SAVE

\$
\$
\$

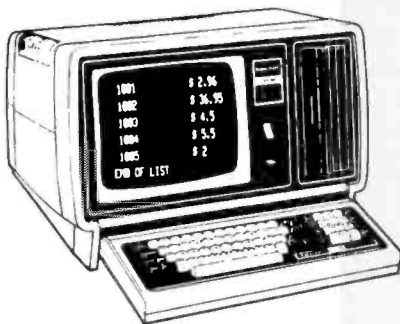

TRS-80
MODEL II Reg. \$3,899⁰⁰
64 K **\$3,439⁰⁰**
26-4002

*We Pay Shipping
No Tax on Out of State
Shipments*

*Warranties Honored by
Radio Shack Stores*

CALL US
For Low, Low
Prices on All
RADIO SHACK
Hardware and
Software

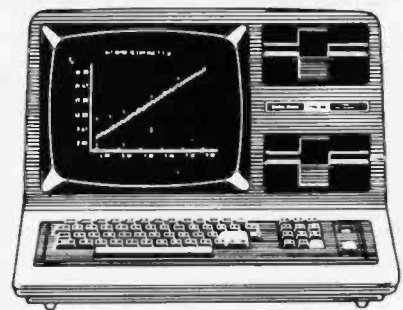

TRS-80 MODEL III Reg. \$2,495⁰⁰
48 K; 2 Disks **\$2,220⁰⁰**
26-1066

(209) 526-1475

Radio Shack

221 McHenry Ave.
Modesto, Calif. 95354

*Certified Checks
Cashiers Checks
Credit Cards*



Franchise Store 7079

- Text-to-speech algorithm vocally reproduces any typed entry
- Unlimited vocabulary
- Standard RS-232C interface

VOTRAX™ brings your computer to life with Type-'N-Talk™.

Now you can hear your computer tell you where you are in a program; taunt you during computer games; praise you; remind you; warn you. Thanks to the unique VOTRAX™ text-to-speech algorithm, your typewritten words are automatically translated into electronic speech—all for just \$375.00.

You type—your computer talks. It's that easy because Type-'N-Talk™ uses ASCII code from your computer. *You just send English text to hear synthesized speech through your audio loudspeaker.*

The smallest personal computer can talk and execute programs simultaneously. Type-'N-Talk™ has a built-in microprocessor and a 750 character buffer so your host computer and memory isn't tied up with text translation.

If you can print it, you can hear it by placing Type-'N-Talk™ between your computer or modem and a terminal. All the data you're sent while online can be seen and heard. You can even "de-select" Type-'N-Talk™ with its data switching options. Data switching allows you to send speech and visual data independently on one data channel.

Look what you get for \$375.00:

- RS-232C interface is compatible with most computers
- Text-to-speech algorithm
- Complete installation and programming instructions
- Baud (75-9600)
- One watt audio amplifier
- 750 character buffer
- SC-01 speech synthesizer chip (data rate: 70-100 bits per second)
- Data switching capability
- Selectable data modes for versatile interfacing
- Data echo of ASCII characters
- Phoneme access modes

The Type-'N-Talk™ unit's simplicity enables the beginning hobbyist to use and enjoy it immediately, yet its total capability can challenge even the most sophisticated user. VOTRAX™ developed Type-'N-Talk™ to function with operator designed programs or with the new VOTRAX™ talking software currently under development. Type-'N-Talk™ is so easy to use, it can also be used without software.

Order now. Toll-free.
1-800-521-1350
Dealer inquiries invited.

Call the toll-free number to order or request additional information. MasterCard or Visa accepted. Charge to your credit card or send a check for \$375.00 plus \$4.00 delivery. Add 4% sales tax in Michigan. California residents add appropriate sales tax.

Send check to:
Votrax™ - Consumer Products Group
500 Stephenson Hwy., Troy, MI 48064

TYPE-'N-TALK™

SAYS IT ALL.



VOTRAX
NOW YOU'RE TALKING.



Take Your Cue From Vista . . .

When it comes to Apples, take your cue from Vista's A800 Eight-Inch Floppy Disk Controller. The A800 offers a cost-efficient approach to software compatible disk memory expansion for your Apple II® computer. The A800 Controller enables Apple II users to access up to five megabytes of online storage through conventional disk operating (DOS) commands.

The Control and DMA Logic provides high speed (1 microsecond per byte) transfer of data from the disk drive directly to the Apple II memory without processor intervention. Plus, the Phase-Locked Loop Data Separator provides the ultimate in data reliability.

AND THERE'S MORE.

The controller is compatible with the most popular disk operating systems for the

It's a Sure Shot.

Apple II computer. It also interfaces to all Shugart/ANSI Standard Eight-Inch Floppy Disk Drives. The A800 provides complete IBM format compatibility in both single and double-density modes.

THE HOT SHOT AT A COOL PRICE.

The A800 is reasonably priced at \$595. A price you can't beat when you compare its quality and performance.

CALL YOUR SHOTS.

Vista offers you a complete line of peripheral equipment to maximize the capabilities of your Apple system including: High capacity Mini-floppy Disk Drives, the Vista Music Machine 9 and the Vista Model 150 Type Ahead Buffer. In addition, Vista offers a line of advanced components fully compatible with the TRS-80* and S-100 based computers.



Vista Computer Company
1317 E. Edinger Avenue
Santa Ana, CA 92705
(714) 953-0523

Call Toll Free 800-854-8017

© Apple II is a registered trademark of Apple Computers, Inc.
* TRS-80 is a trademark of Radio Shack, A Tandy Co.

Tree Searching

Part 2: Heuristic Techniques

Gregg Williams, Senior Editor

Exhaustive tree searches, for reasons that will be explained later, will *eventually* arrive at an optimal path between the start node S and the goal node closest to S. The exponential expansion of many problems can outgrow the memory and speed capabilities of even the largest computers; because of this, methods have been developed that selectively limit the number of nodes expanded but still include those nodes that lead to the closest goal node. These *heuristic techniques* work by extracting information from the node and using it to determine the likelihood of being on the best path to a goal node.

In this article we will be concerned with two types of heuristic techniques, *admissible* and *nonadmissible*, and will experiment with them, using the BASIC program given in the first part of this article. (See "Tree Searching, Part 1: Basic Techniques," September 1981 BYTE, page 72.)

Admissible-Algorithm Theory

One method of searching a problem tree is to order the list of open nodes by giving each node a numeric value and having the program choose the node with the lowest value for immediate expansion (an approach used in the SEARCH program in Part 1 of this article). Although this method can be used with any ordering that produces a successful search, a mild

restriction on the nature of the ordering produces a search algorithm that is guaranteed to find both a goal node and the optimal goal node—that is, the goal node that has the smallest cost associated with it. This algorithm is called *admissible*.

Refer to the partial tree shown in figure 1. (Here we will assume that the paths from S to n and from n to G are the shortest paths available.) Define $g(n)$ as the shortest path from the start node S to node n; define $h(n)$ as the shortest path from n to the *closest* goal node G. Then

$$f(n) = g(n) + h(n)$$

is the cost of the optimal path to a goal node, *given that the solution must go through node n*. (If no such path exists, the cost is said to be undefined; with a program, the appropriate cost variable would be assigned an arbitrarily large number.)

Now that we have the three functions f , g , and h , let us define three more functions, \hat{f} (pronounced "f-hat"), \hat{g} , and \hat{h} , that, for a given situation, are estimates of the theoretical (and often unknown) minimal functions f , g , and h . In other words, $\hat{f}(n)$ is the estimated cost of the minimal path from S through n to G; $\hat{g}(n)$ is the estimated cost of the minimal path from S to n (remember that when we have a path from S to n, it

may not be the *minimal* path); and $\hat{h}(n)$ is the estimated cost of the minimal path from n to the closest goal node (which, at the time, is unknown).

Simply stated without proof, the condition necessary for an algorithm producing $\hat{h}(n)$ to be admissible is that the ordering algorithm must produce a numeric value that is guaranteed, for every node n, to be less than or equal to the cost of the minimal path from n to the closest G. In symbols, this condition is the following:

$$\hat{f}(n) \leq f(n)$$

If this condition is always true, then the ordering algorithm is admissible. (Readers interested in the proof can consult *Problem Solving Methods in Artificial Intelligence*, by Nils J Nilsson, 1971, pages 59 to 65.)

Let us consider two cases of algorithms that are known to be admissible. The first algorithm is that for a breadth-first search, which offers no information about the relative value of any node—that is, $\hat{h}(n)=0$. (Note: the computer program in Part 1 used a different value for the $\hat{h}(n)$ variable D1 for demonstration purposes; however, D1=0 will give the same result.) Since zero is a lower bound on the minimal cost of any node, goal or nongoal (ie: $0 \leq h(n)$), the breadth-first algorithm is confirmed to be ad-

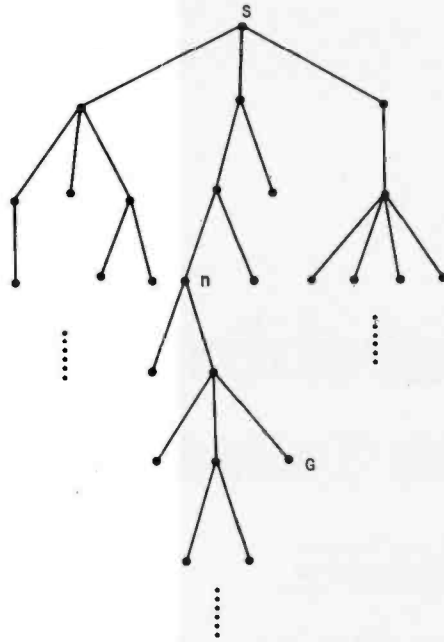

Figure 1: A partially drawn tree. In this representation, each state (or node) of the problem is represented by a point, and each line represents a legal change from one state to the next. Node S is the original problem, with node n and other nodes representing intermediate steps on the way to solution (node G, the goal node).

missible by the above inequality. But, as we know from experience, the breadth-first algorithm is nonselective; that is, it expands all nodes in order of increasing depth until it reaches its first (and therefore minimal) goal node. So we can see that its total absence of heuristic information goes hand in hand with, and is a measure of, its extreme inefficiency.

On the other hand, let us assume an ordering algorithm \hat{h} that returns the *exact* cost of the shortest path from n to G; in other words, $\hat{h}(n) = h(n)$ for all n, which still satisfies the above inequality. What does this mean? A moment's reflection will confirm that, first, since this algorithm represents perfect information about the state of the system, it is guaranteed to reach the nearest goal node G; and, second, that it will do so without expanding one unnecessary node. What could be simpler? Since the search algorithm always expands the node with the smallest \hat{h} value, and since in this case the \hat{h} value is the *exact* cost from that node to the goal node, the search algorithm will inexorably come, with each expansion, one node closer to the goal node. So in this case, the presence of total heuristic information is equivalent to maximum efficiency.

From viewing the above two extremes representing

$$\hat{h}(n) = 0$$

and

$$\hat{h}(n) = h(n)$$

we would expect to find an $\hat{h}(n)$ satisfying

$$0 < \hat{h}(n) < h(n)$$

to be between these two extremes of efficiency, with efficiency increasing as $\hat{h}(n)$, for all nodes n, approaches $h(n)$. This is actually the case: given two admissible ordering algorithms A (generating $\hat{h}(n)$) and A* (generating $\hat{h}^*(n)$), A* is said to be *more informed* if \hat{h}^* is always greater than or equal to \hat{h} , or:

$$\hat{h}(n) \leq \hat{h}^*(n) \leq h(n)$$

It has also been shown that A* is then

Need a Real-Time Multi-Tasking Executive for 8080 and Z80?

AMIX

- Faultless operation proven in world wide use
- Truly hardware independent
- Optimized for fast interrupt response
- Minimal memory requirements
- ROMable for control applications
- Terminal Handler is CP/M BDOS compatible
- Console Driver supports Intel iSBC boards
- SYSGEN speeds user system configuring
- Program in PL/M, Fortran, Pascal or Assembler
- Source code included (Intel or Zilog mnemonics)
- Unlimited use licence agreement
- Complete documentation (available separately)
- Low cost



KADAK Products Ltd.

206-1847 West Broadway Avenue
Vancouver, B.C., Canada V6J 1Y5
Telephone (604) 734-2796

Dealer enquiries invited

CP/M is a trademark of Digital Research Corp.; RMX/80, iSBC are trademarks of Intel Corp.

CP/M®
Interface
Also Available

PRIME SOURCE DISTRIBUTING



COMPUTER SYSTEMS

The Computer with the MmmOST[®] — TeleVideo's Multi-User, Multi-Tasking, Multi-Processor Operating System Technology makes TeleVideo the leader in multiple-user, distributed data processing systems. TeleVideo is incredibly faster than ordinary multiple-user systems, and it is also less expensive!

- Each user has his own Z80 processor
- Individual Programs run under CP/M[®]
- File and record lock-out, and Fata Embraces are handled
- TeleVideo-RM/COBOL supports shared files

TERMINALS

Outstanding Performance, Reliability, Price and Delivery have made TeleVideo the terminal chosen by the majority of new micro computer users.

The newest member of the TeleVideo family, the Model 910, emulates three other terminals, knows 3 foreign languages, has a large set of screen attributes, 19.2K Baud, and a Selectric style Keyboard with numeric pad; but lists for only \$699. Value for the dollar makes the TeleVideo 910 a best buy.

Watch for more new products in the near future that will put TeleVideo further out front.

DEALERS AND OEMs WHO CALL EARLY WILL BE FIRST IN THE SUPPLY LINE.

RIGHT NOW!

BECAUSE:

PRIME SOURCE Delivers computer systems that work. We carry a complete line of microcomputers and peripherals backed by in-house technical expertise. Pretested and Preconfigured systems available.

PRIME SOURCE is a stocking distributor with product ready ship.

PRIME SOURCE Supports the dealer with extras such as flooring plans, demonstration software packages, sales leads from national advertising, and advertising funds for local advertising.

PRIME SOURCE sells to Dealers, Manufacturers, Systems Houses, and Independent Software Vendors. We do not sell to end users.

CP/M[®] is a licensed product supplied by Digital Research, Inc.
MmmOST[®] is a registered trademark of TeleVideo Systems, Inc.

PRIME SOURCE DISTRIBUTING

Circle 304 on Inquiry card.

18380 Enterprise Lane
Huntington Beach, CA 92648
714/842-2208 213/592-4201
Outside California 800/854-6451

FREE SOFTWARE!

Word Processing or Accounting When You Buy a 64k Superbrain!



SUPERBRAIN™
QD - ONLY
\$2950

| | |
|---|--------------|
| SUPERBRAIN 64k List \$3495 | '2650 |
| 10mb HARD DISK Interac List \$4995 | '3350 |
| 10mb HARD DISK Corvus List \$5350 | '4295 |
| 20mb HARD DISK Corvus | '5300 |

| NORTHSTAR COMPUTERS | | PRINTERS | |
|-------------------------|-------|-----------------------------|-------|
| HORIZON II | | C. Itoh 8800 | '650 |
| 32k DD Reg. \$3695 | '2750 | Comet II Parallel | '825 |
| 32k QD Reg. \$3995 | '2805 | Epson MX 80 Parallel | '400 |
| 64k DD Reg. \$4195 | '3125 | Epson MX 80 Serial | '540 |
| 64k QD Reg. \$4495 | '3335 | Starwriter 25cps Parallel | '1405 |
| TERMINALS | | Starwriter 25cps Serial | '1650 |
| Interhub III Reg. \$895 | '720 | Starwriter III 40cps Serial | '1750 |
| Emulator Reg. \$895 | '720 | Starwriter II 45cps | '1795 |

| MODEMS | | MICROPLAN | |
|---|-------|--------------|--|
| Cal Novation acoustic | '160 | The Visicalc | |
| Cal Direct Connect | '189 | For CP/M | |
| Microconnection Direct | '165 | List \$495 | |
| A-J 1256 1200 baud dir. conn. List \$1295 | '925 | \$425 | |
| UPGRADE | | | |
| 5mb Hard Disk Upgrade for Superbrain | '2995 | | |

SOFTWARE
25% OFF LIST ON ALL NORTHSTAR SOFTWARE

ACCOUNTING PLUS
By Systems Plus
Accounts Receivable, Accounts Payable, Inventory, Payroll, General Ledger, Sales Order Entry, Purchase Order Entry, Point of Sale. Excellent software for many systems.

EACH \$395

| PEACHTREE | | |
|-------------------------|-----|------|
| A/R, A/P, G/L, P/R, INV | ea. | '395 |
| CPA, Property Mgmt | ea. | '795 |

MVF SOFTWARE

| | |
|----------------------|------|
| Restaurant Inventory | '250 |
| Client Billing | '450 |

DATA BASE MANAGEMENT

| | |
|-----------|------|
| Condor I | '550 |
| Data Star | '275 |

LANGUAGES

| | |
|---------------------|------|
| C BASIC II COMPILER | '110 |
| MBASIC 80 | '325 |
| MBASIC Compiler | '350 |
| FORTRAN 80 | '450 |
| COBOL 80 | '650 |
| PASCAL UCSD | '300 |
| MT PASCAL | '500 |

CMC SOFTWARE

| | | |
|-------------------------|-----|------|
| A/P, A/R, P/R, G/L, INV | ea. | '250 |
|-------------------------|-----|------|

OTHER SOFTWARE

| | | | |
|--------------------|------|--------------------------------|------|
| Restaurant Payroll | '300 | Word Star | '325 |
| Link 80 | '90 | Mail Merge | '115 |
| QSort | '100 | Benchmark Word Processing | '395 |
| SuperSort | '200 | Benchmark Mail List Management | '350 |
| Magic Wand | '325 | NAO | '100 |
| Magic Menu | '80 | MVF Mailer | '90 |
| Word Pro 80 | '150 | Spellguard | '220 |

PERIPHERALS

| | |
|---|------|
| Corvus Host Multiplexer List \$750 | '625 |
| Master Multiplexer List \$1050 | '875 |
| Mirror Backup List \$790 | '650 |
| Interlace card w/5' cable List \$235 | '195 |
| S-100 Bus Adapter for Superbrain List \$595 | '475 |
| Parallel Port for Superbrain List \$90 | '75 |
| External Adapter List \$30 | '25 |

DISK DRIVES

| | |
|---|------|
| CDC Single side, dbl. density, List \$495 | '225 |
| CDC Double Side, dbl. density, List \$895 | '390 |
| Tanden TM 100-4 Dbl. side, dbl. dens., dbl. track, List \$995 | '600 |

PROMS

| | |
|--------------------------------------|------|
| SB/E prom for Superbrain, List \$205 | '155 |
|--------------------------------------|------|

GRAPHICS

| | |
|--|------|
| AccuSoft Graphics Board, List \$995 | '895 |
| Symbol Generator, List \$225 | '200 |
| Graphics plotter, List \$225 | '200 |
| 3-D Graphics, List \$450 | '400 |
| Surface plotter, List \$495 | '450 |
| Graphics Terminal Emulator, List \$495 | '450 |

TO ORDER, CALL (206)453-8159

Most items shipped from stock. Mastercharge, Visa add 3%. No CODs on hardware. All prices FOB origin. No shipment via Emery Air Freight because of poor claim response in damaged merchandise.

PACIFIC COMPUTER BROKERS

11056 Palatine North
Seattle, WA 98133

Listing 1: The "out-of-place" algorithm. Listing 1a gives the algorithm as implemented in BASIC, to be inserted in the SEARCH program in Part 1; listing 1b shows the structured pseudocode for the algorithm. In this and subsequent listings, the string value of each piece is replaced by its corresponding numeric value (ie: piece "I" has value 1), with "A" through "F" being replaced by the values 10 through 15, respectively.

(1a)

```

9881 REM -----LISTING 1-----
9884 REM
9885 REM "OUT-OF-PLACE" ALGORITHM,
    -ADMISSIBLE
9887 REM
9895 REM -----
9900 R1 = 0
9910 FOR I = 1 TO R9; FOR J = 1 TO R9
9915 Q = ASC (E$(I,J))
9920 IF Q = 46 THEN 9960
9925 IF Q > 64 THEN N = Q - 55: GOTO 9935
9930 IF Q < = 57 THEN N = Q - 48
9935 P1 = R9*(I - 1) + J
9940 REM —P1 IS VALUE OF CORRECT
    TILE IN POSITION I,J
9945 IF N < > P1 THEN R1 = R1 + 1
9960 NEXT J: NEXT I
9965 RETURN
    
```

(1b)

```

9900 value of puzzle (R1) = 0
9910 for each row I
    for each column J
9915 :   Q = ASCII value of row I, column J of puzzle E$
9920 :   if piece not "." (Q ≠ 46)
    :   :   convert piece Q to "true" value N
9935 :   :   P1 = value of piece in row I, column J in goal node
9945 :   :   if current piece ≠ value of same position in goal node
    :   :   :   new value of puzzle = old value of puzzle + 1
    :   :   :   endif
    :   :   endif
9960 :   :   end of for-loop J
    :   end of for-loop I
9965 return
    
```

guaranteed to expand an equal or smaller number of nodes than A (again, see Nilsson, mentioned above).

One more point has to do with a difference between tree and graph searches. The cost of a node about to be expanded, $\hat{g}(n)$, is equal to its theoretical minimal cost $g(n)$ in a tree because, by definition, there is only one path from the root node S to any other node. Since a graph may contain more than one path from S to n, the cost of a path found may not be the minimal one and so must be labeled $\hat{g}(n)$. However, an admissible

algorithm that does not change its nature during the graph search will produce only optimal paths to expanded nodes, so that $\hat{g}(n) = g(n)$; the formal name for the condition that guarantees this result is the *consistency assumption*. All admissible algorithms used in this article satisfy this assumption.

Some Examples

The exhaustive searches examined in Part 1 of this article (breadth-first, depth-first, and limited depth-first algorithms) are all admissible and exhibit one extreme in the information

WHY THE MICROSOFT RAMCARD™ MAKES OUR SOFTCARD™ AN EVEN BETTER IDEA.

Memory — you never seem to have quite enough of it.

But if you're one of the thousands of Apple owners using the SoftCard, there's an economical new way to expand your memory dramatically.

16K ON A PLUG-IN CARD.

Microsoft's new RAMCard simply plugs into your Apple II®, and adds 16k bytes of dependable, buffered read/write storage.

Together with the SoftCard, the RAMCard gives you a 56k CP/M® system that's big enough to take on all kinds of chores that would never fit before (until now, the only way to get this much memory was to have an Apple Language Card installed).

GREAT SOFTWARE: YOURS, OURS, OR THEIRS.

With the RAMCard and SoftCard, you can tackle large-scale business and scientific computing with our COBOL and FORTRAN languages. Or greatly increase the capability of CP/M

applications like the Peachtree Software accounting systems. VisiCalc™ and other Apple software packages can take advantage of RAMCard too.

And RAMCard gives you the extra capacity to develop advanced programs of your own, using the SoftCard and CP/M. *Even with the RAMCard in place, you can still access your ROM BASIC and monitor routines.*

JOIN THE SOFTCARD FAMILY.

The RAMCard is just the latest addition to the SoftCard family — a comprehensive system of hardware and software that can make your Apple more versatile and powerful than you ever imagined.

Your Microsoft dealer has all the exciting details. Visit him soon, and discover a great idea that keeps getting better.

Microsoft Consumer Products, 400 108th Ave. N.E., Suite 200, Bellevue, WA 98004. (206) 454-1315.

16 k

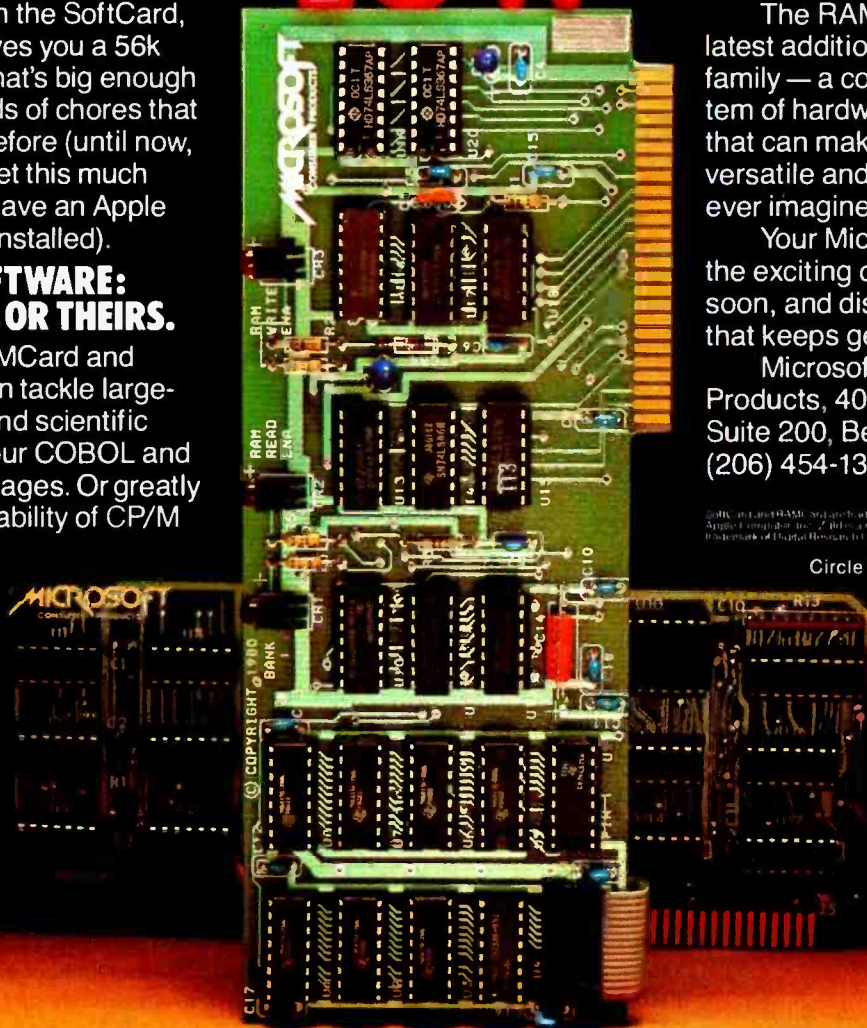

©1981, and the RAMCard are trademarks of Microsoft. Apple II is a registered trademark of Apple Computer, Inc. CP/M is a registered trademark of Digital Research, Inc. VisiCalc is a trademark of Peachtree Software, Inc.

Circle 238 on inquiry card.

MICROSOFT

spectrum: they contribute no heuristic information to the solution of the problem, so $h(n) = 0$. The other extreme, that of perfect information (or $h(n) = h(n)$), is certainly interesting in theory, but impossible to implement in most cases. We will examine two admissible algorithms that fall between these two extremes.

Remember that we are seeking to define a function $f(n)$ that is a lower bound on the minimal number of moves from node n to a goal node G . One plausible algorithm (see listing 1) is the following: $f(n)$ equals the number of squares that are not in the same

position they are in the goal node G . (In the 8- and 15-puzzles used for illustration, there is only one goal node G .) The informed reasoning used to prove that this is a lower bound on the actual cost to the goal node is the following: if a square (not including the "space" square) is out of place, it will take at least one move, if not more, to put it in place; thus, the $h(n)$ generated by this "out-of-place" algorithm will always be less than or equal to the cost of a solution $h(n)$.

Table 1a shows the puzzles used in this article; table 1b shows the results of applying both the breadth-first and

the "out-of-place" algorithms to these puzzles. A comparison of the first seven lines of table 1b prompts several useful observations. First, the breadth-first search is considerably more inefficient than the "out-of-place" algorithm; the computer I used, which has 20 K bytes of workspace and will hold 52 nodes before running out of memory, can complete only a four-move puzzle with the first method, but can complete some twelve-move puzzles with the second method before running out of memory. Second, both algorithms show a roughly linear increase in the number

| (1a) | | | (1b) | | | | | | |
|------|-------------------------|-------------------------|------------------|------------|-------------------------------|----------|------------|--------------------------------|----------|
| Row | Column 1 | Column 3 | Puzzle | Nodes Open | Breadth-First Nodes Closed | Total | Nodes Open | "Out-of-Place" Nodes Closed | Total |
| 1 | 1 2 3 4 5 6 7 . 8 | | | | | | | | |
| 2 | 1 2 3 4 . 6 7 5 8 | 1 2 3 4 5 6 . 7 8 | (1,1) | 3 | 1 | 4 | 3 | 1 | 4 |
| | | | (2,1) (2,3) | 7 4 | 4 3 | 11 7 | 5 3 | 2 2 | 7 5 |
| 3 | 1 2 3 . 4 6 7 5 8 | 1 2 3 . 5 6 4 7 8 | (3,1) (3,3) | 9 10 | 8 9 | 17 19 | 6 4 | 3 3 | 9 7 |
| | | | | | | | | | |
| 4 | 1 2 3 7 4 6 . 5 8 | 1 2 3 5 . 6 4 7 8 | (4,1) (4,3) | 12 16 | 11 21 | 23 37 | 6 6 | 4 4 | 10 10 |
| | | | | | | | | | |
| 5 | 1 2 3 7 4 6 5 . 8 | 1 2 3 5 7 6 4 . 8 | (5,1) (5,3) | *OM* | (29) | *OM* | 9 7 | 7 6 | 16 13 |
| | | | | | | | | | |
| 6 | 1 2 3 7 4 6 5 8 . | 1 2 3 5 7 6 4 8 . | (6,1) (6,3) | | | *OM* | 12 13 | 9 13 | 21 26 |
| | | | | | | | | | |
| 7 | 1 2 3 7 4 . 5 8 6 | 1 2 3 5 7 . 4 8 6 | (7,1) (7,3) | | | *OM* | 13 17 | 10 17 | 23 34 |
| | | | | | | | | | |
| 8 | 1 2 3 7 . 4 5 8 6 | 1 2 3 5 . 7 4 8 6 | (8,1) (8,3) | | | *OM* | 14 25 | 11 26 | 25 51 |
| | | | | | | | | | |
| 10 | 1 2 3 7 . 4 5 8 6 | 1 2 3 5 . 7 4 8 6 | (10,1) (10,3) | | | *OM* | 14 | 13 | 27 |
| | | | | | | | | | *OM* |
| 12 | 1 3 7 2 4 5 8 6 | 1 3 5 2 7 4 8 6 | (12,1) (12,3) | | | *OM* | 20 | 20 | 40 |
| | | | | | | | | | *OM* |
| 14 | 7 1 3 2 . 4 5 8 6 | 1 3 7 5 . 2 4 8 6 | | | | | | | |
| | | | | | | | | | |
| 16 | 7 1 . 2 8 3 5 6 4 | . 3 7 1 8 2 5 4 6 | | | | | | | |
| | | | | | | | | | |
| 18 | 7 8 1 2 . 3 5 6 4 | 3 8 7 1 . 2 5 4 6 | | | | | | | |
| | | | | | | | | | |

Table 1: Comparison of breadth-first and "out-of-place" algorithms on selected problems. The puzzles in table 1a can be identified by a pair of numbers giving the row and column in which the puzzle is found. The row number gives the number of moves to solution; puzzles in the same column are subsets of the same problem. (These match puzzles listed in Part 1 of this article.) Table 1b gives a comparison of breadth-first versus "out-of-place" algorithms for selected problems. The relationship between nodes open and nodes closed is: total = nodes open + nodes closed. (*OM* indicates that the computer's limit of about 50 nodes was exceeded. The parentheses around the 29 in line (5,1) denote that the breadth-first search ran out of room after expanding 29 nodes.) The "out-of-place" algorithm's ability to solve more complex problems using the same amount of memory indicates greater power when compared to the breadth-first search.

Imagine, a true business alternative to VisiCalc™ and dBASE II
It's Here!

LOGICALC and QUEST

Written in UCSD Pascal™



In addition to the basic features found in other financial modeling systems LOGICALC provides the following:

- Conditional expressions allowing "what if" processing together with relational operators (e.g. <, <=, >, >=, =) and logical operators (AND, OR) with parenthesis
- Complete interface to QUEST (SPI's relational data base), ASSET (SPI's Accounting system) and word processor
- Built in financial functions like linear regression, present value, depreciation, consolidation and more
- Column format feature for individual column width, column precision or individual entry precision
- Dump utility to obtain a hard copy of the model to facilitate audit trails
- Merge command to combine two or more reports
- Print command to print entire or partial reports according to parameters you specify including titles, page width and length. If the report to be printed exceeds the width of the printer LOGICALC automatically splits the report into two or more pages which when laid side by side form the complete report.

Only \$290.00

QUEST is a relational data base providing single, multi-user and distributed processing capabilities. Concurrent access to QUEST is handled through a built-in record locking mechanism. QUEST uses a subset of the SQL query language (IBM's recently announced relational query language).

- Interface to application software via high level calls
- User definable screen mask (up to 8 pages per record)
- Arithmetic expression evaluator to combine fields in formulas
- Conditional expression handling ("what if" processing on selected fields)
- Data entry range checking and password protection on selected fields
- Scan for records with partial information.
- Find records qualifying on any number of search criteria using relational and logical operators
- Sort records by as many as 15 key fields (ascending or descending)
- Join, select and project implementation to facilitate relational query processing
- Create, restructuring and recover utilities of files
- Complete interface to LOGICALC AND ASSET (SPI's accounting system)
- Report Generator lets user define report formats, headings, page footing, subtotals, level breaks. Built in arithmetic and logic processor enables the user to design very complex reports.

Only \$490.00

Other Programs which interface to Quest and Logicalc are available now:

- ASSET, SPI's Accounting System
- Medical Billing
- Boutique Management System
- School Management System

Software Products International



5482 COMPLEX STREET, SUITE 115
SAN DIEGO, CA 92123
PHONE (714) 268-4346

Visicalc is a registered trademark of
Personal Software, UCSD Pascal
is a registered trademark of
the Regents, University of California.

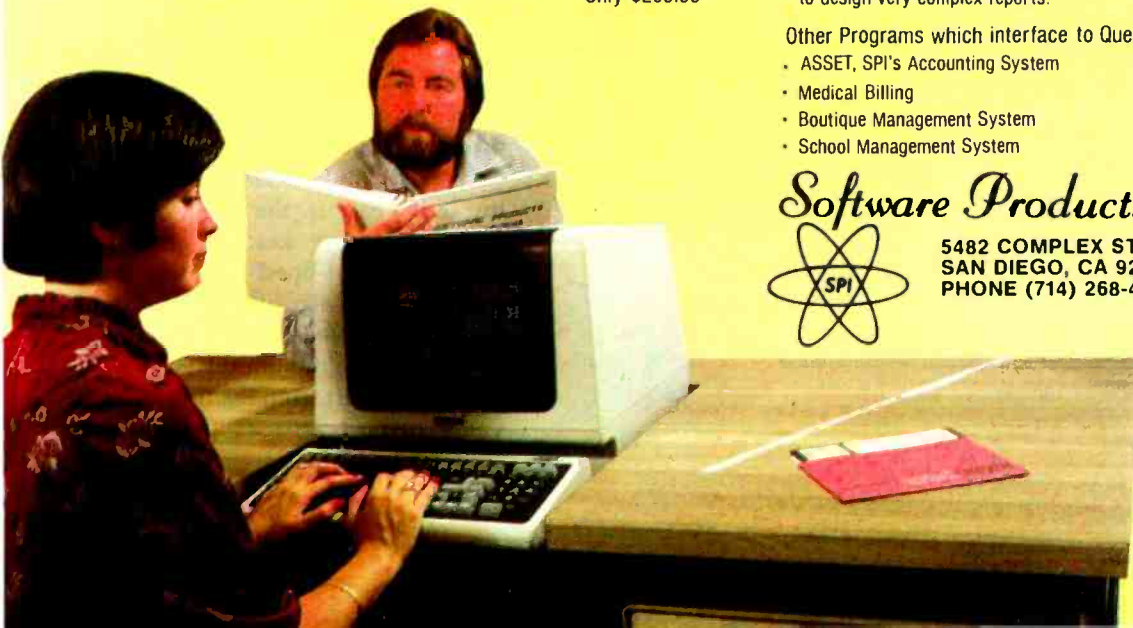

of nodes expanded within a certain range (levels 1-3 and 1-4, respectively), with the ratio of nodes expanded to the theoretically minimum number of nodes to be expanded being roughly 3:1 and 1:1, respectively. Third, this ratio progressively increases outside each algorithm's range of linearity; this implies that the maximum efficiency available from each algorithm decreases with the complexity of the puzzle—in other words, as the puzzle becomes more involved, the \hat{h} that is calculated drifts more and more from the theoretical h toward zero (ie: no information), and the algorithm breaks down (ie: approaches an exhaustive search).

A final observation is that the $(n,1)$ puzzles seem easier to solve than the $(n,3)$ puzzles. (Puzzles with the same last subscript are extensions of each other.) This trend is more obvious on comparison of the numbers in the "nodes closed" column in table 1b (which is a measure of the difficulty of the problem in that it is related to the number of nodes expanded in the attempt to find a solution). Note also that the nonlinear rise of the "nodes closed" column is greater for the $(n,3)$ puzzles than for the $(n,1)$ puzzles. This suggests that the behavior of an algorithm outside the range of linearity described above cannot be expressed by a simple nonlinear func-

tion, but only through a range of values that is highly sensitive to the individual puzzle under consideration.

Minimum-Distance Algorithm

The *minimum-distance algorithm* described here is the most efficient I have worked with—one that I have not been able to improve even when dropping the admissibility constraint. The algorithm (see listing 2) may be described as follows: for each piece in the puzzle (not including the "." piece), the value of the algorithm is increased by the number of rows plus the number of columns the piece is away from its final position in the goal state (ignoring any pieces in the way). For example, if the "1" piece is in row 2, column 3, then that piece is $(2-1) + (3-1) = 3$ squares away from its final goal position (row 1, column 1) and so adds 3 to the \hat{f} value of that puzzle. Table 2 shows the value of puzzle (6,1) using this algorithm.

Because the figure given to each piece is a conservative estimate of how many moves it will take to get that piece into place (it will be more if the other pieces get in the way), the \hat{f} calculated as the sum of these values must be a lower bound on the true cost f associated with a given puzzle; therefore, this minimum-distance algorithm is admissible.

Table 3 shows the result of using this algorithm on the puzzles in Table 1a, with comparison values given for the "out-of-place" algorithm. The results are far more pleasing than those of any algorithm that we have looked at—in fact, you might say this is the first algorithm of any practical use. The algorithm, like the "out-of-place" algorithm, is "perfect" through order 4 (although a counterexample may exist), but notice that the nonlinear increase in the "nodes closed" column is more gradual and more nearly straight-lined for the minimum-distance algorithm than it is for the "out-of-place" algorithm. Although the minimum-distance algorithm does drift from the theoretical h value toward zero as the problem complexity increases, it does so less severely than the "out-of-place" algo-

Listing 2: The minimum-distance algorithm. Listing 2a gives the algorithm in BASIC, to be inserted in the SEARCH program of Part 1; listing 2b is the structured pseudocode.

```
(2a)
9885 REM -----LISTING 2-----
9887 REM
9890 REM MINIMUM-DISTANCE
    REM ALGORITHM; ADMISSIBLE
9893 REM
9910 REM -----
9900 R1=0
9910 FOR I=1 TO R9: FOR J=1 TO R9
9915 Q=ASC (E$(I,J))
9920 IF Q=46 THEN GOTO 9960
9925 IF Q>64 THEN N=Q-55: GOTO 9935
9930 IF Q<=57 THEN N=Q-48
9935 I1=INT ((N-1)/R9)+1
9940 REM —GIVEN SQUARE N,
    REM 1<=N<=15, FIND
9941 REM (I1,J1)=POSITION OF N IN
    REM SOLVED PUZZLE
9945 J1=N-R9*(I1-1)
9950 REM —H-HAT IS SUM OF DISTANCES
    REM EACH SQUARE
9951 REM IS FROM GOAL POSITION; "."
    REM SQUARE NOT COUNTED
9955 R1=R1+ABS(I-I1)+ABS(J-J1)
9960 NEXT J: NEXT I
9965 RETURN
```

```
(2b)
9900 value of puzzle (R1)=0
9910 for each row I
    for each column J
9915 : Q=ASCII value of row I, column J of puzzle E$
9922 : if piece not "." (Q≠46)
    : : convert piece Q to "true" value N
9935 : : I1=row # of piece in goal node
9945 : : J1=column # of piece in goal node
9955 : : new value of puzzle = old value of puzzle +
    : : (difference of row values) + (difference
    : : of column values)
    : : endif
9960 : end of for-loop J
    end of for-loop I
9965 return
```

an Unheard of Price for the CPU/MEMORY You've Heard So Much About — CPU 8085/88 —

Speed, power, reliability: CPU 8085/88 has it all. **Speed?** Both processors run at 5 MHz to complete jobs faster and save you precious time; boards qualified under the CSC* high-reliability program run at 6 MHz, making CPU 8085/88 the fastest S-100 CPU in the business. **Bar none. Power?** No other existing product executes both 8 and 16 bit code with the speed and precision of CPU 8085/88. **Reliability?** While others are still struggling to catch up, we've been delivering CPU 8085/88 for well over a year. In fact, most major software houses are developing 16 bit code on CPU 8085/88 because it's fast, dependable, and reliable.

— RAM 17 —

No other static memory matches our unbeatable combination of high operating speed and ultra-low power consumption. CompuPro's innovative CMOS design techniques restrict current consumption to less than 2 Watts typical, while maintaining an operating speed (no wait states) in excess of 6 MHz. And, unlike some boards that provide only 23 address lines plus phantom or 24 address lines without phantom, RAM 17 gives you 24 address lines plus phantom so that you can take full advantage of the S-100 bus' extended addressing capability.

Both boards, which conform fully to all IEEE 696 S-100 standards and are backed by a 1 year limited warranty, normally list for \$1520... an exceptional value by any standard.

But to introduce you to the benefits of 8/16 bit operation on the S-100 bus, we are now offering both boards for an amazing

\$1220!

(For CSC boards, add \$200.)*

Save time, thanks to ultra-high speed operation; save hassles, thanks to our equalled record for reliability; and now, save money as well. We don't just give you a competitive edge: We do it at a price you can afford.

Call (415) 562-0636 for the name of the authorized CompuPro sales center nearest you, or for placing factory direct VISA/Mastercard orders (prices shown do not include tax or shipping charges).

CompuProTM

division

GODBOUL
ELECTRONICS

OAKLAND AIRPORT, CA 94614

(415) 562-0636

* Boards qualified under the Certified System Component high-reliability program undergo a 200-hour burn-in, extensive quality control testing, and are backed with an extended 2-year warranty.

rithm; this is because the minimum-distance algorithm is more informed than the other algorithm. Its better information is expressed in the generation of fewer erroneous nodes during the solution of a puzzle.

One aspect of table 3 is, however, misleading: the order-12, -14, and -16 puzzles show identical "nodes closed" values for two sets of puzzles that were earlier said to be unequal in complexity, which might suggest that the algorithm somehow minimizes the scatter effect caused by the different complexities of puzzles of the same order postulated earlier. This, however, is not the case: solution by the minimum-distance algorithm of a number of randomly selected order-12 puzzles reassured me that no such minimizing effect was taking place; the values in "nodes closed" for these puzzles were 12, 13, 14, 14, 18, 20, and >20 (this last value was the result of the computer running out of memory).

Although the minimum-distance algorithm is usually reliable, there is at least one type of problem that renders it virtually useless. An example of one such puzzle is given in figure 2, and an analysis of the algorithm's inability to solve it gives us a clue toward the construction of a more powerful admissible algorithm. Although the algorithm gives this puzzle a value of four, I have not been able to find a solution (by hand) of under sixteen moves, and the first fifty nodes of the tree, generated by this algorithm before my computer ran out of memory, show no appreciable gain toward the goal node. In fact, after generating nodes 37 through 40, at level 10 (see figure 2), the algorithm abandons them to expand nodes of levels 2 through 4, clearly indicating that the algorithm has found the nodes on levels 6 through 10 to be unpromising. Although I have failed to find an admissible algorithm that performs better with this puzzle, I am sure that such an algorithm will have to take into account the extra number of moves that pairs of pieces in each other's "home" positions (here, the "5" and "6" and the "7" and "8") generate.

Nonadmissible Algorithms:

Theory

Comparatively little is known about the performance of nonadmissible algorithms—that is, algorithms

whose returned value \hat{h} is not necessarily a lower bound on the true cost of a solution h . This is because no common feature (in terms of the algorithm's goal-finding performance)

| (a) Puzzle | (b) Goal Node | (c) Breakdown of Moves | |
|---------------|------------------|---------------------------------|-----|
| 1 2 3 | 1 2 3 | pieces 1,2,3,6,8 in place | = 0 |
| 7 4 6 | 4 5 6 | piece 4 is 0 rows, 1 column off | = 1 |
| 5 8 | 7 8 | piece 5 is 1 row, 1 column off | = 2 |
| | | piece 7 is 1 row, 0 columns off | = 1 |
| | | f value of puzzle | = 4 |

Table 2: Evaluation of puzzle (6,1) by the minimum-distance algorithm. This algorithm sums the distance each piece is from its final position (the goal node) to arrive at an estimate of the number of moves to solution. Column (a) is the problem posed in puzzle (6,1); column (b) is the goal node; column (c) gives each piece's contribution to the total number of moves to solve the puzzle (the "." piece, which represents the blank, is not included in the evaluation).

| Puzzle | "Out-of-Place" | | Minimum Distance | |
|--------|----------------|-------|------------------|-------|
| | Nodes Closed | Total | Nodes Closed | Total |
| (1,1) | 1 | 4 | 1 | 4 |
| (2,1) | 2 | 7 | 2 | 7 |
| (2,3) | 2 | 5 | 2 | 5 |
| (3,1) | 3 | 9 | 3 | 9 |
| (3,3) | 3 | 7 | 3 | 7 |
| (4,1) | 4 | 10 | 4 | 10 |
| (4,3) | 4 | 10 | 4 | 10 |
| (5,1) | 7 | 16 | 6 | 13 |
| (5,3) | 6 | 13 | 5 | 12 |
| (6,1) | 9 | 21 | 7 | 15 |
| (6,3) | 13 | 26 | 7 | 15 |
| (7,1) | 10 | 23 | 7 | 15 |
| (7,3) | 17 | 34 | 7 | 15 |
| (8,1) | 11 | 25 | 8 | 18 |
| (8,3) | 26 | 51 | 10 | 21 |
| (10,1) | 13 | 27 | 10 | 21 |
| (10,3) | | *OM* | 12 | 24 |
| (12,1) | 20 | 40 | 14 | 29 |
| (12,3) | | *OM* | 14 | 29 |
| (14,1) | | *OM* | 16 | 32 |
| (14,3) | | *OM* | 16 | 32 |
| (16,1) | | *OM* | 18 | 35 |
| (16,3) | | *OM* | 18 | 35 |
| (18,1) | | *OM* | 20 | 40 |
| (18,3) | | *OM* | | *OM* |

Table 3: Comparison of the "out-of-place" algorithm with the minimum-distance algorithm for selected problems.

OKIDATA

Announcing the 80-column Model 82A and 136-column 83A quality Microline printers. Quiet. Long lasting. Exceptional print quality.

- 120 cps
- 9-pin head for true descenders (one year warranty)
- Bidirectional, logic seeking
- Graphics
- Parallel and serial interfaces—standard
- Friction, pin head, and tractor feeds
- All points addressable graphics
- And much more

From Okidata. The company that stands out. Apart from the rest. For more information on Okidata's incomparable line of printers contact us at 111 Gaither Drive, Mt. Laurel, NJ 08054, (609) 235-2600. Also available through authorized dealers.

Making small printers for people who think big.

Okidata is a subsidiary of Oki Electric Industry Company Ltd.

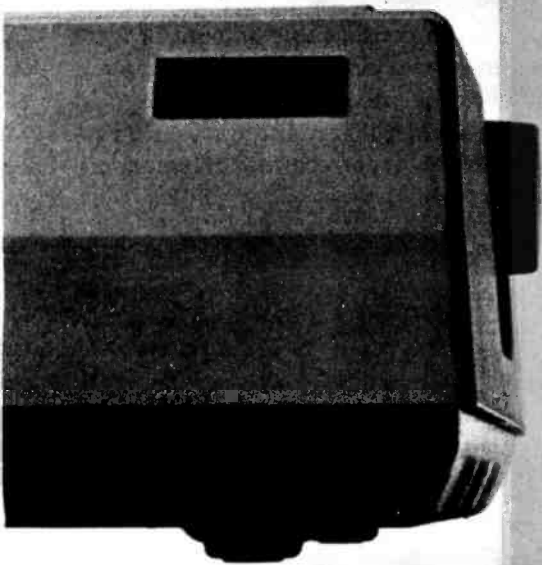

that applies to nonadmissible algorithms as a class has been found: a given nonadmissible algorithm, compared to a good admissible one, may perform anywhere in the range of consistently better to consistently worse. In fact, it is possible to devise a nonadmissible algorithm that is worse than a "no-information" breadth-first search.

In any case, two characteristics of a nonadmissible algorithm follow from its failure to meet the conditions of admissibility. One is that it is not guaranteed to find a goal node; the other is that a goal node found by a

Listing 3: Modification needed to derive the algorithm NA-I (nonadmissible algorithm 1). This modification to the BASIC code in listing 2 delivers misinformation to the SEARCH program, rendering it incapable of solving even the simplest puzzles.

```

9890 REM -----LISTING 3-----
9891 REM
9894 REM ALGORITHM NA - I;
      NONADMISSIBLE
9896 REM INSTRUCTIONS: ADD THIS
      CODE TO LISTING 2
9897 REM (THE MINIMUM-DISTANCE
      ALGORITHM)
9898 REM
9899 REM -----
9961 REM
9962 L1 = 100 - R1
]
]

```

Listing 4: Modification needed to derive the algorithm NA-II (nonadmissible algorithm 2). This modification to the BASIC code in listing 2 consistently performs as well as, or better than, the minimum-distance algorithm. Since the algorithm is nonadmissible, the performance is not guaranteed.

```

9890 REM -----LISTING 4-----
9891 REM
9892 REM ALGORITHM NA - II;
      NONADMISSIBLE
9895 REM
9896 REM INSTRUCTIONS: ADD THIS
      CODE TO LISTING 2
9898 REM
9899 REM -----
9954 REM
9955 I9 = ABS (I - I1); J9 = ABS
      (J - J1); R1 = R1 + I9 + J9
9957 IF I9 > 0 AND J9 > 0 THEN R1 = R1 + 1

```

nonadmissible algorithm may not be an *optimal* goal node (ie: there may exist another, shorter, path to the same node). These are serious but not insurmountable defects when considered in conjunction with a real-work problem because, in the first place, a given algorithm will not be used unless it has a history of solving similar problems. (Nonadmissible algorithms are devised by a process of trial and error, and the only measure of a given algorithm's effectiveness is its ability to produce solutions to problems of a similar complexity whose solutions are already known.) In the second place, the production of an optimal node may not be as important as the production of some goal node, optimal or otherwise.

(Other methods may be used in conjunction with or in place of nonadmissible algorithms to produce a goal node. All these methods sacrifice the guarantee of finding a goal node by economizing on the number of intermediate nodes saved. Successors can be pruned from memory either when they are generated or when memory is filled; or, in a completely different approach, a depth-first search of a given maximum depth sweeps across the tree, storing only the best node encountered thus far.)

Some Examples

An example of a *bad* nonadmissible algorithm is easy to generate: simply subtract the value calculated by the minimum-distance algorithm (which is a good algorithm) from an arbitrarily large number. This results in an algorithm that assigns a high number to a node close to a goal node (making it one of the last to be expanded) and a lower number to a node that is further away from a goal node; see algorithm NA-I, given in listing 3. The algorithm, when run with a problem of order 2 or greater, will fill up almost any computer's memory without producing a solution because this algorithm will expand a "good" node only after it has expanded every worse node in the problem tree. At fifty nodes (my computer's limit) on problem (2,1), the algorithm was much further away from a solution than when it started.

On the other hand, an example of a *good* nonadmissible algorithm—in this case, one that performs better than the minimum-distance algorithm—is much harder to find. In fact, a considerable amount of work in several directions yielded only one positive result. The algorithm, labeled NA-II (see listing 4), is an attempt to correct the minimum-dis-

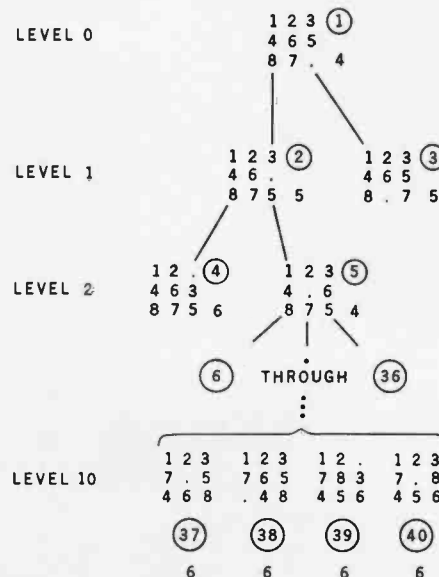

Figure 2: A sample problem that is poorly handled by the minimum-distance algorithm. Although the algorithm predicted four moves to solve the puzzle, the computer ran out of memory before solving it. The circled number by each node indicates the order in which the nodes were generated; the numbers not circled are the *f* values predicted by the algorithm.

Pure Computing Power



The MicroFrame® is **Pure Power** for computing. It is the industry standard for high quality, reliable S-100 mainframes.

TEI manufactures each MicroFrame® with great care. They deliver pure regulated power at the proper level, improving the reliability of your computer. Typically, the output voltages remain virtually constant, even when the power line voltage varies widely. The MicroFrame® will never notice a brown-out . . . and it provides 100 db noise rejection, protecting your computer from power line voltage spikes and noise. Complies with I-EEE S-100.

The combination of the lowest noise bus, a regulated power system and a rugged chassis produces a MicroFrame® without equal.

Distributor and OEM Inquiries Invited

For more information, call Rick Barnes at (713) 738-2300



5075 S. LOOP EAST, HOUSTON, TX. 77033
(713)738-2300 TWX. 910-881-3639

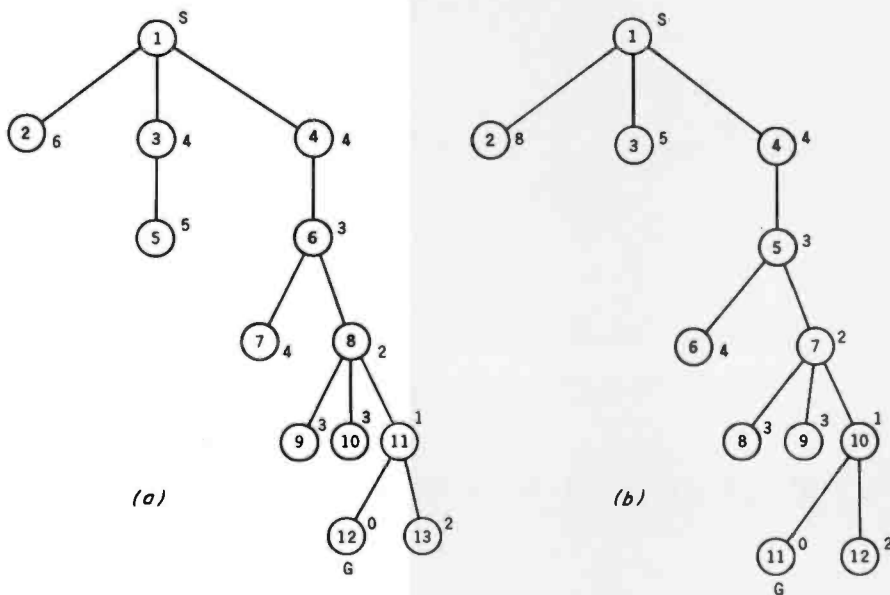

Figure 3: Expansion of puzzle (5,1) by the minimum-distance algorithm (figure 3a) and NA-II (figure 3b). The numbers inside each node denote the order in which they were generated; the numbers not circled are the estimated f values generated by each algorithm. In this case, the nonadmissible algorithm performs slightly better.

tance algorithm for harder problems by adding 1 to the original value for each node that is at least one row and one column away from its position in the goal node. Only two puzzles out of the entire set did better than the minimum-distance algorithm (see table 2), but the rest matched it, making NA-II a slightly better algorithm.

Figures 3a and 3b show the expansion of problem (5,1) by the minimum-distance and NA-II algorithms, respectively, as well as the order in which they were expanded and the calculated \hat{h} estimate by each algorithm. Note that NA-II made the right decision in not expanding node 3, whereas the minimum distance algorithm underestimated the cost of node 3 (whose true cost is 5) and unnecessarily evaluated it. So we see that NA-II, at least in this case, is better than the minimum-distance algorithm because it is less likely to underestimate the value of a node (something that an admissible algorithm tends to do). As an extension of that, however, we confirm that this algorithm is nonadmissible because it sometimes overestimates the value of a node (something that an admissible algorithm cannot do). An example of an overestimated node is node 2 in figure 3b; its true value is 6, but it was estimated at 8 by algorithm NA-II.

Observations and Questions

- The word "cost," up to this point, has only been used to refer to the numeric value associated with the shortest path from the node to the closest goal node. But it has two new and significant meanings when referring to the cost of a solution. One index of the cost of a solution is the number of nodes closed (ie: expanded) by the algorithm—this is the measure we have looked at when comparing the efficiency of two algorithms. But another factor must be considered when either speed or money (as expressed in computer time) is a factor. That factor is the complexity of the evaluating algorithm giving \hat{h} . A more-informed algorithm may generate fewer nodes but may take considerably more computer time to do it. If speed or money

Glossary

- Closed node:** a node whose successors have already been calculated.
- Cost (or value):** a numeric value associated with the shortest path from the start node S to the current node n ; the cost of the first goal node found will have some meaning within the problem being solved.
- Depth:** the number of nodes a given node is away from the start node S .
- Expand:** to calculate all legal successors of the current node.
- Goal node:** any node satisfying the set of conditions defined as the desired final state of the problem.
- Node:** an element of a tree used to represent a given state of the problem.
- Open node:** a node that has not yet been chosen for expansion.
- Ordering algorithm:** a formula or procedure generating an ordering value that represents the node's relative likelihood of being chosen for expansion; the node with the lowest ordering value will be expanded next.
- Problem tree (or tree):** a graphic representation of the problem space (or state space) using dots to represent states, and lines connecting dots to represent the transition from one state to the next; all nodes must be generated from one start node S that represents the beginning state of the problem.
- State:** a specific set of values for the variables that define the problem.
- State-space representation:** a breakdown of the problem into the following components: the state variables that can describe the problem in any of its possible configurations; the operators that generate the next set of values (or states) for the problem given the current set (or state); a beginning state S ; and a description (not necessarily exact) of the goal node to be found.
- Successors:** those nodes representing all valid "next states" for a given node (or state) as defined by the operators of the state-space representation; the node generating the successor nodes is called the parent node.

DON'T WRECK YOUR SYSTEM



**FOR THE FIRST TIME
A BOOK THAT
TELLS ALL THE
DO'S AND DON'TS
FOR COMPUTER
USERS...
SIMPLE,
EASY-TO-READ,
FULLY
ILLUSTRATED**



DID YOU KNOW THAT...

- Most computers require *two* ground lines—a neutral one and a safety ground?
- A telephone ringing on your disk drive may wipe out your diskettes?
- Disks and diskettes must equalize temperature prior to use?
- Most computer breakdowns are due to faulty diskette handling?
- A radio transmitter will disrupt computer operation?

That computer you're using represents a lot of money, a lot of time—both that spent in purchasing just the right one and the time it will save doing the tasks it was made for—and a big investment in your future.

DON'T (Or How to Care For Your Computer), by Rodnay Zaks, is the first book exclusively dedicated to the care, preservation and correct operation of a small computer system: the computer itself, the CRT terminal, the printer, the magnetic disks and tapes—even the computer room.

PLEASE SEND ME **DON'T, (Or How to Care For Your Computer)**
by Rodnay Zaks 200 pp., 100 Illustr., 8" X 9" Ref. C400, \$11.95

MAIL TO: SYBEX DEPT. B101

2344 SIXTH STREET
BERKELEY,
CA 94710
PHONE ORDERS:
INSIDE CA
415/848-8233 OUTSIDE CA
TOLL FREE 800-227-2348

NAME _____ SEND ME YOUR FREE CATALOG
ADDRESS _____
CITY _____ STATE _____ ZIP _____
ADD \$1.50/book UPS or 75¢/book 4th class mail or \$8/book overseas airmail (CA add tax)
Total Amt. Enclosed _____ OR CHARGE MY VISA MC AM EX. CARD NO.
EXP. DATE _____ SIGNATURE _____

becomes a critical factor before the amount of available memory does, it is possible that the user will decide to use the less-informed algorithm.

•(Question 1) How does a heuristic algorithm assist the tree-searching process? (See the textbox "Answers," which appears on page 212.)

•(Question 2) In the description of the minimum-distance algorithm, the "space" square was not included in the summing of "distances from home place." If this were done, would the algorithm be more powerful? Less? Would it still be admissible?

•Is the tree in figure 4 possible if the algorithm is admissible? Yes, but only if the algorithm is mistaken about the estimated value of one of the open

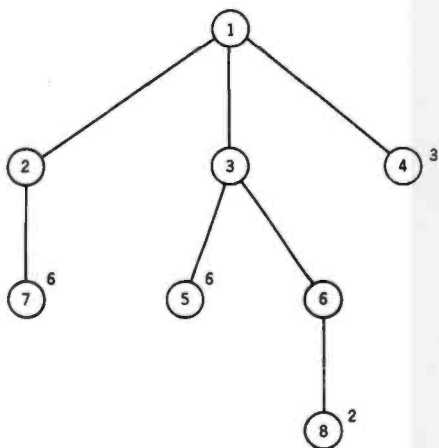

Figure 4: A hypothetical partially expanded tree, used for visualizing questions posed in the text.

nodes (4, 5, 7, and 8). For example, if the optimal goal node is three nodes away from node 4, then the successors of node 8 (or, at the latest, their successors) must all come up with \hat{h} values greater than three so that node 4 will be expanded next. An admissible algorithm will always reach the closest goal node first.

•Is this tree possible if the algorithm is nonadmissible? Yes, a nonadmissible algorithm puts no restrictions on the validity of this tree.

•(Question 3) Remember the meaning of f , g , and \hat{h} : $f(n)$ is the estimated distance from start node S through node n to the closest goal node; $g(n)$ and $\hat{h}(n)$ are the estimated distances from S to n and from n to the same goal node, respectively. Isn't the tree in figure 4 a good argument for using f instead of \hat{h} to order the expansion of nodes?

•(Question 4) The minimum-distance algorithm has been the best algorithm we have seen for the 8- and 15-puzzle. Try adding the line

$$9963 \quad R1=R1 * F9$$

to the \hat{h} -calculating subroutine at 9900. This will increase the \hat{h} value to nodes that were formerly underestimated by the admissible algorithm. The algorithm will now be nonadmissible, but will it also be more "piercing"? Try $F9=1.01, 1.1, 1.5$ (and other values), and test the new algo-

rithm on puzzles of eight moves or more.

•(Question 5) Why is the nonadmissible algorithm NA-I a worse algorithm than the breadth-first search? Isn't an exhaustive search, which uses no heuristic information, the most inefficient search possible?

•As mentioned before, certain modifications to the method of searching may be desirable over the use of a nonadmissible algorithm. In certain situations, the judicious application of one of these methods may be more productive in finding a goal node than the "pure" methods described in this article.

Conclusions

This article has dealt with the searching of state-space trees and graphs. Other kinds of trees (AND/OR trees and game trees, to name two) are used in theorem proving and game playing, and a number of other questions can be raised.

For example, how can we evaluate nonadmissible algorithms? What modifications should we make when we have a limited amount of memory? While I have discovered that x amount of artificial intelligence in a program requires at least " x cubed" amount of work, if not more, I hope that this article will prompt more people to look into (and write about) this interesting branch of artificial intelligence. ■

ACT-85 THE CP/M* TERMINAL WITH BUILT IN LOCAL NETWORK

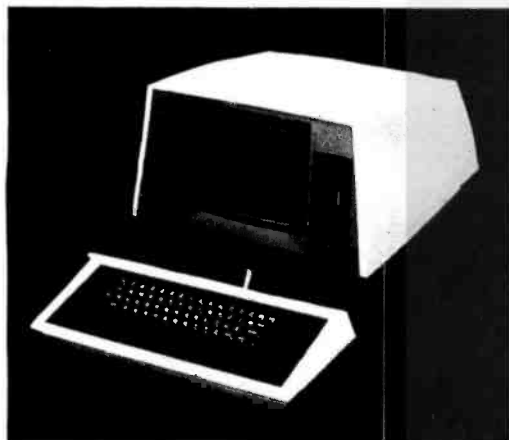

*CP/M is a registered trademark of Digital Research

| NETWORK | MONITOR | MASS STORAGE | COMPUTER |
|--|--|--|--|
| <ul style="list-style-type: none"> access to all printers and disks from any terminal CP/M* runs in each terminal single twisted shielded pair up to 1500 feet 880,000 baud SDLC protocol 32 terminals per line | <ul style="list-style-type: none"> 12" monitor 24 lines of 80 characters reverse video highlighting blinking underlining separate keyboard 38,400 baud effective speed | <ul style="list-style-type: none"> 0 to 4 drives in each terminal: <p>FLOPPIES SHUGART 400, 410, 450 460, 801, 851</p> <p>WINCHESTERS SEAGATE ST506 ST512</p> | <ul style="list-style-type: none"> 8085 cpu 10 mhz crystal 64 K ram two RS-232 ports |

INTRODUCTORY PRICING

| | |
|------------------------|-----------|
| PLAIN TERMINAL | \$1390.00 |
| WITH 1 SA400 | \$1890.00 |
| WITH 1 SA400 & 1 ST506 | \$4400.00 |

autocontrol
INCORPORATED

11744 Westline Ind. Dr.
St. Louis, MO 63141
(314) 432-1313

THE LAST MEMORY

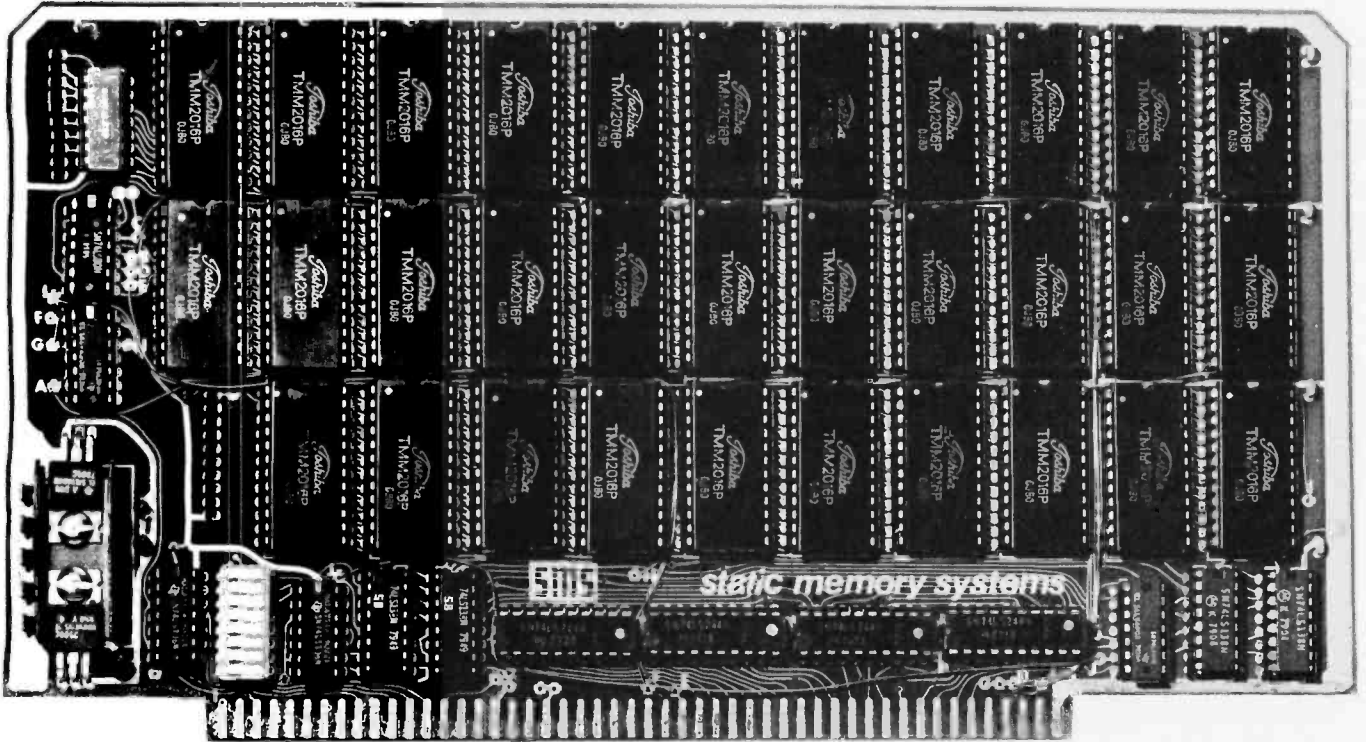

64K STATIC RAM/EPROM BOARD

At last a 64K *STATIC* memory board for S100 systems. But it's not just a 64K static RAM board, *EPROM's* can also be intermixed with RAM making it the only memory board needed for S100 systems. That's why we call it **THE LAST MEMORY**.

- **64K DENSITY**

THE LAST MEMORY uses the new 2016 byte-wide 16K static RAM to achieve a board density twice that possible with old 2114 static memories.

- **2716 EPROM COMPATIBLE**

A separate board is no longer required for EPROM's containing monitors, bootstrap loaders, etc. 2716 EPROM's can be inserted into the board without modification.

- **SIMPLE ADDRESS DECODING**

Where memory is required, just plug a RAM or EPROM in the corresponding socket. Empty memory sockets occupy no memory space, providing compatibility with memory mapped I/O devices.

- **EXTENDED ADDRESSING**

THE LAST MEMORY includes the IEEE S100 extended addresses. These are fully decoded allowing expansion to a full 16 megabyte system memory.

- **FAST**

The standard board allows 4 MHz operation.

- **LOW POWER**

Only one memory IC is ever active in byte-wide memory systems. The result is far less power consumption than older 16K static memory boards.

- **LOW COST**

Its best feature is the price:

| | Kit | A&T |
|----------------|--------|--------|
| RAM-less Board | 99.99 | 139.99 |
| 16K RAM | 249.99 | 289.99 |
| 32K RAM | 389.99 | 429.99 |
| 48K RAM | 519.99 | 559.99 |
| 64K RAM | 639.99 | 679.99 |



static memory systems

15 So. Van Buren Ave.

Suite 209

Freeport, Illinois 61032

(815) 235-8713



Answers

1. A heuristic algorithm assists the tree-searching process using information in the current state (that is, in the current node, without looking at its relationship to any other node but the goal node) to assess the relative likelihood of that node leading to a solution. More likely nodes receive a lower value than less likely nodes, so the controlling program, in choosing to expand next the node with the lowest ordering value, is choosing the node most likely to lead to the shortest solution.

2. This variation of the minimum-distance algorithm is slightly less powerful, primarily because it is no longer admissible. The puzzle

```
1 2 3
4 5 6
7 . 8
```

is a simple counterexample. Since both the "." piece and the "8" piece are one square away from their positions in the

goal state, this algorithm would return the value 2. However, since the true solution value is 1, this one counterexample is enough to show that the algorithm is nonadmissible.

3. If the algorithm used is admissible, the use of h guarantees finding the closest goal node—this is mathematically unarguable. But if the algorithm is nonadmissible and, at the same time, relatively accurate, the use of

$$f(n) = g(n) + h(n)$$

may be a good idea indeed. If the estimate h costs in figure 4 are accurate relative to each other, then

$$\begin{aligned} f(\text{node 4}) &= 1 + h(\text{node 4}) \\ &= 1 + 3 = 4 \\ f(\text{node 8}) &= 3 + h(\text{node 8}) \\ &= 3 + 2 = 5 \end{aligned}$$

may rightly cause node 4 to be expanded first.

4. The results for this new algorithm

will be identical to those of the minimum-distance algorithm, even though the new algorithm may be nonadmissible. Multiplying the results by a constant will change the values of the nodes but not the ordering of the nodes to each other. On the other hand, adding

9963 if $R1 > F8$ THEN $R1 = R1 + F9$

or

9963 IF $R1 < F8$ THEN $R1 = R1 + F9$

will change the relationship of the nodes to each other. Experiment with these for various values of $F8$ and $F9$; a suggested starting value for $F8$ is 4.

5. No. Misinformation is worse than no information at all, and that is what NA-I is giving. In assigning high values to nodes that should be low, and vice versa, this algorithm is forcing the driving program to always expand the least promising node first.

6809 COLOR COMPUTER

EDITOR, ASSEMBLER AND MORE!

NEW!

SOFTWARE DEVELOPMENT SYSTEM

The Micro Works Software Development System (SDS80C) is a complete 6809 editor, assembler and monitor package contained in one Color Computer program pack! Vastly superior to RAM-based assemblers/editors, the SDS80C is non-volatile, meaning that if your application program bombs, it can't destroy your editor/assembler. Plus it leaves almost all of 16K or 32K RAM free for your program. Since all three programs, editor, assembler and monitor are co-resident, we eliminate tedious program loading when going back and forth from editing to assembly and debugging!

The powerful screen-oriented Editor features finds, changes, moves, copies and much more. All keys have convenient auto repeat (typamatic), and since no line numbers are required, the full width of the screen may be used to generate well commented code.

The Assembler features all of the following: complete 6809 instruction set; complete 6800 set supported for cross-assembly; conditional assembly; local labels; assembly to cassette tape or to memory; listing to screen or printer; and mnemonic error codes instead of numbers.

The versatile ABUG monitor is a compact version of CBUG, tailored for debugging programs generated by the Assembler and Editor. It features examine/change of memory or registers, cassette load and save, breakpoints and more. **SDS80C Price: \$89.95**



CRACK THOSE ROMS!

SOURCE GENERATOR: This package is a disassembler which runs on the color computer and generates your own source listing of the BASIC interpreter ROM. Also included is a documentation package which gives useful ROM entry points, complete memory map, I/O hardware details and more. A 16K system is required for the use of this cassette. **80C Disassembler Price: \$49.95**

CBUG IS HERE!

MONITOR TAPE: A cassette tape which allows you to directly access memory, I/O and registers with a formatted hex display. Great for machine language programming, debugging and learning. It can also send/receive RS232 at up to 9600 baud, including host system download/upload. 19 commands in all. Relocatable and reentrant. **CBUG Tape Price: \$29.95**

MONITOR ROM: The same program as above, supplied in 2716 EPROM. This allows you to use the entire RAM space. And you don't need to re-load the monitor each time you use it. The EPROM plugs into the Extended Basic ROM Socket or a modified ROMPACK. **CBUG ROM Price: \$39.95**

LEARN 6809!

6809 ASSEMBLY LANGUAGE PROGRAMMING, by Lance Leventhal, contains the most comprehensive reference material available for programming your Color Computer. **Price: \$16.95**

PARALLEL O!

USE A PARALLEL PRINTER with your Color Computer! Adaptor box plugs into the serial port and allows use of Centronics/Radio Shack compatible printers with parallel interface. Assembled and tested. **PI80C Price: \$69.96**

32K RAM!

MEMORY UPGRADE KITS: Consisting of 4116 200ns. integrated circuits, with instructions for installation. **4K-16K Kit Price: \$39.95. 16K-32K Kit (requires soldering experience) Price: \$39.95**

THE **MICRO WORKS**



GOOD STUFF!

WE SHIP FROM STOCK!

Master Charge/Visa and COD Accepted

P.O. BOX 1110 DEL MAR, CA 92014 714-942-2400

T/Maker II:™ it does a number on VisiCalc!™

VisiCalc is a fine aid for the computation of numerical problems. But it does have two major limitations: it is available only for a small number of systems, and its use is limited strictly to numbers, not words. To overcome these substantial limitations, Lifeboat Associates introduces T/Maker II.

Unlike VisiCalc, T/Maker II is designed to run on most small business computers with CP/M® or similar operating systems and a video terminal with cursor addressing capabilities. And soon there will be T/Maker II versions available for UNIX,™ RT-II™ and other systems.

Works with words as well as numbers. Like VisiCalc, T/Maker II reduces the manual tasks involved in computing and calculating financial documents. But since most business problems and reports involve words as well as numbers, T/Maker II also functions as a full-screen text editor for word processing.

T/Maker II is the most advanced aid for the analysis and presentation of numerical data and text material. In a matter of minutes, an entire document—including all edited text, all figures and all calculations—can be created, reviewed on your screen and reported in printed form.

T/Maker II turns your small business computer into a powerful, sophisticated and convenient tool. A tool that will save you money, time and energy, and eliminate the need for costly time-sharing.

With T/Maker II you can easily perform an unlimited number of analytical and reporting tasks which integrate numerical and text processing. You'll find T/Maker II perfect for such things as:

- Financial Statements
- Statistics
- Profitability Reports
- Revenue and Expense Analyses
- Portfolio Evaluations
- Price Lists
- Rate Structures
- Expense Accounts
- Cash Flow Projections
- Checking Account Reconciliations

... and much, much more.

Easy to learn and use. You don't have to be a programmer to operate T/Maker II. Just follow T/Maker II's easily understood and ordered instructions, set up your data in

rows and columns, define the relationships and T/Maker II will do the rest: it will perform the computations and formatting necessary to prepare your document. When you're finished you can analyze your report on your screen or store it on a diskette. Or, you can have the report printed with presentation quality.

And when any changes have to be made, simply enter the new figure or relationship and tell T/Maker II to adjust and recalculate all the new results.

Editing capabilities. As a full-screen editor for word processing, T/Maker II handles text up to 255 characters wide. It includes features like text formatting and justification, centered titles, a text buffer for block moves and repeated inserts, global search and replace commands for printing your letters, reports and documents. Wide documents are supported by horizontal scrolling.

Low cost. The cost of T/Maker II is only \$275 plus shipping and handling. Dollars well spent once you consider all the time, energy and money it can save. T/Maker II is brought to you exclusively and supported completely by Lifeboat Associates, world's largest computer software publisher. For more information send us the coupon below.

Mail coupon to: Lifeboat Associates,
1651 Third Ave., NY, NY 10028. Or call (212) 860-0300.

Please send me more information on T/Maker II.

Please send me a free Lifeboat Catalog featuring over 200 programs, including integrated accounting and professional practice systems, office tools for bookkeepers and secretaries and sophisticated tools for programmers. 2012

Name _____
Title _____
Company _____
Street _____
City _____
State _____ Zip _____

T/Maker II is a trademark of P. Roizen. Personal Software, Inc. UNIX is a trademark of Digital Research. CP/M is a trademark of Digital Research. RT-II is a trademark of Digital Equipment Corp.

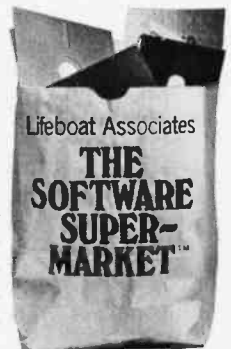

As an example of what T/Maker II can do, see the chart below. The operator entered only the data shown in boldface. T/Maker II calculated and reported all the other values.

| | — Actual — | | | Growth Rate | Total Average | Total (000's) | — Projected — | | |
|--------|---------------|---------------|---------------|-------------|---------------|---------------|---------------|---------|---------|
| | 1978 | 1979 | 1980 | | | | 1981 | 1982 * | 1985 |
| Item A | 42,323 | 51,891 | 65,123 | 24.04 | 53,112 | 159.34 | 80,782 | 100,206 | 191,262 |
| Item B | 45,671 | 46,128 | 49,088 | 3.67 | 46,962 | 140.89 | 50,891 | 52,761 | 58,791 |
| Total | 87,994 | 98,019 | 114,211 | 13.93 | 100,075 | 300.22 | 131,673 | 152,966 | 250,053 |
| % Item | 48.10 | 52.94 | 57.02 | 8.88 | 52.69 | 158.1 | 61.35 | 65.51 | 76.49 |
| % Item | 51.90 | 47.06 | 42.98 | -9.00 | 47.31 | 141.9 | 38.65 | 34.49 | 23.51 |
| Total | 100.00 | 100.00 | 100.00 | — | 100.00 | 300.0 | 100.00 | 100.00 | 100.00 |

*Two intervening years not shown.

LIFEBOAT WORLDWIDE offers you the world's largest library of software. Contact your nearest dealer or Lifeboat:

Lifeboat Associates
1651 Third Ave.
New York, N.Y. 10028
Tel: (212) 860-0300
Telex: 640693 (LBSOFT NYK)
TWX: 710-581-2524

Lifeboat Inc.
Ok Bldg., 5F
1-2-8, Shiba-Daimon
Minato-Ku, Tokyo 105, Japan
Tel: 03-437-3901
Telex: 2423296 (LBJTYO)

Lifeboat Associates, Ltd.
PO Box 125
London WC2H 9LU, England
Tel: 01-836-9028
Telex: 893709 (LBSOFTG)

Lifeboat Associates GmbH
PO Box 168, Aegerstrasse 35
CH 6340 Basel, Switzerland
Tel: 042-31-2931
Telex: 865265 (MICO CH)

Intersoft GmbH
Schlossgartenweg 5
D-8045 Ismaning, W. Germany
Tel: 089-966-444
Telex: 5213643 (ISOFD)

Lifeboat Associates, SARL
10, Grande Rue, Charles de Gaulle
92600 Asnières, France
Tel: 1-733-08-04
Telex: 250303 (PUBLIC X PARIS)

Lifeboat Associates
Software with full support

Drawing with UCSD Pascal and the Hiplot Plotter

Dr James Stork
Humbolt State University
Humbolt Bay Project
Arcata CA 95521

In the course of my work for the University of California Sea Grant program, I have needed to plot oceanographic data on a Houston Instrument Hiplot plotter. Because my operating system is exclusively UCSD Pascal, I have developed routines using that system. I have been completely satisfied with this system and would recommend it to anyone who intends to develop serious microcomputer software beyond the level of simple computer games.

The plotter software shown in the listings demonstrates at least two facilities of the UCSD Pascal system that I have found very useful. These are the ability to easily link an external machine-language subroutine to any Pascal program, and to store a library of often-used units and procedures in the system's library.

The "plotter" Unit

The main unit, called "plotter", is

About the Author

Jim Stork, a research oceanographer, has been "a confirmed computer freak" since the beginning of the microprocessor industry. Recently he has been using a Z80-based microcomputer to do data acquisition and analysis for a computer modeling study of Humbolt Bay.

given in listing 1. Those of you who are familiar with the Pascal language will notice that the normal program heading is absent, and in its place is the declaration "unit plotter;" rather

**Once a unit is written,
compiled, and stored in
the system library, it
can be used by any
Pascal program
through the "uses"
statement.**

than "program plotter;". This is to inform the compiler that the procedures contained in this unit are meant to be linked to another "using" program and are not run alone.

The interface section in listing 1 tells the linker that the following declarations (one type and six procedures) may be used by the program that is linked to the unit. The implementation section variables and procedures are to be used solely in the implementation of the unit and are not to be available to the program using the unit. For example, the procedure "plotstep" cannot be used by the program using the unit (since it is not named in the interface section of

the unit), while the procedure "plotline" can be used.

Once a unit is written, compiled, and stored in the system library, it can be used by any Pascal program by including the statement "uses xxxxx;" after the program heading of the using program (assuming the unit is named "xxxxx" in the library; see the example in listing 2). When the main program is compiled and run, the linker will link the unit into the using program and will link the procedure "plotstep" (which is external to "plotter") into the "plotter" unit.

It is important to note here that "plotstep" is not linked to the "plotter" unit before it is stored in the system library. Both the unit and the external procedure "plotstep" are stored in the system library in their compiled and assembled versions, respectively. The linking of one to the other is done when the linker links them into the using program. (This little piece of knowledge is not mentioned anywhere in the UCSD Pascal manual, and it caused me a considerable amount of grief until I called Softech to get myself back on the right path. The people at Softech have given me a great amount of help above and beyond the call of duty; although their documentation might be less than complete, their helpful attitude with problem calls leaves nothing to be desired.)

The One Printer Solution for the Two Printer Problem.



HIGH SPEED DATA PROCESSING

The new Dual-Mode 200 brings speed and uncompromising print quality to business and professional applications.

Financial statements, inventory reports, labels and more are printed at data processing speeds from 165 cps to 250 cps.

Fully adjustable tractors and a friction feed platen provide precise forms handling for pin-feed and single sheet paper.

Complete "Dot Control" graphics is standard with resolution to 120 x 144 dots per inch.

Interfacing is easy with both E.I.A. RS-232C serial and an ASCII parallel port.

LETTER QUALITY WORD PROCESSING

The Dual-Mode 200 also features letter perfect print you will be proud to use for business letters and reports. Letter Mode speeds range from 42 cps to 60 cps.

The standard Titan 10 pitch font is complemented by an array of optional fonts including Elite 12 pitch, italics, proportionally spaced, OCR-A, scientific and foreign character sets.

Up to 12 font selections may be stored in the printer and interchanged while printing.

The Dual-Mode 200 accepts standard daisy-wheel print commands for word processing system compatibility.

It's the perfect solution for the two printer problem.

The Dual-Mode 200 Printer for the one printer office.

Call or write today for complete specifications

2301 Townsgate Road, Westlake Village, CA 91361, (805) 496-1990

a subsidiary of Datagraphics Corporation

malibu
Electronics Corporation

DOTS DO IT BETTER™

1981



Are you looking for the best tax package in the USA? Call



For the 1981 Tax System

Level 1 : 23 Schedules and Forms
: Multiple Clients

\$250 : Prints IRS Approved Forms

Level 2 : 30 Schedules and Forms
: Multiple Clients
: Prints IRS Approved Forms

\$1,000 : Prints on IRS Forms or Overlays
: Depreciation System
: State Tax Interface
: Integrated Data Base
: Batch Compute and Print

Level 3 : All Features of Levels 1 and 2
plus Partnership Forms and
\$1,750 Schedules

All levels operate under most CP/M formats including Apple. Compiled Microsoft Basic.

State Income Tax Systems are available.

Consider the advantages this State-of-the-Art package can bring to you:

- Complete System
- Versatility
- Complete In-Office Security
- Time Saving
- Pre Year-end Tax Planning

Call or write today for additional information.

Circle _____ for microTax.



22713 Ventura Blvd., Suite F
Woodland Hills, CA 91364
(213) 704-7800

Available at most Professional Computer Retailers

*CP/M is a TM of Digital Research
*Apple is a TM of Apple Computer, Inc.

PLOTLINE (penpos:integer;xplot,yplot:real);

This procedure draws a line. Its parameters are:

penpos: Position of the pen during the plot.

penpos = 0: Initialize the plotter.

This must be done before any plotting can be done. When penpos is 0 the computer assumes that the current pen location is location (0,0)—namely, the lower left corner of the plotting bed. The subroutine will remind you to move the pen to that position before if actually sets these coordinates. When penpos = 0, xplot and yplot can be any values since they will be ignored.

penpos = 1: Pen up (ie: no line will be drawn).

penpos = 2: Pen down (ie: line will be drawn).

xplot: x position (ie: left and right) in inches to which the pen will be moved. This may be any value from 0 to 10 inches.

yplot: y position (ie: forward and backward) in inches to which the pen will be moved. This may be any value from 0 to 7 inches.

PLOTSYMBOL (sym:integer;height:real);

This procedure is used by procedure plotarray to draw one of five symbols to represent a data point. The symbol is drawn at the current pen position. Its parameters are:

sym: Symbol definition.

height: Height of symbol to be drawn.

PLOTWHERE (var px,py:real);

This procedure will place the current pen position coordinates in inches into the variables px and py.

PLOTSTRING(px,py,height,theta:real; line:string);

This procedure plots a string of characters anywhere on the plot. Its parameters are:

px,py: coordinates in inches of lower left corner of first character to be plotted.

height: height of characters in inches.

theta: angle with respect to the x axis at which the characters will be drawn (in degrees).

line: a string variable containing the characters to be drawn (maximum of 80 characters)

Subscripts and superscripts are supported by the software. In order to accomplish superscripting, enclose the letters to be superscripted in brackets (eg: this is a [superscript]). To create subscripts, use the brackets in reverse order (eg: this is a]subscript). If an up-arrow is specified, it will be drawn with a length as specified in the height parameter and pointing in the direction given in the theta parameter. in the direction given in the theta parameter.

PLOTAXIS(px,py,leng,theta,min,max,tic:real;name:string);

This procedure draws an axis with tic marks and optionally labels each mark and writes the name of the axis. Its parameters are:

px,py: the origin of the axis in inches.

leng: the length of the axis in inches. If leng is negative, no labeling of tic marks or axis will be done.

theta: angle of the axis with respect to the x direction in degrees.

min: value of tic mark at origin.

max: value of outer end of axis (these two values are used to calculate the labels of the tic marks).

tic: frequency of tic marks on axis (eg: if tic = 5, tic marks will occur every 5 units on the axis). If tic is negative, the labels will occur on the counter-clockwise side of the axis; otherwise, they will be on the clockwise side.

name: string variable containing the name of the axis.

PLOTARRAY (nopoints,freq,sym:integer;px,py,xmin,xmax,ymin,ymax,height,xlen,ylen:real;var x,y:coord);

This procedure plots an array of x and y coordinates. Its parameters are:

nopoints: Number of points to be plotted.

freq: Frequency of identifying symbol (0 = no symbols, 1 = every point, 2 = every other point, etc). If freq is negative, only the points will be plotted with no interconnecting lines.

sym: Identifier of symbol to be plotted at points:

sym = 1: triangle.

sym = 2: X.

sym = 3: square.

sym = 4: +.

sym = 5: vertical line.

px,py: Coordinates of origin of array plot.

xmin,ymin: Minimum value of variables.

xmax,ymax: Maximum value of variables.

height: Height of symbols in inches.

xlen,ylen: Size of area to be plotted.

x,y: Variables of type coord (no more than 256 points) to be used in the plot; coord is a type that is predefined in the plotter subroutines and may be used in the 'var' section of your program.

Table 1: Summary of procedures and parameters from the Pascal unit "plotter".

THE BACKBONE OF YOUR SYSTEM

The Heath/Zenith 19 Smart Video Terminal gives you all the important professional features, all for under \$700.* You get the flexibility you need for high-speed data entry, editing, inquiry and transaction processing. It's designed to be the backbone of your system with heavy-duty features that withstand the rigors of daily use.

Standard RS-232C interfacing makes the 19 compatible with DEC VT-52 and most computer systems. And with the 19, you get the friendly advice and expert service that makes Heath/Zenith a strong partner for you.

Pick the store nearest you from the list on page 17. And stop in today for a demonstration of the Heath/Zenith 19 Smart Video Terminal. If you can't get to a store, send \$1.00 for the latest Heathkit® Catalog and the new Zenith Data Systems Catalog of assembled commercial computers. Write Heath Co., Dept. 334-824, Benton Harbor, MI 49022.

HEATH/ZENITH

Your strong partner



Completely addressable blinking cursor lets you edit anywhere on screen.

Reverse video by character lets you emphasize words, phrases or paragraphs.

High resolution CRT gives you sharp, easy-to-read image, reduces eye-strain.

Z-80 microprocessor-control makes the Heath/Zenith 19 capable of multitude of high-speed functions. It's the only terminal with ROM source code readily available.

Complete ASCII character set including upper case, lower case with descenders, and special graphic symbols.

80 character by 24 line format, plus 25th line for operator messages and prompts.

Professional quality keyboard, standard typewriter layout, 72 keys, including 12 special function keys.

Insert and delete character or line plus erase to end of line and end of screen make the 19 ideal for sophisticated editors like WORD-STAR.

Cursor and special functions are accessible by keyboard or computer, using either DEC VT-52 or ANSI Standard protocols.

Keypad in calculator format permits fast, easy entry of numeric data.

*In kit form, F.O.B. Benton Harbor, MI. Also available completely assembled at \$995. Prices and specifications are subject to change without notice.

MICROMAIL HAS THE RIGHT TERMINAL AT THE RIGHT PRICE.



Model 912 C shown

TELEVIDEO

| | |
|---------------------------|-----------------|
| 910 ^{NEW!} | \$599.00 |
| 912 | \$699.00 |
| 920 | \$749.00 |
| 950 | \$995.00 |

From this discussion you can see that the unit makes the following procedures available to the using program: plotline, plotsymbol, plotstring, plotwhere, plotarray, and plotaxis. (See table 1 on page 216.) It also makes the definition of the type "coord" available to the using program. In fact, if the procedure "plotarray" is going to be invoked, a variable of the type "coord" *must* be passed as a parameter to it.

The basic plotting algorithm in all of the plotter procedures is expressed in the procedure "plotline".

Basic Plotting Procedures

Now that you're familiar with how the unit interfaces to the using program, let's see how the various procedures accomplish their tasks and how the unit is put together. As you might imagine, the construction of the unit after the implementation and interface sections is simply a series of Pascal procedures with no program body. If we did not want to make these procedures into a unit, we could simply incorporate them into a Pascal program as normal procedures.

The Hiplot plotter can move its pen in eight directions. These are left, right, forward, backward, and the four moves at 45° (see figure 1). In addition, we have the pen-up and pen-down movements. With these ten movements, the plotter is capable of grand and wondrous things.

The most fundamental procedure in the program is the machine-language procedure "plotstep" (see listing 3). The purpose of this procedure is simply to take the elementary pen-movement commands passed to it and send them to the plotter port. (The pen-movement commands are the letters p, q, r, s, t, u, v, w, y, and z sent to the plotter through a serial port.) This procedure was written to operate on a Z80-based computer running at 2.5 MHz with the plotter set to 0.005 inches per step. Because of this, the timing loops might have to be adjusted to allow the procedure to operate correctly on a different machine.

The operation of procedure

QUME Letter Quality

NEW!
SPRINT 9/45/1
\$1919.00

DIABLO Letter Quality

| | |
|----------------|------------------|
| 630..... | \$1959.00 |
| 1640 RO | \$2269.00 |
| 1640 KSR | \$2499.00 |
| 1650 RO | \$2599.00 |
| 1650 KSR | \$2599.00 |

ANADEX

8000
\$829.00

DEC

LA 34 DA
\$969.00

TELETYPE

43 PF (TTL)
\$975.00

ANADEX

| | |
|---------------|------------------|
| DP 9500 | \$1299.00 |
| DP 9501 | \$1299.00 |
| DP 9000 | \$1199.00 |
| DP 9001 | \$1199.00 |

TEXAS INSTRUMENTS

| | |
|--|-------------------|
| 810/2 | \$1,549.00 |
| <small>(includes upper/lower case option)</small> | |
| 810/2 VFC/CP | \$1,679.00 |
| <small>(includes u/1 case, forms control & compressed print)</small> | |

SOROC

| | |
|--------------|------------------|
| IQ 120 | \$689.00 |
| IQ 135 | \$849.00 |
| IQ 140 | \$1099.00 |

DEC

| | |
|-------------------|-----------------------|
| VT 100..... | Call For Price |
| DEC LA 34AA | \$1050.00 |

C. ITOH

CIT 101..... **Call For Price**

NEC

| | |
|------------|-----------------------|
| 5510 | Call For Price |
| 5530 | Call For Price |

CALL TOLL FREE
(800) 854-6028

To Order: Send check to MICROMAIL, P.O. Box 3297, Santa Ana, CA 92703. Personal or company checks require two weeks to clear. Visa/MasterCard accepted. C.O.D. requires a 15% deposit. **Handling:** Add 3% to orders less than \$750, 2% to orders \$751 - \$2,000, 1% to orders over \$2,000. **NOTE:** Handling charges are waived on orders pre-paid in advance by check. **Shipping:** We ship FREIGHT COLLECT via UPS or Motor Freight. Air and Express delivery is available. Prices subject to change without notice.

MICROMAIL

P.O. Box 3297
Santa Ana, CA 92703
Phone: 714/731-4338
TWX: 910 595 1146

Charter Membership Invitation!

FREE SOFTWARE!

Accept our free program. It retails for \$24.95 but it's yours just for previewing America's finest software club.

I want to tell you about the most exciting development that has ever happened to your computer. Then I want to extend an invitation. Neither the development or the invitation need cost you a cent.

- It's not a new terminal.
- It's not any kind of peripheral.
- It's not a new language.
- It's all of these.

It's a club. A club exclusively for people who live and breathe computers, like you—and me.

BUILD A SOFTWARE LIBRARY THAT WILL EXPAND YOUR COMPUTER'S CAPABILITIES TO THE LIMITS OF YOUR IMAGINATION.

Each month we bring you the finest and boldest concepts in computer software from manufacturers all over the world, from categories that include education and business to entertainment and home utilities.

Out of thousands of programs available, we select those that make your computer do more of what you bought your computer for. Programs that keep your computer working throughout the day instead of gathering dust on a desk.

ASC keeps your computer functioning and expanding by supplying the vital

software resources necessary for its growth. Software for the business owner, educator, hobbyist, the family. Software that will continually keep your hardware paced with state of the art technology. With an ASC membership you will be assured that your equipment is never rendered obsolete.

OUR NO-OBLIGATION CHARTER INVITATION

When you become a charter member you get:

- Our free software program on diskette (or hardcopy source code)
- Our informative and very candid newsmagazine
- Discounts on all software programs
- Discounts on major brands of hardware and supplies
- Additional discounts for recommending new members
- Software updates as they become available
- BONUS. Free buy, sell, or swap ad in our newsmagazine (on a space-available basis). A real moneysaver.

Even if you never purchase another program, the free diskette is our gift to you.

Gift acceptance certificate below. Mail today to reserve your free gift.

DISCOUNTS. PROMPT SHIPMENTS.

No more searching through magazine ads and paying top dollar. You save every time you buy. Save on software, hardware, books . . . all computer supplies. For example, next month you can purchase name brand blank diskettes that the "discounters" sell for \$3.50. Our price—\$2.50. That's saving \$10 per box.

HERE'S HOW YOUR CLUB WORKS

All purchases are charged to your account at low member prices. (software programs usually cost \$9.95 to \$24.95 and are always discounted 15 to 40% off manufacturers' suggested list). Every four or so weeks, you will receive our new "Software Compendium" newsmagazine free. It reviews the new programs and provides helpful hints and member input. If you want our "Choice of the Month", do nothing, it will be sent automatically. If you want an alternate, additional, or no diskette at all (which will break your computer's heart), just return the card by the date specified. Unrequested diskettes may be returned at our expense. And all software is supplied with the original manufacturer's warranties. Club members are never subjected to any minimum purchase requirements.

FREE* FLOPPY DISC

for the first 1500 charter members. **Checkbook Balancing.** This program provides a running balance as well as monthly reconciliation and will maintain several checkbooks simultaneously. Menu driven, it contains related file maintenance routines.

Other charter members receive FREE, the hardcopy source code.

*Only a small postage and handling charge

AMERICAN SOFTWARE CLUB, INC

Millwood, N.Y. 10546

I can't wait. Please send me my free gift diskette (or hardcopy source code) and enroll me in American Software Club as outlined in this ad. I understand that all future purchases (no minimum required) are at low members' prices and that a small postage and handling fee is added to all orders. Membership can be cancelled at any time.

Bill me \$1.50 postage and handling.

My computer is an:

APPLE DOS VERSION _____ ATARI 400 _____ 800 _____

CP/M COMPUTER WITH 5 1/4" _____ 8" _____ DISKETTE

PET _____ model # _____ TRS 80 _____ model # _____

I am primarily interested in

- Business _____
Entertainment _____
Household _____
Education _____
All areas _____

Name _____

Address _____

City/State/Zip _____

"plotstep" is straightforward: it simply receives the plot command from the Pascal system (passed on the system stack along with the return address) and checks the status of the plotter (bit 1, port hexadecimal 7D in

this case). It then checks to see if the command is a pen-up or pen-down command, or a pen-movement command. In each case, it takes appropriate timing action depending upon the pen movement requested. If

the Pascal running on your system includes the logical device "REMOUT:", the plotter could be attached to the port addressed by "REMOUT:" and the plotting commands issued to the plotter through that port.

Once this machine-language subroutine is edited and assembled, it is a simple matter to use the linker to incorporate it into a Pascal program as an external procedure or to store it in the system library for use in the "plotter" unit.

The basic plotting algorithm in all of the plotter procedures is expressed in the procedure "plotline". This algorithm is simply passed a parameter ("penpos") that tells it whether the pen move is to be made with the pen up or down, and the endpoint of the next line to draw. It then calculates the best straight-line fit from the current position of the pen ("xpos" and "ypos") to the point selected ("xplot" and "yplot"). With the pen either up (penpos=1) or down (penpos=2), it draws the line. The algorithm used is simply a translation of the BASIC algorithm supplied by Houston Instrument with the plotter into Pascal.

A special case of "plotline" occurs when penpos=0. In this case, the pen is assumed to be at the lower-left corner of the plotter bed, and the variables "xpos" and "ypos" are initialized to that point. The machine-language subroutine "plotinit" is executed during this initialization. The procedure simply initializes the serial

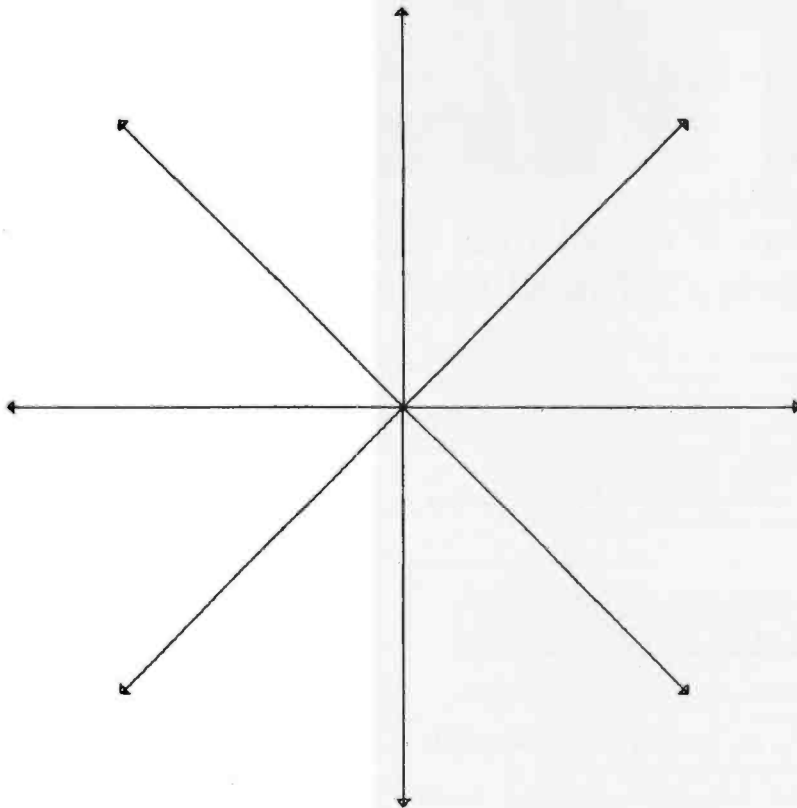

BASIC PLOTTER DIRECTIONS

Figure 1: Basic plotter directions available to the Houston Instrument Hiplot. This drawing was made by the Hiplot plotter.

DISASTER INSURANCE.

PROTECT YOUR HARDWARE FROM THE UNEXPECTED.

Not to mention the unavoidable pollutants in the air. Performance robbing dust, grime, spills and static electricity.

Cover Craft Dust Covers help extend the useful life of your computer equipment at a fraction of the cost. Perhaps that's why more people throughout the world rely on Cover Craft Dust Covers than any other brand.

Visit your local dealer or contact Cover Craft.

Dust Covers for most terminals, disks, printers, modems, etc.

\$8.95-\$15.95
Shipping extra.



COVER CRAFT CORP

PO Box 555, Amherst, NH 03031 • (603) 889-6811

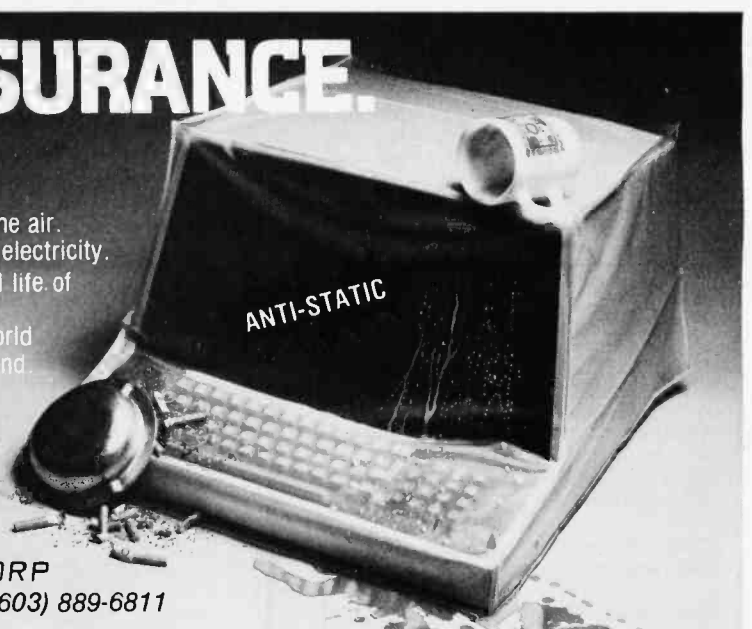

If you don't know a baud from a floppy ... **YOU NEED TO KNOW THE QDP-100 MICROCOMPUTER**

Most people who need computers don't have the time, or desire, to become full-time computer "wizards."

With the budget-priced QDP-100 you get all the time-saving precision information you want from a computer, now and in the future, without all the unnecessary complexity associated with less considerate computers.

QDP-100 IS A FULL-SCALE 8-bit computer, readily upgradeable to 16 bits as your business or professional information-processing needs grow. It uses the IEEE S-100 bus, compatible with CP/M and MP/M disk operating systems.

QDP-100 HANDLES BOTH floppy disks and hard disks to give you total software versatility.

QDP-100 CONNECTS INSTANTLY in to any standard terminal and printer. Both serial and parallel ports are available. Features most micro-computers can't match.

It does more, does it easier, and costs a lot less.

QDP-100 HAS SINGLE BOARD SIMPLICITY. Eliminates the hassle of complex multi-chip, multi-board computers.

QDP-100 IS EASY to learn and to operate. Most owners use their QDP-100 with professional skill and results in short order. Our instruction manual doesn't need an interpreter.

If you'd rather be a wizard with computer results, than with computers, choose the QDP-100. Call or write for literature and full details.

QDP NEEDS A FEW MORE GOOD DEALERS. Attractive, profitable, protected dealerships are still available in several high-potential computer market areas.

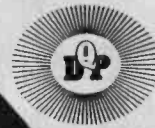

Quasar Data Products

10330 Brecksville Road
Cleveland, Ohio 44141
216/526-0838 Telex: 241596

CP/M and MP/M
are registered trademarks.



★ 20% ★ DISCOUNT COUPON

Bring this COUPON into one of our stores or mail to our Mail Order address shown below and receive a 20% DISCOUNT on purchases from this page of \$50.00 or more. Offer EXPIRES on December 15, 1981

NAME _____
ADDRESS _____
CITY _____ STATE _____
ZIP _____ PHONE NO _____
Coupons accepted only with full name and address filled in.



**CBM8032
32K RAM
80 Column Screen
\$1499.00**

EPROM 2716-5 \$6.50
(5 VOLT)

EPROM Erasing Lamps
 • ERASES 4 CHIPS IN LESS THAN 20 MINUTES
 • SIMPLE TO USE • SAFETY INTERLOCK
 • ERASES 2708, 2716, 1702A, etc.
 UVS-11E \$85.00

**30 MHz
HITACHI
DUAL TRACE
PORTABLE OSCILLOSCOPE**
 MODEL V-302B \$995.00
 More sensitive to your input

Universal Oscilloscope

Probe \$36⁰⁰

SWITCHABLE X1 and X10 Attenuation Factor
 KEY ADDITIONAL FEATURES: • 100MHz bandwidth • Heavy duty tip • Break resistant center conductor • Slender, flexible cable • 6ft. cable length • Wide compensation range • Fits all scopes • Ground reference can be activated at tip • Includes SPRUNG HOOK, I.C. TIP, BNC ADAPTOR, INSULATING TIP and TRIMMER TOOL ACCESSORIES.

ANCRONA
 STORES DO NOT ACCEPT MAIL ORDERS
MAIL ORDER
 P.O. BOX 2208Y CULVER CITY, CA 90230

Minimum Order \$10.00. Add \$2.00 to cover postage and handling. Master Charge and Visa welcomed. Please include your charge card number, interbank number and expiration date. Some items are subject to prior sale. Not responsible for typos. Store pricing may vary from Mail Order pricing. We reserve the right to substitute manufacturer.

| | |
|--|---|
| PHONE ORDERS (213) 641-4064 | ATLANTA 3330 Piedmont Rd. N.E. Atlanta, GA 30305 (404) 261-7100 |
| CULVER CITY 11080 Jefferson Blvd. Culver City, CA 90230 (213) 390-3595 | HOUSTON 2649 Richmond Houston, TX 77098 (713) 529-3489 |
| PORTLAND 1125 N.E. 82nd Ave. Portland, OR 97220 (503) 257-9464 | SANTA ANA 1300 E. Edinger Ave. Santa Ana, CA 92705 (714) 547-8424 |
| SUNNYVALE 1054 E. El Camino Real Sunnyvale, CA 94087 (408) 243-4121 | TUCSON 4518 E. Broadway Tucson, AZ 85711 (602) 881-2348 |

output port to 9600 bps (bits per second) to make it compatible with the data-input rate of the plotter (see listing 4). "Plotline" with the penpos of 0 must be executed before any plotting can be done with the other procedures. In each case of a pen movement, procedure "plotline" checks to make sure that a plot off the bed of the plotter is not being attempted and, if so, reports this to the console rather than attempting the plot.

The procedure "plotstring" uses procedure "plotchar" to draw characters on the plot. Procedure "plotstring" is passed the starting location of the lower-left corner of the first character to be plotted, the height of the characters (which should be a multiple of 0.035 to give the best-formed characters), the angle (in degrees relative to the long axis of the paper) at which the string is to be plotted, and a string of characters to be plotted.

The way in which the characters are plotted is interesting. I decided that I had to develop an interpreter for plotting the various pen moves. Plotting any character, I concluded,

would be a combination of straight lines in the fundamental directions available on the plotter.

Rather than simply using "plotline" to do all the moves for each character, the moves to plot each character are generated in a coded form using two vector pads made up of two groups of keys on the keyboard. One vector pad represents moves with the pen up and the other with the pen down. The letters d, w, a, and x are used for moves in the indicated directions with the pen up, and 7, 8, 9, o, l, k, j, and u for moves in the indicated direction with the pen down. The length and direction of each move are determined by the height and orientation of the character to be plotted. As you can see in the listing of "plotchar", each character is coded as a series of moves terminated with the character "i".

In operation, the procedure takes the character passed to it, assigns the string of moves to the string variable PLOT, then decodes that string into a series of pen movements. A few special cases need to be noted at this

Text continued on page 242

Listing 1: The Pascal unit "plotter". This unit, which can be used by other Pascal programs, contains several routines that simplify the process of drawing lines and characters on the Houston Instrument Hiplot plotter.

unit plotter;

interface (*These procedures and types are available to using program*)

```

type
  coord=array[1..250] of real;
  procedure plotline(penpos:integer;xplot,yplot:real);
  procedure plotsymbol(sym:integer;height:real);
  procedure plotstring(px,py,height,theta:real;line:string);
  procedure plotwhere(var px,py:real);
  procedure plotarray(nopoints,freq,sym:integer;
    px,pv,xmin,xmax,ymin,vmax,
    height,xlen,vlen:real;var x,y:coord);
  procedure plotaxis(px,py,leng,theta,min,max,tic:real;
    name:string);
    
```

implementation (*Everything else is local to the unit*)

```

const
  pi=3.14159;
  screenwidth=79;
  screenheight=23;
var
  clear:char;
  a:array[1..16] of char;
  xpos,ypos:real;
    
```

```

procedure plotstep(step:char);
  external;
    
```

```

procedure plotinit; (*sets up usart for plotter*)
  external;
    
```

```

procedure plotline;
var
  z,x,y,f,d,i,t,e:integer;
    
```

```

procedure initplot;
begin
    
```

Listing 1 continued on page 224

Systems II Ex a total business system.



SYSTEMS II EX — EX for EXTENDED PERFORMANCE. Westware brings you the most completely integrated and simplest to use business software for your Apple Computer. The SYSTEMS II EX is complete with an integrated Database. Yes! The DBII Database can move your system's files into Database format for customized reports or labels.

Although the SYSTEMS II EX is a fully integrated system, you may purchase

Circle 415 on Inquiry card.

individual modules and later add additional modules, such as Job Costing for contractors. The power of our system is in the KSAM Firmware card that plugs into the Apple. This card permits high speed searches and eliminates running sort routines to get your files in order.

SYSTEMS II is available on 5¼" drives, and also on the Corvus hard disk. A Corvus based system will give you the power and capacity that challenges larger computers.

COMING SOON — Cash flow analysis with graphics, Database II with graphics, and Bill of Materials for small manufacturers.

CURRENT OPTIONS AVAILABLE — Job Costing, Cycle Invoicing, Order entry, and Layaway.

All Checks, statements and invoices use NEBS forms.

Dealer and OEM inquiries invited.

Apple is a trademark of Apple Computers.

Westware
Systems II Ex

2455 S.W. 4th Ave.
Suite 2
Ontario, OR 97914
(503) 881-1477

See us at the NORTHEAST
Computer Show Oct 15-18 and
The SOUTHEAST Computer
Show Oct 29-Nov 1.



2455 S.W. 4th Ave.
Suite 2
Ontario, OR 97914
(503) 881-1477

Yes, I would like to sample your software. Please send me the Systems II Demo Package. My check for \$25 is enclosed.

Name _____

Title _____

Company Name _____

Address _____

City _____ State _____ Zip _____

SOFTWARE DEVELOPMENT TOOLS FOR INDUSTRY

CP/M CROSS-ASSEMBLERS

Fast, comprehensive cross-assemblers to run under CP/M.* Extensive pseudops include full listing control, nested conditionals, mnemonic synonyms, and inclusion of external source files. Generate object file, assembly listing, and symbol table from source code for nine popular microprocessor families.

| | |
|--------------|-----------|
| XASM05..... | 6805 |
| XASM09..... | 6809 |
| XASM18..... | 1802 |
| XASM48..... | 8048/8041 |
| XASM51..... | 8051 |
| XASM65..... | 6502 |
| XASM68..... | 6800/6801 |
| XASMF8..... | F8/3870 |
| SASM400..... | COP400 |

Assemblers... \$200.00 each
Manual only... \$ 25.00

8048 DEVELOPMENT PACKAGE

Now you can use the 8048 family of single-chip microcomputers without buying expensive equipment. Develop 8048 software with the XASM48 cross-assembler. Then plug our EPR-48 board into your S-100 system to program the 8748 EPROM version.

8048 Development Package... \$574.00
EPR-48 alone... \$449.00

EPROM SIMULATOR BOARD

Debug dedicated systems quickly. Our PSB-100 PROM Emulator is an S-100 board with up to 8K of RAM. Cable with 24-pin plug replaces 2708 or 2716 EPROM(s) in your target system for instant program testing

PSB-100 EPROM Simulator... \$445.00
w/2K RAM

*Trademark of Digital Research

avocet
systems inc.



804 SOUTH STATE ST.
DOVER, DEL. 19901
302-734-0151

Visa and Mastercharge accepted. We ship 8" single-density and Softcard + 5.25" diskettes. Ask us about other formats. OEM AND DEALER INQUIRES INVITED.

+ Trademark of Microsoft

Listing 1 continued:

```

clear:=chr(26);
write(clear);
gotoxy((screenwidth-47) div 2,screenheight div 2-1);
write('Please type [ret] when plot pen is at the lower');
gotoxy((screenwidth-26) div 2,screenheight div 2);
write('left corner of plotter bed');
readln;
write(clear);
plotinit;
xpos:=0.0;
ypos:=0.0;

a[1]:='p';a[2]:='q';a[3]:='r';a[4]:='q';a[5]:='r';a[6]:='s';
a[7]:='t';a[8]:='s';a[9]:='t';a[10]:='u';a[11]:='v';
a[12]:='u';a[13]:='v';a[14]:='w';a[15]:='p';a[16]:='w';
plotline(1,0,0);
end;(*initplot*)

begin(*plotline*)
case penpos of
0:initplot;
1:plotstep('y');
2:plotstep('z');
end;
if penpos=0 then exit(plotline);
if (xplot>10.25) or (xplot<-0.25) or (yplot>7.25)
or (yplot<-0.25) then
begin
write(clear);
gotoxy((screenwidth-49) div 2,screenheight div 2-1);
writeln('Plotline: Plot attempted off page ('
,xplot:6:2,',',yplot:6:2,')');
gotoxy((screenwidth-17) div 2,screenheight-1);
write('Please type [ret]');
readln;
write(clear);
exit(plotline);
end;
x:=round((xplot-xpos)*200);
y:=round((yplot-ypos)*200);
xpos:=xpos+x/200;
ypos:=ypos+y/200;

(*This section is translated from Houston Instrument *)

f:=abs(x)+abs(y);
if f=0 then exit(plotline);
d:=abs(y)-abs(x);
i:=0;
if y>=0 then i:=2;
t:=x+y;
if t>=0 then i:=i+2;
t:=y-x;
if t>=0 then i:=i+2;
if x<0 then i:=i+10
else i:=8-i;
if d<0 then t:=abs(y)
else
begin
begin
t:=abs(x);
d:=-d;
end;
e:=0;
repeat
z:=t+d+e;
if z<0 then
begin
e:=e+t;
f:=f-1;
plotstep(a[i-1]);
end
else
begin
e:=e+d;
f:=f-2;
plotstep(a[i]);
end;
until f<=0;
end;(*plotline*)

procedure plotstring;
var
step1,xstep1,ystep1,x2step1,y2step1,x3step1,y3step1,
step,xstep,ystep,x2step,y2step,x3step,y3step:real;
j,n:integer;

procedure plotchar(ch:char);
var
rxpos,rypos:real;

```

Listing 1 continued on page 226

Programming power!

APPLE PASCAL™ A HANDS-ON APPROACH

Learn to use the most powerful language your computer can have.

This "hands-on" method gives you *all* the working skills you need to create, run, and debug programs in Pascal on the Apple II or Apple II Plus.

Detailed program examples and practical, step-by-step exercises on the computer itself lead you from fundamentals to such advanced topics as programming style,

data structures, top-down vs. bottom-up design, scalar data types, and recursion.

No math background is required. Users learn full editor and operating features as well as the Pascal language—this is the only *complete* guide to



Pascal for the Apple computer (and only \$14.95!). The volume is spiralbound to lie flat by the keyboard. 429 pages.

Order today. Put the power of Pascal to work for you.

Also available:

BASIC: A HANDS-ON METHOD, 2/e

Herbert D. Peckham
320 pages, \$12.95 Spiral bound

Immediate application of concepts as they are introduced allows you to quickly become proficient in BASIC programming. For use with numerous time-sharing and personal computers, this book emphasizes hands-on experience.

PROGRAMMING BASIC WITH THE TI HOME COMPUTER

Herbert D. Peckham
306 pages, \$12.95

The only complete guide to programming in BASIC on the TI Home Computer. All information is presented using a hands-on method which rapidly builds programming skills.

HANDS-ON BASIC WITH A PET

Herbert D. Peckham
267 pages, \$13.95

Fully explains how to program Commodore Business Machines' PET personal computer using BASIC. A step-by-step presentation of programming with hands-on exercises.

THE ELEMENTS OF PROGRAMMING STYLE 2/e

Brian W. Kernighan and P.J. Plauger
168 pages, \$10.95

This acknowledged classic provides a highly helpful guide to effective, efficient programming for a wide range of tasks. Includes numerous examples and a set of 'rules' of good programming.

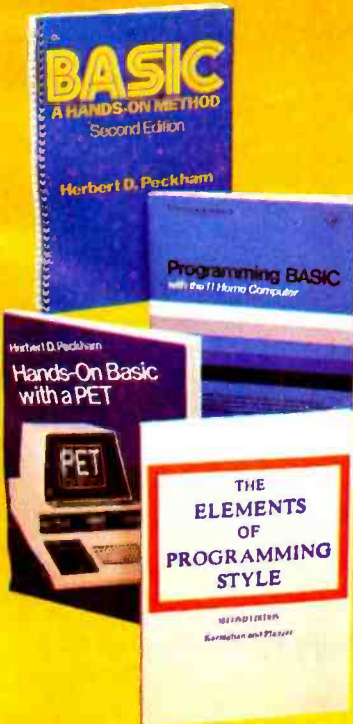

15 DAYS' FREE EXAMINATION!

Mail the coupon today.
Mail to: **McGraw-Hill Book Company**
P.O. Box 400
Hightstown, N.J. 08520

Please send me the book(s) checked for 15 days on approval.

Bill me. After 15 days I will pay for the book(s) I keep, plus local tax, postage, and handling.

Enclosed is my check/money order (including tax).

Charge my

VISA MasterCard (Check one.)

Credit card no. _____ Exp. Date _____

Bank no. (MasterCard only) _____

Signature _____

(Credit card order not valid without signature.)

- APPLE PASCAL, \$14.95 (4917-1-2)
- BASIC: A HANDS-ON METHOD, \$12.95 (49160-7)
- PROGRAMMING BASIC WITH THE TI HOME COMPUTER, \$12.95 (49156-9)
- HANDS-ON BASIC WITH A PET, \$13.95 (49157-7)
- ELEMENTS OF PROGRAMMING STYLE, \$10.95 (34207-5)

Name _____

Street _____

City/State/Zip _____

62-U444-1181-1

SAVE MONEY: Remit with order and we pay all shipping and handling costs. Full return privileges still apply. Order subject to acceptance by McGraw-Hill.

SAM'S BOOKS SAVE UP TO 25%

BUY A SERIES FROM THIS LIST OR INDIVIDUAL TITLES USING THE 5 DIGIT ORDER CODES. ORDER A CATALOG OF ALL SAM'S BOOKS AND SAVE!

SERIES 'A' COMPUTER COOKBOOKS

- No. 21524 - The Cheap Video Cookbook \$5.95
- No. 21723 - Son Of Cheap Video \$8.95
- No. 21697 - 8085A Cookbook \$13.95
- No. 21313 - TV Typewriter Cookbook \$9.95

SERIES 'B' TRS-80

- No. 21741 - Circuit Design Programs for the TRS80 \$12.95
- No. 21633 - TRS-80 Interfacing - Book 1 \$8.95
- No. 21739 - TRS-80 Interfacing - Book 2 \$10.95

SERIES 'C' 8080

- No. 21541 - 8080/8085 Software Design Book 1 \$10.95
- No. 21615 - 8080/8085 Software Design Book 2 \$10.95
- No. 21628 - TEA: An 8080/8085 Assm. Editor \$10.95

SERIES 'D' COMPUTER FUNDAMENTALS

- No. 21698 - Guide Book To Small Computers \$4.95
- No. 21486 - Getting Acquainted With Microcomputers \$8.95
- No. 21634 - Sam's Crash Course In Microcomputers \$17.50
- No. 21653 - Microcomputer Primer (Second Edition) \$11.95
- No. 21483 - Your Own Computer \$1.95

SERIES 'E' Z-80

- No. 21682 - Z80 Microcomputer Design Projects \$12.95
- No. 21500 - Z80 Microcomputer Hand Book \$8.95
- No. 21609 - Z80 Microprocessor Programing & Interfacing, Book 1 \$11.95
- No. 21610 - Z80 Microprocessor Programing & Interfacing, Book 2 \$14.95

SERIES 'F' 6502/6800

- No. 21656 - 6502 Software Design \$11.50
- No. 21459 - How To Program Microcomputers \$8.95
- No. 21684 - How To Program And Interface The 6800 \$15.95
- No. 21726 - 6801, 68701, & 6803 Microcomputer Programming & Interfacing \$13.95

SERIES 'G' COOK BOOKS

- No. 21695 - ICOP-AMP Cookbook (2nd Edition) \$14.95
- No. 21168 - Active Filter Cookbook \$14.95
- No. 21398 - CMOS Cook Book \$10.50
- No. 21527 - IC Converter Cookbook \$13.95
- No. 21416 - IC Timer Cookbook \$9.95
- No. 21035 - TTL Cookbook \$9.50

Series - Prices Indicated are Less 25%

- 'A': 29.10 'E': 36.60
- 'B': 24.64 'F': 37.77
- 'C': 24.64 'G': 55.35
- 'D': 33.98

TOTAL FOR SINGLE TITLES _____

DISCOUNT 15% (-) _____

TOTAL FOR SERIES _____

ORDER A CATALOG LISTING ALL SAM'S BOOKS AND SAVE WITH SPECIAL DISCOUNT PRICES

CATALOG _____ \$1.50

SHIPPING AND HANDLING 50c PER/TITLE _____

5% MN TAX WHERE APPL _____

TOTAL THIS ORDER _____

SEND CHECK OR MONEY ORDER
MAIL TO:
STELLAR SYSTEMS
P.O. BOX N
NORTH BRANCH, MN 55056
Prices may be subject to change without notice.

Listing 1 continued:

```

plot:string[32];
pchar:char;
i:integer;

procedure arrow;
begin
  step1:=0.04;
  xstep1:=step1*cos(theta);
  ystep1:=step1*sin(theta);
  x2step1:=sqrt(2)*step1*cos(theta+pi/4);
  y2step1:=sqrt(2)*step1*sin(theta+pi/4);
  x3step1:=sqrt(2)*step1*cos(theta-pi/4);
  y3step1:=sqrt(2)*step1*sin(theta-pi/4);
  plotline(2,xpos-y2step1,ypos+x2step1);
  plotline(2,xpos+ystep1,ypos-xstep1);
  plotline(2,xpos+ystep1,ypos-xstep1);
  plotline(2,xpos-y3step1,ypos+x3step1);
  exit(plotchar);
end;(*arrow*)

procedure getcode;
begin
  case ch of
    'A','a':plot:='d8888889oolkkkkkkaaawwwwoooi';
    'B','b':plot:='d8888888oolkkjjuuoolkkjuui';
    'C','c':plot:='dddddwjuu7888889ooli';
    'D','d':plot:='d8888888oolkkkkkjuui';
    'E','e':plot:='dddduuuu8888ooou888oooi';
    'F','f':plot:='d8888ooou888oooi';
    'G','g':plot:='ddddwwwwww7uujjkkkkloo988uui';
    'H','h':plot:='d8888888dddkkkkkkwwwuuui';
    'I','i':plot:='dooooo8888888uuoooi';
    'J','j':plot:='dwloo9888888i';
    'K','k':plot:='d8888888dddjjjjllli';
    'L','l':plot:='dddduuuu8888888i';
    'M','m':plot:='d8888888lkk889kkkkk';
    'N','n':plot:='d8888888l1lllwwwkkkkk';
    'O','o':plot:='dd7888889oolkkkkjuui';
    'P','p':plot:='d8888888oolkkjuui';
    'Q','q':plot:='dd7888889oolkkkkjuudwllli';
    'R','r':plot:='d8888888oolkkjuuoolk';
    'S','s':plot:='dwloo9887uu789ooli';
    'T','t':plot:='ddd8888888aaoooi';
    'U','u':plot:='dwwwwwwkkkkkkloo9888888i';
    'V','v':plot:='dwwwwwwkkkkkl19988888i';
    'W','w':plot:='dwwwwwwkkkkkk9988kk118888888i';
    'X','x':plot:='d8899998aaaakl1lllkk';
    'Y','y':plot:='dwwwwwwkkl1998kjjkkk';
    'Z','z':plot:='dwwwwwwooookjjjjkkoooi';
    '.':plot:='ddd8okui';
    '=':plot:='ddwwoooowuuui';
    '>':plot:='d999777i';
    '<':plot:='ddd777999i';
    '$':plot:='dwwooo97uu79ooowaakkkk';
    '!':plot:='cooooooi';
  end;(*case*)
end;(*getcode*)

procedure getcode2;
begin
  case ch of
    '*':plot:='dww9999aakkkdd7777xxoooi';
    '/':plot:='d8899998i';
    'o':plot:='dw9999aaaku8oxxxd8ok8okuui';
    '?':plot:='ddd8w8997uujki';
    '#':plot:='dddwww8okui';
    '&':plot:='dddwwwkkuu88ooonooakki';
    '!':plot:='ddd8okuoji';
    '1':plot:='dwww99kkkkkkkuoooi';
    '2':plot:='dwww9oolkkjjjoooi';
    '3':plot:='dwww9oolkkjjjoooi';
    '4':plot:='dwwwkkkkooowwwwkkkkk';
    '5':plot:='dddwwwuuuukkooollkkjuui';
    '6':plot:='dddwww7uujjkkkkloo9887uuji';
    '7':plot:='dwww8ooookjjkkk';
    '8':plot:='ddwww789oolkjuujkkloo9887i';
    '9':plot:='dwloo988887uujjkkloo9i';
    '0':plot:='dd788888oolkkkkjuui';
    '(':plot:='ddd778889i';
    ')':plot:='dd9988877i';
    '%':plot:='dw9999aaaku8xxxxdo8uki';
    '+':plot:='dddww8888aaxxoooi';
    '-':plot:='dwwwoooi';
    ':':plot:='dww8ukwo8uki';
    '[':plot:='li';
    ']':plot:='2i';
  end;(*case*)
end;(*getcode2*)

```

Listing 1 continued on page 228



NEECO

WHY BUY FROM THE BEST? Service... Support... Software...



MULTI-CLUSTER

For Commodore Systems, allows 3 CPU's (Expandable to 8) to access a single Commodore Disk.
MULTI-CLUSTER (3 CPU's) \$ 795
Each Additional CPU (up to 8) ... \$ 199

commodore

| | |
|--------------------------------------|--------|
| 16K B (16K RAM-40 Column) - Lim. Qty | \$ 995 |
| 32K B (32K RAM-40 Clm.) - Lim. Qty | \$1295 |
| 4016 (16K RAM 4.0 Basic-40 Clm.) | \$ 995 |
| 4032 (32K RAM 4.0 Basic-40 Clm.) | \$1295 |
| 8032 (32K RAM 4.0 Basic-80 Clm.) | \$1495 |
| 8050 Dual Disk (1 Meg Storage) | \$1795 |
| 4040 Dual Disk (343K Storage) | \$1295 |
| 8010 IEEE Modem | \$ 280 |
| C2N Cassette Drive | \$ 95 |
| CBM - IEEE Interface Cable | \$ 40 |
| IEEE - IEEE Interface Cable | \$ 50 |
| VIC 20 Home/Personal Computer | \$ 295 |

ALTOS

| | |
|-----------------------|---------|
| ACS 8000-2 64K 1M | \$ 4500 |
| ACS 8000-15 64K 1M | \$ 5990 |
| ACS 8000-6 208K 14.5M | \$10490 |
| ACS 8000-7 208K 29.0M | \$11690 |
| ACS 8000-10 208K 10M | \$ 8500 |
| ACS 8000-10/MTU | \$10990 |

EPSON PRINTERS

| | |
|---------------------------|--------|
| MX-80 PRINTER | \$ 645 |
| MX-80 FT | \$ 745 |
| MX-100 | \$ 945 |
| MX-70 | \$ 459 |
| INTERFACE CARDS | |
| 8141 (RS-232) | \$ 75 |
| 8150 (2K Buffered RS-232) | \$ 150 |
| 8161 (IEEE 488) | \$ 55 |
| 8131 (Apple Card) | \$ 85 |
| 8230 (Apple Card) | \$ 25 |
| 8220 (TRS-80 Cable) | \$ 35 |

DIABLO 630 PRINTER

| | |
|------------------------------|--------|
| DIABLO 630 - Serial - RS-232 | \$2710 |
| Tractor Option | \$ 250 |

AMDEK MONITORS

| | |
|-----------------------|--------|
| Video 100 12" B+W | \$ 179 |
| Video 300 12" Green | \$ 249 |
| Color I 13" Low Res | \$ 449 |
| Color II 13" High Res | \$ 999 |

INTERTEC COMPUTERS

| | |
|---|--------|
| 64K Superbrain (360 Disk Storage), CP/M™ | \$3495 |
| 64K QD Superbrain (700K Disk Storage), CP/M™ | \$3995 |

*CP/M is a registered trademark of Digital Research.



ATARI COMPUTERS

| | |
|--------------------------------------|-----------|
| Atari 400 (16K RAM) | \$ 399 |
| Atari 800 (32K RAM) - good thru 8/31 | \$1080 |
| Atari 410 RECORDER | \$ 89.95 |
| Atari 810 DISK DRIVE | \$ 599.95 |

NEECO carries all available ATARI Software and Peripherals.

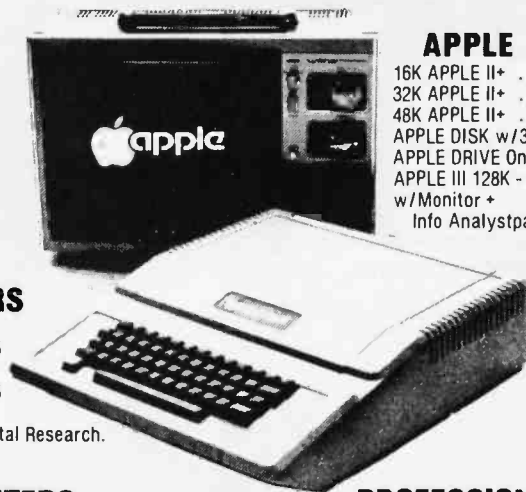

APPLE

| | |
|-----------------------------|--------|
| 16K APPLE II+ | \$1330 |
| 32K APPLE II+ | \$1430 |
| 48K APPLE II+ | \$1530 |
| APPLE DISK w/3.3 DOS | \$ 650 |
| APPLE DRIVE Only | \$ 490 |
| APPLE III 128K - In Stock! | |
| w/Monitor + Info Analystpak | \$4740 |

PROFESSIONAL SOFTWARE

| | |
|-------------------------|-----------|
| WordPro 1 8K | \$ 29.95 |
| WordPro 3 (40 Clm.) 16K | \$ 199.95 |
| WordPro 3+ | \$ 295 |
| WordPro 4 (80 Clm.) 32K | \$ 375 |
| WordPro 4+ | \$ 450 |

JUST A SAMPLE OF THE MANY PRODUCTS WE CARRY. CALL US FOR OUR NEW 60-PAGE CATALOG. WE WILL MATCH ANY ADVERTISED PRICE ON PRODUCTS LISTED UNDER SIMILAR "IN STOCK" CONDITIONS.



NEECO

679 HIGHLAND AVE.
NEEDHAM, MA 02194

(617) 449-1760

Telex: 951021

MON-FRI 9:00 - 5:00



MasterCharge and VISA Accepted

Big sale on K's!

16K ... \$149.95

32K ... \$199.95

48K ... \$249.95

64K ... \$299.95

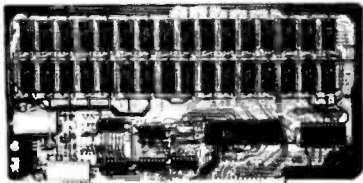

New JAWS-IB

The Ultrabyte Memory Board

Due to the tremendous success of our JAWS I, we were able to make a special purchase of first-quality components at below-cost prices for JAWS-IB. And we are sharing our cost saving with you. But don't be surprised if the next time you see this ad the prices have gone up substantially. Better yet, order now, and get the best memory on the market at the best price on the market.

ONE CHIP DOES IT ALL

Jaws-IB is the Rolls-Royce of all the S100 dynamic boards. Its heart is Intel's single chip 64K dynamic RAM controller. Eliminates high-current logic parts ... delay lines ... massive heat sinks ... unreliable trick circuits. JAWS-IB solves all these problems.

LOOK WHAT JAWS-IB OFFERS YOU

Hidden refresh ... fast performance ... low power consumption ... latched data outputs ... 200 NS 4116 RAM's ... on-board crystal ... RAM Jumper selectable on 8K boundaries ... fully socketed ... solder mask on both sides of board ... phantom line ... designed for 8080, 8085, and Z80 bus signals ... works in Explorer, Sol, Horizon, as well as all other well-designed S100 computers.

10-DAY MONEY-BACK TRIAL: Try a fully wired and tested board for 10 days - then either keep it, return it for kit, or simply return it in working condition.

Continental U.S.A. Credit Card Buyers Outside Connecticut:

TO ORDER CALL TOLL FREE 800-243-7428

From Connecticut Or For Assistance:
(203) 354-9375

Please send the items checked below:

JAWS-IB kit:

- 16K \$149.95*
- 32K \$199.95*
- 48K \$249.95*
- 64K \$299.95*

JAWS-IB Fully Assembled, wired & Tested:

- 16K \$179.95*
- 32K \$239.95*
- 48K \$299.95*
- 64K \$359.95*

EXPANSION KIT, 16K RAM Module, to expand JAWS-IB in 16K blocks up to 64K. \$59.95

*All prices plus \$2 postage and insurance (\$4.00 Canada). Connecticut residents add sales tax.

Total enclosed: \$ _____

- Personal Check Money Order or Cashier's Check
- VISA Master Card (Bank No. _____)

Acct. No. _____ Exp. Date _____

Signature _____

Print Name _____

Address _____

City _____

State _____ Zip _____

NETRONICS R&D Ltd.
333 Litchfield Road, New Milford, CT 06776

Listing 1 continued:

```
begin(*plotchar*)
  rxpos:=xpos;
  rypos:=ypos;
  plot:='i';
  getcode;
  getcode2;
  i:=1;
  pchar:='0';
  while pchar<>'i' do
    begin
      pchar:=plot[i];
      case pchar of
        'd':plotline(1,xpos+xstep,ypos+ystep);
        'w':plotline(1,xpos-ystep,ypos+xstep);
        'a':plotline(1,xpos-xstep,ypos-ystep);
        '7':plotline(2,xpos-x3step,ypos-y3step);
        '8':plotline(2,xpos-ystep,ypos+xstep);
        '9':plotline(2,xpos+x2step,ypos+y2step);
        'o':plotline(2,xpos+xstep,ypos+ystep);
        'l':plotline(2,xpos+x3step,ypos+y3step);
        'k':plotline(2,xpos+ystep,ypos-xstep);
        'j':plotline(2,xpos-x2step,ypos-y2step);
        'u':plotline(2,xpos-xstep,ypos-ystep);
        'x':plotline(1,xpos+ystep,ypos-xstep);
        'l':arrow;
        'l':begin
          rxpos:=rxpos-(height/2)*sin(theta)-
            6*xstep;
          rypos:=rypos+(height/2)*cos(theta)-
            6*ystep;
        end;
        '2':begin
          rxpos:=rxpos+(height/2)*sin(theta)-
            6*xstep;
          rypos:=rypos-(height/2)*cos(theta)-
            6*ystep;
        end;
      end;
      end;(*case*)
      i:=i+1;
    end;(*while*)
    plotline(1,rxpos+6*xstep,rypos+6*ystep);
  end;(*plotchar*)
```

```
begin(*plotstring*)
  theta:=(theta/360)*2*pi;
  step:=height/7;
  xstep:=step*cos(theta);
  ystep:=step*sin(theta);
  x2step:=sqrt(2)*step*cos(theta+pi/4);
  y2step:=sqrt(2)*step*sin(theta+pi/4);
  x3step:=sqrt(2)*step*cos(theta-pi/4);
  y3step:=sqrt(2)*step*sin(theta-pi/4);
  n:=length(line);
  plotline(1,px,py);
  for j:=1 to n do
    plotchar(line[j]);
  end;(*plotstring*)
```

procedure plotsymbol;

```
var
  rxpos,rypos:real;
begin
  rxpos:=xpos;
  rypos:=ypos;
  case sym of
    1:begin(*triangle*)
      plotline(2,xpos,ypos+height/2);
      plotline(2,xpos-height/2,ypos-height);
      plotline(2,xpos+height,ypos);
      plotline(2,xpos-height/2,ypos+height);
      plotline(1,rxpos,rypos);
    end;
    2:begin(*X*)
      plotline(1,xpos-height/2,ypos+height/2);
      plotline(2,xpos+height,ypos-height);
      plotline(1,xpos-height,ypos);
      plotline(2,xpos+height,ypos+height);
      plotline(1,rxpos,rypos);
    end;
    3:begin(*square*)
      plotline(2,xpos,ypos+height/2);
      plotline(2,xpos-height/2,ypos);
      plotline(2,xpos,ypos-height);
      plotline(2,xpos+height,ypos);
      plotline(2,xpos,ypos+height);
      plotline(2,xpos-height/2,ypos);
      plotline(1,rxpos,rypos);
    end;
    4:begin(*+*)
```

Listing 1 continued on page 230

THE FORTH SOURCE™

Specializing in the FORTH Language.

MANUALS & GUIDES

| | PRICE |
|---|--------------|
| <input type="checkbox"/> "Starting FORTH" by Brodie. Prentice-Hall. Best User's manual available (soft cover) | \$ 16.00 |
| <input type="checkbox"/> "Starting FORTH" (hard cover) | 20.00 |
| <input type="checkbox"/> "Using FORTH" by FORTH, Inc. Guide to FORTH concepts | 25.00 |
| <input type="checkbox"/> "A FORTH Primer" by Stevens In-depth self-study manual. | 25.00 |
| <input type="checkbox"/> "Systems Guide to fig-FORTH" by Ting. Excellent guide to inner mechanisms. | 25.00 |
| <input type="checkbox"/> "PDP-11 FORTH User's Guide" by James. Use with PDP-11 Source. | 20.00 |
| <input type="checkbox"/> "Caltech FORTH Manual" by Ewing. Overview and structure. | 12.00 |
| <input type="checkbox"/> "FORTH-79", Latest fig-FORTH standard. | 15.00 |
| <input type="checkbox"/> "FORTH-79 Standard Conversion" by R. C. Smith. Screens, DOES>, error conditions. | 10.00 |
| <input type="checkbox"/> "TinyPASCAL in fig-FORTH" by Zimmer. | 10.00 |
| <input type="checkbox"/> "Threaded Interpretive Languages" by Loeliger. Byte Books. FORTH adapted for Z80. | 20.00 |
| <input type="checkbox"/> "Invitation to FORTH" by Katzan. Petrocelli Books. Limited introduction. | 18.50 |
| <input type="checkbox"/> "Proceedings, 1980 FORML Conference." Technical papers. | 25.00 |
| <input type="checkbox"/> "Proceedings, 1981 Rochester University FORTH Conference." Technical papers. | 25.00 |
| <input type="checkbox"/> "METAFORTH" by Cassady. Cross-compiling, 8080 source code. | 30.00 |

INSTALLATION DOCUMENTS

| | | | |
|--|-------------------------------------|--|------------------------------------|
| <input type="checkbox"/> Installation Manual for fig-FORTH, contains FORTH model, glossary, memory map and instructions. | \$ 15.00 | | |
| Source Listings of fig-FORTH, for specific CPU's and computers. The above Installation Manual is required for implementation. Price per each | 15.00 | | |
| <input type="checkbox"/> 1802 | <input type="checkbox"/> 6502 | <input type="checkbox"/> 6800 | <input type="checkbox"/> 6809 |
| <input type="checkbox"/> 8080 | <input type="checkbox"/> 8086/8088 | <input type="checkbox"/> 9900 | <input type="checkbox"/> APPLE II* |
| <input type="checkbox"/> PACE | <input type="checkbox"/> AlphaMicro | <input type="checkbox"/> PDP-11/LSI-11 | <input type="checkbox"/> NOVA* |

DISKS WITH DOCUMENTATION

| | | | | | |
|--|---|-------------------------------------|---|--|----------|
| fig-FORTH Model and Source Listing, with Printed Installation Manual and Source Listing. | | | | | |
| <input type="checkbox"/> H89/Z89 (5 1/4") | <input type="checkbox"/> APPLE II* (5 1/4") | <input type="checkbox"/> NOVA* (8") | <input type="checkbox"/> 8080/Z80* (8") | | \$ 65.00 |
| Enhanced FORTH Systems with manuals. | | | | | |
| <input type="checkbox"/> APPLE II/III* by MicroMotion. fig-FORTH, FORTH-79 standard, editor, assembler, 187 pg. manual (1-5 1/4") | | | | | 90.00 |
| <input type="checkbox"/> APPLE II* by R. Kuntze. fig-FORTH, editor, assembler, source listing and screens. (2-5 1/4") | | | | | 90.00 |
| <input type="checkbox"/> H89/Z89 by G. Haydon, fig-FORTH, stand alone, source listing, editor, assembler, screens and tutorial on disk (3-5 1/4") | | | | | 250.00 |
| <input type="checkbox"/> H89/Z89 by G. Haydon, fig-FORTH, under CP/M*, source listing, editor, assembler, screens and tutorial on disk (3-5 1/4") | | | | | 175.00 |
| <input type="checkbox"/> TRS-80/I* by Nautilus Sys. fig-FORTH, editor and assembler (1-5 1/4") | | | | | 90.00 |
| <input type="checkbox"/> TRS-80/I or III* by Miller Microcomputer Services. MMSFORTH, editor, assembler interpreter/compiler, virtual memory. (1-5 1/4") | | | | | 130.00 |
| <input type="checkbox"/> NOVA* by Ting. fig-FORTH, editor, assembler, source listing and screens. (1-8") | | | | | 90.00 |
| <input type="checkbox"/> 6809 by Talbot Microsystems. fig-FORTH, interpreter/compiler, editor, assembler, disk I/O. (FLEX* 5 1/4 or 8") | | | | | 100.00 |
| <input type="checkbox"/> 6800 by Talbot Microsystems. fig-FORTH, interpreter/compiler, editor, assembler, disk I/O. (FLEX* 5 1/4 or 8") | | | | | 100.00 |

Special Function FORTH Systems with manuals

| | | | | | |
|--|--------------------------------|------------------------------|------------------------------------|------------------------------------|--------|
| Cross Compilers by Nautilus Systems. Allows extending, modifying, compiling to different target processors, generates ROMable code and forward referencing. Price per each | <input type="checkbox"/> CP/M* | <input type="checkbox"/> H89 | <input type="checkbox"/> TRS-80/I* | <input type="checkbox"/> Northstar | |
| <input type="checkbox"/> 6809 Target Compiler by Talbot Microsystems. | | | | | 200.00 |
| <input type="checkbox"/> 6809 Enhanced System Plus by Talbot Microsystems. 2nd screen editor, macroassembler, tutorial on disk, goodies disk of debugging and documentation tools and utilities. | | | | | 350.00 |
| <input type="checkbox"/> Z-80* Program Development by Laboratory Microsystems with full software floating point arithmetic. | | | | | 250.00 |
| <input type="checkbox"/> Z-80* Cross Compiler (Nautilus) by Laboratory Microsystems. | | | | | 150.00 |
| <input type="checkbox"/> Z-80* for AMD9511 Arithmetic Processor by Laboratory Microsystems. | | | | | 200.00 |
| <input type="checkbox"/> "Going FORTH" by Creature Software. A CAI FORTH tutorial, IBM format, no manual (1-8") | | | | | 150.00 |
| <input type="checkbox"/> HP-85 by H-P. fig-FORTH, editor and assembler (1-5 1/4") | | | | | 65.00 |
| <input type="checkbox"/> HP-85 by H-P. fig-FORTH, editor and assembler (1-5 1/4") | | | | | 65.00 |

ORDERS ONLY (415) 961-4103

DEALER & AUTHOR INQUIRIES INVITED

Ordering Information: Check, Money Order (payable to MOUNTAIN VIEW PRESS), VISA or MasterCard accepted. No COD's or unpaid PO's. California residents add 6 1/2% sales tax. Shipping costs in US Included in price. Foreign orders, pay in US funds on US bank, include for handling and shipping by Air: \$5.00 for each item under \$25.00, \$10.00 for each item between \$25.00 and \$99.00, and \$20.00 for each item over \$100.00. Minimum order \$10.00. All prices and products subject to change or withdrawal without notice. Single system and/or single user license agreement required on some products. *REGISTERED TRADEMARKS

MOUNTAIN VIEW PRESS

PO BOX 4656

MOUNTAIN VIEW, CA 94040

(415) 961-4103

NEW!!! THE ELECTRIC MOUTH*



ELF II VERSION

for S100, Elf II, Apple, TRS-80 Level II*

From \$99.95 kit

Now — teach your computer to talk, dramatically increasing the interaction between you and your machine.

That's right: the ELECTRIC MOUTH actually lets your computer talk! Installed and on-line in just minutes, it's ready for spoken-language use in office, business, industrial and commercial applications, in games, special projects, R&D, education, security devices — there's no end to the ELECTRIC MOUTH's usefulness. Look at these features:

- * Supplied with 143 words/letters/ phonemes/ numbers, capable of producing hundreds of words and phrases.
- * Expandable on-board up to thousands of words and phrases (just add additional speech ROMs as they become available).
- * Four models, which plug directly into S100, Apple, Elf II and TRS-80 Level II computers.
- * Get it to talk by using either Basic or machine language (very easy to use, complete instructions with examples included).
- * Uses National Semiconductor's "Digitaler" system.
- * Includes on-board audio amplifier and speaker, with provisions for external speakers and amplifier.
- * Adds a new dimension and excitement to programming; lets you modify existing programs and games to add spoken announcements of results, warnings, etc.
- * Installs in just minutes.

Principle of Operation: The ELECTRIC MOUTH stores words in their digital equivalents in ROMs. When words, phrases, and phonemes are desired, they are simply called for by your program and then synthesized into speech. The ELECTRIC MOUTH system requires none of your valuable memory space except for a few addresses if used in memory mapped mode. In most cases, output ports (user selectable) are used.

Spoken Material Included

| | | | | | | | | |
|----------|----------|---------------|--------|---------|-------------|--------|------|--------|
| one | eighteen | at | dollar | inches | number | is | c | t |
| two | nineteen | cancel | down | is | if | second | d | u |
| three | twenty | case | equal | it | off | set | e | v |
| four | thirty | cent | error | kilo | on | space | f | w |
| five | forty | 400hertz tone | flow | less | over | star | h | y |
| six | fifty | 800hertz tone | fuel | lesser | parenthesis | stop | l | z |
| seven | sixty | 20ms silence | gallon | limit | percent | slap | | |
| eight | seventy | 40ms silence | go | low | please | than | k | |
| nine | eighty | 80ms silence | gram | lower | plus | the | i | |
| ten | ninety | 160ms silence | great | mark | point | time | m | |
| eleven | hundred | 320ms silence | coral | greater | meter | pound | try | n |
| twelve | thousand | | check | have | mile | pulses | up | o |
| thirteen | million | | zero | high | milli | rate | volt | p |
| fourteen | army | | again | control | higher | minus | re | weight |
| fifteen | ampere | | danger | hour | minute | ready | a | r |
| sixteen | and | | degree | in | near | right | h | s |

*"Elf II" and "The Electric Mouth" are reg. trademarks of Netronics R&D Ltd. "Apple" is a reg. trademark of Apple Computer Inc. "TRS-80 Level II" is a reg. trademark of Tandy Corp.

Continental U.S.A. Credit Card Buyers Outside Connecticut

CALL TOLL FREE 800-243-7428

To Order From Connecticut Or For Technical Assistance, Etc.

Call (203) 354-9375

NETRONICS R&D LTD. Dept B10

333 Litchfield Road, New Milford, CT 06776

Please send the items checked below:

- S100 "Electric Mouth" kit \$99.95
- Elf II "Electric Mouth" kit \$99.95
- Apple "Electric Mouth" kit \$119.95
- TRS-80 Level II "Electric Mouth" kit \$119.95

Add \$20.00 for wired & tested units. All plus \$3.00 postage & insurance. Conn res. add sales tax.

Total Enclosed \$ _____

Personal Check Cashier's Check/Money Order

Visa Master Charge (Bank No. _____)

Acct. No. _____ Exp. Date _____

Signature _____

Print Name _____

Address _____

City _____

State _____ Zip _____

Listing 1 continued:

```

plotline(2,xpos+height/2,ypos);
plotline(2,xpos-height,ypos);
plotline(2,xpos+height/2,ypos);
plotline(2,xpos,ypos+height/2);
plotline(2,xpos,ypos-height);
plotline(2,rxpos,rypos);
end;
5:begin (*vertical line*)
plotline(2,xpos,ypos+height/2);
plotline(2,xpos,ypos-height);
plotline(2,rxpos,rypos);
end;
end;(*case*)
end;(*plotsymbol*)

procedure plotwhere;
begin
px:=xpos;
py:=ypos;
end;

procedure plotarray;
var
pen,i:integer;
begin
if nopoints>250 then
begin
write (clear);
gotoxy((screenwidth-42) div 2,screenheight div 2);
writeln('Plotarray: Plot attempted with >250 points');
gotoxy((screenwidth-17) div 2,screenheight-1);
write('Please type [ret]');
readln;
write (clear);
exit(plotarray);
end;
if (py+ylen>7.0) or (px+xlen>10) then
begin
write (clear);
gotoxy((screenwidth-50) div 2,screenheight div 2-1);
writeln('Plotarray: Plot attempted off page ('
px+xlen:6:2,',',py+ylen:6:2,')');
gotoxy((screenwidth-17) div 2,screenheight-1);
write('Please type [ret]');
readln;
write (clear);
exit(plotarray);
end;
xlen:=(xmax-xmin)/xlen;
ylen:=(ymax-ymin)/ylen;
if freq<0 then pen:=1
else pen:=2;
freq:=abs(freq);
plotline(1,((x[l]-xmin)/xlen)+px,((y[l]-ymin)/ylen)+py);
if freq>0 then plotsymbol(sym,height);
for i:=2 to nopoints do
begin
plotline(pen,((x[i]-xmin)/xlen)+px,
((y[i]-ymin)/ylen)+py);
if (freq>0) then
if ((i+1) mod freq=0) then plotsymbol(sym,height);
end;
end;(*plotarray*)

procedure plotaxis;
var
templ,side:integer;
print:boolean;
amount:string;
thetal,temp,rxpos,rypos,len,per,step:real;

procedure divsteps(theta:real);
begin
theta:=theta+pi/2;
plotline(2,xpos+0.03*cos(theta),ypos+0.03*sin(theta));
plotline(2,xpos-0.06*cos(theta),ypos-0.06*sin(theta));
plotline(2,xpos+0.03*cos(theta),ypos+0.03*sin(theta));
end;

begin(*plotaxis*)
if tic<9 then
begin
tic:=-tic;
side:=-1;
end
else
side:=1;
thetal:=theta;
theta:=(2*pi/360)*thetal;

```

Listing 1 continued on page 232

Strictly Business

If you've ever missed a deadline, forgotten an appointment, waited on late deliveries or lost track of projects, put ANGEL to work for you.

ANGEL is the new software program for microcomputers that helps organize and manage your business flow. It's strictly business.

FAST AND EASY

With a series of simple one-line entries, ANGEL can schedule every phase of your projects and appointments, however simple or complex. Then, each day, ANGEL will give you a run-down of every action that needs to be taken to complete all your work on time, whether it's due tomorrow or ten years from now.

ANGEL's large capacity allows you to log and track up to 2,000 individual projects at once. With ANGEL's help, you can eliminate reams of files and hours upon hours of costly business delays and missed deadlines.

SPEAKS SIMPLE ENGLISH

ANGEL speaks plain English. No computer language to memorize, no codes to decipher. Sit down and talk to it, face-to-face. If ANGEL doesn't understand, it will respond in plain English. If you make a program error, ANGEL tells you how to correct your mistake through the use of a built-in video manual. ANGEL is so easy to use, you can turn it on and enter 30 items in less than five minutes.

WORKS FOR ANY BUSINESS

You can custom-program ANGEL for any business operation — from oil

exploration to insurance, home construction to retail sales.

With a memory capacity that's limited only by the capacity of your disk storage, ANGEL tracks multiple projects for busy executives. The disk comes with an easy-to-understand printed manual, to back up the built-in set of instructions of the program itself.

In addition, a data-proof safeguard system will not let you accidentally erase entries, and a special password code of your choice allows you to keep confidential files.

Put ANGEL to work for you today. You'll never lose track of your work flow again.

ANGEL is recommended for use with any disk-based system that has 48k memory or more. It will operate with any CP/M[®]-based system and the TRS 80[™] (Model I, II or III). The

program comes on standard 5¼- or 8-inch disk, with storage sleeve. Now only \$295.

ANGEL is available only through Time Management Software. It is not sold through any outlets at any price. Order the complete program for better business by calling one of our toll-free numbers or by returning the order blank below.

Call now toll-free to order (Ask for operator 602)

1-800-824-7888 (nationwide, except California, Alaska and Hawaii)

1-800-852-7777 (in California)

1-800-824-7919 (in Alaska and Hawaii)



Yes . . . I need ANGEL to work for me, to organize my business with ultimate ease and efficiency.

NAME _____

ADDRESS _____

CITY _____

STATE _____

ZIP _____

I have enclosed \$295 to avoid delays, shipping and handling charges.

Check

Money Order

C.O.D. (If delivery address is different than above, please specify)

Please specify one: 5¼-inch disk

8-inch disk

Please specify one: CP/M[®] Operating System TRSDOS[™] Operating System

Price includes tax, handling and shipping (except C.O.D. orders)

10A1

**TIME
MANAGEMENT
SOFTWARE[™]**

123 E. Broadway
P.O. Box 727
Cushing, Oklahoma 74023

* Registered trademark of Digital Research, Inc.
** Registered trademark of Tandy Corp.

ANGEL

MICROSETTE CASSETTES



**C-10 C-20
COMPUTER CASSETTES**



**C-60 C-90
AUDIO CASSETTES**

Our computer cassettes provide more users with more reliable data time after time. Our new audio cassettes are perfect for highest quality stereo recording. Credit card buyers may phone (415) 968-1604.

**LOOK AT OUR PRICES
includes boxes and shipping**

| Length | 10 Pack | 50 Pack |
|--------|---------|---------|
| C-10 | \$ 7.50 | \$32.50 |
| C-20 | \$ 9.00 | \$39.00 |
| C-60 | \$13.50 | \$57.50 |
| C-90 | \$17.50 | \$77.50 |

UPS shipment in Cont. USA incl.
We can not ship to P.O. Boxes

| Length | Qty. | Price | Total |
|----------------------------|------|-------|-------|
| | | | |
| SUBTOTAL | | | |
| Calif. Cust. add Sales Tax | | | |
| TOTAL | | | |

Check or money order enclosed
 Charge to: Visa Master Card
 Account No. _____
 Expiration Date _____

SIGNATURE _____

**MICROSETTE CO.
475 Ellis Street
Mt. View, CA 94043**

Listing 1 continued:

```

if (px+leng*cos(theta)>10) or (py+leng*sin(theta)>7) then
begin
  writeln('Plotaxis: plot attempted off page (',
    px+leng*cos(theta),',',py+leng*sin(theta),')');
  write('Please type [ret]');
  readln;
  exit(plotaxis);
end;
if leng<0 then
begin
  print:=false;
  leng:=-leng;
end
else
  print:=true;
len:=leng;
plotline(1,px,py);
per:=(leng-0.01)/(max-min);
while leng>0 do
begin
  if leng>tic*per then step:=tic*per
  else step:=leng;
  divsteps(theta);
  if print then
  begin
    rxpos:=xpos;
    rypos:=ypos;
    templ:=trunc(min*100);
    str(templ,amount);
    insert('.',amount,length(amount)-1);
    temp:=length(amount)/2;
    plotline(1,xpos-(0.086*temp*cos(theta)-
      side*(0.14+(side-1)*0.05)*sin(theta)),
      ypos-(0.086*temp*sin(theta)+side*(0.14+(side-1)*0.05)
        *cos(theta)));
    plotstring(xpos,ypos,0.1,thetal,amount);
    plotline(1,rxpos,rypos);
  end; (*if*)
  plotline(2,xpos+step*cos(theta),ypos+step*sin(theta));
  leng:=leng-step;
  min:=min+tic;
end; (*while*)
if print then
begin
  plotline(1,
    xpos-(len/2*cos(theta)+0.108*round(length(name)/2)
      *cos(theta)-side*(0.35+(side-1)*0.075)*sin(theta)),
    ypos-(len/2*sin(theta)+0.108*round(length(name)/2)
      *sin(theta)+side*(0.35+(side-1)*0.075)*cos(theta)));
  plotstring(xpos,ypos,0.125,thetal,name);
end;
end; (*plotaxis*)
end. (*unit*)
  
```

Listing 2: A demonstration Pascal program that uses the "plotter" unit. The plot drawn by this program is shown in figure 3.

```

program plotter_demo;
uses plotter;

const
  pi=3.14159;

var
  index:integer;
  xpoints,sinypoints,cosypoints:coord;
  xloc,yloc,angle:real;

begin
  (*this segment initializes the arrays*)

  for index:=1 to 250 do
  begin
    angle:=(index-1)/249*2*pi;
    xpoints[index]:=index-1;
    sinypoints[index]:=sin(angle);
    cosypoints[index]:=cos(angle);
  end;

  (*this segment does the plotting*)

  plotline(0,0,0);
  plotstring(3,6.75,0.126,0,'this is a demonstration of the plotter unit');
  plotaxis(0.5,0.5,9.5,0,0,36,6,'angle (in degrees) *10[-1]');
  
```

Listing 2 continued on page 238

SOFTWARE GURU.

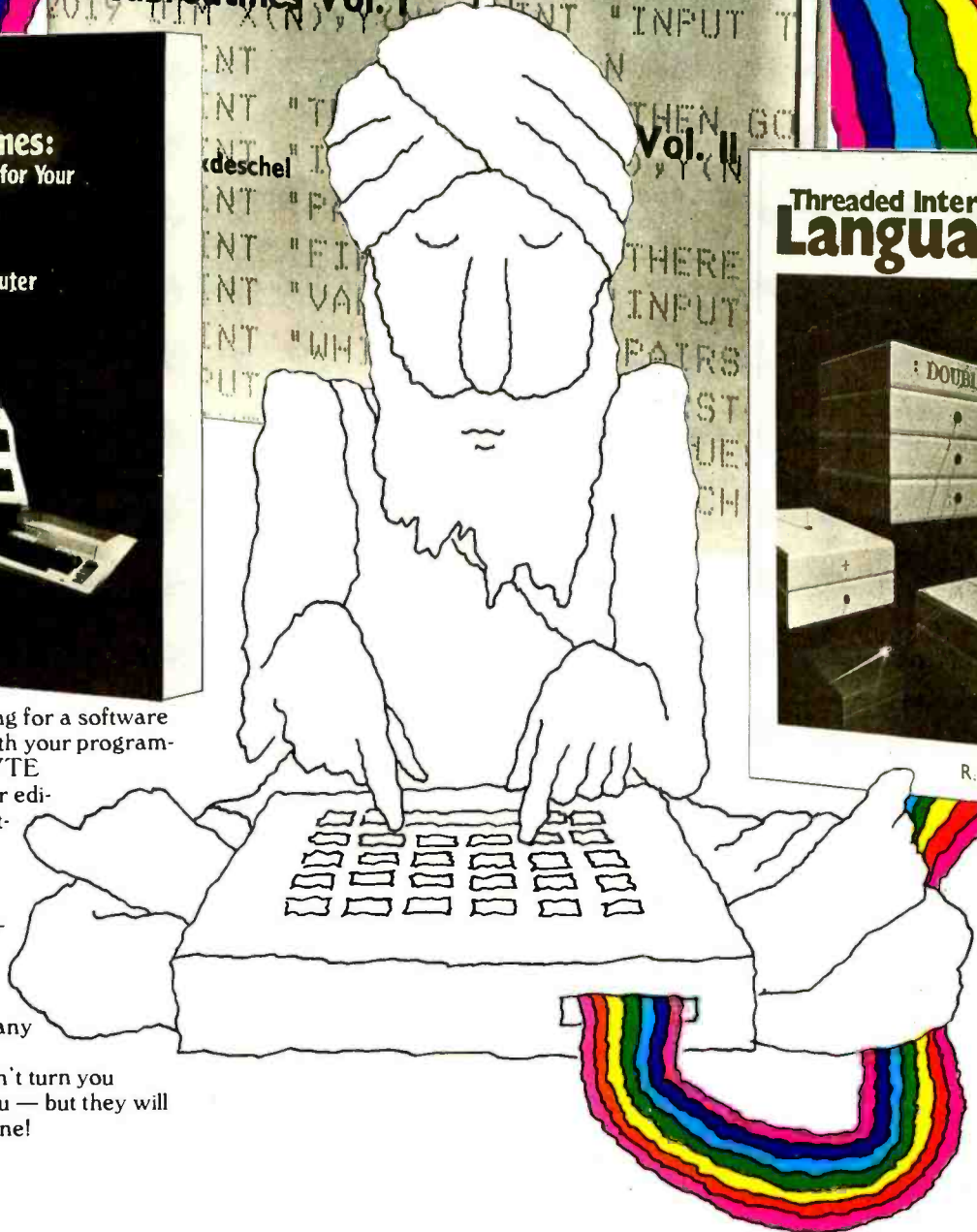
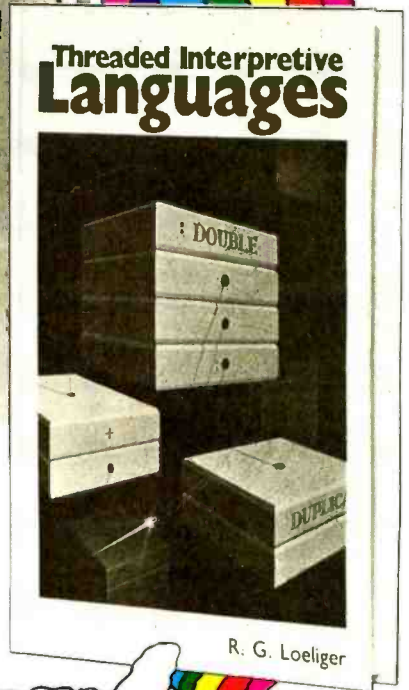
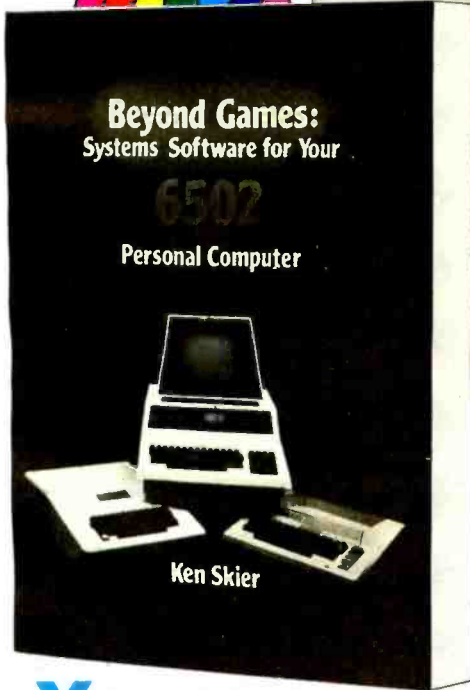
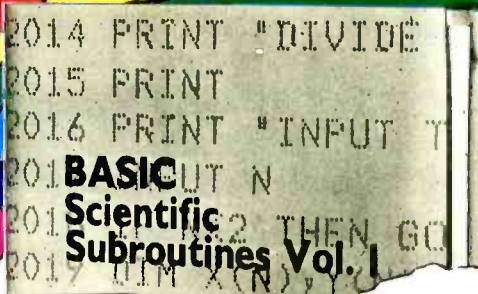
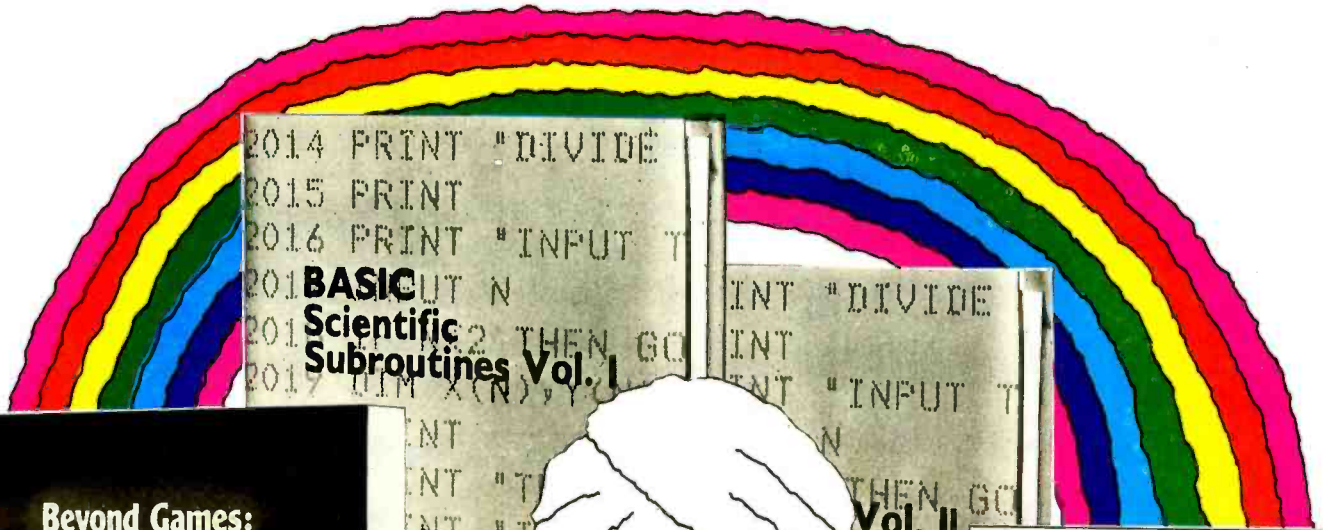

You've been looking for a software source to help with your programming. This month **BYTE BOOKS** features four editions for your thoughtful consideration. A programming guidebook on the 6502, compact threaded languages for the Z80, and two volumes on scientific subroutines. Enough to challenge any hobbyist or scientist.

These books won't turn you into a Software Guru — but they will help you **think** like one!

BYTE BOOKS

McGraw Hill

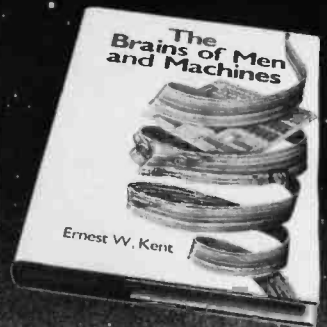
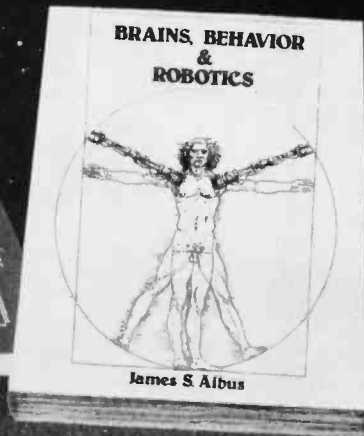
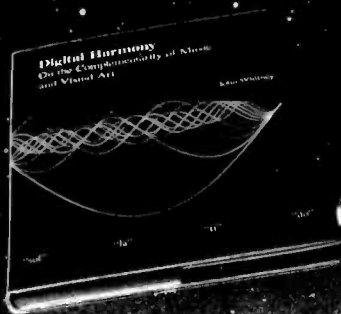

AVAILABLE FALL 1981

DIGITAL HARMONY

by John Whitney

A new synthesis of sight and sound

Digital Harmony lays the foundation for the whole new field of audio-visual art made possible by microcomputers. John Whitney, a pioneer of the special effects technology used in STAR WARS and 2001: A SPACE ODYSSEY, explains the special union of computer graphics and music. His computer-generated visual art graphically depicts the laws of harmonic motion common to all music.

Digital Harmony includes a complete description of Whitney's computer, peripherals, and film techniques. Colorful illustrations are included, as well as the program listings that generated them. The descriptions are sufficient for anyone to begin to explore this new territory as a composer and computer experimenter - transforming the small computer into an ideal instrument for creating compositions in aural and visual art.

John Whitney is on the Faculty in the Department of Art at the University of California, Los Angeles.

ISBN 0-07-070015-X
240 pages
hardcover
over 50 color
photographs

\$21.95

INVERSIONS: A Catalogue of Calligraphic Cartwheels

by Scott Kim
Foreword by Douglas Hofstadter
Backword by Jef Raskin

Surprising symmetries in design and letterforms

Illusion... calligraphy... visual magic - Scott Kim's new book, *Inversions*, delights the eye and enchants the mind. Filled with intriguing designs, words that read the same right-side up and upside down, words within words, and unexpected symmetries, these compositions create a fresh way to look at the alphabet. The text includes the visual principles of symmetry, lettering, and problem solving that are basic to these images. The author also draws parallels to related exercises in perception in such diverse areas as art, music, word play, and mathematics. Scott Kim's original inversion designs first appeared in *Omni* magazine, inspiring an overwhelming reader response. An irresistible challenge, invertible writing appeals to everyone who loves beauty in mathematics and design.

Scott Kim is a doctoral student in Computer Science at Stanford University and is a concert pianist and composer.

ISBN 0-07-034546-5
128 pages
softcover
over 50 illustrations
available summer 1981

\$8.95

BRAINS, BEHAVIOR, AND ROBOTICS

by James S. Albus

Robotics design and applications

This computer-oriented guide explores how the brain functions primarily as a computer device for generating and controlling behavior. The author assesses behavior as a product of three hierarchies of computing modules:

- memory modules
- behavior-generating modules
- sensory-processing modules

A section on artificial intelligence ties this hierarchical model to vital computer science techniques such as planning, problem-solving, machine vision, natural language understanding and knowledge representation. A closing section on robotics discusses the design considerations in constructing a robot control system fashioned after this model of the brain, and explores the current and potential use of robots in our environment.

Dr. James S. Albus is Project Manager with the National Bureau of Standards.

ISBN 0-07-000975-9
400 pages
hardcover
180 illustrations

\$16.95

THE BRAINS OF MEN AND MACHINES

by Ernest W. Kent

Human models for computer design

When the "Brains of Men and Machines" series of articles first appeared in BYTE magazine, the response was immediate and enthusiastic. Now Ernest W. Kent has expanded his ideas about the brain into a full-length book. As researchers begin to unravel the mysteries of the brain's chemical, electrical, and synaptic circuitry, their findings are becoming immediately applicable to advances in robotic behavior and computer design. The Brains of Men and Machines "dissects" the brain to provide new insights into computer design and artificial intelligence.

It is one of the rare books that transcends disciplinary boundaries. In it the ever-increasing relationship between man and machine is freshly examined - a relationship, Professor Kent concludes, that is today being reexamined in the light of man's own neurological self-image.

Dr. Ernest W. Kent is a Professor of Physiological Psychology and Psychopharmacology at the University of Illinois at the Chicago Circle Campus.

ISBN 0-07-034123-0
304 pages
hardcover
illustrated

\$15.95

The BYTE BOOK Collection

Circle 51 on inquiry card.

BASIC SCIENTIFIC SUBROUTINES, VOLUMES 1 AND 2

by Fred Ruckdeschel

BASIC Scientific Subroutines Vol. 1
F.R. Ruckdeschel

Valuable programs for professional and hobbyist

Designed for the engineer, scientist, experimenter, and student, this series presents a complete scientific subroutine package in BASIC.

- Volume 1 covers plotting, complex variables, vector and matrix operation, random number generation, and series approximations.
- Volume 2 continues with least-squares approximation, special polynomial functions, approximating techniques, optimization, roots of functions, interpolation, differentiation, integration, and digital filtering.

These volumes feature routines written in both standard Microsoft and North Star BASIC, extensive appendices, and subroutine cross-references.

Dr. Fred Ruckdeschel is a Principal Scientist with Dynacomp, Inc.

VOLUME 1
ISBN 0-07-054201-5
336 pages
hardcover
illustrated

VOLUME 2
ISBN 0-07-054202-3
384 pages hardcover
illustrated
available Fall 1981

\$19.95

\$23.95

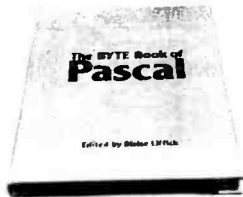

THE BYTE BOOK OF PASCAL

Blaise W. Liffick, Editor

A powerful, structured language

Based on articles, language forums, and letters from BYTE magazine, this work is a valuable software resource. Pascal continues to be popular as a structured programming language. Written for both potential and established users, this book introduces the Pascal language and examines its merits and possible implementations. Featured are two versions of a Pascal compiler, one written in BASIC and the other in 8080 assembly language; a p-code interpreter written in both Pascal and 8080 assembly language; a chess-playing program; and an APL interpreter.

ISBN 0-07-037823-1
334 pages
hardcover

\$25.00

THREADED INTERPRETIVE LANGUAGES

by Ronald Loeliger



How to implement FORTH on your Z80

Threaded languages (such as FORTH) are compact, giving the speed of assembly language with the programming ease of BASIC. They combine features found in no other programming languages. This book develops an interactive, extensible language with specific routines for the Zilog Z80 microprocessor. With the core interpreter, assembler, and data type defining words covered in the text, it is possible to design and implement programs for almost any application and equivalent routines for different processors.

Ron Loeliger is a Senior Analyst with Intermetrics, Inc.

ISBN 0-07-038360-X
272 pages
hardcover
illustrated

\$18.95

BEGINNER'S GUIDE FOR THE UCSD PASCAL SYSTEM

by Kenneth L. Bowles



The most popular Pascal version explained by its creator

Written by the originator of UCSD Pascal System, this informative book is an orientation guide to the UCSD Pascal System. For the novice, this book steps through the System, bringing the user to a sophisticated level of expertise. Once familiar with the System, the reader will find the guide an invaluable reference tool for creating advanced applications. The package offers programs which may be run without alteration on:

- DEC PDP-11 or General Automation minicomputers
- Western Digital Microengines
- 8080, 8085, Z80, 6502, 6800, 9900 or AM-100 based microcomputers (including the popular Apple II and Radio Shack TRS-80 microcomputers)

Dr. Kenneth L. Bowles is Director of the Institute for Information Systems, University of California, San Diego.

ISBN 0-07-006745-7
204 pages
softcover

\$11.95

YOU JUST BOUGHT A PERSONAL WHAT?

by Thomas Dwyer and Margot Critchfield



A Structured Approach to Creative Programming

Intended for both the novice programmer and the experienced computer enthusiast, this book presents practical ideas for personal computer use at home or at work.

Its approach is especially suitable for educational purposes. Written by the leading contributors of computer education material, this book is an entertaining and resourceful tool. There are over 60 ready-to-use programs written in Microsoft and Level II BASIC for the TRS-80 in the areas of educational games, financial record keeping, business transactions, disk-based files, and word processing.

Dr. Thomas Dwyer is a Professor of Computer Science at the University of Pittsburgh.

Margot Critchfield is a doctoral student in Foundations in Education at the University of Pittsburgh.

ISBN 0-07-018492-5
343 pages
softcover
78 illustrations

\$11.95

BEYOND GAMES: SYSTEM SOFTWARE FOR YOUR 6502 PERSONAL COMPUTER

by Kenneth Skier



Creating programs for the Apple, Atari, Challenger and PET computers

At last, a complete programming guidebook for owners of personal computers utilizing the 6502 microprocessor. A self-contained course in structures programming and top-down design, this book presents a powerful set of tools for building an extended dump monitor, disassembler, hexadecimal dump routine, and text editor programs. Programs are thoroughly explained, with clear instructions for modifications.

Kenneth Skier is a Systems Programmer for Wang Laboratories, Inc., and a Lecturer at MIT.

ISBN 0-07-057860-5
440 pages
softcover
illustrated

\$14.95

stimulating, provocative, problem-solving

CIARCIA'S CIRCUIT CELLAR

by Steve Ciarcia



Practical uses for home computers

Imaginative and practical, Ciarcia's Circuit Cellar details a variety of microcomputer projects. A collection of the best articles from the popular series in BYTE magazine, this volume includes

- D/A conversion
- Programming EPROMS
- AC remote-controlled appliances
- digitized speech
- touch input video display

Complete instructions are given on how to construct each project. With amusing anecdotes and an easy-going style, Ciarcia presents his material in such a manner that even a neophyte need not be afraid of it.

ISBN 0-07-010960-5

125 pages

softcover

color photographs and diagrams

\$8.00

CIARCIA'S CIRCUIT CELLAR, VOLUME II

by Steve Ciarcia



More practical uses for home computers

Composed of popular articles from BYTE magazine, this volume tells how microcomputers can be uniquely interfaced to our environment. Projects include

- building a computer controlled home-security system
- computerizing appliances
- transmitting digital information over a beam of light
- building the Intel 8086 microprocessor system design kit
- input-output expansion for the TRS-80

ISBN 0-07-010963-X

224 pages

softcover

photographs and diagrams

\$12.95

MICRO- COMPUTER STRUCTURES

by Henry D'Angelo



Digital Electronics, Logic Design, and Computer Architecture

Today, there is an increasing demand for computer users who are not only well-versed in software, but who can also maintain, modify, and design their own hardware systems.

This text introduces computer users with little or no background in digital hardware to the basic computer structures used in microcomputer design and microcomputer interfacing. Helpful examples and end-of-chapter exercises further illustrate the various concepts presented, and a detailed bibliography provides additional reading opportunities. As a resource and textbook, it will assist

- programmers and systems analysts
- engineers and scientists
- managers
- students

Detailed Instructor's Manual also available.

Dr. Henry D'Angelo is the Associate Dean of the College of Engineering and Professor of Manufacturing Engineering at Boston University.

ISBN 0-07-015294-2

288 pages

hardcover

314 illustrations

available spring 1981

\$18.95

Instructor's Manual

ISBN 0-07-015298-5

softcover

\$8.95

BYTE Books' reputation is based on providing technically accurate, useful, and timely information. Established on the same principle as *BYTE* magazine, BYTE Book's evolved in response to the rapidly expanding audience of home and business computer users. Computer professionals and enthusiastic newcomers need to keep pace with this unabated growth. This selection of BYTE books can expand your library of knowledge and expertise.

**TO ORDER, CALL TOLL
FREE 800-258-5420, OR
FILL OUT YOUR CHOICES
IN THIS COUPON AND
return it with check,
money order, or charge
card number to:**

**BYTE
BOOKS**

70 Main Street
Peterborough,
New Hampshire 03458

BUILD YOUR OWN Z80 COMPUTER

by Steve Ciarcia



Every step spelled out for do-it-yourself buffs

For the engineer, computer technician, student, and anyone interested in building a computer rather than buying one, this practical guide shows how to build a working computer based on the Zilog Z80 microprocessor. Each computer subsystem is fully explained and supported by proven design and testing information. The description focuses on a basic single-board micro-computer containing

- easy expansion to include a video terminal
- a 1 K-byte operating system
- serial and parallel ports
- hexadecimal display
- audio cassette mass storage

Readers can modify the system to meet personal needs.

Steve Ciarcia is a Computer Consultant, Electrical Engineer, and author of "Ask Byte" and "Ciarcia's Circuit Cellar" columns in *BYTE* magazine.

ISBN 0-07-010962-1

330 pages

softcover

available summer 1981

\$15.95

**BYTE
BOOKS**

70 Main Street
Peterborough, New Hampshire 03458

Name _____

Address _____

City _____ State _____ Zip _____

• Check enclosed in the amount of _____

 • Bill Visa. Card Number _____

 • Bill Master Charge. Card Number _____

• Expiration Date _____

Include 75c per book to cover postage and handling.

| TITLE | PRICE | QUANTITY | AMOUNT |
|-------|-------|----------|--------|
| | | | |
| | | | |
| | | | |
| | | | |

SHIPPING

TOTAL

order now . . . !



Circle 53 on inquiry card.

LOWEST PRICE - BEST QUALITY

NORTH STAR



North Star Horizon 2

2-5 1/4 Disk Drives
32K Double Den
Factory assem. & tested
Factory guaranteed
List \$3695

only **\$2697**

POWERFUL NORTH STAR BASIC FREE SUPERB FOR BUSINESS & SCIENCE

| FACTORY ASSEMBLED & TESTED | LIST | ONLY |
|------------------------------------|--------|-------------|
| HORIZON-2-64K-DOUBLE DEN | \$4195 | \$3062 |
| HORIZON-2-32K-QUAD DENSITY | \$3995 | \$2916 |
| HORIZON-2-64K-QUAD | \$4495 | \$3281 |
| HORIZON RAM ASSM 16K = \$279 | | 32K = \$479 |
| HORIZON RAM ASSM 48K = \$679 | | 64K = \$879 |
| HORIZON DISK DRIVE SALE | | |
| DOUB DEN | SAVE! | \$ 445 |
| NORTH STAR HARD DISK 18 Mb | \$5375 | \$3923 |
| NORTH STAR TIME SHARING MULTI-USER | | CALL |

SUPERBRAIN ZENITH

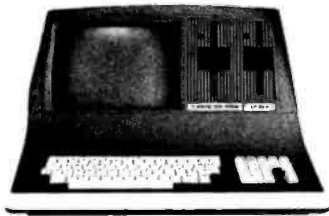

SUPERBRAIN QD 64K
List \$3995 only \$2995



Z-89 48K
List \$2895 only \$2299

TERMINALS Z-19 \$725 INTERTUBE III only \$725

DYNABYTE COMPUTER—SAVE—PHONE

EPSON MX-80—PHONE
ANADEX 9501 \$1349

NEC PRINTER \$2639
TRACTOR,
THIMBLE,
RIBBON
DIP-81 \$395
TEC LETTER QUAL \$1599

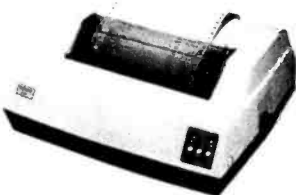

InterSystems

ITHACA INTERSYSTEMS 2A



Z-80A CPU 4 MHz
64K Dynamic RAM
Front panel
V I/O—with interrupts
FDCII Disk Controller
20 slot motherboard

CALL FOR PRICE— TOO LOW TO ADVERTISE!

PASCAL/Z + THE FASTEST PASCAL \$375
Z-8000 & CACHE BIOS—POWERFUL—PHONE
8086 16 BIT CPU & SUPPORT CARD SEATTLE \$695
CALIFORNIA COMPUTER 2210A ONLY \$1795

MORROW 8" DISK

DISCUS 2D + CP/M® 600K ONLY \$929
DISCUS 2 + 2 + CP/M® 1.2 MEGA B. \$1240
ADD DRIVES 2D = \$650 2 + 2 = \$975
2D-DUAL + CP/M® ONLY \$1540

FREE MBASIC FROM MORROW!!



MORROW HARD DISK
26,000,000 BYTES!!
LIST \$4995 ONLY \$3919
CP/M® IS INCLUDED!

SAVE ON MEMORY AND PROGRAMS

| | | | |
|-----------------------------------|-----------------|--------------------------------------|----------------|
| SYSTEMS MEMORY 64K A & T 4MHz | \$590 | WORD STAR | \$315 |
| SYSTEM MEMORY 64K BANK SELECT | \$740 | SPECTRUM | \$269 |
| ITHACA MEMORY 8/16-bit 64K | \$845 | COMPUPRO | SAVE |
| SEATTLE MEMORY 8/16 BIT 16K | \$249 | EZ-CODER Translates English to BASIC | \$71 |
| SSM KITS Z-80 CPU | \$221 | ECOSOFT FULL ACCOUNTING PKG | \$355 |
| VIDEO BRD V83 4MHz | \$412 | BOX OF DISKETTES | \$29 |
| ANADEX PRINTER DP-9500-1 | \$1349 | SECRETARY WORD PROCESSOR | The Best! \$99 |
| CAT NOVATION MODEM | \$169 | GOFAST NORTH STAR BASIC | |
| ECONORAM 2A 8K ASSM | \$179 | OPTIMIZER—FAST | \$71 |
| NSSE 1-22 & P01 TERRIFIC PROGRAMS | ONLY \$10. EACH | Which Computers are BEST? | |
| NORTHWORD \$329 MAILMAN \$246 | | BROCHURE | FREE |
| INFOMAN \$411 | | North Star Documentation refundable | w/HRZ \$35 |
| TARBELL COMPUTER-PHONE | | | |

AMERICAN SQUARE COMPUTERS BEATS ADV. PRICES

American Computers

919-889-4577

KIVETT DR. JAMESTOWN N.C. 27282

919-883-1105

© CP/M is a registered trademark of Digital Research, Inc.

SAVE \$\$\$ SAVE \$\$\$
TRS-80
 MICROCOMPUTERS

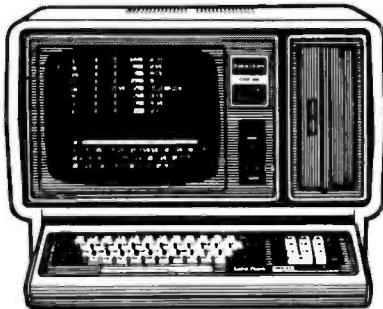

TRS-80 Model II, 64K System
ONLY \$3325.⁰⁰

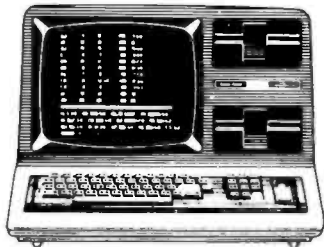

TRS-80 Model III, 32K - 2 Drives
ONLY \$2095.⁰⁰

Great Discounts On All Other TRS-80 Model II and III Add Ons. Color Computers. Printers. Pocket Computers. And All Other Fine Radio Shack * Merchandise.

All Computers Are Brand New. In Factory Sealed Cartons. And Carry A 3 Month Radio Shack * Warranty. F-48 Form Provided.

Most Models In Stock Just Call Collect 512-689-5536. Master Electronics, Inc., 154 N. 5th. Raymondville, Tx. 78580. Remember No Tax On Out-Of-State Shipments.

MASTER ELECTRONICS INCORPORATED

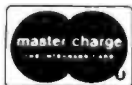

Authorized TRS-80 Dealer,
 Store # F-723

Listing 2 continued:

```
plotaxis(0.5,0.5,5.75,90,-1,1,-0.5,'magnitude');
plotarray(250,-10,3,0.5,0.5,0,249,-1,1,0.07,9.5,5.75,xpoints,sinypoints);
plotarray(250,10,2,0.5,0.5,0,249,-1,1,0.07,9.5,5.75,xpoints,cosypoints);
plotline(1,5.5,6.25);
plotsymbol(3,0.126);
plotwhere(xloc,yloc);
plotstring(xloc+0.25,yloc-0.126/2,0.126,0,'- sine');
plotline(1,5.5,5.75);
plotsymbol(2,0.126);
plotwhere(xloc,yloc);
plotstring(xloc+0.25,yloc-0.126/2,0.126,0,'- cosine');
end.
```

Listing 3: The machine-language procedure "plotstep". This procedure, which is dependent on the hardware implementation given in the text, transmits pen-movement commands to the Hiplot plotter through its associated output port.

```
.PROC PLOTSTEP,1
.PRIVATE PENPOS,RETADDR
STATUS .EQU 07DH
PLOTCMD .EQU 7CH
UPCMD .EQU 79H
DNCMD .EQU 7AH
UP .EQU 0FFH
DOWN .EQU 00H
POP HL ;GET RETURN ADDRESS
LD (RETADDR),HL ;LOAD RETURN ADDRESS
POP BC ;GET CHARACTER
IN A,(STATUS) ;INPUT STATUS
AND 1 ;MASK STATUS BIT
JP Z,PLOTOUT ;WAIT FOR READY
LD A,C ;GET PLOT CHARACTER
OUT (PLOTCMD),A ;PLOT IT
CP UPCMD ;PEN UP?
JP Z,PENUP ;YES, TIME IT OUT
CP DNCMD ;PEN DOWN?
JP Z,PENDN ;YES, TIME IT OUT
LD A,(PENPOS) ;GET PEN POSITION
CP UP ;UP?
JP Z,EXIT ;YES, RETURN
LD B,00H ;LOAD TIMER
LD C,80H ;LOAD TIMER
CALL TIMER
JP EXIT ;RETURN
TIMER DEC BC ;DECREMENT TIMER
LD A,B ;GET TIMER HIGH
CP 00H ;ZEROED OUT?
JP Z,TIMER1 ;YES, TIME FURTHER
JP TIMER ;NO, DO IT AGAIN
TIMER1 LD A,C ;GET TIMER LOW
CP 00H ;TIMED OUT?
JP Z,EXIT ;YES, RETURN
JP TIMER ;CONTINUE TIMING
PENUP LD A,(PENPOS) ;CHECK PEN POSITION
CP UP ;UP?
JP Z,EXIT ;YES, RETURN
LD A,UP ;SET PENPOS UP
LD (PENPOS),A ;PENPOS UP
LD B,02H ;NO, TIME OUT
CALL TIMER
JP EXIT
PENDN LD A,(PENPOS) ;CHECK PEN POSITION
CP DOWN ;DN?
JP Z,EXIT ;YES, RETURN
LD A,DOWN ;SET PENPOS DN
LD (PENPOS),A ;PENPOS DN
LD B,02H ;NO, TIME OUT
CALL TIMER
EXIT LD HL,(RETADDR) ;GET RETURN ADDRESS
JP (HL) ;RETURN
.END
```

Listing 4: The machine-language procedure "plotinit". This procedure initializes the serial output port at the beginning of a drawing session. It is dependent on the specific hardware used in the author's system.

```
.PROC PLOTINIT
LD A,05H
OUT (78H),A
LD A,01H
OUT (78H),A
RET ;RETURN
.END
```

Introducing

DPS-8000TM

*a powerful Z-8000[®] based multi-user system
from Ithaca Intersystems.*

- ◆ A highly flexible, expandable design with separate modules for mainframe and mass storage, offering almost unlimited options for system expansion and a choice of table-top or rack mount styling.
- ◆ A powerful 20 slot S-100 mainframe with Z-8000 CPU, advanced memory management providing up to 128K protected memory per user, up to 2½ Megabytes of parity memory in 256K increments, serial and parallel I/O, and DMA hard disk controller with 32 bit ECC.
- ◆ Coherent*—an advanced multi-user/multi-tasking Unix[†] compatible operating system with enhancements for better file and device handling and real-time responsiveness, and including a full range of utilities and compilers.
- ◆ InterPak 8000TM—a special set of InterSystems utilities designed to aid the programmer in the rapid editing, correcting and documentation of software.

DPS-8000 combines the state of the art in microcomputer hardware and software to provide a highly modular and expandable system with exceptional functionality, reliability and price/performance for the Systems Integrator/OEM, the commercial program developer, and the professional programmer working in the Unix environment in business, scientific, industrial and educational applications.

**FOR COMPLETE SYSTEM
SPECIFICATIONS AND PRICING
CALL OUR TOLL-FREE NUMBER:**

800-847-2088
(outside N.Y.S.)



InterSystemsTM
Ithaca Intersystems Inc.

Micros for bigger ideas.



Distributor Inquiries Invited

Ithaca Intersystems Inc. • 1650 Hanshaw Rd • Ithaca, NY 14850 • Phone: (607) 257-0190 • TWX: 510 255 4346

U.K. Distributor Ithaca Intersystems (U.K.) Ltd. Coleridge Road • London N8 8ED Phone: 01-341 2447 Telex: 299568

†Unix is a registered trademark of Bell Labs *Coherent is a trademark of the Mark Williams Co. TMTrademarks of Ithaca Intersystems Inc. *Registered trademark of Zilog, Inc.

Circle 186 on inquiry card.

AH-HA!



EUREKA!

ALL-RIGHT!

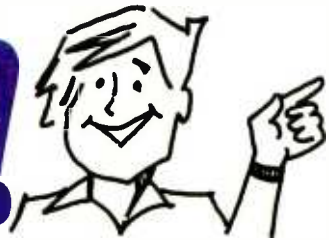

Introducing "Popular Computing," the key to understanding.

Now you don't have to be a computer professional to unlock all the mysteries, potential, and pleasures of home and small business computers. *Popular Computing*, the new monthly magazine from McGraw-Hill, is the key.

Created in response to growing demand for our informative quarterly *onComputing*, *Popular Computing* explores every aspect of personal computers and their use. All reported in easy-to-understand nontechnical language.



The answer to "Computerphobia."

Even the most computer-unsophisticated reader will find *Popular Computing* interesting and stimulating. Every issue will contain straight-talking product reviews,

special news briefs, and feature articles by famous guest contributors (like Isaac Asimov). There'll even be a helpful glossary of computer jargon we couldn't avoid using, and much, much more.

Special Introductory Offer.

Send in this coupon today, and take advantage of *Popular Computing's* Special Introductory Offer.



POPULAR COMPUTING

THE KEY TO UNDERSTANDING
P.O. Box 397, Hancock, NH 03449



SUPER SAVINGS FOR ME... I'm Moll Today to: **POPULAR COMPUTING**
taking advantage of this super introductory P.O. Box 307, Martinsville, NJ 08836
offer of 12 issues for only \$11.97—saving me \$3.03 on the basic rate of \$15.00—and saving me \$18.03 off the 12 issue news-stand rate of \$30.00 if my 30-day review of your first issue doesn't 100% please me. I may cancel my subscription and you will promptly refund ALL my money or give me a FULL credit on my charge card marked below: Check Enclosed for \$11.97 Visa Mastercard

Card No.

Signature

Name (Please Print)

Address

City

State

Expires

Zip

Here's how we spell relief:

SpellStar™



Are you tired of squinting at your video screen to find spelling and typing mistakes in your word processing?

Then you need SpellStar—for prompt relief from the pain and discomfort of proofreading.

SpellStar is an optional addition to WordStar™, already the most powerful and versatile word processing software on the market. SpellStar catches your spelling errors and typing mistakes before they catch you. It will save you inconvenience, embarrassment, and countless hours of staring at your screen. In fact, if time equals money in your business, it won't take long for SpellStar to pay for itself in time saved.

Fast, FAST relief

SpellStar whizzes through your text at thousands of words per minute, comparing what you've written with its 20,000-word dictionary-on-a-disk. It flags every word not in its dictionary, giving you three choices. Change the word. Leave it as is. Or leave it and add it to the dictionary, and it won't get flagged again. You can put it in the main dictionary, or

just as easy, create your own supplemental dictionaries on other disks for such things as specialized terms and client names.

SpellStar vs. the competition

SpellStar is not the first proofreading software on the market. We just made sure it would be the best.

Other programs show you a list of apparently misspelled words on your screen, separate from the document. You must decide what to do about each word without seeing its context—and that can be confusing. But SpellStar actually operates within the WordStar program. So it lets you see each word *in context* before taking action. It's so much easier. And you're always only one keystroke from full word-processing capability.

Other programs give you a 20,000-word dictionary. But we compressed it into half the normal disk space. So there's much more space for your own entries.

Another advantage is SpellStar's many menus and prompts. They're designed to keep you out of the manual and at the keyboard as much as possible.

More help on the way

Once we've handled your word processing, let MicroPro start solving all your computing problems—with our software solutions. MailMerge™, another WordStar option, makes it easy to combine files to produce personalized form letters. SuperSort™ takes on the biggest sorting, merging, and selecting jobs. And DataStar™ handles data entry, retrieval, and update with tremendous power and precision.

Okay, so how do you spell relief now?

M-I-C-R-O-P-R-O.

MicroPro™
INTERNATIONAL CORPORATION

1299 Fourth Street, San Rafael, California 94901
(415) 457-8990; Telex 340-388

Contact us for the name of your nearest dealer.

Runs on most Z80/8080/8085 microcomputers with CP/M (TM of Digital Research), 48K, and terminal with addressable cursor. • Also available for the Apple Computer, requires Microsoft SoftCard. Apple Computer is a registered trademark of Apple Computer, Inc. • MicroPro products sold only through authorized dealers. • © 1981 MicroPro International Corporation.

Text continued from page 222:

point. The characters "[" and "]", when passed in a string, cause subscripts and superscripts to be plotted. Any characters enclosed in brackets (eg: this is a [superscript]) will be plotted spaced up one half the height of the characters, and any character enclosed in "unbrackets" (eg: this is a |subscript|) will be plotted spaced a similar distance below the current line.

The plotting of arrows is another special case. If an arrow is to be plotted, it will be plotted with a height as specified in the parameter passed to "plotstring", but the head of the arrow will always be of the same size. Thus, arrows can be plotted representing, for example, the strength of the current in a given circuit, with the length of the arrow being proportional to the current.

If you want to generate any special characters of your own, it is a simple matter to decide on the shape of the character (which, by the way, must reside within a "box" 7 moves high by 4 moves wide) and generate it by coding the appropriate moves using the two vector pads I described

above. The characters I have already encoded are shown in figure 2.

The procedure "plotwhere" is used to locate the pen on the plotting bed. It is passed two real variables and returns them loaded with the current x and y locations of the plotting pen. This procedure is useful when you want to add a comment or identifying remark to a point or line being drawn on the plot. Simply call "plotwhere", displace the pen an appropriate distance from the current pen position, plot the comment, and return the pen to its initial position.

Graph-Plotting Procedures

The procedure "plotarray" is rather complicated. It is used to plot an array of up to 256 points. Of course, plotting more than that number of points can be done by calling it more than once. The procedure is passed the number of points to be plotted, the frequency of any identifying symbol to be plotted, the identifier of the symbol to be used, the beginning point of the plot, the range of the x and y variables, the height of the symbols, the area the plot is to oc-

cupy, and, last but not least, the two arrays (of type "coord") that contain the x and y coordinates of the desired plot.

This may seem like a large number of parameters to be passing to the procedure, but it allows for a great deal of flexibility in plotting arrays and is, in fact, easier to use in practice than it is to describe. What "plotarray" does is to simply scale the location of the points passed to it and fit them into the space indicated. It then moves the pen to the series of (x,y) points given by the two arrays of "coord"s, with the pen either up or down, depending upon the sign of the frequency of symbols passed. If the frequency of symbols is passed as 0, no identifying symbols will be plotted; if it is 1, every point will be identified; if it is 2, every other point, and so on. If frequency is negative, only the points will be plotted, with no interconnecting lines. As implemented, the points can be identified by five different symbols: triangle, X, square, +, or vertical line. These are selected by passing the symbol as 1, 2, 3, 4, or 5, respective-

THESE ARE THE CHARACTERS AVAILABLE :

ABCDEFGHIJKLMNOPQRSTUVWXYZ0123456789

., => < \$ * / % ? ° , () % + -

THIS IS AN ARROW : 

THIS IS A SUPERSCRIPIT

THIS IS A SUBSCRIPT

Figure 2: An example showing the letters, special characters, and plotting options available through the "plotstring" procedure.

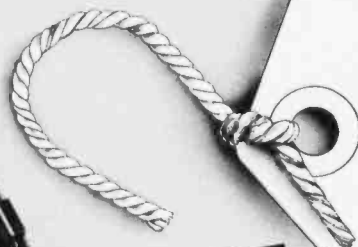

\$3398
10MB

THE HARD DISK

**YOU'VE BEEN
WAITING FOR**

XCOMP introduces a complete micro-size disk subsystem with more...

- **MORE STORAGE**
- **MORE SPEED**
- **MORE VALUE**
- **MORE SUPPORT**

S100 users... The XCOMP subsystem is now available with 10 megabytes of storage; 5 megabytes also available at \$2,898.00. Compare the price and features of any other 5¼-inch — or even 8-inch system, and you'll agree that XCOMP's value is unbeatable.

OUTPERFORMS OTHER HARD DISKS

Floppy disk and larger, more expensive hard disks are no match for this powerful little system. More data is available on every seek: 64K on 10MB and 32K on 5MB. Faster seek time too — an average of 70MS. It provides solid performance anywhere with only 20 watts of power. Data is protected in the sealed enclosure, and the landing zone for heads provides another margin of safety. The optional power board plugs directly into the S100 bus and provides power for the drive.

FAST CONTROLLER

The XCOMP controller is the key to this system's high efficiency operation. Speed-up features include interleave without table lookup, block-deblock with controller buffer, and read lookahead. OEMs worldwide have already proven the outstanding performance of the XCOMP controller.

MORE SOFTWARE

Included with the system is software for testing, formatting, I/O drivers for CP/M®, plus an automatic CP/M driver attach program. Support software and drivers for MP/M® and Oasis® are also available. The sophisticated formatting program assigns alternate sectors for any weak sectors detected during formatting, assuring the lowest possible error rate — at least ten times better than floppies.

WARRANTY

The system has a full one-year warranty on parts and workmanship.

ALSO AVAILABLE FROM XCOMP

- General Purpose controllers (8 bit interface), with easy interface to microprocessor-based systems.
- GP controller adapter that plugs directly into most Z80 computers.
- ST/R GP controller for the 5MB and 10MB drive above, with ST506 type interface.
- SG/R GP controller for SA1000 interface.
- SM/R GP controller for storage module drives.
- ST/S, SG/S, and SM/S, same as above, for the S100 bus.

Quantity discounts available. Distributor, Dealer, and OEM inquiries invited.

See your local Dealer, or call:

XCOMP, Inc.
7566 Trade Street
San Diego, CA 92121
Tel: (714) 271-8730
Telex: 182786



Circle 396 on Inquiry card.

THIS IS A DEMONSTRATION OF THE PLOTTER UNIT

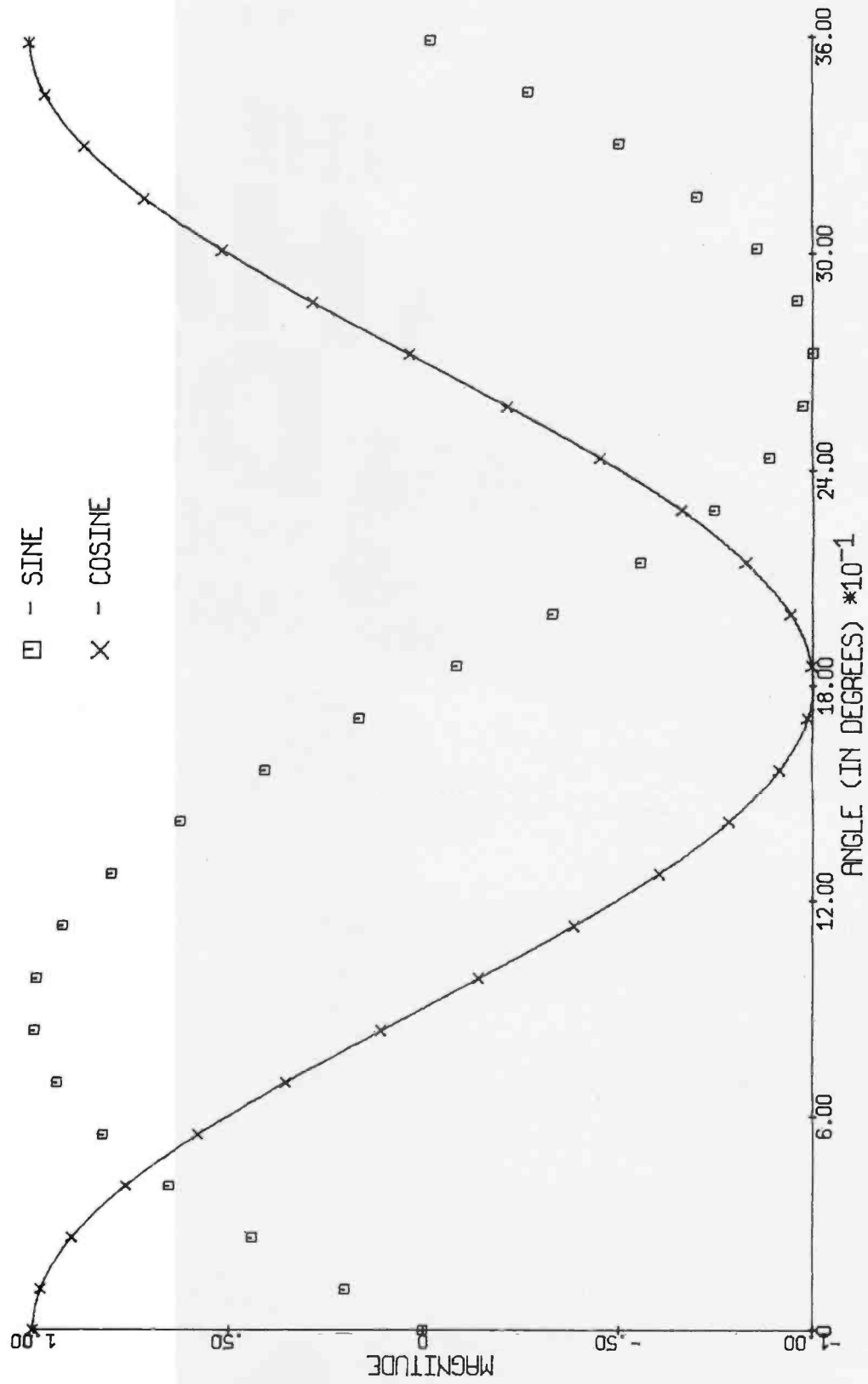

Figure 3: A demonstration of the Hiplot plotter driven by a Pascal program (see listing 2) and the "plotter" unit (given in listing 1).

Take your pick of the litter.

When you're ready to let your computer out and introduce it to the rest of the world, one of the Cat family of Modems is the way to do it.

Take your pick. You can't go wrong. They're all purebreds—from Novation, the recognized world leader in personal communications.



Apple-Cat II™*

Major breakthrough—the intelligent modem. Slips into your Apple. All auto functions, selectable baud rates, Serial RS-232 port, BSR X-10 controller*** easy-to-use self-prompting format. Other options available.

From \$389** including software

Cat Acoustic Modem

Fast, accurate, reliable originate/answer modem—with built-in diagnostics. Just add your computer and phone. Then dial up the world. \$189**

Super Mike

Replace your phone's carbon mike with Super Mike. No more carbon granule problems. Making things perfectly clear has never been so easy.

\$14.95**

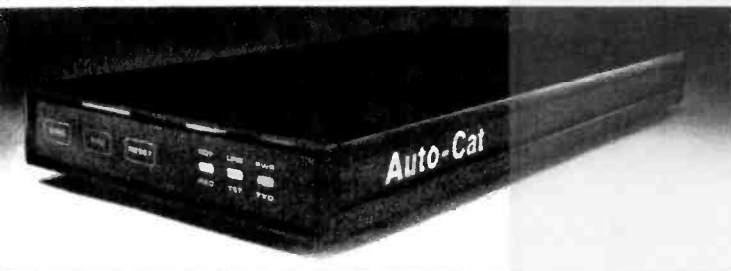
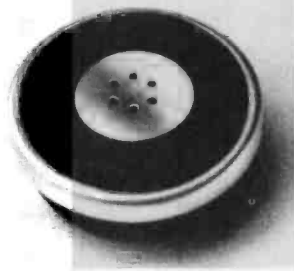

Auto-Cat

Answers automatically and stores data in your computer until you're ready. The world's first LSI 103 modem. State-of-the-art, all digital, crystal controlled direct connect.

You're off the hook for under \$250**



D-Cat

Get the performance and reliability of a direct connect modem (up to 20dB improvement) with the portability and price of an acoustic. Use it at home. Use it at work. Truly unique. So's the price. \$199**



Call for details: **(800) 423-5410**

In California (213) 996-5060

Available from Avnet Electronics, Hamilton Electro, Hamilton Avnet, Kierulff Electronics, Byte Shops, Computerland, and your local computer store.

Novation, Inc., 18664 Oxnard Street, Tarzana, California 91356

*Apple is a registered trademark of Apple Computer Inc. Cat is a trademark of Novation, Inc. which does not make Apple computers.

Suggested retail price *BSR is a trademark of BSR Corporation

ly. The size of the plotted symbol is passed in the height variable.

The procedure "plotsymbol" is used to plot any of the five identifying symbols. These symbols are used in procedure "plotarray" if some identifying point marker is desired. The procedure is passed integers that identify the symbol to be plotted and the height of the desired symbol. The symbol will be plotted centered at the current pen position. This procedure can be used both to identify points on a plot and in a description of the meaning of those points (see the ex-

ample plot in figure 3 and listing 2).

The procedure "plotaxis" is used to plot an axis with its identification and values. It is most often used in conjunction with "plotarray" to plot experimental data but, of course, can be used in any other way for special purposes. The procedure is passed the location of the origin of the axis, its length in inches, the angle of the axis with respect to the long axis of the plotting paper, the minimum and maximum values represented on the axis, how often tic marks should occur on the axis, and the name of the

axis. If length is passed as negative, no labeling of tic marks or axis will occur. If the tic-mark value is passed as negative, the labeling of both axis and tic marks is done on the counter-clockwise side of the axis. This last step is included so labels on axis can be put on the "outside" of the plot area in the case of two-axis plots (see the example plot).

I should mention here that there is a limitation on the size of tic-mark labels. A floating-point error will be generated if you try to make any label larger than ± 327.67 . This is because integer arithmetic is used to translate from the floating-point number to the string variable plotted as the tic-mark label. An easy way around this is to do it as I did in the sample plot and use a factor-of-ten multiplier in the axis label to compensate (see figure 3).

The plot in figure 3 with its accompanying listing demonstrates how the plotter subroutines can be used to generate a plot with a minimum of programming effort.

Implementation Details

These plotter procedures were developed using an SD Systems SBC-100 microprocessor board and a VDB-8024 video board. If they are to be used on systems other than the one described, a few modifications will have to be made. The constants "screenwidth" and "screenheight" defined in the "const" section of the implementation section in listing 1 should be changed to reflect the size of your own screen, and the character variable "clear", defined in procedure "initplot", should be changed to reflect the character that causes your screen to be cleared. Thus, it will only be necessary for you to write your own "plotstep" and "plotinit" subroutines for the "plotter" unit so it is functional on your computer.

I'm not familiar with other plotters, but I suspect that these procedures might be usable on other machines after the appropriate modifications to procedures "plotstep" and "plotline" have been made.

If you would like a copy of the source for these plotter programs, I'd be happy to supply it. Just send me a blank 8-inch floppy disk and \$10, and I will return it to you with the source code for all of the programs described in this article. ■

COMPUTER PROFESSIONALS

DataSaab is the nation's leader in Financial On-Line Systems, and part of one of the world's largest companies. Our present growth rate is so phenomenal we must
INCREASE OUR SOFTWARE STAFF BY 50% BY THE END OF 1981

PROGRAMMERS

We need experienced people—people with a yen to grow with us—degree not required. Real Time, On-Line "hands-on" Mini experience, as well as Assembler essential; COBOL helpful. Positions available in:

- PROGRAM ANALYSIS
- PROGRAMMING
- CODING
- COMMUNICATIONS PROGRAMMING
- DESIGN ANALYSIS
- SYSTEMS ANALYSIS
- DP TRAINING
- DOCUMENTATION

Above openings are at our N.Y. City and Chatsworth Cal. (L.A. vicinity) facilities.

FIELD ENGINEERS

One or more years solid civilian or military experience required. Learn to repair Mini's & peripherals. Lab and Field/Customer site positions available—Nationwide openings.

All positions offer competitive salaries and company benefits, and most importantly, tremendous growth opportunity.

As we are in the process of moving to a larger headquarters facility, we ask that responses be directed to the box number below. Every inquiry will be answered.

DATASAAB

DATASAAB SYSTEMS, INC.
(The ERICSSON GROUP)

P.O. Box 1060, FDR Station, New York, N.Y. 10150
Attn: Laurie Glickman/Bill Watkins, Dept. FS-3

DATASAAB is an Equal Opportunity Employer

Printers Plus

...computers, peripherals, accessories and supplies!



APPLE ACCESSORIES

| | |
|------------------------------|------|
| Apple II & 48K | CALL |
| Disk II w/controller DOS 3.3 | CALL |
| Disk II Add-On | CALL |
| Microsoft Z80 Softcard | 319. |
| 16K Ram Card | 159. |
| CCS Parallel Card | 109. |
| Async Serial Card | 139. |
| Clock/Calendar Card | 109. |
| IEEE Card | 239. |
| A-D Card | 99. |
| Mountain Comp. Romplus | 139. |
| KB Filter ROM | 49. |
| CPS Multifunction Card | 199. |
| Supertalker | 259. |
| Paymar L/C Adapter - New | 49. |
| - Old | 39. |
| M&R Super Mod | 25. |
| Superterm | 319. |
| Videx Video Term | 309. |

APPLE SOFTWARE

| | |
|------------------------------|--------|
| Personal S/W Desktop Plan II | \$169. |
| CCA Data Mgmt | 85. |
| Visicalc | 169. |
| Visiplot | 159. |
| Visitrend/Visiplot | 219. |
| Visidex | 169. |
| Visiterm | 129. |
| Micropro Wordstar | 299. |
| Super-Sort | 159. |
| Mail-Merge | 99. |
| Data Star | 239. |
| Spell Star | 199. |
| Muse Super Text II | 129. |
| Address Book | 44. |
| Form Letter Module | 79. |
| Stoneware-DB Master II | 199. |
| Microcom-MicroCourier | 239. |
| Infotory | 199. |

RIBBONS

| | |
|------------------|--------------|
| NEC | \$77.00/Doz. |
| Qume | 45.00/Doz. |
| Diablo | 66.00/Doz. |
| Anadex | 135.00/6 ea. |
| Tritel | 95.00/Doz. |
| TI/DEC/TTY | 45.00/Doz. |
| Epson | 13.95/ea. |
| MPI/Axdom/Base 2 | 10.00 ea. |

MAGNETIC MEDIA

Premium Quality At Bargain Prices
5 1/4" Diskettes, all Formats

| | |
|---|-------|
| 100% Certified with hub rings, box of 10 | |
| Single sided, single density | 26.95 |
| Single sided, double density | 29.95 |
| Double side, double density | 38.95 |
| 8" Diskettes, All Formats, 100% Certified | |
| Single sided, single density | 29.95 |
| SSSD Error Free | 32.95 |
| Single sided, double density | 39.95 |
| Double sided, double density | 49.95 |

EPSONS

Complete Stock of MX-80, MX-80 F/T
MX-100 Printers, Graphics Chip Sets
Cards and Cables

NOVELL IMAGE 800

List \$1,495 \$1,295.00

150 CPS Heavy Duty Matrix
15" wide carriage, expanded, compressed and double density "correspondence quality" printing at 80, 96 and 136 columns, true descenders, underlining, superscripts, subscripts. Up to 3K Buffer, optional character set and graphics option.

PRINT ELEMENTS

| | |
|------------------------------|---------|
| NEC Thimbles | \$15.95 |
| Plastic Daisy Wheels | |
| for Qume, Diablo, Starwriter | 6.95 |
| Metal Daisy Wheels | 59.00 |
| IBM Selectric Elements | 19.00 |



MODEMS

| | |
|------------------------|--------|
| UDS 103 LP, direct | \$169. |
| 103 JLP Auto Answer | 219. |
| 202 LP 1200 BAUD | 259. |
| NOVATION CAT, acoustic | 159. |
| D-CAT, direct | 169. |
| Auto Cat | 219. |
| Apple Cat | 339. |
| HAYES S100 Micromodem | \$349. |
| Apple Micromodem | 329. |
| Smart Modem | 249. |

VIDEO MONITORS

| | |
|------------------------|--------|
| Zenith 12" Green | \$139. |
| NEC 12" Green | \$239. |
| Amdek 12" B/W (Leedex) | \$139. |
| Amdek 13" Color Lo-Res | \$439. |

VIDEO TERMINALS

| | |
|-----------------|--------|
| Ampex Dialog 80 | \$995. |
| Ampex Dialog 30 | 795. |
| Televideo 920C | 845. |
| Televideo 950 | 995. |



NEC
PC-8000 Series
Microcomputer System.

INTRO
PRICING
\$1099.00

| | |
|--|-------|
| • Z-80A CPU 4 MHz | |
| • 5 user programmable function keys • 82 Keys with numeric keypad • 160 x 100 resolution • 80 character screen | |
| PC-8001A Microcomputer w/32K RAM | 1099. |
| PC-8012A I/O Unit w/32K RAM | |
| Expansion slots | 699. |
| PC-8031A Dual Mini-Disk Drive Unit | 1099. |
| PC-8032A Add-On Dual Mini Disk Drive Unit | 949. |



MPI 88G / 99G MATRIX

High resolution dot-addressable graphics for Apple. Enhanced "correspondence quality" printing. Tractor and friction feed. Serial and Parallel Input. 100 cps Bidirectional printing. 80, 96 and 132 column widths!

| | |
|---------------------------------------|--------|
| 88 G List \$749 | \$589. |
| 99 G List \$849 | \$660. |
| Apple Parallel I/O Card/Cable/Disk .. | \$110. |
| with Graphics Prom (Ap-Pak) | \$145. |
| IEEE I/O Card | \$55. |
| Single Sheet Feeder | \$25. |
| QT Cover | \$25. |

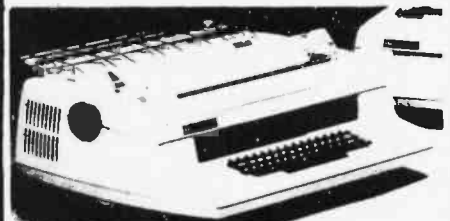

NEC SPINWRITERS

| | |
|------------------------|----------|
| 5510/5530 RO w/tractor | \$2,550. |
| 7710/7730 RO w/tractor | \$2,595. |
| 5520 KSR w/tractor | \$2,850. |
| 7720 KSR w/tractor | \$2,895. |
| 3510/3530 RO | \$1,895. |
| Bi-directional tractor | \$225. |
| Pusher tractor | \$350. |

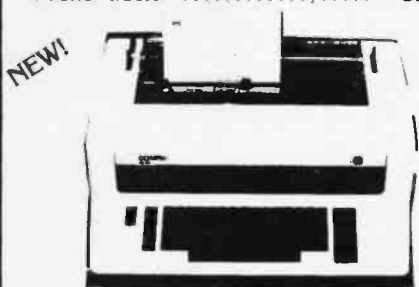

OLYMPIA

Letter quality. Daisy wheel printer/typewriter interfaces to Apple, Atari, NEC, TRS80 and RS232 Serial ports. A truly cost effective letter quality printer that functions as a typewriter.

| | |
|--|----------|
| ES100 RO Computer printer | |
| List \$1690 | \$1395. |
| ES100 Typewriter only | \$1,095. |
| Interface Card Only | \$295. |
| (specify serial or parallel) | |
| I/O Cable (specify serial or parallel) | \$35. |
| Apple Serial Card | \$139. |
| Print Wheels & Ribbons | Call |

TO PLACE YOUR ORDER CALL:

TELEPHONE (714) 744-7314
TELEX 697120
or write to:

PALOMAR
Computer Products

910-105 W. San Marcos Blvd., San Marcos, CA 92069

TERMS OF SALE: Cash, check, money order, bank wire transfer, credit card or purchase orders from qualified firms and institutions. Please include telephone number with order and expiration date on credit card orders. California residents add 6% sales tax. Advertised prices are for prepaid orders F.O.B. shipping point. Add 3% for shipping in U.S. Pricing and availability subject to change without notice.

How could we ever top the "Big 16" package? Here's how...

SUPER SIXTEEN!

SuperSixteen combines our most acclaimed system components in a specially-priced package configuration. Imagine a computer that executes the present library of 8 bit software as well as the 16 bit software of the future...handles the most demanding commercial, industrial, and scientific applications...conforms to all IEEE 696/S-100 standards to allow for compatibility and easy upgrading...runs the new generation of high-performance/enhanced software (such as Sorcim's "SuperCalc" financial planning package)...is backed by a full 1 year—not 90 day—limited warranty...and, unlike many of the "personal" computers being adapted for commercial applications, won't be here today and outgrown tomorrow.

That's exactly what **SuperSixteen** delivers, and at a price that's intended to be as irresistible as the benefits. Each **SuperSixteen** package includes:

- **Dual Processor Board.** Executes both 8 and 16 bit code to handle present and future needs. High speed (5 MHz) 8085 and 8088 processors complete jobs faster.
- **Disk 1 DMA Floppy Disk Controller.** Features lightning fast operation, thanks to properly implemented DMA (with arbitration). Handles up to four 8" or 5.25" floppy disk drives, single or double-sided, single or double density (soft sectored).
- **System Support 1.** All the most popular "extras" on one board: battery operated clock/calendar; RS-232 serial port; battery backup RAM, math processor, and ROM options; triple interval timers; dual interrupt controllers; power fail interrupt; and more.
- **Interfacer 1.** Two RS-232 serial ports, with full handshaking and independently selectable Baud rates up to 19.2 Kbaud, connect to the serial peripherals (printer, terminal) of your choice.
- **128K of Static RAM.** The best components deserve the best memory, which is why 128K of our famous high speed/low power RAM comes standard with every SuperSixteen package.
- **CP/M*-2.2.** The most popular 8 bit operating system, ready to load and go.
- **CP/M*-86.** Ready to load and go for 16 bit operation.
- **Cable and Documentation.** Each package includes three interfacers cables, one disk cable, complete documentation for all hardware, and manuals for both CP/M* operating systems.

816

If purchased separately, these quality components would cost \$4,344. **But SuperSixteen's low package is an amazing \$3,495** - that's like getting 48K of memory for free! (For boards qualified under the **Certified System Component** high-reliability program - with extended 2 year warranty, 200 hour burn-in, and 6 MHz processors - add \$600 to the package price.)

*CP/M is a trademark of Digital Research. Prices shown do not include dealer installation and support services.

You can wait for the other manufacturers to catch up...or you can enjoy the competitive edge offered by **CompuPro** products *right now*. **SuperSixteen** is available at finer computer stores world-wide; call **415-562-0636** for the authorized **CompuPro** sales center nearest you.

EXTRA SAVINGS:
Order a rack mount Enclosure 2 (normally \$895) or desk top Enclosure 2 (normally \$825) at the same time as SuperSixteen, and take \$50 off either price!

CompuProTM

division

GODBOUT
ELECTRONICS

OAKLAND AIRPORT, CA 94614

(415) 562-0636

Circle 77 on inquiry card.

PROVEN Computing SOLUTIONS

We give you more of what you buy a computer for: to gain a competitive edge in your industrial, commercial, or scientific application. While other computers try to make the best of slow memory, slow processors, and me-too engineering, **CompuPro** is delivering solutions for today's commercial computing... proven solutions that create expandable, modular, fast, exceptionally reliable, and truly professional level machines that conform fully to the IEEE 696/S-100 standards. We back all products with a minimum 1 year limited warranty.

**When you depend on your computer, choose a computer on which you can depend:
S-100 from CompuPro.**

- 1 DISK I DMA DISK CONTROLLER.** Disk controllers don't have to be your system's bottleneck: Disk I is lightning fast, thanks to properly implemented DMA (with arbitration) and data transfer that's independent of CPU speed. Handles up to four 8" or 5.25" floppy disk drives, single or double-sided, single or double density (soft sectored). With BIOS for CP/M-80*. Manual available for \$25. A/T \$495, CSC \$595. Coming soon: Disk 2, the fast DMA Hard Disk Controller.
- 2 CP/M-86.** Available only with Disk 1 purchase. Supplied on diskette with full documentation: ready for load and go operation. \$300.
- 3 OASIS* OPERATING SYSTEM.** Single user (\$500) and multi-user (\$850) available for use with CPU Z. Supplied on diskette with full documentation. Coming soon: OASIS 16 for use with 16 bit systems.
- 4 COMPLETE DUAL DISK DRIVE SYSTEM.** With one Disk I board, desktop dual drive enclosure with Shugart SA-800 series drives, and power supply cable. Also includes CP/M-80. **Introductory special: \$2195.**
- 5 SYSTEM SUPPORT 1.** Includes battery operated clock/calendar; sockets for battery backup RAM, optional 9511 or 9512 math processor, and 2716 ROM; RS-232 serial port; triple interval timers; dual interrupt controllers; power fail interrupt; and more. Comprehensive owner's manual includes numerous software examples. \$295 Unkit, \$395 A/T, \$495 CSC (add \$195 to the above prices for the optional math processor).
- 6 8 BIT CPU Z.** A Z80*-based CPU board that includes all standard features plus many convenience options. Meets all IEEE 696/S-100 specifications, including timing. \$225 Unkit, \$295 A/T (both operate at 4 MHz), \$395 CSC (with 6 MHz CPU).
- 7 16/8 BIT CPU 8085/88.** Now there's an easy way to gain 16 bit capability without sacrificing your library of 8 bit software: CPU 8085/88 combines an 8088 CPU to handle 16 bit software and an 8085 CPU for 8 bit software. \$295 Unkit, \$425 A/T (both operate at 5 MHz); \$525 CSC (with 6 MHz 8085 and 8088).
- 8 8088/8086 MONITOR-DEBUGGER SOFTWARE.** Ideal for use with CPU 8085/88. Supplied on single sided, single density, soft sectored 8" disk. CP/M-80 compatible (not required if you have CPM/86). Great development tool; mnemonics used in debug conform as closely as possible to current CP/M DDT mnemonics. \$35.
- 9 8 BIT CPU 8085.** Same as CPU 8085/88, but without 8088. May be easily upgraded to 16 bit operation. \$235 Unkit, \$325 A/T, \$425 CSC.
- 10 INTERFACER 1.** Two RS-232 serial ports, with full handshaking and independently selectable Baud rates, connect your computer to serial peripherals. \$199 Unkit, \$249 A/T, \$324 CSC.
- 11 INTERFACER 2.** Adds three full duplex parallel ports, and one serial port with all the features of an **Interfacer 1** serial port, to your computer. \$199 Unkit, \$249 A/T, \$324 CSC.
- 12 INTERFACER 3-5.** Includes five RS-232 serial ports (2 synchronous/asynchronous, 3 asynchronous) with full handshaking. Includes software programmable Baud rates and many other convenience features. \$599 A/T, \$699 CSC.
- 13 INTERFACER 3-8.** Same as above, but with eight full RS-232 serial ports (2 synchronous/asynchronous, 6 asynchronous). Ideal for multi-user/multi-terminal systems. \$699 A/T, \$849 CSC.
- 14 SPECTRUM COLOR GRAPHICS BOARD.** With 8K of IEEE-compatible static RAM, full duplex bidirectional I/O port for keyboard or joystick interface, and 6847-based graphics generator that can display all 64 ASCII characters. 10 modes of operation, from alphanumerics/semi-graphics in 8 colors to dense 256 X 192 full graphics. \$299 Unkit, \$399 A/T, \$449 CSC.
- 15 6 SLOT HIGH SPEED MOTHERBOARD.** With all edge connectors, Faraday shielding, extensive bypassing, and split active termination. \$89 Unkit, \$129 A/T.
- 16 12 SLOT HIGH SPEED MOTHERBOARD.** Same as above, but with 12 slots. \$129 Unkit, \$169 A/T.
- 17 20 SLOT HIGH SPEED MOTHERBOARD.** Same as above, but with 20 slots. \$174 Unkit, \$214 A/T.
- 18 MEMORY MANAGER.** Extends the addressing of older S-100 machines beyond 64 KBytes to allow for greatly expanded memory capacity. \$59 Unkit, \$85 A/T, \$100 CSC.
- 19 ACTIVE TERMINATOR.** Promotes reliable and accurate data transfer in older machines by properly terminating bus lines, thereby minimizing ringing, crosstalk, overshoot, noise, and other gremlins associated with unterminated lines. \$34.50 Unkit, \$59.50 A/T.
- 20 2708 EPROM BOARD.** This board is the way to store often used routines or pieces of software. \$85 Unkit, \$135 A/T, \$195 CSC (2708s not included).
- 21 DOCUMENTATION.** User manuals are available for all products. **Interfacer 3, \$10; Disk Controller, \$25; System Support 1, \$20; most others, \$5.** Also available: "**CompuPro Product User Manuals: 1975 - 1980**". This 250+ page book includes data on all older **Godbout/CompuPro** products, as well as many newer products such as the **Spectrum Color Graphics** board, **Interfacers 1 and 2, CPU 8085/88, motherboards, CPU Z, and more.** Whether you want to evaluate the innovative engineering behind **CompuPro** products, or study the nuts and bolts of high speed computer operation, this is the book for you. \$20 plus shipping.
- 22 RAM 16-64.** Configurable as 64K X 8 for 8 bit systems or 32K X 16 for 16 bit systems. Static, IEEE-696/S-100 compatible, extended addressing, 10 MHz operation. \$1195 A/T, \$1295 CSC.
- 23 RAM 17-64.** The lowest power (¼ Amp typical) 64K X 8 static board in the business. IEEE-696/S-100 compatible, 4 optional 2K windows, no wait states with 6 MHz Z80. \$1095 A/T, \$1195 CSC, \$875 Unkit.
- 24 RAM 20-32.** For lower density applications. Static, IEEE-696/S-100 compatible, extended addressing or bank select, up to 10 MHz operation. \$559 A/T, \$659 CSC, \$449 Unkit. 8K and 16K versions also available.

Most **CompuPro** products are available in Unkit form. **Assembled/Tested** (both with 1 year warranty), or qualified under the high-reliability **Certified System Component (CSC)** program (200 hour burn-in, 2 year extended warranty, more). Note: Unkits are not intended for novices, as de-bugging may be required due to problems such as IC infant mortality. Factory service is available for Unkits at a flat service charge.

*LEGAL CORNER: Z80 is a registered trademark of Zilog; CP/M is a registered trademark of Digital Research; OASIS is a trademark of Phase 1.

How to Order: Call 415-562-0636 for the name of the authorized **CompuPro** sales center nearest you, or for placing factory direct VISA®/Mastercard® orders. Prices shown do not include tax, shipping charges, or dealer installation/support services.

CompuPro™
division

OAKLAND AIRPORT, CA 94614

(415) 562-0636

GODBOUNT
ELECTRONICS

Evaluate Your Home's Energy Efficiency

Conserve Energy with Your Computer

Kimball Beasley
Wiss, Janney, Elstner and Associates Inc
330 Pfingsten Rd
Northbrook IL 60062

As we are all too well aware, the cost of heating a home has skyrocketed in recent years. Many homeowners, searching for ways to improve the energy efficiency of their homes, add insulation to the walls or roof, install storm windows, or caulk and weather-strip around windows and doors. Money is spent on one or more of these energy-conservation plans only because homeowners expect a reasonable return on their investment in the form of lower heating bills.

Many homeowners, however, will spend a great deal of money on insulation for the walls or ceiling, for example, without having any idea how much their heating costs will actually be reduced. At some thickness, adding more insulation is no longer cost-effective. The "proper" thickness is very difficult to determine. Also, if a house has heat losses through single-pane windows or air leaks from poor weather stripping, adding insulation to the walls will not do much to reduce the overall heat loss. In short, homeowners usually suffer from a lack of information on the thermal properties and energy efficiency of their homes.

There are two basic ways to find the energy savings and return on money invested with a home heating energy-conservation plan:

- Choose a plan, have it done, and wait for the heating bills to arrive to determine actual energy savings.
- Choose a plan and analyze the energy-efficiency improvement to find the energy savings before spending money.

To analyze the energy-efficiency improvement, such factors as climate, existing insulation, and building dimensions must be determined, as well the heat-transfer properties of all exposed surfaces. Inasmuch as each house has unique and complex heat-loss characteristics, any analysis will be somewhat involved.

Listing 1 (see page 258) is a computer program to evaluate the physical properties of a house. The program analyzes and displays heat loss through each exposed building element (walls, windows, etc) and provides the computed heat losses associated with a selected heating energy-conservation plan. The program will run on the Radio Shack TRS-80 Model I and, with few

changes, it can be adapted to most small computers. With this program, the most efficient heating energy-conservation plan can be selected, and the approximate return on investment can be derived from the computed heating-cost savings. Fundamental to this program is the supposition that any heating energy-conservation plan is properly done (i.e., insulation evenly distributed with proper vapor barriers, or good construction practices for installing storm windows or adding weather stripping).

Figure 1 (see page 252) includes a worksheet and an exploded drawing of a typical house. The worksheet and drawing are an aid to help in organizing the required data before working with the computer. The first part of the worksheet asks for the surface area of all exposed building elements through which heat can escape. The second part asks for the thickness and R-factor of insulation already present in the walls, roof, or ceiling. (The R-factor is a measure of how well a material will insulate. The higher the R-factor, the greater the effective insulation.) If the attic is heated, the thickness of insulation in

How to succeed in business without really trying.

For peanuts.

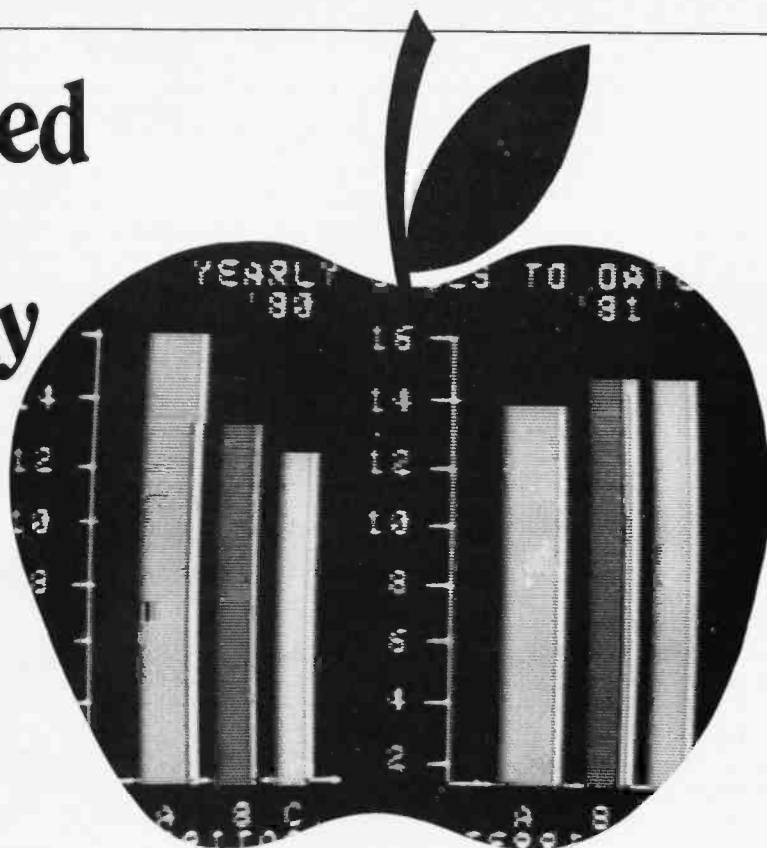

STC is proud to formally announce four field-proven business packages for APPLE users. And an irresistible offer.

All of these programs are straightforward, easy to use, virtually foolproof, and very attractively priced. The prices quoted include both the programs and easy-to-follow instruction manual.

Accounts Payable

Uses ISAM structured routines and all posting is done in seconds as opposed to hours with other programs. Various reports are generated, including cash requirement journal, check register, open invoice report, Y-T-D payment journal, and aging function to tell how many days left for a discount or an invoice. You also get a complete audit trail on all transactions, a current and Y-T-D analysis of all your accounts and vendors, and a check printed on available forms.

Only \$200.

Payroll

Maintains an entire payroll for up to 125 employees. It provides numerous payroll utilities for quick and easy payroll and check generation. It has built-in Federal and State tax tables and provides some remarkable reporting capabilities. **Only \$240.**

Professional Time and Billing

Maintains time and billing data for up to 300 clients. 120 rates (employees) can be on file at any time. Rates may appear as time/expenses/fixed fees. Prints statements on available forms. Generates a variety of transactions and activity reports, and much more. **Only \$325.**

Apartment Management

Maintain financial and managerial data for up to 6 separate apartment complexes. Each complex can contain a maximum of 120 units and 8 different types of units. Generates an operating statement which contains YTD rental income, security deposits, pet deposits, pool deposits, misc. deposits, damage amounts, allowances, expenses and a complete breakdown of apt. units by type. Again, some great reports. **Only \$325.**

Early Bird Offer

If you purchase any one of these programs from your STC dealer within the next 30 days, we'll let you have our new and quite fantastic Coloring Board package for only \$30. This program, normally costing \$60, compares with some hardware capabilities costing \$800 and more. It allows you to quickly create, store and display all types of graphics and text labeling. For example, a bar-chart like the one shown above for display at sales meetings. In short, it has unlimited useful applications for business.

Act now. Contact your local STC dealer for details on this extremely unusual offer. And be sure to check out the rest of our great line of software packages as well.

Dealer inquiries invited.

(Apple is a trademark of Apple Computer Company)

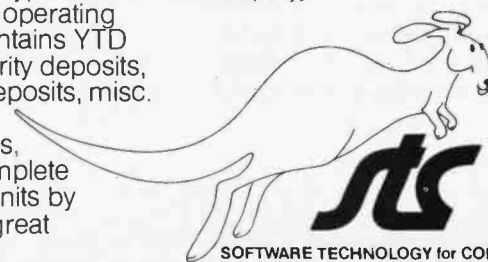

SOFTWARE TECHNOLOGY for COMPUTERS
P.O. Box 428, Belmont, MA 02176 (617) 923-4334

Worksheet

| Exposed Surface Areas | Calculation | Sample House | | Your House | |
|--|--|--|---------------------|---------------------|---------------------|
| | | Calculation | Area in Square Feet | Calculation | Area in Square Feet |
| Total Window Area (N = Number of Windows) | | | | | |
| With Double Panes | $N \times h \times w$ | $11 \times 3 \times 4 =$ | 132 | | |
| With Single Panes | $N \times h \times w$ | $1 \times 5\frac{1}{2} \times 12 =$ | 66 | | |
| | | Total | 198 | Total | |
| Total Wall Area | $(2 \times W \times H) + (2 \times L \times H) -$ Total Window Area | $(2 \times 30 \times 20) + (2 \times 50 \times 20) -$ 198 = | 3002 | | |
| Total Roof/Ceiling Area Roof—If Attic Is Heated Ceiling—If Attic Is Unheated | $(2 \times L \times S) + (W \times A)$ $L \times W$ | $50 \times 30 =$ | 1500 | | |
| Total Door Area (N = Total Number of Doors) | $N \times h \times w$ | $2 \times 7 \times 3 =$ | 42 | | |
| Existing Insulation | | Thickness In Inches | R-Factor (table 1) | Thickness In Inches | R-Factor (Table 1) |
| Insulation in Walls | | 2 | 9 | | |
| Insulation in Roof/Ceiling | Roof | 3 | 11 | | |
| | Ceiling* | 2 | 9 | | |
| | Total | 5 | 20 | | |

*If attic is heated, disregard ceiling insulation.

Sample House

structure:
 H = 20 feet
 W = 30 feet
 L = 50 feet
 A = 6 feet
 S = 16

S can be calculated from A and W:
 $S = \sqrt{W^2/4 + A^2}$

typical window:
 h = 3 feet
 w = 4 feet

picture window:
 h = 5½ feet
 w = 12 feet

typical door:
 h = 7 feet
 w = 3 feet

- ceiling insulation thickness = 2 inches
- roof insulation thickness = 3 inches
- wall insulation thickness = 2 inches

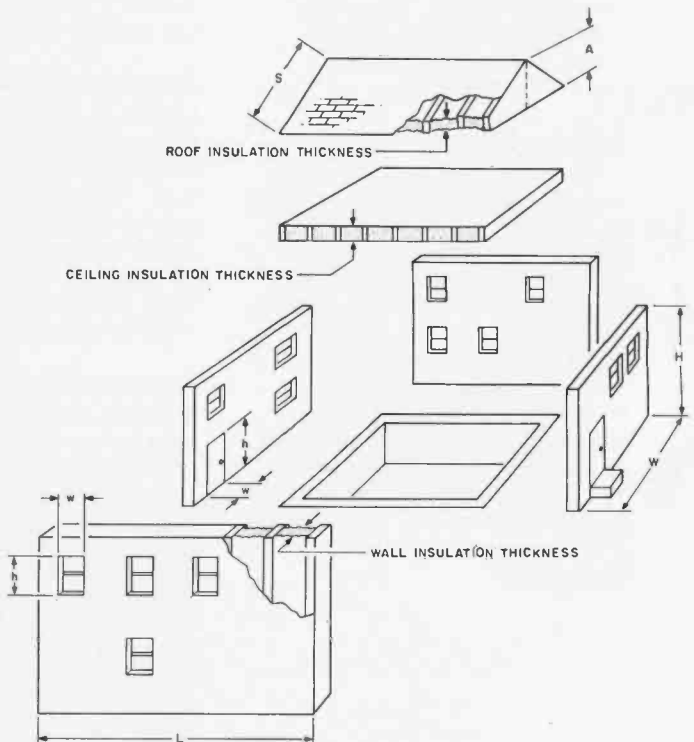

Figure 1: Worksheet and exploded view of house. Data for the sample house is entered here in figure 1a, and the resulting output for two plans is shown in figure 3. Use a photocopy of the blank worksheet (figure 1b) to help organize your data before entering it into the computer.

Worksheet

| Exposed Surface Areas | Calculation | Sample House | | Your House | |
|--|---|------------------------|-----------------------|------------------------|-----------------------|
| | | Calculation | Area in Square Feet | Calculation | Area in Square Feet |
| Total Window Area (N = Number of Windows) | $N \times h \times w$ $N \times h \times w$ | | | | |
| With Double Panes | | | | | |
| With Single Panes | | | | | |
| | | Total | | Total | |
| Total Wall Area | $(2 \times W \times H) +$ $(2 \times L \times H) -$ Total Window Area | | | | |
| Total Roof/Ceiling Area | $(2 \times L \times S) + (W \times A)$ $L \times W$ | | | | |
| Roof—If Attic Is Heated | | | | | |
| Ceiling—If Attic Is Unheated | | | | | |
| Total Door Area (N = Total Number of Doors) | $N \times h \times w$ | | | | |
| | | | | | |
| Existing Insulation | | Thickness In Inches | R-Factor (table 1) | Thickness In Inches | R-Factor (Table 1) |
| Insulation in Walls | | | | | |
| Insulation in Roof/Ceiling | Roof Ceiling* | | | | |
| | Total | | | | |

*If attic is heated, disregard ceiling insulation.

Figure 1b: Blank worksheet to help you organize data before calculating your home's energy efficiency.

the roof and the roof's surface area are entered in the worksheet (ceiling area and insulation do not apply since the ceiling is not exposed to the cold). If the attic is unheated, the ceiling surface area and the combined thickness of insulation in the roof and ceiling are entered in the worksheet (both the roof and ceiling insulation help to reduce the heat flow to the outside). The insulation R-factor is found by checking the thickness and type of insulation in table 1. (See page 254.) For houses with odd shapes, heated annexes, or unheated garages inside the house, the surface area of each wall, window, and so forth exposed to the cold should be added to find the individual total wall, roof, window, and door areas.

Try an Example

The sample house shown in figure 1 is located in Chicago, Illinois, which is situated in heating region number 4 on the map in figure 2. (See page 254.) When the physical characteristics of this house are entered as shown in the program operation section, the heat-loss profile in figure 3a (see page 256) is displayed. This profile shows that most of the heat is lost through the walls. Because the existing roof and ceiling of the sample house are comparatively well insulated, and the sample house has storm windows, I will plan to add 2 inches of loose rockwool (R-factor 9 in table 1) to all the walls.

Figure 3b is the computed heat-loss profile with the added insulation in

the walls. It shows that substantially less heat is lost through the walls with this plan. The overall heat-loss reduction is 21%, and, since the annual heating cost for the sample house is \$900, the yearly saving with this plan is \$191. It must be considered, however, that adding insulation to the walls can be very expensive. If pumping loose fill into all walls costs \$2000, the return on investment is about 9% for the first year for this example (approximately a 10-year breakeven point with constant heating fuel costs). The program operation is shown in figure 4. (See page 260.)

In the sample house, an inspection of the caulking and weather stripping

Z8000

MICRO PRICE for MINI POWER
MICRO-MINI™ matches Series I by IBM
DELIVERING CURRENT ORDERS

You cannot buy a more powerful micro:

- **Power:** 1 to 32 independent users
- **Memory:** directly addresses to 16 Meg!
- **Mapping:** efficient memory management
- **Disk:** 2M to more than 250M
- **Speed:** throughput 10 times Z80
- **Files:** simultaneous access
- **Communication:** inter-user via terminals
- **Security:** all files password protected
- **Options:** expandable in the field
- **Bus:** Intel Multibus™ compatible
- **Languages:** Pascal, BASIC, COBOL, FORTRAN

System 3 \$7053

This 16-bit Multibus™ computer system includes:

- Z8001 CPU and 256K RAM
- 8 serial I/O ports
- 15-slot backplane
- Dual floppy disk drives
- Multiuser Operating System

Field upgrade to 16MB RAM,
 268MB of hard disk, 32 users.
 Pascal, BASIC, C, COBOL and
 FORTRAN languages.

Call for further system specifications.



AMPEX Dialogue 80™

Dialogue 80™ fully-featured video terminal:

- Full ASCII with numeric and edit keypads
- Elegant case with detachable keyboard
- Display 24 lines with 25th status line
- 20 user programmable function keys
- 2 pages display memory (4 optional)
- 11 graphics and 21 control codes
- 10 modes including block, protect, program
- Transparent mode displays control codes

Dialogue 80™\$1045

Dialogue 80™ with phone coupler.....1194

Applications: word processing, data entry, interactive programming, data base inquiry/response/update, transaction processing, whether on-site or remote. For our system or for yours, this interactive terminal is the perfect match.

Prices: Prepaid or Purchase Order Net 10.

Prices subject to change without notice.

Warranty: 120 day minimum on all systems.

Interfacing cables free with all systems.

10% down fixes price, guarantees priority.

MasterCard and VISA cards accepted.



(312) 684-3183

COMPUTEX
 MICROCOMPUTER SYSTEMS
 5710 Drexel, Chicago, IL 60637

around windows and doors reveals noticeable drafts and dried-out caulk material. The caulking and weather stripping improvement plan is evaluated next. The results (figure 3c) show that the total heat-loss reduction is about 12% (or \$112 annually) with the new caulking and weather stripping plan. In the example, this plan costs about \$200, and the return on

investment for the first year is 60% (about a two-year breakeven point).

It is apparent that the caulking and weather stripping plan offers a better return on investment. Assuming that heating fuel costs will increase, however, our wall-insulation plan and other costly improvement plans become more attractive each year. Also, air-conditioned homes will ben-

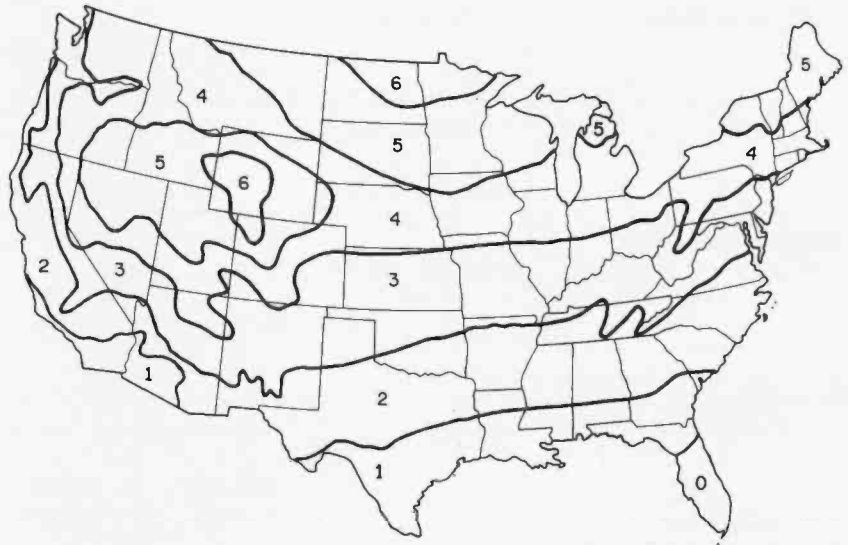

Figure 2: Six heating zones in the continental United States. These play an important part in figuring your heat loss. For other areas, consult your local government. (Source: United States Department of Commerce, National Bureau of Standards.)

| R-Factor | Batts or Blankets | | Loose Fill | | |
|----------|---------------------------------|-----------|-------------|-----------|-----------------|
| | Glass Fiber | Rock Wool | Glass Fiber | Rock Wool | Cellulose Fiber |
| 4 | Wall with no insulation | | | | |
| 6 | Roof/ceiling with no insulation | | | | |
| 9 | 2 | 1½-2 | 3 | 2-2 | 1½-2 |
| 11 | 3½-4 | 3 | 5 | 4 | 3 |
| 13 | 4 | 4½ | 6 | 4½ | 3½ |
| 19 | 6-6½ | 5½ | 8-9 | 6-7 | 5 |
| 22 | 6½ | 6 | 10 | 7-8 | 6 |
| 26 | 8 | 8½ | 12 | 9 | 7-7½ |
| 30 | 9½-10½ | 9 | 13-14 | 10-11 | 8 |
| 33 | 11 | 10 | 15 | 11-12 | 9 |
| 38 | 12-13 | 10½ | 17-18 | 13-14 | 10-11 |
| 44 | 14 | 11½ | 19-21 | 14-16 | 11-13 |

Table 1: R-factors for various types of insulation materials. Insulation thickness is measured in inches.

THE ORIGINAL MAGAZINE FOR OWNERS OF THE TRS-80™* MICROCOMPUTER

* TRS-80™ IS A TRADEMARK OF TANDY CORP.

SOFTWARE
FOR TRS-80™
OWNERS

H & E COMPUTRONICS INC.

MONTHLY
NEWSMAGAZINE
FOR TRS-80™
OWNERS

MONTHLY NEWSMAGAZINE Practical Support For Model I, II & III

NOW IN OUR 4th YEAR

- PRACTICAL APPLICATIONS
- BUSINESS
- GAMBLING • GAMES
- EDUCATION
- PERSONAL FINANCE
- BEGINNER'S CORNER
- NEW PRODUCTS
- SOFTWARE EXCHANGE
- MARKET PLACE
- QUESTIONS AND ANSWERS
- PROGRAM PRINTOUTS
- AND MORE

PROGRAMS AND ARTICLES PUBLISHED IN RECENT ISSUES
INCLUDE THE FOLLOWING:

- FINCALC - A COMPLETE FINANCIAL APPLICATIONS PACKAGE
- INFORMATION SYSTEM REVIEW
- STATISTICAL COMBINATIONS
- PASCAL'S TRIANGLE
- ASSEMBLY LANGUAGE FOR BEGINNERS
- DISK FILES
- MOD-III REVIEW
- KEYBOARD THUNDER AND LIGHTING EXPLAINED
- DOS COMMANDS IN LEVEL II
- PROBABILITY CURVE GENERATOR
- CALCULATOR SIMULATIONS
- THE MEGABYTE GAP
- STOCKS AND BONDS
- BUDGET ANALYSIS (FOR BUSINESS AND HOME)
- NEWDOS/80 REVIEW
- DUTCHING - THE HORSE SYSTEM THAT CAN'T LOSE
- A SIMULATED GOLF GAME
- CONTINUOUS FORM SOURCES
- TAX/SAVER REVIEW
- AND MORE

FREE* WITH
YOUR
SUBSCRIPTION
OR
RENEWAL

FINCALC

A Complete Financial Analysis Package Used To Calculate Markup, Margin, Annuities, Compound Interest, Nominal And Effective Rates, Sinking Funds, Mortgage Calculations, Future Value, Savings and Insurance, Percentage Difference Between Two Numbers, Amortization Schedule and More

SEND FOR OUR NEW 64 PAGE SOFTWARE CATALOG (INCLUDING LISTINGS OF HUNDREDS OF TRS-80™ PROGRAMS AVAILABLE ON CASSETTE AND DISKETTE). \$2.00 OR FREE WITH EACH SUBSCRIPTIONS OR SAMPLE ISSUE

* All programs are supplied on cassette (add \$3 for Diskette Version - add \$5 for modified Mod-II Version).

COMPUTRONICS

MATHEMATICAL APPLICATIONS SERVICE™

50 N. PASCACK ROAD
SPRING VALLEY, NEW YORK 10977

ONE YEAR SUBSCRIPTION \$24

TWO YEAR SUBSCRIPTION \$48

SAMPLE OF LATEST ISSUE \$ 4

START MY SUBSCRIPTION WITH ISSUE

(#1 - July 1978 • #12 - June 1979 • #24 - July 1980 • #30 - January 1981)

NEW SUBSCRIPTION..... RENEWAL.....

NEW TOLL-FREE
ORDER LINE
(OUTSIDE OF N.Y. STATE)
(800) 431-2818



**24 HOUR
ORDER
LINE**
(914) 425-1535



CREDIT CARD NUMBER _____ EXP. DATE _____

SIGNATURE _____ NAME _____

ADDRESS _____ CITY _____ STATE _____ ZIP _____

*** ADD \$12/YEAR (CANADA, MEXICO) - ADD \$24/YEAR AIR MAIL - OUTSIDE OF U.S.A., CANADA & MEXICO ***

WHAT'S BETTER THAN AN ISAM

And Will Turn

MICROSOFT'S
BASIC
COBOL
FORTRAN

DIGITAL'S
PL/I-80

CBASIC
PASCAL/MT+
S-BASIC

CROMEMCO 16K BASIC

into first class application
languages?

MICRO B+™

The first and most complete
implementation of **B-TREE**
index structures for micro-
computers. **B-TREES** eliminate
index file reorganization.

Search

An index of over

**10,000 Key
Values In Less
Than One
Second**

On A Floppy Disk System
for only

\$260.00!

System Houses:

MICRO B+™

Available In Language C

FAIR COM

2606 Johnson Drive
Columbia, MO 65201
(314) 445-3304

©1980 Fair Com

Shipping \$4 USA / \$8 Foreign
We accept VISA and MASTERCARD

PL/I-80 is a trademark of Digital Research
CBASIC is a trademark of Compil Systems, Inc.
S-BASIC is a trademark of Topaz Programming
PASCAL/MT+ is a trademark of MT Micro Systems

(3a) Sample House Energy-Efficiency Analysis

| -----HEAT LOSS PROFILE----- | | |
|-----------------------------|--------------|---------------|
| Loss through Walls | 10916 | BTU/HR |
| Loss through Roof/Ceiling | 2608 | BTU/HR |
| Loss through Windows | 5280 | BTU/HR |
| Air Infiltration Loss | 4328 | BTU/HR |
| Total Heat Loss | 23133 | BTU/HR |

(3b)

Sample House Energy-Efficiency Improvement With Wall-Insulation Addition Plan

| -----HEAT LOSS PROFILE WITH PLAN----- | | |
|---------------------------------------|--------------|---------------|
| Loss through Walls | 6004 | BTU/HR |
| Loss through Roof/Ceiling | 2608 | BTU/HR |
| Loss through Windows | 5280 | BTU/HR |
| Air Infiltration Loss | 4328 | BTU/HR |
| Total Heat Loss | 18221 | BTU/HR |
| Heat Loss Reduction | 21% | |
| Annual Savings in Heating Cost = | \$191 | |

(3c)

Sample House Energy-Efficiency Improvement With Caulking/Weather Stripping Plan

| -----HEAT LOSS PROFILE WITH PLAN----- | | |
|---------------------------------------|--------------|---------------|
| Loss through Walls | 10916 | BTU/HR |
| Loss through Roof/Ceiling | 2608 | BTU/HR |
| Loss through Windows | 5280 | BTU/HR |
| Air Infiltration Loss | 1442 | BTU/HR |
| Total Heat Loss | 20247 | BTU/HR |
| Heat Loss Reduction | 12% | |
| Annual Savings in Heating Cost = | \$112 | |

Figure 3: Energy-efficiency analysis for the sample house as provided by the program in listing 1. The heat-loss profile is based on existing conditions and represents the sample house's current total heat loss. Nearly 47% of the total heat loss is through the walls. Figure 3b shows that by adding 2 inches of loose rockwool, the total heat loss can be reduced by 21%, for an estimated annual savings of \$191. On the other hand, by caulking and weather-stripping the doors and windows, a reduction of 12% of the total heat loss can be achieved at a cost of about \$112. Note that these figures are based on a constant cost for heating. As the cost for heating increases, more expensive methods of improving heat loss become cost-effective.

enefit from most heating energy-improvement plans. If a house is air-conditioned, the plan with a marginally poor return on investment for heating efficiency is probably a worthwhile investment, when the total energy-efficiency improvement is considered.

Other Factors to Consider

The heat-loss properties of each

house can be very complex and subject to many unknown factors. Variations in construction techniques and materials make it impossible to exactly determine heat-transfer coefficients for each building element. The heat lost from air infiltration depends on such indeterminate factors as how loose each door and window fits, outside wind speed, and what amount of time outside doors are left open when entering or exiting. Effectiveness of

H & E COMPUTRONICS INC.

● EVERYTHING FOR YOUR TRS-80* ● ATARI* ● APPLE* ● PET* ●

*TRS-80 is a trademark of the Radio Shack Division of Tandy Corp. - *ATARI is a trademark of Atari Inc. - *Apple is a trademark of Apple Corp. - *Pet is a trademark of Commodore



★ All orders processed within 24-Hours
★ 30-Day money back guarantee on all Software

BUSINESS PAC 100

100 Ready-To-Run

Business Programs

(ON CASSETTE OR DISKETTE).....Includes 110 Page Users Manual.....5 Cassettes (Or Diskettes)

Inventory Control.....Payroll.....Bookkeeping System.....Stock Calculations.....

Checkbook Maintenance.....Accounts Receivable.....Accounts Payable.....

BUSINESS 100 PROGRAM LIST

| | |
|---------------|--|
| 1 RULE7B | Interest Apportionment by Rule of the 78's |
| 2 ANNU1 | Annuity computation program |
| 3 DATE | Time between dates |
| 4 DAYYEAR | Day of year a particular date falls on |
| 5 LEASEINT | Interest rate on lease |
| 6 BREAKEVN | Breakeven analysis |
| 7 DEPRSL | Straightline depreciation |
| 8 DEPRSY | Sum of the digits depreciation |
| 9 DEPRDB | Declining balance depreciation |
| 10 DEPRDDB | Double declining balance depreciation |
| 11 TAXDEP | Cash flow vs. depreciation tables |
| 12 CHECK2 | Prints NEBS checks along with daily register |
| 13 CHECKBK1 | Checkbook maintenance program |
| 14 MORTGAGE/A | Mortgage amortization table |
| 15 MULTMON | Computes time needed for money to double, triple, etc. |
| 16 SALVAGE | Determines salvage value of an investment |
| 17 RRVARIN | Rate of return on investment with variable inflows |
| 18 RRCONST | Rate of return on investment with constant inflows |
| 19 EFFECT | Effective interest rate of a loan |
| 20 FVAL | Future value of an investment (compound interest) |
| 21 PVAL | Present value of a future amount |
| 22 LOANPAY | Amount of payment on a loan |
| 23 REGWITH | Equal withdrawals from investment to leave 0 over |
| 24 SIMPDISK | Simple discount analysis |
| 25 DATEVAL | Equivalent & nonequivalent dated values for oblig. |
| 26 ANNUDEF | Present value of deferred annuities |
| 27 MARKUP | % Markup analysis for items |
| 28 SINKFUND | Sinking fund amortization program |
| 29 BONDDVAL | Value of a bond |
| 30 DEplete | Depletion analysis |
| 31 BLACKSH | Black Scholes options analysis |
| 32 STOCVAL1 | Expected return on stock via discounts dividends |
| 33 WARVAL | Value of a warrant |
| 34 BONDDVAL2 | Value of a bond |
| 35 EPSEST | Estimate of future earnings per share for company |
| 36 BETAALPH | Computes alpha and beta variables for stock |
| 37 SHARPE1 | Portfolio selection model:i.e. what stocks to hold |
| 38 OPTWRITE | Option writing computations |
| 39 RTVAL | Value of a right |
| 40 EXPVAL | Expected value analysis |
| 41 BAYES | Bayesian decisions |
| 42 VALPRINF | Value of perfect information |
| 43 VALADINF | Value of additional information |
| 44 UTILITY | Derives utility function |
| 45 SIMPLEX | Linear programming solution by simplex method |
| 46 TRANS | Transportation method for linear programming |
| 47 EOQ | Economic order quantity inventory model |
| 48 QUEUE1 | Single server queueing (waiting line) model |
| 49 CVP | Cost-volume-profit analysis |
| 50 CONDPFROF | Conditional profit tables |
| 51 OPTLOSS | Opportunity loss tables |
| 52 FQJQOQ | Fixed quantity economic order quantity model |

| | |
|--------------|---|
| 59 WACC | Weighted average cost of capital |
| 60 COMBPAL | True rate on loan with compensating bal. required |
| 61 DISCBAL | True rate on discounted loan |
| 62 MERGANAL | Merger analysis computations |
| 63 FINRAT | Financial ratios for a firm |
| 64 NPV | Net present value of project |
| 65 PRINDLAS | Laspeyres price index |
| 66 PRINDPA | Paasche price index |
| 67 SEASIND | Constructs seasonal quantity indices for company |
| 68 TIMETR | Time series analysis linear trend |
| 69 TIMEMOV | Time series analysis moving average trend |
| 70 FUPRINF | Future price estimation with inflation |
| 71 MAILPAC | Mailing list system |
| 72 LETWRT | Letter writing system-links with MAILPAC |
| 73 SORT3 | Sorts list of names |
| 74 LABEL1 | Shipping label maker |
| 75 LABEL2 | Name label maker |
| 76 BUSBJD | HOME business bookkeeping system |
| 77 TIMECLCK | Computes weeks total hours from timeclock info. |
| 78 ACCTPAY | In memory accounts payable system-storage permitted |
| 79 INVOICE | Generate invoice on screen and print on printer |
| 80 INVENT2 | In memory inventory control system |
| 81 TELDIR | Computerized telephone directory |
| 82 TIMUSAN | Time use analysis |
| 83 ASSIGN | Use of assignment algorithm for optimal job assign. |
| 84 ACCTREC | In memory accounts receivable system-storage ok |
| 85 TERMSPAY | Compares 3 methods of repayment of loans |
| 86 PAYNET | Computes gross pay required for given net |
| 87 SELLPR | Computes selling price for given after tax amount |
| 88 ARBCOMP | Arbitrage computations |
| 89 DEPRSF | Sinking fund depreciation |
| 90 UPSZONE | Finds UPS zones from zip code |
| 91 ENVELOPE | Types envelope including return address |
| 92 AUTOEXP | Automobile expense analysis |
| 93 INSFILE | Insurance policy file |
| 94 PAYROLL2 | In memory payroll system |
| 95 DILANAL | Dilution analysis |
| 96 LOANAFD | Loan amount a borrower can afford |
| 97 RENTPRCH | Purchase price for rental property |
| 98 SALELEAS | Sale-leaseback analysis |
| 99 RRCONVBD | Investor's rate of return on convertible bond |
| 100 PORTVAL9 | Stock market portfolio storage-valuation program |

- CASSETTE VERSION \$99.95
- DISKETTE VERSION \$99.95
- TRS-80* MODEL II VERSION \$149.95

ADD \$3.00 FOR SHIPPING IN UPS AREAS
ADD \$4.00 FOR C.O.D. OR NON-UPS AREAS
ADD \$5.00 OUTSIDE U.S.A, CANADA & MEXICO

COMPUTRONICS!
MATHEMATICAL APPLICATIONS SERVICE™

50 N. PASCACK ROAD
SPRING VALLEY, NEW YORK 10977

**NEW TOLL-FREE
ORDER LINE**
(OUTSIDE OF N.Y. STATE)
(800) 431-2818

**24 HOUR
ORDER
LINE**
(914) 425-1535



| NAME | DESCRIPTION |
|------------|--|
| 53 FQEQWSH | As above but with shortages permitted |
| 54 FQEQQPB | As above but with quantity price breaks |
| 55 QUEUECB | Cost-benefit waiting line analysis |
| 56 NCFANAL | Net cash-flow analysis for simple investment |
| 57 PROFIND | Profitability index of a project |
| 58 CAP1 | Cap. Asset Pr. Model analysis of project |

Circle 162 on inquiry card.

BIGGEST Discounts Ever On TRS-80™

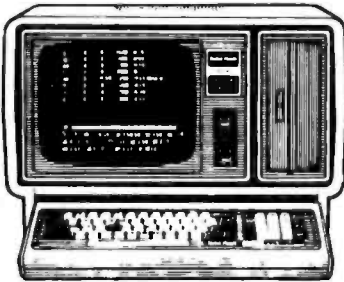

Computers, Accessories & The Following NEW Items

Hewlett-Packard®
HP-85 Personal Computer

Atari® CX-2600
Video Computer System

Magnavox®
Odyssey²
Home Video System

Magnavox®
Magnavision®
Videodisc Player

- **FREE SHIPPING** in 48 continental contiguous States.
- **NO SALES TAX** collected on out-of-state orders.
- **FREE Discount Price List** available.

TOLL FREE ORDER NUMBER
800/531-7466

Texas & Principle Number
512/581-2766

Fort Worth No. 817/625-6333
Telex Number 767339

Pan American Electronics

Sales and Main Office
Dept. 11 • 1117 Conway Ave.
Mission, Texas 78572
NEW Fort Worth Branch
Dept. 11 • 2912 N. Main St.
Fort Worth, Texas 76106

TRS-80 is a Trademark of Tandy Corp.

Listing 1: A TRS-80 BASIC program to perform an energy-efficiency analysis of your home. After asking for your home's vital statistics, the program presents an analysis of your present heat losses. Then, by entering options 1 through 4, you can evaluate the results of the various energy-conservation plans on your house. Data for plans 1 and 4 for the sample house described in the text are shown in figure 3.

```

10 REM-----ENERGY EFFICIENCY ANALYSIS-----
20 CLS
30 REM BUILDING SURFACE AREA AND EXISTING INSULATION
40 INPUT "HEATING ZONE (FROM MAP)";N
50 T=N*10
60 INPUT "TOTAL DOUBLE-PANE WINDOW AREA (SQUARE FEET)";GW
70 INPUT "TOTAL SINGLE-PANE WINDOW AREA (SQUARE FEET)";GA
80 INPUT "TOTAL WALL AREA (SQUARE FEET)";WA
90 INPUT "TOTAL ROOF/CEILING AREA (SQUARE FEET)";RA
100 INPUT "TOTAL DOOR AREA (SQUARE FEET)";DA
110 INPUT "R-FACTOR OF EXISTING WALL INSULATION";WR
120 INPUT "R-FACTOR OF EXISTING ROOF/CEILING INSULATION";RR
130 CLS
140 PRINT "-----HEAT LOSS PROFILE-----"
150 PRINT:WL=(1/(WR+2))*WA*T
160 RL=(1/(RR+3))*RA*T
170 GL=(.45*GW*T)+(1.1*GA*T)
180 DL=.54*(.8*(GA+GW)+DA)*T
190 PRINT "LOSS THROUGH WALLS" "INT(WL); "BTU/HR"
200 PRINT "LOSS THROUGH ROOF/CEILING" "INT(RL); "BTU/HR"
210 PRINT "AIR INFILTRATION LOSS" "INT(DL); "BTU/HR"
220 PRINT "LOSS THROUGH WINDOWS" "INT(GL); "BTU/HR"
230 TL=INT(WL+RL+GL+DL)
240 PRINT
250 PRINT "TOTAL HEAT LOSS" "TL; "BTU/HR"
260 PRINT:PRINT "ENERGY EFFICIENCY IMPROVEMENT PLAN"
270 PRINT
280 PRINT "ADD WALL INSULATION (ENTER 1)"
290 PRINT "ADD ROOF/CEILING INSULATION (ENTER 2)"
300 PRINT "INSTALL STORM WINDOWS (ENTER 3)"
310 PRINT "CAULK AND WEATHERSTRIP (ENTER 4)"
320 INPUT E
330 IF E<3 THEN GOTO 370
340 IF E=3 THEN GL=(.45*(GA+GW))*T
350 IF E=4 THEN DL=.18*(.8*(GA+GW)+DA)*T
360 GOTO 400
370 INPUT "ADDED R-FACTOR OF NEW INSULATION";R
380 IF E=1 THEN WL=(1/(WR+2+R))*WA*T
390 IF E=2 THEN RL=(1/(RR+3+R))*RA*T
400 CLS:PRINT"-----HEAT LOSS PROFILE WITH PLAN-----"
410 PRINT
420 PRINT "LOSS THROUGH WALL" "INT(WL); "BTU/HR"
430 PRINT "LOSS THROUGH ROOF/CEILING" "INT(RL); "BTU/HR"
440 PRINT "LOSS THROUGH WINDOWS" "INT(GL); "BTU/HR"
450 PRINT "AIR INFILTRATION LOSS" "INT(DL); "BTU/HR"
460 PRINT:TN=INT(WL+RL+GL+DL)
470 PRINT "TOTAL HEAT LOSS" "TN; "BTU/HR"
480 PRINT
490 PRINT "HEAT LOSS REDUCTION" "INT(((TL-TN)/TL)*100); "%"
500 PRINT:INPUT "TOTAL ANNUAL HEATING COST";H
510 PRINT
520 PRINT "ANNUAL HEATING COST SAVINGS=$";INT(H*(TL-TN)/TL)
530 PRINT "DO YOU WANT TO CHECK THE EFFICIENCY OF OTHER"
540 INPUT "IMPROVEMENTS ? (ENTER 1 IF YES - 2 IF NO)";X
550 IF X=1 THEN CLS:GOTO 260
560 IF X=2 THEN CLS
570 PRINT "DO YOU WANT TO RUN THIS PROGRAM FOR ANOTHER"
580 INPUT "BUILDING ? (ENTER 1 IF YES - 2 IF NO)";Y
590 IF Y=1 THEN GOTO 20 ELSE CLS
600 PRINT "ENERGY AUDIT PROGRAM TERMINATED"
999 END
    
```



BETA COMPUTER DEVICES

AVAILABLE NOW ... SYSTEM 2800 FROM SYSTEMS GROUP

FEATURES

- IEEE S-100 Bus Compatible Systems, Z80A Based
- Two 8-Inch Drives: Single or Double Sided, Double Density Floppy Disk Drives or 10MB Winchester Hard Disk Drive
- 20MB Winchester and Tape Backup
- 8-Slot Shielded and Terminated Motherboard
- System Software Selection includes CP/M*, MP/M* or OASIS**
- Single-User or Multi-User Systems, Expandable to 6 Users
- Table Top or Rack Mountable
- Two Switched AC Outlets on Rear Panel
- One Year Warranty on Entire System

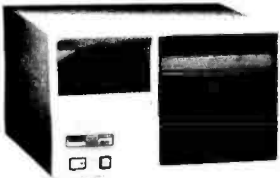
| | |
|--|-----------|
| 2812 CP/M, 2 Single Sided Floppies..... | \$3775.00 |
| 2814 CP/M, 2 Double Sided Floppies..... | 4425.00 |
| 2819 CP/M, 1 10 MB Winchester & 1 Double Sided Floppy..... | 6675.00 |
| 2824 MP/M, 2 Double Sided Floppies.... | 5235.00 |
| 2829 MP/M, 1 10 MB Winchester & 1 Doubled Sided Floppy.... | 7500.00 |



S-100 PRODUCTS

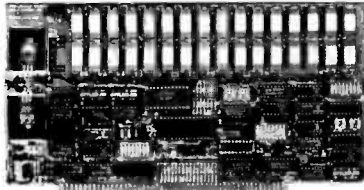

QUALITY RAM FROM SYSTEMS GROUP

- Z-80 4MHZ operation with no wait states
 - IEEE compatible timing - 200 NS 4116's
 - Factory assembled, tested & burned in
- | | |
|---------------------------------------|----------|
| DMB6400 64K (Bank Select, shown)..... | \$749.00 |
| DM6400 64K | 545.00 |
| DM4800 48K..... | 520.00 |
| DM3200 32K..... | 495.00 |

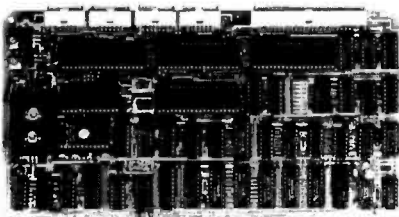

CONFIGURE A COMPLETE S-100 SYSTEM WITH 2nd GENERATION* PRODUCTS FROM SYSTEMS GROUP.

- CPC 2810 (shown) Z-80A processor board (4MHZ) with 4 serial & 2 parallel ports.....\$369.00
- CPC2813 - same as CPC2810 but 2 serial ports only.....\$345.00
- FDC2801/8 - 8" floppy disk controller board, up to 4 single/double sided drives, single or double density.....\$349.00
- INO-2804 - 4 channel serial I/O..... 329.00
- CRA-100 - Cromix* adaptor board.. \$55.00

CALL US FOR OUR MOST CURRENT PRICES!

*2nd Generation is a trademark of Measurement Systems and Controls. Cromix is a trademark of Cromemco, Inc. Tilt-Back is a trademark of Wabash, Inc. CP/M and MP/M are trademarks of Digital Research. OASIS is a trademark of Phase One Systems.

16K MEMORY EXPANSION KIT \$24.00

For Apple, TRS-80 keyboard, Exidy, and all other systems using 4116 dynamic rams or equivalent. All IC's are prime Mitsubishi MI 4116-3, 200 NSEC, burned-in and fully tested.

wabash®



8" or 5 1/4" flexible diskettes certified 100% error free with manufacturers 5 year limited warranty on all 8" media. Soft sectored in Tilt-back* boxes of 10.

(Add \$3.00 for plastic library cases)

| | |
|--|---------|
| 8" single sided, single density..... | \$29.95 |
| 8" single sided, double density..... | 37.95 |
| 8" double sided, double density..... | 48.95 |
| 5 1/4" single sided, single density..... | 27.95 |
| 5 1/4" single sided, double density..... | 29.95 |

Adds Viewpoint CRT....\$589.00

8" DISK DRIVES

| | |
|---|------------|
| Shugart 801R..... | \$390.00 |
| NEC FD1160 (double sided)..... | 595.00 |
| Memorex MRX-101 8" Winchester style, hard disk drive, 10 megabytes..... | \$2,000.00 |

TERMS: Minimum order \$15.00. Minimum shipping and handling \$3.00. Calif. residents add 6% sales tax. Cash, checks, Mastercard, Visa and purchase orders from qualified firms and institutions are accepted. Product availability and pricing are subject to change without notice.

INTERNATIONAL ORDERS: Add 15% to purchase price for all orders. Minimum shipping charge is \$20.00. Orders with insufficient funds will be delayed. Excess funds will be returned with your order. All prices are U.S. only.

6502 PRODUCTS

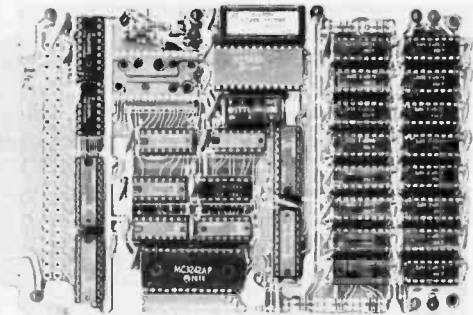

BETA 32K BYTE EXPANDABLE RAM FOR 6502 AND 6800 SYSTEMS

- AIM 65 KIM SYM PET S44-BUS
 - Plug compatible with the AIM-65/SYM expansion connector by using a right angle connector (supplied).
 - Memory board edge connector plugs into the 6800 S44 bus.
 - Connects to PET using an adaptor cable.
 - Uses +5V only, supplied from the host computer.
 - Full documentation. Assembled and tested boards are guaranteed for one full year. Purchase price is fully refundable if board is returned undamaged within 14 days.
- | | |
|--|----------|
| Assembled with 32K RAM..... | \$349.00 |
| & Tested with 16K RAM..... | 329.00 |
| Bare board, manual & 6 hard-to-get parts. 99.00 | |
| PET interface kit. Connects the 32K RAM board to a 4K or 8K PET..... | \$ 69.00 |

BETA
COMPUTER DEVICES

1230 W. COLLINS AVE.
ORANGE, CA 92668
(714) 633-7280



PROGRAM OPERATION

| Computer Display | Sample House Data from Worksheet | Comments |
|--|----------------------------------|--|
| HEATING ZONE (FROM MAP) | 4 | find your heating zone from figure 2 |
| TOTAL DOUBLE-PANE WINDOW AREA (SQUARE FEET) | 132 | using the worksheet, find the area of all exposed surfaces |
| TOTAL SINGLE-PANE WINDOW AREA (SQUARE FEET) | 66 | " |
| TOTAL WALL AREA (SQUARE FEET) | 3002 | " |
| TOTAL ROOF/CEILING AREA (SQUARE FEET) | 1500 | " |
| TOTAL DOOR AREA (SQUARE FEET) | 42 | " |
| R-FACTOR OF EXISTING WALL INSULATION | 9 | measure the existing insulation thickness |
| R-FACTOR OF EXISTING ROOF/CEILING INSULATION | 20 | and find the R-factor from table 1 |
| Heat Loss Profile Displayed | | (see figure 3a) |
| ENERGY-EFFICIENCY IMPROVEMENT PLAN | | |
| ADD WALL INSULATION | | (enter 1) |
| ADD ROOF/CEILING INSULATION | | (enter 2) |
| INSTALL STORM WINDOWS | | (enter 3) |
| CAULK AND WEATHER STRIP | | (enter 4) |
| ADDED R-FACTOR OF NEW INSULATION | 1 | choose plan 1, 2, 3, or 4 |
| Heat Loss Profile with Plan Displayed | 9 | find R-factor of insulation to be added from table 1 |
| Percent Heat Loss Reduction Displayed | | (see figure 3b) |
| TOTAL ANNUAL HEATING COST | 900 | add last year's heating bills—total annual cost |
| Annual Savings in Heating Cost Displayed | | (see figure 3b) |

the existing insulation cannot be exactly determined either. Also, dampness and uneven thickness will alter the heat-transfer properties of insulation.

In short, some assumptions are necessary in this program to express the heat-loss characteristics of the home. For most houses, however, the evaluation provided in this program is reasonably accurate for selecting the best heating energy-conservation plan and determining the approximate saving in heating costs. ■

Several publications are available from the US government to aid in conserving home heating energy. Among them are:

**Building Science #64
Retrofitting Existing Housing for Energy Conservation
Making the Most of Your Energy Dollars**

These and other publications can be obtained by contacting the US Department of Commerce, National Bureau of Standards, Washington DC 20230. Your local power utility company and your home heating fuel supplier may also be able to provide you with literature.

Figure 4: An annotated representation of the information requested by the program in listing 1. Data for the sample house is given.

SCR SUPER-BUYS

UPS ANYWHERE IN CONTINENTAL U.S.

- ① **FREE DECODER PLANS** plus a brochure describing our new UHF-VHF Conversion Kit are yours just by sending us your name, address and an 18c stamp. **FREE**
- ② **VHF VARACTOR-TUNER**, 300 ohms input. Tunable for Channels 2-10-13. All solid-state. Made by leading name manufacturer. New-surplus. **\$495 ea.**
- ③ **BRAND NAME POWER SUPPLIES**, ±5V/6A. Voltage adjustable and IC regulated. Ideal for CMOS, computer-based instruments, etc. New-surplus. **\$2395 ea.**
- ④ **6-FOOT TELEPHONE CORD** with AMP brand, modular phone-jack at one end, and 4-spade-lug leads at the other. Normally priced at \$2.49 each. **99c* ea.**

*Call us for special large quantity pricing quotations.

SCR ELECTRONICS INC.
9533 Valley View Street, Cypress, CA 90630
\$10.00 MIN. ORDER HANDLING/SHIPPING \$5.00
Pay by CHECK, M.O., VISA, M/C, C.O.D.
For Free Buyers Guide Circle No. 000

9 TRACK TAPE DRIVES

800 BPI
45 IPS
FULL MANUAL
\$4850 VALUE



\$2400
NEW IN ORIGINAL BOXES

**PERTEC Model 8840A-9-45
INDUSTRY STANDARD INTERFACE
CAPABLE OF IND. STD. ANSI-IBM DATA FORMAT**

- * READ/WRITE DATA IN STANDARD ANSI-IBM COMPATIBLE FORMAT
- * DUMP WINCHESTERS AND HARD DISKS: 10 inch reels hold up to 3600' of tape 34.58 Megabytes unblocked.
- * EXCHANGE DATA & PROGRAMS WITH LARGE MAIN FRAMES AT SCHOOL, WORK, SERVICE BUREAUS ETC.
- * BARGAIN PRICED MINI-COMPUTER UPGRADE. OEM List \$4850

A large OEM overstock makes these industry standard drives available at a fraction of their current list price. Full size drives handle up to 10.5 inch reels of standard inexpensive 1/2 inch mag tape 19 inch rack mount or use right out of the box on steel shipping frame.

SPECIFICATION SUMMARY: 9-track, 800 BPI, dual head (read after write), 45 IPS read-write, 300 IPS rewind, BOT/EOT sensing, 110 VAC/60-Hz, solid state, recent manufacture, all I/O signals TTL/DTL compatible, tension arm tape buffering, full control panel. Call or write for full set of technical specifications.

INTERFACES: Electrovalue encourages the development of interfaces to popular systems. Interfaces exist for popular minis and are being developed for several hobby computers. If you'd like to develop and document an interface to a popular small system call to discuss discounts.

ELECTROVALUE INDUSTRIAL INC.
P.O. BOX 157-B
MORRIS PLAINS, NJ 07950
Formerly Electrovalue Industrial

Phone reservations and questions are welcome
201/267-1117

Announcing NEW Version 3.0 !!! MOONSHADOW TEXT FORMATTER FOR UCSD PASCAL (TM)

The features that made MTF popular ...

- * input files prepared with Pascal system editor or Pascal program
- * centering and underlining
- * right justification
- * text file concatenation
- * output to any device or text file
- * form-letter production
- * full user control over page dimensions
- * pagination with user-defined "header" and "footer" titles
- * asymmetric margins and titles for even and odd pages
- * output character translation
- * convenient default formatting behavior

Plus the improvements and additions you demanded!

- * Command macros
- * conditional formatting
- * automatic section numbering
- * alternate fonts
- * auto ribbon color change
- * boldfacing
- * Roman or Arabic numeric forms
- * true proportional spacing
- * foreign alphabets fully supported
- * arbitrary control characters may be embedded in text lines
- * user-profile customization for NEC Spawriter and other printers
- * comprehensive user manual
- * much, much more!

Versions available for UCSD Pascal 3.0 (IBM floppy format), and Apple Pascal (TM). Please specify system configuration when ordering.

MTF 3.0 - your UCSD Pascal system - TRUE WORD PROCESSING!

Software diskette and complete manual only \$195. (California residents add 6% sales tax.)

MERRIMACK SYSTEMS
815-817 Douglas Avenue
PO Box 5218
Redwood City CA 94063
Phone (415) 365-6265

UCSD Pascal is a trademark of the Regents of the University of California. Apple Pascal is a trademark of Apple Computer, Inc.

Circle 330 on inquiry card.

Circle 420 on inquiry card.

Circle 218 on inquiry card.

If you want a choice in print wheels, here's the first choice in printers.

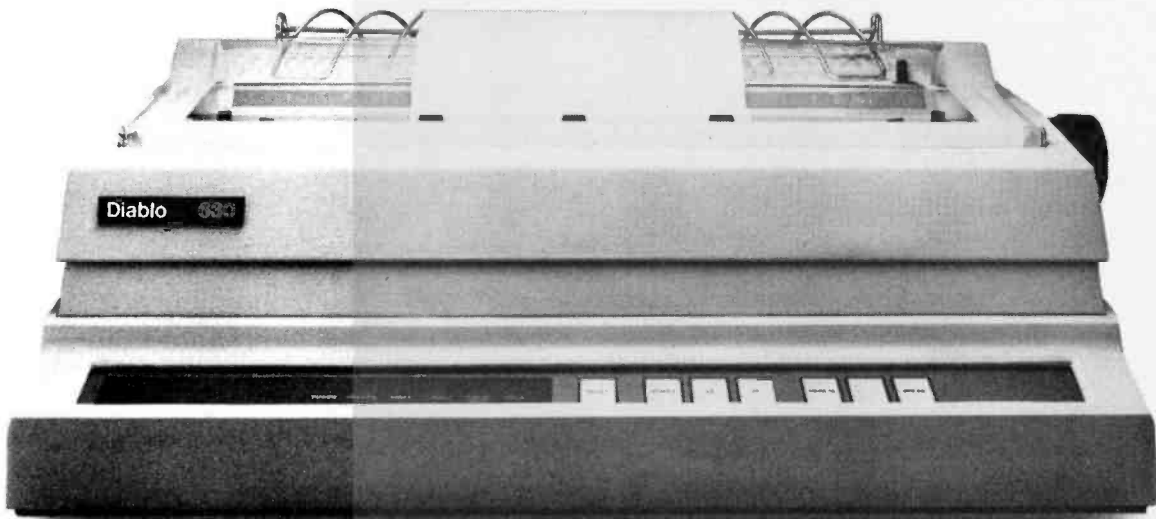

The Diablo 630.

It's the first printer that lets you use either metal or plastic print wheels. So you can choose the print wheel that's just right for the job.

The 630 works as well with a 96-character plastic daisy print wheel as it does with an 88-, 92-, or 96-character metal daisy print wheel. In over 100 different type styles.

Every 630 has fewer moving parts than competitive printers, which makes it more reliable. And it offers unsurpassed print quality. Compatibility with Diablo supplies. And bi-directional printing capability.

So if you want to change your print wheels, you'll just have to change your printer.

To a Diablo 630 printer.

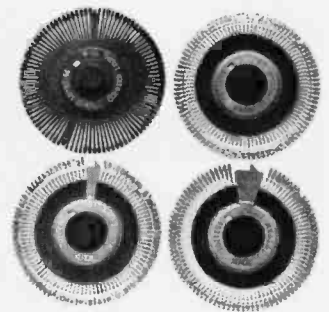

Diablo Systems

XEROX



Get yourself a real chill on **HALLOWEEN** in the nationwide **CompuServe Adventure Tournament.**

Prizes: Grand Masters win two hours of free time on CompuServe.

Runners-up win a CompuServe Adventure T-shirt (Grand Masters win this too.)

Everyone who enters can, on request, receive a large poster of the Gray Morrow art on the opposite page in full color. We'll charge your account \$2.00 for postage and handling.

When? Starting at 6 PM local time on Friday, October 30, running through 5 AM on Monday, November 2.

How? Since this will be our first nationally-advertised tournament, we may have to make some last minute changes following our "in-house" tournament on Labor Day. So check the "What's New" section of the CompuServe Information Service for details preceding the contest. So enter. Collect treasures. Slay dwarves. And practice, practice, practice. How else will we be able to afford the T-shirts?

CompuServe

5000 Arlington Centre Blvd.
Columbus, Oh 43220
Information Service Division
(800) 848-8990

If you're not already a member of the country's largest personal computer network, get on-line now!

How does it work?

Your computer talks to our computers. You need a modem and some special software. Software for the TRS-80® and Apple II® computers are available at many Radio Shack® outlets and all Radio Shack® Computer Centers. Atari® users can access the system via Telelink™ software. Persons owning other brands of computers or terminals can also purchase the CompuServe Information Service through Radio Shack®. In more than 260 U.S. cities you can reach the CompuServe Information Service via a local phone call. The cost is \$5 per hour, billed in minutes, to your charge card, for service between 6 PM and 5 AM local time on weekdays and all day on Saturday, Sunday and most holidays. Limited daytime access is available at a higher rate.

What do I get?

There are more than 175 topics listed in the on-line index. Most first-time users are interested in:

1. News, weather, sports. We offer the electronic editions of many of the major daily newspapers and the AP news and sports wires.
2. CB simulation. "Talk" to other computer users anywhere in the country. We also offer electronic mail.
3. Games. Many, including the multi-player Space War, Star-Trek, four Adventure games.
4. Finance. Again, a wide variety for both historical and current data on stocks, bonds and commodities.
5. Computer user groups (including national bulletin boards) and computer manufacturers' newsletters.
6. Home information. Family Service. Government publications. Aviation news. Energy-saving tips. And more.

When you are ready, CompuServe Information Service can provide you with a lot of big mainframe computer power. But see a demonstration at Radio Shack® right away so you can get on-line before the tournament.

Radio Shack and TRS-80 are trademarks of Tandy Corporation. ATARI and Telelink are trademarks of ATARI, Inc. Apple is a trademark of Apple Computer, Inc.

Bridging the 10-Percent Gap

Paul T Brady
91 Marcshire Dr
Middletown NJ 07748

In my spare time, I'm the administrator of a nature center in Middletown, New Jersey. We have a staff of five, an annual budget approaching \$40,000, a mailing list of 1500 names, annual attendance of 10,000 visitors, and a need to type and/or mimeograph letters, handouts, and other literature. (If you wonder how we can support five people on \$40,000, we can't; some staff members are on the payroll of other agencies.)

And if you were wondering what a nature center has to do with computers, take a minute to think about the figures in the first paragraph. You'll soon see that we were absolutely hurting for a small computer.

This article describes our problems and eventual success in computerizing many of the office functions at the nature center. It's one of many similar stories, I'm sure. But there are also many small businesses like ours, including grocery stores, museums, law offices, and other firms, that could benefit from computers—but won't because of the 10-percent gap.

The 10-Percent Gap

I make two claims:

1. There is already available a wide range of excellent hardware at reasonable prices that can perform the functions a small business requires.
2. There is also an enormous range of available software that will *almost*

do the required job. It will do a 90-percent job. But to bridge the 10-percent gap requires experience and efforts far beyond the abilities or interests of the typical small-business owner. This 10-percent software gap is holding back a virtual explosion of data processing into small businesses.

Background

My computer work began in 1958, programming the TX-0 computer at MIT in machine language (what else). I have sampled many other computers and languages, generally using minicomputers and microcomputers. By profession, I work at Bell Labs and specialize in performance measurements of mid-size systems, especially VAX/VMS systems (made by Digital Equipment Corporation). I also spent many years designing and testing human-factor interfaces to computer systems.

The nature center grew from a citizens' movement in 1969 to save land for a park. We succeeded, and now have a fine 250-acre park with historic buildings and a new nature center. The name of the park is Poricy Park (an Indian name from the 1600s). It is operated by a citizens' committee with an excellent professional staff—who have absolutely no background in computers.

We Needed Help!

The first warning that we needed

data processing came from our inability to manage our mailing list by hand. Just try hand-addressing 1000 envelopes! So I wrote a program to print labels from a name-and-address file and put it on a timeshared system. For many years, this program got occasional use whenever we had a mailing.

But there were problems. The computer system was often down for modifications, especially in the evening hours when we usually used it. It was not available to our staff, we had no dial-up equipment, and we often wouldn't have daytime access even if we could dial in. But the most serious problem was that I was the only person in the world who knew how to use the system. If anything happened to me, good-bye mailing list. We finally realized that we had to become self-sufficient, and that several people had to be able to manage the list.

The second need for a computer was realized soon after we opened the park year-round. Our accounting system, managed in part by nonexpert secretaries and in part by volunteers, was a real headache. We often met at nights, pounding on an adding machine generating yards of tape, trying to find minor errors in entering checks or locating missing deposit entries. The annual tax-return time was a nightmare, when we usually had to plow through everything again.



Searching for a Solution

In early 1979, we came up with partial specifications. We had to fit the mailing list on one floppy disk; this demanded either 8-inch disks or 5-inch quad-density disks. We needed an impact printer with adjustable tractor feed (for labels), and, if possible, of letter quality for secretarial work. Finally, we needed a video terminal; we did not care whether it was separate or incorporated into the main computer. We had no need for video graphics or color, so we could use any standard terminal.

We began by visiting a computer store, a nicely decorated operation with impressive-looking equipment. We were greeted by a friendly salesperson who asked what we wanted. After we explained who we were and what we needed, he immediately told us they had the solution. This so-called solution was a \$15,000 system with bells and whistles, a dot-matrix printer, etc, far out of our price range and probably not even suitable. After finally getting down to a system we might be able to handle, we engaged

in dialogue such as:

Clerk: "Suppose you wanted to play chess."

Us: "We don't want to play chess."

Clerk: "But suppose you do."

Us: "We don't. We want to do accounting and mailing-list management."

A little more of this and we got to see the manager. We asked if the BASIC system, or any other system that came with the machine, had decimal floating-point arithmetic, as

opposed to binary floating-point. (Binary floating-point can have round-off error on fractions, intolerable in accounting. Until recently, most microcomputer systems represented numbers only in integer or binary floating-point format.) The manager answered that their systems had great precision, certainly enough for dollars and cents. We explained that we were not talking about *precision*, the number of digits supported, but the way decimal fractions were

stored internally. The manager got angry and condescending; we got disgusted. No sale.

The next few months produced similar encounters. All dealers claimed to have just what we wanted, except that they never bothered to ask us what we wanted to do with it, or anything at all about our business. This is one of the fundamental problems of dealers. Because they spend so much time talking to computer freaks, they assume everybody wants

to play with systems, languages, and various gadgets. We don't. *Our business is running a nature center—not a computer center.*

Because dealers spend so much time talking to computer freaks, they assume everybody wants to play with systems and languages.

What Causes the Gap?

What causes the gap between software technology and business applications? One reason commonly cited is computer scientists' preference to develop new theories and explore abstract concepts, rather than develop application techniques.

This is illustrated by the "Letters" column in the December 1980 BYTE. There is a letter about a language that will generate a program that will reproduce itself. There's another about stack problems. There's a whole section of comments on the FORTH articles in the August issue. There's even someone who wants to hear more about SNOBOL. (Now there's an oldie!) It's clear there are some pretty sophisticated readers out there.

In my profession as a computer-systems analyst, I often interview computer-science graduates. It is a common lament among interviewers that all we get are people who (1) want to design a new compiler, or (2) want to build an operating system. They are taught the mathematical beauty of stack-oriented languages, or list processors, and so on, and would be right at home with those who wrote the letters to BYTE.

I am certain there's a place for pure programming in our society, but I think the real prizes will go to whoever can make computers understandable and useful to businesses.

The Twain Must Meet

The first part of the solution is to give people the necessary background. Train them in night school, and train their children in grade school. Don't train them how to build self-reproducing programs (unless they really want that), but train them in

business applications of computers.

It may be possible to establish a science of computer applications. It is certainly a challenge to write a new language or operating system, but it is also a challenge to develop a discipline that studies applications. How many computer-science graduates know the elements of accounting? How many have studied business administration? These people are very bright, and if they are exposed to the practical problems businesses encounter, they may discover that applications is itself a challenging problem.

We need better standards of commercial software. I am convinced that a common language is hopeless; BASIC comes as close as any, but computer scientists get ill when it is mentioned. (I can empty a room by stating: "BASIC is my language, and GOTO is my favorite instruction." Mentioning COBOL also produces some pretty neat reactions.) Perhaps we cannot settle on a standard language, but at least it should be one that is widely accepted.

Software should be easy to modify or expand. Maybe I am old-fashioned, but I prefer to get source code; it would have saved me hours with our North Star system. At least, tables of transfer vectors and interface hooks should be documented.

Perhaps what we will eventually come to is an industry, already being established, of businesses that specialize in installing software for other businesses. It may be similar to the auto-service industry. I have no idea how to fix a car, yet I buy one with some confidence that my local mechanic (who I happen to think is pretty good) can take care of whatever happens. The analogy is far from perfect, but perhaps it helps make the point.

Our System

Eventually, from the wide range of equipment and operating systems available, we arrived at our current configuration. It includes:

- a North Star Horizon computer with 48 K bytes of memory and two quad-density disk drives (each disk has 360,000 bytes)
- a Perkin-Elmer Bantam terminal
- a beautifully reconditioned Perkin-Elmer Carousel printing terminal, donated by the Perkin-Elmer Corporation (whose computer division is in the town adjacent to the park; clearly a special case for them to do this)

Some of the equipment was purchased with special private grants. No membership funds were used. I emphasize this because we have not, unfortunately, reached the point where contributors think positively about using their donations for a computer. Typewriter, yes; computer, no. Let's hope this attitude soon changes.

We are very pleased with the equipment, but many other manufacturers would do as well. There is much fine hardware on the market.

The main problems occur in the software. There's plenty of software—but virtually none of it bridges the 10-percent gap.

Why Software Is Inadequate

Here are some reasons why commercially available software was unsuitable for our business:

1. It is too complex. I purchased the manual for an accounting program,

High resolution, dot addressable graphics with vertical resolution of 72 dots per inch and up to 82 dots per inch horizontal resolution.

Single sheet feeder is very simple to use. The only front load feeder available on the market today.*

"Q.T." cover reduces noise to an office comfort level. This is an optional feature to our standard sound deadening case.

1K standard buffer permits the 88G to print while receiving data. The optional 2K buffer allows a 1920 character dump to the printer freeing the CRT.



The Features Leader

Integrated Paper Handling System

Dual tractor/friction feed allows use of pin feed, roll or single sheet paper.

Versatile Interface

Data input from most computers can be supported by the 88G. RS232C serial and Centronics® type parallel is standard. Options can be added for current loop, IEEE 488 and high speed serial inputs.

Letter Quality Capability

The 88G provides a selectable 11 x 7 serif style dot matrix for correspondence printing.

Cost Effective

The 88G has more features than any other impact printer in its price class. First compare the quality of the 88G, then compare the price —the 88G wins! Single unit price is less than \$800.

*Optional



Micro Peripherals, Inc. 4426 South Century Drive Salt Lake City, Utah 84107 (801) 263-3081
The Printer People

California VITEK (714) 744-8305 Computer Potentials (206) 453-9777 Colorado PLS Associates (303) 773-1218 Illinois CW Electronic Enterprises (312) 298-4830 Massachusetts Butler (617) 965-1080 Minnesota Bohlig & Associates (612) 922-7011 New Jersey Hansen & Hughes (201) 652-7055 Oregon Microware (503) 620-8150 Washington Microware (206) 451-8586 Pennsylvania QED Electronics (215) 674-9600 Utah PLS Associates (801) 466-8729 International Europe, Russet Instruments, Ltd. (0734) 868147 Telex: B49721 International, Sintel, (602) 994-3435 Telex: 165-745 Canada Norango (416) 449-2761 Texas Thorson Distributors (214) 233-5744



Photo 1: The nature-center computer system consists of a Perkin-Elmer Bantam terminal, a Perkin-Elmer Carousel printer, and a North Star Horizon computer.

but decided it was overkill for our small business. Many files were manipulated, 5-digit account numbers were used, and fairly elaborate forms were produced. All these were way beyond our needs or ability to handle. In another example, most word-processing systems are fine for professional secretaries or typists, but they have a bewildering array of features. In one popular text editor, virtually every key on the keyboard assumes a special escape role in editing. You can insert, search, delete, search and delete, reformat, and on and on.

2. Much of it is too expensive. We are a small, nonprofit corporation; we barely managed the funds required for the hardware. We simply cannot spend hundreds or thousands more on software.

3. The programs are incompatible with each other. The key used for correcting errors is BACKSPACE in

one program, DELETE in another; in one program, you specify line range 2 through 35 as "2,35" and in another, as "2:35"; the letter "s" stands for "save file" in one program, "w" is used to "write" (save) in another. Our staff would never be able to keep these straight. Some vendors are overcoming this problem by offering complete packages. This is a step in the right direction.

4. The commercial software is nearly impossible to modify. Much of it is shipped as machine-language modules. I have years of bit-picking (or bit-twiddling) behind me, and I still find no beauty in deciphering a memory dump. Or the program is in Pascal, or C, or whatever, and we don't have a compiler for that language.

5. Many programs require disk changes and other potentially dangerous procedures to run them. If profes-

sional system managers sometimes get disks mixed up, what about nature-center employees?

6. The most important reason of all: the programs don't do what we require. Thus, even if we received a package of compatible programs, all with the same human-factor interface, we would still have to make many modifications to suit our needs. I'll illustrate this with two examples: the salary program and the mailing-list manager.

A Salary Package

A salary program is very useful. Employees work odd hours. Some are paid weekly, some hourly. Deduction status for an employee might change during the year. Part-time workers come and go. Income tax W-2 forms have to be prepared every year. It's nice to automate this.

An advertisement offers a "powerful, flexible payroll program. Federal, state, Social Security, etc, withholdings are automatic." But we have some local obstacles.

New Jersey has an unemployment and disability tax that affects only the first \$7500 of income on a per-person basis. This threshold is crossed at different times by different employees. Mary Smith's year-to-date wages last week were \$7404; this week they were \$7581. We have to recognize that \$7500 was crossed, and tax only the proper fraction of the week's pay. The \$7500 figure changes as state policy changes. Does the "powerful, flexible payroll program" handle this tax? [Various other states have exceptional procedures that create prob-

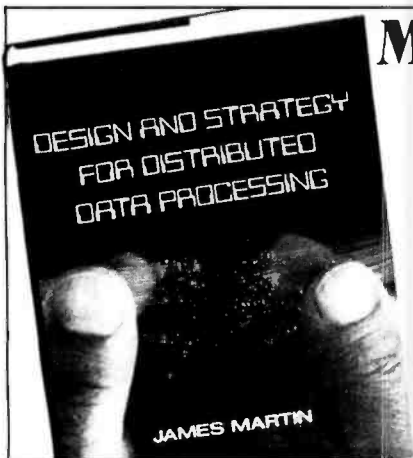

McGraw-Hill Bookstore

Design and Strategy for Distributed Data Processing by James Martin

"The man generally acknowledged to be the computer industry's most widely read author, best attended lecturer, and foremost authority on the social and commercial impact of computers." — Computer World

"Distributed processing is here to stay and will change the way hardware and software are implemented." — James Martin

Here is clear strategy and illustrated techniques of good design for distributed processing. The author skillfully builds understanding of the complex technology. 637 pp. \$37.50

Please print clearly.

McGraw-Hill Bookstore
1221 Avenue of the Americas BY10
N.Y., N.Y. 10020

Please send me _____ copies of
Design and Strategy for Distributed Data Processing by James Martin at \$37.50.

MasterCard Visa AmerExp

Account No. _____ Expires _____

Name _____

Address _____

City _____ State _____ Zip _____

Add sales tax plus \$2.50 postage, handling

The Text Solution for APPLE II®

Now APPLE II® Owners Can Solve Text Problems With VIDEOTERM 80 Column by 24 Line Video Display Utilizing 7 X 9 Dot Character Matrix

Perhaps the most annoying shortcoming of the Apple II® is its limitation of displaying only 40 columns by 24 lines of text, all in uppercase. At last, Apple II® owners have a reliable, trouble-free answer to their text display problem. VIDEOTERM generates a full 80 columns by 24 lines of text, in upper and lower case. Twice the number of characters as the standard Apple II® display. And by utilizing a 7 by 9 character matrix, lower case letters have true descenders. But this is only the start.

VIDEOTERM, MANUAL, SWITCHPLATE

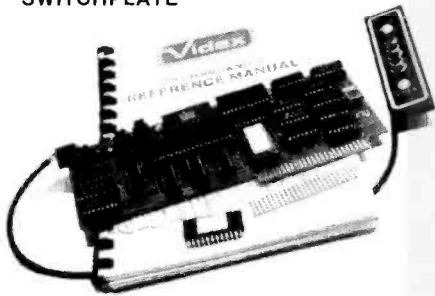

7X12 MATRIX
18X80 OPTIONAL



7X9 MATRIX
24X80 STANDARD

VIDEOTERM

- BASICs** VIDEOTERM lists BASIC programs, both Integer and Applesoft, using the entire 80 columns. Without splitting keywords. Full editing capabilities are offered using the ESCape key sequences for cursor movement. With provision for stop/start text scrolling utilizing the standard Control-S entry. And simultaneous on-screen display of text being printed.
- Pascal** Installation of VIDEOTERM in slot 3 provides Pascal immediate control of the display since Pascal recognizes the board as a standard video display terminal and treats it as such. No changes are needed to Pascal's MISC.INFO or GOTQXY files, although customization directions are provided. All cursor control characters are identical to standard Pascal defaults.
- Other Boards** The new Microsoft Softcard™ is supported. So is the popular D. C. Hayes Micro-modem II™, utilizing customized PROM firmware available from VIDEX. The powerful EasyWriter™ Professional Word Processing System and other word processors are now compatible with VIDEOTERM. Or use the Mountain Hardware ROMWriter™ (or other PROM programmer) to generate your own custom character sets. Naturally, VIDEOTERM conforms to all Apple OEM guidelines, assurance that you will have no conflicts with current or future Apple II™ expansion boards.
- Advanced Hardware Design** VIDEOTERM's on-board asynchronous crystal clock ensures flicker-free character display. Only the size of the Pascal Language card, VIDEOTERM utilizes CMOS and low power consumption ICs, ensuring cool, reliable operation. All ICs are fully socketed for easy maintenance. Add to that 2K of on-board RAM, 50 or 60 Hz operation, and provision of power and input connectors for a light pen. Problems are designed out, not in.
- Available Options** The entire display may be altered to inverse video, displaying black characters on a white field. PROMs containing alternate character sets and graphic symbols are available from Videx. A switchplate option allows you to use the same video monitor for either the VIDEOTERM or the standard Apple II™ display. Instantly changing displays by flipping a single toggle switch. The switchplate assembly inserts into one of the rear cut-outs in the Apple II™ case so that the toggle switch is readily accessible. And the Videx KEYBOARD ENHANCER can be installed, allowing upper and lower case character entry directly from your Apple II™ keyboard.
- Firmware** 1K of on-board ROM firmware controls all operation of the VIDEOTERM. No machine language patches are needed for normal VIDEOTERM use.
- Firmware Version 2.0**
- | | | | |
|------------|---|---------|--|
| Characters | 7 x 9 matrix | Display | 24 x 80 (full descenders) |
| Options | 7 x 12 matrix option; Alternate user definable character set option; Inverse video option. | | 18 x 80 (7 x 12 matrix with full descenders) |

Want to know more? Contact your local Apple dealer today for a demonstration. VIDEOTERM is available through your local dealer or direct from Videx in Corvallis, Oregon. Or send for the VIDEOTERM Owners Reference Manual and deduct the amount if you decide to purchase. Upgrade your Apple II™ to full terminal capabilities for half the cost of a terminal. VIDEOTERM. At last.

Apple II® is a trademark of Apple Computer Inc.
ROMWriter™ is a trademark of Mountain Hardware Inc.
Micromodem II™ is a trademark of D. C. Hayes Associates Inc.
Softcard™ is a trademark of Microsoft
EasyWriter™ is a trademark of Information Unlimited Software Inc.

- PRICE:**
- VIDEOTERM includes manual \$345
 - SWITCHPLATE \$ 19
 - MANUAL refund with purchase \$ 19
 - 7 x 12 CHARACTER SET \$ 39
 - MICROMODEM FIRMWARE \$ 25

APPLE II® OWNERS!

introducing the KEYBOARD & DISPLAY ENHANCER

- PUT THE SHIFT AND SHIFT LOCK BACK WHERE IT BELONGS
- SEE REAL UPPER AND lower CASE ON THE SCREEN
- ACCESS ALL YOUR KEYBOARD ASCII CHARACTERS

Videx has the perfect companion for your word processor software: the **KEYBOARD AND DISPLAY ENHANCER**. Install the enhancer in your APPLE II and be typing in lower case just like a typewriter. If you want an upper case character, use the SHIFT key or the CTRL key for shift lock. Not only that, but you see upper and lower case on the screen as you type. Perfectly compatible with Apple Writer and other word processors like, for example, Super-Text.

If you want to program in BASIC, just put it back into the alpha lock mode, and you have the original keyboard back with a few im-

provements. Now you can enter those elusive 9 characters directly from the keyboard, or require the Control key to be pressed with the RESET to prevent accidental resets.

KEYBOARD AND DISPLAY ENHANCER is recommended for use with all revisions of the APPLE II. It includes 6 ICs, and EPROM and dip-switches mounted on a PC board, and a jumper cable. Easy installation, meaning no soldering or cutting traces. Alternate default modes are dip-switch selectable. You can even remap the keyboard, selecting an alternate character set, for custom applications.

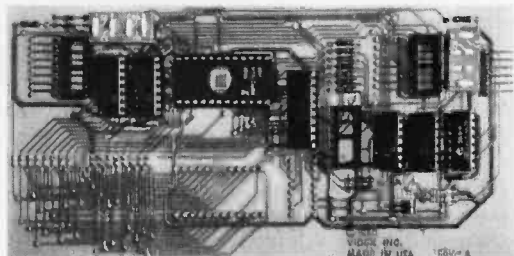

- PRICE:**
- KDE-700 (REV. 7 or greater) \$129.
 - KDE-000 (REV. 6 or less) \$129.

Apple II® is a trademark of Apple Computer, Inc.



VIDEX  
897 N.W. Grant Avenue
Corvallis, Oregon 97330
Phone (503) 758-0521

lems for general-purpose payroll programs....RSS]

The workmen's-compensation audit usually requires salary to be accounted between arbitrary dates, such as February 1 to August 20. Can the package handle that?

No matter what package is offered, we will find *something* we need that is not included.

The Mailing-List Manager

Many mailing-list managers are offered. They usually contain various fixed fields, a few including special *keying* fields. Surely we could use one of these.

Probably not. We had eight years' experience with our first mailing-list program and developed a long wish list for the next one. We don't handle just names and addresses. We handle memberships. We want to record contributions and remarks. If Jack Armstrong donated an enlarger for the darkroom, we want to record that. We might want a list of all people who have contributed since last September. Or all those who con-

tributed last year, but not this year. Or everyone who gave more than \$50. New contributions have to be easy to enter, and an automatic purge should be done on very old contributions to keep the file size reasonable. Key fields should allow "ORing" categories, such as "volunteers or patrons." The program must print labels, give statistical analyses of contribution records, and have internal checks on zip code validity.

If such a program is marketed, we didn't find it. And these requirements are not at all unusual—they are what any business such as ours would reasonably require.

Software Development

In the fall of 1979, uncertain how much software we could purchase and what it would do for us, we received our North Star computer. It came with BASIC, DOS (the North Star disk operating system), and a few memory utilities such as disk copy, hexadecimal or ASCII dump, etc. There was no machine-language assembler or disassembler (symbolic

dump), nor was there a text editor.

Since we had no funds for such software, I began playing with BASIC and found that I liked it very much. Best of all, it allowed direct access to memory with FILL and EXAM (POKE and PEEK) and raw keyboard input of characters, essential for picking up special control keys.

We ended up coding all of our software ourselves. Each program was first outlined and discussed with other computer people and the nature-center staff. Each took a few weeks to write and document. By summer 1980, we had the following programs:

- a text editor
- a program to record field trips we ran, with attendance, date, etc, and an analysis feature to yield summary statistics over any time span for all types of trips
- a payroll program
- a general-accounting package, with a wide range of features, has already saved untold hours of volunteer and staff time

ECT™

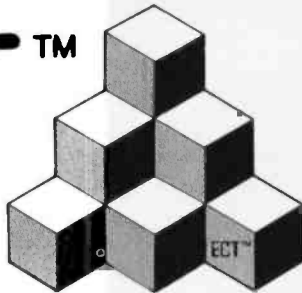

Building Blocks for Microcomputer Systems, Dedicated Controllers and Test Equipment.

R²I/O S-100 ROM, RAM & I/O BOARD

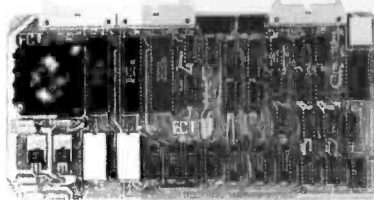

ECT's R²I/O is an S-100 Bus I/O Board with 3 Serial I/O Ports (UART's), 1 Parallel I/O Port, 4 Status Ports, 2K of ROM with the 8080 Apple Monitor Program and 2K of Static RAM.

\$295.00

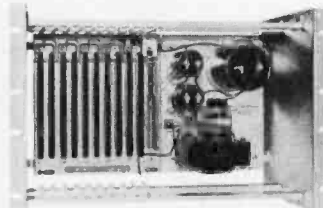

RM-10 S-100 RACK MOUNT CARD CAGE

ECT's RM-10 is a rack mount 10 slot Card Cage with Power Supply, consisting of an ECT-100 rack mount Card Cage (19"W x 12.25"H x 8"D), the MB-10 Mother Board (with ground plane and termination) all 10 connectors and guides and the PS-15A Power Supply (15A @ 8V, 1.5A @ ± 16V).

\$295.00

ECT™

Specializing in Quality Microcomputer Hardware
Industrial • Educational • Small Business • Personal
Card Cages, Power Supplies, Mainframes, CPU's, Memory, I/O, OEM Variations

ELECTRONIC CONTROL TECHNOLOGY (201) 686-8080

763 Ramsey Ave., Hillside, NJ 07205

STATE OF THE ART MEMORY SYSTEMS

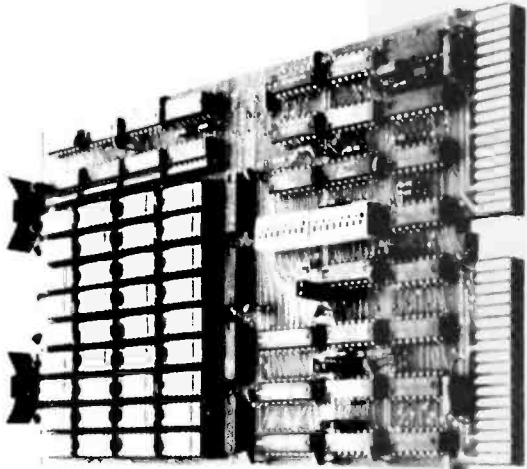

256KB LSI 11/23® SINGLE DUAL WIDTH BOARD

The First and Only 256KB Memory on a Single Dual Board.

4 MEGABYTE ADDRESS FIELD — Most memories available for the DEC PDP 11/23 are only addressable to 256K bytes (18 address lines). The CI-1123 is addressable to 4 mega bytes (22 address lines) so there is no need to worry about obsolescence.

FAST ACCESS AND CYCLE TIME — With an access time of 240 NSEC and cycle time of 400 NSEC one is insured the best throughput on the PDP 11/23 system.

PARITY — The CI-1123 generates and checks parity for each byte of memory. Totally DEC compatible.

BATTERY BACKUP POWER CONSUMPTION — Power requirement for the module is only 1.2 AMP from the 5 volt supply. The CI-1123 is easily configured for battery back-up mode of operation requiring only 300MA from a single 5 V back-up supply for 256KB memory in the down state.

SINGLE QTY. PRICE: 32K x 18 \$575. 128K x 18 \$1925.

512KB SINGLE BOARD MULTIBUS® MEMORY

State of the Art Multibus Memory Design.
First to Offer 512KB on One Board.

The CI-8086 module is compatible with both 8 or 16 bit Multibus Systems.

PARITY — The CI-8086 generates and checks even parity with selectable interrupt on parity error.

FAST ACCESS AND CYCLE TIME — Data access is 270 NSEC and cycle time is 375 NSEC.

16 MEGA BYTE ADDRESSING — The memory is addressable in 16K increments up to 16 mega bytes.

LOW POWER CONSUMPTION — Total power consumption is under 8 watts.

SINGLE QTY. PRICE: 128K x 9 \$1350. 512K x 9 \$2995.

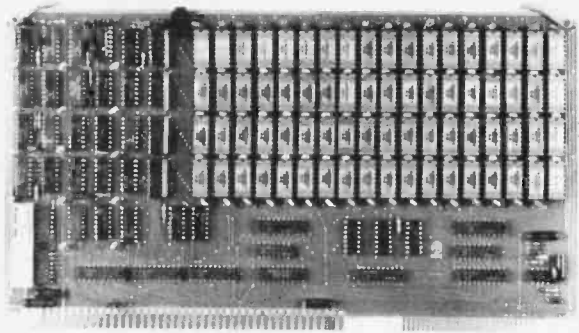

64K x 9 EXORCISER® I SINGLE BOARD MEMORY

For Exorciser I, Exorciser II and Rockwell System 65.

FAST ACCESS AND CYCLE TIME — Data access time is 225 NSEC and cycle time is 400 NSEC, allowing the unit to work as a static RAM at clock rates in excess of 1.5 mega hertz. For 2 mega hertz operation the board can be easily configured to utilize a cycle stealing refresh operation.

ADDRESSING — On-board memory select is available in 4K increments up to 64K words of memory on either the VUA or VXA control inputs.

PARITY — On board even parity with output jumper select to the system bus as a parity error or non-maskable interrupt.

Complete board power consumption is under 7 watts.

SINGLE QTY. PRICE: 64K x 9 \$575.

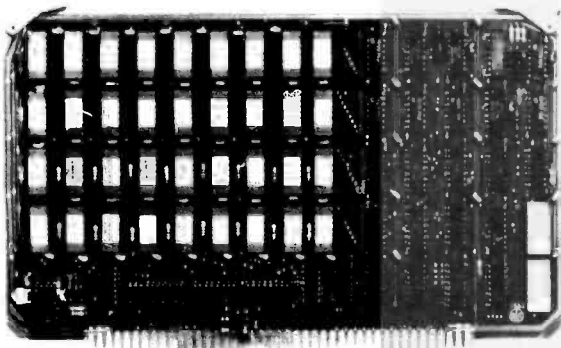

Tested and burned in. Full year warranty.

DON'T ASK WHY WE CHARGE SO LITTLE, ASK WHY THEY CHARGE SO MUCH.



Chrislin Industries, Inc.

31352 Via Colinas • Westlake Village, CA 91362 • 213-991-2254

Multibus is a trademark of the Intel Corp.

LSI II is a trademark of Digital Equipment Corp.

EXORCISER is a trademark of Motorola

**If you're looking for
the best prices
in the U.S.A. on**



TRS-80 MICROCOMPUTERS

We have consistently offered the TRS-80 line at savings up to 20%. You can save up to \$1500 by buying from Computer Discount of America.

ATARI[®] MICROCOMPUTERS



We have the full line of ATARI personal computers and systems.

Model II
26-4002 64K. 1 disc \$3385.00

Model III
26-1061 4K. Level I \$ 610.00
26-1062 16K. Level III \$ 845.00
26-1066 48K. Level II 2-drive/RS-232 \$2115.00

Color Computer
26-3001 4K \$ 329.00
26-3002 16K w/Ext. Basic \$ 499.00

EPSON
MX70 Printer \$ 375.00
MX80 Printer \$ 485.00
MX80FT Printer \$ 639.00

Our savings are as big on expansion interfaces, printers, diskettes, Apple Computers, OKIDATA Microline, C-ITOH Starwriter, Lexicon Modems — everything for your computer.

We have the largest inventory in the Northeast, and most models are in stock, for immediate delivery. Our full price catalog or a price quote is as near as your phone.

**CALL TOLL FREE:
800-526-5313**

**Computer
Discount
of America**

COMPUTER DISCOUNT OF AMERICA, INC.
15 Marshall Hill Road, West Milford Mall
West Milford, New Jersey 07480
In New Jersey Call 201-728-8080

- a label program, which handles any number of files, and prints names, addresses, and optional comments in list or label form, is used for special mailing lists, such as the list of volunteers
- a main mailing-list program that, as already mentioned, also keeps track of contributions

Operating-System Changes

The 10-percent gap exists not only for commercial-application programs, but also for languages and operating systems. The North Star software comes with several pages of documentation on how to make changes to suit your hardware or other special requirements. These were useful, but the beginning programmer might have difficulty understanding the functions of these changes. However, some changes we had to make were not documented, as in the following example.

After writing the text editor and getting it to work with the video terminal, I tried it with the printer. It started off all right, but carriage returns suddenly began to be inserted at seemingly random places in the text. This made the editor unusable, so I had to find what was causing the returns and suppress them.

The problem turned out to be in the operating system. I fixed it in an afternoon with hardware boots, hexadecimal object-code dumps, and some trial and error. It's the kind of thing that turns on a computer buff, but not the manager of a nature center.

Computer 1, Staff 0

When the editor and a few other programs were completed, it was time to introduce the computer to the staff. It was a rather difficult first month. But to judge from my experience with human factors and computers, it was no different from any other first encounter of inexperienced people with computers.

The initial problems were severe but were quickly cured. The worst one involved the inability of people to differentiate which program and which mode they were working in. People would give BASIC commands to the operating system (such as

"RUN") and receive puzzling responses (in this case, "?"). When they finally got into a program I wrote, I expanded on the error messages, but they ignored them anyway. The most common error in the editor was typing text when commands were expected (ignoring the command prompt) and vice versa (ignoring a text prompt). Training and much practice overcame this.

But the most persistent problem, which still exists to a small degree, is getting people to grasp the concept of files. Assume the editor is used to create a file "turtle." The next day, our secretary enters the editor and reads the file "turtle." She modifies it and, instead of writing it back to "turtle," writes it instead to "shell."

Any experienced user of systems like these will realize there are now two files on the disk: "turtle" and "shell." But not the novice. The novice thinks the editor somehow worked on the file "turtle" and refiled it under "shell." In other words, our secretary views the system as a filing cabinet in which a folder was taken out, worked on, and put somewhere else.

The confusion was compounded when "turtle" was read in, "shell" was read in and appended to "turtle," and the result was written to either of the old files or even a new one, "egg." The problem arises because a novice doesn't realize the computer actually works on a special memory or temporary file. The novice insists that the computer is working on "turtle" or "shell" and will not accept the concept of working on this merged file that really has no name and no direct correspondence to any file on the disk.

Some computer-oriented friends suggested an interesting scheme to explain the file concept. We obtained several decks of playing cards and had everyone stand around a table holding five or six cards. I sat at the table playing the role of the computer. Each player's hand was a file, with the name of the player. We began with file "barbara." Instead of putting her cards on the table, I copied them, dealing myself an identical hand from another deck. I then

Q. What do these dealers have in common? A. They sell Tarbell quality products.

ALABAMA

Jelt Consulting
1312 Brookmeade St.
Huntsville 852-4364

ARIZONA

Thought Works
3532 W. Thomas Rd. #2
Phoenix 271-9098
S-100 Inc.
14425 No. 79th St. Suite B
Scottsdale 991-7870
Telegraphic Computer
2113 S. 48th
Tempe 998-3163

Ozymandias Systems
976 S. 5th
Yuma 783-4315

NORTHERN CALIFORNIA

Jaynes Electronics
135 So. Bolinger Rd.
Visalia 733-2515

National Computer
Center, Inc.
3038 No. Cedar Avenue
Fresno 227-8479

Argos Computer
790 W. Shaw Ave. Suite 360
Fresno 221-7211

D & W Digital
1524 Redwood Drive
Los Altos 966-1460

Electrolabs
930 Emerson Avenue
Palo Alto 321-5601

Digital Graphics Systems
935 Industrial Ave
Palo Alto 856-2500

Support Systems
1157 Chess Drive, Suite G
Foster City 349-2340

PKG Systems
1755 Arlington
El Cerritos 235-5261

Computer Store of
San Leandro
701 MacArthur Blvd.
San Leandro 569-4174

Computers West
1300 Creekside, Suite 319
Walnut Creek 944-9431

Buchla Associates
1740 Arch Street
Berkeley 848-0790

Queue Computer Corp.
1044 University Avenue
Berkeley 845-5300

Bell Controls
270 Prospect Drive
San Rafael 924-2990

Aaron Enterprises
790 Pine Lane
San Rafael 479-4268

Computer People
20 Oak Grove Ave.
Woodacre 488-0992

Data Comm Engineering
720-D Capitol Avenue
Capitola 475-3540

RCS Inc.
2116 Walsh Avenue
Santa Clara 244-4505

System Technology
100 A Mt. Hamilton Rd.
San Jose 251-8002

Microbyte Computer Store
2798 So. Bascom
San Jose 377-4685

Electronic Systems
5889 Winfield Blvd.
San Jose 226-4064

Joe Bergin
4354 Vulcan Drive
Sacramento 486-8033

SOUTHERN CALIFORNIA

Versacomp
3016 Waverly Drive #303
Los Angeles 666-4447

Omega Enterprises
921 N. La Jolla Ave.
Los Angeles 656-7388

Cai Blu Corporation
350 S. Figueroa Street
Suite 389
Los Angeles 617-2185

Applied Processor
Laboratories
11808 So. Prairie Ave.
Hawthorne 676-8940

California Digital
4738 W. 56th Street
Lawndale 679-9001

*SAS Computer Products
11766 Sunset Blvd.
Pacific Palisades
459-5674

*Query Computing
Systems Inc.
4812 La Villa Marina Suite F
Marina Del Rey 823-5959

Futra Co.
3447 Torrance Blvd.
Torrance 370-1589

*Computer Place
2530 West Sepulveda
Torrance 325-4754

*Computer Galaxy
14112 San Antonio
Norwalk 863-8008

*Brown Dog Engineering
P.O. Box 427
Lomita 326-8482

Cubertson & Associates
14611 Leahy
Bellflower 920-7438

Action Computer
Enterprise
55 W. Del Mar Blvd.
Pasadena 793-2440

*Dynatron International Co.
9514 Reseda Blvd., Suite 8
Northridge 881-8700

Hobbyworld Electronics
19511 Business Center Dr.
Northridge 886-9200

*Eliam Associates
24000 Bessemer St.
Woodland Hills 348-4278

*Computer World
5848 Sepulveda Blvd.
Van Nuys 786-7411

Data Vector Corporation
2412 N. Keystone St.
Burbank 842-2866

*Astar International Co.
5675 Francis Avenue
Chino 284-0561

Richard Chew
2020 Crown Circle
La Verne 596-3480

E.D.P. Management
5465 Lake Murray Blvd. #D
La Mesa 462-5400

Byte Shop
8038 Clairemont Mesa Blvd.
San Diego 565-8008

Computerland
4233 Convoy Street
San Diego 560-9912

The Computer Center
8205 Ronson Rd.
San Diego 292-5302

*CTC-The Computer People
5560 Ruffin Road
San Diego 565-0505

*Bits n Bytes
679 D. So. State College Bl.
Fullerton 879-8386

International
Scientific USA, Inc.
679 S. State College Blvd.
Suite E
Fullerton 870-9491

*DMM Software
11502 Janette Lane
Garden Grove 534-0115

*Scharf Office Systems Inc.
8562 Acapulco
Huntington Beach
963-2730

*WEH Computer Systems
5881 Grace Circle
Huntington Beach
964-4425

Cotton Associates
1278 Glenneyre #16
Laguna Beach 499-2994

Computer Systems and
Applications
965 No. Main Street
Orange 535-3335

Byte Shop
123 E. Yorba Linda Blvd.
Placentia 524-5380

Advanced Computer
Products
1310 B. East Edinger
Santa Ana 558-8813

*L. Electronics
410 Bell Avenue
Santa Ana 557-8796

*Computers Plus
1827 State Street
Santa Barbara 963-4542

COLORADO

*Epsilon
14501 E. Alameda, Ste. 204
Aurora 344-0874

Business Data Systems
1688 30th Street
Boulder 444-3652

CONNECTICUT

Office Services of
Hamden Inc.
965 Dixwell Avenue
Hamden 624-9917

FLORIDA

Applied Microcomputer
Technology Inc.
241 Old Dirt Road
Tallahassee 878-3385

*Quaray Devices
1033 N. E. 8th Avenue
Gainesville 373-7959

*Matthew-Douglas
Assoc. Inc.
1337 E. Altamonte Drive
Altamonte Spring
830-9611

Byte Shop of Ft. Lauderdale
2176 W. Oakland Park
Ft. Lauderdale 486-2983

Erdman Computer Services
2454 N.E. Dixie Highway
Jensen Beach 334-3366

*Microcomputer
Technology
1549 W. Brandon Blvd.
Brandon 685-6714

GEORGIA

Electromagnetic
Sciences Inc.
125 Technology Park
Norcross 448-5770

*Advanced Computer
Technology
6540 Roswell Road
Atlanta 255-8984

Computerland of Atlanta
2423 Cobb Parkway
Atlanta 577-2449

*H & L Electronics
5144 Peachtree Road
Atlanta 455-0626

HAWAII

*Kahaluu Computing
47-500 Kam
Kaneohe 239-7267

Mahalo Microsystems Ltd.
355 Royal Hawaiian Ave.
Honolulu 922-2152

Small Computer Systems
3140 Wai'alea Avenue
Honolulu 732-5246

ILLINOIS

Lilliput Computer Mart
4446 Oakton Street
Skokie 674-1383

*Midwest
Microcomputers Inc.
708 S. Main Street
Lombard 495-9889

Bles Systems Inc.
7037 West North Avenue
Oak Park 386-3323

Byte Shop
7 So. La Grange Road
La Grange 579-0920

*Wilcox Enterprises
25 W. 178 - 39th St.
Naperville 420-8601

INDIANA

Computer Consulting
Services
4801 N. Michigan
Indianapolis 638-5330

*Smith Computer Systems
530 Pierce Avenue
Dyer 322-5461

Data Domain
2805 E. State Blvd.
Fort Wayne 482-8415

*Data Domain
221 West Dodds
Bloomington 334-3607

*Digital Supply
817 Agathon Drive
Evansville 985-3677

Digital Technology
10 N. 3rd
Lafayette 423-2548

KANSAS

Computer Center
5815 Johnson Drive
Mission 432-2983

LOUISIANA

*Great Southern Computer
Systems
915 Talbot
Thibodaux 446-8432

Computer Electronics
1955 Dallas Drive
Baton Rouge 924-8066

MARYLAND

*R2D2 Enterprises
8232 Bernard Drive North
Millersville 987-4471

MASSACHUSETTES

*The Computer Mart Inc.
1395 Main Street
Route 117 at 128
Waltham 899-4540

*Scientific Consulting
Services
4 Lovell Road
Watertown 926-4046

*William J. Claff
7 Roberts Rd.
Wellesley 235-9505

Computer Shop
590 Commonwealth Ave.
Boston 247-0700

MICHIGAN

Spectrum Computers
26618 Southfield Road
Lathrup Village 559-5252

Unique Business Systems
28783 Greenfield Road
Southfield 559-6300

Lyben Computer Systems
27204 Harper
St. Clair Shores 777-7780

GAW Computertronics
37727 Amrhein Road
Livonia 464-0441

*Jepsan
4180 - 44th Street S.E.
Grand Rapids 698-8700

MINNESOTA

Microprogramming Inc.
1351 Larc Industrial Blvd.
Burnsville 894-3510

Microage Computer Store
83 South 10th
Minneapolis 338-1777

NEW JERSEY

*Oicott International & Co.
62 Hackensack Plank Rd.
Weehawken 863-4200

Computer Emporium
Bldg. 103
Avenues of Commerce
Cherry Hill 667-7555

*Financial Software
54 Grove Street
Haddonfield 795-5607

*A B Computer Products
236 W. County Line Road
Jackson 493-8047

William Electronics Supply
1863 Woodbridge Avenue
Edison 985-3700

*Computer Mart of NJ Inc.
501 Route 27
Iselin 283-0600

NEW MEXICO

Suntech Systems, Inc.
7108 Osuna N.E.
Albuquerque 884-8453

NEW YORK

*Owens Associates
12 Schubert
Staten Island 448-6283

DBIS
One Mayfair Road
East Chester 779-5292

L-2 Computers, Inc.
86-16 Santiago Street
Holliis 479-1400

Baranco
32 Goodwin Place
Northport 261-0452

*Mini Micro Mart
943 W. Genesee Street
Syracuse 422-4467

NORTH CAROLINA

American Square
Computers
4167 Kivett Drive
Jamestown 889-4577

*Digital Dynamics Corp
1118 Clement Avenue
Charlotte 374-1527

Southern Digital
Systems Inc.
Vernon Park Mall,
Suite 806A
Kinston 527-4691

OHIO

*Service Specialist
127 No. Prospect
Oberlin 775-1742

*Cycrom Corporation
3355 Richmond Road
Plaza 230B
Beachwood 461-0875

Tec Mar Inc.
23600 Mercantile Road
Cleveland 464-7410

Computerland of Cleveland
1288 SOM Center Road
Mayfield Height 461-1200

*Cincinnati Computer Store
11711 Princeton Pike
Cincinnati 671-6440

Wholesale/Retail Systems
2705 Lillian Lane
Fairborn 426-8781

RIM Systems
529 S. Hyatt
Tipp City 667-3069

OKLAHOMA

Microolithics Inc.
304 N. Meridian Avenue
Suite 15
Oklahoma City 947-5646

OREGON

Micro Methods
118 S. W. 1st Street
Warrenton 861-1765

WRAM Computer
Corporation
6450 S. W. Parkhill Way
Portland 244-2168

*Computerland of Portland
12020 S. W. Main Street
Tigard 620-6170

PENNSYLVANIA

Erie Computer Company
1253 W. 8th Street
Erie 454-7652

*Marketline Systems Inc.
2337 Philmont Avenue
Huntington Valley
947-6670

Computer Methods
523 Hansen Road
King of Prussia 265-2580

TENNESSEE

*Ace Mini Systems Inc.
1598 Ft. Campbell Blvd.
Trade Winds North
Clarksville 645-3632

*American Systems Inc.
1805 Hayes Street
Nashville 327-0277

TEXAS

Alken Computer Systems
3202 River Oaks Drive
Flower Mound 436-9155

*The Micro Store
634 S. Central Expressway
Richardson 231-1096

Northwest Datacomm
1174 Commerce Drive
Richardson 669-1816

The K.A. Computer Store
9090 Stemmons Freeway
Dallas 634-2667

Data Time Systems
1212 Main Street, Suite 110
Houston 658-8572

*Attech Controls Corp.
13995 Murphy Road,
Building 412
Stafford 499-5697

R & T Henry Electronic
Assembly
613 Pemberton Drive
Channelview 452-4451

*Microtronics, Inc.
2720 Westward
La Marque 935-5020

VIRGINIA

American Computer &
Telecom
11301 Sunset Hills Road
Reston 471-6288

*Xener Corporation
Suite 211
6641 Backlick Road
Springfield 569-5050

Computers Plus
6120 Franconia Road
Alexandria 971-1997

Computer Center
2927 Virginia Beach Blvd.
Virginia Beach 340-1977

WASHINGTON

*Innovative Computing, Inc.
19820 - 60th Avenue N.E.
Seattle 487-2448

Seattle Computer Products
1114 Industry Drive
Seattle 575-1830

Forest Sales
820 - 4th Street
Anacortes 293-5154

Olympic Computers
418 S. Lincoln
Port Angeles 457-3315

WEST VIRGINIA

The Computer Store Inc.
Suite 5
Municipal Parking Bldg.
Charleston 345-1360

Associated Computer
Consultants
1332 Pine View Drive
Morgantown 599-2319

*The Computer Corner, Inc.
22 Beachurst Avenue
Morgantown 292-9700

WISCONSIN

DMA Inc.
545 Meadow Lane
Sheboygan Falls 467-6006

Byte Shop of Milwaukee
6019 W. Layton Avenue
Greenfield 281-7004

Magic Lantern Computers
3313 University Avenue
Madison 233-2026

OUTSIDE U.S.A.

TE and Company
207 Yoko Heights
39 Okuma-Cho
Midorku Yokaha 226 Japan
(045) 473-3171

Canadian Microcomputer
Sys Assoc Ltd.
1188 Main Street
Smithers
B.C. Canada 20J 2N0
(604) 847-4838

The Patent Office
Hurricane Hole
P.O. Boxes 5586
Nassau, Bahamas
(809) 323-1371

Complex
2 Gerts Vej.
2300 Copenhagen Denmark
01-520494

*Jarrod Electronics Inc.
349 Silverstone Drive
Rexdale Ontario Canada
M9V 3J8 (416) 745-6458

Microboards
1-7-1-1003 Salwai-Cho
Chiba City, Chiba 260 Japan
0427 (47) 3081

*Microtech Computers
745 Martin Avenue
Winnipeg, Manitoba
(204) 667-5395

J.T. Microcomputers
109 Koorling Avenue
Thornleigh,
NSW Australia 2120
(02) 8480452

Cesco Electronics Ltd.
4050 Jean Talon St. W.
Montreal
Quebec Canada H4P 1W1
(514) 735-5511

Computer Centre
9 De-La-Beche Street
Swansea, South Wales
SA1 3EX
0792460023

*Dealers who sell Tarbell EMPIRE series computers.</

FREE
with software purchase—
One CPM Handbook

DISCOUNT SOFTWARE

Ad#18

ULTIMATE SOFTWARE PLAN

We'll match any advertised price on any item that we carry. And if you find a lower price on what you bought within 30 days of buying it, just show us the ad and we'll refund the difference. It's that simple.

Combine our price protection with the availability of full professional support and our automatic update service and you have the Ultimate Software Plan. It's a convenient, uncomplicated, logical way to get your software.

DISK WITH MANUAL ONLY

✓ (New items or new prices)

CP/M users: specify disk systems and formats. Most formats available.

| CP/M | | |
|--------------------------------|-------|-------------|
| ARTIFICIAL INTELLIGENCE | | |
| Medical (PAS-3) | | \$849/\$40 |
| Dental (PAS-3) | | \$849/\$40 |
| ASYST DESIGN | | |
| Prof Time Accounting | | \$549/\$40 |
| ✓ General Subroutine | | \$269/\$40 |
| ✓ Application Utilities | | \$439/\$40 |
| COMPLETE BUS. SYSTEMS | | |
| Creator | | \$269/\$25 |
| Reporter | | \$169/\$20 |
| Both | | \$399/\$45 |
| COMPUTER CONTROL | | |
| Fabs (B-tree) | | \$159/\$20 |
| UltraSort II | | \$159/\$25 |
| COMPUTER PATHWAYS | | |
| Pearl (level 1) | | \$ 99/\$25 |
| Pearl (level 2) | | \$299/\$40 |
| ✓ Pearl (level 3) | | \$549/\$50 |
| DIGITAL RESEARCH | | |
| CP/M 2.2 | | |
| NorthStar | | \$149/\$25 |
| TRS-80 Model II (P+T) | | \$159/\$35 |
| Micropolis | | \$169/\$25 |
| Cromemco | | \$189/\$25 |
| PL/I-80 | | \$459/\$35 |
| ✓ BT-80 | | \$179/\$30 |
| Mac | | \$ 85/\$15 |
| Sid | | \$ 65/\$15 |
| Z-Sid | | \$ 90/\$15 |
| Tex | | \$ 90/\$15 |
| DeSpool | | \$ 50/\$10 |
| D.M.A. | | |
| Ascorm | | \$149/\$15 |
| DMA-DOS | | \$179/\$35 |
| CBS | | \$369/\$45 |
| Formula | | \$539/\$45 |
| GRAHAM-DORIAN | | |
| General Ledger | | \$729/\$40 |
| Acct Receivable | | \$729/\$40 |
| Acct Payable | | \$729/\$40 |
| Job Costing | | \$729/\$40 |
| Payroll II | | \$729/\$40 |
| Inventory II | | \$729/\$40 |
| Payroll | | \$493/\$40 |
| Inventory | | \$493/\$40 |
| Cash Register | | \$493/\$40 |
| Apartment Mgt. | | \$493/\$40 |
| Surveying | | \$729/\$40 |
| Medical | | \$729/\$40 |
| Dental | | \$729/\$40 |
| MICRO-AP | | |
| S-Basic | | \$269/\$25 |
| Selector IV | | \$469/\$35 |
| MICRO DATA BASE SYSTEMS | | |
| HDBS | | \$269/\$35 |
| MDBS | | \$795/\$40 |
| ✓ DR5 or QRS or RTL | | \$269/\$10 |
| MDBS PKG | | \$1295/\$60 |
| MICROPRO | | |
| WordStar | | \$319/\$60 |
| Customization Notes | | \$ 89/\$na |
| Mail-Merge | | \$109/\$25 |
| WordStar/Mail-Merge | | \$419/\$85 |
| DataStar | | \$249/\$60 |
| WordMaster | | \$119/\$40 |
| SuperSort I | | \$199/\$40 |
| ✓ Spell Star | | \$175/\$40 |

| | | |
|---------------------------|-------|------------|
| MICROSOFT | | |
| Basic-80 | | \$289/\$na |
| Basic Compiler | | \$329/\$na |
| Fortran-80 | | \$349/\$na |
| Cobol-80 | | \$574/\$na |
| M-Sort | | \$124/\$na |
| Macro-80 | | \$144/\$na |
| Edit-80 | | \$ 84/\$na |
| MuSimp/MuMath | | \$224/\$na |
| MuLisp-80 | | \$174/\$na |
| ORGANIC SOFTWARE | | |
| ✓ TextWriter III | | \$111/\$25 |
| DateBook II | | \$269/\$25 |
| ✓ Milestone | | \$269/\$30 |
| OSBORNE | | |
| General Ledger | | \$ 59/\$20 |
| Acct Rec/Acct Pay | | \$ 59/\$20 |
| Payroll w/Cost | | \$ 59/\$20 |
| All 3 | | \$129/\$60 |
| All 3 + CBASIC-2 | | \$199/\$75 |
| PEACHTREE* | | |
| General Ledger | | \$399/\$40 |
| Acct Receivable | | \$399/\$40 |
| Acct Payable | | \$399/\$40 |
| Payroll | | \$399/\$40 |
| Inventory | | \$399/\$40 |
| Surveyor | | \$399/\$40 |
| Property Mgt | | \$799/\$40 |
| CPA Client Write-up | | \$799/\$40 |
| PS Version | | Add \$129 |
| SOFTWARE WORKS | | |
| Adapt (CDOS to CP/M) | | \$ 69/\$na |
| Ratfor | | \$ 86/\$na |
| SOHO GROUP | | |
| MatchMaker | | \$ 97/\$20 |
| WorkSheet | | \$177/\$20 |
| STRUCTURED SYSTEMS | | |
| GL or AR or AP or Pay | | \$599/\$40 |
| Inventory Control | | \$599/\$40 |
| Analyst | | \$199/\$25 |
| Letterright | | \$179/\$25 |
| QSort | | \$ 89/\$20 |
| SUPERSOFT | | |
| Diagnostic I | | \$ 49/\$20 |
| Diagnostic II | | \$ 84/\$20 |
| Disk Doctor | | \$ 84/\$20 |
| ✓ Forth (8080 or Z80) | | \$149/\$30 |
| Fortran | | \$219/\$30 |
| Fortran w/Ratfor | | \$289/\$35 |
| Other | | less 10% |
| TCS | | |
| GL or AR or AP or Pay | | \$ 79/\$25 |
| All 4 | | \$269/\$99 |
| UNICORN | | |
| ✓ Mince | | \$149/\$25 |
| ✓ Scribble | | \$149/\$25 |
| ✓ Both | | \$249/\$50 |
| WHITESMITHS | | |
| "C" Compiler | | \$600/\$30 |
| Pascal (incl "C") | | \$850/\$45 |
| "DATA BASE" | | |
| FMS-80 | | \$649/\$45 |
| dBASE II | | \$629/\$50 |
| Condor II | | \$899/\$50 |
| Access/80 | | \$749/\$50 |

| | | |
|--------------------------|-------|------------|
| "PASCAL" | | |
| Pascal/MT+ | | \$429/\$30 |
| Pascal/Z | | \$349/\$30 |
| ✓ Pascal/UCSD 4.0 | | \$429/\$50 |
| ✓ Pascal/M | | \$189/\$20 |
| "WORD PROCESSING" | | |
| ✓ WordSearch | | \$179/\$50 |
| SpellGuard | | \$229/\$25 |
| VTS/80 | | \$259/\$65 |
| Maglc Wand | | \$289/\$45 |
| Spell Binder | | \$349/\$45 |
| "OTHER GOODIES" | | |
| The Last One | | \$549/\$95 |
| SuperCalc | | \$269/\$50 |
| Target | | \$189/\$30 |
| BSTAM | | \$149/\$15 |
| ✓ BSTMS | | \$149/\$15 |
| Tiny "C" | | \$ 89/\$50 |
| Tiny "C" Compiler | | \$229/\$50 |
| CBASIC-2 | | \$ 98/\$20 |
| Nevada Cobol | | \$129/\$25 |
| ✓ MicroStat | | \$224/\$25 |
| Vedit | | \$105/\$15 |
| MiniModel | | \$449/\$50 |
| StarPak | | \$449/\$40 |
| Micro B+ | | \$229/\$20 |
| Raid | | \$224/\$35 |
| String/80 | | \$ 84/\$20 |
| String/80 (source) | | \$279/\$na |
| ✓ ISIS II | | \$199/\$50 |
| ✓ Plan 80 | | \$269/\$30 |

APPLE II

| | | |
|--------------------------|-------|------------|
| INFO UNLIMITED | | |
| EasyWriter | | \$224 |
| Datadex | | \$349 |
| Other | | less 15% |
| MICROSOFT | | |
| Softcard (Z-80 CP/M) | | \$259 |
| Fortran | | \$179 |
| Cobol | | \$499 |
| MICROPRO | | |
| Wordstar | | \$269 |
| MailMerge | | \$ 99 |
| Wordstar/MailMerge | | \$349 |
| SuperSort I | | \$159 |
| PERSONAL SOFTWARE | | |
| Viscalc 3.3 | | \$159 |
| CCA Data Mgr | | \$ 84 |
| Desktop/Plan II | | \$159 |
| Visiterm | | \$129 |
| Visidex | | \$159 |
| Visiplot | | \$149 |
| Visitrend/Visiplot | | \$229 |
| Zork | | \$ 34 |
| PEACHTREE* | | |
| General Ledger | | \$224/\$40 |
| Acct Receivable | | \$224/\$40 |
| Acct Payable | | \$224/\$40 |
| Payroll | | \$224/\$40 |
| Inventory | | \$224/\$40 |
| "OTHER GOODIES" | | |
| dBASE II | | \$329/\$50 |
| ✓ VU #3R | | |
| (use w/Viscalc) | | \$ 79 |
| Super-Text II | | \$127 |
| Data Factory | | \$134 |
| DB Master | | \$184 |
| Charles Mann | | less 15% |
| STC | | less 15% |

ORDERS ONLY—CALL TOLL FREE VISA • MASTERCHARGE

1-800-854-2003 ext. 823 • Calif. 1-800-522-1500 ext. 823

Overseas—add \$10 plus additional postage • Add \$2.50 postage and handling per each item • California residents add 6% sales tax • Allow 2 weeks on checks, C.O.D. ok • Prices subject to change without notice. All items subject to availability • ®—Mfgs. Trademark.

THE DISCOUNT SOFTWARE GROUP

6520 Selma Ave. Suite 309 • Los Angeles, Ca. 90028 • (213) 666-7677
Int'l TELEX 499-0032 BVHL Attn: DiscSoft • USA TELEX 194-634 BVHL Attn: DiscSoft •
TWX 910-321-3597 BVHL Attn: DiscSoft

modified my hand (the computer-memory file), all the while pointing out that nothing was happening to her hand. I then copied the new file back to her hand, changing it. Or I copied it to someone else's hand. We concatenated hands, wrote them to different files, and did a variety of things that simulated what computers do.

It worked! This exercise went a long way in clearing up the confusion, and I heartily recommend it to others. But don't let drop-in visitors get the wrong idea about what you're doing with the cards!

A Happy Ending

A few months after our staff's first encounter with the computer, things had settled into a steady state, and the staff was using it productively. At that point, one of the principal users, a secretary, left to help her husband in a small business. (No, they don't have a computer—yet.) The new secretary arrived, and I fully expected to have to start all over with training.

I was wrong. I spent almost no time at all. Instead, *the other staff members trained her*. How's that for a self-reproducing system?

Some of you might think that a happy ending to this story would be to say that our system continues to grow, we are finding more and more uses for the system, hope to expand to a Winchester-technology hard-disk drive, recode everything in ... (Wow, did I almost open Pandora's box!), and look toward a national network for nature-center data communications.

Perhaps some of these things will occur. But in the meantime, we are quite content with the system. I have stopped coding, except for minor improvements, and can now spend my time outdoors finding wild flowers and mushrooms. The staff treats the computer as a piece of standard office equipment, and they welcome the time it has saved them. As our director put it, "We once thought it was an unnecessary complication, and now we depend on it." She might have added, "And we take it for granted." What happier ending could this story have? ■

OUR SECOND GENERATION DP-NET

We at Delta Products have been involved in 'NETWORKING SYSTEMS' for the past eighteen months. During this time we delivered our first net systems to beta test sites. These closely monitored field installations provided invaluable data, which Delta Products has incorporated into the design of our second generation of DP-NET systems.

SECOND GENERATION DP-NET

The S-4500 DP-NET system will support from one to ten users, and provide each with their own Z-80 CPU and 64K of ram memory. Each user will also have access to 40 megabytes of hard disk storage, 17.2 megabytes of file managed tape backup, and floppy disk.

TRUE RECORD & FILE LOCKOUT

By simply reading in the entire record or file you wish to protect, the DP-NET 'DISK SELECTIVE LOCKOUT' guarantees complete data integrity. The DP-NET also allows the use of today's popular micro applications languages (i.e., Cbasic®, Mbasic®, Cobol®, etc.), without having to compensate for the problems inherent to these languages in the multi-user environment, while maintaining GPM compatibility.

INTERACTIVE FAMILY OF SYSTEMS

The S-4500 is but one of many DP-NET configurations utilizing parallel and/or serial communication links. Delta Products also manufactures a wide range of conventional single and multi-user systems operating under CP/M and MP/M. Single and multi-user systems can be upgraded to DP-NET's, because their basic components are utilized in our network systems. We have intentionally developed an interactive family of systems that are completely configurable and compatible, never limiting the ability to adapt to a modification in the application. Delta Products systems are available thru a worldwide network of selective distributors and dealers. Call for the name and number of the one nearest to you.



S-4500



See This System @ Comdex Booth #'s 285, 287

*Cbasic is a registered trademark of Compiler Systems.
Mbasic and Cobol are registered trademarks of Microsoft.
CP/M and MP/M are registered trademarks of Digital Research.*

Discover the Machine Beneath the Machine A ZX80 Monitor Program

R Scott FitzGerald, 570 NW Walnut, Corvallis OR 97330

The most powerful instructions of Sinclair Research's ZX80 BASIC interpreter are PEEK, POKE, and USR. These instructions allow access to the machine beneath the machine by letting you examine, modify, and execute the ZX80's natural language: Z80 machine code.

The Z80 instruction set has all the functions of the 8080 set, plus some extremely powerful commands of its own: block transfers, extensive bit manipulation and testing, indexed and displaced addressing, relative jumps, and programmed I/O (input/output). Besides the 8080 registers, the Z80 has a duplicate register bank and two index registers, an interrupt-vector register, and a dynamic-memory-refresh register. This adds up to a power-packed microprocessor "under the hood" of your ZX80.

So why bother programming in BASIC when Z80 machine language is only a POKE away? One reason may be that the tedium of entering an endless string of POKE statements to run a machine-language program discourages you from venturing outside BASIC.

In this "System Note," I present a monitor program, written in ZX80 BASIC, that gives you the power

to examine and modify memory using octal notation and to execute Z80 machine-language programs. The program MONITOR is designed to run on a ZX80 system with a minimum of 1 K bytes of programmable memory and a 4 K-byte interpreter. After you enter MONITOR in a 1 K-byte system, you will still have enough memory left for a machine-language program more than 150 bytes long.

Listing 1 shows the program MONITOR. When run, MONITOR displays:

OCTAL MONITOR

and the prompt MODE? on the video screen. You then have three choices. You can:

- enter a 1, which will cause a branch to the EXECUTE routine
- enter a 2, which will result in a branch to the EXAMINE/MODIFY routine
- enter a 3, which will result in an exit from MONITOR to the BASIC interpreter

The program uses octal numbers for data input and output because this is the natural number base for use with the Z80 op codes.

Here are MONITOR's modes explained in greater detail:

- Mode 1: EXECUTE. A 1 response to the MODE? prompt permits execution of the machine-language routine you have loaded into memory. Execution will begin at the decimal address specified in response to the START ADDR?(DEC) prompt. The machine-code routine should end with a RET (return) instruction (octal 311) to let the monitor regain control; otherwise, you'll literally have to pull the plug to return the computer to your control. Pulling the plug will erase MONITOR and your machine-code program as well.

Programming Aids for the ZX80

The following items are available from The SofTek Company, POB 4232, Santa Fe NM 87501:

A quick-reference guide for the ZX80 computer that includes error codes, programmable-memory usage, character set, the Z80 microprocessor instruction set, and a couple of applications programs. Item number ZX80QRG. Price \$1.95.

Two dozen BASIC programs for the ZX80, including games, Z80 machine-language programming aids, graphics, finance, string manipulation, and mathematics. Item number ZX80PGM. Price \$5.95.

GRAPHICS + APPLE = GRAPPLER™

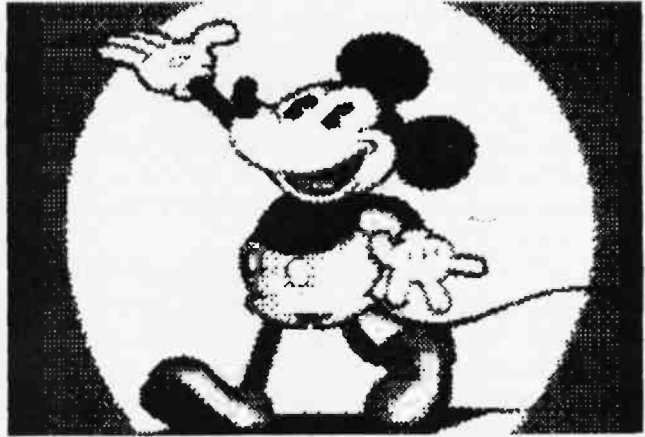
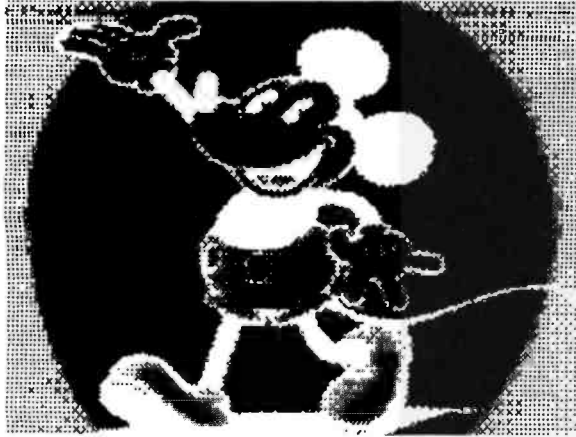

ACTUAL APPLE II SCREEN DUMP USING GRAPPLER AND ANADIX 9501

THE GRAPPLER™ Apple Interface and Cable

A new printer interface that makes graphics easy!

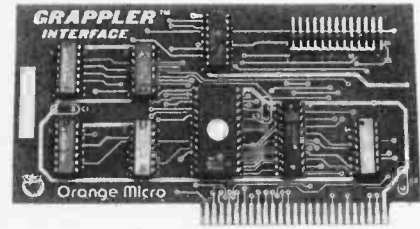

The Grappler™ Interface is the first universal parallel interface card to provide sophisticated on-board firmware for Apple high resolution graphics. No longer does the user need to load clumsy software routines to dump screen graphics — it's all in the chip. Actually, it's our E-PROM, and there are versions to accommodate the Anadex, Epson MX100, MX80* & MX70, IDS Paper Tigers, Centronics 739, and future graphics printers. The Grappler™ accepts 18 simple software commands accessible through the keyboard or user program, making it the most intelligent Apple interface available.

*Requires Graftrax-80

FEATURES

USER BENEFIT

- | | |
|----------------------|---|
| SELECT PAGE | — Choice of Hi-Res Graphics page 1 or page 2 |
| INVERSE GRAPHICS | — Provides reverse graphics of black-on-white, or white-on-black |
| DOUBLE SIZE PICTURE | — Doubles the graphic screen representation vertically & horizontally |
| 90° ROTATION | — Rotates the screen picture 90° |
| CENTER GRAPHICS | — Accomplished through setting left margin thereby centering the graph |
| CHART RECORDER MODE | — Successive horizontal pictures are combined continuously simulating a chart recorder |
| BLOCK GRAPHICS | — For printers with block graphics (e.g. Epson MX80, Okidata M80), the high order bit can be controlled |
| BELL | — For printers with a bell, bell characters are deleted during user program listings |
| MARGINS | — Set left and right margins |
| SKIP-OVER-PERF. | — Set page length; printer will automatically skip 6 lines between each page |
| VARIABLE LINE LENGTH | — For user program listings, sets line length and wraps around with breakpoint at nearest blank |
| TEXT SCREEN DUMP | — The text from a user report or page of program listing can be dumped directly from the screen |

TOLL FREE (800) 854-8275

DEALER INQUIRIES WELCOME

CA, AK, HI (714) 630-3322

 **Orange Micro**
inc.

3150 E. La Palma, Suite G, Anaheim, CA 92806

System Notes

•Mode 2: EXAMINE/MODIFY. In mode 2, you can examine and modify locations in memory, starting at the address you specify after the START ADDR?(DEC) prompt. This routine displays the address and its contents in octal and waits for your input. If you input an octal number from 000 to 377, it will replace the previous contents of that location (assuming that you are not addressing read-only memory). If you enter a -1, the routine will go on to the next byte in memory without modifying anything. Any number outside the -1 to 377 range will terminate the EXAMINE/MODIFY routine and display the MODE? prompt again.

•Mode 3: EXIT. Entering 3 in response to the MODE? prompt lets you exit the monitor, and control returns to the ZX80 BASIC interpreter's text-input module. Don't exit MONITOR, however, if you want to keep a valid copy of your machine-language program in memory. Because the ZX80 BASIC interpreter uses a great deal of memory to display MONITOR, the display file will probably overrun your machine-language program.

The ability to execute Z80 machine-language programs on the ZX80 opens a new dimension to the serious ZX80 programmer. I hope that the program MONITOR will give you easier access to some of the powerful features of your ZX80. ■

Listing 1: A machine-language monitor for the Sinclair ZX80. This program lets you examine and modify sequential memory locations and execute machine-language programs stored in memory.

```
10 CLS
20 PRINT "OCTAL MONITOR"
30 PRINT "MODE?"
40 INPUT M
50 IF (M<1) OR (M>3) THEN GO TO 10
60 CLS
70 GO TO 400*M
400 PRINT "EXEC"
410 GO SUB 2000
420 PRINT "HL=";USR(S)
430 GO TO 20
800 PRINT "EXAM/MOD"
810 GO SUB 2000
820 LET C=0
830 LET D=S
840 LET N=4
850 GO SUB 3000
860 LET D=PEEK(S)
870 LET N=2
880 GO SUB 3000
890 PRINT ":= ";
900 INPUT D
910 PRINT D
920 IF (D<-1) OR (D>377) THEN GO TO 10
930 IF D=-1 THEN GO TO 960
940 GO SUB 4000
950 POKE S,A
960 LET S=S+1
970 LET C=C+1
980 IF C-16*(C/16)=0 THEN CLS
990 GO TO 830
1200 STOP
2000 PRINT "START ADDR?(DEC)";
2010 INPUT S
2020 PRINT S
2030 RETURN
3000 FOR K=0 TO N
3010 LET Q=D/(8**(N-K))
3020 LET D=D-Q*(8**(N-K))
3030 PRINT CHR$(Q+28);
3040 NEXT K
3050 PRINT " ";
3060 RETURN
4000 LET A=0
4010 FOR K=0 TO 2
4020 LET Q=D/(10**(2-K))
4030 LET D=D-Q*(10**(2-K))
4040 LET A=A+Q*(8**(2-K))
4050 NEXT K
4060 RETURN
```

FREE



1981 FALL EDITION CATALOG OF SUPPLIES FOR SMALL BUSINESS COMPUTERS

Our latest edition...yours FREE for the asking! This direct-order catalog features 80 pages of more than 1700 supply products for your small business computer. Plus, we've just introduced 100 new products this fall...specially featured in a 20-page supplement. Some of these popular products are flexible disks (4 brands), printer ribbons (100 types), printout binders (all sizes and colors) and many hard-to-find products. And all are available for immediate shipment from our two stocking distribution centers.

To receive your FREE catalog, simply call 800-323-0628 (in Illinois, call 312-377-0990) or circle the Reader Service Card number below.

VISIBLE COMPUTER
SUPPLY CORPORATION

A Subsidiary of Wallace Business Forms, Inc.
3626 Stern Drive | 1615 S. Stockton St.
St. Charles, Illinois 60174 | Lodi, CA. 95241

Send for your free copy today!

Micro computer software company gets macro results.



"Software is the hottest segment of the personal computer industry. After all, it's the software that solves problems. And Business Week has precisely the type of readers who are looking for solutions to the kinds of problems we solve. Top and middle management of corporations. That's why right from the start we committed a substantial portion of our marketing budget to advertise in Business Week. And we're very pleased with the results. Since our first insertion, our monthly sales have more than doubled."

James M. Dow, President
Microcom, Inc.

When Microcom began in 1980, the Boston-based manufacturer of personal computer software wanted to spread the word to corporate



managers about its first product—an electronic mail package for Apple™ computers called Micro-Courier™. Not only to managers who already have Apples,™ but to the fast-growing market of managers in corporations who are thinking of buying personal computers to help them and their staffs do a better job.

For Microcom's Jim Dow, Business Week brought his market into focus. Business Week has a take-action audience of over 6 million corporate decision makers. And they look to Business Week to keep them informed on computer developments. Business Week is the only general busi-

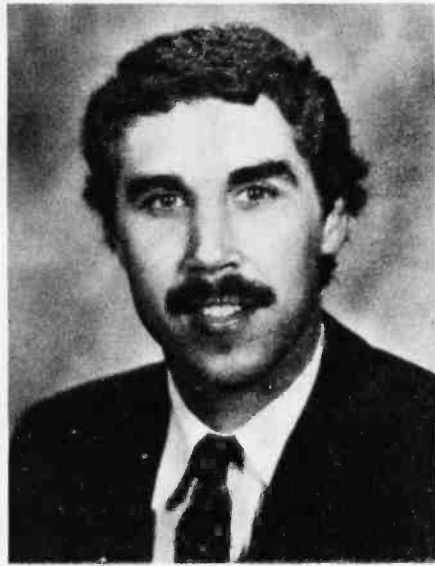

ness publication with an entire editorial section, Information Processing, covering events and trends in the computer industry. Every week.

As Microcom found out, one of the best times to link up with Business Week is right at square one. But for small companies or large companies, Business Week gets big-time advertising results. Call your nearest Business Week representative today.

BusinessWeek



Source: MRI (Spring, '81)/Pub. est.

**PRINT NEATLY,
SO WE KNOW
WHERE TO SEND
YOUR CHECK.**

(PLEASE PRINT: THIS IS YOUR SHIPPING LABEL)

FROM: Name

Address

City/State/ZIP

TO:

Ashton-Tate

Suite 1510

3600 Wilshire Boulevard

Los Angeles, CA 90010

Buying new software is the pits, isn't it?

You read an ad and it sounds terrific, so you ask around, then buy the manual.

So far, so good—so you spring several hundred dollars for the package.

And it does exactly what they said. But to get exactly what you want, you're going to have to change the way you run your business. Or go through so much hassle that you're not sure it's worth it.

So you grit your teeth and suffer, or put it on a shelf to gather dust.

Sounds familiar, doesn't it?

But there is at least one known exception: an exceptional DBMS called dBASE II.

For database fans, an offer you shouldn't refuse.

dBASE II is the only high-performance relational Database Management System for micros. And it's the only DBMS that can help you get the DBMS that's right for you, no matter which DBMS you may want. Here's how:

If you have a 48k micro with CP/M, send us its model number and the size of your drives along with \$700 (CP/M 86 version soon—call if you can't wait).

We'll send you a copy of dBASE II that you can run on your system, solving your problems your way, for 30 days. Then just send everything back and we'll return your money, no questions asked.

During that 30 days, you can find out how much a real database management system can do for you. How it will affect your operations. Exactly what you want done. And precisely how you want to do it.

Then even if you go for some other system, you'll be an informed buyer.

And it never hurts to know what you're doing.

IBM just caught up. So can you.

With dBASE II, you'll get the same kind of system for your micro that IBM introduced a few months ago for their mainframes.

It's a relational DBMS, and that makes it different from any other micro system you've ever seen.

In a relational database, the data is organized as simple tables, with records as the rows and the data fields as the columns, much like your data is organized now. Data relations are logical, so that you can zero in on the specific information you want without knowing a thing about the pre-defined sets, pointers or other cumbersome structures of hierarchal and network DBMS's.

And unlike file management systems, dBASE II gives you program and data independence. You can change your database structure without re-entering your data and without reprogramming, or change some or all of your programs without touching your database. And the same database can be used for any number of different applications.

dBASE II is a stand-alone applications development system.

You don't need an extra support language, because dBASE II comes with its own Applications Development Language (ADL). With ADL, you can use simple English-like statements to manipulate your data, or use built-in structured constructs to prepare sophisticated applications packages. It's simple and easy to use, yet extremely powerful.

You create a new database and start using it in a minute or less. Just type CREATE, then respond to system prompts to name the file and define the fields. Now enter the data.

Add data to an existing database instantly, whether your file has

10 records or 10,000 records, by typing APPEND, then entering the information.

UPDATE, MODIFY, JOIN and REPLACE whole databases or individual records and characters.

Add or delete fields in your database structure without re-entering all your data.

And with dBASE II, it's easy to get information out once you've put the data in.

Do automatic calculations on fields, records and databases with a few keystrokes.

Organize months' worth of data in minutes with REPORT (printing optional), and get your reports today instead of tomorrow. Use the built-in SORT, with single or multiple keys. Or INDEX your data, then FIND it in seconds, even with floppies.

You can use dBASE II interactively or store a sequence of commands to automate your accounting, billing, mailing lists or whatever data you have to manage.

You'll wonder how you managed without it.

dBASE II is the most powerful, easiest to use DBMS you can get for a micro.

And instead of poring over the manual, you can run it hands-on, in-house to see exactly what it can do for you. Try it.

What have you got to lose? We even provide the label so you can send it back.

Ashton-Tate, 3600 Wilshire Blvd., Suite 1510, Los Angeles, CA 90010. (213) 666-4409.

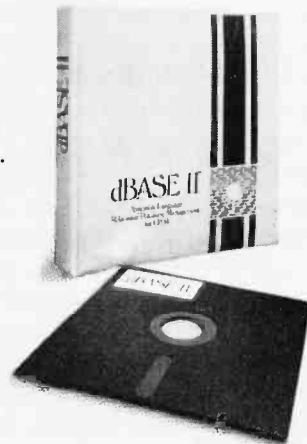

Ashton-Tate

© Ashton-Tate 1981

Graphics Fundamentals

Kathleen Bresnahan Sandifur
624 Six Flags Dr #130
Arlington TX 76011

To make effective use of any graphics system, you must first understand the functions universal to all such systems. For the neophyte, the only readily available method for mastering graphics concepts is to attack a dissertation of incomprehensible detail—an endeavor that can be as frustrating as reading the fine print on your insurance policy.

In this article I try to put some graphics concepts into perspective. Four subroutines of the Hewlett-Packard Graphics/1000 software package are singled out: WINDW, LIMIT, VIEWP, and SETAR. The terms are peculiar to the software package, but the concepts are universal to all graphics. As a vehicle for conveying these concepts, the application program LOGO is presented in this article.

The LOGO program incorporates the four subroutines mentioned above to allow easy manipulation of size, shape, and positioning of a logo. By following the implementation of the four subroutines and the explanation of results related to parameter changes, the uninitiated reader can gain an easy grasp of the graphics function.

The underlying objective of all graphics systems is to capture an image, manipulate it and then project it to another location or surface. The image must first be presented to the graphics system. For the purpose of the sample program, the image was presented by sketching a logo on a sheet of graph paper, approximating this sketch with straight line segments, and tabulating the coordinates for the end points of these segments (see figure 1). The coordinates were calculated by arbitrarily setting x and y axes to correspond to the horizontal and vertical lines of the

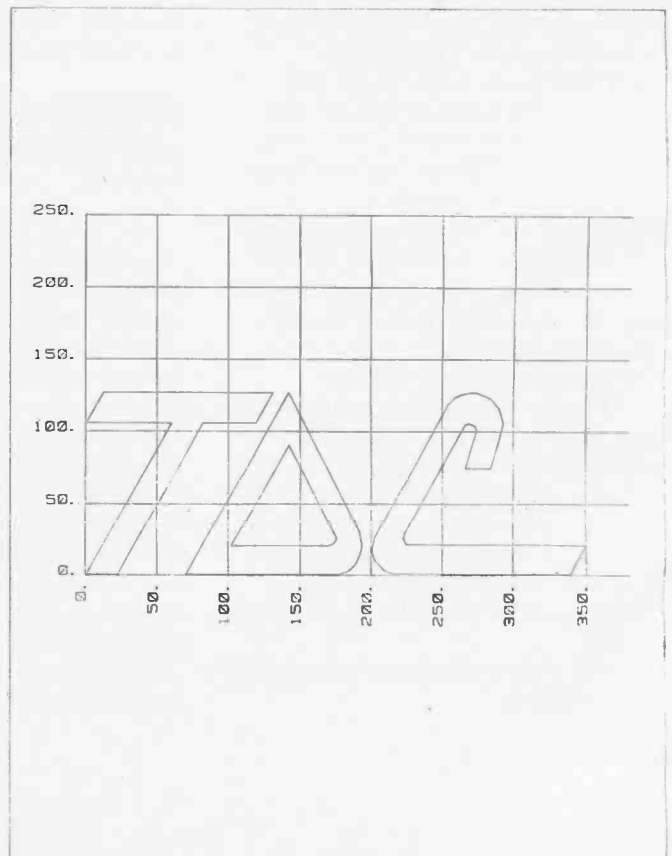

Figure 1: Sketch of the logo letters on graph paper establishing x and y coordinates for the line segments that make up the letters.

4MHZ, DOUBLE DENSITY, COLOR & B/W GRAPHICS . . THE LNW80 COMPUTER

COMPARE THE FEATURES AND PERFORMANCE

| FEATURES | LNW80 | PMC-80** | TRS-80* MODEL III |
|---|-------------------|------------|----------------------|
| PROCESSOR | 4.0 MHZ | 1.8 MHZ | 2.0 MHZ |
| LEVEL II BASIC INTERP. | YES | YES | LEVEL III BASIC |
| TRS80 MODEL I LEVEL II COMPATIBLE | YES | YES | NO |
| 48K BYTES RAM | YES | YES | YES |
| CASSETTE BAUD RATE | 500/1000 | 500 | 500/1500 |
| FLOPPY DISK CONTROLLER | SINGLE/ DOUBLE | SINGLE | SINGLE/ DOUBLE |
| SERIAL RS232 PORT | YES | YES | YES |
| PRINTER PORT | YES | YES | YES |
| REAL TIME CLOCK | YES | YES | YES |
| 24 X 80 CHARACTERS | YES | NO | NO |
| VIDEO MONITOR | YES | YES | YES |
| UPPER AND LOWER CASE | YES | OPTIONAL | YES |
| REVERSE VIDEO | YES | NO | NO |
| KEYBOARD | 63 KEY | 53 KEY | 53 KEY |
| HUMERIC KEY PAD | YES | NO | YES |
| B/W GRAPHICS, 128 X 48 | YES | YES | YES |
| HI-RESOLUTION B/W GRAPHICS, 480 X 192 | YES | NO | NO |
| HI-RESOLUTION COLOR GRAPHICS (NTSC), 128 X 192 IN 8 COLORS | YES | NO | NO |
| HI-RESOLUTION COLOR GRAPHICS (RGB), 384 X 192 IN 8 COLORS | OPTIONAL | NO | NO |
| WARRANTY | 6 MONTHS | 90 DAYS | 90 DAYS |
| TOTAL SYSTEM PRICE | \$1,915.00 | \$1,840.00 | \$2,187.00 |
| LESS MONITOR AND DISK DRIVE | \$1,450.00 | \$1,375.00 | --- |



When you've compared the features of an LNW80 Computer, you'll quickly understand why the LNW80 is the ultimate TRS80 software compatible system. LNW RESEARCH offers the most complete microcomputer system at an outstanding low price. We back up our product with an unconventional 6 month warranty and a 10 days full refund policy, less shipping charges.

LNW80 Computer \$1,450.00
 LNW80 Computer w/B&W Monitor & one 5" Drive \$1,915.00
 All orders must be prepaid, CA residents please include 6% sales tax.
 Contact us for shipping charges

* TRS80 Product of Tandy Corporation.
 ** PMC Product of Personal Microcomputer, Inc.

LNW80

- BARE PRINTED CIRCUIT BOARD & MANUAL \$89.95

The LNW80 - A high-speed color computer totally compatible with the TRS-80*. The LNW80 gives you the edge in satisfying your computation needs in business, scientific and personal computation. With performance of 4 MHz, Z80A CPU, you'll achieve performance of over twice the processing speed of a TRS-80*. This means you'll get the performance that is comparable to the most expensive microcomputer with the compatibility to the world's most popular computer (TRS-80*) resulting in the widest software base.

- FEATURES:
- TRS-80 Model I Level II Software Compatible
 - High Resolution Graphics
 - RGB Output - 384 x 192 in 8 Colors
 - NTSC Video or RF MOD - 128 x 192 in 8 Colors
 - Black and White - 480 x 192
 - 4 MHz CPU
 - 500/1000 Baud Cassette
 - Upper and Lower Case
 - 16K Bytes RAM, 12K Bytes ROM
 - Solder Masked and Silkscreened

LNW SYSTEM EXPANSION

- BARE PRINTED CIRCUIT BOARD
 AND MANUAL \$69.95
 WITH GOLD CONNECTORS \$84.95

The System Expansion will allow you to expand your LNW80, TRS-80*, or PMC-80** to a complete computer system that is still totally software compatible with the TRS-80* Model I Level II.

- FEATURES:
- 32K Bytes Memory
 - 5" Floppy Controller
 - Serial RS232 20ma I/O
 - Parallel Printer
 - Real Time Clock
 - Screen Printer Bus
 - On Board Power Supply
 - Solder Masked and Silkscreened

LNW RESEARCH CORPORATION

2620 WALNUT ST.
 TUSTIN CA. 92680

ORDERS & INFO. NO. 714-544-5744
 SERVICE NO. 714-641-8850

Circle 201 on Inquiry card.

VISA MASTER CHARGE UNLESS NOTED
 ACCEPTED ADD \$3 FOR SHIPPING

LNDoubler & DOS PLUS 3.3D

- Assembled and Tested w/DOS PLUS 3.3D \$175.00

Double-density disk storage for the LNW Research's "System Expansion" or the Tandy's "Expansion Interface". The LNDoubler™ is totally software compatible with any double density software generated for the Percom's Doubler***. The LNDoubler™ provides the following outstanding features.

- Store up to 350K bytes on a single 5" disk
- Single and double density data separation
- Precision write precompensation circuit
- Software switch between single and double density
- Easy plug in installation requiring no etch cuts, jumpers or soldering
- 35, 40, 77, 80 track 5" disk operation
- 120 day parts and labor Warranty

*** Doubler is a product of Percom Data Company, Inc.

DOS PLUS 3.3D

Micro Systems software's double density disk operating system. This operating system contains all the outstanding features of a well developed DOS, with ease in useability.

KEYBOARD

LNW80 KEYBOARD KIT \$84.95

The Keyboard Kit contains a 63 key plus a 10 key, P.C. board, and remaining components.

CASE

LNW80 CASE \$84.95

The streamline design of this metal case will house the LNW80, LNW System Expansion, LNW80 Keyboard, power supply and fan, LNDoubler™, or LNW Data Separator. This kit includes all the hardware to mount all of the above. Add \$12.00 For shipping

PARTS AVAILABLE FROM LNW RESEARCH

- 4116 - 200ms RAM
 - 6 chip set \$26.00
 - 8 chip set \$33.50
 - 16 chip set \$64.00
 - 24 chip set \$94.00
 - 32 chip set \$124.00
- LNW80 "Start up parts set" LNW80-1 \$82.00
- LNW80 "Video parts set" LNW80-2 \$31.00
- LNW80 Transformer LNW80-3 \$18.00
- LNW80 Keyboard cable LNW80-4 \$16.00
- 40 Pin computer to expansion cable \$15.00
- System Expansion Transformer \$19.00
- Floppy Controller (FD1771) and UART (TR1602) \$30.00

Small Business Systems User!

**WHEN BUYING CHECKS,
STATEMENTS AND
INVOICES — LOOK FOR
THIS MARK:**

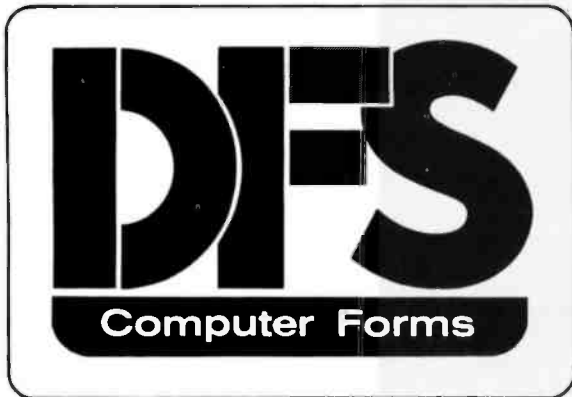

**ON THE DOOR OF YOUR
COMPUTER STORE**

DFS Computer Forms are

- Sold by a Local Business
- Satisfaction Guaranteed
- Available in Small Quantities
- Compatible with Existing Software
- Very Economical

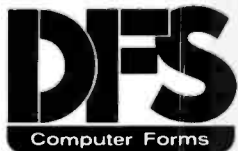

P.O. Box 643 • Townsend, MA. 01469

graph paper. This process is a form of *digitization* and is only one of the many methods available. All have the objective of conveying information in a form recognizable to the graphics system. Coordinates representing the logo are entered at lines 33 to 101 of the sample program (see listing 1). Once the image is made available to the system, the process of capturing the image, manipulating it, and projecting it involves four steps:

- Determine the boundaries surrounding the image to be captured (WINDW).
- Set the limits of the device to the boundaries of the paper or transparency to be used (LIMIT).
- Determine the boundaries within which the image is to be projected on the paper or transparency (VIEWP).
- If you don't want the projected image distorted, then the window surrounding the image and the viewport on the projecting surface must both have the same width/height ratio (SETAR).

WINDW

When the graphics system receives the digitized representation of the image, it needs a frame of reference to designate where the image to be captured is located. To generate this reference frame or *window*, the WINDW subroutine is invoked. The general form of WINDW is:

CALL WINDW(IGCB,X1,X2,Y1,Y2)

where (X1,Y1) designates the lower-left corner of the rectangular window and (X2,Y2) designates the upper-right corner. Because this rectangle is to frame the image or a portion of the image represented in the digitization process, the parameters for the WINDW subroutine must be generated from the same axes, units, and origin used in the digitization process (the ones established on the graph paper).

The setting of the WINDW parameters in line 29 of the sample program to:

CALL WINDW(IGCB,0.,355.,0.,130.)

specifies that the lower-left corner of the rectangular window is zero units in the *x* direction and zero units in the *y* direction (at the *origin* on the graph paper). Also, the upper-right corner of the window is at 355 units in the *x* direction and 130 units in the *y* direction (to the far right and middle of the graph paper). Since the window encompasses the entire logo "TDC," the captured image for graphics manipulation will be the entire logo. If, however, the window had been specified by:

CALL WINDW(IGCB,200.,355.,0.,130.)

then the window would frame only the "C" portion of the logo, and only that image would be available for graphics manipulation.

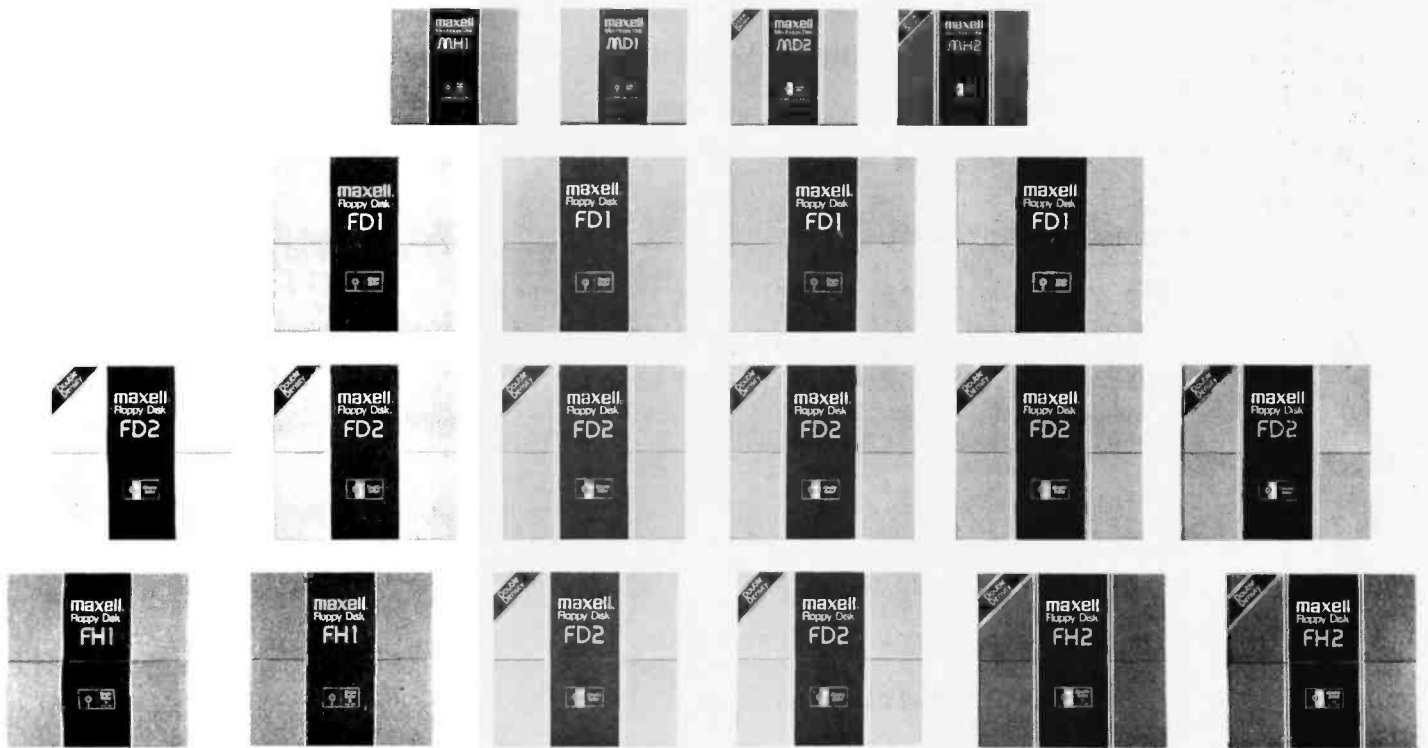

Maxell Floppy Disks. Class of '81.

Not a single dropout among them.

These are the disks that achieve all you expect from them. They are certified free of dropouts. And each one meets or exceeds the most demanding specifications every computer authority can set. That includes ISO, IBM, ECMA, ANSI, JIS and Shugart.

The quality begins with the finest raw materials available, and we make sure the quality stays high. Every Maxell floppy disk must pass an exhaustive series of eight quality control inspections. Under test conditions, after 10,000,000 passes, there is no loss of quality.

Maxell Floppy Disks actually help protect your computer drive heads. The self-cleaning jacket liner

inside every Maxell disk removes dust before it can affect your system. The surface lubricant reduces any chance of disk-caused head-wear.

There are Maxell disks for every disk drive system in operation today. Maxell is leading the way with new disk technology for tomorrow's computers. Your Maxell Business or Maxell Personal Computer Products supplier can put our "honor-grad" to work for you, and for your computer, now and in the future.

Call or write for more information. You'll learn that the care we take manufacturing Maxell Floppy Disks makes them live up to your highest expectations.



maxell 

Listing 1: LOGO, the program used to produce figures in this article. The program is written to run on a Hewlett-Packard Graphics/1000 system.

```

&111A T=00004 IS ON CR00023 USING 00018 BLKS R=0000

0001 FTN4,L
0002 PROGRAM LOGO
0003 C
0004 C THIS PROGRAM DRAWS A LOGO "TDC" (KATHLEEN SANDIFUR 10-79)
0005 C
0006 DIMENSION IGCB(192),IRUF(10),XLUT(5),V(4),W(4),G(2),XL(4)
0007 EQUIVALENCE (LU,IBUF),(ID,IRUF(10))
0008 C
0009 C ESTABLISH ID AND LOGICAL UNIT FOR PLOTTER
0010 C
0011 LUT=LOGLU(I)
0012 WRITE(LUT,01)
0013 01 FORMAT("ENTER LU, ID:")
0014 READ(LUT,*) LU,ID
0015 C
0016 C INITIALIZE PLOTTER & SELECT PEN
0017 C
0018 CALL PLOTB(IGCB,ID,1,LU)
0019 CALL PEN(IGCB,2)
0020 C
0021 C *****
0022 C * REFERENCES IN ARTICLE TO LIMIT, SETAP, VIEWP, WINDOW *
0023 C * REFER TO THE FOLLOWING CALLS *
0024 C *****
0025 C
0026 CALL LIMIT(IGCB,XL(1),XL(2),XL(3),XL(4))
0027 CALL SETAP(IGCB,AR)
0028 CALL VIEWP(IGCB,V(1),V(2),V(3),V(4))
0029 CALL WINDOW(IGCB,W(1),W(2),W(3),W(4))
0030 C
0031 C ***** DRAW "T" *****
0032 C
0033 CALL MOVE(IGCB,22.,0.)
0034 CALL DRAW(IGCB,82.,105.)
0035 CALL DRAW(IGCB,119.,105.)
0036 CALL DRAW(IGCB,131.,126.)
0037 CALL DRAW(IGCB,12.,126.)
0038 CALL DRAW(IGCB,0.,105.)
0039 CALL DRAW(IGCB,60.,105.)
0040 CALL DRAW(IGCB,0.,0.)
0041 CALL DRAW(IGCB,22.,0.)
0042 C
0043 C ***** DRAW "D" *****
0044 C
0045 CALL MOVE(IGCB,70.,0.)
0046 CALL DRAW(IGCB,178.,0.)
0047 CALL DRAW(IGCB,185.,3.)
0048 CALL DRAW(IGCB,190.,8.)
0049 CALL DRAW(IGCB,193.,15.)
0050 CALL DRAW(IGCB,194.,20.)
0051 CALL DRAW(IGCB,193.,25.)
0052 CALL DRAW(IGCB,192.,30.)
0053 CALL DRAW(IGCB,190.,34.)
0054 CALL DRAW(IGCB,142.,126.)
0055 CALL DRAW(IGCB,70.,0.)
0056 C
0057 C ***** INNER "D" START LEFT BOTTOM ****
0058 C

```

Listing 1 continued on page 290

we beat the price...

Exclusive One Year Warranty Included



800™ \$779

WITH ONE YEAR EXTENDED WARRANTY



ATARI 810 DISC DRIVE



\$444

Available without warranty for even less.

ATARI SOFTWARE

| | | | |
|--------------------------------------|----------|----------------------------------|---------|
| CX401 General Accounting | \$399.00 | CX6001 U.S. History | \$23.00 |
| CX402 Accounts Receivable | \$399.00 | CX6002 U.S. Government | \$23.00 |
| CX403 Inventory Control | \$399.00 | CX6003 Supervisory Skills | \$23.00 |
| CX404 Word Processor | \$119.00 | CX6004 World History | \$23.00 |
| CX405 PILOT | \$68.00 | CX6005 Basic Sociology | \$23.00 |
| CX413 MICROSOFT BASIC | \$68.00 | CX6006 Counseling Proced. | \$23.00 |
| CX4101 Invitation to Programming 1 | \$17.00 | CX6007 Principal of Act. | \$23.00 |
| CX4102 Kingdom | \$13.00 | CX6008 Physics | \$23.00 |
| CX4103 Statistics | \$17.00 | CX6009 Great Classics | \$23.00 |
| CX4104 Mailing List | \$17.00 | CX6010 Business Comm. | \$23.00 |
| CX4105 Blackjack | \$13.00 | CX6011 Basic Psychology | \$23.00 |
| CX4106 Invitation to Programming 2 | \$20.00 | CX6012 Effective Writing | \$23.00 |
| CX4107 Biorhythm | \$13.00 | CX6014 Principals of Econ. | \$23.00 |
| CX4108 Hangman | \$13.00 | CX6015 Spelling | \$23.00 |
| CX4109 Graph II | \$17.00 | CX6016 Basic Electricity | \$23.00 |
| CX4110 Touch Typing | \$20.00 | CX6017 Basic Algebra | \$23.00 |
| CX4111 Space Invaders | \$17.00 | CX8106 Bond Analysis | \$20.00 |
| CX4112 States & Capitals | \$13.00 | CX8107 Stock Analysis | \$20.00 |
| CX4114 European Countries & Capitals | \$13.00 | CX8108 Stock Charting | \$20.00 |
| CX4115 Mortgage & Loan Analysis | \$13.00 | CXL4001 Education System Master | \$21.00 |
| CX4116 Personal Fitness Prog. | \$59.00 | CXL4002 Basic Computing Language | \$46.00 |
| CX4117 Invitation to Programming 3 | \$20.00 | CXL4003 Assembler Editor | \$46.00 |
| CX4118 Conversational French | \$45.00 | CXL4004 Basketball | \$24.00 |
| CX4119 Conversational German | \$45.00 | CXL4005 Video Easel | \$24.00 |
| CX4120 Conversational Spanish | \$45.00 | CXL4006 Super Breakout | \$30.00 |
| CX4121 Energy Czar | \$13.00 | CXL4007 Music Composer | \$45.00 |
| CX4125 Conversational Italian | \$45.00 | CXL4009 Chess | \$30.00 |
| | | CXL4010 3-D Tic-Tac-Tow | \$24.00 |

| | |
|-------------------------|---------|
| CXL4011 Star Raiders | \$32.00 |
| CXL4012 Missile Command | \$32.00 |
| CXL4013 Asteroids | \$32.00 |

| | |
|---------------------------------|----------|
| CXL4015 TeleLink | \$20.00 |
| Compuhome | \$74.95 |
| Visicalc | \$149.00 |
| Letter Perfect (Word Processor) | \$119.00 |
| Source | \$89.00 |

Atari® Peripherals:

| | |
|---------------|----------|
| 400 16K | \$329.00 |
| 410 Recorder | \$59.00 |
| 822 Printer | \$359.00 |
| 825 Printer | \$ CALL |
| 830 Modem | \$159.00 |
| 850 Interface | \$ CALL |

Atari® Accessories

| | |
|------------------|----------|
| New DOS 2 System | \$21.00 |
| CX70 Light Pen | \$64.00 |
| CX30 Paddle | \$18.00 |
| CX40 Joy Stick | \$18.00 |
| CX853 16K RAM | \$89.00 |
| Microtek 16K RAM | \$75.00 |
| Microtek 32K RAM | \$169.00 |

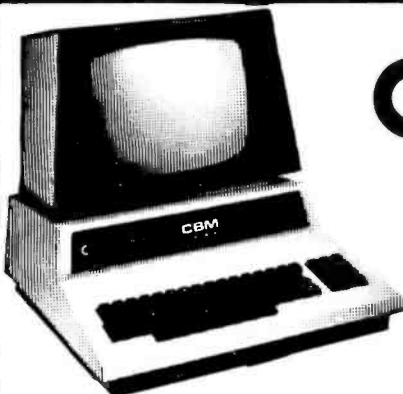

CBM 8032 \$1099

| | |
|-------------------------|-----------|
| 4016 | \$799.00 |
| 4032 | \$999.99 |
| 8096 | \$1795.00 |
| CBM4022 Printer | \$629.00 |
| Tally 8024 | \$1699.00 |
| CBM C2N Cassette Drive | \$69.00 |
| CBM4040 Dual Disk Drive | \$995.00 |
| CBM8050 Dual Disk Drive | \$1349.00 |



commodore



VIC 20
\$259

| | |
|--------------------|---------|
| Vic-TV Modul | \$19.00 |
| Vic Cassette | \$69.00 |
| Vic Disk Drive | \$ Call |
| Vic 6 Pack program | \$44.00 |

CBM Software

| | |
|---|----------|
| WordPro3 Plus | \$199.00 |
| WordPro4 Plus | \$299.00 |
| Commodore Tax Package | \$399.00 |
| Visicalc | \$149.00 |
| EBS Accts. Rec./Inventory Interactive Syst. | \$595.00 |
| BPI General Ledger | \$329.00 |
| OZZ Information System | \$329.00 |
| Dow Jones Portfolio | \$129.00 |
| Pascal | \$239.00 |
| Legal Time Accounting | \$449.00 |
| World Craft 80 | \$289.00 |
| Word Check | \$180.00 |
| Create-A-Base | \$219.00 |
| Power | \$89.00 |
| Socket-2-Me | \$20.00 |
| Jinsam | Call |

Disks

| | |
|------------------------|---------|
| CX8100 Blank Disk (5) | \$22.00 |
| Sycom Blank Disk (10) | \$29.00 |
| Maxell Blank Disk (10) | \$36.00 |
| Maxell Blank Disk (10) | \$46.00 |

Printers

| | |
|---------------------------|-------------------|
| Epson MX-70 | } Call for Prices |
| Epson MX-80 | |
| Epson MX-80 FT | |
| Diablo 630 | |
| Nec 5530 | \$2495.00 |
| TEC 1500 Starwriter 25cps | \$1495.00 |
| TEC 1500 Starwriter 45cps | \$1795.00 |

No Risk, No Deposit On Phone Orders, COD or Credit Card, Shipped Same Day You Call *

* on all in stock units

IN PA, CALL (717) 327-9575

(800) 233-8950



To Order:

Phone orders invited (800 number is for order desk only). Or send check or money order and receive free shipping. Pennsylvania residents add 6% sales tax. Add 3% for Visa or M.C. Equipment is subject to price change and availability without notice. Please call between 11 AM & 6 PM.

COMPUTER MAIL ORDER
501 E. 3RD ST., WILLIAMSPORT, PA 17701

Listing 1 continued:

```
0059      CALL MOVE(IGCB,102.,20.)
0060      CALL DRAW(IGCB,142.,90.)
0061      CALL DRAW(IGCB,175.,27.)
0062      CALL DRAW(IGCB,176.,25.)
0063      CALL DRAW(IGCB,175.,23.)
0064      CALL DRAW(IGCB,173.,21.)
0065      CALL DRAW(IGCB,170.,20.)
0066      CALL DRAW(IGCB,102.,20.)
0067  C
0068  C      ***** DRAW "C"  START LEFT BOTTOM *****
0069  C
0070      CALL MOVE(IGCB,203.,10.)
0071      CALL DRAW(IGCB,202.,13.)
0072      CALL DRAW(IGCB,201.,17.)
0073      CALL DRAW(IGCB,203.,26.)
0074      CALL DRAW(IGCB,255.,118.)
0075      CALL DRAW(IGCB,260.,123.)
0076      CALL DRAW(IGCB,265.,125.)
0077      CALL DRAW(IGCB,270.,126.)
0078      CALL DRAW(IGCB,275.,126.)
0079      CALL DRAW(IGCB,285.,122.)
0080      CALL DRAW(IGCB,291.,115.)
0081      CALL DRAW(IGCB,294.,105.)
0082      CALL DRAW(IGCB,290.,90.)
0083      CALL DRAW(IGCB,285.,74.)
0084  C
0085  C      ***** INNER "C"  START LEFT UPPER *****
0086  C
0087      CALL DRAW(IGCB,267.,74.)
0088      CALL DRAW(IGCB,275.,100.)
0089      CALL DRAW(IGCB,274.,103.)
0090      CALL DRAW(IGCB,272.,104.)
0091      CALL DRAW(IGCB,270.,105.)
0092      CALL DRAW(IGCB,267.,104.)
0093      CALL DRAW(IGCB,224.,29.)
0094      CALL DRAW(IGCB,223.,25.)
0095      CALL DRAW(IGCB,224.,23.)
0096      CALL DRAW(IGCB,225.,21.)
0097      CALL DRAW(IGCB,351.,20.)
0098      CALL DRAW(IGCB,340.,0.)
0099      CALL DRAW(IGCB,215.,1.)
0100      CALL DRAW(IGCB,210.,3.)
0101      CALL DRAW(IGCB,203.,10.)
0102  C
0103  9999 CALL PEN(IGCB,0)
0104      CALL PLOT(IGCB,ID,0)
0105      STOP
0106      END
```

LIMIT

The LIMIT subroutine defines the view surface on the device—in other words, the surface within which all graphics must occur. After deciding on the size of the paper or transparency desired, the width and height dimensions are used to delimit the view surface via the LIMIT subroutine. The general form of LIMIT is:

```
CALL LIMIT(IGCB,X1,X2,Y1,Y2)
```

with the *x* and *y* units specified in millimeters. As a result, all graphics must now occur within an area bounded in

the horizontal direction from *X1* mm to *X2* mm, and in the vertical direction from *Y1* mm to *Y2* mm, with the origin corresponding to the lower-left corner of the device view surface.

In the sample program, a logo is to be projected to a 15-inch by 10-inch sheet of paper (380 mm by 250 mm). Line 26 of the program would incorporate these dimensions as LIMIT parameters as follows:

```
CALL LIMIT(IGCB,0.,380.,0.,250.)
```

To further illustrate the use of the LIMIT subroutine, if

PUT YOUR APPLE TO WORK FOR YOU! WITH THE THUNDERCLOCK PLUS™

As an APPLE user you already know all the things your APPLE can do. Now Thunderware expands that list with the THUNDERCLOCK PLUS, the complete clock/calendar system for your APPLE! Your programs can read the month, date, day-of-week, hour, minute, and second in any of APPLE'S languages. On-board batteries keep your THUNDERCLOCK running accurately when your APPLE is off - for up to 4 years before battery replacement. But that's just the beginning.

The THUNDERCLOCK PLUS is the most useful and versatile peripheral you can put in your APPLE. It can keep your disk files organized by time-and-date-stamping them, it enhances the usability of many of the new business/professional software packages for accounting, filing, and time management, and it can remotely control lights and appliances for security or display purposes in your business or home.

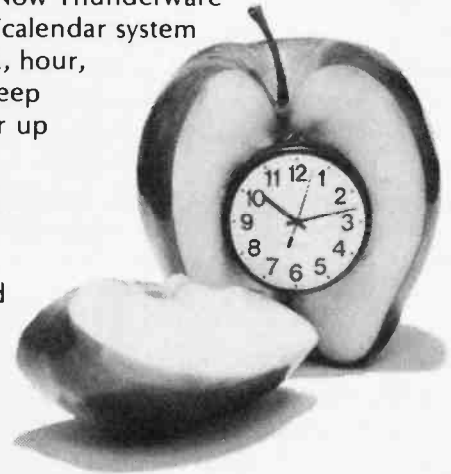

SOFTWARE PRODUCT COMPATIBILITY

Many of today's important software packages for data-base management, business applications, communications, and time management are designed to use the THUNDERCLOCK PLUS. If you have or plan to purchase any of these packages, a THUNDERCLOCK will greatly enhance their usefulness.

●VISIDEX* (Personal Software) ●DB MASTER and MICRO-MEMO (Stoneware) ●MICRO-COURIER and MICRO-TELEGRAM (Microcom) ●THE CASHIER and THE STORE MANAGER (High Technology) ●BUSINESS PLUS and NET-WORKS (Advanced Data Systems) ...and many others!

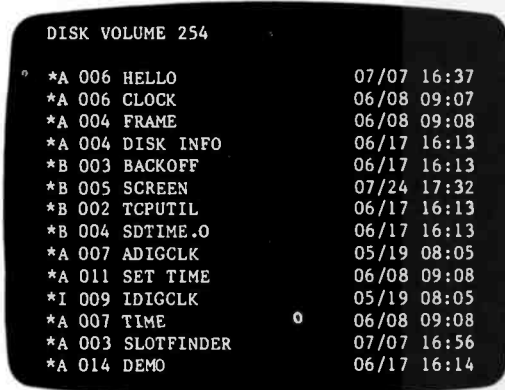

THUNDERWARE'S DOS-DATER

Our new DOS-DATER software upgrades the regular DOS on your disks so that DOS will use the THUNDERCLOCK to time-and-date-stamp disk files. Every time a program is saved or a file is modified, the current date and time to the minute are stored in the CATALOG with the file's name. You can tell at a glance when a program was saved or when any file was last modified. And this time/date stamping feature is completely automatic. That means any program which uses DOS will time/date stamp its files!

REMOTE CONTROL

Add Thunderware's X-10 INTERFACE OPTION to your THUNDERCLOCK PLUS and your APPLE can control lights and appliances through your BSR X-10 Home Control System on your pre-defined schedules. Our powerful SCHEDULER software allows you to create and modify schedules easily and execute them in the 'background', while using your APPLE for other tasks in the 'foreground'. Use your APPLE for energy management, display and security lighting, or laboratory/process control.

Our PASCAL Software lets you use all the THUNDERCLOCK'S features in PASCAL and sets the Fjiler date whenever you boot.

You get all this versatility in just one peripheral system. Backed by a full one year warranty. See your APPLE dealer for a demonstration, or contact us for more information. We'll give your APPLE the best time around!

Suggested retail prices:

THUNDERCLOCK PLUS\$139
X-10 INTERFACE OPTION\$49
PASCAL SOFTWARE DISK\$29
DOS-DATER/DEMO DISK\$29
MANUALS ONLY,each\$5

THUNDERWARE, INC.
P.O. BOX 13322
Oakland, CA 94661
(415)-652-1737

Distributed by Apple Computer, Inc.
and Computerland Corp.

*Requires software supplied on DOS-DATER/DEMO disk.

BSR X-10 is a trademark of BSR (USA) LTD.

APPLE II is a trademark of APPLE COMPUTER, INC

you want to confine graphics to an 8½-inch by 11-inch (215 mm by 280 mm) area, set LIMIT parameters as follows:

```
CALL LIMIT(IGCB,0.,215.,0.,280.)
```

VIEWP

Within the view surface set by LIMIT, the image can be restricted to a desired area. In other words, the logo can be spread across the entire paper or transparency, or confined to only a small area. A *viewport* designates a rectangular portion of the view surface to which the image in the window is to be mapped. The VIEWP subroutine defines the positioning of the viewport, and its general form is:

```
CALL VIEWP(IGCB,X1,X2,Y1,Y2)
```

where (X1,Y1) designates the lower-left corner of the viewport and (X2,Y2) designates the upper-right corner. The *x* and *y* axes correspond to the lower edge and the left edge, respectively, of the LIMIT-designated view surface.

The units for *x* and *y* vary according to the *aspect ratio*, or the ratio of the width to the height of the view surface. If the aspect ratio, abbreviated AR, is greater than 1, the horizontal length of the view surface corresponds to $100 \times \text{AR}$ units, and the vertical length corresponds to 100 units. If AR is less than 1, the vertical length corresponds to $100/\text{AR}$ units and the horizontal

length to 100 units. When CALL LIMIT is not initiated, the view surface defaults to the limit of the device, which for the HP 9872A has an AR of 1.52. Therefore, to position a viewport to cover the upper-right quadrant of the view surface, specify VIEWP as follows:

```
CALL VIEWP(IGCB,76.,152.,50.,100.)
```

The entry of the viewport parameters in the sample program occurs at line 28.

SETAR

At this point in the graphics explanation, the process can be visualized as taking a snapshot and projecting the captured image onto a screen. Everything within the rectangular window is mapped through the rectangular viewport for positioning on the viewing surface, which itself has been delimited via the LIMIT subroutine.

If the rectangular window and the rectangular viewport have the same shape (if the aspect ratio is the same), the image can be transferred *point for point* without distorting any geometric figures. The relative size of images will change, but a circle will remain a circle, and angles between intersecting lines will not change. If the aspect ratio of the window is not the same as that of the viewport, then the image projected on the view surface will be distorted: a circle will become an ellipse, and the angle between intersecting lines will change. To alleviate

MICROSTAT

Microstat is an advanced statistics package designed for use in research, education and industry. Microstat is a file-oriented statistics package with a Data Management Subsystem (DMS) that creates the data files plus the ability to: edit, list, destroy, delete cases, augment, sort, rank-order, lag, move, merge and transform the data. The data transforms include: add, subtract, multiply, divide, reciprocal, log, natural log and antilog, exponential, linear transformations plus adding any number of variables to create new variables.

Once the file is created, it can be used to produce: Descriptive statistics, Hypothesis tests (mean and proportion), ANOVA (one-way, two-way and random blocks), Scatterplots, Frequency distributions, Correlation analysis, Simple and Multiple regression, Time Series, Nonparametric tests (11 of them), Crosstabs and Chi-square, Factorials, Permutations, Combinations, and 8 Probability distributions.

The price of Microstat is \$250.00 and the user's manual is available for \$20.00 and includes sample printouts. Since the printouts reference standard statistics textbooks and journal articles, you can compare the accuracy of Microstat to results produced on much larger systems. No other statistics package seems to have the confidence to do that . . . at any price.

Microstat is available for the North Star DOS and Basic, Microsoft's Basic-80™ (5.03 or later) and Compiler Systems' CBasic2™. Please specify 8" SD (soft-sectored) or North Star 5¼" disk when ordering.

ECOSOFT
P.O. Box 68602
Indianapolis, IN 46268
(317) 283-8883



INTERCHANGE

If you use the CP/M™ operating system, life just got a whole lot easier for you. Interchange is a Z-80™ assembly language program that gives you all of the features that PIP doesn't, plus several unique features. Some of the features of Interchange include:

DIR, in the usual fashion, *plus* listing all files *excluding* those with a specified character. Read/write status is also given.

ERA, as usual *plus exclusive* erases. In addition, a "Q" switch can be used to query on each erase, a "W" allows erases of R/O files without query (normally you are queried), and an "R" switch if system files are to be included.

LIST permits printer listings with formatting controlled by TAB, WIDTH, LINES and WRAP. If you are using the QT Systems Clock Board, listings include the date and time.

COPY including exclusive copies and the optional "Q", "W" and "R" switches plus an "E" switch that queries if the file already exists. It also allows for changing disks in the middle of a copy if either the disk or directory become full. It automatically verifies copies.

STAT, with ambiguous, unambiguous and exclusive listings. It produces an alphabetized listing and includes each file length, total directory entries and space used and unused.

Other commands include RENAME (including ambiguous), HELP, START, END, CLEAR, RESET, DATE, TIME, TAB, WIDTH, LINES, WRAP, QT, SETIT and TYPE. Once you've used Interchange, we doubt that you'll ever use PIP again. The price of Interchange is \$59.95 and the manual is available for \$10.00. Orders must be accompanied with your CP/M serial number. Interchange is recommended for a 32K or larger system and will not run with an 8080 CPU. At the present time, only User 0 is supported.

CBasic2 is a registered trademark of Compiler Systems.
CP/M is a registered trademark of Digital Research.

RAM/COBOL™ MAKES IT ACROSS!

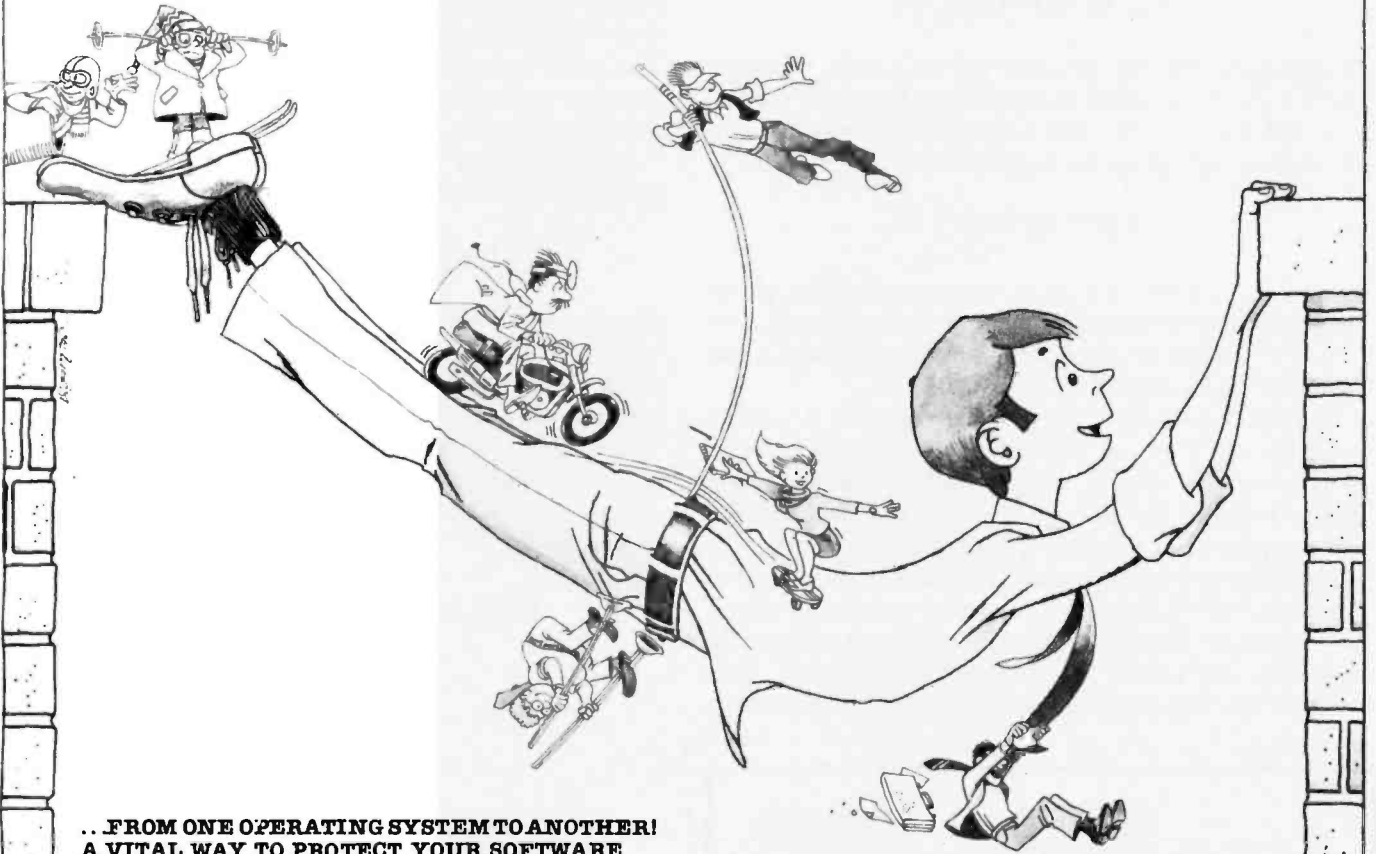

... FROM ONE OPERATING SYSTEM TO ANOTHER! A VITAL WAY TO PROTECT YOUR SOFTWARE INVESTMENT FOR THE FUTURE!!

The **RAM/COBOL** language runs on more different Operating Systems and more different-sized computers than any other similar language. For starters, it runs on NCR and TI minicomputers and, in the micro field, on the CP/M², MP/M², TRSDOS³, OASIS⁴, MOASIS⁴, and UNIX (ONYX version) Operating Systems...to mention only a few.

Until now, serious business software of the scope and flexibility seen in the minicomputer world has not been available on micros. **RAM/COBOL** now allows transfer of such software with a minimum of fuss.

We have participated in such a mini-to-micro transfer of a major set of general business software...using **RAM/COBOL** as the transfer mechanism, of course. Running on literally thousands of minicomputers, these refined, enhanced, and proven software packages cover A/R, A/P, G/L, P/R. Order Entry (with Invoicing and Inventory Control) as well as Sales Analysis. The packages define a new level of achievement for features and flexibility in micro applications software and offer top quality at a reasonable price.

For immediate information, call 714-848-1922 for your complete product descriptions.

MR. SMITH, THIS SOFTWARE WILL DEFINITELY ENHANCE YOUR CURRENT DATA PROCESSING FINANCIAL INDEXING RETRIEVABILITY.

THOSE ARE NICE WORDS.

...PLUS ALL THE OLD, FAMILIAR FAVORITES that we continue to offer, such as:

General Business—Client Accounting (CPA Write-up)
FMS⁶ (Financial Modeling System)
NAD⁷ (Name and Address System)

Real Estate—REAP (Real Estate Acquisition Programs)
PMS (Property Management System)
MLS⁶ (Multiple Listing System)

Health Care—APH⁸ (Automated Patient History)

Word Processing and System Software—Magic Wand⁹
QSORT⁷
CBASIC²¹⁰

and Cybernetics' unique TRS-80³, Model II CP/M offering high performance, hard disk support, and CP/M compatibility.

Trademarks of:

1—Ryan McFarland Corp.; 2—Digital Research, Inc.; 3—Tandy Corp.; 4—Phase One Systems, Inc.; 5—Bell Telephone Laboratories, Inc.; 6—American Business Systems, Inc.; 7—Structured Systems Group, Inc.; 8—Cybernetics, Inc.; 9—Peachtree Software, Inc.; 10—Compiler Systems, Inc.

CYBERNETICS
N
C

TEL. 714-848-1922

8041 NEWMAN AVE, SUITE 208
HUNTINGTON BEACH, CA 92647

this problem when coverage of the largest possible portion of the selected view surface is desired, the subroutine SETAR (set viewport aspect ratio) is used. The general form for SETAR is:

```
CALL SETAR(IGCB,AR)
```

To implement SETAR, calculate the AR for the window. The AR for the window encompassing the entire logo is 2.73 ($355/130 = 2.73$). This value is incorporated at line 27 of the sample program as follows:

```
CALL SETAR(IGCB,2.73)
```

As a result, instead of a point-for-point mapping of the image in the window to the viewport, the mapping is now from the window to a reconfigured viewport which has the aspect ratio selected by SETAR.

This new viewport is shrunk in size so that it just fits inside the old viewport while maintaining an AR corresponding to the window. After shrinking the new viewport to fit inside the old viewport, one dimension of the old viewport will have unused area. The new viewport is centered along this dimension. The image in the window, therefore, will be mapped undistorted to an area within the originally specified viewport, centered along one dimension and totally filling the other dimension. This provides the largest undistorted projection of the image

onto the delimited view surface without requiring undue calculation for viewport positioning.

Parameter Changes

A brief and simplified explanation of each of the four subroutines has now been presented and the location of their implementation in the LOGO program specified. The following will document how individual changes in the subroutine parameters correlate to output changes from the program.

1. Set window to encompass the logo; and default LIMIT, SETAR, and VIEWP parameters.

```
CALL WINDW(IGCB,0.,355.,0.,130.)
```

The resulting output is a recognizable, although distorted, projection of the logo covering the total viewing surface (see figure 2). The projection covers the total viewing surface because of the default mode for LIMIT and VIEWP. Because CALL LIMIT was not initiated, the viewing surface defaults to the physical limits of the device. For the HP9872A, this is equivalent to the following at line 26:

```
CALL LIMIT(IGCB,0.,380.,0.,250.)
```

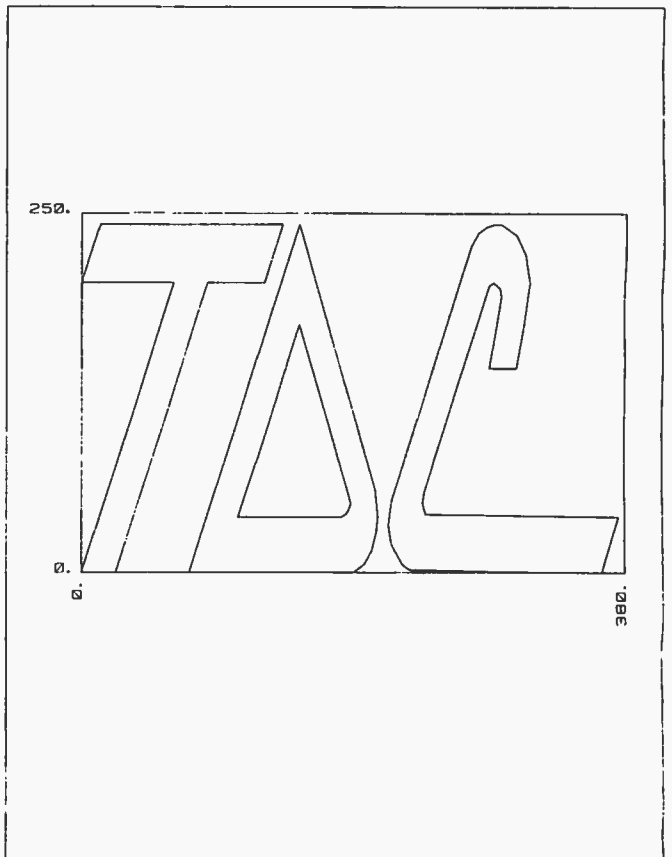



Figure 2: The logo translated to fill the entire graph area. Note the geometric distortion of the letters, which results because the aspect ratio (width/height ratio) of the window and viewport are not equal.



**GEORGIA
EXECUTIVE
MICRO
SYSTEMS INC.**

SEE US
AT THE
SOUTHEASTERN
COMPUTER SHOW
BOOTHS 435, 437

SOUTHEASTERN DISTRIBUTORS FOR:

Ithaca Inter Systems:
PDP-80 / CACHE BIOS / CPM System 80
DPS-8000-16 Bit Multi-user
Unix-Type OS Coherent

ADES:
10-154 MByte HD-w/wo tape back-up
Controllers/Interfaces for Most Systems

**2885 Kellogg Creek Rd., Acworth, GA 30101
(404) 974-4430
DEALER AND OEM INQUIRIES INVITED**

MICRO BUSINESS WORLD

TOLL FREE
1(800)423-5886

COMPUTERS

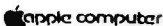

| | List | Our Price | SAVE |
|---------------|-----------|----------------|----------|
| Apple II-16K | \$1330.00 | \$999.00 | \$331.00 |
| Apple II-32K | 1430.00 | | |
| Apple II-48K | 1530.00 | SPECIAL | \$ |
| Apple II-64K | 1725.00 | CALL | \$ |
| Apple II-128K | 3915.00 | 2997.00 | 918.00 |

NEC PC 8001 NEW

CALL

SHARP-64K Z80 FULL KBD YX-3200

1995.00 CALL \$

ALTOS 8CS 8000-15

5990.00 4573.00 1417.00

ATARI PERSONAL COMPUTERS

| | List | Our Price | SAVE |
|-------------------------------------|-----------|-----------|----------|
| 800 16K Bytes of Ram | \$1080.00 | \$ 748.00 | \$332.00 |
| 410 Program Recorder | 90.00 | 77.00 | 13.00 |
| 810 Disk Drive | 600.00 | 457.00 | 143.00 |
| 825 Printer (80 col. Centronic 737) | 999.95 | 769.00 | 230.00 |
| 820 Printer (40 col. impact) | 450.00 | 353.00 | 97.00 |
| 830 Acoustic Modem | 200.00 | 155.00 | 45.00 |
| 850 Interface Module | 220.00 | 192.00 | 48.00 |
| Atari VisiCalc | 200.00 | 164.00 | 36.00 |
| Atari 40K-16K | 595.00 | 327.00 | 304.00 |



HEWLETT PACKARD

| | List | Our Price | SAVE |
|--------------------------------|---------|-----------|---------|
| HP-85 Microcomputer | 3250.00 | 2475.00 | 775.00 |
| HP-83 Microcomputer | 2250.00 | 1777.00 | 473.00 |
| 16K Exp-Memory Module | 295.00 | 255.00 | 40.00 |
| Graphics Plotter 7225 | 2450.00 | 2075.00 | 375.00 |
| Personality Mod. for 7225 | 750.00 | 665.00 | 85.00 |
| 2631B Impact printer | nny dly | 3250.00 | 700.00 |
| Option 020 for 2631B | 150.00 | 125.00 | 25.00 |
| 8 Drives to choose from | | | |
| 829025 | 1300.00 | 1125.00 | 195.00 |
| 9895A 8" Dual Drive | 6850.00 | 5500.00 | 1350.00 |
| Graphics Tablet 9111A | 2050.00 | 1678.00 | 374.00 |
| HP-41 CV New 2.2 bytes mem | 325.00 | 250.00 | 75.00 |
| HP-41-C Calculator | 250.00 | 185.00 | 65.00 |
| Card Reader for 41CV-C | 215.00 | 162.00 | 53.00 |
| Printer for 41CV-C | 385.00 | 289.00 | 101.00 |
| Optical Wand for 41 CV-C | 125.00 | 97.00 | 28.00 |
| Quad Ram equals 4 Mem. Mods | 95.00 | 81.00 | 14.00 |
| Memory Modules for 41C | | 25.00 | \$ |
| HP-97 Programmable Printer | 750.00 | 595.00 | 175.00 |
| HP-67 Programmable Calculator | 375.00 | 295.00 | 80.00 |
| HP-34C Programmable Scientific | 150.00 | 117.00 | 33.00 |
| HP-38C Programmable Bus R/E | 150.00 | 117.00 | 33.00 |
| HP-32E Adv. Scientific | 55.00 | 48.00 | 7.00 |
| HP-37E Business Mgmt | 75.00 | 57.00 | 18.00 |

We carry a large inventory of Libraries, accessories and supplies.

PRINTERS



| | List | Our Price | SAVE |
|----------------------------------|---------|-----------|--------|
| PAPER TIGER | | | |
| 445G with Graphics | 795.00 | 695.00 | 100.00 |
| 460G with Graphics | 1394.00 | 1195.00 | 199.00 |
| 560G New full-size | 1695.00 | 1399.00 | 296.00 |
| EPSON | | | |
| MX Impact | 645.00 | 450.00 | 195.00 |
| MX 70 Impact | 500.00 | 399.95 | 100.05 |
| MY 100 | 995.00 | 895.00 | 100.00 |
| CENTRONICS | | | |
| 737.1 Parallel | 995.00 | 799.95 | 195.05 |
| 737.3 Serial | 1045.00 | 899.95 | 145.05 |
| DIABLO (Letter Quality) | | | |
| 630 R102 bi-directional tractors | 2965.00 | 2699.00 | 266.00 |
| 1640K109 keyboard, tractors | 3072.00 | 2899.95 | 172.05 |
| 630 RO Receive Only | 2740.00 | 2499.95 | 240.05 |
| 1650K 136 keyboard, tractors | 3220.00 | 2999.95 | 220.05 |

SPECIAL OF THE MONTH

QSTAR PRESENTS THE QRAM

16K RAM Expansion Board for the Apple II

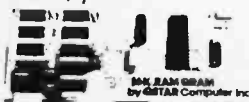

- Expands your 48K Apple to 64K
- Works with Microsoft Z-80 card, VisiCalc, USA ver 2.0 and other software
- Eliminates the need for an Applesoft* or Integer Basic ROM card
- Includes installation and manual of programmable memory
- Fully assembled and tested
- FULL ONE YEAR warranty including parts and labor

Introductory Price: \$149.00

APPLE II STUDENT SYSTEM

SAVE \$655

List \$2450.00



Our Price

\$1795

- Apple II Plus System- 48K RAM
- Disk II Floppy Disk & Interface (DOS 3.3)
- 12" BMC Video Monitor

MONITORS

| | List | Our Price | SAVE |
|---------------------------|----------|-----------|----------|
| NEC Grn.Phos. 12" | \$285.00 | \$239.99 | \$ 46.00 |
| BMC Green Phosphorous 12" | 275.00 | 229.00 | 46.00 |

SANYO MONITORS

High Resolution, Number 1 seller!

| | List | Our Price | SAVE |
|-----------------------------------|----------|-----------|----------|
| 13" Color (new) high quality | \$550.00 | \$388.00 | \$162.00 |
| 12" Green Phosphorous | 360.00 | 235.00 | 125.00 |
| 12" Black & White | 340.00 | 217.00 | 123.00 |
| 15" Black & White | 370.00 | 235.00 | 135.00 |
| 9" Black & White The Best Seller! | 235.00 | 145.00 | 90.00 |

DISKETTES SOLD IN BOXES OF 10 (Min. Purchase)

BUY \$100 of the Following Diskettes

| | List | Our Price | SAVE |
|---------------------------------------|---------|-----------|---------|
| DYSAN | | | |
| 1041 5" SOFT SECTOR | \$ 6.00 | 3.99 | \$ 2.01 |
| 1041D = " DBL DEN. SOFT SEC. | 6.40 | 4.60 | 1.80 |
| 3740 1/8" SOFT SECTOR | 7.25 | 4.75 | 2.50 |
| 3740 1/8" DBL DEN. SOFT SECTOR | 10.75 | 6.90 | 3.85 |
| MAXELL | | | |
| MD-1 5" SOFT SEC. TOR/DBL DEN. | 5.00 | 3.50 | 1.50 |
| MD-2 5" SOFT SECTOR/DBL SIDE/DBL DEN. | 7.00 | 4.90 | 2.10 |
| FD-1 8" SOFT SEC./DBL DEN. | 6.50 | 4.50 | 2.00 |
| FD-2 8" SOFT SEC./DBL SIDE/DBL DEN. | 8.50 | 5.95 | 2.55 |
| MEMOREX | | | |
| 5" 3401 5" SOFT SECTOR | 4.40 | 2.55 | 1.85 |
| 5" 3420 5" SFT. SEC./DBL DEN. | 5.60 | 3.90 | 1.70 |
| 8" 3000 8" SOFT SECTOR | 5.40 | 3.10 | 2.30 |
| 8" 3090 8" SFT. SEC./DBL DEN. | 5.90 | 4.10 | 1.80 |
| 43C1 | 4.00 | 2.05 | 1.95 |

SOFTWARE FOR APPLE II

We will not be undersold



| | List | Our Price | SAVE |
|--|----------|-----------|----------|
| Dow Jones Portfolio Folder | \$ 50.00 | \$ 39.00 | 11.00 |
| Microchess 2.0 Chess Disk | 25.00 | 19.00 | 6.00 |
| The Controller 4.1 General Business System (16 Sector) | 625.00 | 499.00 | 126.00 |
| Apple Post | 50.00 | 39.00 | 19.00 |
| The Shall Games Education I | 30.00 | 24.00 | 6.00 |
| Elementary, My Dear Apple-Education II (16 Sector) | 30.00 | 24.00 | 6.00 |
| Apple How To Education III (16 Sector) | 50.00 | 40.00 | 10.00 |
| Apple Bowl | 25.00 | 19.00 | 6.00 |
| Apple Writer | 75.00 | 60.00 | 15.00 |
| DOS Tool Kit (16 Sector) | 75.00 | 60.00 | 15.00 |
| Dow Jones News & Quotes Reporter (16 Sector) | 95.00 | 76.00 | 19.00 |
| Apple Stellar Invaders | 25.00 | 19.00 | 6.00 |
| Apple Pilot | 70.00 | 49.00 | 21.00 |
| Apple Adventure | 35.00 | 28.00 | 7.00 |
| Apple Music Theory (16 Sector) | 50.00 | 39.00 | 11.00 |
| Apple Tax Planner (16 Sector) | 120.00 | 96.00 | 24.00 |
| Cassettes | | | |
| Integer Basic Cassette Demos (6 tapes) | 30.00 | 24.00 | 6.00 |
| Applesoft Cassette Demos (5 tapes) | 25.00 | 19.00 | 6.00 |
| Apple Fortran | 200.00 | 147.00 | 53.00 |
| DOS 3.3 (16 Sector) | 60.00 | 45.00 | 15.00 |
| Apple Pilot (16 Sector) | 150.00 | 119.00 | 31.00 |
| SOS Tool Kit (16 Sector) | 75.00 | 60.00 | 9.00 |
| Apple FORTRAN (requires A280006) (16 Sector) | 200.00 | 159.00 | 41.00 |
| Language System with Apple Pascal | 495.00 | 399.00 | 96.00 |
| Apple III - Information Analyst | 500.00 | 350.00 | 150.00 |
| Apple Mail List Manager | 150.00 | 130.00 | 20.00 |
| Apple Business Basic | 250.00 | 219.00 | 31.00 |
| Apple System Software & Manuals | 250.00 | 219.00 | 31.00 |
| BPI General Ledger System | \$395.00 | \$319.00 | \$ 76.00 |
| BPI Inventory Package | 395.00 | 319.00 | 76.00 |
| Visidex | 200.00 | 159.00 | 41.00 |
| VisiCalc | 200.00 | 159.00 | 41.00 |
| Desktop Plan II | 200.00 | 159.00 | 41.00 |
| MicroLab Database System | 150.00 | 119.00 | 31.00 |
| Stoneware DB Master | 189.00 | 150.00 | 39.00 |
| Programma Apple Pie | 129.00 | 97.00 | 32.00 |
| Muse SuperText II | 150.00 | 119.00 | 31.00 |
| Softape Magic Window | 99.00 | 72.00 | 27.00 |

1 Year Extended WARRANTY

\$99.00

INQUIRE

8 WINGS SERVICE ELECTION SATISFACTION

MICRO BUSINESS WORLD MAIL ORDER WAREHOUSE

18720 Oldland, Suite 100, Turzina, CA 94534

PHONE: (415) 441-1111 FAX: (415) 441-1111

Name (Please Print) _____

Address _____

City _____ State _____ Zip _____

Q# _____ Make _____ Model _____ Description _____ Price _____ Total _____

CREDIT CARD * _____

Exp. Date _____ Signature _____

TOTAL DUES: _____

TAX IF APPLICABLE * _____

SHIPPING & HANDLING * _____

CREDIT CARDS ADD 3% * _____

TOTAL INCLUDED \$ _____

*California residents add 6% sales tax

*Add 3% for Shipping & Handling - Add 3% surcharge for credit cards

Orders cannot be shipped unless accompanied by payment including shipping and handling and tax where applicable.

We reserve the right to correct typographical errors. This ad supersedes all previous ads.

For the projection to cover the entire viewing surface, the viewport must cover the physical limits of the device. This happens by default since a CALL VIEWP was not executed. For the HP9872A, this is equivalent to entering the following at line 28:

```
CALL VIEWP(IGCB,0.,152.,0.,100.)
```

The entire logo is projected because the window chosen was of the appropriate size and used units corresponding to the units in which the coordinates of the linear segment approximation were entered.

The resulting output is slightly distorted because the AR for the window and the viewport differ. The viewport AR defaulted to 1.52 (380 mm wide by 250 mm high), and the AR for the window is 355/130, or approximately 2.73.

2. Set window to encompass the logo; set viewport aspect ratio to correspond to window aspect ratio (SETAR); and default LIMIT and VIEWP parameters.

```
CALL WINDOW(IGCB,0.,355.,0.,130.)
CALL SETAR(IGCB,2.73)
```

The resulting output is an undistorted projection of the logo centered in the vertical direction and covering the total viewing surface in the horizontal direction (see figure 3). The entire logo was projected because the win-

dow was determined the same way as in the previous example.

The projection was centered in the vertical direction and covered the total horizontal view surface because of the viewport reconfiguration that occurs when the SETAR routine is implemented. With SETAR set to 2.73, the reconfigured viewport corresponds to a rectangle with an AR of 2.73 being shrunk until it just fits within the old viewport. When a rectangle with a 2.73 AR is shrunk to fit within a rectangle with a 1.52 AR, the horizontal dimension will be totally filled and the vertical dimension will have unused space.

As prescribed by the SETAR routine, the reconfigured viewport will be centered in the vertical direction and totally cover the horizontal view surface. When the image within the window is mapped to this reconfigured viewport, it will project an image covering the horizontal direction and centered in the vertical direction. The resulting image is undistorted because the AR of the viewport was designated as 2.73 by SETAR, and the aspect ratio for the window was also 2.73.

3. Set window to encompass the logo; set viewport aspect ratio to correspond to window aspect ratio (SETAR); set the physical view surface (LIMIT) to correspond to an 8½-inch by 11-inch viewgraph; default VIEWP parameters.

STATPRO:

MAINFRAME STATISTICS ON AN APPLE

Statpro is a PASCAL software package designed for the professional researcher seeking solutions with a minimum of effort.

Statpro is grouped into a modular format for sales purposes yet which allows the user to transfer data between modules and other programs with easy to use prompts.

All Statpro modules include at no extra charge:

- | | |
|-------------------------------|------------------------------------|
| (1) Real number data base | (2) Data transformations |
| (3) Questionnaire database | (4) Mailing label database |
| (5) General category database | (6) Graphic printing & editing |
| (7) Corvus compatibility | (8) Sample data for first time use |
| (9) Does cross tabulation | |

Statpro is an integrated database system designed for extensive number crunching.

Statpro, unique in being non-memory dependent allows databases to be limited in size only by disk space. Statpro can enter, receive, send, sort, and transform data.

Transformations include Arithmetic Logarithmic, Exponential, Trigonometric, Powers & Square Roots, Conversions, Random Numbers, Standardized Observations and over 40 English to Metric or Metric to English conversions. Statpro contains several statistical analysis programs, all interlinked and designed to analyze the database records.

Among other features, Statpro has extensive color graphic capabilities, a graphic screen editor, multiple plots per screen, user or computer defined access limits, and choice of symbols and lines. Printing a graph only takes 30 to 120 seconds depending on whether the printer is on Anadex, Epson, Paper Tiger or Silen-type.

(send for brochure)

Blue Lakes Computer

3240 University Ave.
Madison, WI 53705
(608) 233-6502

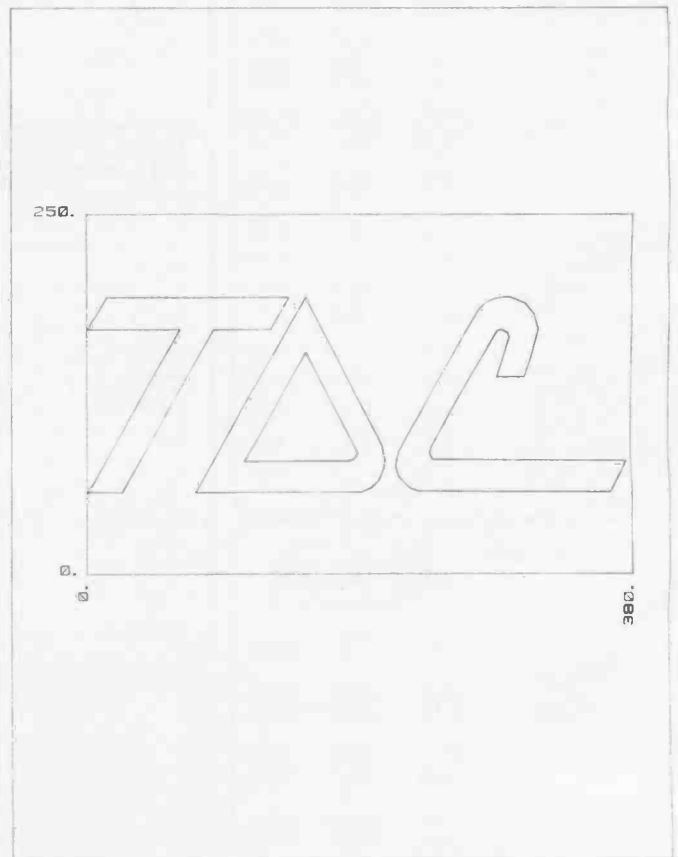
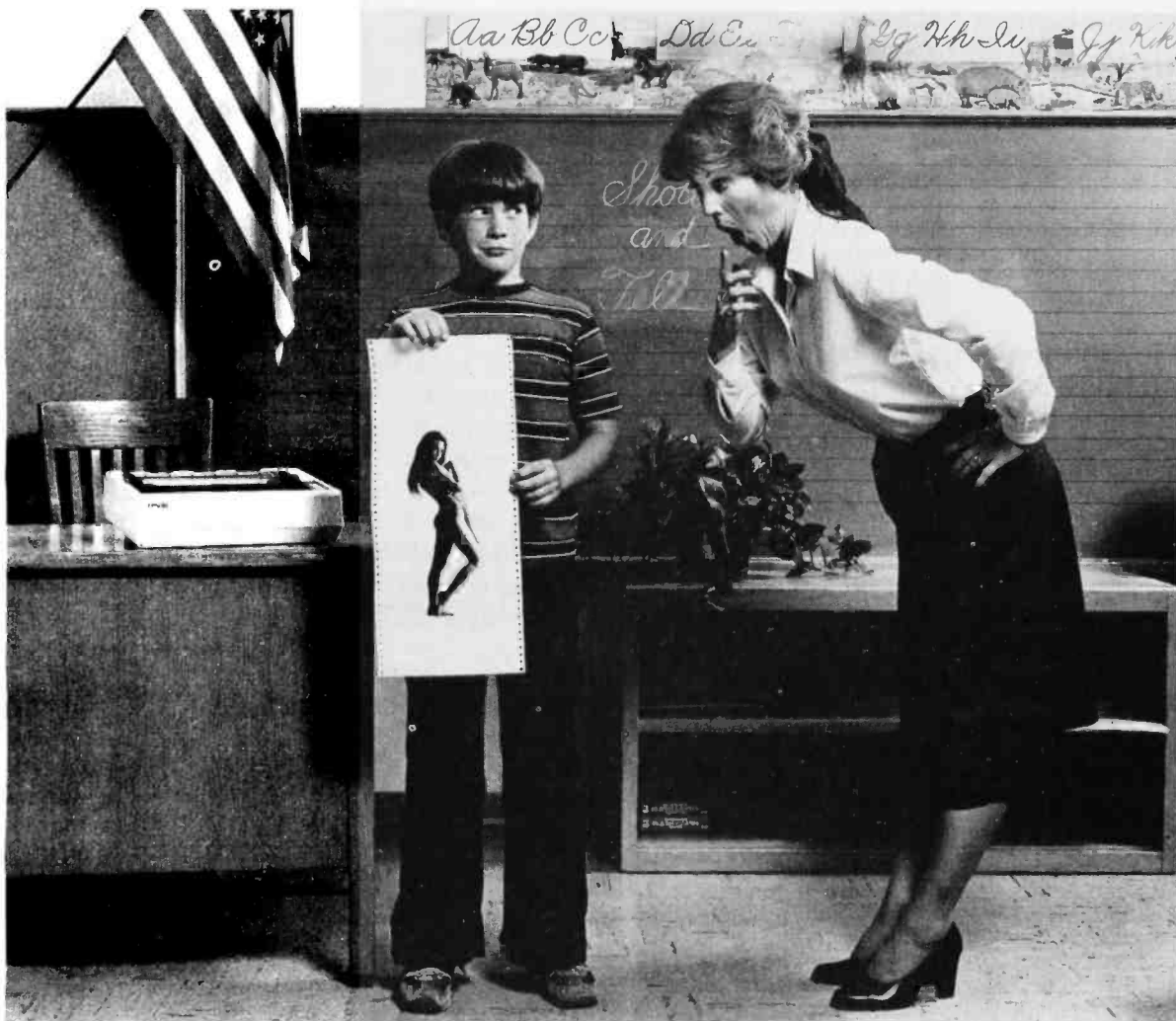

Figure 3: An undistorted projection of the logo vertically centered and covering the total viewing surface in the horizontal direction. Window aspect ratio is equal to viewport aspect ratio.



...And my dad says GRAFTRAX 80
does better graphics than anybody.

Epson.

You might say it's the head of its class. GRAFTRAX 80 gives you the highest resolution dot matrix in the world — up to 120 dots per inch horizontally and 216 dots per inch vertically. Which makes our MX-80 and MX-80 F/T work more like a plotter than a printer.

And that's just for starters.

GRAFTRAX 80 more than doubles the features available in an Epson MX-80 or MX-80 F/T. For instance, we've added nice little touches like an italic character set — which doubles the number of font types to 24. And with GRAFTRAX 80, you can change style, size and density anywhere in the line. And backspace the head. And use block graphics with *any* computer. And redefine all escape codes under software control.

Up to now, you couldn't get some of these features at *any* price. With GRAFTRAX 80, you get 'em all. And more. Lots more.

Best of all, we haven't forgotten all those people who already own an MX-80 or MX-80 F/T. You own the printer that set the standards all the others are following. And you can install GRAFTRAX 80 PROMs yourself, for less than \$100. And make the best even better.

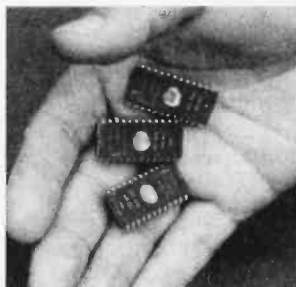

You can see why we say GRAFTRAX 80 is the head of its class. There's nothing else *in* its class.

EPSON
EPSON AMERICA, INC.

3415 Kashiwa Street • Torrance, California 90505 • (213) 539-9140

Introducing a totally new world in professional software for the Apple II and Commodore Pet.

Until recently, the tremendous explosion in micro-computer technology left an unfilled void in real quality software. MicroCraft Systems is totally dedicated to filling that void for the Apple II and the Commodore Pet. With powerful, elegant and versatile software.

Beyond the software house. To a complete 6502 development system.

More than a software distributor or discount house, MicroCraft Systems now provides you with access to a whole new spectrum in software systems. MicroCraft software includes: MacroLink, a complete macroassembler for the 6502, SuperEdit, a full-screen editor with a superb range of powerful capabilities plus, DiskScreen, a screen-oriented disk utility. Complete System \$200/\$40

MacroLink \$125/\$20

Uses text files for source code • Links source code or object code programs • Fully nestable file include capability • Recursive macros • Nestable conditional assembly • Over 50 error messages • File I/O macros • Sample programs • Disk assembler: source code need NOT fit in memory.

SuperEdit \$75/\$20

Full Screen Editor • Single keystroke commands • Uses standard text files • Move cursor by character, line or page • Block move and copy • Search and replace • Macro capability • Plus extra software: SuperEdit '56 x 27' provides 56 x 27 character screen for Apple II • And more!

DiskScreen \$40/\$10

Displays a complete sector in hex and ASCII • Completely visual and interactive • Sector move and copy • To change byte value, move cursor and type.

NOTE: All programs require single disk drive. MacroLink also requires 48K. First price: software and manual. Second price: manual only (applied toward purchase of software).

Call or write for our complete MicroCraft Systems catalog at no extra charge. Other programs include: S.T.A.R. Reading Program • "C" Compiler • Graphics Development Systems • Programs in ROM • SuperEdit for 80 x 24 video cards



MicroCraft Systems, Inc.
In software systems, a name to remember.

188 Kerby Road
Grosse Pointe Farms, MI 48236
(313) 881-3089

Source I.D. CL0472 MicroNet I.D. 70270, 222

VISA or MasterCard accepted. Inquire at your local computer store or order direct.

```
CALL LIMIT(IGCB,0.,215.,0.,280.)
CALL SETAR(IGCB,2.73)
CALL WINDW(IGCB,0.,355.,0.,130.)
```

The resulting output is an undistorted projection of the logo centered in the vertical direction and covering the width of a viewgraph (see figure 4). The restriction of the projection to an 8½-inch by 11-inch area located at the lower left of the device results from setting LIMIT. VIEWP is still defaulted to LIMIT, and the other parameters are the same as for the previous example. As the viewport is shrunk down to fit within LIMIT, it will fill the viewgraph in the horizontal direction and be centered in the vertical direction.

4. Set window to encompass logo; set physical view surface (LIMIT) to correspond to an 8½-inch by 11-inch viewgraph; set viewport to five different locations (line 28); default SETAR.

```
CALL LIMIT(IGCB,0.,215.,0.,280.)
CALL WINDW(IGCB,0.,355.,0.,130.)
CALL VIEWP(IGCB,6.,40.,6.,18.5)      AR = 2.73
                                     (Lower left AR = 2.73)
CALL VIEWP(IGCB,40.,94.,6.,25.8)    (Lower right AR = 2.73)
CALL VIEWP(IGCB,6.,70.,100.5,124.)  (Upper right AR = 2.73)
CALL VIEWP(IGCB,70.,94.,116.2,124.) (Upper left AR = 2.73)
CALL VIEWP(IGCB,20.,80.,25.8,100.5) (Center AR = 0.79)
```

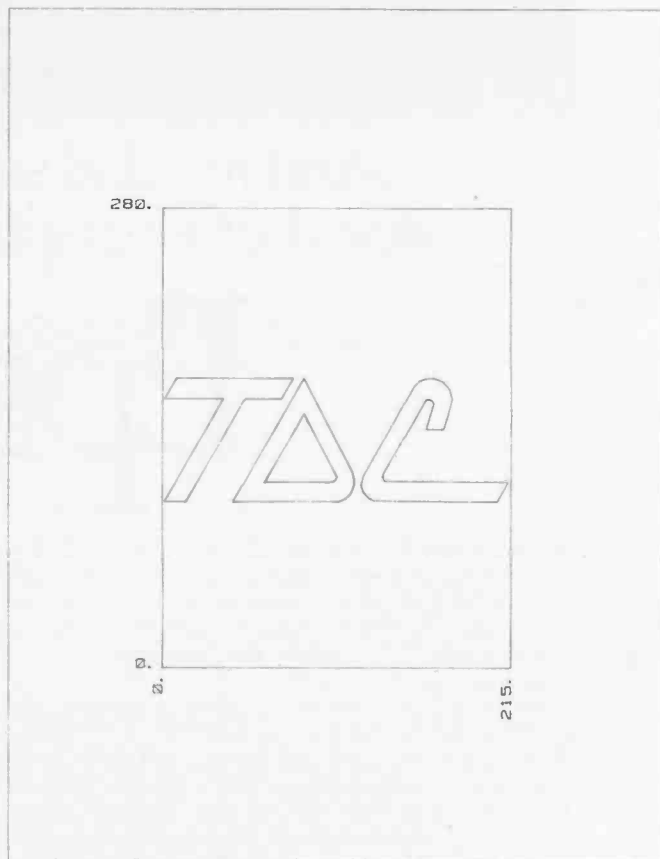

Figure 4: The viewing surface changed to 8½ inches by 11 inches (215 mm by 280 mm). The logo is undistorted, centered in the vertical direction, and expanded to cover the entire viewing surface in the horizontal direction.

QUEST

A SELF-COMPILING RELATIONAL DATABASE

DATABASE SELECTION —

- Uses screen masks to form query
- Provides extensive search capabilities
- Search arguments can include arithmetic/boolean functions, multi-field comparisons
- Queries can generate input for automatic database maintenance
- Queries can be stored in "Query Library" and executed from menu on demand
- Any number of fields can be queried concurrently
- Query output can be routed to disk, CRT report formatter, VISICALC™ or SOURCE™

DATABASE MAINTENANCE —

- Uses sophisticated screen formatting & data entry, like on IBM 3270's!
- Generates it's own screens automatically!
- Handles records up to 4K in length, using multiple screen "Pages"!
- Automatic data compression for increased disk capacity
- Uses SuperKram access method for incredibly fast access, **LESS THAN .2 SECONDS FOR A RECORD!**
- Automatic index creation/maintenance
- Automatic maintenance capabilities
- "Goof-Proof" error handling
- Input can come from VISICALC™ or SOURCE™

DATABASE REPORTING —

- Automatic headlines
- Automatic field editing
- Report fields can be calculated, sub-totaled & cross-footed in any manner desired
- Optional counter breaks may be set
- Automatic grand totals
- Automatic statistics

REQUIREMENTS —

SuperKram (available separately) and: Commodore Pet 32K (40 or 80 col.) and 2040/4040/8050 disk OR Apple II 48K with Applesoft or language system and 2 disk drives or CORVUS.

ONLY \$225

USA UNITED
SOFTWARE
OF
AMERICA
750 THIRD AVE.
NEW YORK NY 10017

Look for the RED-WHITE-BLUE
United Software Display at your local
computer dealer, or send check or
moneyorder, plus \$3.00 shipping

(212) 682-0347 Telex 640055

The resulting output is five projections of the logo within the 8½-inch by 11-inch area. The four corner projections are of various sizes, all undistorted. The center projection is distorted from that of the original sketch (see figure 5).

To understand the significance of the VIEWP parameters entered, the consequence of defaulting the SETAR subroutine must be considered. Not calling SETAR defaults the viewport to the area delimited by LIMIT (the 215-mm by 280-mm viewgraph area). Because the viewport is a rectangle corresponding to the viewgraph area, it has an AR of 0.768 ($215/280 = 0.768$). For the purpose of determining the vertical parameters for viewport positioning, therefore, the height of the viewgraph corresponds to 131 units. (Referring to the explanation of VIEWP: if AR is less than 1, then the vertical view surface is $100/AR$ units, or in this case $100/.768 = 131$ units).

In like manner, the width of the viewgraph corresponds to 100 units. (If AR is less than 1, the horizontal length corresponds to 100 units.) It is of little consequence to calculate parameters for positioning desired viewports. But if undistorted projections are desired, the viewports must be defined with an AR equal to that of the window (2.73). Subsequently, the corner viewports (calculated with an AR of 2.73) generate undistorted projections, while the center viewport calculated with an aspect ratio of 0.79 generates a distorted projection.

Summary

This article is not designed to make you a graphics expert. You still may not know a logical view surface from an illogical one, and normalized device coordinates may not strike you as normal at all. But your perspective on the graphics process should now be broad enough to let you tackle more detailed technical explanations without losing sight of the basics. ■



Figure 5: Confined to an 8½-inch by 11-inch (215 mm by 280 mm) viewing surface, the logo has been projected in 5 different locations and sizes. The 4 corner locations appear undistorted (the aspect ratios of the viewport and the window are the same), while the central figure is distorted (aspect ratios of viewport and window are unequal).

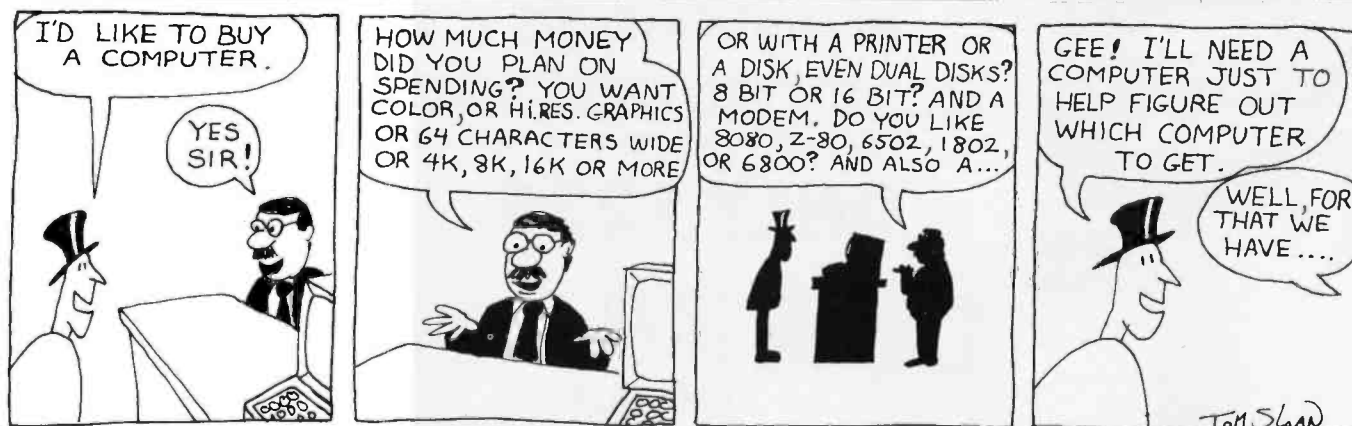

VERSAMODEM

\$119

BIZCOMP

Starting Today, BIZCOMP Takes Over as the Price/Performance Leader

We all know about the old fashioned acoustic coupler. Ask any computer hot-shot. Finicky, prone to room noise, vibration. A mechanical weak-link in your otherwise all-electronic system. RELIABILITY is the key to no-hassle computing. And everybody knows you don't get reliability with mechanical system components. So go ask that computer hot-shot—they'll tell you BIZCOMP's VersaModem all-electronic modem provides the new wave in personal communications. A fully FCC certified direct connection to the telephone network. Exciting? You bet!

Not only can you access The Source, MicroNet, Dow-Jones, Computer Bulletin Boards and University computers—the VersaModem offers access to a variety of specialized online databanks and timesharing services. The VersaModem is simple to install and operate. And it's compatible with standard data terminals and a host of personal computers.

Before you buy a computer modem, look at BIZCOMP's versatility. Look at BIZCOMP's quality. With BIZCOMP's VersaModem you won't need another modem. If your local computer store doesn't already have a VersaModem on display, ask them when they will!

BIZCOMP Communications...
Why not start with the best?

BIZCOMP

P.O. Box 7498 • Menlo Park, CA 94025 • 415/966-1545

Copyright © 1981 Business Computer Corporation

Circle 44 on Inquiry card.

Software Received

Apple

Clone Assembler, a 6502 assembler and disk-based, line-oriented text editor for the Apple II. Floppy disk, \$39.95. Clone Software, 1446 Estes St, Lakewood CO 80215.

Meteoroids in Space, a graphics arcade game for the Apple II and Apple II Plus. Floppy disk, \$9.95. Quality Software, 660 Reseda Blvd, Suite 105, Reseda CA 91335.

Space Raiders, a graphics arcade game for the Apple II and Apple II Plus. Floppy disk, \$29.95. United Software of America, 750 Third Ave, New York NY 10017.

Super Gomoku, a game that simulates checkers for the Apple. Cassette, \$9.95. United Software of America (see address above).

Super Stellar Trek, an adventure game for the Apple II. Floppy disk, \$39.95. Rainbow Computing Inc, 9719 Reseda Blvd, Northridge CA 91324.

Universal Boot Initializer, a utility program for the Apple II that will allow disks to be booted from either DOS 3.2 or 3.3. Floppy disk, \$40. S H Software, POB 5, Marvel ND 58256.

PET

Adventure at Pearl Harbor, a submarine battle game for the Commodore PET. Cassette, \$19.95. United Software of America, 750 Third Ave, New York NY 10017.

Piano Player, a music-generation program for the Commodore PET. Cassette, \$14.95. United Software of

America (see address above).

Space Intruders, a graphics arcade game for the Commodore PET. Cassette, \$29.95. United Software of America (see address above).

Super Gomoku, a game that simulates checkers for the PET. Cassette, \$9.95. United Software of America (see address above).

TRS-80

Balloon Bust, a circus game for the TRS-80 Model I Level II. Cassette, \$15.95. Programma International, 3400 Wilshire Blvd, Los Angeles CA 90010.

Blockade, graphics arcade game for the TRS-80 Color Computer. Cassette, \$10; source list, \$5. Bank Software, 37 Balmoral Dr, Spring Valley NY 10977.

Breakout, graphics arcade game for the TRS-80 Color Computer. Cassette, \$10; source listing, \$5. Bank Software (see address above).

Runaway Racer, a car-racing simulation game for the TRS-80 Model I Level II. Cassette, \$15.95. Programma International (see address above).

Space Colony, an arcade game for the TRS-80 Model I Level II. Cassette, \$15.95.

Programma International (see address above).

Scrip-Fix, a patch for the Scripsit word-processing system for the TRS-80 Model I. Cassette, \$9.95. Programma International (see address above).

Space Intruders, an arcade game for the TRS-80 Model I and III. Floppy disk, \$19.95. Adventure International, POB 3435, Longwood FL 32750.

Starship, graphics arcade game for the TRS-80 Color Computer. Cassette, \$10; source listing, \$5. Bank Software (see address above).

Super Gomoku, a game that simulates checkers for the TRS-80. Cassette, \$9.95. United Software of America, 750 Third Ave, New York NY 10017.

ZX80

A Night in Las Vegas, a Las Vegas gambling simulator for the Sinclair ZX80. Cassette, \$9.95. Lem Laboratories, POB 2382, La Jolla CA 92038.

ZX80 Double Breakout, a graphics arcade game for the Sinclair ZX80. Cassette, \$14.95. Softsync Inc, POB 480, Murray Hill Sta, New York NY 10156. ■

CAT-100 FULL COLOR GRAPHICS

The original 256-color imaging system with high resolution video FRAME GRABBER for the S-100 bus.

Capture and digitize a video frame in 1/60 of a second. Select the best resolution for your application, from 256 to 1280 pixels per TV line. Display your digitized or computer processed image with 256 gray levels or 256 colors on standard B&W, NTSC or RGB color TV monitors.



240x256 Digitized image, 16 levels

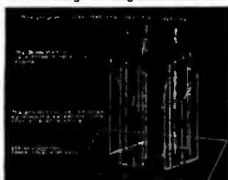

480x512 Computer-generated

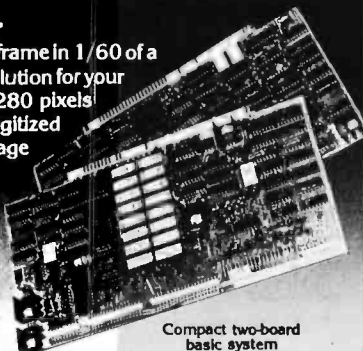

Compact two-board basic system

Features:

- Highest possible quality 480x512x8 digital video image presently available on the market
- Input capability from TV camera or other sources
- Variety of synchronization choices
- 2 selectable video A/D conversion circuits
- Choice of 1, 2, 4, 8, 16 or 32 bits per pixel
- 32K-byte image memory on the basic system
- 32, 64, 128 & 256K byte system capacity
- Lightpen input
- Photographic trigger control input
- Software selectable system parameters
- Interfaces for TRS-80 and other processors
- Comprehensive line of accessories, monitors and support software

SEND FOR FREE CATALOG



DIGITAL GRAPHIC SYSTEMS

935 Industrial Ave., Palo Alto, CA 94303 415/856-2500

This is a list of software packages that have been received by BYTE Publications during the past month. The list is correct to the best of our knowledge, but it is not meant to be a full description of the product or the forms in which the product is available. In particular, some packages may be sold for several machines or in both cassette and floppy-disk format; the product listed here is the version received by BYTE Publications.

This is an all-inclusive list that makes no comment on the quality or usefulness of the software listed. We regret that we cannot review every software package we receive. Instead, this list is meant to be a monthly acknowledgment of these packages and the companies that sent them. All software received is considered to be on loan to BYTE and is returned to the manufacturer after a set period of time. Companies sending software packages should be sure to include the list price of the packages and (where appropriate) the alternate forms in which they are available.

Ten reasons why your floppy disk should be a BASF FlexyDisk®.



More than four decades of experience in magnetic media—BASF invented magnetic recording tape, the forerunner of today's wide range of magnetic media, back in 1934, and was the first independent manufacturer of IBM-compatible floppy disks.

Tough Tyvek sleeve—no paper dust, no static electricity.

Special self-cleaning jacket and liner help eliminate data errors and media wear and tear.

Packaging to suit your requirements—standard flip-top box, Kassette 10® storage case, or bulk pack.

Center hole diameter punched to more accurate standards than industry specifications, for top performance.

100% certification—every single disk is tested at thresholds 2-3 times higher than system requirements, to be 100% error-free.

Bi-axially oriented polyester substrate—for uniform and reliable performance year after year.

For the name of your nearest supplier, write BASF Systems, Crosby Drive, Bedford, MA 01730, or call 617-271-4030.

Cross-linked oxide coating—for low head wear and long trouble-free media life.

Total capability—one of two manufacturers in the world that makes both 8" and 5.25" models, has tape and disk experience, and manufactures floppy disk drives.

Double lubrication—lubricants both in the formula and on the disk surface, to minimize media wear due to head friction.



BASF

Floppy Disks Mag Cards Cassettes Computer Tapes Disk Packs Computer Peripherals

Books Received

Active Filter Design Handbook, G S Moschytz and Petr Horn. New York: John Wiley & Sons, 1981; 17.5 by 25 cm, 316 pages, hardcover, ISBN 0-471-27850-5, \$45.

The Ada Programming Language, I C Pyle. Englewood Cliffs NJ: Prentice-Hall, 1981; 17.5 by 23.5 cm, 293 pages, softcover, ISBN 0-13-003921-7, \$14.95.

BASIC for Students: With Applications, Michael Trombetta. Reading MA: Addison-Wesley, 1981; 16 by 23.5 cm, 291 pages, softcover, ISBN 0-201-07611-X, \$9.95.

Build Program Technique: A Practical Approach for the Development of Automatic Software Generation Systems, John G Rice. New York: John Wiley & Sons, 1981; 15.5 by 23.5 cm, 372 pages, hardcover, ISBN 0-471-05278-7, \$29.95.

CDS/ISIS and MINISIS: A Functional Analysis and Comparison, Robert L Valantin. New York: UNIPUB, POB 433, Murray Hill Sta, 1981; 17.5 by 25 cm, 88 pages, softcover, ISBN 0-88936-296-3, \$6.50.

Computer Acronyms, Abbreviations, Etc., Claude P Wrathall. Princeton NJ: Petrocelli Books, 1981; 15 by 22 cm, 486 pages, hardcover, ISBN 089433-138-8, \$17.50. Also available in softcover for \$14.

Cryptography, A Primer, Alan G Konheim. New York: John Wiley & Sons, 1981; 16.5 by 24 cm, 432 pages, hardcover, ISBN 0-471-08132-9, \$34.95.

Digital Counter Handbook, Louis E Frenzel Jr. Indianapolis IN: Howard W Sams & Company, 1981; 13.5 by 22 cm, 264 pages, softcover, ISBN 0-672-21758-9, \$10.95.

Early British Computers, Simon Lavington. Bedford MA: Digital Press, 1980; 15

by 21 cm, 140 pages, softcover, ISBN 0-932376-08-8, \$8.

Educational Software Directory, Apple II Edition, Sterling Swift Publishing Company. Manchaca TX: Sterling Swift Publishing, 1981; 15 by 22 cm, 103 pages, softcover, ISBN 0-88408-141-9, \$11.95.

From ENIAC to UNIVAC, An Appraisal of the Eckert-Mauchly Computers, Nancy Stern. Bedford MA: Digital Press, 1981; 19 by 24 cm, 286 pages, hardcover, ISBN 0-932376-14-2, \$21.

Fundamental Concepts of Information Modeling, Matt Flavin. New York: Yourdon Press, 1981; 15 by 23 cm, 128 pages, softcover, ISBN 0-917072-22-7, \$10.

How to Design & Build Your Own Custom Robot, David L Heiserman. Blue Ridge Summit PA: Tab Books, 1981; 13 by 21 cm, 462 pages, softcover, ISBN 0-8306-1341-2, \$12.95; hardcover, ISBN 0-8306-9629-6, \$18.95.

How to Plan, Design and Implement a Bad System, Ronald B Smith. Princeton NJ: Petrocelli Books Inc, 1981; 14 by 22 cm, 157 pages, hardcover, ISBN 0-89433-148-5, \$14.

Introduction to Computer Organization, Ivan Tomek. Rockville MD: Computer Science Press, 1981; 16 by 23.5 cm, 456 pages, hardcover, ISBN 0-914894-08-0, \$21.95.

Linear Integrated Circuits, Practice and Applications, Sol D Prensky and Arthur H Seidman. Reston VA: Reston Publishing Company, 1981; 16 by 23.5 cm, 354 pages, hardcover, ISBN 0-8359-4084-5, \$21.95.

Microcomputer Architecture and Programming, John F Wakerly. New York: John Wiley & Sons, 1981; 17 by 23.5 cm, 692 pages, hardcover, ISBN 0-471-05232-9, \$27.95.

The Microelectronics Rev-

olution, edited by Tom Forester. Cambridge MA: MIT Press, 1981; 15.5 by 23.5 cm, 589 pages, softcover, ISBN 0-262-56021-6, \$12.50; hardcover, ISBN 0-262-06075-2, \$25.

The Minicomputer in On-Line Systems, Small Computers in Terminal-Based Systems and Distributed Processing Networks, Martin Healy and David Hebditch. Cambridge MA: Winthrop Publishers, 1981; 18.5 by 24 cm, 334 pages, hardcover, ISBN 0-87626-579-4, \$22.95.

Osborne CP/M User Guide, Thom Hogan. Berkeley CA: Osborne/McGraw-Hill, 1981; 19 by 23.5 cm, 283 pages, softcover, ISBN 0-931988-44-6, \$12.99.

Pascal Programming for the Apple, T G Lewis. Reston VA: Reston Publishing, 1981; 15.5 by 23 cm, 234 pages, softcover, ISBN 0-8359-5454-4, \$12.95.

A Primer on Pascal, Second Edition, Richard Conway, David Gries, and E Carl Zimmerman. Cambridge MA: Winthrop Publishers, 1981; 18.5 by 24.5 cm, 430 pages, hardcover, ISBN 0-87626-675-8, \$17.95; softcover, ISBN 0-87626-671-5, \$12.95.

The Programming Language Landscape, Henry Ledgard and

Michael Marcotty. Chicago IL: Science Research Associates, 1981; 16.5 by 24.5 cm, 460 pages, hardcover, ISBN 0-574-21340-6, \$22.95.

Robot Intelligence with Experiments, David L Heiserman. Blue Ridge Summit PA: Tab Books, 1981; 13 by 21 cm, 322 pages, softcover ISBN 0-8306-1191-6, \$9.95; hardcover, ISBN 0-8306-9685-7, \$16.95.

Software Design: Methods and Techniques, Lawrence J Peters. New York: Yourdon Press, 1981; 17.5 by 25.5 cm, 248 pages, softcover, ISBN 0-917072-19-7, \$23.

Structured Programming in FORTRAN, Louis A Hill Jr. Englewood Cliffs NJ: Prentice-Hall, 1981; 17.5 by 23.5 cm, 526 pages, softcover, ISBN 0-13-854612-6, \$15.95.

Take Aim: Volume I, James Hoyt Clark. Beaverton OR: Matrix Publishers, 1981; 388 pages, 22 by 28 cm, softcover, ISBN 0-916460-29-0, \$16.95.

Video/Computers, How to Select, Mix, and Operate Personal Computers and Home Video Systems, Charles J Sippl and Fred Dahl. Englewood Cliffs NJ: Prentice-Hall, 1981; 18.5 by 24 cm, 246 pages, softcover, ISBN 0-13-941849-0, \$7.95; hardcover, ISBN 0-13-941856-3, \$15.95. ■

This is a list of books received at BYTE Publications during this past month. Although the list is not meant to be exhaustive, its purpose is to acquaint BYTE readers with recently published titles in computer science and related fields. We regret that we cannot review or comment on all the books we receive; instead, this list is meant to be a monthly acknowledgment of these books and the publishers who sent them.

Now NRI takes you inside the new TRS-80 Model III microcomputer to train you at home as the new breed of computer specialist!

NRI teams up with Radio Shack advanced technology to teach you how to use, program and service state-of-the-art microcomputers...

It's no longer enough to be just a programmer or a technician. With microcomputers moving into the fabric of our lives (over 250,000 of the TRS-80™ alone have been sold), interdisciplinary skills are demanded. And NRI can prepare you with the first course of its kind, covering the complete world of the microcomputer.

Learn At Home in Your Spare Time

With NRI training, the programmer gains practical knowledge of hardware, enabling him to design simpler,



more effective programs. And, with advanced programming skills, the technician can test and debug systems quickly and easily.

Only NRI gives you both kinds of training with the convenience of home study. No classroom pressures, no night school, no gasoline wasted. You learn at your convenience, at your own pace. Yet you're always backed by the NRI staff and your instructor, answering questions, giving you guidance, and available for special help if you need it.

You Get Your Own Computer to Learn On and Keep

NRI training is hands-on training, with practical experiments and demonstrations as the very foundation of your knowledge. You don't just program your computer, you go inside it... watch how circuits interact... interface with other systems... gain a real insight into its nature.

You also work with an advanced liquid crystal display hand-held multimeter and the NRI Discovery Lab, performing over 60 separate experiments. You learn troubleshooting procedures

and gain greater understanding of the information. Both microcomputer and equipment come as part of your training for you to use and keep.

Send for Free Catalog... No Salesman Will Call

Get all the details on this exciting course in NRI's free, 100-page catalog. It shows all equipment, lesson outlines, and facts on other electronics courses such as Complete Communications with CB, TV/Audio and Video, Digital Electronics, and more. Send today, no salesman will ever bother you. Keep up with the latest technology as you learn on the latest model of the world's most popular computer. If card has been used, write to:



Training includes new TRS-80 Model III microcomputer, 6-function LCD Beckman multimeter, and the NRI Discovery Lab with hundreds of tests and experiments.

(TRS-80 is a trademark of the Radio Shack division of Tandy Corp.)



NRI Schools
McGraw-Hill Continuing
Education Center
3939 Wisconsin Avenue
Washington, D.C. 20016.

We'll train you for the good jobs!

BYTE LINES

News and Speculation About Personal Computing Conducted by Sol Libes

Smart Credit Card Uses EEPROM: SGS-ATES has introduced XCARD, an electronic credit card that uses an EEPROM (electrically erasable, programmable read-only memory) to keep track of your remaining credit. The EEPROM is encapsulated in a thin plastic card. It's inserted into a reader that accesses the data in the 17-word by 8-bit EEPROM and subtracts the amount charged by writing to the EEPROM. Fifteen bytes are alterable; the others are for identification and security code (to check for fraudulent erasure). Prototypes are being tested in Italy.

Big-Money Prizes In Computer Chess Battle: Big money is waiting for the computer chess program developer whose program defeats a human chess expert. *Omni* magazine is offering \$16,000 to the first program that can beat David Levy, the Scottish National Chess Champion (Elo rating of 2310). (Elo ratings are recognized by the World Chess Federation.) A Netherlands software firm will award \$50,000 to the developer of the first program that bests Max Euwe (Elo rating of 2540), and the Fredkin Foundation of Massachusetts will pay \$100,000 to the program that overpowers the standing world chess champion (typical Elo rating of 2700). Most experts feel these prizes could be won within the next five years, and will certainly be awarded within the next ten years. The United States Chess Federa-

tion has voted to permit computers to compete in sanctioned matches with human players. In 1983, there will be a team-chess tournament in which one team will be entirely computers.

VOS Gains In Popularity: Switching from one computer to another usually means jumping from one DOS (disk operating system) to another. Then, you have to learn how to operate an entirely new system, which often means redeveloping existing software so that it will run. In a commercial environment, this can be very expensive.

To overcome this problem, researchers at the Lawrence Berkeley Laboratory, University of California-Berkeley, have created a VOS (virtual-operating system) as an interface between the DOS and the hardware. Called Software Tools, the system has already been implemented on several dozen systems ranging from IBM, DEC (Digital Equipment Corporation), Honeywell, and Burroughs mainframes to minicomputers and even microcomputers using Digital Research's CP/M DOS. Using a VOS, an organization's software can outlive its hardware, which does away with costly software redevelopment.

The Software Tools VOS is supported by a user group that publishes a newsletter, directory, documentation, holds regular meetings, and makes the Software Tools software available on magnetic media for \$35. For more information contact

Debbie Scherrer, Lawrence Berkeley Laboratory, CSAM-50B/3209, University of California, Berkeley CA 94720.

Anglo-French Videotext Standard: British and French negotiators have agreed on a common videotext/teletext standard that makes Britain's Prestel and France's Antiope systems compatible. Canada also may adopt the standard, which could affect American videotext systems.

Robotics Update: Standard & Poor's predicts that robotic sales in this country will leap from less than \$100 million to nearly \$1 billion by the end of the decade. (As an aside, Japan already uses more than three times as many robots as the U.S.) General Electric has disclosed that it will replace 15,000 workers with 8000 robots during the next five years; and that if it cannot do this, it will not be able to compete economically.

Industrial robots currently cost in the \$7500 to \$250,000 range (with one specialized unit selling for \$2.5 million). The average price is around \$40,000, which is expected to fall to \$10,000 by 1983 as companies such as IBM and Texas Instruments are expected to enter the market.

Robots are projected to cost between \$1.75 to \$4.75 an hour, compared to the \$12 to \$15 per hour wages paid for skilled labor. Their greatest impact has been in the automobile, steel, and aerospace industries. Dr Richard John, Director of the Office of Energy and Environment, of the Transpor-

tation System Center, Cambridge, Massachusetts, has predicted that by 1985 automation will replace more than 200,000 workers in the auto industry.

The Fujitsu Francu robot factory, in Japan, reports that it operates 16 hours a day entirely by robots. Human workers come in for eight hours to complete the final assembly of the machines and robots. Fujitsu feels that it will have the plant completely robotized by 1985. Hitachi claims to have 500 scientists and engineers working on the development of a new generation of robots that will be able to "see, feel, and walk up and down the factory floor supervising other robots."

Microbot Inc of Menlo Park, California, has had its \$1700 robotic arm, used with a Radio Shack TRS-80, on the market for over a year. Thus far, 40 have been sold. Terrapin Inc has sold 150 of its Turtles, which can run a maze or draw pictures. But most of these units have gone into schools, not the home.

The problem is that the cost of a robot that will do meaningful tasks is still very high. Although low-cost sensors and mechanical components are available, a huge amount of expensive electronic processing is required. A general-purpose robot requires a multiprocessor, multitasking computer system, with a high degree of artificial intelligence so that the robot can sense its environment and respond properly within a reasonable time. More advances in artificial-intelligence programming techniques are still needed.



PERT/CPM TIMESAVER

As a project manager, you know the value of careful planning. Oversights and miscalculations can cost you crucial time and money.

MILESTONE is a powerful "Critical Path" Program that can be used for planning and analyzing virtually any project, from the opening of a retail store, to charting the progress of a police investigation; from drawing up a cost estimate for a construction project to scheduling the development (and involved expenses) of a new computer; from keeping track of rental equipment to allowing a winery to chart the evolution of a vintage Chardonnay from harvest to bottling. The applications are endless.

What's more, MILESTONE is one of the easiest software packages to use. Once

the working days, skill categories, wages or salaries and time increments are defined, then MILESTONE is ready to do the work for you. Change, for instance, the estimated completion date of a particular time-critical task, and you'll instantly see its effect on the entire project. All scheduling, manpower costs, associated reports, etc. are immediately re-tabulated. A calendar display allows you to visually follow the activities (200 per project with 64K RAM, 100 with 56K RAM). Examples are included on the disk.

TIME IS MONEY. SAVE BOTH WITH MILESTONE.

Price is \$295. Manual alone—\$30.

SOFTWARE
SOFTWARE
DIGITAL MARKETING
DIGITAL MARKETING

2670 Cherry Lane • Walnut Creek, CA 94596
(415) 938-2880

Dealer inquiries invited.
Dealers outside California call (501) 442-0864.
Inside California call (415) 938-2883.

MILESTONE.™ WHEN TIME IS MONEY.

**A PROJECT MANAGEMENT
AND TIME SCHEDULING
PROGRAM.**

Circle 123 on Inquiry card.



Milestone is a trademark of Organic Software.
CP/M is a trademark of Digital Research.
MILESTONE requires 56K RAM and CP/M. Also available for CP/M-86, Apple Pascal and UCSD Pascal. Specify 8080, Z80, CDOS, 8086, UCSD Pascal or Apple Pascal. Formats: 8" single density IBM soft-sectored, 5¼" NorthStar DD, Micropolis Mod II, Superbrain 3.0, Apple II.

BYTE LINES

Most experts agree that robots will move into the home just as computers have done—but this is still at least five years and maybe as much as 20 years away. We will probably see the first "home robots" performing only specific or limited sets of tasks. Most likely the first applications will be robotic aids for the handicapped. For example, Stanford University has modified an industrial robotic arm for use by quadriplegics. It recognizes voice commands, repeats them for verification, then acts accordingly. Also, it can pick up a telephone, fetch a book, turn pages, pour drinks, or hold a glass. The Veterans Administration is currently testing the unit.

Experimenters interested in building a robot should note that Hobby Robotics Company, POB 997, Lilburn GA 30247, has announced a mobile unit that consists of a body and two arm manipulators. It costs \$1495. The user must supply the electronics. Hobby Robotics also publishes a quarterly newsletter.

Heathkit will jump into the robotics market next year with an under-\$1000 robot kit. It will be mobile and will have a seven-motor manipulator, sonar-type sensor, a Motorola 6809-based controller, and an "experimenter's area" where users can wire circuits. There will be several modes of operation, including automatic and teach/learn modes. It will be primarily an educational tool, teaching modern industrial-control techniques.

New Scheme To Halt Software Piracy:

To cope with software pirates, suppliers have used nonstandard data formats, slashed their prices low, or tried to

ignore the problem. Some have printed their documentation in light blue ink to prevent photocopying.

But this resulted in a catch-22: the suppliers who use nonstandard formats have been severely criticized by purchasers who cannot make backup copies and must return the disk to the supplier if it is damaged. This is a real annoyance and, if the supplier charges for this service, engenders resentment. Format-independent programs that copy the disk bit by bit are available by popular demand.

Now, at long last, Micro Technology Unlimited, Raleigh, North Carolina, and Hal Chamberlin, creator of many innovative microcomputer features, have implemented a previously talked about method for preventing piracy: a software-readable serial number embedded in hardware. Here's how it works: the supplier integrates the code in the software when it is ordered. When the program runs, the two serial numbers are compared; if they do not match, the program doesn't run. Thus, users can make any number of copies and integrate a program with other software to form a new package.

I suspect that the serial number is embedded in a ROM (read-only memory) that uses an algorithm known only to the hardware manufacturer and licensed software vendors. It may use a PLA (programmable-logic array), which cannot be duplicated as simply as a ROM. Also, the software-checking routine has to be done in a clever and subtle way so that it cannot be easily located and bypassed.

Virtual Memory For Microcomputers:

Early

next year, Intel, Zilog, Motorola, and National Semiconductor will introduce integrated circuits to add VMM (virtual-memory management) to 16-bit microprocessors. This will give systems the large-capacity storage previously found only in large mainframes.

VMM creates a more efficient integration of the primary small (but fast) semiconductor main memory and the secondary (slow) large disk storage. It frees the programmer from worrying about the details of storage allocation. Also, it more efficiently manages the use of memory and disk storage when many users share memory.

Zilog, Motorola, and National Semiconductor also will introduce separate MMU (memory-management unit) integrated circuits to work with their 16-bit microprocessors. Intel will unveil a new version of its 16-bit microprocessor that will include an MMU circuit. The Zilog MMU will manage an 8-megabyte memory space compared to the others' 16-megabytes.

Super-Graphics: Nippon Electric Company (NEC) is about to go into production on a new graphics-controller integrated-circuit chip that will make super-color graphics possible on microcomputers. Listen to these specifications: displays 2048 by 2048 pixels (picture elements) in the black-and-white mode or 1024 by 1024 pixels in the color mode; generates all timing and synchronization signals; allows both graphics and text on the same screen; supports up to 64 K (16-bit word) display memory; contains hardware for drawing lines, arcs, circles, rectangles, and char-

acters at 800 ns per pixel; supports two display areas (independently pannable); has an auto-advance cursor; will display 256 characters per row and up to 100 rows per screen; will zoom display to sixteenfold; has a light-pen input; 8-bit interface for microcomputers; and DMA (direct-memory access) capability... all in one 40-pin package. Samples should become available next month with production quantities obtainable early next year. Single-quantity price is expected to be \$150.

To Be A 128 K-Bit Or A 256 K-Bit ROM—That Is The Question:

Although five integrated-circuit manufacturers are providing samples of the new 128 K-bit, or 16 K-byte, ROM (read-only memory), others have opted to skip the that size and go directly to 256 K bits (32 K bytes), notably Motorola. These large-sized ROMs are expected to be used mostly in high-level language processors, intelligent typewriters, smart terminals, language translators, and speech-synthesis systems. You can expect to see 128 K-bit ROMs on the market by year's end and the 256 K-bit ROMs by mid-1982.

Apple Computer Registers Stock Offering:

Apple Computer Inc has registered a proposed public stock offering of 2¼ million shares at \$27.50 each. (Its original offering last year was 5 million shares at \$22 each, although this rose \$7 minutes after going on sale.) Also, the president and vice chairman of Apple (A C Markkula and Michael M Scott) have granted the underwriters options to pur-

a new star is born!

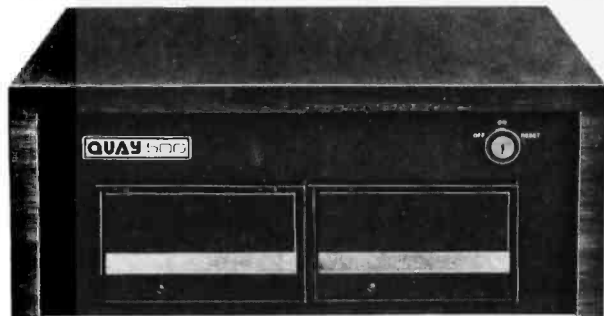

a better computer system
any way you look at it.

The facts speak for themselves. The QUAY 500 SERIES offers more for the money than North Star Horizon® computers.

MORE TECHNICAL FEATURES. A single board computer instead of a backplane with multiple boards, means fewer parts, fewer interconnections and fewer problems □ additional disk capacity for more program storage □ DMA controlled disk transfers for increased system performance □ on-board expansion capabilities for additional parallel and serial ports, and EPROM □ AC convenience outlets □ a more compact design.

IMMEDIATE DELIVERY. The 500 SERIES is available off the shelf for virtually immediate delivery. No waiting for far off delivery dates for this one.

LOWER PRICE. The advanced technology engineered into Quay computers actually lowers our cost to manufacture. The price of the 500 SERIES is about 20% lower than the Horizon-2-32K-D — and our 520 SERIES also offers significant savings over the Horizon-2-32K-Q.

The bottom line is simple. There is a new star in the computer field. The 500 SERIES by Quay. It outshines all of the competition.

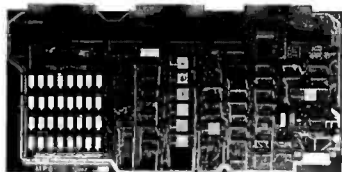

Advanced single board modular design.

COMPARE FOR YOURSELF:

| SPECIFICATION | QUAY 500 | HORIZON-2-32K-D |
|------------------------------|----------------|-----------------|
| Architecture | Single Board | S100 bus |
| CPU | Z80A, 4MHz. | Same |
| Dynamic RAM (std) | 64 Kb. | 32 Kb. |
| Disk drive type | Double density | Same |
| No. of drives (std/max) | 2/4 | Same |
| Capacity per drive (on-line) | 200 Kb. | 180 Kb. |
| Direct Memory Access (DMA) | Yes | No |
| CP/M® disk operating system | Standard | Optional |
| Unit Price | \$2,995. | \$3,095. |

| SPECIFICATIONS | QUAY 520 | HORIZON-2-32K-Q |
|------------------------------|--------------|-----------------|
| Disk drive type | Quad density | Same |
| Capacity per drive (on-line) | 400 Kb. | 360 Kb. |
| Unit Price | \$3,495. | \$3,595. |

The QUAY 500 offers technical superiority — availability — a \$2,500 price!

CP/M® Is a registered trademark of Digital Research

Horizon is a registered trademark of North Star Computers, Inc.

QUAY CORPORATION

P.O. Box 783, 527 Industrial Way West,
Eatontown, N.J. 07724 ■ (201) 542-7340

DISTRIBUTOR AND REPRESENTATIVE INQUIRIES WELCOME

Circle 314 on inquiry card.

chase up to 125,000 of their personal shares, reducing Markkula's and Scott's respective holdings to 12.5% and 4.9%. Xerox has pulled back its interest from 720,000 shares to 470,000 shares.

Apple spent \$9.1 million on research and development in the first half of 1981, compared with \$7.3 million for all of 1980. It also claims to have shipped more than 4000 Apple IIIs by the end of April.

FCC Revises Interference Rules:

The Federal Communications Commission (FCC) has revised its rules regarding the certification of small computers for radio-frequency interference (RFI). The revision clarifies the definition for exempt devices: self-contained devices with clock frequencies of 495 kHz or less are now exempt from certification. However, virtually all microcomputers presently sold have higher clock rates and are not exempt.

If your television set is bothered by RFI from your personal computer, citizen's band radio, etc, you may be interested in obtaining a free booklet entitled "How to Identify and Resolve Radio-TV Interference Problems." It is published and distributed by the FCC.

BASIC Standards Manual Published:

The Government Printing Office has published a two-volume standard on the BASIC language. The standard is based on the ANSI (American National Standards Institute) minimum criteria for the language. The 556-page document describes test programs to check if a BASIC implementation complies with the Federal Information Processing Standard 68 and

ANSI standard X3.60-1978.

Volumes 1 and 2 cost \$4 and \$9.50, respectively. Order them from the Superintendent of Documents, US Government Printing Office, Washington DC 20402. The order numbers are 003-003-02262-4 (Volume 1) and 003-003-02263-2 (Volume 2).

Xerox 820 Personal Computer:

Xerox has introduced a desk-top personal computer, called the Xerox 820. It costs \$2995. Its original internal code name was WORM, which stood for Wonderful Office Revolutionary Machine.

The Xerox 820 uses the Z80 microprocessor, has 64 K bytes of memory, two single-sided single-density 5-inch floppy-disk drives, and two serial and two parallel ports. A Diablo 630 printer is available for another \$2900, and an 8-inch floppy-disk (250 K-byte) drive is \$800.

The 820 uses the CP/M operating system (a de facto microcomputer standard), with certain limitations (e.g., CP/M's powerful input/output byte feature is not implemented). But, it is a significant boost for the CP/M-software market. Also, Xerox will offer Microsoft BASIC, CBASIC-II, COBOL-80, and several currently available CP/M-based software packages.

Xerox will furnish its own version of the popular WordStar word-processing software package. Most of its changes are in redefining the Control sequence functions—which undoubtedly will confuse users who are running the package on other systems.

The video display is memory-mapped and shares low-memory space via a bank I/O (input/output) port-

select scheme; the disk controller uses the popular 1771 integrated circuit. Reset causes a jump to a ROM (read-only memory) in high memory from which the user must boot CP/M, which does not start automatically. A Zilog SIO (serial I/O) integrated circuit is used to handle I/O operations. Although Xerox implies that the 820 can be used as a workstation in an Ethernet network, no internal Ethernet interface is provided at this time.

On the minus side, the Xerox machine has two Control keys, both positioned adjacent to the space bar (they may be easy to hit accidentally). Also, I wonder why Xerox used drives with only 92 K bytes storage per drive, when virtually everyone else has gone to double-sided or double-density drives with two or four times the storage capacity. Both HP (Hewlett-Packard) and IBM have introduced Z80-based personal computers; DEC (Digital Equipment Corporation) may follow suit. Further, Xerox will have to compete with several dozen machines with equal or better specifications, some of which are less expensive and have been available for as long as three years.

On the plus side, Xerox knows that its name can sell a lot of machines, and it has already signed up several large distribution organizations, such as Computerland. It is interesting to note that Xerox's 17 retail stores have been selling Apple computers, I wonder whether this, too, will continue?

Random News Bits:

Apple Computer is offering a free resource guide on using microcomputers as aids for the handicapped. It sum-

marizes work being done in the field and current projects. It includes a bibliography and where to go for help and advice. For a copy of "Personal Computers for the Physically Disabled: A Resource Guide," write to Apple Computer, Resource Guide, Marketing Services Department, 10260 Bandley Dr, Cupertino CA 95014. . . . The People's Republic of China will soon conduct its first national census. The US Commerce Department has sent the Chinese a computer and some US Census Bureau experts to help. The last census was done using the abacus. . . . CompuServe Inc, one of the largest time-sharing systems for home-computer users, claims to have 10,000 customers, concentrated mostly around New York City, the eastern seaboard, the Silicon Valley area, and Los Angeles. . . . Attendance at last April's San Francisco Computer Faire rose to almost 32,000. That's a jump of 12,000 over the year before. . . . The Strafford, Pennsylvania, Public Library has installed a coin-operated TRS-80. The library committee had hoped that students would use the computer for homework, but instead most played games. At fifty cents for 15 minutes, a user can access any one of 24 programs, including one that teaches BASIC. The machine was installed and operated by the same company that supplies the library's photocopier. . . . The Mount Sinai School of Medicine in New York City will conduct an investigation for the Newspaper Guild into possible health problems associated with the use of video-display terminals. . . . "Go public, young firm!" seems to be the cry since Apple tried it last December. Later this year, Vector Graphic, Intertec

Password

1323 RIVER ST.
— (408) 425-5411 —

Distributors
SANTA CRUZ, CA

Single Board System

- Z80A 4Mhz CPU and chip family (optional 6Mhz system)
 - Floppy disk controller which supports 5¼ and 8 inch drives simultaneously (total 4)
 - DMA for the floppy disk drives
 - 2 parallel and 2 serial communication ports
 - Bus expander from the CPU with 256 I/O ports
 - 64K bank select low power RAM
 - Hard disk support (up to 4 drives of mixed sizes)
 - Tape back up support
 - Supports both serial and parallel printers
- \$1295**

Qume Datatrak 8

\$545

Includes 1 year factory warranty

Qume Datatrak 5

\$315

Includes 1 year factory warranty

Qume Sprint 9/45

\$2295

Interlink Modem

- 300–600 baud
 - Asyn/Syn
 - Auto Dial
 - Auto Answer
 - Serial and modular jack interface
 - 2 year warranty
- \$119**

Light Pen

with cord and socket

\$75

Teletek FDC 1

4Mhz CPU

NEC 765 disk controller

\$605

1 year warranty

Floppy Disk

Add-Ons

- Dual double density drives
- Enclosure
- Power supply and fan
- All cables
- 1 year warranty

8" system **\$1375**

5¼" system **\$949**

**IMMEDIATE DELIVERY
QUANTITY DISCOUNTS**

INNOVATIVE PRODUCTS

COMPLETE CATALOG OF COMPUTER EQUIPMENT AT DISCOUNT PRICES.

ANOTHER BOMBSHELL FROM INNOVATIVE PRODUCTS!

\$299 64K—4Mhz.—IEEE Assembled & Tested
64K S-100 DYNAMIC RAM MEMORY

BY COMPUTER SYSTEM RESOURCES

Works with Cromemco, North Star, Teletex, Tarbell, most Z80 and 8080 systems even with DMA.

Guaranteed to work in your system or your money will be refunded within 15 days of purchase.

ALSO AVAILABLE PARTLY POPULATED:

16K \$239.00 32K \$259.00
 48K \$279.00

Q.T. COMPUTER SYSTEMS:

| MODEL | DESCRIPTION (ALL ASSEMBLED & TESTED) | PRICE |
|-----------|--|----------|
| MF•DD12A | 25 A Mainframe: 12 Slot, S100, Dual 8" Drive | \$625.00 |
| MF•18A | 25 A Tabletop Mainframe: 18 Slot, S100 | 450.00 |
| MF•12A | 25 A Mainframe: 12 Slot, S100, Dual 5" Drive | 450.00 |
| Z•80A | Single Board, Z-80 Computer 2/4 Mhz., S-100 | 185.00 |
| Z•80A/22 | Monitor Program for Z•80A & Tarbell or VF-1 | 30.00 |
| RAM 32 | 32K Static RAM Board, Low Power, S-100 | 499.00 |
| OTCIOA | 2 Serial & 4 Parallel Port I/O, S-100 | 339.00 |
| OTCCCSA | Clock Calendar Board, S-100 | 125.00 |
| OTCCCAA | Clock Calendar Board, for Apple | 125.00 |
| OTCCTRS80 | Clock Calendar Module for TRS-80 | 125.00 |

VISTA COMPUTER COMPANY:

| MODEL | DESCRIPTION (ALL ASSEMBLED & TESTED) | PRICE |
|---------|--|-----------|
| V300/25 | Letter Quality Printer, 25 CPS | \$1895.00 |
| V300/45 | Letter Quality Printer, 45 CPS | 2195.00 |
| V-DRIVE | Dual 8" Disk Cabinet, Power Supply, Rack Mountable | 375.00 |

COMPUTER SYSTEM RESOURCES:

| MODEL | DESCRIPTION (ALL ASSEMBLED & TESTED) | PRICE |
|---------|--|----------|
| RAM 16 | 16K Static RAM, S-100 | \$179.00 |
| RAM 16C | Low Power (CMOS) Version of RAM 16, 1.3 Watt | 259.00 |
| RAM 65 | 16K Static RAM, I/O Port Bank Select, S-100 | 189.00 |
| RAM 65C | Low Power (CMOS) Version of RAM 65, 1.4 Watt | 279.00 |
| RAM 32 | 32K Low Power 8 Bit Static RAM, 24 Address Lines | 499.00 |
| RAM 256 | 256K 8/16 Bit Dynamic RAM, Fully IEEE 696 | 1295.00 |
| I/O-8 | 8 Port Serial I/O, Fully IEEE, up to 200K BAUD | 395.00 |

ORDERING INFORMATION:

Minimum Order is \$15.00. Prices quoted do not include shipping and handling. Foreign orders require prepayment by MICR or Money Order in U.S. funds. Purchase Orders accepted from U.S. Government & firms with published A1 Rating from Dunn & Bradstreet. All other orders require prepayment, charge card, or COD shipment.

TOLL-FREE PHONE NUMBER:

Call Toll-Free: 1 (800) 423-5141. In Alaska, California, and Hawaii, call us collect at (213) 883-3244.

TO RECEIVE OUR FREE CATALOG:

Call our Toll-Free (800) number, or circle Reader Service #.

7131 OWENSMOUTH AVE. / #21D
 CANOGA PARK, CALIFORNIA 91303
 213 / 883-3244
 800 / 423-5141



BYTELINES

Data Systems, and Computer Factory Inc will follow Apple's lead. . . . New World Computer Company, Costa Mesa, California, has a novel way to provide Winchester floppy-disk drives have both fixed storage and a removable cartridge. New World has a drive with 4 megabytes fixed and 4 megabytes removable. It costs less than \$1200. . . . Micropolis Corporation will soon start shipping 5-inch floppy-disk drives with 2.2 megabytes formatted storage. . . . Apple will soon offer a videotext interface that will allow the Apple II and III computers to access Canada's Telidon system. AT&T has also decided to make its videotext Telidon-compatible. These systems can deliver computerized data to your home via either cable television, telephone lines, FM subcarrier, or unused television scan lines. Observers expect future enhancements of videotext to provide message/teleconferencing, picture manipulation/animation, and downloading of data files from large systems to personal computers. . . .

Random Rumors:

Word is that HP's (Hewlett-Packard's) personal-computer operations recently split off from the small-computer division and is now a separate entity. HP will soon introduce a multicolor plotter for its Series 80 personal computers. . . . Cromemco, one of the leaders in S-100 Z80-based systems, is expected to release a 68000-based 16-bit processor card that includes a Z80 coprocessor. Rumor is that Cromemco has been working on the card for almost two years. . . . Expect Godbout Electronics to introduce

68000 and 8086 S-100 cards before year's end. . . . It's rumored that DEC (Digital Equipment Corporation) is about to release a personal computer, as HP has already done. HP's system is called the HP-125 and uses a Z80. DEC's desk-top unit will probably contain a Winchester hard-disk drive and either an LSI-11 or a standard processor like the Z80. DEC is already using Microsoft BASIC in its GIGI graphics terminal. . . .

TRS-80 Meets IBM:

Radio Shack has three new software packages that allow various forms of communication between the TRS-80 Model II and IBM mainframe equipment. The first is Reformatter. It converts data on Model II TRSDOS 5-inch floppy disks to the standard IBM format (3741 single-density). This means that Model IIs can now be used for off-line data entry in businesses where System 360/370 or other 3741-compatible equipment is employed. The other programs allow "bisync" (binary synchronous) communications by emulating the IBM 3270 and 3780. The Model IIs serve as online and remote job-entry terminals for IBM 3270- and 3780-compatible equipment. Reformatter sells for \$249; the bisync packages sell for \$995 each, which includes installation by Radio Shack.

MAIL: I receive a large number of letters each month as a result of this column. If you write to me and wish a response, please include a self-addressed stamped envelope.

Sol Libes
 POB 1192
 Mountainside NJ 07081

IF YOU CAN RECOGNIZE VALUE, YOU CAN SAVE;

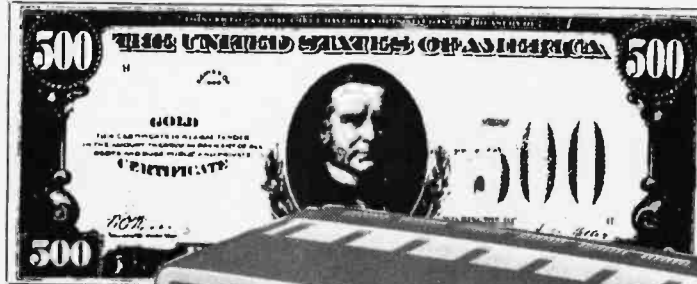

M.T.I. MOD III PLUS

Now You Can
Save \$500 over
comparable models.



*We have taken the basic 16K Model III expanded the memory to 48K and added our MTI Double Density Dual Disk Drive system. Our system is fully compatible with Radio Shack DOS and peripherals.

\$1998

*SAVE \$500. OVER
MODELS WITH COMP.
SPECIFICATIONS.

MOD III/EXPANDED

Same as above but has double storage capacity (708 storage). Your choice of 2 dual headed 40 track drives or 2 single headed 80 track disk drives.

\$2499

MOD III/280

Our largest MOD III, approximately 1.5 mega bytes of storage, utilizes 2 dual headed 80 track, double density disk drives. Complete with manuals and professional operating system. Microsystems DOS plus 3.3.

\$2799

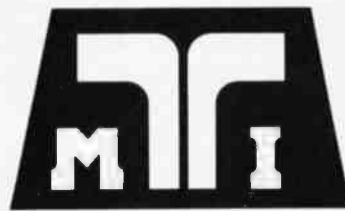

**MICROCOMPUTER
TECHNOLOGY INC.**
3304 W. MACARTHUR,
SANTA ANA, CA 92704
• (714) 979-9923 •

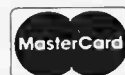

U.S. PRICES
F.O.B. SANTA ANA
CALIFORNIA

DEALER INQUIRIES INVITED

MTI MOD III SALES, PARTS & SERVICE CENTERS -INDEPENDENTS DEALERS

| | |
|----------------------|--------------|
| SAN JOSE, CA | 408 946-1265 |
| SANTA CRUZ, CA | 408 427-0836 |
| LANCASTER, CA | 805 942-5747 |
| HOLTVILLE, CA | 714 356-5185 |
| OXNARD, CA | 805 486-5837 |
| SAN DIEGO, CA | 714 275-4243 |
| TEMPE, AZ | 602 839-0546 |
| PHOENIX, AZ | 602 244-9739 |
| TUCSON, AZ | 602 323-9391 |
| SIERRA VISTA, AZ | 602 458-2479 |
| DENVER, CO | 303 696-0777 |
| CHEYENNE, WY | 307 632-9132 |
| TEXAS | 214 247-6679 |
| N. & S. DAKOTA | 701 594-5674 |
| MIDWEST | 618 345-5068 |
| JOPLIN, MO | 417 781-1748 |
| CLEVELAND, OH | 216 779-6040 |
| MAUMEE, OH | 419 893-4288 |
| GEORGIA | 404 449-8982 |
| FLORIDA | 305 980-9191 |
| TROY, N.Y. | 518 273-8411 |
| GROTON, CT | 203 445-5166 |
| OVERSEAS | |
| REP. OF SOUTH AFRICA | 021-45-1047 |
| AUSTRALIA | 03-877-6946 |

No risk Disk Drives

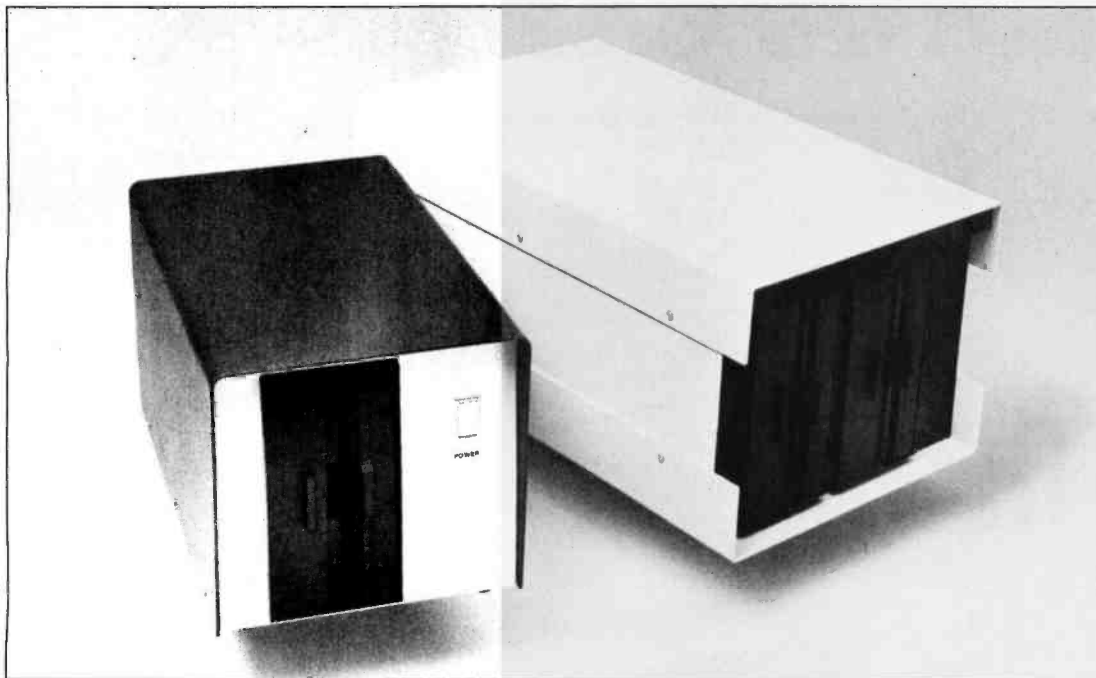

ASAP carries only the highest quality floppy disk drives, to provide you with years of trouble-free service and superior performance.

Data Trak™ double-sided double-density drives from Qume® feature state-of-the-art technology. You get superior data integrity through improved disk life, data reliability and drive serviceability.

Data Trak™ 5 (ANSI 5¼" compatibility) Call for price

Data Trak™ 8 (IBM compatibility) Call for price

Shugart drives have been setting industry quality and reliability standards for years. Shugart's Bi-Compliant™ head assembly provides superior media compliance and high reliability.

Model 801
(standard floppy) \$425.00

Model 850 \$640.00

Dual Disk Drive Cabinet .. \$265.00

ASAP also provides a full line of high reliability disk drive subsystems.

Part No. — Description* Price
DDC+8 sgl — Cabinet for single 8" floppy disk drive ... \$ 185.00

DDC+8-1 — Cabinet with (1) Shugart SA801R installed \$ 595.00

DDC+8-2 — Cabinet with (1) Qume® DT-8 double-sided double-density drive installed \$ 695.00

DDC+88-3 — Cabinet for dual 8" floppy disk drives \$ 275.00

COMBO-8 — Dual cabinet for 8" floppy disk drives (horizontal mounting) \$ 265.00

COMBO-9 — Cabinet for 8" floppy disk drives (vertical mounting) \$ 265.00

COMBO-8/9+1S — Dual cabinet with (1) Shugart SA801R installed (horizontal or vertical mounting) \$ 725.00

COMBO-8/9+2S — Dual cabinet with (2) Shugart SA801R's installed (horizontal or vertical mounting) \$1150.00

COMBO-8/9+1Q — Dual cabinet with (1) Qume® DT-8 double-sided double-density drive installed (horizontal or vertical mounting) \$ 865.00

COMBO-8/9+2Q — Dual cabinet with (2) Qume® DT-8's double-sided double-density drive installed (horizontal or vertical mounting) \$1385.00

X5 — Cabinet for desk top mainframe (small power supply) \$ 200.00

800D — Cabinet for desk top mainframe (standard power supply) \$ 255.00

*All cabinets come complete with power supply, fan and internal cables.

For superior quality, high reliability disk drives, contact ASAP today.

SD SYSTEMS/S-100 BOARDS

| | | |
|---------------|-----|----------|
| EXPANDORAM | 16K | \$240.00 |
| 2 MHz DYNAMIC | 32K | \$258.00 |
| RAM BOARD | 48K | \$276.00 |
| KITS | 64K | \$294.00 |
| EXPANDORAM II | 16K | \$250.00 |
| 4 MHz DYNAMIC | 32K | \$268.00 |
| RAM BOARD | 48K | \$286.00 |
| KITS | 64K | \$304.00 |

SBC-100 KIT 2.5 MHz/Z80 CPU with Serial I/O Ports & SBC 100 Monitor of your choice at no charge. \$299.00

SBC-200 KIT 4 MHz/Z80A CPU with Serial & Parallel I/O Ports & SBC 200 Monitor of your choice at no charge. \$325.00

VERSAFLOPPY I KIT Disk Controller for 5¼" or 8" Drives. Single or Double Slided/Single or Double Density. S-100 Compatible \$250.00

VERSAFLOPPY II KIT Disk Controller for 5¼" or 8" Drives. Single or Double Slided/Single or Double Density. S-100 Compatible \$300.00

PROM 100 KIT S-100/EPROM PROGRAMMER for 2708, 2716, 2732 & (TI) 2516 \$190.00

ALL BOARDS ARE AVAILABLE ASSEMBLED & TESTED. CALL FOR PRICES.

DISKETTES from ASAP

VERBATIM

5¼" DISKETTES

| Part # | Sectoring | Price |
|----------|-----------|------------|
| MD525-01 | Soft | 10/\$27.50 |
| MD525-10 | Hard 10 | 10/\$29.50 |
| MD525-16 | Hard 16 | 10/\$29.50 |

8" DISKETTES

| | | |
|-----------|------|------------|
| FD32-1000 | Hard | 10/\$35.00 |
| FD34-1000 | Soft | 10/\$35.00 |

MEMOREX

5¼" DISKETTES

| Part # | Sides/Density | Sectoring | Price |
|----------|---------------|-----------|------------|
| MEM 3401 | 1/Single | Soft | 10/\$25.00 |
| MEM 3403 | 1/Single | Hard 10 | 10/\$25.00 |
| MEM 3405 | 1/Single | Hard 16 | 10/\$25.00 |

8" DISKETTES

| Part # | Sides/Density | Sectoring | Price |
|----------|---------------|-----------|------------|
| MEM 3060 | 1/Single | Soft | 10/\$35.00 |
| MEM 3101 | 2/Single | Soft | 10/\$45.00 |
| MEM 3090 | 1/Double | Soft | 10/\$45.00 |
| MEM 3102 | 2/Double | Soft | 10/\$55.00 |

DYSAN

5¼" DISKETTES

| Part # | Sides/Density | Sectoring | Price |
|--------|---------------|-----------|------------|
| D-0130 | 1/Single | Soft | 10/\$45.00 |
| D-0226 | 1/Double | Soft | 10/\$46.00 |
| D-0235 | 2/Double | Soft | 10/\$55.00 |

8" DISKETTES

| Part # | Sides/Density | Sectoring | Price |
|--------|---------------|-----------|------------|
| D-0506 | 1/Single | Soft | 10/\$45.00 |
| D-0605 | 2/Double | Soft | 10/\$65.00 |

SCOTCH 3M

5¼" DISKETTES

| Part # | Sides/Density | Sectoring | Price |
|--------|---------------|-----------|------------|
| 744-0 | 1/Single | Soft | 10/\$33.00 |
| 744-10 | 1/Single | Hard 10 | 10/\$33.00 |
| 744-16 | 1/Single | Hard 16 | 10/\$33.00 |
| 745-0 | 2/Double | Soft | 10/\$59.00 |
| 745-10 | 2/Double | Hard 10 | 10/\$59.00 |
| 745-16 | 2/Double | Hard 16 | 10/\$59.00 |

MAXELL

5¼" DISKETTES

| Part # | Sides/Density | Sectoring | Price |
|--------|---------------|-----------|------------|
| MD1 | 1/Single | Soft | 10/\$39.00 |
| MD2D | 2/Double | Soft | 10/\$65.00 |
| MH1 | 1/Single | Hard 16 | 10/\$39.00 |
| MH2D | 2/Double | Hard 16 | 10/\$65.00 |

8" DISKETTES

| Part # | Sides/Density | Sectoring | Price |
|---------|---------------|-----------|------------|
| FD1-128 | 1/Single | Soft | 10/\$45.00 |
| FH1-32 | 1/Single | Soft 32 | 10/\$45.00 |
| FD2-XD | 2/Double | Soft | 10/\$65.00 |

SRW

MEDIA STORAGE CASES

| Part # | Size | Price |
|--------|------|------------|
| SRW-5 | 5¼" | \$2.50 ea. |
| SRW-8 | 8" | \$3.25 ea. |

asap
computer
products, inc.

ATARI 800

(16K) Personal Business Computer Features:

- Computer console
 - Atari 8K basic
 - 57 full stroke alpha-numeric keyboard with four function keys
 - Operator's manual
 - RF modulator
 - Power supply
- Price: \$799.00

Special Offer: Additional 16K RAM FREE with purchase of system.

Atari Optional Accessories

| Model # | Description | Price |
|---------|------------------------------|-----------|
| 810 | Disk Drive System | \$ 455.00 |
| 815 | Disk Drive System | \$1195.00 |
| 820 | 40 Column Dot Matrix Printer | \$ 279.00 |
| 822 | 40 Column Thermal Printer | \$ 349.00 |
| 825 | 80 Column Dot Matrix Printer | \$ 625.00 |
| 830 | Acoustic Modem | \$ 159.00 |
| 850 | Interface Module | \$ 139.00 |
| 410 | Cassette Recorder | \$ 60.00 |
| CX30-04 | Paddle Controls | \$ 17.95 |
| CX40-04 | Joysticks (pair) | \$ 17.95 |

INTRODUCING ASAP's

Atari 800 16K RAM Module \$75.00
1 year warranty parts & labor

Atari Software (Many more available)

| | |
|------------------|----------|
| Basketball | \$ 24.00 |
| Super Breakout | \$ 30.00 |
| Chess | \$ 30.00 |
| Video Easel | \$ 24.00 |
| 3-D Tic Tac Toe | \$ 24.00 |
| Star Raiders | \$ 34.00 |
| Asteroids | \$ 30.00 |
| Music Composer | \$ 42.00 |
| Educational ROM | \$ 19.95 |
| Assembler/Editor | \$ 45.00 |
| Telelink I | \$ 19.95 |
| Space Invaders | \$ 14.95 |
| Missile Command | \$ 30.00 |
| Biorhythm | \$ 12.95 |
| Graph It | \$ 15.95 |
| Energy Czar | \$ 12.95 |
| Mailing List | \$ 16.95 |
| Statistics I | \$ 16.95 |
| Touch Typing | \$ 19.95 |
| Stock Charting | \$ 19.95 |
| Stock Analysis | \$ 19.95 |
| Bond Analysis | \$ 19.95 |
| Word Processor | \$129.95 |

Printers

| Manufacturer/Model # | Price |
|-----------------------|-----------|
| Anacom-150 | \$ 995.00 |
| Anadex-9501 | \$1249.00 |
| Base 2-800B | \$ 650.00 |
| Diablo-630R0 | \$2225.00 |
| C.Itoh Starwriter 45 | \$1925.00 |
| Texas Instruments-810 | \$1650.00 |

The Epson MX-80

80 Column Dot Matrix Printer

SPECIFICATIONS

Print methods: serial impact dot matrix
Print rate: 80 CPS
Print direction: bidirectional
Number of plns in head: 9
Matrix: 9 x 9
Line spacing: 1/8", 1/6", 7/72" μ program-
mable throughput at 10 CPI — logical seeking
function — 105 LPM, 20 character line: 73
LPM, 43 char. line: 48 LPM, 80 char. line.

PRINTING CHARACTERISTICS

Character set: full 90-character ASCII with
descenders.
Graphics characters: 64 block characters

INTERFACES

Standard: Centronics-style 8-bit parallel
Optional: Apple, TRS-80, RS 232

NEW

MX80 FT/Friction Feed
MX-100/132 Column
CALL FOR PRICE & DELIVERY

Modems

| Manufacturer | Model # | Price |
|--------------|--------------|-----------|
| Novation | CAT | \$ 149.00 |
| Novation | d-CAT | \$ 160.00 |
| Novation | Auto-Cat | \$ 229.00 |
| Lexicon | Lex-11 | \$ 139.00 |
| Livermore | LIV-Star 20M | \$ 149.00 |
| UDS | UDS 103 | \$ 189.00 |
| UDS | UDS 202 | \$ 295.00 |

Monitors

| Manufacturer | Model # | Price |
|--------------|-------------|-----------|
| Amdek | 100/12" B&W | \$ 139.00 |
| Amdek | 100-80 | \$ 169.00 |

| | | |
|---------|--------------------|-----------|
| Amdek | 100G/12" Grn. | \$ 169.00 |
| Amdek | Color-1 13" | \$ 375.00 |
| APF | TVM-10/10" B&W | \$ 149.00 |
| Hitachi | VM 910/9" B&W | \$ 210.00 |
| Hitachi | VM 129/12" B&W | \$ 340.00 |
| Sanyo | DM 5012/12" B&W | \$ 270.00 |
| Sanyo | DM 5112ex/12" Grn. | \$ 290.00 |
| Sanyo | DM C6013/13" Color | \$ 475.00 |

Terminals

| Manufacturer | Model # | Price |
|--------------|-------------|-----------|
| Ampex | Dialogue 80 | \$ 899.00 |
| Soroc | IQ120 | \$ 750.00 |
| Soroc | IQ140 | \$1250.00 |
| Televideo | TVI 910 | \$ 650.00 |
| Televideo | TVI 912C | \$ 725.00 |
| Televideo | TVI 950C | \$ 975.00 |

Components

4116's (200 nS)

| | |
|----------------------|-------------|
| Apple, TRS-80, Heath | 8/\$18.00 |
| 16-49 | \$2.15 each |
| 50-99 | \$2.05 each |
| 100 up | \$1.95 each |

2114 L-2/200 nS

| Low-Power 1K x 4 Static RAM | |
|-----------------------------|---------------------------------|
| 1-16 | \$2.95 each 50-99 \$ 2.75 each |
| 17-49 | \$2.85 each 100 up \$2.65 each |
| 74LS240 | \$1.25 each 74LS373 \$1.25 each |
| 74LS241 | \$1.10 each 74LS374 \$1.25 each |
| 74LS244 | \$1.25 each 8T245 \$1.50 each |

2708/450 nS

| | |
|--------------|--------------|
| 1K x 8 EPROM | \$4.00 each |
| | or 8/\$30.00 |

2716/5 Volt

| | |
|-----------------|-------------|
| 2K x 8 EPROM | \$6.25 each |
| 1 year warranty | |

| | | | |
|-----------|---------|---------|---------|
| 8080A-CPU | \$ 2.50 | 8257AC5 | \$15.00 |
| Z80A-CPU | \$ 8.95 | | |
| Z80A-CTC | \$ 8.95 | 320T5 | \$.80 |
| Z80A-DART | \$13.95 | 340T5 | \$.70 |
| Z80A-SIO | \$22.00 | 320T12 | \$.80 |
| 8255AC5 | \$ 6.95 | 340T12 | \$.75 |

| | 1-9 | 10-24 | 25 up |
|-------|--------|--------|--------|
| DB25P | \$2.60 | \$2.50 | \$2.35 |
| DB25S | \$3.50 | \$3.40 | \$3.20 |
| DB25C | \$.95 | \$.85 | \$.75 |

100 Pin IMSAI

Gold/IS-100 Soldertail Connectors
\$2.40 each or 10/\$2.25 each

Capacitors

.1 @12 Volt
Ceramic 8c each or 100/\$7.00

DIP Sockets — Low Profile Tin Soldertail

| Description | 1-9 | 10-49 | 50-99 | 100 up |
|---------------|--------|--------|--------|--------|
| 14 pin tin st | \$.15 | \$.13 | \$.12 | \$.11 |
| 16 pin tin st | \$.16 | \$.14 | \$.13 | \$.12 |
| 18 pin tin st | \$.19 | \$.18 | \$.16 | \$.14 |
| 20 pin tin st | \$.25 | \$.23 | \$.21 | \$.20 |
| 24 pin tin st | \$.26 | \$.24 | \$.22 | \$.20 |
| 28 pin tin st | \$.32 | \$.30 | \$.29 | \$.27 |
| 40 pin tin st | \$.42 | \$.40 | \$.38 | \$.34 |

MICROBYTE Z-80A/ I-O CPU BOARD

- A complete single board Z80A CPU with serial/parallel interface
- Fully compatible with the proposed IEEE S-100 Bus Standard
- Z80A CPU (4MHz version of the Z80)
- 158 instructions — superset of and upward compatible from the 8080's 78 instructions
- Up to 4K of on board Eprom with optional Z80 monitor program — 1K1(2708), 2K1(2716) or 4K(2732)
- Full vectored interrupt capability — 8 bit with MNI (1 bit)
- 2MHz or 4MHz operation is jumper selectable
- Selectable auto-wait state insertion for extending M1*, MREQ*, IORQ* and/or on board ROM
- Dual RS-232 serial I/O ports using the Z80A-DART with individual baud rate selection (from 50 — 19,200 baud)
- Up to 24 bit parallel I/O port — fully programmable Intel 8255A

\$329.00 Assembled & Tested
Optional Monitor Program \$50.00

MICROBYTE FLOPPY DISK CONTROLLER

- DMA to within 16 Mbyte of memory
- State-of-the-art NEC765 LSI Controller
- IEEE S-100 compatible
- DMA arbitration allows use of multiple boards within a system
- PLL data recovery for totally reliable operation
- Write pre-comp switched at mid-disk for reliable double density operation
- Supports up to four (4) drives
- Power On, Power Off or Reset deselects drives to avoid damaging files
- Drive deselect Time Out, deselects drives not in use
- Single or double sided operation
- Single density/double density operation
- 8" standard drives
- Selectable V_{CC} supply for data recovery to eliminate possible noise problems

\$349.00 Assembled & Tested

MICROBYTE 4-PORT I/O BOARD

- Quad RS-232C serial ports. One 20mA current loop port
- Fully IEEE S-100 Bus compatible
- Asynchronous Communications with Z80A-DART(TM) or synchronous communications with Z80A-SIO/0(TM)
- Full set of modem control signals, including RI (Ring Indicator)
- Easily configurable to any type of terminal interface
- I/O servicing environments:
 - (1) Polled
 - (2) Bus vector
 - (3) Z80 mode 2 vector
- Off-board interrupt daisy chain capability
- Special receive conditions:
 - (1) Framing error
 - (2) Parity error
 - (3) Receiver overrun error
- Baud rates selected individually from 50 baud to 300K baud
- 72 hour burn-in

\$265.00 Assembled & Tested
Cables Available (Optional)

MICROBYTE 64K DYNAMIC RAM BOARD

- Fully S-100 bus compatible
- 64K x 8 bit dynamic RAM
- Low power:
 - +8VDC @ 700 mA
 - +16VDC @ 100 mA
 - 16VDC @ 25 mA
- Built-in capacity with LED indicator and vector interrupt
- Memory addressable in four 16K banks
- Hidden refresh
- Gold contacts for high reliability
- 72-hour burn-in
- Memory mapped via DIP switch
- Built-in programmable write-protect
- Programmable control port for parity and bank control
- ALPHA-MICRO compatible

Call for Price

Assembled & Tested

Catalog Request

Please send me your 1981 ASAP Full Line Catalog

Name _____
Company _____ Title _____
Address _____
City _____
State _____ Zip _____

ASAP offers a 30-day buyer protection policy: full money-back guarantee if not totally satisfied.

Ordering information: name, address, phone, ship by: UPS or Mail. Shipping charge: add \$2.50 up to 1 lb. for UPS Blue; add \$1.50 for U.S. Mail (U.S. only) (\$25.00 minimum order). Call for larger shipments.

Terms: We accept cash, check, money orders, Visa & Master Charge (U.S. Funds only). Tax: 6% Calif. Res., COD's and terms available on approval (School P.O.'s Accepted).

asap
computer
products, inc.

1198 E. Willow St., Signal Hill, CA 90806

Toll free outside California:

(800) 421-7701

Inside California:

(213) 595-6431

(714) 891-2663

Ask BYTE

Conducted by Steve Ciarcia

Mall-Order Forum

Dear Steve,

In July 1979, I was enticed by the savings of buying a Radio Shack TRS-80 from a mail-order firm. I chose a company that is still advertising in BYTE today—Pan American Electronics (it had a different name in 1979). I confirmed with the company that its TRS-80s were covered by the Tandy warranty. Still skeptical, I called the TRS-80 Hot Line. To my surprise, I was firmly discouraged from doing business with Pan American and was told that most mail-order TRS-80s were defective. I then called the Tandy World Headquarters and asked for the division manager responsible for Pan American. He assured me that Pan American was legitimate. He couldn't understand the comments from the Hot Line.

I decided to risk it (after all, I'd be covered by the warranty) and sent my check. My TRS-80 arrived, but it did not work. Pan American was very nice and said I could either return it for a refund or exchange, or take it to a local Radio Shack for free warranty service. I did the latter and a loose wire was repaired in 48 hours.

A few months later, contrary to my advice, a friend ordered from Pan American. His TRS-80 had a defective keyboard and was repaired by our local Radio Shack Center. Just recently, another friend received defective disk drives from some other "Authorized Radio Shack Sales Center."

In all three cases, the warranty service was done, and, hence, we are satisfied customers. However, our experiences support the Hot

Line's accusations. Is Tandy pushing defective merchandise through mail-order stores?

Jeff Goodling
Allentown PA

Dear Steve,

I was concerned about buying a TRS-80 by mail, not because I was afraid of a rip-off, but because I'd heard rumors that local stores were being difficult about post-sale support.

To see for myself, I went to a Radio Shack Computer Center in Glendale, California, to check the price on a Model II with a printer, for my own use. The quote I got was about \$1000 higher than I could get by mail (even forgetting the tax). When I mentioned to the salesman that mail order was much cheaper, he said, in effect, try to get support: the mail-order company won't support the machine, and neither would he unless I bought a \$1300 service contract. He was pretty hostile about the whole idea that I might want to save a thousand bucks. He so soured me on the idea of a Model II that I've crossed it off my list of possibles.

At the same time, I was looking for a word processor for business purposes. I checked most of the big companies (Wang, Lanier, IBM, etc) and got a shock: all of them carry their own financing amortized over five years, but Radio Shack does not. Radio Shack, on the other hand, forces you to an outside lender, no matter who you are. We're an old company with plenty of credit, but to Radio Shack it makes no difference. Also, Radio Shack's service con-

tract costs from \$400 to \$800 more than the rest.

It seems that Radio Shack simply isn't interested in the business market—at least it's never going to get it with that kind of financial attitude. Radio Shack's machines are initially cheaper, true, but over five years, with the service, they come out looking very bad. Plus, the attitude of the people associated with the places I talked to left something to be desired.

David Storti
Los Angeles CA

Perhaps it is best if Radio Shack responds directly. Pan American Electronics' reply follows. . . . Steve

Radio Shack Replies:

I can't believe anyone can think we're "pushing defective merchandise through mail-order stores"! That's absurd . . . our reputation would suffer, and we'd end up paying for the repairs anyway. I'd bet the reason Mr Goodling and his friends experienced problems was due to the extra shipping time and mileage. If a local store or dealer had delivered the equipment to the user, it could have been checked out on the spot before delivery.

Any Radio Shack employee telling a customer not to buy from a dealer is speaking against company policy. There are obvious advantages to buying locally, whether through a company store or authorized dealer: checkout prior to delivery and a salesman naturally more anxious to help "his customer" with any problems after the sale. A customer who spends money elsewhere and needs service is very like-

ly to be a lower priority. That's not policy, just a commonsense assessment of human nature at work. Our store personnel are required to help any customer with repairs in a timely fashion. Warranty service requires proof of purchase from a Radio Shack store or authorized dealer. There are some folks selling TRS-80s who aren't authorized dealers, and there is no pass-through warranty if you buy from one of them.

I'm sorry Mr Storti doesn't like our prices or our credit policies. There are always people who can work on less margin, some, it seems, on no margin. We know what it takes to continue our service network and still keep our stockholders happy: Hot Line, Newsletter, new hardware and software development, etc.

As to the credit question, we simply aren't in the time-payment business: Why not criticize the finance company for not manufacturing computers? We offer a leasing program, but apparently it didn't meet Mr Storti's requirements.

I really believe that Radio Shack's attitude toward our customers is good. A salesperson (ours or anyone else's) will resist losing a sale and may naturally be less than enthusiastic about furnishing support to someone else's customer. I apologize to anyone who has received other than courteous treatment from one of our employees in this situation, or who has been led to believe that we as a company condone less than full support on a purchase from an authorized outlet. It just isn't true.

We'd like to be all things to all customers, but we know

FUTRA COMPANY

P.O. BOX 4380 - DEPT. B
TORRANCE, CA 90510
(213) 328-8951

Hours: Mon. - Fri.: 8:00 am to 5:00 pm
Sat: 10:00 am to 4:00 pm (PST)

...nding solutions and being competitive is our business. At Futra Company we believe that it is possible to find solutions to your automation problems at the lowest possible prices. We carry a complete line of products from major manufacturers and a variety of other accessories and software to fit your home, professional and business needs.



**HEWLETT
PACKARD**



HP-85 and HP-83

The Hewlett Packard Computers are powerful problem solvers for professional. Quality built for industrial, scientific and business applications that can not afford a day due to equipment failure. Extremely versatile the HP-85 or HP-83 can offer functions from controlling analysis in an office to controlling devices on test equipment or numerical controlled industrial machines. The HP-85 comes with a tape recorder, printer and a CRT display and the

HP-83 is the same in capabilities of the HP-85 less the tape storage and printer.

HP-85 \$2575.00

HP-83 \$1790.00

82903A HP+85/83 16K Memory Module \$255.00

| Firmware Enhancements: | | Interfaces: | |
|------------------------|---------|------------------------|-------|
| 82936A | | 82937A | HP-IB |
| 82936A ROM Draw | \$ 42 | 82939A Serial (female) | \$339 |
| 85-15001 Mass Stor. | 135 | 82939 opt 001 (male) | \$339 |
| 85-15002 Plotter/Print | \$135 | Same 002 (crnt 1p) | \$339 |
| 85-15003 In/Output | \$274 | 82940A GPIU | \$421 |
| 85-15004 Matrix | \$135 | 82941A BCD | \$420 |
| 85-15005 Adv. Prog. | \$274 | 82949A Printer Int. | \$269 |
| 85-15007 Assembly | \$127.5 | | |



7225 Graphics Plotter \$2089.95
HP 2631B Matrix Printer \$3295.00
HP 82902M Disk Drive \$1275.00

HP APPLICATION PACS \$79.00 each

| | |
|--------------------------------|---|
| 85-13001 Standard | 85-13011 Linear Programming |
| 85-13002 Basic Training | 85-13034 Text Editing |
| 85-13003 Gen. Statistics | 85-13035 Wave Form Analysis |
| 85-13005 Math | 85-13036 Basic Statistics and Data Manipulation |
| 85-13006 AC Circuit Analysis | 85-13037 Regression Analysis |
| 85-13010 Games | |
| 85-13042 VisiCalc PLUS | \$166 |
| 85-13045 Information Mgmt. | \$175 |
| 85-13046 Surveying | \$175 |
| 85-13044 Data Communications | CALL |
| 85-13038 Graphics Presentation | \$175 |



\$309.00 Z-80 Soft Card with CP/M
\$159.00 16K Ram Card

...pen your Apple II computer to a larger world. With the Z-80 Softcard and 16K Ram Card you can now run CP/M compatible software, expand your memory for specific application, act as a firmware card and much more. If you add any boards to your Apple this year these are the ones.

VIDEX 80 x 24 VIDEO TERM AND KEYBOARD ENHANCER

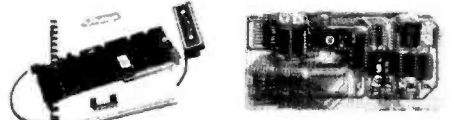

\$269.00 Videoterm
\$110.00 Keyboard Enhancer

ALS "Smartem" 80 column card \$295.00

Maintain optimum software compatibility industry wide. By adding the Videoterm 80 x 24 videoboard and keyboard enhancer your Apple acts similar to CRT Terminals on larger systems. Combine this with the Microsoft Softcard and you've got some system.

APPLE II COMPUTER



**\$1069.00
16K Apple II Plus**

**48K Apple II "Plus" w/factory warranted RAM
\$1129.00**

What can we say except that it's a super system at a steal of a price.

| | | | |
|-------------------------|-------|------------------------|-------|
| •AppleSoft Firmware | \$149 | •Disk II w/cont. | \$509 |
| •Centronix Printer Int. | \$179 | •Disk II 2nd | \$445 |
| •Communications Card | 179 | •Hand Controllers | 27 |
| •High speed serial Int. | 155 | •Vinyl Carrier | 33 |
| •Pascal Lang. Syst. | 379 | •Joystick II | 45 |
| •Integer firmware | 149 | •Graphics Table | 665 |
| •Parallel Print.Int. | 149 | •Silentype Printer 365 | |

OTHER APPLE PRODUCTS

California Computer Systems:

| | | | |
|----------------------|------|------------------------|-------|
| • 12K PROM/ROM Brd | CALL | • Asynchronous Serial | \$129 |
| • Centronics Cable | \$30 | • Synchronous Serial | \$149 |
| • Calendar Clock | \$99 | • Parallel Interface | \$99 |
| • Programmable Timer | \$89 | • Centronics Interface | \$99 |
| • A/D Converter | \$95 | • Arithmetic Proc/Disk | \$325 |
| • GPIB IEEE 488 | CALL | • Arithmetic Proc/ROM | \$345 |

Mountain Computer Inc.

| | | | |
|----------------------|-------|----------------------|--------|
| • Apple Clock | \$210 | • Music System | \$465 |
| • Supertalker | \$255 | • A/D + D/A | \$299 |
| • Romplus | \$131 | • Keyboard Filter | \$48 |
| • Romwriter | \$152 | • Keyboard Filter | \$48 |
| • Romwriter | \$152 | • Copy Rom | \$48 |
| • X10 Controller | \$172 | • I/O Cable Assembly | \$47 |
| • X10 System | \$270 | • Expansion Chassis | \$649 |
| • CPS Multi-function | \$239 | • Card Reader | \$1085 |

Other:

| | | | |
|----------------|-------|-------------------|-------|
| • SSM AIO | \$159 | • ABT Barwand | \$175 |
| • SSM A488 | CALL | • KBC Joystick II | \$45 |
| • ABT Keypad | \$115 | • KBC Keypad II | \$149 |
| • ABT Soft Key | \$145 | • ThunderClock | \$120 |

APPLE II SOFTWARE

Apple Computers:

| | | | |
|------------------|------|--------------------|-------|
| • Apple Post | \$44 | • Stellar Invaders | \$23 |
| • Shell Games | \$28 | • Apple Plot | \$57 |
| • Apple Bowl | \$23 | • Adventure | \$33 |
| • DOS 3.3 Update | \$57 | • AP Music Theory | \$47 |
| • Apple Writer | \$65 | • Tax Planner | \$114 |
| • DOS Tool Kit | \$65 | | |

Personal Software:

| | | | |
|--------------------|-------|----------------------|-------|
| • Visicalc 3.3 | \$159 | • Visiterm | \$125 |
| • Desk Top/Plan II | \$165 | • Visiplot | \$147 |
| • CCA Data Mgt. | \$84 | • Visixid | \$159 |
| | | • VisiTrend/Visiplot | \$229 |

Microsoft: (requires Z80 SoftCard & CP/M)

| | | | |
|---------------------|-------|--------------------|----------|
| • Basic Compiler | \$296 | • COBAL Language | \$562.50 |
| • Assembly Language | \$94 | • Fortran Language | \$149.00 |

Peachtree/40: (requires Z-80 SoftCard & 16K RAM Card)

| | | | |
|---------------------|-------|-------------|-------|
| • General Ledger | \$195 | • Payroll | \$195 |
| • Accounts Rec | \$195 | • Inventory | \$195 |
| • Accounts Payables | \$195 | • Mail List | \$195 |

Misc: (48K All or All+)

| | | | |
|-------------------------|-------|-----------------------------------|----------|
| • Stoneware "DB Master" | \$179 | • Software Publishing Corp. "PFS" | \$87.50 |
| • BPI General Ledger | \$315 | • "PFS: Report" | \$87.50 |
| • BPI Inventory Control | \$315 | • MicroFocus "COBOL" | \$743.00 |
| • BPI Payroll | \$315 | | |
| • BPI Job Cost Sys. | \$315 | | |

DC HAYES
• Micromodem II \$303.00
• Micromodem 100 CALL

NOVATION
• Cat-Modem \$155.00
• D-Cat Modem \$155.00
• Apple Cat \$328.00

OSBORNE COMPUTER \$ CALL
XEROX 820 The Lowest Price - \$ CALL

COMPUTER SUPPLIES:

| | |
|----------------------------------|-------------------------------|
| 3M Scotch 5" Diskettes (10) | 3M Scotch 8" Diskettes (10) |
| • 744-0 5" SS/SD soft sect. \$26 | • 740-0 8" SS/SD \$32 |
| • 744-10 5" SS/SD 10 sect. \$26 | • 741-0 8" SS/DD \$36 |
| • 744-16 5" SS/SD 16 sect. \$26 | • 743-0 8" DS/DD \$44 |
| • 744-0 5" Head Clean.Kit \$29 | • 7400 8" Head Clean.Kit \$30 |
| MISC. | |
| • Silentype Paper (roll) \$4.50 | • Vinyl Disk Sleeves \$6.95 |
| • 5" Vinyl disk sleeves \$6.95 | |

APPLE III COMPUTER

A highly sophisticated system designed to tackle the toughest budgeting, forecasting, scheduling, pricing, and other management analysis and planning tasks. It comes with a built in disk drive and interfaces and sold as a system package.

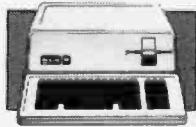

A3P000A system Option A includes: \$4038.00

A3S0128 Apple III 128K
A3S0001 Information Analyst
A3M0005 12" Black & White Monitor

Accessories:

| | |
|---------------------------------|----------|
| • A3M0001 Silentype Printer III | \$292.00 |
| • A3M0003 Disk II for AIII | \$495.00 |

ATARI COMPUTER SYSTEMS ATARI 800 16K Computer

Your price: \$785.00

The Atari 800 Computer with accessories and software make up a complete system for home, educational, financial and business use.

| | | | |
|---------------------|--------|---------------------|-------|
| • Atari 400 | \$347 | • 853 16K RAM Mod | \$83 |
| • 810 Disk Drive | \$475 | • 930 Acoustic Mod | \$156 |
| • 815 Dual Disk Dr. | \$1218 | • 850 Interface Mod | \$60 |
| • 825 80 col.print. | \$780 | • 410 Prog.recorder | \$79 |

CALIFORNIA COMPUTER SYSTEM

The CCS 2210 is a low cost S100, Z80 computer system with 64K of memory, disk controller, parallel/serial I/O and CPM operating system.

\$1743.00

Separate Components

| | | | |
|-------------------|-------|----------------------|-------|
| • 2200A Mainframe | \$373 | • 24221 Disk Cntrir. | \$195 |
| • 2810A CPU | \$220 | • 2718 Par/Ser I/O | \$275 |
| • 2065 64K RAM | \$537 | | |

VIDEO TERMINALS & VIDEO MONITORS

Sanyo:

| | | | |
|---------------------|-------|---------------------|-------|
| • 12" Green Monitor | \$269 | NEC: | |
| • 12" B&W Monitor | \$239 | • 12" Green Monitor | \$282 |
| • 13" Color Monitor | \$432 | • 12" Color (RGB) | CALL |
| • 9" B&W Monitor | \$169 | • 12" Color Monitor | \$402 |
| • 9" Green Monitor | CALL | | |

AMDEK:

| | | | |
|---------------------|-------|-------------------------|-------|
| • 12" B&W Monitor | \$144 | VIDEO TERMINALS: | |
| • 12" Green Monitor | \$174 | • ADDS Viewpoint CRT | \$582 |
| | | • Soroc 130 | \$595 |
| | | • Televideo | \$595 |

EPSON PRINTERS MX-100

Your price \$759.00

Probably the best buy in a printer this year. Compare features with any other and compare price (especially ours). 4 character sizes all may be placed into letter quality enhanced mode. Friction and removable tractor, 9 by 9 to 18 by 18 dot Matrix, logic seeking, and much more. Not to mention DOT PLOTTING?GRAFRAX option built right in. **WOW! What a printer!**

| | | | |
|--------------------|-------|--------------------------------|---------|
| • MX 80 FT Printer | \$569 | • MX Ser.Interface Opt | \$65 |
| • MX 80 Printer | \$479 | • Epson Apple Par.Int. | \$69 |
| • MX 70 Printer | \$394 | • Epson Par.Cable | \$22.50 |
| • MX 80 Ribbons | \$14 | • MX-80 or 80/ft Graf-trax ROM | \$78 |

ALTS COMPUTER SYSTEM

Now a system truly suited to grow with your business. Start with a single terminal system and enlarge up to 4 users. You've heard about what they can do, wait 'til you hear what we sell them for. **CALL TODAY!**

NEC PC-8000 MICROCOMPUTER SYSTEM

Not an apple lover? Check out the new NEC PC-8000—it combines the most wanted features of several leading microcomputers, together with a few wonders of its own. Go see it today, then call us tomorrow for pricing, you just might be surprised.

TERMS: Shipping: add 3% for product shipped within continental USA via UPS surface (minimum \$3.00). If the Order placed is prepaid with U.S. funds in the form of check or money order, a Total Charge of \$3.00 for shipping is all you pay within the continental USA via UPS surface. Allow 14 working days for personal and company checks to clear. Credit card charges limited to \$1000. No COD's. FPO, APO or orders outside continental USA call or write for shipping charges or add 10% to purchase price (any difference will be refunded). California residents add 6% sales tax. All offers subject to change or withdrawal without notice. Warehouse: 20695 S. Western Ave., #124. Visitors by appointment.

we'll lose some customers to the competition. I'm at a loss to understand why Mr Storti's decision to buy from someone else should cause him to have such strong feelings against us.

**Ed Juge, Director
Computer Merchandising
Radio Shack
Ft Worth TX**

Obviously the sort of scare tactics that Mr Goodling experienced by Tandy (Radio Shack) personnel is not appreciated by Pan American Electronics or other dealers (i.e., Authorized Sales Centers). It is unfortunate that some Tandy personnel will try to make a sale or express their competitive nature between the two divisions (company and franchised/dealers) in such a way.

The facts are that the merchandise is the same. The vast majority of those who purchase from independent Radio Shack dealers are very happy with the merchandise and the personal service they receive from the small independent dealer. The added advantage of buying from an independent dealer is that they will often give their customers a better price for exactly the same merchandise.

Radio Shack dealers are not usually located in large cities. Major metropolitan areas are reserved for Radio Shack's company stores. The only access dealers have to the larger metropolitan areas is by advertising in magazines like *BYTE* and by offering consumers a better price for the same merchandise.

The dealers' profit margin is smaller than the company stores', so we sacrifice a lot by discounting. We feel, however, that discounting merchandise is an honest way to make a living. We feel it is inappropriate and unethical to make unwarranted threats or to spread lies about our

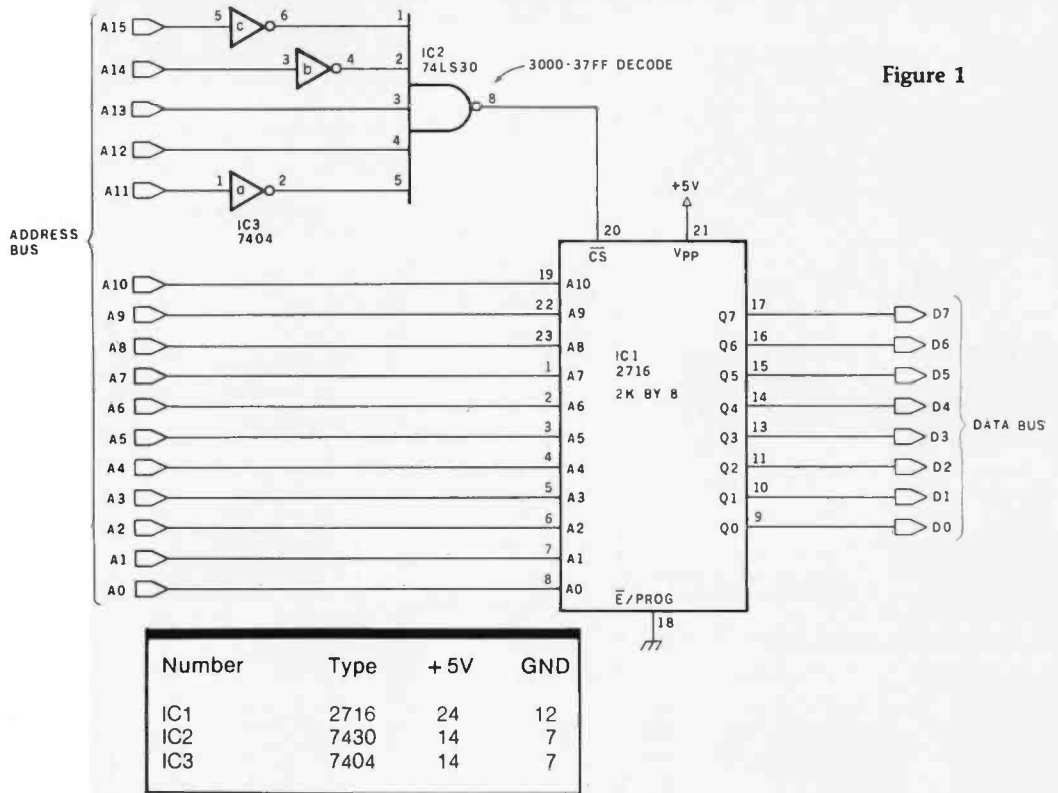

Figure 1

main supplier and our major competitor simply to make an extra dollar.

**Dan Frank, President
Pan American Electronics
Mission TX**

In Need of a Way to the PROM

Dear Steve,
I want to use my TRS-80 Model I and Model III to develop useful programs, and I need peripherals to accomplish the task. Your articles on parallel and serial I/O (input/output) were very helpful in this regard. (See "I/O Expansion for the Radio Shack TRS-80, Part 1: Principles of Parallel Ports," May 1980 *BYTE*, page 22 and "Part 2: Serial Ports," June 1980 *BYTE*, page 42.)

One area that I would like to pursue is that of placing application software in an external PROM (programmable read-only memory). Thus, the application program would not have to be loaded each time it is used.

How to implement an external PROM memory with the TRS-80 expansion port is not clear to me. Can you help?

**Frank Fitzgerald
East Northport NY**

According to Radio Shack's Level II BASIC reference manual for the TRS-80 Model I, there is a reserved (blank) area of memory between 3000 and 3BFF hexadecimal. It's quite possible to configure a 2 K-byte EPROM (erasable PROM) to fit within that address space so that it can be accessed during a program.

Figure 1 is a schematic that demonstrates how this could be attached. You place an applications program in an EPROM in this address space, and whenever you wish to run the program, all you do is jump to address location 3000 hexadecimal and execute.

As for the TRS-80 Model III, this address space appears to be reserved for a system PROM. I haven't actually

dismantled a Model III yet to see if this reference is a "phantom" PROM. . . . Steve

Getting on the Right Trak

Dear Steve,
I found your February 1981 "Circuit Cellar" article very interesting. (See "A Computer-Controlled Tank," page 44.) Since I fiddle with robotics, I would love to try out this ingenious toy. The only problem is that I can't find a store that sells the Big Trak. Could you give me the address of the Milton Bradley company?

Am I correct in assuming that the only parts I must specially order to build this are the Exar Integrated Systems phase-locked loop and the modem listed at the back of the article?

**Marc Weigel
Delta, British Columbia, Canada**

The address you want is Milton Bradley Company, MB Electronics Division, Springfield MA 01101.

QUALITY DISK SOFTWARE

BACKED BY ON-GOING APPLICATIONS SUPPORT

APPLE II (A)

TRS-80 (T)

HOME FINANCE PAK I: Entire Series \$49.95 (A) (T)

CHECK REGISTER AND BUDGET: This comprehensive **CHECKING ACCOUNT MANAGEMENT SYSTEM** not only keeps complete records, it also gives you the analysis and control tools you need to actively manage your account. The system provides routines for **BUDGETING INCOME AND EXPENSE**, **AUTOMATIC CHECK SEARCH**, and **BANK STATEMENT RECONCILING**. CRT or printer reports are produced for **ACTUAL EXPENSE vs BUDGET**, **CHECK SEARCH DISPLAY RECONCILIATION REPORT** and **CHECK REGISTER DISPLAY** by month. Check entry is prompted by user-defined menus of standard purposes and recipient codes, speeding data entry and reducing disk storage and retrieval time. Six fields of data are stored for each check: amount, check no., date, purpose, recipient and **TAX DEDUCTIBLE REMINDER**. **CHECK SEARCH** routines allow searching on any of these data fields. Up to 100 checks/mo. storage \$39.95

SAVINGS: Account management system for up to 20 separate Savings accounts. Organizes, files and displays deposits, withdrawals and interest earned for each account. \$14.95

CREDIT CARD: Get Control of your credit cards with this program. Organizes, stores and displays purchases, payments and service charges for up to 20 separate cards or bank loans. \$14.95

UNIVERSAL COMPUTING MACHINE: \$49.95 (A)

A user programmable computing system structured around a 50 row x 50 column table. User defines row and column names and equations forming a unique computing machine. Table elements can be multiplied, divided, subtracted or added to any other element. Hundreds of unique computing machines can be defined, used, stored, and recalled, for later use. Excellent for sales forecasts, budgets, inventory lists, income statements, production planning, project cost estimates-in short for any planning, analysis or reporting problem that can be solved with a table.

COLOR CALENDAR: \$29.95 (A)

Got a busy calendar? Organize it with Color Calendar. Whether it's birthdays, appointments, business meetings or a regular office schedule, this program is the perfect way to schedule your activities. The calendar display is a beautiful **HI-RES** color graphics calendar of the selected month with each scheduled day highlighted in color. Using the daily schedule, you can review any day of the month and schedule an event or activity in any one of 20 time slots from 8:00 A.M. to 5:30 P.M.

BUSINESS SOFTWARE: Entire Series \$159.95 (A) (T)

MICROACCOUNTANT: The ideal accounting system for small businesses. Based on classic T-accounts and double-entry booking, this efficient program provides a journal for recording posting and reviewing up to 1,000 transactions per month to any one of 300 accounts. The program produces CRT and printer reports covering:

| | |
|---------------------|------------------------------|
| TRANSACTION JOURNAL | BALANCE SHEET |
| ACCOUNT LEDGERS | INCOME AND EXPENSE STATEMENT |

Includes a short primer on Financial Accounting. (48K) \$49.95

UNIVERSAL BUSINESS MACHINE: This program is designed to **SIMPLIFY** and **SAVE TIME** for the serious businessman who must periodically Analyze, Plan and Estimate. The program was created using our Universal Computing Machine and it is programmed to provide the following planning and forecasting tools.

| | |
|------------------------|-------------------------|
| CASH FLOW ANALYSIS | SALES FORECASTER |
| PROFORMA PROFIT & LOSS | SOURCE AND USE OF FUNDS |
| PROFORMA BALANCE SHEET | JOB COST ESTIMATOR |
| REAL ESTATE INVESTMENT | INVENTORY ANALYSIS |

Price, including a copy of the Universal Computing Machine \$89.95

BUSINESS CHECK REGISTER AND BUDGET: Our Check Register and Budget programs expanded to include up to 50 budgetable items and up to 400 checks per month. Includes bank statement reconciling and automatic check search (48K) \$49.95

ELECTRONICS SERIES VOL I & II: Entire Series \$259.95

LOGIC SIMULATOR: SAVE TIME AND MONEY. Simulate your digital logic circuits before you build them. CMOS, TTL, or whatever, if it's digital logic, this program can handle it. The program is an interactive, menu driven, full-fledged logic simulator capable of simulating the bit-time response of a logic network to user-specified input patterns. It will handle up to 1000 gates, including **NANDS**, **NORS**, **INVERTERS**, **FLIP-FLOPS**, **SHIFT REGISTERS**, **COUNTERS** and user-defined **MACROS**, up to 40 user-defined random, or binary input patterns. Accepts network descriptions from keyboard or from **LOGIC DESIGNER** for simulation \$159.95 (A) (T)

LOGIC DESIGNER: Interactive **HI-RES** graphics program for designing digital logic systems. Draw directly on the screen up to 10 different gate types, including **NAND**, **NOR**, **INVERTER**, **EX-OR**, **T-FLOP**, **JK-FLOP**, **D-FLOP**, **RS-FLOP**, **4 BIT COUNTER** and **N-BIT SHIFT REGISTER**. User interconnects gates using line graphics commands. Network descriptions for **LOGIC SIMULATOR** generated simultaneously with the CRT diagram being drawn \$159.95 (A)

MANUAL AND DEMO DISK: Instruction Manual and demo disk illustrating capabilities of both program (s) \$29.95 (A) (T)

ELECTRONIC SERIES VOL III & IV: Entire Series \$259.95

CIRCUIT SIMULATOR: Tired of trial & error circuit design? Simulate & debug your designs before you build them! With **CIRCUIT SIMULATOR** you build a model of your circuit using **RESISTORS**, **CAPACITORS**, **INDUCTORS**, **TRANSISTORS**, **DIODES**, **VOLTAGE** and **CURRENT SOURCES** and simulate the waveform response to inputs such as **PULSES**, **SINUSOIDS**, **SAWTOOHS**, etc. ... all fully programmable. The output is displayed as an **OSCILLOSCOPE-STYLE PLOT** of the selected waveforms (Apple only) or as a printed table of voltage vs time. Handles up to 200 notes and up to 20 sources. Requires 48 RAM \$159.95 (A) (T)

CIRCUIT DESIGNER: Interactive **HI-RES** graphics program for designing electronic circuits. Draw directly on the screen up to 10 different component types, including those referenced above. Components interconnect list for **CIRCUIT SIMULATOR** generated automatically. Requires \$159.95

MATHEMATICS SERIES: Entire Series \$49.95

STATISTICAL ANALYSIS I: This menu driven program performs **LINEAR REGRESSION** analysis, determines the mean, standard deviation and plots the frequency distribution of user-supplied data sets. Printer, Disk, I/O routines \$19.95

NUMERICAL ANALYSIS: **HI-RES** 2-Dimensional plot of any function. Automatic scaling. At your option, the program will plot the function, plot the **INTEGRAL**, plot the **DERIVATIVE**, determine the **ROOTS**, **MAXIMA**, **MINIMA**, **INTEGRAL VALUE** \$19.95

MATRIX: A general purpose, menu driven program for determining the **INVERSE** and **DETERMINANT** of any matrix, as well as the **SOLUTION** to any set of **SIMULTANEOUS LINEAR EQUATIONS**. \$19.95

3-D SURFACE PLOTTER: Explore the **ELEGANCE** and **BEAUTY** of **MATHEMATICS** by creating **HI-RES PLOTS** of 3-dimensional surfaces from any 3-variable equation. Disk save and recall routines for plots. Menu driven to vary surface parameters. Hidden line or transparent plotting \$19.95

ACTION ADVENTURE GAMES: Entire Series \$29.95 (A)

RED BARON: Can you outfly the **RED BARON**? This fast action game simulates a machine-gun **DOGFIGHT** between your **WORLD WAR I BI-PLANE** and the baron's. You can **LOOP**, **DIVE**, **BANK** or **CLIMB** and so can the **BARON**. In **HI-RES** graphics plus sound. \$14.95

BATTLE OF MIDWAY: You are in command of the U.S.S. **HORNETS' DIVE-BOMBER** squadron. Your targets are the Aircraft carriers, Akagi, Soryu and Kaga. You must fly your way through **ZEROS** and **AA FIRE** to make your **DIVE-BOMB** run. In **HI-RES** graphics plus sound. \$14.95

SUB ATTACK: It's April 1943. The enemy convoy is headed for the **CONTROL SEA**. Your sub, the **MORAY**, has just sighted the **CARRIERS** and **BATTLESHIPS'** Easy pickings. But watch out for the **DESTROYERS** - they're fast and deadly. In **HI-RES** graphics plus sound \$14.95

FREE CATALOG-All programs are supplied on disk and run on Apple II w/Disk & Applesoft ROM Card & TRS-80 Level II and require 32K RAM unless otherwise noted. Detailed instructions included. Orders shipped within 5 days. Card users include card number. Add \$1.50 postage and handling with each order. California residents add 6% sales tax. Foreign orders add \$5.00 postage and handling.



SPECTRUM SOFTWARE

142 Carlow, P.O. Box 2084
Sunnyvale, CA 94087

FOR PHONE ORDERS: (408) 738-4387
DEALER INQUIRIES INVITED.



Ask BYTE

Regarding the components necessary to modify the Big Trak as I did, you would need two modem boards. If purchased as kits from the Micro Mint, 917 Midway, Woodmere NY 11598, they include the XR-2211 phase-locked loop and all other components. Other than that you would have to buy the UART (universal asynchronous receiver/transmitter) and CMOS (complementary metal-oxide semiconductor) integrated circuits. Many advertisers in the back pages of BYTE sell these items. . . . Steve

Board Inquiries

Dear Steve,
Is someone going to make

available kits or printed-circuit boards for the project you described in "Build a Low-Cost Logic Analyzer" (April 1981 BYTE, page 36)?
Ivan Whitehouse
Goldendale WA

I completely misjudged the interest in my logic-analyzer project. The only unit I made was the prototype; I figured the interest would be general, but not enough to warrant the expense of having a printed-circuit board made. As you know, printed circuits are available for many of the projects that I present in BYTE, but I usually have some indication beforehand that there will be a reasonable demand.

Unfortunately, it's a little late for me to start the long procedure of designing a board, with so many new things to work on. I'll be sure to gauge response in the future, and there will continue to be printed-circuit boards for many of my projects.

If you want a complete list of all the printed-circuit boards available from my previous articles, drop a note to the Micromint, 917 Midway, Woodmere NY 11598 and request a catalog. . . . Steve

In "Ask BYTE," Steve Ciarcia answers questions on any area of microcomputing. The most representative questions received each month will be answered and published. Do you have a nagging problem? Send your inquiry to:

Ask BYTE
c/o Steve Ciarcia
POB 582
Glastonbury CT 06033

If you are a subscriber to The Source, send your questions by electronic mail or chat with Steve (TCE317) directly. Due to the high volume of inquiries, personal replies will be given as time permits. Please enclose a self-addressed, stamped envelope, and be sure to include "Ask BYTE" in the address.

FIELD PROVEN!!

10 MEGABYTES and MORE for the TRS-80* Model II plus SHARED ACCESS to HARD DISK DRIVE

Hard/Soft Disk System (HSDS) Software allows access as single drive. You can have that 10 Megabyte continuous file - that 50,000 name maillist or inventory! Or a directory with 1000 entries! All completely compatible with TRSDOS 2.0 BASIC. You can mix floppy and hard disk drives. Includes special utilities including HPURGE, DCS Directory Catalog System, HZAP Hard Disk Superzap, and many special formatting options. Three to eight times faster than floppy! RACET quality.

HARD DISK DRIVE & CONTROLLER \$595. Second User \$595.
HSDS Software \$400. (Note: HSDS now also available for CORVUS drives!!)

INFINITE BASIC (Mod I & III Tape or Disk) Mod I \$50.00, Mod III \$60.00
Extends Level II BASIC with complete MATRIX functions and 50 more string functions. Includes RACET machine language sorts! Sort 1000 elements in 9 seconds!! Select only functions you want to optimize memory usage.

INFINITE BUSINESS (Requires Infinite BASIC) Mod I & III \$30.00
Complete printer pagination controls — auto headers, footers, page numbers. Packed decimal arithmetic — 127 digit accuracy +, -, *, /. Binary search of sorted and unsorted arrays. Hash codes.

BASIC CROSS REFERENCE UTILITY (Mod II 64K) \$50.00
SEEK and FIND functions for Variables, Line Numbers, Strings, Keywords. 'All' options available for line numbers and variables. Load from BASIC — Call with 'CTRL'R. Output to screen or printer!

DSM Mod I \$75.00, Mod II \$150.00, Mod III \$90.00
Disk Sort/Merge for RANDOM files. All machine language stand-alone package for sorting speed. Establish sort specification in simple BASIC command File. Execute from DOS. Only operator action to sort is to change diskettes when requested! Handles multiple diskette files! Super fast sort times — improved disk I/O times make this the fastest Disk Sort/Merge available on your TRS-80 (Mod I Min 32K 2-drive system. Mod II 64K 1-drive. Mod III 32K 1-drive)

GSF (Mod I & III Tape or Disk - Specify Memory Size) Mod I \$25; Mod II \$50; Mod III \$30

Generalized Subroutine Facilities. The STANDARD against which all other sorts are compared! And then compare prices! Machine language — fast and powerful! Multi-key multi-variable and multi-key character string. Zero and move arrays. Mod II includes USR PEEKS and POKES. Includes sample programs.

DISCAT (32K 1-drive Min) Mod I, III \$50.00
This comprehensive Diskette Cataloging/Indexing utility allows the user to keep track of thousands of programs in a categorized library. Machine language program works with all TRSDOS and NEWDOS versions. Files include program names and extensions, program length, diskette numbers, front and back, and diskette free space.

KFS-80 (1-drive 32K Min — Mod II 64K) Mod I, III \$100.00; Mod II \$175.00
The keyed file system provides keyed and sequential access to multiple files. Provides the programmer with a powerful disk handling facility for development of data base applications. Binary tree index system provides rapid access to file records.

MAILLIST (1-drive 32K Min - Mod II 64K) Mod I, III \$75.00; Mod II \$150.00
This ISAM-based maillist minimizes disk access times; four keys, no separate sorting. Supports 9-digit zip code and 3-digit state code. Up to 30 attributes. Mask and query selection. Record access times under 4 seconds!!

COMPROC (Mod I & Mod III — Disk only) Mod I \$20; Mod III \$30
Command Processor. Auto your disk to perform any sequence of instructions that you can give from the keyboard. DIR, FREE, pause, wait for user input, BASIC, No. of FILES and MEM SIZE, RUN program, respond to input statements, BREAK, return to DOS, etc. Includes lowercase driver software, debounce and screenprint!

UTILITY PACKAGE (Mod II 64K) \$150.00
Important enhancements to the Mod II. The file recovery capabilities alone will pay for the package in even one application! Fully documented in 124 page manual! XHIT, XGAT, XCOPY and SUPERZAP are used to reconstruct or recover data from bad diskettes! XCOPY provides multi-file copies. "Wild-card" mask select, absolute sector mode and other features. SUPERZAP allows examine/change any sector on diskette include track 0, and absolute disk backup/copy with LTO recovery. DCS builds consolidated directories from multiple diskettes into a single display or listing sorted by disk name or file name plus more. Change Disk ID with DISKID. XCREATE preallocates files and sets 'LOF' to end to speed disk accesses. DEBUGII adds single step, trace, subroutine calling, program looping, dynamic disassembly and more!!

DEVELOPMENT PACKAGE (Mod II 64K) \$125.00
Includes RACET machine language SUPERZAP, Apparat Disassembler, and Model II interface to the Microsoft 'Editor Assembler Plus' software package including uploading services and patches for Disk I/O.

CHECK, VISA, M/C, C.O.D., PURCHASE ORDER
TELEPHONE ORDERS ACCEPTED (714) 997-4950

RACET COMPUTES
1330 N. GLASSSELL, SUITE M,
ORANGE, CA 92667

*TRS-80 IS A REGISTERED TRADEMARK OF TANDY CORPORATION

FMS-80

Organizes Your Organization

FMS-80, a data base management system, offers the user a quick and easy way to organize and efficiently manipulate data so sound decisions can be made on facts displayed.

FMS-80^{***} is the most powerful stand alone DBM program available to the micro-computer industry.

Completely menu driven and written in assembly language it offers these features:

- User definable File Definitions
- Screen Displays
- Reports (with math and field break analysis)
- Selection Criteria (on any or all fields)
- Menus (that applications programs can be selected from)
- Instantaneous data query on indexed records.
- Mathematical manipulation of numeric data fields using the report generator or the programming language EFM (Extended File Maintenance)
- Easy to use video "how to" training tapes are available.
- Manipulation of up to 19 different data files (using EFM) at one time and displaying this information on the screen, gene-

rating reports, generating other data files or on-line updating of input files that already exist

- FMS-80 is able to call other programs like sub-routines in EFM
- FMS-80 is able to read data files that other programs have generated
- No restrictions to record size other than available RAM memory space
- Operates under CP/M[®], MP/M[®] or CDOS[®]

FMS-80 allows the flexibility to quickly create programs that allow data to be entered in a form that a secretary recognizes and generates reports that the manager requires.

If you're continuously asked to do applications programs and don't have time to do it in BASIC, consider FMS-80. For additional information contact

Systems Plus,
3975 East Bayshore,
Palo Alto, CA
94303. Phone
415/969/7047

Systems Plus

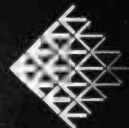

^{***}TM of DJR Associates

[®]TM of Crammen, Sunnyvale, CA

[®]TM of Digital Research, Pacific Grove, CA



BEING OVERCHARGED!

DON'T

Pay Credit Card Surcharges
Pay a U.P.S. C.O.D. "Fee"
Even Pay for the Call!

DO CALL OMEGA TOLL FREE!

**Special
of the Month!**

**EPSON
MX-80**



\$ 469

INTERFACES:

IEEE \$55, TRS-80 \$35,
APPLE INTERFACE & CABLE \$90,
RS-232 \$70

**ATARI 800 16K
\$ 769**



**WEST COAST
1-800-235-3581**

**EAST COAST
1-800-556-7586**

**CALL OMEGA AND FIND OUT WHY WE ARE AMERICA'S FASTEST
GROWING COMPUTER SALES COMPANY!**

ΩMEGA SALES COMPANY

WEST COAST / EAST COAST

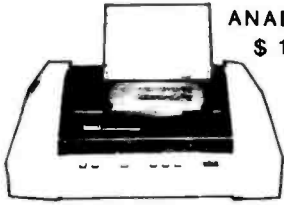

ANADEx
\$ 1249



ATARI 800 32K \$ 749



DIABLO 630
\$ 1995

Tractor option
\$ 245

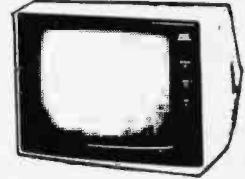

NEC 12" MONITOR
\$ 229

NEC
INTERTEC
OKIDATA
APPLE
TELEVIDEO
COMMODORE
RADIO SHACK
AMDEK
QUME
ATARI

| | |
|--|--------|
| INTERTEC SUPERBRAIN 64K RAM | \$2799 |
| QD SUPERBRAIN | \$2999 |
| NEC 5510 SPINWRITER (7710) | \$2345 |
| NEC 5520 SPINWRITER (7720) | \$2695 |
| NEC 5530 SPINWRITER (7730) | \$2345 |
| NEC 12" MONITOR | \$ 229 |
| OKIDATA MICROLINE-80 | \$ 399 |
| OKIDATA MICROLINE-82 | \$ 529 |
| OKIDATA MICROLINE-83 | \$ 769 |
| DIABLO 630 | \$1995 |
| APPLE II PLUS 48K | \$1139 |
| APPLE DISK w/3.3 DOS Controller | \$ 525 |
| APPLE DISK w/o Controller | \$ 449 |
| HAZELTINE 1420 | \$ 799 |
| NORTHSTAR HORIZON II 32K QD | \$2925 |
| ANADEx DP-9500/9501 | \$1249 |
| TELEVIDEO 912C | \$ 669 |
| TELEVIDEO 920C | \$ 729 |
| TELEVIDEO 950 | \$ 929 |
| CBM 8032 COMPUTER | \$1149 |
| CBM 8050 DISK DRIVE | \$1349 |
| CBM 4032 COMPUTER | \$1029 |
| CBM 4040 DISK DRIVE | \$1029 |
| CBM 4022 | \$ 649 |
| CBM VIC-20 | \$ 269 |
| RADIO SHACK II 64K | \$3245 |
| RADIO SHACK III 16K | \$ 849 |
| LEEDEX/AMDEK 100 | \$ 139 |
| LEEDEX/AMDEK 100G | \$ 169 |
| LEEDEX/AMDEK COLOR-1 13" Color Monitor | \$ 329 |
| MICROTEK 16K RAMBOARD for Atari | \$ 79 |
| MICROTEK 32K | \$ 149 |
| QUME SPRINT 9/45 (Full Panel) | \$2295 |
| ATARI 400 16K | \$ 349 |
| ATARI 825 PRINTER | \$ 650 |
| ATARI 850 INTERFACE | \$ 139 |
| ATARI 810 DISK DRIVE | \$ 449 |
| ATARI 800 | \$ 749 |

PRICES ARE SUBJECT TO CHANGE WITHOUT NOTICE

Call for price list of ATARI software

We carry the complete line of Personal Software

We Accept C.O.D.'s • Stock Shipments Same Day or Next
No Surcharge for Credit Cards • All Equipment Factory Fresh with MFT Warranty

WEST COAST
1-800-235-3581

OMEGA SALES CO.
3533 Old Conejo Rd. #102
Newbury Park, CA 91320
1-805-499-3678
CA. TOLL FREE 1-800-322-1873



EAST COAST
1-800-556-7586

OMEGA SALES CO.
12 Meeting St.
Cumberland, RI 02864
1-401-722-1027

OMEGA SALES COMPANY

Event Queue

October 1981

October-November

Workshops from Virginia Polytech, Virginia Polytechnic Institute and State University, Blacksburg VA. Workshops on microcomputer-design interfacing and programming, digital electronics for automation and instrumentation, and sessions using the TRS-80 are part of the curriculum. All workshops are hands-on with participants designing and testing concepts on the actual hardware. Contact Dr Lindy Leffel, Virginia Polytechnic Institute and State University, Blacksburg VA 24061, (703) 961-5241.

October-January

Electronics Magazine Seminars, various sites throughout the US. *Electronics* magazine and the McGraw-Hill Seminar Center are sponsoring seminars for engineers and managers. Subjects range from digital electronics to microprocessor-system design. Other topics include programming, speech technology and synthesis, microprocessor interfacing, and a hands-on microprocessor workshop. If a company has 10 or more people wanting to take a course, the seminar will be held at the company's plant. For details, contact Carol Clark, c/o McGraw-Hill Seminar Center, 305 Madison Ave, Rm 3112, New York NY 10017, (212) 687-0243.

October 7-9

Institute on Microcomputers for Instruction and Research in Higher Education, Jane S McKimmon Center, North Carolina State University, Raleigh NC. The institute is designed to help high-level educators learn about the

microcomputer and the role it can play in higher education. Contact Joyce Currie, c/o North Carolina Educational Computing Service, POB 12035, Research Triangle Park NC 27709, (919) 549-0671.

October 7-21

The 1981 Far East Computer Tour, Japan, South Korea, Taiwan, and Hong Kong. This tour group will visit various computer-related conferences and exhibitions throughout the Far East. Transportation for this three-week tour, plus shows, meals, and other items are included in trip packages, ranging in price from \$2290 to \$3095. For more information, contact Terry Butler, Commerce Tours International Inc, 870 Market St, Suite 742-744, San Francisco CA 94102, (415) 433-3072.

October 9-11

Rhode Island Computer and Video Electronics Show, Providence Civic Center, Providence RI. This is the first major computer exhibition and show to be held in Rhode Island. Exhibitors and sales teams will present the latest in computers and video products for business, industry, government, education, and home use. Contact New Leaf Productions, Suite 335, 77 Ives St, Providence RI 02906, (617) 679-0089.

October 12-15

Information Management Exposition and Conference: INFO 81, Coliseum, New York NY. Discussions on pre-packaged, customized pre-packaged, and custom-designed software will complement hardware and software exhibits. For more information, contact Clapp & Poliak Inc, 245 Park Ave, New York NY 10167, (212) 661-8410.

October 13-15

Understanding and Using Computer Graphics, New York NY. Headed by Carl Machover, this two-day seminar examines the state of the art in graphic systems. The focus will be on hardware, software, and applications. Contact Bob Sanzo, c/o Frost & Sullivan Inc, 106 Fulton St, New York NY 10038, (212) 233-1080.

October 15-18

The Third Annual Northeast Computer Show and Office Equipment Exposition, Hynes Auditorium, Boston MA. This show will feature hardware, software, and supplies for business, education, government, home, and office use. Office systems and equipment will also be shown. Contact National Computer Shows, 824 Boylston St, Chestnut Hill MA 02167, (617) 739-2000.

October 16-23

The Fourteenth Brazilian Computer Conference and Exhibit, Anhembi Convention and Exhibit Halls, São Paulo, Brazil. This conference will feature technical talks, conference tutorials, roundtable discussions, and special events. Computer-aided design and manufacture in developing countries will also be discussed. Contact Sucesu São Paulo, Rua Tabapuã, 627-1.º andar, 04533, São Paulo, S P, Brazil.

October 18-20

The Annual Conference of the New York State Association for Educational Data Systems (NYS AEDS), Syracuse NY. NYS AEDS is made up of people with an interest in computers and education. Workshops on the educational uses of microcomputer software will be held. Contact Don Ross, Ardsley High School, Ardsley NY 10502.

October 19-23

Wintek's Hand-On Microcomputer Workshop, Lafayette IN. Two- and three-day workshops in microprocessor hardware, software, and interfacing will be offered at Wintek's corporate headquarters. A single-board computer, including a 6800 microprocessor, programmable memory, serial and parallel input/output, and a 1 K-byte ROM (read-only memory) containing a monitor/debug program, will be given to the participants of this workshop. Tuition is \$50 per day. Contact Wintek Corporation, 1801 South St, Lafayette IN 47904, (317) 742-8428.

October 19-23

Systems '81, Munich, West Germany. Computer systems and their applications will be featured. Additional information is available from Kallman Associates, 30 Journal Sq, Jersey City NJ 07306, (201) 653-3304.

October 20-22

The Annual Government-Industry Data Exchange Program (GIDEP) Workshop, Rickey's Hyatt House, Palo Alto CA. The GIDEP annual workshop is open to anyone interested in the exchange of technical information relating to engineering, failure experience, reliability, and maintainability. Contact the Officer-in-Charge, GIDEP Operations Center, Corona CA 91720.

October 20-22

Computerized Office Equipment Expo, Southwest, Astrotball, Houston TX. Approximately 100 exhibitors will present office equipment and supplies, including word-processing systems, at this show. Contact Cahners Exposition Group, 222 W Adams St, Chicago IL 60606, (312) 263-4866.



**if He'd used select[™]
it wouldn't have taken seven days**

Learn SELECT^{*} in just 90 minutes. A whole new word processing software concept that kicks the coded key habit and frees you from complicated instruction manuals. *SELECT* is fast. *SELECT* is logical. With single key mnemonics, you'll use dozens of commands that instantly access the rich capabilities of this system. There's nothing like it.

Simply hit "C" and you'll be ready to Create a document.

Key "I" and you'll be in the Insert mode.

Key "M" and Move entire blocks of text . . . and key dozens more.

That's all there is to it. You'll get all that word processing software promises . . . plus a few surprises.

SELECT with SUPERSPELL.^{*} The only microcomputer software with an integrated spelling dictionary. To proof your text all you do, of course, is to key "S". *SUPERSPELL* with its 10,000 word dictionary scans your text at computer speed then displays and corrects all your typing errors. You can increase *SUPERSPELL*'s word power and customize the dictionary by adding new words, one at a time. Ask to see it today at your local dealer.

SELECT with SUPERSPELL . . . just a little byte more.[™]



SELECT will run on any machine that uses CP/M or MP/M** or its derivatives. It needs 40K of RAM and two disk drives. Special version now available for Radio Shack Mod II*** and Apple II****

^{*} SELECT and SUPERSPELL are trademarks of Select Information Systems Inc.
^{**} CP/M and MP/M are trademarks of Digital Research
^{***} A trademark of Tandy Corp.
^{****} A trademark of Apple Computer Inc.

INFORMATION SYSTEMS[™] 919 Sir Francis Drake Boulevard • Kentfield, California 94904 • (415) 459-4003

Event Queue

October 20-23

Computer-Network Design and Protocols, Boston MA. Integrated Computer Systems (ICS) will be presenting a course on fundamentals in computer communication-network concepts, technology, and implementation. Emphasis is on the practical aspects of network design, interfacing, protocols and packet switching. For a schedule of times and places for this course, contact Ruth Dordick, c/o Integrated Computer Systems, 3304 Pico Blvd, POB 5339, Santa Monica CA 90405, (800) 421-8166; in California (800) 352-8251.

October 21-24

COMPUTA 81, World Trade Center, Singapore. This international show attracts professionals and buyers from Hong Kong, India, and Sri Lanka. Additional information can be obtained from Kallman Associates, 30 Journal Sq, Jersey City NJ 07306, (201) 653-3304.

October 24-25

The Second Annual New Jersey Microcomputer Show and Fleamarket, Holiday Inn (north) Convention Center, Newark International Airport, Newark NJ. This show will feature 75 commercial exhibitors and more than 100 vendors. User-group meetings will be held. Registration is \$5 for both days. Contact Kengore Corporation, 3001 Rt 27, Franklin Park NJ 08823, (201) 297-2526.

October 25-30

The Forty-Fourth Annual Meeting of the American Society for Information Science (ASIS), Washington Hilton Hotel, Washington DC. The theme for this meeting is "The Information Community: An Alliance for Progress." Among the topics to be addressed are information

and creativity, information and society, and overcoming the barriers between information sciences. Contact ASIS, 1010 Sixteenth St, NW, Washington DC 20036, (202) 659-3644.

October 25-28

Issue '81: The Fifth Annual SPSS Software Users Convention, Jack Tar Hotel, San Francisco CA. Issue Inc, the independent, nonprofit association of SPSS software users and coordinators, is presenting its fifth annual convention. The primary purpose of the convention is to inform the user community about new SPSS products. Discussions of special applications will also be featured. Registration fees are \$95 for members and \$115 for nonmembers. For more information, contact Steve Hamburg, c/o Issue Inc, POB 8224, Chicago IL 60680, (312) 329-2400.

October 27-29

Computer Graphics 81, Regent Centre Hotel, London, England. Some of the topics to be covered are graphics systems: hardware and software; animation; image processing; simulation; and business and home graphics. An equipment exhibition will also be presented. For more information, contact Online Conferences Ltd, Argyle House, Northwood Hills, HA6 1TS, Middlesex, England.

October 29-November 1

Southeast Computer Show and Office Equipment Exposition, Atlanta Civic Center, Atlanta GA. For details, see October 15-18.

October 31-November 1

Computers in Ambulatory Medicine, Washington Sheraton, Washington DC. The Society for Advanced Medical Systems and the Society for Computer Medicine are

sponsoring this conference. Basic and advanced tutorials on the fundamentals of medical computing will be featured along with technical sessions and presentations of papers. Fees are \$115 for Society members and \$165 for nonmembers. Contact SCM, 9650 Rockville Pike, Bethesda MD 20014, (301) 530-7120.

October 31-November 2

Annual Meeting of the American Society for Cybernetics, Washington Hilton Hotel, Washington DC. The theme for this meeting is "The New Cybernetics." A goal of the meeting will be to redefine the field of cybernetics and to provide a focus for the research efforts of the Society. Among the topics to be discussed are robotics, problem solving, pattern recognition, remote sensing, and communication networks. Contact Dr Laurence D Richards, Department of Administrative Science, Colby College, Waterville ME 04901, (207) 873-1131, ext 587.

November 1981

November 1-4

DPMA San Francisco '81, San Francisco Civic Center and Brooks Hall, San Francisco CA. This is DPMA's (Data Processing Management Association's) thirtieth annual conference and business exposition. Contact the Conference Coordinator, DPMA, 505 Busse Hwy, Park Ridge IL 60068, (312) 825-8124.

November 5

Invitational Computer Conference, Amsterdam, Netherlands. The Invitational Computer Conference is a one-day computer show designed for quantity buyers. Exhibits and seminars are featured.

For details, contact B J Johnson & Associates Inc, 2503 Eastbluff Dr, Suite 203, Newport Beach CA 92660, (714) 644-6037.

November 8-10

The Twelfth ACM North American Computer Chess Championship, Bonaventure Hotel, Los Angeles CA. A four-round, Swiss-style tournament is planned for this year's championship competition. In addition, a round-robin blitz tournament will be held. Games in this event proceed at a rate of 5 seconds per move. Belle, the current world champion, Chaos, Duchess, Nuchess, and L'Excentrique are among the programs being entered. For more information, contact Professor Monroe Newborn, School of Computer Science, McGill University, 805 Sherbrooke St West, Montreal, Quebec H3A 2K6, Canada.

November 9-10

Software Fair, Stouffers' Riverfront Towers, St Louis MO. This show is made up of software exhibitions from companies whose packages are in current use by members of the Southern and National Industrial Distributors Association. Distributors who are not members of these organizations can also exhibit their wares. Contact Don White or Tony Carroll, 1900 Arch St, Philadelphia PA 19103, (215) 564-3484.

November 9-11

ACM '81, Bonaventure Hotel, Los Angeles CA. This meeting will feature panel discussions on computers, software products in the 1980s, tutorials on computer-aided design, and a survey on the impact of robots on employment. Ray Bradbury and Dr Simon Ramo will speak. Computer exhibits and the North American Computer Chess Tournament will also be held. Contact ACM '81,

APPARAT OFFERS More bytes per buck!



730 K/bytes of storage. Apparat has combined its Newdos/80 operating system and a dual-sided 80 track mini-floppy drive to give you up to 733,440 bytes of storage in a single volume. Newdos/80 version 2.0 expands the capability of double density drives, so you'll have greater applications for your TRS-80® model I and III.

Drives plug directly into an expansion interface (requires installation of a double density controller) or the model III disk bus with our single volume cable so you can now have over 2 megabytes of storage on-line with standard mini-floppy diskettes. Each drive has up to 573 free grams, for a total of 1,719, on a maximum of three 80 track drives, which can be added to a TRS-80 model I. Model III's can have up to 4 dual 80's on-line (almost 3 megabytes).

These drives can "read" standard 35 or 40 track diskettes using Newdos/80 version 2.0 which will allow skipping every other track.

Drives come complete with case, power supply and documentation. The drives are priced at only **\$515** (Cat.

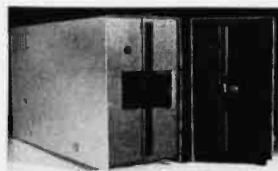

No. 1-705, specify I or III). Now, at 1424 bytes per buck, it just might be the answer to your storage problems. **Special - Two dual 80 track drives only \$999.**

 **Apparat, Inc.**

4401 So. Tamarac Parkway, Denver, CO 80237 (303) 741-1778

Circle 27 on inquiry card.



"ON GOING SUPPORT FOR MICROCOMPUTERS"

Event Queue

POB 24059, Village Station, Los Angeles CA 90024, (213) 536-9735.

November 10-12

Midcon/81 Show and Convention, O'Hare Exposition Center and Hyatt Regency O'Hare, Chicago IL. Talks on microcomputers, energy, memory, communications, and consumer electronics will highlight this show. Contact Electronic Conventions Inc, 999 N Sepulveda Blvd, El Segundo CA 90245, (800) 421-6816; in California (213) 772-2965.

November 12

Invitational Computer Conference, Paris, France. For details, see November 5.

November 16-19

The Canadian Computer Show and Conference, International Centre of Commerce, Mississauga, Ontario Canada. For details, contact Reg Leckie, Industrial Trade Shows of Canada, 36 Butterick Rd, Toronto, Ontario, M8W 3Z8, Canada, (416) 252-7791.

November 17

Invitational Computer Conference, Milan, Italy. For details, see November 5.

November 17-19

Understanding and Using Computer Graphics, Atlanta GA. For details, see October 13-15.

November 19-20

Western Educational Computer Conference, San Francisco CA. Many of the computer-related talks at this conference will cover areas of interest to college instructors and administrators. For details, contact Ron P Langley, Data Processing Services, California State University-Long Beach, 1250 Bellflower Blvd, Long Beach CA 90840.

November 29-December 1

National Telecommunica-

tions Conference, New Orleans LA. This event is sponsored by the IEEE (Institute of Electrical and Electronics Engineers) and the New Orleans chapter of the Communications Society Conference Board. Some of the papers to be presented will discuss communications electronics, including software, terminals, theory, and data and computer communications. Contact G Allan Ledbetter, South Central Bell, 365 Canal St, Rm 1360, New Orleans LA 70140, (504) 528-7350.

December 1981

December 1-3

Legal Info, Shoreham Hotel, Washington DC. Automating legal-information systems is the subject of this conference and exposition. Lawyers who are interested in using computers in their work are invited to attend. Contact Legal Info, 1730 N Lynn St, Suite 400, Arlington VA 22209, (703) 521-6209.

December 1-4

Computer-Network Design and Protocols, Washington DC. For details, see October 20-23.

December 3

California Computer Show, Hyatt Hotel, Palo Alto CA. For details and a schedule of upcoming shows, contact the Show Administrator, c/o Norm De Nardi Enterprises, 95 Main St, Los Altos CA 94022, (415) 941-8440.

December 9-11

1981 Winter Simulation Conference (WSC 81), Peachtree Plaza, Atlanta GA. WSC 81 will feature papers, panel discussions, tutorials on discrete and combined simulation and modeling. The conference will be organized into tutorial, methodology, and application sessions. For in-

formation, contact Claude M Delfosse, CACI Inc, 1815 N Fort Myer Dr, Arlington VA 22209, (703) 841-7800.

December 15-19

Gulf Computer Exhibition, Dubai International Trade Centre, Dubai, United Arab Emirates. IBM, NCR, Apple, Honeywell, Philips, Wang, Hewlett-Packard, Data General, and other well-known manufacturers will be represented at this first exhibition of computer equipment in Dubai. The scope of the show takes in systems ranging from microcomputers to mainframes. Details are available from the Trade Centre Management Company, POB 9292, Dubai, United Arab Emirates, Telex 47474 DITC EM, and from Diana Clifton Sewell, International Office, Seymour House, 17 Waterloo Pl, London, SE1Y 4AR, England.

December 16-18

The Twentieth IEEE Conference on Decision and Control (CDC), Vacation Village Hotel, San Diego CA. The CDC is the annual meeting of the IEEE (Institute of Electrical and Electronics Engineers) Control Systems Society. It is held in cooperation with the Society for Industrial and Applied Mathematics.

The conference will include contributed and invited sessions plus tutorials and presentations in all aspects of the theory and applications of systems involving decision, control, and adaptation. Topics of interest include linear and nonlinear system theory, stability theory, large-scale system theory and decentralized control, estimation, identification, signal processing and stochastic control, and control systems. For more information, contact the Institute of Electrical and Electronics Engineers Inc, 445 Hoes Ln, Piscataway NJ 08854.

December 28-30

Computer Modeling of Linguistic Theory, Grand Hyatt Hotel, New York NY. The ACL (Association for Computational Linguistics) is sponsoring three sessions on computer modeling of linguistic theory in conjunction with the annual meeting of the Linguistic Society of America. New models for grammars and new strategies for parsing will be the areas of most attention. Readings of contributed papers will also be featured. Contact Stan Petrick, IBM Research Center, POB 218, Yorktown Heights NY 10598. ■

In order to gain optimal coverage of your organization's computer conferences, seminars, workshops, courses, etc, notice should reach our office at least three months in advance of the date of the event. Entries should be sent to: Event Queue, BYTE Publications, POB 372, Hancock NH 03449. Each month we publish the current contents of the queue for the month of the cover date and the two following calendar months. Thus a given event may appear as many as three times in this section if it is sent to us far enough in advance.

MULTI-USER OASIS HAS THE FEATURES PROS DEMAND. READ WHY.

Computer experts (the pros) usually have big computer experience. That's why when they shop system software for Z80 micros, they look for the big system features they're used to. And that's why they like Multi-User OASIS. You will too.

DATA INTEGRITY: FILE & AUTOMATIC RECORD LOCKING

The biggest challenge for any multi-user system is co-ordinating requests from several users to change the same record at the same time.

Without proper co-ordination, the confusion and problems of inaccurate or even destroyed data can be staggering.

Our File and Automatic Record Locking features solve these problems.

For example: normally all users can view a particular record at the same time. But, if that record is being updated by one user, automatic record locking will deny all other users access to the record until the up-date is completed. So records are always accurate, up-to-date and integrity is assured.

Pros demand file & automatic record locking. OASIS has it.

SYSTEM SECURITY: LOGON, PASSWORD & USER ACCOUNTING

Controlling who gets on your system and what they do once they're on it is the essence of system security.

(THEN COMPARE.)

Without this control, unauthorized users could access your programs and data and do what they like. A frightening prospect isn't it?

And multi-users can multiply the problem.

But with the Logon, Password and Privilege Level features of Multi-User OASIS, a system manager can specify for each user which programs and files may be accessed—and for what purpose.

Security is further enhanced by User Accounting—a feature that lets you keep a history of which user has been logged on, when and for how long.

Pros insist on these security features. OASIS has them.

EFFICIENCY: RE-ENTRANT BASIC

A multi-user system is often not even practical on computers limited to 64K memory.

OASIS Re-entrant BASIC makes it practical. How?

Because all users use a single run-time BASIC module, to execute their compiled programs, less

memory is needed. Even if you have more than 64K, your pay-off is cost saving and more efficient use of all the memory you have available—because it services more users.

Sound like a pro feature? It is. And OASIS has it.

AND LOTS MORE...

Multi-User OASIS supports as many as 16 terminals and can run in as little as 56K memory. Or, with bank switching, as much as 784K.

Multi-Tasking lets each user run more than one job at the same time.

And there's our BASIC—a compiler, interpreter and debugger all in one. An OASIS exclusive.

Still more: Editor; Hard & Floppy Disk Support; Keyed (ISAM), Direct & Sequential Files; Mail-Box; Scheduler; Spooler; all from OASIS.

Our documentation is recognized as some of the best, most extensive, in the industry. And, of course, there's plenty of application software.

Put it all together and it's easy to see why the real pros like OASIS. Join them. Send your order today.

OASIS IS AVAILABLE FOR

SYSTEMS: Allos; CompuCorp; Cromemco; Delta Products; Digital Group; Digital Microsystems; Dynabyte; Godbout; IBC; Index; Intersystems; North Star; Onyx; SD Systems; TRS 80 Mod II; Vector Graphic; Vorimex.

CONTROLLERS: Bell Controls; Cameo; Corvus; Konan; Micromation; Micropolis; Tarbell; Teletek; Thinkertoys; X Comp.

Write for complete, free Application Software Directory.

PLEASE SEND ME:

| Product | Price with Manual | Manual Only |
|---|-------------------|------------------|
| OPERATING SYSTEM (Includes: EXEC Language; File Management; User Accounting; Device Drivers; Print Spooler; General Text Editor; etc.) SINGLE-USER MULTI-USER | \$150 350 | \$17.50 17.50 |
| BASIC COMPILER/INTERPRETER/DEBUGGER | 100 | 15.00 |
| RE-ENTRANT BASIC COMPILER/INTERPRETER/DEBUGGER | 150 | 15.00 |
| DEVELOPMENT PACKAGE (Macro Assembler; Linkage Editor; Debugger) | 150 | 25.00 |
| TEXT EDITOR & SCRIPT PROCESSOR | 150 | 15.00 |
| DIAGNOSTIC & CONVERSION UTILITIES (Memory Test; Assembly Language; Converters; File Recovery; Disk Test; File Copy from other OS; etc.) | 100 | 15.00 |
| COMMUNICATIONS PACKAGE (Terminal Emulator; File Send & Receive) | 100 | 15.00 |
| PACKAGE PRICE (All of Above) SINGLE-USER MULTI-USER | 500 850 | 60.00 60.00 |
| FILE SORT | 100 | 15.00 |
| COBOL-ANSI '74 | 750 | 35.00 |

Order OASIS from:

Phase One Systems, Inc.
7700 Edgewater Drive, Suite 830
Oakland, CA 94621

Telephone (415) 562-8085
TWX 910-366-7139

NAME _____
STREET (NO BOX #) _____
CITY _____
STATE _____ ZIP _____

AMOUNT \$ _____
(Attach system description; add \$3 for shipping; California residents add sales tax)
 Check enclosed VISA
 UPS C.O.D. Mastercharge
Card Number _____
Expiration Date _____
Signature _____

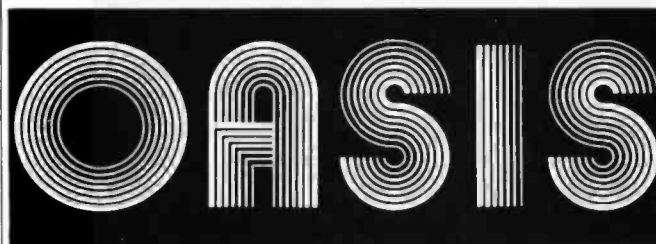

MAKES MICROS RUN LIKE MINIS

DYNACOMP

Quality software for*:

ATARI
PET
APPLE II Plus

TRS-80 (Level II)**
NORTH STAR
CP/M Disks/Diskettes

CARD GAMES

BRIDGE 2.0 (Available for all computers) Price: \$17.95 Cassette/\$21.95 Diskette
An all-inclusive version of this most popular of card games. This program both BIDS and PLAYS either contract or duplicate bridge. Depending on the contract, your computer opponents will either play the offense OR defense. If you bid too high, the computer will double your contract! BRIDGE 2.0 provides challenging entertainment for advanced players and is an excellent learning tool for the bridge novice. See the software review in 80 Software Critique. Rated #1 by Creative Computing.

HEARTS 1.5 (Available for all computers) Price: \$15.95 Cassette/\$19.95 Diskette
An exciting and entertaining computer version of this popular card game. Hearts is a trick-oriented game in which the purpose is not to take any hearts or the queen of spades. Play against two computer opponents who are armed with hard-to-beat playing strategies. HEARTS 1.5 is an ideal game for introducing the uninitiated (your spouse) to computers. See the software review in 80 Software Critique.

STUD POKER (Atari only) Price: \$11.95 Cassette/\$15.95 Diskette
This is the classic gambler's card game. The computer deals the cards one at a time and you (and the computer) bet on what you see. The computer does not cheat and usually bets the odds. However, it sometimes bluffs! Also included is a five card draw poker betting practice program. This package will run on a 16K ATARI. Color, graphics, sound. See review in COMPUTE.

POKER PARTY (Available for all computers) Price: \$17.95 Cassette/\$21.95 Diskette
POKER PARTY is a draw poker simulation based on the book, POKER, by Oswald Jacoby. This is the most comprehensive version available for microcomputers. The party consists of yourself and six other (computer) players. Each of these players you will get to know them has a different personality in the form of a varying propensity to bluff or fold under pressure. Practice with POKER PARTY before going to that expensive game tonight! Apple Cassette and diskette versions require a 32 K (or larger) Apple II.

CRIBbage 2.0 (TRS-80 only) Price: \$14.95 Cassette/\$18.95 Diskette
This is simply the best cribbage game available. It is an excellent program for the cribbage player in search of a worthy opponent as well as for the novice wishing to improve his game. The graphics are superb and assembly language routines provide rapid execution. See the software review in 80 Software Critique.

THOUGHT PROVOKERS

MANAGEMENT SIMULATOR (Atari, North Star and CP/M only) Price: \$19.95 Cassette/\$23.95 Diskette

This program is both an excellent teaching tool as well as a stimulating intellectual game. Based upon similar games played at graduate business schools, each player or team controls a company which manufactures three products. Each player attempts to outperform his competitors by setting selling prices, production volumes, marketing and design expenditures etc. The most successful firm is the one with the highest stock price when the simulation ends.

FLIGHT SIMULATOR (Available for all computers) Price: \$17.95 Cassette/\$21.95 Diskette
A realistic and extensive mathematical simulation of take-off, flight and landing. The program utilizes aerodynamic equations and the characteristics of a real aircraft. You can practice instrument approaches and navigation using radials and compass headings. The more advanced flyer can also perform loops, half-rolls and similar aerobically maneuvers. Although this program does not employ graphics, it is exciting and very addictive. See the software review in COMPUTRONICS. Runs in 16K Atari.

VALDEZ (Available for all computers) Price: \$15.95 Cassette/\$19.95 Diskette
VALDEZ is a computer simulation of super tanker navigation in the Prince William Sound/Valdez Narrows region of Alaska. Included in this simulation is a realistic and extensive 256 x 256 element map, portions of which may be viewed using the ship's alphanumeric radar display. The motion of the ship itself is accurately modeled mathematically. The simulation also contains a model for the tidal patterns in the region, as well as other traffic (tugboats, tankers and drifting icebergs). Chart your course from the Gulf of Alaska to Valdez Harbor! See the software review in 80 Software Critique.

BACKGAMMON 2.0 (Atari, North Star and CP/M only) Price: \$14.95 Cassette/\$18.95 Diskette
This program tests your backgammon skills and will also improve your game. A human can compete against a computer or against another human. The computer can even play against itself. Either the human or the computer can double or generate dice rolls. Board positions can be created or saved for replay. BACKGAMMON 2.0 plays in accordance with the official rules of backgammon and is sure to provide many fascinating sessions of backgammon play.

CHECKERS 3.0 (PET only) Price: \$16.95 Cassette/\$20.95 Diskette
This is one of the most challenging checkers programs available. It has 10 levels of play and allows the user to change his levels at any time. Although providing a very tough game at level 4-8, CHECKERS 3.0 is practically unbeatable at levels 9 and 10.

CHESSE MASTER (North Star and TRS-80 only) Price: \$19.95 Cassette/\$23.95 Diskette
This complete and very powerful program provides five levels of play. It includes castling, en passant captures and the promotion of pawns. Additionally, the board may be preset before the start of play, permitting the examination of "book" plays. To maximize execution speed, the program is written in assembly language (by SOFTWARE SPECIALISTS of California). Full graphics are employed in the TRS-80 version, and two widths of alphanumeric display are provided to accommodate North Star users.

LEM LANDER (32K Apple Disk only) Price: \$16.95 Diskette
Pilot your LEM LANDER to a safe landing on any of nine different surfaces ranging from smooth to treacherous. The game paddles are used to control craft attitude and thrust. This is a real-time high res challenge!

FOREST FIRE! (Atari only) Price: \$16.95 Cassette/\$20.95 Diskette
Using excellent graphics and sound effects, this simulation puts you in the middle of a forest fire. Your job is to direct operations to put out the fire while compensating for changes in wind, weather and terrain. Not protecting valuable structures can result in startling penalties. Life-like variables are provided to make FOREST FIRE! very suspenseful and challenging. Not two games have the same setting and there are 3 levels of difficulty.

NOMINOES JIGSAW (Atari, Apple and TRS-80 only) Price: \$16.95 Cassette/\$20.95 Diskette
A jigsaw puzzle on your computer! Complete the puzzle by selecting your pieces from a table consisting of 60 different shapes. NOMINOES JIGSAW is a virtuoso programming effort. The graphics are superlative and the puzzle will challenge you with its three levels of difficulty. Scoring is based upon the number of guesses taken and by the difficulty of the board set-up. See review in ELECTRONIC GAMES.

MONARCH (Atari only) Price: \$11.95 Cassette/\$15.95 Diskette
MONARCH is a fascinating economic simulation requiring you to survive an 8-year term as your nation's leader. You determine the amount of acreage devoted to industrial and agricultural use, how much food to distribute to the populace and how much should be spent on pollution control. You will find that all decisions involve a compromise and that it is not easy to make everyone happy.

CIOMPIELO (Atari only) Price: \$11.95 Cassette/\$15.95 Diskette
CIOMPIELO is really two challenging games in one. One is similar to NIM; you must bite off part of a cookie, but avoid taking the poisoned portion. The other game is the popular board game REVERSI. It fully uses the Atari's graphics capability, and is hard to beat. This package will run on a 16K system.

*ATARI, PET, TRS-80, NORTHSTAR, CP/M and IBM are registered trademarks and/or trademarks.

**Except where noted, all model I software is available for the Model III. TRS-80 diskettes are not supplied with DOS or BASIC.

DYNACOMP OFFERS THE FOLLOWING

- Widest variety
- Guaranteed quality
- Fastest delivery
- Friendly customer service
- Free catalog
- 24 hour order phone

AND MORE...

STARTREK 3.2 (Available for all computers) Price: \$11.95 Cassette/\$15.95 Diskette
This is the classic Startrek simulation, but with several new features. For example, the Klingons now shoot at the Enterprise without warning while also attacking starbases in other quadrants. The Klingons also attack with both light and heavy cruisers and move when shot at! The situation is hectic when the Enterprise is beset by three heavy cruisers and a starbase S.O.S. is received! The Klingons get even! See the software reviews in A.N.A.L.O.G., 80 Software Critique and Game Merchandising.

BLACK HOLE (Apple only) Price: \$14.95 Cassette/\$18.95 Diskette
This is an exciting graphical simulation of the problems involved in closely observing a black hole with a space probe. The object is to enter and maintain, for a prescribed time, an orbit close to a small black hole. This is to be achieved without coming so near the anomaly that the tidal stress destroys the probe. Control of the craft is realistically simulated using slide jacks for rotation and main thrusters for acceleration. This program employs Hi-Res graphics and is educational as well as challenging.

SPACE TILT (Apple and Atari only) Price: \$10.95 Cassette/\$14.95 Diskette
Use the game paddles to tilt the plane of the TV screen to "roll" a ball into a hole in the screen. Sound simple? Not when the hole gets smaller and smaller! A built-in timer allows you to measure your skill against others in this habit-forming action game.

MOVING MAZE (Apple and Atari only) Price: \$10.95 Cassette/\$14.95 Diskette
MOVING MAZE employs the game paddles to direct a puck from one side of a maze to the other. However, the maze is dynamically (and randomly) built and is continually being modified. The objective is to cross the maze without touching (or being hit by) a wall. Scoring is by an elapsed time indicator, and three levels of play are provided.

ALPHA FIGHTER (Atari only) Price: \$14.95 Cassette/\$18.95 Diskette
Two excellent graphics and action programs in one! ALPHA FIGHTER requires you to destroy the alien starships passing through your sector of the galaxy. ALPHA BASE is in the path of an alien UFO invasion; let five UFO's get by and the game ends. Both games require the joystick and get progressively more difficult the higher you score! ALPHA FIGHTER will run on 16K systems.

THE RINGS OF THE EMPIRE (Atari only) Price: \$16.95 Cassette/\$20.95 Diskette
The empire has developed a new habit: station protection by rotating rings of energy. Each time you blast through the rings and destroy the station, the empire develops a new station with more protective rings. This exciting game runs on 16K systems, employs extensive graphics and sound and can be played by one or two players.

INTRUDER ALERT (Atari only) Price: \$16.95 Cassette/\$20.95 Diskette
This is a fast paced graphics game which places you in the middle of the "Dreadstar" having just stolen its plans. The dreadstar has been alerted and are directed to destroy you at all costs. You must find and enter your ship to escape with the plans. Five levels of difficulty are provided. INTRUDER ALERT requires a joystick and will run on 16K systems.

GIANT SALAMON (Atari only) Price: \$14.95 Cassette/\$18.95 Diskette
This real-time action game is guaranteed addictive! Use the joystick to control your path through salamon courses consisting of both open and closed gates. Choose from different levels of difficulty, race against other players or simply take practice runs against the clock. GIANT SALAMON will run on 16K systems.

TRIPLE BLOKKADE (Atari only) Price: \$14.95 Cassette/\$18.95 Diskette
TRIPLE BLOKKADE is a two-to-three player graphics and sound action game. It is based on the classic video arcade game which millions have enjoyed. Using the Atari Joysticks, the object is to direct your blockading line around the screen without running into your opponent(s). Although the concept is simple, the combined graphics and sound effect lead to "high anxiety".

GAMES PACK I (Available for all computers) Price: \$10.95 Cassette/\$14.95 Diskette
GAMES PACK I contains the classic computer games of BLACK JACK, LUNAR LANDER, CRAPS, HORSERACE, SWITCH and more. These games have been combined into one large program for ease in loading. They are individually accessed by a convenient menu. This collection is worth the price just for the DYNACOMP version of BLACK JACK.

GAMES PACK II (Available for all computers) Price: \$10.95 Cassette/\$14.95 Diskette
GAMES PACK II includes the games CRAZY EIGHTS, JOTTO, ACEY-DOUCEY, LIFE, WUMPIUS and others. As with GAMES PACK I, all the games are loaded as one program and are called from a menu. You will particularly enjoy DYNACOMP's version of CRAZY EIGHTS.

Why pay \$7.95 or more per program when you can buy a DYNACOMP collection for just \$10.95?

MOON PROBE (Atari and North Star only) Price: \$11.95 Cassette/\$15.95 Diskette
This is an extremely challenging "lunar lander" program. The user must drop from orbit to land at a predetermined target on the moon's surface. You control the thrust and orientation of your craft plus direct the rate of descent and approach angle.

SPACE LANES (North Star only) Price: \$14.95 Diskette
SPACE LANES is a simple but exciting space transportation game which involves up to four players (including the computer). The object is to form and expand space transportation companies in a competitive environment. The goal is to amass more net worth than your opponent. The economics include stock purchases and company mergers. Watch your wealth grow!

ADVENTURE

CRANSTON MANOR ADVENTURE (North Star and CP/M only) Price: \$21.95 Diskette
At last! A comprehensive Adventure game for North Star and CP/M systems. CRANSTON MANOR ADVENTURE takes you into mysterious CRANSTON MANOR where you attempt to gather fabulous treasures. Lurking in the manor are wild animals and robots who will not give up the treasures without a fight. The number of rooms is greater and the associated descriptions are much more elaborate than the current popular version of Adventure programs, making this game the top in its class. Play can be stopped at any time and the status stored on diskette.

SPEECH SYNTHESIS

DYNACOMP is now distributing the new and revolutionary TYPE-N-TALK™ (TNT) speech synthesizer from VOICEX. Simply connect TNT to your computer's serial interface, enter text from the keyboard and hear the words spoken. TNT is the easiest-to-program speech synthesizer on the market. It uses the least amount of memory and provides the most flexible vocabulary available anywhere!

Price: \$329.95 (Please add \$4.00 for shipping and handling)

TNT Software

The following DYNACOMP programs are available for use with TNT:

STUD POKER (Atari, 24K)
NOMINOES JIGSAW (Atari, 24K)
ADVENTURE'S PET I (Atari and North Star)
BRIDGE 2.0 (North Star)
CIOMPIELO (Atari, 24K)

Please specify "TNT" versions when ordering.

ABOUT DYNACOMP

DYNACOMP is a leading distributor of small system software with sales spanning the world (currently in excess of 40 countries). During the past two years we have greatly enlarged the DYNACOMP product line, but have maintained and improved our high level of quality and customer support. The achievement in quality is apparent from our many repeat customers and the software reviews in such publications as COMPUTRONICS, 80 Software Critique and A.N.A.L.O.G. Our customer support is as close as your phone. It is always friendly. The staff is highly trained and always willing to discuss products or give advice.

BUSINESS and UTILITIES

SPELLGUARD™ (CP/M only)

Price: \$219.95 Disk
SPELL GUARD is a revolutionary new product which increases the value of your current word processing system (WORDSTAR, GLAG WAND, ELECTRIC PENCIL, TEXT EDITOR II and others). Written entirely in assembly language, **SPELL GUARD** rapidly assists the user in eliminating spelling and typographical errors by comparing each word of the text against a dictionary (expandable to over 20,000 of the most common English words). Words appearing in the text but not found in the dictionary are "flagged" for easy identification and correction. Most administrative staff familiar with word processing equipment will be able to use **SPELLGUARD**™ in only a few minutes.

MAIL LIST 2.2 (Apple, Atari and North Star diskette only)

Price: \$34.95
 This program is unmatched in its ability to store a maximum number of addresses on one diskette (minimum of 1100 per diskette, more than 2200 for "double density" systems). Its many features include alphabetic and zip code sorting, label printing (1, 2, or 3 up), merging of files and a unique keyword seeking routine which retrieves entries by a virtually limitless selection of user defined codes. Mail List 2.2 will even find and delete duplicate entries. A very valuable program!

FORM LETTER SYSTEM rel. 2 (Atari, North Star and Apple Diskettes only)

Price: \$34.95
FORM LETTER SYSTEM (FLS) is the ideal program for creating and editing form letters and address lists. It contains an easy-to-use text editor which produces fully justified text. Special codes are used in the address list to obtain personalized salutations. Form letters are produced by automatically inserting each address into a predetermined portion of your letter. FLS is completely compatible with MAIL LIST 2.2, which may be used to manage and sort your address files.

FLS and MAIL LIST 2.2 are available as a combined package for \$59.95.

SORTIT (North Star only)

Price: \$29.95 Diskette
SORTIT is a general purpose sorting program written in 8080 assembly language. This program will sort sequential data files generated by NORTH STAR BASIC. Primary and optional secondary keys may be numeric or one to nine character strings. SORTIT is easily used with files generated by DYNACOMP's MAIL LIST program and is very versatile in its capabilities for all other BASIC data file sorting.

PERSONAL FINANCE SYSTEM (Atari and North Star only)

Price: \$34.95 Diskette
PFS is a single diskette, menu-oriented system composed of ten different programs. Besides recording your expenses and tax deductible items, PFS will sort and summarize expenses by payee, and display information on expenditures by any of 26 user defined codes by month or by payee. PFS will even produce monthly bar graphs of your expenses by category! This powerful package requires only one disk drive, minimal memory (24K Atari, 32K North Star) and will store up to 600 records per disk (and over 1000 records per disk by making a few simple changes to the programs). You can record checks plus cash expenses so that you can finally see where your money goes and eliminate guesswork and tedious hand calculations.

FAMILY BUDGET (Apple only)

Price: \$34.95 Diskette
FAMILY BUDGET is a very convenient financial record-keeping program. You will be able to keep track of cash and credit expenditures as well as income on a daily basis. You can record tax deductible items and charitable donations. FAMILY BUDGET also provides a continuous record of all credit transactions. You can make daily cash and charge entries to any of 21 different expense accounts as well as to payroll and tax accounts. Data are easily retrieved giving the user complete control over an otherwise complicated (and unorganized!) subject.

INTELINK (Atari only)

Price: \$46.95 Diskette
 This software package contains a menu-driven collection of programs for facilitating efficient two-way communications through a full duplex modem (required for use). In one mode of operation you may connect to a data service (e.g., The SOURCE or MicroNet) and quickly load data such as stock quotations onto your diskette for later viewing. This greatly reduces "connect time" and thus the service charge. You may also record the complete contents of a communications session. Additionally, programs written in BASIC, FORTRAN, etc. may be built off-line using the support text editor and later "uploaded" to another computer, making the Atari a very smart terminal. Even Atari BASIC programs may be uploaded. Further, a command file may be built off-line and used later as controlling input for a time-share system. That is, you can set up your sequence of time-share commands and programs, and the Atari will transmit them as needed; batch processing. All this adds up to saving both connect time and your time.

TEXT EDITOR II (CP/M)

Price: \$29.95 Diskette/\$33.45 Disk
 This is the second release version of DYNACOMP's popular TEXT EDITOR I and contains many new features. With TEXT EDITOR II you may build text files in chunks and assemble them for later display. Blocks of text may be appended, inserted or deleted. Files may be saved on disk in rights justified/centered format to be later printed by either TEXT EDITOR II or the CP/M ED facility. Further, ASCII CP/M files including BASIC and assembly language programs may be read by the editor and processed. In fact, text files can be built using ED and later formatted using TEXT EDITOR II. All in all, TEXT EDITOR II is an inexpensive, easy to use, but very flexible editing system.

DFILE (Atari and North Star diskettes only)

Price: \$19.95
 This handy program allows North Star and Atari disk users to maintain a specialized data base of all files and programs in the stack of disks which invariably accumulates. DFILE is easy to set up and use. It will organize your disks to provide efficient locating of the desired file or program.

FINDIT (North Star only)

Price: \$19.95
 This is a three-in-one program which maintains information accessible by keywords of three types: Personal (e.g., last name), Commercial (e.g., plumbers) and Reference (e.g., magazine articles, record albums, etc.). In addition to keyword searches, there are birthday, anniversary and appointment searches for the personal records and appointment searches for the commercial records. Reference records are accessed by a single keyword or by cross-referencing two or three keywords.

SHOPPING LIST (Atari and North Star only)

Price: \$12.95 Cassette/\$16.95 Diskette
SHOPPING is a program which allows you to purchase at the supermarket. Before going shopping, it will remind you of all the things you might need, and then display (or optionally print) your shopping list and the total cost. Adding, deleting, changing and storing data is very easy. Runs with 16K.

TAX OPTIMIZER (North Star only)

Price: \$59.95 Diskette
TAX OPTIMIZER is an easy-to-use, menu-oriented software package which provides a convenient means for analyzing various income tax strategies. The program is designed to provide a quick and easy data entry. Income tax is computed by all tax methods (regular, income averaging, maximum and alternate minimum tax). The user may immediately observe the tax effect of certain financial decisions. TAX OPTIMIZER has been thoroughly field tested in CPA offices and comes complete with the current tax tables in its data files.

EDUCATION

HODGE PODGE (Apple only, 48K AppleSoft or Integer BASIC)

Price: \$19.95 Cassette/\$23.95 Diskette
LET HODGE PODGE be your child's baby-sitter. Pressing any key on your Apple will result in a different and intriguing "happening" related to the letter or number of the chosen key. The program's graphics, color and sound are a delight for children from ages 1 1/2 to 9. HODGE PODGE is a non-timed dating teaching device which brings a new dimension to the use of computers in education.

TEACHER'S PET II (Available for all computers)

Price: \$11.95 Cassette/\$15.95 Diskette
 This is the first of DYNACOMP's educational packages. Primarily intended for pre-school to grade 3, TEACHER'S PET provides the young student with counting practice, letter-word recognition and three levels of math skill exercises.

MISCELLANEOUS

CRYSTALS (Atari only)

Price: \$ 9.95 Cassette/\$13.95 Diskette
 A unique algorithm randomly produces fascinating graphics displays accompanied with tones which vary as the patterns are built. No two patterns are the same, and the combined effect of the sound and graphics are mesmerizing. CRYSTALS has been used in local stores to demonstrate the sound and color features of the Atari.

NORTH STAR SOFTWARE EXCHANGE (NSSE) LIBRARY

DYNACOMP now distributes the 23 volume NSSE library. These diskettes each contain many programs and offer an outstanding value for the purchase price. They should be part of every North Star user's collection. Call or write DYNACOMP for details regarding the contents of the NSSE collection.

Price: \$9.95 each/\$7.95 each (4 or more)
 The complete collection may be purchased for \$149.95

AVAILABILITY

DYNACOMP software is supplied with complete documentation containing clear explanations and examples. Unless otherwise specified, all program listings are printed on 16K programs (Atari requires 24K). Programs where noted, other programs are available on ATARI, PET, TRS-80 (Level II) and Apple (AppleSoft) cassette and diskette as well as North Star single density (double density compatible) diskette. Additionally, most programs can be obtained on standard (IBM format) 8" CP/M floppy disks for systems running under MBASIC.

STATISTICS and ENGINEERING

DIGITAL FILTER (Available for all computers)

Price: \$39.95 Cassette/\$43.95 Diskette
DIGITAL FILTER is a comprehensive data processing program which permits the user to design his own filter function or choose from a menu of filter forms. The filter forms are subsequently converted into non-recurrence convolution coefficients which permit rapid data processing. In the explicit design mode the shape of the frequency transfer function is specified by directly entering points along the desired filter curve. In the menu mode, ideal low pass, high pass and band-pass filters may be approximated to varying degrees according to the number of points used in the calculation. These filters may optionally also be smoothed with a Hamming function. In addition, multi-stage Butterworth filters may be selected. Features of DIGITAL FILTER include plotting of the data before and after filtering, as well as display of the chosen filter functions. Also included are convenient data storage, retrieval and editing procedures.

DATA SMOOTHER (Not available for Atari)

Price: \$19.95 Cassette/\$23.95 Diskette
 This special data smoothing program may be used to rapidly derive useful information from noisy business and engineering data which are equally spaced. The software features choice in degree and range of fit, as well as smoothed first and second derivative calculation. Also included is automatic plotting of the input data and smoothed results.

FOURIER ANALYZER (Available for all computers)

Price: \$19.95 Cassette/\$23.95 Diskette
 Use this program to examine the frequency spectra of limited duration signals. The program features automatic scaling and plotting of the input data and results. Practical applications include the analysis of complicated patterns in such fields as electronics, communications and business.

TFA (Transfer Function Analyzer)

Price: \$19.95 Cassette/\$23.95 Diskette
 This is a special software package which may be used to evaluate the transfer functions of systems such as hi-fi amplifiers and filters by examining their response to pulsed input. TFA is a major modification of FOURIER ANALYZER and contains an engineering-oriented decibel versus log-frequency plot as well as data editing features. Whereas FOURIER ANALYZER is designed for educational and scientific use, TFA is an engineering tool. Available for all computers.

HARMONIC ANALYZER (Available for all computers)

Price: \$24.95 Cassette/\$28.95 Diskette
HARMONIC ANALYZER was designed for the spectrum analysis of repetitive waveforms. Features include data file generation, editing and storage/retrieval as well as data and spectrum plotting. One particularly unique facility is that the input data need not be equally spaced or in order. The original data is sorted and a cubic spline interpolation is used to create the data file required by the FFT algorithm.

FOURIER ANALYZER, TFA and HARMONIC ANALYZER may be purchased together for a combined price of \$49.95 (three cassettes) and \$59.95 (three diskettes).

REGRESSION I (Available for all computers)

Price: \$19.95 Cassette/\$23.95 Diskette
REGRESSION I is a unique and exceptionally versatile one-dimensional least squares "polynomial" curve fitting program. Features include very high accuracy; an automatic degree determination option; an extensive internal library of fitting functions; data editing; automatic data and curve plotting; a statistical analysis (e.g., standard deviation, correlation, coefficient, etc.) and much more. In addition, new fits may be tried without reentering the data. REGRESSION I is certainly the cornerstone program in any data analysis software library.

REGRESSION II (PARAFIT) (Available for all computers)

Price: \$19.95 Cassette/\$23.95 Diskette
PARAFIT is designed to handle those cases in which the parameters are imbedded (possibly nonlinearly) in the fitting function. The user simply inserts the functional form, including the parameters (A(1), A(2), etc.) as one or more BASIC statement lines. Data and results may be manipulated and plotted as with REGRESSION I. Use REGRESSION I for polynomial fitting, and PARAFIT for those complicated functions.

MULTILINEAR REGRESSION (MLR) (Available for all computers)

Price: \$24.95 Cassette/\$28.95 Diskette
MLR is a professional software package for analyzing data sets containing two or more linearly independent variables. Besides performing the basic regression calculation, this program also provides easy to use data entry, storage, retrieval and editing functions. In addition, the user may interrogate the solution by supplying values for the independent variables. The number of variables and data size is limited only by the available memory.

REGRESSION I, II and MULTILINEAR REGRESSION may be purchased together for \$51.95 (three cassettes) or \$61.95 (three diskettes).

ANOVA (Available for all computers)

Price: \$39.95 Cassette/\$43.95 Diskette
 In the past the ANOVA (analysis of variance) procedure has been limited to the large mainframe computers. Now DYNACOMP has brought the power of this method to small systems. For those conversant with ANOVA, the DYNACOMP software package includes the 1-way, 2-way and N-way procedures. Also provided are the Yates 2^k-1¹ fractional designs. For those unfamiliar with ANOVA, do not worry. The accompanying documentation was written in a tutorial fashion by a professor in the subject and serves as an excellent introduction to the subject. Accompanying ANOVA is a support program for building the data base. Included are several convenient features including data editing, deleting and appending.

IIASIC SCIENTIFIC SUBROUTINES, Volume I (Not available for Atari)
DYNACOMP is the exclusive distributor for the software keyed to the popular text: *BASIC Scientific Subroutines, Volume I* by F. Ruckdeschel see the BYTE/McGraw-Hill advertisement in BYTE magazine, January 1981. These subroutines have been assembled according to chapter. Included with each collection is a menu program which selects and demonstrates each subroutine.

- Collection #1: Chapters 2 and 3: Data and function plotting, complex variables
 - Collection #2: Chapter 4: Matrix and vector operations
 - Collection #3: Chapters 5 and 6: Random number generators, series approximations
- Price per collection: \$14.95 Cassette/\$18.95 Diskette
 All three collections are available for \$39.95 (three cassettes) and \$49.95 (three diskettes).
 Because the text is a vital part of the documentation, *BASIC Scientific Subroutines, Volume I* is available from DYNACOMP for \$19.95 plus 75¢ postage and handling. See review in Dr. Dobbs.

ROOTS (Available for all computers)

Price: \$10.95 Cassette/\$14.95 Diskette
 In a nutshell, **ROOTS** simultaneously determines all the zeroes of a polynomial having real coefficients. There is no limit on the degree of the polynomial, and because the procedure is iterative, the accuracy is generally very good. No initial guesses are required as input, and the calculated roots are substituted back into the polynomial and the residuals displayed.

ACTIVE CIRCUIT ANALYSIS (ACAP) (48K Apple only)

Price: \$25.95 Cassette/\$29.95 Diskette
ACAP is the analog circuit designer's answer to LOGIC SIMULATOR. With ACAP you may examine the response of an active or passive component circuit (e.g., a transistor amplifier, band pass filter, etc.). The circuit may be probed at equal steps in frequency, and the resulting complex (i.e., real and imaginary) voltages at each component junction examined. Its plotting the magnitude of these voltages, the frequency response of a filter or amplifier may be completely determined with respect to both amplitude and phase. In addition, ACAP prints a statistical analysis of the range of voltage responses which result from tolerance variations in the components. ACAP is easy to learn and use. Simply describe the circuit in terms of the elements and their placement, and execute. Circuit descriptions may be saved onto cassette or diskette to be recalled at a later time for execution or editing. ACAP should be part of every circuit designer's program library.

LOGIC SIMULATOR (Apple only; 48K RAM)

Price: \$24.95 Cassette/\$28.95 Diskette
 With **LOGIC SIMULATOR** you may easily test your complicated digital logic design with respect to given set of inputs to determine how well the circuit will operate. The elements which may be simulated include multiple input AND, OR, NOR, EXOR, EXNOR and NAND gates, as well as inverters, J-K and D flip-flops, and one-shots. The response of the system is available every clock cycle. Inputs may be clocked in with varying clock cycle lengths/placements and delays may be introduced to probe for glitches and race conditions. At the user's option, a timing diagram for any given set of nodes may be plotted using IHRES graphics. Save your breadboarding until the circuit is checked by LOGIC SIMULATOR.

LOGIC DESIGNER (North Star and CP/M only)

Price: \$34.95 Diskette
LOGIC DESIGNER is an exceptional Computer Aided Design (CAD) program. With it you may convert a large and complicated digital truth table (the functional specification) into an optimized Boolean logic equation. This equation may then be neatly converted into a circuit design using either NAND or AND/OR gates. Operationally, LOGIC DESIGNER is composed of a BASIC program which calls in a machine language routine to reduce execution time. Example: For a 7 variable by 127 line table, the processing time is only two minutes. LOGIC DESIGNER is clearly a fast and powerful tool for building digital circuitry.

ORDERING INFORMATION

All orders are processed and shipped within 48 hours. Please enclose payment with order and include the appropriate computer information. If paying by VISA or Master Card, include all numbers on card.

Shipping and Handling Charges

Within North America: Add \$1.50

Outside North America: Add 10% (Air Mail)

Delivery

All orders (excluding books) are sent First Class.

Quantity Discounts

Deduct 10% when ordering 3 or more programs. Dealer discount schedules are available upon request.

8" CP/M Disks

Add \$2.50 to the listed diskette price for each 8" floppy disk (IBM soft sectorized CP/M format). Programs run under Microsoft MBASIC or IIASIC-80.

5 1/4" CP/M Disks

All software available on 8" CP/M disks is also available on 5 1/4" disks, North Star format.

Ask for DYNACOMP programs at your local software dealer. Write for detailed descriptions of these and other programs from DYNACOMP.

DYNACOMP, Inc.

1427 Monroe Avenue

Rochester, New York 14618

24 hour order phone: (716) 586-7579 recording

Office phone (9AM-5PM EST): (716) 442-8960

New York State residents please add 7% NYS sales tax.



Clubs and Newsletters

Newsletter for Hams and Computerists

Dits & Bits, The W5YI Report, is published twice a month for the ham radio operator and microcomputer user. Articles on memory, FCC regulations, and other related topics are included. Contact the newsletter at POB 10101, Dallas TX 75207, (214) 690-1063.

Interested in a Central Bulletin-Board Service?

Michael Witt is interested in hearing from people who would like to develop a computer network in which the central system would place calls during the evening hours for reduced telephone rates. The system would be similar to other bulletin-board systems, except messages would be delivered and picked up by the central system instead of users calling in.

Contact Michael Witt, POB 55686, Valancia CA 91355.

Newsletter on Genealogy

Genealogical Computing is a bimonthly newsletter on personal-computer applications involving genealogy. Contact Sara Andreck, c/o Data Transfer Associates, 5102 Pommeroy Dr, Fairfax VA 22032, (703) 978-8490.

Swiss Computer Club

Founded in 1978, the Schweizer Computer Club already has more than 4000 members. Members own PET, Apple, Sorcerer, and other systems, and have a special CP/M group. The

club publishes three newsletters: *Mikro- und Kleincomputer*, a bimonthly; *CBM/PET News*; and *Computerjournal*. Contact Ernst Erb, Schweizer Computer Club, Seeburgstrasse 18, CH-6002 Luzern, Switzerland.

Free Graphics Newsletter

Subscriptions to the *Dynamic Blackboard News*, are free. The *News* features customer applications, new products, technical notes, software news, and hints for graphics users. *Dynamic Blackboard News* is a publication of the Cambridge Development Laboratory. Contact Jean L Graef, Cambridge Development Laboratory, 36 Pleasant St, Watertown MA 02172, (617) 926-0869.

Newsletter on Graphics

Computer Graphics News is published by the National Computer Graphics Association in cooperation with Scherago Associates Inc. The tabloid serves as a news source for the computer-graphics community. For further information, contact Scherago Associates Inc, 1515 Broadway, New York NY 10036, (212) 730-1050.

Heath Users Group in California

Covering Riverside, San Bernardino, and West Los Angeles counties in Southern California, the Tri-County Heath Users Group welcomes members and visitors to its bimonthly meetings. Meetings are held the first Saturday of each month at the Heathkit Electronic Center

1555 N Orange Grove, in Pomona, and on the third Saturday of each month at the University of California-Riverside, Rm 1111, Watkins Facility. Meetings begin at 2 PM.

CP/M Users Group

The Sacramento Microcomputer Users Group is a CP/M users group that publishes a monthly newsletter called *Push & Pop*. Contact the group at POB 161513, Sacramento CA 95816, (916) 363-3962.

Pocatello Microcomputer Club

Members of the Pocatello Microcomputer Club use most of the popular computers on the market today. Anyone interested in computers is welcome to join. Contact the club at POB 8106, Pocatello ID 83209, (208) 232-4462.

PETs in Canada

The Toronto PET Users Group (TPUG) has a disk library available for members and nonmembers. The library has approximately 1400 programs provided by TPUG members and from other clubs. Membership is encouraged even if you live too far away to attend meetings. Contact TPUG, c/o Chris Bennett, 381 Lawrence Ave West, Toronto, Ontario, M5M 1B9, Canada, (416) 783-1645.

Science Network and Newsletter

The *COGNET Newsletter* seeks to disseminate information on cognitive simulation,

computational linguistics, and artificial intelligence. The Center for Cognitive Science is also working on a computer network for those involved in these areas of research. For details, contact *COGNET*, Center for Cognitive Science, POB 1911, Brown University, Providence RI 02912. ■

BYTE's Bits

Industry's Eyes on New LISP Computer

LMI has been granted a license from the Artificial Intelligence Laboratory of MIT (Massachusetts Institute of Technology) to construct and commercially market the MIT CADR machine. This system is specifically designed as a programmer environment for LISP. According to an LMI spokesman, most LISP programs are developed on the DEC (Digital Equipment Corporation) PDP-10 mainframes, but the LMI system, although in the format of a personal computer, provides up to sixty-four times the virtual address space. The base price of the LMI machine is \$80,000.

Until recently, LISP usage has been associated with research conducted at educational institutions. But now that Control Data Corporation and Texas Instruments have ordered LMI machines, LISP's commercial usage will be seen in expert systems, VLSI (very large-scale integrated) circuit design, and natural-language processing.

LMI is headquartered in Los Angeles, California. ■

“OUR NEWEST DEVELOPMENT IN THE CONTINUING EXPANSION OF THE UCSD p-SYSTEM™ SOFTWARE. VERSION IV.”

JOHN BRACKETT, President, SofTech Microsystems



Backed by a dedicated team of professionals, SofTech Microsystems continues to enhance the world's most widely-used, portable software development system. Today it's the UCSD p-System, Version IV.

Able to run on most major microprocessors including 8086, Z-80, 8080, 8085, 6502, 6809, 9900 and LSI-11™, Version IV is the developer's tool to make perfect programs more possible. It consolidates all the best features of earlier versions, while allowing for much larger applications, concurrent processing and improved debugging. With the addition of BASIC, more macro cross-assemblers, and improved documentation, Version IV is truly a total, professional software development and execution environment.

And, it's backed by SofTech Microsystems, the first to deliver a complete, portable software system for most major microprocessors with UCSD Pascal™, FORTRAN-77, BASIC, and multiple assemblers.

For tomorrow, the expansion continues. More 16 bit microprocessor installations. The performance impact of native code generation. New system utilities and languages. New tools for creating applications more rapidly. The SofTech Microsystems team is at work today to increase your options for the future.

Get the software system that's going places. Distribution licenses and single copies available. Write or call for details, so you can start going places, too.

SOFTech
MICROSYSTEMS
A SUBSIDIARY OF SOFTECH

For the software that's going places.

9494 Black Mountain Road, San Diego,
CA 92126, (714) 578-6105
TWX 910-335-1594

UCSD p-System and UCSD Pascal are trademarks of the Regents of the University of California. LSI-11 is a trademark of Digital Equipment Corp.

A Closer Look at the TRS-80 Color Computer

Woody Baker
Rte 11, Box 4780
Lufkin TX 75901

People who have purchased the TRS-80 Color Computer know that Radio Shack is reluctant to disclose much information about the internal workings of its computers—preferring that all work requiring the opening of the outer case be performed by an authorized service center. However, it is possible to find much of this information; a bit of digging, a few phone calls to Fort Worth, and a disassembler from the Micro Works of Del Mar, California, enabled me to obtain the information presented here.

The TRS-80 Color Computer is based on the Motorola 6809E microprocessor. [The "E" indicates the series—in this case, the 6809 model capable of multiprocessing, although this capability is not used in the TRS-80 Color Computer....SM] The unit uses a Motorola 6847 video-display-generator IC (integrated circuit) for the color display—meaning there are a number of memory locations within the computer that control which of the eleven modes the IC is in. If you know these locations, you can access the modes not provided by Radio Shack's software.

Memory Organization

The TRS-80 Color Computer uses page 0 (memory locations decimal 0000 through 0256) as a scratch pad. The Motorola 680X microprocessors all have the ability to use a special mode of addressing called *direct page* (the same as the 6502 *zero page* mode). The enhancement added to the 6809 is the ability to select which 256-byte page to treat as page 0. In order for the 6809 to maintain 680X-family compatibility, the default remains page 0. Microsoft followed this default in its BASIC interpreter written for the Color Computer—leaving most of the important memory locations within page 0.

Since Microsoft uses the same conventions in all its BASIC interpreters, it can be concluded that the BASIC in the Color Computer is organized in a manner similar to its BASIC for 6502-based computers. The pointers to the start and end of BASIC and the start and end of variables are the same. Also, the storage format is the same for BASIC lines (a 2-byte pointer to the start of the line, followed by a 2-byte line number, and then the token code terminated by a zero).

The Video Window

As shown in tables 1 through 4, the TRS-80 Color

Computer allows a surprising degree of control to the programmer. The video window is unique in that it can be moved around within available memory, which in this case is from 0000 through 7FFF. You can set it to location 0 and watch the scratch-pad locations change as the computer is running. This is where the information summarized in table 4 comes from. In order to set the video memory to page 0, just POKE any value into decimal location 65480. When the POKE is executed, it clears bit 1 of the 7-bit binary word contained in the Motorola 6883 SAM (synchronous address multiplexer) that controls the base location of the video screen. To restore the video window to its normal location, POKE any value into location 65481—resetting bit 1.

The 6 bytes referred to in table 1 control the memory-mapping mode of the 6847 VDG (video display generator). The 6883 SAM IC maps memory into the video circuits and can be thought of as a 3-bit number that selects the amount of memory available to the VDG. This 3-bit register is controlled by the locations shown in table 1. The desired result can again be obtained by POKEing any values into these locations—toggling 3 bits into the SAM circuit. The VDG control lines are located in port 65314 and select the mode of the VDG. In order to switch the Color Computer into another graphics mode, you first set the available memory to match the mode, and then select the mode via the port. It's necessary to turn the control lines on at the port and also set the video memory size via the locations shown in table 2.

Table 2 shows the locations that control the base page of the video memory. In order to locate the base page, the TRS-80 Color Computer hardware takes the 7-bit word these 14 bytes specify and multiplies it by 512—resulting in the location of the base page.

Locations shown in table 3 are either used by the 6809 for interrupts or are assigned other functions by Radio Shack. Although I was told their names by a Radio Shack representative, I didn't find out their exact functions. Apparently, you can select four different clock speeds using these locations. Although I encourage you to experiment with them, it's easy to lose your video-sync signal when fooling with these locations.

Programmable-memory locations are shown in table 4. The keyboard buffer is terminated by a 0, and a PEEK(732) returns the token for the first keyword found

When Eight Is Not Enough: CP/M-86™ and CBASIC/86™

"In 1977 Compiler Systems, Inc. introduced CBASIC™ as a CP/M® programming language. It quickly became the most widely used BASIC dialect. Since then CBASIC has been adapted for use on systems supporting MP/M™ and TRSDOS."

"At Compiler Systems we learned the lessons of the past well. So well, that in the relatively short time we've been in the software business, we managed to make history ourselves. In fact, CBASIC is the standard for CP/M-based business systems."

— Gordon Eubanks, CSI president

Today CSI offers CBASIC/86 designed for 16-bit microcomputer-based systems running under CP/M-86. CBASIC/86, now available worldwide, is based on concepts first used by CBASIC including such business-oriented features as: BCD arithmetic with fourteen-digit precision; full format control of printed reports; random and sequential records of any length (not limited to 256 bytes); aids to structured design, i.e. multiple line functions and control structures as well as excellent file-handling and stringing capabilities.

But perhaps the best of CBASIC/86 becomes clear when you're using it. To learn more about CSI's commitment to support CBASIC/86 and CP/M-86 call (213) 355-1063 and discuss putting CBASIC/86 on your system.

Send this coupon today, we'll send details that go a long way toward answering your questions.

Name/Date _____

Company _____

Address _____

City/State/Zip _____

OEMs contact us for pricing

CBASIC/86 **CSI**
WORLDWIDE DISTRIBUTION FROM

Compiler Systems, Inc., 37 N. Auburn Ave., P.O. Box 145
Sierra Madre, CA 91024, (213) 355-1063

Circle 73 on inquiry card.

ATLANTIC COMPUTER INDUSTRIES FOR:

IMS, MORROW DESIGNS, CALIFORNIA COMPUTER SYSTEMS, ADDS, VECTOR, APPLE, ITHACA INTERSYSTEMS, IBM, SCION, NEC, T.I., MUSYS, ASHTON-TATE, HAZELTINE, ANADEX, HAYES, NOVATION, PER SCI, MICROPOLIS, SHUGART, and much more.

IMS 5000 AND 8000 SYSTEMS

Outstanding reliability and performance. These systems feature a Z80A CPU, S-100 bus, double density drives (either single or double sided), DMA disk controller, 64K RAM, 2 serial & 1 parallel port, and includes CP/M® Hard disk and multi user, software options.

5000 Desk Top with dual, single sided mini drives \$3,225
8000 Desk Top with dual, single sided 8" drives \$4,775

MORROW DESIGNS - DECISION I \$1,450

Decision I was designed to be the most versatile and cost effective multi-user, multi-tasking microcomputer available today. Decision I CPU features a 4-6 MHZ Z80A, sophisticated memory hardware, a real time clock and UNIX software. Floppy and Hard disk drives available.

ADD'S MULTI-VISION I \$3,229

Features 64K RAM, MUON advanced operating system, upgradable to multi-user, multi-tasking operations. Extensive support software and utilities available.

MUSYS SINGLE BOARD COMPUTER \$1,295

Bootstrap PROM. Z 80 processor, 64K dynamic RAM, console serial port, S-100 parallel interface.

EPSON

MX-80 \$ 499
MX-100 \$ 775

NEC

5510 (serial interface) .. \$2,749
5530 (parallel interface) \$2,749

QUME - Letter Quality

Sprint 5/45 KSR \$2,990
Sprint 5/45 RO \$2,625

ANADEX

DP 9500/9501 \$1,299
DP 9000/9001 \$1,219
High resolution, 200 cps.

MICROANGELO from SCION

High resolution graphics system complete w. 15" monitor, cabling and software \$2,225
S-100 Graphics Card \$ 925

QUME DRIVES

Data Track 8", double sided disk drives \$ 575
2 for \$1,100
2 Qume DT 8" complete with cabinet, power supply, fan \$1,595

MORROW FLOPPY DISKS

Discus 2D, 1 drive ... \$ 950
Discus 2D, 2 drive ... \$1,559
2+2, 1 drive \$1,259
2+2, 2 drive \$2,260
All complete with CP/M® & MBASIC.

ADD'S VIEWPOINT CRT

NEW! Detached keyboard, programmable function keys, 2 position tilt screen . \$ 599

TELEVIDEO

912C \$ 749
920C \$ 799
950 \$ 999

ATLANTIC
COMPUTER INDUSTRIES CORP.

80 BROAD STREET
SUITE 404
NEW YORK, N.Y. 10004
PHONE: 212 - 376-5978

Systems Notes

in the line. In order to use this as an input routine, you would need to preface each line with a REM statement—resulting in the first character after REM being located at 733. The input routine uses the same buffer but doesn't do any tokenizing. A flag may exist that disables the tokenizing routine. Once the keyboard-input

| Hexadecimal Address | Decimal Address | Function |
|---------------------|-----------------|----------|
| FFC0 | 65472 | Clear V0 |
| FFC1 | 65473 | Set V0 |
| FFC2 | 65474 | Clear V1 |
| FFC3 | 65475 | Set V1 |
| FFC4 | 65476 | Clear V2 |
| FFC5 | 65477 | Set V2 |

Table 1: The six locations within the TRS-80 Color Computer's programmable memory that control the memory-mapping mode of the Motorola 6847 VDG (video display generator). The graphics mode is selected via port 65314 and the available memory must be set to match the mode. See listing 1 for an example of a program that does this.

| Hexadecimal Address | Decimal Address | Function |
|---------------------|-----------------|-------------|
| FFC6 | 65478 | Clear bit 0 |
| FFC7 | 65479 | Set bit 0 |
| FFC8 | 65480 | Clear bit 1 |
| FFC9 | 65481 | Set bit 1 |
| FFCA | 65482 | Clear bit 2 |
| FFCB | 65483 | Set bit 2 |
| FFCC | 65484 | Clear bit 3 |
| FFCD | 65485 | Set bit 3 |
| FFCE | 65486 | Clear bit 4 |
| FFCF | 65487 | Set bit 4 |
| FFD0 | 65488 | Clear bit 5 |
| FFD1 | 65489 | Set bit 5 |
| FFD2 | 65490 | Clear bit 6 |
| FFD3 | 65491 | Set bit 6 |
| FFD4 | 65492 | Clear bit 7 |
| FFD5 | 65493 | Set bit 7 |

Table 2: The TRS-80 Color Computer's programmable-memory locations that control the base-page location of the video memory. In order to calculate the base-page location, the hardware multiplies the resulting 7-bit number contained in the Motorola 6883 SAM (synchronous address multiplexer) by 512.

| Hexadecimal Address | Decimal Address | Function |
|---------------------|-----------------|----------------------|
| FFD6 | 65494 | Bank switch |
| FFD7 | 65495 | Clear bit 2 clk rate |
| FFD8 | 65496 | Set bit 2 clk rate |
| FFD9 | 65497 | Clear bit 1 clk rate |
| FFDA | 65498 | Set bit 1 clk rate |
| FFDB-FFDF | 65499-65505 | Memory size jumpers |
| FFF0-FFFF | 65520-65535 | 6809 vectors |

Table 3: A few miscellaneous control and interrupt locations within programmable memory. Hexadecimal locations FFD7 through FFDA control the processor speed (nominally, 0.894 MHz). Although experimentation is encouraged, the user should be aware that these locations are tied to video-sync generation and may result in a temporary loss of video.

INFORMATION LINE (714) 549-7373

TOLL FREE ORDER LINES
(800) 854-0523 - OUTSIDE CALIF.
(800) 432-7066 -
WITHIN CALIF.

COMPUTIQUE®

hp HEWLETT
PACKARD
HEADQUARTERS

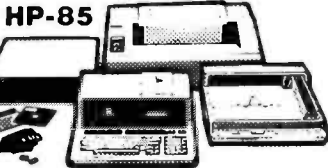

A STANDARD FOR PROFESSIONALS

| | |
|----------------------------|--------|
| HP-67 | 289.95 |
| HP-97 | 584.95 |
| HP-33C SCI | 79.95 |
| HP-34C SCI | 114.95 |
| HP-38C BUS/RE | 119.95 |
| HP-32E SCI | 49.95 |
| HP-37E BUS | 59.95 |
| HP-41, 41CV | CALL |
| HP-85 | CALL |
| HP-83 NEW | CALL |
| HP-125 NEW COMPUTER SYSTEM | CALL |



HP-41C

Complete Enhancements,
Peripherals and Accessories

The PHONE CONTROLLER

BY DICTOGRAPH



NOW
99.95

- Dials any of 30 stored numbers
- Quartz clock displays time and elapsed time automatically
- Automatically re-tries a busy phone a number of pre-programmed times
- Built-in speaker for group listening
- For home and business use.

TOSHIBA

NOW
99.95

**BC-1232PV
DIGITRON
DESK TOP CALCULATOR**

12-DIGIT PRINT/DISPLAY FOR FAST, ACCURATE CALCULATING AT HOME OR FOR BUSINESS

WE WILL MEET OR BEAT ANY COMPETITOR'S PRICE ON MOST ITEMS IF HE HAS THE MERCHANDISE IN STOCK

MAIL & PHONE
ORDERS ONLY

WRITE OR CALL FOR FREE CATALOG

NEWPORT BEACH
COSTA MESA
3211 S HARBOR BLVD
SANTA ANA CA 92704
(714) 549-7373

All units shipped in original factory cartons with accessories according to manufacturer's specification. Visa, Mastercard, S Order, Pers Ck (14 wrkg days to clear), COD accepted Min \$4.95 for shipping in USA. Air on reqst. CA res. add 6% sales tx. All mdse. subject to availability. prices subject to change. Send orders to dept.



apple computer MEANS BUSINESS

INTRODUCING **apple III**

Apple III is a highly integrated computer system evolved from the Apple II design and optimized to best serve the professional user. The new computer will be offered in package configurations for personal use in professional applications. Look at these special Apple III features:

- an 80-character upper/lower case display, disc drive and integrated peripheral interfaces
- enhanced graphics capability
- an emulator mode allowing Apple II software to be run on the Apple III



APPLE II PLUS

**BEST
PRICES
U.S.A.**

**AUTHORIZED
DEALER
AND LEVEL 1
SERVICE CENTER**

- APPLE II, II PLUS (16K, 32K, 48K)
- APPLE III
- DOS 3.3
- APPLE PLOT
- APPLE PASCAL (64K)
- APPLE FORTRAN
- VISICALC 16 SEC
- VISIPLLOT
- VISITREND
- APPLE WRITER
- GRAPHICS TABLET
- BPI (GL, AR, & PAYROLL)
- MODEM
- DOW JONES NEWS & QUOTES
- DECISION EVALUATOR
- CONTROLLER (GEN LEDGER)
- MICRO-COURIER
- EPSON
- CENTRONICS
- QUME
- SILENTYPE
- ANADIX
- SANYO, BW, COLOR, GREENSCREEN
- EXTENDED WARRANTY

COMPLETE BUSINESS, EDUCATIONAL & GAME SOFTWARE AVAILABLE.

YOU'LL WONDER HOW YOU EVER GOT ALONG WITHOUT IT.

| | NOW | SAVE |
|----------------------------|------------|------|
| 1050 ECONOMY ANSWER | NEW 119.95 | 30. |
| 1450 SMALL WONDER | 189.95 | 90. |
| 1550 TOUCH SYSTEM | 259.95 | 120. |
| 1750 VOICE ACTIVATE | 229.95 | 100. |
| 960 MEMORY DIALER HANDHELD | NEW 79.95 | 20. |

CODE-A-PHONE

The Telephone Answering System®

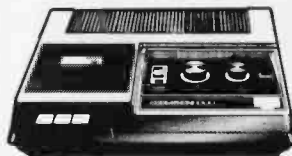

AND AMERICA IS GETTING THE MESSAGE.

CASIO. WHERE MIRACLES NEVER CEASE



| DEPTH-TESTED TO 100 METERS | W-100 | CA-90 INVADER GAME CALCULATOR WATCH | PRICE |
|----------------------------|----------------------------------|-------------------------------------|-------|
| | AA-81 2-WAY DIG/ANALOG ALARM | | 49.95 |
| | VL-TONE MUSICAL INSTRUMENT/ CALC | | 69.95 |
| | W100 DEPTH TESTED ALARM CHRONO | | 39.95 |
| | FX7100 SCI CHRONO ALARM CALC | | 49.95 |
| | FX3500 SCI PROGRAMMABLE CALC | | 39.95 |
| | FR100 DESK-TOP PRINT/DISPLAY | | 79.95 |

ALSO: CANON, TOSHIBA, NSC, SEIKO, MATTTEL, PEARLCORDER, ITT, GTE, AND MANY OTHERS ALL AT GREAT PRICES!



INNOVATIONS FROM
Texas Instruments

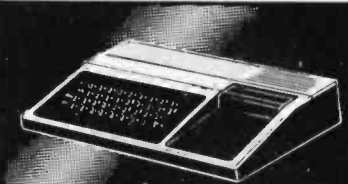

FREE SPEECH SYNTHESIZER WITH PURCHASE OF TI-99/4

GET A \$20 REBATE ON THE TI-59 PROGRAMMABLE.

| | | | |
|----------------|--------|--------------------|--------|
| TI-54 SCI NEW | 39.95 | SPEAK & SPELL READ | 59.95 |
| TI-55II NEW | 44.95 | SPEAK & MATH | 59.95 |
| TI-57 PROG SCI | 39.95 | TOUCH & TELL NEW | 54.95 |
| PC-100C | 169.95 | TI-5100 DISPLAY | 39.95 |
| LCO-PROG NEW | 59.95 | TI-5010 HAND/PRINT | 49.95 |
| TI-30II NEW | 18.95 | TI-5120 PRINTER | 59.95 |
| TI-35SP SCI | 22.50 | TI-5130 PRINT/DISP | 79.95 |
| TI-40 SCI NEW | 28.95 | TI-5135 PRINT/DISP | 79.95 |
| BUS ANAL I | 19.95 | TI-5142 PRINT/DISP | 99.95 |
| BUS ANAL II | 44.95 | TI-58C PROG CALC | 89.95 |
| BUS CARD | 39.95 | TI-59 960 PROG | 179.95 |
| MBA | 54.95 | INVEST ANALYST | 48.95 |

PLUG INTO CONTROL

CONTROL LIGHTS AND APPLIANCES AUTOMATICALLY AND INSTANTLY.



| | |
|-----------------------------|------------|
| TC 211 TIMER | 59.95 |
| TS 555 5 pc TIMER SET | NEW 119.95 |
| PK 300 3 pc MINI CONTROLLER | 49.95 |

BSA SYSTEM X-10

THE SHARP EDGE SHARP

| | |
|---------------------------------|-----------|
| EL-670 ELECTRONIC PIANO | |
| CLOCK/CALCULATOR | NEW 69.95 |
| CT-665E TALKING CLOCK | NEW 99.95 |
| EL-7001 ALPHANUMERIC CALC | 139.95 |
| CT-455E POCKET DIG/ALARM | |
| CLOCK | 24.95 |
| EL-5100 PROG/ALPHANUMERIC | 89.95 |
| EL-6200 ALPHANUMERIC | 99.95 |
| EL-1188 HANDHELD PRINT/DISPLAY | 49.95 |
| EL-1182 DESK TOP PRINT/DISPLAY | 74.95 |
| EL-5813 SCIENTIFIC PROGRAMMABLE | 34.95 |

| | |
|--------------------|--------|
| CHESS CHALLENGER 7 | 89.95 |
| SENSORY CHESS | 129.95 |

MATTTEL ELECTRONICS

| | |
|--------------------|--------|
| INTELLIVISION | 259.95 |
| GAME CARTRIDGES | 27.95 |
| HORSERACE ANALYZER | 27.95 |

| | |
|--------------------|--------|
| TOUCH THE FUTURE | |
| ATARI 400 (16K) | 294.95 |
| VISICALC AVAILABLE | CALL |

| | |
|--|--------|
| MP600 CORDLESS HANDHELD PHONE (700' RANGE) | 189.95 |
|--|--------|

WILSHIRE CENTER
3285 WILSHIRE BLVD
(213) 385-7777

LOS ANGELES
11986 WILSHIRE BLVD
(213) 820-0423

PASADENA
260 S LAKE AVE
(213) 795-3007

TARZANA
18665 VENTURA BLVD
(213) 705-7507

BREA
1080 E IMPERIAL HWY
(714) 990-6600

TORRANCE/LAWDALE
16611 HAWTHORNE BLVD
(213) 370-5795



Professional Discounts

Circle 97 on Inquiry card.

System Notes

routine and the character-output routine are located, machine-language programming should be much easier on the Color Computer.

Applications

Since the video screen can be moved around in memory via one of the registers in the SAM circuit, you can use the information presented here to page through memory. If you are in the alphanumeric-graphics mode

| Hexadecimal Address | Decimal Address | Function |
|---------------------|-----------------|------------------------------------|
| 19-1A | 25-26 | Pointer to start of BASIC |
| 1B-1C | 27-28 | Pointer to end of program |
| 1D-1E | 29-30 | Pointer to variables |
| 1F-20 | 31-32 | Pointer to start of arrays |
| 88-89 | 136-137 | Pointer to current cursor position |
| 8C | 140 | Location of sound frequency |
| 8E | 142 | Duration of sound |
| 94 | 148 | Cursor color |
| A8-AA | 168-170 | Jump vector to 43376 |
| 10C-10E | 268-270 | Jump vector to 43274 |
| 10F-111 | 271-273 | Jump vector to 41046 |
| 112-114 | 274-276 | Jump vector to 45974 |
| 11D-11F | 285-287 | Jump vector to 45509 |
| 2DD-3DC | 733-988 | Keyboard buffer |
| 601 | 1535 | Start of BASIC work space |

Table 4: BASIC control and other miscellaneous locations within page 0 of the TRS-80 Color Computer's programmable memory.

(the default), you can obtain an ASCII snapshot of memory. All the characters in the ASCII code range will show up in the video display. Moving the window to the BASIC work space allows you to look at your BASIC program. If you do this before doing a CLOAD, you can watch memory filling up with a program. Since you can move the screen back and forth, you can think of it as a "paging-mode" terminal. With the appropriate software, you should also be able to make a sophisticated screen-oriented editor. You cannot go above hexadecimal 7FFF, or page 64.

Putting the computer in the 64 by 64 color mode (listing 1) lets you use only half the screen. However, since you know where the starting pointers to BASIC are, you can change them and move the BASIC program down in memory to allow you to use more memory for the screen. This is accomplished by POKEing the new address into locations 19 through 1A hexadecimal or 25 through 26 decimal, and then doing a NEW command by jumping to location AD19 (or 44313). Now you can use V0 through V2 to allocate more screen memory.

You can also go into other modes: POKEing a 240 into port 65413 puts you into high-resolution mode, which takes 6 K bytes of programmable memory for the screen. In this mode, everywhere there is a "1" in memory, a lit dot appears on the screen, and everywhere there is a "0" in memory, a black (unlit) dot appears on the screen.

ADA

JANUS

the language that is based on the past but looks to the uses of the future:

JANUS is a true compiler for a subset of ADA. ADA is the much awaited U.S. Department of Defense language. With JANUS, it is available now on your CP/M system.

JANUS has such features as:

- Separate Compilation
- Records with variants
- Subranges, Enumerations, and Arrays
- Initialized Variables
- Integers and Arbitrary Precision Reals
- Produces ROMable, Re-entrant 8080 machine code and much more . . .

JANUS is the face of the future. The structured language that you need for efficient programming. This is your chance to get to the head of the crowd and learn the language that will be the language of the 80's.

JANUS requires an 8080/8085 or Z80 CPU, 56K of memory, and at least one 8" floppy disk. JANUS is supplied on a single density 8" floppy. For \$250, you get the JANUS compiler, linker, assembler, and owners manual.

CP/M is a trademark of Digital Research, Inc.
ADA is a trademark of the U.S. Department of Defense

RR SOFTWARE

specialists in state of the art programming

P.O. BOX 1512

MADISON, WISCONSIN 53701

COMPUTERWARE™

PRODUCTS FOR THE
COLOR COMPUTER

PROGRAMMER'S TOOL KIT
Power Pack: 2K ROM monitor and 6K RAM memory
Assembler: full featured
2-pass with all 6809 mnemonics
Editor: write letters & programs—print with your printer
\$199.95

PASCAL
learn structured programming and get greater speed (requires Power Pack) **\$39.95**

COLOR DATA ORGANIZER
collect, organize, and print your information in a data base **\$24.95**

MEMORY — 16K
\$37.95

MAGIKUBE \$19.95
Rubik's Cube in Color

SHIP FROM STOCK

COLOR INVADERS
for 16K machine **\$24.95**
* Version for Power Pack users **\$19.95**

FINANCE PROGRAMS #1
loans & investments **\$21.95**

LO RES GRAPHIC GAMES

#1 Mind War. Invaders **\$19.95**
#2 Break-out slots. Over-the-Hill **\$17.95**
#3 Keno. Bingo Flip-Flop **\$18.95**

ADVENTURE
Calixto Island **\$19.95**
Black Sanctum **\$19.95**

32K MEMORY EXPANSION BOARD
easy to install

Dealer Inquiries Invited

WRITE OR CALL FOR COMPLETE INFO PACKAGE

COMPUTERWARE™

Dept. C • Box 668
Encinitas, CA 92024 • (714) 436-3512

6809 Specialists Computerware is a trademark of Computerware.

**AFTER YOU'VE SEEN
HOW ALL THE
OTHER PRINTERS
STACK UP...**

**THE ONE ON TOP
WILL SURPRISE YOU.**



The Novell IMAGE 800 dot matrix printer is on top because it is *the* performance printer. The printer mechanism has been running in the lab continuously since January, 1980—24 hours a day, 7 days a week—without failing—and it's still going. That's Novell quality. That's 100% duty cycle.

The Novell IMAGE 800 is state-of-the-art: microprocessor controlled... 30 programmable functions... compressed or expanded print... correspondence quality print... 11 channel programmable VFU.

If you require 150 CPS print speed and 136 column output, you can't do better anywhere. And at \$1,395, *we're hundreds less than comparable units.*

Check these other features:

- 80 or 132 columns
- Bi-directional print
- 9 x 9 dot matrix
- Dual tractor paper feed
- RS232C or parallel interface
- 110-9600 baud
- 6 or 8 lines per inch vertical spacing
- Tear bar
- True descenders
- Subscripting & superscripting
- Vertical tabulation

Compare. Find out how the others stack up. It won't take you long to see why Novell is on top. A Novell IMAGE 800 dot matrix printer can help you stay on top, too. Because higher performance means lower overhead. For all the details, call us at (801) 226-8202. You'll be profitably surprised.

GENEROUS OEM DISCOUNTS.
DISTRIBUTOR INQUIRIES INVITED.

 **NOVELL**
DATA SYSTEMS

1170 No. Industrial Park Drive, Orem, Utah 84057
Telephone: (801) 226-8202

Circle 422 on inquiry card.

SORCERER SOFTWARE from QUALITY SOFTWARE

All Programs Are On Cassette

VISI-WORD by Lee Anders

From preparing short letters to writing a book, word processing becomes easy and inexpensive using VISI-WORD, a cassette based word processor. VISI-WORD is designed to interface with just about any printer you can attach your Sorcerer to. VISI-WORD can accept control characters, which allows you to issue special commands to those printers with graphics controls, font control, and the like. A special feature of VISI-WORD, from which it gets its name, is the "command display off" feature. This command eliminates all special end of line markers and other non-printing characters and automatically performs right-justification, centering, and indenting right on the video, so that you can see what your text will look like before it is printed. Other features of VISI-WORD include four separate buffers (to assist with form letters, boiler plating, and shifting text around), automatic page numbering and titling, partial print, and locating strings. **\$59.95**

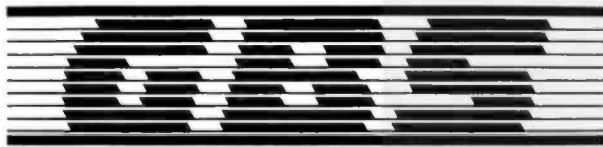

General Business System

by Lee Anders

GBS is a general purpose programming system that can be used for many business applications. Use this system to create, edit, format, and print mailing lists. Or set up an inventory system, an accounts receivable file, or a payroll system. Or use it to enter orders. Delete, modify or append records, and then summarize and tabulate the results. You design (with the help of an extensively documented user manual) a system of records. Then use the power of GBS to compute, sort, select, merge, add, and modify your data. GBS will provide you with the kind of fast, accurate, flexible tools you always knew a home computer could provide. Four example application programs are included. Of course, you don't need to use GBS for business. You can use it for personal finance, club or personal record keeping, or almost any type of problem that involves the management of records. Written in machine language with flexible cassette interfacing, this program requires a Sorcerer with at least 32K of memory. **\$99.95**

FORTH for the Sorcerer. Now Sorcerer owners can enjoy the convenience and speed of the fascinating FORTH programming language. Based on fig-FORTH and adapted for the Sorcerer by James Albanese, this version uses simulated disk memory in RAM and does not require a disk drive. Added to standard fig-FORTH are an on-screen editor, a serial RS-232 driver, and a tape save and load capability. Numerous examples are included in the 130 pages of documentation. Requires 32K or more of RAM. **\$59.95**

ARROWS AND ALLEYS™ by Vic Tolomei

The latest of Quality Software's great arcade games for the Sorcerer is ARROWS AND ALLEYS, by Vic Tolomei. You drive your car in a maze of alleys. Your task is to eliminate a gang of arrows that constantly pursues you. You have a gun and the arrows don't, but the arrows are smart and they try to stay out of your sights and will often attack from the side or from behind. Eliminate the arrows and another, faster gang comes after you. Four levels of play. Requires 16K or more of RAM. **\$17.95**

We have more than 20 programs for the Sorcerer
PLEASE WRITE FOR OUR CATALOG



QUALITY SOFTWARE

6660 Reseda Blvd., Suite 105, Reseda, CA 91335
Telephone 24 hours, seven days a week: (213) 344-6599

HOW TO ORDER: If there is no SORCERER dealer near you, you may order directly from us. MasterCard and Visa cardholders may place orders by telephone. Or mail your order to the address above. California residents add 6% sales tax. **Shipping Charges:** Within North America orders must include \$1.50 for shipping and handling. Outside North America the charge for airmail shipping and handling is \$5.00. Pay in U.S. currency.

*The name "SORCERER" has been trademarked by Exidy, Inc.

System Notes

Listing 1: A program for the TRS-80 Color Computer demonstrates video-mode switching. This program sets the computer to a 64- by 64-character graphics mode. Each byte maps into four consecutive blocks on the screen, with a 2-bit code used to indicate which of the four available colors (in this mode) each block will be. In this graphics mode, each horizontal line of blocks is 16 characters wide, as opposed to 32 characters (bytes) wide in the normal mode of operation. Since this mode requires 1 K bytes of programmable memory, with 512 bytes allocated to the screen, you can only work with the upper half of the video display. See the text for further details.

```

5 POKE 65495,0:REM SPEED PROCESSOR UP
10 BA = 1300:REM BASE OF THE CHARACTER
15 POKE 65314,129:POKE 65473,0:REM SET COLOR
  GRAPHICS MODE C
20 FOR I = 1024 TO 1535:POKE I,0:NEXT I:REM PAINT 1/2
  SCREEN GREEN
30 FOR I = 1 TO 8:REM 8 LINES PER CHARACTER
40 FOR J = 1 TO 3:REM 3 BYTES PER LINE
50 READ A:POKE BA + (I*16) + J,A:REM PUT THE
  CHARACTER DOWN
60 NEXT J:NEXT I
70 GOTO 70:REM LOOP SO WE DON'T MESS DISPLAY UP
80 DATA 0,255,0,3,255,192,15,60,240,15,255,240,15,225,240
90 DATA 0,195,0,3,60,192,8,195,48
100 END
    
```

A rather interesting location is 148 (hexadecimal 92). This location changes madly when you put video into page 0. This is the so-called heartbeat of the system—the storage location for the color byte that specifies the color of the cursor. POKEing a 0 there makes the cursor go away.

The 6809 machine-code interrupt vectors at hexadecimal locations FFF0 through FFFF all point to programmable memory (except the reset vector). The reset vector points to cold-start BASIC. This routine is in ROM (read-only memory), and has the responsibility of resetting all other vectors and initializing memory. It checks if the machine has been on or has just been turned on. If it has just been turned on, it initializes most of the scratch-pad locations. If you just hit a reset, it leaves certain pointers alone, notably the pointers to your BASIC program.

Conclusion

There is much more to be learned about the TRS-80 Color Computer. I hope this article inspires you to go digging. I'd like to hear from people who discover other interesting facts about it. Hopefully, this information will give you a good start toward understanding your new computer. ■

[Editor's Note: It's a little-known fact that Radio Shack publishes technical service manuals for all its computer products. These manuals are available to the general public and contain a wealth of "inside" information and troubleshooting procedures. The manuals are not stocked by Radio Shack dealers. Contact your local Radio Shack store for the price and ordering information. Also, see "What's Inside Radio Shack's Color Computer?" in the March 1981 BYTE, page 90....SM]

Computerize your bookkeeping without terrifying your bookkeeper.

Introducing The Boss.™ the most advanced, yet most understandable, financial accounting system. Designed to automate your bookkeeping without confusion or mistakes.

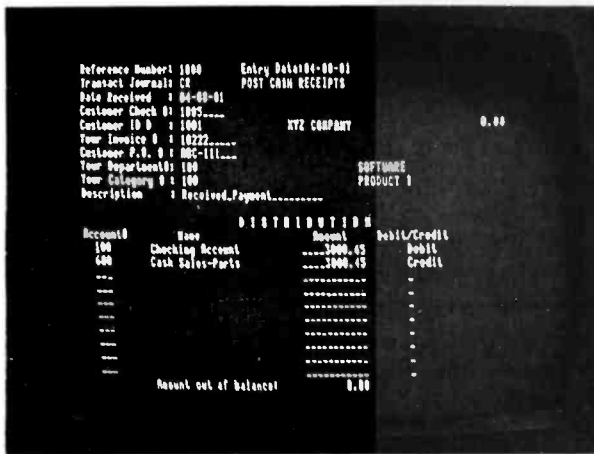

Typical screen format - actual photograph.

If "fear of the unknown" is standing between you and computerization, you should find out about The Boss.

The Boss system is immediately comprehensible to bookkeepers because it utilizes virtually the same format they're used to.

So even someone with no previous computer experience can easily learn and operate The Boss system.

Features seldom found in packaged software.

The Boss system is fully interactive, fully departmentalized and exceptionally fast. It can generate an astounding number of complex reports at the touch of a button.

General Ledger and Accounts Receivable and Payable transactions can be entered in any order in a single program.

Up-to-the-minute financial reports can be obtained without batch processing.

The Boss system computes financial ratio analysis.

It protects data from unauthorized personnel as well as computer malfunction.

And it has the largest programming and storage capacity of any micro system.

The Boss runs on most small business computers with CP/M® or similar operating systems. Its cost is only \$2,495.

Get full support from Lifeboat.

The Boss is brought to you exclusively and supported completely by Lifeboat Associates, world's largest computer software publisher. For more information about how you can profit from this extraordinary financial accounting system, send us the coupon below. Or call (212) 860-0300.

For more information on The Boss, mail coupon to Lifeboat Associates, 1651 Third Avenue, New York, NY 10028.

Name _____

Title _____

Company _____

Street _____

City _____

State _____

Zip _____



2011

Boss is a trademark of Balances Computer Corp. CP/M is a trademark of Digital Research, Inc.

LIFEBOAT WORLDWIDE offers you the world's largest library of software. Contact your nearest dealer or Lifeboat:

Lifeboat Associates
1651 Third Ave.
New York, N.Y. 10028
Tel: (212) 860-0300
Telex: 640693 (LBSOFT NYK)
TWX: 710-581-2524

Lifeboat Inc.
OK Bldg., 5F
1-2-8, Shiba-Dalmon
Minato-ku, Tokyo, 105 Japan
Tel: 03-437-3901
Telex: 2422723 (ASRTYOJ)

Lifeboat Associates, Ltd.
PO Box 125
London WC2H 9LU, England
Tel: 01-836-9028
Telex: 893709 (LBSOFTG)

Lifeboat Associates GmbH
PO Box 168, Aegerstrasse 35
CH 6340 Baar, Switzerland
Tel: 042-31-2931
Telex: 865265 (MICO CH)

Intersoft GmbH
Schlossgartenweg 5
D-8045 Ismaning, W. Germany
Tel: 089-966-444
Telex: 5213643 (ISOFD)

Lifeboat Associates, SARL
10, Grande Rue Charles de Gaulle
92600 Asnieres, France
Tel: 1-733-08-04
Telex: 250303 (PUBLIC X PARIS)

Lifeboat Associates

Software with full support

Four Roads to Understanding Radio Shack's TRS-80

Yvon Kolya, POB 22, Peterborough NH 03458

Pathways Through the ROM

George Blank, editor
Softside Publications
6 South St, Milford
NH 03055, 1979, 1980
116 pages, softcover
\$19.95

Pathways Through the ROM is actually a compilation of several manuals and articles already available separately. They are:

- *The TRS-80 Disassembled Handbook* by Robert Richardson (the first nine chapters)
- SUPERMAP by Roger Fuller (chapter 10)
- HEX-MEM Monitor, a program by John T Phillipp (chapter 11; originally published in the February issue of *PROG/80*)
- Z80 Disassembler, a program by George Blank (chapter 12; originally published in the June issue of *PROG/80*)
- DOS Map by John Hartford (chapter 13)
- "The WD1771 Controller Specification Bulletin" (chapter 14; available from Western Digital Corporation)

By collecting these works in one volume, Softside Publications has simplified the programmer's chore of gathering information about Level II DOS routines and

The four books reviewed here purport to give assembly-language programmers a key to the mysteries of Radio Shack's TRS-80 Model I Level II ROM (read-only memory) and DOS (disk operating system). Because each book approaches the subject in a different way, it is difficult to compare them all in the framework of a general discussion, so I have considered them separately. At the conclusion of each review, I have outlined the book's strengths and weaknesses as an aid to the prospective buyer.

has significantly reduced the cost (separately, these six items would cost over \$34).

The first nine chapters (from *The TRS-80 Disassembled Handbook*) cover decoding Level II ROM CALL locations; integer-, single-, and double-precision arithmetic; four short demonstration programs; ROM trig, exponent, and log routines; miscellaneous ROM routines; an alphabetical list of ROM CALL addresses; two programs—one in BASIC, the other in assembly code; and a short self-test.

In the introduction to his original work, Robert Richardson states that the handbook came out of a series of lectures he gave. Unfortunately, the lectures were very general; examples are included mainly in the demonstration programs. It is obvious that Richardson feels the readers should do their own experimentation, using his handbook as a beginning. He provides very little to guide you through the ROM beyond pointing out the road

signs so that you won't get hopelessly lost.

The most valuable portions of Richardson's handbook are the various tables included. For example, three separate figures list the BASIC functions with the locations of their respective ASCII (American Standard Code for Information Interchange) representations in ROM; the locations of their CALL addresses (not the same locations as the ASCII codes); the addresses themselves in decimal form, in hexadecimal form, and in POKE form (decimal low-order byte followed by high-order byte, ie: 174-29 instead of 7598 decimal or 1DAE hexadecimal).

Chapter 10 is Roger Fuller's SUPERMAP, a listing of ROM entry addresses and what the code at each address does when accessed properly. Also provided is information on the various cassette-tape storage formats used by the ROM. All in all, this is an informative and useful chapter.

Chapter 11 contains the in-

structions and listing of a simple BASIC monitor. Its sole purpose is to provide several memory-examining capabilities, if you don't already have a monitor.

Chapter 12 is a Z80 object-code disassembler. It's handy, too, if you don't already have one.

Chapter 13, devoted to mapping TRSDOS and NEWDOS, is a valuable inclusion. The two *overlay* regions used by the DOSes are defined, and the addresses and uses of the various DOS systems are identified and labeled. All of the Radio Shack TRS-DOS system files (SYS0 to SYS6) are covered. Also given is the command structure necessary to call any of the DOS commands from an assembly-language program. This chapter and Chapter 10 make *Pathways Through the ROM* well worth the money, giving you information not available anywhere else.

Chapter 14 is merely the Western Digital FD1771-01 floppy-disk formatter controller specification sheets (17 pages). If you plan to write a program to access the disk drives directly without using any of the DOSes, these specification sheets are a must. This is definitely not a beginner's project. The specifications, written for expert assembly-language programmers, include command flow-

SVA MAKING APPLES GROW

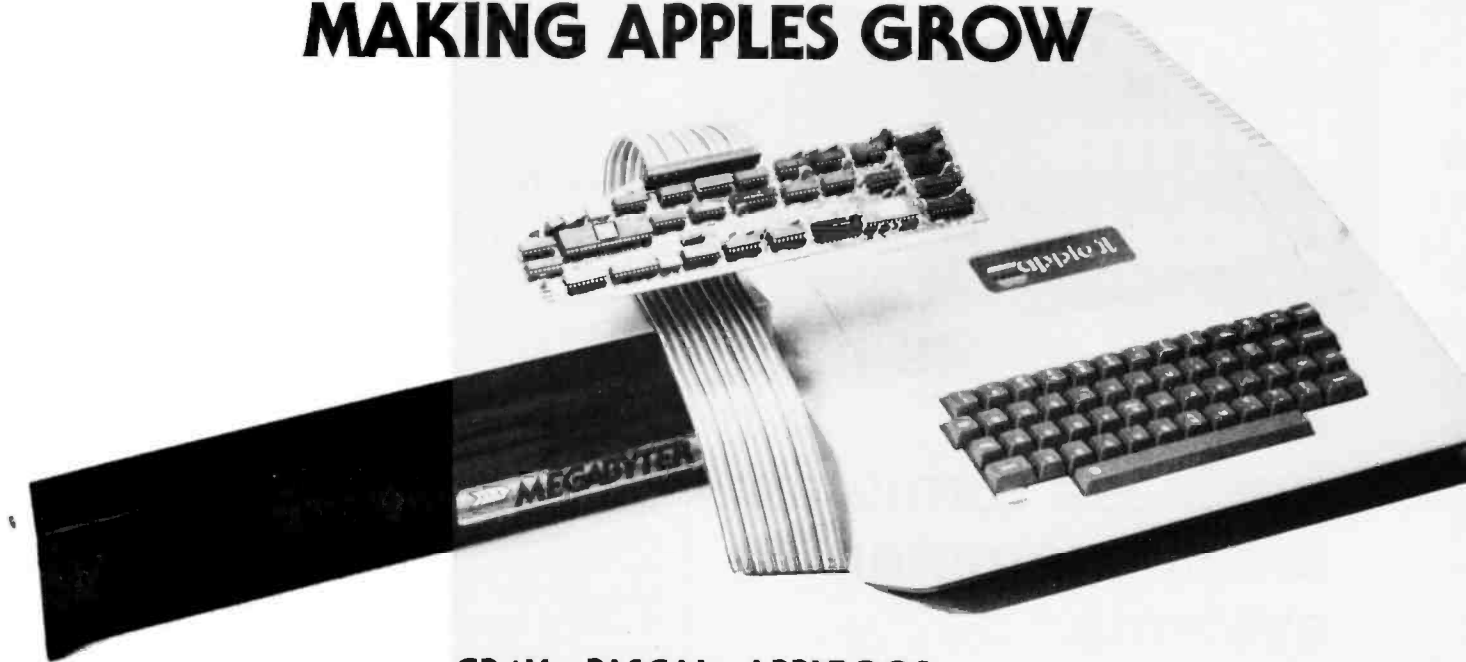

CP/M • PASCAL • APPLE DOS **AMS 8000** MEGABYTE SYSTEM

The AMS 8000 Megabyte System is for the serious user who wants to expand the capability of his Apple* by increasing online data storage, and reducing disk handling. It brings a new dimension to your Apple, making your data portable to other computers and gives you the reliability associated with IBM standard 8" floppy disks.

The AMS 8000 provides an Apple memory system with 1/2 to 4 Megabytes of removable, online, easy-to-use Apple formatted data ready to plug-in and operate. The system is at home in any setting and matches the styling of your Apple.

The AMS 8000 preserves your current software investment by maintaining rigid compliance with APPLE DOS interface specifications. Since standard Apple DOS commands are used, most software currently running under APPLE DOS 3.2, 3.3, Apple UCSD Pascal 1.1, or Microsoft CP/M*2.2 will run with AMS 8000. Apple mini disks may be used at any time.

Because of the IBM 3740 single density format, you now have the opportunity to exchange data with other computers such as IBM, INTEL, Radio Shack, DEC, etc. or operating systems like CP/M, UCSD Pascal, etc.

The controller circuitry utilizes a state-of-the-art LSI floppy disk controller and data separator to provide automatic single and double density operation. A proprietary high speed SOFT-DMA data transfer technique guarantees compatibility with all other DMA cards and will not interfere with memory refresh.

For a cost effective, reliable, and software compatible memory system from the originator of 8" floppy disk systems for the Apple, try the AMS 8000 from SVA . . . SVA means Business.

*Trademark Apple Computer. CP/M Trademark Digital Research.

Look what the complete AMS 8000 memory system with its field proven hardware and complete support software, deluxe industrial quality cabinet, reliable industry standard IBM 3740 8-inch floppy disk drives, dual density controller, self-contained power supplies and high density cooling means to you:

INCREASED STORAGE & FLEXIBILITY

- Increase online storage up to 4 Mega bytes
- Expand your maximum accounts and file size
- Add high speed efficient hard disk backup

IMPROVED COMPATIBILITY

- Operate with single AND double density DOS, CP/M, Pascal
- Enhance your existing mini-disks and software
- Copy any IBM 3740 or IBM System 34 Format 8" disk
- Interchange data with other computers

SIMPLIFIED OPERATION

- Utilize standard Apple DOS and DOS commands
- Reduce disk handling and I/O slot usage
- Gain automatic single/double density operation
- Gain automatic single/double sided drive operation
- Change to voice coil drives with one switch

SEVEN DAY BURN IN AND TEST POLICY

- 1 Year Warranty



SORRENTO VALLEY ASSOCIATES
11722 Sorrento Valley Road
San Diego, CA 92121
(714) 452-0101

FREE Computer Forms Catalog

with 32 pages of continuous business forms for small computer systems

Send today for our NEW full color 32 page catalog with programming guides, prices and order forms for continuous checks, invoices, statements, envelopes, stock paper and labels.

- Quality products at low prices
- Available in small quantities
- Fast Service
- Money Back Guarantee
- Convenient TOLL-FREE ordering

Fast Service by mail or...PHONE TOLL FREE
1 + 800-225-9550
 Mass. residents 1 + 800-922-8560
 8:30 a.m. to 5:00 p.m. Eastern Time Monday — Friday

| | |
|--|------------|
| Please rush a new computer forms catalog to: | CODE 22460 |
| Name | _____ |
| Company | _____ |
| Street | _____ |
| City, State and Zip | _____ |
| Phone | _____ |
| Computer make & model | _____ |

**Neb's
Computer Forms**
 78 Hollis Street, Groton, Mass. 01471
A division of New England Business Service, Inc.

Book Review

charts, pin assignments, timing specifications, information on formatting tracks, disk read and write operations, and other technical information.

The last section, the appendix, is very confusing. The table of contents calls it a "Reference Table of Memory Contents." What it actually is I don't know. It contains the following:

- a decimal column going from 0 to 255
- a hexadecimal column counting from 0 to FF, matched to the decimal column
- a column labeled EXT, which makes sense only if it is related to the Z80 assembly-code mnemonics
- a column of the corresponding Z80 op codes, matched to the hexadecimal column (which seems to support the assumption about the EXT column)
- a column labeled ASCII for the numbers 0 through 127, which changes to GRAPHIC for the numbers 128 through 191, and changes a last time to TAB for the numbers 192 through 255
- a column labeled TRS-80 Controls for the numbers 0 through 63, changing to TRS-80 BASIC for the numbers 64 through 255.

None of these has anything to do with a table of memory contents.

Conclusions

• Unfortunately, *Pathways Through the ROM* is only a compilation of the separate works just discussed. No attempt has been made by the editor to tie these different items together into a cohesive whole. Each work uses a different approach and different writing style. This makes the manual difficult to read and at times a frustrating experience. It also means that some of the information is repeated needlessly.

• As if this didn't make it difficult enough, the manual itself is poorly put together (and I don't mean physically). There are numerous typographical errors and many outright editorial mistakes, including figures with incorrect or no labels, and references to figures which are not in the book. This is possibly the result of its being a hasty compilation of several different works.

• *Pathways Through the ROM* contains information on the floppy-disk controller and the DOS commands not present in the other ROM manuals I have seen. Because of this, it might be of use to the serious assembly-language programmer who has a disk system.

Inside Level II: A Programmer's Guide to the TRS-80 ROM

John Blattner and
Bryan Mumford
Mumford Micro
Systems, POB 435,
Summerland CA 93067,
1980, 65 pages,
softcover, \$19.95

In their preface, the authors say the main objective of *Inside Level II* is "to provide the information necessary for utilizing these routines [stored in the ROM] in your own assembly-language programs." This is quite accurately accomplished. The second objective, which the book doesn't achieve, is "to detail an efficient scheme for linking assembly-language and BASIC programs."

To realize the first objective, the authors have selected the routines they believe will be of interest to assembly-language programmers, and have carefully outlined each step involved in their use. Thus, not all the routines in the ROM are ac-

Qume® Data Trak™ Floppy Disk Drives

Distributed
by: **asap**
computer
products, inc.

The Data Trak™ 5 double-sided double-density drive uses state-of-the-art technology to give you superior data integrity through improved disk life, data reliability, and drive serviceability using 5¼" media.

Qume's independent head load yields wear characteristics far superior to competitive drives. This superior wear performance produces savings on both diskette usage and drive maintenance.

Improved data reliability, resulting from superior amplitude and bit shift characteristics, optimizes operator efficiency and reduces processing time for end-users.

And Data Trak's unique modular design means simplified field servicing for you and your customers.

Design Features

Expanded storage capacity • Two-sided, double-density

Proven head carriage assembly • Ceramic head with tunnel erase • Dual-head flex mounting arrangement • Superior head load dynamics

Precise lead screw actuator • Fast access time — 12 ms track-to-track • Low friction and minimum wear • Low power dissipation

Additional features • Industry standard 5¼" media format • ISO standard write protect • Door lock out for media protection • Requires DC voltage only • Daisy Chain up to 4 drives • Heads load on command independent of loading media

Product Specifications

Performance Specifications • Capacity: Unformatted: 437.5K or 500K bytes; Qume Formatted: 286.7K or 327.7K bytes • Recording Density: 5456 BPI • Track Den-

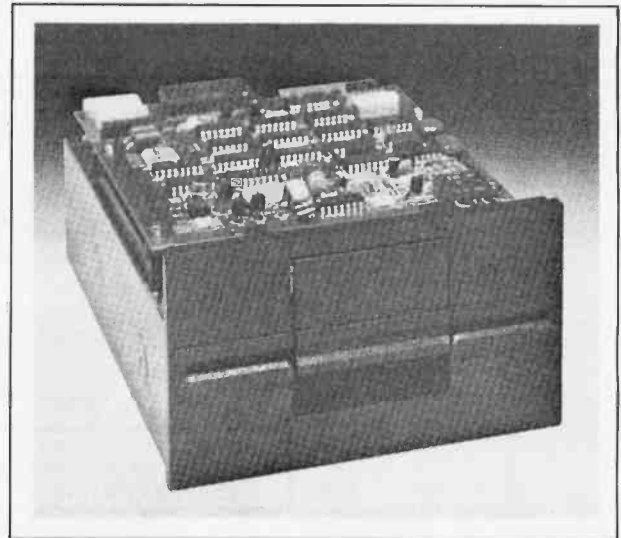

sity: 48 TPI • Cylinders: 35 or 40 • Tracks: 70 or 80 • Recording Method: FM or MFM • Rotational Speed: 300 RPM • Transfer Rate: 250K bits/second • Latency (avg.): 100 ms • Access Time: Track-to-track 12 ms; Settling 15 ms • Head Load Time: 50 ms

The Data Trak™ 8 double-sided double-density drive uses state-of-the-art technology to give you superior data integrity through improved disk life, data reliability, and drive serviceability.

Qume's innovative approach to controlling head load dynamics yields wear characteristics far superior to competitive drives. In independent evaluation, Data Trak 8 is setting industry standards for tap test performance. This superior wear performance produces savings on both diskette usage and drive maintenance.

Improved data reliability, resulting from superior amplitude and bit shift characteristics, optimizes operator efficiency and reduces processing time for end-users.

And Data Trak's unique modular design means simplified field servicing for you and your customers.

Design Features

Expanded storage capacity • Two-sided, double-density

Fully IBM compatible • IBM 3740 and System 32 drives • IBM 3600 and 4964 drives • IBM System 34 drives

Proven head carriage assembly • Ceramic head with tunnel erase • Dual-head flex mounting arrangement • Superior head load dynamics

Fast, precise steel belt drive • Fast access time — 3 ms track-to-track • Low friction and minimum wear • Low power dissipation

Additional features • ISO standard write protect • Programmable door lock • Negative DC voltage not required • Daisy Chain up to 4 drives • Side-by-side mounting in standard 19" RETMA rack • Compatible with Shugart SA850/SA851

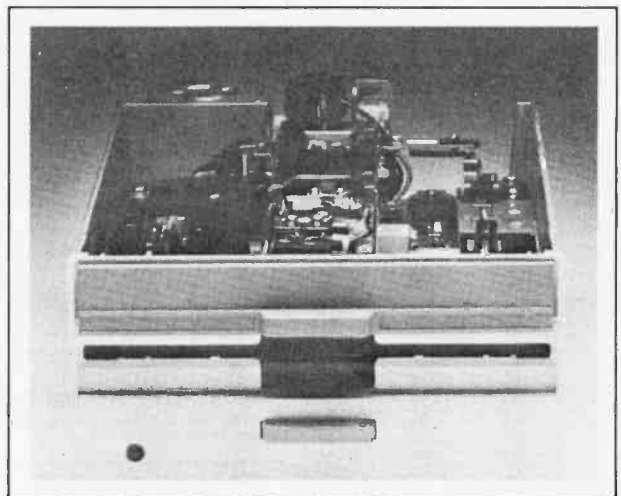

Product Specifications

Performance Specifications • Capacity: Unformatted: 1.6 Mbytes/disk; IBM Format: 1.2 Mbytes/disk • Recording Density: 6816 BPI • Track Density: 48 TPI • Cylinders: 77 • Tracks: 154 • Recording Method: MFM • Rotational Speed: 360 RPM • Transfer Rate: 500Kbits/second • Latency (avg.): 83 ms • Access Time: Track-to-track 3 ms; Settling 15 ms; Average 91 ms • Head Load Time: 35 ms • Disk: Diskette 2D or equivalent

asap
computer
products, inc.

1198 E. Willow, Signal Hill, CA 90806

Call Toll Free (800) 421-7701

AUTHORIZED DISTRIBUTOR FOR QUME
CALL FOR PRICE AND DELIVERY

(213) 595-6431 or (714) 891-2663 In California

FOR ONLY \$129.95 Learn Computing From The Ground Up

Build a Computer kit that grows with you, and can expand to 64k RAM, Microsoft BASIC, Text Editor/Assembler, Word Processor, Floppy Disks and more.

EXPLORER/85

Here's the low cost way to learn the fundamentals of computing, the all-important basics you'll need more and more as you advance in computer skills. For just \$129.95 you get the advanced-design Explorer/85 motherboard, with all the features you need to learn how to write and use programs. And it can grow into a system that is a match for any personal computer on the market. Look at these features: 8085 Central Processing Unit, the microprocessor "heart" of the Explorer/85. (Join the millions who will buy and use the 8080/8085 this year alone!)... Four 8-bit plus one-half input/output ports from which you can input and output your programs, as well as control exterior switches, relays, lights, etc. a cassette interface that lets you store and reload programs you've learned to write... deluxe 2,000 byte operating system/monitor makes it easy to learn computing in an important way... allows simpler, faster writing and entering of programs... It permits access by you to all parts of the system so you can check on the status of any point in the program... It allows tracing each program step by step, with provision for displaying all the contents of the CPU (registers, flags, etc.)... and it does much more!

You get all this in the starting level (Level A) of the Explorer/85 for only \$129.95. Incredible! To use, just plug in your 8VDC power supply and terminal or keyboard/display... if you don't have them, see our special offers below.

- Level A computer kit (Terminal Version) ... \$129.95 plus \$3 P&H*
- Level A kit (Hex Keypad/Display Version) ... \$129.95 plus \$3 P&H*

LEVEL B — This "building block" converts the motherboard into a two-slot S100 bus (Industry standard) computer. Now you can plug in any of the hundreds of S100 cards available.

- Level B kit ... \$49.95 plus \$2 P&H*
- S100 bus connectors (two required) ... \$4.85 each, postpaid.

LEVEL C — Add still more computing power; this "building block" mounts directly on the motherboard and expands the S100 bus to six slots.

- Level C kit ... \$39.95 plus \$2 P&H*
- S100 bus connectors (five required) ... \$4.85 each, postpaid.

LEVEL D — When you reach the point in learning that requires more memory, we offer two choices: either add 4k of a memory directly on the motherboard, or add 16k to 64k of memory by means of a single S100 card, our famous "JAWS".

- Level D kit (CHECK ONE) ... 4k on-board ... \$49.95 plus \$2 P&H*
- 16k S100 "JAWS" ... \$149.95 plus \$2 P&H*
- 32k S100 "JAWS" ... \$199.95 plus \$2 P&H*
- 48k S100 "JAWS" ... \$249.95 plus \$2 P&H*
- 64k S100 "JAWS" ... \$299.95 plus \$2 P&H*

LEVEL E — An important "building block" it activates the 8k ROM/EPROM space on the motherboard. Now just plug in one 8k Microsoft BASIC or your own custom programs.

- Level E kit ... \$3.95 plus \$0 P&H*

Microsoft BASIC — It's the language that allows you to talk English to your computer! It is available three ways: 8k cassette version of Microsoft BASIC (requires Level B and 12k of RAM minimum; we suggest a 16k S100 "JAWS" — see above) ... \$69.95 postpaid.

8k ROM version of Microsoft BASIC (requires Level B and 8k ROM and 4k RAM; just plug into your Level E sockets. We suggest either the 4k Level D RAM expansion or a 16k S100 "JAWS" ... \$99.95 plus \$2 P&H*.)

Disk version of Microsoft BASIC (requires Level B, 32k of RAM, floppy disk controller, 8" floppy disk drive) ... \$125 postpaid.

TEXT EDITOR/ASSEMBLER — The editor/assembler is a software tool (a program) designed to simplify the task of writing programs. As your programs become longer and more complex, the assembler can save you many hours of programming time. This software includes an editor program that enters the programs you write, makes changes, and saves the programs on cassettes. The assembler performs the clerical task of translating symbolic code into the computer-readable object code. The editor/assembler program is available either in cassette or a ROM version.

Editor/Assembler (Cassette version; requires Level B and 8k (min.) of RAM) ... we suggest 16k "JAWS" (see above) ... \$59.95 plus \$2 P&H*

Editor/Assembler (ROM version; supplied on an S100 card; requires Level B and 4k RAM (min.) — we suggest either Level D or 16k "JAWS") ... \$99.95 plus \$2 P&H*

8" FLOPPY DISK — A remarkable "building block." Add our 8" floppy disk when you need faster operation, more convenient program storage, perhaps a business application, and access to the literally thousands of programs and program languages available today. You simply plug them into your Explorer/85 disk system — it accepts all IBM-formatted CP/M programs.

8" Floppy Disk Drive ... \$499.95 plus \$12 P&H*
- Floppy Controller Card ... \$199.95 plus \$2 P&H*
- Disk Drive Cabinet & Power Supply ... \$69.95 plus \$3 P&H*
- Drive Cables (set up for two drives) ... \$25.00 plus \$1.50 P&H*
- CP/M 2.2 Disk Operating System; includes Text Editor/Assembler, dynamic debugger, and other features that give your Explorer/85 access to thousands of existing CP/M-based programs ... \$150.00 postpaid.

NEED A POWER SUPPLY? Consider our AP-1. It can supply all the power you need for a fully expanded Explorer/85 (note: disk drives have their own power supply). Plus the AP-1 fits neatly into the attractive Explorer steel cabinet (see below).

AP-1 Power Supply, kit (8V & 5 amp) in deluxe steel cabinet ... \$39.95 plus \$2 P&H*

NEED A TERMINAL? We offer you choices: the least expensive one is our Hex Keypad/Display kit that displays the information on a calculator-type screen. The other choice is our ASCII Keyboard/Computer Terminal kit, that can be used with either



- 1. Plug in Neutronic's Hex Keypad/Display
- 2. Add Level B in nearest to CPU
- 3. Add 4k RAM
- 4. Plug in Level E here; connect Neutronic's Microsoft Editor/Assembler to ROM
- 5. Add two S100 boards
- 6. Add your own custom circuits (prototyping card)
- 7. Connect terminal

- CRT monitor or a TV set (if you have an RF modulator)
- Hex Keypad/Display kit ... \$69.95 plus \$2 P&H*

ASCII Keyboard/Computer Terminal kit featuring a full 128 character set, 8k1 case, full cursor control, 75 ohm video output, convertible to baudout output, selectable baud rate, RS 232-C or 20 mA I/O, 32 or 64 character by 16 line format ... \$149.95 plus \$3 P&H*

Steel Cabinet for ASCII Keyboard/Terminal ... \$19.95 plus \$2.50 P&H*

RF Modulator kit (allows you to use your TV set as a monitor) ... \$8.95 postpaid.

12" Video Monitor (10MHz bandwidth) ... \$139.95 plus \$5 P&H*

Deluxe Steel Cabinet for the Explorer/85 ... \$49.95 plus \$3 P&H*

Fan for cabinet ... \$15.00 plus \$1.50 P&H*

ORDER A SPECIAL-PRICE EXPLORER/85 PAK — THERE'S ONE FOR EVERY NEED.

Beginner Pak (Save \$28.00) — You get Level A (Terminal Version) with Monitor Source Listing (\$25 value) AP-1, 5-amp. power supply, Intel 8085 Users Manual ... (Reg. \$199.95) SPECIAL: \$169.95 plus \$4 P&H*

Experimenter Pak (Save \$53.00) — You get Level A (Hex Keypad/Display Version) with Hex Keypad/Display, Intel 8085 User Manual, Level A Hex Monitor Source Listing, and AP-1 5-amp. power supply ... (Reg. \$279.95) SPECIAL: \$219.95 plus \$6 P&H*

Deluxe Microsoft BASIC Pak (Save \$103.00) — You get Levels A (Terminal Version), B, D (4k RAM), E, 8k Microsoft In ROM, Intel 8085 User Manual, Level A Monitor Source Listing, and AP-1, 5-amp. power supply ... (Reg. \$439.70) SPECIAL: \$339.95 plus \$7 P&H*

ADD A ROM-VERSION TEXT EDITOR/ASSEMBLER (Requires Levels B and D or S100 Memory) ... \$99.95 plus \$2 P&H*

Starter 8" Disk System — Includes Level A, B floppy disk controller, one CDC 8" disk drive, two-drive cable, two S100 connectors; just add your own power supplies, cabinets and hardware ... (Reg. \$1065.00) SPECIAL: \$999.95 plus \$13 P&H* ... 32k Starter System, \$1045.95 plus \$13 P&H* ... 48k Starter System, \$1145.95 plus \$13 P&H* ... Add to any of above Explorer steel cabinet, AP-1 five amp. power supply, Level C with two S100 connectors, disk drive cabinet and power supply, two sub-D connectors for connecting your printer and terminal ... (Reg. \$225.95) SPECIAL: \$199.95 plus \$13 P&H* ... Complete 8k System, Wired & Tested ... \$1650.00 plus \$28 P&H* ... Special! Complete Business Software Pak (Save \$625.00) — Includes CP/M 2.2 Microsoft BASIC, General Ledger, Accounts Receivable, Accounts Payable, Payroll Package ... (Reg. \$1325) SPECIAL: \$699.95 postpaid.

*P&H stands for "postage & insurance." For Canadian orders, double this amount.

Continental Credit Card Buyers Outside Connecticut:

TO ORDER

Call Toll Free: 800-243-7428

To Order From Connecticut, or For Technical Assistance, call (203) 354-9375

★ (Clip and mail entire ad) ★

SEND ME THE ITEMS CHECKED ABOVE

Total Enclosed (Conn. Residents add sales tax); \$ Paid by:

Personal Check Cashier's Check/Money Order

VISA MASTER CARD (Bank No. _____)

Acct. No. _____ Exp. Date _____

Signature _____

Print Name _____

Address _____

City _____

State _____ Zip _____

Book Review

tually dealt with. For example, the AUTO, CLEAR, and EDIT commands are not even mentioned.

For each routine, you are told exactly what is being done, followed by the precise procedure in BASIC to get the desired result. You are also given warnings about what types of errors to expect, both in Level II and disk BASIC, and what you can do to prevent them.

The book's introduction is short (only three pages) and covers how the TRS-80 represents numbers, uses the registers, and links to disk BASIC.

The rest of the book is divided into three parts:

- the Level II ROM and reserved programmable memory
- linking assembly-language and BASIC programs together
- appendices

Part I (chapters 1 through 10) starts off by explaining exactly what each byte in reserved memory contains. For example, the bytes at hexadecimal addresses 40AA to 40AC hold the seed used by the TRS-80 random-number generator. This information is followed by the entry points to Level II commands and functions and the transfer points for disk BASIC commands. All this is in Chapter 1.

Chapter 2 tackles registers, buffers, and the passing of variables from storage to buffers and back.

Chapter 3 concerns the conversion routines for changing a numeric variable from one precision to another, such as converting a single-precision number to double precision or to an integer, or a numeric string to binary or vice versa. Examples are given of short routines that can be used to access the ROM properly from your own program.

Chapters 4 and 5 handle the arithmetic operations and the higher math functions (and even give the amount of time required by the routines to execute), while Chapter 6 explains the keyboard input, from single-character to numeric to string input.

Chapters 7 through 10 discuss the rest of the instructions, cassette I/O (input/output), video display, VARPTR (which returns the address of a variable), and the stack pointer.

Part II begins with Chapter 11, which, according to its title, is about assemblers and monitors. Actually, it merely suggests you use an assembler similar to Radio Shack's ED-TASM and a monitor, preferably the one sold by Mumford Micro Systems (publisher of *Inside Level II*). Fortunately, this chapter is only one page long.

Chapter 12 gets down to the technique of mixing BASIC and machine-language programs. Unfortunately, the methods discussed are somewhat awkward. The authors believe that machine-language routines of a mixed program should reside in low memory, and they go to a great deal of trouble outlining how this can be done, covering CLOADING and CSAVE-ing techniques. Some of the advice is common sense (i.e., debug the machine-language routine before you combine it with the BASIC program and vice versa). Because of the difficulty of combining programs in this style, I think the authors have failed in their avowed purpose. They did not even consider the prospect of embedding the machine-language routines in BASIC REM (remark) statements. This is easily done by loading your monitor above the BASIC program and replacing the body of the REM statement with your machine-language routine.

ATARI® SOFTWARE PIRACY: THIS GAME IS OVER.

ATARI® has led the industry in the development of video games such as ASTEROIDS™ and MISSILE COMMAND™. The outstanding popularity of these games has resulted from the considerable investment of time and resources which ATARI has made in their development. We appreciate the worldwide response from the videophiles who have made our games so popular.

Unfortunately, however, some companies and individuals have copied ATARI games in an attempt to reap undeserved profits from games that they did not develop. ATARI must protect its investment so that we can continue to invest in the development of new and better games. Accordingly, ATARI gives warning to both the intentional pirate and to the individuals simply unaware of the copyright laws that ATARI registers the audiovisual works associated with its games with the Library of Congress and considers its games proprietary. ATARI will protect its rights by vigorously enforcing these copyrights and by taking the appropriate action against unauthorized entities who reproduce or adapt substantial copies of ATARI games, regardless of what computer or other apparatus is used in their performance.

We ask that legitimate software developers cooperate with us to protect our property from any form of software piracy, imitation or infringement. ATARI is currently offering copyright licenses for a limited number of its games to selected software developers. If you happen to be selling a software product which performs a game similar to any ATARI game (such as a game created for a home computer), please contact us immediately. Write to the attention of: Patent Counsel, ATARI, Inc., 1265 Borregas Ave., Sunnyvale, Calif. 94086



 A Warner Communications Company
© 1981, ATARI, INC.

Circle 34 on inquiry card.

Book Review

Another important omission was an explanation of how to make your program a "load-and-go" type, eliminating the need to return to either the system level or the BASIC level after your program loads.

The three appendices are only two pages each. The first is a simple hexadecimal-to-decimal conversion chart, while the second is a ma-

chine-language program for recording a composite BASIC and machine-language program on tape (but the composite program must be in the format preferred by the authors, with the machine-language routines "below" the BASIC program). The last appendix is the most valuable, giving a machine-language program that allows faster recording of DATA

tapes by shortening the length of the leader and the sync byte.

Like the other books reviewed here, it has no index; however, the table of contents is detailed and makes up for the lack of an index.

Conclusions

• All of the steps required by BASIC when accessing the

ROM from your own program are carefully outlined: what to do, when to do it, and where to do it.

• Part II is of use only to programmers who do not write programs in pure machine language and must use hybrid programs instead.

• My only complaint might be that the book is too concise, with explanations a little too short for the beginner.

• I recommend this book to serious machine-language programmers.

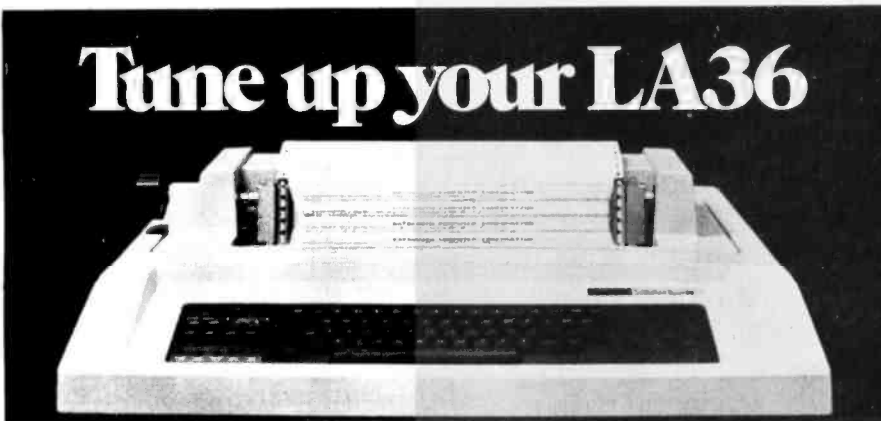

The DS120 Terminal Controller makes your LA36 perform like a DECwriter® III.

The Datasouth DS120 gives your DECwriter® II the high speed printing and versatile performance features of the DECwriter® III at only a fraction of the cost. The DS120 is a plug compatible replacement for your LA36 logic board which can be installed in minutes. Standard features include:

- 165 cps bidirectional printing
- Horizontal & Vertical Tabs
- Page Length Selection
- 110-4800 baud operation
- 1000 character print buffer
- X-on, X-off protocol
- Self Test
- RS232 interface
- 20 mA Current Loop interface
- Top of Form
- Adjustable Margins
- Double wide characters
- Parity selection
- Optional APL character set

Over 5,000 DS120 units are now being used by customers ranging from the Fortune 500 to personal computing enthusiasts. In numerous installations, entire networks of terminals have been upgraded to take advantage of today's higher speed data communications services. LSI microprocessor electronics and strict quality control ensure dependable performance for years to come. When service is required, we will respond promptly and effectively. Best of all, we can deliver immediately through our nationwide network of distributors. Just give us a call for all the details.

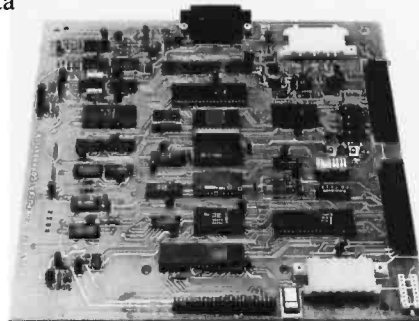

datasouth computer corporation

4740 Dwight Evans Road • Charlotte, North Carolina 28210 • 704/523-8500

The BOOK: Accessing the TRS-80 ROM

Raymond E Daly IV,
Stephen C Hill, Roy
Soltoff, Thomas B
Stibolt Jr, and Richard
P Wilkes
Insiders Software
Consultants, POB 2441,
Springfield VA 22152,
1980, 123 pages,
softcover, \$14.95

According to the introduction, *The BOOK* (volume I of a three-volume set) is dedicated to the math routines of Level II BASIC. It claims to be written for the novice to machine-language programming, while not "talking down" to the expert. I must say that the authors certainly have achieved their objectives.

The first three chapters (32 pages) deal with the formats, accumulators, and data manipulations for using the ROM math routines, as well as the actual functions. In the first chapter, you are given a leisurely and thorough explanation of how the TRS-80 Level II ROMs store and use memory addresses, binary numbers, and the memory accumulators. Numerous examples are used to make these techniques as clear as possible.

The second chapter details the ROM data-manipulation

The system is here!

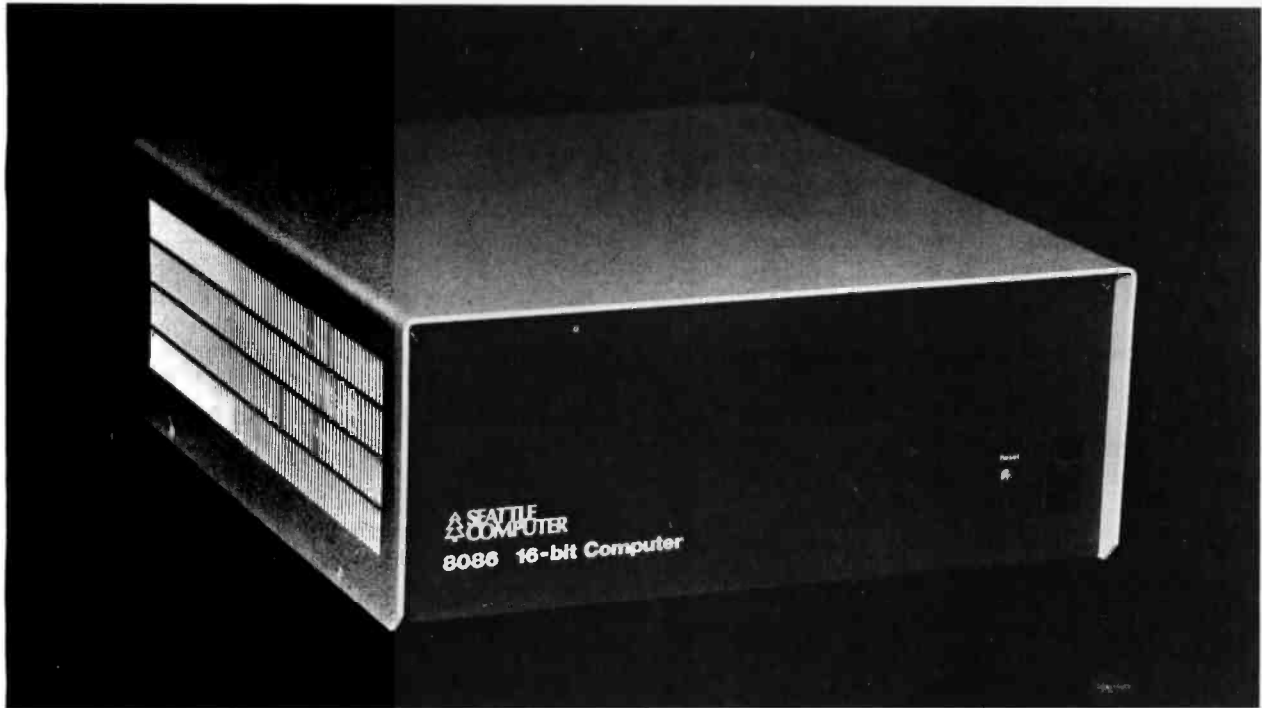

- 8 Mhz. 8086 CPU Set
- 128K Static RAM with 100 nsec. Chips
- Double-density Floppy Disk Controller
- 22-Slot Constant Voltage Powered Mainframe
- High-Performance 86-DOS Disk Operating System

\$4,785.⁵⁰ Fully Assembled, tested, ready to run. (Requires terminal and disk drives)

TO ORDER:

May be ordered through your local computer store or factory direct. Shipping paid by Seattle Computer on prepaid USA and Canadian orders. All boards fully assembled, tested, guaranteed one year. Mainframe guaranteed 90-days.

Software

We have the following Microsoft high-level languages running under 86-DOS.

- | | |
|------------------------------|-------|
| • BASIC-86 Interpreter | \$400 |
| • BASIC-86 Compiler | \$400 |
| • Fortran-86 | \$600 |
| • Pascal-86 | \$600 |
| • Cobol-86 | \$900 |
| • Macro-86 Assembler | \$300 |

Check for new additions

 **SEATTLE
COMPUTER**

1114 Industry Dr. Seattle WA 98188

Circle 331 on inquiry card.

Information Hotline

206/575-1830

Book Review

techniques and routines, with examples of how to move data from the ROM *work area* to your program's memory area and how to use the data-conversion routines (such as the ASCII string-to-binary number-conversion routine).

Chapter 3 gives accurate and complete instructions on interfacing the actual math routines to your own program. The authors have included a good deal of "extra" code in setting up their examples. This approach is particularly useful in illustrating

good programming techniques and makes it much easier for the novice to use the routines immediately, but it makes it much harder to find out what the bare requirements are to use a ROM routine and to adapt the routines more precisely to your needs.

Chapter 4 is not simply a disassembly of the math routines of the ROM, but a completely commented source-code listing with established labels. This was probably done by disassembling the ROM and assigning labels

and comments. This method gives the byte number, a label name (where applicable), the Z80 mnemonic (but not the extended mnemonics), and a comment field. It does not give the actual op codes stored at those bytes. This was probably an attempt to avoid infringement of Tandy (Radio Shack) and Microsoft copyrights. (Because this volume is devoted to the math routines, only that portion of the disassembly dealing with those routines has been reproduced in *The BOOK*.)

This disassembly is followed by Appendix A containing the whole label table for the entire Level II ROM, not just those labels dealing with the math routines. The authors say they did this to assist curious programmers in finding their way through the ROM. Each label's start and, where applicable, end address are printed as shown in table 1.

Appendix B contains three lengthy examples of how to use the routines in actual programs. Appendix C is a program listing of a disassembler in BASIC.

Conclusions

• *The BOOK*, like *Inside Level II*, is very thorough in its treatment of the math routines, but unlike *Inside Level II*, it gives numerous examples and copious explanations. This is a real help for the novice, and it also tends to prevent the expert from jumping to erroneous conclusions.

• Because of the use of labels in the disassembly, it is very easy to see and understand how the Level II ROMs actually operate.

• *The BOOK* does not give you the locations and procedures needed by the ROM; rather, it provides short, simple programs that use the ROM routines. For the nov-

ice, this could be a handicap in learning how to use the routines efficiently.

Microsoft BASIC Decoded & Other Mysteries for the TRS-80

James Favour
IJG Computer Services
1260 W Foothill Blvd,
Upland CA 91786,
1981, 310 pages,
softcover, \$29.95

Microsoft BASIC Decoded, the latest "ROM book" on the market, is by far the thickest and most complete to date. It is the second volume on the TRS-80 published by IJG Computer Services, the first being *TRS-80 Disk & Other Mysteries*.

Microsoft BASIC Decoded takes a completely different tack from the other books discussed here: it attempts to give a *total* overview of the Level II ROM operating system and Microsoft BASIC. It starts by explaining what is meant by an *operating system*, and what the TRS-80 has by comparison with this general idea.

Next, the book takes you through the process of turning on the TRS-80 computer, both with and without disk drives attached. It also tells you how the BASIC interpreter operates. Other chapters explain the ROM subroutines, cassette and disk I/O, addresses and tables used, and disk BASIC memory overlays.

Its best selling point, however, is the inclusion of a disassembly of the entire TRS-80 Model I Level II ROM set, both the old and the new ones, from hexadecimal 0000 all the way to hexadecimal 302A, with almost every line commented in plain English as to its purpose. The format

| Start | End | Label | Description |
|-------|------|--------|------------------------|
| 0B3D | 0B58 | INTSNG | Take Integer of Single |
| 0B59 | 0B9D | INTDBL | Take Integer of Double |

Table 1

End User Software

Take the
BIG 5
for
\$675

INTERACTIVE General Ledger, Accounts Receivable and Payable with Order Entry, Payroll, Inventory and Fixed Assets

Take the complete system including source code, documentation and initialization disk for only \$675.00

Requirements: CBAS2, CP/M by Digital Research, 48K RAM, Dual 8" drives

Call Today 408/429-8544

Big End User discounts on many other business applications software



End User Software

150 Felker Street
Santa Cruz, California 95060

S-100-8

INCLUDING CP/M2.2®

FEATURES!

TERMINAL

- Feather Touch Capacitance Keyboard
- 60 Key Standard ASCII PLUS + Hex Keypad PLUS + 8 Special Function Keys PLUS + 20 Screen Editing Keys
- SOROC Type Screen Attribute Set
- Half Intensity

COMPUTER

- 8 Slot S-100
- 64K Dynamic Ram
- 4MHZ Z-80
- Serial Printer Port (150-19.2K)
- Double Density Disk Controller
- Programmable Baud Rate
- Programmable Keyboard Set

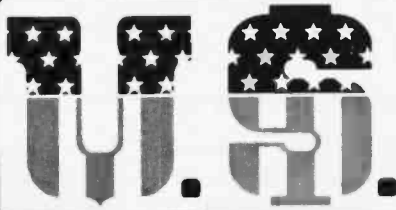

MICRO SALES

11 EDISON DRIVE ★ NEW LENOX ★ ILLINOIS 60451
 CALL TOLL FREE: 1-800-435-9357 ★ MONDAY thru SATURDAY
 (ILLINOIS RESIDENTS CALL: 815-485-4002) ★ 8:00 a.m. to 6:30 p.m.

TERMS: Prepayment — C.O.D. up to \$100.00 — M/C Visa
 \$5.00 Processing and Handling added to each order PLUS
 Shipping Charges.

Please allow personal check to clear before shipment.

WITH: 8" SS/DD Drives Only \$2850.00
 5 1/4" SS/DD Drives Only \$2700.00



CALL FOR
 QUOTE ON
 DIFFERENT DRIVE
 OPTIONS

TERMINALS

- Televideo 950 — \$950.00
- Televideo 920C — \$740.00
- Televideo 912C — \$665.00
- Televideo 910 — \$575.00

Ampex Dialog 80
 w/ Detachable Keyboard
 \$950.00

Call For Price & Availability On Other Terminals.

PRINTERS

- EPSON MX 80
 Only \$470.00

- C-ITOH Comet I
 Only \$499.00

- Anadex 9501
 Graphic Printer
 Only \$1275.00

Call For Price & Availability On Other Printers.

FLOPPY DISK DRIVES

DUAL DRIVE SUBSYSTEM \$995.00

\$195.00 w/no Drives
 If this looks like a Lobo
 Drive System, don't be
 fooled. Just because it
 looks like one, works like
 one, smells like one, and tastes like one (?)
 doesn't mean it has to cost like one!



2 SHUGART 801R
 POWER SUPPLY

TWIN VERTICAL DRIVES\$ 5" \$550.00 — 8" \$980.00

Attractive, convenient and
 compact Two Drive Mass
 Storage includes Power
 Supply, Drives, Cabinets, and
 Cables. Double Sided,
 Double Track available too!



- Shugart 801's \$395.00
- Shugart 851's \$585.00
- Qume DT-8's \$575.00

CP/M2.2 is a TM of Digital Research Inc.

Book Review

is very straightforward:

byte number — Z80 op code
— mnemonic — comment

The mnemonics are restricted solely to the primary commands because the printing of the extended mnemonics would probably be a violation of the copyright laws.

In an effort to make it simpler for you to use this disassembly, the book pages have been predrilled to fit a three-ring binder and the binding has been prepared for easy removal of this section. This is a brilliant idea, and I wonder why more publishers don't do this; there are many books that I wish had been made in this way.

Not only does the loose-leaf binder make it easier to work with the pages, but it also makes it possible for you to insert your own pages of comments wherever you want to. And that's not all: because most programmers will want to include the extended mnemonics in their binders, a simple scheme has been devised to accommodate this desire. Each page of the disassembly is a standard 8½- by 11-inch sheet of 66 lines (four of the lines are blank, to provide spacing at the top and the bottom). This means that any printer capable of printing 66 lines per 11-inch page will be able to produce a disassembly to match the book pages perfectly. The only qualification is that you have to use a disassembler that automatically paginates after printing 62 lines.

If you use the Apparat Disassembler, which is what the author used, you should have a perfect match to the book. This scheme is very well thought out. The book's disassembly even goes so far as to note the errors of disassembly that most disassemblers will make (i.e., the dis-

assembler doesn't know when it is mistakenly decoding a table of addresses or ASCII messages to the operator).

All in all, the publisher and author have done a remarkably efficient job of making it as easy as possible for you to have a correct and complete disassembly of the TRS-80 Model I Level II ROMs. This disassembly is Chapter 8 of the book and occupies 246 pages. It covers the entire old ROM set that Radio Shack originally sold (it displayed RADIO SHACK LEVEL II BASIC when the machine was turned on). Chapter 7 (only three pages long) points out the few differences between the old ROM set and the new ROM set (which displays R/S LII BASIC). Without a doubt, these two chapters alone would have made a "best seller" in the personal-computer field.

As I mentioned before, the first six chapters are devoted to the gargantuan task of trying to tell you precisely how the Level II ROMs work, and they simply do not live up to the standard set in the last two chapters.

Chapter 1 contains the explanations of memory use, Level II operation, interpretation, and execution; and, in general, it provides a simple overview of just what it is that the Level II ROMs do to control the TRS-80 system.

The second chapter is a tremendous letdown. It is supposed to be a guide to accessing the different ROM subroutines, but it is poorly written and incomplete. The explanations are not simple, and the format used is not explained. There are no warnings as to possible problems arising from the use of routines; and the sample programs don't tell you what you need to know to use the routines.

Neither this chapter nor

any of the others explains the method used by the ROMs to store numbers, except to note that integer numbers require 2 bytes of memory, single-precision numbers need 4 bytes, and double-precision numbers need 8 bytes. To balance this omission, the author has included a precise mathematical explanation of the formulas used by the ROM to compute the functions of sine, cosine, tangent, arctangent, exponentiation, natural logarithm, and square root. This information is not duplicated in any of the other books about the ROM.

Finally, not all of the subroutines that should have been included have been included. For example, Chapter 2 gives the routines used to turn on the cassette-drive motor, how to read and write the leader bytes, and how to read and write data. It does not tell you how to turn off the cassette motor, although you can find this information in the disassembly of Chapter 8 if you are patient.

Chapter 3, a considerable improvement over Chapter 2, concerns cassette and disk I/O formats and timing and includes timing diagrams for the cassette data. The disk section gives the controller commands—head seek, step, restore, etc. It goes into detail on the data formats on the disk, covering the GAT (granule allocation table), the HIT (hash index table), the disk DCBs (device-control blocks), and the directory sectors. In fact, the only other book that goes into more detail on the disk-data formats is *TRS-80 Disk & Other Mysteries*.

Chapter 4 is devoted to all of the tables used by the Level II ROMs and to lists of addresses of important routines. In addition to the table of Level II reserved words and their respective ROM addresses, there are tables of the

hierarchy of arithmetic operations, data-conversion routines, and error codes. Other tables, which are built in memory by BASIC for program execution, include the Mode Table, the Program Statement Table, and the Literal-String Pool (where the garbage collection routine spends all of its time). This chapter is crammed with information, but it is written more for the expert programmer than for the novice.

Chapters 5 and 6 are example programs illustrating methods of using the ROM routines in your own programs to do such things as initiate your own new BASIC commands and using the DOS overlay concept in a BASIC program to execute a program longer than the available memory (i.e., run a 64 K-byte program in a machine with only 32 K bytes of memory).

Conclusions

- This book is physically very well designed for maximum use by programmers who want to understand the Level II ROM and add to the information provided in the book.

- The writing is uneven, sometimes clear enough for the novice, sometimes not.

- Despite its flaws of omission and the unevenness in the first chapters, the disassembly and its design make this one ROM book that everyone should buy. ■

Teach your little Apple to talk to Western Union, Telex and TWX.

Albany

Omaha

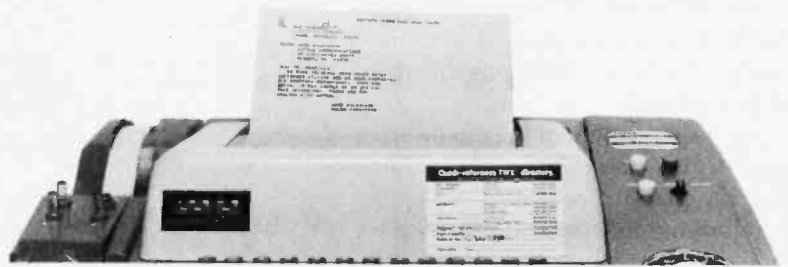

Micro-Telegram™ lets your Apple II™ computer access Western Union™ services, worldwide. You can send Mailgrams®. Send and receive TWX®, Telex, and international cables. Receive Infomaster® up-to-the-minute news, stock, foreign exchange, gold, futures, sports, and ski reports. Use your Apple™ to wire money. To send flowers. To check the snow at Sun Valley. To see what the Yen is selling for. To contact over 900,000 TWX and Telex subscribers around the world.

And because it's more intelligent than a mechanical Teletype™ machine, Micro-Telegram lets you edit messages right on the screen, sends them automatically without you in attendance, keeps subscriber directories and distribution lists, prints when you want it to, and asks you in plain English for your commands. Besides, it doesn't clatter and churn out reams of paper.

Call our toll-free number today. And make your little Apple heard 'round the world.

MICROCOM

We make little computers talk big.

Call 800-547-5995, ext. 188, toll-free, for the Micro-Telegram-Apple dealer nearest you. *Dealer inquiries invited.*

Microcom, Inc., 89 State Street, Boston, MA 02109. (617) 367-6362

Apple and Apple II are trademarks of Apple Computer, Inc. Western Union, Infomaster and TWX are trademarks of Western Union, Inc. Teletype is a trademark of the Teletype Corp.

System Notes

Two Short Graphics Programs for the OSI C-1P

John F Leahy
30345 Chualar Canyon Rd
Chualar CA 93925

Here are two pattern-producing video graphics programs for the Ohio Scientific Challenger 1P microcomputer. With one of these running in some conspicuous spot at your next party, you'll be amazed at the attention it attracts.

Be careful, though. You or your guests may go crazy trying to figure out the pattern, because the pseudo-random-number generator is used for both displays.

You choose your own rise and decay times for the display elements. The parameters 1000 and 1500 are suggested for starters. There'll be no decay, however, if the decay time is set at less than the rise time.

To speed up the action, use a delay limit of 500 or less. To slow it down, try 3000 or higher.

Happy viewing! ■

Listing 1: *This OSI BASIC program displays fascinating random graphics patterns on your video display.*

```
10 FOR X = 1 TO 30: ? : NEXT
20 INPUT "RISE TIME (1000?)"; E
30 INPUT "DECAY TIME (1500?)"; F
40 FOR X = 1 TO 30: ? : NEXT
50 C = INT (RND(1)*255)
60 D = 0
70 L = INT (RND(1)*920)
80 L = L + 53314
90 POKE L,C
100 D = D + 1
110 IF D > E THEN C = 32
120 IF D = F GOTO 50
130 GOTO 70
```

Listing 2: *A variation of the display program in listing 1.*

```
10 FOR X = 1 TO 30: ? : NEXT
20 INPUT "DECAY TIME (1500?)"; M
30 FOR X = 1 TO 30: ? : NEXT
40 I = INT (RND(1)*M)
50 C = INT (RND(1)*255)
60 L = INT (RND(1)*920)
70 L = L + 53314
80 POKE L,C
90 FOR T = 1 TO I: NEXT
100 POKE L,32
110 GOTO 40
```

LOW PRICES

Circle 81 on Inquiry card.

TERMINALS

| | | |
|-----------|-------------|---------|
| ADDS | Regent 25 | \$ 815. |
| | Viewpoint | 625. |
| AMPEX | Dialogue 80 | 965. |
| | Dialogue 30 | 865. |
| TELEVIDEO | TVI 950 | 950. |

PRINTERS

| | | |
|--------------|-----------|-------|
| PRINTRONIX | P:300 | 5195. |
| | P:600 | 6980. |
| DIABLO 630-3 | w/Tractor | 2295. |

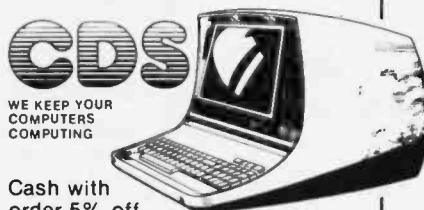

Cash with
order 5% off.

Computer Designs and Services
5575 Magnatron Blvd., Ste. D
San Diego, CA 92111
Tel. 714-571-2763
TWX 910-335-1620

DISK DRIVES

RMS 10 MB 5¼
with XCOMP Controller \$ 3895.

AMPEX
The Capricorn 160 MB 8990.

CONTROL DATA
also available.

MEMORIES

MICRODATA, DEC,
DATA GENERAL . . .

COMPUTER SYSTEMS
64 KB with 2.4 MB disk 3990.

Control Data — all models.



Now for adults.



**Creates,
Edits,
Formats.**

Textwizard™ transforms Atari into a powerfully serious word processor.

Textwizard™ is no kids game. It's a sophisticated and complete word processing program for the **Atari 800 computer.

Here is instant control over the creation, editing and formatting of any writing. Insert words. Replace phrases. Delete sentences. Move paragraphs. Automatically repositions surrounding text. *Textwizard™ does it all with over 50 simple commands.

On your command, Textwizard™ will search out and correct mistakes throughout your document. And it protects you from common operating errors by warning you before you make them.

Textwizard™ will print out as many original "copies" as you need. In boldface, elongated or condensed lettering, upper or lowercase, with proportional spacing. And you can store your work on a diskette.

So, whether you write legal briefs, computer programs, or The Great American novel, Textwizard™ can make your work easier. And though it's no toy, it's fun to use.

At \$99.95, you don't have to write a best-seller to afford Textwizard™. Textwizard™ is another of the many creative products from Datasoft.

Datasoft Inc.™
COMPUTER SOFTWARE

Software for people who aren't easy to please.

19519 Business Center Drive / Northridge, California 91324 / (213) 701-5161

Check your local software dealer or

Send check or money order with \$2.00 postage/handling. California residents, add 6% sales tax.

*Textwizard will perform on a 32K system with one or more disc drives. It is compatible with the Atari® 825, Centronics® 737 and Epson® MX-80 printers.

**Atari is a registered trademark of Atari Computers Inc.

Circle 414 on inquiry card.

Memory Manipulator Eliminate Hex-a-phobia

Louis P Witt Jr, 1302 41st St, Orlando FL 32805

Under Radio Shack Level II BASIC, you can store short machine-code subroutines in string variables. The strings cannot be loaded via cassette, however, because several ASCII (American Standard Code for Information Interchange) codes will be interpreted as end characters and cause a loss of data. Therefore, the only way to use the strings as storage is to either POKE the code into memory or list it in the program as DATA elements, both of which require converting the data to decimal first.

Memory Manipulator is an attempt to solve that problem and the hassles of translating characters to ASCII codes, or any combination of hexadecimal, ASCII, or decimal conversion. It is an outgrowth of my intense dislike for errors that are due to base conversions creeping in and destroying what could have been a good program.

Program Operation

Memory Manipulator (see listing 1) allows you to input data in either hexadecimal, ASCII, or decimal, store the data at any location in programmable memory, and list it in any of the three forms on a video display or a line printer. Each function of the program is essentially independent of the other; the only routines shared are the hexadecimal-to-decimal conversion section at line 5000 and its reciprocal function at 6000. The remainder of the functions can be inserted or omitted as you see fit. The program uses about 3600 bytes of memory; however, this can be greatly reduced by deleting remarks and using multiple-statement program lines. There are not too many remarks, because the program is essentially self-explanatory.

Text continued on page 362

Listing 1: Memory Manipulator program, written in Radio Shack Level II BASIC. This program takes data input as ASCII characters, decimal numbers, or hexadecimal numbers and places the hexadecimal equivalents into a specified area of memory. It also can read hexadecimal data from memory and display it in any of the above forms.

```
10 'MEM MANIPULATOR
20 'BY LOUIS P. WITT,JR.
30 '
40 'THIS ROUTINE-
50 '   FOKES & PEEKS IN
60 '       HEX
70 '       DECIMAL
80 '       ASCII
90 '   ALLOWS ALL ADDRESSES INPUT AS HEX
94 CLEAR 500
95 DEFSTR A-C
100 '
110 'MENU
120 CLS :PRINT CHR$(23)
125 PRINT:PRINT
MEMORY MANIPULATOR
130 PRINT"1 HEX FOKE
140 PRINT"2 HEX PEEK
150 PRINT"3 DEC FOKE
160 PRINT"4 DEC PEEK
162 PRINT"5 ASC FOKE
165 PRINT"6 ASC PEEK
170 PRINT:PRINT
180 INPUT"SELECTION";N
190 ON N GOTO 1000,2000,3000,4000,7000,8000
200 GOTO 120
1000 PRINT"FOKE MEMORY
1010 INPUT"START WITH";X$
1020 GOSUB 5000 'CVRT TO DEC
```

Listing 1 continued on page 358

Computer Systems for R & D

Data Acquisition & Control Systems

16 to 256 ch.; Programmable gain; Voltage or current output;
12, 14, or 16 bit; 30 to 125 KHz; Stepping motor control

8086 16 Bit Micro Systems

31 MByte Winchester Drives
256 KByte Memory Boards
8086 Software

Real Time Video Digitization Systems

Compatible with MP/M® and MP/M-86®

— for 8 bit systems one 256K board will support up to 7 users.

8/16 bit transfer
for 8 & 16 bit systems

256 switch selectable I/O ports for memory bank addressing

Hardware and software bank select in 8K/32K segments

Parity detection with interrupt and LED indication

Industrial Quality

64K / 256K

S-100 RAM

64K Boards each \$595
4 for \$2295

256K Boards each \$2495
4 for \$9495

Full DMA capability

24/20/16 bit address decoding

Address selection on any 8K/32K boundary

Disable 8K/32K segments in hardware or software

Special circuitry allows error-free operation in even the noisiest S-100 systems

Meets IEEE 696 Specifications

See our catalog for many other fine S-100 and Apple Boards including: — Analog to Digital Converters (16 - 256 channels; 12, 14, or 16 bit accuracy; 30, 40, 100, or 125 KHz; programmable gain; timer/counters) — Digital to Analog Converters (12 bit accuracy, 3 microsecond conversion) — 8086 CPU Board — I/O Boards — 16K Static RAM — Real-time Video Digitizer and Display.

©MP/M and MP/M-86 are registered trademarks of Digital Research, Inc.



23600 Mercantile Rd. • Cleveland, OH 44122

TECMAR, INC.
(216) 464-7410

LEAPAC SERVICES
LEAPAC SERVICES
APAC SERVICES
PAC SERVICES
AC SERVICES
E SERVICES
SERVICES **NEW**
SERVICES **\$239**
SERVICES
VICES **L2D 2.0**
ICES **2D GRAPHICS**
ES **Subroutine Package**
S **CALL or WRITE for DETAILS**

LEAPAC SERVICES (916) 381-1717
 8245 Mediterranean Way
 Sacramento, California 95826

SOFTWARE PRODUCTS

THE ART OF ELECTRONICS
 Paul Horowitz & Winfield Hill

Bypass Capacitor · Lead Inductance · Impedance · Op-Amp · Mosfet Switch
 3-Terminal Regulator · Emitter Follower Current Source · Precision A/D
 Confused by the *other half* of electronics? *The Art of Electronics* combines a comprehensive stand-alone treatment of both analog and digital electronic design, boot-strapping the reader through to an advanced level of design proficiency. This fresh non-mathematical view of electronics emphasizes circuit *design* and *implementation*, illustrated with hundreds of examples stressing the tradeoffs involved in the choice of circuit configurations, device types, and component values. It provides an easy entry into electronics for the inexperienced, yet its wealth of valuable insights and techniques makes it an ideal reference for the computer hobbyist, specialist, or electronic engineer.

\$24.95

CONTENTS

1. Foundations
2. Transistors
3. Feedback & Operational Amplifiers
4. Active Filters & Oscillators
5. Voltage Regulators & Power Circuits
6. Field-Effect Transistors
7. Precision Circuits & Low-Noise Techniques
8. Digital Electronics
9. Digital Meets Analog
10. Minicomputers
11. Microprocessors
12. Electronic Construction Techniques
13. High-Frequency & High-Speed Techniques
14. Measurements & Signal Processing

YES! Please send me *The Art of Electronics*
 CAMBRIDGE UNIVERSITY PRESS
 Dept. E
 32 East 57th St.
 New York, NY 10022

Name _____
 Address _____
 City _____
 State _____ Zip _____

Payment enclosed
 Master Charge Interbank # _____
 VISA
 Card # _____ Exp. _____
 Signature _____

Programming Quicksies

Listing 1 continued:

```

1030 N=X          'START WITH N
1040 X=N
1050 GOSUB 6000 ' CVRT TO HEX
1060 PRINT"MEM=>"X$;
1070 INPUTX$
1080 GOSUB 5000 ' CVRT TO DEC
1085 IF N>32767 THEN
        N=-1*(65536-N)
1090 POKE N,X    'STORE
1095 IF N<0 THEN
        N=65536+N
1100 N=N+1      'NEXT CELL
1110 GOTO 1040  'LOOP
1111 '
1112 '
1113 '
1114 '
2000 'READ MEMORY
2010 INPUT"1 FOR CRT
        2 FOR PRINTER";P

2020 INPUT"START AT";X$
2030 GOSUB 5000 'CVRT TO DEC
2040 N=X
2050 INPUT"END AT";X$
2060 GOSUB 5000 'CVRT TO DEC
2065 CLS
2070 FI=X
2080 FORN=N TO FI STEP 16
2090 X=N
2100 GOSUB 6000 'CVRT TO HEX
2110 PRINT X$"=">" ;
2115 IFF=2THENLPRINTX$"=">" ;
2120 FOR M=0 TO 15
2125 R=N+M ; IF R>32767
        THEN R=-1*(65536-R)
2130 X=PEEK(R)
2140 GOSUB 6000 'CVRT TO HEX
2150 X$=RIGHT$(X$,2)
2160 PRINTX$;" ";
2170 IFF=2THEN LPRINTX$;" ";
2180 NEXT M
2185 PRINT
2187 IF F=2 THEN LPRINT" "
2190 NEXT N
2200 GOTO 120
2210 '
2211 '
2212 '
2213 '
2214 '
3000 PRINT"DECIMAL POKE MEMORY
3010 INPUT"START ADDRESS";X$
3020 GOSUB 5000 'CVRT DEC
3030 N=X
3040 X=N :GOSUB 6000
3050 PRINTX$;
3060 INPUTJ
3065 IF J>255 OR J<0 THEN 120
3070 R=N ; IF R>32767 THEN
        R=-1*(65536-R)
3080 POKE R,J
3090 N=N+1
3091 '
3092 '
3093 '
3094 '
3100 GOTO 3040
4000 PRINT"DECIMAL PEEK MEMORY
    
```

Listing 1 continued on page 360

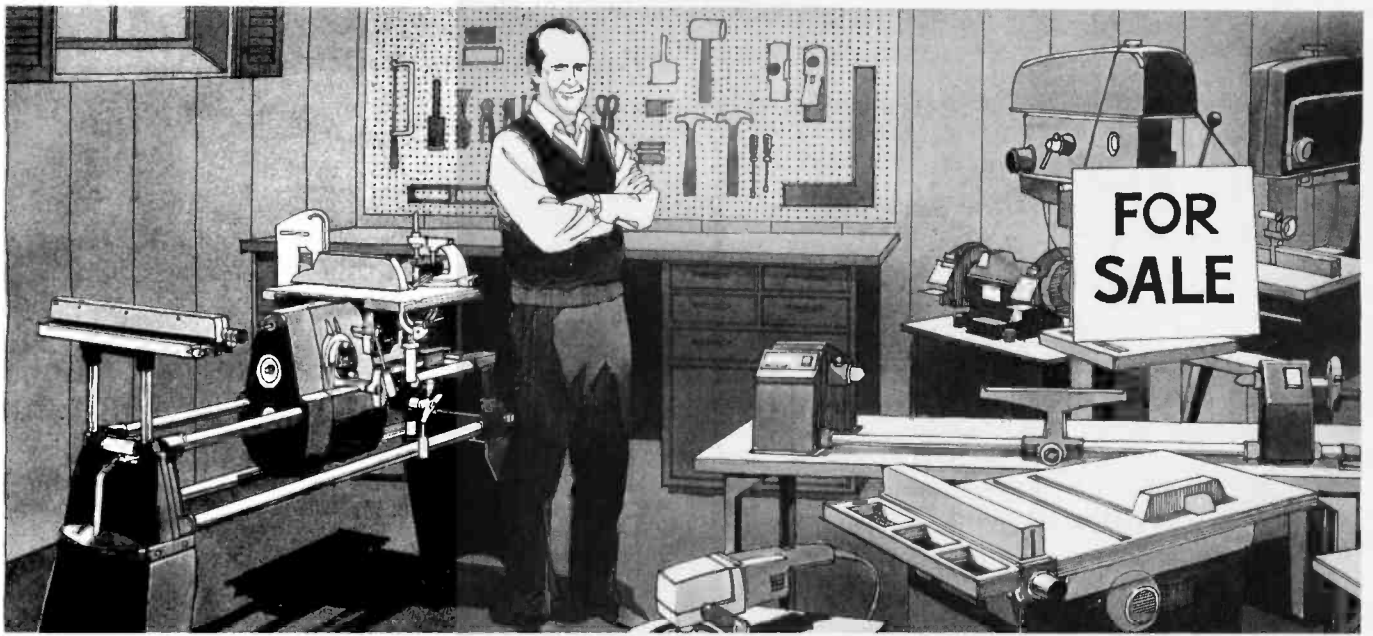

Jack McAlister had \$12,000 worth of power tools. Here's why he sold them!

"My shop was equipped with commercial tools in which I had an investment of \$12,000 or more. I sold all my machines at a nice profit, and purchased one Mark V... I can do anything I was doing on all the machines, this gives me a lot more room and I have several thousand in the bank. What more could I ask for?"

— Jack McAlister, Tucker, Georgia

Jack McAlister learned something that a lot of woodworkers, from beginners to experts, already know. You don't *need* a shop full of expensive power equipment to do just about any job you could imagine. All you need is a Shopsmith MARK V.

The 5-in-1 tool that does it all.

The Shopsmith MARK V is actually a complete workshop in a single, compact unit no bigger than a bicycle. One rugged, precision-built motor powers five basic tools: 10" table saw, 16½" vertical drill press, horizontal boring machine, 34" lathe and 12" disc sander.

It actually lets you do more than individual power tools because you can

borrow features from one tool to enhance the capabilities of another. And it's so easy to use that after only about an hour's practice, you'll be able to change from one function to another in less than 60 seconds.

With the MARK V's capacity and precision, you'll soon find yourself getting professional results on projects you now wouldn't dream of tackling. You'll discover why we call the MARK V "The tool to start with ... the system you grow with."

Find out what Jack McAlister and 250,000 other MARK V owners already know.

Don't you owe it to yourself to find out more about the MARK V — the single machine that can actually *replace* \$12,000 or more in power tools — yet *costs* just a fraction of that figure?

Mail the coupon today for your FREE Information Kit.

Find out more about the amazing MARK V. Simply mail the coupon below and we'll send you a FREE Information Kit. Your Kit will include a booklet, "What To Look For When You Buy Power Tools," plus all the details on the incredible MARK V. You'll also learn how you can actually use it in your home, for a full 30 days, *without risking a penny!*



Shopsmith Inc.

The Home Workshop Company
750 Center Drive
Vandalia, Ohio 45377

Mail this coupon today!

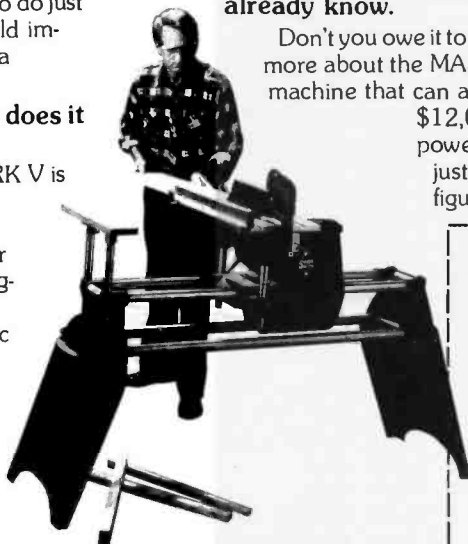

©Shopsmith, Inc. 1981



Shopsmith Inc.
The Home Workshop Company
750 Center Drive
Vandalia, Ohio 45377

Dept. 354H

YES! Please send me my FREE Information Kit on the Shopsmith MARK V, including illustrated brochure and "What To Look For When You Buy Power Tools" booklet ... PLUS all the details on how I can test-use the MARK V at home, without risk, for 30 days. I understand that this information is FREE and I am under no obligation.

Name _____

Address _____

City _____

State _____ Zip _____



Components Express, Inc.
 "Have you kissed your computer lately?"
 1380 E. Edinger, Unit CC Santa Ana, CA 92705 (714) 558-3972

BROAD BAND MICROWAVE RECEIVER SYSTEM
1.8GHZ to 2.4 GHZ

only **\$295.00**



With built-in-converter to channel 2, 3, or 4 of any standard TV set.

RANGE: Line of sight to 250 miles.
SCOPE: Will receive within the frequency band from satellites, primary microwave stations, and repeater microwave booster stations.
CONTENTS: Packaged in 19"x19"x4 1/2" corrugated carton complete with:

- 24" Dish
- Feed-Horn Receiver
- Mounting Bracket
- Mounting Clamp
- Instructions
- 300 Ohm to 75 Ohm Adapter
- 750 Ohm to 300 Ohm Adapter
- 60 Feet Coax Cable with Connectors
- 3 Feet Coax Cable with Connectors

WARRANTY:
 180 days for all factory defects and electronic failures for normal useage and handling. Defective sub assemblies will be replaced with new or re-manufactured sub assembly on a 48 hour exchange guarantee.

This system is not a kit and requires no additional devices or equipment other than a TV set to place in operation. **DEALER INQUIRIES INVITED.**

Programming Quickies

Listing 1 continued:

```

4010 INPUT "1 FOR CRT
      2 FOR PRINTER";P
4020 INPUT "START ADDRESS";X$
4030 GOSUB 5000 'CVRT DEC
4040 N=X
4050 INPUT "END ADDRESS";X$
4055 GOSUB 5000
4057 CLS
4060 FI=X
4070 FORN=N TO FI STEP 10
4080 X=N : GOSUB 6000
4090 PRINTX$=">";
4100 IFF=2THENLPRINTX$=">";
4110 FOR M=0 TO 10
4120 R=N+M :IF R>32767 THEN
      R=-1*(65536-R)
4130 PRINT USING " ### ";PEEK(R);
4140 IFF=2 THEN LPRINT USING
      " ### ";PEEK(R);

4150 NEXTM
4160 PRINT
4170 IFF=2THENLPRINT " "
4180 NEXT N
4190 INPUTZ$;GOTO120
4200 '
4210 '
4211 '
4212 '
4213 '
4214 '
5000 'X=DEC VALUE OF X$(HEX)
5010 X=0
5015 IF LEN(X$)=0 THEN 5120
5020 A1=LEFT$(X$,1)
5030 X1=ASC(A1)
5040 X1=X1-48
5050 IF X1>9 THEN X1=X1-7
5060 IF X1<0 OR X1>15 THEN 120
5070 X=X*16+X1
5090 X$=RIGHT$(X$,LEN(X$)-1)
5100 GOTO 5015
5120 RETURN
5130 '
5140 '
5141 '
5142 '
6000 'X$=HEX VALUE OF X
6010 X$=""
6020 FOR Q=3 TO 0 STEP -1
6030 X1=FIX (X/16CQ)
6040 X=X-X1*16CQ
6050 X1=X1+48
6060 IF X1>57 THEN X1=X1+7
6070 X$=X$+CHR$(X1)
6080 NEXT Q
6090 RETURN
6091 '
6092 '
6093 '
6094 '
7000 PRINT "ASCII POKE"
7010 INPUT "START ADDRESS";X$
7020 GOSUB 5000
7030 N=X
7040 X=N
7050 GOSUB 6000
7060 PRINTX$=">";
7070 A=INKEY$;IFA="" THEN7070
    
```

Listing 1 continued on page 362

4.25 DISK

IBM 2770
IBM 2780
IBM 3270
IBM 3741
IBM 3780
IBM 3776

Software for Your Microcomputer
 8080 Z80 8086 Z8000

WINTERHALTER & ASSOCIATES, INC.
 SPECIALISTS IN DATA COMMUNICATIONS
 3825 ZEEB ROAD
 DEXTER, MICHIGAN 48130
 313-426-3029 or
 313-665-5582



When it comes to microcomputer software we wrote the book.

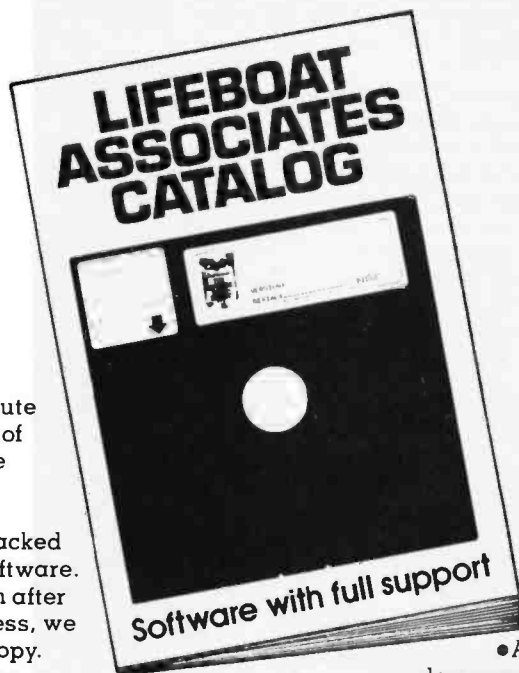

How do you stay up-to-the-minute with the rapidly changing world of microcomputer software? Get the Lifeboat Catalog.

The Latest Innovations

The new Lifeboat Catalog is packed with the latest state-of-the-art software. And if we publish a new program after the latest catalog has gone to press, we enclose a flash bulletin in your copy.

The Greatest Selection

Because Lifeboat is the world's largest publisher of microcomputer software, our catalog offers you the greatest selection of programs for business, professional and personal use. Our more than 200 programs range from integrated accounting and professional practice systems to office tools for bookkeepers and secretaries to sophisticated tools for programmers. Included are business systems, word processors, programming languages, database management systems, application tools and advanced systems utilities.

We specialize in software that runs on most small business computers. Our more than 60 media formats, including floppy disks, data cartridges, magnetic tape and disk cartridges, support well over 100 computer brands of domestic and foreign manufacture.

LIFEBOAT WORLDWIDE offers you the world's largest library of software. Contact your nearest dealer or Lifeboat:

Lifeboat Associates
1651 Third Ave.
New York, N.Y. 10028
Tel: (212) 860-0300
Telex: 640693 (LBSOFT NYK)
TWX: 710-581-2524

Lifeboat Inc.
OK Bldg. 5F
1-2-8, Shiba-Daimon
Minato-ku, Tokyo 105, Japan
Tel: 03-437-3901
Telex: 2423296 (LBJTYO)

Lifeboat Associates, Ltd.
PO Box 125
London WC2H 9LU, England
Tel: 01-836-9028
Telex: 893709 (LBSOFTG)

Lifeboat Associates GmbH
PO Box 168, Aegerstrasse 35
CH 6340 Baar, Switzerland
Tel: 042-31-2931
Telex: 865265 (MICO CH)

Intersoft GmbH
Schlossgartenweg 5
D-8045 Ismaning, W. Germany
Tel: 089-966-444
Telex: 5213643 (ISOFD)

Lifeboat Associates, SARL
10, Grande Rue Charles de Gaulle
92600 Asnieres, France
Tel: 1-733-08-04
Telex: 250303 (PUBLIC X PARIS)

Mail coupon to: Lifeboat Associates,
1651 Third Avenue, New York, New York 10028
or call (212) 860-0300.

- Please send me a free Lifeboat Catalog.
 Please send me *Lifelines* subscription information.

Name _____ Title _____
Company _____
Street _____
City _____ State _____ Zip _____

Lifelines is a trademark of Lifelines Publishing Corporation.

Get Full Support

We give the crucial dimension of after-sales service and full support to everything we sell. That includes:

- A telephone hotline where technical and customer service representatives will answer your questions 11 hours a day.

- An update service for software and documentation.

- Telephone, telex and mail-order service at the New York headquarters and at overseas offices in England, France, Switzerland, West Germany and Japan.

- Export service providing software delivery to six continents.

- Subscriptions to *Lifelines*TM, the monthly magazine that offers comparative reviews, tips, techniques, identified bugs and updates that keep you abreast of change.

Get It Now

Lifeboat now serves tens of thousands of satisfied customers with our breadth of up-to-date, fully tested, fully supported and competitively priced software.

You may not need all we offer, but we offer just what you need. After all, we wrote the book.

2013

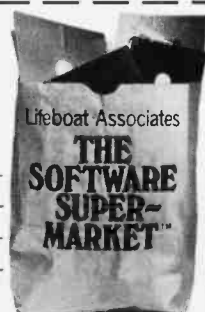

Lifeboat Associates
Software with full support

SB-80

The Price Is Nice.

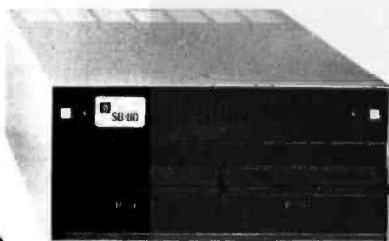

Introductory offer... \$2425.

Basic system with: 600K bytes
 • 1.2 megabytes \$2990.
 • 2.4 megabytes \$3490.

Single Board Technology

A Z80A CPU combined with the CP/M® operating system opens new vistas to software availability for eight-bit micros. FORTRAN, COBOL, BASIC, APL, PL/1 and Pascal are available now to accommodate today's scientific, educational, sophisticated small business and personal system users.

- 4 MHz Z80A CPU
- CP/M 2 operating system
- 64K 200ns main memory
- 8-inch dual floppy drives
- 50-pin expansion connector
- 2-serial ports
- 2-parallel ports
- 4-counter/timers
- Hard disk options available

Quantity discounts are available.
 OEM Inquiries are invited. Please contact:



Colonial Data Services Corp.

105 Sanford Street, Hamden, Connecticut 06514
 (203) 288-2524 Telex: 956014

©CP/M is a registered trademark of Digital Research, Inc.

Programming Quickies

Listing 1 continued:

```

7075 PRINTA
7080 R=N : IF R>32767 THEN
      R=-1*(65536-R)
7090 POKE R,ASC(A)
7100 N=N+1
7110 GOTO 7040
7111 '
7112 '
7113 '
7114 '
8000 PRINT"ASCII PEEK MEMORY
8010 INPUT"1 FOR CRT
      2 FOR PRINTER";P
8020 INPUT"START ADDRESS";X$
8030 GOSUB 5000
8040 N=X
8050 INPUT"ENDING ADDRESS";X$
8060 GOSUB 5000
8070 FI=X
8090 FOR N=N TO FI STEP 16
8090 X=N : GOSUB 6000
8100 PRINTX$=">" ;
8110 IF F=2 THEN LPRINTX$=">" ;
8120 FORM=0 TO 15
8130 R=N+M : IF R>32767 THEN
      R=-1*(65536-R)
8140 J=PEEK(R)
8150 IF J<32 OR J>127 THEN
      J=46
8160 PRINT CHR$(J);" ";
8170 IFF=2 THEN LPRINT CHR$(J);" ";
8180 NEXT M
8190 PRINT
8200 IFF=2 THEN LPRINT " "
8210 NEXT N
8220 INPUTZ$;GOTO 120
8221 END
8222 '
8223 '
8224 '
    
```

Text continued from page 356:

Under Level II BASIC, POKE and PEEK first convert their operands to 2-byte signed integers, having a range of -32768 to +32767. Since memory locations can go as high as 65535, this range would be inadequate. The sequence before the POKES and PEEKs (such as line 1085 in listing 1) works out the integer value that will properly address the location you desire. If you're operating a 16 K-byte (or less) machine, you can omit these statements.

There are no formal exits from the loops in the program sections, so an intentional error or the BREAK key must be used. Usually this is bad practice, since rerunning the program will lose variables or leave a job half done. In this case, it is acceptable because arguments are not being passed from section to section.

Using the Program

Before you load this program, set aside some high memory by means of the MEMORY SIZE? parameter; otherwise, you can destroy the program as soon as you POKE anything into memory.

World War II rages across Europe... Castle Wolfenstein is occupied by the army of the Reich and converted into battle-front headquarters. You have been captured and brought to the Castle for interrogation by the dreaded SS. From a hiding place behind the stones of the dungeon a dying cellmate produces a Mauser M-98 pistol fully loaded with ten bullets and gives it to you. Your new mission: Find the Nazi war plans and escape Castle Wolfenstein alive.

Castle Wolfenstein™ is an action adventure game from MUSE demanding fast thinking and quick manual response. Use game paddles, joystick, or your computer keyboard. Castle Wolfenstein™ generates an unlimited variety of castle layouts, each more difficult to escape than the last. For the Apple II and Apple II Plus with 48K. \$29.95

CASTLE WOLFENSTEIN™
 by Silas S. Warner

MUSE SOFTWARE™

Copyright © 1981 MUSE Software, Inc.
 All rights reserved.

330 N. CHARLES STREET
 BALTIMORE, MD 21201
 (301) 659-7212

HAYDEN BOOKS PUT THE WORLD OF MICROCOMPUTING AT YOUR FINGERTIPS!

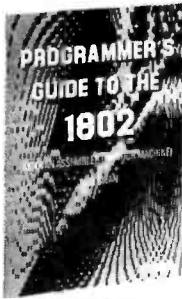

New! **WEBSTER'S MICROCOMPUTER BUYER'S GUIDE** (Webster) A detailed reference guide useful to both first-time and experienced users. It provides extensive information on the wide variety of microcomputer systems and suppliers, including new Japanese products. Each microcomputer system description includes a brief overview, central processing systems, peripherals, software, pricing and main office. Business, educational and professional applications of microcomputer systems are detailed. The book is divided into four sections: Microcomputer Theory and Applications; Independent Software Products; Microcomputers and Microcomputer Systems; CRT Displays, Printers and Printing Terminals. Includes glossary, charts, graphs and illustrations. **5129-8, \$25.00**

PROGRAMS FOR BEGINNERS ON THE TRS-80 (Blechman) A valuable book of practical and interesting programs for home use that can be understood and used immediately by the beginner in personal computer programming. Learn step-by-step how 21 sample TRS-80 programs work. Techniques are described line-by-line within the programs, and a unique Matri-Dex™ matrix index enables you to locate other programs using the same BASIC commands and statements. Detailed descriptions, complete listings, explanations of what each program does, and instructions for modifications included. **5182-4, \$8.95**

PROGRAMMER'S GUIDE TO THE 1802 (With An Assembler For Your Machine) (Swan) *The only assembly language primer that has an assembler!* Here's a worthwhile text that teaches assembly language for the 1802 microprocessor. Coverage includes everything from the binary number system and the fundamentals of machine language, to the development of a working 1802 assembler. Simple written in non-technical language, the text is intended for the beginner, but contains information that will be appreciated by experts. **5183-2, \$7.95**

HOME COMPUTERS CAN MAKE YOU RICH (Weisbecker) For every home computer owner and non-owner interested in spare-time income opportunities. You'll be introduced to the microcomputer industry, types of people involved in it, and how to learn more about this new field. Discusses basic principles of making money, freelance writing, programming, consulting, inventing, investing, and much more. **5177-8, \$6.50**

PROBLEM-SOLVING PRINCIPLES FOR PROGRAMMERS: Applied Logic, Psychology, and Grit. (Lewis) A valuable test for improving your problem-solving techniques in computer programming. Provides problem-solving background and alternate solutions. Introduces basic building blocks of problem solving, independent prescriptions, and remedies for typical programming problems. A special chapter on the top-down approach and a section on debugging included. **5138-7, \$9.95**
(Special FORTRAN version, 5430-0)
(Special BASIC version, 5200-6)
(Special PASCAL version, 5767-9)

BASIC COMPUTER PROGRAMS IN SCIENCE AND ENGINEERING (Gilder) Save time and money with this collection of 114 ready-to-run BASIC programs for the hobbyist and engineer. There are programs to do such statistical operations as means, standard deviations averages, curve-fitting and interpolation. There are programs that design antennas, filters, attenuators, matching networks, plotting, and histogram programs. All programs have been tested and are fairly universal. **0761-2, \$9.95**

BASIC COMPUTER PROGRAMS FOR BUSINESS: Vols. 1 & 2 (Sternberg) A must for small businesses using micros as well as entrepreneurs. Each program is documented with a description of its functions and operation, a complete listing in BASIC, a symbol table, sample data, and one or more samples. **5162-X, Vol. 1, \$9.95**
5178-6, Vol. 2, \$10.95

ORDER TODAY!

Hayden Book Company, Inc.
50 Essex St., Rochelle Park, NJ 07662

Please send me the book(s) checked on 15-day FREE examination. At the end of that time, I will send payment, plus postage and handling, or return the book(s) and owe nothing. On all prepaid, Visa or Master Card orders, publisher pays postage and handling. Residents of NJ and CA must add sales tax. Name of individual ordering must be filled in. Payment must accompany orders from PO Box Numbers. Offer good in US only.

- | | | |
|---------------------------------|---------------------------------|---------------------------------|
| <input type="checkbox"/> 0761-2 | <input type="checkbox"/> 5162-X | <input type="checkbox"/> 5183-2 |
| <input type="checkbox"/> 5129-8 | <input type="checkbox"/> 5177-8 | <input type="checkbox"/> 5200-6 |
| <input type="checkbox"/> 5138-7 | <input type="checkbox"/> 5178-6 | <input type="checkbox"/> 5430-0 |
| | <input type="checkbox"/> 5182-4 | <input type="checkbox"/> 5767-9 |

Name _____

Address _____

City / State / Zip _____

B 10/81-009

Available at your local computer store!

For Orders and Inquiries Call Toll Free

HAYDEN HOTLINE
800-631-0856

Hayden

50 Essex Street, Rochelle Park, NJ 07662 **Book Company, Inc.**

Programming Quickies

If you use the program to convert a short routine to decimal so that you can place the converted codes into a data statement of another program, load the system tape containing the data to be converted and use the decimal PEEK function in listing 1. All addresses are given and returned in hexadecimal. If you want the addresses in decimal, replace the GOTO 5000 statements following the address input with:

N=VAL (X\$)

Also, check inside the display loops for similar changes.

Memory Manipulator can be used to examine the contents of any section of memory. If you have a program in memory that works (ie: you already spent a night debugging it), you can use the hexadecimal PEEK function to get a hard copy of the code in memory. (See listing 2.) If you're ever searching for a particular routine in ROM (read-only memory), this function could be equally beneficial. To find the subroutine, insert a few lines into the program in listing 1 that will test the contents of the bytes it reads for the machine instruction you are looking for.

For example, if you want to find the routine in the Level II BASIC ROM that converts values to strings for display, change the print lines in the hexadecimal PEEK

section so that it only prints when the next 3 bytes contain the numeric codes for a CALL 0033 Z80 instruction. This approach won't be fast and you'll have a lot of searching to do, but it beats rewriting a routine that's already in the machine.

This program was written with the intention of adding and changing the code as special situations arise, so make alterations freely.

Perhaps "hex-a-phobia" will be cured in short order! ■

Listing 2: Sample outputs of the program in listing 1 showing the contents of memory locations hexadecimal 4A00 to 4AFF. Listing 2a shows the equivalent ASCII characters. Note that locations which contain codes not associated with printable ASCII characters are displayed as dots (.). Listings 2b and 2c show the decimal and hexadecimal equivalents, respectively.

(2a)

```

4A00=>=> * ; * * J * * * H * 0
4A10=> 1 0 . ? J . . R . N v M : .
4A20=> R . 3 2 7 6 7 . . . .
4A30=>R . . 1 . ( 6 5 5 3 6 . R ) . U
4A40=>J * . . * * * * * * * *
4A50=>( R ) ; * w J f . . F * 2 * *
4A60=> . * . * * * * * * * *
4A70=>; * ( R ) ; * * * J 6 * . H . . J
4A80=>@ * . . . J J * . P * 2 * . .
4A90=>* . . J T . . N . . J * . . Z
4AA0=>$ : * 1 2 0 . . . J h . . . .
4AB0=>J r * : * * * * J s . . . .
4AC0=>J t * : * * * * J u . . . .
4AD0=>J v * : * * * * J * . . . X =
4AE0=>D E C ) V A L U E . O F X $ (
4AF0=>H E X ) * . J * . X * 0 * . K
    
```

(2b)

```

4A00=> 61 62 34 59 0 20 74 14 16 129 32
4A0A=> 32 77 213 48 32 189 32 49 48 0 63
4A14=> 63 74 24 16 82 213 78 205 77 32 58
4A1E=> 58 143 32 82 212 51 50 55 54 55 32
4A28=> 32 202 10 32 32 32 32 82 213 206
4A32=> 204 49 207 40 54 53 53 51 54 206 82
4A3C=> 82 41 0 85 74 34 16 178 32 191 32
4A46=> 32 34 32 35 35 35 32 34 59 229 40
4A50=> 40 82 41 59 0 119 74 44 16 143 80
4A5A=> 80 213 50 32 202 32 175 32 191 10 32
4A64=> 32 32 32 32 32 34 32 35 35 35 32
4A6E=> 32 34 59 229 40 82 41 59 0 126 74
4A78=> 74 54 16 135 77 0 132 74 64 16 178
4A82=> 178 0 146 74 74 16 143 80 213 50 202
4A8C=> 202 175 34 32 34 0 154 74 84 16 135
4A96=> 135 32 78 0 167 74 94 16 137 90 36
4AA0=> 36 58 141 49 50 48 0 175 74 104 16
4AAA=> 16 58 147 251 0 183 74 114 16 58 147
4AE4=> 147 251 0 191 74 115 16 58 147 251 0
4AE6=> 0 199 74 116 16 58 147 251 0 207 74
4AC8=> 74 117 16 58 147 251 0 215 74 118 16
4AD2=> 16 58 147 251 0 245 74 136 19 58 147
4ADC=> 147 251 88 61 68 69 67 32 86 65 76
4AE6=> 76 85 69 32 79 70 32 88 36 40 72
4AF0=> 72 69 88 41 0 253 74 146 19 88 213
    
```

(2c)

```

4A0C=>3D 3E 22 3E 00 14 4A 0E 10 B1 20 4D 05 30 20 BD
4A10=>20 31 30 00 3F 4A 18 10 52 05 4E CD 4D 20 3A 8F
4A20=>20 52 04 33 32 37 36 37 20 CA 0A 20 20 20 20
4A30=>52 05 CE 31 CF 28 36 35 35 33 36 CE 52 29 00 55
4A40=>4A 22 10 B2 20 BF 20 22 20 23 23 23 20 22 3E E5
4A50=>28 52 29 3E 00 77 4A 2C 10 8F 50 05 32 20 CA 20
4A60=>AF 20 BF 0A 20 20 20 20 20 22 20 23 23 20 22
4A70=>3E E5 28 52 29 3E 00 7E 4A 36 10 87 4D 00 84 4A
4A80=>40 10 B2 00 92 4A 4A 10 BF 50 05 32 CA AF 22 20
4A90=>22 00 9A 4A 54 10 87 20 4E 00 A7 4A 5E 10 89 5A
4AA0=>24 3A 8D 31 32 30 00 AF 4A 68 10 3A 93 FE 00 B7
4AB0=>4A 72 10 3A 93 FE 00 BF 4A 73 10 3A 93 FE 00 C7
4AC0=>4A 74 10 3A 93 FE 00 CF 4A 75 10 3A 93 FE 00 D7
4AD0=>4A 76 10 3A 93 FE 00 F5 4A 88 13 3A 93 FE 58 3D
4AE0=>44 45 43 20 56 41 4C 55 45 20 4F 46 20 58 24 2B
4AF0=>48 45 58 29 00 FD 4A 92 13 58 05 30 00 12 4E 97
    
```

Complete AIM 65 Expansion

For complete AIM 65 expansion, Forethought Products brings you the AIM-Mate Series, quality expansion products with price, performance and versatility that puts them in a class of their own.

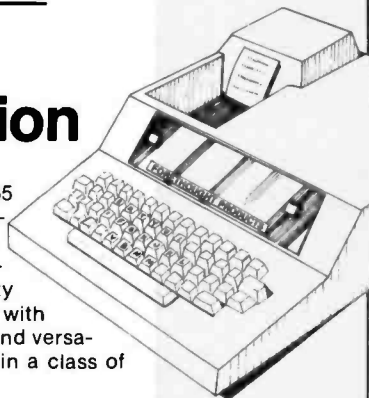

AIM-Mate Series expansion, including RAM (to 48K), PROM, I/O, video and floppy disk interface, STD BUS interface, parity protection and more, lets you configure the kind of system you need.

The compact AIM-Mate case puts it all together in a sturdy, portable, desk top unit.

Write today for complete details on the AIM-Mate System- AIM 65 expansion products for the professional.

**FORETHOUGHT
PRODUCTS**

87070 Dukhobar Road, Eugene, Oregon 97402 (503) 485-8575

LOGO

A POWERFUL NEW DIRECTION IN MICROCOMPUTER PROGRAMMING

After many years of extensive research and development comes LOGO, a powerful new programming language designed to put control of the microcomputer back into the hands of the programmer. Now children and adults alike can embark on a voyage of self-discovery as *they* teach the computer to think (not vice versa). Working in the LOGO environment can inspire the programmer to "think about thinking" and, in effect, become the architect of their own learning experience. Simply stated, LOGO represents a giant step forward in the world of microcomputer programming.

LOGO Computer Systems Inc. is a new company which has been formed to develop and distribute LOGO software, hardware, written material and training services. For more information, contact your local computer dealer or write to us directly.

logo
computer
systems inc.

150 Montarville Blvd.
Suite 200
Boucherville, Quebec
Canada J4B 6N1
(514) 641-0966

368 Congress St.
Boston, Mass.
U.S.A. 02210

(617) 451-2646

Use a Relative Subroutine Call for Relocatable Z80 Programs

George S Losey
Hawaii Institute of Marine Biology
POB 1346
University of Hawaii at Manoa, Coconut Island
Kaneohe HI 96744

Zilog's Z80 microprocessor has many improvements over its predecessor, the Intel 8080A microprocessor. One nagging difficulty, however, is the lack of higher-level languages that take full advantage of the Z80 operation codes. If you want complete control of its capabilities, assembly-language or machine-executable object-code programming is a must.

In machine language, there are methods of writing relocatable programs that use a patched routine for accomplishing calls to subroutines. These methods are valuable for fast interrupt servicing and similar applications, especially when programs are in modular form but not residing in specific memory locations.

Although the Z80's operation-code set is well suited to my needs, I grew frustrated when I found more and more applications for my microcomputer. Suddenly, the EPROM- (erasable programmable read-only memory) based program residing at hexadecimal addresses E400 through E5FF had to be moved to E800 through E9FF. All would have been well if the EPROM's software had used the six *relative-jump* operation codes. The program was relocatable, however, because it didn't contain any references to specific (absolute) addresses.

Many programs can be written without using jump and call instructions that cannot be relocated. However, if many portions of your program demand the use of a similar set of instructions, such as querying an output device or performing arithmetic manipulation, the headaches begin. Such programs should usually be written in a modular form with a main program that jumps back and forth to frequently used subroutines.

Modular programs use *call* instructions to access the subroutines. Since the call instruction contains the absolute address of the subroutine (using immediate external addressing), the code is not relocatable without changing all of the subroutine-call addresses. The general philosophy of modular programming with a main program that calls a variety of subroutines is certainly sound. (See the article by James Lewis, "Some Notes on Modular Assembly Programming," December 1979 BYTE, page 222.) A glance at the operation-code listings for powerful software such as the Cromemco Resident Monitor reveals a bewildering jungle of subroutine calls that pack an impressive set of capabilities into a 1 K-byte chip. But if you decide to locate this monitor anywhere

P&T CP/M[®]2 Supports Hard Disk Storage for the TRS-80 Model II

P&T CP/M 2 now supports two popular hard disk subsystems for the Mod II; thus you can combine all the features of the best CP/M for the Mod II with the speed and capacity of the hard disk drives.

Cameo Electronics

- uses mature cartridge disk technology for maximum reliability
- supports up to 4 drives
- removable cartridges make backup and data transfer fast and easy

Corvus System

- support for 10 and 20 Mbyte drives
- special mirror utility allows backup by logical drive
- supports up to 4 drives



Price: \$250 (FOB Goleta) for P&T CP/M 2-hard disk version (CA residents add 6% sales tax)

PICKLES & TROUT

P. O. BOX 1206. GOLETA. CA 93116. (805) 685-4641

CP/M is a registered trademark of Digital Research. TRS-80 is a trademark of Tandy Corp.

COMPUTERS—TERMINALS—MODEMS!

MODEMS AND COUPLERS

Connect your Apple, TRS-80 or any other computer or terminal to the phone lines!

Penril



**Penril
300/1200**

Penril 300/1200—Bell 212A style \$799
Bell 212A style. 1200 baud and 300 baud. Manual originate, auto-answer. Full duplex. RS232. Direct connect to phone lines via RJ11C standard extension phone voice jack. 1 year warranty.



U.S. Robotics
USR-330A
Bell 103/113 style
USR-330D
Bell 103/113 style

USR-330D \$339

Bell 103/113 style. 330 baud. Manual originate, auto-answer. Half/full duplex. RS232. 1 year warranty. Direct connect to phone lines via RJ11C standard extension phone voice jack.

USR-330A \$399
Same as USR-330D but includes auto-dial capability.

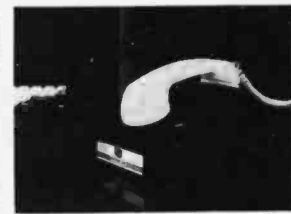

U.S. Robotics
**The
Phone Link
Acoustic
Modem**

Bell 103/113 style \$179
300 baud. Sleek, low profile. Originate and answer capability. Half/full duplex. Self-test. RS232. Light displays for On, Carrier, Test, Send Data, Receive Data. 15 oz.

Digital Equipment Corporation

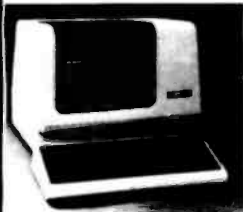

DEC VT100

DEC VT100 ... \$1499

Detachable keyboard. Separate numeric keypad with function keys. Business forms character set. Reverse video. Selectable double-size characters. Bidirectional smooth-scrolling. 80 cols or 132 cols. Split screen. Settable tabs. Line drawing graphic characters. Status line. Key-Click.

CRT's

Perkin-Elmer
Corporation



Superowl 1251

Perkin-Elmer Superowl 1251 \$1499
Intelligent, editing CRT. Detachable keyboard. 32 fully programmable function keys. Intelligent printer part. Business forms character set. Block mode. Protected fields. Blinking fields. Numeric fields. Reverse video. Half intensity. Polling. Down line loading of options. Remote control of all options by host computer. Settable tabs. Status line. Separate numeric keypad. Transparent mode.

Perkin-Elmer Corporation

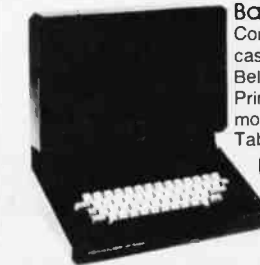

Bantam 550B \$643
Compact. Silent. Upper/lower case. 80th col. wrap-around. Bell. Integrated numeric pad. Printer port. Transparent mode. Editing features. Tabbing.

Bantam 550E .. \$729
Same as 550B plus separate numeric keypad and cursor direction keys.

Bantam 550S \$849
Same as 550E plus block mode, 8 function keys, and protected fields, reverse video fields, half intensity fields, blinking fields.

HARDCOPY TERMINALS

& PRINTERS

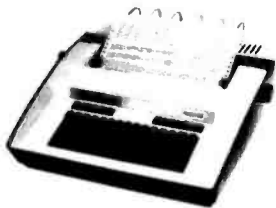

**Teletype
Model 43**

Teletype
Corporation

Teletype Model 43 KSR with RS232
and Connector Cable \$999
30 CPS. Dot matrix. 132 cols. True descenders on lower case. Excellent print quality for dot matrix printer. Pin feed.



DEC LA120

Digital Equipment
Corporation

DEC LA120 ... \$2169

180 CPS. Dot matrix. Upper/lower case. 1K buffer. Designed for 1200 baud communications. 30 character answerback message. Adjustable line spacing. Adjustable character sizes including double sized characters. Settable horizontal and vertical tabs. Top-of-form capability. RS232.



DEC LA34DA ... \$899

30 CPS. Dot matrix. Upper/lower case. 4 character sizes. Up to 217 cols per line. 6 lines per inch settings. Friction feed. Settable tabs. RS232.

DEC LA34AA \$979

30 CPS. Dot matrix. Upper/lower case. 8 character sizes including double size characters. 6 lines per inch settings. Up to 217 cols per line. Friction feed. Settable horizontal and vertical tabs. Top-of-form capability.

Options for LA34AA and LA34DA

Tractor Feed Mechanism \$89
Numeric Keypad w/ Function Keys .. \$69
Pedestal \$100
Paper Out Sensor \$25
APL Capability with APL Keycaps .. \$499
2K Buffer with Text Editor and 1200 Baud
Communications Capability \$499

NEC Corporation
NEC Spinwriter 5510 & 5520



5520 KSR Spinwriter \$2986
55 CPS. Impact printer. Selectric print quality. Changeable print fonts. 110, 300 and 1200 baud data rate. Numeric keypad. Friction and tractor feed.

5510 Spinwriter \$2645
55 CPS. Impact printer. Selectric print quality. Changeable print fonts. 110, 300 and 1200 baud data rate. Friction and tractor feed.

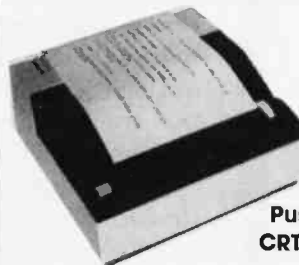

Perkin-Elmer
Corporation

**Pussycat 650/655
CRT Screen Printer**

650/655 Pussycat CRT Screen Printer. \$869
100 CPS. Extremely compact and quiet. 110 to 9600 baud rate. 2K buffer. Ideal for producing rapid, reliable hardcopy of your CRT screen display. Can be added to any CRT with our interface option.

Leasing rates and lease/purchase plan information is available on request.
All equipment is shipped with a 10 day money back guarantee.
We offer full service, on site maintenance plans on all equipment.
All equipment in stock.



U.S. ROBOTICS INC.
203 N. WABASH SUITE 1718 CHICAGO, ILL 60601
Circle 376 on inquiry card.

SALES
GENERAL OFFICES
SERVICE

(312) 346-5650
(312) 346-5651
(312) 733-0497

TERMINALS FROM TRANSNET

PURCHASE PLAN • 12-24 MONTH FULL OWNERSHIP PLAN • 36 MONTH LEASE PLAN

| DESCRIPTION | PURCHASE PRICE | PER MONTH | |
|-------------------------------|----------------|-----------|--------|
| | | 12 MOS | 36 MOS |
| DEC | | | |
| LA36 DECwriter II | \$1,095 | \$105 | \$ 58 |
| LA34 DECwriter IV | 995 | 95 | 53 |
| LA34 DECwriter IV Forms Ctrl. | 1,095 | 105 | 58 |
| LA120 DECwriter III KSR | 2,295 | 220 | 122 |
| LA120 DECwriter III RO | 2,095 | 200 | 112 |
| VT100 CRT DECscope | 1,595 | 153 | 85 |
| VT132 CRT DECscope | 1,995 | 190 | 106 |
| TEXAS INSTRUMENTS | | | |
| T1745 Portable Terminal | 1,595 | 153 | 85 |
| T1765 Bubble Memory Terminal | 2,595 | 249 | 138 |
| TI Insight 10 Terminal | 945 | 90 | 53 |
| T1785 Portable KSR, 120 CPS | 2,395 | 230 | 128 |
| T1787 Portable KSR, 120 CPS | 2,845 | 273 | 152 |
| T1810 RO Printer | 1,895 | 182 | 102 |
| T1820 KSR Printer | 2,195 | 211 | 117 |
| DATAMEDIA | | | |
| DT80-1 CRT Terminal | 1,695 | 162 | 90 |
| DT80-3 CRT Terminal | 1,295 | 125 | 70 |
| DT80-5L APL 15 CRT | 2,295 | 220 | 122 |
| LEAR SIEGLER | | | |
| ADM3A CRT Terminal | 875 | 84 | 47 |
| ADM31 CRT Terminal | 1,450 | 139 | 78 |
| ADM42 CRT Terminal | 2,195 | 211 | 117 |
| HAZELTINE | | | |
| 1420 CRT Terminal | 945 | 91 | 51 |
| 1500 CRT Terminal | 1,095 | 105 | 58 |
| 1552 CRT Terminal | 1,295 | 125 | 70 |
| TELEVIDEO | | | |
| 920 CRT Terminal | 895 | 86 | 48 |
| 950 CRT Terminal | 1,075 | 103 | 57 |
| NEC SPINWRITER | | | |
| Letter Quality, 55 15 RO | 2,895 | 278 | 154 |
| Letter Quality, 55 25 KSR | 3,295 | 316 | 175 |
| QUME | | | |
| Letter Quality KSR, 55 CPS | 3,395 | 326 | 181 |
| Letter Quality RO, 55 CPS | 2,895 | 278 | 154 |
| CENTRONICS | | | |
| 730 Desk Top Printer | 715 | 69 | 39 |
| 737 W/P Desk Top Printer | 895 | 86 | 48 |

FULL OWNERSHIP AFTER 12 OR 24 MONTHS • 10% PURCHASE OPTION AFTER 36 MONTHS

MICROCOMPUTERS

APPLE • COMMODORE • HP85 • DEC LSI 11

ACCESSORIES AND PERIPHERAL EQUIPMENT

ACOUSTIC COUPLERS • MODEMS • THERMAL PAPER • RIBBONS • INTERFACE MODULES • FLOPPY DISK UNITS



TRANSNET CORPORATION

1945 ROUTE 22 • UNION, N.J. 07083 • (201) 688-7800
TWX 710-985-5485

SAVE SALE SAVE SALE SAVE SALE SAVE

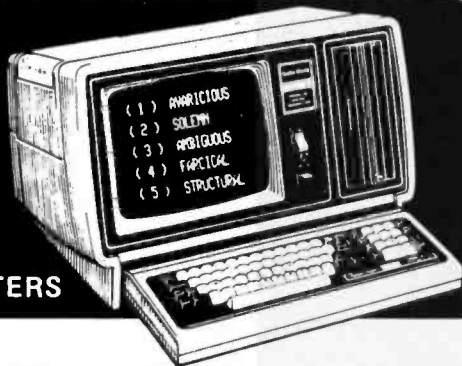

TRS-80 COMPUTERS

Model II 64K 3360.00 freight included
Model III 32K 2150.00 freight included
Daisy Wheel Printer 1710.00 freight included

We can save you more on all the TRS-80 Computers, and we will! All items are brand new. We have the full line of TRS-80 computer products. Call collect (303) 945-2864 for price quotes.

WE PAY ALL SHIPPING
NO TAXES ON OUT OF STATE SHIPMENTS

W-B SPORTING GOODS

727 Grand Avenue
Glenwood Springs, Colorado 81601
CALL COLLECT (303) 945-2864

SAVE SALE SAVE SALE SAVE SALE SAVE SALE

Technical Forum

except the intended address range of hexadecimal E000 through E3FF, sharpen your wits and your pencil, and best of luck to you. There are more than just a few immediate-external address references to change.

To explore this dilemma further, it is important to understand three basic differences between a *relative jump* and a *call* in the Z80 instruction set. First, the relative jump is a 2-byte instruction that requires from seven to twelve external clock cycles for fetching and execution, while the call instruction demands 3 bytes and ten to seventeen clock cycles. (Score a few points for the relative jump for saving 1 byte of programming space and 1 to 2 microseconds, at 4 MHz.)

Second, the relative jump leaps to the same point in the program regardless of where the program resides in memory, because the jump is made relative to the current value of the *program counter*. In contrast, the call instruction includes a 2-byte address for the jump destination, which will obviously be wrong if the program is moved to another region of memory. Whenever the program is moved, the 2-byte address must be changed. (Score a pile of points for the relative jump.)

Third, alas, the ignorant subroutine that is accessed via a relative jump has no idea how to return to the proper location if it is accessed from more than one place in the main program. The call instruction includes an "intelligent return" that lets the subroutine jump right back to the next instruction following the call. (Don't despair, save those relative-jump points for later.)

Dennis Kitsz suggested a simple solution to this problem that is fast and requires only a few bytes more than a standard subroutine. (See "Relative Subroutines for the Z80," December 1979 BYTE, page 87.) The only restrictions to its use are that the program cannot reside in ROM (read-only memory), and each time the program is moved, a single 2-byte address in the program must be changed. [Also, most programmers prefer to avoid self-modifying code. . . . RSS] However, besides the restriction to programmable memory, an error in the calculation of the 2-byte address can destroy the program.

There is another method, which I'll explain shortly, that is more complex but works in ROM and needs no changes when the program is moved.

The intelligent return is allowed because the call instruction accomplishes one task that cannot be accomplished by any of the other Z80 operation codes: a subroutine call pushes the value of the program counter onto the stack while the return from the subroutine pops it back. The program counter is, of course, the register that tells the Z80 the address for the next instruction to be fetched. If only you could take a peek or push at the program counter before executing a relative jump, the *relative call* would be born. A relative-called subroutine could make an intelligent return to the main program, and the modular program would have relocatable code. Unfortunately, for some undoubtedly sound reason, one

cannot directly push from, pop to, or otherwise gain direct access to the program counter in the Z80 microprocessor.

If you can stand a few sacrifices, I found that the Z80 can be coerced to make a relative call. First, the fastest and most direct method for implementing a relative call demands that 5 bytes of page-zero programmable memory, beginning at one of the eight restart locations accessed with the Z80's RST instruction (hexadecimal 0000, 0008, 0010, 0018, 0020, 0028, 0030, or 0038), be available for storage of a routine that gains access to the program counter. Second, each relative call must have a 3-byte instruction code, while the actual fetching and execution of the call will require seventy-one to seventy-six external clock cycles. This means that, at a 4 MHz clock rate, a relative call will take around 15 microseconds longer than a normal subroutine call. Third, return from the subroutine must be unconditional, but it will require only four external clock cycles instead of the ten required to return from a normal call. Fourth, the HL register pair must be available for use during the relative call to the subroutine.

The trick is to use the single-byte RST (*restart*) instruction as the call instruction. A restart forces a jump to a 5-byte routine in page zero of memory, and pushes the program counter onto the stack where it is accessible. While you have the program counter's contents cornered on the stack, the 5 bytes of instructions in page zero are used to copy it into an accessible register pair and increment it to point to the instruction immediately following the relative call. You then return from page zero to the main program and execute the relative call. "Intelligent return" from the subroutine is accomplished by a jump to the address indicated by the register pair in which you stored the value of the program counter at the time the RST was encountered.

A simple example is given in listing 1. The 5-byte routine is stored in page zero from hexadecimal 0008 to 000C. The relocatable program code is located in a space around address hexadecimal 0F00. The HL register pair is used to store the return address for the relative call.

The first relative call begins at hexadecimal 0F00 with an RST 8 instruction, which pushes the program counter onto the stack and jumps to hexadecimal 0008. The stored value of the program counter (hexadecimal 0F01) is copied into HL with the pop- and push-stack operations. It is then incremented to point to the instruction following the relative call (hexadecimal 0F03). Execution returns to the relative jump at hexadecimal 0F01. A relative jump is made to the subroutine at location 0F50. At the end of the subroutine, an "intelligent return" is made to location 0F03 by jumping to the address contained in register HL (JP (HL), a *register-indirect jump*). When the same subroutine is relative-called by the instructions at addresses hexadecimal 0F20 through 0F22, the same sequence occurs except that the address register,

In Less Than 3 Minutes

Your IBM Model 50, 60, or 75
Electronic Typewriter
can be an RS232C PRINTER or TERMINAL



CALIFORNIA MICRO COMPUTER Models 5060 and 5061 can be installed easily and require NO modifications to the typewriter.

For additional information contact:

CALIFORNIA MICRO COMPUTER
9323 Warbler Ave., Fountain Valley, CA.
92708 (714) 968-0890

ROBOTS The Future Arrives

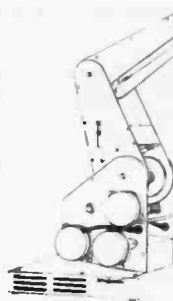

Intelligent machines are rapidly appearing in homes, automobiles, offices and factories. Affordable cameras, speech synthesizers, and even robot arms are now on the market. Such advances are giving microcomputers the power to see, hear, grasp objects, and to move around the room. Where can you learn about this technology? In **Robotics Age Magazine**, the journal of intelligent machines.

Robotics Age reports the experience of hobbyists building their own robots, the latest products from industry, and the most powerful techniques from research labs. The face of the world is changing. Join us as we enter the **Robotics Age**.

YES! I want to stay up-to-date on this fascinating new technology!

Name _____ Title _____

Company _____ Address _____

City/State/Province/Country _____ Postal Code _____

| | United States | Canada Mexico* | Foreign Rates* |
|--|---------------|----------------|----------------|
| <input type="checkbox"/> 1 year (6 issues) | \$15 | \$17 | \$19 |
| <input type="checkbox"/> 2 years (12 issues) | \$28 | \$32 | \$36 |
| <input type="checkbox"/> 3 years (18 issues) | \$39 | \$45 | \$51 |

*US Funds on US Bank
 Bill VISA MasterCard Bill me (N. America only)

Card No. _____ Exp. _____

Signature _____

Send to: **ROBOTICS AGE**, PO Box 512, Tujunga, CA 91042

HL, will contain a different return address, 0F23. The same instruction at the end of the subroutine returns to the main program at 0F23.

The simplest method of creating the relative call is to store the 5-byte routine in page zero by using a 17-byte initialization routine, shown here as listing 2, at the beginning of the main program. It only needs to be executed once, so long as you do not overwrite its storage area.

There are many variations on this theme. Most notably, any of the conditional relative jumps may be used, including the Z80's loop-implementing jump instruction, DJNZ. More important, some systems may require modification of the basic technique. For example, if the HL register is busy or must be used to pass information to the subroutine, the 3-byte relative-call instruction could be expanded to 5 bytes by adding the EXX instruction (register-set exchange, Z80 op code D9) *before and after* the RST 8 instruction, *and* before the intelligent return instruction (JP (HL), Z80 op code E9) in the subroutine, *and* after the relative-jump portion of the relative call. The relative-call sequence in listing 1, for example, would become 3 bytes longer (D9 CF D9 18 4D

D9) while the return from the relative call would become 1 byte longer (D9 E9). Note that if this technique is used for any relative call to a subroutine, it *must* be used for *all* relative calls to *that* subroutine, since the subroutine now contains a register-exchange instruction.

If the complementary sets of registers, HL and HL', are both unavailable, as in an interrupt-servicing program, the IX or the IY index registers could be used. However, incrementing, pushing, and popping these registers requires still more bytes of instructions and more time to execute.

Another interesting possibility exists if you are unable to use page-zero programmable memory. You could, of course, replace the RST instruction with a 3-byte call instruction to some other idle memory location. But idle locations have a habit of not remaining idle as your applications evolve. However, if you already have a non-relocatable ROM program, such as a resident monitor, it may be possible to find a 5-byte space that you can steal as a permanent storage location for the 5 bytes formerly placed in page zero. You then have the program merely execute a 3-byte call instruction to that address rather than execute the 1-byte RST instruction.

Listing 1: Sample implementation of the relative-call (relocatable-subroutine call) function on a Z80-based system. Instead of using the normal subroutine-call instruction, subroutines are accessed with a RST (reset) and a relative jump. The RST calls a routine in low memory that sets up the return address by placing the proper return address in the HL register pair. This initialization routine then returns to the relative-jump instruction immediately following the RST. The RST jumps to the actual subroutine being called. At the end of each subroutine, a normal return is emulated with a jump to the address contained in the HL register.

| | Hexadecimal Address | Object Code | Instruction Mnemonic | Comment |
|--------------|---------------------|----------------------------|----------------------|--|
| Page Zero | 0008 | E1 | POP HL | ; copy PC (program counter) into HL |
| | 0009 | E5 | PUSH HL | |
| | 000A | 23 | INC HL | ; increment HL to point to subroutine return address |
| | 000B | 23 | INC HL | |
| | 000C | C9 | RET | ; return to the relative call |
| Main Program | 0F00 | CF | RST 8 | ; call page-zero "peek" at PC |
| | 0F01 | 18 4D | JR +4D | ; execute "relative call" |
| | 0F03 | (sequence of instructions) | | |
| Main Program | 0F20 | CF | RST 8 | ; call page-zero "peek" at PC |
| | 0F21 | 18 2D | JR +2D | ; execute "relative call" |
| | 0F23 | (sequence of instructions) | | |
| Subroutine | 0F50 | (sequence of instructions) | | ; start of subroutine |
| | ???? | E9 | JP (HL) | ; return from relative call |

Listing 2: Program to set up the 5-byte initialization routine in low memory (hexadecimal location 0008, in this example).

| Hexadecimal Address | Object Code | Instruction Mnemonic | Comment |
|---------------------|-------------|----------------------|---|
| N | 21 08 00 | LD HL, 0008 | ; load page-zero call pointer |
| N+3 | 36 E1 | LD (HL), E1 | ; load 5-byte string into page zero of memory |
| N+5 | 23 | INC HL | |
| N+6 | 36 E5 | LD (HL), E5 | |
| N+8 | 23 | INC HL | |
| N+9 | 36 23 | LD (HL), 23 | |
| N+B | 23 | INC HL | |
| N+C | 36 23 | LD (HL), 23 | |
| N+E | 23 | INC HL | |
| N+F | 36 C9 | LD (HL), C9 | |

For example, one version of the Cromemco Resident Monitor includes a string of ASCII (American Standard Code for Information Interchange) characters stored to provide a header output, beginning at hexadecimal location E3F0. I really don't care whether the header says "CROMEMCO ZM1." or "HOWDY" or "%@\$\$. This is a convenient space to stick the 5 bytes from page zero so long as I am careful to change any other features of the monitor that refer to this string before programming the EPROM. For my purposes, I can merely shift the whole string 5 bytes backwards so that I lose two carriage returns and "CRO". The 5-byte routine from page zero can then begin at E3FB.

Do be careful if you try this sort of thing. Don't erase your old EPROM until you are certain your modification works. Another version of the same monitor has a string of spare bytes (containing hexadecimal character FF) from address E3F5 to E3FF. Inasmuch as any character can be written over an FF on an EPROM, the 5-byte code can be programmed directly onto the chip containing the code without altering the monitor in any way. Of course, once the 5 bytes are firmly installed in ROM, you can forget the nuisance of having to use the 17-byte initialization routine in listing 2. Merely rewrite your instruction-code manual to list the op codes for your newly created relative-call and return-from-relative-call instructions. ■

WOW

APPLE II PLUS

64K* only \$1249

*16K RAM CARD INCLUDED WITH FACTORY 48K SYSTEM

48K APPLE II PLUS.....\$1089
DISK II DRIVE & CONTROLLER..\$499

DISK II DRIVE ADD-ON.....\$439
 SILENTYPE PRINTER & CARD.....\$349
 Z-80 SOFTCARD.....\$299
 HAYES MICROMODEM II.....\$299
 16K RAM CARD.....\$130
 VIDEX VIDEOTERM 80 COLUMN.....\$269

SEE PAGES 148, 149 and 503 FOR MANY MORE PRODUCTS AT UNBEATABLE PRICES

ORDER TOLL FREE

800-854-6654

CALIFORNIA & OUTSIDE CONTINENTAL U.S. (714) 698-8088

CONSUMER COMPUTERS MAIL ORDER
8314 PARKWAY DRIVE LA MESA, CA 92041

adc has the
ADVANTAGE™



from NorthStar™

North Star's ADVANTAGE is the first integrated desktop standalone computer to offer mini-computer-grade bit-mapped graphics. The ADVANTAGE features 64K dynamic RAM, a 12" P31 green phosphor display, two quad capacity drives, an 87 key Selectric™ style keyboard by Keytronic, business graphics software and North Star GDOS and GBASIC. The ADVANTAGE fully supports software written in North Star DOS and BASIC, and with the optional Graphics CP/M package, will run any CP/M compatible software.

Options for the ADVANTAGE include additional serial or parallel I/O boards, a hardware floating point arithmetic board, North Star Graphics CP/M™, and the complete line of North Star Application Software, including ACCPAC, NorthWord and Inventory/Analysis.

The price is an unbelievable \$3,999. Orders are being accepted now, with limited deliveries starting October 1.

Don't forget that ADC sells, services and supports the entire North Star line including the HORIZON™ microcomputer, software, and accessories. Call today for more information.

Aurora Data Corporation • Box 4011 • Arlington, VA 22204-0011 (703) 522-6692
 ADVANTAGE, HORIZON and NORTHWORD are trademarks or registered trademarks of North Star Computers, Inc. ACCPAC is a trademark of Basic Software Group. CP/M is a registered trademark of Digital Research. Selectric is a registered trademark of IBM.

BASIC, Pascal, or Tiny-c? A Simple Benchmarking Comparison

Phil Hughes, POB 2847, Olympia WA 98507

Three of the most popular high-level languages for microcomputers are BASIC, Pascal, and tiny-c. I developed a card-shuffling program in each of these languages, and my experience should help you select the language for your needs.

One way of stating the card-shuffling algorithm is: "Store and print the integers from 0 through 51 in a random sequence." To ensure that the programs perform equivalent functions, I added the following conditions:

- The result is to be printed with ten integers per line.
- Following the result, the message "ALL DONE!" is to be printed on a new line.
- The algorithm is to get a random number, check to see if it has already been used, and if not, the number is to be stored. The sequence is to be repeated until fifty-two numbers have been generated.
- The shuffling procedure must be implemented as a subroutine, and it must be reusable.

Experts or fans of each language could argue with my conditions, saying that they are prejudicial in favor of a certain language. That was not my intent.

I began by looking at the shuffling routine in a Blackjack game that a friend was playing. Its method was to keep a list of the used cards and generate a new card each time there was a draw. At this time, the new card was added to the used list. When the used-card list was full, a reshuffle, which consisted of clearing the used list, was forced.

I wondered how long it would take to perform the shuffle by selecting all the cards at one time and storing them in an array. This method seemed closer to what you do with an actual deck of cards.

I had been working on a tiny-c interpreter, so I decided to code my idea first in tiny-c. Because of tiny-c's long execution time, I then tried my algorithm in Pascal. Finally, I wrote a BASIC version to complete the comparison.

An important factor in this comparison is my experience with each language. I learned BASIC in 1970 as part of my job, and I have used it for development of quick

programs for large-computer systems ever since. I have used various BASIC interpreters on microcomputers for the past three years. I have developed a tiny-c interpreter, but I have actually written only two tiny-c programs, each about thirty lines long. I have written three or four short Pascal programs. Armed with this information, decide for yourself which language you would use for a given set of conditions and a given problem.

Tiny-c Coding

Listing 1 is the tiny-c program, and listing 2 is the result of executing the program. The first nine lines of the program listing are a (pseudo) random-number generator. This routine appeared in the *Tiny-c Owner's Manual* (available from Tiny-c Associates). Although this can be

Listing 1: *The card-shuffling routine coded in the tiny-c language. The first nine lines of source code generate pseudorandom numbers. The actual shuffling algorithm is coded beginning with the line starting with "shuffle".*

```
int seed,last
random int little,big{
int range
if(last==0)seed=last=99
range=big-little+1
last=last*seed
if(last<0)last=-last
return little+(last/8)%range
}
int cards(51)
shuffle{int current;current=0
int temp,1
while (current<52){
i=0
temp=random(0,51)
while (i<current){
if(cards(i)==temp) break
i=i+1
}
if(i==current){
cards(current)=temp
current=current+1
}
}
return
}
test{
shuffle
int i;i=0
while (i<52){
pn cards(i)
i=i+1
if(i%10==0)pl""
}
pl"all done!"
}
```

Listing 2: Sample execution of the tiny-c program of listing 1.

```
>.test
29 32 45 21 51 10 12 24 39 25
22 50 30 1 19 46 44 37 20 26
18 28 34 7 3 49 0 42 27 14
35 13 4 41 6 31 43 23 38 33
40 36 48 8 5 2 16 9 11 17
47 15
all done!
>
```

thought of as a library function, I decided to include it in the program. The next seventeen lines are the "shuffle" routine. Finally, the last ten lines (starting with "test()") are the main program that calls "shuffle" and prints the result.

It was easy to go from the design to the actual tiny-c program. It took ten minutes to code the program and another fifteen minutes to enter it and get it running. My biggest problem with tiny-c is remembering that == is the relational operator for equality. That mistake cost me a few minutes of debugging time.

Pascal Coding

Listings 3 and 4 show the Pascal program and its execution. Pascal does not have a built-in random-number generator. I borrowed ideas from the sample programs that come with the Lucidata Pascal compiler to code the function RANDOM in listing 3. The only difficult part of the

Listing 3: The card-shuffling routine coded in Lucidata Pascal. An explicit random-number-generating function is used here, as in tiny-c.

```
PASCAL P-COMPILER ( VERSION 2 ) : COPYRIGHT C 1980 D.R.GIBBY
0 PROGRAM TEST;(* Shuffle cards and print result *)
0 VAR
0 CARDS : ARRAY[1:52] OF INTEGER;
0 I : INTEGER;
0 SEED : INTEGER;
0 PROCEDURE SHUFFLE;
4 VAR
4 CURRENT,TEMP,I : INTEGER;
4 FUNCTION RANDOM(LITTLE,BIG : INTEGER) : INTEGER;
8 VAR
8 RANGE : INTEGER;
8 BEGIN
12 IF(SEED=0) THEN SEED:=99;
32 RANGE:=BIG-LITTLE+1;
52 SEED:=SEED*31;
64 SEED:=SEED MOD 1009;
76 RANDOM:=LITTLE+SEED MOD RANGE;
100 END;
104 BEGIN
108 CURRENT:=1;
116 REPEAT
116 I:=1;
124 TEMP:=RANDOM(1,52);
144 WHILE ((CARDS[I]<>TEMP) AND (I<CURRENT)) DO I:=I+1;
196 IF (I=CURRENT) THEN BEGIN
208 CARDS[CURRENT]:=TEMP;
224 CURRENT:=CURRENT+1;
236 END;
236 UNTIL (CURRENT=53);
248 END;
252 BEGIN (* MAIN PGM *)
256 SEED:=0;
264 SHUFFLE;
268 FOR I :=1 TO 52 DO BEGIN
288 WRITE (CARDS[I]);
304 IF ((I MOD 10)=0) THEN WRITELN;
324 END;
344 WRITELN;
348 WRITELN ("ALL DONE!");
368 END;
```

GET THE BUG OUT OF YOUR PROGRAM!



Locate the bug in your program quickly with the all-new BUG CATCHER. Reliable and easy to use, this timesaver fits easily in pocket or case. Functional for any computer where EPROMs



are used. Capable of halting the cpu at any specific address. Stop losing time and patience. BUG CATCHER is the efficient answer. \$195 complete (plus applicable sales tax).



BUG CATCHER

MARTEC SYSTEMS, INC.
P.O. BOX 2069, NEWBURGH, NY 12550 (914) 265-4044

INFLATION FIGHTER



\$2995

GET THE BEST

In the Interface Age Prime Number Benchmark the EXO times in at under 661 seconds. One of the fastest 8-bit machines on the market today. It can save a 16K file to disk in just under 4 seconds, and will run rings around the Altos, Northstar, Apple or TRS-80. If this isn't enough, we're running a fall special that makes it less expensive than the 5 1/4 inch competition.

- Z80 4MHZ
- Dual 8" Drives
- 2 Serial I/O
- Operating System and Utilities
- 64K RAM
- 1.2 MB Storage
- 2 Parallel I/O

THE BEST VALUE ON THE MARKET TODAY



MICRO BUSINESS ASSOCIATES, INC.
500 SECOND STREET
SAN FRANCISCO, CA 94107 415-957-9195

DEC LSI-11 Components

Dependable service
at discount prices
Domestic
and Export

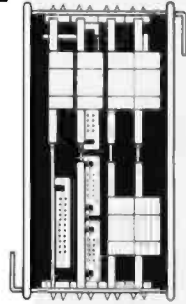

Mini
Computer Suppliers, Inc.

25 Chatham Rd., Summit, N.J. 07901
Since 1973
(201) 277-6150 Telex 13-6476

©Mini Computer Suppliers, Inc.
1979

Professional Graphics System

SAVE
\$1086⁰⁰

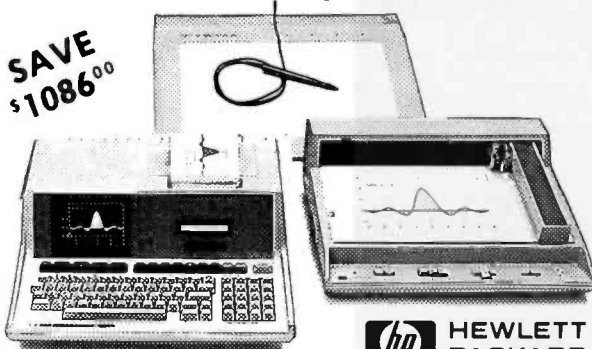

System includes:

- HP-85A Computer List \$3250
- Graphic Tablet 9111A List \$2050
- Graphic Plotter 7225B List \$2450
- Personality Module Opt. 085 List \$ 750
- HP-IB 82937A List \$ 395
- ROM Drawer 82936A List \$ 45
- Printer/Plotter ROM # 85-15002 List \$ 145

Total List Price \$9085

SAVE \$1086

Now Only \$7999

HP-83 Desktop Computer Only \$1650

Introducing HP's New Graphic Printer Only \$995



**FARNSWORTH
COMPUTER CENTER**

1891 N. Farnsworth Ave. (at the E-W Tollway)
Aurora, Ill. 60505 Ph. (312) 851-3888

WEEKDAYS 10-8; SAT. 10-5

Listing 4: Sample execution of the Pascal program of listing 3.

+++RUN, SHUFFLE

```
F-6800 RUN-TIME SYSTEM V 1.2 : COPYRIGHT C 1978 LUCIDATA
USABLE CONTIGUOUS MEMORY $8000
DEFAULT STACK RESERVATION $1000
CHANGE VALUE ?
```

| | | | | | | | | | |
|----|----|----|----|----|----|----|----|----|----|
| 43 | 34 | 3 | 11 | 30 | 52 | 1 | 8 | 17 | 45 |
| 31 | 15 | 27 | 4 | 36 | 33 | 23 | 12 | 25 | 22 |
| 21 | 7 | 51 | 37 | 44 | 18 | 26 | 10 | 38 | 41 |
| 5 | 32 | 2 | 6 | 42 | 9 | 46 | 24 | 13 | 40 |
| 29 | 39 | 47 | 14 | 28 | 16 | 50 | 48 | 49 | 20 |
| 35 | 19 | | | | | | | | |

ALL DONE!

END OF PROGRAM EXECUTION.

+++

conversion from tiny-c to Pascal was deciding how to do the equivalent operation of the tiny-c "break" keyword. ("Break" signifies that the innermost "while" loop is to be terminated immediately.) This was implemented in Pascal as part of the WHILE condition.

The development and testing of the Pascal program took about one hour, plus the time necessary to develop the RANDOM function. Much of this time was attributable to Pascal's being a compiled language. This made it necessary for me to use a text editor separate from the language system to make program changes. The biggest problem I have with Pascal's grammar is remembering that := is the assignment operator.

BASIC Coding

Finally, listings 5 and 6 are the BASIC version of the shuffling program and the execution results. BASIC had the advantage of its built-in random-number function,

Listing 5: The card-shuffling routine coded in TSC BASIC. The built-in RND random-number function is used.

```
50 DIM C(51)
100 GOSUB 1000
200 FOR I=0 TO 51
210 PRINT C(I);
220 IF INT((I+1)/10)=(I+1)/10 THEN PRINT
230 NEXT I
240 PRINT
250 PRINT "ALL DONE!"
300 END
1000 J=0
1010 T=INT(RND(0)*52)
1020 IF J=0 THEN 1060
1030 FOR I=0 TO J-1
1040 IF C(I)=T THEN 1010
1050 NEXT I
1060 C(J)=T
1070 J=J+1
1080 IF J<52 THEN 1010
1090 RETURN
```

Listing 6: Sample execution of the BASIC program of listing 5.

READY

RUN -

| | | | | | | | | | |
|----|----|----|----|----|----|----|----|----|----|
| 27 | 31 | 26 | 48 | 9 | 0 | 36 | 15 | 2 | 17 |
| 40 | 49 | 39 | 29 | 51 | 1 | 3 | 30 | 6 | 44 |
| 50 | 5 | 35 | 20 | 18 | 19 | 46 | 28 | 37 | 10 |
| 24 | 16 | 4 | 14 | 47 | 25 | 7 | 8 | 12 | 42 |
| 38 | 22 | 34 | 21 | 23 | 13 | 11 | 45 | 43 | 41 |
| 32 | 33 | | | | | | | | |

ALL DONE!

which made the program appear much smaller and helped out the execution time. The first part of the program is the main routine. Lines 1000 through 1090 are the shuffling subroutine. It took thirty minutes to develop and test this program. The hardest part was converting the hierarchical structure of the shuffling subroutine into the available control structures of BASIC. This resulted in a FOR...NEXT loop and three IF statements.

Table 1 shows the execution times of each of these programs on a Southwest Technical Products Corporation 6800 system with a 1 MHz system clock rate. Note that Pascal is compiled, with the compilation process taking about thirty seconds. Table 2 shows the vendors for the three language systems.

Conclusions

Tiny-c is an easy-to-work-with language that supports structured programming. The source-code interpreter is extremely slow compared with a fast BASIC interpreter, but offers features such as long variable names and structured constructs. These capabilities make debugging easy. Also, tiny-c is easy to learn. A tiny-c interpreter for program development and a compiler for generating production programs would be an effective combination.

Pascal offers the structured constructs of tiny-c and much more. The execution speed of a compiled Pascal program is fast. The price you pay for this is a complicated language that is considered by many to be difficult for a beginner to learn. The complexity of Pascal makes availability of a source-code interpreter unlikely (although a source-code interpreter for a subset of Pascal is certainly possible). The complexity of full Pascal increases development time, but once created, a Pascal program is efficient and relatively easy to understand.

BASIC offers what initially appears to be the shortest program. However, on closer inspection of the tiny-c program, I found the following. If you were to remove

the random-number function from the tiny-c program (and put it in the tiny-c function library) and move all the compound statement-delimiter brackets to the same lines as their preceding statements, the tiny-c and BASIC programs would have the same number of lines. The main problems with BASIC (at least of most dialects) are its lack of long variable names and hierarchical control constructs. These two deficiencies make the BASIC program difficult to understand.

In spite of the individual problems with these languages, each has its place. I hope that I have helped you select the language that best fits your needs. ■

BYTE's Bits

Scholarship Competition Under Way

The fourth annual International Computer Programs (ICP) Scholarship award competition for college and university computer science and computer technology students is under way. The ICP award covers one year's tuition plus expenses to an American college or university of the winner's choice, up to a maximum of \$5000.

Selection of the award is based on the student's cumulative grade-point average in his or her field of study, overall grade-point average, need for financial aid, participation in data processing- and school-related activities, leadership ability, and accomplishments and awards. Also, finalists will be asked to submit a written essay.

Applications for the competition are available at most financial aid departments. To qualify, applicants must be either sophomores or juniors pursuing an undergraduate degree and matriculated in a computer science or technology program at an American college or university. Deadline for filing applications is November 15, 1981.

For more information, contact Sheila Cunningham, Scholarship Director, ICP,

9000 Keystone Crossing, Indianapolis IN 46240, (317) 844-7461.

Literary Text Project

The Literary Text Project is a nonprofit, voluntary effort by a group of scholars to establish a computerized system of custom publishing works of English literature.

The scholars perceived that conventional publishers were not keeping in print low-cost selections of many poems written from 1660 to 1800, so they created a data base containing the text of poems. Users can order from a catalog printed copies of any poem in the data base, or any selection of several poems, thus creating a customized anthology.

As of April 1981, 150 titles by major and minor poets were available through the system. The works of Alexander Pope and William Blake are excluded from the list because of their wide availability. Plans are under way to expand the collection and the project into other kinds of literature and other fields.

Voluntary editorial efforts, advice, and inquiries are solicited. Contact Literary Text Project, c/o Dr Stephen Ackerman, 136 North Carolina Ave SE, Washington DC 20003. ■

| Language | Execution Time |
|-----------------------------|----------------|
| Tiny-c Version 1.1 | 160 seconds |
| Lucidata Pascal Version 2.2 | 16 seconds |
| TSC Extended BASIC | 23 seconds |

Table 1: Comparison of execution times for the card-shuffling routine coded in three high-level languages.

| Language System | Vendor |
|-----------------|--|
| Pascal | Lucidata Ltd, POB 128, Cambridge, CB2 5EZ, England |
| Tiny-c | Tiny-c Associates, POB 269, Holmdel NJ 07733 |
| BASIC | TSC (Technical Systems Consultants), POB 2570, West Lafayette IN 47906 |

Table 2: Companies selling the three language systems compared here.

A Fast, Ancient Method for Multiplication

Jostein Nyberg
Odv Solbergsv 100
Oslo 9, Norway

There are several ancient algorithms that adapt surprisingly well to the computer. One such example is the "Russian Peasant Method" for multiplication, which was discovered by Western visitors to Russia in the nineteenth century. However, the method is actually much older than that. It was used by Egyptian mathematicians as early as 1800 BC, although it was not stated as a completely systematic algorithm.

To explain this method, let A and B denote two numbers. A can be any number, while B must be a non-negative integer. The problem is to calculate their product P . The method is:

1. Let $P = 0$
2. If B is odd, let $P = P + A$
3. Let $A = A + A$
4. Let $B = \text{integer part of } B/2$
5. If B is nonzero, repeat from step 2; otherwise the algorithm terminates.

An example will clarify how this works. Here are successive values of A and B , when their initial values are 175 and 18:

| | | | | | | |
|----|-----|-----|-----|------|------|------|
| A: | 175 | 350 | 700 | 1400 | 2800 | 5600 |
| B: | 18 | 9 | 4 | 2 | 1 | 0 |

Adding those A s for which the corresponding B s are odd, we have:

$$P = 350 + 2800 = 3150$$

which is the required result of 175 times 18. You may wish to try more examples to convince yourself that this procedure works correctly.

Notice that if A and B are unsigned integers expressed in binary, the doubling of A in step 3 can be performed by a left shift of A . Finding the integer part of $B/2$ in step 4 corresponds to a right shift of B . Furthermore, the B in step 2 is odd if its least-significant bit is 1.

Listing 1 shows a relocatable subroutine written in 6502 assembly language; also included is the hexadecimal object code. When the subroutine is entered, it is assumed that the low- and high-order bytes of A are found at memory locations 0000 and 0001 (hexadecimal), respectively. The low- and high-order bytes of B are found at locations 0002 and 0003, respectively. When the end of the subroutine is reached, locations 0004 and 0005 will contain the product P . If needed, the routine can be made shorter and faster by using the index registers (X and Y) for the product, instead of memory locations.

It is assumed here that P does not exceed 16 bits. If three or four bytes are required, it's relatively easy to expand the subroutine.

Multiplication routines similar to the one in listing 1 are found in arithmetic software and are coded in various languages. This does not mean that the routines' inventors were intentionally using the Russian Peasant Method. Probably, they were just imitating the familiar pencil-and-paper method for multiplication. As a matter of fact, when the numbers involved are binary and the algorithms are executed using the same instruction set, these two methods are identical.

A multiplication routine that looks slightly different, listing 1b, is often shown in microprocessor and micro-computer manuals. As a rule, this method should not be used. The loop starting at HALF is always entered sixteen times. Thus, the looping can continue to no purpose after B reaches 0.

The Russian Peasant Method can be modified to per-

form exponentiation. By setting *P* equal to 1 in step 1 and changing the addition in steps 2 and 3 to multiplication, the resulting value of *P* will be *A* raised to the power of *B*. Of course, steps 2 and 3 now assume that a multiplication routine is available. This method for exponentiation was stated by a Persian mathematician in the year 1414. ■

Reference

1. Knuth, D E. *The Art of Computer Programming*, Vol 2. Reading MA: Addison-Wesley, 1969. Pages 399 and 400.

Listing 1: Relocatable subroutines for fast integer arithmetic on the MOS Technology 6502 microprocessor. Listing 1a shows a machine-language routine for multiplication by the Russian Peasant Method; listing 1b gives a version seen frequently in textbooks.

(1a)

| Object Code | Label | Mnemonic | |
|-------------|--------|----------|--------|
| A9 00 | MULT | LDA | #0 |
| 85 04 | | STA | PLOW |
| 85 05 | | STA | PHIGH |
| 46 03 | HALF | LSR | BHIGH |
| 66 02 | | ROR | BLOW |
| 90 0D | | BCC | DOUBLE |
| 18 | | CLC | |
| A5 04 | | LDA | PLOW |
| 65 00 | | ADC | ALOW |
| 85 04 | | STA | PLOW |
| A5 05 | | LDA | PHIGH |
| 65 01 | | ADC | AHIGH |
| 85 05 | | STA | PHIGH |
| 06 00 | DOUBLE | ASL | ALOW |
| 26 01 | | ROL | AHIGH |
| A5 02 | | LDA | BLOW |
| 05 03 | | ORA | BHIGH |
| D0 E3 | | BNE | HALF |
| 60 | | RTS | |

(1b)

| Object Code | Label | Mnemonic | |
|-------------|--------|----------|--------|
| A9 00 | MULT | LDA | #0 |
| 85 04 | | STA | PLOW |
| 85 05 | | STA | PHIGH |
| A2 10 | | LDX | #\$10 |
| 46 03 | HALF | LSR | BHIGH |
| 66 02 | | ROR | BLOW |
| 90 0D | | BCC | DOUBLE |
| 18 | | CLC | |
| A5 04 | | LDA | PLOW |
| 65 00 | | ADC | ALOW |
| 85 04 | | STA | PLOW |
| A5 05 | | LDA | PHIGH |
| 65 01 | | ADC | AHIGH |
| 85 05 | | STA | PHIGH |
| 06 00 | DOUBLE | ASL | ALOW |
| 26 01 | | ROL | AHIGH |
| CA | | DEX | |
| D0 E6 | | BNE | HALF |
| 60 | | RTS | |

YOUR MICROCOMPUTER'S KEY IS SOFTWARE

Software is the key to using your computer's power. Our CP/M® Compatible Software Catalog is your single source for locating your microcomputer software solutions. We're Digital Research, and our CP/M operating system is used by over 200,000 microcomputer owners. Our catalog lists over 100 domestic and foreign companies with software for commerce, industry, government, the professions and specialty applications. Send this coupon and \$5 to: Digital Research, P.O. Box 579H, Pacific Grove, CA 93950. (Calif. residents add 30¢ sales tax.)

Name: _____

Title: _____

Company: _____

Address: _____

City/State/Zip: _____

Check Enclosed



Card Number _____

Exp. Date _____



DIGITAL RESEARCH®



CP/M is a registered trademark of Digital Research.
© Copyright 1981 Digital Research

Low-Cost Built-In Modem Card for Model 43 Teletype®

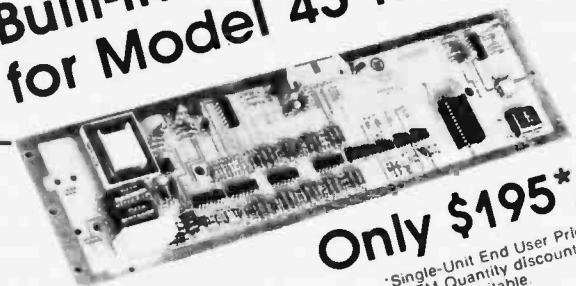

Only \$195*

*Single-Unit End User Price. OEM Quantity discounts available

Omnitec's Model 9143AD Modem Card installs simply and quickly to most Model 43 Teletype Terminals, converting them to a Full Communications terminal. This new Direct Connect, Auto-Answer Modem has all of the most desired features —

- 300 Baud Rate.
- Automatic Voice to Data Transfer.
- FCC Registered Connection to Switched Telephone Network.
- Automatic Disconnect in both Originate and Auto-Answer Modes.
- Bell 100 Series and 212A Low-Speed Compatibility.

\$195 - TO ORDER CALL 800-528-8423
STAND ALONE UNIT AVAILABLE SOON!



OMNITEC DATA
New Dimensions in Modems

2405 South 20th Street • Phoenix, Arizona 85034

Integral Data's Paper Tiger 460

Eliakim Willner, datatronics inc, 675 Third Ave, New York NY 10017

Until very recently, a prospective purchaser of a computer printer had to choose between letter quality and speed. The letter-quality printers, which most often use daisy-wheels to produce fully formed characters, are too slow for typical data-processing applications. Faster printers usually employ a dot-matrix print head that produces readable, but not letter-quality, type.

A new breed of printer on the market today shows refinements in dot-matrix technology, producing type that approaches letter quality without sacrificing speed. Integral Data Systems' 460, the "Paper Tiger," is a worthy representative of this new breed. With minor exceptions, the IDS 460 has every feature that a hobbyist or small-business user could reasonably expect to find.

The printer is about as wide as most in the dot-matrix family, but it is taller and not as deep. It appears to be solidly constructed and designed to withstand heavy use. Most of the electronics, including a microprocessor to control the many advanced functions, are contained on a single, easily accessible circuit board under the printer's enclosure.

The enclosure is made of durable structural foam and has a pleasing look. Most of the controls are conveniently placed. On the upper right-hand side of the printer are a formset/online/offline switch and a formfeed/linefeed switch (see photo 1). The IDS 460 also has a self-test switch on the upper left-hand side which generates a repetitive test pattern. (Upon power-up, a diagnostic routine automatically clears the buffer and tests the printer's memory.) Next to the self-test switch are two DIP (dual-inline package) switches placed so that it is easy to change their settings deliberately, but difficult to do so accidentally. These switches are used for selecting many of the printing options that will be discussed shortly.

The IDS 460 has indicators for power-on, online, and fault. The fault indicator flashes when the power-up diagnostic encounters a hardware problem and lights when the printer runs out of paper.

Under the cover is a knob that moves the print-head mechanism back and forth, thus varying print intensity. This is useful for accommodating changing paper thickness. When printing thick labels, for example, the print head can be moved further back from the ribbon, saving wear on the head without affecting the quality of the print.

Unfortunately, this control is not easy to use. The knob is not calibrated, so trial and error is required to get

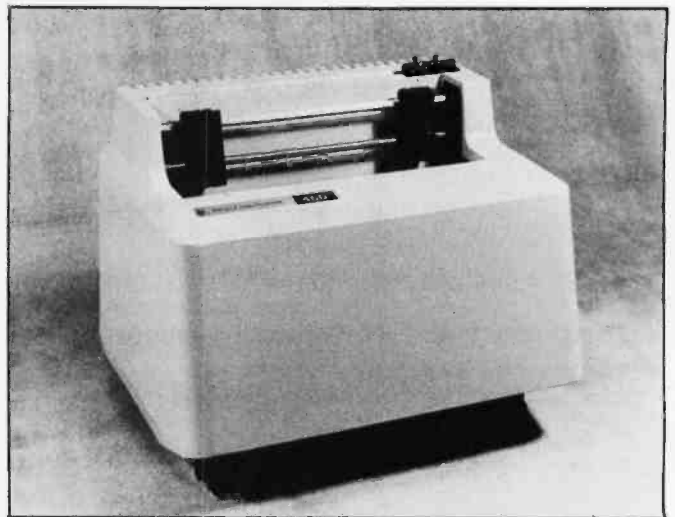

Photo 1: The Integral Data Systems' Model 460 dot-matrix printer, better known as the Paper Tiger. At the upper right are the formset/online/offline switch and the formfeed/linefeed switch.

the correct print intensity. If only one kind of form is to be used, this adjustment need only be done once. If the form is changed frequently, however, the constant re-adjustment can be inconvenient.

Still more inconvenient is the fact that this knob is placed beneath the printer enclosure. The enclosure is secured to the chassis with four knurled retainer nuts. To remove the enclosure the nuts are loosened and the enclosure is lifted directly upwards. There is little clearance between the enclosure and the chassis. Invariably the enclosure rubs against the circuit board or the tractor mechanism, or snags the ribbon. The knob for varying print intensity should certainly have been placed outside the enclosure.

Other controls are placed underneath the enclosure. These include the 115/220 V switch and various jumpers used to select the desired interface, but these are used infrequently.

Two secure tractors move paper through the IDS 460. There is no problem handling thick labels or multiple-part forms. Fanfold or roll paper up to ten inches wide may be used. (The IDS 560 is similar in many respects to the 460, but it accommodates paper up to fourteen inches wide.) An internal paper-roll holder that fits under the enclosure is available as an option, as is a paper-catch

At a Glance

Name

Paper Tiger 460

Use

High-speed, correspondence-quality printer

Manufacturer

Integral Data Systems
Milford NH 03055

Dimensions

31 by 40 by 32 cm (12½ by 15¾ by 12½ inches)

Price

\$1295

Hardware

Any computer capable of sending ASCII characters via parallel or serial interface; requires standard RS-232 cable (not supplied)

Software

None, apart from the standard printer driver for a particular operating system

Hardware Options

Dot Plot graphics, paper-roll holder, paper-catch basket,

letter carrier, various interfacing cables and connectors

Features

Printer speed, 150 cps; paper slew rate, 5½ inches per second; built-in self test and diagnostics; printing pitch sizes of 5, 10, 12, 16.8 characters per inch; fixed/proportional spacing; software-controlled text justification; line buffering (extended buffering with graphics); bidirectional printing; selectable line spacing; selectable page format; variable line length; programmable functions; impression control

Power Requirements

115 VAC at 60 Hz or 230 VAC at 50 Hz (for European operation); user selectable

Documentation

Comprehensive 65-page illustrated owner's manual

Audience

Anyone desiring both letter-quality and high-speed print-out

TEXAS COMPUTER SYSTEMS

TRS-80 COMPUTERS

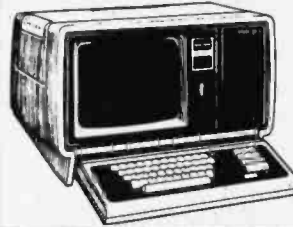

Model II 64K \$3288

An excellent computer for your business needs. Easy expandability & compatibility. No formal operator training needed. All accessories available—disk expansions, printers, software, at our low discount prices. Our fast, fully insured air freight service can assure most deliveries within seven days after payment is received.

Model III 16K \$835

With TCS Memory:

Model III 32K \$979

Model III 32K \$909

Model III 48K \$1089

Model III 48K \$969

Model III 48K 2 Disk RS232 \$2100

Model III 32K 1 Disk \$1729

Model III 48K 1 Disk \$1849

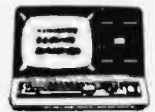

Corvus Hard Disks \$Call

5, 10, or 20 megabytes of storage for the Model I, II, or III, configured with TRSDOS, NEWDOS 80, or CP/M for one or several computers sharing a single hard drive simultaneously. Easy expandability and compatibility. Also fits Apple, Superbrain, Altos, and most other computers. Don't wait on other's promises. We can deliver this proven system now. Call us for the lowest price!

Pocket Computer & Acc. \$Call

Pocket Computer Printer Interface In stock.

Color Computer

4K Level 1 \$319

With TCS Memory:

16K Level I \$439

16K Level I \$369

16K Extended Basic \$489

16K Extended Basic \$449

Epson Printers \$Call

Letter quality matrix printer has full software control of 40, 80, 66 or 132 columns. 80 cps bidirectional tractor feed, disposable printhead. \$300 less than nearest competitive printer. Lists \$645. Call for our low price.

MX-80 Tractor Feed

MX-100 Graphtrax, Friction

MX-80 FT Friction and Tractor

and Tractor up to 15" wide.

Graphtrax for MX-80, MX-80 FT, graphics option.

Word Processor Package \$2679

Includes 2 Disk Model III with 48K, Epson MX-80 Tractor Feed with cable, and word processing software ready to operate. Lists at \$3300. Our low price special this month: **\$2679**. For MX-80 FT Tractor and Friction, add \$99.

• Payment: Money Order, Cashier's Check, Certified Check. Personal checks take 3 wks. VISA, MC, add 3%.

• Prices subject to change any time.
• No tax out-of-state. Texans add 5%.
• Delivery subject to availability.
• Shipping extra, quoted by phone.

TEXAS COMPUTER SYSTEMS

Box 951, Brady Texas 76825

For fast, efficient service, we can air freight from Dallas to major a/p near you. Call for information.

Toll Free Number 800-433-5184

Texas Residents 817-274-5625

AVAILABLE TODAY

from **MSD**: the XENIX™ Operating System, Microsoft's Adaption of Bell Laboratories Time-Tested UNIX™ Version 7 Operating System.

MSD provides this comprehensive line of products for the UNIX community:

- XENIX Operating System
- Screen Oriented Text Editor for VT-100 Compatible Terminals
- Database Manager and Report Generator Which Will Easily and Efficiently Control Large Accumulations of Information
- Accounts Receivable System Which Can Be Used to Monitor and Control Receivables in Order to Improve Cash Flow
- Uni-Calc™ — An Electronic Spreadsheet Which Makes Financial Analysis, Forecasting and Business Planning Easier

In addition to reliable Software pre-configured for your Hardware, **MSD** will provide complete user support by:

- Answering your telephone questions
- Providing new releases as available
- Supplying you with the best Hardware for your UNIX requirements

MSD Corporation
 2449 Camelot Court, SE
 Grand Rapids, MI 49506
 (616) 942-5060

MANAGEMENT SYSTEMS DEVELOPMENT
 Uni-Calc, UNIX and XENIX are trademarks of MSD Corp., Bell Laboratories and Microsoft respectively

basket and a letter carrier that allows printing of letters on single sheets.

The ribbon comes in a sealed cartridge, which "facilitates fast, easy replacements" according to the manufacturer. The ribbon must still be handled manually, however, and I did not find the cartridge any easier to install than an ordinary—and far less expensive—spool.

Although this ribbon is said to have a longer life than an ordinary ribbon, it is easily tangled when the enclosure is removed and replaced; then the cartridge must be discarded. A new one costs \$12. The user is warned to use only cartridges supplied or approved by Integral Data Systems, although the item appears to be standard.

The IDS 460 can be connected immediately to almost any computer. Other printers require that the buyer specify the interfacing standard when placing an order. This printer has built-in circuitry for almost any interfacing standard. A jumper selects either parallel (Centronics-compatible) or RS-232 serial interfacing. The XON/XOFF handshaking protocol used by many of the daisy-wheel printers is also recognized. The user can select any one of five serial baud rates up to 9600 baud by using the DIP switches on the top of the printer. The DIP switches also allow the user to easily define the parity-checking functions for received data.

I had a little difficulty getting the printer to operate properly when connected to my LSI-11/2-based system. The individual I spoke to at IDS was knowledgeable and helpful. He suspected that the problem might be traced to the printer's firmware and offered to send me a set of revised PROMs. I discovered that the problem was not in the printer at all; nevertheless, the new PROMs arrived promptly, and at no cost.

The IDS 460 shines particularly well in the area of print quality: it is superb and well complemented by a powerful array of character and forms-control options. The characters are clear, crisp, and well formed. The letters are not the mere outlines produced by most dot-matrix printers, but are shapely and filled in, almost like letters off a printing press. Distinct dots are not visible because the print head produces the dots in an overlapping pattern.

Four different print densities are software or DIP switch selectable—5, 10, 12, or 16.8 characters per inch. The following are also hardware or software selectable: proportional spacing (you can even control the amount of space between characters), text justification (l), line spacing at either 6 or 8 lines per inch, and one of eight form lengths, from 3 to 14 inches. And despite the excellent print quality, the speed of the printer compares favorably with the faster dot-matrix printers. The IDS 460 uses bidirectional printing and logic that minimizes motion of the print head over white space on the page.

The IDS 460 firmware performs many of the functions normally handled by text editors; it should be relatively easy to program a text editor to take advantage of the

Disc/3
MART, INC.

GO FOR IT!

FOR PRICE, QUALITY & RELIABILITY

| | |
|--|-----------|
| ACOUSTIC COUPLERS | CALL |
| ADDS VIEWPOINT Terminal | \$ 585.00 |
| ANACOM Printer (Ser/Par) 150 CPS | 1095.00 |
| ANADEx Printer DP-9000 | 1199.00 |
| BASE 2 850 Impact Printer | 700.00 |
| EATON Dot Matrix Parallel | 399.00 |
| EPSON Printers (All) | CALL |
| MICRO TERM Terminals | CALL |
| OKIDATA Microline Series | CALL |
| PAPER TIGER 460G | 1145.00 |
| COMBINATION SPECIAL: | |
| Apple II Plus 48K, w/Drive & Controller; | |
| Epson MX80 Printer, | |
| Interface & Cable | 2225.00 |

CALL FOR QUOTES ON ANY OTHER MICRO PRODUCTS

We are dealers for BASF, DYSAN, 3M(SCOTCH) Diskettes, Cartridges, Mag Tape, etc. In addition we carry a complete line of Printer Ribbons and other data processing accessories.

Disc/3
MART, INC.

1840 LINCOLN BLVD.,
 SANTA MONICA, CA 90404
 (213) 450-5911 (CALL COLLECT)

PRICES SUBJECT TO CHANGE

The IDS 460 -- A Demonstration

```
10 PRINT "For program listings, a 'no frills' format is preferred."  
20 PRINT "In that case, one would use the standard 80 column listing"  
30 PRINT "with no proportional spacing or text justification."  
40 END
```

For word processing, however most writers will opt to use proportional spacing. This means that individual letters will be of different widths, giving the document a more professional appearance. The ability to do this is characteristic of better letter quality printers.

Notice that more characters can be fit on a line that is proportionally spaced, giving the text a "smaller" look. When one uses the smallest type size in conjunction with the proportional spacing feature the result is text that is quite small -- suitable for footnotes, perhaps.

This size is the one that I generally use, 12 characters per inch. The IDS 460 is a versatile printer. The manufacturer promises to make it even more versatile by making available PROM chips to enable switching between two typefaces. With this feature it would be possible to switch back and forth from a language to another. However, if you do not want to wait for the PROM chips to become available, you can accomplish the same thing by using the graphics function of this printer.

"I hear you have a new printer, Eli, ויש לי!"

Figure 1: Sample printout of the Integral Data Systems' Model 460. Although the Hebrew characters in the last line were printed using graphics features, IDS is planning to introduce PROMs that will permit switching from one language to another.

many features. Examples of some of these features include the following: the DIP switches may be used to enable or disable an automatic one-inch skip at form boundaries; horizontal tab positions can be set by using software escape sequences; on receiving a horizontal tab character, the print head tabs to the next specified column in the line. You can also set vertical tab positions—in fact, you can program three separate vertical tab schedules since there are three separate vertical tab characters. Print-head motion and paper motion are extremely precise. Horizontal tabbing may be specified in 1/120 inch increments; vertical tabbing in 1/12 inch increments.

One other minor inconvenience is that no default tab setting takes effect when the printer is powered up. This means that unless the user remembers to explicitly program tab positions, the printer ignores the tab character. In text, the tab character is frequently used, instead of blanks, to conserve storage space. If you send such text to

the printer before setting tabs, the text will look as if all the blanks mysteriously disappeared. The solution is simply to set the tabs, but there really should be a default setting.

In addition to its text-processing prowess, the IDS 460, when equipped with the Dot Plot option, is an excellent graphics printer. Sending a control-C to the printer puts it into graphics mode, and every following character is interpreted as a graphics pattern until graphics mode is switched off with another control-C.

Each character controls seven dots in the vertical plane. Each bit in the 7-bit ASCII (American Standard Code for Information Interchange) code of the character activates a different dot, with the leftmost bit corresponding to the lowest of the seven dots. If the ASCII code sent is 1000011, for example, the IDS 460 prints the bottom dot and the two top dots. A graphics carriage control advances the paper a distance of seven dots.

Conclusions

- The IDS 460 has excellent print quality—probably the best of all dot-matrix printers in its price range. The nine-wire head uses both vertical and horizontal overlapping of dots to make fully formed characters and give lower-case letters full descenders.
- The bidirectional, logic-seeking printing minimizes print-head motion and assures high-speed operation.
- Interfacing the IDS 460 to a variety of printers is remarkably simple because the printer contains *both* RS232 and parallel interfaces.
- The only real drawbacks result from the difficulty of removing the cover and the placement of the print-intensity switch inside. Before changing from paper of one thickness to paper of another thickness, the user must remove the cover and adjust the print-intensity switch.

- Although the printer lacks a friction-feed feature and can't handle single sheets of paper, it does offer extremely precise paper handling.
- The IDS 460 has a convenient self-test feature and an indicator that lights or flashes when paper runs out or hardware problems occur.
- When equipped with the Dot Plot option, the IDS 460 offers outstanding graphics features.
- Judging by its willingness to help when I encountered a problem, Integral Data Systems can be relied on for product support.
- I recommend the IDS 460 to anyone who can't spend several thousand dollars and yet needs a printer that has both excellent print quality and the speed of dot-matrix technology. ■



IF YOU ENJOY MUSIC, WHY JUST LISTEN?

You and your Apple could be making beautiful music together!

Join the thousands of Apple owners who are making music — without the years of practice needed for conventional instruments. You can quickly and easily enter a song from sheet music. Just follow the detailed examples and instructions provided.

THE PRODUCT. ALF's economical 9-voice Music Card MC1 is just \$195, the gourmet 3-voice Music Card MC16 is \$245 (use 2 for 6 voices or 3 for 9). Both come with detailed manual, complete software, and cable for connection to your stereo system.

THE SOFTWARE. We're convinced our product is by far the easiest to use and most versatile system for the Apple. You get many features not available in other systems, plus a very large note capacity. And no customer has ever reported a "bug" or error.

THE HARDWARE. ALF strives for the best quality possible. No MC1 card has ever been returned with a manufacturing defect.

THE COMPANY. ALF has been making computer-controlled synthesizers since 1975. We made the first music peripheral for the Apple — and it's still one of the most popular.

Available through Apple dealers, or write for more information.

WANT TO DUPLICATE DISKS QUICKLY?

ALF's disk duplication service has been a major source of quality reproduction for Apple-compatible software houses since 1980. Now you can use the same techniques for fast and accurate reproduction yourself, with ALF's Copy System. Why spend over \$10,000 for a duplication system when for just \$595 you can connect the ALF Copy System to your own Apple! Copying time is about 37 to 17.3 seconds, depending on number of drives used. That's over 1,600 disks in 8 hours from a single system. Are you completely confident of your present copying methods? At ALF, accurate reproduction is more important than speed. The ALF Copy System is designed to produce perfect copies every time.

Special hardware and software copies any standard 13 or 16 sector Apple format disk. Hardware plugs easily into computer — no permanent changes required. If you wish to do your own drive maintenance, the manual tells how to use standard Shugart procedures and accessories, and all necessary software is included.

Too busy to get into disk copying? You can still count on ALF's convenient copying service. Ask about our copy-resistant and "double boot" services too!

Write for complete details.



NEED CONVENIENT FLOPPY DISK PROTECTION?

ALF's Floppy Boxes are specially designed to offer great protection with more convenient use than other methods. They're designed with two layers of corrugated cardboard with a special "cross-grain" construction for extra strength. The standard square size holds 1-3 minifloppies for mailing or packing in products. The larger rectangular size holds minifloppies plus a standard 5½ x 8½ booklet (8½ x 11 folded in half). Available with an adhesive closure tab for use as a mailer (just seal with tab, address other side, and mail). Software houses: write for details on attractive, protective packaging for your products.

Small quantity price is 75¢ for standard box.

Available singly at computer dealers, in large quantities from ALF. (New dealer inquiries invited.)

Aug. 81



ALF PRODUCTS INC. 1448 ESTES DENVER, CO 80215

The Mauro Proac Plotter

Mark Dahmke
1515 Superior Apt 15
Lincoln NE 68521

The Mauro Proac plotter provides the small-computer user with an inexpensive way of obtaining high-quality graphics. The plotter uses a novel method of controlling the paper—it embosses a pattern on the edge of the paper that is used to guide the paper across the drive roller. A centrifugal blower creates a pressure drop across the

paper writing surface, assuring that the paper is held in place. Both X and Y axes are driven by stepper motors, and the pen is moved up and down by a solenoid.

The plotter will accept single 21.5- by 28-cm (8½- by 11-inch) sheets, 28- by 43-cm (11- by 17-inch) sheets, or a 28-cm (11-inch) continuous roll (if equipped with the roll-paper option).

At a Glance

Hardware

Mauro MP-250
Proac plotter

Use

general-purpose
plotter

Manufacturer

Mauro Engineering
Rt 1 Box 133
Mount Shasta CA 96067
(916) 926-4406

Price

plotter, \$695
RS-232C serial interface,
\$195
TRS-80 or Apple
interface, \$85

Features

plots on ordinary 8½ by
11 paper
choice of pen colors and
line widths
0.005 inch/step resolution
2.5 inch/second plotting
speed

Software

full vector driver soft-
ware available for
8080/Z80, 6502, and

6800 microprocessors;
two-dimensional and
perspective plotting pack-
ages available; may be
driven from FORTRAN,
BASIC, etc.

Hardware required

any 8080/Z80, 6502, or
6800 microprocessor; re-
quires either a 6-bit
parallel output port or
the RS-232C interface op-
tion.

Hardware options

roll paper adapter
RS-232C serial data
interface
TRS-80 or Apple II
interface cards

Documentation

26-page manual including
interfacing requirements,
sample software drivers,
and a listing of the 8080
assembler interface
program.

Audience

anyone requiring quality
pen-plotter graphics at
low cost.

Control Circuit

The electronics package will accept control signals from the host computer via six data lines: -Y, +Y, -X, +X, pen-control (up/down), and home. Limit switches are provided on all axes to prevent overrun of the pen. The electrical interface consists of TTL (transistor-transistor logic) signals. All lines come out to a 10-pin Molex connector on the back of the plotter.

Sending commands to the plotter is somewhat more complicated. For example, if you want to step in the +X direction, you have to hold the -X line high (logic 1) and send four positive-going pulses to the +X input. This causes the motor to advance one 0.005-inch step in the +X direction. The same procedure is required for the other three controls (-X, +Y, and -Y). The pen may be lowered by pulling the pen-control line low (logic 0) after it has been placed in the high (logic 1) state. Raising or lowering the pen takes approximately 100 ms.

Serial Interface

The serial interface allows users with an RS-232C serial data port to communicate with the plotter without having to wire up a special cable for the parallel interface. It normally runs at 1200 bps (bits per second), but may be switched to 110, 300, or 2400 bps. The interface expects to see 7 data bits and 1 or 2 stop bits. The eighth, or parity, bit is ignored. To communicate with the serial interface, several bytes are sent in the following sequence:

Byte 0: Control word

Byte 1: Y LOB, (low-order bits) bits 0 to 6 (bit 7 ignored)

Byte 2: Y HOB, (high-order bits) bits 0 to 4 (bit 5 is the sign bit, and bit 6 is the pen-control bit)

Byte 3: X LOB, bits 0 to 6 (bit 7 ignored)

Main/Frames from \$200

- 14 Basic Models Available
- Assembled & Tested
- Power Supply:
8v@15A, ± 16v@3A
- 15 Slot Motherboard
(connectors optional)
- Card cage & guides
- Fan, line cord, fuse, power
& reset switches, EMI filter
- 8v@30A, ± 16v@10A
option on some models

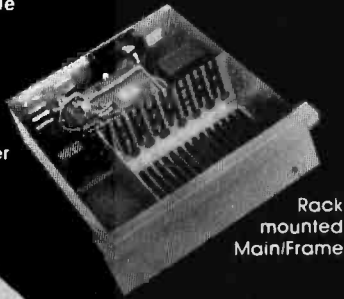

Rack
mounted
Main/Frame

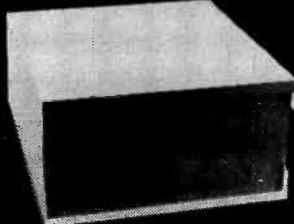

8" Floppy Main/Frame
(includes power for
drives and main/frames)

Write or call for our
brochure which includes our
application note:
'Building Cheap Computers'
INTEGRAND

8474 Ave. 296 • Visalia, CA 93277 • (209) 733-9288
We accept BankAmericard/Visa and MasterCard

EXPAND APPLE AND ATARI 16K RAM CARD

These exciting new additions to our line will meet the demand for low cost alternatives to the higher priced language and ram cards. The ConComp Apple II 16K Ram Card will work with all existing software compatible with the Apple Language Card¹ and the Microsoft Z-80 Softcard.² Allowing up to 64K of user memory, the Ram Card helps make complete use of Pascal, CP/M,³ and larger programs like VisiCalc.³ The Atari 800² version is compatible with all Atari software.

Both cards are constructed using high-speed high-quality dynamic RAM and come with a full one year warranty.

For more information please call or write.

APPLE II
\$130
ATARI 800
\$89

¹Trademark of Apple Computer Inc.
²Trademark of Atari Inc.
³Trademark of Personal Software Inc.
⁴Trademark of Digital Research
⁵Trademark of Microsoft Consumer Products, Inc.

Available from:
ConComp Industries
8338 Center Dr.
La Mesa, CA 92041
(714) 464-6373
Dealer Inquiries Invited

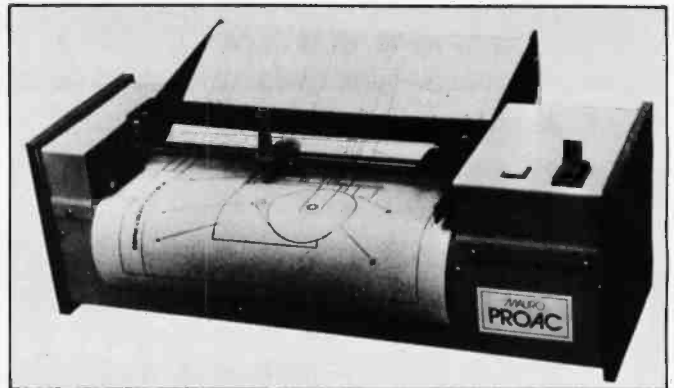

Photo 1: The Mauro plotter is a low-cost, well-engineered unit designed with the small-system user in mind.

Byte 4: X HOB, bits 0 to 4 (bit 5 is sign bit, bits 6 and 7 are ignored)

The control word tells the interface how it should interpret the succeeding bytes. Bits 0, 1, and 2 define how many vectors (4-byte groups of bytes 1 through 4) will be sent. Bit 4 indicates whether the buffer-full response of the interface is a pulse on the RS-232C CTS (Clear to Send) line or a specific character. Bits 3, 5, and 6 are reserved, and bit 8 is ignored.

Software

Several device drivers for the 8080/Z80, 6800, and 6502 microprocessors (in both BASIC and assembly language) are provided with the plotter and the interface. The program driving the plotter (without the serial interface) uses the same byte order and format as the above protocol for the serial interface. This greatly simplifies conversion (not to mention program compatibility) from one to the other.

Another vendor—Leapac Services (8245 Mediterranean Way, Sacramento CA 95806)—supplies several two- and three-dimensional plotting packages at reasonable prices. The L2D package is a simple two-dimensional package with Calcomp-compatible routines. The L3P is a three-dimensional perspective-plot package containing over seventy subroutines, including zoom, fly-by, and animation functions.

Both packages are available from Leapac on either CP/M-format 8-inch floppy disks or North-Star-format 5-inch disks. Each package is provided as a linkable library for Microsoft-compatible compilers such as FORTRAN-80, COBOL-80, MACRO-80, and the BASIC compiler.

Conclusions

In general, I found the documentation of the Mauro plotter to be adequate but not exceptional. The plotter itself is well engineered and constructed. I had few problems with the unit, except for a troublesome serial interface. However, this was quickly replaced after a call to Mauro Engineering. Of the many plotters I have looked at over the past three years (with hopes of finding one I could afford), the Mauro Proac plotter comes closest to being the ideal small plotter. ■

The Radio Shack FORTRAN Package

Tim Daneliuk, 4927 North Rockwell, Chicago IL 60625

FORTRAN, a high-level programming language geared to scientific and mathematical programming, is probably one of the few languages to have found "universal" acceptance. Until recently, however, FORTRAN (FORmula TRANslator) has been unavailable to the personal computer user.

For those who are familiar only with BASIC (Beginner's All-Purpose Symbolic Instruction Code), a few words concerning "compiled" and "interpreted" languages are in order. BASIC as implemented on the TRS-80 is an *interpreted* language. As a program runs, it is translated, line by line, from English (which the computer can't understand) to the computer's own "machine language." Each line of the program is executed as it is interpreted. Note that the program (called *source code*) never changes: it is simply interpreted each time you type the RUN command.

FORTRAN, on the other hand, is a *compiled* language. As in BASIC, the source code is written in English-like statements which, though not identical to those in BASIC, are similar in principle (ie: there are such elements as input/output statements, arithmetic expressions, and logical expressions). To run the FORTRAN program, however, you must use a special machine-language routine called a *compiler*. The compiler goes through source code and creates a second machine-language program, called *object code*. This transformation from source to object code is performed once—thereafter, when you want to run your program, you actually execute the machine-language object code produced by the compiler.

For this reason, programs written in compiled languages such as FORTRAN are very fast: typically twenty to thirty times faster than the equivalent algorithm written in an interpreted language. The price for this efficiency is increased difficulty in editing and debugging because a program must always be compiled before it can be run.

The Package

With the exception of a few extensions and restrictions, the FORTRAN package described here conforms to the

1966 ANSI (American National Standards Institute) FORTRAN. Radio Shack's FORTRAN (actually written by Microsoft and licensed to Radio Shack) comes in a three-ring binder that includes two 5-inch floppy disks and about 200 pages of documentation. The documentation is not a tutorial in FORTRAN, however, and if you don't know FORTRAN, it is probably insufficient. Radio Shack recommends several textbooks to augment the information supplied.

The FORTRAN package comprises four files. Disk 1 contains the FORTRAN compiler and the editor; Disk 2 contains the linking loader and the FORTRAN library. Each file has an associated section of documentation, and there is a sample FORTRAN program, along with instructions for entering, compiling, linking, and running it. Each disk has the TRSDOS 2.3 operating system on it.

At a Glance

Name

Radio Shack
FORTRAN

Type

High-level language
compiler

Manufacturer

Licensed by Microsoft
to Radio Shack
One Tandy Ctr
Forth Worth TX 76102
(817) 390-3011

Price

\$99.95

Format

Two 5-inch floppy
disks

Language

Z80 machine language

Computer

Radio Shack Model I
Level II with expansion
interface,
minimum 32 K bytes
of memory, and at
least one disk drive
(two recommended)

Documentation

Approximately 200
pages in a loose-leaf
binder

Audience

Language enthusiasts,
FORTRAN users, and
users with scientific
and mathematical ap-
plications

Happy Hands

Offers Discounts on All

TRS-80TM

COMPUTERS

We Have What You Are Looking For

PROMPT SHIPPING

AVAILABLE SERVICE CONTRACTS

DISCOUNTED PRICES COMPABLE TO ANY OTHERS

NO TAX ON OUT OF STATE SHIPMENTS

Call Collect For Prices And Shipping Schedules

505-257-7865

HAPPY HANDS

or write

P.O. DRAWER I

RUIDOSO, NEW MEXICO

88345



Free. Fast. And
a phone call
away.

INMAC INTRODUCES
THE SOLUTION TO YOUR MICRO SUPPLY
AND ACCESSORY NEEDS.

- One-Stop Shopping. This new catalog offers over 1,000 products specifically for Micro Computers. Compatible with Apple, Atari, Northstar, TRS-80s and many others.
- Convenient Ordering. By mail or phone, ordering supplies and accessories from this catalog will be quick and easy.
- Fast Delivery. We'll ship your order within 24 hours from our distribution centers in New Jersey, California, Illinois and Texas. Overnight delivery available.
- Top Quality Products. Virtually all our products are guaranteed for at least one year. Risk-free trial of any product for 45 days.

Send for your FREE
Inmac Catalog or call
(408) 727-1970.
Available June 1, 1981.

Inmac

Dept. Micro, 2465 Augustine Drive,
Santa Clara, CA 95051

The documentation claims that the Disk BASIC files are included, but they were nowhere to be found on my copies.

Although this FORTRAN package is best suited for systems with dual disk drives, I was able to use it successfully on a single drive system. The only real disadvantages were that I had to exchange the disks constantly (a problem familiar to anyone who has tried to make a copy of a disk using a single drive system), and the amount of free disk space was limited. The reason for this is that the disk containing the final executable command files—created from your source code—will always contain part of the FORTRAN software. This will be discussed later in the article.

The Editor

The Microsoft heritage is most apparent in the editor. Anyone familiar with the Level II BASIC or Microsoft EDTASM (Editor-Assembler) editing commands will feel right at home with this editor. It is also the best-documented portion of the package, although in my

Extensions to ANSI-66 FORTRAN

- If *c* is used in a 'STOP *c*' or 'PAUSE *c*' statement, *c* may be any six ASCII characters.
- Error and end-of-file branches may be specified in READ and WRITE statements using the ERR = and END = options.
- The standard subprograms PEEK, POKE, INP, and OUT have been added to the FORTRAN library.
- Statement functions may use subscripted variables.
- Hexadecimal constants may be used wherever Integer constants are normally allowed.
- The literal form of Hollerith data (character string between apostrophe characters) is permitted in place of the standard nH form.
- Holleriths and Literals are allowed in expressions in place of Integer constants.
- There is no restriction to the number of continuation lines.
- Mixed-mode expressions and assignments are allowed, and conversions are performed automatically.

Restrictions on ANSI-66 FORTRAN

- The COMPLEX data type is not implemented. It may be included in a future release.
- The specification statements must appear in the following order:
 - a) PROGRAM, SUBROUTINE, FUNCTION, BLOCK DATA
 - b) Type, EXTERNAL, DIMENSION
 - c) COMMON
 - d) DATA
 - e) Statement functions
- A different amount of computer memory is allocated for each of the data types: Integer, Real, Double Precision; and Logical.
- The equal sign of a replacement statement and the first comma of a DO statement must appear on the initial statement line.

judgment it presents the least difficulty.

The purpose of the editor is to create, edit, and store FORTRAN source code. It assigns line numbers and increments to the program statements. The line numbers are not actually part of the FORTRAN program, but they exist so that specific lines can be called for editing. Only certain FORTRAN statements such as DO loops and WRITE operations require line numbers, and these are included in the FORTRAN statement-field.

The usual interline and intraline editing commands are provided. The interline commands can insert, delete, replace, and print lines, or groups of lines, in the program. The intraline commands edit characters or groups of characters within a given program line (eg: a character can be deleted within a line of the program and then replaced with three other characters).

The line editing commands are simply extensions of the editing facilities provided with Radio Shack's Level II and Disk BASIC software. However, the elegance of this editor is substantiated by the presence of two other commands: Find and Substitute. The Find command finds a given string of text within a source file and prints out the corresponding line numbers. The Substitute command is similar to the Find command, except that a given character string can be replaced with another character string in a selected group of lines. It would, for example, be possible to substitute FORMAT(2 for FORMAT(5 wherever it appears in lines 100 to 500. These two commands are tremendous time-savers, particularly if you are editing long files in which the same change must be made many times.

There are two final features of interest. First, as is common to most FORTRAN source listings, the editor appends page numbers to the listing, as necessary, which facilitates the organization of long files. Second, the editor can be used to edit certain BASIC and other non-FORTRAN files. (The BASIC file must be stored as a text file.) This allows you to use the find/substitute commands when editing BASIC files.

The Compiler

The FORTRAN user never comes into direct contact with the compiler. Rather, he writes source code according to the strict grammatical rules of the language. The compiler in turn is able to recognize and process the source code. As mentioned previously, this FORTRAN fundamentally conforms to the ANSI-66 standard. The text box on the left, excerpted from the reference manual, shows the departures from the standard.

FORTRAN is recognized as a language that is well-suited to the scientific and mathematical user. This bias is reflected in the data types that are available:

Integer: from -32768 to 32767

Real: seven-digit precision from $\pm 10^{-38}$ to $\pm 10^{+38}$

Double precision: same as real except with 16-digit precision

Logical: used in logical operations such as AND, OR

Literal: alphanumeric strings

Hexadecimal: numbers in base 16



Multi-Application Processing System

WORD PROCESSING



ORDER PROCESSING



ACCOUNTING (MORE)





THREE COMPUTERS IN ONE!

THE DIGIAC MAPS® CT-80 SYSTEM

Multi-User, Multi-Tasking, Cost Effective.

- 3 business systems can run concurrently - that's 3 times the overall system productivity!
- Time share word processing, accounting, order processing, inventory, forms processing, billing & more!
- 3 workstations can share data base - preparations can be done by several operators concurrently!
- All workstations can share common peripherals.
- Uses DIGIAC MAPS-80 operating system. (Digital Research MP/M)
- High level language processors including Fortran - Basic - Pascal - Cobol.
- Complete Turn-key system for ease of operation & learning!



For Additional Information Contact:
MAPS, Commercial Products Division of:
DIGIAC CORPORATION
 175 Engineers Road, Smithtown, N.Y. 11787
 Phone: (516) 273-8600
MP/M is a trademark of Digital Research Corp.

SATELLITE TRACKING SOFTWARE BY STI



SAT TRAK INTERNATIONAL

APPLE II
SORCERER
TRS-80

An international group of professionals has designed and programmed SATELLITE TRACKING SOFTWARE, a unique package of five separate programs that allow you to set up your own Satellite Tracking Station using your microcomputer. Beginners, professionals, and educators will all appreciate the technical excellence of this easy to use software. Satellite positions are calculated and displayed or printed out, including the following data: altitude, azimuth, elevation, right ascension, declination, and range, for any time — past, present, or future. The 30 page operator's manual includes notes on interpreting NASA documents and taking observations. The Apple, TRS-80, and Sorcerer versions plot satellite positions on a map of the world. The Sorcerer version is available only on cassette. The TRS-80 version is for a Model I, level II TRS-80.

Cassette or Diskette (Apple, TRS-80, Sorcerer) \$ 49.95
 FORTRAN listing (other systems) \$150.00
 FORTRAN program on punched cards \$175.00

(all prices include documentation)

DISTRIBUTED EXCLUSIVELY BY

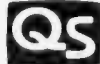

QUALITY SOFTWARE
 6660 Reseda Blvd., Suite 105, Reseda, CA 91335
 (213) 344-6599

ASK FOR QUALITY SOFTWARE products at your favorite computer store. If necessary you may order directly from us. MasterCard and Visa cardholders may place orders by calling us at (213) 344-6599. Or mail your check or bankcard number to the address above. California residents add 6% sales tax. *Shipping Charges:* Within North America orders must include \$1.50 for shipping and handling. Outside North America the charge for airmail shipping and handling is \$5.00. Pay in U.S. currency.

One glaring omission is the complex data type. Standard ANSI FORTRAN allows direct manipulation of complex variables—a real time-saver when solving problems in physics, electronics and related fields. I suspect that this data type was omitted because of the memory it would require to handle complex variables. Nevertheless, it should have been offered as an option (ie: two versions of the compiler, one with and one without the complex variable type).

This version of FORTRAN is characterized by extensive formatting statements that give the programmer great control over how data is input, output, and stored. These statements include numeric, logical, Hollerith (or string), and scaling-type format commands. User-defined functions are also allowed through the construction of function subprograms. The usual transcendental functions, such as sine, cosine, and arctangent, are included, as well as the hyperbolic tangent. And, of course, the

package includes all standard FORTRAN arithmetic and control statements such as GOTO (three kinds), IF, and PAUSE.

The Linker and FORTRAN Library

The linker relocates in memory the object code that was created by the compiler, and it must do so in a manner that will allow the object code to be directly executed. In other words, the linker goes through the relocatable object file that the compiler has created, and from this, creates a command file that can be directly executed under TRSDOS 2.3. During this process, the linker references another file called FORLIB. FORLIB contains all the standard routines for addition, subtraction, transcendental functions, etc, so the compiler does not have to recreate the same machine-language routines that appear commonly. Rather, it references the FORTRAN subroutine library as necessary.

FORTRAN Patchwork

I found a few bugs in Radio Shack's FORTRAN editor that were not apparent at first. On the whole, they are minor, such as the inability to stop screen scrolling with "<SHIFT> @". But a rather severe bug exists when index files are created. The editor creates an index file when extremely long source files are written. This helps in loading large source files during subsequent editing sessions. Unfortunately, I got "garbage" in my program source listings when files were augmented by Edit-80-created index files. Killing the index file and loading the source file without it fixed the problem. Your local Radio Shack dealer has two patches to rectify these problems: one for Disk EDTASM (catalog number 700-2210) and one for FORTRAN (catalog number 700-5210). . . . TD

CATCH THE S-100 INC. BUS!



| | LIST PRICE | OUR SPECIAL CASH PRICE |
|---|------------|------------------------|
| S.D. Systems 80x24 Video Board A&T | 556.00 | 420.00 |
| S.D. Systems Versafloppy II Double Density Disk Controller w/SDOS, DDBIOS, VDIAG3, & Monitor; A&T | 500.00 | 380.00 |
| Shugart SA 800/801R Bare Drive | 600.00 | 399.00 |
| IMC Disk Box for 5¼" Drives | 39.00 | 29.00 |
| SSM I/O-4 Kit 2 Parallel + 2 Serial | 210.00 | 168.00 |
| Mullen TB-4 Extender Kit w/Probe | 59.00 | 47.00 |

Subject to Available Quantities • Prices Quoted Include Cash Discounts. Shipping & Insurance Extra.

We carry all major lines such as
S.D. Systems, Cromemco, Ithaca Intersystems, North Star,
Sanyo, ECT, TEI, Godbout, Thinker Toys, SSM.
For a special cash price, telephone us.

Please note our new address.

S-100, inc.

14425 North 79th Street, Suite B
Scottsdale, Arizona 85260
800-528-3138 • 602-991-7870

Hours: Mon. - Fri. — 9 a.m. to 6 p.m. MST

GO!...



**GET YOUR SHARE OF THE MICRO MARKET!
IF A NUDGE IS ALL YOU NEED, READ ON....**

HARDWARE — Boards, systems and support at the right price, featuring CCS, Televideo and others.

SOFTWARE — Many industry-standard packages and some unique surprises, such as:

- AUTOGEN** — Interactively reconfigure your CP/M® BIOS. Bring new peripherals on-line quickly.
- READER** — Analyze your English prose. Measure how easy or hard it is to read.
- TL** — Do discrete-event simulation on a micro. Write parallel programs, schedule resources, much more.

**INTERESTED? GET OUR CATALOG FOR THE FULL STORY!
CALL OR WRITE NOW!**

MICROCOMPUTER APPLICATIONS, INC.
11125 JOLLYVILLE ROAD, AUSTIN, TX 78759
(512) 346-5284

Running the System

Four steps are required in order to use the system:

1. Writing and editing the FORTRAN program
2. Compiling the source code to relocatable object code
3. Linking the object code to memory and creating a command file
4. Executing the program

One particularly nice feature of the compiling process is that it will, at your request, not only create an object file, but also an assembly-language listing of your program. It's a great way to learn how your computer "thinks" FORTRAN. One other advantage of the package also appears at the time of compilation. If you wish, you can compile the source code down to machine code that is suitable for loading into ROM (read-only memory).

To check for syntax and other errors in your FOR-

TRAN program, you can compile the code without creating the object file on disk. The compiler runs through the program and then displays error and warning messages. Once an error-free object file is created, it is linked. It can then be run immediately or stored as a command file to run under TRSDOS 2.3. In single drive systems, the relocatable object file must always be on the disk containing the linker and FORTRAN library. Consequently, free disk space is limited since these two files occupy 25 grams of space.

Benchmarks

If you've never used FORTRAN, you're probably asking, "Why go through all this effort to write and execute a program?" The answer is threefold: speed, speed, and speed! There is no doubt that virtually any problem solved in FORTRAN could be solved, say, in BASIC. But unless you enjoy waiting, you should consider FOR-

The perfect marriage of Superbrain™ and Winchester.™

700K or 350K
floppy storage

5 Megabytes
hard disk storage

Finally, a price-performance
breakthrough for mass storage
in a one-piece, handsomely
styled desk-top computer.

- 5 1/4" Micro-Winchester™ 5 Mbyte (formatted) hard disk.
- 700K or 350K floppy disk back up.
- Dual Z-80 processors with 64K RAM.
- Dual RS232 ports.
- Complete and ready to run with CP/M™ 2.2.

DEALER & OEM
INQUIRIES INVITED

TELEPHONE (206) 453-9777
TOLL FREE 1-800-426-2963



- Largest Intertec distributor in the United States.
- Distributor for C. Itoh, MPI, Epson.
- Seagate, Tandem drives.
- Corvus hard disks, multiplexers.
- Superbrain S-100 bus, graphics, and parallel port.
- Software: MicroPro, Accounting Plus, Peachtree, Condor, Benchmark.

SuperFive ALSO DISTRIBUTED BY:

Compu Data
1 Bala Cynwyd Plaza
Bala Cynwyd, Pennsylvania 19004
Telephone (215) 667-6843

Diversified Data
8043 W. 82nd
Indianapolis, Indiana 46278
Telephone (317) 299-0115

CMC International
A Division of Computer Marketing Corporation

11058 Main, Suite 125, Bellevue, WA 98004
(206) 453-9777

DISCOUNT PRICES

Microcomputers & Peripherals



North Star • SWTPC • Lear-Siegler
Hazelintine • Centronics • Cromemco
Wabash • InterSystems and others

Fast, off the shelf delivery.
Call TOLL FREE 800/523-5355

MARKETLINE SYSTEMS, Inc.
2337 Philmont Ave., Huntingdon Valley, Pa. 19006
215/947-6670 • 800/523-5355

Dealer Inquiries Invited

START YOUR OWN COMPUTER CO.

HOW TO START YOUR OWN SYSTEMS HOUSE \$36.
7th edition, October 1981

Written by the founder of a successful systems house, this fact-filled 220-page manual covers virtually all aspects of starting and operating a small systems company. It is abundant with useful, real-life samples: contracts, proposals, agreements and a complete business plan are included in full, and may be used immediately by the reader. Proven, field-tested solutions to the many problems facing small turnkey vendors are presented.

HOW TO BECOME A SUCCESSFUL COMPUTER CONSULTANT \$28.
by Leslie Nelson, 3rd revised edition, September 1981

Independent consultants are becoming a vitally important factor in the micro-computer field, filling the gap between the computer vendors and commercial/industrial users. The rewards of the consultant can be high: freedom, more satisfying work and doubled or tripled income. This manual provides comprehensive background information and step-by-step directions for those interested to explore this lucrative field.

FREE-LANCE SOFTWARE MARKETING \$30.
by B.J. Korites, 3rd edition, June 1980

Writing and selling computer programs as an independent is a business where • you can get started quickly, with little capital investment • you can do it full time or part time • the potential profits are almost limitless. This best-seller by Dr. Korites explains how to do it.

HOW TO START YOUR OWN WORD PROCESSING SERVICE \$39.50
by Leslie Nelson, November 1981

Turn a small investment into a steady, money making business that adds \$10,000, \$50,000 or \$100,000 to your income. Detailed start-up, marketing and operations plans are included.

Send check, money order, VISA, Master Charge or American Express # and exp. date. Publisher pays 4th class shipping. Add \$1.00 per book for UPS shipping. For faster shipment on credit card orders call (201) 783-6940.

ESSEX PUBLISHING CO., Dept. 2
285 Bloomfield Avenue • Caldwell, N.J. 07006

Listing 1: Benchmark programs that compare Radio Shack BASIC, an interpreted language, with Radio Shack FORTRAN, a compiled language. The BASIC program (1a) took almost twenty times as long as the FORTRAN program (1b) to calculate the answer.

(1a)

```
100 DEFDBL C,D:DEFINT A,B
105 FOR A=0 TO 100
110 FOR B=0 TO 100
115 C=(A^2)+(B^2)
120 D=D+C
125 NEXT B,A
130 PRINT TAB(20)D
135 END
```

(1b)

```
00100 DOUBLE PRECISION C,D
00105 INTEGER A,B
00110 DO 10 A=0, 100
00115 DO 20 B=0, 100
00120 C=(A**2)+(B**2)
00125 D=D+C
00130 20 CONTINUE
00135 10 CONTINUE
00140 WRITE(5,30)D
00145 30 FORMAT (20X,D15.9)
00150 END
```

TRAN for "number crunching" applications.

The benchmark that is described here demonstrates this difference vividly. It consists of nested loops in which two numbers are squared, added together, and then added to the previous total. Listings 1a and 1b show the program listings. Note that the eight-line BASIC program looks fairly innocuous: it took 20 minutes, 44 seconds, to run. Once the FORTRAN program was compiled and linked, the command file required only 1 minute, 4 seconds, to run. (I also had a chance to run a similar program using CBASIC 2 running under CP/M. Even this compiled BASIC ran about 4 minutes—over three times as long as FORTRAN.)

However, in terms of total time required, the languages are fairly comparable. It took me almost 20 minutes to write, edit, compile, and link the FORTRAN program, whereas the BASIC program occupied about 4 minutes to write and edit. This won't always be true, for in longer, less trivial programs, FORTRAN will come out ahead every time. This is particularly true for programs that are reused, since linking and compiling are one-time operations. In such instances the command file will run in just over a minute, whereas the BASIC program will always leave you time to watch the evening news.

Conclusions

- The FORTRAN package is powerful and elegant.
- The price is right. At a little less than \$100, this package compares favorably to software at three times the cost.
- My biggest complaint is the absence of the complex data type. No FORTRAN system should be without it.
- If you're tired of long run times and you aren't challenged by BASIC anymore (or you just want to expand your programming horizons) this is the package for you. ■

The Variable-Duty-Cycle Algorithm

Timothy Stryker, Software Technology Inc, Precision Rd
Danbury CT 06810

Every now and then a novel technique for handling data comes to light which, while not immediately obvious, is actually very simple and can be used in a wide variety of applications.

One example of such a technique is the use of the *linked-list* data structure, which allows the programmer to create ordered sets of entries into which new entries can be inserted and from which existing entries can be easily deleted. Another example is the use of *semaphores*, which have many applications that center around the allocation of resources to sets of processes.

A new technique in this category has recently been added to the list. Pioneered by Albert G Love of General DataComm Industries, the technique initiates an event so that it occurs a specified proportion of the times that another event occurs.

Let us call the event that is conditionally initiated the "kickee," and the other event, typically something that occurs at even intervals in time or space, the "kickor." Now define three quantities, called the *duty-master*, the *duty-cycle*, and the *duty-counter*. The ratio of the duty-cycle to the duty-master will determine the proportion of kickee to kickor events. (The duty-counter is a scratch quantity that will ordinarily be initialized, say at power-up, to zero.) Each time the kickor event occurs, we do the following:

```
duty-counter := duty-counter minus duty-cycle
if duty-counter is now negative
then do
  <initiate kickee>
  duty-counter := duty-counter plus duty-master
end
```

This procedure may seem sufficiently abstract as to be totally useless, so let's consider a concrete example: a D/A (digital-to-analog) converter constructed of one bit from a computer parallel output port, one resistor, and one capacitor. The resistor and capacitor are connected so as to form a simple low-pass filter, as shown in figure 1. Now you can run the BASIC program shown in listing 1 on the computer.

Depending on the values of resistance and capacitance, and the speed at which the program executes, the voltage at the analog output point will be a more or less steady 3.75 V. By changing the constant in the DATA statement in line 100, any arbitrary voltage between 0 and 5 V can be obtained.

In this example, the duty-master is the constant 5 appearing in line 70, the duty-cycle is the variable V, and the duty-counter is the variable C. The kickor is the occurrence of a pass through the loop extending from line 30 to line 90, and the kickee is the decision to output a 1,

**DISK DRIVE WOES?
PRINTER INTERACTION?
MEMORY LOSS?
ERRATIC OPERATION?**

**Don't
Blame The
Software!**

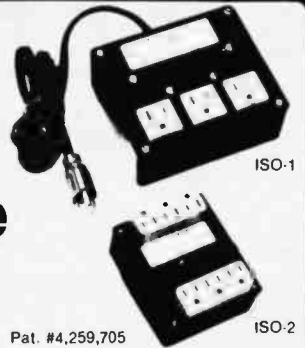

Power Line Spikes, Surges & Hash could be the culprit!
Floppies, printers, memory & processor often interact! Our patented ISOLATORS eliminate equipment interaction AND curb damaging Power Line Spikes, Surges and Hash.

- ISOLATOR (ISO-1) 3 filter isolated 3-prong sockets; Integral Surge/Spike Suppression; 1875 W Maximum load, 1 KW load any socket \$62.95
- ISOLATOR (ISO-2) 2 filter isolated 3-prong socket banks; (6 sockets total); Integral Spike/Surge Suppression; 1875 W Max load, 1 KW either bank \$62.95
- SUPER ISOLATOR (ISO-3), similar to ISO-1 except double filtering & Suppression \$94.95
- ISOLATOR (ISO-4), similar to ISO-1 except unit has 6 Individually filtered sockets \$106.95
- SUPER ISOLATOR (ISO-11) similar to ISO-2 except double filtering & Suppression \$94.95
- CIRCUIT BREAKER, any model (add-CB) Add \$ 8.00
- CKT BRKR/SWITCH/PILOT (-CBS) Add \$16.00

AT YOUR
DEALERS

Master-Card, Visa, American Express
Order Toll Free 1-800-225-4876
(except AK, HI, PR & Canada)

Electronic Specialists, Inc.

171 South Main Street, Natick, Mass. 01760

Technical & Non-800: 1-617-655-1532

Listing 1: This BASIC program uses the VDC algorithm to provide a steady output voltage when combined with the simple circuit in figure 1. A change in the value of the DATA statement will alter this voltage. Program line 80 must output the contents of B to the appropriate output port.

```

10 C=0
20 READ V
30 B=0
40 C=C-V
50 IF C>=0 THEN 80
60 B=1
70 C=C+5
80 <output B to port>
90 GOTO 30
100 DATA 3.75
    
```

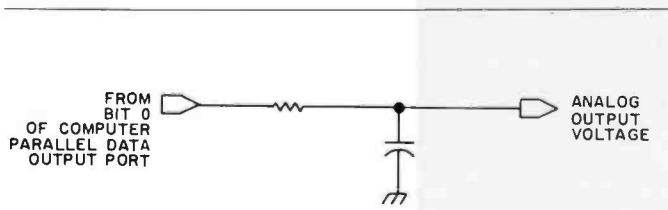

Figure 1: Low-pass filter that converts the digital output of the single-bit data port to an analog signal.

instead of a 0, to the port. The utility of this example could be considerably enhanced through the use of assembly language and real-time interrupts, but the utility of the basic scheme should be clear: assuming that each pass through the loop requires the same amount of time, the waveform output to the port will have an average duty-cycle precisely equal to the ratio between the duty-cycle, V, and the duty-master, 5. In addition, the waveform will bounce back and forth between 0 and 5 V at the maximum possible rate given the desired duty cycle and the available processing time, which will make the low-pass filter's job as easy as possible in reducing ripple at the analog output.

The variety of ways in which this same basic technique can be applied is extraordinary. Consider the case in which two integer quantities need to be kept as close to a given ratio as possible while both are gradually increased from zero to some higher number. Normally this would involve substantial amounts of multiplication and/or division, or have drawbacks in terms of either minimum increment size or worst-case error. However, use of the VDC (Variable-Duty-Cycle) algorithm makes the task straightforward: simply call the two integers I and J, and let the desired ratio between them be K:L. Pick a number, M, which is greater than or equal to both K and L, and, each time you wish to increase I and/or J by a small amount, do the following:

```

C := C-K
if C<0
then do
    < increment I >
    C := C+M
end
D := D-L
if D<0
then do
    < increment J >
    D := D+M
end
    
```

This process, of course, merely combines two instances of the VDC algorithm, using a common duty-master, M. The duty-cycle quantities are K and L, the duty-counters are C and D. The method requires virtually no processing time or memory space, is completely processor- and language-independent, and presents no theoretical limitation on the degree of precision with which the desired ratio may be maintained.

Technical Forum is a feature intended as an interactive dialog on the technology of personal computing. The subject matter is open-ended, and the intent is to foster discussion and communication among readers of BYTE. We ask that all correspondents supply their full names and addresses to be printed with their commentaries. We also ask that correspondents supply their telephone numbers, which will not be printed.

STRETCH THE POWER

Of Your HP-85 or Commodore Pet/CBM With TNW's IEEE-488 Bus System Building Blocks...



TNW-2000

TNW's RS-232 SERIAL INTERFACES

Connect your PET/CBM to any RS-232 Serial Printer, Plotter, CRT Terminal, Modem, or other device.

| | | |
|-----------------|---|--------------|
| TNW-1000 | ONE CHANNEL OUTPUT ONLY | \$129 |
| TNW-2000 | ONE CHANNEL INPUT AND OUTPUT | \$229 |
| TNW-232D | TWO CHANNELS, INPUT & OUTPUT, 12 RS-232 CONTROL SIGNALS | \$369 |

TURN YOUR PET INTO A TERMINAL

Access Timesharing Systems and Bulletin Boards with TNW's Pterm Software and full service telephone modem:

| | | |
|----------------|------------------------------------|--------------|
| TNW-103 | AUTO ANSWER/AUTO DIAL USE WITH DAA | \$389 |
|----------------|------------------------------------|--------------|

Pterm also works with acoustical couplers and other modems interfaced to the PET with the TNW-2000 or TNW-232D. Electronic mail and TWX Terminal programs also available. All units are addressable IEEE-488 devices, complete with power supply cabinet, full documentation and one year warranty.

TNW CORPORATION

3351 Hancock St. • San Diego, CA., 92110 (714) 225-1040
 TWX910-335-1194
 Visa/Mastercharge Welcome • Dealer inquiries invited

Nothing that we have seen so far suggests that the duty-cycle quantity could not vary from one occurrence of the kickor to the next. This is very handy for, among other things, modeling the effects of acceleration and velocity upon the position of an object. Suppose we are designing a real-time graphics game in which there will be a cannon capable of launching a projectile on a parabolic path toward a target. Is it possible to generate a parabolic path without resorting to a multiplication routine? Indeed it is!

We accomplish this by treating the projectile's horizontal and vertical velocity components as duty cycles, where the common kickor is a routine that runs at evenly spaced intervals in time, and the kickees are routines that move the projectile one cell horizontally and one cell vertically. Typically, the projectile's horizontal velocity component is a constant in the forward direction, and is easy to handle using the formula we have seen here. To deal with the possibility that the projectile could, vertically, be moving either up or down, we will have to introduce the concept of a negative duty-cycle. If M is the duty-master, H and V the horizontal and vertical duty-cycle/velocities, and C and D the duty-counters, the kickor routine looks like this:

```

C := C - H
if C < 0
then do
  < move projectile one cell to the right >
  C := C + M
end
D := D - V
if D < 0
then do
  < move projectile one cell up >
  D := C + M
end
else if D > = M
then do
  < move projectile one cell down >
  D := D - M
end
< decrease V by a fixed amount >

```

Photo 1 shows the set of projectile positions that are obtained when M is 125, H is 25, and V starts off at 75 and is decremented each kickor pass by 1 until it reaches -75.

More complex (but perhaps less useful) patterns can be generated if the kickee is permitted to change the value of the duty-cycle or duty-master, if the kickee of one VDC is made the kickor of another, and so on. But even in the simple forms given here, the applications of this algorithm range from data-communications multiplexing to printer/plotter control to industrial process simulation to—who knows what? Perhaps you will be the next to add to the list. ■

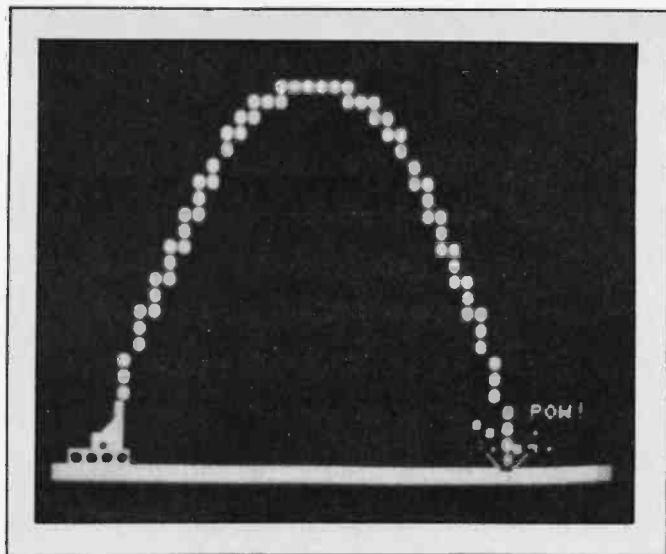

Photo 1: The VDC algorithm can be used to predict the parabolic path of a projectile without the use of multiplication or division.

Clipper™



LINE VOLTAGE TRANSIENT CLIPPING

Features Parallel Operation 5000 Hits/Second

| | |
|--|--|
| <p>PROTECTS:</p> <ul style="list-style-type: none"> • Computers • Micro-Computer Systems • Word Processors • Cash Registers • Power Supplies | <p>PROTECTS AGAINST:</p> <ul style="list-style-type: none"> • High Energy Voltage Transients • On-Off Switching • Lightning Induced Transients • Inrush of On/Off Power |
|--|--|

DYMARC

INDUSTRIES, INC.



TRANSIENT VOLTAGE
SURGE SUPPRESSOR LISTED

Dealer Inquiries Invited.

7133 Rutherford Rd. Baltimore, Md. 21207
(301) 298-3130
800-638-9098

Dynamic Simulation in BASIC

S J Houng
 c/o BYTE Publications Inc
 POB 372
 Hancock NH 03449

If you plan to parachute out of an airplane, you may want to know the terminal velocity of the open chute. If you are an amateur rocket launcher, you may want to know what orbits can be obtained from a preprogrammed multistage rocket. Answers to these questions can be quickly obtained from a personal computer programmed in BASIC.

In general, dynamic systems can be represented by a set of ordinary differential equations, such as those shown in the figures. The solution can be found by computer simulation using numerical analysis. We will use Euler's method to solve a set of differential equations.

Euler's method states that for a given first-order equation

$$\frac{dx}{dt} = f(t, x)$$

the solution can be obtained by the following routine:

$$\begin{aligned} x_{n+1} &= x_n + hf(t_n, x_n) \\ t_{n+1} &= t_n + h \end{aligned}$$

where:

$$n = 0, 1, 2, \dots$$

The solution x_{n+1} at the time t_{n+1} can be calculated from the previous solution x_n at t_n . Therefore, the complete solution can be found, step by step, from the given initial condition x_0 at t_0 . The parachuting problem in figure 2 can be solved, in BASIC, by repeatedly using the following statements in a BASIC program:

$$\begin{aligned} V &= V + H * (G - D * V * V / M) \\ T &= T + H \end{aligned}$$

Begin with the initial velocity V and time T .

Euler's method definitely solves first-order equations. But how about the second-order equations in figures 2 through 4? We need a magic (mathematical) transformation here. For a given second-order equation:

$$\frac{d^2x}{dt^2} + A\frac{dx}{dt} + Bx = F$$

if $x_1 = x$ and $x_2 = dx/dt$, we obtain the following simultaneous first-order equations:

$$\frac{dx_1}{dt} = x_2$$

$$\frac{dx_2}{dt} = F - Ax_2 - Bx_1$$

The above equations are mathematically equivalent to the original second-order equation. Euler's method can be applied to solve them in BASIC as follows:

THE COMPUTER FOR PROFESSIONALS



**HEWLETT
PACKARD**

HP-85

\$2595



| | |
|--|--------|
| HP-83 | \$1795 |
| HP-85 16K Memory Module | \$249 |
| 5 1/4" Dual Master Flexible Disc Drive ... | \$2129 |
| Graphics Plotter (7225B) | \$2079 |
| New Printer w/Graphics | \$799 |

No risk or deposit on C.O.D. orders. 3% surcharge on credit card orders. In stock items shipped same day.

CALL TOLL FREE

MCD 800-233-8950





Micro Computer Distributing
 501 East Third Street
 Williamsport, PA 17701 (717) 327-9575

$$\begin{aligned}
 F_1 &= H \cdot X_2 \\
 F_2 &= H \cdot (F - A \cdot X_2 - B \cdot X_1) \\
 X_1 &= X_1 + F_1 \\
 X_2 &= X_2 + F_2 \\
 T &= T + H
 \end{aligned}$$

Start with the initial conditions X_1 and X_2 at T .

This magic transformation can be easily extended to the n th-order equation. The result is a set of n simultaneous first-order equations that can be solved by Euler's method.

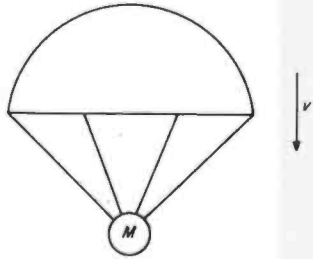
This same transformation can also be applied to the moon-landing and rocket-launching problems in figures 5 and 6. Each second-order equation produces two first-order equations. The result is a set of four simultaneous



v = velocity
 M = mass
 D = drag
 g = gravity

$$\frac{dv}{dt} = g - \frac{D}{M} v^2$$

Figure 1: Determining the terminal velocity of a mass descending by a parachute requires solving a first-order differential equation. Computers can solve this equation using Euler's method.

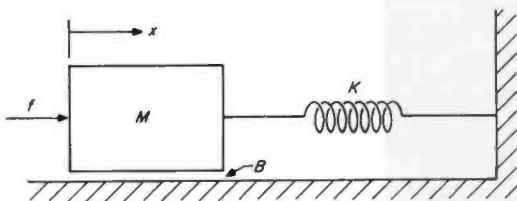

x = displacement
 M = mass
 K = spring
 B = friction
 f = force

$$\frac{d^2x}{dt^2} + \frac{B}{M} \frac{dx}{dt} + \frac{K}{M} x = \frac{f}{M}$$

Figure 2: Solving the second-order differential that describes a dynamic mass-spring-friction system requires transforming the second-order equation into two simultaneous first-order equations and applying Euler's method.

THE BIGGEST NAME IN LITTLE COMPUTERS™

TRS-80™ Model II — Your Best Buy
In a Business Microcomputer

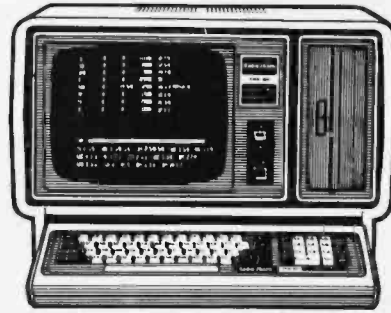

UP
TO
15%
OFF!
on

TRS-80™ computers,
software and peripherals

Similar values on all merchandise

CALL TOLL FREE:

800-351-1580

Van Horn Office Supply

701 W. Broadway -- P O Box 1060

Van Horn, Texas 79855

DEALER G055

Form F48 Provided

Standard Warranty on Merchandise

THE NATIONWIDE SUPERMARKET OF SOUND®



COMPUTER HOBBYIST SPECIALS!

WHILE THEY LAST!!!!
SAVE!!



Daisy Wheel
Terminals

RS-232, used, off-lease. Features Diablo Hytype 1 printer, up to 30 CPS, plot & text modes, dual pitch and much, much more. Includes data, operation manual, schematics. "As-is" machines may need some service.

Add \$40 for Hdlg. and Pkg. Pay Shipping When Delivered. NOW ONLY \$999.00 ea. AS-IS ONLY \$799.00 ea.

Modified I/O "SELECTRIC*-II" Printer

Stepper driven platen & carrier. Takes Selectric II ribbon cartridges. Steppers reduce mechanical failure rate. Uses opto-sensors for all feedback and keyboard sensing and solenoids for character selection & functions. Sophisticated design. Rebuild into a typewriter or drive with a micro processor for bi-directional printing & 4-way plotting. Does not include drive circuitry or power supply. Mostly whole. "as-is" no type element included. Includes I/O data & schematics. Fantastic possibilities. Removed from sophisticated word processors. * Reg. Trademark of IBM Corp.



NOW ONLY \$349.00 ea.

Add \$20 For Hdlg. & Pkg. - Pay Shipping When Del.



Write or Call for our Bargain-Packed PERIPHERAL FLYER!!

Prices are Subject to Change on All Items



COMPUTERS,
PERIPHERALS,
UNLIMITED!

617/372-8637

18 GRANITE STREET
HAVERHILL, MASS. 01830



MasterCharge & VISA Accepted





32K Static Ram Memory with Ultimate features

- Bank Select
- Extended Address
- 8/16 bit Data
- \$465 with 32KB
- \$295 with 16KB
- \$149 without memory chips
- All assembled and Tested

Features: Model-32KUS Uniselect: 3
 • 8/16 bit wide data • Extended Addressing, 24 bit • Bank Select by ports and bits - compatible with Cromemco, Alpha Micro, North Star and others • Fully Static and low power - 600 mA typ. • Two 16KB addressing, 32K bank select, with window capability in 2K increments • EPROM (2716) can be mixed with RAM • Provision for Battery back - up • Fast Access Time - 250 nsec, will run with Z80/Z8000 to 4 Mhz, 8086/8088 or 68000 to 8 Mhz without wait states.

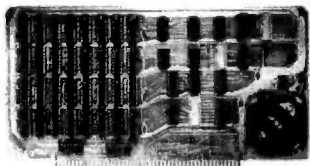

16K Static Ram Memory

- Bank Select
- \$195 Assembled and tested with lower power, 200 nsec chips

Features: Model-16KUS 'Uniselect'
 • Fully Static - uses 2114L-2
 • Bank Select by ports and bits - compatible with Cromemco, Alpha Micro

Other S-100 boards Available: Z80 CPU with 8 levels of Interrupts, I/O, ROM, RAM interface with built in Audio Cassette.

All boards conform to IEEE696/S100 specifications, fully socketed, screened legends, solder masks, Gold contacts, and Guaranteed for One Full Year. Deliver is from stock to 72 hours. Ordering: MC, Visa, C.O.D. accepted, Add \$5.00 for C.O.D. Personal check takes 7 to 15 days to clear before shipping. Undamaged boards can be returned within 10 days for full refund. Illinois residents add 5 1/4% sales tax

O.E.M. & DEALER PRICING AVAILABLE

S.C. Digital P.O. Box 906 Phone: Aurora, IL 60507 (312) 897-7749

Technical Forum

first-order equations for each problem. For example, in the rocket-launching problem, if $x_1=R$, $x_2=dR/dt$, $x_3=\theta$, and $x_4=d\theta/dt$, we obtain:

$$\frac{dx_1}{dt} = x_2$$

$$\frac{dx_2}{dt} = \frac{T}{M} \sin\phi - g + x_1(x_4)^2$$

$$\frac{dx_3}{dt} = x_4$$

$$\frac{dx_4}{dt} = \frac{T}{M} \cos\phi - \frac{2}{x_1}(x_2)(x_4)$$

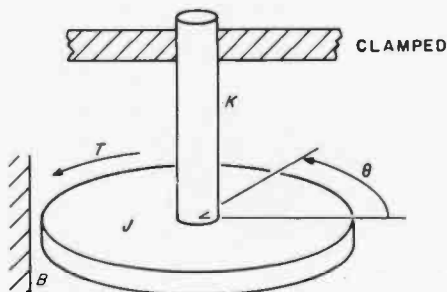

- θ = angular displacement
- J = moment of inertia
- K = spring
- B = friction
- T = torque

$$\frac{d^2\theta}{dt^2} + \frac{B}{J} \frac{d\theta}{dt} + \frac{K}{J} \theta = \frac{T}{J}$$

Figure 3: Euler's method can also be applied to the second-order differential equation of a rotational system.

MEMOREX FLEXIBLE DISCS

BUY THE BEST FOR LESS. Lowest prices. **WE WILL NOT BE UNDERSOLD!!** Buy any quantity. Call free (800) 235-4137 for prices and information. Dealer inquiries invited. C.O.D.'s accepted.

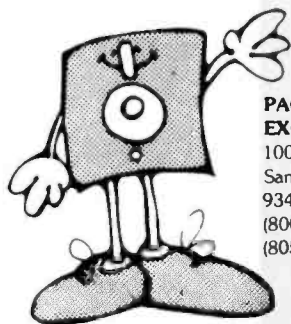

PACIFIC EXCHANGES
 100 Foothill Blvd.
 San Luis Obispo, CA
 93401. In Cal call
 (800)592-5935 or
 (805)543-1037

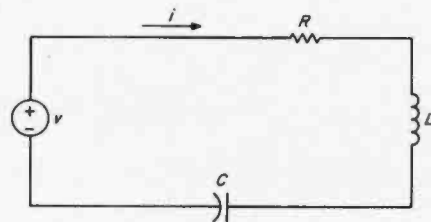

- q = charge
- i = current
- v = voltage
- R = resistance
- L = inductance
- C = capacitance

$$i = \frac{dq}{dt}$$

$$\frac{d^2q}{dt^2} + \frac{R}{L} \frac{dq}{dt} + \frac{q}{LC} = \frac{v}{L}$$

Figure 4: This RLC (resistive-inductive-capacitive) circuit is described by both first-order and second-order differential equations.

The corresponding BASIC programming is:

```

F1 = H*X2
F2 = H*(T1*SIN(P1)/M - G + X1*X4*X4)
F3 = H*X4
F4 = H*(T1*COS(P1)/M - 2*X2*X4/X1)
X1 = X1 + F1
X2 = X2 + F2
X3 = X3 + F3
X4 = X4 + F4
T = T + H
    
```

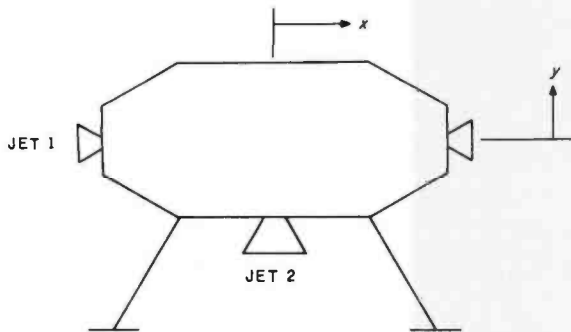

$x, y = \text{displacement}$
 $\text{Jet1, Jet2} = \text{thrust}$
 $g = \text{gravity}$

$$\frac{d^2x}{dt^2} = \pm \frac{\text{Jet1}}{M}$$

$$\frac{d^2y}{dt^2} = g - \frac{\text{Jet2}}{M}$$

Figure 5: Euler's method can be applied to a moon-landing simulation, solving the four simultaneous first-order equations derived from two second-order differential equations.

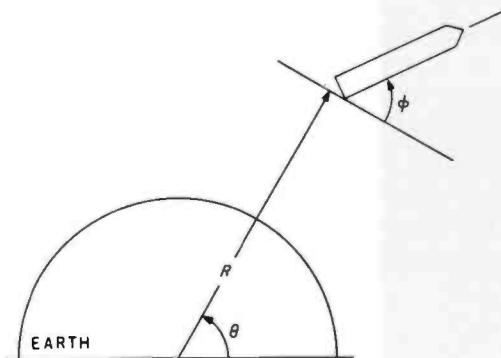

$R = \text{radial displacement}$
 $\theta = \text{angular displacement}$
 $M = \text{mass}$
 $g = \text{gravity}$
 $T = \text{thrust}$
 $\phi = \text{turnover angle}$

$$\frac{d^2R}{dt^2} - R \left(\frac{d\theta}{dt} \right)^2 = \frac{T}{M} \sin \phi - g$$

$$\frac{d^2\theta}{dt^2} + \frac{2}{R} \left(\frac{dR}{dt} \right) \left(\frac{d\theta}{dt} \right) = \frac{T}{M} \cos \phi$$

Figure 6: Solving this rocket-launch simulation involves applying Euler's method to four simultaneous first-order differential equations.

© MicroTech Exports 1980

GETS FILES ACROSS!

With **REFORMATTER** disk utilities you can read and write IBM 3740 and DEC RT-11 single density formatted diskettes on your CP/M® system.

REFORMATTER enables you to access large system databases, improve data exchange with other organizations, increase program development capabilities, and use your micro in distributed processing.

REFORMATTER programs feature bi-directional data transfer and full directory manipulation. ASCII/EBCDIC conversion provided with CP/M ↔ IBM. *MP/M is now fully supported.*

Program Data Sheets, Application Guides, and Machine Compatibility Guides available.

Each program \$195.00 from stock. Specify CP/M ↔ IBM or CP/M ↔ DEC. Order from MicroTech Exports, Inc., 467 Hamilton Ave., Suite 2, Palo Alto, CA 94301 ☐ Tel: 415/324-9114 ☐ TWX: 910-370-7457 MUH-ALTOS ☐ Dealer and OEM discounts available.

CP/M® is a registered trademark of Digital Research.

DISCOUNT PRICES

MICROCOMPUTERS
 CRT TERMINALS
 PRINTERS
 DISKETTES
 SOFTWARE

WE'RE ON THE
EAST COAST

DUPRÉ ENTERPRISES, INC.

MICROCOMPUTER SALES DIVISION

SUITE 6 NELSON BLDG. (201) 461-8086
 271 FORT LEE ROAD 9 AM-3 PM
 LEONIA, NJ 07605 MON.-FRI.

Convert your IBM Selectric®/Electronic into a letter quality printer for under \$600

Driven by any Micro or Mini Computer



12919 Alcosta Boulevard
San Ramon, CA 94583

Call Toll Free:
800-227-2148



BYTE Back Issues for sale



The following issues are available:

- 1976: July
 - 1977: April thru December except October
 - 1978: February thru December except October and November
 - 1979: January thru December except March
 - 1980: January, March thru August
 - 1981: February to current Issue except March
- Cover price for each issue through August 1977 is \$1.75
Domestic; \$2.75 Canada and Mexico; \$3.75 Foreign.
September 1977 through October 1979 issues are \$2.50
Domestic; \$3.50 Canada and Mexico; \$4.50 Foreign.
November 1979 to current is \$3.00 Domestic; \$4.00 Canada
and Mexico; \$5.00 Foreign.

Send requests with payment to:

BYTE Magazine
70 Main St, Peterborough NH 03458
Attn: Back Issues

Please allow 4 weeks for domestic delivery
and 8 weeks for foreign delivery.

* Payments from foreign countries must be made
in US funds payable at a US bank

Technical Forum

Listing 1: A BASIC program that uses Euler's method for solving differential equations. The example is used to solve the two first-order differential equations derived from the mass-spring-friction system in figure 2.

```

1 REM MASS-SPRING-FRICTION SYSTEM
5 H=0.1
10 PRINT"FRICION B/M = ",
20 INPUT B
22 IF B<0 THEN END
24 PRINT"NO. OF DATA = ",
26 INPUT N
30 X1=0
40 X2=0
50 T=0
60 FOR I=1 TO N
70 FOR J=1 TO 2
80 F1=X2
90 F2=1-B*X2-X1
100 X1=X1+H*F1
110 X2=X2+H*F2
120 T=T+H
130 NEXT J
140 PRINT"T=";T,"X1=";X1,"X2=";X2
150 NEXT I
160 GOTO 10
    
```

FRICION B/M = ? 0.4

NO. OF DATA = ? 10

| | | |
|---------|--------------|--------------|
| T = .2 | X1 = .01 | X2 = .196 |
| T = .4 | X1 = .058316 | X2 = .372714 |
| T = .6 | X1 = .140785 | X2 = .524336 |
| T = .8 | X1 = .252147 | X2 = .646391 |
| T = 1 | X1 = .386318 | X2 = .735829 |
| T = 1.2 | X1 = .536677 | X2 = .791063 |
| T = 1.4 | X1 = .696359 | X2 = .811945 |
| T = 1.6 | X1 = .858536 | X2 = .799682 |
| T = 1.8 | X1 = 1.01669 | X2 = .756717 |
| T = 2 | X1 = 1.16484 | X2 = .686553 |

FRICION B/M = ? -9

Starting with the initial location (R, θ) and velocity $(dR/dt, d\theta/dt)$, the launching orbit can be calculated with the turnover function $\phi(t)$ and the multistage rocket-thrust function $T(t)$.

One question remains. What value of h should be used in Euler's method? The h is the time increment (or step size) of the computation. Based on the numerical analysis, h must satisfy the following stability condition:

$$h < \frac{2}{\left| \frac{\partial f(t,x)}{\partial x} \right|}$$

to have a stable numerical computation. The computed solution approximates the exact solution if the value of h is chosen according to the stability condition; otherwise the computed solution may not be a solution at all. In practice, we have to use the maximum estimated value of the partial differentiation $|\partial f/\partial x|$ in the stability condition. This guarantees a stable computed solution for all cases.

Let's try Euler's method on the mass-spring-friction system shown in figure 2. The analytic solution of the system is well known. Thus, we can use this computer example as a test for the accuracy of Euler's method. Assume the following data:

$$\text{forcing function } \frac{f}{M} \begin{cases} = 1, & \text{for } t \geq 0 \\ = 0, & \text{for } t < 0 \end{cases}$$

$$\text{spring/mass ratio } \frac{k}{M} = 1$$

$$\text{friction/mass ratio } 0 \leq \frac{B}{M} \leq 10$$

and the initial conditions, $x(0)=0$ and $dx(0)/dt=0$ at $t=0$. The equivalent simultaneous first-order equations are:

$$\frac{dx_1}{dt} = x_2 = f_1$$

$$\frac{dx_2}{dt} = 1 - \frac{B}{M}x_2 - x_1 = f_2$$

The partial differentiations are:

$$\frac{\partial f_1}{\partial x_1} = 0 \quad \text{and} \quad \frac{\partial f_2}{\partial x_2} = -\frac{B}{M}$$

Thus, we should choose step size h according to the following conditions:

$$h_1 < \frac{2}{\left| \frac{\partial f_1}{\partial x_1} \right|} < \infty$$

$$h_2 < \frac{2}{\left| \frac{\partial f_2}{\partial x_2} \right|} = \frac{2}{\left(\frac{B}{M} \right)_{max}} = 0.2$$

where $h_1 < \infty$ indicates a don't-care case. Therefore, $h = h_2 < 0.2$ is the only guideline we have to follow. Let's choose $h=0.1$. The BASIC program is shown in listing 1. You specify the B/M value, and the solution is printed out immediately.

You now have a powerful computer tool for solving ordinary differential equations of the n th order. Most engineering problems are represented by ordinary differential equations. You can sit down and relax now; let your computer do the engineering design work. ■

Reference

1. Carnahan, B, H A Luther, and J O Wilkes. *Applied Numerical Methods*. New York: John Wiley & Sons Inc, 1969, pages 344 through 365.

Now Available COMPUSTAR SUPERBRAIN ♦ SUPERBRAIN 5MB

East Coast **DEALERS & OEM's** wanted

Kramer Systems International, Inc. is an authorized established distributor for the complete Intertec Data Systems Product line. We have a proven record of providing full support and services to all of our customers.

COMPUSTAR
Model 10
Model 20
Model 30
Model 40

DISC STORAGE SYSTEMS
10 MB
32 MB
96 MB

SUPERBRAIN
SUPERBRAIN 0D
SUPERBRAIN 5MB

SOFTWARE
BASIC-80
BASIC Compiler
COBOL-80
FORTRAN-80
Accounts Payable
Accounts Receivable
General Ledger
Payroll
Word Star
Mail Merge
Data Star
Super Sort
Word Master
Spell Star



FANTASTIC DISCOUNTS AVAILABLE

MAINTENANCE & SUPPORT

On-site maintenance in the Greater Washington area and selected areas throughout the east coast. Modular replacement available to all customers with 48 hour response in most cases. Our maintenance personnel are experienced knowledgeable professionals who have trained government and commercial technicians in the repair and maintenance of the Superbrain.

Kramer Systems International, Inc. has successfully installed hundreds of COMPUSTARS, SUPERBRAINS and INTERTUBES throughout the world.

Join the **WINNING TEAM** —
Fantastic opportunities exist NOW!!!

Call or Write
KRAMER SYSTEMS INTERNATIONAL, INC.

8403 Dixon Avenue
Silver Spring, MD 20910
301-585-7480

SB-80

The Price Is Nice.



Introductory offer... \$2425.

- Basic system with: 600K bytes
- 1.2 megabytes \$2990.
 - 2.4 megabytes \$3490.

Single Board Technology

A Z80A CPU combined with the CP/M® operating system opens new vistas to software availability for eight-bit micros. FORTRAN, COBOL, BASIC, APL, PL/1 and Pascal are available now to accommodate today's scientific, educational, sophisticated small business and personal system users.

- 4 MHz Z80A CPU
- CP/M 2 operating system
- 64K 200ns main memory
- 8-inch dual floppy drives
- 50-pin expansion connector
- 2-serial ports
- 2-parallel ports
- 4-counter/timers
- Hard disk options available

Quantity discounts are available. OEM inquiries are invited. Please contact:

S & M Systems, Inc.
P.O. Box 1225, 2 Washington Street
Haverhill, MA. 01830
(617) 373-1599

• CP/M is a registered trademark of Digital Research, Inc.
See us at the N.E. Computer Show, Oct. 15-18, Booth 822

Build a Versatile Keyboard Interface for the S-100

David R Richards
c/o BYTE Publications Inc
POB 372
Hancock NH 03449

One of the first decisions you confront as the builder or purchaser of a microcomputer is how to communicate with it. There are three options:

- Use the front panel (if one exists). This is so slow, awkward, and error-prone that it merits no further discussion.
- Interface a video terminal or teletypewriter to the computer, usually by means of a serial I/O (input/output) port. This solution is easy to implement, but is often quite expensive.
- Interface a keyboard to the computer for input and use a video display processor driving a television monitor for output. Since it uses the intelligence of the microprocessor instead of duplicating it, this method is lower in cost and superior in flexibility when compared to a stand-alone terminal.

One goal in building my S-100 system was the development of hardware and software to provide all the capabilities of an intelligent text-editing terminal that could be used to communicate with a mainframe timesharing system. The third alternative was clearly the way to go. I discovered that while suitable video processors are readily available, keyboards are more of a problem. The only one I found was a surplus keyboard unit.

The keyboard I chose was manufactured by Clare-Pendar. This and very similar keyboards are available from several sources. It will output the full 7-bit ASCII character

set and has both a normal shift lock and an uppercase lock that affects only the alphabetic characters and a few special characters—putting the keyboard into a 6-bit ASCII or TTY mode. It generates a positive-going strobe signal whenever a character-generating key is pressed. Several special function keys are provided, including Repeat and Break keys; however, these keys only ground their associated output lines. The keyboard uses a MOS (metal-oxide semiconductor) encoder device and requires -12 VDC and $+5$ VDC.

Keyboard Interface

There is a significant reason why a standard parallel I/O board cannot provide an adequate interface to this keyboard. A standard handshaking parallel-input port issues a *busy* signal when it is waiting for the processor to accept a character in its buffer. If a keyboard that does not have a *busy* input outputs another character during this time, the contents of the input buffer will be changed. In most systems, this does not actually occur, since the processor has no trouble keeping up with a human operator. However, in an interrupt driven real-time system, the keyboard input process may be preempted by a higher-priority process and thus may be unable to handle characters as fast as they are typed. In such a circumstance, the keyboard must be locked out until the processor is able to accept input; otherwise, characters will be skipped.

The inverse problem is more likely when mating a surplus keyboard to a microcomputer: if the key signal lasts

longer than it takes the processor to read a character in the buffer, this character will be read over and over until the signal terminates. Both of these problems are avoided if the busy signal clears the key signal immediately and blocks any subsequent key signals until the processor reads the character. Since most keyboards do not provide such a facility, it must be provided by the interface.

Since my Clare-Pendar keyboard has no on-board repeat oscillator, this must also be included in the interface. If the Repeat key is held down while any character-generating key is pressed, I wanted that character to be repeated until the key is released.

Finally, I wanted the Break key to be operational, since some timesharing systems take special action on sensing a Break. Break is not a control character; on a terminal with a standard current loop interface, it open circuits the current loop as long as it is pressed. For an RS-232C interface, Break forces the transmit line to a space condition as long as it is pressed. Thus, it is necessary for software to sense when the Break key is pressed and released. The serial communication interface I use is based on a 6850 ACIA (asynchronous communications interface adapter), and this software outputs the appropriate code to the device control register to cause a Break (space) level to be transmitted when the Break key is first pressed and then resets the control register when the key is released.

For the reasons outlined above, I designed and built a special-purpose keyboard interface. It is basically a standard parallel input port, but it

The keyboard is addressed as two adjacent I/O channels; the control/status channel is the even address, while the data channel is the odd address.

also handles the busy signal on board, incorporates a repeat oscillator, allows the processor to ascertain the status of the Break key, and provides both +5 VDC and -12 VDC to the keyboard. I also decided to make provision for connecting a paper-tape reader in place of the keyboard in order to load software supplied on that medium (rare though it is these days).

Software Interface

The keyboard is addressed as two adjacent I/O channels; the control/status channel is the even address, while the data channel is the odd address. Any pair of addresses may be chosen by appropriate strapping of true or inverted A1 through A7 address lines to the inputs of IC10 (see figure 1). The true address signal is used if the corresponding bit in the chosen address is a 1 and the inverted signal is used if the bit is a 0.

Output to the control/status channel is used to enable or disable interrupts from the interface. If bit 0 is a 1, interrupts are enabled; if it is a 0, interrupts are disabled. The rest of the bits are ignored. Interrupts are also disabled when power is first applied.

If enabled, an interrupt signal is generated whenever a character is output by the keyboard and is available to the processor, or while the Break key is pressed. This signal may be strapped to the interrupt line (INT) or any of the vectored interrupt lines (VI0 - VI7) if a vectored interrupt controller is used.

Input from the control/status channel enables the processor to read the keyboard status register. Bit 0 is a 1 whenever an interrupt would be

CPU'S & SUPPORT CHIPS

| | | | |
|------------|--------|------------------|---------|
| 8080A | - 3.75 | 8226 | - 2.75 |
| 8085A | - 7.50 | 8228 | - 4.50 |
| AM2301 | - 8.95 | 8251 | - 6.95 |
| 8212 | - 3.60 | 8257 | - 7.95 |
| 8214 | - 2.90 | 280A 510 | - 12.95 |
| 8224 | - 4.50 | 8275 | - 16.95 |
| MM5307 | - .95 | | |
| 2114L3 | - 2.75 | 2706 | - 4.95 |
| 4116-3 | - 2.50 | 2716 5V | - 4.95 |
| 4116-2 | - 3.50 | 2832 | - 16.95 |
| 2110Z-3 | - 3.00 | 8253 | - 1.95 |
| 2102-4 | - 3.00 | 825115 | - 4.95 |
| MK4027-3 | - 3.50 | 825127 | - 2.25 |
| MK4026-11 | - 2.95 | 825126 | - 1.95 |
| TMS4045 25 | - 4.50 | 825129 | - 2.25 |
| MS5404NL | - 3.95 | 825131 | - 2.25 |
| 2101-1 | - 2.45 | 825130 | - 1.95 |
| MS5270 | - 3.95 | AM9218C | - 2.95 |
| MK4008P | - 1.95 | 8256-6 (174188A) | - 1.25 |
| IM7001 | - 4.95 | | |

| | | | |
|----------|--------|------------|--------|
| UART's | | | |
| AYS 1013 | - 3.75 | M8880A | - 8.95 |
| TR1602B | - 3.95 | COV2017 | - 3.75 |
| PT1482B | - 3.75 | AY3-8500-1 | - 1.95 |
| AY3-8700 | - 2.25 | | |

| | | | |
|---------------------|--------|-----------------|--------|
| INTERFACE & DRIVERS | | SHIFT REGISTERS | |
| 1488 | - .90 | MM1402 | - 1.75 |
| 1489 | - 1.10 | MM1403 | - 1.75 |
| 8130 | - 2.50 | MM1404 | - 1.75 |
| 8830 | - 2.50 | MM5013 | - 1.50 |
| 8833 | - 2.50 | MM5016 | - 2.50 |
| 8834 | - 2.50 | MM5095 | - 2.50 |
| 8837 | - 2.00 | MM5096 | - 2.50 |
| 8838 | - 2.00 | MM5097 | - 2.50 |
| 87380 | - 1.00 | MM5098 | - 2.50 |
| MM5369 | - 2.50 | MM5099 | - 2.50 |

| | |
|--------------------------|-----------|
| 14 PIN HEADERS | 3.75/1.00 |
| 16 PIN HEADERS | 4.00 |
| 24 PIN HEADERS | 7.50 |
| 40 PIN HEADERS | 1.10 |
| 50 PIN EDGEBOARD CONN. | 3.95 |
| 26 PIN EDGEBOARD CONN. | 2.50 |
| 50 PIN RIGHT ANGLE CONN. | 3.95 |
| 20 PIN RIGHT ANGLE CONN. | 2.25 |

| | |
|------------------------|---------|
| PRINTED CIRCUIT BOARD | |
| 4" x 6" DOUBLE SIDED | |
| EPoxy BOARD 1/4" THICK | |
| 6.60 ea. | 5.42/60 |

| | |
|--------------------------------|--------|
| EPoxy GLASS VECTOR BOARD | |
| 1/16" thick with 1/10" spacing | |
| 4 1/2" x 6 1/2" | \$1.95 |

| | |
|--|---------|
| DATL'S DAC-08E0 | |
| 8 bit DAC - \$7.95 | |
| INTER-SIL DIGIBP ANALOG SWITCH/7 CHANNEL DRIVERS | \$11.50 |
| INTER-SIL FT04-12 CPK 12 BIT A/D CONVERTER | \$26.50 |
| REDICON SAD 1024 ANALOG SWITCH | \$10.95 |

| | | |
|----------|------------|------------|
| 74800 30 | 74574 70 | 745158 125 |
| 74502 30 | 74586 70 | 745159 175 |
| 74503 30 | 74589 190 | 745160 175 |
| 74504 40 | 74512 70 | 745161 150 |
| 74506 45 | 745133 140 | 745175 175 |
| 74508 40 | 745135 150 | 745184 150 |
| 74510 30 | 745138 175 | 745257 150 |
| 74511 35 | 745130 110 | 745258 140 |
| 74515 40 | 745130 110 | 745260 150 |
| 74520 40 | 745153 110 | 745280 150 |
| 74530 40 | 745151 175 | 745373 225 |
| 74532 40 | 745157 125 | |

| | |
|--|----------|
| 7 WATT LD 65 LASER | |
| DIODE IR \$8.95 | |
| 25 watt Infra Red Pulse (SG 2006 equiv.) Laser Diode (Spec sheet included) \$24.95 | |
| 2N3820 P FET | \$.45 |
| 2N5457 N FET | \$.45 |
| 2N2646 UJT | \$.45 |
| ER 900 TRIGGER DIODES | \$41/100 |
| 2N 6028 PROG. UJT | \$.65 |

| | | |
|-----------------|----------|-----------|
| DISC CAPACITORS | | |
| 1UF 16V | 10/51.00 | 100/58.00 |
| 01UF 35V | 16/51.00 | 100/55.00 |

| | |
|----------------|---------|
| IN4148 (IN914) | 15/1.00 |
|----------------|---------|

| | |
|---------------------|------------------|
| TANTALUM CAPACITORS | |
| 47UF 35V \$51.00 | 10UF 35V \$.40 |
| 68UF 35V \$51.00 | 22UF 10V \$.30 |
| 1UF 35V \$51.00 | 15UF 16V \$31.00 |
| 2.2UF 20V \$51.00 | 30UF 6V \$14.00 |
| 3.3UF 20V \$51.00 | 33UF 20V \$.60 |
| 4.7UF 35V \$51.00 | 47UF 20V \$.85 |
| 6.8UF 35V \$31.00 | 120UF 6V \$.78 |
| | 200UF 20V \$1.25 |

| | |
|--------------------|---------|
| SANKEN | |
| AUDIO POWER AMPS | |
| Si 1010 G 10 WATTS | \$ 7.50 |
| Si 1020 G 20 WATTS | \$12.50 |
| Si 1050 G 50 WATTS | \$27.50 |
| 200 PRV 1A LASCR | .95 |

| | |
|---------------|--------|
| RS232 | |
| CONNECTORS | |
| DB 25P male | \$3.25 |
| DB 25S female | \$4.25 |
| HOODS | \$1.50 |

| | |
|---|--|
| POSTAGE RATES | |
| ADD 10% FOR ORDERS UNDER \$20.00 | |
| ADD 5% FOR ORDERS BETWEEN \$20.00 AND \$50.00 | |
| ADD 3% FOR ORDERS ABOVE \$50.00 | |

C/MOS

| | | | | | | | |
|------|------|------|--------|-------|--------|--------|--------|
| 4001 | - 20 | 4027 | - 40 | 4081 | - 20 | 74C74 | - 40 |
| 4002 | - 20 | 4028 | - 36 | 4082 | - 20 | 74C78 | - 40 |
| 4006 | - 85 | 4029 | - 75 | 4083 | - 80 | 74C83 | - 130 |
| 4007 | - 27 | 4030 | - 25 | 4089 | - 175 | 74C85 | - 140 |
| 4008 | - 65 | 4034 | - 2.25 | 4091 | - 95 | 74C86 | - 90 |
| 4009 | - 45 | 4035 | - 75 | 4092 | - 65 | 74C90 | - 90 |
| 4010 | - 45 | 4040 | - 65 | 4093 | - 65 | 74C93 | - 90 |
| 4011 | - 45 | 4041 | - 95 | 4094 | - 65 | 74C94 | - 90 |
| 4012 | - 20 | 4043 | - 95 | 4095 | - 1.50 | 74C95 | - 175 |
| 4013 | - 30 | 4044 | - 95 | 4096 | - 25 | 74C160 | - 1.00 |
| 4014 | - 95 | 4045 | - 95 | 4097 | - 1.75 | 74C161 | - 1.00 |
| 4015 | - 55 | 4047 | - 90 | 4098 | - 70 | 74C163 | - 1.15 |
| 4016 | - 95 | 4048 | - 95 | 4099 | - 1.75 | 74C165 | - 1.25 |
| 4017 | - 80 | 4050 | - 40 | 74C00 | - 27 | 74C173 | - 1.00 |
| 4018 | - 95 | 4051 | - 85 | 74C02 | - 27 | 74C174 | - 1.30 |
| 4019 | - 45 | 4052 | - 75 | 74C08 | - 30 | 74C176 | - 1.00 |
| 4020 | - 70 | 4053 | - 75 | 74C09 | - 27 | 74C192 | - 1.00 |
| 4021 | - 55 | 4054 | - 95 | 74C14 | - 50 | 74C195 | - 1.00 |
| 4022 | - 80 | 4059 | - 20 | 74C20 | - 27 | 74C206 | - 5.50 |
| 4023 | - 20 | 4071 | - 25 | 74C22 | - 45 | | |
| 4024 | - 45 | 4072 | - 20 | 74C73 | - 75 | | |
| 4025 | - 25 | 4076 | - 55 | | | | |
| | | 4077 | - 35 | | | | |

| | |
|--|----------|
| SPECIALS | |
| 8X300 - SIGNETICS 16 BIT MICROCONTROLLER | 89.00 |
| 4 ea. 2716 (1+5V) | 22.00 |
| 8 ea. 4116-3 RAM'S | 16.75 |
| 10 ea. B164E 64K RAM (150NS) | 99.50 |
| L144H IR + VISIBLE DETECTOR | 3/\$1.00 |
| MM5307 - Baud Rate Generator | \$9.95 |
| 50 PIN RIBBON CONNECTORS | 3.95 |
| 40 PIN RIBBON CABLE CONN. | 3.25 |
| 20 PIN RIBBON CABLE CONN. | 2.65 |
| 10 PIN RIBBON CABLE CONN. | 1.75 |

| | |
|---|--|
| RS 232 CABLE | |
| 10 Conductor, # 22 color coded wire, gray PVC outer cover, 3/8" diameter .40 per ft. - 100'/\$30.00 | |
| Add 20% postage for orders under 100' | |
| Add 10% postage for orders over 100' | |
| SPECIALS GOOD THRU OCT. 1981 | |

| | |
|---------------------|------------|
| CRYSTALS \$3.45 ea. | |
| 2.000 MHz | 6.144 MHz |
| 3.000 MHz | 10.000 MHz |
| 3.57 MHz | 18.000 MHz |
| 5.000 MHz | 18.432 MHz |
| 6.000 MHz | 20.000 MHz |

| | |
|--------------|------------------|
| DIP SWITCHES | |
| CTS 206-4 | 4 POSITION 1.25 |
| CTS 206-8 | 8 POSITION 1.50 |
| CTS 206-10 | 10 POSITION 1.95 |

| | |
|--------------------------------|--------------------|
| MINIATURE MULTI-TURN TRIM POTS | |
| 50, 100, 5K, 10K, 250K | \$.75 each 3/42.00 |

| | |
|-------------------------------------|--------|
| NO. 30 WIRE WRAP WIRE SINGLE STRAND | |
| 100' | \$1.40 |

| | |
|-----------------------|----------|
| 40 CONDUCTOR 3M CABLE | |
| #28 WIRE | \$.75/FT |

| | | | |
|------------------|------|------|-------|
| SCR's | | | |
| 1.6A 6A 35A 110A | | | |
| 100 | 45 | 80 | 1140 |
| 200 | 70 | 1190 | 9.00 |
| 400 | 1.20 | 1.40 | 2.60 |
| 600 | 1.80 | 3.60 | 15.00 |

| | | | | | | |
|-----------------------------|-----|-----|------|------|-------|-------|
| TRIAC's | | | | | | |
| PRV 1A 3A 12A 50A 125A 240A | | | | | | |
| 100 | .06 | .14 | .35 | .90 | 4.25 | 6.00 |
| 200 | .07 | .20 | .40 | 1.30 | 5.25 | 9.00 |
| 400 | .09 | .25 | .65 | 1.50 | 6.50 | 12.00 |
| 600 | .11 | .30 | .80 | 2.00 | 8.50 | 15.00 |
| 800 | .15 | .35 | 1.00 | 2.50 | 10.50 | 18.00 |
| 1000 | .20 | .45 | 1.25 | 3.00 | 12.50 | 26.00 |

| | |
|---|-----------|
| FP 100 PHOTO TRANS | \$.50 |
| RED, YELLOW, GREEN or AMBER LARGE LED'S 2" | \$1.00 |
| RED/GREEN BIPOLEAR LED'S | \$.95 |
| MALC02 IR LED | \$.75 |
| MRO14B PHOTO DARL XTOR | \$.50 |
| IL-S OPTO-ISOLATOR | \$.45 |
| IWATT ZENERS: 3.3, 4.7, 5.1, 5.6, 6.8, 8.2, 9.1, 10, 12, 15, 18, or 22V | \$.61/100 |

| | |
|----------------------------|--------|
| SFC 3301 - 50 PRV 30A | |
| FAST RECOVERY DIODE (35ns) | \$2.25 |
| 20KV 250MA DIODE | \$1.90 |

| | | | | | | |
|-----------------------------|-----|-----|------|------|-------|-------|
| SILICON POWER RECTIFIERS | | | | | | |
| PRV 1A 3A 12A 50A 125A 240A | | | | | | |
| 100 | .06 | .14 | .35 | .90 | 4.25 | 6.00 |
| 200 | .07 | .20 | .40 | 1.30 | 5.25 | 9.00 |
| 400 | .09 | .25 | .65 | 1.50 | 6.50 | 12.00 |
| 600 | .11 | .30 | .80 | 2.00 | 8.50 | 15.00 |
| 800 | .15 | .35 | 1.00 | 2.50 | 10.50 | 18.00 |
| 1000 | .20 | .45 | 1.25 | 3.00 | 12.50 | 26.00 |

| | | | |
|-------------|--------|--------|--------|
| CLOCK CHIPS | | | |
| MM5314 | \$4.75 | MM5316 | \$4.95 |
| MM5387AA | 5.95 | | |

| | |
|--------------------------|--------|
| .5V at 800ma SOLAR CELLS | |
| 3" diameter | \$4.35 |

| | |
|--------------------|-------------------------|
| 7 SEGMENT DISPLAYS | |
| FSC8024 4 digit | DL-707 C.A. 3" \$7.50 |
| C.C. 8" display | \$5.95 |
| FND 503 C.C. 5" | \$8.95 |
| FND 510 C.C. 5" | \$8.95 |
| DL-704 .3" C.C. | MAN 5 C.C. Green \$7.50 |
| MAN 82 C.A. | Yellow \$7.50 |

TRANSISTOR SPECIALS

| | |
|---------------------------------|---------|
| JN1307 PNP GE TO 5 | 1.40 |
| JN404A PNP GE TO 18 | 3/41.00 |
| MEP 6014 - PNP GE TO 18 | 81.95 |
| TIP 111 - PNP 1.50 TIP 145 | 81.95 |
| 2N6233 NPN SWITCHING POWER | 81.95 |
| 1N4001 50V 1A SILICON RECTIFIER | 11.00 |
| 2N3772 NPN ST TO 3 | 11.00 |
| 2N4349 NPN ST TO 3 | 11.00 |
| 2N3737 NPN ST TO 3 | 11.00 |
| 2N3738 NPN ST TO 3 | 11.00 |
| 2N3739 NPN ST TO 3 | 11.00 |
| 2N3740 NPN ST TO 3 | 11.00 |
| 2N3741 NPN ST TO 3 | 11.00 |
| 2N3742 NPN ST TO 3 | 11.00 |
| 2N3743 NPN ST TO 3 | 11.00 |
| 2N3744 NPN ST TO 3 | 11.00 |
| 2N3745 NPN ST TO 3 | 11.00 |
| 2N3746 NPN ST TO 3 | 11.00 |
| 2N3747 NPN ST TO 3 | 11.00 |
| 2N3748 NPN ST TO 3 | 11.00 |
| 2N3749 NPN ST TO 3 | 11.00 |
| 2N3750 NPN ST TO 3 | 11.00 |
| 2N3751 NPN ST TO 3 | 11.00 |
| 2N3752 NPN ST TO 3 | 11.00 |
| 2N3753 NPN ST TO 3 | 11.00 |
| 2N3754 NPN ST TO 3 | 11.00 |
| 2N3755 NPN ST TO 3 | 11.00 |
| 2N3756 NPN ST TO 3 | 11.00 |
| 2N3757 NPN ST TO 3 | 11.00 |
| 2N3758 NPN ST TO 3 | 11.00 |
| 2N3759 NPN ST TO 3 | 11.00 |
| 2N3760 NPN ST TO 3 | 11.00 |
| 2N3761 NPN ST TO 3 | 11.00 |
| 2N3762 NPN ST TO 3 | 11.00 |
| 2N3763 NPN ST TO 3 | 11.00 |
| 2N3764 NPN ST TO 3 | 11.00 |
| 2N3765 NPN ST TO 3 | 11.00 |
| 2N3766 NPN ST TO 3 | 11.00 |
| 2N3767 NPN ST TO 3 | 11.00 |
| 2N3768 NPN ST TO 3 | 11.00 |
| 2N3769 NPN ST TO 3 | 11.00 |
| 2N3770 NPN ST TO 3 | 11.00 |
| 2N3771 NPN ST TO 3 | 11.00 |
| 2N3772 NPN ST TO 3 | 11.00 |
| 2N3773 NPN ST TO 3 | 11.00 |
| 2N3774 NPN ST TO 3 | 11.00 |
| 2N3775 NPN ST TO 3 | 11.00 |
| 2N3776 NPN ST TO 3 | 11.00 |
| 2N3777 NPN ST TO 3 | 11.00 |
| 2N3778 NPN ST TO 3 | 11.00 |
| 2N3779 NPN ST TO 3 | 11.00 |
| 2N3780 NPN ST TO 3 | 11.00 |
| 2N3781 NPN ST TO 3 | 11.00 |
| 2N3782 NPN ST TO 3 | 11.00 |
| 2N3783 NPN ST TO 3 | 11.00 |
| 2N3784 NPN ST TO 3 | 11.00 |
| 2N3785 NPN ST TO 3 | 11.00 |
| 2N3786 NPN ST TO 3 | 11.00 |
| 2N3787 NPN ST TO 3 | 11.00 |
| 2N3788 NPN ST TO 3 | 11.00 |
| 2N3789 NPN ST TO 3 | 11.00 |
| 2N3790 N | |

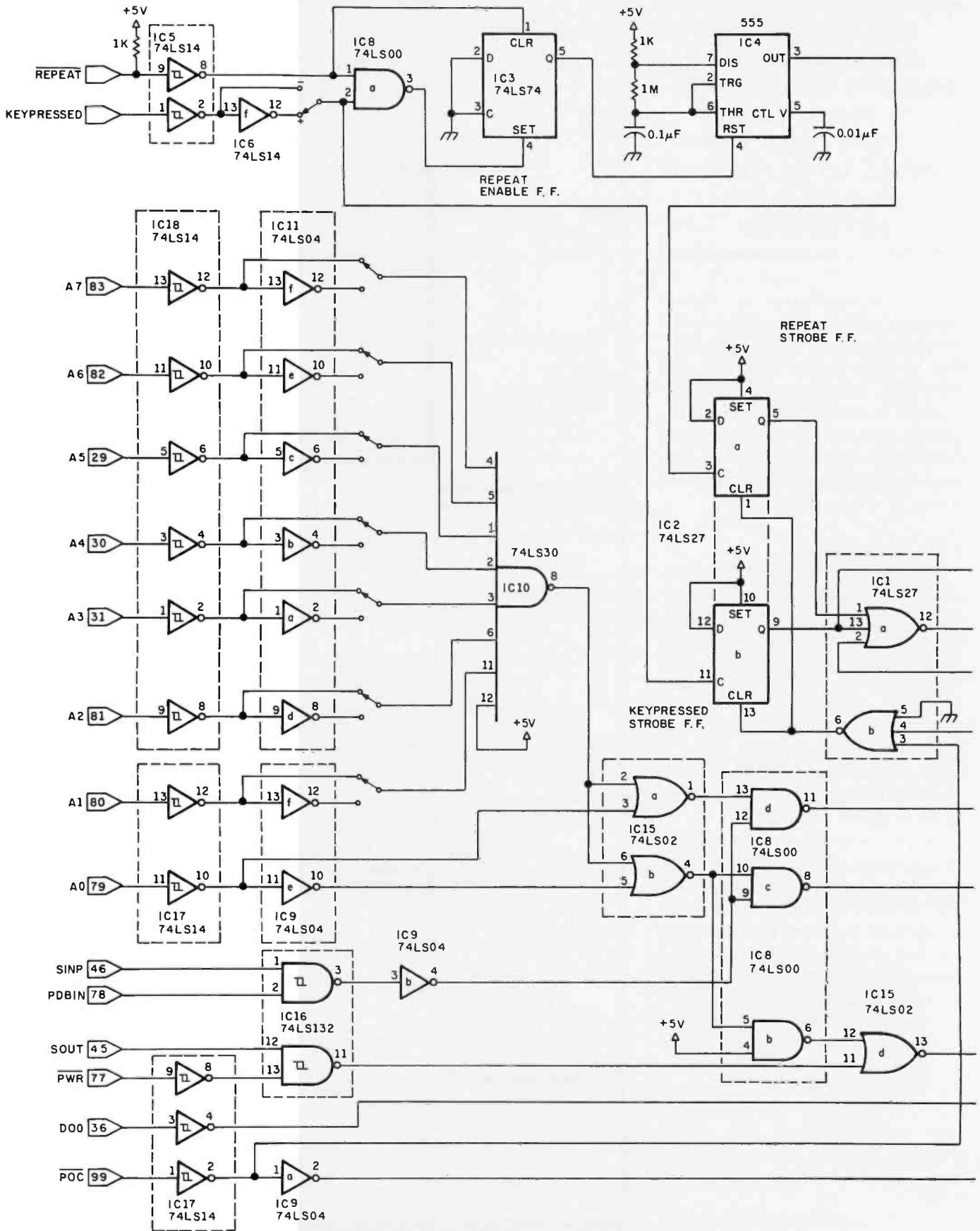
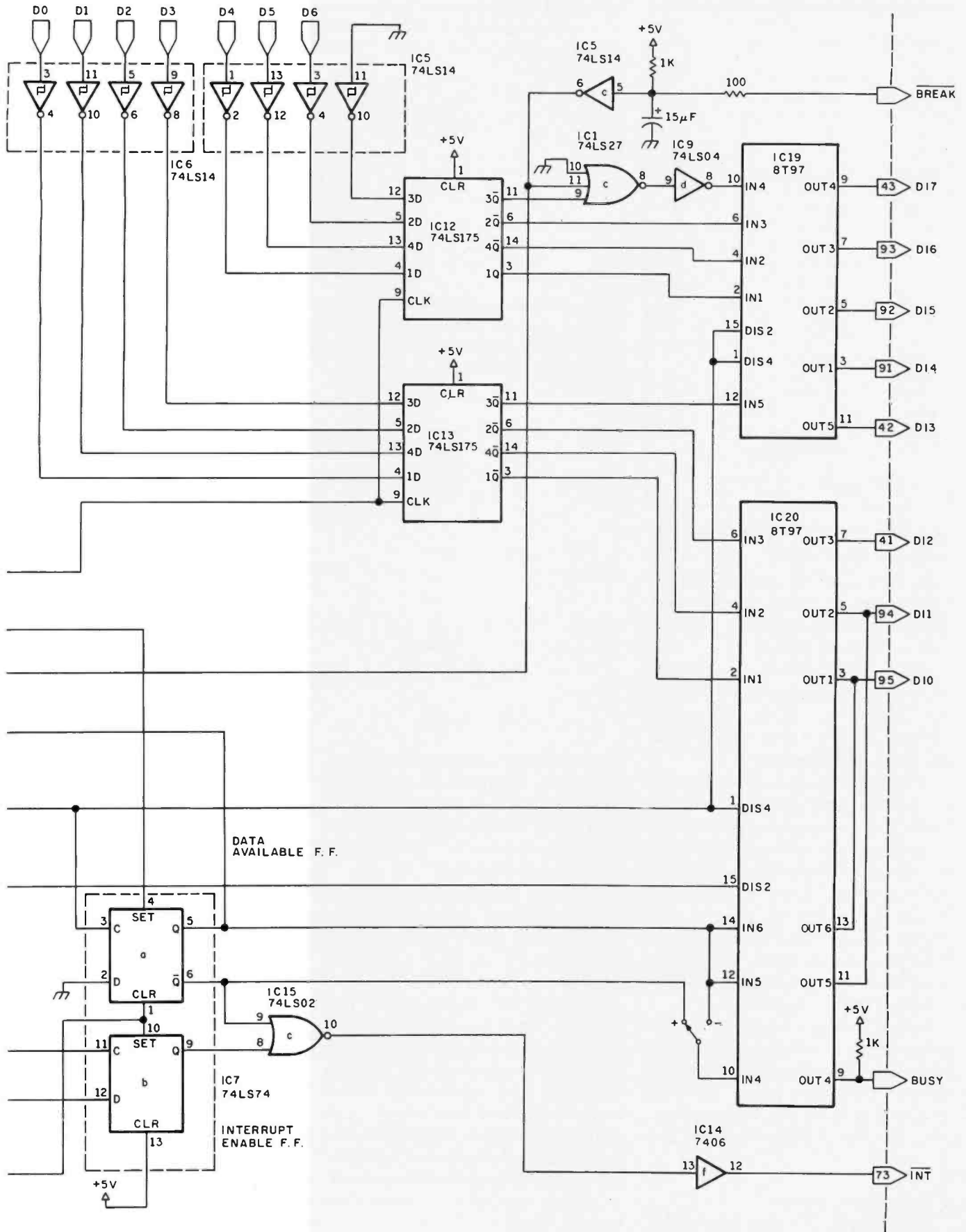

Figure 1: Schematic diagram for the S-100 keyboard interface. The address jumpers shown are for channels 0 and 1. Keypressed and busy signals may be active high (+ jumper) or active low (- jumper). If a vectored interrupt board is used, the interrupt signal may be jumpered to the processor interrupt line (INT) or any of the vectored interrupt lines (V10 through V17). The interrupt sig-



nal should be left unconnected if interrupts are not used. Data line D7 should be connected to ground inside the keyboard cable 25-pin plug. If a paper-tape reader is connected in place of the keyboard, D7 is used for the high-order data bit. (See power connections on page 404.)

selected, coincidence of PDBIN and SINP causes H-8 to go low, enabling the status drivers so the processor can read the state of the Data-Available flip-flop. Coincidence of PWR and SOUT causes G-13 to go high, clocking DO0 into the Interrupt-Enable flip-flop.

If the data channel is selected, coincidence of PDBIN and SINP causes H-11 to go low, enabling the data drivers so the processor can read the latched-keyboard data. The trailing (rising) edge of this signal also clocks a 0 into the Data-Available flip-flop, clearing it.

The Break signal, after conditioning, is ORed with bit 7 of the data latch IC12. The keyboard generates only 7 bits of data, so bit 7 is strapped to ground inside the keyboard connector plug and the processor interprets bit 7 as the Break key. The Break signal is also ORed with the outputs of the Keypressed-Strobe and Repeat-Strobe flip-flops and hence, like them, can set the Data-Available flip-flop.

If a paper-tape reader is connected in place of the keyboard, the Break input is left unconnected so that bit 7 is used for data from the reader. The true or inverted Data Available signal is also available on the busy line T-6 to allow a conventional handshaking interface with the reader.

If the Interrupt-Enable and Data-Available flip-flops are both set, the output T-12 of the interrupt bus driver goes low.

The Power-On Clear signal (POC) initializes the interface by clearing the Keypressed-Strobe, Repeat-Strobe, Data-Available, and Interrupt-Enable flip-flops.

Construction

I constructed the interface on a Processor Technology wire-wrap prototype board. This is supplied with the LM340T-5 regulator, heat sink, and decoupling capacitors needed for the +5 VDC supply. I constructed a zener-regulated -12 VDC supply in the discrete component area below the heat sink.

Wire-wrap sockets (16-pin) are not supplied with the board and must be obtained separately. Figure 3 shows

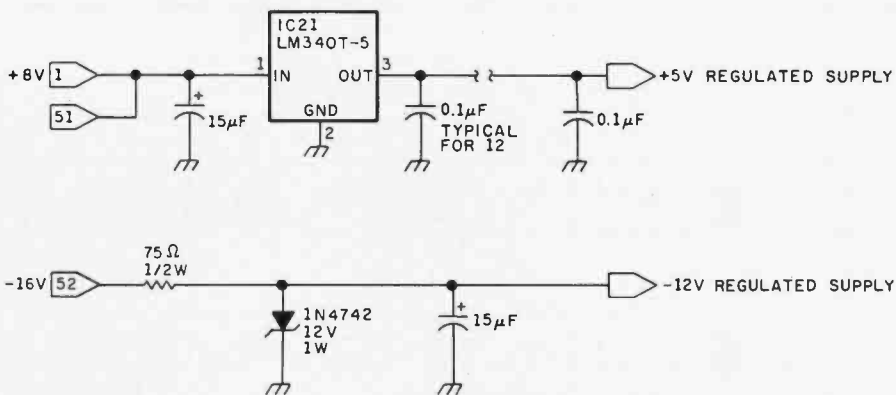

Figure 2: Schematic diagram of the interface power supply. The 0.1 µf capacitors on the +5 VDC output are ceramic disk despiking capacitors.

recommended component placement, designed to simplify interconnections and minimize wire lengths. All pins of the lower row of sockets, which provide connections to the bus lines, should be soldered to the board. It is sufficient to solder the four corner pins of the rest of the sockets. The sockets should be oriented so that, when viewed from the rear (pin) side of the board, pin 1 is in the upper left-

hand corner, pin 8 is soldered to the ground land, and pin 16 is soldered to the +5 VDC land. Between each pair of sockets, a pair of holes is left, one connected to +5 VDC and the other connected to ground. These are intended for the installation of 0.1 µf ceramic disk bypass capacitors for +5 VDC supply despiking. I installed the capacitors at the locations shown in figure 3. (The disk

THE TSE-HARDSIDE 1982 MICRO-COMPUTER BUYER'S GUIDE

TSE-HARDSIDE

1982
Micro-
Computer
Buyer's
Guide

is now available! We've included such valuable information as print samples from each of the printers we carry, feature-by-feature comparisons of Micro-Computer systems in an easy-to-read table format, an informative article on Micros, and pages and pages of complete product descriptions.

We're making this valuable reference available for only \$2.95 (refundable on your next purchase from TSE-HARDSIDE.) Charge customers are welcome to call our toll-free number: 1-800-258-1790 (in NH call 673-5144) THE TSE-HARDSIDE 1982 MICRO-COMPUTER BUYER'S GUIDE will soon arrive at your address via first class mail.

Send to:

TSE-HARDSIDE
Dept. C, 14 South Street
Milford, NH 03055

Yes! Send me the B10
TSE-HARDSIDE 1982 Micro-Computer Buyer's Guide.

I've enclosed \$2.95 Please send only your FREE Price List
Charge to my credit card MasterCard Visa

Card No. _____
Interbank No. _____ Exp. Date _____
Signature _____
Name _____
Address _____
City _____
State _____ Zip Code _____

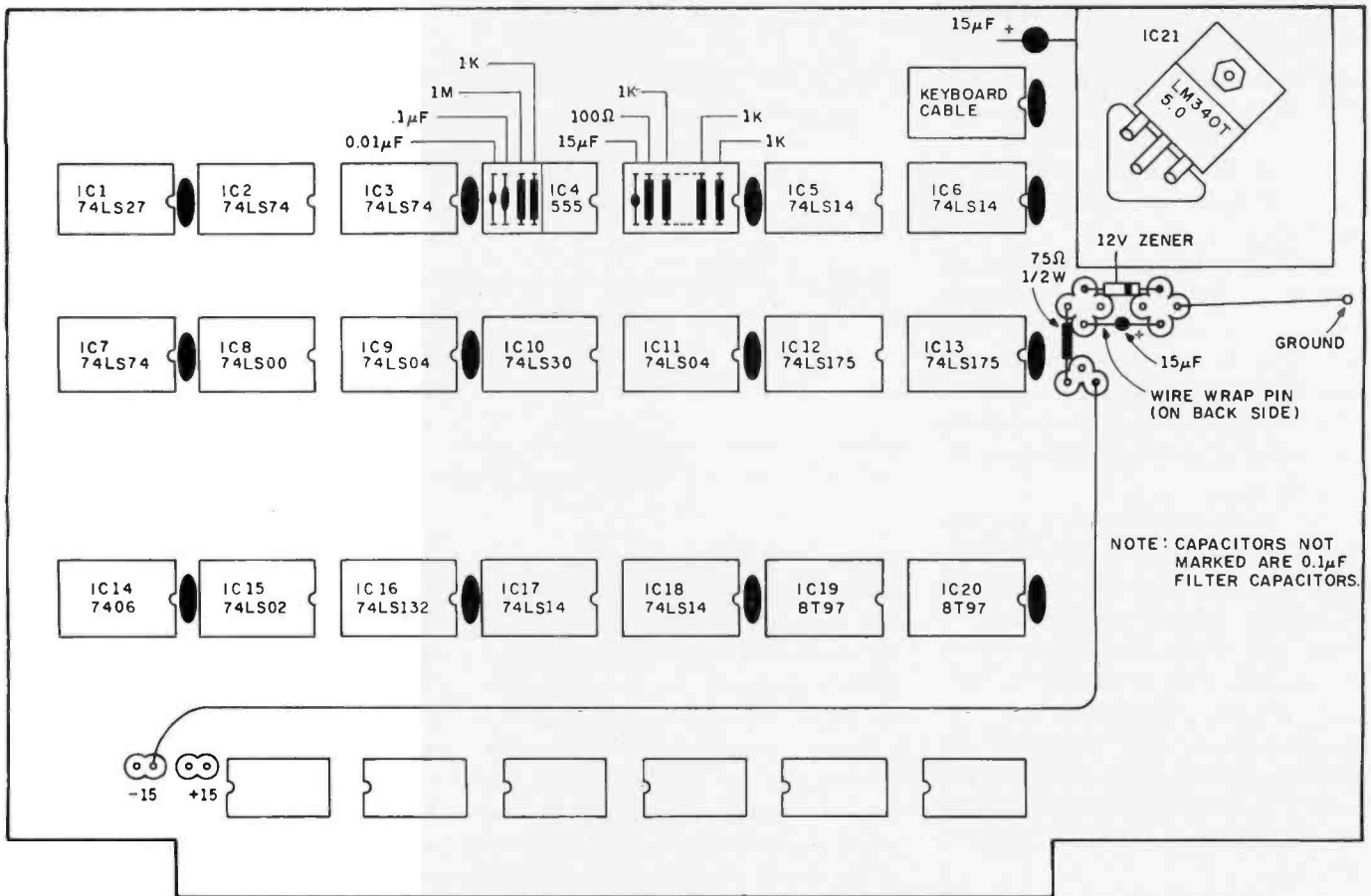

Figure 3: Component placement for the interface board. The ceramic disk despiking capacitors referred to in figure 2 are shown between the integrated circuit sockets.

| Function | Interface 16-Pin DIP Connector | Back Panel DB-25S Connector | Clare-Pendar Keyboard Edge Connector |
|----------|--------------------------------|-----------------------------|--------------------------------------|
| KP | 2 | 1 | H |
| BUSY | 15 | 2 | — |
| D0 | 3 | 3 | 3 |
| D1 | 14 | 4 | C |
| D2 | 4 | 5 | 4 |
| D3 | 13 | 6 | D |
| D4 | 5 | 7 | B |
| D5 | 12 | 8 | 1 |
| D6 | 6 | 9 | A |
| D7 | 11 | 10 | — |
| REPEAT | 7 | 11 | 5 |
| BREAK | 10 | 12 | E |
| + 5 VDC | 16 | 15 | 9 |
| - 12 VDC | 1 | 14 | 10 |
| GROUND | 8 | 13 | 8 |

Table 1: Pinout connections for the cable between the keyboard and the S-100 interface board.

capacitors supplied with the board were too large to fit between the sockets and I had to use physically smaller ones.)

All integrated circuits, regardless of the number of pins, are inserted with pin 1 in pin 1 of the 16-pin sockets. It is then necessary to install a short

wire-wrapped jumper from pin 8 (ground) of the socket to pin 7 for 14-pin circuits and to pin 1 for the 8-pin 555.

The discrete timing components for the 555 oscillator, the pull-up resistors for the repeat and busy lines, and the components for the break line conditioning circuit are soldered to two DIP (dual in-line pin) header plugs as shown in figure 3. These plugs are then installed in sockets at the locations shown.

Connections to the keyboard are made through a 16-pin socket. I used a 16-conductor flat cable jumper with a DIP plug at one end to connect this socket to a 25-pin socket (DB-25S) on the computer's back panel. Table 1 shows the pinouts for both sockets. I then made up a 6-foot cable with a 25-pin plug (DB-25P) at one end and a 20-contact printed-circuit edge connector (AMP 582963-2 with 42839-4 pins and a 582501-1 polarizing key) at the other to mate with the keyboard. ■

PERT Organization

A Technique for Evaluating Schedules

W Douglas Maurer
Department of Electrical Engineering
and Computer Science
George Washington University
Washington DC 20052

The acronym PERT stands for Program Evaluation and Review Technique, a mathematical method used by thousands of computer programmers on both large and small systems to solve one of the basic problems of middle-level managers: how to determine the relative importance of the tasks under their supervision.

Let us define a middle-level manager as a person responsible for a project comprised of many tasks. Various low-level managers, each responsible for one particular task, report to the middle-level manager. (By contrast, the top-level manager is more concerned with deciding which projects to undertake, and formulating policy.) The basic purpose of the middle-level manager is to anticipate possible obstacles and still complete the project on time.

A Typical Problem

In order to more clearly illustrate the middle-level manager's problem, let's be specific and assume that the project is the construction of the fifth floor of a seven-story office building.

The project begins with the forming and the pouring of concrete. The procedure is supposed to take six days, but for some reason it takes

seven days. Now the project is a day behind schedule.

At this point, the manager looks at the various tasks: plumbing, spray fireproofing, and so on, and notes that while most of them will require from three to five days, the installation of electrical wiring in the wall will require sixteen days. Accordingly, he hires a few more electricians, and the electrical wiring is installed in fourteen days. Now the project is a day ahead of schedule.

**In several ways,
the calculation of T2
is the reverse of
the calculation of T1**

Or is it? After the walls have been wired, the next step involves the lath and plaster, which can't be started until the insulation has been installed. The insulation requires only three days, but that can't progress until the electrical testing has been completed, and that requires three days. Of course, the testing can't begin until the ceiling air ducts and fixtures are in, which takes five days...and so on and so on. The upshot is that the pro-

ject is still one day behind.

The problem in this example (taken, as is much of the material in this article, from *Fundamentals of Data Structures*, see references) is that the electrical wiring is not a *critical activity* (ie: a task that causes the *entire* project to slip if it falls behind schedule). In fact, in this example the manager should have hired *fewer*, not more, electricians, and allowed the wiring to take as many as twenty-eight days. The extra money could have been used to hire more people for the spray fireproofing and installation of ceiling ducts and fixtures, which *are* critical activities.

But how can the manager determine what is a critical activity and what is not? This is where PERT comes in.

Analyzing Problems with PERT

There are many ways to apply PERT. I will illustrate one simple application. The first step is to *number* each task, or activity, in such a way that they can be performed in numerical order. For example, we cannot require that activity number 7 be finished before activity number 4 is started, for if this is the case, then activity number 4 should be designated

as some number higher than 7. If there are n activities, then they should be numbered from 1 to n .

To adapt our scheme to computer notation, we will now set up a two-dimensional array, called B. If we require that for each pair of activity numbers I and J, I be finished before J can start, we set $B(I, J) = 1$. Otherwise, we set $B(I, J) = 0$. (If we use a version of BASIC that does not allow double subscripts for arrays, or if we

use assembly language, we can employ the following trick: set up a single array A, containing n^2 elements, where n is the number of activities, and then refer to each $B(I, J)$ array element as $A(K)$, where we have assigned $K = n \times (I-1) + J$ before referring to $A(K)$. Thus, elements $B(1,1)$ through $B(1,n)$ are represented as $A(1)$ through $A(n)$; $B(2,1)$ through $B(2,n)$ as $A(n+1)$ through $A(2n)$; and so on.)

We initialize this double array to all zeros and then input various pairs of numbers I and J, where we want to set $B(I, J) = 1$ according to the above rule. We also set up another array T, such that $T(I)$ is the amount of time taken by activity number I. If $T(7) = 5$, then activity number 7 takes five days to complete. (Actually it could be five weeks, or even five hours, just as long as the same units are used throughout the array T.) All the numbers $T(I)$, as I varies from 1 to n , must be entered.

Now we have all the input we need, and we can proceed to calculate which activities are critical. We must first set up an array that we will call T1, such that each element $T1(I)$ is the earliest starting time for the activity number I. If $T1(5) = 9$, then activity number 5 cannot be started before the ninth day of the project. (From now on, we will assume that all times are given in days.)

A possible reason why $T1(5)$ might equal 9 is revealed in figure 1. The numbers in circles are activity numbers, and we have drawn arrows between activities; all activities linked by incoming arrows must be completed before the next activity can begin. Activity number 1 takes five days, and activity number 3 takes three days. If we look only at the upper part of the diagram, we might think that activity number 5 could start after eight days. However, if we look at the rest of the diagram, we see that we have to perform activity number 2, which takes four days, and then number 4, which takes five days, before we can do number 5. So number 5 cannot, indeed, start until after nine days.

(One confusion that often arises is that if a task requires three days, and it is begun, let us say, on Monday, the task should be finished by Wednesday. Yet Wednesday is two, not three days after Monday. The solution to this paradox is to consider a day as a 24-hour period. If a task is started at 8 am Monday, and it takes three days, we consider it to be finished at 8 am Thursday, although in reality it will be finished by 5 pm Wednesday.)

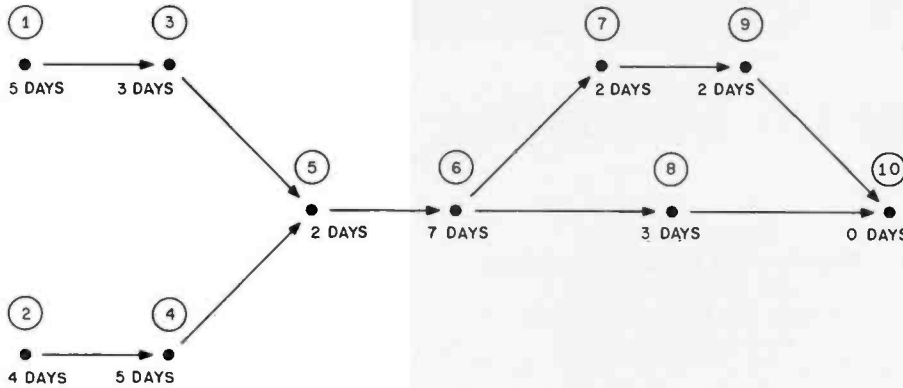

Figure 1: Typical project containing ten tasks, or activities. Each task requires a certain number of days for completion and can be begun only when the preceding tasks have been finished.

DOCUMATE/PLUS^{T.M.}

What kind of indexing program do you want?!

When The Orthocode Corporation designed Documate/Plus, we thought we were giving the world a simple, easy-to-use, no-frills method for **generating, sorting and collating tables of contents and indexes** from WordstarTM data files.

Then the letters started arriving. In addition to gratifying cudors for bug-free operation on a variety of systems using Wordstar, we read of *unexpected, unforeseen, unanticipated* uses for our new Documate/Plus. . . . Like the user who indexed boxes of old technical manuals. . . . Or the user who is cross-referencing business correspondence.

We particularly liked hearing from the user who indexed his 700-page book, boiling down 168K bytes of references into a 38K-byte multi-level index with "see" and "see also" notations. That's what we designed Documate/Plus to do. But this user found a way to do his indexing **without Wordstar!** And that's something we had not foreseen.

Build master indexes for research notes, books and articles, series of books and articles, hardware and software documentation, business correspondence . . . data files of every description.

Documate/Plus is Today's Most Flexible Indexing System For Professional And Business Information Processing

Documate/Plus is available on standard 8" CP/M and 5 1/4" Northstar diskettes.

- Documate/Plus Program with Manual \$125.00
- Manual Only \$ 10.00
- Special Pricing to update existing Documate users.

(Add \$4.00 for shipping and handling. California residents add sales tax.)

ORTHOCODE

The Textware Company

THE ORTHOCODE CORPORATION
P.O. Box 6191 • Albany, CA 94706
(415) 832-8175

• WordStar is a trademark of MicroPro International
• CP/M is a trademark of Digital Research

In figure 1, the arrow drawn between activities I and J corresponds to $B(I, J) = 1$. Thus we have $B(1, 3) = 1$ and $B(3, 5) = 1$. It is debatable whether or not we should set $B(1, 5) = 1$; after all, activity number 1 must be completed before activity number 5 can begin, but only in an implied sense. In this case, it does not really matter if $B(1, 5) = 1$. In general, redundant pairs of activities can either be provided as input or left out; the critical-activity calculation will come out the same, regardless.

The calculation of the earliest starting time, $T1(I)$, is performed as I varies from 1 to n . At each stage, we look at all $B(K, I)$, for K less than I, such that $B(K, I) = 1$. If nothing has to finish before activity number I can start, then we set $T1(I) = 0$, since activity number I can now clearly start at time zero. In setting up the problem of figure 1, we would set $T1(1) = 0$ and $T1(2) = 0$.

If there is one array element $B(K, I)$ that satisfies the condition above, then we add $T1(K)$, the earliest time at which activity K can start, to $T(K)$, the time that activity K takes. Thus, in figure 1, in order to calculate $T1(3)$, we would add $T1(1)$ and $T(1)$. We find that activity 1 can start at time zero, and it takes five days. Clearly, activity 3 cannot start until after five days—that is, $T1(3) = 5$. In the same way, we calculate $T1(4) = 4$.

If there is more than one element $B(K, I)$ that satisfies the condition, then we perform the above calculation several times and choose the largest answer. Let us calculate $T1(5)$ as shown in figure 1. We have:

$$\begin{aligned} T1(3) &= 5 \\ T(3) &= 3 \\ T1(3) + T(3) &= 8 \end{aligned}$$

and

$$\begin{aligned} T1(4) &= 4 \\ T(4) &= 5 \\ T1(4) + T(4) &= 9 \end{aligned}$$

This is the calculation we made before. One condition is that activity number 5 cannot start until after eight days; the other condition is that ac-

tivity number 5 cannot start until after nine days. Therefore, it is the ninth-day starting date that is important. In general, there might be three or more cases that we have to consider, and we take the largest of the calculations.

The resulting values of $T1(I)$, for all I, are shown in figure 2. In practical cases, usually the last activity in the project is to clean up, and we cannot clean up before we have finished

everything else. In the next calculation, we must assume that the last activity cannot be started before everything else is finished. If this is not the case, we set up a dummy activity, like activity number 10 in figures 1 and 2. This takes no time at all and ends the project.

If $T(I) = J$, this does not necessarily mean that activity number I must begin at time J. Look at activities 6, 7, 9, and 10 in figure 2, and suppose that

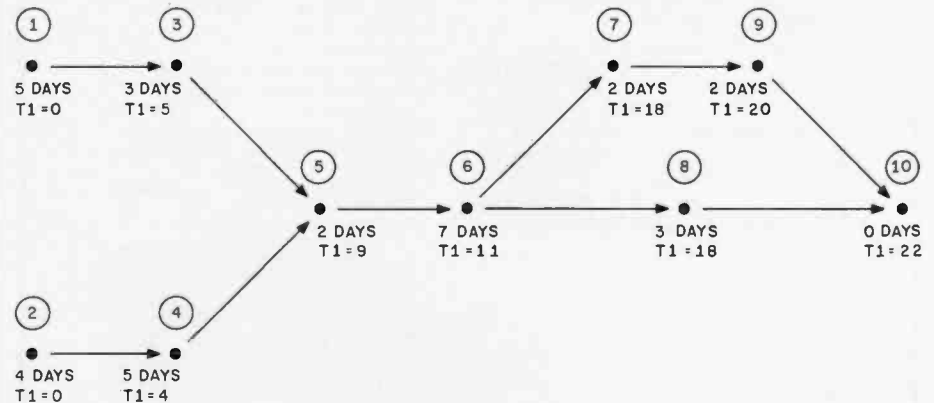

Figure 2: For each activity in figure 1, $T1$ (the earliest time that each activity can start) can be calculated according to the scheduled completion times of preceding activities.

ATTENTION GOVERNMENT D P USERS AND PURCHASERS

We represent many fine micro products and manufacturers on the U.S. Government's GSA Schedule, including

**Apple, Cromemco, Micropolis
and Seequa Computers**

Purchasing from the Schedule will save you the time consumed by the bid process. Products shipped throughout the United States and world-wide. Visit or write any of our stores for more information or to receive our catalogue of products represented.

**Computers,
Etc.....
the dependable store**

257 West Street, Annapolis, MD 21401 — (301) 268-6505
13A Allegheny Avenue, Towson, MD 21204 — (301) 296-0520
9330 Georgia Avenue, Silver Spring, MD 20910 — (301) 588-3748
6671 Backlick Road, Springfield, VA 22150 — (703) 644-5500
Plaza 38, 2442 Route 38, Cherry Hill, NJ 08002 — (609) 779-0023
Callers outside metropolitan areas served by our stores

Please call (301) 268-5801

Career Opportunities Available * An Equal Opportunity Employer

UNBELIEVABLE!

State-of-the-art Single-Board computer now available! Can be used in S-100 (Master, Slave, Multi or Single user) or Stand-Alone configurations.

FINALLY, state-of-the-art performance is available at an affordable price.

COMPARE THESE FEATURES:

- Z80A or Z80B
- 4 TIMERS (ZCTC)
- 64K RAM (64KX1 CHIPS)
- 2 SERIAL PORTS (ZSIO)
- 4 PARALLEL PORTS (ZPIO)
- UP TO 16K EPROM (Z732)
- NEC FLOPPY DISK CONTROLLER (UP TO FOUR 8" DOUBLE SIDED/DOUBLE DENSITY DRIVES)
- INTELLIGENT WINCHESTER INTERFACE
- ON-BOARD EPROM BURNER (DOES NOT REQUIRE 24V)

FOR THESE SINGLE QUANTITY PRICES:

- 4MZ VERSION (Z80A) **\$895⁰⁰**
- 6 MZ VERSION (Z80B) **\$1,195⁰⁰**
- 4 MZ SLAVE PROCESSOR (NO DISK CONTROLLERS ON BOARD) **\$795⁰⁰**
- 6 MZ SLAVE PROCESSOR (NO DISK CONTROLLERS ON BOARD) **\$1,095⁰⁰**

The S-100 version of this product can act as a Master processor, Slave processor, or Intelligent peripheral controller. Intra-processor communication is achieved through the use of efficient, high speed buss transfers using special hardware/software techniques.

We also have what we think is one of the best implementations of a CP/M BIOS available off the shelf. The BIOS has the following features:

- All Devices **INTERRUPT DRIVEN**
- Type Ahead Input/Output Buffers
- Real-Time Clock
- Time Of Day Clock
- Multi-level User Password Support
- Menu Driven Utilities for Format, Disk Copy, etc.
- Unique Configuration Utility Program for Setting Baud Rates, Changing Step Time, Changing Passwords, etc.
- Cylinder Concept used for Double Sided /Double Density Configuration Resulting In Increased Performance

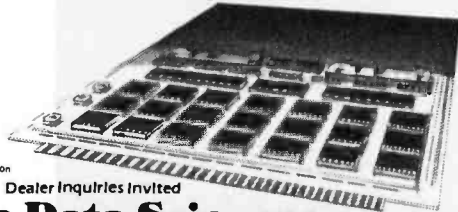

CP/M is a registered trademark of Digital Research Corporation

Dealer Inquiries Invited

Sierra Data Sciences

1800 East Shaw Avenue • Suite 164 • Fresno, California 93710 • (209) 224-0520

they all start at the times given; that is, on the eleventh, eighteenth, twentieth, and twenty-second days, respectively. Now look at activity number 8. It is *scheduled* to begin on the eighteenth day, but it could also begin on the nineteenth day (because the task takes three days, and by the time it is finished we are up to day twenty-two, which is activity number 10—the end of the project.)

We are now ready to start the next calculation. This time we are calculating a set of values called T2(I), for all I from 1 to n, but we will calculate them in reverse order. That is, we will calculate T2(n) first, then T2(n-1), and so on, and calculate T2(1) last.

To speed up a project, we must accelerate an activity that lies on every critical path

The time T2(I) is the *latest* time that activity number I can *end* without causing the entire project to slip. A moment ago we saw that activity number 8 could occur on either the eighteenth or the nineteenth day, and it would end on either the twenty-first or the twenty-second day. Therefore T2(8) would be 22, because the twenty-second day is the latest time that activity number 8 can end.

Before we see how to calculate T2(I), let us see how we can use it. In our example, we have T1(8) = 18 and T2(8) = 22. What does this mean? It means that activity number 8 *cannot* start before day eighteen, and it *must* finish by day twenty-two. Therefore, this activity cannot take more than four days. In fact, it is supposed to take three days (T(8) = 3), and it can slip by one day, but not more than one day (otherwise, the entire project will slip). In this case, activity number 8 is *not* critical. If it were scheduled to take four days—that is, if T(8) were equal to 4—then it *would* be critical. So as soon as we calculate T2(I) for all I, we will know immediately which activities are critical.

To calculate T2(I), we look at all

SciTronics introduces . . .

REAL TIME CLOCKS

with full Clock/Calendar Functions

The Worry-free Clocks for People Who Don't Have Time to Worry!!

What makes them worry-free?

- Crystal controlled for high (.002%) accuracy
- Lithium battery backup for continuous clock operation (6000 hrs!!!)
- Complete software in BASIC-including programs to Set and Read clock
- Clock generates interrupts (seconds, minutes, hour) for foreground/background operation

Applications:

- Logging Computer on time
- Timing of events
- Use it with the SciTronics Remote Controller for Real Time control of A.C. operated lights and appliances

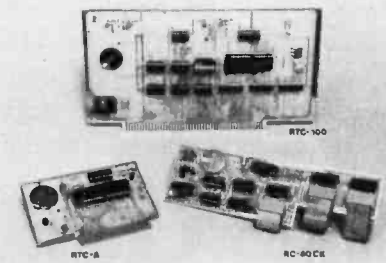

Versions available for:

- S-100 bus computers **RTC-100 \$159**
- Apple II computer **RTC-A \$129**
- SciTronics RC-80 owners **RC-80CK \$109**

Send **SciTronics Inc.**
Check or money order to: 523 S. Clewell St., P.O. Box 5344
Bethlehem, PA 18015
(215) 868-7220

Please list system with which you plan to use controller • Master Charge and Visa accepted. COD's accepted. PA residence add sales tax.

$B(I, J)$, for J greater than I , such that $B(I, J) = 1$. If there are no instances (which, under our assumptions, will happen only for the last activity in the project, ie: $I = n$) we set $T2(I)$ equal to $T1(I) + T(I)$. That is, the last activity must start by time $T1(I)$, and it requires time $T(I)$, so it must finish by time $T1(I) + T(I)$ in order to get the entire project done in the least amount of time that is consistent with the data we have provided about all its various activities.

If there is *one* $B(I, J)$ that satisfies the condition above, then we subtract $T(J)$ (the time that activity J takes) from $T2(J)$, the latest time that activity J can be finished while keeping the project on schedule. Since the values of $T2(I)$ are being calculated in reverse order, we can assume that $T2(J)$ has already been calculated. In the project shown in figure 2, we get the value of $T2(9)$ by subtracting $T(11)$ from $T2(11)$, because activity 10 takes no time, and the answer is 22. We get $T2(7)$ by subtracting $T(9)$ from $T2(9)$, and the answer is 20.

Note what this last answer means. The ninth activity takes two days, and it *must* be done by day twenty-two. This means that it *must* start by day twenty. If we look at figure 2, we can see that this implies that activity number 7 must also be finished by day twenty. In the same way, we calculate $T2(8) = 22$.

Finally, if there is *more than one* $B(I, J)$ that satisfies the condition, then we perform the above calculation several times and choose the *smallest* answer. For example, if we calculate $T2(6)$ in figure 2, we have:

$$\begin{aligned} T2(7) &= 20 \\ T(7) &= 2 \\ T2(7) - T(7) &= 18 \end{aligned}$$

and:

$$\begin{aligned} T2(8) &= 22 \\ T(8) &= 3 \\ T2(8) - T(8) &= 19 \end{aligned}$$

This means that activity number 6 must end by the eighteenth day, and also by the nineteenth day. Therefore, the eighteenth-day deadline is

the one we must heed. We can observe a number of ways in which the calculation of $T2$ is the reverse of the calculation of $T1$: we go from back to front; we look at $B(I, J)$ instead of $B(K, I)$; we must have J larger than I , instead of K smaller than I ; and when there are several calculations at one place, we take the smallest, instead of the largest, of the results.

The resulting values of $T2(I)$, for all

I , are shown in figure 3. We can now look at $T1(I)$ and $T2(I)$, for all I , and calculate which activities are critical. As we have noted above, activity number I is critical if $T2(I) - T1(I) = T(I)$; otherwise, it is not. The critical activities in figure 3 are numbers 2, 4, 5, 6, 7, 9, and 10. The non-critical activities are 1, 3, and 8.

We now have the answer to the manager's problem in this case: activ-

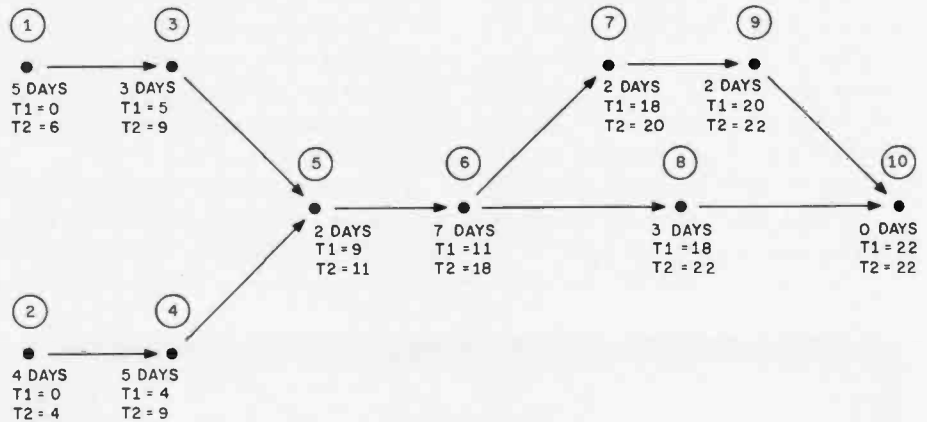



Figure 3: $T2$ (the latest time that each activity can be finished without throwing the entire project behind schedule) can be calculated for each activity in the project of figure 1.

THE ANSWER BOOK The Unabridged!

- THE MOST AUTHORITATIVE DICTIONARY OF ITS KIND
- Comprehensive—more than 260,000 entries; 2,091 pages; large format 9" x 12" page size; 9 lbs 14 oz.
- Up-to-Date—with new words and terms
- Easy to Use—more than 50,000 example phrases and sentences; 2,000 illustrations; 10,000 synonym lists and studies; thumb-indexed
- Full-color ATLAS; much, much more

\$49.95, now at your bookstore

RANDOM HOUSE



**THE
RANDOM
HOUSE
DICTIONARY
of the
ENGLISH
LANGUAGE**
The
Unabridged
Edition

ities 1, 3, and 8 should *not* be accelerated because they will not affect the project's completion time. On the other hand, any one of these three activities could slip by one day without affecting completion time. (In fact, activities 1 and 8, or activities 3 and 8, could both slip, but not both activities 1 and 3.)

The critical activities can all be seen to lie on one path from the beginning to the end of the project. This is called a *critical path*. In general, there might be more than one critical path in a project. If an activity is critical, it cannot slip without affecting project time—that is, if it is on a critical path. On the other hand, speeding up any one activity will not speed up the entire project unless the accelerated activity is on *every* critical path.

Machine Coding Considerations

If the total number of activities is so large that we cannot fit all of the array elements $B(I, J)$ into the number of available words of memory, we may use the following trick. Since each element $B(I, J)$ is either 0 or 1 (such a matrix B is often called a *boolean matrix*), we can put each element into a single bit of a memory location. On an 8-bit machine, working in assembly language, we would represent $B(I, J)$ by first dividing J by 8 and obtaining a quotient of K and a remainder of L . We would then store $B(I, J)$ in the L th bit of $B(I, K)$, and the dimensions of B would now be n by $n/8$ instead of n by n .

To accomplish this representation, we use an auxiliary table P , such that table element $P(1)$ is the zeroth bit

(from the right—ie: in the binary number's units bit), element $P(2)$ is the first bit (ie: the number's 2^1 bit), $P(3)$ is the second bit (ie: 2^2 or 4), and so on. We can set up this table by setting $P(1) = 1$ and then $P(I+1) = 2 \times P(I)$ for $I = 1$ to 7. To set the L th bit of X , we perform the logical OR of $P(L+1)$ and X , and store it in X ; to test the L th bit of X , we perform the logical AND of $P(L+1)$ and X , and test the zero status flag. On a 16-bit machine, we do the same analysis, substituting 16 for 8.

In integer BASIC, even on an 8-bit machine, each integer is customarily stored in 16 bits. If the logical AND and OR functions are not available in the given dialect of BASIC, or by means of standard library functions, then we can test the L th bit of X by adding it to itself (that is, shifting it 1 bit to the left) $N-1-L$ times, and seeing whether or not the result is negative. We can set the L th bit of X by *adding* $P(L+1)$ to X , provided that we know this bit is not set (by testing it as above).

Exploring Further

Further analyses of critical paths or critical activities will be found in Ellis Horowitz and Sartaj Sahni's *Fundamentals of Data Structures*. These authors describe two graphical models of a project—the AOV (activity on vertex) model, in which each vertex of a graph like figure 1 corresponds to an activity, and the AOE (activity on edge) model, in which an activity corresponds to an edge, or arrow between nodes. The critical-path algorithm given there is actually for the AOE model, whereas the one I give here is for the AOV model. The authors also provide a discussion of an algorithm (called *topological sort*) which can be used to renumber all the activities if the numbering that is used does not satisfy our fundamental property of carrying out all activities in the project in their numerical order. ■

Reference

1. Horowitz, Ellis and Sartaj Sahni. *Fundamentals of Data Structures*. Rockville MD: Computer Science Press, 1976.

Announcing a long-awaited service...the Universal Software Directory

Now, software users can save money.

The Directory will help you find an alternative to the costly, time-consuming task of program development. (So why re-invent the wheel? Use your best efforts elsewhere.)

And authors can realize returns on their programs.

You've invested time and money in developing software. The Directory will put you in

touch with potential buyers for your package.

Here's how it works:

Authors submit information on their software packages, including scope, hardware requirements, operating environment, documentation, maintenance available, etc. These descriptions are updated daily into the Directory data base.

Users seeking applications packages describe their needs. We provide them with referrals on all appropriate software.

For FREE information mail this coupon today or write to Universal Software Directory, P.O. Box 5549, Dept. 20, San Mateo 94402.

To: Universal Software Directory
P.O. Box 5549
Dept. 20
San Mateo
CA 94402

Please send me the following free information:

Buyers Guide Authors Kit

Name _____

Company (Optional) _____

Street _____

City _____ State _____ Zip _____

Specific Application Area of Interest _____

Should the DO Loop Become an Assembly-Language Construct?

Glenn L Williams
Gould Inc
Instruments Division
3631 Perkins
Cleveland OH 44114

The 1970s saw the inception and growth of microprocessors as well as continuing growth and improvement in the architecture and processing power of minicomputers. Although the architecture of CPUs (central processing units) has varied widely through the years, the majority of the new 16-bit microprocessors have emulated, to various degrees, the stack-pointer architecture once found in the DEC (Digital Equipment Corporation) PDP-11.

The stack pointer is used to control an area in program memory where temporary data and subroutine- and interrupt-return addresses can be stored separately from the main program. The stack-pointer approach has proved useful to programmers because it allows reentrant, nonself-modifying subroutines. This approach can be contrasted with machines (e.g., the DEC PDP-8) where a subroutine return address is saved in the first location of the subroutine proper, which can reside only in programmable memory.

An additional feature now found in most processors is the familiar processor-status register containing flag bits formed from the result of ALU

(arithmetic logic unit) operations on data. With conditional branch, jump, jump to subroutine, and return (as well as interrupt) instructions available on the various processors, program loops can become very compact and intricate.

A well-designed instruction set can give the engineer and programmer every degree of freedom and every feature desired. But does it?

An Example

Take the case of the assembly-language program in which a positive binary word in memory is required for the next sequence of instructions. But for various reasons (known only to the programmer), the word may instead be stored as a *negative* value.

In the Motorola 6800, Fairchild F8, and even the Motorola 68000 microprocessors, such a value must be loaded and tested for positive status. If negative status results, the data must be complemented via a branch to the proper code before returning to normal program execution. There has been one processor available for some time, however, that performs the absolute-value conversion with a single instruction: Texas Instruments' TMS-9900.

Obviously, there are other instructions that could make programming tasks far simpler. Disregarding for a moment the desire of manufacturers to minimize microcode requirements to limit the size of silicon wafers, and

the argument that some missing instructions can be "worked around" through use of other instruction chains, it is obvious that highly innovative and useful instructions can still be invented by clever users and designers of computers. Users still need more innovative instructions to help relieve the monumental programming requirements of the 1980s. (After all, where would computers be if architecture development stopped with the invention of the subroutine and the carry bit?)

The following discussion will show how one set of "new" instructions (or acceptable variations) can be found scattered, piecemeal, in a number of existing modern processors, but that *no one processor* supplies the user with the entire set. In particular, the first new instruction, requiring merely a modified stack pointer, has yet to be found in a survey of a number of late-model processors. This instruction, along with its mate, allows assembly-language programming of DO loops.

"New" Instructions

For the discussion of these instructions shown in conceptual form in table 1, I ask the reader to assume that the processor has at least one stack pointer, one or more accumulators, and, perhaps, additional main registers. This model, in figure 1, resembles the architecture of the PDP-11 and 6800.

About the Author

Glenn L Williams is a Senior Design Engineer for Gould Inc Instruments Division. Currently, he is designing hardware and software for a new line of digital oscillographic recorders. Mr Williams has worked with microprocessors since the early 1970s. His personal interests include amateur radio and astronomy.

\$ SAVE \$

CALL MBC, (203) 342 2747

COMPUTERS

| | | |
|----------------------------------|--|---------|
| ATARI | | |
| 800 16K | | \$ 759 |
| 400 16K | | \$ 365 |
| NORTH STAR | | |
| HRZ-1Q-64K-HD5 WINCH.HARD DISK | | |
| SAVE OVER \$1600.00 | | \$CALL |
| HRZ-2Q-64K-ASM | | \$Call |
| HRZ-2Q-64K-ASM | | \$Call |
| ZENITH | | |
| Z-89 GA All In One computer | | \$2068 |
| Z-89 FA 48K and drive | | \$2275 |
| COMMODORE | | |
| CBM,PET 32K COMPUTER | | \$ 975 |
| LIMITED QUANTANTITY & TIME | | |
| 8032 Large 80 Col.Screen | | \$Call |
| 8050 Dual Disk Drive 1 Meg | | \$Call |
| 4032 B or N 40 Col. Screen | | \$Call |
| 4040 Dual Disk Drive 360K | | \$Call |
| Vic-20 Color Computer | | \$ 275 |
| HEWLETT-PACKARD | | |
| HP-85 | | \$2795 |
| HP-83 | | \$all |
| HP Calculators Also in Stock !!! | | |
| INTERTEC SUPERBRAIN | | |
| 64K-DD | | \$2795 |
| 64K-QD | | \$3180 |
| ALDOS SYSTEMS | | |
| ACS 8000-2 1 Meg FD | | \$2990 |
| ACS 8000-10 4 User | | \$6795 |
| ONYX | | |
| C5000 64K 6.1 Meg | | \$6990 |
| C8001 128K 10 Meg | | \$9990 |
| C8002 512K 18 Meg | | \$16900 |

PRINTERS

| | | |
|---------------------------------|--|--------|
| DIABLO 630 | | \$2185 |
| NEC SPINWRITER 5530/5510 | | \$2490 |
| NEC 5520 KSR | | \$2890 |
| C.ITOH | | \$1499 |
| OLYMPIA-ES 100 Quality Printer | | |
| Printer/Typewriter with interf. | | |
| RS-232,Paralell,488 IEDE | | \$1250 |
| IDS Paper Tiger 445G | | \$ 695 |
| 460G | | \$ 899 |
| 560G | | \$1150 |
| ANADEX 9500/9501 | | \$1290 |
| CENTRONICS | | |
| 730-1 | | \$ 590 |
| 737-1 | | \$ 699 |
| EPSON | | |
| MX-80 With Friction Feed | | \$ 495 |
| Roll Paper Holder | | \$ 18 |
| MX-70 | | \$ 395 |
| MX-100 | | \$Call |
| MX-80 F/T | | \$Call |
| OKIDATA | | |
| Microline 80 Paralell | | \$ 375 |
| 82 Bi-Directional | | \$ 495 |
| 83 136 col. 120cps | | \$ 750 |

TERMINALS

| | | |
|-------------------------------|--|--------|
| TELEVIDEO | | |
| 910 | | \$ 599 |
| 912 | | \$ 725 |
| 920C | | \$ 775 |
| 950 | | \$ 995 |
| INTERTUBE III/ Emulator | | \$ 725 |
| SOROC IQ 120 | | \$ 749 |
| ZENITH Z-19 | | \$ 820 |
| LEEDEX/AMDEK 100 Green Screen | | \$ 165 |

Items may be ordered by phone, mail or COD. Visa & Master Charge accepted. Factory Sealed, Manufacturers warranty
--- Prices subject to change ---

(203) 342-2747

**Multi-Business
Computer Systems Inc.**

28 MARLBOROUGH STREET
PORTLAND, CONN. 06480
TWX/TELEX 710-428-6345
M-F 9-6 SAT. 9:30-3:00

Mnemonic

Function

| | |
|------------|---|
| DO n | The address of the instruction following this one (PC + 2) is saved on the DO stack, along with the loop-counter value n. The DO loop will then begin at the instruction following this one (at PC + 2). (See figure 2.) |
| NXT | The ending instruction of a DO loop. In the DO construct, the value n is decremented and tested for 0. If n does not equal 0, the execution is resumed at the location saved in the DO stack. If n does equal 0, program execution continues at the next instruction after NXT. DO loop nesting is permitted by virtue of stack control. |
| ABS N | Converts binary value at effective address N to absolute binary value and stores it back in N or in an accumulator. Processor-status-word flag is set if value was originally positive. |
| ASC N | Converts a 4-bit binary value at effective address N to its ASCII equivalent (0 through F). |
| BIN N | Tests a value at effective address N to see if it is a legal hexadecimal ASCII character symbol (0 through F). If it is, the character is converted to the 4-bit binary equivalent. If it is not, a processor status flag is set and conversion does not occur. |
| SRCH n, M | Searches for the word or character n in a page of memory beginning at effective address M until either the first occurrence of that character or end-of-page. (Page size fixed at some value.) If the search fails, a processor status flag is set. If the search succeeds, the location of the character is saved in a temporary register. |
| SRCH n, -M | Similar to above, but search proceeds in a negative direction from effective address M to end-of-page. |

Table 1: Innovative and useful instructions, some of which are now available to microprocessor users. These instructions are not all available on any one processor.

It is interesting to consider how these instructions have been implemented in various processors. These data are shown in table 2. The seven instructions listed are not to be construed as the only instructions eligible for consideration. They are presented as thought-provoking examples.

The DO Loop Instructions

Frequent use of nested execution loops (DO . . . CONTINUE loops in FORTRAN, FOR . . . NEXT loops in BASIC) raise the question: Why not allow a DO loop construct in assembly language (i.e., in the architecture of the processor itself)? Conceptually, a processor architecture to accomplish DO loops would take the structure of figure 1b, where a DO pointer addressing a DO stack has been added to a processor of simple architecture resembling the 6800 microprocessor.

The DO stack would function as a conventional stack, except, unlike a conventional stack that saves the next (return) address for a subroutine, the DO stack saves the next (looping) address followed by an additional value n. (See figure 2.) The value n is the in-

teger number of times the loop is to cycle. The loop is initiated with the DO n instruction, but program flow continues inline.

The value n could reside in an accumulator or some other processor register rather than residing in program memory immediately after the DO op code. Then a reference to a location or register that contained the address of the operand value would remove the need for self-modifying code if n were to be a variable (e.g., DO (n) or DO R_n). To show as simply as possible the operation of the DO instruction, the general form DO n will be used here.

The DO loop is bounded by an NXT instruction op code. Upon reaching this instruction, the control logic in the processor uses the DO pointer to reference the location of the value n on the DO stack. The value n is then temporarily pulled and decremented. If the value of n is not 0 after the decrement, the new n value is pushed back onto the stack, and the next two stack values (D-2 and D-1) are read out as the address to loop back to for further iteration. Figure 2 compares the conventional stack pointer to the new DO pointer in more detail.

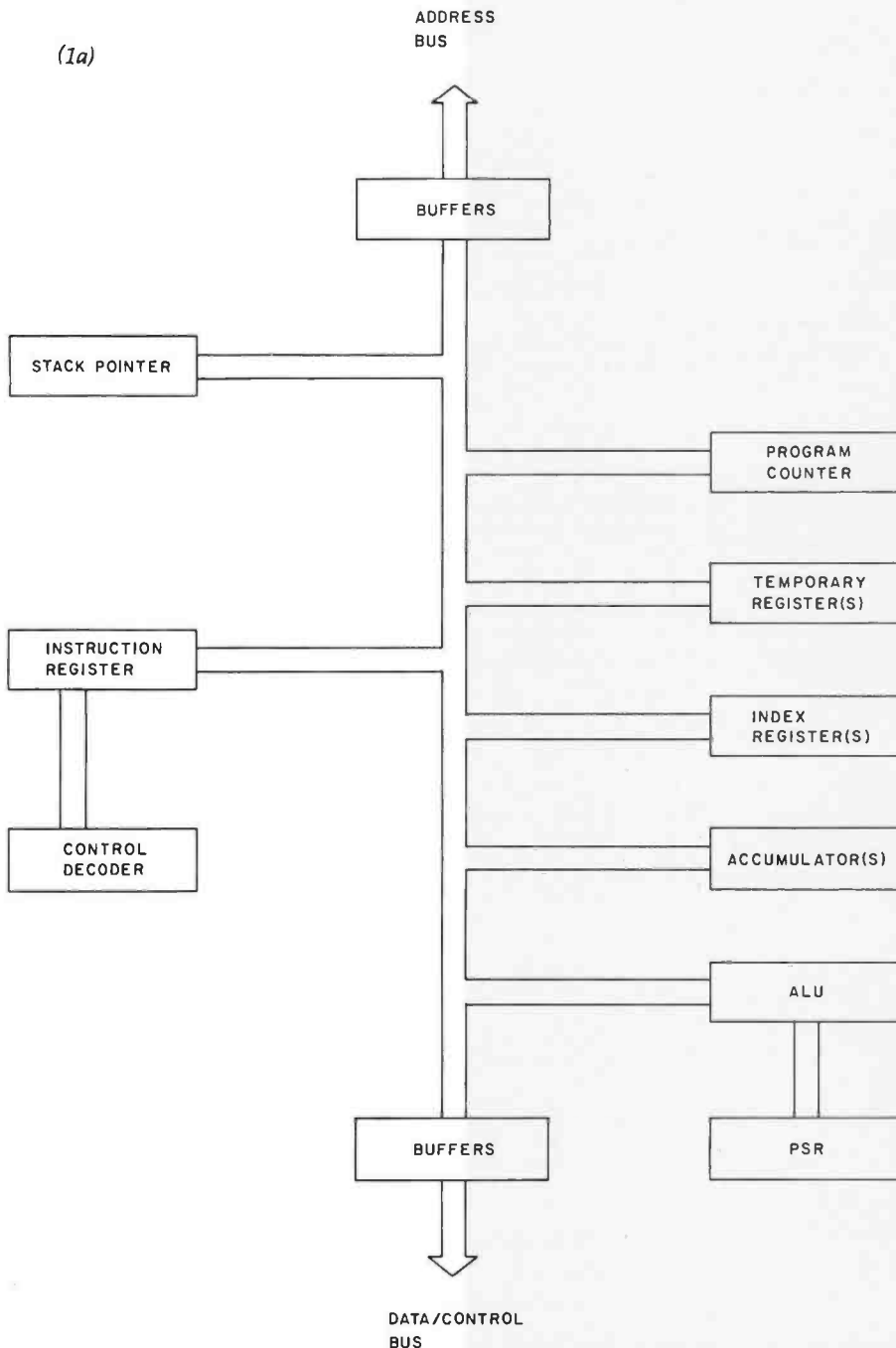

Figure 1: Block diagram of a typical processor with stack pointer. Figure 1a is based on the 6800 microprocessor; in figure 1b (see page 416), the DO Pointer has been added.

If the value n is 0 after being decremented, however, the DO loop is defined as being completed. The DO pointer is adjusted to its preloop value (D) and execution continues with the first instruction after the NXT op code.

DO loops can be nested using these rules. Well-designed DO loops configured under the same nesting rules as FORTRAN or BASIC would not

terminate prematurely. The DO pointer could be in error only through procedures that are commonly accepted as illegal in high-level languages or procedures in assembly-language programming similar to illegal exits from subroutines and interrupts.

A DO loop controlled by a DO pointer would then match high-level language requirements and would re-

MMSFORTH VERSION 2.0: MORE FOR YOUR RADIO SHACK TRS-80 MODEL I OR MODEL III!

- ★ **MORE SPEED**
10-20 times faster than Level II BASIC.
- ★ **MORE ROOM**
Very compact compiled code plus VIRTUAL MEMORY makes your RAM act larger. Variable number of block buffers, 31-char. unique word names use only 4 bytes in header!
- ★ **MORE INSTRUCTIONS**
Add YOUR commands to its 79-STANDARD-plus instruction set!
Far more complete than most Forths: single & double precision, arrays, string-handling, clock, more.
- ★ **MORE EASE**
Excellent full-screen Editor, structured & modular programming
Word search utility
THE NOTEPAD letter writer
Optimized for your TRS-80 with keyboard repeats, upper/lower case display driver, full ASCII, single- & double-width graphics, etc.
- ★ **MORE POWER**
Forth operating system
Interpreter AND compiler
8080 Assembler
(Z80 Assembler also available)
Intermix 35- to 80-track disk drives
Model III System can read, write & run Model I diskettes!
VIRTUAL I/O for video and printer, disk and tape
(10-Megabyte hard disk available)

mmsFORTH

THE PROFESSIONAL FORTH FOR TRS-80

(Over 1,500 systems in use)

MMSFORTH Disk System V2.0 (requires 1 disk drive & 16K RAM, 32K for Model III) \$129.95*

AND MMS GIVES IT PROFESSIONAL SUPPORT

Source code provided
MMSFORTH Newsletter
Many demo programs aboard
MMSFORTH User Groups
Inexpensive upgrades to latest version
Programming staff can provide advice, modifications and custom programs, to fit YOUR needs.

MMSFORTH UTILITIES DISKETTE: includes FLOATING POINT MATH (L2 BASIC ROM routines plus Complex numbers, Rectangular-Polar coordinate conversions, Degrees mode, more), plus a full Forth-style Z80 ASSEMBLER; plus a powerful CROSS-REFERENCER to list Forth words by block and line. All on one diskette (requires MMSFORTH V2.0, 1 drive & 32K RAM) \$39.95*

FORTHCOM: communications package provides RS-232 driver, dumb terminal mode, transfer of FORTH blocks, and host mode to operate a remote TRS-80 (requires MMSFORTH V2.0, 1 drive & 32K RAM) \$39.95*

THE DATAHANDLER V1.2: a very sophisticated database management system operable by non-programmers (requires MMSFORTH V2.0, 1 drive & 32K RAM) \$59.95*

MMSFORTH GAMES DISKETTE: real-time graphics & board games w/source code. Includes BREAKFORTH, CRASHFORTH, CRYPTOQUOTE, FREEWAY, OTHELLO & TICTACFORTH (requires MMSFORTH V2.0, 1 drive & 32K RAM) \$39.95*

Other MMSFORTH products under development

FORTH BOOKS AVAILABLE

MMSFORTH USERS MANUAL - without Appendices, for non-owners \$17.50*

STARTING FORTH - best companion to our manual \$15.95*

INVITATION TO FORTH - detailed beginner book on figFORTH \$17.50*

THREADED INTERPRETIVE LANGUAGES - advanced, excellent analysis of MMSFORTH-like language \$18.95*

PROGRAM DESIGN & CONSTRUCTION - intro. to structured programming, good for Forth \$13.95*

FORTH .79 STANDARD MANUAL - official reference to 79-STANDARD word set, etc \$12.95*

CALTECH FORTH MANUAL - good on Forth internal structure, etc \$10.00*

FORTH SPECIAL ISSUE, BYTE Magazine (Aug. 1980), we stock this collector's item for Forth users and beginners \$4.00*

* ORDERING INFORMATION: Software prices include manuals and require signing of a single system, single-user license. SPECIFY for Model I or Model III! Add \$2.00 SH plus \$3.00 per MMSFORTH and \$1.00 per additional book. Mass. orders add 5% tax. Foreign orders add 20%. UPS COD, VISA & M/C accepted; no unpaid purchase orders, please.

Send SASE for free MMSFORTH information
Good dealers sought

Get MMSFORTH products from your
computer dealer or
**MILLER MICROCOMPUTER
SERVICES (B10)**

61 Lake Shore Road, Natick, MA 01760
(617) 653-6136

**NO FRILLS!
NO GIMMICKS!
JUST GREAT
DISCOUNTS
MAIL ORDER ONLY**

ATARI 800
Personal Computer System **\$74900**

NORTHSTAR
Horizon II 32K **234900**
Horizon II Quad **279900**
Horizon II 64K **299900**
Horizon Quad 64K **339900**

TELEVIDEO
Model 912 **74900**
Model 920 **79900**
Model 950 **107900**

HAZELTINE
Model 1420 **79500**
Model 1421 **69500**
Model 1500 **84900**
Model 1510 **104900**
Model 1520 **122900**
Espirit **64900**
Executive 80
Model 20 **119500**
Model 30 **139500**

OKIDATA
Microline 80 **55900**

SOROC Technology
Model IQ 120 **69900**
Model IQ 140 **104900**

CROMEMCO
System 3 **569500**
Model Z2H **799500**

QANTEX
Model 6000 150 CPS
parallel interface **114900**
Model 6000 150 CPS
serial interface **119500**

DECwriter IV
Model LA-34 **93900**

We'll meet or beat any advertised prices!

Most items in stock for immediate delivery.
Factory sealed cartons. Full manufacturer's guarantee.
All products subject to availability.
All prices subject to change.

DATA DISCOUNT CENTER

135-53 Northern Blvd., Flushing, N.Y. 11354
Visa • Master Charge • N.Y.S. residents add Sales Tax
Shipping F.O.B. N.Y.

Phone Orders Call (212) 895-5577

(1b)

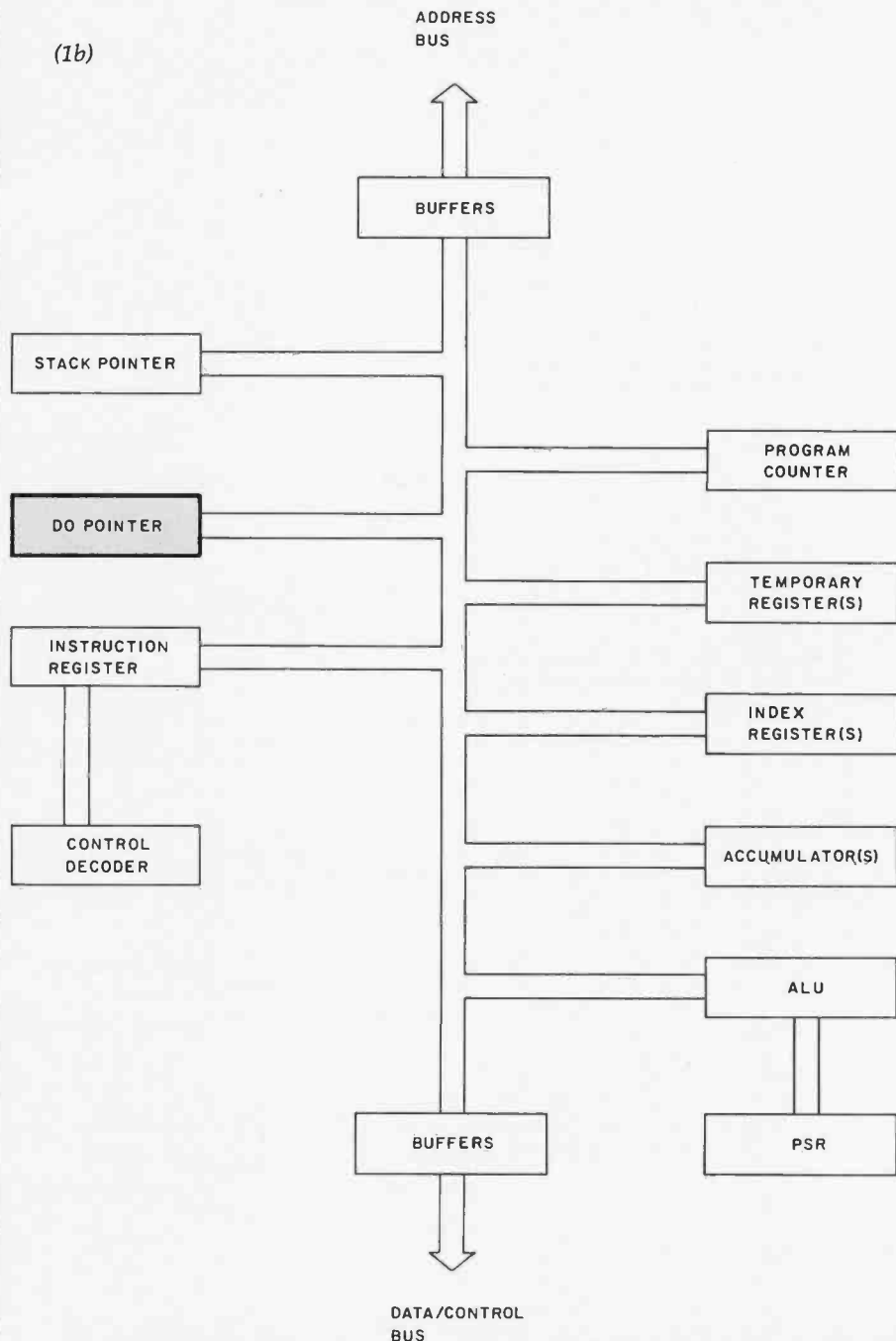

| Mnemonic | Present Similar Implementation (and processor) |
|---------------------|--|
| DO <i>n</i> | none(?) |
| NXT | DB _{cc} (Motorola 68000) LOOPE/LOOPNE (Intel 8086) |
| ABS N | ABS N (Texas Instruments TMS 9900) |
| ASC N | |
| BIN N | XLAT ASCII TBL (Intel 8086) |
| SRCH <i>n</i> , M | SEAF O, Md (Advanced Micro Devices HEX-29) |
| SRCH <i>n</i> , - m | LOCC <i>n</i> , L, M (DEC VAX 11/780) CPIR (CPDR) (Zilog Z80) SCAZ TXT LINE (Intel 8086) |

Table 2: Present implementations of "new" instructions.

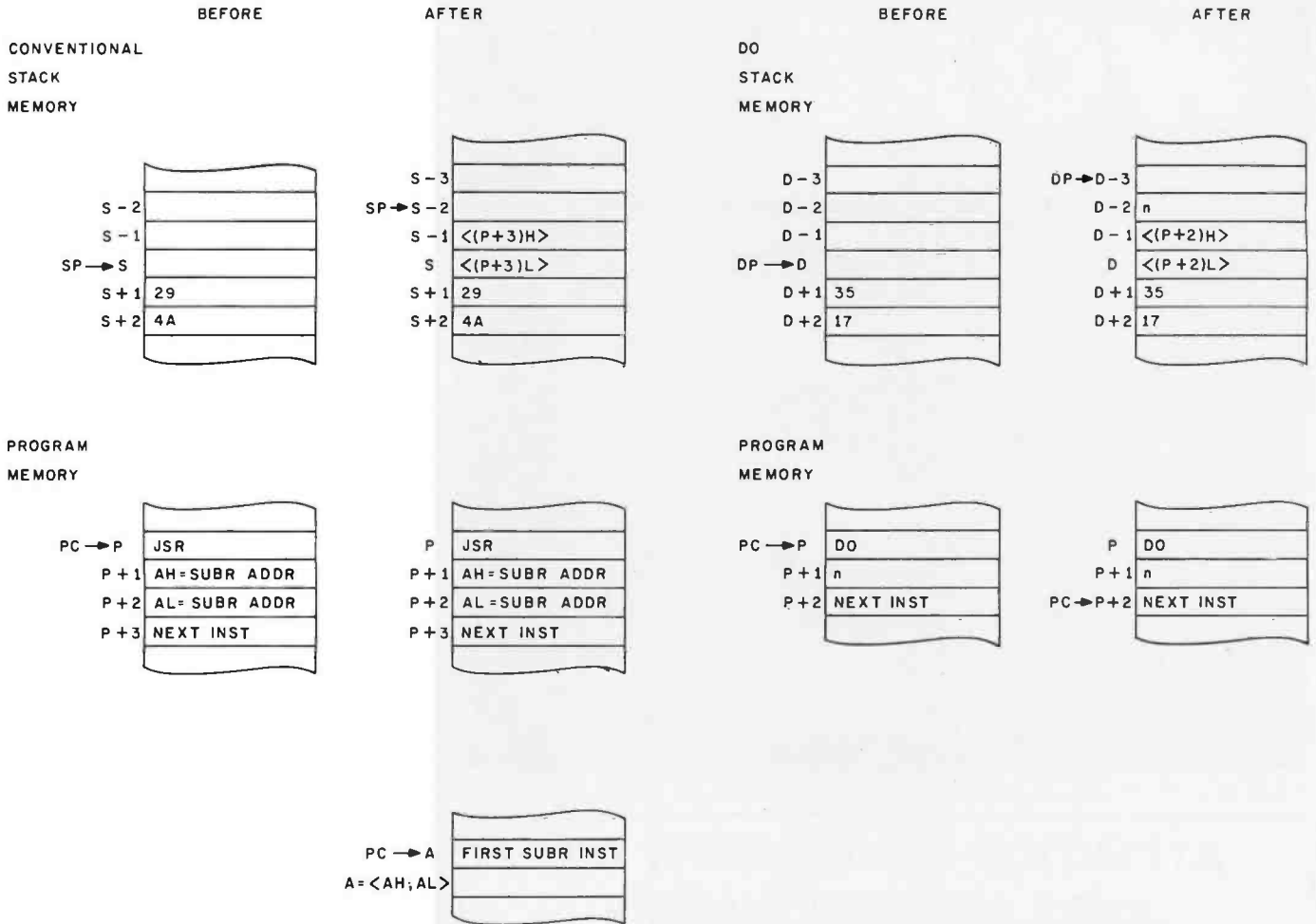

Figure 2: Comparison of a Jump to Subroutine instruction with proposed DO instruction. This diagrams the positions of the SP (stack pointer) relative to the PC (program counter) and the DP (DO Pointer) relative to the PC—both before and after the respective instructions have been executed (based on the architecture of the Motorola 6800 microprocessor).

lieve compiler writers of the burden of performing these operations with long strings of assembly-language instructions. The DO loop would also be made available to assembly-language programmers and microprocessor-hardware engineers.

What about the processors currently competing on the market? In table 2, there is a reference to the DB_{cc} instruction of the 68000 microprocessor, which performs the function of the proposed NXT instruction. But the user is left without the benefits of the automatic stacking operations of the proposed DO Pointer.

Variations

Studies of op-code usage have shown that the DO loop feature I've

described could be "appended" to common op codes, such as ADD, SUB, IN, and OUT, so a common function could have the added features of automatic DO pointing. For example:

```
DO n
SUB CONSTANT
NXT
```

would become:

```
SUBDO n, CONSTANT
NXT
```

This approach, however, involves a departure from the regularity desired in modern instruction-set designs.

Single instructions with the loop-

and-decrement mode are already available in several forms on the Z80 (LDIR and LDDR for moves; CPIR and CPID for the SRCH function; INIR, INDR, OTIR, and OTDR for input/output; and DJNZ for a function similar to NXT). The Z80 does these without benefit of a true DO pointer and without being able to combine arithmetic instructions and other general functions under one main DO loop.

It is feasible (and imperative) that a general DO architecture be included in future processor designs. There is a demonstrable need for the DO architecture, and it has been shown how such operations can be incorporated easily into many of the available architectures.

THE WORDTM \$75⁰⁰ COMPLETE

SPELLING PROOFREADER and COMPUTER DICTIONARY

The WORD is out!

Works with the editor of your choice to find those lurking spelling errors and sneaky typos.

SPELLING CHECKER

- 45,000 word dictionary
- Checks over 10 pages/minute
- Handles apostrophes, hyphens
- Marks mistakes in file
- CDOSTM, CP/MTM compatible
- Needs only 32K system

EXTRA FEATURES

- Automatic rhyme finder
- Crossword puzzle solver
- Correct spelling finder
- Word counter
- Word frequency analyzer
- Dictionary builder

AVAILABLE FOR:

- 8" Single Density CP/MTM
— soon —
- 5 1/4" North StarTM
- 5 1/4" SuperbrainTM
- AppleTM / SoftcardTM CP/M

OASIS SYSTEMS

(714) 291-9489

2765 Reynard Way, San Diego, CA 92103

ATTENTION GOVERNMENT D P USERS AND PURCHASERS

We represent many fine micro products and manufacturers on the U.S. Government's GSA Schedule, including

*Apple, Cromemco, Micropolis
and Seequa Computers*

Purchasing from the Schedule will save you the time consumed by the bid process. Products shipped throughout the United States and world-wide. Visit or write any of our stores for more information or to receive our catalogue of products represented.

**Computers,
Etc.....
the dependable store**

257 West Street, Annapolis, MD 21401 — (301) 268-6505
13A Allegheny Avenue, Towson, MD 21204 — (301) 296-0520
9330 Georgia Avenue, Silver Spring, MD 20910 — (301) 588-3748
6671 Backlick Road, Springfield, VA 22150 — (703) 644-5500
Plaza 38, 2442 Route 38, Cherry Hill, NJ 08002 — (609) 779-0023

Callers outside metropolitan areas served by our stores

Please call (301) 268-5801

Career Opportunities Available * An Equal Opportunity Employer

Summary

Modern processor instruction sets are by no means complete, if complete is defined as providing for all simple, regular instructions that could be of significant value to programmers and engineers. Instead, an all too common complaint is that a few basic instructions are either non-existent or difficult to find in most processors, and trade-offs in original designs of many processors have left some addressing modes incompletely supported. For example, one popular microprocessor implements branches, jumps, and subroutine jumps, but omits the branch to subroutine that is so useful in writing position-independent code.

It seems that restrictions of semiconductor die size has often "squeezed out" some useful instructions as a one-time cost savings. The result: programmers endlessly emulate desired, but unavailable, instructions with long sequences of other existing instructions. This has proved costly.

The magnitude of the programming tasks to be accomplished in the coming years could be reduced considerably with more useful assembly-language instructions. The challenge of the 1970s was to design newer and better processors. The challenge for the 1980s is to promote the evolution of processors with high-level instruction sets to help alleviate the software-management problem. The DO loop is one example of assembly-language- and processor architecture-related development that should be considered. ■

References

1. *Computer Structures: Readings and Examples*. C Gordon Bell and Allen Newell. McGraw-Hill, 1971.
2. *VAX11/780 Software Handbook*. Digital Equipment Corporation, 1977.
3. *M6800 Microprocessor Application Manual*. Motorola. McGraw-Hill Inc, 1975.
4. *Build a Microcomputer, Chapter VIII, HEX 29*. Advanced Micro Devices, 1979.
5. *9900 Family System Design and Data Book*. Texas Instruments, 1978.
6. *MC68000 Microprocessor Users Manual*. Motorola, 1979.

Apple Pascal Cross-Reference

Robert J Woodhead, Siro-tech Software Products
6 Main St, Ogdensburg NY 13669

Debugging a long or complex program can be made much easier by using reference listing. A utility program can easily generate one from the source code, listing the line numbers of all program statements in which each variable or named constant is used.

Niklaus Wirth developed an efficient binary-tree-search algorithm for this purpose (discussed in his book *Algorithms + Data Structures = Programs*. Englewood Cliffs NJ: Prentice-Hall, 1975). The algorithm was used in the program APPLE3:CROSSREF provided with the Apple Pascal system. I found CROSSREF unsatisfactory in some ways, however, so I took the basic concepts and developed my own version of the cross-reference program, adding features that make the program better suited for use with the Apple Pascal language system.

The new features include:

- ignoring the characters in comments and quoted-string literals
- dividing the source-code and cross-reference listings into pages with titles
- automatically extending the search into separate disk

files that contain source code routed to the compiler by the include-file mechanism

- top-down recursive design

The result is a more readable output listing for programs written in Pascal.

My modified version of the Wirth cross-reference-generator program is shown in listing 1, and its own cross-reference table is shown in listing 2.

A disadvantage of the program given here is that the data tables containing the cross-references are stored in memory, thus limiting the size of the input programs that can be processed. An improved version that I have developed stores the tables on disk, allowing cross-referencing of very large programs. You can obtain both the improved version and a spooler program that lets you specify multiple files for printing from my company for \$20. A floppy disk containing both source and pseudocode files is provided. ■

Interested readers can contact Siro-tech Software Products at (315) 393-2640.

Listing 1: *Apple Pascal cross-reference program based on a similar utility program provided with the Apple Pascal language system. This version includes several useful additions. Note paging and titling of the listing.*

```
1: (*#I-,R- *)
2:
3: PROGRAM CROSSREF;
4:
5: (*****
6: (*
7: (* CROSS REFERENCE GENERATOR USING BINARY TREE.
8: (* FROM WIRTH,ALGORITHMS+DATA STRUCTURES=PROGRAMS,P206 *)
9: (*
10: (* MODIFIED 17-SEP-80 BY ROBERT WOODHEAD FROM APPLE3:
11: (* CROSSREF PROGRAM. OPTIMIZED FOR PASCAL TEXTFILE
12: (* CROSSREFERENCING, WITH THE FOLLOWING FEATURES.
13: (*
14: (* 1) LISTING IS PAGED
15: (* 2) CONTENTS OF COMMENTS AND QUOTED STRINGS ARE NOT
```

Listing 1 continued on page 421

Circle 142 on inquiry card.

CHOOSE...

Choose an Apple Desk



A compact bi-level desk ideal for an Apple computer system. This 42" x 31 1/2" desk comes with a shelf to hold two Apple disk drives. The top shelf for your TV or monitor and manuals can also have an optional paper slot to accommodate a printer.

Choose a Micro Desk

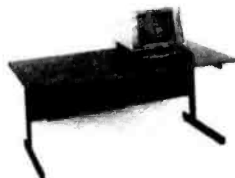

Get your micro computer off the desk top and into the micro shelf under our Designer Series desks. Suitable for the North Star, Dynabyte, Vector Graphics, and Altos computers. The desks come in a variety of sizes and colors.

Choose a Mini Rack



Mini racks and mini micro racks have standard venting, cable cut outs and adjustable RETMA rails. Choose a stand alone bay or a 48", 60", or 72" desk model in a variety of colors and wood tones. A custom rack is available for the Cromemco.

Choose a Printer Stand



The Universal printer stand fits the:

| | |
|--------------------|------------------------|
| Centronics 700's | Diablo 1600's & 2300's |
| Dec LA 34 | T.I. 810 & 820 |
| NEC Spinwriter | Okidata Slimline |
| Lear Siegler 300's | Anadex 9500's |

Delivery in days on over 200 styles and colors in stock. Dealer inquiries invited.

**ELECTRONIC SYSTEMS
FURNITURE
COMPANY**

17129 S. Kingsview Avenue
Carson, California 90746
Telephone: (213)538-9601

HIS CONTRIBUTIONS WERE MADE POSSIBLE BY YOURS.



When you give to the United Negro College Fund, you help support 41 private, four-year colleges and graduate schools. Colleges that could be training a black professional you may need someday.

Send your check to: United Negro College Fund, Box B, 500 E. 62nd Street, New York, New York 10021. We're not asking for a handout, just a hand.

No one can do it alone.

GIVE TO THE UNITED NEGRO COLLEGE FUND.

A mind is a terrible thing to waste.

A public service of this magazine and The Advertising Council.



Programming Quickies

Listing 1 continued:

```

16: (* INCLUDED IN THE CROSS REFERENCE *)
17: (* 3) PROGRAM WILL FIND AND INCLUDE FILES THAT WOULD *)
18: (* BE INCLUDED BY THE COMPILER INCLUDE MECHANISM *)
19: (* 4) PROGRAM CONSIDERABLY CLEANED UP! *)
20: (* *)
21: (******)
22:
23: CONST C1=10; (* LENGTH OF TOKENS STORED IN LIST *)
24: C2=10; (* NUMBERS PER LINE OF XREF LIST *)
25: C3=6; (* DIGITS PER NUMBER IN XREF LIST *)
26: C4=30000; (* MAX LINE NUMBER IN PRINTOUT *)
27: LP=57; (* # OF LINES/PAGE (66-6-3 MARGINS) *)
28:
29: TYPE ALPHA=PACKED ARRAY[1..C1] OF CHAR;
30: WORDREF=^WORD;
31: ITEMREF=^ITEM;
32: WORD=RECORD
33: KEY: ALPHA; (* TOKEN *)
34: FIRST, LAST: ITEMREF; (* LINKEDLIST OF LINES*)
35: LEFT, RIGHT: WORDREF; (* TREE POINTERS *)
36: END;
37: ITEM=PACKED RECORD
38: LNO: 0..C4; (* LINE NUMBER *)
39: NEXT: ITEMREF; (* LINK POINTER *)
40: END;
41:
42: VAR ROOT: WORDREF; (* ROOT TO TREE OF TOKENS *)
43: K : INTEGER; (* LENGTH OF CURRENT TOKEN *)
44: N : INTEGER; (* CURRENT LINE NUMBER *)
45: ID : ALPHA; (* TOKEN BEING PROCESSED *)
46: A : ALPHA; (* TOKEN BEING BUILT *)
47: CH : CHAR; (* CURRENT TOKEN CHARACTER *)
48: LINLEN; (* OF THE CURRENT LINE *)
49: CHARPOS: INTEGER;
50: FLEVEL : INTEGER; (* FILE WE ARE CURRENTLY USING *)
51: LINE: STRING[255]; (* CURRENT LINE BEING PROCESSED *)
52: F1,
53: F2;
54: G : TEXT; (* INPUT AND OUTPUT TEXTFILES *)
55: TITLE: STRING; (* TITLE OF PRINTOUT *)
56: SOURCE; (* INPUT AND OUTPUT FILENAMES *)
57: DEST: STRING[20];
58:
59: (* PAGER DETERMINES IF A PAGE EJECT IS REQUIRED, AND IF *)
60: (* SO, IT DOES IT AND PRINTS THE HEADER *)
61:
62: PROCEDURE PAGER;
63:
64: BEGIN (* PAGER *)
65:
66: IF (N MOD LP)=0 THEN
67: BEGIN
68: Writeln('<N>S, ' > [', MEMAVAIL:6, ' J']');
69:
70: IF N>0 THEN
71: BEGIN
72: Writeln(G);
73: Writeln(G);
74: Writeln(G);
75: END;
76: Writeln(G);
77: Writeln(G, 'XREF LISTING OF FILE ',

```

Listing 1 continued on page 422



SITTING PRETTY

You can use just about any desk for a computer terminal stand. But with CF&A, you're sitting pretty. Our full range of desks, workstations, and terminal stands are designed to accommodate a variety of computer equipment. Choose from our Classic Series desks, DR Series desks and enclosures, specialty items like our Apple II desk, or a universal printer stand. You'll be sitting pretty with attractive color selections, durable construction, versatile configurations, useful options, competitive prices, quick delivery, and personal service. It's our way of doing business.

CF&A

**Computer Furniture and
Accessories, Inc.**
1441 West 132nd Street
Gardena, CA 90249
(213) 327-7710

Send for our FREE Catalog

ADDRESS LABELS
FROM AVERY
ONLY

\$15.00

Shipping is even included,
but you must mention Ad #B9
when you order

This special price is just to
introduce you to our catalog
of computer accessories and
word processing supplies.
We offer you 25-50% off on
products like 3M-Scotch®
brand diskettes, computer
paper, ribbons, printwheels,
binders, and alot more.

**THESE ARE THE BEST
ADDRESS LABELS
YOU CAN BUY**

- TRACTOR FEED
- EXTRA HEAVY
BACKING PREVENTS
SKEWING DURING
PRINTING
- ACCURATELY
REFOLDS AFTER
PRINTING
- SPECIAL
NON-SMEAR
LABEL PAPER
- STANDARD
LABEL SIZE
3½ x 15/16

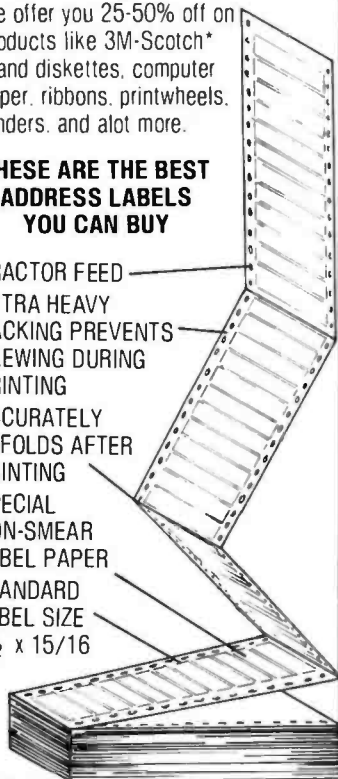

**BOX OF
5000 LABELS**



TRICOR

3601 S. 9th St.
Kalamazoo, MI 49009
TOLL FREE: (800) 253-4358
In Michigan: (616) 375-7519

- Please send me _____ box(es)
of address labels at \$15.00 per box.
(Ad # B9)
- I don't need the labels, but please
put me on your catalog mailing list.

Name _____
Company _____
Address _____
City _____
State/Zip _____
•3M Co.

Programming Quickies

Listing 1 continued:

```

78: SOURCE;
79: ' '(74-9-21-LENGTH(SOURCE));
80: 'PAGE ';
81: ((N DIV LP)+1)*4);
82: WRITELN(G);
83: WRITELN(G, ' '(37-(LENGTH(TITLE) DIV 2));
84: TITLE);
85: WRITELN(G);
86: WRITELN(G);
87: END;
88:
89: (* IN CASE YOU ARE WONDERING WHY IT'S 74 AND 37 INSTEAD *)
90: (* OF 80 AND 40 IN THOSE WRITELNS, IT'S BECAUSE 80 COL *)
91: (* PAPER USUALLY WILL HOLD <80 COLS. THE CHANGES MAKE *)
92: (* SURE YOU WILL SEE THE PAGE NUMBERS, ETC *)
93:
94: END; (* PAGER *)
95:
96: (* GETLINE READS A NEW LINE FROM THE INPUT FILE. IF *)
97: (* IT DETECTS AN END OF FILE, IT PRINTS OUT THE XREF *)
98:
99: PROCEDURE GETLINE;
100:
101: (* ENDITALL PAGE EJECTS AND STARTS THE XREF LIST, THEN *)
102: (* EXITS THE PROGRAM *)
103:
104: PROCEDURE ENDITALL;
105:
106: (* PRINTTREE RECURSIVELY CALLS ITSELF TO PRINT THE TREE *)
107: (* OF CROSS REFERENCES *)
108:
109: PROCEDURE PRINTTREE(W: WORDREF);
110:
111: (* PRINTWORD PRINTS A SINGLE CROSS REFERENCE *)
112:
113: PROCEDURE PRINTWORD(W: WORD);
114:
115: VAR
116: L: INTEGER;
117: X: ITEMREF;
118:
119: BEGIN (* PRINTWORD *)
120:
121: PAGER;
122: N:=N+1;
123: WRITE(G, ' ',W.KEY);
124: X:=W.FIRST;
125: L:=0;
126:
127: REPEAT
128:
129: IF L=C2 THEN
130: BEGIN
131: PAGER;
132: N:=N+1;
133: WRITELN(G);
134: L:=0;
135: WRITE(G, ' ',C1+1);
136: END;
137:
138: L:=L+1;
139: WRITE(G, X^.LNO:C3);
140: X:=X^.NEXT;
141:

```

Listing 1 continued:

```

142: UNTIL X=NIL)
143:
144: WRITELN(G);
145:
146: END; (* PRINTWORD *)
147:
148: BEGIN (* PRINTTREE *)
149:
150: IF W<> NIL THEN
151: BEGIN
152: PRINTTREE(W<.LEFT);
153: PRINTWORD(W);
154: PRINTTREE(W<.RIGHT);
155: END;
156:
157: END; (* PRINTTREE *)
158:
159:
160: BEGIN (* ENDITALL *)
161:
162: WHILE (N MOD LP)<>0 DO
163: BEGIN
164: N:=N+1;
165: WRITELN(G);
166: END;
167:
168: PRINTTREE(ROOT);
169:
170: EXIT(PROGRAM);
171:
172: END; (* ENDITALL *)
173:
174: (* ANINCLUDE OPENS THE INCLUDE FILE AND READS *)
175: (* IN THE FIRST LINE *)
176:
177: PROCEDURE ANINCLUDE;
178:
179: VAR
180: SOFNAME;
181: EOFNAME:INTEGER; (* CHARACTER POS PTRS *)
182: THAME :STRING; (* TEMP FILE NAME *)
183:
184: BEGIN (* ANINCLUDE *)
185:
186: SOFNAME:=POS('(*#I ')LINE)+4;
187:
188: THAME:=LINE;
189: DELETE(THAME,1,SOFNAME);
190:
191: EOFNAME:=POS('*)',THAME);
192:
193: IF EOFNAME=0 THEN
194: EXIT(ANINCLUDE); (* WAS NOT AN INCLUDE? *)
195:
196: THAME:=COPY(THAME,1,EOFNAME-1);
197:
198: WRITELN('INCLUDE FILE -->',THAME);
199:
200: FLEVEL:=2;
201: RESET(F2,THAME);
202:
203: IF IORESULT>0 THEN
204: BEGIN
205: CLOSE(F2);
206: FLEVEL:=FLEVEL-1;
207: END;

```

Listing 1 continued on page 424

Lowest Prices on Personal Computers

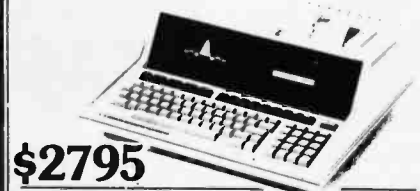

ATARI® 400... \$359

**HEWLETT
PACKARD HP-85**

HP-85 Accessories

5 1/4" Dual Master Disc Drive List \$2500... \$2125
 5 1/4" Single Master Disc Drive List \$1500... \$1275
 HP 7225A Graphics Plotter List \$2050... \$1845
 HP-85 16K Memory Module List \$395... \$355
 HP-85 Application Pacs Standard List \$95... \$85
 Serial (RS-232C) Interface Module List \$395... \$355
 GPIO Interface Module List \$495... \$445

new HP-83 List \$2250
\$1895

NEW! HP-41CV with five times
more memory

built in.
List \$325

\$249

HP-41C
List \$250

\$199

HP-32E Scientific w/Statistics — \$53.95
 HP-33C Scientific Programmable \$79.95
 HP-34C Advanced Scientific
 Programmable — 123.95
 HP-37E Business Calculator — \$49.95

**Personal
PC computer
Systems**

609 Butternut Street
 Syracuse, N.Y. 13208
(315) 475-6800

Prices do not include shipping by UPS. All prices and offers subject to change without notice.

SPECTACULAR OFFERS

BASF "FLEXYDISK"...
Superior Quality data storage medium. Certified and guaranteed 100% error free.



SINGLE SIDED-SINGLE DENSITY

5 1/4" or 8" Diskettes 10/\$24
5 1/4" or 8" Vinyl Storage Pages 10/\$5

MAXELL-DISKETTES
The best quality diskette money can buy. Approved by Shugart and IBM.



Sold only in boxes of 10

5", 1 side \$3.30
8", 1-side \$3.90
5", 2-side \$4.25
8", 2-side \$5.60

ALL MAXELL DISKETTES ARE DOUBLE DENSITY

LIBRARY CASE...
3-ring binder album. Protects your valuable programs on disks. Fully enclosed and protected on all sides. Similar to Kas-sette storage box.



Library 3-Ring Binder \$6.50
5 1/4" Mini Kas - sette/10 \$2.49
8" Kas-sette/10 \$2.99

DISKETTE DRIVE HEAD CLEANING KITS
Prevent head crashes and insure efficient, error-free operation.



5 1/4" or 8" \$19.50

SFD CASSETTES
C-10 Cassettes 10/\$7
(All cassettes include box & labels)
Get 8 cassettes, C-10 sonic and Cassette/8 library album for only \$8.00
(As illustrated)



HARDHOLE
Reinforcing ring of tough mylar protects disk from damage

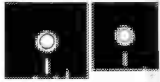

5 1/4" Applicator \$3 5 1/4" Hardholes \$6
8" Applicator \$4 50/8" Hardholes \$8

VISA • MASTERCARGE • MONEY ORDERS
CERTIFIED CHECK • FOR PERSONAL CHECKS
ALLOW TWO WEEKS • C.O.D. REQUIRES A 10%
DEPOSIT • CAL. RES. ADD 6% SALES TAX
MIN \$2 SHIPPING & HANDLING • MINIMUM
ORDER \$10 • SATISFACTION GUARANTEED
OR FULL REFUND
Write for our free catalog

ABM PRODUCTS

8868 Clairemont Mesa Blvd.
San Diego, CA 92123

Toll Free
1-800-854-1555
For Orders Only

For information or California orders
(714) 268-3537

Programming Quickies

Listing 1 continued:

```

208:
209:     GETLINE)           (* THE FIRST LINE OF FILE*)
210:
211: END; (* ANINCLUDE *)
212:
213: BEGIN (* GETLINE *)
214:
215:     IF FLEVEL=2 THEN     (* CHECK AND HANDLE EOF *)
216:         BEGIN
217:             IF EOF(F2) THEN(* MOVE BACK TO FILE 1 *)
218:                 BEGIN
219:                     CLOSE(F2);
220:                     FLEVEL:=1
221:                 END
222:             END
223:         ELSE
224:             IF EOF(F1) THEN
225:                 ENDITALL;
226:
227:         PAGER;
228:         N:=N+1;
229:
230:     IF FLEVEL=1 THEN
231:         READLN(F1,LINE)
232:     ELSE
233:         READLN(F2,LINE);
234:
235:     LINE:=CONCAT(LINE,' ');
236:
237:     LINELEN:=LENGTH(LINE);
238:     CHARPOS:=1;
239:     WRITELN(CHARPOS,' ',LINE);
240:
241:     IF POSC('(*#I ',LINE)>>0 THEN
242:         IF FLEVEL=1 THEN
243:             ANINCLUDE;
244:
245:     END; (* GETLINE *)
246:
247: (* READCH IS THE FUNNEL THROUGH WHICH THE REST *)
248: (* OF THE PROGRAM GETS CHARACTERS. IT FILTERS *)
249: (* OUT COMMENTS AND QUOTED STRINGS *)
250:
251: PROCEDURE READCH;
252:
253: (* NEXTCHAR ASSIGNS TO CH THE NEXT CHAR IN THE *)
254: (* INPUT STREAM *)
255:
256: PROCEDURE NEXTCHAR;
257:
258: BEGIN (* NEXTCHAR *)
259:
260:     WHILE CHARPOS>LINELEN DO (* SKIPS BLANKS *)
261:         GETLINE;
262:
263:         CH:=LINE[CHARPOS];
264:         CHARPOS:=CHARPOS+1
265:
266:     END; (* NEXTCHAR *)
267:
268: (* SPANQUOTE SKIPS CHARACTERS UNTIL IT FINDS A *)
269: (* QUOTE (') CHARACTER. IT THEN CALLS READCH TO *)
270: (* READ IN A VALID CHARACTER. SINCE READCH MAY *)
271: (* CALL SPANQUOTE OR SPANCOMMENT, THE EFFECT IS *)
272: (* TO KEEP RECURSIVELY CALLING UNTIL WE ARE NOT *)
273: (* IN A COMMENT OR A QUOTE! *)

```

Listing 1 continued:

```

274: (1
275: (* PS: DONT YOU JUST LOVE RECURSION! *)
276:
277: PROCEDURE SPANQUOTE;
278:
279: BEGIN (* SPANQUOTE *)
280:
281:     REPEAT
282:         NEXTCHAR
283:     UNTIL CH='''';
284:
285:     READCH
286:
287: END; (* SPANQUOTE *)
288:
289: (* SPANCOMMENT DOES A SIMILAR DASTARDLY THING *)
290: (* AS SPANQUOTE. ONE COMPLICATION IS THAT WE *)
291: (* HAVE TO LOOK OUT FOR THINGS COMMENTS LIKE: *)
292: (** *)
293: (** **)
294: (****)
295: (* THIS IS DONE BY A WHILE INSIDE A REPEAT *)
296:
297: PROCEDURE SPANCOMMENT;
298:
299: BEGIN (* SPANCOMMENT *)
300:
301:     NEXTCHAR; (* FLUSH THE * OF THE LEADING PAREN*)
302:     NEXTCHAR; (* GET THE FIRST CHAR TO LOOK AT *)
303:     REPEAT
304:         WHILE CH>'*' DO (* FIND AN ASTERIX *)
305:             NEXTCHAR;
306:             NEXTCHAR; (* GET THE CHARACTER AFTER *)
307:             UNTIL CH=')'; (* IF A ) WE ARE OK, ELSE IT *)
308:             (* MAY BE A * SO REPEAT! *)
309:
310:     READCH
311:
312: END; (* SPANCOMMENT *)
313:
314: BEGIN (* READCH *)
315:
316:     NEXTCHAR; (* READ THE CHARACTER *)
317:
318:     IF CH=''' THEN (* SKIP IF NEEDED *)
319:         SPANQUOTE
320:     ELSE
321:         IF CH='(' THEN
322:             IF CHARPOS<=LINELEN THEN
323:                 IF LINE[CHARPOS]='*' THEN
324:                     SPANCOMMENT;
325:
326: END; (* READCH *)
327:
328: (* PROCEDURE SEARCH WILL SEARCH FOR THE TOKEN *)
329: (* IN ID, AND IF FOUND, INSERT THE LINE# IN ITS *)
330: (* LINKED LIST. OTHERWISE IT WILL CREATE IT *)
331:
332: PROCEDURE SEARCH(VAR W1: WORDREF);
333:
334: VAR
335:     W: WORDREF;
336:     X: ITEMREF;
337:
338: BEGIN
339:

```

Listing 1 continued on page 426

MTI stocks 'em all for faster delivery.

No hidden charges. Prices include delivery.
Ask about our "QED" discounts.
VISA and MasterCard orders accepted.

| | MTI Price |
|--|--------------|
| VIDEO TERMINALS | |
| VT100 DECscope | \$ 1635 |
| VT132 DECscope | 1995 |
| ADM 3A (dumb terminal) | 595 |
| ADM 5 (dumb with visual attributes) | 645 |
| ADM 31 (2 page buffer) | * |
| ADM 32 (ergonomic ADM 31) | * |
| ADM 42 (8 page buffer avail.) | * |
| TI 940 (2 page buffer) | 1795 |
| TI "Insight Series 10" personal term. .. | 895 |
| Hazeltine Executive 80 Model 20 | 1375 |
| Hazeltine Executive 80 Model 30 | 1715 |
| Hazeltine Esprit | 645 |
| 1410 (Hazeltine dumb terminal) | 825 |
| 1420 (dumb terminal) | 895 |
| 1421 (Consul 580 & ADM 3A comp.) | 850 |
| 1500 (dumb terminal) | 1045 |
| 1510 (buffered) | 1145 |
| 1520 (buffered, printer port) | 1395 |
| 1552 (VT52 compatible) | 1250 |
| GRAPHICS TERMINALS | |
| VT100 with graphics pkg. | 3250 |
| ADM 3A with graphics pkg. | 1875 |
| ADM 3A+ with graphics pkg. | 1925 |
| 300 BAUD TELEPRINTERS | |
| LA34-DA DECwriter IV | 995 |
| LA34-AA DECwriter IV | 1095 |
| LA36 DECwriter II | 1295 |
| Teletype 4310 | 1095 |
| Teletype 4320 | 1195 |
| Diablo 630 RD | 2295 |
| Diablo 1640 KSR | 2775 |
| Diablo 1650 KSR | 2635 |
| TI 743 (portable) | 1190 |
| TI 745 (port/built-in coupler) | 1485 |
| TI 763 (port/bubble memory) | 2545 |
| TI 765 (port/bubble/b.l. coupler) | 2595 |
| TI "Insight Series 10/1" pers. term. | 895 |
| 600 BAUD TELEPRINTERS | |
| TI 825 RO impact | 1450 |
| TI 825 KSR impact | 1570 |
| TI 825 RD pkg. | 1625 |
| TI 825 KSR Pkg. | 1795 |
| TI 840 RO impact | 1095 |
| TI 840 KSR impact | 1245 |
| 1200 BAUD TELEPRINTERS | |
| LA120 RO (forms package) | 2095 |
| LA120 AA DECwriter III (forms pkg.) | 2295 |
| TI 783 (portable) | 1645 |
| TI 785 (port/built-in coupler) | 2270 |
| TI 787 (port/internal modem) | 2595 |
| TI 810 RO impact | 1455 |
| TI 810 RO pkg. | 1690 |
| TI 820 KSR impact | 2025 |
| TI 820 RO | 1850 |
| TI 820 KSR pkg. | 2195 |
| TI 820 RO pkg. | 2075 |
| 2400 BAUD | |
| Dataproducts M200 (2400 baud) | 2595 |
| DATAPRODUCTS LINE PRINTERS | |
| 8300 (300 LPM band) | 5535 |
| 8600 (600 LPM band) | 6861 |
| 8900 (900 LPM band) | 10164 |
| 8P1500 (1500 LPM band) | 16785 |
| 2230 (300 LPM drum) | 7723 |
| 2260 (600 LPM drum) | 9614 |
| 2290 (900 LPM drum) | 12655 |
| ACOUSTIC COUPLERS | |
| A/J A242-A (300 baud orig.) | 242 |
| A/J 247 (300 baud orig.) | 315 |
| A/J 1234 (Vadic compatible) | 595 |
| Vadic VA 3413 (300/1200 orig.) | 825 |
| Vadic VA 3434 (1200 baud orig.) | 845 |
| MODEMS | |
| GDC 103A3 (300 baud Bell) | 395 |
| GDC 202S/T (1200 baud Bell) | 565 |
| GDC 212-A (300/1200 baud Bell) | 850 |
| A/J 1256 (Vadic compatible) | 825 |
| VA 103 (300 baud orig./ans.in phone) | 235 |
| VA 3451 (orig./ans. triple modem) | 885 |
| VA 3455 1200 baud orig./ans. | 770 |
| CASSETTE STORAGE SYSTEMS | |
| Techtran 816 (store/forward) | 1050 |
| Techtran 817 (store/for/speed up) | 1295 |
| Techtran 818 (editing) | 1795 |
| Techtran 822 (dual) | 2295 |
| FLOPPY DISK SYSTEMS | |
| Techtran 950 (store/forward) | 1395 |
| Techtran 951 (editing) | 1995 |

*Please call for quote



Distributors, New York, New Jersey and Ohio.
New York:
516/482-3500, 212/895-7177, 518/449-5959
Outside N.Y.S.: 800/645-8016
New Jersey: 201/227-5552
Ohio: 216/464-6688

MAIL ORDER ONLY

Micro Computer DISCOUNT Co

QUALITY • DELIVERY • SERVICE

Your One Stop For... Quality and Huge Savings

★ MONTHLY ★ SPECIALS ★

COMMODORE

★ 8032 \$995 ★

CBM/VISI CALC

★ \$1975
INCLUDES: ★

- 8032 Computer
- Dual Disk Drive & Cable
- VisiCalc 80 Col. Software



EPSON

Call for Best Price & Delivery

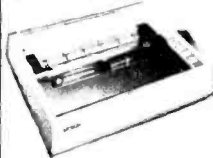

COMMODORE

16K - \$775
32K - \$975
2022 - \$595
4040 - \$995
8050 - \$1395
8032 - \$995



QUME SPRINT 9

Call For Price

SUPERBRAIN*

64K - \$2245
64KQD - \$2595



ATARI
800 - \$759
400 - 339



CENTRONICS
CALL FOR PRICES

MONITORS

Sanyo 9" ——— B & W — \$175
Sanyo 12" ——— B & W — 229
Sanyo 12" ——— Green — 279
NEC 12" ——— Green — 239
BMC 12" ——— Green — 239
Zenith 13" ——— Color — 339
Amdex 13" ——— Color — 359

* (DENOTES ITEMS SHIPPED F.O.B. NYC)

MAIL ORDER ONLY

Send Certified Check (Personal or Company Checks require 2 weeks to clear.) We pay all shipping and insurance charges except items marked with asterisk. VISA, MasterCard add 5%. N.Y.S. Residents add appropriate sales tax.

PHONE (212) 986-7690

Micro Computer Discount Company
60 E. 42nd St. Suite 411 New York, NY 10017

Programming Quickies

Listing 1 continued:

```

340:   W:=W1;           (* ROOT OF BINARY (SUB)TREE *)
341:
342:   IF W=NIL THEN
343:     BEGIN          (* IF (SUB)TREE IS NIL, CREATE *)
344:       NEW(W);      (* WORD RECORD *)
345:       NEW(X);      (* AND LINE# RECORD *)
346:       WITH W DO
347:         BEGIN
348:           KEY:=ID;  (* STUFF IN THE DATA *)
349:           LEFT:=NIL;
350:           RIGHT:=NIL;
351:           FIRST:=X;
352:           LAST:=X;
353:         END;
354:         X^.LNO:=N;
355:         X^.NEXT:=NIL;
356:         W1:=W;
357:       END
358:     ELSE           (* NON EMPTY TREE *)
359:       IF ID<W^.KEY THEN
360:         SEARCH(W^.LEFT) (* RECURSIVE SEARCH! *)
361:       ELSE
362:         IF ID>W^.KEY THEN
363:           SEARCH(W^.RIGHT) (* AND AGAIN *)
364:         ELSE
365:           BEGIN (* FOUND IT, ADD DATA *)
366:             NEW(X);
367:             X^.LNO:=N;
368:             X^.NEXT:=NIL;
369:             W^.LAST^.NEXT:=X;
370:             W^.LAST:=X;
371:           END;
372:
373:     END; (* SEARCH *)
374:
375: BEGIN (* MAIN *)
376:
377:   ROOT:=NIL; (* EMPTY TREE TO START *)
378:   FLEVEL:=1; (* ON FIRST FILE AT THE START *)
379:   N:=0;
380:
381:   WRITELN(CHR(12), 'MODIFIED XREF PROGRAM - 17-SEP-80 BY RJW');
382:   WRITELN;
383:   WRITELN('ENTER A TITLE FOR YOUR XREF BELOW:');
384:   WRITELN;
385:   READLN(TITLE);
386:   WRITELN;
387:   REPEAT
388:     WRITE('SOURCE FILE ? >');
389:     READLN(SOURCE);
390:     IF POS(' ', SOURCE)=0 THEN SOURCE:=CONCAT(SOURCE, '.TEXT');
391:     RESET(F1, SOURCE);
392:     UNTIL IORESULT=0;
393:
394:   REPEAT
395:     WRITE('DEST FILE ? >');
396:     READLN(DEST);
397:     REWRITE(G, DEST);
398:     UNTIL IORESULT=0;
399:
400:   WRITELN;
401:   WRITELN('<LINE#> [MEMORY]');
402:   WRITELN('-----');
403:
404:   GETLINE; (* INITIALIZE THE SYSTEM *)
405:
406:

```

Listing 1 continued:

```

407: REPEAT      (* FOREVER MORE *)
408:
409:     REPEAT  (* FIND 1ST CHAR IN A TOKEN *)
410:         READCH;
411:     UNTIL CH IN ['A'..'Z'],'a'..'z'],'0'..'9'];
412:
413:     K:=0;    (* ZERO LENGTH OF TOKEN AND TOKEN! *)
414:
415:     FILLCHAR(A,SIZEOF(A),' ');
416:
417:     REPEAT  (* FILL UP TOKEN *)
418:
419:         IF K<<C1 THEN
420:             BEGIN  (* ADD CHAR TO TOKEN *)
421:                 K:=K+1;
422:                 A[K]:=CH;
423:             END;
424:
425:         READCH;    (* GET NEXT CHAR IN TOKEN *)
426:
427:     UNTIL NOT(CH IN ['A'..'Z'],'a'..'z'],'0'..'9');
428:
429:     ID:=A;        (* INSERT TOKEN INTO TREE *)
430:     SEARCH(ROOT);
431:
432: UNTIL FALSE    (* WILL HIT EOF IN GETLINE *)
433:
434: END.

```

Listing 2: Table of the cross-reference generator as produced by the program in listing 1.

| | XREF OF XREF | | | | | | | | | |
|-----------|--------------|-----|-----|-----|-----|-----|-----|-----|-----|-----|
| 0 | 38 | 66 | 70 | 125 | 134 | 162 | 193 | 203 | 241 | 380 |
| | 391 | 393 | 399 | 413 | | | | | | |
| 1 | 29 | 81 | 122 | 132 | 135 | 138 | 164 | 189 | 196 | 196 |
| | 206 | 220 | 228 | 230 | 238 | 242 | 264 | 379 | 421 | |
| 10 | 23 | 24 | | | | | | | | |
| 12 | 382 | | | | | | | | | |
| 2 | 83 | 200 | 215 | | | | | | | |
| 20 | 57 | | | | | | | | | |
| 21 | 79 | | | | | | | | | |
| 255 | 51 | | | | | | | | | |
| 30000 | 26 | | | | | | | | | |
| 37 | 83 | | | | | | | | | |
| 4 | 81 | 186 | | | | | | | | |
| 5 | 68 | | | | | | | | | |
| 57 | 27 | | | | | | | | | |
| 6 | 25 | 68 | | | | | | | | |
| 74 | 79 | | | | | | | | | |
| 9 | 79 | | | | | | | | | |
| A | 46 | 415 | 415 | 422 | 429 | | | | | |
| ALPHA | 29 | 33 | 45 | 46 | | | | | | |
| ANINCLUDE | 177 | 194 | 243 | | | | | | | |
| ARRAY | 29 | | | | | | | | | |
| BEGIN | 64 | 67 | 71 | 119 | 130 | 148 | 151 | 160 | 163 | 184 |
| | 204 | 213 | 216 | 218 | 258 | 279 | 299 | 314 | 338 | 343 |

Listing 2 continued on page 428

Programming Quickies

Listing 2 continued:

| | | | | | | | | | | |
|----------|-----|-----|-----|-----|-----|-----|-----|-----|-----|-----|
| | 347 | 365 | 376 | 420 | | | | | | |
| C1 | 23 | 29 | 135 | 419 | | | | | | |
| C2 | 24 | 129 | | | | | | | | |
| C3 | 25 | 139 | 239 | | | | | | | |
| C4 | 26 | 38 | | | | | | | | |
| CH | 47 | 263 | 283 | 304 | 307 | 318 | 321 | 411 | 422 | 427 |
| CHAR | 29 | 47 | | | | | | | | |
| CHARPOS | 49 | 238 | 260 | 263 | 264 | 264 | 322 | 323 | | |
| CHR | 382 | | | | | | | | | |
| CLOSE | 205 | 219 | | | | | | | | |
| CONCAT | 235 | 391 | | | | | | | | |
| CONST | 23 | | | | | | | | | |
| COPY | 196 | | | | | | | | | |
| CROSSREF | 3 | | | | | | | | | |
| DELETE | 189 | | | | | | | | | |
| DEST | 57 | 397 | 398 | | | | | | | |
| DIV | 81 | 83 | | | | | | | | |
| DO | 162 | 260 | 304 | 346 | | | | | | |
| ELSE | 223 | 232 | 320 | 358 | 361 | 364 | | | | |
| END | 36 | 40 | 75 | 87 | 94 | 136 | 146 | 155 | 157 | 166 |
| | 172 | 207 | 211 | 221 | 222 | 245 | 266 | 287 | 312 | 326 |
| | 353 | 357 | 371 | 373 | 423 | 434 | | | | |
| ENDITALL | 104 | 225 | | | | | | | | |
| EOF | 217 | 224 | | | | | | | | |
| EOFNAME | 181 | 191 | 193 | 196 | | | | | | |
| EXIT | 170 | 194 | | | | | | | | |
| F1 | 52 | 224 | 231 | 392 | | | | | | |
| F2 | 53 | 201 | 205 | 217 | 219 | 233 | | | | |
| FALSE | 432 | | | | | | | | | |
| FILLCHAR | 415 | | | | | | | | | |
| FIRST | 34 | 124 | 351 | | | | | | | |
| FLEVEL | 50 | 200 | 206 | 206 | 215 | 220 | 230 | 242 | 379 | |
| G | 54 | 72 | 73 | 74 | 76 | 77 | 82 | 83 | 85 | 86 |
| | 123 | 133 | 135 | 139 | 144 | 165 | 239 | 398 | | |
| GETLINE | 99 | 209 | 261 | 405 | | | | | | |
| ID | 45 | 348 | 359 | 362 | 429 | | | | | |
| IF | 66 | 70 | 129 | 150 | 193 | 203 | 215 | 217 | 224 | 230 |
| | 241 | 242 | 318 | 321 | 322 | 323 | 342 | 359 | 362 | 391 |
| | 419 | | | | | | | | | |
| IN | 411 | 427 | | | | | | | | |
| INTEGER | 43 | 44 | 49 | 50 | 116 | 181 | | | | |
| IORESULT | 203 | 393 | 399 | | | | | | | |
| ITEM | 31 | 37 | | | | | | | | |
| ITEMREF | 31 | 34 | 39 | 117 | 336 | | | | | |
| K | 43 | 413 | 419 | 421 | 421 | 422 | | | | |
| KEY | 33 | 123 | 348 | 359 | 362 | | | | | |
| L | 116 | 125 | 129 | 134 | 138 | 138 | | | | |
| LAST | 34 | 352 | 369 | 370 | | | | | | |
| LEFT | 35 | 152 | 349 | 360 | | | | | | |
| LENGTH | 79 | 83 | 237 | | | | | | | |
| LINE | 51 | 186 | 188 | 231 | 233 | 235 | 235 | 237 | 239 | 241 |
| | 263 | 323 | | | | | | | | |
| LINELEN | 48 | 237 | 260 | 322 | | | | | | |
| LNO | 38 | 139 | 354 | 367 | | | | | | |

| | | | | | | | | | | |
|-------------|-----|-----|-----|-----|-----|-----|-----|-----|-----|-----|
| LP | 27 | 66 | 81 | 162 | | | | | | |
| MEMAVAIL | 68 | | | | | | | | | |
| MOD | 66 | 162 | | | | | | | | |
| N | 44 | 66 | 68 | 70 | 81 | 122 | 122 | 132 | 132 | 162 |
| | 164 | 164 | 228 | 228 | 239 | 354 | 367 | 380 | | |
| NEW | 344 | 345 | 366 | | | | | | | |
| NEXT | 39 | 140 | 355 | 368 | 369 | | | | | |
| NEXTCHAR | 256 | 282 | 301 | 302 | 305 | 306 | 316 | | | |
| NIL | 142 | 150 | 342 | 349 | 350 | 355 | 368 | 378 | | |
| NOT | 427 | | | | | | | | | |
| OF | 29 | | | | | | | | | |
| PACKED | 29 | 37 | | | | | | | | |
| PAGER | 62 | 121 | 131 | 227 | | | | | | |
| POS | 186 | 191 | 241 | 391 | | | | | | |
| PRINTTREE | 109 | 152 | 154 | 168 | | | | | | |
| PRINTWORD | 113 | 153 | | | | | | | | |
| PROCEDURE | 62 | 99 | 104 | 109 | 113 | 177 | 251 | 256 | 277 | 297 |
| | 332 | | | | | | | | | |
| PROGRAM | 3 | 170 | | | | | | | | |
| READCH | 251 | 285 | 310 | 410 | 425 | | | | | |
| READLN | 231 | 233 | 386 | 390 | 397 | | | | | |
| RECORD | 32 | 37 | | | | | | | | |
| REPEAT | 127 | 281 | 303 | 388 | 395 | 407 | 409 | 417 | | |
| RESET | 201 | 392 | | | | | | | | |
| REWRITE | 398 | | | | | | | | | |
| RIGHT | 35 | 154 | 350 | 363 | | | | | | |
| ROOT | 42 | 168 | 378 | 430 | | | | | | |
| SEARCH | 332 | 360 | 363 | 430 | | | | | | |
| SIZEOF | 415 | | | | | | | | | |
| SOFNAME | 180 | 186 | 189 | | | | | | | |
| SOURCE | 56 | 78 | 79 | 390 | 391 | 391 | 391 | 392 | | |
| SPANCOMMENT | 297 | 324 | | | | | | | | |
| SPANQUOTE | 277 | 319 | | | | | | | | |
| STRING | 51 | 55 | 57 | 182 | | | | | | |
| TEXT | 54 | | | | | | | | | |
| THEN | 66 | 70 | 129 | 150 | 193 | 203 | 215 | 217 | 224 | 230 |
| | 241 | 242 | 318 | 321 | 322 | 323 | 342 | 359 | 362 | 391 |
| | 419 | | | | | | | | | |
| TITLE | 55 | 83 | 84 | 386 | | | | | | |
| TNAME | 182 | 188 | 189 | 191 | 196 | 196 | 198 | 201 | | |
| TYPE | 29 | | | | | | | | | |
| UNTIL | 142 | 283 | 307 | 393 | 399 | 411 | 427 | 432 | | |
| UHR | 42 | 115 | 179 | 332 | 334 | | | | | |
| U | 109 | 113 | 123 | 124 | 150 | 152 | 153 | 154 | 335 | 340 |
| | 342 | 344 | 346 | 356 | 359 | 360 | 362 | 363 | 369 | 370 |
| U1 | 332 | 340 | 356 | | | | | | | |
| WHILE | 162 | 260 | 304 | | | | | | | |
| WITH | 346 | | | | | | | | | |
| WORD | 30 | 32 | 113 | | | | | | | |
| WORDREF | 30 | 35 | 42 | 109 | 332 | 335 | | | | |
| WRITE | 123 | 135 | 139 | 389 | 396 | | | | | |
| WRITELN | 68 | 72 | 73 | 74 | 76 | 77 | 82 | 83 | 85 | 86 |
| | 133 | 144 | 165 | 198 | 239 | 382 | 383 | 384 | 385 | 387 |
| | 401 | 402 | 403 | | | | | | | |
| X | 117 | 124 | 139 | 140 | 140 | 142 | 336 | 345 | 351 | 352 |
| | 354 | 355 | 366 | 367 | 368 | 369 | 370 | | | |

Multiple Regression for the TRS-80

Thomas William Madron
 Manager, Academic Computing Services
 North Texas State University
 POB 13495
 Denton TX 76203

Within the context of a large number of scientific and technological problems it is necessary to be able to predict a score or value of a variable (Y) from one or more predictors (X s). One method commonly used to accomplish this feat is *multiple linear regression*.

This article deals primarily with converting the mathematics of linear regression into a general-purpose BASIC computer program; therefore, only a very brief discussion of the mathematics is presented. Readers should consult the references for this article for a detailed treatment of multiple linear regression.

The fundamental equation for linear regression using a single predictor is:

$$Y' = a + bx$$

where Y' (Y prime) constitutes the predicted value(s) of the *dependent* variable; X is the predictor or *independent* variable; a the intercept constant; and b the regression coefficient. Suffice it to say, at this point, that multiple regression is an extension of simple linear regression:

$$Y' = a + b_1X_1 + b_2X_2 + \dots + b_nX_n$$

where $X_1 \dots X_n$ constitutes a set of predictors and $b_1 \dots b_n$ a set of regression coefficients.

The primary problem in computing a regression lies in determining values for a and b . One formula that may be used to calculate a is:

$$a = \bar{Y} - b\bar{X}$$

where \bar{Y} (Y -bar) and \bar{X} (X -bar) are the mean values for Y and X . As with the prediction formula, there is a straightforward extension to the multivariate case:

$$a = \bar{Y} - b_1\bar{X}_1 - b_2\bar{X}_2 - \dots - b_n\bar{X}_n$$

One of the primary problems, then, is to solve for the b s so that we may calculate the equation.

For one or two independent variables, the calculations for the regression coefficients are straightforward, but with more than two independent variables it is useful to use a computer. It turns out that to obtain the coefficients, we need to solve a set of simultaneous equations. The easiest way to do the arithmetic is with *matrix* algebra.

In order to obtain all the coefficients we need, we can use the following formula (boldface letters denote matrices):

$$\mathbf{B} = \mathbf{R}\mathbf{R}^{-1} \times \mathbf{R}\mathbf{Y}$$

where \mathbf{B} is a vector (in BASIC, a one-dimensional array), $\mathbf{R}\mathbf{R}^{-1}$ is the inverse of the matrix (in BASIC, a two-dimensional array) of correlations between all of the independent variables taken two at a time; and $\mathbf{R}\mathbf{Y}$ is a vector of correlation coefficients of each independent variable with the dependent variable. (A correlation coefficient is a measure of the extent to which two variables vary together and, in the two-variable case, is identical to the "standardized" regression coefficient b^* [b -star].) The vector \mathbf{B} has as its elements these coefficients, or b^* s (b -stars). The b^* s can be

turned into b s through the use of the following formula:

$$b_j = b^*_j (s_y/s_j)$$

where s_y is the standard deviation of the dependent variable and s_j is the standard deviation of each j th independent variable. This article does not propose to explain matrix algebra, so suffice it to say that the computations for inverting matrices can be found in the book by Kerlinger and Pedhazur (reference 3) and in the articles by Adler (references 1 and 2).

In interpreting the results of regression, several additional statistics are useful. The first of these is the coefficient of multiple correlation, which is simply the correlation between the observed and predicted Y values (usually designated by the capital letter R). The proportion of variance in the dependent variable explained by the set of independent variables is given by the square of R . The significance of R^2 can be calculated using an F -test. It turns out that once we have accomplished the matrix arithmetic described above, R^2 can be easily calculated:

$$R^2 = b^*_{1r_{y1}} + b^*_{2r_{y2}} + \dots + b^*_{nr_{yn}}$$

and $R = \sqrt{R^2}$. The F -test is also a straightforward calculation:

$$F = \frac{R^2/k}{(1 - R^2)/(N - k - 1)}$$

where k is the number of independent variables and N is the number of observations. F can be tested for the probability of occurrence by con-

sulting a table of F values, or by computation as in the program described. Now let's turn the arithmetic into a useful BASIC program.

Program Description

When doing statistical programming it is often desirable to produce a program that has general applicability to a wide range of data. Indeed, for large computers, a number of extensive general-purpose statistical packages are available. Alas, such is not the case for microcomputers. But,

the programs provided will run easily on a 16 K-byte Radio Shack TRS-80 Model I Level II computer. Except for the routines used to format the output for the TRS-80 video monitor, no unusual BASIC keywords are used. Later in this article we show how the program might be simplified if BASIC matrix functions were available (they are not for standard TRS-80 BASIC).

Many regression programs combine the routines to generate correlation matrices with the regression calculations. Because there are a

number of valuable uses for a "stand-alone" correlation program, I have provided two separate programs; data for the second is transferred by an output file from the first. The program in listing 1 generates a correlation matrix from keyboard or tape input. On option, the matrix can be saved on tape. The program in listing 2 calculates regression. It would be easy to substitute disk I/O (input/output) for tape I/O. Both programs consist of a main calling pro-

Text continued on page 445

Listing 1: The correlation-matrix program (1a) and a test run (1b). Written in BASIC for the Radio Shack TRS-80 Model I Level II, this program provides a "stand-alone" correlation matrix that may be saved on cassette tape.

```

1000 / CORRELATION MATRIX PROGRAM
1010 CLEAR:DEFINT I-N
1020 / IF THE ZEROth ELEMENT OF THE ARRAYS ARE USED, THEN
1030 / IB MUST = ZERO, ELSE IB=1. ND=THE MAXIMUM DIMENSION
1040 / FOR EACH ARRAY (MAX VARIABLES).
1050 IB=0:ND=15
1060 DIM R(ND,ND),A(ND),S(ND)
1070 CLS:PRINT "CORRELATION MATRIX PROGRAM"
1080 PRINT "BY THOMAS WM. MADRON"
1090 PRINT "2132 SAVANNAH TRAIL"

```

Listing 1a continued on page 432

SAVE \$\$

DISCOUNT PRICES

SAVE \$\$



| | |
|--------------------|---------|
| 16K APPLE II | 1049.00 |
| 32K APPLE II | 1074.00 |
| 48K APPLE II | 1099.00 |
| DISK W/CONTROLLER | 499.00 |
| DISK ONLY | 445.00 |
| APPLESOFT CARD | 139.00 |
| INTEGER CARD | 139.00 |
| PASCAL SYSTEM | 399.00 |
| SILENTYPE PRINTER | 349.00 |
| HAYES MICROMODEM | 295.00 |
| Z-80 SOFTCARD | 295.00 |
| VIDEX 80 COL. BRD. | 295.00 |
| 16K RAM BOARD | 169.00 |

RAM MEMORY

| | |
|-------------------------|-------|
| FOR TRS-80, APPLE II | |
| 16K SET 4116's (200 NS) | 24.95 |



| | |
|----------------------|---------|
| 400 16K | 349.00 |
| 800 16K | 759.00 |
| 410 Recorder | 64.00 |
| 815 Disk | 1199.00 |
| 810 Disk | 489.00 |
| 822 Printer | 359.00 |
| 825 Printer | 779.00 |
| 830 Modem | 159.00 |
| 850 Interface Module | 179.00 |
| CX853 RAM | 85.00 |
| CX70 Light Pen | 64.00 |
| CX30 Paddle | 18.00 |
| CX40 Joystick | 18.00 |

VERBATIM DISKETTES

| | |
|------------------|-------|
| Box of 10 5 1/4" | 29.50 |
| Box of 10 8" | 39.50 |



North Star Computers

| | |
|------------------|---------|
| HR2-2D-32K | 2795.00 |
| HR2-20-48K | 2956.00 |
| HR2-2D-64K | 3145.00 |
| HR2-2Q-32K | 2975.00 |
| HR2-2Q-48K | 3165.00 |
| HR2-2Q-64K | 3360.00 |
| HRAM 32K | 469.00 |
| HRAM 48K | 662.00 |
| HRAM 64K | 849.00 |
| HDS-18 HARD DISK | 4025.00 |
| MDS-DRV-D | 495.00 |
| MDS-DRV-Q | 665.00 |
| ADC-1-D | 740.00 |
| ADC-2-D | 995.00 |
| ADC-1-Q | 795.00 |
| ADC-2-Q | 1285.00 |

PRINTERS

| | |
|------------------------|---------|
| EPSON MX-70 | 399.00 |
| EPSON MX-80 | 499.00 |
| EPSON MX-80 FT | 599.00 |
| GRAFTRAX | 90.00 |
| INTERFACE (APPLE) | 75.00 |
| CABLE | 22.50 |
| CENTRONICS 737-1 | 795.00 |
| CENTRONICS 737-3 | 855.00 |
| IDS 445G | 815.00 |
| IDS 460G | 1195.00 |
| IDS 560G | 1450.00 |
| NEC 5510 W/TRACTORS | 2650.00 |
| NEC 5520 KSR W/TRAC. | 2995.00 |
| QUME 5/45 SPRINT | 2675.00 |
| FORMS TRACTOR | 195.00 |
| STARWRITER W/TRAC. | 1695.00 |
| STARWRITER W/O TRACTOR | 1500.00 |

General Information:

We carry a large selection of hardware and software by other companies. Send for our catalog. We are an authorized repair center for APPLE, ATARI, NORTH STAR, AND EPSON.

PRICES SUBJECT TO CHANGE WITHOUT NOTICE. MARYLAND RESIDENTS ADD 5% SALES TAX

FREDERICK COMPUTER PRODUCTS, INC.

5726 INDUSTRY LANE
FREDERICK, MD. 21701

Store Hours:
MON. THRU THURS. 9:30 AM—9:00 PM
FRI. AND SAT. 9:30 AM—5:00 PM

TO ORDER CALL: (301) 694-8884

Listing 1a continued:

```
1100 PRINT "DENTON, TX 76201":PRINT
1110 INPUT "ENTER TOTAL NUMBER OF VARIABLES TO BE CORRELATED";NV
1120 IF NV>ND THEN PRINT "*** TOO MANY VARIABLES ***":GOTO 1110
1130 / NV MUST BE PASSED TO CORL AS A STRING VARIABLE (NV$)
1140 NV$=STR$(NV):N=NV-(1-IB):GOSUB 4000 :NR=N:NC=N:GOSUB 3000
1150 CLS:INPUT "DO YOU WANT THE CORRELATION MATRIX REPRINTED";Y$
1160 IF LEFT$(Y$,1)="Y" THEN GOSUB 3000
1170 CLS:END
3000 / SUBROUTINE TO PRINT A MATRIX
3010 / NR=NUMBER OF ROWS, NC=NUMBER OF COLUMNS, IF
3020 / IB=0 THEN NR=NR-1 AND NC=NC-1, IB=STARTING
3030 / POINT FOR ARRAYS,
3040 FOR I=IB TO NR STEP 10:IA=I+9:IF IA>=NR THEN IA=NR
3050 FOR J=IB TO NC STEP 9:JA=J+8:IF JA>=NC THEN JA=NC
3060 CLS:PRINT "CORRELATION MATRIX":PRINT TL$
3070 F1$="VAR:";G1$="  ###":F2$="####":G2$="  .##"
3080 PRINT F1$;
3090 FOR L=J TO JA:PRINT USING G1$;L+1;;NEXT L:PRINT
3100 FOR L=I TO IA
3110 PRINT USING F2$;L+1;;FOR M=J TO JA
3120 PRINT USING G2$;R(L,M);:NEXT M:PRINT:NEXT L
3130 PRINT @ 960,"TYPE 'C' TO CONTINUE";
3140 Y$=INKEY$:IF Y$="C" THEN 3150 ELSE 3140
3150 NEXT J: NEXT I
3160 RETURN
4000 / COMPUTE MEANS, SIGMAS, CORRELATIONS
4010 / N=NUMBER OF VARIABLES, N=N-1 IF IB (STARTING
```

Select a modem for your computer ... easy as ABC.

CHOOSE A. The Smart One™, Model AM232, with its own built in microcontroller. Auto Dials, Auto Answers, Auto Modes (originate/answer), "Direct Connect" for any computer with an RS232 interface ... \$299.00.

CHOOSE B. The Acoustic Modem, Model AM11/A, for the Apple*. Comes complete with a powerful operating system. Supports 25 easy to use keyboard commands and operates interactively with your programs. No interface card required! ... \$179.00.

CHOOSE C. The "Direct Connect" Modem, Model AM11, for the Apple*. Comes complete with a powerful operating system. Supports Auto Dial, Auto Answer, 27 easy to use keyboard commands and operates interactively with your programs. No interface card required! ... \$289.00.

Be a part of the information revolution. It's fun, exciting, informative, educational. Call or write your order today. COD's accepted.



MICROMATE ELECTRONICS, INC.
2094 Front Street • East Meadow, New York 11554 • Telephone 516.794.1072
All "Direct Connect" modems are FCC certified. *Registered trademark of Apple Computer, Inc.

Listing 1a continued:

```
4020 / ELEMENT IN ARRAYS=0, ELSE N=N.
4030 GOSUB 4120
4040 GOSUB 4210
4050 T=NS:FOR I=IB TO N:A(I)=A(I)/T
4060 S(I)=SQR(R(I,I)/T-A(I)E2):NEXT I
4070 FOR I=IB TO N:FOR J=I TO N:IF S(I)*S(J)=0.0 THEN 4090
4080 R(J,I)=(R(I,J)/T-A(I)*A(J))/(S(I)*S(J))
4090 R(I,J)=R(J,I):NEXT J:R(I,I)=1.0:NEXT I
4100 IF Y3#="Y" THEN GOSUB 4480
4110 RETURN
4120 / SETUP PARAMETERS FOR CORL
4130 CLS:INPUT "ENTER ANALYSIS NAME":TL#
4140 INPUT "ARE THE DATA FROM TAPE":Y1#
4150 INPUT "DO YOU WISH TO SAVE THE DATA ON TAPE":Y2#
4160 INPUT "DO YOU WISH TO SAVE THE MATRIX":Y3#
4170 Y1#=LEFT$(Y1#,1):Y2#=LEFT$(Y2#,1):Y3#=LEFT$(Y3#,1)
4180 IF Y1#+Y2#<>"YY" THEN RETURN
4190 PRINT "***ERROR***YOU CANNOT BOTH READ AND SAVE DATA TAPE"
4200 PRINT "RUN IS TERMINATED":END
4210 / INPUT/OUTPUT SUBROUTINE FOR CORL
4220 CLS:NS=0:IF Y1#<>"Y" THEN 4230 ELSE 4240
4230 IF Y2#<>"Y" THEN 4290
4240 PRINT "PLACE DATA TAPE IN RECORDER"
4250 PRINT @ 960,"TYPE 'C' TO CONTINUE";
4260 Y#=INKEY#:IF Y#="C" THEN 4270 ELSE 4260
4270 IF Y1#="Y" THEN 4280 ELSE 4290
4280 CLS:PRINT "DATA ARE BEING ENTERED FROM TAPE":GOTO 4310
```

Listing 1a continued on page 434

NOW!

NEW PRODUCTS! NOW AVAILABLE FROM AUTOMATED EQUIPMENT

TELEVIDEO SYSTEM I

The Televideo System I is a CP/M® based single-user computer system. State-of-the-art design and single board construction accounts for Televideo's reliability and exceptional price performance. Cobol, Basic, PL/1 and Fortran are just a few of the high level languages available. As your needs grow so can your Televideo computer system. The System I can be a satellite computer of a larger network of user stations using the multi-processor multi-tasking System II or System III. System I includes TS-81 computer, Televideo 910 terminal (950 terminal available at additional cost) and CP/M® 2.2. Nation wide on-site service is available through General Electric service company.

System I specifications: Z80A, 64K Ram, 4K diagnostic Eprom, two 5" 360K drives, serial and parallel port.



CP/M® is a licensed product supplied by Digital Research, Inc.

See Televideo System Ad.

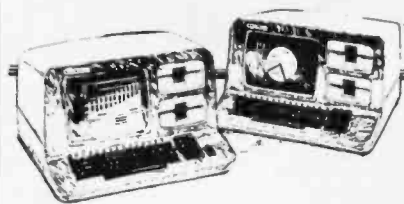

NORTHSTAR ADVANTAGE COMPUTER

The Northstar Advantage Computer is an integrated package including full graphics capability. Line charts, bar graphs, pie charts and 3 dimensional displays are all possible as part of Northstar's optional graphics/DOS operating system or CP/M® graphics package. All Northstar applications software is available for the Advantage Computer. Slots for 6 additional expansion cards are included.

Specifications: Z80A CPU, 64K Ram, Green screen 12" monitor, 240 x 640 pixel graphics resolution, sculptured typewriter-like keyboard, two 5" 360K drives.

V.I.P.'s call A.E.I.

Because A.E.I. tests before shipping, has expertise on all items offered, and is price competitive.



AUTOMATED EQUIPMENT, INC.

18430 WARD STREET, FOUNTAIN VALLEY, CALIFORNIA 92708

See these products and a full line of peripheral equipment in our showroom.

ZENITH

Zenith Data Systems with world famous quality and reliability are now available from A.E.I. The Z89 and Z90 are standalone micro computers with a one piece design that simplifies installation and operation. With the board line of PeachTree accounting software and Micro-Pro word processing software the Zenith computers are the ideal small business systems. Heathkit/Zenith educational courses are available making the Zenith computer an excellent choice for the first time buyer.

Zenith specifications:

Z89—48K ram standard, Z80cpu, 2 serial ports, built in 12" terminal, one 5" 100K drive, expandable.

Z90—64K ram standard, Z80 cpu, 2 serial ports, built in 12" terminal, one 5" 200K drive, expandable.



(714) 963-1414

(800) 854-7635

Listing 1a continued:

```

4290 CLS:PRINT "ENTER DATA FOR EACH VARIABLE"
4300 PRINT "TYPE 'END' WHEN DATA ENTRY COMPLETED"
4310 IF Y1$="Y" THEN INPUT #-1,NV$
4320 IF Y2$="Y" THEN PRINT #-1,NV$
4330 NV=VAL(NV$):FOR I=IB TO N:A(I)=0.0
4340 FOR J=IB TO N:R(I,J)=0.0:NEXT J:NEXT I
4350 FOR I=IB TO N
4360 IF Y1$<>"Y" THEN PRINT "OBS";NS+1;"VAR";I+1;
4370 IF Y1$="Y" THEN INPUT #-1,S$ ELSE INPUT S$
4380 IF S$="END" THEN 4460 ELSE S(I)=VAL(S$):NEXT I
4390 IF Y2$<>"Y" THEN 4420
4400 FOR I=IB TO N:S$=STR$(S(I))
4410 PRINT #-1,S$:NEXT I
4420 FOR I=IB TO N:A(I)=A(I)+S(I)
4430 FOR J=I TO NV-1:R(I,J)=R(I,J)+S(I)*S(J):NEXT J:NEXT I
4440 NS=NS+1
4450 GOTO 4350
4460 IF Y2$="Y" THEN PRINT #-1,"END"
4470 RETURN
4480 / MATRIX OUTPUT SUBROUTINE
4490 CMD"T":CLS:PRINT "PREPARE MATRIX TAPE AND RECORDER"
4500 PRINT @ 960,"TYPE 'C' TO CONTINUE";
4510 Y$=INKEY$:IF Y$="C" THEN 4520 ELSE 4510
4520 PRINT #-1,TL$:PRINT #-1,NV,NS
4530 FOR I=IB TO N: PRINT #-1,A(I),S(I):NEXT I
4540 FOR I=IB TO N: FOR J=I TO N:IF I=J THEN 4560
4550 PRINT #-1,R(I,J)

```

WE DISCOUNT PRICES — NOT SERVICE



APPLE II PLUS 48K
\$1,099

APPLE II PLUS 16K \$1,025

HARDWARE

| | |
|---|------|
| DISK II DRIVE & INTERFACE | 499 |
| DISK II SECOND DRIVE | 439 |
| BASF 5 1/4" DISKETTES (10) | 25 |
| LANGUAGE SYSTEM W/PASCAL | 379 |
| INTEGER BASIC FIRMWARE CARD | 149 |
| APPLESOFT II FIRMWARE CARD | 149 |
| CENTRONICS PRINTER INTERFACE CARD | 179 |
| HIGH-SPEED SERIAL INTERFACE CARD | 145 |
| GRAPHICS TABLET | 649 |
| APPLE IEEE-488 INTERFACE CARD | 339 |
| M&R SUP-R-MOD RF MODULATOR | 25 |
| MICROSOFT Z-80 SOFTCARD SYSTEM | 299 |
| MICROSOFT 16K RAM CARD | 169 |
| VIDEX 80 COLUMN BOARD | 295 |
| HAYES MICROMODEM II | 299 |
| AMDEX 13" COLOR MONITOR | 429 |
| NEC 12" GREEN MONITOR | 255 |
| SILENTYPE PRINTER W/INTERFACE | 350 |
| EPSON MX-100 | 829 |
| QUME SPRINT 5/45 PRINTER | 2499 |



SOFTWARE

| | |
|--|-----|
| APPLE DOS TOOLKIT | 65 |
| APPLE PLOT | 60 |
| TAX PLANNER | 99 |
| APPLE FORTRAN | 159 |
| APPLE PILOT | 119 |
| APPLEWRITER | 65 |
| DOW JONES PORTFOLIO EVALUATOR | 45 |
| DOW JONES NEWS & QUOTES REPORTER | 85 |
| THE CONTROLLER | 495 |
| VISICALC (16 SECTOR) | 159 |
| VISIPILOT | 149 |
| VISITREND/VISIPILOT | 215 |
| DESKTOP PLAN II | 159 |
| BPI BUSINESS SOFTWARE (EACH) | 335 |
| SUPER TEXT II | 125 |
| PROGRAMMA APPLE PIE | 110 |
| EASYWRITER (80 COLUMNS) | 219 |
| D.B. MASTER | 180 |
| WORD STAR | 299 |
| MICROSOFT FORTRAN | 149 |



ATARI 800 16K
\$749

| | |
|-----------------------------------|------|
| ATARI 400 (16K) | 350 |
| 410 PROGRAM RECORDER | 69 |
| 810 DISK DRIVE | 439 |
| 815 DUAL DISK DRIVE | 1199 |
| 16K RAM MEMORY MODULE | 89 |
| MICROTEK 32K RAM | 179 |
| 850 INTERFACE MODULE | 159 |
| 830 ACOUSTIC MODEM | 159 |
| 825 PRINTER (CENTRONIC 737) | 699 |
| JOYSTICK PAIR | 18 |
| LIGHT PEN | 65 |
| ATARI VISICALC | 149 |
| BASIC LANGUAGE | 45 |
| ASSEMBLER EDITOR | 45 |
| MUSIC COMPOSER | 45 |
| STAR RAIDER | 39 |
| COMPUTER CHESS | 30 |
| BASKETBALL | 30 |
| TELELINK | 20 |
| DATASOFT TEXT WIZARD | 79 |

computer age, inc.

Authorized Apple Dealer & Service Center

4688 CONVOY STREET, SAN DIEGO, CA 92111

(714) 565-4062 (800) 854-1941

TO ORDER: Please send cashier's check, money order or personal check (allow 10 business days to clear). VISA and Master Card credit card service add 3%. American Express credit card service add 5%. Shipping, handling and insurance in U.S. add 3% (minimum \$4). California residents add 6% sales tax. Foreign orders add 10% for shipping. Equipment is subject to price change and availability. All equipment carries factory warranty. Store prices differ from mail order prices. TELEX: 697120 DATAMAX-SDG

CALL OR WRITE FOR A COMPLETE PRICE LIST

Listing 1a continued:

```
4560 NEXT J:NEXT I
4570 CMD"R":RETURN
```

(1b)

```
RUN
CORRELATION MATRIX PROGRAM
BY THOMAS WM. MADRON
2132 SAVANNAH TRAIL
DENTON, TX 76201
```

```
ENTER TOTAL NUMBER OF VARIABLES TO BE CORRELATED? 3
ENTER ANALYSIS NAME? TEST DATA
ARE THE DATA FROM TAPE? N
DO YOU WISH TO SAVE THE DATA ON TAPE? Y
DO YOU WISH TO SAVE THE MATRIX? Y
PLACE DATA TAPE IN RECORDER
TYPE 'C' TO CONTINUE ENTER DATA FOR EACH VARIABLE
TYPE 'END' WHEN DATA ENTRY COMPLETED
OBS 1 VAR 1 ? 19
OBS 1 VAR 2 ? 23
OBS 1 VAR 3 ? 182
OBS 2 VAR 1 ? 24
OBS 2 VAR 2 ? 28
OBS 2 VAR 3 ? 212
OBS 3 VAR 1 ? 21
OBS 3 VAR 2 ? 29
OBS 3 VAR 3 ? 180
```

Listing 1b continued on page 436

| | | | | | | | | | | | | | | | | | | | | | | | | | | | | | | | | | | | | | | | | | | | | | | | | | | | | | | | | | | | | | | | | | | | | | | | | | | | | | | | | | | | | | | | | | | | | | | | | | | | | | | | | | | | | | | | | | | | | | | | | | | | | | | | | | | | | | | | | | | | | | | | | | | | | | | | | | | | | | | | | | | | | | | | | | | | | | | | | | | | | | | | | | | | | | | | | | | | | | | | | | | | | | | | | | | | | | | | | | | | | | | | | | | | | | | | | | | | | | | | | | | | | |
|---|--|-----------|-----------|--------|-------|-------|---------|--------|---------|-------|---------|--------|---|--------|----|---------|------|--------|----|---------|------|--------|----|---------|-----|--------|----|---------|------|--------|----|---------|------|--------|----|---------|------|--------|----|---------|------|--------|----|---------|------|--------|-----|---------|------|--------|-----|---------|------|--------|-----|---------|------|--------|-----|---------|------|--------|-----|---------|------|--------|------|---------|------|--------|------|---------|------|--|---------|---------|---------|--------|---------|---------|---------|--------|---------|---------|---------|--------|---------|---------|---------|--------|---------|---------|---------|--------|---------|---------|----------|--------|---------|---------|----------|--------|---------|---------|----------|--------|---------|---------|----------|--------|---------|---------|----------|---------|---------|---------|----------|---------|---------|---------|----------|---------|---------|---------|----------|---------|---------|---------|----------|---------|---------|---------|----------|---------|---------|---------|----------|---------|---------|---------|----------|---------|---------|---------|----------|---------|---------|---------|----------|---------|---------|---------|----------|---------|---------|---------|----------|---|---------|----|----------|---------|---------|----|----------|---------|---|------|----------|---------|---------|------|--------|---------|---------|--------|------|---------|---------|------|--------------------|---------|--------|--------------------|-------|---------|---------------------|--------|----|--------------------|---------|------|---------------------|---------|-------|------|-----------|-------|-----------|-------|-----------------|--------|--|--|-------|------|--------|------|------|-------|----|------|------------|----|-------|------------|-------|------|-----------------|-------|------|---------------|------|------|--------------|------|------|--------------|------|------|-------------|------|------|------------|------|----|-------|------|----|-------|------|--|--|---|
| <p>COMPUTERS ATARI 800™ COMPUTER SYSTEM</p> <p>16k → \$750.00 48k → \$898.00</p> <p>"APPLE II Plus"</p> <p>48k → \$1199.00 64k → \$1399.00</p> | <p>74 S00</p> <table border="1"> <tr><td>74S00</td><td>39</td><td>74S138</td><td>75</td></tr> <tr><td>74S02</td><td>45</td><td>74S140</td><td>1.00</td></tr> <tr><td>74S03</td><td>38</td><td>74S158</td><td>75</td></tr> <tr><td>74S04</td><td>39</td><td>74S174</td><td>1.35</td></tr> <tr><td>74S06</td><td>39</td><td>74S175</td><td>1.35</td></tr> <tr><td>74S10</td><td>39</td><td>74S182</td><td>75</td></tr> <tr><td>74S15</td><td>45</td><td>74S189</td><td>4.25</td></tr> <tr><td>74S20</td><td>55</td><td>74S201</td><td>6.75</td></tr> <tr><td>74S22</td><td>55</td><td>74S240</td><td>2.75</td></tr> <tr><td>74S30</td><td>75</td><td>74S244</td><td>2.95</td></tr> <tr><td>74S37</td><td>55</td><td>74S251</td><td>2.75</td></tr> <tr><td>74S50</td><td>65</td><td>74S287</td><td>2.95</td></tr> <tr><td>74S51</td><td>49</td><td>74S288</td><td>2.95</td></tr> <tr><td>74S64</td><td>55</td><td>74S299</td><td>5.75</td></tr> <tr><td>74S74</td><td>65</td><td>74S470</td><td>9.25</td></tr> <tr><td>74S86</td><td>95</td><td>74S471</td><td>9.50</td></tr> <tr><td>74S112</td><td>1.95</td><td>74S473</td><td>9.50</td></tr> <tr><td>74S132</td><td>1.45</td><td>74S474</td><td>9.50</td></tr> </table> | 74S00 | 39 | 74S138 | 75 | 74S02 | 45 | 74S140 | 1.00 | 74S03 | 38 | 74S158 | 75 | 74S04 | 39 | 74S174 | 1.35 | 74S06 | 39 | 74S175 | 1.35 | 74S10 | 39 | 74S182 | 75 | 74S15 | 45 | 74S189 | 4.25 | 74S20 | 55 | 74S201 | 6.75 | 74S22 | 55 | 74S240 | 2.75 | 74S30 | 75 | 74S244 | 2.95 | 74S37 | 55 | 74S251 | 2.75 | 74S50 | 65 | 74S287 | 2.95 | 74S51 | 49 | 74S288 | 2.95 | 74S64 | 55 | 74S299 | 5.75 | 74S74 | 65 | 74S470 | 9.25 | 74S86 | 95 | 74S471 | 9.50 | 74S112 | 1.95 | 74S473 | 9.50 | 74S132 | 1.45 | 74S474 | 9.50 | <p>COMPONENTS</p> <table border="1"> <tr><td>SN7400M</td><td>18</td><td>SN7482M</td><td>30</td></tr> <tr><td>SN7402M</td><td>22</td><td>SN7489M</td><td>49</td></tr> <tr><td>SN7404M</td><td>21</td><td>SN7493M</td><td>45</td></tr> <tr><td>SN7408M</td><td>22</td><td>SN7495M</td><td>50</td></tr> <tr><td>SN7410M</td><td>18</td><td>SN7496M</td><td>89</td></tr> <tr><td>SN7412M</td><td>20</td><td>SN74122M</td><td>39</td></tr> <tr><td>SN7413M</td><td>22</td><td>SN74136M</td><td>95</td></tr> <tr><td>SN7414M</td><td>29</td><td>SN74141M</td><td>69</td></tr> <tr><td>SN7416M</td><td>27</td><td>SN74151M</td><td>65</td></tr> <tr><td>SN7417M</td><td>29</td><td>SN74153M</td><td>56</td></tr> <tr><td>SN7420M</td><td>17</td><td>SN74154M</td><td>125</td></tr> <tr><td>SN7425M</td><td>20</td><td>SN74155M</td><td>75</td></tr> <tr><td>SN7430M</td><td>17</td><td>SN74157M</td><td>58</td></tr> <tr><td>SN7437M</td><td>26</td><td>SN74160M</td><td>80</td></tr> <tr><td>SN7438M</td><td>24</td><td>SN74161M</td><td>65</td></tr> <tr><td>SN7440M</td><td>18</td><td>SN74163M</td><td>85</td></tr> <tr><td>SN7442M</td><td>45</td><td>SN74164M</td><td>87</td></tr> <tr><td>SN7443M</td><td>42</td><td>SN74165M</td><td>55</td></tr> <tr><td>SN7445M</td><td>64</td><td>SN74174M</td><td>80</td></tr> <tr><td>SN7451M</td><td>19</td><td>SN74175M</td><td>79</td></tr> <tr><td>SN7454M</td><td>19</td><td>SN74180M</td><td>75</td></tr> <tr><td>SN7474M</td><td>27</td><td>SN74181M</td><td>115</td></tr> <tr><td>SN7475M</td><td>35</td><td>SN74393M</td><td>1.65</td></tr> </table> | SN7400M | 18 | SN7482M | 30 | SN7402M | 22 | SN7489M | 49 | SN7404M | 21 | SN7493M | 45 | SN7408M | 22 | SN7495M | 50 | SN7410M | 18 | SN7496M | 89 | SN7412M | 20 | SN74122M | 39 | SN7413M | 22 | SN74136M | 95 | SN7414M | 29 | SN74141M | 69 | SN7416M | 27 | SN74151M | 65 | SN7417M | 29 | SN74153M | 56 | SN7420M | 17 | SN74154M | 125 | SN7425M | 20 | SN74155M | 75 | SN7430M | 17 | SN74157M | 58 | SN7437M | 26 | SN74160M | 80 | SN7438M | 24 | SN74161M | 65 | SN7440M | 18 | SN74163M | 85 | SN7442M | 45 | SN74164M | 87 | SN7443M | 42 | SN74165M | 55 | SN7445M | 64 | SN74174M | 80 | SN7451M | 19 | SN74175M | 79 | SN7454M | 19 | SN74180M | 75 | SN7474M | 27 | SN74181M | 115 | SN7475M | 35 | SN74393M | 1.65 | <p>CONT'D</p> <p>EPROMS</p> <table border="1"> <tr><td>2716</td><td>SV 450MS</td><td>4.75ea</td></tr> <tr><td>TMS2716</td><td></td><td>5.25ea</td></tr> <tr><td>2708</td><td>450MS</td><td>2.75ea</td></tr> <tr><td>2732</td><td></td><td>11.50ea</td></tr> <tr><td>4116</td><td>300MS 2.00ea 8 for</td><td>12.00</td></tr> <tr><td></td><td>200MS 2.35ea 8 for</td><td>15.00</td></tr> <tr><td>2141L</td><td>300MS 2.95 ea 4 for</td><td>2.75ea</td></tr> <tr><td></td><td>200MS 3.50ea 4 for</td><td>3.00ea</td></tr> <tr><td>2111</td><td>450MS 2.50ea 10 for</td><td>2.00ea</td></tr> </table> <p>CPU's</p> <table border="1"> <tr><td>Z 80</td><td>7.95</td></tr> <tr><td>Z 80A CTC</td><td>10.50</td></tr> <tr><td>Z 80A CPU</td><td>10.50</td></tr> <tr><td>Z 80 002 16 64K</td><td>129.00</td></tr> <tr><td>8085A</td><td>13.50</td></tr> <tr><td>2901A</td><td>7.50</td></tr> <tr><td>MC6800</td><td>9.50</td></tr> </table> <p>MISC</p> <table border="1"> <tr><td>2102</td><td>450MS</td><td>95</td></tr> <tr><td>8038</td><td>2.95 1103A</td><td>75</td></tr> <tr><td>NE555</td><td>.27 UPD765</td><td>17.85</td></tr> <tr><td>1488</td><td>1.10 Hoopy disk</td><td>w spe</td></tr> <tr><td>1489</td><td>1.10 UK N2001</td><td>1.95</td></tr> <tr><td>8726</td><td>1.30 TMS4400</td><td>1.40</td></tr> <tr><td>8728</td><td>1.30 MC4008P</td><td>1.75</td></tr> <tr><td>8212</td><td>2.75 MH4026</td><td>1.55</td></tr> <tr><td>8216</td><td>2.75 D3624</td><td>1.95</td></tr> <tr><td>95</td><td>D3001</td><td>1.95</td></tr> <tr><td>95</td><td>D3002</td><td>1.95</td></tr> </table> | 2716 | SV 450MS | 4.75ea | TMS2716 | | 5.25ea | 2708 | 450MS | 2.75ea | 2732 | | 11.50ea | 4116 | 300MS 2.00ea 8 for | 12.00 | | 200MS 2.35ea 8 for | 15.00 | 2141L | 300MS 2.95 ea 4 for | 2.75ea | | 200MS 3.50ea 4 for | 3.00ea | 2111 | 450MS 2.50ea 10 for | 2.00ea | Z 80 | 7.95 | Z 80A CTC | 10.50 | Z 80A CPU | 10.50 | Z 80 002 16 64K | 129.00 | 8085A | 13.50 | 2901A | 7.50 | MC6800 | 9.50 | 2102 | 450MS | 95 | 8038 | 2.95 1103A | 75 | NE555 | .27 UPD765 | 17.85 | 1488 | 1.10 Hoopy disk | w spe | 1489 | 1.10 UK N2001 | 1.95 | 8726 | 1.30 TMS4400 | 1.40 | 8728 | 1.30 MC4008P | 1.75 | 8212 | 2.75 MH4026 | 1.55 | 8216 | 2.75 D3624 | 1.95 | 95 | D3001 | 1.95 | 95 | D3002 | 1.95 | <p>SPECIALS</p> <p>3 inch MUFFIN FAN w/ring cord \$9.95</p> <p>UPD 765C: Floppy Disk Controller \$17.95 w/specs</p> <p>2732A: 250nsec. EPROM 15.50</p> <p>AY5-1013A: 30K BAND UART \$3.95</p> <p>REAL-TIME CLOCK CALENDAR (MSK 5832)</p> <p>Description: Mono Metal Gate CMOS IC</p> <p>Features: Time, Month, Date, Year, & Day of Week Bus Oriented 1 Bit Data Bus 1 Bit Address R/W Hold Select Inter Signal 32 768KHz. Metal Control 5V Pow Sup Low Power Dissipation</p> <p>\$7.45 w/specs</p> <p>XTAL \$3.85</p> | <p>GLOBAL Logic Probes</p> <p>LP-1: \$40.00 Pulse width to 50nsec. Resp. rated to 50MHz</p> <p>LP-3: \$60.00 Pulse width to 5nsec. Resp. to over 60MHz</p> <p>LPK-1: Logic Probe Kit - complete nothing extra to buy Min. pulse width 10nsec. \$18.95</p> | <p>CARDS</p> <p>MICROSOFT Z80 \$295.00</p> <p>16K RAM \$160.00</p> <p>VIDEO TERM \$295.00</p> <p>80 column</p> |
| 74S00 | 39 | 74S138 | 75 | | | | | | | | | | | | | | | | | | | | | | | | | | | | | | | | | | | | | | | | | | | | | | | | | | | | | | | | | | | | | | | | | | | | | | | | | | | | | | | | | | | | | | | | | | | | | | | | | | | | | | | | | | | | | | | | | | | | | | | | | | | | | | | | | | | | | | | | | | | | | | | | | | | | | | | | | | | | | | | | | | | | | | | | | | | | | | | | | | | | | | | | | | | | | | | | | | | | | | | | | | | | | | | | | | | | | | | | | | | | | | | | | | | | | | | | | | | | | | | | | |
| 74S02 | 45 | 74S140 | 1.00 | | | | | | | | | | | | | | | | | | | | | | | | | | | | | | | | | | | | | | | | | | | | | | | | | | | | | | | | | | | | | | | | | | | | | | | | | | | | | | | | | | | | | | | | | | | | | | | | | | | | | | | | | | | | | | | | | | | | | | | | | | | | | | | | | | | | | | | | | | | | | | | | | | | | | | | | | | | | | | | | | | | | | | | | | | | | | | | | | | | | | | | | | | | | | | | | | | | | | | | | | | | | | | | | | | | | | | | | | | | | | | | | | | | | | | | | | | | | | | | | | |
| 74S03 | 38 | 74S158 | 75 | | | | | | | | | | | | | | | | | | | | | | | | | | | | | | | | | | | | | | | | | | | | | | | | | | | | | | | | | | | | | | | | | | | | | | | | | | | | | | | | | | | | | | | | | | | | | | | | | | | | | | | | | | | | | | | | | | | | | | | | | | | | | | | | | | | | | | | | | | | | | | | | | | | | | | | | | | | | | | | | | | | | | | | | | | | | | | | | | | | | | | | | | | | | | | | | | | | | | | | | | | | | | | | | | | | | | | | | | | | | | | | | | | | | | | | | | | | | | | | | | |
| 74S04 | 39 | 74S174 | 1.35 | | | | | | | | | | | | | | | | | | | | | | | | | | | | | | | | | | | | | | | | | | | | | | | | | | | | | | | | | | | | | | | | | | | | | | | | | | | | | | | | | | | | | | | | | | | | | | | | | | | | | | | | | | | | | | | | | | | | | | | | | | | | | | | | | | | | | | | | | | | | | | | | | | | | | | | | | | | | | | | | | | | | | | | | | | | | | | | | | | | | | | | | | | | | | | | | | | | | | | | | | | | | | | | | | | | | | | | | | | | | | | | | | | | | | | | | | | | | | | | | | |
| 74S06 | 39 | 74S175 | 1.35 | | | | | | | | | | | | | | | | | | | | | | | | | | | | | | | | | | | | | | | | | | | | | | | | | | | | | | | | | | | | | | | | | | | | | | | | | | | | | | | | | | | | | | | | | | | | | | | | | | | | | | | | | | | | | | | | | | | | | | | | | | | | | | | | | | | | | | | | | | | | | | | | | | | | | | | | | | | | | | | | | | | | | | | | | | | | | | | | | | | | | | | | | | | | | | | | | | | | | | | | | | | | | | | | | | | | | | | | | | | | | | | | | | | | | | | | | | | | | | | | | |
| 74S10 | 39 | 74S182 | 75 | | | | | | | | | | | | | | | | | | | | | | | | | | | | | | | | | | | | | | | | | | | | | | | | | | | | | | | | | | | | | | | | | | | | | | | | | | | | | | | | | | | | | | | | | | | | | | | | | | | | | | | | | | | | | | | | | | | | | | | | | | | | | | | | | | | | | | | | | | | | | | | | | | | | | | | | | | | | | | | | | | | | | | | | | | | | | | | | | | | | | | | | | | | | | | | | | | | | | | | | | | | | | | | | | | | | | | | | | | | | | | | | | | | | | | | | | | | | | | | | | |
| 74S15 | 45 | 74S189 | 4.25 | | | | | | | | | | | | | | | | | | | | | | | | | | | | | | | | | | | | | | | | | | | | | | | | | | | | | | | | | | | | | | | | | | | | | | | | | | | | | | | | | | | | | | | | | | | | | | | | | | | | | | | | | | | | | | | | | | | | | | | | | | | | | | | | | | | | | | | | | | | | | | | | | | | | | | | | | | | | | | | | | | | | | | | | | | | | | | | | | | | | | | | | | | | | | | | | | | | | | | | | | | | | | | | | | | | | | | | | | | | | | | | | | | | | | | | | | | | | | | | | | |
| 74S20 | 55 | 74S201 | 6.75 | | | | | | | | | | | | | | | | | | | | | | | | | | | | | | | | | | | | | | | | | | | | | | | | | | | | | | | | | | | | | | | | | | | | | | | | | | | | | | | | | | | | | | | | | | | | | | | | | | | | | | | | | | | | | | | | | | | | | | | | | | | | | | | | | | | | | | | | | | | | | | | | | | | | | | | | | | | | | | | | | | | | | | | | | | | | | | | | | | | | | | | | | | | | | | | | | | | | | | | | | | | | | | | | | | | | | | | | | | | | | | | | | | | | | | | | | | | | | | | | | |
| 74S22 | 55 | 74S240 | 2.75 | | | | | | | | | | | | | | | | | | | | | | | | | | | | | | | | | | | | | | | | | | | | | | | | | | | | | | | | | | | | | | | | | | | | | | | | | | | | | | | | | | | | | | | | | | | | | | | | | | | | | | | | | | | | | | | | | | | | | | | | | | | | | | | | | | | | | | | | | | | | | | | | | | | | | | | | | | | | | | | | | | | | | | | | | | | | | | | | | | | | | | | | | | | | | | | | | | | | | | | | | | | | | | | | | | | | | | | | | | | | | | | | | | | | | | | | | | | | | | | | | |
| 74S30 | 75 | 74S244 | 2.95 | | | | | | | | | | | | | | | | | | | | | | | | | | | | | | | | | | | | | | | | | | | | | | | | | | | | | | | | | | | | | | | | | | | | | | | | | | | | | | | | | | | | | | | | | | | | | | | | | | | | | | | | | | | | | | | | | | | | | | | | | | | | | | | | | | | | | | | | | | | | | | | | | | | | | | | | | | | | | | | | | | | | | | | | | | | | | | | | | | | | | | | | | | | | | | | | | | | | | | | | | | | | | | | | | | | | | | | | | | | | | | | | | | | | | | | | | | | | | | | | | |
| 74S37 | 55 | 74S251 | 2.75 | | | | | | | | | | | | | | | | | | | | | | | | | | | | | | | | | | | | | | | | | | | | | | | | | | | | | | | | | | | | | | | | | | | | | | | | | | | | | | | | | | | | | | | | | | | | | | | | | | | | | | | | | | | | | | | | | | | | | | | | | | | | | | | | | | | | | | | | | | | | | | | | | | | | | | | | | | | | | | | | | | | | | | | | | | | | | | | | | | | | | | | | | | | | | | | | | | | | | | | | | | | | | | | | | | | | | | | | | | | | | | | | | | | | | | | | | | | | | | | | | |
| 74S50 | 65 | 74S287 | 2.95 | | | | | | | | | | | | | | | | | | | | | | | | | | | | | | | | | | | | | | | | | | | | | | | | | | | | | | | | | | | | | | | | | | | | | | | | | | | | | | | | | | | | | | | | | | | | | | | | | | | | | | | | | | | | | | | | | | | | | | | | | | | | | | | | | | | | | | | | | | | | | | | | | | | | | | | | | | | | | | | | | | | | | | | | | | | | | | | | | | | | | | | | | | | | | | | | | | | | | | | | | | | | | | | | | | | | | | | | | | | | | | | | | | | | | | | | | | | | | | | | | |
| 74S51 | 49 | 74S288 | 2.95 | | | | | | | | | | | | | | | | | | | | | | | | | | | | | | | | | | | | | | | | | | | | | | | | | | | | | | | | | | | | | | | | | | | | | | | | | | | | | | | | | | | | | | | | | | | | | | | | | | | | | | | | | | | | | | | | | | | | | | | | | | | | | | | | | | | | | | | | | | | | | | | | | | | | | | | | | | | | | | | | | | | | | | | | | | | | | | | | | | | | | | | | | | | | | | | | | | | | | | | | | | | | | | | | | | | | | | | | | | | | | | | | | | | | | | | | | | | | | | | | | |
| 74S64 | 55 | 74S299 | 5.75 | | | | | | | | | | | | | | | | | | | | | | | | | | | | | | | | | | | | | | | | | | | | | | | | | | | | | | | | | | | | | | | | | | | | | | | | | | | | | | | | | | | | | | | | | | | | | | | | | | | | | | | | | | | | | | | | | | | | | | | | | | | | | | | | | | | | | | | | | | | | | | | | | | | | | | | | | | | | | | | | | | | | | | | | | | | | | | | | | | | | | | | | | | | | | | | | | | | | | | | | | | | | | | | | | | | | | | | | | | | | | | | | | | | | | | | | | | | | | | | | | |
| 74S74 | 65 | 74S470 | 9.25 | | | | | | | | | | | | | | | | | | | | | | | | | | | | | | | | | | | | | | | | | | | | | | | | | | | | | | | | | | | | | | | | | | | | | | | | | | | | | | | | | | | | | | | | | | | | | | | | | | | | | | | | | | | | | | | | | | | | | | | | | | | | | | | | | | | | | | | | | | | | | | | | | | | | | | | | | | | | | | | | | | | | | | | | | | | | | | | | | | | | | | | | | | | | | | | | | | | | | | | | | | | | | | | | | | | | | | | | | | | | | | | | | | | | | | | | | | | | | | | | | |
| 74S86 | 95 | 74S471 | 9.50 | | | | | | | | | | | | | | | | | | | | | | | | | | | | | | | | | | | | | | | | | | | | | | | | | | | | | | | | | | | | | | | | | | | | | | | | | | | | | | | | | | | | | | | | | | | | | | | | | | | | | | | | | | | | | | | | | | | | | | | | | | | | | | | | | | | | | | | | | | | | | | | | | | | | | | | | | | | | | | | | | | | | | | | | | | | | | | | | | | | | | | | | | | | | | | | | | | | | | | | | | | | | | | | | | | | | | | | | | | | | | | | | | | | | | | | | | | | | | | | | | |
| 74S112 | 1.95 | 74S473 | 9.50 | | | | | | | | | | | | | | | | | | | | | | | | | | | | | | | | | | | | | | | | | | | | | | | | | | | | | | | | | | | | | | | | | | | | | | | | | | | | | | | | | | | | | | | | | | | | | | | | | | | | | | | | | | | | | | | | | | | | | | | | | | | | | | | | | | | | | | | | | | | | | | | | | | | | | | | | | | | | | | | | | | | | | | | | | | | | | | | | | | | | | | | | | | | | | | | | | | | | | | | | | | | | | | | | | | | | | | | | | | | | | | | | | | | | | | | | | | | | | | | | | |
| 74S132 | 1.45 | 74S474 | 9.50 | | | | | | | | | | | | | | | | | | | | | | | | | | | | | | | | | | | | | | | | | | | | | | | | | | | | | | | | | | | | | | | | | | | | | | | | | | | | | | | | | | | | | | | | | | | | | | | | | | | | | | | | | | | | | | | | | | | | | | | | | | | | | | | | | | | | | | | | | | | | | | | | | | | | | | | | | | | | | | | | | | | | | | | | | | | | | | | | | | | | | | | | | | | | | | | | | | | | | | | | | | | | | | | | | | | | | | | | | | | | | | | | | | | | | | | | | | | | | | | | | |
| SN7400M | 18 | SN7482M | 30 | | | | | | | | | | | | | | | | | | | | | | | | | | | | | | | | | | | | | | | | | | | | | | | | | | | | | | | | | | | | | | | | | | | | | | | | | | | | | | | | | | | | | | | | | | | | | | | | | | | | | | | | | | | | | | | | | | | | | | | | | | | | | | | | | | | | | | | | | | | | | | | | | | | | | | | | | | | | | | | | | | | | | | | | | | | | | | | | | | | | | | | | | | | | | | | | | | | | | | | | | | | | | | | | | | | | | | | | | | | | | | | | | | | | | | | | | | | | | | | | | |
| SN7402M | 22 | SN7489M | 49 | | | | | | | | | | | | | | | | | | | | | | | | | | | | | | | | | | | | | | | | | | | | | | | | | | | | | | | | | | | | | | | | | | | | | | | | | | | | | | | | | | | | | | | | | | | | | | | | | | | | | | | | | | | | | | | | | | | | | | | | | | | | | | | | | | | | | | | | | | | | | | | | | | | | | | | | | | | | | | | | | | | | | | | | | | | | | | | | | | | | | | | | | | | | | | | | | | | | | | | | | | | | | | | | | | | | | | | | | | | | | | | | | | | | | | | | | | | | | | | | | |
| SN7404M | 21 | SN7493M | 45 | | | | | | | | | | | | | | | | | | | | | | | | | | | | | | | | | | | | | | | | | | | | | | | | | | | | | | | | | | | | | | | | | | | | | | | | | | | | | | | | | | | | | | | | | | | | | | | | | | | | | | | | | | | | | | | | | | | | | | | | | | | | | | | | | | | | | | | | | | | | | | | | | | | | | | | | | | | | | | | | | | | | | | | | | | | | | | | | | | | | | | | | | | | | | | | | | | | | | | | | | | | | | | | | | | | | | | | | | | | | | | | | | | | | | | | | | | | | | | | | | |
| SN7408M | 22 | SN7495M | 50 | | | | | | | | | | | | | | | | | | | | | | | | | | | | | | | | | | | | | | | | | | | | | | | | | | | | | | | | | | | | | | | | | | | | | | | | | | | | | | | | | | | | | | | | | | | | | | | | | | | | | | | | | | | | | | | | | | | | | | | | | | | | | | | | | | | | | | | | | | | | | | | | | | | | | | | | | | | | | | | | | | | | | | | | | | | | | | | | | | | | | | | | | | | | | | | | | | | | | | | | | | | | | | | | | | | | | | | | | | | | | | | | | | | | | | | | | | | | | | | | | |
| SN7410M | 18 | SN7496M | 89 | | | | | | | | | | | | | | | | | | | | | | | | | | | | | | | | | | | | | | | | | | | | | | | | | | | | | | | | | | | | | | | | | | | | | | | | | | | | | | | | | | | | | | | | | | | | | | | | | | | | | | | | | | | | | | | | | | | | | | | | | | | | | | | | | | | | | | | | | | | | | | | | | | | | | | | | | | | | | | | | | | | | | | | | | | | | | | | | | | | | | | | | | | | | | | | | | | | | | | | | | | | | | | | | | | | | | | | | | | | | | | | | | | | | | | | | | | | | | | | | | |
| SN7412M | 20 | SN74122M | 39 | | | | | | | | | | | | | | | | | | | | | | | | | | | | | | | | | | | | | | | | | | | | | | | | | | | | | | | | | | | | | | | | | | | | | | | | | | | | | | | | | | | | | | | | | | | | | | | | | | | | | | | | | | | | | | | | | | | | | | | | | | | | | | | | | | | | | | | | | | | | | | | | | | | | | | | | | | | | | | | | | | | | | | | | | | | | | | | | | | | | | | | | | | | | | | | | | | | | | | | | | | | | | | | | | | | | | | | | | | | | | | | | | | | | | | | | | | | | | | | | | |
| SN7413M | 22 | SN74136M | 95 | | | | | | | | | | | | | | | | | | | | | | | | | | | | | | | | | | | | | | | | | | | | | | | | | | | | | | | | | | | | | | | | | | | | | | | | | | | | | | | | | | | | | | | | | | | | | | | | | | | | | | | | | | | | | | | | | | | | | | | | | | | | | | | | | | | | | | | | | | | | | | | | | | | | | | | | | | | | | | | | | | | | | | | | | | | | | | | | | | | | | | | | | | | | | | | | | | | | | | | | | | | | | | | | | | | | | | | | | | | | | | | | | | | | | | | | | | | | | | | | | |
| SN7414M | 29 | SN74141M | 69 | | | | | | | | | | | | | | | | | | | | | | | | | | | | | | | | | | | | | | | | | | | | | | | | | | | | | | | | | | | | | | | | | | | | | | | | | | | | | | | | | | | | | | | | | | | | | | | | | | | | | | | | | | | | | | | | | | | | | | | | | | | | | | | | | | | | | | | | | | | | | | | | | | | | | | | | | | | | | | | | | | | | | | | | | | | | | | | | | | | | | | | | | | | | | | | | | | | | | | | | | | | | | | | | | | | | | | | | | | | | | | | | | | | | | | | | | | | | | | | | | |
| SN7416M | 27 | SN74151M | 65 | | | | | | | | | | | | | | | | | | | | | | | | | | | | | | | | | | | | | | | | | | | | | | | | | | | | | | | | | | | | | | | | | | | | | | | | | | | | | | | | | | | | | | | | | | | | | | | | | | | | | | | | | | | | | | | | | | | | | | | | | | | | | | | | | | | | | | | | | | | | | | | | | | | | | | | | | | | | | | | | | | | | | | | | | | | | | | | | | | | | | | | | | | | | | | | | | | | | | | | | | | | | | | | | | | | | | | | | | | | | | | | | | | | | | | | | | | | | | | | | | |
| SN7417M | 29 | SN74153M | 56 | | | | | | | | | | | | | | | | | | | | | | | | | | | | | | | | | | | | | | | | | | | | | | | | | | | | | | | | | | | | | | | | | | | | | | | | | | | | | | | | | | | | | | | | | | | | | | | | | | | | | | | | | | | | | | | | | | | | | | | | | | | | | | | | | | | | | | | | | | | | | | | | | | | | | | | | | | | | | | | | | | | | | | | | | | | | | | | | | | | | | | | | | | | | | | | | | | | | | | | | | | | | | | | | | | | | | | | | | | | | | | | | | | | | | | | | | | | | | | | | | |
| SN7420M | 17 | SN74154M | 125 | | | | | | | | | | | | | | | | | | | | | | | | | | | | | | | | | | | | | | | | | | | | | | | | | | | | | | | | | | | | | | | | | | | | | | | | | | | | | | | | | | | | | | | | | | | | | | | | | | | | | | | | | | | | | | | | | | | | | | | | | | | | | | | | | | | | | | | | | | | | | | | | | | | | | | | | | | | | | | | | | | | | | | | | | | | | | | | | | | | | | | | | | | | | | | | | | | | | | | | | | | | | | | | | | | | | | | | | | | | | | | | | | | | | | | | | | | | | | | | | | |
| SN7425M | 20 | SN74155M | 75 | | | | | | | | | | | | | | | | | | | | | | | | | | | | | | | | | | | | | | | | | | | | | | | | | | | | | | | | | | | | | | | | | | | | | | | | | | | | | | | | | | | | | | | | | | | | | | | | | | | | | | | | | | | | | | | | | | | | | | | | | | | | | | | | | | | | | | | | | | | | | | | | | | | | | | | | | | | | | | | | | | | | | | | | | | | | | | | | | | | | | | | | | | | | | | | | | | | | | | | | | | | | | | | | | | | | | | | | | | | | | | | | | | | | | | | | | | | | | | | | | |
| SN7430M | 17 | SN74157M | 58 | | | | | | | | | | | | | | | | | | | | | | | | | | | | | | | | | | | | | | | | | | | | | | | | | | | | | | | | | | | | | | | | | | | | | | | | | | | | | | | | | | | | | | | | | | | | | | | | | | | | | | | | | | | | | | | | | | | | | | | | | | | | | | | | | | | | | | | | | | | | | | | | | | | | | | | | | | | | | | | | | | | | | | | | | | | | | | | | | | | | | | | | | | | | | | | | | | | | | | | | | | | | | | | | | | | | | | | | | | | | | | | | | | | | | | | | | | | | | | | | | |
| SN7437M | 26 | SN74160M | 80 | | | | | | | | | | | | | | | | | | | | | | | | | | | | | | | | | | | | | | | | | | | | | | | | | | | | | | | | | | | | | | | | | | | | | | | | | | | | | | | | | | | | | | | | | | | | | | | | | | | | | | | | | | | | | | | | | | | | | | | | | | | | | | | | | | | | | | | | | | | | | | | | | | | | | | | | | | | | | | | | | | | | | | | | | | | | | | | | | | | | | | | | | | | | | | | | | | | | | | | | | | | | | | | | | | | | | | | | | | | | | | | | | | | | | | | | | | | | | | | | | |
| SN7438M | 24 | SN74161M | 65 | | | | | | | | | | | | | | | | | | | | | | | | | | | | | | | | | | | | | | | | | | | | | | | | | | | | | | | | | | | | | | | | | | | | | | | | | | | | | | | | | | | | | | | | | | | | | | | | | | | | | | | | | | | | | | | | | | | | | | | | | | | | | | | | | | | | | | | | | | | | | | | | | | | | | | | | | | | | | | | | | | | | | | | | | | | | | | | | | | | | | | | | | | | | | | | | | | | | | | | | | | | | | | | | | | | | | | | | | | | | | | | | | | | | | | | | | | | | | | | | | |
| SN7440M | 18 | SN74163M | 85 | | | | | | | | | | | | | | | | | | | | | | | | | | | | | | | | | | | | | | | | | | | | | | | | | | | | | | | | | | | | | | | | | | | | | | | | | | | | | | | | | | | | | | | | | | | | | | | | | | | | | | | | | | | | | | | | | | | | | | | | | | | | | | | | | | | | | | | | | | | | | | | | | | | | | | | | | | | | | | | | | | | | | | | | | | | | | | | | | | | | | | | | | | | | | | | | | | | | | | | | | | | | | | | | | | | | | | | | | | | | | | | | | | | | | | | | | | | | | | | | | |
| SN7442M | 45 | SN74164M | 87 | | | | | | | | | | | | | | | | | | | | | | | | | | | | | | | | | | | | | | | | | | | | | | | | | | | | | | | | | | | | | | | | | | | | | | | | | | | | | | | | | | | | | | | | | | | | | | | | | | | | | | | | | | | | | | | | | | | | | | | | | | | | | | | | | | | | | | | | | | | | | | | | | | | | | | | | | | | | | | | | | | | | | | | | | | | | | | | | | | | | | | | | | | | | | | | | | | | | | | | | | | | | | | | | | | | | | | | | | | | | | | | | | | | | | | | | | | | | | | | | | |
| SN7443M | 42 | SN74165M | 55 | | | | | | | | | | | | | | | | | | | | | | | | | | | | | | | | | | | | | | | | | | | | | | | | | | | | | | | | | | | | | | | | | | | | | | | | | | | | | | | | | | | | | | | | | | | | | | | | | | | | | | | | | | | | | | | | | | | | | | | | | | | | | | | | | | | | | | | | | | | | | | | | | | | | | | | | | | | | | | | | | | | | | | | | | | | | | | | | | | | | | | | | | | | | | | | | | | | | | | | | | | | | | | | | | | | | | | | | | | | | | | | | | | | | | | | | | | | | | | | | | |
| SN7445M | 64 | SN74174M | 80 | | | | | | | | | | | | | | | | | | | | | | | | | | | | | | | | | | | | | | | | | | | | | | | | | | | | | | | | | | | | | | | | | | | | | | | | | | | | | | | | | | | | | | | | | | | | | | | | | | | | | | | | | | | | | | | | | | | | | | | | | | | | | | | | | | | | | | | | | | | | | | | | | | | | | | | | | | | | | | | | | | | | | | | | | | | | | | | | | | | | | | | | | | | | | | | | | | | | | | | | | | | | | | | | | | | | | | | | | | | | | | | | | | | | | | | | | | | | | | | | | |
| SN7451M | 19 | SN74175M | 79 | | | | | | | | | | | | | | | | | | | | | | | | | | | | | | | | | | | | | | | | | | | | | | | | | | | | | | | | | | | | | | | | | | | | | | | | | | | | | | | | | | | | | | | | | | | | | | | | | | | | | | | | | | | | | | | | | | | | | | | | | | | | | | | | | | | | | | | | | | | | | | | | | | | | | | | | | | | | | | | | | | | | | | | | | | | | | | | | | | | | | | | | | | | | | | | | | | | | | | | | | | | | | | | | | | | | | | | | | | | | | | | | | | | | | | | | | | | | | | | | | |
| SN7454M | 19 | SN74180M | 75 | | | | | | | | | | | | | | | | | | | | | | | | | | | | | | | | | | | | | | | | | | | | | | | | | | | | | | | | | | | | | | | | | | | | | | | | | | | | | | | | | | | | | | | | | | | | | | | | | | | | | | | | | | | | | | | | | | | | | | | | | | | | | | | | | | | | | | | | | | | | | | | | | | | | | | | | | | | | | | | | | | | | | | | | | | | | | | | | | | | | | | | | | | | | | | | | | | | | | | | | | | | | | | | | | | | | | | | | | | | | | | | | | | | | | | | | | | | | | | | | | |
| SN7474M | 27 | SN74181M | 115 | | | | | | | | | | | | | | | | | | | | | | | | | | | | | | | | | | | | | | | | | | | | | | | | | | | | | | | | | | | | | | | | | | | | | | | | | | | | | | | | | | | | | | | | | | | | | | | | | | | | | | | | | | | | | | | | | | | | | | | | | | | | | | | | | | | | | | | | | | | | | | | | | | | | | | | | | | | | | | | | | | | | | | | | | | | | | | | | | | | | | | | | | | | | | | | | | | | | | | | | | | | | | | | | | | | | | | | | | | | | | | | | | | | | | | | | | | | | | | | | | |
| SN7475M | 35 | SN74393M | 1.65 | | | | | | | | | | | | | | | | | | | | | | | | | | | | | | | | | | | | | | | | | | | | | | | | | | | | | | | | | | | | | | | | | | | | | | | | | | | | | | | | | | | | | | | | | | | | | | | | | | | | | | | | | | | | | | | | | | | | | | | | | | | | | | | | | | | | | | | | | | | | | | | | | | | | | | | | | | | | | | | | | | | | | | | | | | | | | | | | | | | | | | | | | | | | | | | | | | | | | | | | | | | | | | | | | | | | | | | | | | | | | | | | | | | | | | | | | | | | | | | | | |
| 2716 | SV 450MS | 4.75ea | | | | | | | | | | | | | | | | | | | | | | | | | | | | | | | | | | | | | | | | | | | | | | | | | | | | | | | | | | | | | | | | | | | | | | | | | | | | | | | | | | | | | | | | | | | | | | | | | | | | | | | | | | | | | | | | | | | | | | | | | | | | | | | | | | | | | | | | | | | | | | | | | | | | | | | | | | | | | | | | | | | | | | | | | | | | | | | | | | | | | | | | | | | | | | | | | | | | | | | | | | | | | | | | | | | | | | | | | | | | | | | | | | | | | | | | | | | | | | | | | | |
| TMS2716 | | 5.25ea | | | | | | | | | | | | | | | | | | | | | | | | | | | | | | | | | | | | | | | | | | | | | | | | | | | | | | | | | | | | | | | | | | | | | | | | | | | | | | | | | | | | | | | | | | | | | | | | | | | | | | | | | | | | | | | | | | | | | | | | | | | | | | | | | | | | | | | | | | | | | | | | | | | | | | | | | | | | | | | | | | | | | | | | | | | | | | | | | | | | | | | | | | | | | | | | | | | | | | | | | | | | | | | | | | | | | | | | | | | | | | | | | | | | | | | | | | | | | | | | | | |
| 2708 | 450MS | 2.75ea | | | | | | | | | | | | | | | | | | | | | | | | | | | | | | | | | | | | | | | | | | | | | | | | | | | | | | | | | | | | | | | | | | | | | | | | | | | | | | | | | | | | | | | | | | | | | | | | | | | | | | | | | | | | | | | | | | | | | | | | | | | | | | | | | | | | | | | | | | | | | | | | | | | | | | | | | | | | | | | | | | | | | | | | | | | | | | | | | | | | | | | | | | | | | | | | | | | | | | | | | | | | | | | | | | | | | | | | | | | | | | | | | | | | | | | | | | | | | | | | | | |
| 2732 | | 11.50ea | | | | | | | | | | | | | | | | | | | | | | | | | | | | | | | | | | | | | | | | | | | | | | | | | | | | | | | | | | | | | | | | | | | | | | | | | | | | | | | | | | | | | | | | | | | | | | | | | | | | | | | | | | | | | | | | | | | | | | | | | | | | | | | | | | | | | | | | | | | | | | | | | | | | | | | | | | | | | | | | | | | | | | | | | | | | | | | | | | | | | | | | | | | | | | | | | | | | | | | | | | | | | | | | | | | | | | | | | | | | | | | | | | | | | | | | | | | | | | | | | | |
| 4116 | 300MS 2.00ea 8 for | 12.00 | | | | | | | | | | | | | | | | | | | | | | | | | | | | | | | | | | | | | | | | | | | | | | | | | | | | | | | | | | | | | | | | | | | | | | | | | | | | | | | | | | | | | | | | | | | | | | | | | | | | | | | | | | | | | | | | | | | | | | | | | | | | | | | | | | | | | | | | | | | | | | | | | | | | | | | | | | | | | | | | | | | | | | | | | | | | | | | | | | | | | | | | | | | | | | | | | | | | | | | | | | | | | | | | | | | | | | | | | | | | | | | | | | | | | | | | | | | | | | | | | | |
| | 200MS 2.35ea 8 for | 15.00 | | | | | | | | | | | | | | | | | | | | | | | | | | | | | | | | | | | | | | | | | | | | | | | | | | | | | | | | | | | | | | | | | | | | | | | | | | | | | | | | | | | | | | | | | | | | | | | | | | | | | | | | | | | | | | | | | | | | | | | | | | | | | | | | | | | | | | | | | | | | | | | | | | | | | | | | | | | | | | | | | | | | | | | | | | | | | | | | | | | | | | | | | | | | | | | | | | | | | | | | | | | | | | | | | | | | | | | | | | | | | | | | | | | | | | | | | | | | | | | | | | |
| 2141L | 300MS 2.95 ea 4 for | 2.75ea | | | | | | | | | | | | | | | | | | | | | | | | | | | | | | | | | | | | | | | | | | | | | | | | | | | | | | | | | | | | | | | | | | | | | | | | | | | | | | | | | | | | | | | | | | | | | | | | | | | | | | | | | | | | | | | | | | | | | | | | | | | | | | | | | | | | | | | | | | | | | | | | | | | | | | | | | | | | | | | | | | | | | | | | | | | | | | | | | | | | | | | | | | | | | | | | | | | | | | | | | | | | | | | | | | | | | | | | | | | | | | | | | | | | | | | | | | | | | | | | | | |
| | 200MS 3.50ea 4 for | 3.00ea | | | | | | | | | | | | | | | | | | | | | | | | | | | | | | | | | | | | | | | | | | | | | | | | | | | | | | | | | | | | | | | | | | | | | | | | | | | | | | | | | | | | | | | | | | | | | | | | | | | | | | | | | | | | | | | | | | | | | | | | | | | | | | | | | | | | | | | | | | | | | | | | | | | | | | | | | | | | | | | | | | | | | | | | | | | | | | | | | | | | | | | | | | | | | | | | | | | | | | | | | | | | | | | | | | | | | | | | | | | | | | | | | | | | | | | | | | | | | | | | | | |
| 2111 | 450MS 2.50ea 10 for | 2.00ea | | | | | | | | | | | | | | | | | | | | | | | | | | | | | | | | | | | | | | | | | | | | | | | | | | | | | | | | | | | | | | | | | | | | | | | | | | | | | | | | | | | | | | | | | | | | | | | | | | | | | | | | | | | | | | | | | | | | | | | | | | | | | | | | | | | | | | | | | | | | | | | | | | | | | | | | | | | | | | | | | | | | | | | | | | | | | | | | | | | | | | | | | | | | | | | | | | | | | | | | | | | | | | | | | | | | | | | | | | | | | | | | | | | | | | | | | | | | | | | | | | |
| Z 80 | 7.95 | | | | | | | | | | | | | | | | | | | | | | | | | | | | | | | | | | | | | | | | | | | | | | | | | | | | | | | | | | | | | | | | | | | | | | | | | | | | | | | | | | | | | | | | | | | | | | | | | | | | | | | | | | | | | | | | | | | | | | | | | | | | | | | | | | | | | | | | | | | | | | | | | | | | | | | | | | | | | | | | | | | | | | | | | | | | | | | | | | | | | | | | | | | | | | | | | | | | | | | | | | | | | | | | | | | | | | | | | | | | | | | | | | | | | | | | | | | | | | | | | | | |
| Z 80A CTC | 10.50 | | | | | | | | | | | | | | | | | | | | | | | | | | | | | | | | | | | | | | | | | | | | | | | | | | | | | | | | | | | | | | | | | | | | | | | | | | | | | | | | | | | | | | | | | | | | | | | | | | | | | | | | | | | | | | | | | | | | | | | | | | | | | | | | | | | | | | | | | | | | | | | | | | | | | | | | | | | | | | | | | | | | | | | | | | | | | | | | | | | | | | | | | | | | | | | | | | | | | | | | | | | | | | | | | | | | | | | | | | | | | | | | | | | | | | | | | | | | | | | | | | | |
| Z 80A CPU | 10.50 | | | | | | | | | | | | | | | | | | | | | | | | | | | | | | | | | | | | | | | | | | | | | | | | | | | | | | | | | | | | | | | | | | | | | | | | | | | | | | | | | | | | | | | | | | | | | | | | | | | | | | | | | | | | | | | | | | | | | | | | | | | | | | | | | | | | | | | | | | | | | | | | | | | | | | | | | | | | | | | | | | | | | | | | | | | | | | | | | | | | | | | | | | | | | | | | | | | | | | | | | | | | | | | | | | | | | | | | | | | | | | | | | | | | | | | | | | | | | | | | | | | |
| Z 80 002 16 64K | 129.00 | | | | | | | | | | | | | | | | | | | | | | | | | | | | | | | | | | | | | | | | | | | | | | | | | | | | | | | | | | | | | | | | | | | | | | | | | | | | | | | | | | | | | | | | | | | | | | | | | | | | | | | | | | | | | | | | | | | | | | | | | | | | | | | | | | | | | | | | | | | | | | | | | | | | | | | | | | | | | | | | | | | | | | | | | | | | | | | | | | | | | | | | | | | | | | | | | | | | | | | | | | | | | | | | | | | | | | | | | | | | | | | | | | | | | | | | | | | | | | | | | | | |
| 8085A | 13.50 | | | | | | | | | | | | | | | | | | | | | | | | | | | | | | | | | | | | | | | | | | | | | | | | | | | | | | | | | | | | | | | | | | | | | | | | | | | | | | | | | | | | | | | | | | | | | | | | | | | | | | | | | | | | | | | | | | | | | | | | | | | | | | | | | | | | | | | | | | | | | | | | | | | | | | | | | | | | | | | | | | | | | | | | | | | | | | | | | | | | | | | | | | | | | | | | | | | | | | | | | | | | | | | | | | | | | | | | | | | | | | | | | | | | | | | | | | | | | | | | | | | |
| 2901A | 7.50 | | | | | | | | | | | | | | | | | | | | | | | | | | | | | | | | | | | | | | | | | | | | | | | | | | | | | | | | | | | | | | | | | | | | | | | | | | | | | | | | | | | | | | | | | | | | | | | | | | | | | | | | | | | | | | | | | | | | | | | | | | | | | | | | | | | | | | | | | | | | | | | | | | | | | | | | | | | | | | | | | | | | | | | | | | | | | | | | | | | | | | | | | | | | | | | | | | | | | | | | | | | | | | | | | | | | | | | | | | | | | | | | | | | | | | | | | | | | | | | | | | | |
| MC6800 | 9.50 | | | | | | | | | | | | | | | | | | | | | | | | | | | | | | | | | | | | | | | | | | | | | | | | | | | | | | | | | | | | | | | | | | | | | | | | | | | | | | | | | | | | | | | | | | | | | | | | | | | | | | | | | | | | | | | | | | | | | | | | | | | | | | | | | | | | | | | | | | | | | | | | | | | | | | | | | | | | | | | | | | | | | | | | | | | | | | | | | | | | | | | | | | | | | | | | | | | | | | | | | | | | | | | | | | | | | | | | | | | | | | | | | | | | | | | | | | | | | | | | | | | |
| 2102 | 450MS | 95 | | | | | | | | | | | | | | | | | | | | | | | | | | | | | | | | | | | | | | | | | | | | | | | | | | | | | | | | | | | | | | | | | | | | | | | | | | | | | | | | | | | | | | | | | | | | | | | | | | | | | | | | | | | | | | | | | | | | | | | | | | | | | | | | | | | | | | | | | | | | | | | | | | | | | | | | | | | | | | | | | | | | | | | | | | | | | | | | | | | | | | | | | | | | | | | | | | | | | | | | | | | | | | | | | | | | | | | | | | | | | | | | | | | | | | | | | | | | | | | | | | |
| 8038 | 2.95 1103A | 75 | | | | | | | | | | | | | | | | | | | | | | | | | | | | | | | | | | | | | | | | | | | | | | | | | | | | | | | | | | | | | | | | | | | | | | | | | | | | | | | | | | | | | | | | | | | | | | | | | | | | | | | | | | | | | | | | | | | | | | | | | | | | | | | | | | | | | | | | | | | | | | | | | | | | | | | | | | | | | | | | | | | | | | | | | | | | | | | | | | | | | | | | | | | | | | | | | | | | | | | | | | | | | | | | | | | | | | | | | | | | | | | | | | | | | | | | | | | | | | | | | | |
| NE555 | .27 UPD765 | 17.85 | | | | | | | | | | | | | | | | | | | | | | | | | | | | | | | | | | | | | | | | | | | | | | | | | | | | | | | | | | | | | | | | | | | | | | | | | | | | | | | | | | | | | | | | | | | | | | | | | | | | | | | | | | | | | | | | | | | | | | | | | | | | | | | | | | | | | | | | | | | | | | | | | | | | | | | | | | | | | | | | | | | | | | | | | | | | | | | | | | | | | | | | | | | | | | | | | | | | | | | | | | | | | | | | | | | | | | | | | | | | | | | | | | | | | | | | | | | | | | | | | | |
| 1488 | 1.10 Hoopy disk | w spe | | | | | | | | | | | | | | | | | | | | | | | | | | | | | | | | | | | | | | | | | | | | | | | | | | | | | | | | | | | | | | | | | | | | | | | | | | | | | | | | | | | | | | | | | | | | | | | | | | | | | | | | | | | | | | | | | | | | | | | | | | | | | | | | | | | | | | | | | | | | | | | | | | | | | | | | | | | | | | | | | | | | | | | | | | | | | | | | | | | | | | | | | | | | | | | | | | | | | | | | | | | | | | | | | | | | | | | | | | | | | | | | | | | | | | | | | | | | | | | | | | |
| 1489 | 1.10 UK N2001 | 1.95 | | | | | | | | | | | | | | | | | | | | | | | | | | | | | | | | | | | | | | | | | | | | | | | | | | | | | | | | | | | | | | | | | | | | | | | | | | | | | | | | | | | | | | | | | | | | | | | | | | | | | | | | | | | | | | | | | | | | | | | | | | | | | | | | | | | | | | | | | | | | | | | | | | | | | | | | | | | | | | | | | | | | | | | | | | | | | | | | | | | | | | | | | | | | | | | | | | | | | | | | | | | | | | | | | | | | | | | | | | | | | | | | | | | | | | | | | | | | | | | | | | |
| 8726 | 1.30 TMS4400 | 1.40 | | | | | | | | | | | | | | | | | | | | | | | | | | | | | | | | | | | | | | | | | | | | | | | | | | | | | | | | | | | | | | | | | | | | | | | | | | | | | | | | | | | | | | | | | | | | | | | | | | | | | | | | | | | | | | | | | | | | | | | | | | | | | | | | | | | | | | | | | | | | | | | | | | | | | | | | | | | | | | | | | | | | | | | | | | | | | | | | | | | | | | | | | | | | | | | | | | | | | | | | | | | | | | | | | | | | | | | | | | | | | | | | | | | | | | | | | | | | | | | | | | |
| 8728 | 1.30 MC4008P | 1.75 | | | | | | | | | | | | | | | | | | | | | | | | | | | | | | | | | | | | | | | | | | | | | | | | | | | | | | | | | | | | | | | | | | | | | | | | | | | | | | | | | | | | | | | | | | | | | | | | | | | | | | | | | | | | | | | | | | | | | | | | | | | | | | | | | | | | | | | | | | | | | | | | | | | | | | | | | | | | | | | | | | | | | | | | | | | | | | | | | | | | | | | | | | | | | | | | | | | | | | | | | | | | | | | | | | | | | | | | | | | | | | | | | | | | | | | | | | | | | | | | | | |
| 8212 | 2.75 MH4026 | 1.55 | | | | | | | | | | | | | | | | | | | | | | | | | | | | | | | | | | | | | | | | | | | | | | | | | | | | | | | | | | | | | | | | | | | | | | | | | | | | | | | | | | | | | | | | | | | | | | | | | | | | | | | | | | | | | | | | | | | | | | | | | | | | | | | | | | | | | | | | | | | | | | | | | | | | | | | | | | | | | | | | | | | | | | | | | | | | | | | | | | | | | | | | | | | | | | | | | | | | | | | | | | | | | | | | | | | | | | | | | | | | | | | | | | | | | | | | | | | | | | | | | | |
| 8216 | 2.75 D3624 | 1.95 | | | | | | | | | | | | | | | | | | | | | | | | | | | | | | | | | | | | | | | | | | | | | | | | | | | | | | | | | | | | | | | | | | | | | | | | | | | | | | | | | | | | | | | | | | | | | | | | | | | | | | | | | | | | | | | | | | | | | | | | | | | | | | | | | | | | | | | | | | | | | | | | | | | | | | | | | | | | | | | | | | | | | | | | | | | | | | | | | | | | | | | | | | | | | | | | | | | | | | | | | | | | | | | | | | | | | | | | | | | | | | | | | | | | | | | | | | | | | | | | | | |
| 95 | D3001 | 1.95 | | | | | | | | | | | | | | | | | | | | | | | | | | | | | | | | | | | | | | | | | | | | | | | | | | | | | | | | | | | | | | | | | | | | | | | | | | | | | | | | | | | | | | | | | | | | | | | | | | | | | | | | | | | | | | | | | | | | | | | | | | | | | | | | | | | | | | | | | | | | | | | | | | | | | | | | | | | | | | | | | | | | | | | | | | | | | | | | | | | | | | | | | | | | | | | | | | | | | | | | | | | | | | | | | | | | | | | | | | | | | | | | | | | | | | | | | | | | | | | | | | |
| 95 | D3002 | 1.95 | | | | | | | | | | | | | | | | | | | | | | | | | | | | | | | | | | | | | | | | | | | | | | | | | | | | | | | | | | | | | | | | | | | | | | | | | | | | | | | | | | | | | | | | | | | | | | | | | | | | | | | | | | | | | | | | | | | | | | | | | | | | | | | | | | | | | | | | | | | | | | | | | | | | | | | | | | | | | | | | | | | | | | | | | | | | | | | | | | | | | | | | | | | | | | | | | | | | | | | | | | | | | | | | | | | | | | | | | | | | | | | | | | | | | | | | | | | | | | | | | | |
| <p>MONITORS</p> <p>video 100 video 100</p> <p>12 inch 12MHz BLACK & WHITE VIDEO MONITOR AMDAHL LEEDEX Corp \$365.00</p> <p>12 inch 12MHz GREEN Phos. VIDEO MONITOR CONOR IT \$365.00</p> <p>CONCORD COMPUTER PRODUCTS</p> <p>1971 SO. STATE COLLEGE ANAHEIM, CALIF. 92806 (714) 937-0637 CHECK - M/O NO COD</p> <p>*10. MIN ORDER / CA. RES. ADD 6% FRT.</p> <table border="1"> <tr><td>\$10-49</td><td>\$2.00</td><td>\$250-499</td><td>\$3.00</td></tr> <tr><td>50-99</td><td>4.00</td><td>500-999</td><td>4.00</td></tr> <tr><td>100-240</td><td>8.00</td><td>1000-UP</td><td>CALL</td></tr> </table> <p>send \$1.00 for '81 catalog</p> | \$10-49 | \$2.00 | \$250-499 | \$3.00 | 50-99 | 4.00 | 500-999 | 4.00 | 100-240 | 8.00 | 1000-UP | CALL | <p>74LS00</p> <table border="1"> <tr><td>74LS00</td><td>28</td><td>74LS158</td><td>.80</td></tr> <tr><td>74LS02</td><td>28</td><td>74LS161</td><td>.83</td></tr> <tr><td>74LS03</td><td>28</td><td>74LS162</td><td>.89</td></tr> <tr><td>74LS04</td><td>28</td><td>74LS163</td><td>.98</td></tr> <tr><td>74LS06</td><td>22</td><td>74LS164</td><td>.85</td></tr> <tr><td>74LS08</td><td>29</td><td>74LS165</td><td>.86</td></tr> <tr><td>74LS09</td><td>28</td><td>74LS169</td><td>1.55</td></tr> <tr><td>74LS10</td><td>26</td><td>74LS170</td><td>1.75</td></tr> <tr><td>74LS14</td><td>.80</td><td>74LS174</td><td>.85</td></tr> <tr><td>74LS20</td><td>.22</td><td>74LS175</td><td>.86</td></tr> <tr><td>74LS21</td><td>.26</td><td>74LS190</td><td>.85</td></tr> <tr><td>74LS26</td><td>.40</td><td>74LS191</td><td>1.25</td></tr> <tr><td>74LS27</td><td>.27</td><td>74LS196</td><td>.85</td></tr> <tr><td>74LS28</td><td>.37</td><td>74LS197</td><td>.78</td></tr> <tr><td>74LS30</td><td>.29</td><td>74LS221</td><td>1.25</td></tr> <tr><td>74LS32</td><td>.31</td><td>74LS240</td><td>1.65</td></tr> <tr><td>74LS38</td><td>.31</td><td>74LS241</td><td>1.65</td></tr> <tr><td>74LS42</td><td>.63</td><td>74LS243</td><td>1.55</td></tr> <tr><td>74LS48</td><td>.77</td><td>74LS244</td><td>1.55</td></tr> <tr><td>74LS54</td><td>.38</td><td>74LS251</td><td>2.45</td></tr> <tr><td>74LS75</td><td>.55</td><td>74LS251</td><td>1.25</td></tr> <tr><td>74LS86</td><td>.45</td><td>74LS253</td><td>.85</td></tr> <tr><td>74LS90</td><td>.50</td><td>74LS257</td><td>.85</td></tr> <tr><td>74LS93</td><td>.85</td><td>74LS259</td><td>1.85</td></tr> <tr><td>74LS96</td><td>.80</td><td>74LS260</td><td>.55</td></tr> <tr><td>74LS107</td><td>.43</td><td>74LS273</td><td>1.55</td></tr> <tr><td>74LS113</td><td>.45</td><td>74LS279</td><td>1.55</td></tr> <tr><td>74LS122</td><td>.35</td><td>74LS290</td><td>1.25</td></tr> <tr><td>74LS123</td><td>.80</td><td>74LS293</td><td>1.85</td></tr> <tr><td>74LS125</td><td>.80</td><td>74LS365</td><td>.85</td></tr> <tr><td>74LS126</td><td>.79</td><td>74LS367</td><td>.75</td></tr> <tr><td>74LS138</td><td>.64</td><td>74LS373</td><td>1.45</td></tr> <tr><td>74LS139</td><td>.59</td><td>74LS378</td><td>1.45</td></tr> <tr><td>74LS151</td><td>.49</td><td>74LS377</td><td>1.25</td></tr> <tr><td>74LS153</td><td>.49</td><td>74LS669</td><td>1.55</td></tr> <tr><td>74LS157</td><td>.80</td><td>74LS670</td><td>1.85</td></tr> </table> | 74LS00 | 28 | 74LS158 | .80 | 74LS02 | 28 | 74LS161 | .83 | 74LS03 | 28 | 74LS162 | .89 | 74LS04 | 28 | 74LS163 | .98 | 74LS06 | 22 | 74LS164 | .85 | 74LS08 | 29 | 74LS165 | .86 | 74LS09 | 28 | 74LS169 | 1.55 | 74LS10 | 26 | 74LS170 | 1.75 | 74LS14 | .80 | 74LS174 | .85 | 74LS20 | .22 | 74LS175 | .86 | 74LS21 | .26 | 74LS190 | .85 | 74LS26 | .40 | 74LS191 | 1.25 | 74LS27 | .27 | 74LS196 | .85 | 74LS28 | .37 | 74LS197 | .78 | 74LS30 | .29 | 74LS221 | 1.25 | 74LS32 | .31 | 74LS240 | 1.65 | 74LS38 | .31 | 74LS241 | 1.65 | 74LS42 | .63 | 74LS243 | 1.55 | 74LS48 | .77 | 74LS244 | 1.55 | 74LS54 | .38 | 74LS251 | 2.45 | 74LS75 | .55 | 74LS251 | 1.25 | 74LS86 | .45 | 74LS253 | .85 | 74LS90 | .50 | 74LS257 | .85 | 74LS93 | .85 | 74LS259 | 1.85 | 74LS96 | .80 | 74LS260 | .55 | 74LS107 | .43 | 74LS273 | 1.55 | 74LS113 | .45 | 74LS279 | 1.55 | 74LS122 | .35 | 74LS290 | 1.25 | 74LS123 | .80 | 74LS293 | 1.85 | 74LS125 | .80 | 74LS365 | .85 | 74LS126 | .79 | 74LS367 | .75 | 74LS138 | .64 | 74LS373 | 1.45 | 74LS139 | .59 | 74LS378 | 1.45 | 74LS151 | .49 | 74LS377 | 1.25 | 74LS153 | .49 | 74LS669 | 1.55 | 74LS157 | .80 | 74LS670 | 1.85 | <p>IC SOCKETS</p> <table border="1"> <tr><td>7808</td><td>85</td><td>8 PIN</td><td>10/1.20</td></tr> <tr><td>7812</td><td>85</td><td>14</td><td>10/1.40</td></tr> <tr><td>7816</td><td>1.60</td><td>16</td><td>10/1.60</td></tr> <tr><td>MC1350P</td><td>1.15</td><td>18</td><td>10/1.90</td></tr> <tr><td>MC1358P</td><td>1.50</td><td>20</td><td>10/2.80</td></tr> <tr><td>LM380</td><td>1.20</td><td>22</td><td>10/2.80</td></tr> <tr><td>LM565M</td><td>.95</td><td>24</td><td>10/2.80</td></tr> <tr><td>LM741</td><td>.25</td><td>28</td><td>10/3.80</td></tr> <tr><td>MC1458P</td><td>.55</td><td>40</td><td>10/4.75</td></tr> <tr><td>LM720</td><td>.30</td><td></td><td></td></tr> <tr><td>LM386</td><td>1.75</td><td></td><td></td></tr> </table> <p>TERMINALS</p> <p>Synertek "KTM-3" LOW COST TERMINAL WITH KEYBOARD AND VIDEO I/O \$689.00 \$499.00</p> | 7808 | 85 | 8 PIN | 10/1.20 | 7812 | 85 | 14 | 10/1.40 | 7816 | 1.60 | 16 | 10/1.60 | MC1350P | 1.15 | 18 | 10/1.90 | MC1358P | 1.50 | 20 | 10/2.80 | LM380 | 1.20 | 22 | 10/2.80 | LM565M | .95 | 24 | 10/2.80 | LM741 | .25 | 28 | 10/3.80 | MC1458P | .55 | 40 | 10/4.75 | LM720 | .30 | | | LM386 | 1.75 | | | <p>\$5712</p> <p>AS SHOWN</p> <p>OR</p> <p>14500</p> <p>THE MPD 117 Turns an ordinary outlet into a controlled power source \$179.50</p> <p>SHELF / DESK MOUNTED #5722 \$155.00</p> <p>DESC. IN THE COMPANY'S DIGITAL TALKER THE SERVICE WILL BRING YOU THE BEST IN PRICE AND SERVICE. PLEAS. TO ORDER.</p> <p>Tbar</p> <p>Apple Expansion Kit 16K Memory Add-On Includes Instructions \$25.95</p> <p>TRS-80 16K Add-On Instructions & Dip Switches \$25.95</p> | <p>KEYBOARD ENHANCER \$120.00</p> <p>CALIF COMP SYS APPLE CLOCK \$124.00</p> <p>PROTO BOARD \$25.00</p> <p>PRINTERS EPSON MX-80 \$560.00 CENTRONICS 737-1 \$950.00 753-1 \$2,995.00 BASE II inc 8008 \$649.00 850 \$749.00</p> | | | | | | | | | | | | | | | | | | | | | | | | | | | | | | | | | | | | | | | | |
| \$10-49 | \$2.00 | \$250-499 | \$3.00 | | | | | | | | | | | | | | | | | | | | | | | | | | | | | | | | | | | | | | | | | | | | | | | | | | | | | | | | | | | | | | | | | | | | | | | | | | | | | | | | | | | | | | | | | | | | | | | | | | | | | | | | | | | | | | | | | | | | | | | | | | | | | | | | | | | | | | | | | | | | | | | | | | | | | | | | | | | | | | | | | | | | | | | | | | | | | | | | | | | | | | | | | | | | | | | | | | | | | | | | | | | | | | | | | | | | | | | | | | | | | | | | | | | | | | | | | | | | | | | | | |
| 50-99 | 4.00 | 500-999 | 4.00 | | | | | | | | | | | | | | | | | | | | | | | | | | | | | | | | | | | | | | | | | | | | | | | | | | | | | | | | | | | | | | | | | | | | | | | | | | | | | | | | | | | | | | | | | | | | | | | | | | | | | | | | | | | | | | | | | | | | | | | | | | | | | | | | | | | | | | | | | | | | | | | | | | | | | | | | | | | | | | | | | | | | | | | | | | | | | | | | | | | | | | | | | | | | | | | | | | | | | | | | | | | | | | | | | | | | | | | | | | | | | | | | | | | | | | | | | | | | | | | | | |
| 100-240 | 8.00 | 1000-UP | CALL | | | | | | | | | | | | | | | | | | | | | | | | | | | | | | | | | | | | | | | | | | | | | | | | | | | | | | | | | | | | | | | | | | | | | | | | | | | | | | | | | | | | | | | | | | | | | | | | | | | | | | | | | | | | | | | | | | | | | | | | | | | | | | | | | | | | | | | | | | | | | | | | | | | | | | | | | | | | | | | | | | | | | | | | | | | | | | | | | | | | | | | | | | | | | | | | | | | | | | | | | | | | | | | | | | | | | | | | | | | | | | | | | | | | | | | | | | | | | | | | | |
| 74LS00 | 28 | 74LS158 | .80 | | | | | | | | | | | | | | | | | | | | | | | | | | | | | | | | | | | | | | | | | | | | | | | | | | | | | | | | | | | | | | | | | | | | | | | | | | | | | | | | | | | | | | | | | | | | | | | | | | | | | | | | | | | | | | | | | | | | | | | | | | | | | | | | | | | | | | | | | | | | | | | | | | | | | | | | | | | | | | | | | | | | | | | | | | | | | | | | | | | | | | | | | | | | | | | | | | | | | | | | | | | | | | | | | | | | | | | | | | | | | | | | | | | | | | | | | | | | | | | | | |
| 74LS02 | 28 | 74LS161 | .83 | | | | | | | | | | | | | | | | | | | | | | | | | | | | | | | | | | | | | | | | | | | | | | | | | | | | | | | | | | | | | | | | | | | | | | | | | | | | | | | | | | | | | | | | | | | | | | | | | | | | | | | | | | | | | | | | | | | | | | | | | | | | | | | | | | | | | | | | | | | | | | | | | | | | | | | | | | | | | | | | | | | | | | | | | | | | | | | | | | | | | | | | | | | | | | | | | | | | | | | | | | | | | | | | | | | | | | | | | | | | | | | | | | | | | | | | | | | | | | | | | |
| 74LS03 | 28 | 74LS162 | .89 | | | | | | | | | | | | | | | | | | | | | | | | | | | | | | | | | | | | | | | | | | | | | | | | | | | | | | | | | | | | | | | | | | | | | | | | | | | | | | | | | | | | | | | | | | | | | | | | | | | | | | | | | | | | | | | | | | | | | | | | | | | | | | | | | | | | | | | | | | | | | | | | | | | | | | | | | | | | | | | | | | | | | | | | | | | | | | | | | | | | | | | | | | | | | | | | | | | | | | | | | | | | | | | | | | | | | | | | | | | | | | | | | | | | | | | | | | | | | | | | | |
| 74LS04 | 28 | 74LS163 | .98 | | | | | | | | | | | | | | | | | | | | | | | | | | | | | | | | | | | | | | | | | | | | | | | | | | | | | | | | | | | | | | | | | | | | | | | | | | | | | | | | | | | | | | | | | | | | | | | | | | | | | | | | | | | | | | | | | | | | | | | | | | | | | | | | | | | | | | | | | | | | | | | | | | | | | | | | | | | | | | | | | | | | | | | | | | | | | | | | | | | | | | | | | | | | | | | | | | | | | | | | | | | | | | | | | | | | | | | | | | | | | | | | | | | | | | | | | | | | | | | | | |
| 74LS06 | 22 | 74LS164 | .85 | | | | | | | | | | | | | | | | | | | | | | | | | | | | | | | | | | | | | | | | | | | | | | | | | | | | | | | | | | | | | | | | | | | | | | | | | | | | | | | | | | | | | | | | | | | | | | | | | | | | | | | | | | | | | | | | | | | | | | | | | | | | | | | | | | | | | | | | | | | | | | | | | | | | | | | | | | | | | | | | | | | | | | | | | | | | | | | | | | | | | | | | | | | | | | | | | | | | | | | | | | | | | | | | | | | | | | | | | | | | | | | | | | | | | | | | | | | | | | | | | |
| 74LS08 | 29 | 74LS165 | .86 | | | | | | | | | | | | | | | | | | | | | | | | | | | | | | | | | | | | | | | | | | | | | | | | | | | | | | | | | | | | | | | | | | | | | | | | | | | | | | | | | | | | | | | | | | | | | | | | | | | | | | | | | | | | | | | | | | | | | | | | | | | | | | | | | | | | | | | | | | | | | | | | | | | | | | | | | | | | | | | | | | | | | | | | | | | | | | | | | | | | | | | | | | | | | | | | | | | | | | | | | | | | | | | | | | | | | | | | | | | | | | | | | | | | | | | | | | | | | | | | | |
| 74LS09 | 28 | 74LS169 | 1.55 | | | | | | | | | | | | | | | | | | | | | | | | | | | | | | | | | | | | | | | | | | | | | | | | | | | | | | | | | | | | | | | | | | | | | | | | | | | | | | | | | | | | | | | | | | | | | | | | | | | | | | | | | | | | | | | | | | | | | | | | | | | | | | | | | | | | | | | | | | | | | | | | | | | | | | | | | | | | | | | | | | | | | | | | | | | | | | | | | | | | | | | | | | | | | | | | | | | | | | | | | | | | | | | | | | | | | | | | | | | | | | | | | | | | | | | | | | | | | | | | | |
| 74LS10 | 26 | 74LS170 | 1.75 | | | | | | | | | | | | | | | | | | | | | | | | | | | | | | | | | | | | | | | | | | | | | | | | | | | | | | | | | | | | | | | | | | | | | | | | | | | | | | | | | | | | | | | | | | | | | | | | | | | | | | | | | | | | | | | | | | | | | | | | | | | | | | | | | | | | | | | | | | | | | | | | | | | | | | | | | | | | | | | | | | | | | | | | | | | | | | | | | | | | | | | | | | | | | | | | | | | | | | | | | | | | | | | | | | | | | | | | | | | | | | | | | | | | | | | | | | | | | | | | | |
| 74LS14 | .80 | 74LS174 | .85 | | | | | | | | | | | | | | | | | | | | | | | | | | | | | | | | | | | | | | | | | | | | | | | | | | | | | | | | | | | | | | | | | | | | | | | | | | | | | | | | | | | | | | | | | | | | | | | | | | | | | | | | | | | | | | | | | | | | | | | | | | | | | | | | | | | | | | | | | | | | | | | | | | | | | | | | | | | | | | | | | | | | | | | | | | | | | | | | | | | | | | | | | | | | | | | | | | | | | | | | | | | | | | | | | | | | | | | | | | | | | | | | | | | | | | | | | | | | | | | | | |
| 74LS20 | .22 | 74LS175 | .86 | | | | | | | | | | | | | | | | | | | | | | | | | | | | | | | | | | | | | | | | | | | | | | | | | | | | | | | | | | | | | | | | | | | | | | | | | | | | | | | | | | | | | | | | | | | | | | | | | | | | | | | | | | | | | | | | | | | | | | | | | | | | | | | | | | | | | | | | | | | | | | | | | | | | | | | | | | | | | | | | | | | | | | | | | | | | | | | | | | | | | | | | | | | | | | | | | | | | | | | | | | | | | | | | | | | | | | | | | | | | | | | | | | | | | | | | | | | | | | | | | |
| 74LS21 | .26 | 74LS190 | .85 | | | | | | | | | | | | | | | | | | | | | | | | | | | | | | | | | | | | | | | | | | | | | | | | | | | | | | | | | | | | | | | | | | | | | | | | | | | | | | | | | | | | | | | | | | | | | | | | | | | | | | | | | | | | | | | | | | | | | | | | | | | | | | | | | | | | | | | | | | | | | | | | | | | | | | | | | | | | | | | | | | | | | | | | | | | | | | | | | | | | | | | | | | | | | | | | | | | | | | | | | | | | | | | | | | | | | | | | | | | | | | | | | | | | | | | | | | | | | | | | | |
| 74LS26 | .40 | 74LS191 | 1.25 | | | | | | | | | | | | | | | | | | | | | | | | | | | | | | | | | | | | | | | | | | | | | | | | | | | | | | | | | | | | | | | | | | | | | | | | | | | | | | | | | | | | | | | | | | | | | | | | | | | | | | | | | | | | | | | | | | | | | | | | | | | | | | | | | | | | | | | | | | | | | | | | | | | | | | | | | | | | | | | | | | | | | | | | | | | | | | | | | | | | | | | | | | | | | | | | | | | | | | | | | | | | | | | | | | | | | | | | | | | | | | | | | | | | | | | | | | | | | | | | | |
| 74LS27 | .27 | 74LS196 | .85 | | | | | | | | | | | | | | | | | | | | | | | | | | | | | | | | | | | | | | | | | | | | | | | | | | | | | | | | | | | | | | | | | | | | | | | | | | | | | | | | | | | | | | | | | | | | | | | | | | | | | | | | | | | | | | | | | | | | | | | | | | | | | | | | | | | | | | | | | | | | | | | | | | | | | | | | | | | | | | | | | | | | | | | | | | | | | | | | | | | | | | | | | | | | | | | | | | | | | | | | | | | | | | | | | | | | | | | | | | | | | | | | | | | | | | | | | | | | | | | | | |
| 74LS28 | .37 | 74LS197 | .78 | | | | | | | | | | | | | | | | | | | | | | | | | | | | | | | | | | | | | | | | | | | | | | | | | | | | | | | | | | | | | | | | | | | | | | | | | | | | | | | | | | | | | | | | | | | | | | | | | | | | | | | | | | | | | | | | | | | | | | | | | | | | | | | | | | | | | | | | | | | | | | | | | | | | | | | | | | | | | | | | | | | | | | | | | | | | | | | | | | | | | | | | | | | | | | | | | | | | | | | | | | | | | | | | | | | | | | | | | | | | | | | | | | | | | | | | | | | | | | | | | |
| 74LS30 | .29 | 74LS221 | 1.25 | | | | | | | | | | | | | | | | | | | | | | | | | | | | | | | | | | | | | | | | | | | | | | | | | | | | | | | | | | | | | | | | | | | | | | | | | | | | | | | | | | | | | | | | | | | | | | | | | | | | | | | | | | | | | | | | | | | | | | | | | | | | | | | | | | | | | | | | | | | | | | | | | | | | | | | | | | | | | | | | | | | | | | | | | | | | | | | | | | | | | | | | | | | | | | | | | | | | | | | | | | | | | | | | | | | | | | | | | | | | | | | | | | | | | | | | | | | | | | | | | |
| 74LS32 | .31 | 74LS240 | 1.65 | | | | | | | | | | | | | | | | | | | | | | | | | | | | | | | | | | | | | | | | | | | | | | | | | | | | | | | | | | | | | | | | | | | | | | | | | | | | | | | | | | | | | | | | | | | | | | | | | | | | | | | | | | | | | | | | | | | | | | | | | | | | | | | | | | | | | | | | | | | | | | | | | | | | | | | | | | | | | | | | | | | | | | | | | | | | | | | | | | | | | | | | | | | | | | | | | | | | | | | | | | | | | | | | | | | | | | | | | | | | | | | | | | | | | | | | | | | | | | | | | |
| 74LS38 | .31 | 74LS241 | 1.65 | | | | | | | | | | | | | | | | | | | | | | | | | | | | | | | | | | | | | | | | | | | | | | | | | | | | | | | | | | | | | | | | | | | | | | | | | | | | | | | | | | | | | | | | | | | | | | | | | | | | | | | | | | | | | | | | | | | | | | | | | | | | | | | | | | | | | | | | | | | | | | | | | | | | | | | | | | | | | | | | | | | | | | | | | | | | | | | | | | | | | | | | | | | | | | | | | | | | | | | | | | | | | | | | | | | | | | | | | | | | | | | | | | | | | | | | | | | | | | | | | |
| 74LS42 | .63 | 74LS243 | 1.55 | | | | | | | | | | | | | | | | | | | | | | | | | | | | | | | | | | | | | | | | | | | | | | | | | | | | | | | | | | | | | | | | | | | | | | | | | | | | | | | | | | | | | | | | | | | | | | | | | | | | | | | | | | | | | | | | | | | | | | | | | | | | | | | | | | | | | | | | | | | | | | | | | | | | | | | | | | | | | | | | | | | | | | | | | | | | | | | | | | | | | | | | | | | | | | | | | | | | | | | | | | | | | | | | | | | | | | | | | | | | | | | | | | | | | | | | | | | | | | | | | |
| 74LS48 | .77 | 74LS244 | 1.55 | | | | | | | | | | | | | | | | | | | | | | | | | | | | | | | | | | | | | | | | | | | | | | | | | | | | | | | | | | | | | | | | | | | | | | | | | | | | | | | | | | | | | | | | | | | | | | | | | | | | | | | | | | | | | | | | | | | | | | | | | | | | | | | | | | | | | | | | | | | | | | | | | | | | | | | | | | | | | | | | | | | | | | | | | | | | | | | | | | | | | | | | | | | | | | | | | | | | | | | | | | | | | | | | | | | | | | | | | | | | | | | | | | | | | | | | | | | | | | | | | |
| 74LS54 | .38 | 74LS251 | 2.45 | | | | | | | | | | | | | | | | | | | | | | | | | | | | | | | | | | | | | | | | | | | | | | | | | | | | | | | | | | | | | | | | | | | | | | | | | | | | | | | | | | | | | | | | | | | | | | | | | | | | | | | | | | | | | | | | | | | | | | | | | | | | | | | | | | | | | | | | | | | | | | | | | | | | | | | | | | | | | | | | | | | | | | | | | | | | | | | | | | | | | | | | | | | | | | | | | | | | | | | | | | | | | | | | | | | | | | | | | | | | | | | | | | | | | | | | | | | | | | | | | |
| 74LS75 | .55 | 74LS251 | 1.25 | | | | | | | | | | | | | | | | | | | | | | | | | | | | | | | | | | | | | | | | | | | | | | | | | | | | | | | | | | | | | | | | | | | | | | | | | | | | | | | | | | | | | | | | | | | | | | | | | | | | | | | | | | | | | | | | | | | | | | | | | | | | | | | | | | | | | | | | | | | | | | | | | | | | | | | | | | | | | | | | | | | | | | | | | | | | | | | | | | | | | | | | | | | | | | | | | | | | | | | | | | | | | | | | | | | | | | | | | | | | | | | | | | | | | | | | | | | | | | | | | |
| 74LS86 | .45 | 74LS253 | .85 | | | | | | | | | | | | | | | | | | | | | | | | | | | | | | | | | | | | | | | | | | | | | | | | | | | | | | | | | | | | | | | | | | | | | | | | | | | | | | | | | | | | | | | | | | | | | | | | | | | | | | | | | | | | | | | | | | | | | | | | | | | | | | | | | | | | | | | | | | | | | | | | | | | | | | | | | | | | | | | | | | | | | | | | | | | | | | | | | | | | | | | | | | | | | | | | | | | | | | | | | | | | | | | | | | | | | | | | | | | | | | | | | | | | | | | | | | | | | | | | | |
| 74LS90 | .50 | 74LS257 | .85 | | | | | | | | | | | | | | | | | | | | | | | | | | | | | | | | | | | | | | | | | | | | | | | | | | | | | | | | | | | | | | | | | | | | | | | | | | | | | | | | | | | | | | | | | | | | | | | | | | | | | | | | | | | | | | | | | | | | | | | | | | | | | | | | | | | | | | | | | | | | | | | | | | | | | | | | | | | | | | | | | | | | | | | | | | | | | | | | | | | | | | | | | | | | | | | | | | | | | | | | | | | | | | | | | | | | | | | | | | | | | | | | | | | | | | | | | | | | | | | | | |
| 74LS93 | .85 | 74LS259 | 1.85 | | | | | | | | | | | | | | | | | | | | | | | | | | | | | | | | | | | | | | | | | | | | | | | | | | | | | | | | | | | | | | | | | | | | | | | | | | | | | | | | | | | | | | | | | | | | | | | | | | | | | | | | | | | | | | | | | | | | | | | | | | | | | | | | | | | | | | | | | | | | | | | | | | | | | | | | | | | | | | | | | | | | | | | | | | | | | | | | | | | | | | | | | | | | | | | | | | | | | | | | | | | | | | | | | | | | | | | | | | | | | | | | | | | | | | | | | | | | | | | | | |
| 74LS96 | .80 | 74LS260 | .55 | | | | | | | | | | | | | | | | | | | | | | | | | | | | | | | | | | | | | | | | | | | | | | | | | | | | | | | | | | | | | | | | | | | | | | | | | | | | | | | | | | | | | | | | | | | | | | | | | | | | | | | | | | | | | | | | | | | | | | | | | | | | | | | | | | | | | | | | | | | | | | | | | | | | | | | | | | | | | | | | | | | | | | | | | | | | | | | | | | | | | | | | | | | | | | | | | | | | | | | | | | | | | | | | | | | | | | | | | | | | | | | | | | | | | | | | | | | | | | | | | |
| 74LS107 | .43 | 74LS273 | 1.55 | | | | | | | | | | | | | | | | | | | | | | | | | | | | | | | | | | | | | | | | | | | | | | | | | | | | | | | | | | | | | | | | | | | | | | | | | | | | | | | | | | | | | | | | | | | | | | | | | | | | | | | | | | | | | | | | | | | | | | | | | | | | | | | | | | | | | | | | | | | | | | | | | | | | | | | | | | | | | | | | | | | | | | | | | | | | | | | | | | | | | | | | | | | | | | | | | | | | | | | | | | | | | | | | | | | | | | | | | | | | | | | | | | | | | | | | | | | | | | | | | |
| 74LS113 | .45 | 74LS279 | 1.55 | | | | | | | | | | | | | | | | | | | | | | | | | | | | | | | | | | | | | | | | | | | | | | | | | | | | | | | | | | | | | | | | | | | | | | | | | | | | | | | | | | | | | | | | | | | | | | | | | | | | | | | | | | | | | | | | | | | | | | | | | | | | | | | | | | | | | | | | | | | | | | | | | | | | | | | | | | | | | | | | | | | | | | | | | | | | | | | | | | | | | | | | | | | | | | | | | | | | | | | | | | | | | | | | | | | | | | | | | | | | | | | | | | | | | | | | | | | | | | | | | |
| 74LS122 | .35 | 74LS290 | 1.25 | | | | | | | | | | | | | | | | | | | | | | | | | | | | | | | | | | | | | | | | | | | | | | | | | | | | | | | | | | | | | | | | | | | | | | | | | | | | | | | | | | | | | | | | | | | | | | | | | | | | | | | | | | | | | | | | | | | | | | | | | | | | | | | | | | | | | | | | | | | | | | | | | | | | | | | | | | | | | | | | | | | | | | | | | | | | | | | | | | | | | | | | | | | | | | | | | | | | | | | | | | | | | | | | | | | | | | | | | | | | | | | | | | | | | | | | | | | | | | | | | |
| 74LS123 | .80 | 74LS293 | 1.85 | | | | | | | | | | | | | | | | | | | | | | | | | | | | | | | | | | | | | | | | | | | | | | | | | | | | | | | | | | | | | | | | | | | | | | | | | | | | | | | | | | | | | | | | | | | | | | | | | | | | | | | | | | | | | | | | | | | | | | | | | | | | | | | | | | | | | | | | | | | | | | | | | | | | | | | | | | | | | | | | | | | | | | | | | | | | | | | | | | | | | | | | | | | | | | | | | | | | | | | | | | | | | | | | | | | | | | | | | | | | | | | | | | | | | | | | | | | | | | | | | |
| 74LS125 | .80 | 74LS365 | .85 | | | | | | | | | | | | | | | | | | | | | | | | | | | | | | | | | | | | | | | | | | | | | | | | | | | | | | | | | | | | | | | | | | | | | | | | | | | | | | | | | | | | | | | | | | | | | | | | | | | | | | | | | | | | | | | | | | | | | | | | | | | | | | | | | | | | | | | | | | | | | | | | | | | | | | | | | | | | | | | | | | | | | | | | | | | | | | | | | | | | | | | | | | | | | | | | | | | | | | | | | | | | | | | | | | | | | | | | | | | | | | | | | | | | | | | | | | | | | | | | | |
| 74LS126 | .79 | 74LS367 | .75 | | | | | | | | | | | | | | | | | | | | | | | | | | | | | | | | | | | | | | | | | | | | | | | | | | | | | | | | | | | | | | | | | | | | | | | | | | | | | | | | | | | | | | | | | | | | | | | | | | | | | | | | | | | | | | | | | | | | | | | | | | | | | | | | | | | | | | | | | | | | | | | | | | | | | | | | | | | | | | | | | | | | | | | | | | | | | | | | | | | | | | | | | | | | | | | | | | | | | | | | | | | | | | | | | | | | | | | | | | | | | | | | | | | | | | | | | | | | | | | | | |
| 74LS138 | .64 | 74LS373 | 1.45 | | | | | | | | | | | | | | | | | | | | | | | | | | | | | | | | | | | | | | | | | | | | | | | | | | | | | | | | | | | | | | | | | | | | | | | | | | | | | | | | | | | | | | | | | | | | | | | | | | | | | | | | | | | | | | | | | | | | | | | | | | | | | | | | | | | | | | | | | | | | | | | | | | | | | | | | | | | | | | | | | | | | | | | | | | | | | | | | | | | | | | | | | | | | | | | | | | | | | | | | | | | | | | | | | | | | | | | | | | | | | | | | | | | | | | | | | | | | | | | | | |
| 74LS139 | .59 | 74LS378 | 1.45 | | | | | | | | | | | | | | | | | | | | | | | | | | | | | | | | | | | | | | | | | | | | | | | | | | | | | | | | | | | | | | | | | | | | | | | | | | | | | | | | | | | | | | | | | | | | | | | | | | | | | | | | | | | | | | | | | | | | | | | | | | | | | | | | | | | | | | | | | | | | | | | | | | | | | | | | | | | | | | | | | | | | | | | | | | | | | | | | | | | | | | | | | | | | | | | | | | | | | | | | | | | | | | | | | | | | | | | | | | | | | | | | | | | | | | | | | | | | | | | | | |
| 74LS151 | .49 | 74LS377 | 1.25 | | | | | | | | | | | | | | | | | | | | | | | | | | | | | | | | | | | | | | | | | | | | | | | | | | | | | | | | | | | | | | | | | | | | | | | | | | | | | | | | | | | | | | | | | | | | | | | | | | | | | | | | | | | | | | | | | | | | | | | | | | | | | | | | | | | | | | | | | | | | | | | | | | | | | | | | | | | | | | | | | | | | | | | | | | | | | | | | | | | | | | | | | | | | | | | | | | | | | | | | | | | | | | | | | | | | | | | | | | | | | | | | | | | | | | | | | | | | | | | | | |
| 74LS153 | .49 | 74LS669 | 1.55 | | | | | | | | | | | | | | | | | | | | | | | | | | | | | | | | | | | | | | | | | | | | | | | | | | | | | | | | | | | | | | | | | | | | | | | | | | | | | | | | | | | | | | | | | | | | | | | | | | | | | | | | | | | | | | | | | | | | | | | | | | | | | | | | | | | | | | | | | | | | | | | | | | | | | | | | | | | | | | | | | | | | | | | | | | | | | | | | | | | | | | | | | | | | | | | | | | | | | | | | | | | | | | | | | | | | | | | | | | | | | | | | | | | | | | | | | | | | | | | | | |
| 74LS157 | .80 | 74LS670 | 1.85 | | | | | | | | | | | | | | | | | | | | | | | | | | | | | | | | | | | | | | | | | | | | | | | | | | | | | | | | | | | | | | | | | | | | | | | | | | | | | | | | | | | | | | | | | | | | | | | | | | | | | | | | | | | | | | | | | | | | | | | | | | | | | | | | | | | | | | | | | | | | | | | | | | | | | | | | | | | | | | | | | | | | | | | | | | | | | | | | | | | | | | | | | | | | | | | | | | | | | | | | | | | | | | | | | | | | | | | | | | | | | | | | | | | | | | | | | | | | | | | | | |
| 7808 | 85 | 8 PIN | 10/1.20 | | | | | | | | | | | | | | | | | | | | | | | | | | | | | | | | | | | | | | | | | | | | | | | | | | | | | | | | | | | | | | | | | | | | | | | | | | | | | | | | | | | | | | | | | | | | | | | | | | | | | | | | | | | | | | | | | | | | | | | | | | | | | | | | | | | | | | | | | | | | | | | | | | | | | | | | | | | | | | | | | | | | | | | | | | | | | | | | | | | | | | | | | | | | | | | | | | | | | | | | | | | | | | | | | | | | | | | | | | | | | | | | | | | | | | | | | | | | | | | | | |
| 7812 | 85 | 14 | 10/1.40 | | | | | | | | | | | | | | | | | | | | | | | | | | | | | | | | | | | | | | | | | | | | | | | | | | | | | | | | | | | | | | | | | | | | | | | | | | | | | | | | | | | | | | | | | | | | | | | | | | | | | | | | | | | | | | | | | | | | | | | | | | | | | | | | | | | | | | | | | | | | | | | | | | | | | | | | | | | | | | | | | | | | | | | | | | | | | | | | | | | | | | | | | | | | | | | | | | | | | | | | | | | | | | | | | | | | | | | | | | | | | | | | | | | | | | | | | | | | | | | | | |
| 7816 | 1.60 | 16 | 10/1.60 | | | | | | | | | | | | | | | | | | | | | | | | | | | | | | | | | | | | | | | | | | | | | | | | | | | | | | | | | | | | | | | | | | | | | | | | | | | | | | | | | | | | | | | | | | | | | | | | | | | | | | | | | | | | | | | | | | | | | | | | | | | | | | | | | | | | | | | | | | | | | | | | | | | | | | | | | | | | | | | | | | | | | | | | | | | | | | | | | | | | | | | | | | | | | | | | | | | | | | | | | | | | | | | | | | | | | | | | | | | | | | | | | | | | | | | | | | | | | | | | | |
| MC1350P | 1.15 | 18 | 10/1.90 | | | | | | | | | | | | | | | | | | | | | | | | | | | | | | | | | | | | | | | | | | | | | | | | | | | | | | | | | | | | | | | | | | | | | | | | | | | | | | | | | | | | | | | | | | | | | | | | | | | | | | | | | | | | | | | | | | | | | | | | | | | | | | | | | | | | | | | | | | | | | | | | | | | | | | | | | | | | | | | | | | | | | | | | | | | | | | | | | | | | | | | | | | | | | | | | | | | | | | | | | | | | | | | | | | | | | | | | | | | | | | | | | | | | | | | | | | | | | | | | | |
| MC1358P | 1.50 | 20 | 10/2.80 | | | | | | | | | | | | | | | | | | | | | | | | | | | | | | | | | | | | | | | | | | | | | | | | | | | | | | | | | | | | | | | | | | | | | | | | | | | | | | | | | | | | | | | | | | | | | | | | | | | | | | | | | | | | | | | | | | | | | | | | | | | | | | | | | | | | | | | | | | | | | | | | | | | | | | | | | | | | | | | | | | | | | | | | | | | | | | | | | | | | | | | | | | | | | | | | | | | | | | | | | | | | | | | | | | | | | | | | | | | | | | | | | | | | | | | | | | | | | | | | | |
| LM380 | 1.20 | 22 | 10/2.80 | | | | | | | | | | | | | | | | | | | | | | | | | | | | | | | | | | | | | | | | | | | | | | | | | | | | | | | | | | | | | | | | | | | | | | | | | | | | | | | | | | | | | | | | | | | | | | | | | | | | | | | | | | | | | | | | | | | | | | | | | | | | | | | | | | | | | | | | | | | | | | | | | | | | | | | | | | | | | | | | | | | | | | | | | | | | | | | | | | | | | | | | | | | | | | | | | | | | | | | | | | | | | | | | | | | | | | | | | | | | | | | | | | | | | | | | | | | | | | | | | |
| LM565M | .95 | 24 | 10/2.80 | | | | | | | | | | | | | | | | | | | | | | | | | | | | | | | | | | | | | | | | | | | | | | | | | | | | | | | | | | | | | | | | | | | | | | | | | | | | | | | | | | | | | | | | | | | | | | | | | | | | | | | | | | | | | | | | | | | | | | | | | | | | | | | | | | | | | | | | | | | | | | | | | | | | | | | | | | | | | | | | | | | | | | | | | | | | | | | | | | | | | | | | | | | | | | | | | | | | | | | | | | | | | | | | | | | | | | | | | | | | | | | | | | | | | | | | | | | | | | | | | |
| LM741 | .25 | 28 | 10/3.80 | | | | | | | | | | | | | | | | | | | | | | | | | | | | | | | | | | | | | | | | | | | | | | | | | | | | | | | | | | | | | | | | | | | | | | | | | | | | | | | | | | | | | | | | | | | | | | | | | | | | | | | | | | | | | | | | | | | | | | | | | | | | | | | | | | | | | | | | | | | | | | | | | | | | | | | | | | | | | | | | | | | | | | | | | | | | | | | | | | | | | | | | | | | | | | | | | | | | | | | | | | | | | | | | | | | | | | | | | | | | | | | | | | | | | | | | | | | | | | | | | |
| MC1458P | .55 | 40 | 10/4.75 | | | | | | | | | | | | | | | | | | | | | | | | | | | | | | | | | | | | | | | | | | | | | | | | | | | | | | | | | | | | | | | | | | | | | | | | | | | | | | | | | | | | | | | | | | | | | | | | | | | | | | | | | | | | | | | | | | | | | | | | | | | | | | | | | | | | | | | | | | | | | | | | | | | | | | | | | | | | | | | | | | | | | | | | | | | | | | | | | | | | | | | | | | | | | | | | | | | | | | | | | | | | | | | | | | | | | | | | | | | | | | | | | | | | | | | | | | | | | | | | | |
| LM720 | .30 | | | | | | | | | | | | | | | | | | | | | | | | | | | | | | | | | | | | | | | | | | | | | | | | | | | | | | | | | | | | | | | | | | | | | | | | | | | | | | | | | | | | | | | | | | | | | | | | | | | | | | | | | | | | | | | | | | | | | | | | | | | | | | | | | | | | | | | | | | | | | | | | | | | | | | | | | | | | | | | | | | | | | | | | | | | | | | | | | | | | | | | | | | | | | | | | | | | | | | | | | | | | | | | | | | | | | | | | | | | | | | | | | | | | | | | | | | | | | | | | | | | |
| LM386 | 1.75 | | | | | | | | | | | | | | | | | | | | | | | | | | | | | | | | | | | | | | | | | | | | | | | | | | | | | | | | | | | | | | | | | | | | | | | | | | | | | | | | | | | | | | | | | | | | | | | | | | | | | | | | | | | | | | | | | | | | | | | | | | | | | | | | | | | | | | | | | | | | | | | | | | | | | | | | | | | | | | | | | | | | | | | | | | | | | | | | | | | | | | | | | | | | | | | | | | | | | | | | | | | | | | | | | | | | | | | | | | | | | | | | | | | | | | | | | | | | | | | | | | | |

Listing 1b continued:

OBS 4 VAR 1 ? 28
OBS 4 VAR 2 ? 30
OBS 4 VAR 3 ? 225
OBS 5 VAR 1 ? 28
OBS 5 VAR 2 ? 28
OBS 5 VAR 3 ? 199
OBS 6 VAR 1 ? 30
OBS 6 VAR 2 ? 26
OBS 6 VAR 3 ? 207
OBS 7 VAR 1 ? 30
OBS 7 VAR 2 ? 26
OBS 7 VAR 3 ? 200
OBS 8 VAR 1 ? 26
OBS 8 VAR 2 ? 25
OBS 8 VAR 3 ? 212
OBS 9 VAR 1 ? 14
OBS 9 VAR 2 ? 29
OBS 9 VAR 3 ? 206
OBS 10 VAR 1 ? 30
OBS 10 VAR 2 ? 28
OBS 10 VAR 3 ? 224
OBS 11 VAR 1 ? 21
OBS 11 VAR 2 ? 28
OBS 11 VAR 3 ? 210
OBS 12 VAR 1 ? 30
OBS 12 VAR 2 ? 27
OBS 12 VAR 3 ? 212
OBS 13 VAR 1 ? 28
OBS 13 VAR 2 ? 25
OBS 13 VAR 3 ? 206
OBS 14 VAR 1 ? 30
OBS 14 VAR 2 ? 27
OBS 14 VAR 3 ? 216
OBS 15 VAR 1 ? 30
OBS 15 VAR 2 ? 29
OBS 15 VAR 3 ? 212
OBS 16 VAR 1 ? 30
OBS 16 VAR 2 ? 28
OBS 16 VAR 3 ? 208
OBS 17 VAR 1 ? END

PREPARE MATRIX TAPE AND RECORDER
TYPE 'C' TO CONTINUECORRELATION MATRIX
TEST DATA

| VAR: | 1 | 2 | 3 |
|------|-------|-------|------|
| 1 | 1.00 | -0.01 | 0.47 |
| 2 | -0.01 | 1.00 | 0.37 |
| 3 | 0.47 | 0.37 | 1.00 |

TYPE 'C' TO CONTINUEDO YOU WANT THE CORRELATION MATRIX REPRINTED? Y
CORRELATION MATRIX

TEST DATA

| VAR: | 1 | 2 | 3 |
|------|-------|-------|------|
| 1 | 1.00 | -0.01 | 0.47 |
| 2 | -0.01 | 1.00 | 0.37 |
| 3 | 0.47 | 0.37 | 1.00 |

TYPE 'C' TO CONTINUEREADY

>

APPLE HEADQUARTERS



Now! Write a letter and print immediately!

- Apple II w/48K.
- Disc w/cont.
- Sanyo 9" Monitor.
- Epson MX-80.
- Epson Interface.
- Epson Cable.
- Apple Writer.

Complete Package
Now Only \$2522⁰⁰

Apple II w/48K \$1169.00
For 220V Add \$100

BUSINESSMAN'S SPECIAL

- Apple II plus 48K.
- Apple Disc Drive II and Interface DOS 3.3.
- Sanyo 9" B&W Monitor
- Visicalc 3.3 Software

Only \$2039⁰⁰

5 1/4 DISKETTES FOR APPLE & OTHER MICROS

MEMOREX Box of 10 \$27.00
MAXELL Box of 10 \$35.00
BASAF Box of 10 \$35.00

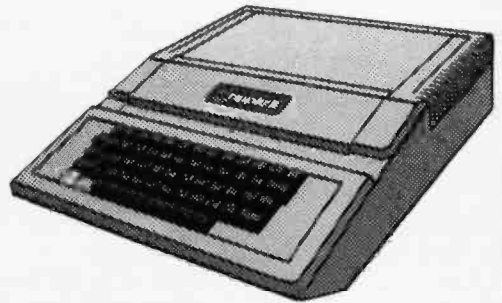

Full line of software in stock!

APPLE II ACCESSORIES

| | | | |
|--------------------------------|-------|-----------------------------|-------|
| DC HAYES MICRO MODEM II | \$309 | WORD STAR by MICRO PRO 3.0 | \$269 |
| VIDEX 80 COLUMN VIDEO TERMINAL | \$290 | APPLE SILENT TYPE PRINTER | \$339 |
| VYDEX KEYBOARD ENHANCER | \$112 | APPLE CLOCK/CALENDAR | \$249 |
| VISI CALC. 3.3 | \$159 | BPI GENERAL LEDGER | \$320 |
| SUP'R MOD | \$33 | BPI ACCOUNTS RECEIVABLE | \$320 |
| Z80 SOFT CARD | \$298 | BPI INVENTORY CONTROL | \$320 |
| THE SOURCE | \$99 | HIGH SPEED SERIAL INTERFACE | \$174 |

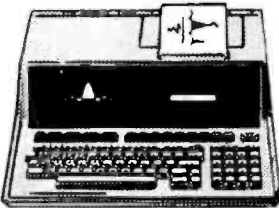

HEWLETT PACKARD

A Complete Computer System In One Small Package.

The HP-85 is a powerful BASIC language computer, complete w/keyboard, CRT display, printer & tape drive all in one 20 pound unit. 16K RAM, expandable to 32K Reg. 3250.00

Now Only \$2595⁰⁰

HP-83 Reg. 2250.00 \$1750⁰⁰

HP 41CV 269.95 Optical Wand I/41C 98.50
HP 41C 189.95 Printer I/41C 289.00
memory module only 27.50 Card Reader I/41C 189.95

7225B Graphics Plotter 2200 \$1699
82901M 5 1/4" Dual Master Flex. Disc Drive 2500 \$1900
2631B Impact Printer 3950 \$2,895

ATARI

ATARI 800 with 16K



CALL FOR LOW PRICE

Full line of ATARI software available

Texas Instruments TI 99/4 Computer

Designed to be the first Computer for the skilled user, or the beginner.

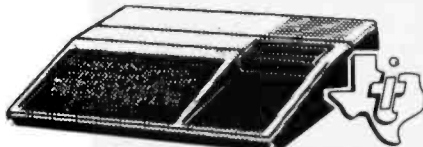

Orig. 950.00 Now Only \$379⁰⁰

Disc Drive Contr. 224.95 Solid State Printer 295.00
Disc Memory Drive 349.95 RF Modulator 39.95

SPECIALS

TI 59 Program 179.95 TI 58C Program 89.95
Less Manuf. Rebate -20.00 PC 100C Printer 157.50
YOUR COST 159.95 for 58/59

EPSON

MX-80 Printer \$499⁹⁵

MX-100FT Printer \$784⁹⁵

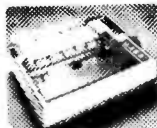

Sanyo Monitors

VM-4509 9" B&W 169.95
DM-5012CX 12" B&W 259.95
DM-5112CX 12" Green 289.95
DMC-6013 13" Color 449.95
Electro Home 9" Green 204.95

ORIGINAL GENUINE IBM 8" Floppy Diskettes at Lowest Prices!

| | |
|--------------------|--------|
| IBM #2305845 SS SD | \$3.44 |
| IBM #2305830 SS SD | \$3.44 |
| IBM #1669954 SS SD | \$3.44 |
| IBM #1766870 DS SD | \$4.59 |
| IBM #2736700 DS SD | \$4.59 |
| IBM #1669550 SS SD | \$3.44 |
| IBM #1669044 DS DD | \$5.19 |
| IBM #1669045 DS DD | \$5.19 |
| IBM #1766872 DS DD | \$5.19 |



TERMINALS

Perkin-Elmer Bantam Terminal \$779



ADDS Applied Digital Data Systems Inc. VIEWPOINT

Only \$610



910 \$655
920 C \$799

PRINTERS

| | | |
|-------------------|----------------|---------|
| TEXAS INSTRUMENTS | 440G Graph | \$975 |
| TI 810 | 445G Graph | \$790 |
| TI 820 KSR | 460G Graph | \$1299 |
| DIABLO | 560G Graph | \$1595 |
| 630 | 440 | \$899 |
| 1650 RO | 445 | \$699 |
| 1650 KSR | 460 | \$1275 |
| 1640 RO | QUOME SPRINT | |
| 1640 KSR | 5/45 RO | \$2,450 |
| DEC WRITER | 5/55 RO | \$2,550 |
| LA34 | 5/55 KSR | \$2,850 |
| PAPER TIGER | CENTRONICS | |
| 445G Graph | 739-3 Serial | \$840 |
| | 739-1 Parallel | \$840 |

CORPORATE ACCOUNTS WELCOME

47st. photo

Cameras • Electronics • Audio • Video • Computers • Darkroom • Accessories

67 West 47th St. New York, N.Y. 10036
SUNDAY 10-4, DAILY 9-8, FRIDAY 9-2



(212)260-4410

TOLL FREE OUT OF STATE

800-221-7774
800-221-5858
800-223-5661

Items on sale for limited time only, and are subject to limited availability. Not responsible for typographical errors. This ad supersedes all other ads prior to Oct. '81. All orders subject to verification and acceptance. Minimum shipping and handling \$4.95.

Listing 2: The regression calculating program (2a) and a test run (2b) written for the TRS-80 Model I Level II.

```
(2a)
1000 / MULTIPLE REGRESSION PROGRAM
1010 CLEAR:DEFINT I-N
1020 / IF THE ZEROth ELEMENT OF THE ARRAYS ARE USED, THEN
1030 / IB MUST = ZERO, ELSE IB=1. ND=THE MAXIMUM DIMENSION
1040 / FOR EACH ARRAY (MAX VARIABLES),
1050 IB=0:ND=15
1060 DIM RY(ND,IB),R(ND,ND),X(ND,ND),A(ND),S(ND),B(ND,IB)
1070 DIM IX(ND),BE(ND)
1080 CLS:PRINT "MULTIPLE LINEAR REGRESSION PROGRAM"
1090 PRINT "BY THOMAS WML MADRON (1979)"
1100 PRINT "2132 SAVANNAH TRAIL"
1110 PRINT "DENTON, TX 76201"
1120 FOR I=0 TO 800:NEXT I
1130 GOSUB 4000 :N=NV-(1-IB):NR=N:NC=N:GOSUB 3000
1140 CLS:INPUT "DO YOU WANT THE CORRELATION MATRIX REPRINTED";Y$
1150 IF LEFT$(Y$,1)="Y" THEN GOSUB 3000
1160 CLS:INPUT "VARIABLE NUMBER OF DEPENDENT VAR. FOR THIS RUN";IY
1170 IY=IY-(1-IB)
1180 INPUT"NUMBER OF INDEPENDENT VARIABLES IN THIS RUN";NI
1190 IF NI+1>NV THEN PRINT "*** TOO MANY VARIABLES ***":
      GOTO 1160
1200 PRINT "ENTER VARIABLE NUMBERS FOR INDEPENDENT VARIABLES"
1210 N=NI-(1-IB)
1220 FOR I=IB TO N:INPUT IM:IX(I)=IM-(1-IB):NEXT I
```

50 MHz DIGITAL MEMORY OSCILLOSCOPE IN A PERSONAL COMPUTER

TWO CHANNEL DIGITAL MEMORY OSCILLOSCOPE. The Model 85 provides two signal input channels on one board and the time base system on a separate board. Both vertical channels have a full 50 MHz bandwidth. Digitization is performed by high-speed sample and hold circuitry and an eight bit A/D converter to ensure high resolution and accuracy.

FULLY PROGRAMMABLE. Automated measurements were never simpler. Programmable features such as vertical attenuation, time base, trigger level, AC/DC/GND input and more, make the Model 85 a true laboratory and factory quality instrument.

APPLE II* and APPLE II PLUS* COMPATIBLE. The Model 85 Digital Memory Oscilloscope plugs directly into the Apple II peripheral slots. Easily installed—just plug in the vertical and horizontal boards, attach probe connectors, load the software, and you are ready to make precision measurements.

DIGITAL STORAGE. All the convenient features of digital storage: refresh display for easy viewing, precision measurements, unlimited storage time, signal processing, waveform storage on disk. Now with the Model 85 Oscilloscope and personal computer combination, you can create your own sophisticated signal analysis system.

A NEW PERFORMANCE STANDARD. The Model 85 Digital Memory Oscilloscope establishes a new performance standard in instrument systems. Furthermore, priced at less than \$1,000, it represents outstanding value. For more information on the Model 85, send for a copy of our product brochure by writing:

*Trademark of Apple Computer Inc.



Northwest Instrument Systems
P.O. Box 1309 • 1/503/297-7471
Beaverton, Oregon 97075



**NORTHWEST INSTRUMENT
SYSTEMS
MODEL 85 OSCILLOSCOPE**

```

1230 N=NI-(1-IB)
1240 FOR I=IB TO N:K=IX(I):FOR J=I TO N
1250 L=IX(J):X(I,J)=R(K,L):X(J,I)=X(I,J)
1260 NEXT J:X(I,I)=1.0:NEXT I
1270 FOR I=IB TO N:J=IX(I):RY(I,IB)=R(IY,J):NEXT I
1280 GOSUB 6000 :N1=N:N2=IB:N3=N:GOSUB 2000
1290 A0=A(IY):R3=0
1300 FOR I=IB TO N:J=IX(I):BE(I)=B(I,IB)*(S(IY)/S(J))
1310 A0=A0-BE(I)*A(J):R3=R3+B(I,IB)*RY(I,IB):NEXT I:R4=SQR(R3)
1320 F1$="VAR      MEANS      SIGMAS      ZERO-R      BETA      B      R2-X(I)"
1330 F2$="###  #####.##  #####.##  ##.###  ##.###  ###.##  ##.###"
1340 FOR I=IB TO N STEP 10:J=I+9
1350 IF J>N THEN J=N
1360 CLS:PRINT TL$
1370 PRINT F1$
1380 FOR K=I TO J:L=IX(K)
1390 R5=R3-((B(K,IB)/SQR(X(K,K))))CZ
1400 PRINTUSING F2$:IX(K)+1,A(L),S(L),RY(K,IB),B(K,IB),BE(K),R5
1410 NEXT K:PRINT @ 960,"TYPE 'C' TO CONTINUE":
1420 Y$=INKEY$:IF Y$="C" THEN 1430 ELSE 1420
1430 NEXT I
1440 CLS:PRINT TL$:PRINT "INTERCEPT=":A0
1450 PRINT "MULTIPLE R=":R4:"R-SQUARED=":R3
1460 D1=NI:D2=NS-(NI)-1:F1=(R3*D2)/((1-R3)*D1):GOSUB 5000
1470 PRINT "FOR DF1=":D1:"AND DF2=":D2:"F=":F1:"P=":P
1480 PRINT "NUMBER OF OBSERVATIONS=":NS

```

Listing 2a continued on page 440

| | | |
|---|---|--|
|  |  |  |
| MX80 — \$469 | APPLE II — \$1179 | M83A — \$875 |
| APPLE GRAPHICS PARALLEL INTERFACE Full Hi res Graphics for Epson, Okidata, etc. | | \$89 |
| | | TRS80 BIDIRECTIONAL I/O PORT Cascadable with Selectable Addressing |
| | | \$39 |
| ADDS Viewpoint — \$565 | INTERFACES SSM-AIO — \$160 CFS-CARD — \$199 | SOROC 120 — \$729 135 — \$799 |
| ALTOS ACS 8000-15 — \$4750 | NORTHSTAR HR64DD — \$2895 HR64QD — \$3280 | SOFTWARE All Major Brands — \$CALL |
| ANADEX 9500 — \$1225 9501 — \$1275 | LOBO Apple Drive/Card — \$390/\$90 TRS80 Drive/Interface — \$260/\$90 Apple DD Drive — \$2740 | TELEVIDEO 912 — \$669 950 — \$949 |
| ATARI 400 16K — \$349 800 32K — \$740 | MODEMS HAYS-MICROMODEM — \$325 Novation-Cat — \$155 Penril - 300/1200 (212A) — \$795 | TI 810 — \$1475 820 — \$1795 |
| GENTRONICS 730 — \$600 737 — \$750 | MONITORS APF — \$125 SANYO-BW — \$159 Sanyo-Green — \$249 Color — \$425 Amdek-Green — \$159 Color — \$350 | OKIDATA M80 — \$395 SL125 — \$3150 M82A — \$585 SL250 — \$4200 M83A — \$875 M84 — \$1175 |
| DATASOUTH DS120 — \$595 DS180 — \$1295 | MPI 88G — \$595 99G — \$695 | XTRAS Memory-16K 200ns — \$19.95 Game Paddle Extension — \$14.95 Game Paddles — \$19.95 |
| DIABLO 630 — \$2150 1640 — \$2575 | NEC 5510 — \$2540 5520 — \$2800 | IDSII Blue Break Out Box — \$250 |
| DISKETTES Scotch — \$2.50 Dysan — \$3.50 | | ZENITH Z19 — \$775 Z89 — \$2195 |
| EPSON MX70 — \$379 MX100 — \$449 | | |
| HAZELTINE 1800 — \$995 Esprit — \$675 | | |
| DISCOUNT LINE 1-800-528-8960 | EXPOTEK CORPORATION INTERNATIONAL 2231 West Shangri La Road, Phoenix, AZ 85029 | ARIZONA 1-602-861-3181 EXPORT TWX - 910-950-1194 |

Listing 2a continued:

```
1490 PRINT @ 960,"TYPE 'C' TO CONTINUE";
1500 Y$=INKEY$;IF Y$="C" THEN 1510 ELSE 1500
1510 CLS:INPUT "DO YOU WANT ANOTHER RUN";Y5$
1520 IF LEFT$(Y5$,1)="Y" THEN 1530 ELSE CLS:END
1530 RUN
2000 / MATRIX MULTIPLICATION
2010 / N1=NUMBER OF ROWS IN B AND X, N2=NUMBER OF
2020 / OF COLUMNS IN B AND RY, N3=NUMBER OF COLUMNS
2030 / IN X AND NUMBER OF ROWS IN RY, SUBTRACT 1 FROM
2040 / FROM EACH IF IB=0,
2050 FOR I=IB TO N1
2060     FOR J=IB TO N2
2070         B(I,J)=0
2080             FOR K=IB TO N3
2090                 B(I,J)=B(I,J)+X(I,K)*RY(K,J)
2100             NEXT K
2110         NEXT J
2120 NEXT I:RETURN
3000 / SUBROUTINE TO PRINT A MATRIX
3010 / NR=NUMBER OF ROWS, NC=NUMBER OF COLUMNS, IF
3020 / IB=0 THEN NR=NR-1 AND NC=NC-1, IB=STARTING
3030 / POINT FOR ARRAYS,
3040 FOR I=IB TO NR STEP 10:IA=I+9:IF IA>=NR THEN IA=NR
3050 FOR J=IB TO NC STEP 9:JA=J+8:IF JA>=NC THEN JA=NC
3060 CLS:PRINT "CORRELATION MATRIX":PRINT TL$
3070 F1$="VAR:";G1$="   ###";F2$="####";G2$="   ##,##"
3080 PRINT F1$;
```

A REFURBISHED DAISY WHEEL TERMINAL
FOR PERSONAL COMPUTER USERS AND SMALL BUSINESSES.

Now you can have letter-quality printing and professional features for just \$1,450*

AJ daisy wheel printer terminals are renowned for exceptional performance, high reliability, and applications versatility. Now you can have all this for only \$1,450* in our special limited offer.

- 30 cps *letter-quality* printing
- Changeable type faces
- Full ASCII keyboard with numeric pad
- High resolution X-Y plotting
- Complete electronic forms control
- 128-character buffer
- Asynchronous RS-232 interface
- Printwheel, ribbon cartridge, and cable included
- 30-day parts/labor warranty

And you can choose from a list of options including forms tractor, pin-feed platen, paper trays, side shelves, extra printwheels, APL keyboard and 2K buffer.

Call your nearest AJ regional office for details: San Jose, CA (408) 946-2900; Rosemont, IL (312) 671-7155; Hackensack, NJ (201) 488-2525. Or check the phone book for the number of your local AJ sales/service office.

*Price excludes options and is subject to change without notice. Model shown includes certain options. Offer available only in the contiguous U.S.

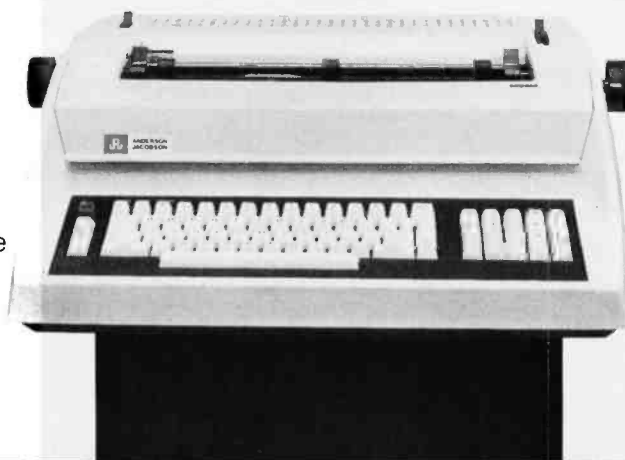

**ANDERSON
JACOBSON**

Listing 2a continued:

```
3090 FOR L=J TO JA:PRINT USING G1%;L+1;;NEXT L:PRINT
3100 FOR L=I TO IA
3110 PRINT USING F2%;L+1;;FOR M=J TO JA
3120 PRINT USING G2%;R(L,M);;NEXT M:PRINT:NEXT L
3130 PRINT @ 960,"TYPE 'C' TO CONTINUE";
3140 Y$=INKEY$:IF Y$="C" THEN 3150 ELSE 3140
3150 NEXT J: NEXT I
3160 RETURN
4000 ' MATRIX INPUT FROM TAPE ROUTINE
4010 CMD"T":CLS:PRINT "PREPARE MATRIX TAPE AND RECORDER"
4020 PRINT @ 960,"TYPE 'C' TO CONTINUE";
4030 Y$=INKEY$:IF Y$="C" THEN 4040 ELSE 4030
4040 INFUT #-1,TL$:INFUT #-1,NV,NS
4050 N=NV-(1-IB)
4060 FOR I=IB TO N:INFUT #-1,A(I),S(I):NEXT I
4070 FOR I=IB TO N:FOR J=I TO N:IF I=J THEN 4090
4080 INFUT #-1,R(I,J)
4090 NEXT J:NEXT I
4100 FOR I=IB TO N:FOR J=I TO N:IF I=J THEN R(I,J)=1:GOTO 4110
    ELSE R(J,I)=R(I,J)
4110 NEXT J:NEXT I
4120 CMD"R":RETURN
5000 ' PROBABILITY OF OCCURENCE OF F,T,Z,CHI-SQ
5002 ' ADAPTED FROM DONALD J. VELDMAN, FORTRAN PROGRAMMING
5004 ' FOR THE BEHAVIORAL SCIENCES (NEW YORK: HOLT, RINEHART
5006 ' AND WINSTON, 1967), PP. 129-131.
5010 ' D1, D2, F1 MUST BE SET BEFORE CALL
```

Listing 2a continued on page 442

ADVANCED S-100 BUS PRODUCTS

LDP1/2

The LDP1/2 utilizes the advanced 8088 processor to provide up to 8 times the throughput of a 4 MHz Z80A processor. The powerful instruction set of the 8088 is ideally suited to higher level languages such as PASCAL and PL/1. The 10 slot motherboard leaves 7 slots for USER expansion. With the option of a 10 MByte Winchester and MP/M-86, the LDP mainframe becomes a powerful multiuser system with the capability of handling 8 users without the degradation in performance experienced with Z80 MP/M systems. The performance of the LDP1 and LDP2 has never before been available for such an affordable price.

FEATURES:

- LDP88, 8088 CPU board
- LDP72, advanced floppy disk controller
- LDP64K dynamic RAM
- 1 serial RS232 port
- 10 slot motherboard
- 1 8" Shugart 801R drive (LDP1), 2 Shugart 801R's (LDP2)
- 4K EPROM socket for user population

OPTIONS:

- HAZITALL
- 8" 10 MByte Winchester (replaces 1 Shugart 801 in LDP2)
- MP/M-86 multiuser system
- Woodgrained 7 slot chassis

PRICES

LDP88 CPU
LDP72 FDC
LDP64K RAM
LDP128K RAM
LDP256K RAM
HAZITALL
LDP1
86-DOS
CP/M-86
Microsoft BASIC 86

ASSEMBLED & TESTED

\$ 349.95
274.95
695.00
1295.00
2095.00
325.00
3295.00
195.00
250.00
350.00

Call for LDP1 option prices and board kit prices.

CP/M-86 and MP/M-86 are trademarks of Digital Research
86-DOS is a trademark of Seattle Computer Products

LDP88 8088 CPU BOARD

- 8088 CPU 5 MHz operation upgradeable to 8 MHz • 9 vectored interrupts • Fully complies with IEEE 696 electrical and timing specs
- RS232 serial port with modem controls • 1K bytes of static RAM • 2 EPROM sockets (2716 or 2732) • 8087 upgrade kit available in Sept.
- 8 bit bus eases interface to other S100 bus boards • 1MByte address space • 65K I/O ports

64/256K MEMORY

- 8 or 16 bit operation • Meets all IEEE 696 specs • Access time 350 ns from PSYNC low • Intel 8203 dynamic RAM controller • 24 or 16 bit address decoding • No wait states with 5 MHz 8088 or 8086
- Parity with Error interrupt generation • No DMA RESTRICTIONS
- 64K board is upgradeable to 256Kbyte board

HAZITALL

- 2 Serial RS232 ports • 2 parallel ports with handshake control
- Math processor support (8231/9511 or 8232/9512) • WINCHESTER DISK support • Real time programmable interrupt • Clock/calendar with battery back up • Synchronous data communication supported

LDP72 FLOPPY DISK CONTROLLER

- IBM compatible single and double density format • Single or double sided drives • Programmable data record length (128 to 8192 bytes/sector) • Multi sector and multi track transfer capability • Parallel seeks on up to 4 drives • On board digital data separator • Software selectable single or double density operation • Separate connectors for 5 1/4" and 8" drives • Software selection of standard or minidrives allowing mixing of both drives on a single controller

**LOMAS
DATA
PRODUCTS**

11 Cross Street
Westborough, MA 01581
Telephone (617) 366-4335

Listing 2a continued:

```

5020 / S IS RETURNED AS SIGNIFICANCE LEVEL
5030 P1 = 1.0
5040 IF D1 * D2 * F1 = 0.0 THEN 5260
5050 IF F1 < 1.0 THEN 5100
5060 A = D1
5070 B = D2
5080 F = F1
5090 GOTO 5130
5100 A = D2
5110 B = D1
5120 F = 1.0 / F1
5130 A1 = 2.0 / (9.0 * A)
5140 B1 = 2.0 / (9.0 * B)
5150 X = ((1.0 - B1) * FC.333333 - 1.0 + A1)
5160 Y = SQR(B1 * FC.666667 + A1)
5170 Z = ABS(X / Y)
5180 IF B < 4.0 THEN 5200
5190 GOTO 5210
5200 Z = Z * (1.0 + .08 * ZC4 / BC3)
5210 Z1 = (.115194+Z*(.000344+Z*.019527))
5220 P1= .5/(1.0+Z*(.196854+Z*Z1))C4
5230 IF F1 < 1.0 THEN 5250
5240 GOTO 5260
5250 P1 = 1.0 - P1
5260 P=P1
5270 RETURN
6000 / MATRIX INVERSION USING EXCHANGE METHOD
    
```

DISK III

100% Compatible

Model III Disks



Disk III Single Drive Assy.¹
\$599.00

Disk III Dual Drive Assy.
\$864.00

IMMEDIATE DELIVERY COMPARE & SAVE

VR DATA's Disk III features:

- Completely compatible w/TRSDOS™
- State-of-the-art circuitry.
- Fully tested, calibrated and burned in.
- Warranty 120 days
- Installation with simple hand tools
- Optional dual side and/or 80tk.
- Conforms to FCC Class B Specs.

¹DISK III single drive assembly includes: one 40 track 5¼" double density drive, power supply, controller, mounting hardware, and applicable cables.

Prices subject to change without notice.

VR Data

777 Henderson Boulevard
Folcroft, PA 19032

To order call toll free: (800) 345-8102 or (215) 461-5300 in PA.



DISK SUPPLY CO.

Suite 439 • 111 S. Olive St. • Media, PA 19063 • (215) 461-5437

\$100.00 min. order

Call for prices on items not listed. Prices subject to change.

CALL FULL LINE OF CCS BOARDS
LEXICON MODEM \$105.00
SPECIAL Limited OFFER
Integral Data 560G \$1347.00
EPSON MX100 \$710.00
EPSON MX80 \$490.00 MX80 FT \$590.00
NEC 5510/5530 w/trac. \$2650.00
DIABLO 630 w/trac. \$2184.00
w/trac. \$1499.00
C. ITOH STARWRITER (25 cps) \$2204.20
ZENITH Z89/48K-1 DRIVE \$2990.00
64K SUPERBRAIN \$2640.00 QD \$2990.00
DRIVES-LOBO/TANDON/MPI-Form \$270.00

Sample Prices

Big Savings

small ad:

Listing 2a continued:

```
6010 ' N, IB MUST BE SET PRIOR TO CALL
6020 IF N>ND THEN 6030 ELSE 6050
6030 PRINT "MATRIX SIZE IS LIMITED TO";ND
6040 PRINT "YOU HAVE A SIZE OF";N;END
6050 FOR K=IB TO N:D=-1/X(K,K)
6060 FOR J=IB TO N:IF J=K THEN 6060
6070 X(K,J)=X(K,J)*D
6080 NEXT J
6090 D=-D
6100 FOR I=IB TO N:IF I=K THEN 6160
6110 E=X(I,K)
6120 FOR J=IB TO N:IF J=K THEN 6140
6130 X(I,J)=X(I,J)+X(K,J)*E;GOTO 6150
6140 X(I,K)=X(I,K)*D
6150 NEXT J
6160 NEXT I
6170 X(K,K)=D;NEXT K;RETURN
```

(2b)

```
>RUN
MULTIPLE LINEAR REGRESSION PROGRAM
BY THOMAS WM. MADRON (1979)
2132 SAVANNAH TRAIL
DENTON, TX 76201
PREPARE MATRIX TAPE AND RECORDER
TYPE 'C' TO CONTINUECORRELATION MATRIX
```

Listing 2b continued on page 444

How can Carrel™ teach Alice about Wonderland?

As a trainer you should know!

The Coloney Intelligent Learning Carrel™ is the answer to your individualized training needs.

Carrel™ is a custom-built student learning station that contains an exciting new interactive video system. Now you can have the power of computer assisted and computer managed instruction with the impact of high speed access to video. The system includes: the Apple II Plus™ microcomputer, a laser reflective videodisc player, a color monitor and the Coloney Interface Package. A new learning experience awaits your students in the wonderland of computer controlled stereo sound, beautiful high resolution video and colorful computer graphics. An ever patient Carrel™ coaxes, questions, and delights while answering your student's needs in an individualized learning environment. Best of all, Carrel™ is inexpensive. At Coloney we continue to give you reasons to make us your number one choice in interactive training.

Apple II Plus is a registered trademark of Apple Computer Inc.
The Coloney Intelligent Learning Carrel and Carrel are trademarks of Coloney Productions



**COLONEY
PRODUCTIONS**
1248 Blountstown Hwy. Tallahassee, FL 32304 [904] 575-0691

Listing 2b continued:

TEST DATA

```
VAR:      1      2      3
  1  1.00 -0.01  0.47
  2 -0.01  1.00  0.37
  3  0.47  0.37  1.00
```

TYPE 'C' TO CONTINUEDO YOU WANT THE CORRELATION MATRIX REPRINTED? N
VARIABLE NUMBER OF DEPENDENT VAR. FOR THIS RUN? 3
NUMBER OF INDEPENDENT VARIABLES IN THIS RUN? 2
ENTER VARIABLE NUMBERS FOR INDEPENDENT VARIABLES
? 1
? 2

TEST DATA

| VAR | MEANS | SIGMAS | ZERO-R | BETA | B | R2-X(I) |
|-----|-------|--------|--------|--------|------|---------|
| 1 | 26.19 | 4.81 | 0.4743 | 0.4791 | 1.19 | 0.1354 |
| 2 | 27.25 | 1.79 | 0.3679 | 0.3740 | 2.50 | 0.2250 |

TYPE 'C' TO CONTINUEDTEST DATA

INTERCEPT= 107.825

MULTIPLE R= .604004 R-SQUARED= .364821

FOR DF1= 2 AND DF2= 13 F= 3.73333 P= .0514039

NUMBER OF OBSERVATIONS= 16

TYPE 'C' TO CONTINUEDO YOU WANT ANOTHER RUN? N

READY

>



PRICE BREAKTHROUGH 16K RAM BOARDS FOR APPLE JUST \$129.95

HAVE YOU BEEN WAITING FOR THE COST OF EXPANSION BOARDS TO COME DOWN? YOUR WAIT IS OVER. UP UNTIL NOW RAM EXPANSION HAS COST AS MUCH AS \$195.00. NOW OMEGA MICROWARE IS PROUD TO ANNOUNCE THE ARRIVAL OF A TRULY AFFORDABLE EXPANSION CARD.

NOW YOU CAN RUN PASCAL, FORTRAN, 56K CPM WITH A Z80 SOFTCARD, INTEGER BASIC, APPLESOFT AND OTHER LANGUAGES ON YOUR APPLE. NOW YOU CAN INCREASE USUABLE MEMORY FOR VISICALC. NOW YOU DON'T HAVE TO PAY A FORTUNE TO HAVE ALL THIS.

AT \$129.95, OMEGA'S RAMEX 16 IS THE LOWEST PRICED CARD AVAILABLE TODAY.

WHAT DO YOU GIVE UP WHEN YOU PURCHASE THIS FIRST REALLY AFFORDABLE RAM EXPANSION CARD? WELL, YOU GIVE UP HAVING TO REMOVE ONE RAM CHIP FROM THE MOTHER BOARD OF YOUR APPLE. YOU GIVE UP HAVING TO STRAP A CABLE FROM THE CARD TO YOUR MOTHER BOARD. THAT'S IT. WHAT YOU GET IS A SIMPLE, RELIABLE, BOARD THAT JUST PLUGS IN. MEMORY REFRESH IS ACCOMPLISHED ON THE BOARD ITSELF.

THE RAMEX 16 IS GUARANTEED NOT JUST FOR 90 DAYS. NOT EVEN 6 MONTHS OUR WARRANTY IS FOR ONE FULL YEAR FROM DATE OF PURCHASE. WE WILL REPAIR OR REPLACE ANY BOARD THAT IS DEFECTIVE THROUGH MANUFACTURE FOR A PERIOD OF ONE YEAR AFTER PURCHASE PROVIDED THIS DAMAGE IS NOT USER INFLICTED.

ORDER YOUR RAMEX 16 NOW BY CALLING TOLL FREE 1-800-835-2246. KANSAS RESIDENTS CALL 1-800-362-2421. MASTERCARD OR VISA ACCEPTED OR SEND \$129.95. ILLINOIS RESIDENTS ADD \$7.80 SALES TAX.

ANOTHER QUALITY PRODUCT FROM OMEGA MICROWARE, INC. FORMERLY OMEGA SOFTWARE PRODUCTS, INC.

222 SO. RIVERSIDE PLAZA
CHICAGO, IL 60606
PHONE 312-648-1944

©OMEGA MICROWARE, INC.

APPLE AND APPLESOFT ARE REGISTERED TRADEMARKS OF APPLE COMPUTER, INC. PASCAL IS A REGISTERED TRADEMARK OF THE REGENTS OF THE UNIV. OF CA. SAN DIEGO. VISICALC IS A REGISTERED TRADEMARK OF PERSONAL SOFTWARE. CPM IS A REGISTERED TRADEMARK OF DIGITAL RESEARCH INC. Z80 IS A REGISTERED TRADEMARK OF ZILOG, INC. SOFTCARD IS A REGISTERED TRADEMARK OF MICROSOFT.

Correlation Program

| Line Numbers | Routine |
|--------------|-------------------------------|
| 1000-1170 | main program |
| 3000-3160 | matrix-printing subroutine |
| 4000-4570 | correlation-matrix subroutine |
| 4120-4200 | read correlation parameters |
| 4210-4470 | data-input routine |
| 4480-4570 | matrix-tape-output routine |

Regression Program

| Line Numbers | Routine |
|--------------|--------------------------------------|
| 1000-1530 | main program |
| 2000-2120 | matrix-multiplication subroutine |
| 3000-3160 | matrix-printing subroutine |
| 4000-4120 | matrix input from tape |
| 5000-5270 | probability-of-occurrence subroutine |
| 6000-6170 | matrix-inversion subroutine |

Table 1: Organization of the correlation and regression programs. The main difference between the two is in the subroutines that begin at line 4000. It is impossible to consolidate the two into a single program (see text for details).

Text continued from page 431:

gram and a series of subroutines (easily noted in the listings).

Modifying the Programs

The correlation program and the regression program are similarly organized (see table 1), but the latter reads data exclusively from a tape file generated by the correlation program. If a consolidated program is preferred, the correlation subroutine in the correlation program can be substituted for the matrix-input-from-tape subroutine in the regression program. Both subroutines begin at line 4000 in their respective programs. A consolidated program takes only about 6 K bytes of memory.

Because the program is based on matrix algebra, several of the subroutines can be replaced with BASIC matrix functions. While Level II BASIC for the TRS-80 has no matrix functions, it is possible to obtain a software package (from Racet Computes of Orange, California) that provides those functions. And other BASICs, of course, may have the functions. For example, with the Racet functions, the matrix-inversion subroutine (lines 6000 through 6170) of the regression program could be changed to the following:

```
6000 'MATRIX INVERSION
```

```
6010 I = &MINV(R,X,NV-1,
D1,D2): RETURN
```

Or in a DEC (Digital Equipment Corporation) BASIC system, it might appear as follows:

```
6000 'MATRIX INVERSION
6010 MAT C = INV(R)
6020 RETURN
```

In both cases, some other (minor) changes would have to be made to the main program, but both techniques could be used. Built-in matrix functions, such as the example from DEC, do not typically use the zeroth row or column of arrays, thus wasting considerable memory. If these programs are implemented using such functions, however, the variable IB (line 1050) can simply be changed to 1, thus eliminating the use of the zeroth row and column throughout the program. The Racet functions use the zeroth row and column, and IB would be left unchanged. Bear in mind that these are only examples and that if the matrix functions are available, the program might be simplified in other ways as well.

Since arrays in Level II BASIC can be dynamically dimensioned, a variable (ND) is also set in line 1050 to the largest number of variables that might be contained with any given memory size. Even in a



Make Your Dreams Come True With Computer Shopper

Now you can expand your system or get a new one at prices you had never dreamed possible by taking advantage of the thousands of bargains each month in COMPUTER SHOPPER.

COMPUTER SHOPPER is THE publication for buying, selling and trading new and used micro and mini-computer equipment and software.

- Buy, Sell or Trade
- 48 Big (11" x 14") pages
- Over 20,000 readers nationwide
- Low classified ad rates--only 10¢ a word for subscribers
- Hundreds of ads from individuals
- Money back guarantee

Double Bonus for New Subscribers

New subscribers are entitled to a FREE 20 word classified ad to use for software or used equipment (a \$2.00 value) plus a FREE ISSUE (13 months for the price of 12) all for the low subscription price of ONLY \$10.00.

SAVE OVER 50% OFF the single copy price of \$1.50. Add it up:

| | |
|--------------------------------|---------|
| 12 issues @ \$1.50..... | \$18.00 |
| One free issue..... | \$1.50 |
| Free 20 word classified ad.... | \$2.00 |

TOTAL VALUE.....\$21.50
NOW ONLY \$10.00. You save \$11.50.

MasterCard or VISA subscription orders only
Call TOLL FREE FOR FASTEST SERVICE
1-800-327-9920

MasterCard or VISA classified ad orders only
Call TOLL FREE FOR FASTEST SERVICE
1-800-327-9926 Offer expires 1-31-82

COMPUTER SHOPPER
P.O. Box F135 • Titusville, FL 32780
305-269-3211

16 K-byte machine, the dimensionality could be expanded beyond the default (ND = 15). Parameters for each problem are established conversationally in both programs, and parameters for regression can be found in lines 1130 through 1220. Questions requiring a yes or no answer can be answered with either "Y" or "YES" or "N" or "NO".

Data needed by the regression program includes the sequential number of the dependent variable in the run (a sequential number from 1 to the total number of variables correlated), the number of independent variables (any number from 1 to the total number of independent variables for the run), and the sequential variable numbers of NI, the number of independent variables. The program is structured so that at the end of a run, the user is asked if there will be another run (from some subset of the variables correlated). This capacity is especially useful when doing activities such as causal modeling.

All printing, whether of the cor-

relation matrix or other elements of the analysis, is formatted to fit the display screen of the TRS-80 (16 lines by 64 characters). The display is stopped at various stages throughout the program and information is communicated to the user with the following BASIC statements:

```
xxxx PRINT @ 960,"TYPE 'C' TO
CONTINUE";
yyyy Y$ = INKEY$: IF Y$ = "C"
THEN zzzz ELSE yyyy
zzzz next line
```

Many BASICs may not have the INKEY\$ function that accepts input from the keyboard without waiting for the Enter or Return key to be pressed. To work properly, it must be placed in a loop, as illustrated. The PRINT @ 960 statement prints the message at position 960 (the 16th line of the display) on the screen.

Actual calculation of the statistics for the regression begins at line 1230. The correlation matrix R(I,J) is subset into X(I,J), which includes only the

independent variables for the run (lines 1230 through 1260). Array X(I,J) is inverted to provide the information necessary to calculate the b^* s. The call to the matrix inversion routine is at line 1280 (GOSUB 6000). In lines 1290 through 1460, several statistics are calculated and displayed for each independent variable, including the mean, standard deviation, zero-order correlations with the dependent variable, b^* , b , and R^2 with the variable deleted. The last statistic is useful in evaluating the impact of a given independent variable on the total regression. Finally, the summary regression statistics are calculated and printed in lines 1440 through 1490, including the intercept a , R , R^2 , F , degrees of freedom for F , and p (the probability of occurrence of F). The probability is calculated with a call to the probability subroutine (GOSUB 5000). The rationale for the computational algorithm is given in Veldman's book (reference 5, pages 129 through 131). The same subroutine can also be used

BUILD YOUR COMPUTER BREADBOARDS & INTERFACES FASTER AND EASIER WITH NEW VECTOR PLUGBOARDS

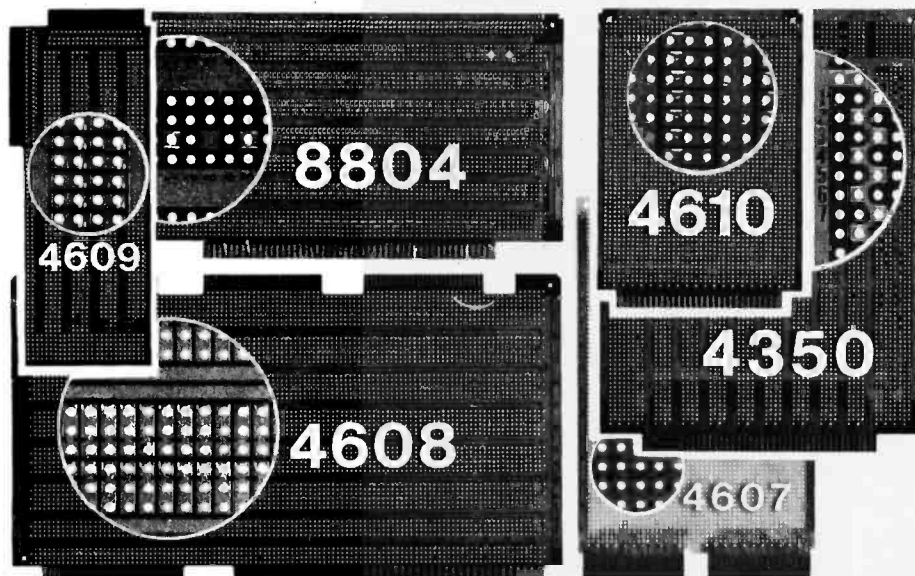

4610 series – for STD-BUS-WW, solderable and unpatterned models.

4608 series – for Intel/National SBC/BLC 80-WW solderable, or unpatterned.

8804 series – for S-100. Five models available.

4607 – for DEC LSI-11/PDP8-11, Heath-11.

4609 – for Apple II, Super-Kim, Pet Commodore with Expandamem.

4350 – for TI 980 Computer.

4611 series – for Motorola Exorciser,™ Rockwell AIM65 expansion.

Send for FREE brochure!

New RACK MOUNTING CAGES & ENCLOSURES AVAILABLE.

Everything in this ad is available through distributors or factory direct, from stock, if not available locally.

 **Vector Electronic Company**
INCORPORATED

12460 Gladstone Ave., Sylmar, CA 91342; (213) 365-9661, TWX (910) 496-1539

to calculate the probability of occurrence for t statistics, z , and chi-square (see reference 5). The program then tests for another run or terminates execution (lines 1510 through 1520).

Extensions and Modifications

If the computer being used is a Radio Shack TRS-80 Model I, the correlation and regression programs will run as presented here. If the program is being implemented on another computer, it is likely that most of the screen-formatting routines will have to be changed. As mentioned above, the regression program can be simplified by replacing the matrix subroutines with machine-language matrix functions (such as those from Racet) or with native functions (such as exist in DEC BASIC). The number of variables that can be used by the program can be increased or decreased by changing only the initialized value of ND in line 1050 of both programs. The number of variables depends on memory size, but even on a 16 K-byte machine the number could be increased significantly.

All I/O of original data is handled in the correlation-matrix subroutine with calls to internal subprograms. If a floppy-disk drive is available, a decided advantage can be gained by saving the data and matrix on disk rather than on tape. Because the matrix can be saved, it can be used for input not only to regression but also to other programs. One possible addition to regression might be to add a routine to allow input of the means, standard deviations, and correlation matrix from the keyboard so that published matrices might be analyzed. The original input data can also be saved on tape and could be used in the regression program to calculate predicted values of Y and residuals.

The keyboard data-entry routine (beginning at line 4210 of the correlation program) is rather primitive and includes no means for verifying the veracity of the data—such a check method might be a useful addition to the program. While there are techniques for calculating a multiple re-

gression other than the one presented here, one of the primary strengths of this approach is that the regression is actually calculated from the correlation matrix. Consequently, it is possible to calculate correlations when some data is missing (different N s for different pairs of variables).

There are pitfalls when doing this, but unless there is a lot of missing data (especially on large samples), it is quite useful. The actual correlation routine could be modified to handle missing data, and perhaps some scheme for differentially weighting observations might be included to allow the user to modify various distributions. Again, some caution should be exercised when doing such modifications to the data. In any event, if such modifications are made, they need be made only in the correlation subroutine—the regression program need not be touched.

As a final note, the various subroutines provided in this program are sufficiently general so that they can be used in other programs de-

signed by the reader. In fact, only the calling program is specific to the regression or correlation functions. It would save time to build a subroutine library that could have general applicability. Although Level II BASIC does not provide the means for merging all or part of programs from tape to existing programs in memory (Radio Shack Disk BASIC does have a merge function), several software vendors currently supply such utilities that will do the job nicely. ■

References

1. Adler, Alfred. "The Micro-Mathematician." *Interface Age*. October 1979, page 39. (Includes a discussion of matrix algebra.)
2. Adler, Alfred. "The Micro-Mathematician." *Interface Age*. November 1979, page 30. (Discusses matrix inversion.)
3. Kerlinger, Fred N and Elazer J Pedhazur. *Multiple Regression in Behavioral Research*. New York: Holt, Rinehart and Winston, 1973. (See especially chapters 3 and 4.)
4. Racet Computes. Infinite BASIC. (Matrix and string package for the TRS-80). 702 Palmdale, Orange, CA 92665.
5. Veldman, Donald. *FORTRAN Programming for the Behavioral Sciences*. New York: Holt, Rinehart and Winston, 1967.

Want high interest AND free checks?

With an EQUITABLE Money Market Account, you'll enjoy:

- High current earnings.
- Free checks (of \$500 or more).
- Low-risk portfolio.
- No interest penalty for withdrawals.

Start with as little as \$2,500—add \$100 or more whenever you choose.

For more information and a Prospectus, mail this coupon or phone toll free, any time:

800-345-8540.
In Pa., 1-800-662-5180.

The EQUITABLE Money Market Account
EQUICO Securities, Inc.
3 Westchester Plaza
Elmsford, NY 10523

YES, I want more complete information on the Equitable Money Market Account, Inc., including management fees and expenses. Please send me a Prospectus so that I may read it carefully before I send money.

500 BY

Name _____
(Please print)

Address _____

City _____

State _____ Zip _____

Telephone _____
(area code) (number)

This offering may not yet be available in some states.

Advised by The EQUITABLE Life, with over 120 years of investment experience.

**THE EQUITABLE
MONEY MARKET
ACCOUNT**

A money market fund distributed by EQUICO Securities, Inc., a wholly owned subsidiary of The Equitable Life Assurance Society of the United States, the Account's Investment Adviser.



Bits and Bytes in Pascal

And Other Binary Wonders

There are no "secrets" in this article. I will simply show you some tricks that can be performed with UCSD Pascal. Like many programming tricks, these are of interest for two main reasons: to ease complicated system programming and to encourage fun programming.

All of the facts that I use can be found in the documentation available for UCSD Pascal (developed at the University of California at San Diego). However, these features have been documented very lightly up to now, with little or no explanation. Before I attempt to explain them I want to cover myself as follows: everything in this article has been tested with Apple II Pascal (both the original release and the current Version 1.1). Except as noted, I believe it should apply to other versions of UCSD Pascal—but I don't guarantee it.

Be warned: If you employ these tricks, you will abandon some of the safety features of the language. This could easily result in incomprehensible bugs in your program. Even if the program works correctly, you may run into trouble when you try to modify it. You should also be aware that tricks that work with your present system may not work with an updated version. Furthermore, the people who sold you your UCSD Pascal are under no obligation to support any features that they don't document themselves.

David Cásseres
Apple Computer Inc
10260 Bandlely Dr
Cupertino CA 95014

However, if you study these tricks you'll be able to do some things that are otherwise impossible. You'll also gain some insights into how the system works when it runs a Pascal program. You will find that your Pascal program can treat memory as a collection of bytes, which are in turn made up of bits; that data types are more changeable than they appear; that AND, OR, and NOT are more powerful than you thought; and that you can access specific machine locations in the same way you would with the PEEK and POKE keywords of BASIC.

Background

The original definition of Pascal is contained in the *Pascal User Manual and Report* by Kathleen Jensen and Niklaus Wirth. I call this original definition Classical Pascal, in order to distinguish it from UCSD Pascal. Classical Pascal was intended for use as a teaching language, and as such it embodies many features that support "good" programming practice. It even has features that *enforce* good practice.

Good practice, in programming or anything else, depends on what

you're trying to achieve. For example, suppose you're developing a driver program for an exotic peripheral device. The question is, can you do the job conveniently and efficiently with normal good-practice programming in Classical Pascal? And the answer is, you could—but you'd prefer to circumvent the strictures of Classical Pascal. Perhaps you'd like to treat an integer value as an array of bits, or access a machine location by its physical address without using machine language.

A major assumption of Classical Pascal philosophy is *strong typing* (ie: any value represents data of one type only, and it cannot be directly interpreted as if it were of another type). Jensen and Wirth did provide a mechanism for defeating strong typing—the free-union record variant—but they didn't explain its use in the *Pascal User Manual and Report*. I will do so later in this article.

Another assumption of Classical Pascal is that there are only two boolean values, represented by the built-in constants TRUE and FALSE. But in UCSD Pascal, a boolean value can actually be any pattern of 16 bits and it is *interpreted* as either true or false. The boolean operators AND, OR, and NOT are usually assumed to do single operations on values of TRUE and FALSE; actually, however, they are *bitwise logical operators* with 16-bit operands. This per-

mits some uses of boolean values and operations that are normally not considered part of Pascal.

Representing Scalar Values

In order to understand and apply these special techniques, you need to know how some of the data types are represented internally. The following sections provide details on how data is represented in binary for each scalar data type. A later section deals with arrays. (By the way, when I say "scalar" I don't include the real-data type. Jensen and Wirth define the real type as a scalar type, but then they continually modify by saying "any scalar type except real." The fact is that real types are not very similar to other scalar types and I consider them a different category. If you're a purist, you can whisper "except real" each time the word "scalar" appears.)

The basic unit of storage in UCSD Pascal software is a 16-bit word that consists of two 8-bit bytes (on most microcomputers). The least-signifi-

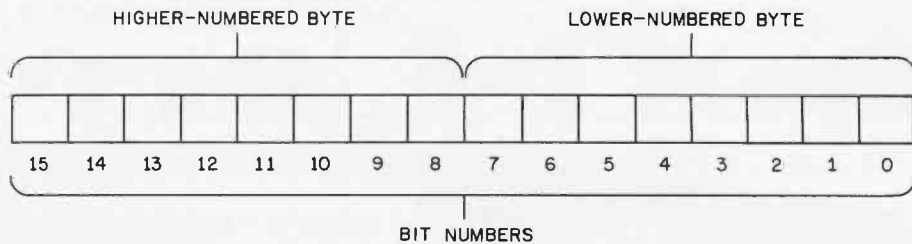

Figure 1: Representation of a 16-bit word in UCSD Pascal. Every nonpacked scalar value is represented as two 8-bit bytes; least-significant bits are stored in the lower-numbered byte, while most-significant bits are stored in the higher-numbered byte.

cant byte is at the lower of the two byte addresses. Figure 1 shows how to visualize a word; the least-significant bit is bit 0. Every nonpacked scalar value is represented in *one word*, as a 16-bit binary number.

Integers

An integer value is represented in one word as a binary number, with the least-significant bits in the low-numbered byte. Two's-complement notation is used to represent negative integers; thus, the most-significant bit of the binary number is a sign bit for the integer. If it is a 1, the integer

value is negative and must be interpreted accordingly (see table 1).

Characters

A character is represented in one word by its ASCII (American Standard Code for Information Interchange) code. Since ASCII codes are in the range 0 through 255, they only require 1 byte; the character code is represented in the low-numbered byte of the word. (The most-significant byte contains 0s.)

Booleans

A boolean value is represented in

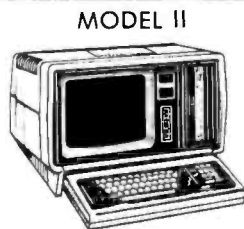

MODEL II
26-4002
64K 1 Drive
\$3297.00

We carry the full line of TRS-80 Computers. All sold at Discount Prices.

DISCOUNT
TRS-80® **BUY DIRECT**
COMPUTER SPECIALISTS

CALL US...

WRITE US FOR A
FREE CATALOG

SAVE MONEY

1-800-841-0860 Toll Free Order Entry



MODEL III
26-1061 4K I..... \$609.00
26-1062 16K III..... 849.00
26-1066 48K III
W/2 Drives, RS232..... 2077.00

MICRO MANAGEMENT SYSTEMS, INC.

No Taxes on Out Of
State Shipments

Immediate Shipment
From Stock on Most Items

DOWNTOWN PLAZA SHOPPING CENTER
DEPT. # 1
115 C. SECOND AVE. S.W.
CAIRO, GEORGIA 31728

(912) 377-7120 Ga. Phone No. & Export
TRS-80 is a registered trademark of the Tandy Corp.

A copy of the manufacturer's warranty can be obtained free upon specific written request to the Electronic's Department of our Cairo, Georgia Retail Store.

Soft-Core

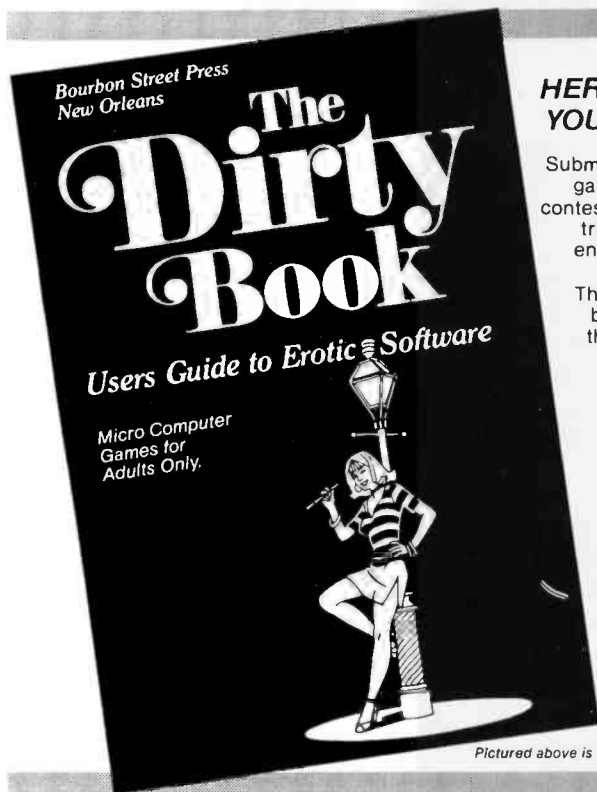

HERE'S A NEW CONTEST YOU'LL LOVE TO ENTER!

Submit your favorite micro-computer game program to the "Dirty Book" contest. You can win an expense-paid trip to fabulous New Orleans and enjoy the exciting French Quarter and all that jazz. The "Dirty Book" will expose your bedtime games and programs to thousands of prospective buyers when the premiere issue is published in the Fall.

Direct all inquiries for subscription information and further details on our contest to:

The Dirty Book

c/o The Bourbon Street Press
3225 Danny Park
New Orleans
(Metairie) LA 70002
(504) 455-5330

Pictured above is the cover illustration of our premiere issue.

| Integer Value | Stored Number | | |
|---------------|---------------|-------------|-----------------------|
| | Decimal | Hexadecimal | |
| 0 | 0 | 0 | |
| 1 | 1 | 1 | |
| . | . | . | |
| . | . | . | |
| 32766 | 32766 | 7FFE | |
| 32767 | 32767 | 7FFF | (2 ¹⁵ - 1) |
| -32768 | 32768 | 8000 | (2 ¹⁵) |
| -32767 | 32769 | 8001 | |
| . | . | . | |
| . | . | . | |
| -2 | 65534 | FFFE | |
| -1 | 65535 | FFFF | (2 ¹⁶ - 1) |

Table 1: Two's-complement notation. Both positive and negative integers are represented by using the most-significant bit as a sign bit. Negative integers are represented as binary numbers in the range 32768 to 65535.

one word. The logical true or false value is represented by the least-significant bit of the least-significant byte. For most purposes, this is the only meaningful bit and all others are ignored — but read on.

ATTENTION GOVERNMENT D P USERS AND PURCHASERS

We represent many fine micro products and manufacturers on the U.S. Government's GSA Schedule, including

Apple, Cromemco, Micropolis and Seequa Computers

Purchasing from the Schedule will save you the time consumed by the bid process. Products shipped throughout the United States and world-wide. Visit or write any of our stores for more information or to receive our catalogue of products represented.

**Computers,
Etc.....
the dependable store**

257 West Street, Annapolis, MD 21401 — (301) 268-6505
13A Allegheny Avenue, Towson, MD 21204 — (301) 296-0520
9330 Georgia Avenue, Silver Spring, MD 20910 — (301) 588-3748
6671 Backlick Road, Springfield, VA 22150 — (703) 644-5500
Plaza 38, 2442 Route 38, Cherry Hill, NJ 08002 — (609) 779-0023
Callers outside metropolitan areas served by our stores
Please call (301) 268-5801

Career Opportunities Available * An Equal Opportunity Employer

User-Defined Scalars

When you declare a user-defined scalar type, each of its value identifiers is associated with an ordinality value; the first one declared has an ordinality of 0, the next has an ordinality of 1, and so forth. For example, the declaration:

```
VAR DAY: (MON, TUES, WED, THURS, FRI, SAT, SUN);
```

creates a variable DAY whose possible values (at the source program level) are MON through SUN. These are associated with the ordinalities 0 through 6; thus, MON corresponds to 0, TUES corresponds to 1, and SUN corresponds to 6. If DAY is assigned a particular value, such as the following:

```
DAY := WED
```

the value is represented in binary as the number 2, because WED corresponds to 2.

Implications

By combining this information on

representation of scalars with the following facts about the ORD and ODD functions, you can do some interesting things.

The ORD and ODD Functions

The familiar ORD function accepts a noninteger scalar value as its parameter, and returns an integer which is the ordinality of that value within its type. This is done in a strikingly simple way: ORD merely returns the very same value that was passed to it, and since ORD is, by definition, an integer function, the returned value is now interpreted as an integer. The method works because every non-packed scalar value is represented in the same way: as a 16-bit binary number. The integer value of the binary number is the ordinality of the scalar value.

The ODD function accepts any integer as its parameter; it returns true if the integer is odd, and false if the integer is even. Notice that odd and even depend only on the last bit of an integer value (you will recall that true

and false depend only on the last bit of a boolean value). ODD actually returns the same value that was passed to it; since ODD is, by definition, a boolean function, the returned value is now interpreted as a boolean value.

This implies that the binary form of any scalar value can be interpreted according to its original type, or as an integer, or as a boolean value. Accordingly:

- To interpret the binary value of any noninteger scalar S as an integer, use ORDS(S).
- To interpret the binary value of any integer N as a boolean, use ODD(N).
- To interpret the binary value of any noninteger scalar X as a boolean, use ODD(ORD(X)).

Incidentally, the SUCC and PRED functions work by simply incrementing or decrementing the binary value of a scalar (its ordinality) and returning the result as a scalar of the same type.

The program BITFIDDLER (listing 1) is a simple-minded application of these ideas. It allows you to see an integer value as a list of bit values, set a selected bit, and clear a selected bit. In order to do this, it makes use of the fact that AND, OR, and NOT are 16-bit operations. It sets up an array of 16 integer values, each of which has a 1 in one particular bit and 0s in all other bits (the values are powers of 2).

Each of these power-of-2 values can be used in the TSTBIT function to test the corresponding bit of an integer via the AND operation. The result of the AND is a nonzero integer if the tested bit is a 1, and a 0 integer if the bit is a 0. The SETBIT procedure sets a bit by using the OR operation, and the CLEARBIT procedure clears a bit by using AND NOT.

To make these operations possible, the integer values must first be converted to type boolean by the ODD function. Then the boolean operation (AND, OR, or AND NOT) is per-

Olympic Sales Company

SERVING YOU SINCE 1947

Main Showroom & Offices:
216 South Oxford Avenue
Los Angeles, CA 90004

WE HONOR
VISA and MASTERCARD



TELEX: 67 34 77

ORDER DESKS open 7 Days a Week!
7:00 AM to 7:00 PM Mon thru Sat
Sunday Noon to 5:00 PM

Order Desks: (213) 739-1130

TOLL-FREE TOLL-FREE
(outside Calif.) (within Calif.)

800-421-8045 800-252-2153

Write & request our FAMOUS Catalog!
Hundreds & hundreds of products from many manufacturers such as SONY, CASIO, VICTOR, CODE-A-PHONE, MATTEL, SHARP, CANON, and on and on... too many to list here!

All goods subject to availability; this ad supersedes all previous ads; we are not responsible for typographical errors; we will meet or beat any advertised prices if the competition has the goods on hand.
Minimum shipping and handling \$4.95.
All orders subject to verification and acceptance.

hp HEWLETT PACKARD

| | Retail | Your Cost |
|--------------------------------|---------|-----------|
| HP-85 Microcomputer | 3250.00 | 2595.00 |
| HP-83 Microcomputer | 2250.00 | 1795.00 |
| 16K Exp-Memory Module | 295.00 | 259.95 |
| Graphics Plotter 7225 | 2450.00 | 2089.95 |
| Personality Mod. for 7225 | 750.00 | 679.95 |
| 2631B Impact printer/hvy duty | 3950.00 | 3295.00 |
| Option Q20 for 2631B | 150.00 | 129.95 |
| 8 Disk Drives to choose from: | | |
| 82902S | 1300.00 | 1149.95 |
| 9895A 8" Dual Drive | 6850.00 | 5595.00 |
| Graphics Tablet 9111A | 2050.00 | 1699.95 |
| HP-41CV New 2.2K bytes mem | 325.00 | 259.95 |
| HP-41C Calculator | 250.00 | 188.95 |
| Card Reader for 41CV/C | 215.00 | 168.95 |
| Printer for 41CV/C | 385.00 | 284.95 |
| Optical Wand for 41CV/C | 125.00 | 97.95 |
| Quad Ram equals 4 Mem. Mods | 95.00 | 84.95 |
| Memory Modules for 41C | | 26.95 |
| HP-97 Programmable Printer | 750.00 | 579.95 |
| HP-67 Programmable Calculator | 375.00 | 297.95 |
| HP-34C Programmable Scientific | 150.00 | 117.95 |
| HP-38C Programmable Bus. R/E | 150.00 | 119.95 |
| HP-32E Adv. Scientific | 55.00 | 48.95 |
| HP-37E Business Mgmt. | 75.00 | 58.95 |

We carry a large inventory of Libraries, accessories and supplies.

apple computer

We are an AUTHORIZED SERVICING APPLE DEALER

the best price in America!

16K-32K-48K-96K-128K

Drive with controller DOS 3.3 and others...
80 column cards
Dow Jones & Quote Reporter
DC Hayes Micromodem II
and others...

Graphics Tablet
Pascal and Fortran
Languages
VisiCalc and more and more

APPLE III 96K and 128K "CALL US"
Ask for Package One to Three Special Prices!

Texas Instruments

| | | |
|---------------------------------------|--------|----------|
| Ti-99/4 Home Computer | 950.00 | \$379.95 |
| 10" Color Monitor for 99/4 | 650.00 | 319.95 |
| 32K Exp. Mem. Module | 399.95 | 314.95 |
| Extended Basic, a MUST for 32K Module | 100.00 | 75.00 |
| Speech Synthesizer | 150.00 | 129.95 |
| Disk Memory Drive | 500.00 | 397.95 |
| RF Modulator | 69.50 | 49.50 |
| Telephone Coupler (Modem) | 225.00 | 189.95 |
| Printer (solid state) | 400.00 | 319.95 |
| Ti-59 Programmable Calculator | 295.00 | 199.95 |
| Ti-58C Programmable Calculator | 130.00 | 93.95 |
| PC-100C Prntr/Plotr for 59/58 | 225.00 | 149.95 |
| Ti-57 Scientific Calculator | 99.95 | 39.95 |
| MBA Finance & Business | 70.00 | 51.95 |
| Ti Investment Analyst | 65.00 | 46.95 |
| Ti-55 Sluile Rule | 40.00 | 32.95 |
| Ti-Program Hexilecm/Octal | 65.00 | 48.50 |

We carry a large inventory of software, accessories and supplies.

OHIO SCIENTIFIC

Professional Computers Retail Your Cost
C8PDF-48K 3495.00 3195.00

- Dual 8" Drives
- 64 col x 32 line/color
- 7 MIPS - FAST!
- Many more standard features

Fortran & Pascal available

Many other OSI products available - at discounted prices, of course!

ATARI PERSONAL COMPUTER

*****SPECIAL! ATARI 400 (16K)*****
Retail: \$595.00 Your Cost: \$339.95
Language cartridge not included; Optional basic language cartridge: \$54.95

| | | |
|------------------------------------|---------|--------|
| 800 16K bytes of RAM | 1080.00 | 759.95 |
| 410 Program Recorder | 90.00 | 79.95 |
| 810 Disk Drive | 600.00 | 469.95 |
| 825 Printer (80 col Centronic 737) | 999.95 | 779.95 |
| 820 Printer (40 col impact) | 450.00 | 359.95 |
| 830 Acoustic Modem | 200.00 | 159.95 |
| 850 Interface Module | 220.00 | 179.95 |
| Atari VisiCalc | 200.00 | 169.95 |

Large inventory of software and accessories.

PRINTERS

| | | |
|----------------------------------|---------|-----------|
| • OIABLO (Letter Quality) | Retail | Your Cost |
| 630 R102 bi-directional/tractors | 2965.00 | 2699.00 |
| 1640K109 keyboard, tractors | 3072.00 | 2899.95 |
| 630 RO Receive only | 2710.00 | 2499.95 |
| 1650K136 keyboard/tractors | 3220.00 | 2999.95 |
| • CENTRONICS dot matrix | | |
| 700-9 Parallel, heavy duty | 1460.00 | 1199.95 |
| 704-9 Serial, heavy duty | 1795.00 | 1599.95 |
| 737-1 Parallel | 995.00 | 799.95 |
| 737-3 Serial | 1045.00 | 899.95 |
| 704-11 Parallel | 1870.00 | 1695.00 |
| P-1 Electrostatic | 495.00 | 189.95 |
| • PAPER TIGER | | |
| 445G with graphics | 795.00 | 695.00 |
| 460G with graphics | 1391.00 | 1195.00 |
| 560G New full size | 1695.00 | 1399.00 |
| • EPSON | | |
| MX 80 Impact printer | 645.00 | 499.95 |
| MX 70 Impact printer | 500.00 | 399.95 |
| MX 80 FT cut sheet/tractor | 745.00 | 639.95 |
| MX 100 FT 15" paper | 945.00 | 789.00 |

WE ALSO HAVE

| | | |
|-----------------------------------|--------|-----------|
| • NOVIATION Modems | Retail | Your Cost |
| CAT | 199.95 | 159.95 |
| D-CAT | 199.95 | 159.95 |
| APPLE-CAT Direct connect | 349.95 | 314.95 |
| • SANYO Monitors | | |
| High Resolution, Number 1 seller! | | |
| 13" Color (new) high quality | 550.00 | 399.95 |
| 12" Green Phosphorous | 360.00 | 239.95 |
| 12" Black and White | 340.00 | 219.95 |
| 15" Black and White | 370.00 | 239.95 |
| 9" B/W the best seller! | 235.00 | 149.95 |

AMDEK (Leedex) High Quality Monitors

| | | |
|---|--------|--------|
| 100 12" B/W, 12 MHz | 179.00 | 129.95 |
| 100-80 12" B/W, metal cab., space for floppy | 199.00 | 159.95 |
| 100-G 12" Green, 12 MHz | 199.00 | 159.95 |
| 300-G 12" Green, 18 MHz | 249.00 | 189.95 |
| Color I 13" Color, NTSC comp. 449.00 | 329.95 | |
| input, audio amp & speaker | | |
| Color II 13" Color, RGB input, hi res graphics, speaker | 999.00 | 699.95 |
| • HAZELTINE Video Display Terminals | | |
| • SHUGART Disk Drives | | |
| • DEC VT100 & VT103 | | |

Call us for your DISCOUNTED price TODAY!

NEW! From TI-Series 10 Personal Information Terminal Retail 995.00 Your Cost 795.00

Listing 1: The BITFIDDLER program uses the ODD and ORD functions to manipulate data types. In the TSTBIT function and the SETBIT and CLEARBIT procedures, ODD is used to convert integer values into type boolean so that a bitwise boolean operation can be performed. (ORD then converts the result back to type integer.)

```

PROGRAM BITFIDDLER;
(*This program takes an integer value from the keyboard and
 displays its value as a list of 16 bit values. Then it
 sets a specified bit, displays the bit values again, clears
 a specified bit, and displays once more: *)

(*Declare a subrange type for indexing the bits of
 an integer value:*)
  TYPE BITNUMBER = 0..15;

(*Declare an array of 16 integers -- one for each bit
 of an integer value:*)
  VAR BITVAL: ARRAY [BITNUMBER] OF INTEGER;
      I: BITNUMBER;
      INNUM, NUMBER: INTEGER;

(*A procedure to initialize the array so that each BITVAL[I] has a
 1 in bit I and 0's in all other bits:*)
  PROCEDURE INITIALIZE;
  VAR I:BITNUMBER;
  BEGIN
    BITVAL[0] := 1;
    FOR I := 1 TO 15 DO BITVAL[I] := 2*BITVAL[I-1]
  END;

(*A function to return true if a particular bit of an integer value
 is a 1, or false if the bit is a 0:*)
  FUNCTION TSTBIT (BITPOS: BITNUMBER; N: INTEGER): BOOLEAN;
  BEGIN
    TSTBIT := ORD(
      ODD(N)
      AND
      ODD(BITVAL[BITPOS])
    )
    <> 0
  END;

(*A procedure to analyze an integer value and report each bit:*)
  PROCEDURE ANALYZE(N: INTEGER);
  VAR I: BITNUMBER;
  BEGIN
    FOR I := 0 TO 15 DO BEGIN
      WRITE('Bit ', I, ' of ', N, ' is a ');
      IF TSTBIT(I, N) THEN Writeln('1')
      ELSE Writeln('0')
    END;
  END;

(*A procedure to set (to 1) a particular bit of an integer variable:*)
  PROCEDURE SETBIT (BITPOS: BITNUMBER; VAR N: INTEGER);
  BEGIN
    N := ORD(
      ODD(N)
      OR
      ODD(BITVAL[BITPOS])
    )
  END;

(*A procedure to clear (to 0) a particular bit of an integer variable:*)
  PROCEDURE CLEARBIT (BITPOS: BITNUMBER; VAR N: INTEGER);
  BEGIN
    N := ORD(
      ODD(N)
      AND NOT
      ODD(BITVAL[BITPOS])
    )
  END;

```

formed. This gives a boolean result, which is converted back to type integer by the ORD function.

The boolean constants FALSE and TRUE are always represented as the 16-bit binary numbers 0 and 1, respectively. ORD(FALSE) is 0 and ORD(TRUE) is 1. In other words, FALSE has 0s in all 16 bits, while TRUE has a 1 in the least-significant bit and 0s in the other 15 bits.

As the BITFIDDLER program shows, there are other boolean values besides FALSE and TRUE—values that have 1s in other bit positions besides bit 0. I call these other values *strange* boolean values. For example, ODD(3) is a boolean true value but it is *strange*—it is represented by the 16-bit binary number for 3, not 1. It has 1s in both bit 0 and bit 1.

Use of Strange Booleans

In the BITFIDDLER program, we deliberately created strange boolean values, but you should be aware that a strange value can arise inadvertently. As shown above, ODD of any integer except 0 or 1 will give a strange value; the result is also strange when you complement a normal boolean value by using the NOT operator, because 1s appear in bits 1 through 15. In both of these cases, Classical Pascal says the result should be either TRUE or FALSE.

You might wonder how strange boolean values can work correctly in IF, WHILE, and REPEAT statements. They work because the system ignores all bits except the least-significant bit when it looks at the boolean value in an IF, WHILE, or REPEAT. Similarly, when two boolean values are compared, all bits except the least-significant bit are ignored.

But Classical Pascal allows other, less obvious uses of boolean values:

- A CASE statement can be controlled by a boolean value (with cases labeled TRUE and FALSE).
- An array index can be of type boolean.
- A FOR statement can have a boolean control variable that goes from one boolean value TO (or DOWNTO)

Listing 1 continued on page 453

Listing 1 continued:

```
BEGIN
  INITIALIZE;
  INNUM := 1;
  REPEAT
(*Get number from user:*)
  WRITE('Type an integer (-100 to quit): '); READLN(INNUM);
  NUMBER := INNUM;
(*Demonstrate testing the bits:*)
  ANALYZE(NUMBER);
(*Demonstrate setting a bit:*)
  WRITE('Set what bit in the value ', NUMBER, '? '); READLN(I);
  SETBIT(I, NUMBER);
  ANALYZE(NUMBER);
(*Demonstrate clearing a bit:*)
  WRITE('Clear what bit in the value ', NUMBER, '? '); READLN(I);
  CLEARBIT(I, NUMBER);
  ANALYZE(NUMBER)
  UNTIL INNUM = -100
END.
```

another boolean value.

•A set of booleans whose possible members are the values TRUE and FALSE can be declared.

These uses may seem unusual, but they're normal in the sense that they are part of Classical Pascal. How do these uses work when a strange boolean value is involved?

You'll have to determine this answer for yourself, by experimentation. There are now so many versions of UCSD Pascal that I don't know how each of them deals with, say, a strange boolean value used as an array index. Some versions cannot handle strange boolean values in these situations. (The current Version 1.1 release of Apple II Pascal does

handle strange boolean values correctly in all cases.)

Representation of Arrays

A nonpacked array of scalar values is represented simply as a sequence of words, with each word containing one scalar value as previously described.

When the array is packed, each value does not necessarily take up one word. The word is still the unit of storage, but each word can contain more than one value if it has enough bits. Consider the declaration:

```
VAR OCTAL: PACKED ARRAY[0..63]
  OF 0..7;
```

which creates an array OCTAL of 64 elements. Each element is an integer value in the range of 0 through 7, and requires 3 bits. Since a word contains 16 bits, 5 array elements can be packed into a word. The elements are packed so that the first element is in bits 0 through 2, the second is in bits 3 through 5, and so on, to the fifth ele-

AVAILABLE COMPUTER BOOKS

| | |
|--|---|
| Pascal ISBN 0-918398-28-7 \$12.95 | How to Get Started with CP/M ISBN 0-918398-32-0 \$9.95 |
| Computers For Everybody ISBN 0-918398-49-3 \$4.95 | Instant BASIC ISBN 0-918398-71-5 \$9.95 |

Write or call for free catalog!

dilithium Press

Most bookstores and computer stores carry our books.
Call our toll-free number for the one nearest you.

1000 Redwood Drive
Berkeley, CA 94708
(415) 841-1322

ment in bits 12 through 14. Bit 15 is unused. The next element goes in bits 0 through 2 of the next word.

The following specific cases are of particular interest:

- A char value requires 8 bits. In a packed array of char, each word of storage contains two char values: the first is in bits 0 through 7, the second in bits 8 through 15.
- A value of the subrange type 0..255 also requires 8 bits and can be thought of as a "byte"-type value.

Storage in a packed array of 0..255 is the same as for packed char values.

- A boolean value requires only one bit; in a packed array of boolean, each word contains 16 values. The first value is in bit 0; the last is in bit 15.

The above applies only as long as the variables remain packed. Whenever a value is unpacked from a packed variable, it is expanded to occupy a full word with 0s in any "unused" bits. This occurs whenever the value is

used in an expression.

Free-Union Variants

An ordinary variant record has a tag-field value that is stored as part of the record. Your program can use the tag-field value to determine how the variant data is interpreted. This is useful when the variant data is of a specific type; the tag field serves as a safeguard against misinterpreting the variant data.

Here, however, we are interested in purposely interpreting the same data in more than one way. This can be accomplished with an ordinary variant record: simply ignore the tag field. If you use a *free-union* variant, you can eliminate the tag field altogether; this saves memory and also makes the maneuver a little more obvious.

A free-union variant looks like an ordinary variant, except that the tag-field identifier is omitted. A tag type is still required, as are case labels. For example:

```
VAR FOXY: RECORD CASE BOOLEAN OF
  FALSE: (INT: INTEGER);
  TRUE: (BOOL: BOOLEAN)
END;
```

Now FOXY.INT refers to a value of type integer, and FOXY.BOOL refers to a value of type boolean. Both refer to the same word of data. The labels FALSE and TRUE, corresponding to the tag type BOOLEAN, are chosen as a matter of convenience; you can use any type that has enough possible values to use as case labels. In the BINARY program shown in listing 2, the type THREWAY is declared solely for use as a tag type for a free union that has three cases.

In the BITFIDDLER program, we used the INITIALIZE procedure to set up an array of integers, each integer having a 1 in one bit, and 0s in all other bits. This was accomplished by making the value of each integer a power of two. In the TSTBIT function and the SETBIT and CLEARBIT procedures, we used ODD to convert one of these integer values to a boolean value with a 1 in a particular bit.

In the BINARY program we use a

BOOKKEEPING MADE SIMPLE

| | |
|---------------------------------|------------------------------|
| GENERAL LEDGER FUNCTIONS | ACCOUNTS PAYABLE |
| 1 Set-Up & Review Accounts | 40 Payables Ledger |
| 2 Post to General Ledger | 41 Write Payable Checks |
| 3 Close Month/Year | 42 Accounts Payable Labels |
| 4 Daily Journal | |
| 5 Monthly Journal | ACCOUNTS RECEIVABLE |
| 6 Monthly Detail Report | 50 Receivable Ledger |
| 7 Trial Balance | 51 Customer Billing |
| 8 Income Statement | 52 Receivable Aging |
| 9 Balance Sheet | 53 Interest Add-On |
| 10 Chan of Accounts | 54 Receivable Labels |
| PAYROLL FUNCTIONS | SPECIAL FUNCTIONS |
| 20 Adjust Tax Tables | 60 Initialization |
| 21 Payroll Ledger | 61 Index Update |
| 22 Write Payroll Checks | 62 Update & Post to Files |
| 23 Print W-2 | 63 Special Directories |
| 24 Initialize New Pay Period | 64 General Directory |
| | 65 Adjust Budget |
| | 66 Comparative Budget Report |
| | 67 Call End of Session |
| 30 CALL OPTIONAL TASKS MENU | |

The Menu

- ▶ A Combined General Ledger, Accounts Payable, Accounts Receivable, and Payroll
- ▶ Expandable to Include Inventory, Order Entry, Certified Payroll, or Mail List
- ▶ Complete Easy-To-Follow Manual and Instructions
- ▶ For Microcomputers using CP/M, OASIS or TRSDOS Operating System
- ▶ 64 K Minimum, Hard Disk Compatible
- ▶ Demonstration Disk Available

CP/M, OASIS and TRSDOS are TM's of Digital Research, Phase One Systems and Tandy Corp., respectively.

THE BOOKKEEPER SYSTEM™

Dealer Inquiries Welcome



(615) 452-1027

179 West Smith Street, Gallatin, TN 37066

We're Writing Programs For People

free union as a more powerful means of accessing individual bits of a boolean value—and more. This is a three-way free union that allows the same word of data to be treated as an

integer, a boolean value, or an array of 16 boolean values.

Multidimensional Arrays

When you know how to access

data in memory in this fashion, the representation of data values becomes more interesting. Consider multidimensional arrays.

When an array has more than one index, the last index varies most rapidly and the first index varies least rapidly. For example, in a two-dimensional array the second index can be thought of as a "column" index that steps along a row, and the first index can be thought of as a "row" index that steps from one row to the next. The elements in a row are contiguous in memory. Another way to think of this is that the declaration:

Listing 2: *The BINARY program employs free union to access the individual bits of a word. The word can also be accessed as an integer or a boolean. The distinction is made in the field of the record VALUE: the BINOUT procedure references VALUE.BITS with a subscript to access a bit, while the main program references VALUE.INT to access the word as an integer, or VALUE.BOOL to access it as a boolean.*

```
PROGRAM BINARY;
(*This program takes an integer value from the keyboard and
displays its value as a 16-bit binary number by treating it as
a packed array of 16 one-bit boolean values. Then it treats
the value as one 16-bit boolean value, complements it, and
again displays the result as a 16-bit binary number: *)

TYPE
(*A type to use as tag type in a 3-way free union: *)
  THREEWAY=(A,B,C);
(*An index type for 16-element arrays: *)
  BITINDEX=0..15;
(*An array type of 16 booleans, each one represented as a bit: *)
  BITARRAY=PACKED ARRAY[BITINDEX] OF BOOLEAN;
(*A free union record type, which can represent an integer,
or a bit array, or a boolean; same 16 bits in all cases: *)
  THREETYPES=RECORD CASE THREEWAY OF
    A: (INT:INTEGER);
    B: (BITS:BITARRAY);
    C: (BOOL:BOOLEAN)
  END;

VAR
(*A general index variable: *)
  I:INTEGER;
(*A variable of the free union type: *)
  VALUE:THREETYPES;

(*A procedure which takes a parameter of free union type,
treats it as a bit array, and writes the 16 bits out
as 1's and 0's: *)
  PROCEDURE BINOUT(NUM:THREETYPES);
(*An index variable: *)
  VAR K:BITINDEX;

  BEGIN
(*Scan the 16 bits, most significant first: *)
  FOR K:=15 DOWNTO 0 DO
(*If the bit is "true," write a 1; if it's "false," write a 0: *)
  IF NUM.BITS[K] THEN WRITE('1')
    ELSE WRITE('0');

  Writeln;
END;

(*Main program: *)
BEGIN
(*Prompt the user for a decimal integer: *)
WRITE('Type Number: ');
(*Store it as an integer value: *)
READLN(VALUE.INT);
(*write it as a binary integer: *)
BINOUT(VALUE);
(*Complement the value as a 16-bit boolean: *)
VALUE.BOOL:=NOT VALUE.BOOL;
(*Write it as a binary integer: *)
BINOUT(VALUE);
Writeln
END.
```

```
VAR TABLE: ARRAY[0..9, 0..4]
  OF INTEGER;
```

is exactly equivalent to:

```
VAR TABLE: ARRAY[0..9] OF ARRAY[0..4]
  OF INTEGER;
```

The ARRAY[0..4] OF INTEGER is a one-dimensional array, so its elements are contiguous. The ARRAY[0..9] OF ... is also a one-dimensional array whose elements are arrays.

Beware of multidimensional packed arrays! Remember that for each dimension of the array, the unit of storage into which values are packed is the word, so each array that makes up the multidimensional array occupies an integral number of words, with possible unused bits. For example, you might declare an 8-by-8 packed array of boolean (1-bit) elements:

```
VAR X: PACKED ARRAY[0..7,0..7]
  OF BOOLEAN;
```

If you expect that X will be stored so that all 64 elements are contiguous bits within 8 contiguous bytes, you are wrong. The declaration is equivalent to:

```
VAR X: PACKED ARRAY[0..7] OF PACKED
  ARRAY[0..7] OF BOOLEAN;
```

Each row of X is a packed array[0..7] of boolean, and occupies one word: 16 bits, not 8. X contains eight of these words (16 bytes); the most-significant 8 bits of each word are unused.

Listing 3: PEEKing and POKEing. As shown in figure 3a, a two-way free-union record type can represent either a pointer value or an integer value. A direct reference to a physical location can be performed with the functions shown in figure 3b.

```
(3a)
TYPE BYTE = 0..255;
MEMBYTE = PACKED ARRAY [0..0] OF BYTE;
LOCATION = RECORD CASE BOOLEAN OF
    TRUE: (ADDR: INTEGER);
    FALSE: (PTR: ^MEMBYTE)
END;
```

```
(3b)
PROCEDURE POKE (ADDRESS:INTEGER; VALUE:BYTE);
VAR LOC: LOCATION;
BEGIN
    LOC.ADDR := ADDRESS;
    LOC.PTR^[0] := VALUE
END;

FUNCTION PEEK (ADDRESS:INTEGER): BYTE;
VAR LOC: LOCATION;
BEGIN
    LOC.ADDR := ADDRESS;
    PEEK := LOC.PTR^[0]
END;
```

At this point, LOC.PTR ↑ [0] is a direct reference to the contents of byte location 32766. We can now declare a POKE procedure and a PEEK function (see listing 3b).

As in BASIC, there is one wrinkle to using PEEK and POKE. Because of the two's-complement notation for negative integers, the largest possible positive integer value is 32767, or $2^{15}-1$. In order to represent a physical address greater than this, you must use a negative integer to get the desired binary number (see table 1).

Going Further

You now have enough information to make experiments that will tell you even more about the inside workings of your system, and you may even discover more useful programming tricks. Remember the warning, though: tricky programming may work once, but you can receive a nasty surprise when you change your program, switch systems, or try to use an updated version of UCSD Pascal. ■

shown in listing 3a.

If LOC is a variable of type LOCATION we can assign a physical address,

such as 32766, by writing:

```
LOC.ADDR := 32766
```

NOW!

V.I.P.'s Call A.E.I.

V.I.P.'s call A.E.I. because A.E.I. tests before shipping, has expertise on all items offered, and is price competitive.



TELEVIDEO COMPUTER

| | List | Sell |
|--------------------|-------|------|
| System 1 Computer | 3995 | CALL |
| System 2 Computer | 8995 | CALL |
| System 3 Computer | 19995 | CALL |
| TS-80 user station | 1795 | CALL |



NORTHSTAR HORIZON COMPUTERS

| | List | Sell |
|------------------|------|------|
| HRZ-20-32K | 3695 | 2495 |
| HRZ-20-64K | 4195 | 2895 |
| HRZ-20-32K | 3995 | 2890 |
| HRZ-20-64K | 4495 | 3250 |
| HDS-18 Hard Disc | 5374 | 3890 |



NORTHSTAR ADVANTAGE COMPUTER

| | List | Sell |
|-----------------|------|------|
| ADV-20-64K | 3995 | CALL |
| SIO Board | 175 | CALL |
| PIO Board | 200 | CALL |
| FPB Board | 399 | CALL |
| Graphics Option | 299 | CALL |



MORROW DECISION COMPUTER

| | List | Sell |
|------------------|------|------|
| Decision 1 BASIC | 1725 | 1350 |
| Decision 2 | CALL | CALL |
| 65K Static Ram | 1000 | 780 |
| Switchboard I/O | 259 | 210 |

Select drives from Morrow disc systems for desired configuration



ZENITH DATA SYSTEMS

| | List | Sell |
|----------------------|------|------|
| VM-121 Green Monitor | 160 | 125 |
| Z-19 Terminal | 995 | 750 |
| Z-89 Computer | 2895 | 2140 |
| Z-90 Computer | 3195 | 2490 |

—Call for Accessory Pricing—
Peachtree Software Available



TELEVIDEO TERMINALS

| | List | Sell |
|---------------|------|------|
| 910 Terminal | 699 | 585 |
| 912C Terminal | 925 | 670 |
| 920C Terminal | 995 | 750 |
| 950 Terminal | 1195 | 950 |



NORTHSTAR SOFTWARE

| | List | Sell |
|--------------------|------|------|
| Northword D O | 399 | 295 |
| Mailmanager D O | 299 | 235 |
| Infomanager D O | 499 | 365 |
| General Ledger D O | 999 | 795 |
| A/R D O | 599 | 475 |
| A/P D O | 599 | 475 |



SYSTEMS GROUP

| | List | Sell |
|---------------------|------|------|
| 2800 Computer | 5635 | 3595 |
| DM-6400 Memory | 760 | 585 |
| DMB-6400 Memory | 995 | 735 |
| CPC-2813 CPU-I/O | 460 | 365 |
| FDC-2801 Controller | 465 | 370 |



MORROW DISC SYSTEMS

| | List | Sell |
|--------------------|------|------|
| Discus 2D 1 Drive | 1895 | 1450 |
| Discus 2D 2 Drive | 1875 | 1450 |
| Discus 2+2 1 Drive | 1395 | 1150 |
| Discus 2+2 2 Drive | 2495 | 1945 |
| M26 Hard Disc | 4495 | 3525 |
| M20 Hard Disc | 4795 | 3850 |



MICROPRO SOFTWARE

| | List | Sell |
|----------------|------|------|
| Wordstar | 495 | 300 |
| Apple Wordstar | 375 | 275 |
| Spellstar | 250 | 190 |
| Mailmerge | 150 | 100 |
| Dalastar | 350 | 250 |
| Supersort | 250 | 190 |



NEC PRINTERS

| | List | Sell |
|---------------------|------|------|
| 3510-1 30CPS Serial | 2450 | 2050 |
| 7710-1 55CPS SERIAL | CALL | CALL |
| 7720-1 KSR Serial | CALL | CALL |
| 5510-1 55CPS Serial | 3055 | 2495 |
| 5520-1 KSR Serial | 3415 | 2895 |



TEXAS INSTRUMENTS PRINTERS

| | List | Sell |
|--------------------|------|------|
| TI-810 BASIC | 1895 | 1495 |
| TI-810 Full ASCII | 1995 | 1580 |
| TI-810 FLO/CP | 2195 | 1760 |
| TI-820 R/O BASIC | 1995 | 1625 |
| TI-820 KSR Package | 2395 | 1950 |



OUME PRINTERS

| | List | Sell |
|---------------------|------|------|
| Sprint 9 35CPS R/O | 1995 | 1700 |
| Sprint 9 45CPS R/O | 2300 | 2000 |
| Sprint 9 55CPS R/O | 2400 | 2050 |
| Full Control Option | 155 | 150 |
| Memory Option | 150 | 150 |



MODEMS

| | List | Sell |
|--------------------|------|------|
| Cal Modem | 189 | 140 |
| D-Cal | 199 | 150 |
| Auto-Cal | 249 | 190 |
| Apple-Cal | 389 | 310 |
| DC Hayes Micro-100 | 379 | 330 |



DISCS—CABLES

| | List | Sell |
|----------------|------|------|
| Memorex 5" 1D | 47 | 27 |
| Memorex 5" 2D | 55 | 36 |
| Memorex 8" 1D | 65 | 40 |
| Memorex 8" 2D | 70 | 45 |
| RS-232 C Cable | 30 | 20 |
| RS-232 D Cable | 40 | 25 |

—SEE THESE PRODUCTS AND MORE IN OUR SHOWROOM—
PRICES CHANGE DAILY—CALL OR VISIT FOR CURRENT PRICING



AUTOMATED EQUIPMENT, INC.
18430 WARD STREET, FOUNTAIN VALLEY, CALIFORNIA 92708

(714) 963-1414
(800) 854-7635

Circle 39 on inquiry card.

October 1981 © BYTE Publications Inc 457

Apple Analog-to-Digital Conversion in 27 Microseconds

Michael A Seeds, Associate Professor of Astronomy
and Harold F Levison
Joseph R Grundy Observatory
Franklin and Marshall College
POB 3003
Lancaster PA 17604

We began designing a computer-controlled data-acquisition system for the Franklin and Marshall College observatory, when suddenly we realized that we would have to build our own A/D (analog-to-digital) circuit board. Most commercially available A/D boards are designed for the S-100 bus or computer buses other than the Apple II. The only board we found specifically designed for the Apple was both expensive (\$395) and very slow (400 milliseconds). At this time, various manufacturers are announcing new A/D boards for the Apple, but these, too, are expensive, and at least one of these has only 8-bit resolution. Our data system required 10-bit accuracy and high-speed performance. The circuit we designed to meet these requirements costs less than \$100. (See table 1.)

Circuit Description

The Apple A/D circuit can be divided into four sections. The input section consists of two 741-type operational amplifiers and an AD582 sample/hold amplifier. The op amps accept a signal between 0 and 10 V and provide a zero offset adjustment. The AD582 device follows the input voltage until it receives a control signal indicating that an analog-to-digital conversion is to take place. It then samples the input voltage and holds its output to that voltage for the duration of the conversion. Thus, the AD582 provides a constant voltage (adjustable with gain control) for the conversion process, preventing a rapidly changing input signal from destroying the accuracy of the conversion. The heart of the circuit's second section is an AD571 analog-to-digital converter device, which performs the actual conversion of voltage levels to digital data. (Both the AD571 and the AD582 are

manufactured by Analog Devices, POB 280, Norwood MA 02062.) Section three contains the three-state-output latch devices, a 74125 and a 74LS244. On command from the microprocessor, these connect the output of the AD571 converter to the system data bus. Finally, the fourth section contains a 74LS138 demultiplexer that decodes the address bus input, controlling the actual operation of the A/D circuit through a 7400 quad two-input NAND device and a 7404 hex-inverter package.

The 7400 NAND gates play a critical role in the operation of this circuit. Address signals appear on the Apple II system bus for less than 1 microsecond, but the AD571 converter requires a pulse no shorter than 2 microseconds to initiate a conversion. Expanding the pulse width of this control signal with a flip-flop constructed from a 7400 device satisfied this requirement.

Referring to figure 1, a conversion begins when the

| | | |
|---|-----------------------------------|---------|
| 1 | Apple protoboard | \$24.00 |
| 2 | 741 op amps | 0.80 |
| 1 | AD582 sample-and-hold amplifier | 14.05 |
| 1 | AD571 analog-to-digital converter | 23.00 |
| 1 | 7404 hex Inverter | 0.25 |
| 1 | 7400 quad dual-input NAND gates | 0.22 |
| 1 | 74LS138 demultiplexer | 0.99 |
| 1 | 74LS125 tri-state latch | 0.89 |
| 1 | 74LS244 tri-state latch | 2.95 |
| 1 | 10 K 10-turn potentiometer | 10.65 |
| 1 | 10 K 1-turn potentiometer | 3.30 |
| | Total | \$81.10 |

Table 1: List of components necessary to build the A/D converter shown in figure 1. The prices given by the author may not be representative of current component prices.

processor writes a datum to hexadecimal memory location C0A0 (assuming the A/D circuit card is plugged into slot two of an Apple). This sends the card select line (\overline{DS}) into a low state, enabling the 74LS138 demultiplexer to decode the zero value present on the three least-significant lines of the address bus, A_0 to A_2 . Output zero of the 74LS138 (the START line in figure 1) goes low, which, combined with the R/\overline{W} (READ/WRITE) line already in a low state from the processor write, sets the flip-flop and forces the $B+\overline{C}$ line high. This tells the AD571 to prepare for a conversion. When it is ready, the converter sends the \overline{DR} line high, resetting the flip-flop, sending $B+\overline{C}$ low and initiating the conversion. Thus the addition of the flip-flop permits the AD571 to start a conversion only when it is ready, assuring that the sub-microsecond pulses on the address bus will start a conversion.

The \overline{DR} line remains high while the AD582 chip is making a conversion—about 25 microseconds. When \overline{DR} goes low, the conversion is complete and the data is

ready. This \overline{DR} line could be used to provide an interrupt, but we chose to bring it to the data bus through a three-state latch and allow the computer to test \overline{DR} repeatedly until it goes low. Because the circuit operates so fast, machine-language programs test \overline{DR} only twice before it goes low, and BASIC programs do not run fast enough to catch \overline{DR} while it is still high. Thus, testing \overline{DR} with a software loop wastes very little time.

Operation

When the A/D card is signaled to begin a conversion,

| Number | Type | + 5 | GND | - 12 V | + 12 V |
|--------|---------|-----|-----|--------|--------|
| IC1 | LM741 | | | 4 | 7 |
| IC2 | LM741 | | | 4 | 7 |
| IC3 | AD582 | | | 5 | 10 |
| IC4 | AD571 | 10 | | 12 | |
| IC5 | 7404 | 14 | 7 | | |
| IC6 | 7400 | 14 | 7 | | |
| IC7 | 74LS138 | 16 | 8 | | |
| IC8 | 74125 | 14 | 7 | | |
| IC9 | 74LS244 | 20 | 10 | | |

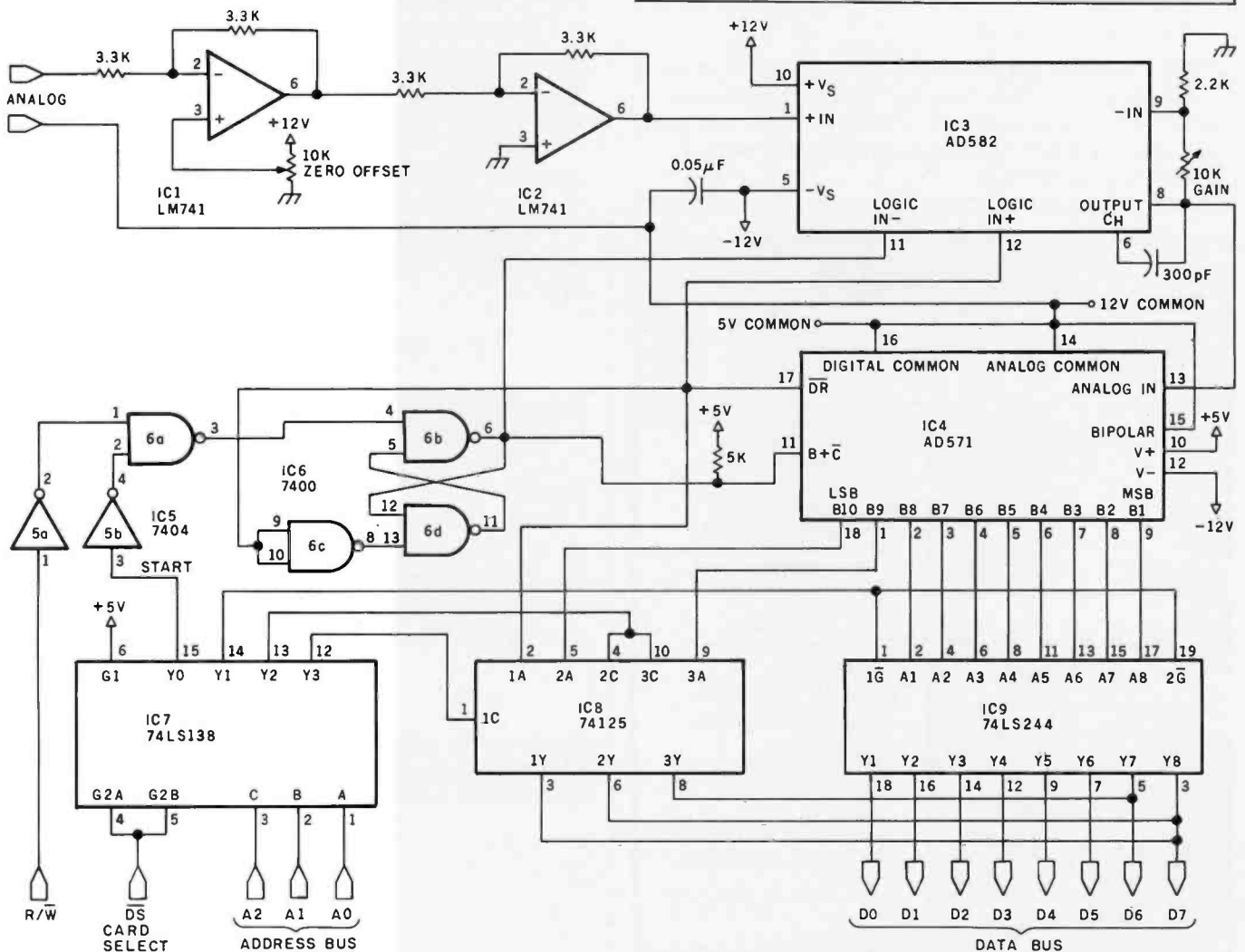

Figure 1: Schematic of the A/D converter built on an Apple II plug-in prototyping card using ordinary soldering techniques. Two special components from Analog Devices comprise the heart of this fast and inexpensive circuit. This circuit can be easily adapted to other computer systems.

the input circuit samples the analog voltage to be converted and holds it constant during the conversion. The A/D device makes the conversion, and once the 10 bits of data are ready, the board signals the computer by pulling \overline{DR} low. The computer may then read the 8 MSBs (most-significant bits) in 1 byte and the 2 LSBs (least-significant bits) in another. If 8-bit resolution is sufficient, the 2 LSBs can be ignored.

Operation from a 6502 machine-language program is accomplished as follows. (Again, we assume the card is in slot 2.) The execution of STA \$C0A0 (write the contents of the accumulator to hexadecimal location C0A0) begins a conversion. The computer then checks to see if the data is ready by LDA \$C0A3 (read from C0A3). As soon as

the eighth bit in this cell goes to 0, the data is ready and the computer can read the 8 MSBs with LDA \$C0A1 and the 2 LSBs with a LDA \$C0A2.

On our board, we found that the fifth bit of location C0A2 fluctuated between 0 and 1. When the computer is reading the contents of location C0A2, the 6 LSBs are undefined. The computer should recognize these as 0s, but that may not always be the case because of variations in the components. The solution is to mask the byte read from location C0A2 with an AND #\$C0 (logical AND with the hexadecimal value C0). This ensures that the 6 low-order bits will be 0. Similarly, the contents of location C0A3 can be masked by an AND #\$80 to be sure that only the eighth bit can be a 1.

The A/D board can also be operated from BASIC programs by using a POKE 49312,0 to begin the conversion and PEEK (49313) and PEEK (49314) to read the high- and low-order parts of the data. You must beware, however, of undefined bits in the low-order word. These can cause confusion and limit the board to 8-bit resolution when it is used from a BASIC program. These hexadecimal and BASIC commands are summarized in table 2.

The best arrangement for using the card from a BASIC program uses a short machine-language program to handle the actual conversion and masking. The program shown in listing 1 will assure that no undefined bits confuse the data. The program is relocatable and communicates with other programs via zero page locations FE and FF. The AND instructions mask off undefined bits.

If this subroutine is called from a BASIC program, the two words of data can be combined into a single number by:

$$X = \text{PEEK}(254) * 4 + \text{PEEK}(255) / 64$$

Division by 64 is necessary because the 2 LSBs occupy the two highest-order bits of the word in hexadecimal C0A2.

Speed

Analog Devices lists the speed of its AD571 chip as 25 μ s, typical. Tests of our A/D board indicate that the time from the beginning of a conversion until the data is ready is about 27 μ s. The time needed to read the 10 bits of data and store them in memory locations is about

Listing 1: The 6502 machine-language routine called from BASIC that assures that no undefined bits will confuse the data read from the A/D circuit.

| | | | |
|----------|-------|------------|-------------------------|
| 8D A0 C0 | Begin | STA \$C0A0 | Start a conversion |
| ADA3 C0 | Test | LDA \$C0A3 | Get \overline{DR} |
| 29 80 | | AND #\$80 | Mask off undefined bits |
| D0 F9 | | BNE Test | Test \overline{DR} |
| ADA1 C0 | | LDA \$C0A1 | Get 8 bits of data |
| 85 FE | | STAZ \$FE | Store in zero page |
| ADA2 C0 | | LDA \$C0A2 | Get 2 bits of data |
| 29 C0 | | AND #\$C0 | Mask off undefined bits |
| 85 FF | | STAZ \$FF | Store in zero page |
| 60 | | RTS | |

| Command | 6502 Machine Language | BASIC |
|---------------------|-----------------------|---------------|
| Begin Conversion | STA \$C0A0 | POKE 49312,0 |
| Get \overline{DR} | LDA \$C0A3 | PEEK (49315)* |
| 8 MSBs | LDA \$C0A1 | PEEK (49313) |
| 2 LSBs | LDA \$C0A2 | PEEK (49314) |

*Unnecessary for BASIC programs

Table 2: Control and status commands for the A/D converter. Note that 2 bytes must be read to get 10-bit resolution. The memory locations specified and the machine-language and BASIC instructions are from the original installation on an Apple II.

NEVADA COBOL



Edition II of Nevada COBOL, a subset of ANSI-74, features:

- Copy statement for library handling.
- CALL...USING...CANCEL.
- PERFORM...THRU...TIMES...UNTIL...Paragraph or section names.
- IF...NEXT SENTENCE...ELSE...NEXT SENTENCE AND/OR <=> NOT.
- GO TO...DEPENDING ON.
- Unique easily understood diagnostic error messages.
- Interactive ACCEPT/DISPLAY...
- RELATIVE (random) access files.
- Sequential files both fixed and variable length.
- DISPLAY, 16-bit binary or packed decimal (COMP-3) data types with up to 18-digit accuracy.
- INSPECT...TALLYING...REPLACING.
- ADD, SUBTRACT, MULTIPLY, DIVIDE, GIVING, ROUNDED, ON SIZE ERROR.
- Generates optimized 8080 machine language at up to 500 statements per minute.

\$149⁹⁵

DISKETTE AND MANUAL

• Uses CP/M or MP/M operating system to work with TRS-80, Apple's with softcard, North Star, Superbrain, Micropolis, and many other microcomputers. Needs a minimum of 16K of RAM. Uses single density 8" or 5 1/4" diskette.



ELLIS COMPUTING
SOFTWARE TECHNOLOGY

600 41st Avenue
San Francisco, CA 94121

CP/M, MP/M and TRS-80 are registered TM's of Digital Research and Tandy Corporation.

WE WELCOME C.O.D's



(415) 751-1522.

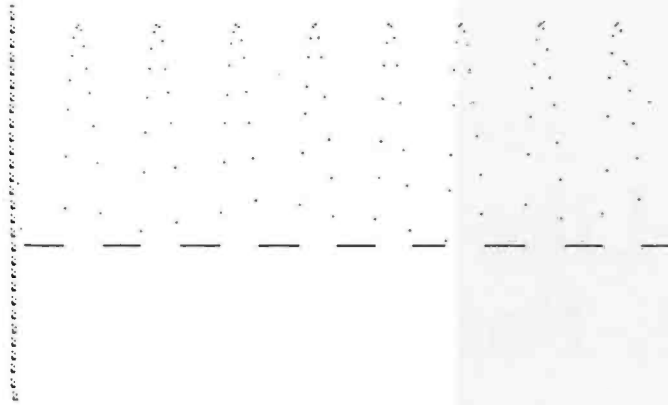

Figure 2: A 1 kHz signal sampled at 8-bit resolution thirty-one times per cycle. Note that since the circuit described does not accept negative-input signals, the lower half of this signal has been clipped off.

24 μ s minimum, so the card can sample the input approximately every 50 μ s. The overhead for data handling could be cut to 9 μ s by using only the 8 MSBs.

Our operating system must be able to sample the input signal at a minimum of 1000 times per second at the direction of 1-millisecond interrupts from the clock. The speed of our A/D board gives us plenty of time to read the data, modify it as necessary, calculate the next empty address of memory (skipping over page 1 of the high-resolu-

tion display), and store the data. The system then waits for the next 1-millisecond interrupt before beginning the next conversion.

Figure 2 illustrates the speed of the card as used in our system. The input signal is a 1 kHz sine wave. The A/D converter accepts only positive voltages, so the negative portion of the sine wave is clipped. With the data-acquisition system free-running, independent of clock interrupts, and accepting only 8-bit resolution, the computer could sample the input signal thirty-one times per cycle.

Setup

This circuit has two controls that must be adjusted before the converter is used in any specific application. For example, the prototype (developed under a grant from the National Science Foundation) is used at an observatory to detect the light of a particular star as it disappears behind the moon. To compensate for excessive moonlight that can interfere with the measurements, the system is focused on a moonlit portion of the sky near the target star, and the zero offset control (see the schematic in figure 1) is adjusted until the converter gives a zero reading. The system is then focused on the target star and the gain control is adjusted for a full-scale reading (maximum output corresponds to maximum brightness). This ability to compensate for a variety of input conditions makes the A/D system adaptable to a wide assortment of applications. ■

PMC PERSONAL COMPUTER
Ideal for small businesses, schools, colleges, homes, etc. Suitable for the experienced, inexperienced, hobbyist, teacher, etc.

EG3000 Series

WITH NEW EXTRA KEYS!

ONLY \$575
POSTAGE \$20

● 16K user RAM plus extended 12K Microsoft BASIC in ROM ● Fully TRS-80 Level II software compatible ● Huge range of software already available ● Self contained. PSU, UHF modulator, and cassette ● Simply plugs into video monitor or UHF TV ● Full expansion to disks and printer ● Absolutely complete — just fit into mains plug.

ONE YEAR GUARANTEE SAVE DOLLARS

SHARP PC1211

\$190

COMPUTER POWER THAT ONCE FILLED A ROOM CAN NOW BE CARRIED IN YOUR POCKET!

● Programs in BASIC ● "QWERTY" Alphabetic Keyboard ● 1.9K Random Access Memory ● Long Battery Life.

ONE YEAR GUARANTEE

TV GAME BREAK OUT KIT

Has got to be one of the world's greatest TV games. You really get hooked. Has also 4 other pinball games and lots of options. Good kit for up grading old amusement games.

MINI KIT PCB, sound & vision modulator, memory chip and de code chip. Very simple to construct \$30.00
OR PCB \$6.00 MAIN LSI \$17.00

TTL SALE

| | | |
|---------------|----------------|------------------|
| 74LS00 \$0.15 | 74LS74 \$0.45 | 74LS365 \$0.75 |
| 75LS04 \$0.15 | 74LS86 \$0.55 | 74LS373 \$2.20 |
| 74LS05 \$0.20 | 74LS93 \$0.90 | Z80A \$5.50 |
| 74LS10 \$0.29 | 74LS157 \$1.20 | Z80 \$4.20 |
| 74LS32 \$0.35 | 74LS165 \$1.75 | REG. 7805 \$0.90 |

SOCKETS LOW PROFILE

| | | |
|---------------|---------------|---------------|
| 14 PIN \$0.10 | 18 PIN \$0.15 | 24 PIN \$0.25 |
| 16 PIN \$0.10 | 20 PIN \$0.15 | 40 PIN \$0.30 |

10V Power Adapter 600ml. \$6.90 UHF Modulators \$9.90

GET YOURSELF A NEW EPSON MX80 & MX70 PRINTER AND SAVE A FORTUNE

Price on application

Interface Cards for Apple, Pet, TRS80, and PMC — RS232 Interface Cards not necessary for parallel.

Full TRS80 POSTAGE \$20

ONE YEAR GUARANTEE

COMP PRO MIXER

Professional audio mixer that you can build yourself and save over \$200.

Only \$199 for complete kit.

power supply \$50.00

POSTAGE \$20

ACCESSIT AUDIO ADD-ONS

LOOK! MICROACE/SINCLAIR USERS

8K FLOATING POINT SUPER ROM PACK

WITH NEW MANUAL ONLY \$35

MICROACE/SINCLAIR VIDEO UPGRADE KIT

Only runs with NEW ROM (Smooth screen display) ONLY \$29

MICROACE/SINCLAIR 16K RAM PLUS EXPANSION BOARD

3 SLOTS WITH EXTRA POWER SUPPLY

ONLY 16K \$149 ONLY 4K \$110

MicroAce A COMPLETE COMPUTER

A new generation of miniature computers

2K Kit ONLY \$149 Post and Packing FREE

IMMEDIATE DELIVERY

Sinclair is a Registered Trademark of Sinclair Research Ltd.



Please make checks and money orders payable to **MicroAce** or phone your order quoting **Master Charge, Visa, Diners Club or American Express** number for immediate despatch. Add 6% Tax for Shipments inside California. **MicroAce**, 1348 East Edinger, Santa Ana, California, Zip Code 92705. Telephone: (714) 547 2526

PS—A FORTH-Like Threaded Language, Part 1

Valo G Motalygo
1091 Tanland Dr #204
Palo Alto CA 94303

[**Editor's Note:** Alan Taylor of Computerworld once called the FORTH programming language "not so much a language itself as a hotbed for growing other languages." The PS language described in this article is a new language with its roots in the FORTH hotbed and the concept of subroutine-threaded code (see "Varieties of Threaded Code for Language Implementation" by Terry Ritter and Gregory Walker in the September and October 1980 issues of BYTE). This is an advanced theoretical article that draws heavily on a working knowledge of FORTH. For further information, see "What Is FORTH? A Tutorial Introduction" by John S James, and the other FORTH articles, in the August 1980 BYTE devoted to the language....GW]

The main purpose of a programming system is to facilitate the user's communication with the computer.

I believe that operating systems or programming languages accepting something like conventional text are close to being ideal where the user-computer interface is concerned. All the other advantages or disadvantages of any particular system are "problem-oriented." In other words, what is convenient for one user might be unacceptable for another. Let us consider programming systems that are supposed to be useful for all potential users, beginning with the simplest system of this kind—assembly language.

There are many flaws with assemblers: assembly-language programs are not portable, they are difficult to write and debug, the user must have detailed knowledge of the computer hardware, and so on. However inconvenient it is, an assembly language is still a general-purpose programming system, much as the computer is a general-purpose data-processing device.

On the other hand, designers of high-level languages have to pay for obliterating low-level potential by sup-

porting painful procedures of introducing assembler subroutines into a high-level program.

Thus, the problem with low-level languages is that they are not convenient to use; the problem with high-level languages is that they cannot be considered general-purpose programming systems because of their lack of low-level capabilities and their tendency to force programming structures that might not be optimal for the problem at hand.

The multilevel approach to programming has enriched FORTH with many interesting features.

FORTH is a good example of a multilevel system where this conflict is partially resolved. The multilevel approach to programming has enriched FORTH with many interesting features (see the article "What Is FORTH? A Tutorial Introduction" by John S James on page 100 of the August 1980 BYTE).

The principal idea of FORTH is to use a set of general-purpose low-level subroutines for encoding new ones, which can be further used for introducing more sophisticated programs. To implement this simple idea, FORTH provides the user with a set of tools, briefly described below.

FORTH maintains a dictionary where every subroutine is stored with its name and either an object code or a sequence of pointers to other subroutines in the dictionary. A dictionary entry is called a *word* and the address of a word in the dictionary is called a *word pointer*. In some FORTH systems, the sequence of the word pointers is preceded by a short piece of object code that executes (or "chains") the words being pointed to. A dictionary entry also contains the address of the previous word to facilitate searching for a word in the dictionary.

The low-level words in FORTH are stack operations like DUP (duplicate the number on the top of the stack), DROP, SWAP, + (add the two numbers on the stack), AND, OR, NOT, and @ (pronounced fetch and

About the Author

Valo G Motalygo is on the staff of Friends Amis Inc, involved with the Quasar hand-held computer, and is currently working on an implementation of PS.

meaning replace an address on the top of the stack with its contents). All the stack operations are described more thoroughly in the "FORTH Glossary" (August 1980 BYTE, page 186).

The stack operations can be considered an expanded instruction set. Data can be introduced and accessed with the help of words like VARIABLE , CONSTANT , { ." } (pronounced dot-quote and meaning compile and type an ASCII string), &X (push ASCII code of X onto the parameter stack), etc. [Remember that BYTE uses braces to delineate certain FORTH words and phrases; see the PS Syntax text box for more details....GW]

It is easy to write programs in FORTH, but it is a pain in the neck to program in FORTH's assembler.

A programmer can define new words through the low-level ones or through the previously defined words, using such auxiliary tools as the control structures { IF...ELSE...ENDIF }, { BEGIN...AGAIN }, { BEGIN...UNTIL }, { DO...LOOP }, etc.

FORTH also has the capability of defining new words in the assembly language of the computer FORTH is running on. These words can be executed or used in high-level definitions as other words are used. Unfortunately, FORTH's assembler does not allow many of the facilities used while defining high-level words. For example, stack manipulations (DUP , DROP , SWAP , etc) are not supported, and no FORTH words can be mixed with the assembler code.

It is easy to write programs in FORTH itself, but it is a pain in the neck to program in FORTH's assembler. This is because you must abandon the capabilities of the high level and descend to an entirely new language—one that significantly differs from conventional assemblers, as well as from FORTH itself.

The reason why FORTH's assembler is not an organic part of FORTH is that these languages have different outputs: executable object code (for the FORTH assembler), and word pointers that must be chained to get executed (for FORTH itself). One way to resolve this conflict is a FORTH-like system that generates only object code without generating the word pointers. This two-part article describes the structure of a simple system of this kind, called PS (for Programming System).

Introduction to PS

Let us consider a programming system that is able to accept the following text:

```
ORIGIN xxxx nn nnnn nn nnnn ...  
RUN yyyy
```

The words *nn* and *nnnn* represent 8- and 16-bit hexadecimal numbers. When a 16-bit number is compiled, the

compilation address (also called *code pointer*) is incremented by 2. When an 8-bit number is compiled, the compilation address is incremented by 1.

ORIGIN is a special word that executes at compilation time. It takes the next word (*xxxx*) from the text, converts it to a 16-bit number, and sets the compilation address equal to this number.

RUN is another special word; it takes the next word (*yyyy*), converts it to a 16-bit number, and calls a subroutine at the address given by this number.

This primitive system has only one significant flaw: it is not very convenient to write programs directly in object code. But let us disregard the lack of convenience momentarily and think of an initial PS implementation. The compilation process operates as follows:

1. Read the next word from the text.
2. If it is a number, push it into the code and go to 1.
3. If it is a special word, execute it and go to 1.

The system will be more convenient with more special words defined. One such example is LABEL (which is used as { LABEL <name> }). It stores the word <name> together with the current compilation address into the dictionary.

We are considering a FORTH-like system that has a dictionary with all the necessary information about the special words. That is, now that the word LABEL is introduced, the PS dictionary contains three words: ORIGIN , RUN , and LABEL . The word LABEL allows the use of names instead of numbers in some situations.

Our system must be able to distinguish among several kinds of words: special words like ORIGIN or LABEL ; numbers; and labels, which are replaced with the number

PS Syntax

PS, like FORTH, uses punctuation in some of its words, which makes representing them in text a difficult problem. To decrease the chance of confusion while trying not to clutter text unnecessarily, we will sparingly use braces, {}, to isolate the character string within as a PS word or phrase. Braces will be used only under the following situations:

- when the material being quoted is a phrase of PS words (eg: { 26 LOAD } or { 3 5 + })
- with the PS words { , } (comma), { : } (colon), { ; } (semicolon), { ! } (exclamation point), { ' } (single quote mark), { " } (double quote mark), { [} (left bracket), and {] } (right bracket)
- with any word using punctuation marks (eg: { ." })

All other PS words will be set apart by a space on either side of the word. So, in this article, braces will always signal a PS word or phrase. The braces are not part of the word or phrase, and PS words will never use braces within the body of a figure or listing....GW

assigned to the label. We will use the phrase "value of the word" or the shorthand notation *V* to denote the current compilation address of the word, as stored in the dictionary with the word.

The new PS compilation process is:

1. Read the next word.
2. If it is a number, push it into the code and go to 1.
3. If it is a special word, execute it and go to 1.
4. If it is a label, push *V* into the code and go to 1.

The next step is to introduce undefined labels to allow forward references. If PS hits a name that is not in the dictionary, it assumes that the name's value will be defined later by LABEL. Meanwhile, PS makes a fake entry for this name with the value of the word, *V*, temporarily set to the current compilation address, also compiling 0000 into the code area instead of some real value (see figure 1a).

If PS hits an undefined label for the second time, it compiles the address of the fake entry (ie: the address of the previous reference to the undefined label) into the code area and sets *V* to the current code pointer decremented by 2, linking locations where the undefined label is used (see figure 1b).

When the LABEL statement is encountered, it must determine whether the word being defined has been used before. If it has, LABEL replaces the linked dummy pointers pointed to by the fake *V* with the value of the current code pointer. After this is done, *V* is also set to the value of the current code pointer, resolving the forward reference and turning the fake entry into the real one (see figure 1c).

It is more convenient to link and resolve forward references if the dictionary is separated from the code.

In general, PS links forward references to each other and to the value of the undefined word, with LABEL resolving forward references by storing the current code pointer in the locations linked by PS. If the word NEW is compiled at the address *cccc*, the resolved references appear as in figure 1c. The technique used here is essentially identical to that used by many one-pass assemblers and compilers.

It is more convenient to link and resolve forward references if the dictionary is separated from the code. This is because when PS hits a new word, a fake entry for this word is created before the space required to hold the code of the undefined word is known. This is very different from FORTH, which requires that every word be defined before it is used.

A More Sophisticated PS

This system has to distinguish between special words,

numbers, defined labels, and undefined labels. Let us assume that the type of the word (*T*) is stored in the dictionary with the name and its value. The new version of PS is then as follows:

1. Read the next word.
2. If it is a number, push it into the code and go to 1.
3. If it is an old word, check its type:
 If *T* = special, execute and go to 1.
 If *T* = defined, push the value of the word (*V*) into the code area and go to 1.

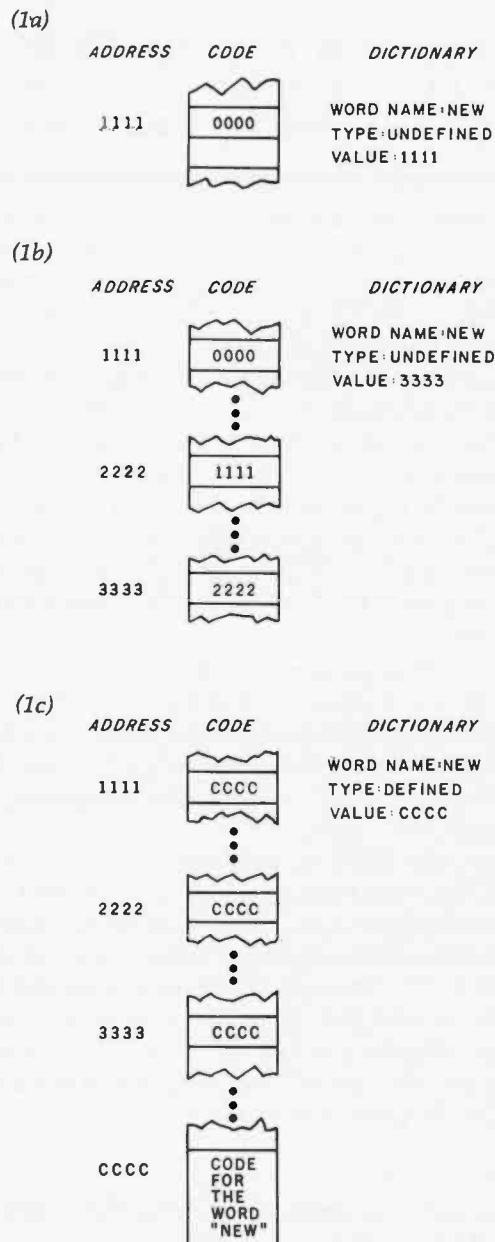

Figure 1: Handling of forward references in PS. Figure 1a shows what happens when the word NEW is first encountered as an undefined word. Figure 1b shows several occurrences of the word NEW linked together. When the word NEW is finally defined (by use of the word LABEL), the address of NEW is put into its dictionary listing and into the previous references to it.

If T = undefined, link the reference as described above and go to 1.

- If it is a new word (ie: not encountered before):
Make a new entry (that is, add this word to the dictionary), set the type to "undefined," set V to the code pointer, push 0000 into the code, and go to 1.

Let us introduce another special word "->" (pronounced "jump to" and used as { -> <name> }). This word compiles a jump to the address corresponding to the word <name> .

Now that labels can be compiled by the special word ->, we can interpret the nonspecial words as names of subroutines that are to be compiled as JSR V, where JSR is a "jump to subroutine" instruction and V is the address of the subroutine. (We assume a 6502-based system here. You would substitute the appropriate machine-language instruction for systems based on other microprocessors.) So the principal idea of FORTH (ie: building programs from previously defined subroutines) is fully implemented now that the words LABEL and -> have been introduced.

Our system will be more useful if it can execute the compiled words. To switch PS from compilation to execute mode, we can introduce two special words: { [} (left bracket), which enables the execute mode, and {] } (right bracket), which enables the compile mode.

PS with the execute and compile modes looks as follows:

- Read the next word.
- If it is a number (this is discussed in more detail below).
- If it is an old word in compile mode, check its type:
If T = defined, compile JSR V and go to 1.
If T = undefined, compile JSR (link), link it as described above, and go to 1.
If T = special, execute it and go to 1.
- If it is an old word in execute mode, check its type:
If T = defined, execute it and go to 1.
If T = undefined, print an error message, go to 1.
If T = special, execute it and go to 1.
- If it is a new word in compile mode:
Make an entry, set the type to "undefined," compile JSR 0000, go to 1.
- If it is a new word in execute mode, print an error message, go to 1.

An inquisitive reader now has at least two questions: what about arithmetic operations with labels, and what should happen to numbers?

The problem with numbers is that in one mode we want them to be compiled into the code; in another mode we want them to be pushed onto the parameter stack. The problem with arithmetic expressions is that we want addresses to be computed at compilation time.

The solution for both problems is to consider the compiled code as the parameter stack. That is, at run time we can push parameters into the free memory that follows

McGraw-Hill Bookstore

TAB Quality Paperbacks

- 33 Challenging Computer Games for TRS-80/Apple/PET** by David Chance. Learn-by-playing manual. 238 pp. \$7.95
- Computer Graphics** — with 29 ready-to-run programs by David Chance. For the home computerist. 256 pp. \$8.95
- Playing the Stock & Bond Markets with Your Personal Computer** by L. R. Schmeltz. For the hobbyist. 308 pp. \$9.95
- Microcomputer Interfacing Handbook: A/D and D/A** by Joseph J. Carr. What conversion is, interfacing. 336 pp. \$8.95.
- PASCAL** by David L. Heiserman. Loading the TRS-80 with this convenient language and use of it. 350 pp. \$9.95
- 67 Ready-To-Run Programs in BASIC: graphics, home & business, education, games** by W. Scott Watson. 182 pp. \$6.95

Well organized •
Easy to read •
Drawings • Charts

McGraw-Hill Bookstore
1221 Avenue of the Americas, N.Y., N.Y. 10020

Send me (circle) book 1 2 3 4 5 6 BY 101

No. Copies _____

Check or credit card only: Visa Amer Exp MasterCard

Acct. No. _____ Expires _____

Name _____

Address _____

City _____ State _____ Zip _____

For U.S. add applicable sales tax, plus \$2.50 each for postage and handling. Foreign costs slightly higher.

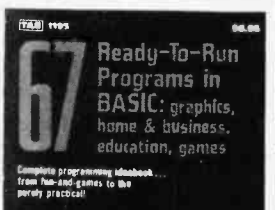
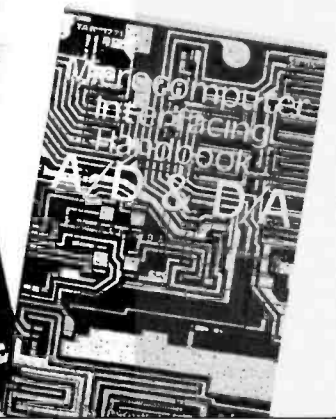
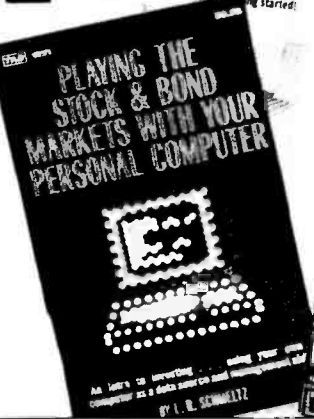
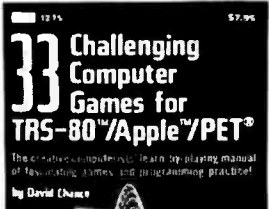

the compiled code. To keep track of the stack entries, we can increment (or decrement) the same code pointer used at compilation time. If the stack is used correctly, the code is not destroyed. Or we can check before every stack operation to make sure that the compiled code is never destroyed.

We will say that a number is *pushed onto the parameter stack* or *pushed into the code* or *compiled* whenever the number is stored in the location pointed to by the current code pointer. Then, in execute mode, numbers can be pushed into the code and added, multiplied, divided, etc, by the words +, -, /, and *. In compile mode, a number can be compiled with a preceding code that pushes the number onto the parameter stack at run time. This is done by the words PSHN (push number) and NUMBER, which will be discussed in part 2.

The use of the free space after the compiled code as a parameter stack adds much to the simplicity and flexibility of PS.

Low-Level Programming in PS

Let us assume that we have implemented PS with all the special words and stack operations described earlier. Let us also suppose that all the necessary subroutines are written in conventional assembly language, like that of the 6502 microprocessor, and are represented in the PS dictionary (ie: their names and addresses are stored in the PS dictionary with the assignment of the appropriate types).

Later, when speaking of the computer or the assembler, we mean the computer PS is running on and its assembler. We will also assume that the computer has a stack pointer for maintaining the computer stack and that the JSR instruction leaves the return address on the computer stack, just as it is done in the 6502. If there is no hardware stack, software can be written to simulate one.

Now, we will reexamine the simplest case—when PS is in execute mode with only numbers being compiled. If we want to compile an address or a 16-bit signed integer, we simply type in the number with either a leading zero (for positive numbers) or a minus sign (for negative numbers). Examples are 0x, 0xx, 0xxx, 0xxxx, -x, -xx, -xxx, and -xxxx. (Because PS accepts undefined words, it needs a way to distinguish numbers.) If we want to compile an instruction code or an 8-bit number, we can say #xx, where # is a special word that converts xx to an 8-bit number and pushes it into the code.

Our system will be more convenient if we introduce two more auxiliary words: CONST and BCONST. These are used as { CONST <name> nnnn } and { BCONST <name> # nn }, where nnnn and nn represent 16- and 8-bit numbers, respectively.

CONST (constant) makes a new entry in the PS dictionary for the <name> and compiles code that will push nnnn into the code at run time.

BCONST (byte constant) acts similarly, pushing an 8-bit number into the code at run time. The special word

is used with BCONST to emphasize the difference between CONST and BCONST. BCONST is used basically to compile 1 byte of object code. Thus, we can define the instruction set of the computer as a set of byte constants with whatever mnemonics we like. For example, on the 6502:

```
BCONST JSR # 20
BCONST JMP # 4C
BCONST RTS # 60
```

allow use of the mnemonics for the instructions "jump to subroutine," "jump via direct addressing," and "return from subroutine," instead of hexadecimal numbers 20, 4C, and 60. Also, naming the Boolean constants:

```
CONST TRUE 01
CONST FALSE 0
```

makes a program more readable.

To handle variables, the word VAR is used as { VAR <name> nnnn }. When VAR is executed, it creates a new entry for the word <name> and compiles object code that pushes the address of the memory location following this code onto the parameter stack at run time. The number nnnn is compiled by the text interpreter and is used to initialize the contents of the variable. One-byte variables can be defined as { VAR <name> # nn }.

A special word " (quote) is used as { " aaaaaaa" }, where aaaaaaa is a string of ASCII characters. The first quote compiles the following string preceded by its byte count. The second quote terminates the string. The space after the first quote is required so the text interpreter can identify quote as a word in its own right.

Strings can be defined in PS as follows: { VAR <name> " <some text>" }. When the word <name> is executed, the address of the string is pushed onto the parameter stack.

Arrays can be defined with the help of a special word called ARRAY, used as { ARRAY <name> nnnn }. When the word <name> executes, it pushes the address of the nnnn bytes, allocated for the array, onto the stack.

This completes part 1 of this article. In part 2, we will look at examples of low-level and high-level code in PS, and add a PS dictionary that includes some of the more technical details of the language. ■

Acknowledgments

I want to thank the programmers and management of Friends Amis Inc for their help and support in carrying out this work, especially Jim Houha and Rick Greicar, who nearly rewrote the manuscript; Victor Eliashberg of VARIAN Associates, who helped me realize the significance of hardware-software relationships; Anya Kroth of the University of California at Santa Cruz for her sharp remarks and kind criticism; Dave Boulton, FORTH consultant and member of the editorial review board of the FORTH Interest Group, and Bill Wilkinson of Optimized Systems Software, who made this work more understandable. Samuel Feldman of Hewlett-Packard made this work more understandable for the author himself.

Recursive Procedures for the 6502 Microprocessor

Dr Phillip W Dennis, 15314½ Larch Ave, Lawndale CA 90260

In recursive applications, the limited stack size of MOS Technology's 6502 8-bit microprocessor is a drawback. Due to the 6502's stack being restricted to one page (256 bytes starting at location 256, or page one of memory), subroutine calls are limited to a maximum of 128 levels. If the stack is used for temporary storage (or the recursive procedure calls other subroutines), then the depth of recursion possible is even less. Conversely, the Motorola 6800 microprocessor has a 16-bit stack pointer and the ability to locate the stack anywhere in memory.

Recently, I was confronted with this restriction during a conversion of S Tucker Taft's M6800 LISP interpreter to the 6502. (See reference 1.)

The stack-management routines in this "System Note" are based upon the 6800 routines in Mr Taft's article. The

major difference is that the 6800 can relocate its stack rapidly via the TXS instruction, while the 6502 must perform a slower 256-byte move of the stack page to main memory.

The technique for carrying out 6502 recursive procedures requires the procedure to detect two conditions—the overflow of the stack and the underflow of the stack. To detect overflow, each call to the recursive procedure must be accompanied by a check of the stack pointer. If the recursive procedure requires a certain number of bytes of stack storage per call (STKMIN), then a call to the procedure when the stack pointer is within STKMIN bytes of the stack top results in a stack overflow. At this point, code is executed to move the current stack to main memory, pointers are saved to point to the

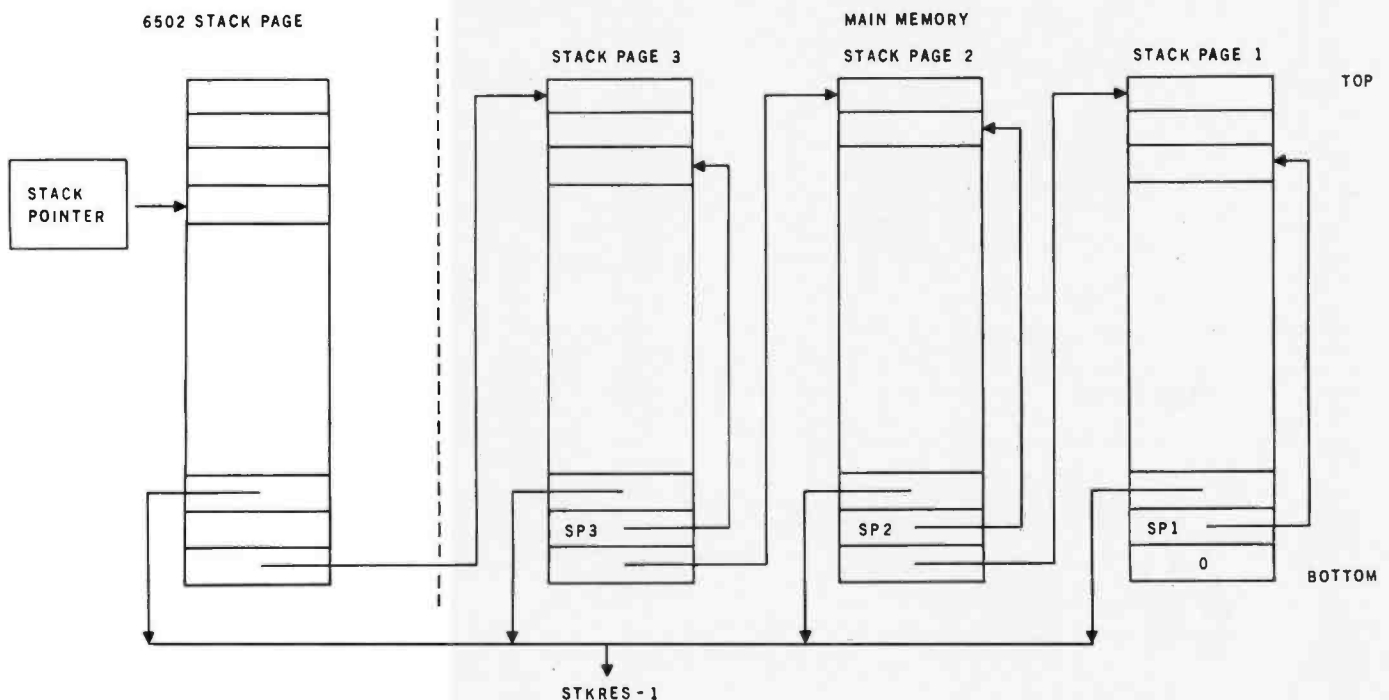

Figure 1: Typical stack configuration during execution of a recursive procedure that uses the stack-management routines. When the normal 256-byte stack page (page one of the 6502 memory space) is full, the contents are moved to another part of memory, freeing an additional 256 bytes of stack space. If the stack pointer returns to the bottom of the current stack page, the stack-restore routine (STKRES) moves the previous stack page (if any) back from main memory to page one, where it is treated as the current stack. The value of the stack pointer at the time that page was moved to main memory (stored as SP1, SP2, etc) is also restored.

System Notes

area where the stack was moved, and the stack pointer is reinitialized to the bottom of page one.

Detection of a stack underflow normally occurs in only one instance—when the recursive procedure is returning to a level with a return address located in the portion of the stack that was moved to main memory. It is the responsibility of the underflow-detection routine to restore the stack from main memory. One way to detect the underflow condition is to check the stack pointer prior to every return from the recursive procedure, and if an underflow is detected, branch to a stack-restoring routine. This method is slow, tedious to code, and wasteful of precious memory.

Fortunately, there's a more elegant way to detect underflow. This is done by initializing the bytes at the bot-

tom of the 6502 stack to point to a stack-restore routine. Thus, a return executed at the moment of underflow actually returns to the stack-restore routine, whose function is to restore the stack to the state prior to its move to main memory. This state can be represented by the value of the stack pointer at the moment it was moved to main memory and a pointer to the previously moved stack page. Figure 1 shows the memory configuration at a typical moment of execution.

Note that the implementation presented here assumes a memory-management scheme in which the stack pages in main memory are allocated from the low end of memory in increasing order, while all other data is allocated starting at the high end of memory in decreasing order. The pointers to these boundaries (figure 2) are stored at sym-

Listing 1: Assembly-language stack-management routines for recursive 6502 procedures: STKINIT initializes the special stack; STKCHK checks for stack overflow; STKRES, executed at stack underflow, restores the previous stack to page one of the 6502 memory.

```

:L151
1000 * ////////////////////////////////////////////////////
1010 * ///
1020 * /// STACK MANAGEMENT ///
1030 * /// PACKAGE FOR RECURSIVE ///
1040 * /// 6502 PROCEDURES. ///
1050 * ///
1060 * /// BY P.W. DENNIS ///
1070 * ///
1080 * /// SYMBOLIC LABELS = ///
1090 * ///
1100 * /// (TOP) := POINTER TO ///
1110 * /// DATA AT HIMEM ///
1120 * /// (NEXT) := POINTER TO ///
1130 * /// PREV STACK ///
1140 * /// PAGE. ///
1150 * /// LOMEM := INITIAL LOC. ///
1160 * /// FOR 1 ST ///
1170 * /// STACK MOVE. ///
1180 * /// MEMFUL := MEMORY FULL ///
1190 * /// ERROR EXIT ///
1200 * /// STKMIN := STACK SPACE ///
1210 * /// REQUIRED BY ///
1220 * /// THE RECURSIVE ///
1230 * /// PROCEDURE ///
1240 * ///
1250 * ////////////////////////////////////////////////////
1260 *
1270 *
1280 * ////////////////////////////////////////////////////
1290 * ///
1300 * /// STACK INITIALIZATION ///
1310 * ///
1320 * /// PLACE IN LINE AS FIRST ///
1330 * /// INSTRUCTIONS OF ///
1340 * /// PROGRAM ///
1350 * ///
1360 * ////////////////////////////////////////////////////
1370 *
1380 LDX #LOMEM ; INIT POINTER
1390 STX NEXT ; TO LOW END
1400 LDX #LOMEM ; OF MEMORY FOR
1410 STX NEXT+1 ; 1 ST STACK MOVE
1420 *
1430 LDX #STKRES-1 ; INIT STACK "BOTTOM"
1440 STX #IFC ; TO POINT TO
1450 LDX #STKRES-1 ; STACK RESTORE
1460 STX #IFB ; ROUTINE
1470 LDX #%FA ; AND INIT
1480 TXS ; STACK POINTER
1490 *
1500 * ////////////////////////////////////////////////////
1510 * ///
1520 * /// STACK CHECK ROUTINE ///
1530 * ///
1540 * /// JSR STKCHK AS 1 ST ///
1550 * /// INSTRUCTION OF A ///
1560 * /// RECURSIVE PROCEDURE. ///
1570 * ///
1580 * ////////////////////////////////////////////////////
1590 *
1600 STKCHK .EQ *

1610 *
1620 TSX ; CHECK STACK FOR OVERFLOW
1630 CPX #STKMIN ; ENOUGH SPACE ?
1640 BCC STKSAV ; NO, GO SAVE STACK
1650 RTS ; YES, JUST RETURN
1660 *
1670 STKSAV .EQ *
1680 *
1690 LDY NEXT ; SAVE LINK
1700 STY %IFE ; TO
1710 LDY NEXT+1 ; STACK PAGE IN
1720 STY %IFF ; MAIN MEMORY.
1730 *
1740 INY ; SKIP UP TO NEXT PAGE
1750 CPY TOP+1 ; CHECK FOR COLLISION WITH
1760 * ; STUFF AT HIGH END OF MEMORY
1770 *
1780 BCC STKSV1 ; NO COLLISION, GO MOVE STACK.
1790 JMP MEMFUL ; GO TELL BAD NEWS.
1800 *
1810 STKSV1 .EQ *
1820 *
1830 STY NEXT+1 ; SAVE POINTER
1840 INX ; SKIP OVER CURRENT
1850 INX ; RETURN ADDRESS
1860 STX #IFD ; AND SAVE CURRENT STACK POINTER.
1870 *
1880 LDY #0 ; INDEX FOR 256 BYTE MOVE
1890 STKSV2 LDA #100,Y
1900 STA (NEXT),Y
1910 DEY
1920 BNE STKSV2
1930 *
1940 PLA ; NOW SET UP RETURN TO CALLER
1950 STA #IF9
1960 PLA
1970 STA #IFA
1980 LDX #%FB ; RESET STACK POINTER TO POINT
1990 TXS ; TO BOTTOM OF STACK (%FA) AFTER RETURN
2000 RTS ; AND RETURN.
2010 *
2020 * ////////////////////////////////////////////////////
2030 * ///
2040 * /// STACK RESTORE ROUTINE ///
2050 * ///
2060 * ////////////////////////////////////////////////////
2070 *
2080 STKRES .EQ *
2090 *
2100 LDY #0 ; INDEX FOR 256 BYTE MOVE.
2110 STKRS1 LDA (NEXT),Y
2120 STA #100,Y
2130 DEY
2140 BNE STKRS1
2150 *
2160 LDA #IFE ; RESTORE LINK
2170 STA NEXT ; TO NEXT
2180 LDA #IFF ; STACK PAGE
2190 STA NEXT+1 ; IN MAIN MEMORY
2200 *
2210 LDX #IFD ; RESTORE OLD
2220 TXS ; STACK POINTER
2230 RTS ; AND RETURN.

```

bolic locations NEXT and TOP, respectively.

Also, this implementation does not assume that stack pages in main memory are page aligned (ie: the stack area starts on a page boundary). If they were page aligned, the low byte of NEXT would always be 0. This would free an extra byte of stack space and simplify the STKCHK and

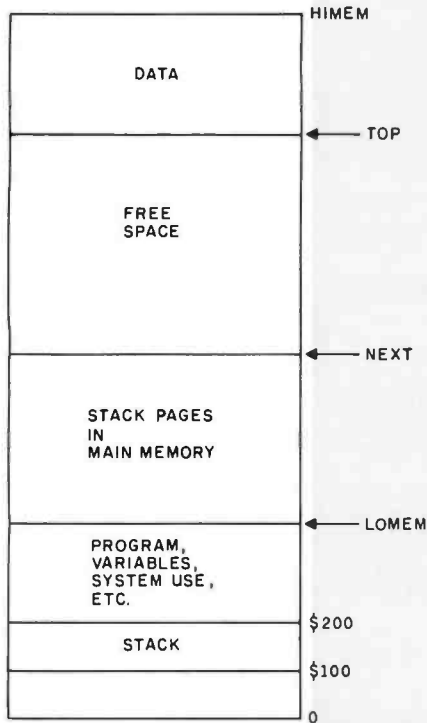

Figure 2: This stack-management technique, developed on the Apple II, assumes system-memory management as shown here.

STKRES routines by deleting the code that refers to the low byte of NEXT.

Finally, note that if an application requires several recursive procedures, then STKMIN should be marked as:

$$STKMIN = \max \{STKMIN_1, \dots, STKMIN_N\}$$

where $STKMIN_i$ is the stack storage required by the i th recursive procedure. Alternatively, to avoid wasting time, program the STKCHK routine to check a table of STKMINs indexed by the Y register. The calling procedure identifies itself as the caller by setting the Y register to point to the appropriate table entry. Line 1630 in listing 1 would then be replaced by:

```
TXA
CMP MINTAB,Y
```

The stack-management routines written on an Apple II using the S-C II assembler are given in listing 1. (The S-C assembler is available from S-C Software, POB 5537, Richardson TX 75080.) ■

Reference

1. Taft, S Tucker. "The Design of an M6800 LISP Interpreter." August 1979 BYTE, pages 132-152. Reprinted with complete 6800 assembly-language code for LISP interpreter as Document 112 in the BYTE Nybbles Library, now out of print.

IS YOUR North Star OUT OF SORTS?

INCREASE YOUR BASIC'S SORTING POWER OVER 1800%!

N*SORT is easy to use and will perform sorts on one and two dimensional or string arrays using optional sort keys. For example, to alphabetize A\$:

```
10 A$ = "ZYXWVUTS" \ REM Define String
20 SRT A$.LEN(A$).1 \ REM Sort A$
```

N*SORT interfaces to any release 4 or later North Star Basic and can be yours for **ONLY \$89** plus \$1.50 shipping. Calif. Res. add 6% tax. Send check VISA or M/C. Complete Brochure Available

SZ Software Systems

1269 Rubio Vista Road, Altadena, Calif. 91001 (213) 791-3202

Circle 357 on inquiry card.

6800 Micro Modules

FOR INTERFACING TO: sensors, transducers, analog signals, solenoids, relays, lamps, pumps, AC motors, DC motors, stepper motors, keyboards, displays, 488 GPIB.

ADDITIONAL FEATURES: 6800 MPU, counter/timer, fail safe battery back up

WINTEK

Wintek Corp.
1801 South Street
Lafayette, IN 47904
317-742-8428

Circle 393 on inquiry card.

NEW! for the '89 from **MAGNOLIA MICROSYSTEMS**

DOUBLE DENSITY DISK CONTROLLER

for both 5 1/4" & 8" drives
only **\$595** complete
including CP/M™ 2.2

MAGNOLIA MICROSYSTEMS, INC.
2812 Thorndyke W., Seattle 98199
(206) 285-7266 (800) 426-2841

CP/M is a trademark of Digital Research.

Circle 208 on inquiry card.



META TECHNOLOGIES



26111 Brush Avenue, Euclid Ohio 44132
CALL TOLL FREE 1-800-321-3552 TO ORDER
IN OHIO, call (216) 289-7500 (COLLECT)

1001 THINGS TO DO WITH YOUR PERSONAL COMPUTER

BY MARK SAWUSCH

333 pages \$7.95

333 pages, written in simple terms, of "what-to-do" and "how-to-do-it". Suitable not only for microcomputers, but for programmable calculators as well. Includes program listings, formulas, a glossary of computer terms and more! Definitely a MUST BUY!

A PARTIAL LIST OF APPLICATIONS

| | |
|---------------------------------|-------------------------|
| Real Estate Evaluation | Test Your Typing Speed |
| Astrology | Finances & Investments |
| Income Tax | Biorythm |
| Speed Reading | Energy Efficiency |
| Personality Test | Antenna Design |
| Statistical Analysis | Letter Writing |
| Logic Circuit Analysis | Recipe Index/Calculator |
| Carpenter and Mechanic's Helper | |
| General Purpose Clock Timer | |

"OTHER MYSTERIES" VOLUME III

by Dennis Kitsz

Call now and place your order for this new book, "THE CUSTOM TRS-80™ & OTHER MYSTERIES", from IJG, Inc. More than 300 pages, with over 60 photographs, of projects for the hardware hobbyist. Includes schematics, PC layouts, software driver code, etc. for such do-it-yourself undertakings as high resolution graphics, reverse video, real-time clock/calender, music synthesis, ROM/RAM additions and more!

THE CUSTOM TRS-80™ \$29.00
CALL FOR AVAILABILITY

MICROPARAPHERNALIA NEWDOS by APPARAT

NEWDOS/80 by Apparat \$149.95
 NEWDOS + to
 NEWDOS/80 UPGRADE CALL
 NEWDOS + with ALL UTILITIES
 35-track \$69.95
 40-track \$79.95

BOOKS

TRS-80™ DISK
AND OTHER MYSTERIES .. \$19.95
MICROSOFT™ BASIC DECODED \$29.95

Let your TRS-80™ Teach You ASSEMBLY LANGUAGE

REMSOFT's unique package, "INTRODUCTION TO TRS-80™ ASSEMBLY PROGRAMMING" includes ten 45-minute lessons on audio cassettes, a display program for each lesson providing illustration & reinforcement, and a text book on TRS-80™ Assembly Language Programming. Includes useful routines to access keyboard, video, printer and ROM. Requires 16K - Level II, Model I.

REMASSEM-1 \$69.95
FOR DISK SYSTEMS \$74.95

Let Your TRS-80™ Teach You ASSEMBLY LANGUAGE DISK I/O TECHNIQUES

REMSOFT does it again! REMDISK-1 is a concise, capsulated supplement to REMASSEM-1. Package consists of two 45-minute lessons on audio cassettes, and display programs providing illustration and reinforcement. Provides specific track and sector I/O techniques, and sequential and random file access methods and routines.

REMDISK-1 \$29.95

Let Your TRS-80™ Test Itself With THE FLOPPY DOCTOR & MEMORY DIAGNOSTIC

by DAVE STAMBAUGH

A complete checkup for your Model I. THE FLOPPY DOCTOR completely checks every sector of 35- or 40-track disk drives. Tests motor speed, head positioning, controller functions, status bits and provides complete error logging. THE MEMORY DIAGNOSTIC checks for proper write/read, refresh, executability and exclusivity of all address locations. Includes both diagnostics and complete instruction manual.
SYSTEM DIAGNOSTICS \$19.95

An improved version of the SYSTEM DIAGNOSTICS above. Designed for single or double density, 35-, 40-, 77-, or 80-track disk drives. Includes new and modified tests. Features THE FLOPPY DOCTOR, Version 3.0.
SYSTEM DIAGNOSTICS-V3 .. \$24.95

Single Sided, Soft-Sector 5 1/4-inch,
(for TRS-80™) Mini-floppy

DISKETTES

\$21.95

box of 10

PLAIN JANE™

These are factory fresh, absolutely first quality (no seconds!) mini-floppies. They are complete with envelopes, labels and write-protect tabs in a shrink-wrapped box.

PLAIN JANETM Diskettes \$21.95
10 boxes of 10 (each box) \$21.50

PLAIN JANE™ Gold

Introducing MTC's premium generic diskette. Single-Sided, Soft-Sector, DOUBLE-DENSITY, 5 1/4-inch diskettes with reinforcing HUB-RINGS. Individually 100% ERROR-FREE certified. Invest in GOLD!

PLAIN JANETM Gold \$25.95

VERBATIM'S PREMIUM DISKETTES DATALIFE™

Seven data-shielding improvements mean greater durability and longer data life. These individually, 100% error-free certified diskettes feature thicker oxide coating, longer-lasting lubricant, improved liner, superior polishing and more! Meets or exceeds IBM, Shugart, ANSI, ECMA and ISO standards.

VERBATIM DATALIFETM DISKETTES
5 1/4-inch (box of 10)
MD525-01 \$26.95
10 boxes of 10 (each box) \$25.95
8-inch FLOPPIES
Double-Density, FD34-8000 . \$43.95

'RINGS' & THINGS

HUB RING KIT for 5 1/4" disks \$10.95
HUB RING KIT for 8" disks \$12.95
REFILLS (50 Hub Rings) \$ 5.95
CLEANING KIT for 5 1/4" drives \$24.95
5 1/4-inch diskette case \$3.50
8-inch diskette case \$3.95
5 1/4-inch File Box for
50 diskettes \$24.95
8 inch File Box for
50 diskettes \$29.95

TRS-80 is a trademark of the Radio Shack Division of Tandy Corporation. DATALIFE is a trademark of VERBATIM. PLAIN JANE, AIDS-I, AIDS-III, CALCS-III, CALCS-IV, MERGE-III are trademarks of MTC.
© 1981 by Metatechnologies Corporation, Inc.

MOST ORDERS SHIPPED WITHIN ONE BUSINESS DAY

Products damaged in transit will be exchanged.

PRICES IN EFFECT October 1, 1981 THRU October 31, 1981,

Prices, Specifications, and Offerings subject to change without notice.

8110

WE ACCEPT

- VISA
- MASTER CHARGE
- CHECKS
- MONEY ORDERS
- C.O.D.

- Add \$3.00 for shipping & handling
- \$3.00 EXTRA for C.O.D.
- Ohio residents add 6 1/2% sales tax.

What's New?

MISCELLANEOUS

TRS-80 Color Computer ROMs

Eigen Systems will take any Color BASIC or Extended Color BASIC program for the TRS-80 Color Computer and transfer it from cassette to a ROM (read-only memory) that plugs into the Color Computer's external port. Prices start at \$45. Contact Eigen Systems, POB 10234, Austin TX 78766, (512) 837-4665.

Circle 500 on inquiry card.

An Expandable Microprocessor Trainer

The Omnibyte Trainer 1 microprocessor training module can be expanded from a simple teaching unit to a complete disk-based system. The main board of this two-board system contains a Motorola MC6808 microprocessor, 1.25 K bytes of programmable memory, provisions for up to 4 K bytes of PROM (programmable read-only memory), and onboard input/output capability. This board can function as a stand-alone computer. The trainer-interface board features an 8-digit display, keyboard encoder, command and data keys, and a hexadecimal keypad. A 2 K-byte monitor program and hardware trace circuitry are also included. Optionally available are parallel and serial interfaces, a data-rate generator, and expansion-card connectors. The Trainer 1 package contains a manual, all data sheets, schematics, monitor source-code listing, and a book on microprocessors. Prices range from \$349.95 to \$526.45. Contact Omibyte Corporation, 245 W Roosevelt Rd, Building 1-5, West Chicago IL 60185, (312) 231-6880.

Circle 502 on inquiry card.

Powerful Word Processor for the Apple

The Executive Secretary works with 40- or 80-column screens interchangeably, displays lower-case, and features a real shift key. The Executive Secretary also features page numbering and headers, file merge and unmerge, block operations, automatic insertion of full phrases for user-defined abbreviation, automatic envelope addressing, card-file system, IF and relational commands for conditional printing based on the contents of a data base, file chaining and nesting, and the ability to interface with Data Factory, Information Master, and VisiCalc files. It also permits keyboard input dur-

ing print operation; right- and left-justified tabs; interface with California Computer Systems' clock board for time stamping of documents; embedded or external printer commands; character, word, and line insert, replace or delete; selective or global search and replace; a built-in interface to the Hayes Micromodem II; menu-driven operation; and a manual. The Executive Secretary costs \$250. For details, contact Aurora Systems Inc, 2040 E Washington Ave, Madison WI 53704, (608) 249-5875.

Circle 501 on inquiry card.

Heath/Zenith Systems Sourcebook

The Information Center Sourcebook is a guide for Heath/Zenith computer-system users who are interested in compatible products from sources other than Heath/Zenith. The Sourcebook features sections for hardware, software, printed matter, and business-applications software, as well as listings of dealers and service centers. It is available for \$20 from the Information Center, 642-A W Rhapsody, San Antonio TX 78216, (512) 340-1561.

Circle 503 on inquiry card.

An Analysis of the Courseware Market

The 1981 Courseware Market Report is a reference book for companies and institutions preparing educational software. The report contains information on the creation and distribution of courseware and a competitive analysis of courseware materials. Market statistics, hardware and courseware suppliers, discussions of programming, and speculations on the future for computers in education are some of the topics covered in the study. The 1981 Courseware Market Report is available for \$175 from Shotwell and Associates, 44 Montgomery St, Suite 505, San Francisco CA 94104, (415) 956-2273. Circle 504 on inquiry card.

Where Do New Products Items Come From?

The information printed in the new products pages of BYTE is obtained from "new product" or "press release" copy sent by the promoters of new products. If in our judgment the information might be of interest to the personal computing experimenters and homebrewers who read BYTE, we print it in some form. We openly solicit releases and photos from manufacturers and suppliers to this marketplace. The information is printed more or less as a first-in first-out queue, subject to occasional priority modifications. While we would not knowingly print untrue or inaccurate data, or data from unreliable companies, our capacity to evaluate the products and companies appearing in the "What's New?" feature is necessarily limited. We therefore cannot be responsible for product quality or company performance.

What's New?

MISCELLANEOUS

Rockwell's 68000

Rockwell International's Electronic Devices Division has unveiled the R68000 16-bit microprocessor. The device addresses up to 16 megabytes, has more than 1000 instructions, and can process 8-, 16-, or 32-bit data. The R68000 can be sampled in 4 and 6 MHz versions; an 8 MHz version is under development.

Additional devices in the R68000 family will include a peripheral controller, a memory manager, a DMA (direct memory access) controller, and a multiprotocol communications controller.

The price for the 4 MHz R68000 is \$210, the 6 MHz version is \$220, and the projected cost of the 8 MHz device is \$250. Contact Rockwell International, Electronic Devices Division, 3310 Miraloma Ave, POB 3669, Anaheim CA 92803, (714) 632-2321. Circle 505 on inquiry card.

FORTH on a ROM

Martin Schaaf's full Z80 fig-FORTH on a ROM (read-only memory) replaces the BASIC ROM in the TRS-80 Model I. A screen editor, 8080/Z80 assemblers, and a metacompiler that reproduces FORTH from high-level code are included. The price is \$250 from Martin Schaaf, POB 1001, Daly City CA 94017.

Circle 508 on inquiry card.

48 K-Byte Board for the Atari

The MM48001 is a 48 K-byte programmable-memory board for the Atari 400. It makes Atari 800 software compatible with the 400. The board costs \$299. Contact Intec, Suite 111, 3387 Del Rosa North, San Bernardino CA 92404, (714) 864-5269.

Circle 499 on inquiry card.

ZEN and the Art of Programming

ZEN is an operating system in the North Star format using 5-inch floppy disks. The system includes a word processor with line justification, file creation, and search and insertions. The monitor comes with memory testing, repeat cross-functions, and port controls. The assembler has global labels, partial print designation, stops, and trial assembly. It is available for \$75 from Zenrad Controls Company, 1575 A P S, Santa Barbara CA 93103, (805) 965-4996. Circle 506 on inquiry card.

System 6220 Counter/Timers

The System 6220 multifunction counter/timers can be combined to provide an array of display and control functions. Production quantities, flow, rotation, displacement, frequency, and elapsed time can be measured in process monitoring, test systems, and production control. Prices start at \$115 for the 6222 counter/timer. Contact Newport Electronics Inc, 630 E Young St, Santa Ana CA 92705, (714) 540-4914. Circle 509 on inquiry card.

CP/M Business Software

Rocky Mountain Software Systems has a complete business-software system available for \$199. The system is comprised of four software packages: General Ledger, Accounts Receivable, Accounts Payable, and Payroll. Written in MBASIC, the system will run on any CP/M-based microcomputer with at least 48 K bytes of programmable memory. Individual packages can be purchased separately for \$59. Contact Rocky Mountain Software Systems, POB 3282, Walnut Creek CA 94598.

Circle 512 on inquiry card.

Computer Pollution Control

Electronic Specialists Inc, 171 S Main St, Natick MA 01760 (617) 655-1532, has announced Super Isolator, a device designed to control electrical spikes, surges, and noise. Super Isolator features three individually filtered AC sockets. Equipment interactions and disruptive or damaging power-line pollution are controlled. The Super Isolator controls pollution for an 1875 W load. Each socket can handle a 1000 W load. The Model ISO-3 Super Isolator costs \$94.95.

Circle 507 on inquiry card.

Memory Boards for the Atari

The AT-16, a 16 K-byte, 200 ns memory board, and the AT-32, a 32 K-byte, 200 ns board, are compatible with all existing Atari 400 and 800 software and hardware. They install with no modifications. The AT-16 costs \$119.50, and the AT-32 costs \$199.50. Contact Microtek Peripherals Corporation, 9514 Chesapeake Dr, San Diego CA 92123, (800) 854-1081; in California (714) 278-0630.

Circle 510 on inquiry card.

TRS-80 Space Raiders

Space Raiders is a machine-language program that creates a detailed simulation of outer space combat. Current and target position, fuel, shield energy, and heading are all displayed. There are five levels of play.

Space Raiders runs on 16 K-byte Level II TRS-80 Model I microcomputers. It costs \$24.95. Contact Bosen Electronics, 445 E 800 North, Spanish Fork UT 84660, (801) 798-9553.

Circle 513 on inquiry card.

What's New?

MISCELLANEOUS

64 K-Byte Board for S-100 Systems

The CI-S100 memory board is designed specifically for Sol, Cromemco, North Star, and other S-100 systems. The 64 K-byte dynamic board doesn't require WAIT states at 2 or 4 MHz. It is addressable in 4 K increments up to 512 K bytes. Features include expandability to 512 K bytes with a bank-select feature that allows users to select up to eight 64 K-byte cards. The hidden refresh does not interfere with block DMA (direct memory access) WRITE applications.

The CI-S100 costs \$575. Contact Chrislin Industries Inc, 31352 Via Colinas 102, Westlake Village CA 91361, (213) 991-2254.

Circle 541 on inquiry card.

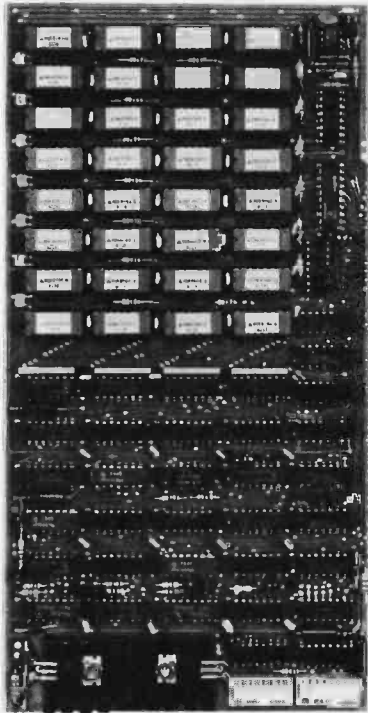

2 K-Byte ROM from Motorola

The MCM65516L43M is a 2 K-byte CMOS (complementary metal-oxide semiconductor) ROM (read-only memory). It is compatible with CMOS microprocessors that share address and data lines. The output-enable pin can be programmed for active high or low, or MOTEL (ie: MOTorola, INTEL) mode, which provides compatibility with Motorola's 6800 series or Intel's 8085 microprocessors. A monitor program for the Motorola CMOS MC146805E2 microprocessor is included on this ROM. Contact the MOS Integrated Circuit Division, Motorola Semiconductor Products Inc, Austin TX 78721, (512) 928-6660.

Circle 542 on inquiry card.

Programmable Array-Logic Designers Kit

PALKIT is designed to acquaint engineers with the Programmable Array Logic (PAL) family of integrated circuits. PAL circuits are used to reduce the number of 5400 and 7400 series components needed in circuit designs. By combining functions of TTL (transistor-transistor logic) devices, PAL circuits can reduce total package count by as much as 12 to 1.

The kit contains one preprogrammed master PAL circuit and seven unprogrammed circuits. Four of the unprogrammed devices are for combinatorial functions. The other three are for sequential functions. A PAL data sheet, instructions for programming, a paper tape, and an engineering reference card are included. The PALKIT is available for \$99.95 from Monolithic Memories, 1165 E Arques Ave, Sunnyvale CA 94086, (408) 739-3535.

Circle 543 on inquiry card.

EPROM Programming

Logic Technology Services Inc (LTSI) is offering an EPROM (erasable programmable read-only memory) programming service. A program from a master EPROM, truth table, or paper tape can be reproduced to a compatible device, which is provided by LTSI. The service can be performed for 2704/2708s, 2716s, 2732s and 2764s.

Fees range from \$9.95 to \$45.95, depending upon EPROM. EPROMs can be erased for \$0.25 per device. A truth table for reproduction can be entered for an additional \$15 per 1000 words. A nonreturnable copy of the truth table should be provided. Quantity prices are available to clients who provide the components.

For details, contact Logic Technology Services Inc, 2400 E Oakton, Arlington Heights IL 60005, (312) 364-4670.

Circle 544 on inquiry card.

Fiber-Optic Transmitter and Receiver Modules

The MFOLO2T fiber-optic transmitter and the MFOLO2R receiver modules are designed for digital-communication systems. The transmitter module incorporates an LED (light-emitting diode) with an output of 70 μ W, which can provide data transmission over a distance of 1 kilometer; greater distances can be achieved with other cables and emitters. The receiver has a bandwidth from DC to 200 kbps (bits per second), a dynamic range of 25 dB, and is TTL- (transistor-transistor logic) compatible. The modules are compatible with plastic- or glass-fiber cable and operate from a single +5 V supply. Full-duplex, star, daisy chain, and other system designs can be achieved.

The MFOLO2T costs \$36.80, and the MFOLO2R costs \$42.50. Contact Motorola Semiconductor Products Inc, POB 20912, Phoenix AZ 85036, (602) 244-4556.

Circle 545 on inquiry card.

What's New?

MISCELLANEOUS

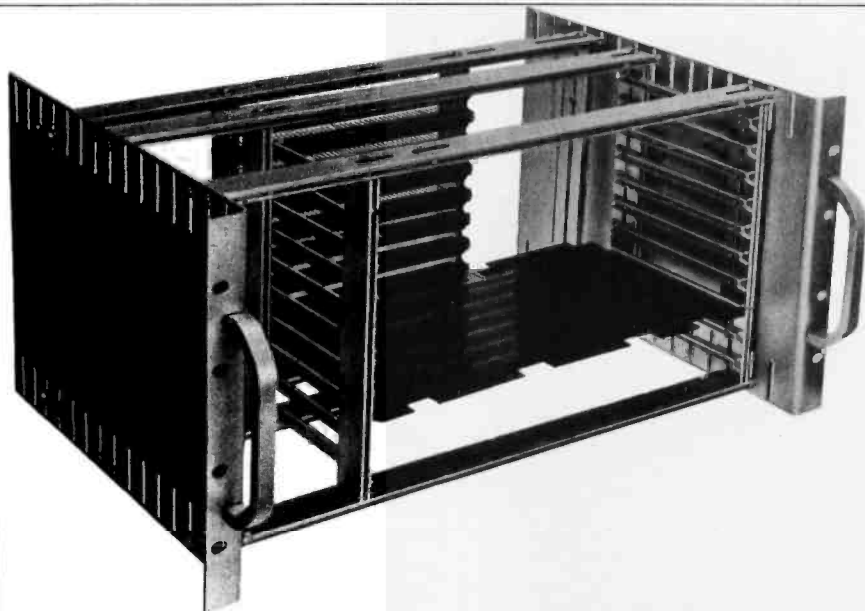

Universal Card Cage

The CCK-80 card cages let designers package systems using Series-80 Multibus, S-100, Motorola, and Rockwell microcomputers and accessory cards. The fully adjustable, ten-board cages are priced at \$79 each.

Additional space along the side of each cage can hold two fans and can be used for power supplies or other equipment. The rear cross members accept card-edge

connectors or motherboards. The cage fits any standard 19-inch rack and weighs five pounds.

Cage accessories include card-edge connectors, bottom- and side-hinged front panels, latches, screw-attached front panels, top and bottom covers, handles, and tilt-up feet. Contact Vector Electronic Company, 12460 Gladstone Ave, Sylmar CA 91342, (213) 365-9661.

Circle 514 on inquiry card.

Keyboard Actuator

When interfaced with microcomputers, such as the TRS-80, PET, or Apple, the KGS-80 keyboard actuator turns IBM Selectric and SCM typewriters into printers. The KGS-80 rests on the typewriter keyboard and plugs into the computer's printer interface. No modifications are necessary and no software is required to operate the device. Details on this \$599 peripheral can be obtained from Kogyosha Company Ltd, 179 Riveredge Rd, Tenafly NJ 07670, (201) 569-8769.

Circle 515 on inquiry card.

Prevent Static Damage

Wescorp has static-dissipative desk and bench covers of soft vinyl to protect products from static electricity damage. The WS-227-1B Stat-Mat reduces vibration and glare and is water and chemical resistant. Static resistance meets DOD (Department of Defense) handbook specifications. The covers are available in 2- and 4-foot widths cut to any length up to 100 feet. The cost is \$4 per square foot.

Contact Wescorp, 1155 Terra Bella Ave, Mountain View CA 94043, (415) 969-7717.

Circle 517 on inquiry card.

64 K-Byte Static Memory Board for the S-100 Bus

The RAM 17 is a 64 K-byte static board for S-100 microcomputers. It is guaranteed to run with 6 MHz Z80s and 10 MHz 8086/8088s. The board features power dissipation of less than 2 W and 24-bit addressing. The RAM 17 can be addressed on any 64 K page boundary and can be disabled in 16 K blocks. The upper 8 K block can have 2 K windows disabled for memory-mapped peripherals.

RAM 17 uses 2 K by 8-bit static integrated circuits that are compatible with 2716 EPROMs (erasable programmable read-only memory). Prices range from \$1095 to \$1595. Contact CompuPro, Godbout Electronics, POB 2355, Oakland Airport CA 94614, (415) 562-0636.

Circle 516 on inquiry card.

Color-Graphics Display Controller

The NEC μ PD7220 integrated circuit operates between the video-display memory and the microprocessor bus. It performs most of the tasks required to generate displays and to manage display memory. Compatible with 8080/8085/8086, Z80, 6800, and other processors, the device minimizes host-processor software overhead. It features DMA (direct memory access) control, graphics figure-drawing capabilities, and a light-pen input. The unit has a 5 MHz clock rate and requires a single +5 V supply.

Samples of the μ PD7220 are priced below \$100. Contact NEC Microcomputers Inc, 173 Worcester St, Wellesley MA 02181, (617) 237-1910.

Circle 518 on inquiry card.

What's New?

PUBLICATIONS

Catalog of More Than 2000 Rental Items

Genstar Rental Electronics Inc, which specializes in the short-term rental of electronic equipment, has a free catalog that lists its rental items. The catalog is divided into 47 categories that range from amplifiers to test chambers. There are analyzers, generators and meters of all types, plus microcomputers, microprocessor instrumentation, PROM (programmable read-only memory) programmers, oscilloscopes, and data terminals. For your copy, contact Genstar Rental Electronics Inc, 19527 Business Center Dr, Northridge CA 91324, (213) 993-7368.

Circle 519 on inquiry card.

Directory of Robotics Products

The Robotics Industry Directory contains a summary of the available products in the robotics industry. Robots, robot subsystems, components, general technical specifications, pricing data, and marketing contacts are featured. Also included is information on consulting firms, personnel recruiting, engineering design, systems integration, and custom-manufacturing. The final section provides information on the activities of public organizations, university research, and private research laboratories. The Directory costs \$24.95. Contact Robotics Industry Directory, POB 725, La Canada CA 91011, (213) 352-7937.

Circle 520 on inquiry card.

Man/Machine Communications

Speech Technology is a quarterly magazine concerning man and machine communications. It deals with the state of the art in voice synthesis and recognition for the engineer, scientist, educator, manager, and other users. Articles on linear-predictive coding, adding word recognition to a system, and new applications, such as a voice-activated door lock, are among the topics covered. New products, events, and a newsletter are also featured. A one-year subscription is \$50 from Media Dimensions Inc, 525 E 82nd St, New York NY 10028, (212) 680-6451.

Circle 521 on inquiry card.

SUNNY LOW LOW COST POWER SUPPLIES

FOR S-100, FLOPPY DISKS.



KIT 1, 2 & 3 For S-100

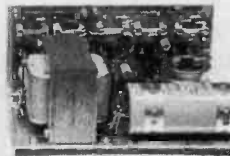

R3 For Three 8" or 5 1/4" Disk Drives

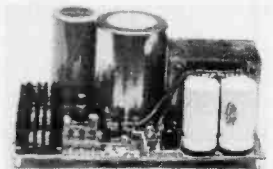

S3 2 in 1 Unit for S-100 and two 8" or 5 1/4" Disk Drives. It fits most Disk System Mainframes.

S-100 POWER SUPPLY KITS (OPEN FRAME WITH BASE PLATE, 3 HRS. ASSY. TIME)

| ITEM | USED FOR | @ + 8 Vdc | @ - 9 Vdc | @ + 16 Vdc | @ - 16 Vdc | @ + 28 Vdc | SIZE W x D x H | PRICE |
|-------|-----------------|-----------|-----------|------------|------------|------------|-------------------|-------|
| KIT 1 | 15 CARDS SOURCE | 15A | | 2.5A | 2.5A | | 12" x 5" x 4 7/8" | 52.95 |
| KIT 2 | SYSTEM SOURCE | 25A | | 3A | 3A | | 12" x 5" x 4 7/8" | 59.95 |
| KIT 3 | DISK SYSTEM | 15A | 1A | 2A | 2A | 4A | 14" x 6" x 4 7/8" | 67.95 |

DISK DRIVE POWER SUPPLY "R3" REGULATED, OPEN FRAME, ASSY. & TESTED 67.95

SPECS + 5V @ 5A OVP. -5V @ 1A + 24V @ 5A. SHORTS PROTECT. 2 SIZES AVAIL. 1) 9" (W) x 6 1/4" (D) x 4 3/8" (H). 2) 9" (W) x 4 7/8" (D) x 5 1/4" (H) OPTION 1) REPLACE + 24V BY + 12V. 2) FOR SIZE 1 ONLY. ADD + 12V @ 1A. AT AN ADDITIONAL \$12.00. IDEAL FOR THREE 8" or 5 1/4" FLOPPY DISK DRIVES. SUCH AS SHUGART 801/851. SIEMANS FDD 100-8/200-8 OR 100-5 ETC.

DISK SYSTEM PWR SUPPLY "S3" OPEN FRAME, ASSY. & TESTED. COMPACT SIZE: 10" (W) x 6" (D) x 5" (H) 92.95

REGULATED OUTPUTS FOR DISK DRIVES +5V @ 4A. -5V @ 1A. +24V @ 4A (OR + 12V @ 4A). SHORTS PROTECT. UNREGULATED OUTPUTS FOR S-100 +8V @ 14A. + 16V @ 3A (OPTION. ADD OVP FOR +5V. ADD \$5.00) A COMPLETE UNIT FOR DISK SYSTEM WITH THE MAINFRAME CONTAINING 12 SLOTS & TWO 8" or 5 1/4" DISK DRIVES.

POWER TRANSFORMERS (WITH MOUNTING BRACKETS)

| ITEM | PRIMARY | SECONDARY #1 | SECONDARY #2 | SECONDARY #3 | SIZE W x D x H | PRICE |
|------|---------|----------------|------------------|----------------|--------------------------|-------|
| T1 | 110/120 | 2 x 8 Vac, 15A | 28 Vac, CT, 2.5A | | 3 3/4" x 3 3/8" x 3 1/8" | 21.95 |
| T2 | 110/120 | 2 x 8 Vac, 25A | 28 Vac, CT, 3.5A | | 3 3/4" x 4 3/8" x 3 1/8" | 27.95 |
| T3 | 110/120 | 2 x 8 Vac, 15A | 28 Vac, CT, 2.5A | 48 Vac, CT, 2A | 3 3/4" x 4 3/8" x 3 1/8" | 29.95 |
| T4 | 110/120 | 2 x 8 Vac, 6A | 28 Vac, CT, 1.5A | 48 Vac, CT, 3A | 3 3/4" x 3 3/8" x 3 1/8" | 22.95 |
| T5 | 110/120 | 2 x 8 Vac, 6A | 28 Vac, CT, 2A | | 3" x 3" x 2 1/2" | 14.95 |

SHIPPING For each power supply \$5.50 in Calif., \$7.50 in other states, \$14.00 in Canada. For each Transformer \$5.00 in all States, \$10.00 in Canada. Calif. Residents add 6% Sales Tax.

MAILING ADDRESS:

P.O. BOX 4296

TORRANCE, CA 90510

TELEX: 830-5010

ANSWER BACK FOR TELEX SUNYCO TRUC

SUNNY INTERNATIONAL
(TRANSFORMERS MANUFACTURER)
(213) 328-2425 MON-SAT 9-6

SHIPPING ADDRESS:

22129 1/2 S. VERMONT AVE

TORRANCE, CA 90502



What's New?

PUBLICATIONS

S-100 Products Catalog

Ackerman Digital Systems Inc, the maker of processor boards and other items for S-100 systems, has published a catalog of its products. Music and 6809 processor boards, PROM (programmable read-only memory) programmers, and other devices are described in the catalog. For a copy, contact Ackerman Digital Systems Inc, 110 N York Rd, Elmhurst IL 60126, (312) 530-8992.

Circle 523 on inquiry card.

Electronic Learning

Electronic Learning magazine is a bimonthly publication for educators who buy and use electronic hardware and software in elementary and secondary education. A nontechnical source of ideas and information, it includes articles on the use of microcomputers, video cassettes, videodiscs, and other aids in education. For more information, contact Scholastic Inc, 50 W 44th St, New York NY 10036, (212) 944-7700.

Circle 524 on inquiry card.

Looking for a Certain Publication?

The Westlake Guide lists periodicals and offers package subscriptions for computer, electronics, video, telecommunications, and business publications. A copy of the guide costs \$1. Contact Westlake Subscription Service, 4200 S Louise, Sioux Falls SD 57106, (605) 331-6930.

Circle 522 on inquiry card.

Apple Software Directorles

Apple Software Directorles is a three-volume set that lists available business, games, and educational software for Apple computers. It includes the names and addresses of more than 400 software vendors.

The Apple Software Directory—Volume 1: Business Guide costs \$5.95. Volume 2: Games Directory costs \$4.95. Volume 3: Educational Guide costs \$5.95. Contact WIDL Video, 5245 W Diversey, Chicago IL 60639, (312) 622-9606.

Circle 526 on inquiry card.

UNIX Products List Available

A directory of UNIX and C products is now available on a subscription basis from InfoPro Systems. The UNIX software list includes suppliers of UNIX, C compilers and interpreters, data-base systems, other languages on UNIX, applications and business packages, user groups, utilities, hardware vendors, and UNIX-like systems. A yearly subscription to the UNIX Software List is \$18. For details, contact InfoPro Systems, POB 33, East Hanover NJ 07936, (201) 625-2925.

Circle 527 on Inquiry card.

Computers In Science Teaching

The Journal of Computers in Science Teaching is a quarterly publication on the use of computers in science instruction. It features research studies on teaching science and tutorials. There are lists and reviews of science software, announcements of conferences and events, and book reviews. The Journal of Computers in Science Teaching is published by the Association for Computers in Science Teaching, POB 4825, Austin TX 78765, for \$7 per year.

Circle 525 on Inquiry card.

Computer Merchandising

Computer Merchandising covers sales and manufacturing in the computer industry. It investigates the ebb and flow of the educational computer marketplace, peripherals, and promotions to increase sales. Interviews with people in the industry are also featured. This monthly publication costs \$18 per year and is available from Computer Merchandising Magazine, 15720 Ventura Blvd, Suite 610, Encino CA 91436, (213) 995-0436.

Circle 529 on inquiry card.

Educational Computer

Educational Computer is an information exchange for elementary, high school, college, and university students and educators. In its pages, Educational Computer addresses such topics as the impact of microcomputers in schools, colleges, and universities. Also, separate departments feature letters from readers, editorials, book reviews, events, classified ads, and administrative feedback. The yearly subscription rate (6 issues) is \$12. Contact Educational Computer Magazine, POB 535, Cupertino CA 95015, (408) 252-3224.

Circle 530 on inquiry card.

IEEE Publications Catalog

A publications catalog is available from the Computer Society of the IEEE (Institute of Electrical and Electronics Engineers). The catalog lists more than 300 publications and covers all aspects of applications, methodologies, and techniques in computer software and hardware. It also contains technical-level tutorial texts for the computer scientist and engineer. For a free copy of the 1981 Pubs Catalog, write to the Computer Society Press, POB 639, Silver Spring MD 20901.

Circle 528 on inquiry card.

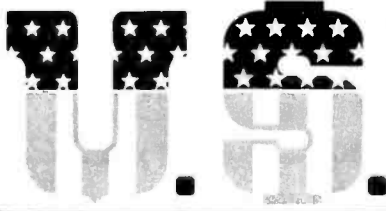

MICRO SALES

DEALS □ DEALS □ DEALS

SHOP HERE AND
SAVE!

(MINIMUM ORDER \$10.00)

This is **ABSOLUTELY** the **LOWEST PRICE EVER** for a Hi Speed (300 NS) LO-LO Power 32K RAM. 4K by 1 Chips are organized in Selectable Banks.

\$250

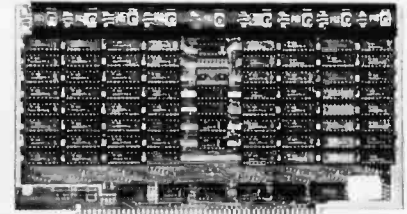

★ Extended Address Lines A16 - A17

★ Phantom Line

★ 9 Regulators

(KIT)

S-100 BOARDS and ACCESSORIES



Z - 80 CPU

The first time this world popular CPU offered in Kit. Two serial, 3 parallel, CTC, EProm Z-80 at 4 mhz. Software buad rate, etc. (Less Prom. & Cable)



\$250.00

EXPANDABLE RAM

★ SPECIAL ★ SPECIAL ★

This is the best all around 64K board you can buy. If after you see it, you don't agree return for full refund. Bank Select by extended address lines or I.O. 40H.



★ **\$400.00 A&T** ★

S1 - MOD (KIT)

\$199.00



Complete S-100 12 Slot Computer. Ample system power with regulated power for drives. Excellent for Subsystem or Hobby use. Four hours to build. (6 conn., incl., less fans)



U\$ - D\$K \$275.00

Double-Density 8" and 5" Disk Controller designed for S-100 IEEE standards. Uses Western Digital 1795, 1691, 2143 Chip Set.



S-100 CARD EXTENDER

\$12.50

(Gold Contacts)

As long as there is a price war, we will fight your battle. Compare at your local Department store and buy US MICRO.



S-100 - CONNECTOR

TI or Better



SOLDER TAIL

\$2.50

CCS S-100

- 2810 CPU Only — \$250.00
- 2422 Dsk Cont Only — \$300.00
- 2065C 64K Only — \$425.00
- 2032C 32K Only — \$620.00
- 2718 2x2 Only — \$305.00
- 2200A Mainframe Only — \$349.00
- 2501 Mother Board Only — \$106.00
- 2116C 16K Static Ram 200ns Only — \$309.00
- 2520K Extender Board Only — \$ 52.00

CHIPS - CHIPS - CHIPS - CHIPS -

Z - 80 - A

\$6.95

4MHZ Beastie with extra instructions!

Z-80 SUPPORT

CTC — \$6.55

SIO — \$25.50

PIO — \$6.50

DMA — \$18.75

All 4MHZ (who wants 2MHZ ?)

2716s **\$7.75** (450 NS)

2708s **\$4.75** (450 NS)

Remember when 2716s were \$50.00 and hard to get? These units are so beautiful it's hard to part with them. But we will, for a small price. Guaranteed!

4116s

Expansion 16K Dynamic RAMs **\$2.50**

for Apple, TRS-80 S-100 systems. T.I., Mostek Intel. Call for manufacturer.

200 NS

2114s

\$2.75 ea.

One of the world's two most popular STATIC RAMS. Factory prime tested units. Sold in lots of 8 only. FUJITSU, HITACHI, etc.



200 NS

TMS — 4044

MM — 5257

INTEL 2147

\$4.00

250 NS

The other of the world's most popular STATIC RAMS. This one is 4K by 1 organization.

U.S. Micro Sales can also supply a vast array of IC's. Because of space limitations we can not list them all. We can also supply power supplies - sockets - heat sinks - tools etc., etc., etc.

Please Call For Pricing & Availability

Circle 375 on inquiry card.

What's New?

MISCELLANEOUS



Votrax Speech Circuit

The SC-01 speech-synthesizer integrated circuit combines electronically generated phonemes to produce an unlimited vocabulary. Votrax's technique doesn't limit the number of words and phrases to a fixed amount or format as synthesizers that reconfigure words and phrases from pre-recorded human voice tracts do. Designers can build their own vocabulary through a system that contains an algorithm that auto-

matically translates English text into phonemes. One second of speaking time requires 70 to 100 bits of memory with this device.

The speech-synthesizer chip is available at prices starting at \$95 each, for a minimum of five units. The Votrax Sales Division of Votrax Inc is located at 500 Stephenson Hwy, Troy MI 48084, (800) 521-1350; in Michigan (313) 588-0341.

Circle 536 on Inquiry card.

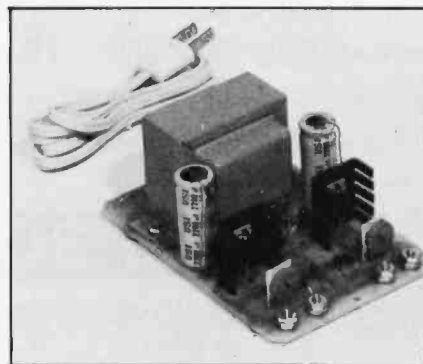

5 to 15 V DC Dual Power-Supply Kit

The JE215 power-supply kit provides adjustable regulated positive and negative output voltages from 5 to 15 V DC. Power output for each supply ranges from 5 V DC at 500 mA to 15 V DC at 175 mA. The JE215 kit retails for \$24.95 from Jameco Electronics, 1355 Shoreway Rd, Belmont CA 94002, (415) 592-8097. Circle 540 on inquiry card.

PROMs with Titanium-Tungsten Fuses

Monolithic Memories' line of 1 K- and 2 K-byte PROMs (programmable read-only memories) uses titanium-tungsten (TiW) fuses and requires only 70 mA of current with no loss in speed. Access times are 55 ns for the 1 K PROM and 60 ns for the 2 K device. Pin-compatible with standard Schottky PROMs, these units are organized as 256-by-4-bit and 512-by-4-bit arrays. The PROMs have full Schottky clamping, three-state or open-collector outputs, and transistor inputs for low-input current. A new programming technique eliminates the need for a separate programming pin as found on Ni-chrome-fused PROMs.

Prices range from \$3.75 to \$10.55. Contact Monolithic Memories, 1165 E Arques Ave, Sunnyvale CA 94086, (408) 739-3535. Circle 539 on inquiry card.

Switched-On DOS

The DOS Switch allows a DOS-3.3-equipped Apple II to boot either DOS 3.3 or 3.2 floppy disks without need of the BASICS disk. The switch doesn't require support software or modifications to established 3.2 disks. The device plugs into the Apple without soldering or permanent wiring changes. The DOS 3.3 P5A boot PROM (programmable read-only memory) and the DOS 3.2 P5 boot PROM are needed for installation. The DOS Switch costs \$29.95 and is available from the Micro Computer Center, 7900 Paragon Rd, Dayton OH 45459, (513) 435-9533.

Circle 537 on Inquiry card.

Aid for the Physically Disabled

The Viewpoint Optical Indicator is an incandescent lamp mounted onto a headband. It enables the physically disabled individual with good head control to indicate objects, words, or symbols on a manual-communication board. The band can be worn on the head, hand, or wrist. The lamp can be positioned for use in a wheelchair, bed, or on a prone board. A rechargeable power-pack stores a day's charge. The device costs \$189 and is available from Prentke Romich Company, RD 2, POB 191, Shreve OH 44676, (216) 567-2906. Circle 538 on inquiry card.

WE WILL NOT BE UNDERSOLD

DISK DRIVES



FOR TRS-80* Model I
 CCI-100 5 1/4", 40 Track (102K) \$299

ADD-ON DRIVES FOR ZENITH Z-89
 CCI-189 5 1/4", 40 Track (102K) \$394
 Z-87 Dual 5 1/4" system \$995

External card edge and power supply included. 90 day warranty/one year on power supply.

RAW DRIVES

5 1/4" TEAC or TANDON \$ CALL
 8" SHUGART 801R \$ CALL

DISKETTES

Box of 10
 5 1/4" Maxell \$40 BASF/Verbatim \$26.95
 8" Maxell \$45 BASF/Verbatim \$36.00

PLASTIC FILE BOX—Holds 50 5 1/4" diskettes \$19.00
 PLASTIC LIBRARY CASE 5 1/4" \$3.00 8" \$ 4.00
 HEAD CLEANING DISKETTE \$25.00
 FLOPPY SAVER \$10.95 RINGS \$ 6.95

16K RAM KITS

200ns for TRS-80,* Apple II, (specify): 2 for \$37 \$19
 Jumpers \$2.50

SYSTEM SPECIAL

Apple II Plus 48K w/drive and controller. Epson MX-80 printer and interface. SUP-R Mod RF Modulator: List \$2965 You Pay \$2299

COMPUTERS/TERMINALS

ARCHIVES 64K, 2-Drives, 77 Track \$ CALL
 ALTOS ACS8000 Series \$ CALL
 ZENITH 48K, all-in-one computer \$2200
 ZENITH Z-19 \$ 725
 TELEVIDEO 910 \$559 920C \$ 729 950 \$1039
 IBM 3101 Display Terminal \$1189
 ATARI 400 \$ 359 800 \$ 795
 MATTEL INTELLIVISION \$ 259
 APPLE PERIPHERALS \$ CALL

S-100 CALIFORNIA COMPUTER SYSTEMS

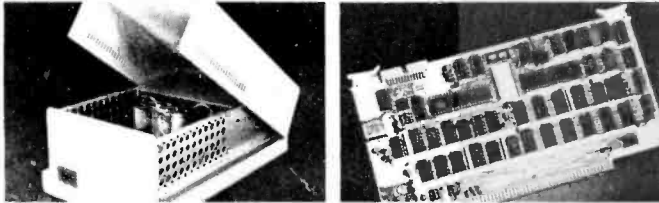

MAINFRAME Model 2200A \$349
 Z80 CPU Model 2810 \$259
 MOTHER BOARD Model 2501 \$106
 16K STATIC RAM, 200ns Model 2116C \$309
 32K STATIC RAM, 200ns Model 2032C \$619
 64K DYNAMIC RAM Model 2065C \$580
 FLOPPY DISC CONTROLLER Model 2422A \$345
 EXTENDER BOARD Model 2520K \$ 52
 2P + 2S I/O Model 2718A \$309

For fast delivery, send certified checks, money orders or call to arrange direct bank wire transfers. Personal or company checks require two to three weeks to clear. All prices are mail order only and are subject to change without notice. Call for shipping charges.

PRINTERS



NEC SPINWRITER
 Letter Quality High Speed Printer R.O. \$2395
 R.O. with tractor feed \$2555
 KSR with tractor feed \$2795

NEC SPINWRITER 3500 Series \$CALL
EPSON MX-70 MX-80 MX-80FT MX100 \$CALL
PAPER TIGER
 IDS 445 Graphics & 2K buffer \$ 695
 IDS 460 Graphics & 2k buffer \$ 799
 IDS 560 Graphics \$ 999
ANADEX DP-8000 \$849 DP-9500/01 \$1295
OKIDATA
 Microline 80 Friction & pin feed \$CALL
 Microline 80 Friction, and pin & tractor feed \$CALL
 Microline 82 Friction & pin feed \$CALL
 Microline 83 120 cps, uses up to 15" paper \$CALL
CENTRONICS 739, new model with graphics \$ 739
C. ITOH
 Starwriter I 25 cps, parallel interface \$1449
 Starwriter I 25 cps, serial interface \$1529
 Starwriter II 45 cps, parallel interface \$1829
 Starwriter II 45 cps, serial interface \$1949

PRINTER SPECIAL

SEIKOSHA GP-80M List \$399 You Pay \$319

MONITORS

BELL & HOWELL 9" B & W BHD911 \$175
LEEDEX 12" B & W \$129 12" Green Screen \$159
 13" Color \$329
SANYO 9" B & W \$149 12" Green Screen \$238
 12" B & W \$219 13" Color \$406
ZENITH 13" Color \$349 12" Green Screen \$129

TELECOMMUNICATIONS

LIVERMORE STAR MODEM 2-year guarantee \$125
 UNIVERSAL DATA SYSTEMS UDS-103 \$179
 D-CAT HARD WIRED DIRECT MODEM \$189
 AUTO-CAT Auto Answer, Direct Connect Modem \$249
 APPLE-CAT II \$349
 D.C. HAYES MICRO-MODEM \$295
 D.C. HAYES SMART-MODEM \$235
 CCI Telnet Communications Package \$135

APPLE ACCESSORIES AND SOFTWARE

VISICALC \$155.00 DB MASTER \$159.00
 CPS MULTIFUNCTION CARD \$189.00
 Z-80 SOFTCARD \$259.00
 VIDEX BOARD \$255.00
 KEYBOARD ENHANCER \$110.00
 16K CARD \$159.00
 APPLE JOYSTICK \$ 49.00
 SUP-R MOD \$ 25.00
 CCS CARDS \$ CALL
 GALAXIAN \$ 22.95
 SPACE ALBUM \$ 35.00
 ASTEROIDS \$ 17.95
 FLIGHT SIMULATOR \$ 29.00
 WIZARD & PRINCESS \$ 28.00
 SARGON 2 \$ 29.00
 MYSTERY HOUSE \$ 24.00 HI-RES FOOTBALL \$ 35.00

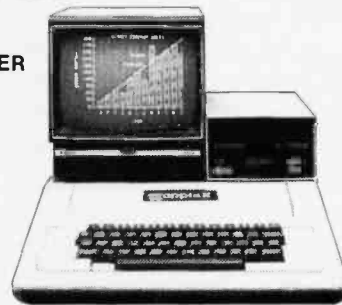

DEALER (NATIONAL/INTERNATIONAL) INQUIRIES INVITED

Send for FREE Catalogue

The CPU SHOP

TO ORDER CALL TOLL FREE 1-800-343-6522

TWX: 710-348-1796 Massachusetts Residents call 617/242-3361

5 Dexter Row, Dept. B10M
 Charlestown, Massachusetts 02129
 Hours 10AM-6PM (EST) Mon.-Fri. (Sat. till 5)

Technical Information call 617/242-3361
 Massachusetts Residents add 5% Sales Tax
 Tandy Corporation Trademark® Digital Research.



What's New?

MISCELLANEOUS

High-Resolution Touch Screens

With the TSD 12- and 15-inch Touch Screen Digitizers, you can enter data by touching a computer display with your finger. The screen's high-resolution also permits the entry of graphic data. The Touch Screens can be retrofitted onto existing video displays, and in most cases no modifications are necessary. The thin, transparent, curved panel, consisting of two conductive films separated by an insulating space, mounts in front of the video display; an interface board is connected to the panel with a cable. When the panel is touched, one conductive layer touches the other, yielding a voltage that is converted into the necessary information and transmitted as an RS-232C message or a parallel 8-bit, 3-state message.

The 12-inch model costs \$650 and the 15-inch device is priced at \$700. Contact TSD Display Products Inc, 35 Orville Dr, Bohemia NY 11716, (516) 589-6800. Circle 531 on inquiry card.

16 K-Byte Programmable Memory Circuits

Fujitsu Microelectronics has a family of 16 K-byte dynamic programmable-memory integrated circuits with single 5 V power-supply requirements and access times as fast as 100 ns. The MB8117 and MB8118 devices are available with 100 or 235 ns cycle times.

Features include 182 mW power dissipation, bias generator, read-write-modify, hidden refresh, page-mode capability, and TTL- (transistor-transistor logic) compatible inputs. Contact Fujitsu Microelectronics, 2945 Oakmead Village Ct, Santa Clara CA 95051, (408) 727-1700. Circle 532 on inquiry card.

EPROM Has High Standards

Advanced Micro Devices has a 32 K-bit EPROM (erasable programmable read-only memory) that meets the MIL-STD-883 and INT-STD-123 quality standards. Organized as 4 K bytes by 8 bits, the Am2732 operates from a single +5 V supply. It offers three-state outputs, fully static operation, and a two-line control that makes Chip Enable and Output Enable available. This eliminates bus contention and the need for external buffers and chip controls.

The Am2732 costs \$31.50. Contact Advanced Micro Devices, 901 Thompson Pl, Sunnyvale CA 94086, (408) 732-2400. Circle 533 on inquiry card.

In-Circuit Microcomputer Tester

Patuck Inc's microcomputer analyzer is a hand-held device that clips directly to the microprocessor to be tested by means of a 40-pin chip clip. It can single-step the microprocessor or let it run free to a selected error vector or trap address. A trace capability allows examination of the 63 machine cycles that precede breakpoint. Interchangeable interfaces are available for Z80-, 8080/85-, 6502-, 6800-, 2650-, 6802-, and 6501-based microcomputers.

The Microcomputer Analyzer costs \$829. Interfaces are \$61 each. Contact Patuck Inc, 5073 Russell Ave, Pennsauken NJ 08109, (609) 662-0677. Circle 534 on inquiry card.



PROM Copier/Verifier

The cloneAprom PROM (programmable read-only memory) copier/verifier duplicates a 5 V master 2716 EPROM (erasable PROM) in 138 seconds. It features two ZIF (zero insertion force) sockets, pass/fail indicators, and a

power supply. Both a 2732 and a 220 VAC, 50 Hz version are available.

The cloneAprom costs \$299. Contact Alloy Engineering Company Inc, 12 Mercer Rd, Natick MA 01760, (617) 655-3900. Circle 535 on inquiry card.

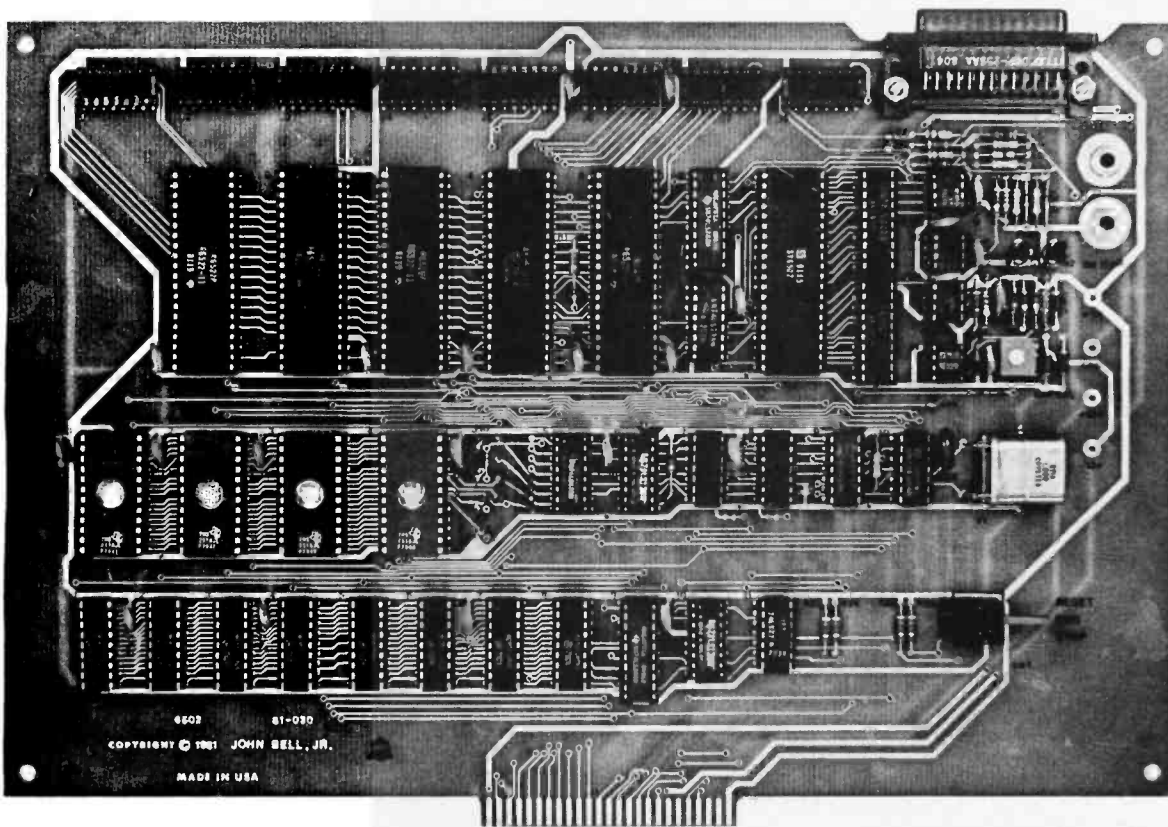

JBE I MICROCOMPUTER

John Bell Engineering's low-cost JBE I Microcomputer - based on the powerful 6502 processor - is specifically designed for WORK, LEARNING, DEVELOPMENT AND CONTROL. The JBE I has a unique combination of features:

- 6502 Microprocessor
- 4 6522 VIAs (8 parallel I/O ports)
- 1 AY5-1013 (UART serial port)
- Cassette Interface
- 4K 2114 RAM Memory
- 8K or 16K EPROM Memory
- Monitor and Tiny Basic
- Variety of Support Cards

- Use your JBE I to PROGRAM 2716s, TALK to you, CONTROL the world.
- JBE I interfaces with JBE's EPROM Programmer, Parallel Input Speech Synthesizer, A-D & D-A Converter and Solid State Switches.
- Save your programs easily and accurately using the cassette interface.
- Use your JBE I for:

CONTROL

- Home security and lighting systems
- Irrigation systems
- Model Trains
- Solar heating and power systems

DEVELOPMENT

- Software for work and home
- Learning aids for children at home and school
- Development system for JBE 6502 Microcomputer

LEARNING

- Microcomputer Technology
- Machine language and Basic programming
- The three R's for children

JBE I is available fully populated, partially populated or as a bare board for OEM and the dedicated hobbyist:

The fully populated version includes:

| | |
|-------------|------------------|
| 6502 CPU | 4K RAM |
| 4 6522 VIAs | Monitor EPROM |
| AY5-1013 | Tiny Basic EPROM |

Partially Assembled Version includes:

| | |
|------------|---------------|
| 6502 CPU | 1K RAM |
| 1 6522 VIA | Monitor EPROM |
| AY5-1013 | |

All versions include complete documentation. For information write: John Bell Engineering, P.O. Box 338, Redwood City, CA 94064. (415) 367-1137. OEM Pricing available.



FOR MASTER CHARGE, VISA AND C.O.D. ORDERS CALL (415) 367-1137 OR SEND CHECK TO THE ABOVE ADDRESS, DEPT. JI. PLEASE INCLUDE 5% FOR SHIPPING AND HANDLING INSIDE USA AND 10% OUTSIDE USA.

What's New?

SYSTEMS



Microlite Microcomputer

The Microlite microcomputer is a self-contained system that includes the microprocessor, keyboard, 24-line by 80-character plasma display, and two 5-inch floppy-disk drives capable of storing up to 350 K bytes. Microlite has provisions for serial communications.

Options for the Microlite include a dot-matrix printer that can be housed in the console and support for up to four 8-inch floppy-disk drives. Hard-disk drives are also available. For more information on the Microlite II, contact QI Corporation, 125 Ricefield Ln, Hauppauge NY 11787, (516) 543-7800.

Circle 590 on inquiry card.

Pascal Development System for CP/M

The PDS-80 Pascal Development System for CP/M applications is designed with the systems integrator and applications-software developer in mind. A Cache BIOS for CP/M uses the DMA (direct-memory access) and interrupt capabilities of the disk controller and memory to buffer whole tracks in extended memory, which speeds up execution times.

Included in the system is Pascal/Z, a native-code compiler that generates ROMable (read-only memory) and reentrant object code, relocatable object modules, and permits separate compilation. A 2.4-megabyte dual-disk drive, choice of mainframe, Cache BIOS, Pascal/Z, and CP/M come with the development system. Five utilities are also included: InterEdit, a screen-oriented editor; Spell, a spelling editor with a 10,000-word modifiable dictionary; Quickcopy, for copying disks faster than the PIP utility; Help, an access to documentation; and Compare, a quick view of the difference between two files.

The PDS-80 Development System costs \$7995. Contact Ithaca Intersystems Inc, 1650 Hanshaw Rd, Ithaca NY 14850.

Circle 591 on inquiry card.

Omninet from Corvus

Omninet is a 1-megabyte-per-second network that uses a shielded twisted-pair cable for connecting microcomputers. The network allows the interconnection of up to 64 microcomputers and peripherals in a 4000-foot serial link. The intelligent component of the system is the Omnet transporter, which interfaces to the microcomputer or peripheral and provides for the transfer of messages without software intervention or requiring a control processor. Omnet will work with Corvus Constellation software, providing up to 80 megabytes of shared storage.

Available for the Apple II, Onyx C8000, and Digital Equipment Corporation LSI-11 computers, Omnet will also connect to all Corvus peripherals. Future transporters are being designed for TRS-80, Apple III, S-100, Atari, Commodore, Altos, and other popular microcomputers.

Omninet transporter units are priced at \$495 for the Apple II and S-100, \$750 for LSI-11 computers, and \$650 for the Onyx C8000. A disk server for Corvus Winchester disks will retail for \$990. For more information, contact Corvus Systems Inc, 2029 O'Toole Ave, San Jose CA 95131, (408) 946-7700.

Circle 592 on inquiry card.

Datamac Series 1200

The Datamac 1200 series of microcomputers can be expanded with external floppy-disk drives of any density, track, or side configuration. Provision is made for using the video display to set breakpoints and single-step through programs for debugging. Among the models available is the 1255 microcomputer. It contains a Z80 microprocessor, 64 K

bytes of programmable memory, input/output ports, keyboard, video display, dual 5-inch double-sided double-density disk drives, and the CP/M operating system.

The Model 1255 with two drives capable of storing 780 K bytes lists for \$4695. Contact Datamac Computer Systems, 3333-F Octavius Dr, Santa Clara CA 95051, (408) 727-0561.

Circle 593 on inquiry card.

10 MHz 68000

Motorola Semiconductor Group has announced the availability of a 10 MHz MC68000L10 microprocessor. Samples are available for \$449. Contact your local Motorola representative or the Motorola Semiconductor Group, 3501 Ed Bluestein Blvd, Austin TX 78721, (512) 928-6119.

Circle 594 on inquiry card.

COMPUTER STOP

ORDER BY PHONE
MON.—SAT.
10-6

2545 W. 237 St. Torrance, CA. 90505

(213) 539-7670 PST
TELEX: 678401 TAB IRIN

LOWEST PRICES IN THE WEST, NORTH, SOUTH & EAST



apple computer 1-800-421-1947
Sales and Service

| | |
|-------------------------------------|--------|
| NEC 8001A | \$1100 |
| NEC 8012A | \$ 750 |
| NEC 8031A | \$1100 |
| NEC RGB Monitor | \$ 999 |
| NEC General Accounting System | \$ 350 |

APPLE HARDWARE

| | |
|---------------------------------------|-----|
| Parallel Printer Interface Card | 160 |
| Communications Card | 195 |
| High Speed Serial Interface | 160 |
| Pascal Language System | 425 |
| Centronics Printer Interface | 185 |
| Applesoft Firmware Card | 160 |
| Integer Firmware Card | 160 |
| Disk][with Controller DOS 3.3 | 529 |
| Disk][only | 475 |
| Graphics Tablet | 625 |

OTHER HARDWARE

| | |
|---|------|
| All Music Synthesizer (3 Voice) | 245 |
| 9 voice | 175 |
| ABT Numeric Keypad | 119 |
| Micromodem][..... | 295 |
| Apple Clock | 245 |
| Rom Plus with Keyboard Filter | 175 |
| Introl/X-10 System | 250 |
| Romwriter | 150 |
| DoubleVislon 80 x 24 Video Interface | 245 |
| CCS Arithmetic Processor | 399 |
| CCS Parallel Interface | 119 |
| 16K Ram Card | 145 |
| Microworks DS-65 Digisector | 339 |
| SVA 8 inch Disk Controller | 350 |
| Sup-R-Mod | 30 |
| CCS Synchronous Serial Interface | 159 |
| CCS Asynchronous Serial Interface | 159 |
| Corvus 10 Meg. Hard Disk | 4395 |
| Corvus Constellation | 595 |

MISCELLANEOUS/SUPPLIES

| | |
|--|----|
| 16K RAM (200-250 NS) | 29 |
| Verbatim Datalife Diskette (Box of 10) | 30 |
| Dysan Diskettes (Box of 5) | 22 |
| Apple Diskettes (Box of 10) | 45 |
| Verbatim Diskette Boxes (Holds 50 Disks) | 18 |
| Silentype Paper (Box of 10 rolls) | 40 |



MONITORS/DISPLAYS

| | |
|---|-----|
| Leedex Video 100 12" | 140 |
| Sanyo 9" Monitor | 195 |
| KG-12C Green Phos. Monitor | 275 |
| Sanyo 12" Green Phosphor. Monitor | 275 |
| NEC 12" Green Phosphor. Monitor | 275 |
| Sanyo 12" B/W Monitor | 250 |

PRINTERS

| | |
|---|------|
| Apple Silentype with Interface | 525 |
| IDS 445 (Paper Tiger) with Graphics | 650 |
| IDS 460 with Graphics | 1049 |
| IDS 560 with Graphics 10) | 1199 |
| Centronics 737 | 795 |
| NEC Spinwriter (RO, Serial) | 2650 |

SOFTWARE

| | |
|---|-----|
| The Controller | 525 |
| Apple Post (Mailing List Program) | 45 |
| Easywriter Professional System | 195 |
| Apple Pie 2.0 | 110 |
| DB Master Data Management | 175 |
| The Cashier | 210 |
| Apple Writer | 65 |
| Visicalc | 175 |
| CCA Data Management System | 90 |
| Full Screen Mapping for CCA DMS | 59 |
| Pascal Interactive Terminal Software (PITS) | 29 |
| Basic Interactive Terminal Software (BITS) | 29 |
| Data Capture | 45 |
| Data Factory DMS | 110 |
| Apple Plot | 55 |
| Apple Pilot | 120 |
| Magic Wand Word Processor (Needs Z-80 Softcard) | 345 |
| Dow Jones Portfolio Evaluator | 45 |
| Fortran | 140 |

ORDERING INFORMATION: Phone orders invited using VISA, MASTERCARD or bank wire transfers. VISA & MC credit card service charge of 2%.

Mail order may send charge card number (include expiration date), cashier's check, money order or personal check (allow 10 business days to clear.) Please include a telephone number with all orders. Foreign orders (excluding Military PO's) add 10% for shipping. All funds must be in U.S. dollars (letters of credit permitted). Shipping, Handling and insurance in U.S. add 3% (minimum \$4.00). California residents add 6% sales tax. Our low margins prohibit us to send COD or on purchase orders or open account (please send for written quotation). All equipment is subject to price change and availability. Equipment is new and complete with the manufacturer warranty. We do not guarantee merchantability of products sold. All returned equipment is subject to a 15% restocking fee. We ship most orders within 2 days.

RETAIL STORE PRICES MAY DIFFER FROM MAIL ORDER PRICES.

WE ARE A MEMBER OF THE CHAMBER OF COMMERCE.

PLEASE SEND ORDERS TO:
COMPUTER STOP, 2545 W. 237 St., TORRANCE, CA 90505

What's New?

SYSTEMS

New Z80 Board

The CPC-2810 Z80-based processor board is designed for the S-100 bus. It features two or four serial I/O (input/output) channels, software-selectable data rates, two parallel I/O channels with handshaking, eight vectored priority interrupts, and compatibility with most disk controllers. All asynchronous serial channels can be made fully synchronous. I/O interfaces are customized through the use of external personality boards. The CPC-2810 Z80 board costs \$495 from Measurement Systems & Controls, 1601 Orangewood, Orange CA 92668, (714) 633-4460. Circle 595 on inquiry card.

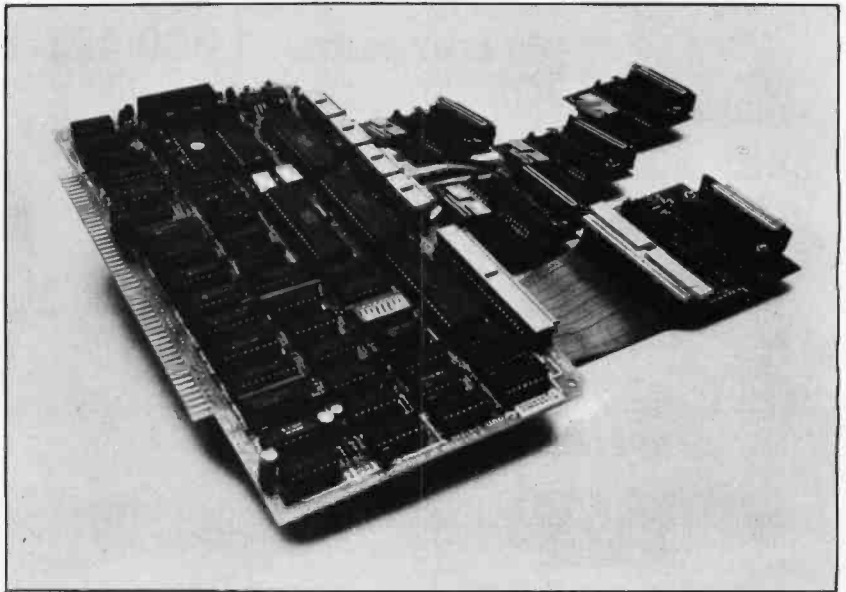

A Very Portable Terminal

LEX 21 is a small, lightweight, low-cost printing and communications terminal. The LEX 21 terminal features a built-in modem, keyboard, and a thermal printer that displays upper- and lowercase characters. It measures 22 by 28 by 7.1 cm (8½ by 11 by 2¾ inches), weighs 2.25 kg (5 pounds), and takes up half a standard briefcase. Two K bytes of

memory and a 1 K-byte line buffer are standard. The selectable transmission rates are 10 or 30 characters per second. The LEX 21 is designed for business and professional people for use in offices, homes, and when traveling. The LEX 21 costs \$1195. Contact Lexicon Corporation, 8355 Executive Center Dr, Miami FL 33166, (305) 592-4404. Circle 596 on inquiry card.



CBM 8032 Color Computer

The CBM 8032 microcomputer now has color. The Color 8032 features a 12-inch, 80-character by 25-line video display, 73-key upper- and lowercase keyboard, and numeric keypad. It also features a high-resolution RGB (red/green/blue) color monitor that displays eight colors in the text and graphics modes.

CBM 8032 software runs on the Color Computer without modification. Using the Control key, users can change foreground and background color combinations, or use reverse field for highlighting. In the graphics mode, the Color Computer provides 160 by 100 dot resolution. The computer contains a 32 K-byte screen edit ROM that provides color-handling capability. The CBM version 4.0 BASIC interpreter remains unchanged. Contact Commodore Business Machines Inc, 681 Moore Rd, King of Prussia PA 19406, (215) 337-7100.

Circle 597 on inquiry card.

Best prices anywhere! Now a Toll-Free "800"

COMPUTERS

ZENITH data systems

Z-89.... List

\$2895

OUR PRICE

\$2229



SUPERBRAIN

By INTERTEC

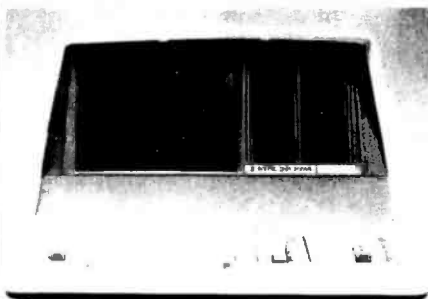

| | |
|----------------|--------|
| 64K DD..... | \$2695 |
| 64K QD..... | \$2995 |
| DSS-10MEG..... | \$3195 |
| INTERTUBE..... | \$725 |
| Emulator..... | \$725 |

CROMEMCO

CS2, List \$4695..... **OUR PRICE \$3679**

CS3, List \$7995..... **OUR PRICE \$6349**

NORTH STAR

HORIZON II

| | |
|------------------------------|--------|
| HRZ-2-32DD, List \$3695..... | \$2879 |
| HRZ-2-64DD, List \$4195..... | \$3269 |
| HRZ-2-Q32, List \$3995..... | \$3115 |
| HRZ-2Q64, List \$4495..... | \$3505 |

Intersystems..... CALL FOR PRICES

TERMINALS

TeleVideo



| | |
|--------------------|-------|
| Televideo 910..... | \$579 |
| 912C..... | \$679 |
| 920C..... | \$779 |
| 950..... | \$979 |

SOROC



| | |
|------------------|--------|
| Soroc IQ120..... | \$689 |
| IQ130..... | \$579 |
| IQ135..... | \$719 |
| IQ135 w/g..... | \$789 |
| IQ140..... | \$1049 |

HAZELTINE

| | |
|-----------|------|
| 1420..... | CALL |
| 1500..... | CALL |
| 1510..... | CALL |



ZENITH

Z19

\$719

PRINTERS

CENTRONICS

| | |
|----------------------|--------|
| 739-1..... | \$749 |
| 739-3..... | \$799 |
| 704-11 parallel..... | \$1569 |
| 709-9..... | \$1519 |

TI 810



| | |
|----------------------|--------|
| 810 Basic..... | \$1289 |
| 810 Full Option..... | \$1599 |
| 820 RO Basic..... | \$1545 |
| 820 KSR Basic..... | \$1739 |

| | |
|---------------|------|
| NEC 7510..... | CALL |
| 7520..... | CALL |

Diablo 630..... \$2049

| | |
|---------------------|--------|
| PaperTiger 460..... | \$799 |
| 460G..... | \$843 |
| 560G..... | \$1099 |

Epson..... CALL FOR PRICES

DISK SYSTEMS

MORROW

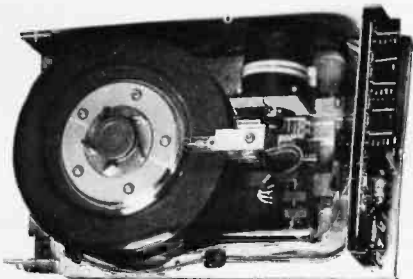

| | |
|---------------------|--------|
| Discus 2D..... | \$849 |
| Dual Discus 2D..... | \$1389 |
| 2+2..... | \$1199 |
| M-26..... | \$3599 |
| M-10..... | \$2999 |

Most items in stock for immediate delivery. Factory sealed cartons, w/full factory warranty. NYS residents add appropriate sales tax. Prices do not include shipping. VISA and Master Charge add 3%. C.O.D. orders require 25% deposit. Prices subject to change without notice.

COMPUTERS WHOLESAL

P.O. Box 144 Camillus, N.Y. 13031

800-448-5715

In N.Y. call 315-472-2582



What's New?

SYSTEMS

Multuser System

The System/48 is a multiuser system for small- to medium-size businesses. It can accommodate up to eight simultaneous users and has 20 megabytes of Winchester hard-disk storage.

MAGIC is an operating system for the System/48. It provides a means for direct-indexed access to several billion bytes of storage. The DataMagic II is a data-base system that provides a screen formatter, the BASIC language, a report generator, and an edit, update, and query processor package. For complete details, contact TEI Inc, 5075 S Loop E, Houston TX 77033, (713) 738-2300.

Circle 598 on inquiry card.

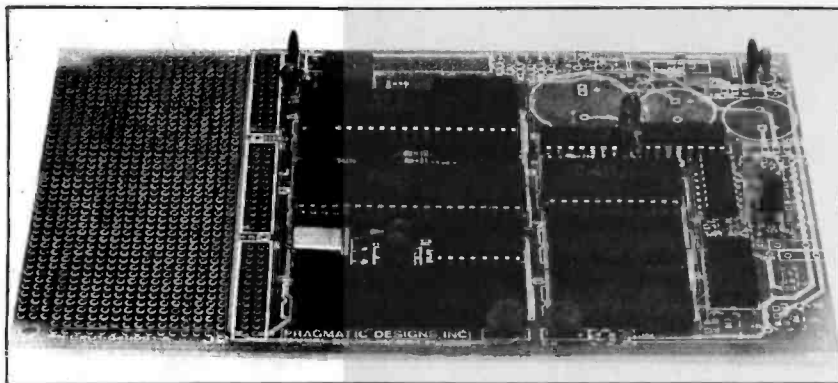
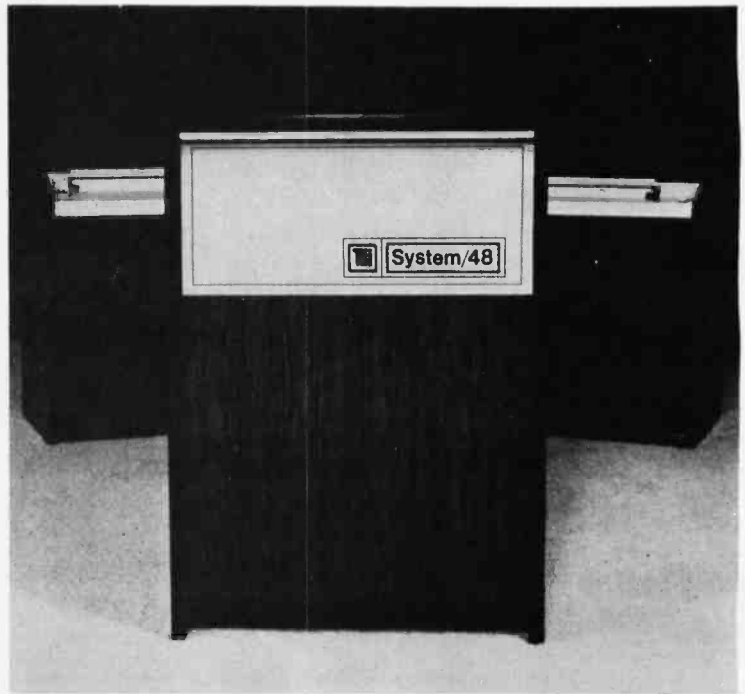

Single-Board 8085 Computer

CPU-1 is an 8085-based micro-computer similar to the Intel 80/04 board. It is designed specifically for dedicated control applications. The system operates at 3 MHz and includes 256 bytes of programmable memory, 22 I/O (input/output) lines, one serial I/O port, one programmable counter/timer, and two sockets for 1 to 4 K bytes of EPROM (erasable programmable read-only memory). Only an external transfor-

mer is needed to complete the system. A printed-circuit board area is provided for user development. Applications programs for CPU-1 can be developed using any 8080/8085 development system.

The price for CPU-1 is \$185. An expanded version with more memory and I/O lines costs \$220. Contact Pragmatic Designs Inc, 950 Benicia Ave, Sunnyvale CA 94086, (408) 736-8670.

Circle 599 on inquiry card.

Econet Network

The Econet network system for interconnecting computers and peripherals uses a four-wire connector. It allows a separation of up to 1 kilometer between stations and is compatible with all Acorn (or other microcomputer) systems. A ten-station network with a 400 K-byte file station costs £3000 (approximately \$6000); additional stations cost £50 (about \$100). Up to 255 stations can be interconnected with a data transfer rate of up to 210,000 bps (bits per second). Collision-detect circuitry and a collision-arbitration algorithm minimize the need for retries. Econet hardware fits inside a computer, and the software resides in 4 K bytes of ROM (read-only memory).

Econet was primarily designed for schools and institutions, but it can be used in any environment. For more information, contact Acorn Computer Ltd, 4a Market Hill, Cambridge, CB2 3NJ, England. Circle 600 on inquiry card.

PRIORITY ONE ELECTRONICS

MICROPOLIS™ S-100 DISC DRIVE SUB SYSTEMS

1
ONE



315K BYTES PER SIDE ON 5 1/4" OF COURSE! Micropolis, the world's largest manufacturer of high density 5 1/4" disk drives, has been doing it for years. And reliably at that.

An ordinary 5 1/4" floppy provides just 35 tracks per side and stores only 70K bytes. This is not nearly enough for anything useful, so Micropolis uses 77 tracks per side. Each track is then formatted with 16 sectors (hard) at 256 bytes per sector, yielding an impressive 315K bytes per side.

Micropolis drives have a larger capacity than many 8" disk drives, though they only occupy the space of a 5 1/4" floppy. The 315K byte capacity is roughly 4 times the capacity of a standard 5 1/4" drive. This is what we call QUAD DENSITY.

To achieve the high density capability, you may think Micropolis had to sacrifice speed or reliability. NOT SO! The track to track access time is only 30ms with a high speed data transfer rate of 250,000 bits per second.

By creating this high density format, Micropolis is able to keep your initial subsystem costs to a minimum. Your cost is less than \$.002 per byte. That's a BIG VALUE in a small package.

For example, most 5 1/4" floppy disks cut costs by using a less expensive, less accurate plastic cam or cam follower to position the read/write head. Most 8 inch floppy disks use a better approach, with a rolled steel lead screw for this function.

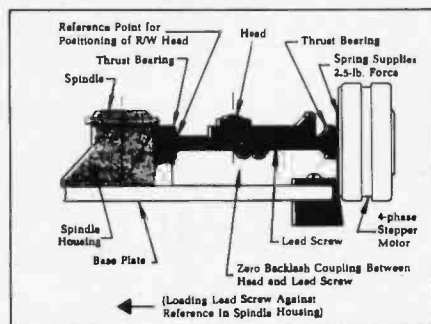

MICROPOLIS has a unique disk centering mechanism wherein the center of the disk fits over a profiled spindle and is clamped into place while the spindle rotates to assist centering.

MICROPOLIS goes them one better and uses an all-steel system, with a precision-ground steel lead screw and steel follower. It costs more but gives you greater storage capacity with lower cost per thousand bytes. Not so incidentally, the steel construction (compared to plastic) significantly increases reliability, too. There's even a built-in File Protect feature that prevents accidental loss of valuable data. (A file protected diskette cannot be written on.)



Buy a dual drive Micropolis and see the light. With our built-in LED that instantly indicates the drive selected, drive address, and File Protect.

Heat can cause numerous read and write errors that can become hazardous to your data. The major heat producing power supply components are mounted to a large heat sink, external to the cabinet, by the power switch and fuse (located at the rear of the cabinet). This design is to assure that the drive components are kept as cool as possible to assure reliable data recovery.

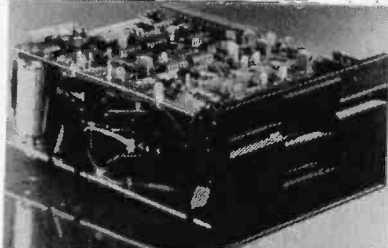

The temperature compensation loop in a MICROPOLIS drive includes only the disk, preloaded leadscrew and spindle housing. The baseplate is specifically excluded since its expansion is compensated by a proportional change in the preload of the leadscrew.

MICROPOLIS has a reputation for getting along with most everybody. Compatibility is not a problem with MICROPOLIS. Their disk drives and/or subsystems can be easily integrated into systems such as Polymorphic, Cromemco, CCS, Ithaca Intersystems, Godbout, Northstar, Jade, Big Z, QT SBC 2/4, and many others. Many OEM manufacturers rely on MICROPOLIS to get the job done efficiently. In fact, to date they have delivered over 200,000 double track density drives; more than all of their competitors combined. Companies like Commodore, Exidy, Harris and Vector Graphic, to name just a few. Years from now, you can look back with a secure feeling knowing you made the best choice: MICROPOLIS.

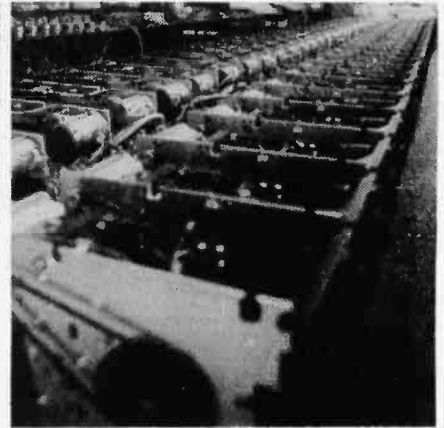

Disk drives being assembled for delivery to Priority One Electronics.

As the world's largest distributor of MICROPOLIS SUBSYSTEMS, PRIORITY ONE ELECTRONICS is able to buy MICROPOLIS disk drives by the thousands and receive special pricing. That special pricing we receive is passed on to you in the form of tremendously discounted prices.

MICROPOLIS™ S-100 SUB-SYSTEMS

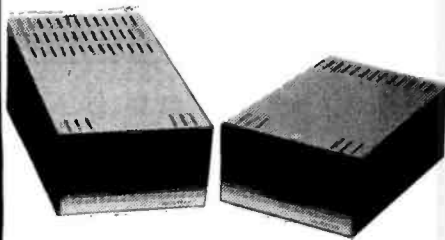

MICROPOLIS disk subsystems are expandable to keep up with your ever increasing needs. Up to four drives/heads may be daisy-chained on one S-100 controller board. With all four drives/heads in operation, you have access to over 1.2 MEGABYTES of on-line storage.

WITH MICROPOLIS, complete means COMPLETE. Each subsystem comes complete with controller interface, cable, and software. The software includes the MDDS operating system, extended basic, assembler and editor. MDDS is a complete package, including an assembler, editor, file management functions and utilities, which provides total support. BASIC is a self-contained package which provides a powerful set of tools for developing, testing, executing, and maintaining BASIC programs.

BASIC is designed for microcomputers with at least 24K bytes of RAM and Micropolis Meta-Floppy disk system. DOS can be used alone in a 16K byte memory system.

Activating the built-in Auto load ROM brings up the system under control to the DOS executive. Basic can be accessed by issuing a simple DOS command.

Both packages are designed for flexible, efficient programming. Both packages use the same file structure and file management scheme for total compatibility. Programs created under DOS can be loaded and accessed from BASIC. Data files created under BASIC can be processed by user written application programs running under the DOS. Everything you need to get "On Line" in one complete package.

MICROPOLIS provides total integration, which means they control everything from beginning to end. The result is a better drive for you, backed by a full 120 days factory warranty.

Anyone can cut price by lowering capacity or eliminating valuable features. But there's no long term advantage in it. Not for the user. Or the manufacturer.

MICROPOLIS takes a better approach, even though it's more difficult, by using advanced design to provide more capability while lowering cost.

| MODEL | CAPACITY (KBYTES) | HEADS/DRIVE | DRIVES/ ENCLOSURE | LIST PRICE |
|-----------|-------------------|-------------|-------------------|------------|
| MCP1053M2 | 630 | 1 | 2 | \$1534.00 |
| 30 lbs. | | 77/100TPI | Yes | \$888.00 |
| MCP1053M4 | 1260 | 2 | 2 | \$1888.00 |
| 30 lbs. | | 154/100TPI | Yes | \$1388.00 |
| MCP1043M2 | 150 | 1 | 1 | \$939.00 |
| 15 lbs. | | 77/100TPI | Yes | \$888.00 |
| MCP1043M4 | 315 | 2 | 1 | \$1107.00 |
| 15 lbs. | | 154/100TPI | Yes | \$888.00 |
| MCP1041M2 | 630 | 1 | 1 | \$838.00 |
| 15 lbs. | | 77/100TPI | No | \$840.00 |
| MCP1041M4 | 630 | 2 | 1 | \$1005.00 |
| 15 lbs. | | 154/100TPI | No | \$780.00 |

COMPLETE W/S-100 CONTROLLER, CABLES, MANUALS AND MICROPOLIS MDDS AND BASIC

ADD-ON DRIVES

| | | | | |
|-----------|------|------------|-----|-----------|
| MCP1033M2 | 630 | 1 | 2 | \$1301.00 |
| 30 lbs. | | 77/100TPI | Yes | \$888.00 |
| MCP1033M4 | 1260 | 2 | 2 | \$1638.00 |
| 30 lbs. | | 154/100TPI | Yes | \$1108.00 |
| MCP1023M2 | 315 | 1 | 1 | \$689.00 |
| 15 lbs. | | 77/100TPI | Yes | \$488.00 |
| MCP1023M4 | 630 | 2 | 1 | \$855.00 |
| 15 lbs. | | 154/100TPI | Yes | \$648.00 |
| MCP1021M2 | 315 | 1 | 1 | \$586.00 |
| 15 lbs. | | 77/100TPI | No | \$480.00 |
| MCP1021M4 | 630 | 2 | 1 | \$754.00 |
| 15 lbs. | | 154/100TPI | No | \$580.00 |

NOTE: Add-on modules do not include Controller, User's Manual or Diskettes.

ACCESSORIES

| | | |
|--------------|--|---------|
| MCP1091-01 | Regulator kit for 1041, 1021, 1015 and 1016. | \$20.00 |
| MCP1092-01 | Relocatable bootstrap kit | \$25.00 |
| MCP 1003-032 | Poly 88 kit (relocated BASIC MDDS 4.0A) | \$25.00 |

MANUALS

| | | |
|------------|--|---------|
| MCP1084-01 | User's Manual for Micropolis S-100 Meta System. Describes operation, configuring, installation of systems, explains details of our Disk Extended BASIC and DOS, and discusses diskette programming in general. 5 1/2" (included with all subsystems) | \$50.00 |
| MCP1084-02 | Maintenance Manual for all Micropolis floppy disk drives. | \$50.00 |

DISKETTES, ETC.

| | | |
|-------------|------------------------------------|---------|
| VR080577-10 | 77 Track Cert. Single Side. Box 10 | \$48.00 |
| VR080578-10 | 77 Track Cert. Double Side. Box 10 | \$88.00 |
| VRBF005 | 5 1/4" Head Cleaning Kit | \$28.00 |

OEM & DEALER INQUIRIES INVITED

PRIORITY ONE ELECTRONICS

9161 DEERING AVE. • CHATSWORTH, CA 91311

ORDER TOLL FREE (800) 423-5922 CA, AK, HI CALL (213) 709-5464

Terms: U.S. VISA, MC, BAC, Check, Money Order. U.S. Funds Only. CA residents add 6% Sales Tax. MINIMUM PREPAID ORDER \$15.00. Include MINIMUM SHIPPING & HANDLING of \$2.50 for the first 3 lbs., plus 25¢ for each additional pound. Orders over 50 lbs. sent freight collect. Just in case, please include your phone no. Prices Subject to change without notice. Credit Card orders will be charged appropriate freight.



CALIFORNIA COMPUTER SYSTEMS

\$100

| | |
|--|-----------------------------|
| 2032 32K STATIC RAM A & T. | |
| 450 NSEC. \$579.00, 300 NSEC. \$585.00, 200 NSEC. \$629.00 | |
| 2116 16K STATIC RAM A & T. | |
| 450 NSEC. \$285.00, 300 NSEC. \$289.00, 200 NSEC. \$329.00 | |
| 2065 64K DYNAMIC RAM A & T. | \$548.95 |
| 2200 S-100 MAIN FRAM A & T. | \$379.95 |
| 2422 FLOPPY DISC WITH CP/M 2.2™ | \$329.95 |
| 2802 6502 PROCESSOR A & T. | \$282.95 |
| 2810A Z80 CPU A & T. | \$249.95 |
| 2710A 4 SERIAL 1/0 A & T. | \$291.95 |
| 2718A 2 SERIAL, 2 PARALLEL A & T. | \$305.95 |
| 2720A 4 PARALLEL A & T. | \$214.95 |
| PROTO BOARDS WW | \$39.95, SOLOERTAIL \$29.95 |

APPLE PRODUCTS

| | |
|------------------------------------|----------|
| 7114A 12K ROM/PROM. | \$68.50 |
| 7424A CALENDAR/CLOCK. | \$106.95 |
| 7440A PROGRAMMABLE TIMER. | \$98.50 |
| 7470A A TO D CONVERTER. | \$105.95 |
| 7490A GPIB (IE 488) INTERFACE. | \$265.95 |
| 7710A ASYNC SERIAL. | \$125.95 |
| 7712A SYNC SERIAL. | \$153.95 |
| 7720A PARALLEL STANDARD. | \$98.95 |
| 7720B PARALLEL CENTRONICS. | \$98.95 |
| 7811B ARITHMETIC PROCESSOR W/DISC. | \$342.95 |
| 7811C ARITHMETIC PROCESSOR W/ROM. | \$342.95 |
| 7500A WW BOARD. | \$22.95 |
| 7510A SOLDERABLE BOARD. | \$23.95 |

SOFTWARE

| | |
|---|---------|
| 2610 CP/M™ MACRO ASSEMBLER ON DISK. | \$76.95 |
| 2620 CP/M™ SYMBOLIC INSTRUCTION DEBUGGER. | \$64.25 |
| 2630 CP/M™ TEXT FORMATER. | \$64.25 |
| 2640 CP/M™ BACKGROUND PRINT UTILITY. | \$42.95 |

OTHER CCS PRODUCTS ARE AVAILABLE.
CALL FOR PRICE.



MICROCOMPUTER PRODUCTS

\$100 PRODUCTS

| | |
|------------------------------|--------------------------|
| CB1A 8080 PROCESSOR PCBD. | \$32.95 |
| KIT | \$155.95, A & T \$215.95 |
| CB-2 280 PROCESSOR BOARD. | |
| KIT | \$198.95, A & T \$269.95 |
| VB1C 64 x 16 VIDEO, PCBD. | \$32.95 |
| KIT | \$153.95, A & T \$199.95 |
| VB2 64 x 16 VIDEO, PCBD. | \$32.95 |
| KIT | \$175.95, A & T \$234.95 |
| VB3 80 CHARACTER VIDEO 4MHZ. | |
| KIT | \$345.95, A & T \$425.95 |
| UPGRADE RAMS FOR VB-3 | \$42.00 |

| | |
|---------------------------------|--------------------------|
| 104 2 PARALLEL, 2 SERIAL, PCBD. | \$32.95 |
| KIT | \$155.95, A & T \$194.95 |

| | |
|-----------------------------------|--------------------------|
| PB-1 2708, 2716 PROGRAMMER BOARD. | |
| KIT | \$135.95, A & T \$185.95 |

| | |
|-----------------------|--------------------------|
| MB-10 16K STATIC RAM. | |
| KIT. | \$299.95, A & T \$339.95 |

APPLE PRODUCTS

| | |
|--|--------------------------|
| A488 IEEE 488 INTERFACE. | \$399.95 |
| A10 SERIAL/PARALLEL INTERFACE. | |
| KIT | \$125.95, A & T \$155.95 |
| AS10 SERIAL I/O | |
| KIT | \$87.95, A & T \$97.95 |
| API0 PARALLEL 10 | |
| KIT (W/O CABLES) . . . \$67.95, A & T (W/O CABLES) . . . \$87.95 | |

OTHER SSM PRODUCTS ARE AVAILABLE.
CALL FOR PRICES.

MIKOS

MONDAY-FRIDAY, 8:00 TO 12:00, 1:00 TO 5:30
THURSDAYS, 8:00 TO 9:00 P.M.

(415) 728-9121

P.O. BOX 955 • EL GRANADA, CA 94018
PLEASE SEND FOR IC, XISTOR AND COMPUTER PARTS LIST

**OCT. SPECIAL SALE
ON PREPAID ORDERS**

(CHARGE CARDS AND C.O.D. OR P.O. NOT AVAILABLE ON THESE OFFERS)

APPLE SALE. 5% OFF OF CCS APPLE COMPUTER PRODUCTS.



| | |
|-----------------------------|-------------------------|
| MEM-3 32K STATIC RAM, PCBD. | \$36.95 |
| KIT LESS RAM | \$95.95, A & T \$135.95 |

| | |
|----------------------------|--------------------------|
| CPU-2 Z80 PROCESSOR, PCBD. | \$32.95 |
| KIT LESS ROM. | \$109.95, A & T \$149.95 |

| | |
|----------------------------|------------------------|
| EPM-2 16K/32K EPROM, PCBD. | \$32.95 |
| KIT LESS ROM. | \$65.95, A & T \$99.95 |

| | |
|--------------------------|--------------------------|
| FPB-1 FRONT PANEL, PCBD. | \$48.50 |
| KIT | \$144.95, A & T \$184.95 |

| | |
|-----------------------------|-------------------------|
| CPU-1 8080 PROCESSOR, PCBD. | \$29.95 |
| KIT | \$89.95, A & T \$129.95 |

| | |
|------------------------------------|-------------------------|
| QMB-12 13 SLOT MOTHER BOARD, PCBD. | \$39.95 |
| KIT | \$95.95, A & T \$135.95 |

OTHER WAMECO PRODUCTS ARE AVAILABLE.
CALL FOR PRICES.

MIKOS PARTS ASSORTMENTS ARE ALL FACTORY MARKED PARTS KITS INCLUDE ALL PARTS LISTED AS REQUIRED FOR THE COMPLETE KIT LESS PARTS LISTED ALL SOCKETS INCLUDED.

LARGE SELECTION OF LS TTL AVAILABLE.
PURCHASE \$50.00 WORTH OF LS TTL AND GET 10% CREDIT TOWARD ADDITIONAL PURCHASES. PREPAID ORDERS ONLY.

VISA or MASTERCHARGE. Send account number, interbank number, expiration date and sign your order. Approx. postage will be added. Check or money order will be sent post paid in U.S. If you are not a regular customer, please use charge, cashier's check or postal money order. Otherwise there will be a two-week delay for checks to clear. Calif. residents add 6% tax. Money back 30-day guarantee. We cannot accept returned IC's that have been soldered to. Prices subject to change without notice. \$10 minimum order. \$1.50 service charge on orders less than \$10.00.

ELECTRONICS CENTER

CALL TOLL FREE

1-800-228-4097

Call For "Unbelievable" Low Low Prices
On These Lines:

AMDEK
APPLE
ATARI
BASE 2
CENTRONICS
COMMODORE
DC HAYES
HAZELTINE
LEEDEX

MACROTRONICS
MAXELL
MICROSOFT
MOUNTAIN HARDWARE
N.E.C.
NORTHSTAR
PANASONIC
SANYO
SYNCOM



YOUR

ELECTRONICS PLAYGROUND

1840 "O" Street Lincoln, Nebraska 68508
In Nebraska Call (402) 476-7331



INCREDIBLE? BELIEVE IT!

PRINTERS



150 cps bidirectional-9x9 dot matrix, quietized case, 136 col, vertical form control and many other functions

\$1195

We feel this printer offers the best price/performance ratio available. RS-232 serial to 19,200 baud x-on, x-off add \$40



Teletype 40, 300 LPM-typewriter quality, RS-232 interface. This quality printer is available in many configurations including forms access, quietized case, etc. from **Only \$2928**

Teletype 43 from **\$995**

Teletype AP-200, 340 cps dot matrix (similar to Data Prod. M-200) **\$2799**

NEC Spinwriter-55 cps, bidirectional, letter quality R.O. **\$2560** KSR **\$2799**

DIABLO 630-40 cps, bidirectional, daisy wheel, plot/graph **\$2449**

QUME Sprint 9/45 cps, daisy wheel **\$2228**

C. ITOH Starwriter, 25 cps, daisy wheel **\$1575**

C. ITOH Starwriter, 45 cps, daisy wheel **\$1849**

EPSON MX-80, 80 cps, 9x9 dot matrix **\$C449**

ANADEX 9500/9501, up to 200 cps, high resolution dot **\$1349**

OKIDATA Microline 80, 80 cps, 9x7 dot matrix **\$490**

Microline 82, bidirectional, friction/pin feed **\$599**

Microline 83, bidirectional, 120 cps, uses 15" paper **\$875**

TI-810, 150 cps, Basic **\$1449**

Package-Compressed print, vertical form control **\$1630**

CENTRONICS 704-9, 180 cps, 9x9 dot matrix, 132 col, RS-232 **\$1595**

704-11, 180 cps, 9x9 dot matrix, 132 col, parallel **\$1695**

730, 100 cps, 7x7 dot matrix, same as R.S. LP11 **\$660**

739, 100cps, nx9 dot matrix, **\$849**

DEC LA-34 **\$1085**

1DS 460G **\$892**

S-100 SPECIALTIES



DPZ-80A, CPU, 64K ram, floppy cont., RS-232 port, S-100 IEEE, 8 slot in Adds terminal, inc. CP/M 2.2 **\$CALL**

Delta has Winchester based networks of up to 16 users available.



Call us for best prices on these high quality 2nd generation boards and systems.



These high quality, reliable products have made CCS defacto industry standard for S-100 products Assembled and tested:

2200 H.D. Mainframe, 20 a. P.S., 12 slot MB **\$434** **\$359**

2065C 64K dynamic RAM/Bank Select **\$720** **\$580**

2810A Z-80 CPU, serial port, ROM monitor **\$310** **\$259**

2422A Floppy Cont, CP/M 2.2, ROM monitor **\$425** **\$345**

IMS 8000 DT — w/64k. 1.2 MB 8" floppies, 2 serial, 3 par. CPM 2.2 **\$CALL**

FULL 2 YEAR WARRANTY!

Z-80 CPU **\$310**

Dz Disk controller **\$354**

64K Dynamic Ram **\$648**

MICROBYTE FULL SYSTEMS AVAILABLE **\$call**

SUPERBRAIN Similar savings on the full lines of CCS, SSM, NNC, MORROW, DELTA,

NORTHSTAR, ITHACA INTERSYSTEMS, GODBOUT, NEC, TELEVIDEO, IMS

ZENITH, ADDS, DEC, DATA GEN., ATARI, DYNABYTE.

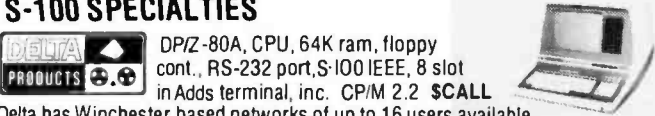

8" DISK DRIVE SALE

8" SHUGART SA801R \$450 **8" SHUGART SA 851R** \$669 2 for \$1289

QUME DATATRACK 8 \$625 2 for \$1199

Enclosure, power supply for 2 8" drives A&T **\$299**

NNC industrial grade enclosure for 2 drives with P.S. **\$445**

MORROW Discus 2D + CP/M®, MICROSOFT BASIC **\$950**

Discus 2 + 2 + CP/M®, MICROSOFT BASIC **\$1195**

HARD DISK SPECIALS

CORVUS 10MB and controller **List \$5350** **only \$C449**

20MB and controller **List \$6450** **only \$C449**

Constellation Network Multiplexer and **Mirror Video Tape Disk Backup**

MORROW 26MB + controller + CP/M 2.2®, M basic **\$4495** **\$3821**

controller, CDC Hawk Drive (5 fix, 5 rem) **\$6995** **\$5995**

controller, Western Dynex (5 fix, 5 rem) **\$5995** **\$5099**

Winchester 5 1/4 drives complete with case, cable,

software, S-100 controller. Adapter avail. for use with

any Z-80 system. Cartridge drive controllers avail. **List**

5MB Quantity discounts available! **\$2898**

10MB **\$3398**



S33-33MB Drive and Controller **\$4468**

S66-66 MB Drive and Controller **\$5925**

PRIAM 8" and 14" Winchester/tape subsystems avail.

We carry the full line of ADES disk and tape controllers and subsystems.

FULLY CONFIGURED BUSINESS SYSTEMS

The following are some examples of the fully assembled and tested business and scientific computer systems which we offer. All include 64K bytes RAM, Z-80A 4mh CPU. We offer a full line of quality, tested software.

Delta TVD w/ 1.2 Mb floppy drives, 2 serial, 3 parallel ports **\$CALL**

Delta 1004 w/10 MB hand disk, 1 MB floppy, 6 serial, 3 parallel ports **\$CALL**

CCS 2210A w/floppy controller, 1 serial port **\$1849**

CCS 300-1A w/1.2MB floppy drives, 2 serial, 2 parallel ports **\$4849**

CCS 400-1A w/10MB hard disc, 2 serial, 2 parallel ports **\$6999**

NNC 80 w/1 MB floppy drives, 2 serial, 3 parallel ports **\$3799**

NNC 80W w/ .5MB floppy, 8.4MB hard disc, (OASIS optional) **\$6693**

ALTOS single and multi-user systems **\$call**

MORROW Decision 1, MICROSOFT basic, UNIX **\$call**

XEROX, 820 Desktop computer-64K, 2 floppys, (CP/M AVAIL.) **List \$2995** **\$CALL**

We offer multi-user networks by **DELTA, DISCOVERY, TELEVIDEO, MUSYS, IMS, DIGITAL, MICRO.**

TERMINALS

AMPEX DIALOGUE 30, 80 **\$CALL**

TELEVIDEO 910 C (multi-terminal) **\$699** **\$599**

920 C **\$1030** **\$789**

950C **\$1195** **\$989**

SOROC IQ 120 **\$995** **\$729**

HAZELTINE ESPRIT **\$745** **\$669**

DEC VT-100 **\$2050** **\$1575**

Similar savings for our **HAZELTINE** and **LEAR SIEGLER** lines

LOOK HERE! **AMPEX**

Call us for ALL your software needs **Dialogue 80™**

SYSTEMS HOUSES & EDUCATIONAL INSTITUTIONS

GIVEN SPECIAL CONSIDERATION.



ALL OF OUR PERIPHERALS CAN BE CONFIGURED FOR RADIO SHACK® MODEL II

DEALER and INTERNATIONAL INQUIRIES WELCOME

WASHINGTON COMPUTER SERVICES

an affiliate of **WASHINGTON ELECTRIC COMPANY** est. 1912

CUSTOM COMPUTER ROOM WIRING SINCE 1960

97 Spring Street

New York, N.Y. 10012

Hours: 8AM-5:30PM (EST) Mon.-Fri.

TO ORDER: CALL OUR TOLL-FREE NUMBER:

★ (800) 221-5416 ★ In N.Y. State and for technical information call 1-(212) 226-2121

For fast delivery, send certified checks, money order or call to arrange direct bank wire transfers. Personal or company checks require two to three weeks to clear. All prices are mail order only. Prices subject to change without notice; call for latest prices. Prices include 2% cash discount. N.Y. residents add sales tax.

Quantex is a trademark of North Atlantic Industries, Inc.

Radio Shack® is a trademark of the Tandy Corp.

CP/M® is a trademark of Digital Research

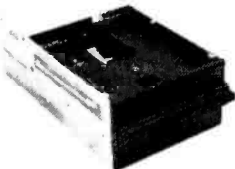
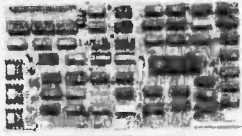

| | | | |
|--|--|--|--|
|  | | FLOPPY DISK DRIVES Qume Datatrak-8 \$540 Virtually the industry standard. High quality/reliability. Full featured, double-sided, double density. SA851R \$540 Full featured drive, double sided, double density SA801R \$430 Single sided, double density, very consistent FDD100-8 \$430 Qume Datatrak 5 5 1/4" \$345 SA-400 5 1/4" \$299 Tandon TM-100 48 TPI 5 1/4" \$350 96 TPI \$425 We are expecting a large shipment of mini's, many types. Call for details. | CPU CCS 2810 \$ 275 Godbout Z-80A \$ 275 Godbout 8085A \$ 295 |
| CONTROLLERS Tarbell single density kit \$195 Tarbell single density A & T \$310 Tarbell double density A & T \$425 CCS 2422 w/CPM 2.2 \$350 Godbout Disk 1 \$450 MDA MXV-21 LSI-11 controller \$1050 (RX-01, RX-02 compatible) | |  | MEMORY CCS 2065 64K dynamic \$ 625 CCS 2116 32K static \$ 675 Godbout RAM 17 64K \$ 995 |
| MISCELLANEOUS CCS Mainframe \$395 2 Disk drive enclosure \$ 95 (fits Siemens, Shugart, Qume) CP-206 power supply \$110 (powers two floppies) | | Cable Kits 2 drives \$ 35 3 drives \$ 40 4 drives \$ 45 Diskettes ss \$39/10 - ds \$59/10 | I/O CCS 2710 4 SIO \$ 325 Godbout Interfacer 1 \$ 225 Godbout Interfacer 2 \$ 225 |
| | | | Qume S/5 - Daisy Wheel Printer Sprint 5/45 RO \$2699 Sprint 5/55 RO 2829 Sprint 5/45 KSR 3029 Sprint 5/55 KSR 3159 Forms Tractor 210 Pinfeed platen 155 Paper Guide 30 Paper Basket 50 many print wheels, ribbons, & more available. |

Terms of sale: cash or checks, purchase orders from qualified firms and institutions. Minimum order \$25. CA residents add 6% tax. Prices subject to change without notice. All goods subject to prior sale. Minimum shipping/handling charge \$4.00.

Electrolabs
 POB 1608, Palo Alto, CA 94302 (415) 321-5601

CALL TOLL FREE:

1-800-547-2492



APPLE HARDWARE

| | |
|-------------------------------|--------|
| DISK DRIVE w/33 CONTROLLER | \$499 |
| DISK DRIVE ONLY | \$429 |
| SILENTYPE PRINTER w/INTERFACE | \$349 |
| GRAPHICS TABLET | \$599 |
| APPLE SOFT OR INTEGER CARD | \$139 |
| PASCAL LANGUAGE CARD | \$369 |
| PARALLEL PRINTER CARD | \$129 |
| SERIAL PRINTER CARD | \$159 |
| CENTRONICS PRINTER CARD | \$149 |
| LOWER CASE ADAPTOR | \$39 |
| 16K RAM CARD (MICROSOFT) | \$159 |
| Z-80 CARD (MICROSOFT) | \$329 |
| MICROMODEM (HAYES) | \$279 |
| SMART MODEM (HAYES) | \$229 |
| MOUNTAIN CLOCK | \$249 |
| MOUNTAIN MUSIC SYSTEM | \$479 |
| MOUNTAIN A/D CONVERTER | \$299 |
| MOUNTAIN INTROL/X-10 CONTROL | \$179 |
| MOUNTAIN C.P.S. MULTIFUNCTION | \$239 |
| 10 KEYPAD (A.B.T.) | \$129 |
| SUP-R-TERM (80 COLO BY M&R) | \$299 |
| SUP-R-MOD (MODULATOR BY M&R) | \$22 |
| 16K MEMORY EXPANSION | \$49 |
| JOYSTICK (T.G. OR PROGRAMMA) | \$49 |
| 9" B&W MONITOR (SANYO) | \$145 |
| 9" B&W MONITOR (N.E.C.) | \$149 |
| 12" B&W MONITOR (SANYO) | \$189 |
| 12" GREEN MONITOR (SANYO) | \$229 |
| 13" COLOR MONITOR (T.I.) | \$319 |
| I.D.S. 445G PRINTER | \$689 |
| I.D.S. 460G PRINTER | \$799 |
| I.D.S. 560G PRINTER | \$999 |
| EPSON MX-80 PRINTER | \$479 |
| EPSON MX-100 PRINTER | \$829 |
| EPSON CABLE AND INTERFACE | \$89 |
| N.E.C. SPINWRITER PRINTER | \$2499 |
| QUME 5/45 PRINTER | \$2499 |
| TEXAS INSTRUMENT 99/4 | \$399 |

ATARI HARDWARE

| | |
|--------------------------|-------|
| CX-2600 VIDEO GAME | \$149 |
| 410 PROGRAM RECORDER | \$59 |
| 810 DISK DRIVE | \$429 |
| 820 PAINTER | \$319 |
| 820 PRINTER | \$249 |
| 822 PRINTER | \$339 |
| 825 PRINTER | \$569 |
| 830 MODEM | \$149 |
| 850 INTERFACE MODULE | \$139 |
| 853 16K MEMORY EXPANSION | \$89 |

SOFTWARE

| | |
|-----------------------------|-------|
| VISICALL (ARARI) | \$139 |
| BASIC (ATARI) | \$49 |
| VISICALL | \$139 |
| VISIDEX | \$139 |
| VISIPILOT | \$129 |
| VISITERM | \$109 |
| VISITREND | \$179 |
| D.O.S. TOOL KIT | \$59 |
| D.O.S. 3.3 UPDATE | \$49 |
| MICROLAB DATA FACTORY | \$129 |
| D B MASTER (STONEWARE) | \$179 |
| APPLE WRITER | \$59 |
| SUP-R-TEXT II | \$109 |
| WORDSTAR | \$279 |
| B.P.I. FOSTWARE (each) | \$319 |
| GENERAL BUSINESS CONTROLLER | \$509 |
| SOFT-TECH PAYROLL | \$179 |
| STOCKFLEX INVENTORY | \$369 |
| ADVENTURE | \$29 |
| ZOAK | \$29 |
| SARGON CHESS | \$29 |
| GALAXIAN | \$22 |

CALL FOR OTHER HARDWARE AND SOFTWARE

Toll free number for order desk only. In Oregon and for service or warranties call (503) 479-4150. Bank wires, cashiers checks and bankcards accepted immediately. Allow 10 days for personal checks. Master Charge and VISA add 2%, sorry no C.O.D.'s. Add 2% (minimum \$4.00) for all U.P.S. shipments to cover freight, handling and insurance. \$100.00 minimum order. Prices subject to change without notice. NOTE: We are registered with the State of Oregon, have been in electronic sales and service for 5 years and are fully qualified for repair of any micro computer system. Three full-time certified technicians insure one-day turnaround on most Apple repairs.

"A Unique Combination of Quality Products, Competitive Prices, and Service"



530 N.E. 'E' Street • Grants Pass, Ore. 97526

SERIOUS S-100 USERS:
We configure to your needs. Multi-user, multiprocessor, hard disk, tape backup, alternative DOS—we have the right product at the right price.



QT SYSTEM+



- 4 MHz Z-80A, 2 serial, 2 parallel
- 2 8" floppies, double density
- 64K Ram, EPROM monitor for RS-232
- CP/M 2.2
- Optional 6, 8 or 12 slot motherboard
- Optional single or double-sided floppies
- Burned In—just add video terminal
- MSYS-SS(6) ... \$3415
- MSYS-SS(8) ... 2845
- MSYS-SS(12) ... 3605
- SYS+DS(6) ... \$4270
- SYS+DS(8) ... 4365
- SYS+DS(12) ... 4460

QT MINI-SYSTEM+



- MINI-SYSTEM+ (5 1/4")
- Above with 5 1/4" floppies
- MSYS+SS(6) ... \$2745
- MSYS+SS(8) ... 2845
- MSYS+SS(12) ... 2945
- MSYS+DS(6) ... \$3045
- MSYS+DS(8) ... 3145
- MSYS+DS(12) ... 3245

QT DISK PACKAGES



- DDC-88-2 2-801R, cab., ps. fan ... \$1225
- DDC-88-22 2-Queme DT-8, cab., ps. fan ... 1625
- DDC-88-3 Cabinet, ps. fan, cables ... 300
- DDC-88-4 Cabinet only ... 60

QT MAINFRAMES

- 18A power supply, S-100
- Drive power supply
- Specify motherboard slots
- Specify 8", 5 1/4" or no floppy
- 2-8" Floppy w/motherboard
- MF8-6 ... \$600
- MF8-8 ... 625
- MF8-12 ... 650
- 2-5 1/4" Floppy—w/motherboard
- MF5-6 ... \$425
- MF5-12 ... 475
- No Floppy—w/motherboard
- MF+12 ... \$425
- MF+18 ... 475
- MF+22 ... 575

QT SINGLE 8" CABINET



- Accepts one 8" floppy
- Power supply, fan, AC filter
- 117v AC/220v AC
- Data cable, power cables
- DDC+8 ... \$165

QT S-100 CARD CAGES

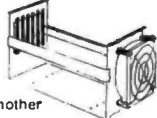

- 6, 8 or 12 slot
- Accepts Silence+ mother
- With card guides
- Accepts 4" fan
- Specify with mother, with fan
- 6 Slot (5 1/2" w x 10 1/4" d x 6" h)
- CC+6 ... \$24
- CC+8M ... 85
- CC+6M/F ... 110
- 8 Slot (7 1/4" w x 10 1/4" d x 6" h)
- CC+8 ... \$37
- CC+8M ... 95
- CC+8M/F ... 130
- 12 Slot (11 1/4" w x 10 1/4" d x 6" h)
- CC+12 ... \$60
- CC+12M ... 110
- CC+12M/F ... 145

QT SILENCE+ S-100 Motherboards

- Full ground shield network
- Specify board, kit, or assembled
- 6-B ... \$22 8-B ... \$25 12-B ... \$28
- 6-K ... 38 8-K ... 52 12-K ... 67
- 6-A ... 47 8-A ... 65 12-A ... 85
- 18-B ... \$48 22-B ... \$73
- 18-K ... 97 22-K ... 138
- 18-A ... 135 22-A ... 185

QT SBC+2/4

- Kit ... \$190 A&T ... \$290

QT Z+80 CPU

- Kit ... \$160 A&T ... 215

QT EXPANDABLE+RAM

- EXP+16 ... \$265 EXP+48 ... \$300
- EXP+32 ... 285 EXP+64 ... 320

QT I/O+

- Kit ... \$260 A&T ... \$365

QT CLOCK/CALENDAR+

- S-100/Apple/TRS ... \$140

ADES S-100 HARD DISK



- PRIAM 8" and 14" Winchesters
- With S-100 controller, BIOS
- Cables, cabinet, power supply
- First # = hard disk MByte, second # = tape cartridge MByte
- S10 ... \$3275 S10/10 ... \$6190
- S34 ... 5420 S34/20 ... 8495
- S33 ... 4255 S33/20 ... 7525
- S66 ... 5660 S66/20 ... 8860

SIERRA DATA S-100 Z80A/B

Single Board Computer

- CPU, 4 timers, 64K Ram
- 2 serial, 4 parallel, 16K Eprom
- Floppy controller, D-D
- Winchester interface
- Eprom programmer
- Specify 4 or 6 MHz, master or slave
- 4M ... \$875 6M ... \$1150
- 4S ... 775 6S ... 1050
- Recommended DOS (CP/M compatible)
- Single ... \$300 Multi-CPU ... \$750



BISON 256K RAM

- 64K IC's, dynamic
- S-100, 4MHz
- Assembled and tested, 64K or 256K
- B256-64 ... \$470
- B256-256 ... 995

COMPUTER RESOURCES 256K S-100 Dynamic Ram

- 8 MHz capable, 8 or 16 bit CPU
- Parity detect
- Full IEEE 696
- Assembled and tested, with 64K or 256K
- CR256-64 ... \$900
- CR256-256 ... 1300

SEALS IS BACK

Seals 64K Static S-100

- Uses Fujitsu MB8167, 16K+1 static in 20 pin
- 70ns: DMA to 14MHz
- Complete 16 bit or 8 bit flexibility
- IEEE S-100 and Cromix compatible
- List ... \$1195 Now ... \$1050

STATIC MEMORY SYSTEMS 64K Static S-100

- See ad, this issue
- Intermix RAM and EPROM
- 200ns, very low power
- SMS-64K A&T ... \$550

NEC PERSONAL COMPUTER PC-8000 Family

- 80x24 display, hi-res color
- Upper and lower case
- Most popular in Japan
- Features compare with Apple III
- System: CPU, I/O, Disks ... \$2897



Authorized Dealer

APPLE II+

- 48K ... \$1175

TELEVIDEO

- 950C ... \$975
- 920C ... 745
- ADDS VIEWPOINT ... 625

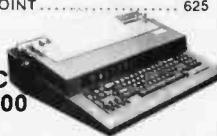

XYMEC HY-Q 1000

Daisywheel Printer/Typewriter

- Bold, underline, reverse, right justify, center
- 10, 12 and 15 plch
- Automatic error correction
- 15 character display
- Fast, nationwide service
- SAVE \$400
- Parallel ... \$2450
- RS-232 ... 2675
- IEEE-488 (GPIB) ... 2525
- Tractor ... 325

800-421-5150

STARWRITER



- Daisywheel printer, Diablo compatible
- Nationwide service
- Centronics parallel or RS-232 serial
- 25 cps or 45 cps, specify
- 25-P ... \$1400 25-S ... \$1500
- 45-P ... 1750 45-S ... 1850
- Tractor ... \$200

IDS PAPER TIGERS

- #445 ... \$ 710
- #460G ... 1050
- #560G ... 1300

EPSON MX-80

- Friction upgrade ... \$500
- For Apple parallel w/cable ... 110

EPSON MX-100

- Wide carriage
- Friction, tractor, graphics
- "Correspondence" quality print
- Unbeatable price ... \$795

FOR APPLE

2 MBYTE FLOPPY FOR APPLE

- 2 double density, double sided 8" drives
- Cabinet, power supply, cable, controller
- DOS 3.3 compatible (Pascal and CP/M optional)
- This package is best, spec for spec, price for price.
- Sugg. List ... \$2550 Now Only ... \$2050
- SAVE \$500 CP/M Patch \$75 Pascal Patch \$75

- 16K Ram card ... \$85
- 64K Ram card ... 345
- Add-on mini floppy ... 375

DISK DRIVES

- 801R ... \$410 B51 ... \$250
- DT-8 ... 585 B52 ... 320
- 850R ... 610 B91 ... 320
- FDD120-8 ... 375 B92 ... 430

MICROPOLIS 8" HARD DISKS, with controller

- #1221 9MB ... \$2475
- #1222 27MB ... 3014
- #1223 45MB ... 3604

Floppy-Data: Card Edge



Type SD • Jade

- DSC-34-1 Single, mini ... \$24
- DSC-34-2 Dual, Mini ... 29
- DSC-34-4 Quad, Mini ... 34
- DSC-50-1 Single, 8" ... 24
- DSC-50-2 Dual, 8" ... 24
- DSC-50-4 Quad, 8" ... 40

SD SYSTEMS



MULTI-USER BOARD SET

- 38062 SBC-200 (RS-232) ... \$ 471
- 38059 Versafloppy II (RS-232) ... 500
- 38023 Expandom RAM II-64K (2 pcs.) ... 1400
- 38032 MPC-4...4 port serial ... 764
- 39039 COSMOS (CP/M compatible) ... 350

- List \$3485
- Queme DT-8 (1 pc.) ... N/C
- CBASIC II ... N/C
- Package of the year award ... \$3485

All SD Items available.

- 38007 Z-80 Starter Board ... \$424
- 38013 VDB-8024 (60 Hz) ... 444
- 38020 Expandom II-16K ... 310
- 38023 Expandom II-64K ... 370
- 38025 PROM 100 ... 248
- 38059 Versafloppy II (RS-232) ... 400
- 38060 Versafloppy II (VDB-8024) ... 400
- 38061 SBC-200 (VDB-8024) ... 376
- 38062 SBC-200 (RS-232) ... 376

CALIFORNIA COMPUTER SYSTEMS



15% DISCOUNT
All CCS items available.

- S-100
- 2032A 32K Static - 2 MHz ... \$561
- 2032B 32K Static - 4 MHz ... 641
- 2116A 16K Static - 2 MHz ... 297
- 2116B 16K Static - 4 MHz ... 331
- 2200A Mainframe ... 368
- 2210A System ... 1825
- 2422A Floppy Controller ... 360
- 2710A 4-Port Serial ... 289
- 2718A Serial/Parallel ... 306
- 2720A 4-port Parallel ... 212
- 2810A Z80 CPU ... 263

TELETEK

- FDC-1 Single Board Computer ... \$685
- FDC-2 Double Density Controller ... 325

INTEGRATED CIRCUITS

- 4116 (200ns) ... \$2.00 8257 ... \$17.95
- 2114 (450ns) ... 2.00 8295 ... 16.50
- 2708 ... 3.50 MC14411 ... 11.00
- 2716 (5V) ... 6.50 14411Xtal ... 4.95
- 2716 (5-12V) ... 8.00 1771B01 ... 24.95
- 2732 ... 13.00 1791A01 ... 37.95
- 4164 (200ns) ... 25.00 S2350 ... 7.95
- Z-80A ... 12.95 N8T26 ... 2.50
- 8080A ... 3.50 1488 ... 1.25
- 8085A ... 20.00 1489 ... 1.25
- 8086-4 ... 60.00 D3242 ... 10.15
- TMS9900 ... 29.95 TMS5501 ... 19.00
- 8212 ... 3.50 TR1602B ... 4.50
- 8214 ... 4.50 6845P ... 22.00
- 8228 ... 6.00 4118 ... 18.95
- 8238 ... 6.00 DP8304BN ... 4.00
- 8251 ... 7.00

BULK DISKETTES

- Single side, double density
- Specify hard, soft, # of sectors
- Sold in hundreds
- 5 1/4" ... \$215/100 8" ... \$275/100
- Library cases:
- 5 1/4" ... \$25/10 8" ... \$32/10

ANTI-STATIC CHAIR MAT

- 4'x5" black, hard
- With ground strap
- New religion—thousands of believers
- List ... \$185 Special ... \$160

CABLES

- RS-232 - male/male - 9 ft ... \$24
- RS-232 - male/male - 18 ft ... 29
- RS-232 - male/female - 9 ft ... 29

FLOPPY-DATA: PIN TYPE CCS • Tarbell • Teletek

- DSP-34-1 Single, Mini ... \$24
- DSP-34-2 Dual, Mini ... 29
- DSP-34-4 Quad, Mini ... 34
- DSP-50-1 Single, 8" ... 24
- DSP-50-2 Dual, 8" ... 29
- DSP-50-4 Quad, 8" ... 34
- 8" Floppy-DC Power
- PDC-8 24" long ... \$7

Apple is a trademark of Apple Computer, Inc. CP/M and MP/M are trademarks of Digital Research. TRS-80 is a trademark of Radio Shack.



MAIL ORDER: P.O. Box Q, Sherman Oaks, CA 91423
RETAIL: 15618 S. Inglewood Ave., Lawndale, California 90260
(213) 970-1476 (800) 421-5150 1/2 Block South of San Diego Fwy.

TERMS OF SALES: Cash, checks, credit cards, C.O.D. Accounts available to education, government, and qualified businesses. Calif. residents add 6% sales tax. F.O.B. Lawndale, \$3 minimum shipping and handling.

wabash®

When it comes to Flexible Disks, nobody does it better than Wabash.

MasterCard. Visa Accepted.
Call Free: (800) 235-4137



PACIFIC EXCHANGES
100 Foothill Blvd
San Luis Obispo, CA
93401 (In Cal. call
(805) 543-1037)

Circle 288 on inquiry card.

PROCAP

EAGLES ?
COWBOYS ?

RAIDERS ?
RAMS ?

If you'd like to know NOW, before the big game

With PROCAP and your TRS-80™, you can use statistics and probability theory to predict the results of this week's big games. And more. PROCAP

- Gives offensive and defensive ratings for every National Football League team
- Predicts range of results and probable score for each game
- Allows computer matchup of any two teams (Great for playoffs!)
- Gives "up-to-the-minute" standings, statistics, and ratings for each NFL Division

PROCAP is easy to use and comes with extensive documentation

Disk or cassette version is only \$49.95

To order, call our toll free number NOW. Money back guarantee, so you can't lose.

Dial (800) 543-3000, operator 400
In Ohio, dial (800) 582-1364, operator 400

* Please specify TRS-80 Model 1.0 or 2.0, cassette version only or TRS-80 Model III disk cassette or 3.5" floppy disk



The Trinity Computer Group • Software Agent/Publisher

Circle 403 on inquiry card.

QUARTZ CRYSTALS

| | | | | | | |
|----------|---------|---------|---------|---------|---------|----------|
| 3218 | 5.2478 | 0.8336 | 20.000 | 36.2865 | 42.8518 | 45.8128 |
| 5380 | 5.610 | 9.0640 | 20.4988 | 35.3636 | 42.8768 | 47.8368 |
| 1.000 A | 5.7143 | 9.0860 | 22.1184 | 37.9628 | 42.9758 | 47.8838 |
| 1.8432 A | 5.855 | 10.000 | 22.8558 | 38.3768 | 42.9828 | 48.000 |
| 1.8437 | 5.892 | 10.240 | 25.5568 | 38.4448 | 43.0008 | 48.3008 |
| 2.000 A | 6.000 | 10.4968 | 26.5008 | 38.6758 | 43.0378 | 48.6568 |
| 2.0071 A | 6.144 | 10.7558 | 26.6708 | 38.9758 | 43.0748 | 48.7008 |
| 2.4578 A | 6.15000 | 10.8758 | 27.000 | 39.3128 | 43.1858 | 48.7668 |
| 2.500 A | 6.29700 | 10.8368 | 27.0006 | 39.5038 | 43.2568 | 49.1308 |
| 2.6537 | 6.400 | 11.1360 | 27.6506 | 39.6668 | 43.3388 | 49.3338 |
| 2.9950 | 6.5636 | 11.156 | 28.4006 | 39.7538 | 43.3708 | 49.8128 |
| 3.000 A | 6.75200 | 11.2186 | 28.6276 | 39.8768 | 43.4778 | 50.2508 |
| 3.0071 | 6.75840 | 11.2800 | 28.7538 | 39.9628 | 43.4778 | 51.0558 |
| 3.200 | 6.8003 | 11.4778 | 29.8158 | 40.4448 | 43.4448 | 51.3128 |
| 3.2168 | 7.0063 | 11.5566 | 29.9378 | 40.5078 | 43.5558 | 51.7778 |
| 3.500 | 7.1038 | 11.6816 | 30.0648 | 40.8128 | 43.5298 | 51.8508 |
| 3.579 | 7.0916 | 12.440 | 30.3806 | 40.8336 | 43.6668 | 52.8128 |
| 4.000 | 7.1836 | 14.3187 | 30.6758 | 40.8758 | 43.7778 | 56.7508 |
| 4.1943 | 7.2586 | 14.4308 | 30.8158 | 40.8888 | 43.8128 | 60.0008 |
| 4.3426 | 8.000 | 15.000 | 31.4378 | 40.9758 | 43.8148 | 60.7508 |
| 4.4853 | 8.0556 | 15.4408 | 31.7538 | 41.0000 | 43.8518 | 61.7508 |
| 4.6103 | 8.1416 | 15.5066 | 31.9008 | 41.1666 | 43.8888 | 70.4008 |
| 4.6503 | 8.1818 | 16.000 | 32.000 | 41.3158 | 43.9258 | 75.0008 |
| 4.8303 | 8.3303 | 16.3848 | 33.2006 | 41.8378 | 44.0008 | 80.3338 |
| 4.9152 | 8.4998 | 17.2248 | 33.6758 | 42.0008 | 44.0378 | 99.8668 |
| 5.000 | 8.5768 | 17.2272 | 34.5558 | 42.3668 | 44.2768 | 102.6668 |
| 5.0588 | 8.8056 | 18.000 | 34.7538 | 42.6758 | 44.7778 | 101.4568 |
| 5.1203 | 8.9608 | 18.4320 | 34.9776 | 42.7006 | 45.1256 | 103.0668 |
| 5.1650 | 8.9900 | 19.4680 | 35.8256 | 42.7538 | 45.3006 | 103.4668 |
| 8.1858 | 9.47208 | 19.7528 | 36.000 | 42.8148 | 46.7006 | 104.9918 |

ALL A — \$2.99 ALL B — \$1.99 10 OR MORE DISCOUNT

ADD \$1.00 SHIPPING
CAL RES. ADD 6% SALES TAX
FREE OSCILLATOR SCHEMATICS
WITH ANY ORDER

QUALITY COMPUTER PARTS
P.O. BOX 743 / CHATSWORTH, CA 91311

Circle 310 on inquiry card.

UV EPROM ERASER



\$49.95

- ERASES ALL UV ERASABLE EPROMS (2708, 2716, 2532, 2564, etc.)
- QUICK FIFTEEN MINUTE ERASE TIME
- ERASES OVER FIFTEEN EPROMS AT A TIME
- LAMP LIFE, 7700 HOURS
- TIMER AND SAFETY INTERLOCK SWITCH OPTION

• DEALER-INQUIRIES INVITED •

QUV-T8 49.95
Shipping 2.50
COD charges 1.50
Timer & Switch option 20.00
Delivery app. 20 days

Send Check or COD order to:
LOGICAL DEVICES, INC.
781 W. Oakland Park Blvd.
Ft. Lauderdale, Fla. 33311
(305) 974-0967

Circle 202 on inquiry card.

EPSON

DOT MATRIX PRINTERS
SUPER DISCOUNTS ON

MX-80F/T ~~\$699~~ **NOW**
LOWER!
MX-80 ~~\$499~~ **IN**
LOWER!
MX-100 ~~\$990~~ **STOCK**
LOWER!

We also stock direct connect cables for TRS-80, Apple, Atari, Pet or RS 232

CALL TOLL FREE

1-800-344-7493

In CA and for service (209) 667-2888



GRAPHICS ROM'S
AVAILABLE

MACROTRONICS, inc.

125 N. Garden State Blvd
Turlock, California 95360

Circle 206 on inquiry card.

FACTORY PRIME STATIC RAM CHIPS

2114 Super Low Power
200ns 1Kx4 \$ 2.90
6514 CMOS 300ns 1Kx4 \$ 6.90
6116 CMOS 200ns 2Kx8 \$22.50
Add \$5.00 Handling on Orders Under \$200.00

FACTORY PRIME From the same shipments used in GIMIX Professional quality boards.

32KB STATIC RAM CARDS
for the SS50 and SS50C BUS

(16KB — \$298.12), (24KB — 348.14)
(32KB — \$398.15)

NEW! 64KB BATTERY BACK UP CMOS RAM CARDS

Two independently addressable 32KB blocks, each with extended addressing.

(56KB - \$994.56), (64KB - \$1088.64)

2MHZ 6809 56KB SS50 SYSTEMS \$2498.29

DISK SYSTEMS AVAILABLE

GIMIX inc.



1337 W. 37th Place • Chicago, IL 60609
(312) 927-5510 • TWX 910-221-4055
The Company that delivers.

Quality Electronic products since 1975.
GIMIX™ and GHOST™ are Registered Trademarks of GIMIX INC.

Circle 159 on inquiry card.

ANALOG ↔ DIGITAL DIGITAL ↔ ANALOG

CONVERSION MODULES

SOFTWARE
GAIN CONTROL

high accuracy 16-channel programmable gain instrumentation amplifier
conversion time 2 to 15 kHz
12-bit sample and hold amplifier
9-channel differential high accuracy
custom board test 5-100
mixable high and low inputs gain from 1 to 1024
16-channel 10 bit A/D converter
programmable gain instrumentation amplifier
12-bit sample and hold amplifier
9-channel differential high accuracy
custom board test 5-100

For additional details about the AD-100-4 and other fine California Data Corporation 100% individually tested, high reliability products, circle the reader service card number below or for faster response write or call us.

CALIFORNIA DATA CORPORATION
3475 Old Conejo Road, Suite C-10
Newbury Park, CA 91320
(805) 498-3651

Circle 54 on inquiry card.

floppy disks.

100% CERTIFIED AND TESTED
PREMIUM QUALITY



Immediate off the shelf delivery... one box or quantity orders welcome.

SAVE UP TO 40%

CALL OUR ORDER DESK NOW!

(805) 985-9824



MASTERCARD — VISA — C.O.D.



NATIONAL DATA SUPPLIES, INC.

Circle 259 on inquiry card.

Convert your TRS-80 into a DEVELOPMENT SYSTEM

Z-80 In-Circuit emulation and EPROM/EEPROM programming in a single compact unit.



Debug stand-alone systems with program in TRS-80 RAM, then copy working program into PROM.

Only \$329 including personality module for 2716, 2516, 2758, 2508, 2532, 2816, 2808, 48016.

ORION INSTRUMENTS

172 Otis Ave, Woodside, CA 94062
(415) 851-1172

Circle 282 on inquiry card.

DIGITAL RESEARCH COMPUTERS

(214) 271-3538

32K S-100 EPROM CARD

NEW!

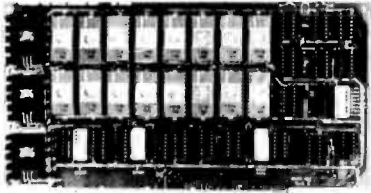

\$79.95
KIT

USES 2716's
Blank PC Board - \$34
ASSEMBLED & TESTED
ADD \$30

SPECIAL: 2716 EPROM's (450 NS) Are \$9.95 Ea. With Above Kit.

KIT FEATURES:

1. Uses +5V only 2716 (2Kx8) EPROM's.
2. Allows up to 32K of software on line!
3. IEEE S-100 Compatible.
4. Addressable as two independent 16K blocks.
5. Cromemco extended or Northstar bank select.
6. On board wait state circuitry if needed.
7. Any or all EPROM locations can be disabled.
8. Double sided PC board, solder-masked, silk-screened.
9. Gold plated contact fingers.
10. Unselected EPROM's automatically powered down for low power.
11. Fully buffered and bypassed.
12. Easy and quick to assemble.

32K SS-50 RAM

\$299.00 KIT

For 2MHZ
Add \$10

Blank PC Board
\$50

For SWTPC
6800 - 6809 Buss

Support IC's
and Caps
\$19.95

Complete Socket Set
\$21.00

Fully Assembled,
Tested, Burned In
Add \$30

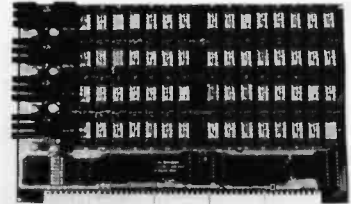

At Last An affordable 32K Static RAM with full 6809 Capability.

FEATURES:

1. Uses proven low power 2114 Static RAMS.
2. Supports SS50C - EXTENDED ADDRESSING.
3. All parts and sockets included.
4. Dip Switch address select as a 32K block.
5. Extended addressing can be disabled.
6. Works with all existing 6800 SS50 systems.
7. Fully bypassed. PC Board is double sided, plated thru, with silk screen.

16K STATIC RAM KIT-S 100 BUSS

PRICE CUT!

\$169.95
KIT

FOR 4MHZ
ADD \$10

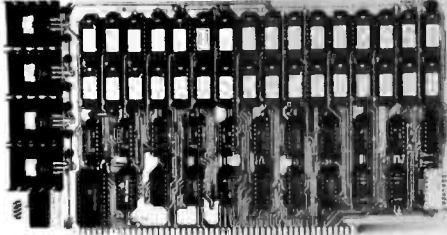

KIT FEATURES:

1. Addressable as four separate 4K Blocks.
2. ON BOARD BANK SELECT circuitry. (Cromemco Standard!). Allows up to 512K on line!
3. Uses 2114 (450NS) 4K Static Rams.
4. ON BOARD SELECTABLE WAIT STATES.
5. Double sided PC Board, with solder mask and silk screened layout. Gold plated contact fingers
6. All address and data lines fully buffered.
7. Kit includes ALL parts and sockets.
8. PHANTOM is jumpered to PIN 67.
9. LOW POWER: under 1.5 amps TYPICAL from the +8 Volt Buss.
10. Blank PC Board can be populated as any multiple of 4K.

BLANK PC BOARD W/DATA-\$33
LOW PROFILE SOCKET SET-\$12
SUPPORT IC'S & CAPS-\$19.95
ASSEMBLED & TESTED-ADD \$35

**OUR #1 SELLING
RAM BOARD!**

16K STATIC RAM SS-50 BUSS

PRICE CUT!

\$159 KIT

FULLY STATIC!

FOR 2MHZ
ADD \$10

FOR SWTPC
6800 BUSS!

ASSEMBLED AND
TESTED - \$35

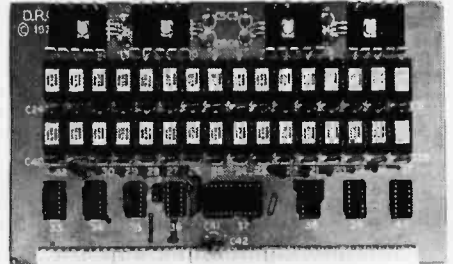

KIT FEATURES:

1. Addressable on 16K Boundaries
2. Uses 2114 Static Ram
3. Fully Bypassed
4. Double sided PC Board. Solder mask and silk screened layout
5. All Parts and Sockets included
6. Low Power: Under 1.5 Amps Typical

BLANK PC BOARD-\$35 COMPLETE SOCKET SET-\$12
SUPPORT IC'S AND CAPS-\$19.95

NEW! STEREO! S-100 SOUND COMPUTER BOARD NEW!

At last, an S-100 Board that unleashes the full power of two unbelievable General Instruments AY3-8910 NMOS computer sound IC's. Allows you under total computer control to generate an infinite number of special sound effects for games or any other program. Sounds can be called in BASIC, ASSEMBLY LANGUAGE, etc.

KIT FEATURES:

- * TWO GI SOUND COMPUTER IC'S.
 - * FOUR PARALLEL I/O PORTS ON BOARD.
 - * USES ON BOARD AUDIO AMPS OR YOUR STEREO.
 - * ON BOARD PHOTO TYPING AREA.
 - * ALL SOCKETS, PARTS AND HARDWARE ARE INCLUDED.
 - * PC BOARD IS SOLDERMASKED, SILK SCREENED, WITH GOLD CONTACTS.
 - * EASY, QUICK, AND FUN TO BUILD, WITH FULL INSTRUCTIONS.
 - * USES PROGRAMMED I/O FOR MAXIMUM SYSTEM FLEXIBILITY.
- Both Basic and Assembly Language Programming examples are included.

SOFTWARE:

SCL™ is now available! Our Sound Command Language makes writing Sound Effects programs a SNAP! SCL™ also includes routines for Register-Examine-Modify, Memory-Examine-Modify, and Play-Memory. SCL™ is available on CP/M™ compatible diskette or 2708 or 2716. Diskette - \$24.95 2708 - \$19.95 2716 - \$29.95. Diskette includes the source. EPROM'S are ORG at E000H. (Diskette is 8 Inch Soft Sected)

4K STATIC RAM

National Semi. MM5257. Arranged 4K x 1. +5V, 18 PIN DIP. A Lower Power, Plug in Replacement for TMS 4044. 450 NS. Several Boards on the Market Will Accept These Rams. SUPER SURPLUS PURCHASE! PRIME NEW UNITS!

8 FOR \$16 32 FOR \$59.95

COMPLETE KIT!

\$84.95

(WITH DATA MANUAL)

BLANK PC
BOARD W/DATA
\$31

SPECIAL PURCHASE!

UART SALE!

TR1602B - SAME AS TMS6011,
AY5-1013, ETC. 40 PIN DIP

TR1602B

\$2.95
EACH

4 For \$10.00

CRT CONTROLLER CHIP

SMC #CRT 5037. PROGRAMMABLE FOR 80 x 24, ETC. VERY RARE SURPLUS FIND. WITH PIN OUT. \$12.95 EACH.

NEW! G.I. COMPUTER SOUND CHIP

AY3-8910. As featured in July, 1979 BYTE! A fantastically powerful Sound & Music Generator. Perfect for use with any 8 Bit Microprocessor. Contains: 3 Tone Channels, Noise Generator, 3 Channels of Amplitude Control, 16 bit Envelope Period Control, 2-8 Bit Parallel I/O, 3 D to A Converters, plus much more! All in one 40 Pin DIP. Super easy Interface to the S-100 or other busses. \$11.95 PRICE CUT!

SPECIAL OFFER: \$14.95 each Add \$3 for 60 page Data Manual.

TERMS: Add \$2.00 postage. We pay balance. Orders under \$15 add 75¢ handling. No C.O.D. We accept Visa and MasterCard. Tex. Res. add 5% Tax. Foreign orders (except Canada) add 20% P & H. Orders over \$50, add 85¢ for insurance.

Digital Research Computers
(OF TEXAS)

P.O. BOX 401565 • GARLAND, TEXAS 75040 • (214) 271-3538



IPEX **NEW!**

Interface Converts Your Typewriter into Printer

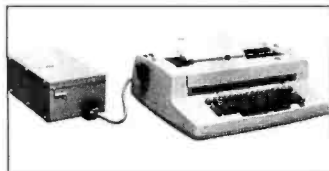

- Finest print quality
- Easy installation
- Fits IBM SELECTRIC[®] typewriter with no modification.
- For TRS-80[®], Apple[®], or any parallel or RS232 port.
- Write or phone for more information, today!
- Low cost
- Quick delivery

— U.S. and worldwide sales —



INTERNATIONAL INC.
16140 Valerio St.
Van Nuys, CA 91406 USA

TEL: 213/781-0020 TLX/TWX: 910-495-1767

Circle 184 on Inquiry card.

PRIAM

Disk Subsystems
and
Accessories,
(SMD interface available)

lowest cost and greatest established reliability for H.P., DEC, Apple, Z-80, 8085 . . . and so on.

We can show you how to overcome
"foreign disk" warranty worries.

Special Opportunity:

14A. S-100 Power Supply Kit

Input: 95-220VAC, 50/60 Hz
Outputs: 14A @ ± 8VDC **\$29⁹⁵**
2A @ ± 18VDC

Includes: UL Spec. Transformer, Rectifiers, Computer Grade Capacitors. RFI line filter, and Schematics.

ADVANCED TECHNOLOGY

735 Loma Verde, Palo Alto, CA 94303
415-493-5930

Send 36 ct SASE for our 16 page flyer.

Circle 11 on Inquiry card.



DATAPoint

1134 Diskette Systems

16k Processor with Four Diskettes
(1 Megabyte). 80 CPS Matrix
Printer. Nationwide maintenance
available.

\$2,645

SOFTWARE AVAILABLE
DISK OPERATING SYSTEM
SORT UTILITY
ISAM UTILITY
ALSO AVAILABLE FOR \$250 EACH.
A/P, A/R, GENERAL LEDGER, PAYROLL, TIME
ACCOUNTING, AND INVENTORY

AMERICAN COMPUTER EXCHANGE

100 N. MAIN ST. BOX 52
CHAGRIN FALLS, OH 44022
216-247-2100

Circle 19 on Inquiry card.

FORTH FOR/MATT[™]

SCREEN EDITOR

A MUST FOR THE SERIOUS FORTH PROGRAMMER

- All code is Forth-79 standard. Each line of code is fully explained and flow-charted (Forth style) for easy modification.
- This editor works just like the popular word processors on the market except it is written in high level Forth and is confined to the 1024 byte boundary of a Forth screen.
- There are over 20 different commands for cursor positioning, text modification, tabs, relocating lines, spreading lines, and moving lines to other screens.
- Insert mode is toggled on and off for midstream insertions and deletions. Text ahead of CP is moved right during insertion and left during deletion if insert mode is on.
- Column position is displayed at all times.
- Bomb proof — all unused control codes are trapped.
- Must be used with a CRT that has cursor addressing or with a memory mapped video.
- Send check or money order in the amount of \$50.00 and receive complete source code, flowcharts, documentation, and instructions for bringing up on your system.

KV33 CORPORATION
P.O. BOX 27246
TUCSON, AZ 85726
(602) 889-5722



Circle 193 on Inquiry card.

BIBLIOTEK

The Bibliographic Management System

- Includes journals, books and symposia (patents, technical reports, government documents available soon!)
- A minimum of 500 references per bibliography
- Rapid citation entry through multi-page video forms
- Search by authors, titles, editors, dates and/or keywords
- User defined output formats
- Requires 48K Apple II, ROM Applesoft & two drives
- \$300.00

Scientific Software Products

3171 Donald Avenue
Indianapolis, IN 46224
(317) 289-0407

IN residents add 4% tax please Dealer inquiries welcome
Apple II and Applesoft are trademarks of Apple Computer Co., Inc.
Visa and MasterCard Accepted

Circle 327 on Inquiry card.

FULL ELIZA FOR YOUR MICRO!

AT LAST! A FULL IMPLEMENTATION of the original ELIZA program is now available to run on your microcomputer! Created at MIT in 1966, ELIZA has become the world's most celebrated artificial intelligence demonstration program. ELIZA is a non-directive psychotherapist who analyzes each statement as you type it in and then responds with her own comment or question. Response time is virtually instantaneous and her remarks are often startlingly appropriate. Designed to run on a large mainframe, ELIZA has hitherto been unavailable to small computer users except in greatly stripped down versions lacking the sophistication which made the original program so fascinating. Now, a new version possessing the full power and range of expression of the original is available to run on any CP/M based microcomputer system with at least 48K of RAM. Supplied as a 2K .COM (machine language) file on a standard 5 1/4" diskette, the program is being offered for a limited time at the introductory price of only \$25. And if you want to find out how she does it for herself, too, we'll include the complete Source Program, written in Microsoft BASIC 80, version 5.0K, for only \$20 additional. Order your copy of ELIZA today and you'll never again wonder how to respond when one of your friends says, "Okay, let's see what this computer of yours can actually do!"

HERE IS AN ACTUAL SAMPLE OF ELIZA'S CONVERSATIONAL ABILITY:

(ELIZA's comments are printed in capital letters)

All men are alike:
IN WHAT WAY?
They're always bugging us about something or other.
CAN YOU THINK OF A SPECIFIC EXAMPLE?
Well, my boyfriend made me come here.
YOUR BOYFRIEND MADE YOU COME HERE. THAT'S INTERESTING. I need some help, that much seems certain.
WHAT WOULD IT MEAN TO YOU IF YOU GOT SOME HELP?
Perhaps I could learn to get along with my mother.
TELL ME MORE ABOUT YOUR FAMILY.
You are like my father in some ways.
WHAT RESEMBLANCE DO YOU SEE?
You are afraid of me.
DOES IT PLEASE YOU TO BELIEVE I AM AFRAID OF YOU?
My father is afraid of everybody.
WHAT ELSE COMES TO MIND WHEN YOU THINK OF YOUR FATHER?
Bullies.
DOES THAT HAVE ANYTHING TO DO WITH THE FACT THAT YOUR BOYFRIEND MADE YOU COME HERE?

ARTIFICIAL INTELLIGENCE RESEARCH GROUP

921 NORTH LA JOLLA AVENUE
LOS ANGELES, CALIFORNIA 90046
(213) 656-7368 (213) 654-2214
MC, VISA, and CHECKS ACCEPTED

Circle 30 on inquiry card.



FREE!

1981
DISCOUNT
ELECTRONICS
CATALOG

JOIN THE PAK!

Send for our Free catalog and become a member of our exclusive Pak. Our members receive Poly Paks' exciting catalog several times a year. We offer: Penny Sales, Free Premiums and Low, Low Prices on a wide variety of

Electronic Products such as Computer Peripherals, Integrated Circuits, Speakers, Audio Equipment, Rechargeable Batteries, Solar Products, Semiconductors, and much, much more! Take advantage of our 25 years as America's foremost Supplier of discount electronics.

POLY PAKS, INC.
P.O. BOX 942, B710
S. LYNNFIELD, MA. 01940

Over
4.5 Million
Satisfied
Customers

(617) 245-3828

Circle 300 on Inquiry card.

CP/M[®] Compatible

\$GOLD DISK\$

Z-80 Software

Z-80 Disassembler **\$175.**
ppd
creates assembly language source files

E-Z Text **\$75.**
ppd
unique text file word processor

Bower-Stewart & Associates

POST OFFICE BOX 1389
HAWTHORNE, CALIFORNIA 90250
213 / 676-5055
Trademark
Digital Research.



Circle 47 on Inquiry card.

database manager for TRS-80[®] Model I

- CREATE random access disk files
15 fields or 255 bytes/record
Files can span 4 disk drives
Password protected file access
- Database DIRECTORY displays all user files and their attributes
- Powerful TRANSACTIONS — add, edit, read, delete & list records
Efficient binary tree sorts
- Sophisticated QUERY with multi-key relational & logical operations
- REPORT formatter requires only for user to select desired fields
Automatic sub & grand totals
May be used with lower case
- Entirely MENU DRIVEN operation
- Extensive error trapping routines
- User oriented instruction manual
- Requires 32k — 2 disk drives

Introductory price **\$59.95**

Visa and MasterCard accepted

mentor software

816 McLane Ave — Morgantown, WV 26505

© Tandy Corp. Trademark

Circle 217 on Inquiry card.



THE STAR MODEM

From Livermore Data Systems

| | |
|----------------|------------|
| RS232 MODEM | SALE \$128 |
| IEEE 488 MODEM | SALE \$199 |
| RS232 CCITT | \$170 |
| IEEE 488 CCITT | \$280 |

STAR Modem is the price performance leader with a full 2 YEAR FACTORY WARRANTY.

MILOT Intelligent Plotter

by Watanabe Instruments (Digiplot)

SPECIAL
\$1195

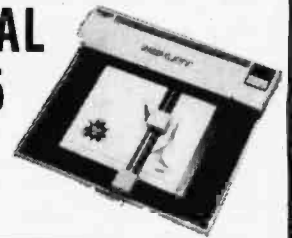

We carry Apple II+ from Bell & Howell

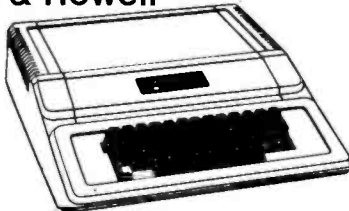

| | |
|---|-------|
| REVERSAL (Spracklen) 32K Apple | 28.00 |
| Super FORTH 48K Apple | 40.00 |
| Energy Miser for PET, Apple, or Zenith | 24.50 |
| Data Manager (Lutus) 24K Apple | 40.00 |
| Histo-Graph (Boyd) 48K Apple | 24.50 |
| Data-Graph (Boyd) 48K Apple | 40.00 |
| Apple II User's Guide (Osborne) | 12.00 |
| Introduction to Pascal (Sybex) | 10.30 |
| Pascal Handbook (Sybex) | 12.00 |
| Graphics Cookbook for Apple | 9.90 |
| Musical Applications of Micros (Chamberlin) | 20.00 |
| Basic FORTRAN (Coan) | 7.25 |

SPECIALS

| | |
|--|------|
| EPSON MX-80 Printer | |
| EPSON MX-80 F/T Printer | |
| EPSON MX-70 Printer | |
| EPSON MX-100 Printer | |
| Centronics 739 Printer with Dot Graphics | 675 |
| STARWRITER Daisy Wheel Printer | 1445 |
| ZENITH DATA SYSTEMS | |
| Z19 Video Terminal | 729 |
| Z89 with 48K | 2150 |
| Extra 16K RAM | 115 |
| Z-47 Dual 8" Drive | 2775 |

| | |
|---------------------------------------|-----|
| Zenith ZVM-121 Green Phosphor Monitor | 120 |
| Zenith Color Monitor | 360 |
| Amdek Color Monitor | 360 |

Synertek Systems

| | |
|--------------------------------------|------------|
| SYM-1. Microcomputer SALE | 209 |
| SYM BAS-1 BASIC or RAE 1/2 Assembler | 85 |
| KTM-2/80 Synertek Video and Keyboard | 349 |
| KTM-3/80 Synertek Tubeless Terminal | 400 |

Complete CBM BUSINESS SOFTWARE PACKAGE

Can be tailored to meet most business requirements

PROGRAM YOUR OWN EPROMS

Branding Iron for PET/CBM \$79
EPROM Programmer with software for all ROM versions. Includes all necessary hardware and software to program or copy 2716 and 2532 EPROMS.

EARL for PET/CBM \$ 65

Editor, Assembler, Relocator, Linkeditor

FORTH for PET 50

Conforms to FIG Standards

SuperGraphics 30

Machine Language Graphics routines for PET/CBM

KMMM PASCAL for PET/CBM 85

Includes translator for ROMable machine code

RAM/ROM for PET/CBM

4K or 8K bytes of softROM with optional Battery Backup Programmable like RAM, protectable like ROM. Plugs into ROM socket in any large keyboard PET/ROM to use. Plugs into ROM socket in any large keyboard PET/CBM. Save your ROM images on disk, load in RAM/ROM to use.

| | |
|-----------------------|-------|
| RAM/ROM with 4K | \$ 85 |
| RAM/ROM with 8K | 120 |
| Battery Backup Option | 30 |

| | | | | |
|-------------------------------------|------|---------|-------------------|----------|
| 6502 | 7.45 | 10/6.95 | 50/6.55 | 100/6.15 |
| 6502A | 8.40 | 10/7.95 | 50/7.35 | 100/6.90 |
| 6520 PIA | 5.15 | 10/4.90 | 50/4.45 | 100/4.15 |
| 6522 VIA | 6.45 | 10/6.10 | 50/5.75 | 100/5.45 |
| 6532 | 7.90 | 10/7.40 | 50/7.00 | 100/6.60 |
| 2114-L200 ns RAM | 3.75 | 25/3.50 | 100/3.25 | |
| 2114-L300 ns RAM | 3.15 | 25/2.90 | 100/2.65 | |
| 2716 EPROM | 7.00 | 5/6.45 | 10/5.90 | |
| 2532 EPROM | | | 14.50 | |
| 6116 Hitachi 2K x 8 CMOS STATIC RAM | | | 14.50 | |
| 4116 200ns | | | 8 for \$20 | |
| Zero Insertion Force 24 pin Socket | | | \$2.00 | |

CASSETTES - AGFA PE-611 PREMIUM

High output, low noise, 5 screw housing, labels.

C-10 10/5.65 50/25.00 100/48.00

C-30 10/7.30 50/34.00 100/66.00

All other lengths available. Write for price list.

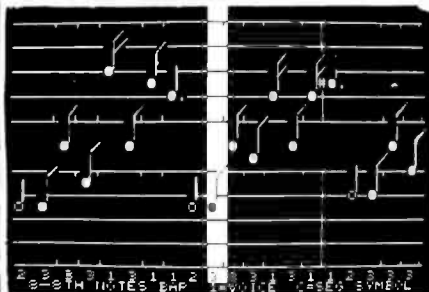

4 PART HARMONY MUSIC SYSTEM for PET

The Visible Music Monitor, by Frank Levinson, allows you to easily enter, display, edit, and play 4 part harmony music. Includes whole notes thru 64ths (with dotted and triplets), tempo change, key signature, transpose, etc. The KL-4M unit includes D to A converter and amplifier (add your own speaker).

KL-4M Music Board with VMM Program \$59.90



CBM-PET SPECIALS

FREE Up to \$380 free merchandise with purchase of one of following CBM-PET items: **FREE**

| | |
|--|----------|
| 8032 32K, 80 x 25 CRT, business keyboard | 1495 320 |
| Micro Mainframe - available soon | |
| 8050 Dual Disk Drive - 1 megabyte capacity | 1795 380 |
| 8250 Dual Disk Drive - 2 megabyte available soon | |
| 2031 Single Disk Drive | 695 135 |
| 4016 full size graphics keyboard | 995 200 |
| 4032 full size graphics keyboard | 1295 275 |
| 4040 Dual Disk Drive | 1295 275 |
| 4022 Tractor Feed Printer | 795 160 |
| C2N External Cassette Deck | 75 13 |
| VIC 20 Personal Computer | 300 25 |
| Used CBM/PET Computers | CALL |
| 8024-9 High Speed Printer available | |

WRITE FOR SYSTEM PRICES

*** EDUCATIONAL DISCOUNTS ***

Buy 2 PET/CBM Computers, receive 1 FREE

| | |
|---|--------|
| WordPro 3+ - 32K CBM, disk, printer | 250 |
| WordPro 4+ - 8032, disk, printer | 335 |
| OZZ Data Base System for CBM 8032 | 335 |
| VISICALC for PET or ATARI | 170 |
| SM-KIT - Super PET ROM Utilities | 40 |
| Programmers Toolkit - PET ROM Utilities | 34.90 |
| PET Spacemaker II ROM Switch | 36.00 |
| 2 Meter PET to IEEE or IEEE to IEEE Cable | 40.00 |
| Dust Cover for PET | 6.90 |
| IEEE-Parallel Printer Interface for PET | 110.00 |
| IEEE-RS232 Printer Interface for PET | 120.00 |
| The PET Revealed | 17.00 |
| Library of PET Subroutines | 17.00 |

DISK SPECIALS

| | | | |
|--|---------|---------|----------|
| SCOTCH (3M) 5 1/4" | 10/2.85 | 50/2.75 | 100/2.65 |
| SCOTCH (3M) 8" | 10/2.90 | 50/2.80 | 100/2.70 |
| Verbatim 5 1/4" | 10/2.45 | 50/2.40 | 100/2.35 |
| (add 1.00 for 5 1/4" Verbatim plastic storage box) | | | |
| Verbatim 8" Dbl. Dens. | 10/3.45 | 50/3.35 | 100/3.25 |
| BASF 5 1/4" | 10/2.40 | 20/2.35 | 100/2.30 |

WRITE for prices on WABASH Disks

WE STOCK MAXELL DISKS

| | |
|------------------------|---------------------|
| Diskette Storage Pages | 10 for 3.95 |
| Disk Library Cases | 8" - 2.85 5" - 2.15 |

ATARI 800 \$745

All Atari Modules 20% OFF

ATARI EDUCATIONAL PLAN Write for details.

A P Products 15% OFF

A P Hobby-Blox 15% OFF



ALL BOOK and SOFTWARE PRICES DISCOUNTED

| | |
|---------------------------------------|-------|
| The 8086 Book (Osborne) | 14.00 |
| Z8000 Assembly Language Programming | 16.90 |
| PET Personal Computer Guide (Osborne) | 12.75 |
| PET and the IEEE-488 Bus (Osborne) | 13.60 |
| 6502 Assembly Language (Osborne) | 14.45 |
| Programming the 6502 (Zaks) | 10.45 |
| 6502 Applications Book (Zaks) | 10.45 |
| 6502 Software Cookbook (Scelbi) | 9.45 |
| CP/M Handbook (w/ MP/M) Zaks | 11.85 |
| Practical BASIC Programs (Osborne) | 13.60 |
| Some Common BASIC Programs (Osborne) | 12.75 |

WRITE FOR CATALOG.

Add \$1.25 per order for shipping. We pay balance of UPS surface charges on all prepaid orders. Prices listed are on cash discount basis. Regular prices slightly higher.

252 Bethlehem Pike
Colmar, PA 18915

215-822-7727 **A B Computers**

IC-IRS will Find It

IC-IRS \$37.50 1980 CMDB \$29.95

IC-IRS by Island Cybernetics is THE Information Retrieval System for indexing and retrieving entries with large amounts of FREE FORM TEXT, such as ABSTRACTS; CORRESPONDENCE FILES (with complete letters); Attorney's CASE NOTES, CONTRACTS, WILLS; MD's and Scientist's JOURNAL ARTICLES; or any other similar type of Information. EASY TO USE.

COMPUTERIZE your CARD FILES or MAIL LISTS.

IC-IRS runs as a ".com" file on CP/M* compatible systems with 2 disk drives and 32K memory. IC-IRS is written in CONVERS for fast execution. It searches the 984 entry 1980 COMPUTER MAGAZINE ARTICLE DATA BASE in 25 seconds using combinations of KEY WORDS with up to 65 "and"s and 32 "or"s.

Get IC-IRS and the 1980 COMPUTER MAGAZINE ARTICLE DATA BASE (1980 CMDB) on standard 8"SD disks or 5 1/4" disks in several popular formats.

IC-IRS 2.07 with manual = \$37.50 + \$2.50 postage.
1980 CMDB = \$29.95 (no postage with IC-IRS)

Call (512) 258-6310 and use your MASTERCARD or VISA, use the bingo card or write to:

FYI, INC.
P. O. Box 10998 #615
Austin, Texas 78766

CP/M is a registered trademark of Digital Research

Circle 156 on Inquiry card.

LOWEST POSSIBLE PRICES BEST POSSIBLE WARRANTY



model III 16K

\$839

color
computer 4K

\$310



Call TOLL FREE 1-800-343-8124

computer plus

Write for your free catalog.

245A Great Road

Littleton, MA 01460

617 • 486 • 3193

TRS-80 is a registered trademark of Tandy Corp

Circle 86 on Inquiry card.



FULL PERFORMANCE CP/M* computer
\$1995 list

dealer-distributor discounts



Alspa Computer, Inc.

5215 Scotts Valley Drive

Scotts Valley, CA 95066

(408) 438-3326

*trademarks of Digital Research, Inc.

Circle 15 on Inquiry card.

LABELS

295

perM

15/16"x3 1/2" white pressure
1 up - pin feed sensitive

PRICE INCLUDES SHIPPING

Packed 5M per box - Min. order 1 box -\$14.75

Check with order - Mass Residents add 5% Sales Tax



CHECK-MATE

P.O. Box 103, Randolph, MA 02368

Telephone: 617-963-7694

Circle 64 on Inquiry card.

MEMOREX FLEXIBLE DISCS

WE WILL NOT BE UNDER-SOLD!! Call Free (800)235-4137 for prices and information. Dealer inquiries invited and C.O.D.'s accepted.

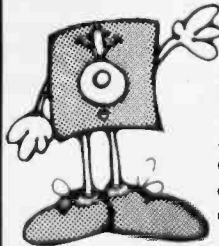

PACIFIC EXCHANGES

100 Foothill Blvd.

San Luis Obispo,

CA 93401 In Cal.

call (800) 592-5935

or (805) 543-1037

Circle 289 on Inquiry card.

COMPUTER SHOWS

SECOND ANNUAL
NJ MICROCOMPUTER
SHOW AND FLEAMARKET - 1981
NEWARK, NEW JERSEY

Sat. Oct. 24 & Sun. Oct. 25
10-5:30 PM & 10-3:00 PM
HOLIDAY INN (NORTH)

NJ Turnpike • Exit 14

(Take Route 1-9 Service Road - Follow Signs)

REGISTRATION \$5.00 -

FLEAMARKET ONLY \$3.00

Fleamarket Permits \$5/Spot

(Includes Admission)

Commercial Exhibits • User Groups • Fleamarket

SECOND ANNUAL
NATIONAL "80" MICROCOMPUTER
SHOW (FOR TRS-80* USERS)

April 29, 30, May 1, 1982

NEW YORK STATLER HOTEL

NEW YORK CITY

100 Exhibit Booths • Speakers • User Groups

*TRS-80 is a Trademark of Tandy Corporation

For Registration, Exhibitor or Fleamarket

Information Contact:

KENGORE CORPORATION

3001 Route 27 • Franklin Park, NJ 08823

(201) 297-2526

1802 fig-FORTH

high-level compiler language
10-20X faster than BASIC
ELF II / SuperELF / Other
w/assembler-editor \$60
w/macro-asmemb.
screen-editor \$80
extras
on cassette / requires 12k+RAM

software for small computers

P.O. Box 8463
Austin, Texas
78712

1983 Rio Grande
Austin, Texas
78765

VISA

1-512-477-2287

master charge

Circle 155 on Inquiry card.

Z-80 and 8086 FORTH

Z-80 FORTH—a complete program development system. Uses standard CP/M* compatible random access disk files for screen storage. Package includes: Interpreter/compiler with virtual memory management, line editor, screen editor, Z-80 Assembler, de-compiler, utilities, demonstration programs, and 80 page user manual. System requirements: Z-80 microcomputer, 48 kbytes RAM, CP/M 2.2 or MP/M* 1.1. \$50.00

Z-80 FORTH WITH NAUTILUS SYSTEMS CROSS-COMPILER. Extend/modify the FORTH runtime system, recompile on a host computer for a different target computer, generate headerless code, generate ROMable code with initialized variables. Supports forward referencing to any word or label. Produces load map and list of unresolved symbols. 107 page manual. System requirements as for Z-80 FORTH above. \$200.00

8086 FORTH with line editor, screen editor, assembler, and utilities. Uses standard CP/M compatible random access files for screen storage. Requires 8086 or 8088 microcomputer, 64 kbytes RAM, and CP/M-86 operating system. \$100.00

MACHINE TEST PROGRAM PACKAGE for Z-80 systems. Includes memory, floppy disk, printer, and terminal tests with all source code. Requires CP/M 2.2. \$50.00

All software distributed on eight-inch soft sectorized single density diskettes. Prices include shipping by first class or UPS within USA or Canada. COD charges extra. Purchase orders accepted at our discretion. (CP/M and MP/M are registered trademarks of Digital Research, Inc. Z-80 is a registered trademark of Zilog, Inc.)

Laboratory Microsystems
4147 Beethoven Street
Los Angeles, CA 90066
(213) 390-9292

Circle 195 on Inquiry card.

RS-232 PROBLEMS?

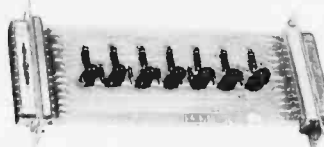

LET THE RS-232 TESTER HELP YOU SOLVE YOUR COMPUTER INTERFACE PROBLEMS. DESIGNED TO CONNECT IN SERIES WITH ANY RS-232 INTERFACE, IT DISPLAYS THE STATUS OF SEVEN OF THE MOST IMPORTANT LINES: TRANSMIT DATA, RECEIVE DATA, REQUEST TO SEND, CLEAR TO SEND, DATA SET READY, CARRIER DETECT, AND DATA TERMINAL READY. THE RS-232 TESTER REQUIRES NO POWER AND MAY BE LEFT IN THE LINE PERMANENTLY.

\$39.95 POST PAID

B & B ELECTRONICS

BOX 475/MENDOTA, IL 61342

Circle 40 on Inquiry card.

This is a partial listing of over 500 items available from 600 authorized Jim-pak Distributors:

TTL

| | | | |
|------|--------|-------|--------|
| 7400 | 2/.85 | 7490 | .85 |
| 7402 | 2/.85 | 7493 | .85 |
| 7404 | 2/.85 | 74100 | 2.25 |
| 7406 | 2/1.19 | 74109 | 2/1.19 |
| 7407 | 2/1.19 | 74121 | .69 |
| 7408 | 2/.89 | 74123 | .99 |
| 7410 | 2/.85 | 74150 | 1.95 |
| 7414 | .99 | 74154 | 1.95 |
| 7417 | 2/1.10 | 74157 | .99 |
| 7420 | 2/.85 | 74161 | 1.19 |
| 7447 | 1.19 | 74164 | 1.59 |
| 7474 | .69 | 74174 | 1.59 |
| 7475 | .79 | 74175 | 1.49 |
| 7476 | .69 | 74192 | 1.19 |
| 7485 | 1.19 | 74193 | 1.19 |
| 7486 | 2/1.19 | 74367 | .99 |
| 7489 | 2.99 | 74393 | 1.95 |

GRAB BAGS



| | | | |
|--------------------------|------|---------------------------|------|
| GB100 Cer. Caps. (100) | 2.95 | GB123 Heat Sinks (30) | 3.95 |
| GB101 Mylar Caps. (60) | 4.95 | GB127 Transistors (100) | 3.95 |
| GB102 Electrolytics (60) | 4.95 | GB137 Chokes (50) | 3.95 |
| GB103 Tantalums (40) | 4.95 | GB139 Term. Strips (40) | 3.95 |
| GB108 TTL IC's (50) | 4.95 | GB140 Spcr/Stndfr (150) | 2.95 |
| GB110 Asst. LEDs (100) | 5.95 | GB141 Washers (200) | 2.95 |
| GB113 Trimmers (30) | 4.95 | GB145 Lugs (100) | 2.95 |
| GB116 1/4w Resist. (200) | 2.95 | GB154 1/2w Resist. (100) | 2.95 |
| GB117 1/2w Resist. (200) | 2.95 | GB162 7-Seg. Dsplys. (50) | 5.95 |
| GB120 Slide Switch (25) | 3.95 | GB173 3/8" Pots. (100) | 5.95 |

LS Schottky

| | | | |
|--------|------|---------|------|
| 74LS00 | .55 | 74LS109 | .79 |
| 74LS02 | .55 | 74LS123 | 1.95 |
| 74LS04 | .69 | 74LS138 | 1.49 |
| 74LS08 | .55 | 74LS139 | 1.49 |
| 74LS10 | .55 | 74LS154 | 2.49 |
| 74LS14 | 1.09 | 74LS157 | 1.49 |
| 74LS30 | .55 | 74LS161 | 1.79 |
| 74LS32 | .69 | 74LS174 | 1.79 |
| 74LS38 | .69 | 74LS175 | 1.79 |
| 74LS42 | 1.49 | 74LS192 | 1.89 |
| 74LS47 | 1.49 | 74LS193 | 1.89 |
| 74LS48 | 1.79 | 74LS221 | 1.95 |
| 74LS73 | .79 | 74LS244 | 2.49 |
| 74LS74 | .79 | 74LS245 | 3.49 |
| 74LS75 | .99 | 74LS367 | 1.29 |
| 74LS85 | 1.95 | 74LS374 | 2.49 |
| 74LS90 | 1.09 | 81LS97 | 2.49 |

POTENTIOMETERS

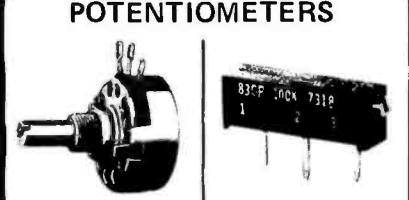

2 Watt @ 70°C
7/8" Slotted Shaft
Linear Taper

3/4 Watt @ 70°C
15 Turn Pot.
Linear Taper

| | | | | | |
|-------|-----|------|------|------|------|
| 1K | 5K | 10K | 100Ω | 500Ω | 1K |
| 25K | 50K | 100K | 5K | 10K | 50K |
| 1 Meg | | | 100K | 500K | 1Meg |

CMU .. \$2.95 830P .. \$1.79

NEW! JE215 Adjustable Dual Power Supply

General Description: The JE215 is a Dual Power Supply with independent adjustable positive and negative output voltages. A separate adjustment for each of the supplies provides the user unlimited applications for IC current voltage requirements. The supply can also be used as a general all-purpose variable power supply.

FEATURES:

- Adjustable regulated power supplies, pos. and neg. 1.2VDC to 15VDC.
- Power Output (each supply): 5VDC @ 500mA, 10VDC @ 750mA, 12VDC @ 500mA, and 15VDC @ 175mA.
- Two, 3-terminal adj. IC regulators with thermal overload protection.
- Heat sink regulator cooling
- LED "on" indicator
- Printed Board Construction
- 120VAC input
- Size: 3-1/2" w x 5-1/16" L x 2" H



JE215 Adj. Dual Power Supply Kit (as shown) .. \$24.95

(Picture not shown but similar in construction to above)

JE200 Reg. Power Supply Kit (5VDC, 1 amp) .. \$14.95
JE205 Adapter Brd. (to JE200) ±5, ±9 & ±12V .. \$12.95
JE210 Var. Pwr. Sply. Kit, 5-15VDC, to 1.5amp .. \$19.95

SOCKETS

| Low Profile | | Wire Wrap | |
|-------------|--------|----------------------|------|
| 8 pin LP | 2/.59 | 14 pin WW tin | .75 |
| 14 pin LP | 2/.69 | 14 pin WW gold | 1.09 |
| 16 pin LP | 2/.79 | 16 pin WW tin | .79 |
| 18 pin LP | 2/.89 | 16 pin WW gold | 1.19 |
| 20 pin LP | 2/.99 | 24 pin WW gold | 1.69 |
| 22 pin LP | 2/1.09 | 40 pin WW gold | 2.75 |
| 24 pin LP | .79 | 14 p. plug/cover | 1.29 |
| 28 pin LP | .82 | 16 p. plug/cover | 1.39 |
| 36 pin LP | .99 | 24 p. plug/cover | 1.95 |
| 40 pin LP | 1.19 | Also, The Molex Line | |

CMOS

| | | | |
|------|------|------|------|
| 4000 | .69 | 4030 | .79 |
| 4001 | .69 | 4040 | 1.95 |
| 4002 | .69 | 4044 | 1.39 |
| 4006 | 1.95 | 4046 | 2.49 |
| 4009 | .89 | 4047 | 2.75 |
| 4010 | .85 | 4049 | .89 |
| 4011 | .69 | 4051 | .89 |
| 4012 | .85 | 4050 | 1.95 |
| 4016 | .85 | 4066 | 1.19 |
| 4017 | 1.49 | 4069 | .79 |
| 4018 | 1.49 | 4070 | .79 |
| 4020 | 2.19 | 4071 | .79 |
| 4023 | .49 | 4081 | .69 |
| 4024 | 1.29 | 4093 | 1.19 |
| 4027 | .89 | 4511 | 1.95 |

DIODES & TRANSISTORS

| | | | |
|--------|--------|---------|--------|
| IN751 | 2/.59 | 2N2219A | 2/1.19 |
| IN757 | 2/.59 | 2N2222A | 2/.89 |
| IN1188 | 2.69 | 2N2907A | 2/.89 |
| IN3600 | 5/.99 | 2N3055 | .99 |
| IN4001 | 4/.59 | 2N3772 | 2.25 |
| IN4004 | 4/.69 | 2N3904 | 2/.69 |
| IN4007 | 4/.79 | 2N3906 | 2/.69 |
| IN4148 | 10/.99 | 2N4401 | 2/.79 |
| IN4733 | 2/.69 | 2N4403 | 2/.79 |
| IN4734 | 2/.69 | 2N5129 | 2/.69 |
| IN4735 | 2/.69 | 2N5139 | 2/.69 |
| IN4742 | 2/.69 | 2N5210 | 2/.79 |
| IN4744 | 2/.69 | 2N5951 | 2/1.29 |

CONNECTORS

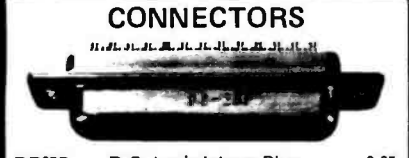

| | | |
|----------|-----------------------|------|
| DB25P | D-Subminiature Plug | 3.95 |
| DB25S | D-Subminiature Socket | 4.95 |
| DB51226 | Cover for DB25P/S | 2.25 |
| 22/44SE | P.C. Edge | 2.95 |
| UG88/U | BNC Plug | 2.19 |
| UG89/U | BNC Jack | 3.95 |
| UG175/U | UHF Adapter | .59 |
| SO239 | UHF Panel Recp. | 1.49 |
| PL258 | UHF Adapter | 1.95 |
| PL259 | UHF Plug | 1.95 |
| UG260/U | BNC Plug | 2.39 |
| UG1094/U | BNC Bulkhead Recp. | 1.49 |

DESK TOP ENCLOSURES

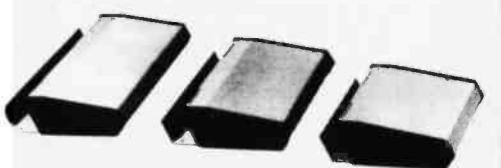

DTE-8 (Pictured) .. \$31.95
DTE-11 (Pictured) .. 34.95
DTE-14 (Pictured) .. 36.95
DTE-HK (Case for JE600) .. 47.95
DTE-AK (Case for JE610) .. 52.95

CAPACITORS

| Dipped Tantalum | | ELECTROLYTIC | |
|-----------------|--------|---------------|-------|
| .1mfd @ 35V | 2/.89 | 1mfd @ 50V | 3/.69 |
| .47mfd @ 35V | 2/.89 | 4.7mfd @ 50V | 2/.59 |
| 1mfd @ 35V | 2/.89 | 10mfd @ 50V | 2/.69 |
| 2.2mfd @ 25V | 2/1.09 | 22mfd @ 50V | 2/.79 |
| 3.3mfd @ 25V | 2/1.19 | 47mfd @ 50V | 2/.89 |
| 4.7mfd @ 25V | 2/1.39 | 100mfd @ 50V | .59 |
| 10mfd @ 25V | 1.19 | 220mfd @ 50V | .69 |
| 33mfd @ 25V | 3.95 | 1000mfd @ 25V | 1.19 |
| | | 2200mfd @ 16V | 1.39 |

100V MYLAR

| | |
|-------------|--------|
| .001-.01mfd | 4/.79 |
| .022mfd | 4/.89 |
| .047mfd | 4/.99 |
| .1mfd | 4/1.19 |
| .22mfd | 4/1.29 |

50V CERAMIC

| | |
|--------------|-------|
| 10pf-.022mfd | 4/.59 |
| .047mfd | 4/.69 |
| .1mfd | 4/.79 |

LINEAR

| | | | |
|----------|------|---------|------|
| LM301N | .59 | LM7805T | 1.75 |
| LM305H | 1.39 | LM7812T | 1.75 |
| LM307N | .75 | LM7815T | 1.75 |
| LM308N | 1.19 | LM380N | 1.49 |
| LM309K | 2.25 | LM384N | 2.49 |
| LM310N | 2.69 | LM555N | .69 |
| LM311N | 1.49 | LM556N | 1.49 |
| LM317T | 2.29 | LM565N | 1.95 |
| LM318N | 2.95 | LM566N | 1.95 |
| LM319N | 2.95 | LM567N | 1.79 |
| LM320K-5 | 2.25 | LM723N | .79 |
| LM7905T | 1.75 | LM741N | .65 |
| LM7912T | 1.75 | LM1310N | 2.95 |
| LM7915T | 1.75 | LM1458N | .99 |
| LM323K | 5.95 | LM1488N | 1.59 |
| LM324N | 1.29 | LM1489N | 1.59 |
| LM337T | 2.29 | LM1800N | 4.49 |
| LM339N | 1.29 | 76477N | 3.95 |

JOYSTICKS



JS-100K 100K Linear Taper Pots .. \$5.49
JVC-40 40K (2) Video Controller .. 5.95

MICROPROCESSORS

| | | |
|-----------|---------------------------|-------|
| Z80A | CPU (4MHz) | 14.95 |
| MC6800 | 8 Bit MPU | 14.95 |
| 8080A | CPU | 6.95 |
| 8212 | 8 Bit I/O Port | 3.95 |
| 8216 | BI-Directional Bus Driver | 4.49 |
| 2513/2140 | Character Generator | 12.95 |
| 8T97 | Tri-State Hex Buffer | 2.25 |
| AY-5-1013 | 30K Baud UART | 6.95 |
| AY-5-2376 | 88-Key Keyboard Encoder | 13.95 |
| 2114-3 | 4K Static RAM (300ns) | 6.95 |
| MK4116 | 16K Dynamic RAM (250ns) | 4.95 |
| 2708 | 8K EPROM | 6.95 |
| 2716 | 16K EPROM (+5V) | 10.95 |

WALL TRANSFORMERS

AC250 250mA 12VAC (117V/60Hz) .. \$3.95
DV9200 200mA 9VAC (117V/60Hz) .. 3.95

Function Generator Kit



Provides 3 basic waveforms: sine, triangle and square wave. Freq. range from 1 Hz to 100K Hz. Output amplitude from 0 volts to over 6 volts (peak to peak). Uses a 12V supply or a ±6V split supply. Includes chip, P.C. Board, components & instructions.

JE2206B ... \$19.95

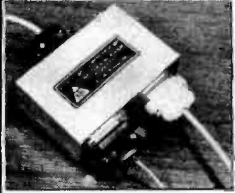

**TERMINAL
DATA
CORPORATION**

**MODEL 1200 RS-232 BI-DIRECTIONAL
DATA SPLITTER**
available in kit form

Model 1200K gives the terminal or microprocessor user a second interface for a printer, plotter, cassette or tape drive. It operates at any speed & isolates the two output devices from each other, while providing 2 RS-232 interfaces from the terminal or microprocessor.

The kit consists of 3 RS-232 connectors, printed circuit board, all necessary components, enclosure, mounting hardware & assembly instructions \$75.00

write or call

TERMINAL DATA CORP.
11878 Coakley Cir.
Rockville, MD 20852
(301) 881-7655

Circle 364 on inquiry card.

ZEN is HERE

**FAST SCREEN EDITING
for CP/M & NORTH STAR
OPEN PROGRAMS WITH SOURCE FILES**

ZEN™ offers you very fast screen editing without line numbers. You are in control and ZEN may be reassembled to change or add custom features. Call system and return without losing the file. Justify even old disc files to any length. Save, append, find, selectively print and much more, with ease. Monitor functions are built in, extensions can be added.

ZEN's 4-way cursor control is much easier to use than any other word processor. Use for mailing lists, records, correspondence and source files of .ASM, .BAS, .ASC, .PRN, .TXT, etc. types. A 32k system with console is necessary but addressable cursor is not required.

CPM version for 1.4 thru MPM releases, use their assembler and line command conventions which can include multiple command lines.

North Star DOS versions have a disc assembler, an extensive monitor and some Basic utilities. They use the N.S. line editing conventions.

| | |
|---------------------|----------------------|
| Specify version # | ZEN1.1 5" SD NS 2000 |
| ZEN2.1 8" SD SS CPM | ZEN1.2 5" DD NS 2000 |
| ZEN2.2 5" DD NS CPM | ZEN1.3 5" DD NS 0100 |

| | |
|----------------------|-------------------|
| Disc and Manual \$75 | Manual alone \$15 |
| CA residents add 6% | Send check to: |

Dealer Enquiries welcome.

©1984 ZEN Controls Company. All Rights Reserved. No part of this publication may be reproduced without written permission.

ZENRAD CONTROLS COMPANY
PHONE 805/965-4996
1575 A.P.S. SANTA BARBARA CA 93103

Circle 397 on inquiry card.

**NEW 16K-RAM
PERSONAL COMPUTER**

**\$229⁰⁰ FACTORY SALE
PRICE**

For \$229⁰⁰ you get the new Interact Model "R" Computer, 16K-RAM, 2K-ROM, 8080A Microprocessor, color, sound, full 53 keyboard, high speed cassette, AC adapter, R.F. Modulator, Black Console Case, 90 days parts and labor warranty, owners' guide, FCC approved.
15 DAY FREE TRIAL Return within 15 days complete and undamaged for refund of purchase price.

PROTECTO ENTERPRIZES
BOX 550, BARRINGTON, IL 60010
TO ORDER PHONE 312/382-5244

Circle 308 on inquiry card.

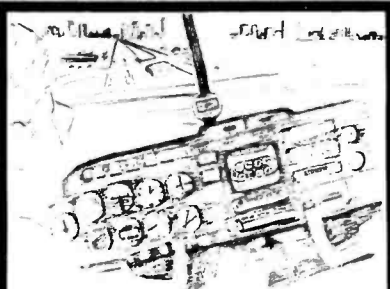

**NEW IFR FLIGHT SIMULATOR
RUNS ON
Apple II 48K Applesoft DOS 3.3**

Puts you behind a set of Instruments so real you could actually fly an airplane with them.

No toy this. It includes all primary Instruments, ADF, ILS, and VOR approaches, and, even an XY plot after each flight.

\$25.00 at your Computer Store.

Or direct from
PROGRAMMERS SOFTWARE
Box 199
Cabot ARK 72023
(501) 843-2988

Circle 307 on inquiry card.

WANTED:

**APPLE, PET, TRS-80, CP/M
SOFTWARE**

Westico is a publisher and distributor of professional software for microcomputers. If you have a new program ready for distribution or want your existing programs to reach a larger market, contact:

Phillip Woellhof, V.P. Mktg.
Westico, Inc.
25 Van Zant Street
Norwalk, CT 06855
(203) 853-6880

To increase your profits, take advantage of Westico's worldwide promotion and distribution.

WESTICO
The Software Express Service

**ZENITH/Heath
Users**

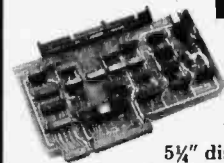

**Double Your
5 1/4" disk storage
capacity without adding a drive.**

Get twice as much from your H88 or H89 microcomputer. Our FDC-880H floppy disk controller, in conjunction with your 5 1/4" drives, for example, expands memory capacity from 256 bytes to 512 bytes per sector.

And it handles single and double-sided, single and double-density, 8" and 5 1/4" drives — simultaneously.

Call 714/275-1272 today or write for details.



C.D.R. Systems Inc.

Controlled Data Recording Systems, Inc.
7667 Vickers St., San Diego, CA 92111

Circle 62 on inquiry card.

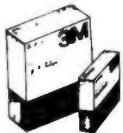

**Scotch®
DISKETTES**

SAVE 40% Write for our complete list.

5 1/4" Sgl. Dens. 26.70/10
Specify soft, 10 or 16 hard sectors

8" Sgl. Dens. 27.30/10
8" Dbl. Dens. 35.80/10
Specify soft or 32 hole hard

Add \$2.00 shipping - Michigan add 4% tax

LYBEN COMPUTER SYSTEMS
27204 Harper Ave.
St. Clair Shores, MI 48081

Authorized Distributor
Information Processing Products



Circle 205 on inquiry card.



Solve your disc problems, buy 100% surface tested Dysan diskettes. All orders shipped from stock, within 24 hours. Call toll FREE (800) 235-4137 for prices and information. Visa and Master Card accepted. All orders sent postage paid.

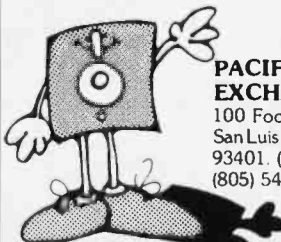

**PACIFIC
EXCHANGES**
100 Foothill Blvd.
San Luis Obispo, CA
93401 (In Cal. call
(805) 543-1037.)

Circle 290 on inquiry card.

**TRS-80™* Models 1 & 3
SYSTEM DIAGNOSTIC . . . \$99.95**

Tests every component of your TRS-80 for proper operation: ROM, RAM, Video Display, Key board, Line Printer, Cassette Recorder, Disk Drives, RS-232 Interface. Continuous or monitored operation.

PENCIL PATCH . . . \$19.95
Fixes the Electric Pencil™ Model 1 version so that it runs on the Model 3. (You must already own the Model 1 version.)

SMART TERMINAL . . . \$69.95
The intelligent telecommunication program that enables your TRS-80 to be used as a timesharing terminal. Automatic transmission to and from another computer. Control keys, break key, lower case, cassette and disk files compatible with both Electric Pencil™ and Scripsit programs.

Send S.A.S.E. for Free Catalog.

HOWE SOFTWARE

14 Lexington Road, New City, NY 10956
*TRS-80 is reg. TM of RadioShack div. of Tandy Corp.

Circle 171 on inquiry card.

THE COMPUTER COPY STAND.

- For all detachable keyboards and Apple II □ Easy on the eye (and back).
- Keeps paper work in front of operator and in line with screen. □ Perfect for word processing, data entry, and programming. □ Non-magnetic Lineguide™ tilt adjustable.

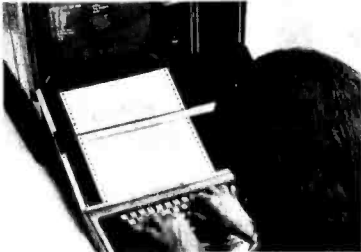

Pkay Corporation

P.O. Box 11463 • Costa Mesa, CA 92627
714/548-2081

Circle 299 on Inquiry card.

DON'T GET STUCK.

Sloppy software contracts cost money and cause misunderstandings. Consult us *before* you sign a contract. We offer contract services to both customers *and* suppliers.

Call or write
Robert E. Brown, Esq.
(716) 232-5300.

- Basic ■ Forth ■ Cobol
- Fortran ■ Others

Middleton,
Wilson, Boylan & Gianniny,
Attorneys at Law
900 Midtown Tower, Rochester, NY 14604

Circle 242 on Inquiry card.

SLIDER ALL FOR QUALITY COMPONENTS

GODBOUNT Epson MX-80
ELECTRONICS Ampex TeleVideo

ALL ASSEMBLED

| | | |
|---------------------------|-------------|----------------|
| CPU Z 6MHz CSC | \$308 | CPU Z 4MHz 179 |
| CPU 8085/88 CSC | 399 | CPU 8085/8 319 |
| DISK 1 | 371 | CPM*80 135 |
| CPM*86 w/d1 | 235 | OASIS CALL |
| DISK SYSTEM | CALL | INTERFACER 187 |
| INTERFACER 3(5) | 467 | INT-FAC(8) 547 |
| BIG 8 PKG | 1795 | RAM 20 32K 425 |
| RAM 17 64K | 821 | SPECTRUM 297 |
| ENCLOSURE 2 DK | 619 | ENCLOS 867 671 |
| 6MHz CPU Z SYSTEM | 64K DUAL 8" | 3795 |
| 6MHz CPU 8085/8088 SYSTEM | 64K | 3895 |
| EPSON MX80 | 460 | MX100FT 765 |
| TELEVIDEO 910,920, & 950 | CALL | |
| AMPEX DIALOGUE | 975 | ADDS V.P. 549 |

ALL PRICES SUBJECT TO CHANGE
CPM IS TRADEMARK OF DIGITAL RESEARCH

PO BOX 951
WESTMINSTER CA 92683
714 295 1745

Circle 337 on Inquiry card.

SPECIALS of the MONTH

| | |
|--|----------------|
| ATARI 800 Computers | \$ 750.00 |
| ATARI 810 Disc Drives | \$ 450.00 |
| ATARI Software | 25% off |
| APPLE II & 48 K Computers | \$1,150.00 |
| LOBO Disc Drive for APPLE II | \$ 395.00 |
| 8" Dual Drive Subsystems 2.4Mb | |
| DS-DD complete | \$1,795.00 |
| CDC LARK Subsystems 16Mb w/1 | |
| cartridge-power supply-cables | \$5,200.00 |
| Complete Word Processing System | |
| with DIABLO Printer | \$4,200.00 |
| CALIFORNIA Computer Systems 300 Dual | |
| 8" Drive Computer, 64K RAM, OASIS-2.4 | |
| Mb Disc memory, 25 serial ports, 1 | |
| Centronics compatible parallel port, a | |
| televideo 910 CRT-COMLETE! | \$5,800.00 |
| EPSON MX-70 Printers | \$ 385.00 |
| EPSON MX-80-F/T Printers | \$ 685.00 |
| IDS 460G Printers | \$ 800.00 |
| IDS 560G Printers | \$1,150.00 |
| CITOH STARWRITER 25 Printers | \$1,380.00 |
| DIABLO 630 RD Printer | \$2,240.00 |
| NEC SPINWRITERS | Call for price |
| APPLE Peripherals | Call for price |
| MOUNTAIN HARDWARE CPS | |
| Multifunction Cards | \$ 180.00 |

219/838-5350

Meade's
DATA SYSTEMS

"THE COMPLETE SYSTEMS AND SUPPORT TEAM"

MARKET SQUARE SHOPPING CENTER, RIDGE RD. & CALUMET AVE., MUNCIE, IN 47321

Circle 215 on Inquiry card.

AUTO-DIAL/ AUTO-ANSWER

MODEM
FOR
\$224.95!*



The MICROCONNECTION™ can dial and answer the telephone, run printers, decode busses, transcribe transmissions, answer/originate and direct-connect to the telephone system. Lots of terminal and host software too. For more information write or phone:

the *microperipheral corporation*

2643 A - 151st Pl. N.E.
Redmond, WA 98052
(206) 881-7544



*R5232 MICROCONNECTION™

Circle 37 on Inquiry card.

BASYS/1 CMOS Single-Board Computers for ROBOTICS



BASYS/1 is a CMOS microcomputer for real-world applications. It contains the on-board I/O to handle motors, switches, lights, and solenoids directly, without external parts. To demonstrate, we built ITSABOX, the Intelligent Turtle Robot. He's programmed to speak 8TH, our version of FORTH, and cost under \$300. Parts: BASYS/1 - 2 stepping motors, 2 sensing switches, an RS-232C connector, batteries and a box. Drop us an SASE and we'll tell you all about him.

TMSI does not sell ITSABOXes, but we do design and build CMOS microsystems for control applications. If your application could use the advantages of CMOS logic and micro-computer technology, give us a call!

BASYS/1 with 1K RAM, .5K ROM. KIT \$185,
assembled \$220

TECHNICAL MICRO SYSTEMS, INC.

TMSI 366 Cloverdale
Ann Arbor, MI 48105
(313) 994-0784

Circle 359 on inquiry card.

Fast Action Games For Your Apple!

Sirius Software, Inc.

Dealer inquiries invited.

For more information contact your
local computer dealer. (916) 920-1939
2011 Arden Way #2 Sacramento, CA 95825

Circle 336 on Inquiry card.

The V.I.P.* IS HERE!

*Versatile Instrumentation Peripheral

Perfect for Use in Process Control and Data Acquisition Systems or in Standalone Instrumentation

High Performance and Resolution

Extremely Cost Effective

- * Single Card S100 A/D, D/A, Digital I/O
- * Instrumentation Amplifier Input Channel
- * D/A Voltage and Current Source Output
- * Full 12 Bit Resolution
- * Software Configurable Analog Circuitry
- * 25 μ s A/D Conversion Time
- * 48 High Voltage, High Current Digital Drivers, 100 mA per Output
- * Drives LED Display and Decimal Points with Software Selectable ROM Decoding
- * Two Double Pole Utility Relays
- * 8 Bit TTL-Compatible Input
- * Self-Test Capability

\$595

Fully assembled and tested. Documentation and applications software provided. Check, MO, MC, Visa accepted. MA residents add 5% sales tax. \$4 shipping and handling charge.

AUTOMATED CONTROL SYSTEMS

1105 Broadway
Somerville, MA 02144
(617) 628-5373

Circle 37 on Inquiry card.

CHIPS & DALE

THE INFLATION FIGHTERS!

— RAM —

4116 200ns 8/ \$15.75

2114L 300ns 8/ \$18.45

4164 200ns \$27.00

— EPROM —

2716 (5V)450ns 8/ \$5.35 ea. \$5.75 ea.

2732 (5V)450ns 8/ \$13.00 ea. \$14.00 ea.

We buy from Manufacturer's Authorized Distributors. All Chips are fully Guaranteed. Call for quantity pricing. Please allow up to 3 wks. for personal checks to clear.

Add \$2.50 Shipping & Handling
C.O.D. \$3.00. Wash. residents add 5.4% Sales Tax

CHIPS & DALE

P.O. Box 31607

Seattle, Wash. Zip 98103

Master Charge

1-206-524-9126

VISA accepted.

Circle 68 on Inquiry card.

QUEST ELECTRONICS

P.O. Box 4430X
Santa Clara, CA 95054
Will call: 2322 Walsh Ave.
(408) 988-1640 TWX 910-338-2139

Same day shipment. First line parts only. Factory tested. Guaranteed money back. Quality IC's and other components at price points.

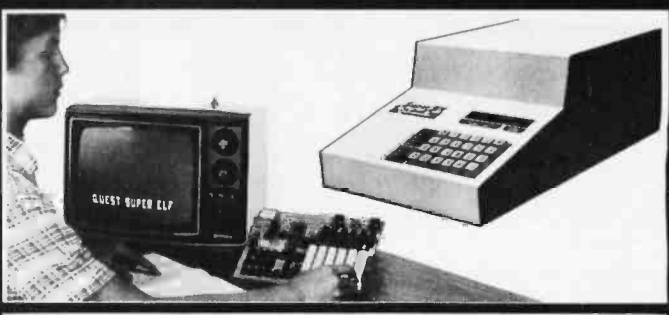

RCA Cosmac 1802 Super Elf Computer \$106.95

Compare features before you decide to buy any other computer. There is no other computer on the market today that has all the desirable benefits of the Super Elf for so little money. The Super Elf is a small single board computer that does many big things. It is an excellent computer for training and for learning programming with its machine language and yet it is easily expanded with additional memory, Full Basic, ASCII Keyboards, video character generation, etc.

Before you buy another small computer, see if it includes the following features: ROM monitor; State and Mode displays; Single step; Optional address displays; Power Supply; Audio Amplifier and Speaker; Fully socketed for all IC's; Real cost of in warranty repairs; Full documentation.

plus load, reset, run, wait, input, memory protect, monitor select and single step. Large, on board displays provide output and optional high and low address. There is a 44 pin standard connector slot for PC cards and a 50 pin connector slot for the Quest Super Expansion Board. Power supply and sockets for all IC's are included in the price plus a detailed 127 pg. instruction manual which now includes over 40 pgs. of software info, including a series of lessons to help get you started and a music program and graphics target game. Many schools and universities are using the Super Elf as a course of study. OEM's use it for training and R&D.

Remember, other computers only offer Super Elf features at additional cost or not at all. Compare before you buy. Super Elf Kit \$106.95. High address option \$8.95. Low address option \$9.95. Custom Cabinet with drilled and labelled Plexiglas front panel \$24.95. All metal Expansion Cabinet, painted and silk screened, with room for 5 S-100 boards and power supply \$57.00. NiCad Battery Memory Saver Kit \$6.95. All kits and options also completely assembled and tested.

The Super Elf includes a ROM monitor for program loading, editing and execution with SINGLE STEP for program debugging which is not included in others at the same price. With SINGLE STEP you can see the microprocessor chip operating with the unique Quest address and data bus displays before, during and after executing instructions. Also, CPU mode and instruction cycle are decoded and displayed on 8 LED indicators.

An RCA 1861 video graphics chip allows you to connect to your own TV with an inexpensive video modulator to do graphics and games. There is a speaker system included for writing your own music or using many music programs already written. The speaker amplifier may also be used to drive relays for control purposes.

A 24 key HEX keyboard includes 16 HEX keys

QUEST SUPER ELF

Super Expansion Board with Cassette Interface \$89.95

This is truly an astounding value! This board has been designed to allow you to decide how you want it optioned. The Super Expansion Board comes with 4K of low power RAM fully addressable anywhere in 64K with built-in memory protect and a cassette interface. Provisions have been made for all other options on the same board and it fits neatly into the hardware cabinet alongside the Super Elf. The board includes slots for up to 6K of EPROM (2708, 2758, 2716 or TI 2716) and is fully socketed. EPROM can be used for the monitor and Tiny Basic or other purposes. A 1K Super ROM Monitor \$19.95 is available as an on board option in 2708 EPROM which has been preprogrammed with a program loader/editor and error checking multi file cassette reader/write software, (relocatable cassette file) another exclusive from Quest. It includes register save and readout, block mode capability and video graphics driver with blinking cursor. Break

points can be used with the register save feature to isolate program bugs quickly, then follow with single step. If you have the Super Expansion Board and Super Monitor the monitor is up and running at the push of a button.

Other on board options include Parallel Input and Output Ports with full handshake. They allow easy connection of an ASCII keyboard to the Input port. RS 232 and 20 mA Current Loop for teletype or other device are on board and if you need more memory there are two S-100 slots for static RAM or video boards. Also a 1K Super Monitor version 2 with video driver for full capability display with Tiny Basic and a video interface board. Parallel I/O Ports \$9.85, RS 232 \$4.50, TTY 20 mA 1/1 \$1.95, S-100 \$4.50. A 50 pin connector set with ribbon cable is available at \$15.25 for easy connection between the Super Elf and the Super Expansion Board.

Power Supply Kit for the complete system (see Multi-volt Power Supply).

Quest Super Basic V5.0

A new enhanced version of Super Basic now available. Quest was the first company worldwide to ship a full size Basic for 1802 Systems. A complete function Super Basic by Ron Center including floating point capability with scientific notation (number range ± 17Eⁿ), 32 bit integer ± 2 billion; multi dim arrays, string arrays, string manipulation; cassette I/O; save and load, basic, data and machine language programs; and over 75 statements, functions and operations.

Elf II Adapter Kit \$24.95

Plugs into Elf II providing Super Elf 44 and 50 pin S-100 bus expansion. (With Super Expansion). High and low address displays, state and mode LED's optional \$18.00.

Type-N-Talk by Votrax

Text to speech synthesizer with unlimited vocabulary, built-in text to speech algorithm, 70 to 100 bits per second speech synthesizer, RS232C interface \$345.00.

Super Color S-100 Video Kit \$129.95

Expandable to 256 x 192 high resolution color graphics. 6847 with all display modes computer controlled. Memory mapped. 1K RAM expandable to 6K. S-100 bus 1802, 8080, 8085, 280 etc. Dealers: Send for excellent pricing/margin program.

Editor Assembler \$25.00

(Requires minimum of 4K for E/A plus user source)

1802 Tiny Basic Source Listing \$19.00

Super Monitor V2.0/2.1 Source Listing \$20.00

1802 16K Dynamic RAM Kit \$149.00

Expandable to 64K. Hidden refresh w/clocks up to 4 MHz w/no wait states. Addl. 16K RAM \$25.00. Tiny Basic Extended on Cassette \$15.00. (Added commands include String, Array, Cassette I/O etc.) S-100 4-slot expansion \$ 9.95. Super Monitor V1.1 Source Listing \$15.00

FREE: Send for your copy of our NEW 1981 QUEST CATALOG. Include 48¢ stamp.

| INTEGRATED CIRCUITS | | CONNECTORS | | KEYBOARDS | | |
|---------------------|-----------|------------|--------|-----------|-------------|------|
| 7400TTL | LM339-5 | 1.35 | CD4076 | 2.50 | 214L 4500S | 4.00 |
| 7400TTL | LM339-12 | 1.35 | CD4077 | 2.50 | 214L 3000S | 2.95 |
| 7400TTL | LM339-15 | 1.35 | CD4078 | 2.50 | 8-116 2000S | 4.10 |
| 7400TTL | LM339-20 | 1.35 | CD4079 | 2.50 | MM5262 | 4.00 |
| 7400TTL | LM339-25 | 1.35 | CD4080 | 2.50 | MM5260 | 2.50 |
| 7400TTL | LM339-30 | 1.35 | CD4081 | 2.50 | MM5250 | 1.00 |
| 7400TTL | LM339-35 | 1.35 | CD4082 | 2.50 | MM5230 | 0.94 |
| 7400TTL | LM339-40 | 1.35 | CD4083 | 2.50 | PD11B3 | 1.00 |
| 7400TTL | LM339-45 | 1.35 | CD4084 | 2.50 | PD11D-4 | 5.00 |
| 7400TTL | LM339-50 | 1.35 | CD4085 | 2.50 | PS101L | 0.95 |
| 7400TTL | LM339-55 | 1.35 | CD4086 | 2.50 | 47420A | 0.95 |
| 7400TTL | LM339-60 | 1.35 | CD4087 | 2.50 | 85 82525 | 2.90 |
| 7400TTL | LM339-65 | 1.35 | CD4088 | 2.50 | 91102A | 1.50 |
| 7400TTL | LM339-70 | 1.35 | CD4089 | 2.50 | 100 pm edge | 3.50 |
| 7400TTL | LM339-75 | 1.35 | CD4090 | 2.50 | 86 pm edge | 4.00 |
| 7400TTL | LM339-80 | 1.35 | CD4091 | 2.50 | 100 pm edge | 3.50 |
| 7400TTL | LM339-85 | 1.35 | CD4092 | 2.50 | MM5270 | 5.50 |
| 7400TTL | LM339-90 | 1.35 | CD4093 | 2.50 | MM5250 | 1.00 |
| 7400TTL | LM339-95 | 1.35 | CD4094 | 2.50 | MM5230 | 0.94 |
| 7400TTL | LM339-100 | 1.35 | CD4095 | 2.50 | MM5210 | 0.94 |
| 7400TTL | LM339-105 | 1.35 | CD4096 | 2.50 | MM5200 | 0.94 |
| 7400TTL | LM339-110 | 1.35 | CD4097 | 2.50 | MM5190 | 0.94 |
| 7400TTL | LM339-115 | 1.35 | CD4098 | 2.50 | MM5180 | 0.94 |
| 7400TTL | LM339-120 | 1.35 | CD4099 | 2.50 | MM5170 | 0.94 |
| 7400TTL | LM339-125 | 1.35 | CD4100 | 2.50 | MM5160 | 0.94 |
| 7400TTL | LM339-130 | 1.35 | CD4101 | 2.50 | MM5150 | 0.94 |
| 7400TTL | LM339-135 | 1.35 | CD4102 | 2.50 | MM5140 | 0.94 |
| 7400TTL | LM339-140 | 1.35 | CD4103 | 2.50 | MM5130 | 0.94 |
| 7400TTL | LM339-145 | 1.35 | CD4104 | 2.50 | MM5120 | 0.94 |
| 7400TTL | LM339-150 | 1.35 | CD4105 | 2.50 | MM5110 | 0.94 |
| 7400TTL | LM339-155 | 1.35 | CD4106 | 2.50 | MM5100 | 0.94 |
| 7400TTL | LM339-160 | 1.35 | CD4107 | 2.50 | MM5090 | 0.94 |
| 7400TTL | LM339-165 | 1.35 | CD4108 | 2.50 | MM5080 | 0.94 |
| 7400TTL | LM339-170 | 1.35 | CD4109 | 2.50 | MM5070 | 0.94 |
| 7400TTL | LM339-175 | 1.35 | CD4110 | 2.50 | MM5060 | 0.94 |
| 7400TTL | LM339-180 | 1.35 | CD4111 | 2.50 | MM5050 | 0.94 |
| 7400TTL | LM339-185 | 1.35 | CD4112 | 2.50 | MM5040 | 0.94 |
| 7400TTL | LM339-190 | 1.35 | CD4113 | 2.50 | MM5030 | 0.94 |
| 7400TTL | LM339-195 | 1.35 | CD4114 | 2.50 | MM5020 | 0.94 |
| 7400TTL | LM339-200 | 1.35 | CD4115 | 2.50 | MM5010 | 0.94 |
| 7400TTL | LM339-205 | 1.35 | CD4116 | 2.50 | MM5000 | 0.94 |
| 7400TTL | LM339-210 | 1.35 | CD4117 | 2.50 | MM4990 | 0.94 |
| 7400TTL | LM339-215 | 1.35 | CD4118 | 2.50 | MM4980 | 0.94 |
| 7400TTL | LM339-220 | 1.35 | CD4119 | 2.50 | MM4970 | 0.94 |
| 7400TTL | LM339-225 | 1.35 | CD4120 | 2.50 | MM4960 | 0.94 |
| 7400TTL | LM339-230 | 1.35 | CD4121 | 2.50 | MM4950 | 0.94 |
| 7400TTL | LM339-235 | 1.35 | CD4122 | 2.50 | MM4940 | 0.94 |
| 7400TTL | LM339-240 | 1.35 | CD4123 | 2.50 | MM4930 | 0.94 |
| 7400TTL | LM339-245 | 1.35 | CD4124 | 2.50 | MM4920 | 0.94 |
| 7400TTL | LM339-250 | 1.35 | CD4125 | 2.50 | MM4910 | 0.94 |
| 7400TTL | LM339-255 | 1.35 | CD4126 | 2.50 | MM4900 | 0.94 |
| 7400TTL | LM339-260 | 1.35 | CD4127 | 2.50 | MM4890 | 0.94 |
| 7400TTL | LM339-265 | 1.35 | CD4128 | 2.50 | MM4880 | 0.94 |
| 7400TTL | LM339-270 | 1.35 | CD4129 | 2.50 | MM4870 | 0.94 |
| 7400TTL | LM339-275 | 1.35 | CD4130 | 2.50 | MM4860 | 0.94 |
| 7400TTL | LM339-280 | 1.35 | CD4131 | 2.50 | MM4850 | 0.94 |
| 7400TTL | LM339-285 | 1.35 | CD4132 | 2.50 | MM4840 | 0.94 |
| 7400TTL | LM339-290 | 1.35 | CD4133 | 2.50 | MM4830 | 0.94 |
| 7400TTL | LM339-295 | 1.35 | CD4134 | 2.50 | MM4820 | 0.94 |
| 7400TTL | LM339-300 | 1.35 | CD4135 | 2.50 | MM4810 | 0.94 |
| 7400TTL | LM339-305 | 1.35 | CD4136 | 2.50 | MM4800 | 0.94 |
| 7400TTL | LM339-310 | 1.35 | CD4137 | 2.50 | MM4790 | 0.94 |
| 7400TTL | LM339-315 | 1.35 | CD4138 | 2.50 | MM4780 | 0.94 |
| 7400TTL | LM339-320 | 1.35 | CD4139 | 2.50 | MM4770 | 0.94 |
| 7400TTL | LM339-325 | 1.35 | CD4140 | 2.50 | MM4760 | 0.94 |
| 7400TTL | LM339-330 | 1.35 | CD4141 | 2.50 | MM4750 | 0.94 |
| 7400TTL | LM339-335 | 1.35 | CD4142 | 2.50 | MM4740 | 0.94 |
| 7400TTL | LM339-340 | 1.35 | CD4143 | 2.50 | MM4730 | 0.94 |
| 7400TTL | LM339-345 | 1.35 | CD4144 | 2.50 | MM4720 | 0.94 |
| 7400TTL | LM339-350 | 1.35 | CD4145 | 2.50 | MM4710 | 0.94 |
| 7400TTL | LM339-355 | 1.35 | CD4146 | 2.50 | MM4700 | 0.94 |
| 7400TTL | LM339-360 | 1.35 | CD4147 | 2.50 | MM4690 | 0.94 |
| 7400TTL | LM339-365 | 1.35 | CD4148 | 2.50 | MM4680 | 0.94 |
| 7400TTL | LM339-370 | 1.35 | CD4149 | 2.50 | MM4670 | 0.94 |
| 7400TTL | LM339-375 | 1.35 | CD4150 | 2.50 | MM4660 | 0.94 |
| 7400TTL | LM339-380 | 1.35 | CD4151 | 2.50 | MM4650 | 0.94 |
| 7400TTL | LM339-385 | 1.35 | CD4152 | 2.50 | MM4640 | 0.94 |
| 7400TTL | LM339-390 | 1.35 | CD4153 | 2.50 | MM4630 | 0.94 |
| 7400TTL | LM339-395 | 1.35 | CD4154 | 2.50 | MM4620 | 0.94 |
| 7400TTL | LM339-400 | 1.35 | CD4155 | 2.50 | MM4610 | 0.94 |
| 7400TTL | LM339-405 | 1.35 | CD4156 | 2.50 | MM4600 | 0.94 |
| 7400TTL | LM339-410 | 1.35 | CD4157 | 2.50 | MM4590 | 0.94 |
| 7400TTL | LM339-415 | 1.35 | CD4158 | 2.50 | MM4580 | 0.94 |
| 7400TTL | LM339-420 | 1.35 | CD4159 | 2.50 | MM4570 | 0.94 |
| 7400TTL | LM339-425 | 1.35 | CD4160 | 2.50 | MM4560 | 0.94 |
| 7400TTL | LM339-430 | 1.35 | CD4161 | 2.50 | MM4550 | 0.94 |
| 7400TTL | LM339-435 | 1.35 | CD4162 | 2.50 | MM4540 | 0.94 |
| 7400TTL | LM339-440 | 1.35 | CD4163 | 2.50 | MM4530 | 0.94 |
| 7400TTL | LM339-445 | 1.35 | CD4164 | 2.50 | MM4520 | 0.94 |
| 7400TTL | LM339-450 | 1.35 | CD4165 | 2.50 | MM4510 | 0.94 |
| 7400TTL | LM339-455 | 1.35 | CD4166 | 2.50 | MM4500 | 0.94 |
| 7400TTL | LM339-460 | 1.35 | CD4167 | 2.50 | MM4490 | 0.94 |
| 7400TTL | LM339-465 | 1.35 | CD4168 | 2.50 | MM4480 | 0.94 |
| 7400TTL | LM339-470 | 1.35 | CD4169 | 2.50 | MM4470 | 0.94 |
| 7400TTL | LM339-475 | 1.35 | CD4170 | 2.50 | MM4460 | 0.94 |
| 7400TTL | LM339-480 | 1.35 | CD4171 | 2.50 | MM4450 | 0.94 |
| 7400TTL | LM339-485 | 1.35 | CD4172 | 2.50 | MM4440 | 0.94 |
| 7400TTL | LM339-490 | 1.35 | CD4173 | 2.50 | MM4430 | 0.94 |
| 7400TTL | LM339-495 | 1.35 | CD4174 | 2.50 | MM4420 | 0.94 |
| 7400TTL | LM339-500 | 1.35 | CD4175 | 2.50 | MM4410 | 0.94 |
| 7400TTL | LM339-505 | 1.35 | CD4176 | 2.50 | MM4400 | 0.94 |
| 7400TTL | LM339-510 | 1.35 | CD4177 | 2.50 | MM4390 | 0.94 |
| 7400TTL | LM339-515 | 1.35 | CD4178 | 2.50 | MM4380 | 0.94 |
| 7400TTL | LM339-520 | 1.35 | CD4179 | 2.50 | MM4370 | 0.94 |
| 7400TTL | LM339-525 | 1.35 | CD4180 | 2.50 | MM4360 | 0.94 |
| 7400TTL | LM339-530 | 1.35 | CD4181 | 2.50 | MM4350 | 0.94 |
| 7400TTL | LM339-535 | 1.35 | CD4182 | 2.50 | MM4340 | 0.94 |
| 7400TTL | LM339-540 | 1.35 | CD4183 | 2.50 | MM4330 | 0.94 |
| 7400TTL | LM339-545 | 1.35 | CD4184 | 2.50 | MM4320 | 0.94 |
| 7400TTL | LM339-550 | 1.35 | CD4185 | 2.50 | MM4310 | 0.94 |
| 7400TTL | LM339-555 | 1.35 | CD4186 | 2.50 | MM4300 | 0.94 |
| 7400TTL | LM339-560 | 1.35 | CD4187 | 2.50 | MM4290 | 0.94 |
| 7400TTL | LM339-565 | | | | | |

STOCK MARKET NORTH STAR

Double Dens Disk w programs, data on over 100 stocks

Create, build, maintain data files on stock prices

Adjust for splits, stk divs compute relative strength

Portfolio Performed data from disk files, gain, rate of gain, yield for each item and for total

Evaluate call options risk reward Requires North Star BASIC DOS, 32K Disk \$35 document \$4 separate

Lands Associates
8005 30th St. S.E.
Everett, WA 98205

Circle 194 on Inquiry card.



The Largest HP Dealer
in Connecticut
Calculators and Computers

the Carrington Company

METALS DRIVE, P.O. BOX 392
SOUTHINGTON, CONN. 06489

An Instock/Full Service Company
Call for discounts
Connecticut Toll Free: 1-800-982-3731
Out of State Call: 203/628-5511



68KFORTH

New SYSTEMS LANGUAGE for ERG 68-696 CPU and Motorola's KDM board. O/S, Compiler, Monitor, Assembler, Interpreter, Virtual Memory, Screen Editor, DBL Precision Arithmetic and more. Enhanced FIG-FORTH Vocabulary. Environment: stand alone, Bell Lab's UNIX, or Whitesmiths' IDRIS, etc.

\$795

EMPIRICAL RESEARCH
GROUP, INC.
PO Box 1176
Milton, WA 98354
206-631-4855

Circle 144 on inquiry card.

CLEAN POWER.



NEW FROM SGL WABER

The electricity that powers your personal computer systems is "polluted." Filled with voltage spikes and noise interference that can cause information loss, equipment malfunction and premature circuit failure.

Protect your data and equipment. Purify your power with a new Power Master[®] Line Monitor Power Conditioner. Just plug in. Free 20 page Catalog, 8 models.



SGL WABER Electric A division of SGL Industries, Inc.
300 Harvard Ave./Westville, NJ 08093 (609) 456-5400

Circle 404 on inquiry card.

OPTION

THE STOCK OPTIONS
ANALYSIS SYSTEM

A complete software package for valuing puts and calls and analyzing all types of option investment positions with your microcomputer (Apple, TRS-80, CP/M systems*).

complete system \$250⁰⁰
manual only \$15⁰⁰



505 Gilchrist / 713-696-1456
College Station, Tx. 77840

*TM TANDY, APPLE, DRI, respectively.

Circle 152 on inquiry card.

PASSIVE SOLAR ENERGY PROGRAM

Glassize[®]—the program to aid you in selecting an appropriate passive glazing area. Glassize[®] allows you to balance aesthetics with economics. Package includes disc for TRS-80 or Apple II along with users manual containing sizing methods and climatic data for 200 U.S. cities. \$150 postpaid.

The Camreden Company
Route 4 • Box 62
Rome, New York 13440

Circle 60 on inquiry card.

ATARI



GRAPHICS HARDCOPY

ON: EPSON PRINTERS
CENTRONICS 739
IDS 445G
TREND/COM

Dumps anything on the screen to the printer

To Order Toll Free
1-800-344-7493

In CA. & for Service (209) 667-2888



MACROTRONICS, inc.
1125 N. Golden State Blvd.
Turlock, California 95380



Circle 207 on Inquiry card.



| | | | |
|-----|------------------|-------|--------|
| 800 | 16K | _____ | \$740. |
| 400 | 16K | _____ | \$339. |
| 410 | Recorder | _____ | \$59. |
| 810 | DISK | _____ | \$449. |
| 850 | Interface | _____ | \$169. |
| 830 | Modem | _____ | \$159. |
| | 16KRAM | _____ | \$75. |
| 820 | Printer | _____ | \$260. |
| 822 | Printer | _____ | \$349. |
| 825 | Printer | _____ | \$625. |
| 483 | The Programmer | _____ | \$55. |
| 484 | The Communicator | _____ | \$330. |

Call or write for discount on software.

EMPIRE SYSTEMS CORPORATION
18604 Rolling Acres Way
Oliney, Maryland 20832
Call (301) 774-7330

Prices subject to change

Circle 410 on Inquiry card.

UNIPROM

THE VERSATILE EPROM HANDLING SYSTEM
Reads/Programs 2704, 2708, 2758, 2508, 2516 (T.I.), 2716 (single supply), 2532 (T.I.), 2732 (T.I. pinout), and Intel/NEC 8755A!

Expandable for 2732 (INTEL pinout). TMS 2716 (3 supply), 2564 (T.I.).

No personality modules required or additional power supplies required.

S-100 compatible.

Disk-based software (Z80 only) includes a "MENU" display command, commands usually found in system monitors, and versatile CDOS and CP/M compatible disk I/O commands. Also available in a single 2716 EPROM (8080 or Z80) without the "MENU" and disk I/O commands.

UNIPROM board (A & T) with extensive manual — \$245.00.

UNIPROM disk-based software (specify 5.25" or 8" CDOS, 8" CP/M, or 5.25" NORTHSTAR CP/M) — \$48.00.

UNIPROM EPROM based software, write for flyer. VISA/MASTER

CER-TEK, INC.
6020 Doniphan Dr.
El Paso, Texas 79932
(915) 581-6697

CDOS is a registered trademark of CROMECO, INC.
CP/M is a registered trademark of DIGITAL RESEARCH, INC.
NORTHSTAR is a registered trademark of NORTHSTAR COMPUTER, INC.

Circle 63 on inquiry card.

PRICE BREAKTHROUGH

We've done it again! As a leader in small computer sales we must constantly find new ways to save customers money while offering quality products. Our most popular seller, the Apple II Plus, is now available with 64K of user RAM at the unbeatable price of only \$1249. This is possible because we manufacture the 16K RAM Card that expands the factory Apple II 48K to it's maximum capacity of 64K. The Ram Card allows use of Integer and Applesoft Basic and other languages like Pascal. It's a must for large data bases, Visicalc, and the Z-80 cards. The card is made from high quality components and has a full one year warranty.

64K APPLE II PLUS*
*48 K Apple II Plus with 16K Ram Card
ONLY \$1249

16K ONLY \$1025 **48K ONLY \$1089**
DISK II DRIVE WITH CONTROLLER CARD **\$499**
DISK II DRIVE ADD ON **\$439**



Apple Cards and Hardware

| | |
|--|------|
| 16K Ram Card by CCI | 130 |
| Language System w/Pascal | 379 |
| Silentye Printer w/Interface Card | 349 |
| Hayes Micromodem II | 299 |
| Novation Apple-Cat II | 339 |
| Videx Vidioterm 80 Column w/Graphics | 269 |
| Z-80 SoftCard by Microsoft | 299 |
| 16K RamCard by Microsoft | 159 |
| ABT Numeric Keypad (old or new kybrd) | 110 |
| ALF 3 Voice Music Card | 239 |
| ALF 9 Voice Music Card | 169 |
| Lazer Lower Case Plus | 55 |
| Micro-Sci Disk Drives (A-40 & A-70) | CALL |
| SSM AIO Serial/Parallel Card A&T | 189 |
| Sup-R-Terminal 80 Column Card | 329 |
| SVA ZVX4 Megabyte 8" Disk Controller | 329 |
| SVA 2+2 Single Den. 8" Disk Controller | 345 |
| ThunderClock Plus | 119 |
| Symtec Hi-Res Light Pen | 210 |
| Integer or Applesoft Firmware Card | 145 |
| Graphics Tablet | 619 |
| Parallel Printer Interface Card | 135 |
| Hi-Speed Serial Interface Card | 135 |
| Smarterm 80 Column Card | 299 |
| Joystick by Keyboard Co. | 45 |
| Music System (16 Voices) | 479 |
| A/D + D/A Interface | 289 |
| Expansion Chassis | 599 |
| Introl/X-10 Controller Card | 169 |
| Clock/Calendar Card | 225 |
| CPS Multi-function Card | 189 |
| Supertalker SD-200 | 239 |
| Romplus + Card | 135 |
| Romwriter Card | 149 |
| Clock/Calendar Module | 99 |
| GPIB IEEE-488 Card | 249 |
| Asynchronous Serial Interface Card | 129 |
| Centronics Parallel Interface Card | 99 |
| Arithmetic Processor Card | 299 |

We carry all CCI cards, please call for best prices.

Software for the Apple

| | |
|----------------------------------|------|
| Visicalc 3.3 | 169 |
| CCA Data Management | 85 |
| DB Master | 169 |
| WordStar (Apple 80 col. version) | 299 |
| Applewriter | 65 |
| Easywriter | 225 |
| Peachtree Business Software | CALL |
| VisiTerm | 129 |
| VisiTerm/VisiPlot | 219 |
| Real Estate Analyzer | 89 |
| Tax Preparer | 99 |
| DOS Toolkit | 65 |
| Tax Planner | 99 |
| Dow Jones Portfolio Evaluator | 45 |
| Dow Jones News & Quotes Reporter | 85 |
| Apple Fortran | 165 |
| Controller Gen. Bus. System | 499 |

Printers

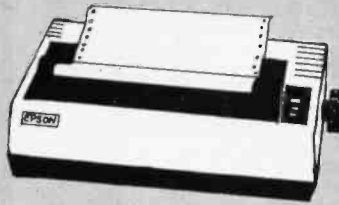

Epson MX-80 CALL

| | |
|------------------------------------|------|
| Anadex 9500/9501 w/2K Buffer | 1299 |
| C. Itoh Starwriter 25 CPS | 1499 |
| C. Itoh Starwriter 45 CPS | 1899 |
| Epson MX-70 | CALL |
| Epson MX-80 F/T | CALL |
| Paper Tiger IDS-445 | 699 |
| Paper Tiger IDS-460 | 949 |
| Paper Tiger IDS-560 | 1249 |
| Silentye w/Apple II Interface card | 349 |
| Qume Sprint 5/45 | 2495 |

TOLL FREE ORDER LINE
800-854-6654
California and outside
Continental US
(714) 698-8088
TELEX 695000 BETA CCMO

Video Monitors

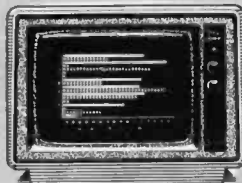

| | |
|--|------|
| Amdex/Leedex Video 100 12" B&W | 139 |
| Amdex (Hitachi) 13" Color | 359 |
| NEC 12" Green Phosphor Screen | CALL |
| NEC 12" RGB Hi-Res Color | CALL |
| Panasonic 13" Color | 449 |
| Sanjo 9" B&W | 185 |
| Sanjo 9" Green Phosphor Screen | CALL |
| Sanjo 12" B&W | 269 |
| Sanjo 12" Green Phosphor Screen | 285 |
| Sanjo 13" Color w/excellent resolution | 449 |

Atari Personal Computer



ATARI 800 16K \$749

| | |
|------------------------------------|------|
| Atari 400 16K | 349 |
| 410 Program Recorder | 65 |
| 810 Disk Drive | 449 |
| 815 Dual Disk Drive (Dbl. Den.) | 1295 |
| 822 Thermal Printer | 349 |
| 860 Interface Module | 159 |
| 16K Ram Memory Module | 149 |
| 16K Ram Memory Module (by ConComp) | 89 |

NEC Microcomputer



| | |
|------------------------------------|------|
| PC-8001A 32K Ram Computer | CALL |
| PC-8012A I/O Unit w/32K Ram | CALL |
| PC-8031A Dual Mini-Disk Drive Unit | CALL |

Please write for more information about the NEC computer.

Ordering Information: Phone orders using VISA, MASTERCARD, AMERICAN EXPRESS, DINER'S CLUB, CARTE BLANCHE, bank wire transfer, cashier's or certified check, money order, or personal check (allow ten days to clear). Unless prepaid with cash, please add 5% for shipping, handling and insurance. (minimum 5.00). California residents add 6% sales tax. We accept CODs. OEM's, Institutions and corporations please send for a written quotation. All equipment is subject to price change and availability without notice. All equipment is new and complete with manufacturer's warranty (usually 90 days). Showroom prices may differ from mail order prices.

Send Orders to:

consumer computers Mail Order
8314 Parkway Drive
La Mesa, California 92041

3M scotch®

Buy the finest in data recording products from your DISKONNECTION.

| | Price/10 |
|-------------------------------|---------------------|
| 5 1/4" (soft, 10 or 16 hard) | \$ 27 ⁰⁰ |
| 8" (single side / density) | 27 ⁰⁰ |
| 8" (reversible, sgl. density) | 40 ⁰⁰ |
| 8" (sgl. side, dbl. density) | 35 ⁰⁰ |
| 8" (dual side, dbl. density) | 40 ⁰⁰ |
| MC or VISA, add | 1 ⁰⁰ |

- Postage and handling included
- Send check, MO, MC or VISA to,

DISKONNECTION
POB. 538
Mpls. Minnesota 55440
 /612/871-1677 before noon CST

Circle 129 on inquiry card.

STATISTICAL SOFTWARE

ELF — Stepwise regression, factor analysis, correlation coefficients, crosstabs, simple statistics, t-tests, ANOVA, stepwise discriminant analysis, all BASIC transformations and more. \$200.00

TWIG/ARIMA — Box-Jenkins for seasonal and non-seasonal models, identification, non-estimation and forecasting. Introductory Price: \$250.00.

Each includes a database manager, numeric software keypad, and is menu-driven. Each requires an Apple II with Applesoft, 48K, and DOS 3.3.

For further information, write

The Winchendon Group
 3907 Lakota Road
 P.O. Box 10114
 Alexandria, VA 22310

* Apple II and Applesoft are trademarks of the Apple Computer Company

Circle 366 on inquiry card.

MULTIBUS for SALE:

| | |
|------------|--------|
| SBC 86/12A | \$1200 |
| SBC 80/30 | \$ 450 |
| SBC 064 | \$ 900 |
| SBC 604 | \$ 85 |
| SBC 614 | \$ 85 |
| BLC 556 | \$ 175 |

Much more in stock. We buy/swap/sell any/all computer systems. Add 2% for shipping/handling.

Oracle Electronics & Trading Co., Inc.

467 Hamilton Ave., Suite 22
 Palo Alto, CA 94301
 (415) 321-7650

Circle 279 on inquiry card.

MAILING LABELS ETC.

Continuous Form Fanfold Pin-Feed White & Colored Printout Paper, STOCK & CUSTOM Office Forms, File Cards, Rubber Stamps, Marking Devices, Offset Printing, Double Copy, Price Marking & Roll Labels, Pressure Sensitive, Cheshire, Plain or Gummed Back & Heath Sensitive Mailing Labels etc. at LOWEST POSSIBLE PRICES & Fast Delivery.

SAMPLE PRICES: (Postpaid)

| 3 1/2 x 15/16 Labels | Pressure Sensitive | Gummed Back |
|----------------------|--------------------|-------------|
| 5,000 | \$ 16.50 | \$ 13.75 |
| 10,000 | \$ 31.50 | \$ 26.75 |
| 15,000 | \$ 46.50 | \$ 39.50 |
| 20,000 | \$ 60.00 | \$ 51.25 |

Conn. Customers Please Add Sales Tax. Catalog \$1.00 (Refundable) or FREE with your order.

HANDICRAFTS Dept. BT
 24 Winter St., Stamford, Ct. 06905

Circle 163 on inquiry card.

NEW S-100 DOUBLE HEIGHT*

10" HIGH PROTOTYPE BOARD

- Regulators provide 5V @ 4A, ± 12V @ 1A
- Accepts over 120 IC's plus 3M-type connectors
- Heavy power distribution with 28 distributed 0.1 ufd caps



13" HIGH EXTENDER CARD

- Scope probe hanger on each trace
- Ground trace between signal lines
- Heavy power traces with removable jumpers for current measurement

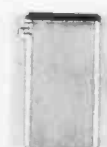

Inner Access Corporation
 Box 888
 Belmont, CA 94002
 (415) 591-8295

* Boards meet IEEE-696 compliance HH specifications.

Circle 176 on inquiry card.

68000

ERG68-696 68000 CPU in production. Meets or exceeds IEEE696 S-100 standard.

\$1995

Available software: Z80 emulator, 68K FORTH systems language, Whitesmiths UNIX-like IDRIS—O/S with C or Pascal compilers.

Integrated 6800 systems also available.

EMPIRICAL RESEARCH GROUP, INC.
 PO Box 1176
 Milton, WA 98354
 206-631-4855

Circle 145 on inquiry card.

\$ GET YOUR SHARE \$

Join the thousands of winners who have built on their computer interest to create a successful data processing-based business, and:

SHARE IN THE MINI/MICROPROCESSING BOOM
 Read this exciting new book:

MAKING IT IN DATA PROCESSING — ON YOUR OWN IN THE EIGHTIES

Written by experts in the computer business, this book contains all you need to get started, including:

- How to locate manufacturers who will help finance your new venture.
- What types of business are available and are best for you.
- Actual sources of Venture Capital looking for new businesses.
- Complete guides to pricing, sales promotion, advertising, publicity, and marketing.
- Dozens of sources of information to help you build your business.

To order, just clip this ad and send with only \$19.95 to:

THE SEABIRD PRESS
 PO Box 461, Lexington, MA 02173
Full 30 day money back guarantee

Circle 430 on inquiry card.

PROBLEM:

How to mate your CP/M® or ISIS® system to the

Z-8000

(without losing all your present capabilities)

SOLUTION:

ZEX is the software connection which permits Z-8000 applications to run under your current operating system, resulting in portable 16-bit software which runs under CP/M or ISIS! And ZEX is user-configured for any Z-8000 alternate bus master, so that it can support your prototype hardware, as well as commercially available Z-8000 boards.

ZAS is a complete Z-8000 Development Package, which includes a powerful relocatable cross assembler (ZAS), a flexible object task builder (ZLK), and an absolute object loader (ZLD), as well as the ZEX run time module. The package was developed specifically for the Z-8000, and supports the complete Zilog instruction syntax for both the Z8001 and Z8002, including support for mixed segmented and non-segmented code.



WESTERN WARES

ZAS Package CP/M .. \$395
 ISIS-II .. \$495
 Manual Only .. \$25
 Supplied on Single Density 8" Disk
 CP/M Digital Research, Inc. ISIS II Intel Corp.
 Box C. Norwood, CO 81423 (303)327-4898

Circle 391 on inquiry card.



Computer compatible Paper Tape Punch

From Addmaster Corporation — a self-contained paper tape punch which makes 5, 6, 7 or 8-level tapes at speeds up to 50 cps. Parallel data keyboard inputs, manual back space, tape low lamp, TTL level compatible, 5-8 level (ANSI), optional RS232C I/O serial port are features. Maximum 8" reel, standard hub. (1000 feet). Optional attachment for standard fanfold tape.
Contact Addmaster Corporation, 416 Junipero Serra Drive, San Gabriel, CA 91776. Telephone: (213) 681-3098

Circle 7 on inquiry card.

Here we grow again !!!

Grand Opening Sale

We're celebrating the latest addition to Jade's Retail Division - our new store located in Woodland Hills at 21800 Ventura Blvd.

New from Jade The Bus Probe

Inexpensive S-100 Diagnostic Analyzer

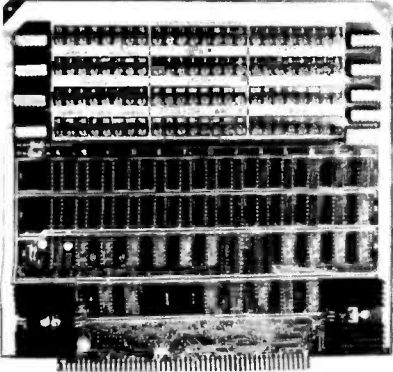

So your computer is down. And you don't have an oscilloscope. And you don't have a front panel... You're not alone - most computers have their occasional bad days. But without diagnostic equipment such as an oscilloscope (expensive!) or a front panel (expensive!), it can be very difficult to pinpoint the problem. Even if you have an extender board with a superfast logic probe, you can't see more than one signal at a time. You're stuck, right?

Not anymore; Jade is proud to offer our cost-effective solution to the problems mentioned above: **THE BUS PROBE**.

Whether you're a hobbyist with a cantankerous kluge or a field technician with an anxious computer owner breathing down your neck, you'll find **THE BUS PROBE** speeds your repair time remarkably. Just plug in **THE BUS PROBE** and you'll be able to see all the IEEE S-100 signals in action. **THE BUS PROBE** allows you to see inputs, outputs, memory reads and writes, instruction fetches, DMA channels, vectored interrupts, 8 or 16 bit wide data transfers, plus the three bus supply voltages.

An on-board pulse generator can provide repetitive resets, interrupts, or wait states, for trouble shooting.

TSX-200B Bare board \$59.95
 TSX-200K Kit \$119.95
 TSX-200A A&T \$149.95



NEC

4 MHz Z80 CPU, 80 x 25 display with graphics and 8 colors, 32K RAM, 24K ROM, parallel serial/cassette interfaces, upper/lower case, numeric keypad, 10 special function keys, uses CP M 2.2.

NEC-8001A 32K CPU/keyboard ... \$1095.00
 NEC-8012A I/O with 32K RAM ... \$695.00
 NEC-8031A Dual disk unit ... \$1095.00
 VDM-651200 12" green CRT ... \$269.95
 NEC-1202D Hi-res RGB color CRT ... \$1045.00
 VDC-651212 12" color monitor ... \$479.95
 NEC-9010S CP/M 2.2 for NEC ... \$150.00
 NEC-90005 Gen. acting softer ... \$375.00

Intersell Sellum I

NEC Spinwriter w/ Intelligent Controller

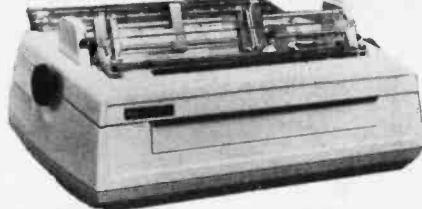

Standard serial, Centronics parallel, and current loop interfaces • Selectable baud rates 50 to 19,200
 • Automatic bidirectional printing • Logic seeking • 650 character buffer with optional 16K buffer • 55 characters per second print speed • Comes with vertical forms tractor, ribbon, thimble and cable • Diablo compatible software • Available with or without optional front panel

PRD-55511 1K no front panel \$2795.00
 PRD-55512 16K no front panel ... \$2895.00
 PRD-55515 1K w/front panel \$2995.00
 PRD-55516 16K w/front panel ... \$3095.00

Intersell NEC 3500Q

Intersell has announced that, available in September, they will offer a version of the new NEC Model 3500Q Spinwriter (30 cps) that will bring to the customer the same standard features as the Sellum I (except the tractor assembly which is optional on the 3500Q) but incorporating the added features of the NEC Model 3500Q

PRD-55351 3500Q 1K \$1995.00
 PRD-55352 3500Q 16K \$2095.00
 PRA-55100 Deluxe tractor option .. \$300.00

JADE

Disk Sub-Systems

Shugart, Siemens, Qume



Handsome metal cabinet with proportionally balanced air flow system • Rugged dual drive power supply • Power cable kit • Power switch, line cord, fuse holder, cooling fan • Never-May rubber feet • All necessary hardware to mount 2-8" disk drives, power supply, and fan • Does not include signal cable

Dual 8" Subassembly Cabinet

END-000420 Bare cabinet \$59.95
 END-000421 Cabinet kit \$225.00
 END-000431 A & T \$359.95

8" Disk Drive Subsystems

Single Sided, Double Density

END-000423 Kit w/ 2 FD100-8Ds ... \$924.95
 END-000424 A & T w/ 2 FD100-8Ds \$1124.95
 END-000433 Kit w/ 2 SA-801Rs ... \$999.95
 END-000434 A & T w/ 2 SA-801Rs \$1195.00

8" Disk Drive Subsystems

Double Sided, Double Density

END-000426 Kit w/ 2 DT-8s \$1224.95
 END-000427 A & T w/ 2 DT-8s ... \$1424.95
 END-000436 Kit w/ 2 SA-851Rs ... \$1455.00
 END-000437 A & T w/ 2 SA-851Rs \$1695.00

Circle 188 on inquiry card.



-Special
Sale Price-

QUME DT-8

8" Double-Sided, Double-Density Disk Drive

1 Drive ... \$524.95 each
 2 Drives ... \$499.95 each
 10 Drives \$479.95 each

Jade Part Number MSF-750080

SIEMENS 8"

8" Single-Sided, Double-Density Disk Drive

1 Drive ... \$384.95 each
 2 Drives ... \$349.95 each
 10 Drives \$324.95 each

Jade Part Number MSF-201120

Shugart 801R

8" Single-Sided, Double-Density Disk Drive

1 Drive ... \$394.95 each
 2 Drives ... \$389.95 each

Jade Part Number MSF-10801R

MPI B-51

5 1/4" Single-Sided, Double-Density Disk Drive

1 Drive ... \$234.95 each
 2 Drives ... \$224.95 each
 10 Drives \$219.95 each

Jade Part Number MSM-155100

END-000213 Case & power supply \$74.95

Micro-Sci

Apple Disk Drives

Increased Capacity - Decreased Price

40 or 70 track drives • operates with DOS 3.2 and 3.3, Language System, and the Z80 Softcard • 40 and 70 track drives may be mixed on your Apple II • With two 40 track drives you get a 12.5% increase in capacity, 300% improvement in track-to-track access, and save about 15% • With two 70 track drives instead of four 35 track drives you get the same capacity, 300% improvement in track-to-track access time, and save about 45%.

IOD-2340A A-40 with cable \$399.95
 IOD-2370A A-70 with cable \$529.95
 IOD-2300A Micro-sci controller \$89.95

Grand Opening Sale

★★★★★ San Diego ★★★★★ Hawthorne ★★★★★ Woodland Hills ★★★★★

Printers



Dual-Mode 200 - Malibu

200 CPS/9 x 9 matrix or 70 CPS/19 x 18 matrix for letter quality, stores up to 12 different fonts, hi-res dot graphics, single sheet and tractor feed, RS-232C and parallel interfaces
PRM-35200 Dual-Mode 200 \$2695.00

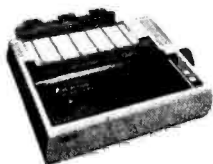

BEST BUY in PRINTERS - Epson

- MX-70** 132 column, 80 CPS, 5 x 7 dot matrix, adjustable tractor feed, & graphics
PRM-27070 List \$459 \$399.95
- MX-80** 132 column, 80 CPS, bi-directional/logic seeking printing, 9 x 9 dot matrix, adjustable tractor feed, & 64 graphics characters
PRM-27080 List \$645 \$474.95
- MX-80FT** same as MX-80 with friction feed
PRM-27082 List \$745 \$574.95
- MX-100** 233 column, correspondence quality, ultra-high resolution graphics, up to 15" paper, friction feed & removable adjustable tractor feed, 18 x 18 dot matrix, 80 CPS, programmable forms handling
PRM-27100 List \$945 \$795.00
- PRA-27084** Serial interface \$69.95
PRA-27088 Serial intf & 2K buffer \$144.95
PRA-27081 Apple card \$74.95
PRA-27082 Apple cable \$22.95
PRA-27086 IEEE 488 card \$52.95
PRA-27087 TRS-80 cable \$32.95
PRA-27085 Graftrax II \$95.00
PRA-27083 Extra ribbon \$14.95

Accessories for Apple



16K MEMORY UPGRADE

Add 16K of RAM to your TRS-80, Apple, or Exidy in just minutes. We've sold thousands of these 16K RAM upgrades which include the appropriate memory chips (as specified by the manufacturer), all necessary jumper blocks, fool-proof instructions, and our 1 year guarantee.
MEX-16100K TRS-80 kit \$25.00
MEX-16101K Apple kit \$25.00
MEX-16102K Exidy kit \$25.00

16K RAM Card - Microsoft

(There is life after 48K)

MEX-16300A A & T \$174.95

Z-80* CARD for APPLE

Two computers in one, Z-80 & 6502, more than doubles the power & potential of your Apple, includes Z-80* CPU card, CP/M 2.2, & BASIC-80
CPX-30800A A & T \$299.95

APPLE CLOCK - Cal Comp Sys

Real time clock w/battery-back-up

IOK-2030A A & T \$109.95

8" DISK CONTROLLER

New from Vista Computer, single or double sided, single or double density, compatible with DOS 3.2/3.3, Pascal, & CPM 2.2, Shugart & Qume compatible

IOD-2700A A & T \$499.95

8" DRIVES for APPLE

Controller, DOS, two 8" double density drives, cabinet, power supply, & cables

Special Package Price Kit \$1399.95

PRINTER INTERFACE - C.C.S.

Centronics type I/O card w/ firmware

IOI-2041A A & T \$99.95

AIO, ASIO, APIO - S.S.M.

Parallel & serial interface for your Apple (see Byte pg 11)

IOI-2050K Par & Ser kit \$139.95
IOI-2050A Par & Ser A & T \$169.95
IOI-2052K Serial kit \$89.95
IOI-2052A Serial A & T \$99.95
IOI-2054K Parallel kit \$69.95
IOI-2054A Parallel A & T \$89.95

A488 - S.S.M.

IEEE 488 controller, uses simple basic commands, includes firmware and cable, 1 year guarantee, (see April Byte pg 11)

IOX-7488A A & T \$399.95

CPS MULTICARD - Mtn. Computer

Three cards in one! Real time clock/calendar, serial interface, & parallel interface - all on one card.

IOX-2300A A & T \$199.95

Apple-CAT - Novation

Software selectable 1200 or 300 baud, direct connect, auto-answer/auto-dial, auxiliary 3-wire RS232C serial port for printer.

IOM-5232A Save \$50.00!!! \$325.00

Single Board Computers



AIM-65 - Rockwell

6502 computer with alphanumeric display, printer, & keyboard, and complete instructional manuals

CPK-50165 1K AIM \$424.95
CPK-50465 4K AIM \$499.95
SFK-74600008E 8K BASIC ROM \$99.95
SFK-64600004E 4K assembler ROM \$84.95
PSX-030A Power supply \$64.95
ENX-000002 Enclosure \$54.95
 4K AIM, 8K BASIC, power supply, & enclosure
Special package price \$675.00

Z-80* STARTER KIT - SD Systems

Complete Z-80* computer with RAM, ROM, I/O, display, keyboard, manual, and kluge area.

CPS-30010K Kit \$369.95
CPS-30010A A & T \$459.95

SYM-1 - Synertek Systems

Single board computer with 1K of RAM, 4K of ROM, key-pad, LED display, 20ma & cassette interface on board.

CPK-50020A A & T \$249.95

Video Terminals

VIEWPOINT - ADDS

Detachable keyboard, serial RS232C interface, baud rates from 110 to 19,200, auxiliary serial output port, 24 x 80 display, tiltable screen, international character set

VDT-501210 Sale Priced \$639.95

TELEVIDEO 950

Detachable keyboard, split screen with line lock, etched CRT, programmable function keys, on-screen status line, buffered auxiliary port, 14 x 10 dot matrix, self test, serviced nationwide by General Electric

VDT-901250 List \$1195.00 \$995.00

Video Monitors

Leedex / Amdek

Reasonably priced video monitors

VDM-801210 Video 100 12" B&W . . . \$139.95
VDM-801230 Video 100-80 12" B&W \$179.95
VDM-801250 12" Green Phospor . . . \$169.95
VDC-801310 13" Color I \$379.95

12" COLOR MONITOR - NEC

Hi-res monitor with audio & sculptured case
VDC-651212 Color Monitor \$479.95

12" GREEN SCREEN - NEC

20 MHz, P31 phosphor video monitor with audio, exceptionally high resolution - A fantastic monitor at a very reasonable price
VDM-651200 12" monitor \$269.95

EPROM Erasers

EPROM ERASERS

L.S. Engineering UV eraser for up to 48 EPROMs
XME-3200 A & T \$39.99

Spectronics hi intensity industrial eraser

XME-3100 Without timer \$69.50
XME-3101 With timer \$94.50

Accessories for TRS-80

DISK DRIVES for TRS-80

23% more storage, 8 times faster, 40 track with free patch, 120 day warranty.

MSM-12410C Save \$125.00 !!! \$325.00

8" DISK DRIVES for MODEL II

2 double density drives with cabinet, power supply, & cables

END-000433 Kit \$1050.00

END-000434 Assembled \$1250.00

WCA-5036A Cable (required) \$29.95

16K Atari . . . \$359.95

ATARI 800 - Atari

Complete personal computer with high resolution color graphics, built-in RF modulator, 4 controller ports, internal speaker, 16K RAM & 8K ROM

SYO-2080A 16K Atari 800 \$759.95

Atari 800 with 32K of RAM \$799.95

Atari 800 with 48K of RAM \$849.95

SYO-2040A 16K Atari 400 \$359.95

MSM-330810 Disk drive \$595.00

MSM-330815 Dual drive \$1395.00

IOX-5050A 850 interface \$199.95

MEX-16853K 16K RAM module \$69.95

SFI-241011005 Viscalc \$184.95

Grand Opening Sale

Circle 187 on inquiry card.

★★★★★ San Diego ★★★★★ Hawthorne ★★★★★ Woodland Hills ★★★★★

S-100 PROM Boards

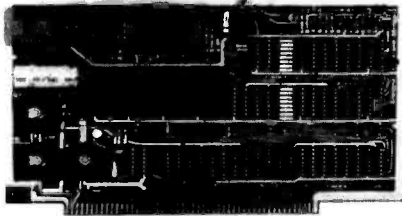

PB-1 - S.S.M.

2708, 2716 EPROM board with built-in programmer
MEM-99510K Kit \$154.95
MEM-99510A A & T \$219.95

PROM-100 - SD Systems

2708, 2716, 2732, 2758, & 2516 EPROM programmer
MEM-99520K Kit \$219.95
MEM-99520A Jade A & T \$269.95

EPROM BOARD - Jade

16K or 32K uses 2708's or 2716's, 1K boundary
MEM-16230K Kit \$79.95
MEM-16230A A & T \$119.95

S-100 Video

VB-3 - S.S.M.

80 characters x 24 lines expandable to 80 x 48 for a full page of text, upper & lower case, 256 user defined symbols, 160 x 192 graphics matrix, memory mapped, has key board input.

IOV-1095K 4 MHz kit \$349.95
IOV-1095A 4 MHz A & T \$439.95
IOV-1096K 80 x 48 upgrade \$39.95

VDB-8024 - SD Systems

80 x 24 I/O mapped video board with keyboard I/O, and on-board Z-80A*.
IOV-1020K Kit \$399.95
IOV-1020A Jade A & T \$459.95

VIDEO BOARD - S.S.M.

64 characters x 16 lines, 128 x 48 matrix for graphics, full upper/lower case ASCII character set, numbers, symbols, and greek letters, normal/reverse/blinking video, S-100.
IOV-1051K Kit \$149.95
IOV-1051A A & T \$219.95
IOV-1051B Bare board \$34.95

Motherboards

ISO-BUS - Jade

Silent, simple, and on sale - a better motherboard
 6 Slot (5 1/4" x 8")
MBS-061B Bare board \$19.95
MBS-061K Kit \$39.95
MBS-061A A & T \$49.95
 12 Slot (9 3/4" x 8")
MBS-121B Bare board \$29.95
MBS-121K Kit \$69.95
MBS-121A A & T \$89.95
 18 Slot (14 1/2" x 8")
MBS-181B Bare board \$49.95
MBS-181K Kit \$99.95
MBS-181A A & T \$139.95

Mainframes

MAINFRAME - Cal Comp Sys

12 slot S-100 mainframe with 20 amp power supply
ENC-112105 Kit \$329.95
ENC-112106 A & T \$399.95

DISK MAINFRAME - N.P.C.

Holds 2 8" drives and a 12 slot S-100 system. Attractive metal cabinet with 12 slot motherboard & card cage, power supply, dual fans, lighted switch, and other professional features
ENS-112325 with 25 amp p.s. \$699.95

S-100 Memory

MEMORY BANK - Jade

4 MHz, IEEE S-100, bank selectable, 8 or 16 bit, expandable from 16K to 64K
MEM-99730B Bare board \$49.95
MEM-99730K Kit, no RAM \$199.95
MEM-16730K 16K kit \$219.95
MEM-32731K 32K kit \$239.95
MEM-48732K 48K kit \$259.95
MEM-64733K 64K kit \$279.95
 Assembled & tested add \$50.00

EXPANDORAM II - S D Systems

4 MHz RAM board expandable from 16K to 64K
MEM-16630K 16K kit \$275.95
MEM-32631K 32K kit \$295.95
MEM-48632K 48K kit \$315.95
MEM-64633K 64K kit \$335.95
 Assembled & tested add \$50.00

64K RAM - Calif Computer Sys

4 MHz bank port / bank byte selectable, extended addressing, 16K bank selectable, PHANTOM line allows memory overlay, 8080 / Z-80 / front panel compatible.
MEM-64565A A & T \$575.00

64K STATIC RAM - Mem. Merch.

64K static S-100 RAM card, 4-16K banks, up to 8 MHz
MEM-64400A A & T \$825.00

32K STATIC RAM - Jade

2 or 4 MHz expandable static RAM board uses 2114L's
MEM-16151K 16K 4 MHz kit \$169.95
MEM-32151K 32K 4 MHz kit \$299.95
 Assembled & tested add \$50.00

16K STATIC RAM - Mem Merchant

4 MHz 16K static RAM board, IEEE S-100, bank selectable, Phantom capability, addressable in 4K blocks, "disable-able" in 1K segments, extended addressing, low power
MEM-16171A A & T \$174.95

S-100 Disk Controller

DOUBLE-D - Jade

Double density controller with the inside track, on-board Z-80A*, printer port, IEEE S-100, can function on an interrupt driven buss
IOD-1200K Kit \$299.95
IOD-1200A A & T \$375.00
IOD-1200B Bare board \$59.95

VERSAFLOPPY II - SD Systems

New double density controller for both 8" & 5 1/4"
IOD-1160K Kit \$339.95
IOD-1160A A & T \$379.95

DOUBLE DENSITY - Cal Comp Sys

5 1/4" and 8" disk controller, single or double density, with on-board boot loader ROM, and free CP/M 2.2* and manual set.
IOD-1300A A & T \$369.95

S-100 I/O

S.P.I.C. - Jade

Our new I/O card with 2 SIO's, 4 CTC's, and 1 PIO
IOI-1045K 2 CTC's, 1 SIO, 1 PIO .. \$179.95
IOI-1045A A & T \$239.95
IOI-1046K 4 CTC's, 2 SIO's, 1 PIO .. \$219.95
IOI-1046A A & T \$299.95
IOI-1045B Bare board w/ manual ... \$49.95

I/O-4 - S.S.M.

2 serial I/O ports plus 2 parallel I/O ports
IOI-1010K Kit \$179.95
IOI-1010A A & T \$249.95
IOI-1010B Bare board \$35.00

S-100 CPU

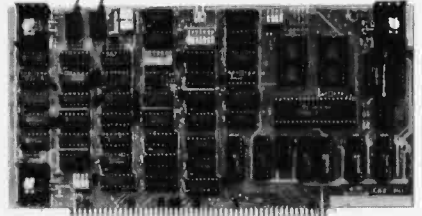

CB-2 Z-80 CPU - S.S.M.

2 or 4 MHz Z-80 CPU board with provision for up to 8K of ROM or 4K of RAM on board, extended addressing, IEEE S-100, front panel compatible.

CPU-30300K Kit \$239.95
CPU-30300A A & T \$299.95

2810 Z-80* CPU - Cal Comp Sys

2/4 MHz Z-80A* CPU with RS-232C serial I/O port and on-board MOSS 2.2 monitor PROM, front panel compatible.
CPU-30400A A & T \$269.95

SBC-200 - SD Systems

4 MHz Z-80* CPU with serial & parallel I/O ports, up to 8K of on-board PROM, software programmable baud rate generator, 1K of on-board RAM, Z-80 CTC.

CPC-30200K Kit \$339.95
CPC-30200A Jade A & T \$399.95

THE BIG Z* - Jade

2 or 4 MHz switchable Z-80* CPU with serial I/O, accomodates 2708, 2716, or 2732 EPROM, baud rates from 75 to 9600

CPU-30201K Kit \$139.95
CPU-30201A A & T \$189.95
CPU-30200B Bare board \$35.00

Novation Cat Modem

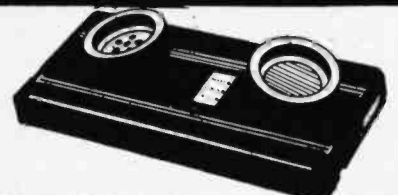

IOM-5200A List price \$189.95 \$125.00

D-CAT 300 baud, direct connect modem
IOM-5201A Special sale price \$169.95

AUTO-CAT Auto answer/originate, direct connect
IOM-5230A Special sale price \$239.95

SMARTMODEM - Hayes

Sophisticated direct-connect auto-answer/auto-dial modem, touch-tone or pulse dialing, RS-232C interface, programmable
IOM-5400A Smartmodem \$269.95

Place Orders Toll Free

Continental U.S. Inside California
800-421-5500 800-262-1710

For Technical Inquires or Customer Service call:
213-973-7707

JADE

Computer Products

4901 W. Rosecrans, Hawthorne, Ca 90250

TERMS OF SALE: Cash, checks, credit cards, or Purchase Orders from qualified firms and institutions. Minimum Order \$15.00. California residents add 6% tax. Minimum shipping & handling charge \$3.00. Pricing & availability subject to change

INTELLIGENT VIDEO I/O FOR S-100 BUS

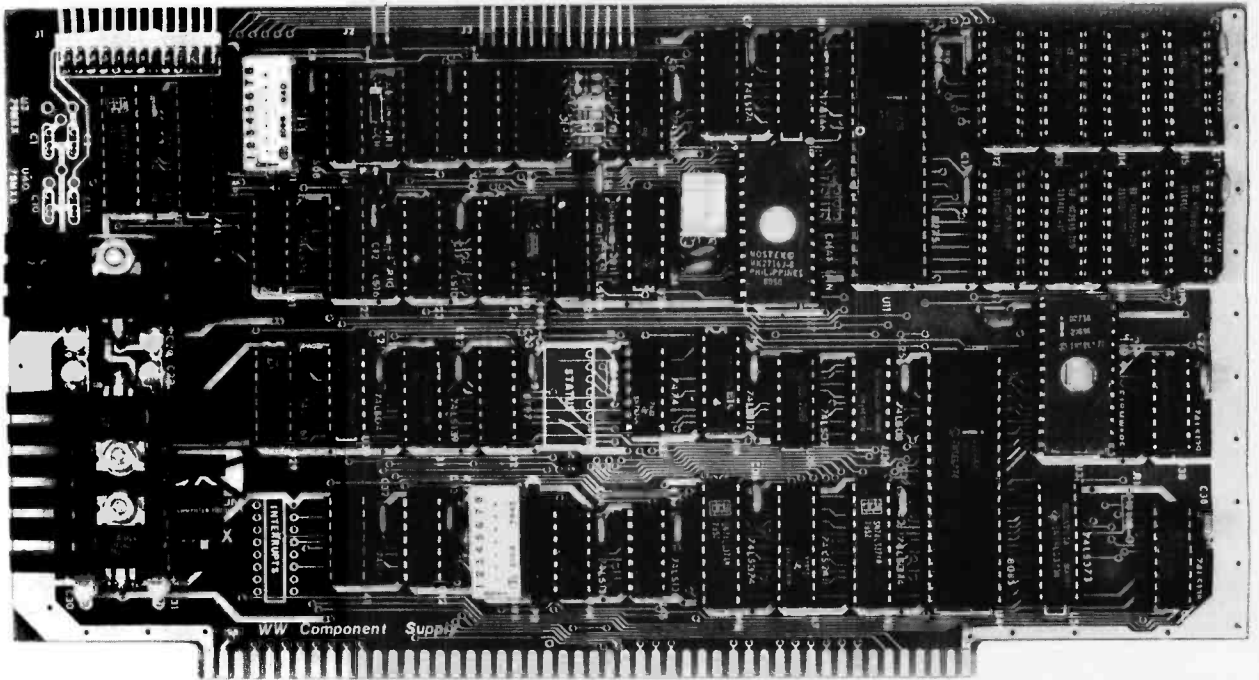

VIO-X

The VIO-X Video I/O Interface for the S-100 bus provides features equal to most intelligent terminals both efficiently and economically. It allows the use of standard keyboards and CRT monitors in conjunction with existing hardware and software. It will operate with no additional overhead in S-100 systems regardless of processor or system speed.

Through the use of the Intel 8275 CRT controller with an onboard 8085 processor and 4k memory, the VIO-X interface operates independently of the host system and communicates via two ports, thus eliminating the need for host memory space. The screen display rate is effectively 80,000 baud.

The VIO-X1 provides an 80 character by 25 line format (24 lines plus status line) using a 5 x 7 character set in a 7 x 10 dot matrix to display the full upper and lower case ASCII alphanumeric 96 printable character set (including true descenders) with 32 special characters for escape and control characters. An optional 2732 character generator is available which allows an alternate 7 x 10 contiguous graphics character set.

The VIO-X2 also offers an 80 character by 25 line format but uses a 7 x 7 character set in a 9 x 10 dot matrix allowing high-resolution characters to be used. This model also includes expanded firmware for block mode editing and light pen location. Contiguous graphics characters are not supported.

Both models support a full set of control characters and escape sequences, including controls for video attributes, cursor location and positioning, cursor toggle, and scroll speed. An onboard Real Time Clock (RTC) is displayed in the status line and may be read or set from the host system. A checksum test is performed on power-up on the firmware EPROM.

Video attributes provided by the 8275 in the VIO-X include:

- FLASH CHARACTER
- INVERSE CHARACTER
- UNDERLINE CHARACTER or
- ALT. CHARACTER SET
- DIM CHARACTER

The above functions may be toggled together or separately.

The board may be addressed at any port pair in the IEEE 696 (S-100) host system. Status and data ports may be swapped if necessary. Inputs are provided for parallel keyboard and for light pen as well as an output for audio signalling. The interrupt structure is completely compatible with Digital Research's MP/M ©.

Additional features include:

- HIGH SPEED OPERATION
- PORT MAPPED IEEE S-100 INTERFACE
- FORWARD/REVERSE SCROLL or
- PROTECTED SCREEN FIELDS
- CONVERSATIONAL or BLOCK MODE (opt)
- INTERRUPT OPERATION
- CUSTOM CHARACTER SET
- CONTROL CHARACTERS
- ESCAPE CHARACTER COMMANDS
- INTELLIGENT TERMINAL EMULATION
- TWO PAGE SCREEN MEMORY

VIO-X1 - 80 x 25 5x7 A & T **\$295.00**

Conversational Mode

VIO-X2 - 80 x 25 7x7 A & T **\$345.00**

Conversational & Block Modes

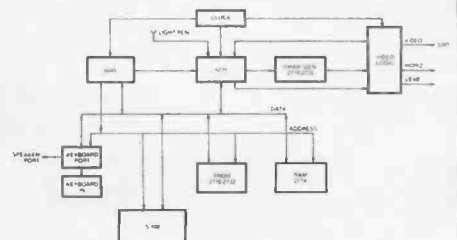

VIO-X S-100 I/O INTERFACE



FULCRUM
COMPUTER PRODUCTS

Distributed by: **WW COMPONENT SUPPLY INC.** 1771 JUNCTION AVENUE • SAN JOSE, CA 95112 • (408) 295-7171

California Digital

Post Office Box 3097 B • Torrance, California 90503



DISKETTES

FREE PLASTIC LIBRARY CASE INCLUDED WITH THE PURCHASE OF EVERY BOX OF DISKETTES

Private labels for California Digital by one of the most respected producers of magnetic media. Each diskette is certified double density at 40 tracks. For many extended media life each diskette is manufactured with a reinforced hub-hole. And of course, a plastic library case is included with every box of diskettes. (MSD-010/0110)

\$24.95
BOX

Ten boxes \$22.75 One hundred boxes \$21.50

| MINIDISKETTES | Box | 10 boxes | Box | 10 boxes |
|--------------------|---------|----------|--------------------|-----------------|
| Memorex 3101 | \$21.00 | \$25.00 | Search 7440R10(16) | \$31.00 \$29.00 |
| Verbatim 5250(110) | 29.00 | 27.00 | Hyson | 35.00 43.00 |

| 5.25" DISK | Search | Box | 10 boxes | Hyson | Box | 10 boxes | MINI | Box | 10 boxes |
|-------------------------|--------|-------|----------|--------|--------|----------|------|-----|----------|
| Single side/single den. | 740-0 | 35.43 | 37.00 | 340.47 | 300.53 | 3.3 | 3.3 | | |
| Single side/double den. | 741-0 | 45.32 | 3740/41 | 75.73 | 300.37 | 3.3 | | | |
| Double side/double den. | 743-0 | 65.32 | na. | na. | na. | 315 | 40.4 | | |

SEARCH brand head cleaning kit. 234.95 (MSA-CM500) please specify 5 1/4" if applicable. Prices available on request for tape, cartridges, diskpacks, volume diskettes.



26 Megabyte
Hard Disk Drive
from
**GEORGE MORROW'S
Thinker Toys**

\$3495

| Other Morrow Products: | | |
|----------------------------|---------|--|
| Additional hard disk | \$38.00 | |
| Busca 20 1 drive | 9.50 | |
| Busca 20 2 drive | 10.27 | |
| Busca 20 1 drive | 12.50 | |
| Busca 20 2 drive | 23.27 | |
| Disk Jockey 2D controller | \$343 | |
| Disk Jockey 1 Controller | 12% | |
| 31/2" hard disk Controller | 623 | |
| Switchboard interface | 219 | |
| "New" Keyboard | 273 | |
| 31/2" Flo. Magnetic hard | 250 | |

MEMOREX 8" DISKETTES

\$25

Recently the Memorex Corporation had a competition on a contract for a truck load of eight inch diskettes. California Digital was fortunate to be offered this load of prime magnetic media.

These diskettes are UNBRANDED

but are guaranteed first quality Memorex brand. (2600 single den.) Like all diskettes sold by California Digital, a library case is supplied free with the purchase of every box. This offer is subject to remaining inventory on hand.



**BSR
SYSTEM
X-10**

The new BSR timer runs your home just like clockwork. Turns on lamps and appliances with your away from home. Completely compatible with your existing System X-10 devices. BSR Timer eight channel \$65.00 Master control console 34.95 Ultrasonic Controller 19.95 Appliance Module 500 W. \$13.05 Lamp Module 300 Watts 13.95 NEW full control wall switch 14.50

S-100 Mother Board \$35

Quiet
Buss

IMSAI
18 Slot
CAL-M18

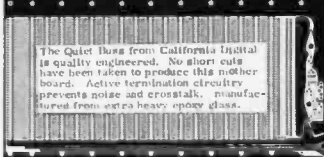

The Quiet Buss from California Digital is quality engineered. No short cuts have been taken to produce this mother board. Active termination circuitry prevents noise and crosstalk. Manufactured from extra heavy epoxy glass.

SWITCHES



| DIP SWITCHES | | | | TORGEL'S | | | |
|--------------|------|-----|-----|----------------|------|------|------|
| | 100+ | 1K+ | 1K+ | 100+ | 1K+ | 1K+ | 100+ |
| 4 | .88 | .73 | .68 | 7101 on/on | 1.19 | 1.50 | |
| 7 | .89 | .83 | .79 | 7102 on/off/on | 1.39 | 1.19 | |
| 8 | 1.03 | .91 | .87 | 7108 on/off | 1.39 | 1.19 | |
| 2 | 1.19 | .99 | .91 | 7005 on/off | 1.85 | 1.63 | |

CONNECTORS

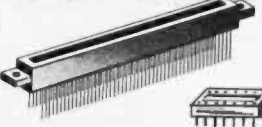

GOLD EDGE CONNECTORS

| | | |
|-------------------------|--------|--------|
| 5-100 125' centers | each | 100' |
| Insul solder 230' row | \$2.95 | \$2.50 |
| Insul wire wrap (TD) | 3.05 | 3.30 |
| Sullins Hi-Rel. 230' | \$2.50 | 4.00 |
| Sullins Hi-Rel. W/W | 5.35 | 4.90 |
| Sullins (Altair - 140') | 4.95 | 4.30 |

"D" Type

| | | | |
|---------------|--------|--------|------|
| DB25 male | \$1.00 | \$1.40 | 25' |
| DB25 female | 2.25 | 2.90 | 1.00 |
| DB hood | 1.90 | 1.35 | 1.20 |
| DA15' male | 2.35 | 2.15 | 2.00 |
| DA15S female | 3.25 | 3.10 | 2.90 |
| DA hood 2/P | 1.60 | 1.35 | 1.30 |
| DB 25S male | 2.40 | 2.35 | 2.25 |
| DB 25S female | 3.35 | 3.15 | 2.05 |
| DB hood 2/P | 1.35 | 1.15 | 1.05 |
| DC 37' male | 4.20 | 4.00 | 3.70 |
| DC 37S female | 6.00 | 3.75 | 3.50 |
| DC hood 2/P | 2.25 | 2.00 | 1.75 |
| DB25P male | 5.50 | 5.10 | 4.75 |
| DB25S female | 9.40 | 8.60 | 8.00 |
| DB25 hood 2/P | 2.60 | 2.40 | 2.10 |

INTEGRATED CIRCUIT SOCKETS

| | Low Profile | Wire Wrap |
|--------|-------------|-----------|
| 8 pin | \$1.0 | \$2.0 |
| 14 pin | 1.0 | .85 |
| 16 pin | 1.2 | 1.1 |
| 18 pin | 1.5 | 1.3 |
| 24 pin | 2.2 | 2.4 |
| 40 pin | .42 | .40 |

CENTRONICS

| | | | |
|----------|------|------|------|
| 57-30360 | 7.95 | 6.75 | 3.75 |
|----------|------|------|------|

RIIHAN CABLE CONNECTORS

| | | | |
|----------------|------|------|------|
| 17/24 5' cable | 4.85 | 4.15 | 4.85 |
| 20/40 TRS-80 | 5.85 | 5.05 | 4.70 |
| 25/50 8" disk | 5.90 | 5.15 | 4.50 |



ZENITH GREEN PHOSPHOR MONITOR

The new Zenith ZVM-121 features a P31 green phosphor tube along with 15 MHz bandwidth. Switch selectable for 40/80 character screen. Fully compatible with 80 column Apple cards. VDM-2131 20 lbs.

\$119

10 + '109 100 + '99

Shugart Associates



\$395
801/ R Disk Drive 15 lbs.
Shugart 801/R with CP206 power supply, muffin exhaust fan, complete in dual enclosure with all the necessary harnessing cables. Documentation included. 38 pounds. MSD-1801. Same as above but with two Shugart 801R disk drives. 50 pounds. MSD-2801. Disk drive cable, 6 feet 50 conductor with edge card connector at both ends. WGA-5505 \$25.00. Export Disk drives. 220V. 50MHz aid \$50.00 per disk drive.

SHUGART 801R \$395

NEW from Shugart Technology 5 Megabyte Hard Disk Drive

Packaged in the same physical size as the industry standard 5 1/4" minifloppy disk drive. The micro-Winchester stores thirty times as much data (6.38 megabytes unformatted), accesses data twice as fast (170 milliseconds) and transfers data twenty times faster (5.0 megabits per second.)

The ST506 is factory sealed to protect the media from environmental contaminants. Requires only DC voltage. Dual California Digital 5 1/4" enclosure. \$1500 ST506 drive and power supply.

Shugart Associates SA400 removable media disk drive for above package. \$300

Regulated Power Supply 5 VOLT 5AMP \$1195

The USED surplus power supply was removed from working equipment. Pass transistor regulation outputs five volts at a conservative five amps suitable for TTL hobby applications. SPC-P51 8 pounds.

**TOLL FREE ORDER LINE
(800) 421-5041
TECHNICAL & CALIFORNIA
(213) 679-9001
TWX 910 325-6212**

MEMORY

| | |
|-------------------------------|------------------------------|
| 64K DYNAMIC \$11.95 | 16K STATIC \$13.95 |
| 4164 100-19.75 | 2167 200ns. |
| 16K DYNAMIC \$2.10 | 2716 EPROM \$4.95 |
| 4116 100-11.85 | 100-14.50 1K-14.00 |



2732 EPROM SALE \$8.95

STATIC

| | 100+ | 32+ | 100+ | 1K+ |
|---------------|------|------|------|------|
| 21102 450ns. | 1.19 | 1.05 | .99 | |
| 21102 250ns. | 1.49 | 1.45 | 1.39 | |
| 2114L 150ns. | 3.05 | 2.95 | 2.75 | 2.50 |
| 2114L3 300ns. | 4.25 | 3.75 | 3.00 | 2.75 |
| 4044-1 450ns. | 4.95 | 4.50 | 4.25 | 4.00 |
| 4044-2 250ns. | 5.50 | 4.95 | 4.50 | 4.35 |
| 5257-3 300ns. | 4.47 | 4.25 | 4.05 | 3.75 |

EPROM

| | | | | |
|---------------|-------|-------|------|------|
| 2708 450ns. | 4.95 | 4.50 | 3.75 | 3.25 |
| 2716 5V. | 4.95 | 4.50 | 4.00 | |
| 2716 tri-volt | 9.95 | 9.00 | 8.25 | 7.50 |
| 2732 Intel | 9.00 | 8.50 | 8.00 | |
| 2532 TI | 21.50 | 19.00 | | |
| 2764 | | | | |



**direct connect
MODEM** Your Choice
\$169

Direct connect is the only modem line of information for the earliest computers (as demonstrated with a cassette recorder). Choose either of these two great units.

The Universal Data Systems 103LP is a search selectable between answer and order mode. It has 16K 103LP compatible. Directly connected to the new modulation technique. The process of how this technology. No need to locate modulation device. The 5.5" outer receptacle. MS-103LP 2 pounds.

Available for 40 computers from the new BEE modular hardware. Ideal for multiple line office telephone. Requires external AC power. MS-0103LP 2 lbs.

Universal Data Auto Answer 103LPJ '219
Novation Auto Cat RS232 '239



Circle 55 on inquiry card.

All merchandise sold by California Digital is premium grade. Shipping: First five pounds \$2.00; each additional add \$4.00. Foreign orders 10% shipping. Excess will be refunded. California residents add 6% sales tax. C.O.D.'s discouraged. Open accounts extended to state supported educational institutions and companies with a "Strong Dun & Bradstreet." Warehouse: 15608 Inglewood Blvd. Visitors by appointment.

California Digital

Post Office Box 3097 B • Torrance, California 90503

CONTROL DATA

CL416 MATRIX PRINTER

\$1395

In a dark corner of a Control Data warehouse our scouts have recently located a small quantity of brand new, vintage 1978, Control Data CL-416 matrix printers. The CL-416 was designed for extra heavy duty industrial applications. Please do not confuse this work horse printer with the new low cost imports. The unit prints a full 96 character ASCII set at a conservative 175 characters/second. One kilobyte buffer accepts RS232 signals up to 9600 baud. Vertical forms control unit provides added flexibility for business applications. The CL-416 has a split primary power transformer to allow field voltages between 115 and 230 volts. Original cost of the printer is estimated at \$5,000. California Digital blow out price is only \$1,395. Shipped via motor freight in factory sealed containers. SPC-CL416

World's Best Selling Printer

EPSON MX80

Immediate Delivery

Only **\$475**

Correspondence quality printing. A lot of printers costing a lot more can't touch the MX-80's performance. It gives you a choice of 40, 80, 66 or 132 columns of printing in as many as four distinct printing density modes. A total of twelve different combinations which can accommodate nearly any printing requirement.

Bi-directional printing. Logical seeking of shortest lines. 80 CPS, 64 graphics characters. Forms handling. The list of standard features goes on and on. The fact is that there are few printers that can compete with the MX-80 at ANY price. And none—ZERO—in its extraordinarily affordable price range.

AB CDEFGHIJ LMNOPQRS TUVWXYZ ABCDEFGHIJ

Paper Tiger
560G
\$1395



NEC Spinwriter
5510P/S
\$2795



The world processing quality Spinwriter prints at speeds up to 55 characters per second. The Model 5510P/S is supplied with both parallel and RS-232C serial interfaces. Also included is the optional local access unit, along with print file-side and remote file-side. The Model 5510P/S has keyboard IBM Model 5529P/S available. 2000PS, PIN-5320P/S 75 lbs.

PRINTRONIX
P-300 \$450
P-600 \$6150



PRINTERS

| | | | | | |
|----------------|----------|-------|----------------|-----------|------|
| Epson MX80 | PKEMX80 | \$475 | NEC/Sellum 1 | PRN510ps | 2695 |
| Epson MX80FT | PKEMX80F | 595 | NEC/Sm 16K | PRN516ps | 2795 |
| Epson MX100 | PKEMX100 | 825 | TEC/Starwrit. | PRV300 | 1395 |
| Amdek 9500 | PKA9500 | 1295 | Okidata 80 | PRC80 | 419 |
| Amdek 5001 | PKA5001 | 1295 | Okidata 82 | PRC82 | 619 |
| Anacomp 150 | PKA150 | 1075 | Okidata 83 | PRC83 | 895 |
| IDS Paper Tgr. | PKI460G | 1095 | Tulotype 43K | PTT420K | 1095 |
| IDS Tiger 760 | PKI560G | 1350 | Texas Ins. 810 | PR1810C | 1450 |
| Diablo 630 | PKI630 | 2150 | Tex. Ins 810C | PR1810C | 1795 |
| Diablo 1650 | PKI1650 | 2850 | Centronics 730 | PRC730P | 529 |
| Diablo 1640 | PKI1640 | 2496 | Centronics 737 | PRC737P | 695 |
| Dotasouth 180 | PKI180 | 1350 | Centronics 739 | PRC739P | 795 |
| Printronic 300 | PKP300 | 4500 | Centrx 704-Y | PRC704-Y | |
| Printronic 600 | PKP600 | 6150 | Centrx.704-11 | PRC704-11 | |

IBM 3101 Display Terminal

IBM Direct Price \$1295

California Digital

discount price **\$1195**



New from the Amplex Corporation. The Dialogue 80 features removable keyboard, displayable two pages (four optional) dual program keys, half intensity protected fields and status lines. Transmits data either block, line or character mode. Excellent value. VDT-D80 shipping 37 lbs.

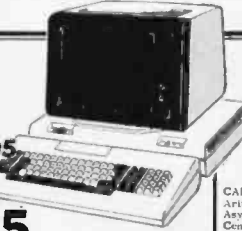

AMPEX DIALOGUE 80 CRT TERMINAL

\$995

ACCESSORIES FOR THE APPLE COMPUTER

| | |
|------------------------------------|-------|
| CALIFORNIA COMPUTER SYSTEMS | |
| Asynchronous serial interface 710 | 129 |
| Centronics interface card 7728 | 95 |
| 12K PhOM Module 7114 | 60 |
| Calendar/Clock, Bus back-up 7424 | 95 |
| Parallel interface 7720A | 99 |
| Programmable Timer 7740A | 99 |
| Analog/Digital converter 7470A | 99 |
| MICROSOFT PRODUCTS | |
| Apple to Z-80 CPU card | 370 |
| D. C. HAYES PRODUCTS | |
| Microdotem for Apple | 319 |
| COMPUTER STOP PRODUCTS | |
| Double Vision/80 Column Video | 250 |
| INTERACTIVE STRUCTURES | |
| 16 Channel A/D card AIO/2 | 275 |
| MOUNTAIN COMPUTER PRODUCTS | |
| Intro X-10 system for BSR | \$239 |
| Intro X-10 card only | 169 |
| 16 channel AD/DA 8 bit | 319 |
| Apple Clock battery back-up | 225 |
| Supertalker SD200 | 215 |
| ROM Plus with filter | 165 |
| ROM Writer/Programmer | 149 |
| APPLE BRAND PRODUCTS | |
| Apple Language card | 450 |
| Floppy disk with controller | 560 |
| Floppy disk without controller | 485 |
| Apple parallel interface | 175 |
| SSM MICROCOMPUTER | |
| Dual serial parallel interface AIO | 300 |
| SORRENTO VALLEY ASSOCIATES | |
| 8" floppy controller (Pascal) | 360 |

VIDEO TERMINALS

| | | |
|-------------------------------------|-----------|------|
| ADDS Viewpoint | VDT-RVP | 595 |
| ADDS Regent 25 numeric cluster | VDT-R25 | 850 |
| ADDS Regent 30 25th status line | VDT-R30 | 950 |
| ADDS Regent 40 limited graphics | VDT-R40 | 1195 |
| ADDS Regent 60 Block mode | VDT-R60 | 1495 |
| Amplex Dialogue 80 two page, detach | VDT-D80 | 995 |
| Digital Equipment VT-100 | VDT-V100 | 1595 |
| Digital Equipment VT-132 | VDT-V132 | 1895 |
| Direct VP-800A emulator | VDT-P800 | call |
| Hazeltine 1410 | VDT-H1410 | 750 |
| Hazeltine 1420 | VDT-H1420 | 795 |
| Hazeltine 1500 | VDT-H1500 | |
| Hazeltine 1510 | VDT-H1510 | |
| Hazeltine 1520 | VDT-H1520 | |
| Hewlett Packard 2621A | VDT-HP21A | |
| Hewlett Packard 2621P | VDT-HP21P | |
| IBM 3101-10 character mode green | VDT-3101 | 1195 |
| IBM 3101-20 block mode | VDT-31012 | 1395 |
| Lear Seigler 3A upper case only | VDT-L3A | 850 |
| Lear Seigler ADM5 | VDT-L5 | 945 |
| Lear Seigler ADM31 | VDT-L31 | 1385 |
| Lear Seigler ADM42 | VDT-L42 | 1995 |
| Visual 200 | VDT-V200 | 995 |
| Televideo 910C (new) | VDT-T910 | 595 |
| Televideo 912C | VDT-T912 | 665 |
| Televideo 920C | VDT-T920 | 745 |
| Televideo 950C detachable keybd. | VDT-T950 | 985 |
| Zenith Z-19 | VDT-Z-19 | 735 |

VIDEO MONITORS

| | |
|-----------------------|-------|
| BMC KG12C 18MHZ | \$259 |
| P-31 grn phosphor | 129 |
| Leedex/Amdek 12"100 | 169 |
| Leedex 100-80 | 197 |
| Hiltachi color 13" | 389 |
| Zenith color 13" | 379 |
| NEC green phosphor | 219 |
| Panasonic color 10" | |
| Sanyo 9" BW | 149 |
| Sanyo 12" green phos. | 235 |
| Sanyo 15" BW | 259 |
| Sanyo 13" color | 419 |

S-100 BOARDS

| | |
|---|-------|
| CPU BOARDS | |
| Calif. Computer 2810A Z-80 | |
| 13.4K 4MHz BDC-C5316 | \$250 |
| Godbout Z-80 24 bit 4MHz | |
| Godbout 8085/8086 dual 16 bit processor BDC-G80 | 375 |
| Measurement Systems Z-80 | |
| 4 serial/2 parallel real time clock, 8 vector BDC-MZ80 | 395 |
| SD Systems SHC-200 Z-80 | |
| with serial A-parallel I/O ports BDC-SHC2 | 385 |
| Teletek F10C-1 single board CPU & floppy disk controller plus I/O | 695 |
| MAIN FRAMES | |
| Calif. Computer 2900A 12 slot power supply ENM-C2900 | 349 |
| TEL 12 slot table ENM-T12 | 650 |
| Godbout mainfr. ENM-GM1P | |
| MEMORY BOARDS | |
| Calif. Computer 2065A 64K dynamic memory BDC-M2065 | 9425 |
| Calif. Computer 2016 16K static memory BDC-M2016 | 230 |
| Calif. Computer 2042 32K static memory BDC-M2042 | 585 |
| Godbout Ram 17 64K static memory BDC-M17 | 1025 |
| SD Systems 16K static BDC-M16 | 205 |
| 16K dynamic BDC-M16D | 375 |
| Measurement Systems LM16640 for Alpha Micro BDC-M16640 | 685 |
| EPROM BOARDS | |
| Digital Research 32K 7319 proms extra BDC-M7319 | 99 |
| S3 Systems 16K 100 programmer BDC-M100 | 250 |
| FLOPPY DISK CONTROLLER | |
| Calif. Computer 2422A with 2.2 CPM BDC-C2422 | 329 |
| Godbout "Disk One" features the NEC 765 controller, DMA arbitration BDC-G10 | 385 |
| Measurement Systems 765 ehhp. module & double density error recovery BDC-M765 | 410 |
| SD Systems Versafloppy II double density BDC-VF2 | 419 |
| Tarbell D/D BDC-TF2 | 419 |
| Morrow Design Disk Jockey I single density BDC-M1J1 | 195 |
| Morrow Design Disk Jockey II double density BDC-M2J2 | 315 |
| INTERFACE BOARDS | |
| Calif. Computer 2718 I/O 2 serial/2 par BDC-C2718 | |
| Morrow Designs Switchboard 2 serial/4 par BDC-MSB | 219 |
| Morrow Designs AltBoard 2 serial/2 par BDC-M2A | 375 |
| Godbout Interface Two 2 serial/2 par BDC-LE1 | 199 |
| Godbout Interface Two 1 serial/3 par BDC-GH2 | 199 |
| SPECIALTY BOARDS | |
| GT Computer real time clock/calendar BDC-G2C | 135 |
| Artex Eldec. Wire wrap printer type board BDC-AW2 | 205 |
| Artex Eldec. General Purpose proto board BDC-MGP | 25 |
| Godbout Spectrum color board BDC-LSC | 260 |
| D. C. Hayes S-100 Micro-mouse BDC-M1M1 | 350 |
| Mullen Products extender board A logic probe kit BDC-M1FH1 | 49 |
| Mullen Products Opto-control board kit BDC-M1OC | 130 |

SYSTEMS

APPLE II \$1150
48K MEMORY



\$2550 **HP85**



| | | | | | |
|---------------|-----------|------|---------------|-----------|--------|
| Hew/Pack 85 | SYSHP85 | 2650 | Superbrain64Q | SYSSB64Q | \$3350 |
| Hew/Pack 83 | SYSHP83 | 1895 | Superbrain64D | SYSSB64D | 2650 |
| Altos ACS8000 | SYSCS8000 | 3295 | Northstar 64Q | SYSN64Q | 2895 |
| Osborne 1 | SYSOH1 | 1795 | Northstar 64D | SYSN64D | 2895 |
| Commodore | SYSC6032 | 1495 | NEC/PC8000 | SYSPC8000 | call |
| Commodore | SYSC8096 | 1795 | Apple II Plus | SYSAIP | 1170 |

Rotron Muffin Fan

\$14.77 \$12.00 @ 1000
10.50 @ 1000

115 VAC. 7 Watts WR2A1
Factory fresh Muffin fans
NOT pull-outs. EMF-4M



TOLL FREE ORDER LINE
(800) 421-5041
TECHNICAL & CALIFORNIA
(213) 679-9001

TWX 910 325-6212



All merchandise sold by California Digital is premium grade. Shipping: First five pounds \$2.00; each additional add \$.40 Foreign orders 10% shipping. Excess will be refunded. California residents add 6% sales tax. COD's discouraged. Open accounts extended to state supported educational institutions and companies with a "Strong Dun & Bradstreet." Warehouse: 15608 Inglewood Blvd. Visitors by appointment.

FREE

**PLASTIC LIBRARY CASE SUPPLIED WITH
PURCHASE OF EVERY TEN DISKETTES**

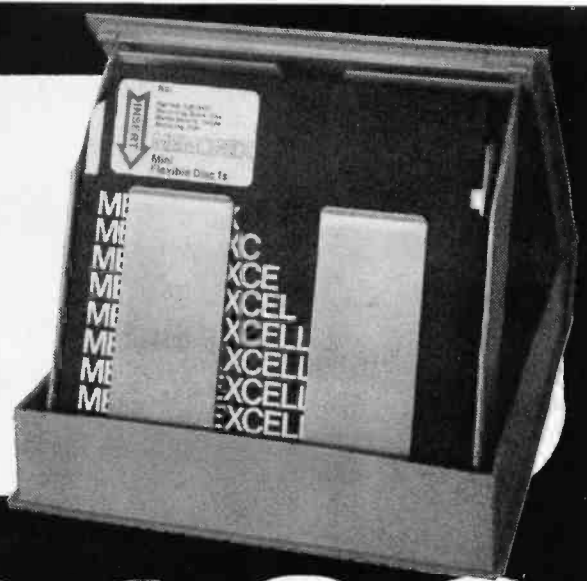

MEMOREX FLEXIBLE DISKETTES

\$1.99

Quantity One Hundred

INVENTORY REDUCTION SALE!

California Digital has recently purchased over 200,000 Memorex Diskettes. Frankly we have over committed and must liquidate our excess inventory. This is your chance to take advantage of this special buying opportunity. All diskettes sold by California Digital include a free library case (\$5.00 value.) Offer expires November 30, 1981. Shipping: 5 1/4" Mini-Diskette add \$6.00 per hundred. Eight inch add \$12.00 per hundred. Calif. residents add 6%

| Part Number | Description | Quantity | List Price | Prepaid One Hundred | Credit Card Net 30 | Less Than One Hundred | Extension |
|-------------|--|----------|------------|---------------------|--------------------|-----------------------|-----------|
| 3401 | Five Inch for Apple, TRS80, PET, Atari | | \$4.50 | \$1.99 | 2.15 | 2.49 | |
| 3403 | Five Inch Ten Sector for Horizon, Zenith/Heath | | 4.50 | 1.99 | 2.15 | 2.49 | |
| 3405 | Five Inch Sixteen Sector Vector Graphics | | 4.50 | 1.99 | 2.15 | 2.49 | |
| 3431 | Five Inch Soft Sector with Reinforced Hub Ring | | 4.65 | 2.19 | 2.35 | 2.69 | |
| 3060 | Eight Inch Single Side Diablo, IBM 3740 | | 5.00 | 2.19 | 2.35 | 2.69 | |
| 3090 | Eight Inch Double Density Radio Shack Model II | | 6.50 | 2.95 | 3.19 | 3.49 | |
| 3114 | Eight Inch Double Side Double Density | | 7.00 | 3.49 | 3.75 | 4.95 | |

| | | | |
|------------|---------|----------|-----------|
| Individual | Company | | Sub Total |
| Address | Phone | | Tax |
| City | State | Zip | Shipping |
| Card No. | Exp. | Computer | Total |



CALIFORNIA DIGITAL

Order Toll Free!

(800) 421-5041

(213) 679-9001

Circle 56 on inquiry card. 4738 - 156th Street • Lawndale, Calif. 90260

ok PRODUCTS



JUST WRAP KIT

Just Wrap tool for daisy chain wiring. Tool strips as it wraps and cuts. Includes one 50 foot spool of wire.

| Part No. | Description | Price |
|----------|--------------------------|---------|
| JW-1* | Just Wrap Tool | \$14.95 |
| JWK-6 | Tool w/4 Spools and JUW1 | 24.95 |
| R-JW* | 50 Ft. Replacement Wire | 3.49 |
| JUW-1 | Unwrapping Tool | 3.49 |

*Specify Color: Red, Blue, White or Yellow.

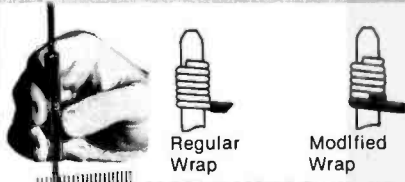

HAND WRAP TOOL

| Part No. | Description | Price |
|----------|-------------|--------|
| WSU30 | Regular | \$6.95 |
| WSU30M | Modified | 7.95 |

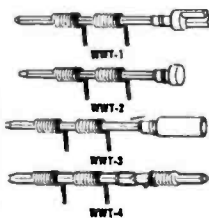

TERMINALS

- .025 (0,63mm) Square Post
- 3 Level Wire-Wrapping
- Gold Plated 25 PER PKG.

| Part No. | Description | Price |
|----------|--------------------------|--------|
| WWT-1 | Slotted Terminal | \$4.98 |
| WWT-2 | Single Sided Terminal | 2.98 |
| WWT-3 | IC Socket Term. | 4.98 |
| WWT-4 | Double Sided Terminal | 1.98 |
| INS 1 | Insertion Tool for above | 2.49 |

SOCKET WRAP - ID

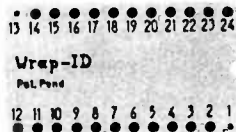

Slipped onto socket before wrapping to identify pins.

| Part # | Price | Bulk Price | Part # | Price | Bulk Price |
|--------|---------|------------|--------|--------|------------|
| 14ID | 1.49/10 | 5.50/100 | 22ID | 1.49/5 | 5.95/50 |
| 16ID | 1.49/10 | 5.95/100 | 24ID | 1.49/5 | 5.95/50 |
| 18ID | 1.49/10 | 5.00/50 | 28ID | 1.49/5 | 6.50/50 |
| 20ID | 1.49/5 | 5.00/50 | 40ID | 1.49/5 | 5.00/25 |

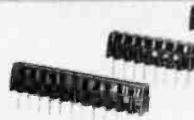

P.C.B. TERMINAL STRIPS

The TS strips provide positive screw activated clamping action, accommodate wire sizes 14-30 AWG (1,8-0,25mm). Pins are solder plated copper, .042 inch (1mm) diameter, on .200 inch (5mm) centers.

| Part No. | Description | Price |
|----------|---------------------|--------|
| TS- 4 | 4-Pole | \$1.69 |
| TS- 8 | 8-Pole | 2.59 |
| TS-12 | 12-Pole | 3.49 |
| TS6MD | 2-Pole Interlocking | 3/1.79 |



DESOLDERING PUMP

Easy one hand operation. Rugged all metal construction. Replaceable TEFLON® Tip. Self cleaning on each stroke. Suction precisely regulated for reliable desoldering without damage to delicate circuitry.

| Part No. | Description | Price |
|----------|------------------|--------|
| DSPI | Desoldering Pump | \$9.95 |

LOGIC PROBE



Compatible with all logic families using a 4 to 15V power supply. Thresholds automatically programmed. Visual indication of logic levels to show high, low, bad level or open circuit logic pulses.

- 10 N sec. pulse responses
- 120 K input impedance.
- Automatic resetting memory.
- Includes tip with protective cap & coiled cord.

PRB-1 \$36.95

LOGIC PULSER

Superimposes a pulse train (20 pps) or a single pulse onto the circuit node under test without un-soldering IC's.

- Automatic polarity sensing
- 2 us pulse width
- Finger tip push button actuated
- Includes tip with protective cap & coiled cord.

PSL-1 \$48.95

VACUUM VISE

Unique vacuum-based light duty vise for precision handling of small components and assemblies. Rugged ABS construction. 1 1/2" (32mm) travel for maximum versatility. Also features screw lugs for permanent installation.



| Part No. | Description | Price |
|----------|-------------|--------|
| VV1 | Vacuum Vise | \$3.49 |

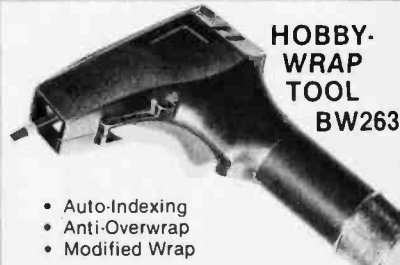

HOBBY-WRAP TOOL BW263

- Auto-Indexing
- Anti-Overwrap
- Modified Wrap

| Part No. | Description | Price |
|----------|---------------------|---------|
| BW2630 | Tool | \$19.85 |
| BT30 | #30 Bit (not incl.) | 3.95 |
| BT2628 | #28 Bit (not incl.) | 7.95 |
| BC1 | Batteries & Charger | 14.95 |

INSERTION/EXTRACTION TOOLS

| Part No. | Description | Price |
|----------|-----------------------------|--------|
| INS1416 | 14-16 pin Inserter | \$3.49 |
| MOS1416 | 14-16 pin MOS Safe Inserter | 7.95 |
| MOS2428 | 24-28 pin MOS Safe Inserter | 7.95 |
| MOS40 | 40 pin MOS Safe Inserter | 7.95 |
| EX1 | 14-16 pin IC Extractor | 1.49 |
| EX2 | 24-40 pin IC Extractor | 7.95 |



WK-7 IC INSERTION KIT

Complete IC Inserter/ Extractor Kit Individual Components (listed above) \$22.95

IC DISPENSER

Allows IC's to be dispensed from their tube 1 at a time and picked up by insertion tools above.

- Dispenses 8-42 pin IC's
- Compatible with all IC carrying tubes
- Use with WK7 for MOS safe insertion.

| Part No. | Description | Price |
|----------|--------------------|---------|
| MDD1 | 1 Chan. Dispenser | \$21.85 |
| MDD5 | 5 Chan. Dispenser | 83.43 |
| MDD10 | 10 Chan. Dispenser | 160.45 |

* * *No Discount.

OLL FREE ORDERING NUMBER 1-(800) 423-7144

IDC CONNECTORS



RIGHT ANGLE HEADERS
SOLDER TAIL WIRE WRAP

| Size | Part No. | Price | Part No. | Price |
|------|----------|--------|----------|--------|
| 10 | IDH10SRB | \$1.20 | IDH10WRB | \$2.60 |
| 20 | IDH20SRB | 1.90 | IDH20WRB | 4.15 |
| 26 | IDH26SRB | 2.75 | IDH26WRB | 5.35 |
| 34 | IDH34SRB | 3.75 | IDH34WRB | 6.25 |
| 40 | IDH40SRB | 3.75 | IDH40WRB | 7.35 |
| 50 | IDH50SRB | 4.75 | IDH50WRB | 9.20 |

.1" Spacing. Mounts on PC Board & Mates with IDS Socket below. Ejector Bars - 4/1.00.



EDGE CARD CONNECTORS

| Size | Part No. | Price |
|------|----------|--------|
| 10 | IDE10B | \$3.95 |
| 20 | IDE20B | 4.35 |
| 26 | IDE26B | 5.00 |
| 34 | IDE34B | 6.05 |
| 40 | IDE40B | 6.90 |
| 50 | IDE50B | 7.50 |

.1" Spacing. Crimps onto cable with ordinary vise & mates with standard .062" Card Edge.

RIBBON CABLE

| Size | Solid Color | | Color Coded | |
|------|-------------|---------|-------------|---------|
| | 10 ft. | 100 ft. | 10 ft. | 100 ft. |
| 10 | 2.90 | 17.00 | 4.00 | 30.00 |
| 14 | 3.40 | 23.80 | 5.00 | 42.00 |
| 16 | 3.70 | 27.20 | 5.60 | 48.00 |
| 20 | 4.40 | 34.00 | 7.00 | 60.00 |
| 24 | 5.00 | 40.80 | 8.00 | 72.00 |
| 26 | 5.40 | 44.20 | 8.60 | 78.00 |
| 34 | 6.80 | 57.80 | 11.00 | 102.00 |
| 40 | 7.80 | 68.00 | 13.00 | 120.00 |
| 50 | 9.50 | 85.00 | 16.00 | 150.00 |



25 PIN "D" CONNECTORS

| Solder Style | Part No. | Price |
|--------------|----------|--------|
| Male | DB25P | \$2.95 |
| Female | DB25S | 3.95 |
| Cover | DB25C | 1.50 |

| IDC Style | Part No. | Price |
|-----------|----------|-------|
| Male | IDB25P | 6.25 |
| Female | IDB25S | 6.60 |
| Cover | IDB25C | 1.60 |

Solder Style solders onto cable, IDC Style crimps onto cable with vise. 9, 15, 37 and 50 pin available also.



CABLE PLUGS

| Size | Part No. | Price |
|------|----------|--------|
| 14 | IDP14B | \$1.45 |
| 16 | IDP16B | 1.65 |
| 24 | IDP24B | 2.50 |
| 40 | IDP40B | 4.15 |

.1" Spacing. Crimps onto cable with ordinary vise & plugs into standard IC Socket.



SOCKETS

| Size | Part No. | Price |
|------|----------|--------|
| 10 | IDS10B | \$1.88 |
| 20 | IDS20B | 2.75 |
| 26 | IDS26B | 3.50 |
| 34 | IDS34B | 4.50 |
| 40 | IDS40B | 5.40 |
| 50 | IDS50B | 6.50 |

.1" Spacing. Crimps onto cable with ordinary vise & mounts to header sold above.

WIRE WRAP SUPPLIES

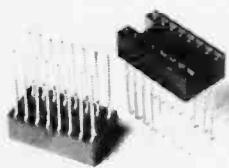

WIRE WRAP WIRE

| Length | #30 Wire Wrap Wire | | |
|--------|--------------------|---------|--------|
| | 100/Bag | 500/Bag | 1K/Bag |
| 2.5" | \$1.38 | \$3.94 | \$6.81 |
| 3.0" | 1.43 | 4.25 | 7.46 |
| 3.5" | 1.51 | 4.57 | 8.11 |
| 4.0" | 1.56 | 4.88 | 8.73 |
| 4.5" | 1.63 | 5.21 | 9.39 |
| 5.0" | 1.69 | 5.54 | 10.04 |
| 5.5" | 1.74 | 5.92 | 10.69 |
| 6.0" | 1.82 | 6.23 | 11.34 |
| 6.5" | 2.11 | 7.08 | 12.99 |
| 7.0" | 2.19 | 7.44 | 13.68 |
| 7.5" | 2.29 | 7.78 | 14.40 |
| 8.0" | 2.35 | 8.12 | 15.10 |
| 8.5" | 2.40 | 8.46 | 15.80 |
| 9.0" | 2.46 | 8.92 | 16.51 |
| 9.5" | 2.53 | 9.15 | 17.22 |
| 10.0" | 2.63 | 9.58 | 17.91 |

All lengths are overall, including 1" strip on each end. Choose from colors; Red, Blue, Black, Yellow, White, Green, Orange, and Violet.

| Size | Part No. | Each | Tube |
|------|------------|------|--------------------|
| 08 | ICN083WBSG | .44 | 52x .39 = \$20.28 |
| 14 | ICN143WBSG | .53 | 30x .46 = \$13.80 |
| 16 | ICN163WBSG | .58 | 26x .50 = \$13.00 |
| 18 | ICN183WBSG | .78 | 23x .68 = \$15.64 |
| 20 | ICN203WBSG | 1.00 | 21x .85 = \$17.85 |
| 22 | ICN224WBSG | 1.07 | 19x .92 = \$17.48 |
| 24 | ICN246WBSG | 1.09 | 17x 1.09 = \$15.98 |
| 28 | ICN286WBSG | 1.43 | 15x 1.23 = \$18.45 |
| 40 | ICN406WBSG | 1.85 | 10x 1.60 = \$16.00 |

Selective Plating provides gold In contact where it counts. 3-level wrap. Save by buying sockets by the tube. All gold available at 1/2¢/pin extra charge.

* * * No Discount

WIRE KITS

| Kit No. 1 - \$9.95 | | | |
|---------------------|--------|------|--------|
| 250 | 3" | 100 | 4 1/2" |
| 200 | 3 1/2" | 100 | 5" |
| 100 | 4" | 100 | 6" |
| Kit No. 2 - \$24.95 | | | |
| 250 | 2 1/2" | 250 | 5" |
| 500 | 3" | 100 | 5 1/2" |
| 500 | 3 1/2" | 100 | 6" |
| 500 | 4" | 100 | 6 1/2" |
| 250 | 4 1/2" | 100 | 7" |
| Kit No. 3 - \$34.95 | | | |
| 250 | 2 1/2" | 500 | 4 1/2" |
| 500 | 3" | 500 | 5" |
| 500 | 3 1/2" | 500 | 5 1/2" |
| 500 | 4" | 500 | 6" |
| Kit No. 4 - \$59.95 | | | |
| 500 | 2 1/2" | 1000 | 4 1/2" |
| 1000 | 3" | 1000 | 5" |
| 1000 | 3 1/2" | 1000 | 5 1/2" |
| 1000 | 4" | 1000 | 6" |

ORDERING INFORMATION

Prepaid orders over \$50 shipped prepaid via UPS. All others add \$3.00 for handling. VISA, MC, COD's and open account orders will be charged freight. \$15 minimum order. \$100 minimum open account order.

DISCOUNT SCHEDULE

| Order Amount | Discount |
|--------------|----------|
| \$15 - 99 | Net |
| 100 - 199 | less 10% |
| 200 - 499 | less 15% |
| 500 - 999 | less 20% |
| 1000 up | less 25% |

Discount and the name of this magazine must be mentioned at time of order to get discount. Discount applies on all items except as noted, "No Discount."

7400

| | | | |
|----------|------|----------|------|
| SN7400N | 19 | SN74123N | 59 |
| SN7400Z | 22 | SN74125N | 39 |
| SN7402N | 22 | SN74126N | 44 |
| SN7403N | 22 | SN74128N | 59 |
| SN7404N | 22 | SN74132N | 69 |
| SN7405N | 23 | SN74136N | 75 |
| SN7406N | 23 | SN74139N | 95 |
| SN7407N | 23 | SN74141N | 110 |
| SN7408N | 26 | SN74142N | 95 |
| SN7409N | 23 | SN74143N | 95 |
| SN7410N | 22 | SN74144N | 2.95 |
| SN7411N | 29 | SN74145N | 62 |
| SN7412N | 29 | SN74147N | 95 |
| SN7413N | 39 | SN74148N | 120 |
| SN7414N | 59 | SN74150N | 109 |
| SN7416N | 29 | SN74151N | 67 |
| SN7417N | 29 | SN74152N | 67 |
| SN7420N | 22 | SN74153N | 67 |
| SN7421N | 25 | SN74154N | 1.19 |
| SN7422N | 29 | SN74155N | 78 |
| SN7423N | 29 | SN74156N | 78 |
| SN7425N | 29 | SN74157N | 69 |
| SN7426N | 29 | SN74158N | 1.65 |
| SN7427N | 25 | SN74160N | 88 |
| SN7430N | 23 | SN74162N | 89 |
| SN7432N | 29 | SN74163N | 87 |
| SN7437N | 25 | SN74164N | 87 |
| SN7438N | 29 | SN74165N | 87 |
| SN7439N | 29 | SN74166N | 1.20 |
| SN7440N | 19 | SN74167N | 1.35 |
| SN7441N | 79 | SN74170N | 1.69 |
| SN7442N | 57 | SN74172N | 4.75 |
| SN7443N | 95 | SN74173N | 79 |
| SN7444N | 95 | SN74174N | 89 |
| SN7445N | 79 | SN74175N | 85 |
| SN7446N | 79 | SN74176N | 85 |
| SN7447N | 65 | SN74177N | 75 |
| SN7448N | 79 | SN74179N | 1.34 |
| SN7450N | 19 | SN74180N | 75 |
| SN7451N | 19 | SN74181N | 1.75 |
| SN7453N | 19 | SN74182N | 1.75 |
| SN7454N | 19 | SN74184N | 2.25 |
| SN7459N | 25 | SN74185N | 2.25 |
| SN7460N | 23 | SN74186N | 9.95 |
| SN7470N | 29 | SN74188N | 3.90 |
| SN7472N | 29 | SN74190N | 1.15 |
| SN7473N | 34 | SN74191N | 1.15 |
| SN7474N | 34 | SN74192N | 85 |
| SN7475N | 38 | SN74193N | 85 |
| SN7476N | 34 | SN74194N | 85 |
| SN7479N | 4.60 | SN74195N | 88 |
| SN7480N | 49 | SN74196N | 85 |
| SN7482N | 95 | SN74197N | 1.35 |
| SN7483N | 55 | SN74198N | 3.39 |
| SN7485N | 65 | SN74199N | 1.39 |
| SN7486N | 35 | SN74221N | 1.19 |
| SN7489N | 1.75 | SN74251N | 95 |
| SN7490N | 39 | SN74273N | 1.05 |
| SN7491N | 57 | SN74279N | 75 |
| SN7492N | 45 | SN74283N | 1.40 |
| SN7493N | 45 | SN74284N | 3.90 |
| SN7494N | 69 | SN74285N | 3.90 |
| SN7495N | 65 | SN74290N | 1.25 |
| SN7496N | 69 | SN74298N | 95 |
| SN7497N | 2.90 | SN74368N | 68 |
| SN7498N | 1.20 | SN74366N | 68 |
| SN74107N | 32 | SN74367N | 68 |
| SN74109N | 37 | SN74368N | 68 |
| SN74116N | 1.95 | SN74390N | 1.45 |
| SN74121N | 29 | SN74393N | 1.90 |
| SN74122N | 39 | SN74400N | 1.90 |

74LS00

| | | | |
|---------|------|----------|------|
| 74LS00N | 26 | 74LS164N | 1.19 |
| 74LS01N | 28 | 74LS165N | 89 |
| 74LS02N | 28 | 74LS166N | 2.48 |
| 74LS03N | 28 | 74LS168N | 1.15 |
| 74LS04N | 35 | 74LS169N | 1.15 |
| 74LS05N | 28 | 74LS170N | 1.99 |
| 74LS08N | 28 | 74LS173N | 89 |
| 74LS09N | 35 | 74LS174N | 89 |
| 74LS10N | 28 | 74LS175N | 89 |
| 74LS12N | 35 | 74LS181N | 2.20 |
| 74LS13N | 47 | 74LS190N | 1.15 |
| 74LS13N | 47 | 74LS191N | 1.15 |
| 74LS14N | 95 | 74LS192N | 98 |
| 74LS15N | 33 | 74LS193N | 98 |
| 74LS20N | 33 | 74LS194N | 98 |
| 74LS21N | 36 | 74LS195N | 95 |
| 74LS22N | 33 | 74LS196N | 89 |
| 74LS26N | 33 | 74LS197N | 89 |
| 74LS27N | 33 | 74LS221N | 1.15 |
| 74LS28N | 33 | 74LS240N | 1.69 |
| 74LS30N | 26 | 74LS241N | 1.69 |
| 74LS32N | 33 | 74LS242N | 1.69 |
| 74LS33N | 55 | 74LS243N | 1.69 |
| 74LS37N | 49 | 74LS244N | 1.49 |
| 74LS38N | 35 | 74LS247N | 2.20 |
| 74LS40N | 26 | 74LS247N | 1.10 |
| 74LS42N | 79 | 74LS248N | 1.10 |
| 74LS47N | 79 | 74LS249N | 1.19 |
| 74LS48N | 95 | 74LS251N | 1.40 |
| 74LS51N | 26 | 74LS253N | 98 |
| 74LS54N | 29 | 74LS257N | 85 |
| 74LS55N | 29 | 74LS257N | 85 |
| 74LS57N | 45 | 74LS259N | 2.95 |
| 74LS57N | 45 | 74LS260N | 65 |
| 74LS57N | 45 | 74LS261N | 2.49 |
| 74LS57N | 45 | 74LS266N | 59 |
| 74LS57N | 45 | 74LS273N | 1.75 |
| 74LS58N | 79 | 74LS275N | 4.40 |
| 74LS58N | 1.19 | 74LS279N | 59 |
| 74LS58N | 45 | 74LS283N | 99 |
| 74LS59N | 57 | 74LS290N | 99 |
| 74LS59N | 75 | 74LS293N | 99 |
| 74LS59N | 75 | 74LS295N | 1.10 |
| 74LS59N | 75 | 74LS303N | 1.49 |
| 74LS59N | 75 | 74LS324N | 1.75 |
| 74LS59N | 75 | 74LS347N | 1.95 |
| 74LS59N | 75 | 74LS348N | 1.95 |
| 74LS59N | 75 | 74LS352N | 1.19 |
| 74LS59N | 75 | 74LS353N | 1.19 |
| 74LS59N | 75 | 74LS363N | 1.49 |
| 74LS59N | 75 | 74LS365N | 69 |
| 74LS59N | 75 | 74LS366N | 69 |
| 74LS59N | 75 | 74LS367N | 69 |
| 74LS59N | 75 | 74LS368N | 69 |
| 74LS59N | 75 | 74LS373N | 1.89 |
| 74LS59N | 75 | 74LS374N | 1.89 |
| 74LS59N | 75 | 74LS375N | 69 |
| 74LS59N | 75 | 74LS377N | 1.95 |
| 74LS59N | 75 | 74LS385N | 1.95 |
| 74LS59N | 75 | 74LS386N | 1.95 |
| 74LS59N | 75 | 74LS390N | 1.95 |
| 74LS59N | 75 | 74LS393N | 1.95 |
| 74LS59N | 75 | 74LS395N | 1.70 |
| 74LS59N | 75 | 74LS399N | 2.35 |
| 74LS59N | 75 | 74LS424N | 2.95 |
| 74LS59N | 75 | 74LS568N | 1.75 |
| 74LS59N | 75 | 74LS570N | 2.29 |
| 74LS59N | 75 | 74LS588N | 1.69 |
| 74LS59N | 75 | 74LS596N | 1.69 |
| 74LS59N | 75 | 74LS597N | 1.69 |
| 74LS59N | 75 | 74LS598N | 1.69 |
| 74LS59N | 75 | 74LS599N | 1.69 |
| 74LS59N | 75 | 74LS633N | 1.05 |

16K UPGRADE ONLY
\$24.95
SPECIFY COMPUTER

HP HEWLETT PACKARD

HP-85 \$2695.00

HP 7225 Graphics Plotter 1795.00
 HP 16K Memory Module 265.00
 HP 5 1/4" Dual Master Flex. Disk Drive 2100.00
 HP 5 1/4" Single Master Flex. Disc Drive 1295.00
 HP Personality Module 700.00
 HP ROM Drawer 40.00
 HP Plotter/Printer ROM 130.00
 HP Input/Output ROM 260.00
 HP Matrix ROM 130.00
 HP Serial Interface (RS-232C) 350.00

HP-83 \$1850.00

HP-41: Powerful. Yet Easy to Use

- The HP-41 communicates with you in words as well as numbers.
- You can customize the HP-41 to your own design.
- Programming is fast and easy.
- Continuous Memory saves everything.
- Optional Peripherals allow you to expand capabilities.

HP-41 System I 398.00
 HP-41 System II 675.00
 HP-41C HP-Card Reader 178.00
 275.00 HP-Optical Wand 105.00
 HP-41C HP-Plotter/Printer 315.00
 198.00 HP-Quad RAM 85.00

ADVANCED COMPUTER PRODUCTS

apple computer Sales and Service

Apple II® 64K

- 2-80 Softcard
- 16K Ram Card
- Disk II w/contoller
- Apple II w/48K

Call for more pricing!

Total Value \$2719.00 your price \$2229.00
save! For Pascal System add \$425.00

Apple II hardware clearance up to 25% off

| | | | | |
|----------------------------------|--------|-----|------------------------------|---------|
| VISTA COMPUTER | | | | |
| Discrete™/Uninterruptible P.S. | 395.00 | New | CCS Parallel Card 7220A | 155.00 |
| Vocalizer™/Voice Card | 225.00 | New | Apple Computer | |
| Video 80™/Video Card | 325.00 | New | Apple II-Speed Serial I/O | 178.95 |
| Video 40™/40 col enhancement | 175.00 | New | Centronics Printer I/O | 179.95 |
| A 800 Quad Density 8" Controller | 595.00 | New | Apple II™ Firmware | 159.95 |
| Microsoft™ 2.80 Softcard | 299.00 | | Apple II Graphics Tablet | 244.95 |
| Microsoft 18K Ramcard | 169.00 | | Apple Photocopy Card | 599.95 |
| 5.25K HD Serial Parallel I/O | 165.00 | | Apple Disk II w/cont. 3.5 | 529.95 |
| CCS Asynchronous 2710 A Serial | 639.00 | | Apple Disk II | 459.95 |
| Apple Joy stick "OESU" | 54.95 | | Apple Disk II | 459.95 |
| Mountain Computer | | | Parallel Language Card | 159.95 |
| Removie | 169.00 | | Parallel Printer Card | 159.95 |
| ROM Writer | 159.00 | | Communication Card | 169.00 |
| Inte-IO | 169.00 | | Integer ROM Card | 159.95 |
| Inte-IO-10 Ramloc Cont. Sys. | 289.00 | | Call. Prod. Vascic Keyboard | 189.95 |
| Super-Tamer | 239.00 | | M & R Apple Fan | 189.95 |
| Music System | 499.00 | | M & R S/P Floppy | 29.95 |
| CPM Emulation | 229.00 | New | Corvus S/M Hard Disk | 3699.00 |
| Explosion Chamber | 899.00 | New | Corvus 10K Hard Disk | Call |
| DC Hayes Microcomem II | 299.00 | New | Corvus 20M Hard Disk | Call |
| DC Hayes Smart Modem | 249.95 | New | Corvus Cartridge Unit | Call |
| Thunderbolt | 125.00 | New | Corvus Mirror | Call |
| X-10 I/O Option | 48.95 | New | ACD HP Upgrade Kit | 24.95 |
| Pascal For Apple II | 29.00 | New | Scan Voice Recognition VET-2 | 655.00 |

HP-41-CV

Completely Assembled
W/Applications Manual

- Automation or Robotic Assembly
- Education In Robotic Principles
- Artificial Intelligence Experiments
- Computer Art and Games

\$1695.00

Armonic Software for TRS-80
w/Applications Manual \$39.95
 Applications/Reference Manual \$16.95

MINIMOVER-5 ROBOTIC ARM

Completely Assembled
W/Applications Manual

- Automation or Robotic Assembly
- Education In Robotic Principles
- Artificial Intelligence Experiments
- Computer Art and Games

\$1695.00

Armonic Software for TRS-80
w/Applications Manual \$39.95
 Applications/Reference Manual \$16.95

apple Triple Play!

- Apple III 128K RAM Information Analysis Pkg 12" Green Photocopy Monitor Disk II for Apple III \$100.00
- Apple III 128K RAM Information Analysis Pkg 12" Green Photocopy Monitor Disk II for Apple III \$100.00
- Apple III 128K RAM Information Analysis Pkg 12" Green Photocopy Monitor Disk II for Apple III \$100.00

Buy a System and Save

We only offer Apple CPM software which has been evaluated by our software staff.

New apple software

Vistacalc—Now Better Than Ever 169.00
 Visiplot—Graph your Viscalc Worksheets 149.00
 Visitrend/Visiplot—Visiplot w/Trend Analysis 239.00
 Visidex—The Ultimate DBMS Viscalc Compatible Visiterm—Communicate w/other Systems 219.00
 BPI General Ledger 299.00
 BPI Accounts Receivable 299.00
 BPI Inventory 299.00
 Stockfile Inventory System 349.00
 Intery Inventory System 289.00
 Microcom Microcursor 229.00
 Microcom Microtelegraph 229.00
 Accounting Plus II Biz Pkg. 1250.00
 StoneWare DB Master 189.00
 StoneWare Utility Pkg (For above) 89.00

WORDSTAR—The Benchmark of WORDPROCESSING software requires 2-80 & 80Kx24 349.00
 VTS-80 CPM-WordProcessor or has no screen menus uses new keycaps (supplied) to display key functions. 319.00 New
 MAIL-MERGE-A Wordstar Enhancement Pkg. allows front-letter generation & chained printing. 169.00
 SPELL-CAR-VTS wordproofed Wordstar & VTS-80 Text files against an expandable 20,000 word dictionary. 169.00
 SUPER SORT-Will sort, merge, & perform record selection on your CPM Data Files. 169.00
 FORTRA 80 By Microsoft 195.00
 COBOL 80 By Microsoft 749.00
 ACS BASIC ACCOUNTING SYSTEM. Total accounting system includes G/L, A/R, A/P, PAYROLL. 699.00 New

Breakthru In Apple II® Mass Storage!

Vista 800 Quad Density DMA 8" Disk Controller

Model A800... only \$595.00

Special Complete Subsystem Offer

- V1000 w/Two Qume DataTrack 8 • Cable, ready to run
- A800 Apple II 8" Disk Controller

Total Value \$2939.00 your price \$2495.00

ATARI 800 & 400

Personal Computer System

ATARI 800 \$799.00
 ATARI 400 \$375.00

ATARI 800 Includes: Computer Console, BASIC Lang. Cartridge, BASIC Language Programming Manual, 800 Operator's Manual w/Notebook, 16K RAM Module, Power Supply, TV Switch Box.

| | | | |
|---------------------------------|--------|----------------------------------|-------|
| Atari | 55.00 | Spring | 35.00 |
| 810 Disk Drive | 499.00 | Home Finance | 35.00 |
| Atari 800 | 799.00 | Business System Control Programs | 35.00 |
| 800 Printer-30 Cals | 350.00 | U.S. History | 35.00 |
| 8K RAM | 79.00 | U.S. Geography | 35.00 |
| 8K RAM | 94.95 | Supervisory Skills | 35.00 |
| 850 Interface | 189.95 | Word History | 35.00 |
| Program Recorder | 69.00 | Basic Society | 35.00 |
| Maths - ROM Cartridge | 29.00 | Cursing Procedures | 35.00 |
| Educator System Waste Cartridge | 29.00 | Principles of Accounting | 35.00 |
| Star BASIC | 55.00 | Star BASIC | 35.00 |
| Assembler Debug | 59.00 | Great Classics English | 35.00 |
| Business Communications | 35.00 | Business Communications | 35.00 |
| Basic Typing | 42.00 | Basic Typing | 35.00 |
| Effective Writing | 39.00 | Effective Writing | 35.00 |
| Auto Mechanics | 35.00 | Auto Mechanics | 35.00 |
| Process of Economics | 42.00 | Process of Economics | 35.00 |
| Basic Algebra | 35.00 | Basic Algebra | 35.00 |
| Basic Geometry | 35.00 | Basic Geometry | 35.00 |
| Basic Trigonometry | 35.00 | Basic Trigonometry | 35.00 |
| Basic Calculus | 35.00 | Basic Calculus | 35.00 |
| Basic Statistics | 35.00 | Basic Statistics | 35.00 |
| Basic Probability | 35.00 | Basic Probability | 35.00 |
| Basic Logic | 35.00 | Basic Logic | 35.00 |
| Basic Philosophy | 35.00 | Basic Philosophy | 35.00 |
| Basic Literature | 35.00 | Basic Literature | 35.00 |
| Basic Science | 35.00 | Basic Science | 35.00 |
| Basic Social Studies | 35.00 | Basic Social Studies | 35.00 |
| Basic Art | 35.00 | Basic Art | 35.00 |
| Basic Music | 35.00 | Basic Music | 35.00 |
| Basic Physical Education | 35.00 | Basic Physical Education | 35.00 |
| Basic Health | 35.00 | Basic Health | 35.00 |
| Basic English | 35.00 | Basic English | 35.00 |
| Basic Spanish | 35.00 | Basic Spanish | 35.00 |
| Basic French | 35.00 | Basic French | 35.00 |
| Basic German | 35.00 | Basic German | 35.00 |
| Basic Italian | 35.00 | Basic Italian | 35.00 |
| Basic Japanese | 35.00 | Basic Japanese | 35.00 |
| Basic Chinese | 35.00 | Basic Chinese | 35.00 |
| Basic Korean | 35.00 | Basic Korean | 35.00 |
| Basic Hindi | 35.00 | Basic Hindi | 35.00 |
| Basic Urdu | 35.00 | Basic Urdu | 35.00 |
| Basic Persian | 35.00 | Basic Persian | 35.00 |
| Basic Arabic | 35.00 | Basic Arabic | 35.00 |
| Basic Hebrew | 35.00 | Basic Hebrew | 35.00 |
| Basic Russian | 35.00 | Basic Russian | 35.00 |
| Basic Polish | 35.00 | Basic Polish | 35.00 |
| Basic Czech | 35.00 | Basic Czech | 35.00 |
| Basic Slovak | 35.00 | Basic Slovak | 35.00 |
| Basic Hungarian | 35.00 | Basic Hungarian | 35.00 |
| Basic Romanian | 35.00 | Basic Romanian | 35.00 |
| Basic Bulgarian | 35.00 | Basic Bulgarian | 35.00 |
| Basic Greek | 35.00 | Basic Greek | 35.00 |
| Basic Latin | 35.00 | Basic Latin | 35.00 |
| Basic Ancient Greek | 35.00 | Basic Ancient Greek | 35.00 |
| Basic Ancient Roman | 35.00 | Basic Ancient Roman | 35.00 |
| Basic Medieval | 35.00 | Basic Medieval | 35.00 |
| Basic Renaissance | 35.00 | Basic Renaissance | 35.00 |
| Basic Baroque | 35.00 | Basic Baroque | 35.00 |
| Basic Rococo | 35.00 | Basic Rococo | 35.00 |
| Basic Neoclassical | 35.00 | Basic Neoclassical | 35. |

ADVANCED COMPUTER PRODUCTS

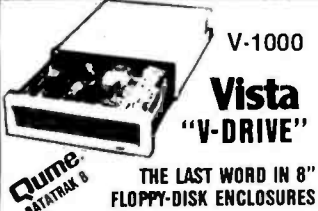

V-1000 Vista "V-DRIVE"
THE LAST WORD IN 8" FLOPPY-DISK ENCLOSURES

THE VISTA V-1000 FLOPPY-DISK DRIVE SUBSYSTEM
 • Deluxe chassis with internal slide access for drive operation and mounting...
 • Built to mechanically and electrically accommodate single drives...
 • 8-inch Winchester and Shugart floppy disk drives...
 • Capacity from 15 to 40 megabytes...
 • Industrial quality cables with cast brass heads...
 • Latest all state-of-the-art OS/2 starters...
 • Additional Savings From our return mail rebate...
 • Includes all the extra charge the normal retailer...
 • Features modular construction with removable sub-assembly...
 • Comes out right to you by easy service and maintenance.

DISCOUNT PRICES
 CABINET (w/2) single sided drive (including power supply & cable) \$ 395
 CABINET (w/2) double sided drive (including power supply & cable) \$1495
 CABINET (w/2) double sided drive (including power supply & cable) \$1995

FOR TRS 80® MODEL I, PMC 80, ZENITH H89, S-100, etc.
ONLY 310⁰⁰ ea. MODEL V-801, 80 TRACKS, SS ONLY 425⁰⁰ ea.

2 DRIVE CABLE... 29.95 4 DRIVE CABLE... 39.95

MOSTEK MK4015 4K Dynamic RAM
 Refresh while supply lasts only .49¢
 Pin equivalent to MK4027 except has 1 ms.

S-100 WW \$2.99 each

FIRST QUALITY AT SURPLUS PRICE

2708 EPROMS PRIME-450 Ns.

8 for \$29.95

4K STATIC RAM SELL-OFF

Zilog 6104-4
 Same as TMS 4044 but designed specifically for Z-80 based systems. This is full-spec 4K x 1 RAM, 450 Ns.

While supply lasts \$1.49 each.

SPECIAL PURCHASE \$59.95 Limited Supply \$59.95
 16K Altair RAM Boards. Fully Populated as TS.

FLOPPY DISK DRIVES

QUAME® DataTrack 8
 • Double Sided
 • Double Density
ACP LOW PRICE \$569.95

Tandon TM100-1 5 1/4" Disk Drive... 249.85
 MPI B5-15K... 40 Tracks... 238.95
 Shugart SA400-5V... 35 Tracks... 295.00
 Shugart 800/801R... 35... 449.00
 Siemens Shugart Compatible Model FDD-120 BD... 329.00
 PERCSI Model 277 Dual... 1195.00
 MPI B5 3V... Dual... 348.00
 WAGO/SIEMENS 82... 290.00
 MPI 01 Double Track Density Single Side, 80 Tracks... 375.00
 MPI 02 Double Track Density Double Side, 160 Tracks... 475.00

6800 MICROMODULE™ PRICE LIST

| MODEL NO. | DESCRIPTION | PRICE |
|-----------|---------------------------------|----------|
| 9600A | Single Board Microcomputer | \$495.00 |
| 9609 | Advanced Single Bd Comp (8509) | \$595.00 |
| 9601 | 16 Slot Mother Board | 175.00 |
| 9602 | Card Cage | 75.00 |
| 9603 | 8 Slot Mother Board | 100.00 |
| 9604 | Power Supply | 275.00 |
| 9605 | OC Input/Power Supply | 325.00 |
| 9610 | Utility Proto Board | 329.00 |
| 9611 | Arith Proc/Memory Module | 495.00 |
| 9612 | Bu/Rec'd Utility Proto Board | 49.00 |
| 9616 | 32K EPROM/ROM Module | 250.00 |
| 9617 | EPROM Programming Head | 250.00 |
| 9620 | 16 Channel Parallel I/O Module | 295.00 |
| 9627 | 16K Static RAM I/O Module | 385.00 |
| 9628 | 16K Static RAM Module 470ns | 385.00 |
| 9629 | 32K Static RAM 450ns | 695.00 |
| 9629A | 32K Static RAM 200ns | 895.00 |
| 9630 | Card Extender | 62.00 |
| 9640 | Multiple Programmable Timer | 395.00 |
| 9640 | 8 Channel Duplex Serial I/O Mod | 395.00 |
| 9645 | Intelligent Tape Controller | 550.00 |
| 96103 | 32/32 I/O Module | 275.00 |
| 96702 | Contact Closure Module | 350.00 |

\$24.95 TRS-80/APPLE \$24.95
 MEMORY EXPANSION KITS.
 4116's, 16K (200/250 ns.)

16K RAM
 Specify Computer
 Call For Volume Pricing

CENTRONICS PRINTER Model 737
 • Centronics complete printer
 • The 737 has everything. Check and compare the features.
 • New low price **\$835.00**

32K STATIC RAM BOARD
 2 or 4 MHz Expandable uses 2114L's
S-100
 16K 4 MHz Kit... 159.95
 16K 4 MHz A.T... 217.95
 32K 4 MHz Kit... 289.95
 32K 4 MHz A.T... 339.00
 Bare Board... 39.95
 Bare Bd. wall parts less mem... 99.95

NEW! from Zilog
 Z-8 CPU comes with Zyl Basic & debug program on the I.C. **\$69.95 w/data**

BIPOLAR CPU SALE
 Signetics 8 x 300 8 bit CPU
 While stock lasts 14.95 ea.

UV "Eprom" Eraser
 Model UVs-11E \$69.95
 Holds 1 to Eprom's at a time. Backed by 45 years experience.
 Model S-52T... \$325.00
 Professional Industrial Model

NON-LINEAR SYSTEMS, INC. TOUCH-TEST 20
 DIGITAL MULTIMETER \$319⁹⁵

BECKMAN DIGITAL MULTIMETERS
 TECH 300 Digital Multimeter... \$110
 TECH 310 Digital Multimeter... \$140
 TECH 320 Digital Multimeter... \$189
 VC-201 Vinyl Carrying Case... \$10
 DC-202 Deluxe Carrying Case... \$24
 HV-211 High Voltage Probe... \$35
 RP-221 RP Probe... \$42
 CL-231 AC Current Clamp... \$10
 DL-241 Deluxe Test Lead Kit... \$10
 TL-242 Square Test Leads... \$6

INTERSYSTEMS
 The Preferred S-100 Box
 The new Series II CPU Board features a 4 MHz Z-80A CPU and full-feature front panel. 20-slot actively terminated motherboard, with 25 amp power supply (50/60 Hz operation, incl. 68 cm fan).
 DPS-1, List \$1795
 ACP Price \$1499

SYSTEM 2A
 with Z-80A CPU 4 MHz, 64K RAM, I/O Board, 20 slots, front panel, double density disk controller board. Full 1-year warranty.
 List \$3795 ACP Price \$2995

NEC PC-8000 Series Microcomputer System.

NEW INTRO PRICING \$1099.00

2 x 80A CPU 4 MHz
 5 user programmable function keys
 82 Keys key with numeric keypad
 160x100 resolution
 80 character screen
 PC-8001A Microcomputer w/32KRAM \$1295.00 1099.00
 PC-8012A I/O Unit w/32K RAM \$795.00 699.00
 Expansion I/O Unit w/32K RAM \$1295.00 1099.00
 PC-8024A Dual Mini-Disk Drive Unit \$1095.00 949.00
 PC-8024A Impact Matrix Printer, Tractor/Friction Feed \$695.00 789.00
 PC-8024A Cable for PC-8024A Printer \$695.00 449.00
 JB-1201(MA) High Resolution Graphics Monitor \$295.00 299.00
 Color Monitor w/RGB Input \$1195.00 1049.00
 PC-8019A RGB Cable for JB-1201(MA) \$195.00 179.00
 Basic Language Learning Guide \$195.00 195.00
 PC-8019A Microcomputer Reference Manual \$14.95 14.95
 PC-8019A I/O Unit User's Manual \$14.95 14.95
 PC-8019A Dual Disk User's Manual \$14.95 14.95

FIRST TO OFFER PRIME PRODUCTS TO THE HOBBYIST AT FAIR PRICES!

1. Proven Quality Factory tested products only.
2. Guaranteed Satisfaction
 Call For Special School Discounts

SALE \$164 \$19.95

MICROPROCESSORS

| | |
|----------------------|----------|
| 28001 16 bit to 8/16 | \$189.00 |
| 28002 16 bit to 64K | 149.00 |
| 2801 | 9.95 |
| 2802 | 13.95 |
| F-8 (3850) | 16.95 |
| 8008A-8MHz | 19.95 |
| 8080A | 9.75 |
| 8088A | 14.75 |
| 8008-1 | 9.90 |
| 8008-2 | 14.95 |
| 2901A | 14.95 |
| 2901B | 14.95 |
| 2901C | 14.95 |
| 2901D | 14.95 |
| 2901E | 14.95 |
| 2901F | 14.95 |
| 2901G | 14.95 |
| 2901H | 14.95 |
| 2901I | 14.95 |
| 2901J | 14.95 |
| 2901K | 14.95 |
| 2901L | 14.95 |
| 2901M | 14.95 |
| 2901N | 14.95 |
| 2901O | 14.95 |
| 2901P | 14.95 |
| 2901Q | 14.95 |
| 2901R | 14.95 |
| 2901S | 14.95 |
| 2901T | 14.95 |
| 2901U | 14.95 |
| 2901V | 14.95 |
| 2901W | 14.95 |
| 2901X | 14.95 |
| 2901Y | 14.95 |
| 2901Z | 14.95 |

STATIC RAMS

| | | | |
|-------------|------|-------|-----|
| 21L02 450ns | 1.25 | 25.99 | 100 |
| 21L02 250ns | 1.30 | 125 | 99 |
| 21L02 150ns | 1.50 | 155 | 115 |
| 21L01-1 | 2.95 | 365 | 310 |
| 21L01-2 | 2.95 | 285 | 261 |
| 21L01-3 | 2.95 | 285 | 261 |
| 21L01-4 | 2.95 | 285 | 261 |
| 21L01-5 | 2.95 | 285 | 261 |
| 21L01-6 | 2.95 | 285 | 261 |
| 21L01-7 | 2.95 | 285 | 261 |
| 21L01-8 | 2.95 | 285 | 261 |
| 21L01-9 | 2.95 | 285 | 261 |
| 21L01-10 | 2.95 | 285 | 261 |
| 21L01-11 | 2.95 | 285 | 261 |
| 21L01-12 | 2.95 | 285 | 261 |
| 21L01-13 | 2.95 | 285 | 261 |
| 21L01-14 | 2.95 | 285 | 261 |
| 21L01-15 | 2.95 | 285 | 261 |
| 21L01-16 | 2.95 | 285 | 261 |
| 21L01-17 | 2.95 | 285 | 261 |
| 21L01-18 | 2.95 | 285 | 261 |
| 21L01-19 | 2.95 | 285 | 261 |
| 21L01-20 | 2.95 | 285 | 261 |
| 21L01-21 | 2.95 | 285 | 261 |
| 21L01-22 | 2.95 | 285 | 261 |
| 21L01-23 | 2.95 | 285 | 261 |
| 21L01-24 | 2.95 | 285 | 261 |
| 21L01-25 | 2.95 | 285 | 261 |
| 21L01-26 | 2.95 | 285 | 261 |
| 21L01-27 | 2.95 | 285 | 261 |
| 21L01-28 | 2.95 | 285 | 261 |
| 21L01-29 | 2.95 | 285 | 261 |
| 21L01-30 | 2.95 | 285 | 261 |

FLOPPY DISK I/O
 1771 01 8" MiniFloppy 24.95
 1781 Dual Floppy 29.95
 1791 Dual Floppy 36.95
 1791 02 Dual Floppy 44.95
 1791 02 DS Floppy 44.95
 1797 01 DS Floppy 44.95
 1891 Data Separator 18.95
 2143 Clock Gen. 18.95

FLOPPY CHIP SET
 Double Sided Includes: 1797
 \$79.95/set 2142

A/D CONVERTERS
 8700 8 bit Binary 13.00
 8701 10 bit Binary 22.00
 8702 Volt to Freq Conv. 7.25
 8703 3 1/2 Digit BCD 13.95
 1408 16 bit 3.95
 DAC01 D to A 5.95
 DAC02 8 bit 3.95
 DAC 100 9.95

TV CHIPS/SOUND
 AY38500 16 Games B/W 4.95
 AY38515 Color Converter 2.95
 AY38501 16 Character Game 4.95
 AY38606 1 Wipeout Game 9.50
 AY38607 1 Shooting Game 8.95
 AY38608 16 Character Game 4.95
 SN76477 16 Sound Generator 3.95
 MM53201 2 TV Synch Gen 3.95
 MM53688 Prescaler 1.95
 LM1889 RF Modulator 3.95
 MM53100 NSC Color TV 3.95
 MM53101 Color TV 3.95
 M8R Module 29.95

WAVEFORM GEN.
 8038 Function Gen. 4.50
 MM53100 VCO 2.95
 LM566 VCO 1.95
 XR2206 Function Generator. 5.25

SHIFT REGISTERS
 2504V 1.49 MM5306 2.95
 2507A 1.49 MM5306 2.95
 2517V 1.49 MM5306 2.95
 2524V 1.49 251A 1.95
 2525V 1.49 3357 6.95
 2527 1.49 3341 4.95
 2528 1.49 3343 17.95
 2529 1.49 3357 6.95
 2533 1.49 3301 1.95
 3347 5.95 9408 9.95

CDS DIPSWITCHES
 CTS206-1 1.75 CTS206-7 1.75
 CTS206-4 1.75 CTS206-8 1.95
 CTS206-2 1.75 CTS206-9 1.75
 CTS206-6 1.75 CTS206-10 1.95

CONNECTORS (GOLD)
 DB25P IRS2321 3.25
 DB25S Female 3.75
 Hood 1.26
 Set w/Hood, Sale 2.95
 2244 WW, 5/7, KM 2.95
 4386 WS, 5/7, KM 2.95
 50/100 S-100 Connector w/L 3.95
 50/100 S-100 Connector w/L 3.95

NAKED PC
 S-100 Sound Board... \$34.95
 8006A CPU... \$49.95
 32K Static RAM (2114)... 39.95
 8K EPROM (2708)... 24.95
 2708/2716 CPU Exprom... 29.95
 ACP Proto Bd... 22.95
 Vector 8800 Photo... 22.00
 Vector 8800 1 1/2 slot MB... 29.95
 ACP Extender w/Conn... 18.95
 13 Slot Mother Board (W/MC) 32.95
 5 Slot Mother Board (W/MC) 28.95
 8 Slot Mother Board (Expandable) 34.95
 Flyer PCB 18" SHUGART 39.95
 50/100 S-100 Connector... 3.95
 Alpine Sound Bd... 24.95

PRINTERS

EPSON
 MX-60... \$495.00
 MX-80 FT... \$595.00
 MX-100... \$895.00
 MX-70... \$795.00

TERMINALS

TELEVIDEO
 912C... \$799
 920C... \$849
 950C... \$995

SANYO MONITORS
 UM4500 9" \$195.95
 DM8012 12" BW 239.00
 DM111 Green 249.00
 DM112 13" color 415.00
 NEC Green 259.00
 AMDEKLEEDX Video 100/140/200
 AMDEKLEEDX 12" Color 399.00
 AMDEKLEEDX 12" Green 179.00

TERMS: Use check, M/C, VISA, AMEX, CB or COD. COD requires 25% deposit. Charge Orders please include expiration date. Foreign pay U.S. Funds. Order by phone, mail or FAX. Minimum order \$25. Please include magazine title and phone no. SHIPPING U.S.A. add \$2.00 for first 2 lbs. We reserve the right to substitute items. Not responsible for typos. Some items subject to prior sale. We reserve the right to limit quantities. Some items subject to previous metal order. Metal pricing may vary from Mail Order. We reserve the right to substitute manufacturer.

DYNAMIC RAMS

| | |
|-----------------------------|-------|
| 4164 16 116 16K (16 Pin) | 2.68 |
| 501 of 8 416's 209 Ns | 24.95 |
| 4116 16 116 16K (16 Pin) | 2.40 |
| 4050 4K x 118 Pin | 1.95 |
| 4060 4K x 112 Pin | 1.95 |
| 4096 4K x 118 Pin | 2.40 |
| 3104 4K x 118 Pin | 4.75 |
| 4027 4K x 118 Pin (VUP) 414 | 4.95 |
| 5261 1.95 64K 1103 .95 | |
| 5262 1.95 64K 800L 4.95 | |
| 5270 1.95 64K 800L 7.95 | |
| 5280 4.95 64K 800L 4.95 | |
| 5280 4.95 64K 800L 11.50 | |

ADVANCED SUPPORT
 AM1214A16K Processor 178.00
 9512 Arith Processor 18.95
 9513 Logic Timing 79.95
 9514A DMA Controller 18.95
 9515 Universal Interrupt 18.95

Z-80 SUPPORT CHIPS

| | |
|-----------------|-------|
| 280-PHO 2.5 MHz | 8.75 |
| 280-PIO 4.0 MHz | 12.95 |
| 280-CTC 2.5 MHz | 8.75 |
| 280-CTC 4.0 MHz | 12.95 |
| 280-DMA 2.5 MHz | 28.95 |
| 280-DMA 4.0 MHz | 35.95 |
| 280-SIO 4.0 MHz | 39.40 |
| 280-SIO 2.5 MHz | 35.95 |
| 280-SIO 1.0 MHz | 39.40 |
| 280-SIO 2.5 MHz | 35.95 |
| 280-SIO 1.0 MHz | 39.40 |

8080/8088 SUPPORT

| | |
|---------------------|-------|
| 8155 91818 I/O | 24.95 |
| 8155 I/O with Eprom | 64.85 |
| 8202 Dyn. Ram Cont. | 34.95 |
| 8203 138 Decoder | 3.88 |
| 8212 8 bit I/O | 2.75 |
| 8214 Priority Int. | 5.25 |
| 8216 8255 | 2.75 |
| 8224 Clock Gen. | 3.95 |
| 8224A (44MHz) | 2.95 |
| 8228 8255 | 2.95 |
| 8228 Bus Driver | 2.95 |
| 8228 Sys Control | 4.50 |
| 8228 8255 | 2.95 |
| 8243 I/O Exp. | 15.95 |
| 8246 Asyn. Comm. | 15.95 |
| 8251 Prog. I/O | 11.95 |
| 8251 Int. Timer | 12.95 |
| 8255 Prog. I/O | 6.50 |
| 8255 8255 | 11.95 |
| 8259 Prog. Int. | 15.95 |
| 8275 CRT Controller | 49.95 |
| 8279 Prog. Keyboard | 15.95 |

6800 SUPPORT CHIPS

| | |
|-----------------------|-------|
| 68010 128 x 8 Ram | 4.75 |
| 68012 256 x 8 Ram | 6.40 |
| 68011 | 6.50 |
| 68012 Priority Int. | 10.75 |
| 68013 8255 w/ E Prom | 18.95 |
| 68014 68050 CRT Cont. | 29.95 |
| 68015 Color CRT | 29.95 |
| 68016 8255 | 11.95 |
| 68017 Serial Adapter | 5.95 |
| 68018 Modem | 10.95 |
| 68019 8255 | 11.95 |
| 68020 1.0MHz OSC | 25.95 |
| 68021 | 6.95 |
| 68022 Bus Driver | 2.95 |
| 68023 | 11.95 |
| 68024 | 24.95 |
| 68025 | 24.95 |

6502 SUPPORT CHIPS

| | |
|--------------------|-------|
| 8520 PMA | 7.85 |
| 8522 Mult | 11.95 |
| 8523 8255 (50/100) | 21.95 |
| 6532 | 19.95 |
| 6531 | 19.95 |
| 6530 | 19.95 |

BIPOLAR PROMS

IC SPECIAL PURCHASE

| | |
|-----------------------|------|
| 82509 64x9 Ram | 8.95 |
| DP8304 Detail Driver | 2.95 |
| DA5652A D/A Converter | 2.95 |
| MC1503 Speed A/D | 7.95 |
| MC6862 SDA</ | |

National Semiconductor Clock Modules

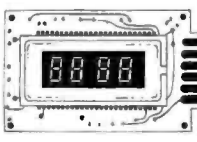

12VDC AUTOMOTIVE/INSTRUMENT CLOCK

APPLICATIONS:

- In dash auto clocks
- After-market auto/RV clocks
- Aircraft marine clocks
- 12VDC oper. Instru.
- Portable/battery powered Instru.

Features: Bright 0.3" green display. Internal crystal time base. ±0.5 sec./day accur. Auto. display bright/less control logic. Display color filterable to blue, blue-green, green & yellow. Complete — just add switches and lens.

MA1003 Module (3.05" x 1.61" x 0.75" H x .58" D) . \$16.95

CLOCK MODULES

| | |
|--|-------|
| MA1023 7" Red Digital LED Clock Module | 8.95 |
| MA1026 7" Dig. LED Alarm Clock/Thermometer | 18.95 |
| MA5036 3" Red Digital LED Clock/Timer | 6.95 |
| MA1002 5" Red Digital LED Clock & Xformer | 9.95 |
| MA1010 8" Red Digital LED Clock | 7.95 |
| MA1032 C.B.A. 5" Digital LCD Clock | 17.95 |
| MA1043 7" Green Digital LED Clock | 8.95 |

TRANSFORMERS

| | |
|--|------|
| 102-P20 Xformer for MA1023, 1043 & 5036 Models | 3.49 |
| 102-P22 Xformer for MA1026 Clock Modules | 3.49 |
| 102-P24 Xformer for MA1010 Clock Modules | 3.49 |



8 OHM SPEAKER
2 1/4" — 8 Ohm — .25 watt
A0201
\$1.25 ea. 2/\$1.95 ea. 10/\$7.95 ea.

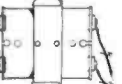

BATTERY HOLDER

- Holds 2 ea. C cells
- Aluminum Case
- 5" leads

BH-801-159
\$4.95 each 10/\$3.95

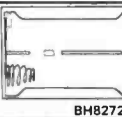

BATTERY HOLDER

- Holds 4 ea. C cells
- Plastic case
- 9" leads

BH82721
\$4.95 each 10/\$4.25

EPROM Erasing Lamp



- Erases 2708, 2716, 1702A, 52030, 52040, etc.
- Erases up to 4 chips within 20 minutes.
- Maintains constant exposure distance of one inch.
- Special conductive foam liner eliminates static build-up.
- Built-in safety lock to prevent UV exposure.
- Compact — only 7.5" x 2.75" x 2"
- Complete with holding tray for 4 chips.

UVS-11E Replacement Bulb \$16.95
UVS-11E \$79.95

JOYSTICKS



JS-5K
JVC-40

| | |
|---|--------|
| JS-5K 5K Linear Taper Pots | \$5.25 |
| JS-100K 100K Linear Taper Pots | \$4.95 |
| JVC-40 40K (2) Video Controller in case | \$4.95 |

6-Digit Clock Kit

- Bright .300 ht. comm. cathode display
- Uses MM5314 clock chip
- Switches for hours, minutes and hold modes
- Hrs. easily viewable to 20 ft.
- Simulated walnut case
- 115 VAC operation
- ±12 or 24 hr. operation
- Incl. all components, case & wall transformer
- Size: 6 1/2" x 3 1/8" x 1 3/4"

JE701 \$19.95

NEW JE215 Adjustable Dual Power Supply

General Description: The JE215 is a Dual Power Supply with independent adjustable positive and negative output voltages. A separate adjustment for each of the supplies provides the user unlimited applications for IC current voltage requirements. The supply can also be used as a general all-purpose variable power supply.

FEATURES:

- Adjustable regulated power supplies, pos. and neg. 1.2VDC to 15VDC
- Power Output (each supply):
5VDC @ 500mA, 10VDC @ 750mA,
12VDC @ 500mA, and
15VDC @ 175mA
- Two, 3-terminal adj. IC regulators with thermal overload protection.
- Heat sink regulator cooling
- LED "on" indicator
- Printed Board Construction
- 120VAC input
- Size: 3 1/2" x 5 1/16" x 2 1/4"

JE215 Adj. Dual Power Supply Kit (as shown) . . . \$24.95
(Picture not shown but similar in construction to above)
JE200 Reg. Power Supply Kit (5VDC, 1 amp) . . . \$14.95
JE205 Adapter Brd. (to JE200) ±5, ±9 & ±12V. \$12.95
JE210 Var. Pwr. Sply. Kit, 5-15VDC, to 1.5amp. \$19.95

MICROPROCESSOR COMPONENTS

| 8080A/8080A SUPPORT DEVICES | | DATA ACQUISITION (CONTINUED) | |
|---|-------|--|-------|
| IN5380A CPU | 5.95 | ADC0808CCN 8-Bit A/D Converter (8-Ch, Multil.) | 5.28 |
| OPR212 8-Bit Input/Output | 3.25 | ADC0811CCN 8-Bit A/D Converter (16-Ch, Multil.) | 13.95 |
| OPR214 Priority Interrupt Controller | 5.95 | DAK0801CCN 8-Bit D/A Converter (8-Ch, 10-Bits) | 13.95 |
| OPR216 8-Bit Directional Buffer Driver | 3.49 | DAK0802CCN 10-Bit D/A Conv. Micro. Comp. (0.20% E) | 8.49 |
| OPR228 Clock Generator/Driver | 3.95 | DAK0803CCN 10-Bit D/A Converter (0.80% Lin.) | 8.49 |
| OPR230 8-Bit Driver | 3.48 | DAK0804CCN 10-Bit D/A Converter (0.20% Lin.) | 5.95 |
| OPR228 System Controller/Bus Driver | 4.95 | DAK0805CCN 12-Bit D/A Converter (0.20% Lin.) | 11.99 |
| OPR234 System Controller | 6.95 | CO4061N 8-Channel Multiplexer | 1.95 |
| IN5434 I/O Expander for 4 Series | 16.95 | AV-5101 30K 8A/D UART | 6.49 |
| IN5429 8-Bit Nonvolatile Memory Element | 5.95 | | |
| OPR251 Prog. Conv. I/O (USART) | 1.95 | 1101 20K Static RAM's | 1.95 |
| OPR252 Prog. Interval Timer | 0.95 | 1103 100K Dynamic | 0.95 |
| OPR253 Prog. Interval I/O (PPI) | 2.49 | 2101 (801) 20K Static | 1.99 |
| OPR254 Prog. OVA Control | 0.95 | 2102 100K Static | 1.75 |
| OPR255 Prog. Interrupt Control | 0.95 | 2102L 100K Static | 1.95 |
| OPR275 Prog. CRT Controller | 29.95 | 2111 (811) 20K Static | 1.95 |
| OPR279 Prog. Keyboard/Display Interface | 9.95 | 2112 20K Static 8A/D5 | 4.95 |
| OPR303 System Timing Element | 6.95 | 2114 100K Static 40ns | 3.25 |
| OPR304 8-Bit Bi-Directional Receiver | 3.95 | 2114L 100K Static 40ns Low Power | 3.49 |
| OPR307 8-Bit Bi-Directional Receiver | 3.95 | 2116L 2 100K Static 200ns | 4.95 |
| OPR308 3-Bit Bi-Directional Receiver | 3.95 | 2116L-2 100K Static 200ns Low Power | 3.95 |
| OPR310 Octal Latched Peripheral Driver | 5.25 | 75200 75K Static | 6.75 |
| OPR311 Octal Latched Peripheral Driver | 5.25 | 4186A (L4081A) 16K Dynamic 200ns (MM5290N-4) | 2.95 |
| | | 4186B 64K Dynamic 200ns | 4.95 |
| | | MM2147L 4096K 1-16 RAM's | 7.95 |
| | | 3101 20K Static | 7.95 |
| | | 102K4 Dynamic Fully Decoded | 4.95 |
| | | MM5302 7K x 1 Dynamic | 4.95 |
| | | MM5302B 4096K Dynamic | 4.95 |
| | | MM5302C 2 (4116) 16K Dynamic 200ns (UPD41611-3) | 2.95 |
| | | MM5302D 16K (2K x 8) Static 200ns | 1.95 |
| | | MM5302E 16K (2K x 8) Static 200ns | 1.95 |
| | | UPD414H/4K/8K/47 4K Dynamic 100ns | 4.95 |
| | | TS4504A/45N 4K Static | 5.95 |
| | | TV-5100 40K Static | 9.95 |

| 6800/6800 SUPPORT DEVICES | | MICROPROCESSOR CHIPS | |
|--|-------|--|-------|
| MC68000 MPU | 4.95 | 240 (1802) CPU (8K/160N-4) (4MHZ) | 11.95 |
| MC68010 CPU 16-Bit Static RAM | 14.95 | 240A (180-1) CPU (8K/160N-4) (4MHZ) | 13.95 |
| MC68011 Peripheral Inter. Adapt. (MC68020) | 7.49 | CDP1802 CPU | 18.95 |
| MC68012 Peripheral Inter. Adapt. (MC68010) | 7.49 | 255 150UJ CPU | 3.95 |
| MC68013 1024-Bit ROM (MC68A010) | 14.95 | HD16K16A00 CPU-4-Bit Static (Com. Temp. Grade) | 19.95 |
| MC68014 Asynchronous Comm. Adapter | 6.95 | MC68502 MPU w/Clock (8K Bytes Memory) | 11.95 |
| MC6852 Synchronous Serial Data Adapter | 6.95 | IN5302A-4 CPU-8-Bit (80MHz) | 7.95 |
| MC6860 4096-Bit Digital MODEM | 10.95 | IN5302B CPU-8-Bit (120bytes RAM) | 7.95 |
| MC6862 2400bps Modulator | 12.95 | IN5302C-4 CPU (2-Byte RAM) | 24.95 |
| MC6860A Quad 3-Stat8 Bus Trans. (MC6820) | 3.25 | IN5302D CPU w/Static micro interpreter | 29.95 |
| | | PI808 CPU | 9.95 |
| | | TM5900JL MPU-16-Bit | 29.95 |

| MICROPROCESSOR CHIPS | | PROMS/EPROMS | |
|--|-------|---------------------------|---------|
| 1802A (1802) CPU (8K/160N-4) (4MHZ) | 11.95 | 2K EPROM (4Kv, +5V, +12V) | 5.95 |
| 240A (180-1) CPU (8K/160N-4) (4MHZ) | 13.95 | 8K EPROM (8Kv, +5V) | 9.95 |
| CDP1802 CPU | 18.95 | 16K EPROM (16Kv, +5V) | 14.95 |
| 255 150UJ CPU | 3.95 | 32K EPROM (32Kv, +5V) | 24.95 |
| HD16K16A00 CPU-4-Bit Static (Com. Temp. Grade) | 19.95 | 64K EPROM (64Kv, +5V) | 44.95 |
| MC68502 MPU w/Clock (8K Bytes Memory) | 11.95 | 128K EPROM (128Kv, +5V) | 74.95 |
| IN5302A-4 CPU-8-Bit (80MHz) | 7.95 | 256K EPROM (256Kv, +5V) | 144.95 |
| IN5302B CPU-8-Bit (120bytes RAM) | 7.95 | 512K EPROM (512Kv, +5V) | 294.95 |
| IN5302C-4 CPU (2-Byte RAM) | 24.95 | 1M EPROM (1Mv, +5V) | 594.95 |
| IN5302D CPU w/Static micro interpreter | 29.95 | 2M EPROM (2Mv, +5V) | 1194.95 |
| PI808 CPU | 9.95 | 4M EPROM (4Mv, +5V) | 2394.95 |
| TM5900JL MPU-16-Bit | 29.95 | 8M EPROM (8Mv, +5V) | 4794.95 |

| SHIFT REGISTERS | | ROM'S | |
|--------------------------------------|-------|--|------|
| MM5300H Quad 2-Bit Dynamic | 5.00 | 25K120J Character Generator (Upper Case) | 9.95 |
| MM5300L CPU 10-Bit Dynamic | 4.95 | 25K120K Character Generator (Lower Case) | 9.95 |
| MM5300M CPU 10-Bit Static | 4.95 | | |
| MM5300H Quad 4-Bit Accumulator | 11.95 | | |
| MM5300L 256-Bit Dynamic | 2.95 | | |
| MM5300M 1024-Bit Dynamic/Accumulator | 13.95 | | |
| MM5300H 500K/512-Bit Dynamic | 1.95 | | |
| MM5300L Octal 10-Bit | 9.95 | | |
| MM5300M 1024-Bit Dynamic | 1.95 | | |
| 2518N Hex 12-Bit Static | 3.50 | | |
| 2518P Hex 12-Bit Static | 3.50 | | |
| 2519V 512-Bit Dynamic | 0.99 | | |
| 2520V 1024-Bit Dynamic | 2.95 | | |
| 2521V 256-Bit Static | 2.95 | | |
| 2522V Octal 256-Bit Static | 4.00 | | |
| 2523V Dual 240-Bit Static | 4.00 | | |
| 2524V Quad 80-Bit Static | 2.95 | | |
| 2525V 8-Bit (2048) ROM | 6.00 | | |

| DATA ACQUISITION | | MICROPROCESSOR MANUALS | |
|---|-------|------------------------|------|
| AF10-1CN Universal A/D Filter | 5.95 | MC-280 User Manual | 5.00 |
| AF12-1CJ Touch Tone Low Band Filter | 15.95 | MC-CDP1802 User Manual | 7.50 |
| AF12-1CJ Touch Tone High Band Filter | 15.95 | MC-5100 User Manual | 7.50 |
| LM4314H Precision 1/2-Watt Op Amp | 1.15 | | |
| LM4317 Constant Current Source | 1.30 | | |
| LM4332 Temperature Transducer | 1.40 | | |
| LF135N JFET Input Op Amp | 1.10 | | |
| LF263N Precision 1/2-Watt Op Amp | 1.15 | | |
| LM93H Temp. Comp. Pres. Ref. (150mV/C) | 4.95 | | |
| ADC0808CCN 8-Bit A/D Converter (1 LSB) | 4.95 | | |
| ADC0801CCN 8-Bit D/A Converter (0.20% Lin.) | 3.25 | | |

ELECTRONIC TOY MOTORS

| TYPICAL CHARACTERISTICS | | EFFICIENCY | |
|-------------------------|---------|------------|---------|
| Typical Power Input | 0.20W | Current | 0.20A |
| Operating Voltage | 3.0V | Speed | 900 RPM |
| Current | 0.20A | Temp. | 0.90 |
| Speed | 900 RPM | Output | 0.260 W |
| Temp. | 0.90 | W | 1.30 |
| Output | 0.260 W | W | 57.0 |
| W | 1.30 | W | 0.97 |

.93" O.D. x 1.201" Length
MABUCHI RE280 \$.99 each . . . 10/\$7.50 . . . 100/\$50.00

JE608 PROGRAMMER 2704/2708 EPROM PROGRAMMER

GENERAL APPLICATIONS:

- To program EPROMs 2704 and 2708.
- Developmental system for microprocessor circuits
- To read the contents of a pre-programmed EPROM
- To compare EPROMs for content differences
- To emulate a programmed EPROM
- To store program in RAM's for alterations
- Three separate Display Registers: 8 LED's for Hex Key entries, 10 LED's (2 for Address Register and 8 LED's for Data Memory Register, The Data Memory Register displays the contents of the RAM's from the EPROM chip. Development of microprocessor systems by means of a ribbon cable from the programmer panel test socket to the EPROM socket and the microprocessor board. Rapid checking/verification of programmed data changes. User may move data from a master to RAM's or write into RAM's with keyboard entries. Allow manual stepping manipulation (up and down) at any address location. Stand alone EPROM Programmer consisting of a 16-Channel EPROM Adapter assembly, Programmer Board assembly with 4 power supplies and a LED/Teal Socket Panel Board assembly. The Teal Socket is zero force insertion type. Power requirements: 115VAC, 60Hz, 6W. Compact desk-top enclosure. Color-coordinated design & case with light tan panels and molded in mocha brown. Size: 3 1/4" H x 1 1/4" W x 8 1/4" D. Weights 5 lbs.

The JE608 EPROM Programmer is a completely self-contained unit which is independent of computer control and requires no additional systems for its operation. The EPROM can be programmed from the Hexadecimal Keyboard or from a pre-programmed EPROM. The JE608 Programmer can emulate a programmed EPROM by the use of its internal RAM circuits. This will allow the user to test or program a program for a system, prior to programming a chip. Any changes in the program can be entered directly into the memory circuits with the Hexadecimal Keyboard so that rewriting the entire program will not be necessary. The JE608 Programmer contains a Programmer Board w/25 IC's & includes power supplies of: 5V, +4.5V, +12V and -26V. The Hexadecimal Keyboard and LED/Teal Socket Panel Board are separate assemblies within the system.

JE608K Kit \$389.95
JE608A Assembled and Tested \$499.95

JE608-16K ADAPTER BOARD FOR 2716/2758 EPROMS

GENERAL DESCRIPTION: The JE608-16K Adapter Board allows the JE608 Programmer to be modified for the additional programming of the 2716 and 2758 EPROMs. The socket provides for adding an address switch for the 2716 and also for selecting the proper power and timing pulses to be applied to the EPROM. Programming and erasing the 2716 (16K) EPROM is done separately to each half (1024-bits) of the EPROM because of the existing 8K RAM capacity in the JE608 Programmer.

JE608-16K Adapter Board Kit \$29.95
JE608-Upgrade (Send assembled JE608 to factory for adapter installation) \$99.95
JE608A-16K Mod. Assembled JE608 w/Adapter (JE608-16K) Installed \$599.95

\$10.00 Min. Order — U.S. Funds Only
Calif. Residents Add 6% Sales Tax
Postage — Add 5% plus \$1 Insurance

Spec Sheets — 25¢
Send 86¢ Postage for your
FREE 1982 JAMECO CATALOG

PHONE ORDERS WELCOME (415) 592-8097

ameco ELECTRONICS

MAIL ORDER ELECTRONICS — WORLDWIDE
1355 SHOREWAY ROAD, BELMONT, CA 94002
PRICES SUBJECT TO CHANGE

BOOKS

| National Semiconductor — Intell — Intel | |
|---|------------|
| 30001 National CMOS Data Book | 46.95 |
| (840 pages) 74C, CD4000, and A/D Converters | |
| 30002 National Interface Data Book | 46.95 |
| (704 pages) DP, DS8000, DS3600, DS7500, etc. | |
| 30003 National Linear Data Book | 37.95 |
| (1376 pages) LM, LF, AD, DAC, DA, LH Series | |
| 30004 National Series 80 — Board Level Computer (124 pages) | 44.95 |
| 30005 National TTL Logic Data Book | 44.95 |
| (824 pages) 7400, LS, L, H, S, and DM8000 Series | |
| 30006 Buy above 100 30001, 2, 3, 4, 5 ea. set. | 924.95/lot |
| 30007 Intell. Data Book (1074 pages) | 46.95 |
| 01040 Intel Component Data Catalog — DS7500, etc. | 410.00 |

AG and DC Wall Transformers

| Part No. | Input | Output | Price |
|----------|-----------|---------------|--------|
| AC 250 | 117V/60Hz | 12 VAC 250mA | \$3.95 |
| AC 500 | 117V/60Hz | 12 VAC 500mA | \$4.95 |
| AC1000 | 117V/60Hz | 12 VAC 1 amp | \$5.95 |
| AC1700 | 117V/60Hz | 9 VAC 1.7 amp | \$9.95 |
| DV 9200 | 117V/60Hz | 9 VDC 200A | \$3.25 |
| DC 900 | 120V/60Hz | 9 VDC 500mA | \$3.95 |

CONNECTORS

| Part No. | Description | Price |
|----------|-----------------------------|--------|
| DB25P | D-Subminiature Plug | \$2.95 |
| DB25S | D-Subminiature Socket | \$3.50 |
| D20418-2 | Screw Lock Hdr. (2) DB25S/P | \$2.99 |
| DB25126 | Cover for DB25P/S | \$1.75 |
| 22/44SE | P.C. Edge (22/44 Pin) | \$2.95 |
| UG88/U | BNC Plug | \$1.79 |
| UG89/U | BNC Jack | \$3.75 |
| UG10/U | UHF Adapter | \$.49 |
| SO239 | UHF Panel Recp. | \$1.28 |
| PL258 | UHF Adapter | \$1.60 |
| PL259 | UHF Plug | \$1.60 |
| UG260/U | BNC Plug | \$1.79 |
| UG1094/U | BNC Bulkhead Recp. | \$1.28 |

TRS-80 16K Conversion Kit

Expand your 4K TRS-80 System to 16K.
Kit comes complete with:
* 8 ea. MM5290A (UPD416/4116) 16K Dyn. Rams (* NS)
* Documentation for Conversion
TRS-16K2 * 150NS \$29.95
TRS-16K3 * 200NS \$24.95
TRS-16K4 * 250NS \$19.95

JE610 ASCII Encoded Keyboard Kit

The JE610 ASCII Keyboard Kit can be interfaced into most any computer system. The kit comes complete with an industrial grade keyboard switch assembly (62-keys), IC's, sockets, connector, electronic components and a double-sided printed wiring board. The keyboard assembly requires +5V @ 150mA and -12V @ 10 mA for operation. Features: 60 keys generate the 126 characters, upper and lower case ASCII set. Fully buffered. Two user-definable keys provided for custom applications. Caps lock for upper-case-only alpha characters. Utilizes a 2376 (40-pin) encoder read-only memory chip. Outputs directly compatible with TTL/DTL or MOS logic arrays. Easy interfacing with a 16-pin dip or 18-pin edge connector. Size: 3 1/4" H x 14 1/4" W x 8 3/4" D

JE610/DTE-AK (After assembled as pictured above) . . . \$124.95

JE610 Kit 62-Key Keyboard, PC Board, & Components (no case) . . . \$ 79.95

K62 62-Key Keyboard (Keyboard only) . . . \$ 34.95

DTE-AK (case only — 3 1/4" H x 14 1/4" W x 8 3/4" D) \$ 49.95

JE610/DTE-AK (After assembled as pictured above) . . . \$124.95

JE610 Kit 62-Key Keyboard, PC Board, & Components (no case) . . . \$ 79.95

K62 62-Key Keyboard (Keyboard only)



PRIORITY ONE ELECTRONICS
TOLL FREE
1-800-423-5922

S-100 CPU

CPU-2 - GODBOUT
 2/4 MHZ Z80 CPU 24 Bit Addressing

| | | |
|----------|-------------|-----------------|
| GBT 160U | UnKit | \$225.00 |
| GBT 160A | A&T | \$199.00 |
| GBT 160C | CSC 3-6 MHZ | \$375.00 |

DUAL PROCESSOR 8085-8088 - GODBOUT
 5 MHZ Provides true 16 Bit Power with a standard 8 bit S-100 bus

| | | |
|-----------|-------|----------|
| GBT 1612U | UnKit | \$295.00 |
| GBT 1612A | A&T | \$399.00 |
| GBT 1612C | CSC | \$498.00 |

BOARD WITH 8085 ONLY

| | | |
|----------|-------|----------|
| GBT 161U | UnKit | \$235.00 |
| GBT 161A | A&T | \$305.00 |
| GBT 161C | CSC | \$399.00 |

2810 Z80 CPU-CA. COMP. SYST.
 2/4 MHZ Z80A CPU with RS-232C Serial I/O Port complete with Monitor PROM for 2422 Disk Controller

| | | |
|----------|-----|----------|
| CCS 2810 | A&T | \$280.00 |
|----------|-----|----------|

CS2 Z80 CPU - S.S.M.
 2/4 MHZ will accept 2716, or 2732, or RAM RUN/STOP and single step switches

| | | |
|---------|-----------------|----------|
| SSMCB2K | Kit | \$260.00 |
| SSMCB2A | A&T | \$310.00 |
| SSMZ80M | SSM Z80 Monitor | \$89.00 |

CHIA 8080 CPU - S.S.M.
 8080CPU, 1K RAM, Holds 1 2708, 1 8 Bit parallel input port.

| | | |
|----------|-----------------|----------|
| SSMCB1A | Kit | \$183.00 |
| SSMCB1A | A&T | \$225.00 |
| SSM8080M | SM 8080 Monitor | \$59.00 |

S-100 RAM

64K STATIC RAM - GODBOUT
 RAM 17, 10 MHZ, 2 Watt, DMA Compatible

| | | |
|------------|---------|-----------|
| GBT-175A48 | A&T 48K | \$950.00 |
| GBT-175C48 | CSC 48K | \$1050.00 |
| GBT-175A64 | A&T 64K | \$900.00 |
| GBT-175C64 | CSC 64K | \$1395.00 |

64K DYNAMIC RAM - CCS
 4 MHZ, on board refresh, DMA compatible, 24 bit address.

| | | |
|-----------|-----|----------|
| CCS-2065A | A&T | \$599.00 |
|-----------|-----|----------|

32K STATIC RAM - GODBOUT
 RAM 20 10 MHZ, 4K byte block disable, available 16, 24, or 32K

| | | |
|------------|---------|----------|
| GBT-184A16 | A&T 16K | \$319.00 |
| GBT-184C16 | CSC 16K | \$418.00 |
| GBT-184A24 | A&T 24K | \$449.00 |
| GBT-184C24 | CSC 24K | \$539.00 |
| GBT-184A32 | A&T 32K | \$449.00 |
| GBT-184C32 | CSC 32K | \$720.00 |

32K STATIC RAM - CCS
 4 MHZ, Bank select, 8/16 bit data A&T 32K.

| | | |
|----------|---------|----------|
| CCS-2032 | A&T 32K | \$599.00 |
|----------|---------|----------|

16K STATIC RAM - GODBOUT
 RAM 14, 10 MHZ, 24 bit addressing

| | | |
|----------|---------|----------|
| GBT-143A | A&T 16K | \$189.00 |
| GBT-143C | CSC 16K | \$399.00 |

16K STATIC RAM - CCS
 4 MHZ, 8/16 bit data, bank select A&T 16K.

| | | |
|-----------|---------|----------|
| CCS-2118A | A&T 16K | \$299.00 |
|-----------|---------|----------|

8K STATIC RAM - GODBOUT
 Econoram II 2MHZ, 8K, No doubt, the most popular S-100 RAM ever built.

| | | |
|----------|----------|---------|
| GBT-114U | UnKit 8K | \$99.95 |
|----------|----------|---------|

S-100 ROM

PEI PROM PROGRAMMER - SSM
 Programs 2708 or 2716's, operates as-a 4K/8K EPROM board as well.

| | | |
|----------|-----|----------|
| SSM-PB1K | Kit | \$154.95 |
| SSM-PB1A | A&T | \$219.00 |

ECONOROM 2708 - GODBOUT
 16K x 8 EPROM Board using 2708, Power on Jump to any 256 byte

| | | |
|----------|-------|----------|
| GBT 125U | UnKit | \$85.00 |
| GBT 125A | A&T | \$120.00 |
| GBT 125C | CSC | \$175.00 |

S-100 DISK CONTROLLERS

DISK 1 - GODBOUT
 DMA, Soft Sector, Controls 8" or 5 1/4", single or double density

| | | |
|-----------|--|----------|
| GBT 171A | A&T | \$450.00 |
| GBT 171C | CSC | \$555.00 |
| GBT CPM80 | CP/M 2.2 for Z80/8085 with Manuals & BIOS 8" S.D. disk | \$175.00 |
| GBT CPM88 | CP/M for 8086 with manuals & BIOS 8" S/D disk | \$300.00 |

2422A - CA. COMP. SYST.
 I/O Mapped, controls 8" or 5 1/4", single or double density

| | | |
|----------|--------------------------|----------|
| CCS-2422 | A&T with CPM 2.2 8" S.D. | \$365.00 |
|----------|--------------------------|----------|

DISK JOCKEY 1 - MORROW
 Single density disk controller with serial I/O, controls 8"

| | | |
|----------|-----|----------|
| MDSJ1108 | A&T | \$219.00 |
|----------|-----|----------|

DISK JOCKEY 2D - MORROW
 I/O Mapped, controls 8", single or double density, serial I/O

| | | |
|----------|-------------------|----------|
| MDSJ2208 | A&T with CP/M 2.2 | \$375.00 |
|----------|-------------------|----------|

DISK DRIVES

801R - ERUGART
 Single sided double density most popular 8" drive

| | | |
|------------|---------------------------|----------|
| SHU801R | \$425.00 ea. or 2 or more | \$395.00 |
| SHUSA801RM | Manual for 801R drives | \$10.00 |

DT-4 - QUIMÉ
 Data track 8 double sided, double density

| | | |
|---------|---------------------------|--------------|
| QME-DT8 | \$625.00 ea. or 2 or more | \$800.00 ea. |
|---------|---------------------------|--------------|

DISK CABINETS

V-100 - VISTA
 Dual 8" drive cabinet with power supply. Rack or Desk Mount

| | | |
|----------|--|----------|
| VIS-V100 | | \$395.00 |
|----------|--|----------|

SINGLE 8" - Q.T.
 Single 8" cabinet with power supply

| | | |
|----------|--|----------|
| QTC-DDC8 | | \$195.00 |
|----------|--|----------|

8" CABINETS - VISTA
 Single 5" with P.S.

| | | |
|----------|---------------------|---------|
| VIS-9801 | Single 5" with P.S. | \$75.00 |
| VIS-9802 | Dual 5" with P.S. | \$95.00 |

S-100 DISK SUBSYSTEMS

DISCUS SINGLE SIDED MORROW
 8" DBL Density drives with cabinet, power supply controller, with CP/M 2.2 and Microsoft Basic

| | | |
|----------|---------------------|-----------|
| MDSF1218 | Single Drive System | \$950.00 |
| MDSF1228 | Dual Drive System | \$1598.00 |

DISCUS DOUBLE SIDED - MORROW
 8" DBL Density/sided drives with cabinet Power supply controller, with CP/M 2.2 and Microsoft Basic

| | | |
|----------|---------------------|-----------|
| MDSF2218 | Single Drive System | \$1250.00 |
| MDSF2228 | Dual Drive System | \$2195.00 |

26MB HARD DISK - MORROW

Special purchase, limited stock - 26MB formatted hard disk complete with cabinet, P.S., Controller, CP/M 2.2 and Microsoft Basic

| | | |
|----------|----------------------|-----------|
| MDS-M26S | 26 MB Subsystem List | \$4495.00 |
|----------|----------------------|-----------|

SALE

★ \$3495.00 ★
SAVE \$1,000.00

FLASH!!
 Purchase the GBT-1612A (CPU 8085-8088) and GBT-175A (64 RAM 17 64K) together for \$1195.00
 See page 203 for further details.
 Order pdp spec n



PRIORITY ONE ELECTRONICS

9161-B DEERING AVE. • CHATSWORTH, CA 91311

Terms U.S. VISA, MC, BAC, Check Money Order, U.S. Funds Only. CA residents add 6% Sales Tax. MINIMUM PREPAID ORDER \$15.00. Include MINIMUM SHIPPING & HANDLING of \$25.00 for the first 3 lbs. plus 25¢ for each additional pound. Orders over 50 lbs. sent freight collect. Just in case, please include your phone no. Prices subject to change without notice. We will do our best to maintain prices thru October, 1981. SOCKET and CONNECTOR prices based on GOLD, not exceeding \$700.00 per oz.
 Sales Prices Valid only if you mention publication and month. Credit Card orders will be charged appropriate freight.

S-100 I/O BOARDS

SYSTEM SUPPORT I - GODBOUT
 Serial port (software prog baud), 4K EPROM or RAM provision, 15 levels of Interrupt, real time clock, optional math processor

| | | |
|----------|------------|----------|
| GBT-162U | UnKit | \$295.00 |
| GBT-162A | A&T | \$360.00 |
| GBT-162C | CSC | \$460.00 |
| GBT-9512 | Math Chib. | \$195.00 |

MPX CHANNEL BOARD - GODBOUT
 I/O Multiplexer, using 8085A-2 cpu on board

| | | |
|----------|-----|----------|
| GBT-186A | A&T | \$450.00 |
| GBT-186C | CSC | \$550.00 |

INTERFACER I - GODBOUT
 Two Serial I/O

| | | |
|----------|-----|----------|
| GBT-133A | A&T | \$219.00 |
| GBT-133C | CSC | \$298.00 |

INTERFACER II - GODBOUT
 Three parallel, one serial I/O board

| | | |
|----------|-----|----------|
| GBT-150A | A&T | \$219.00 |
| GBT-150C | CSC | \$298.00 |

INTERFACER III - GODBOUT
 Eight channel multi-use serial I/O board

| | | |
|----------|-----|-----------|
| GBT1748A | A&T | \$629.00 |
| GBT1748C | CSC | \$ 775.00 |

INTERFACER 3 WITH 5 SERIAL PORTS

| | | |
|----------|-----|----------|
| GBT1745A | A&T | \$559.00 |
| GBT1745C | CSC | \$629.00 |

MULTI I/O - MORROW DESIGNS
 Three Serial, Two parallel

| | | |
|-----------|-----|----------|
| MDSMB3200 | A&T | \$309.00 |
|-----------|-----|----------|

SWITCHBOARD-MORROW DESIGNS
 Two serial I/O, four parallel I/O, one status port, one strobe port

| | | |
|----------|-----|----------|
| MDSB2411 | A&T | \$239.00 |
|----------|-----|----------|

I/O4 - SSM

Two serial I/O, two parallel I/O

| | | |
|---------|-----|----------|
| SSM104K | Kit | \$210.00 |
| SSM104A | A&T | \$260.00 |

SM-SM

Music synthesizer board

| | | |
|---------|----------|----------|
| SSMSBIK | Kit | \$249.00 |
| SSMSBIA | A&T | \$310.00 |
| SSMSBIS | Software | \$ 25.00 |

S-100 VIDEO BOARDS

SPECTRUM - GODBOUT
 Color Graphics board with Parallel I/O.

| | | |
|----------|-------------------|----------|
| GBT-144U | UnKit | \$299.00 |
| GBT-144A | A&T | \$349.00 |
| GBT-2D | Sublogic Software | \$ 35.00 |

VB - J S.S.M.

80 x 24 or 48 character video display Memory Mapped, Parallel Keyboard port

| | | |
|------------|-------------------|----------|
| SSM-VB3K24 | Kit 80x24 | \$349.00 |
| SSM-VB3A24 | A&T 80x24 | \$429.00 |
| SSM-VB3UP | Upgrade Kit 80x48 | \$ 30.00 |

VB2 - SSM

I/O Mapped Video Board, with Parallel Keyboard port. 64x16

| | | |
|----------|-----|----------|
| SSM-VB2K | Kit | \$169.00 |
| SSM-VB2A | A&T | \$229.00 |

VBIC - SSM

Memory Mapped Video Board 64x16 character display or 64x16 graphics display

| | | |
|-----------|-----|----------|
| SSM-VBICK | Kit | \$169.00 |
| SSM-VBICA | A&T | \$220.00 |

S-100 MOTHERBOARDS

MOTHERBOARD - GODBOUT
 Active termination. 6-12-20 slot

| | | |
|----------|---------------|----------|
| GBT-153U | Unkit 6 slot | \$ 89.00 |
| GBT-153A | A&T 6 slot | \$119.00 |
| GBT-154U | Unkit 12 slot | \$129.00 |
| GBT-154A | A&T 12 slot | \$149.00 |
| GBT-155U | Unkit 20 slot | \$174.00 |
| GBT-155A | A&T 20 slot | \$189.00 |

S-100 MISC.

CEO17 ACTIVE TERMINATOR-GODBOUT

| | | |
|----------|-----|----------|
| GBT-106U | Kit | \$ 34.95 |
|----------|-----|----------|

2520 - CCS

Extender/terminator, Active and/or passive

| | | |
|-----------|-----|----------|
| CCS2520AK | Kit | \$ 59.00 |
|-----------|-----|----------|

EXTENDER/LOGIC PROBE-MULLEN

| | | |
|-----------|-----|----------|
| MUL-CK004 | Kit | \$ 59.00 |
|-----------|-----|----------|

OMI VECTOR JUMP - SSM
 with prototyping area

| | | |
|----------|-----|----------|
| SSM-OB1A | Kit | \$ 65.00 |
| SSM-OB1A | A&T | \$ 90.00 |

Circle 305 on inquiry card.

CA, AK, HI CALL
 (213) 709-5464

STAR MODEM FROM LIVERMORE LIST PRICE \$199.00 SALE PRICE \$129.00

0 to 300 baud data rate. Compatible with Bell 103 and 113. Answer/Originate. Full/Half Duplex. Special self test features.

RS232 and "D" SUB-MINIATURE CONNECTORS



P= Plug, Male Type - S= Socket, Female Type - C= Cover, Hood

| PART NO. | DESCRIPTION | PRICE | | |
|-------------|---|---------|---------|---------|
| | | 1-9 | 10-24 | 25-99 |
| CND-DE9P | 9 pin male | \$ 2.10 | \$ 1.90 | \$ 1.70 |
| CND-DE9S | 9 pin female | \$ 2.70 | \$ 2.40 | \$ 2.10 |
| CND-DE9C | 9 pin cover | \$ 1.50 | \$ 1.25 | \$ 1.10 |
| CND-DA15P | 15 pin male | \$ 2.75 | \$ 2.45 | \$ 2.15 |
| CND-DA15S | 15 pin female | \$ 3.95 | \$ 3.60 | \$ 3.20 |
| CND-DA15C | 15 pin cover | \$ 1.50 | \$ 1.30 | \$ 1.10 |
| CND-DB25P | 25 pin male | \$ 3.50 | \$ 3.25 | \$ 3.00 |
| CND-DB25S | 25 pin female | \$ 4.60 | \$ 4.35 | \$ 4.20 |
| CND-DB51212 | 1 pc. grey hood | \$ 1.60 | \$ 1.45 | \$ 1.30 |
| CND-P25H | 2 pc. grey hood | \$ 1.50 | \$ 1.25 | \$ 1.10 |
| CND-DB51226 | 2 pc. black hood | \$ 1.90 | \$ 1.65 | \$ 1.45 |
| CND-DC37P | 37 pin male | \$ 5.80 | \$ 5.10 | \$ 4.45 |
| CND-DC37S | 37 pin female | \$ 7.70 | \$ 7.70 | \$ 6.70 |
| CND-DC37C | 37 pin cover | \$ 1.80 | \$ 1.55 | \$ 1.30 |
| CND-DD50P | 50 pin male | \$ 0.75 | \$ 0.75 | \$ 0.70 |
| CND-DD50S | 50 pin female | \$11.65 | \$10.25 | \$ 8.90 |
| CND-DD50C | 50 pin cover | \$ 2.08 | \$ 1.80 | \$ 1.60 |
| CND-D2041B | Hardware set 2 pr. RS232, DB25P, EIA | \$ 1.00 | \$.80 | \$.70 |
| CND-RS2328F | Class 1 cable 8 con. 8 ft. Cent. 700 Series | \$19.95 | \$17.95 | \$15.95 |
| CND-5730360 | Printer connector | \$ 9.00 | \$ 7.50 | \$ 6.00 |

MICROCOMPUTER PRODUCTS 6502 SERIES

| PART NO. | PRICE | PART NO. | PRICE |
|----------|------------|----------|---------|
| 2016P3 | 8/\$100.00 | 6502 | \$12.95 |
| 2114N3L | 8/\$28.00 | 6502A | \$18.95 |
| 5257N3L | 8/\$50.00 | 6520 | \$8.95 |
| 2732 | 8/\$120.00 | 6522 | \$10.95 |
| 2716 | 8/\$50.00 | 6530-002 | \$21.95 |
| 2708 | 8/\$32.00 | 6530-003 | \$21.95 |
| | | 6530-004 | \$21.95 |
| | | 6530-005 | \$21.95 |
| | | 6532M | \$21.95 |
| | | 6551M | \$21.95 |

8080 SERIES

| PART NO. | PRICE |
|-----------|---------|
| INS 8080A | \$5.50 |
| INS 8085A | \$19.95 |
| DP8212N | \$2.95 |
| DP8214N | \$5.25 |
| DP8216N | \$2.95 |
| DP8224N | \$3.25 |
| DP8224-4N | \$9.95 |
| DP8226N | \$3.50 |
| DP8228N | \$5.55 |
| DP8238N | \$5.55 |
| INS8250N | \$15.00 |
| INS8251N | \$7.50 |
| INS8253N | \$17.95 |
| INS8255N | \$6.80 |
| INS8257N | \$16.45 |
| INS8259N | \$18.00 |
| INS8275N | \$59.95 |
| INS8279N | \$49.95 |

6800 SERIES

| PART NO. | PRICE | PART NO. | PRICE |
|----------|---------|----------|---------|
| MC6800P | \$11.95 | MC6802P | \$17.95 |
| MC6808P | \$9.95 | MC6809P | \$34.95 |
| MC6821P | \$5.95 | MC6828P | \$14.95 |
| MC6840P | \$14.95 | MC6845P | \$31.00 |
| MC6847P | \$14.95 | MC6850P | \$5.41 |
| MC6852P | \$5.79 | MC6854P | \$24.95 |
| MC6860P | \$10.89 | MC6862P | \$12.00 |
| MC6875L | \$7.40 | MC68710P | \$12.50 |
| MC68750P | \$12.50 | | |

Z80 SERIES

| | |
|----------|---------|
| Z80A | \$14.95 |
| Z80AP10 | \$14.95 |
| Z80ACTC | \$13.95 |
| Z80ADMA | \$45.00 |
| Z80AS700 | \$59.95 |
| Z80AS701 | \$59.95 |
| Z80AS102 | \$59.95 |

FLOPPY DISC CONTROLLER

| | |
|------------|---------|
| FD1771B-01 | \$24.95 |
| FD1791B-01 | \$44.95 |

CompuPro™ from BOBBOUT ELECTRONICS

10 MHZ 16K A&T STATIC S-100 RAM GBT-143A \$169.00 Ea
List \$349.00 **3/\$450.00**



• Operates up to 10 MHZ (90 ns RAM Chips)
• Assembled & Tested • Meets or exceeds all IEEE 696/S-100 specifications (including timing). • Fully static design eliminates the timing problems associated with dynamic memories. • Switch selectable choice of 24 address lines conforming to the IEEE 696/S-100 extended addressing specifications, or 16 address lines as used in older S-100 systems. • Ideal for multi-user installations. • Board is addressable as one 16K x 8 block on any 4K boundary. • Switch selectable PHANTOM disable and write protect. • + 5 Volt operation (requires no other supply voltages). • Low power operation (900 mA typical, 1200 mA maximum). • 1 year Factory Warranty.



VCT-8804
S-100 "ANY DIP" has full power and ground planes back to back. Boards accommodates .3, .4, .6, .9" Dips.
1-4 \$24.67 5-9 \$22.34 10-24 \$20.02
APPLE PLUGBOARD
Vector 4809 Peripheral Interface Plugboard for construction of custom circuits. Plug compatible with Apple II, Commodore PET and Super Kim microcomputers.
VCT-4609
1-4 \$20.74 5-9 \$18.79 10-24 \$16.84



VCT-8800V
Universal Microcomputer/processor plugboard use with S-100 bus. Complete with heat sink & hardware. 53" x 10" x 1/16".
1-4 \$22.48 5-9 \$20.37 10-24 \$18.26
VCT-8801-1
Same as 8800V except plain, less power buses & heat sink.
1-4 \$15.67 5-9 \$14.24 10-24 \$12.82

Vector Plugboards

| | | | |
|---|---------|--|---------|
| VCT-3682 9.6" x 4.5" | \$13.63 | VCT-3667 9.6" x 4.5" | \$13.33 |
| VCT-3682-2 6.5" x 4.5" | \$11.04 | VCT-3677 9.6" x 4.5" | \$10.68 |
| Hi-Density Dual-In-Line Plugboard for Wire Wrap with Power & Grd. Bus Epoxy Glass 1/16" 44 pin con. spaced .156 | | Gen. Purpose D.I.P. Boards with Bus Pattern for Solder or Wire Wrap. Epoxy Glass 1/16" 44 pin con. spaced .156 | |

| | |
|---|---------|
| VCT-3690-12 | \$26.64 |
| CARD EXTENDER | |
| Card Extender has 100 contacts 50 per side on .125 centers. Attached connector is compatible with S-100 Bus Systems. VCT-3690 6.5" 22/44 pin .156 ctrs. Extenders ... \$15.66 | |
| VCT-3662 6.5" x 4.5" | \$8.69 |
| VCT-3662-2 9.6" x 4.5" | \$10.85 |

1/16" Vector BOARD .042 diaholes on 0.1 spacing for IC's

| Phenolic | PART NO. | SIZE | PRICE |
|-------------|--------------|-------------|-------------------------|
| | VCT-84P44-X | 4.5" x 6.5" | 1-9 \$1.56 10-19 \$1.40 |
| | VCT-169P44-X | 4.7" x 17" | \$3.69 \$3.32 |
| Epoxy Glass | PART NO. | SIZE | PRICE |
| | VCT-84P44 | 4.5" x 6.5" | \$1.83 \$1.65 |
| | VCT-84P44 | 4.5" x 8.5" | \$2.25 \$2.03 |
| | VCT-169P44 | 4.5" x 17" | \$4.61 \$4.15 |
| | VCT-169P48 | 8.5" x 17" | \$9.00 \$8.10 |

TRS-80/APPLE MEMORY EXPANSION KITS 4116's RAMS
from Leading Manufacturers (16Kx1 200ns)
8 for \$20.00
Add \$3.00 for programming Jumpers for TRS-80 Keyboard

POWERLINE INSOLATOR
GOF-1BARW3 SH. WT. 3 lbs.
List Price \$59.95
Sale Price **\$29.00**
A MUST FOR EVERY OFFICE WITH DATA PROCESSING EQUIPMENT

SPECIAL PURCHASE GOLD 16 FIN LOW PROFILE LC. C-35 BOOKETS
TIG-16LP pkg. of 100 \$16.00
TIG-16LP pkg. of 1000 \$120.00
OEMS Stock up at this LOW PRICE

ZERO INSERTION FORCE TEST SOCKETS

| | 1-9 | 10-24 | 25-99 |
|-----------|---------|--------|--------|
| ZIP-16DIP | \$ 5.50 | \$5.35 | \$4.95 |
| ZIP-24DIP | \$ 7.50 | \$7.25 | \$6.95 |
| ZIP-40DIP | \$10.25 | \$9.85 | \$9.50 |

6 OUTLET MULTI USE CORD REEL
SH. WT. 5 LBS.
GOF-CR1 22 ft. Cord \$24.95
GOF-CR50 50 ft. Cord \$49.95

1M-10A List \$104.95 SPECIAL \$69.95 with tube
Perfectly balanced fluorescent lighting with precision magnifier lens. Tough thermoplastic shade. Easy lens removal. New wire clip design permits easy installation and removal of fluorescent tube. Comes

LEDU
with plastic shield to protect tube from soiling and damage.
Colors: Gray, Black, and Chocolate Brown. Comes with one 22 watt T-9 Circline fluorescent tube, 3 diopter lens. 10 lbs.
\$69.95

SEND \$1.00 for 60 Page CATALOG

PRIORITY ONE ELECTRONICS
MEMBER MTA NEDA
9161-B DEERING AVE. • CHATSWORTH, CA 91311
ORDER TOLL FREE (800) 423-5922 CA, AK, HI CALL (213) 709-5464
Terms U.S. VISA, MC, BAC. Check Money Order. U.S. Funds Only. CA residents add 6% Sales Tax. MINIMUM PREPAID ORDER \$15.00. Include MINIMUM SHIPPING & HANDLING of \$2.50 for the first 3 lbs., plus 25¢ for each additional pound. Orders over 50 lbs. sent freight collect. Just in case, please include your phone no. Prices subject to change without notice. We will do our best to maintain prices thru October 1981. SOCKET and CONNECTOR prices based on GOLD, not exceeding \$700.00 per oz. Sales Prices Valid only if YOU mention publication and month. Credit Card orders will be charged appropriate freight.

PRIORITY ONE ELECTRONICS

**1
ONE**

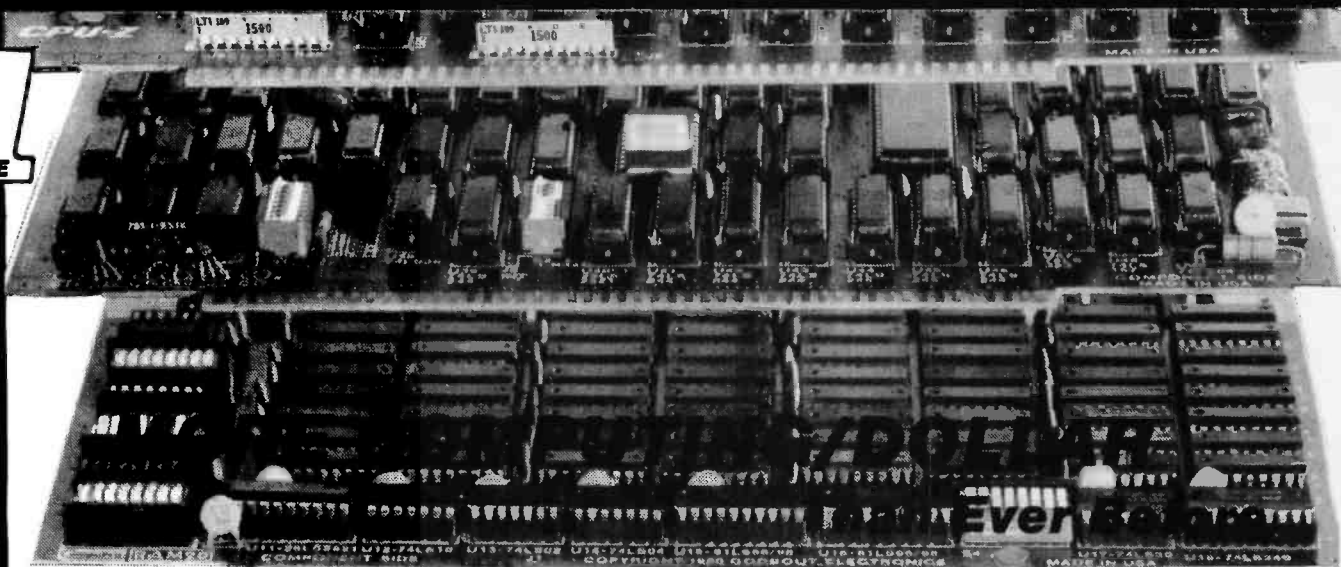

PRICE \$1095.00 SAVING: \$429.00

SOURCE: PRIORITY 1 ELECTRONICS Manufacturer: COMPUPRO From GODBOUT (Of Course)

CPU-Z

The **CPU Z** board is an 8 bit workhorse that not only includes all standard Z80A* features, but also has the necessary options to ensure backward compatibility with most older S-100 mainframes. This board optionally runs at slower clock speeds if needed, generates MWRITE for systems requiring this signal, and even includes a plug that accepts the connector from an IMSAI type front panel. Other features include:

- Full compliance with all IEEE 696/S-100 specifications (including timing specifications).
 - Downward compatible with the vast library of 8080 software.
 - 24 bit addressing allows access to 16 megabytes of memory.
 - Ideal for multi-user installations.
 - Designed for high speed operation that greatly increases system throughput (switch selectable choice of 2 or 4 MHz operation for **Assembled/Tested** boards; choice of 3 or 6 MHz for boards qualified under the **CSC** high-reliability program).
 - Provision for adding up to 8 kilobytes of on-board memory (2716/2732 EPROMs or 6116 RAMs—not included with board).
 - On-board memory sockets may be disabled under software control to allow overlapping RAM.
 - On-board fully maskable vectored interrupts for interrupt driven systems.
 - Power-on clear (POC) generates SLAVE CLR* and pRESET*.
 - Selectable automatic wait state insertion for servicing M1* Instructions—MRQ*—I/ORQ*— or the on-board memory (may be inserted in any or all of the above).
 - Automatic jump upon Reset or power-on to any 256 byte boundary.
 - Non-maskable interrupt on bus pin 12, as per IEEE 696 specs.
- This powerful and flexible CPU board provides the sophisticated operation required by today's S-100 computers, while allowing for complete compatibility with older systems as well. But perhaps best of all, **CPU Z** is cost-competitive with boards that do considerably less. When you need a powerful 8 bit CPU board that is at home with the latest (as well as some of the earliest) S-100 systems, **CPU Z** is the answer.

DISK 1 HIGH PERFORMANCE FLOPPY DISK CONTROLLER

Finally, a floppy disk controller worthy of bearing the **CompuPro** name is now available for integration into your S-100 system. The **DISK 1** floppy controller incorporates numerous features that were previously unavailable on a DMA floppy disk controller board. **DISK 1** fully complies with the IEEE 696 bus standard, **INCLUDING DMA ARBITRATION!**

- Third generation INTEL 8272/NEC 765A LSI floppy disk controller.
- High speed cycle stealing DMA interface for processor independent data transfer between system memory and flexible disk.
- Handles up to four 8 or 5.25 inch floppy disk drives.
- Single or double density/single or double sided capability.
- Supports IBM 3740 soft sectored formats.
- 24 bit DMA addressing with data transfer across 64 K boundaries for data transfer throughout the 16Mbyte memory map.
- I/O mapped interface allows contiguous system memory. (**DISK 1** occupies no memory space)
- On board Phantom boot EPROM for automatic startup.
- On board serial port for initial system startup.
- Board compatible with MP/M, OASIS, CP/M-80 and CP/M-86.
- CP/M-80 and CP/M-86 available for **DISK 1**.
- CPU speed independent data transfer for operation up to 10MHz.
- Fully arbitrated DMA interface as per IEEE 696 for allowing multiple DMA devices without conflict.
- May be interrupt driven for multi-user environments.
- Up to 600K bytes per side (8 inch drive) for an on-line total of up to 4.8M bytes (4 drives - double sided-double density).

All these features should convince you that **DISK 1** is the only choice when creating the highest performance S-100 disk system available - day and in the future. The **DISK 1** provides the advanced capabilities required by high performance single and multi-user microcomputer systems. Whether designing a new disk system or upgrading a lower performance disk system, **DISK 1** yields the best cost/performance ratio available today.

RAM 20 10 MHz 32K STATIC RAM

You don't have to pay a lot of money for a lot of memory: despite the surprisingly low price, **RAM 20** includes all the features that you would expect in a memory board where cost is no object. Available in 16K, 24K and 32K configurations, **RAM 20** includes the most sought after features for any quality memory board:

- Meets or exceed all IEEE 696/S-100 specifications (including timing)
- Fully static design eliminates the timing problems associated with dynamic memories.
- Switch-selectable choice of 24 address lines conforming to the IEEE 696/S-100 extended addressing (16 megabyte) specification, or 16 address lines as used in bank select and older S-100 systems, memory addressing (including Cromemco, Alpha Micro, and others) as well as newer systems conforming to the IEEE 696 extended addressing protocol.
- Ideal for multi-user installations.
- CSC and Assembled/Tested boards are designed for CPU speeds up to 10 MHz.
- Board is addressable as one 32K x 8 block on any 4K boundary.
- Each 4K row can be individually disabled via DIP switch.
- Switch selectable PHANTOM disable and write protect.
- +5 Volt operation (required no other supply voltages).
- Thorough bypassing of all supply lines.
- Careful thermal design to minimize heat build-up.
- Heavy power and ground traces.
- Low power operation (1200 mA typical, 1500 mA maximum).

RAM 20 delivers the high-density memory needed by every S-100 computer system - in a cost-effective and exceptionally well-designed package. Whether for 24 bit address systems or bank select systems,

RAM 20 provides economical and cost-effective mass storage.

ANOTHER PRIORITY 1 EXCLUSIVE!

We went to GODBOUT and made a special buy on the nucleus of the best S-100 Z80A* systems ever.

LOOK AT WHAT YOU GET:

- 1 GBT160A 2/4 MHz Z80 CPU \$295.00
- 1 GBT164A32 32K 10MHz Static Ram \$559.00
- 1 GBT171A DMA Disk Controllers \$495.00
- 1 GBTCPM80 CP/M 2.2 \$175.00

IT ALL ADDS UP TO \$1524.00

TOTAL PACKAGE PRICE \$1095.00

You Save \$429.00

ORDER PART NO. PDBGBTSG

Now it gets even better, add 2 Shugart 801R disk drive cabinets with power supply, data cable & OEM manual.

IT ALL ADDS UP TO \$2854.00

TOTAL PACKAGE PRICE \$2250.00

You Save \$604.00

ORDER PART NO. PDBGBTSH

Shipped Freight Collect

TAKE A DEEP BREATH! SIT DOWN!

We made a special buy on a quantity of REMEX 4000 Double Density, Double Sided 8" disk drives. Install those in the VISTA cabinet in place of the Shugarts and you will have a system that you never dreamed possible.

PDBGPT Adds Up to \$3254.00

TOTAL PACKAGE PRICE \$2450.00

You Save \$854.00

That's Right! For only \$200 more you can have double sided drives, DOUBLE THE CAPACITY! DOUBLE THE SPEED: 3ms!!!

Because of the limited quantities and anticipated high demand for these systems, we recommend that you call and confirm the availability of the system you desire.

Need A Mainframe For Your System?

Deduct 10% from our already discounted prices on GODBOUT & TEI. Mainframes if ordered with any of these specials.

PRIORITY ONE ELECTRONICS

WHY WAIT ANY LONGER???

SUPERSIXTEEN

IS HERE TODAY!!!!

Look What \$3495.00 Will Buy!

HERE'S WHAT EACH PACKAGE INCLUDES:

Dual Processor Board. With this high speed board (5 MHz operation), you have the capability to use the vast library of 8 bit software available today, as well as the enhanced 16 bit software being developed at major software houses for tomorrow's demanding applications.

Disk 1 DMA Floppy Disk Controller. This is the product that started the trend to high speed, DMA disk controllers. For maximum flexibility, it handles up to four 8" or 5.25" floppy disk drives, single or double-sided, single or double density (soft sectored).

System Support 1. All the most popular "extras" are on this one board: battery operated clock/calendar, RS-232 serial port; battery backup RAM, math processor, and ROM options; triple interval timers; dual interrupt controllers; power fail interrupt; and more.

Interfacer 1. Two RS-232 serial ports, with full handshaking and independently selectable Baud rates up to 19.2 Kbaud, connect to the serial peripherals (printer, terminal) of your choice.

128K of Static RAM. The best components deserve the best memory, which is why 128K of our famous high speed (10MHz)/low power ram comes standard with every SuperSixteen package.

CP/M*-2.2. The most popular 8 bit operating system, ready to load and go.

CP/M*-86. Rdy to load and go for 16 bit operation.

Cables and Documentation. Each package includes three interfacer cables, one disk I/O cable, complete documentation for all hardware, and manuals for both CP/M* operating systems.

Now to the best part of all. If purchased separately, these quality components would list for \$4,344. **But SuperSixteen's low package price is an amazing \$3,495,**

YOU SAVE \$849.00

(For boards qualified under the Certified System Component high-reliability program - with extended 2 year warranty, 200 hour burn-in, and 6 MHz processors - add \$600 to the package price. Standard SuperSixteen packages come with usual 1 year limited warranty.)

PDGBTSJ SuperSixteen A&T **\$3495.00**

PDGBTSK SuperSixteen CSC **\$4095.00**

Sh. Wt. 15 lbs.

SAVE EVEN MORE, when you add 2 Shugart 801R disk drives, and a dual Vista Cabinet with Power Supply and Shugart OEM Manual.

PDGBTSL **\$4650.00**

PDGBTSM With CSC Systems **\$5250.00**

YOU SAVE \$1024.00

Shipped Freight Collect

*CP/M is a registered trademark of Digital Research.



MicroFrame®

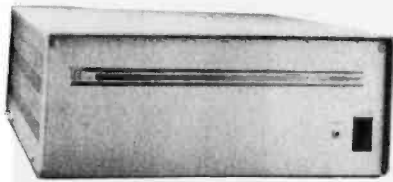

From the power supply through the sturdy chassis, TEI constructs and assembles each mainframe with great care. Every TEI mainframe utilizes a constant voltage transformer (CVT) which delivers clean regulated power at the proper level, reducing the heat in the computer cards. The output voltage on the transformer remains nearly even with the input voltage varying from approximately 85V to 140V. This means the mainframe will never notice voltage variations or even a brownout. It also provides 100 dB noise rejection to protect the computer from voltage spikes and line noise.

No need for a dedicated line or expensive noise filters. TEI was the first manufacturer to offer the CVT in its complete computer product line and is still on of few manufacturers to offer the CVT as standard equipment.

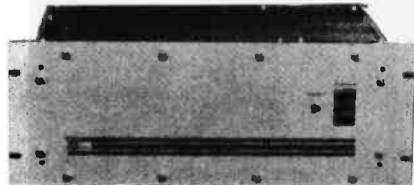

TEI22 slot and 12 slot mainframes offer a S-100 motherboard which is grounded, shielded and actively terminated for high speed operation now or for later upgrading. Each mainframe is shipped completely assembled, tested and burned in, with fan, washable filter, all connectors and card guides. Rackmount models are available in both 22 and 12 slot mainframes. The combination of the lowest noise bus, a regulated CVT power system and a rugged chassis produces a mainframe without equal.

S-100 MAINFRAMES

| | | LIST PRICE | OUR PRICE |
|-------------------|-------------------|------------|-----------|
| TEIMCS 112 | 12 Slot Desk | \$885.00 | \$615.00 |
| TEIMCS 122 | 22 Slot Desk | \$845.00 | \$760.00 |
| TEIRM 12 | 12 Slot Rackmount | \$800.00 | \$720.00 |
| TEIRM 22 | 22 Slot Rackmount | \$845.00 | \$850.00 |

Shipping Weight: On 12 Slot Mainframes 35 lbs.
On 22 Slot Mainframes 50 lbs.

12 slot: + 8V @ 17A ± 16V @ 2A: 35 lbs.
22 slot: + 8V @ 30A ± 16V @ 4A: 50 lbs.

Shipping Weight: On 12 Slot Mainframes 40 lbs.
On 22 Slot Mainframes 55 lbs.

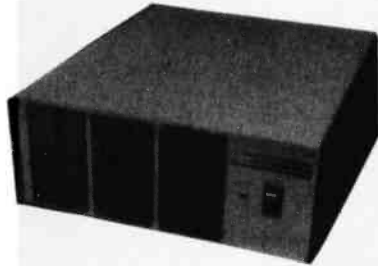

S-100 MAINFRAME WITH 12 SLOT MOTHERBOARD AND CUTOUTS FOR 3 5 1/4" FLOPPY DISK DRIVES

| | | LIST PRICE | OUR PRICE |
|----------------|-------------------|------------|-----------|
| TEITF12 | 12 Slot Desk | \$895.00 | \$825.00 |
| TEIRF12 | 12 Slot Rackmount | \$795.00 | \$715.00 |

DUAL 8" DISK DRIVE CHASSIS
For Shugart 800/801R with internal power cables provided.

| | | LIST PRICE | OUR PRICE |
|---------------|------------|------------|-----------|
| TEIDFD | Desk Top | \$535.00 | \$485.00 |
| TEIRFD | Rack Mount | \$725.00 | \$870.00 |

*Priority 1 Electronics is a master distributor for T.E.I. Dealers & OEM's. Call for quantity pricing.

LIST PRICE: \$2495.00

SPECIAL PRICE \$1595.00

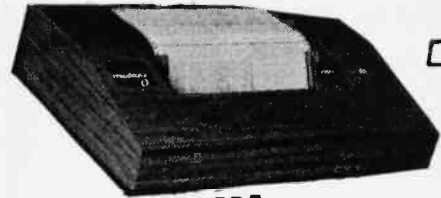

malibu

Electronics Corporation

10 x 9 DOT MATRIX WITH TRUE DECENDERS ALPHANUMERICS/GRAPHICS PRINTER

We were able to acquire this most popular printer when Malibu replaced this model with a new version. These printers, still in the factory sealed containers are available at tremendous savings on a first-come, first-served basis.

SPECIFICATIONS: 165 CPS • 132 char per line • Graphics res 60HX 72V • Adj. tractor feed 3" to 16" width • 10 character per inch or 5 expanded lines per inch 2, 3, 4, 5, 6, 8, 10 for alpha numerics 12 for graphics • paper load front or bottom • complete self test mode • self-contained intelligent controller card handles both serial and parallel interfaces • audible signaling • out of paper detection • bidirectional w/logic seeking.

MALIBU165 Serial/Parallel Interface **\$1595.00**

MALIBU1652 Parallel only Interface **\$1450.00**

Shipped Freight Collect.

CompuPro™ from GODBOUT ELECTRONICS



Now...a place to put this CompuPro or other S-100 boards. The enclosures are available in either desk top or rack mount (including slides) and both have the following features:

Enclosure

- Quiet fan provides for cool system operation.
- Two switched convenience outlets on the rear.
- Line filter for electrical noise suppression.
- dCircuit breaker for safe operation.
- Lighted RESET BUTTON FOR "POWER ON" indication.
- Punchouts on rear for 12 DB-25 connectors.
- Punchouts on rear for 2 DD-50 connectors.
- Positive pressurized for ease of filtration.
- Provisions for mounting a front panel.
- Physically 18 1/2" deep, 7" high, 17" wide (rack front panel 19" wide).

Motherboard

- Actively terminated at both ends of motherboard.
- Ground shield between every signal trace.
- Convenient power plug for connecting all D.C. power.
- RESET connector provided.
- Front panel provisions on the 20 slot version.
- Extra power connectors for more efficient power distribution 12 slot and 20 slot versions.
- Through by passing of all power lines.

Power Supply

- Twenty-five Amps at 8.0 volts D.C.
- Three Amps each at + 16 and - 16 volts D.C.
- Outputs vary less than 5% over input range of 100 AC to 130 VAC.
- Constant voltage transformer.
- All outputs fused.

With all the features listed above, the individual assembling a system can be sure that he will have the very best foundation possible for an IEEE696-s-100 system that will give years of reliable service. And because of the constant voltage transformer the power outputs can be kept near the minimum required with no worry about system failure. This allows the system to run cooler, and the regulators to stay cooler also.

| | | LIST PRICE | OUR PRICE |
|-------------------|--------------------|------------|-----------|
| GBTENC20RM | 20 Slot Rack Mount | \$895.00 | \$825.00 |
| GBTENC20DK | 20 Slot Desk Top | \$825.00 | \$760.00 |

Shipping Weight 55 lbs.



PRIORITY ONE ELECTRONICS



9161 DEERING AVE. • CHATSWORTH, CA 91311

ORDER TOLL FREE (800) 423-5922 CA, AK, HI CALL (213) 709-5464

TERMS: U.S., VISA, MC, BAC, Check, Money Order. U.S. Funds Only. CA residents add 6% Sales Tax. MINIMUM PREPAID ORDER \$15.00. Include MINIMUM SHIPPING & HANDLING of \$2.50 for the first 3 lbs., plus 25¢ for each additional pound. Orders over 50 lbs. sent freight collect. Just incase, please include you phone no. Prices subject to change without notice. Credit Card orders will be charged appropriate freight. Prices subject to change without notice. We will do our best to maintain prices through October, 1981.

16K Memory

4116-200ns

8/17.50

ALL MERCHANDISE 100% GUARANTEED!

CALL US FOR VOLUME QUOTES

JDR MICRODEVICES, INC IS PROUD TO
ANNOUNCE THE OPENING OF OUR
NEW RETAIL SHOWROOM

**BAY AREA RESIDENTS
STOP BY 1224 BASCOM AVE.**

LS SERIES

| | | | |
|---------|------|---------|------|
| 74LS00 | .25 | 74LS164 | .95 |
| 74LS01 | .25 | 74LS165 | .95 |
| 74LS02 | .25 | 74LS166 | 2.40 |
| 74LS03 | .25 | 74LS168 | 1.75 |
| 74LS04 | .25 | 74LS169 | 1.75 |
| 74LS05 | .25 | 74LS170 | 1.75 |
| 74LS08 | .35 | 74LS173 | .80 |
| 74LS09 | .25 | 74LS174 | .95 |
| 74LS10 | .25 | 74LS175 | .95 |
| 74LS11 | .35 | 74LS181 | 2.15 |
| 74LS12 | .35 | 74LS189 | 9.95 |
| 74LS13 | .45 | 74LS190 | 1.00 |
| 74LS14 | 1.00 | 74LS191 | 1.00 |
| 74LS15 | .95 | 74LS192 | .85 |
| 74LS20 | .25 | 74LS193 | .95 |
| 74LS21 | .35 | 74LS194 | 1.00 |
| 74LS22 | .25 | 74LS195 | .95 |
| 74LS26 | .35 | 74LS196 | .85 |
| 74LS27 | .35 | 74LS197 | .85 |
| 74LS28 | .35 | 74LS221 | 1.20 |
| 74LS30 | .25 | 74LS240 | 1.85 |
| 74LS32 | .35 | 74LS241 | 1.85 |
| 74LS33 | .55 | 74LS242 | 1.85 |
| 74LS37 | .55 | 74LS243 | 1.85 |
| 74LS38 | .35 | 74LS244 | 1.75 |
| 74LS40 | .25 | 74LS245 | 2.85 |
| 74LS42 | .55 | 74LS247 | .75 |
| 74LS47 | .75 | 74LS248 | 1.25 |
| 74LS48 | .75 | 74LS249 | .99 |
| 74LS49 | .75 | 74LS251 | 1.30 |
| 74LS51 | .25 | 74LS253 | .85 |
| 74LS54 | .35 | 74LS257 | .85 |
| 74LS55 | .35 | 74LS258 | .85 |
| 74LS63 | 1.25 | 74LS259 | 2.85 |
| 74LS73 | .40 | 74LS260 | .65 |
| 74LS74 | .45 | 74LS266 | .55 |
| 74LS75 | .50 | 74LS273 | 1.65 |
| 74LS76 | .40 | 74LS275 | 3.35 |
| 74LS78 | .50 | 74LS279 | .55 |
| 74LS83 | .75 | 74LS280 | 1.98 |
| 74LS85 | 1.15 | 74LS283 | 1.00 |
| 74LS86 | .40 | 74LS290 | 1.25 |
| 74LS90 | .65 | 74LS293 | 1.85 |
| 74LS91 | .89 | 74LS295 | 1.05 |
| 74LS92 | .70 | 74LS298 | 1.20 |
| 74LS93 | .65 | 74LS324 | 1.75 |
| 74LS95 | .85 | 74LS352 | 1.55 |
| 74LS96 | .95 | 74LS353 | 1.55 |
| 74LS107 | .40 | 74LS363 | 1.35 |
| 74LS109 | .40 | 74LS364 | 1.95 |
| 74LS112 | .45 | 74LS365 | .95 |
| 74LS113 | .45 | 74LS366 | .95 |
| 74LS114 | .50 | 74LS367 | .70 |
| 74LS122 | .45 | 74LS368 | .70 |
| 74LS123 | .95 | 74LS373 | 1.85 |
| 74LS124 | 2.99 | 74LS374 | 1.80 |
| 74LS125 | .95 | 74LS377 | 1.45 |
| 74LS126 | .85 | 74LS378 | 1.18 |
| 74LS132 | .75 | 74LS379 | 1.35 |
| 74LS136 | .55 | 74LS385 | 1.90 |
| 74LS137 | .99 | 74LS386 | .65 |
| 74LS138 | .75 | 74LS390 | 1.90 |
| 74LS139 | .75 | 74LS393 | 1.90 |
| 74LS145 | 1.20 | 74LS395 | 1.65 |
| 74LS147 | 2.49 | 74LS399 | 1.70 |
| 74LS148 | 1.39 | 74LS447 | .37 |
| 74LS151 | .75 | 74LS490 | 1.95 |
| 74LS153 | .75 | 74LS668 | 1.69 |
| 74LS154 | 2.35 | 74LS669 | 1.89 |
| 74LS155 | 1.15 | 74LS670 | 2.20 |
| 74LS156 | .95 | 74LS674 | 9.65 |
| 74LS157 | .75 | 74LS682 | 3.20 |
| 74LS158 | .75 | 74LS683 | 2.30 |
| 74LS160 | .90 | 74LS684 | 2.40 |
| 74LS161 | .95 | 74LS685 | 2.40 |
| 74LS162 | .95 | 74LS688 | 2.40 |
| 74LS163 | .95 | 74LS689 | 2.40 |

8200

| | |
|--------|-------|
| 8202 | 45.00 |
| 8205 | 3.50 |
| 8212 | 1.95 |
| 8214 | 3.90 |
| 8216 | 1.85 |
| 8224 | 2.50 |
| 8226 | 1.85 |
| 8228 | 4.95 |
| 8237 | 19.95 |
| 8238 | 4.95 |
| 8243 | 4.50 |
| 8250 | 14.95 |
| 8251 | 5.50 |
| 8253 | 9.85 |
| 8253-5 | 9.85 |
| 8255 | 5.25 |
| 8255-5 | 5.25 |
| 8257 | 9.00 |
| 8259 | 7.00 |
| 8272 | 39.95 |
| 8275 | 29.95 |
| 8279 | 10.50 |
| 8279-5 | 10.50 |
| 8282 | 6.65 |
| 8283 | 6.65 |
| 8284 | 5.80 |
| 8286 | 6.65 |
| 8287 | 6.65 |
| 8288 | 25.00 |
| 8289 | 49.95 |

MPU'S

| | |
|--------|-------|
| 8035 | 16.95 |
| 8039 | 19.95 |
| 8080A | 3.95 |
| 8086 | 12.95 |
| 8086 | 99.95 |
| 8088 | 39.95 |
| 8155 | 11.95 |
| 8156 | 11.95 |
| 8185 | 29.95 |
| 8185-2 | 39.95 |
| 8741 | 39.95 |
| 8748 | 69.95 |
| 8755 | 49.95 |

Z80

| | |
|------------|-------|
| Z80 | 8.95 |
| Z80A | 9.95 |
| Z80B | 19.95 |
| Z80-PIO | 6.50 |
| Z80A-PIO | 8.60 |
| Z80-CTC | 6.50 |
| Z80A-CTC | 8.65 |
| Z80-DART | 15.25 |
| Z80A-DART | 18.75 |
| Z80-DMA | 17.50 |
| Z80-DMA | 27.50 |
| Z80-SIO/0 | 23.95 |
| Z80A-SIO/0 | 28.95 |
| Z80-SIO/1 | 28.95 |
| Z80-SIO/2 | 23.95 |
| Z80A-SIO/2 | 28.95 |
| Z80-SIO/9 | 17.95 |
| Z80A-SIO/9 | 22.95 |

MISC.

| | | | |
|--------|------|----------|-------|
| 8T26 | 1.69 | 3242 | 9.95 |
| 8T28 | 2.49 | AY5-1013 | 3.95 |
| 8T95 | .99 | TR1602 | 4.95 |
| 8T96 | .99 | IM6402 | 7.95 |
| 8T97 | .99 | 1771 | 24.95 |
| 8T96 | .99 | 1791 | 36.95 |
| 1488 | .99 | 1793 | 49.95 |
| 1489 | .99 | UPD765 | 39.95 |
| DM8131 | 2.95 | 8272 | 39.95 |
| 14411 | 9.95 | 74C923 | 5.95 |

MA1012A CLOCK MODULE

- 1/2" RED LED CHARACTERS
- 12-HOUR FORMAT
- FACTORY ASSEMBLED
- JUST ADD SWITCHES
- COMPLETE WITH SPECIAL TRANSFORMER AND SPECS.

\$8⁹⁹ ea. 3/\$24⁰⁰

TRANSISTORS

| | | |
|--------|---------|----------|
| PN2222 | 10/1.00 | 100/8.99 |
| 2N3904 | 10/1.00 | 100/8.99 |
| 2N3906 | 10/1.00 | 100/8.99 |
| 2N3055 | .79 | 10/6.99 |
| IN4148 | | 25/1.00 |
| IN4004 | | 10/1.00 |

6502

| | |
|-------|-------|
| 6502 | 6.95 |
| 6502A | 12.95 |
| 6504 | 6.95 |
| 6505 | 8.95 |
| 6520 | 4.95 |
| 6522 | 9.95 |
| 6532 | 14.95 |
| 6551 | 14.95 |

CALL JDR BEFORE YOU BUY!
WE WILL BEAT ANY COMPETITOR'S PRICES

800-538-5000

800-662-6233

(CALIFORNIA RESIDENTS)

T.V. CIRCUITS

6800

| | |
|------|-------|
| 6800 | 6.95 |
| 6802 | 11.95 |
| 6809 | 37.95 |
| 6810 | 4.60 |
| 6820 | 4.95 |
| 6821 | 4.95 |
| 6828 | 9.95 |
| 6834 | 16.95 |
| 6840 | 14.95 |
| 6843 | 42.95 |
| 6844 | 44.95 |
| 6845 | 29.95 |
| 6847 | 15.95 |
| 6850 | 4.75 |
| 6852 | 5.75 |
| 6860 | 10.95 |
| 6862 | 11.95 |
| 6871 | 25.95 |
| 6875 | 6.95 |
| 6880 | 2.95 |

MC1330 1.89

| | |
|--------|------|
| MC1350 | 1.29 |
| MC1358 | 1.79 |
| LM380 | 1.29 |
| LM386 | 1.50 |
| LM565 | .99 |
| LM741 | .29 |
| LM1310 | 2.90 |
| LM1800 | 2.99 |
| LM1889 | 2.49 |

EPROMS

| | | | | |
|---------|----------------------|-------|-------|------|
| 1702 | 256 x 8 (1us) | 4.95 | 8pcs | 4.50 |
| 2708 | 1024 x 8 (450ns) | 3.95 | 3.50 | |
| 2758 | 1024 x 8 (450ns)(5v) | 9.95 | 8.95 | |
| TMS2516 | 2048 x 8 (450ns)(5v) | 7.95 | 6.95 | |
| 2716 | 2048 x 8 (450ns)(5v) | 5.95 | 5.50 | |
| 2716-1 | 2048 x 8 (350ns)(5v) | 12.95 | 11.95 | |
| TMS2716 | 2048 x 8 (450ns) | 9.95 | 8.95 | |
| TMS2532 | 4096 x 8 (450ns)(5v) | 19.95 | 17.95 | |
| 2732 | 4096 x 8 (450ns)(5v) | 16.50 | 15.95 | |

STATIC RAMS

| | | | | |
|-----------|----------------------|---------|--------|------|
| 2101 | 256 x 4 (450ns) | 1.95 | 100pcs | 1.85 |
| 2102-1 | 1024 x 1 (450ns) | .89 | .85 | |
| 21L02-1 | 1024 x 1 (450ns)(LP) | 1.29 | 1.15 | |
| 2111 | 256 x 4 (450ns) | 2.99 | 2.49 | |
| 2112 | 256 x 4 (450ns) | 2.99 | 2.79 | |
| 2114 | 1024 x 4 (450ns) | 8/17.95 | 2.10 | |
| 2114L-2 | 1024 x 4 (200ns)(LP) | 8/22.95 | 2.45 | |
| 2114L-3 | 1024 x 4 (300ns)(LP) | 8/21.95 | 2.45 | |
| 2114L-4 | 1024 x 4 (450ns)(LP) | 8/18.95 | 2.25 | |
| TMS4044-4 | 4096 x 1 (450ns) | 3.49 | 3.25 | |
| TMS4044-3 | 4096 x 1 (300ns) | 3.99 | 3.75 | |
| TMM2016 | 2048 x 8 (200ns) | CALL | | |
| HM6116 | 2048 x 8 (200ns) | CALL | | |

DYNAMIC RAMS

| | | | | |
|----------|--------------------|---------|--------|------|
| 4027 | 4096 x 1 (250ns) | 2.50 | 100pcs | 2.00 |
| 4116-150 | 16,384 x 1 (150ns) | 8/19.95 | 2.35 | |
| 4116-200 | 16,384 x 1 (200ns) | 8/17.50 | 1.95 | |
| 4116-300 | 16,384 x 1 (300ns) | 8/16.95 | 1.85 | |
| 4164 | 65,536 x 1 (200ns) | CALL | | |

LP=LOW POWER

DIP SWITCHES

| | |
|------------|-----|
| 4 position | .85 |
| 5 position | .90 |
| 6 position | .90 |
| 7 position | .95 |
| 8 position | .95 |

CONNECTORS

| | |
|--------------|------|
| RS232 MALE | 3.25 |
| RS232 FEMALE | 3.75 |
| RS232 HOOD | 1.25 |
| S-100 ST | 3.95 |
| S-100 WW | 4.95 |

LEDS

| | |
|----------------|---------|
| Jumbo Red | 10/1.00 |
| Jumbo Green | 6/1.00 |
| Jumbo Yellow | 6/1.00 |
| 5082-7760 43°C | .79 |
| MAN74 3°C | .99 |
| MAN72 3°C | .99 |

IC SOCKETS

| | |
|-----------|-----|
| 8 pin ST | .13 |
| 14 pin S1 | .15 |
| 16 pin WW | .17 |
| 18 pin ST | .20 |
| 22 pin ST | .29 |
| 24 pin ST | .30 |
| 28 pin ST | .40 |
| 40 pin ST | .49 |

| | |
|------------------|------|
| ST = SOLDER TAIL | |
| 8 pin WW | .59 |
| 14 pin WW | .69 |
| 16 pin WW | .69 |
| 18 pin WW | .99 |
| 20 pin WW | 1.09 |
| 22 pin WW | 1.39 |
| 24 pin WW | 1.49 |
| 28 pin WW | 1.69 |
| 40 pin WW | 1.99 |

WW = WIREWRAP

VOLTAGE REG'S

| | | | |
|--------|------|--------|------|
| 7805T | .89 | 7905T | .99 |
| 7808T | .99 | 7912T | .99 |
| 7812T | .89 | 7915T | 1.19 |
| 7815T | .99 | 7924T | 1.19 |
| 7824T | .99 | | |
| 7805K | 1.39 | 7905K | 1.49 |
| 7812K | 1.39 | 7912K | 1.49 |
| 7815K | 1.39 | 79105 | .79 |
| 78L05 | .69 | 79L12 | .79 |
| 78L12 | .69 | 79L15 | .79 |
| 78L15 | .69 | LM317K | 3.95 |
| LM309K | 1.49 | LM323K | 4.95 |
| LM317T | 1.95 | LM337K | 3.95 |

T=TO-220 K=TO-3 L=TO-92

JDR MICRODEVICES, INC.

1224 Bascom Ave.
Campbell, CA 95008

800-538-5000 • 800-662-6233 (Calif.)

408-247-4852

TERMS: For shipping include \$2.00 for UPS Ground, \$3.00 for UPS Blue Label Air. \$10.00 minimum order. Bay Area residents add 6 1/2% sales tax. California Residents add 6% tax. We reserve the right to limit quantities and substitute manufacturer. Prices subject to change without notice. Send SASE for complete list.



Circle 190 on inquiry card.

2716 EPROMS 450NS (5V)

8/5.50 ea.

ALL MERCHANDISE 100% GUARANTEED!

CALL US FOR VOLUME QUOTES

CMOS

| | | | | | | | |
|--------|------|--------|-------|------|------|-------|-------|
| 74C00 | .35 | 74C374 | 2.75 | 4019 | .45 | 4098 | 2.49 |
| 74C02 | .35 | 74C901 | .80 | 4020 | .95 | 4099 | 1.95 |
| 74C04 | .35 | 74C902 | .85 | 4021 | .95 | 14409 | 8.95 |
| 74C08 | .35 | 74C903 | .85 | 4022 | 1.15 | 14410 | 8.95 |
| 74C10 | .35 | 74C905 | 10.95 | 4023 | .35 | 14411 | 9.95 |
| 74C14 | 1.50 | 74C906 | .95 | 4024 | .75 | 14412 | 12.95 |
| 74C20 | .35 | 74C907 | 1.00 | 4025 | .35 | 14419 | 2.95 |
| 74C30 | .35 | 74C908 | 2.00 | 4026 | 1.65 | 4502 | .95 |
| 74C32 | .50 | 74C909 | 2.75 | 4027 | .65 | 4503 | .65 |
| 74C42 | 1.75 | 74C910 | 9.95 | 4028 | .80 | 4508 | 1.95 |
| 74C48 | 2.10 | 74C911 | 10.00 | 4029 | .95 | 4510 | .95 |
| 74C73 | .65 | 74C912 | 10.00 | 4030 | .45 | 4511 | .95 |
| 74C74 | .85 | 74C914 | 1.95 | 4034 | 2.95 | 4512 | .95 |
| 74C76 | .80 | 74C915 | 2.00 | 4035 | .85 | 4514 | 1.25 |
| 74C83 | 1.95 | 74C918 | 2.75 | 4040 | .95 | 4515 | 2.25 |
| 74C85 | 1.95 | 74C920 | 17.95 | 4041 | 1.25 | 4516 | 1.55 |
| 74C86 | .95 | 74C921 | 15.95 | 4042 | .75 | 4518 | 1.25 |
| 74C89 | 4.50 | 74C922 | 5.95 | 4043 | .85 | 4519 | 1.25 |
| 74C90 | 1.75 | 74C923 | 5.95 | 4044 | .85 | 4520 | 1.25 |
| 74C93 | 1.75 | 74C925 | 6.75 | 4046 | .95 | 4522 | 1.25 |
| 74C95 | 1.75 | 74C926 | 7.95 | 4047 | .95 | 4526 | 1.25 |
| 74C107 | 1.00 | 74C927 | 7.95 | 4049 | .55 | 4527 | 1.95 |
| 74C150 | 5.75 | 74C928 | 7.95 | 4050 | .55 | 4528 | 1.25 |
| 74C151 | 2.25 | 74C929 | 19.95 | 4051 | .95 | 4531 | .95 |
| 74C154 | 3.25 | 74C930 | 19.95 | 4053 | .95 | 4532 | 1.95 |
| 74C157 | 1.75 | 4000 | .35 | 4060 | 1.45 | 4538 | 1.95 |
| 74C160 | 2.00 | 4001 | .35 | 4066 | .75 | 4539 | 1.95 |
| 74C161 | 2.00 | 4002 | .25 | 4068 | .40 | 4543 | 2.70 |
| 74C162 | 2.00 | 4006 | .95 | 4069 | .35 | 4555 | .95 |
| 74C163 | 2.00 | 4007 | .29 | 4070 | .35 | 4556 | .95 |
| 74C164 | 2.00 | 4008 | .95 | 4071 | .30 | 4581 | 1.95 |
| 74C165 | 2.00 | 4009 | .45 | 4072 | .30 | 4582 | 1.95 |
| 74C173 | 2.00 | 4010 | .45 | 4073 | .30 | 4584 | .95 |
| 74C174 | 2.25 | 4011 | .35 | 4075 | .30 | 4585 | .95 |
| 74C175 | 2.25 | 4012 | .25 | 4076 | .95 | 4702 | 12.95 |
| 74C192 | 2.25 | 4013 | .45 | 4078 | .30 | 4724 | 1.50 |
| 74C193 | 2.25 | 4014 | .95 | 4081 | .30 | 80C07 | .95 |
| 74C195 | 2.25 | 4015 | .95 | 4082 | .30 | 80C95 | .85 |
| 74C200 | 5.75 | 4016 | .45 | 4085 | .95 | 80C96 | .95 |
| 74C221 | 2.25 | 4017 | 1.15 | 4086 | .95 | 80C97 | .95 |
| 74C373 | 2.75 | 4018 | .95 | 4093 | .95 | 80C98 | 1.20 |

7400 SERIES

| | | | |
|-------|------|-------|-------|
| 7400 | .19 | 74128 | .55 |
| 7401 | .19 | 74132 | .45 |
| 7402 | .19 | 74136 | .50 |
| 7403 | .19 | 74141 | .65 |
| 7404 | .19 | 74142 | 2.95 |
| 7405 | .22 | 74143 | 2.95 |
| 7406 | .22 | 74144 | 2.95 |
| 7407 | .22 | 74145 | .60 |
| 7408 | .24 | 74147 | 1.75 |
| 7409 | .19 | 74148 | 1.20 |
| 7410 | .19 | 74150 | 1.35 |
| 7411 | .25 | 74151 | .65 |
| 7412 | .30 | 74152 | .65 |
| 7413 | .35 | 74153 | .55 |
| 7414 | .55 | 74154 | 1.40 |
| 7416 | .25 | 74155 | .75 |
| 7417 | .25 | 74156 | .65 |
| 7420 | .19 | 74157 | .55 |
| 7421 | .35 | 74159 | 1.65 |
| 7422 | .29 | 74160 | .85 |
| 7423 | .29 | 74161 | .70 |
| 7425 | .29 | 74162 | .85 |
| 7426 | .29 | 74163 | .85 |
| 7427 | .29 | 74164 | .85 |
| 7428 | .45 | 74165 | .85 |
| 7430 | .19 | 74166 | 1.00 |
| 7432 | .29 | 74167 | 1.95 |
| 7433 | .45 | 74170 | 1.65 |
| 7437 | .29 | 74172 | 5.95 |
| 7438 | .29 | 74173 | .75 |
| 7440 | .19 | 74174 | .89 |
| 7442 | .49 | 74175 | .89 |
| 7443 | .65 | 74176 | .89 |
| 7444 | .69 | 74177 | .75 |
| 7445 | .69 | 74178 | 1.15 |
| 7446 | .59 | 74179 | 1.75 |
| 7447 | .69 | 74180 | .75 |
| 7448 | .69 | 74181 | 2.25 |
| 7450 | .19 | 74182 | .75 |
| 7451 | .23 | 74184 | 2.00 |
| 7453 | .23 | 74185 | 2.00 |
| 7454 | .23 | 74186 | 18.50 |
| 7460 | .23 | 74190 | 1.15 |
| 7464 | .39 | 74191 | 1.15 |
| 7465 | .39 | 74192 | .79 |
| 7470 | .35 | 74193 | .79 |
| 7472 | .29 | 74194 | .85 |
| 7473 | .34 | 74195 | .85 |
| 7474 | .35 | 74196 | .79 |
| 7475 | .49 | 74197 | .75 |
| 7476 | .35 | 74198 | 1.35 |
| 7480 | .59 | 74199 | 1.35 |
| 7481 | 1.10 | 74221 | 1.35 |
| 7482 | .95 | 74246 | 1.35 |
| 7483 | .50 | 74247 | 1.25 |
| 7484 | .50 | 74248 | 1.85 |
| 7485 | .65 | 74249 | 1.95 |
| 7486 | .35 | 74251 | .75 |
| 7489 | 4.95 | 74259 | 2.25 |
| 7490 | .35 | 74265 | 1.35 |
| 7491 | .40 | 74273 | 1.95 |
| 7492 | .50 | 74276 | 1.25 |
| 7493 | .49 | 74279 | .75 |
| 7494 | .65 | 74283 | 2.00 |
| 7495 | .55 | 74284 | 3.75 |
| 7496 | .70 | 74285 | 3.75 |
| 7497 | 2.75 | 74290 | .95 |
| 74100 | 1.00 | 74293 | .75 |
| 74107 | .30 | 74298 | .85 |
| 74109 | .45 | 74351 | 2.25 |
| 74110 | .45 | 74365 | .65 |
| 74111 | .55 | 74366 | .65 |
| 74116 | 1.55 | 74367 | .65 |
| 74120 | 1.20 | 74368 | .65 |
| 74121 | .29 | 74376 | 2.20 |
| 74122 | .45 | 74390 | 1.75 |
| 74123 | .55 | 74393 | 1.35 |
| 74125 | .45 | 74425 | 3.15 |
| 74126 | .45 | 74426 | .85 |
| | | 74490 | 2.55 |

74S00 SERIES

| | | | | | | | |
|-------|------|--------|------|--------|-------|--------|-------|
| 74S00 | .44 | 74S74 | .69 | 74S163 | 3.75 | 74S258 | 1.49 |
| 74S02 | .48 | 74S85 | 2.39 | 74S168 | 4.65 | 74S260 | 1.83 |
| 74S03 | .48 | 74S86 | 1.44 | 74S169 | 5.44 | 74S274 | 19.95 |
| 74S04 | .79 | 74S112 | 1.59 | 74S174 | 1.09 | 74S275 | 19.95 |
| 74S05 | .79 | 74S113 | 1.98 | 74S175 | 1.09 | 74S280 | 2.90 |
| 74S08 | .48 | 74S114 | 1.50 | 74S181 | 4.47 | 74S287 | 4.75 |
| 74S09 | .98 | 74S124 | 2.77 | 74S182 | 2.95 | 74S288 | 4.45 |
| 74S10 | .69 | 74S132 | 1.24 | 74S188 | 3.95 | 74S289 | 6.98 |
| 74S11 | .88 | 74S133 | .98 | 74S189 | 14.95 | 74S301 | 6.95 |
| 74S15 | .70 | 74S134 | .69 | 74S194 | 2.95 | 74S373 | 3.45 |
| 74S20 | .68 | 74S135 | 1.48 | 74S195 | 1.89 | 74S374 | 3.45 |
| 74S22 | .98 | 74S138 | 1.08 | 74S196 | 4.90 | 74S381 | 7.95 |
| 74S30 | .48 | 74S139 | 1.25 | 74S197 | 4.25 | 74S387 | 5.75 |
| 74S32 | .98 | 74S140 | 1.45 | 74S201 | 14.95 | 74S412 | 2.98 |
| 74S37 | 1.87 | 74S151 | 1.19 | 74S225 | 8.95 | 74S471 | 9.95 |
| 74S38 | 1.68 | 74S153 | 1.19 | 74S240 | 3.98 | 74S472 | 16.85 |
| 74S40 | .44 | 74S157 | 1.19 | 74S241 | 3.75 | 74S474 | 17.85 |
| 74S51 | .78 | 74S158 | 1.45 | 74S251 | 1.90 | 74S482 | 15.60 |
| 74S64 | .79 | 74S161 | 2.85 | 74S253 | 7.45 | 74S570 | 7.80 |
| 74S65 | 1.25 | 74S162 | 3.70 | 74S257 | 1.39 | 74S571 | 7.80 |

PROMS

| | | | | |
|--------|----------|----|---------|-------|
| 74S188 | (82S23) | OC | 32 x 8 | 3.95 |
| 74S287 | (82S129) | TS | 256 x 4 | 4.75 |
| 74S288 | (82S123) | TS | 32 x 8 | 4.45 |
| 74S387 | (82S126) | OC | 256 x 4 | 5.75 |
| 74S471 | | TS | 256 x 8 | 9.95 |
| 74S472 | (82S147) | TS | 512 x 8 | 16.85 |
| 74S474 | (82S141) | TS | 512 x 8 | 17.85 |
| 74S570 | (82S130) | OC | 512 x 4 | 7.80 |
| 74S571 | (82S131) | TS | 512 x 4 | 7.80 |

NEED FAST PARTS?

DYNAMIC RAMS

| | | | |
|------|-------|---------|---------|
| 4116 | 150NS | 16K x 1 | 8/19.95 |
| 4116 | 120NS | 16K x 1 | 8/29.95 |

STATIC RAMS

| | | | |
|------|-------|--------|------|
| 2147 | 55NS | 4K x 1 | 9.95 |
| 6116 | 150NS | 2K x 8 | CALL |
| 6116 | 120NS | 2K x 8 | CALL |

EPROMS

| | | | |
|---------|-------|--------|-------|
| 2716-1 | 350NS | 2K x 8 | 12.95 |
| 2732A | 250NS | 4K x 8 | 25.95 |
| 2732A-2 | 200NS | 4K x 8 | 32.95 |

MPU's

| | | | |
|---------|------|------|-------|
| Z-80B | CPU | 6mHz | 19.95 |
| Z-80B | CTC | 6mHz | 17.95 |
| Z-80B | PIO | 6mHz | 17.95 |
| 68B00 | CPU | 2mHz | 10.95 |
| 68B21 | PIA | 2mHz | 12.95 |
| 68B50 | ACIA | 2mHz | 12.95 |
| 8085A-2 | CPU | 5mHz | 16.95 |

APPLE OWNERS

EXPAND YOUR 48K COMPUTER TO 64K

SUPER RAM • II

- PLUG IN SLOT #
- GOLD PLATED CONTACTS
- INCLUDES 5 JUMPER OPTIONS
- INCLUDES 5 RAM-ROM OPTIONS
- ENJOY THE BEST OF BOTH WORLDS
- 16K RAM (RANDOM ACCESS MEMORY)
- THIS IS SOPHISTICATED FIRMWARE
- EXPANDS YOUR 48K APPLE TO 64K OF PROGRAMMABLE MEMORY
- ELIMINATES THE NEED FOR APPLESOFT™ OR INTEGER BASIC ROM CARD
- ALLOW YOU TO RUN APPLE'S NEW FORTRAN PACKAGE. ALSO PASCAL AND PILOT
- KEYBOARD CONTROL SELECTION OF RAM OR MOTHER BOARD ROM LANGUAGE
- INCLUDES INSTALLATION INSTRUCTIONS AND APPLICATIONS NOTES
- THE SOFTWARE DEVELOPED BY VARIOUS VENDORS FOR YOUR (64K) SHOULD NOW WORK AS THEY ADVERTISED
- THE MOST VERSATILE RAM EXPANSION ON THE MARKET TODAY

UNIQUE 1 YEAR WARRANTY! \$168.00

APPLE FAN

"COOL-IT"

- TAN COLOR
- SAVE DOWN TIME
- LONG LIFE MOTOR
- LOW NOISE IS A MUST
- SAVE REPAIR CHARGES
- INCREASES RELIABILITY
- CLIPS ON—NO HOLES OR SCREWS
- MINIMUM QUIETNESS IS DUE TO THE DRAW EFFECT OF AIR THROUGH YOUR COMPUTER AND A SPECIAL FAN AND MOTOR DESIGN
- THOSE EXTRA PLUG-IN CARDS CAN CAUSE EXTRA HEAT

HOW TO HOOK IT UP

1. Clip it on your APPLE
2. Unplug your 120V cable (you won't need it)
3. Plug short 120V cable from Super Fan II to the back of your computer
4. Plug the supply cable from Super Fan II to your 120V power source
5. Turn on the rocker switch and a built-in red ready light comes on
6. You are all set "COOL IT"

UNIQUE 1 YEAR WARRANTY! \$69.00

*APPLE IS A TRADEMARK OF APPLE COMPUTER INC.

JDR MICRODEVICES, INC.

1224 Bascom Ave.

Campbell, CA 95008

800-538-5000 • 800-662-6233 (Calif.)

408-247-4852

TERMS: For shipping include \$2.00 for UPS Ground, \$3.00 for UPS Blue Label Air. \$10.00 minimum order. Bay Area Residents add 6 1/2 % sales tax. California Residents add 6% sales tax. We reserve the right to limit quantities and substitute manufacturer. Prices subject to change without notice. Send SASE for complete list.

Circle 190 on Inquiry card.

4K STATIC RAM 8/\$20.00

2114 LOW POWER 200 NS

74LS00

| | | | | | |
|---------|------|---------|------|---------|-------|
| 74LS00 | .25 | 74LS123 | .90 | 74LS259 | 2.80 |
| 74LS01 | .25 | 74LS124 | 2.95 | 74LS260 | .60 |
| 74LS02 | .25 | 74LS125 | .90 | 74LS261 | 2.45 |
| 74LS03 | .25 | 74LS126 | .80 | 74LS266 | .50 |
| 74LS04 | .25 | 74LS132 | .75 | 74LS273 | 1.60 |
| 74LS05 | .25 | 74LS136 | .50 | 74LS275 | 3.30 |
| 74LS08 | .30 | 74LS138 | .75 | 74LS279 | .50 |
| 74LS09 | .25 | 74LS139 | .75 | 74LS280 | 1.95 |
| 74LS10 | .25 | 74LS145 | 1.10 | 74LS283 | .95 |
| 74LS11 | .30 | 74LS147 | 2.25 | 74LS290 | 1.20 |
| 74LS12 | .30 | 74LS148 | 1.25 | 74LS293 | 1.80 |
| 74LS13 | .40 | 74LS151 | .75 | 74LS295 | 1.00 |
| 74LS14 | .75 | 74LS153 | .75 | 74LS298 | .95 |
| 74LS15 | .30 | 74LS155 | .90 | 74LS299 | 2.50 |
| 74LS20 | .25 | 74LS156 | .90 | 74LS323 | 3.95 |
| 74LS21 | .30 | 74LS157 | .75 | 74LS324 | 1.75 |
| 74LS22 | .25 | 74LS158 | .75 | 74LS347 | 1.95 |
| 74LS26 | .30 | 74LS160 | .90 | 74LS348 | 1.95 |
| 74LS27 | .35 | 74LS161 | .90 | 74LS352 | 1.50 |
| 74LS28 | .35 | 74LS162 | .90 | 74LS353 | 1.50 |
| 74LS30 | .25 | 74LS163 | .90 | 74LS353 | 1.35 |
| 74LS32 | .35 | 74LS164 | .90 | 74LS355 | .90 |
| 74LS35 | .55 | 74LS165 | .90 | 74LS366 | .90 |
| 74LS37 | .50 | 74LS166 | 2.00 | 74LS367 | .65 |
| 74LS38 | .35 | 74LS168 | 1.70 | 74LS368 | .85 |
| 74LS40 | .25 | 74LS169 | 1.70 | 74LS373 | 1.15 |
| 74LS42 | .50 | 74LS170 | 1.70 | 74LS374 | 1.75 |
| 74LS47 | .75 | 74LS173 | .75 | 74LS375 | .65 |
| 74LS48 | .75 | 74LS174 | .90 | 74LS377 | 1.40 |
| 74LS49 | .75 | 74LS175 | .90 | 74LS385 | 1.85 |
| 74LS51 | .25 | 74LS181 | 2.10 | 74LS386 | .60 |
| 74LS54 | .35 | 74LS189 | 9.95 | 74LS390 | 1.85 |
| 74LS55 | .35 | 74LS190 | .95 | 74LS393 | 1.85 |
| 74LS56 | 1.20 | 74LS191 | .95 | 74LS395 | 1.60 |
| 74LS73 | .35 | 74LS192 | .80 | 74LS399 | 1.65 |
| 74LS74 | .40 | 74LS193 | .90 | 74LS424 | 2.95 |
| 74LS75 | .50 | 74LS194 | .95 | 74LS447 | .35 |
| 74LS76 | .40 | 74LS195 | .90 | 74LS490 | 1.90 |
| 74LS78 | .50 | 74LS196 | .80 | 74LS630 | 75.00 |
| 74LS83 | .75 | 74LS197 | .80 | 74LS640 | 3.00 |
| 74LS85 | 1.10 | 74LS221 | 1.15 | 74LS641 | 3.00 |
| 74LS86 | .40 | 74LS240 | 1.15 | 74LS642 | 3.00 |
| 74LS90 | .60 | 74LS241 | 1.15 | 74LS645 | 3.00 |
| 74LS91 | .80 | 74LS242 | 1.85 | 74LS668 | 1.65 |
| 74LS92 | .65 | 74LS243 | 1.85 | 74LS669 | 1.85 |
| 74LS93 | .60 | 74LS244 | 1.00 | 74LS670 | 2.15 |
| 74LS96 | .80 | 74LS245 | 1.95 | 74LS674 | 9.60 |
| 74LS96 | .80 | 74LS247 | .75 | 74LS682 | 3.15 |
| 74LS107 | .40 | 74LS248 | 1.20 | 74LS683 | 2.25 |
| 74LS109 | .40 | 74LS249 | .95 | 74LS684 | 2.35 |
| 74LS112 | .40 | 74LS251 | 1.25 | 74LS685 | 2.35 |
| 74LS113 | .40 | 74LS253 | .80 | 74LS688 | 2.35 |
| 74LS114 | .50 | 74LS257 | .80 | 74LS689 | 2.35 |
| 74LS122 | .45 | 74LS258 | .80 | | |

74S00

| | | | |
|--------|------|--------|-------|
| 74S00 | .40 | 74S163 | 3.70 |
| 74S02 | .45 | 74S168 | 4.60 |
| 74S03 | .45 | 74S169 | 5.40 |
| 74S04 | .75 | 74S174 | 1.05 |
| 74S05 | .75 | 74S175 | 1.05 |
| 74S08 | .45 | 74S181 | 4.45 |
| 74S09 | .75 | 74S182 | 2.90 |
| 74S10 | .65 | 74S188 | 3.90 |
| 74S11 | .80 | 74S189 | 14.90 |
| 74S15 | .65 | 74S194 | 2.90 |
| 74S20 | .65 | 74S195 | 1.85 |
| 74S22 | .75 | 74S196 | 4.85 |
| 74S30 | .45 | 74S197 | 4.20 |
| 74S32 | .95 | 74S201 | 14.90 |
| 74S37 | 1.85 | 74S225 | 8.90 |
| 74S38 | 1.65 | 74S240 | 3.95 |
| 74S40 | .40 | 74S241 | 3.70 |
| 74S51 | .75 | 74S251 | 1.85 |
| 74S64 | .75 | 74S253 | 7.40 |
| 74S65 | 1.20 | 74S257 | 1.35 |
| 74S74 | .65 | 74S258 | 1.45 |
| 74S85 | 2.35 | 74S260 | 1.80 |
| 74S86 | 1.40 | 74S274 | 19.90 |
| 74S112 | 1.55 | 74S275 | 19.90 |
| 74S113 | 1.95 | 74S280 | 2.85 |
| 74S114 | 1.45 | 74S287 | 4.70 |
| 74S124 | 2.75 | 74S288 | 4.40 |
| 74S132 | 1.20 | 74S289 | 6.95 |
| 74S133 | .95 | 74S301 | 6.90 |
| 74S134 | .65 | 74S373 | 3.40 |
| 74S135 | 1.45 | 74S374 | 3.40 |
| 74S138 | 1.05 | 74S381 | 7.90 |
| 74S139 | 1.20 | 74S387 | 5.70 |
| 74S140 | 1.40 | 74S412 | 2.95 |
| 74S151 | 1.15 | 74S471 | 9.90 |
| 74S153 | 1.15 | 74S472 | 16.80 |
| 74S157 | 1.15 | 74S474 | 17.80 |
| 74S158 | 1.40 | 74S482 | 15.50 |
| 74S161 | 2.80 | 74S570 | 7.75 |
| 74S162 | 3.70 | 74S572 | 7.75 |

74C00 CMOS

| | | | |
|--------|------|--------|-------|
| 74C00 | .35 | 74C195 | 2.20 |
| 74C02 | .35 | 74C221 | 2.20 |
| 74C04 | .35 | 74C240 | 2.20 |
| 74C08 | .35 | 74C244 | 2.20 |
| 74C10 | .35 | 74C373 | 2.70 |
| 74C14 | 1.45 | 74C374 | 2.70 |
| 74C20 | .35 | 74C901 | .80 |
| 74C30 | .35 | 74C902 | .80 |
| 74C32 | .50 | 74C903 | .80 |
| 74C42 | 1.70 | 74C904 | .80 |
| 74C48 | 2.05 | 74C905 | 10.90 |
| 74C73 | .65 | 74C906 | .90 |
| 74C74 | .85 | 74C907 | .90 |
| 74C76 | 1.90 | 74C908 | 2.00 |
| 74C83 | 1.90 | 74C909 | 2.70 |
| 74C86 | .90 | 74C910 | 9.90 |
| 74C89 | 4.50 | 74C911 | 9.90 |
| 74C90 | 1.70 | 74C912 | 9.90 |
| 74C93 | 1.70 | 74C914 | 1.90 |
| 74C96 | 1.70 | 74C915 | 1.90 |
| 74C107 | .95 | 74C917 | 2.70 |
| 74C150 | 5.70 | 74C918 | 1.90 |
| 74C151 | 2.20 | 74C920 | 16.00 |
| 74C154 | 3.20 | 74C922 | 5.90 |
| 74C157 | 1.75 | 74C923 | 5.90 |
| 74C160 | 1.95 | 74C925 | 6.70 |
| 74C161 | 1.95 | 74C926 | 7.90 |
| 74C162 | 1.95 | 74C927 | 7.90 |
| 74C163 | 1.95 | 74C928 | 7.90 |
| 74C164 | 1.95 | 74C929 | 7.90 |
| 74C165 | 1.95 | 74C930 | 7.90 |
| 74C173 | 1.95 | 74C932 | 1.95 |
| 74C174 | 2.20 | 74C941 | 2.75 |
| 74C175 | 2.20 | 74C989 | 9.90 |
| 74C192 | 2.20 | 80C95 | .85 |
| 74C193 | 2.20 | 80C96 | .90 |
| 80C97 | .90 | 88C30 | 3.95 |
| 82C19 | 4.95 | 88C29 | 3.95 |

4000CMOS

| | | | | | |
|------|------|------|------|------|------|
| 4000 | .35 | 4040 | .95 | 4501 | .50 |
| 4001 | .35 | 4041 | .95 | 4502 | .95 |
| 4002 | .35 | 4042 | .75 | 4503 | .65 |
| 4006 | .95 | 4043 | .85 | 4505 | 8.95 |
| 4007 | .35 | 4044 | .85 | 4506 | 1.25 |
| 4008 | .95 | 4046 | .95 | 4507 | .95 |
| 4009 | .45 | 4047 | .95 | 4508 | 1.95 |
| 4010 | .45 | 4048 | .75 | 4510 | .95 |
| 4011 | .35 | 4049 | .55 | 4511 | .95 |
| 4012 | .35 | 4050 | .55 | 4512 | .95 |
| 4013 | .45 | 4051 | .95 | 4514 | 2.25 |
| 4014 | .95 | 4052 | .95 | 4515 | 2.25 |
| 4015 | .95 | 4053 | .95 | 4516 | 1.50 |
| 4016 | .45 | 4055 | 2.75 | 4518 | 1.25 |
| 4017 | .95 | 4056 | 2.75 | 4519 | 1.25 |
| 4018 | .95 | 4059 | 9.95 | 4520 | 1.25 |
| 4019 | .45 | 4060 | 1.25 | 4522 | 1.25 |
| 4020 | .95 | 4066 | .75 | 4526 | 1.25 |
| 4021 | .95 | 4068 | .40 | 4527 | 1.75 |
| 4022 | .95 | 4069 | .40 | 4528 | 1.25 |
| 4023 | .35 | 4070 | .40 | 4531 | .95 |
| 4024 | .75 | 4071 | .30 | 4532 | 1.75 |
| 4025 | .35 | 4072 | .30 | 4539 | 1.75 |
| 4026 | 1.95 | 4073 | .30 | 4543 | 1.95 |
| 4027 | .65 | 4075 | .30 | 4553 | 4.95 |
| 4028 | .80 | 4076 | .95 | 4555 | .95 |
| 4029 | .95 | 4078 | .50 | 4556 | .95 |
| 4030 | .45 | 4081 | .40 | 4558 | 2.25 |
| 4031 | 1.50 | 4082 | .40 | 4568 | 5.95 |
| 4032 | 2.75 | 4085 | .95 | 4581 | 1.95 |
| 4033 | 2.75 | 4086 | .95 | 4582 | 1.95 |
| 4034 | 2.75 | 4093 | .95 | 4584 | .95 |
| 4035 | .85 | 4094 | 3.95 | 4585 | .95 |
| 4037 | 2.50 | 4099 | 1.75 | 4702 | 9.95 |

LINEAR

| | | | | | |
|--------|------|--------|------|---------|------|
| 7805CT | .85 | LM301V | .75 | LM567V | 1.25 |
| 7812CT | .85 | LM308V | .75 | LM723 | .50 |
| 7815CT | .95 | LM309K | 1.50 | LM733 | .95 |
| | | LM311V | .60 | LM741V | .30 |
| | | LM317T | 1.90 | LM747 | .75 |
| 7805KT | 1.40 | LM317K | 3.75 | LM748V | .60 |
| 7812KT | 1.40 | LM318N | 1.50 | LM1414 | 1.50 |
| 7815KT | 1.40 | LM323K | 3.75 | LM1458V | .65 |
| 78L05 | .65 | LM324N | .60 | DS1488N | 1.00 |
| 78L12 | .65 | LM337K | 3.95 | DS1489D | 1.00 |
| 7905CT | .95 | LM339 | .75 | LM1889 | 2.45 |
| 7912CT | .95 | LM377 | 2.25 | LM3900 | .60 |
| 7915CT | 1.15 | LM380 | 1.25 | LM3909 | .90 |
| | | LM386V | 1.25 | LM3914 | 3.75 |
| | | | | LM3915 | 3.75 |
| 7905K | 1.50 | LM555V | .40 | LM3916 | 3.75 |
| 7912K | 1.50 | LM556 | .70 | DS75451 | .40 |
| 79L05 | .75 | LM565 | .95 | DS75452 | .40 |
| 79L12 | .75 | LM566V | 1.50 | DS75453 | .40 |
| 79L15 | .75 | | | | |

HANLEY ENGINEERING CORP

13400 Northrup Way #20

Bellevue, WA. 98005

1-800-426-2668

1-206-643-0792

Include 3.00 for Ups Ground

Include 4.00 for Ups Blue

Include 4.00 for 1st Class Mail

Washington State add 5.4% Sales Tax

16K Memory 8/\$16.00

4116 200NS

8200

| | |
|-----------|-------|
| 8155 | 11.25 |
| 8185 | 29.95 |
| 8202 | 45.00 |
| 8205 | 3.95 |
| 8212 | 1.90 |
| 8214 | 3.85 |
| 8216 | 1.80 |
| 8224 | 2.50 |
| 8226 | 1.80 |
| 8228 | 4.90 |
| 8238 | 4.90 |
| 8243 | 4.50 |
| 8251A | 5.45 |
| 8253 | 9.80 |
| 8255A - 5 | 5.20 |
| 8257 - 5 | 8.95 |
| 8259A | 6.95 |
| 8271 | 60.00 |
| 8272 | 39.95 |
| 8275 | 29.95 |
| 8279 - 5 | 10.00 |
| 8282 | 6.60 |
| 8283 | 6.60 |
| 8284A | 5.75 |
| 8286 | 6.60 |
| 8287 | 6.60 |
| 8288 | 25.00 |
| 8289 | 49.95 |
| 8755A | 45.00 |

Z80

| | |
|--------------|-------|
| Z80 | 6.70 |
| Z80A | 7.25 |
| Z80B | 19.00 |
| Z80 PIO | 6.00 |
| Z80A IO | 7.10 |
| Z80B PIO | 15.50 |
| Z80 CTC | 6.00 |
| Z80A CTC | 7.10 |
| Z80B CTC | 15.50 |
| Z80 DMA | 18.50 |
| Z80A DMA | 22.50 |
| Z80 SIO / 0 | 18.50 |
| Z80A SIO / 0 | 22.50 |
| Z80 SIO / 1 | 18.50 |
| Z80A SIO / 1 | 22.50 |
| Z80 SIO / 2 | 18.50 |
| Z80A SIO / 2 | 22.50 |

6800

| | |
|-------|-------|
| 3242 | 8.00 |
| 3480 | 9.00 |
| 6800 | 5.75 |
| 6802 | 11.00 |
| 6809 | 25.00 |
| 6810 | 3.50 |
| 6821 | 3.50 |
| 6840 | 9.00 |
| 6843 | 41.00 |
| 6845 | 22.00 |
| 6847 | 12.25 |
| 6850 | 3.50 |
| 6852 | 3.50 |
| 6875 | 7.00 |
| 6880 | 1.80 |
| 6882 | 4.70 |
| 6885 | 1.80 |
| 6888 | 1.80 |
| 6889 | 1.80 |
| 68488 | 12.50 |

6502

| | |
|-----------|-------|
| 6502 | 7.90 |
| 6502A | 10.00 |
| 6504 | 8.45 |
| 6504A | 9.30 |
| 6512 | 9.20 |
| 6512A | 10.00 |
| 6520 | 4.40 |
| 6521 | 6.15 |
| 6521A | 6.70 |
| 6522 | 8.75 |
| 6522A | 11.70 |
| 6532 | 11.25 |
| 6532A | 12.40 |
| 6545 - 1 | 22.50 |
| 6545A - 1 | 28.95 |
| 6551 | 11.95 |
| 6551A | 12.95 |

CPU

| | |
|-----------|-------|
| 8085A | 3.95 |
| 8085A | 8.95 |
| 8085A - 2 | 11.95 |
| 8086 | 99.95 |
| 8088 | 39.95 |
| 8748 | 30.00 |

CALL
HANLEY FIRST
800-426-2668
206-643-0792

EPROMS

| | | | | |
|-----------|-----------|----------|-------|-------|
| 2708 | AMD | 3 Supply | 45ONS | 3.50 |
| 2716 | Hitachi | +5 | 45ONS | 7.00 |
| 2716 | National | +5 | 45ONS | 7.00 |
| 2716 | Intel | +5 | 45ONS | 7.00 |
| 2716-1 | Intel | +5 | 35ONS | 9.50 |
| 2716 | T.I. | 3 Supply | 45ONS | 7.50 |
| 2716 | Motorola | 3 Supply | 45ONS | 7.50 |
| 2732 | NEC | +5 | 45ONS | 16.00 |
| 2732 | Mitsubish | +5 | 45ONS | 16.00 |
| 2732 | Intel | +5 | 45ONS | 17.00 |
| 7232A | Intel | +5 | 25ONS | 17.00 |
| 2732A - 3 | Intel | +5 | 30ONS | 16.00 |
| 2732A - 2 | Intel | +5 | 20ONS | 20.00 |
| 2532 | Hitachi | +5 | 45ONS | 18.00 |

AUGAT LOW PROFILE SOCKETS

These Are High Reliability Industry Standard Sockets

| | | |
|-------|-----------|-----|
| 8PIN | 208-AG29D | .10 |
| 8PIN | 208-AG29D | .10 |
| 14PIN | 214-AG29D | .16 |
| 16PIN | 216-AG29D | .18 |
| 18PIN | 218-AG29D | .20 |
| 20PIN | 220-AG29D | .22 |
| 22PIN | 222-AG29D | .24 |
| 24PIN | 224-AG29D | .26 |
| 28PIN | 228-AG29D | .28 |
| 40PIN | 240-AG29D | .42 |

4K x 1 STATIC RAM

MOTOROLA MCM6641-20
4044-200NS EQUIV.

\$4.50

4164
64 x 1
200 NS
CALL

SOLID STATE SCIENTIFIC

256 x 4 CMOS RAM 45ONS
SCM5101E-1

\$3.75

HITACHI

2K x 8 CMOS RAM 150NS
Pin Compatible with 2716
HM6116P-3 CALL

HANLEY ENGINEERING CORP

13400 Northrup Way #20
Bellevue, WA. 98005
1-800-426-2668
1-206-643-0792

Include 3.00 for Ups Ground
Include 4.00 for Ups Blue
Include 4.00 for 1st Class Mail
Washington State add 5.4% Sales Tax

Unclassified Ads

FOR SALE: H-B. serial I/O board. 20 K programmable memory. Extended BASIC. and all documentation. \$500. 10% with balance COD. M H Endres. Box 8. Spint Lake ID 83869. (208) 623-5911.

FOR SALE: Slightly used Apple II disk drive without controller. Less than 6 months old. \$250 or best offer. Bill Werthing. 14 Rego Ave. Centereach NY 11720.

FOR SALE: Complete system: IMSAI 8080 computer with 64 K memory, Lear-Siegler ADM-3 terminal, and Altair disk drive. Good condition. Best offer on all three. Jim Fritz. 1413 Harmony Ln. Annapolis MD 21401. (301) 757-7019.

WANTED: Complete documentation for Digital Systems DSC-2 microprocessor and disk. Texas Instruments TI-810 printer, and ADM-3A terminal. All missing when purchased at auction. Also, need information on adding lowercase to printer and display. Please state price in letter. N C Heimkay. POB 446. Milliken Ontario. LOH 1K0 Canada. (416) 297-4337 after 6 PM ET.

FOR SALE: Complete Space Invaders board set, including power-supply board (the arcade version). An 8080A-based computer with high-resolution composite video output and extensive sound-synthesizing capability. No read-only memories—needs 2716, 2708, or equivalent. Full schematic included. Program listing available. \$150. Send check or SASE for more information. Rom Mahboubi. 910 S Orange Ave. Short Hills NJ 07078.

FOR SALE: IBM 3275 Model 2 display terminal with keyboard and documentation. Excellent condition. \$1200. B Pekey. (305) 862-0875.

FOR SALE: ASR33 Teletype with paper-tape reader/punch, modem, touch-tone telephone pad, and stand. \$425. Altair 8800A computer with S-100 bus, 24 K programmable memory, and serial/parallel I/O: \$550. Heathkit IM-16 voltmeter: \$18. TRW MPY-16 high-speed 16-bit by 16-bit multiplier chip: \$40. Lenny Heath. 6618-D Lake Hill Dr. Raleigh NC 27609. (919) 876-4168.

FOR SALE: Heath H-14 printer. Like new. \$400 plus shipping. Dr Walt Atkins. Otrs 4410A, USAF Academy CO 80840. (303) 472-1362.

FOR SALE: 32 K TRS-80 Model I with TRS-80 disk drive and TRSDOS. Includes all manuals, cassette player, all cables, and TRS-80 Editor/Assembler. Other software includes Space Invaders and other games. \$1800. Robert Topping. 17 Cognac Dr. Lake Saint Louis MO 63367.

FOR SALE: Brand-new SD Systems SBC-200 single-board computer and SD Systems Versafloppy II disk controller. Assembled and tested by SD Systems. Total list price is \$840. Will sell for \$600 if purchased together. James Adams. 6405 Maryland Ave. Hammond IN 46323. (219) 844-4691. No collect calls accepted.

FOR SALE: New original package: LOBOS 8-inch dual-drive cabinet plus power supply. Technico TI9900, 16-bit processor system, 64 K programmable memory, disk-controller board, DOS, 3.0 Super BASIC plus EAL. Perfect operating condition. Full documentation and schematics. \$3500 or best offer. Sam White. 643 Indiana Ave. Venice CA 90291. (213) 549-2500 or 396-0936.

FOR SALE: BYTE #1 thru August 1979. 48 issues; \$100 or best offer. Extra BYTES #1 thru #4; best offer. KiloBaud Microcomputing #1 thru August 1978. 20 issues; \$50 or best offer. Extra KiloBaud Microcomputing #1 thru #5; best offer. HP-524D counter. \$25C 100 thru 500 MHz. \$25A 10 thru 100 MHz. \$26A video amplifier. \$26C period multiplier, plug-ins, manuals, used as laboratory standard; best reasonable offer. Sandy Frazier. 5325 Curry Ford Rd #A203. Orlando FL 32806.

WANTED: A source of programs on Tarbell cassettes. I've just bought a Tarbell interface board to act as archival storage, and want to correspond with a Tarbell users group or an individual with programs to sell or trade. Has anybody interfaced the Tarbell board to the Mega tape system. ALPHA-1, using the S-100 bus? I would like to hear from you. Duane L Erwin. 335 S Wabash. Bradley IL 60915. (815) 933-7566 days.

WANTED: Computer Music Journal back issues: volume 1, numbers 1, 2, and 4. John Valente. Box 9, Marlboro VT 05344.

WANTED: Used Apple II disk drive (DOS 3.3) with controller card. Give price and all pertinent details. Michael Levin. 18 Peacock Farm Rd. Lexington MA 02173. (617) 862-5134 collect.

FOR SALE: Model ASR33 teletypewriter. Extra ribbons and paper. Manuals and schematics. \$450. Will deliver within 200 miles of Alamogordo. David L Marshall. 1803 Scenic Dr. Alamogordo NM 88310. (505) 437-6374.

WANTED: A Digital Group Systems digital cassette drive (Phi-Deck). It should be in good condition with the original connectors, and in the range of \$50 to \$100. Send name, phone, hours you can be reached, and price. Brad Manske. 1315 W 5th. North Platte NE 69101.

FOR SALE: Heath-89 48 K programmable memory, serial interface board, one floppy, HDOS plus Heath BASIC and assembly-language programming courses, and extras. \$1900. John Guerrero. 172 Ludlam Ave. Elmont NY 11003. (516) 354-1797.

FOR SALE: KIM-1 microcomputer with manuals and power supply: \$125. KIM 6502 software (books, games, applications): \$20. 77-key ASCII-encoded, word-processing keyboard. Excellent condition, documentation included; \$45. Mark Beall. 2505 Manorwood Dr. Puyallup WA 98371.

FOR SALE: Word processor/text editor for North Star. Includes utility programs with documentation on disk. Needs only 24 K, BASIC, and one disk. Easy-to-use line-oriented editor works with any ASCII terminal, including Teletype or CRT. Word processor allows commands in the file, and chaining to other text files, like subroutines in a program. \$30. Mark Arnold. 1400 Grand Ave. Laramie WY 82070.

FOR SALE: Commodore PET 2001 computer. Original 8 K version with video buffer and twelve program tapes, including Microchess 2.0. \$500. Floyd Wilson. 903 W Sweet Ave. Bismarck ND 58501. (701) 258-9023.

FOR SALE: MicroAce ZX80 2 K (like Sinclair) with manual (Sinclair manual, too) and power pack in original box. Works good. Fantastic for the beginner learning BASIC or the experienced Z80 machine-language programmer. First money order for \$129 takes it. M Neldich. 18 Hillside Ln N. Syosset NY 11791. (516) 921-3603.

FOR SALE: Integer firmware card for Apple II plus. Includes Programmer's Aid No. 1; \$100. Fred M Gentile. 10182 Valley Forge Dr. Huntington Beach CA 92646. (714) 962-8447.

FOR SALE: AJ B41 terminal. IBM 2741 equivalent with acoustic coupler. Like new. Recently factory adjusted. 15-inch wide plates. Very high-quality Selectric mechanism. \$840. R Dobbs. 1746 Clarkson Rd #G. Richmond VA 23224.

SWAP: TRS-80 Model I. Color, or Model III cassette programs. Games, information processing, and machine-language monitor. No business or education. Also, have M3 machine-language utilities and programs. Send cassette with a few of your programs and your needs (500 bps for I and III) and I will return it with the best of mine. Would also like information on your M3 disk experiences. Steve Kolokowsky. 8 Wilson Ct. Spring Valley NY 10977.

FOR SALE: Heath H-14 printer. Nearly new. Calibrated at a Heath center. \$490. Neal De Loya. Rte 1. Onalaska WI 54650. (608) 783-7767 evenings.

FOR SALE: Ithaca Intersystems Z80-based S-100 processor board. Socketed, populated (on-board 2708 1 K EPROM included), assembled and tested: \$110. S-100 8 K Ithaca Intersystems static-memory board. Uses 2102 chips, fully socketed. 2 K populated: \$60. Parallel ASCII keyboard. Assembled and tested, in chassis with power supply. TTL parallel ASCII output with data-valid strobe: \$60. Highest bidder takes. Send SASE. Roy Makrucki. 251 Pleasant Ridge Dr. Saine MI 48176. (313) 429-1286.

WANTED: Hewlett-Packard HP-97 calculator. H Verhoeven. Box 4636. Mountain View CA 94040.

FOR SALE: Quest Super ELF with low-address display option. \$85. Glenn Andreas. Rte 1-7600 Hwy D East. Lake Tomahawk WI 54539.

FOR SALE: 10 MHz 8086 processor. \$60. Intersil IM6100 Family Sampler (PDP-B with 1 K read-only memory monitor, 256 words programmable memory, serial I/O): \$50. Programmable/EPROM memories (eight 4 K by 1 programmable memories, six 2716 and one 2708 EPROMs): \$75. IC grab bag (forty-five 7400 series digital, ten op amps, voltage regulators, seven segment LEDs): \$15. Gregg Marshall. 967 Almond Dr. Oakley CA 94598.

FOR SALE: VDB-8024 video board. S-100, assembled and tested. 80 columns by 24 lines. Video enhancements include scroll, tab, reverse, blinking, and underline. Protect feature. 32 special characters, including Greek and math symbols. Addressable cursor. Very fast. Complete documentation included. Still under warranty. \$275 plus COD. Tom Kirby. 318 W Clay. Blacksburg VA 24060.

FOR SALE: Alpha Micro computer system: AM100 64 K processor, SOROC IO 120 terminal, AM200 floppy-disk controller board. AM300 G port serial I/O mux. Wangco/Orbis B7 dual-disk drive, TI-810 serial printer. Business software available. Best offer. Ron Bogaards. 108 Peace St. Pella IA 50219. (515) 628-9295.

FOR SALE: SwTPC 6B/2, two serial, one parallel. 20 K programmable memory, 4 K EPROM, EPROM programmer and eraser, JPC cassette interface and recorder, CFM, two memory-mapped video boards, lots of software, and twenty cassettes. In excellent condition with complete documentation for \$600. Also, AC-30: \$75. Send SASE for more details. Joe Williams. 2780 Janiteil Rd. Colorado Springs CO 80906. (303) 599-4828 or 473-8060 evenings.

FOR SALE: S-100 boards: TDL Z80 ZPU, SMB1, SMB2, parallel I/O (4 ports), four 16 K programmable memories, Jade Z80 4 MHz, \$50 each. KIM-1 system: 40 K, ASCII keyboard, TV interface, power supply, software, and BASIC. \$160. Jade: two 8-inch dual-disk/double-density controller drives, PROM boot, CP/M 2.2, cabinet, power supply, cables, manuals, system disks, and utilities. For S-100. Used approximately two hours. Cost \$1400. Sell \$700. Send money order or cashier's check and phone number (confirmation of sale). Brian Graves. Abbot Hill Rd. Wilton NH 03086.

UNCLASSIFIED POLICY: Readers who are soliciting or giving advice, or who have equipment to buy, sell or swap should send in a clearly typed notice to that effect. To be considered for publication, an advertisement must be clearly noncommercial, typed double spaced on plain white paper, contain 75 words or less, and include complete name and address information.

These notices are free of charge and will be printed one time only on a space available basis. Notices can be accepted from individuals or bona fide computer users clubs only. We can engage in no correspondence on these and your confirmation of placement is appearance in an issue of BYTE.

Please note that it may take three or four months for an ad to appear in the magazine.

Reader Service

| Inquiry No. | Page No. | Inquiry No. | Page No. | Inquiry No. | Page No. | Inquiry No. | Page No. |
|-------------|------------------------------|-------------|-----------------------------|-------------|----------------------------|-------------|-----------------------------|
| 1 | 47th STREET PHOTO 437 | 84 | COMPUTER FURN. & ACCSS. 421 | 165 | HAPPY HANDS 386 | 247 | MINI MICRO MART 499 |
| 2 | A B DIGITAL DESIGN 55 | 85 | COMPUTER MAIL ORDER 289 | 166 | HAYDEN BOOK CO INC 363 | 249 | MORROW DESIGNS 184, 185 |
| 3 | AB COMPUTERS 495 | 86 | COMPUTER PLUS 496 | 167 | HAYES MICROCOMP.PROD. 161 | 250 | MOUNTAIN COMPUTER 19 |
| 4 | ABM PRODUCTS 424 | 87 | COMPUTER SHOPPER 445 | * | HEATH COMPANY 16, 17, 217 | 251 | MOUNTAIN VIEW PRESS 229 |
| 5 | ACKERMAN DIGITAL SYS 58 | 88 | COMPUTER SPCLTIES. 100, 101 | 168 | HEWLETT-PACKARD 137 | 252 | MPI 267 |
| * | ACTION COMPUTER 167 | 89 | COMPUTER STOP, THE 483 | 169 | HOUSTON INSTRUMENTS 49 | 253 | MSD 380 |
| 6 | ADAPTIVE DATA & ENERGY 145 | * | COMPUTER WRHSE. 123 | 170 | HOUSTON INSTRUMENTS 49 | 254 | MT MICROSYSTEMS 80 |
| 7 | ADDMASTER CORP. 504 | 90 | COMPUTERS ETC. 409 | 171 | HOWE SOFTWARE 498 | 255 | MT MICROSYSTEMS 81 |
| 8 | ADV.COMP.PROD. 514, 515 | 91 | COMPUTERS ETC. 418 | 172 | I.B.C. 188 | 256 | MTI 425 |
| 9 | ADV.MICRO SYS. 66 | 92 | COMPUTERS ETC. 450 | 426 | IMS INT'L. 67 | 257 | MULTI BUSN.COMP.INC. 414 |
| 10 | ADV.OPERATING SYS. 143 | 93 | COMPUTERS PERIPH.UNLTD 395 | 174 | INFOSOURCE,INC. 128 | 258 | MUSE COMPANY 362 |
| 11 | ADVANCED TECH 494 | 94 | COMPUTERS WHOLESale 485 | 175 | INMAC 386 | 259 | NAT'L DATA SUPPLIES 492 |
| 12 | ADVENTURE INT'L. 117 | 95 | COMPUTERWARE 338 | 176 | INNER ACCESS 504 | 260 | NATIONAL TRICOR 422 |
| * | ALF PRODUCTS, INC 382 | 96 | COMPUTEX CORP 254 | 177 | INNOVATIVE PROD. 312 | 261 | NEBS 344 |
| 13 | ALPHA BYTE STORAGE 51 | 97 | COMPUTIQUE 337 | 178 | INNOVATIVE SFTW.APPL. 72 | 262 | NEC AMERICA 95 |
| 14 | ALPHA BYTE STORAGE 124, 125 | 412 | COMPUIVIEW PROD.INC. 68 | 179 | INSOFT CORP. 53 | 263 | NECCO 227 |
| 15 | ALSPA COMP.SYS. 496 | 413 | COMPUIVIEW PROD.INC. 68 | 180 | INTEGRAL DATA SYS. 63 | 264 | NET PROFIT COMP. 90 |
| 17 | ALTOS COMP.SYS. 88, 89 | 98 | COMPUIVIEW PROD.INC. 69 | 181 | INTEGRAND 384 | * | NETRONICS 228, 230, 346 |
| 428 | AMERICAN COMP. & ENG 107 | 99 | CONCOMP IND. 371 | 405 | INTEL 152, 153 | 266 | NORTH AMER TECH 82 |
| 18 | AMDEK CORP. 162 | 399 | CONCOMP IND. 384 | 183 | INTERTEC DATA SYS. 175 | 267 | NORTH AMER TECH 116 |
| 19 | AMER.COMP.EXCH. 494 | 101 | CONCORD COMP.PROD. 435 | 184 | IPEX INT'L. 494 | 268 | NORTH STAR COMPUTERS 105 |
| * | AMER.SFTW.CLUB 219 | 102 | CONSUMER COMP. 148, 149 | 185 | ITHACA INTERSYSTEMS 8, 9 | 269 | NORTHWEST INSTR.SYS. 438 |
| 21 | AMER.SQUARE COMP. 237 | 103 | CONSUMER COMP. 503 | 186 | ITHACA INTERSYSTEMS 239 | 270 | NOVATION 245 |
| 22 | ANCIE LABS 106 | 105 | COVER CRAFT 220 | 187 | JADE COMP.PROD. 506, 507 | 422 | NOVELL 339 |
| 23 | ANCRONA 222 | 106 | CPI 134 | 188 | JADE COMP.PROD. 508 | * | NRI SCHOOLS ELECTR.DIV. 305 |
| 24 | ANDERSON JACOBSON 440 | 107 | CPU SHOP, THE 479 | 189 | JAMECO ELECTR. 516, 517 | * | OASIS SYSTEMS 418 |
| 25 | ANTEX DATA SYS. 130 | 108 | CROMEMCO CII. 1 | 190 | JDR MICRODEVICES 522, 523 | 271 | OHIO SCIENTIFIC INSTR. C IV |
| 26 | APPARAT INC 129 | 109 | CROMEMCO 2 | 191 | JIM-PAK 497 | 272 | OKIDATA CORP. 205 |
| 27 | APPARAT INC 327 | * | CYBERNETICS, INC. 293 | 192 | KADAK PRODUCTS 196 | 273 | OLYMPIC SALES 451 |
| * | APPLE COMPUTER INC 12 | 407 | D & W DIGITAL 174 | * | KENGORE CORP. 496 | 276 | OMEGA MICROWARE,INC. 444 |
| 28 | APPLE COMPUTER INC 13 | * | DATA DISCOUNT CTR 416 | 421 | KRAMER SYS.INT'L 399 | 275 | OMEGA SALES 322, 323 |
| 425 | APPLE COMPUTER INC 13 | 111 | DATAFACE 28 | 193 | KV 33 494 | 277 | OMNI RESOURCES 85 |
| 29 | APPLIED ANALYTICS 132 | * | DATASAB 246 | 194 | L & S 502 | 278 | OMNITEC DATA 377 |
| 30 | ARTIFICIAL INT'L RESRCH 494 | 414 | DATASOFT 355 | 195 | LABORATORY MICROSYS. 496 | 279 | ORACLE ELECTR. 504 |
| 31 | ASAP COMP.PROD.INC. 314, 315 | 112 | DATASOUTH COMP.CORP. 159 | 196 | LEADING EDGE PROD CIII | 280 | ORANGE MICRO 157 |
| 32 | ASAP COMP.PROD.INC. 345 | 113 | DATASOUTH COMP.CORP. 348 | 197 | LEAPAC SERVICES 358 | 281 | ORANGE MICRO 279 |
| 33 | ASHTON-TATE 282, 283 | 114 | DELTA PRODUCTS 275 | 198 | LIFEBOAT ASSOC. 213 | 282 | ORION INSTRUMENTS 492 |
| 427 | ATLANTIC COMPUTER. IND. 336 | 117 | DESIGNER SOFTWARE 103 | 199 | LIFEBOAT ASSOC. 341 | 283 | ORTHOCODE GROUP 408 |
| 34 | ATARI 347 | * | DFS COMP.FORMS 286 | 200 | LIFEBOAT ASSOC. 361 | 284 | OSBORNE COMPUTERS 33 |
| 35 | ATARI,INC. 61 | 118 | DIABLO SYS INC 261 | 201 | LNW RESEARCH 285 | 285 | OSBORNE/MCGRAW-HILL 76, 77 |
| 16 | ATON INT'L. 142 | 119 | DIGIAC CORP 387 | 202 | LOGICAL DEVICES 492 | * | OWENS ASSOC. 138, 139 |
| 418 | AURORA 371 | 120 | DIGITAL ELECT.SYS. 164 | 203 | LOGO COMP.SYS. 365 | 286 | PACIFIC COMP BRK. 198 |
| 36 | AUTOCONTROL INC 210 | 121 | DIGITAL GRAPHIC SYS 302 | 204 | LOMAS DATA PRODUCTS 441 | 287 | PACIFIC EXCHANGES 396 |
| 37 | AUTOMATED CONTR.SYS. 500 | 122 | DIGITAL MARKETING 6 | 205 | LYBEN COMP.SYS. 498 | 288 | PACIFIC EXCHANGES 492 |
| 38 | AUTOMATED EQUIPMNT. 433 | 123 | DIGITAL MARKETING 307 | 206 | MACROTRONICS 492 | 289 | PACIFIC EXCHANGES 496 |
| 39 | AUTOMATED EQUIPMNT. 457 | 124 | DIGITAL RESEARCH 171 | 207 | MACROTRONICS 502 | 290 | PACIFIC EXCHANGES 498 |
| * | AVOCET 224 | 125 | DIGITAL RESEARCH 377 | 208 | MAGNOLIA MICROSYS. 469 | 291 | PAGE DIGITAL 512, 513 |
| 40 | B&B ELECTR. 496 | * | DIGITAL RESEARCH COMP. 493 | 209 | MALIBU ELECTR. CORP. 215 | 292 | PALOMAR COMP.EQUIP. 247 |
| 41 | BASF SYSTEMS 303 | 126 | DILITHIUM PRESS 453 | 210 | MARKETLINE SYS INC 390 | 293 | PAN AMERICAN ELEC INC. 258 |
| * | BELL,JOHN ENGL. 481 | 127 | DISC/3 MART INC. 380 | 211 | MARTEC 373 | 294 | PASSWORD DISTR. 311 |
| * | BETA COMP.DEVICES 259 | 128 | DISCOUNT SFTW.GRP,THE 274 | 212 | MARYMAC INDUSTRIES 112 | 295 | PCD SYSTEMS INC. 24 |
| 43 | BISON PRODUCTS 491 | * | DISK SUPPLY 442 | 213 | MASTER ELECTR. INC. 238 | 296 | PEACHTREE SOFTWARE 190 |
| 44 | BIZCOMP 301 | 129 | DISKONNECTION, THE 504 | 214 | MAXELL DATA PRODUCTS 287 | * | PERCOM DATA 7, 14, 15 |
| 45 | BLUE LAKES COMPUTING 296 | 130 | DUAL SYS.CONTROL CORP. 60 | * | MCGRAW-HILL BOOK CO. 225 | 297 | PERSONAL COMPUTERS 423 |
| 46 | BOURBON ST PRESS 450 | 131 | DUAL SYS.CONTROL CORP. 62 | * | MCGRAW-HILL BOOK CO. 268 | 406 | PHASE ONE SYS. INC. 329 |
| 47 | BOWER-STEWART 494 | 132 | DUAL SYS.CONTROL CORP. 64 | * | MCGRAW-HILL BOOK CO. 465 | 298 | PICKLES & TROUT 366 |
| 49 | BUSINESS OPERTING SYS 27 | 133 | DUOSOFT CORP. 181 | 215 | MEADE'S DATA SYS. 500 | 299 | PKAY CORP. 500 |
| 50 | BUSINESS WEEK 281 | 140 | DUPRE ENTERPRISES,INC. 397 | 216 | MEAS.SYS. & CONTROLS 29 | 300 | POLY PAKS 494 |
| * | BYTE BOOKS 233 | 134 | DYMARC IND. 393 | * | MEAS.SYS. & CONTROLS 31 | * | POPULAR COMPUTING 240 |
| 51 | BYTE BOOKS 234 | 135 | DYNACOMP 330, 331 | * | MEDIAMIX 98 | 301 | POWER ONE INC. 179 |
| 52 | BYTE BOOKS 235 | 137 | ECOSOFT 292 | 217 | MENTOR SOFTWARE 494 | 302 | PRIME SOURCE 133 |
| 53 | BYTE BOOKS 236 | 138 | EDMUND SCIENTIFIC CO 180 | 218 | MERRIMACK SYSTEMS 260 | 303 | PRIME SOURCE 141 |
| * | BYTE PUBL,INC. 398 | 139 | ELECTROLABS 490 | 219 | META TECHNOLOGIES 470 | 304 | PRIME SOURCE 197 |
| * | C.S.MARKETING 165 | 141 | ELECTRONIC CONTROL 270 | 220 | MICRO AGE COMP.STORE 169 | 417 | PRIORITY ONE 487 |
| 61 | CALIF.COMP.SYS 91 | 141 | ELECTRONIC SPOLISTS 391 | 221 | MICRO BUSN. ASSOC. 373 | 305 | PRIORITY ONE 518, 519 |
| 54 | CALIF. DATA CORP 492 | 142 | ELECTRONIC SYS.FURN 420 | 222 | MICRO BUSN. WORLD 295 | 306 | PRIORITY ONE 520, 521 |
| 55 | CALIF. DIGITAL 509, 510 | 143 | ELECTRONICS CENTER 488 | 222 | MICRO COM 353 | 307 | PROGRAMMERS SFTW EX. 498 |
| 56 | CALIF. DIGITAL 511 | 416 | ELECTROVALUE 260 | 223 | MICRO COMP.DISC.CO. 426 | 411 | PROGRAMS ULTD 186 |
| * | CALIF.MICROCOMP. 369 | 410 | EMPIRE SYS.CORP 502 | 224 | MICRO COMP.DISTR. 394 | 308 | PROTECTO ENTERPR. 498 |
| 58 | CAMBRIDGE UNIV.PRESS 358 | 144 | EMPIRICAL RESRCH GRP. 502 | 225 | MICRO DATA BASE SYS 109 | 309 | PURCHASING AGENT,THE 78 |
| 59 | CAMECO ELECTR,INC 119 | 145 | EMPIRICAL RESRCH GRP. 504 | 226 | MICRO FOCUS 97 | 310 | QUALITY COMP.PARTS 492 |
| 60 | CAMRODEN CO.,THE 502 | * | END USER SOFTWARE 350 | 227 | MICRO HOUSE 73 | 311 | QUALITY SOFTWARE 340 |
| * | CARRINGTON CO.,THE 502 | 147 | EQUON AMERICA 297 | 227 | MICRO MANAGEMENT SYS. 449 | 312 | QUALITY SOFTWARE 387 |
| 62 | CDR 498 | 148 | EQUITABLE MONEY MRK. 447 | 428 | MICRO MINT 107 | 313 | QUASAR DATA PROD,INC. 221 |
| 81 | CDS 354 | * | ESCON 398 | 228 | MICRO PRO INT'L. 241 | 314 | QUAY CORP 309 |
| 63 | CER-TEK INC 502 | 149 | ESSEX PUBLISHING 390 | 229 | MICRO WORKS, THE 212 | 315 | QUEST ELECTR. 501 |
| 64 | CHECK-MATE 496 | 150 | EXPOTEK 439 | 230 | MICROACE 461 | 316 | R.C.ELECTRONICS 96 |
| 65 | CHECKS-TO-GO 118 | * | FAIRCROM 256 | 231 | MICROCOMP.TECH,INC. 313 | 317 | R.P.SOFTWARE 338 |
| 66 | CHIPS & DALE 500 | 151 | FARNSWORTH COMP.CTR. 374 | 232 | MICROCOMPUTER APP. 388 | 318 | RACET COMPUTES 320 |
| 67 | CHRISLIN INDUSTRIES 271 | 152 | FINANCIAL SFTW.SYS. 502 | 233 | MICROCOMPT SYZ 298 | 319 | RADIO SHACK 57 |
| 68 | CMC,INT'L. 389 | 153 | FORETHOUGHT PRODUCTS 364 | 234 | MICROEMAIL 218 | 320 | RADIO SHACK-GLNW.SPR. 368 |
| 69 | CODE WORKS,THE 122 | 154 | FREDERICK COMP.PROD. 431 | 235 | MICROMATE ELECTR,INC. 432 | 321 | RADIO SHCK FRNC.#7079 192 |
| 70 | COLONEY PRODUCTIONS 443 | 155 | FSS 496 | * | MICROMPERIPH.CORP,THE 500 | * | RANDOM HOUSE 411 |
| 71 | COLONIAL DATA SERVICE 362 | 274 | FUTRA 317 | 236 | MICROSETTE INC. 232 | 322 | RCA 48 |
| 73 | COMPILER SYS,INC 335 | 156 | FYI INC. 496 | 237 | MICROSOFT (CPD) 191 | 323 | RCE ELECTR. 490 |
| 74 | COMPONENTS EXPRESS 360 | 157 | GEORGIA EXEC.MICRO 294 | 238 | MICROSOFT (CPD) 199 | 324 | ROBOTICS AGE 369 |
| 75 | COMPUDIAL,INC. 104 | 158 | GIMIX INC 46 | 239 | MICROSTUF,INC. 18 | 325 | S C DIGITAL 396 |
| 76 | COMPUMART 120, 121 | 159 | GIMIX INC 492 | 240 | MICROTAX 216 | 429 | S & M SYSTEMS 399 |
| 78 | COMPUPRO/GODBOU 203 | 160 | GRAFFCOM SYS. 20 | 241 | MICROTECH EXPORTS 397 | 326 | S-100 INC 388 |
| 77 | COMPUPRO/GODBOU 248, 249 | 161 | H & E COMPUTRONICS 255 | 242 | MIDDLETON,WILSON 500 | 327 | SCIENTIFIC SFTW.PROD 494 |
| 79 | COMPUERVE 262, 263 | 162 | H & E COMPUTRONICS 257 | 243 | MIKOS 488 | 328 | SCION CORP 5 |
| 80 | COMPUTER AGE 434 | 163 | HANDICRAFTS 504 | 244 | MILLER MICROCOMP.SERV. 415 | 329 | SCITRONICS 410 |
| 82 | COMPUTER DISC.OF AM. 272 | 164 | HANLEY ENGNRING 524, 525 | 245 | MINI MICROCOMP SFTW 111 | * | SCOTSDALE SYSTEMS 30 |
| 83 | COMPUTER EXCHANGE 276, 277 | | | 246 | MINI COMP.SUPPLIERS 374 | 330 | SCR ELECTR. 260 |
| | | | | | | 430 | SEABIRD PRESS, THE 504 |
| | | | | | | 331 | SEATTLE COMP PRODS 349 |
| | | | | | | 332 | SELECT INFO SYS. 325 |
| | | | | | | 404 | SGL WABER 502 |
| | | | | | | 334 | SHOPSMITH 359 |
| | | | | | | 335 | SIERRA DATA SCIENCES 410 |
| | | | | | | 336 | SIRIUS SOFTWARE 500 |
| | | | | | | 337 | SLUDER 500 |
| | | | | | | 341 | SOFTTECH MICROSYS 333 |
| | | | | | | 342 | SOFTWARE HOWS 113 |
| | | | | | | 343 | SOFTWARE PROD,INT'L. 201 |
| | | | | | | 333 | SFTW TECH FOR COMP. 251 |

To get further information on the products advertising in BYTE, fill out the reader service card with your name and address. Then circle the appropriate numbers for the advertisers you select from the list. Add an 18-cent stamp to the card, then drop it in the mail. Not only do you gain information, but our advertisers are encouraged to use the marketplace provided by BYTE. This helps us bring you a bigger BYTE. The index is provided as an additional service by the publisher, who assumes no liability for errors or omissions. *Correspond directly with company.

Reader Service

| Inquiry No. | Page No. | Inquiry No. | Page No. | Inquiry No. | Page No. | Inquiry No. | Page No. |
|-------------------------------|----------|-----------------------------|----------|--------------------------------|----------|-------------------------------|----------|
| * SOLID STATE SALES 401 | | 357 SZ SOFTWARE SYSTEMS 469 | | 370 TRANSNET CORP. 368 | | 386 VISIBLE COMP.SUPPLY 280 | |
| 344 SORCIM 135 | | 358 TARBELL ELECTR. 273 | | 371 TRANSWAVE CORP. 177 | | 389 VISTA COMPUTER CO 193 | |
| 345 SORRENTO VALLEY ASSOC 343 | | 359 TECH.MICRO SYS. 500 | | 403 TRINITY GROUP 492 | | * VOTRAX 194 | |
| 346 SPECIALIZED BUSN SYS 178 | | * TECHNICAL SYS CONS 21 | | 372 TSD DISPLAY PROD. 22 | | 401 VR DATA 442 | |
| 347 SPECTRUM SOFTWARE 319 | | 360 TECMAR INC 357 | | 373 TSE/HARDSIDE 405 | | 390 WASHINGTON COMP.SERV. 489 | |
| 348 SSM MICRO COMP PROD 11 | | 361 TEI,INC 59 | | 374 U.S. MICRO SALES 351 | | 391 * WESTERN WARES 504 | |
| 408 STATCOM CORP. 71 | | 362 TEI,INC 207 | | 375 U.S. MICRO SALES 477 | | * WESTICO INC. 115, 498 | |
| 350 STATIC MEMORY SYS 211 | | 363 TELEVIDEO INC 183 | | 376 U.S. ROBOTICS 367 | | 415 * WESTWARE 223 | |
| 400 STELLAR SYSTEMS 226 | | 364 TERMINAL DATA SYS. 498 | | * UNITED SFTW OF AM 299 | | * WHITESMITHS LTD 99 | |
| 351 STRUCTURED SYS.GRP. 35 | | 365 TEXAS COMP.SYS. 379 | | 377 UNIVERSAL SFTW.DIRCT. 412 | | 409 WICAT 25 | |
| * SUNNY INT'L. 475 | | * TEXAS INSTRUMENTS 65 | | 378 UNIVERSAL SFTW.STUDIOS 454 | | 392 WILD HARE COMP.SYS. 189 | |
| * SUPERSOFT 83, 93 | | * THUNDERWARE 291 | | 379 UVEON COMP.SYS. 79 | | 366 WINCHENDON GRP.THE 504 | |
| 352 SUPERSOFT 131 | | 338 TIME MNGMNT. SFTW. 23 | | 380 VAN HORN OFFICE SUPP. 395 | | 393 WINTEK CORP. 469 | |
| 353 SYBEX 209 | | 339 TIME MNGMNT. SFTW. 127 | | 382 VANGUARD SYS.GRP. 75 | | 394 WINTERHALTER & ASSOC. 360 | |
| * SYNCHRO SOUND 136 | | 340 TIME MNGMNT. SFTW. 231 | | 383 VECTOR ELECTR. 446 | | 395 WW COMPONENT SUPPLY 505 | |
| 354 SYNCRONICS 52 | | * TINNEY,RBT.GRAPHICS 456 | | 384 VECTOR GRAPHICS 87 | | 396 X COMP 243 | |
| 355 SYS.INTERFACE CONS. 182 | | 368 TNW CORP. 392 | | * VERTICAL DATA SYS.INC. 94 | | 397 ZENRAD CONTROLS 498 | |
| 356 SYSTEMS PLUS 321 | | 369 TRAK CO.,THE 173 | | 385 VIDEX 269 | | * ZOBEX 151 | |

BOMB

BYTE's Ongoing Monitor Box

| Article # | Page | Article | Author(s) |
|-----------|------|--|---------------------|
| 1 | 26 | The IBM Personal Computer: First Impressions | Lemmons |
| 2 | 36 | Build an Intelligent EPROM Programmer | Ciarcia |
| 3 | 50 | Ultra-Low-Cost Network for Personal Computers | Clements, Daugherty |
| 4 | 70 | The Atari Tutorial, Part 2: Graphics Indirection | Crawford |
| 5 | 86 | Atari's Telelink I | Fiint |
| 6 | 92 | Local-Area Networks, Possibilities for Personal Computers | Saal |
| 7 | 114 | Prepare Your Program for Publication | Johnson |
| 8 | 126 | Software Protection in the United Kingdom | Hayman |
| 9 | 140 | Network Tools, Ideas for Intelligent Network Software | Reintjes |
| 10 | 176 | A Simple Implementation of Multitasking | Brown |
| 11 | 195 | Tree Searching, Part 2: Heuristic Techniques | Williams |
| 12 | 214 | Drawing with UCSD Pascal and the Hiplot Plotter | Stork |
| 13 | 250 | Evaluate Your Home's Energy Efficiency, Conserve Energy with Your Computer | Beasley |
| 14 | 264 | Bridging the 10-Percent Gap | Brady |
| 15 | 284 | Graphics Fundamentals | Sandifur |
| 16 | 378 | Integral Data's Paper Tiger 460 | Willner |
| 17 | 383 | The Mauro Proac Plotter | Dahmke |
| 18 | 385 | The Radio Shack FORTRAN Package | Daneluik |
| 19 | 400 | Build a Versatile Keyboard Interface for the S-100 | Richards |
| 20 | 407 | PERT Organization | Maurer |
| 21 | 413 | Should the DO Loop Become an Assembly-Language Construct? | Williams |
| 22 | 430 | Multiple Regression for the TRS-80 | Madron |
| 23 | 448 | Bits and Bytes in Pascal, And Other Binary Wonders | Casseres |
| 24 | 458 | Apple Analog-to-Digital Conversion in 27 Microseconds | Seeds |
| 25 | 462 | PS—A FORTH-Like Threaded Language, Part 1 | Motalygo |

July Bomb Results: Clarca and the Sun

It came as no surprise to us that Steve Ciarcia's article, "Build a Z8-Based Control Computer with BASIC, Part 1," finished first in the July BOMB competition. Steve's latest technological breakthrough has prompted numerous comments and inquiries, both to him and to BYTE. He will receive the \$100 first prize.

Second place for July went to George E Mobus for his article, "Harvesting the Sun's Energy." George will receive \$50 for his description of a computer model that determines the amount of solar energy received by a flatplate collector.

"Multiprocessing with Motorola's MC6809E," by Hunter Scales, took third place. He showed how to implement a multiprocessor environment using the new MC6809E.

"WORDSWORTH, TAKE A LETTER." ^{T.M.}



THE FIRST SUPER-SIMPLE LETTER QUALITY WORD PROCESSOR IN THE WORLD THAT CAN SIT NEXT TO YOUR SECRETARY — FOR LESS THAN \$5,000.

"Wordsworth™" removes the fear and loathing many people have about things called "computers" and "word processing." Because Wordsworth just sits at a desk and does what he's told. With unique new, simplified software, it can tell its typist what to do—step by simple step—to perform even the most complicated tasks.

It can not only "take a letter," but it can revise it, customize it in millions of ways (quite literally), personalize it, print it on your letterhead or business form so you can't tell it from hand-typed . . . in short, everything but put it in an envelope.

Moreover, it can perform all sorts of mundane business functions,

like general ledgers and accounting reports, using easily available industry-compatible CP/M™ software.

Installation? Plug it in. (Cable supplied.)

Size? Bigger than a breadbox—but not by much. It's about half as big, or less, than systems that can't do half as much. Definitely desktop—a sub-compact 20" by 40".

Service? Available everywhere.

Price? About \$4,995. Complete and ready to go.

For the name of your nearest dealer—and a free hands-on demonstration—just pick up the nearest telephone.

TOLL-FREE 1-800-343-6833.

In Massachusetts, call collect (617) 828-8150. Telex 951-624.

LEADING EDGE™

Leading Edge Products, Inc., 225 Turnpike Street, Canton, Massachusetts 02021
DEALERS: For immediate delivery from the Leading Edge Inventory Bank™ on "Wordsworth" and other of the industry's most popular products, just give us a call.

Circle 196 on inquiry card.

"Over 15,000 items in inventory could be a nightmare. But it's not 'cause my Challenger computer works like a dream."

"My fastener business is growing rapidly. I have over 800 customers utilizing my 15,000 inventory items daily. Keeping track of inventory, orders, and receivables at this volume level could be a nightmare. But it's not 'cause my Challenger computer works like a dream. Terrific, Ohio Scientific!"

*Richard Nolan, President,
Aerospace Nylok Corp.,
Hawthorne, New Jersey*



Ohio Scientific was first to add Winchester hard disk drives to microcomputers. This advanced technology allows low cost microcomputers to store over 100 times as much information on line as they could before.

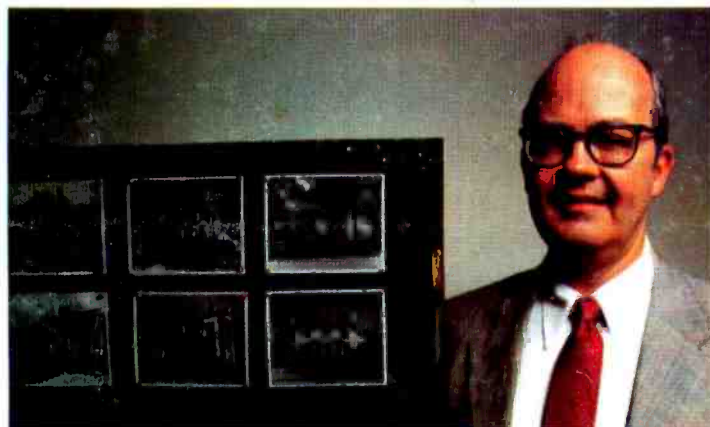

"With our Challenger computer we've developed sophisticated real estate programs and information files that give our customers and our sales associates that extra edge in fast, accurate real estate market information analysis and forecasting. We now have a strong managerial accounting and market information system as well as word processing at an affordable cost. Terrific, Ohio Scientific!"

*Charles Smith, Jr., President, Montague, Miller & Co., Realtor
Charlottesville, Virginia*

OHIO SCIENTIFIC HARD DISK BASED MICROCOMPUTERS START AT LESS THAN \$10,000 AND ARE SOLD BY MORE THAN 400 DEALERS NATIONWIDE. FOR THE ONE NEAREST YOU, CALL 1-800-321-6850 TOLL FREE.



"I'm a fuel oil jobber, and I can't believe how reliable my Challenger has been, with all it has to keep track of. But, it's been doing it for two years now, and that's terrific, Ohio Scientific!"

*Wade Carlson,
Vice President,
Wally Carlson & Sons,
Lindstrom, Minnesota*

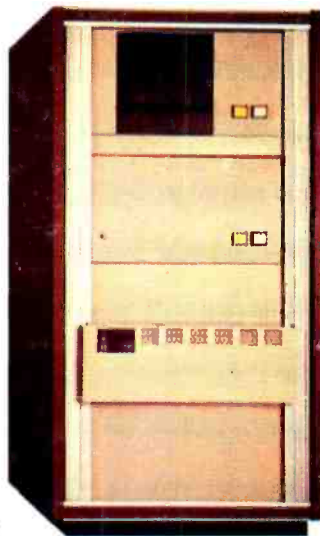

terrific!

OHIO SCIENTIFIC

a **MACOM** Company

1333 SOUTH CHILLICOTHE ROAD
AURORA, OH 44202 • (216) 831-5600