

NOVEMBER 1980 Volume 5, Number 11 \$2.50 in USA/\$2.95 in Canada

# BYTE<sup>®</sup>

A MCGRAW-HILL PUBLICATION

the small systems journal

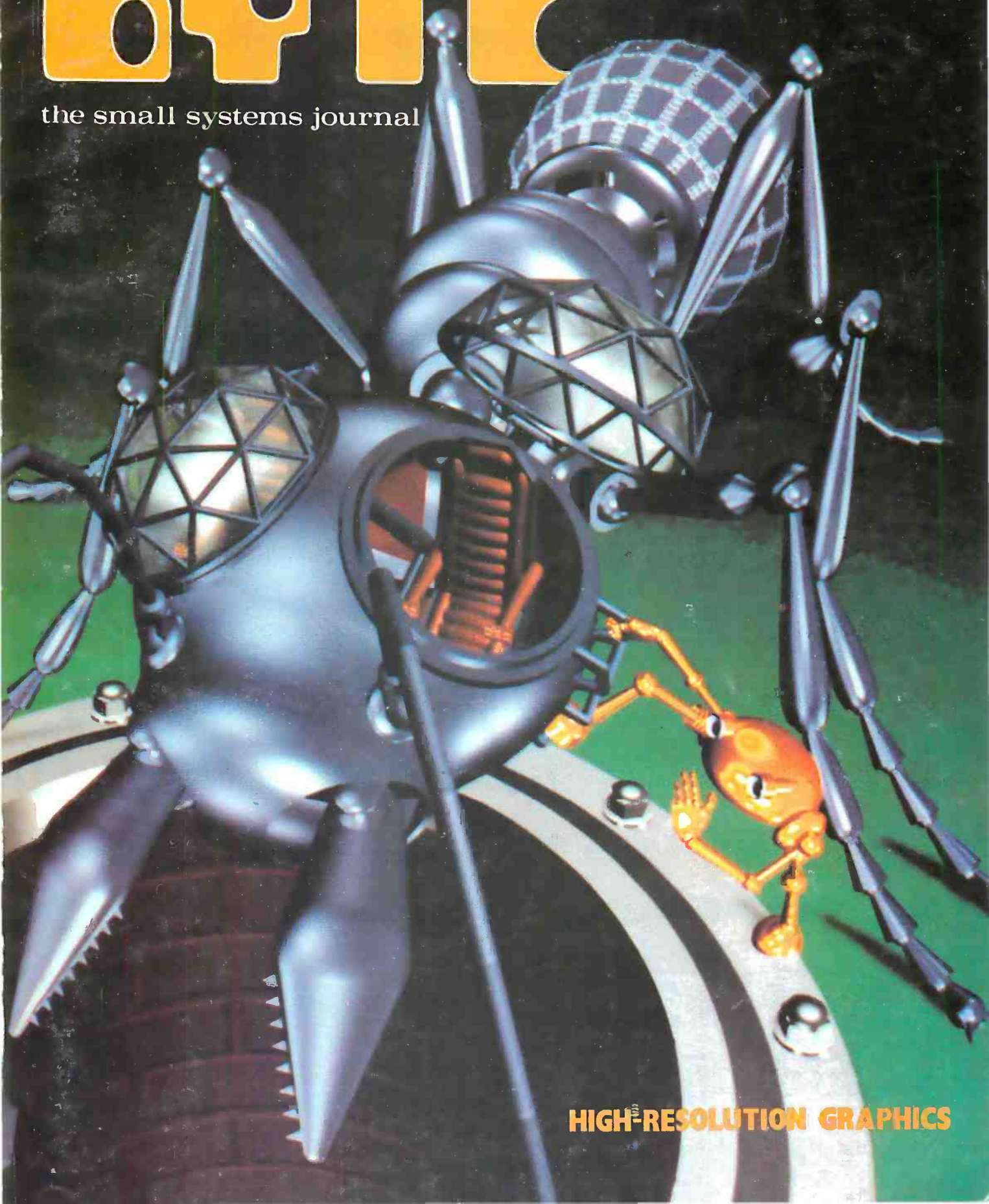

HIGH-RESOLUTION GRAPHICS

---

# WHAT ARE YOU LOOKING FOR IN A SYSTEM?

**VERSATILITY** – Data bus—motherboard design allows you to configure a system to the end users exact needs.

**EXPANDABLE** – Minimum RAM capacity 56K Expandable to 768K. Two I/O ports – Expandable to seventeen.

**MASS STORAGE**— 3.0 M/bytes on 5¼" flexible disks. (4 drives) 5.0 M/bytes on 8 inch flexible disks—(4 drives)  
40 M/bytes on "Winchester" fixed disk.

**SOFTWARE** – Operating System – Multitasking, multiuser with memory management.  
Languages – FORTRAN, Pascal, BASIC, PILOT  
Utilities – Debug, Sort-Merge, Diagnostics – over 40 others.  
Data Processing – General Ledger, Receivables, Payables, Payroll, Jobcost, Mail List,  
Inventory, Record Management System.  
Word Processing – Text Editor and Processor – device independent with proportional spacing  
bidirectional printing.

**COST EFFECTIVE**—System consisting of 128K processor, terminal, and 2.4 M/byte dual eight-inch disk drives –  
less than \$6,000.00 (O.E.M. 100 quantity)



SOUTHWEST TECHNICAL PRODUCTS CORPORATION

219 W. Rhapsody

San Antonio, Texas 78216

(512) 344-0241

---

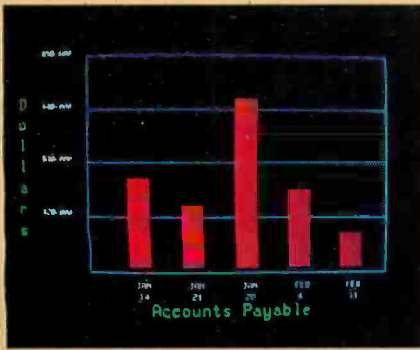

Management Information Display

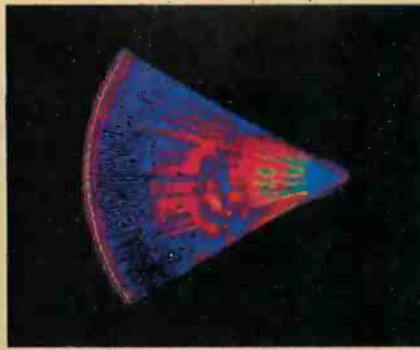

Ultrasonic heart sector scan



High-resolution display with alphanumerics

## Get the professional color display that has BASIC/FORTRAN simplicity

### LOW-PRICED, TOO

Here's a color display that has everything: professional-level resolution, enormous color range, easy software, NTSC conformance, and low price.

Basically, this new Cromemco Model SDI\* is a two-board interface that plugs into any Cromemco computer.

The SDI then maps computer display memory content onto a convenient color monitor to give high-quality, high-resolution displays (756 H x 482 V pixels).

When we say the SDI results in a high-quality professional display, we mean you can't get higher resolution than this system offers in an NTSC-conforming display.

The resolution surpasses that of a color TV picture.

### BASIC/FORTRAN programming

Besides its high resolution and low price, the new SDI lets you control with optional Cromemco software packages that use simple BASIC- and FORTRAN-like commands.

Pick any of 16 colors (from a 4096-color palette) with instructions like DEFCLR (c, R, G, B). Or obtain a circle of specified size, location, and color with XCIRC (x, y, r, c).

\*U.S. Pat. No. 4121283

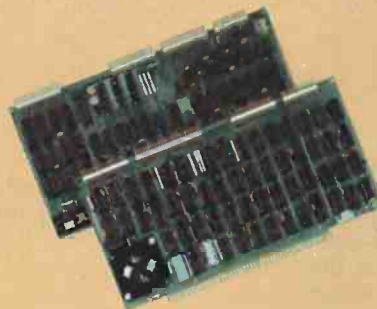

Model SDI High-Resolution Color Graphics Interface

### HIGH RESOLUTION

The SDI's high resolution gives a professional-quality display that strictly meets NTSC requirements. You get 756 pixels on every visible line of the NTSC standard display of 482 image lines. Vertical line spacing is 1 pixel.

To achieve the high-quality display, a separate output signal is produced for each of the three component colors (red, green, blue). This yields a sharper image than is possible using an NTSC-composite video signal and color TV set. Full image quality is readily realized with our high-quality RGB Monitor or any conventional red/green/blue monitor common in TV work.



Model SDI plugs into Z-2H 11-megabyte hard disk computer or any Cromemco computer

### DISPLAY MEMORY

Along with the SDI we also offer an optional fast and novel two-port memory that gives independent high-speed access to the computer memory. The two-port memory stores one full display, permitting fast computer operation even during display.

### CONTACT YOUR REP NOW

The Model SDI has been used in scientific work, engineering, business, TV, color graphics, and other areas. It's a good example of how Cromemco keeps computers in the field up to date, since it turns any Cromemco computer into an up-to-date color display computer.

The SDI has still more features that you should be informed about. So contact your Cromemco representative now and see all that the SDI will do for you.



280 BERNARDO AVE., MOUNTAIN VIEW, CA 94040 • (415) 964-7400  
Tomorrow's computers today



## Here's the state of the art in low-cost hard-disk computers

### 11 MEGABYTES OF

#### FAST HARD-DISK STORAGE

Yes, the Cromemco Model Z-2H is in a class by itself in the computer field.

These Z-2H features tell you why:

- 11 megabytes of hard-disk storage
- 64 kilobytes of fast RAM
- Two dual-sided floppy disk drives
- Z-80A type processor
- Fast 4 MHz operation—150 nanosecond access time
- Fast hard-disk transfer rate of 5.6 megabits/second
- Low cost

And that's not all you get. Not nearly.

#### BROAD SOFTWARE SUPPORT

You also get Cromemco software support—the broadest software sup-

port in the microcomputer field. Software that Cromemco is known for. Like this:

- Structured BASIC
- FORTRAN IV
- RATFOR (RATional FORtran)
- COBOL
- Z-80 Macro Assembler
- Word Processing System
- Data Base Management

And more all the time.

#### FIELD PROVEN

The Z-2H is clearly in a class by itself. We introduced it last summer. It's field proven. It's reliable.

And it's rugged. Housed in a sturdy, all-metal cabinet.

#### EASILY EXPANDABLE

As always with Cromemco, you get expandability. The fast 64K RAM in this Model Z-2H can be expanded to 512 kilobytes. That amount of RAM combined with 11 megabytes of hard-disk storage gives you enormous

computer power—the equal or even beyond what much larger computers sometimes offer.

What's more, this computer gives you a 12-slot card cage. That's to plug in your special circuits as well as additional RAM and interface cards.

This expandability is supported by still more Cromemco value—the Z-2H's heavy-duty power supply that gives you 30A at 8V and 15A at  $\pm 18V$  to support plug-ins.

#### LOW COST — SEE IT NOW

The Z-2H is real. It's been in the field for many months. It's proven itself.

You should see the Z-2H now. Contact a Cromemco representative and arrange for a demo. Learn that Cromemco is a survey-winner for reliability.

And learn that the Z-2H is under \$10K.

In the long run it always pays to get the best.



**Cromemco**  
I n c o r p o r a t e d

280 BERNARDO AVE., MOUNTAIN VIEW, CA 94040 • (415) 964-7400  
Tomorrow's computers today



Page 22

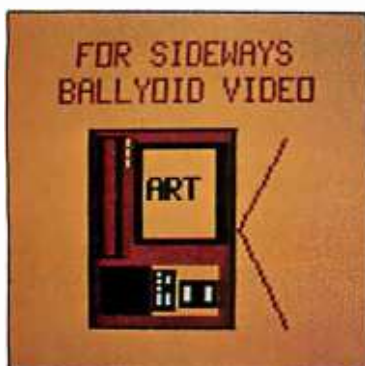

Page 90

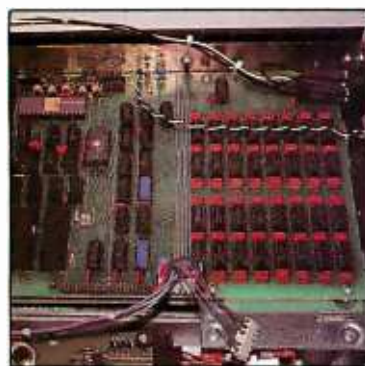

Page 158



Page 172

## Foreground

**32 HOME IN ON THE RANGE! AN ULTRASONIC RANGING SYSTEM**  
by *Steve Ciarcia*

Combine automatic sonar ranging and infrared-light detection in a computer-controlled scanner.

**64 MICROGRAPH, PART 1: DEVELOPING AN INSTRUCTION SET FOR A RASTER-SCAN DISPLAY** by *E Grady Booch*

Micrograph is an intelligent, low-cost, color-graphics terminal that interfaces to any microcomputer and standard, unmodified color television receiver.

**126 GRAPHIC COLOR SLIDES, PART 1** by *Alan W Grogono*

The first of this two-part article gives a series of useful subroutines for generating color images on a Compucolor II.

**148 THREE-DIMENSIONAL GRAPHICS FOR THE APPLE II** by *Dan Sokol and John Shepard*

With this popular computer, use a two-color scheme to generate three-dimensional figures.

**296 A GENERAL INTERPOLATING GRAPHICS PACKAGE FOR THE TRS-80** by *D K Cohen and Devon Crowe*

Interpolate between points of a graphed function and three-dimensional figures.

**340 AN 8088 PROCESSOR FOR THE S-100 BUS, PART 3**  
by *Thomas Woodward Cantrell*

This monitor program takes advantage of some powerful software and architectural aspects of the 8088 processor.

## Background

**22 THE FUTURE OF COMPUTER GRAPHICS** by *Bruce Eric Brown and Stephen Levine*

Take a look at the future of graphics hardware and applications.

**90 LANGUAGE CONTROL STRUCTURES FOR EASY ELECTRONIC VISUALIZATION** by *Dr Thomas DeFanti*

Zgrass, a hybrid of language and hardware, can be used to solve graphic-display problems.

**180 A SIMPLIFIED THEORY OF VIDEO GRAPHICS, PART 1**  
by *Allen Watson III*

Part 1 covers the principles of television and computer-generated graphics.

**206 GETTING TO KNOW YOUR MONITOR** by *Ron Dalpiaz*

Meet the most frequently used human/computer interface — the video terminal.

**220 DIGITAL STORAGE OF IMAGES** by *Thomas Williams*

Theory and practice of digital-image capture and storage are explained in detail.

**244 MACHINE PROBLEM SOLVING, PART 3: THE ALPHA-BETA PROCEDURE** by *Peter Frey*

In the conclusion of this series, we discover how searching for information stored in tree structures can be made more efficient.

**361 ADD MACRO EXPANSION TO YOUR MICROCOMPUTER, PART 2**  
by *David C Brown*

Notes on implementation and options are presented in this final part.

## Nucleus

6 Editorial  
16 Letters  
62, 86 Technical Forum  
108 Book Reviews  
112, 114, 292, 322 BYTE's Bugs  
114 Books Received  
116, 145 Programming Quickies  
119 BYTE's Bits  
147 Clubs and Newsletters  
158, 190, 196 Product Reviews

172 SIGGRAPH Convention Report  
240 BYTELINES  
266 Ask BYTE  
314 Event Queue  
343 Tom Sloan Cartoon  
372 What's New?  
430 Unclassified Ads  
431 BOMB Results  
431 BOMB  
432 Reader Service

## Publishers

Virginia Londoner,  
Gordon R Williamson  
**Associate Publisher**  
John E Hayes  
**Assistant**  
Cheryl A Hurd

**Founding Editor**  
Carl T Helmers Jr

**Editor-in-Chief**  
Christopher P Morgan  
**Editors**

Richard S Shuford, Gregg Williams,  
Curtis P Felgel, Harold Nelson  
Stan Mlastkowski

**Consulting Editor**  
Mark Dahmke

**Book Editor**  
Bruce A Roberts  
**Chief Copy Editor**  
David W Hayward

**Copy Editors**  
Faith Hanson, Warren Williamson,  
Robin M Moss, Anthony J Lockwood  
**Assistant to the Editors**

Falth Ferry  
**Assistants**  
Debe Wheeler, Karen A Cilley

**New Products Editor**  
**Clubs, Newsletters**  
Charles Freiberg

**Drafting**  
Jon Swanson

**Production Director**  
Nancy Estle  
**Assistant Production Director**  
Christine Dixon  
**Production/Advertising Coordinator**  
Wal Chlu Li

**Production Art**  
Holly Carmen LaBossiere,  
Deborah Porter  
**Chief Typographer**  
Sherry McCarthy

**Typographers**  
Debi Fredericks, Donna Sweeney

**Advertising Director**  
Thomas Harvey  
**Assistants**  
Ruth M Walsh, Ms. Marion Gagnon  
Barbara J Greene, Rob Hannings

**Special Projects Coordinator**  
Jill E Callihan  
**Marketing Coordinator**  
Laura A Hanson

**Circulation Manager**  
Gregory Splitzfaden  
**Assistants**  
Agnes E Perry, Melanie Bertonl,  
Barbara Varnum, Louise Menegus,  
Andrew Jackson

**Dealer Sales**  
Thomas Yanni

**Controller**  
Daniel Rodrigues  
**Assistant**  
Mary E Fluhr  
**Accounts Receivable Specialist**  
Karen Burgess  
**Accounts Receivable Assistant**  
Jeanne Cilley

**Receptionist**  
Jacqueline Earnshaw  
**Traffic Department**  
Mark Sandagata



## In This Issue

The cover for this issue of BYTE is a still from a 90-minute computer-animated cartoon called *The Works*. The photo was provided by Dick Lundin and Lance Williams and is constructed from quadric surfaces and polygons, using texture-mapping and normal-perturbation techniques. The background was painted by Paul Xanter—programming credit also goes to Tom Duff and Duane Palyka. A trailer of *The Works* was shown at SIGGRAPH '80 (page 172), although the film itself may not be finished for another two years.

A number of the articles for this month's theme were solicited with the help of Jay Nickson and Ken Lodding; their editorial begins on page 6. Both are employed by DEC (Digital Equipment Corporation): Jay is the manager of the *human interface* program for simplifying man/machine communications, Ken is a senior software engineer whose long-term interests intermix art and computer graphics.

### Publisher's Note

As most readers will have observed, the September Fifth anniversary issue marked the beginning of a new phase for BYTE. The jump from a 300-page to a 400-page issue means a 33% increase in the material presented to our readers each month.

Because advertisements tend to be more visible than editorial content (especially in a technical journal), some readers may suspect that the larger issues mean merely more ads. But, in fact, the larger issues have approximately one third more editorial content. The new size does create design and manufacturing problems, however. The solution to these problems includes a redesign of the editorial pages of BYTE to make the editorial content easier to find and use. We expect the new format to be implemented early in 1981.

We are confident that the increased editorial content and new format will make BYTE even more of a bargain as well as a more useful tool for our readers. And that, after all, is what it's all about.

Virginia Londoner  
Publisher

Officers of McGraw-Hill Publications Company: Paul F McPherson, President; Executive Vice Presidents: James E Boddorf, Gene W Simpson; Group Vice President: Daniel A McMillan; Senior Vice President-Editorial: Ralph R Schulz; Vice Presidents: Kemp Anderson, Business Systems Development; Stephen C Croft, Manufacturing; Robert B Doll, Circulation; James E Hackett, Controller; William H Hammond, Communications; Eric B Herr, Planning and Development; John W Patten, Sales; Edward E Schlrmer, International.

Officers of the Corporation: Harold W McGraw Jr, President, Chief Executive Officer and Chairman of the Board; Robert F Landes, Senior Vice President and Secretary; Ralph J Webb, Treasurer.

BYTE is published monthly by BYTE Publications Inc, 70 Main St, Peterborough NH 03458, a wholly-owned subsidiary of McGraw-Hill, Inc. Address all mail except subscriptions to above address: phone (603) 924-9281. Address subscriptions, change of address, USPS Form 3579, and fulfillment questions to BYTE Subscriptions, PO Box 590, Martinsville NJ 08836. Controlled circulation postage paid at Waseca, Minnesota 56093 - USPS Publication No. 528890 (ISSN 0360-5280). Canadian second class registration number 9321. Subscriptions are \$18 for one year, \$32 for two years, and \$46 for three years in the USA and its possessions. In Canada and Mexico, \$20 for one year, \$36 for two years, \$52 for three years. \$32 for one year air delivery to Europe. \$32 surface delivery elsewhere. Air delivery to selected areas at additional rates upon request. Single copy price is \$2.50 in the USA and its possessions, \$2.95 in Canada and Mexico, \$4.00 in Europe, and \$4.50 elsewhere. Foreign subscriptions and sales should be remitted in United States funds drawn on a US bank. Printed in United States of America.

Address all editorial correspondence to the editor at the above address. Unacceptable manuscripts will be returned if accompanied by sufficient first class postage. Not responsible for lost manuscripts or photos. Opinions expressed by the authors are not necessarily those of BYTE. Entire contents copyright © 1980 by BYTE Publications Inc. All rights reserved. Where necessary, permission is granted by the copyright owner for libraries and others registered with the Copyright Clearance Center (CCC) to photocopy any article herein for the base fee of \$1.00 per copy of the article or item plus 25 cents per page. Payment should be sent directly to the CCC, 21 Congress St., Salem, MA 01970. Copying done for other than personal or internal reference use without the permission of McGraw-Hill is prohibited. Requests for special permission or bulk orders should be addressed to the publisher.

BYTE® is available in microform from University Microfilms International, 300 N Zeeb Rd, Dept PR, Ann Arbor MI 48106 USA or 18 Bedford Row, Dept PR, London WC1R 4EJ England.



Subscription WATS Line: (800) 258-5485

Office hours: Mon-Thur 8:30 AM - 4:30 PM, Friday 8:30 AM - Noon, Eastern Time

### NATIONAL ADVERTISING SALES REPRESENTATIVES:

**NORTHEAST (617) 444-3946**  
Hajar Associates  
280 Hillside Ave.  
Needham Heights MA 02194

**MIDWEST (312) 864-3467**  
Hajar Associates  
2405 Lawndale  
Evanston IL 60201

**EAST & SOUTH (212) 682-5844**  
Hajar Associates  
121 Fifth Ave.  
New York NY 10017

**SOUTHWEST (714) 540-3554**  
**NORTHEAST (415) 964-0706**  
Hajar Associates  
1000 Elwell Ct., Suite 227  
Palo Alto CA 94303

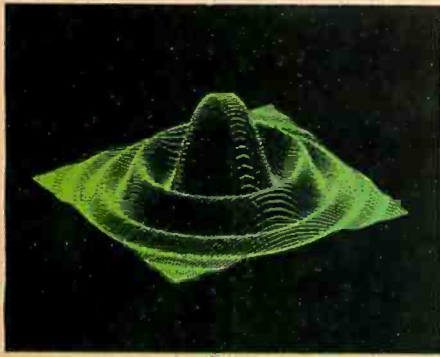

# MICROANGELO

HIGH RESOLUTION GRAPHICS SINGLE BOARD COMPUTER

by

**SCION**  
CORPORATION

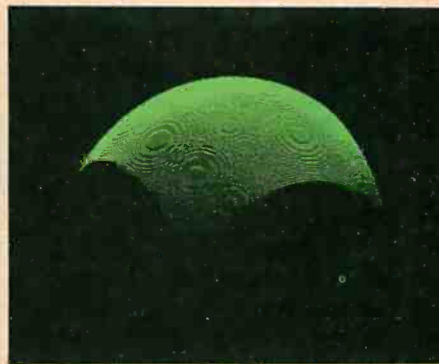
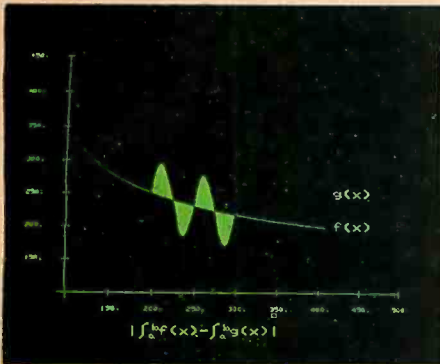

RS-170 composite or direct drive output

Local or external sync generation

4 or 5 Mhz Z80 micro-processor

60 hertz real-time clock

8 level interrupt tie-in

IEEE S100 bus compatible

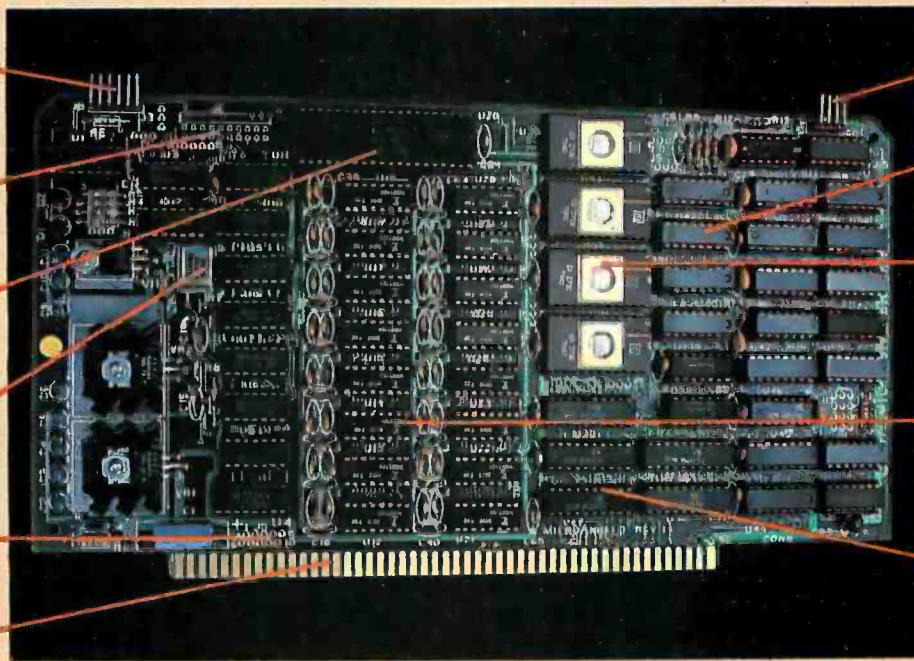

Light pen interface

Time multiplexed refresh

4K resident Screenware™ Pak I operating system

32K RAM isolated from host address space

High speed communications over parallel bus ports

## Screenware™ Pak I

A 4K byte operating system resident in PROM on MicroAngelo™ Pak I emulates an 85 character by 40 line graphics terminal and provides over 40 graphics commands. Provisions exist for user-defined character sets and directly callable user extensions to Screenware Pak I.

## Host Resident Terminal Software

An interface software package that coordinates input/output from the MicroAngelo™ graphics board, the MicroAngelo™ keyboard, and your computer. The result is a flexible, yet sophisticated graphics terminal.

**SCION Corporation**  
8455-D Tyco Road  
Vienna, Va. 22180  
(703) 827-0888

**European Distributor:**  
Micro Diversions UK Ltd.  
17/19 Mesnes Street  
Wigan, England WN1 1QP  
09-423 4311

Circle 3 on Inquiry card.

# Have some great memories.

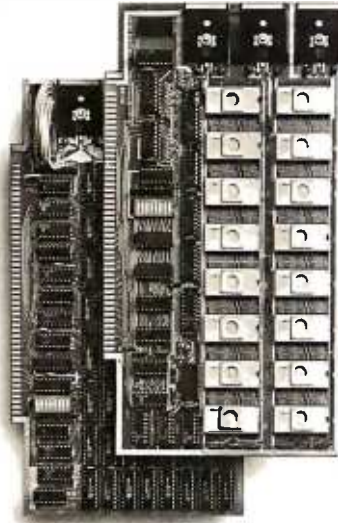

## 16K PROM boards.

- PROM card has 2708-type memory
- Quality board construction ■ 0-4 wait states
- Address any 4K group to any 4K boundary
- Control up to 8 banks of memory ■ Fully assembled and tested ■ PRICE—\$300

(California residents add 6% sales tax)

## Expandable 5 MHz RAM boards.

- 8—32K expandable RAM board uses TI 4044 memory runs at 5MHz ■ Fast 250 ns access time
- Bank select ■ Address any 4K block to any 4K boundary ■ Quality board construction

PRICE—8K—\$175; 16K—\$315; 24K—\$475; 32K—\$620; 8K add-on kits—\$135

(California residents add 6% sales tax)

Call or write Artec for details



**ARTEC ELECTRONICS, INC.**

605 Old County Rd., San Carlos, CA 94070  
Telephone (415) 592-2740

# Editorial

## The World of Computer Graphics

Guest Editorial by Ken Lodding and Jay Nickson

Man is a visual animal. He surrounds himself with graphic images. Images are employed to convey information, to explain concepts, and to communicate feelings. The ability to draw is instinctive. It materializes in infants soon after the start of verbal development, perhaps to complement the slowly developing verbal skills. Although the ability to draw tends not to become as fully developed as verbal skills, images continue to provide much of the adult human communications ability. Pictures are a primary information-carrying channel: the histogram accompanying a financial article, the plot of a mathematical function, and the illustrations in *BYTE* are but a few examples.

The importance of graphics for conveying information arises from the nature of man's visual system. The eye provides an extremely high-bandwidth information channel for transferring the data to be processed by the brain's optic center. The importance of this channel can be seen from the redundancy built into the system and from the distribution of optic nerve fibers in the brain. It is believed that no less than six different brain sites are directly serviced by connecting optic nerve fibers. (See reference 4.) The fundamental importance of visual information is reflected in the old adage, "seeing is believing," and in the observation that *understand* is one of the synonyms of the word *see*. Text fails to use our native abilities to comprehend information fully because it presents data in a linear, sequential fashion. Contrast this with graphical images, which can be processed in a single viewing—a phenomenon called *preattentive perception*. (See reference 6.)

The computer has become a primary source or conveyor of information, yet the main interface between man and machine has remained the serially oriented text display. The net result is that, as the volume of data available to be presented increases, the user's communication channel becomes swamped with an avalanche of text output. The volume of this avalanche far too often restricts the comprehension of the information. The information is obscured as effectively as if it had been encrypted. The spectacle of the computer user literally buried under reams of printed output has ceased to be an amusing cartoon and has become a nightmare for too many. To cope with the flood of information, the computer user is turning to graphics.

The information-transfer rate of a graph can be many orders of magnitude greater than an equivalent text presentation. Conceptually, a graph has greater information density than a table. Compare the plot of a sine curve with a table of sine values. Each value within the table corresponds to a specific point on the graph. However, the plot displays a far greater number of points than could the most extended table. A high information-transfer rate results from the greater data density and the faster operation of the human mind and visual system. Patterns, periodic functions, trends, and comparisons can often be obtained "by inspection" of a graph, while understanding a tabular display requires much more time and effort. This is not, however, accomplished without a cost. The only penalty paid for speed is the loss of precision: a graph cannot be read to the same number of significant digits as can be obtained from a table. This loss of precision is not a problem, as the specific data value of interest can be extracted from the function or table of data used to generate the plot initially.

### About the Authors

Ken Lodding and Jay Nickson are employed by the Digital Equipment Corporation in Merrimack, New Hampshire.





# “For reliable data storage, I recommend systems with Shugart disk drives.”

Tom Knight, President—  
Nycom, Los Altos, California

“The last thing you need when you put your personal computer or small business system to work is a disk drive that you can’t rely on. If the drive quits, your system is out of business.”

That’s why more and more manufacturers and dealers depend on Shugart disk drives for reliable data storage. These professionals don’t want disk drive problems any more than you do. Shugart has a

large family of drives, too—in all sizes and capacities to suit your system storage needs. For the smaller system, the original 5¼-inch Minifloppy™ stores 250 to 500 kilobytes (single or double-sided)—that’s about 50 to 100 pages of printed material. Our single and double-sided 8-inch floppies store 800 to 1600 kilobytes. And for systems that need a larger data base, our 8-inch or 14-inch fixed disk drives

store from 5 to 58 megabytes. No other manufacturer offers such a wide variety of disk storage for personal computer and small business systems.

Word processing, general business, accounting—big system or small, you can rely on Shugart drives. We’re known as the Headstrong company for good reason. We’re Headstrong about reliability, quality, and value. Ask your dealer. He knows us.

## Rely on the Headstrong Company.

 Shugart

475 Oakmead Parkway, Sunnyvale, California 94086

In addition to presenting data in a rapid, meaningful fashion, an important benefit of computer graphics is the ability to present images realistically. Plotting a topological surface, modeling DNA, creating an architectural rendering, and simulating a pilot's view from the cockpit of an aircraft are all enhanced by presenting the image in a manner which gives the viewer a sense that the picture is not an illusion. To achieve greater realism, a prime factor is to provide the illusion of depth. Perspective, hidden-line removal, shading, and highlighting all provide depth cues to the viewer. This month's computer-generated cover by Lance Williams of the New York Institute of Technology clearly illustrates the current state of the art as applied to an artistic endeavor. The same techniques are available and can be employed when graphically representing numeric data.

### Three-Dimensional Graphics

To provide the illusion of depth, a three-dimensional model can be defined. Establishing the viewer's geometric relationship to the model and following the rules of perspective, the model image is mathematically projected onto a two-dimensional viewing plane. Although providing good visual depth cues (eg: parallel lines appearing to meet at a point), there is no real illusion of depth; in other words, the model image is still "flat." To correct this, the phenomenon of *stereopsis* (from the Greek, meaning "solid sight") can be employed. You may be familiar with the 1847 Brewster stereoscope. Here, the approach taken to give the illusion of depth was to photograph the same scene twice, having moved the camera about 6 cm sideways between photos. The two images could then be viewed through a stereoscope that utilized a prism and lens system to alter the image paths to the eye, so that the two views seemed to originate from a common point. (The old-fashioned stereopticon and the modern View-Master are variations on this theme.) The observer's visual system fused the two images, giving the illusion of a three-dimensional image.

Various computer-graphic techniques using the same principles have been developed. A common technique is to employ glasses with electro-optic shutter eyepieces to provide the image separation. With the electro-optic glasses, the *cyclopic* video display presents left- and right-perspective images in alternate frames, which are then synchronized with the electro-optic shutters. The left eye is presented with the left stereograph, while the right eye's view is blanked by the optical shutter; the image and shutter swap for the right eye. The viewer's internal visual system fuses the image to give the appearance of depth. For an example of this, see "The Future of Computer Graphics," page 22.

A different approach to providing left and right images to the visual system uses color to separate the images. Using a device called an *anaglyph*, the left view is presented in one color, and the right in a different color. Color filters control which eye sees what view. A program for generating and viewing anaglyphs is presented in the article "Three-Dimensional Graphics for the Apple II." (See page 148.) While the traditional colors employed are red and green, any two colors and corresponding filters could be used, because the illusion is based on the separation of the images, and has nothing to do with the particular colors. The phenomenon is as apparent to a



## PASCAL/Z™ - Q.E.D.

Ithaca Intersystems PASCAL/Z is the most powerful CP/M™ compatible Z-80™ Pascal compiler ever . . . and here's why:

PASCAL/Z generates true Z-80 native code — ROMable and re-entrant — 5-10X faster than P-code interpreters; permits separate compilation; supports Direct File Access and variable length STRINGS; utilizes fast one-pass recursive descent organization; the macro-assembler generates relocatable object modules; and much, much more.

Complete package includes compiler, macro-assembler, linker/loader and source for the full library on one disk; with free copy of Jensen/Wirth book and complete documentation. Only \$395.00.

IT'S DEMONSTRABLE!

Don't just take our word for it. Ask for a demonstration of these features and more today at Computerland® and other full-service computer stores.

Ithaca Intersystems Inc., 1650 Hanshaw Road  
P.O. Box 91, Ithaca, N.Y. 14850. Phone (607) 257-0190

Computerland is a registered trademark of Computerland Corporation.  
CP/M and Z-80 are trademarks of Digital Research Corp. and Zilog, Inc. respectively.  
PASCAL/Z and InterSystems are trademarks of Ithaca Intersystems Inc.

**InterSystems™**  
Ithaca Intersystems Inc.

**Micros for bigger ideas.**



## Outside of the garden you need a computer that can grow.

For the average garden-variety home and hobby operation, a high quality personal computer is a real temptation. But let's face it: in the world of business, engineering and scientific applications you need a system that can keep up with bigger ideas.

Bigger ideas today mean the power and flexibility to move the micro up to and beyond the level of yesterday's minis. More memory to hold bigger data bases. More flexibility to handle a variety of data entry devices. More programming and computing power for numbercrunching and applications development. And easy upgrade to 16 bit operation when you need it.

Intersystems has that, and more. The power and flexibility of the versatile S-100 bus, with 20 slots of expandability for up to 16 individually-addressable DMA devices and up to 1 Megabyte of memory, fully accessible to all users via our unique memory management system. Plus reliable Intersystems design and manufacture, and the support of our PASCAL/Z™...the most powerful Z-80™ compiler ever.

For really serious computing, our front panel provides a powerful diagnostic tool for debugging or development. Combined with a scope, it allows you to look at any location in the circuitry, set breakpoints, trigger and view one-shot events, and many other activities usually possible only with expensive logic analyzers. No wonder it's fast becoming the tool of choice for repair technicians and custom hardware designers.

Intersystems Series II is the most complete line of fully IEEE 696 compatible S-100 boards...easily upgradeable to our MPU 8000™ or other 16 bit S-100 CPU's as they become available...so you're never locked out of rapid expansion, or locked into obsolescence, by dependency on a proprietary product line.

So if you've left those garden-variety applications behind, come to Intersystems and get a system that will grow as big as your next idea. Get it from the people who know small computers...your Computerland store...or other fine full service computer dealers.

Ithaca Intersystems Inc., 1650 Hanshaw Road  
P.O. Box 91, Ithaca, N.Y. 14850.  
Phone (607) 257-0190 TWX: 510 255 4346.

Z-80 is a trademark of Zilog, Inc.  
PASCAL/Z MPU 8000 and InterSystems are trademarks of Ithaca Intersystems Inc.

**InterSystems™**  
Ithaca Intersystems Inc.

**Micros for bigger ideas.**

color-blind person as it is to a viewer with normal color vision. For those interested in further information, the book *Seeing* is an excellent reference on vision in general and stereopsis in particular. (See reference 4.)

A more recent and unique approach to presenting three-dimensional images is SpaceGraph, developed by Dr Larry Sher. His technique uses a vibrating mirror and a video display. The technique is to generate on the display two-dimensional "slices" of the three-dimensional object to be viewed. The slices are rapidly generated in synchronization with the dynamic motion of the mirror, the front slice being generated when the mirror is extended toward the viewer, the back slice when the mirror is concaved away from the viewer, and the intermediate slices as appropriate for the travel of the mirror between these extremes. The rapid sequence of images is fused by the viewer's visual system to give the illusion of a "space filling" object. (See reference 7.)

Those adventuresome souls who find three-dimensions insufficient for their purposes can use computer graphics as an aid for visualizing objects which, theoretically, exist in four or more dimensions. If you are interested in this area, *Hypergraphics* is a good introduction to the subject. (See reference 3.) The book includes hyperstereograms of such objects as hypercubes or tesseract, hypercones, and other denizens of higher dimensions.

Animation is another technique that can assist in user comprehension of data. Often we are dealing with information gathered at discrete intervals over a period of time. Here, the problem of analyzing data is one of

understanding what is occurring to the data elements over some length of time. Animation provides a looking glass into the time domain. Flowing, three-dimensional images can represent anything from an economic world model to a bridge under stress.

### Hidden Benefits

There are times when animation provides the viewer with unexpected information—information which, in retrospect, was present but not readily discernible by any other method of examination. An interesting example of this situation involves the simulation of an internal combustion engine. The simulation, performed at a research laboratory, wrote out data in the conventional manner: stacks of numbers. At the same laboratory, some time after the engine simulation had been completed and used for experiments, a different group of researchers developed a computer-animation system. The engine simulation was selected as a good demonstration of the new graphics software, and a computer-generated film was produced. During the screening of the film it was noticed that small rectangular elements, used to represent idealized gas packets, displayed a strange, unexpected oscillation at their endpoints. Review of the animation software provided no explanation for this erratic behavior. Close examination of output from the original simulation revealed that the oscillations were indeed present. This fact had not been previously noticed because the information had been obscured by a combination of the tremendous amount of data, the smallness of the oscillation, and the extended period over which it occurred. What had in fact been found were acoustical-wave phenomena occurring within the cylinder of the engine, which could potentially be used for the development of more efficient engines. The events went unnoticed until a computer-generated movie was constructed.

In the 30 years since its beginnings, computer-generated graphics has grown steadily, but not spectacularly. Previously the costs of both the display and the computer resources needed to support graphic displays have limited the impact. Rapidly falling memory prices and television technology have renewed the interest in computer graphics. The combination of a television raster display and a memory-intensive, bit-mapped architecture makes possible a graphic system capable of providing full-color, dynamic images with previously unheard of realism and economy. "Micrograph, Part 1: Developing an Instruction Set for a Raster-Scan Display," describes the design and construction of a color-display processor that costs approximately \$250 to build. (See page 64.) This is possible only because of the plummeting cost of hardware. This is a cost reduction of three orders of magnitude in 15 years, with color added for free!

### Graphics Software

The advent of inexpensive graphics hardware has, not unexpectedly, spurred the development of graphics software. The traditional approach for supporting graphics has been to provide a collection of subroutines that perform the graphic-display functions. These subroutines are called from languages whose orientation is toward the manipulation of text and numerical data. This approach is fine if you only want to accumulate data and make a

## FLOPPY DISK FACTORY DIRECT FLOPPY DISK FACTO



- Buy factory direct from the manufacturer of floppy disks sold exclusively under other well-known brand names.
- Save distribution costs on reversible 5.25" floppy disks, which are 100% certified for 40 track, dual side, double density and all other standard applications.
- **50%** savings on 5.25" floppy disks with new factory-direct 2.2 megabyte capacity "Diskit".
- Factory-direct "Diskit", includes twelve floppy disks and accessories, plus a head cleaner disk and solution packaged in a bookcase binder for easy access, handling and storage. "Diskit" complete for the introductory price of only \$49.50 plus \$2.50 freight and handling. Normal price \$59.50. **Order now and save \$10.00** (CA residents add 6½% sales tax).
- Available in hard and soft sector configurations; when ordering indicate number of sectors — 1, 10 or 16.
- Send check or money order to:

### Factory Direct

P.O. Box 60759  
Sunnyvale, CA 94088

For VISA or MasterCard call toll-free

**(800) 824-7888**

In Calif. (800) 852-7777

In Alaska & Hawaii (800) 824-7919

**Ask for Operator 98**

# Why not kill two birds with one stone?

If you have an Apple\* and you want to interface it with parallel and serial devices, we have a board for you that will do both. It's the AIO.<sup>TM</sup>

## Serial Interface.

The RS-232 standard assures maximum compatibility with a variety of serial devices. For example, with the AIO you can connect your Apple\* to a video terminal to get 80 characters per line instead of 40, a modem to use time-sharing services, or a printer for hard copy. The serial interface is software programmable, features three handshaking lines, and includes a rotary switch to select from 7 standard baud rates. On-board firmware provides a powerful driver routine so you won't need to write any software to utilize the interface.

## Parallel Interface.

This interface can be used to connect your Apple\* to a variety of parallel printers. The programmable I/O ports have enough lines to handle two printers simultaneously with handshaking control. The users manual includes a software listing for controlling parallel printers or, if you prefer, a parallel driver routine is available in firmware as an option. And printing is only one application for this general purpose parallel interface.

## Two boards in one.

The AIO is the only board on the market that can interface the Apple to both serial and parallel devices. It can even do both at the same time. That's the kind of innovative design and solid value that's been going into SSM products since the beginning of personal computing. The AIO comes complete with serial PROM's, serial and parallel cables, and complete documentation including software listings. See the AIO at your local computer store or contact us for more information.



2190 Paragon Drive  
San Jose, California 95131  
(408) 946-7400

\*Apple is a  
TM of Apple  
Computers,  
Inc.



# Maybe we can save you a call.

Many people have called with the same questions about the AIO. We'll answer those and a few more here.

**Q:** Does the AIO have hardware handshaking?

**A:** Yes. The serial port accommodates 3 types—RTS, CTS, and DCD. The parallel port handles ACK, ACK, BSY, STB, and STB.

**Q:** What equipment can be used with the AIO?

**A:** A partial list of devices that have actually been tested with the AIO includes: IDS 440 Paper Tiger, Centronics 779, Qume Sprint 5, NEC Spinwriter, Comprint, Heathkit H14, IDS 125, IDS 225, Hazeltine 1500, Lear Siegler ADM-3, DTC 300, AJ 841.

**Q:** Does the AIO work with Pascal?

**A:** Yes. The current AIO serial firmware works great with Pascal. If you want to run the parallel port, or both the serial and parallel ports with Pascal, order our "Pascal Patcher Disk."

**Q:** What kind of firmware option is available for the parallel interface?

**A:** Two PROM's that the user installs on the AIO card in place of the Serial Firmware PROM's provide: Variable margins. Variable page length. Variable indentations, and Auto-line-feed on carriage return.

**Q:** How do I interface my new printer to my Apple using my AIO card?

**A:** Interconnection diagrams for many popular printers and other devices are contained in the AIO Manual. If your printer is not mentioned, please contact SSM's Technical Support Dept. and they will help you with the proper connections.

**Q:** I want to use my Apple as a dumb terminal with a modem on a timesharing service like The Source. Can I do that with the AIO?

**A:** Yes. A "Dumb Terminal Routine" is listed in the AIO Manual. It provides for full and half duplex, and also checks for presence of a carrier.

**Q:** What length cables are provided?

**A:** For the serial port, a 12 inch ribbon cable with a DB-25 socket on the user end is supplied. For the parallel port, a 72 inch ribbon cable with an unterminated user end is provided. Other cables are available on special volume orders.

The AIO is just one of several boards for the Apple that SSM will be introducing over the next year. We are also receptive to developing products to meet special OEM requirements. So please contact us if you have a need and there is nothing available to meet it.



SSM Microcomputer Products  
2190 Paragon Drive  
San Jose, California 95131  
(408) 946-7400

# The man, the wi

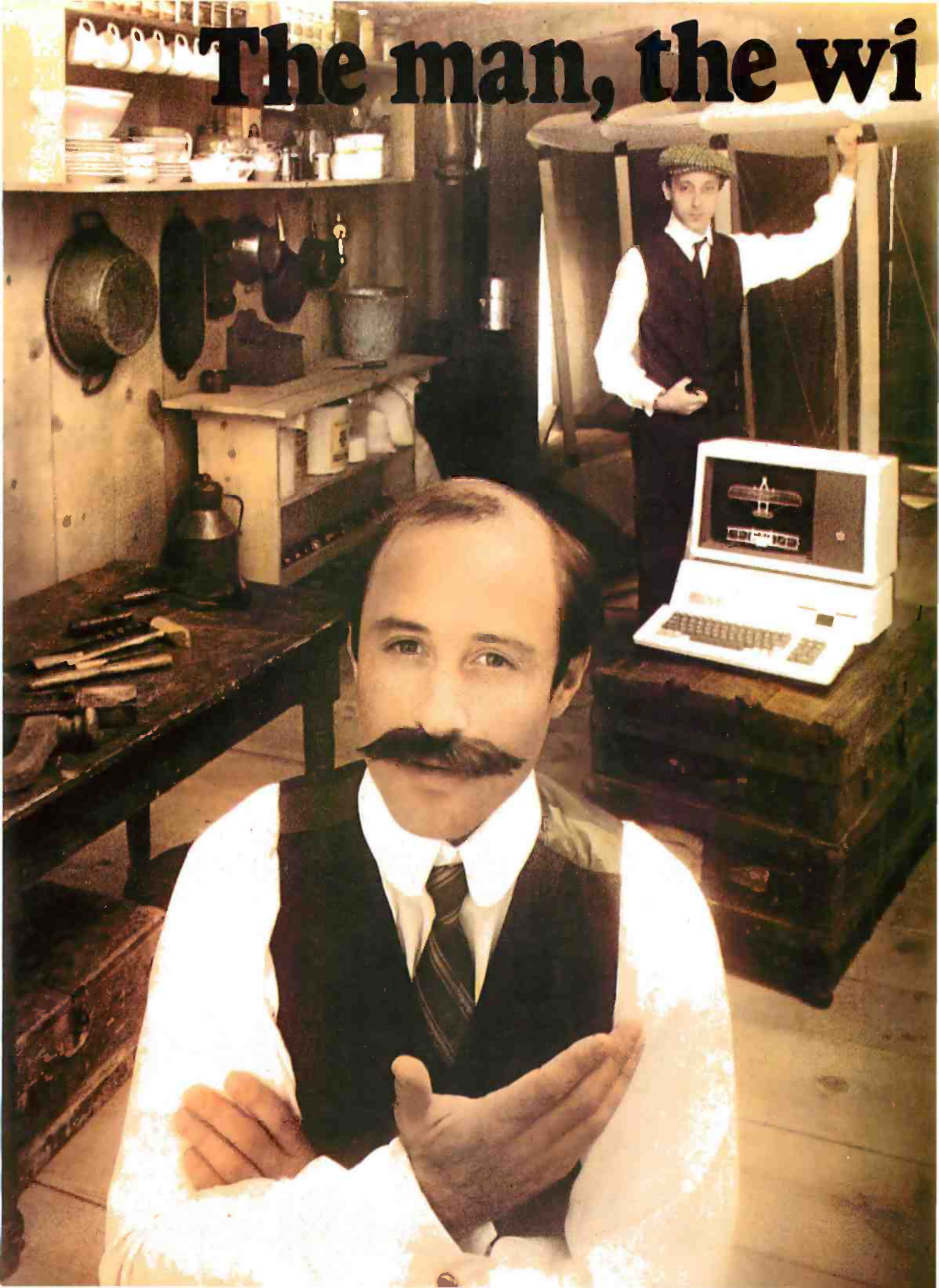

# ng and the Apple.

If you could talk to Orville Wright, he'd tell you the problems he faced as a turn-of-the-century engineer. You could tell him all about the technological solutions available to today's engineer and scientist... particularly a 20th century phenomenon that tests assumptions and defines models before a project gets off the ground. The Apple personal computer.

## Computation, calculation, analysis...the power to pilot your projects.

With a highly-integrated system from the extensive Apple personal computer family, Orville and brother Wilbur would have increased their productivity. Perhaps even launched the Kitty Hawk Flyer well before 1903.

An Apple in their hangar would have freed them from the time and tedium of crunching numbers by hand.

An Apple in your lab or office will give you the problem-solving capabilities you demand from a big computer... without the time-consuming problems typical of remote processing.

But the Apple system solution doesn't stop there. It keeps on soaring with proven performance, power and expandability



Apple's existing software library includes a program that plots the shape of an airfoil, given its parameters.

that's unparalleled for analyzing alternative paths of design and modeling a wide variety of physical processes.

Want more memory? Depending on your choice of system, Apple has memory expandable to 64K bytes or 128K bytes. Prefer wide displays? Choose 40 or 80 characters. Need to control instruments in the lab? Get on the IEEE 488 bus. Over

100 companies also supply peripherals for Apple because Apple is the most popular personal computer with the least complicated interface.

Want an efficient system of data storage and access? Apple's 5 1/4" disk drive not only offers you increased application versatility, but high density (143K bytes), high speed and low cost. You can even add up to four or more drives to your Apple system. With proven reliability, no wonder it's the most popular drive on the market today.

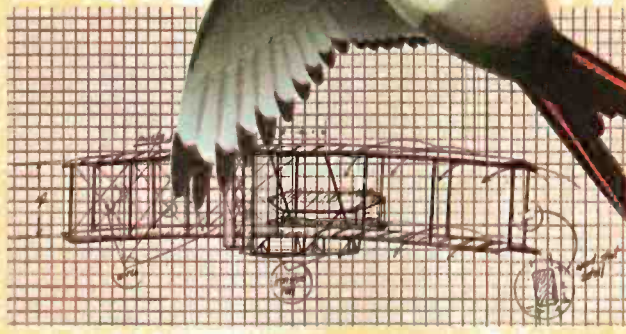

*Wilbur determined that birds didn't have to constantly flap their wings to fly. With an Apple, he could've determined the fixed-wing design of the Kitty Hawk Flyer much faster.*

## FORTRAN that helped to design a 20th century flying machine.

Fluent in the same language that helped to design the 747, Apple FORTRAN lets you tackle differential equations at the touch of a key. And since more than 170 companies also offer software for the Apple family, you can have one of the most impressive program libraries ever... including vast subroutine libraries for math, science, engineering and statistics. When you write

parts selection. Learn why Apple emerges as the technological leader of reliable personal computer products that increase your productivity.

Let the Apple dealer show you how, by putting the system of your choice through its paces. He'll tell you about our extended warranty, support and service. And he'll prove that a personal computer is not just a flight of fancy but a serious solution. Don't let history pass you by. Visit your nearest Apple dealer, or call 800-538-9696. In California, 800-662-9238.

your own programs, the Apple also speaks in languages other than FORTRAN: Pascal, BASIC, PILOT and 6502 assembly language.

## Where to learn more about Apple, the small-yet-serious solution.

Let your imagination soar with Apple.

Discover the 20th century tool versatile enough to monitor quality controls and manufacturing schedules, orchestrate tolerance tests and determine alternative

 **apple computer**



# AN EXCITING NEW WAY TO POLISH THE APPLE . . .

## CHEM LAB SIMULATIONS FROM HIGH TECHNOLOGY!

**High Technology** introduces two new and effective education packages . . . **Chem Lab Simulation #1 and #2 . . .** designed for use with the Apple II™ computer.

Developed by a chemistry professor at Oklahoma State University, both programs realistically and dynamically illustrate the laws of basic chemistry. They provide virtually unlimited results and instant feedback!

Suitable for high school or college level introductory chemistry students, the programs are an invaluable lecture aid. And for individual study, they provide first-hand student involvement as well as help solve the perennial teaching problems of limited time, space, and resources.

### CHEM LAB SIMULATION #1 . . .

uses APPLE's™ high resolution graphics to simulate:

- An acid-base titration experiment
- Determination of an unknown weak acid, including a titration experiment and a pH-meter experiment
- Determination of Avogadro's Number, including a titration experiment and a monomolecular film experiment



### CHEM LAB SIMULATION #2 . . .

written in machine language for fast response time, uses APPLE's™ colorful low-resolution graphics to simulate:

- The Ideal Gas Law
- The Kinetic-Molecular Theory
- The Principles of Entropy



See your nearest dealer today, or contact:



**High Technology, Inc.™**

P.O. Box 14665  
Oklahoma City, OK 73113  
(405) 840-9900

APPLE™ is a registered trademark of APPLE COMPUTER, INC.

picture from it. The subroutine approach excludes the possibility of treating graphical objects as variables within the language, or using them within statements and expressions. Some research work has been done which includes the concept of graphical objects and operators within a language structure. To date, there have been a number of different approaches to the problem of handling graphical objects. Deeply intertwined in the problem is our fundamental lack of understanding of how to provide graphics support. Viewed from the perspective of a language, what fundamental primitives must be provided? What are the appropriate data types? How are expressions constructed? What operators need to be provided? The list of unknowns goes on and on. "Language Control Structures for Easy Electronic Visualization," by Dr Tom DeFanti, addresses this area. (See page 90.) Some examples of other, experimental, graphics languages are given in references 2 and 5. SHAZAM (Smalltalk's sHaded imAge Zippy Animated Moviemaker) is an interesting animated-movie language written in Smalltalk. (See reference 1.) In no way does this list exhaust the progress that has been made in graphics languages, but rather it reflects a small sampling of recent work.

All the aspects of graphics we have discussed allow us to construct windows into universes, real or imaginary. Computer graphics is exciting because with this tool we can witness the unraveling of a DNA molecule, or the collision of galaxies. We can watch the structure of the universe as it expands from the moment of the theoretical big bang, or, reversing entropy, see it collapse into the primordial particle. We can plot a mathematical function, view an economic trend, or travel faster than light to where robotic insects populate metallic worlds. Best of all, we can make it all seem real, because we can see it! ■

#### References

1. Baecker, R. "A Conversational Extensible System for the Animation of Shaded Images." *Computer Graphics*, Volume 10, Number 2, Summer 1976.
2. Bergman, S and A Kaufman. "BGRAF 2: A Real-Time Graphics Language With Modular Objects and Implicit Dynamics." *Computer Graphics*, Volume 10, Number 2, Summer 1976.
3. Brisson, D (editor). *Hypergraphics — Visualizing Complex Relationships in Art, Science and Technology*. Westview Press, 1978.
4. Frisby, J. *Seeing*. New York: Oxford University Press, 1980.
5. Gonzales, C and J Vial. "GRAL — A Graphic Computer Language for Intelligent Terminals." *Proceedings of the Conference on Computer Graphics, Pattern Recognition and Data Structures*, May 1975.
6. Myers, W. "Computer Graphics: A Two Way Street." *Computer*, July 1980.
7. Shershow, H. "Realistic Spatial Display." *Digital Design*, June 1980.
8. Walters, T and W Harris. "Graphics in Depth." *BYTE*, Volume 3, Number 5, May 1978, page 16.

#### Articles Policy

BYTE is continually seeking quality manuscripts written by individuals who are applying personal computer systems, designing such systems, or who have knowledge which will prove useful to our readers. For a more formal description of procedures and requirements, potential authors should send a large (9 by 12 inch, 30.5 by 22.8 cm), self-addressed envelope, with 28 cents US postage affixed, to BYTE Author's Guide, 70 Main St, Peterborough NH 03458.

Articles which are accepted are purchased with a rate of up to \$50 per magazine page, based on technical quality and suitability for BYTE's readership. Each month, the authors of the two leading articles in the reader poll (BYTE's Ongoing Monitor Box or "BOMB") are presented with bonus checks of \$100 and \$50. Unsolicited materials should be accompanied by full name and address, as well as return postage.



TRS-80\* Model I Computer Owners . . .



## Double-density storage. It's really here!

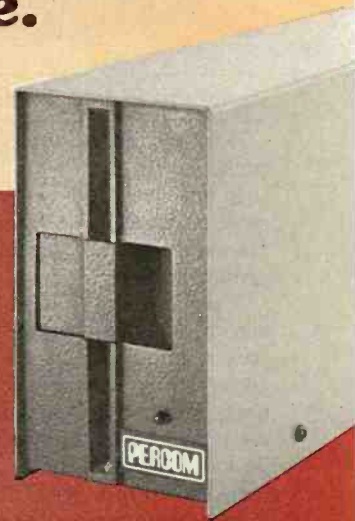

Here at Percom. And your authorized Percom dealers.

And double-density storage is here in a big way. Because now you can choose from *three different levels* of mini-disk systems — all *double-density rated*.

And get the storage that precisely meets your application needs.

Not to mention the service and quality that's made Percom the industry leader.

Although rated for double-density operation, all levels of Percom drives *work equally well in single-density applications*.

You can operate these drives in ordinary single-density format using TRSDOS\*, Percom OS-80™ or any other single-density operating system.

Or, you can add a Percom DOUBLER™ to your Tandy Expansion Interface and store data and programs in *either* single- or double-density format.

Under double-density operation, you can store as much as *350 Kbytes* of formatted data — depending on the drive model — on one side of a five-inch minidiskette.

That's *four times* the capacity of standard Model I mini-disks, almost *100 Kbytes more than* the capacity of the *eight-inch IBM 3740* format!

Available in 1-, 2- and 3-drive configurations in all three model lines, Percom *burned-in, fully-tested* drives start at only \$399.

### TFD-40™ Drives



TFD-40 Drives store 180 Kbytes (double-density) or 102 Kbytes (single-density) of **formatted** data on one side of a 40-track minidiskette. Although economically priced, TFD-40 drives receive the same full Percom quality control measures as TFD-100 and TFD-200 drives.

### TFD-100™ Drives



TFD-100 drives are "flippy" drives. You store twice the data per minidiskette by using both sides of the disk. TFD-100 drives store 180 Kbytes (double-density) or 102 Kbytes (single-density) **per side**. Under double-density operation, you can store a 70-page document on one minidiskette.

### TFD-200™ Drives



TFD-200 drives store 350 Kbytes (double-density) or 197 Kbytes (single-density) on one side of a minidiskette. By comparison, 3740-formatted eight-inch disks store only 256 Kbytes. Enormous on-line storage capacity in a 5" drive, plus proven Percom reliability. That's what you get in a TFD-200.

the DOUBLER™ — This proprietary adapter for the TRS-80\* Model I computer packs approximately twice the data on a disk track.



Depending on the type of drive, you can store up to four times as much data — 350 Kbytes — on one side of a minidiskette as you can store using a Tandy standard Model I computer drive.

Easy to install, the DOUBLER merely plugs into the disk controller chip socket of your

Expansion Interface. No rewiring. No trace cutting.

And because the DOUBLER reads, writes and formats *either* single- or double-density disks, you can continue to run all of your single-density software, then switch to double-density operation at any convenient time.

Included with the PC card adapter is a TRSDOS\*-compatible double-density disk operating system, called DBLDOS™, plus a CONVERT utility that converts files and programs from single- to double-density or double- to single-density format.

Each DOUBLER also includes an on-card high-performance *data separator circuit* which ensures reliable disk read operation.

The DOUBLER works with standard 35-, 40-, 77- and 80-track drives rated for double-density operation.

*Note.* Opening the Expansion Interface to install the DOUBLER may void Tandy's limited 90-day warranty.

**Drive enclosures, power supplies** Percom drive enclosures are finished in compatible silver enamel. Three sizes accommodate either 1, 2 or 3 drives. Drive power supplies are heavy duty, cool-running open-frame design. Three-wire ac power cords are safer, have lower noise pickup.

**Free software patch** This software patch, called PATCH PAK™, upgrades TRSDOS\* for operation with improved 40- and 77-track drives. For single-density operation only.

Quality Percom products are available at authorized dealers. Call toll free 1-800-527-1592 for the address of your nearest dealer or to order directly from Percom. Prices and specifications subject to change without notice.

™ trademark of Percom Data Company, Inc.

\* trademark of Tandy Radio Shack Corporation which has no relationship to Percom Data Company.

# PERCOM

PERCOM DATA COMPANY, INC.  
211 N. KIRBY • GARLAND TX • 75042  
(214) 272-3421

# Letters

## Moore Praise Comes FORTH

If FORTH is trickery, give me more trickery.

In my view, FORTH is a common-sense approach to programming. Granted, there are also bits of pure genius thrown in.

It makes sense to put all the routines used by the operating system, compiler, parser, editor, etc, in one dictionary conveniently accessible to the user at all times. That is, if they will fit. One of the bits of genius of FORTH is that they do indeed fit with room to spare for user-defined routines. The result is instant liberation from the "systems man" who tries but can't please everyone. It is your computer, and with FORTH you have access to everything on it.

It makes sense to use a stack to pass parameters between routines and to separate this stack from the return-address stack. You end up with a language that is designed to compute rather than to be read. Every step in FORTH is directed toward computing a result. FORTH is a sequence of com-

mands rather than statements as found in BASIC or Pascal. The functions of computing and documentation are separated. Hence I strongly disagree with Gregg Williams' advice (see August 1980 BYTE, page 130) that the user should introduce intermediate variables to improve readability. I concur with his objective, but I would encourage their use only in the commentary where they belong. There is no point to introducing unnecessary variables in the computing process. In the commentary, intermediate variables can and should be used very effectively to help describe the computations that are occurring on the stack without interfering with the process.

While FORTH takes away the expository statement, it does give back an important documenting feature, namely relative ease in preparing precise common-language definitions of each routine. All FORTH routines have a describable goal, and most of the action takes place on the stack. Hence FORTH routines tend to be simpler to describe. I have never seen a glossary for a language or operating system that comes

even close to the completeness and conciseness of the fig-FORTH glossary supplied by the FORTH Interest Group. It is a gem, a complete English-language description of FORTH. Every routine on the computer is concisely defined in English.

You have to have faith that taking the sacred function of documenting out of the language and turning it over to the user to do as he sees fit will work. After a while, you begin to wonder if Milton Friedman didn't write FORTH for his television series *Free to Choose*.

Finally, it makes sense to give the programmer a shot at controlling the compiler, especially when the compiler has access to all the routines of the system. C H Moore has shown with FORTH that compilers do not have to be large inflexible systems which try to take into account every eventuality and really can't do it. The result of this bit of FORTH trickery is a powerful compiler so tiny that it can be made interactive and used on line with no batch processing, linking loader, or other monstrosity which we are accustomed to associate with a compiler.

How small (or big) is tiny? The fig-FORTH system supplied by the FORTH Interest Group for the 6502 contains 220 primitive routines (not including the Editor or Assembler) that occupy a total of 6221 bytes. By my count, 34 of these routines are compiler functions, and they occupy a total of 982 bytes. My guess is that this is an order of magnitude smaller than other compilers of comparable power. That is trickery.

If there ever is a contest for the all-time ingenious software development, I would like to nominate C H Moore's best, the { ;CODE } routine and/or its logical extension  
{ < BUILDS ... DOES > }.

Edgar H Fey Jr  
Edgar H Fey Jewelers Inc  
1156 Fox Valley Ctr  
Aurora IL 60505

## Flash: Magic Exists!

I was delighted to see an issue of BYTE devoted to FORTH. As a user of and tinkerer with STOIC for 5 years, I heartily agree with the various authors' ravings about the extensibility, flexibility, and increase in productivity provided by FORTH. I was, however, amused at the many ways in which postfix (reverse-Polish) notation was rational-

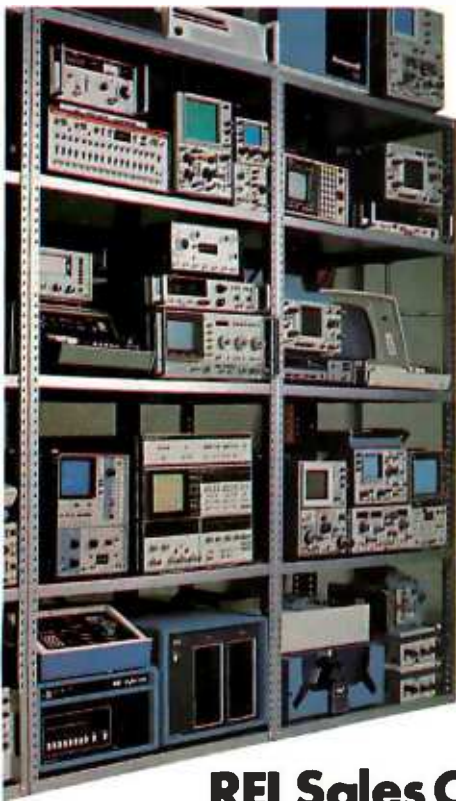

**Thousands  
of  
"like new"  
products  
with  
money back  
guarantees.**

**REI Sales Company  
(800) 227-8409**

In California (213) 993-7368, (415) 968-8845 or (714) 879-0561

# INTRODUCING THE NEW INTERTUBE III™



In late 1978, Intertec conceived the idea of the InterTube Video Display Terminal. Since that time, we've greatly enhanced its operation with the addition of many new exciting features. But perhaps the most significant announcement in the InterTube line of video terminals is our new InterTube III.

The new \$895\* InterTube III obsoletes dumb terminals and out-performs the smart ones. Powerful standard features include: a full 24 line by 80 character display, 128 upper and lower case ASCII characters, reverse video, complete cursor addressing and control, an 18 key numeric pad, user-defined function keys, blinking, a self-test mode, protected and unprotected fields, below-the-line descenders, automatic key repeat, twin RS232 serial ports and character and line insert/delete. Incredible!

InterTube III also boasts newly designed processor, video and power supply circuits. All in all, the InterTube III is what we believe to be the most powerful, reliable video terminal available today. And it costs less than its predecessor - our popular InterTube II.

InterTube III users will appreciate the many painstaking hours of human engineering which insure effortless operation without operator fatigue. InterTube III's new high resolution, non-glare CRT provides the sharpest possible display image. And our newly designed keyboard has that expensive "feel" you normally find only on terminals costing two to three times as much. But, most importantly, the InterTube III features state-of-the-art design with just three easily removable modules. So, with only a common screwdriver, servicing is a snap!

Better yet, we've got a nationwide service network with outlets located in over 50 cities to provide fast and efficient on-site or depot maintenance. Plus, an extended warranty program is also available.

If you're an existing InterTube user, you no doubt have discovered the exceptional value the InterTube really is. And, if you're not, why not call or write us today for the name and address of your nearest InterTube III dealer. Intertec video terminals are distributed worldwide and may be available in your area now.



2300 Broad River Rd, Columbia, SC 29210  
(803) 798-9100 TWX: 810-666-2115

Circle 10 on Inquiry card.

ized as being a better or more efficient way to do things even though it renders programs "write only" or at best difficult to read.

Since maintainability of programs becomes even more critical when productivity is increased tenfold or more, I feel that the requirement of postfix notation by FORTH is a serious shortcoming. There is nothing mystical about postfix notation; all compilers and interpreters must eventually reach this form because that is the order in which the computer must carry out its operations.

Over the past two years Jeff Morris and I have added various superstructures onto FORTH (one per application) that

attempted to combine the better features of Pascal (eg: record structures, algebraic notation) with the power and flexibility of FORTH. The outcome of all of these experiments was a conceptual breakthrough which resulted in the invention of Magic. Magic has all the advantages of FORTH, plus, Magic programs are readable (thus maintainable).

For example, the FORTH (or Magic) statement:

$$B@ C@ + A@ * A!$$

can also be written in Magic as:

$$A: = A*(B + C)$$

and in fact compiles in three fewer words (since the @s are not needed), and the FORTH (or Magic) statement:

$$A@ B@ = IF$$

can also be written in Magic as:

$$IF(A.EQ.B)$$

Magic is a major enhancement to the basic compilation structure of FORTH (a metaFORTH), not simply an add-on superstructure. Magic programs typically compile more slowly (due to the increased complexity of the compiler) but require less memory and run faster than equivalent FORTH programs.

The concept of metaFORTH is discussed briefly in the article by Kim Harris. (See "FORTH Extensibility: or How to Write a Compiler in Twenty-five Words or Less," August 1980 BYTE, page 164.) This is the direction of the future and will be the source of some super-powerful programming tools in the next decade. Magic is a first step in that direction.

I hope and expect that new metaFORTH languages such as Magic will be developed so that FORTH users can have their cake and eat it too. The time has come to stop justifying the unreadability of postfix notation.

Arnold Epstein PhD  
Director, Software Development  
Otek Inc  
7 Corporate Pl  
5 Bedford St  
Burlington MA 01803

---

#### Needs Tektronix Secrets

---

Can a BYTE reader help me? I have a Tektronix 4051 computer which came with a BASIC interpreter. Some of my programs must run faster, and I would like to rewrite them in machine code. Tektronix states that machine code is unsupported on the 4051 and suggests spending another \$10,500 for a faster Model 4052. Someone somewhere is programming the 4051 in machine code, as "Space Tag" on the demonstration tape is in machine code and runs incredibly faster than ordinary BASIC programs.

Richard Daily  
800 Charlesgate Dr  
St Louis MO 63122

---

#### Information Please

---

I recently acquired a Video Brain home computer built by A Umtech Company. The serial number is 003087 and the model number is 101A. It was built in either Santa Clara or Sunnyvale,

# APPLE USERS!

Technicians! Hobbyists! Engineers! Repairmen!

## NEW! 16 CHANNEL VARIABLE A-D BOARD!

Now you can digitally display, store, analyze and print your measurements!

The NEW ADC-16B A-D Board can be used for: POSITION MEASUREMENTS

PRESSURE MEASUREMENTS  
PHOTOELECTRIC MEASUREMENTS  
TEMPERATURE MEASUREMENTS  
A COMPUTERIZED  
VOLT-OHM METER

YOU GET A COMPLETE SOFTWARE PACKAGE INCLUDING A TEST KIT, CALIBRATION METHOD AND VARIOUS APPLICATIONS! Only 179<sup>95</sup>

This is a Variable Gain Board that allows increased measurements from 5 volts up to 100 volts.

**CTA** COMPUTER TECHNOLOGY ASSOCIATES

ORDER TODAY! Credit Card Users Call TOLL FREE!  
1-800-854-2003 ext. 815 In California Call 800-522-1500 ext. 815

Computer Technology Associates  
5812 Cromo Drive, Suite 102, El Paso, Texas 79912

Please rush me \_\_\_\_\_ NEW ADC-16B A-D Boards at the introductory price of 179<sup>95</sup> each.

Check Enclosed  MasterCard  Visa  Diners Club

Card No. \_\_\_\_\_ Exp. Date \_\_\_\_\_

Name \_\_\_\_\_

Address \_\_\_\_\_

City \_\_\_\_\_ State \_\_\_\_\_ Zip \_\_\_\_\_

Texas residents add 5% sales tax.

Please allow 4-6 weeks for delivery.

# Mountain Computer can now

# EXPAND

## Your Apple II Peripheral Capacity EXPANSION CHASSIS

### Quality You Expect

Eight more slots for your Apple! Now you can bank-select eight more peripheral slots with immediate or deferred software commands—like having up to 16 peripheral cards “on line”—or use the Select/Deselect switch mounted on the front panel.

Expansion Chassis' heavy-duty power supply is primarily for peripherals, without the heavy demand of motherboard support chips required in your Apple. This means much more power is available for peripherals than in your Apple itself! If you've run out of room in your Apple—Expansion Chassis is your answer. Drop by your Apple dealer for a demonstration, or contact Mountain Computer for the location of the dealer nearest you.

### Performance You Demand

- Eight mirror image I/O slots of the Apple
- Fully buffered, bi-directional data lines
- Apple II compatible interface card
- Dual selection capability; hardware or software
- Immediate or deferred selection in software mode
- From BASIC, a single POKE command turns the chassis ON or OFF
- Compatible with all software
- Dedicated power supply with approved power transformer



**Mountain Computer**  
INCORPORATED

300 Harvey West Blvd., Santa Cruz, CA 95060  
(408) 429-8600 TWX 910 598-4504



**Mountain Computer**  
INCORPORATED

IN USE

POWER

California. I understand it has a Fairchild F-8 8-bit microprocessor. It has 1 K bytes of programmable memory and 4 K bytes of read-only memory.

What I am looking for are cartridge programs, which have a 45-terminal bus, the expander sets, or anything that would be interchangeable. Also, any information or leads would be gratefully appreciated by me and my friends.

Richard L Rowland  
7072 Kenwood  
Las Vegas NV 89117

---

### An Overlooked FORTH Vendor

The staff at Dattricon Corporation was both delighted and disappointed with the August 1980 BYTE. Our delight stems from the extensive coverage of the language FORTH and Charles H Moore's interesting article, "The Evolution of FORTH, an Unusual Language," page 76.

However, we were disappointed with BYTE's failure to mention Dattricon's ACS 12-PRO or Dattricon's 4 K D-FORTH. Dattricon's implementation of FORTH resides in 4 K bytes of EPROM (erasable programmable read-only memory), produces code that can be placed into ROM (read-only memory), and provides for interrupt handling and the automatic setting of the data-transfer rate. Our ACS 12-PRO, with D-FORTH and the STD BUS interface, is a very powerful 6800-based single-board computer. A development package is also available for generating application EPROMs.

Jed W Heald, President  
Dattricon Corporation  
7911 NE 33rd Dr  
Suite 200  
Portland OR 97211

*We at BYTE were surprised to find additional FORTH vendors advertising in our August 1980 issue. Other vendors include Rockwell International (for the AIM microcomputer, see page 67 of the August 1980 BYTE), Kenyon Microsystems (for 6809 systems, see page 104 of the same issue), Sirius Systems (for the Radio Shack TRS-80, see page 171), Quality Software (for the Exidy Sorcerer, see page 208), Eric Rehnke (for the KIM, SYM, and AIM computers, see page 290), the Software Farm (for the TRS-80, see page 292), and Professional Management Services (for the Alpha Micro, see page 294). FORTH vendors not listed in the August 1980 BYTE are invited to submit a two-paragraph product release, which will be published in a future BYTE "What's New?" column....GW*

---

### FORTH Is Better Than LISP, He Cs

Unlike BYTE's earlier issue on LISP, the August issue on FORTH did an excellent job in making this intriguing language readily understood. The articles did not come right out and say that FORTH is so machine-efficient due to the user preprocessing his logic into postfix notation, but most readers should realize this.

Although I can tolerate that sort of notation for a desk calculator, it is unbearable for computer data processing. Although the C language is philosophically different, it is a threaded language which is much preferable.

Dick Sims  
185 Freeman St, Apt 951  
Brookline MA 02146

---

### Check Out a Computer

I always look forward to the new issue of BYTE and was especially eager to read the July 1980, Computers and Education issue. Arthur Luehrmann's article, "Computer Illiteracy—A National Crisis and a Solution for It," page 88, struck home on a point with which I wholeheartedly agree: "this country's general public is woefully ill-prepared to live and work in the Age of Information."

I was, however, disturbed by the fact that the role of public libraries was never mentioned. Public libraries are in a unique position to help solve the problem: they serve people of all ages, regardless of educational background; they are generally open more hours than schools; they are, perhaps more than any other institution, vitally interested in an information-aware public; they specialize in providing access to information, and they are free.

Many public libraries have microcomputers available for public use and provide a complement of interactive programs for individuals to learn with. Libraries that have done this report extensive and enthusiastic use of the equipment.

It's a sorry fact that most people have just never had the opportunity to even see a computer system. Until the opportunity to see, touch, and use computers is afforded, computers will remain shrouded in mystery for the vast majority of people of all ages. The public library is one of the best hopes we have to alleviate this problem.

Carlton A Sears  
Adult Services Coordinator  
Asheville-Buncombe Library System  
67 Haywood St  
Asheville NC 28801

*Letters continued on page 122*

# A growing line of tools to expand the Apple.

**7440A Programmable Interrupt Timer Module.** Time events in four operating modes—continuous, single shot, frequency comparison, and pulse width comparison. Includes three 16-bit interval timers, plus flexible patch area for external interface. Programmable interrupts, on-board ROM, and much more.

**7720A Parallel Interface.** Two bi-directional 8-bit I/O ports will connect your Apple to a variety of parallel devices, including printers, paper tape equipment, current relays, external on/off devices. Full featured, programmable interrupts, supports DMA daisy chaining.

**7811B Arithmetic Processor.** Interfaces with Applesoft, so you just plug in and run. Based on the AM 9511 device, provides full 16/32-bit arithmetic, floating point, trigonometric, logarithmic, exponential functions. Programmed I/O data transfer, much, much more.

**7710A Asynchronous Serial Interface.** Conforming to RS-232-C thru E 1978 standard, this card will drive a variety of serial devices such as CRT terminals, printers, paper tape devices, or communicate with any standard RS-232 device, including other computers. Full hand-shaking, and fully compatible with Apple PASCAL!

**7470A 3½ BCD A/D Converter.** Converts a DC voltage to a BCD number for computerized monitoring and analysis. Typical inputs include DC inputs from temperature or pressure transducers. Single channel A/D, 400 ms per conversion.

**7490A GPIB IEEE 488 Interface.** A true implementation of the IEEE 488 standard—the standard protocol for instrumentation and test devices. Control and monitor test instruments such as digital voltmeters, plotters, function generators, or any other device using the IEEE 488.

**7114A PROM Module.** Permits the addition to or replacement of Apple II firmware without removing the Apple II ROMs. Available with on-board enable/disable toggle switch.

**7500 A Wire Wrap Board.** For prototyping your own designs.

**7510A Solder Board.**

**7590A Extender Board.**

**7016A 16K Dynamic Memory Add-On.**

Watch this space for new CCS products for the Apple. We've got some real surprises in the works. To find out more about the CCS product line, visit your local computer retailer. The CCS product line is available at over 250 locations nationally, including most that carry the Apple. Or circle the reader service number on this ad.

Apple II, Apple II Plus, and Applesoft are trademarks of the Apple Corporation.

## CCS makes the difference.

# We see the Apple a little differently.



## We see it as a good way to get things done.

Apple has built a great computer. We at CCS have built a great line of peripherals and components to expand the Apple. To do almost anything you want to get done with a computer.

If you want to do business with an Apple, we've got tools to connect the Apple to standard business printers and terminals. Or to modems, for communications over telephone lines, with other computers, even with other Apples.

If you want to apply your Apple to engineering, scientific, or graphic projects, we've got tools for high-powered,

high-speed math functions, and fast, high resolution graphics. And tools to connect the Apple to lab test equipment like function generators or plotters.

And we have tools to connect the Apple to the outside world, including A/D converters and interval timers with external interface.

We make components for the S-100 bus, the PET, and the TRS-80, too. We built our products to deliver hard-nosed value to the OEM, and to the inventor who knows the best, at prices that are unbeaten.

To find out how much computer your Apple II can be, see things our way. Because for serious users with serious uses for the Apple, we've got the tools.



**California Computer Systems**

250 Caribbean Sunnyvale, CA 94086 (408) 734-5811

# The Future of Computer Graphics

---

Bruce Eric Brown  
and  
Stephen Levine  
Lawrence Livermore National Laboratory  
University of California  
POB 808  
Livermore CA 94550

---

Predicting the future can place one in a very precarious position. Although technology is moving forward at such a pace that it is almost impossible to look a long way down the road, we *do* have a good idea of what the *near-future* trends will be. So here I will discuss where the trends in computer-generated graphics are headed.

Computer graphics is the fastest-growing segment of the computer industry. Although many existing computers already have graphics capabilities, the future is even brighter. Since personal computer users will make up the largest percentage of the computer graphics market, the standard color television receiver will be the most common

---

#### Editor's note:

*It was only 5 years ago when the first annual computer graphics show was held. The Philadelphia show was sponsored by SIGGRAPH (the Association for Computing Machinery's Special Interest Group on Computer Graphics). At that time, the show attracted ten vendors and a few hundred visitors. SIGGRAPH-80, which was held this summer in Seattle, brought to that city over 100 vendors, about 6000 visitors, and filled twenty-four times the space of SIGGRAPH-75. So you can surmise how the computer graphics field will continue to grow....SM*

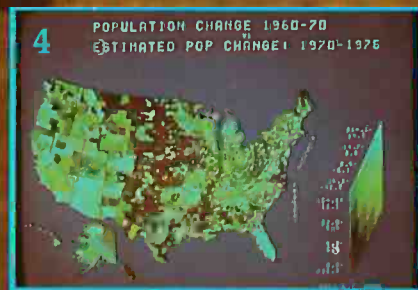
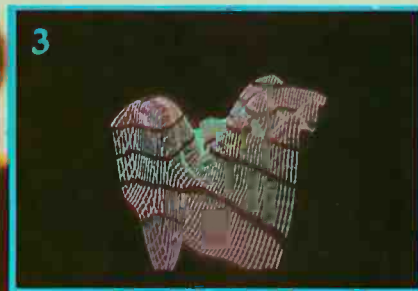
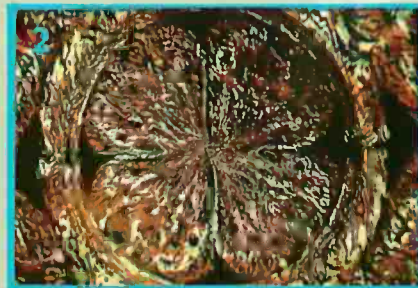

display device. Research is continually going on in video-generation techniques, and we can expect the quality of video images to improve dramatically.

Also on the horizon is the use of networks. Best of all, the price of graphics systems should continue to fall, and as they do, the number of applications will increase drastically.

#### Three Dimensions

This is an exciting time for experimentation with computer

graphics. Looking into our crystal video display, we can see many changes coming within the next few years. True three-dimensional displays will become common. Researchers will finally be able to see their models in three dimensions without the need of special glasses, stereo pairs, or by viewing two-dimensional projections.

Already in existence are integral hologram displays made from computer-generated images. (An example is shown in photo 9.) The





**Photo 1:** A computer-generated composite view of a DNA molecule using both ball-and-stick and space-filling models. Using keyboard control, the configuration of the model can be changed and it can be rotated in any direction. Such models are already assisting scientists in their research and will have an even bigger role in the coming years. Photo courtesy of Nelson Max, Lawrence Livermore National Laboratory.

**Photo 2:** Computer-generated art by Los Angeles artist David M. As you can see, computer graphics could revolutionize the world of art.

**Photo 3:** A perspective view of a two-dimensional array of numbers. Photo courtesy of Melvin L Prueitt, Los Alamos Scientific Laboratory.

**Photo 4:** Census data plotted to show population changes. This is an example of the type of material which could be available on a computer network with wide-band capabilities, such as cable television. Courtesy of Edward Zimmerman, White House.

**Photo 5:** A ground-level view of a computer-generated airport scene used in a real-time flight simulator. Photo courtesy of Marconi Radar Systems.

### Raster-Scan Displays

Low-priced memory will also change the look of computer graphics. Up to the present, the market has been dominated by storage tubes and calligraphic (ie: stroke-writing) displays; however, raster-scan displays can be refreshed from a frame buffer of semiconductor memory. Therefore, in the coming years, we can expect the graphic-terminal market to be dominated by raster-scan devices. The standard display will be a color television receiver connected as a micro-processor-controlled intelligent terminal. The cost of some of these graphics terminals will be at or near the cost of a modern color television receiver.

Raster-scan color television will probably be the graphics standard for the following reasons:

- The US video standard is well established.
- It has a large industry supporting it.
- The cost of developing another standard is prohibitive.
- The great numbers of personal computer users will help determine the trend. Why buy a color output monitor when you already have one or several available at home?

holograms are made by photographing 1080 computer-generated images on 35mm film and transferring them to the hologram. In a few years it will be possible to generate these directly; we might even see a laser-driven, computer-controlled, holographic-image output device.

There are currently several methods in use for displaying three-dimensional television images, but the most promising uses an interlaced television picture. The even scan lines

display an image for viewing with the right eye and the odd scan lines have an image for the left eye. The screen is viewed through a pair of glasses whose lenses are made with PLZT (lead lanthanum zirconate titanate) ceramic. Voltage pulses synchronized with the display of the odd and even fields darken the left and right lenses alternately. As a result, the viewer sees a true three-dimensional image. Photo 10 is a composite view of a display showing the images for both the left and right eyes.

Top-of-the-line video displays will include devices with 1000-line resolution (already available) as well as a number with 2000-line resolution. The cost of these will be significantly higher than that of a modern color television receiver.

On a raster-scan display, each dot on the screen is known as a picture element or pixel. Since each pixel is displayed 30 times a second, the image generator must either generate 30 Hz or store the pixel intensities in memory. Frame-buffer systems usually use dual-ported memory which both stores the image and refreshes the display.

To simplify things, let's assume a square picture with the standard 500 lines and each line containing 500 pixels. To display a completely black-and-white line image with no shades of gray we would need 250,000 (500 by 500) bits or 32 K bytes of memory. In order to display gray levels, the number of bits used for each pixel must be increased. To display color, we either divide the number of bits available among the three primary colors (red, green, and blue) or use a color map. A color map takes each pixel value stored and outputs the three intensities: the most common method is to use 1 byte input and 3 byte output. The number of colors which can be displayed is the product of the number of output intensities for each color. At a given time, only a subset, which is limited by the input values, can be displayed. If we use 8 bits in, 24 bits out, we can display any 256 colors of the 16,777,216 available.

In the near future we should be seeing 2000-line resolution systems with 24 bits per pixel (1 byte for each of the three primary colors and 12 bits per color in the map). 12 megabytes of memory would be needed for such a system. With memory prices expected to continue to fall, in about 5 years the major cost element of such a system would be the monitor and electronics.

### Vector Displays

Although it appears that raster-scan displays will

have the major share of the graphics market, line-drawing (ie: vector-display) systems will continue to grow, though at a slower rate. There are basically two types of line-drawing systems: the storage tube and the refresh calligraphic writer.

Storage tubes available today have higher resolution and greater image stability than most refresh systems. One disadvantage of the storage tube

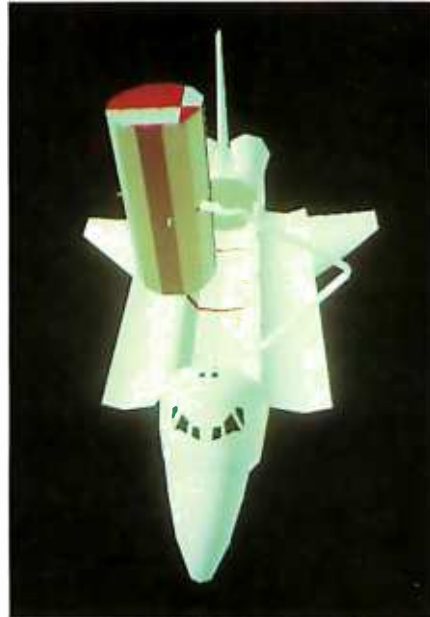

Photo 6 (above): An example of the computer-generated graphics used to train space-shuttle pilots at the Johnson Space Center in Houston, Texas.

Photo 7 (below): The control panel for an experimental fusion reactor at Lawrence Livermore National Laboratory. Transparent touch panels mounted over the color video displays have eliminated most switches. To control the reactor, the operators need only to touch the screen over the desired control area shown on the screen. Photo courtesy of Glenn Spreckert.



is the lack of selective erasure. In order to remove one line the entire screen must be erased and redrawn. With refresh displays the line is removed from the display list and the line is redrawn on the next refresh cycle.

Calligraphic displays can display about 20,000 three-dimensional vectors or 100,000 two-dimensional vectors at 30 Hz. In the next few years we can also expect a doubling of these capacities.

Raster-scan display buffers can also be used to display vector images and should begin to replace calligraphic displays as faster hardware becomes available. Many users will probably prefer the somewhat slower speed of the raster scan since they are able to display continuous-tone color images.

### Input

One tool which should see much use in the future is a transparent touch panel mounted over the face of a video screen. As shown in photo 7, an automated nuclear-reactor control room is one of the many possible applications. (Note the lack of switches.)

### Hard Copy

Currently, one of the major problems of graphic terminal users is how to satisfactorily get hard-copy output. The most common method is to use a camera to take a picture of the video screen. A device is also available which records the video output directly on film. Both of these methods leave much to be desired. The final solution may not necessarily come from the manufacturers of graphic terminals. The goal of copying machine companies is a dry method of putting a color image on a piece of paper (like

the current, dry black-and-white-image method).

At present, the device with the highest-quality color output is the film recorder. For raster output devices, the resolution of current recorders is 4000 by 4000 pixels, each with a range of 256 intensities. These devices use

# Hard and Fast...



## ...Bulk Storage from Industrial Micro Systems

### THE NEW MODEL 16

The new Industrial Micro Systems Model 16 Hard Disk Subsystem is a "fixed-removable" high speed, bulk storage device providing from 32 megabytes (32 million characters) to 96 megabytes of on-line storage for the Industrial Micro Systems-8000 or Series 5000 microcomputer systems. The Model 16 includes a credenza enclosure that provides a quiet, strong and attractive package for office or industrial applications where large memory is required. The Model 16 also includes a fully buffered DMA S-100 bus controller for fast and easy interfacing.

### WINCHESTER TECHNOLOGY WITH BUILT-IN BACKUP

The Model 16 includes a 16 megabyte removable cartridge and a 16, 48, or 80

megabyte fixed media that employs Winchester 3340 technology. Files and programs may be copied between the fixed media and the removable cartridge for fast, easy backup and archival storage.

### FAST ACCESS

The interface between the Model 16 hard disk and the Industrial Micro Systems computer is provided by the Hard Disk Controller. The Hard Disk Controller utilizes Direct Memory Access (DMA) for fast data transfer with minimum processor intervention. The maximum data transfer rate is 1.2 megabytes per second and the controller fully buffers the data, a sector at a time, to and from the disk. **Available in 220 V, 50 HZ Versions**



Now you don't have to look hard for fast computing power. Contact your Industrial Micro Systems Dealer today.

## INDUSTRIAL MICRO SYSTEMS

Marketing

628 N. Eckhoff, Orange, CA 92668  
(714) 978-6966

Manufacturing

2800 Lockheed Way, Carson City, NV 89701  
(702) 883-7611

See us at Comdex '80 Nov. 18-21, 1980 Las Vegas Convention Center.

as many as seven filters and multiple passes are made on the film to create full-color images. Additive-color red,



**Photo 8:** A problem in hydrodynamics illustrated through the use of computer graphics. The photo is part of a series illustrating a steel rod impacting a steel plate. Color changes represent areas of varying stress. In the future, such graphics will be widely used in education. Photo courtesy of Lawrence Livermore National Laboratory.



**Photo 9:** Integral hologram of a molecule created by photographing 1080 computer-generated images on 35mm film and then transferring them to a hologram. In the future computers will be able to generate holograms directly. Photo courtesy of Donald L. Vickers, Lawrence Livermore National Laboratory.

green, and blue filters or subtractive-color yellow, cyan, and magenta filters are used. In both systems, the seventh color is neutral for plotting black-and-white images. We can expect to see more of these recorders available in the near future, and some of the stripped-down models should be available at lower prices.

Another group of devices which fit into this category of film output are COM (computer-output-on-microfilm) devices. Many of those currently available have graphic capability as well as variable intensity. At the present time, COM devices are mainly used for alphanumeric-fiche output. Currently only black-and-white machines are available, although color-fiche machines are expected to be produced in the future. The most important consideration is the need for high-quality, large-format color images. The resolution of current COMs is about 32,000 by 32,000 pixels. Although higher resolution is theoretically possible, such devices will not be produced until a need for them is demonstrated.

Laser recorders may soon capture a portion of the expanding graphics market. Since a laser beam has much more energy to deposit on film than a CRT (ie: video display) image, laser recorders will be much faster than existing methods. On a modern film recorder, one full-intensity pass at 4000 by 4000 pixels takes about 1 minute. To record the same amount of data, the laser requires 1 second or less. The energy of a laser beam is great enough that a split beam could record up to five copies at the same time.

A current weak link in laser systems is the deflection systems. Although solid-state methods are being developed, rotating mirrors are used today. Another drawback with any system that uses film is that unless users have their own processing facilities, film development takes at least 24 hours and sometimes much longer.

The Xerox 6500 color copier can be interfaced to a number of terminals for image-recording, or it can be connected to computers for direct output. Ink-jet plotters, printers with color ribbons, and flat bed-drum plotters with color pens are included in this class of output devices. Continued improvements in speed and color reproduction can be expected.

The brightest future is for the video

disk. Today, these devices can hold 50 minutes (180,000 frames) of video per disk. Although the initial cost is high, the great number of frames available makes this device the ideal output and storage medium.

### Computers — The Future

Although so far I've concentrated on graphics hardware, what about the future of the beast behind the display — the computer?

It seems likely that within a few years the home computer user will have a choice of several 32-bit virtual machines with at least a million words of expandable, central memory, and 100 million words of disk space. This type of system will be ideal for a color-frame buffer system.

### Applications

Since pictures are a very efficient means of communication, the future applications of computer graphics are virtually unlimited. Photo 6 is a photograph of computer-generated graphics used to train space-shuttle pilots. Within the next few years, games and simulations with graphics of nearly the same quality will be available to the personal computer user. The PLZT glasses described earlier will be used to provide three-dimensional images for the would-be space-shuttle or 747 pilot. You can also expect the technology to be put to use in amusement parks. The Disneyland people have already used computer-generated graphics in some of their attractions and are continuing to develop them for future use.

### Networks

There are a number of advantages to having your own, isolated personal computer, but connecting it to a network opens up a vast new world. Networks designed specifically for personal computer users, such as The Source, are already in existence. Unfortunately, the narrow bandwidth of conventional voice-grade telephone lines severely limits graphic capabilities.

One future possibility is the use of cable television for networks with graphic capabilities. Cable is increasingly available in all but the most rural areas and has wide bandwidth, portions of which are not used. Personal computer users could tap into this resource and use the extra bandwidth for local communication nets.

Another possibility is to have the

# ATARI® PERSONAL COMPUTER SYSTEMS THAT GROW WITH YOU



## Start with a better computer.

Atari computers have built-in capabilities you can't even add onto many other personal computers. Three programming formats (ROM cartridge, disk and cassette). A 57 key upper/lower case ASCII keyboard with 29 keystroke graphics symbols. 128 colors and hues. Four separate sound channels and a built-in speaker. Four controller ports. A built-in RF

©1980, Atari, Inc.

Ⓜ A Warner Communications Company  
Atari reserves the right to make changes to products or programs without notice.

modulator and FCC approval for connection to any TV. Plus, nationwide Atari Authorized Service Centers. And more.

## Add memory.

The ATARI 800™ is supplied with 16K of memory. You can expand up to a full 48K of RAM with 8K or 16K Memory Modules™ you install yourself. In less than a minute. The ATARI 400's™ 8K of RAM may be expanded to 16K at Authorized Service Centers. Both may be expanded to 26K of ROM with slip-in ROM cartridge programs.

**Add peripherals.** The ATARI 410™ audio-digital program recorder. Single or dual density\* disk drives. The ATARI 800 individually addresses up to four drives. Add the ATARI 850™ RS232 Interface Module. Add high speed 40 or 80-column printers. Add an acoustic modem for remote data access. Add a light pen.\* And there are more Atari peripherals on the way.

**Add programs.** Choose among dozens of programs in Atari's rapidly expanding software library. Programs categories include:

- Personal Finance & Record Keeping
- Personal Interest & Development
- Professional Applications
- Education
- Information & Communication
- Entertainment
- Programming Languages
- Small Business Accounting

**Add it up.** With Atari, you start with more. And you can build to more. Because Atari offers you personal computer systems that grow with you. Ask your Atari retailer to give you a full demonstration of Atari computers, peripherals and programs. Complete systems. Because when other people were thinking hardware and software, Atari was thinking systems.

\*Available Fall, 1980



## PERSONAL COMPUTERS

1265 Borregas Avenue, Sunnyvale, CA 94086

Call toll-free (800) 538-8547 (Except Alaska and Hawaii)  
(In California: (800) 672-1404) for the name of your nearest Atari retailer.

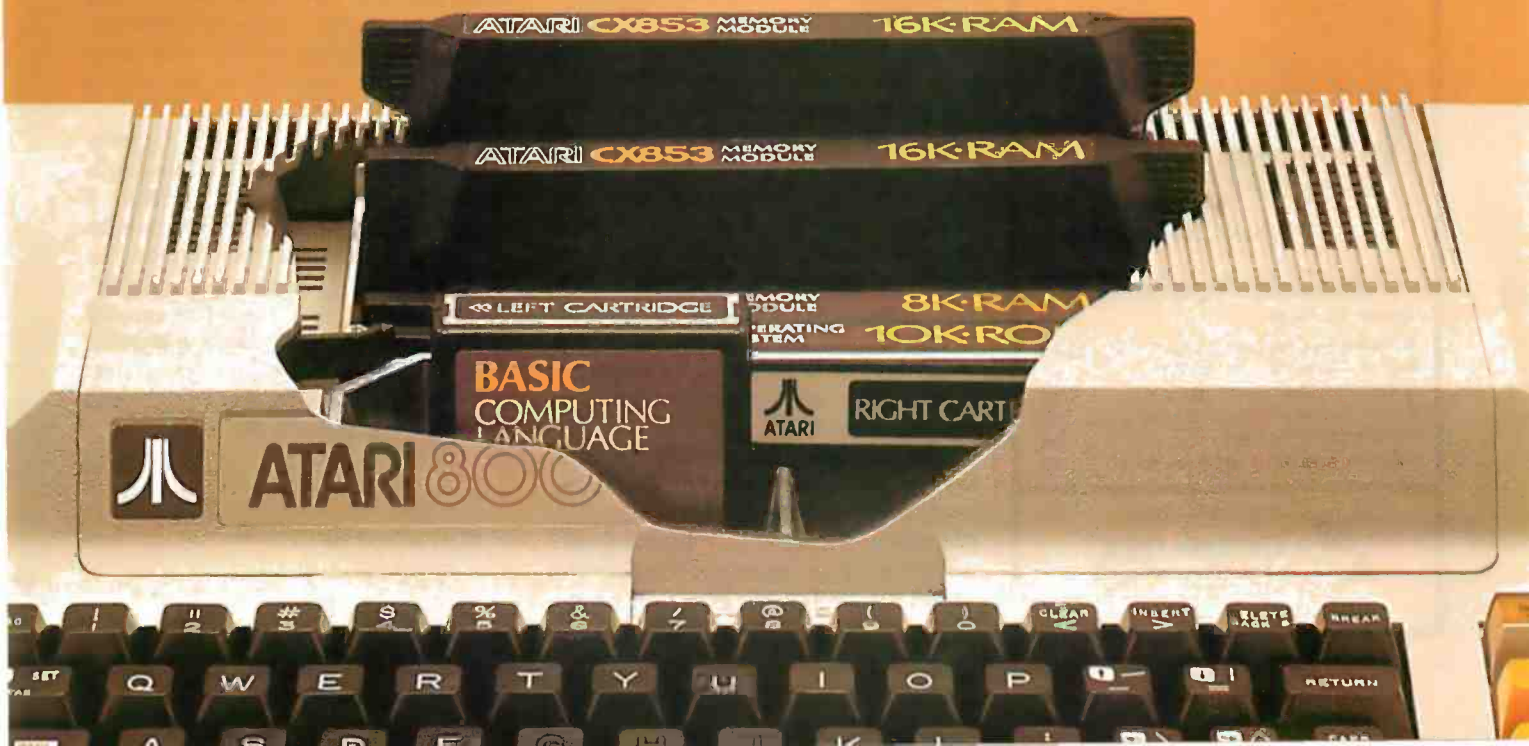

# New Z8000

The System X8000 MICRO-MINI™ based on the 16-bit Zilog Z8000 processor is available for **immediate delivery**.

**FEATURES** (partial list)

- Zilog Z8000 CPU
- Intel Multibus compatible
- Unique memory management system allows up to **16 megabytes** of memory
- Optional 9511 arithmetic processor
- 8-level vectored + non-maskable interrupts
- Two programmable timers
- On-board monitor ROM option
- Full "Multimaster" capabilities allow multiple processors and/or DMA devices on the same bus
- Flexible and/or hard disk controller
- Powerful disk-based operating system
- Memory boards: 16K, 32K, 48K, 64K, 96K, 128K
- 15-slot backplane
- Heavy-duty switching power supply
- Industrial quality throughout

**Prices start from \$998.** System discounts. Call for prices on complete custom systems.

**SYSTEM X9020**  
(CPU Manual \$19.95)



**\$4195\*** The SUPER-MICRO™  
READY TO RUN

**SYSTEM FEATURES** (partial list)

- Pascal MICROENGINE™ X9000**
- 16 bit P-code CPU
  - 64K bytes RAM/Full DMA
  - Floppy disk controller (SS or DS)
  - Floating point hardware (IEEE standard)
  - System software with enhancements
  - 2 serial, 2 parallel ports
  - Pascal compiler, text editors, file manager, CPU & memory diagnostics, symbolic Pascal debugger, linker, utilities and more.

**Floppy Disk Drives (2)**

- 1M combined memory
- Double density, single sided
- Standard 8" diskettes
- 6 ms track to track



**\$900\***  
With CPU

**MODEL X-920**  
DISPLAY/EDIT TERMINAL

\*LIMITED TIME cash price. 10% DOWN guarantees priority. Master Charge & VISA cards accepted.

**System discounts**

- ADM3A+ plus RG graphics (512x256) ... \$1995
- NEC Spinwriter 5510 or 5530 w/trac ..... 2895
- Anadex DP-9500 printer (60dpi) ..... 1595
- X-912 CRT (less 18 function keys) ..... 799
- P-E 550 CRT ("Bantam") ..... 740
- Siemens standard 8" drive (ss/sd-dd) .... 399

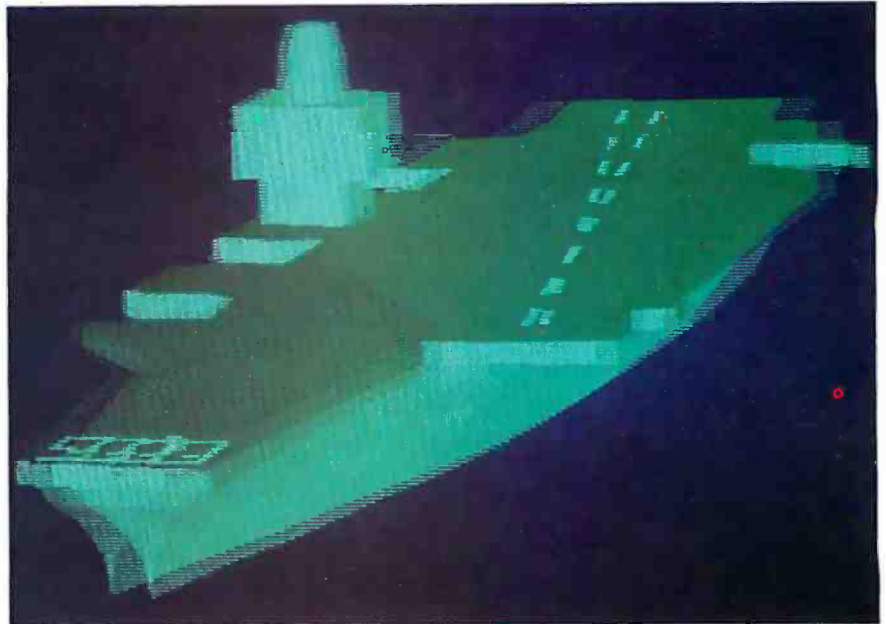

**Photo 10:** Interlaced left-eye and right-eye view of a computer-generated image of an aircraft carrier. The image is viewed in three dimensions when the user wears glasses with lenses made of PLZT (lead lanthanum zirconate titanate) ceramic. The lenses by the right and left are darkened alternately by voltage pulses synchronized to the display. Photo courtesy of John A Roese and Larry E McCleary, the Naval Ocean Systems Center.

cable-television company provide a main computer to control the network and act as a data base. The range of services which could be provided is virtually limitless. An example is shown in photo 4, where census data has been plotted to show population changes.

**Exploring the Future**

Computer graphics have exciting possibilities as an artistic medium. It's been said that computer-generated color graphics will revolutionize art in the same way that acrylics changed the world of artists who once worked with oil paints. Photo 2 shows computer-generated art by Los Angeles artist David M.

The simulators discussed earlier will also be widely used by filmmakers. Special effects, instead of being animated one frame at a time, could be programmed and filmed in real time. For instance, a director could ask for an airport scene on a clear day, as in photo 5. By changing a parameter, the same scene could be created on a foggy day.

The motion picture industry is in the forefront of developing and using sophisticated systems for computer-generated graphics. Increasingly higher levels of realism will be created in the future and the time-consuming

tasks of creating special effects and editing will be performed using laser scanner/recorders and video disks. In terms of dollars, the movies will be one of the largest users of computer graphics for the near future.

Applications, as we've seen, are limited only by our present imaginations. Photo 1 shows a computer-generated composite view of a DNA (deoxyribonucleic acid) molecule using both ball-and-stick and space-filling models. Such displays will speed up the rate of research. The molecule model can be rotated, changed in configuration, and taken home for the scientist to use on his personal computer.

Classroom displays will greatly surpass the audio-visual methods commonly used today. Photo 8 shows a hydrodynamic problem with impact calculations displayed through color changes. A computer display of this sort could be created and updated in the midst of a lecture.

In the wide world of computer-graphic applications, we have only scratched the surface. ■

# THE UNBEATABLE S-100 MEMORY

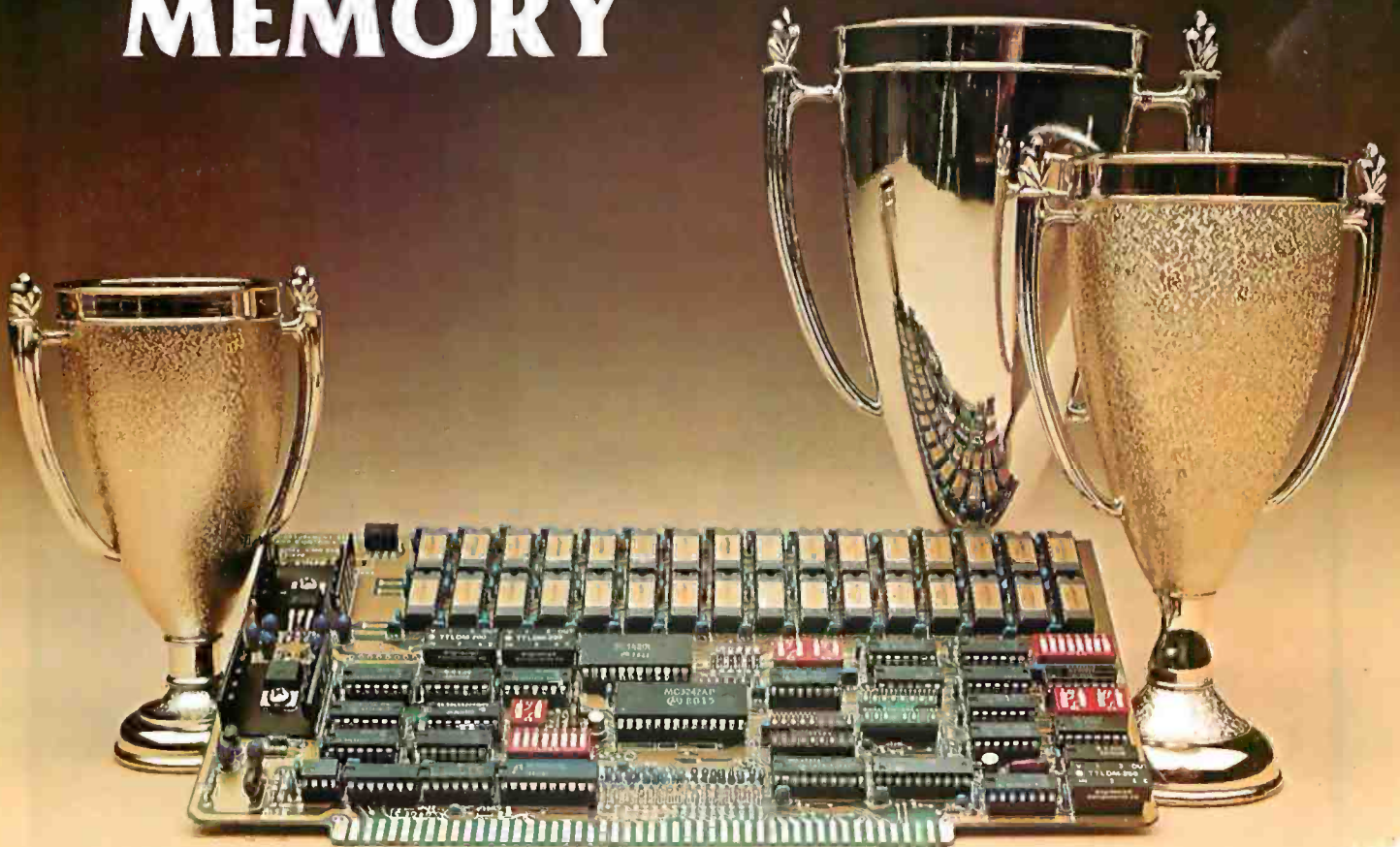

That's the MEASUREMENT systems & controls DMB Series of S-100 bus memory modules, fully compatible with **ALPHA MICRO, CROMEMCO, NORTH STAR, MP/M,** and most other S-100 systems.

Definitely a winner, the DMB Series is available with Bank Select (DMB6400) or without (DM6400) and utilizes industrial quality construction, provides outstanding reliability, and is backed by dedicated customer service and a one year guarantee.

The DMB6400 uses I/O port addressing for the bank select feature. A switch provides the ability to select any one of the 256 I/O ports for addressing the memory banks. The memory is configured as four totally independent 16K software selectable banks, with each bank addressable on any 16K boundary.

Outstanding features such as those listed below make the DMB series the UNBEATABLE S-100 Memory.

- Four independent 16K software selectable banks.
- Each bank is independently addressable on any 16K boundary.
- Switch selectable bank sizes — from 16K to 64K in 16K increments.
- Eight banks (512K) per I/O port for each of the 256 ports.
- Z-80 4MHz operation with no wait states using transparent refresh.
- On-board diagnostic LED's.
- Low power — 8 watts maximum.
- Reliable, tested and burned-in memory.
- IEEE S-100 compatible timing.
- One year guarantee.
- Attractive Dealer & OEM Prices.

See your nearest computer dealer, or contact us for the complete story on the UNBEATABLE S-100 Memory.

## Systems Group

A Division of MEASUREMENT systems & controls  
incorporated

867 North Main St. / Orange, Calif. 92668 / (714) 633-4460  
TWX/TELEX: 678 401 TAB IRIN

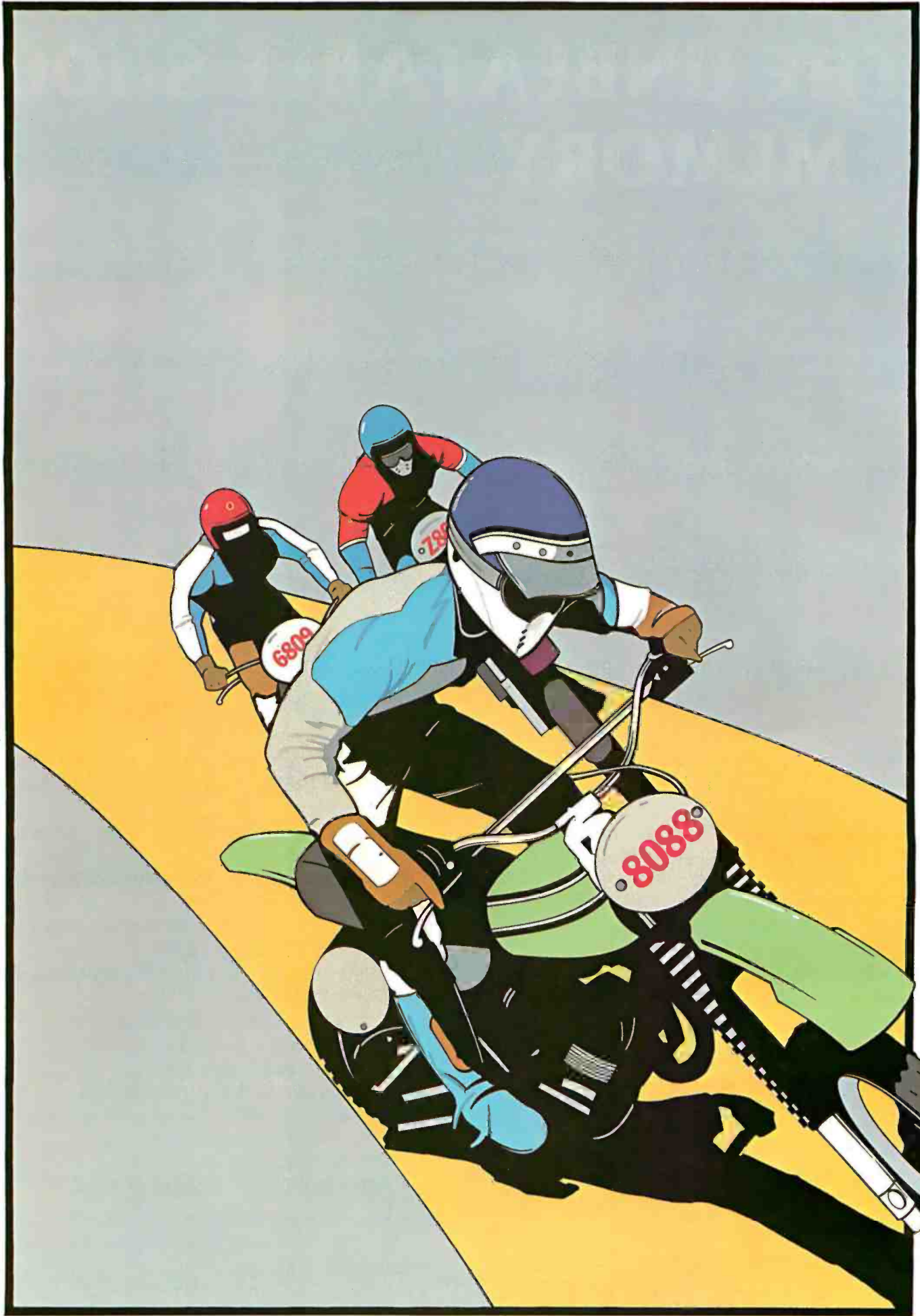



# 8-Bit Champion

**In price-performance, look to Intel's powerful iAPX 88 microprocessor to leave the pack behind. Both now and down the road.**

In price-performance races, the iAPX 88 is the one to beat. It's two times faster than the Z-80A and the 6809. And recent benchmark tests show that the iAPX 88, with its 8088 CPU, consistently outperforms its closest competitors in memory efficiency, ease of programming and throughput—as by as much as 4 to 1. This is especially important in high-performance tasks such as block moves, character searches, word shifts, and 16-bit multiplies. All critical for applications like word processing, terminal control, scientific instrumentation and industrial control.

And because it's the only 8-bit microprocessor that addresses up to 1 million bytes of memory, the 8088 can take on large programs. Without having to slow down due to overlays or memory bank switching, like other 8-bit processors.

## Tough price competitor

In price competition with other 8-bit microprocessors, the iAPX 88 has become the front runner.

You save dramatically on

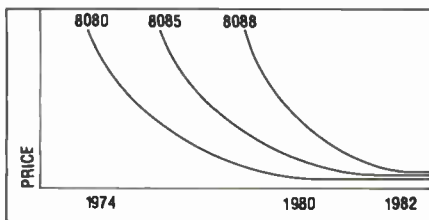

8-Bit Microprocessor Price Trends

memory chips, too. The iAPX 88 takes—on the average—30% less memory than competitors for the same programs. Then too, it allows you to use lower cost memory to get the same throughput as competitors. With a 5MHz 8088, you can use our 450ns memories and still outperform a 4MHz Z-80 requiring 250ns chips. Depending on

the application, your cost savings here can be substantial.

## No contest now with new Intel software

To unleash the new power that the iAPX 88 puts in your hands, it takes more powerful software—



the kind only Intel delivers today. Software that produces object code directly and gives you important extensions that allow you to fine-tune the software to your application.

Software such as PASCAL-88, the block-structured application language rapidly becoming the one most widely used. With our PASCAL-88, you can do direct port I/O and interrupt handling, as well as independent program module compilation. And produce code that runs faster than other, P-code interpreter versions.

Along with PASCAL-88, you get PL/M-88, our systems implementation language, our ANSI-compatible FORTRAN, and our ASM-88 macroassembler. So with more software capability than you've ever had before, now you

can choose the right language tool for each application—whatever it calls for.

## Get out in front with complete development support

All the development support tools you need are ready to go today from Intel. Start with the Intellec® Microcomputer Development System. Add to that our ICE-88™ in-circuit emulator. Together they give you CPU emulation in real time, plus features like symbolic debugging, diagnostic commands and program trace capability. With these tools you'll get your products to market faster than by any other route.

## Looking down the road

Best of all, with the iAPX 88, your investment in today's solution is protected. Since the 8088 is 100% object-code compatible with the 16-bit 8086—plus its future generations, the iAPX 186 and iAPX 286—you have the industry's only guaranteed headstart on the path to the future. Regardless of which language you're writing in.

So if you want to outdistance the pack, choose the iAPX 88—available today from your local Intel distributor. To get your copy of benchmark results, contact your local Intel sales office or distributor. For more information write Intel Corporation, 3065 Bowers Avenue, Santa Clara, CA 95051. Or call (408) 987-8080.

**intel delivers solutions.**

Europe: Intel International, Brussels, Belgium.  
Japan: Intel Japan, Tokyo. United States and Canadian distributors: Alliance, Aimag/Stroum, Arrow Electronics, Avnet Electronics, Component Specialties, Hamilton/Avnet, Hamilton/Electro Sales, Harvey, Industrial Components, Pioneer, L.A. Varah, Wyle Distribution Group, Zentronics.

## Home In on the Range! An Ultrasonic Ranging System

---

Steve Ciarcia  
POB 582  
Glastonbury CT 06033

---

Each month I try to present a hardware project that is both interesting and relatively easy to build. Unfortunately, it's not as simple as picking a topic and quickly whipping up some circuit. More often than not, I have a number of potential topics and projects on the fire at the same time. Some are in limbo and just waiting for the right parts. Others are postponed when it turns out that the necessary hardware is something that could be better built by NASA (National Aeronautics and Space Administration) than by a computer hobbyist.

One topic that has always interested me is the concept of automatic ranging. I became involved with this idea when I wrote an article entitled "I've Got You In My Scanner," November 1978 *BYTE*, page 76. The original article was about an infrared sensor and parabolic reflector mounted to rotate on a stepper-motor shaft. With computer-controlled stepping, the result was something like the sweep of a radar antenna. The project was sensitive to infrared and visible light.

The scanner, parabolic-reflector, and stepper-motor combination could easily tell the direction of a light source to an angular resolution

of 7.5°. It could make a 180° sweep, stop, and then follow the brightest object in its field of view. By



**Photo 1:** A computer-controlled, stepper-motor-driven infrared and ultrasonic ranging scanner. An infrared-sensitive photo Darlington transistor (GE L14F2) is mounted at the focus of a parabolic reflector, which is attached to the shaft of a stepper motor; the ultrasonic transducer is mounted above it.

The infrared sensor and drive mechanism were described in a previous *Circuit Cellar* article, "I've Got You in My Scanner! A Computer Controlled Stepper Motor Light Scanner."

recognizing the absence of known light sources (when the light path is blocked), it could even function as part of an intrusion alarm.

However, even though it could "see," the infrared scanner could not tell how far an object was in front of it, or detect the presence of a non-luminous body crossing its path. What I really wanted was a device that could provide the computer with range as well as direction. That's when I started hanging around the camera shop.

### Polaroid to the Rescue

The automatic focusing system on the Polaroid SX-70 Sonar OneStep Land camera intrigued me. I had considered tearing a camera apart just to use the ranging unit for my scanner, but sanity prevailed and I went back to designing my own circuit. Somewhere between thoughts of "Who'd really build this thing anyway?" and "I hope everyone can find all these components," I started seeing ads from Polaroid offering just what I wanted, without the camera.

The solution came in the form of an Ultrasonic Ranging System Designer's Kit sold by Polaroid for \$125. The kit contains a technical manual, two instrument-grade electrostatic ultrasonic transducers, a modified SX-70 ultrasonic circuit board, an experimental demonstrator display board, and two Polapulse 6 V batteries. With this unit I was able to enhance my original infrared-scanner

---

*Diagrams and schematics of the Ultrasonic Ranging System Designer's Kit were provided through the courtesy of Polaroid Corporation.*

---

# Now! North Star Application Software!

North Star now offers application software for use on the HORIZON! Now you have one reliable source for both hardware and software needs! The first packages available are:

## **NorthWord—**

NorthWord is a simple-to-operate word processing system designed for use with the popular North Star HORIZON. NorthWord enables you to increase office efficiency and cut document typing time and cost. NorthWord incorporates the most sought-after word processing features: easy editing, on-screen text formatting, simultaneous document printing, and much more. NorthWord can be integrated with other North Star software packages to produce customized letters, labels and reports quickly and efficiently.

## **MailManager—**

MailManager enables you to compile and maintain complete organized mailing lists. Lists are easily accessible and can be compiled with a great deal of flexibility. Entries, corrections and deletions are easily made. The North Star MailManager can print your list on individual envelopes, on mailing labels, or in compact summary form.

## **InfoManager—**

InfoManager is a powerful list-oriented, data management system. It will accept up to 50 categories of information for each record and has the ability to select and sort before printing. The North Star InfoManager has power and flexibility for many applications: product inquiry, inventory, customer/client records, calendar reminders, and as an easy way to fill in often-used forms.

## **GeneralLedger—**

General Ledger and Financial Reporting, two programs in one, maintains general ledger accounts based on such input as checks, bank deposits and journal entries, and uses the information in the general ledger to produce customized financial statements and financial reports.

NorthWord is the central building block for all the North Star application software to follow. Packages now being tested include other accounting and professional application packages. For more information or a demonstration, contact your local North Star dealer.

**NorthStar** 

North Star Computers, Inc.  
1440 Fourth Street  
Berkeley, CA 94710  
(415) 527-6950  
TWX/Telex 910-366-7001



design to include automatic range detection. The new scanner system incorporating the Polaroid unit is shown in photo 1. More on this later.

### Polaroid Ultrasonic Ranging System

The Polaroid Ultrasonic Ranging

System Designer's Kit costs \$125 (This offer is good until December 31, 1980. Photo 2 shows the Designer's Kit as received.), and is available from:

Polaroid Corporation  
Ultrasonic Ranging Marketing

Department 465 E  
20 Ames St  
Cambridge MA 02139  
telephone (800) 225-1618

Two primary components compose the ranging unit. They are the electrostatic transducer (see photo 3) and the ultrasonic transceiver board (see photo 4). Together these components are capable of detecting the presence and distance of objects within a range of approximately 0.9 feet (0.3 meters) to 35 feet (10.6 meters) with a resolution of  $\pm 1.2$  inches ( $\pm 30$  mm, or 0.29% of range).

In operation, a pulse is transmitted toward a target, and the resulting echo is detected. The elapsed time between initial transmission and echo detection can be used to find the distance by taking this round-trip time and multiplying it by the speed of sound. For a transmitted pulse to leave the transducer, strike a target 2 feet (0.61 meters) away, and return to the transducer, it requires 3.55 ms (1.78 ms per foot, or 5.84 ms per meter, during the round trip).

Essential to system operation is the transducer (shown disassembled in photo 5). It acts as a speaker in the transmit mode and as an electrostatic microphone in the receive mode. The transducer is 1.5 inches (38.1 mm) in diameter and consists of a 0.003 inch (0.07 mm)-thick gold-plated foil stretched over a concentrically



Photo 2: Polaroid Ultrasonic Ranging System Designer's Kit, which includes ultrasonic sonar transducers, electronic circuitry, and a detailed specifications booklet.



Photo 3: Close-up view of the Polaroid Ultrasonic Transducer.

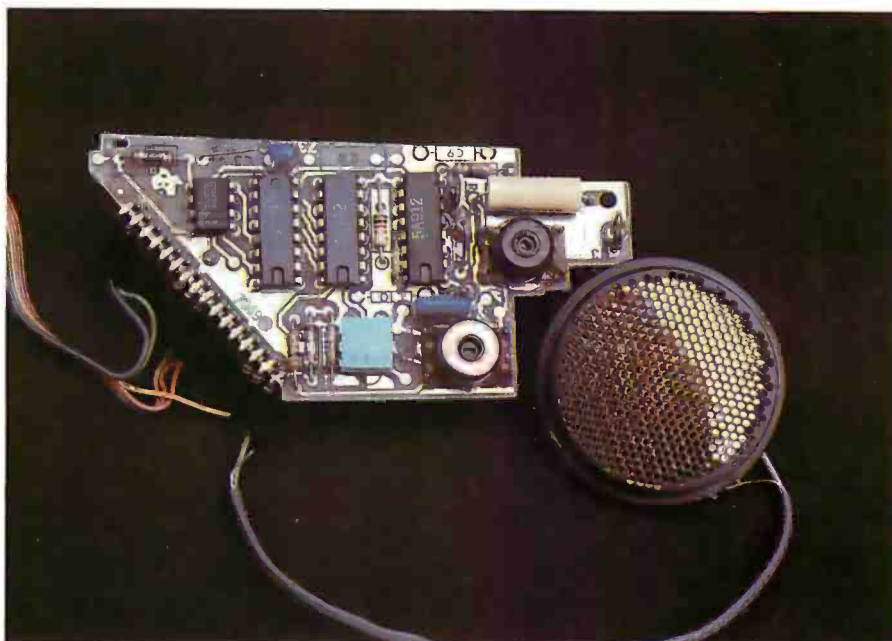

Photo 4: Close-up of the ultrasonic circuit board, which contains custom analog and digital integrated circuits.

National Microsoftware Producers

ANNOUNCES

# VTS/80<sup>TM</sup>

Video Typing System for 8080, 8085 and Z80's

PROFESSIONAL QUALITY

WORD PROCESSING PACKAGE FOR

CP/M\* COMPATIBLE MICROCOMPUTERS

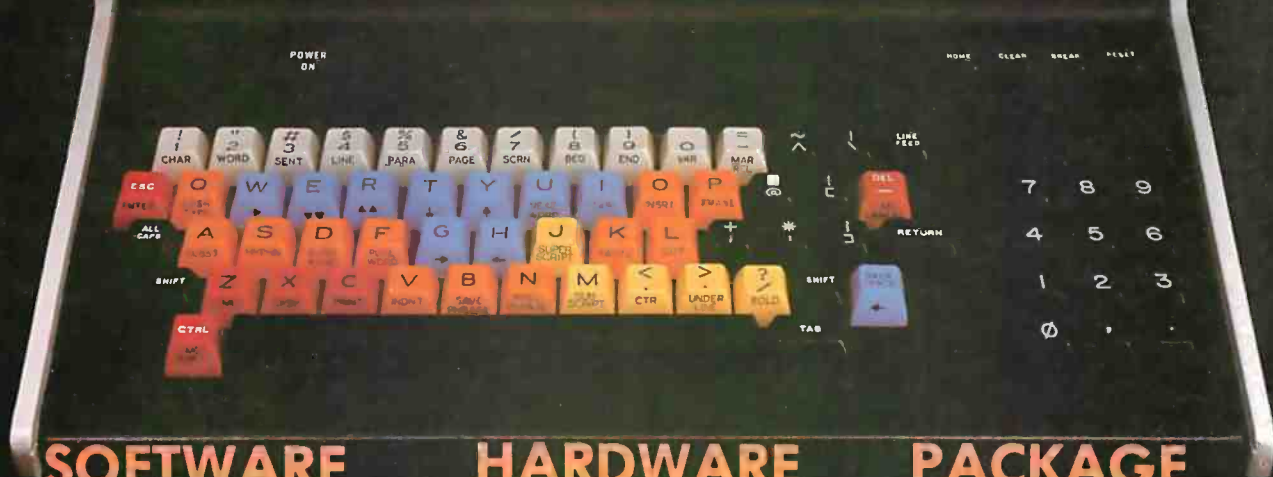

## SOFTWARE

- CP/M COMPATIBLE
- EASILY OPERATED BY OFFICE PERSONNEL
- CONTAINS ALL PROFESSIONAL WORD PROCESSING FEATURES
- PROMPTS ON SCREEN GUIDE USER THROUGH FUNCTIONS
- COMPARABLE TO DEC, NBI, Q Y X, WANG . . .

## HARDWARE

- OPERATES ON 8080, 8085 AND Z80 MICRO-COMPUTERS WITH 48K MEMORY
- CHOICE OF 5" OR 8" FLOPPY DISKETTES
- REPLACEMENT KEYTOPS PROVIDED FOR MOST CRT's
- SUPPORTS SERIAL AND WORD QUALITY PRINTERS (DIABLO, NEC, QUME)

## PACKAGE

- REPLACEMENT KEYTOPS COLOR CODED BY FUNCTION
- MANUAL WITH EXTENSIVE GRAPHICS DESIGNED FOR THE FIRST-TIME USER
- SELF STANDING MANUAL IN EASEL BINDER
- SPANISH, FRENCH, GERMAN, DUTCH VERSIONS AVAILABLE

SOLD THROUGH AUTHORIZED DEALERS AND DISTRIBUTORS ONLY

O.E.M. INQUIRY INVITED

SUGGESTED RETAIL PRICE \$549.00



NATIONAL MICROSOFTWARE PRODUCERS, INC.  
3169 FILLMORE STREET  
SAN FRANCISCO CA 94123 USA  
415-346-7025 TELEX 171790

\* CP/M is a registered trademark of Digital Research

WORD PROCESSING SOFTWARE



## WHAT IF

we cut taxes 7%,  
up the prime rate  
2% double defense  
spending, while  
eliminating Saturday  
mail delivery?

**T/MAKER** helps me  
juggle the imponderables  
fast and gives me a national  
overview on my CRT screen. (Yuk!)

**T/MAKER** can integrate numerical and  
text data, making analysis easy and  
then print out a document in hard copy  
for the clods on Capitol Hill.

**T/MAKER** is a wonderful tool for data  
analysis. It is easy to set up calculations  
for rows and columns of tabular data,  
automatically perform the  
computations, review the results and  
then modify some of the data to see the  
impact on the over all results. Several  
days of manual work can be  
accomplished in minutes.

**T/MAKER** is a full screen editor for word  
processing which handles text up to 255  
characters wide. It includes features like  
text formatting and justification, text  
buffer for block moves and repeated  
inserts, global search and replace and  
commands for printing your letters,  
reports and documents.

**T/MAKER** can perform an unlimited  
number of analysis and reporting tasks  
which integrate numerical and text  
processing. For example:

- Financial Statements • Balance Sheets
- Statistics • Growth & Projections •
- Profitability Reports • Revenues &
- Expenditures • Portfolio Analysis • Price
- Lists • Rate Structures • Inventory
- Valuation . . . . . and much, much more.

**T/MAKER** requires a 48K CP/M system,  
a total of 240K bytes of disk storage,  
CBASIC-2, and a CRT computer  
terminal with cursor addressing and  
clear screen.

**T/MAKER** system is \$275.00 complete  
with documentation and quick-  
reference card.  
Documentation alone is \$25.00.

## LIFEBOAT ASSOCIATES

1651 Third Ave. NY, NY 10028

(212) 860-0300  
International Telex 220501

**T/MAKER** is a trademark  
of P. Roizen  
CP/M is a trademark  
of Digital Research



grooved aluminum plate. When the  
metallic backplate is in proximity to  
the foil, it forms a capacitor. The foil  
is the moving element which converts  
electrical energy into sound and the  
returning echo into electrical energy.

The diameter of the transducer de-  
termines the directionality of the

transducer. The acoustical signal-  
strength lobe pattern, or acceptance  
angle, during operation is shown in  
figure 1. The graph indicates that the  
transducer is fairly directional.

When the unit is activated, the  
transducer emits a sound pulse. The  
crystal-controlled electrical pulse

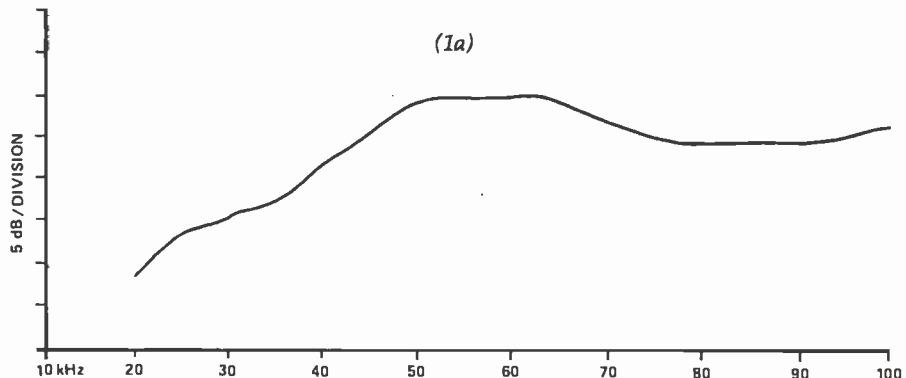

TYPICAL TRANSMIT RESPONSE

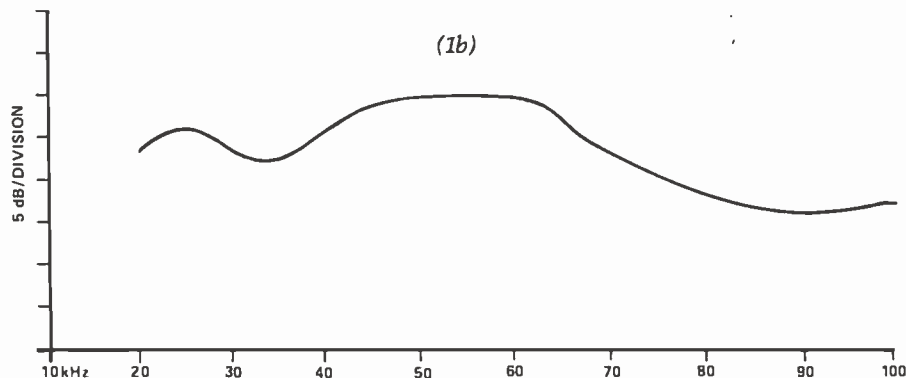

TYPICAL FREE-FIELD RECEIVE RESPONSE

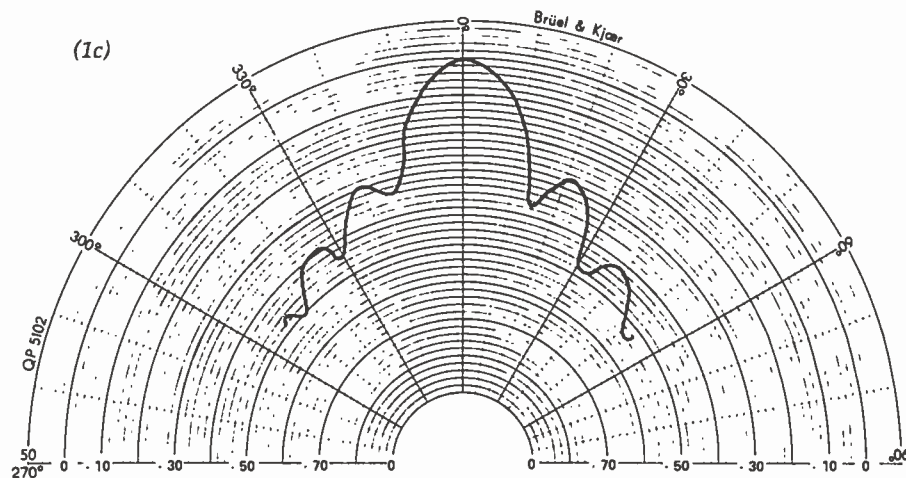

TYPICAL BEAM PATTERN  
AT 50 kHz

Figure 1: Typical transmission frequency-response curve (1a), reception frequency-response curve (1b), and radial-beam pattern (1c) of the Polaroid ultrasonic transducer. The beam pattern was measured at 50 kHz, with dB values normalized to on-axis response.

# Memory Expansion Module for TRS-80\*

**All you have  
to remember  
is to plug it in**



Three assembled and tested configurations are available:

Without RAM  
(MT-32A @ \$119.50)

With 16K RAM  
(MT-32B @ \$159.50)

With 32K RAM  
(MT-32C @ \$199.50)

Introducing the MT-32. Our new, brilliantly designed Printer/Memory expansion module for the TRS-80. This unit will add 16K or 32K of dynamic RAM to your basic 16K machine. The module also contains circuitry to drive Microtek's MT-80P dot matrix printer, or any other Centronics-compatible printer.

No hardware modification to your TRS-80 is required. Just plug into your bus connector and you are ready to go.

All Microtek products are covered by a one year warranty.

\* TRS-80 is a Registered Trademark of Tandy Corp.

Available from Microtek  
or your nearest computer dealer.

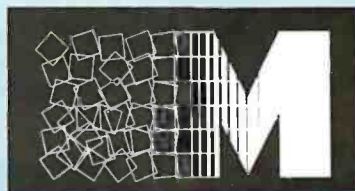

**MICROTEK**inc.

9514 Chesapeake Drive  
San Diego, CA 92123  
Tel. (714) 278-0633  
Outside Calif. call toll free: 800-854-1081  
TWX 910-335-1269

# MEMORY TRANSPLANT

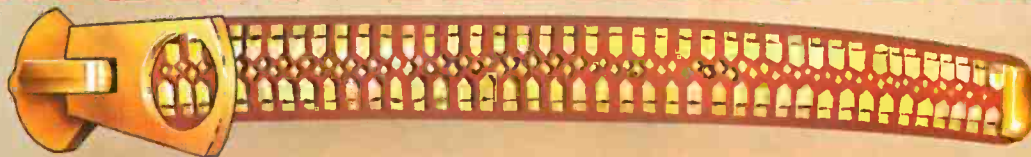

Circle 21 on Inquiry card.

## SPECIALS



### NORTH STAR HORIZON:

HRZ-2-32K-DD-ASM.....	\$2275
HRZ-2-32K-Q-ASM.....	\$2675
NORTHWORD DQ.....	\$ 295
MAIL MANAGER.....	\$ 235
INFO-MANAGER.....	\$ 365
GENERAL LEGER.....	\$ 775
ACC. REC. OR ACC. PAY..	\$ 445
WORD STAR.....	\$ 320

### COMMODORE (PET):

2001 32K.....	\$1090
8032 (80 COLUMN SCREEN)	\$1599
2040 DUAL DRIVE.....	\$1090
8050 DUAL DRIVE (IMEG).	\$1499
2022 TRACTOR PRINTER...	\$ 749

### APPLE II PLUS CALL FOR PRICE

ATARI 800..... \$ 799

TI 99/4 CONSOLE&MONITOR.. \$ 1190

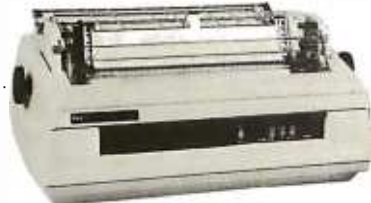

### SPINWRITERS FROM NEC:

5510 RO OR 5530 RO	\$2490
5520 KSR SERIAL.....	\$2790

### CENTRONICS:

730.....	\$ 659
737-1 (LETTER QUALITY)	\$ 849
(WE CARRY THEIR COMPLETE LINE)	
PAPER TIGER 440G.....	\$ 990

BASE II 800MST..... \$ 649

### OTHER PRINTERS WE STOCK:

ANADEX, COMPRINT, EATON, EPSON,  
TELETYPE, TI, ETC-CALL FOR PRICE  
DISPLAY TERMINALS

HAZELTINE 1420.....	\$ 949
1500.....	\$ 999
(WE CARRY THEIR COMPLETE LINE)	
INTERTUBE II.....	\$ 775

TELEVIDEO 914..... \$ 850

MOST ITEMS IN STOCK.  
PRICES SUBJECT TO CHANGE

MULTI-BUSINESS COMPUTER SYS.  
28 MARLBOROUGH STREET  
PORTLAND, CONN. 06480

(203)342-2747 TWX 710-428-6345  
M-F 9-6 SAT. 9:30-3:00



Photo 5: Expanded view of the Polaroid ultrasonic sonar transducer. Behind a honeycomb grill, a 0.003-inch (0.07 mm)-thick gold-coated foil stretches over a concentrically grooved aluminum plate. The retainer at left holds the parts in place.

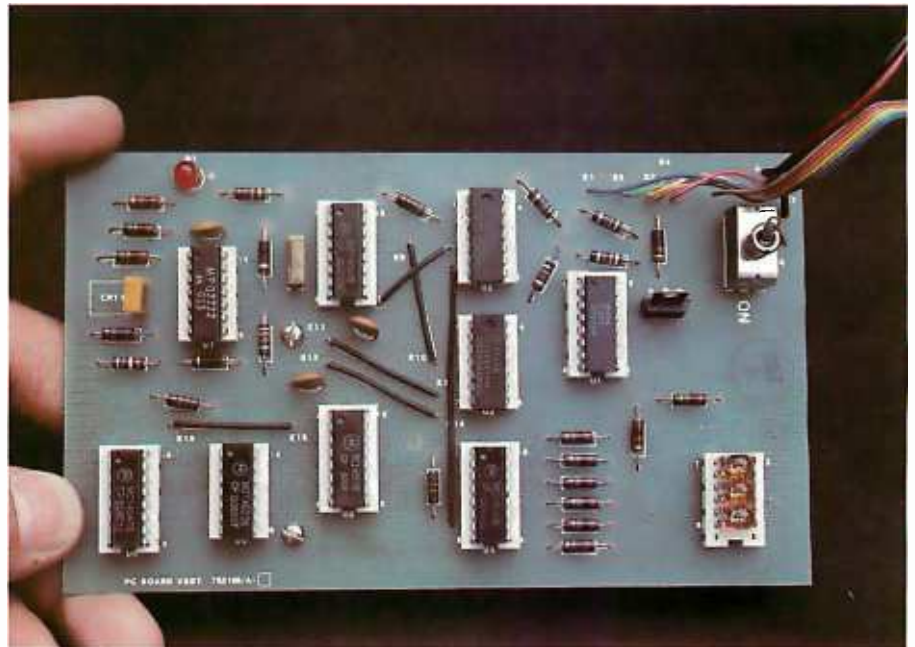

Photo 6: The EDB, which contains the electronic circuitry shown in figure 4. The three-digit LED display is at the upper right.

generated by the driver circuit is a 300 V high-frequency 1 ms "chirp" consisting of fifty-six pulses at four carefully chosen frequencies: eight cycles at 60 kHz, eight cycles at 57 kHz, sixteen cycles at 53 kHz, and twenty-four cycles at 50 kHz. This

combination is used to overcome certain topographical characteristics of the area into which the signal is being transmitted, where a single frequency might be cancelled and no echo would be received.

Text continued on page 42



# PERMANENT RELIEF

Of today's and tomorrow's Word Processing problems



## Apple PIE

Apple PIE (Programma International Editor) and FORMAT (text formatter) offer full strength solutions to today's word processing problems. These versatile, powerful programs provide document preparation and word processing capabilities previously found only on much larger computer systems.

PIE is a general purpose, full screen editor that uses control keys and function buttons to provide a full range of editing capabilities such as search and replace, delete, copy, insert, move. Changes may be made directly anywhere on the screen and are shown as they are performed.

FORMAT uses simple instructions embedded in the input text to describe the desired appearance of the final document. It handles centering, underlining, indenting, page numbering,

+

## Formatter

margins, headers, footers, even form letters, and includes a proofing capability.

These high-quality, cost-effective programs come with comprehensive documentation and run on a 32K Apple II. They are available through your local computer store or direct from Programma International, Inc. at the introductory price of \$79.95\*.

VIDEX VERSION T.M.

DOUBLE VISION T.M.

SUPR TERM VERSION T.M.

STANDARD VERSION

\*December 1, \$129.95.

# PROGRAMMA

3400 Wilshire Boulevard  
Los Angeles, California 90010



or

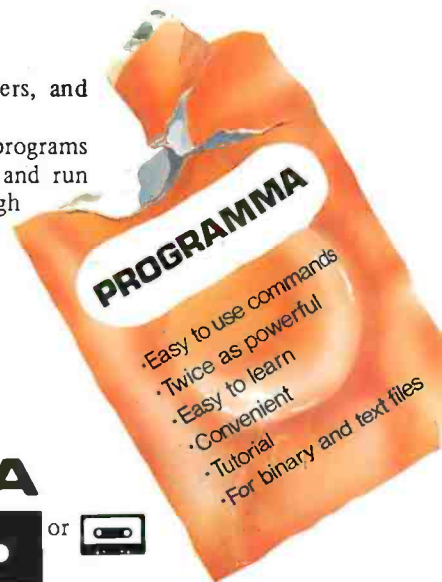

Simple enough for the beginner. Versatile enough for the professional.

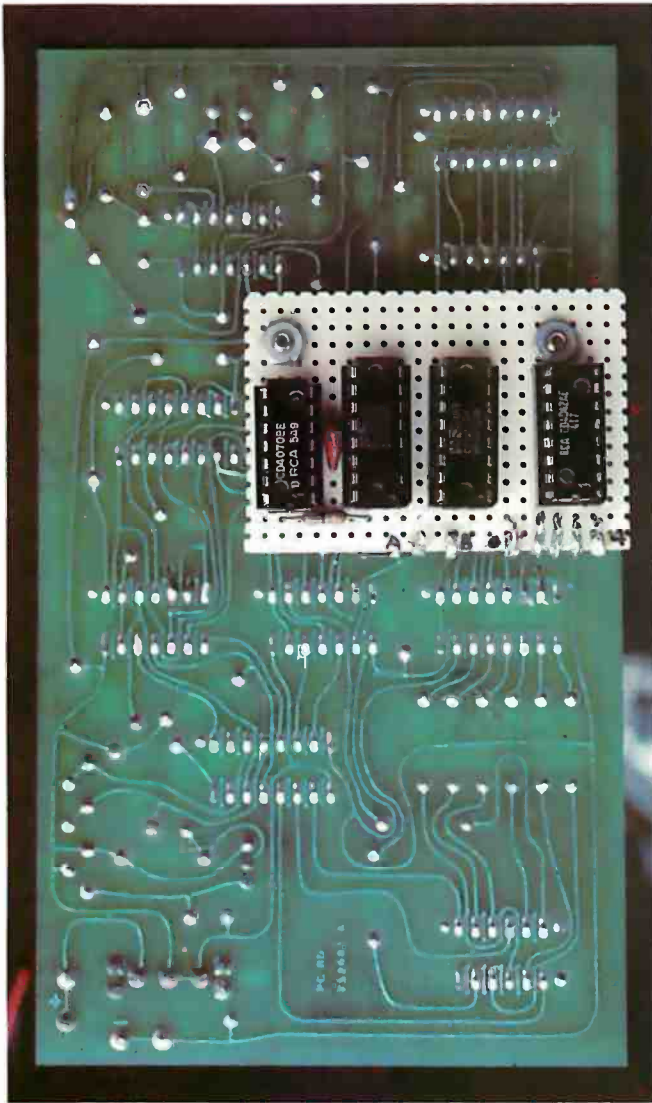

Photo 7: The prototype of the interface circuit of figure 5 has been attached to the EDB. The interface allows a computer to read the three-digit distance value.



Photo 8: Close-up of the back side of the reflector and transducer of the scanner, showing the mounting apparatus.

## THERE IS A BETTER WAY: A.C.T. II for the 8086/8088 ... only \$175.

A.C.T. II (Assembly Coded Translator) is a cross-assembler that lets you develop 8086/8088 code on any CP/M based 8080, 8085, or Z80 machine. Compare with competing software: A.C.T. II supports more Intel mnemonics and costs less, while delivering features such as assembly speeds greater than 1000 lines/minute, macro support, a comprehensive set of pseudo-ops, absolute assemblies, system text file support, local proc definition, code file format (standard Intel hex), and many more special features.

A.C.T. II fits in 24K of RAM (including CP/M). Complete with manual (available separately for \$20) and sample programs.

A.C.T. II IS ALSO AVAILABLE. Develop 6502, 6800, 8080, 8085, and Z80 code on any 8080, 8085, or Z80 machine running under CP/M. Same features as A.C.T. II; \$125 with manual (manual available separately for \$15).

**SPECIAL COMBINATION PRICE:** For a limited time, A.C.T. I and A.C.T. II are available for \$225 including all manuals.

## PASCAL at a Basic Price: \$175 complete

CP/M compatible PASCAL/M includes features such as built-in error checking, console cursor controls, extensions chosen for compatibility with other popular PASCALS, complete random file and long integer (32 bit) support, full Wirth implementation, all I/O totally compatible with CP/M file structure, optional updating service, full access to CP/M data files written in other languages and stored under CP/M, and much more.

PASCAL/M fits in 56K of RAM (including CP/M) and includes a 90 page manual (available separately for \$10). You may never go back to BASIC again!

**How to order:** All disks are shipped on single-sided, single-density, soft-sectored CP/M compatible media. PASCAL/M: Specify Z80/8080 or Z80+9511 math chip version (all are \$175). We accept UPS COD, Mastercard® VISA®, personal checks (allow time to clear), and certified checks. Californians add sales tax. Add \$10 outside USA.

order — call 408-248-5543

CP/M is a trademark of Digital Research  
A.C.T. I and A.C.T. II are trademarks of Sorcim



P.O. BOX 32505  
SAN JOSE, CALIFORNIA 95152

# NEW DISK SYSTEM POLISHES APPLE™

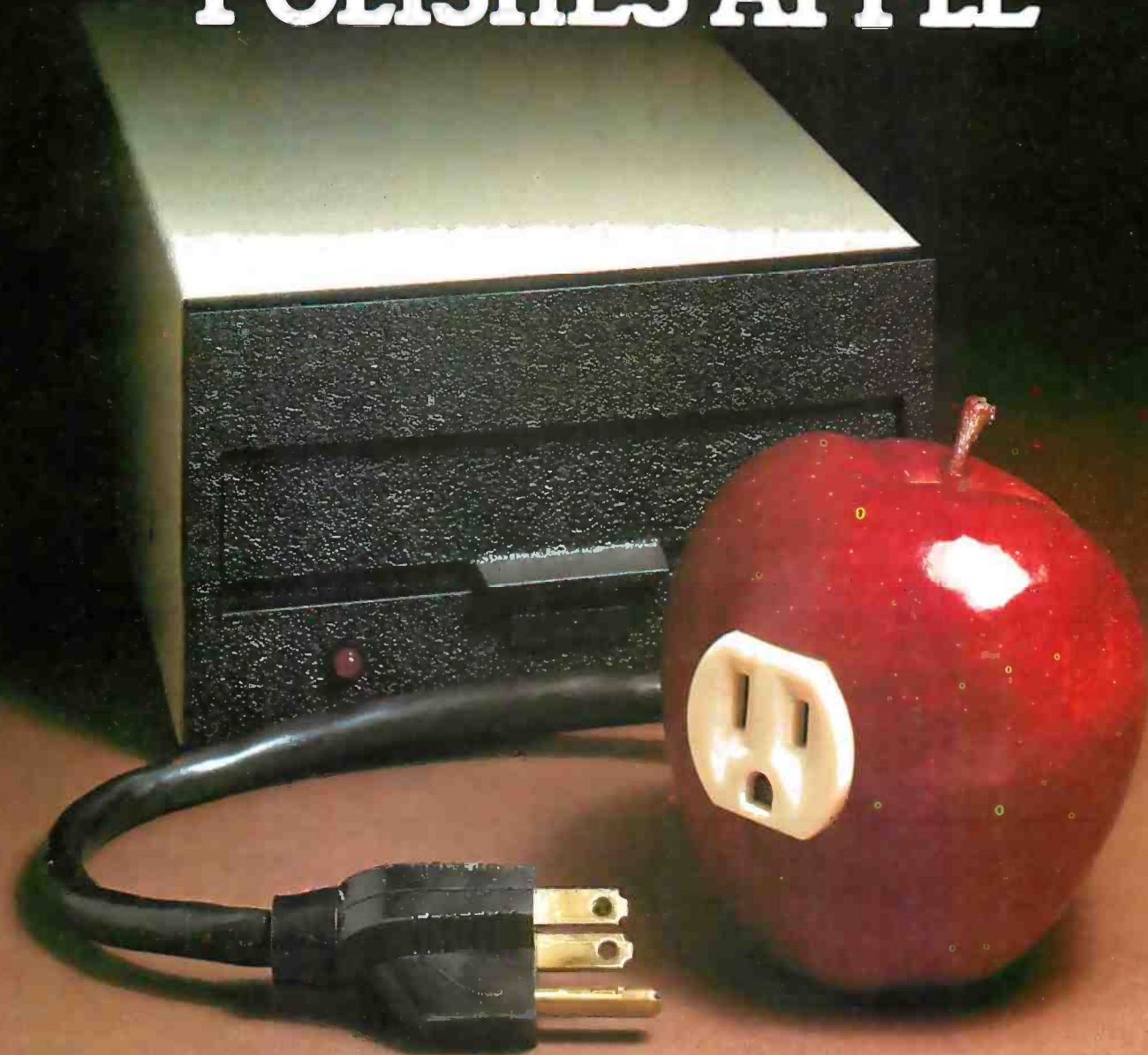

Micro-Sci's new disk drive family really makes your Apple shine.

Both the A-40 and A-70 offer extra performance plus the ability to read existing diskettes written on Apple Disk II systems.

And a jumper selectable boot prom for 13 and 16 sector interger Basic or 8 sector Pascal comes standard.

The Model A-40 actually costs a lot less than Apple Disk II drives. Yet it provides 40 tracks instead of

35, along with up to 20K increase in capacity. Maybe an extra 20K isn't anything to write home about, but the speed sure is—5 ms track to track vs. Apple's 15 ms.

The Model A-70, on the other hand, features twice the tracks and capacity of the Apple Disk II, but it costs only a few dollars more.

The secret of outstanding performance and reliability is a state-of-the-art design incorporating a band positioner, instead of a plastic

cam, plus an improved media centering system.

## **SPECIAL DISCOUNT.**

One A-40 plus controller is priced at only \$495 and the second drive is just \$395. You can save up to \$200 per system over Apple II drive prices.

And you can save even more if you act now. Contact us today for a special \$50 introductory discount on your Micro-Sci A-40 or A-70 system order.

**μ-SCI**

MICRO-SCI

1405 E. CHAPMAN AVENUE • SUITE E • ORANGE, CALIFORNIA 92666 • 714/997-9260

MICRO-SCI IS A DIVISION OF STANDUN CONTROLS, INC.

Apple and Apple II are registered trademarks of APPLE COMPUTERS INC., SAN JOSE, CALIFORNIA

Text continued from page 38:

The ultrasonic circuit board controls both the transmit and receive operating modes. It contains both digital and analog circuitry. In addition to transmitting the chirp and processing the echo, this circuit also tailors the amplifier sensitivity depending upon the object distance. Lower amplification is needed for close echoes, while higher amplification is needed for distant echoes. This is accomplished by increasing the amplifier gain and Q (ratio of reactance to resistance) in steps. Figure 2 is a block diagram of the ultrasonic circuit board.

### Experimental Demonstration Board

The ultrasonic circuit board previously described is a modified camera assembly. The EDB (Experimental Demonstration Board, shown in photo 6) is not a camera component; it was designed specifically as a user interface to the ultrasonic board.

Text continued on page 48

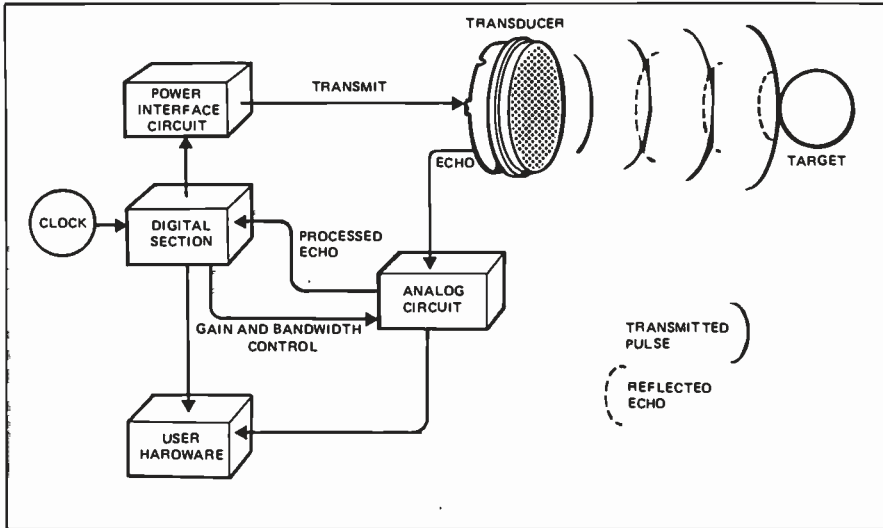

Figure 2: Block diagram of the ultrasonic circuit. The circuit board contains a variety of custom components and is slightly modified from the unit used in SX-70 Land cameras. This circuit, as well as the EDB, is powered by a 6 V Polapulse battery. It seemed to work acceptably with a 5 VDC power supply.

The block labelled "User Hardware" can be the EDB or any interface that can convert the ultrasonic circuit board's time-gated output into useful form.

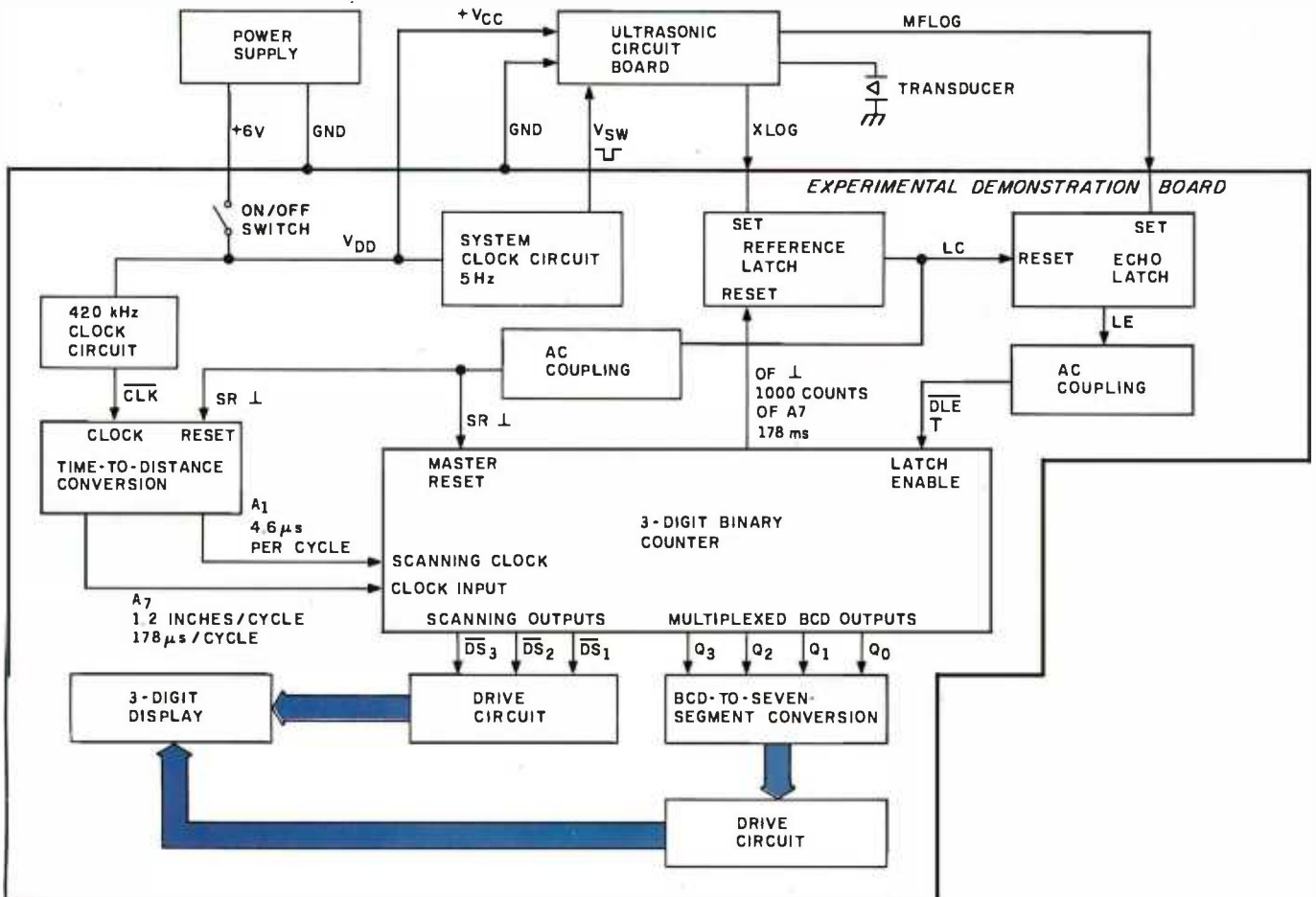

Figure 3: Block diagram of the Polaroid Experimental Demonstration Board.



## Even at 5:12 a.m., it's hard to quit playing Personal Software™ strategy games.

A quick game before turning in can become an all-night session when you load any of the Personal Software™ strategy games into your Apple,\* PET\* or TRS-80.\* They'll challenge, teach and entertain you. And now there are two new games—Gammon Gambler™ and Checker King™—joining Bridge Partner,™ Time Trek™ and the best-selling Microchess.™

**Gammon Gambler** is a sure bet. With ten levels of skill, you can begin a novice and become an expert. Whichever level you play, the computer moves so quickly you don't have to wait. The program follows U.S. tournament rules, and includes the doubling cube to spice up the game. Written for the Apple and PET by Willy Chaplin.

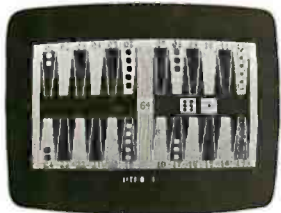

Gammon Gambler

**Checker King**—you probably forgot how much fun it is! If you move and change your mind, take it back and move again—without a peep from the computer. Play eight skill levels. Add and remove pieces. Save three board positions for later play. And solve three challenging checker puzzles. Written by Michael Marks for the Apple, PET and TRS-80.

**Microchess**, the most widely used personal computer chess program, is a nearly perfect chess opponent for the total novice or the advanced enthusiast. Written by Peter Jennings for the Apple, PET and TRS-80.

**Bridge Partner.** You against the computer in over 10 million different hands of contract bridge. You can even specify the hands' high card points. Written by George Duisman for the Apple, PET and Level II TRS-80.

**Time Trek** is easy to learn, difficult to master and impossible to forget. Take command of a starship in real-time action to make the galaxy safe again. PET version by Brad Templeton. TRS-80 program by Joshua Lavinsky.

Personal Software, Inc., also produces the VisiCalc™ program (the software that's revolutionizing personal

computing), CCA Data Management System, the Vitafacts series and other exciting software for the Apple, PET and TRS-80.

Now that you've read about the Personal Software programs, go see a demonstration. For the name of your nearest Personal Software dealer, call (408) 745-7841 or write to Personal Software Inc., 1330 Bordeaux Dr., Sunnyvale, CA 94086.

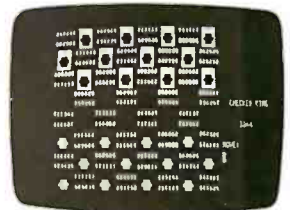

Checker King



# PERSONAL SOFTWARE



STRATEGY GAMES SERIES

\*Apple is a trademark of Apple Computer, Inc.; PET is a trademark of Commodore Business Machines, Inc.; TRS-80 is a trademark of the Radio Shack Division of Tandy Corp.

# While they were thinking hardware and software, we were thinking



16K SUPER RAM  
32K SUPER RAM  
16K MEMORY MASTER  
24K MEMORY MASTER

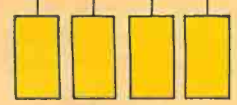
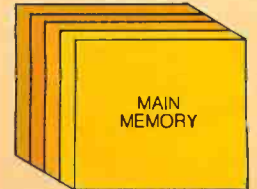

8 INCH 1.2 MEGABYTE  
FLOPPY DISKS

**S-100 SYSTEMS.** From add-in memory boards to add-on hard disk. High performance S-100 busboards. Single, dual and quad-density disk systems with up to 1.2 megabytes on a single floppy disk drive. I/O boards. All, with the Morrow Designs systems approach to hardware and software.

**COST EFFECTIVE SYSTEMS.**

Morrow Designs Discus M26 offers 26 usable megabytes of memory for just \$4,995. About \$192 per megabyte. And, it's a complete system, including a Shugart SA4008 Winchester-type sealed-media hard disk, power supply, cables, and cabinet with fan. The single board controller supervises all data transfers, communicating

with the CPU through 3 I/O ports (command, status, data). The controller can generate interrupts at the completion of each command. A 512-byte sector buffer is on-board. And the system is available for S-100 mainframes.

**SYSTEMS FOR SYSTEMS.** Whether you're building systems or trying to expand your present system at reasonable costs, Morrow Designs offers complete, cost-effective subsystems.

Modular systems that allow you to build your system your way.

**SOFTWARE FOR SYSTEMS.** Morrow Designs backs each subsystem with high-quality, fully-tested software. INSTALL software allows you to attach



# systems.

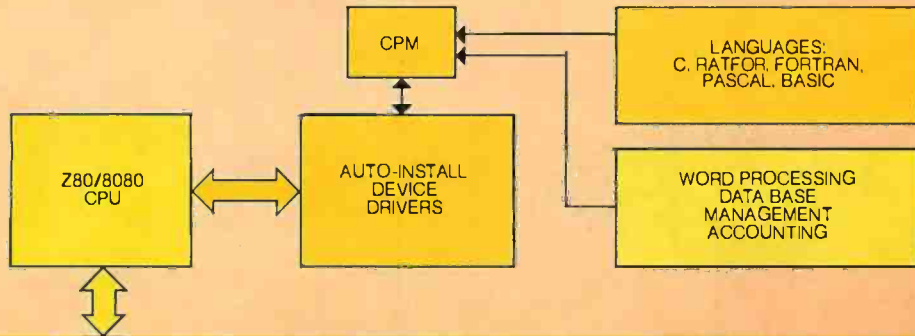

IEEE STANDARD S-100 BUS

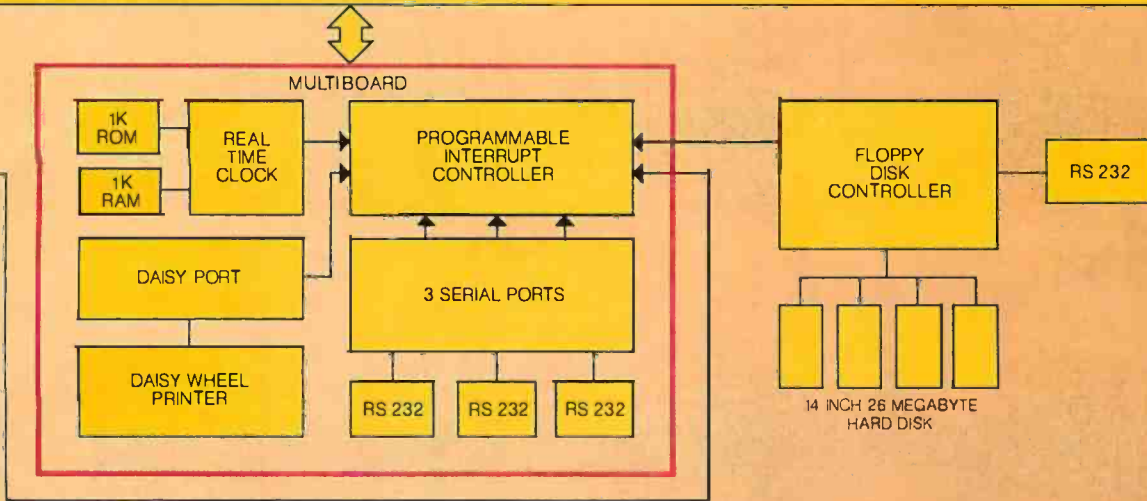

any Morrow disk system to any CP/M system operating under CP/M. Morrow CPM/CDOS software allows you to attach any Morrow disk drive to Cromemco Systems. In fact, if software runs under CP/M, it will run on any Morrow Designs hardware.

### COMPARE PERFORMANCE.

Hardware performance. Software performance. System performance. Any Morrow Designs disk drive, hard or floppy, can be mixed and matched through Morrow Designs standard software. And all necessary hardware, software and firmware is included with each system.

**NOW, COMPARE PRICE.** Morrow Designs products offer maximum efficiency at minimum cost. But we don't cut corners. What that means



to you is reliable system efficiency at cost effective prices.

Better systems for less. See Morrow Designs full line of memory and I/O, plus floppy disk/and the M26 hard disk system at your computer supplier. Or, send in the coupon for our full line catalog. Can't wait. Call us at (415) 524-2101.

## MORROW DESIGNS

5221 Central Ave. Richmond, CA 94804

Gentlemen, Please send me your complete OEM hardware and software specifications. Plus the name of my nearest distributor.

Name \_\_\_\_\_  
 Company \_\_\_\_\_  
 Address \_\_\_\_\_  
 City \_\_\_\_\_ State \_\_\_\_\_ Zip \_\_\_\_\_

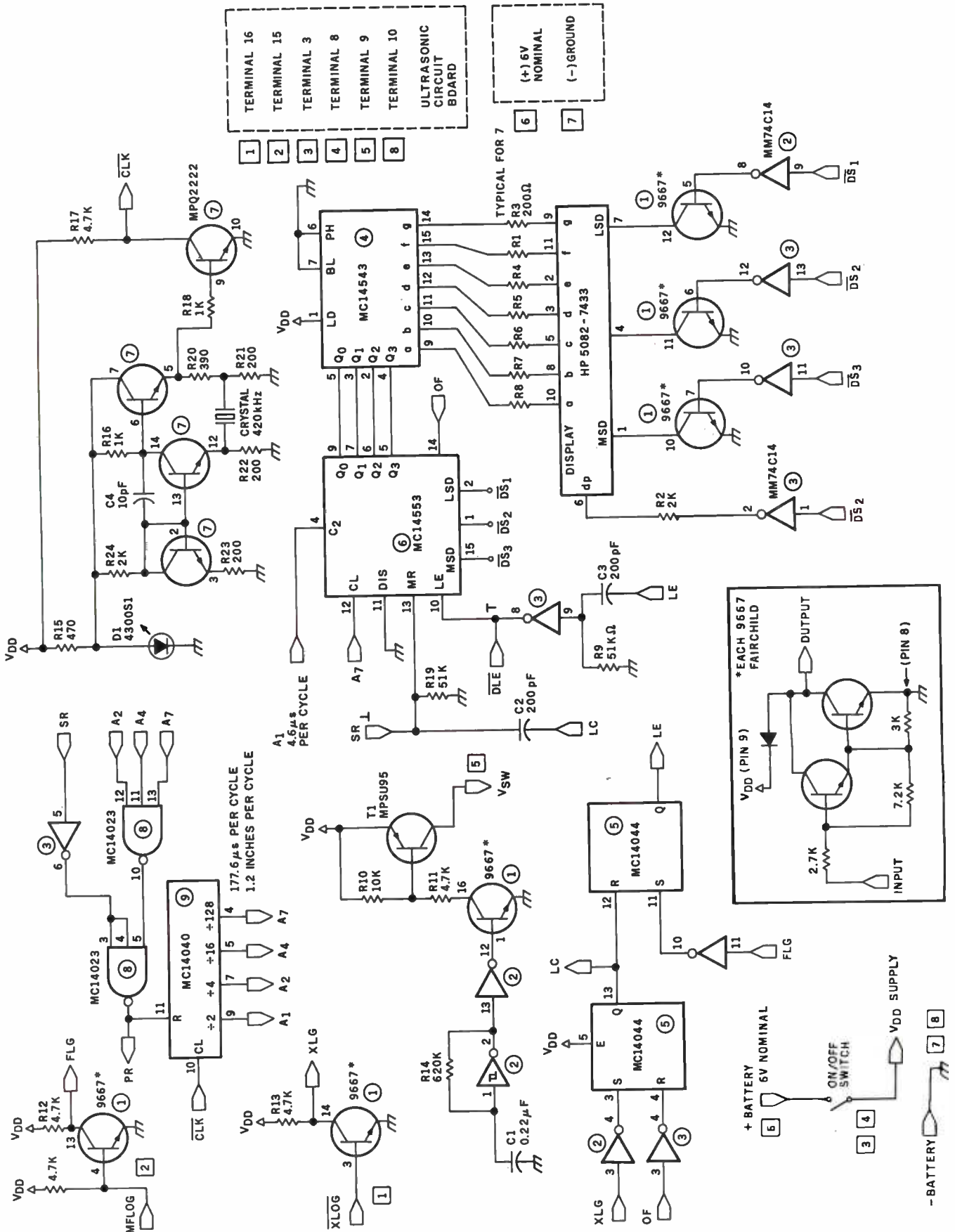
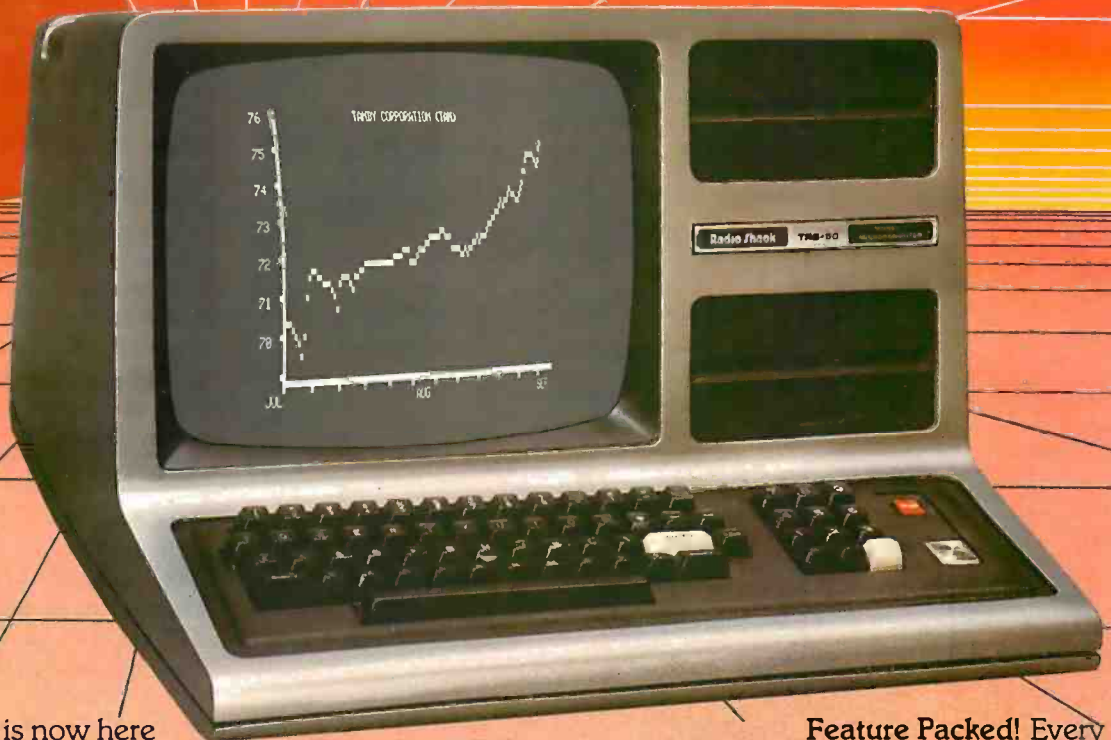

Figure 4: Schematic diagram of the EDB. This board contains all the necessary circuitry to convert the raw data of the sonar transmit/receive time interval into a numeric distance value and display it on a three-digit LED display.



# The TRS-80™ Model III. A New Standard in Personal Computers!



The new standard is now here — this beautiful, feature-packed, one-piece desktop computer system at a very, very affordable price. Continuing the TRS-80 tradition begun with our famous Model I, the amazing Model III gives you everything you've always wanted in a personal computer—including easy expandability.

**It Talks Your Language!** Model III is available with either Level I or powerful new Model III BASIC. Best news of all is that nearly all Model I software is compatible with Model III, so you already have a huge library of applications to choose from. Radio Shack already offers over 80 quality packages — from games to sophisticated business programs to word processing.

**Big Storage Capacity!** Model III BASIC features dual-speed cassette loading (1500 and 500 baud). You can expand your Model III to

## Radio Shack is Lowering the Cost of High Technology!

As  
Low \$699\*  
As

support up to four (two integral) double-density disks at 175K each for a total system capacity of up to 670K bytes.

**Powerful Memory!** Up to 48K of internal memory is easily added, since no expansion interface is required. Model III is completely self-contained. Start with a 4K Level I system or move up to our 16K Model III BASIC right away for the applications you need.

**High-Resolution Display!** Every Model III has a sharp display of 16 lines of 64 characters. Model III BASIC adds lower case plus graphics and special characters.

**Feature Packed!** Every Model III includes a parallel printer interface and 65-key keyboard. Model III BASIC adds "extras" like a real time clock, scroll protect, keyboard controlled screen print, and RS-232 firmware.

**And It's Very Affordable!** The 4K Level I system is only \$699.\* The 16K version with powerful Model III BASIC is just \$999.\* So why wait, step up to the new standard now. Available at Radio Shack stores, dealers and Computer Centers everywhere.

**Radio Shack®**  
The biggest name in little computers™

**Send me your TRS-80 Catalog!**

Radio Shack, Dept. 81-A-40  
1300 One Tandy Center  
Fort Worth, Texas 76102

Name

Street

City

State

Zip

Phone

Text continued from page 42:

The EDB contains all the necessary electronic circuitry to convert the transmit/receive time interval into a figure indicating distance (in feet) and present it on a three-digit LED (light-emitting diode) display. Figure 3 is a block diagram of the EDB, while figure 4 shows the schematic diagram.

Connecting the EDB to the computer requires some thought. The output of the EDB is a three-digit display with a numeric output range of 00.9 to 35.0 in increments of 0.1 feet. The multiplexed display is controlled by a three-digit binary counter with strobed digit-select lines. It uses a single BCD (binary-coded decimal)-to-7-segment decoder/driver. At any instant, only one digit is energized, but because of the persistence of human vision, they all appear to be illuminated. Unfortunately, this multiplexed display output is not very computer-compatible and requires additional interface circuitry.

### Decoding the EDB Output

Figure 5 is the schematic diagram of a four-integrated-circuit interface that decodes the counter output on the EDB and latches the digits while the computer reads them. Essentially the circuit consists of a three-input demultiplexer (IC2), an edge detector (IC4), a 4-bit latch (IC1), and an output buffer (IC3). The four-chip circuit is conveniently mounted on a piece of perforated circuit board and attached to the rear of the EDB, as illustrated in photo 7.

When the MSD (most-significant digit) of the LED display is energized, the  $\overline{DS}_3$  line is low. The data on  $Q_0$  thru  $Q_3$  at this time form the BCD value of that number. Similarly, when  $\overline{DS}_2$  goes low, the data lines will hold the second digit value. IC2 is a 4-to-1-line demultiplexer with the three digit strobes as inputs. A 2-bit TTL (transistor-transistor logic)-compatible parallel output from the computer determines which of these channels is routed through the multiplexer. To get  $\overline{DS}_1$ , the LSD (least-significant digit), the input code to the EDB interface would be 00. A binary code of 10 would set channel 3, allowing  $\overline{DS}_3$  to go through. A summary of the codes is given in table 1.

The inputs to IC2 are offset by one channel due to the peculiar timing of the EDB. While the  $\overline{DS}_3$  line is

Bit 1	Bit 0	Output Digit to Computer
0	0	$\overline{DS}_1$ (LSD)
0	1	$\overline{DS}_2$
1	0	$\overline{DS}_3$ (MSD)
1	1	n/a

Table 1: Correspondence of the 2-bit digit-select codes with the EDB output data sent to the computer.

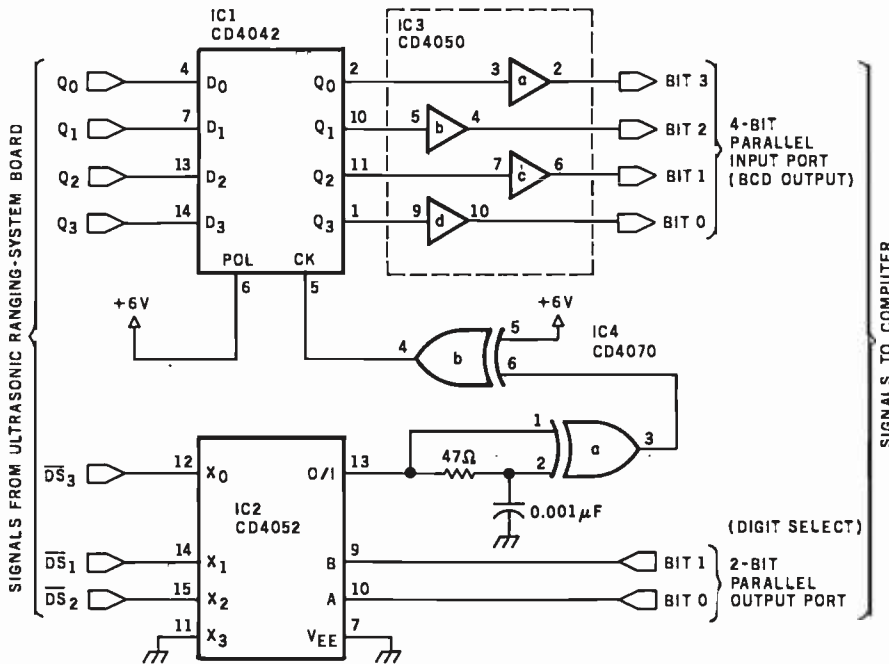

Figure 5: Schematic diagram of an interface that allows a computer to directly read the three-digit LED display of the EDB, using four integrated circuits. Through 2 bits of a parallel output port, the computer sends a digit-select code and then reads the corresponding BCD value of the selected digit through 4 bits of a parallel input port.

Number	Type	+6 V	GND
IC1	CD4042	16	8
IC2	CD4052	16	8
IC3	CD4050	1	8
IC4	CD4070	14	7

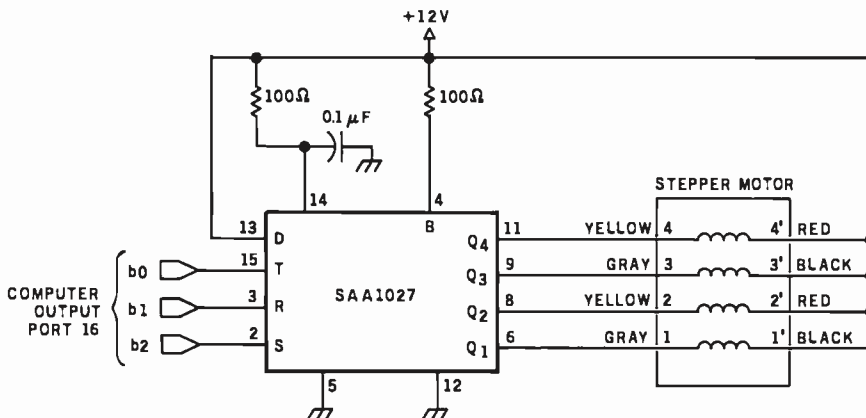

Figure 6: Stepper motor and controller used in the infrared and ultrasonic scanner. The motor is a North American Philips K82701-P2 type, which turns 7.5° per step. It operates on 12 VDC.

The SAA1027 integrated circuit is available from Signetics or from North American Philips, Cheshire, Connecticut, (203) 272-0301.



MODEL 800 • WITH SUNFLOWERS

## A NEW MASTERPIECE IN PRINTERS

The MODEL 800 MST is certainly pleasing to look at, but its true beauty lies beneath the surface. A glimpse at its features reveals why it is rapidly becoming the most sought after printer in the world . . .

- Four standard interfaces:
  - RS-232 (15 baud rates)
  - Centronics compatible parallel
  - IEEE-488
  - 20ma current loop
- Six line densities: 64, 72, 80, 96, 120, 132
- 100 CPS at all six densities
- Unidirectional or bidirectional printing
- Sixteen horizontal and ten vertical tabs
- Elongated characters in all six densities
- 1920 character buffer
- Uses either perforated or roll paper
- Fully adjustable tractors to 9 1/2"
- Auto self-test
- Up to 10 character fonts
  - Standard 96 character ASCII
  - User defined character font
  - Provision for up to eight additional fonts
- Dot resolution graphics in six densities
- Variable line spacing control from 0 to 64 dots in half-dot increments
- Auto form-feed for any form length at any line spacing
- Heavy-duty all aluminum chassis
- 110vac or 220vac, 50/60Hz.
- 100 million character printhead
- Measures only 15" wide, 3" high, and 11" deep
- Weighs only 15 lbs.

. . . . . but maybe its most attractive feature is the price . . . . . \$699.00.

base 2, inc.

P.O. BOX 3548 FULL., CAL. 92634 / (714) 992-4344



ORIG



ANS



## NOW: AN ORIGINATE/ANSWER 103 FOR LESS THAN \$200

- Switch-selectable originate/answer
- FCC certified for direct-connect
- Fits under your phone
- No AC required
- Only \$195 (quantity one)

UDS technology now adds a Bell-compatible originate/answer 103 to the family of line-powered modems. No AC connection or power supply required; operating power comes directly from the phone line. The unit fits underneath your desk phone. With the TALK/DATA switch in the TALK position, you have an ordinary phone; move to DATA and you're in contact with the whole datacomm world at any speed up to 300 bps.

For details, contact: Universal Data Systems, 5000 Bradford Drive, Huntsville, AL 35805. Telephone 205/837-8100, TWX 810-726-2100

"Confidence in Communications"

# Universal Data Systems



Member  
IDCMA

DISTRICT OFFICES: Summit, NJ, 201/522-0025 • Blue Bell, PA, 215/643-2336 • Atlanta, 404/952-3463 • Chicago, 312/441-7450 • Dallas, 214/385-0426 • Santa Ana, 714/972-4619 • Sunnyvale, 408/738-0433 • Boston, 617/875-8868.

Created by Dayner/Hall, Inc., Winter Park, Florida

# SUPERBRAIN®



32K or 64K (Double or Quad Density units available). Uses two Z-80 CPU's. Commercial-type terminal with 12" monitor. Dual double density minifloppies. Over 350 kilobytes of storage (twice that with quad density drives). Two serial RS232 ports, I/O ports standard. Expandable with optional S-100 S-100 interface. Comes with CP/M™ 2.2 operating system. MiniMicroMart includes BASIC interpreter and can supply a wide range of CP/M Development and Application software.

w/32K Double Density, List \$2995. **\$2685**  
 w/64K Double Density, List \$3345..... **\$2883**  
 w/64K Quad Density, List \$3995..... **\$3595**  
 64K Special Quad Version..... **\$3395**

## INTERSYSTEMS

formerly ITHACA AUDIO



DPS-1, List \$1795

### LIMITED TIME \$1299\*

The new Series II CPU Board features a 4 MHz Z-80A CPU and a full-feature front panel. 20-slot actively terminated motherboard, with 25 amp power supply (50/60 Hz operation, incl. 68 cfm fan).

COMPLETE SYSTEM with InterSystem 64K RAM, I/O Board w/priority interrupt and double density disk controller board. Full 1-year warranty, List \$3595

**ONLY \$2895\***

Above less disk controller, \$3195..... **\$2539\***

\* Limited Time offer expires Sept. 15, 1980.

## HEWLETT-PACKARD HP-85A

Desk-Top  
Computer

**Call  
for  
Price!**

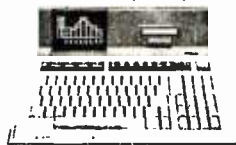

F.O.B. shipping point. All prices subject to change and all offers subject to withdrawal without notice. Advertised prices are for prepaid orders. Credit card and C.O.D. 2% higher. C.O.D. may require deposit.

— WRITE FOR FREE CATALOG —

## MiniMicroMart

1618 James Street  
Syracuse, NY 13203 (315) 422-4467

**Listing 1:** A BASIC program that uses the interface circuit shown in figure 5 to read the three-digit distance value from the EDB and display the distance on the computer printer. A sample execution follows the BASIC-language statements.

```

100 REM THIS PROGRAM ALLOWS A COMPUTER TO READ AND DISPLAY
110 REM DISTANCE AS MEASURED BY THE POLAROID ULTRASONIC
120 REM RANGING SYSTEM DEMONSTRATOR BOARD. RANGE .9 TO 35 FT.
130 REM
140 REM
150 GOSUB 250
160 PRINT "DISTANCE TO TARGET IS ";S;" FEET"
170 GOTO 150
180 REM
190 REM
200 REM THIS ROUTINE SETS AND READS THE 3 DIGITS ON THE
210 REM RANGING BOARD.
220 REM IT IS A THREE STEP PROCESS: SET THE DIGIT; READ THE
230 REM DIGIT VALUE; AND MASK OFF EVERYTHING EXCEPT THE 4 BIT
240 REM CHARACTER.
250 FOR T=0 TO 2
260 OUT 16,T
270 S(T)=INP(16)
280 S(T)=S(T) AND 15
285 S=(S(2)*10)+(S(1)*1)+(S(0)*.1)
290 NEXT T
300 RETURN
    
```

RUN

```

DISTANCE TO TARGET IS 3.3 FEET
DISTANCE TO TARGET IS 3.4 FEET
DISTANCE TO TARGET IS 3.5 FEET
DISTANCE TO TARGET IS 3.4 FEET
DISTANCE TO TARGET IS 3.3 FEET
DISTANCE TO TARGET IS 3.4 FEET
DISTANCE TO TARGET IS 3.3 FEET
DISTANCE TO TARGET IS 3.4 FEET
DISTANCE TO TARGET IS 3.4 FEET
DISTANCE TO TARGET IS 3.5 FEET
DISTANCE TO TARGET IS 3.3 FEET
    
```

**Listing 2:** A BASIC program that causes the scanner to make a 180° scanning sweep in twenty-five steps and prints the distance measurements in the form of a bar graph. Figure 7a shows the output from the execution of this program on the system set up in the Circuit Cellar.

```

100 REM THIS PROGRAM MAKES A 180 DEGREE SCAN AND RECORDS THE
110 REM DISTANCE TO SOLID OBJECTS EVERY 7.5 DEGREES.
120 REM
130 REM STEPPER MOTOR CONTROLLER ATTACHED TO PORT 18
140 REM ULTRA SONIC RANGING UNIT ATTACHED TO PORT 16
150 REM
160 REM
170 DIM Z(25)
180 OUT 18,1 :OUT 18,255 :REM PRESET STEPPER CONTROLLER
190 REM
200 REM CLOCKWISE SCAN
210 REM BIT 2 IS SET HIGH AND BIT 0 IS TOGGLED
220 FOR D=0 TO 24
230 OUT 18,5
240 GOSUB 470
250 OUT 18,4
260 NEXT D
270 REM
280 REM COUNTERCLOCKWISE SCAN
290 REM BITS 1 AND 2 ARE HELD HIGH AND BIT ZERO IS TOGGLED
300 FOR D=0 TO 24
310 OUT 18,7
320 GOSUB 570
330 OUT 18,6
340 NEXT D
350 REM
    
```

Listing 2 continued on page 56

# STOP PLAYING GAMES AND GET DOWN TO BUSINESS

## Corvus Transforms the Personal Computer into a Powerful Business Tool.

In business, professional offices, and schools throughout the world, thousands of Corvus intelligent peripherals bring mass storage, increased speed, and multi-user capability to a variety of microcomputers. Current applications include accounts receivable and payable, medical records, mailing lists, inventories, word processing, insurance, mathematics and science, and other large and complex files.

Corvus proven Winchester disk technology provides 10 to 80 million bytes of capacity, fully compatible with your current operating system. This is up to 500 times the capacity of a floppy disk.

The Corvus CONSTELLATION links up to 64 computers in a state-of-the-art multi-processor network. It provides shared mass storage, pipes for inter-computer communication, and system spooling for sharing of peripherals such as printers. Performance far exceeds that of larger and more expensive networks.

Backup data protection and archival storage are provided by the Corvus MIRROR (Patent Pending), a low-cost backup using standard video cassette recorders.

Contact your local Corvus dealer for the full story about these innovative new products.

### ★ ★ **CORVUS SYSTEMS**

- ★ 2029 O'Toole Avenue
  - ★ San Jose, California 95131
- (408) 946-7700/TWX 910-338-0226

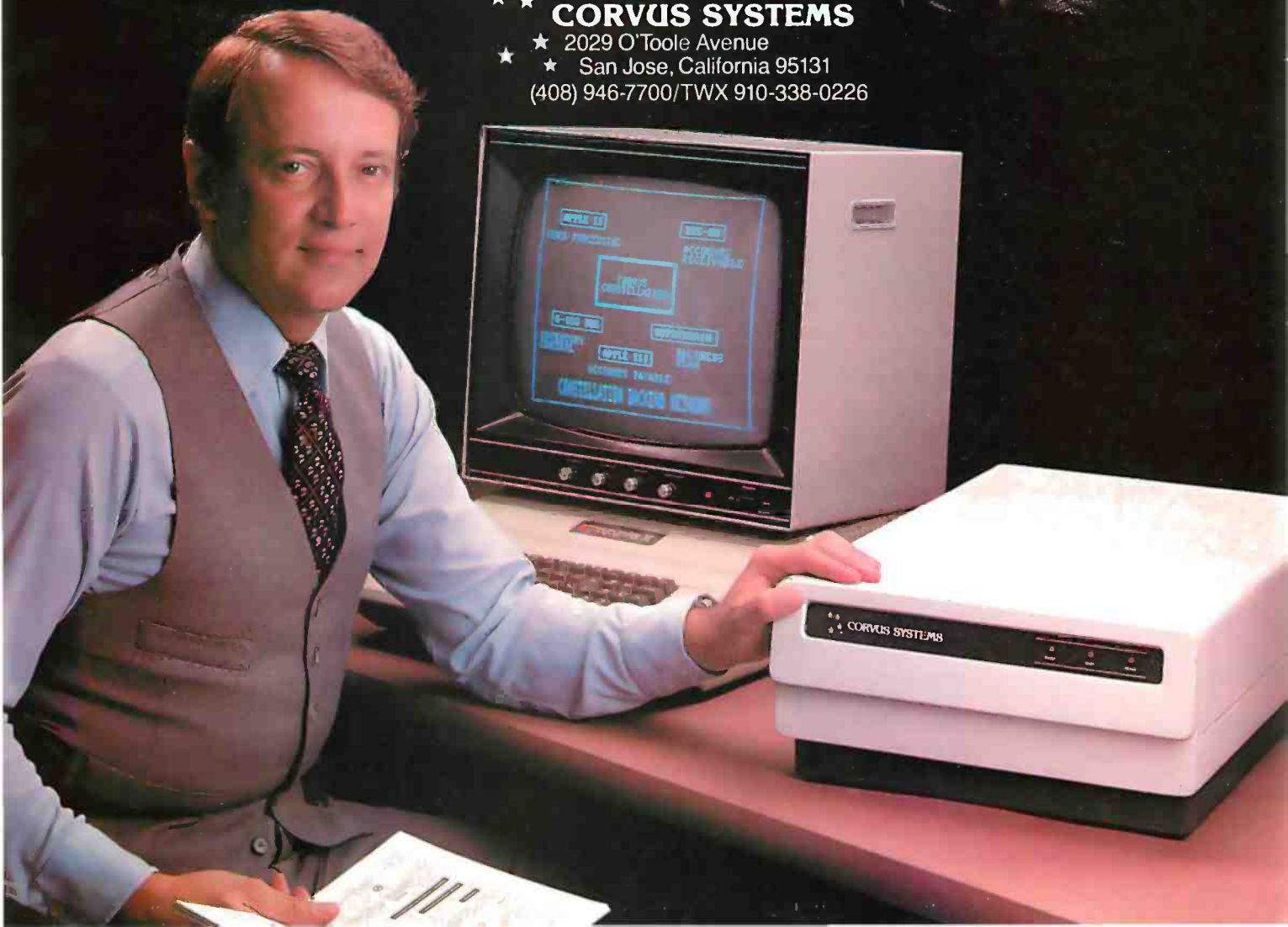

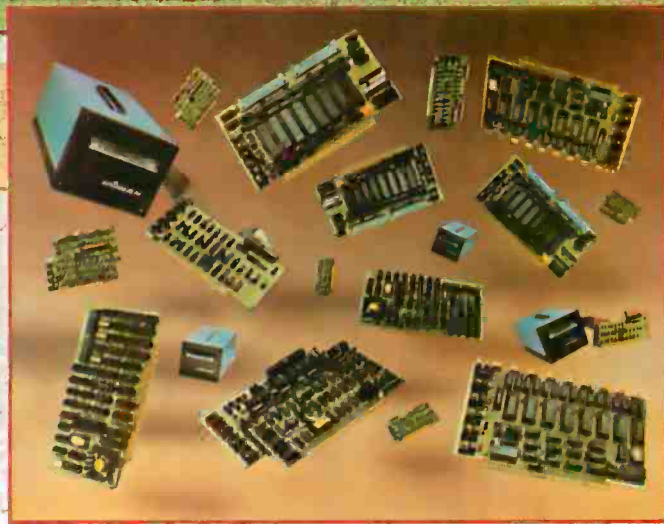

# New power at your fingertips.

**Konan presents Hard Disk Control, Tape Control, and Serial I/O Boards for S-100 computers.** Konan, known throughout the industry for its leading, innovative, guaranteed controllers for S-100 systems, does it again. Now, it offers you more of the expanded capabilities you need:

First, there's Konan's complete line of hard disk, mass storage subsystems and controllers. These high reliability products include the SMC-100™ storage module (SMD or CDC 9760 interface) hard disk controller for the S-100 Bus, DAT-100 Winchester type hard disk tape backup controller, the HARD-TAPE™ system, and the new KNX-500™ hard disk controller which is software compatible with Alpha Micro AM-500\*. Also, coming soon: Shugart technology mini hard disk controller and 9 track reel to reel tape controller.

Now, Konan introduces OCTOPLUS™ and OMNIPORT™, two new serial I/O boards. OCTOPLUS™, the 8-port board, offers a real time clock and full interrupt control. And the 16 port OMNIPORT™ offers you an efficient, economical board where more than 8 ports are needed.

With these and other quality products, Konan shows again that when it comes to S-100 systems, it is definitely in control. (And all at attractive O.E.M. and dealer prices.)

For complete information, call Konan's direct, toll-free information line 800-528-4563.

Or write to: Konan Corporation, 1448 North 27th Avenue, Phoenix, AZ 85009, FWX/TELEX 9109511552

**KONAN**  
**KONAN**  
**KONAN**™

\*Alpha Micro AM-500 is a trademark of Alpha Micro Systems.  
IN CONTROL, SMC-100, HARD TAPE, KNX-500, OCTOPLUS, and OMNIPORT are trademarks of Konan Corporation.



I N C O N T R O L

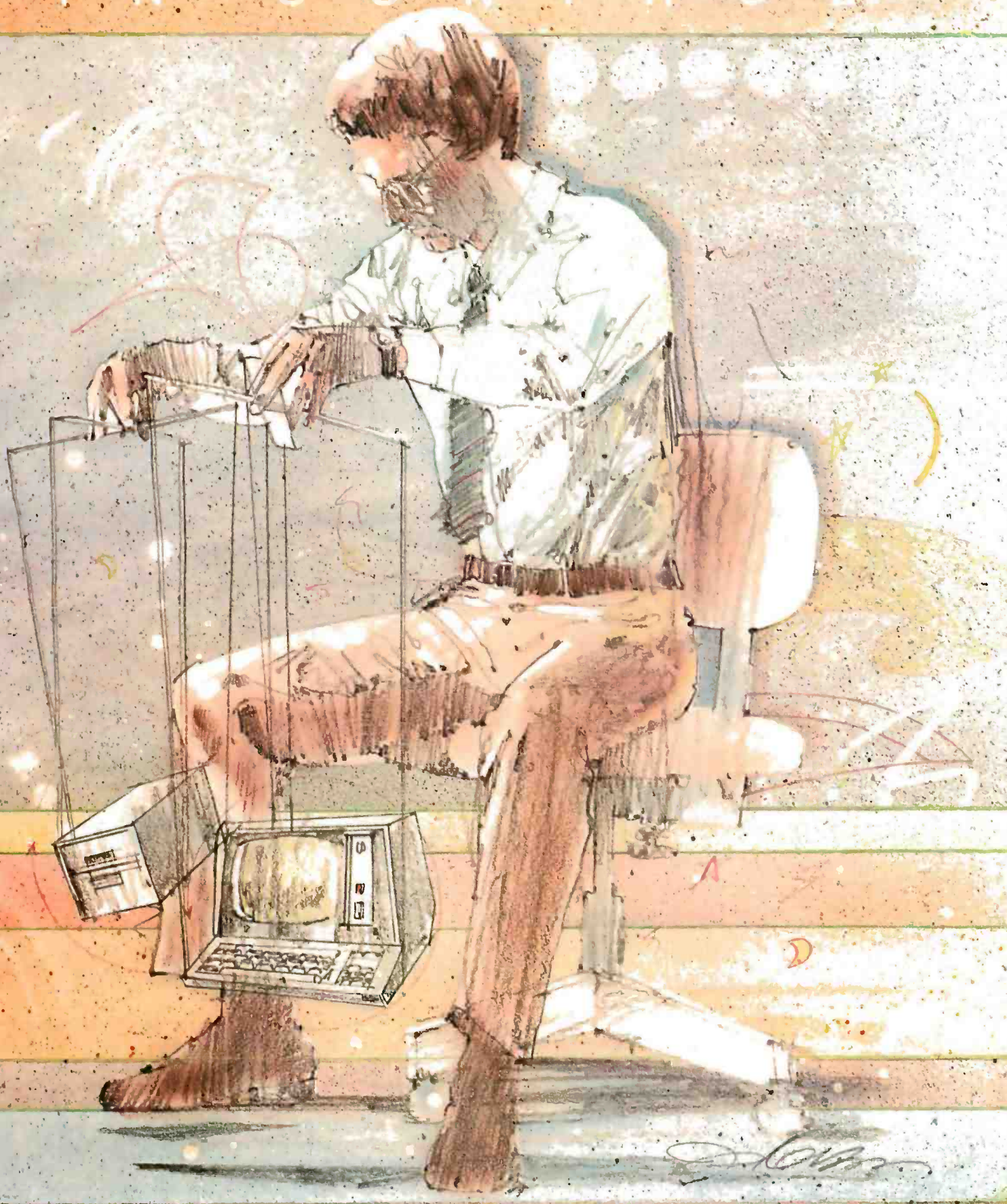

*[Handwritten signature]*

# MTI stocks 'em all for faster delivery.

No hidden charges. Prices include delivery.  
VISA and MasterCard orders accepted.

## VIDEO TERMINALS

VT100 DECscope.....	\$ 1750
VT132 DECscope.....	2295
ADM-3A (dumb terminal) .....	*
ADM-3A+ (dumb terminal) .....	*
ADM-31 (2 page buffer) .....	*
ADM-42 (8 page buffer avail.) .....	*
1410 (Hazeltine dumb terminal) .....	825
1420 (dumb terminal) .....	895
1421 (Consul 580 & ADM-3A comp.)....	895
1500 (dumb terminal) .....	1045
1510 (buffered) .....	1145
1520 (buffered printer port) .....	1395
1552 (VT-52 compatible) .....	1350

## 300 BAUD TELEPRINTERS

LA34-DA DECwriter IV .....	1045
LA34-AA DECwriter IV .....	1295
Teletype 4310 .....	1085
Teletype 4320 .....	1225
Diablo 630 RO .....	2295
Diablo 1640 RO .....	3085
Diablo 1640 KSR .....	3285
Diablo 1650 RO .....	3185
Diablo 1650 KSR .....	3385
TI 743 (portable) .....	1190
TI 745 (portable/built-in coupler) .....	1585
TI 763 (portable/bubble memory) .....	2690
TI 765 (port/bubble mem/b-i coupler) ..	2895

## 600 BAUD TELEPRINTERS

TI 825 RO impact .....	1565
TI 825 KSR impact .....	1645
TI 825 RO Pkg. ....	1750
TI 825 KSR Pkg. ....	1895

## 1200 BAUD TELEPRINTERS

LA120-AA DECwriter III (forms pkg.) ..	2245
LA180 DECprinter I .....	2195
TI 783 (portable) .....	1745
TI 785 (port/built-in coupler) .....	2395
TI 787 (port/internal modem) .....	2845
TI 810 RO impact .....	1800
TI 810 RO Pkg. ....	2047
TI 820 KSR impact .....	2057
TI 820 KSR Pkg. ....	2275
TI 820 RO .....	1895
TI 820 RO Pkg. ....	2047

## 2400 BAUD

Dataproducts M200 (2400 baud) .....	2595
-------------------------------------	------

## DATAPRODUCTS LINE PRINTERS

B300 (300LPM band) .....	5535
B600 (600LPM band) .....	6861
2230 (300LPM drum) .....	7723
2260 (600LPM drum) .....	9614
2290 (900LPM drum) .....	12655

## ACOUSTIC COUPLERS

A/J A242-A (300 baud orig.) .....	242
A/J 247 (300 baud orig.) .....	315
A/J AD342 (300 baud orig./ans.) .....	395
A/J 1234 (Vadic compatible) .....	895
A/J 1245 (300/1200 Bell comp.) .....	695

## MODEMS

GDC 103A3 (300 baud Bell) .....	395
GDC 202S/T (1200 baud Bell) .....	565
GDC 212-A (300/1200 baud Bell) .....	850
A/J 1256 (Vadic compatible) .....	825

## CASSETTE STORAGE SYSTEMS

Techtran B16 (store/forward) .....	1050
Techtran B17 (store/for/speed up) .....	1295
Techtran B18 (editing) .....	1795
Techtran B22 (dual) .....	2295
MFE 5000 (editing) .....	1495

## FLOPPY DISK SYSTEMS

Techtran 950 (store/forward) .....	1395
Techtran 951 (editing) .....	1995

\*Please call for quote.



Applications Specialists & Distributors  
Great Neck, New York/Cleveland, Ohio.

N.Y.: 516/482-3500 & 212/895-7177  
800/645-8016, Ohio: 216/464-6688

Listing 2 continued:

```

360 REM
370 REM PLOT RANGES AS BAR GRAPH
380 FOR D=0 TO 24
390 FOR W=1 TO INT(Z(D))
400 PRINT "***";
410 NEXT W
420 PRINT" "
430 NEXT D
440 GOTO 220
450 REM
460 REM
470 REM STEP DELAY AND RANGE SAMPLE ROUTINE
480 FOR T=0 TO 2
490 OUT 16,T
500 S(T)=INP(16) :S(T)= S(T) AND 15
510 NEXT T
520 Z(D)=(S(2)*10)+(S(1)*1)+(S(0)*.1)
530 FOR Q=0 TO 10 :NEXT Q
540 RETURN
550 REM
560 REM
570 FOR Q1=0 TO 100 :NEXT Q1
580 RETURN

```

Listing 3: A short BASIC program that demonstrates one method for using the ultrasonic scanning device in a security system.

```

100 REM THIS PROGRAM DEMONSTRATES HOW THE ULTRASONIC RANGING
110 REM BOARD CAN BE USED AS AN INTRUSION DETECTOR.
120 REM
130 REM
140 A=1 :GOSUB 220 :REM TAKE FIRST DISTANCE READING
150 GOSUB 330
160 A=2 :GOSUB 220 :REM TAKE SECOND DISTANCE READING
170 IF ABS(X(1))-ABS(X(2))>=.3 THEN GOTO 280
180 IF ABS(X(2))-ABS(X(1))>=.3 THEN GOTO 280
190 GOTO 140 :REM CONTINUE SCAN
200 REM
210 REM
220 FOR T=0 TO 2
230 OUT 16,T
240 S(T)=INP(16) :S(T)=S(T) AND 15
250 NEXT T
260 X(A)=(S(2)*10)+(S(1)*1)+(S(0)*.1)
270 RETURN
280 PRINT" I GOT YOU IN MY SCANNER AT ";X(2);" FEET."
290 REM AN ALARM ROUTINE WOULD BE PLACED HERE
300 GOTO 140
310 REM
320 REM
330 REM SAMPLE RATE DELAY TIMER
340 FOR Y=0 TO 200 :NEXT Y
350 RETURN

```

RUN

I GOT YOU IN MY SCANNER AT 11.4 FEET.

Text continued from page 50:

is held high, and bit 0 is toggled to produce each step. To drive the motor counterclockwise, bits 1 and 2 are held high, and bit 0 is toggled for each step. The new scanner can read the distance at each step.

Listing 2 is a program that causes the scanner to make a 180° scan and prints out the distance measurements

in the form of a bar graph, demonstrated here in figure 7a.

To help you understand the mode of operation and value of the ranging device, I have also sketched the area of the Circuit Cellar where the measurements were taken. (See figure 7b.)

The scanner (the red object in figure 7b) was placed on a tripod at a



# INTRODUCING VIDEOPRINT: The picture perfect peripheral.

Videoprint 3000 is the convenient economical means of obtaining distortion-free hardcopy from your Apple computer graphics display in full, brilliant color. The entire system is self contained in the convenient desk-top unit shown above.

Videoprints eliminate such off-the-screen photography problems as barrel distortion, color desaturation and loss of color fidelity. Videoprints also minimize the effects of raster lines and video noise.

Videoprints are instantly produced with Polaroid® SX-70 or Polacolor 4" x 5" films, as well as with conventional color negative or 35mm slide transparency films, offering you a range of handy sizes. The pictures are made at the push of a button.

If you've ever wanted to distribute copies of computer

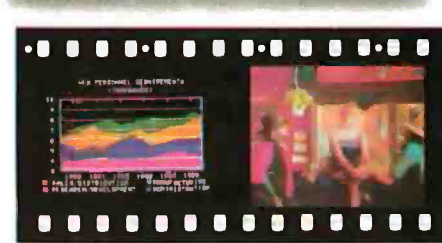
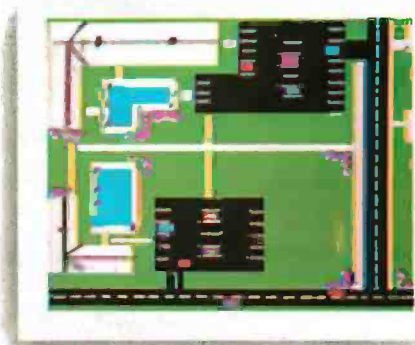

graphics or file them in your permanent records, or send them through the mail or project them as slides, you need Videoprint.

Hook up to one single cable and you're ready to capture any image on the Apple monitor screen. Other personal computers with color graphics capability work with the Videoprint 3000, too.

In fact, if you use computer graphics in any form, you really need Videoprint 3000. Find out all about this exciting new tool. Write or call us today for your local dealers' location.



**IMAGE  
RESOURCE**

The Videoprint People.

Image Resource Corporation  
2260 Townsgate Road, Westlake Village, CA 91361  
(805) 496-3317

Videoprints shown were produced by an Apple II with graphics tablet, or by live images on 3/4" videotape.

"Polaroid," "Polacolor" and "SX-70" are registered trademarks of the Polaroid Corporation.

height of 5 feet (1.5 meters), about 2 feet (0.6 meters) in front of my desk area. The parabolic reflector was pointed 90° to the left of center so that a 180° scan resulted in it ending up pointing 90° right of center. At each of the twenty-five steps it took to reach this point, it measured the distance to the nearest obstruction to its line of detection. For comparison, the blue dotted lines in figure 7b show where each step should have been and what should have been in the way of the sonar "beam."

The program of listing 2 printed the graph bar corresponding to each step,

starting with step 1. At the position reached after step 1, the system recorded a distance of about 5 feet (1.5 meters) to the VTR (videotape recorder) on the counter top. The same result was obtained for the next two steps. At the position reached after step 4 (about 30° around), the scanner was pointing between the stereo system and the TRS-80 computer on the desk to the right. This was indicated by a reading of about 15 feet (4.6 meters), measuring the distance to the bookcase on the far wall.

The next couple of steps had the

TRS-80 directly in the path of the scanner beam, and then the path of the beam was open to the far wall again for a couple of steps. The rest of the scan was similarly significant in that the range detector accurately described the perimeter from its viewpoint. Most important, however, was the demonstration of the sensitivity of the ranging device. At steps 9 and 16, the only object in the path between the scanner and the wall was a 4-inch (10 cm) ceiling-support column about 7 feet (2.1 meters) away. In both cases the obstruction was accurately identified.

We now have a device that can rotate to a particular position and accurately measure the distance to any object it "sees." A practical use of the range detector is as a security device. When the wall is known to be 16 feet (4.8 meters) away from the scanner, a sudden reading of 9 feet (2.7 meters) indicates that someone or something just moved in front of the range detector. The program of listing 3 allows the range detector to be used as a motion detector.

### In Conclusion

I have demonstrated only two uses for the Polaroid Ultrasonic Ranging System Demonstrator Kit. The majority of applications I've heard about thus far have been independent projects that utilize the ranging system *without* the additional capabilities of a computer. They include a walking cane (with audio feedback) for the visually handicapped, a 0 to 35 foot (0 to 11 meter) altimeter for the *Gossamer Albatross* aircraft (for its English Channel crossing), and as an electronic "dip stick" for measuring liquid levels in storage tanks.

I hope that once you realize how easy it is to attach this automatic ranging system to a computer, you'll have as much fun experimenting with it as I have. Unfortunately, a new problem has arisen. Until now, one of the major reasons I haven't attempted to build a robot was the amount of expense and technical effort required to make it "see." Now I'll have to find a new excuse. ■

## Microhouse. Microprice.



We will attempt to meet or beat any advertised price on hardware or software!

**INDUSTRIAL MICRO SYSTEMS**, the industrial-strength microcomputers priced like the light-weights. All IMS systems feature a Z80 4 MHz CPU, S-100 bus with 10 (series 5000) or 12 (series 8000) slot motherboard, DMA (IBM-compatible) double-density floppy disk controller, 32K high speed (250 nS) static RAM, rugged power supply, two RS232 serial ports and one parallel port (all expandable). Each IMS system comes in your choice of an attractive desk-top or rackmount enclosure. CP/M is included.

#### SERIES 5000 with 5 1/4" drives

With two single-sided, double-density drives **\$2531.20**  
With two double-sided, double-density drives **2908.75**

#### SERIES 8000 with 8" drives

With one single-sided, double-density drive **\$3359.00**  
With two single-sided, double-density drives **4029.00**  
With one double-sided, double-density drive **3659.00**  
With two double-sided, double-density drives **4549.00**

#### HIGH SPEED IMS S-100 MEMORY BOARDS

16K 250 nS static RAM **290.00**  
32K 250 nS static RAM **585.00**  
64K Dynamic RAM **937.50**

**CALL FOR MORE INFORMATION ON THE NEW IMS/SHUGART 8" WINCHESTER SYSTEM**

#### FROM THE PRINT SHOP...

CENTRONICS PRINTERS	List	Microhouse
730-1 100 cps 80 col.	\$795.00	<b>\$639.00</b>
730-3 same with RS232 interface	845.00	<b>718.00</b>
737-1 Letter-quality dot-matrix	995.00	<b>849.00</b>
704-9 180 cps, 132 col., RS232 interface	2180.00	<b>1895.00</b>
700-9 60 cps, 132 col.	1375.00	<b>1149.00</b>

#### TEXAS INSTRUMENTS PRINTERS

810 RO, 150 cps, 256 FIFO buffer	1895.00	<b>1580.00</b>
820 RO, 150 cps, 1280 FIFO, full ASCII	1995.00	<b>1679.00</b>

#### NEC SPINWRITERS

5510 SERIAL or 5530 PARALLEL	3055.00	<b>2459.00</b>
------------------------------	---------	----------------

#### THE GOOD SILVER

WORDSTAR 2.1 The premier word-processing software by MicroPro	List	Microhouse
WORDSTAR 2.1 with MailMerge	495.00	<b>349.98</b>
	645.00	<b>489.98</b>

DATASTAR data entry, retrieval, and update system from MicroPro	350.00	<b>279.98</b>
---	--------	---------------

SUPERSORT sort/merge/extract software gives your CP/M micro the power of a key-to-disk system	250.00	<b>199.98</b>
---	--------	---------------

BASIC 80 INTERPRETER by Microsoft, ANSI compatible, disk-extended	350.00	<b>287.50</b>
BASIC COMPILER	395.00	<b>330.00</b>

WHITESMITHS C conforms to full UNIX version 7 C. One of the best C compilers for micros on the market	620.00	<b>600.00</b>
---	--------	---------------

#### TCS/Atlanta Accounting System:

General Ledger	compare at 530.00	<b>175.00</b>
Accounts Receivable	compare at 530.00	<b>175.00</b>
Accounts Payable	compare at 530.00	<b>175.00</b>
Payroll	compare at 530.00	<b>175.00</b>
All four packages		<b>595.00</b>
Sample printouts (all 4 pkgs included)		<b>10.00</b>
Manuals (one pkg per manual) Each		<b>35.00</b>

#### CALL OR WRITE FOR FREE CATALOG



#### MASTER CARD OR VISA WELCOME

PRICES AND SPECIFICATIONS SUBJECT TO CHANGE WITHOUT NOTICE

# Microhouse™

511 North New Street Bethlehem, PA 18018 (215) 868-8219

#### Next Month:

Automated testing of electronic products using programs written in a high-level computer language.

# When you pick a Daisy... Pick Vista's V300 Printer.



**\$1895.**

## There are Daisies! . . . And, There are Daisies! . . . But Vista has a Peach!

The Vista V300 is exactly that, a "peach" of a daisy wheel printer both from the standpoint of price and performance.

Think of it, a printer at nearly half the price (when compared to models even remotely competitive in quality) combined with the ultimate in reliability, print quality, and flexibility.

Typical Comments: "Superb print quality!", "Highly reliable.", "Definitely letter quality. . . I can't believe the price tag.", "Best use I've seen yet of LSI Technology."

But judge for yourself — look at the V300 features and keep in mind this is a letter quality printer at dot matrix prices.

- Tractor option available
- Print Speed — 25 CPS (Optional 45 CPS for \$2,195)
- Print Wheel — Industry standard 96-character Daisy Wheel (including the extended-life dual plastic wheels)
- Service — Prompt maintenance/service agreements available nationwide
- Interface — Industry standard parallel (RS232-C optional)
- Printable Columns — 136
- Warranty — 90 days parts and labor, one year parts only
- Proportional, bi-directional printing • Programmable VFU
- Extensive self-test functions • Hardware and software compatible

Vista does it again! Quality, Price and Performance with a peach of a daisy wheel printer.



**IMMEDIATE DELIVERY**

For Further Information  
Call Toll Free (800) 854-8017

The Vista Computer Company 1401 Borchard Street • Santa Ana, California 92705 • 714/953-0523

## AND, Vista Has a Complete V100 Word Processing System for Only \$4995!

The Vista V100 is a complete word processing system that includes:

- Exidy Sorcerer Computer, 48K
- V200E20 Disc Drive System, Double Density
- Sanyo Data Display Monitor
- Vista V300 Printer Full Character Daisy Wheel
- Wordstar, CPM 1.4 (Includes E Basic)
- Can also be used for Data Processing



**OUR MEDIA IS**

Over the past seven years we've earned a name for ourselves by making the best magnetic media in the business. Precision magnetic media — Diskettes, Mini Diskettes, Diagnostic Diskettes, Rigid Discs, Disc Packs, and Disc Cartridges — all certified to be 100% error free both on-track **and** between the tracks.

Now we're making it easier for you to buy the best. Just dial Dysan direct TOLL FREE at 800/538-8150 or 408/988-3472 (in California) or contact your local Dysan office listed below.

Precision magnetic media from Dysan. Our media says it all.

 **Dysan**  
CORPORATION

5440 Patrick Henry Drive  
Santa Clara, CA 95050  
408/988-3472



Call your local Dysan office:

**Dysan Corporation**  
5440 Patrick Henry Drive  
Santa Clara, CA 95050  
408/988-3472

19600 Fairchild  
Suite 150  
Irvine, CA 92713  
714/851-9462

13201 Bell Red Road  
Suite 205  
Bellevue, WA 98004  
206/455-4725

# OUR MESSAGE.

## Kinetic String Art for the Apple

Louis Cesa, 305 Doris Ave, Vestal NY 13850

The accompanying photographs were produced using high-resolution graphics on the Apple II computer. As interesting as the pictures are, they do not do justice to the real-time art that takes place on the screen. The photographs show only time slices at different stages in the development of the kinetic string art. On the screen one can see shapes forming and gradually being replaced by other shapes in a continuous display of color and motion.

### Algorithm Description for Kinetic String Art Program

#### 1. Initialize Variables:

```
X1=X2=Y1=Y2=CNT1=CNT2=0;  
DIM C(150), TX1(150), TX2(150), TY1(150),  
TY2(150);  
AT=1
```

2. Erase the line from TX1(AT), TY1(AT) to TX2(AT), TY2(AT) of color C(AT).

3. If CNT1=0 then choose a new random color and a new random CNT1.  
COLOR=1+RND(3)  
CNT1=5\*(1+RND(10))

4. If CNT2=0 then choose new step sizes for DX1, DY1, DX2 and DY2 and a new random CNT2:  
DX1=RND(9)-4  
DY1=RND(9)-4  
DX2=RND(9)-4  
DY2=RND(9)-4  
CNT2=5\*(1+RND(10))

5. Compute new X1, Y1, X2, Y2 for next line and test for screen boundaries. For example,

```
470 PX1=X1+DX1  
480 IF PX1>=0 AND PX1<=MX THEN 500  
490 PX1=X1: DX1=-DX1  
500 X1=PX1
```

6. Draw the new line from X1, Y1 to X2, Y2.

7. Store the coordinates and color of the new line in:

```
C(AT), TX1(AT), TX2(AT), TY1(AT), TY2(AT)
```

8. Step AT to next position in table.

```
AT=AT+1  
IF AT > 150 THEN AT=1
```

9. Go to step 2.

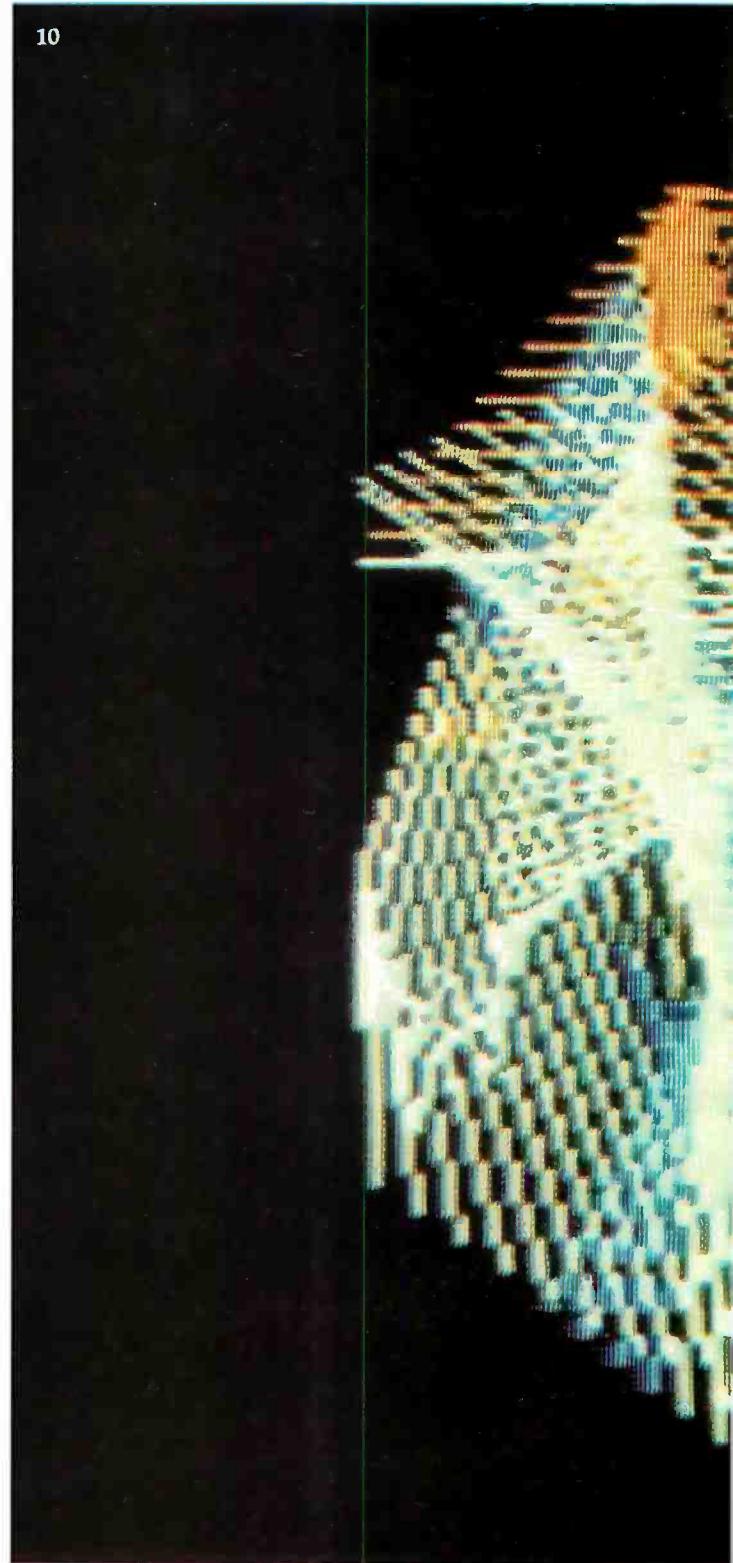

The algorithm used is quite simple. (See textbox. Contractual agreements preclude publishing a listing of the program.) The pictures are drawn by a line segment making a random walk on the screen. An initial pair of endpoints is chosen at random; also chosen at random are color, number of lines to be drawn with that color, step size for each endpoint (in the x and y directions), and number of times that the step sizes are to be used. Successive lines are drawn by advancing the endpoints of the line by the chosen step size in the x and y directions.



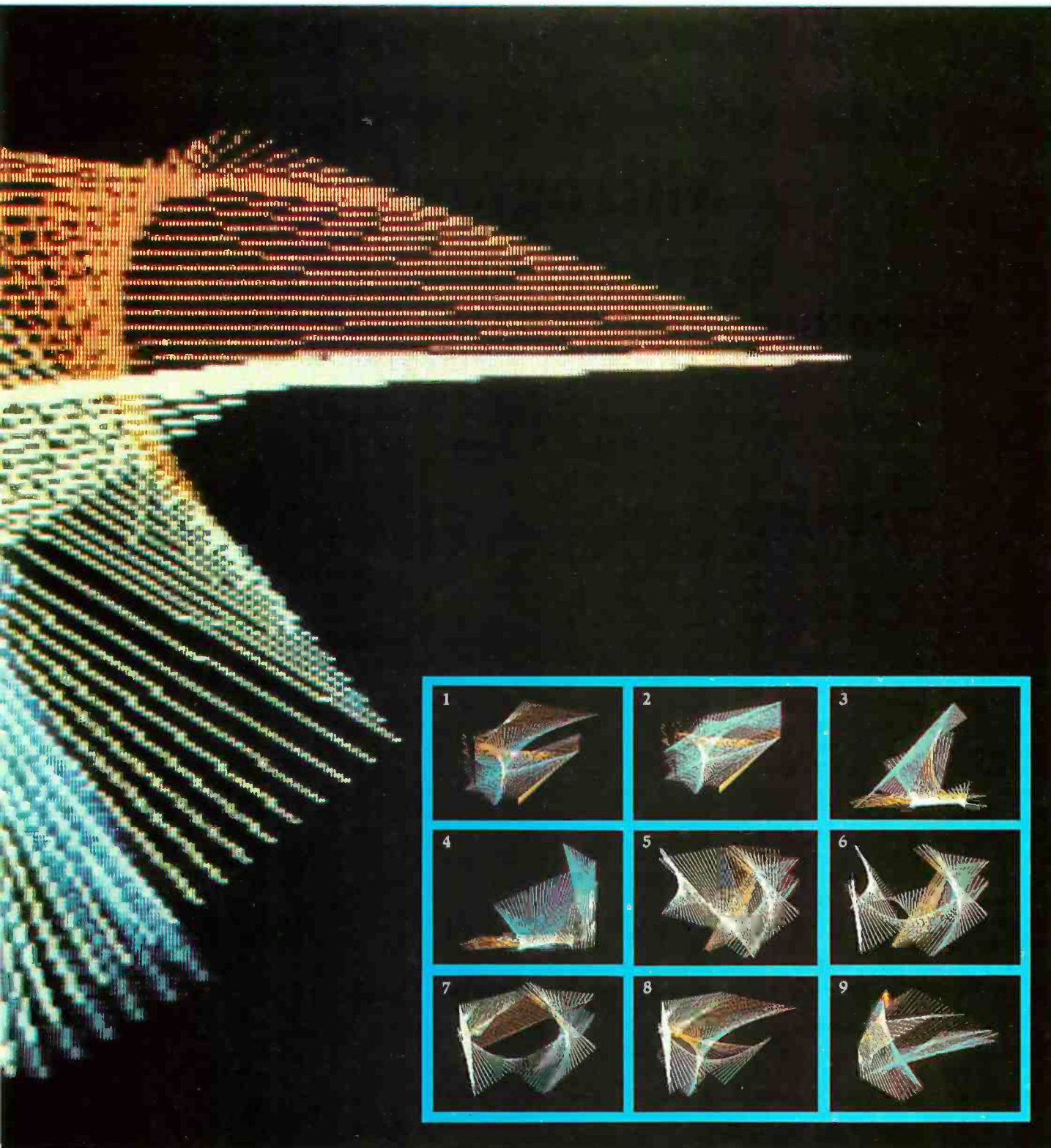

Whenever the number of times that an action was to be executed (such as number of lines to be drawn in a given color) is exhausted, new random values for that quantity and for the number of times that the quantity should be used, are chosen. If a point attempts to walk off the screen, it is reflected back.

The designs in the accompanying photographs are formed by 150 lines. The program was coded so that when the 151st line is added, the first line is deleted, and so on. This is done by a routine that keeps track of each

line segment currently on the screen. When the table contains 150 lines, this routine erases the oldest line segment before adding a new one. (This effect can be noted in photos 1 and 2.) Interesting effects can be obtained by using different algorithms to choose the new line to be added at each iteration. For example, an interesting effect is obtained with just 10 lines on the screen and choosing random endpoints for each new line (essentially a visual image of white noise). ■

# Micrograph

## Part 1: Developing an Instruction Set for a Raster-Scan Display

---

E Grady Booch  
4314 Driftwood Dr  
Colorado Springs CO 80907

---

Simply stated, computer graphics is the technique of visual communication from computer to man. (See reference 14.) Interactive computer graphics is an important subset of this broad field and relates to computer-generated displays that can interact with a user in real or near-real time. Interactive graphics started with attempts to use the CRT (cathode-ray tube) as a computer output device. (See reference 12.) The Whirlwind I in 1950 and Sketchpad in 1963 are examples of early attempts at interactive computer-graphics systems. Since that time, two distinct classes of CRT-based devices have been developed for use in interactive graphics: calligraphic (or vector) devices and raster-scan (as in a television receiver) devices.

The area of vector graphics "has for several years been sufficiently mature to justify efforts at standardization within it." (See reference 8.) A large body of information is available on the design of such systems. (See reference 13.) However, the same is

not necessarily true of raster-scan devices. Until recently, raster-scan technology has not been economically feasible. Decreasing hardware costs, especially for memory, have facilitated the trend toward raster-scan displays. (See reference 3.) The emergence of raster-scan displays has a side benefit, namely that "raster-scan technology is the only economical way to achieve color in full-sized displays." (See reference 4.)

For the microcomputer user, this means that he can add moderate-resolution color graphics to a system at an affordable price, using raster-scan technology. The benefits of color graphics for the personal computer are obvious: not only are color displays dazzling and eye-catching, but more important, they add a new dimension for communicating with a computer. Microcomputers with color-graphics capabilities have been available for some time, such as the Apple II and the Compucolor. Within the past year, however, Motorola and AMI (American

Microsystems Incorporated) have released a LSI (large-scale integration) chip, called a video-display generator, which performs all the video functions necessary to produce a color-graphics and alphanumerics display on a standard, unmodified color television. As a result, low-cost color-graphics displays are now possible for the personal computer user.

This three-part article presents the theory, design, and construction of a low-cost, color-graphics display processor called Micrograph, which is based on the Motorola MC6847 video-display generator. (See photo 1.) Essential characteristics of Micrograph are described in the text box. In the remainder of this article, I will review the characteristics of interactive computer-graphics systems, followed by an overview of the Micrograph design. Subsequent articles will concern the hardware construction details for Micrograph and the software necessary to control the system.

---

### About the Author

E Grady Booch is currently a computer systems design engineer with the Air Force Space and Missile Test Center. He is involved with the development of a high-resolution color-graphics system for tracking missile launches. Grady received his bachelor of science and master of science degrees in computer science from the United States Air Force Academy and the University of California, Santa Barbara, respectively.

---

### Micrograph Features:

- 64 by 64, 128 by 128, and 256 by 192 pixel resolutions are available.
- Up to eight different colors are displayed at one time.
- It contains a single-board processor, based on Zilog Z80 processor and Motorola MC6847 Video Display Generator.
- Construction cost: about \$275.

- High-level graphics primitives support.
- Both graphics and alphanumerics are supported.
- It interfaces to a host microcomputer via three 8-bit input/output ports (status, input, and output) and by radio-frequency or video entry to a standard, unmodified color television.

# WHEN OPPORTUNITY KNOCKS ...

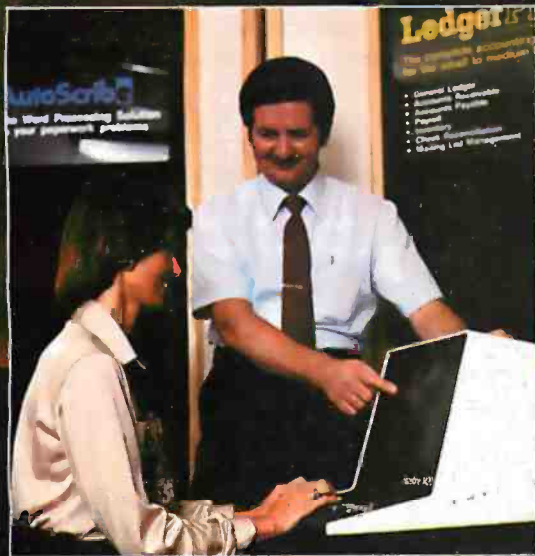

Open the door, and experience the dream. Your own business, the one you've always yearned for. No more limits on your creativity or earning potential. No more working for someone else.

If you're a successful computer professional and have access to some capital, chances are you could own a MicroAge Computer Store. MicroAge Computer Stores are built around a whole new concept of what a computer store should be. Designed to provide solutions, not just sell hardware.

MicroAge Computer Stores are firmly positioned in the business and professional marketplace. And as a MicroAge Computer Store owner, you'll be backed by one of the acknowledged leaders, industry pioneers in microcomputing. Contact the Director of Franchising today to receive a complete Franchise Information Package free of charge and at no obligation. Opportunity is knocking ... you'll see what we mean.

**MicroAge**  
**COMPUTER STORE**

1425 W. 12th Place • Tempe, AZ 85281 • (602) 967-1421

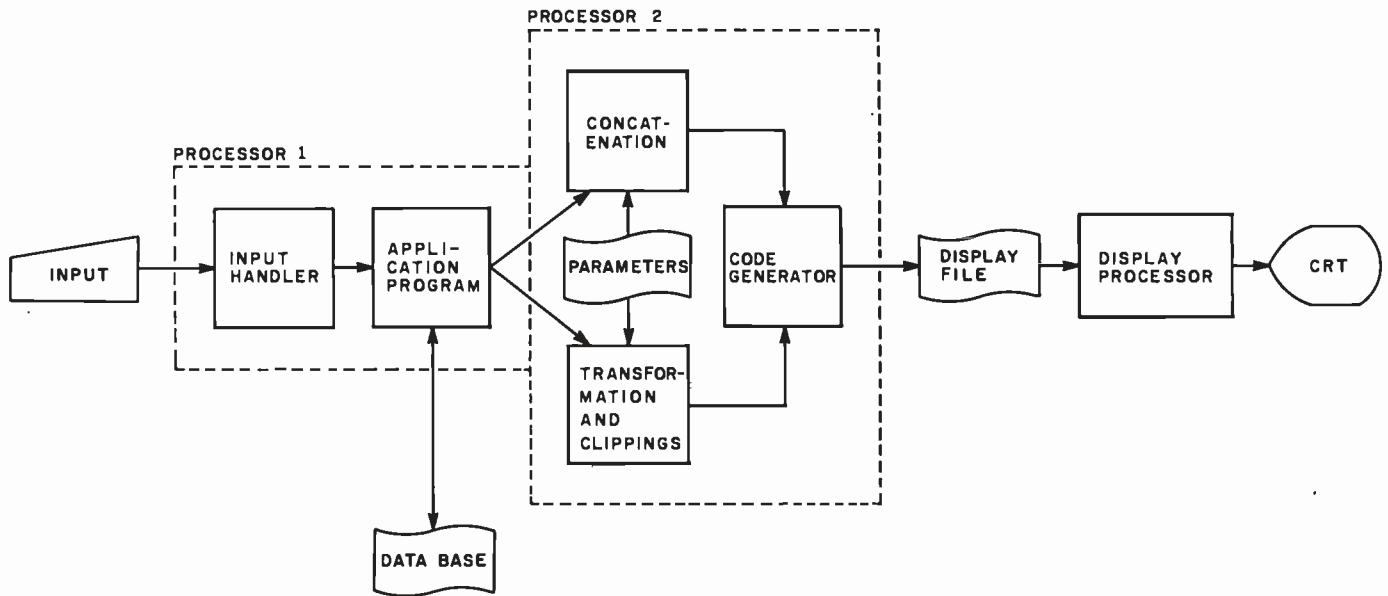

**Figure 1:** A general block diagram of an interactive graphics-display system. The functions of Processor 1 and Processor 2 may be performed by the same device; however, the output of Processor 1 must be a structured abstract of the image to be displayed, for the graphics package (Processor 2) to operate. (The figure is from *Principles of Interactive Computer Graphics*, by Newman and Sproull. Copyright 1973, used with permission of McGraw-Hill Book Company.)

### Background on Interactive Computer-Graphics Systems

Newman and Sproull, in their book *Principles of Interactive Computer*

*Graphics* (reference 12), present an excellent model of a generalized interactive graphics system, as reproduced in figure 1. Processor 1,

which is not necessarily a different physical processor than Processor 2, handles program-specific processing for a particular graphics application. The output of this processor is generally a structured, abstract representation of the set of images that will be displayed.

Processor 2 represents the processing that is to be handled by a graphics package, as it is commonly called. This processor manipulates the abstract representations, performing transformations (such as rotation, translation, and scaling) and clipping as needed. The output of this processor is generally a display file consisting of instructions that are meaningful to a physical display processor. The display processor uses these instructions to produce an image upon some type of display device. For interactive graphics, these processes must occur very rapidly.

Numerous graphics packages for commercial systems exist to handle the requirements of Processors 1 and 2. SIGGRAPH (Special Interest Group on Computer Graphics) of the ACM (Association for Computing Machinery) has proposed a standard for such systems. However, for our purposes, we must turn our attention to the display processor itself. Before examining the design for a color-

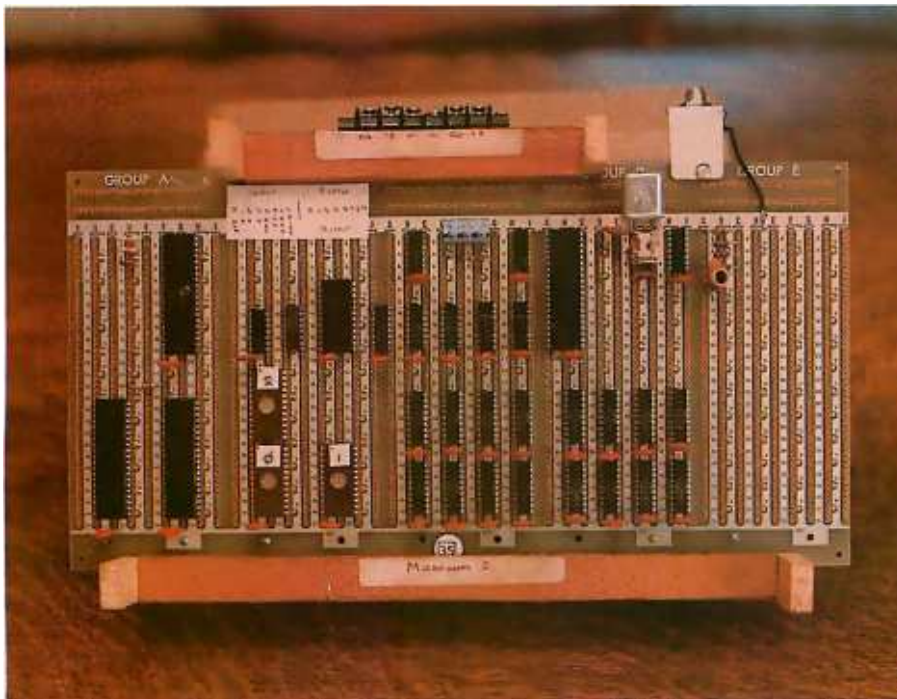

**Photo 1:** A view of the completed Micrograph prototype, based on the Motorola MC6847 video-display generator. Use of this integrated circuit greatly simplifies hardware design by eliminating the complex divider-chains usually found in homebrew video displays.

# UniFLEX™



## Multi-User

UniFLEX is the first full capability multi-user operating system available for microprocessors. Designed for the 6809 and 68000, it offers its users a very friendly computing environment. After a user 'logs-In' with his user name and password, any of the system programs may be run at will. One user may run the text editor while another runs BASIC and still another runs the C compiler. Each user operates in his own system environment, unaware of other user activity. The total number of users is only restricted by the resources and efficiency of the hardware in use.



## Multi-Tasking

UniFLEX is a true multi-tasking operating system. Not only may several users run different programs, but one user may run several programs at a time. For example, a compilation of one file could be initiated while simultaneously making changes to another file using the text editor. New tasks are generated in the system by the 'fork' operation. Tasks may be run in the background or 'locked' in main memory to assist critical response times. Inter-task communication is also supported through the 'pipe' mechanism.



## Support

The design of UniFLEX, with its hierarchical file system and device independent I/O, allows the creation of a variety of complex support programs. There is currently a wide variety of software available and under development. Included in this list is a Text Processing System for word processing functions, BASIC interpreter and precompiler for general programming and educational use, native C and Pascal compilers for more advanced programming, sort/merge for business applications, and a variety of debug packages. The standard system includes a text editor, assembler, and about forty utility programs. UniFLEX for 6809 is sold with a single CPU license and one years maintenance for \$450.00. Additional yearly maintenance is available for \$100.00. OEM licenses are also available.

## FLEX™

UniFLEX is offered for the advanced microprocessor systems. FLEX, the industry standard for 6800 and 6809 systems, is offered for smaller, single user systems. A full line of FLEX support software and OEM licenses are also available.



Box 2570, West Lafayette, IN 47906  
(317) 463-2502 Telex 276143

™UniFLEX and FLEX are trademarks of Technical Systems Consultants, Inc.

graphics display processor, we must consider the characteristics of calligraphic and raster-scan displays.

### Comparison of Display Devices

Four basic technologies exist to support interactive graphics:

- calligraphic
- raster-scan
- storage-tube
- plasma

Three of these devices (calligraphic, raster-scan, and storage-tube) are CRT-based, but only two (calligraphic and raster-scan) are adaptable to interactive, rapidly

moving displays.

Calligraphic displays produce images by drawing vectors using end-point information. A relative or absolute position is presented to the display, and the electron beam is deflected from its current position. Analog methods of vector generation can produce high-resolution vectors. Symbols are usually generated as a collection of vectors. Special hardware may also exist to produce circles and arcs, but these features are generally not cost-effective.

Calligraphic displays can achieve resolutions of up to 4096 by 4096 pixels (ie: picture elements) which corresponds to 16,777,216 elements (which is why I don't consider 256 by 256 pixels or even 512 by 512 pixels as "high resolution"). (See reference 11.) Therefore, a 21-inch-diagonal rectangular CRT will typically have a spot size of 0.02 inches (0.5 mm). (See reference 9.) Vectors using these techniques will appear sharp rather than granular. Several thousand vectors may be displayed flicker-free.

Calligraphic displays can produce color images using beam-penetration tubes. This type of CRT has multiple layers of phosphor coating on the face of the tube. Individual colors (usually four different colors) are produced by varying the anode voltage

and hence the depth of beam penetration.

Raster-scan displays produce an image much like commercial television by generating a full screen of horizontal lines. This set of lines (the raster) is modulated in the Z axis (intensity and color) to produce an image. Vectors are drawn using digital scan-line-conversion techniques which compute every point along the vector. Symbols are usually generated using a character generator which directly plots each point of the symbol.

Raster-scan displays can achieve resolutions up to 2048 by 2048 in monochrome and 1024 by 1024 in color, which corresponds to roughly one million pixels (for color). (See reference 9.) The limited resolution for color displays results from the difficulty in producing shadow masks and the granularity of the phosphor-dot triples used in constructing the CRT. Because of the nature of the raster-scan CRT, the individual dots have insignificant overlap and therefore vectors appear coarse and stair-stepped. However, techniques such as *ordered-dithering* and *anti-aliasing* algorithms exist to reduce the effect of granularity. (See references 7, 10, and 12.) Stair-stepping (or aliasing) is most noticeable in near-

#### Glossary

**Aliasing:** As used here, a granular or stair-stepped appearance in an image caused by the display screen being divided into a finite number of elements. This effect is most noticeable on low-resolution displays and on high-resolution displays with near-horizontal or near-vertical lines.

**Calligraphic Display:** A display that produces an image from a collection of vectors and points, by directing the electron beam in the X and Y directions corresponding to the vector endpoints.

**Display Processor:** A special-purpose peripheral processor that is dedicated to producing a visual image on some type of display (usually a CRT) based on special graphics instructions in a display list.

**Instancing:** The technique of defining one image, then being able to perform transformations to reproduce the same image in several different places on the display.

**Pixel:** A picture element.

**Raster-Scan Display:** A display that produces images, just as in television, by amplitude modulation of the Z-axis beam along a full screen of horizontal lines (the raster).

**Scan-Line Conversion:** An algorithm used to calculate each individual point along a vector, given the starting and ending points.

**Transformation:** Modifications of an image, such as translation (movement in the X, Y, or Z axis), rotation (also in any axis), and scaling (also in any axis).

#### CALLIGRAPHIC DISPLAY

##### Advantages

- High resolution (4096 by 4096).
- Thousands of vectors can be displayed.

##### Disadvantages

- Analog circuitry often requires adjustment.
- Limited colors (usually four).
- Display has low brightness.
- Limited intensities are possible.
- Shading of large areas impossible.
- Flicker occurs when too many vectors are displayed.
- Ghosting occurs on rapidly moving displays.

#### RASTER-SCAN DISPLAY

##### Advantages

- Digital circuitry is quite reliable.
- Many colors possible (more than 2<sup>16</sup>).
- Display is high intensity.
- Many (gray scale) intensities exist.
- Shading areas is simple.
- Display does not flicker.
- Display has high contrast.

##### Disadvantages

- Moderate resolution (1024 by 1024 color).
- Digital scan-line conversion is slow.

Table 1: Comparison of calligraphic (ie: vector) and raster-scan displays.

# 68000

When the 68K™ and 68K MiniFrame™ were first announced in June, the computer and data processing world responded to their incredible features with never-before-seen excitement!

The 68K constitutes a new standard in the micro/mini computer industry. The 68K boasts the power, features and speed of a mini computer, but at a micro price. And our software is ready now — when you need it! We are proud to offer this most complete 68,000 based product line!

The first two months of 68K production are already sold out! Place your 30% deposit now to reserve the next available unit!



<b>Hardware</b>	
68K Two Board Set (128K bytes RAM)	\$3995
68K Mini Frame (256K bytes RAM)	\$6995
Additional RAM (128K bytes)	\$595
<b>Software</b>	
Disk Operating System	\$500
68,000 Assembler	\$350
Industrial Pascal Compiler	\$400
Text Editor	\$150
Floating Point	\$100
<b>Documentation</b>	
Hardware Documentation	\$100
Software Documentation	\$100

<b>Processor Type</b>	Motorola MC68000 Motorola MC68009 for I/O, Disk, and memory management.
<b>Processor Speed</b>	8 MHz.
<b>Bus Type</b>	Proprietary connector. Adapters available for S-100, Versabus, and others.
<b>RAM</b>	Up to 512KBytes. Additional RAM boards up to 4 billion bytes. Parity.
<b>Memory Management</b>	Relocation and limit registers, virtual memory, and demand paging.
<b>PROM</b>	1 to 32 KBytes firmware including I/O queuing and debugging, memory management.
<b>Parallel I/O</b>	4 Parallel ports. High-speed DMA port for Winchester or hard disk interface.
<b>Serial I/O</b>	6 Serial RS-232 ports.
<b>Disk I/O</b>	Single/Double Density Floppy Disk Controller for up to 4 8" Drives.
<b>Other Features</b>	Memory Management, Prioritized Interrupt Handling, DMA, Multiprocessing and Multitasking Capabilities. Virtual memory.
<b>Disk Drives</b>	Dual Shugart 8" Double Density.
<b>Miniframe</b>	19" Rack Mountable. Includes Power Supply and I/O Connectors, dual 8" disk drives.



## MicroDaSys

PO Box 36215, Los Angeles, CA 90036 (213)731-0876

For three years, MicroMed™ and MicroDent™ have been the finest micro-based medical and dental billing systems in the world. Now, in the latest revision, MicroMed and MicroDent represent the most complete, comprehensive, and cost-effective software billing packages ever.

If you are a physician considering the installation of a billing system for your medical or dental office, then MicroMed and MicroDent are for you.

The SoftwareHows™ division of MicroDaSys is a leader in solution-oriented office tools. Both MicroMed and MicroDent provide the most cost-effective way to automate your patient accounting and record keeping procedures.

**MicroMed and MicroDent offer:**

- Complete billing for small practices or busy groups.
- Handling of **any** insurance forms (including Medi-Cal, Champus, etc.)
- Automatic Patient Recall system.
- Multiple insurance coverage for any patient.
- Printing of patient statements automatically.
- Instant recall of patient ledgers on CRT or printer.
- Daily transactions include treatment details.
- Insurance preauthorization (dental).
- All the reports you need for a successful practice:
  - Activity reports itemized by physician.
  - Daily, monthly and year-to-date totals by physician.
  - Service profitability analysis.
  - Aged accounts receivable.
- Mail list data base extracts patients on the basis of 15 selection criteria.
- Mailing labels, lists and form letter facilities, all automatically.

Not only is your billing system a time and money saver, but best of all it entitles you to terrific tax advantages. MicroMed and MicroDent include CBASIC2 source code and comprehensive documentation. And the price is right! Version 1.60F (floppy based) is just \$995 and Version 1.65FH (floppy and/or hard disk) is \$1500. If you don't have the latest version 2.06 of CBASIC2, we can supply it for just \$150. To get you started, we include sample computer forms. A Demo Disk is available to dealers, consultants and OEM's. Call or write today for your free brochure, sample forms and reports.

**Then say Ah...HA!**

Lucrative quantity discounts to dealers and OEMs.



a division of

MicroDaSys P.O. Box 36275 Los Angeles, CA 90036 Phone: (213) 731-0876 TWX: 9103212378

## SAY AH...HA!



Did you see our October ad for the unique and powerful Data Base Integration™ accounting SolutionWare™?

- Management oriented
- Fully integrated
- Powerful
- Easy to use

In addition to our superior Accounts Payable and Receivable, General Ledger and Payroll modules, OrderRight™, MicroDaSys Inventory™, and VersaSort™ make the SoftwareHows DBI™ business package the only serious choice for today's software needs.

**Don't hesitate!** Call or write today and ask us why our business software sets a new standard of excellence!

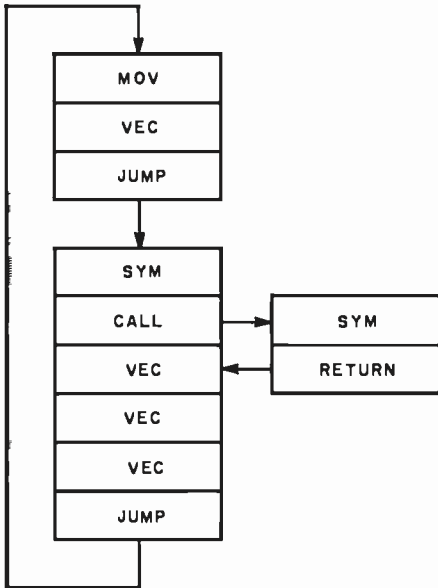

Figure 2: The display list of primitive instructions performed by the display processor of a calligraphic (ie: vector) display. The loop is performed repeatedly by the processor to guide the display electronics. A new or modified display is produced by altering the display list.

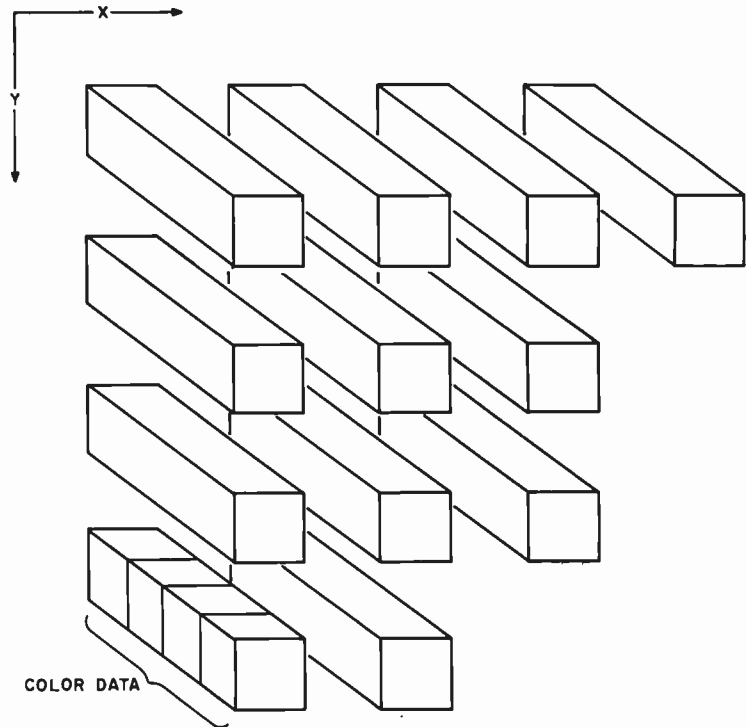

Figure 3: A color raster-scan frame buffer. Each pixel (ie: picture element) on the screen is represented by a unique set of X and Y coordinates. Every coordinate is associated with some amount of color information (in this case, 4 bits). This data may be used to specify an address in a color-look-up table such as figure 4.

vertical and near-horizontal lines. Any number of vectors, up to and including a full CRT screen, can be displayed without flicker.

Color raster-scan displays produce their images by exciting triads of dots or rectangles at each pixel. Each triad generally consists of one red, one blue, and one green element. Different colors (in excess of  $2^{16}$ ) can be produced by exciting each element at different levels of intensity.

Clearly, the use of each type of display is associated with certain advantages and disadvantages, as summarized in table 1.

### Controlling a Calligraphic Display

As mentioned previously, a calligraphic display draws vectors based upon endpoint information. Even the most complex images can be created as a collection of vectors. Because of the short persistence of the CRT phosphors required for a fast calligraphic display, once a vector is drawn, it will disappear very quickly, typically in just a few milliseconds. Thus, the entire display must be continuously refreshed to avoid flicker and a loss of portions of the image.

Refresh rates vary with the intensity of the display, but the image must be refreshed at least 30 times per second.

These requirements give rise to a structure called a *display list*. As figure 2 indicates, a display list is simply a collection of primitive instructions for the display processor. The display processor repeatedly scans this list to send vector-drawing information to the display electronics. To modify a display, Processor 2 (of figure 1) simply points the display processor to a new display list, or inserts or deletes a portion of the existing list. Generally, a display list is stored external to the display processor in the host-processor memory and is addressed via DMA (direct memory access).

Numerous instruction sets have been devised for calligraphic-display processors. Since displays at this primitive level are very difficult to control, the trend is toward higher-level graphics languages. However, all primitive instruction sets must contain certain basic features, including primitives to move the beam, draw a line, draw a character, call a subroutine, and change colors or intensity.

### Controlling a Raster-Scan Display

Unlike calligraphic displays, raster-scan displays generally employ what is known as a frame buffer. The frame buffer is essentially a block of memory that maintains a one-to-one correspondence with the set of pixels. In other words, there exists one memory location for every pixel. A pixel can be specified in one or more bits, as figure 3 indicates. Thus, color information for a pixel is stored at each memory location. In color raster-scan displays, this memory location does not necessarily hold physical color information, but often supplies a pointer to a color-look-up table, as figure 4 indicates. Thus, for example, a pixel may be specified by 4 bits, but the color information may be translated to any sixteen of a possible  $2^{16}$  colors. This technique allows the display of many different colors with a conservation of memory. The techniques of *contrast stretching* and *pseudocoloring* can be easily achieved with a color-look-up table.

A raster-scan display does require a large amount of memory to implement the frame buffer. For example, a display with a resolution of 512 by



# Do more than ever before— spend less than you planned



## Heath makes the All-In-One Computer more versatile

Many satisfied customers know Heath takes the risk out of buying a balanced computer system. With the Heathkit All-In-One Computer, you get 16K Random Access Memory (expandable to 48K), keyboard, video terminal and floppy disk system — together in one self-contained, compact unit — for up to hundreds of dollars less than comparable systems.

Heath now makes the All-In-One Computer more versatile than ever! The new Heathkit H77 Floppy Disk System gives the All-In-One even more data storage and recall capacity. Combined, the All-In-One and H77 Floppy Disk give you up to 300K

bytes of on-line data storage — enough to hold entire files. You can mount operating system and program disks at the same time, to make computing even faster.

You can run programs written in MICROSOFT™ BASIC™ and Assembly Languages, and all current software written for the popular Heathkit H8 Computer.

Heath User's Group (HUG) will share with you a library of over 500 programs to make your computer serve you in ways you never imagined.

There's no better way to learn about computer systems — and save money — than by building one yourself.

Concise, easy-to-follow Heathkit assembly manuals show you the way, from start to finish. And a nationwide network of service centers protects your computer investment.

Join the Heathkit computer family today — and pocket the savings!

For complete details on Heathkit computer systems, as well as nearly 400 other electronic kits for your home, work or pleasure, send today for your free, value-packed Heathkit catalog. Or pick up your copy at the nearest Heathkit Electronic Center.

# Heathkit®

SEND FOR FREE CATALOG

VISIT YOUR HEATHKIT STORE

Write to: HEATH COMPANY,  
DEPARTMENT 334-714,  
BENTON HARBOR, MI 49022



In the U.S. and Canada, visit your nearby Heathkit Electronic Center where Heathkit products are also displayed, sold and serviced. See the white pages of your phone book. In the U.S., Heathkit Electronic Centers are units of Veritechnology Electronics Corporation.

512 by 8 requires 256 K bytes of memory. This drawback is one of the primary reasons that raster-scan devices have only recently become cost-effective.

Using a frame buffer, an image is drawn by inserting color information into the memory location corresponding to the appropriate pixel. This architecture has the feature of producing flicker-free images; however, to draw vectors the display processor must calculate every point along the vector. Scan-line-conversion algorithms that calculate the points of a vector (given the endpoints) exist, but such algorithms are slow compared to analog techniques used in calligraphic displays. Once an image is written into the frame buffer, it will be continuously displayed. Refresh is not required by the host, but the image cannot be modified as a calligraphic display can.

Clearly, the characteristics of color raster-scan displays present control problems unlike those for calligraphic displays. We must therefore not only exploit the inherent color-display potential, but we must also deal with the problems of selectively updating a raster-scan display. As the next section indicates, we can adapt calligraphic control techniques to effectively control a color raster-scan display.

### Primitives for a Color Raster-Scan Display

To develop an instruction set for a color-graphics display processor, we must first establish our requirements. We assume as a minimum that these primitive instructions will be executed by an intelligent display processor having both a single-frame buffer and a color-look-up table. Therefore, we require that:

- The set of graphics primitives must permit the construction of any image within the physical limitations of the raster-scan display. The set doesn't need to be minimal: efficiency is a more important characteristic.
- The graphics primitives must be implementation-independent. The primitives must be applicable to any resolution and not be constrained by word size or any similar characteristic of the target processor.
- The graphics primitives must be



**SYBEX** has the keys to BASIC

**Have more fun ...  
Learn more BASIC**

**Hands-on BASIC!**

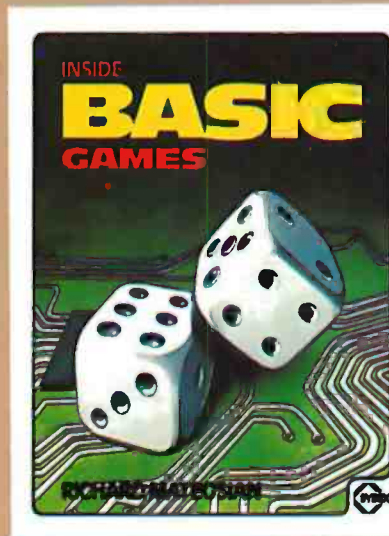

### INSIDE BASIC GAMES

by Richard Mateosian

300 pp 100 illustr. Ref B245  
7" x 9" ISBN 0-89588-055-5 \$13.95

Describes BASIC programming techniques within the framework of real games. Blackjack and craps, math games and others are presented and analyzed in detail, teaching the reader to design effective programs as well as to play the games. An effective and enjoyable way for anyone with an elementary knowledge of BASIC to learn to design and program algorithms. The programs are written in MICROSOFT BASIC and can run on a PET/CBM, APPLE II or TRS-80 among others.

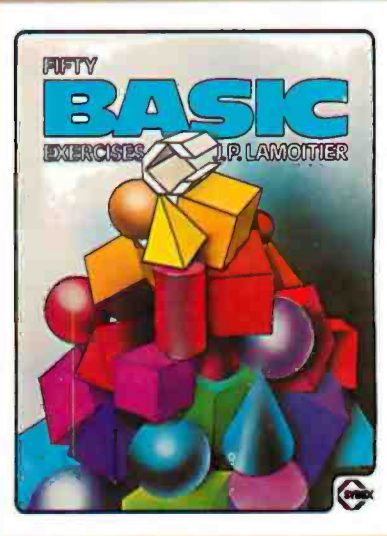

### FIFTY BASIC EXERCISES

by J. P. Lamotier

300 pp 140 illustr. Ref B250  
7" x 9" ISBN 0-89588-056-3 \$12.95

The BASIC book with style. This is the book for the educated reader, designed to teach BASIC through actual practice. Each of fifty graduated exercises is explained in full detail with flowcharts and program listings. Applications for mathematics, business, physics, accounting, games and statistics illuminate BASIC programming techniques and develop the reader's ability to consistently write attractive, effective programs. Includes a comparison and evaluation of useful BASIC extensions. All programs are written in MICROSOFT BASIC.



the leader in computer education, enters a new era with the simultaneous publication of four new books on high level languages. These volumes employ the same effective methods developed by SYBEX to teach machine language programming in such best sellers as PROGRAMMING THE Z80 and PROGRAMMING THE 6502. From YOUR FIRST COMPUTER and the CP/M HANDBOOK to the new BASIC and PASCAL series, SYBEX is meeting the changing needs of the micro generation.

**SYBEX—Anticipating your needs in computer education ...**



# SYBEX unlocks PASCALS

**A unique  
reference for all PASCALS**

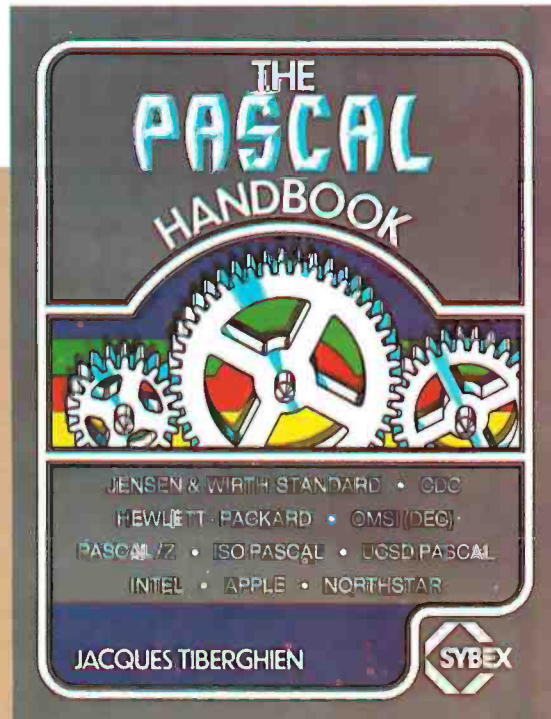

## THE PASCAL HANDBOOK

by Jacques Tiberghien  
300 pp 150 illustr. Ref 320  
7" x 9" ISBN 0-89588-053-9 \$14.95  
A completely new approach to PASCAL. Every PASCAL symbol, reserved word, identifier and operation is described in alphabetical order. Each entry includes definition, syntactic diagram and semantic description, implementation, variations and program examples. Easy to use, comprehensive and concise, this unique handbook is indispensable to all PASCAL users. Covers most versions of PASCAL including Jensen and Wirth (Standard and CDC Version), H-P 1000, OMSI (DEC), PASCAL/Z, ISO and UCSD PASCAL.

**Finally a PASCAL book  
for everyone**

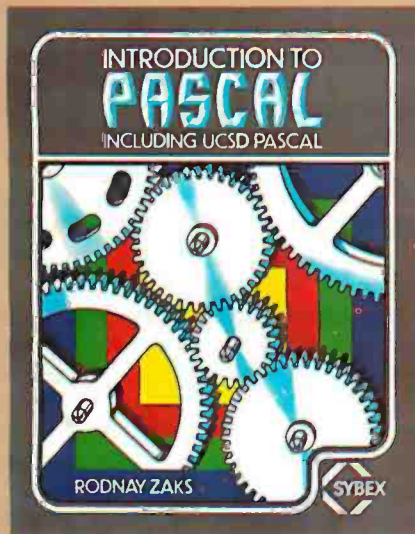

## INTRODUCTION TO PASCAL (INCLUDING UCSD PASCAL)

by Rodney Zaks  
320 pp 100 illustr. Ref P310  
7" x 9" ISBN 0-89588-050-4 \$12.95

A simple, step-by-step guide to the elegant language of PASCAL. The logical format, clear explanations of each concept, symbol and operation, and the progressive exercises at the end of each chapter will have everyone—beginners, students and professionals—writing effective programs in a short time. This first volume in the SYBEX PASCAL series covers Standard PASCAL as well as UCSD PASCAL, the most widely used version on small computers.



MAIL TO: SYBEX  
DEPT. B11  
2344 SIXTH STREET  
BERKELEY, CA 94710  
PHONE ORDERS: 415/848-8233

PLEASE SEND ME

- FIFTY BASIC EXERCISES \$12.95       INSIDE BASIC GAMES \$13.95  
 INTRODUCTION TO PASCAL \$12.95       THE PASCAL HANDBOOK \$14.95

NAME \_\_\_\_\_

ADDRESS \_\_\_\_\_

CITY \_\_\_\_\_ STATE \_\_\_\_\_ ZIP \_\_\_\_\_

PLUS  \$1.50/book UPS or  75¢/book 4th class mail (CA add tax)

TOTAL AMT. ENCLOSED \_\_\_\_\_ OR CHARGE MY  VISA  MC  AM. EX.

CARD # \_\_\_\_\_ EXP. DATE \_\_\_\_\_

SIGNATURE \_\_\_\_\_

PLEASE SEND ME YOUR FREE CATALOG

NO FRILLS!  
NO GIMMICKS!  
JUST GREAT  
**DISCOUNTS**  
MAIL ORDER ONLY

**ATARI 800**

Personal Computer System ..... **\$79900**

**NORTHSTAR**

Horizon II 32K ..... **234900**  
Horizon II Quad ..... **279900**  
Horizon II 64K ..... **299900**  
Horizon Quad 64K ..... **339900**

**TELEVIDEO**

912 ..... **74900**  
920 ..... **79900**

**HAZELTINE**

1420 ..... **79500**  
1500 ..... **84900**  
1510 ..... **104900**  
1520 ..... **122900**

**OKIDATA**

Microline 80 ..... **69900**

**SOROC Technology**

IQ 120 ..... **69900**  
IQ 140 ..... **99900**

**CROMEMCO**

System 3 ..... **569500**  
Z2H ..... **799500**

**INTERTEC**

Superbrain 32K ..... **249500**  
Superbrain 64K ..... **279500**

**DECwriter IV**

LA34 ..... **97900**

**TEXAS INSTRUMENT**

810 Multi Copy .....  
Impact Printer ..... **149900**

**We'll meet or beat any advertised prices!**

Most items in stock for immediate delivery  
Factory sealed cartons. Full manufacturer's guarantee.

**DATA DISCOUNT CENTER**

Box 100 135-53 Northern Blvd., Flushing, N.Y. 11354  
Visa • Master Charge • N.Y.S. residents add Sales Tax  
Shipping F.O.B. N.Y.

Phone Orders Call 212-465-6609

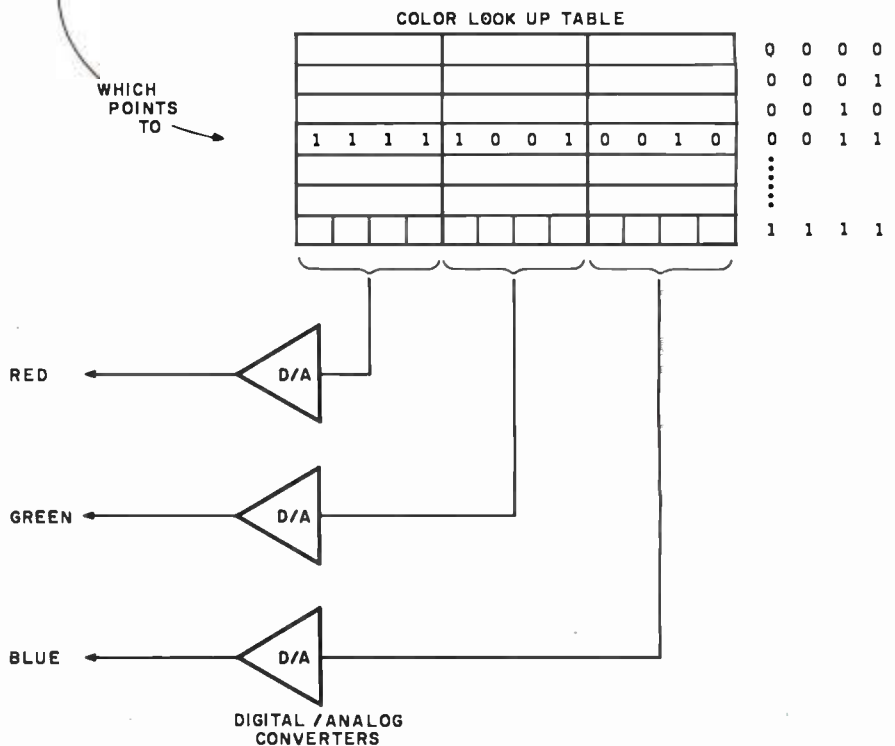
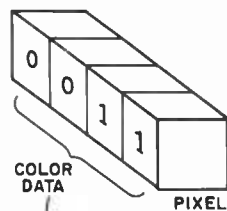

Figure 4: Color-look-up table. Using this scheme, a 4-bit value from the frame buffer (shown in figure 3) can select one of sixteen predefined colors. In this example, each color is composed of various intensities of red, green, and blue. Other systems may specify colors by indicating values for intensity, hue, and saturation.

adaptable to a display-list structure, since display lists are a well-established form of control for display processors and hence permit straightforward integration with generalized graphics-support software in the host processor.

**Graphics Primitives**

As explained previously, we know that raster-scan and calligraphic displays are architecturally different. However, our third requirement indicates that both classes of displays must at least appear identical to the user. Therefore, our graphics primitives become an abstraction for the control of a raster-scan display. We must design a set of primitives independent of the actual architecture of the display. Just as with the benefits of using a high-level programming language, the use of abstractions in controlling a graphics

display allows the user to concentrate upon producing images rather than concerning himself with the mechanics of the implementation.

Before examining the primitives for a color raster-scan display, it is important that you understand two very critical abstractions. First, it is necessary that the user visualize the display processor as manipulating a two-dimensional Cartesian surface, with the origin of the space at some predefined location (usually the center, or lower left-hand corner) on the display surface. There may or may not be a direct mapping of pixel data in the display-processor memory to this surface: the actual implementation should be invisible to the user.

From the previous section, we know that the display processor doesn't need to be concerned with identification of objects that are displayed in this space, but rather we

# Pump Up Your TRS-80 with the ES/F Mass Storage System



THESE FACTS SPEAK FOR THEMSELVES!

	CASSETTE	ES/F	MINI-DISK
<b>SPEED</b> (Seconds to load "Blackjack")	56	6 (5' wafer)	6½
<b>CAPACITY</b> (thousands of bytes)	38 (C-20)	64 (75' wafer)	59 (TRSDOS)
<b>RELIABILITY</b> (Designed for digital data?)	NO	YES	YES
<b>SYSTEM COST</b> (First unit plus interface)	\$60	\$250	\$800
<b>MEDIA COST</b> (in quantities of ten)	\$3.10 cassette	\$3.00 wafer	\$3.20 disk

Let's face it. Cassette players were not designed to store digital data and programs. That's why we designed a digital storage system using a continuous tape loop: the Exatron Stringy/Floppy (ES/F) and the Wafer. There's no expensive interface to buy—the ES/F comes ready to pump up your TRS-80.\*

Once your TRS-80\* is pumped up by our ES/F . . . you won't want to deflate it. We're so sure, that we offer an unconditional 30-day money-back guarantee and a one-year limited warranty. Over 2,000 TRS-80\* owners have met the wafer . . . why don't you? 

# TRS-80

## EXATRON'S STRINGY/FLOPPY...

## SPEED, CAPACITY AND RELIABILITY FOR ONLY \$249.50



CALL  
OUR HOTLINE  
(800)-538-8559

IN CALIFORNIA,  
CALL (408)-737-7111

exatron, inc.  
181 Commercial Street  
Sunnyvale, Calif. 94086

\*TRS-80 is a registered trademark of Tandy Corp.

### JDR MICRODEVICES, INC.

is expanding its wholesale electronics operations to provide you with the best pricing available. JDR gives you the highest quality components along with great service that gets your order out the door in 24 hours.

### MEMORY SPECIALS

2101	450ns	2.49	1702	4.95
2102	450ns	.99	2708	6.25
21L02	450ns	1.29	2716	5v 14.95
2112	450ns	2.99	2732	59.95
2114	450ns	4.99	2-80	9.95
4116	200ns	5.99	8085A	12.95
<b>4116</b>		<b>250ns</b>	<b>8/39.95</b>	

### LS SERIES

LOOK AT THIS LS PRICING!

74LS00	.32	74LS85	1.23	74LS175	1.09
74LS02	.38	74LS86	.45	74LS191	1.31
74LS04	.35	74LS93	.71	74LS195	1.39
74LS08	.38	74LS95	1.11	74LS221	1.28
74LS10	.32	74LS109	.49	74LS240	1.89
74LS20	.35	74LS138	.79	74LS241	1.89
74LS30	.35	74LS139	.79	74LS244	1.79
74LS32	.39	74LS151	.79	74LS283	1.03
74LS38	.39	74LS153	.79	74LS298	1.24
74LS42	.79	74LS157	.79	74LS367	.99
74LS51	.35	74LS158	.82	74LS368	.99
74LS54	.35	74LS161	.99	74LS373	1.85
74LS73	.44	74LS163	.99	74LS374	1.81
74LS74	.48	74LS174	1.19	74LS377	1.48

### OTHER SPECIALS

7400	10/1.99	95H90	7.95
7404	10/1.99	RED LED	10/1.00
7447	5/2.49	GREEN LED	6/1.00
7490	5/1.99	YELLOW LED	6/1.00
7493	5/1.99	2N3904	8/1.00
74151	3/1.99	2N3906	8/1.00
74153	3/1.99	2N3055	.79
74157	3/1.99	4MHZ Crystal	2.00
74161	5/3.99	5MHZ Crystal	2.00
74163	5/3.99	10MHZ Crystal	2.00

### LINEAR IC'S

LM301-8	.34	LM555-8	.39
LM310	.64	LM556	.69
LM3118	.64	LM565	.99
LM318-8	1.49	LM567	1.29
LM319	1.29	LM741-8	.29
LM324	.59	LM747	.79
LM377	2.29	LM1458-8	.69
LM380	1.29	LM1889	2.49

### REGULATORS

7805T	.89	7905T	.99
7812T	.89	7912T	.99
7815T	.99	7905K	1.29

### DIP SWITCHES

4 position	.99
5 position	1.02
6 position	1.06
7 position	1.09
8 position	1.14

### IC SOCKETS

14 pin	10/1.49
16 pin	10/1.69
24 pin	4/1.00
IMSAI S-100 edge connector solder tail gold 2.49	

### MA1012A CLOCK MODULE

Complete alarm clock module with special transformer and spec sheets included. Just add switches. 8.99 3/24

**TERMS:** include \$2.00 for shipping. \$10.00 minimum order. Send SASE for complete catalog

### JDR MICRODEVICES, INC.

1101 South Winchester Blvd.  
San Jose, California 95128  
408 247-4852

need only to be able to manipulate the pixel data that forms these objects.

The second abstraction which we must develop concerns *graphics-display registers*. These registers are defined in the display processor and may be addressed by the user to set up global image parameters, such as current vector type, or to provide immediate processor-status information, such as the current X and Y position. Clearly, these registers may be implemented in diverse portions of the display hardware. Concerning the second requirement, it is important that the user sees these registers as an easily addressable set that may be referenced by the host processor. As we shall see, the use of graphics-display registers helps reduce the scope of some of the graphics primitives that are necessary to control a color raster-scan display.

It is evident, as with any graphics display, that the minimum set of instructions we need includes only a point-positioning and a vector-drawing primitive. But clearly, this set is by no means efficient. Thus, I will present and defend the set of graphics primitives for a color raster-scan display which will be implemented in Micrograph. Next I will present the primitive instructions in their mnemonic form in order to maintain their implementation independence.

As with a calligraphic display, one of the most fundamental operations we perform is point positioning. Since a raster-scan display does not produce an image by beam movement, but rather by Z-axis modulation, we must abstract current X and Y coordinates, which may also be addressed as graphics-display registers. To increase the utility of a move primitive (ie: primitive instruction specifying a movement), we must include several options. To begin, both absolute and relative point positioning are necessary. The need for absolute positioning is obvious; relative positioning permits an entire display to be defined relative to a single point in the image, which is an essential feature if subroutines and instancing are to be supported.

Furthermore, remember that the elements of an image are often closely spaced: thus, we need options for long and short movement. With a

long movement, we may express a point position in the full-screen coordinates (for either absolute or relative positioning). With a short movement, we may express a point position with a limited maximum value (such as 0 to 7, again either absolute or relative). Therefore, it's possible to decrease display-list memory requirements with the use of short movements, which take less storage than a long instruction. Finally, it is often necessary to simply plot a single point. To do so, we must include the option to illuminate or not. If we illuminate, we obviously must include a parameter for the color of the point. Mnemonically, our move primitive can be represented as:

MOV T,M,C,I,(±)X,(±)Y

where:

T = type (Short or Long movement)

M = mode (Absolute or Relative positioning)

C = color

I = illuminate (Yes or No)

X = X position or offset (with a sign on the relative mode)

Y = Y position or offset (with a sign on the relative mode)

For example, the primitive:

MOV S,R,4,Y,+3,-4

moves the current X,Y position by an offset of (3,-4) and illuminates that point in a color whose code is 4.

The next obvious primitive we need performs vector drawing. With the same justification as for the move primitive, we must permit the options of long and short vectors. We assume that the starting point of the vector is the current X,Y position, and the endpoints are determined by either absolute or relative positioning. Just as with a move primitive, we must also be able to specify the color of the vector. Finally, we must be able to define the current vector type, such as solid, dashed, or dotted vectors. Experience indicates that such line types are rarely used. Therefore, rather than specifying this parameter in the primitive itself, we assume that we have available a graphics-display register that defines the current line type. Mnemonically, our vector primitive

# Chief Relief

For years many small business system buyers thought that in order to get "real" performance and enough storage to be a "real" business system they would have to sacrifice the family jewels.

But with the introduction of the Smoke Signal Chieftain series office computers a lot of people's minds have been changed.

Because we designed the highly reliable Chieftain small business system with the most innovative combination of performance and efficiency around.

At your fingertips there are 64,000 characters of random access memory and you can address anywhere from 740,000 characters to 2 million characters with Smoke Signal's new double density controller. For larger concerns, there's a 20M byte hard disk available.

At a time when other small computer manufacturers tell you "you're on your own", Smoke Signal offers an abundance of easy-to-use software programs such as order entry, inventory control,

accounts receivable, invoice entry, payroll, word processing and much, much more. There's BASIC, COBOL and FORTRAN — even a multi-user BOS (Business Operating System) that allows for numerous users simultaneously.

Chieftain systems starting at under \$200.00 per month display performance on par with systems costing twice to three times as much.

So call (213) 889-9340 for your nearest authorized Smoke Signal dealer — he'll be glad to demonstrate the Chieftain's high reliability and ease of operation.

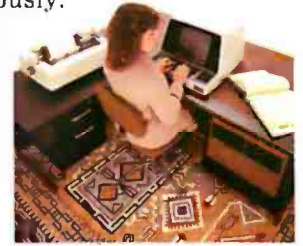

For dealers only, circle 45  
All other inquiries, circle 44

**SMOKE SIGNAL**



**BROADCASTING**

31336 Via Colinas, Westlake Village, California 91361. (213) 889-9340



can be represented as:

VEC T,M,C,(±)X,(±)Y

where:

- T = type (Short or Long movement)
- M = mode (Relative or Absolute endpoints)
- C = color
- X = X position or offset (with a sign in the relative mode)
- Y = Y position or offset (with a sign in the relative mode)

For example, the primitive:

VEC L,A,15,255,180

draws a vector (with the color coded 15) from the current X,Y position to the pixel (255,180).

We must have an instruction that allows us to call a subroutine. Such a primitive is essential to support object instancing. Furthermore, since we assume the existence of an intelligent target display processor, we must expand our primitive to permit a call to a display-processor subroutine. Such

an option allows the user to execute his own predefined routines, which can possibly decrease the image-generation time and reduce some of the processing burden from the host for often-used routines. Clearly, this option is not essential, but it does allow the user to exploit the full capabilities of the display processor. Mnemonically, our call primitive (ie: primitive instruction to call a subroutine) can be represented as:

CALL T,N

where:

- T = type of subroutine (Processor or Graphics)
- N = name or number of subroutine

For example, the primitive:

CALL G7

calls the graphics subroutine number 7.

Along with the call primitive, we obviously must have a primitive which allows us to return from a subroutine. Our return primitive instruction can be represented as:

RET

Text is often an element of a display and therefore warrants its own primitive. It is important to realize that text usually occurs as a string of symbols rather than a single symbol. Therefore, we must include an option to display a number of contiguous symbols. Furthermore, in terms of the symbols themselves, we may wish to use either a standard alphanumeric font or a user-defined font. Therefore, we assume the availability of a programmable symbol generator. As will be explained, the user may define his own set of symbols and then display a string of symbols by using the symbol primitive, passing it the codes for the appropriate symbols. Mnemonically, our symbol primitive can be represented as:

SYM N,S<sub>0</sub>..S<sub>n-1</sub>

where:

- N = number of symbols in the string
- S<sub>i</sub> = symbol code

# ECT™

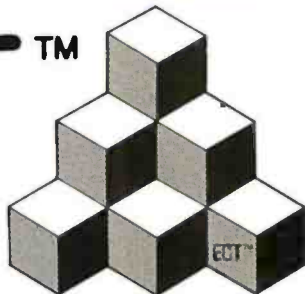

## Building Blocks for Microcomputer Systems, Dedicated Controllers and Test Equipment.

### R<sup>2</sup>I/O S-100 ROM, RAM & I/O BOARD

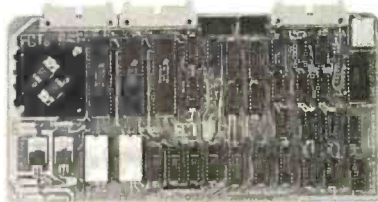

ECT's R<sup>2</sup>I/O is an S-100 Bus I/O Board with 3 Serial I/O Ports (UART's), 1 Parallel I/O Port, 4 Status Ports, 2K of ROM with the 8080 Apple Monitor Program and 2K of Static RAM.

**\$295.00**

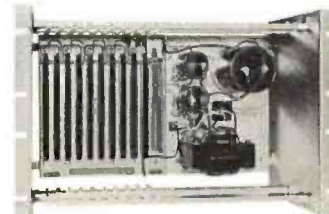

### RM-10 S-100 RACK MOUNT CARD CAGE

ECT's RM-10 is a rack mount 10 slot Card Cage with Power Supply, consisting of an ECT-100 rack mount Card Cage (19"W x 12.25"H x 8"D), the MB-10 Mother Board (with ground plane and termination) all 10 connectors and guides and the PS-15A Power Supply (15A @ 8V, 1.5A @ ± 16V).

**\$295.00**

Specializing in Quality Microcomputer Hardware  
Industrial • Educational • Small Business • Personal  
Card Cages, Power Supplies, Mainframes, CPU's, Memory, I/O, OEM Variations

# ECT™ ELECTRONIC CONTROL TECHNOLOGY (201) 686-8080

763 Ramsey Ave., Hillside, NJ 07205



# NOW CLEANING YOUR OWN DISKETTE HEADS COULD SAVE YOU A \$40 SERVICE CALL. AND A LOT MORE.

The recording heads on your diskette drives may be dirty—and that can cause you a lot of grief. There's the serviceman you have to call when the machine doesn't perform. (You know how much service calls cost these days!) There's machine down-time. Idle data entry clerks. All the other delays a cranky machine can cause.

And that service call might not even be necessary.

## **3M solves the problem in seconds—and leaves your heads**

### **"Computer Room Clean".**

The Scotch® head-cleaning diskette kit lets you clean the read-write heads on your 8" or 5¼" diskette drives. In just 30 seconds, without any disassembly, mess or bother, the heads can be completely cleansed of dirt, dust, magnetic oxides—all the things that can get into your machines every day. And foul them up.

Just saturate the special white cleaning pad in its jacket with the cleaning solution. Then insert the jacket into the diskette drive and turn it on. Your machine does the rest. The



heads are microscopically cleaned without wear, without abrasion.

This 3M head-cleaning diskette kit has been evaluated and approved by major diskette drive manufacturers. It's the best possible way to clean your heads without service calls or machine teardowns.

**At only \$1 per cleaning—  
it's the best insurance you  
can get.**

This fast-cleaning new Scotch kit comes with everything you need (including special fluid, applicator tip, cleaning diskettes) to handle up to 30 cleanings. That's only about a dollar a cleaning.

With the Scotch head-cleaning diskette kit, you could save yourself a lot more than just a service call. So try this remarkable kit today. For the name of



*A Scotch cleaning diskette shown before use, and after 15 cleanings of recording heads.*

the dealer nearest you, call toll free: 800-328-1300. (In Minnesota, call collect: 612-736-9625.) Ask for the Data Recording Products Division.



# 3M

For example, if we have defined a 128-character ASCII (American Standard Code for Information Interchange) set of symbols, the primitive:

SYM 5,68,80,77,80,83

displays the string "COLOR".

Also, as noted earlier, we may need to synchronize our display with the display frame rate, especially if we wish to perform animation with smooth movements. Therefore, we need a primitive that suspends display processing until the end of a frame or until after a certain number

of frames. Mnemonically, our wait primitive can be represented as:

WAIT N

where:

N = number of frames to wait

For example, the primitive:

WAIT 7

suspends processing for seven frames.

Since we have assumed the existence of a color-look-up table to facilitate pseudocoloring and contrast-stretching, we must provide

some method of controlling such a structure. There are two common methods for the organization of such tables. One method allows for the definition of a color by the proportions of red, green, and blue elements (the colors which physically make up a pixel). This method is easily performed in hardware, but it is not readily adaptable to common English color descriptions (such as hot pink or sea green). A preferred method, which we shall use, defines a color by its hue, intensity, and saturation. This classification refers to, respectively, the gradation of color (red, pink, purple), the brightness of the color, and the purity, or amount of black, in the color (dark red, fire-engine red).

We abstract the existence of a three-part table (which will actually be implemented in hardware) that is used as a color-look-up table. Since this table is user-alterable, we will refer to its parts as *color memories*. (They would usually be implemented as programmable-memory elements.) In order to generalize this primitive, we need to be able to update the entire table, one entire portion of the table (hue, intensity, or saturation), or all the parameters for a given color code. This table will allow selection of  $2^n$  colors out of a  $2^{i+h+s}$  color set where  $n$  is the pixel size in bits and  $i$ ,  $h$ , and  $s$  are, respectively, the word size of the intensity, hue, and saturation color memory. For example, if  $n = i = h = s = 4$ , we can select one of sixteen colors out of a  $2^{12}$  color set. Mnemonically, our load-color-memory primitive can be represented as:

LCRAM R,M,(A),C,

where:

- R = reference (Intensity, Hue, or Saturation color memory, or All)
- M = mode (Single address or All addresses in table)
- A = address (optional)
- C = color data for the color memory

For example, the primitive:

LCRAM A,S,2,5,7,2



## D-Cat.™ Everything you'll ever need in a basic, direct modem.

There's only one originate/answer modem that gives you the performance and reliability of a direct connect modem with the portability and price of an acoustic. Novation's new D-Cat.

D-Cat is the only direct modem that's FCC approved for handset jack connection with any modular phone. Use it at home or at work on a 50-pin, six line business phone. Talk to D-Cats, Cats, or any other Bell 103 compatible modem.

D-Cat also has all the features you want: full duplex capability, voice/data

monitor, up to 20 dB performance improvement over acoustic, hold function, privacy button, self-test, and a remarkable price. Only \$199.

But best of all, it's from Novation. The recognized world leader in personal communications.

**D-Cat** by  
**Novation**

Call for details:

**(800) 423-5410**

In California (213) 996-5060

Available at Avnet Electronics, Hamilton Electro, Hamilton Avnet, Kierulff Electronics, Byte Shops, Computerland, and your local computer store.

Novation, Inc., 18664 Oxnard Street, Tarzana, California 91356

# The first personal computer for under \$200.

**The Sinclair ZX80.**  
**A complete computer—**  
**only \$199.95 plus \$5.00 shipping.**

Now, for just \$199.95, you can get a complete, powerful, full-function computer, matching or surpassing other personal computers costing several times more.

It's the Sinclair ZX80, the computer that independent tests prove is faster than all previous personal computers. The computer that "Personal Computer World" gave 5 stars for 'excellent value.'

The ZX80 cuts away computer jargon and mystique. It takes you straight into BASIC, the most common, easy-to-use computer language.

You simply take it out of the box, connect it to your TV, and turn it on. And if you want, you can use an ordinary cassette recorder to store programs. With the manual in your hand, you'll be running programs in an hour. Within a week, you'll be writing complex programs with confidence.

All for under \$200.

**Sophisticated design makes the ZX80 easy to learn, easy to use.**

We've packed the conventional computer onto fewer, more powerful LSI chips—including the Z80A microprocessor, the faster version of the famous Z80. This makes the ZX80 the world's first truly portable computer (6½" x 8½" x 1½" and a mere 12 oz.). The ZX80 also features a touch sensitive, wipe-clean keyboard and a 32-character by 24-line display.

Yet, with all this power, the ZX80 is easy to use, even for beginners.



## Your course in computing.

The ZX80 comes complete with its own 128-page guide to computing. The manual is perfect for both novice and expert. For every chapter of theory, there's a chapter of practice. So you learn by doing—not just by reading. It makes learning easy, exciting and enjoyable.

## The ZX80's advanced design features.

Sinclair's 4K integer BASIC has performance features you'd expect only on much larger and more expensive computers. These include:

- Unique 'one touch' entry. Key words (RUN, PRINT, LIST, etc.) have their own single-key entry and are stored as a single character to reduce typing and save memory space.
- Automatic error detection. A cursor identifies errors immediately to prevent



entering programs with faults.

- Powerful text editing facilities.
- Also programmable in machine code.
- Excellent string handling capability—up to 26 string variables of any length.
- Graphics, with 22 standard symbols.
- Built-in random number generator for games and simulations.

Sinclair's BASIC places no arbitrary restrictions on you—with many other flexible features, such as variable names of any length.

And the computer that can do so much for you now will do even more in the future. Options will include expansion of 1K user memory to 16K, a plug-in 8K floating-point BASIC chip, applications software, and other peripherals.

## Order your ZX80 now!

The ZX80 is available only by mail from Sinclair, a leading manufacturer of consumer electronics worldwide. We've already sold tens of thousands of units in Europe, so demand will be great.

To order by mail, use the coupon below. But for fastest delivery, order by phone and charge to your Master Charge or VISA. The ZX80 is backed by a 30-day money-back guarantee, a 90-day limited warranty with a national service-by-mail facility, and extended service contracts are available for a minimal charge.

Price includes TV and cassette connectors, AC adaptor, and 128-page manual.

All you need to use your ZX80 is a standard TV (color or black and white). The ZX80 comes complete with connectors that easily hook up to the antenna terminals of your TV. Also included is a connector for a portable cassette recorder, if you choose to store programs. (You use an ordinary blank cassette.)



The ZX80 is a family learning aid. Children 10 and above will quickly understand the principles of computing—and have fun learning.

Phone orders only: (203) 265-9171. We'll refund the cost of your call.

Information: General and technical—(617) 367-1988, 367-1909, 367-1898, 367-2555. Phones open Monday-Friday from 8 AM to 8 PM EST.

# sinclair

Sinclair Research Ltd., 475 Main St.,  
 P.O. Box 3027, Wallingford, CT 06492.

BY-11-0

To: Sinclair Research Ltd., 475 Main St., P.O. Box 3027, Wallingford, CT 06492.

Please send me \_\_\_\_\_ ZX80 personal computer(s) at \$199.95\* each (US dollars), plus \$5 shipping. (Your ZX80 may be tax deductible.)

I enclose a check/money order payable to Sinclair Research Ltd. for \$\_\_\_\_\_.

Name \_\_\_\_\_

Address \_\_\_\_\_

City \_\_\_\_\_ State \_\_\_\_\_ Zip \_\_\_\_\_

Occupation: \_\_\_\_\_ Age: \_\_\_\_\_

Intended use of ZX80: \_\_\_\_\_

Have you ever used a computer?  Yes  No.

Do you own another personal computer?  Yes  No. \*For Conn. deliveries, add sales tax.

# Buy By Mail and Save!

## COMPUTERS



- INTERTEC SuperBrain® 32K . \$2495
- 64K RAM, List \$3345 . . . . . \$2695
- 64K Quad, List \$3995 . . . . . \$3395
- NORTH STAR Horizon I®
- 16K D.D. Kit . . . . . \$1259
- 32K D.D. Kit . . . . . \$1579
- 32K Assembled, List \$2695 . . . . \$2149
- Horizon 2 32K DD, Assm., \$3095 \$2439
- 32K Q.D, Assm., List \$3595 . . . . \$2859



- CROMEMCO Z-2, List \$995 . . . \$ 829
- System 2, 64K, List \$3990 . . . \$3179
- System 3, 64K, List \$6990 . . . \$5479
- ATARI® 400, List \$630 . . . . \$ 489
- 800, List \$1080 . . . . . \$ 839
- TI-99/4, List \$1150 . . . . . \$ 985

## DISK SYSTEMS

- THINKER TOYS® Disc 2D . \$ 939
- Dual Disc 2D . . . . . \$1559
- Disc 2 + 2, List \$1549 . . . . \$1288

## PRINTERS & TERMINALS

- PAPER TIGER IDS-440 . . . . \$ 849
- with Graphics Option . . . . \$ 949
- CENTRONICS 730-1, List \$995 . \$ 639
- 737, List \$995 . . . . . \$ 849
- T.I. 810 . . . . . \$1575
- INTERTUBE II, List \$995 . . . . \$ 729
- PERKIN-ELMER Bantam 550 . . \$ 789
- TELEVIDEO 912C . . . . . \$779
- 920C . . . . . \$ 839
- HAZELTINE 1420 . . . . . \$ 839
- 1500 . . . . . \$ 879
- SOROC 120 . . . . . \$ 745

## FLOPPY DISKS SPECIAL

5 1/4" Box of 10 ONLY \$29.95

(specify TRS-80, North Star, SuperBrain, etc.)

Most items in stock for immediate delivery. Factory sealed cartons w/full factory warranty. NYS residents add appropriate sales tax. Prices do not include shipping. VISA and Master Charge add 3%. C.O.D. orders require 25% deposit. Prices subject to change without notice.

# Computers Wholesale

P.O. Box 144 Camillus, NY 13031

(315) 472-2582

loads all parameters for the color memories at the indexed color code of 2. The hue, intensity, and saturation are loaded at this address with the data 5, 7, and 2, respectively.

In order to exploit the full capabilities of the frame buffer, we must have some method to access individual elements of the buffer. And we must have the capability of loading all or portions of the frame buffer in order to support selective filling and erasing. If we do not provide this function, it becomes very difficult to produce solid colored or shaded images, which is one of the important advantages of a raster-scan display. Furthermore, if we allow the host to directly load individual elements of the frame buffer, we can produce a full frame that implements algorithms such as *depth queuing* and *shading* that cannot be performed otherwise by the display processor at the pixel level. Thus it is apparent that we do need some sort of load-pixel primitive. In order to increase the utility of this primitive, however, we must introduce the concept of the *viewport*.

Through the graphics-display registers, we can define a rectangular area on the display by a pair of X,Y coordinates (the left and right X boundary and the top and bottom Y boundary). Thus, rather than loading the full screen, we can reference the area bounded by a viewport. This feature permits us to load areas of the display or even to mask portions of the display. To further increase the generality of this primitive, we must also permit loading a single pixel. This feature allows us to change the color of the point we are currently at. We could do the same with the MOV primitive, but this instruction would be shorter. Finally, we can define our load-pixel primitive as:

LPIX R,C<sub>0</sub>..C<sub>n</sub>,

where:

- R = reference (Full frame, Viewport, or X, Y)
- C<sub>i</sub> = color data

Along with this primitive, we must add that a predefined order of filling the pixels must be maintained, such as left to right, bottom to top. For example, the primitive:

LPIX F,0,0,0,0...

loads the entire display with a single color 0.

The next primitives we need do not actually produce an image, but support the previous primitives. First, since we have assumed the existence of graphics-display registers, we must allow the host to load the registers with a value. In this work, we do not specify the types or numbers of graphics-display registers, since they may vary from system to system. However, certain registers will be consistent, such as vector type and current X and Y position. Mnemonically, our load-register primitive can be represented as:

LREG, N,V

where:

- N = register name or number
- V = value to be loaded

For example, the primitive:

LREG X,4096

loads the X register with the value 4096.

Since some of these registers contain status information, it is important that the host be able to read back the value in the register. For example, if the display processor supports a light pen, it may be necessary for the host to read back the X and Y position coordinates. Mnemonically, our read-register-primitive can be represented as:

RREG N

where:

- N = register name or number

For example, the primitive:

RREG Y

reads the contents of the Y register and returns the value to the host.

Since we have assumed the existence of subroutines, there must be some way of loading subroutines in the display-processor memory: thus we need a load-subroutine primitive. We obviously need the parameters of

*Text continued on page 276*

# WordPro<sup>TM</sup> Word Processing Software

Turn your Commodore CBM/PET computer  
into a highly sophisticated word processing system

Everyone expected it would happen sooner or later... with WordPro it already has! Now all the marvelous benefits of an advanced stand-alone wordprocessor are available with the WordPro series of software and the systems they create.

If you've already been shopping for software in the crowded word-processing marketplace, you've probably determined the features you really want. You'll find WordPro has them, and more.

And if you haven't begun to shop yet, we urge you to compare, because only by comparison will you fully appreciate how complete and sophisticated WordPro software really is.

## WORDPRO GIVES YOU THREE LEVELS TO CHOOSE FROM

**WORDPRO 1** is ideal for hobbyists, students and organizations who can benefit from the advantages of a basic wordprocessor without the program refinements of a commercially oriented system. WordPro 1 is recommended for use with the CBM/PET 8/16K, C2N cassette and interfaced printer.



## WORDPRO SOFTWARE IS LOADED WITH THE LATEST INNOVATIONS

Sophisticated systems programmed with leading edge wordprocessing features, WordPro is a series of programs designed specifically for use with the Commodore CBM/PET computers, peripherals and compatible typewriter quality printers.

**WORDPRO 3** converts the CBM/2001 32K computer into a highly sophisticated 40-column screen wordprocessor. This program incorporates the advanced features considered important to effective wordprocessing, including nearly every entering, editing, memory and printing feature available today. WordPro 3 is recommended for use with CBM/PET 32K (40-column) computer, CBM Dual Disk Drive, and a properly interfaced printer.

## WHAT MAKES WORDPRO THE BEST?

Our research has shown that while many wordprocessing packages have comparable features to WordPro, none can surpass Wordpro's EASE OF USE AND FLEXIBILITY. Wordpro operators need not be familiar with computer commands or functions. WordPro is easy to learn for anyone with ordinary typing skills.



**WORDPRO 4** has it all! With this program, you will have everything you could want from a wordprocessor... and then some. WordPro 4 includes every feature found on WordPro 3, but with the added advantage of an 80-column display screen. The 80-column display simplifies text editing and makes entering text in columnar formats effortless. And with a few simple keystrokes, you'll be able to visualize on the screen exactly how your document will look prior to printing it out. WordPro 4 is designed for use with the Commodore CBM 8032 computer, CBM Dual Disk Drives, and a properly interfaced printer.

**Professional Software Inc.**  
166 Crescent Rd., Needham, MA 02194  
(617) 444-5224

\*WordPro Dealer Inquires Invited\*  
WordPro was developed by Steve Punter of Pro-Micro Software Ltd., and is marketed exclusively by Professional Software Inc.

WordPro is a registered trademark of Professional Software Inc. CBM is a registered trademark of Commodore Business Machines.

# SUPER

**Now With Multi-Key Capabilities For Apple & Pet**

Since KRAM™ was introduced in 1979 it has fast become known as the users. Now, after hundreds of requests we have added MULTI-KEY,

IBM/370 users have VSAM (Virtual Storage Access Method) to provide fast, flexible keyed-access to their data. Now SUPER KRAM (Keyed Random Access Method), from United Software of America, gives Apple and Pet users the same flexibility, substantially increasing the processing power of the Apple and Pet.

Until SUPER KRAM the only "random access" capability in the Apple and Pet consisted of a crude form of "relative record" processing. While this is usable for very simple applications, it falls far short of the needs of today's business and analytical applications. Using SUPER KRAM records may be processed by any one of multiple "Key" values, which may consist of any kind of data: numbers, letters, special characters, etc. Even Apples's long-awaited DOS 3.3 doesn't have anything like this!!

## KRAM™ 2.0 Regular Features

- Written in 6502 machine code Basic compatible
- Create/Open a dataset
- Put record by key
- Add & delete records by key
- Get any record by Full/Partial key
- Access by any key in as little as .2 sec. (.1 sec. with Corvus disk)
- Supports multiple disks
- Read next or previous record
- Dynamic space allocation
- Dynamic space reclamation
- Dynamic index compression
- Files never need reorganization
- Compatible with language systems

**KRAM™ 2.0 Only \$99.95**

# APPLE / ATARI

*"Precise, humanized, well documented an excellent value" are the applauds being given*

**3-D  
ANIMATED  
COLOR  
GRAPHICS**



**Written in machine code.**

## APPLE WORLD by Paul Lutus

**The Program made famous on National TV!**

APPLE WORLD turns your Apple into a sophisticated graphics system capable of creating animated three-dimensional color images, projecting them in true perspective on the screen, rotate them, move them closer, further away, and many other exciting and imaginative things.

Draws objects with 65,000 points per side.

A powerful screen-oriented text editor is included to facilitate image formation. This program was recently featured on Tom Snyder's Prime Time Saturday TV Show and is now available for sale.

APPLE WORLD'S powerful editor is so easy to use that children will love it. You can now "sketch" your dream house, boat, car, or fantasy empire. Then view it as it would be seen from 10,000 feet, or you can ZOOM in until the screen is filled with a doorknob. You could then go inside and move from room to room examining furniture placement as your screen rotates within the room. Images or specific parts of images can easily be saved to disk or printer.

Does all this sound like science fiction? You won't think so after you have visited Apple World.

**Introductory Price \$59.95**

36 page manual included

**For 48K Apple II or Plus with Disk**

Look for the RED-WHITE-BLUE  
United Software Display at your local  
computer dealer, or send check or  
money order, plus \$3.00 shipping to:

**USA UNITED  
SOFTWARE  
OF  
AMERICA**

750 3RD Avenue,  
New York NY 10017  
(212) 682-0347

Telex 640055

**DEALER INQUIRIES INVITED**

# KRAM™

By Ken Germann

## You've Asked For It, Now You Got It!

quickest and most powerful access method for serious Apple and Pet MULTI-INDEX, functions, as well as increasing processing speed.

### SUPER KRAM'S™ Added Features

- MULTIKEY SUPPORT — Allowing simultaneous access to a KRAM file by more than one key field.
- HI-SPEED READ — This feature allows increased I/O speed up to 60% faster during processing of SUPER KRAM read next, read previous, put and delete requests.
- IMPROVED INDEX ARCHITECTURE — Allowing faster index searches and more efficient disk space utilization.
- INTEGRATED BASIC COMMANDS — Allowing SUPER KRAM™ commands to be coded in-line with Basic, providing easier usage of KRAM than ever before.
- USER-SPECIFIABLE BUFFER POOL — Allowing the user to specify how many KRAM files are allowed open at one time; will support any number of KRAM files.

- LOGICAL RECORDS (KEYS MAY BE NON-UNIQUE) — Records added to the KRAM files are immediately accessible by any of the defined keys for the file (Automatic Upgrade).
- KRAM 2.0 files are totally compatible with SUPER KRAM

### Requirements

Apple & Pet requirements - KRAM 2.0 and SUPER KRAM are designed to work with both Apple II's, Disk II, and Corvus Systems 10 Megabyte Winchester Disk, and Commodore's 2040, 3040, and 8050 Disk units. KRAM 2.0 and SUPER KRAM require 32K/48K Apple and a least on disk drive. (KRAM 2.0 requires Integer Basic in ROM). KRAM and SUPER KRAM work on any 40/80 column 16K/32K Pet.

**SUPER KRAM™ Only \$175**

# BREAKTHROUGHS

these sophisticated programs designed to meet the stringent needs of individuals and business professionals.

## NEW 3-D SUPERGRAPHICS & 3-D GAME DEVELOPMENT SYSTEM IN COLOR

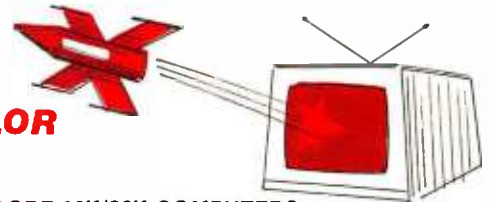

by Paul Lutus

Watch colorful butterflies, birds, fly across your Apple or Atari screen with true 3 dimensional perspective. Have rocket ships fly out at you in this incredible high speed graphics package. 3-D SUPERGRAPHICS™ is a 6502 machine language program that will interface to your Basic or machine language programs or games using simple "DOS-like" commands.

### Features include:

- Simple image entry through editor
- Objects up to 256 points per side
- Uses all hi-res colors
- Allows mixed colored text & graphics for prompts and captions
- Translates on 3 axes
- Individual axis scales
- 21 different commands
- Rotate object by 1.4° to 360° increments at machine speeds

**For 48K Apple II or Plus with Disk II \$39.95 for disk**

**For ATARI 800 with 40K memory (disk optional) \$39.95 for tape**

### FOR COMMODORE 16K/32K COMPUTERS

**DATABASE MANAGEMENT SYSTEM** — A comprehensive, interactive system like those run on mainframes! Six modules comprising 42K of programming allow you to; create, edit, delete, display, print, sort, merge, etc., etc. - databases of up to 10,000 records. Printer routines automatically generate reports and labels on demand. 60 pages of concise documentation are included. Requirements - 16-32K PET and 2040 Dual Disk (printer optional) ..... **COST \$125**

### OTHER SOFTWARE

	Stock Analyzer .....	22.95
	Mortgage .....	14.95
<b>APPLE COMPUTERS</b>		
Super Space Wars .....	\$ 9.95	
States & Capitals .....	9.95	
Moving Point .....		
Average .....	19.95	
Stock Options .....	24.95	
Finance .....	12.95	
Bonds .....	12.95	
	Space Intruders .....	9.95
	("Best Game of 1979") .....	\$19.95
	Jury/Hostage .....	9.95
	Kentucky Derby/Roulette .....	9.95
	Alien I.Q./Tank .....	9.95
	Tunnelvision/Maze Chase .....	14.95
	Submarine Attack .....	9.95
	Battle of Midway .....	7.95
	Laser Tank Battle .....	9.95
	Swarm .....	14.95
	Baseball .....	9.95
	Super Startrek .....	14.95
	PET Music Box .....	29.95
	Stock Options .....	24.95
	Finance .....	12.95
	Bonds .....	12.95

## A Line-Failure Indicator

Hank Olson, POB 339, Menlo Park CA 94025

Have you ever come back from work looking forward to an evening of home computing, only to find that nothing works? The program that was almost debugged during previous evenings is gone?

While nothing short of nonvolatile memory will completely solve this problem, the simple line-failure indicator described here will alert you to problems that occurred while you were away. A simple glance at the three-color display of LEDs (light-emitting diodes) will at least let you know what you are in for. The indicators light as follows:

- green: power is on, no recent failures
- yellow: power has failed and returned
- red: power has been off for a short time
- none: power has been off for a long time

Having different colored LEDs seems best from a human-interface point of view, even though their voltage requirements differ somewhat.

The circuit of the line-status indicator is shown in figure 1. The basic power supply uses a common 6.3 V filament transformer and a bridge rectifier of four 1N4001 diodes. The primary is controlled by SW1, a double-pole switch which prevents the battery from discharging when the unit is off. This supply must provide the current to light one LED plus energize a small relay coil. This represents about 150 ohms, so the RC (resistor/capacitor) time constant of the power-supply filter is about 0.15 seconds. Therefore, if you return to find the yellow indicator on, you will know that there has been a line-voltage dropout of 0.3 seconds or longer.

Looking at figure 1, we see that the green LED is held on by SCR1. The SCR gate can only be triggered into conduction manually by means of SW2. Once this push-button switch (SW2) is (momentarily) closed, a pulse of current enters the gate of the SCR from the 0.1  $\mu$ F capacitor; and the SCR goes into conduction. Since this SCR operates on DC, it will stay in conduction until the DC supply fails (meaning that there is an AC line dropout).

When the DC supply fails, the relay K1 is de-energized, closing the "normally closed" contacts and lighting the

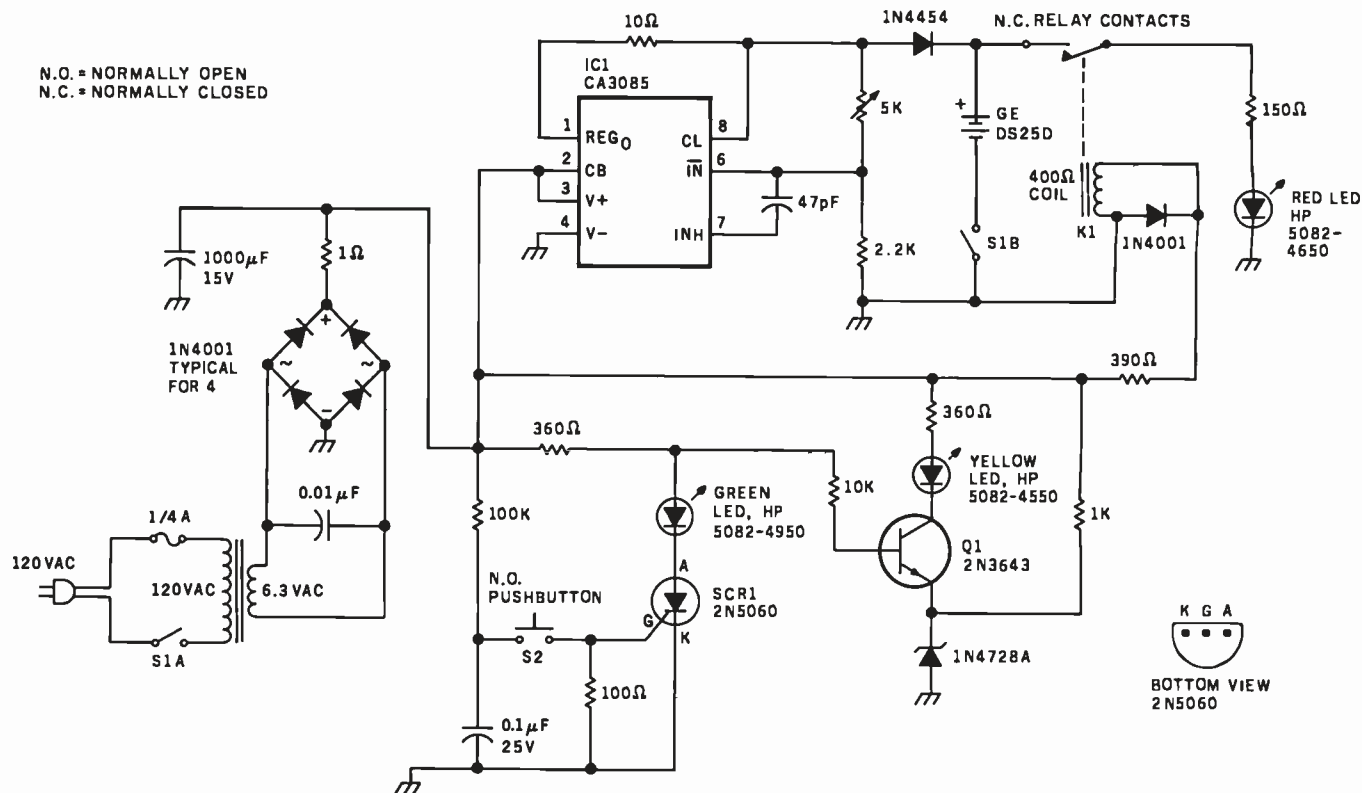

Figure 1: This power-line-failure indicator uses a silicon-controlled rectifier to detect voltage dropouts. If power should fail for more than 0.3 seconds, the SCR ceases to conduct and the green LED is extinguished, while the red LED lights. The red LED remains on as long as power is out; its power is drawn from a set of rechargeable batteries. Should power return, the red LED goes out and the yellow one is illuminated to indicate this sequence of events.





# At \$795\*, how tough can these new Tigers be?

Introducing the new Paper Tiger™ 445 with the most rugged printing mechanism ever put in a low-cost matrix printer.

The 445 comes with a reliable ballistic-type print head and an advanced cartridge ribbon that lasts four times longer than many cassette or spool ribbons. Two separate heavy duty motors drive the print head and advance the paper. Plus you get true tractor paper feed.

And the new 445 gives you the performance you expect from the Paper Tiger family of printers. You can software-select character sizes, print 80- and 132-column formats, adjust paper width and length, even generate six-part business forms. All at unidirectional print speeds to 198 characters per second.

Need more stripes? Specify DotPlot™, a sophisticated raster graphics option.

If you've got an Apple\*\*, TRS-80\*\*\* or other personal computer, get your paws on the tough new Paper Tiger™ 445 from IDS.

The people who invented low-cost matrix printing just growled.

Call TOLL FREE 800-258-1386 (in New Hampshire, Alaska and Hawaii, call 603-673-9100.)

Or write:  
Integral Data Systems, Inc.,  
Milford, New Hampshire  
03055.



## Paper Tiger 445

 Integral Data Systems, Inc.

Traditional

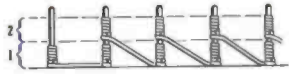

Wire-Wrapping

**NEW**

**JUST WRAP**



Wire-Wrapping

**WHY CUT?  
WHY STRIP?  
WHY NOT ...**

**JUST WRAP™**

WIRE WRAPPING TOOL

- AWG 30 Wire
- .025" Square Posts
- Daisy Chain or Point To Point
- No Stripping or Slitting Required

JUST WRAP™

- Built In Cut Off
- Easy Loading of Wire
- Available Wire Colors:
- Blue, White, Red & Yellow

PATENTED U.S.A.

FOREIGN PATENTS PENDING

JUST WRAP TOOL WITH ONE 50 FT. ROLL OF WIRE		
COLOR	PART NO.	U.S. LIST PRICE
BLUE	JW-1-B	\$14.95
WHITE	JW-1-W	14.95
YELLOW	JW-1-Y	14.95
RED	JW-1-R	14.95
REPLACEMENT ROLL OF WIRE 50 FT.		
BLUE	R-JW-B	\$ 2.98
WHITE	R-JW-W	2.98
YELLOW	R-JW-Y	2.98
RED	R-JW-R	2.98
JUST WRAP-UNWRAPPING TOOL		
	JW-1	\$ 3.49

\*Minimum billings \$25.00, add shipping charge  
\$2.00/New York State residents add applicable tax



**OK Machine & Tool Corporation**

3455 Conner St., Bronx, N.Y. 10475 U.S.A.  
Tel. (212) 994-6600 Telex 125091



red LED. The 1N4454 serves to disconnect the two-cell nickel-cadmium (nicad) battery from U1 during power outages, so that the *only* load on the battery is the LED. Use of a relay to actuate the battery-to-LED circuit is the best method, because it closes the circuit with nearly zero resistance, while consuming *no* power in the process. The two-cell nicad, a General Electric DS25D, is a rather small unit made for printed-circuit board mounting and thus fits in easily. This tiny battery will light the red LED for several hours when fully charged.

When AC power returns, DC is quickly restored to energize K1 and to charge the battery via IC1, the regulator. IC1 is a voltage regulator, but it also has current-limit capability. The 10-ohm resistor between pins 1 and 8 of the regulator causes charge current to be limited to 20 mA, even if the battery is nearly discharged. As the battery charges and its terminal voltage approaches the regulated voltage output to which IC1 is set, current drops below 20 mA and tapers off in the "constant-voltage" charge mode.

Meanwhile, the SCR remains nonconducting, which allows current to flow via the 360-ohm and 10 k-ohm resistors to the base of Q1, forward-biasing this transistor and lighting the yellow LED. Thus the yellow LED indicates that power has failed and returned. The red LED has, of course, been extinguished with the energizing of K1.

The final step in the sequence is when the person who uses this line-failure detector notices that the yellow LED is lit, and resets SW2. This act causes SCR1 to conduct, diverting current from the base of Q1, extinguishing the yellow LED and lighting the green LED.

Since it takes between 1.5 and 1.8 V to light an LED, I chose a battery consisting of two nicad cells in series. This gives a battery voltage of 2.4 V, which is adequate to light LEDs of all colors, using series dropping resistors. Since the battery is charged in series with a 1N4454, the voltage-regulator output should be set (by means of the 5 k-ohm variable resistor) to between +2.9 and +3.1 V. This accounts for the series forward-voltage drop in the 1N4454. Note that an RCA-CA3085 is used as a regulator. An LM305H (National Semiconductor) will not substitute for this integrated circuit since it's not made to regulate below +4.5 V. The older National LM300H would work, however.

K1 can be any small relay having a coil voltage from 4 to 8 V DC, with a set of normally closed contacts. The series resistor is adjusted to drop the unregulated +8 V of the DC supply to the desired voltage of the relay coil. In my own case, a small relay (from an old radiosonde transmitter) which had a 400-ohm coil and which closed reliably on +4 V was used. A 390-ohm resistor was then used to drop the +8 V supply to the coil voltage of +4 V. ■

*Technical Forum is a feature intended as an interactive dialog on the technology of personal computing. The subject matter is open-ended, and the intent is to foster discussion and communication among readers of BYTE. We ask that all correspondents supply their full names and addresses to be printed with their commentaries. We also ask that correspondents supply their telephone numbers, which will not be printed.*

# Look what's happened to HIPLØT™

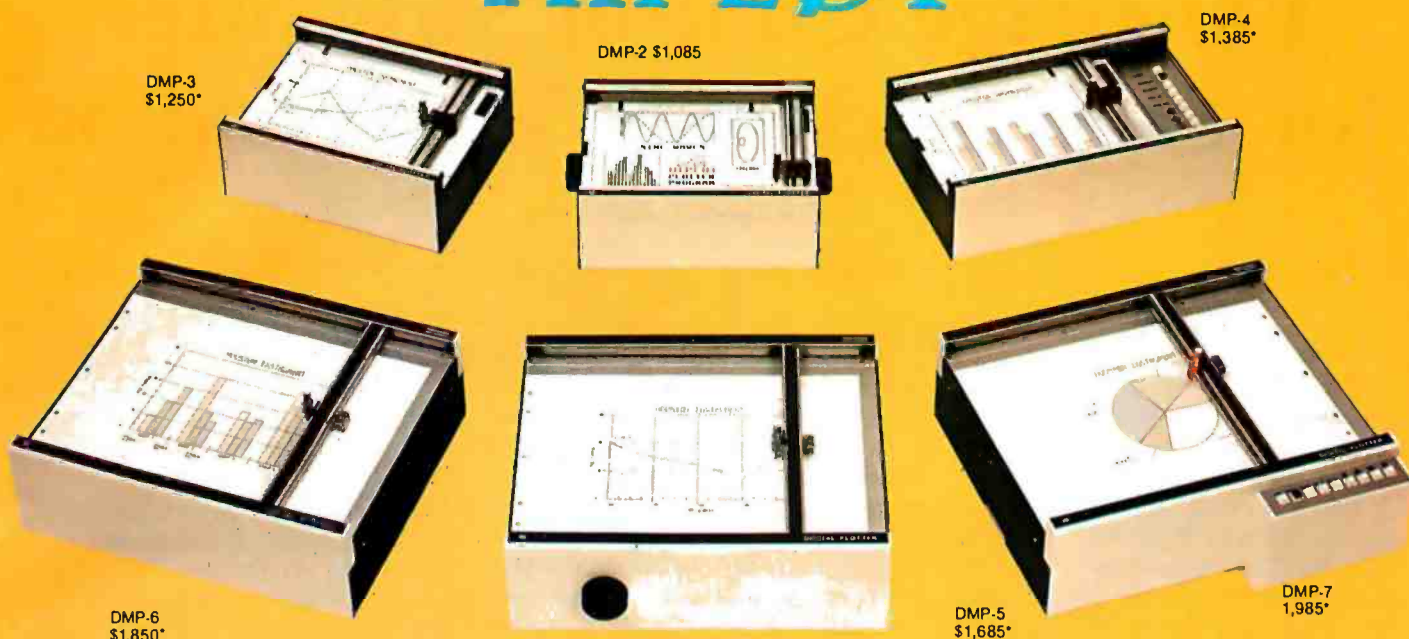

## It's grown into a complete family of quality low cost digital plotters

Yes, they are UL listed! \*\*

Circle 53 for literature  
Circle 54 to have representative call

In just two short years, The HIPLØT has become the most popular digital plotter among small systems users. With a record like that, what can we do for an encore? WE'VE INTRODUCED A COMPLETE LINE OF HIPLØTS...with a model suited for just about every plotting application.

The HIPLØT DMP Series is a new family of digital plotters with both "standard" and "intelligent" models available with surface areas of 8½" x 11" (DIN A4) and 11" x 17" (DIN A3). For the user needing a basic reliable plotter, we have the "old standard" DMP-2 (8½" x 11") and the "new standard" DMP-5 (11" x 17"). For those needing a little more capability, there are the DMP-3 (8½" x 11") and the DMP-6 (11" x 17")—both

microprocessor controlled and providing easy remote positioning of the X and Y axes (perfect for the OEM). For those who want this intelligence plus the convenience of front panel electronic controls, we've provided the DMP-4 (8½" x 11") and the DMP-7 (11" x 17").

The "standard" plotters come complete with an RS-232-C and a parallel interface. The "intelligent" DMP plotters accept data from either an RS-232-C or Centronics data source. For the "standard" plotters, software is available from our ever expanding "Micrographic Users Group." The "intelligent" HIPLØTs use our exclusive DM/PL™ language which minimizes plot software to a fraction of that normally as-

sociated with digital plotting.

With the new DMP Series, high quality digital plotting can now be a part of your system. It just doesn't make sense to be without this valuable tool when there is a DMP plotter with the plot size, speed and capabilities that are exactly tailored to your specific needs...and your budget.

Prices for the DMP series range from \$1,085\* to \$1,985\*.

For complete information contact Houston Instrument, One Houston Square, Austin, Texas 78753. (512)837-2820. For rush literature requests, outside Texas call toll free 1-800-531-5205. For technical information ask for operator #2. In Europe contact Houston Instrument, Rochester-laan 6, 8240 Gistel, Belgium. Telephone 059/27-74-45.

™ HIPLØT and DM/PL are Trademarks of Houston Instrument

houston instrument  
GRAPHICS DIVISION OF  
**BAUSCH & LOMB**



\*U.S. suggested retail prices only.  
\*\*DMP 2, 3 and 4 UL listed  
DMP 5, 6 and 7 UL listing pending

# Language Control Structures for Easy Electronic Visualization

---

Dr Thomas DeFanti  
Electronic Visualization Laboratory  
University of Illinois at Chicago Circle  
POB 4348  
Chicago IL 60680

---

Control structures are the program-flow manipulation features of the language that you use to beat your computer into submission. BASIC's control structures are embodied in the RUN, GOTO, GOSUB, and RETURN keywords and a few functions, certainly an impoverished set. Highly structured languages like Pascal are rigidly limited to the control structure of subroutines. Lowly structured approaches like assembly language are necessary to implement

higher-level languages and real-time systems, because the lack of enforced structure allows an infinite variety of control structures to be used at a cost of great human effort. The execution-speed gain in using assembly language is more due to the efficient building of customized tables and linked lists than to efficiency in adding, subtracting, multiplying, and dividing numbers.

Assembler coding is by no means easy. Note the word "easy": it's

important because in one sense it means "accessible." In this case, it's your access to complex electronic visualizations.

Electronic visualizations are important because producing and manipulating images, especially animated ones, is a truly multidimensional task which reflects our real-world interactions much more than maintaining an accurate laundry list or printing payroll checks. Producing them demands a lot from software,

1a



1b



Photos 1a and 1b: Sample output from the GRASS/Image Processor. Photo 1a was made by Guenther Tetz, and photo 1b by Dan Sandin and the author.

# Orange Micro

"SPECIALIZING IN PRINTERS  
AND CRT'S"

## CENTRONICS 737 (RADIO SHACK LINE PRINTER IV)

*Word Processing Print Quality*



• 18 x 9 dot matrix; suitable for word processing • Underlining • proportional spacing • right margin justification • serif typeface • 50/80 CPS • 9½" Pin Feed/Friction feed • Reverse Platen • 80/132 columns

CENTRONIC 737-1 ..... (List \$995)      \$Call

## MALIBU

*The Small Business Printer;  
Letter Quality & Speed.*



• 10 x 9 dot matrix • Letter quality print; Lower case descenders • High speed; 165 CPS, Bidirectional, Logic seeking • Wide carriage, Adjustable tractors to 16" • Vertical forms control • Variable line spacing • User programmable character set • DOT RESOLUTION GRAPHICS

MALIBU 165 ..... (List \$2495)      \$2195

## EPSON TX80

*A Reliable, Graphics Printer*



• 5 x 7 dot matrix • 125 CPS • Double wide characters • Dot resolution graphics & 64 special graphic characters • 6/8 lines per inch • Vertical forms control • Adjustable tractors • Heavy duty — Highly reliable

EPSON TX80 ..... (List \$799)      \$Call

## ANACOM

*Low Cost, High Speed, Wide Carriage*

• 9 x 9 dot matrix • Lower case descenders • Wide carriage • Adjustable tractors to 16" • 150 CPS, Bidirectional, Logic Seeking

ANACOM 150 ..... (List \$1350)      \$1250

## EPSON MX80

*Low-Priced Professional Print Quality*

• 9 x 9 dot matrix • Lower case descenders • 80 CPS • Bidirectional, Logic seeking Tractor feed • 40, 66, 80, 132 columns per line • 64 special graphic characters

EPSON MX80 ..... (List \$645)      \$Call

## OKIDATA MICROLINE SERIES

*TRS-80 Graphics Compatibility*



• 9 x 7 dot matrix • 80 CPS • 80, 132 columns — 64 shapes for charts, graphs & diagrams • Double wide characters • 6/8 lines per inch • Up to 3 part copy • Friction & pin feed • 200 M character head warranty

OKIDATA MICROLINE 80 ..... (List \$800)      \$599

## THE SMALL COMPUTER PRINTER by Brent Weston

This illustrated booklet provides the information you need about today's small printers. There are many printers available, each with different features and capabilities. *The Small Computer Printer* will guide you in determining which printer best fits your applications. A complete feature comparison chart is included representing over 40 small printers. A printer is a big investment — learn all about them before you buy one.

**\$795**



## TELEVIDEO CRT'S PRICES SLASHED!

TVI 912C } Please Call Toll Free  
TVI 920C } Prices are too low to  
advertise

## BASE 2

*The Hobbyist Printer With The Most Features*



• Graphics • Tractors/Friction Feed • 2K Input Buffer • RS-232 Serial, Centronics® Parallel, IEEE-488, 20 ma • TRS-80 Cable option • 100 CPS • Fast form feed • User programmable character set • 64, 72, 80, 96, 120, 132 Columns/line • Expanded characters • Automatic skip-over-perforation • Horizontal & Vertical tabs • Programmable vertical line spacing • Intel 8085 Microprocessor — over 40 software commands

BASE 2 800B ..... (List \$699)      \$649

## PRINTERS

CENTRONICS 730 Radio Shack Line Printer II ..... (List \$795) \$ 639  
OKIDATA MICROLINE 82 & 83 ..... \$ Call  
NEC 5530-5 letter quality, RO, parallel, tractors ..... (List \$2970) \$ 2599  
PAPER TIGER IDS 440 w/graphics and 2K buffer ..... (List \$1094) \$ 939  
PAPER TIGER IDS 460 w/graphics, 9 x 9 dot matrix ..... (List \$1295) \$ Call  
QUME 5/45 typewriter quality ..... (List \$2905) \$ 2559

## INTERFACE EQUIPMENT

APPLE II - BASE 2 parallel graphics interface board + cable ..... \$ 160  
APPLE II - EPSON TX80  
parallel graphics interface board + cable ..... \$ 110  
SSM AIO BOARD Apple Serial/parallel interface ..... (List \$225) \$ 199  
MICROTRONICS Atari parallel interface ..... \$ 69  
ATARI 850 Interface module, serial/parallel ..... \$ 199  
TRS-80 CABLES ..... \$ Call

**TOLL FREE  
(800) 854-8275**

**CA, AK, HI (714) 630-3322**

At Orange Micro, we try to fit the right printer to your application.  
Call our printer specialists for free consultation.

**CALL FOR FREE CATALOG**

Phone orders WELCOME. Same day shipment for VISA, MASTER CHARGE, and AMERICAN EXPRESS. Personal checks require 2 weeks to clear. Add 3% for shipping and handling. California residents add 6%. Manufacturer's warranty included. Prices subject to revision.

**Orange  
Micro**   
3148 E. La Palma, Suite E  
Anaheim, CA 92806

and making their access easy requires paying attention to the provision of rich control structures in a language.

*Electronic Visualization* is an intentionally broad term meant to conjure thoughts of computer graphics, animation, image processing, video synthesis, and even advanced word-processing. Anyone successfully producing images for communication is unlikely to reject a technique for reasons of algorithmic purity (as a computer scientist might feel forced to do). Computer hobbyists use the tools at hand, and electronic visualization is the means to the end and the end product of using these tools. Simultaneously, it can be *both* because we are seeing the vast increase of real-time imaging systems, even in microcomputer-based configurations; and controlling these real-time systems can be as feedback-intensive as playing a musical instrument or driving a racing car.

Just to unify the concepts so far, think about this question: what besides the cosmetic packaging governs our choice of a musical instrument or an automobile? It is a combination of capability and user

---

The most successful approaches to date are basically highly developed, beautifully evolved kluges.

---

control, of course: having one without the other is useless. So why are the programming languages currently available so impoverished on the control-structure side?

Perhaps it is because computers were invented to process payrolls, not images. Television, on the other hand, is image-oriented and currently uses a host of presently emerging real-time digital techniques and increasingly flexible control structures. As a matter of fact, just about all the television you see these days is digitally processed for purposes of synchronization.

Television is a high-speed medium conducive to parallel and pipeline processing. You are driving television rather than generating it. TV cameras are on all the time and you, as direc-

tor, are fading, switching, adding titles and constantly throwing away images that you don't want. Control is the name of the game.

The television folk are not about to give up rich, real-time control structures and the computer folk won't give up language. How to get them together is the essence of the task at hand.

## Getting Computers and Television Technology Together

Looking at the history of control structures for computer graphics and for television, we see that most computer-graphics usage, with the obvious and exciting exception of video games, is some variety of non-real-time plotting. This is where the money is and where the language development for computer-aided design has been focused. No manufacturer of equipment for computer graphics (excepting the video-game people) now depends on animation for solvency. Plotting is slow and often merely the side output of a large FORTRAN finite-element analysis program. Visual aesthetics are rarely the primary concern, if any concern at all. People who use such systems are highly skilled and highly paid technicians who became that way by having to deal with plotting packages as a condition of employment. If the job were easy, they wouldn't get paid so much.

We are just reaching the point of electronically generating and manipulating images, in real time, under program control. How do we design languages to deal with real time? Or, more important, why do we want such a language, an alphanumeric string-oriented language, at all? Why not use picture-based languages with symbols for motions and timing?

## How Can You Control Images Easily?

After about ten years of living with this obvious and nagging question, some conclusions became clear. First, purist approaches to electronic visualization are hopeless. Image control employs a hybrid of languages, several input devices, picture-oriented commands, custom hardware, and a smattering of idiosyncrasies. The most successful approaches to date are basically

A CREATION OF COMPUTER HEADWARE

# WHATSIT?

*(Wow! How'd All That Stuff get In There?)*

**A sophisticated, self-indexing filing system—flexible, infinitely useful and easy to use, that adapts to your needs.**

### WHATSIT's unique capabilities:

**Multiple Entries allowed per field:** For example, a bibliographic file can associate each work with any number of authors. WHATSIT allocates file space as needed for each.

**New Data Fields added "on the fly":** You're not confined to a particular "record layout" that must be declared in advance. Your file evolves to fit your needs.

P.O. Box 14815 • San Francisco, CA 94114 • Tel: (415) 621-2106

**Immediate Response:** Even in the largest files, WHATSIT responds in seconds, thanks to pointer linkages and hash coding.

**Conversational Dialogue:** Query and update requests may be intermixed in any order, without returning to a "menu selector."

**NEW**  
**Apple II Plus**  
**WHATSIT at special**  
**introductory price:**  
**\$95**

(Regular price, \$150  
after December 31, 1980).

WHATSIT comes ready to run on your Apple, Apple II Plus, AlphaMicro NorthStar, or CP/M computer. See your dealer for a full demonstration... or write or call:

**HARDHAT**  
Software

The **MAGIC WAND**<sup>TM</sup> is  
**ALMOST  
PERFECT.**

**We've been saying it for a few months now, and the reviewers seem to agree.**

“ Until I saw the Magic Wand, if I were allowed to own one and only one editor, Word Star\* would have been it. . . . My personal preference is for Pencil or Magic Wand for text creation. ”

**Jerry Pournelle**

*On Computing, Summer 1980*

“ The basic functions of the Magic Wand editor are as easy to learn as those of Electric Pencil\*. . . . Magic Wand dominates in the area of print formatting. ”

**Larry Press**

*On Computing, Summer 1980*

“ Of all the word processors I have used (and that includes a dozen or more), the Magic Wand is the most versatile. The Wand has almost all of the features of other processors, plus many new ones of its own. It measures up to even the word-processing software running on the largest mainframe computers. ”

**Rod Hallen**

*Microcomputing, June 1980*

“ The Magic Wand is one of the most flexible word processing packages available, and should be considered by any potential word processing purchaser. ”

**Glenn A. Hart**

*Creative Computing, August 1980*

**Available for both the CP/M® and OASIS operating systems**

**small business applications, inc.**

3220 Louisiana • Suite 205 • Houston, Texas 77006 • 713-528-5158

Electric Pencil is a trademark of Michael Shryer Software, Inc.  
WordStar is a trademark of Micro Pro International, Inc.  
CP/M is a registered trademark of Digital Research Corp.

highly developed, beautifully evolved kluges. We know what "purism" in coding FORTRAN and BASIC does to image production. Purism in television technique eliminates computer graphics as we know it. So how about using graphic symbols to save the day?

Using symbols in a menu and some sort of manual-selection mechanism is an approach taken by many FORTRAN graphics systems. This limits the number of symbols to those defined in the menu and there is no user-level extensibility in that you cannot create new symbols out of

sequences of old symbols, which eliminates the one truly unique feature of computers. To state it bluntly, you can't program with a menu.

What happens, however, if you do find a system that provides for the combination of nonalphanumeric symbols in meaningful ways? In an extremely advanced case, it should look something like Japanese, and you might note that the language used to program computers in Japan is a *phonetic alphanumeric transcription* of their language. They do not program in their extremely beautiful

and rich symbol set. Eliminating alphanumeric languages is not such a hot idea, except in turnkey systems.

The second conclusion gestating for the past ten years is that complete parallelism is necessary for controlling images in meaningful ways. You simply must be able to develop sequences independently and merge them in ways that do not necessitate rewriting the programs. Xerox's Smalltalk and certain other languages have this capability, as do television technology and everyday life: making this parallelism easily accessible takes real care.

The third conclusion is that a flexible priority scheme is needed. Some tasks are more important than others, just as in real life and computer operating systems. It is essential to give this capability to the user of an electronic visualization system.

Fourth, providing for user extensibility at several levels is the only way people will easily be able to use a system for applications not envisioned by the designer. I will discuss this later.

Fifth, the system must be software-fault tolerant. Fault-tolerant hardware has been a research area of great importance to real-time control systems, yet language purists still think people should solve problems in structured, orthodox, algorithmic ways. A computer language should provide as many paths to a given communication as possible, as natural languages do, and the kind of error handling that a friend would offer. Allowing nonstructured, non-procedural, "seat-of-the-pants" programming is often the only salvation when the final goal is aesthetically defined, and is, perhaps, not at all clear. It has been called "fuzzy programming," and it's easy to throw in the recursive, value-returning, clever structured-programming capabilities as well, but limiting yourself to these latter approaches stifles human creativity, problem-solving, and sideways thinking.

## Tax Practitioners / CPAs: Successful Tax Professional Reveals Effective Practice Development Formula....

"Every tax professional...whether he is desirous of expanding his practice, or just better serving his existing clientele (or both)...can profit from this system."

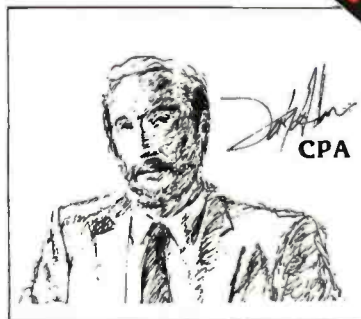

Are you satisfied with the growth of your tax practice?

Successful practice development is a perplexing problem facing all tax professionals today. The field tested MICROTAX professional tax preparation software package can provide you with an innovative solution...and at the same time enable you to serve your existing clientele in a more professional and timely manner.

Consider the advantages this state-of-the-art package can bring to your practice:

- **Complete System...**  
...containing Federal Individual, Corporate AND State Individual returns. The system is designed to accept information, summarize the data, compute the tax, and print the returns; including all forms and schedules required by the I.R.S.
- **Versatile**  
MicroTax is cost-efficient for practices preparing as few as 20 returns per tax season...but comes with a fast mode, capable of processing 2,000 returns—or more!
- **Best Of All...**  
...and this is really exciting...MicroTax allows you to offer **pre-year-end tax planning** to your clients—enabling you to predict the potential liability and take steps to minimize the tax in a timely manner.
- **Complete In-Office Security**  
—no risk of sensitive client information falling into the wrong hands.
- **Saves Time**  
Compared with conventional service bureaus, MicroTax offers virtually instant turn-around time.
- **More Professional**  
Greater range of services allows you to present a more professional appearance to your clients.
- **Requirements:**  
CP/M, Microsoft Basic & 48K Memory
- **Introductory Price ('til Dec. 1, 1980)**  
MicroTax is available as a three part system:
 

Federal Individual	\$750.00	Annual Updates
State Individual	250.00	Are Available
Corporate	250.00	

MicroTax is a versatile and money-saving tool that NO tax professional should be without (it's been selected for use by COMPU-TAX of Utah).

Call or write today for additional information, or your nearest dealer. Problems that can't wait?  
Call Don White our VP. of Research and Development, direct, at (213) 668-0238.

Circle 272 for microTax

Circle 58 for SOFTWARE Inc.

**microTAX**  
Income Tax Software Specialists

Available at most  
Professional computer retailers

Exclusive Distributor  
**S.O.F.T.W.A.R.E.†, Inc.**

3600 WILSHIRE BOULEVARD, #1510, LOS ANGELES, CALIFORNIA 90010 • (213) 738-9972

## Zgrass — A Language for Easy Electronic Visualization

Zgrass is a programming language and operating system written in assembly language for the Z80 microprocessor by Nola Donato, Jay Fenton, and me. Not surprisingly, it embodies all the control structures mentioned so far in this article and



# THE DAWN OF A NEW AGE

## The 2nd Generation™ is here!

MEASUREMENT systems & controls proudly introduces its new and exciting "2nd Generation" family of S-100\* compatible products. Each has been specifically designed for use with multi-user and network operating systems such as MP/M, CP/NET, and OASIS. Every product is fully tested and burned-in, comes with a 1 year guarantee, and offers you features not currently available from any other source.

**Z80 PROCESSOR BOARD** — The most powerful CPU board available today. Outstanding features include 4MHz operation, high-speed serial and parallel I/O utilizing DMA or programmed control, eight vectored priority interrupts, and a real time clock.

**MULTI-USER SERIAL I/O BOARD** — For use in expanded systems requiring up to eight additional serial I/O ports. Features include: 16 maskable

vectored priority interrupts, RS-232C interfaces with full handshake, asynchronous or synchronous operation with asynchronous baud rates to 19,200. Available in four or eight channel versions.

**DOUBLE DENSITY FLOPPY DISK CONTROLLER BOARD** — controls up to four 5¼-inch or 8-inch disk drives using IBM soft sectored formats. It features 1K of on-board buffering, DMA controlled data transfers and the performance characteristics of the superior NEC 765 chip.

**64K BANK SELECTABLE MEMORY BOARD** — Features include I/O port addressing for bank select with 256 switch selectable I/O ports for the memory bank addressing. The memory is configured as four totally independent 16K software-selectable banks, with each bank addressable on any 16K boundary.

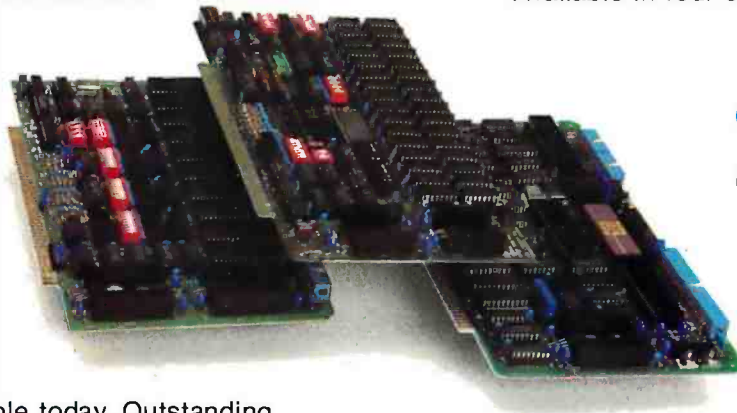

\*All products meet the new IEEE standards.

## Systems Group

A Division of MEASUREMENT systems & controls  
incorporated

*"Attractive Dealer & OEM Prices"*  
See your nearest computer dealer, or  
contact us for the complete story on  
The 2nd Generation.

867 North Main St. / Orange, Calif. 92668  
(714) 633-4460 TWX / TELEX: 678 401 TAB IRIN

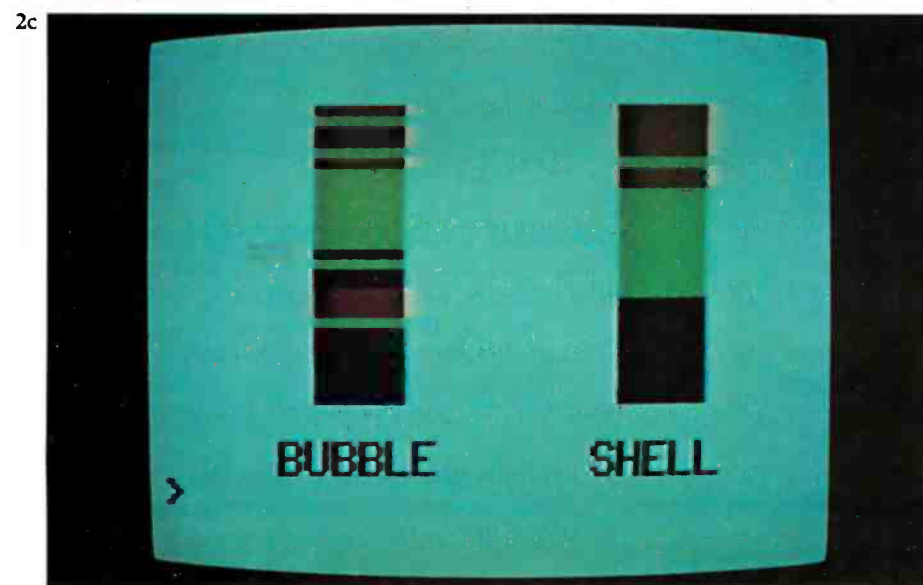
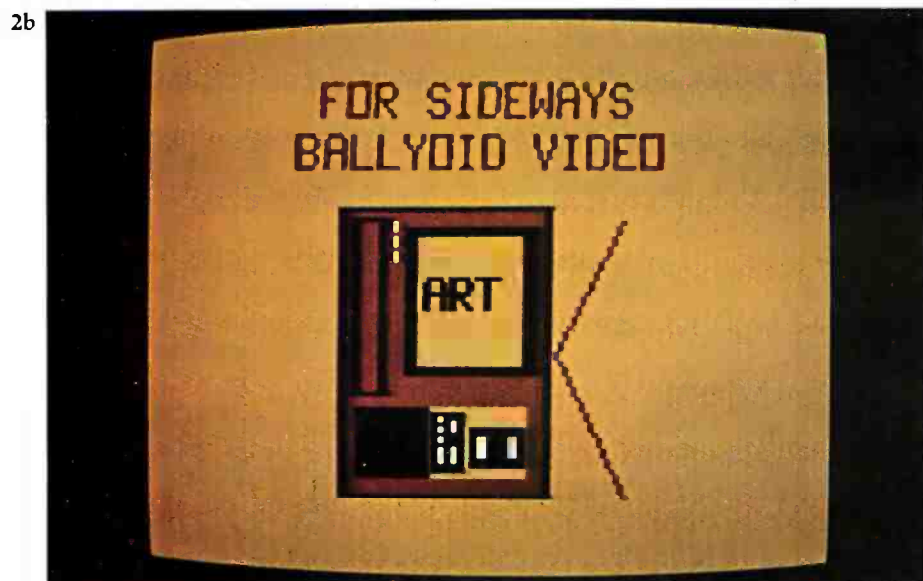

Photos 2a, 2b, and 2c: Sample output from the first Zgrass system, with a resolution of 160 by 102 pixels, with 2 bits per pixel. Photo 2a was made by Copper Giloth, and photos 2b and 2c by Nola Donato.

has been in development for ten years.

Zgrass started out as GRASS (Graphics Symbiosis System), a language designed to bring the immense complexity of a Digital Equipment Corporation PDP-11/45 and as Vector General 3DR Display system within the grasp of artists and educators at Ohio State University. It has high levels of interaction, parallelism, priority, and tree-structured manipulations of vector-defined objects. Photos from this system can be seen in "About the Cover... And Some More of the Same," in the October 1977 BYTE, page 22.

GRASS depends on \$120,000 of equipment to run — rather expensive for a single-user system — but it is one of the first highly developed non-FORTRAN interactive graphics systems for use by artists.

In 1973, Dan Sandin, inventor of the Image Processor, brought color television usage to our computer graphics work at the University of Illinois at Chicago Circle. Dan and I developed most of the ideas about control structures presented here. Photos 1a and 1b show some output from the GRASS/Image Processor system.

Generating a complete programming language with parsers, compilers, and graphics takes a lot of human effort. More than ten person-years of programming were devoted to GRASS, aided by generous support from the National Science Foundation, National Endowment for the Arts, and others.

GRASS is totally oriented toward real-time generation and control of images for the simple reason that television cannot easily be slowed down for long and/or time-lapse exposures as can be done with film. The control structures for GRASS were developed ad hoc and became increasingly idiosyncratic. Nola Donato, a postgraduate student of mine, decided to teach me how to generalize many of the programming-language concepts. The result was GRASS3, which later became Zgrass.

In 1977, I was led to Jeff Frederiksen at Dave Nutting Associates, who was developing a deluxe home computer for Bally Corporation using the custom integrated circuits they had developed for the Bally Arcade video game. The pros-

## Don't play games with your company's money.

Our entry level computer system is the first step in a full range of computer products. Not the last step in a full range of computer games.

We call it VIP. The Vector Intelligent Partner. And with a price of just \$3695, you can't get more computer for your money.

VIP has all the assets and none of the liabilities of other entry level systems. It starts off with a lot more disk capacity. It has the same computational power, uses the same software as our larger systems, and can be upgraded at any time. So you avoid the expense of new hardware and software when you outgrow your current system.

You'll be able to do low cost word processing, mail list sorting, database management and accounting. You can even do software development.

VIP is perfect for salesmen, real estate brokers, insurance agents, small business owners and corporate department heads.

Because at Vector, improving your business is the best way to improve our business.

For information contact Vector, 31364 Via Colinas, Westlake Village, CA 91362. Or call 213/991-2302.



# VECTOR

## Economy Sized Computers™

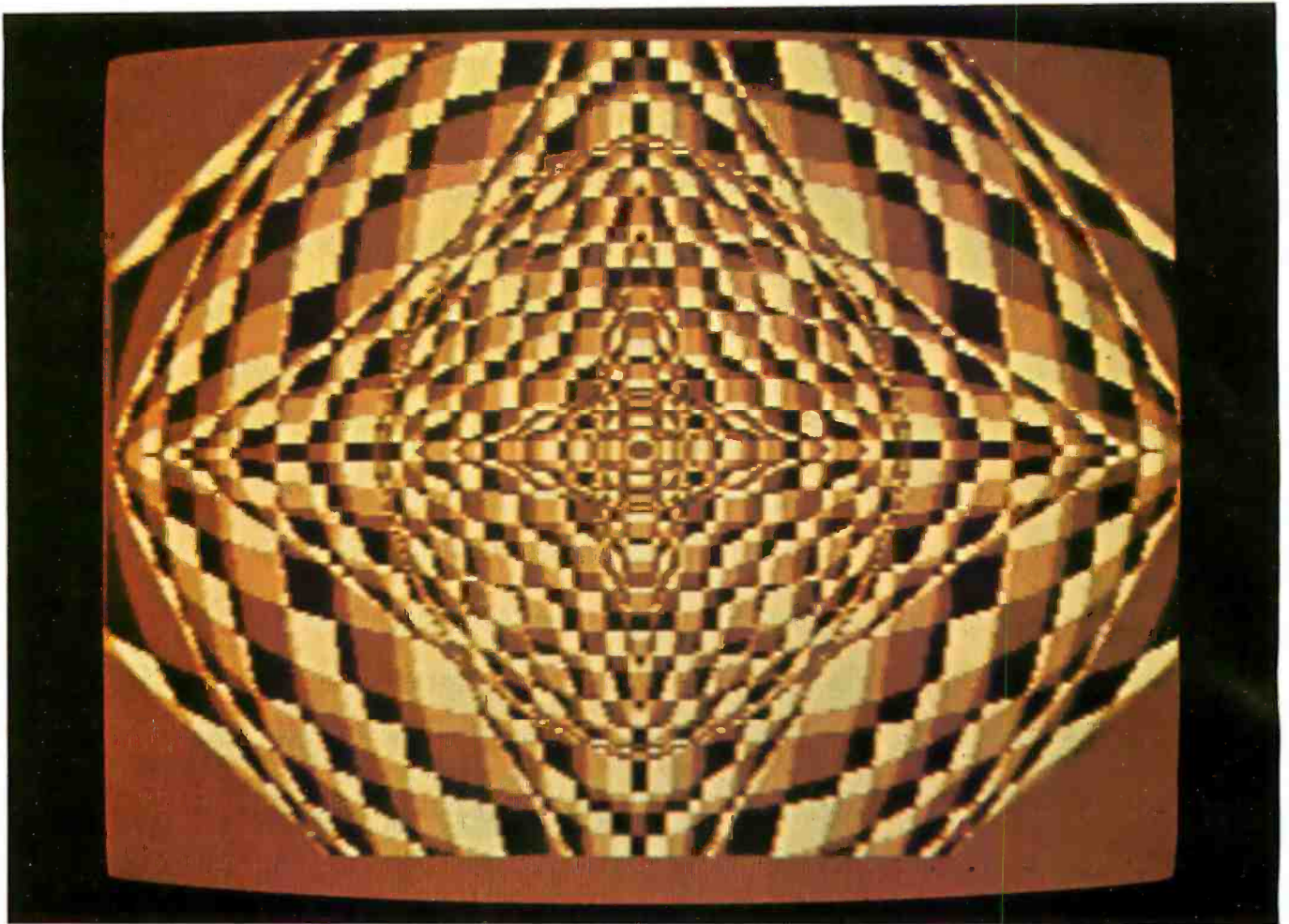

Photo 3: Sample output from a later version of Zgrass, with a resolution of 320 by 204 pixels with 2 bits per pixel. Photo 3 was made by Frank Dietrich.

pect of developing a language for fun, one that had user-orientation as the benchmark rather than how many FOR-NEXT loops you could execute per unit time was too good to pass up. I was contracted to produce Zgrass, and in a year, Nola Donato, Jay Fenton (a legendary wizard of video games and pinball-machine operating systems), and I had generated 9000 lines of code. (Much of the work was done not in a lab but in a cabin in the woods of Wisconsin!) Examples of output from this system are seen in photos 2a, 2b, and 2c. Note that the resolution of this first Zgrass machine is 160 by 102 pixels (ie: picture elements), with 2 bits per pixel.

Some confusion arose about whether we were producing a hobbyist machine or a home computer for consumers, so the project was suspended. Even now nobody really knows what a "consumer computer" is supposed to be.

From consulting with less enlightened would-be consumer computer manufacturers, I have perceived that they follow the rather negative view of consumerism. (Few people reading this article would be considered only consumers — I assume that BYTE readers are mostly hobbyists or professionals.) Consumerism is based on great market penetration, and the big question is: "How do you get 90% market penetration like color TV?"

It is also based on consuming, that is, wearing out or getting sick of hardware and software so you go buy more and consume it. The user is expected to supply no creativity, just assume a passive, susceptible-to-entertainment pose — this reminds you of television watching, doesn't it? Well, anything requiring creative energy is akin to hobbyism.

Consumer computers do exist in the form of video games that you can get bored with and buy more — even the advertisements invariably cite the

number of new games to be available each month. I don't know how to write a programming language that wears out, though. User-extensibility is planned "nonobsolescence." Zgrass is not a consumer language by current standards.

The project is on active status again, but this time with a hobbyist/professional orientation. We believe there are many people who want a recordable image-producing system for around \$3000. The current configuration includes:

- Z80 processor with 16 K bytes of EPROM and 48 K bytes of programmable memory
- custom graphics integrated circuits and floating-point hardware
- dual UARTs (universal asynchronous receiver/transmitters) for connection to larger computers, printers, etc
- RBG (red, blue, green) monitor for best color resolution

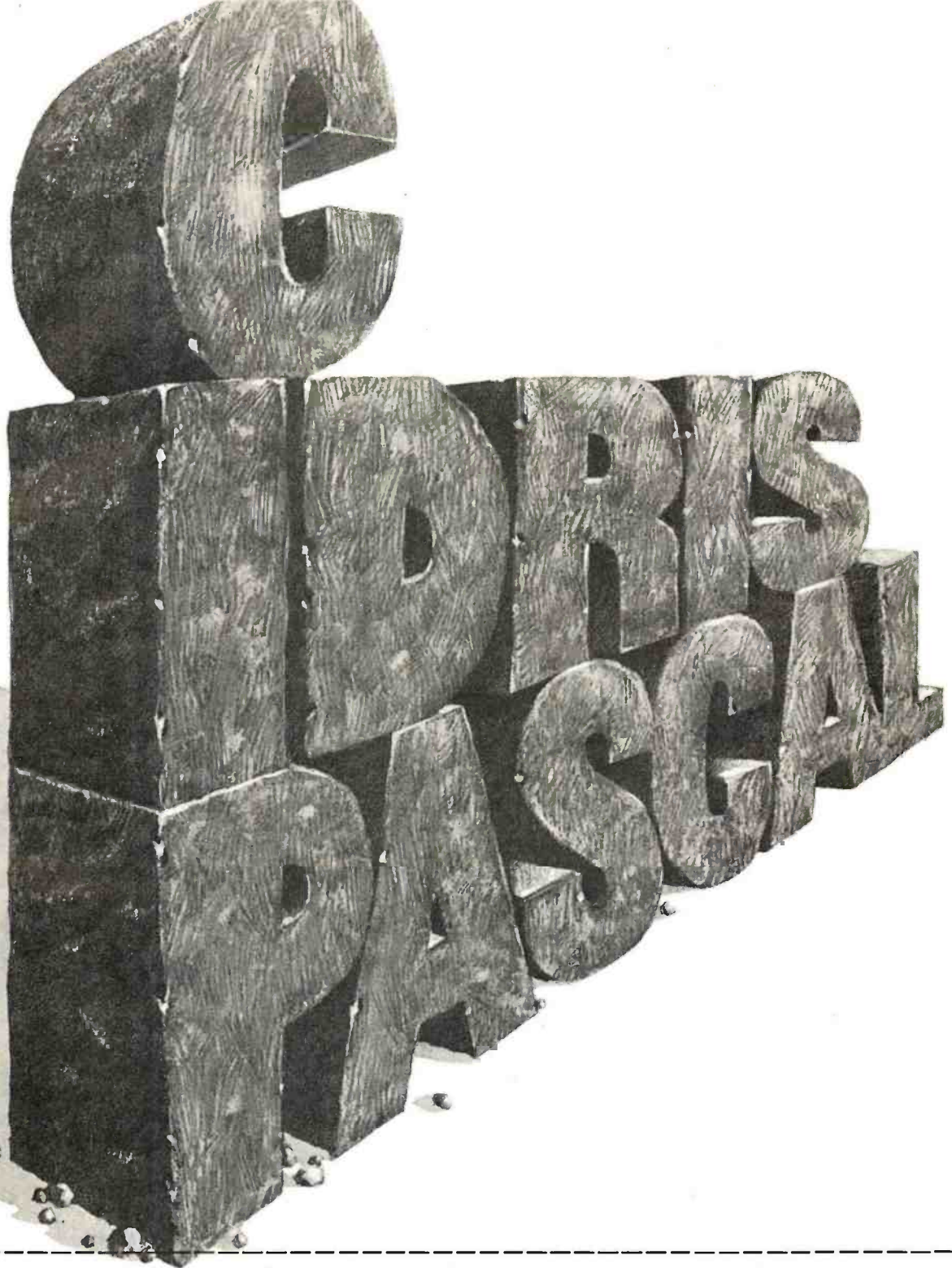

Please send your free software catalog.

(Check which software is of particular interest)

- C COMPILER. Optimized native code for VAX 11/780, PDP-11, LSI-11, Z80, 8085, 8080. Full C language as defined in Kernighan and Ritchie, with comprehensive portable library. Cross compilers available. Runs under VMS, IAS, RSX-11D, RSX-11M, RSTS/E, RT-11, UNIX, Idris, CDOS, CP/M. From \$600
- IDRIS OPERATING SYSTEM. System calls and file system identical to UNIX V6, including pipelines. Utilities include shell, editor, assembler, loader, archiver, compare, copy, grep, etc., plus system utilities for file system maintenance. Runs on LSI-11, PDP-11. From \$1000.
- PASCAL COMPILER. Optimized native code for VAX 11/780, PDP-11, LSI-11, Z80, 8085, 8080. Full Pascal language as defined in Jensen and Wirth, with standard library. Includes C compiler and portable library, permitting intermixed C and Pascal. Cross compilers available. Runs under VMS, IAS, RSX-11D, RSX-11M, RSTS/E, RT-11, UNIX, Idris, CDOS, CP/M. From \$750.

Idris is a trademark of Whitesmiths Ltd.  
UNIX is a trademark of Bell Laboratories  
CP/M is a trademark of Digital Research Co.

VMS, RSX-11, RT-11, RSTS/E, VAX,  
PDP-11, LSI-11 are trademarks of Digital  
Equipment Corporation.

Name \_\_\_\_\_  
Company \_\_\_\_\_  
Street \_\_\_\_\_  
City \_\_\_\_\_ State \_\_\_\_\_ Zip \_\_\_\_\_

**Whitesmiths, Ltd.**  
Software for grownups.  
(212) 799-1200  
P.O.B. 1132 Ansonia Station, New York, N.Y. 10023

- alphanumeric terminal (which the user provides)
- provision for floppy disks, tablet, other I/O (input/output) devices

Eight Zgrass units in this configuration have been alive and well and tied into the Bell-Laboratory-developed UNIX operating system since January 1980. Although I have only discussed software design, I must mention that the hardware to test the concepts really exists! See photo 3 and note that the resolution is now 320 by 204 pixels, with 2 bits used per pixel.

### Details of Zgrass Control Structures

Programs in Zgrass are called *macros*. Macros are stored as ASCII (American Standard Code for Information Interchange) character strings and normally contain executable Zgrass commands. The fundamental unit of execution in Zgrass is a command, which is either an assignment statement or a function call.

Zgrass does not require declaration of variable types (with the exception of array dimensioning). The software automatically does all conversions

that make sense based on the context. Any argument can be a function call whose returned value is converted to whatever is needed, if at all possible. Literals, indirect references, variables, built-in commands, user-defined commands, and user-defined macros are all handled by the same parser, so the syntax is very predictable. The fact that there are no restrictions on name length helps to produce easily read code.

### User-Level Extensibility

Extensibility in Zgrass is achieved in two major ways. First, you can write macros which return values, produce graphics, or ask questions; or, through string-manipulation primitives written by Barb Wilson, you can generate other macros. Macros use arguments in exactly the same way as system commands, and are even named and called like system commands.

To reiterate, macros are simply strings of ASCII characters. When a macro is called, an MIB (Macro Invocation Block) is automatically built. It gives information on the invoking function call, the passed-argument

list, and pointers to local variables, and provides room for the returned value. MIBs form a stack which implements the subroutines and block structuring of the language. When the macro returns, the MIB is deleted along with the local variables and unused literal arguments, if any, and control is passed back to the caller.

If arguments are to be passed to a macro, they are read by the normal input command, and print statements are suppressed as long as there are arguments left. If no arguments are present or an insufficient number are passed, the print statements function normally and the macro asks for input from the terminal. This allows macros to be used whether or not you know the arguments wanted, with no extra code by the author of the macro.

Macros can also be executed in parallel as background jobs. When called and suffixed by a ".B", the Macro Invocation Block is added to a background linked list. After that, the macro will run forever (it restarts at the beginning when it tries to return) until Control-C or the stop command selectively kills it. Photo 2c shows two sorting algorithms being compared for execution speed in real time, a tricky task in most languages, easy in Zgrass.

The background parallelism is achieved by interleaving execution of the macro statements. The MIB contains all relevant context for execution, including a pointer to the next command to execute, so switching MIBs after each line has been completed is simple and gives the functional parallelism. If there are five background macros, each one gets a line executed, in turn, round-robin fashion. This construct is simple and straightforward with no bizarre side-effects except that unusually time-consuming commands will make the parallelism temporally step somewhat. Background interleaving is easily understood and used even by the most naive users.

Meanwhile, the keyboard is still active. When the user types a command line, it is executed at a higher priority than the background macros. If the user initiates a macro at keyboard level, it will finish before the background macros continue. In any event, the keyboard overrides the background, again in an obvious, predictable way.

# REAL WORLD INTERFACE FOR YOUR APPLE II

## A/D + D/A

Commercial, scientific, and industrial data acquisition and control functions are now practical with Mountain Hardware's A/D + D/A card. Superfast conversion time permits high frequency and other applications not possible with silver cards.

If you've got a data acquisition or control application, Mountain Hardware has the answer with A/D + D/A. Drop by your Apple dealer and put your world on a silver platter.

**A/D + D/A features:**

- Single PC card
- 16 channels analog to digital input
- 16 channels digital to analog output
- 8  $\mu$ s conversion time
- 8 bit resolution
- I/O cable assembly available
- Operating manual contains sample applications with schematics, parts list, and guides for easy start-ups.
- Self-test diagnostic software

**Mountain Hardware**  
LEADERSHIP IN COMPUTER PERIPHERALS  
A Division of Mountain Computer, Inc.  
300 Harvey West Blvd., Santa Cruz, CA 95060  
(408) 429-600

# COMPUTERS—TERMINALS—MODEMS!

**NEW!**

## TI-99/4 Home Computer



Optional color monitor  
**\$449**

Main console unit  
**\$889**

(Includes RF modulator for use with any TV)

Write for a list of extensive program modules available—everything in games, education, and home computer applications.

**NEW!**

## From Perkin-Elmer 1250 Super Owl

**\$1799**



Intelligent CRT

Incredibly powerful and flexible

- 24 fully programmable function keys
- Full screen editing capabilities
- RAM memory for down line loading by host computer
- Built-in printer port
- Full polling capabilities
- Detachable keyboard
- Optional light pen
- Much more!

## Penril 300/1200 Modem

Connect any computer or terminal to the phone lines.

- 1200 Baud—Bell 212A **\$799**
- 300 Baud
- Originate/Auto answer
- Full duplex
- RS232
- 1 year warranty



Direct connection to the phone lines via RJ11C standard extension phone jack

## USR-330 Modem

- 0-300 Baud—Bell 103/113
- Originate/Auto answer
- Half/Full duplex
- RS232
- 1 year warranty

**\$339**



Direct connection to the phone lines via RJ11C standard extension phone jack

## USR-1600P Computer

**NEW!**

**\$4099**



**PASCAL**

With **power** and **speed** for business, educational, and scientific applications.

W.D. Microengine™-based single board computer with 64K RAM

- 1 megabyte of floppy disc
- 2 parallel ports
- 2 serial ports
- Floppy disc controller with DMA
- File manager
- Screen oriented editor
- Single cabinet design
- Includes power supply

## Perkin-Elmer Bantam 550 CRT

**\$749**



- Transparent mode
- Addressable cursor
- Editing functions
- Upper/lower case
- Compact

## The Phone-Link Acoustic Modem **NEW!**

- Sleek, low profile
- 0-300 Baud
- Originate/Answer modes
- Half/Full duplex
- Self-test
- RS232—Will work with any RS232 computer or terminal
- LED displays of all functions
- 1 year warranty



**\$179**

At your computer store now!

## Perkin-Elmer 650/655 CRT Page Printer

- 100 CPS
- Quiet
- Compact
- RS232

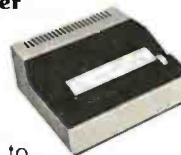

- Can be added to any CRT with our interface option.

**\$999**

The printer designed to give you rapid, reliable, hard copy of your CRT screen display.



## DEC LA34

**\$969**

- Teletype 43 plug compatible
  - Variable character sizes
  - Full width paper
  - Many more features
- Write for print sample

**Teletype Model 43KSR \$1049**  
**Microterm Mime IIA CRT \$819**  
**Microterm ACT VA .....\$779**



We offer full service, on-site maintenance plans on all equipment.  
Any product may be returned within 10 days for a full refund.

**U.S. ROBOTICS INC.**  
203 N. WABASH, SUITE 1718 CHICAGO, ILL. 60601

SALES  
GENERAL OFFICES  
SERVICE

(312) 346-5650  
(312) 346-5651  
(312) 733-0497

The user may also specify programs to run as the result of a clock interrupt. When a macro call is suffixed by a ".F", the Macro Invocation Block is chained into a list that is polled every 1/60 second. The user sets the frequency of execution from 1 to 32,768 sixtieths of a second. These foreground macros execute on a higher priority level than the keyboard and background macros so they will start up just about on time (again, delayed only by a time-consuming graphics command). Foreground macros allow a keyboard command to be slipped in during context switching.

Zgrass, then, has three effective levels of priority with parallelism at two of the three levels. Since the Macro Invocation Block maintains all context information, even recursive programming is possible at any level.

One of the severe problems in interpretive, extensible languages like Zgrass is the overhead of parsing and looking up names in name tables. For this reason, Zgrass has a compiler which eliminates the overhead and dramatically increases speed. All the automatic conversions, priority, and

parallelism continue to work. Compiling does eliminate some of the interactive debugging features, so you usually debug on the noncompiled version first.

### Zgrass System Extensibility

Zgrass also allows extensibility at the system-command level. A system such as this should allow an experienced programmer to write new commands in assembler and interface them to the system easily, certainly without changing the EPROMs (erasable, programmable read-only memories). A transfer vector in low memory and a series of Z80 RST (special restart subroutine-call) instructions allow communication with about one hundred system routines which do parsing, type conversion, graphics primitives, and so on.

Documentation explains what these routines do, and anyone with a cross assembler (or patience for hand assembly) can write new commands of which the system has no prior knowledge. Such extensibility allows virtually infinite variety of specialty graphics commands, device drivers, and so forth to be written and

distributed to others on audio tape, disk, or over telephone lines. Terry Disz wrote a debugging program used as a disk-resident command for setting break-points, dumping memory and registers and so on. This capability is not for everyone, but it's there.

The maximum size of one of these user-written nonresident commands is 4 K bytes. Since the typical Zgrass machine has 30 K bytes of programmable memory, the amount of potential custom code is immense. All housekeeping for storage allocation and deletion, maintenance of temporary scratch-pad areas and general cleanup is done by system routines. You only concentrate on the details, obeying a few rules for writing position-independent code.

One further type of extensibility is easy to get. Zgrass has an extra UART which talks to other computers quite nicely. Larger computers can send graphics and character data to your Zgrass machine. Zgrass units can even talk to one another at up to 19.2 k bps!

### Error Handling, Debugging and Automated Instruction

Zgrass was designed from the beginning to be a language for writing CAI (computer-aided instruction) programs. In particular, it was designed to be self-teaching to a fairly high degree. When Zgrass is used as a CAI system, the result of providing parallelism, string manipulation, and good error handling is that the student always has the power of the whole language to explore while the author of the CAI programs is also in control.

Since macros are character strings, they can be built and executed. You can take student input, make it into a program (before the student even knows how to edit), let parameters be changed, show the results, and verify certain classes of results both during execution and after. The approaches we have taken to Zgrass CAI are beyond the scope of this article, so I will just mention the system features which make CAI possible.

Error-handling routines normally generate error-message numbers on the terminal. There are about sixty of them and they are quite specific. During regular programming, they are used in conjunction with single stepping, variable printing and other debugging techniques to identify

## SOFTWARE ENGINEERS

### WE'RE KNOWN BY THE COMPANY WE KEEP.

Wescom, Inc. has joined with Rockwell International. This move will strengthen our already enviable industry standing. We are seeking bright professionals interested in a career at the leading edge of the telecommunications industry.

These positions require a BSEE or BSCS with a minimum of 1-3 years software design experience. Experience in control processing, real time, and/or 8080 ASSEMBLY language is considered a plus.

#### SYSTEMS SOFTWARE

Provide the design for new call processing features and systems, modular functional descriptions and interfaces, software architectural and data base design.

#### OPERATING SYSTEMS SOFTWARE

Design and develop software that maintains a system that's operated by stored program control. Involvement also includes design and implementation of administrative diagnostic and fault recovery programs.

#### SOFTWARE METHODOLOGY

Explore and initiate software techniques for future switching systems development. Areas of interest include structured design techniques, high-level languages, documentation schemes and software testing mechanisms.

We offer a competitive salary, generous benefits and the assurance that you'll be in good company with an innovative leader in the design, development and manufacture of sophisticated telephone equipment and systems.

We are an equal opportunity employer. Minorities, women and handicapped are encouraged to apply. For more information, send a letter or resume, or call:

Dennis Kebrdle  
Wescom, Inc.  
Rockwell International  
8245 S. Lemont Rd.  
Downers Grove, IL 60515  
(312) 985-9000, ext. 2349



**Rockwell  
International**

...where science gets down to business



# "We designed a computer family that multiplies dealer sales."

Geof Karlin  
Director of Systems Development



"At ADDS, we've just designed a unique computer family that multiplies your selling power because it expands customers' computing power.

"We call it ADDS Multivision—a trio of stacking, CP/M®-compatible computers that lets users upgrade without any change in their programs. It works like this:

"MULTIVISION 1 (top module) is a get-started computer with a 5 MHz processor, 64K bytes of RAM and mini disk storage capacity of 700K bytes. It lists for \$3,785 without terminal.

"MULTIVISION 2 (top and bottom modules) provides 5M or 10M bytes of hard-disk storage. Priced thousands less than other hard-disk systems, it lists for \$7,995 with 5M bytes of disk.

"MULTIVISION 3 (entire stack) tops off the line, giving you a multi-user system with up to 256K bytes of RAM that supports up to four display terminals simultaneously.

"We even offer an ADDS-developed package that lets Multivision function as a word processor.

"Since its introduction at the NCC, thousands have inquired where to buy Multivision. We'd like to give them your name."

For information on dealer opportunities, write: S. Eric McErlain, Systems Division, Applied Digital Data Systems Inc., 100 Marcus Boulevard, Hauppauge, N.Y. 11787.

CP/M is a registered trademark of Digital Research, Inc.

See us at COMDEX '80, Booth 304.

# ADDS

## SOMETHING EXTRA IN EVERYTHING WE DO

# MULTIVISION

# Your vehicle for com The Challenger 8P DF.

The general purpose microcomputer was first introduced as a computer for hobbyists and experimenters. However, as the industry has grown, microcomputers have become specialized for personal use or for small business use. There is virtually no computer for the serious experimenter with one important exception, the Ohio Scientific Challenger 8P.

The C8P is unique in that it incorporates the features of state-of-the-art personal computers, with the memory and disk storage capacity of business computers, along with the "mainframe" bus architecture and open ended expansion capability of industrial control computers.

## Personal Computer Features

The C8P DF's specs beat all personal computers hands down. It executes instructions two to three times faster, and displays more alphabetic characters on its screen than other

models. It has upper and lower case and graphics in 16 colors. The C8P's *standard* I/O capabilities are far more extensive than any other computer, with joystick and keypad interfaces, sound output, an 8-bit D/A converter, 16 parallel I/O lines, modem and printer interfaces, AC remote control and security monitor interfaces and a universal accessory port that accepts a prom blaster, 12-bit analog I/O module, solderless prototyping board and more.

Ohio Scientific offers a large library of personal applications programs, including exciting action games such as Invaders and Star Trek, sports simulations, games of logic

and educational games, personal applications such as biorhythms, calorie counter, home programs such as checking and savings account balancers and a home budgeter just to name a few. A new Plot BASIC makes elaborate animations easy, and music composition program allows you to play complex multi-part music through the computers DAC.

At the systems level the machine comes standard with OS-65D, an advanced disk operating system with Microsoft BASIC and an interactive Assembler Editor. Optional software includes UCSD PASCAL and FORTRAN and an Information Management System (OS-MDMS). Dozens of independent software suppliers now also offer personal programs for the C8P.

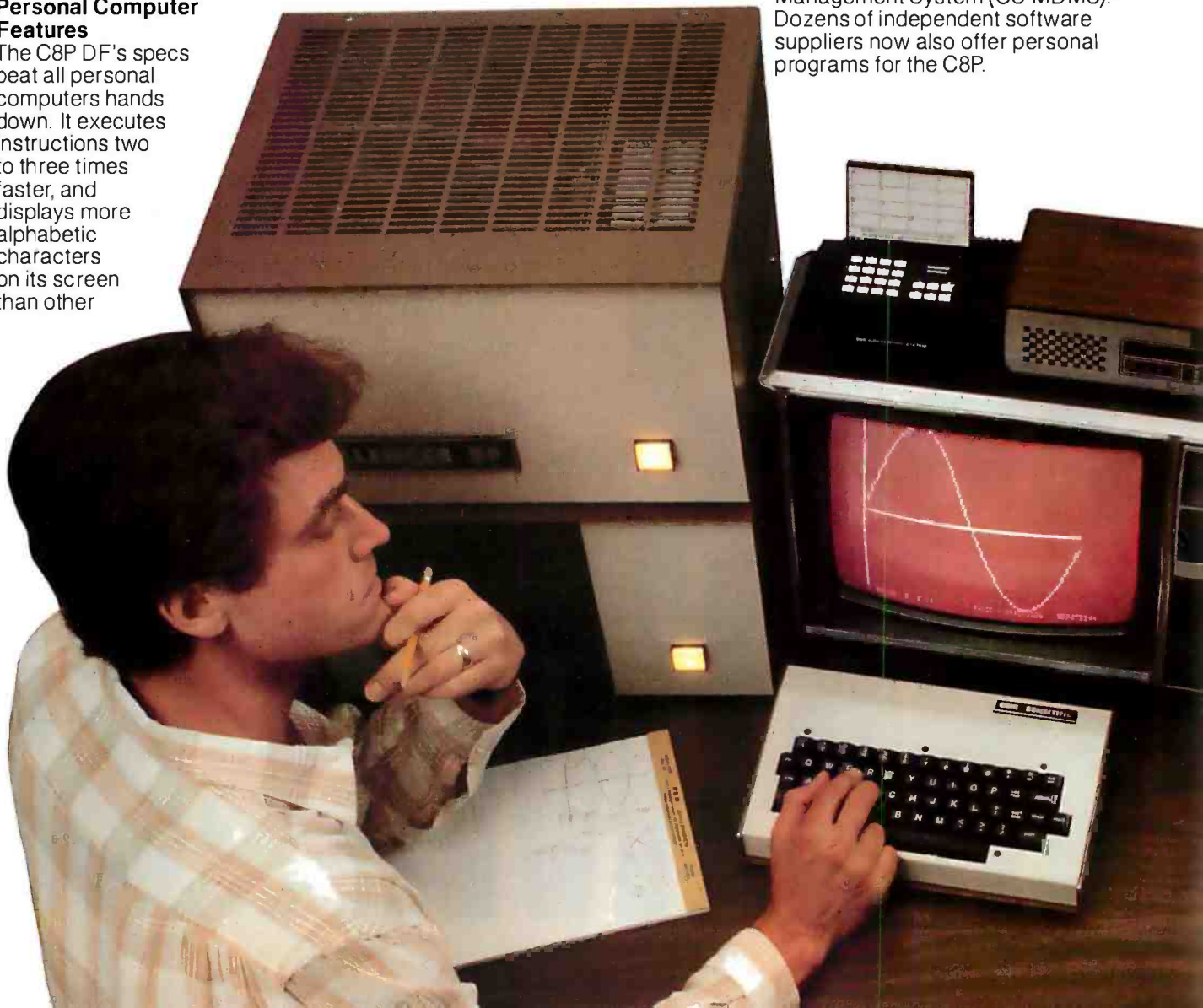

# puter explorations.

## Business Computer Features

The C8P DF utilizes dual 8" floppy disk drives which store up to eight times as much information as personal computer mini-floppies, and an available double-sided option expands capacity to 1.2 megabytes of on-line storage. The C8P DF is compatible with Ohio Scientific's business computer software, including OS-65U an advanced operating system, and an Information Management System (OS-DMS) with supplementary inventory, accounting, A/R-A/P, payroll, purchasing, estimation, educational grading and financial modeling packages. The system also supports word processing (WP-3) and a fully integrated small business accounting system (OS-AMCAP V1.6). The C8P DF's standard modem and printer ports accept high-speed matrix printers and word-processing printers directly.

## Home Control and Industrial Control

The C8P DF has the most advanced home monitoring and control capabilities ever offered in a computer system. It incorporates a real time clock and a unique FOREGROUND/BACKGROUND operating system which allows the computer to function with normal BASIC programs, at the same time it is monitoring external devices. The C8P DF comes standard with an AC remote control interface, which

allows it to control a wide range of AC appliances and lights remotely, without wiring, and an interface for home security systems which monitors fire, intrusion, car theft, water levels and freezer temperature, all without messy wiring. In addition, the C8P DF can accept Ohio Scientific's Votrax voice I/O board and/or Ohio Scientific's new universal telephone interface (UTI). The telephone interface connects the computer to any telephone line. The computer system is able to answer calls, initiate calls and communicate via touch-tone signals, voice output or 300 baud modem signals. It can accept and decode touch-tone signals, 300 baud modem signals and record incoming voice messages. These features collectively give the C8P DF capabilities to monitor and control home functions with almost human-like capabilities.

For process control applications, a battery back up calendar clock with automatic computer restart capabilities is available. Ohio Scientific's unique accessory ports allow the connection of a nearly unlimited number of 48 line parallel I/O cards and 12-bit high speed instrumentation quality analog I/O modules to the computer by inexpensive 16-pin ribbon cables.

## Exploring New Frontiers

Ohio Scientific's vocalizer software processes normal BASIC print statements with conventional spellings and speaks them clearly in real-time

on computers equipped with the UTI (CA-15B or CA-14A). This voice output capability, combined with the C8P's remote control, remote sensing, telephone interface capabilities and reasonable cost open up new frontiers for computer applications.

## Documentation

The C8P DF is not a beginner's computer and doesn't come with beginner's documentation. However, Ohio Scientific does offer detailed documentation on the computer which is meaningful for experts, including a Howard Sams produced hardware service manual that includes detailed block diagrams, schematics, parts placement diagrams and parts lists. Ohio Scientific is now also offering fully documented Source Code in machine readable form for OS-65D, the Challenger 8P's operating system allowing experimenters and industrial users to customize the system to their specific applications.

## What's Next?

Ohio Scientific is working on a speech recognizer to complement the UTI system, with a several hundred word vocabulary. The company is also developing an 8 megabyte low-cost, add-on hard disk for use in conjunction with natural language parsing to further advance the state-of-the-art in small computers. The modular bus architecture of the C8P assures system owners of being able to make use of these new developments as they become available just as the owner of a 1976 vintage Challenger can directly plug in voice output, the UTI and other current state-of-the-art OSI products.

The C8P DF with dual 8" floppies, BASIC and two operating systems costs about \$3000, only slightly more than you would pay for a dual mini-floppy equipped personal computer with only a fraction of the capabilities of the C8P.

**For more information and the name of the dealer nearest you, call 1-800-321-6850 toll free.**

**OHIO SCIENTIFIC**  
1333 SOUTH CHILLICOTHE ROAD  
AURORA, OH 44202 • [216] 831-5600



problems. When teaching, however, the CAI program must trap errors. These fall into three types: syntax, nontermination, and logic.

To trap syntax errors, you should use the ONERROR command which transfers the control to a diagnostic section of the program that you, as a CAI author, will have provided. There you can get the error number, the erroneous argument, and even the entire ASCII text of the line in error with the GETERROR command. You can then explain the problem to the user in whatever level of detail you wish.

Indefinite loops are caught with the LOOPMAX command which sets a limit to the number of control transfers (ie: skips and GOTOs). Once the limit is exceeded, an error is generated and trapped as explained

earlier. So, you can catch nonterminating programs or be very meticulous and require efficiency from advanced students by lowering the LOOPMAX appropriately.

Logic errors are trickier and the general case is impossible. However, if you choose suitable problems to solve, you can do some very nice verification. For graphic tasks, the CMPARA command can check a student's building of an image against a prototype. The CAI author can tell if the student's image is a proper subset of the prototype and let it continue. Once a stray pixel is written, CMPARA returns a value of -2 which means the image is "mixed up," and you inform the student immediately. This approach clearly falls short of genuine artificial intelligence, but it is nevertheless quite useful.

Several classes at the University of Illinois at Chicago Circle have been taught with great success using a GRASS-coded prototype (called GAIN, by Tom Towle).

### Conclusions

Zgrass is a language/system designed to provide easy access to computer graphics and, in general, to computing. It has sophisticated real-time structures and control capability, and it's friendly, extensible, and fun. The language is more efficient than BASIC, more user-oriented than FORTRAN or Pascal, and it has the kind of language-control structures that will help you create your mind's fantastic visualizations on your video screen with more ease than ever before. ■

### Glossary

**Color:** The 256 colors available in Zgrass form an abbreviated spectrum. You can get four colors on the screen at any one time. The default colors are white, red, green, and blue. They are also known as color 0, color 1, color 2, and color 3. The values are stored in \$L0, \$L1, \$L2, and \$L3 unless you modify \$HB to use the right-side colors \$R0, \$R1, \$R2, and \$R3.

**Color Map:** The color map is the way Zgrass translates color 0 thru color 3 to the 256 available colors. The hardware looks at the values of \$L0 thru \$L3 before it writes a pixel to the screen. If it is writing a 0, it uses the color stored in \$L0; if it is writing a 1, it uses the color stored in \$L1, and so on. To change the color map so 1 refers to yellow instead of red, set \$L1 to 127. There are actually two color maps, the \$Ls and the \$Rs. You get to the \$Rs by setting \$HB.

**Color Option:** The possible values for color option are 0 thru 15. You may need to study your truth tables for inclusive-OR and exclusive-OR (XOR) logical operations to really understand what's going on. The following is functionally true, however:

### Color Option

### Meaning

- |    |   |
|----|---|
| 0  | replace with color 0 (white)  |
| 1  | replace with color 1 (red)  |
| 2  | replace with color 2 (green)  |
| 3  | replace with color 3 (blue)   |
| 4  | don't draw (actually XOR with 00)   |
| 5  | XOR screen with color 1 (01 binary)   |
| 6  | XOR screen with color 2 (10 binary)   |
| 7  | XOR screen with color 3 (11 binary)   |
| 8  | change red to white, blue to green (clear bit 0)  |
| 9  | change green to white, blue to red (clear bit 1)  |
| 10 | OR with 01 (if red or white, stay red; if blue or green, stay blue)                           |
| 11 | OR with 10 (if green or white, stay green; if red or blue, stay blue)                         |
| 12 | replace with red only if white were there   |
| 13 | replace with green only if white or red were there  |
| 14 | increment the color there by 1 (white to red, red to green, green to blue, and blue to white) |
| 15 | decrement the color there by 1 (white to blue, red to white, green to red, and blue to green) |

**Macro:** A string that is supposed to contain legal Zgrass commands. Most programming languages call such things "programs" or "subroutines," but we call them macros. Macros are effectively user-defined commands. Macros can behave just like commands in the sense that you can pass arguments to macros with the INPUT command and return values with the RETURN command. You define a macro just like you define a string, with an assignment to a name or by using EDIT.

**String:** A collection of characters (ie: numbers, letters, punctuation) delimited (ie: enclosed) by single or double quotes or balanced (ie: enclosed) by brackets or braces. If you have to use a string delimiter in a string, make sure that it is delimited by a different string delimiter or things will get very confused. Most likely it will consider the rest of your macro as part of the string. Examples:

```
"THIS IS A LONGER STRING"
"PRINT A*B*C
SKIP -1 ; THIS STRING
COULD BE A MACRO TOO"
[THIS IS HOW TO PUT A
QUOTE IN A STRING: " "]
[1234]
[ ]
```

**ENHANCED 'TINY' PASCAL**

We still call it 'Tiny' but it's bigger and better than ever! This is the Famous Chung/Yuen 'Tiny' Pascal with more features including recursive procedures/functions & disk I/O.

'Tiny' Pascal is fast. Programs execute up to ten times faster than similar BASIC programs.

**SOURCE TOO!** We still distribute source, in 'Tiny' Pascal, on each discette sold. You can even recompile the compiler, add features or just gain insight into compiler construction.

'Tiny' Pascal is perfect for writing text processors, real time control systems, virtually any application which requires high speed. Requires: 36K CP/M. Supplied with complete user manual and source on discette: \$85.00      Manual alone \$10.00

**StackWork's FORTH**

A full, extended FORTH interpreter/compiler produces COMPACT, ROMABLE code. As fast as compiled FORTRAN, as easy to use as interactive BASIC.

**SELF COMPILING:** Includes every line of source code necessary to recompile itself.

**EXTENSIBLE:** Adds functions at will.

Z80 or 8080 ASSEMBLER included

Single license, OEM licensing available

Please specify CPU type: Z80 or 8080

Requires: 32K CP/M.

Supplied with extensive user manual and tutorial: \$150.00

Documentation alone: \$25.00

**Protect your software investment by buying source! Prevent obsolescence, create custom versions, or use our systems as sources for 'library functions!'**

The source code for all our programs, including the ones on this page, is available from us, either at additional cost, or if noted, included in the price. The programs on this page are distributed with machine readable source at no additional cost.

# SUPERSOFT

## Your Source for

# SOURCE

**TFS—Text Formatting System**

An extremely powerful formatter. More than 50 commands. Supports all major features including:

- left & right margin justification
- user defined macros
- dynamic insertion from disk file
- underlining and backspace

TFS lets you make multiple copies of any text. For example: Personalized form letters complete with name & address & other insertions from a disk file. Text is not limited to the size of RAM making TFS perfect for reports or any big job.

Text is entered using CP/M standard editor or most any CP/M compatible editor. TFS will link completely with Super-M-List making personalized form letters easy.

Requires: 24K CP/M

Source to TFS in 8080 assembler (can be assembled using standard CP/M assembler) plus user manual: \$250.00.

Object code only with user manual: \$85.00

Manual alone: \$20.00

**TERM**

A complete intercommunications package for linking your computer to other computers. Link either to other CP/M computers or to large timesharing systems. TERM is comparable to other systems but costs less, delivers more and source is provided on discette!

With TERM you can send and receive ASCII and Hex files (COM too, with included conversion program) with any other CP/M computer which has TERM or compatible package. Allows real time communication between users on separate systems as well as acting as timesharing terminal.

- Engage/disengage printer
- error checking and auto retry
- terminal mode for timesharing between systems
- conversational mode
- send files
- receive files

Requires: 32K CP/M.

Supplied with user manual and 8080 source code: \$110.00

Manual alone: \$15.00

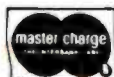

CP/M Formats: 8" soft sectored, 5" Northstar,  
5" Micropolis Mod II, Vector MZ

\*CP/M REGISTERED TRADEMARK DIGITAL RESEARCH

**SUPERSOFT ASSOCIATES • P.O. BOX 1628 • CHAMPAIGN, IL 61820**  
**(217) 359-2112**

DATEBOOK for Tue Jan 1 - Not printed since the last change.

	First one	Second one	Third one
8:00	John Smith/reat canal		Ed Jones/check up and x-rays
8:20			
8:30		Dennis Johnson/wisdom teeth extraction	
8:40			
8:50			
9:00	Kathy Nelson/check up		Judith Washington/restoration
9:20			
9:30			
9:40			
9:50	Mike Silva/restoration		
10:00			
10:10	George Kennedy/restoration		
10:20			
10:30			
10:40		Thelma Carter/check up	
10:50			
11:00			

Schedule Cancel Modify Look for openings Hold in Reschedule list  
 Today Next day Future Print day's appts Display person's appts  
 Key in an option letter, number or space for a new display, or 0 to quit

## INTRODUCING DATEBOOK™ THE NEW OFFICE APPOINTMENT CALENDAR PROGRAM

DATEBOOK™ helps manage time just like a common office appointment book, but with the speed and accuracy of a computer. DATEBOOK™ eliminates the scribbles, erasures, and frustration of searching through the book for a specific opening.

DATEBOOK™ is ideal for Doctors, Dentists, Lawyers, Salesmen, Repairmen, or in any situation where time management is critical to office efficiency. Its menu display and one-key options make DATEBOOK™ one of the easiest programs to learn and use.

DATEBOOK™ features include:

- Appointment scheduling, cancelling, modifying and rescheduling.
- Automatically searches for openings according to time of day, day of week, and week of year.
- Displays all scheduled appointments for a specified person.
- Lists day's schedule (Screen or hard copy).
- Can be customized to accommodate any workday/hours schedule.

DATEBOOK™ is written in PASCAL and is available to run on CP/M as well as UCSD PASCAL systems.

**(415) 455-4034**

only **\$295**  
Dealer discounts available.

**Organic Software**  
naturally  
bug free

1492 Windsor Way, Livermore, CA 94550

## Book Reviews

### Applied Mathematical Physics With Programmable Pocket Calculators

by Robert M Eisberg  
McGraw-Hill Book Company,  
New York NY,  
1976

176 pages, softcover  
\$9.95

This book by Professor Eisberg of the University of California, Santa Barbara is interesting on three counts. First, it introduces the reader to numerical methods for differentiation, integration, and solution of differential equations. Second, these methods are applied to the general problems of mathematical physics, starting with the motion of an oscillator and finishing with Schrödinger's equation. Third, the programs for the solution of the equations in these fields are given for the Hewlett-Packard HP-25 and the Texas Instruments SR-56 calculators.

A reader's first reaction might be that the programs apply only to the solution of the problems of mathematical physics. However, the mathematical procedures that were aimed at these calculators may also be applied to any computer. Furthermore, the problems are in the field of physics, but the methods of solution of these problems should be of interest to the general reader.

This book discusses the derivative and methods of obtaining it, followed by programs and examples. Problems for testing the program are also given. Procedures for integration and summation are introduced with the appropriate programs and examples for solution.

The numerical procedure for the solution of second-

order differential equations is developed without the great depth required for mathematical development. These equations are given for both undamped and damped motion, as well as the driven oscillator. The program development and the results obtained are interesting.

The harmonic oscillator section is followed by the coupled oscillator. The examples for the coupled oscillators and their motion are interesting not only for the study of the motion of such systems, but also for the solution of the simultaneous equations involved.

The concept of central force motion is introduced, including orbital path determination. This section concludes with alpha particle scatter due to repulsive forces. A "random" number generator program is introduced and applied to problems of entropy, or run-down evaluation.

Finally, Schrödinger's time-independent equation is introduced and evaluated, and programs are given for the harmonic oscillator and the potential well.

This is an admirable little book on mathematics applied to physics and the programming of such material for the HP-25 and SR-56 programmable calculators. It is also of great interest to the computer programmer because of the procedures discussed, which are adaptable to the computer.

WB Agocs  
Department of Physical  
Sciences  
Kutztown State College  
Kutztown PA 19530

### The Little LISPer

by Daniel P Friedman  
Science Research  
Associates Inc  
Palo Alto CA, 1974

# WHY CIS COBOL LETS YOUR MICROCOMPUTER PERFORM LIKE A MAINFRAME.



Now, you can use a microcomputer for sophisticated business applications ... because now there's CIS COBOL. Micro Focus developed this COBOL so your microcomputer can run the same programs as a minicomputer or a mainframe.

CIS COBOL is Micro Focus' Compact, Interactive, Standard COBOL which offers the advantages of COBOL ... powerful data structure features, English-like language, existing programmer expertise ... to provide you with a full commercial language. You won't be restricted by size either: a 64K byte microcomputer will compile up to 8000 lines of COBOL, more if the program's split into dynamically loaded modules.

## Choose a Compact Compiler.

The Compact compiler runs on 32K byte microcomputer systems. Its powerful subset includes full support for random, indexed and sequential files.

## Or choose the Standard Compiler.

The Standard CIS COBOL compiler requires a minimum 48K of user RAM. A super-set of the Compact compiler, implementing ANSI '74 COBOL to Federal Low-intermediate Level.

The same CIS COBOL extensions for conversational working, screen control, interactive debugging, and special peripheral support are in both compilers. And there are more reasons to consider CIS COBOL:

- It conforms fully to the ANSI '74 standard, so programs are portable upwards and downwards to minis or mainframes.
- Its interactive features enable mainframe programmers to get results fast ... working on inexpensive microcomputers.

## Forms

The FORMS utility lets you build a screen layout online at the CRT. Then it automatically generates COBOL record descriptions for inclusion in your program.

## Forms-2

A superset of FORMS, it eliminates the need to write simple data entry and inquiry programs, because the programs can be automatically generated from screen definitions.

## Environment

CIS COBOL products run on the 8080 or Z80 microprocessors under the CP/M\* operating system, and on the LSI-11 or PDP-11 processors under RT-11. They are distributed in a variety of disk formats and come with a utility that enables you to use any make of CRT.

## OEMs

Intel has adopted CIS COBOL and offers it (as iCIS-COBOL) for their Intellec and

Intellec II systems. Ideal for OEM's or private label, CIS COBOL was developed entirely by Micro Focus. Send inquiries for CIS COBOL object packs and application vendor terms to MICRO FOCUS or its licensed distributors. Distributor terms also available from MICRO FOCUS.

Send me more information for:  811

- Single Copy Users  
 Reseller and Distributor Licensing

Name \_\_\_\_\_

Title \_\_\_\_\_

Company \_\_\_\_\_

Address \_\_\_\_\_

City/State \_\_\_\_\_

Zip/Phone \_\_\_\_\_

Computer Model \_\_\_\_\_

Version of DOS \_\_\_\_\_



**MICRO FOCUS™**

Micro Focus Inc. • 1601 Civic Center Drive •  
Santa Clara • CA 95050 • Tel: (408) 984-6961 •  
Telex: 171-135 MISSION SNTA

U.K. Office • 58 Acacia Road • St. Johns Wood •  
London NW8 6AG • Tel: 01 722 8843 • Telex:  
228536 MICROF G

58 pages, softcover  
\$3.95

It might seem a little odd to review a six-year-old book, but there is a good reason for it in this case: LISP has only recently become available for microcomputers. John Allen (guest editor of the August 1979 BYTE special issue on LISP) has promised that his LISP Company will unveil a full line of LISP systems. It will start with a Z80 version and proceed to much more capable LISPs for the new 16-bit microprocessors. Also, LISP interpreters from other sources exist for Z80, 6800, and AM-100 processors.

The next question is how does one learn LISP? Reference manuals give too much detail and not enough feel for the language. Most introductory material gives too little detail and not enough feel for the language, and nearly all books on LISP make the mistake of telling the student what LISP functions are and

what they do instead of how to use them. There is an alternative to all this. One can obtain *The Little LISPer*, study it for a short time, and come away with a firm grasp of the essentials of LISP. This grasp is sufficient to make sense out of the rest of the material concerning LISP and LISP-based systems that one might encounter.

*The Little LISPer* was originally written to provide a two-week course for non-programmers. It is one of the best introductions to any language that I have ever read. I went straight through it the day I got it. The sequence of topics (interleaving functions, data structures, programming principles, recursive programming techniques) is laid out with a deft touch that has the student progressing much faster than he realizes. This organization of the material allows the reader to build up a sophisticated sense of the patterns inherent in LISP structures

almost without noticing.

Other features that contribute to the relaxed, but speedy, progress of the student are the organization of the entire text into carefully constructed sets of questions and answers and the light humorous touch of the examples.

LISP operates on list structures, and most of the data used in the book are lists of foods. One of the problems for the reader is to determine the list that results from inserting the atom ROAST after the atom CHUCK in a list beginning:

(HOW (MUCH WOOD)) . . .

Unfortunately the text breaks off too soon, leaving the reader with a clear sense of things he was just about ready to do, but will have to find out about elsewhere. In any case, the author says the reader is "better prepared than he realizes" to learn the details of a full LISP system and many more advanced programming techniques. It is only necessary to become familiar with the full range of features of a complete LISP system before diving into the world of artificial intelligence and numerous other fields.

LISP is a realization and extension (in notation, not computing power) of Church's lambda calculus, one of the most powerful mathematical tools in existence. It is generally considered a remarkable achievement to teach a powerful mathematical technique to nonmathematicians. As far as I am concerned, though, this kind of teaching should be normal, and the usual "math is hard and you're too dumb to learn it" approach should be thrown away. The fact is that most people are not too dumb to learn mathematics of whatever sort, but few people are clever enough to learn improperly presented mathematics. It seems that even fewer are clever enough to present it well. I am delighted to have an opportunity to point out an in-

stance of top-quality textbook writing and to offer my congratulations to Daniel Friedman.

Mokurai Cherlin  
APL Business Consultants Inc  
POB 1131  
Mt Shasta CA 96067

## Mathematical Elements for Computer Graphics

by David Rogers and  
J Alan Adams  
McGraw-Hill Book  
Company, New York  
NY, 1976  
Softcover, 239 pages  
\$12.95

One of the ironies of computer graphics is that it is the aspect of computer use that most attracts people who do not like mathematics, while it is one of the few fields of computing (contrary to popular belief) that require mathematics. *Mathematical Elements for Computer Graphics* is a good sourcebook of the mathematics, the formulae, and the algorithms required to implement graphics packages and applications on computers of any size. It is especially well suited to personal-computer use, since all of the algorithms are presented in BASIC.

Rogers and Adams assume several things about the reader. First, they assume that the reader is writing, or wants to write, software for a line-drawing display (such as those produced by Tektronix). If you have a television-technology display (like most small-computer users), you will need to devise the software to make it draw lines. They also assume that the reader has a substantial background in mathematics. Unfortunately for this subject, a substantial mathematical background means three terms of college-level calculus plus matrix algebra. Also, the algorithms are presented in Dartmouth BASIC, which requires a fair amount of conversion before it will

## the electric pencil II™

©1980 Michael Shroyer

### for the TRS-80 Model II\* Computer



The Electric Pencil is a Character Oriented Word Processing System. This means that text is entered as a continuous string of characters and is manipulated as such. This allows the user enormous freedom and ease in the movement and handling of text. Since lines are not delineated, any number of characters, words, lines or paragraphs may be inserted or deleted anywhere in the text. The entirety of the text shifts and opens up or closes as needed in full view of the user. Carriage returns as well as word hyphenation are not required since each line of text is formatted automatically.

As text is typed and the end of a screen line is reached, a partially completed word is shifted to the beginning of the following line. Whenever text is inserted or deleted, existing text is pushed down or pulled up in a wrap around fashion. Everything appears on the video display screen as it occurs thereby eliminating any guesswork. Text may be reviewed at will by variable speed or page-at-a-time scrolling both in the forward and reverse directions. By using the search or the search and replace function, any string of characters may be located and/or replaced with any other string of characters as desired. Specific sets of characters within encoded strings may also be located.

When text is printed, The Electric Pencil automatically inserts carriage returns where they are needed. Numerous combinations of Line Length, Page Length, Character Spacing, Line Spacing and Page Spacing allow for any form to be handled. Right justification gives right-hand margins that are even. Pages may be numbered as well as titled.

### the electric pencil

→ Personal Word Processing System

The TRSDOS versions of The Electric Pencil II are our best ever! You can now type as fast as you like without losing any characters. New TRSDOS features include word left, word right, word delete, bottom of page numbering as well as extended cursor controls for greater user flexibility. BASIC files may also be written and simply edited without additional software.

Our CP/M versions are the same as we have been distributing for several years and allow the CP/M user to edit CP/M files with the addition of our CONVERT utility for an additional \$15.00. CONVERT is not required if only quick and easy word processing is required. A keyboard buffer permits fast typing without character loss.

	CP/M	TRSDOS
Serial Diablo, NEC, Oume	\$ 300.00	\$ 350.00
All other printers . . . . .	\$ 275.00	\$ 325.00

The Electric Pencil II is still available for TRS-80 Model I users. Although not as sophisticated as Electric Pencil II, it is still an extremely easy to use and powerful word processing system. The software has been designed to be used with both Level I (16k system) and Level II models of the TRS-80. Two versions, one for use with cassettes, and one for use with disk, are available on cassette. The TRS-80 disk version is easily transferred to disk and is fully interactive with the READ, WRITE, DIR, and KILL routines of TRSDOS.

TBC	Cassette . . . . .	\$ 100.00
TRD	Disk . . . . .	\$ 150.00

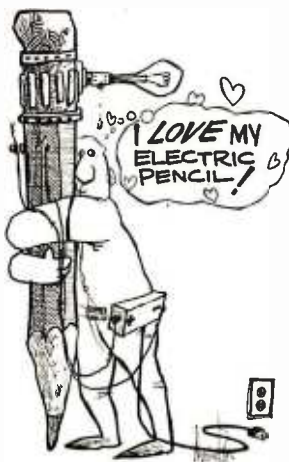

### Features

TRSDOS or CP/M Compatible • Supports Four Disk Drives • Dynamic Print Formatting • Diablo, NEC & Oume Print Packages • Multi-Column Printing • Print Value Chaining • Page-at-a-time Scrolling • Bidirectional Multispeed Scrolling • Subsystem with Print Value Scoreboard • Automatic Word & Record Number Tally • Global Search & Replace • Full Margin Control • End of Page Control • Non Printing Text Commenting • Line & Paragraph Indentation • Centering • Underlining • Boldface



\*TRS-80 is a registered trade mark of Radio Shack, a division of Tandy Corp.

**m ss** MICHAEL SHROYER SDFT WARE, INC.  
1198 Los Robles Dr.  
Palm Springs, CA, 92262  
(714) 323-1400



# When It Comes To Add-on Memory...

## LOBO Has It All.

LOBO DRIVES manufactures a full line of S-100 computer compatible disk drives. All drives are software compatible with most S-100 disk operating systems and applications software programs. Only LOBO DRIVES offers you the variety and choice of floppy and fixed disk drives. Choose from 5¼ and 8-inch floppies, 5¼ and 8-inch Winchester technology fixed disk drives, and several Floppy/Fixed disk combinations. Each LOBO DRIVES system is thoroughly tested and burned-in and has the famous LOBO DRIVES One Year, 100% Parts/Labor Warranty.

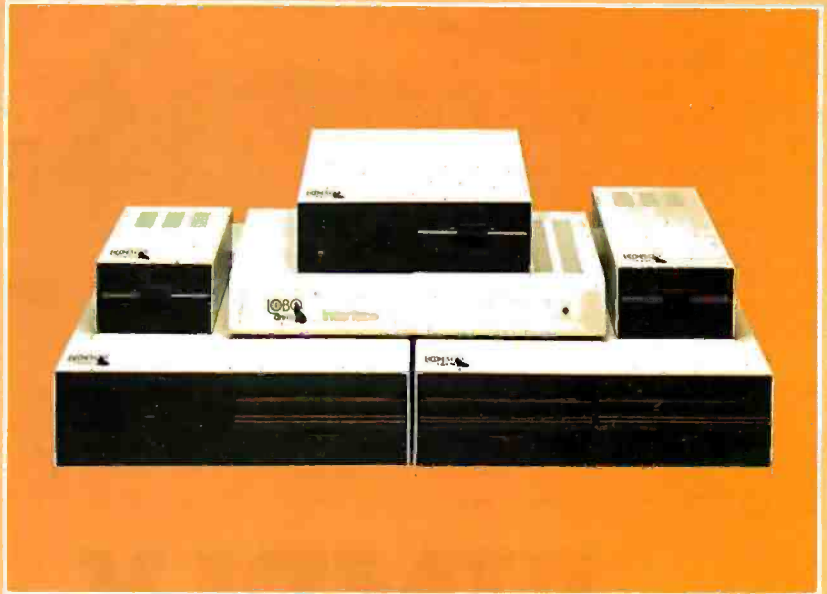

### MODEL 400 5¼-INCH FLOPPY DISK MEMORY SYSTEM

A high-speed (298) Msec Access, high-reliability (8000 hrs MTBF), low-cost floppy disk memory system. It is available in both soft and hard sector formats, and a choice of single or double density configurations.

- Up to 220 KBytes Capacity
- Single/Double Density
- Soft Sector Format
- Complete Software Compatibility

### MODEL 800/850 DUAL FLOPPY DISK DRIVE MEMORY SYSTEM

LOBO DRIVES offers you a choice of single-sided, single or double density (Model 800) or double-sided, single or double density (Model 850) dual 8-inch memory subsystems. Each system comes complete with chassis and power supply, cables, controller and interface.

- Compatible with Most S-100 DOS Systems
- Up to 3.2 MByte Capacity

### MODEL 1850 DUAL FLOPPY/FIXED DISK MEMORY SYSTEM

No more worries about back-up. LOBO DRIVES has combined the latest state-of-the-art Winchester technology with the proven reliability and dependability of its Model 850 8-inch floppy disk drive to bring you the ultimate in memory expansion for your S-100 computer. The Model 1850 is the ideal memory system for small business and word processing applications.

- 5 or 10 MByte Fixed Disk Capacity
- 1.6 MByte Floppy Disk Capacity
- Software Compatibility
- Sealed Environment
- Winchester Reliability
- 70 Msec Average Access Time

### MODEL 950 DUAL FLOPPY/FIXED DISK MEMORY SYSTEM

All the advantages of Winchester technology fixed disk memory: large capacity (6.38 MBytes), high speed (170 Msec avg. access time), and extended reliability, combined with the convenience of a built-in floppy disk back-up in one cabinet. Only LOBO can bring you the storage capacity of 16 mini-floppies at a fraction of the price.

- The Storage Capacity of 16 Mini-Floppies
- Built-in Back-up
- 170 Msec Access (Avg)
- Software Compatibility

See your nearest dealer, call, or write for the complete LOBO DRIVES story... find out just how competitively priced a quality drive can be.



935 Camino Del Sur  
Goleta, California 93017  
(805) 685-4546  
Telex: 658 482



# SIMPLY BEAUTIFUL.

CF&A furniture looks terrific. But beauty is more than skin deep. That's why our line of desks, stands, and enclosures also features rugged construction, low cost, and quick delivery. In a wide range of sizes and configurations. With accessories to meet your individual requirements. With a smile and a thank you. Call CF&A. We make it simple. We make it beautiful.

## CF&A

**Computer Furniture and  
Accessories, Inc.**  
1441 West 132nd Street  
Gardena, CA 90249  
(213) 327-7710

work in Microsoft BASIC or BASIC-E.

For those of you who have not yet been scared off, you will learn algorithms and techniques for: scaling, rotation, curve representation, three-dimensional displays, three-dimensional transformation, and surface description and display. Of course, I am only summarizing; Rogers and Adams break these topics down into 65 sections, plus algorithms.

So why buy (or borrow) this book? If you want a text to teach yourself computer graphics, this is the wrong book. It will not really tell you how to put all of the algorithms together into a usable package or application. But, if you already know something about computer graphics and need a reference to give or compare formulae and algorithms, then this is definitely the right book. A caveat is in order: I have not checked any of the algorithms or programs for typographical accuracy. Which is to say, it's a good reference, but not a good text. ■

John A Lehman  
716 Hutchins #2  
Ann Arbor MI 48103

### BYTE's Bugs

#### Duplicated NAND Gate

A drafting error marred Steve Ciarcia's article "A Build-It-Yourself Modem for Under \$50" (August 1980 BYTE, page 22). The pin numbers for a section of an integrated circuit were incorrectly marked, duplicating the numbers for a different section.

In figure 1b on page 28, the NAND gate of IC4c should have had its input indicated as being on pins 8 and 9, with output on pin 10. The pin numbers for IC4d are correct as shown. ■

# Very sharp printout at very low payout

**\$595\***



## The Heath H-14 Printer gives you high-performance features at one of the lowest prices anywhere...

- 5 x 7 dot matrix and high quality impact printhead give you clear, easy-to-read images
- Standard 96-character ASCII set, UPPER and lower case
- Operator or software-selectable line widths; 132, 96, or 80 characters
- Compatibility with any computer having RS-232C or 20 mA current loop serial interface, with handshaking
- Sprocket paper feed, with adjustable spacing, to keep paper moving smoothly
- Sustainable print speed approximately 30 characters per second
- "Paper jammed" and "paper out" signals to prevent loss of data
- Selectable baud rates from 110 to 4800
- Convenience of standard fan-fold paper, 2.5 to 9.5 inches wide
- Chrome wire rack to keep paper neat

### Visit your Heathkit Service Center

H-14 Printers are on display at the 61 Heathkit Electronic Centers throughout the U.S. and Canada. See your telephone white pages for the location nearest you.

In the U.S. Heathkit Electronic Centers are units of Veritechnology Electronics Corporation.

\*In kit form, FOB Benton Harbor, MI. Also available completely assembled at \$895.00, FOB Benton Harbor. Prices subject to change without notice.

Circle 70 on Inquiry card.

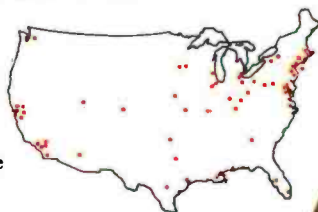

The H-14's remarkable price includes connecting cables, paper rack, paper, and ribbon — so you're all ready to run. And service for the H-14 is available at 61 Heathkit Electronic Centers in the U.S. or Canada.

Check out the microprocessor-based H-14 Printer today, in kit form or factory assembled. You'll find complete details in the newest, FREE Heathkit Catalog. Send for yours today, or pick one up at the nearest Heathkit Electronic Center. Dealer inquiries on assembled units are invited, too.

**Complete service, so you're never left out in the cold**

**Heath**<sup>®</sup>  
Computer Systems

**Send for  
FREE Catalog**

Write to: Heath Company,  
Dept. 334-716  
Benton Harbor, MI 49022



# SYNCHRO-SOUND THE COMPUTER PEOPLE

A PERFECT  
SUPER SPECIAL MATCHED PAIR!



Texas Instruments  
810 Multi Copy  
Impact Printer

Intertec  
Super Brain  
Computer Terminal

ONLY **\$4295.**



Lear Siegler  
ADM 3A  
ADM 3A+



Soroc  
Technology  
IQ 120  
IQ 140



DECwriter IV  
LA34



Okidata  
Microline 80



Northstar  
Horizon II  
Horizon II Quad



Many of our prices are too low to advertise!  
PLEASE CALL OR WRITE

We carry a full line of: ADDS, QUME, TELETYPE, CROMEMCO, FLORIDA DATA SYSTEMS, SCOTCH, MAXELL, VERBATIM, ALPHA-MICRO, ATARI, INTEGRAL DATA, LIVERMORE COUPLERS, HAZELTINE, TEXAS INSTRUMENTS, DIGITAL MICRO SYSTEMS and others.



## SYNCHRO-SOUND

ENTERPRISES, INC.  
THE COMPUTER PEOPLE

193-25 Jamaica Ave.  
Jamaica, New York 11423  
TWX 710-582-5886

PHONE ORDERS CALL:  
New York 212/468-7067  
Los Angeles 213/628-1808  
Chicago 312/641-3010  
Dallas 214/742-6090

## Books Received

The following is a list of books received at BYTE Publications during this past month. Although the list is not meant to be exhaustive, its purpose is to acquaint BYTE readers with recently published titles in computer science and related fields. We regret that we cannot review or comment on all the books we receive; instead, this list is meant to be a monthly acknowledgement of these books and the publishers who sent them.

**Bit-Slice Microprocessor Design**, Jim Brick and John Mick; McGraw-Hill Book Company, New York NY 1980; 7¼ by 9½ inches (20 by 24.5 cm), 398 pages, hardcover, ISBN 0-07-041781-4, \$18.50.

**Computer Peripherals for Minicomputers, Microprocessors, and Personal Computers**, C Louis Hohenstein; McGraw-Hill Book Company, New York NY 1980; 6 by 9 inches (15.5 by 23 cm), 312 pages, hardcover, ISBN 0-07-029451-8, \$19.50.

**Early British Computers**, Simon Lavington; Digital Press, Bedford MA 1980; 5¼ by 8¼ inches (15 by 21 cm), 130 pages, softcover, ISBN 0-932376-08-8, \$8.

**A Guide to Structured COBOL with Efficiency Techniques and Special Algorithms**, Pacifico A Lim; Van Nostrand Reinhold, New York NY 1980; 6 by 9 inches (15.5 by 23 cm); 272 pages, hardcover, ISBN 0-442-24585-8, \$18.95.

**Master Handbook of Electronic Tables & Formulas**, third edition, Martin Clifford; Tab Books, Blue Ridge Summit PA 1980; 6 by 8¼ inches (15.5 by 21 cm), 313 pages, softcover, ISBN 0-8306-1225-4, \$8.95.

**More Chess and Computers: The Microcomputer Revolution, The Challenging Match**, David Levy, Monroe Newborn; Computer Science Press, Potomac MD 1980; 5¼ by 8¼ inches (13.5 by 20.5 cm), 117 pages; softcover, ISBN 0-914894-07-2, \$12.95.

**Practical Area Navigation**, Paul Garrison; Tab Books, Blue Ridge Summit PA 1980; 6 by 9¼ inches (15.5 by 23 cm), 224 pages; soft-

cover, ISBN 0-8306-2286-1, \$5.95.

**Practical BASIC Programs**, Lon Poole; Osborne/McGraw-Hill, Berkeley CA 1980; 8¾ by 10¾ inches (20.5 by 26.6 cm), 171 pages, softcover, ISBN 0-931988-38-1, \$15.

**Project Whirlwind: The History of a Pioneer Computer**, Kent C Redmond and Thomas M Smith; Digital Press, Bedford MA 1980; 7¾ by 9½ inches (18.6 by 24.5 cm), 280 pages, hardcover, ISBN 0-932376-09-6, \$21.

**Some Common BASIC Programs**, third edition, Mary Borchers and Lon Poole; Osborne/McGraw-Hill, Berkeley CA 1980; 8¾ by 10¾ inches (20.5 by 27.5 cm), 195 pages; softcover, ISBN 0-931988-06-3.

**Structured BASIC and Beyond**, Wayne Amsbury; Computer Science Press, Potomac MD 1980; 6 by 9 inches (15.5 by 23 cm), 310 pages, softcover, ISBN 0-914894-16-1, \$10.95. ■

## BYTE's Bugs

### The First Shall Be Last

The Washington Area Computer Society (WACS) meets on the *last* Friday of the month (not the first) on the campus of the Catholic University of America in Washington, DC, in the first-floor lecture room in Keane Hall, starting at 7:30 PM. Incorrect information about the meeting time had been published in a past issue of BYTE. ■



# BASIC SOFTWARE LIBRARY

**NOW ★ 10 ★ Volumes and Growing**

WHY Pay hundreds of dollars for Software that does Not work when WE offer the BEST available Software for only a few dollars a program. And what is better OURS WORKS!

We have over 100,000 in circulation since 1975 and we are still around and That's more than Anyone else can say. We used to sell hundreds of programs individually, the programs in Volume X were sold for several years at over \$10,000, in Volume III for over \$6,000 but a few years ago we decided to promote software to the mass public and it was an instant success.

**For Homeowners, Businessmen, Engineers, Hobbyists, Doctors, Lawyers, Men and Women**

Vol. I \$24.95	Vol. II \$24.95	Vol. III \$39.95	Vol. IV \$9.95	Vol. V \$9.95	Vol. VIII \$19.95	Vol. IX \$19.95	Vol. X \$69.95	
Business & Personal Programs	Animals Four Astronaut Bagel Bio Cycle Cannons Checkers Craps Dogfight Golf Judy Line Up Pony Roulette Sky Diver Tank Teach Me	Binomial Chi-Sq. Coef. Confidence 1 Confidence 2 Correlations Curve Differences Dual Plot Exp-Distri Least Squares Paired Plotpts Polynomial Fit Regression Stat 1 Stat 2 T-Distribution Unpaired Variance 1 Variance 2 XY. APPENDIX A	Beam Conv. Filter Fit Integration 1 Integration 2 Intensity Lola Macro Max. Min. Navaid Optical Planet PSD Rand 1 Rand 2 Solve Sphere Trian Stars Track Triangle Variable Vector	Billing Inventory Payroll Risk Schedule 2 Shipping Stocks Switch	Bingo Bonds Bull Enterprise Football Funds 1 Funds 2 Go-Moku Jack Life Loans Mazes Poker Popul Profits Qubic Rates Retire Savings SBA Tic-Tac-Toe	Andy Cap Baseball Compare Confid 10 Descrip Differ Engine Fourier Horse Integers Logic Playboy Primes Probab Quadrac Red Baron Regression 2 Road Runner Roulette Santa Stat 10 Stat 11 Steel Top Vary Xmas APPENDIX B	1040-Tax Balance Checkbook Instol 78 Deprec 2 APPENDIX C Favorites	Auto Cypher Hurrtrac ID Lorana Map Navigate Omega Patterns Radar RDF

Almost every single program included in these volumes will run in every Computer system that operates in Basic. A few changes may be required for some Basics but most of these changes are covered in one of the Tables and Appendices included in Volumes III, V, VI, VIII, and X.

Volume VI — Disk programs are compatible with TRS-80 disk basic. The disk programs in Volumes VI, VII and X are written in (CP/M) M Basic and Disk Extended Microsoft Basic. Other programs written in 8K Basic.

**★SPECIAL BONUS★ 15% discounts on single purchase of full set by December 31st, 1980**

Unconditional Money Back Guarantee.

Add \$1.50 per volume handling, all domestic shipments sent U.P.S. except APO and P.O. Box which go parcel post. Foreign orders add \$6.00/volume for air shipment and make payable in U.S. dollars only.

AVAILABLE AT MOST COMPUTER STORES

Master Charge and Bank Americard accepted.

Our Software is copyrighted and may not be reproduced or sold.

Unlike others we have NOT raised our prices in five years

**KEMCO, LTD.**

P.O. Box 2096L Ashland, VA 23005

**Sales HOT LINE 1-804-798-1147**

**IN GERMANY**

Ing. W. Hofacker, GmbH  
Holzkirchen, W. Germany

**IN HOLLAND**

Nanton Press B.V.  
Bilthoven, Holland

**OVER 116,000 IN USE TODAY**

## Complex Number Subroutines

William R Harlow, Department of Mechanical and Industrial Engineering, 836 Rhodes Hall, University of Cincinnati, Cincinnati OH 45221

I teach numerical methods to engineering students at the University of Cincinnati, where we have an Amdahl computer. Also, various departments have purchased Heath, IMSAI, Radio Shack, and Wang systems. Although the big system has built-in hardware to perform complex operations, the smaller systems must have them implemented as subroutines.

Besides the four fundamental operations of addition, subtraction, multiplication, and division, there are several important functions of a complex variable. These include  $\log(z)$ ,  $e^z$ ,  $\sin(z)$ ,  $\cos(z)$ ,  $z^n$ , and others. Since addition and subtraction are so easy to handle, they are not included in the routines listed here.

Listing 1 gives a set of BASIC routines to do the complex operations listed in table 1. Other functions not

**Listing 1:** Subroutines for manipulation of complex numbers. See table 1 for a description of the functions calculated. Note that some of the routines use the constant #PI, which should be set to 3.1415926535.

```

1000 REM
1010 M1=A1*A2-B1*B2:M2=A1*B2+A2*B1:RETURN
2000 REM
2010 D=A2^2+B2^2
2020 R1=(A1*A2+B1*B2)/D:R2=(A2*B1-A1*B2)/D:RETURN
3000 REM
3010 R=SQR(A1^2+B1^2):I=SGN(A1)+3*SGN(B1)+4
3020 ON I GOTO 3050,3060,3070,3110,3080,3090,3100,3060
3030 B=ARCTAN(B1/A1)-#PI:GOTO 3120
3050 B=(-#PI/2):GOTO 3120
3060 B=ARCTAN(B1/A1):GOTO 3120
3070 B=#PI:GOTO 3120
3080 B=0:GOTO 3120
3090 B=#PI+ARCTAN(B1/A1):GOTO 3120
3100 B=#PI/2:GOTO 3120
3110 P1,P2=0:GOTO 3120
3120 R0=P*LOG(R):R=EXP(R0)
3130 P1=R*#COS(P*B):P2=R*#SIN(P*B):RETURN
4000 REM
4010 I=SGN(A1)+3*SGN(B1)+4
4020 IF I=4 THEN 4120
4030 L=.5*LOG(A1^2+B1^2)
4040 ON I GOTO 4060,4070,4080,4120,4090,4100,4110,4070
4050 L2=ARCTAN(B1/A1)-#PI:GOTO 4130
4060 L2=(-#PI/2):GOTO 4130
4070 L2=ARCTAN(B1/A1):GOTO 4130
4080 L2=(#PI):GOTO 4130
4090 L2=0:GOTO 4130
4100 L2=#PI+ARCTAN(B1/A1):GOTO 4130
4110 L2=#PI/2:GOTO 4130
4120 PRINT "LOG(Z) IS UNDEFINED":STOP :RETURN
4130 L1=L:RETURN
5000 REM
5010 E1=EXP(A1)*#COS(B1):E2=EXP(A1)*#SIN(B1):RETURN
6000 REM
6010 U1=(EXP(B1)-EXP(-B1))/2:U2=(EXP(B1)+EXP(-B1))/2
6020 S1=SIN(A1)*U2:S2=#COS(A1)*U1:RETURN
7000 REM
7010 U1=(EXP(B1)-EXP(-B1))/2:U2=(EXP(B1)+EXP(-B1))/2
7020 C1=#COS(A1)*U2:C2=SIN(A1)*(-U1):RETURN
8000 REM
8010 IF B1<>0 THEN 8050
8020 IF A1<0 THEN 8040
8030 R1=SQR(A1):R2=0:RETURN
8040 R1=0:R2=SQR(-A1):RETURN
8050 R=SQR(A1^2+B1^2)
8060 R1=SQR((R+A1)/2):R2=SGN(B1)*SQR((R-A1)/2):RETURN
    
```

Line Number	Operation type	Input; Use	Other Variables Used	Output
1000	product $z_1 \times z_2$	A1,B1;A2,B2		M1,M2
2000	quotient $z_1 / z_2$	A1,B1;A2,B2	D	Q1,Q2
3000	power $z^n$	A1,B1	P,R,I,B	P1,P2
4000	natural logarithm $\ln z$	A1,B1	I,L	L1,L2
5000	exponential $e^z$	A1,B1		E1,E2
6000	sine $\sin z$	A1,B1	U1,U2	S1,S2
7000	cosine $\cos z$	A1,B1	U1,U2	C1,C2
8000	square root $z^{1/2}$	A1,B1	R	R1,R2

**Table 1:** Table of complex number operations performed by subroutines in listing 1. In the "Input" column (A1, B1) refers to the complex number  $A1 + Bi$ , where  $i$  is the square root of  $-1$ . In the "Output" column, the two numbers listed are the real and imaginary parts of the answer; eg: the output variables M1 and M2 of the multiplication routine mean that the result of the multiplication is the complex number  $M1 + M2i$ .

# The best in data base management for your micro-computer

Get the most out of your micro-computer. Use our advanced and progressive data management system.

**HDBS** is an extended hierarchical data base system offering

- fixed length records
- file-level read/write protection
- one-to-many set relationships

**MDBS** is a full network data base system offered as an upgrade from HDBS... or it may be ideal as your initial system. **Unique and versatile**, it adds these features:

- full network CODASYL-oriented data structures
- variable length records
- multiple levels of read/write protection
- one-to-one, many-to-one, and many-to-many sets
- non-redundancy of data, easy updating
- occurrences of a record type may own other occurrences of the same type
- a single set may have multiple owner and member record types

**MDBS-DRS.** As an add-on to MDBS, the DRS system offers extraordinary flexibility in data base restructuring to meet new needs.

- Item, record, and set types can be added, deleted, or renamed in an existing data base as well as other data base characteristics. You can redesign the data base after it is already on-line!

**MDBS-RTL.** As an add-on to MDBS, the RTL (Recovery Transaction Logging) logs all data base transactions, so that in the event of a system failure, the data base can be recovered with minimal loss of information.

- The recovery processor permits selective reloading of the data base from the transaction file. Users can log messages, indicate complex transaction sequences, and effect selective control over the recovery process.

**MDBS-QRS.** An interactive Report-Writer/Query-System for HDBS/MDBS data bases. Features...

- may be customized for non-technical users
- complex retrieval conditions may be specified
- detailed reports can be quickly generated
- wildcard and "match-one" string specifications included

## HDBS and MDBS Packages Include:

- DDL data definition language analyzer/editor
- 260-page users manual
- DMS data management routines callable from host language
- Sample application program and DDL files
- Relocator to re-org all routines
- System specific manual for bringing up our software



54-page "primer" on data base systems for micro-computers — only \$10.00 per copy.

Dealer Demo-Package (\$60.00) includes Primer, HDBS/MDBS Manuals, Demo-Disk, etc.

NEW!

## Both HDBS and MDBS Systems . . .

- Run under . . . CP/M® with CBASIC; Microsoft BASICs, FORTRAN or COBOL; InterSystem PASCAL/Z; Sorcim PASCAL/M; Micro Focus CIS COBOL; Digital Research PL/I OASIS TRSDOS and NEWDOS (Models I and II) with Disk BASIC North Star DOS with North Star BASIC Apple DOS and Applesoft BASIC Machine Language Interface available on all above systems.
- Up to 254 record-types definable in the data base; each record-type may contain up to 255 item-types; each item-type may be up to 9,999 bytes in length.
- Names of data items, records, sets, and files are wholly user definable.
- Commands to add, delete, update, search, and traverse the data base.
- Straightforward use of ISAM-like structures.
- Records can be maintained in several sorted orders.
- Written in machine language for maximum execution efficiency and minimal memory usage.
- Independent of types and sizes of disk drives. Support data base spread over several disk drives (max.8); disks may be mini- or full-sized floppies or hard disks.
- Available versions: Z80 (requires approx. 18K), 6502 (approx. 30K), 8080 (approx. 22K) Total memory requirement must allow for buffer areas. For Apple users, a language card is recommended.
- 8086 version available. (Call or write for details and prices.)

## Ordering information (applicable to Z80, 8080 and 6502 versions):

HDBS (Version 1.04)	\$ 300.00	When ordering, specify intended use with . . .
MDBS (Version 1.04)	900.00	1. North Star DOS and BASIC
DRS	300.00	2. CP/M® - CBASIC
RTL	300.00	3. CP/M® - Microsoft BASIC 4.XX
ORS	300.00	4. CP/M® - Microsoft BASIC 5.XX
HDBS upgrade to MDBS	650.00	5. CP/M® - Microsoft BASIC or FORTRAN Compiler
MDBS with DRS, RTL, and ORS	1500.00	6. CP/M® - Microsoft COBOL-80
HDBS/MDBS Manual	35.00	7. CP/M® - InterSystem PASCAL/Z
DRS Manual	5.00	8. CP/M® - Sorcim PASCAL/M
RTL Manual	5.00	9. CP/M® - Digital Research PL/I
ORS Manual	5.00	10. CP/M® - Micro Focus CIS COBOL
System Specific Manuals (each)	5.00	11. TRSDOS/NEWDOS and TRS Disk BASIC (Models I and II)

Within a given operating system, add \$125.00 for each additional language selected.

For prices outside the U.S. and Canada, please ask for price lists.

Indiana residents add 4%.

Add \$2.50 handling fee for non-cash order (\$5.00 outside U.S.).

We accept Visa and Master Charge.

Setting standards of excellence for data base software . . . worldwide.

**Micro Data Base Systems, inc.**

Box 248, Lafayette, Indiana 47902  
317-448-1616



included could be the hyperbolic and inverse trigonometric functions. The square root of a complex number was included even though it is a special case of  $z^n$ . The only complicated ones are the power and the logarithm. This is due to the angle utilized.

The subroutines have been given large line numbers so that they may be put at the end of a program. Users can certainly renumber these lines or use only those needed for a particular problem.

Two rather simple problems (see listings 2 and 3) are included to demonstrate the use of the functions. Both make use of Newton's method to solve for the roots of a function. This is done using the following iterative formula to obtain a better approximation of  $z$ ,  $z_{k+1}$ , from the current approximation,  $z_k$ :

$$z_{k+1} = z_k - f(z_k)/f'(z_k) \text{ where } k=1,2,\dots$$

An initial or starting value of  $z$  is selected ( $z = x + iy$ ). Thus  $z_1 = x_1 + iy_1$  is used in  $f(z_1)$  and  $f'(z_1)$ . This will generate a  $z_2$  which is fed back into the right-hand side of the equation to give a  $z_3$ , and so on.

The method is rapid in convergence and quite stable. If a certain  $z_k$  should make  $f'(z_k)$  very small or zero, however, it is best to restart with a new  $z_1$ . In the programs shown, a test to stop cycling is made on the  $f(z)$ :

IF SQR(F1<sup>2</sup>+F2<sup>2</sup>) < 1E-6 THEN . . .

This statement stops the iteration when the complex error has a magnitude of less than  $10^{-6}$ . ■

**Listing 2: Example program using the subroutines of listing 1.** The program given in listing 2a attempts to find a root of the function  $f(z) = e^z - z^2$ . Note that its derivative  $f'(z) = g(z) = e^z - 2z$ . Listing 2b shows two separate runs of the program with starting points of (1,1) and (-1,0); the final results are underlined. Due to the cyclic nature of  $e^z$ , there are an infinite number of solutions to this problem.

(2a)

```

10 INPUT " KEY IN X,Y ",X,Y
12 PRINT
15 PRINT TAB(14);X,Y
20 A1=X:B1=Y
30 GOSUB 5000
40 F=2
50 GOSUB 3000
60 F1=E1-F1:F2=E2-F2
65 IF SQR(F12+F22)<1E-6 THEN 120
70 G1=E1-2*A1:G2=E2-2*B1
80A1=F1:B1=F2:A2=G1:B2=G2
90 GOSUB 2000
100 X=X-Q1:Y=Y-Q2
110 GOTU 15
120 STOP " ROOT DETERMINED. KEY RUN FOR A NEW SET"

```

(2b)

$X_1 = 1$	$Y_1 = 1$
<u>2.912389622375</u>	<u>2.575157181739</u>
2.187132232955	2.174648753578
1.760811047732	1.808824533853
1.603663701734	1.596954184978
1.58722527008	1.54253028231
1.588042823737	1.540223443863
<u>1.588047264669</u>	<u>1.540223501065</u>

$X_1 = -1$	$Y_1 = 0$
-1.7330434605249	0
-1.7038077863239	0
<u>-1.7034674683272</u>	<u>0</u>

**Listing 3: Example program using the subroutines of listing 1.** The program given in listing 3a attempts to find a root of the function  $f(z) = 2z^2 + (-6 - i)z + (20 - i) = (2z + 4 - i)(z - 5)$ . (Its roots are  $(-2 + 0.5i)$  and  $5$ .) The derivative  $f'(z) = g(z) = 4z + (-6 - i)$ . Two runs of the program are shown in listing 3b, with the final results underlined.

(3a)

```

10 INPUT " KEY IN X,Y ",X,Y
12 PRINT
15 PRINT TAB(14);X,Y
20 A1=X:B1=Y
40 F=2
50 GOSUB 3000
60 F1=2*F1:F2=2*F2
70 A2=-6:B2=-1
80 GOSUB 1000
90 F1=F1+M1-20:F2=F2+M2+5
95 IF SQR(F12+F22)<1E-6 THEN 200
100 G1=4*A1-6:G2=4*B1-1
110 A1=F1:B1=F2:A2=G1:B2=G2
120 GOSUB 2000
130 X=X-Q1:Y=Y-Q2
140 GOTU 15
200 STOP " ROOT DETERMINED. KEY RUN FOR A NEW SET"

```

(3b)

$X_1 = 1$	$Y_1 = 1$
-3.307692307727	-4.461538461515
-1.45941644561	-1.379310344755
-1.434942737807	-.532192367931
-2.053130882705	-.4886935917174
-2.00036624035	-.4998063289247
<u>-2.00000001228</u>	<u>-.499999788526</u>

$X_1 = 2$	$Y_1 = 2$
2.207547169882	-2.226415094319
2.830440251643	1.193459119487
4.902563504007	-1.877088064073
4.604564248345	-1.193451138577
5.015324400454	2.68292464E-02
4.999923902019	1.12126002E-04
<u>4.999999999177</u>	<u>-2.49265620E-04</u>

**6809 S-100** ads™

**SINGLE BOARD COMPUTER**

- MEETS I.E.E.E. S-100 STANDARD
  - 10 addressing modes
  - 24 indexed sub modes
  - auto increment/decrement
  - constant indexing from PC
- **4K/8K/16K ROM** • **2K RAM**  
ROM/RAM relocatable on 4K boundary
- **ACIA; PIA; 8080 SIMULATED I/O**
- **20 PARALLEL I/O LINES** • **256 I/O PORTS**  
ACIA provides RS-232 lines for asynchronous communications with limited modem control at 8 selectable baud rates; I/O locatable at any 4K boundary
- P.C. Board & Manual \$69.95  
with Monitor \$99.95
- **ASSEMBLED & TESTED WITH 2K RAM & MONITOR \$349.50**
- **adsMON; ADS MONITOR**  
Examine and change registers and memory; punch and load in Motorola format; user definable interrupt service and more  
\$39.95 in 2716 EPROM

MasterCharge/VISA Accepted

Illinois residents add sales tax Add 2.5% for shipping

**Ackerman Digital Systems, Inc.**

110 N. York Rd., Suite 208, Elmhurst, Ill. 60126 (312) 530-8992



# BYTE's Bits

## International Systems and Courseware Exchange

One of the greatest deterrents facing organizations that desire to purchase a microcomputer is the fact that the development of systems applications software is costly and time-consuming. In an attempt to find a solution to this situation, John Earle Associates Inc has met with educators, professionals, and business people to discuss means for alleviating this problem.

These discussions culminated in the establishment of the International Systems and Courseware Exchange (ISCE). The purposes of the ISCE are to enable schools, businesses, and professionals to license others to use their proprietary courseware and systems for an annual fee on a lease basis, and to recover the developmental costs of the software through the licensing fee. All schools, governmental agencies, doctors, lawyers, engineers, accountants, businesses, manufacturers, and free-lance developers of systems applications, courseware, or games are welcome to participate, as providers or as users; or as is the case within many businesses and schools, they may be included in both categories.

A free catalog will be provided to each individual or organization with listings in the catalog. Catalogs will be available to others for \$10.

The first catalog containing listings of software and all information necessary to order or submit programs will be published in January, 1981. Catalog entries dealing with administrative or business applications should be mailed to Howard R Baldwin, Registrar, University of Akron, 3220 Miles NW, Canton OH 44718. Catalog entries concerning educational or professional

applications should be sent to Swen A Larsen, Dean of Science and Technology, World University, Barbosa esq Guayama, Hato Rey, Puerto Rico 00917. For a copy of the catalog or for more information, contact John Earle Associates Inc, POB 12213, Loiza Station, Santurce, Puerto Rico 00914.

## Pass the Salt and the Computer, Please

Eleven of the nation's newspapers affiliated with the AP (Associated Press) are experimenting with electronic delivery of news to the home. Through the joint efforts of the newspapers, the AP, and CompuServe Inc, an information networking firm, a daily electronic edition will be published for at least six months. The results of this test will be shared with the 1300 daily newspapers and 3500 radio and television stations that are a part of the AP news cooperative.

The newspapers participating are *The Columbus Dispatch*; *The Washington Post*; *Los Angeles Times*; *The New York Times*; *Chicago Sun-Times*; *The St Louis Post-Dispatch*; *The Minneapolis Star and Tribune*; *The Atlanta Journal and Constitution*; *The Norfolk Virginian-Pilot and Ledger-Star*; *San Francisco Chronicle*; and *The Middlesex News* (Framingham, Massachusetts). Each newspaper contributes news items and computing expertise to produce the news that is delivered to the CompuServe computers. Customers with a terminal and modem merely have to place a telephone call to link up with the electronic editions. Home users are charged \$5 per hour, billed in 1-minute increments. The service

operates from 6 PM to 5 AM weekdays and all day on weekends and holidays.

The experimenters hope that the test will provide substantial information on marketing the service, promotion, design of the data base, and new sources of advertising revenue. For more information, contact CompuServe Inc, 5000 Arlington Centre Blvd, Columbus OH 43220, (614) 457-8600.

## Tuition-Free Program for Women in Electrical Engineering

A brochure from the University of Dayton outlines a National Science Foundation-sponsored Fast-Track program for women interested in electrical engineering. To qualify, an applicant must hold a bachelor's degree in mathematics, physics, or a related science. Participants earn a certificate that serves to advance them to an

academic level equivalent to that of an electrical engineering graduate. Credits earned can be applied toward a bachelor's degree in electrical engineering. A Fast-Track staff at the university offers counseling and guidance, assists in part-time work placement, arranges for partial living expense stipends and placement in engineering jobs at program conclusion. The program commences January 5, 1981, and lasts thru December 19, 1981. Copies of the brochure, entitled *Women Interested in Engineering*, can be obtained by writing or calling Carol M Shaw, Assistant Dean, School of Engineering, University of Dayton, Dayton OH 45469, (513) 229-2736. ■

SAVE AT THE APPLE COMPUTER SUPERMARKET...

# "COMPUTERS 'R' US"

UNBEATABLE MAIL ORDER DISCOUNTS  
A SUBSIDIARY OF CONSUMER COMPUTERS

**CHRISTMAS SUPER SALE**

APPLE II PLUS  
OR APPLE II STANDARD

16K FOR ONLY \$925

48K FOR ONLY \$1049

DISK II DRIVES \$485  
W/CONTROLLER

PASCAL SYSTEM \$425

SEE PAGE 391  
FOR MORE PRODUCTS AND  
ORDERING INFORMATION

OFFER EXPIRES DEC. 31 1980

ORDER TOLL FREE: 1-800-854-6654  
CALIFORNIA, BACKORDER OR TECHNICAL INFO: (714) 698-8088  
CREDIT CARD USERS PLEASE SEE ORDERING INSTRUCTIONS ON PAGE 391

# TOGETHER...A New Beginning

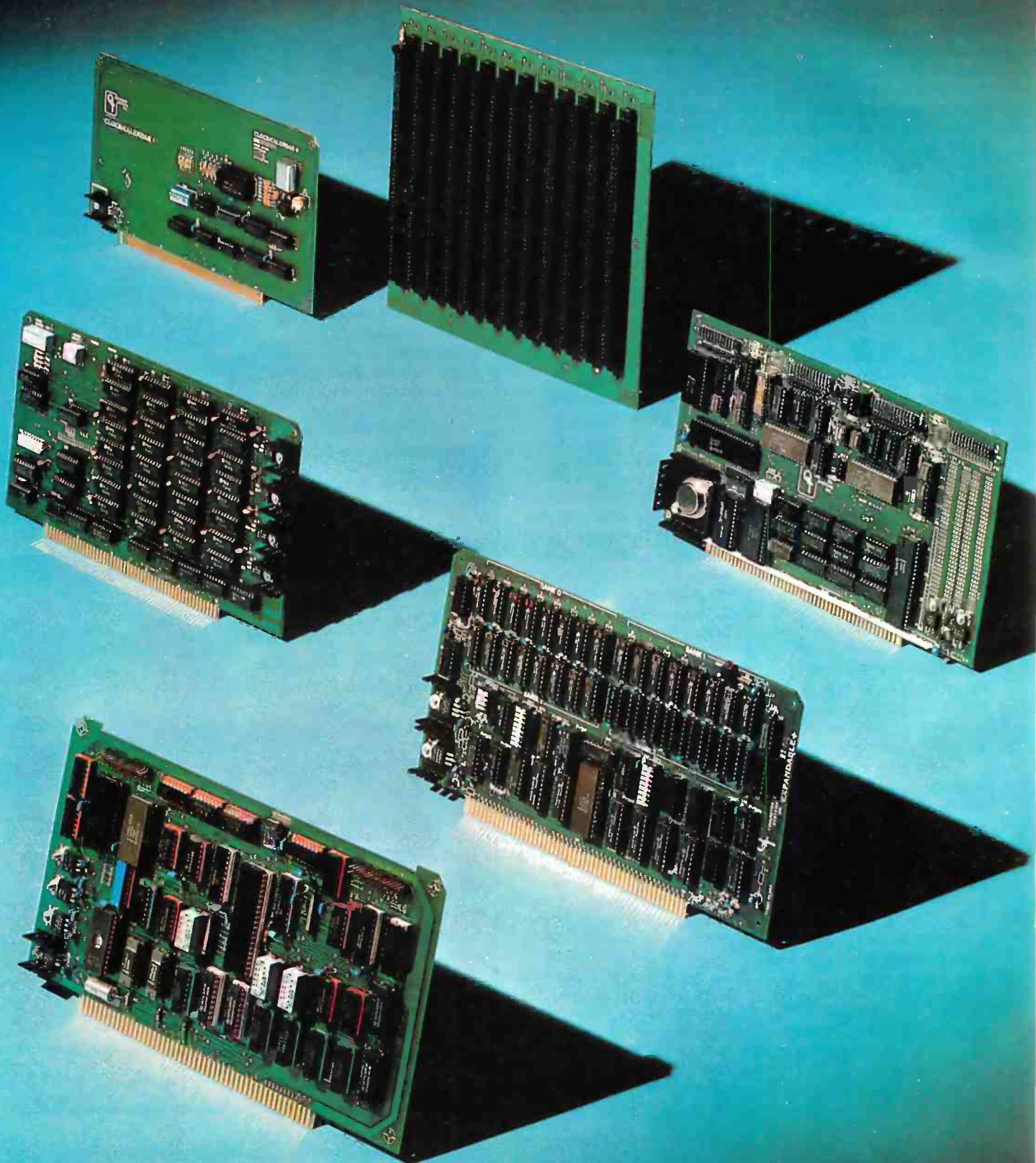

# nning!

## Manufacturing and marketing micro products is our only business.

QT is committed to building uncommon features and quality into each of its micro user products. We're offering you the lowest prices on the QT System + and other fine products. It's our new beginning.

■ **Look At These QT System + Features:**  
 2 Megabyte storage (standard)  
 • Up to 16 Megabytes storage available • Mainframe with power supply and fan • Televideo 920C terminal • CPU-Z80-4MHZ • Two 8" disk drives • Floppy disk controller (double density) • Dynamic Memory (48K—expandable to 64K) • 2K Monitor program and Disk Bios on 2716 EPROM  
 • RAM/RDM/PROM, up to 8K in any combination on CPU • Hard Disk Compatible • 2 Serial/2 Parallel Ports • Real Time Clock • EPROM Programmer • CP/M™ 2.2 or 1.4 Operating System • MP/M® Compatible • Full line of business software available.

**SYSTEM + SS (1 Megabyte)**  
 Sgl Side/DbI Den \$4295.00,  
**SYSTEM + DS (2 Megabytes)**  
 DbI Side/DbI Den \$4995.00



■ **Silence + Mother Boards**  
 No need for termination • Very high crosstalk rejection • 6, 8, 12 and 18 slots available • Has operated to 14 MHz quietly.

Bare Bd.	6-Slot	8-Slot	12-Slot	18-Slot
Kit	\$24.95	\$26.95	\$29.95	\$49.95
A&T	\$39.95	\$54.95	\$69.95	\$99.95

■ **SBC + 2/4**  
 1K RAM On Board • 2 Programmable Timers • Power On Jump to On-Board 1K or 2K EPROM (2708-2716) • 2 Separate Parallel Ports • Programmable Baud Rate Selection (110 to 9600) • Serial I/O Port (RS-232).

Bare Board	\$60.00	Kit	\$190.00
1K Mem. Kit	\$12.00	A&T	\$280.00

■ **Expandable + Dynamic Memory (16K to 64K)**  
 Uses 3242 Refresh Chip with delay line • Quiet four layer PC Bd • Supports 16K, 32K, 48K or 64K of memory • 24 Address lines per IEEE specifications • Bank on/off signal selected by I/O port 40 (Hex) per industry standard.

Bare Board	\$70.00	48K Kit	\$480.00
16K Kit	\$280.00	48K A&T	\$550.00
16K A&T	\$325.00	64K Kit	\$525.00
32K Kit	\$360.00	64K A&T	\$625.00
32K A&T	\$425.00		

■ **I/O +**  
 Two Independent SYNC/ASYN Serial Ports • One Strobed 8-Bit Parallel Input Port With Handshaking • Three 8-Bit Parallel Ports (Undedicated, User Configured) • Three Independent 16-Bit Timers • 8 Level Priority Interrupt Controller.

Bare Board	\$69.00	A&T	\$375.00
Kit	\$275.00		

■ **RAM + 65**  
 2 or 4MHZ • 16K Static RAM • Uses 2114L static RAMS • Addressable in 4K steps • Memory protection in 1K increments • Features bank selection.

2MHZ		4MHZ	
Bare Board	\$20.00	Kit	\$225.00
Kit	\$200.00	A&T	\$250.00
A&T	\$240.00		

■ **Clock/Calendar +**  
 Day, Week, Month, Year • 24 Hour Time, or 12 Hour AM PM (selectable) • Interval Interrupt Timer: 1024 Hz (approximately 1 millise), 1 Sec, 1 Min, 1 Hour • On Board Battery Backup • Available for Apple & TRS-80.

Bare Board	\$45.00	A&T	\$150.00
Kit	\$100.00		

■ **Mainframe + MF +**  
 • Cabinet • 30A Pwr Supply • 12 or 18 Slot Motherboard • Fan-cooled • AC Line Filter to eliminate EMI • A&T • Power and Reset Switches on front panel.

MF + 12	\$450.00
MF + 18	\$500.00
MF + W/O Motherbrd	\$400.00

■ **Mainframe + MF + MD**  
 Accepts 2 Each 5 1/4" Disk Drives • 18A Pwr Supply • 6-12 Slot Motherboard • Dual-mini-disk provision • Disk Drive Power Supply • AC line filter to eliminate EMI • Power and reset switches on front panel.

MF + MD12	\$500.00
MF + MD6	\$450.00
MF + MD W/O Motherbrd	\$400.00

■ **DDC-8 +**  
 Available in Brown or TRS 80 Colors • Disk Cabinet for Single 8" Drive • Data Cable • Fan • Accepts Percsi, Shugart, Siemens, Remex, QUME.

DDC-8 + \$250.00  
 Also Available: S-100 (Smart) Proto Board +. Ask for our catalog.

**WARRANTY:** 1 year against defects in material and workmanship from date of shipment on all QT products.

Apple is a trademark of Apple Computer, Inc. CP/M™ and MP/M™ are trademarks of Digital Research. TRS-80 is a trademark of Radio Shack.

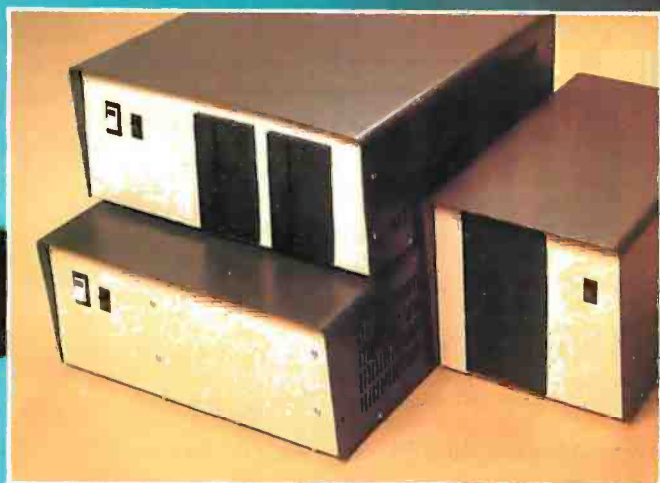

15620 South Inglewood Avenue  
 Lawndale, CA 90260  
 (213) 970-0952  
 Call TOLL FREE: 800-421-5150  
 (Except Alaska, California and Hawaii)



Cards Welcome



# PROBLEM:

$$\text{INT}(X^N + X * \text{SIN}(X^2), X)$$

# SOLUTION:

Surprised? You should be. Because until now, no software could solve anything but the most basic arithmetic problems without a series of complicated steps.

A big disadvantage? If you use a microcomputer for scientific, educational or engineering applications, you bet it is. That's why Microsoft has come up with a solution of its own. muMath.

muMath is a symbolic math package you'll recognize immediately as a major advance in microcomputer software.

muMath lets you efficiently and accurately perform the most complex mathematical operations: Exact, infinite precision rational arithmetic. Unbound variables. Complex expressions (even equations may be included). Exact solution of algebraic equations. Plus logarithmic, exponential and trigonometric simplifications and transformations.

That's right. It does in an instant what took you years

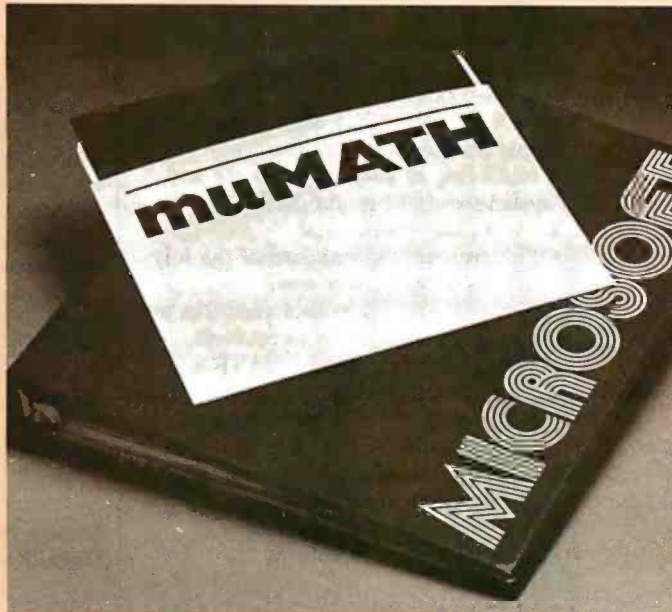

to learn at school. Rational arithmetic. Algebra. Trigonometry. Transcendental functions. Symbolic differentiation (including ordinary and partial derivatives.) Symbolic integration of indefinite and definite integrals. Matrix arithmetic and algebra.

Trigonometric simplification? But of course. Just type:

```
?SIN(2*Y)*(4*COS(X)^3
-COS(3*X)+SIN(Y)*COS
(X+Y+#P1)-COS(X-Y));
Then instantly muMath
returns:
@4*SIN(Y)*COS(X)*COS(Y).
Adding fractions? Need
you ask?
?1/3+5/6+2/5+3/7;
@419/210.
```

muMath is written in muSIMP, which is included in the muMath package.

muSIMP is an applicative, recursive language, ideal for describing complex mathematical concepts.

Because of its highly interactive nature and hierarchical structure, muMATH is an excellent math teaching device, from simple arithmetic to calculus.

muMATH is currently available for the CP/M® operating system.

The complete system, including muMATH and muSIMP on disk and documentation is \$250. Runs under CP/M.

Just what you need? We thought so. Shoot some questions at us about muMATH. We have all the answers.

Also new from Microsoft: the muLISP interpreter for CP/M. An efficient and reliable LISP system fully capable of supporting serious artificial intelligence efforts. \$200.

CP/M is a registered trademark of Digital Research.

# MICROSOFT

10800 NE Eighth  
Suite 819  
Bellevue, WA 98004  
206-455-8080  
Telex 328945

**We set the standard.**

Circle 76 on Inquiry card.

## BYTE's BOMB Cards

From the first year of BYTE to the present we have put great stock in your monthly comments that accompany BOMB (BYTE's Ongoing Monitor Box) cards. We really do read every one of them, and we are often influenced by your comments. What follows is a representative sampling from the cards over the past few issues. By the way, if you'd like to add your votes on this month's articles to our tally, simply fill out the BOMB card at the back of the magazine, using the article table on the second-to-last page as a guide....CM

### Pournelle:

- The User's Column is a very good idea—keep on!
- Pournelle is great!
- More Pournelle please. I'm subscribing.
- Very interesting theme. No more Pournelle, please.
- [Pournelle wrote the] best article on TRS-80 since BYTE began.
- Are Pournelle's articles only to be semiregular? I vote for more.
- Pournelle alone will get me to subscribe.
- Pournelle has no finesse.
- Pournelle helped me decide between Radio Shack, Apple, and Atari... TRS-80 and Omikron here I come.
- Jerry Pournelle's column told me far more about TRS-80 add-ons than I have managed to learn in many weeks of searching.

### Ciarcia:

- Mr Ciarcia has done it again.
- Don't lose Steve, he's worth his weight in gold!
- You should put two or three more

Steve Ciarcias on the payroll.

- Ciarcia's article was excellent, but only Bo Derek gets a 10.

### CAI:

- [I was] glad to have some really good info on CAI
- There were too many articles on CAI.
- CAI makes as much sense as substituting computer-game playing for physical education. Education is achieved through dint of personal dedication and mental application of effort. Chrome-plated push-button gee-gaws cannot substitute for same.

### Others:

- Excellent editorial.
- The editorial by Dr Braun rated a ten.
- Editorials should be rated.
- Your product description of the Apple III was terrific—and they say regular magazines can't get new products published quickly.
- I found the product description of the Apple III outstanding.
- Not being so good at hardware and "systems stuff," I found the July issue more readable than usual.
- Surprisingly, the standard of the July issue was exceptionally low.
- After I finish this BOMB card, I'm going to fill out the subscription form.
- The quality of articles in BYTE is slowly going downhill.
- [July was the] best overall issue of BYTE in a while!
- [July was] a rather dull issue—let's keep it on a professional level.
- Indeed you *are* starting to speak English instead of "highbrow."

### How About...

- More hardware!
- More language-oriented articles!
- More homebrew articles!
- More on 16-bit processors!

- Emphasis on personal applications?
  - Less educational material—more technical articles?
  - Publishing "Favorite Benchmarks" as they come in.
  - Publishing information about the Signetics 2650 microprocessor?
- Coming up:
- I would like to see articles on homebrew graphics terminals.
  - I would appreciate more articles on the new 16- and 32-bit microprocessors.
  - I would very much like to see in-depth articles on speech recognition.
  - When will you publish more articles on artificial intelligence?
  - It would be nice if more articles could appear on fantasy games....

## CP/M Vendors?

As the developers of CP/M and MP/M, we at Digital Research are preparing a list of vendors of CP/M-compatible software. We would appreciate the help of BYTE readers in compiling this list for distribution to all interested persons who contact us.

If you are currently marketing CP/M-compatible software, please send us any or all literature pertaining to your software. If you have any questions, please contact Curt Geske, at Digital Research, POB 579, Pacific Grove CA 93950, or (408) 649-3896.

Thank you.

Marilyn Darling  
Digital Research ■

## S-100 USERS: GIVE YOUR COMPUTER THE GIFT OF SIGHT!

The DS-80 Digisector® is a random access video digitizer. It works in conjunction with a TV camera (either interlaced or non-interlaced video) and any S-100 computer conforming to the IEEE standards. Use it for:

- Precision Security Systems
- Moving Target Indicators
- Computer Portraiture
- Fast To Slow Scan Conversion
- Robotics
- Reading UPC Codes, schematics, paper tape, musical scores



● IMAGE PROCESSED BY DS-80 ●

### CHECK THESE FEATURES:

- High resolution** — a 256 x 256 picture element scan
- Precision** — 64 levels of grey scale
- Speed** — Conversion time of 14 microseconds per pixel
- Versatility** — scanning sequences user programmable
- Economy** — a professional tool priced for the hobbyist; comes fully assembled, tested and burned in, with fully commented portrait printing software.

Price: \$349.95 MasterCharge and Visa

THE MICRO  
WORKS

P.O. BOX 1110, DEL MAR, CA 92014 714-942-2400

# A Few Extraordinary Products for Your 6800/6809 Computer

## SS-50 Bus LFD-400™ and LFD-800™ Systems

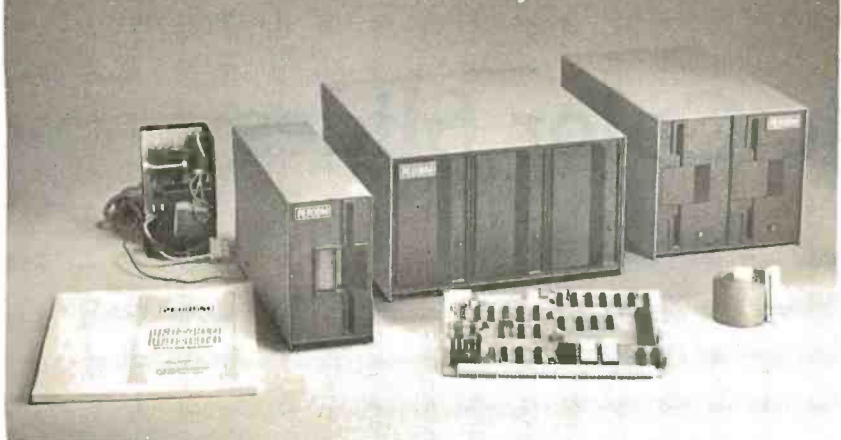

From Percom . . .

Low Cost  
Mini-Disk Storage  
in the Size You Want

Percom mini-disk systems start as low as \$599.95, ready to plug in and run. You can't get better quality or a broader selection of disk software from any other microcomputer disk system manufacturer — at any price!

Features: 1-, 2- and 3-drive systems in 40- and 77-track versions store 102K- to 591K-bytes of random access data on-line • controllers include explicit clock/data separation circuit, motor inactivity time-out cir-

cuit, buffered control lines and other mature design concepts • ROM DOS included with SS-50 bus version — optional DOSs for EXORciser\* bus • extra PROM sockets on-board • EXORciser\* bus version has 1K-byte RAM • supported by extended disk operating systems; assemblers and other program development/debugging aids; BASIC, FORTRAN, Pascal and SPL/M languages; and, business application programs.

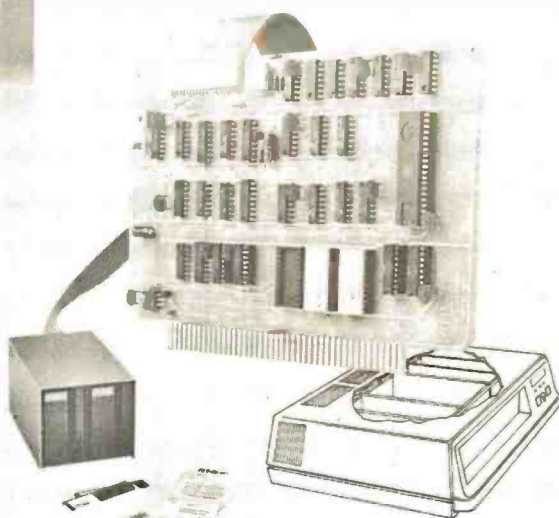

EXORciser\* Bus LFD-400EX™ -800EX™ Systems

## Versatile Mother Board, Full-Feature Prototyping Boards

Printed wiring is easily soldered tin-lead plating. Substrates are glass-epoxy. Prototyping cards provide for power regulators and distributed capacitor bypassing, accommodate 14-, 16-, 24- and 40-pin DIP sockets. Prototyping boards include bus connectors, other connectors and sockets are optional.

**MOTHERBOARD** — accommodates five SS-50 bus cards, and may itself be

plugged into an SS-50 bus. Features wide-trace conductors. Price: \$21.95

**SS-50 BUS CARD** — accommodates 34- and 50-pin ribbon connectors on top edge, 10-pin Molex connector on side edge. Price: \$24.95.

**SS-30 BUS CARD** — 1¼-inch higher than SWTP I/O card, accommodates 34-pin ribbon connector and 12-pin Molex connector on top edge. Price: \$14.95.

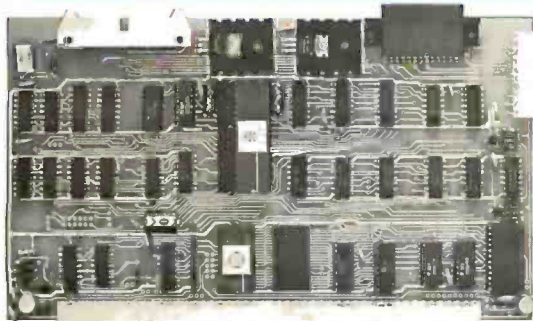

## The SBC/9™. A "10" By Any Measure.

The Percom SBC/9™ is an SS-50 bus compatible, stand-alone Single-Board Computer. Configured for the 6809 microprocessor, the SBC/9™ also accommodates a 6802 without any modification. You can have state-of-the-art capability of the '09. Or put to work the enormous selection of 6800-coded programs that run on the '02.

The SBC/9™ includes PSYMON™, an easily extended 1-Kbyte ROM OS. Other features include:

- Total compatibility with the SS-50 bus. Requires no changes to the motherboard, memory or I/O.
- Serial port includes bit-rate generator. RS-232-C compatible with optional subminiature 'D' connector installed. 10-pin Molex connector provided.
- Eight-bit, non-latched, bidirectional parallel port is multi-address extension of system bus. Spans a 30-address field; accommodates an exceptional variety of peripheral devices. Connector is optional.
- Includes 1-Kbyte of static RAM.
- Costs only \$199.95 with PSYMON™ and comprehensive users manual that includes source listing of PSYMON™.

™ trademark of Percom Data Company, Inc.  
• trademark of the Motorola Corporation.

Prices and specifications subject to change without notice.

## The Electric Window™: Instant, Real-Time Video Display Control

Memory residency and outstanding software control of display format and characters make this SS-50 bus VDC card an exceptional value at only \$249.95. Other features:

- Generates 128 characters including all ASCII displayable characters plus selected Greek letters and other special symbols.
- Well-formed, easy-to-read 7x12-dot characters. True baseline descenders.
- Character-store (display) memory included on card.
- Provision for optional character generator EPROM for user defined symbols.
- Comprehensive users manual includes source listing of Driver software. Driver — called WINDEX™ — is also available on mini-diskette through the Percom Users Group.

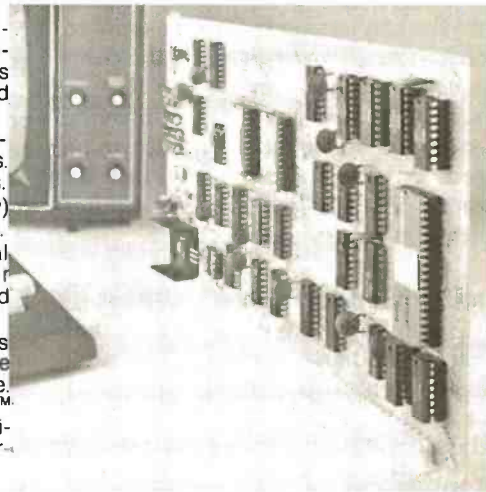

PERCOM DATA COMPANY, INC.  
211 N. KIRBY GARLAND, TEXAS 75042  
(214) 272-3421

Products are available at Percom dealers nationwide. Call toll-free, 1-800-527-1592, for the address of your nearest dealer, or to order direct.

Circle 79 on inquiry card.

# Graphic Color Slides

## Part 1

---

Alan W Grogono  
Associate Professor  
Department of Anesthesiology  
Upstate Medical Center  
State University of New York  
750 E Adams St  
Syracuse NY 13210

---

Color slides of graphs, bar charts, and other visual aids are a valuable addition to various public presentations. When made using conventional methods, the slides are expensive to produce and difficult to modify. But when the slide is produced by photographing a computer-generated color image (as described in my article, "Making Color Slides with an Intecolor Microcomputer," January 1980 BYTE, page 20), the slide can be produced inexpensively and the image can be modified easily. Points, lines, bars, and curves can be drawn to represent numeric data.

Unfortunately, writing the program that creates the screen image can be tedious and time-consuming. Many aspects of the program design, such as the selection of suitable scales and the conversion from user-units to screen-units, can be done by the computer. The subroutines given here in listing 1 have been written to provide a common set of routines that can be used to generate different kinds of graphs on a Compucolor II computer with a minimum of effort.

### Design Considerations

Ergonomic texts (ie: those that analyze human engineering factors) suggest that scales are most convenient for the user if they are subdivided in steps that are powers of ten—1, 10, 100, 0.1, 0.001, etc. Double- and half-size steps (2 and 0.5) are also acceptable for intermediate ranges, although other scale intervals (such as 0.75, 1.5, 3, 4) should be avoided. Based on this, I have written

---

Writing the program that creates the screen image can be tedious and time-consuming.

---

subroutines to select a suitable step size from the series: 0.1, 0.2, 0.5, 1, 2, 5, 10, 20, 50...

The ideal number of steps depends upon the application. On graph paper, where fine measurements may be made, a large number of smaller steps is useful. On a video monitor or in a color slide, however, a smaller number of large steps is preferable because it is less confusing; around four to eight steps seem to be appropriate. The scale should start and end at a multiple of the step size.

A program that satisfies these criteria should be easy to write; some readers might want to stop at this point and write their own. Unfortunately, there are several pitfalls for the unwary. At several stages of the calculation and graph preparation, it is necessary to avoid calculation errors (for example, producing 2.99999 or 3.00001 instead of 3). Similarly, scale zero might be calculated as 1.000E-06, which looks odd if printed on a graph scale.

The first step of the scaling process is to calculate the range of the data, R, and make an initial guess for the value of the step size, JUMP. This value can be obtained from table 1, or it can be calculated from the follow-

ing equation:

$$\text{JUMP} = 4 * 10^{\lfloor \text{INT}(0.434295 * \text{LOG}(R/1.21)) \rfloor}$$

(This is essentially line 10315 of the BASIC program in listing 1; the constant 0.434295 is used to obtain the base-10 logarithm from the Compucolor BASIC LOG function, which returns the natural or base-e logarithm.)

Once the initial value of JUMP has been calculated, it is repeatedly divided by 2 until the resulting value for JUMP is less than or equal to one-fourth the value of the range R; this assures that the graph will have at least four steps in the range. The constant 1.21 is chosen to give the relationship between R and JUMP shown in table 1.

### Implementation Notes

The program has been written, tested, and employed to illustrate this article on a Compucolor II. The BASIC interpreter recognizes two-letter variable names but tolerates longer names (ie: AXIS, AXES and AX are all equivalent). Names were chosen to avoid BASIC reserved words such as INT, OR, ON, STEP. Thus the variable COLOR has been spelled COLOUR, and JUMP has been used in place of STEP. For graphics work this version of the language employs the word PLOT followed by one or more arguments. Table 2 lists the more important plotting codes.

*Text continued on page 138*



# SUPER BRAIN QD™

Once in a great while someone comes along with a simple improvement for an already great product. Take our SuperBrain, for example. Really a simple concept. A high-powered, low cost micro-computer packaged in an attractive desk top cabinet. So how do you improve on that?

## WE DID IT...

It wasn't enough that our SuperBrain had such standard features as twin double density 5¼" drives with over 300,000 bytes of disk storage. A full 32K of dynamic RAM - expandable to 64K in seconds. A CP/M\* Disk Operating System which assures compatibility to literally hundreds of application packages presently available. A crisp, 12" non-glare screen with a full 24 line by 80 column display. A full ASCII keyboard with a separate keypad and individual cursor control keys. Twin RS232C serial ports for fast and easy connection to a modem and/or a printer. And, dual Z80 processors which operate at 4 MHz to insure lightning-fast program execution. No, it wasn't enough. So we made it better.

## ANNOUNCING SUPERBRAIN QD...

Our new QD model has all of the features of our phenomenally popular SuperBrain with the addition of double-sided disk drives and an extra 32K of dynamic RAM. So, for only a modest increase in price, you can order your next SuperBrain with more than twice the disk and memory storage capability. But, best of all, the new QD model has the same tough, rugged construction and exceptional quality that made our SuperBrain such a success.



## HOW DID WE DO IT?

The secret of SuperBrain QD's incredible disk storage lies within our new double-density double-sided disk drives. A total of nearly 720,000 bytes of data are formatted on two specially designed 5¼" drives. And that's more than enough to get you started with most serious small business applications. And SuperBrain QD's standard 64K of dynamic RAM will handle even the most complicated programming tasks.

Of course, if you're into megabytes instead of kilobytes, you may think neither SuperBrain is right for you. Not so! Intertec offers 20-96 megabytes of hard-disk storage which connects in seconds to either the SuperBrain or SuperBrain QD. So, your original investment is always protected. As you grow. No matter how much your needs expand.

## BUT IS IT RELIABLE?

Our best salesmen are our present users. Not only have SuperBrain users been impressed with the inherent reliability of the system, they tell us that no other microcomputer system available today offers such a unique modular design concept. Just about the only tool required to easily

maintain the system is a common screwdriver. And Intertec's total commitment to product service and customer support, with service outlets in most major cities, insures your original investment will be a valuable one for many years to come.

## THE DECISION IS YOURS.

Whether your next SuperBrain is a regular model or our QD version, you will have the satisfaction of knowing you purchased what is becoming one of the world's most popular micro-computer systems. And regardless of which model you choose, you'll probably never outgrow it because you can keep expanding it.

So, call or write us today for more information. Intertec systems are distributed worldwide and may be available in your area now.

Circle 80 on Inquiry card.



2300 Broad River Rd., Columbia, SC 29210  
(803) 798-9100 TWX: 810-666-2115



By Netronics

ASCII/BAUDOT,  
STAND ALONE



# Computer Terminal

COMPLETE FOR ONLY \$149.95

The Netronics ASCII/BAUDOT Computer Terminal Kit is a microprocessor-controlled, stand alone keyboard/terminal requiring no computer memory or software. It allows the use of either a 64 or 32 character by 16 line professional display format with selectable baud rate, RS232-C or 20 ma. output, full cursor control and 75 ohm composite video output.

The keyboard follows the standard typewriter configuration and generates the entire 128 character ASCII upper/lower case set with 96 printable characters. Features include onboard regulators, selectable parity, shift lock key, alpha lock jumper, a drive capability of one TTY load, and the ability to mate directly with almost any computer, including the new Explorer/85 and ELF products by Netronics.

The Computer Terminal requires no I/O mapping and includes 1k of memory, character generator, 2 key rollover, processor controlled cursor control, parallel ASCII/BAUDOT to serial conversion and serial to video processing—fully crystal controlled for superb accuracy. PC boards are the highest quality glass epoxy for the ultimate in reliability and long life.

### VIDEO DISPLAY SPECIFICATIONS

The heart of the Netronics Computer Terminal is the microprocessor-controlled Netronics Video Display Board (VID) which allows the terminal to utilize either a parallel ASCII or BAUDOT signal source. The VID converts the parallel data to serial data which is then formatted to either RS232-C or 20 ma. current loop output, which can be connected to the serial I/O on your computer or other interface, i.e., Modem.

When connected to a computer, the computer must echo the character received. This data is received by the VID which processes the information, converting to data to video suitable to be displayed on a TV set (using an RF modulator) or on a video monitor. The VID generates the cursor, horizontal and vertical sync pulses and performs the housekeeping relative to which character and where it is to be displayed on the screen.

Video Output: 1.5 P/P into 75 ohm (EIA RS-170) • Baud Rate: 110 and 300 ASCII • Outputs: RS232-C or 20 ma. current loop • ASCII Character Set: 128 printable characters—

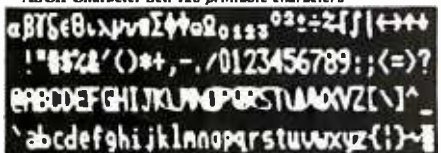

BAUDOT Character Set: A B C D E F G H I J K L M N O P Q R S T U V W X Y Z - ? : ; \$ # ( ) . , ' / 0 1 2 3 4 5 6 7 8 9 : ; = > ?  
Cursor Modes: Home, Backspace, Horizontal Tab, Line Feed, Vertical Tab, Carriage Return. Two special cursor sequences are provided for absolute and relative X-Y cursor addressing • Cursor Control: Erase, End of Line, Erase of Screen, Form Feed, Delete • Monitor Operation: 50 or 60Hz (jumper selectable).

Continental U.S.A. Credit Card Buyers Outside Connecticut

**CALL TOLL FREE 800-243-7428**

To Order From Connecticut Or For Technical Assistance, Etc. Call (203) 354-9375

Netronics R&D Ltd., Dept. B11  
333 Litchfield Road, New Milford, CT 06776

Please send the items checked below—

- Netronics Stand Alone ASCII Keyboard/Computer Terminal Kit, \$149.95 plus \$3.00 postage & handling.
- Deluxe Steel Cabinet for Netronics Keyboard/Terminal In Blue/Black Finish, \$19.95 plus \$2.50 postage and handling.
- Video Display Board Kit alone (less keyboard), \$89.95 plus \$3 postage & handling.
- 12" Video Monitor (10 MHz bandwidth) fully assembled and tested, \$139.95 plus \$5 postage and handling.
- RF Modulator Kit (to use your TV set for a monitor), \$8.95 postpaid.
- 5 amp Power Supply Kit In Deluxe Steel Cabinet (±8VDC @ 5 amps, plus 6-8 VAC), \$39.95 plus \$2 postage & handling.

Total Enclosed (Conn. res. add sales tax) \$ \_\_\_\_\_

By—

- Personal Check     Cashiers Check/Money Order
- Visa                     Master Charge (Bank # \_\_\_\_\_)

Acct. # \_\_\_\_\_

Signature \_\_\_\_\_ Exp. Date \_\_\_\_\_

Print Name \_\_\_\_\_

Address \_\_\_\_\_

City \_\_\_\_\_

State \_\_\_\_\_ Zip \_\_\_\_\_

Send Me More Information

Listing 1: Collection of plotting subroutines and driver program for the Compucolor II. See text and listing remarks for further description of the subroutines.

```

5 REM KY 5 REM      GRAPHS. (C) A.W.GROGONO.  AUG. 1979
6 REM      SUBROUTINES V1
40 RESTORE :CLEAR 200:DIM I$(12)
50 DATA 1,2,6,4:FOR I= 1TO 4:READ COLOUR(I):NEXT I
60 REM WRITE:  60 DIM(ARRAY(25,1)) TO USE EQUATION SUB
90 PLOT 29,27,24,15,14,2,255,6,1,12,3,16,3:REM CLEAR PAGE
100 REM
101 REM
110 REM  SUBROUTINES  7000 ERASE/REVIEW IMAGES
120 REM                9000 COMPLETE GRAPH OUTLINE
130 REM                10000 DATA ENTRY
140 REM                10100 EQUATION PLOTTING
150 REM                10200 FIND LITTLE AND BIG
160 REM                10300 CALCULATE DATA FOR BORDERS
170 REM                10500 DRAW BORDERS
180 REM                10700 CONVERT USER UNITS TO GRAPH
190 REM                10800 GRAPH UNITS TO TEXT POSITION
200 REM                11000 PLOT POINTS
210 REM                11100 PLOT VECTORS
220 REM                11200 PLOT Y-BARS
230 REM                11300 PLOT X-BARS
235 REM                11500 SAVE ON DISK
240 REM                11800 SELECT COLORS
250 REM                11900 PAUSE
260 REM
270 END

490 REM WRITE EQUATION AT 500, EG: 500 Y= X^2 - 3* X
510 RETURN
6900 REM
6901 REM
6902 REM  ERASE/REVIEW IMAGES
6903 REM
7000 PLOT 2,255,27,24,6,11,14,12,3,11,7:REM IMAGE ERASE/REVIEW
7005 FOR I= 1TO 12:I$(I)= CHR$(48+ I- 7*( <I> 9)):NEXT I
7010 PRINT "E R A S E / R E V I E W  I M A G E S":PRINT
7020 PRINT ,, "1.  REVIEW IMAGES. ":PRINT
7030 PRINT ,, :INPUT "2.  ERASE IMAGES.  ENTER NUMBER: "; I
7040 IF I= 2THEN 7100
7050 I$= "REVIEWED":GOSUB 7200
7060 FOR I= LOWTO HIGH:PLOT 3,64,29,27,4:REM LOSE CURSOR
7070 PRINT "LOAD SCREEN.DIS; "+ I$(I):PLOT 27,27:REM IMAGE
7080 INPUT " "; I$:NEXT I:RETURN
7100 I$= "ERASED":GOSUB 7200
7110 PLOT 27,4:FOR I= HIGHTO LOWSTEP - 1
7120 PRINT "DEL SCREEN.DIS; "+ I$(I):NEXT I
7130 PLOT 27,27:PRINT "IGNORE FCS ERROR - EFN";
7140 PRINT " DURING RENAMING":PLOT 17,10,27,4
7150 J= HIGH- LOW+ 1:FOR I= LOWTO 12- J:REM CLOSE GAP
7160 PRINT "REN SCREEN.DIS; "+ I$(I+ J)+ " TO SCREEN.DIS; "+ I$(I)
7180 NEXT I:PLOT 27,27:RETURN
7200 PLOT 6,5* I- 4,12,27,4:PRINT "DIR":REM DIRECTORY
7210 PLOT 27,27:PRINT , "IMAGES ARE LISTED  SCREEN.DIS; N  ";
7220 PRINT "WHERE N IS THE NUMBER. ":PRINT
7230 PRINT , "ENTER #S OF FIRST AND LAST IMAGES TO BE "; I$; " : "
7235 PRINT :PRINT ,, "FOR A ENTER 10, FOR B ENTER 11 ETC. "
7240 PRINT :PRINT ,, :INPUT "FIRST "; LOW:REM
7250 PRINT :PRINT ,, :INPUT " LAST "; HIGH:REM
7260 PRINT :PRINT ,, :INPUT "PUSH RETURN TO ADVANCE"; I$:RETURN

```

Listing 1 continued on page 130

# Major Impact.



## Meet IMP 2, the stylish impact printer with three way paper handling.

Designed for desk top use, this sleek unit combines an ultra-low profile with a unique fan-cooled printing system that can knock out 80, 96, or 132 columns of crisp hardcopy with continuous throughput of one line per second.

**Three way paper handling.** IMP 2 features three way paper handling for forms, single sheets and paper rolls, with tractors adjustable from 1.5 inch to 9½ inches. Software control of forms length, printer select/deselect together with a choice of three standard interfaces make IMP 2 the most versatile printer available in its price range.

**Interfaces abound.** IMP 2 provides parallel, RS232C and 20mA current loop as standard equipment. But if you need something special, we can supply interfaces

for just about any system — high speed serial, Apple, Pet, TRS-80, IEEE 488... you name it.

**Versatile character sets.** 96 ASCII character set is standard. And you can select six character sizes, even graphics, under software control. Options include full page buffering and special character sets.

**Service — a big difference.** No other printer manufacturer offers Axiom's combination of low cost plus nation-wide service and distribution — in the USA and 18 overseas countries.

**Pssst — the price!!!** With all this performance, the price is low. Just \$795 for IMP 2 (\$695 for IMP 1, without tractor feed). And that's the single unit price.

Better phone, write or mail the bingo card today!

# AXIOM

AXIOM CORPORATION

5932 San Fernando Road, Glendale, CA 91202  
Tel: (213) 245-9244 • TWX: 910-497-2283

The days of complicated, unreliable, dynamic RAM are gone:

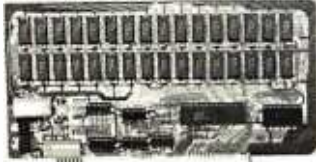

# INTRODUCING JAWS

the ultrabyte memory board

**\$199.95** (complete kit with 16K memory)

Netronics consistently offers innovative products at unbeatable prices. And here we go again — with JAWS, the ultrabyte 64K S100 memory board.

### ONE CHIP DOES IT ALL

JAWS solves the problems of dynamic RAM with a state-of-the-art chip from Intel that does it all. Intel's single chip 64K dynamic RAM controller eliminates high-current logic parts . . . delay lines . . . massive heat sinks . . . unreliable trick circuits.

### REMARKABLE FEATURES OF JAWS

Look what JAWS offers you: Hidden refresh . . . fast performance . . . low power consumption . . . latched data outputs . . . 200 NS 4116 RAMs . . . on-board crystal . . . 8K bank selectable . . . fully socketed . . . solder mask on both sides of board . . . designed for 8080, 8085, and Z80 bus signals . . . works in Explorer, Sol, Horizon, as well as all other well-designed S100 computers.

**GIVE YOUR COMPUTER A BIG BYTE OF MEMORY POWER WITH JAWS — SAVE UP TO \$90 ON INTRODUCTORY LIMITED-OFFER SPECIAL PRICES!**

UNDECIDED? TRY A WARED 16K JAWS IN YOUR COMPUTER ON OUR 10-DAY MONEY-BACK OFFER (SPECIFY YOUR COMPUTER).

CONTINENTAL U.S.A. CREDIT CARD BUYERS: OUTSIDE CONNECTICUT CALL

**CALL TOLL FREE 800-243-7428**

From Connecticut Or For Registration, (203) 354-9375 Dept. B11

**NETRONICS RESEARCH & DEVELOPMENT LTD.**  
333 Litchfield Road, New Milford, CT 06776

Please send the items checked below:

- JAWS 16K RAM kit, No. 6416, \$199.95.\*
- JAWS 16K RAM fully assembled, tested, burned in, No. 6416W, \$229.95.\*
- JAWS 32K RAM kit, No. 6432, (reg. price \$329.95), SPECIAL PRICE \$299.95.\*
- JAWS 32K RAM fully assembled, tested, burned in, No. 6432W, (reg. price \$369.95), SPECIAL PRICE \$339.95.\*
- JAWS 48K RAM kit, No. 6448, (reg. price \$459.95), SPECIAL PRICE \$399.95.\*
- JAWS 48K fully assembled, tested, burned in, No. 6448W, (reg. price \$509.95), SPECIAL PRICE \$449.95.\*
- JAWS 64K RAM kit, No. 6464, (reg. price \$589.95), SPECIAL PRICE \$499.95.\*
- JAWS 64K RAM fully assembled, tested, burned in, No. 6464W, (reg. price \$649.95), SPECIAL PRICE \$559.95.\*
- Expansion kit, JAWS 16K RAM module, to expand any of the above in 16K blocks up to 64K, No. 16EXP, \$129.95.\*

\*All prices plus \$2 postage and handling. Connecticut residents add sales tax.

Total enclosed: \$

- Personal Check  Money order or Cashiers Check
- VISA  MASTER CHARGE (Bank No. ....)

Acct. No. \_\_\_\_\_ Exp. Date \_\_\_\_\_

Signature \_\_\_\_\_

Print Name \_\_\_\_\_

Address \_\_\_\_\_

City \_\_\_\_\_

State \_\_\_\_\_ Zip \_\_\_\_\_

Send me more information

Listing 1 continued:

```

8988 REM
8989 REM
8990 REM   PREPARE COMPLETE GRAPH OUTLINE
8991 REM
8992 REM           CALCULATES LIMITS, SCALE VALUES AND
8993 REM           DRAWS OUTLINE WITH TIC MARKS, SCALES,
8994 REM           TITLE AND AXES LABELS
8995 REM
9000 REM   GRAPH OUTLINE
9010 GOSUB 10200:REM DATA RANGE
9020 GOSUB 10300:REM AUTOSCALE
9030 GOSUB 10500:RETURN :REM FRAME
9980 REM
9981 REM
9982 REM   ENTER:
9983 REM
9984 REM           TITLE$
9985 REM           NUMBER OF DATA POINTS
9986 REM           LABEL$(0) FOR X-AXIS
9987 REM           LABEL$(1) FOR Y-AXIS
9988 REM           ARRAY(NUMBER,2) OF DATA POINTS
9989 REM
9990 REM   NOTE: IF CHOICE = 1 THEN ONLY 1 AXIS IS ENTERED
9991 REM
10000 PLOT 6, 1, 12, 14, 3, 18, 13:REM DATA ENTRY
10010 PRINT "D A T A   E N T R Y"
10015 PLOT 10, 9, 9:INPUT "GRAPH TITLE: "; TITLE$
10020 PLOT 10, 9, 9:INPUT "NUMBER OF DATA POINTS: "; NUMBER
10021 DIM ARRAY(NUMBER+ 2, 2)
10024 PLOT 10, 9, 9:INPUT "X-AXIS UNITS, INDEPENDANT: "; LABEL$(0)
10025 IF CHOICE= 1 THEN LABEL$(1)= "NUMBER":GOTO 10030
10026 PLOT 10, 9, 9:INPUT "Y-AXIS UNITS, DEPENDANT: "; LABEL$(1)
10028 LABEL$(2)= LABEL$(1)
10030 FOR ITEM= 1 TO NUMBER:REM ENTER POINTS
10040 IF ITEM- 1 < > 10* INT ((ITEM- 1)/ 10) THEN 10060:REM PAGE
10050 PLOT 12, 10, 10:PRINT "POINT", , LABEL$(0):REM
10055 IF CHOICE < > 1 THEN PLOT 28:PRINT , , , "" ; LABEL$(1)
10060 IF ITEM- 1 = 5* INT ((ITEM- 1)/ 5) THEN PLOT 10:REM SPACE
10070 PRINT :PRINT "" ; ITEM, , :INPUT "" ; ARRAY(ITEM, 0):REM
10075 IF CHOICE= 1 THEN NEXT ITEM:RETURN
10080 PLOT 28, 18, 9, 9, 9, 9:INPUT "" ; ARRAY(ITEM, 1)
10085 ARRAY(ITEM, 2)= ARRAY(ITEM, 1):NEXT ITEM:RETURN
10090 REM
10091 REM
10092 REM   WRITE EQUATION
10093 REM
10094 REM           TESTS IS THE EQUATION WRITTEN
10095 REM           INPUT LITTLE(0)
10096 REM           INPUT BIG(0)
10097 REM           CALCULATES ARRAY(25,2) FROM EQUATION
10098 REM
10100 PLOT 6, 5, 14, 12, 3, 12, 7:REM EQUATION PLOTTING
10110 PRINT "E Q U A T I O N   P L O T T I N G":PRINT :REM
10120 NUMBER= 25:X= 1:Y= .9999:GOSUB 490
10130 IF Y < > .9999 THEN 10140:REM JUMP IF EQUATION AT LINE 500
10132 PLOT 3, 16, 11:PRINT "TYPE EQUATION AT LINE 500":PRINT
10133 PRINT , , "USING THE RULES OF BASIC.":PRINT :PRINT
10134 PRINT , , "EXAMPLE: 500 Y=X^2-3*X":PRINT :REM
10135 PRINT , , "NOW TYPE 500 .....":PRINT
10136 PRINT , , "THEN TYPE RUN AND PRESS RETURN":END

```

Listing 1 continued on page 132



# EVERYONE WINS

*Selecting software for your Ohio Scientific computer is a chancy task at best. There are few trustworthy vendors with a national reputation. There are no consistent quality standards and the documentation is often cryptic and inaccurate. If you are lucky enough to find a good package, there's no guarantee of ongoing support. A wrong choice results in months of wasted time, effort, and money.*

*With the Software Federation, you no longer take that risk. The Software Federation was formed by three of the largest Ohio Scientific hardware dis-*

*tributors to select and market quality software through reputable dealers nationwide.*

## DEALERS

*The Software Federation solves the dealer's problems by providing low cost access to high quality software with the sort of demonstration packages, documentation, and support that the dealer needs to successfully sell machines.*

## AUTHORS

*The Software Federation solves the independent vendor's problems by providing a proprietary method of software protection, aggressive enforcement of software licenses, a strong dealer base, primary support, and national advertising.*

## END USERS

*The Software Federation solves the user's problems by providing quality software, exceptional documentation, after-the-sale support, and optional software maintenance services.*

*Why risk making the wrong choice? With the Software Federation, everyone wins!*

*See the dealer in your area for a complete turnkey demonstration.*

## Software Packages

BUS-1 Original of popular series, sold "as is" \$99  
BUS-1I Unlicensed version of BUS-1 \$150  
BUS/DMS Most current version of BUS series, completely reworked, DMS compatible \$850  
fig-FORTH A complete Forth Interest Group version for OSI. Not a kludge \$175  
MEMTEST/2 New edition of popular memory test \$50  
WP-INT Interface between WP-2 and OSI-DMS for form letters \$80  
**Amway Distributors Package \$995**  
DATA DIRECTOR Complete rewrite of OSI-DMS Nucleus by BBS, command oriented, very interactive \$995  
System Exerciser Self-prompting test routines for end user troubleshooting \$60  
Med-Bill/Farragher Single doctor client billing \$995  
Manufacturing Control System Hard disk based. Standalone inventory with job costing and bill-of-materials \$3500  
Fast Floppy Dumper Floppy disk backup for hard disk systems \$125  
WP6502 65U word processor from DQFLS \$125  
USUS Software Exchange Library 6 disk set of UCSD Pascal programs, includes USUS membership \$80  
Mailer Text processor, keyed files & sort capability, good mass mailer, DMS compatible \$190  
Payroll Very thorough package for floppy or hard disk, DMS compatible \$495  
General Ledger Multi-division/department support, journal based, floppy or hard disk, DMS compatible \$495

## Affiliated Dealers

TriComp Inc. Denver, CO 80221  
Total Data Systems Ft. Collins, CO 80525  
Data Services Computer Corp. Denver, CO 80239  
Tra-Sta Computer Shoppe Pueblo, CO 81005  
Business Data Systems, Inc. Boulder, CO 80301  
Tek-Aids Industries Inc. Arlington Hts., IL 60004  
KMH Galesburg, IL 61401  
Practical Computer Springfield, IL 62703  
Databus Grayslake, IL 60038  
MAP Systems Peoria Hts., IL 61614  
Business Computer of Joliet Cresthill, IL 60435  
Cybertronics Houston, TX 77084  
CSB Houston, TX 77057  
Computer Management Systems Mitchell, SD 57301  
Frisch Computer St. Paul, MN 55113  
Farragher & Assoc. Milwaukee, WI 53213  
Specialized Computer Systems Jackson, MI 49204  
Community Computers Arlington, VA 22201  
Delta Data Distributors Memphis, TN 38118  
International Automation New Kensington, PA J5608  
Whitlock International, Inc. Detroit, MI 48219

## Software Federation INC.

44 University Drive  
Arlington Hts., IL 60004  
Phone: 312/259-1355



TM

# OUR PRICES ARE TOO LOW TO ADVERTISE!

CHECK THEM—CALL TOLL FREE!  
**800-243-7428**  
LOOK WHAT WE OFFER!

- **HAZELTINE**  
Terminals
- **CENTRONICS**  
Printers
- **LEAR-SIEGLER**  
Terminals/Printers
- **DATA PRODUCTS**  
Printers
- **ANADEX**  
Printers

## BE SMART- DON'T BUY UNTIL YOU CHECK OUR PRICES!

- MASTERCHARGE
- VISA — COD
- PERSONAL CHECK
- MONEY ORDER

### **NETRONICS**

RESEARCH & DEVELOPMENT, LTD.  
333 Litchfield Rd., New Milford, CT 06776

Listing 1 continued:

```

10140 IF TITLE$< > "" THEN 10145
10142 PRINT :PRINT ,, "ENTER TITLE (E.G. EQUATION): "
10143 PRINT :PRINT ,, :INPUT "":TITLE$
10145 PRINT :PRINT ,, :INPUT "ENTER LOWEST X VALUE: ";LITTLE(0)
10150 PRINT :PRINT ,, :INPUT "      HIGHEST X VALUE: ";BIG(0)
10160 X= LITTLE(0):FOR ITEM= 1TO 25:GOSUB 490:REM Y FROM EQUAN
10170 ARRAY(ITEM,0)= X:ARRAY(ITEM,1)= Y
10180 X= X+ (BIG(0)- LITTLE(0))/ 24:NEXT ITEM:RETURN :REM INC X
10190 REM
10191 REM
10192 REM      FIND LITTLE(AXIS) AND BIG(AXIS)
10193 REM      FROM ARRAY(NUMBER,1) IN BOTH AXES
10194 REM
10200 FOR AXIS= 0TO 1:GOSUB 10210:NEXT AXIS:RETURN :REM LO, HI
10210 LITTLE(AXIS)= ARRAY(1,AXIS):BIG(AXIS)= ARRAY(1,AXIS)
10215 FOR ITEM= 1TO NUMBER
10220 IF ARRAY(ITEM,AXIS)> LITTLE(AXIS) THEN 10230
10225 LITTLE(AXIS)= ARRAY(ITEM,AXIS)
10230 IF ARRAY(ITEM,AXIS)< BIG(AXIS) THEN 10240
10235 BIG(AXIS)= ARRAY(ITEM,AXIS)
10240 NEXT ITEM:RETURN
10288 REM
10289 REM
10290 REM      CALCULATE FRAME FROM LITTLE(AXIS) AND BIG(AXIS)
10291 REM
10292 REM              JUMP(AXIS)   IS STEP LENGTH
10293 REM              LOW(AXIS)    IS SCALE LOW
10294 REM              HIGH(AXIS)   IS SCALE HIGH
10295 REM              SCALE(AXIS)  IS SCALE LENGTH
10296 REM              GAPS(AXIS)   IS NUMBER OF STEPS
10297 REM
10300 FOR AXIS= 0TO 1:GOSUB 10310:NEXT AXIS:RETURN :REM SCALE
10310 RANGE= (BIG(AXIS)- LITTLE(AXIS))/ 1.21
10315 JUMP(AXIS)= 4* 10^ (INT (.434295* LOG (RANGE)))
10320 DEF FN I(I)= JUMP(AXIS)* INT (I/ JUMP(AXIS)+ .0001)
10325 FOR I= 1TO 3:JUMP(AXIS)= JUMP(AXIS)/ 2
10330 HIGH(AXIS)= - FN I(- BIG(AXIS))
10340 LOW(AXIS)= FN I(LITTLE(AXIS))
10350 SCALE(AXIS)= HIGH(AXIS)- LOW(AXIS)
10360 GAPS(AXIS)= INT (1.0001* SCALE(AXIS)/ JUMP(AXIS))
10370 IF GAPS(AXIS)< 4 THEN NEXT I
10380 EVEN= 2* JUMP(AXIS)* INT (- SCALE(AXIS)/ JUMP(AXIS)/ 2.1)
10390 HIGH(AXIS)= LOW(AXIS)- EVEN
10395 SCALE(AXIS)= HIGH(AXIS)- LOW(AXIS):RETURN
10480 REM
10481 REM
10482 REM      DRAW BORDERS WITH SCALES AND TITLES
10483 REM
10484 REM              USER MAY ALTER
10485 REM              MINSCREEN(AXIS) AND MAXSCREEN(AXIS) BUT
10486 REM              SELECT VALUES TO MAKE
10487 REM              RANGE A MULTIPLE OF 24.  ALSO:
10489 REM
10490 REM              IN 0 AXIS VALUES MUST BE MULTIPLES OF 2
10491 REM              IN 1 AXIS VALUES MUST BE MULTIPLES OF 4
10492 REM
10493 REM              RATIO(AXIS) IS CALCULATED FROM
10494 REM              RANGE AND SCALE(AXIS)
10495 REM

```

Listing 1 continued on page 134

# The best news since CP/M... customizable full screen editing

North Star	Sorcerer
Heath H8/H89	TRS-80 Model I
Super Brain	TRS-80 Model II
Most other CP/M Systems with CRT or Memory Mapped Displays.	

## Changes You Make On the Screen Become The Changes to the File.

Full screen editing is the fastest and easiest method of editing all types of text files. Straight forward enough for novices, yet also the choice of professionals. VEDIT is a proven full screen editor with unequalled features. You will appreciate that you can easily edit 10 times faster than with a command editor. Since VEDIT is customizable, it adapts to your applications and preferences, instead of requiring you to adapt to it.

VEDIT is ideally suited to program development and it's special features make it the most valuable development tool a programmer can have. VEDIT appeals to word processing users too. Many simple text editing tasks, such as mailing lists, are faster and easier to do with VEDIT than with more complex word processors.

### Features of VEDIT:

Full screen editor with status line and cursor. The screen continuously displays the region of the file being edited. Changes are made by first moving the cursor to the text you wish to change. You can then overtype, insert any amount of new text or hit a function key. These changes are immediately reflected on the screen and become the changes to the file.

Full array of cursor movements with single key movement to begin and end of lines and to tab positions.

Function keys for character delete, line delete and allowing line splitting and concatenating. Text movement is very easy using a text register.

Flexible command mode allows global search and substitute, repetitive editing operations.

File handling allows files to be merged on input, split on output, drive selection and more. Blocks of text are readily copied from one file to another.

Disk buffering can automatically perform Read/Write for files larger than available main memory.

Tabs settable to any positions. Tab key inserts tab character or spaces to next tab position.

Extensive 60 page, clearly written manual with sections for both the beginning and experienced user.

### You Customize the Fastest Editor for Word Processing, C-Basic, Fortran and Assembler:

Keyboard layout for all cursor and function keys.

Your screen size. (Up to 70 lines, 200 columns).

Default Tab positions and various parameters.

Scrolling methods.

Cursor type, blinking, reverse video.

Its ideal for diverse hardware, keyboards and applications.

For OEMs too.

**Ordering:** Specify your CRT terminal type, video board or microcomputer, the 8080/Z80 or Z80 code version, and disk format required.

**Standard Package:** Disk and manual . . . . . \$110

**Manual:** Price refunded with software purchase \$ 15

**PHCEON V-100:** 24 X 80 Video display board . . . \$445

**VISA and MASTER CHARGE Welcome.  
Attractive Dealer Terms.**

See us at Northeast Computer Show Booth 418

# Compuview Products, Inc.

618 Louise / Ann Arbor, Michigan 48103

Call Anytime - (313) 996-1299

Now-Break Through The 64K  
Micro-Memory Limit!

# SWEET SIXTEEN

Bank Selectable 16K Static RAM

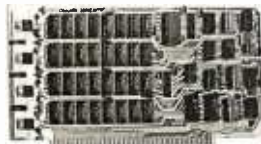

**SAVE \$50.00**  
**LIMITED TIME OFFER**

Don't buy any more antique RAMs (RAM without bank select) — now there's Netronic's new SWEET SIXTEEN board featuring a universal software bank select system. SWEET SIXTEEN is capable of addressing 2,048 different banks. With SWEET SIXTEEN boards you can add memory beyond the 64K limit, or expand to a multi-terminal system.

### LOOK AT THESE FEATURES:

- 300 NS, low power 2114's.
- Software Bank Selector — Universal decoder works with Cromenco, Alpha Micro, Netronics, most other systems, or your design. Onboard dip switches: Bank Select Enable; Reset Enable; Reset Disable; Port Address; Port Data.
- All Inputs And Outputs meet the proposed IEEE standards for the S-100 bus.
- 4.0 MHz Operation.
- Schmitt Trigger Buffer on all signals for maximum noise immunity.
- Addressable On 16k Boundaries, 0-64k, dip switch selectable.
- Phantom Option, dip switch selectable.
- PWR/MWRITE Option, dip switch selectable.
- LED Indicator to display status.
- Glass Epoxy PC Board with gold-plated contacts and double-sided solder mask.
- Fully Socketed.
- Four Separate Regulators for maximum stability.

**10-Day Money-Back Policy For Wired & Tested Unit:** Try a fully wired board — then either keep it, return it for kit, or simply return it in working condition.

Continental U.S.A. Credit Card Buyers  
Outside Connecticut:

**CALL TOLL FREE:**

**800-243-7428**

From Connecticut Or For Assistance:  
(203) 354-9375

Please send the items checked below:

- SWEET SIXTEEN kit: No. S-16 ... (reg. price \$249.95) now \$199.95\*
- SWEET SIXTEEN, fully assembled, tested, burned in: No. S-16W ... (reg. price \$289.95) now \$239.95\*

\*Plus \$2 postage & insurance. Connecticut residents add sales tax.

Total Enclosed: \$ \_\_\_\_\_

- Personal Check     Money Order/Cashier's Check
- VISA     Master Charge (Bank No. \_\_\_\_\_)
- Acct. No. \_\_\_\_\_ Exp. Date \_\_\_\_\_

Signature \_\_\_\_\_

Print Name \_\_\_\_\_

Address \_\_\_\_\_

City \_\_\_\_\_

State \_\_\_\_\_ Zip \_\_\_\_\_

**NETRONICS**

RESEARCH & DEVELOPMENT, LTD.  
333 Litchfield Rd., New Milford, CT 06776

Listing 1 continued:

```

10496 REM PLACE IS CALCULATED FOR
10497 REM TIC MARKS AND SCALE NUMBERS
10498 REM
10500 PLOT 2, 255, 27, 24, 29, 15, 6, COLOUR(1), 12:REM DRAW FRAME
10505 MINSCREEN(0)= 18:MAXSCREEN(0)= 114
10510 MINSCREEN(1)= 16:MAXSCREEN(1)= 112
10515 FOR AXIS= 0 TO 1:RANGE= MAXSCREEN(AXIS)- MINSCREEN(AXIS)
10520 RATIO(AXIS)= RANGE/ SCALE(AXIS):NEXT AXIS
10522 PLOT 3, (MAXSCREEN(0)+ MINSCREEN(0))/ 4- LEN (TITLE$)/ 2
10523 PLOT 29- MAXSCREEN(1)/ 4:PRINT TITLE$
10525 FOR AXIS= 0 TO 1
10530 PLOT 6, COLOUR(1), 2, 250- 4* AXIS, MINSCREEN(AXIS)- 1
10540 PLOT MINSCREEN(1- AXIS)- 1
10545 PLOT MAXSCREEN(AXIS)+ 2- 2* (AXIS= 1)
10550 PLOT MAXSCREEN(1- AXIS)+ 2- 2* (AXIS= 0)
10555 PLOT MAXSCREEN(AXIS)+ 2- 2* (AXIS= 1), 255
10560 J= JUMP(AXIS)/ 2
10565 FOR PLACE= LOW(AXIS) TO HIGH(AXIS)+ JSTEP JUMP(AXIS)
10570 GOSUB 10700:REM TIC MARKS
10580 GRAPH(1- AXIS)= MINSCREEN(1- AXIS)- 2:REM OUTSIDE FRAME
10590 PLOT 6, COLOUR(1):GOSUB 11010
10600 PLOT 6, COLOUR(2):REM NUMBERS
10620 IF ABS (PLACE)< JUMP(AXIS)/ 2 THEN PLACE= 0:REM NO EXPON
10630 GRAPH(1- AXIS)= MINSCREEN(1- AXIS)- 8+ 4* AXIS
10640 GOSUB 10800:PLACE$= STR$ (PLACE)
10650 PLOT 3, TEXT(0)- LEN (PLACE$)/ (2- AXIS), TEXT(1)
10660 PRINT PLACE$:NEXT PLACE:NEXT AXIS
10662 PLOT 3, MAXSCREEN(0)/ 2- 4- LEN (LABEL$(0))
10664 PLOT 34- MINSCREEN(1)/ 4:PRINT LABEL$(0)
10666 PLOT 3, MINSCREEN(0)/ 2- 6, 29- MAXSCREEN(1)/ 4
10670 PRINT LABEL$(1):RETURN
10688 REM
10689 REM
10690 REM CALCULATE SCREEN GRAPH POSITION
10691 REM
10692 REM CONVERTS PLACE IN USER UNITS
10693 REM TO GRAPH(AXIS) FROM
10694 REM RATIO(AXIS), LOW(AXIS), MINSCREEN(AXIS)
10695 REM
10700 J= RATIO(AXIS)* (PLACE- LOW(AXIS)):REM CONVERT USER UNITS
10710 GRAPH(AXIS)= MINSCREEN(AXIS)+ J+ .0001:RETURN
10790 REM
10791 REM
10792 REM CALCULATE SCREEN TEXT POSITION
10793 REM
10794 REM CONVERTS GRAPH(AXIS) PLOTTING UNITS
10795 REM TO TEXT(AXIS) FOR CURSOR POSITION
10796 REM
10800 TEXT(0)= GRAPH(0)/ 2:REM GRAPH UNITS TO CURSOR POS
10810 TEXT(1)= INT (31.75- GRAPH(1)/ 4):RETURN
10988 REM
10989 REM
10990 REM PLOT POINTS OR LINES
10991 REM
10992 REM ARRAY(NUMBER, 1) IS PLOTTED EITHER
10993 REM AS POINTS OR AS CONTINUOUS LINE
10994 REM
11000 FLAG= 1:GOSUB 11150:RETURN :REM POINTS
11010 PLOT 2, GRAPH(0), GRAPH(1), 255:RETURN :REM POINT

```

Listing 1 continued on page 138



# The Perfect Fit

The Micromodem II data communications system and the Apple II\* computer. What better combination to maximize the capabilities of your personal computer!

This popular direct connect modem can transmit data between an Apple II and another Apple II, a terminal, another microcomputer, minicomputer or even a large time-sharing computer anywhere in North America. The Micromodem II has unique automatic dialing and answer capabilities which further increases the communications possibilities between the Apple II and another computer or terminal.

You can send and/or receive messages or data when you are out of your office, home or out of town. Your branch business locations can communicate with each other regarding inventory and other matters over the phone. Or you can communicate with friends across the country. And you can access information utilities like the SOURCE for various business and personal applications.

The Micromodem II consists of two parts. One part includes the printed circuit board which holds the Micromodem II, ROM firmware and the serial interface. The board plugs directly into the Apple II providing all the functions of a serial interface card plus programmable auto dialing and auto answer capabilities. The on-board ROM firmware enables the Micromodem II to operate in any of three modes to perform different tasks-terminal mode, remote console and program control mode.

The other part of the Micromodem II datacomm system is a Microcoupler which connects the Micromodem board and Apple II to a telephone line. The Microcoupler gets a dial tone, dials numbers, answers the phone and hangs up when a transmission is over. There are none of the losses or distortions associated with acoustic couplers. The Microcoupler is compatible with any North American standard telephone lines and is FCC-approved for direct connection in the U.S. It works with standard dial phone service or Touch-tone service.

The Micromodem II is completely compatible with Bell 103-type modems. Full and half-duplex operating modes are available as well as speed selectable transmission rates of 110 and 300 bps.

Why not increase your Apple II's capabilities by outfitting it with the sophisticated Micromodem II data communications system? The Micromodem II is available at retail computer stores nationwide. For the store nearest you, call or write:



**Hayes Microcomputer Products Inc.**

5835 Peachtree Corners East, Norcross, Georgia 30092 (404) 449-8791

™ Micromodem II is a trademark of Hayes Microcomputer Products, Inc.

\* Apple II is a registered trademark of Apple Computer Inc.

The Micromodem II can also be used with the Bell & Howell computer.



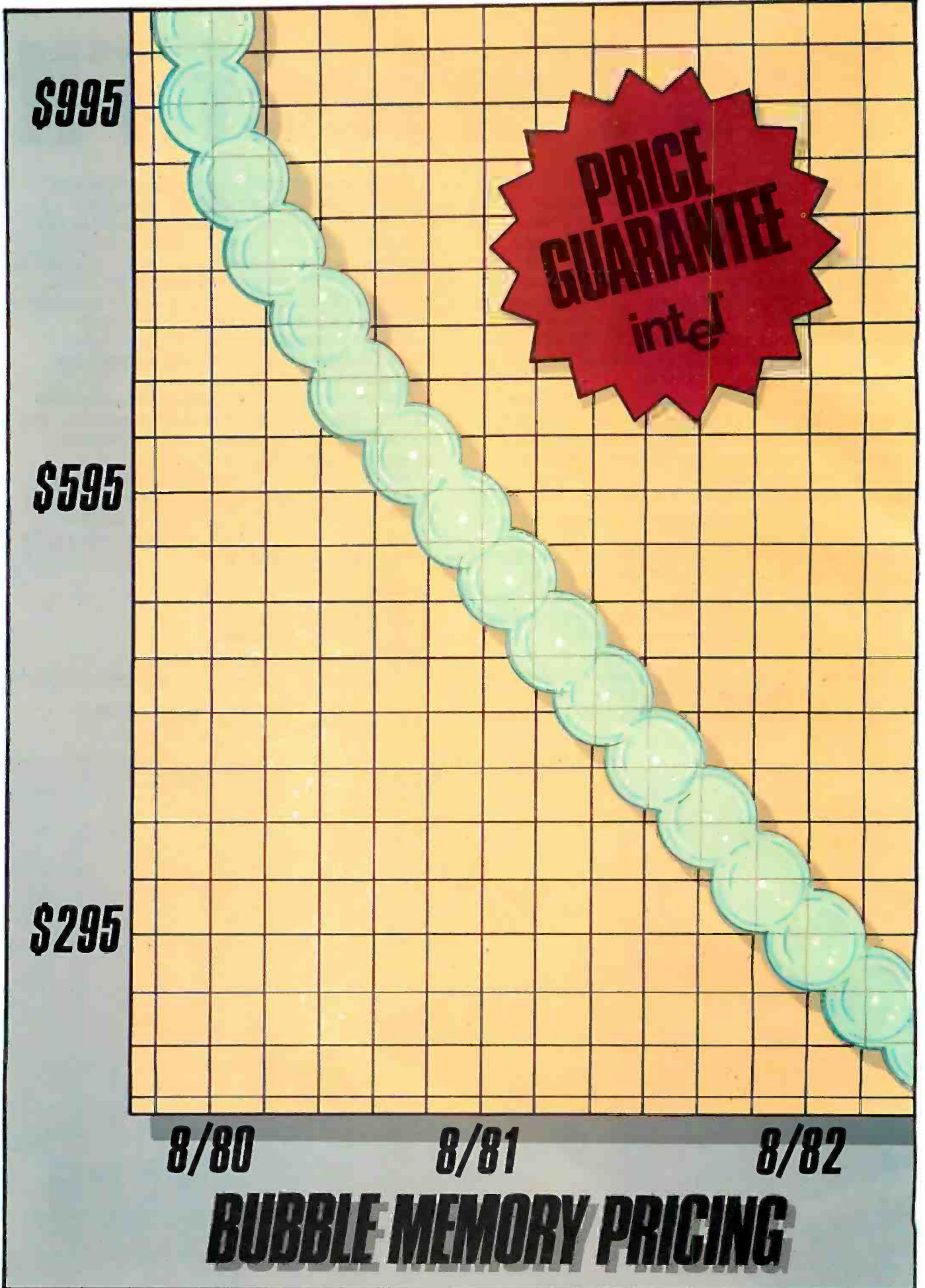

# Bubble Price Break

**Intel reduces prototyping prices of 1-megabit bubble memories by 40% now. And guarantees a volume price of \$595 for complete component sets by August 1981.**

Fast-breaking bubble technology. You've been hearing about it for years. Now Intel announces the kind of break you've been waiting for: a price break.

On August 11th, Intel lowered its 100-unit price for the BPK72 Bubble Memory Kit by 40% to \$995—less than 100 millicents per bit.

By August 1981, the price of megabit bubble memories ordered in 5,000-unit lots will be an unprecedented \$595. That's 60 millicents per bit. Not "projected." Not "expected." *Guaranteed.*

One year later, for 25,000-piece orders, the unit price will be \$295—cutting the per-bit price in half once more. Again, we guarantee it.

How can Intel guarantee such a sharp price reduction? Simple. Intel was the first to bring production 1-megabit bubble memories to market. We've been delivering them for over a year, for a wide range of applications, and now we're moving prices down the manufacturing learning curve.

## Get more than bubbles

Intel's bubble memory is a complete set of bubble components for microprocessor-based applications. This set consists of six special support ICs: a controller, a formatter/sense amp., three packages for coil driving and a current pulse generator. It interfaces to Intel® and other microprocessor system buses via the controller, which handles up to eight bubble memory packages, and provides built-in power fail protection and error correction.

The bubble element and its small set of associated ICs can be

treated as a peripheral subsystem. This allows designers to concentrate on higher level system objectives, instead of spending time learning the intimate details of bubble device interfacing. Thus minimizing expense in hardware and software development.

## Add more value to your product

With Intel's solid-state bubble memory, all that moves is the information. That means high reliability and low maintenance for your products, even in harsh or unclean environments—the kind where disks and tapes won't go. And since the memory is completely nonvolatile, your data



remains secure when the power goes off. No battery backup or replacement is necessary.

Furthermore, Intel's bubble memory system is small, lightweight and silent. By packing over 1 million bits into less than 100 square centimeters of board space, it allows you to reduce the size, weight and power con-

sumption of your products.

As the natural mass storage for LSI microprocessor-based systems, Intel's megabit bubble memory makes it practical to design more features into your equipment. So now you can build in programmability. Portability. Reduced service and repair costs. All with ensured data integrity, even in hostile environments. Consider what that means in your applications.

## Start designing now

Everything you need to start designing your next generation product is included in our Bubble Memory Prototype Kit (BPK72), available now from distributor stock. It contains all the components necessary for a 1-megabit system, plus a printed circuit board and complete documentation.

To find out how bubble memories can give you that competitive edge in your next project—and to receive our bubble brochure, contact your local Intel sales office/distributor. Better yet, have one of our field sales engineers give you a firm quote based on exactly what you need for your next product. Write Intel Corporation, 3065 Bowers Avenue, Santa Clara, CA 95051. Or call (408) 987-8080.

**intel® delivers solutions.**

Europe: Intel International, Brussels, Belgium.  
Japan: Intel Japan, Tokyo. United States and Canadian distributors: Alliance, Almac/Strom, Arrow Electronics, Avnet Electronics, Component Specialties, Hamilton/Avnet, Hamilton/Electro Sales, Harvey, Industrial Components, Pioneer, L.A. Varah, Wyle Distribution Group, Zentronics.

Listing 1 continued:

```

11020 PLOT 2, 242, GRAPH(0), GRAPH(1), 255: RETURN : REM VECTOR
11100 FLAG= 0: GOSUB 11150: RETURN : REM VECTORS
11150 PLOT 6, COLOUR(3): FOR ITEM= 1 TO NUMBER: FOR AXIS= 0 TO 1
11160 PLACE= ARRAY<ITEM, AXIS>: GOSUB 10700: NEXT AXIS
11170 ON 2+ <ITEM= 1 OR FLAG= 1> GOSUB 11010, 11020
11180 NEXT ITEM: RETURN
11188 REM
11189 REM
11190 REM PLOT BAR GRAPHS
11191 REM
11192 REM ARRAY<NUMBER, 1> IS PLOTTED EITHER
11193 REM AS VERTICAL OR AS HORIZONTAL BARS
11194 REM
11200 FLAG= 1: GOSUB 11310: RETURN : REM Y-BAR
11300 FLAG= 0: GOSUB 11310: RETURN : REM X-BAR
11310 COLOUR= 2: FOR ITEM= 1 TO NUMBER
11320 COLOUR= COLOUR+ 1+ 2* <COLOUR= 4>: PLOT 6, COLOUR<COLOUR>
11330 FOR AXIS= 0 TO 1: PLACE= ARRAY<ITEM, AXIS>
11340 GOSUB 10700: NEXT AXIS
11350 PLOT 2, 250- FLAG* 4, MINSCREEN<FLAG>: REM X OR Y BAR
11360 FOR I= GRAPH(1- FLAG) TO GRAPH(1- FLAG)+ 1
11370 PLOT I, GRAPH<FLAG>: NEXT I: PLOT 255: NEXT ITEM: RETURN
11490 REM
11491 REM
11492 REM SAVE IMAGES ON DISK
11493 REM
11494 REM IMAGES SAVED AS SCREEN.DIS
11495 REM

```

Listing 1 continued on page 140



Photo 1: Variation of text height and color. Both text height and color can be changed under program control.

Text continued from page 126:

Subscripts for array variables commence at 0. In consequence, if NUMBER = 25 and AXES = 1, then the BASIC statement DIM ARRAY (NUMBER, AXES) will define an array with dimensions 26 and 2.

Values of 0 or -1 are assigned to results of logical operations: 0 for false and -1 for true. This property is used in line 11170 of listing 1.

It is also possible to change the height and color of displayed text (as shown in photo 1); this is done occasionally within the body of the program in listing 1.

### The Subroutines

Listing 1 contains the subroutines that together can be used to produce a graph on the color video-display screen. Subscripted variables, when used with a subscript of 0, refer to some horizontal component of the graph; a subscript of 1 refers to some vertical component of the graph. Certain calculation subroutines (for example, 10200 and 10300) can be accessed at a line ending in "00" to perform calculations for both the X and Y axes, or they can be accessed at the corresponding line ending in "10" to calculate for only one axis.

Some of the more important subroutines are described briefly in the paragraphs that follow:

- 7000—Review or erase images; this subroutine enables graphs stored on disk to be reviewed (displayed) or erased from the disk.
- 9000—Prepare complete graph outline; this subroutine consists of three subroutines that examine the data and draw the appropriate graph frame (see also subroutines 10200, 10300, and 10500).
- 10000—Data entry; the title of the graph, the axes' labels, and data

A 10 Megabyte Winchester  
hard disk based,  
S100 Computer for

**\$7500???**

**YOU BET!!!**

We'll give you 20 to 1  
(storage that is)!



NNC Electronics 15631 Computer Lane  
Huntington Beach CA 92649 (714) 893-4120

# CENTRONICS MODEL 737: Give Your Business the Advantage

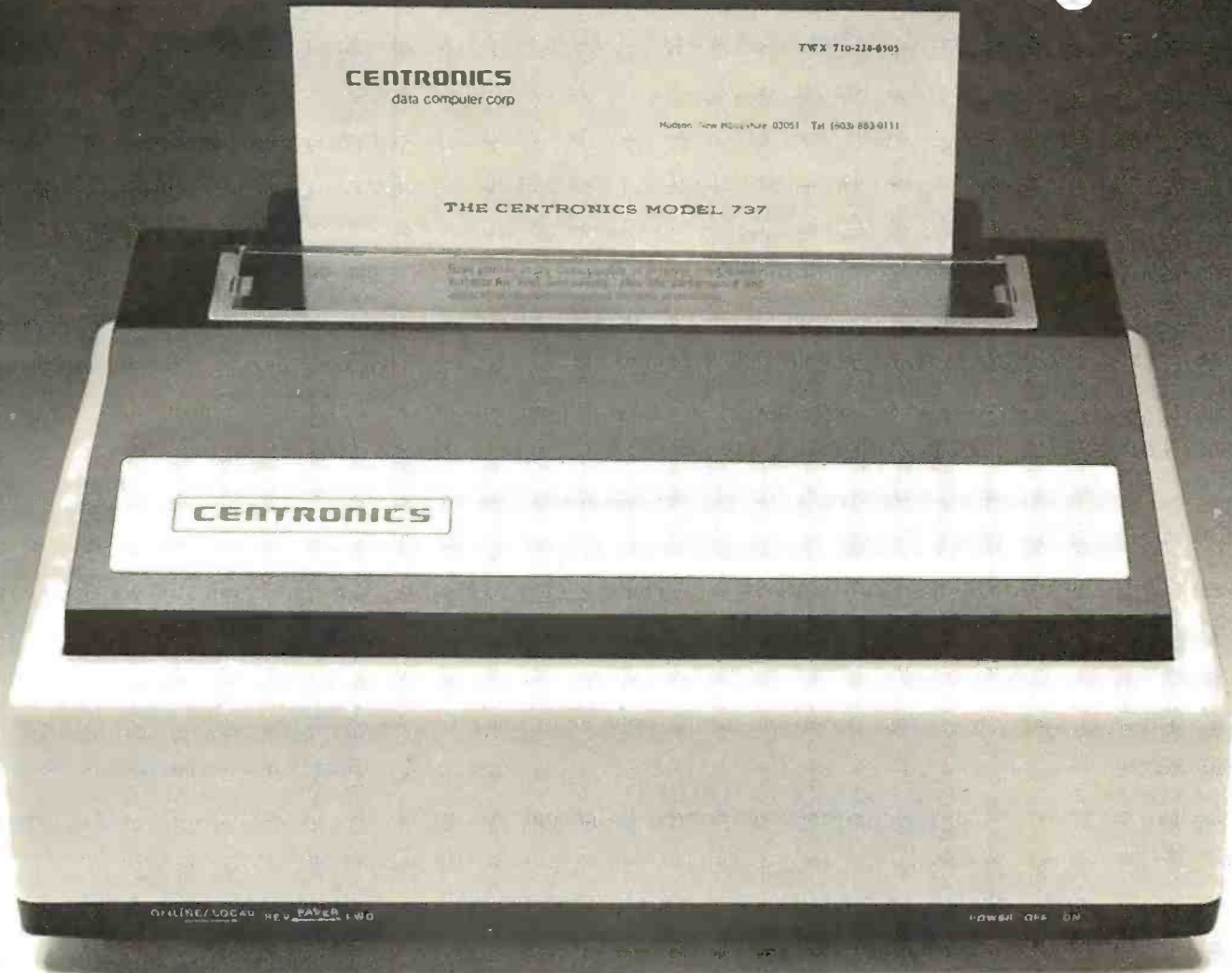

Centronics' new Model 737 means you get more than ever from a printer. Outstanding print quality. Fast, quiet operation. Ready to handle text processing, word processing, or electronic mail in addition to regular small business requirements. And it meets every business' prime requirement: low cost.

## Outstanding Print Quality

Model 737 is the first small business printer to offer correspondence quality printing. Characters with true descenders as well as underlining. Proportional spacing, the ability to justify right margins and serif typeface makes the 737 ideal for text processing applications. Standard business data processing spacing makes it available for applications ranging from letters to aged accounts receivable reports. The steel platen assures crisp, clean print impression.

## Unexpected Features

Leave it to Centronics to have some surprises in the new Model 737. You get the ability to print subscripts and superscripts (particularly important for chemical or mathematical applications). The field proven 700 Series printhead technology and fewer moving parts mean reliability that you wouldn't expect in a compact, low-cost printer.

And the 737 is quiet. An optional acoustic cover makes it ideal for office environments.

## Pick Your Paper

Run letterhead paper for correspondence, roll paper for general information, or fan-fold paper for standard data processing (payroll, billing, inventory, etc.). You can, with the 3-way paper handling ability of the Model 737.

## The Printer of the Future... Today

Never before has one printer offered such high quality, reliability, and applications flexibility at such low cost. (If you don't need the correspondence quality of the 737, our Model 730 delivers 100 c.p.s. at even greater savings.)

## Why Wait?

The new Model 737 is now available for delivery. For more information: call (603) 883-0111, Centronics Data Computer Corporation, Hudson, New Hampshire 03051, or any of our 15 U.S.A. or 9 international sales offices.

All Centronics products are supported by the largest worldwide service network of any independent printer company. Always use genuine Centronics ribbons and accessories.

**CENTRONICS® PRINTERS**  
...the advantage

Listing 1 continued:

```

11500 PLOT 6, COLOUR(2), 3, 0, 31, 11, 3, 13, 31:REM SAVE ON DISK
11510 INPUT "ENTER S TO SAVE, OR PRESS RETURN: "; I$:PLOT 28, 11
11520 IF I$ < > "S" THEN 11540
11530 PLOT 27, 4:PRINT "SAVE SCREEN. DIS 0000-6FFF":PLOT 27, 27
11540 RETURN
11780 REM
11781 REM
11782 REM SELECT COLORS
11783 REM
11784 REM COLOUR(1) FRAME
11785 REM COLOUR(2) SCALE
11786 REM COLOUR(3) GRAPH 1
11787 REM COLOUR(4) GRAPH 2
11788 REM
11800 PLOT 6, 4, 3, 0, 31, 11, 3, 16, 31:REM COLOR SELECTION
11802 INPUT "ENTER C TO CHANGE COLOR: "; K$
11804 PLOT 6, COLOUR(2), 3, 0, 31, 11: IF K$ < > "C" THEN RETURN
11806 PLOT 6, 38, 12, 3, 23, 7, 14:PRINT "COLOR SELECTION"
11810 PRINT :PRINT ,,:INPUT "TOUCH COLOR FOR BACKGROUND: "; I$
11820 I= (ASC (I$)- 16)* 8:PLOT 6, I, 12, 3, 16, 11:REM BKD
11830 PLOT 6, I/ 8* 9+ 2+ 4* (I) 40)
11840 DATA "FRAME", "SCALES", "GRAPH1", "GRAPH2":RESTORE 11840
11850 FOR J= 1 TO 4:READ I$:PLOT 3, 16, 9+ 2* J:PRINT "FOR "; I$:
11860 INPUT " "; J$:COLOUR(J)= I+ ASC (J$)- 16
11870 PLOT 6, COLOUR(J), 3, 32, 9+ 2* J:PRINT I$:NEXT J:RETURN
11890 REM
11891 REM
11892 REM PAUSE
11893 REM
11894 REM "PRESS RETURN TO CONTINUE"
11895 REM BLINKS BRIEFLY AT BOTTOM OF GRAPH
11896 REM
11900 PLOT 6, COLOUR(1), 31, 3, 18, 31:REM PAUSE
11910 PRINT "PRESS RETURN TO CONTINUE":FOR I= 1 TO 100:NEXT I
11920 PLOT 15, 3, 0, 31, 11:INPUT " "; I$:RETURN

```

Range of Values, R, to Be Plotted	Initial Value for JUMP
0.121 ≤ R < 1.21	0.4
1.21 ≤ R < 12.1	4.0
12.1 ≤ R < 121	40.0
121 ≤ R < 1210	400.0
1210 ≤ R < 12100	4000.0

Table 1: Initial value for step size (JUMP) given the range (R) of the variable to be plotted. The table can be continued in both directions by either multiplying or dividing all the numbers in a line by 10. Once the initial value for JUMP is found, it is repeatedly divided by 2 until the step size used subdivides the range into at least four intervals—that is, until  $JUMP \leq (R/4)$ .

are entered in this subroutine. Certain applications (eg: histograms) require only one set of data to be entered. If CHOICE=1, then the subroutine fills only ARRAY (n,1), that is, the data entries are placed in ARRAY (0,0), ARRAY (1,0), ARRAY (2,0), and so on. If CHOICE is not equal to 1, then this subroutine expects two sets of data to be entered, filling both ARRAY (n,0) and ARRAY (n,1). The Y-axis data is duplicated in a third column, ARRAY (n,2), thus allowing this data to be manipulated later without being destroyed.

- 10100—Equation plotting; this subroutine tests to see that no equation exists, then invites the user to write an equation at line 500. The equation takes the form  $Y = (\text{some arithmetic expression using } X)$ . Once the equation exists, the subroutine asks for a title and the X-axis limits. The program then uses the equation to calculate twenty-five equidistant data points to fill ARRAY (n,1).
- 10200—Find big and little; this subroutine determines the largest and smallest values for the data and stores them in arrays BIG (n) and LITTLE (n).
- 10300—Prepare values for frame; the step size (JUMP) is calculated in accordance with the constraints described above. This value is used to determine the HIGH and LOW values for the scale. GAPS is the number of JUMPS in the length of the axis (variable SCALE).
- 10500—Draw borders with scales and titles; this subroutine draws

PLOT 2	Enter graph-plotting mode
PLOT 2, X, Y	Point at X,Y
PLOT 2, 242, X, Y	Vector to X,Y
PLOT 2, 250, X0, Y, XM	Horizontal bar at Y from X0 to XM
PLOT 2, 246, Y0, X, YM	Vertical bar at X from Y0 to YM
PLOT 3, T, L	Cursor to tab T at line L
PLOT 6, C	Defines the color of both the foreground and background
PLOT 8	Cursor to home
PLOT 9	Tab 8 spaces
PLOT 10	Line feed (move cursor down one line)
PLOT 11	Erase line
PLOT 12	Erase page
PLOT 14	Double-height text
PLOT 15	Normal-height text, with blink mode off
PLOT 16 thru PLOT 23	Changes color of foreground or background (whichever is active)
PLOT 27, 4: PRINT "[disk commands]":	
PLOT 27, 27	Execute floppy-disk command
PLOT 27, 10	Write text vertically
PLOT 27, 24	Write text horizontally
PLOT 28	Cursor up
PLOT 29	Enable background color
PLOT 31	Blink on
PLOT 255	Cancel graph-plotting mode

Table 2: Table of plot codes in Compucolor BASIC. Many functions associated with the color video-display screen are achieved by the use of the PLOT command. The table of PLOT commands here includes all those used in listings 1 and 2.

# MICROWORLD<sup>®</sup>

## SPECIALS

CALL TOLL FREE: 1-800-528-1418



### ARCHIVES BUSINESS COMPUTER

The latest in all-in-one computers is now available from MicroWorld! The new, compact Archives Business Computer is CP/M-based, S-100 compatible, and includes 64K RAM as standard equipment. The Archives also features an amazing storage capacity . . . up to 1.5 megabytes on built-in, dual 5 1/4" drives! The detachable microprocessor-controlled keyboard includes a righthand numeric pad, lefthand function keycluster, and 23 relegendable function keys. A full 25-line by 80-character display is provided by the 12" green phosphor monitor. Screen attributes include inverse video, blink and underline in any of 8 intensities. Options for the Archives Business Computer include a direct-wire modem, hardware floating point chip, and an extensive selection of applications software!

CALL FOR PRICE!



#### DIABLO 630 RO

Letter-quality, up to 40 cps printer offers complete interchangeability between metal and plastic print wheels! Universal Interface, baud rates to 9600, optional forms tractor.

CALL FOR PRICE!



#### LEXICON LX-11

Priced lower than Novation, lower than Livemore! New Bell 103A-compatible, RS232-compatible modem has special battery-powered option!

CALL FOR PRICE!

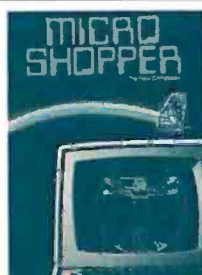

#### MICROSHOPPER

New edition of the best selling computer consumer guide! Includes more than 100 photos, dozens of hardware and software product reviews . . . feature articles, glossary, and more!

\$10.00 POSTAGE PAID



#### TELEVIDEO 920B

Your best terminal buy, loaded with features! Full-function keyboard, 24 x 80 display, blink, reverse, self-test!

CALL FOR PRICE!



#### ATARI 800 SYSTEM

MicroWorld now offers complete systems based around the Atari 800 Personal Computer . . . Inter-

face Module, choice of printers, disk drives, program recorder, modem, extensive software library!

CALL FOR SPECIAL PRICE!

### FREE FREIGHT

MicroWorld provides the most attractive mail-order offer in the computer industry. The nation's largest inventory, plus our own automated order processing allows us to pass on unrivaled savings! And now . . . **FREE FREIGHT** on any product featured on this page! We'll pay the surface freight on any computer or peripheral product in this ad. Call MicroWorld today, the source you can trust!

# MICROWORLD

1425 W. 12th Place, Tempe, AZ 85281

Master Card and Visa orders welcomed!

**Listing 2: Demonstration program for the subroutines of listing 1. This short program, when added to the program in listing 1, allows the user to make a graph of a collection of points, an equation, or a series of vertical bars.**

```

5 REM KY 5 REM      GRAPHS. (C) A.W.GROGONO.  AUG. 1979
6 REM      DEMONSTRATION PROGRAM FOR USE WITH SUBROUTINES
40 RESTORE :CLEAR 200:DIM I$(12)
50 DATA 1,2,6,4:FOR I= 1TO 4:READ COLOUR(I):NEXT I
90 PLOT 29,27,24,15,14,2,255,6,1,12,3,16,3:REM CLEAR PAGE
280 REM
290 REM
300 PRINT "S E L E C T   G R A P H   T Y P E:":PRINT
310 PRINT :PRINT ,,"1.  X/Y SCATTER"
320 PRINT :PRINT ,,"2.  PLOT EQUATION"
330 PRINT :PRINT ,,"3.  Y-BAR GRAPH"
340 PRINT :PRINT ,,:INPUT "ENTER 1 - 3: ";K:PLOT 28,11
350 IF K< 1OR K> 3THEN 340
360 IF K< > 2THEN 390
370 RESTORE :CLEAR 200:FOR I= 1TO 4:READ COLOUR(I):NEXT I
380 K= 2:DIM ARRAY(25,1):REM DIMENSIONS FOR EQUATION
390 ON KGOSUB 10000,10100,10000:REM PREPARE DATA ARRAY
400 GOSUB 9000:REM FRAME
410 ON KGOSUB 11000,11100,11200:REM SCATTER, LINE, Y-BARS
420 GOSUB 11900:REM PAUSE
430 GOSUB 11500:REM SAVE
440 GOSUB 11800:REM SELECT COLORS
450 IF K$= "C"THEN 400
460 GOTO 5

```

the borders for the graph with its scales, labels, and title. The length of each number or word is employed to ensure appropriate positioning. The value of **RATIO**, calculated here, is used in the subroutine at line 10700.

- 10700—Convert units to screen; a value on one of the axes (in variable **PLACE**) is converted to its corresponding screen position (stored in variable **GRAPH**).
- 10800—Converts units for text position; a screen position variable, **GRAPH**, is converted to its corresponding cursor position and stored in variable **TEXT**.
- 11000 and 11100—Plot points or lines; the data points in **ARRAY** are plotted as separate points (11000) or as points joined by lines (11100).
- 11200 and 11300—Plot Y-bars or X-bars; the quantities in **ARRAY** are plotted as vertical (11200) or as horizontal bars (11300).
- 11500—Save image on disk; this subroutine transfers the finished graph to disk for recall later.
- 11800—Select colors; the colors for the background, frame, scales, and graphs are selected with this routine.
- 11900—Pause; this subroutine causes the words "PRESS RETURN TO CONTINUE" to flash briefly beneath the graph.

### A Demonstration Program

The program in listing 2 was written to demonstrate the color-graphics subroutines. Graph type 1 allows data to be entered and displayed as separate points. The program initially selects the colors shown in photo 2a, but the user can select his own colors, as shown in photo 2b.

Photos 3a and 3b illustrate the use of the equation-plotting subroutine, graph type 2. Photo 3a shows the program colors for the first range selected (-2 to +2); photo 3b shows a different set of colors selected by the user for the longer range (-4 to +4). Photo 4a shows how a variable, such as income, can be displayed as a Y-bar, as an example of graph type 3. Photos 4b and 4c show the same data using different colors selected by the user.

The brevity of listing 2 shows that minimal program writing is required to produce these graphs. In fact, if only one type of graph is required

## FREE your keyboard — interact directly with the screen. Why waste time typing? Use a 3-G Light Pen.

— Mail Coupon or Call Today for Immediate Delivery —

■ In his business, Al Zenker of Zenker Dental labs in Pennel, Pennsylvania uses our pens for data entry. Harry Lee of Pittsfield, Massachusetts uses the pen to select telephone numbers to be dialed by his computer. Thorwald Esbensen of Micro-Ed. Inc. in Minneapolis, Minnesota writes education software for the 3-G Light Pen Swiss Air Dispatch at Kennedy Airport in New York uses our pens to speed up its business operations. Dr. Richard Kerns of East Carolina University incorporates our pen in a demonstration with a voice synthesizer to teach his students how to use computers. In Holland, Johan Smilde uses a 3-G Light Pen to experiment with graphics.

■ These people have discovered the benefits of using a 3-G Light Pen. Wouldn't a 3-G Light Pen make your system more versatile and more functional? Yes, of course it would!

■ Don't Wait — order your pen today and receive:

- 1) 3-G Light Pen
- 2) Demonstration cassettes (with Professional TRS-80, PET and Apple)
- 3) Sample program listing
- 4) Complete documentation and instructions
- 5) Other Light Pen software and games available.

■ NO ASSEMBLY NECESSARY. READY TO PLUG IN AND USE.

■ Complete documentation so you can write your own program in BASIC. No machine language coding necessary.

■ All 3-G Professional models plug into machine ports. Economy model plugs into cassette and batteries are included.

3-G Company, Inc. Dept. BT  
Rt. 3, Box 28A, Gaston, OR 97119  
(503) 662-4492

Remember, 3-G offers a 30-day unconditional Money back GUARANTEE

TRS-80 Economy \$19.95     TRS-80 Professional \$34.95     PET Professional \$31.95     Apple Professional \$32.95

Yes, I want to make my computer more versatile. Rush me \_\_\_\_\_ 3-G Light Pens (Add \$1.50 for mailing and handling — \$6.00 foreign.)

Enclosed is:  check or money order     Master Charge     Visa   

Card No \_\_\_\_\_ Exp. date \_\_\_\_\_

NAME \_\_\_\_\_

ADDRESS \_\_\_\_\_

CITY \_\_\_\_\_ STATE \_\_\_\_\_ ZIP \_\_\_\_\_



A 3-G LIGHT PEN INTERACTING DIRECTLY WITH THE SCREEN.



# THE KURTA GRAPHIC TABLET

## A VERSATILE INPUT DEVICE FOR SMALL COMPUTERS

- 8½" x 11" TABLET SURFACE
- PEN
- COMPATIBILITY WITH 7" x 9" DISPLAYS
- MINIMUM INTERFACE AND SOFTWARE REQUIREMENTS

KURTA Graphic Tablets provide the small computer user with a method of enhancing his or her present setup without making a large expenditure. For example, because of the recessed tablet surface, an 8½" x 11" pad of paper fits snugly, virtually eliminating

re-location problems. Hard copy is easily obtained using the pen with replaceable ball point cartridge. The KURTA Graphic Tablet is directly compatible with standard 7" x 9" display screens and since the tablets' data output directly matches the computer capabilities, the interface and software requirements are minimized. KURTA is "the new leader in graphic message input and delivery."

For more information about the KURTA Graphic Tablet see your nearest computer dealer or contact us direct.



A simulation



(eg: points joined by lines), then the total program would be:

```

300 GOSUB 10000 : REM DATA
    ENTRY
310 GOSUB 9000 : REM FRAME
320 GOSUB 11100 : REM PLOT
    LINES
330 GOSUB 11900 : REM PAUSE
340 END

```

Of course, this assumes the presence of the subroutines given in listing 1.

2a

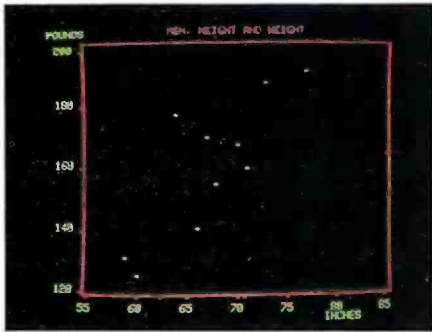

2b

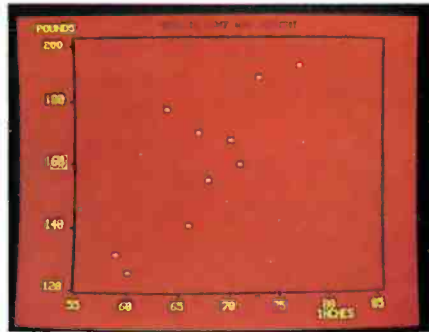
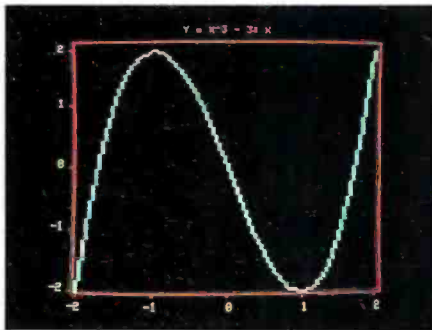

Photo 2: Examples of point-plotting mode. The computer automatically chooses the colors of photo 2a, but the user can override this to select any other color combination, as in photo 2b. The slight "pincushion" effect can be eliminated by the addition of a corrective kit supplied by Compucolor.

3a



3b

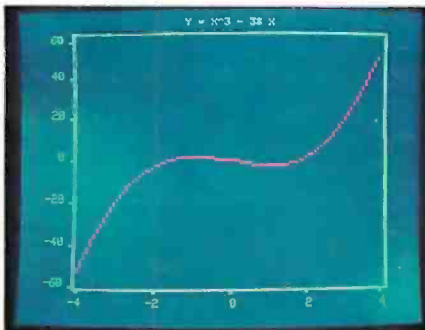
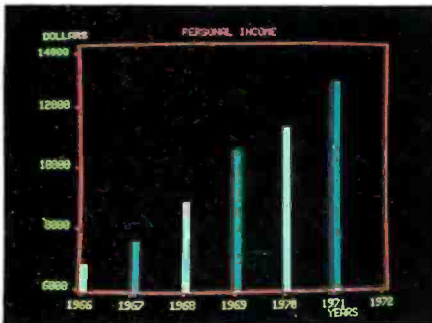
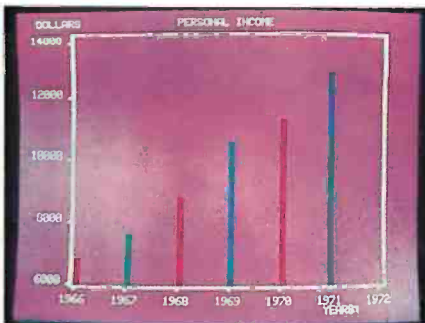

Photo 3: Examples of equation-plotting mode. The range of both the X and Y axes can be changed, as can the choice of colors. Photo 3a illustrates the standard colors as selected by the computer; photo 3b shows another graph with colors of the user's choice.

4a



4b



4c

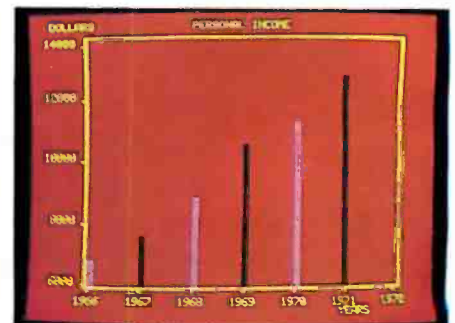

Photo 4: Examples of bar-graph-plotting mode. Here, the same data is displayed in the standard colors (photo 4a) and two sets of user-selected colors (photos 4b and 4c). Horizontal bar graphs can also be displayed.

In such a program and in the demonstration program, the X-axis and Y-axis graph scales are determined automatically by the program except where the user selects the X-axis limits for the equation.

### Summary

The subroutines in listing 1 were written to illustrate the principles used in determining neat graph scales, and emphasis has been placed on these calculations. The frame is

drawn just outside the area in which points will be graphed. This avoids the problem of graphing points that lie directly on the frame; it also avoids the possibility of the color for a nearby graph point spilling onto the frame. The program generates an even number of scale increments for each axis; this ensures uniform spacing of both tick marks and numbers. Colors are critical when the screen is being photographed; light colors on dark backgrounds show up best (this is discussed in detail in my previous article in the January 1980 BYTE).

These subroutines can be used in many graphics applications. As written, they employ two-letter names as well as the variables X, Y, I, J, K, I\$, J\$, and K\$. This allows the user all the remaining single letters. If the user's program defines NUMBER (number of points) and fills ARRAY with the appropriate data, then the subroutines in listing 1 can be used to generate a graph. The graph will be labeled as well if the user defines the variables TITLE\$, LABEL\$(0), and LABEL\$(1).

The photographs used to illustrate this article have been created using a Compucolor II with 16 K bytes of user memory but without the Pincushion Correction Kit. The barrel distortion on the top and bottom can be reduced by using a telephoto lens, but the pincushion effect on each side will then be worse unless the correction kit is installed.

Next month, Part 2 of this article will use the subroutines given here to construct several other kinds of graphs: a different kind of equation-plotting routine, a histogram with the equivalent Gaussian (bell-shaped) curve superimposed, linear and other kinds of regression plotting, and a monthly analysis graph of more than one variable. ■

## Simple Base Conversions for the TRS-80

James M Curran, 24 Greendale Rd, Cedar Grove NJ 07009

I have noticed that decimal-to-hexadecimal and decimal-to-octal conversions are usually accomplished by means of subroutines, most of which require three to four statements. This is efficient enough for users of a low-level BASIC; however, computer enthusiasts with a BASIC interpreter containing the DEF FN (define function) command long for a simple one-statement conversion. Here are such conversion statements. For those of you who need to convert hexadecimal or octal to decimal, these conversions are also included. I have even thrown in a decimal-to-binary function.

*Listing 1: Definitions for five base-conversion functions. The first statement defines the function for converting decimal to binary numbers. The second and third definitions give the functions for converting from decimal to hexadecimal and from hexadecimal to decimal numbers. Notice that the variable HX\$ must be initialized for both of these. The last two statements define the functions for converting from decimal to-octal and from octal to decimal numbers.*

```

1. DEF FN DB#(D)=(D AND 1)+(D AND 2)*5+(D AND 4)*25+
  (D AND 8)*125+(D AND 16)*625+
  (D AND 32)*3125+(D AND 64)*15625+
  (D AND 128)*78125

2. HX$="0123456789ABCDEF"
  DEF FN DH$(D)=MID$(HX$, (D AND -4096)/4096+1-
  (D>32767)*16, 1)+
  MID$(HX$, (D AND 3840)/255+1, 1)+
  MID$(HX$, (D AND 240)/16+1, 1)+
  MID$(HX$, (D AND 15)+1, 1)

3. HX$="0123456789ABCDEF"
  DEF FN HSD(H$)=(INSTR(HX$, MID$(H$, 1, 1))-1)*4096+
  (INSTR(HX$, MID$(H$, 2, 1))-1)*256+
  (INSTR(HX$, MID$(H$, 3, 1))-1)*16+
  (INSTR(HX$, MID$(H$, 4, 1))-1)

4. DEF FN DO#(D)=(D AND 7)+(D AND 56)*1.25+
  (D AND 448)*1.5625+
  (D AND 3584)*1.953125+
  (D AND 28672)*2.44140625

5. DEF FN OSD(OS)=VAL(MID$(OS, 1, 1))*3276+
  VAL(MID$(OS, 2, 1))*4096+
  VAL(MID$(OS, 3, 1))*512+
  VAL(MID$(OS, 4, 1))*64+
  VAL(MID$(OS, 5, 1))*8+
  VAL(MID$(OS, 6, 1))
  
```

These functions can also be used as subroutines by those without the DEF FN command. An AND-statement is necessary, because it performs a logical-AND operation which is used in all three routines to convert decimal to the various other bases.

The first function, which I call FNDB#, returns the binary equivalent of the argument as an eight-digit integer.

The hexadecimal equivalent of the argument is returned by the second function, FNDH\$, as a four-character string with leading zeros. Arguments greater than 32767 (7FFF hexadecimal) must be signed; ie: reduced by 65536. For a 1-byte conversion, only the second half of the function is necessary.

My third function, called FNH\$, converts the argument, which must be a four-character string, into its decimal equivalent. In this function, the INSTR command is employed; if your BASIC does not have it, it is easily replaced with a BASIC subroutine. Its function is to return the position in the first string at which the second string begins. FNH\$ can also be made into a 1-byte routine by using its second half. Both FNH\$ and FNDH\$ require HX\$ to be initialized.

The final two functions for decimal-to-octal conversions (FNDO# and FNO\$D) work similarly to their hexadecimal counterparts. ■

SAVE AT THE APPLE COMPUTER SUPERMARKET...

## "COMPUTERS 'R' US"

UNBEATABLE MAIL ORDER DISCOUNTS  
A SUBSIDIARY OF CONSUMER COMPUTERS



**CHRISTMAS  
SUPER  
SALE**



**APPLE II PLUS  
OR APPLE II STANDARD**

**16K FOR ONLY \$925**

**48K FOR ONLY 1049**

**DISK II DRIVE \$485**  
W/CONTROLLER

**PASCAL \$425  
SYSTEM**

SEE PAGE 391  
FOR MORE PRODUCTS AND  
ORDERING INFORMATION

OFFER  
EXPIRES  
DEC. 31  
1980



ORDER TOLL FREE: 1-800-854-6654

CALIFORNIA, BACKORDER OR TECHNICAL INFO: (714) 698-8088  
CREDIT CARD USERS PLEASE SEE ORDERING INSTRUCTIONS ON PAGE 391

# The Brains of Men and Machines

by Ernest W. Kent

When the "Brains of Men and Machines" series of articles originally appeared in *BYTE* magazine, the response was immediate and enthusiastic. Now Ernest W. Kent has expanded his ideas about the brain into a full-length book.

As researchers begin to unravel the mysteries of the brain's chemical, electrical, and synaptic circuitry, their findings are becoming immediately applicable to advances in robotic behavior and computer design. **The Brains of Men and Machines** "dissects" the brain to provide new insights into computer design and artificial intelligence.

It is one of the rare books that transcends disciplinary boundaries. In the ever increasing relationship between man and machine is freshly examined — a relationship, Professor Kent concludes, that is today being reexamined in the light of man's own neurological self-image.

Hardcover 304 pages

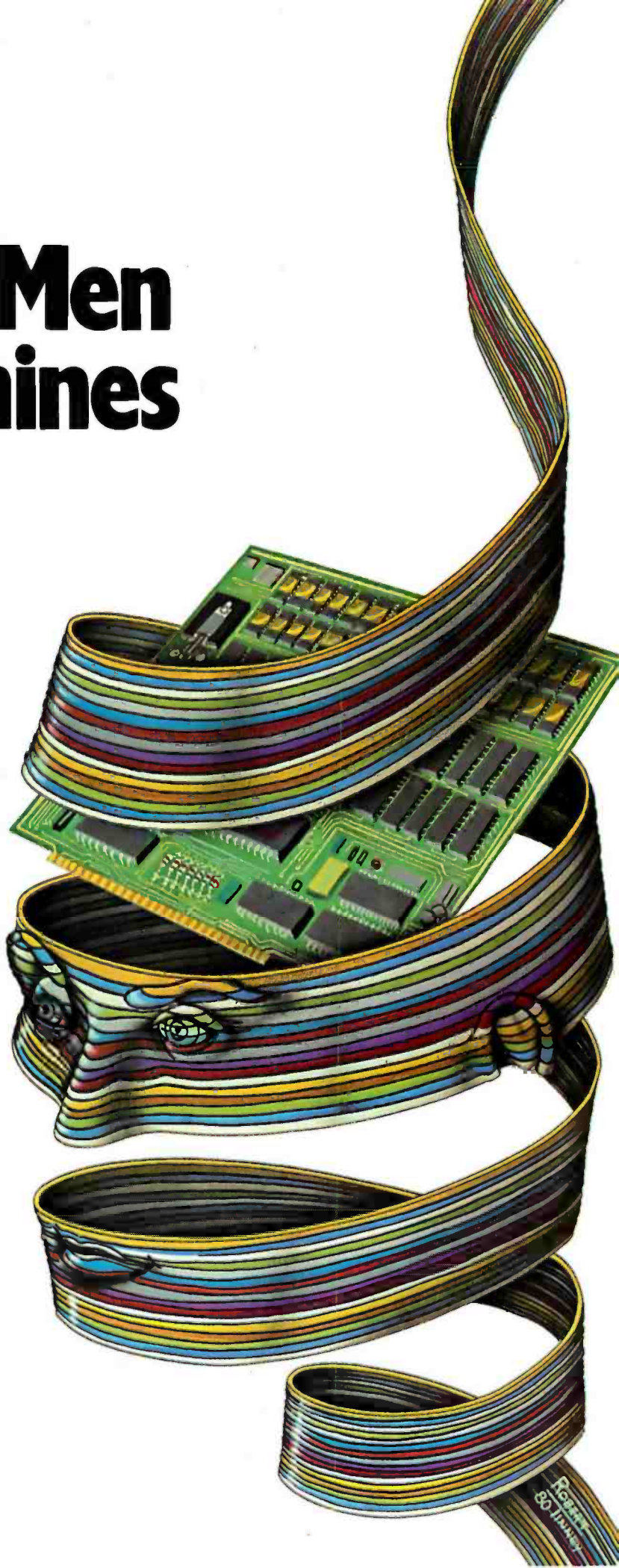

**BYTE BOOKS** 70 Main St.  
Peterborough, NH 03458

B11

ISBN #0-07-034123-0

Price \$15.95

Please remit in U.S. funds or draw on a U.S. Bank

Please send  \_\_\_\_\_ copies of  
**The Brains of Men and Machines**

Name \_\_\_\_\_ Title \_\_\_\_\_ Company \_\_\_\_\_

Street \_\_\_\_\_ City \_\_\_\_\_ State/Province \_\_\_\_\_ Code \_\_\_\_\_

Check enclosed in the amount of \$ \_\_\_\_\_

Bill Visa  Bill Master Charge

Card No. \_\_\_\_\_

Exp. Date \_\_\_\_\_

Add 75¢ per book to cover  
postage and handling.

Available in October



Garrett  
80 January

# Clubs and Newsletters

## A Club in Augusta

The CSRA Computer Club is a group of computer hobbyists and professionals that enjoy working and playing with computers. Dues are \$6 per year and everyone interested in computers is invited to attend the meetings held at 7:30 PM on the third Thursday of each month in the Student Center of the Medical College of Georgia, Laney Walker and 15th streets in Augusta, Georgia. A monthly newsletter is also published. Contact the club at CSRA Computer Club, POB 284, Augusta GA 30903.

## TRS-80 Group in Manchester

The Manchester TRS-80 Users Group meets the first Sunday of each month at Raytheon Company, Island Pond Rd, in Manchester, New Hampshire. For information, contact Scott Mitchell, 346 S Taylor St, Manchester NH 03103, (603) 624-0089.

## Classroom Computer News

*Classroom Computer News* is a bimonthly newsletter written for teachers and administrators and covers the technical and the human side of using computers in schools, as well as developments in the microcomputer industry. Each issue includes application programs, tutorials, book reviews, new product reviews, and industry news briefs. Interviews with innovators in the educational computing field, accounts of teachers' and administrators' personal experiences with microcomputers, overviews of software, and analyses of trends within the industry are covered. Subscription rates for *Classroom Computer News* are \$9 per year. Contact *Classroom Comput-*

*er News*, POB 299, Cambridge MA 02138, (617) 661-6164.

## TI 99/4 Users Unite

There are many Texas Instruments TI 99/4 users interested in swapping information, programs, and other

related items. If you are interested in starting a users group, or simply establishing contact with other users, write to Larry Morrow, 8075 Spring Garden Ct, W Chester OH 45069.

## News and Trading Newsletter

*The Midwest Buss* is a newsletter and trading forum. The newsletter includes buy-and-sell columns

and articles on hardware and software. Ads are \$1 per line. A line consists of 60 characters, punctuation and spaces included. All ads should be printed or typewritten. Include phone numbers and addresses on a separate portion of the card. The deadline for submission of ads or articles is the twenty-sixth of each month. *The Midwest Buss* is mailed on the first of each month. Subscriptions are \$6 per year. Contact *The Midwest Buss*, 441 E Bernhard, Hazel Park MI 48030. ■

# THE FIRST

## FULL SPEC 50-WATT SWITCHING POWER SUPPLY FOR

UNDER...

# \$ 125

**\$115.00 UNIT  
QUANTITY**

A handful of compact switching power at the incredibly low price of \$115!

But don't be misled by price. This is no stripped down, coverless pretender that tries to pass as a switcher.

POWER-ONE'S new SD Series is a true high performance switching power supply in every sense of the word. It meets impressive specifications while employing the absolute latest state-of-the-art power conversion techniques. Yet it's smaller, lighter, and more reliable than the rest.

All at a cost that combines affordability with the finest features of switching technology. The result is a dramatic new dimension in switching power supply value.

See for yourself. For fast action, write or phone for our new 1980 Catalog with complete details on the exciting new SD Series.

Models Chart

MODEL	VOLTAGE	CURRENT
SD5-10	5V	10A
SD12-4.2	12V	4.2A
SD15-3.4	15V	3.4A
SD24-2.1	24V	2.1A
SD28-1.8	28V	1.8A



# POWER-ONE D.C. POWER SUPPLIES

Power-One, Inc. • Power One Drive • Camarillo, CA 93010  
(805) 484-2806 • (805) 987-3891 • TWX 910-336-1297

Circle 92 on Inquiry card.

# Three-Dimensional Graphics for the Apple II

---

Dan Sokol  
John Shepard  
211 Fall Creek Dr  
Felton CA 95018

---

Many articles have been written regarding three-dimensional graphics on home computers. Some involve highly complex hardware such as spinning mirrors, while others rely upon computation-intensive software to project three-dimensional objects on a two-dimensional plane.

Taking an innovative step backwards and rediscovering an old technique, I have been able to create three-dimensional pictures using my Apple II computer. I have generated a number of visually stimulating displays in this manner and would like to share with you the methods used, with the hope that you too will discover new ways to use your computer.

The method is simple. Just take a piece of cardboard, and with a pair of scissors, cut out a pair of eyeglass frames. Next, put a red filter over the left eye opening in the frame and a green filter over the right opening (I did say it was an old ideal). When viewing the screen with the glasses on, anything colored red will not be visible to your right eye, and anything green will not be visible to your left eye (you may have to adjust the tint on your television to optimize this). Anything white will be visible to both eyes.

The image that falls on the retina of your right eye will be the green image on the video monitor, but it will appear to be white! (It's all done in your brain.) The same is true of the red image in relation to your left eye. (We will refer to the red image in our software as violet. This is because the Apple HI-RES graphics cannot generate red.) [However, see "More Colors for Your Apple," by Allen Watson III, June 1979 BYTE, page 60...RSS]

## Creating an Image

As you can see by figures 1a and 1b, an image that seems to appear in front of the screen can be made by drawing the green image to the left of the red one. An image that appears behind the screen is simulated by placing the green image to the right of the red one. The apparent depth is determined by the distance between the two colored images.

It should be mentioned that the brain requires a frame of reference to judge distance "properly." An efficient way to provide this reference is to put a white border around the screen. This will define the *neutral plane*. Naturally, any objects on this plane need be drawn only once in white.

The program in listing 1 generates a set of lines which appear to disappear into the distance.

Another simple program is presented in listing 2. This one generates a three-dimensional box.

Using the shape-generator programs provided by Apple, the user can make objects appear to be various sizes and depths. This effect can be seen by running the program in listing 3.

You can place as many objects in space as you have room for. There are, however, some guidelines.

- You should draw your images from *back to front*. This way any overwriting will look natural.
- As you approach the neutral plane, the two images get closer together. Any place that they are coincident should be white. This can be handled with software. (I didn't say easily.)
- Using other colors generates an unbalanced image in the neutral plane—you experiment.
- You will have to adjust your color television set to match the color of the filters that are being used. The best way to do this is to draw a small green square and a small red square on the screen. Then place a

*Text continued on page 154*

If you  
just bought  
another  
printer,  
boy are  
you gonna  
be sorry.



# Epson.

The Epson MX-80. It's not just another worked-over rehash of last year's model. It's our top-of-the-line 80-column printer. It's new. From the ground up. And it's the most revolutionary printer to hit the market since Epson invented small printers for the 1964 Olympics in Tokyo. Don't take our word for it, though. Compare. There simply isn't a better value in an 80-column printer. Period.

But here's the fact that's going to stand the printer world on its ear. The MX-80 sports the world's first *disposable* print head. After it's printed about 50 million characters, you can throw it away. Because a new one costs less than \$30, and the only tool you need to change it is attached to the end of your arm.

Now that's revolutionary, but that's only the beginning. The MX-80 also prints bidirectionally at 80 CPS with a logical seeking function to minimize print head travel time

---

*The world's first disposable print head. It has a life expectancy of over 50 million characters, yet it's so simple, you can change it with one hand. And it costs less than—repeat less than—\$30.*



and maximize throughput. It prints 96 ASCII, 64 graphic and eight international characters in a tack-sharp 9x9 matrix. And it provides a user-defined choice of 40, 80, 66 or 132 columns and multiple type fonts.

We spent three long years developing the MX-80 as the first of a revolutionary series of Epson MX Printers. We employed the most advanced automatic assembly and machining techniques in existence to produce a printer that is incredibly versatile, remarkably reliable and extraordinarily inexpensive. It's a printer that could only come from the world's largest manufacturer of print mechanisms: Epson.

If it sounds like we're proud of the MX-80, we are. Not only does it do things some of the world's most expensive printers can't do, it'll do them for you for less than \$650. That's right. Under \$650.

And if that isn't revolutionary, we don't know what is.

**EPSON**  
EPSON AMERICA, INC.

23844 Hawthorne Boulevard, Torrance, California 90505, Telephone (213) 378-2220

**Listing 1:** *This Apple integer BASIC program generates three-dimensional lines disappearing into infinity.*

```
0 XO=YO=COLR=SHAPE=ROT=SCALE
5 INIT=2048: CLEAR=2062: PLOT=2830: LINE=2836: DRAW=2871: XDRAW=2884
10 BLACK=0: WHITE=127: VIOLET=85: LET GREEN=42
100 CALL INIT: POKE -16302,0:
150 REM BUILD THE BORDER
200 COLR=WHITE:XO=0:YO=0: CALL PLOT:XO=279: CALL LINE:YO=191: CALL LINE:XO=0: CALL LINE:YO=0: CALL LINE
205 XO=1:YO=1: CALL PLOT:XO=278: CALL LINE:YO=190: CALL LINE:XO=1: CALL LINE:YO=1: CALL LINE
250 REM
251 REM
252 REM
500 REM LINES TO INFINITY
510 COLR=VIOLET:XO=25:YO=180: CALL PLOT:XO=260:YO=20: CALL LINE:XO=70:YO=180: CALL LINE
520 COLR=GREEN:XO=60: CALL PLOT:XO=270:YO=20: CALL LINE:XO=10:YO=180: CALL LINE
550 END
```

**Listing 2:** *An Apple integer BASIC program for generating a three-dimensional box.*

```
0 XO=YO=COLR=SHAPE=ROT=SCALE
5 INIT=2048: CLEAR=2062: PLOT=2830: LINE=2836: DRAW=2871: XDRAW=2884
10 BLACK=0: WHITE=127: VIOLET=85: LET GREEN=42
100 CALL INIT: POKE -16302,0:
150 REM BUILD THE BORDER
200 COLR=WHITE:XO=0:YO=0: CALL PLOT:XO=279: CALL LINE:YO=191: CALL LINE:XO=0: CALL LINE:YO=0: CALL LINE
205 XO=1:YO=1: CALL PLOT:XO=278: CALL LINE:YO=190: CALL LINE:XO=1: CALL LINE:YO=1: CALL LINE
600 REM
601 REM
602 REM
603 REM A BOX...
610 COLR=WHITE:XO=150:YO=50: CALL PLOT:XO=250: CALL LINE:YO=150: CALL LINE:XO=150: CALL LINE:YO=50: CALL LINE
615 COLR=GREEN:YO=75:XO=40: CALL LINE
620 XO=140: CALL LINE:XO=250:YO=50: CALL LINE
622 XO=250:YO=150: CALL PLOT
625 XO=140:YO=175: CALL LINE:XO=40: CALL LINE:XO=150:YO=150: CALL LINE:XO=40:YO=175: CALL PLOT
630 YO=75: CALL LINE:XO=140: CALL PLOT:YO=175: CALL LINE
635 XO=41:YO=75: CALL PLOT:YO=175: CALL LINE:XO=141: CALL PLOT:YO=75: CALL LINE
637 COLR=VIOLET
640 XO=30:YO=185: CALL PLOT:YO=85: CALL LINE:XO=130: CALL LINE:YO=185: CALL LINE
642 XO=250:YO=150: CALL LINE
645 XO=130:YO=185: CALL PLOT:XO=30: CALL LINE
650 XO=150:YO=150: CALL LINE:XO=30:YO=85: CALL PLOT:XO=150:YO=50: CALL LINE
660 XO=130:YO=85: CALL PLOT:XO=250:YO=50: CALL LINE
680 END
```

**Listing 3:** *This program uses the shape stored in the Apple II shape table and transforms it into three-dimensional form.*

```
0 XO=YO=COLR=SHAPE=ROT=SCALE
5 INIT=2048: CLEAR=2062: PLOT=2830: LINE=2836: DRAW=2871: XDRAW=2884
10 BLACK=0: WHITE=127: VIOLET=85: LET GREEN=42
100 CALL INIT: POKE -16302,0:
150 REM BUILD THE BORDER
200 COLR=WHITE:XO=0:YO=0: CALL PLOT:XO=279: CALL LINE:YO=191: CALL LINE:XO=0: CALL LINE:YO=0: CALL LINE
205 XO=1:YO=1: CALL PLOT:XO=278: CALL LINE:YO=190: CALL LINE:XO=1: CALL LINE:YO=1: CALL LINE
250 REM
700 REM
701 REM
710 REM
800 REM 3-D SQUARES
801 REM USE SHAPE #1
802 REM SHAPE #1 = 01 01 24 3F 3F 36 36 2D 2D 24 00
805 ROT=0: SCALE=1: SHAPE=1: XO=5: YO=5
810 FOR I=1 TO 7: SCALE=I: COLR=GREEN: XO=XO+(I#4): YO=YO+(I#4)
820 CALL XDRAW: COLR=VIOLET: XO=XO+I: YO=YO+I: CALL XDRAW: NEXT I
830 XO=XO+32: YO=90: COLR=GREEN: SCALE=SCALE+2: CALL XDRAW: COLR=VIOLET: YO=YO+8: XO=XO+8: CALL XDRAW
840 XO=XO+42: YO=YO-42: COLR=GREEN: SCALE=SCALE+2: CALL XDRAW: COLR=VIOLET: YO=YO+9: XO=XO+9: CALL XDRAW
999 END
```

#### **Editor's Note:**

##### **Some Comments on the Programs**

The three programs in this article assume that the high-resolution graphics routines have been loaded into the Apple II starting at hexadecimal location C00. The instruction LOMEM:4096 should be executed before loading the programs to protect these routines.

When I was typing these pro-

grams into the Apple, I noticed that line 10 of each listing has the statement LET GREEN = 42. At the time I could not understand why the LET keyword was used, so I deleted it. Several syntax errors later I realized the answer.

When "GREEN = 42" is parsed by the BASIC interpreter, the token GR (for graphics mode) is recognized. The rest of the line (EEN = 42) is then unrecognizable

to the parser. When "LET GREEN = 42" is analyzed, the keyword LET tells the parser that the next token will be a variable. Therefore, GREEN is not broken into two tokens (GR and EEN).

This little trick could prove very useful when you wish to use a variable name which contains a keyword.





# More than meets the eye.

The new Series 5000 is mighty for its size. In more than several thousand ways!

In fact, it's the first small system offering over a megabyte of integrated mini-floppy capacity. And with its super memory management, you can have better than 300k of RAM in desk or desktop versions. But hardware is just the beginning of the story.

It's the wide selection of software that really makes this system mighty.

Operating systems? Choose CP/M\* with CBASIC†—the most widely accepted small computer operating system ever. Or MVT-FAMOS,\*\* a multi-user, multi-tasking operating system with file management like the big guys, Or MICROCOBOL,††

also for multiple users, but implemented in COBOL, familiar to commercial users the world over.

And applications programs for these operating systems number in the thousands. From real estate to accounting, taxes to inventory control, they're all available at low cost—ready to run.

When you add these software and hardware features to Industrial Micro Systems' reputation for rugged, reliable quality products you'll begin to see it all. A lot more systems than your first glance reveals.

See even more at your dealer. Call us to find out the name of your nearest dealer. He'll tell you everything you need to know. And really open your eyes!

\* Trademark of Digital Research Inc.

\*\* Trademark of MVT Microcomputer Systems Inc.

† Trademark of Software Systems

†† Product of CAP.CPP

## INDUSTRIAL MICRO SYSTEMS

628 N. Eckhoff St., Orange, CA 92668, (714) 978-6966  
2800 Lockheed Way, Carson City, NV 89701

**Today one dollar buys  
 $\frac{1}{3}$  of a business phone call.**



# Today one dollar buys 6¼ readers who actually see your sales message.



**As your selling dollar buys less and less, it pays more and more to advertise in McGraw-Hill magazines.**

As prices keep going up and up, McGraw-Hill magazines help 10.8 million decision-makers keep costs down.

For example, *Chemical Week* told chemical processing managers and professionals how exports credits could lower their debt-servicing costs. And *Engineering News-Record* showed the construction industry how to cope with the destructive effects of the 1981 federal budget.

By helping 10.8 million readers solve their inflation problems, we help you solve yours.

Today, the price of reaching one potential customer in McGraw-Hill magazines is only 16¢.<sup>1</sup> This compares to a cost of \$6.07 for sending a business letter,<sup>2</sup> over \$3.50 for a business phone call,<sup>3</sup> and an in-person sales call which, believe it or not, now costs \$137.02.<sup>4</sup>

In times like these, when everything costs more, you may be tempted to spend less on your advertising budget. But our Laboratory of Advertising Performance (LAP) Report #5262 demonstrates that "Industrial companies that maintained or increased their advertising expenditure during the 1974-75 recession enjoyed higher sales growth than those that cut advertising." Write 1221 Avenue of the Americas, New York, N.Y. 10020 for LAP Report #5262 today. And let us help you make your advertising more efficient, as the price of all other selling tools becomes more expensive.

<sup>1</sup>One reader-noted impression in the average McGraw-Hill publication.  
<sup>2</sup>The Dartnell Institute of Business Research. <sup>3</sup>Telephone Marketing  
by Murray Roman, P. 87. McGraw-Hill 1976. <sup>4</sup>Laboratory of Advertising  
Performance Report #8013.5. McGraw-Hill Research.

**McGraw-Hill Magazines**



**With inflation,  
we're an even better buy.**

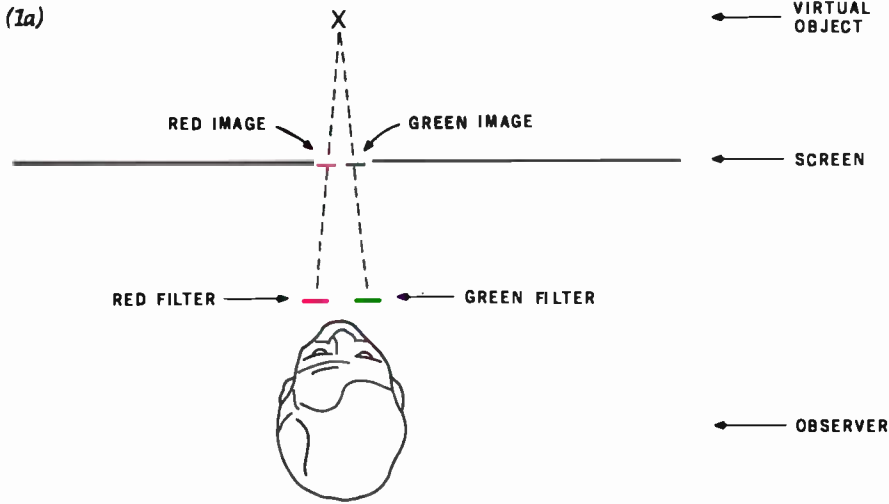
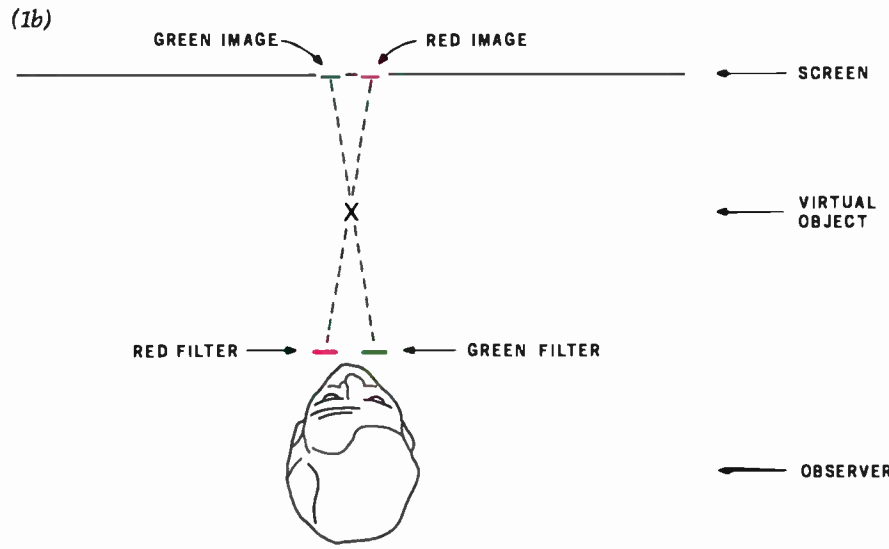

Figure 1: A figure which appears to be behind the video screen can be produced by drawing the red image on the left side of the screen and the green image on the right side (see figure 1a). By reversing these two images, the image will appear to be in front of the video screen (see figure 1b).



Text continued from page 148:

piece of the green filter over the red square and a piece of the red filter over the green square. Adjust the tint, chrominance (if you have one), and color knobs so that both squares disappear (as much as possible...you may have to double up the filters).

- If you aren't worried about using your color television for other entertainment, you can make the following adjustments to it. On the back of the set are three controls that are (usually) labeled red, green, and blue (or R, G, B; or red screen, blue screen, green screen). These adjust the relative intensity of the three electron guns. If you first mark the initial positions of the three controls with a pencil,

you will be able to reset them when you are finished. The adjustment is simple. Turn the blue screen off! This removes all the blue dots from the screen, only red and green remain. After adjusting the television as described in the previous step, reverse the positions of the filters (red over red, green over green) and adjust the red screen so that the intensity of the two squares through the filters appears the same.

- We used colored cellophane, available at most art supply stores, for filters.

There are a number of games that can be adapted to three-dimensional displays with this technique. Have fun!

## Hazeltine Distributors:

- ALABAMA:** Huntsville, W. A. Brown Instruments, Inc. (205) 883-8660
- ALASKA:** Anchorage, Global Communications, Inc. (907) 276-4532
- ARIZONA:** Phoenix, Data Systems Marketing (602) 265-5246; Leasametric (602) 258-1225; PLS Associates, Inc. (602) 279-1531; Tempe, Hamilton Avnet Electronics (602) 275-7853; The Phoenix Group (602) 884-9247
- CALIFORNIA:** Anaheim, Leasametric (714) 634-9525; Beringham, Data Access Systems (415) 692-5711; Camarillo, Data Access Systems (213) 530-4100; Data Systems Marketing (213) 324-1151; Costa Mesa, Hamilton Avnet Electronics (714) 641-4100; Avnet Electronics (714) 754-6111; Culver City, Hamilton Avnet Electronics (213) 558-2000; Leasametric (213) 670-0461; Foster City, Leasametric (415) 574-4441; Hawthorne, Hamilton Avnet Electronics (213) 970-2950; Hayward, Byte Industries, Inc. (415) 783-8272; The Phoenix Group (415) 887-2851; Irvine, Computer Datalcom, Inc. (714) 540-6327; Data Systems Marketing (714) 540-2312; Kanon, American Peripheral Exchange (415) 457-0822; Los Angeles, David Jamison Carlyle Corp. (213) 277-4562; Marikona, American Peripheral Exchange (415) 229-3810; Mountainview, Data Systems Marketing (415) 941-0240; Newport Beach, David Jamison Carlyle Corp. (714) 640-0355; Northridge, Dayco-Forester Associates, Inc. (213) 952-8831; Oxnard, Consolidated Data Terminals (415) 533-8125; Orinda, David Jamison Carlyle Corp. (415) 254-8376; Rancho Santa Fe, Consolidated Data Terminals (213) 970-1030; San Diego, Data Systems Marketing (714) 560-9222; Electronic Marketing Specialists (714) 560-3133; Hamilton Avnet Electronics (714) 571-7510; Leasametric (714) 565-7475; Santa Clara, American Peripheral Exchange (408) 244-0260; Sherman Oaks, Electronic Marketing Specialists (213) 990-4244; Sunnyvale, Electronic Marketing Specialists (408) 245-9291; Hamilton Avnet Electronics (408) 743-3355; Torrance, The Phoenix Group, Inc. (513) 533-8134; Tuolumne, Electronic Marketing Specialists (714) 832-9920
- COLORADO:** Denver, Data Systems Marketing (303) 573-5133; Leasametric (303) 429-7900; PLS Associates, Inc. (303) 773-1218; Englewood, Hamilton Avnet Electronics (303) 779-9998
- CONNECTICUT:** West Haven, Westwood Associates (203) 932-6383; Southbury, J. J. Wild, Inc. (203) 264-9494
- DELAWARE:** Newark, Westwood Associates (302) 454-1113
- FLORIDA:** Fort Lauderdale, Hamilton Avnet Electronics (305) 971-2900; W. A. Brown Instruments, Inc. (305) 776-4800; Melbourne, W. A. Brown Instruments, Inc. (305) 723-0766; Orlando, Leasametric (305) 857-3500; W. A. Brown Instruments, Inc. (305) 425-5555; Tallahassee, W. A. Brown Instruments, Inc. (904) 878-8642; Tampa, W. A. Brown Instruments, Inc. (813) 977-0914
- GEORGIA:** Atlanta, Data Access Systems (404) 449-5435; W. A. Brown Instruments, Inc. (404) 455-1035; Lake City, Westwood Associates (404) 961-0712; Norcross, Hamilton Avnet Electronics (404) 448-0800; Leasametric (404) 449-6123
- HAWAII:** Honolulu, David Jamison Carlyle Corporation (808) 531-5136; Kaneohe, Data Systems Marketing (808) 247-0934
- ILLINOIS:** Chicago, David Jamison Carlyle Corporation (312) 475-1500; Elk Grove Village, Leasametric (312) 595-2700; Peripheral Support Inc. (312) 593-5900; Morton Grove, Data Access Systems (312) 967-0440; Schaumburg, Hamilton Avnet Electronics (312) 678-6310
- INDIANA:** Indianapolis, Hamilton Avnet Electronics (317) 844-9333; South Bend, General Micro Computer (219) 277-4972
- KANSAS:** Lenexa, North Supply Company (913) 888-9800; Loonam Associates, Inc. (913) 888-2124; Overland Park, Hamilton Avnet Electronics (913) 888-8900; Shawnee Mission, Inland Associates, Inc. (913) 362-2366
- KENTUCKY:** Jeffersontown, Loonam Associates (502) 499-8280
- LOUISIANA:** Mandeville, W. A. Brown Instruments, Inc. (504) 626-9701
- MARYLAND:** Baltimore, Hamilton Avnet Electronics (301) 796-5000; Westwood Associates (301) 358-7812; Gaithersburg, Leasametric (301) 948-9700; Lanham, Data Access Systems (301) 459-3377
- MASSACHUSETTS:** Cambridge, Compunet Corporation (617) 491-2700; Needham, J. J. Wild, Inc. (617) 444-2366; Norwood, Data Access Systems (617) 759-6420; Woburn, Hamilton Avnet Electronics (617) 273-7500; Leasametric (617) 935-7780
- MICHIGAN:** Ann Arbor, Compunet Corporation (313) 994-3200; Livonia, Hamilton Avnet Electronics (313) 522-4700; Troy, Data Access Systems (313) 589-1409
- MINNESOTA:** Burnsville, Leasametric (612) 894-6060; Edina, Hamilton Avnet Electronics (612) 941-3801; Minneapolis, Loonam Associates (612) 831-1616
- MISSOURI:** Earth City, Hamilton Avnet Electronics (314) 344-1200; St. Louis, Inland Associates (314) 821-3742; Loonam Associates (314) 427-7272
- NEBRASKA:** Omaha, Loonam Associates (402) 333-5502
- NEW HAMPSHIRE:** Merrimack, J. J. Wild, Inc. (603) 424-4717
- NEW JERSEY:** Allendale, Leasametric (201) 825-9000; Bogota, Dytel (201) 487-7737; Cherry Hill, The Dataloger, Inc. (609) 779-0800; Hamilton Avnet Electronics (609) 424-0300; Chatham, Westwood Associates (609) 829-7280; Fairfield, Hamilton Avnet Electronics (201) 575-3390; Metuchen, David Jamison Carlyle Corporation (201) 946-9669; Mountain Lakes, Data Access Systems (201) 335-3322; Palisades Park, Data Access Systems (201) 944-2005; Roseland, TSC Data Terminals (201) 245-6333; Springfield, Westwood Associates (201) 376-4242; Union, Transnet Corporation (201) 688-7800
- NEW MEXICO:** Albuquerque, Data Systems Marketing (505) 294-5790; PLS Associates, Inc. (505) 255-2320
- NEW YORK:** Fairport, Data Access Systems (716) 377-2080; Great Neck, M. S. Corbett Corporation (212) 466-1777; Hightstown, Computer Support Enterprises (212) 468-7067; Latham, Camer on Associates, Inc. (518) 371-5947; Melville, Hamilton Avnet Electronics (516) 454-6060; New York, Byte Shop East, Inc. (212) 889-4204; Data Access Systems (212) 564-9301; Leasametric (212) 594-6900; John D. Owens Associates, Inc. (212) 448-6283; Dytel (212) 889-3888; Pittsford, J. Cameron Associates, Inc. (716) 386-1681; Plainville, Leasametric (516) 293-5881; Rochester, Hamilton Avnet Electronics (716) 475-9130; East Syracuse, Hamilton Avnet Electronics (315) 437-2641; Syracuse, Leasametric (315) 455-5611
- NORTH CAROLINA:** Durham, W. A. Brown Instruments, Inc. (919) 683-1580
- OHIO:** Cincinnati, Interactive Information Systems (513) 761-0132; Cleveland, Data Access Systems (216) 473-2131; Hamilton Avnet Electronics (216) 831-3500; Mt. Pleasant, M.T. Systems (216) 454-6688; Pro-Data Corporation (216) 229-8100; Dayton, Hamilton Avnet Electronics (513) 433-0610; Leasametric (513) 898-1707
- OREGON:** Bend, Data Systems Marketing (503) 388-3612; Hillsboro, Data Systems Marketing (503) 640-4883
- PENNSYLVANIA:** Aston, M.P.I. Newco Products, Inc. (215) 485-8180; Dale Cwynard, Data Access Systems (215) 667-8315; Folcroft, Leasametric, Inc. (215) 583-2000; Huntingdon Valley, Marketing Systems, Inc. (215) 947-6670
- SOUTH CAROLINA:** Columbia, W. A. Brown Instruments, Inc. (803) 798-8070
- TENNESSEE:** Oak Ridge, W. A. Brown Instruments, Inc. (615) 482-5761
- TEXAS:** Austin, Hamilton Avnet Electronics (512) 837-8911; Dallas, Leasametric (214) 661-9193; Houston, CMC Marketing Corporation (713) 985-4960; Data Access Systems (713) 682-5965; Hamilton Avnet Electronics (713) 780-1717; Leasametric (713) 875-3996; Data Access Systems (214) 256-5536; Hamilton Avnet Electronics (214) 661-8204
- UTAH:** Salt Lake City, Data Systems Marketing (801) 487-8281; Hamilton Avnet Electronics (801) 972-2800; R. S. Associates, Inc. (801) 466-8729
- VIRGINIA:** Newport News, Atlantic Communications (804) 380-8496; Sterling, Comsel Corporation (703) 525-5888; Vienna, Comsel Corporation (703) 938-5264
- WASHINGTON:** Bellevue, Hamilton Avnet Electronics (206) 643-3950; Bothell, Data Systems Marketing (206) 487-3571; Redmond, Consolidated Data Terminals (206) 883-9100; Leasametric (206) 883-6510; Tukwila, Data Access Systems (206) 251-5070
- WISCONSIN:** Milwaukee, Hamilton Avnet Electronics (414) 784-4510; Peripheral Support, Inc. (414) 774-1000; Waukegan, Loonam Associates (414) 548-9790

# Smart shopping

***Your Hazeltine distributor has all the terminals you need.***

You can save time by taking all your TTY terminal needs to one source — your local Hazeltine distributor. Right in your neighborhood, your distributor offers the same quality, the same service and the same comprehensive warranty program that you would get by contacting Hazeltine directly.

The Hazeltine distributor can give you easy access to a broad selection of Hazeltine products, including the economical Hazeltine 1400/1500 series of conversational and editing terminals, the high performance Modular One family, and — soon — the new Hazeltine Executive 80™ line of sophisticated smart terminals. An experienced sales professional, your local distributor is ready to provide full product and application support.

Most important, each of our authorized distributors has Hazeltine's full support. You will find that Hazeltine's entire field and factory organization supports the distributor when you need delivery, warranty service, or even just the answer to a question.

Be a smart shopper. Call your nearest Hazeltine distributor — part of our winning team for the eighties.

Hazeltine Corporation,  
Computer Terminal Equipment,  
Greenlawn, NY 11740.  
(516) 549-8800 Telex: 96-1435

Hazeltine and the Pursuit of Excellence



**Answers for  
the Eighties**



**Hazeltine  
1400 Series**

performance  
economy terminals

**Hazeltine  
1500 Series**

performance in  
economy terminals





Software with Manual Above

Software with Manual Above

Software with Manual Above

T/MAKER—Powerful new tool for preparing management reports with tabular data. Makes financial modeling projects easy. Do you want a weekly profitability report? Set up the table and compute. Just change the sales figures for next week and compute. You have a new report! T/MAKER includes a full screen editor for setting up tables which pages left, right, up and down. Compute includes standard arithmetic, percents, exponents, common transcendental functions, averages, maxima, minima, projections, etc. Requires 48K CP/M. CBASIC-2. CRT Terminal with addressable cursor positioning. \$275/\$25

BSTAM—Utility to link one computer to another also equipped with BSTAM. Allows file transfers at full data speed (no conversion to hex), with CRC block control/check for very reliable error detection and automatic retry. We use it! It's great! Full wildcard expansion, send + COM, etc. 9600 baud with wire, 300 baud with phone connection. Both ends need one. Standard and versions can talk to one another. This software requires a knowledge of assembler language for installation. \$150/\$10

BSTMS—Intelligent terminal program for CP/M systems. Permits communication between micros and mainframes. Sends character data files to remote computers under complete control. System can record character data sent from remote computer systems and data banks including programs to EXPA and COMPRESS binary files for transmission. This software requires a knowledge of assembler language for installation. \$200/\$25

WHATSI?—Interactive data-base system using associative tags for retrieval information by subject. Hashing and random access used for fast response. Requires CBASIC-2. \$175/\$25

SELECTOR III-C2—Data Base Processor to create and maintain multi-key data bases. Prints formatted sorted reports with numerical summaries or mailing labels. Comes with sample applications, including Sales Activity, Inventory, Payables, Receivables, Check Register, and Client/Patient Appointments, etc. Requires CBASIC-2. Supplied in source. \$295/\$20

GLECTOR—General Ledger option to SELECTOR III-C2. Interactive system provides for customized COA. Unique chart of transaction types insure proper double entry book-keeping. Generates balance sheets, P&L statements and journals. Two year record allows for statement of changes in financial position report. Supplied in source. Requires SELECTOR III-C2. CBASIC-2 and 56K system. \$350/\$25

DMA
CBS—Configurable Business System is a comprehensive set of programs for defining custom data files and application systems without using a programming language such as BASIC, FORTRAN, etc. Multiple key fields for each data file are supported. Set-up program customizes system to user's CRT and printer. Provides fast and easy interactive data entry and retrieval with transaction processing. Report generator program does complex calculations with stored and derived data, record selection with multiple criteria, and custom forms. Sample inventory and mailing list systems included. No support language required. \$395/\$40

MICROPRO

SUPER-SORT I—Sort, merge, extract utility as absolute executable program or linkable module in Microsoft format. Sorts fixed or variable records with data in binary, BCD, Packed Decimal, EBCDIC, ASCII, floating & fixed point, exponential, held justified, etc. Even variable number of fields per record. \$225/\$25

SUPER-SORT II—Above available as absolute program only. \$175/\$25

SUPER-SORT III—As II without SELECT/EXCLUDE. \$125/\$25

DATASTAR—Professional forms control entry and display system for key-to-disk data capture. Menu driven with built-in learning aids. Input field verification by length, mask, attribute (i.e. upper case, lower case, numeric, auto-dup, etc.). Built-in arithmetic capabilities using keyed data, constant and derived values. Visual feedback for ease of forms design. Files compatible with CP/M/MP/M supported languages. Requires 32K CP/M. \$350/\$35

WORD-STAR—Menu driven visual word processing system for use with standard terminals. Text formatting performed on screen. Facilities for text paginate, page number, justify, center and underscore. User can print one document while simultaneously editing a second. Edit facilities include global search and replace, Read/Write to other text files, block move, etc. Requires CRT terminal with addressable cursor positioning. \$445/\$40

WORD-STAR-MAIL-MERGE—As above with option for production mailing of personalized documents with mail lists from DATASTAR or NAD. \$575/\$40

WORD-MASTER Text Editor—In one mode has super set of CP/M's ED commands including global searching and replacing, forwards and backwards in file in video mode, provides full screen editor for users with serial addressable cursor terminal. \$145/\$25

MAGIC WAND—Word processing system with simple, easy to use full screen text editor and powerful print processor. Editor has all standard editing functions including text insert and delete, global search and replace, block move and library files for boiler plate text. Print processor formatting commands include automatic margins, pagination, headings & footings, centered and justified text. Also prints with true proportional spacing, merges with data files for automatic form letters, and performs run-time conditional testing for varied output. Requires 32K CP/M and CRT terminal with addressable cursor. \$395/\$40

TEXTWRITER III—Text formatter to justify and paginate letters and other documents. Special features include insertion of text during execution from other disk files or console, permitting recipe documents to be created from linked fragments on other files. Has facilities for sorted index, table of contents and footnote insertions. Ideal for contracts, manuals, etc. Now compatible with Electric Pencil\* and Word-Star prepared files. \$125/\$20

DATEBOOK—Program to manage time just like an office appointment book but using the speed and memory of a computer. Keeps track of three appointment schedules (three dental chairs, three attorneys, etc.) at once. Appointments consist of name, reason for the appointment, the date and time, and the length of the appointment. System can be quickly customized for the individual user. Many helpful features for making, changing, finding, and reporting appointments. Requires 48K CP/M and 180K bytes diskette storage. Not available for Apple CP/M. \$295/\$25

PEACHTREE SOFTWARE\*
General accounting software for small businesses. Each product can be used alone or with automatic posting to the general ledger. Supplied in source for Microsoft BASIC 4.51.

Table with 2 columns: Product Name and Price. Includes GENERAL LEDGER, ACCOUNTS PAYABLE, ACCOUNTS RECEIVABLE, PAYROLL, INVENTORY, MAILING ADDRESS, and PROPERTY MANAGEMENT.

GRAHAM-DORIAN SOFTWARE SYSTEMS

Comprehensive accounting software written in CBASIC-2 and supplied in source code. Each software package can be used as a stand-alone system or integrated with the General Ledger for automatic posting to ledger accounts. Requires CBASIC-2.

Table with 2 columns: Product Name and Price. Includes GENERAL LEDGER, ACCOUNTS PAYABLE, ACCOUNTS RECEIVABLE, INVENTORY SYSTEM, JOB COSTING, APARTMENT MANAGEMENT, and CASH REGISTER.

POSTMASTER—A comprehensive package for mail list maintenance that is completely menu driven. Features include keyed record extraction and label production. A form letter program is included which provides neat letters on single sheet or continuous forms. Includes NAD file translator. Requires CBASIC-2. \$150/\$20

STRUCTURED SYSTEMS GROUP

Complete interactive accounting software for business. Each product can be used stand-alone or with automatic posting to the general ledger. Each product is thoroughly tested and very well documented. Each product requires CBASIC-2.

Table with 2 columns: Product Name and Price. Includes GENERAL LEDGER, ACCOUNTS RECEIVABLE, ACCOUNTS PAYABLE, PAYROLL, and INVENTORY CONTROL.

LIFELINES NEWSLETTER FROM LIFEBOAT

LIFELINES is the first step in software support for the serious microcomputer user. Each issue reports new revisions together with information on the purpose for each such release, be it for correction of bugs\* or the addition of features and facilities.

Feature Articles! New Software! Product Comparisons! Info on CP/M Users Group!

SUBSCRIPTION INFORMATION:

\$18 for twelve issues: U.S., Canada, and Mexico. \$40 for twelve issues: all other countries. \$2.50 for each back issue: U.S., Canada, and Mexico. \$3.60 for each back issue: all other countries. Send Check to LIFELINES, 1651 Third Avenue, New York, N.Y. 10028 or use your VISA or MASTERCARD—call (212) 722-1700

ANALYST—Customized data entry and reporting system. User specifies up to 75 data items per record. Interactive data entry, retrieval, and update facility makes information management easy. Sophisticated report generator provides customized reports using selected records with multiple level breakpoints for summarization. Requires a disk sort utility such as OSORT, SUPER-SORT or VSORT and CBASIC-2. \$250/\$15

LETTERRIGHT—Program to create, edit and type letters or other documents. Has facilities to enter, display, delete and move text, with good video screen presentation. Designed to integrate with NAD for form letter mailings. Requires CBASIC-2. \$200/\$25

NAD Name and Address selection system—Interactive mail list creation and maintenance program with output as full reports with reference data or restricted information for mail labels. Transfer system for extraction and transfer of selected records to create new files. Requires CBASIC-2. \$100/\$20

QSORT—Fast sort/merge program for files with fixed record length, variable field length information. Up to five ascending or descending keys. Full back-up of input files created. \$100/\$20

CONDIMENTS

HEAD CLEANING DISKETTE—Cleans the drive Read/Write head in 30 seconds. Diskette absorbs loose oxide particles, fingerprints, and other foreign particles that might hinder the performance of the drive head. Lasts at least 3 months with daily use. Specify 5" or 8". Single sided \$20 each/\$55 for 3 Double sided \$25 each/\$65 for 3

DC 300 Data Cartridges Specify 450 XL or 300 certified. Pack of 5. \$100

FLIPPY DISK KIT—Template and instructions to modify single sided 5 1/4" diskettes for use of second side in single sided drives. \$12.50

FLOPPY SAVER—Protection for center holes for 5" and 8" floppy disks. Only 1 needed per diskette. Kit contains centering post, pressure tool and tough 7 mil mylar reinforcing rings for 25 diskettes. 5" Kit \$14.95 5" Rings only \$7.95 8" Kit \$16.95 8" Rings only \$8.95

PASCAL USER MANUAL AND REPORT—By Jensen and Wirth. The standard textbook on the language. Recommended for use by Pascal/Z, Pascal/M and Pascal/MT users \$12

- THE C PROGRAMMING LANGUAGE—By Kernighan and Ritchie. The standard textbook on the language. Recommended for use by BDS C, lincy C, and Whitesmiths C users. \$12
STRUCTURED MICROPROCESSOR PROGRAMMING—By the authors of SMAL/80. Covers structured programming, the 8080/8085 instruction set and the SMAL/80 language. \$20
ACCOUNTS PAYABLE & ACCOUNTS RECEIVABLE—CBASIC—By Osborne/McGraw-Hill. \$20
GENERAL LEDGER—CBASIC—By Osborne/McGraw-Hill. \$20
PAYROLL WITH COST ACCOUNTING—CBASIC—by Osborne/McGraw-Hill. \$20

Hearty Appetite.

\*CP/M and MP/M are trademarks of Digital Research. Z80 is a trademark of Zilog, Inc. UNIX is a trademark of Bell Laboratories. WHATSI? is a trademark of Computer Headware. Electric Pencil is a trademark of Michael Shroyer Software. TRS-80 is a trademark of Tandy Corp. Pascal/M is a trademark of Sorcim. SoftCard is a trademark of Microsoft. Apple is a trademark of Apple Computer. PASM, PLINK, BUG and µBUG are trademarks of Phoenix Software Associates Ltd. CPAlDS is a trademark of Computer Tax Service, Inc. MAGIC WAND is a trademark of Small Business Application, Inc. Peachtree Software is a trademark of Retail Sciences, Inc.

Recommended system configuration consists of 48K CP/M, 2 full size disk drives, 24 x 80 CRT and 132 column printer.

Modified version available for use with CP/M as implemented on Heath and TRS-80 Model I computers.

User license agreement for this product must be signed and returned to Lifeboat Associates before shipment may be made.

This product includes/excludes the language manual recommended in Condiments.

Serial number of CP/M system must be supplied with orders.

Requires Z80 CPU.

Ordering Information

MEDIA FORMAT ORDERING CODES

When ordering, please specify format code.

LIFEBOAT ASSOCIATES MEDIA FORMATS LIST. Diskette, cartridge disk and cartridge tape format codes to be specified when ordering software for listed computer or disk systems. All software products have specific requirements in terms of hardware or software support, such as MPU type, memory size, support operating system or language.

Table with 4 columns: Computer system, Format Code, Computer system, Format Code. Lists various software products and their compatibility with different hardware configurations.

Prices reflect distribution on 8" single density diskettes. If a format is requested which requires additional diskettes, a surcharge of \$8 per additional diskette will be added. Prices F.O.B. New York Shipping, handling and C.O.D. charges extra. Manual cost applicable against price of subsequent software purchase. The sale of each proprietary software package conveys a license for use on one system only.

Lifeboat Associates THE SOFTWARE SUPER-MARKET. Includes a small image of a software box.

Lifeboat Associates 1651 Third Avenue, N.Y., N.Y. 10028 (212) 860-0300

## The Altos ACS8000 Single-Board Computer

---

Mark Dahmke  
1515 Superior St, Apt 15  
Lincoln NE 68521

---

Altos Computer Systems of San Jose, California, manufactures a series of powerful Z80-based computers aimed mainly at the small-business and scientific-laboratory markets. The company offers a wide variety of models — from one 8-inch, single-density, Shugart floppy-disk drive with 32 K bytes of main memory to four double-density, 8-inch floppy-disk drives, and a hard-disk subsystem with as much as 58 megabytes of on-line storage.

### Hardware Design

The ACS8000 series are all single-circuit-card computers based on a Z80A microprocessor running at 4 MHz. All systems come with at least 32 K bytes of 4116 dynamic memory devices. This is expandable to 64 K bytes on two versions of the ACS8000, and to 208 K bytes on the third version.

The system also comes with a 2708 EPROM (erasable programmable read-only memory) that contains the ALTOS-E monitor program. The 2708 is active until CP/M is boot-loaded: it is then disabled and disappears so the entire memory-address space is available as programmable memory. This technique is widely used and is referred to as "phantom read-only memory."

---

### About the Author

Mark Dahmke is a consulting editor for BYTE Publications and also operates a computer consulting business. He has been involved with computers since 1974 and does a great deal of systems hardware and software design. His interests include writing, photography, voice synthesis, and computer graphics.

---

### Serial Ports

Even the smallest Altos system comes with a dual-channel, serial I/O (input/output) device. One channel is used for the system console, and the other is set up to drive a printer or another device, such as a modem. The console channel is preset by the ALTOS-E monitor firmware to 9600 bps, with 1 start bit, 1 stop bit, 8 data bits, and no parity. It runs in full-duplex (ie: simultaneous-bidirectional) mode. The 9600 bps data rate of the console is not alterable, but the printer characteristics can be changed after the system is booted up.

### Parallel Ports

All Altos computers come with at least two user-defined parallel ports. There are actually two Z80 PIO (parallel input/output) devices, each with two ports, but one is used to

control disk operations. The user-definable ports are accessible through an external connector that may be connected to a printer, an EPROM programmer, or a parallel-input keyboard. Both ports are fully programmable.

### The Counter-Timer Circuit

The Z80 CTC (counter-timer circuit) is a programmable counter-timer that has four independent channels. Three of the channels (addresses 0 thru 2) are used by the system to set console and printer data rates and disk-head load-delay times. The fourth channel is available to the user and can be programmed as an interval timer or real-time clock.

### The Floppy-Disk Controller

The Altos single-density model uses the Western Digital 1771-1

### A Visit to Altos

Altos computers have acquired quite a reputation for reliability — it's the sort of thing you hear by word-of-mouth in this industry. To find out more, I paid a visit to Altos recently at the invitation of Dr Roger Vass, the Vice-President of Marketing.

Roger described the extensive quality-control procedures used at Altos, which include several burn-in tests of individual components and complete systems in its testing ovens. Another reason for the low failure rate of the computers (eg: less than 1% are returned to the plant because of

defects) is that Altos computers use a single printed-circuit board for the entire computer, thus eliminating many potential inter-connection problems.

Interestingly, Altos sells more computers (ie: about 55% at present) overseas than it does domestically, due in part to the company's vigorous marketing activity in Europe. Roger sees the European market as having great potential for American personal-computer companies. Certainly, the growth of the number of publications and public interest at overseas trade shows confirms this. . .CM



For your Horizon —



North Star  
Horizon Computer  
with 5" Floppy Disks

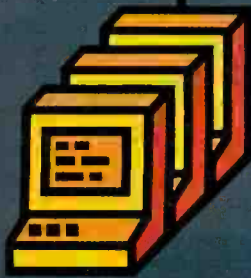

Display  
Terminals

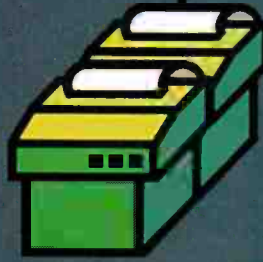

Printers

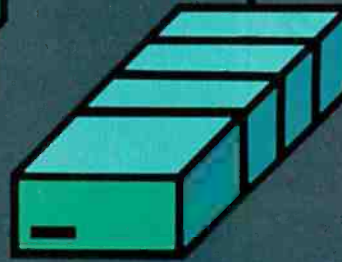

Up To Four  
Hard Disks

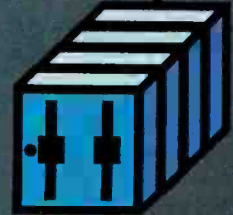

Up To Four 8"  
Floppy Disks

## More power, work, flexibility!

**JOEDOS™** — Jointly Operate Everything Disk Operating System. Switch from North Star™ BASIC to CP/M™ and back again with a simple command. Floating point and standard 8, 10, 12, and 14 digit precisions of North Star BASIC, as well as Digital Research's CP/M all on the same hard disk unit.

Designed to operate with the DISCUS M26™ 26.5 megabyte (formatted) Winchester-technology hard disk unit and North Star's Micro Disk System, JOEDOS brings you large mainframe performance at microcomputer cost and reliability. CP/M disk activity is amazingly quick through JOEDOS; access to North Star BASIC programs and files is unbelievable!

Speed and enormous storage capacity (as much as 106 megabytes) are only the beginning. Through JOEDOS, each hard disk unit may appear to be one drive or many different "drives" (as many as 147 double density 180K North Star 5¼" drive-size segments). As many as seven of these segmented "drives" may be addressed at any particular time. Segment size, file size and directory size are variable according to user's requirements. Maximum file size is 16 megabytes, while the maximum directory size for each segment is 8,160 entries.

JOEDOS — Micro Mike's hard disk operating system. Requires DISCUS M26 hard disk unit and controller and North Star Micro Disk System for operation. Includes CP/M. JOEDOS and manual **\$495**

**JOESHARE™** — North Star Horizon™/DISCUS Hard Disk Timesharing System. Micro Mike's popular interrupt-driven, bank switching timesharing for North Star Horizon computer is now available with all the features of JOEDOS hard disk operating system. JOESHARE allows multiple users to access as many as four 26.5 megabyte hard disk units, simultaneously operating programs through North Star DOS or through CP/M.

JOESHARE — Micro Mike's North Star Horizon timesharing/DISCUS hard disk operating system. Requires North Star Horizon and DISCUS M26 hard disk unit for operation. Includes CP/M. JOESHARE and manual **\$750**

**HDSHARE™** — North Star Horizon/North Star Hard Disk Timesharing System. A version of JOESHARE with all of the features of JOESHARE using the North Star hard disk. HDSHARE allows multiple users to access as many as four 18 megabyte North Star hard disk units, simultaneously operating programs through North Star DOS or through CP/M.

HDSHARE — Micro Mike's North Star Horizon timesharing/North Star hard disk operating system. Requires North Star Horizon and North Star hard disk system for operation. Includes CP/M. HDSHARE and manual **\$750**

**5.2SHARE™** — North Star Horizon/Floppy Disk Timesharing System. Micro Mike's floppy disk timesharing system has some new enhancements. 5.2SHARE now supports 8, 10, 12, and 14 digit floating point and standard North Star BASIC with as many as four DISCUS 8" drives, operating in conjunction with the Horizon's 5¼" drives to provide in excess of 5 megabytes of external storage.

5.2SHARE — Micro Mike's interrupt-driven, bank switching timesharing for the North Star Horizon computer. Includes 8" drive software interface. For double density or quad capacity systems only. 5.2SHARE and manual **\$395**

**DOSCHG™** — Micro Mike's 8" drive interface to North Star DOS and BASIC. Requires North Star Micro Disk System and DISCUS 8" drives and controller for operation. DOSCHG and manual **\$150**

Program operation manuals are available for preview before software purchase.

Program Operation Manuals for each program **\$25**  
(Applies toward purchase of program)

Programs are available in double density/quad capacity format only. Prices are subject to change without notice.

Contact your North Star dealer or Micro Mike's. Send \$1 for descriptive literature.

JOEDOS, JOESHARE, HDSHARE, 5.2SHARE and DOSCHG are registered trademarks of Micro Mike's, Incorporated  
North Star and Horizon are registered trademarks of North Star Computers, Inc.  
DISCUS and M26 are registered trademarks of Morrow Designs, Inc.  
CP/M is a registered trademark of Digital Research, Inc.  
Copyright 1980 Micro Mike's, Inc. All rights reserved worldwide.

*Mike's*  
Micro Mike's, Inc.

905 South Buchanan Amarillo, Texas 79101 USA Telephone: 806/372-3633  
**making technology uncomplicated... for People**

# Could you pass this Red Cross swimming test?

SWIM:

1. Breaststroke—100 Yds.
2. Sidestroke—100 Yds.
3. Crawl stroke—100 Yds.
4. Back crawl—50 Yds.
5. On back (legs only)—50 Yds.
6. Turns (on front, back, side).
7. Surface dive—underwater swim—20 Ft.
8. Disrobe—float with clothes—5 mins.
9. Long shallow dive.
10. Running front dive.
11. 10-minute swim.

Anybody who's taken a Red Cross swim course knows how tough it can be.

There's a good reason.

We believe drowning is a serious business.

Last year alone, we taught 2,589,203 Americans not to drown—in the seven different swim courses we offer all across the country. (Incidentally, most of the teaching—as with almost everything American Red Cross does—is done by dedicated volunteers.)

A good many of the youngsters not only are learning to keep *themselves* safe. Thousands upon thousands of them are learning to become lifesavers.

And the life they save—it just might be your own.



**Red Cross**  
is counting  
on you.



Photo 1: Front view of the Altos ACS 8000-2 computer, which has 64 K bytes of memory and two dual-density, single-sided disk drives.

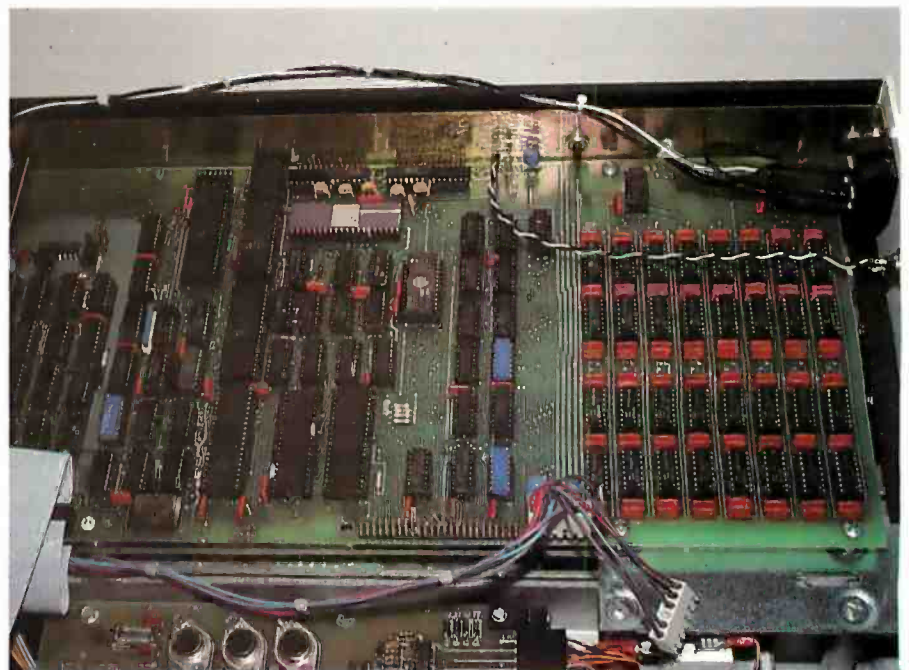

Photo 2: Interior view of the ACS 8000-2, which is, as are all the Altos models, a single-board, Z80-based computer.

floppy-disk controller/formatter device to manage up to four 8-inch drives. The 1771-1 is directly integrated into the single-board design of the Altos.

The double-density version requires some additional control circuitry and uses the 1791-1 device;

thus the board supporting double-density disks is slightly larger. All versions of the ACS8000 are available with either single-sided or double-sided Shugart drives.

All boards have a fifty-pin expansion connector that allows the user to access all Z80 address, data, and con-

Whatever happened to eenie, meenie, miney, mo?

This may put the Godfather out of business.

I could be another Solomon...

If only my heart would stop racing...

It must use Bayesian, weighted factor analysis, and...

Brilliant! Like a window into the future.

...a perfect gift for that urban cowgirl!

Maybe this'll help me choose a career...

I could use it to select my staff.

Would I rather have Winston's millions or Billy Joe's love?

Hmmmm... could be my ticket to the Boardroom.

Can't any of these people afford \$29.95?

Should I buy stock or commodities in this economy?



## When DecisionMaster speaks everybody listens.<sup>TM</sup>

Let's face it. We all have to make decisions. Decisions that can change our lives. Decisions that can make us happy or unhappy. Decisions that could win us fame or fortune. Now, DecisionMaster can help you make the best decisions of your life.

Use Bayesian theory to peer into the future... even if you've never heard of the Bayes' Rule. Do a complete weighted factor analysis... without knowing what one is. Use discounted cash flow to compare investment alternatives without bothering with present value tables. These and other sophisticated theories that were once the exclusive domain of professors and top business executives are *built into* DecisionMaster's algorithms... so you can use them at the touch of a key!

DecisionMaster is easy to use. It features:

- A fully documented manual developed by an authority in the field.
- A unique program-controlled cross reference system.
- A powerful formatted-screen data entry system.

You'll use DecisionMaster in hundreds of routine decisions, as well as more important ones such as • Buying a house • Changing jobs • Selecting investment • Evaluating insurance policies • Expanding product lines • Leasing vs. purchasing.

If you buy only one computer program this year, make it DecisionMaster. And when it speaks, listen.

# DECISIONMASTER<sup>TM</sup>

To order, see your software dealer or return this form with your check to: DecisionMaster, Dept. B4, 10428 Westpark, Houston, Texas 77042. Add \$1.50 for shipping and handling.

Apple II\* (32K) \$29.95  
 TRS-80\*\* (Level II-32K) \$29.95  
 TRS-80\*\* (Model III) \$39.95

Name \_\_\_\_\_ State \_\_\_\_\_  
 Address \_\_\_\_\_  
 City \_\_\_\_\_ Zip \_\_\_\_\_

CHARGE by phone toll-free: 1-800-231-5768 Ext. 306  
 (In Texas: 1-800-392-2348) or return this form:  
 VISA  MasterCard Bank Code \_\_\_\_\_  
 Account No. \_\_\_\_\_  
 Signature \_\_\_\_\_  
 Expiration Date \_\_\_\_\_

\*Apple II is a registered trademark of Apple Computers, Inc.  
 \*\*TRS-80 is a trademark of the Radio Shack Division of Tandy Corp.

# NOW YOU'RE TALKING!

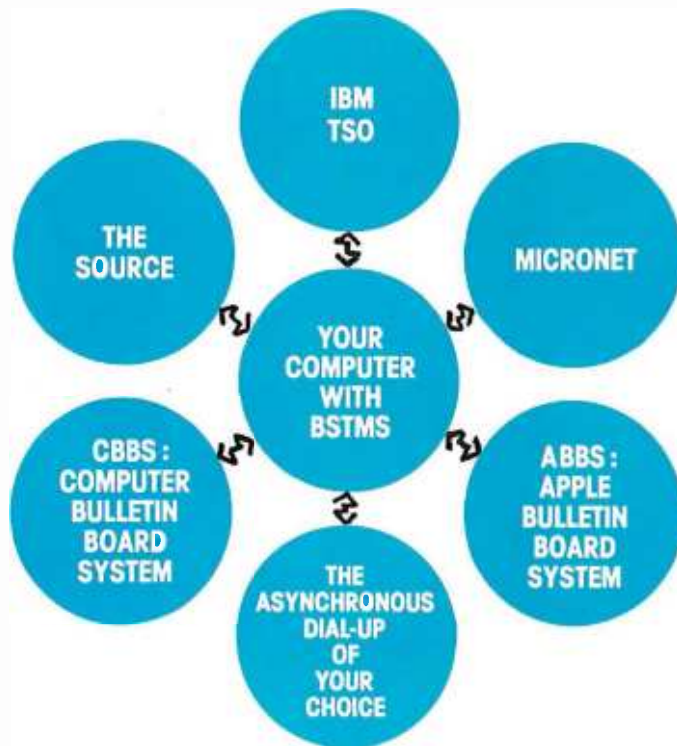

## “BSTMS”

Byrom Software Terminal Monitor System

**The missing link between your CP/M system and remote computers everywhere!**

- talks to most dial-up remote computers.
- stores data from remote computers in CP/M files.
- copies data to CP/M list device if desired.
- transmits files to the remote computer.
- it will even “talk” to another CP/M console.
- features EXPAND and COMPRESS programs to translate binary files into character files and vice versa.
- uses the same simple installation procedure as BSTAM.

This system is great for recording data from remote time-sharing systems! It makes it possible to do local processing of data on a micro and then transmit it to the mainframe.

This software requires a knowledge of assembler language for installation.

**\$200** per computer.

**\$25** for manual alone.

Prices reflect distribution on 8" single density diskettes. If a format is requested which requires additional diskettes, a surcharge of \$5. Per additional diskette will be added.

Apple is a trademark of Apple Computer.  
MicroNET is a trademark of CompuServ.  
CP/M is a trademark of Digital Research.

**Lifeboat Associates**

1651 Third Avenue, New York, N.Y. 10028  
(212) 860-0300 Telex: 220501



trol lines. Altos does not use the connector for expansion purposes because of its single-board philosophy, but it is there for the special needs of the users.

### Optional Components

The ACS8000 has provisions for some special components that are optional on all of the standard systems. The Z80 DMA (direct memory access) controller is a very sophisticated device that can be programmed to perform block data transfers from memory to memory, from memory to an I/O port, or vice versa. The device can also be programmed to search for a byte within a block, with or without transfer of the block. The device has one DMA channel that can be set up to work in four different modes:

- single-byte mode — in which each memory access operates on a single byte of data
- burst mode — in which the device keeps control of the bus for as long as data is continuously ready
- continuous mode — in which the device retains bus control for the entire operation
- transparent mode — in which the device operates only during memory refresh time so it does not slow down the processor

I was informed by Altos that, although the Z80 DMA device can be plugged into the system, there is no way to use it under CP/M. The OASIS multiuser operating system is set up to use DMA to access a disk, however.

The Advanced Micro Devices Am9511 arithmetic processor is another optional device that provides fixed and floating-point arithmetic and floating-point trigonometric and mathematical operations. It may be used to speed up computational capabilities of the system. All commands and data transfers take place on an 8-bit, bidirectional data bus. Transfers to and from the 9511 may be handled by the Z80 under program control (with IN and OUT instructions) or through the Z80 DMA device. The Am9511 can be programmed to generate interrupts upon completion of arithmetic functions.

Altos also plans to introduce a 2708/2716 EPROM programmer that will plug into the parallel-port con-

*Text continued on page 166*

# SAVE

on  
add-ons  
for

# APPLE® and TRS-80®

## "APEX" NEW DISK OPERATING SYSTEM FOR THE APPLE®

Fully Professional DOS for the Apple II. The result of two years of extensive development, APEX provides a complete program development and file management system. A comprehensive command set allows the user to perform almost any imaginable disk operation.

- Command structure similar to CPM® and main frame systems. Contains 20 command words.
- Easy program interface. Simple communications.
- Capable of handling 5 inch, 8 inch, and hard disks.
- Safety features to protect against accidental data loss. Features include backup files, directory, read after-write & limit checks.
- 4 times faster than CPM®.
- Auto default structure eliminates tedious typing by automatically setting up command strings, file names, etc.
- Functional on both single and multi-drive systems.
- Device handler structure for interfacing peripherals.

The APEX package includes all of the tools for a complete assembly language development system, high speed two pass resident assembler and a powerful macro editor.

The complete APEX package with operating system, assembler, editor and manuals, also includes utilities to maintain files.

**APEX**  
**\$99**

**RELATED SOFTWARE**  
**XPLO** \$79  
**FOCAL™** \$59

## SAVE ON APPLE II 16K



**FREE MEMORY UPGRADE KIT TO 48K WITH PURCHASE OF APPLE II 16K \$1195 (MTI ONLY)**

### INTRODUCTORY OFFER

**SAVE \$300** TRS-80 Graphics List \$949



**OKIDATA MICROLINE 80 OUR PRICE \$649**

**Z-80 SoftCard \$399**

The Source ..... \$100  
Applesoftware.. \$29.95

## MTI APPLE 8" DISK SYSTEM

- \*One SA800R Floppy
- \*1 Drive Chassis & Power Supply
- \*Controller, Cable and DOS

**\$1439**

### Drives for any Microcomputer

Does not include power supply & cabinet.

Perfec FD200 .....	\$282	FD250 .....	\$359
Shugart SA400 .....	\$279	SA800/801 .....	\$479
MPI B51 .....	\$279	B52 .....	\$349
MPI B91 .....	\$399	B92 .....	\$525

### Printers

Centronic 779 .....	\$1,069
Base 2 .....	\$649
Centronics 737 .....	\$939
Centronics 702-9 .....	\$1,995
Anadex 9501 .....	\$1,549
Malibu .....	\$2,395
Spinwriter .....	\$2,549



Daisy Wheel ..... \$1,779

## NEWDOS 80

A new enhanced NEWDOS for the TRS-80.

The most powerful Disk Operating System for the TRS-80, designed for the sophisticated user and professional programmer who demands the ultimate.

NEWDOS/80 is the planned upgrade from NEWDOS 2.1. Some of the features are:

- New BASIC commands for files with variable record lengths up to 4095.
- Mix or match drives. Use 35, 40 or 80 track 5" disk drives or 8" disk drives, or combo.
- Security boot-up for BASIC or machine code application programs.
- New editing commands.
- Enhanced RENUMBER that allows relocation.
- Command chaining.
- Device handling for routing to display and printer simultaneously.
- DFG function: striking of D, F and G keys allows user to enter a mini-DOS without disturbing program.
- Compatible with NEWDOS & TRSDOS.
- Machine language Superzap/80 2.1 utilities and enhanced debug and copy.

**\$149**

### Disk Drive Sale!

Complete with power supply and chassis.

T-3 Shugart SA400 .....	\$339
Perfec FD200, 40 track .....	\$379
*T-5 MPI B51, 40 track .....	\$369
*TF-7 Micropolis 77 track .....	\$579
TDH-1 Dual Sided drive 35 track .....	\$499
TF-3M Drive Sys 2 Shugart .....	\$699



### Disk Expansion System

*2 Shugart SA400 TF-3 .....	\$678
*1 Two-Drive Cable .....	\$ 26
*1 Expansion Interface 32K .....	\$459
*1 35-track DOS+ .....	\$ 99
<b>TOTAL LIST PRICE .....</b>	<b>\$1262</b>

**SPECIAL PRICE ONLY \$1,149**

Same as above but includes TRS-80® Level II .....

**\$1949**

NEWDOS+ 40 track .....	\$110
NEWDOS+ 35 track .....	\$ 99
Microconductor, Data Base Mgr. Mod I .....	\$249
Mod II .....	\$399
AJA Business Pkg .....	\$359
The Source .....	\$100
Basic Compiler .....	\$195
Mail List .....	\$60
Electric pencil .....	\$150

### NEW

**TF-8 80 TRACK DISK DRIVE \$639**  
Double Your Capacity

**TF-9 DUAL 80 TRACK DISK DRIVE \$789**  
Quadruple Your Capacity

## 8" Floppy Disk Drive System

for Model I

- One SA801 Floppy
- NEWDOS 80
- Cable & Adapter

**\$1095**



**MTI MICROCOMPUTER TECHNOLOGY INCORPORATED**



**Apparat, Inc.**

3304 West MacArthur  
Santa Ana, CA 92704  
(714) 979-9923

TELEX 678-401 TABIRIN  
Order Desk Only 800-854-7222

ALL PRICES CASH DISCOUNTED  
FREIGHT FOB/FACTORY  
ASK FOR OUR FREE CATALOGUE

4401 South Tamarac Parkway  
Denver, CO 90237  
(303) 741-1778

## CP/M Features With Altos Systems

All the standard CP/M system utilities are available:

- **ED:** context (text) editor.
- **ASM:** CP/M standard (no-frills) 8080 assembler.
- **LOAD:** loader, converts hexadecimal-ASCII format files to absolute machine-code files.
- **DDT:** CP/M Dynamic Debugging Tool.
- **PIP:** Peripheral Interchange Program that is used to move and copy disk files from disk to disk and can also be used to copy files from disk to printer or from a reader device to disk.
- **SYSGEN:** CP/M utility that generates new system disks.
- **DUMP:** prints the contents of a file on the display in hexadecimal (base 16) form.
- **SUBMIT:** CP/M batch facility: executes a series of console commands from a disk file.

Some additional commands and utilities are available:

- **MOVCPM:** CP/M utility that is used to relocate the CP/M operating system depending on system memory size.
- **STAT:** displays status of various device assignments and shows the amount of free space left on each on-line.
- **MTS:** memory-test program that performs a destructive memory test on system memory.
- **SETUP:** utility that modifies the boot-load sector of a disk. It also allows a disk to be flagged for single- or double-density operation and sets the printer data rate at boot-load time.
- **REFORM:** disk-formatting utility that allows the user to format a disk for single- or double-density operation. Disks may be formatted to be either IBM 3740-compatible or Intel ISIS-II format. Altos has its own format for double density.
- **DTEST:** disk-test utility that checks out both drives and disks on the system.
- **SINGLE:** followed by the letter designation of a drive (A, B, C, D), will set up the drive for

single-density operation.

- **DOUBLE:** works the same as **SINGLE** but sets the designated drive for double-density operation.
- **COPY:** will copy data track by track from the disk in drive A to drive B.
- **FILES:** will display the file-control-block information in hexadecimal for all files on a disk.

Other files are included with the system:

- **BOOT.ASM:** an assembler source for the boot loader.
- **ALTOSE.ASM:** an assembler source for the ALTOS-E 2708 EPROM.
- **CBIOS.ASM:** an assembler source for the custom Basic Input/Output System (CBIOS) in CP/M. This allows the user to make further operating-system modifications as needed.

## UCSD Pascal Operating System

### Initializing the System

In order to make UCSD (University of California, San Diego) Pascal fully operational on the Altos, a user-written procedure that does direct cursor addressing on video terminals must be added to the operating system. Referred to as **GOTOXY**, the procedure accepts two integer variables as input and positions the cursor on the screen accordingly. Since there are so many different video terminals, it is the responsibility of the user to write the **GOTOXY** procedure. After compiling it, the user must execute a program called **BINDER** which links **GOTOXY** to the **SYSTEM.PASCAL** file.

The other initialization program is called **SETUP**. When executed, the user is given a set of options including **Help** and **Teach**. **SETUP** modifies a table of key assignments and terminal commands, allowing the user to customize the operating system to a particular terminal. Most keys may also have a prefix (eg: **Escape**) to allow for terminals that send escape sequences for certain user-definable keys. For example, many terminals have a separate keypad for cursor control

(eg: **Up**, **Down**, **Home**, etc). The escape sequence for "cursor home" on many terminals is **Escape-H**; or 27,72 in decimal ASCII codes. In **SETUP**, the cursor-home function could be defined as having a prefix code and the decimal value 72 (or H as the character code).

### Other Features

The Pascal Operating System has some other unique features. When compiling a program, Pascal will list error messages and ask if you want to continue or return to the editor. If the latter option is chosen, the operating system loads the editor and places the cursor on the character where the compilation error was detected. This feature saves a great deal of time when correcting syntax and logic errors.

The Filer also has some interesting features. Basically, the Filer is a utility program that lists directories of disks and manipulates files directly in the conventional disk-operating-system mode. On request, the Filer will create a duplicate directory for backup purposes. The Filer also has a routine for locating bad blocks on disk. If a bad sector is found, it will be marked as an immovable file in the directory.

Altos is marketing Pascal/M and a C compiler. The firm is also in the process of providing hard-disk backup on cartridge tape. The company is also introducing an asynchronous communications package for Altos computers (price: \$100) and a bisynchronous IBM 3780 protocol package that allows the Altos to go on line in batch mode to an IBM host computer. The price is \$1000.

In version II.0 of Pascal, the Debugger package is missing. I was informed by Altos that it was having problems with it and that a new version would be available with the next release. Altos also said that Pascal/M does have a full Debug option and that it will be available shortly.

# For those special people who've stepped ahead with a mini-computer



## Maxell offers a way to stay ahead.

A Maxell 5¼" Mini-Disk will consistently let you maximize the capability of your system today, and as your involvement with it grows, tomorrow as well. Maxell Mini-Disks are all made with the same exacting 100% certification and critical dependability of the Maxell 8" Floppy Disk. So you *know* your 5¼" Maxell Mini-Disks meet or exceed the same ISO and Shugart specifications industry requires.

There are double density Maxell single and double-sided 5¼" Mini-Disks for soft and hard sector systems. And 8" Maxell Floppy Disks for every disk drive configuration. See your computer supply dealer or write to us for more information. If you are a computer products dealer, write for the growing opportunities Maxell Business Products Division offers you with our 8" Floppy and 5¼" Mini-Disks.

**maxell**   
BUSINESS PRODUCTS DIVISION

Maxell Corporation of America, Business Products Division, 60 Oxford Drive, Moonachie, N.J. 07074 Tel: 201-440-8020

nector. This project has been delayed because of software development priorities.

### Hard-Disk Capability

Altos' third single-board version of the ACS8000 has an on-board hard-disk controller in addition to the floppy-disk controller. Hard-disk storage may start at 14.5 megabytes and can be expanded up to 58 megabytes.

### Multiuser Versions

The system that I received was an ACS8000-2 with 64 K bytes of memory and two dual-density, single-sided floppy-disk drives. As described in the literature, the ACS8000-2/MU2 is a two-user system with 112 K bytes of memory and two double-density single-sided drives.

Memory is divided into banks, with a 16 K-byte system area and two or more 48 K-byte user areas. A four-user ACS8000-2/MU4 is the same as an MU2 but with 208 K bytes of memory. The largest non-hard-disk configuration would be an ACS8000-

## All Altos systems run either CP/M or Altos multiuser executive AMEX.

4/MU4 with 208 K bytes of memory for four users and four double-density, double-sided floppy-disk drives.

The smallest hard-disk multiuser configuration would be an ACS8000-6/MU2 with 112 K bytes of memory, two double-density, single-sided drives and a one-platter hard disk yielding 14.5 megabytes of space. This system would have four serial I/O ports and two parallel ports.

The largest configuration would be an ACS8000-9/MU4 with 208 K bytes for four users, four double-density, double-sided floppy-disk drives and 58 megabytes of hard-disk space. A total of six serial ports and two parallel ports would be available on the system; these can be used to support four terminals and two other peripherals.

### Software

All Altos systems run either Digital Research's CP/M operating system or Altos multiuser executive AMEX. AMEX is functionally compatible with CP/M, using the same disk formats and operating-system conventions. If you plan to use a hard disk, AMEX is a necessity since straight CP/M supports only floppy disks. CP/M version 2.0, which directly supports hard disks, and MP/M, the multiprogramming version of CP/M, are also available.

### Optional Software

The Altos CP/M has been customized to allow for printout *spooling* and *despooling*. In this process, printed material is stored on disk until the printer is free. This option allows printers to be driven in the background mode so that printing may go on while the computer is doing something else.

Another software option is for use with the Microsoft FORTRAN-80 compiler. A FORTRAN service-subroutine library called APULIB makes use of the Am9511 floating-point processor to speed up arithmetic computations in FORTRAN by a factor of 10 or more. A typical FORTRAN program performing extensive calculations could run about four times faster with APULIB.

The other major software option is the UCSD Pascal operating system. Altos offers it as a separate and distinct operating system for the ACS8000. This operating system consists of a file manager, an editor, a Pascal compiler, a BASIC compiler, a macroassembler for the Z80, an interactive debugger, and a linker/librarian. UCSD (University of California, San Diego) Pascal runs as a P-machine interpreter. All portions of the operating system and some other run-time subroutines are written in Pascal, with the exception of portions of the P-machine interpreter. Pascal is also patched to handle the Am9511 arithmetic processor for greater computational speed. The Z80 CTC is also set up to act like a real-time clock. Unfortunately, the real-time clock is not accessible by the user; it is used internally to improve the performance of the disk interface.

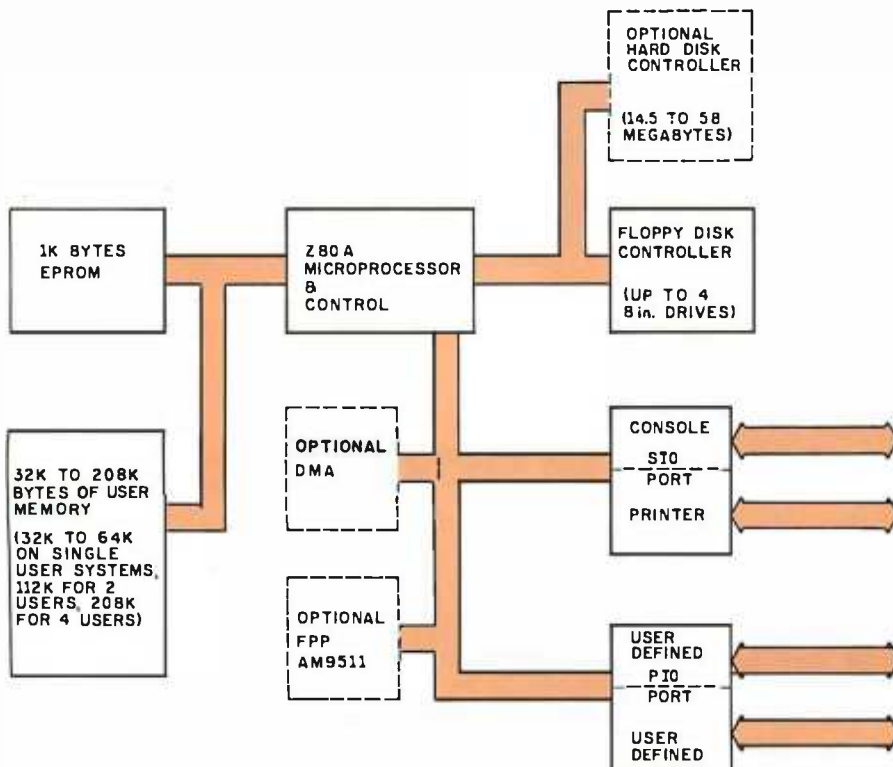

Figure 1: Block diagram of the Altos ACS8000 systems.

### Altos Documentation

The manual shipped with the Altos consists of the following segments:





## Beautiful “Computer Chess” Reproduction—only \$7.95!

This dramatic reproduction of the October '78 Byte cover art has been produced with the same care and quality as limited edition prints—yet it is available for the price of a poster.

The overall size is 18" x 22", which includes a 1½" border. It is printed on heavy, 80 lb., matte finish, coated stock, excellent for the finest framing if desired.

The price of this quality reproduction is \$7.95, plus \$2.00 for mailing tube, handling, and postage. In addition, the artist, Robert Tinney, will select the 100 finest prints from this first edition for his personal signature and number. These 100 signed and numbered prints will be sold on a strictly first come basis for \$24.00 plus \$1.00 postage and handling.

See coupon below for ordering.

Send me \_\_\_\_\_ of the \$7.95 posters, and \_\_\_\_\_ of the 100 signed prints. I have included \$2.00 for postage and handling.

Please charge this to my \_\_\_\_\_  
 Visa/Master Charge: \_\_\_\_\_  
 Name: \_\_\_\_\_  
 Address: \_\_\_\_\_  
 City: \_\_\_\_\_  
 State: \_\_\_\_\_ Zip: \_\_\_\_\_  
 Visa card number: \_\_\_\_\_  
 Master Charge no.: \_\_\_\_\_  
 signature \_\_\_\_\_  
 Card expires: \_\_\_\_\_

Make check payable to:  
**robert tinney graphics**  
 1864 N. Pamela Drive  
 Baton Rouge, LA 70815

- an operating manual which contains a hardware and software overview section
- setup and checkout guides
- a CP/M operating guide
- a troubleshooting section
- all the schematic diagrams

The manual also includes the SA800/801 disk-drive maintenance manual and six publications from Digital Research covering all aspects of CP/M.

### Setting Up and Using a New System

My Altos is hooked up to a video terminal set to 9600 bps. When power is applied, the Altos displays the two prompt characters %\* on the console, which means that the EPROM monitor is in control. (If reset is depressed, the same response is given.) If a floppy disk is inserted into drive A (the drive on the right-hand side) and reset is depressed, the monitor will automatically begin loading the operating system from the disk. If you are running CP/M, the message "32 K ALTOS DOS VERS 1.47" will be displayed, followed by A> on the next line. The A character means that the disk in drive A is the currently active disk, while the > indicates that CP/M is ready to receive commands.

After the machine displayed the A> prompt, I tried to enter the DIR

command to display the directory, with no success. I reset the system and tried again — still nothing. Then I decided to check the RS-232 cable and connectors to see if the transmit and receive lines were hooked up properly. After experimenting with my own 8080-based system to make sure the terminal would talk to it and still finding no problems, I called Altos: the gentleman I spoke with suggested that I make sure that pin 20 (Data Terminal Ready) of the RS-232 cable was hooked up. I took apart my cable and found that pin 20 was not connected. A quick resoldering job solved the problem. (I later discovered that the Altos manual discusses the problem in the section on troubleshooting, but I had apparently not seen it on my first reading of the manual.)

One of my complaints about the Altos is that the console data rate is defined in firmware — in the EPROM. The system can be used only if you have a 9600 bps terminal (at least, to start with). Even after the initial load, there is no way to easily modify the data rate short of creating a new EPROM.

CP/M has a SETUP command that allows the user to change the boot-load characteristics of a disk. The printer data rate, the system clock rate (2 MHz or 4 MHz), and the density of the disk may be redefined for each system disk. It would seem

reasonable to be able to modify the console data rate also, but this is not currently the case.

### Formatting Disks

The next thing I tried to do was to create a backup copy of the master system disk. The documentation for this procedure is fairly accurate, but important instructions are left out.

The first step is to insert a blank disk (with the label side facing down) into drive B, the left-hand drive. The REFORM command will reformat a disk for any of several disk formats. After typing in REFORM, the computer asks you to enter a number corresponding to the type of format that will be used and to indicate whether the blank disk is in drive B (in a two-drive system) or drive D (in a four-drive system).

The first time I tried to format a disk, I got errors on top of errors. The documentation failed to mention that the write protect notch on the disk must be covered to allow read/write operation. Since I usually work with 5-inch floppy disks, I am used to covering the write protect notch to protect a disk, not to unprotect it. After trying everything I could think of, it finally occurred to me that the notch might need to be covered to work. [This method of disk protection is standard for 8-inch disks, so neither Altos nor its documentation is in error here. Still, this situation

#### At a Glance

Name of computer	Altos ACS8000 series	Software included	ALTOS-E monitor (in read-only memory)
Manufacturer	Altos Computer Systems 2360 Bering Dr San Jose CA 95131 (408) 946-6700	Hardware options	an 9511 arithmetic-processor board; Winchester hard disk; multiple users
Price	from \$2840 (ACS8000-1S)	Software options	Operating systems: AMEX, CP/M, MP/M, OASIS, UCSD Pascal.
Processor	Z80A (8-bit)	Languages	FORTRAN-80; MBASIC, MBASIC-80, CBASIC II; COBOL-80, CIS COBOL; Vanguard APL, PL/I-80, Z80 Macro Assembler
Memory	64 K bytes (expandable to 208 K bytes on a multiuser system)		
Mass Storage	one to four 8-inch, single- or double-density, single- or double-sided, Shugart floppy-disk drives		
Other hardware features	includes serial printer port, two user-definable parallel ports		

# THE SOLUTION STORE <sup>SM</sup>



## ... Makes The Difference!

MicroAge Computer Stores sell solutions to your professional, business and household-management problems, not just hardware. That's what makes the MicroAge difference! From systems integration to easy-to-understand application software, research and development to warranty service and repair, systems consulting to training and installation. In all these, we offer the latest, most innovative approaches. That's why we are the forerunners... the pioneers in the microcomputer industry.

But don't just take our word for it. Visit the MicroAge Computer Store nearest you and see the difference solutions make. We have differences you'll experience with every time- and money-saving idea. The difference that will keep you satisfied now and for years to come!

**MicroAge**  
**COMPUTER STORE**

*"Where Vision Becomes Reality"*

611 Rockville Pike  
Rockville, Maryland  
(301) 840-9315

1707 Monroe Avenue  
Rochester, New York  
(716) 244-9000

2065B El Camino Real West  
Mountainview, California  
(415) 964-7063

83 South 10th Street  
Minneapolis, Minnesota  
(612) 338-1777

24 W. Camelback  
Phoenix, Arizona  
(602) 265-0065

2591 Hamilton Road  
Columbus, Ohio  
(614) 868-1550

5742 E. Broadway  
Tucson, Arizona  
(602) 790-8959

1220 Melbourne Drive  
Hurst, Texas  
(817) 284-3413

2525 N. Scottsdale Road  
Scottsdale, Arizona  
(602) 941-8794

1490 W. Spring Valley Road  
Richardson, Texas  
(214) 234-5955

4550-50 E. Cactus  
Phoenix, Arizona  
(602) 996-2910

**Coming soon to:**  
El Paso, Texas  
Denver, Colorado

**FOR FRANCHISE OPPORTUNITY INFORMATION CALL (602) 967-1421**

always causes problems for people who are accustomed to working with 5-inch floppy disks. . . .GW]

### Altos Demonstration Programs

The CP/M disk that came with the system had a number of demonstration programs, including a biorhythm program in BASIC, a rather poor implementation of tic-tac-toe, a number-guessing game, and a program that did nothing but compute and print square roots. The business package demonstration programs included a payroll generator and an automobile parts-list/inventory program.

The only documentation provided with any of these business demo programs was a single typed page giving

hopelessly inadequate operating instructions. I never succeeded in making any of the nongame programs work.

### Final Remarks

●The hardware of the Altos ACS8000 is well designed, although the documentation of some of its components is absent. The computer uses several sophisticated, optional support chips such as the counter-timer, the serial and parallel ports, and the Am9511 arithmetic processor. However I had to look over the manufacturers' specification sheets and application notes to find out anything about them.

●The software of the Altos ACS8000 is not as well supported, but the

CP/M, AMEX, UCSD Pascal, and OASIS operating systems are available. Altos has provided no software support for the specialized hardware built into the system.

●Languages available from Altos include FORTRAN-80, MBASIC, MBASIC-80, CBASIC II, COBOL-80, CIS COBOL, Vanguard APL, PL/I-80, and Z80 Macro Assembler. Numerous other languages are available from other sources for use with the CP/M operating system.

●The Altos ACS8000 is strong on hardware and weak on software and documentation. Perhaps someday the Altos people will get around to documenting and supporting the best selling points of their product line. ■

SciTronics introduces the first small computer based power monitor . . .

# NEW! ENERGY WATTCHER™

Now have your computer continuously measure, calculate and record your power consumption and cost. Receive energy reports every minute, 15 minute, hour, day and month period.

- Available for TRS-80-I, Apple II & S-100 computers.
- Easy installation clip-on probes supplied.
- Qualify for a 15% energy tax credit.
- Compatible with Remote Controller & Real Time Clock for complete Energy Management System.
- Inexpensive—only \$295.

### Remote Controller & Real Time Clock Available

Have full computer control of up to 256 lights, appliances and even wall switches **without special wiring**. The SciTronics REMOTE CONTROLLER permits direct control of the inexpensive BSR remote line-carrier switches sold by Sears, Radio Shack and many others.

- Controls all 256 BSR remote switches—not just 16
- Hardware driven—requires minimal software
- No ultrasonic link—prevents erratic operation
- No BSR command module necessary
- Real time, crystal controlled clock available

The controller comes complete with full documentation, sample software and is designed to work with most of the popular computers including any S-100 based system, TRS-80-1, Apple II, Heath H8 and others.

Real time clocks are available for all of the above computer systems. When used with the controller, true time scheduling is realized. All clocks are crystal controlled and have battery backup for accurate and reliable operation. Interrupts allow Foreground/Background operation of two programs simultaneously. Clock data includes year, month, date, day of week, hour, minute, and second.

### Applications:

- Make your entire home or apartment computer controlled
- Save energy by controlling lights & appliances
- Control security systems & alarms



Remote switches not included

ENERGY WATTCHER	<b>\$295.</b>
S-100 CONTROLLER BOARD	<b>\$159.</b>
S-100 REAL TIME CLOCK BOARD	<b>\$139.</b>
ENCASED CONTROLLER (TRS-80, Apple II etc.)	<b>\$184.</b>
ENCASED CONTROLLER & REAL TIME CLOCK (TRS-80, Apple II etc.)	<b>\$269.</b>
APPLE II CLOCK BOARD	<b>\$109.</b>

Send check or money order to: **SciTronics Inc.**  
523 S. Clewell St., P.O. Box 5344  
Bethlehem, PA 18015  
(215) 868-7220

Please list system with which you plan to use peripheral. Master Charge and Visa accepted. PA residents add sales tax. COD's accepted.

Dealer Inquiries Invited

# GOOD NEWS FOR CBASIC-2<sub>tm</sub> USERS

# INTRODUCING QBASIC

Now you can move up to  
a 16 bit multi-user system with  
*a real machine code compiler*  
that accepts your existing programs.

QBASIC is the latest in Marinchip Systems growing line of software for our M9900 computer. While preserving source language compatibility with the widely used CBASIC-2<sub>tm</sub> language, QBASIC generates real machine code for the M9900's 16 bit processor. QBASIC programs run up to ten times faster. Separate compilation of program modules is permitted. Assembly language calls are made more simple and flexible.

So, if you like CBASIC<sub>tm</sub>, but are limited by its performance and the hardware and operating systems it runs on, contact us about our new QBASIC.

**Marinchip Systems**

QBASIC is only the latest member of the M9900 hardware and software line that include the following major features:

- \* Advanced 16 bit processor
- \* S-100 Bus flexibility
- \* Unix<sub>tm</sub> like multi-user operating system
- \* Memory size up to 16 megabytes
- \* Pascal, Assembler, and BASIC<sub>tm</sub> interpreter
- \* Hard disc or floppy available
- \* Prompt quantity delivery with attractive discounts
- \* Applications available: General Ledger, Accounts Payable and Receivable, Payroll, and Text Formatter

Computer Power and Human Reason  
16 St. Jude Road

- \* Superb user manuals
- \* Three year track record of hardware and software reliability
- \* Systems, boards, kits, and software available
- \* Both 8 and 16 bit memory supported

Complete dual floppy single user systems from \$5500, and floppy or hard disc multi-user systems configured to your requirements.

Call or write for complete specifications and price list.

CBASIC is a trademark of Compiler Systems  
UNIX is a trademark of Bell Laboratories  
BASIC is a trademark of the Trustees of Dartmouth College

Mill Valley, CA 94941  
(415) 383-1545

# Seventh Annual SIGGRAPH Conference

---

Kenneth Livingston  
225 Nebraska Hall  
University of Nebraska  
Lincoln NE 68508

Mark Dahmke  
1515 Superior, Apt 15  
Lincoln NE 68521

---

The Association for Computing Machinery (ACM) Special Interest Group on Computer Graphics (SIGGRAPH) held its seventh annual conference on July 14 thru 18, at the Seattle (Washington) Center (former site of the Seattle World's Fair). This conference, like all of the recent SIGGRAPH conferences, was extremely well attended. Over 1200 people registered for the two-day preconference tutorials. More than 2300 people registered for the three-day conference itself. Participants came from nearly every state, Canada, several European countries, and Japan.

## Preconference Tutorials

Each year, the conference organizers have sought to provide participants with an opportunity to not only attend the conference, but also to acquire additional information and expertise about graphics through a series of tutorial sessions. These are led by well-known computing and graphics professionals from both industry and education. This year's eight tutorial sessions included these topics:

- Introduction to Computer Graphics
- Introduction to Raster Graphics
- Advanced Raster Graphics
- Computer-Aided Design
- Low-Cost Graphics
- Graphic Design and Information Graphics
- Animation Graphics
- User Interfaces to Graphic Systems

These tutorials ranged in level of expertise from novice to expert and provided a means for everyone to advance technically.

The session on low-cost computer graphics addressed issues relating to the use of graphics capabilities of personal-computing hardware. Many of these systems can be configured at costs of about \$2000. Given today's economy, systems in this price range can be very appealing to small businesses, public-school systems, and small

colleges and universities. At the other end of the scale are large CAD/CAM (Computer-Aided Design/Computer-Aided Manufacturing) systems. Typically, these systems are quite expensive, ranging from \$40,000 to \$300,000 for top-of-the-line systems. Obviously, smaller and less expensive (and, therefore, less comprehensive and versatile) systems exist. The computer-aided design tutorial addressed the needs of medium- and large-scale industry users of CAD/CAM systems.

Included in this session were discussions of CAD/CAM standards for data bases and techniques used for geometric modeling. Geometric modeling is a term used to describe the process of representing a three-dimensional object by a series of Cartesian, polar, or homogeneous coordinates with (or without) a series of equations. The object may or may not exist prior to the construction of the numerical or geometric model.

Three other tutorials on raster graphics and animation were oriented toward the use of raster-scan devices. Because raster-scan devices essentially use standard television technology, there is a significant price and performance advantage in their use. Personal-computer owners should be aware of this advantage, as many microcomputer systems have utilized raster-scan (television) technology from the beginning. Discussions of algorithms for modeling three-dimensional objects, simulation of light sources (shading and shadows), surface textures, and display optimization dominated these sessions. An emphasis was placed on the creation of realistic-looking images.

Another group of tutorials centered on what might be termed *human factors* in computer graphics. Human factors means the interface between human beings and machines. It is an area of computing in general that, while not being totally overlooked, has certainly been slighted. Those of us involved in interactive computing (including graphics) realized long ago, by necessity, how important a friendly, forgiving, and possibly even *natural* interface is for successful communication between people and machines. The frustration of having an interactive program bomb or hang before completing its task can be overwhelming.

Our batch-oriented colleagues have discovered this recently, primarily because on-line data bases are becoming more popular, and more batch-oriented computing professionals are finding their way into interactive projects. Recently, we have begun to discover the importance of aesthetically pleasing and more understandable graphic output. Many computer-graphics specialists have come into this area from the technical side, rather than from the artistic side. It should come as no surprise, then, that graphic designers can offer much sound advice about graphics layout and design. This information can be very valuable in businesses where executives are accustomed to expecting and demanding professional quality for graphics presented at board meetings and in annual reports. Two tutorials concentrated on psychological aspects, design methodologies, subjective evaluation, and design concepts as they relate to computer-graphics systems.

All of the tutorials were well attended. Although we were unable to attend all of them (they ran concurrently), those sessions we attended were well thought out and carefully presented.

---

Photos 1 thru 6 by Kenneth Livingston.

---

**MODEL II**



26-4002  
**64K 1 Drive**  
**\$3499.00**

**MODEL III**



26-1061 4K I.....\$630.00  
26-1062 16K III..... 900.00  
26-1063 32K III  
2-Drives, RS232..... 2246.00



**CENTRONICS**

Fast 100 CPS Centronics  
730 Printer.....\$675.00  
Text Quality Centronics  
737 Printer..... \$850.00

**Model II Cobol Compiler**  
**\$360.00**  
**Cobol Run Time Package**  
**\$36.00**

**AUTHORIZED  
TRS-80®  
DEALER A301**

**COMPUTER SPECIALISTS**

- 26-1056 16K Level II System with Keypad. \$670.00
- 26-1145 RS-232 Board..... 84.00
- 26-1140 "O" K Interface..... 249.00
- 26-1141 "16" K Interface..... 365.00
- 26-1142 "32" K Interface..... 476.00
- 26-1160 Mini Disk - Drive O..... 424.00
- 26-1161 Mini Disk - Additional..... 424.00
- 26-1154 Lineprinter II..... 720.00
- 26-1156 Lineprinter III..... 1799.00
- 26-1180 Voice Synthesiser..... 339.00
- 26-1181 VOXBOX..... 145.00
- 26-1104 Factory Upper/Lower  
Case Modification Installed..... 70.00
- 26-1506 Scripsit - Tape..... 60.00
- 26-1563 Scripsit - Disk..... 85.00

NOTE: Call for availability of VIDEO TEX, Model III, Color, and other new products.

**ALL OTHER R.S. SOFTWARE  
FURNITURE, STANDS, CABLES  
AND ACCESSORIES DEDUCT  
10% FROM CATALOG PRICE**

Novation Cat Modem.. \$149.00  
CCA Data Management  
System..... 72.00  
Adventure Games  
Games 1-9 each..... 14.00

**Pocket Computer**

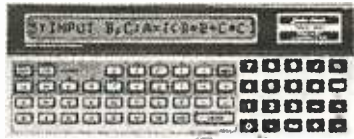

26-3501 1.9K P.C..... \$225.00  
26-3503 Cassette I/F..... 45.00  
14-812 Recorder..... 72.00

**MODEL I**



26-1054  
**4K Level II**  
**\$552.00**

**COLOR**



26-3001 4K..... \$360.00  
26-3002 16K..... 540.00  
26-3010 Color Video..... 360.00  
26-1206 Recorder..... 54.00  
26-3008 Joysticks..... 22.50



**Acorn  
Software  
Products, Inc.**

**GAMES:**

Alien Invasion..... \$9.00  
Stock Market..... 9.00  
Star Trek..... 9.00  
Block 'Em..... 9.00  
Ting-Tong..... 9.00

**UTILITIES:**

System Savers..... 14.00  
**EDUCATION:**  
Language Teacher..... 18.00

**FREE: PRICE LIST  
UPON REQUEST**

**1-800-841-0860 Toll Free Order Entry**

**MICRO MANAGEMENT SYSTEMS, INC.**

No Taxes on Out Of  
State Shipments

Immediate Shipment  
From Stock on Most Items

**DOWNTOWN PLAZA SHOPPING CENTER**  
115 C SECOND AVE. S.W.  
CAIRO, GEORGIA 31728  
**(912) 377-7120 Ga. Phone No.**

Full Factory Warranty  
on All Items Sold.

Largest Inventory  
In the S.E. U.S.A.

\*TRS-80 is a registered trademark of the Tandy Corp.

## The Conference

In an attempt to emphasize the importance of graphic-design concepts and the human-factors side of computer graphics, the first session was a special panel presentation chaired by Aaron Marcus, research consultant at Lawrence Livermore Laboratories. This panel featured graphic designers from the United States and Europe. They agreed that we have seen far too many examples of poorly designed graphics—especially computer-generated graphics. Anyone engaging in computer graphics would do well to obtain and read some good textbooks on graphic design, in addition to their computer-graphics texts. While a chart or graph is more understandable than a table of numbers, a well-designed chart or graph is more readable than one which has had no design principles applied to its creation.

The remainder of Wednesday's sessions were split into two concurrent sessions. Papers presented in one group of sessions were quite technical in nature: "The Theory, Design, Implementation and Evaluation of a Three-Dimensional Surface Detection Algorithm" and "Simulation and Expected Performance Analysis of Multiple Processor Z-Buffer Systems." Papers presented in the other group of sessions were more applications-oriented: "Geographic and Data Base Systems" and "Computer Graphics Moves into the Business World."

The latter area is of specific interest to one of us (Livingston), who is currently involved in the integration of computer graphics and market research. According to Carl Machover of Machover Associates, who chaired the business-graphics panel discussion, there are four computers used in business applications for every computer used in CAD/CAM types of applications. Assuming that these figures are accurate, the business-computer graphics potential is enormous. This position is supported by IBM's recent entry into the low-cost, color, business-graphics marketplace with its Model 3279 display terminal. Recent articles in *Harvard Business Review* (January 1980) and the *Wall Street Journal* also seem to reinforce this position.

Thursday's sessions embraced a wide variety of topics. Sessions dedicated to graphics software and languages, surfaces, and applications filled the morning. Papers were presented at these sessions ranging from the design of a LISP-based graphics language, to three-dimensional representation and rendering algorithms, and to stereographic displays of atmospheric data. (This latter session proved to be very interesting to us for reasons having little to do with computer graphics. The materials chosen for displays represented conditions existing in the Omaha, Nebraska, area—sixty miles away from our homes—when the 1975 tornado struck that area.)

Thursday-afternoon sessions were oriented toward rather specialized areas of computer graphics:

- Computer Graphics and Television
- Animation
- CAD/CAM
- User Views of CAD/CAM

Recent uses of computer graphics in television were discussed, including a presentation by ABC Sports on their use during the Winter Olympics. The CAD/CAM sessions included reports on graphics used in planning electrical-distribution systems, ship-hull design, and graphics at the Ford Motor Company. There was also a panel discussion addressing productivity gains and expect-

tations achieved through the use of CAD/CAM systems.

Friday's sessions included discussions of graphics standards, human factors (more), and raster techniques. The question of graphics standards is of particular importance to those who regularly attempt to transport graphics programs or systems from one computing environment to another. While other areas of computing developed standards long ago (eg: COBOL, FORTRAN, Pascal, etc), the graphics area had not attempted such a feat until quite recently. This has all begun to change, thanks to the work of the SIGGRAPH CORE standards committee.

The human-factors presentations included discussions on color and how it is perceived by the human eye, and on a prototype voice- and gesture-input interface being developed at MIT. An afternoon session on raster-graphics techniques completed the conference program.

Perhaps the only negative criticism we offer concerns the famous SIGGRAPH film festival. This has become an annual event since its informal inception, at the first SIGGRAPH conference, on the balcony of one participant's dormitory room at the University of Colorado in Boulder. This year's film festival was held in a hotel ballroom designed to hold no more than 1500 people. With 1900 people packed into the crowded space, and lines waiting to get in, the hotel's management restricted access to the ballroom for safety reasons. A greatly abbreviated second showing left many participants frustrated. The film festival is a forum for some of the best computer graphics and animation produced during the preceding year and is always enlightening and well attended. We sincerely hope next year's conference committee takes the film festival's popularity into consideration during planning.

## The Exhibition

Although this was the seventh annual SIGGRAPH conference, it was only the fifth annual SIGGRAPH exhibition. There were ninety-nine vendors listed in the exhibition guide for SIGGRAPH '80. At SIGGRAPH '76 (the first exhibition), there were only ten. This says much about the growth of this part of the industry. Another indicator of growth, according to Ken Anderson of the *Anderson Report* (a newsletter devoted to computer graphics), is the fact that last year the computer-graphics industry reached \$1 billion in delivered products. The computing industry as a whole does approximately \$40 billion in delivered products per year.

Several vendors at the exhibition were of special interest to personal-computer users. ABW Corporation demonstrated its TEKSIM package. TEKSIM allows the Apple II user to access the Tektronix Plot-10 software. Although the Apple/TEKSIM combination offers only about one-fourth the resolution of a Tektronix terminal, advantages such as lower cost, color displays, selective erase, and standard video output are claimed by the vendor. Apple Computer Inc displayed both the Apple II and III computers. Calcomp, which most of us think of as a vendor for the large-host user, demonstrated its 1051 drum plotter (among other products). The Model 1051 is an RS-232C-compatible, relatively low-cost product, which, considering Calcomp's quality reputation and service organization, makes it a viable product for passive-graphics production on small systems.

Cromemco, with which most personal-computer users are familiar, brought its line of high- and medium-resolution graphics hardware to the exhibition. Recent



emphasis on efficient software designed to increase the productivity of the programmer and end user is evident in Cromemco's recently announced high-resolution graphics-software package. Digital Engineering, Inc, was present with its Retro-Graphics printed-circuit board. This transforms the Lear-Siegler ADM-3A terminal into a graphics terminal compatible with the Tektronix Plot-10 software package. This company also makes a cross-hair graphic-input cursor and a printer for the modified terminal. Houston Instruments, a division of Bausch & Lomb Corporation, displayed much of its pen-plotter line and its more recently developed electro-static plotter line.

An eight-color, eight-pen digital plotter was displayed by Soltec Corporation. This is an interesting approach to low-cost, multipen, passive graphics. The plotter is basically a single-pen plotter with "parking stalls" for additional pens and enough native intelligence to relocate each pen for changes in color and line weight, or for an optional cross-hair cursor for digitizing. Summagraphics exhibited its popular Bit-Pad One, a low-cost approach to graphic-data-entry problems.

Tektronix was present with nearly everything in its line of graphics terminals and its stand-alone 4050 series of desk-top graphics computers. Hewlett-Packard also displayed its line of desk-top graphics computers including the Model 9845C color machine. The space-shuttle image on this machine was very impressive.

Also present were vendors oriented toward heavy



Photo 1: Megatek's new Wizzard color terminal. It also heralds the development of Megatek's device-independent software.



Photo 2: Overview of exhibition area. The Calcomp booth is in the center foreground. Tektronix is in the center mid-way back. IBM and Hewlett-Packard are in the center rear and Megatek is to the right in the foreground.

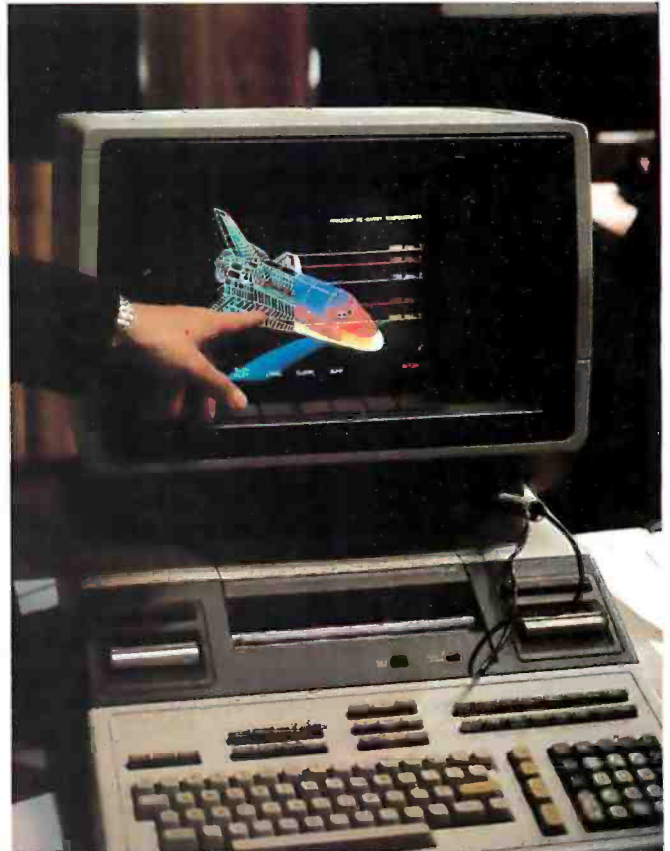

Photo 3: The Hewlett-Packard 9845C color desk-top computer is being demonstrated by using an image of the space shuttle.

SAVE AT THE APPLE COMPUTER SUPERMARKET...

# "COMPUTERS 'R' US"

UNBEATABLE MAIL ORDER DISCOUNTS  
A SUBSIDIARY OF CONSUMER COMPUTERS

**CHRISTMAS SUPER SALE**

master charge  
VISA

**APPLE II PLUS  
OR APPLE II STANDARD**

16K FOR ONLY **\$925**

48K FOR ONLY **1049**

**DISK II DRIVE \$485  
W/CONTROLLER**

**PASCAL SYSTEM \$425**

SEE PAGE 391  
FOR MORE PRODUCTS AND  
ORDERING INFORMATION

OFFER  
EXPIRES  
DEC. 31  
1980

**ORDER TOLL FREE: 1-800-854-6654**  
CALIFORNIA, BACKORDER OR TECHNICAL INFO: (714) 698-8088  
CREDIT CARD USERS PLEASE SEE ORDERING INSTRUCTIONS ON PAGE 391

graphics users. CAD/CAM applications by Computervision, Inc, were shown. IBM showed entries for all levels: the 3279 color terminal for low- to mid-level business-graphics users, the 3277 graphics-attachment feature for the mid-level engineering users, and the 3250 for CAD/CAM applications. Vector General and Adage featured their high-performance vector-display devices. Megatek, with a popular display booth, exhibited its new line of Wizzard graphics terminals.

With nearly 100 vendors displaying recent developments, it is not possible to describe all the new products. Suffice it to say that there was something for everyone at the exhibition. If too little information could be gleaned from vendor representatives at their display booths, many vendors also conducted forum sessions from morning until evening. Technical and management people were there to answer more detailed questions about their products.

There are three things we want to reemphasize as being significant in the computer-graphics industry:

- First, the continued development of lower-cost color graphics terminals—the user's capital expenditures are critical in justifying new approaches in problem solving.
- Second, an increased emphasis on graphics-software standards yielding greater productivity for software developers and end users.
- Finally, the beginning use of computer graphics by and

for management, as opposed to its historically limited use as an engineering tool.

These items are very important to the growth of the computer-graphics industry. This exhibition, the conference, and the tutorials were dedicated to enhancing these three areas.

Harvey Kriloff and Robert Ellis, cochairmen of the SIGGRAPH '80 conference, and the SIGGRAPH '80 committee are to be commended for the quality of this year's conference. Next year's conference will be held in Dallas, Texas, and is scheduled for August 3 thru 7. Somehow we expect it to be hotter than the 75 degrees of Seattle. If present trends hold up, however, it will also be a fine and interesting conference. ■

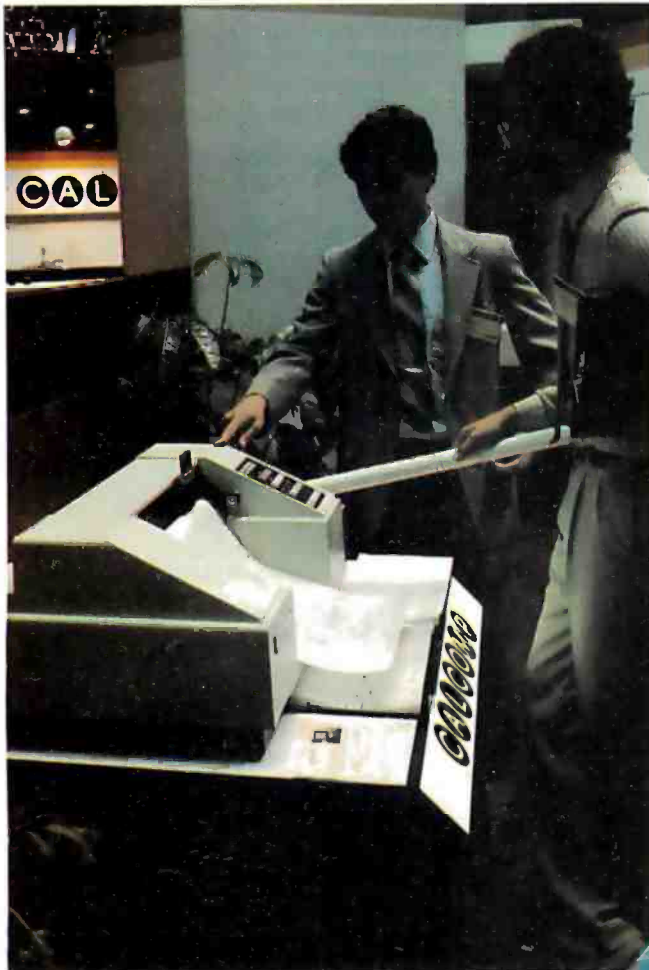

Photo 4: A Calcomp representative demonstrates the Model 1051 digital plotter.

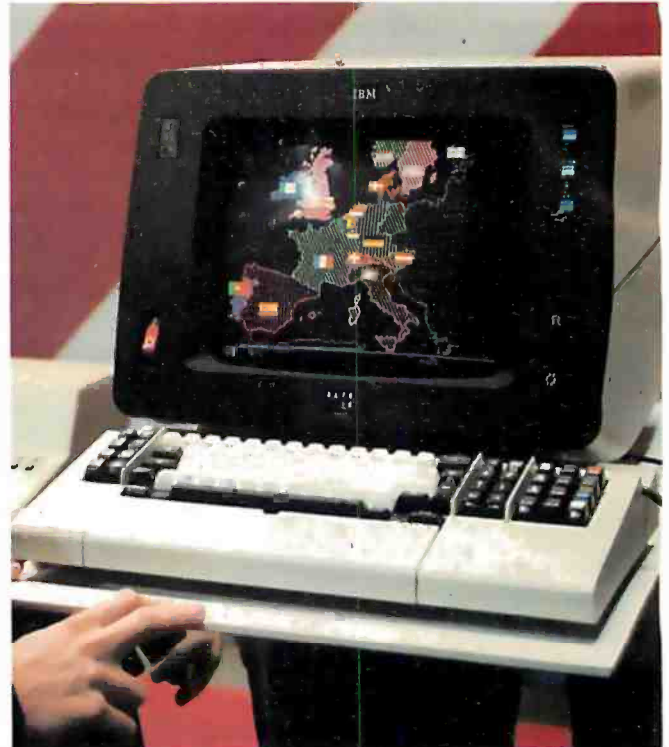

Photo 5: IBM's Model 3279 color-graphics terminal. This terminal is oriented toward business and management graphics rather than toward engineering applications.



Photo 6: The Tektronix Model 4054 features a large-screen storage display tube and built-in cartridge-tape drive, with disk drives optional.

# ΩMEGA WHOLESALE COMPUTER PRICES

## SALES DIRECT TO THE PUBLIC

CO. 12 Meeting St., Cumberland, R.I. 02864

*Christmas Specials*

When you buy:

You receive:

You receive:

When you buy:



Atari 800  
\$749

1-8K plug in  
RAM Module

**FREE**

— (\$124.95 value)

1 Box (10 Pcs)  
8" Diskettes

**FREE**



TRS-80  
Model II - \$3449



Apple II  
16K - \$999  
(Regular or Plus)

1 Apple Tape  
Recorder

**FREE**

— (\$40 value)

Microsoft Basic  
for only  
\$162.50



INTERTEC SUPERBRAIN  
32K RAM - \$2449.00  
64K RAM - \$2649.00



NEW!  
ATARI 825  
PRINTER — \$949

Atari Interface  
Module

**FREE**

— (\$219.95 value)

Statistics Pak  
or  
Carrying case

**FREE**

— (\$95 value each)



HP-85 — \$2899

APPLE II DISK  
with Controller — \$495

**FREE**

1 Box (5 Pcs)  
Diskettes

NEC Spinwriter  
5530 or 5510  
\$2449

SOROC IQ 120  
\$699

EPSON MX-80  
80 Character, 9x9 Dot Matrix  
Roll & Pin Feed Printer  
for your Apple, TRS-80  
or Commodore \$599



**FREE**

Interface to  
Your Computer

OKIDATA MICROLINE 80 — \$529

ΩMEGA OFFERS THE BEST DELIVERY AND PRICE ON:

APPLE • ATARI • TRS-80 MODEL II • INTERTEC •  
T.I. 810 • HEWLETT-PACKARD-85 • SOROC •  
COMMODORE • NEC • QUME • CENTRONICS

ΩMEGA sells only factory fresh, top quality merchandise to out customers.  
ΩMEGA will try to match any current advertised price with similar purchase conditions.  
Before you buy anywhere else — be sure to call ΩMEGA Sales Co.

1-401-722-1027

ΩMEGA ships via UPS, truck or air. COD's, VISA, Mastercharge accepted.  
"A member in good standing of the Better Business Bureau."



We carry a complete line  
of the above equipment.  
For information and  
further pricing call:

**TOLL FREE**

**1-800-556-7586**

TELEX: 952106



9K RAM (8K user available),  
14K BASIC interpreter  
operating system ROM.

User-programmable, in  
both BASIC and MC6800  
machine language.

Built-in RF  
modulator.

Built-in sound  
synthesizer.

Two built-in  
game controllers,  
with joysticks and  
numeric keypads.

Built-in cassette  
deck, with both digital  
and audio tracks.

Load in excess of  
1500 baud rate.  
Saves and loads  
programs in  
45 seconds  
or less.

Keyword shift plate.

Full, standard, 53-key  
typewriter keyboard.

Built-in speaker.

Microphone jack  
enables you to  
add audio to  
program tapes.

High resolution picture  
on your TV screen, in  
8 colors.

256 x 192 graphics mode.

# All that computer for \$599.

## The Imagination Machine, the personal computer from APF Electronics.

**T**he Imagination Machine is more personal computer than you'd expect at \$599.

The Imagination Machine is a superbly designed, expandable, user-programmable computer system... at \$599.

No other personal computer on the market can touch it, at that price.

### Read what it brings you:

First of all, The Imagination Machine has 9K RAM and 14K BASIC-IN-ROM. A full 53-key professional, typewriter keyboard. A high-resolution picture on your TV set, in eight colors. Fast loading (1500+ baud rate), built-in dual-track cassette deck, for APF's digitally recorded tape programs. Built-in sound synthesizer. And, even a built-in RF modulator, which is a \$40 option on other computer systems.

### All that, plus user-programmability.

We know sophisticated users aren't going to be satisfied forever using preprogrammed software. (Even though we offer a large library of educational, entertainment, home and business management programs.) So, we made The Imagination Machine user programmable, in both BASIC and MC6800 machine language. To simplify matters, we've just developed the first and only BASIC TUTOR course on cassette. With it, you can learn to program The Imagination Machine in BASIC, with hands-on training, right at the computer.

### Some exceptional features.

The Imagination Machine has several unique features that can help you use your time at the computer more effectively.

For example, it stores programs and data on the same cassette tape. (With other computers, you have to read programs from one tape into the computer, remove the tape, put in another tape and store your data on the new tape.)

Another special feature is The Imagination Machine's unique keyword system, which simplifies

BASIC programming. The machine has 24 different programs statements and commands printed at the top of the keyboard. You can enter these 24 into your program without retyping them every time you use them. Instead of typing out "PRINT;" for example, you just press two keys and the word appears on the screen. The system helps prevent typing errors and can speed up entering programs.

A third feature is Timed Response Monitoring, which automatically adjusts the computer's pace and level to your own. It makes "tutoring programs," for instance, easier and more interesting to follow.

And then there are The Imagination Machine's three graphic display modes: 1. Alpha numerics, mixed with low-resolution graphics in as many as eight colors. 2. High resolution — up to eight colors — 128 x 192 display. 3. High resolution graphics — up to four colors — with 256 x 192 display.

### And expandability.

A personal computer that can't grow along with your growing requirements soon becomes obsolete. So, we designed The Imagination Machine to be expandable. By adding APF's optional "Expansion Box" and interface cartridges, you can hook up any compatible floppy disk or printer, or an additional 8K RAM memory cartridge.

### Full mini-floppy system **\$995.**



For small business and professional use, you may require a full mini-floppy

system. In that case, order APF's System II. It includes The Imagination Machine, the "Expansion Box," floppy disk interface and 72K-byte, mini-floppy disk drive. All for just \$995! No one can come close to that price.

### You can't beat our prices or our guarantee.

If you can find a better personal computer system for the money, let us know. In the meantime, we stand by our statement: There is no other personal computer on the market that offers so much for so little. And if you order now, we'll even include our \$19.95 APF Technical Reference Manual, with complete schematics, absolutely free.

Order The Imagination Machine directly from APF Electronics, with the assurance that if you are not completely satisfied, you can return it within 30 days of purchase for a complete refund. To order, or to learn the name of the dealer nearest you, call TOLL FREE 1-800-223-1264. New York residents call 212-869-1960. MasterCard and VISA accepted.

### Price list:

System I, The Imagination Machine.	\$599.
System II, Mini-floppy System (Includes The Imagination Machine, BB-2, and Mini- floppy Disk Drive).	\$995.
BB-1. Expansion Box with RS232 cartridge.	\$199.95
BB-2. Expansion Box with floppy disk interface cartridge.	\$199.95
8K RAM memory cartridge.	\$ 99.95
RS232 cartridge.	\$149.95
Floppy-disk Interface cartridge.	\$149.95
Mini-floppy Disk Drive.	\$399.95

\$599. Manufacturer's suggested retail price.

**APF**electronics inc.  
1501 Broadway New York, NY 10036

# A Simplified Theory of Video Graphics

## Part 1

---

Allen Watson III  
1261 Robbia Ct  
Sunnyvale CA 94087

---

This is an interesting time for choosing a personal computer, especially if you are looking for one with a graphics display. As you can see from the summary of specifications in table 1, the available graphics capabilities of the personal computers are all different, and no one model has a clear advantage over all the others. To make your choice even more difficult, some models exhibit undocumented quirks that are not apparent from the specifications.

Your choice of a video-graphics system will depend on what you want to do with graphics and on the performance of the different computers. While I can't help with the first aspect of your decision, I may be able to help you understand system performance by explaining the operating principles of video displays and describing the various combinations of features available on popular personal computers.

### The Importance of Video Graphics

Many applications of personal computers are modeled on conventional practices that have been developed over a period of several

years, while graphics displays have been too expensive for general use until quite recently. Many existing computer programs do not use even the simplest graphics, although there are several notable exceptions, such as chess games that use high-resolution graphics to display the board and pieces, and music editors that display standard musical notation.

Here's the important point: computer-graphics displays can produce schematic diagrams, music scores, flowcharts, architectural drawings, and the like that are much easier for the person using the computer to understand than the unadorned columns of numbers that are usually associated with computers. Of course, you still might not be able to afford video-graphics displays as powerful as the one used by NASA to simulate the view seen by the pilot of the space shuttle during its return from orbit. Even though they have their limitations, the current small-computer displays will enable you to do a lot of interesting things.

### Raster-Scan Video

While there are several different ways of displaying information on a video screen, all of the personal computers presently available use the same kind of *raster-scan* technique that ordinary television does. We'll take a look at the basic features of this technique, since they are shared by all inexpensive video displays.

Television is an imperfect compromise among several factors:

- resolution, which determines how

- much detail we can display
- frame rate (to be discussed later), which is the number of complete pictures transmitted in 1 second
- bandwidth, a measure of the frequency response, of the equipment involved

An increase either in resolution or in frame rate requires an increase in bandwidth, which adds to the cost of the equipment. If we must keep within a limited bandwidth, we can obtain better resolution only at the expense of jerkier motion and vice versa. There is a type of television called *slow-scan*, for example, that manages to transmit reasonably detailed images over the narrow-bandwidth channels used by amateur radio operators, but the resulting frame rate is so low that the illusion of motion is lost. We will see how much bandwidth is necessary for ordinary television after we look at the raster-scan process itself.

If we display a sequence of images that change only slightly from one to the next, and do it fast enough, the eye will not be able to separate them: *persistence of vision* will cause the separate images to fuse into a "moving" picture. In order to transmit such a sequence of images electronically, each image must be dissected into a series of dots that may be transmitted one at a time. The television camera does this by rapidly scanning the image in a series of horizontal lines which form a *raster*. The lines are scanned one after another in the same way that a person scans the lines of letters on a printed page. Reading is a process of converting information,

---

#### About the Author

Allen Watson III began writing FORTRAN programs for scientific analysis soon after receiving his bachelor's degree in mathematics. Later, as a full-time programmer, he wrote IBM System/360 assembly-language programs for the computer-aided design of calculators and has prepared and presented training courses about the Fairchild F-8 and Motorola 6800. Allen is currently writing and editing user manuals for Apple computers.

---

Start learning and computing for only **\$129.95** with a **Netronics 8085-based computer kit**. Then expand it in low-cost steps to a business/development system with **64k or more RAM, 8" floppy disk drives, hard disks and multi-terminal I/O**.

# THE NEW EXPLORER/85 SYSTEM

**Special! Full 8" floppy, 64k system for less than the price of a mini! Only \$1499.95!**

(Also available wired & tested. \$1799.95)

Imagine — for only \$129.95 you can own the starting level of Explorer/85, a computer that's expandable into full business/development capabilities — a computer that can be your beginner system, an OEM controller, or an IBM-formatted 8" disk small business system. From the first day you own Explorer/85, you begin computing on a significant level, and applying principles discussed in leading computer magazines. Explorer/85 features the advanced Intel 8085 cpu, which is 100% compatible with the older 8080A. It offers on-board S-100 bus expansion. Microsoft BASIC in ROM, plus instant conversion to mass storage disk memory with standard IBM-formatted 8" disks. All for only \$129.95, plus the cost of power supply, keyboard/terminal and RF modulator if you don't have them (see our remarkable prices below for these and other accessories). With a Hex Keypad/display front panel, Level "A" can be programmed with no need for a terminal, ideal for a controller, OEM, or a real low-cost start.



Level "A" is a complete operating system, perfect for beginners, hobbyists, industrial controller use. \$129.95



Full 8" disk system for less than the price of a mini (shown with Netronics Explorer/85 computer and new terminal). System features floppy drive from Control Data Corp., world's largest maker of memory storage systems (not a hobby brand!)



Level "A" With Hex Keypad/Display.

## LEVEL "A" SPECIFICATIONS

Explorer/85's Level "A" system features the advanced Intel 8085 cpu, an 8355 ROM with 2k deluxe monitor/operating system, and an advanced 8155 RAM I/O . . . all on a single motherboard with room for RAM/ROM/PROM/EPROM and S-100 expansion, plus generous prototyping space.

**PC Board:** Glass epoxy, plated through holes with solder mask. • I/O: Provisions for 25-pin (DB25) connector for terminal serial I/O, which can also support a paper tape reader . . . cassette tape recorder input and output . . . cassette tape control output . . . LED output indicator on SOD (serial output) line . . . printer interface (less drivers) . . . total of four 8-bit plus one 6-bit I/O ports. • Crystal Frequency: 6.144 MHz. • Control Switches: Reset and user (RST 7.5) interrupt . . . additional provisions for RST 5.5, 6.5 and TRAP interrupts onboard. • Counter/Timer: Programmable, 14-bit binary. • System RAM: 256 bytes located at F800. Ideal for smaller systems and for use as an isolated stack area in expanded systems. • RAM expandable to 64K via S-100 bus or 4k on motherboard.

**System Monitor (Terminal Version):** 2k bytes of deluxe system monitor ROM located at F000, leaving 8000 free for user RAM/ROM. Features include tape load with labeling . . . examine/change contents of memory . . . insert data . . . warm start . . . examine and change all registers . . . single step with register display at each break point . . . debugging/training feature . . . go to execution address . . . move blocks of memory from one location to another . . . fill blocks of memory with a constant . . . display blocks of memory . . . automatic baud rate selection to 9600 baud . . . variable display line length control (1-255 characters/line) . . . channelized I/O monitor routine with 8-bit parallel output for high-speed printer . . . serial console in and console out channel so that monitor can communicate with I/O ports.

**System Monitor (Hex Keypad/Display Version):** Tape load with labeling . . . tape dump with labeling . . . examine/change contents of memory . . . insert data . . . warm start . . . examine and change all registers . . .

single step with register display at each break point . . . go to execution address. Level "A" in this version makes a perfect controller for industrial applications, and is programmed using the Netronics Hex Keypad/Display. It is low cost, perfect for beginners.

**HEX KEYPAD/DISPLAY SPECIFICATIONS**  
Calculator type keypad with 24 system-defined and 16 user-defined keys. Six digit calculator-type display, that displays full address plus data as well as register and status information.

## LEVEL "B" SPECIFICATIONS

Level "B" provides the S-100 signals plus buffers/drivers to support up to six S-100 bus boards, and includes: address decoding for onboard 4k RAM expansion selectable in 4k blocks . . . address decoding for onboard 8k EPROM expansion selectable in 8k blocks . . . address and data bus drivers for onboard expansion . . . wait state generator (jumper selectable), to allow the use of slower memories . . . two separate 5 volt regulators.

## LEVEL "C" SPECIFICATIONS

Level "C" expands Explorer/85's motherboard with a card cage, allowing you to plug up to six S-100 cards directly into the motherboard. Both cage and card are neatly contained inside Explorer's deluxe steel cabinet. Level "C" includes a sheet metal superstructure, a 5-card gold plated S-100 extension PC board that plugs into the motherboard, just add required number of S-100 connectors.



Explorer/85 With Level "C" Card Cage.

## LEVEL "D" SPECIFICATIONS

Level "D" provides 4k of RAM, power supply regulation, filtering decoupling components and sockets to expand your Explorer/85 memory to 4k (plus the origi-

nal 256 bytes located in the 8155A). The static RAM can be located anywhere: from 8000 to EFFF in 4k blocks.

## LEVEL "E" SPECIFICATIONS

Level "E" adds sockets for 8k of EPROM to use the popular Intel 2716 or the TI 2516. It includes all sockets, power supply regulator, heat sink, filtering and decoupling components. Sockets may also be used for 2k x 8 RAM IC's (allowing for up to 12k of onboard RAM).

## DISK DRIVE SPECIFICATIONS

- 8" CONTROL DATA CORP. professional drive.
- Data capacity: 401,016 bytes (SD), 802,032 bytes (DD), unformatted.
- Access time: 25ms (one track).
- LSI controller.
- Write protect.
- Single or double density.

## DISK CONTROLLER/I/O BOARD SPECIFICATIONS

- Controls up to four 8" drives.
- 1771A LSI (SD) floppy disk controller.
- Onboard data separator (IBM compatible).
- 2 Serial I/O ports.
- Autoload to disk system when system reset.
- 2716 PROM socket included for use in custom applications.
- Onboard crystal controlled.
- Onboard I/O baud rate generators to 9600 baud.
- Double-sided PC board (glass epoxy).

## DISK DRIVE CABINET/POWER SUPPLY

- Deluxe steel cabinet with individual power supply for maximum reliability and stability.

## ORDER A COORDINATED EXPLORER/85 APPLICATIONS PAK!

**Beginner's Pak (Save \$26.00!) — Buy Level "A" (Terminal Version) with Monitor Source Listing and AP-1 5-amp Power Supply: (regular price \$199.95), now at SPECIAL PRICE: \$169.95 plus post. & insur.**  
**Experimenter's Pak II (Save \$53.40!) — Buy Level "A" (Hex Keypad/Display Version) with Hex Keypad/Display, Intel 8085 User Manual, Level "A" Flex Monitor Source Listing, and AP-1 5-amp Power Supply: (regular price \$279.35), all at SPECIAL PRICE: \$219.95 plus post. & insur.**

**Special Microsoft BASIC Pak (Save \$103.00!) — Includes Level "A" (Terminal Version), Level "B", Level "D" (4k RAM), Level "E", 8k Microsoft in ROM, Intel 8085 User Manual, Level "A" Monitor Source Listing, and AP-1 5-amp Power Supply: (regular price \$439.70), now yours at SPECIAL PRICE: \$328.95 plus post. & insur.**

**ADD A TERMINAL WITH CABINET, GET A FREE RF MODULATOR: Save over \$114 at this SPECIAL PRICE: \$499.95 plus post. & insur.**

**Special 8" Disk Edition Explorer/85 (Save over \$104!) — Includes disk-version Level "A", Level "B", two S-100 connectors and brackets, disk controller, 64k RAM, AP-15-amp powersupply, Explorer/85 deluxe steel cabinet, cabinet fan, 8" SD/DD disk drive from famous CONTROL DATA CORP. (not a hobby brand!), drive cabinet with power supply, and drive cable set-up for two drives. This package includes everything but terminal and printers (see coupon for them). Regular price \$1630.30, all yours in kit at SPECIAL PRICE: \$1499.95 plus post. & insur. Wired and tested, only \$1799.95.**

**Special! Complete Business Software Pak (Save \$625.00!) — Includes CP/M 2.0, Microsoft BASIC, General Ledger, Accounts Receivable, Accounts Payable, Payroll Package: (regular price \$1325), yours now at SPECIAL PRICE: \$699.95.**

Please send the items checked below:

- Explorer/85 Level "A" kit (Terminal Version) . . . \$129.95 plus \$3 post. & insur.
- Explorer/85 Level "A" kit (Hex Keypad/Display Version) . . . \$129.95 plus \$3 post. & insur.
- 8k Microsoft BASIC on cassette tape, \$64.95 postpaid.
- 8k Microsoft BASIC in ROM kit (requires Levels "B", "D" and "E") . . . \$99.95 plus \$2 post. & insur.
- Level "B" (S-100) kit . . . \$49.95 plus \$2 post. & insur.
- Level "C" (S-100 6-card expander) kit . . . \$39.95 plus \$2 post. & insur.
- Level "D" (4k RAM) kit . . . \$69.95 plus \$2 post. & insur.
- Level "E" (EPROM/ROM) kit . . . \$3.95 plus \$10 p.h.
- Deluxe Steel Cabinet for Explorer/85 . . . \$49.95 plus \$3 post. & insur.
- Fan For Cabinet . . . \$13.00 plus \$1.50 post. & insur.
- ASCII Keyboard/Computer Terminal kit: features a full 128 character set, udl case, full cursor control; 75 ohm video output; convertible to baudot output; selectable baud rate, RS-232-C or 20 ma, I/O, 32 or 64 character by 16 line formats, and can be used with either a CRT monitor or a TV set (if you have an RF modulator) . . . \$149.95 plus \$3.00 post. & insur.
- Deluxe Steel Cabinet for ASCII keyboard/terminal . . . \$19.95 plus \$2.50 post. & insur.
- New! Terminal/Monitor: (See photo) Same features as above, except 12" monitor with keyboard and terminal is in deluxe single cabinet: kit . . . \$399.95 plus \$7 post. & insur.
- Haze-line terminals: Our prices too low to quote. — CALL US
- Lear-Sigler terminals/printers: Our prices too low to quote. — CALL US
- Hex Keypad/Display kit . . . \$69.95 plus \$2 post. & insur.

- AP-1 Power Supply Kit ±10V @5 amps) in deluxe steel cabinet . . . \$39.95 plus \$2 post. & insur.
- Gold Plated S-100 Bus Connectors . . . \$4.85 each, postpaid.
- RF Modulator kit (allows you to use your TV set as a monitor) . . . \$8.95 postpaid.
- 16k RAM kit (S-100 board expands to 64k) . . . \$199.95 plus \$2 post. & insur.
- 32k RAM kit . . . \$299.95 plus \$2 post. & insur.
- 48k RAM kit . . . \$399.95 plus \$2 post. & insur.
- 64k RAM kit . . . \$499.95 plus \$2 post. & insur.
- 16k RAM Expansion kit (to expand any of the above in 16k blocks up to 64k) . . . \$99.95 plus \$2 post. & insur. each.
- Intel 8085 cpu Users' Manual . . . \$7.50 postpaid.
- 12" Video Monitor (10MHz bandwidth) . . . \$139.95 plus \$5 post. & insur.
- Beginner's Pak (see above) \$169.95 plus \$4 post. & insur.
- Experimenter's Pak (see above) . . . \$219.95 plus \$6 post. & insur.
- Special Microsoft BASIC Pak Without Terminal (see above) . . . \$329.95 plus \$7 post. & insur.
- Same as above, plus ASCII Keyboard Terminal With Cabinet, Get Free RF Modulator (see above) . . . \$499.95 plus \$10 post. & insur.
- Special 8" Disk Edition Explorer/85 (see above) . . . \$1499.95 plus \$26 post. & insur.
- Wired & Tested . . . \$1799.95 plus \$26 post. & insur.
- Extra 8" CDC Floppy Drives . . . \$499.95 plus \$12 post. & insur.
- Cabinet & Power Supply For Drive . . . \$69.95 plus \$3 post. & insur.
- Drive Cable Set-up For Two Drives . . . \$23 plus \$1.50 post. & insur.

- Disk Controller Board With I/O Ports . . . \$199.95 plus \$2 post. & insur.
- Special: Complete Business Software Pak (see above) . . . \$699.95 postpaid.

SOLD SEPARATELY:

- CP/M 1.4 . . . \$100 postpaid.
- CP/M 2.0 . . . \$130 postpaid.
- Microsoft BASIC . . . \$23 postpaid.
- Intel 8085 cpu User Manual . . . \$7.50 postpaid.
- Level "A" Monitor Source Listing . . . \$23 postpaid.

Continental U.S.A. Credit Card Buyers (outside Connecticut)  
**CALL TOLL FREE: 800-243-7428**  
To Order From Connecticut Or For Technical Assistance, call (203) 354-4375

Total Enclosed (Conn. res. add sales tax) \$ \_\_\_\_\_  
Paid By: \_\_\_\_\_  
 Personal Check    Cashier's Check/Money Order  
 VISA    Master Charge (Bank No. \_\_\_\_\_)  
Acct. No. \_\_\_\_\_ Exp. Date: \_\_\_\_\_  
Signature \_\_\_\_\_  
Print Name: \_\_\_\_\_  
Address: \_\_\_\_\_  
City: \_\_\_\_\_  
State: \_\_\_\_\_ Zip: \_\_\_\_\_

**NETRONICS Research & Development Ltd.**  
333 Litchfield Road, New Milford, CT 06776

# CP/M® SOFTWARE

## 8080 Emulator

RAID is a software-based system rivaling hardware emulators costing thousands of dollars. RAID is absolutely the most advanced and sophisticated debugging system ever developed for a computer. Fully symbolic, including labels, operands and op-code mnemonics, RAID combines real-time and emulation modes in a single package. Tracing by *prime path*, *individual instructions*, *subroutines* and *breakpoints* is supported. Special feature allows emulation and real-time modes to function together for high speed emulations. Other features include memory search facilities, disk access by track and sector, single-step, multi-step, block move, user-selectable radix, etc. Over 70 commands in all. Requires 24K min. CP/M®<sup>2</sup> system.

Raid .....\$250  
Manual only .....\$ 25

## ISIS<sup>1</sup> Conversion

ISIS<sup>1</sup> to CP/M® conversion utilities permit CP/M® users to read or write files to or from an ISIS<sup>1</sup> diskette. The package consists of three utility programs that *read*, *write* and display the ISIS<sup>1</sup> directory.

ISIS - CP/M® Utilities .....\$250  
Manual only .....\$ 5

## Floating Point Package

'FPP' is a set of 8080 assembly language subroutines that provide 12 digit BCD arithmetic functions for *add*, *subtract*, *multiply*, and *divide*. BCD arithmetic means no conversion errors and minimal conversion time. Source code is supplied on standard 8" diskette.

FPP on CP/M® diskette .....\$200  
FPP on ISIS<sup>1</sup> diskette .....\$200  
Manual only .....\$ 10

<sup>1</sup>ISIS is a trademark of Intel Corporation.  
<sup>2</sup>CP/M® is a registered trademark of Digital Research.



586 Shades Crest Road  
Birmingham, Al.

Send check or money order to:  
P.O. Box 3373 A  
Birmingham, Al. 35205  
Phone: 205 933-1659

Computer Model	Text:		Graphics:		Color:	
	Lines by Characters	Method	Resolution	Aspect Ratio	No. of	Method
Apple II	24 by 40	Subcell Mapping	40 by 48 280 by 192	4:3 4:3	16 6	NTSC NTSC
Atari 400 and 800	24 by 40	Subcell Mapping	160 by 80 280 by 192	8:5 4:3	16 4	NTSC NTSC
Commodore PET	25 by 40	Special	320 by 200	4:3	--	----
CompuColor II	32 by 64	Subcell	128 by 128	4:3	8	R-G-B
Exidy Sorcerer	30 by 64	Special	512 by 240	4:3	--	----
Radio Shack TRS-80	16 by 64	Subcell	128 by 48	4:3	--	----
Texas Instruments TI-99/4	24 by 32	Special	256 by 192	4:3	16	NTSC

**Table 1:** A summary of some of the features available in personal computer displays. The graphics capabilities of available personal computers differ, and no one model seems to have a clear advantage. NTSC (National Television System Committee) indicates that American-standard color-video conventions are used. R-G-B indicates that separate red, green, and blue video signals are sent to the monitor.

which is actually all present on the page simultaneously, into a sequence of words that follow one another in time. In a similar fashion, the raster-scan process converts a picture into a sequence of rapidly changing signal levels which represent the brightness of successive points on each scanning line.

When this rapidly changing signal is picked up by a television-receiving set, it is converted back into a visible raster on the screen of the picture tube. The neck of the picture tube contains an *electron gun* that projects a beam of electrons onto a thin layer of phosphor on the inside of the screen. Wherever the electron beam strikes the phosphor it produces a spot of light whose brightness depends on the intensity of the signal being received.

If the electron beam is swept across the screen so that the spot of light is always in the same relative position as the scanning dot in the camera, the picture will be recreated on the screen. The circuits in the television set controlling the position of the beam must be able to keep in step with the camera, so the picture information is interrupted for a short time at the end of each line (and for a longer time at the end of each frame). During these intervals the signal is changed to an intensity level that is never used for picture information, thus creating *synchronization pulses* that the television circuits can distinguish from the picture signal.

In this country, the repetition rate for the picture-scanning process was

set at 60 scans per second so that interference from the 60 Hz AC power line will be synchronized; that is, any visible interference effect will stand still on the screen and be less noticeable than it would be if it were moving. Scanning the entire picture 60 times per second amounts to a lot of information per unit of time, and thus requires a very wide bandwidth. The television designers discovered that they could cut the bandwidth requirement in half by making the camera scan every other line during alternate scanning cycles called *fields*. Two successive fields cover all the lines in the raster 30 times each second, to make a *frame*. (See figure 1.) Since the lines of the two alternate fields mesh between each other, this technique is called *interlaced scanning*.

This seems like a rather complicated way of getting 30 frames per second, and you may be wondering whether television wouldn't work just as well with a straightforward scan of the entire raster, 30 times per second. This concept is fine as far as the 60 Hz power-line interference is concerned, but 30 frames per second is too slow for the human eye to merge the image into a continuous picture without noticeable flicker. If you are familiar with filmed motion pictures, you know that they are projected at only 24 frames per second, but a shutter interrupts each frame so that the effective flicker rate is actually 48 frames per second, fast enough for motion to appear continuous.

There are other factors which also



# Data Terminals From MICROMAIL? YES,

Because We Offer....

... A 'Personal Approach'

Towards the Quick and Efficient Handling of Your Individual Order.

... Inventory.

The Equipment You Select is Readily Available from Our Stock.

... Terminals Only.

We Specialize in Data Terminal Equipment.



**DIABLO 630**

- Uses metalized or plastic print wheels.
- Automatic bi-directional printing.
- Maximum print speed is 40 characters/second.
- Variable column spacing, 120 positions/inch.
- Variable line spacing, 48 positions/inch.
- Forms control; bi-directional paper feed; horizontal and vertical tabs; left, right, top and bottom margins.

**\$1999.00**

Optional Forms Tractor - \$200.00

**DIABLO 1650**

- Prints at 40 cps, using 88, 92, or 96 char. metalized printwheels.
- Vertical resolution 1/48". Horizontal 1/120". Capable of proportional spacing, bidirectional printing, and graphics under software control.
- Bidirectional normal and direct tabs. Left, right, top and bottom margins.

**R.O. \$2890.00  
KSR \$3155.00**

**DIABLO 1640**

- Uses plastic printwheel and prints at 45 cps. Otherwise, shares identical features with 1650 including:
  - Friction or tractor feed, up to 15" wide.
  - Cartridge ribbon, fabric or carbon.

**R.O. \$2745.00  
KSR \$3050.00**

**T.I. 810**

- Includes upper/lower case option.
- Bidirectional printing at 150 cps.
- Tractor-feed-forms, 3" to 15" wide.

**\$1599.00**

- Options:
- Forms length control - \$100.00
  - Vertical Format Control with Compressed Print - \$125.00



**DECwriter LA 34**

(Shown with optional forms tractor and numeric keypad).

- Prints 10, 12, 13.2, or 16.5 characters per inch, upper/lower case.
- 2, 3, 4, 6, 8, or 12 lines per inch.
- Friction feed, paper width to 15 inches.

**\$969.00**

Options:

- Numeric keypad - \$80.00
- Adjustable forms tractor - \$130.00

**Model 'AA' \$1,099.00**



**ANADEx DP-9500/9501**

- High Density Graphics
- Parallel, RS-232C, and Current Loop interfaces standard.
- Double width printing
- 132/175 or 132/220 columns.
- 50 to 220+ lines/min., 150/200 CPS 9 x 7/7 x 9 font or 120/200 CPS with 11 x 9/7 x 9 font.
- 9-wire print head, 650 million character life.
- Bi-Directional printing with shortest distance sensing logic.
- Adjustable width tractor paper feed.

**Call For Low Price**



**SOROC IQ 120**

- Displays 80 x 24, upper/lower case.
- Separate numeric keypad and cursor keys.
- Protected fields displayed at reduced intensity.

**\$689.00**



**SOROC IQ 140**

- 117-key detachable keyboard with numeric cluster and cursor control.
- Insert/delete line, insert/delete character.
- Underline, blink, reverse, 1/2 intensity, protected and blank fields.
- Printer port with independent baud rate - prints line, partial or full screen.

**\$1099.00**



**TELEVIDEO 912/920**

- Insert/delete line, insert/delete character, line/page erase.
- Reverse video, blinking, underline, 1/2 intensity, protected field, blank security field.
- Uses 7 x 10 dot matrix for a high quality w/l case display with descenders.
- Standard typewriter or teletype keyboard; numeric keypad.
- Model 920 includes 17 dedicated keys for function and editing.
- Block or character transmission, auxiliary printer port.
- Cursor up, down, left, right return, home, load, read, tab and back tab.

**Call For Low Price**



**TELETYPE 43**

- Prints 132 columns, upper/lower case with true descenders.
- 30 character/second print speed, 110-300 baud.
- Uses 12" wide by 8.5" pinfeed paper.
- Print position scale, paper guide and supply rack.

**\$999.00**

MICROMAIL • BOX 3297 • SANTA ANA, CA 92703  
(714) 731-4338

**Write or Call In for Our Free Catalogue!**

TO ORDER: Send check or money order to: MICROMAIL, P.O. Box 3297, Santa Ana, CA 92703. Personal or company checks require two weeks to clear. All equipment includes factory warranty.

SHIPPING: We ship freight collect by UPS when possible. Larger terminals are shipped by motor freight. Air and express delivery is available on all products.

HANDLING: All orders are subject to MICROMAIL's handling charges. Less than \$750.00, add 3%. \$750.00 to \$2,000.00, add 2%. Over \$2,000.00, add 1%.

**CIRCLE COMPUTER SALES**

Discount computer brokers  
Northern California's Finest!

THINKERTOYS®	List Price	Our Price
Discus M26® 26 Megabyte Disk The best S100 Winchester disk system on the market	4995	4089
Discus® 2D Dbl Dens 8" Floppy 600K bytes per drive	1199	999
Discus® 2 + 2 Dbl Side 8" Floppy 1200K bytes per drive (All Thinkertoys disk systems include CP/M® at no charge)	1545	1299
Add-on Dbl-Dens 8" Disk Drive	795	669
Add-on Dbl-Side 8" Disk Drive	1195	999
Disk Jockey® 2D Controller	429	365
16K SuperRam® Static RAM	349	295
32K SuperRam® Static RAM	699	585
16K MemoryMaster Bank-Select	399	335
24K MemoryMaster Bank-Select	549	465
Switchboard Serial/Parallel I/O	259	217
DECISION IR Computer System		call
<b>NORTH STAR COMPUTERS</b>		
HORIZON® 2 Drive 32K D/D	3095	2537
HORIZON® 2 Drive 32K Quad	3595	2947
HDS-18 18-Megabyte Hard Disk	4999	4097
RAM32 32K Dynamic RAM	739	599
RAM16 16K Dynamic RAM	499	419
NorthStar Application Software		call
<b>GODBOUT ELECTRONICS</b>		
Z80 Processor - 4Mhz, PDJ, EPROM, Interrupts	295	249
Dual Processor - 8085/8088 Ease into 16-bit processing	425	359
Econoram IIA 8K Static RAM ... OLO RELIABLE	189	158
Econoram XIV 16K Static RAM	349	295
Econoram XX 32K Static RAM bank-select or extended addressing very low power . . . a great buy	699	594
Interfacer I Dual Serial I/O A very flexible board Full RS232 handshaking	249	207
Interfacer II Serial/Parallel I/O	249	207
<b>PRINTERS</b>		
Diablo 630 - The low-cost DAISY These will be hard to get	2695	2395
NEC 5515 RD Serial Interface Diablo-compatible interface	2850	2499
<b>USED ALPHA MICROS</b>		
		Call
<b>TERMINALS</b>		
Hazeltine 1420	995	895
Hazeltine 1500	1225	1049
Televideo 920C	975	877
<b>MEASUREMENT SYSTEMS</b>		
OM6400 64K Dynamic RAM	895	657
OMB 64K Dynamic Bank-Select RAM Excellent reliability, low cost, low power . . . a good buy	1195	857
<b>ALTOS</b>		
ACS8000-2 64K Dbl-Dens, Sgl-Sided	4500	3995
ACS8000-5 64K DEMO . . . can upgrade to 4 users and hard disk	5990	4795
<b>MICRO PRO</b>		
Word Star	495	379
Super Sort	250	189
Data Star	350	269
Mail Merge (Requires Word Star)	150	119

Prices subject to change without notice. Delivery subject to availability.

Circle Computer Sales  
700 Larkspur Landing Circle  
Larkspur, CA 94939  
415-461-2616

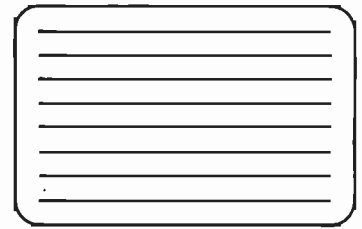
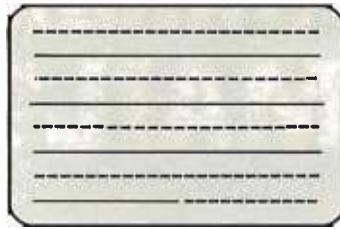

Figure 1: A comparison of the interlaced (1a) and noninterlaced (1b) raster-scanning schemes. The standard home television receiver displays a picture made up of two alternating fields, each composed of 262½ lines. The lines are interlaced to produce a high-resolution picture that can be transmitted on a narrow bandwidth signal.

complicate video-display timing. The vertical-retrace interval provides time for the television circuits to return the scanning dot to the top of the screen after each field has been completed. Since no picture information should be viewed during this time, the electron beam must be turned off or blanked: so, this time is also called the vertical-blanking interval.

A complete frame consists of two field scans and two vertical-retrace intervals. Television in the United States uses a total of 525 lines per frame or 262.5 lines per field. Each vertical retrace uses 21 lines, leaving 241.5 lines per field for the transmission of picture information. The odd half-line per field is necessary in order to make the lines of alternate fields interlace properly.

At 30 frames per second, 525 lines per frame is equivalent to 15,750 lines per second or 63.5 μs per line. Since all the lines are scanned in the same direction, the scanning dot must be returned across the screen between the end of one line and the start of the next. This is called horizontal retrace and takes about 15 μs.

**Video Monitor Versus the Standard Receiver**

So that the engineers at the television station can monitor the quality of the signal that is being transmitted, the picture is displayed on a video monitor (something like a television set without the antenna and tuner). It does not pick up other television broadcasts but is connected directly to the station equipment generating video signals. If the outgoing video signal already has the horizontal and vertical synchronizing pulses, it is called composite video. Most video monitors are also capable of accepting the video signals and synchronizing signals separately.

Because the monitor gets the signal

before it has been through the various distortions imposed on it by the transmission and reception equipment, the picture displayed on a monitor is much sharper than the one on a home television set. The bandwidth of the video signal displayed by a home set is limited to less than 4.5 MHz, while most video monitors can handle 12 MHz or more.

Home television receivers display less of the picture in another respect: they crop off the edges by generating a raster which is too large for the screen. This deliberate overscanning is done so that the unavoidable errors in the positioning of the raster (caused by manufacturing tolerances and changes in the power-line voltage) will not leave unsightly gaps at the edges of the picture. In television broadcasting, no important activity is allowed to occur near the edges of the picture where it might be lost. Personal computers that use standard television receivers for their displays must have similar precautions: data is never displayed on the parts of lines near the sides of the screen, or anywhere on the top or bottom lines.

The television signal is transmitted over the air after it is impressed onto a VHF (very-high-frequency) or UHF (ultra-high-frequency) radio signal by modulation. Modulation is the modification of some characteristic of the VHF or UHF signal, or carrier, in step with the changes in the information that is being transmitted. The particular frequency used for the carrier determines which channel you tune your TV set to in order to pick it up. Circuits in the television can detect the changes in the carrier and extract the information they contain: specifically, the composite-video signal.

If we want to display our computer-generated video on an or-

# SIRIUS 80+

## High Performance Low Cost Floppy Add-Ons!

The SIRIUS SYSTEMS 80+ Series of Floppy Disk add-ons are designed to provide unmatched versatility and performance for your TRS-80+. Consisting of four different add-ons, there is a 80+ Series Floppy Disk Drive to meet your needs.

### COMMON CHARACTERISTICS

- 5ms track-to-track access time
- Auto-Eject
- 180 day WARRANTY
- Exceptional speed stability - 11/2%
- Single/Double Density operation
- Mix any or all 80+ Series on the SS Standard cable

### SPECIFIC CHARACTERISTICS

The SIRIUS 80+1 - a single sided, 40 track Drive. Offering 5 more tracks than the Radio Shack model, it cost \$120 less. Formatted data storage is 102K/204K Bytes Single/Double Density.

**SIRIUS 80+1 ..... \$379.95**

The SIRIUS 80+2 is a dual sided, 80 track (40 per side) Disk Drive. It appears to the TRS-80+ as TWO 40 track drives yet COST LESS THAN HALF THE PRICE! Even greater savings result since data is recorded on both sides of the media instead of only a single side. This unit may require the SS Standard cable. Formatted data storage is 204K/408K Bytes Single/Double Density.

**SIRIUS 80+2 ..... \$449.95**

The SIRIUS 80+3 - a single sided, 80 track Drive. Offering 2 1/2 times the storage of a standard Radio Shack Disk Drive, the 80+3 greatly reduces the need for diskettes correspondingly. Additionally, because of the increased storage and faster track-to-track access time, the 80+3 allows tremendously increased throughput for disk based pro-

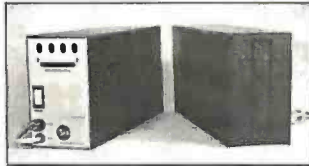

grams! The 80+3 includes SIRIUS's TRAKS-PATCH on diskette (for use with 96 tpi drives). Formatted data storage is 204K/408K Bytes Single/Double Density.

**SIRIUS 80+3 ..... \$499.95**

The SIRIUS 80+4 - a dual sided, 160 track (80 per side) 5 1/4" monster! The ultimate in state-of-the-art 5 1/4" Floppy Disk Technology, the 80+4 is seen by the TRS-80+ as two single sided disk drives. Thus, in terms of capacity, one 80+4 is equivalent to 4% standard Radio Shack drives - at a savings of over 73% (not to mention diskettes!!!). (With a double density converter the available memory is huge!) The 80+4 (a 96 tpi drive) includes TRAKS-PATCH on diskette and may require the SS Standard cable. Formatted storage is 408K/816K Bytes Single/Double Density.

**SIRIUS 80+4 ..... \$649.95**

All 80+ Series Floppy Disk add-ons operate at 5ms track-to-track but are Expansion Interface limited to 12ms for the TRS-80+.

\*TRS-80@ of Tandy Corp.

### ACCESSORIES

- SS Standard 2 Drive Cable ..... \$29.95
- NEWDOS/80-Sophisticated Operating System for the TRS-80+ from Apparat ..... \$149.95

## Save up to 10% with these SIRIUS Packages!

NEWDOS/80, SIRIUS 80+3, and Two Drive Cable .....	<b>\$624.95</b>
NEWDOS/80, SIRIUS 80+4, and Two Drive Cable .....	<b>\$749.95</b>
NEWDOS/80, Two (2) SIRIUS 80+3's, Two Drive Cable .....	<b>\$1080.95</b>
NEWDOS/80, Two (2) SIRIUS 80+4's, Two Drive Cable .....	<b>\$1349.95</b>

# PRIAM Hard Disks Now Available from SIRIUS SYSTEMS!

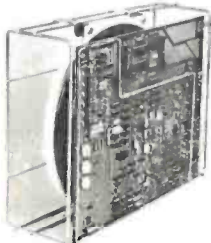

PRIAM's high-performance, low-cost Winchester disc drives speed up throughput and expand data storage from 20 megabytes to 154 megabytes. And a single controller can be used to operate 14-inch-disc drives with capacities of 33, 66, or 154 megabytes or floppy-disc-size drives holding 20 and 34 megabytes. So it's easy to move up in capacity, or reduce package size, without changing important system elements or performance.

- Fast, Linear Voice Coil Positioning
- 10 ms track-to-track positioning
- Fully servoed head positioning
- Dedicated servo tracks
- DC Power required only!
- Simple, parallel Interface
- Optional SMD Interface
- 50 ms Average Positioning time
- 90 ms Maximum Positioning Time
- 6.4 ms Average Latency

### THE PRIAM LINEUP

Model/Disc Size	Capacity	Size	Weight	Price
DISKOS 3350 (14")	33Mbytes	7" x 17" x 20"	33 lbs.	\$2995
DISKOS 6650 (14")	66 Mbytes	7" x 17" x 20"	33 lbs.	\$3749
DISKOS 15450 (14")	154 Mbytes	7" x 17" x 20"	33 lbs.	\$4695
DISKOS 2050 (8")	20 Mbytes	4.62" x 8.55" x 14.25"	20 lbs.	\$2995
DISKOS 3450 (8")	34 Mbytes	4.62" x 8.55" x 14.25"	20 lbs.	\$3745
DISKOS 1070	10.6 Mbytes	floppy-size	(low)	<b>\$2195</b>

All PRIAM DISKOS Drives have a Transfer Rate of 1.03 Mbytes/Sec. Optional SMD interface available for \$150.

SIRIUS SYSTEMS offers cases and enclosures for all PRIAM Hard Disk Drives. All 14" Winchester Drives will mount in our 14" Standard Case. The 8" Winchester have two alternatives: a single drive case and a dual drive case. All SIRIUS SYSTEMS Winchester drive cases include Power Supply, internal cabling, switches, fan, extra AC outlet (not switched, but fused) and possess very adequate ventilation. Drive addressing is done on the rear of the Case and not on the drive itself to provide ease of use during operation. All WINCHESTER REAR DRIVE Cases are Warranted for a full year and come in our standard blue-black color scheme. Consult us for current availability and pricing.

## Introducing the Versatile, Low-Cost OMEGA Series Controller

As new technological advances bring down the cost of fast, reliable mass data storage, the need for an inexpensive, versatile controller have become greater and greater. To meet this need, SIRIUS SYSTEMS' OMEGA Series Controller was designed.

The SIRIUS OMEGA Series Controller Module utilizes an on-board microprocessor to mediate data transfer to a wide variety of peripherals from an equally wide variety of host computer systems. Up to four Winchester Hard Disks (8" or 14"), four 5 1/4" Floppy Disk Drives and/or up to eight 8" Floppy Disk Drives may be in use at one time. Host systems interfacing is accomplished via a parallel or a serial interface. With the addition of a Personality module, the OMEGA Series Controller Module is directly compatible with many popular computer systems (among them the TRS-80+, Apple, Heath, and others). Provision is made for the addition of a streaming tape drive, also.

### SPECIFIC HARDWARE

#### FEATURES INCLUDE:

- Control of up to twelve Floppy Disk Drives (eight 8" and/or four 5 1/4")
- 8" and/or 5 1/4" Disk Drive Utilization
- Single (FM) or Double (MFM) density data storage
- Hard or Soft sectored diskette usage
- Utilization of "Quad" density (96 tpi) 8" or 5 1/4" Disk Drives

- Control of up to four WINCHESTER type PRIAM DISKUS Disk Drives
- 8" or 14" may intermix on the same cable
- Accommodates 8" and/or 14" drives of 5.3Mbytes to 15.4Mbytes
- Ultra-Fast data transfers
- Extremely flexible host-controller interfacing

### SPECIFIC SOFTWARE

#### FEATURES INCLUDE:

- Dynamic format modifications via command words
- Extremely flexible format acceptance for unusual data storage formats
- Easily interfaces to standard operating systems (TRS-DOS, CP/M, etc)
- Operates in either get/put sector mode or data string mode
- Performance parameters may be changed by EPROM replacement or Dynamic Reprogramming

CP/M<sup>®</sup> of Digital Research

Dedicated systems cards are also available on a limited basis for the STD-BUS and the S 100. These cards feature shared memory also (again, software selectable) in addition to the regular OMEGA Series Controller Module features. Consult SIRIUS SYSTEMS for current price and availability for the entire line of OMEGA Series Memory Units and Controllers. Dealer inquiries are invited.

## What TFOKTH Is - and what it has to offer YOU!

TFOKTH is a unique growth programming language for the TRS-80+ that combines the best features of an interpreter and a compiler all in one functional easy-to-use package. TFOKTH cannot be simply compared with Fortran, BASIC or PASCAL. This high speed, high level modular code offers the speed found in many FORTRAN compilers yet retains the on-line conveniences found in BASIC INTERPRETERS by flagging input errors as they occur line-by-line. Unlike PASCAL, TFOKTH needs no "run-time" package for support. Serving as an operating system, compiler, assembler, interpreter, virtual memory manager, all in one: TFOKTH makes easy, efficient, structured re-entrant programs a natural consequence.

The key to TFOKTH's flexibility and ease of use lies in its use of a stack for parameters and a unique dictionary for WORDS. These WORDS are stated in terms of other WORDS already defined in the dictionary. It is this rich set of WORDS that provides DO LOOPS, IF-THEN-ELSE statements, BEGIN-END statements, virtual memory, any number base (to base 32) for input or output, a macro assembler, re-entrant code, multithread dictionary, line editor, excellent math package (16 bit integers, double precision floating point, SIN, COS, TAN, EXP and LOG) and it runs under either TRSDOS or NEWDOS. Assembler inherently nests with high level in an easy fashion. Complicated drivers for new devices take only a few lines of TFOKTH which saves both memory and disk space!

TFOKTH is a procedural language specifying a process rather than a desired result. The ability to have the language grow in the direction the user desires is excellent for novel applications. New data types and new processes can become part of the language. Due to the modular constructions, a very compact code is produced which executes at exceptionally high speeds between machine code and machine code plus 20% typical overhead speeds. Memory requirements can be "less" than assembler coding or other high level languages.

TFOKTH comes complete for the TRS-80+ with as little as 16K of memory and a single Disk Drive using either TRS-DOS or NEWDOS. It provided on diskettes and an optional Math and Utilities package is available.

Through TFOKTH an excellent way to develop new languages, provide simple control of device (including video monitors, A/D and D/A converters and burglar alarms) and to implement tasks requiring monitoring and decision is offered. Many WORDS to handle peripherals are part of basic TFOKTH and others may be added easily. Often, substantial hardware development can be eliminated by using TFOKTH to do the major digital or reduction of data.

For many applications a minimal task may be written in high level (or mixture of assembler and high level) code: loaded, assembled and prior to execution may be written to the disk as a ready to execute machine code/EXE module with the DOS.

TFOKTH (on diskette - specify for Standard or 96 tpi Disk Drives) .....	<b>\$129.95</b>
TFOKTH with the addition of TRAKS-PATCH (a powerful combination!) .....	<b>\$136.95</b>

## STATE-OF-THE-ART DISK DRIVES

### QUME<sup>®</sup> DataTrak 8 8" Disk Drive DOUBLE SIDED! DOUBLE DENSITY!

High performance Double Sided Disk 8" Disk Drive ■ Single or Double Density ■ Door Lock and Write Protect INCLUDED! ■ Negative DC Voltage not required ■ Low Power Operation

- FAST! 3ms track-to-track access
- Low friction and minimum wear
- Superior or Head Load Dynamics

QUME DataTrak 8 .....	<b>\$574.95</b>
	<b>(2/\$549 ea)</b>
QUME Technical Manual .....	<b>\$6.95</b>
Connector Set #3 (AC, DC, & Card Edge) .....	<b>\$10.95</b>
Connector Set #4 (AC and DC) .....	<b>\$2.95</b>

### MPI 51/52 & 91/92 5 1/4" Disk Drives

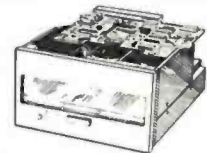

- Fast! 5ms track-to-track access
- Exclusive Pulley-Band Design
- Unique Door/Ejector Mechanism
- Reliable 1 1/2% Speed Stability
- Single/Double Density Operation
- Industry/ANSI Standard Interface

MPI 51 (Single Head/40 tracks) 125K/250K Bytes Single/Double Density ..	<b>\$259.95</b>
MPI 52 (Dual Head/80 tracks (40/side)) 250K/500K Bytes Single/Double Density ..	<b>\$349.95</b>
MPI 91 (Single Head/80 tracks) 250K/500K Bytes Single/Double Density ..	<b>\$399.95</b>
MPI 92 (Dual Head/160 tracks (80/side)) 500K/1000K Bytes Single/Double Density ..	<b>\$524.95</b>
MPI Technical Manual .....	<b>\$6.95</b>
** Unformatted data storage	



7528 Oak Ridge Highway  
Knoxville, Tennessee 37921

## TO ORDER CALL (615) 693-6583

Phone Orders Accepted 9AM-7PM (EST) Mon-Fri

We accept MC, VISA, AE, COD (requires Certified Check, Cashier's Check or Cash) and Checks (personal checks require 14 days to clear). SHIPPING AND HANDLING: \$7.00 per Floppy Disk Drive or 80+ Module ■ 5% for other items (any excess will be refunded) ■ Foreign Orders add 10% for Shipping & Handling. Payment in U.S. currency ■ Tennessee residents add 6% Sales Tax ■ VOLUME DISCOUNTS AVAILABLE

dinary television set, we must either modify the set internally to give it a direct composite-video input, like that of a video monitor, or else we must add a *modulator* to our computer. The modulator acts like a tiny broadcasting station; it generates a VHF or UHF carrier that corresponds to a standard television channel (which is not being used by a local transmitting station) and modulates it with the computer video signal. The modulated signal can then be connected to the receiver's antenna terminals.

### Displaying Computer Data

For our computer to produce a display on a television set or a video monitor, it must generate a composite-video signal. Generating the horizontal and vertical synchronizing pulses is relatively easy, since they just repeat over and over in a fixed numerical relationship. Our computer's internal clock can serve as a stable high-frequency source for a few additional circuits to use in producing the horizontal and vertical synchronizing signals.

---

## Combining functions helps to keep the cost of personal computing down.

---

To make the display circuits in personal computers simpler and less expensive, the whole complicated business of interlaced scanning lines and alternating fields has been eliminated in most cases. Instead, the odd half-line per field, which would have been needed to make the field lines interlace, is omitted; this leaves 262 lines per field. Without the interlace, the lines of any two successive fields appear in exactly the same places, so we can just as well think of a computer display as having 60 frames per second, with 262 lines per frame. In fact, a different number of lines per frame may be used if the designer finds it convenient, but the number must be within a few percent of 262 for the display to work with a standard television set.

### Video Refresh

While synchronization is easy, generating a video signal with our computer is a little more difficult. First of all, a television picture must be continually regenerated by repeating the entire scanning process 60 times per second. This continual regeneration of the display is called *video refresh*; it requires a stream of data at a rate much too fast for our computer to keep up with—if the system had to compute the data anew for every scan. Instead, most computer designers set aside enough memory to store all of the data that will appear on the display. This reserved memory is called the *video-refresh memory*. Circuits designed especially for video-displaying read data from the refresh memory, in step with the video-synchronizing pulses, and transform the data into the video signal which is displayed.

Using part of the computer's own memory for video refresh has not been the general rule. Most large computer systems include video terminals that are independent of the main computer and contain their own

# NEW EATON 7000+ PERSONAL COMPUTER PRINTER

Now you can add hard copy capability to your computer with plug-in simplicity that matches up to any micro system. And with the Eaton 7000+ dot-matrix printer, you get complete printout versatility at an affordable price.

#### Interfaces with any personal computer

Apple, Commodore Pet, TRS-80, Northstar and others—no matter what type of computer you have or are thinking of buying, Eaton 7000+ fits. Just plug it in and start printing. You'll get virtually maintenance-free operation with a minimum of moving parts. And minimum life of 100 million characters with Eaton's newest printhead, while the print



mechanism is designed for a minimum of 10 million cycles.

#### High performance design

The 7000+ features uni-directional printing at a speed of 1.25 lines per second. It accepts any standard single or 2-ply roll paper from 3/4" to

---

## PLUG IN AND PRINT OUT— IN SECONDS!

---

3/8" wide and prints 3/8" line with 40 to 64 adjustable character capacity.

For immediate information call: Eaton Printer Product Operations, 307/856-4821.

For descriptive literature and the name of your nearest dealer write Eaton Corporation, Count Control/Systems Division, 901 South 12th St., Watertown, WI 53094.

**Dealer inquiries invited.**

**EATON**  
Electrical/Electronic Control

GO 16-BIT NOW — WE HAVE MADE IT EASY

# 8086

8 Mhz. 2-card CPU Set

**\$595**

WITH 86-DOS™

ASSEMBLED, TESTED, GUARANTEED

With our 2-card 8086 CPU set you can upgrade your Z80 8-bit S-100 system to run three times as fast by swapping the CPUs. If you use our 16-bit memory, it will run five times as fast. Up to 64K of your static 8-bit memory may be used in the 8086's 1-megabyte addressing range. A switch allows either 4 or 8 Mhz. operation. Memory access requirements at 4 Mhz. exceed 500 nsec.

The EPROM monitor allows you to display, alter, and search memory, do inputs and outputs, and boot your disk. Debugging aids include register display and change, single stepping, and execute with breakpoints.

The set includes a serial port with programmable baud rate, four independent programmable 16-bit timers (two may be combined for a time-of-day clock), a parallel in and parallel out port, and an interrupt controller with 15 inputs. External power may be applied to the timers to maintain the clock during system power-off time. Total power: 2 amps at +8V, less than 100 ma. at +16V and at -16V.

86-DOS™, our \$195 8086 single user disk operating system, is provided without additional charge. It allows functions such as console I/O of characters and strings, and random or sequential reading and writing to named disk files. While it has a different format from CP/M, it performs similar calls plus some extensions (CP/M is a registered trademark of Digital Research Corporation). Its construction allows relatively easy configuration of I/O to different hardware. Directly supported are the Tarbell and Cromemco disk controllers.

The 86-DOS™ package includes an 8086 resident assembler, a Z80 to 8086 source code translator, a utility to read files written in CP/M and convert them to the 86-DOS format, a line editor, and disk maintenance utilities. Of significance to Z80 users is the ability of the translator to accept Z80 source

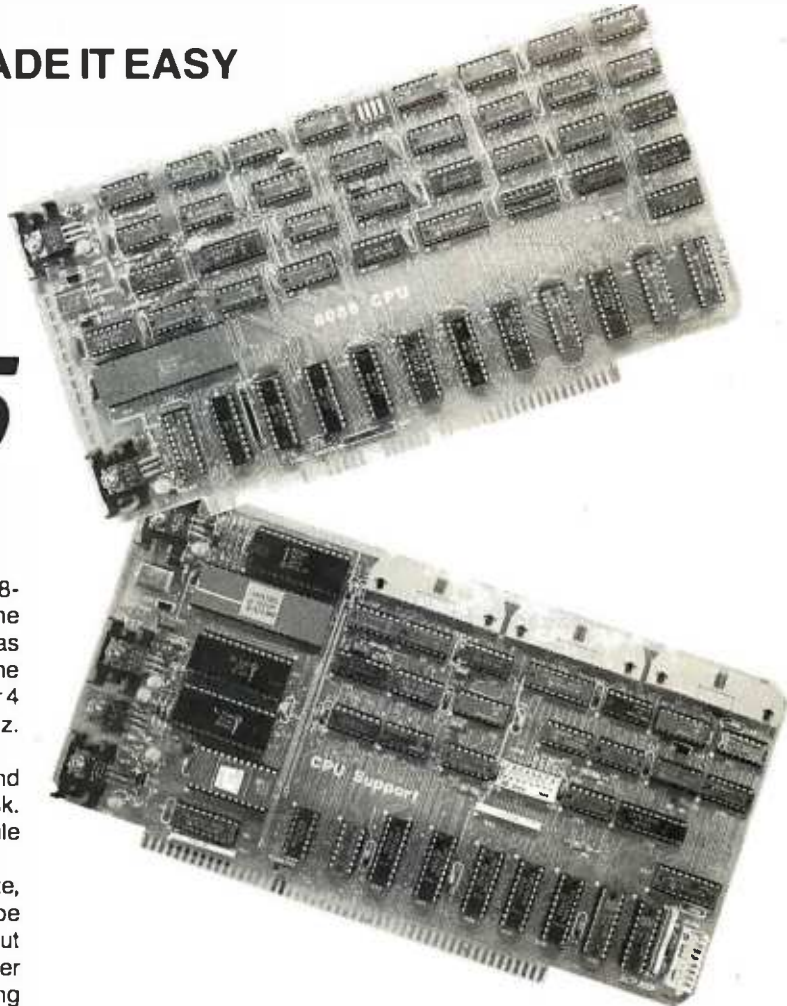

code written for CP/M, translate this to 8086 source code, assemble the source code, and then run the program on the 8086 processor under 86-DOS. This allows the conversion of any Z80 program, for which source code is available, to run on the much higher performance 8086.

BASIC-86 by Microsoft is available for the 8086 at \$350. Several firms are working on application programs. Call for current software status.

All software licensed for use on a single computer only. Non-disclosure agreements required. Shipping from stock to one week. Bank cards, personal checks, CODs okay. There is a 10-day return privilege. All boards are guaranteed one year — both parts and labor. Shipped prepaid by air in US and Canada. Foreign purchases must be prepaid in US funds. Also add \$10 per board for overseas air shipment.

## 8/16 16-BIT MEMORY

This board was designed for the 1980s. It is configured as 16K by 8 bits when accessed by an 8-bit processor and configured 8K by 16 bits when used with a 16-bit processor. The configuration switching is automatic and is done by the card sampling the "sixteen request" signal sent out by all S-100 IEEE 16-bit CPU boards. The card has all the high noise immunity features of our well known PLUS RAM cards as well as "extended addressing". Extended addressing is a replacement for bank select. It makes use of a total of 24 address lines to give a directly addressable range of over 16 megabytes. (For older systems, a switch will cause the card to ignore the top 8 address lines.) This card ensures that your memory board purchase will not soon be obsolete. It is guaranteed to run without wait states with our 8086 CPU set using an 8 Mhz. clock. Shipped from stock. Prices: 1-4, \$280; 5-9, \$260; 10-up, \$240.

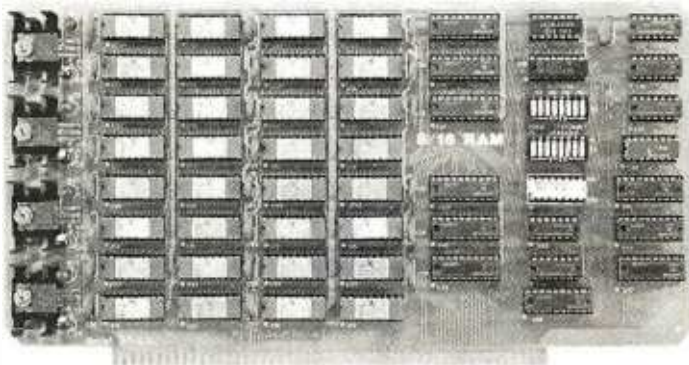

**Seattle Computer Products, Inc.**

1114 Industry Drive, Seattle, WA. 98188  
(206) 575-1830

refresh memory. In other words, a small personal computer is a hybrid: part computer, part terminal. Combining functions in this way helps to keep the cost of personal computing down. Also, putting the refresh memory into the computer makes changing the display faster and easier.

### Bit-Mapped Displays

There are several different methods of transforming the data stored in the refresh memory into an effective video display. The most straightforward method is to take the data just as it is read from the refresh memory and transmit it to the display 1 bit at a time. Each 1 bit in this serial bit stream appears on the screen as a spot of light, and each 0 bit as darkness. The size of the refresh memory is matched to the picture scan so that for each bit in the refresh memory there is one spot on the display screen. A one-to-one correspondence of this kind is called a *map*, and this technique for generating computer video displays is called *bit mapping*. An example of a bit-mapped display is shown in photo 1.

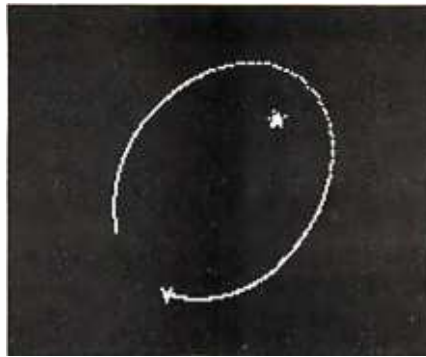

Photo 1: Example of a bit-mapped display. This simulation of a spaceship in orbit around a star is done on a 180-bit by 150-bit map.

Since we can program the computer to store data bits into the refresh memory in any pattern we desire, this kind of display can have all the versatility we want, but there are some drawbacks. For one thing, this system requires a large refresh memory. To store a display which is 200 dots high by 300 dots across, for example, takes 60,000 bits or 7500 bytes. Bit-mapped displays are relatively slow, too; just storing 0s into this much memory in order to

clear the screen to black takes close to 1 second with the fastest micro-processor.

Displaying only letters and numbers means we can get by with a much smaller refresh memory than is needed for bit mapping. A letter that occupies eight rows of eight dots requires 8 bytes of memory in the bit-mapped display, but we can encode the same letter in ASCII (American Standard Code for Information Interchange) and reduce the size of the refresh memory by a factor of 8. This means that instead of sending the data bits directly to the display, it is necessary to decode each stored character and generate the appropriate video information. To do this, the refresh circuits send the character code (along with signals that indicate which of the eight rows of dots is currently being displayed) to another circuit called a *character generator*. The character generator is little more than a read-only memory that contains the video bit patterns for each of the characters we want to display.

Having a smaller refresh memory more than compensates for the additional cost of the character generator. For example, our 200-dot by 300-dot display has a capacity of 925 characters, in twenty-five rows of thirty-seven characters each. The bit-mapped memory needed for this is 7500 bytes, but we can store 925 characters in only 925 bytes if we use the character generator. It takes only one-eighth as long to update the refresh memory, too. The main drawback is its lack of versatility; we can only display characters of a fixed size and spacing. Obviously, a method of getting many different shapes without increasing the size of the refresh memory would be more flexible.

Using a byte of memory for each character, in all possible combinations of 8 bits, requires a total of 256 different codes. A complete set of uppercase and lowercase letters, numbers, and punctuation takes only ninety-six codes, leaving 160 combinations that we can assign to special shapes useful for graphics. Each special shape must be designed using the same number of dots and rows as the other characters. It may often be necessary to use several of them to make up the image of one object in the display. We can allow for this by setting up special characters such as

(212) 986-7690			
<b>MAIL ORDER ONLY</b>			
Micro Computer		Your One Stop For... Quality and Huge Savings	
<b>DISCOUNT</b> Company			
QUALITY • DELIVERY • SERVICE			
60 E. 42nd St. Suite 411 New York, NY 10017			
 <b>CENTRONICS</b> 737-1 — \$895	 <b>APF</b> IM1 - \$495 IM2 - \$988	 <b>COMMODORE</b> 8K - \$729 16K - \$888 32K - \$1088 2022 - \$695 2040 - \$1088 8050 - \$1435 8032 - \$1495	 <b>APPLE</b> 16K - \$ 959 48K - \$1059 Disk — \$529 Other Products Avail
 <b>PAPER TIGER</b> 440G - \$895	 <b>XYMEC</b> HQ 1000 - \$2395	 <b>NEC SPINWRITER</b> 5510 - \$2795 5520 - \$2990	 <b>SUPERBRAIN*</b> *32K - \$2445 64K - \$2645 64KQD - \$3395 *32K add-in memory only \$10 with purchase
 <b>*XEROX</b> 1740 RO - \$2619 1740 SR - \$2995 1750 RO - \$2795 1750 KSR - \$3170 1730 - \$2195			
<b>MAIL ORDER ONLY</b>			
Send Certified Check (Personal or Company Checks require 2 weeks to clear.)			
We pay all shipping and insurance charges except items marked with asterisk.			
VISA, MasterCard add 5% N.Y.S. Residents add appropriate sales tax.			
* (DENOTES ITEMS SHIPPED F.O.B. NYC)			
<b>PHONE (212) 986-7690</b>			

straight-line segments, corners, intersections, and so on, in various orientations.

Several personal-computer manufacturers have taken this approach. While keeping the speed and small refresh memory of the character-generator-based design, they also have a reasonable graphics capability with good resolution. To compensate for the limited number of special shapes that you can have with this method, the Exidy and Texas Instruments computers have *programmable* character generators so that you can design your own shape characters and change them as needed.

### Character Subcells

There is another way to add graphics capability to the character-generator display. Suppose we divide each of the character cells into four subcells, each of which is four dots square. By displaying any combination of these four subcells, with all dots illuminated, there will be sixteen possible shapes which we can display in each character location. By allocating sixteen extra character codes to represent these sixteen combinations, we can have a very versatile graphics system; however, it won't have much resolution. Dividing each character in half horizontally and vertically converts the twenty-five rows of thirty-seven characters in our example to a 50-block by 74-block graphics display.

We could increase the resolution by dividing the character cells into smaller pieces, but the number of combinations of blocks we would have to encode would increase very quickly. If we divide each cell by 4 in each direction, we increase the resolution to 100 by 148; but, there will be sixteen subcells in each character cell so we must store 16 bits of data for each cell. Since there are 65,536 different 16-bit codes, using read-only memory for the character generator becomes impractical. Instead, it is necessary to devise some logical method for generating the subcell patterns by decoding an extra byte of information, using additional circuitry. Also, the refresh memory would have to be twice as big to store these 2-byte codes. This may help to explain why the personal computers that use this approach have relatively low resolution. ■

# ENTREPRENEURS NEEDED

**MORE THAN EVER IN THE MICRO-COMPUTER INDUSTRY.**

The shortage of knowledgeable dealers/distributors is the #1 problem of microcomputer manufacturers. Over 300 new systems houses will go into business this year, but the number falls short of the 1200 needed. It is estimated that the nationwide shortage of consultants will be over 3000 by 1981. The HOW TO manuals by Essex Publishing are your best guide to start participating in the continued microcomputer boom.

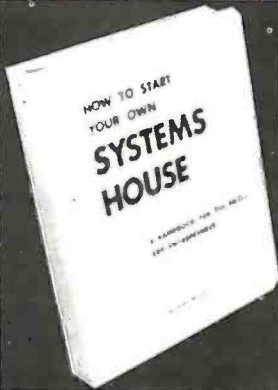

\$36. No. 10

Documentation • Solutions to the Service Problem • How to Write a Good Business Plan • Raising Capital

### HOW TO START YOUR OWN SYSTEMS HOUSE

6th edition, March 1980

Written by the founder of a successful systems house, this fact-filled 220-page manual covers virtually all aspects of starting and operating a small systems company. It is abundant with useful, real-life samples: contracts, proposals, agreements and a complete business plan are included in full, and may be used immediately by the reader.

Proven, field-tested solutions to the many problems facing the small systems house are presented.

From the contents:

- New Generation of Systems Houses
- The SBC Marketplace
- Marketing Strategies
- Vertical Markets & IAPs
- Competitive Position/Plans of Major Vendors
- Market Segment Selection & Evaluation
- Selection of Equipment & Manufacturer
- Make or Buy Decision
- Becoming a Distributor
- Getting Your Advertising Dollar's Worth
- Your Salesmen: Where to Find Them
- Product Pricing
- The Selling Cycle
- Handling the 12 Most Frequent Objections Raised by Prospects
- Financing for the Customer
- Leasing
- Questions You Will Have to Answer Before the Prospect Buys
- Producing the System
- Installation, Acceptance, Collection
- The Service Problem
- Protecting Your Product
- Should You Start Now?
- How to Write a Good Business Plan
- Raising Capital

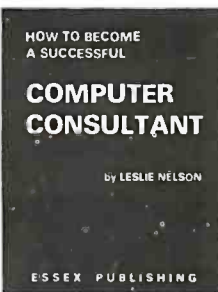

\$28. No. 16

pitfalls • How consultants' associations can help you • The National Register of Computer Consultants • How others did it: real-life sample cases • and much more.

### HOW TO BECOME A SUCCESSFUL COMPUTER CONSULTANT

by Leslie Nelson, May 1980

Independent consultants are becoming a vitally important factor in the microcomputer field, filling the gap between the computer vendors and commercial/industrial users. The rewards of the consultant can be high: freedom, more satisfying work and doubled or tripled income. HOW TO BECOME A SUCCESSFUL COMPUTER CONSULTANT provides comprehensive background information and step-by-step directions for those interested to explore this lucrative field:

- Established consulting markets
- How to get started
- Itemized start-up costs
- Are you qualified?
- Beginning on a part-time basis
- The Marketing Kit
- Should you advertise?
- Five marketing tips
- Getting free publicity
- How much to charge
- When do you need a contract?
- Sample proposals
- Which jobs should be declined
- Future markets
- The way to real big money
- Avoiding the legal

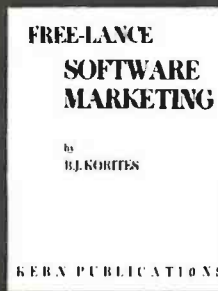

\$30. No. 32

training users and providing maintenance and support. It also contains sample software contracts that have been used in actual software transactions. Also included are tips on how to negotiate with a large corporation, ways of avoiding personal liability, techniques for obtaining free computer time and hints on how to run a free-lance software business while holding a full-time job.

### FREE-LANCE SOFTWARE MARKETING

3rd edition, June 1980

Writing and selling computer programs as an independent is a business where • you can get started quickly, with little capital investment • you can do it full time or part time • the potential profits are almost limitless. Since the demand for computer software of all kinds is growing at an explosive rate, the conditions for the small entrepreneur are outstanding.

This manual will show you how to sell your own computer programs using these proven techniques: • direct to industries • through consulting firms • through manufacturers of computer hardware • in book form • mail order • through computer stores. It will show you how to profitably sell and license all types of software ranging from sophisticated analytical programs selling for thousands of dollars, down to simple accounting routines and games for personal computers.

**ESSEX PUBLISHING CO. Dept. 2**  
285 Bloomfield Avenue • Caldwell, N.J. 07006



Order books by number. Send check, money order (U.S.), VISA or Master Charge #. Publisher pays 4th class shipping. For Air Mail shipping add \$2.50 per book in USA and Canada, \$5.00 in Europe, \$8.00 elsewhere. N.J. residents add 5% sales tax.

No. 10     No. 16     NO. 32     Check enclosed     Credit card

Name \_\_\_\_\_

Address \_\_\_\_\_

City \_\_\_\_\_ State \_\_\_\_\_ Zip \_\_\_\_\_

Card # \_\_\_\_\_ Exp. \_\_\_\_\_

For faster shipment on credit card orders call (201) 783-6940 between 9 and 5 Eastern time.

## The Power of VisiCalc

---

Robert E Ramsdell  
POB 59  
Rockport MA 01966

---

### At a Glance

<b>Software:</b>	<i>VisiCalc</i>
<b>Type:</b>	<i>Screen-oriented matrix calculator for projections, budgeting, and many other numeric/data manipulations</i>
<b>Author:</b>	<i>Software Arts Inc</i>
<b>Distributor:</b>	<i>Personal Software Inc, 1330 Bordeaux Dr, Sunnyvale CA 94086, (408) 745-7841</i>
<b>Price:</b>	<i>\$150.00</i>
<b>Format:</b>	<i>5-inch floppy disk</i>
<b>Language:</b>	<i>Machine language</i>
<b>Computers:</b>	<i>Apple II, Apple II+ or Apple III; Radio Shack TRS-80, Model I or II; Atari 800; Commodore PET and CBM computers, minimum 32 K bytes of programmable memory required, 48 K or more recommended</i>
<b>Documentation:</b>	<i>Loose-leaf binder with eighty-page tutorial manual, reference card</i>
<b>Audience:</b>	<i>Businessmen, accountants, attorneys, real-estate investors — anyone who needs to use a calculator for determining options available under different scenarios</i>

screen facilitates and enhances the manageability and interactivity of the program.

Since I am a certified public accountant, the majority of applications I have written are oriented towards accounting, a usage for which VisiCalc is particularly appropriate. In addition, I know of several attorneys who are using the program for estate- and gift-planning, one of whom is maintaining his accounts receivable, as well, on VisiCalc. A number of real-estate agents are using it to perform real-property investment analysis.

### About the Program

VisiCalc is an electronic scratch sheet that is sixty-three columns wide (lettered A thru BK) and 254 rows long (numbered 1 thru 254). Any column/row coordinate can be referred to by any other column/row coordinate arithmetically or trigonometrically. Once the relationships between the coordinates have been established in the model, a change in any value which affects other values will be instantly updated. This gives the computer operator the ability to play instant what-if situations with the value in the matrix.

The program has a great deal of flexibility in its formatting, allowing any coordinate to be a label or a value, and allowing columns to be adjusted from three characters to full-screen width. The screen can be split into two windows, either horizontal or vertical, and each can be scrolled independently of the other. This makes the comparison of information extremely easy. Values can be formatted as full-decimal notation (up to eleven significant digits), two-place decimal (for financial usage), and integer.

An annoyance that I have found in the program is its inability to round off integers, which causes columns to add up imperfectly. This often creates the need for a great deal of additional work when attempting to prepare financial information directly from the model.

One of the most powerful features of VisiCalc is its ability to replicate an entire series of coordinate functions with a few keystrokes. When creating models with a series of identical calculations (such as a 10-year business forecast), only the calculations for the first column must be entered. Then the subsequent columns can replicate the same calculations (VisiCalc automatically uses the new coordinates) in a matter of seconds. This is a tremendous time-saving device when elaborate models are being created. The authors of VisiCalc have also provided the ability to insert, delete, and move entire rows and columns. This feature is useful if the model is finished and

### Introduction

The most exciting and influential piece of software that has been written for any microcomputer application is VisiCalc. I've been using VisiCalc almost full-time for the past six months and have written over 300 applications (which I refer to as models) for the program. During that time I have learned its strengths and weaknesses and have found that the authors have allowed for a tremendous number of variables and contingencies in its operation. The instant communication between the operator and the

---

### About the Author

Robert E Ramsdell, CPA, is a microcomputer consultant who lives and works in Rockport, Massachusetts. His company, Pansophics, Ltd, published federal income tax models for 1979 and 1980 using VisiCalc and markets several other financial modeling packages.

---



the user discovers that an important calculation was omitted.

VisiCalc can be interfaced through most printers, and various printer configuration routines are set up directly through the program. The program will output to a printer with any number of character widths, so the choice of printer depends on the needs of individual users. Finally, the methods by which the program loads, saves, and deletes models on the disk are very well designed.

### Specific Applications

Accounting applications abound for VisiCalc. Financial analysis, business forecasts, and projections which formerly required hours can be completed with VisiCalc in a matter of minutes. The pricing on a bill-of-materials inventory can be updated in a matter of seconds. Productions estimates can be updated instantly. Different scenarios can be examined and variables and constants interchanged until a workable model is achieved. Even with the advent of programmable electronic calculators, the complexity of forecasting (due to the interdependency of the variables) has limited the accountant to either the most rudimentary forecast or the extremely expensive alternative of time-sharing on a large computer.

Sophisticated and statistically valid time-series analysis can be performed on VisiCalc. Lead and lag regression analysis becomes as easy as entering the various formulas. Each of the variables can be changed or updated, and the results of the new analysis will be instantly displayed.

Small businesses will also find uses for VisiCalc. A

model can be created which will allow for the printing of a financial statement whenever a trial balance is entered. Financial ratios and analysis are easily performed. The model can even calculate income tax and compare the current results with those of a previous period or a budget. (Some marketed models even print out tax returns.) Also, budgets are relatively easy to prepare (thanks to the replicate command), and changes and updates are easily entered.

More complex models can be designed for areas such as real estate and stock market investment analysis, where many interdependent variables must be given consideration. A change in any of these variables will instantly cause the entire model to be updated, and new comparisons can be made.

### Documentation

VisiCalc comes with an eighty-page tutorial manual that's very useful for the beginner and a well-designed reference card. After one reading, however, the manual is not of very much help in running the program. A new manual is being written and may be available soon. In addition, several books are in preparation which will aid the VisiCalc owner in using the program.

### Program Constraints

The primary constraint of the VisiCalc program is the programmable memory available to the user. In the Apple II, for example, a 48 K-byte machine will have about 25 K bytes available to the user for modeling. This may sound like a lot, but in fact model files require a lot of room. To compound this problem there is no easy way to

## E · X · P · A · N · D

**YOUR  
TRS-80\*  
or  
S-100**

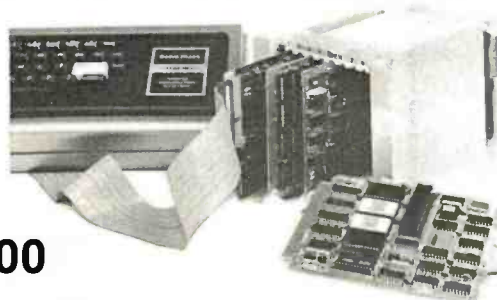

### INTRODUCING THE XTD-TRS INTERFACE CARD FOR THE STD BUS

This card permits direct connection between the TRS-80\* and the STDBUS system. The TRS-80\* can even be used as a development system for Z-80 STD BUS. QC MicroSystems distributes a full line of STD BUS products from a number of manufacturers including Mostek, Xitex, Intelligence Systems.

#### Xitex XTD-TRS Interface Card

DDT-80  
ROM

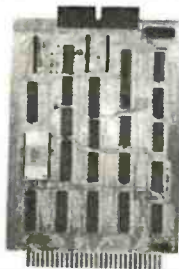

**\$260 Includes: DDT-80 ROM**

#### OFF THE SHELF STD BUS PRODUCTS

##### AVAILABLE NOW:

MDX-CPU1	\$260	Z80 CPU/RAM/PROM
MDX-CPU2	\$295	Z80 CPU/RAM/PROM
MDX-DRAM 8/32		Dynamic RAM
MDX-PIO	\$250	Parallel I/O
MDX-A/D 8,10,12		A/D Converters
MDX-D/A 8, 12		D/A Converters
SYS-CPM*		CP/M 2.2 Disk S.W.
MDX-MATH	\$699	Floating Point Math
MDX-SIO	\$260	Serial I/O
XTD-VDT		Video Interface
PROM-I	\$165	PROM Programmer
MDX-EPROM/UART	\$225	Combination PROM/UART
CARD CAGES		8-22 Slot with MotherBoard
POWER SUPPLY	\$135	

\*Contact QC for Pricing Options

### —200 NS MEMORY!!—

High speed 4116 RAMS for Maximum Reliability from your TRS-80\*.

#### SET OF 8 FOR \$44

<b>OTHER RAMS</b>		
2114 UCB 1K X 4 450 NS		\$(1-9) 5.00
4118N-4 1K x 8 250 NS		24.00
4104N-4 4K x 1 250 NS		10.50

<b>PROMS</b>		
2716T-12 2K x 8 650 NS		13.75
2716T-8 2K x 8 450 NS		14.50

<b>Z80 PARTS</b>	<b>2.5 MHZ</b>	<b>4.0 MHZ</b>
	\$(1-9)	\$(1-9)
Z80-CPU	11.00	15.00
Z80-PIO	8.50	11.00
Z80-CTC	8.50	11.00
Z80-DMA	29.00	37.00
Z80-SIO	37.50	45.00

<b>MISC.</b>		
12" Video Monitor B&W		\$149.00

#### Ask For Our Full Catalog Of Products And Services

MasterCharge, Visa, American Express, Check, C.O.D. accepted. Add \$3.00 for U.S. Shipping & Handling. Allow two weeks for shipment. Min. order of \$10.00. All products covered by a 90 day OEM warranty. Prices subject to change without notice.



Overseas Inquiries Welcome!

**Micro  
Systems** P.O. BOX 401326  
GARLAND, TEXAS 75040  
(214) 343-1282

Ask for our complete catalogue!

**You can talk to more  
computers, faster and easier,  
with the  
VET/2 from SCOTT**



The Scott VET/2 is a compact, highly versatile Voice Entry Terminal developed for TRS-80 users — and available soon for the PET and APPLE computers. Key features of the VET/2 include:

- Easy to use — all programs may be written in Level II BASIC. One USRn statement is all that's needed to allow your program to be voice controlled.
- Performance comparable to systems costing \$10,000 or more.
- High accuracy (98+%) and fast recognition.
- Supplied with demo programs and software tools.
- Connects directly to screen printer I/O port.
- Simplified training mode with automatic prompting.
- Overlay features make vocabulary size virtually unlimited.

The user manual fully describes the operation and training procedures for the VET/2 and includes complete instructions on interfacing the VET with BASIC programs.

*All hardware covered by 90-day warranty. Software guaranteed for replacement only. Prices subject to change without notice.*

Send coupon or telephone today for more information!

**SCOTT**

INSTRUMENTS 815 North Elm Denton, Texas 76201 817/387-1054

Please place my order for:

- VET/2 (includes manual and shipping) \$898.50
  - VET/2 Operator's Manual \$7.20
- Texas residents add 5% tax  
California residents add 6% tax

- Payment Enclosed
- Master Charge
- VISA
- C.O.D.
- Exp. Date \_\_\_\_\_

Card No. \_\_\_\_\_

Ship to: \_\_\_\_\_

Address \_\_\_\_\_

City \_\_\_\_\_ State \_\_\_\_\_ Zip \_\_\_\_\_

Sig. \_\_\_\_\_ All orders must be signed.

move information between models (for example, in a business consolidation), so that using the same basic information in different models can be a big chore.

The only other limiting factor is the fact that the VisiCalc disk cannot be copied or backed up. The obvious reason for this to avoid software piracy, but it could prove to be a problem if someone decided that 5¼ inches was the perfect size for a coaster. There is a dealer program for instant replacement, however.

### Data Interchange Format

Software Arts Inc, the creator of VisiCalc, has developed a common language for data (which it uses in VisiCalc) called the DIF (Data Interchange Format). The basic goal of the DIF is to allow the interchange of data between many different kinds of programs (such as data bases, graphing programs, report generators etc). The type of data which is addressed by the DIF is data which is stored in tabular form — columns and rows. By setting up a standard for such data handling it becomes easy to manipulate the data through program control.

Programmers and others who are interested in learning more about the DIF or would like to purchase the *Programmer's Guide to Data Interchange Format* (\$1.50) should write to The DIF Clearinghouse, POB 70, MIT Branch, Cambridge MA 02139.

### Conclusions

- VisiCalc is an extremely well-designed software package that can be used by anyone with or without a programming background. There is no programming language involved in the use of VisiCalc.
- The instant interaction between the user and the screen facilitates the understanding of the manipulation of the variables in the matrix.
- The ability to interchange data with other programs helps make VisiCalc an integral part of any business systems package.
- VisiCalc is the first program available on a microcomputer that has been responsible for sales of entire systems. ■

## Farewell to the Florida panther.

No one knows how many Florida panthers are still alive. Perhaps fewer than 100. If these mountain lions die, another creature will be gone from the earth forever... the victim, first, of predator elimination programs, and more recently, of ever-shrinking habitat.

But we don't have to bid farewell to the Florida panther. The National Wildlife Federation has awarded a grant to researchers to study the panther and its future... and to draw up a plan for saving it. That's just one small example of how the National Wildlife Federation is working to save endangered species from extinction. You can be a part of the effort.

Join the National Wildlife Federation, Department 108, 1412 16th Street, NW, Washington, DC 20036.

*-Technological Breakthrough-*

# COMPUTER-METER

*Microprocessor technology and the inventors of the digital meter have teamed up to bring you the world's most versatile test instrument.*



Computers for the home. Toys that speak. *Machines that think.* Space age technology brings new changes to your world every day. Even those of us who work with this new technology are constantly amazed by the latest applications of the ubiquitous microprocessor. And here is a remarkable new way for computer technology to simplify your work life. When the president of our company (a businessman, not a technician) saw one of the pre-production models of this new test instrument at a trade show, even he recognized it for what it is: a remarkable new way for anyone involved with electronics to save time, money, and space. We've shown it to our technicians and their reactions were similar, though more down-to-earth: "I want it!"

There's much more to tell about this incredible little meter that takes the place of at least 3 separate test instruments, but we're sure that the Touch Test 20 will end up very near the top of your equipment list.

## STAYING AHEAD

For three decades, the inventors of the Touch Test 20, Non-Linear Systems, have made a science of staying ahead through innovation in test equipment. In 1952, NLS propelled electronic testing into the space age by introducing the world's first digital voltmeter, and they have remained committed to first rate value and performance through sophisticated, yet simplified electronic test tools. Their battery powered portable oscilloscopes have "lightened the load" of both field and laboratory engineers all over the world, and NLS digital panel meters have also become a world-wide standard.

The Touch Test 20 adds to the NLS reputation for accuracy and reliability and we're proud to be among the first to be able to offer it to you.

## 3 lb 8 oz TEST LAB

We think the Touch Test 20 is miniaturization at its best, because no compromises in accuracy and versatility were made in the process of squeezing a trunk full of test equipment into a rechargeable battery powered portable test lab.

It will measure AC voltage, AC current, resistance, capacitance, conductance, temperature, DC voltage, DC current, continuity, and test diodes - 20 key test functions, 10 electrical parameters and 44 ranges. Now, you can take one lab to the field instead of a cumbersome collection of

individual testers. And in the lab, the Touch Test 20 will go a long way toward cleaning up the cluttered array of equipment found on most test or troubleshooting benches.

## JUST TOUCH

The "touch" in Touch Test 20 means no more knobs and dials to fiddle with: selection of the various functions is accomplished by a tap of the finger on one of the touch sensitive switches on the front panel. When you switch functions, there's an audible bleep and an LED lights to show the function selected. Selecting the range is also a beautifully simple procedure - just touch one of the switches below the display to shift the decimal point to the appropriate place for the signal you're measuring.



**Non-Linear Systems, Inc.**  
Specialists in the science of staying ahead.

## SPECIFICATIONS

VOLTS ..... 1 mV to 1 kV @ .2%  
AMPERES ..... 1 uA to 10 A @ 1%  
OHMS .. 10 uOhm to 19.99 MOhm @ .25%  
TEMPERATURE .. -40° C to +150° C +/- 3°  
CAPACITANCE .. 1 pF to 199.9 uF @ 1%  
CONDUCTANCE .01 nS to 199.9 nS @ .2%  
DIODE TEST ... 1 mV to 1999 mV @ .2%  
SIZE ..... 2.9" x 6.4" x 7.5"  
WEIGHT .. 3 lbs 8 oz (including batteries)

## EVEN IDIOTS

While no instrument is totally idiot-proof, the Touch Test 20 certainly comes close: when any function is selected, this instrument automatically selects the least sensitive range of the function, to avoid embarrassing but all too common smoke test situations. We're told (though we do not advise such mistreatment), that you can plug the test leads into a 120 volt wall socket and select any function without causing terminal damage to the instrument.

To complement these remarkable capabilities, the Touch Test 20 is shipped ready to go to work for you, complete with a charger unit, rechargeable batteries, high quality test probes, a component test block, and a temperature probe.

## ONE YEAR WARRANTY

Each Touch Test 20 is individually tested and "burned-in" at elevated temperatures to

assure the quality of the instrument shipped to you. However, should the unlikely happen, the manufacturer stands behind their reputation for reliability with a full one-year limited warranty against any defects in material or workmanship. This of course excludes damage brought about through any kind of abuse, and the warranty extends only to the original purchaser.

## PRIORITY SHIPMENT

We at JADE have been in the business of supplying computers and related equipment for five years now, and we've always guaranteed our customer's satisfaction. We know that you'll be happy with this piece of equipment, so try it for thirty days; if the Touch Test 20 doesn't live up to your expectations, we'll quickly refund the purchase price. And don't worry about slow delivery - the manufacturer has assured us that we will have priority shipment of the Touch Test 20 directly from the factory. This plus our computerized order processing system assures you of the fastest possible delivery.

## CALL US TOLL FREE

To order your Touch Test 20 send \$425.00 plus \$2.95 shipping and handling to JADE Computer Products, 4901 West Rosecrans, Hawthorne, California 90250 (California residents please add 6% sales tax). Credit card buyers may use one of our toll free numbers listed below.

JADE Computer Products has been an industry leader in the microcomputer field for over five years - further assurance of our dedication to fast service and continued product support.

**JADE**  
Computer Products

4901 West Rosecrans Ave  
Hawthorne, California 90250

Continental US... 800-421-5500  
Inside California . 800-262-1710  
Los Angeles Area 213-973-7707

Call for your free copy of our catalog containing over 4000 different computer products.



### CBM™ 8032 BUSINESS COMPUTER

The new Commodore 8032 Business computer offers a wide screen display to show you up to 80-character lines of information. Text editing and report formatting are faster and easier with the new wide-screen display. The 8032 Business Computer also provides a resident Operating System with expanded functional capabilities. You can use Basic on the 8032 Business Computers in both interactive and program modes, with expanded commands and functions for arithmetic, editing, and disk file management. The CBM 8032 Business Computer is ideally suited for the computing needs of the business marketplace. Call for additional information.



**\$1795**

- \*32K RAM, 14K 4.0 BASIC
  - \*IEEE BUS \*80 x 25 CRT
  - \*Ideal for Word Processing
- or other business/technical computer uses.



**\$1695**

### CBM™8050 DUAL DRIVE FLOPPY DISK

The CBM 8050 Dual Drive Floppy Disk is a much enhanced version of the intelligent CBM 2040 Disk Drive. The CBM 8050 has all of the features of the CBM 2040, and provides more powerful software capabilities, as well as one megabyte of online storage capacity. The CBM 8050 supplies relative record files and automatic diskette initialization. It can copy all the files from one diskette to another without copying unused space. The CBM 8050 also offers improved error recovery and the ability to append to sequential files.



### MULTI-USER TIME SHARE OFFERED TO YOU BY THE NEECO MULTI-CLUSTER

At a low entry cost, up to eight CBM computers can transfer data bi-directionally to one CBM Dual Disk Drive. The MULTI-CLUSTER, designed with its own independent power supply, provides a connection from one CBM computer work station to other CBM computer work stations, allowing data transfer and data access on a priority queuing basis. This system provides the cost effectiveness required in a multi-using environment by establishing the dual disk drive as a central mass storage unit. This provides a high degree of disk accessibility.

The standard configuration of this system allows 3 CBM\* microcomputers (maximum of 8) connected through the MULTI-CLUSTER to the IEEE port of the 2040 Disk Drive. More CBM's can be added to the system according to the user's need.

#### MULTI-CLUSTER

#### Standard Components

- One Multi-Cluster Controller . . . . . MC800A
- Three Channel Modules . . . CM-100

#### Additional Component Prices

- Each extra CM-100 . . . . . \$250
- Output Printer Module . . . . . \$200
- (for Centronics Protocol) . . . . . \$200

Multi-Cluster is a product of BMB Compuscience.

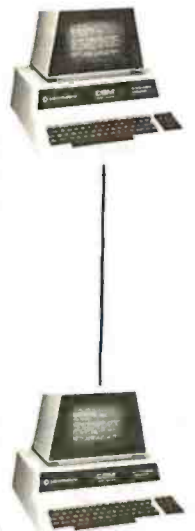

NEECO  
PROUDLY  
ANNOUNCES

## ... DATASOURCE 1

**"A full featured Database Manager for the Commodore 8032"**

Never before has a true Database been available for Commodore Computers. DATASOURCE 1 contains database capabilities you would not expect on a microcomputer system. Capabilities like selective search by any sub-field or field within a record, mathematic manipulation, up to 120 fields per screen display, and much much more! DATASOURCE 1's major feature is total usability! DATASOURCE was designed for use by you!

#### MAJOR FEATURES INCLUDE:

- SCREEN ORIENTED • SELECTIVE OR SEQUENTIAL SEARCHES • UP TO 120 SORTABLE DISPLAY FIELDS • UP TO 2 DISPLAY SCREENS OF DATA PER RECORD • HUNT FUNCTION (find characters in any record) • POWERFUL MATHEMATICAL MANIPULATION • SUPPORT PROGRAMS INCLUDE: FILE OR EDIT SCREEN RECORD, POWERFUL SORT/MERGE, DIRECTORY MANAGER, EXTENDED OUTPUT REPORT GENERATOR, FULL COMPATIBILITY WITH WORDPRO 4™ FILES, AND MUCH, MUCH MORE! EMINENTLY USABLE BY NOVICE USERS.

#### MAJOR USES INCLUDE:

- MAILING LIST MANAGEMENT • QUERY/CALL INFORMATION • A/R AGING MANAGEMENT • CASH FLOW FORECASTS • FILE MANAGEMENT • ANY PROJECT/PROBLEM THAT REQUIRES INVENTORY DATA OR FILE MANIPULATION!

CALL FOR  
DATASOURCE  
LITERATURE!

**\$495**

\*Requires DOS 2.0 or DOS 2.5

AVAILABLE TO DEALERS FROM MICROAMERICA

WordPro 4 is a registered trademark of Professional Software Inc.

### NEECO

679 Highland Ave.  
Needham, MA  
02194

Mon-Fri 9:30-5:30  
MasterCharge &  
Visa Accepted

**(617) 449-1760**  
Telex: 951021

### MICROAMERICA DISTRIBUTING

"Nationwide distributors of Computer Equipment"  
21 Putnam Street  
Needham, MA  
02194

**(617) 449-4310**

Circle 117 for NEECO

Circle 118 for Microamerica

**NEECO  
PROUDLY  
INTRODUCES**

# ALDOS COMPUTERS



**ALDOS ACS 8000-5**

- Dual 8" floppy disks
- Megabyte storage
- 64K RAM
- Totally expandable to Hard Disk (29MB) and Multi-User

**ALDOS OFFERS OUR USERS  
TOTAL SYSTEM CAPABILITIES  
AND FLEXIBILITY . . .**

- Z80 based • CP/M • Multi-User
- Hard Disk • Seven languages
- MP/M • NEECO system support
- Full Word Processing

**\$5990**

**"ALDOS Computers offer you System Flexibility and Reliability"**

**CONTACT NEECO FOR ADDITIONAL INFORMATION ON HOW ALTOS CAN BECOME YOUR COMPUTER SOLUTION.**

Altos computers range in price from less than \$3000 to over \$14,000. Altos Computer Systems' capabilities range from single disk-single user to 29 Megabytes-Multi-User.

ALTOS computers are distributed to Dealers/OEMs in the N.E. Region by MICROAMERICA

## SUPERBRAIN SOFTWARE

(Business Packages written in MicrosoftBASIC)

Trial Tested Osborne Business Packages on the Superbrain

- |                       |          |   |
|-----------------------|----------|---|
| • Accounts Receivable | \$250.00 | <b>Complete 4 Module Package \$795</b><br><b>MicrosoftBASIC \$325</b> |
| • General Ledger      | \$250.00 |   |
| • Accounts Payable    | \$250.00 |   |
| • Payroll Package     | \$250.00 |   |

**SUPERBRAIN**

- 32K RAM \$2795**
- 64K RAM \$2995**
- FORTRAN \$ 450**

**SPECIAL OFFER!**

Purchase a 64K Superbrain at \$2995 and will include MBASIC5 for only \$250! (regularly \$350)

**SPECIAL OFFER! - Purchase**

a Centronics 704-9 (RS232, 180 CPS, retail \$2380) printer and a 64K Superbrain together for only \$4595 - cash price only.

"The Superbrain is ideal for use as an intelligent terminal or stand alone microcomputer system for OEM's, commercial customers, and other sophisticated computer users."

- Two 5.25" Shugart Minifloppies with over 300 K (CP/M Version 2.2 or later) Disk Storage.
- Integrated in a single compact housing.
- CP/M operating System with MBASIC5 and other interpreters/compilers available.
- 32K or 64K RAM models available.
- 2 I/O Ports - one fully enabled RS232 port for communications. Other port for RS232 serial printer output.
- Too many software packages are now available to list them here.

**OEM/DEALER INQUIRIES**

All pricing and specifications are subject to change.



**\$2995**

**SUPERBRAIN™**

The Honor Graduate

**NEECO**

679 Highland Ave.  
Needham, MA  
02194

Mon-Fri 9:30-5:30  
MasterCharge &  
Visa Accepted

**(617) 449-1760**  
Telex: 951021

**MICROAMERICA DISTRIBUTING**

"Nationwide distributors of Computer Equipment"  
21 Putnam Street  
Needham, MA  
02194

**(617) 449-4310**

## The MicroAngelo Video Display

Mark Dahmke  
1515 Superior St  
Lincoln NE 68521

### Introduction

The MicroAngelo high-resolution raster graphics display stands well above other S-100 graphics displays in its price and performance range. Since the MicroAngelo is actually a single-board microcomputer, a great number of functions that previously had to be performed by the host computer are now done in *firmware* on the graphics board. Rather than using the memory-address space of the host as a graphics display buffer (32 K bytes in this case), the host communicates with the MicroAngelo through two parallel ports with simple yet powerful commands. The MicroAngelo decodes these commands and automatically performs the desired functions independently of the host processor. With this parallel-processing capability, system response time is greatly enhanced.

### Hardware Overview

The MicroAngelo consists of a Z80A microprocessor

with 32 K bytes of on-board programmable memory and 4 K bytes (expandable to 8 K bytes) of PROM (programmable read-only memory) firmware. The board contains all hardware necessary to generate a 512 by 480 dot black-and-white display for a television monitor (10 MHz bandwidth or greater). The board communicates with the host through two parallel ports which may be addressed to any of eight blocks of ports from hexadecimal 00 to F0. The video monitor may be connected via composite video (RS-170 standard) or direct-drive transistor-transistor-logic-level video, horizontal and vertical synchronization.

The MicroAngelo has four possible interrupt sources: data from host, data to host, light pen, and 60 Hz timer. Whenever a data byte is sent by the host or the host reads a data byte sent to it, an interrupt will occur in the MicroAngelo. An interrupt will occur when the light pen is fired and also when the timer produces a pulse. Of these four possible interrupts only the data from host and light pen sources is usually enabled.

### At a Glance

<b>Hardware:</b>	<i>MicroAngelo high-resolution graphics display.</i>	
<b>Use:</b>	<i>High-resolution raster-scan graphics display which may be used to draw character or graphics images on a standard television monitor.</i>	
<b>Manufacturer:</b>	<i>Scion Corporation 8455-D Tyco Rd Vienna VA 22180 (703) 827-0888</i>	
<b>Price:</b>	<i>The MicroAngelo graphics board and firmware (the S-100 board only) is \$1095. Also available is the Graphics Subsystem which includes the MicroAngelo S-100 board, a graphics keyboard (IBM Selectric-style keyboard with some special function keys) and a high-resolution 15-inch monitor. Cost: \$2495. A light pen is optional.</i>	<b>Firmware:</b> <i>MicroAngelo and the host computer is facilitated by two parallel ports. The MicroAngelo also has a dumb terminal emulation mode. PROM (programmable read-only memory) firmware is provided on-board the MicroAngelo. High-level commands may be sent via parallel ports. Such functions as "turn on dot" or "draw vector" are implemented by single commands. The on-board Z80 intercepts these commands and performs the desired functions.</i>
<b>Features:</b>	<i>The MicroAngelo S-100 board generates a 512 by 480 dot black-and-white raster display. Communication between the</i>	<b>Hardware required:</b> <i>Any S-100 mainframe computer or any computer which has an S-100 bus adapter. Although the MicroAngelo uses a Z80 microprocessor, the host processor need not be 8080/Z80 compatible.</i>
		<b>Documentation:</b> <i>An eighty-page user's manual is supplied.</i>
		<b>Audience:</b> <i>Anyone requiring high-resolution intelligent graphics on a small system.</i>

# New

## S-100 A/D & TIMER

# New

Tecmar's new A/D and Timer Board is designed to meet sophisticated data acquisition needs. The board can accommodate various A/D modules providing options such as 12, 14, 16 bit accuracy; 100 MHz throughput; variable ranges and gains. It contains a powerful timer circuit (AMD 9513) which can start A/D conversion and can also be used independently for time of day, event counting, frequency shift keying and many other applications.

### TM-AD200 FEATURES

- Complies with IEEE S-100 specifications
- Transfers data in 8 or 16 bit words
- 30 KHz throughput standard
- 12 bit accuracy standard
- Jumper-selectable for 16 single-ended or 8 true differential channels
- External trigger of A/D
- Provision for synchronizing A/Ds
- Data overrun detection
- Data is latched providing pipelining for higher throughput
- Input ranges:  $\pm 10V$ ,  $\pm 5V$ , 0 to  $+10V$ , 0 to  $+5V$
- Output formats: Two's complement, binary, offset binary
- Auto channel incrementing

- I/O or memory mapped
- Utilizes vectored interrupt or status test of A/D
- Provision for expansion to 256 channels

### TIMER FEATURES

- 5 independent 16 bit counters (cascadable)
- 15 lines available for external use
- Time of day
- Event counter
- Alarm comparators on 2 counters
- One shot or continuous frequency outputs
- Complex duty cycle and frequency shift keying outputs
- Programmable gating and count source selection
- Utilizes vectored interrupt

### TM-AD200 OPTIONS

- Programmable gain up to 500
- 14 bit accuracy
- 16 bit accuracy
- Screw terminal and signal conditioning panel with optional thermocouple cold junction compensation

- 100 KHz throughput with 12 bit accuracy
- Low level, wide range (10mV to 10V FSR) permitting low level sensors such as thermocouples, pressure sensors and strain gauges to be directly connected to the module input



## TECMAR, INC.

(216) 382-7599

23414 Greenlawn • Cleveland, OH 44122

If your data acquisition needs are simple, the original Tecmar S-100 A/D Board will meet your needs.

### TM-AD100 FEATURES

\$495

- Complies with IEEE S-100 specifications
- 16 single-ended or 8 true differential channels
- 12 bit accuracy
- 25 KHz throughput
- I/O or memory mapped
- Input ranges:  $\pm 10V$ ,  $\pm 5V$ , 0 to  $+10V$ , 0 to  $+5V$
- Minimal software required.

For digital to analog conversion, Tecmar's D/A Board provides four independent 12 bit high speed D/A channels.

### TM-DA100 FEATURES

\$395

- Complies with IEEE S-100 specifications
- 4 independent digital to analog converters
- 12 bit accuracy
- 3  $\mu$ sec settling time
- I/O or memory mapped
- Output ranges:  $\pm 2.5V$ ,  $\pm 5V$ ,  $\pm 10V$ , 0 to  $+5V$ , 0 to  $+10V$

### S-100 BOARDS

8086 CPU W/vectored interrupts	\$450
RAM 8Kx16/16Kx8	\$395
8086 PROM-I/O	\$495
Serial and Parallel I/O	\$350
Parallel I/O & Timer	\$350

TRS-80<sup>1</sup>

PET<sup>2</sup>

KIM<sup>2</sup>

APPLE

- A/D**
- ▶ 12 Bit High Speed
  - ▶ 8 Ch. Differential
  - ▶ 16 Ch. Single-ended
  - ▶ Each A/D Module \$495

- D/A**
- ▶ 12 Bit High Speed
  - ▶ 4 Channel
  - ▶ Each D/A Module \$395

TRS-80 or PET expansion board, power supply, and enclosure \$200.  
Kim expansion board and power supply \$150.

### S-100 Real Time Video Digitizer

- Digitizes and Displays in 1/60 sec, flicker-free
- 16 Gray Levels
- Switch Selectable to display Black and White Graphics (8 pixels/byte)
- Maximum Resolution: 512 pixels/line x 240 lines
- Minimal software requirements

\$850

<sup>1</sup>Reg. Trademark of Tandy Corp.  
<sup>2</sup>Reg. Trademark of Commodore

Data Acquisition Systems and  
Video Microcomputer Systems Available

A connector is provided for the light pen interface. Several commercially available light pens will work with the MicroAngelo.

### Jumper Options

Several on-board jumpers are provided for special applications. For example, it is possible to increase the clock speed of the Z80A microprocessor (and hence the speed of the board) from 4 MHz to 5 MHz, assuming that all the components are capable of operating at that speed. Interrupts (as previously discussed) may be enabled or disabled. The number of visible scan lines may be changed from the default 480 to 448 lines. If this option is chosen, the user is responsible for display management. The PROM sockets may be jumped to either the default 1 K byte per PROM or 2 K bytes per PROM.



**Photo 1:** *The MicroAngelo Graphics Subsystem. Included in the subsystem are the MicroAngelo S-100 board, the 15-inch high-resolution black-and-white monitor, and a special keyboard that has an IBM Selectric-style layout plus some special function keys on the far left and right. The light pen is optional.*

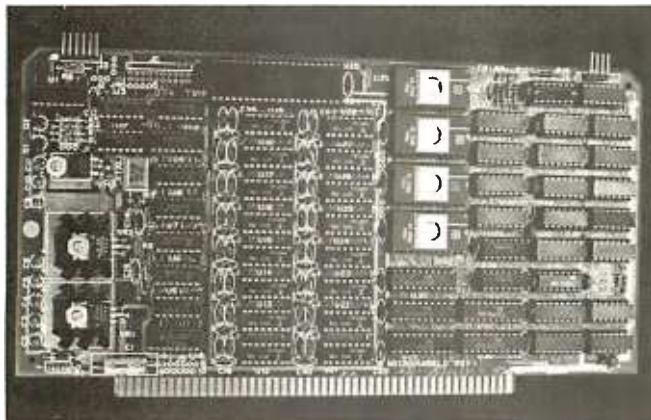

**Photo 2:** *A close-up of the MicroAngelo S-100 board. The board has a Z80A microprocessor, 32 K bytes of memory, and four 2708 PROMs (expandable to 8 K bytes 2716 PROMs). The board is actually a stand-alone 32 K computer. The video display generates 512 by 480 dots. In the ALPHA mode, up to 85 by 40 characters may be displayed on the screen.*

### Adapting-MicroAngelo to Non-S-100 Systems

Since the MicroAngelo uses a simple parallel-port interface to the host system, it may be attached to almost any host system. Data is transferred via the eight parallel input and eight output lines of the S-100 bus connector. Power is supplied through pin 1 (+8 V), pin 2 (+18 V), pin 52 (-18 V), and pin 50 (ground). Address bus lines A7, A6, A5, A4 and pDBIN may be tied permanently high (+5 V); A1 and pWR are tied low (ground). A0 is connected to the host to select whether port 0 or 1 is addressed. (MicroAngelo uses two ports.) sINP and sOUT are connected to the host as input-and-output-control command lines. Using this twelve-line interface, the MicroAngelo becomes a stand-alone graphics display device. If interrupts are required, they may be easily added to the above set of signals.

### Firmware

The MicroAngelo firmware is what makes the board so powerful. It takes all the work out of designing software and applications programs for the MicroAngelo. The Screenware Pak I is a well-integrated firmware package that allows the board to be used as a terminal emulator, a graphics display, or both.

If a byte is sent to the MicroAngelo (via the parallel port), it is interpreted by the firmware in one of two ways. If bit 7 (the most significant bit) is turned on, the byte is seen as a command. If it is off, the firmware treats it as an ASCII character and passes it to the terminal or ALPHA mode program.

In the text mode, the board will display forty lines with eighty-five characters per line. Text and graphics may be mixed on the screen. In the dumb terminal mode, the firmware will respond to the following control codes: backspace, horizontal tab, line feed, form feed, carriage return, escape, and delete.

Several features are available in the terminal mode. It is possible to display black-on-white or white-on-black characters, for example. Underlining may be turned on and off, and character overstriking may be allowed or disallowed. Two fonts are available, the standard character set or a user-defined font. The winking cursor may be displayed or inhibited, and the scroll mode may be changed. Scrolling may be done on a line-by-line basis, or, to improve response time, block scrolling may be done. Cursor addressing is available — rows run from 0 to 39, columns from 0 to 84. It is also possible to query the firmware to obtain the current cursor location.

### Graphics-Mode Commands

The display may be manipulated in many ways in the graphics mode. First, the graphics cursor may be set to a value, read or queried, or set to the contents of the alpha cursor and vice versa. The format for most graphics-mode commands is:

<Command> <xh> <xl> <yh> <yl>

where *xh* and *xl* are the high and low bytes of the X coordinate and *yh*, *yl* are the high and low bytes of the Y coordinate respectively (in hexadecimal). The coordinates (384,256) would be sent as:

<Command> <01> <80> <01> <00>



# THE NEXT GENERATION OF MICROCOMPUTERS IS HERE AT QUASAR DATA PRODUCTS



**16 BIT POWER**  
**Z-8000<sup>3</sup>**

AND STILL RUN YOUR 8 BIT SOFTWARE



**8 BIT POWER**  
**Z-80<sup>4</sup>**

**IF YOU see it our way then we think we have the products for you:**

- The S-100 bus is here to stay. It is not the greatest but with proper termination it works reliably at high speeds, and since it is now an IEEE standard, it is well defined.
- The 8 BIT systems are useful but they are the limiting factor for many applications.
- The 16 BIT systems are the way future systems will go. Why not? There is very little price difference and an order of magnitude performance difference.
- The real usefulness of the 16 BIT microprocessors will be determined by the software.
- The systems using 5 1/4 inch disk drives really do not have adequate memory storage or computer power for many business or scientific applications.
- Sixty-four kilobytes of addressable RAM, the maximum for 8 BIT systems, is not adequate for many business or scientific applications.
- It is not worth buying 8 BIT systems or boards now if you can get the same software with 16 BIT systems at about the same price.

- The new 16 BIT microprocessors have power comparable to minicomputers but do not require the same overhead in terms of downtime, maintenance, or initial investment. They are more versatile in many applications such as real time applications.

### THIS IS WHAT QDP HAS AVAILABLE:

- A Z-8000 Board that can plug into your existing S-100 Bus System (see below for description)
- A complete Z-8000 System (see below for description).
- A Z-8000 System configured for your exact needs.
- Software to allow you to run all the available Z-80/8080 software including CP/M.
- Software that includes a Monitor, Debugger, Disassembler, and Basic.
- Software options: a) Extended Monitor, b) Simulators for 8080, Z-80, 6800, 6502, 1802.
- A Z-80 System (QDP-100) that is upward compatible with the Z-8000.

### THIS IS WHAT IS COMING FROM QDP:

- A 128 kilobyte RAM card.
- UNIX<sup>2</sup> operating system.

## Z-8000 SERIES 16 BIT CPU S-100 BOARD — CAN BE PLUGGED INTO YOUR EXISTING SYSTEM \$695.00

- Fully S-100 IEEE compatible.
- Supports existing 8 BIT memory and 8 BIT peripheral boards.
- Capable of reading and/or writing 8 BIT, 16 BIT, or mixes 8 BIT and 16 Bit memories automatically.
- 8 BIT and/or 16 BIT peripheral modules can simultaneously co-exist in the same bus without any modifications.
- Capable of operating as a slave processor to enable your existing CPU to control the Z-8000.

**Industrial  
Quality**

- Supports either segmented CPU or non-segmented CPU.
- Power-on and reset jump dip switch selectable.
- Jumper selectable 2 or 4 MHz. operation.
- Dip switch selectable number and type of wait states.

### SOFTWARE

- Z-80 emulator enables you to execute your existing 8 BIT software without any modifications and allows you to run CP/M immediately.
- Extended Monitor, Debugger, Disassembler.

## QDP-8100 WITH 2 MEGABYTES STORAGE STANDARD (OPTIONAL 4 MEGABYTES)

- Z-8000 series 16 BIT CPU S-100 Board - see above

### SOFTWARE (Provided with system)

- CP/M 2.2' operating system
- Basic
- Z-80/8080 Emulator
- Monitor, Debugger, Disassembler software
- Optional software: Pascal
- UNIX<sup>2</sup> operating system coming

**\$6,395.**

## SYSTEMS



## QDP-100 WITH 2 MEGABYTES STORAGE STANDARD (OPTIONAL 4 MEGABYTES)

- Z-80 series 8 BIT CPU S-100 Board (4 MHz. Z-80, Double density disk Controller, 2716 Prom Burner 2 Parallel & 2 Serial Ports, real time clock)

### SOFTWARE (Provided with system)

- CP/M 2.2' operating system
- Basic
- Accounts Receivable, General Ledger, Accounts Payable, Payroll with Cost Accounting
- Optional software: Fortran, Pascal, Cobol, C

**\$4,995.**

### EACH SYSTEM CONTAINS:

- Intelligent CRT terminal (80 characters X 24 lines)
- 64 kilobytes RAM
- Two 8 inch, double sided, double density floppy disk drives with controller
- 2 serial and 1 parallel (2 parallel for QDP-100) ports
- Attractive woodgrain cabinet with power supplies and cabling

FULL TECHNICAL SUPPORT FROM THE STAFF AT QUASAR DATA PRODUCTS

## 4 Mhz 64K Dynamic RAM

16K - '250" 32K - '350" 48K - '450" 64K - '549"

## TELETEK DBL. DENSITY, DBL. SIDED

Disk Controller Board.....'395"

## QUASAR FLOPPY SYSTEM

- Two MFE DBL sided drives • Cable • Case & Power Supply assembled and tested Wood cabinet ..... '1895"

## QUASAR 2 MEG FLOPPY

- 2 MFE double sided drives
- Teletek disk controller board
- Power supply & cable
- Wood cabinet
- CP/M version 2.2 & bios
- Assembled & tested ..... '2295"

Dealer Inquiries Invited. Hours: 9-5:30 M-F

Specifications Subject To Change



**MFE** Double Sided - Double Density 8" Floppy Disk Drives. (the best) ..... '650"  
Using the Teletek Controller under CP/M, THIS DRIVE WILL GIVE YOU ALMOST ONE MEGABYTE PER DISK DRIVE.  
Power supply for above ..... '110"

## PAPER TIGER

Includes Graphics ..... '949"

Cable for TRS-80 ..... '39"

Call for Apple

## TI - 820

Serial Printer -

Full package options... '1995"

\*CP/M™ Digital Research

\*UNIX™ Bell Lab

\*Z-8000™ Zilog

\*Z-80™ Zilog

Checks, money orders accepted

Add \$2.50 freight charges on orders under 10 lbs. Over 10 lbs. F.O.B. Cleveland

**QUASAR DATA PRODUCTS**

10330 Brecksville Rd., Brecksville, OH 44141 (216) 526-0838 or 526-0839



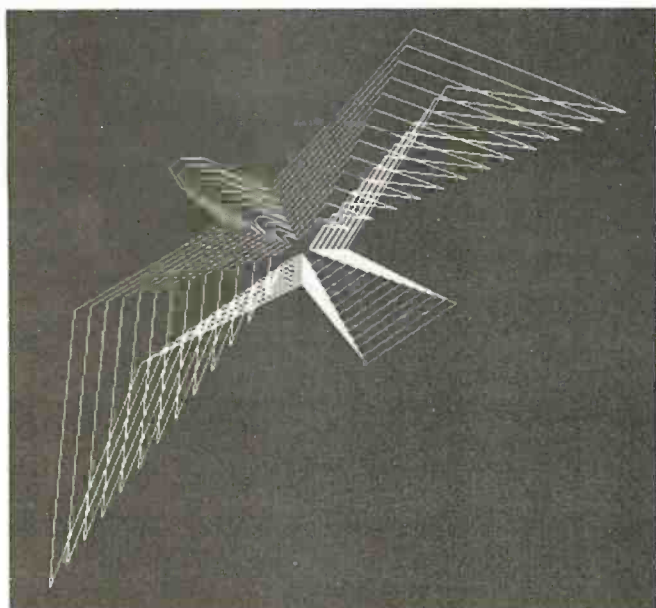

INVOICE

JOHN OLSON  
ENGINEERING SPECIALTIES  
1501-B PINE STREET  
DORHED, CT 06830

JOHN OLSON  
ENGINEERING SPECIALTIES  
1501-B PINE STREET  
DORHED, CT 06830

QTY	UNIT	DESCRIPTION	UNIT PRICE	EXT. PRICE
1	EA	MICROANGELO GRAPHICS BOARD	\$ 3,285.00	\$ 3,285.00
		LESS DEPOSIT	\$ 250.00	\$ 250.00
		FREIGHT AND PACKAGING	\$ 126.25	\$ 126.25
		TOTAL		\$ 3,161.25

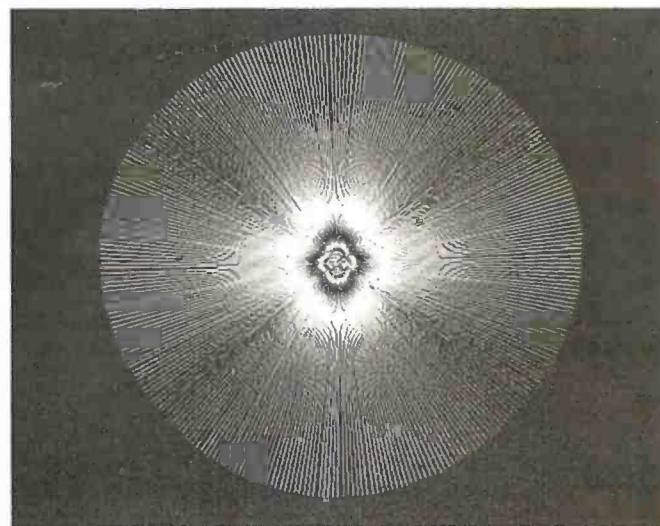
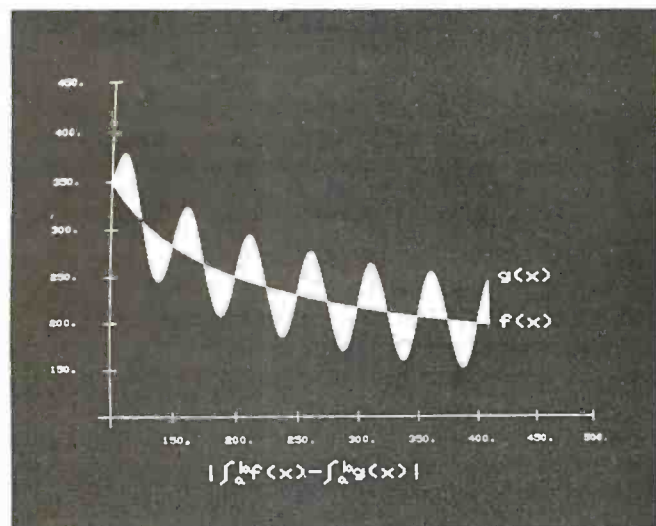
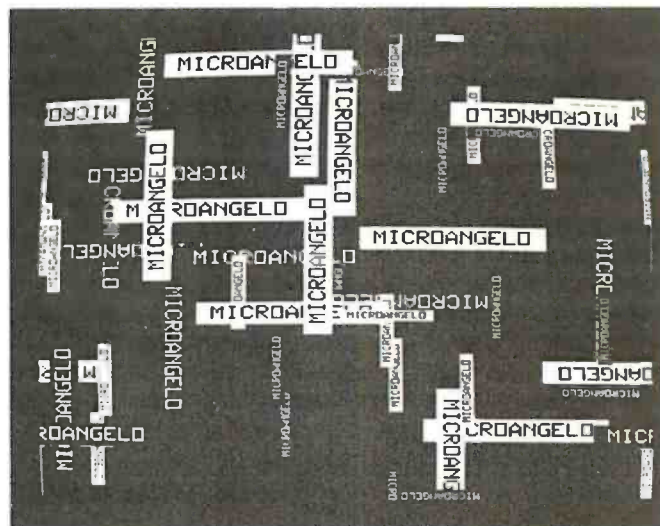
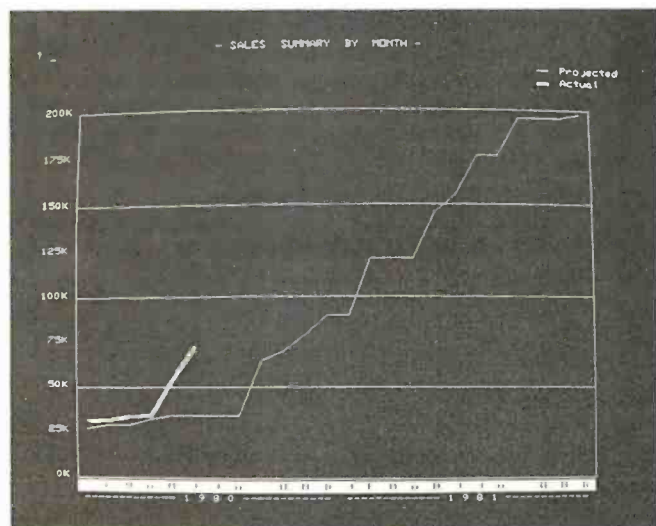

Photo 3a, 3b, 3c, 3d, 3e, 3f: Sample displays produced with the MicroAngelo graphics board. Vectors may be drawn with single high-level commands.

# AUTOMATED EQUIPMENT INCORPORATED

## Toll-Free Ordering 1-800-854-6003 714-739-4701

Outside Calif.  
Inside Calif.  
Outside Cont. USA



### TERMINALS

TELEVIDEO 912B.....	\$698
TELEVIDEO 912C.....	698
TELEVIDEO 920B.....	748
TELEVIDEO 920C.....	748
SOROC IQ-120.....	695
ZENITH A-19.....	850
HAZELTINE 1500.....	850



### NORTHSTAR

HRZ-1-32K-D.....	\$1990
HRZ-2-32K-D.....	2295
HRZ-1-32K-Q.....	2450
HRZ-2-32K-Q.....	2690
ADDITIONAL 16K RAM.....	365
ADDITIONAL 32K RAM.....	565
HARD DISC SYSTEM.....	3935
DM6400 64K RAM MAY BE SUBSTITUTED FOR ASM 32K NORTHSTAR FOR \$140. NORTHSTARS WITHOUT MEMORY AVAIL- ABLE.	



### PRINTERS

NEC 5510 (TRACT., RIB., THIM).....	\$2600
NEC 5515 (TRACT., RIB., THIM).....	2700
NEC 5520 (TRACT., RIB., THIM).....	2900
NEC 5530 (TRACT., RIB., THIM).....	2600
MALIBU.....	2295
TI-810.....	1495
TI-820.....	1640
EPSON MX80.....	CALL
ANADEX DP-8000.....	795
ANADEX DP-9500.....	1345

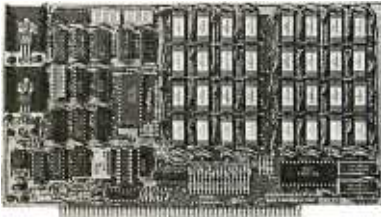

### BOARDS

	KIT	ASM
CB2 Z80CPU.....	\$200	\$265
VB1C VIDEO.....	140	190
VB2 VIDEO.....	155	210
VB3 VIDEO.....	375	440
IO4 INTERFACE.....	165	225
SB1 SYNTHESIZER.....	195	270
<b>MEASUREMENT SYSTEMS MEMORY</b>		
DM 3200 32K 4MHZ.....		480
DM 6400 64K 4MHZ.....		595
DMB3200 32K 4MHZ BANK SELECT.....		630
DMB6400 64K 4MHZ BANK SELECT.....		745

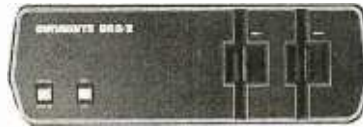

### DYNABYTE

DB 8/1 48K.....	\$ 2395
DB 8/1 64K.....	2715
DB 8/2 48K.....	3900
DB 8/2 64K.....	4200
DB 8/4 SINGLE.....	3030
DB 8/4 DUAL.....	3830
10M WINCHESTER.....	4630
32M PHOENIX.....	11800
64M PHOENIX.....	15000
96M PHOENIX.....	18000



### MORROW

DISCUS-1 1 DRIVE.....	\$ 815
DISCUS-1 2 DRIVE.....	1465
DISCUS 2D 1 DRIVE.....	970
DISCUS 2D 2 DRIVE.....	1635
DISCUS 2+2 1 DRIVE.....	1265
DISCUS 2+2 2 DRIVE.....	2245
DISC JOCKEY 1.....	190
DISC JOCKEY 2D.....	350
DISCUS M26 HARD DISC.....	3990
ADDITIONAL HARD DISC.....	3685

### SOFTWARE

WORDSTAR.....	\$350
MAILMERGE.....	100
DATASAR.....	250
N.S. PASCAL.....	175
MAGIC WAND.....	290
CBASIC.....	100
BOOKKEEPER.....	800

ADDITIONAL DISCOUNTS FROM OUR  
SOFTWARE PRICES WHEN PURCHASING  
A SYSTEM FROM US

GRAHAM-DORIAN		STRUCTURED SYS	
JOB COSTING.....	\$700	ACCTS REC.....	\$700
INVENTORY.....	475	ACCTS PAY.....	700
CASH REG.....	475	GEN LEDG.....	700
APARTMENT.....	475	PAYROLL.....	700
MEDICAL.....	700	INVENTORY.....	425

### MISC

NEC THIMBLES.....	\$ 16
NEC RIBBONS.....	6
RS 232 CABLE 5'.....	20
RS 232 CABLE 10'.....	25
LEDEX MONITOR.....	125
NOVATION CAT.....	165

### DISCS-BOX OF 10

VERBATUM 5 1/4	1 SIDE	\$27
VERBATUM 5 1/4	2 SIDE	45
VERBATUM 8	1 SIDE	35
VERBATUM 8	2 SIDE	55
OTHERS		CALL

We will try to beat any advertised price.

**Automated Equipment Inc.**  
Suite #D  
4341 W. Commonwealth Ave.  
Fullerton, Calif. 92633

**OPEN MON-FRI 8 AM TO 5 PM**

**TERMS:** All prices listed are cash discounted and are subject to change or withdrawal. Credit cards and COD's are accepted at 2% additional handling charge. Universities and Well Rated Firms NET-10.

**SHIPPING:** ADDITIONAL IN ALL CASES.

**TECH. ASSISTANCE:** WE TRY TO HELP INTERFACE AND TROUBLESHOOT CALL 714-739-4701

Replacing <Command> with <84> would cause the firmware to set the graphics cursor to (384,256) on the screen. Some commands have no operands such as "clear screen". It is possible, with one command, to toggle the screen figure/ground. This means that every dot on the screen will be complemented (ie: reversed). If a dot is on (white), it will be turned off (black) and vice versa.

Individual dots may be turned on, off, complemented or queried. The form of this group of commands is also:

<Command> <xh> <xl> <yh> <yl>

In the case of the query command, the response is a single byte from the firmware with a value of 1 or 0.

A vector, the next level of sophistication, may also be turned on, off or complemented. The endpoint of the vector is specified in the command, and the starting point is assumed to be the current value of the graphics cursor.

It is also possible to work with *regions* of the display. If we wish to turn on all dots in a box with corners (X1,Y1), (X2,Y1), (X1,Y2), (X2,Y2) the command:

<95> <x1h> <x1l> <y1h> <y1l>  
<x2h> <x2l> <y2h> <y2l>

would be sent. Regions may also be turned off or complemented.

Characters may be *plotted* depending on the graphics cursor and the mode selected for graphics characters. Options available include:

- normal-size or double-size characters
- black-on-white or white-on-black
- direction and orientation

Alternate characters may be defined. When the ALPHA mode alternate-character-set option is employed, sending an ASCII character to the firmware will display the alternate character instead of the standard font character. To define the character, the following sequence of bytes must be sent:

<9A> <asc> <s11> <s10>  
<s9> ... <s1> <s0>

where 9A is the command, "asc" is the ASCII character code assigned to the character, and s11, s10, ... s0 are the twelve scan lines (6 bits wide) that make up the character in a 6 by 12 dot array.

### Using the Light Pen

The light pen provides a convenient means of entering data or drawing on the screen without having to enter numeric coordinates. The coordinates of the pen may be read directly, along with a flag indicating whether or not the pen has been fired since it was last queried. Cross hairs may be displayed at any point on the screen when using the light pen. Another set of commands allows the cross hairs to be displayed, moved, and queried without regard to the light pen.

### Memory Uploading/Downloading

Several commands are provided for dumping and loading the screen, thus allowing the user to save images on disk and restore them for later viewing or editing. Memory blocks may be examined or deposited allowing quick loading of alternate character fonts or user-written code. The firmware allows the user to deposit Z80 instructions in unused blocks of on-board memory. The user code may be defined as an op code and thereafter treated as just another firmware command.

### Concerning Gray Levels and Color

The one drawback of the MicroAngelo is that it does not have gray levels — meaning the ability to have levels in between black and white or on and off. However, I was informed by Scion that another product, as yet unnamed, is available. This is another S-100 board which mixes the output of three or more MicroAngelo boards to produce *color, gray levels, or both*; four colors can be obtained with as few as two boards. This scheme does require more than one MicroAngelo board, but compared to other graphics displays with 512 by 480 resolution, this approach is still cost-effective. The board does offer interesting possibilities: 256 gray levels, the 256 possible hues or colors, and the winking of dots on an individual dot basis. Also, it is possible to use the winking effect to alternate between two colors.

### Conclusions

The MicroAngelo video display system provides quality high-resolution graphics capabilities to S-100 bus (or similar) microcomputer systems, with an exceptional price-to-performance ratio.

On-board firmware provides a simple but powerful set of commands that makes system integration easy.

Although the board is designed to run on the S-100 bus, it can be easily adapted to almost any other bus or input/output port organization and does not require an 8080 or Z80 host computer. ■

TWICE THE BYTE!



8" DISK CONTROLLER  
NOW—DOUBLE SIDED OPTION!

- DOUBLES APPLE II STORAGE
- APPLE DOS COMPATIBLE
- SHUGART 800 OR 850 COMPATIBLE
- IBM 3740 DATA ENTRY CAPABILITY
- CP/M, UCSD PASCAL CAPABILITY

Available at your local APPLE Dealer: \$400.



SORRENTO VALLEY ASSOCIATES

11722 SORRENTO VALLEY RD.  
SAN DIEGO, CA 92121

# PMC-80

## Level II 16K at \$645



## SOFTWARE COMPATIBLE

- Reads all Level II BASIC tapes
- Reads all SYSTEM tapes
- Full range of peripherals
- Video output for monitor and TV
- Optional FASTLOAD at 8000 baud
- Optional Upper/Lower case

The PMC-80 is a "work-alike" computer to the popular TRS-80\* Model I, Level II by Tandy, Radio Shack. The PMC-80 has 16K bytes of RAM and the complete Level II 12K BASIC ROM by Microsoft that makes it 100% software compatible with programs from Radio Shack and from the hundreds of other independent suppliers. The built-in cassette player reads standard Radio Shack programs for the TRS-80\*.

Sold through computer stores.

The PMC-80 will operate with any of the many peripherals Radio Shack and other independent vendors have invented to plug into the TRS-80\*. Most importantly, the Interface Adapter permits Expansion Interfaces with memory expansion to 48K to be added. An Expansion Interface will also permit the addition of Radio Shack compatible 5¼" disks and disk operating systems, RS 232, printers, etc.

\*TRS 80 is a registered trademark of Tandy, Radio Shack.

### Personal Micro Computers, Inc.

475 Ellis Street, Mountain View, CA 94043

(415) 962-0220

# The Age of Affordable Pers



In 1978 Ohio Scientific introduced a revolutionary new low cost computer — the Superboard II. This computer provides all important personal computer features on a single board at a cost of under \$300. The Superboard II received rave reviews by microcomputer experts such as:

"We can heartily recommend the Superboard II computer system for the beginner who wants to get into microcomputers with a minimum of cost. Moreover, this is a 'real' computer with full expandability!"

POPULAR ELECTRONICS MARCH, 1979

"The Superboard II weighs in at \$279 and provides a remarkable amount of computing for this incredible price!"

KILOBAUD MICROCOMPUTING FEBRUARY, 1979

"The Superboard II and its fully dressed companion the Challenger 1P series incorporate all the fundamental necessities of a personal computer at a very attractive price. With the expansion capabilities provided, this series becomes a very formidable competitor in the home computer area."

INTERFACE AGE APRIL, 1979

"The graphics available permit some really dramatic effects and are relatively simple to program . . . The fact that the system can be easily expanded to include a floppy means that while you are starting out with a low-cost minimal system, you don't have to throw it away when you are ready to go on to more complex computer functions. At \$279, Superboard II is a tough act to follow."

RADIO ELECTRONICS JUNE, 1979

"The Superboard is an excellent choice for the personal computer enthusiast on a budget."

BYTE MAY, 1979

Since the introduction of Superboard II, the cost of personal computers has actually gone up with new models by major manufacturers ranging from \$1000 to well over \$4000 due to the general cost of inflation and the increasing functionality included in these computers. Today Cleveland Consumer Computers is offering you the original Superboard II at its original price of just \$279. In today's economy this is by far the best buy

in personal computing ever!

The Superboard II can entertain your whole family with spectacular video games and cartoons, made possible by its ultra high resolution graphics and super fast BASIC. It can help you with your personal finances and budget planning, made possible by its decimal arithmetic ability and cassette data storage capabilities. It can assist you in school or industry as an ultra

powerful scientific calculator, made possible by its advanced scientific math functions and built-in "immediate" mode which allows complex problem solving without programming! This computer can actually entertain your children while it educates them in topics ranging from naming the Presidents of the United States to tutoring trigonometry — all possible by its fast extended BASIC, graphics and data storage ability.

The machine can be economically expanded to assist in your business, remotely control your home, communicate with other computers and perform many other tasks via the broadest line of expansion accessories in the microcomputer industry.

This machine is super easy to use because it communicates naturally in BASIC, an English-like programming language. So you can easily instruct it or program it to do whatever you want, but you don't have to. You don't because it comes with a complete software library on cassette including programs for each application stated above. Ohio Scientific also offers you hundreds of inexpensive programs on ready-to-run cassettes. Program it yourself or just enjoy it; the choice is yours.

The Superboard II comes fully assembled and tested. It requires + 5V at 3 Amps and a video monitor or TV with RF converter to be up and running. **\$279.00**

## Standard Features:

- Uses the ultra powerful 6502 Microprocessor.
- 8K Microsoft BASIC-in-ROM. Full feature BASIC runs faster than currently available personal computers and all 8080 based business computers.
- 4K static RAM on board expandable to 8K.
- Full 53-key keyboard with upper/lower case and user programmability.
- Kansas City standard audio cassette interface for high reliability.
- Full machine code monitor and I/O utilities in ROM.

# Personal Computing is Still Here.



Mini-Floppy Disk Drive

Direct access video display has 1K of dedicated memory (besides 4K user memory), features upper case, lower case, graphics and gaming characters for an effective screen resolution of up to 256 x 256 points. Normal TV's with overscan display about 24 rows of 24 characters without overscan up to 30 x 30 characters.

## Optional Extras:

- Available 610 expander board features up to 24K static RAM (additional), dual mini-floppy interface, and an OSI 48 line expansion interface.
- Assembler/Editor and Extended Machine Code monitor available.
- 630 I/O Expander. RGB color and NTSC composite color outputs with up to 16 colors, Dual 8-axis joystick interface, AC remote control interface which mates with AC-12P, home security interface which mates with the AC-17P, 16-line parallel I/O interface, 16-pin I/O bus interface which allows the connection of parallel I/O lines or high speed analog I/O module, or a PROM blaster or solderless interface prototyping board, programmable sound generator and program selectable modem and high speed printer ports, and more.

**Freight Policies** All orders of \$100 or more are shipped freight prepaid. Orders of less than \$100 please add \$4.00 to cover shipping costs. Ohio Residents add 5.5% Sales Tax.

**Guaranteed Shipment** Cleveland Consumer Computers & Components guarantees shipment of computer systems within 48 hours upon receipt of your order. **Our failure to ship within 48 hours entitles you to \$35 of software. FREE.**

**Hours:**  
Call Monday thru Friday  
8:00 AM to 5:00 PM E.D.T.



## Software:

Ohio Scientific and independent suppliers offer hundreds of programs for the Superboard II, in cassette and mini-floppy form. Here is a sampling of popular Ohio Scientific programs for the Superboard II.

EDUCATIONAL PROGRAMS	SBII&CIP	Price
BASIC Tutor Series	SCE-336	\$35.00
Clock Tutor	SCE-333	6.50
Continents Quiz	SCE-332	6.50
Definite Integral	SCE-326	6.50
French Drill & Tutor	SCE-339	6.50
German Tutor & Drill	SCE-342	6.50
Hangman (8K)	SCE-324	9.00
Log Tutors 1-3	SCE-344	6.50
Math Blitz	SCE-329	6.50
Math Intro	SCE-319	6.50
Mathink	SCE-337	9.00
Matrix Tutors 1-3	SCE-345	6.50
Metric Tutor & Quiz	SCE-335	6.50
Spanish Drill & Tutor	SCE-352	6.50
Spelling Quiz	SCE-333	6.50
Trig Tutor (8K) I & II	SCE-318	6.50
BUSINESS PROGRAMS		
Address Book	SCB-523	9.00
Advertisement Demo	SCB-520	6.50
Inventory Demo	SCB-518	6.50
Mailing List (8K)	SCB-524	6.50
Straight & Constant Depreciation	SCB-500	9.00
Time Calculator	SCB-525	9.00
PERSONAL PROGRAMS		
Biorhythm	SCP-716	9.00
Calorie Counter	SCP-708	6.50
Checking Account	SCP-719	9.00
Loan Finance	SCP-717	6.50
Personal Calendar	SCP-718	6.50
Savings Account	SCP-720	9.00
GAME PROGRAMS		
Baseball I	SCG-975	6.50
Black Jack	SCG-955	6.50
Civil War	SCG-977	6.50
Destroyer	SCG-951	6.50
High Noon	SCG-960	6.50
Hockey	SCG-979	6.50
Lander	SCG-925	6.50
New York Taxi	SCG-956	6.50
Poker	SCG-962	6.50
Racer	SCG-949	6.50
Space War	SCG-942	6.50
Star Trek	SCG-946	6.50
Star Wars	SCG-926	6.50
Tic-Tac-Toe	SCG-945	6.50
Tiger Tank	SCG-950	14.00



610 Board



CS-600

## Hardware:

Superboard II	as specified in the advertisement.	\$279
610 Board	For use with Superboard II and Challenger I.P. 8K static RAM expandable to 24K or 32K system total. Accepts up to two mini-floppy disk drives. Requires +5V@ 4.5 amps.	298
Mini-Floppy Disk Drive	Includes Ohio Scientific's PICO DOS software and connector cable. Compatible with 610 expander board. Requires +12V@ 1.5 amps and +5V@ 0.7 amps.	299
630 Board	As specified in the advertisement.	229
AC-3P	12" combination black and white TV/video monitor.	159
4KP	4K RAM chip set.	79
PS-005	5V 4.5 amp power supply for Superboard II.	35
PS-003	Mini-floppy power supply.	29
CIP Sams	CIP/Superboard II Manual.	8
OS-65D	V3.2 Disk Operating System with 9-digit extended BASIC, random access and sequential files.	49
CS-600	Metal case for Superboard II, 610 and 630 board and two power supplies.	49
CS-610	Metal case for single floppy disk drive and power supply.	49
AC-12P	Wireless AC remote control system. Includes control console, two lamp modules and two appliance modules for use with 630 board.	175
AC-17P	Home security system. Includes console, fire detector, window protection devices and door unit for use with 630 board.	249
C4P Sams	C4P Manual.	16
C3 Sams	Challenger III Manual.	40

## To Order:

Or to get our free catalog **CALL 1-800-321-5805 TOLL FREE.** Charge your order to your **VISA** or **MASTER CHARGE ACCOUNT** Ohio Residents Call: (216) 464-8047. Or write, including your check or money order, to the address listed below.

**CLEVELAND CONSUMER COMPUTERS & COMPONENTS**  
P.O. Box 46627  
Cleveland, Ohio 44146

## Order Form:

CLEVELAND CONSUMER COMPUTERS & COMPONENTS P.O. Box 46627 Cleveland, Ohio 44146

- Superboard II \$279.  630 Board \$229.  
 610 Board \$298.  AC-3P 12" B-W Monitor \$159.  
 Mini-Floppy Disk Drive \$299.  CIP Sams Manual \$8.  
 (Attach separate sheet for other items.)

NAME: \_\_\_\_\_

ADDRESS: \_\_\_\_\_

CITY: \_\_\_\_\_ STATE: \_\_\_\_\_ ZIP: \_\_\_\_\_

Payment by: VISA: \_\_\_\_\_ MASTER CHARGE: \_\_\_\_\_ MONEY ORDER: \_\_\_\_\_

Credit Card Account # \_\_\_\_\_

Expires: \_\_\_\_\_ Interbank # (Master Charge) \_\_\_\_\_

TOTAL CHARGED OR ENCLOSED: \$ \_\_\_\_\_ (Ohio Residents add 5.5% Sales Tax)

All orders shipped insured UPS unless otherwise requested. FOB Cleveland, Ohio.

# Getting to Know Your Monitor

Ron Dalpiaz  
308 High St Box 573  
Tuscarawas OH 44682

There are few more satisfying pursuits than constructing, operating, and maintaining a personal computer system. The brave souls who develop their systems from discrete kits, preferring to assemble the "ideal" combination of peripherals, can feel justifiably proud of their accomplishments.

Inevitably, system failures will occur and can usually be remedied by personal knowledge and help from numerous books and articles on computer-circuit theory. But one frequently neglected area is the operational theory of the most used human-to-computer interface: the monochrome video monitor.

The video monitor is a basic part of most personal computer systems. The theory described here applies to converted television receivers and professional monitors. The two differ mostly in the video amplifier's frequency response and the cathode-ray-tube phosphor color: a professional monitor has a greater frequency response and a green phosphor. Additionally, the professional monitor has no tuner, intermediate frequency amplifier, video detector, sound or AGC (automatic gain control) sections, which are necessary in the broadcast receiver. The latter must have these sections rendered inoperable or selectively switched out when used as a monitor. Our discussion will assume a professional monitor with direct video entry.

## The Picture Tube

The fundamental part of the video monitor is the CRT (cathode-ray tube). Various circuits are used to deflect and modulate the beam.

Figure 1 shows the elements found in the modern picture-tube electron-gun assembly. 6.3 V applied to the heater causes electrons to be emitted or "boiled off" from the cathode surface. The electrons are pulled toward the phosphorus screen by the high positive potential existing at the accelerating anode surrounding the bell of the picture tube. Typically,

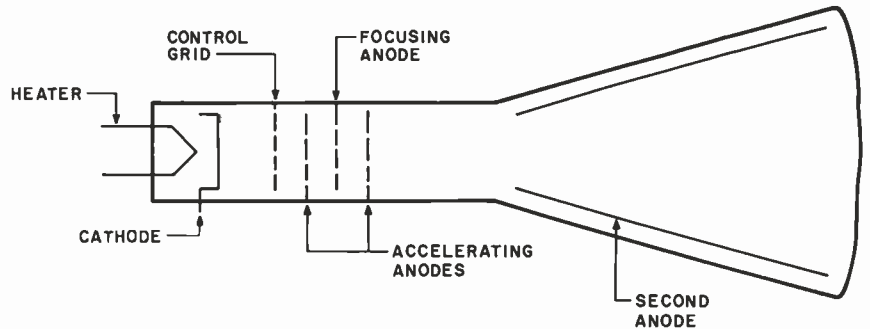

Figure 1: Internal structure of a cathode-ray tube. The electron beam is emitted by the cathode when it is heated. Electrons are attracted to the screen by a high voltage (12 kV to 20 kV) on the second anode.

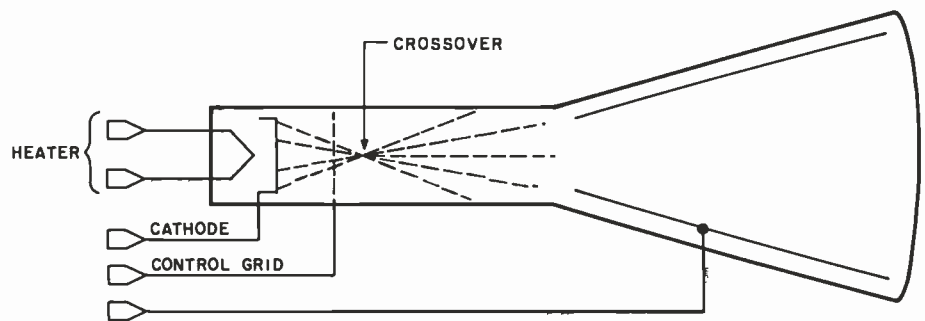

Figure 2: The crossover effect. Two accelerating anodes, in conjunction with the focusing anode, are used to give a sharp beam and a well-defined screen image. Without the focusing arrangement, the electron beam diverges and splatters.

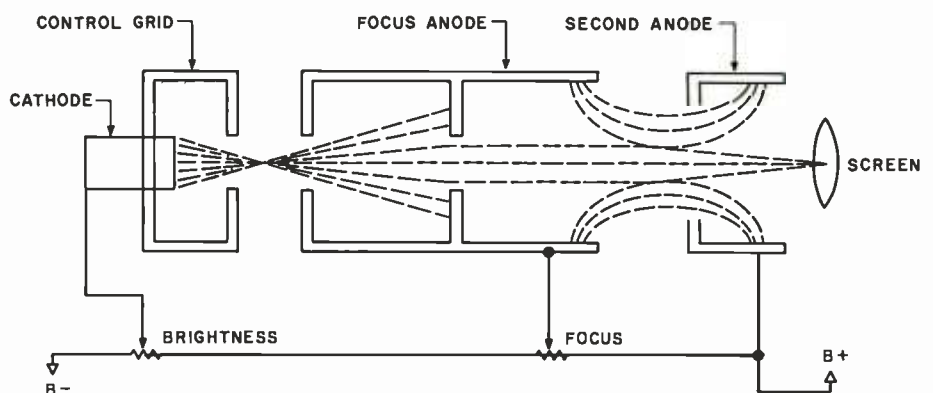

Figure 3: Focusing the beam. By applying the proper potentials to the anodes and control grids, the electron beam can be "squeezed" to a pinpoint, for displaying the image on the screen.





### What do you need?

Program listings . . . inventory listings . . . custom logos and letters . . . mailing labels in a multitude of sizes . . . custom forms and the data to complete them . . . curve plotting or bar graphs . . . digitized images from video or bit pads . . . multi-part forms . . . preprinted forms . . . tickets . . . and the list goes on . . .

### How do we do it?

High speed bi-directional full logic printing; two standard character sets, upper/lower case with descenders; high speed font at 165 cps; letter quality font at 90 cps; expanded characters, solid underlining; programmable character sets; complete dot control graphics; adjustable tractor feed 3"-16"; user adjustable platen; programmable tabs, forms length and line spacing; out of paper signal; self-test; interface options — RS-232C, Centronics parallel, Apple, S-100; and the list goes on . . .

## The Malibu Model 165

Find out if it's the easy solution to your hard copy needs — contact your local computer dealer or you can write or call us today for complete specifications and print samples — you won't be disappointed.

**Versatility, Quality and Reliability: We build it in.**

**malibu**  
Electronics Corporation

*Dealers and OEM'S, call us about our new purchase programs with prices, terms and delivery to meet your needs too.*

2301 Townsgate Road, Westlake Village, CA 91361 (805) 496-1990  
a subsidiary of **Datametrics Corporation**

Circle 127 on Inquiry card.

voltages of 12 kV to 20 kV are fed to this anode from the monitor's high-voltage section.

The emitted electrons pass through various control grids and arrive at the screen in the form of a luminescent dot. The brilliance of the dot is controlled by adjusting the potential at the control grid. A voltage more negative than the cathode surface decreases the beam brilliance, while a more positive voltage increases the beam brilliance. Varying the control-grid voltage modulates the beam and produces the shades of black and white that form the picture elements on the monitor screen.

The two accelerating anodes, in conjunction with the focusing anode, are used to give a sharp, well-defined screen image. Without these anodes, the electron beam, after passing through the control grid, would encounter *crossover* and become broad and splattered, as shown in figure 2.

By applying the proper potentials to the accelerating anodes and the focus anode, the beam is squeezed and formed into a well-defined pinpoint suitable for displaying the images on the screen. This result is

shown in figure 3.

### Deflection Circuits and Rastering

The processes described so far would result in a black screen with a single bright dot in the center of the picture tube. The first step in obtaining a display on the screen is to pull the electron beam from side to side; this illuminates a line on the screen. The beam can be moved from top to bottom, in order to illuminate a whole screen of lines. If this is done rapidly enough, this will produce illumination over the entire area of the picture tube. This process is called *rastering*, and the dimly illuminated screen with no data information present is called the raster.

The *deflection yoke* consists of electromagnetic coils arranged in a vertical and horizontal configuration and is fitted around the picture tube neck; it is the primary device used for deflecting the electron beam. To move the beam from the top to the bottom of the screen (vertically), a rapidly rising (and more rapidly falling) sawtooth-current waveform is passed through the vertical windings

of the yoke. Figure 4 shows a sawtooth waveform produced by a typical vertical circuit and the resultant vertical sweep of the beam.

As the current rises (Time A), the buildup of magnetic flux causes the beam to be swept from the top to the bottom of the screen. When the sawtooth reaches maximum value, it rapidly falls to 0 (Time B), causing the beam to be *retraced* from the bottom back to the top of the screen, where the process begins again. During the beam sweep from top to bottom, the trace is visible, but during the retrace the beam is cut off by the *retrace blanking circuitry* to avoid undesirable retrace lines from showing. Vertical sweep of the beam normally occurs 60 times per second.

The sawtooth wave is produced in an oscillator and amplifier section of the television monitor and is fed to the vertical windings of the deflection yoke 60 times per second. Vertical beam deflection, if used alone, would result in a bright vertical line in the center of the darkened screen. To complete the rastering process, the beam must also be deflected from left to right, and this is accomplished by the horizontal circuitry.

The horizontal windings in the deflection yoke are also fed with a sawtooth current originating in the horizontal oscillator and output circuitry. The frequency of this sawtooth is 15,750 Hz. The rising sawtooth current is passed through the horizontal windings in the yoke, causing the beam to be deflected from the left to the right side of the picture. The beam is then cut off by the *horizontal blanking circuitry*, and the rapidly falling sawtooth current sweeps the beam back to the left side of the screen to repeat the process. Figure 5 illustrates a typical horizontal oscillator and deflection circuit and the resultant screen trace.

The horizontal sawtooth voltage is produced by the horizontal oscillator and output section. The sawtooth is coupled into a horizontal output transformer before being fed to the deflection yoke windings. The main purpose of this transformer is to produce the high voltage necessary for the accelerating anode at the picture tube. The rapidly falling sawtooth voltage present during beam retrace is fed to the horizontal output transformer which steps it up to a

## FINDING SOLUTIONS AND BEING COMPETITIVE IS OUR BUSINESS.

Having problems and looking for a computer to help solve them? Are you finding computer dealers come in one of two ways? Either Full system support with Full price or Take it or Leave it with Low price. At Omega we don't believe that you should have to make a choice. Yes, we're in business to sell products but also, to solve your problems. Our prices will be the lowest possible. Our support and product quality will be second to none. Check out our Mail Order prices in this ad (our retail prices will be higher). See if you don't agree with our first claim. For our second claim, call us with your data processing needs and problems. Better yet, come in and see us. Finding solutions and being competitive is our business. We never forget either of them.



APPLE II "PLUS" 16K 48K \$ 929.95 1079.95

<b>Apple II Accessories:</b>	
Disk II with Controller	..... \$485.00
Disk II 2nd drive	..... 435.00
Graphics Tablet	..... 665.00
Language System with PASCAL	..... 395.00
Silentype Printer w/int	..... 489.00
Integer Firmware Card	..... 152.00
Z-80 Softcard	..... 259.00
Videx Videoterm 80 col Card	..... 279.00
Sanyo 12" Green Monitor	..... 179.00

Calculators: (\$2.00 shipping charge)

<b>Hewlett Packard</b>			
HP-85	..... CALL	HP-41C	..... \$269.00
HP-67	..... \$299.00	HP-97	..... 589.00
HP-34C	..... 127.00	HP-38C	..... 127.00
<b>Texas Instruments</b>			
TI-58C	..... 109.00	TI-59	..... 209.00
<b>Cannon</b>			
P10-D	..... 80.00	P7-D	..... 80.00
<b>Sharp</b>			
6200	..... 98.00	5813	..... 35.00
5100	..... 89.00	5102	..... 80.00

Mail Order Terms of Sale: Price based on prepaid orders. Visa or Master Charge orders may have service charge added to purchase price. No COD's. Allow 14 working days for personal and company checks to clear. All orders (unless specified in ad) within Continental U. S. shipped U.P.S. no charge. APO or out of Continental U. S. write or call for shipping charges. All prices subject to change and all orders subject to withdrawal without notice. CA residents add 6% sales tax.

## OMEGA MICRO COMPUTERS

The Problem Solving Company 3447 Torrance Boulevard • Torrance, California 90503 • (213) 370-9456

Text continued on page 212

# Now NRI takes you inside the world's most popular microcomputer to train you at home as the new breed of computer specialist!

**NRI teams up with Radio Shack to teach you how to use, program and service microcomputers...make you the complete technician.**

It's no longer enough to be just a programmer or a technician. With microcomputers moving into the fabric of our lives (over 200,000 of the TRS-80™ alone have been sold), interdisciplinary skills are demanded. And NRI can prepare you with the first course of its kind, covering the complete world of the microcomputer.

## **Learn At Home in Your Spare Time**

With NRI training, the programmer gains practical knowledge of hardware, enabling him to design simpler, more effective programs. And, with advanced programming skills, the technician can test and debug systems quickly and easily.

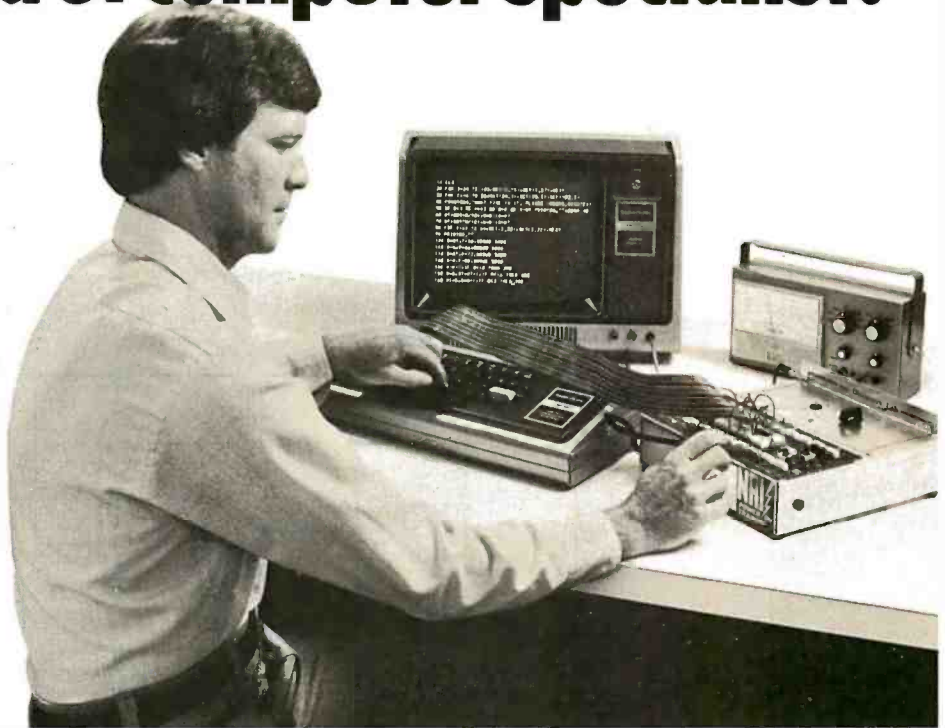

Only NRI gives you both kinds of training with the convenience of home study. No classroom pressures, no night school, no gasoline wasted. You learn at your convenience, at your own pace. Yet you're always backed by the NRI staff and your instructor, answering questions, giving you guidance, and helping you over the tough spots.

## **Explore the TRS-80 Inside and Out**

NRI training is hands-on training, with practical experiments and demonstrations as the very foundation of your knowledge. You don't just program your computer; you introduce and correct faults...watch how circuits interact...interface with other systems...gain a real insight into its nature.

You also build test instruments and the NRI Discovery Lab, performing over 60 separate experiments in the process. You learn how your trouble-shooting tools work, and gain greater understanding of the information they give you. Both micro-

computer and equipment come as part of your training for you to use and keep.

## **Send for Free Catalog... No Salesman Will Call**

Get all the details on this exciting course in NRI's free, 100-page catalog. It shows all equipment, lesson outlines, and facts on other electronics courses such as Complete Communications with CB, TV and Audio, Digital Electronics, and more. Send today, no salesman will ever bother you. Keep up with the latest technology as you learn on the world's most popular computer. If card has been used, write to:



**Training includes TRS-80 computer, transistORIZED volt-ohm meter, digital frequency counter, and the NRI Discovery Lab with hundreds of tests and experiments.**

(TRS-80 is a trademark of the Radio Shack division of Tandy Corp.)



## **NRI Schools**

McGraw-Hill Continuing  
Education Center  
3939 Wisconsin Avenue  
Washington, D.C. 20016.

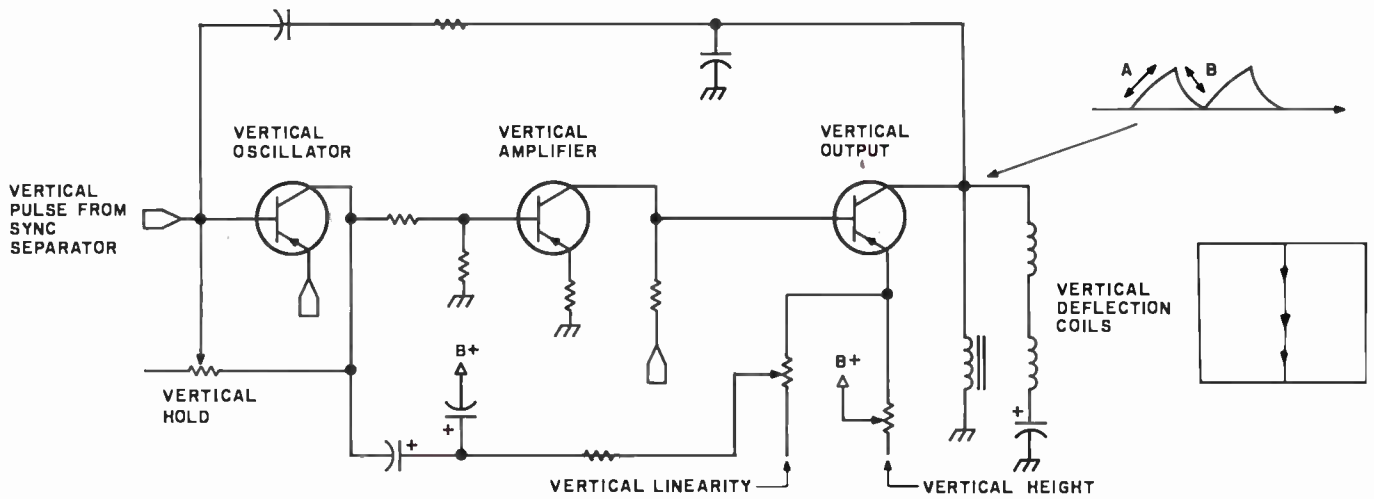

Figure 4: Typical vertical oscillator/amplifier section. The circuitry shown creates a sawtooth waveform to drive the vertical deflection coils. This enables the electron beam to move from the top of the screen to the bottom 60 times per second.

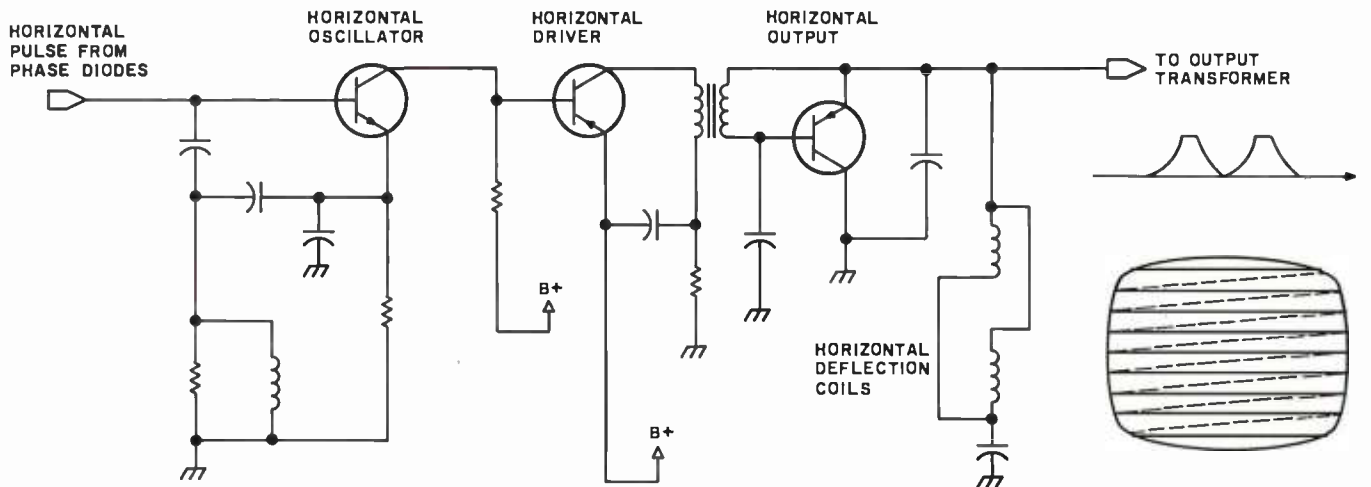

Figure 5: Typical horizontal oscillator and output yoke. The horizontal deflection coils are driven in a manner similar to the vertical deflection coils, but at a much higher rate of 15,750 Hz.

# UCSD\* System for TRS-80 Model II†

The most portable operating system now supports FORTRAN. Pascal and/or FORTRAN modules are compiled in universal P-code, so they can run on most microprocessors, often without recompiling. Programs execute up to 10 times faster than comparable BASIC programs, and use much less memory. Ready to run on TRS-80 Model II (64K).

## FEATURES

- Interactive operating system—dynamic overlays, disk file handling, run-time support and block I/O routines.
- Fast, one pass compilers.
- Two Editors—one screen oriented for programming and text editing, one character oriented for hard copy terminals.
- File handler to manipulate disk files.
- Macro-assembler that produces code for linking with Pascal or Fortran programs.
- Linker for link-editing of object and assembly code modules.
- Library of program modules and utilities.

## PLUS, from PCD Systems

- Disk formatting program to initialize diskettes in single or double density formats.
- Configuration program for serial I/O.
- Disk-set program to permit separate assignment of density and format characteristics for each disk drive.

## DOCUMENTATION

- UCSD System Manual (400 pages).
- Beginner's Guide To UCSD Pascal.
- Pascal User Manual & Report.
- Fortran User's Manual with Fortran systems.

## PRICES

- UCSD System with Pascal Compiler \$350
- with Pascal and Fortran Compilers \$500
- Fortran Compiler alone (requires Version II.0) \$200
- P-Code Interpreter alone (either LSI-11 or Z-80) \$ 85
- Optional Utility Programs
  - CP/M<sup>‡</sup> to Pascal file conversion \$ 50
  - TRSDOS\* to Pascal file conversion \$ 50
  - Z-80 Disassembler/Dump program \$ 50

## ALSO AVAILABLE

- UCSD System for MINC<sup>§</sup> or PDT<sup>§</sup>.
- Z-80 Adaptable System (you write BIOS).
- UCSD System for CP/M environments.

PCD Systems is a licensed distributor of the UCSD System for Pascal and Fortran. Dealer inquiries are invited.

# PCD Systems, Inc.

PO Box 143 Penn Yan, NY 14527 315-536-3734

\*Trademark of the Regents of the University of California †Trademark of Tandy Corporation ‡Trademark of Digital Research §Trademark of Digital Equipment Corporation



DIP-84  
PRINTER

DIP-80B  
PRINTER

# A line of Hi-Q Printers\*

DIP-81  
PRINTER  
**\$499.00**  
RETAIL

- 100 CPS Bidirectional
- 100% Continuous Duty Cycle
- High Performance
- Low Profile for Desk Top Installation
- Low Cost
- 100 Million Character Print Head
- Stylish, Measures 15" wide, 9" deep & 3.5" high
- Human-Engineered for Ease of Service

*\*High-Quotient of performance to cost.*



**DISTRIBUTOR/DEALER INQUIRIES INVITED**

**DIP, inc.** 121 Beach Street • Boston, MA 02111 • (617) 482-4214

Buy an Atari 800 16K for



**\$747**

and your savings have just begun:

add'l 16K Ram	\$139.95	Joysticks	\$14.95
add'l 8K Ram	\$84.95	Star Raiders	\$39.95
410 Program Rec.	\$59.95	29.95 Rom Packs	\$19.95

**COMPUTERS**



Horizon II 32K DD*	\$2399
Horizon II 32K Quad*	\$2799
Industrial Micro 5000 D.D.	\$2499
Altos ACS-8000-5	\$4995
Zenith (Hearth) Z-89, 48K	\$2299
Dynabyte DB 8/1 48K	\$2345
TI 99/4 w/Monitor	\$899

**PRINTERS**



Okidata Microline 80	\$546
Comprint GP (Apple, TRS-80)	\$495
Paper Tiger w/graphics	\$879
MPI 88T	\$624
Centronics 737	\$829
Diablo 630	\$2349
NEC 5510	\$2589

**TERMINALS**



P.E. Bantam (w/non-glare)	\$689
Soroc IQ 120 (Pre-tested)	\$749
Televideo 912C	\$749
Televideo 920C	\$799
Hazeltine 1500	\$899
Visual Tech 200	\$945

**HOW TO ORDER**

Mail-Order Only

2% cash discount incl. Prices subject to change. Product subject to availability. Az. residents add 5% F.O.D. Scottsdale, Factory Warranties included.

\*Our Horizons are better than their Horizons. call us, we'll tell you why.

**Scottsdale Systems**

6730 E. McDowell Road #103

Scottsdale, Az. 85257

Open 6 to 6 PM - M-Fri.



**(602) 941-5856**

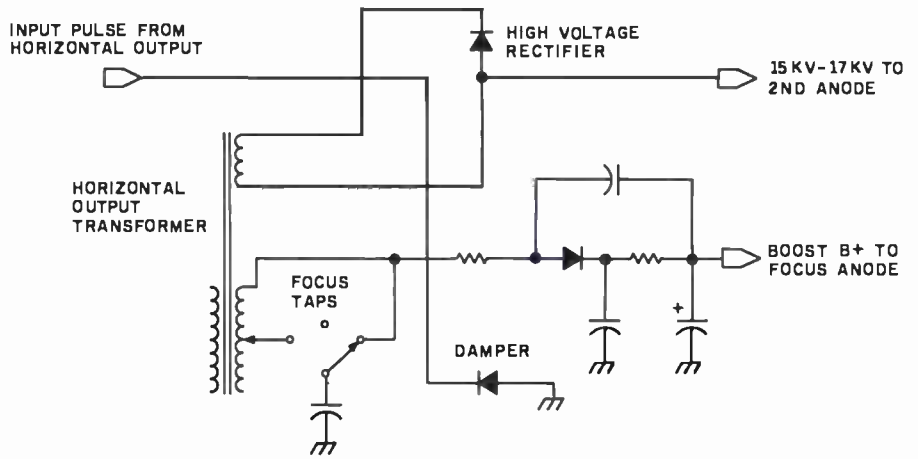

Figure 6: Typical high-voltage circuit. High-frequency AC from the horizontal-deflection circuitry is also used to produce the high voltage supplied to the focusing and second anodes. After passing through a step-up transformer, the AC is rectified and filtered for use in various other circuits.

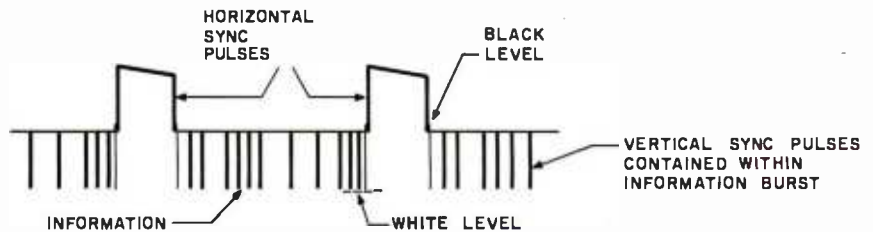

Figure 7: Composite video signal. The signal sent to most video displays contains large pulses used to keep the horizontal oscillator in time with the picture information. The picture information is essentially an on/off control of the electron beam. In most video monitors, a low pulse turns the beam on, illuminating a dot on the screen; an intermediate voltage turns the beam off.

Text continued from page 208:

very high potential. This pulsating high voltage is then rectified, filtered, and applied to the picture tube anode. Various taps on the transformer give alternate circuit voltages, including the focus voltage. Figure 6 illustrates a typical high-voltage circuit.

The production of high voltage to accelerate the electron beam combined with the horizontal and vertical deflection of the beam all work together to produce a dimly illuminated raster on the screen.

**Interlaced Scanning**

A careful study of the raster reveals the precision with which it is produced. The raster is usually composed of 525 finely spaced parallel horizontal lines, approximately 480 of which are visible within the viewing area of the picture tube. The number of lines and the scanning method used depend on the particular video interface used, and I will assume a high-quality monitor used with a video system outputting sixty-four or more characters per line.

The vertical oscillator and output section utilize an interlaced scanning method which traces 262.5 lines across the screen in 1/60 second, then returns to trace a second set of 262.5 lines *between* the previous lines. Each set of lines is called a field, and the two fields combined produce one complete data picture or frame. When the electron beam is modulated to produce a picture, one frame occurs once each 1/30 second, and thirty complete pictures occurring each second are sufficient to give the illusion of a continuous display. Exceptions to this process are video-interface techniques which do not interlace their fields but which trace a complete picture in one field. The 60 Hz scan rate can also vary.

**The Composite Video Signal**

In order to synchronize the monitor's vertical and horizontal oscillators with the video-interface output, a composite video signal or separate video and synchronization signals are coupled to their respective stages. The purpose of the syn-

# Suddenly, RCA makes talking to your computer a lot cheaper.

## New interactive data terminal with color graphics—only \$369.\*



RCA's new VP-3301 is a professional quality, ASCII encoded, interactive data terminal, suitable for a wide variety of industrial, educational, business and individual applications requiring interactive communication between computer and user. Connects directly to your computer or to a standard modem for over the phone access to time sharing networks and data bases. And it's compatible with networks such as those provided by CompuServe Information Services and Source Telecomputing Corp. Microprocessor intelligence and LSI video control integrated circuits bring performance, features and flexibility at a low price. Operates from 5 volt power supply (included).

Unique color locking circuitry creates sharp, jitter free, true color graphics and rainbow free characters.

You can display the entire field of characters in any of 8 colors against any of 8 background colors (8 gray scales with monochrome monitors). Or to add special emphasis, you can display individual letters, words or lines in different colors or in reverse video.

The VP-3301 offers you a choice of two software-selectable display formats: Either 40 characters by 24 lines. Or 20 characters by 12 lines.

The terminal's resident character set consists of 52 upper and lower case alphabetic, 10 numerals, 32 punctuation/math symbols and 31 control characters.

You can also define a total of 125 of your own characters. Including: Greek letters and other foreign alphabets, graphic symbols, large graphics building blocks, playing card suits, unique character fonts and "little green men."

The keyboard section features flexible-membrane key switches with contact life rated at greater than five million operations. A finger positioning overlay and positive keypress action give good operator "feel".

An on-board sound generator and speaker provides aural feedback for key presses and may also be activated with escape sequences to provide an audio output.

The sealed keyboard surface is spill proof and dust proof. This, combined with high noise immunity CMOS circuitry, makes the VP-3301 ideal for hostile environments.

Output is industry standard asynchronous RS232C or 20 mA current loop with 6 switch-selectable baud rates and 8 selectable data formats.

You can connect the terminal directly to a 525 line color or monochrome monitor. Or to a standard TV set using your RF modulator.

For more information, contact RCA MicroComputer Marketing, New Holland Avenue, Lancaster, PA.

**Or call our toll-free number: 800-233-0094.**

\*Suggested user price.

# RCA

# BKG 10.

The improved version of BKG 9.8, the backgammon playing program that defeated the world backgammon champion by a score of 7-1 of Monte Corlo in July, 1979.

**BKG 10.** developed utilizing the expertise of Paul Magriel, former world backgammon champion and author of Backgammon, has emerged as one of the best pieces of artificial intelligence software available on microcomputer.



**BKG 10. features:**

- Version I utilizes direct cursor control for professional display of board, disc, cube, etc.
- Version II adds printer/disc IO of game in progress, enables board set-up of non-standard points and simulation capabilities.
- BKG 10. incorporates advanced SNAC functions (Smooth & Nonlinear Application Coefficients) as described in *Scientific American*, June, 1980
- Plays by ABPA Tournament Rules, including: doubling, match play and optionally the Crawford Rule. BKG 10. VI will play either side. VII enables machine -- machine play for simulation applications.
- BKG 10. responds quickly, making most moves in under 15 seconds (2 MHz), or 7 seconds (4MHz).
- BKG 10. was written entirely in Z-80 Assembler.

**BKG 10.** has the additional capability of suggesting moves and doubling decisions.

• **SYSTEM REQUIREMENTS** •

Z-80 Processor, 32K 1PA, CP/M or compatible operating system, cursor addressable video terminal & 8" floppy drive. VII requires printer and additional drive.

**BKG 10. \$79.00** single license fee **\$129.00** PRICE INCLUDES:

Two non-copiable diskettes and a complete 30 page manual.  
Software Update subscription available  
INTELLIGENCE SYSTEMS LTD., 124 S. DELAWARE STREET  
INDIANAPOLIS, IN. 46204 (317) 631-5514

For Mastercard, VISA, or C.O.D. orders only

**Call Now: 800-824-7888** TOLL FREE

Alaska/Hawaii 800.824.7919  
Ask for Operator 105

# BKG 10.

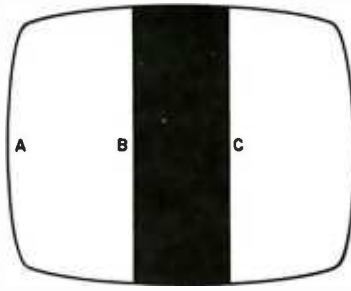

(a)

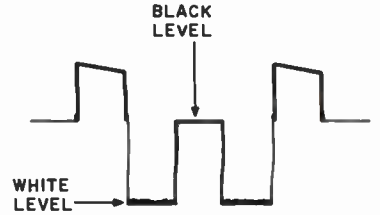

(b)

**Figure 8:** Sample video display and corresponding composite video signal. The low portion of the composite signal (b) turns on the electron beam to illuminate the screen (a). When the intermediate voltage of the black portion is encountered, the beam is turned off. As the composite signal returns to the low white level, the screen is illuminated again.

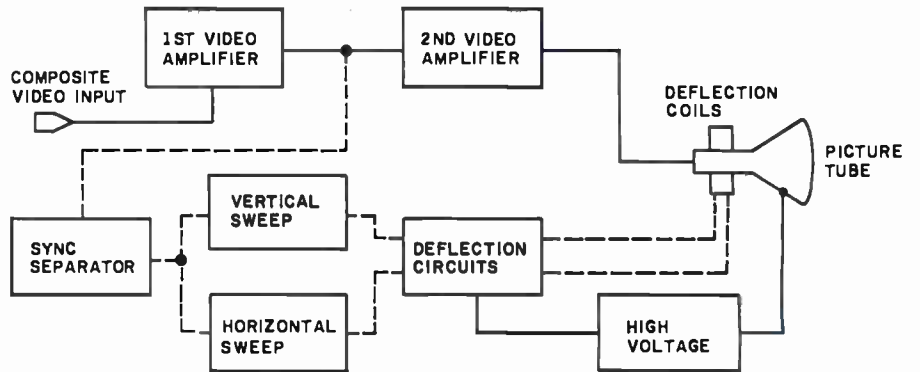

**Figure 9:** Block diagram of the signal path in a typical monitor. The solid lines represent actual video information, while the dashed lines indicate the path of synchronization signals.

chronization signals is to time the vertical and horizontal oscillator stages to the video information fed to the picture tube. Figure 7 is a sketch of the most widely implemented composite video signal.

This signal contains both the horizontal and vertical synchronization pulses (called *sync* pulses) and is applied to the *sync separator* where the horizontal and vertical pulses are separated, amplified, and sent to their respective oscillators to synchronize their respective traces. Included in the vertical sync pulses (assuming interlaced scanning is used) are equalization pulses whose function is to assure that the second field of lines is interlaced with the first.

**Electron-Beam Modulation**

The last link in the chain to create an image is to modulate the electron beam, turning it on and off to display white dots on the dim raster; this forms the dot matrices arranged as alphanumeric characters. The infor-

mation contained in the composite video signal is actually a series of voltage reference levels which are amplified in the video amplifier and applied to the control grid or cathode of the picture tube to turn the electron beam on or cut it off. The black field in the display is represented by a voltage near the black level just under the horizontal sync pulse. Figure 7 illustrates this. The white dots in the picture are represented by the white level, or minimum voltage. In scanning the display shown in figure 8a, when the beam begins its trace at point A, the voltage level is minimum, or white as in figure 8b. When point B is reached, the voltage level jumps to the black reference level and cuts off the beam at the picture tube. A black screen is evident. At point C, the beam is on again, and white is presented.

Production of a display on a video terminal is more complex, but the beam is modulated in the same way to produce numerous dots of white





# Cromemco

incorporated  
Tomorrow's Computers Today

**Now..**

Discover Savings and Service with

**EBS**

MAIL ORDER DIVISION

**ORDER TOLL FREE**

- WE ARE PROUD to be an AUTHORIZED CROMEMCO DEALER
- CROMEMCO stands for quality, reliability and obsolescence insurance
- CROMEMCO is widely recognized as a microcomputer industry leader
- CROMEMCO provides strong support for their dealers and end-users
- THE BOTTOM LINE - it's what you buy AND where you buy it . . . WE CARE!

**New..**

**CROMIX IS HERE!**

The exciting new multi-user, multi-tasking operating system with many added capabilities.

**New..**

**RPG II**

Exclusive offering of this important business language by a microcomputer manufacturer

**LISP**

The language for Artificial Intelligence research

**New..**

**BUSINESS SYSTEMS SOFTWARE!**

General Ledger  
Accounts Payable  
Accounts Receivable  
Inventory

**New..**

**SYSTEM ZERO!**

The S-100 personal computer with Cromemco reliability.

**16 FDC**

Double density disk controller

**New..**

**QUADART!**

4 port serial I/O  
**INTELLIGENT I/O CONTROLLER!**  
On board Z-80  
Use these together for results you won't believe!

An integrated turnkey system that requires no computer programming knowledge. Produced and supported by Cromemco, and designed to make full use of the advanced features found in Cromemco hardware.

**SYSTEMS: List Our Price**

**SYSTEM 2** 3990 3190.  
*Now double density!*  
Dual double-sided mini floppy disk drives; 64K RAM

**SYSTEM 3** 7395. CALL  
*Now double density!*  
2 Mbyte of dual double-sided 8" floppy disk; 64K RAM

**Z-2H** 9995. CALL  
*Now double density!*  
11 Mbyte integral hard disk; 2 double-sided 5" floppy disks; 64K RAM

All Cromemco systems feature the S-100 industry standard bus, 4 MHz Z-80 CPU, 64K RAM, and can be easily upgraded to multi-user, multi-tasking capability.

**PERIPHERALS:**

**3102 "SMART" TERMINAL**  
40 function keys; detachable keyboard with 14-key numeric pad

**3703 DOT-MATRIX PRINTER**  
180 CPS; 18-inch platen; 132 columns; bi-directional with double buffering

**3355A FULL LETTER PRINTER**  
55 CPS; 15-inch platen; quality impression suited to camera copy

BOARDS:	List	Our Price
SGL. CARD COMP.	450.	380.
8K BYTESAVERII	245.	210.
32K BYTESAVER	295.	CALL
ZPU	395.	335.
4FDC	495.	420.
64KZ	1785.	1510.
TU-ART	295.	250.
SDI	595.	CALL

High resolution color graphics interface

**LANGUAGES: List Our Price**

COBOL, now updated	95.	90.
FORTRAN IV	95.	90.
MACRO ASSEMBLER	95.	90.
16K BASIC	95.	90.
32K BASIC	295.	275.
DATA BASE MGMT.	95.	90.
WORD PROCESSING	95.	90.
RATFOR	195.	180.
TRACE	95.	90.

**EBS BUSINESS SOFTWARE:**

GENERAL LEDGER; ACCOUNTS PAYABLE; ACCOUNTS RECEIVABLE; PAYROLL (Calif.); INVENTORY; ORDER ENTRY

List Price \$995. each

Customization available

Call or write for our low mail order prices on all CROMEMCO products . . . or on PERSCI disk drives, MEASUREMENT SYSTEMS boards, BASE 2, QUME, SOROC, ADDS, TVI, NEC SPINWRITER or other quality products.

**EXECUTIVE BUSINESS SYSTEMS**

20457 E. Valley Blvd., Walnut, CA 91789  
(714) 594-5736

**WE ALSO OFFER:**

- Complete analysis of your system needs
- Installation, training, support & maintenance
- Custom applications software

AT OUR REGULAR CONSULTING RATES  
Phone inquiries welcome



Prices shown are for "Cash with Order"

COLLECT PHONE ORDERS WELCOME or Send check or M.O. (Personal or Co. checks require 2 wks. to clear) Please include phone number. Shipping charges will be added, Within Calif. add applicable sales tax. Factory warranty included. All prices subject to revision.

CDOS® Cromemco, Inc.

CP/M® Digital Research

CBASIC™ Compiler Systems

(corresponding to data elements sent from the video interface). Alternate methods employ black data elements on a white field. The frequency response of the video amplifier stages determines how fast the beam can be turned on and off; the faster the response, the more data elements can be displayed on each line with good resolution.

### Home Television Receivers

The video amplifier section in a professional monitor differs greatly from that in a television receiver. Television receivers can rarely be modified to produce dots of a rate beyond 5 MHz, while monitors can be purchased with from 12 to 100 MHz response. The converted television receiver must have its tuner, intermediate frequency amplifier and sound section switched out when employing direct video input. The limited frequency response generally allows only up to thirty-two characters per line, but the low cost of such receivers makes them an attractive choice.

After injection and amplification of the composite video signal in a televi-

sion receiver used for video display, the video is separated from the synchronization pulses, and the latter are sent to the synchronization section. The separated video information is then amplified by the video amplifier, coupled to the picture tube, and used to modulate the electron beam. In systems using separate video and synchronization inputs, the vertical and horizontal pulses are not processed in a synchronization separator, but are fed directly to their respective oscillators. The separate video is directly coupled to the video output stage.

### Troubleshooting

When all the circuits described above are working in perfect unison and are synchronized by the composite video signal, a stable display will be produced. A malfunction at any stage in the monitor creates a problem peculiar to that particular section. So, what do you do when the monitor fails?

The first step is to obtain a good, accurate schematic of the circuitry (preferably *before* any problems occur). The manufacturer should sup-

ply this. Locating problems can be somewhat simplified by considering a monitor as consisting of the sections shown in the block diagram of figure 9. Using this diagram, we can observe the signal flow lines to generally predict the section where the problem may lie. Some symptoms and their solutions will prove helpful.

- **No Video or Raster:** Assuming that the power supply is functioning, the absence of raster could mean that the electron beam is not being deflected across the picture tube screen. Perhaps no beam is present, so the logical checkpoint is the high-voltage section to see if the beam accelerating potential is present. Use of a high-voltage probe is necessary here.

If the high voltage is present at the anode of the picture tube, it is best to measure voltages at the control grid and cathode of the picture tube, assuming that a visual check revealed that the heater was lit. Having cleared the picture tube and proving that a beam can be formed, proceed to check the horizontal-sweep section where

## 32 K BYTE MEMORY RELIABLE AND COST EFFECTIVE RAM FOR 6502 & 6800 BASED MICROCOMPUTERS

AIM 65-\*KIM\*SYM  
PET\*S44-BUS

- \* PLUG COMPATIBLE WITH THE AIM-65/SYM EXPANSION CONNECTOR BY USING A RIGHT ANGLE CONNECTOR (SUPPLIED) MOUNTED ON THE BACK OF THE MEMORY BOARD.
- \* MEMORY BOARD EDGE CONNECTOR PLUGS INTO THE 6800 S 44 BUS.
- \* CONNECTS TO PET OR KIM USING AN ADAPTOR CABLE.
- \* RELIABLE—DYNAMIC RAM WITH ON BOARD INVISIBLE REFRESH—LOOKS LIKE STATIC MEMORY BUT AT LOWER COST AND A FRACTION OF THE POWER REQUIRED FOR STATIC BOARDS.
- \* USES +5V ONLY, SUPPLIED FROM HOST COMPUTER.
- \* FULL DOCUMENTATION, ASSEMBLED AND TESTED BOARDS ARE GUARANTEED FOR ONE YEAR AND PURCHASE PRICE IS FULLY REFUNDABLE IF BOARD IS RETURNED UNDAMAGED WITHIN 14 DAYS.

ASSEMBLED WITH 32K RAM	\$395.00
& WITH 16K RAM	\$339.00
TESTED WITHOUT RAM CHIPS	\$279.00
HARD TO GET PARTS (NO RAM CHIPS)	
WITH BOARD AND MANUAL	\$109.00
BARE BOARD & MANUAL	\$49.00

PET INTERFACE KIT—CONNECTS THE 32K RAM BOARD TO A 4K OR 8K PET. CONTAINS: INTERFACE CABLE, BOARD STANDOFFS, POWER SUPPLY MODIFICATION KIT AND COMPLETE INSTRUCTIONS. \$49.00

U.S. PRICES ONLY

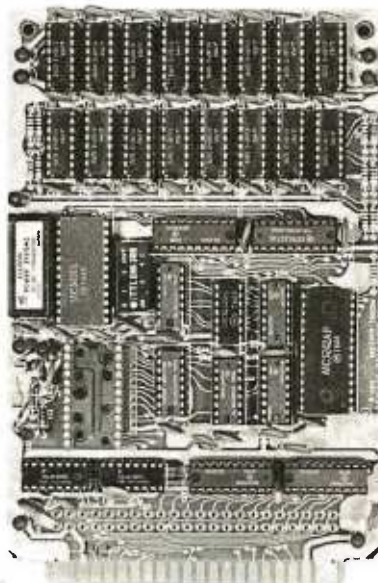

## 16K MEMORY EXPANSION KIT ONLY \$58

FOR APPLE, TRS-80 KEYBOARD, EXIDY, AND ALL OTHER 16K DYNAMIC SYSTEMS USING MK4116-3 OR EQUIVALENT DEVICES.

- ★ 200 NSEC ACCESS, 375 NSEC CYCLE
- ★ BURNED-IN AND FULLY TESTED
- ★ 1 YR. PARTS REPLACEMENT GUARANTEE
- ★ QTY. DISCOUNTS AVAILABLE

ALL ASSEMBLED BOARDS AND MEMORY CHIPS CARRY A FULL ONE YEAR REPLACEMENT WARRANTY

**BETA**  
COMPUTER DEVICES

1230 W. COLLINS AVE.  
ORANGE, CA 92668  
(714) 633-7280

Call. residents please add 6% sales tax. Mastercharge & Visa accepted. Please allow 14 days for checks to clear bank. Phone orders welcome. Shipping charges will be added to all shipments.

## HÄNDLER CONCESSIONAIRES DISTRIBUIDORES O.E.M.

AUSGEZEICHNETE GROSS =  
HANDELSPREISE stellen nur einen  
Aspekt unseres Händlerprogrammes  
dar. Treten Sie noch heute mit uns  
in Verbindung. (Wir sprechen  
Deutsch)



UN EXCELLENT PRIX DE GROS  
ne représente qu'un seul aspect de  
notre programme de distribution in-  
ternationale. Mettez-vous en contact  
avec nous aujourd'hui pour recevoir  
plus de renseignements. (On parle  
français!)



EL EXCELENTE PRECIO AL  
MAYOREO que ofrecemos repre-  
senta sólo un aspecto de nuestro  
programa de distribución inter-  
nacional. Póngase en contacto con  
nosotros para información más  
detallada. (Se habla español!)

A.D.D.S.	IND. MICRO
ANADIX	OKIDATA
APPLE	SOROC
CENTRONICS	SUPERBRAIN
CROMEMCO	TELEVIDEO
HAZELTINE	TEXAS INSTR.



**MICRO-COMPUTER BROKERS**  
INTERNATIONAL  
6819-P, North 21st Avenue  
Phoenix, Arizona 85015 U.S.A.  
Telephone: (602) 242-9961  
Telex: (0) 668382

voltages originate which directly  
or indirectly affect both horizontal  
and vertical deflections of the  
beam. The final step would be a  
check of the deflection system  
itself.

- No Video — Raster Present: A raster always indicates that vertical and horizontal sweep, deflection, high-voltage and low-voltage sections are working. Assuming a video signal is present, we should investigate all portions of the monitor's video amplifier section, also the picture-tube-control-grid and cathode circuits.
- Raster and Video Present — Vertical Rolling: Assuming the vertical hold control does not stop the vertical roll, this indicates that the vertical oscillator is not in step with the video interface signal. The obvious starting point is the vertical sweep section, particularly the vertical oscillator.
- Raster and Video Present — Horizontal Lines: This problem is very similar to the above vertical problem, except that horizontal lines are the problem. Again, this indicates that the horizontal oscillator is out of step with the video interface circuitry. Investigate the horizontal oscillator to correct this problem.
- Raster, Video Present — Display Rolling and Drifting Sideways: This is both a vertical *and* horizontal problem. Obviously the circuit feeding both horizontal and vertical oscillators is at fault, and this would be the synchronization separator or amplifier. When symptoms or tests indicate one section as the probable point of trouble, proceed to check voltages for direct-current biasing and use an oscilloscope to investigate waveforms.

Troubleshooting is a logical, step-by-step procedure. In repairing your monitor, the screen is the best visual aid you have, and should be utilized to the utmost in preliminary generalizations as to the problem circuit. And troubleshooting a video monitor yourself, whether or not it's homebrew, can give you the satisfaction of knowing your hardware a little bit more. ■

# Buying Power

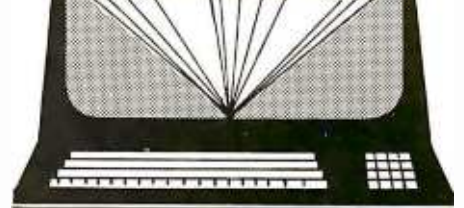

## You can buy wholesale

without being a corporate giant. The Purchasing Agent provides a personalized commercial buying service for companies and individuals.

The Purchasing Agent will get you the lowest wholesale price by:

- Aggressively bidding wholesalers against each other on your order,
- Consolidating orders for volume discounts, and
- Using professional buyers' thorough knowledge of the computer market.

The Purchasing Agent will get you the quickest deliveries direct from wholesalers' inventories.

Here are examples of items clients have purchased recently through The Purchasing Agent and the prices paid. (Prices shown include the buying fee.)

### COMPUTERS

Alpha Micro 10 MEG	\$11,203
Altos 64K, 1MEG	3,370
Commodore CBM 32K	1,344
Dynabyte DB 8/1 64K	2,480
EXIDY 48K Sorcerer	1,118
HP-85	2,970
North Star Hozi II 32K D.D.	2,332
Super Brain 64K	2,600
TI 99/4	859
Zenith Z-80 16K	1,960
Zenith Z-89 48K	2,214

### PRINTERS

Anadex 9500	\$1,204
Base 2	493
Centronics 737	749
Diablo 630	2,139
Diablo 1640 RO	2,622
Intergal Data Paper Tiger	852
NEC 5510 W/Tractors	2,520
Qume Sprint 5 R/O	2,445
TI 810 Basic	1,480

### VIDEO DISPLAY

Hazeltine 1500	\$854
Lear Siegler ADM3A +	812
Televideo 912C	685
Televideo 920C	754
Zenith Z-19	798

### SOFTWARE

Ward Star	\$275
Magic Wand	220

Over 200 computers, CRT's and printers plus software.

All products are new and carry full manufacturer's warranty against original defects. Wholesale prices are subject to change without notice. The Purchasing Agent has a minimum fee of \$75.00.

## THE PURCHASING AGENT

18 Daisy Lane  
Orinda, CA 94563  
(415) 376-9020

# FIRST CLASS Interfacing

CompuPro's feature-packed S-100 I/O boards conform to the IEEE 696/S-100 standard to provide reliable, cost-effective interfacing between your computer and its associated peripherals (such as terminals and printers).

**Interfacer I** is a dual channel, full RS-232 serial board. Hardware UARTs perform all basic I/O operations, thus freeing the CPU from the need to perform these routines; this increases speed and reliability.

**Interfacer II** incorporates one channel of serial I/O (identical to an Interfacer I serial port), three full duplex parallel ports for handling I/O data, and a separate full duplex parallel port for status and interrupt control to give unparalleled interfacing flexibility.

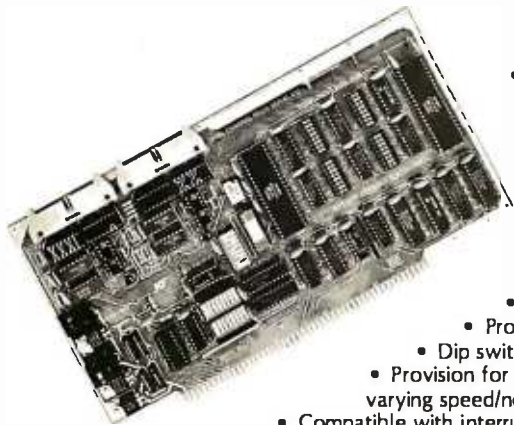

- Dual RS-232 ports with full handshake
- Independently selectable Baud rates for each port, up to 19.2 KBaud – simultaneously drives slow and fast devices (such as teletype/terminal combinations)
- EIA line drivers and receivers
  - Conversion to TTL, current loop (20 mA), and RS-232 levels for interfacing to almost any kind of serial device
  - On-board crystal timebase for freedom from system clock variations
  - Software programmable UART parameters, interrupt enables, and handshaking lines (handshaking lines are full RS-232 – not just a three wire system)
- Operates with 2 or 4 MHz systems
- Provision for optically isolated current loop for each channel
  - Dip switch selectable port addresses
- Provision for custom frequency compensation on both receive and transmit sides (accommodates varying speed/noise situations or unusual cable lengths)
- Compatible with interrupt-driven I/O systems

## Interfacer I

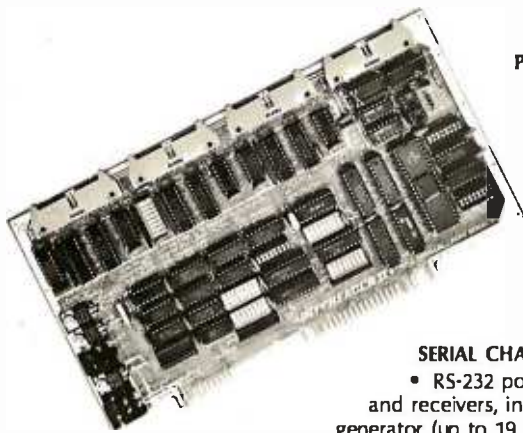

### PARALLEL CHANNELS

- Latched input and output data with 24 mA drive current
- Each full duplex port has strobe, attention, and enable bits (each with selectable polarity); an input interrupt; and 16 data lines, giving a three port total of 48 true data lines
  - Interrupts for each input port
    - Separate 25 pin connectors with power for each channel
    - Separate status port for interrupt mask and port status
    - No mode selection/initialization required
- Handles Centronics type interface, daisy type printers, and interfaces to A/D converters

### SERIAL CHANNEL

- RS-232 port includes all features of an Interfacer I serial channel, such as EIA line drivers and receivers, interfacing to almost any kind of serial device, on-board crystal controlled Baud rate generator (up to 19.2 KBaud), full interrupt capability, etc.
- Works with any software I/O drivers developed for the Interfacer I

## Interfacer II

Either board costs **\$199 unkit** (sockets, bypass capacitors pre-soldered in place), **\$249 assembled**, and **\$324** qualified under the Certified System Component high-reliability program.

These and other CompuPro products are available at finer computer stores world-wide;

write us direct if there's no store in your area.

TERMS: Californians add tax. Allow 5% for shipping, excess refunded. VISA®/Mastercard® orders call (415) 562-0636, 24 hours. Please include street address for UPS delivery.

**CompuPro**™  
Bldg. 725, Oakland Airport, CA 94614

from

**GODBOUT**  
ELECTRONICS

Please note: Several of our unkits have been significantly reduced in price - however, we must caution that unkits are not intended for novice builders. While assembly is simple, de-bugging may be required to bring up an unkit due to such problems as IC infant mortality. It is assumed that most unkit users will have sufficient test equipment and knowledge to do their own de-bugging; however, factory service for unkits is available for a flat service charge.

CompuPro products are also available assembled, or qualified under our high-reliability Certified System Component (CSC) program (200 hour burn-in, extensive testing, more).

## FULLY STATIC MEMORY

Our memories feature fully static design to eliminate dynamic timing problems, IEEE spec compatibility, 4/5 MHz operation, low power, extensive bypassing, and careful thermal design. CSC memories will run with 10 MHz CPU clock, speeds on the S-100 bus (while drawing half the current of non-CSC boards) to give high speed, ultra-low power operation.

If you're looking for specs - if you're looking for performance - if you're looking for exceptional value, then look no further than the RAM series from CompuPro.

### S-100 RAM XX (with bank select and IEEE compatible extended addressing)

	unkit	asm	CSC
16K RAM XX-16	\$319	\$399	\$479
24K RAM XX-24	\$439	\$539	\$629
32K RAM X-32	\$559	\$699	\$799

### OTHER S-100 MEMORY

8K RAM IIA	\$159	\$189	\$239
16K RAM XIV	\$279	\$349	\$429

(Includes IEEE compatible extended addressing.)

### SBC/BLC MEMORY

32K RAM XI	n/a	n/a	\$1050
------------	-----	-----	--------

## COMPUPRO S-100 MOTHERBOARDS: DESIGNED FOR THE FUTURE, AVAILABLE NOW

Specifically designed to handle the new generation of 5 to 10 MHz CPUs coming on line (as well as present day 2 and 4 MHz systems), these advanced motherboards feature Faraday shielding between all bus signal lines to minimize crosstalk, active termination that splits the termination load between each end of every bus line, and mechanical compatibility with Godbout, Vector, Insaic, TEL, and similar enclosures. Available in "unkit" form (edge connectors and termination resistors pre-soldered in place for easy assembly), or fully assembled and ready to go.

- #CK-024 20 slot motherboard with edge connectors -  
unkit \$174, asm \$214
- #CK-025 12 slot motherboard with edge connectors -  
unkit \$129, asm \$169
- #CK-026 6 slot motherboard with edge connectors -  
unkit \$89, asm \$129

## PASCAL/M + MEMORY SPECIAL

PASCAL - easy to learn, easy to apply - can give a microcomputer with CP/M more power than many minis. We supply a totally standard Wirth PASCAL/M 8" diskette by Sorcim, with manual and Wirth's definitive book on PASCAL, for \$150 with the purchase of any memory board. Specify Z-80 or 8080/8085 version. PASCAL/M available separately for \$175. CP/M is a trademark of Digital Research

## OTHER S-100 BUS PRODUCTS

Active Terminator Board	\$34.50 kit
Memory Manager Board	\$59 unkit, \$85 asm, \$100 CSC
Mullen Extender Board	\$59 kit
Mullen Relay/Opto-Isolator Control Board	\$129 kit, \$179 asm

**COMING SOON:**  
The kind of startling  
new RAM development  
you've come to expect  
from the memory leader.  
Stay tuned!

VISIT FINER COMPUTER STORES WORLD-WIDE FOR MORE INFORMATION ON THESE  
OUTSTANDING PRODUCTS, OR WRITE US DIRECT IF THERE'S NO STORE IN YOUR AREA.

**CompuPro**™  
Bldg. 725, Oakland Airport, CA 94614

from **GODBOUT**  
ELECTRONICS

Z80 is a trademark of Zilog  
TR-80 is a trademark of the Tandy Corporation  
PASCAL/M is a trademark of Sorcim

## CPU-Z: 8 BITS OF Z80A POWER FOR THE S-100 BUS

Superior design in a true IEEE-compatible board (timing specs available on request) gives the power for future expansion as well as system flexibility. Includes all standard Z-80A features along with power on jump/clear, on-board fully maskable interrupts for interrupt-driven systems, selectable automatic wait state insertion, provision for adding up to 8K of on-board EPROM, IEEE compatible 16/24 bit extended addressing, and much more. Works with 6 MHz Z80As; supplied with 4 MHz CPU. \$225 unkit, \$295 asm, \$395 CSC.

## CPU 8085/88: 16 BIT DUAL PROCESSING POWER FOR THE S-100 BUS

CPU 8085/88 uses an 8088 CPU for true 16 bit power with a standard 8 bit S-100 bus, and an 8085 for compatibility with CP/M and 8080 software. Accesses up to 16 megabytes of memory, meets all IEEE S-100 bus specifications (timing specs available on request), runs 8085 and 8086 code in your existing mainframe as well as Microsoft 8086 BASIC and Sorcim PASCAL/M, runs at 5 MHz for speed as well as power, and is built to the same stringent standards that have established our leadership in S-100 bus components. \$295 unkit, \$425 asm, (both operate at 5 MHz); \$525 CSC (with 5 MHz 8085, 6 MHz 8088).

CPU 8085 (single processor version of above): \$235 unkit, \$325 asm, \$425 CSC.

## SPECTRUM S-100 COLOR GRAPHICS BOARD

Includes 8K of IEEE-compatible static RAM; full duplex bidirectional parallel I/O port for keyboard, joystick, etc. interface; and 6847-based graphics generator that can display all 64 ASCII characters. 10 modes of operation, from alphanumeric/semi-graphics in 8 colors to ultra-dense 256 x 192 full graphics. 75 Ohm RS-170 line output and video output for use with FCC approved modulators. \$339 unkit, \$399 asm, \$449 CSC. You don't have to settle for black and white graphics or stripped-down color boards; specify the CompuPro Spectrum.

Want graphics software? Sublogic's 2D Universal Graphics Interpreter (normally \$35) is yours for \$25 with any Spectrum board purchase.

## 2708 S-100 EPROM BOARD \$85 unkit

4 independently addressable 4K blocks, with dipswitch selectable jump start built right into the board. Includes all support chips and manual, but does not include EPROMs.

## GODBOUT COMPUTER ENCLOSURE \$289 desktop, \$329 rack mount

This handsome enclosure does justice to the finest computer system. Includes dual AC outlets and fuseholder on rear, heavy-duty line filter, and black anodized front panel (with textured vinyl painted cover for desktop version). Pre-drilled base accepts our high-performance S-100 motherboards or types by Vector, California Digital, and others. Rack mount version includes slides for easy pull-out from rack for maintenance or board changing.

## NEW LOW PRICE 16K DYNAMIC RAMS - 8/\$39!!

Lowest price ever on one of our most popular items. Expands memory in TRS-80\* -I and -II, as well as machines made by Apple, Exidy, Heath H89, newer PETs, etc. Low power, high speed (4 MHz). And \$3 for 2 dip shunts plus TRS-80\* conversion instructions. Limited quantity - first come, first served.

## DC ROBOT MOTOR SPECIAL

DC fractional horsepower motor runs on about 1 to 5V. Not a servo motor by any means, but good for experimenting with robots, toys, games, etc. 10/\$2.95

**FREE CATALOGUE:** Find out more about our product line. For 1st class delivery, add 41 cents in stamps; foreign orders add \$2 (refundable with order).

**TERMS:** Cal res add tax. Allow 5% for shipping, excess refunded. Orders under \$15 add \$1 handling. VISA®/Mastercard® orders (\$25 min) call (415) 562-0636, 24 hrs. Please include street address for UPS delivery. Sale prices good through cover month of magazine, other prices subject to change without notice.

# Digital Storage of Images

---

Thomas Williams  
39A Mill St  
Maynard MA 01754

---

The availability of inexpensive computer memory has brought high-resolution gray-scale and color graphics within the reach of the home computer experimenter. Over the last decade the ability to capture video signals in digital form, manipulate the stored data, and display it has moved from military and research engineers to undergraduates and interested hobbyists.

## Quantization

Before examining methods of capturing video signals, let's look at image quantization, which is the process of converting an image into one or more arrays of numbers. The value of each array element represents the measure of light present in the area of a corresponding point in the original image. These array or picture elements are called pixels.

A typical gray-scale image might be quantized into a two-dimensional array of values that range from 0 to 15, representing intensity values from black to white. If the array were 256 by 256 elements or 64 K pixels, each with a 4-bit value, the array would occupy 32 K 8-bit bytes of memory.

## Scanning

To perform the quantization, the image is scanned by a transducer capable of converting light into an electronic signal. This signal is sampled periodically, and each sample is converted into a numeric value. Transducer sensitivity, scanning rate, and sampling rate all affect the quality and form of the digital image.

There are basically four methods of

scanning images. The first requires the movement of the transducer with respect to the image or scene. This is typically done by drum scanners where an image is spun under a light source and photodiode. (See figure 1.)

---

No matter how much effort is spent on improving the system, the results are only as good as the input.

---

The second method deflects either a light beam or sensor optics in two dimensions to scan the image. This method is often used in a device called a flying-spot scanner; such devices were used during the first decades of television for transferring movies to video form for broadcast.

The third method is the use of a television camera. In a television tube (ie: a vidicon) the image is focused on a target that is scanned with an electron beam. (See figure 2.) It can be thought of as a CRT (cathode-ray tube) working in reverse.

The fourth method, which is still rather expensive, is the photodiode-array camera. It uses an integrated circuit which contains an array of photodiodes and circuitry to help scan the array. Advantages of this camera over vidicons are the stability of its geometry (as vidicons require electron-beam deflection which is never completely repeatable and accurate) and the inherent immunity to

shock (as vidicons are vacuum tubes and thus sensitive to abuse).

## Video Costs

As with anything electronic, there are uncontrollable costs of precious metals and precision parts, and controllable costs of design and assembly. Hardware hobbyists with good supplies of parts can usually find clever ways of cutting costs. Most of us, though, have limited resources and must buy kits or search for bargains on assembled equipment. Video cameras sometimes show up at flea markets in various states of repair and can provide you with a good video signal at very low cost. Home-video enthusiasts and closed-circuit security systems have also provided a marketplace for inexpensive cameras.

Cameras with sufficient quality for use with digital image-capture systems can be quite expensive. The increased costs usually provide more geometric linearity and a more uniform imaging-target surface. Black-and-white cameras range in price from about \$200 to \$10,000. At the lower end of the price scale you can expect about 5% error in the linearity of the vertical and horizontal scanning. Usually these errors are not noticeable. Geometric linearity is only important when the image-capture system is used for a precise geometric task, such as measurement of object size.

Target nonuniformity is a source of concern. Inexpensive cameras may have differences in video level (for uniform illumination) across the im-

# Why is the 88G Printer the new industry leader?



## QUALITY

The attractive, durable 88G casework is formed from impact-resistant, flame-retardant Styron. Microprocessor controlled stepper motors provide precision control over print head and paper positioning. Computer quality tractors position paper for readability and are fully adjustable to accommodate varying paper widths.



## LONG LIFE RIBBON CARTRIDGE

Ribbon difficulties are minimized through use of a continuous loop cartridge with a five million character life. It is easily changed without opening the case, and without any complicated or messy threading operations.



## VERSATILITY

The 88G prints a full upper and lower case 96 character ASCII set with a crisp, clear 7x7 matrix in 80, 96, or 132 column formats. For text processing and correspondence applications, an 11x7, 80 column serif style matrix can be selected by switch or software command. The dual tractor/pressure-feed paper drive system allows the user to choose either pin-feed, roll, or single sheet papers up to 9.5 inches wide.

Complete forms control allows the 88G to be quickly configured for printing single or multiple-ply invoices, purchase orders, checks, or any type of preprinted form. Optional paper roll holders and single sheet feeders can be quickly attached.

The wide use range of the 88G makes it the perfect companion for business systems, data processing, RO teleprinter and terminal printer applications.

## GRAPHICS

A high-resolution, dot-addressable graphics option can be added for applications requiring plotting, printing of screen graphics, drawings, illustrations, etc. Single dot print resolution greatly extends the usefulness of the graphics capability. Selection of one of the four horizontal dot densities available customizes the graphic printout, and alphanumeric characters can easily be included for titling of graphs and illustrations.

## PRICE

Every detail is directed toward providing a heavy-duty, commercial quality printer for only \$749.00. No other printer on the market today can provide its quality, features and performance at a comparable price. The 88G is an obvious industry leader.



## MICROPROCESSOR CONTROLLED INTERFACE

The microprocessor array provides the intelligence for a dual RS232 serial and a Centronics® type parallel interface. Both inputs are fully buffered to allow the 88G to receive data and print simultaneously. A 1K character buffer is standard with a 2K buffer available as an option.

The short line thruput of the 88G has been increased by incorporation of a *Quick Cancel* feature that fully utilizes the bidirectional/unidirectional printing capabilities. Built-in diagnostic and self-test capabilities allow the user to easily pinpoint system problems and a *Power On* confidence test verifies operational status of the printer each time power is applied.



®Centronics is a registered trademark of the Centronics Data Computer Corp.

# **mpi**

Micro Peripherals, Inc.  
2099 West 2200 South  
Salt Lake City, Utah 84119  
Phone (801) 973-6053

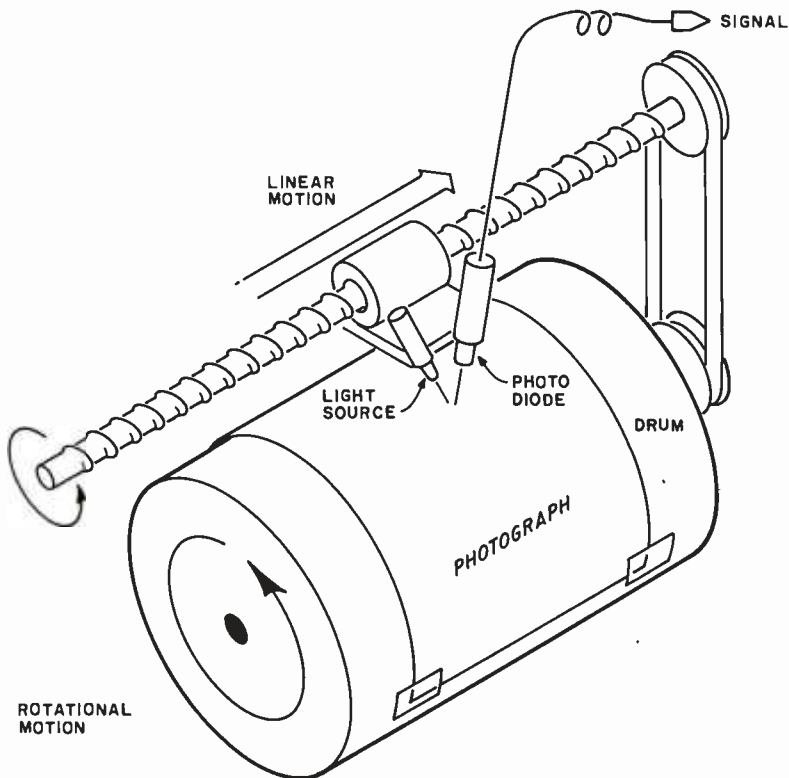

**Figure 1:** A drum scanner produces high-quality results by moving the photograph relative to the sensor. Its drawbacks are that it requires precision mechanical construction, works very slowly, and the signal it produces is not video-compatible.

age as much as 20%. This error (also called *shading*) is still present in more expensive cameras where it's typically reduced to 10% or less. Fortunately, the shading effect changes slowly across the image target. Actual defects in the target are often found in inexpensive cameras, leading to black or white spots in the image.

It is possible to make some correction for the effects of shading and defects after the image is quantized. To do so, you first quantize an image of a solid-gray surface. The deviation of each point's value from the average value indicates the amount of correction that is necessary. By storing this image (or an image of corresponding correction values) the recorded target sensitivity can be used to improve the quality of another image quantized from the same television camera.

A television camera is to an image-capture system as an antenna is to a television set. No matter how much effort is spent on improving the system, the results are only as good as the input. Although the system can be made to compensate for some of the deviations in the camera, improvement of the video source is usually the choice for further investment once an image-capture system is in place.

A video image is normally generated in a 4:3 aspect ratio. This means that a properly operating camera produces it in a format that must be presented on a screen with three units of height and four units of width. Typical television sets are adjusted to approximately this ratio. If the video signal is quantized into a square array of square pixels, only a portion of each line should be quantized. (See figure 5.) Because there are approximately 512 lines of useful video image in a frame (approximately 256 lines in a field), it is often convenient to work with 512 or 256 squared resolutions. Some manufacturers of quantizers offer nearly square pixels by quantizing during 3/4 of the horizontal period, while others offer square pixels by digitizing the entire image at 640 by 512, 320 by 256, or other resolutions. Still others offer rectangular pixels. To achieve square pixels, the sampling rates must be increased by a factor of 1.33. If the entire image is to be quantized with square pixels, the memory requirements must also be increased by a factor of 1.33.

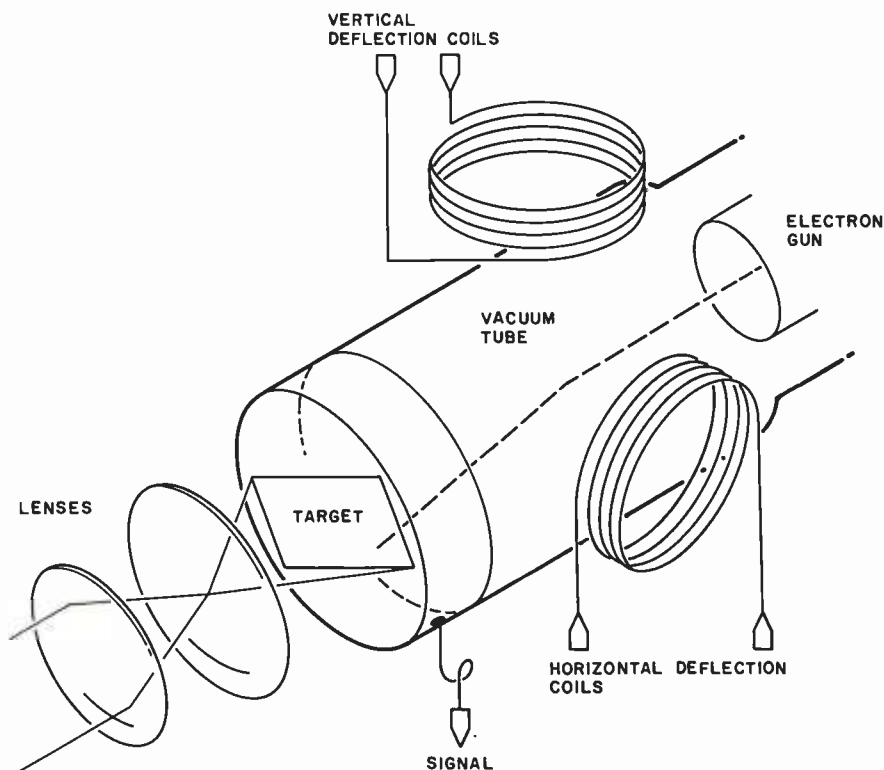

**Figure 2:** A vidicon tube. This most popular method of converting an image into an electronic signal uses a photo-sensitive imaging target which is scanned by an electron beam. The resulting signal is the scanned image in the form of a changing voltage. Disadvantages of the vidicon are its unstable geometry (since electron-beam deflection is never completely repeatable and accurate) and its low resistance to shock (since vidicons are vacuum tubes).



# If you want a choice in print wheels, there's only one choice in printers.

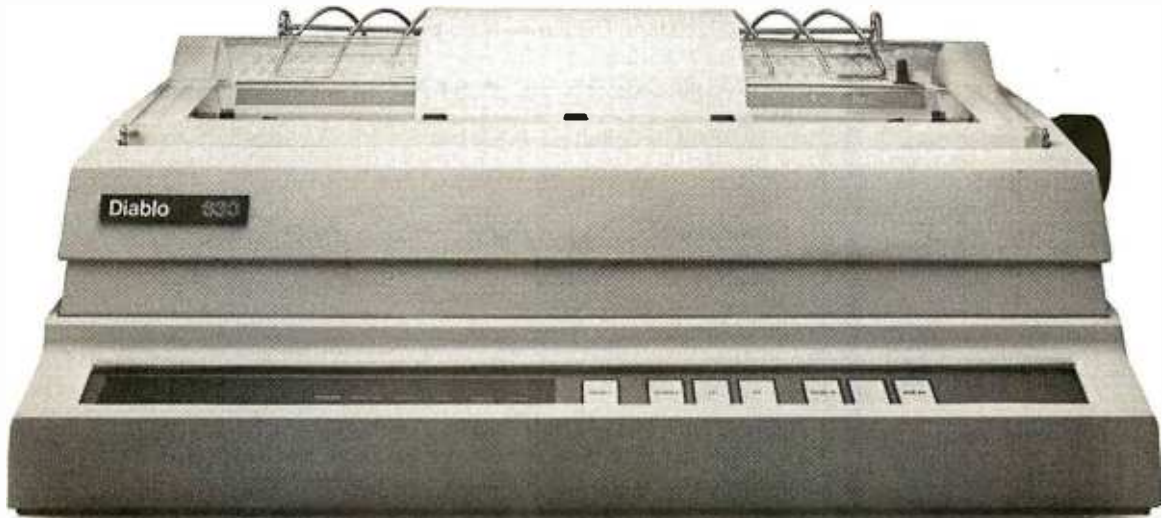

The Diablo 630.

It's the only printer that lets you use either metal or plastic print wheels. So you can choose the print wheel that's just right for the job.

The 630 works as well with a 96-character plastic daisy print wheel as it does with an 88-, 92-, or 96-character metal daisy print wheel. In over 100 different type styles.

Every 630 has fewer moving parts than competitive printers, which makes it more reliable. And it offers unsurpassed print quality. Compatibility with Diablo supplies. And bi-directional printing capability.

The 630 is the only printer in the world that uses both metal and plastic wheels.

So if you want to change your print wheels, you'll just have to change your printer.

To a Diablo 630 printer.



## Diablo Systems

## XEROX

Diablo® and XEROX® are trademarks of XEROX CORPORATION.

Circle 139 on Inquiry card.

BYTE November 1980 223

# S-100 Monitor/Control Modules . . .

Order these heavy duty industrial quality boards—best overall specs in the industry, finest components and workmanship, IEEE standard for S-100 bus.



Guaranteed to operate with Cromemco, North Star and most other S-100 systems. All manuals include applications programs in BASIC. DIP switch selectable port base address.

## A/D MODULE

Dependable high-speed analog-to-digital conversion. 12-bit precision. 32 single-ended input channels, or 16 true differential inputs. High-speed sample and hold amplifier. 25  $\mu$ sec conversion time. Precision analog multiplexer. Vectored interrupt capability. Optional instrumentation amplifier with gain from 1 to 1,000. AIM-12, standard input module with instrumentation amplifier . . . \$725  
AIM-12B, input module only . . . \$635  
AIM-11B, 11-bit precision module . . . \$575

## D/A MODULE

Four independent channels for digital-to-analog conversion. 12-bit precision over full 0° to 70°C range. Jumper selectable outputs. Binary or 2's complement digital inputs. Flexible bit-mapping jumpers allow compatibility with any existing I/O mapped software (either 12- or 8-bit). Super simple programming. AOM-12, output module . . . \$495

## REAL TIME CLOCK

Features new OKI CMOS clock chip for day, date, hours, minutes, and seconds. 12 or 24 hour time format. On-board battery backup. Full year operation without battery replacement. Read or write time directly from I/O port. Vectored interrupt capability. CLK-24 . . . \$250

**ALSO AVAILABLE:** Industrial control output current module, 4-20 mA — \$395. Nonvolatile CMOS memory, 250 nsec, 4K bytes with battery backup — \$395. 8K CMOS memory — \$590. 16K CMOS memory — \$990. Thermocouple compensation module — \$350.

California: add 6% tax.  
**Money back guarantee. 10-day trial.**  
OEM and dealer inquiries invited.



system reliability/system integrity  
**DUAL SYSTEMS CONTROL CORP.**  
1825 Eastshore Hwy., Dept. B  
Berkeley, CA 94710 (415) 549-3854

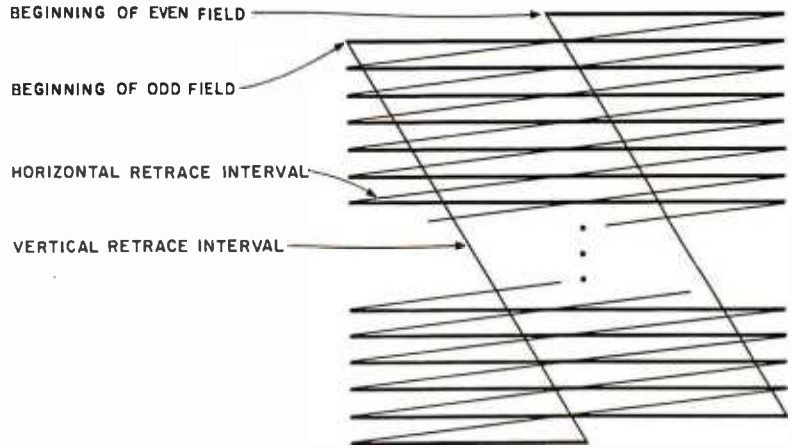

Figure 3: Video lines are interlaced in a 2:1 ratio to reduce image flicker. Each frame of a video image (1/30 second) is made up of two fields. During the first 1/60 second the even-numbered lines are scanned, followed by the odd-numbered lines during the second 1/60 second. The luminance signal (black-and-white intensity) is indicated by the heavy lines. The narrow lines indicate intervals during which the electron beam is off in order for the deflection circuits to prepare for the next luminance signal.

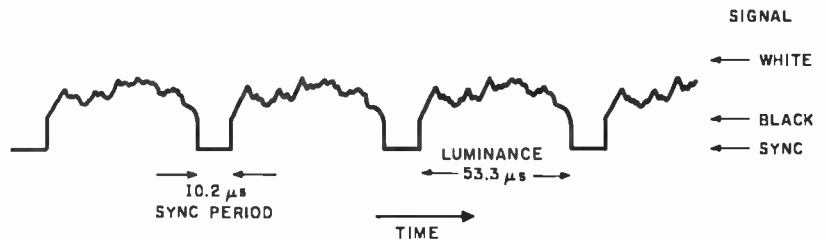

Figure 4: Each line of a video signal is composed of a horizontal active-line period (53.3  $\mu$ s), which contains the luminance information, and a sync period (10.2  $\mu$ s), which contains reference levels and the horizontal sync period.

## Noise and Averaging

Video signals, like all signals, contain noise. It arises from several sources, primarily the circuits which amplify the sensor output. Very high quality video sources can have signal-to-noise ratios exceeding 45 dB. This is approximately equivalent to a noise of  $\pm 1/2$  the least-significant bit in a 7-bit quantization. However, many inexpensive home cameras, videotape, and off-the-air sources often exhibit signal-to-noise ratios worse than 25 dB or about  $\pm 1/2$  the least-significant bit in a 4-bit quantization. Why is it that such noisy video is still quite acceptable to a viewer? The noise is random; it changes every 1/30 second; and the eye averages out the noise. If you carefully view still video frames, such as on television sports events, the noise becomes apparent.

To improve the noise figure and the quality of the captured image, a number of frames can be pointwise averaged. Several frames are used to accomplish this: the first frame is

digitized and stored; the second and successive frames are digitized; and each value is added to the corresponding stored value. The resulting array of numbers is divided by the number of frames used. Thus, the value for each point becomes the average of digitized values for that point across all the frames used, effectively cancelling out random noise. The improvement can be quite dramatic in situations where considerable noise is present. One can expect to achieve about  $6.3 \times \log_2 N$  dB improvement for  $N$  frames up to a practical limit of about 45 dB. This maximum figure depends on the signal source, and the improvement depends on the randomness of the noise.

## Sampling

The process of quantization consists of a sampling and a digitization phase. The sampling phase determines exactly when the signal value is to be frozen in time so the instantaneous value can be converted into a

# CHRISLIN YEARS AHEAD IN MEMORY DESIGN

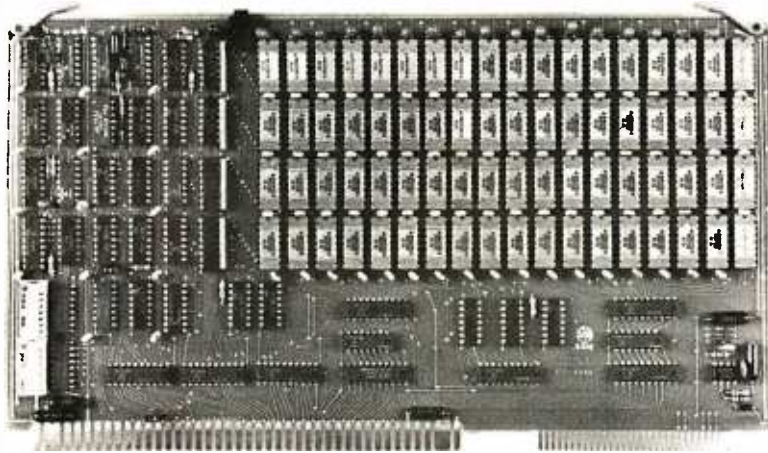

**WE'VE DONE IT AGAIN** — State of the Art Multibus® Memory Design. First to offer up to 512K on one board, and CHRISLIN again brings pricing sanity to the memory market. Why pay over \$2000 for our competitor's 64K x 8 memory board when we will give you the CI-8086 128K x 9 memory for just \$1500 or better yet, the CI-8086 512K x 9 memory module for \$4700.

Up to 512K bytes in a single option slot. Available in 64K, 96K, 128K, 256K, or 512K configurations. On board parity generator checker, for both 8 bit or 16 bit systems. Off shelf deliveries.

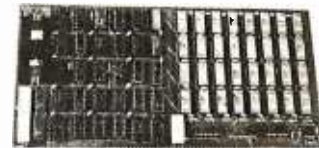
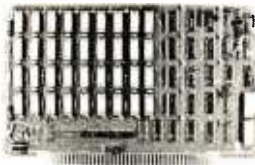

**CI-6800-2** — 16KB to 64KB. Plugs directly into Motorola's EXORciser I or II. Hidden refresh up to 1.5 Mhz. Cycle stealing at 2 Mhz. Addressable in 4K increments with respect to VXA or VUA. On board parity. **64K x 9 \$995.00.**



**CI-S100** — 16KB to 64KB. Transparent hidden refresh. No wait states at 4 Mhz. Compatible with Alpha Micro and all Major 8080, 8085 and 280 Based S100 Systems. Expandable to 512K bytes thru Bank Selections. **64K x 8 \$750.00.**

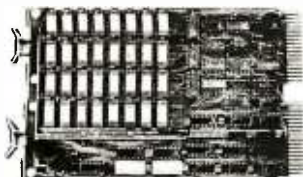

**CI-8080** — 16KB to 64KB on a single board. Plugs directly into MDS 800 and SBC 80/10. Addressable in 4K increments up to 64K. **16KB \$390.00. 64KB \$750.00.**

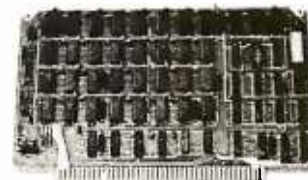

**CI-1103** — 16KB to 256KB on a single dual height board. Plugs directly into LSI 11/2, H11 or LSI 11/23. Addressable in 2K word increments up to 256KB. **8K x 16 \$390.00. 32K x 16 \$750.00. 128K x 18 \$2880.00.**

**CI-6800** — 16KB to 64KB on a single board. On board hidden refresh. Plugs directly into EXORciser I and compatible with Rockwell's System 65. Addressable in 4K increments up to 64K. **16K x 8 \$390.00. 64K x 8 \$750.00.**

Tested and burned in. Full year warranty.

***DON'T ASK WHY WE CHARGE SO LITTLE, ASK WHY THEY CHARGE SO MUCH.***



## ***Chrislin Industries, Inc.***

Computer Products Division

31352 Via Colinas • Westlake Village, CA 91362 • 213-991-2254

Multibus is a trademark of the Intel Corp.

LSI II is a trademark of Digital Equipment Corp.

EXORciser is a trademark of Motorola.

number (ie: digitized). The sampling function is accomplished by periodically pulsing a sample circuit. The value of the video signal is then used to charge a capacitor that holds that value during the time needed by the digitizer until the next sample pulse. A sample-and-hold circuit provides the necessary components in hybrid or monolithic form. (See figure 6.)

The choice of sampling rate determines the spatial resolution with which the video signal is quantized. The sampling theorem tells us that a sample frequency must be chosen that is at least twice the value of the highest frequency component in the signal that we wish to record. Thus if we choose to sample at 10 MHz, or once every 100 ns, we will be able to record components of the video signal which are changing at rates up to 5 MHz. Sampling at this rate guarantees adequate data for all normal black-and-white video sources, since they contain very little energy beyond 4 MHz.

Examination of the sampling process shows that if there are frequency components in the signal above half of the sampling rate, false informa-

tion (called *aliasing*) results. (See figure 7.) The aliasing component is effectively a beat frequency between the sampling frequency and the signal components above *half* the sampling frequency. In the case of standard video, the luminance signal is already filtered to roll-off in amplitude above 4 MHz. However, the chrominance signal in color video occupies the range from about 3 MHz to 4.5 MHz.

Therefore, you must either filter the signal to remove frequencies above about 3 MHz, derive a pure luminance signal from a properly designed video demodulator, or use a strictly luminance source, such as a black-and-white television camera. When digitizing at lower resolutions (and sampling at lower rates), the signal must be filtered accordingly.

The quality of a quantized video signal depends on accurate timing. If every element of the digital image is to be precisely aligned with the corresponding element in the video lines above and below it, the digitizer clock must be precisely synchronized with the television horizontal-sync signal. Also, the digitizer clock must not drift during the time between

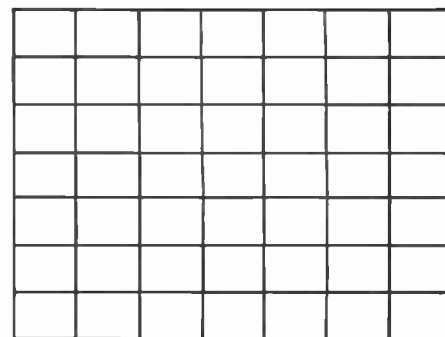

(a)

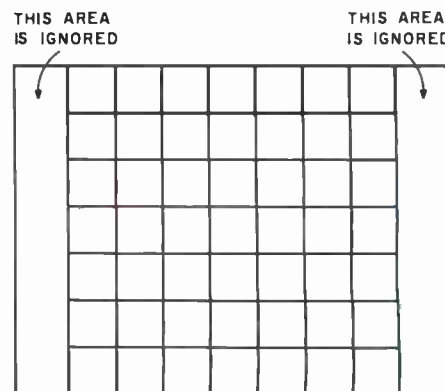

(b)

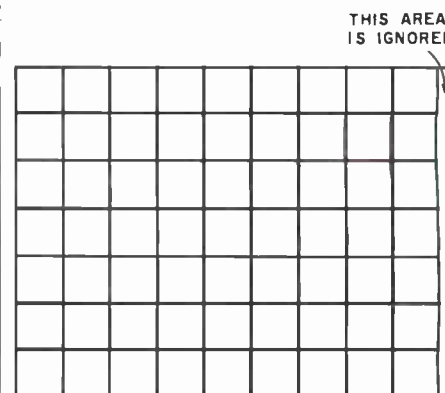

(c)

**Figure 5:** The aspect ratio (width:height) of normal video is 4:3. The aspect ratio of each individual pixel is determined by the image-sampling rate.

**a:** This 7 by 7 square array of rectangular pixels is produced by sampling the same number of points per line as there are lines in a frame. For example, each line in an American-standard television frame (512 lines) would be scanned as 512 points.

**b:** By increasing the sampling rate by 1.33, square pixels result and a 7 by 7 array results from a square portion of the frame.

**c:** With the same increase in the sampling rate as in b, nearly the entire frame can be quantized into a 9 by 7 rectangular array of square pixels.



## PUT TIME AND BSR CONTROL IN YOUR APPLE II

# THUNDERCLOCK PLUS™

**AN INTERFACE FOR THE BSR X-10**

- Control AC outlets with your BSR Command Console and APPLE II
- All 22 BSR commands at your program's fingertips
- Up to 128 separate dim/bright levels
- THUNDERWARE'S Scheduler software will control AC outlets in the background, while you run another program in the foreground

**A REAL-TIME CLOCK/CALENDAR**

- Provides month, date, day-of-week, hour, minute, and second
- Software selectable time formats: 24 hour or AM/PM ASCII string, or as numeric values
- Provides interrupts which can be enabled or disabled under software control
- On board battery allows accurate time-keeping for up to 2 years even with your APPLE turned off

**BOTH FEATURES ON ONE CARD**

- On-board firmware makes the THUNDERCLOCK PLUS™ exceptionally easy to use
- Read or set time, control interrupts, and send BSR commands with simple BASIC "INPUT" and "PRINT" statements
- Completely APPLE II compatible: INT and FP BASIC or PASCAL with Unit support
- At an affordable introductory price for both!

THUNDERCLOCK PLUS™.....	\$119.00
Clock, BSR interface, and User's manual	
THUNDERWARE SCHEDULER.....	\$24.95
Diskette with Scheduler, examples, demos, and Scheduler manual	
PASCAL SOFTWARE.....	\$19.95
Diskette with PASCAL Unit for clock and BSR interface	

**TO ORDER TOLL FREE (VISA/MC) CALL:**  
800-227-6204 Ext. 307 (Outside California)  
800-632-2131 Ext. 307 (California Only)  
California residents add 6% sales tax  
BSR X-10 is a trademark of BSR (USA) LTD. APPLE II is a trademark of APPLE COMPUTER, INC



**OR WRITE FOR INFORMATION:**  
THUNDERWARE INCORPORATED  
P.O. Box 13322, Oakland, CA 94661

# Elegance and power in a mathematical language.

## APL

by Phelps Gates.



Software you can rely on.

Now, a high-level, scientific programming language that doesn't cost \$200 or \$300 for the home computer. This language is perfect for the mathematician, scientist, engineer, or anyone who just wants to learn a new language. The power of this language is in its strong mathematical operations, especially with regard to matrices and vectors. Programs requiring matrix multiplication or other matrix problem solving that would require hours of programming time in BASIC are solved quickly and with effort in APL. Not only is math made easy, but upon gaining proficiency in APL programming various string manipulations become child's play.

To aid in learning APL, lessons are included on the disk. Starting from the basics, you are brought step by step through the various programming techniques involved with APL. These lessons act as a tutor in a "learning by doing" atmosphere which will have you "talking APL" in no time. Also available is the book, **APL: An Interactive Approach**, which reinforces many of the examples given in the lessons. The book also provides additional insight into APL programming.

### LIMITATIONS

Due to the absence of the special APL character set on the TRS-80, APL-80 uses shifted letters to represent the various APL characters. These shifted letters are identified on the screen by a graphics block before each shifted letter. If you have a modified TRS-80 (Electric Pencil Modification), a lower case driver is included to display the shifted letters on the screen.

In addition to the keyboard limitations, there are several other limitations. Lamination, domino, and matrix inverse are not implemented but can be derived with user-defined functions.

Multiple specifications must be split into two statements unless the left-hand assignment is to a quad. This also applies to implied multiple specifications.

Reduction and reshape (p) are not permitted for empty arguments; the argument of add/drop may not be scalar; empty indices are not permitted.

A quad (q) can't be typed in response to a quad (nor can the name of a function which itself gets input from a quad). Quote-quad (m) is permitted.

No more than 32 user functions can be defined in a single workspace and a function may not contain more than 255 lines.

A comment (c) must occupy a separate line; a comment can't follow a function statement on the same line.

In the tape version, arrays are limited to five (5) dimensions.

### FEATURES

APL-80 on disk contains the following features: )SAVE and )LOAD workspace on disk; )COPY other workspaces into current ones; Return to DOS for directory or commands without losing your workspace; Send output to lineprinter; Five workspaces of lessons included; Sequential and random files; 15 digit precision; Monadic and dyadic transposition; Easy editing within FUNCTION lines; Latent expression (FUNCTION can "come up running" when loaded); Tracing of function execution; Real-time clock; User-control of random link; Workspace is 25587 bytes (in 48K machine); Arrays may have up to 63 dimensions.

### COMMANDS | APL-80

APL-80 supports the following commands: Absolute value, add, and, assign, branch, catenate, ceiling, chr\$/asc, circular, combinatorial, comment, compress, deal, decode, divide, drop, encode, equal, expand, exponential, factorial, floor, format, grade down, grade up, greater, greater/equal, index generator, indexing, index of, inner product, label, less, less/equal, logarithm, maximum, member, minimum, multiply, nand, negate, nor, not, not equal, or, outer product, peek, poke, quad, quote quad, random, ravel, reciprocal, reduction, reshape, residue, reverse, rotate, scan, shape, sign, system, subtract, take, transposition.

### SPECIFICATIONS

Minimum system requirements: 32K disk system (48K recommended) Includes APL-80, Five workspaces of lessons, instruction manual.

Price: \$39.95 on disk

Reduced feature: 16K Level II tape version, no lessons.

Transpositions, format, and inner product not implemented. Reduced domain for some functions. 6 digit accuracy.

Price: \$14.95 on cassette

**APL: An Interactive Approach**

Price: \$16.95 (\$3.00 shipping charge)

## *The Software Exchange*

TO ORDER TOLL-FREE

1-800-258-1790

(In NH call 673-5144)

# SAVE MORE THAN 20%

NORTH STAR — INTERTUBE — MICROTEK  
ZENITH — RCA-COSMAC — ITHACA  
THINKER TOYS — GODBOUT — SUPERBRAIN

The smartest computers at the smartest price



FACTORY ASSEMBLED & TESTED		LIST ONLY	
HORIZON-1-32K-DOUBLE DEN		\$2895	\$1994
HORIZON-2-32K-DOUBLE DEN		3095	2299
HORIZON-2-32K-QUAD DENSITY		3595	2899
HORIZON-2-84K-QUAD+HARD DISK		9329	7199
HORIZON MEMORY ASSM	18K 389 32K	579	
HORIZON MEMORY KIT	18K 359 32K	535	
NORTH STAR HARD DISK 18 Mb		4999	3939
PASCAL FOR NORTH STAR ON DISK		199	150
Powerful NORTH STAR BASIC. The Best			FREE
2 NORTH STAR SOFTWARE DISKS w/HORIZON			FREE
NSSE 1-22 & P01 TERRIFIC PROGRAMS		ONLY	10
NORTHWORD 299 MAILMAN 239	INFOMAN	389	
RCA-COSMAC VP-111 99	RCA COSMAC VP-711	189	
COLORI RAINBOW 385 CAT-100 1389	SPECTRUM	289	
ITHACA FRONT PANEL COMPUTER 84K		3195	2895
Z-8001 CPU CARD 18-bit ITHACA S-100 8Mb			1179
ITHACA MEMORY 8/18-bit 84K		995	845
SEATTLE 8088 CPU 18 bit 10 x faster			550
SEATTLE MEMORY 8/18 BIT 18K 4MHz			358
SSM KITS Z-80 CPU 221 VIDEO BRD VB3 4MHz			412
MEASUREMENT MEMORY 84K A & T 4MHz			598
MEASUREMENT MEMORY 84K BANK SELECT			789
ECONDRAM XIV UNKIT 18K	299	254	
CENTRAL DATA 84K RAM	885	589	
DISCUS/20 A & T + CP/M	1199	975	
THINKER TOYS HARD DISK 28 Mb	4995	3995	
DISCUS/2+2 1.2 Mbytes A & T	1549	1285	
TARBELL DISK CONTROLLER DD	495	445	
TARBELL CASSETTE INTERFACE KIT	120	109	
SUPERBRAIN	2995	2385	
SUPERBRAIN QUAD DENSITY	3995	2995	



ZENITH-HEATH Z-89 48K	2895	2495
INTERTUBE II SMART TERMINAL	995	725
ZENITH-HEATH SMART TERMINAL	995	739
ZENITH-HEATH WH-11 18bit COMPUTER		2895
CAT NOVATION MODEM	179	189
MICROTEK PRINTER	795	875
ANADEX PRINTER DP-8000	995	885
ANADEX PRINTER DP-9500-1	1650	1389
NEC PRINTER Fast Typewriter Quality	2915	2789
SECRETARY WORD PROCESSOR The Best!	85	77
TEXTWRITER III Book Writing Program	125	112
GOFAST NORTH STAR BASIC Spander Upper	79	71
PDS SUPER Z-80 ASSEMBLER & More	99	89
SUPER BASIC DEBUGGER 889 COMPILER 135	HDS	40
EZ-80 MACHINE LANGUAGE TUTOR 25	STATISTICS	190
EZ-CODER Translates English to BASIC	79	71
ECDOSOFT FULL ACCOUNTING PKG	350	315
BOX OF DISKETTES 29 IN PLASTIC CASE		30
Which Computers are BEST? BROCHURE		FREE
North Star Documentation refundable w/HRZ		20

ORDER 2 or more COMPUTERS... BIGGER DISCOUNTS  
YES WE WILL BEAT OUR COMPETITION'S PRICE!  
FACTORY ASSEMBLED & FACTORY WARRANTY

## AMERICAN SQUARE COMPUTERS

KIVETT DR • JAMESTOWN NC 27282  
(919)-889-4577

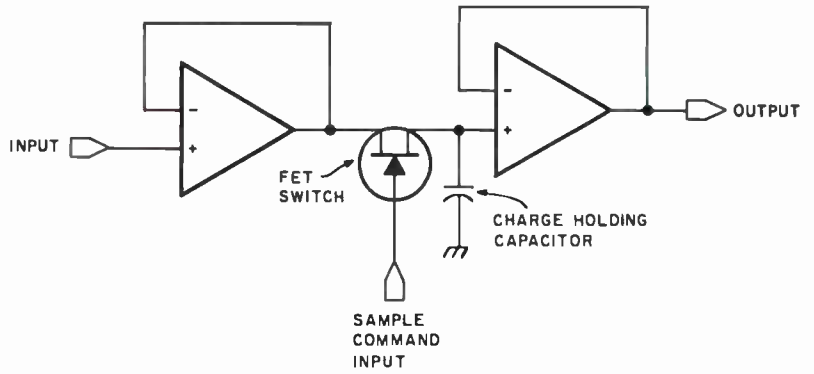

Figure 6: An image is quantized in two phases: sampling and digitization. Sampling freezes the signal value so that it can be converted into a number (digitized). A sample-and-hold circuit such as shown here performs the sampling phase. Because of the low output impedance of the first operational amplifier, the capacitor is charged nearly instantaneously when the switch is operated by the video signal. The high input impedance of the second operational amplifier holds the capacitor at its full charge during the time the digitizer reads the signal.

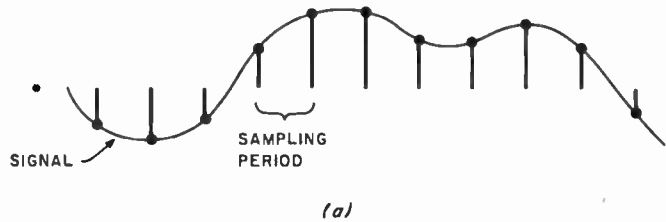

Figure 7a: A correctly sampled video signal. Each dot indicates an instantaneous value read by the digitizer.

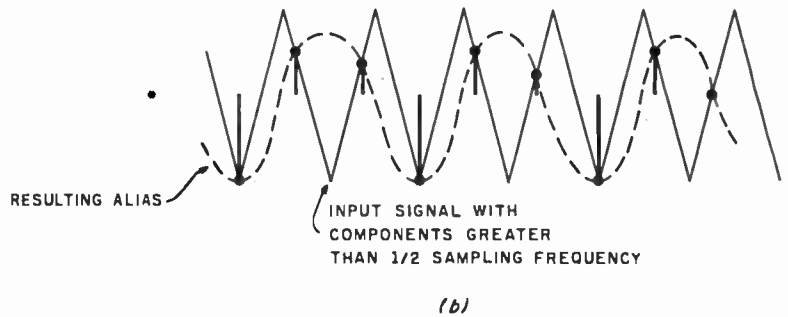

Figure 7b: If high-frequency components are present in the video signal which are above one-half the sampling rate, false information (aliasing) results. Aliasing is a beat frequency between the sampling frequency and those signal components above one-half the sampling frequency. A low-pass filter is used to filter the frequency components and eliminate aliasing.

horizontal-sync pulses. It is as much the attention to timing as to the high-speed technology that makes quality digitized video a reality.

### Low-Speed Digitization

The digitizer, or A/D (analog-to-digital) converter, is commonly thought of as a device that takes on the order of 20  $\mu$ s to 50  $\mu$ s to determine an 8-bit or 12-bit value. Such converters are inexpensive and are adequate for sampling slowly changing signals, such as an audio signal.

To digitize a video signal with such a converter, you can sample the signal no more often than about once per scan line. (See figure 8.) During the first frame, the first point of each line is digitized. During the second frame, the second point of each line is digitized, and so forth, until the entire image is digitized. If 512 samples per line are needed, 512 frames of video would be required to digitize every point. Thus, it would take about 17 seconds to complete the digitization of one frame. To do this the camera

# The Empire has expanded!

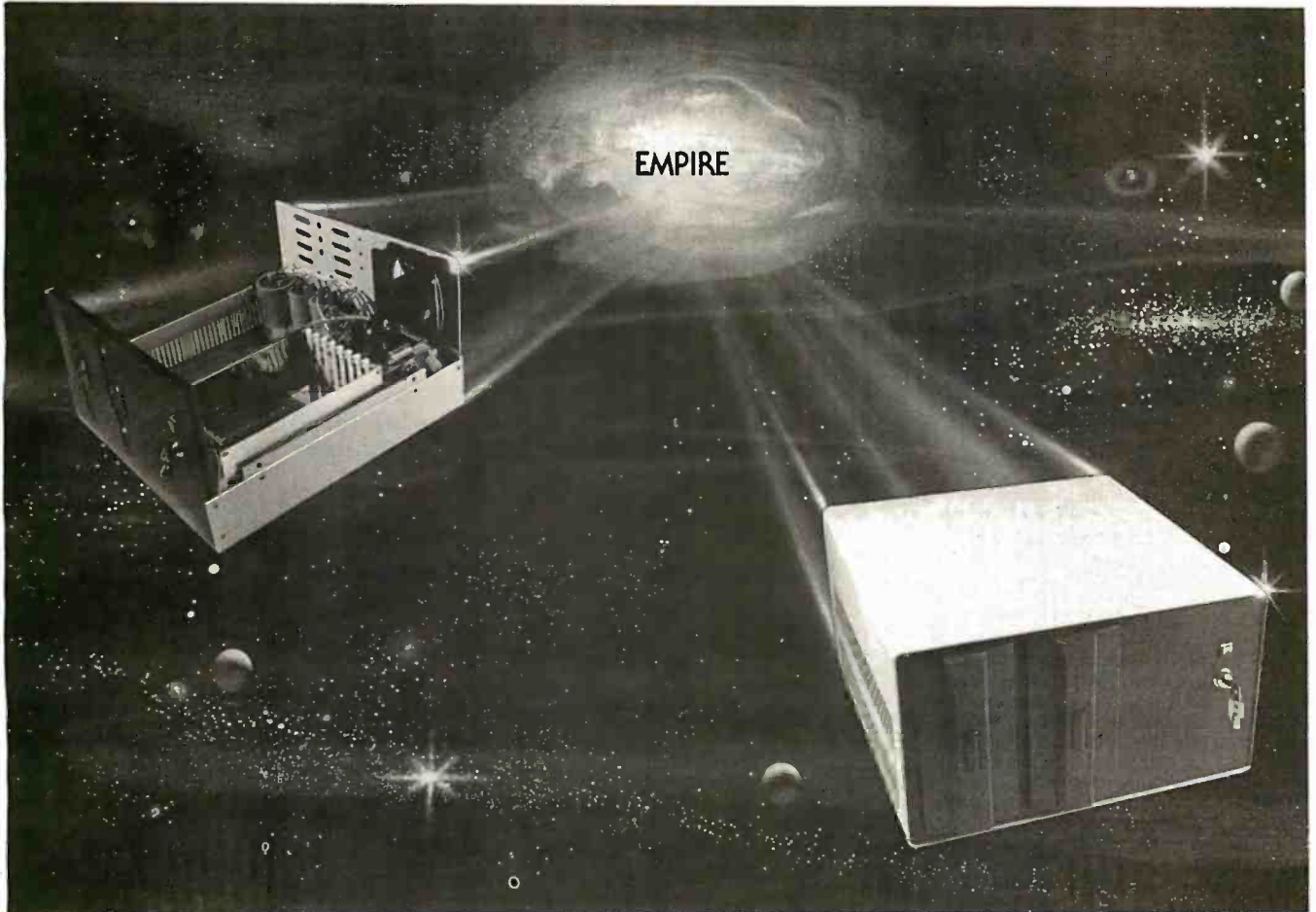

## New Mainframe opens more areas for development

**In one quantum leap** Tarbell has expanded its popular Empire (the vertical disk subsystem) into a full line. This entire series now encompasses 5 variations. Each one contains different components so the S-100 system designer, hobbyist, or serious business user can arrive at the exact custom state he wants and needs.

**The basic Empire still includes** two Shugart or Siemens 8" disk drives; the compact cabinet with fan and power supply; a Tarbell floppy disk interface; CP/M\*; Tarbell BASIC; the necessary cables, connectors and complete documentation. Naturally, it's fully assembled and Tarbell tested.

**The new, top of the line Empire** contains the basic model's components with the Tarbell design-approved Mainframe. Beside the 8-slot S-100 motherboard with an active terminated bus, there's a cardcage with card guides and a double-density interface.

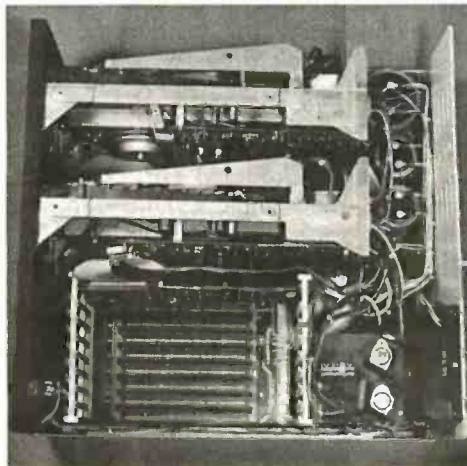

### You're the master of your Empire

You can call the shots in the Empire. Tarbell's made sure of that by offering them as complete subsystem packages . . . or, as separate units. For example, the mainframe may be ordered with 1, 2 or no drives. Whichever way you go, however, you always get the

reliability of Tarbell tested components and leadership-engineering.

**To get control** of your own Empire, see your quality computer store for quick delivery. Or, contact us for dealer locations or further information.

CP/M is a trademark of Digital Research.

*Tarbell*  
Electronics

950 Dohlen Place - Suite B  
Carson, California, 90746  
(213) 538-4251 / 538-2254



## WHAT IF

our Elves, Reindeer and Rudolph are insufficient in the year 2001?

**T/MAKER'S** projections indicate interplanetary vehicles will have to be built in massive quantities in order to satisfy universal demand. Wow, we have to start shipping to Pluto almost immediately.

**T/MAKER** helps me stay on top of everything by giving me a total view on my CRT screen. We just input the latest census figures along with toy type requests and it goes to work really fast. **T/MAKER** can take text and numerical data, integrate the data and print out hard copy reports for our work stations throughout the universe.

**T/MAKER** is a wonderful tool for data analysis. It is easy to set up calculations for rows and columns of tabular data, automatically perform the computations, review the results and then modify some of the data to see the impact on the over all results. Several days of manual work can be accomplished in minutes.

**T/MAKER** is a full screen editor for word processing which handles text up to 255 characters wide. It includes features like text formatting and justification, text buffer for block moves and repeated inserts, global search and replace and commands for printing your letters, reports and document.

**T/MAKER** can perform an unlimited number of analysis and reporting tasks which integrate numerical and text processing. For example:

- Financial Statements • Balance Sheets
- Statistics • Growth & Projections • Profitability Reports • Revenues & Expenditures • Portfolio Analysis • Price Lists • Rate Structures • Inventory Valuation. . . . and much, much more.

**T/MAKER** requires a 48K CP/M system, a total of 240K bytes of disk storage, CBASIC-2, and a CRT computer terminal with cursor addressing and clear screen.

**T/MAKER** system is \$275.00 complete with documentation and quick-reference card.

Documentation alone is \$25.00.

## LIFEBOAT ASSOCIATES

1651 Third Ave. NY, NY 10028  
(212) 860-0300

International Telex 220501

**T/MAKER** is a trademark

of P. Roizen

CP/M is a trademark

of Digital Research

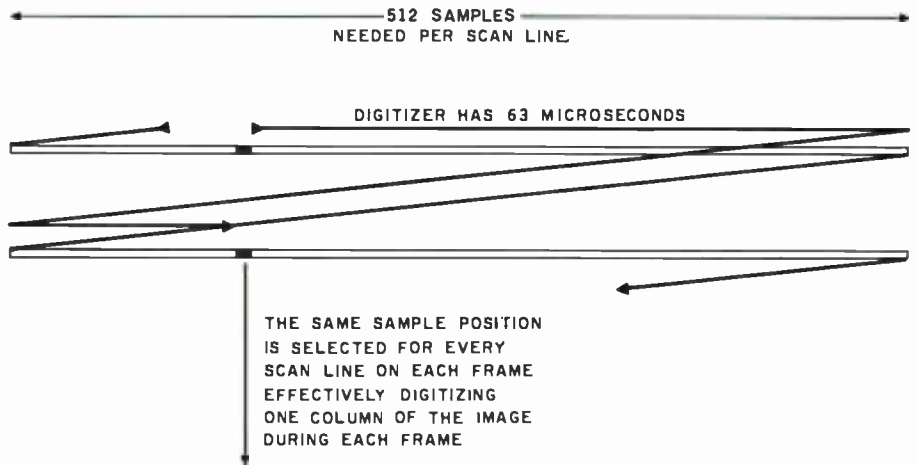

Figure 8: By sampling a single point per scan line, the digitization of each pixel can be completed within 63  $\mu$ s, and data is produced at a slow enough rate (15.7 k bytes/second) for transfer to mass storage.

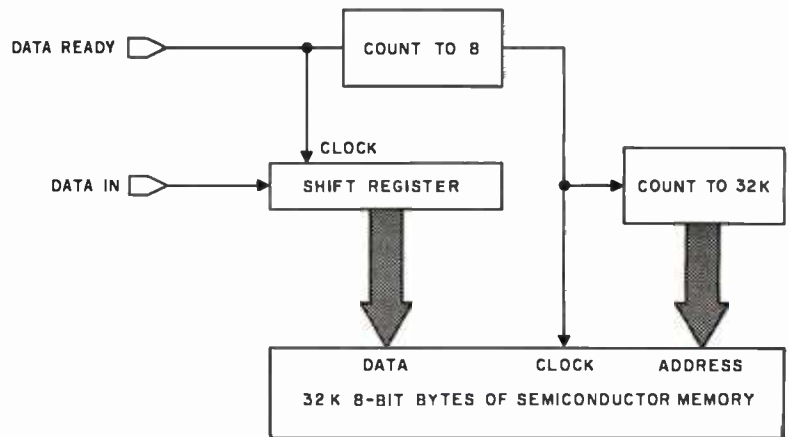

Figure 9: Through the use of a shift register, standard programmable memory can be used to transfer a single-bit image at video rates. If a single bit is deposited into the shift register every 100 ns, an 8-bit value can be deposited into memory every 800 ns. The same process can be reversed for displaying the image.

must be stationary on a tripod with respect to the object being viewed to keep the image stable. Tape players with freeze-frame options might seem attractive for this purpose. However, home videotape machines do not produce a truly stable image and are not usually adequate for this purpose.

The digitizer has plenty of time to produce a digital value. Precision is defined by the number of quantization levels, and more can be obtained for a small additional cost. Unfortunately, the sample circuitry must sample a very precise portion of the video signal, and its accuracy becomes more important if greater quantization levels are desired. Additionally, the decay rate of the sample circuitry becomes important because the sample must be held for up to 50  $\mu$ s versus the 100 ns

necessary for the high-speed digitization technique.

The advantages of slow digitization are the use of a relatively inexpensive A/D converter and low data rates, permitting direct storage of the data using floppy disks. The disadvantages are the need to hold the camera and scene stable for a length of time (depending on resolution) and the inability to capture other video sources, such as television programs and videotape. The requirements for the sampling phase are also more substantial than those for the high-speed method.

There is a hidden disadvantage of the low-speed method. The stored image cannot be readily viewed by reversing the process. The only way to reproduce the data in image form is to place a photographic camera in



# Settle for More from Your TRS-80

**BASIC Compiler.** With TRS-80 BASIC Compiler, your Level II BASIC programs will run at record speeds! Compiled programs execute an average of 3-10 times faster than programs run under Level II. Make extensive use of integer operations, and get speeds 20-30 times faster than the interpreter.

Best of all, BASIC Compiler does it with BASIC, the language you already know. By compiling the same source code that your current BASIC interprets, BASIC Compiler adds speed with a minimum of effort.

And you get more BASIC features to program with, since features of Microsoft's Version 5.0 BASIC Interpreter are included in the package. Features like the WHILE . . . WEND statement, long variable names, variable length records, and the CALL statement make programming easier. An exclusive BASIC Compiler feature lets you call FORTRAN and machine language subroutines much more easily than in Level II.

Simply type in and debug your program as usual, using the BASIC interpreter. Then enter a command line telling the computer what to compile and what options to use.

Voila! Highly optimized, Z-80 machine code that your computer executes in a flash! Run it now or save it for later. Your compiled program can be saved on disk for direct execution every time.

Want to market your programs? Compiled versions are ideal for distribution.\* You distribute only the object code, not the source, so your genius stays fully protected.

BASIC Compiler runs on your TRS-80 Model I with 48K and disk drive. The package includes BASIC Compiler, linking loader and BASIC library with complete documentation. \$195.00.

\*Microsoft royalty information for the sale of programs compiled with BASIC Compiler is available from Microsoft.

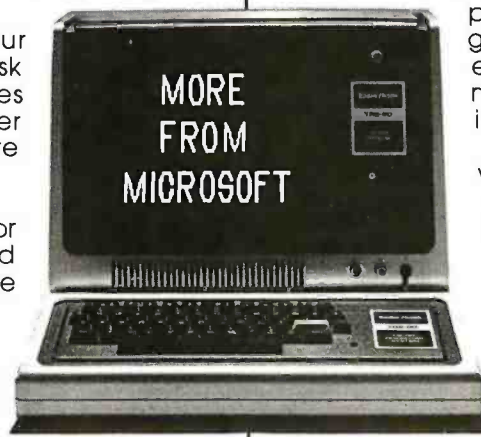

## muMATH Symbolic Math System

expands your TRS-80 beyond the limits of numerical evaluation to a much higher level of math sophistication.

Symbolic mathematics is muMATH's power. For the first time, algebra, trigonometry, calculus, integration, differentiation and more can be performed on a system smaller than an IBM 370. And in a fraction of the time you could do them manually.

Yet for all its power, muMATH is simple to use.

To perform a differentiation you could enter:  
?DIF (A\*X ↑ 3 + SIN(X ↑ 2),X);

In almost no time, the computer would reply with: @2\*X\* $\cos(X \uparrow 2) + 3*A*X \uparrow 2$ .

Or to add fractions: ?1/3 + 5/6 + 2/5 + 3/7;

The instantaneous answer: 419/210.

Or to perform a more difficult trigonometric expansion you enter: SIN(2\*Y)\*(4\* $\cos(X) \uparrow 3 - \cos(3*X) + \sin(Y)*( \cos(X+Y+\#PI) - \cos(X-Y) )$ );

Just a few seconds later, the computer replies: @4\*SIN(Y)\* $\cos(X)*\cos(Y)$ .

muMATH has virtually infinite precision with full accuracy up to 611 digits.

If you use math, you'll find countless ways to save time and effort with muMATH. It's a professional tool for engineers and scientists. A learning tool for students at any level from algebra to calculus.

And if you want to expand your capabilities even beyond the standard muMATH, the option is open. muSIMP, the programming language in which muMATH is written, is included in the muMATH package. A superset of the language LISP, muSIMP is designed especially for interactive symbolic mathematics and other artificial intelligence applications.

muMATH and muSIMP were written by The Soft Warehouse, Honolulu, Hawaii. Priced at \$74.95, the package includes muMATH, muSIMP and a complete manual. It requires a Model I TRS-80 with 32K and single disk. muMATH for the Apple II Computer will be available later this year.

You can buy muMATH and BASIC Compiler at computer stores across the country that carry Microsoft products. If your local store doesn't have them, call us. 206-454-1315. Or write Microsoft Consumer Products, 400 108th Ave., NE, Suite 200, Bellevue, WA 98004.

**MICROSOFT**  
CONSUMER PRODUCTS

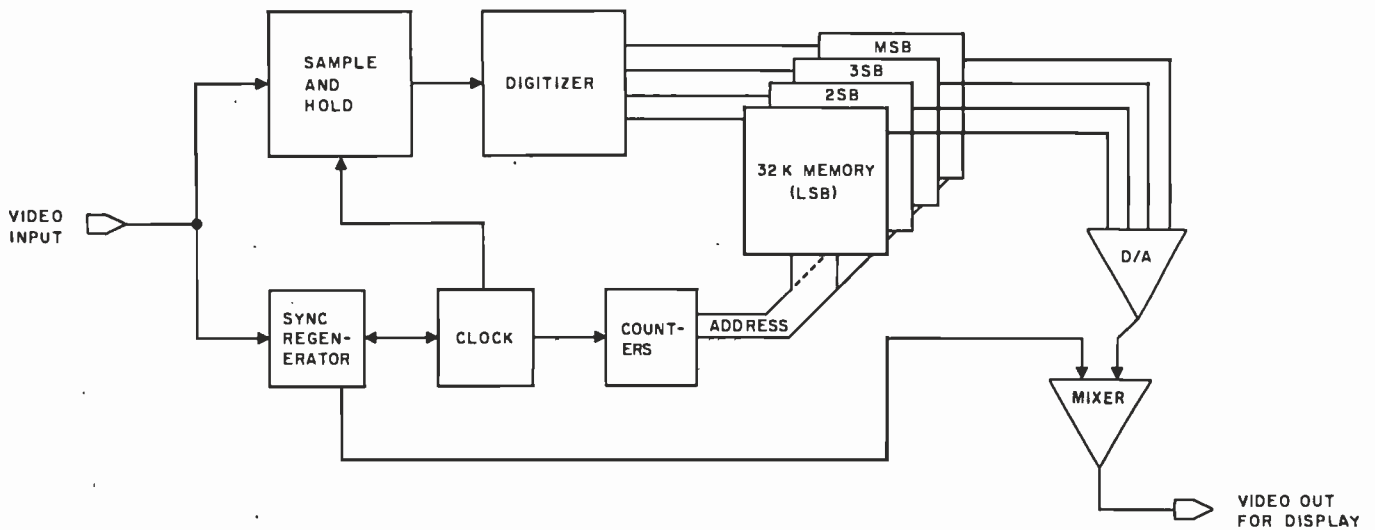

Figure 10: Block diagram of an image-quantization system. In this example, a single memory board is used for each bit of quantization. Four boards would be needed for a 4-bit quantization.

# SOFTWARE FOR THE HARDCORE

We know you hardcore bit hackers will recognize the computing power derived from combining the FORTH language with the 6809, today's most advanced 8 bit microprocessor.

And we know you'll understand this machine's 16 bit math, indirect addressing and two stacks are ideally suited for implementing FORTH.

But...should anyone need further convincing that FORTH provides a new dimension in power, speed and ease of operation, consider the following:

- It's a modern, modular, structured-programming high-level compiled language.
- It's a combined interpreter, compiler, and operating system.
- It permits assembler code level control of machine, runs near speed of assembler code, and uses less memory space than assembler code.
- It increases programmer productivity and reduces memory hardware requirements.

- It replaces subroutines by individual words and related groups of words called Vocabularies. These are quickly modified and tested by editing 1024-character text blocks, called screens, using built-in editor.

tFORTH is a basic system implemented for SS-50 buss 6809 systems with the TSC FLEX 9.0 disk operating system. It is available on 5 1/4" or 8" single density soft-sectored floppy disks. **\$100.00**

tFORTH+ consists of tFORTH plus a complement of the following FORTH source code vocabularies: full assembler, cursor controlled screen editor, case statements, extended data types, general I/O drivers. **\$250.00**

fIrmFORTH is an applications package for use with tFORTH. It provides for recompilation of the tFORTH nucleus, deletion of superfluous code and production of fully rommable code. **\$350.00**

Call or write today.

**KENYON**  
MICROSYSTEMS

3350 Walnut Bend, Houston, Texas 77042 • (713) 978-6933

Circle 147 on inquiry card.

Also available for 6800

front of a television monitor and open the shutter for 17 seconds while the data are converted back into video, one point per line. Then, of course, the film must be processed: this is hardly conducive to interactive use.

## High-Speed Digitization

If we want to digitize 512 points during each scan line, the converter must operate at very high speeds. The active portion of a video line is about 53  $\mu$ s. Roughly, this means it must quantize the signal once every 100 ns. Such converters were available 10 years ago for about \$2000, but today they can be built for less than \$100! Next I'll examine the problems of storing the data produced at this rate.

Most home computers have central memory that can be cycled at about 250 ns to 1000 ns per 8-bit transfer. If the digitizer obtains one 4-bit quantity every 100 ns (at 512 samples per line with rectangular pixels), or 8 bits every 200 ns, standard computer memory cannot cope with the speed requirement. Most experimenters own configurations with 32 K bytes

## How much vigorous activity does your child get each day at school? If you don't know, find out.

To do better in the classroom now, to be fit and healthy later in life, children need at least one school period a day of physical education. But most schools are not providing this. And many schools require none at all.

Send for our free checklist and find out how your schools score. Then, do something about it.

Write Checklist, President's Council on Physical Fitness and Sports, Washington, D.C. 20201.

# SUPERBRAIN<sup>®</sup> HARDWARE, SOFTWARE,



As the Western United States' largest distributor of SuperBrain<sup>®</sup> hardware and software,

**WE WILL NOT BE UNDERSOLD  
BY ANY ADVERTISED PRICE!**

Huge volume purchases for national and international marketing gives us the chance to get you rock bottom prices from the factory.

Our SuperBrain<sup>®</sup> prices are the lowest in the country, and our assistance in hardware and software information will be pleasant and helpful at all times.

## SOFTWARE.

	CBasic	MBasic	
Accounts Receivable	X	X	\$250.00
Accounts Payable	X	X	250.00
General Ledger	X	X	250.00
Payroll	X	X	250.00
Inventory	X	X	250.00
Restaurant Payroll	X		250.00
Job Costing	X		250.00
Mailing List	X	X	150.00
Word Processing	X		195.00
"Magic Wand"			325.00

## PROGRAM LANGUAGES.

C Basic	125.00
M Basic	300.00
Fortran	450.00
Cobol	650.00

# AND MORE.

Model 88T Impact Matrix Printer 595.00!

### •Other Printers Available:

- T-1 810
- Anadex
- Diablo
- NEC
- Qume



Dealer Inquiries Invited.

Circle 148 on Inquiry card.



Computer Marketing Corporation  
116 South Mission  
Wenatchee, WA 98801  
(509) 663-1626

or less of central memory. Although 32 K bytes would be barely sufficient for a 256 by 256 4-bit image, 128 K bytes are necessary for a 512 by 512 4-bit image. Therefore, memory is usually dedicated to the image-storage function and accessed by the computer through either a processor-controlled or DMA (direct-memory access) port.

The problem of providing large memories capable of 200 ns cycle times can be solved by the sequential nature of data transfers. By dividing memory into a number of parallel segments it's possible to use memories with 800 ns read/write-cycle times to simultaneously digitize, display, and communicate with the computer.

Proper memory organization

allows ease of expansion, depending on whether higher spatial resolution or more bits per picture element are anticipated in the future. Also, good designs can be software-reconfigured to trade off spatial resolution for the number of bits per pixel. Methods for reconfiguration are left for the ambitious designers to discover on their own.

### A Hypothetical Design

Assume that we'll require a 512 by 512 image with 4-bit quantization of each pixel. Memory is physically organized as four 32 K-byte memory boards. This is because there are 256 K points in the image, and we wish to have 1 bit of each 4-bit pixel value on each memory board. We will use memory which transfers 8-bit quantities.

If we shift 1 bit every 100 ns into a serial-in, parallel-out shift register, then every 800 ns the resulting 8-bit value can be deposited into memory. (See figure 9.) The same process can be reversed for real-time display. To do so, the memory is read every 800 ns, the 8-bit value is placed into a parallel-in, serial-out shift register, and shifted out at 100 ns per pixel.

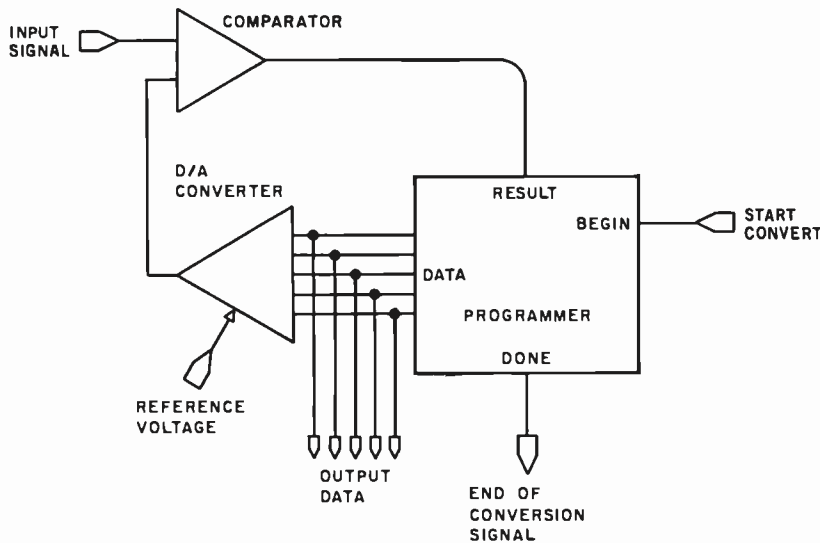

Figure 11: The configuration of a conventional A/D converter.

### FEATURES INCLUDE:

- Uses Standard Typewriter Ribbon (Model 101B-80)
- Built-In Power Supply
- 5 x 7 Dot Matrix Character Generator or 10 x 7 or 10 x 14 Dot Matrix
- Standard 96 ASCII Character Font
- Upper and Lower Case Printing
- Up to 88 Characters Per Line
- Single Line Print Rate Is  
\*\*110/160 CPS
- Average Print Rate Is  
\*\*55/60 CPS For Ten Lines
- Graphics Capability With Extended Character Modes
- Programmable With 32 System Level Software Commands
- Standard Parallel and Serial Interface
- Reset Interface
- Baudrate Select From 110 to 9600
- Manual Paper Advance (Model 101B-80)
- Manual Selftest
- Adjustable Tractor Width From 1 to 9 1/2 Inches (Model 101B-80)

\*\*Model 101A-40 & 101B-80 Respectively

## 80 COLUMN LOW COST IMPACT PRINTER



\$495 Kit, 101B-80KE

\$545 Assembled & Tested 101B-80E

**COOSOL, INC.** P.O. BOX 743, ANAHEIM, CA 92805 (714) 545-2216 7 Days a Week

# 5,000,000 Reasons to replace your 5-inch Floppies with a low-cost, high-performance Hard-Disk.



**5 megabytes instantly expand the program and data storage horizons on your H-89, TRS-80, or S-100 microcomputer system.**

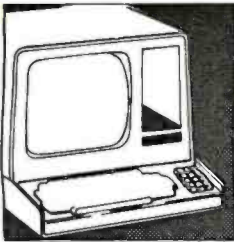

Just slip 5 megabytes of on-line data storage into place in your standard 5-inch floppy disk openings, and suddenly your capability horizons have dramatically shifted. Upwards. Now your CP/M\* S-100 microcomputer system, or H-89 Heathkit (HDOS or CPM 2.2) computer system can utilize the kind of high-reliability and rapid-access mass storage which today's sophisticated programming demands.  A company named

ACT has created a complete package at a price so good, you couldn't walk away from it. The 5-inch package includes the remarkable Shugart Technology ST 506 hard-disk drive with 6.3 megabytes of unformatted mass storage and a micro-sequencing controller card with complete floppy disk-like interfacing. Hard-disks have never been more affordable.  If you are wondering just how these ultra-fast, high throughput hard-disk drives will work with your multi-terminal or real-time transaction oriented systems: now you can get some straight answers. Clip and mail the coupon for quick response to all your questions. Or better yet, give us a call today at (703) 471-6288 for some no-nonsense reasons why your system needs to ACT now. Quantity pricing is available to meet the needs of Original Equipment Manufacturers; check the box on the coupon.

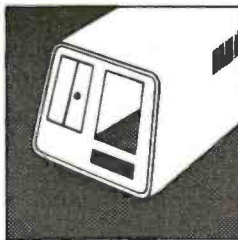

American Computer and Telecommunications Corporation

Circle 150 on Inquiry card.

Clip and mail coupon to:

11301 Sunset Hills Road  
Suite A-4, Reston, VA 22090  
(703) 471-6288

## Tell me more about the ACT 5-inch hard-disk drive package:

My present 5-inch hard-disk drive interests center around:

- S-100 Microcomputer Systems
- H-89 Heathkit Computer Systems
- TRS-80 Radio Shack Computer Systems
- Send me quantity price schedule

Name \_\_\_\_\_  
 Title \_\_\_\_\_  
 Company \_\_\_\_\_  
 Address \_\_\_\_\_  
 City, State, Zip \_\_\_\_\_  
 Phone (\_\_\_\_) \_\_\_\_\_

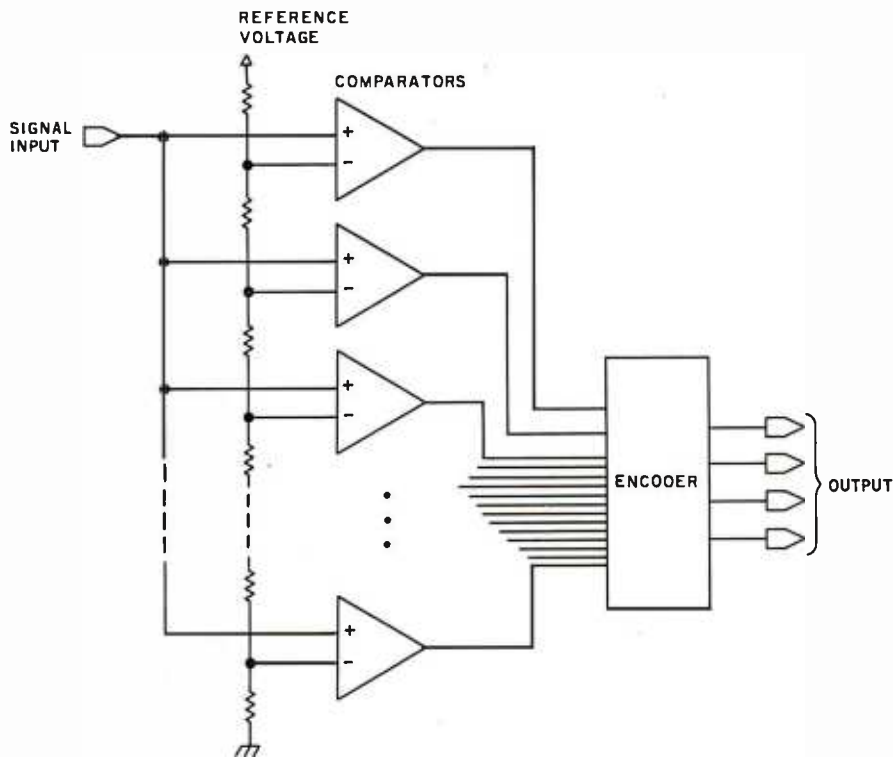

Figure 12: The small number of bits required for image quantization makes flash (or parallel) A/D conversion practical. One comparator is used for each quantization level. For a 4-bit quantization, sixteen comparators would be needed. A reference voltage equal to full scale is fed to a voltage divider to form a set of comparator thresholds. The output of each comparator is then fed to the encoder, where the number of on comparators is converted into a binary output. Parallel converters are available in DIP form and allow for high data-conversion rates.

To achieve the desired number of quantization bits per pixel, we stack the appropriate number of memory boards. (See figure 10.) In our case, four boards would be needed for 4-bit pixels. Of course, there would have to be an address bus common to all boards and an extra board to provide control and A/D conversion. The extra board would be needed to decode the video sync signals to keep memory-addressing in step with the video signal. Additionally, D/A (digital-to-analog) conversion and sync generation are necessary to drive a display monitor.

Notice that the memory is running at very slow speeds by modern standards. If we use memory that allows two operations per 800 ns, the computer can access or deposit data completely transparent to the digitization or display process.

Now consider high-speed A/D converters. Normal converters use a D/A converter, a programmer, and a comparator to derive a numerical quantity representing the voltage on the input. (See figure 11.) The programmer tries successive numbers, generating successive voltages out of the D/A converter. These voltages are compared with the analog input to determine if they are above or below the input voltage. The comparator output is used by the programmer to decide what number to try next until the process converges on a final value.

The fastest A/D programs take about as many tries as there are bits of quantity. Each try consumes as much time as the total of the programmer gate delay, the D/A-gate delay, the D/A-settling time, and the comparator-settling time. The fastest converters perform conversion on the order of the 100 ns per bit. This is obviously unacceptable for our purposes, since we consider 4 bits to be a minimum quantization and 100 ns to 200 ns to be a maximum conversion time.

The small number of bits that are required does make another conversion technique very practical. It has several names, the most popular being *flash* or *parallel* conversion. It consists of one comparator for each quantization level, or sixteen comparators for 4 bits. (See figure 12.) A reference voltage equal to full scale is fed to a voltage divider (ie: a network of resistors) to form a set of comparator thresholds, and the outputs

## HEATHKIT®

computer products and Zenith Data Systems get even better when you subscribe to Buss: The Independent Newsletter of Heath Co. Computers. Buss spreads the latest news of compatible hardware and software from many vendors. The newsletter is not affiliated with any of these and does not depend on income from ads. So Buss has to please only its subscribers—over 2900 of them.

Readers' candid reports of their discoveries save other subscribers headaches—and money. Innovations published in Buss have included hardware modifications and software fixes. And, since it is not a company-controlled publication, Buss can deal with both the weaknesses and strengths of Heath Co. Computer products.

Buss is a proven newsletter that keeps getting better—it's been published since April 1977. If you subscribe this month you'll receive a free directory of over 50 suppliers of hardware and software for Heathkit® computers and Zenith Data Systems. You have the choice of starting your Buss subscription with the latest issue or available back issues (about 14). All this information will be mailed first class (by air mail overseas). Full refund guaranteed if you're not satisfied. Payment must be in U.S. dollars payable on a U.S. bank or by Master Charge or Visa.

Issues:	12	18	24
<b>U.S. &amp; Canada</b>	<b>\$17.98</b>	<b>\$24.75</b>	<b>\$29.95</b>
Overseas	25.00	30.00	35.00

Buss, 325-B Pennsylvania Ave., S.E., Washington, DC 20003

# The COMPUTER FACTORY

TO ORDER CALL (212) 687-5000

## SUPERBRAIN™

INTERTEC  
DATA  
SYSTEMS  
64K  
ONLY  
**\$2995**



32K \$2795

More than an intelligent terminal, the SuperBrain outperforms many other systems costing three to five times as much. Endowed with a hefty amount of available software (BASIC, FORTRAN, COBOL), the SuperBrain is ready to take on your toughest assignment. You name it! General Ledger, Accounts Receivable, Payroll, Inventory or Word Processing... the SuperBrain handles all of them with ease.

### FEATURES INCLUDE:

• 2 dual-density minifloppies with 360K bytes of disk storage • A CP/M Disk Operating System with a high-powered text editor, assembler and debugger.

### Model QD

720K Bytes disk storage  
and 64K RAM  
**\$3895**

### SUPER BRAIN HARD DISKS

10 Megabyte	16 Fixed-16 Removable
<b>\$3995</b>	<b>\$9995</b>

## NEW 80 COLUMN



CBM  
Basic 4.0  
Operating  
System

- 80 column by 25 line display
- 12" CRT
- New screen editor
- Split screen processing
- Super fast string handling
- 15 additional basic commands
- Supports relative record processing

Model 8016 16K memory	Model 8032 32K memory
<b>\$1495</b>	<b>\$1795</b>

## NEW 8050 DUAL DISK

1 million bytes on-line storage  
and DOS 2.0 operating system

- Supports relative record (Random Access)
- Faster more reliable only **\$1695**

## Commodore Computer

These low cost Commodore PET Business Computers have virtually unlimited business capabilities. Accounts Receivable, Inventory Records, Payroll, and other accounting functions.



- PET 16N & 32N  
COMPUTERS
- Full size keyboard
  - 16 or 32,000 Bytes Memory
  - Level III Operating System
  - Full Screen Editor
  - Upper lower case & 64 graphic characters



PET DUAL  
FLOPPY DISK

- Stores 360,000 Bytes on-line
- Microprocessor controlled
- Uses single or dual sided floppies



HI-SPEED PRINTER

- 150 characters per second • Up to 4 copies 8" wide
- Microprocessor Controlled • Prints All Graphics • Full Formatting Capability

## PERIPHERALS

- 24K Memory Expansion \$499
- 16K Memory Expansion 399
- PET to RS232 Serial 129
- 2 Way Serial Communication 229
- Modem Board for PET 375
- Analog to Digital Board for 16 Devices 275
- Second Cassette Drive 95

## DIP-81 BIDIRECTIONAL 100 CPS MATRIX PRINTER

- Centronics interface
  - Serial add \$50
  - Ribbon cartridge
  - Up to 4 copies
  - 80 column
- \$495**



ANDERSON JACOBSON Parallel \$1130  
841 I/O Terminal ideal for word processing and small businesses. Serial \$1230

- ASCII Code
- 15 CPS Printout
- High Quality Selectric Printing
- Reliable heavy duty mechanism
- Completely Refurbished by A.J.
- Delivered FREE to nearest service center



## NEW AMPEX HARD DISK

5 Fixed  
5 Removable  
Only \$5995

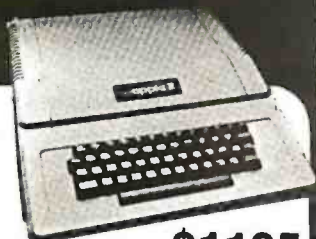

APPLE II PLUS **\$1195**

A complete self-contained computer system with APPLESOFT floating point BASIC in ROM, full ASCII keyboard in a light weight molded carrying case.

### Features Include:

- auto-start ROM
- Hi-Res graphics and 15 color video output.
- Expandable to 48K.

Supertalker .....	\$279	Micromodem .....	\$379
Disk .....	595	Superterm (24 x 80) .....	395
Add-on Disk .....	495	Speechlab .....	229
Pascal Card .....	495	Communication Card .....	225
Business Software .....	625	Modem .....	200
Monitor .....	159	Graphics Printer .....	595
Printer Card .....	180	Graphics Tablet .....	795

## apple III IS FINALLY HERE 128K RAM!!

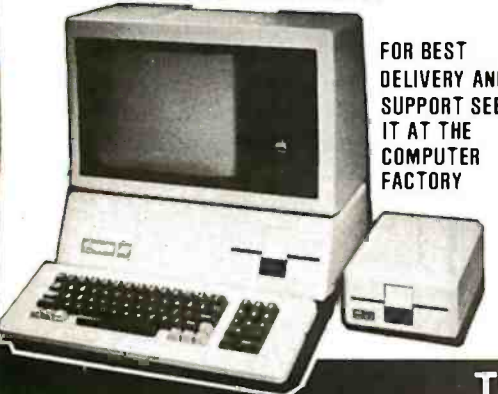

FOR BEST  
DELIVERY AND  
SUPPORT SEE  
IT AT THE  
COMPUTER  
FACTORY

## CENTRONICS 704

- 180 cps Bi-Directional • Up to 15" Paper Width • 9 x 9 Matrix
  - Upper/Lower Case
  - Tractor Feed
  - RS-232 Serial Interface
- \$1895**  
List \$2500



## CENTRONICS 700-9

- \$1295** List \$1895
- 60 cps • Up to 15" paper width
  - Tractor Feed • Parallel Interface for Apple & TRS-80 • 2 channel vertical forms! • Top of Form!

## CENTRONICS (Letter quality)

737 Serial \$995  
737 Parallel \$965

## CENTRONICS

730 Serial \$775  
730 Parallel \$745



## XEROX 1730 Letter Quality Printer

- List \$2755 **Special \$2495**
- 40 Cps
  - 90 Day On Site Warranty
  - Uses all 100 metal & plastic daisy wheels
  - Automatic bidirectional printing
  - Fewer moving parts



**XYMEC HQ 1000**  
with 10, 12, 15 Pitch & Proportional Spacing

- Z-80 controlled
- Up to 198 columns

**\$2495**

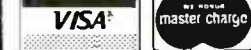

Min. Credit Card Order \$75

N.Y. residents add 8% sales tax  
• Same day shipment on prepaid and credit card orders

TO ORDER CALL (212) 687-5000

Open Mon-Fri. 10-6 Sat. 11-5

The COMPUTER FACTORY

485 Lexington Ave., New York, NY 10017 (46th St. Lobby)

Foreign order desk — Telex 640055

## The Nature of Video Images

The video standard has three primary components, synchronization signals, a luminance (black-and-white) signal, and a chrominance (color) signal. The synchronization (sync) signals tell the receiver when to begin a new frame and a new line. The luminance signal provides intensity values that comprise a picture. The signals are effectively separate, allowing compatibility between color and black-and-white television receivers. Our primary interest here is the luminance signal, but the chrominance signal must still be considered. It must be filtered out of a color video signal before quantization. (The reason for this requirement has been described in the section on sampling.)

Each complete picture, called a

frame, takes 1/30 second to complete. To reduce flicker, 2:1 interlacing is used. During the first 1/60 second, the even-numbered lines are displayed; and during the second 1/60 second, the odd-numbered lines are displayed. Each set of lines (half of the frame) is called a field. (See figure 3.)

Each field consists of 262.5 lines, each line transmitted in 63.5  $\mu$ s. Nine of these lines are used for the vertical synchronization pulse, which is actually a series of pulses that are easy for receiver circuits to recognize. Each line is composed of a horizontal active-line period during which luminance information is present, and a sync period when reference levels and the horizontal sync signal are present. The horizontal active period is 53.3  $\mu$ s, and the sync period is 10.2  $\mu$ s. (See figure 4.)

of the comparators are fed to an encoder. The analog voltage determines which comparators are on, and the encoder then turns the number of on comparators into the corresponding binary number. The only delays are the settling time of one comparator and the encoder-logic delay. I've built three of these for under \$100. They are also commercially available in DIP (dual-in-line package) form in 3-bit or 4-bit designs that allow for cascading to achieve 1 or 2 additional bits.

## Summary

Inexpensive semiconductor memory and other technological developments have made digital image storage with real-time video input and output a practical reality for the home computer experimenter. Several complete hardware and software systems are available for the display and digitization of real-time video. At least one company offers an inexpensive, real-time digitizer and display, while several offer very inexpensive digitizers to accomplish low-speed digitization. A high-speed system costs \$1500 to \$5000 or more, depending on options. The primary price difference is due to the amount of image memory desired. Low-speed systems range from about \$350 to \$4000.

Flash-conversion products range from \$30 to \$90 for 3-bit and 4-bit units with about 30 MHz maximum rate. These save you the headaches of finding matched resistor values for homebrew flash converters.

Although there isn't enough information in this brief article to construct an image-capture system, there should be enough to familiarize an ambitious designer with the techniques and problems. You would be well advised to obtain a technical manual from a manufacturer to help assess the potential difficulties. With healthy competition in the growing marketplace for image-capture and display, the power/price ratio of complete systems will continue to increase. ■

## Attention TRS-80 Mod II owners: P&T CP/M<sup>®</sup> 2 has more to offer!

**More Disk Storage** 596K bytes with double density on standard single sided disk drives. If that's not enough, versions are available for double sided expansion drives (1.2M bytes per disk) and the Cameo Hard disk system (10M bytes).

**More CRT Functions** P&T CP/M 2 has the most advanced screen driver available for the Mod II including: erase to end of line/screen, insert/delete line, cursor addressing, non-scrolling area on screen, and much more.

**More Serial I/O Capabilities** The serial drivers in P&T CP/M 2 support ETX/ACK, XON/XOFF, and request to send handshaking. Direct control of the serial ports is also available for special applications.

**More Documentation** We provide the standard CP/M manuals and our own 150 page manual written specifically for P&T CP/M 2.

**More Utilities** We have added 14 of our own utility programs for the Mod II to the standard CP/M utilities.

**More Useful System Functions** P&T CP/M 2 has all sorts of useful features you won't find elsewhere: type-ahead buffer for keyboard input, system time of day clock, automatic program execution, and lots more.

### Prices

Standard P&T CP/M 2	\$185
P&T CP/M 2 for Shugart 850 2 sided drives	\$220
P&T CP/M 2 for Cameo Hard Disk system	\$250

We also carry these other software packages:

Magic Wand text processor	\$350
VEDIT text editor	\$110
LYNC data communication program	\$95
MCALL intelligent terminal program	\$65
MAC macro assembler	\$90
Pascal/M	\$175
Microsoft Basic-80 Interpreter	\$325
Microsoft Basic-80 Compiler	\$350

CBASIC2 (improved performance)	\$105
Osborn accounting software (requires CBASIC 2; manuals extra)	each package \$95; all four \$295

Also available are single and double sided expansion disk drives and the Cameo Hard Disk System. Call or write for details.

Prepaid, COD, Mastercharge or Visa orders accepted  
Shipping extra. California residents add 6% sales tax.



## PICKLES & TROUT

P.O. BOX 1206, GOLETA, CA 93017, (805) 967-9563

CP/M is a trademark of Digital Research Inc.

TRS-80 is a trademark of Tandy Corp.



Exciting, entertaining software for the Apple II and Apple II Plus\*

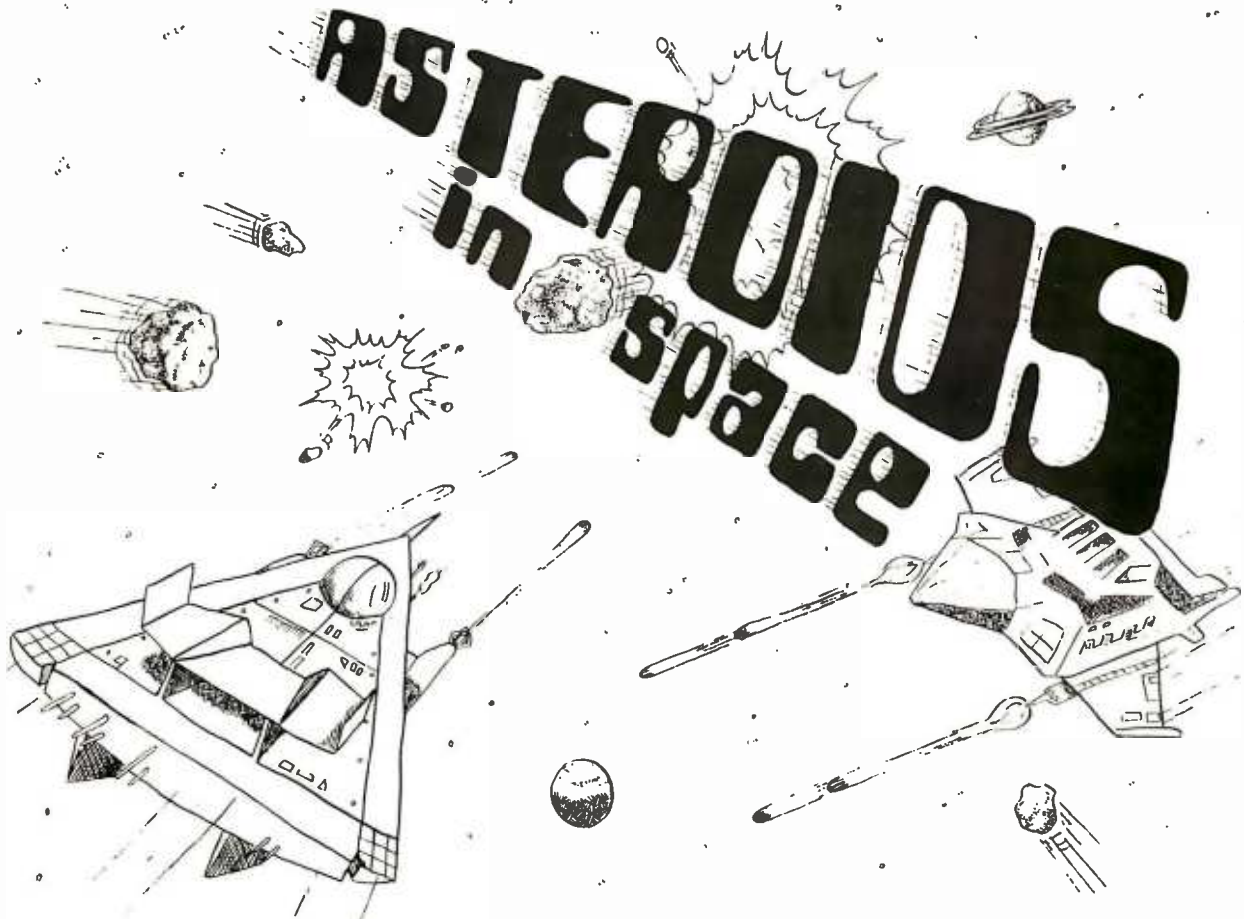

If you liked "Invaders", you'll love ASTEROIDS IN SPACE by Bruce Wallace. Your space ship is traveling in the middle of a shower of asteroids. Blast the asteroids with lasers, but beware — big asteroids fragment into small asteroids! The Apple game paddles allow you to rotate your space ship, fire its laser gun, and give it thrust to propel it through endless space. From time to time you will encounter an alien space ship whose mission is to destroy you, so you'd better destroy it first! High resolution graphics and sound effects add to the arcade-like excitement that this program generates. Runs on any Apple II with at least 32K and one disk drive. On diskette — \$19.95

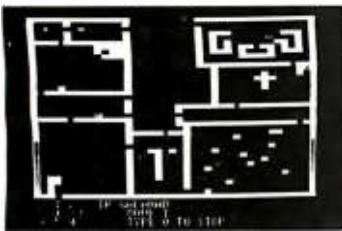

FRACAS™ by Stuart Smith. A fantastic adventure game like no other — up to eight players can participate in FRACAS at the same time. Journey in the land of FAROPH, searching for hidden treasure while warding off all sorts of unfriendly and dangerous creatures like the Ten Foot Spider and the Headless Horseman. You and your friends can compete with each other or you can join forces and gang up on the monsters. Your location is presented graphically and sound effects enliven the battles. Save your adventure on diskette or cassette and continue it at some other time. Requires at least 32K of RAM. Cassette: \$19.95 Diskette: \$24.95

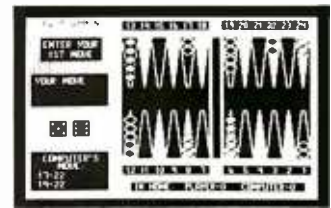

FASTGAMMON™ by Bob Christiansen. Sound, hi res color, and cartoons have helped make this the most popular backgammon-playing game for the Apple II. But don't let these entertaining features fool you — FASTGAMMON plays serious backgammon. Requires at least 24K of RAM. Cassette: \$19.95 Diskette: \$24.95

BATTLESHIP COMMANDER™ by Erik Kilk and Matthew Jew. A game of strategy. You and the computer each start out by positioning five ships of different sizes on a ten by ten grid. Then the shooting starts. Place your volleys skillfully — a combination of logic and luck are required to beat the computer. Cartoons show the ships sinking and announce the winner. Sound effects and flashing lights also add to the enjoyment of the game. Requires at least 32K of RAM. Cassette: \$14.95 Diskette: \$19.95



# QUALITY SOFTWARE

6660 Reseda Blvd., Suite 105, Reseda, CA 91335

WHERE TO GET IT: Call us at (213) 344-6599 for the name of the Quality Software dealer nearest you. If necessary, you may order directly from us. MasterCharge and Visa cardholders may place orders by telephone and we will deduct \$1 from orders over \$19 to compensate for phone charges. Or mail your order to the address above. California residents add 6% sales tax. SHIPPING CHARGES: Within North America orders must include \$1.50 for first class shipping and handling. Outside North America the charge for airmail shipping and handling is \$5.00 — payable in U.S. currency.

\*"Apple II" and "Apple II Plus" are trademarks of Apple Computer, Inc.

# BYTE LINES

NEWS AND SPECULATION ABOUT PERSONAL COMPUTING

Conducted by Sol Libes

**DEC Opens Computer Museum:** Digital Equipment Corporation (DEC), the pioneer in minicomputers, has opened a "computer museum" in the lobby and mezzanine level of its Marlboro, Massachusetts, "Tower Building." It illustrates, through actual equipment, the evolution from calculator to microcomputers. The exhibits include precomputer devices, the four generations of digital logic used in computers, and some early computer systems (eg: PDP-1 with the original *Spacewar* program and others). The museum is open to the public.

**Random News Bits:** Casio, Inc, the Japanese electronics manufacturer, has introduced a personal computer in the US. The FX-9000P can store programs directly in 4 K-byte CMOS (complementary metal-oxide semiconductor) memory cartridges (with lithium batteries) that can be removed from the unit. The basic unit is priced under \$900.... Pascal can now be considered as having "made it." IBM has announced that Pascal will be available for IBM systems using OS/VS and VM/CMS operating systems. IBM will charge \$235 a month for it. To think that most microcomputer users pay less than IBM's monthly charge to buy Pascal outright.... A study conducted by the National Institute for Occupational Safety and Health found that video-terminal users suffer problems of eye strain, blurred

vision, color perception, numbness, and loss of strength in their arms. These users also experience higher levels of anxiety, depression, confusion, and fatigue....The University of Southern California will offer a graduate degree in voice I/O (input/output). The curriculum includes courses in electrical and biomedical engineering, communications, computer science, linguistics, otolaryngology, and psychology...

**Fujitsu Overtakes IBM In Japan:** For the past thirty years, IBM has dominated data processing over the entire globe. Now, however, it is reported that in Japan Fujitsu, Ltd, has overtaken IBM in sales. Fujitsu and several other Japanese computer suppliers are now preparing a massive onslaught into the US and European markets.

**IEEE Local Network Standard Moves Ahead:** The IEEE Local Network Standards Committee expects to have a draft of its standard by year's end. At this time, it appears that the Ethernet system, proposed by Xerox, Digital Equipment Corporation, and Intel, will *not* be adopted as the standard. The reasons for this are that Ethernet is still in a preliminary-definition state with many areas not precisely defined. Further, Ethernet is highly depen-

dent on coaxial cables and a particular modulation technique. Also, Ethernet does not have any provision for acknowledging datagrams, which could lead to possible incompatibilities in error control between different manufacturer's devices.

**Super Computer Planned:** The Ames Research Center of NASA (National Aeronautics and Space Administration) is planning a special super computer capable of performing a billion floating-point operations per second. The computer will be designed to simulate a wind tunnel. It is expected to have 40 M words of directly addressable memory plus 200 M words of block-addressable memory. NASA wants the system operational in 1986.

**US Government Shifting To Smaller Computers:** The US government now has a reported 15,000 computers in operation, worth more than \$5.4 billion. The trend is shifting from large, costly mainframes to smaller units. In fact, now at least two-thirds of the machines cost less than \$50,000. The GSA (General Services Administration) recently disclosed that at the end of 1979 the three leading computer suppliers were Digital Equipment Corporation (3656 units), Sperry Univac (1778 units), and IBM (1284 units). However, IBM still ranked

number one in dollars (\$1.45 billion), Control Data was second (\$754 million), and Sperry Univac was third (\$686 million).

**Ribbon Recycling:** The word-processing and printer markets have created the new business of recycling printer ribbons. About fifty vendors are offering consumers recycled ribbons at a saving of as much as 60%, along with deliveries in 5 to 10 days. Several ribbon manufacturers are introducing sealed ribbon cartridges to prevent recycling. They claim that sealing improves ribbon reliability.

**Microsoft Signs UNIX Agreement:** Microsoft, of Bellevue, Washington, has signed an agreement with Western Electric for the rights to develop and market versions of UNIX, an operating system originated by Bell Laboratories. The Microsoft versions will be specifically designed for 16-bit microprocessors, such as the Intel 8086, Zilog Z8000, and Motorola 68000. The Microsoft version will be called XENIX. UNIX seems to be the most popular minicomputer timesharing operating system in current use. It is very popular in the educational community, probably because Western Electric sold it to educational institutions for a very low fee. However, due to its sophisticated features, UNIX has been gaining in popularity in the profes-

# SOFTWARE SOFTWARE DIGITAL MARKETING™ DIGITAL MARKETING™

DIGITAL MARKETING • 2670 CHERRY LANE • WALNUT CREEK • CALIFORNIA 94596 • (415) 938-2880

## REPORT WRITER™

Mini-word and arithmetic calculation processor designed to generate reports with ledger of figures and numeric calculations. Built-in calculator functions and calculator to paper errors. Saves data. Reports can be printed as often as desired. Changes in data can be easily entered and saved. "Cause and Effect" analysis easily computed using Recalculate function.

Typical applications are:

- ★ Appreciation Schedules
- ★ Capitol Expenditure Proposals
- ★ Profit/Loss Projections
- ★ Balance Sheet Projections
- ★ Budget Analysis
- ★ Job & Labor Analysis

\$150. Manual alone \$25.

Requires 48K RAM & Microsoft Basic Formats: 8" single density, NorthStar 2D & Micropolis Mod II

## DATEBOOK™

NEW! for NorthStar, Micropolis, TRS-80 Mod II & any other CP/M based operating system.

End paging through an appointment book forever! Easy to learn & use.

- ★ Replaces your office appointment book
- ★ Searches for openings that fit time of day, day of week & day of year constraints
- ★ Appointments made, modified or cancelled by a few key strokes
- ★ Copies of day's appointments can be quickly printed
- ★ Schedule appointments 4 months in advance - plus

\$295. Manual alone - \$25.

## FILETRAN™

The TRSDOS to CP/M and CP/M to TRSDOS file translation system. FILETRAN transfers files by file name from one disk to another. May also be used to search any program for all occurrences of a string. Can be used to generate a variable cross-reference. Helps to convert Level II BASIC programs to Micro-soft Basic. Formats: 8" single density, NorthStar 2D & TRS-80.

\$149.

## MAGIC WAND™

CP/M-based word processing system for 8" soft-sectored & 5 1/4" NorthStar or Micropolis.

- ★ Full screen text editing
- ★ Full text formatting commands
- ★ Merging with external data files
- ★ Variables
- ★ Conditional commands
- ★ True proportional printing

\$350.

## PASCAL/M™

CP/M™ compatible language for 8" 8080/780 CPU's, NorthStar 2D, Cromemco CDOS & Superbrain.

- ★ Random access files
- ★ Run-time debug support
- ★ Over 45 extensions to Standard Pascal
- ★ Requires 54K RAM

\$175. Manual alone - \$10.

## ACT™

CP/M compatible macro assembler for 280, 8080/85, 6502 & 6800.

One assembler that supports all major 8 bit micros and runs under CP/M. Formats: 8" single density, NorthStar, & Superbrain. Requires 24K RAM.

\$125. Manual alone - \$15.

## ACT II - CP/M 2.x compatible cross assembler for 8086/8088.

\$175. Manual alone - \$15.

ACT I and ACT II purchased together - \$225.

## S-BASIC™

Produces chainable, relocatable native code.

- ★ Fully defined user functions & procedures
- ★ Local & global variables
- ★ Single & double precision floating point
- ★ Fixed point packed BCD
- ★ Integer, string & character data types
- ★ Packed binary disk storage

Requires 40K RAM. Format 8" single density, NorthStar 2D & Micropolis Mod II.

SPECIAL INTRODUCTORY PRICE! \$250.  
\$295. January 1, 1981

## PEARL™

The application software generator for 8" single density, NorthStar 2D, Micropolis Mod II & Superbrain. Pearl asks questions that a programmer would have to answer to code the system. You answer the questions & Pearl uses built-in logic to construct both subroutines & mainline programs. The system then compiles & executes your program code.

- Level 1: For Personal Computing - \$130.
- Level 2: The Business Assistant - \$350.
- Level 3: Advanced Software Development - \$650.

CBASIC™ required.  
Manuals alone - \$25. each

## ULTRASORT-II™

The sort/merge/select utility for CBASIC2 written in assembly language. Can be loaded by CBASIC during run-time; also can be used as a stand-alone utility. Formats: 8" single density, NorthStar 2D & Micropolis Mod II.

\$175.

## CBASIC2™

Industry standard intermediate code compiler with run-time interpreter. Features include chaining, integer & external precision arithmetic. CP/M, MP/M & relocated TRS-80 versions available. As well as 8" single density, NorthStar 2D & Micropolis Mod II.

\$120.

## COPYWRITER™

A powerful CP/M Word Processing System which includes a fast screen editor and is exceptionally easy to learn and use. Copywriter supports both vertical and horizontal scrolling for 132 column printers. File size is limited only by disk size. The print formatting program allows control over output word processing files, and permits the insertion of variable data into form letters. Full proportional printing is also supported.

**COPYWRITER+** Includes an integrated mailing list system which can:  
select any range of zip codes for printing  
select which fields to fill into merge  
select by title, position or department within a company  
Output can sort for bulk mailings by state and zip code.

COPYWRITER - \$395.

COPYWRITER+ - \$595. Manual alone \$35.  
Requires 56K RAM. 8" single density IBM format

## PAYSOFT™

Easy to use, yet powerful and flexible payroll program for 8" single density, NorthStar 2D & TRS-80.

- ★ Simplified data base construction.
- ★ Minimum system operation time
- ★ Enter hours worked - gross & net pay calculated
- ★ Federal, State, FICA, SDI withholdings are automatic

Requires 48K RAM  
\$195.

## SELECTOR IV™

A totally self-contained CP/M Data Base System providing complete data, procedural, query, and report definition functions. Allows records to be managed on a one-for-one basis, as well as in 'batch' mode where several files can communicate with each other in a variety of ways. Includes multiple 'key fields'. Requires 54K RAM.

\$550. Manual alone \$25.

Formats: 8" single density, NorthStar 2D & Micropolis Mod II.

## TEXTWRITER III™

NEW FEATURES! A text formatting program for NorthStar & TRS-80 DOS, Micropolis MDOS & any CP/M based system.

- ★ Proportional spacing & enhanced printing for
  - Diablo
  - Qume
  - NEC printers
- ★ Enhanced printing includes ribbon color change, dual pitch, reverse line feed,
  - UNDERSCORE
  - SUPERSCRIPT
  - BOLDFACE
  - DOUBLE STRIKE
  - STRIKEOUT
  - SUBSCRIPT

\$125. Manual alone - \$25.

Report Writer is a trademark of Carolina Business Computers, Inc. Paysoft & FILETRAN are trademarks of Ready Corp. Selector IV is a trademark of Micro-AP, Inc. Pearl is a trademark of CPU International. Pascal/M & ACT are trademarks of Small Business Applications, Inc. Textwriter & Datebook are trademarks of Organic Software. Ultrasort II is a trademark of Computer Control Systems, Inc. Copywriter is a trademark of Systonics TRS-80 is a trademark of Tandy Corp. CP/M & MP/M are trademarks of Digital Research. Superbrain is a trademark of Interfac Data Systems. S-Basic is a trademark of Tapaz Programming. Prices effective until January 1, 1981. For shipping add \$4. In US: \$10. outside US per package. California residents add appropriate state sales tax. Terms: Prepaid check, M/C or VISA or in US COO (UPS) Dealer inquiries invited.

sional and business worlds as well.

Microsoft plans to charge an initial fee for the package ranging from a low of \$500 to \$3000 for a four-user system. The company also has plans to adapt its BASIC, FORTRAN, and COBOL compilers to run under XENIX. Microsoft has purchased a DEC PDP-11/70 minicomputer specifically for the XENIX development project. The Z8000 version is slated for introduction by year's end, and the 8086 and 68000 versions are to follow sometime in the second quarter of 1981.

Considering that Digital Research plans on developing only an 8086 version of its very popular CP/M operating system, it seems likely that Microsoft's XENIX will become the dominant operating system for 16-bit microcomputer systems.

## 5-inch Winchester Disk Drives Coming On Strong:

At least a half-dozen companies will have 5-inch hard-disk drives on the market late in the first half of 1981. Latest to jump on the 5-inch disk-drive bandwagon are International Memories Inc (IMI) (the Cupertino, California, firm that marketed the first 8-inch Winchester drive) and Shugart Associates (the largest producer of floppy-disk drives). These drives typically store 5 million to 7 million bytes and sell for less than \$1000 in OEM (original equipment manufacturer) quantities.

## 64 K-Bit Memory Devices Becoming Available:

Several integrated-circuit manufacturers are currently supplying samples of the new 64 K-bit programmable memory circuits to OEMs for evaluation and development. Look to see these devices in use starting in early 1981.

The introduction of these

components has already caused the price of 16 K-bit devices to drop significantly; just a few months ago, these circuits cost six to eight dollars—now they are four or five dollars. Currently, the 64 K-bit memories are in the forty- to sixty-dollar range, which may drop to thirty or thirty-five dollars in production quantities.

It is expected that Japanese suppliers will dominate the 64 K-bit device marketplace. The 16 K-bit device market has been dominated by American suppliers, although the Japanese currently have 40% of that market. The demand for the 64 K-bit memories does not, as yet, appear to be very strong. However, the price erosion of the 16 K-bit memories and increasing competition from Japanese suppliers should cause the 64 K-bit memory prices to drop quickly.

**P**rotecting The Software Copyright: Software vendors are very concerned about software being pirated by unauthorized copying. The problem is acute simply because it is very easy to duplicate cassette- and disk-based software. Further, it isn't especially difficult to copy software stored in read-only memories.

The personal-computer user does not appear to be the cause of the problem because most of that type of pirating is for personal use, and it occurs only on a small scale without a significant impact on vendor sales. However, several software vendors are complaining that software pirates are making copies of their software packages and selling them. The software pirate frequently changes the name of the software package and may even make some minor changes so that the consumer is unaware that the software is a fraud. The practice appears to be widespread outside the US,

where this kind of activity is very difficult to prevent.

As a result, software vendors are seeking ways to prevent pirating. Several are now experimenting with software techniques that cause the copied software to self-destruct if it is run on an unauthorized machine. I suspect that this will prove to be a deterrent for the experimenter and small-time thief, but the professional software pirate should be able to overcome this system.

**T**andy, Apple, And Commodore Are Top Personal-Computer Performers: Each year *Datamation* analyzes and rates the top one hundred computer companies. For the second year in a row, Tandy Corporation (parent company of Radio Shack), Apple Computer, and Commodore have made that list. In fact, for this past year Tandy ranked thirty-ninth (up from last year's fifty-eighth), Apple ranked sixty-first (up from one-hundredth last year), and Commodore ranked seventy-fifth (up from ninety-fourth last year). Tandy had gross sales of \$150 million, a 131% increase. Apple had \$75 million in sales, up from \$10 million the previous year, a 650% increase. Commodore had \$55 million sales, a 150% increase.

These three personal-computer makers had the highest growth rates of the top one hundred computer-product vendors in the US. IBM, which ranked number one in total sales, had only a 7% increase in sales.

**T**alking Computers To Be The Rage: 1981 should be the year that consumers first see the widespread use of voice output in products ranging from computers to household appliances. Many manufacturers are currently supplying

samples of speech-synthesis integrated circuits to OEM customers. The manufacturers include Texas Instruments, National Semiconductor, General Instrument, Hitachi, and Votrax. The Hitachi HD38880 integrated circuit, for example, can produce up to 200 words or one hundred seconds of speech from data stored in a 128 K-bit ROM (read-only memory). The Texas Instruments TMS5200, essentially the same device used in the Speak & Spell toy, has been given an 8-bit data-bus interface and should operate easily with personal computers.

**R**andom Rumors: It is rumored that Intel, Motorola, and Fujitsu are all working on the development of microprocessors that will implement the IBM System/370 instruction set. Performance is expected to be comparable to an IBM 370/115. IBM is rumored to already have such an integrated-circuit version running.... Xerox is rumored to be attempting to buy Apple Computer.... Digital Equipment Corporation is rumored ready to release a 16-bit microprocessor device that will be compatible with 8080, Z80, and 6800 support circuits. It is expected to have the power of a PDP-11/23. At least one company is rumored to be investigating an S-100 implementation....

**MAIL:** I receive a large number of letters each month as a result of this column. If you write to me and wish a response, please include a stamped, self-addressed envelope.

Sol Libes  
POB 1192  
Mountainside NJ 07092

## CP/M<sup>®1</sup> - based Business Software for TRS-80<sup>®2</sup> computers on . . . . . . the fastest Mod-II CP/M with the most features!!!

- |   |  |   |
|---|--|---|
| <ul style="list-style-type: none"> <li>• Over 610,000 bytes/disk</li> <li>• Downloading package included</li> <li>• 1,200 baud operation of serial printers without data loss</li> <li>• Single drive backup</li> </ul> | <ul style="list-style-type: none"> <li>• Mixed single/double density on any of 4 drives (even a 1-drive system)</li> <li>• Ultra-fast disk operation</li> <li>• Emulation of cursor addressing for any of several "dumb" CRTs</li> </ul> | <ul style="list-style-type: none"> <li>• Auto-LF printer support &amp; ASCII top-of-form software (LP/III)</li> <li>• Supplemental document describing our implementation</li> <li>• User-settable function keys</li> </ul> |
|---|--|---|

**MOD-II CP/M** ..... \$250.00     **MOD-I CP/M** ..... \$150.00     **CBASIC2<sup>®3</sup>** (Mod I or II) ..... \$110.00

The following software for Mod-II CP/M only unless otherwise stated (\*-requires CBASIC2):

- |  |   |
|--|---|
| <p><b>RM/COBOL<sup>®4</sup></b> - Only COBOL for CP/M with alternate keys (multi-key ISAM), CRT screen handling, interactive debug, Z80 code, and the most useful Level 2 features. <b>Compatible with Tandy's COBOL-but runs faster!</b> ..... \$495.00</p> <p><b>PMS</b> (Property Management System) - Interactive, menu-driven system includes full G/L, budgeting, cash journal, delinquency list, tenant activity/rent roll, complete audit trail and reports on vacancies, lost rent, and vendors ..... \$650.00*<br/>demo disk &amp; manual ..... 75.00*</p> <p><b>APH</b> (Automated Patient History) - General-purpose question-asking, answer-printing system furnished as self-administered review-of-systems general patient history (Mod-I also) ... \$175.00*</p> | <p><b>MAGIC WAND<sup>®5</sup></b> - Full-feature word processing, true proportional spacing, file merging, and use of full-screen editor for source programs or data ..... \$400.00</p> <p><b>RPA</b> (Residential Property Analysis) - Analyzes income and expense, financing, taxes, inflation and depreciation on home, condo, or apartments over a user-selectable time. Shows payoff in terms of ROI, Cap rate, cash-on-cash. Amortization schedules and worksheet ..... \$300.00*<br/>demo disk &amp; manual ..... 35.00*</p> <p><b>RBC</b> (Rent/Buy Comparison) - Sales or investment tool to compare renting and savings account investment vs. purchasing a particular property ..... \$250.00*<br/>demo disk &amp; manual ..... 35.00*</p> |
|--|---|
- Osborne & Assoc. CBASIC source programs (Mod-I also):
- |   |  |
|---|--|
| <b>Payroll w/Cost Accounting</b> ..... \$250.00*        | <b>General Ledger w/Cash Journal</b> ..... \$250.00* |
| <b>Accts. Payable/Accts. Receivable</b> ..... \$250.00* | <b>O&amp;A CBASIC Books (ea.)</b> ..... \$ 20.00     |

### Verbatim<sup>®6</sup> media: (Qty. 100 prices)

- |  |  |
|--|--|
| 5 1/4" single density ..... \$2.50 ea.       | 8" single density ..... \$ 3.00 ea.    |
| 8" certified double density ..... \$4.00 ea. | 450' tape cartridges ..... \$20.00 ea. |



8041 Newman Ave., Suite 208  
Huntington Beach, CA 92647  
(714) 848-1922

Registered trademark of:

- \*1 Digital Research
- \*2 Tandy Corp.
- \*3 Compiler Systems, Inc.
- \*4 Ryan-McFarland Corp.
- \*5 Small Business Applications, Inc.
- \*6 Verbatim Corp.



Distributed in U.K. by:  
Microcomputer Applications Ltd.  
11, Riverside Court,  
Caversham, Reading, England  
TEL: (0734) 470425

## DG/H8 — THE TOTAL SYSTEMS CONCEPT

### THE DG-80 ZILOG Z80 BASED CPU — \$249.00 (Documentation Only \$25.00)

#### FEATURES:

- |   |   |   |
|---|---|---|
| <ul style="list-style-type: none"> <li>• Compatible with Heath<sup>®</sup> H8 hardware and software</li> <li>• Z80 CPU — Enhanced instruction set</li> <li>• Provisions for up to 8K ROM/EPROM and/or 4K RAM</li> <li>• Jump-On-Reset to any 1K boundary</li> <li>• DIP switch selectable wait</li> </ul> | <ul style="list-style-type: none"> <li>states for any or all 8K blocks of memory</li> <li>• All Z80 interrupt response modes available</li> <li>• Interrupt Acknowledge and Dynamic Memory Refresh signals available on bus</li> <li>• Frequently selected options by DIP switch or solderless jumper</li> <li>• Machined contact gold sockets for</li> </ul> | <ul style="list-style-type: none"> <li>ROM/EPROM, RAM</li> <li>• Includes many advanced features for future expansion</li> <li>• Assembled, tested and guaranteed</li> <li>• Extensive operations manual and Z80 PROGRAMMING MANUAL</li> <li>90 DAY WARRANTY</li> </ul> |
|---|---|---|

**DG-64D 64K — \$529.00     48K — \$480.00     32K — \$431.00     16K — \$382.00     8K — \$333.00**

#### BEST RAM EVER AVAILABLE FOR THE H8.

#### FEATURES:

- |  |  |
|--|--|
| <ul style="list-style-type: none"> <li>• Up to 64K bytes capacity Dynamic RAM</li> <li>• Hardware bank selectable in 8K increments</li> <li>• Software bank selectable in 16K increments through I/O port</li> <li>• On-board bank select/CPU ROM disable port, addressable to any of 256 I/O addresses</li> <li>• Up to 8 boards controllable through one I/O port (allows page mode operation)</li> <li>• On-board transparent refresh for 8080 or Z80 micro-processor backed up by asynchronous refresh upon loss of normal program execution.</li> <li>• 4 MHz operation with no wait states required</li> <li>• Low power consumption — less than 8 watts</li> <li>• Assembled, tested, &amp; burned-in</li> <li>90 DAY WARRANTY</li> </ul> | <p><b>Documentation Only \$15.00</b></p> |
|--|--|

#### DG-FP8 — \$69.95

Monitor/Utility package for DG-80 CPU provides functions of PAM-8 as well as the following:

- |  |   |
|--|---|
| <ul style="list-style-type: none"> <li>• Split Octal or Hexidecimal Entry and Display</li> <li>• Z80 monitor features such as display alternate register sets, display index registers,</li> <li>• "Shorthand" display of memory contents pointed to by general purpose</li> </ul> | <ul style="list-style-type: none"> <li>registers</li> <li>• Supports STANDARD CP/M provided by D-G as well as HDOS</li> <li>• Provides firmware support for DG-ADP4, 4 MHz hardware</li> <li>• Includes single step features</li> </ul> |
|--|---|

Documentation Only - \$15.00 (Source Listing Not Included)

#### DG-ADP4 — \$19.95

Plug-in hardware modification to allow operation of the Heath<sup>®</sup> H17 disk system with the DG-80 at 4 MHz. Requires the use of the DG-FP8 firmware package.

#### 16K CHIP SETS \$49.00

(8-4116 Type Dynamic RAMS) for DG- 32D, DG-64D, Apple<sup>®</sup>, TRS-80<sup>®</sup>, H88/ 89<sup>®</sup>, and Pet<sup>®</sup>

#### DG-CMD1 — \$29.95

ROM disable port for use with the Heath<sup>®</sup> H8 computer. Addressable to any of 256 I/O ports. Allows the use of a full 64K of RAM when used in conjunction with the DG-80 CPU and the DG-FP8 hardware/firmware package (NOT REQUIRED FOR SYSTEMS UTILIZING THE DG-64D MEMORY BOARD)

#### DG-FP8/DG-ADP4 — TOGETHER — \$79.95

Save on Combination Purchase Reg. \$89.90

**STANDARD CP/M Ver 2.2     \$130.00**

**DG-32D — 32K — \$339.00 — 16K — \$287.00 — 8K — \$235.00 — DOCUMENTATION \$12.00**

CP/M is a registered trademark of Digital Research of Pacific Grove, California. Heath, HDOS, H8, H88/89 & PAM8 are registered trademarks of the Heath Company. Z80 is a registered trademark of Zilog Corp. PET is a registered trademark of Commodore. Apple is a registered trademark of Apple Computer. TRS-80 is a registered trademark of TANDY Corp.



Ordering Information: Products listed available from DG Electronic Developments Co., P.O. Box 1124, 1827 South Armstrong, Denison, Tx. 75020. Check, Money Order, VISA or Master Charge accepted. Phone orders (charge only) call (214) 465-7805. No COD's. Freight prepaid. Allow 3 weeks for personal checks to clear. Texas residents add 5%. Foreign orders add 30%.

# Machine Problem Solving

## Part 3: The Alpha-Beta Procedure

---

Professor Peter Frey  
Northwestern University  
Cresap Neuroscience Laboratory  
2021 Sheridan Rd  
Evanston IL 60201

---

### Zero-Sum Games

In many problem-solving situations, the wisdom of a particular decision often depends upon the range of options that someone else may have. Many real-world decision-making environments can be modeled in terms of a two-person game. When each player is aware of his own and his opponent's options at each choice point, the game is described as one of *perfect information*. If the rules of the game require that each player's gain must come at the expense of the other, then the game is strictly competitive, or *zero-sum*. Familiar games that meet these criteria are chess, checkers, three-dimensional tic-tac-toe, go, gomoku, and Othello.

The first two articles in this series considered decision-making situations in which a single individual was responsible for a series of choices. By constructing programs that searched among a large number of choice combinations, we were successful in developing mechanical solutions for these problems. When two people are making choices and each is trying to better his own position at the other's expense, the standard look-ahead search that we described earlier is no longer adequate.

### Minimax Strategy

Instead, it is necessary to consider choices in which the two players attempt to satisfy conflicting goals. Most of the important strategic ideas which are used in analyzing these games date back to a very influential book which was written in 1944 by Von Neumann and Morgenstern (see reference 4).

The key idea for our present purposes is the *minimax* strategy. In analyzing any given position in the game, a

look-ahead tree is constructed which represents the sequence of options that the two players have (as a hierarchical branching structure which grows exponentially as one proceeds away from the initial position).

The minimax strategy consists of evaluating "final" positions at some arbitrary depth (usually defined by practical constraints of time and space) and then following parent nodes all the way down the tree to the starting position. This path is defined by assuming that each player will decide among the options that are available to him at his choice points by selecting the one that guarantees the best possible outcome.

If the terminal evaluations are chosen such that high numbers favor the first player (and low numbers favor the second player), the first player is expected to choose the pathway that guarantees as large a terminal value as possible, and the second player is expected to choose the pathway that guarantees as small a terminal value as possible. In practical terms, the first player always maximizes, the second player always minimizes.

This description would seem to explain the derivation of the name. This is not historically correct, however. The "minimax" name is actually based on the underlying strategic idea that each player attempts to minimize his opponent's maximum potential gain.

### History and Practicality

The minimax technique appeared to be of limited practicality when it was first discovered because of the rapid increase in the number of terminal positions as the look-ahead tree grows. The number of terminal positions that need to be analyzed in a minimax search is equal roughly

# DYNACOMP

Quality software for:

ATARI  
PET  
APPLE II Plus

TRS-80 (Level II)  
NORTH STAR  
CP/M 8" Disk

## GAMES

### BRIDGE 2.0

Price: \$17.95 Cassette  
\$21.95 Diskette

An all-inclusive version of this most popular of card games. This program both BIDS and PLAYS either contract or duplicate bridge. Depending on the contract, your computer opponents will either play the offense OR defense. If you bid too high, the computer will double your contract! BRIDGE 2.0 provides challenging entertainment for advanced players and is an excellent learning tool for the bridge novice.

### HEARTS 1.5

Price: \$14.95 Cassette  
\$18.95 Diskette

An exciting and entertaining computer version of this popular card game. Hearts is a trick-oriented game in which the purpose is not to take any hearts or the queen of spades. Play against two computer opponents who are armed with hard-to-beat playing strategies.

### CRIBBAGE 2.0 (TRS-80 only)

Price: \$14.95 Cassette  
\$18.95 Diskette

This is a well-designed and nicely executed two-handed version of the classic card game, cribbage. It is an excellent program for the cribbage player in search of a worthy opponent as well as the beginner wishing to learn the game, in particular the scoring and jargon. The standard cribbage score board is continually shown at the top of the display (utilizing the TRS-80's graphics capabilities), with the cards shown underneath. The computer automatically scores and also announces the points using the traditional phrases.

### CHESS MASTER (North Star and TRS-80 only)

Price: \$19.95 Cassette  
\$23.95 Diskette

This complete and very powerful program provides five levels of play. It includes castling, en passant captures and the promotion of pawns. Additionally, the board may be preset before the start of play, permitting the examination of "book" plays. To maximize execution speed, the program is written in assembly language (by SOFTWARE SPECIALISTS of California). Full graphics are employed in the TRS-80 version, and two widths of alphanumeric display are provided to accommodate North Star users.

### STARTREK 3.2

Price: \$ 9.95 Cassette  
\$13.95 Diskette

This is the classic Startrek simulation, but with several new features. For example, the Klingons now shoot at the Enterprise without warning while also attacking starbases in other quadrants. The Klingons also attack with both light and heavy cruisers and move when shot at! The situation is hectic when the Enterprise is besieged by three heavy cruisers and a starbase S.O.S. is received! The Klingons get even!

### SPACE TILT (Apple only)

Price: \$10.95 Cassette  
\$14.95 Diskette

Use the game paddles to tilt the plane of the TV screen to "roll" a ball into a hole in the screen. Sound simple? Not when the hole gets smaller and smaller! A built-in timer allows you to measure your skill against others in this habit-forming action game.

### GAMES PACK I and GAMES PACK II

Price: \$ 9.95 each, Cassette  
\$13.95 each, Diskette

GAMES PACK I contains BLACKJACK, LUNAR LANDER, CRAPS, HORSESHOE, SWITCH and more. GAMES PACK II includes CRAZY EIGHTS, JOTTO, ACEY-DUCEY, LIFE, WUMPUS and others.

Why pay \$3.95 or more per program when you can buy a DYNACOMP collection for just \$9.95!

## STATISTICS and ENGINEERING

### DATA SMOOTHER

Price: \$14.95 Cassette  
\$18.95 Diskette

This special data smoothing program may be used to rapidly derive useful information from noisy business and engineering data which are equally spaced. The software features choice in degree and range of fit, as well as smoothed first and second derivative calculation. Also included is automatic plotting of the input data and smoothed results.

### FOURIER ANALYZER

Price: \$14.95 Cassette  
\$18.95 Diskette

Use this program to examine the frequency spectra of limited duration signals. The program features automatic scaling and plotting of the input data and results. Practical applications include the analysis of complicated patterns in such fields as electronics, communications and business.

### TFA (Transfer Function Analyzer)

Price: \$19.95 Cassette  
\$23.95 Diskette

This is a special software package which may be used to evaluate the transfer functions of systems such as hi-fi amplifiers and filters by examining their response to pulsed inputs. TFA is a major modification of FOURIER ANALYZER and contains an engineering-oriented decibel versus log-frequency plot as well as data editing features. Whereas FOURIER ANALYZER is designed for educational and scientific use, TFA is an engineering tool.

FOURIER ANALYZER and TFA may be purchased together for a combined price of \$29.95 (Cassettes) and \$37.95 (Diskettes).

### REGRESSION I

Price: \$19.95 Cassette  
\$23.95 Diskette

REGRESSION I is a unique and exceptionally versatile one-dimensional least squares "polynomial" curve fitting program. Features include very high accuracy; an automatic degree determination option; an extensive internal library of fitting functions; data editing; automatic data and curve plotting; a statistical analysis (e.g., standard deviation, correlation coefficient, etc.) and much more. In addition, new fits may be tried without reentering the data. REGRESSION I is certainly the cornerstone program in any data analysis software library.

Circle 158 on inquiry card.

## Availability

DYNACOMP software is supplied with complete documentation containing clear explanations and examples. All programs will run within 16K program memory space (ATARI requires 24K). Except where noted, programs are available on ATARI, PET, TRS-80 (Level II) and Apple (Applesoft) cassette and diskette as well as North Star single density (double density compatible) diskette. Additionally, most programs can be obtained on standard 8" CP/M floppy disks for systems running under MBASIC.

## BUSINESS and UTILITIES

### MAIL LIST II (North Star only)

Price: \$21.95

This many-featured program now includes full alphabetic and zip code sorting as well as file merging. Entries can be retrieved by user-defined code, client name or Zip Code. The printout format allows the use of standard size address labels. Each diskette can store more than 1100 entries (single density; over 2200 with double density systems).

### TEXT EDITOR I (Letter Writer)

Price: \$14.95 Cassette  
\$18.95 Diskette

An easy to use, line-oriented text editor which provides variable line widths and simple paragraph indenting. This text editor is ideally suited for composing letters and is quite capable of handling much larger jobs.

### FINDIT (North Star only)

Price: \$19.95

This is a three-in-one program which maintains information accessible by keywords of three types: Personal (e.g., last name), Commercial (e.g. plumbers) and Reference (e.g. magazine articles, record albums, etc). In addition to keyword searches, there are birthday, anniversary and appointment searches for the personal records and appointment searches for the commercial records. Reference records are accessed by a single keyword or by cross-referencing two or three keywords.

### DFILE (North Star only)

Price: \$19.95

This handy program allows North Star users to maintain a specialized data base of all files and programs in the stack of disks which invariably accumulates. DFILE is easy to set up and use. It will organize your disks to provide efficient locating of the desired file or program.

### COMPARE (North Star only)

Price: \$12.95

COMPARE is a single disk utility software package which compares two BASIC programs and displays the file sizes of the programs in bytes, the lengths in terms of the number of statement lines, and the line numbers at which various listed differences occur. COMPARE permits the user to examine versions of his software to verify which are the more current, and to clearly identify the changes made during development.

### COMPRESS (North Star only)

Price: \$12.95

COMPRESS is a single-disk utility program which removes all unnecessary spaces and (optionally) REMARK statements from North Star BASIC programs. The source file is processed one line at a time, thus permitting very large programs to be compressed using only a small amount of computer memory. File compressions of 20-50% are commonly achieved.

### GRAFIX (TRS-80 only)

Price: \$12.95 Cassette  
\$16.95 Diskette

This unique program allows you to easily create graphics directly from the keyboard. You "draw" your figure using the program's extensive cursor controls. Once the figure is made, it is automatically appended to your BASIC program as a string variable. Draw a "happy face", call it H\$ and then print it from your program using PRINT H\$! This is a very easy way to create and save graphics.

### TIDY (TRS-80 only)

Price: \$10.95 Cassette  
\$14.95 Diskette

TIDY is an assembly language program which allows you to renumber the lines in your BASIC programs. TIDY also removes unnecessary spaces and REMARK statements. The result is a compacted BASIC program which uses much less memory space and executes significantly faster. Once loaded, TIDY remains in memory; you may load any number of BASIC programs without having to reload TIDY!

## SIMULATIONS and EDUCATION

### BLACK HOLE (Apple only)

Price: \$14.95 Cassette  
\$18.95 Diskette

This is an exciting graphical simulation of the problems involved in closely observing a black hole with a space probe. The object is to enter and maintain, for a prescribed time, an orbit close to a small black hole. This is to be achieved without coming so near the anomaly that the tidal stress destroys the probe. Control of the craft is realistically simulated using side jets for rotation and main thrusters for acceleration. This program employs Hi-Res graphics and is educational as well as challenging.

### VALDEZ

Price: \$14.95 Cassette  
\$18.95 Diskette

A simulation of supertanker navigation in the Prince William Sound and Valdez Narrows. The program uses an extensive 256X256 element radar map and employs physical models of ship response and tidal patterns. Chart your own course through ship and iceberg traffic. Any standard terminal may be used for display.

### FLIGHT SIMULATOR

Price: \$17.95 Cassette  
\$21.95 Diskette

A realistic and extensive mathematical simulation of take-off, flight and landing. The program utilizes aerodynamic equations and the characteristics of a real airfoil. You can practice instrument approaches and navigation using radials and compass headings. The more advanced flyer can also perform loops, half-rolls and similar aerobatic maneuvers.

### TEACHER'S PET: I

Price: \$ 9.95 Cassette  
\$13.95 Diskette

This is the first of DYNACOMP's educational packages. Primarily intended for pre-school to grade 3, TEACHER'S PET provides the young student with counting practice, letter-word recognition and three levels of math skill exercises.

## Ordering Information

All orders are processed and shipped postpaid within 48 hours. Please enclose payment with order along with computer information. If paying by VISA or Master Card, include all numbers on card. For orders outside North America add 10% for shipping and handling.

Add \$3.00 for 8" floppy disk (soft sector, CP/M, Microsoft BASIC)

Deduct 10% when ordering 3 or more programs.

Ask for DYNACOMP programs at your local software dealer. Write for detailed descriptions of these and other programs from DYNACOMP.

**DYNACOMP, Inc.**  
6 Rippingale Road  
Pittsford, New York 14534  
(716) 586-7579



New York State residents please add 7% NYS sales tax.

**MORE FOR YOUR  
RADIO SHACK  
TRS-80 MODEL I !  
THE DATAHANDLER**

**DATABASE MANAGEMENT  
SYSTEM IN MMSFORTH**

Now the power, speed and compactness of MMSFORTH drive a major applications program for many of YOUR home, school and business tasks! Imagine a sophisticated database management system with flexibility to create, maintain and print mailing lists with multiple address lines. Canadian or the new 9-digit U.S. ZIP codes, and multiple phone numbers, plus the speed to load hundreds of records or sort them on several fields in 5 seconds! Manage inventories with selection by any character or combination. Balance checkbook records and do CONDITIONAL reporting of expenses or other calculations. File any records and recall selected ones with optional upper/lower case match, in standard or custom formats. Personnel, membership lists, bibliographies, catalogs of record, stamp and coin collections—you name it! ALL INSTANTLY, without wasted bytes, and with cueing from screen so good that non-programmers quickly master its use! With manual, sample data files and custom words for mail list and checkbook use.

Technical: Handles data as compressed indexed sequential subfiles of up to 25K characters (9K in 32K RAM). Access 1-4 diskettes. Modified Quicksort. Optionally precompiles for 5-second program load. Self-adjusts for many routine mods. Structured and modular MMSFORTH source code ideal for custom modifications.

THE DATAHANDLER V1.1, a very sophisticated database management system operable by non-programmers (requires Disk MMSFORTH, 1 drive & 32K RAM); with manuals ..... \$59.95\*

**mmsFORTH**

**THE PROFESSIONAL FORTH  
FOR TRS-80 MODEL I**

(Over 1,000 systems in use)

MMSFORTH Disk System V1.9 (requires 1 disk drive & 16K RAM) ..... just \$79.95\*  
MMSFORTH Cassette System V1.8 (requires Level II BASIC & 16K RAM) ..... \$59.95\*

**AND MMS GIVES IT  
PROFESSIONAL SUPPORT**

Source code provided  
MMSFORTH Newsletter  
Many demo programs aboard  
MMSFORTH User Groups  
Programming staff can adapt  
THE DATAHANDLER to YOUR needs.

MMSFORTH UTILITIES DISKETTE: Includes FLOATING POINT MATH (L2 BASIC ROM routines plus Complex numbers, Rectangular-Polar coordinate conversions, Degrees mode, more), plus a full Forth-style Z80 ASSEMBLER; plus a powerful CROSS-REFERENCER to list Forth words by block and line. All on one diskette (requires MMSFORTH, 1 drive & 16K RAM), .. \$39.95\*

**FORTH BOOKS AVAILABLE**

MICROFORTH PRIMER — comes with MMSFORTH; separately ..... \$15.00\*  
USING FORTH — more detailed and advanced than above ..... \$25.00\*  
FORTH TUTORIAL MANUAL — very readable Intro. to U/Rochester Forth ..... \$19.95\*  
CALTECH FORTH MANUAL — good on Forth internal structure, etc ..... \$6.95\*

\* — Software prices are for single-system user license and include manuals. Add \$2.00 S/H plus \$1.00 per additional book; Mass. orders add 5% tax. Foreign orders add 15%. UPS COD, VISA & MIC accepted; no unpaid purchase orders, please.

Send SASE for free MMSFORTH information.  
Good dealers sought.

Get MMSFORTH products from your  
computer dealer or  
**MILLER MICROCOMPUTER  
SERVICES (B2)**

61 Lake Shore Road, Natick, MA 01760  
(617) 653-6136

Circle 157 on inquiry card.

to the average number of options at each choice raised to a power equal to the depth of the search tree. For example, consider the game of chess, which averages thirty-eight options at each choice point. A minimax search considering a look-ahead of four moves for each player would have  $38^4$  terminal positions. That is more than 4 trillion (4,000,000,000,000) positions.

You do not have to be a mathematical genius in order to determine that a process that grows exponentially like this one is going to get out of control very quickly. Because of this exponential explosion and because there were no computers in the 1940s, the minimax algorithm initially received little attention.

In practical terms, the first player always maximizes, the second player always minimizes.

**The Alpha-Beta Technique**

In 1956, at the Dartmouth Summer Research Conference on Artificial Intelligence (see reference 1), John McCarthy pointed out that Bernstein's chess program did not need to analyze all of the terminal positions in order to select the move that was best in terms of the minimax strategy.

Although no formal description of the idea was given at that time, several of the game-playing programs written in the late 1950s appear to have employed an enhanced version of the minimax procedure, which has come to be called the  $\alpha$ - $\beta$  (ie: alpha-beta) pruning algorithm. The name seems to have been coined by McCarthy.

The first clear description of the technique for English-speaking audiences was published in 1969 by Slagle and Dixon (see reference 3). The  $\alpha$ - $\beta$  procedure provides a remarkable increase in the efficiency of the search process; and, with the advent of the high-speed computer in the late 1960s and 1970s, the minimax idea finally came of age.

Although there are many references to the  $\alpha$ - $\beta$  minimax technique in the popular literature, the procedure has not received much detailed analysis in the academic literature. The best expository presentation on this topic is a recent paper by Knuth and Moore (see reference 1). The technical details that enhance the efficiency of the  $\alpha$ - $\beta$  strategy are scattered throughout a number of hard-to-find sources. The purpose of this article is to summarize the main ideas and to present a sample program with the key algorithms.

**Treasure Search**

To provide an explicit example, I have devised a new game that is easy to play and is easily programmed. One of the difficulties of describing the  $\alpha$ - $\beta$  minimax procedure within the context of a familiar game is that move generation and position evaluation are sufficiently complex that these aspects of the program tend to mask the fine points of the  $\alpha$ - $\beta$  search. The game we will consider involves very straightforward move-generation and position-evaluation routines. For this reason, we will be



An Extraordinary Offer to introduce you to the benefits of Membership in

# ELECTRONICS BOOK CLUB

invites you to take  
this 1,442-page  
Computer Library  
for only

# \$2.95

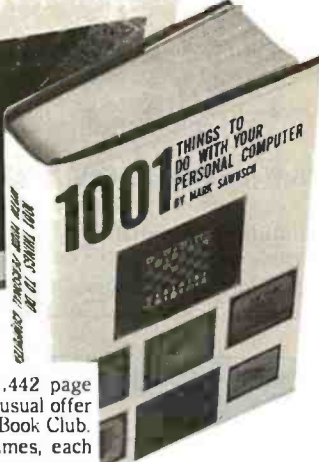
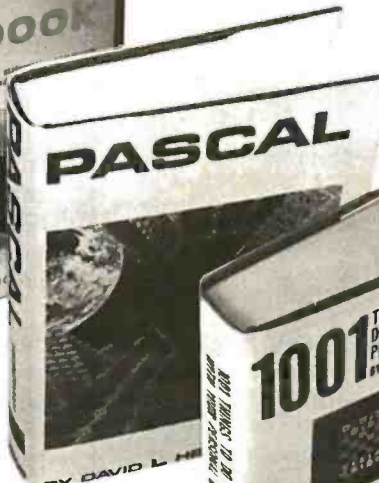
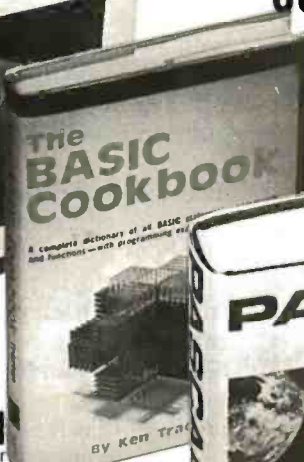

**You  
Get ALL  
FIVE Of These  
Huge Books  
For Only  
\$2.95**

### Troubleshooting Microprocessors And Digital Logic

A complete guide to modern microprocessor/microcomputer troubleshooting and servicing that shows you how to do it all... how to understand and troubleshoot digital/logic and microprocessor circuits, how to dig into their operating systems, and how to locate and repair problems quickly and easily. You'll learn about binary codes, system interfacing, input/output devices, flowcharts, using oscilloscopes, logic probes, etc., when troubleshooting, testing, and repairing TTL logic gates, clock pulses, random-access memories, CPU's, VCR's, videodisc players, complete minicomputer systems like the TRS-80, TV games, TV tuners. 308 pps., 229 illus. List \$12.95

### Handbook Of Microprocessor Applications

How to use microprocessors in a wide variety of applications... including interfacing and using machine language programming! Clearly explains and examines the concepts crucial to the use of microprocessors and fully details every phase of logic and machine decisions: Boolean algebra, the truth table, OR, NOR, AND and NAND functions, etc. Learn to document and analyze a problem, locate any given step, calculate forward jumps, use timing loops, calculate delays and more. State machines, input/output functions, data buses, ROM and RAM. This book is practical... and focuses on the how-to of using microprocessor chips. 308 pps., 94 illus. List \$14.95

### The BASIC Cookbook

A complete dictionary of all BASIC statements, commands, and functions—with programming examples and flowcharts—thoroughly defines the BASIC vocabulary, illustrates the definitions with sample programs, and clarifies the programs with matching flowcharts. You'll learn how to use each BASIC term in a workable program. ARRAY, COS, END, FOR-TO, GOSUB, INPUT, LIST, RANDOMIZE, REM, SCRATCH, SGN, SQR, TAN. It also defines programming terms that apply to APL, ALGOL, COBOL, FORTRAN, RPG, P.L.I., and other languages. 140 pps., 49 illus. List \$7.95

### PASCAL

A programmer's guide to using Pascal, Tiny Pascal and Super-soft Tiny Pascal... including actual programs and helpful exercises! Starting with how to load a TinyPascal cassette into a TRS-80 system, goes through all the steps necessary to become proficient in this new language. Learn to read syntax diagrams; use WRITE statements to print characters and do TRS-80 graphics; enter integers with READ statements; use logic with AND, OR and NOT, etc. You'll also find out how to put together complete READ and WRITE programs, and use repetitive (looping) statements to write unending loops... plus how to "goof-proof" entries. 350 pps., 106 illus. List \$15.95

### 1001 Things To Do With Your Personal Computer

Over 1,000 time-saving, money-saving, effort-saving and just-plain-fun applications—with actual programs, printouts, flowcharts, diagrams and illustrations. Twelve Chapters contain programs for any use and taste, and applications for everyone: business and financial, mathematical, technical and scientific, educational, statistical, control and peripheral, hobbies and games. Includes a shorthand translator, weather forecasting, precise values for camera settings, animated films, model railroads, controlling household devices like wood stoves, Morse code, almost 100 games. 336 pps., 100 illus. List \$12.95

- ✓ Only \$2.95 for ALL FIVE!
- ✓ Regular List Price \$64.75
- ✓ Top-Quality Hardbinding
- ✓ Contains the very latest info on computers!
- ✓ Over 500 illustrations
- ✓ Contains over 275,000 words
- ✓ 1442 data-packed pages

Let us send you this 5-volume, 1,442 page Computer Library as part of an unusual offer of a Trial Membership in Electronics Book Club.

Here are quality hardbound volumes, each especially designed to help you increase your know-how, earning power, and enjoyment of electronics and computers. Whatever your interest in electronics/computers, you'll find Electronics Book Club offers practical, quality books that you can put to immediate use and benefit.

This extraordinary offer is intended to prove to you, through your own experience, that these very real advantages can be yours... that it is possible to keep up with the literature published in your areas of interest, and to save substantially while so doing. As part of your Trial Membership, you need purchase as few as four books during

the coming 12 months. You would probably buy at least this many anyway, without the substantial savings offered through Club Membership.

To start your Membership on these attractive terms, simply fill out and mail the coupon today. You will receive the 5-volume Computer Library for 10-day inspection. YOU NEED SEND NO MONEY. If you're not delighted, return the books within 10 days and your Trial Membership will be cancelled without cost or obligation.

ELECTRONICS BOOK CLUB, Blue Ridge Summit, Pa. 17214

## Facts About Club Membership

- The 5 introductory books carry a publisher's retail price of \$64.75. They are yours for only \$2.95 for all 5 (plus postage/handling) with your Trial Membership.
- You will receive the Club News, describing the current Selection, Alternates, and other books, every 4 weeks (13x a year).
- If you want the Selection, do nothing; it will be sent to you automatically. If you do not wish to receive the Selection, or if you want to order one of the many Alternates offered, you simply give instructions on the reply form (and in the envelope) provided, and return it to us by the date specified. This date allows you at least 10 days in which to return the form. If, because of late mail delivery, you do not have 10 days to make a decision and so receive an unwanted Selection, you may return it at Club expense.
- To complete your Trial Membership, you need buy only four additional monthly Selections or Alternates during the next 12 months. You may cancel your Membership any time after you purchase these four books.
- All books—including the introductory Offer—are fully returnable after 10 days if you're not completely satisfied.
- All books are offered at low Member prices, plus a small postage and handling charge.
- Continuing Bonus: If you continue after this Trial Membership, you will earn a Dividend Certificate for every book you purchase. Three Certificates plus payment of the nominal sum of \$1.99 will entitle you to a valuable Book Dividend of your choice which you may choose from a list provided Members.

## ELECTRONICS BOOK CLUB

Blue Ridge Summit, Pa. 17214

Please open my Trial Membership in ELECTRONICS BOOK CLUB and send my 5-volume Computer Library, invoicing me for only \$2.95 plus shipping. If not delighted, I may return the books within 10 days and owe nothing, and have my Trial Membership cancelled. I agree to purchase at least four additional books during the next 12 months after which I may cancel my membership at any time.

Name \_\_\_\_\_ Phone \_\_\_\_\_

Address \_\_\_\_\_

City \_\_\_\_\_

State \_\_\_\_\_ Zip \_\_\_\_\_

(Valid for new Members only. Foreign and Canada add 15%.) BY-1180

able to concentrate on the tree-searching algorithm in the absence of unwanted distractions.

This new game is called Treasure Search and is played on an 8-by-8 grid. A digit between 1 and 9 is randomly assigned to each of the sixty-four squares. Each contestant has a single playing piece which is initially positioned in the central portion of the grid. The players take turns moving their pieces. A piece can be moved only one square at a time in one of four orthogonal directions (ie: north, south, east, or west). The object of the game is to

Treasure Search 4	
	8 6 1 7 5 8 9 6
	4 9 5 6 2 6 9 1
George	4 1 4 6 4 7 4 1
0	9 1 4 * 7 5 3 5
	6 2 5 9 X 4 4 4
TRS-80	5 9 9 3 4 8 8 1
0	3 7 6 2 4 5 1 8
	8 8 6 4 6 9 1 3
Which Direction for X?	

Table 1: Starting position for Treasure Search. The human player moves the "X" one square at a time and attempts to collect as many big numbers as possible. The computer moves the "\*" on alternate turns with the same objective. The first player to accumulate one hundred points wins.

visit squares where a large number has been assigned and to collect as many of these as possible. Once a number has been taken from a square, that location is empty and subsequent visits provide no additional benefits. The first player to accumulate one hundred or more points wins the game.

Table 1 depicts the playing board as it might appear at the start of the game. The human player has the token designated as "X" and always moves first. Move selection is made by pressing one of the four arrow keys (←, →, ↑, ↓) on the computer keyboard. The program I will present is written for the Radio Shack TRS-80 computer in Level II BASIC.

### The Treasure Search Game

The specific numbers that appear in table 1 are set randomly at the beginning of each game; therefore, a new playing field is present for each and every game. The strategy for each player is to find a pathway in which he can collect large numbers for himself and at the same time deny large numbers to his opponent. The game was originally planned for young children. I have subsequently found that it is fun for children of all ages.

To begin my presentation, I will provide a listing of the computer instructions for creating the playing field and accepting moves from the human player. Subsequently, I will present the algorithm for selecting moves for the machine and then discuss enhancements that substantially increase the efficiency of the search.

### The Program

The initial statements in this program are very similar to those at the beginning of its two predecessors. Certain housekeeping functions are required, such as setting aside memory for string storage, clearing the video display, telling the machine to treat all variables as integers, resetting the "seed" for the random-number generator, and initializing important variables:

```
100 CLEAR 100: CLS: DEFINT A-Z: RANDOM:
    SH = 0: ST = 0
```

(Several versions of this program are given in the body of the text and in listings 1 thru 3.) The variables SH and ST represent the cumulative score for the human and the TRS-80, respectively.

Our next objective is to solicit the human player's name so that we can communicate with him in a civilized manner:

```
110 PRINT@463, "PLEASE ENTER YOUR NAME";:
    INPUT N$
```

The next step is to create several arrays that will be needed by the program. Two arrays are needed for remembering move directions (A and D), one is needed to provide an internal representation of the playing field (B), and several more are used by the tree search: M stores the move that is being considered at each level of the look-ahead tree; E stores the evaluation score for each of those moves; Q keeps track of which moves have been considered at each level of the tree; V keeps track of the best pathway value for each level of the tree; Z



SAVE TRS-80's

We have discounts, manufacturer's warranties, FREE shipping and insurance and a TOLL FREE ORDER NUMBER available. **CALL US!**

**Pan American Electronics**  
Incorporated

**Radio Shack**  
AUTHORIZED SALES CENTER

1117 Conway, Mission, Texas 78572  
TOLL FREE ORDER NUMBER 800/531-7466  
Texas & Principal Number 512/581-2765



# The Software Exchange has it all!

One phone call

# 1-800-258-1790

gives you access to all these fine companies.

(IN NH CALL 673-5144)

## SOFTWARE

Microsoft  
Apparat  
Racet  
Hayden  
Muse  
Ritam  
Softape  
Lance Micklus  
Image  
Quality Software  
Web Associates  
Small Systems Software  
On-Line Systems  
Creative Computing  
Personal Software  
Scott Adams  
Acorn Software  
Synergistics  
Strategic Simulations  
Automated Simulations  
Avalon Hill  
Micro America  
Edu Ware  
Instant Software  
Interpro  
Micro Auto Systems  
Peripherals Unlimited  
Program Design  
Personal Finance Systems  
Small Business Systems Group  
Syntonic  
Seabrees Computing

## HARDWARE

Square 1  
Computer Resources Company  
Radio Shack  
Commodore Pet  
Atari

Percom  
Centronics  
NEC  
Sun  
Okidata  
Source/TeleComputing  
Computer Case Co.  
MicroMint  
Eaton LRC  
Cover Craft  
BSR  
BASF  
Corvus  
Archbold Electronics  
ESP  
Novation  
AMP Recording Studios  
Dysan

## BOOKS

Hayden  
Wiley  
Scelbi  
Compusoft  
Dilithium  
Sams  
Radio Shack  
SoftSide  
Addison Wesley  
International Jewelers  
Dome Publishing



**The Software Exchange** 6 SOUTH ST., MILFORD, NH 03055

To order: Call Toll-Free 1-800-258-1790 (in NH call (603) 673-5144)

The Software Exchange & HardSide (Div. of Robitaille & Sons, Enterprises, Inc.), SoftSide Publications



VISA



**OPTIMIZED SYSTEMS  
SOFTWARE  
PRESENTS**

**CONTROL PROGRAM/APPLE**  
the DOS you have been waiting for

OSS CP/A is an all new, disk-based operating system which provides commands and utilities similar to CP/M®. CP/A has byte and block I/O, a simple assembly language interface, and direct access via Note and Point. And it's easy to add your own commands or device handlers. CP/A is expandable, flexible, consistent, easy-to-use and available now with compatible program products:

**BASIC** — Some of the features of OSS BASIC are syntax checking on program entry, true decimal arithmetic (great for money applications), 32K byte string sizes, flexible I/O, long variable names (up to 255 significant characters), and the ability to get and put single bytes.

**BUSINESS BASIC WITH PRINT USING** — This is virtually the only basic available on the Apple that has PRINT USING. It also has record I/O statements and all the features of our standard BASIC.

**EDITOR/ASSEMBLER/DEBUG** — OSS EASMD is a total machine language development package. The editor provides functions like FIND, REPLACE, etc. The assembler uses standard 6502 mnemonics, can include multiple files in one assembly, and can place the object code in memory or to a disk file.

Prices of CP/A with:

BASIC .....	\$ 69.95
Business BASIC .....	84.95
EASMD .....	69.95
BASIC + EASMD .....	109.95
Business BASIC + EASMD .....	124.95

Requires 48K RAM and DISK

Add \$3.50 for shipping and handling in continental USA. California residents add 6%. VISA/Master Charge welcome. Personal checks require two weeks to clear.

**SEE YOUR DEALER or ORDER TODAY**

**OPTIMIZED SYSTEMS SOFTWARE**  
is a product of

Shepardson Microsystems, Inc.  
20395 Pacifica Dr., Suite 108B  
Cupertino, CA 95014  
(408) 257-9900

remembers a "killer" move for each level of the tree (this is explained later in this article); and PV is used to remember the principal variation that is selected by the tree search. The lines we will need are:

120 DIM A(8), B(99), D(4), E(12), M(12)  
130 DIM PV(12,12), Q(12), V(12), Z(12)

The array representing the playing field, B, is treated as a 10-by-10 grid with the first row having indices of 0 to 9, the second row, 10 to 19, the third row 20 to 29, etc. With this organization, the "squares" adjacent to any position are always separated by a constant value. The square to the right is always the current square plus 1. The square to the left is always the current square minus 1. To go up, add 10; to go down, subtract 10. For move generation, we create an array with the following coefficients:

140 D(1) = -10: D(2) = -1: D(3) = 1: D(4) = 10

We will use a special feature of the TRS-80's architecture to produce moves for the human player. A special array is needed to take advantage of the fact that the keyboard is memory-mapped.

150 A(1) = 10: A(2) = -10: A(4) = -1:  
A(8) = 1: CLS

Since our program is designed for children of all ages, we will let the human player adjust the playing strength of the machine. Young children can play against a weak opponent. Older children can select a more competitive opponent.

160 PRINT@461, "TRS-80 PLAYING STRENGTH  
(1 TO 5)";:INPUT Y

The larger the number, the deeper we will have the machine search.

The variable DM is used to set the maximum depth of the look-ahead search. It is defined as twice the value Y minus 1. This will produce searches of one ply, three plies, five plies, seven plies, and nine plies for playing-strength settings from 1 to 5. A five-ply search involves three moves for the machine and two for the human opponent. [A ply is a move by either opponent; the combination of one move by both sides is called a play or a turn; thus two plies equal one move. . . GW] It is also necessary to create the array that provides an internal representation of the playing field. This is done by assigning a digit from 1 to 9 to each of the squares in the playing area:

170 DM = 2\*Y: FOR I = 11 TO 88:  
B(I) = RND(9): NEXT I

The squares that surround the grid are used to designate the edge of the board and are set to a value of 99 for this purpose:

180 FOR I = 0 TO 10: B(I) = 99: NEXT I:  
FOR I = 89 TO 99: B(I) = 99: NEXT I  
190 FOR I = 19 TO 79 STEP 10: B(I) = 99:  
B(I + 1) = 99: NEXT I

# THE OASIS RECIPE FOR QUALITY APPLICATION SOFTWARE.

**H**appy customers are fast making Single & Multi-User OASIS recognized as the super system software. BUT, system software is only as good as the applications it runs. And that's where OASIS really cooks.

**A**pplication software developers particularly like OASIS because it lets them blend unique performance features with their own products—in other words, build better software. Security features like User Accounting with Logon, Password and Privilege Level; File and Automatic Record Locking; Private, Shared and Public Files. Speed and convenience of Keyed Index (ISAM) Files. Economy from Compiled Re-Entrant BASIC that makes multi-user systems practical on as little as 64K memory. And lots more.

**B**ecause OASIS has better development tools—and more of them—creating very sophisticated software is possible, practical, easier, faster. Just one example: BASIC that is an Interpreter and Compiler with Debugger and Editor. If you do your own development, you'll really appreciate these kinds of features. For software

professionals, they make providing superior products much more cost attractive.

**A**dd all the ingredients together and, whether you do it yourself or buy it off the shelf, the pay-off is a wide selection of top-performing, top-quality application software that does more so you do less.

OASIS; Single or Multi-User with a sizzling array of features and tools; almost unlimited software possibilities (*and application software for Single-User OASIS is Multi-User compatible*); the most extensive documentation in the industry—indeed, you get a lot to like. And that's put OASIS System Software\* among the hottest products on the market.

**D**rop us a line today for a complete, free Application Software Directory. And see your OASIS Distributor, or send the coupon direct, to get the products you want. Try us. We believe you'll savor the OASIS recipe.

\* For Z80 based computers.

**OASIS IS AVAILABLE FOR SYSTEMS:** Altos; Compucorp; Cromemco; Delta Products; Digital Group; Digital Microsystems; Dynabyte; Godbout; IBC; Index; Intersystems; North Star; Onyx; SD Systems; TRS 80 Mod II; Vector Graphic; Vorimex.

**CONTROLLERS:** Bell Controls; Cameo; Corvus; Konan; Micromation; Micropolis; Tarbell; Teletek; Thinkertoys; X Comp.

#### APPLICATION SOFTWARE AVAILABLE FOR OASIS:

Accounts Payable; Accounts Receivable; General Ledger; Mail List Pak; Order Entry; Inventory Control; Inventory Tracking Pak; Word Processors.

Architects & Pro Designers Timekeeping & Job Cost Analysis; Cable TV Subscriber Billing Sys; Construction Mgt Pak; Construction Pak; Contractors Tracking Pak; Distributors Pak; Dental Office Mgt Pak; Medical Billing Sys; Pharmacy Prescription Processing with A/R; Management Analysis Pak; Real Estate Office Mgt; Restaurant Pak; Sewer & Water Utility Info Pak.

Bisynchronous Communication Pak; 2780/3780/3270 Emulators; File & Screen Mgr with Report Generator; Full Network Data Base Mgt Sys; Game Pak; Hierarchical Data Base Mgt Sys; Radlogs (Radio Station Logs/Schedules/Programming/Billing with A/R, A/P, G/L).

**THESE ITEMS ARE NOT AVAILABLE DIRECT FROM PHASE ONE SYSTEMS, INC.**—please write for ordering instructions and complete, free Application Software Directory. If you have items you would like listed in the Directory, send us complete information.)



**MAKES MICROS  
RUN LIKE MINIS**

#### PLEASE SEND ME:

Product	Price with Manual	Manual Only
<b>OPERATING SYSTEM</b> (Includes: EXEC Language; File Management; User Accounting; Device Drivers; Print Spooler; General Text Editor; etc.) SINGLE-USER MULTI-USER	\$150 350	\$17.50 17.50
<b>BASIC COMPILER/INTERPRETER/DEBUGGER</b>	100	15.00
<b>RE-ENTRANT BASIC COMPILER/INTERPRETER/DEBUGGER</b>	150	15.00
<b>DEVELOPMENT PACKAGE</b> (Macro Assembler; Linkage Editor; Debugger)	150	25.00
<b>TEXT EDITOR &amp; SCRIPT PROCESSOR</b>	150	15.00
<b>DIAGNOSTIC &amp; CONVERSION UTILITIES</b> (Memory Test; Assembly Language; Converters; File Recovery; Disk Test; File Copy from other OS; etc.)	100	15.00
<b>COMMUNICATIONS PACKAGE</b> (Terminal Emulator; File Send & Receive)	100	15.00
<b>PACKAGE PRICE</b> (All of Above) SINGLE-USER MULTI-USER	500 850	60.00 60.00
<b>FILE SORT</b>	100	15.00
<b>COBOL-ANSI '74</b>	750	35.00

Order OASIS from:

**Phase One Systems, Inc.**  
7700 Edgewater Drive, Suite 830  
Oakland, CA 94621

Telephone (415) 562-8085  
TWX 910-366-7139

NAME \_\_\_\_\_  
STREET (NO BOX =) \_\_\_\_\_  
CITY \_\_\_\_\_  
STATE \_\_\_\_\_ ZIP \_\_\_\_\_

**AMOUNT \$** \_\_\_\_\_

(Attach system description; add \$3 for shipping;

California residents add sales tax)

Check enclosed  VISA

UPS C.O.D.  Mastercharge

Card Number \_\_\_\_\_

Expiration Date \_\_\_\_\_

Signature \_\_\_\_\_

Announcing the most important utility ever introduced for the TRS-80\* Model I and Model II—

# ENHBAS<sup>TM</sup>

ENHBAS is an Enhanced Basic extension module, which loads at the top of BASIC, adding many commands and background tasks—

Over 30 new commands added to your BASIC:

- SORT**-Multi-keying, multi-tagging array sort. Sorts thousands of items in mere seconds, all with one command!
- JNAME**-Use line labels along with line numbers in branching statements, as in assembly language, using the ENHBAS commands GTO and CSUB (special GOTO and GOSUB).  
How many times have you wanted to use variables to reference line numbers? Now you can! GTO and CSUB allow variable expressions as operands, such as in GTO X+40.
- WHILE / WEND**-New, structured programming loop construct. Makes for more logical program flow (less GOTO's).
- EXEC / EVAL**-Two new, extremely powerful functions! EVAL evaluates an algebraic expression in string form. With EVAL you can manipulate complex functions in string form, and then evaluate them. EXEC executes a string expression as if it were a BASIC program line! With EXEC, your computer can actually write its own programs and execute them!
- CALL**-Pass control to machine language subroutines at any address, passing parameters both ways.
- CLM / PAGE**-Set up automatic page roll-over and other line printer functions from BASIC.
- All these and many more!**

In addition to the above commands, Model I ENHBAS contains vector graphics and drawing commands. Model II ENHBAS has many functions suited to business programming—ISAM file handling commands, RS-232 access, and many more; along with several Model I BASIC commands left out of Model II (PEEK, POKE, OUT, etc.).

ENHBAS includes many background utilities (Model I version):

- User-definable cursor
- Key click
- Two-tone beep on error
- Automatic lower-case
- Automatic debounce
- Short-entry commands (Shift-letter prints command)
- Real Control keys
- One letter commands
- Formatted LISTings

ENHBAS is available for:

16K Model I—Level-II Tape .....	\$39.95
32K Model I Disk .....	\$39.95
32K Model III (avail. 11/1/80) .....	\$39.95
32K Model II (on TRSDOS disk) .....	\$99.95

\*TRS-80 is a reg. trademark of Radio Shack, a Tandy Co.

### Other software:

CSG PILOT-Disk-based, high level language. 32K Model I Disk .....	\$59.95
Z-EMULATOR-Executes assem. lang. lines. 16K Model I—Level-II Tape .....	\$29.95
32K Model I Disk .....	\$29.95
ENHCOMP-Integer subset BASIC compiler. Full graphics. Requires RS Editor/Assembler. 32K Model I Disk .....	\$24.95
ABBREVI-Model-I abbrev. in Level-II/Disk. 16K Model I—Level-II Tape .....	\$24.95
32K Model I Disk .....	\$24.95

Dealer and OEM inquiries invited.

## The Comsoft Group

6008 N.Keystone Ave., Dept. B  
Indianapolis, IN 46220  
(317) 257-3227

The playing field also needs to be presented on the video display, along with a title for the game:

```
220 CLS: FOR I = 11 TO 88: IF B(I) = 99 THEN 240
230 X$ = RIGHT$(STR$(B(I),1): GOSUB 1000
240 NEXT I: PRINT@22, "TREASURE SEARCH";Y;
```

The subroutine starting at line 1000 computes a location on the video screen (R = row; C = column) and prints a character there:

```
1000 R = INT (I/10): C = I-10*R:
      K = 141 + (8-R)*64+C*4
1010 PRINT@K, X$;: RETURN
```

Our next objective is to enhance our video display by printing the names of the contestants on the left-hand side of the screen where the score will be recorded. We also need to put each player's piece on the playing field and to define several useful variables. Y\$ is a string variable of twelve blank spaces. Z\$ is similar except it represents thirty-two blank spaces. These two variables will be used when we wish to erase part of the video display. The variable T represents the position (row-column) of the computer piece, and H represents the position of the human piece:

```
250 PRINT@256, N$;: PRINT@448, "TRS-80";:
      Y$ = STRING$(12, " ")
260 T = 54: T$ = "": H = 45:
      H$ = "X": Z$ = STRING$(32, " ")
270 I = T: X$ = T$: GOSUB 1000:
      B(T) = 99: B(H) = 99
280 I = H: X$ = H$: GOSUB 1000: GOTO 300
```

The position where each player's piece is located is not available for a move, so those positions in the B array are temporarily set to the value 99.

Now we are ready to create the module that solicits the human's move. First we will start with a message to present when the requested move is not legal. This can occur if the human attempts to move off the playing field or to a position occupied by the machine's playing piece:

```
290 PRINT@788, "ILLEGAL MOVE, TRY AGAIN";:
      FOR I=1 TO 999: NEXT I
```

In most situations, line 290 will not be executed. Instead, the message will usually be a request for the human player's move:

```
300 PRINT@788,Z$;:
      PRINT@788, "WHICH DIRECTION FOR X";
```

The machine waits for the human's response by doing a rapid cycle from the beginning to the middle of line 310. When a keyboard response occurs, the machine checks a special location in memory that keeps track of the arrow keys and determines which bit has been set by the key-press:

```
310 IF INKEY$ = "" THEN 310 ELSE R = PEEK(16444)
```

The player's response is then processed to determine the

# TERRIFIC TRIO: Z80, OASIS, MAROT.

A superior operating system and top application software bring out the best in a microcomputer. That's why Marot offers the OASIS\* Operating System and compatible software for owners of Z80 based micros. They make a terrific trio.

**1 Z80 MICROS** —great machines. Tandy's TRS-80 MOD II\* with DMA, bank select possibilities and nationwide service. Altos. Cromemco. Horizon. And many others. Great machines—but it takes a great operating system to tap their full potential.

**2 ENTER OASIS** —available from Marot. OASIS is fast emerging as *the* operating system for Z80 commercial applications and serious programmers. Why?...rapid formatting and back-up of diskettes; efficient disk utilization; excellent line editor and document processor for file management and textwriting; user accounting with logon, password, privilege level and use accounting; machine independence of programs, data and text files; sequential, direct and keyed index (ISAM) files; interpreted and compiled BASIC; COBOL-ANSI '74; single and multi-user versions; and more. No wonder pros say 'OASIS makes micros run like minis!'

**3 APPLICATION SOFTWARE** —available from Marot. OASIS is your active, invisible partner supporting these excellent, ready-to-run products:

*Magic Wand*.\* The wordprocessor combining the ease of screen editing with micro power.

*HDBS*\*\* For data management needs restricted to hierarchical tree structure and fixed length records.

*MDBS*\*\* Handles full network CODASYL oriented data structures and variable length records.

*ABS*\*\*\* Quality office management systems—accounts receivable and payable, general ledger, etc.—the total interacting, user-oriented business package. Written in COBOL; available with source code.

A *Law* package. And ready soon: complete medical management, real estate, restaurant, pharmacy, management analysis packages, and others.

Marot and its Dealers offer OASIS and many professional software products to individuals, OEMs and dealers. Licensing arrangements are also available. Just call or write and start your own terrific trio.

----- PLEASE SEND ME: -----

(Circle what you would like and send order with payment to the address shown below.)

SEND COMPLETE INFORMATION

Product	Price
MAGIC WAND*	\$400
<b>ABS ACCOUNTING (call or write)</b>	
MDBS, full network	\$900
HDBS	300
Report Generator, Query System	300
Primer (Other options available)	10

Magic Wand, MDBS and HDBS are available for several operating systems.  
 \*OASIS is the trademark of Phase One Systems, Inc.  
 \*\*HDBS and MDBS are produced by Micro Data Base Systems, Inc.  
 \*\*\*American Business Systems, Inc.  
 TRS-80 is the registered trademark of the Tandy Corporation.  
 Magic Wand is the registered trademark of Small Business Systems, Inc.

Product	Price	
	with Manual	Manual Only
<b>OASIS</b>		
<b>OPERATING SYSTEM</b> (Includes: EXEC Language; File Management; User Accounting; Device Drivers; Print Spooler; General Text Editor; etc.)		
SINGLE-USER	\$150	\$17.50
MULTI-USER	350	17.50
<b>BASIC COMPILER/INTERPRETER/DEBUGGER</b>	100	15.00
<b>RE-ENTRANT BASIC COMPILER/INTERPRETER/DEBUGGER</b>	150	15.00
<b>DEVELOPMENT PACKAGE</b> (Macro Assembler; Linkage Editor; Debugger)	150	25.00
<b>TEXT EDITOR &amp; SCRIPT PROCESSOR</b>	150	15.00
<b>DIAGNOSTIC &amp; CONVERSION UTILITIES</b> (Memory Test; Assembly Language; Converters; File Recovery; Disk Test; File Copy from other OS; etc.)	100	15.00
<b>COMMUNICATIONS PACKAGE</b> (Terminal Emulator; File Send & Receive)	100	15.00
<b>PACKAGE PRICE (All of Above)</b>		
SINGLE-USER	500	60.00
MULTI-USER	850	60.00
<b>FILE SORT</b>	100	15.00
<b>COBOL-ANSI '74</b>	750	35.00



**MAROT SOFTWARE SYSTEMS  
YOUR EASTERN SOURCE**

Send order to:  
**Marot Software Systems, Inc.**  
**35 East 85th Street**  
**New York City, NY 10028**  
 Telephone (212) 534-5499

NAME \_\_\_\_\_  
 STREET (NO BOX #) \_\_\_\_\_  
 CITY \_\_\_\_\_  
 STATE \_\_\_\_\_ ZIP \_\_\_\_\_  
 AMOUNT \$ \_\_\_\_\_

(Attach system description; add \$3 for shipping.)  
 Check enclosed  VISA  
 UPS C.O.D.  Mastercharge  
 Card Number \_\_\_\_\_  
 Expiration Date \_\_\_\_\_  
 Signature \_\_\_\_\_

new square (J) for his piece.

A test is also made to make sure that the new square is on the playing field and not currently occupied by the machine's piece:

```
320 R = INT(R/8): J = H + A(R)
330 IF B(J) = 99 THEN 290 ELSE PRINT@788, Z$;
```

If the move is legal, the necessary changes are made to the video display and to the internal representation of the board. In addition, the player's score is modified approximately and a check is made to determine if the game is over:

```
360 I = H: B(I) = 0: X$ = "--":
  GOSUB 1000: SH = SH+B(J)
370 H = J: B(H) = 99: I = H: X$ = H$:
  GOSUB 1000
380 PRINT@321, SH,: IF SH > 99 THEN 930
```

### Move-Selection Strategy

This completes the module for soliciting and processing the move selected by the human player. We can see that Treasure Search is much easier to program than more familiar games such as chess or checkers. We are now ready to address the major focus of this article, namely, move selection by the machine. As a first approximation, I will present a relatively simplistic strategy and then subsequently will consider more sophisticated approaches.

The following initial strategy surveys the playing field in each of the four directions from the current position (T) of the machine's playing piece and selects as the best move (BM) the square which has the largest value (BV):

```
530 BV = -1: I = 0
540 I = I + 1: J = T + D(I): IF B(J) = 99 THEN 560
550 IF B(J) > BV THEN BM = J: BV = B(J)
560 IF I < 4 THEN 540
```

This is equivalent to a look-ahead search of one ply. Once a move has been selected, it is then necessary to make that move on the video display and to make the appropriate changes in the internal representation of the playing field. In addition, the score for the machine needs to be modified and a check needs to be made to determine if the game is over:

```
800 I = T: B(I) = 0: X$ = "--":
  GOSUB 1000: PRINT@179, Y$:
810 T = BM: ST = ST+B(T): B(T) = 99:
  I = T: X$ = T$
820 GOSUB 1000: PRINT@513, ST,:
  IF ST < 100 THEN 300
```

To complete the program, we need two messages to signal the end of the game:

```
910 PRINT@915,
  "THANK YOU FOR A PLEASANT GAME";
920 GOTO 920
930 PRINT@917,
  "CONGRATULATIONS, YOU WIN";: GOTO 920
1000 R = INT(I/10): C=I-10*R:
  K = 141+(8 - R)*64+C*4
1010 PRINT @ K, X$: RETURN
```

*[Please note that this simple version of the game is not the version given in listing 1. To acquire this version, type in all the BASIC lines presented so far in the text. . . GW]*

### Implementing $\alpha$ - $\beta$ Techniques

If you run this program on a TRS-80, it will play a legal game, but it will not be particularly challenging. Your children will probably enjoy playing it because they will beat it most of the time. A one-ply look-ahead does not produce brilliant play. To make the machine more intelligent, we need to add the  $\alpha$ - $\beta$  minimax algorithm. To do this, we will substitute the following code for lines 530 to 560:

```
510 DT = DM
520 L = 1: SC = 0: S = -1
530 V(0) = -99: V(1) = -99: M(0) = T:
  M(1) = H
```

The maximum depth of the search, DT, is set to the value DM which was calculated at line 170. Next, we initialize several key variables. The depth of the search (L) starts with a value of 1. The variable that remembers the cumulative difference between the changes in the players' scores (SC) is set to zero. The variable that keeps track of which player has the move (S) is set to a -1.

The array that retains the best values obtained so far at each level of the tree is initialized at a -99 for index values of 0 and 1. The array that keeps track of the move (M) currently being considered at each level of the tree is set to the value T (the location of the machine's piece) for the index value of 0 and to H (the location of the human's piece) for the index value of 1.

The first move considered in the look-ahead process will be for the machine. The value of L at the base of the tree will be 2. You may think this a bit curious, but it is a useful strategy since we will want to refer to  $V(L - 2)$  and  $M(L - 2)$  at several points in the search process.

To begin the main loop of the tree search, we increase the depth (L) by 1 and then initialize the variable Q (an index for the moves that have already been considered at this level of the tree), the variable S (an index indicating whose turn it is to move), and the variable V (the value for the best move found so far at this level of the tree):

```
540 L = L + 1: Q(L) = 0: S = -S: V(L) = V(L - 2)
```

The next step is to increment the Q index so that the machine can consider the next move option at this level of the tree. If we have exhausted all of the move options at this level, it is time to branch to a special section of code that instructs the machine to back up one level in the tree:

```
580 Q(L) = Q(L) + 1: IF Q(L) > 4 THEN 760
```

If the move options at this level have not been exhausted, the machine is instructed to generate the location (J) of a square to which the player can consider moving:

```
590 J = M(L - 2) + D(Q(L))
```



# THE ULTIMATE REFINEMENT. PL/I FOR YOUR MICRO.

**IBM's told us about PL/I for years. Now, we're telling them something.**

**PL/I Subset G.** Newly designed expressly for minicomputers by an ANSI committee of PL/I experts. All the best application programming features, refined to match contemporary programming practices.

**PL/I-80™ for Microcomputers.** Based on Subset G, PL/I-80 runs under our CP/M® and MP/M™ operating systems.

**PL/I-80 Means Performance.** In an independent benchmark, PL/I-80 was tested against 34 other high-level languages for 8-bit processors, and came out on top. \*

## PL/I-80 versus the best of several languages:

PL/I-80	1.00
FORTRAN	1.21
BASIC COMPILER	1.32
PL/M	1.71
PASCAL COMPILER	1.89
PASCAL INTERPRETER	17.07
BASIC INTERPRETER	34.57

\* Execution time ratio, Eratosthenes Sieve

**Subset G is a brand new language with a new following.** DEC®, Data General, and Prime now support it, and the list is growing. There's no better way to protect your software investment.

**PL/I-80 from Digital Research.** Fast. Economical. Refined. With the programming power of minicomputer PL/I. The package includes compiler, run-time library, linkage editor and relocating macro-assembler, plus three comprehensive manuals. All for only \$500. (Domestic USA price only)

## Interested in Refinement?

Call or write Digital Research. Experts in refinement.

 **DIGITAL RESEARCH®**

P.O. Box 579  
801 Lighthouse Avenue  
Pacific Grove, CA 93950  
408-649-3896  
TWX 910 360 5001



## Making Moves

Move generation is quite simple because  $M(L-2)$  always represents the current location of the piece of the player whose turn it is to move and  $D(Q(L))$  represents one of the four directions in which a move can potentially be made. I say potentially because the new location could be off the playing field or could already be occupied by the opponent's piece. Our next statement checks for this:

```
600 IF B(J) = 99 THEN 580 ELSE M(L) = J: E(L) = B(J)
```

If the move is legal, the new location is recorded as the current move at this level in array  $M$ , and the digit at this location is recorded as the current value at this level in array  $E$ . In addition, the internal representation of the playing field,  $B$ , is modified to reflect this move, and the variable  $SC$  is altered to keep track of the relative points accumulated by each player:

```
610 B(J) = 99: B(M(L - 2)) = 0: SC = SC + S * E(L)
```

In order to provide a visible record of the machine's "thought" process, the machine is instructed to print the move location ( $J$ ), the cumulative change in the score at this point ( $SC$ ), and the best value so far at this level,  $V(L)$ , in the empty area on the right side of the video display. The machine also checks to see if the current depth is the maximum possible depth. If not, it branches to line 540 which starts the main loop again by going one level higher in the tree:

```
620 PRINT@179 + 64*L, J; SC; V(L); " ";  
IF L < DT THEN 540
```

If the search is at the maximum depth (ie:  $L = DT$ ), then the machine records the current value of  $SC$  as a potential new best value:

```
670 V(L + 1) = -S * SC
```

The next step is to reverse the move we just made. When a new move is made, the board representation is updated at line 610. When the move is taken back at line 680, we refer to the process of "downdating" the board:

```
680 B(M(L)) = E(L): B(M(L - 2)) = 99:  
SC = SC - S * E(L)
```

## Negamax

To determine whether the value recorded at line 670 is better than the current value at this level, we employ the *negamax* procedure (see reference 1). This is equivalent to the minimax procedure except that its implementation requires fewer programming steps. Rather than minimizing and maximizing at every other level, the negamax approach always maximizes the results at a given level, but it reverses the arithmetic signs at every other level to produce the identical result as the minimax procedure. (You may recognize the similarity between this approach and the use of the logical NOR operation in circuit design. Two levels of NOR logic are equivalent to a level of ANDs followed by a level of ORs.) The following line implements the negamax calculations:

```
700 IF V(L) < -V(L + 1) THEN  
V(L) = -V(L + 1) ELSE 580
```

If the new value is worse than or equal to the current value, the machine branches to line 580 and considers another move at this level. If the new value is better than the current value, the machine continues to the next statement:

```
740 IF L = 2 THEN BM = M(L):  
PRINT@180, BM; V(2);
```

If the search process is at the base of the tree ( $L = 2$ ), then the new best move is recorded for later use and an announcement of our new find is printed on the video display. This includes both the new location,  $BM$ , and the net difference in the score produced by the anticipated sequence of moves,  $V(2)$

## Evaluating for Cutoff

At line 700, the minimax rule was applied to select the best option for the player with the move. The next consideration is whether the current move will produce an  $\alpha$ - $\beta$  cutoff. The logic for this decision is based on the idea that the opponent may already have a move at this level in the tree that guarantees him a value that is at least as

# \$ GOLD DISK \$ CP/M® Compatible Z-80 Disassembler

- RECREATES Z-80 ASSEMBLY LANGUAGE SOURCE FILES FROM ABSOLUTE CODE (.COM FILES) FOR ALTERATION.
- FEATURES MNEMONIC LABELS FOR EASY PROGRAM TRACING.
- INCLUDES COMPLETE DOCUMENTATION AND FREE UTILITY FOR SPECIFYING AND DECODING ASCII SECTIONS OF CODE.
- OPERATES UNDER MINIMUM CP/M® CONFIGURATION (16K RAM).
- DOCUMENTATION ONLY: \$12 (MAY BE APPLIED TO DISK ORDER).

\$ 62<sup>00</sup>

POSTPAID

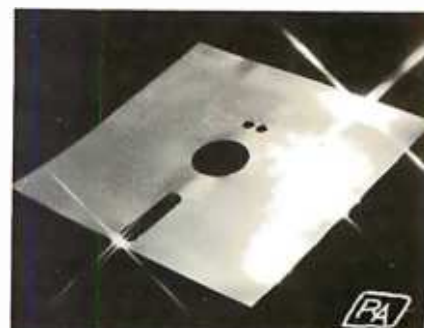

"WORTH ITS WEIGHT IN GOLD"

ONE DAY SERVICE FOR CREDIT  
CARD CUSTOMERS: ORDER DISK  
BY PHONE FREE! (WE WILL PAY  
YOU BACK FOR THE PHONE CALL)

CALIF. RESIDENTS ADD 6% SALES TAX.



BOWER-STEWART & ASSOCIATES  
P.O. BOX 1389  
HAWTHORNE, CA. 90250  
(213) 676-5055



SPECIFY DRIVE AND SYSTEM  
AVAILABLE ON 5 1/4" OR 8" IBM SS/SD DISK  
\*CP/M IS A TRADEMARK OF DIGITAL RESEARCH

A MCGRAW-HILL PUBLICATION

# onComputing™

GUIDE TO PERSONAL COMPUTING

**GETTING STARTED**  
What You Need And What It Will Cost

**EQUIPMENT REVIEWS**  
TRS-80, Apple, Sorcerer and PET

Best-Selling Author  
**JERRY POURNELLE**  
"Writing With A Microcomputer"

**THE BINARY WORLD**

Also...

**A PERSONAL  
COMPUTER DIRECTORY**  
**COMPUTER CLUBS:  
WHO NEEDS THEM?**

Plus much much more  
for the new computer user

# When will the Personal Computer Explosion touch YOU?

Are you prepared for the explosive transformation? Right in your own home? Electronic mail. Personalized investment analysis. Foreign language tutorial. Home energy management. Robots. Computer music. Secretarial service. Diet and menu planning. And more, more, more.

**onComputing™** the new McGraw-Hill quarterly, prepares you for the enormous changes coming during the

1980's (Some are already here). **onComputing™** explains in nontechnical language what personal computers are, how they work, and how you can use them at home, for fun and profit.

Don't let the personal computer explosion catch you off guard. Know what's happening and help make it happen! Prepare now for the exciting future with a subscription to **onComputing™!**

Call Toll-Free  
**800-258-5485**

Start your  
subscription today.

**onComputing™** Subscription Dept. P.O. Box 307, Martinsville, NJ 08836

DOMESTIC subscription rate:

U.S. 1 yr. (4 issues) @ \$8.50  Canada & Mexico, 1 yr. (4 issues) @ \$10.00

FOREIGN (to expedite service, please remit in U.S. funds drawn on a U.S. bank.)

Europe (and all other countries, except above), 1 yr. @ \$12.00 — surface delivery.

Bill Visa  Bill Master Charge  Bill me (North America only)

Card Number

Expiration

Signature

Name (please print)

Street/Apartment Number

City

State/Province/Country Code

7BBO

Please allow 6-8 weeks for processing.

good as the one we are considering in the current branch.

This procedure is easy to implement but not particularly easy to understand. The general idea was explained by an example by W D Maurer in an earlier issue of this magazine (see reference 2), and a detailed exposition is provided by Knuth and Moore (reference 1). For our pur-

**Listing 1:** Listing for the game of Treasure Search, written for the TRS-80 using Level II BASIC. This game, in its various versions, illustrates the usefulness of alpha-beta pruning when searching a tree for the best strategy in a two-player game. The game, as written here, plays an unmodified alpha-beta strategy against a human player. See listings 2 and 3 for additions that cause the computer to play more rapidly.

```

100 CLEAR 100: CLS: DEFINT A-Z: RANDOM: SH = 0:
    ST = 0
110 PRINT@463, "PLEASE ENTER YOUR NAME": INPUT N$
120 DIM A(8), B(99), D(4), E(12), M(12)
130 DIM PV(12,12), Q(12), V(12), Z(12)
140 D(1) = -10: D(2) = -1: D(3) = 1: D(4) = 10
150 A(1) = 10: A(2) = -10: A(4) = -1: A(8) = 1: CLS
160 PRINT@461, "TRS-80 PLAYING STRENGTH (1 TO 5)":
    INPUT Y
170 DM = 2*Y: FOR I = 11 TO 88: B(I) = RND(9): NEXT I
180 FOR I = 0 TO 10: B(I) = 99: NEXT I: FOR I = 89 TO 99:
    B(I) = 99: NEXT I
190 FOR I = 19 TO 79 STEP 10: B(I) = 99: B(I + 1) = 99:
    NEXT I
220 CLS: FOR I = 11 TO 88: IF B(I) = 99 THEN 240
230 X$ = RIGHT$(STR$(B(I)),1): GOSUB 1000
240 NEXT I: PRINT@22, "TREASURE SEARCH": Y:
250 PRINT@256, N$: PRINT@448, "TRS-80":
    Y$ = STRING$(12, " ")
260 T = 54: T$ = "": H = 45: H$ = "X":
    Z$ = STRING$(32, " ")
270 I = T: X$ = T$: GOSUB 1000: B(T) = 99: B(H) = 99
280 I = H: X$ = H$: GOSUB 1000: GOTO 300
290 PRINT@788, "ILLEGAL MOVE. TRY AGAIN":
    FOR I = 1 TO 999: NEXT I
300 PRINT@788, Z$: PRINT@788, "WHICH DIRECTION FOR
    X":
310 IF INKEY$ = "" THEN 310 ELSE R = PEEK(16444)
320 R = INT(R/8): J = H + A(R)
330 IF B(J) = 99 THEN 290 ELSE PRINT@788, Z$:
360 I = H: B(I) = 0: X$ = "-": GOSUB 1000: SH = SH + B(I)
370 H = J: B(H) = 99: I = H: X$ = H$: GOSUB 1000
380 PRINT@321, SH: IF SH > 99 THEN 930
510 DT = DM
520 L = 1: SC = 0: S = -1
530 V(0) = -99: V(1) = -99: M(0) = T: M(1) = H
540 L = L + 1: Q(L) = 0: S = -S: V(L) = V(L - 2)
580 Q(L) = Q(L) + 1: IF Q(L) > 4 THEN 760
590 J = M(L - 2) + D(Q(L))
600 IF B(J) = 99 THEN 580 ELSE M(L) = J: E(L) = B(J)
610 B(J) = 99: B(M(L - 2)) = 0: SC = SC + S * E(L)
620 PRINT@179 + 64 * L, J: SC: V(L): " ": IF L < DT THEN
    540
670 V(L + 1) = -S * SC
680 B(M(L)) = E(L): B(M(L - 2)) = 99: SC = SC - S * E(L)
700 IF V(L) < -V(L + 1) THEN V(L) = -V(L + 1) ELSE 960
740 IF L = 2 THEN BM = M(L): PRINT@180, BM: V(2):
750 IF V(L) < -V(L - 1) THEN 580
760 L = L - 1: S = -S: PRINT@243 + 64 * L, Y$: IF L > 1
    THEN 680
800 I = T: B(I) = 0: X$ = "-": GOSUB 1000: PRINT@179, Y$:
810 I = BM: ST = ST + B(T): B(T) = 99: I = T: X$ = T$:
820 GOSUB 1000: PRINT@513, ST: IF ST < 100 THEN 300
910 PRINT@915, "THANK YOU FOR A PLEASANT GAME":
920 GOTO 920
930 PRINT@917, "CONGRATULATIONS, YOU WIN":
    GOTO 920
1000 R = INT(I/10): C = I - 10 * R: K = 141 + (8 - R) * 64 +
    C * 4
1010 PRINT@K, X$: RETURN

```

poses, the job is accomplished by a single statement:

```
750 IF V(L) < -V(L - 1) THEN 580
```

If the condition specified in line 750 is satisfied, then a cutoff is not called for, and the process branches to line 580, where the next move option is considered at this level. If the condition in line 750 is not satisfied, the process continues to line 760, which instructs the machine to back up one level in the tree:

```
760 L = L - 1: S = -S: PRINT@243 + 64 * L, Y$:
    IF L > 1 THEN 680
```

The backup procedure includes decreasing the value of L by 1, changing the index that indicates which player has the move, erasing the move information printed on the right side of the video display, and branching to line 680 to execute the downdate instructions for the new value of L. If the value of L decreases to 1, all options at the base of the tree have been examined and the search is completed. In this case, the machine drops to line 800 and makes the move which has been stored by variable BM.

It is important to note that the jump to line 680 for downdating is followed by execution of the minimax test (line 700) for a new best move at the new value of L; sometimes the program proceeds again to line 750, where another cutoff may occur. Note, also, that line 760 can be entered from two different locations. In addition to dropping through from line 750, the machine can be directed to line 760 from line 580 as a result of exhausting all possible move options at a given level. The  $\alpha$ - $\beta$  test at line 750 provides a means for terminating the search at a node before all of the options have been analyzed.

The version of Treasure Search just completed is given in listing 1.

### Traditional Techniques

This completes the  $\alpha$ - $\beta$  minimax module. You may be surprised that this algorithm can be presented in only a few lines of BASIC. The simplicity of the presentation is possible because we used the negamax procedure and because Treasure Search is a simple game. It is very straightforward in terms of move generation (line 590), move evaluation (line 600), and the ease of updating (line 610) and downdating (line 680) the internal representation of the playing field. This simplicity also means that the algorithm will execute fairly rapidly, and thus a search of nontrivial depth can be completed in a reasonable amount of time.

The algorithm that I have presented for the  $\alpha$ - $\beta$  minimax procedure is quite different from the one that appears in most textbooks. Traditionally, the algorithm generates all of the moves at each node and then orders them using a plausibility routine before proceeding to the next deeper level of the tree. This approach is based on

**Listing 2:** To implement the killer heuristic, these lines are to be added to listing 1, replacing line 590 of listing 1 and inserting lines 550, 560, and 710.

```

550 J = Z(L): I = 0
560 I = I + 1: IF J = M(L - 2) + D(I) THEN 600 ELSE IF I < 4
    THEN 560
580 J = M(L - 2) + D(Q(L)): IF J = Z(L) THEN 580
710 IF L > 2 THEN Z(L) = M(L)

```

# A Microcomputer for everyone at a Micro Price

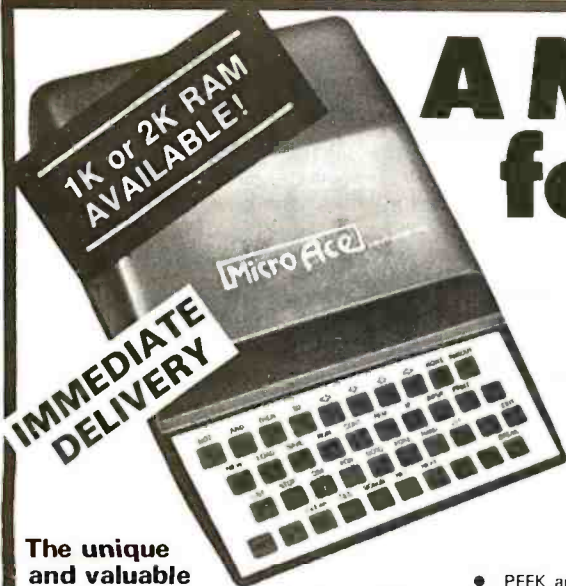

The **MicroAce** - a new generation of miniature computers  
**A COMPLETE COMPUTER for \$149.00 for 1K Kit**

Post and Packing FREE  
 (Add 6% Tax for Shipments inside California)

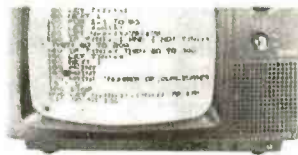

## The unique and valuable components of the MicroAce

The MicroAce is not just another personal computer. Quite apart from its exceptionally low price, the MicroAce has two uniquely advanced components: the powerful BASIC interpreter, and the simple teach yourself BASIC manual.

The unique versatile BASIC interpreter offers remarkable programming advantages:

- Unique 'one-touch' key word entry: the MicroAce eliminates a great deal of tiresome typing. Key words (RUN, PRINT, LIST, etc.) have their own single-key entry.
- Unique syntax check. Only lines with correct syntax are accepted into programs. A cursor identifies errors immediately. This prevents entry of long and complicated programs with faults only discovered when you try to run them.
- Excellent string-handling capability - takes up to 26 string variables of any length. All strings can undergo all relational tests (e.g. comparison). The MicroAce also has string input - to request a line of text when necessary. Strings do not need to be dimensioned.
- Up to 26 single dimension arrays.
- FOR/NEXT loops nested up to 26.
- Variable names of any length.
- BASIC language also handles full Boolean arithmetic, conditional expressions, etc.
- Exceptionally powerful edit facilities, allows modification of existing program lines.
- Randomise function, useful for games and secret codes, as well as more serious applications
- Timer under program control.

- PEEK and POKE enable entry of machine code instructions, USR causes jump to a user's machine language sub-routine.
- High-resolution graphics with 22 standard graphic symbols.
- All characters printable in reverse under program control.
- Lines of unlimited length.

## 'Excellent value' indeed!

For just \$149.00 (excluding handling charge) you get everything you need to build a personal computer at home... PCB, with IC sockets for all ICs; case; leads for direct connection to a cassette recorder and television (black and white or color); everything!

Yet the MicroAce really is a complete, powerful, full-facility computer, matching or surpassing other personal computers at several times the price.

The MicroAce is programmed in BASIC, and you can use it to do quite literally anything, from playing chess to managing a business.

The MicroAce is pleasantly straightforward to assemble, using a fine-tipped soldering iron. It immediately proves what a good job you've done: connect it to your TV... link it to the mains adaptor... and you're ready to go.

## Fewer chips, compact design, volume production-more power per Dollar!

The MicroAce owes its remarkable low price to its remarkable design: the whole system is packed on to fewer, newer, more powerful and advanced LSI chips. A single SUPER ROM, for instance, contains the BASIC interpreter, the character set, operating system, and monitor. And the MicroAce 1K byte

RAM (expandable to 2K on board) is roughly equivalent to 4K bytes in a conventional computer - typically storing 100 lines of BASIC. (Key words occupy only a single byte.)

The display shows 32 characters by 24 lines.

And Benchmark tests show that the MicroAce is faster than all other personal computers.

No other personal computer offers this unique combination of high capability and low price.

## The MicroAce teach-yourself BASIC manual.

If the features of the BASIC interpreter mean little to you - don't worry. They're all explained in the specially-written book *free* with every kit! The book makes learning easy, exciting and enjoyable, and represents a complete course in BASIC programming from first principles to complex programs. (Available separately-purchase price refunded if you buy a MicroAce later.) A hardware manual is also included with every kit.

**The MicroAce Kit:**  
**\$149.00 with 1K COMPLETE**  
**\$169.00 with 2K**

Demand for the MicroAce is very high: use the coupon to order today for the earliest possible delivery. All orders will be despatched in strict rotation. If you are unsuccessful in constructing your kit, we will repair it for a fee of \$20.00, post and packing FREE. Of course, you may return your MicroAce as received within 14 days for a full refund. We want you to be satisfied beyond all doubt - and we have no doubt that you will be.

280 A microprocessor chip, widely recognised as the best ever made.

Sockets for TV, cassette recorder, power supply.

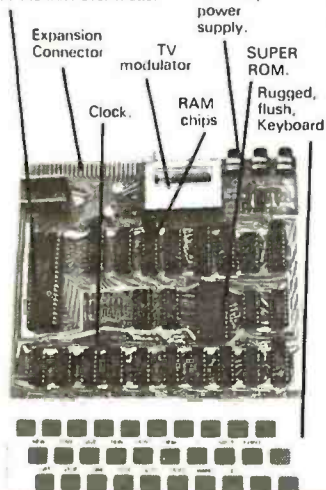

## Your MicroAce kit contains...

- Printed circuit board, with IC sockets for all ICs.
- Complete components set, including all ICs-all manufactured by selected world-leading suppliers.
- New rugged keyboard, touch-sensitive, wipe-clean.
- Ready-moulded case.
- Leads and plugs for connection to domestic TV and cassette recorder. (Programs can be SAVED and LOADED on to a portable cassette recorder.)
- Mains adaptor of 600 mA at 9VDC nominal unregulated.
- FREE course in BASIC programming and user manual.

## JOIN THE REVOLUTION - DON'T GET LEFT BEHIND - ORDER YOUR MICRO ACE NOW!!

Send Check, Money Order or quote your Credit Card No. to:  
**MicroAce** 1348 East Edinger, Santa Ana, California, Zip Code 92705.  
 or phone (714) 547 2526 quoting your Credit Card Number.

Quantity	Description	Unit Price	TOTAL
	MicroAce Kit 1K	\$149.00	
	MicroAce Kit 2K	\$169.00	
	Manual	\$10.00	
	1K Upgrade Kit	\$29.00	
Shipments inside California add 6% TAX		<b>TOTAL</b>	

- Amex.
- Diners
- Check
- Money Order
- Master Charge
- Visa

Card No. \_\_\_\_\_  
 Exp. Date. \_\_\_\_\_

Name \_\_\_\_\_  
 Address \_\_\_\_\_  
 City \_\_\_\_\_ State \_\_\_\_\_ Zip \_\_\_\_\_

the well-known finding that the efficiency of the  $\alpha$ - $\beta$  method is increased greatly when the strongest moves for each player are examined first at each level of the tree. The disadvantage of generating, ordering, and storing all of the moves at each level is that most of them will never be examined if an  $\alpha$ - $\beta$  cutoff occurs. If a cutoff can be produced by some other means, a great deal of time and memory can be saved by ignoring most of the moves at each node and omitting the ordering process.

The obvious question is, of course, how can we have our cake and eat it too? The competition among chess programmers over the last decade has led to some useful discoveries that are relevant to this problem. We will consider two of these discoveries that are especially effective in increasing the efficiency of the  $\alpha$ - $\beta$  minimax procedure. The first is the *killer heuristic* and the second is the *iterative search*.

### The Killer Heuristic

The killer heuristic is a simple, yet powerful, idea that greatly improves move ordering. Instead of trying to order moves on the basis of a special plausibility analysis, the killer procedure simply remembers moves that were effective in the past. That is, information generated as a byproduct of the regular tree search is remembered; and it is applied later on in the search when a similar situation is encountered. In our implementation, we will remember the move that was judged most recently to be the best by the minimax rule at each level of the tree; each time we visit a new node in the tree, this move will be tried first.

To implement this idea, a few additions and modifications are necessary (see listing 2). When the tree search moves to a higher level, the first move examined should be the killer for that level (lines 550 and 560 of listing 2).

First, the appropriate move is read from the Z array, then a check is made to make sure the move is legal. If the killer does not produce an immediate cutoff, the search process will revert back to the normal procedure of examining each of the possible options. This process is controlled at lines 580 and 590.

We need to modify line 590 of listing 1 to make sure that a move is not examined twice (first as the killer and then as a regular option).

The final step in implementing the killer heuristic is to provide a means for remembering the move which is currently most effective in terms of the minimax strategy at each level of the look-ahead tree. This is accomplished by recording the current move each time the search process finds that it is the best one so far; this is done at line 700 of listing 1.

If the process is at the base of the tree ( $L = 2$ ), then the move need not be recorded since the killer strategy does not apply at this level. It is too late to define a move that should be searched first at the base of the tree. By not altering the killer at  $L = 2$ , we make sure that the move examined initially will be searched only once even if it turns out not to be the one eventually chosen.

The killer heuristic is a very powerful addition to the  $\alpha$ - $\beta$  minimax algorithm. It requires only a small change in the algorithm, involves a negligible amount of time in terms of code execution, and often results in a decrease of 50% or more in the number of nodes actually visited in the search tree. At the deeper levels of the tree, it accomplishes essentially the same function as plausibility

ordering, but does it much more efficiently.

The killer heuristic does not provide a means for ordering the moves when the machine is constructing the initial "limb" of the look-ahead tree. Because the search is a depth-first search, the process begins by selecting a sequence of moves that starts at the base node and goes to the maximum depth. The  $\alpha$ - $\beta$  cutoffs are most effective if this initial limb contains the strongest moves at each node for each player. This first stage of the search can be very time-consuming if the moves that are initially examined are eventually discarded for better ones. Because the killer heuristic employs strong moves only after they have been discovered by the regular search process, it is not helpful in structuring the initial "limb" of the look-ahead process.

### The Iterative Technique

A different technique has proven its effectiveness for this purpose. This procedure is the *iterative tree search*. Its effectiveness for increasing the efficiency of the  $\alpha$ - $\beta$  minimax procedure was discovered serendipitously. At Northwestern University, for example, the Slate-Atkin chess-programming team was concerned about time control in move selection. Occasionally, in a complex position, their chess program would conduct its regular look-ahead search and would not complete the task in the amount of time anticipated. In several instances, the search would require four to five times as long as anticipated. This was a serious problem because chess tournaments are conducted under strict time allowances. If a program takes too much time for move selection during the early stages of the game, very little time will be available when it is needed during the latter part of the contest.

To cope with this problem, Slate and Atkin implemented an iterative procedure whereby the search is conducted in stages. At first, a complete two-ply search is conducted, then a three-ply search, then a four-ply search, etc, until a search of the desired depth is reached. The advantage of this procedure for time control is that a search can be aborted at any time and the machine can fall back upon the move selected by the immediately preceding search of one less ply in depth. It is possible to use information gained in the early, shallow searches to help structure (ie: order) the deeper searches.

Interestingly enough, Slate and Atkin discovered that this ordering information caused an increase in the efficiency of the deeper searches which more than made up for the time spent conducting the shallow searches. They also found that the beneficial effect of the iterations increases as the depth of search increases.

The iterative search is much easier to implement than you might think. The key idea for enhancing the efficiency of the  $\alpha$ - $\beta$  search is that the best sequence of moves (as judged by the minimax strategy) from a shallow search can be used to order the initial moves in the deeper search which follows. It is necessary to develop and record the *principal variation* for each of the searches.

This means that, instead of remembering just the best move at the base of the tree, the machine needs to record the best moves for each side at every level of the tree. Thus, it predicts the initial move, the best reply, the best counter-reply, etc. This principal variation is then used for selecting the initial limb for the next deeper search in

**A New Book  
From BYTE Books**

# Threaded Interpretive Languages

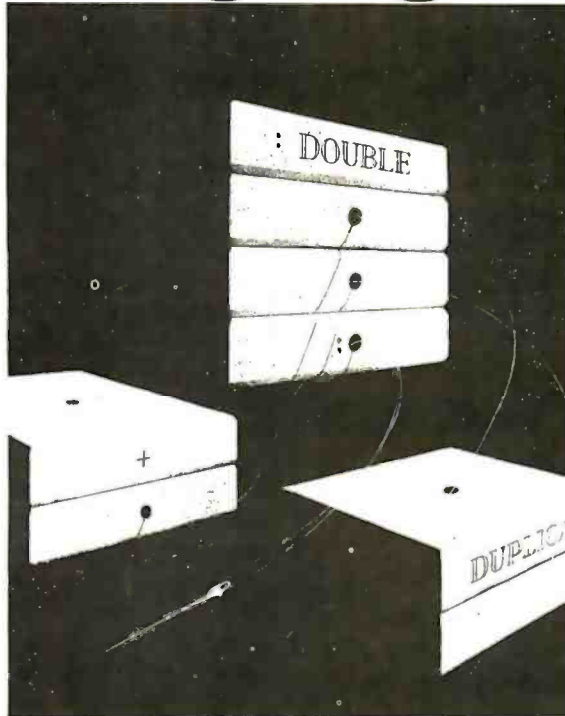

R. G. Loeliger

Threaded languages (such as FORTH) are an exciting new class of languages. They are compact and fast, giving the speed of assembly language with the programming ease of BASIC, and combine features found in no other programming languages. An increasing number of people are using them, but few know much about how they work. Is a threaded language interpreted or compiled? How much memory overhead does it require? Just what is an "inner interpreter?" **Threaded Interpretive Languages**, by R. G. Loeliger, concentrates on the development of an interactive, extensible language with specific routines for the ZILOG Z80 microprocessor. With the core interpreter, assembler, and data type defining words covered in the text, it is possible to design and implement programs for almost any application imaginable. Since the language itself is highly segmented into very short routines, it is easy to design equivalent routines for different processors and produce an equivalent threaded interpretive language for other development systems. If you are interested in learning how to write better FORTH programs or you want to design your own powerful, but low-cost, threaded language specific to your needs, this book is for you.



This and other BYTE/McGraw-Hill books are available from BYTE Books or your local computer store.

ISBN 0-07-038360-X  
Price \$18.95

B11

Please send \_\_\_\_\_ copies of Threaded Interpretive Languages

\_\_\_\_\_  
Name Title Company

\_\_\_\_\_  
Street City State/Province Code

- Check enclosed in the amount of \$ \_\_\_\_\_  
 Bill Visa       Bill Master Charge  
 Card No. \_\_\_\_\_  
 Exp. Date \_\_\_\_\_

Add 75¢ per book to cover postage and handling.  
Please remit in U.S. funds or draw on a U.S. Bank.



70 Main St.  
Peterborough, NH 03458

## HAYDEN TALKS SYSTEMS...

New!

### **MICROPROCESSOR SOFTWARE DESIGN**

(ed. Schindler) A *must* for systems designers and software engineers! This edited compilation of articles from Electronic Design magazine covers the full spectrum of applications software. Includes discussions from top-down design through operating system specifications featuring languages such as BASIC and PASCAL. # 5190-5. \$13.25.

New!

### **DIGITAL COMPUTER SIMULATION**

(Maryanski) System simulation studies are simplified with this new book! Text discusses general properties of significant systems for computer simulation, the mechanism for the development of programs that simulate discrete systems. GPSS and Simscript. CSMP, the System Dynamics approach to continuous simulation, and disciplines in which simulation modes are applied. # 5118-2. \$15.95.

### **THE 8086 PRIMER: An Introduction to its Architecture, System Design and Programming**

(Morse) Written by the man responsible for the architectural definition of the 8086 processor. Reviews processors in general and discusses the 8086 in detail — including information never before published. Also covers motivation for the design of the 8086 chip, corrected procedures, and internal architecture. # 5165-4. \$9.95.

**Available at your local  
computer store!**

Write to:

**Hayden Book Company,  
Inc.**  
50 Essex Street  
Rochelle Park, NJ 07662

or Call Toll Free, 24 hours a day,  
(1-800-827-3777, ext. 302)\*  
TO CHARGE YOUR ORDER TO  
Master charge or Visa!  
Minimum order is \$10.00;  
Customer pays postage and handling.  
From Missouri, call  
1-800-892-7655, ext. 302.

**Listing 3: Additions to listing 1 to implement an iterative tree search algorithm. These lines are to be added to the combination of listings 1 and 2.**

```
500 FOR I = 4 TO DM: Z(I - 2) = PV(2,I): NEXT I
510 IF PV(2,3) = H THEN DT = DM ELSE DT = 2
720 I = L: PV(L,I) = M(L): IF L = DT THEN 740
730 I = I + 1: PV(L,I) = PV(L + 1,I): IF I < DT THEN 730
780 IF DT = DM THEN 800
790 FOR I = 2 TO DT: Z(I) = PV(2,I): NEXT I: DT = DT + 2:
      GOTO 520
```

the iteration. In our present algorithm, we employ this strategy by placing the principal variation from the previous search in the killer array at the start of each iteration.

The first requirement is the development and storage of the principal variation. This is fairly difficult to explain but not very difficult to implement (see lines 720 and 730 of listing 3). Once we have a principal variation, we then modify the initial preparation for the look-ahead search (see lines 500 and 510 of listing 3).

This accomplishes two important things. At line 500, the killer array receives the moves for each side that were ascertained to be best on the move calculation from the previous turn (not the previous iteration of this turn, but rather the last time the machine made a move). The index I-2 is used because the first two moves anticipated by that variation (one for the machine and one for the opponent) have already been played.

Line 510 checks to see if the opponent actually made the anticipated move. If so, an iterative search is unnecessary since the principal variation from the previous move calculation provides the same ordering information as would be obtained by the iterations. The search depth, DT, is therefore set to the maximum depth, DM. If the opponent does not make the anticipated move, an iterative search is required and therefore the search depth, DT, is set at the minimum value. Note that DT = 2 calls for a one-ply search.

When a search has been completed, it is necessary to determine if the maximum depth has been reached or whether another iteration is required. If the latter case holds true, the principal variation from the most recent iteration is stored in the killer array and the search depth is increased. In our present implementation, each iteration is two plies deeper than its predecessor. Lines 780 and 790 of listing 3 accomplish this task.

### **Analysis of Modifications**

With these additions, the program will select a move in the Treasure Search game by using an iterative  $\alpha$ - $\beta$  minimax procedure enhanced by the killer heuristic. To demonstrate the power of this modified algorithm, I have made some sample runs which count the number of nodes visited in the look-ahead tree in an actual game with and without the various modifications. These results are very informative.

The program was examined in four variations: minimax,  $\alpha$ - $\beta$  minimax,  $\alpha$ - $\beta$  minimax with the killer heuristic, and iterative  $\alpha$ - $\beta$  minimax with the killer heuristic. The version involving the minimax strategy without  $\alpha$ - $\beta$  is produced simply by replacing line 750 with:

```
750 GOTO 580
```



# Make Your Dreams Come True

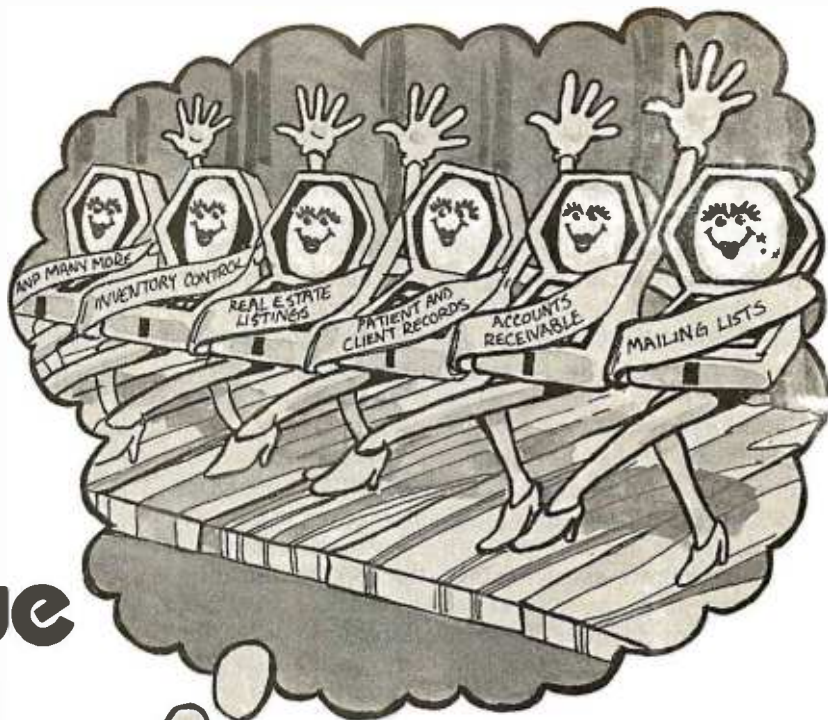

PRISM's flexibility and ease of use are combined with its full spectrum of features and capabilities to make it the ideal DBMS for a wide range of business applications. Mailing Lists, Patient Records, Real Estate Listings, and Client Billings are just a few of the possibilities. And **PRISM™** provides the quality, performance, and affordability you have come to expect from MAG software products.

To find out how **your** dreams can become realities, see your **PRISM™** dealer today.

Micro Applications Group, 7300 Caldas Avenue, Van Nuys, California 91406, (213) 881-8076.

Imagine sitting down at your computer system and developing that specialized application you've always dreamed about — with absolutely **no programming!**

Now you can with **PRISM™** — the first Data Base Management System that provides the Total Solution to your information management needs. With **PRISM™**, you can have your application up and running in a matter of minutes — not months.

PRISM requires CP/M and CBASIC. (CP/M is a registered trademark of Digital Research. CBASIC is a trademark of Compler Systems.)

## PRISM™

"The Total Solution" **MAG**

© MAG 1980

This eliminates all of the  $\alpha$ - $\beta$  cutoffs.

To insure comparability of our results, an initial game configuration (digit assignment) was constructed and placed in an array such that each game started with the playing field depicted in table 1. In addition, the same series of moves was made by the human opponent in each game. Each version of the program calculated a move for the machine's first four times to play. In each case, the search depth was set for a seven-ply search. The number of nodes in each of the look-ahead trees is presented in table 2. The node count for the iterative search is the sum across all iterations.

An analysis of these results demonstrates the powerful effect of the  $\alpha$ - $\beta$  procedure. By using the IF statement at line 750 in the  $\alpha$ - $\beta$  versions, the search effort is reduced dramatically. In our example with a seven-ply search and with four options at each node, the  $\alpha$ - $\beta$  modification reduces the node count by a factor of about 10. Since there is an approximate linear relationship between the number of nodes in the tree and computation time, the  $\alpha$ - $\beta$  procedure selects a move in one-tenth the time of the full minimax search. Since the two procedures always select the same move, this enhancement in speed comes at essentially no extra cost.

The results in table 2 indicate that the killer heuristic is also a powerful addition to the  $\alpha$ - $\beta$  algorithm. In our example, the node count was reduced by 30% to 50% by simply remembering moves that had proved themselves effective at an earlier stage in the search.

This modification also provides substantial benefits at minimal extra cost in terms of processing time and memory requirement. The empirical analysis presented in table 2 also demonstrates the beneficial effects of the iterative procedure. The number of nodes generated in the calculation for the first move was reduced by almost 25% despite the fact that searches of one ply, three plies, and five plies were conducted prior to the seven-ply search.

In the calculations for moves 2, 3, and 4, the prior principal variation correctly predicted the human's move so that the machine dispensed with the iterations because it already had the ordering information they would have produced. The results presented in table 2 clearly indicate that the iterative procedure enhances the efficiency of the search process.

### Improvements

A comparison of the full minimax procedure as it was employed in the early 1950s with the modern, enhanced  $\alpha$ - $\beta$  procedure indicates a truly dramatic increase in search efficiency. The full minimax procedure averaged approximately 17,000 nodes for the first four move calculations. The modern algorithm as presented in this article averaged approximately 600 nodes for these same four calculations. This difference is large enough to convert an impractical but elegant idea into a powerful programming tool. I should also point out that the effectiveness of these procedures would be even more notable if we had examined a game like chess with more than thirty options at each node instead of a simple game with only four options at each node.

There is an additional way to increase the efficiency of the  $\alpha$ - $\beta$  search. In the present program, the evaluations of the terminal positions are based on a cumulative process in which the treasures collected at each node in the tree

	Number of Nodes in the Look-ahead Tree			
	First Move	Second Move	Third Move	Fourth Move
Minimax	13157	18456	20029	17609
$\alpha$ - $\beta$ Minimax	1965	1650	1641	1794
$\alpha$ - $\beta$ Minimax with Killer Heuristic	969	1023	926	830
Iterative $\alpha$ - $\beta$ Minimax with Killer Heuristic	753	571	675	363

**Table 2: An empirical analysis of the minimax algorithm and enhancements as applied to the Treasure Search game. Each version of the program conducted a seven-ply look-ahead search.**

are added or subtracted to a running total. As the search process nears the maximum depth of the tree, it is possible to set boundary conditions (ie: a window) that determine whether the final value can influence the selection process.

In many cases, the nonterminal score will be sufficiently deviant that the search can be terminated prematurely without any change in the ultimate decision process. This enhancement can significantly reduce the time required to complete the search.

### Strategic Weakness

This program for Treasure Search will play a fairly intelligent game. As presented here, however, it has a major weakness. When the game reaches its final stages, the machine continues to search for a pathway which gives it the greatest amount of treasure *in the long run*. This is not an optimal strategy because the game is won or lost at this stage by short-range planning. The first player to reach 100 wins. The machine with its present strategy may pass up a large treasure which would provide an immediate win in favor of a smaller one which ultimately leads to a rich lode. This could throw away an easy win.

Serious players may wish to introduce a special set of instructions for the endgame to correct for this weakness. The machine's game can also be strengthened by converting the program to assembly language. The deeper the look-ahead search, the greater the apparent intelligence of the machine. Conversion to assembly language will permit the program to search six plies deeper without increasing move-selecting time.

This article should provide useful information to anyone who wishes to write a game program which employs the  $\alpha$ - $\beta$  minimax procedure. ■

### References

1. Knuth, D E, and R W Moore, "An Analysis of Alpha-Beta Pruning," *Artificial Intelligence*, 1975, Volume 6, pages 293 thru 326.
2. Maurer, W D "Alpha-Beta Pruning," November 1979 BYTE, pages 84 thru 96.
3. Slagle, J R, and J K Dixon, "Experiments with Some Programs That Search Game Trees," *Journal of the Association for Computing Machinery*, 1969, Volume 16, pages 189 thru 207.
4. Von Neumann, J, and O Morgenstern, *Theory of Games and Economic Behavior*. Princeton NJ, Princeton University Press, 1944.

# CP/M\* compatible software

## SYSTEM MAINTENANCE

**DIAGNOSTICS I:** Easily the most comprehensive set of CP/M compatible system check-out programs ever assembled. Finds hardware errors in your system, confirms suspicions, or just gives your system a clean bill of health.

Tests:

- Memory
- CPU (8080/8085/Z80)
- Terminal
- Disk
- Printer

To our knowledge the CPU test is the first of its kind anywhere. Diagnostics I can help you find problems before they become serious. A good set of diagnostic routines are a must in any program library.

Minimal requirements: 24K CP/M. Supplied with complete user manual: \$60.00 Manual alone: \$15.00.

## ACCOUNTING

**ACCOUNTS PAYABLE/RECEIVABLE:** A complete, user oriented package which features:

- automatic postings to general ledger (optional)
- accounts payable: • check printing with invoice • invoice aging
- accounts receivable: • progress billing • customer statements
- partial invoice payments • invoice aging

The entire package is menu driven and easy to learn and use. It incorporates error checking and excellent user displays. This package can be used stand alone or with the General Ledger below.

Supplied with extensive user manual: \$200.00. Manual alone: \$20.00.

**GENERAL LEDGER:** A complete, user oriented package which features:

- Accepts postings from external programs (i.e. AP/AR above)
- Accepts directly entered postings
- Maintains account balances for current month, quarter, and year and previous three quarters
- Financial reports: trial balance, income statement balance sheet, and more.

Completely menu driven and easy to learn and use. Excellent displays and error checking for trouble free operation. Can be used stand alone or with Accounts Payable/Receivable above.

Supplied with extensive user manual: \$200.00. Manual alone: \$20.00.

Both require 48K CP/M, terminal with cursor positioning, home and clear home, one 8" disk or two 5" disks. CBASIC2 required.

## TEXT PROCESSING

**TFS—Text Formatting System:** An extremely powerful formatter. More than 50 commands. Supports all major features including:

- left & right margin justification
- user defined macros
- dynamic insertion from disk file
- underlining and backspace

TFS lets you make multiple copies of any text. For example: Personalized form letters complete with name & address & other insertions from a disk file. Text is not limited to the size of RAM making TFS perfect for reports or any big job.

Text is entered using CP/M standard editor or most any CP/M compatible editor. TFS will link completely with Super-M-List making personalized form letters easy.

Requires: 24K CP/M.

Supplied with extensive user manual: \$85.00. Manual alone: \$20.00.

Source to TFS in 8080 assembler (can be assembled using standard CP/M assembler) plus user manual: \$250.00.

## MAILING LIST

**SUPER-M-LIST:** A complete, easy to use mailing list program package. Allows for two names, two address, city, state, zip and a three digit code field for added flexibility. Super-M-List can sort on any field and produce mailing labels direct to printer or disk file for later printing or use by other programs. Super-M-List is the perfect companion to TFS. Handles 1981 Zip Codes!

Requires: 48K CP/M.

Supplied with complete user manual: \$75.00. Manual alone: \$10.00.

## UTILITIES

**Utility pack #1:** A collection of programs that you will find useful and maybe even necessary in your daily work (we did!). Includes:

- CMP:** Compare two files for equality
  - ARCHIVER:** Compacts many files into one, useful when you run out of directory entries.
  - SORT:** In core sort of variable length records.
  - XOIR:** Extended, alphabetical directory listing with groupings by common extension.
  - PRINT:** Formatted listings to printer.
  - PG:** Lists files to CRT a page at a time.
- ... plus more ...

Requires: 24K CP/M

Supplied with instructions on discette: \$50.00

## PROGRAMMING LANGUAGES

**FORTH:** a full, extended FORTH interpreter/compiler produces COMPACT, ROMABLE code. As fast as compiled FORTRAN, as easy to use as interactive BASIC.

**SELF COMPILING:** Includes every line of source code necessary to recompile itself.

**EXTENSIBLE:** Adds functions at will.

Z80 & 8080 ASSEMBLERS included

Single license, OEM licensing available

Please specify CPU type: Z80 or 8080

Supplied with extensive user manual and tutorial: \$150.00

Documentation alone: \$25.00

**ENHANCED 'TINY' PASCAL:** We still call it 'Tiny' but it's bigger and better than ever! This is the Famous Chung/Wuen 'Tiny' Pascal with more features added. Features include:

- recursive procedures/functions
- integer arithmetic
- CASE
- FOR (loop)
- sequential disk I/O
- one dimensional arrays
- IF ... THEN ... ELSE
- WHILE
- 'PEAK' & 'POKE'
- READ & WRITE
- REPEAT ... UNTIL
- more

'Tiny' Pascal is fast. Programs execute up to ten times faster than similar BASIC programs.

**SOURCE TOO!** We still distribute source, in 'Tiny' Pascal, on each discette sold. You can even recompile the compiler, add features, or just gain insight into compiler construction.

'Tiny' Pascal is perfect for writing text processors, real time control systems, virtually any application which requires high speed. Requires: 36K CP/M. Supplied with complete user manual and source on discette: \$85.00.

Manual alone: \$10.00.

## SOFTWARE SECURITY

**ENCODE/DECODE:** A complete software security system for CP/M. Encode/Decode is a sophisticated coding program package which transforms data stored on disk into coded text which is completely unrecognizable. Encode/Decode supports multiple security levels and passwords. A user defined combination (One billion possible) is used to code and decode a file. Uses are unlimited. Below are a few examples:

- data bases
- general ledger
- inventory
- payroll files
- correspondence
- account's pay/rec
- programs
- tax records
- mailing lists

Encode/Decode is available in two versions:

Encode/Decode I provides a level of security suitable for normal use. Encode/Decode II provides enhanced security for the most demanding needs. Both versions come supplied on discette and with a complete user manual.

Encode/Decode I: \$50.00

Encode/Decode II: \$100.00 Manual alone: \$15.00

## INTERCOMPUTER COMMUNICATIONS

**TERM:** a complete intercommunications package for linking your computer to other computers. Link either to other CP/M computers or to large timesharing systems. TERM is comparable to other systems but costs less, delivers more and source is provided on discette!

With TERM you can send and receive ASCII and Hex files (COM too, with included conversion program) with any other CP/M computer which has TERM or compatible package. Allows real time communication between users on separate systems as well as acting as timesharing terminal.

- Engage/disengage printer
- error checking and auto retry
- terminal mode for timesharing between systems
- conversational mode
- send files
- receive files

Requires: 32K CP/M.

Supplied with user manual and 8080 source code: \$110.00

Manual alone: \$15.00.

CP/M Formats: 8" soft sectored, 5" Northstar, 5" Micropolis Mod II, Vector MZ

All Orders and General Information:

**SUPERSOFT ASSOCIATES**

P.O. BOX 1628

CHAMPAIGN, IL 61820

(217) 359-2112

Technical Hot Line: (217) 359-2691

(answered only when technician is available)

\*CP/M REGISTERED TRADEMARK DIGITAL RESEARCH

*SuperSoft*

**First in Software Technology**



# Ask BYTE

Conducted by Steve Ciarcia

## The Automatic Apartment

Dear Steve,

I would like to congratulate you on your remote-control article using the BSR X-10 ("Computerize a Home," January 1980 BYTE, page 28). I have built a unit, and it is now so

much a part of my life that I take it for granted. It wakes me up, controls the lights, and guards the apartment in conjunction with a simple burglar alarm.

I have envisioned a system of lighting control that would illuminate any room that I enter, while darkening the one I just left.

*In "Ask BYTE," Steve Ciarcia answers questions on any area of microcomputing. The most representative questions received each month will be answered and published. Do you have a nagging problem? Send your inquiry to:*

Ask BYTE  
c/o Steve Ciarcia  
POB 582  
Glastonbury CT 06033

*If you are a subscriber to The Source, send your questions by electronic mail or chat with Steve (TCE317) directly. Due to the high volume of inquiries, personal replies cannot be given. Be sure to include "Ask BYTE" in the address.*

For this system to work, it must keep track of the number of people in the apartment (if there are more than one), and it must be able to sense their motion from room to room. Thus, if one person is in the living room, and he goes to the kitchen, the kitchen light should come on, while the living room light should go off. If there were more than one person in the living room, the light should remain on until the last person has left. Of course, manual control should be available, and the system should be able to recognize any sensing errors it may make, and reset itself accordingly.

Obviously, I need a doorway sensor that will detect a person passing through, and also detect the direction he is going. Would you suggest ultrasonic sensors, or would infrared optical sensors be more practical? Could you provide some circuit ideas to help me along?

Jim Porter

*I am always glad to hear*

*from someone who takes computer control seriously. Having a computer and automating your apartment makes being "gadget happy" sound almost respectable. In any case, I am familiar with your problem, and I'll try to offer a few circuits that might help.*

*When I first got involved with security systems, I did a lot of investigation on motion detectors, ultrasonics, and infrared systems. Very few companies offer automatic systems that count people and control lights in rooms. This should give you some indication of what you are getting yourself into.*

*Two possible methods that come to mind are detecting the motion of people within a room or counting them as they enter and exit.*

*Motion detectors usually incorporate one of three techniques: infrared, ultrasonic, and microwave. The infrared types are the cheapest. They rely upon changes in ambient light,*

*Text continued on page 270*

## MARYMAC INDUSTRIES, INC.



To Place An Order  
1-800-231-3680

Questions & Answers  
Texas 1-713-392-0747

### AUTHORIZED SALES CENTER

**BRAND NEW IN CARTONS DELIVERED.** Marymac Industries owns & operates Radio Shack® dealership in Katy, Texas. Warranties will be honored by all company owned Radio Shack® stores, & participating franchisees and dealer authorized sales centers. Save State Sales Tax. Texas Residents Add Only 5% Sales Tax. Open Mon.-Sat. 10-7. We pay freight and insurance. No extra charge for Master Charge & Visa. Call us for reference in or near your city. Ref: Katy National Bank, Katy, Texas. Radio Shack® Authorized Sales Center, 21969 Katy Fwy, Katy, Houston Texas 77450.

## WE OFFER ON REQUEST

- Federal Express
- Houston Intercontinental Airport Delivery
- U.P.S. BLUE
- References from people who have bought computers from us probably in your city

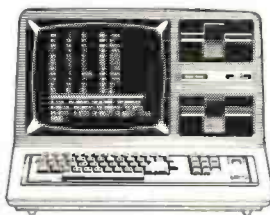

In stock TRS-80 Model I & II  
Taking orders for Model III

Where Your Dollar Means More  
**Save**  
**10% 15%**  
**OR MORE**

## WE ALWAYS OFFER

- NO extra charge for Master Charge or Visa
- We always pay the freight and insurance
- Toll free order number
- Our capability to go to the giant Tandy Computer warehouse 5 hours away, in Ft. Worth, Texas, to keep you in stock.

ED McMANUS



JOE McMANUS



# Now Graphics for your computer

## \$680

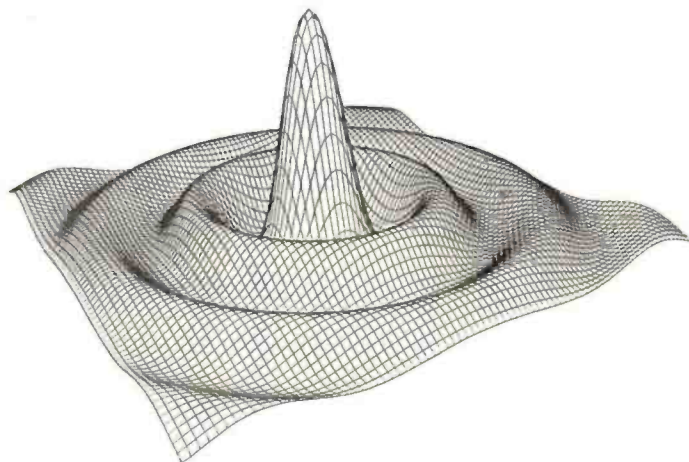

Expand your computer's capabilities with this easy-to-use drum plotter.  
The Strobe Model 100 interfaces to any computer to generate professional quality graphics.

**OFFERING** High Resolution Graphics Output \* Outstanding Performance \* Assembler Coded Drivers for High Speed Plotting \* Precise Operator Controls \* Interactive Coordinate Input

**ALSO AVAILABLE** Hardware Interfaces for — TRS-80 · APPLE II · PET · S-100.

Applications Software Package providing vector plotting and variable size alphanumeric for: TRS-80 Level II BASIC, Applesoft BASIC, Northstar BASIC, CBASIC, Microsoft BASIC & FORTRAN.

\* TRS-80, APPLE II, and PET are trademarks of Tandy Corp., Apple Computer Co. and Commodore Business Machines, respectively.

Circle 170 on inquiry card.

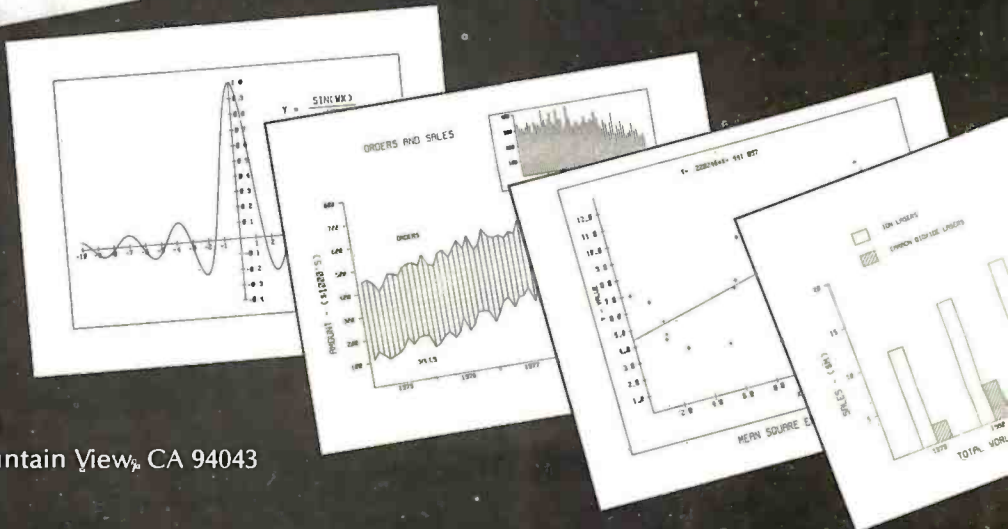

**STROBE INCORPORATED**  
897-5A Independence Avenue, Mountain View, CA 94043  
(415) 969-5130

1a

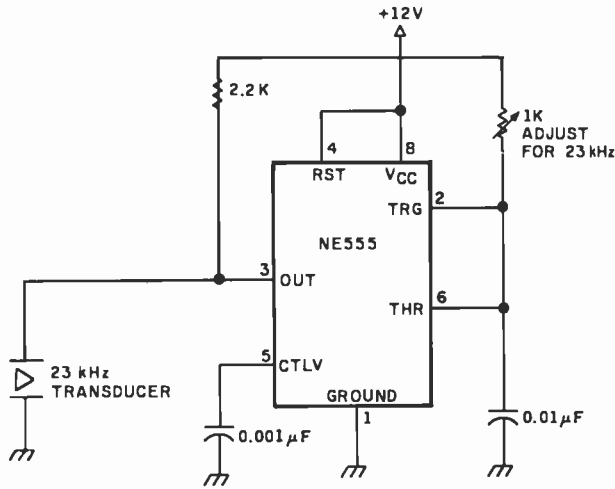

Number	Type	+ 5 V	GND	+ 12 V
IC1	LM1812	8	5, 10, 15	12
IC2	NE555	8	1	
IC3	7404	14	7	

1b

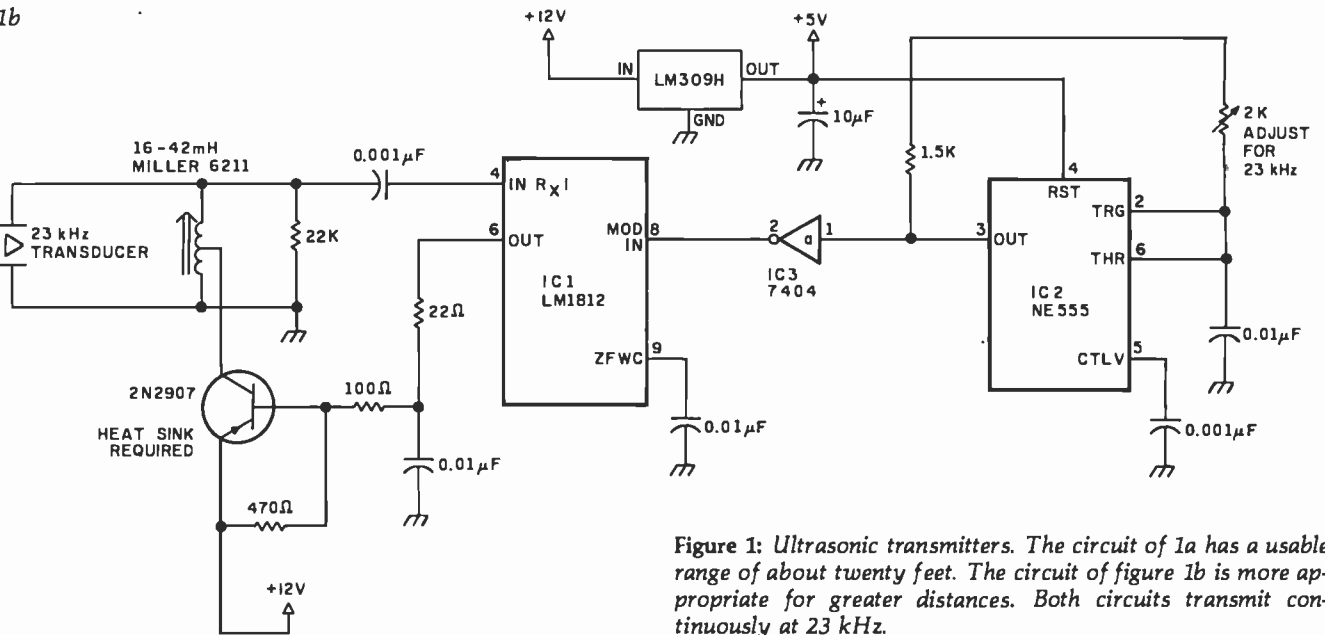

Figure 1: Ultrasonic transmitters. The circuit of 1a has a usable range of about twenty feet. The circuit of figure 1b is more appropriate for greater distances. Both circuits transmit continuously at 23 kHz.

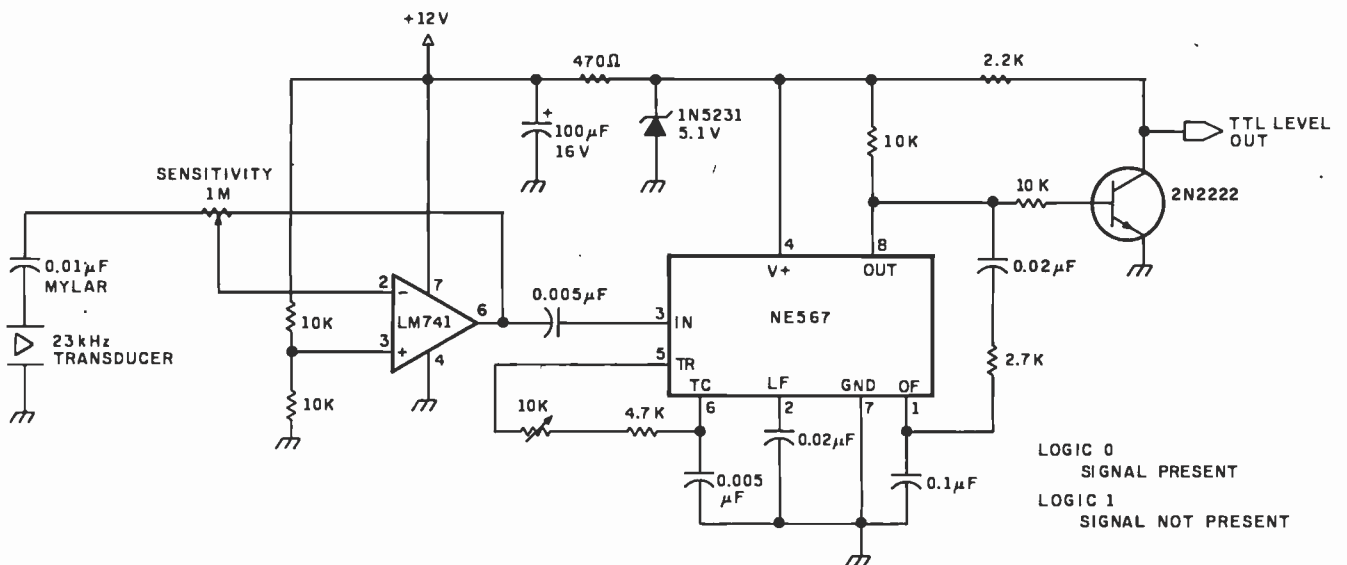

Figure 2: Ultrasonic receiver. This simple receiver has TTL-compatible outputs, and it will work with either transmitter in figure 1.



# OSBORNE MEANS BUSINESS!

## Discover What A Truly Great Business System Can Mean For You!

Buying a business software package can be a difficult and frustrating process. Your needs won't conform to any standardized system, and you can't take the time to develop your own system from scratch. After all, why re-invent the wheel?

Before you (or anybody else) installs a computer system for your business, you owe it to yourself to read our books.

OSBORNE/McGraw-Hill has published these celebrated business programs in book form to help you know what's in a good business software package and what it can do for you.

### What to expect from a GOOD business system

Osborne's three business books are renowned for excellence in design and in documentation. Each book is written from a system user's point of view, and carefully describes the mechanical design of the system, including the function and operation of each program. Our books explain in detail how to use the programs. What's more, they contain complete program listings and supporting technical documentation, like data file structure, hardware requirements and specific information about changing and installing the programs. These are also available, ready to run on your computer, from independent dealers in the Osborne Dealer Network. Call or write for a dealer referral list.



### PAYROLL WITH COST ACCOUNTING\*

### ACCOUNTS PAYABLE/ ACCOUNTS RECEIVABLE\*

### GENERAL LEDGER\*

**Order Form:** \*The books are available in both Wang BASIC and C-BASIC  
Please send me the following books:

Title	Price	Quantity	Amount
Payroll w/Cost Acctg. - CBASIC	\$20.00		
Accounts Payable/Receivable - CBASIC	\$20.00		
General Ledger - CBASIC	\$20.00		
			Tax
			Shipping
			TOTAL

Tax: Calif. residents only 6% / 6 1/2% BART  
Shipping: allow 4 weeks 0.75C per book  
USA, \$4.00 foreign

Please send information package for:

End user  Dealer

Name: \_\_\_\_\_

Address: \_\_\_\_\_

City: \_\_\_\_\_

State: \_\_\_\_\_ ZIP: \_\_\_\_\_

**OSBORNE/McGraw-Hill**  
630 Bancroft Way, Dept. B10  
Berkeley, CA 94710

For faster shipment or credit card, phone (415) 548-2805



1124

Text continued from page 266: and the latest designs incorporate an active photosensitive integrated circuit. In fact, Delco Electronics (7 Oakland St, POB 2, Amesbury MA 01913) was offering an under-\$30 kit a while back. In your application, with lights flashing on and off this may not be a reliable approach.

There are many ultrasonic systems on the market, and they range in price from \$50 to \$100. My only criticism of them is that they are prone to false alarms and you may find that the harmonics interfere with the BSR system. If you'd like to try placing one across a doorway or diagonally across a room, you could try the circuits shown in figures 1 and 2. These units operate at 23 kHz. Depending upon the sensitivity setting, they will detect most anything passing through the beam. For small rooms, you won't need much

power, so the circuit of figure 1a should suffice. If you need a range of greater than twenty feet, use the higher-power version shown in figure 1b. The receiver for either circuit is shown in figure 2. By the way, the output is TTL (transistor-transistor logic)-compatible. Normally the signal will be a logic 0 (ie: nothing interrupting the beam between the transmitter and receiver); the signal will go to a logic 1 only when someone walks into the room.

The most effective system for detecting motion uses microwave radiation—similar to police radar and operating on the same X-band frequency. In my experience, these are the best by far. They are relatively false-alarm free and very sensitive. I have them installed throughout my home, and I have found their reliability to be exceptional. Unfortunately, they

are expensive (in the range of \$150 to \$400 for domestic installations). A good unit is the Midex 55 made by Solfan (665 Clyde Ave, Mountain View CA 94043). Solfan's more expensive units have contact-closure outputs which would work well in your application.

The final solution to your problem might be to build a people counter. The circuit in figure 3 (sent to me by William Curlew) might be exactly what you need. It consists of two photodetectors (and two separate light sources) mounted in the doorjamb. Normally the light beam is uninterrupted and the output of the photodetectors is low. As long as there is light on both sensors, the output of IC2b is low. As someone starts through the doorway, one of the sensors goes high, clocking the JK flip-flop into one of two direction states. When the person fully enters the doorway, blocking both

the sensors, a trigger pulse is generated and sent to gates 2c and 2d. Depending upon the state of the flip-flop, the clock pulse will be directed to either the count-up or count-down line of the 4-bit up/down counter, IC5. The counter will increment as people walk into the room and decrement they walk out. A manual reset is provided to start things out correctly. When the 4 outputs are tied to a parallel input port, your computer can read it as often as necessary to determine how many people are left in the room. Since the counting is done in hardware, timing is not critical. It will accommodate only fifteen people in its present form, so don't have too many guests at your parties. Finally, for absolute certainty, you may want to use it with the ultrasonic circuits previously discussed. Steve

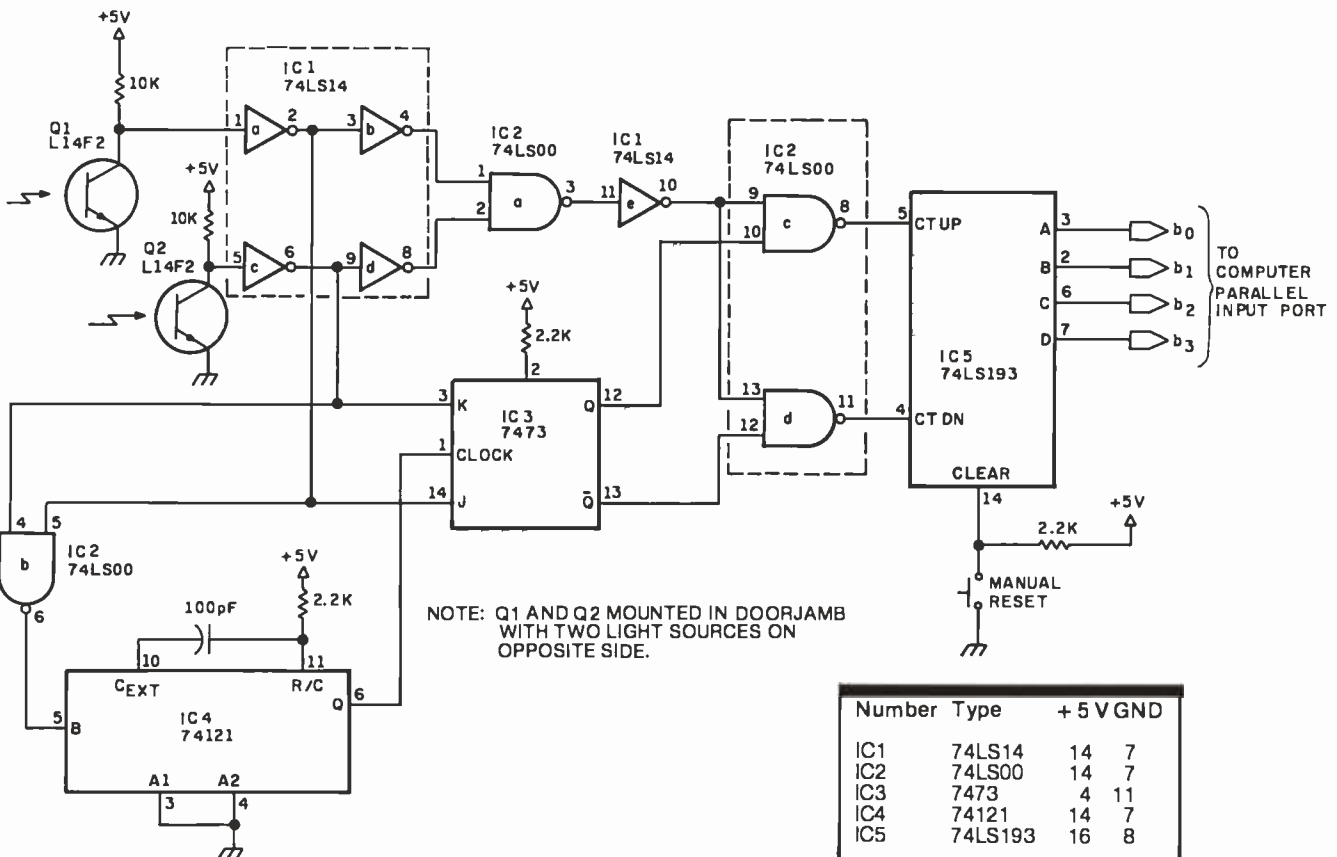

Figure 3: This circuit is capable of optically detecting the passage of people through a doorway and maintaining a count of people in a room. The photo-transistors sense motion through the doorway and cause the count stored in IC5 (a 4-bit binary counter) to either be incremented or decremented, depending upon the direction of passage.



# SUPER SAVINGS ON SOFTWARE

Limited Time Offer — Offer Expires December 31, 1980

## DIGITAL RESEARCH

Double Density or Quad DISK WITH MANUAL / MANUAL ONLY

CP/M® 1.4 Northstar . \$149/\$25

CP/M® 2.2 Cromemco \$189/\$25

*(Specify Single or Double Density)*

## TRS-80®

Model I CP/M 1.4 ..... \$129

Model II CP/M 2.2 ..... \$149

## MICROSOFT

Basic 80 ..... \$269/\$25

Basic Compiler ..... \$325/\$25

Fortran 80 ..... \$349/\$25

## MICROPRO

Word-Star (Ver. 2.1) .. \$349/\$40

Word-Star 2.1

with Mail Merge ..... \$465/\$65

Mail-Merge

(Requires 2.0 or 2.1) . \$119/\$20

DataStar ..... \$269/\$35

Word-Master ..... \$119/\$25

SuperSort I ..... \$189/\$25

SuperSort II ..... \$159/\$25

SuperSort III ..... \$109/\$25

## COMPUTER PATHWAYS

• Pearl (level 1) ..... \$89/\$25

• Pearl (level 2) ..... \$279/\$25

• Pearl (level 3) ..... \$529/\$25

## MICRO-AP

• Selector III-C2 ..... \$249/\$20

• Selector IV ..... \$429/\$35

• Glector ..... \$289/\$25

S-Basic Compiler .... \$289/\$25

## WHITESMITHS

"C" Compiler .... CALL FOR PRICE

Pascal (incl "C") . CALL FOR PRICE

## INTERSYSTEMS

Pascal/Z Version 3 A Z-80

Native Code Pascal Compiler

**\$345**

• Requires CBASIC-2

® Mfgs. Trademark

\* □ Supplied in source code

□ Requires MICROSOFT BASIC

## SHIPPING & INSURANCE

\$2.50 Per Package. Prices

Assumed Advanced Prepayment

COD & Charge Cards 2% Higher

## Business Applications Software

### PEACHTREE

\*□ General Ledger ... \$399/\$40

\*□ Accts Receivable .. \$399/\$40

\*□ Accts Payable ..... \$399/\$40

\*□ Payroll ..... \$399/\$40

\*□ Inventory ..... \$399/\$40

\*□ Property Mgt ..... \$799/\$40

\*□ C.P.A. Client Write-Up \$799/\$40

\*□ Mailing Address ... \$349/\$40

## SUPER SPECIAL!

Purchase General Ledger,

A/P, A/R, Payroll

(Structured Systems, Peachtree or Graham-Dorian)

AND

DEDUCT AN ADDITIONAL

\$100

From The Total Order

### STRUCTURED SYSTEMS

• General Ledger ..... \$699/\$25

• Accts Receivable ... \$699/\$25

• Accts Payable ..... \$699/\$25

• Payroll ..... \$699/\$25

• Inventory Control ... \$399/\$25

• Analyst ..... \$189/\$15

• Letterright ..... \$189/\$25

• NAD ..... \$85/\$20

QSORT ..... \$85/\$20

### GRAHAM-DORIAN

\*• General Ledger .... \$699/\$35

\*• Accts Receivable .. \$699/\$35

\*• Accts Payable ..... \$699/\$35

\*• Payroll ..... \$699/\$35

\*• Inventory ..... \$699/\$35

\*• Cash Register ..... \$449/\$35

\*• Apartment Mgt. ... \$449/\$35

\*• Job Costing ..... \$699/\$25

### APPLE OWNERS

Now Available!

On Microsoft Z80/CPM

Conversion Unit For The Apple  
THE APPLESOFT

— Call For Price —

Also Available For Use With It

PEACHTREE

Business Software Application Packages

CALL FOR BARGAIN PRICES

**ALL  
LIFEBOAT ASSOCIATES  
SOFTWARE  
LESS 10%**

**C BASIC II  
\$89**

**ALL  
COMPUTER DESIGN  
LABS SOFTWARE  
LESS 20%**

**ELECTRIC  
PENCIL  
LESS 15%**

All Offers Subject To Withdrawal  
All Prices Scheduled To Change  
December 31, 1980

All Prices Are For Software Supplied On Standard IBM Compatible 8" Single-Density Disk. Add \$10.00 Per Disk For The Following 5¼" CPM® Compatible Formats:

-Northstar DD

-Northstar SD

-Northstar Quad

-Micropolis QD

(Vector Graphics)

Superbrain 3.0, DD or QD

(Some 5¼" Transfers Require More Than One Disk). For Other Formats Contact Us For Pricing. Specify Format To Avoid Delay  
8" Assumed If Not Specified

Circle 172 on Inquiry card.



# MiniMicroMart, Inc.

1618 James Street, Syracuse, NY 13203 (315) 422-4467

TWX 710-541-0431

## Remote Control in Europe

Dear Steve,

Please tell me if the X-10 remote-control system by BSR could be operated on 220 V 50 Hz in Europe. I see from the schematic diagrams and various pictures it is designed to work on 110 V 60 Hz. Do they have a 220 V system? If not, is there any way I could adapt the system to work on a 220 V system.

Please tell me where I can buy the set (ie: common console, cordless controller, appliance module, lamp module, in-wall switch module) using an American Express card; maybe from Sears as you said in your article. If so, please let me know the address of Sears; for that matter, any reliable dealer who accepts American Express. I'll be grateful for the two answers. Next time you are in Europe drop in and see us. We have a wood stove too, and I hope to connect it to the

central heating system.  
**Rangith Amitrigala**  
Brugg, Switzerland

*Up to this point the X-10 system has been available only in the American version (115 VAC 60 Hz). The custom LSI (large-scale integration) device used in the American units, surprisingly enough, can work on either 50 or 60 Hz. The polarity set on pin 13 of the command-console integrated circuit selects either of the two operating frequencies. These consoles cannot, however, be easily converted from 115 V to 220 V operation without considerable component changes.*

*A call to BSR (USA) Ltd in New Jersey produced some fruitful answers to your question. Even though BSR is working on a European version of the X-10, another company has just announced availability of a 220 V 50 Hz unit. I suggest that you contact this firm for price and delivery. The*

source is: Busch-Jaeger Elektro GmbH, 5880 Ludenscheid, Freisenberg, Post Fach 1280, West Germany (BRD).

*As for Sears Roebuck and Company, it is my understanding that the firm accepts only its own credit card. Rather than worry about which stores will accept your credit card, you may find it easier to go your local bank (in Switzerland) and arrange for a letter of credit or bank draft when ordering from an American company.*  
Steve

## Operational Amplifiers

I have been using the AD284] isolation operational-amplifier system that you described in "Mind Over Matter" (June 1979 BYTE, page 49) as an EKG (electrocardiogram) monitor, in conjunction with a surplus chart recorder. Can you recommend some books that will

help me to learn more about operational amplifiers?  
**Matsutoshi Uchiyama**  
Tokyo, Japan

*I am glad you are gaining experience with the circuit. As far as expanding your mind a little, I suggest the following books:*

- Operational Amplifiers—Design and Applications, *Jerald G Graeme, Gene E Tobey, and Lawrence P Huelsman, McGraw-Hill Book Company, New York NY 1971.*
- Applications of Operational Amplifiers—Third Generation Techniques, *Jerald G Graeme, McGraw-Hill Book Company, New York NY 1973.*
- Handbook of Operational Amplifier Circuit Design, *David F Stout and Milton Kaufman, McGraw-Hill Book Company, New York NY, 1976.*

*I hope these help.*  
Steve

## Beyond "Cyclops"

Dear Steve,

I consider your series of articles the best collection of homebrew-type construction ideas and projects available to the personal-computer experimenter. Your article "Self-Refreshing LED Graphics Display" (October 1979 BYTE, page 58) has prompted me to write you.

I'd like to propose a project to you. I understand that a construction project called "Cyclops" appeared in *Popular Electronics* that actually used a dynamic-memory integrated circuit to act as a "pseudo-image sensor." Can this unique idea be extended to larger-area memory devices? The 4 K-byte circuit would make a nice 64-by-64 element array.  
**Jesse Newton**

*Thanks for the pat on the back. Sometimes late at night I need it.*

*I remember that article*

Introducing ...

**MINDex** & MINDexCHANGE  
system—one softsources

System—one is a Pascal based information storage and retrieval system. Softsources are ready made databases of computing resources, contract clauses, bibliographic references, and more.

**MINDex** is suitable for the researcher, lawyer, contractor, educator, and student. Virtually anyone assembling or accessing text based information may benefit from this versatile and productive information management tool.

**MINDex** can scan volumes of data for you and extract what is most relevant to your needs.

**MINDex** is designed to adapt to your special vocabulary through a simple dictionary of key words or through a more complex but effective thesaurus of key concepts as defined by associated word groups.

**MINDex** can assist a legal practice or contractor's office in the generation of legal documents from standard clauses, and in searching case briefs for legal precedents.

# **mINDex** infosystems

**MINDex** Features:

- Variable length text records which may span files and disks to accommodate large databases.
- Ranked retrieval in order of closest match to your inquiry.
- Interactive inquiry as well as retrieval from inquiry archive files.
- Fully automatic association of your key words to all or a selected range of text records.
- Optional indexing on all text in a record or on delimited key word groups and the ability to suppress key group output.
- Formatting and output controls with specifiable destination.

Introductory prices:

**MINDex** system — one, for UCSD Pascal I.5, II.0, or PASCAL/M with sample databases and manual ... \$ 175

**MINDex** manual only ... \$ 20

MINDexCHANGE softsources from \$ 25  
prices vary with database, please inquire for specifics.

Contact: **MINDex** infosystems  
81 Centennial Loop, Suite A  
Eugene, Oregon 97401  
Ph: (503)485-5827

Shipped on 8" single-density soft sectored diskettes.

UCSD Pascal is a registered trademark of The Regents of the University of California. PASCAL/M is a trademark of Sorcim.

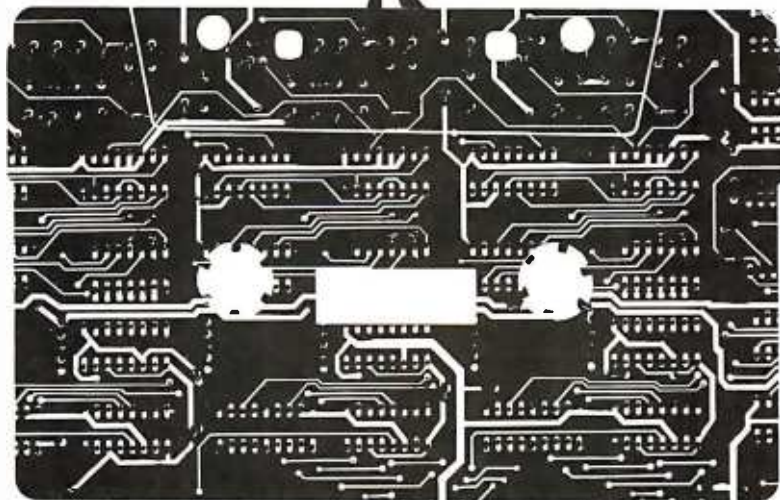

# SAMS CIRCUIT DESIGN SOFTWARE.

37 TECHNICAL PROGRAMS TO LET YOU SPEND LESS TIME ON ROUTINE CALCULATIONS, STATISTICS, ANALYSES... MORE TIME ON CREATIVE DESIGN AND ENGINEERING.

Sams—the leader in technical publishing—now offers the most advanced engineering software systems available. These tested, documented, debugged programs can be used as stand-alone programs or as subroutines for more complex programs.

■ **FASTER INFORMATION**—Solve simultaneous equations with real and complex coefficients and polynomial roots. Quickly determine the effects of an infinitely variable set of design parameters. Plot graphs for various functions while varying scales to fit data.

■ **EASY TO RUN**—7 cassettes include 37 debugged programs.

- PLOTTING GRAPHS FOR VIDEO DISPLAY (5 Programs)**  
Histograms. Cartesian Plots. Semi-Logarithmic Plots. Log-Log Plots. Polar Plots. #26006. \$16.95.
- PLOTTING GRAPHS FOR LINE PRINTER (3 Programs)**  
Cartesian Plots. Semi-Logarithmic Plots. Polar Plots. #26000. \$16.95.
- ACTIVE FILTER DESIGN (6 Programs)**  
Low and High-Pass (Bessel, Butterworth, 1, 2, and 3-dB Chebyshev). Slope-Variable Filter. Bandpass Filters with Q's less than 10 and 50. Staggered-Tuned Butterworth Bandpass Filters (2, 3, or 5 poles). Notch Filter. #26001. \$21.95.
- DESCRIPTIVE STATISTICS & REGRESSION ANALYSIS (3 Programs)**  
Descriptive Statistics (mean, standard deviation, variance, kurtosis, z-scores). Curvilinear Regression (linear, inverse, polynomial, exponential, logarithmic). Multivariable Linear Regression. #26002. \$21.95.
- ELECTRONICS I (5 Programs)**  
Zener Diode Voltage Regulator Design. 555 Timer Design (monostable and astable circuits). Transistor Bias Parameters. Single-Stage Transistor Amplifier Design. Heat Sink Selection and Design. #26003. \$16.95.
- ELECTRONICS II (7 Programs)**  
4-Quadrant Arctangent Function. Rectangular/Polar Conversion and Complex Number Mathematics. Minimum and Maximum Values of an Array. Roots of Polynomials with Real Coefficients. Inverse Laplace Transforms of a Transfer Function. Solution of Simultaneous Equations with Real and Complex Coefficients. #26004. \$16.95.
- ELECTRONICS III (8 programs)**  
Average and RMS Values of a Periodic Function. Fourier Series Expansion of a Periodic Function. Fourier Transform and Spectrum Plot. Analysis of Damped Oscillations. Impedance Matching Pads. Pi-TEE (delta-woye) Transforms. #26005. \$16.95.
- CIRCUIT DESIGN PROGRAMMING BOOK FOR THE TRS-80.**  
Circuit Design Programs for the TRS-80 by Howard M. Berlin features all of the programs listed above...and more. #21741. \$12.95.

■ **FULLY DOCUMENTED**—Easy-to-read and follow instructions.

■ **DESIGNED FOR POPULAR MICROCOMPUTERS**—Designed for use on TRS-80\* systems having Level II BASIC and at least 16K RAM; many of the routines can be adapted to run on other popular computers. Programs will be available soon for Apple and Ohio Scientific.

■ **PROGRAMMED, TESTED, AND DEBUGGED BY HOWARD M. BERLIN**—Howard M. Berlin—an author in the Blacksburg Series—is an electrical engineer with the Chemical Systems Laboratory at Aberdeen Proving Ground, Maryland, and has been adjunct instructor in the Department of Electrical Engineering at the University of Delaware.

Indicate quantities in the boxes and return entire ad with order.

Mail to: Howard W. Sams & Co., Inc. • P.O. Box 7092  
4300 West 62nd Street  
Indianapolis, IN 46206. (317) 298-5400.

AMOUNT OF ORDER: \$ \_\_\_\_\_  
(add local tax where applicable)

PAYMENT ENCLOSED ADD48  
 CHECK  MONEY ORDER  
 VISA  MASTER CHARGE Interbank No. \_\_\_\_\_

Expiration Date: \_\_\_\_\_

Account No.: \_\_\_\_\_

Name (print): \_\_\_\_\_

Signature: \_\_\_\_\_

Address: \_\_\_\_\_

City: \_\_\_\_\_ State: \_\_\_\_\_ Zip: \_\_\_\_\_

SEND INFORMATION ABOUT PRICE AND AVAILABILITY FOR SAMS SOFTWARE FOR:  APPLE  OHIO SCIENTIFIC.

Sams Software Systems are available from major Sams Distributors and Computer Stores. Prices good in U.S.A. only. In Canada, contact Lerbrook Industries, Ltd., Scarborough, Ontario, M1H 1H5, Canada. Offer expires 1/31/81.

\*TRS-80 is a registered trademark of Radio Shack, a division of Tandy Corp.

# Sams Books®

well, and I have wanted to try exactly what you suggest. I've waited because I want fairly high resolution. Perhaps with the new 32 K and 64 K bit devices I will try it. Give me a little time.

The real problem I have is that there are so many good article ideas. I still want to put a computer in a car, do something with solar heat, remote control, and robotics. As long as you haven't been dissatisfied with everything so far, I trust that I'll find something interesting in the meantime. Steve

#### Across-the-Sea File

Dear Steve,

I read with great interest your article "Computerize a Home" (January 1980 BYTE, page 28), and I am interested in the BSR X-10 system.

I contacted the Commercial Section of the US Embassy here and also my employer's purchasing agent in New York, but neither could find me the address of

the BSR Company. I would appreciate it if you could tell me the manufacturer's address.

Thank you.  
Z Lapidot  
Rehovot, Israel

The address for BSR is: BSR (USA) Ltd, Rt 303, Blauvelt NY 10913, telephone: (914) 358-6060. There are many stocking distributors for its products including: The Software Exchange, 6 South St, Milford NH 03055.

BSR is an English company, and there may be outlets closer to you than those listed here. Steve

#### Point-to-Point

Dear Steve,

My compliments for a fine set of articles over the years. Only recently have I had the time to try some of the projects you write about. I am planning to build the DVM (digital voltmeter) from your article in the January 1978 BYTE ("Add More Zing to

the Cocktail," page 37).

I have contacted the printed-circuit board manufacturer that you mentioned in your article, but it no longer has boards available for that particular project. I do have all the components, and would like to avoid the tedium of hand-wiring the project. Do you have any boards available for a reasonable price?

I plan to use this circuit as part of a solar-energy-collector measurement system (among other things). I'm also trying to work out a method to manage energy consumption around the house. Frank J Pakulski

A lot of people have built and are using the DVM interface you mention. (Please note a typographical error in table 1 of that article. On IC1 pin 24 is +5 V, pin 13 is ground, and pin 12 is -5 V.) I'm sorry that the company that once sold the components no longer supplies them. I have noticed

that companies such as Jameco sell the MC14433 DVM chip, but not the printed-circuit board.

Recently, I have been arranging for boards and kits on some of my articles. This time the sources are more closely regulated and the boards and parts will be available far into the future. Steve

#### In-Depth Information Center

Dear Steve,

I would like you to recommend some texts that would introduce me to computer hardware, from basic switching theory through the actual architecture of a computer. I'm tired of superficial prose intended for the general consumer. I need some more in-depth information that is found only in engineering texts. You know, something that presents the computer from the electronics engineer's point of view in a well-structured manner. What do you suggest? As a postscript, I would also like to learn about Pascal.

Daniel R Shook

You ask an extremely difficult question. I have talked to other computer enthusiasts and it seems that (given the wide variety of texts and computer books being published) no two can agree on what is best. I have felt that there is a void in this area, and, as a matter of fact, I have just written a book on building a Z80 computer system from scratch. It's above the introductory level, but not just for engineers—similar to my articles. It should be published in early 1981.

In the meantime, I suggest you join the McGraw-Hill Electronic & Control Engineers book club. Many of its monthly selections are introductory texts written for engineers.

A good book on Pascal is Pascal User Manual and Report—Second Edition, by Jensen and Wirth from Springer-Verlag. Steve ■

## ARTIFICIAL INTELLIGENCE For Your C/PM<sup>®</sup> or S-100 SYSTEM

"SHIVA™" is a highly-sophisticated VIRTUAL-PERSONALITY™ multi-level multi-user multi-tasking executive (operating system) for S-100 based systems. It provides your microcomputer system immediately with power comparable to that of large-frame maxi-computers for a remarkably small price, yet SHIVA™ requires surprisingly little R.A.M. area, and is conversational!!! SHIVA's™ English-like input/output is interactive, dynamic, and may be reconfigured or expanded by the user. And SHIVA™ gives you the freedom to expand indefinitely... with tremendous hardware and software choice: SHIVA™ supports hard disks and floppies... R.A.M. addressing beyond 64 kilobytes... time-sharing... multi-level user-reconfigurable password protection... and features shell-commands similar to UNIX® in structure!! SHIVA™ is compatible with C/PM® and C/DOS® for easy implementation and near universal software support!!! SHIVA™ is available for 8080, 8085, MC6800, 6502, and Z80®-based systems.

Versions are in development for ZILOG Z8000® 16-BIT, INTEL 8086® and INTEL iApx-432® 32-BIT PROCESSORS...

And Omega Research™ is dedicated to non-obsolescence and system superiority in software choice... SHIVA™ supports BASIC, FORTRAN, COBOL, a MACRO-ASSEMBLER, DATA BASE MANAGEMENT, ALGOL-60, PASCAL... interfaces in development for UNIX®, C, LISP, PL/I, APL, and RT-11®.

And needless to say, SHIVA™ is very fast... SHIVA™... \$350... Available on 8" I.B.M. Soft-Sector Diskettes and 5" C/DOS® (Cromemco) Diskettes. Includes complete Documentation... M.C. & Visa orders accepted

"SHIVA™", "VIRTUAL-PERSONALITY™" and "OMEGA RESEARCH™" are trademarks of OMEGA RESEARCH. "RT-11" is a trademark of DIGITAL EQUIPMENT CORPORATION. "UNIX" is a trademark of BELL LABORATORIES. "C/PM" is a trademark of DIGITAL RESEARCH OF CALIFORNIA. "C/DOS" is a trademark of CROMEMCO, Inc. "Z-80" and "Z-8000" are trademarks of ZILOG, Inc. "INTEL" is a trademark of INTEL CORPORATION.

No shipments prior to return of signed software license agreement. For detailed information on "SHIVA™", send \$1.00 postage and handling to:



CALIFORNIA RESIDENTS ADD 6% SALES TAX

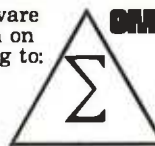

OMEGA RESEARCH™

P.O. Box 479  
Linden, Ca. 95236  
(209) 334-6666

9am to 5pm Mon.-Fri.

# WE CAN TAKE YOU FROM WATERLOO TO THE SUPER BOWL. (By way of the North Atlantic.)

In the few short months since we introduced Computer Bismarck™, we've transported over 2500 adventurous minds to the North Atlantic — there to recreate the historic battle between the awesome German warship and the British Home Fleet. The startling realism and excitement of that experience have prompted many well-seasoned travelers to proclaim it "...unique among computer games and board games alike.\*" One enthusiast had this to say: "The wealth of detail...is hardly short of fantastic. Only real war rooms...in the Pentagon have ever before been able to simulate a battle in this manner.\*\*" Now we offer two more strategy games to embark you on new flights of the imagination.

## COMPUTER NAPOLEONICS™

takes you to the battlefields of Waterloo on the fateful day of June 18, 1815. Here, the greatest battle ever fought is about to begin, awaiting only your commands to set the amassed armies in motion.

You and your friend choose your role — either as the military genius, Napoleon, or as the Duke of Wellington, the iron-willed leader of the Anglo-Allied forces. The video screen displays the map of the Belgian countryside with the artillery, infantry, and cavalry units under your respective commands.

**AS NAPOLEON**, you must utilize your superior combat strength and numbers to deal Wellington a quick and decisive defeat before his Prussian ally can supply reinforcements. Speed is of the essence. But any tactical blunders in military deployment will result in a repeat of history — Napoleon's ignominious defeat.

**AS THE DUKE OF WELLINGTON**, you must not only survive the onslaught of the French artillery, cuirassiers, and the dreaded Imperial Guard, you must also inflict sufficient damage to Napoleon's forces to prevent his relentless northward march of conquest.

**THE COMPUTER**, in our solitaire scenario, plays Wellington while you play Napoleon. Two levels of play are provided by making the entry of Prussian reinforcements variable. This makes the need for French military decisiveness and devastating execution even more critical.

## FOR THE NOVICE AND THE ADVANCED.

Computer Napoleonics has all the advantages of your basic, traditional wargame — meticulous detail, realism, and playability. Plus one. Because the computer keeps track of all the rules, neither player can make an illegal move. This makes learning it a cinch (mastery is quite another matter), and it will convert the novice wargamer into a fanatic in no time.

The advanced wargamer will find the computer a worthy opponent indeed, and the two levels of play in the solitaire version will challenge the most experienced of strategists.



## COMPUTER QUARTERBACK™

propels you onto the playing field of the Super Bowl. From its multiple offensive and defensive plays and its real-time playing conditions to the animated video display of the gridiron and the halftime statistics, no strategy football game has ever been more complete in detail or as exciting in realism. Three versions are offered: Semi-Pro, Pro, and Computer-as-Opponent.

**SEMI-PRO** presents you with a choice of 18 offenses and 14 defenses. Here, you will begin to learn the intricacies of football; the thrill of the perfectly executed two-minute drill; the agony of the fumble, interception, and penalty. On offense, you will learn to read the defense and call audibles as needed.

After you have mastered the Semi-Pro version, it's time to move on to the Big Time...the Pro version!

**THE PRO VERSION** not only gives you every offense (36) and defense (24 plus double-teaming capabilities and special alignments) you could ever want, it also gives you the team you want! With 2.7 million computer dollars, you get to draft a team to your style and specifications. Spend more on your quarterback and receivers and your passing game may very well be unstoppable...but your running game may suffer for lack of funds.

**THE COMPUTER** eliminates all the organizational drudgery of conventional board games. It plays scorekeeper, referee, umpire, and linesman. As timekeeper, it makes you play in real-time. Take longer than 30 seconds to hike the ball and five yards will be marched off against you for delay-of-game.

"**THE ROBOTS**" is the team most ably coached by your friendly computer. It's ready to play any time you are. It even "learns" your tendencies and patterns through time, and it will make the necessary tactical adjustments. It plays so well you must be in top form to stand a chance against it.

All you need to start on these mind journeys is an Apple II with Applesoft ROM card, 48K memory, and a mini-floppy disc drive. For \$59.95, Computer Napoleonics comes with the game program mini-disc, two mapboard cards, a rule book, and two player-aid charts. Computer Quarterback, for \$39.95, gives you the game disc, a rule book, and four play diagram charts.

Credit card holders, call 800-648-5600 (toll free) and charge your order to your VISA or MASTERCHARGE. In Nevada, call 800-992-5710. For Computer Quarterback, ask for Operator 178; for Computer Napoleonics, Operator 179.

While you're at it, you can also get our other games:

- Computer Bismarck for your Apple: \$59.95 (Operator 180)
- Computer Bismarck, TRS-80 48K Disc: \$59.95;
- 32K Cassette: \$49.95

- Computer Ambush (a tactical simulation of man-to-man combat in World War II) for your Apple: \$59.95 (Operator 181)

To order by mail, send your check to Strategic Simulations Inc., Dept. B, 450 San Antonio Road, Suite 62, Palo Alto, CA 94306. Our 14-day money back guarantee assures your satisfaction.



STRATEGIC SIMULATIONS INC.

\*Creative Computing, Aug. 1980.

\*\*Popular Mechanics, Aug. 1980.

Apple is a registered trademark of Apple Computer Inc.  
TRS-80 is a registered trademark of Tandy Corporation.

Text continued from page 82:

subroutine name, length, and the subroutine instructions. Thus, our load-subroutine primitive can be represented as:

LSUB N,L,D<sub>0</sub>..D<sub>n-1</sub>

where:

- N = subroutine name or number
- L = subroutine length
- D<sub>i</sub> = subroutine instructions

For example, the primitive:

LSUB CLIP,5,D<sub>0</sub>..D<sub>4</sub>

loads a subroutine named CLIP with the given five instructions.

In order to maintain a sense of symmetry with these primitives, we need to include a primitive to read back a given subroutine. Although this feature does not affect the displayed image, it does aid the host in debugging and keeping track of the current status of the display. Thus, we require a read-subroutine primitive, which can be represented as:

RSUB N

where:

N = subroutine name or number

For example, the primitive:

RSUB CLIP

reads the instructions of the subroutine CLIP and presents the data to the host.

We have also assumed the existence of a programmable symbol generator. In order to support this feature, there is the need for some method of loading the generator. We either need to load an entirely new font definition in the symbol generator or alter only certain symbols: thus we must provide the option of loading the entire set or only one element. We can define each symbol by providing data which represents either the vectors that make up the symbol or by defining a bit pattern that forms the image of the symbol. In either case, our load-symbol primitive can be represented as:

LSYM M,(A,)D<sub>0</sub>..D<sub>n</sub>

where:

- M = mode (All symbols or a Single symbol)
- A = symbol code (optional: for single symbol only)
- D<sub>i</sub> = data mask defining the symbol

For example, the primitive:

LSYM S,80,D<sub>0</sub>..

loads the symbol numbered 80 with the given data mask.

Symmetrically, we must include a primitive to read back the data describing a single or all symbols. This feature is necessary to be able to produce hard copies of the displayed image. The host must know, if an image is to be plotted, how the current font is defined. We use the same justification as above to support the option of reading all or only selected symbols. Mnemonically, our read-symbol primitive can be represented as:

**Call on John D. Owens for all Your Computer Needs**

JOHN STARTED PROGRAMMING IN 1959 AND HAS WORKED ON THE IBM 704, UNIVAC I, NCR 304, CDC 6600, IBM 360/370 AND MANY OTHERS. WHEN YOU CALL ON US, JOHN'S EXTENSIVE EXPERIENCE BECOMES AVAILABLE TO YOU.

**IMS 5000 and 8000 Systems**  
The new rising stars! Beautifully designed and constructed with the Industrial Micro System reputation for fine quality. These systems feature a Z80 CPU, S-100 bus; double density drives (either single or double sided) CP/M®. 5000 series uses mini floppies, 8000 uses maxi floppies. Hard disk and MP/M now available.

Model 5-00125 with two double density drives. 32K Static RAM ..... \$2,765  
Model 8-00125 as above but with 8" drives ..... \$4,185

**AMPEX DFR-900 HARD DISK DRIVES**  
Winchester media; 16MB removable; 32, 64 or 96 MB fixed. These drives are totally integrated with the IMS hardware and CP/M. We can furnish a package consisting of an IMS system, your choice of CRT or printer, optional hard disk and applications software.

<p><b>DRIVES</b></p> <p>Per Sci 299B Now Available!!! ..... \$2,200 Cabinet and power supply ..... \$300 Per Sci 277. \$1,210 Shugart ..... \$525 MPI B51 ..... \$265 B52 ..... \$365 Innotronics and QUME also available</p> <p><b>HAZELTINE 1500</b> ..... \$885 1510 ..... \$980 1520 ..... \$1,210 1420 (two year warranty) ..... \$775</p> <p><b>DEC LA 35/36 Upgrade</b> ..... \$750 Increases baud rate to 1200. Microprocessor controlled. Many features include TOF, tabs and margin control.</p>	<p><b>TELEVIDEO SMART CRTs</b></p> <p>912 B and C ..... \$780 920 B and C ..... \$850</p> <p><b>IMS MEMORY 16 K static</b> ..... \$285 32 K static ..... \$585 64 K Dynamic with parity ..... \$950</p> <p><b>TEI MAINFRAMES, S-100</b></p> <p>12 slot ..... \$500 22 slot ..... \$670</p> <p><b>TARBELL</b></p> <p>Double density controller ..... \$420 Cables ..... \$40</p>
--	---

We have no reader inquiry number. Call on us for product sheets. Dealer inquiry invited. Prices subject to change without notice. CODs accepted at no extra charge.

**CALIF. COMPUTER SYSTEMS CONTROLLER** Single or double density; 5¼ or 8" drives. ROM Addressable. Price includes CP/M® 2.2 ..... \$395

**WE EXPORT:** Overseas Callers: TWX 710 588 2844  
Phone 212 448-6298 or Cable: OWENSASSOC

**We Are Known for Our Prompt and Courteous Service!**

**JOHN D. OWENS**  
Associates, Inc. 212 448-6298  
212 448-2913 12 Schubert Street  
Staten Island, New York 10305

RSYM M,(A)

where:

M = mode (All symbols or a Single symbol)  
A = symbol code (optional: for single symbol only)

For example, the primitive:

RSYM A

reads back the entire font definition to the host.

In order to fully support a requirement for hard copy, two final primitives have to be provided. First, since we have assumed the existence of a color-look-up table, we must have some manner of reading back the values of the table to the host. Otherwise, the host would have to keep track of the current color definitions. This primitive thus reduces the host's bookkeeping and allows information on the actual displayed colors to be read back. For the same reasons as we described for the load-color-memory primitive, we must support the same options of reading back either the entire table, one entire parameter, or all parameters for one color code. Mnemonically, we can represent our read-color-memory primitive as:

RCRAM R,M,(A)

where:

R = reference (Intensity, Hue, or Saturation color memory, or All)  
M = mode (Single address or All addresses)  
A = address (optional: for single address only)

For example, the primitive:

RCRAM I,A

reads back the contents of the entire intensity color memory.

Finally, we must be able to read back values of the pixel data itself. This feature is necessary not only for the support of hard copy, but allows the host to interrogate the display to read back the values of pixels at specified points in the image. We use the same justification as for the load-pixel primitive to support the various options of reference (full-frame, viewport, or X,Y). Mnemonically,

our read-pixel primitive can be represented as:

RPIX R

where:

R = reference (Full-frame, Viewport, or X,Y)

For example, the primitive:

RPIX F

reads back the contents of the entire display-frame buffer.

This completes our set of graphics

(255, 255)

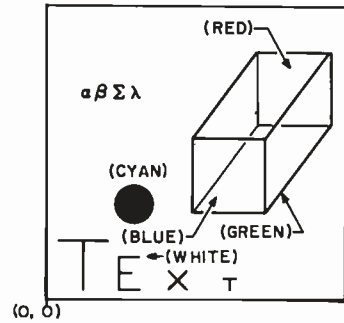

Figure 5: A sample of the images produced by Micrograph using the primitives of listing 1.

### Call on John D. Owens for all Your Computer Needs

**TELETYPE Model 43 Inventory Sale!!!**  
 Model 4320 AAK and AAL ..... \$1,085  
 Model 4330 punch/reader. 10 or 30 CPS.  
 8 level, 1" tape ..... \$2,595  
 Limited supply of Model 45 available.

**IBM 3101 CRT Model 10** ..... \$1,195  
**Model 20** ..... \$1,395  
 Selectric-like, detached keyboard. 9x16 dot matrix.  
 Maintenance contract from IBM only \$70 per year.

**ITHACA INTERSYSTEMS**  
 Full S-100 IEEE Compatibility! Full 24 address bits. DMA  
 disk controller. SYSTEM 2A includes 20 slot mainframe  
 with front panel, 64K Dynamic RAM. Z80 CPU, 4 MHZ,  
 extended addressing capability. 4 parallel, 2 serial I/O,  
 floppy controller. Our discounted price ..... \$3,236

**MARINCHIP SYSTEMS M9900**  
 Elegant 16 bit CPU, S-100 compatible Multi user, multi pro-  
 cessor operating system. Extended precision commercial  
 BASIC, FORTH, META, PASCAL, Word Processor and  
 Text Editor. Fast and powerful!  
 Complete kit and software package ..... \$550  
 Assembled ..... \$700  
 We configure complete systems with floppy or hard disk.  
**MARINCHIP USERS: QBASIC for the 9900** ..... \$220  
 16 bit, 32K words, 64K BYTES memory ..... \$1,050

**MICROANGELO** ..... \$2,280  
 High resolution graphics system. Microangelo features 15",  
 22MHZ, green phosphor screen, 72 key keyboard; includes  
 complete cabling and software. From SCION.

**GRAPHICS SOFTWARE** On line, real time, for the  
 M9900 to drive the Microangelo. For use in design of PC  
 board masks, IC masks and other applications usually re-  
 quiring a \$200,000 system.

**COMPUTER TO COMPUTER COMMUNICATIONS**  
 Enables communications from a micro to a terminal or to  
 another micro, mini or maxi computer. Modes of opera-  
 tion: TERMINAL (your system acts like an intelligent ter-  
 minal), FILE-TO-FILE, LOCAL (Disk commands),  
 Full/Half Duplex on 8" or 5" disks.COM to COM mode  
 does full CRC 16 errorcheck and retransmits block on error.  
 Object Code ..... \$75 Source Code ..... \$150

- INDUSTRIAL
- MICRO
- SYSTEMS
- TELETYPE
- HAZELTINE
- IBM
- TELEVIDEO
- TEI
- TARBELL
- CORVUS
- PER SCI
- NEC
- ITHACA
- INTERSYSTEMS
- MARINCHIP
- DATA SOUTH
- QUME
- CENTRONICS
- TEXAS
- INSTRUMENTS
- ATARI
- DEC
- CALIFORNIA
- COMPUTER
- SYSTEMS
- KONAN
- EDGE
- TECHNOLOGY
- INNOTRONICS
- XEROX
- DIABLO
- INTEGRAL
- DATA SYSTEMS
- CROMEMCO
- SOROC
- MICROPRO
- TELETEK
- NOVATION
- AMPEX
- CDC
- NORTH STAR
- COMMODORE
- SCION
- MPI
- POWER ONE
- MEASUREMENT
- SYSTEMS
- AND CONTROL

WE OFFER A FULL RANGE OF EXPERT CONSULTING SERVICES COVERING ALL AREAS OF COMPUTER APPLICATIONS AND SYSTEMS.

**JOHN D. OWENS**  
Associates, Inc.

SEE OUR AD ON FACING PAGE

# POCKET ASCII TERMINAL

**MIDGET  
DUPLEX UNIT  
WITH MAN-SIZED  
CAPABILITIES**

Here's \$395 worth of convenience for anyone working with digital systems. Carry it anywhere in a pocket, valise or toolkit to enter and retrieve data, run diagnostics, change constants, test data links, etc.



Look at its facilities:

- Transmits 128 ASCII codes
- Can display last 30 characters received
- Displays full 64-character ASCII set on clear 16-segment LEDs
- 25-line RS232/c compatible interface
- Single 5V supply required at 400mA typical
- 110 or 300 baud transmission selectable
- Parity codes, stop bits settable to your standard
- Obeys bell, cursor and data format control codes

Phone or write us for more details now:

**GR ELECTRONICS**  
1640 Fifth Street,  
Santa Monica, CA 90401.  
Telephone: (213) 395-4774.  
Telex: 65-2337 (BT Smedley SNM).



primitives for a color raster-scan display. The graphics primitives are summarized in table 2. Note that this list does not include primitive instructions for operations such as circle or arc generation. Such features can be generated by existing primitives (using the vector-drawing primitive). Furthermore, circle and arc primitives are difficult to generalize and cannot easily support any more complex curves: their utility is therefore very limited for the cost of their implementation in terms of support hardware and display-processor software. Furthermore, features such as transformations are not included at this level since they presuppose a definite image structure that cannot be known by the display processor. Other

*Text continued on page 292*

Listing 1: This arrangement of primitives developed for Micrograph was used to produce the images in figure 5.

```

MOV 20,10 (T)
VEC SHORT_REL,WHITE,20,30
MOV 5,30 (T)
VEC SHORT_REL,WHITE,25,30
MOV 30,10 (E)
VEC SHORT_REL,WHITE,30,20
MOV 30,10 (E)
VEC SHORT_REL,WHITE,40,10
MOV 30,15 (E)
VEC SHORT_REL,WHITE,40,15
MOV 30,20 (E)
VEC SHORT_REL,WHITE,40,20
MOV 50,10 (X)
VEC SHORT_REL,WHITE,60,20
MOV 50,20 (X)
VEC SHORT_REL,WHITE,60,10
MOV 70,10 (T)
VEC SHORT_REL,WHITE,70,15
MOV 65,15 (T)
VEC SHORT_REL,WHITE,75,15
LREG VPORT,30,45,40,60 (rectangle
around circle)
LPIX VPORT,CYAN,0..CYAN,149
LREG VPORT,120,60,200,120 (part of
cube)
LPIX VPORT,BLUE
LREG VPORT,170,170,250,230 (part of
cube)
LPIX VPORT,RED
MOV 120,60
VEC SHORT_REL,GREEN,170,170 (part
of cube)
MOV 200,60
VEC SHORT_REL,GREEN,250,230 (part
of cube)
MOV 120,120
VEC SHORT_REL,GREEN,170,250 (part
of cube)
MOV 20,200
SYM 4,α,β,Σ,λ (from user-defined
font)
    
```

5 types of primitives, 37 instructions, 300 parameters

## DATA DISK SYSTEMS

### CP/M\* FOR NORTH STAR SYSTEMS

CP/M 2.2 — The industry standard software bus, specially tailored for the North Star disk systems and 8080, 8085, 286 microcomputers. Fully supports all standard North Star 40 and single, double or quad capacity disk drives. A minimum of 24K of continuous ram memory starting at location zero is required. The following Digital Research (dr) and Datadisk Systems (ds) programs are included on your CP/M diskette: \$150/\$25

**ED (dr)** — Text Editor. Used to write programs in most languages and modify any ASCII disk file. Delete, substitute, search on character/string/file number/relative position, block move, global change, macro commands. ED is your window to CP/M compatible software.

**ASM (dr)** — 8080 Assembler. Uses standard 8080 mnemonics and pseudo-ops. Conditional assembly, HEX file generation, assemble listings, multi-disk file transfer.

**PIP (dr)** — Peripheral Interchange Program. File transfer between disk and logical devices. Software file routing, concatenation, pagination, text extraction, case conversion, line numbering and much more.

**SUBMIT (dr)** — Batch ED, PIP, DOT, ASM and associated parameters into user defined processes.

**DOT (dr)** — Dynamic Debugging Tool. 8080 assembly language run-time monitor. Real-time between break points, tracing, full internal register display and alteration at any step, single step, disk service, assembly, the list goes on and on. If you write device controllers, DOT is an invaluable tool.

**STAT (dr)** — Status/alteration of logical-physical devices, disk drive parameters, storage space, file size.

**LOAD (dr)** — Convert 8080 'HEX' files (output of ASM) into machine executable code. Programs are then executed by typing the program name.

**MOVCPM (dr)** — Reconfigure your system to another memory size.

**SYSGEN (dr)** — Create new system diskette.

**DSTAT (dr)** — Multi-purpose Disk Status routine. Logically assign disk drives to operate with any combination of single density, double density, single side, double side, as well as standard or sequential disk sectoring. An optional selection allows fast stepping and optimal sectoring to significantly reduce disk-intensive program execution time. An additional feature permits system re-configuration to quad capacity. This allows double density owners to upgrade with no additional software expense.

**COPY (ds)** — Diskette duplication and verification.

**XSUB (dr)** — Extends the power of SUBMIT to include automatic file input to programs.

**FORMAT (ds)** — Prepare diskette for use with CP/M 2.2.

### FOLLOWING SOFTWARE AVAILABLE IN MOST 5.25 AND 8 INCH FORMATS

**MAC** — 8080 Macro assembler. 280 instruction library included. \$45/\$15

**DESPDOL** — Simultaneous 100 print and user operation. \$45/\$15

**TEX** — Text formatter. Quality hardcopy. \$70/\$15

**SIB** — Symbolic instruction debugger. Multiple pass points, back track, histogram, source code labels. \$85/\$15

**ZSIO** — Same as SID for the 280 instruction set. \$95/\$15

**COMPILER SYSTEMS CBASIC.2 rel2.06**  
Compiler extended disk BASIC. Self documenting, source code protection, line numbers not required. \$95/\$15

California residents add 6% sales tax.  
Additional formats available soon.  
Structured Systems International is a CP/M and CBASIC-2  
CP/M is a registered trademark of Digital Research.  
© 1981 rel2.06 documentation. All rights reserved.  
Continuing the fine tradition of Digital Research.  
Shipping: \$2.00 C.O.D. \$2.00

**MT microSYSTEMS PASCAL/MT** — requires 32K minimum memory. Symbolic debugger, BCD or floating point. Optimized for the CP/M environment. Produces compact machine code. \$250/\$25

**STRUCTURED SYSTEMS (requires CBASIC-2)**

GENERAL LEDGER	\$695/\$25
INVENTORY	\$195/\$25
ACCOUNTS PAYABLE	\$895/\$25
ACCOUNTS RECEIVABLE	\$895/\$25
PAYROLL	\$695/\$25
ANALYST	\$225/\$20
LETTERDRIT	\$175/\$20
OSORT	\$35/\$10
MAO	\$75/\$10

**SHOARD HARDDISK** 6 mo. warranty, direct connection to North Star  
13.7 MBYTE \$4995  
26.4 MBYTE \$4995

**LNE PRINTER** — multi-font, multi-language, up to 132 col. soft left and right, 125 cps, much more. \$195

**VEHATM** multi-disk (sets of 10) \$24.95

DATA DISK SYSTEMS, P.O. BOX 195, POWAY, CA 92064, (714) 578-3831



50 N. PASCACK ROAD  
SPRING VALLEY, NEW YORK 10977

\* APPLE IS A TRADEMARK OF THE APPLE CORP.



## FROM COMPUMAX BUSINESS SYSTEMS

The COMPUMAX business applications programs are written with the novice computer user in mind. They are easy to use, yet powerful in their capabilities. Further, COMPUMAX supplies the BASIC source code. Thus the programs are easy to modify.

### MICROLEDGER

This General Ledger system performs the essential functions of dual entry bookkeeping and matches revenues and expenses.

MICROLEDGER includes the following programs:

- LEDGER 1 - builds and maintains the CHART OF ACCOUNTS file. This file contains both current and accumulated totals for each account.
- LEDGER 2 - builds and updates the JOURNAL TRANSACTION file.
- LEDGER 3 - lists both the JOURNAL file and the CHART OF ACCOUNTS.
- LEDGER 4 - computes the TRIAL BALANCE and executes POSTING of journal transactions into the CHART OF ACCOUNTS. An AUDIT TRIAL of all transaction is output.
- LEDGER 5 - produces the PROFIT AND LOSS STATEMENT.
- LEDGER 6 - produces the BALANCE SHEET. Assets, liabilities and owners' equities are shown by account and by totals. .... \$140.00

### MICROPAY

An Accounts Payable system, MICROPAY includes the following program & functions: PAY 1 - initializes both Transaction and Master files, then begins the Accounts Payable process by inputting and adding records in the Transaction file.

- PAY 2 - allows for changes and deletions of Transaction and Master records.
- PAY 3 - reports outstanding Accounts Payables in four categories; under 30 days, 31-60 days, 61-90 days, and over 90 days.
- PAY 4 - reports all outstanding Accounts Payables for a single customer or for all customers, and computes Cash Requirements.
- PAY 5 - reports all outstanding Accounts Payables for a single date or for a range of dates and computes the Cash Requirements.
- PAY 6 - lists both the Transactions and Master files.
- PAY 7 - prints checks and accumulates and journalizes Accounts Payables. This program simultaneously creates entries for the MICROLEDGER file. .... \$140.00

### MICROREC

An Accounts Receivable system, MICROREC includes the following programs and functions:

- REC 1 - initializes Accounts Receivable files, adds A/R record and prints invoices.
- REC 2 - accepts receipt of customer payments and changes or deletions of A/R Transaction or Master file records.
- REC 3 - reports outstanding Accounts Receivables in four categories: under 30 days, 31-60 days, 61-90 days, and over 90 days.
- REC 4 - reports all outstanding Accounts Receivables for a single customer, or for all customers and computes Cash Projections.
- REC 5 - produces reports for all outstanding Accounts Receivables for a single date or for a range of dates and computes Cash projections.
- REC 6 - lists Transaction and Master files and accumulates and journalizes Accounts Receivables, creating JOURNAL entries which communicate with the MICROLEDGER JOURNAL file. .... \$140.00

### MICROINV

This Inventory Control system presents a general method of Inventory Control and produces several important reports. Its program includes:

- INV 1 - initializes Transaction and Master files and adds and updates Transaction and Master records.
- INV 2 - handles inventory issued or received, creating inventory records. This program also accumulates and journalizes transactions, producing JOURNAL entries which communicate with the MICROLEDGER file.
- INV 3 - lists both Transaction and Master files.
- INV 4 - produces the STOCK STATUS REPORT, showing the standard inventory stock data and stock valuation, and the ABC ANALYSIS breaking down the inventory into groups by frequency of usage.
- INV 5 - gives a JOB COST REPORT/MATERIALS, showing allocation of materials used year-to-date by each job or work code. (This is complemented by the Job Cost Report/Personnel in the MICROPERS program.)
- INV 6 - computes and provides the E.O.Q. (Economic Order Quantities) .... \$140.00

### MICROPERS

This is a Payroll/Personnel program whose functions include:

- PERS 1 - initializes the Master file and allows for entry and updates of Master records.
- PERS 2 - initializes the Payroll file and allows for entry and updates of payroll records.
- PERS 3 - lists an Employee Master Record or the entire Employee Master file; lists a single Payroll Record or the entire Payroll file.
- PERS 4 - computes Payroll and prints the PAYROLL REGISTER. Prints PAYCHECKS and creates JOURNAL entries to be fed into the MICROLEDGER JOURNAL file.
- PERS 5 - produces the JOB COST REPORT/PERSONNEL, computes the quarterly 941 bank deposit, and the Annual W-2 run. .... \$140.00

All COMPUMAX programs available in machine readable format (diskette form) for the following machines:

TRS-80™ Model I	Micropolis 1053/11
APPLE II	Microsoft under CP/M
PET	CBASIC under CP/M
	Cromemco

## FROM ADVENTURE INTERNATIONAL (By Scott Adams)

1. **ADVENTURELAND** - You wander through an enchanted world trying to recover the 13 lost treasures. You'll encounter wild animals, magical beings, and many other perils and puzzles. Can you rescue the Blue Ox from the quicksand? Or find your way out of the maze of pits? Happy Adventuring . . . . .
2. **PIRATE'S ADVENTURE** - "Yo ho ho and a bottle of rum" You'll meet up with the pirate and his daffy bird along with many strange sights as you attempt to go from your London flat to Treasure Island. Can you recover Long John Silver's lost treasures? Happy Sailing, matey . . . . .
3. **MISSION IMPOSSIBLE ADVENTURE** - Good morning, your mission is to...and so it starts. Will you be able to complete your mission in time? Or is the world's first automated nuclear reactor doomed? This one's well named. It's hard, there is no magic, but plenty of suspense. Good luck . . . . .
4. **VOODOO CASTLE** - Count Cristo has had a fiendish curse put on him by his enemies. There he lies, with you his only hope. Will you be able to rescue him or is he forever doomed? Beware the Voodoo Man . . . . .

- ★ All orders processed within 24-Hours
- ★ 30-Day money back guarantee on all Software (less a \$3 penalty for handling)

5. **THE COUNT** - You wake up in a large brass bed in a castle somewhere in Transylvania. Who are you, what are you doing here, and WHY did the postman deliver a bottle of blood? You'll love this Adventure, in fact, you might say it's Love at First Byte . . . . .
  6. **STRANGE ODYSSEY** - Marooned at the edge of the galaxy, you've stumbled on the ruins of an ancient alien civilization complete with fabulous treasures and unearthly technologies. Can you collect the treasures and return or will you end up marooned forever? . . . . .
  7. **MYSTERY FUN HOUSE** - Can you find your way completely through the strangest Fun House in existence, or will you always be kicked out when the park closes? . . . . .
  8. **PYRAMID OF DOOM** - An Egyptian Treasure Hunt leads you into the dark recesses of a recently uncovered Pyramid. Will you recover all the treasures or more likely will you join its denizens for that long eternal sleep? . . . . .
  9. **GHOST TOWN** - Explore a deserted western mining town in search of 13 treasures. From rattlesnakes to runaway horses, this Adventure's got them all! Just remember, Pardner, they don't call them Ghost Towns for nothin'. (Also includes new bonus scoring system!) . . . . . \$14.95 Per Adventure
- \* Note: Apple requires 24K and has no lower case.  
† Recommended for the novice adventurer, with many built-in HELPS!

## FROM PERSONAL SOFTWARE INC.

**VISICALC** . . . . . \$150.00

Take virtually any problem you would explore using calculator, pen, and paper, working in rows and columns. Apply VisiCalc and you'll see why every reviewer of this product has said the same thing: VisiCalc is the most useful, most important program yet developed for personal computing.

With VisiCalc, you work with an electronic worksheet of up to 63 columns and 254 rows. At the juncture of any column and row you can type in words and numbers. VisiCalc automatically performs all arithmetic functions, net present value, and transcendental functions - instantly!

**CCA DATA MANAGEMENT SYSTEM** . . . . . \$74.95

### DMS Features:

File Creation and Maintenance:

- Fields may be alphanumeric, numeric, integer, floating point, or fixed decimal with commas.
- Fields may be COMPUTED FIELDS. DMS will compute any field within a record, using constants or other fields in the same record. Functions include add, subtract, multiply, divide, and raise exponential powers.
- Records are easily located, using the SCAN feature. SCAN for records with a field over, below, or between a range of values.
- Records are easily added and updated. DMS "prompts" you with questions.
- Multi-diskette capabilities for larger files - up to 85,000 characters per file!
- Sort the records into almost any order, using up to 10 fields as "keys". So you can sort for customer numbers; within zip code, for instance.
- Delete records, "compact" files, and backup files on data diskettes easily.

### Report Features:

- Print reports with records in any order.
- Select fields to be printed.
- Print mailing labels.
- Numeric totals and subtotals can be specified when a value in an unrelated field in the same record changes. For example, sort, subtotal, and print according to department, or month, or customer number, or model number.

**GUARANTEED PROFIT 91% WINS PLACES 32% AVERAGE PROFIT AT ALL TRACKS-1978**  
SHOWS

**THE HORSE SELECTOR II (FLATS)** (By Dr. Hal Davis) . . . . . \$50.00

New simplified version of the original Horse Selector. The first Horse Selection System to actually calculate the estimated odds of each horse.

- HIGHER PROFITS (OVER 100%) POSSIBLE THROUGH SELECTIVE BETTING ON:**
- Rates each horse in 10 seconds.
  - Easy to follow rules.
  - Can be used with any Apple II Computer.
  - 100% money back guarantee (returned for any reason).
  - Uses 4 factors (speed rating, track variant, distance of the present race, distance of the last race)
  - Using the above factors, the Horse Selector calculates the estimated odds. BET on horses whose actual payoff (from the Tote Board or Morning Lines) is higher than payoff based on estimated odds.
  - Using the above factors, the Horse Selector calculates the estimated odds. BET on any selected horse with an estimated payoff (based on Tote Board or Morning Lines) higher than calculated payoff (based on Horse Selector II).
  - Source listing for the TRS-80™, TI-59, HP-67, HP-41, Apple and BASIC Computers.
  - No computer or calculator necessary (although a calculator would be helpful for the simple division used to calculate estimated odds)

**FREE Dutching Tables** allows betting on 2 or more horses with a guaranteed profit.



**24 HOUR ORDER LINE**  
(914) 425-1535



**NEW TOLL-FREE ORDER LINE**  
(OUTSIDE OF N.Y. STATE)  
**(800) 431-2818**

ADD \$2.00 FOR SHIPPING UPS AREAS  
ADD \$3.00 FOR C.O.D. OR NON-UPS AREAS  
ADD \$4.00 OUTSIDE U.S.A, CANADA & MEXICO



# YOUR MODEL II CAN HAVE SNAPP!



## SNAPP II EXTENDED BASIC

A family of enhancements to the Model II BASIC interpreter. Part of the package originated with the best of APPARAT, INC.'s thoughts in implementing NEWDOS BASIC. The system is written entirely in machine language for SUPER FAST execution. The extensions are fully integrated into Model II BASIC, and require NO user memory, and NO user disk space. The package is made up of the following five modules, each of which may be purchased separately:

**XDASIC** - Six single keystroke commands to list the first, last, previous, next, or current program line, or to edit the current line. Ten single character abbreviations for frequently used commands: AUTO, CLS, DELETE, EDIT, KILL, LIST, MERGE, NEW, LLIST, and SYSTEM. \$25

**XREF** - A powerful cross-reference facility with output to display and/or printer. Trace a variable through the code. Determine easily if a variable is in use. \$40

**XDUMP** - Permits the programmer to display and/or print the value of any or all program variables. Identifies the variable type for all variables. Each element of any array is listed separately. \$40

**XRENUM** - An enhanced program line renumbering facility which allows specification of an upper limit of the block of lines to be renumbered, supports relocation of renumbered blocks of code, and supports duplication of blocks of code. \$40

**XFIND** - Permits quick and easy location of specified strings or keywords within the program text. \$30

**SAVE** - on the purchase of the entire package. \$140



## CONVERT

This remarkable utility converts "V" format files (the sequential format used by the SHACKS, COBAL and BASIC Compilers) to the "F" format files (the sequential file format used by the BASIC Interpreter and BASCOM), and vice versa. Without this product, programs written for the interpreter will have to be RE-KEYED to be used by the SHACKS Compiler BASIC. \$75.00



## SKRUNCH

A SUPER FAST TRSDOS UTILITY. Compresses your BASIC programs to an absolute minimum. Typically saves 30-40% space, even for programs without REM statements! Also results in 7-10% improvement in execution speed. \$35



## SBASIC — Model I and Model II

Program in a high-level, full structured BASIC! The BEST of the BASIC pre-processors. PERFORM named subroutines. CONDITIONAL case structures. WHILE loops. UNTIL loops. And much more. Forget about line numbers. Model II version is compiled, and SUPER FAST. From Ultimate Computer Systems

Model I \$50  
Model II \$75



## DOSFIX

A collection of patches to TRSDOS and BASIC to enhance their usability and function. Includes our well-known BREAK7E patches to keep the break key from being used accidentally. FREE WITH ANY MODEL II SOFTWARE PACKAGE.



## FRIEND

### FOUR NEW TRSDOS COMMANDS!

**SHOW** - A much better multi-disk directory display. Let's you see only those files you want, and includes date of last update.  
**MOVE** - A much better file copying command. Copy/Move whole groups of files, renaming them at the same time, if desired, with just 1 command!

**ERASE** - Better than KILL, better than PURGE.  
**PRINT** - Print BASIC programs from disk, whether saved in ASCII or compressed.

All 4 DOS commands allow fast processing of one, or complete groups of files, based on generic naming and wild card specifications. Enhanced functions too numerous to fully describe here.

### EXAMPLES:

**SHOW PAY\*/BAS\***

Directory display of all 'BAS\*' files on all diskettes which begin with 'PAY.'  
**MOVE PAY\*/BAS:1 TO =/OLD:3**

Save current versions of payroll programs to drive 3, changing extensions to 'OLD.'  
**MOVE OLD\*/? TO NEW =/= :1**

Copy all files on drive 0 which begin with 'OLD,' regardless of extension, to drive 1, changing the first 3 letters of the filename to 'NEW,' but retaining the same file extension. Save time!

Reduce frustration!

Eliminate ERROR 33!

\$75



## HOST II / TERMI

Allows 'remote control' of a Model II from another Model II, or any ASCII terminal. If terminal is a Model II, accurate screen positioning (PRINT @) is fully supported! Requires NO user memory! This system is designed to provide software support to our customer locations without ever leaving the office. \$50



## BUGZAP

A powerful utility oriented toward the machine language programmer. Display/Modify/Print/Memory/Disk sectors. Use this to help you learn more about the Internals of the Model II. \$50



## HOST II / TERMI

Allows 'remote control' of a Model II from another Model II, or any ASCII terminal. If terminal is a Model II, accurate screen positioning (PRINT @) is fully supported! Requires NO user memory! This system is designed to provide software support to our customer locations without ever leaving the office. \$50



## HOST II / TERMI

Allows 'remote control' of a Model II from another Model II, or any ASCII terminal. If terminal is a Model II, accurate screen positioning (PRINT @) is fully supported! Requires NO user memory! This system is designed to provide software support to our customer locations without ever leaving the office. \$50



## 8160 Corporate Park Dr.

Cincinnati, Ohio 45242

Ohio residents call collect

(513) 891-4496

Call Toll Free

1-800-543-4628

Most products will soon be available for the Model I. CALL FOR DETAILS!



## MASTER / SLAVE

This software package was designed to support the transferring of files from one Model II to another, via direct connection or modem/phone line connection. ALL kinds of files, and baud rates up to 9600 are fully supported. Transfer files in either direction, even with the SLAVE Model II UNATTENDED! \$150



## SPOOLER — Model I and Model II

Our workhorse! This package, available for Model I, in the TRSDOS/NEWDOS or NEWDOS 80 versions, or for the Model II, greatly enhances system performance when running typical business applications. Many applications have been benchmarked to run nearly TWICE AS FAST with the SPOOLER installed. Installs in minutes, and no changes are required to your programs. Preferred Model II versions require NO user memory. Optional features for the Model II version only: Serial printer support, and DISK SPOOLING support. The DISK SPOOLING support is particularly recommended for word processing applications. \$100

SERIAL PRINTER OPTION \$50

DISK SPOOLING OPTION \$50



## ROUTE

Causes LPRINT data to be sent to the video screen! A great help in writing and debugging programs when no printer is available, you have a slow printer, or you are just in a hurry. Can be turned on and off from within your BASIC program. Requires NO user memory. \$25



## SCREEN

Supports the copying of the full video screen to the printer. Can be invoked by the operator with a keystroke, or from your program with a USR call. Requires NO user memory. \$25



## SAVE

Retrieve the resident BASIC program following an accidental SYSTEM, or a system crash. DON'T BE WITHOUT THIS ONE. YOU NEVER KNOW WHEN YOU WILL NEED IT! \$35



## TERMS OF SALE:

Credit card customers, add 3% C.O.D. customers add \$3. Ohio residents add 4 1/2% sales tax. Shipments normally made the same day we receive your order.



## OUR GUARANTEE:

If your diskette arrives damaged, we will replace it without charge. If you ever accidentally damage it, we will replace it for a \$10 handling charge. For a period of one year, we will provide you with any enhancements or updates for a \$10 handling charge. For a period of one year, if errors are discovered in the programs, they will be corrected without charge. In the event we cannot correct an error, you may return the program material for a refund.

TRS-80 is a trademark of the Radio Shack division of Tandy Corporation. NEWDOS and NEWDOS/80 are trademarks of Apparat, Inc.

```

140 ; DEFINITIONS: *****
141 ;
142 ; DEFINITIONS PROVIDES GLOBAL DEFINITIONS OF VARIOUS
143 ; STRUCTURES AND VARIABLES.
144 ;
145 DEFINE EQU $
146 RESPTM: EQU 0
147 FOOTR: EQU 4096
148 MSTACK: EQU MSTACK+64
149 NSTACK: EQU MSTACK+64
150 SFRMST: EQU MSTACK+64
151 RELOC: EQU -ESTRUCT
152 GDR: EQU RELOC+EGDR0
153 GDR0: EQU RELOC+EGDR1
154 GDR1: EQU RELOC+EGDR2
155 GDR2: EQU RELOC+EGDR3
156 GDR3: EQU RELOC+EGDR4
157 GDR4: EQU RELOC+EGDR5
158 GDR5: EQU RELOC+EGDR6
159 GDR6: EQU RELOC+EGDR7
160 GDR7: EQU RELOC+EGDR8
161 GDR8: EQU RELOC+EGDR9
162 GDR9: EQU RELOC+EGDR10
163 GDR10: EQU RELOC+EGDR11
164 GDR11: EQU RELOC+EGDR12
165 GDR12: EQU RELOC+EGDR13
166 GDR13: EQU RELOC+EGDR14
167 GDR14: EQU RELOC+EGDR15
168 GDR15: EQU RELOC+EGDR16
169 SLINK: EQU RELOC+SLINK
170 L00: EQU RELOC+L00
171 L01: EQU RELOC+L01
172 L02: EQU RELOC+L02
173 L03: EQU RELOC+L03
174 L04: EQU RELOC+L04
175 L05: EQU RELOC+L05
176 L06: EQU RELOC+L06
177 L07: EQU RELOC+L07
178 L10: EQU RELOC+L10
179 L11: EQU RELOC+L11
180 L12: EQU RELOC+L12
181 L13: EQU RELOC+L13
182 L14: EQU RELOC+L14
183 L15: EQU RELOC+L15
184 L16: EQU RELOC+L16
185 L17: EQU RELOC+L17
186 SLONG6: EQU RELOC+SLONG6
187 S00: EQU RELOC+S00
188 S01: EQU RELOC+S01
189 S02: EQU RELOC+S02
190 S03: EQU RELOC+S03
191 S04: EQU RELOC+S04
192 S05: EQU RELOC+S05
193 S06: EQU RELOC+S06
194 S07: EQU RELOC+S07
195 S10: EQU RELOC+S10
196 S11: EQU RELOC+S11
197 S12: EQU RELOC+S12
198 S13: EQU RELOC+S13
199 S14: EQU RELOC+S14
200 S15: EQU RELOC+S15
201 S16: EQU RELOC+S16
202 S17: EQU RELOC+S17
203 SPTR: EQU RELOC+SPTR
204 SOFF: EQU RELOC+SOFF
205 GPC: EQU RELOC+GPC
206 REF: EQU RELOC+REF
207 M: EQU RELOC+M
208 MM: EQU RELOC+MM
209 MN: EQU RELOC+MN
210 SX: EQU RELOC+SX
211 SY: EQU RELOC+SY
212 COLOR: EQU RELOC+COLOR
213 XLRK: EQU RELOC+XLRK

```

```

214 NHIL: EQU RELOC+NHIL
215 FREE: EQU STRUCT+NHIL+1
216 SYMAB: EQU 6143
217 FOF: EQU 6143
218 FRO: EQU 7163
219 CR3: EQU 7164
220 CR2: EQU 7200
221 RBTOM: EQU FRO
222 RTOP: EQU L4335
223 ;
224 *****
225 *****
226 *****
227 ;
228 ; MAIN *****
229 ;
230 ; THIS IS THE DRIVER FOR MICROGRAPH. AFTER INITIALIZING
231 ; SP, MAIN CALLS INIT, FETCH AND EXEC ARE CALLED ON
232 ; THEM TO PROCESS THE GRAPHICS PRIMITIVES.
233 ;
234 ; CALLS: JRTY
235 ; FETCH
236 ; EXEC
237 ;
238 ; CALL BY NOT APPLICABLE
239 ;
240 ; REGISTERS SP (STACK POINTER)
241 ;
242 ; I/O NONE
243 ;
244 ; STRUCTURES NONE
245 ;
246 ; MAIN: LD SP,STACK
247 ; CALL INIT
248 ; CALL FETCH
249 ; CALL EXEC
250 ; JR LOOP
251 ;
252 *****
253 *****
254 *****
255 ; XERR *****
256 ;
257 ; XERR SERVICES AN ERROR CONDITION. XERR IS CALLED UPON
258 ; AS A TRAP TO THE NON MASKABLE INTERRUPT VECTOR.
259 ; XERR ALLOWS A SYSTEM RESET, REGISTER DUMP, OR MEMORY
260 ; DUMP VIA THE DIAGNOSTIC DIRECTIVES.
261 ;
262 ; CALLS SENDY
263 ;
264 ; CALLED BY NON MASKABLE INTERRUPT
265 ;
266 ; REGISTERS A (DUMP)
267 ; B (DUMP)
268 ; C (DUMP)
269 ; D (DUMP)
270 ; E (DUMP)
271 ; H (DUMP)
272 ; L (DUMP)
273 ; IX (DUMP)
274 ; IY (DUMP)
275 ; SP (DUMP)
276 ;
277 ; I/O PORT 2 (STATUS)
278 ; PORT 4 (INPUT)
279 ;
280 ; STRUCTURES GDR15 (STATUS)
281 ;
282 ; XERR: EI
283 ; PUSH AF
284 ; SET 0,(IX+GDR15)
285 ; SET 0,(IX+GDR13)
286 ; SET 1,(IX+GDR15)
287 ; LD 0,(IX+GDR15)

```

## OS-9™ LEVEL TWO MULTIUSER OPERATING SYSTEM

**T** rue multitasking, multiuser OS for timesharing or real-time control applications.

- Sophisticated memory management permits use of over one megabyte.
  - Versatile, easy-to-use input/output supports multiple devices.
  - UNIX™-like file structure including hierarchical directories, pipes, filters, and byte-addressable random access files.
  - Provides log-on password protection and user file security.
  - Can run on small, inexpensive systems with floppy disks and as little as 32K memory.
- \$495.00\*

## OS-9™ LEVEL ONE OPERATING SYSTEM

**A** multitasking real-time operating system for software development, process control and smaller multi-user applications.

- Versatile input/output system can support multiple devices using interrupt-driven, DMA, or program-controlled data transfer. Users can easily add additional I/O devices.
  - Tape or disk-based versions available.
  - Disk versions support UNIX™-like hierarchical directory structure and byte-addressable random-access files.
  - Memory management for single address-space (up to 64K).
- Disk version \$150.00\*  
 Tape version \$95.00

## BASIC09™ PROGRAMMING LANGUAGE SYSTEM

**E** xtended BASIC language compiler/interpreter with integrated text editor and debug package. Runs standard BASIC programs or minimally-modified PASCAL programs.

- Permits multiple named program modules having local variables and identifiers. Modules are reentrant, position independent and ROMable.
- Additional control statements for structured programming: IF ... THEN ... ELSE, FOR ... NEXT, REPEAT ... UNTIL, WHILE ... DO, LOOP ...

## INTRODUCING

# 6809 SOFTWARE POWER TOOLS

BY MICROWARE®

ENDLOOP, EXITIF ... ENDEXIT.

- Allows user-defined data types and complex data structures. Five built-in data types: byte, integer, 9 digit floating-point, string and boolean.
  - Outperforms any other BASIC on any 8-bit MPU.
  - Available on ROM, disk or cassette tape. Runs under OS-9™ Level One or Level Two.
- Disk or tape \$195.00\*

## MICROSOFT 6809 BASIC

**S** tandard Microsoft BASIC optimized for the 6809 and OS-9™.

- Four data types: integer, string, single precision and double precision floating point.
  - Program trace and edit capabilities.
  - Automatic line numbering and renumbering.
  - Supports random and sequential file I/O. Full PRINT USING for formatted output.
- Disk or tape \$250.00

## OS-9™ TEXT EDITOR

**M** inimum-keystroke macro text editor useful for text preparation or interactive word processing.

- User-defined macros with parameters permit virtually unlimited command expansion. Macros can be saved, loaded

and edited.

- Buffer, line and character oriented commands.
  - Search, change and extend operations.
  - Permits multiple input/output files.
- Disk or tape \$75.00  
 ROM set (2716) \$90.00

## OS-9™ INTERACTIVE ASSEMBLER

Compact Motorola compatible assembler for machine language program development.

- Operates in "batch" mode or interactive line-by-line mode.
  - Facilities for generation of OS-9™ memory modules and system calls.
  - Formatted listings include syntax and context error checking.
  - Runs on OS-9™ Level One or Level Two.
- Disk or tape \$75.00  
 ROM set (2716) \$90.00

## OS-9™ INTERACTIVE DEBUGGER

**F** acilitates testing and debugging of machine-language programs.

- Includes common "monitor" functions: memory examine/change, breakpoints, display/change registers, etc.
  - Calculator mode evaluates arithmetic expressions in hex, decimal or binary.
  - Access to system commands.
  - Available on ROM, disk or cassette tape.
- Disk or tape \$35.00  
 ROM (2716) \$50.00

BASIC 09 is a trademark of Motorola. OS-9 is a trademark of Motorola and Microware®. UNIX is a trademark of Bell Telephone Laboratories.

Most software is available on ROM, diskette and tape in versions for many popular 6809 computers. Source listings and yearly maintenance/update service are sold separately for most programs.

\*Specify manufacturer and type of CPU and I/O controllers. Contact Microware® for specific availability.



**MICROWARE®**

Microware Systems Corp. Dept. B1  
5835 Grand Avenue  
Des Moines, Iowa 50304  
(515) 279-8844

```

00A9 D302      288      OUT (2),A      ;DISPLAY THE STATUS
00AB DDC80F66  289      BIT 4,(IX+GDR15) ;WAIT FOR DIRECTIVE
00AF 28FA      290      JR Z,XERR0     ;JUMP UNTIL RECEIVED
00B1 0E04      291      IN A,(4)      ;GET THE DATA
00B3 DDC80FA6  292      RES 4,(IX+GDR15) ;RESET THE STATUS
00E7 F5        293      PUSH AF      ;SAVE A AND F
0088 0D7E0F  294      LD A,(IX+GDR15) ;GET THE STATUS
008D D302      295      OUT (2),A    ;OUTPUT THE STATUS
008E D302      296      POP AF       ;RESTORE A AND F
008F 0E04      297      BIT 7,A     ;TEST FOR IF SET
00C0 CE2F     298      JP NZ,RESTART ;RESTART IF SET
00C2 CE77     299      BIT 6,A     ;TEST FOR DIRLECTIVE
00C5 2D4F     300      JR NZ,XERR1  ;JUMP IF SET
00C7 F1      301      POP AF       ;RESTORE A AND F
00C8 F5      302      PUSH AF     ;SAVE A COPY OF A AND F
00C9 0E04      303      CALL SENDY ;SEND A
00CA 0E04      304      LD A,B     ;GET B
00CB 0E04      305      CALL SENDY ;SEND B
00CC 0E04      306      LD A,C     ;GET C
00CD 0E04      307      CALL SENDY ;SEND C
00CE 0E04      308      LD A,D     ;GET D
00CF 0E04      309      CALL SENDY ;SEND D
00D0 0E04      310      LD A,E     ;GET E
00D1 0E04      311      CALL SENDY ;SEND E
00D2 0E04      312      LD A,H     ;GET H
00D3 0E04      313      CALL SENDY ;SEND H
00D4 0E04      314      LD A,L     ;GET L
00D5 0E04      315      CALL SENDY ;SEND L
00D6 0E04      316      LD A,(STRUCT+XERR1),IX ;GET IX
00D7 0E04      317      LD A,(IX+XERR1) ;GET LOW BYTE
00D8 0E04      318      CALL SENDY ;SEND 154
00D9 0E04      319      LD A,(IX+XERR1+J) ;GET HIGH BYTE
00DA 0E04      320      CALL SENDY ;SEND IT
00DB 0E04      321      LD A,(STRUCT+XERR1),JY ;GET JY
00DC 0E04      322      LD A,(IX+XERR1) ;GET LOW BYTE
00DD 0E04      323      CALL SENDY ;SEND IT
00DE 0E04      324      LD A,(IX+XERR1+1) ;GET HIGH BYTE
00DF 0E04      325      CALL SENDY ;SEND IT
00E0 0E04      326      EXX        ;SAVE PRIMARY REGISTERS
00E1 2E00      327      LD L,0     ;CLEAR POINTER
00E2 2E00      328      LD H,0     ;CLEAR POINTER
00E3 0E04      329      ADD HL,SP ;GET THE STACK POINTER
00E4 0E04      330      LD A,L     ;GET THE LOW BYTE
00E5 0E04      331      CALL SENDY ;SEND IT
00E6 0E04      332      LD A,H     ;GET THE HIGH BYTE
00E7 0E04      333      CALL SENDY ;SEND IT
00E8 0E04      334      EXX        ;RESTORE PRIMARY REGS
00E9 0E04      335      POP AF     ;DO IT AGAIN
00EA 0E04      336      JR XERR0  ;DO A AND F
00EB 0E04      337      POP AF     ;SAVE A AND F
00EC 0E04      338      EX AF,AF  ;SAVE PRIMARY REGISTERS
00ED 0E04      339      EXX        ;TEST THE INPUT
00EE 0E04      340      XERR2: BIT 4,(IX+GDR15) ;GET THE DATA
00EF 0E04      341      JR Z,XERR2 ;JUMP IF NOT SET
00F0 0E04      342      IN A,(4)  ;GET THE LOW ADDRESS
00F1 0E04      343      LD L,A    ;SAVE THE LOW ADDRESS
00F2 0E04      344      RES 4,(IX+GDR15) ;RESET THE FLAG
00F3 0E04      345      LD A,(IX+GDR15) ;GET THE STATUS
00F4 0E04      346      OUT (2),A ;SEND THE STATUS
00F5 0E04      347      XERR3: BIT 4,(IX+GDR15) ;TEST THE INPUT
00F6 0E04      348      JR Z,XERR3 ;JUMP IF NOT SET
00F7 0E04      349      IN A,(4)  ;GET THE DATA
00F8 0E04      350      LD H,A    ;SAVE THE HIGH ADDRESS
00F9 0E04      351      RES 4,(IX+GDR15) ;RESET THE FLAG
00FA 0E04      352      LD A,(IX+GDR15) ;GET THE STATUS
00FB 0E04      353      OUT (2),A ;SEND THE STATUS
00FC 0E04      354      LD A,(HL) ;GET THE MEMORY DATA
00FD 0E04      355      CALL SENDY ;SEND THE DATA
00FE 0E04      356      EXX        ;RESTORE PRIMARY REGS
00FF 0E04      357      EX AF,AF  ;RESTORE A AND F
0100 0E04      358      JP XERR0  ;DO IT AGAIN
0101 0E04      359      ; FRAME *****
0102 0E04      360      ; FRAME *****
0103 0E04      361      ; FRAME *****
0104 0E04      362      ; FRAME IS THE INTERRUPT SERVICE ROUTINE FOR A FRAME

```

```

363 ; COUNT INTERRUPT (FIRST PRIORITY, MASKABLE INTERRUPT).
364 ; FRAME FIRST SETS THE FRAME INTERRUPT FLAG, INCREMENTS
365 ; THE FRAME COUNT, CALLS NULL, THE FRAME SERVICE
366 ; ROUTINE IN RAM, AND THEN RESETS THE FRAME INTERRUPT
367 ; FLAG. NOTE THAT THE OUTPUT TO THE DISPLAY PORT FORCES
368 ; A RESET OF THE INTERRUPT FOR THE FRAME INTERRUPT.
369 ; SINCE THE INTERRUPT IS PRODUCED ON THIS PORT.
370 ; CALLS NULL
371 ; CALLED BY FIRST PRIORITY MASKABLE INTERRUPT
372 ;
373 ; REGISTER A (TEMPORARY)
374 ; REGISTER F (TEMPORARY)
375 ; REGISTER IX (INDEX)
376 ; PORT 0 (DISPLAY)
377 ; PORT 1 (STATUS)
378 ; PORT 2 (STATUS)
379 ; I/O
380 ; STRUCTURES GDR4 (FRAME COUNT)
381 ; GDR14 (DISPLAY FORMAT)
382 ; GDR15 (STATUS)
383 ;
384 ; FRAME: PUSH #F ;SAVE A AND F
385 ; EI ;ENABLE INTERRUPTS
386 ; SET FRAME INTERRUPT
387 ; LD A,(IX+GDR15) ;GET GDR15
388 ; INC (IX+GDR4) ;INCREMENT FRAME COUNT
389 ; CALL STRUCT+NULL ;CALL NULL IN RAM
390 ; OUT (2),A ;SEND IT
391 ; INC (IX+GDR4) ;INCREMENT FRAME COUNT
392 ; CALL STRUCT+NULL ;CALL NULL IN RAM
393 ; LD A,(IX+GDR14) ;GET THE DISPLAY FORMAT
394 ; OUT (0),A ;SEND IT
395 ; RES 2,(IX+GDR15) ;RESET FRAME INTERRUPT
396 ; LD A,(IX+GDR15) ;GET THE STATUS
397 ; OUT (2),A ;UPDATE A AND F
398 ; POP AF ;RETURN FROM INTERRUPT
399 ; RETI
400 ; INPUT *****
401 ; INPUT IS THE INTERRUPT SERVICE ROUTINE FOR AN INPUT
402 ; INTERRUPT (SECOND PRIORITY, MASKABLE INTERRUPT).
403 ; INPUT SIMPLY SETS THE INPUT INTERRUPT FLAG IN GDR15.
404 ; CALLS NONE
405 ; CALLED BY SECOND PRIORITY MASKABLE INTERRUPT
406 ;
407 ; REGISTER A (TEMPORARY)
408 ; REGISTER F (TEMPORARY)
409 ; REGISTER IX (INDEX)
410 ; PORT 0 (STATUS)
411 ; GDR15 (STATUS)
412 ;
413 ; INPUT: PUSH AF ;SAVE A AND F
414 ; EI ;ENABLE INTERRUPTS
415 ; SET 4,(IX+GDR15) ;SET INPUT INTERRUPT
416 ; LD A,(IX+GDR15) ;GET GDR15
417 ; OUT (2),A ;UPDATE THE STATUS
418 ; POP AF ;RESTORE A AND F
419 ; RETI ;RETURN FROM INTERRUPT
420 ; OUTPUT *****
421 ; OUTPUT IS THE INTERRUPT SERVICE ROUTINE FOR AN OUTPUT
422 ; INTERRUPT (THIRD PRIORITY, MASKABLE INTERRUPT).
423 ; OUTPUT SIMPLY SETS THE OUTPUT INTERRUPT FLAG IN
424 ; GDR15.
425 ; CALLS NONE
426 ; CALLED BY THIRD PRIORITY MASKABLE INTERRUPT
427 ;
428 ; REGISTER A (TEMPORARY)
429 ; REGISTER F (TEMPORARY)
430 ; REGISTER IX (INDEX)
431 ; PORT 0 (STATUS)
432 ; GDR15 (STATUS)
433 ;
434 ; OUTPUT: PUSH AF ;SAVE A AND F
435 ; EI ;ENABLE INTERRUPTS
436 ; SET 4,(IX+GDR15) ;SET OUTPUT INTERRUPT
437 ; LD A,(IX+GDR15) ;GET GDR15
438 ; OUT (2),A ;UPDATE THE STATUS
439 ; POP AF ;RESTORE A AND F
440 ; RETI ;RETURN FROM INTERRUPT

```



# META TECHNOLOGIES

## FOR YOUR DISK SYSTEM



### FILE BOX DISKETTE STORAGE SYSTEM



**\$19<sup>80</sup>\*** for 5 1/4" disks  
for 8" disks . . . \$24.95\*

MTC brings you the ULTIMATE diskette storage system, at an affordable price. Storing 50 to 60 diskettes, this durable, smoke-colored acrylic unit provides easy access through the use of index dividers and adjustable tabs. Unique lid design provides dust-free protection and doubles as a carrying handle.

#### PLASTIC LIBRARY CASES (not shown)

An economical form of storage for 10 to 15 diskettes, and is suitable for your bookshelf! Case opens into a vertical holder for easy access.

5 1/4-inch or 8-inch diskette case . . . \$3.00\*

Single Sided, Single Density, Soft-Sector'd  
5 1/4-inch. (for TRS-80™) Mini-floppy

### DISKETTES

**\$19<sup>80</sup>\*** box of 10

Meta Technologies strikes again . . . at the competition! These are factory fresh, absolutely first quality (no seconds!) mini-floppies. They are complete with envelopes, labels and write-protect tabs in a shrink-wrapped box.

#### INTRODUCING PLAIN JANE™ DISKETTES

The Beautiful Floppy  
with the Magnetic Personality™

In 1980 alone, MTC has sold nearly a third of a million dollars worth of brand-name diskettes. If anyone knows quality, we do. And these are quality diskettes. The catch? They are in a plain white box. You're not paying for fancy printing, fancy labels or fancy names on the packaging. We don't even put our own label on the package (labels cost money). At this introductory price (our regular price will be \$21.95 per box of 10) we cannot offer quantity or dealer discounts.

PLAIN JANE™ Diskettes . . . . \$19.80 \*

VERBATIM brand Diskettes (box of 10)

5 1/4-inch (for TRS-80™)  
MD525-01 . . . . . \$23.95  
10 boxes of 10 . . . (each box) . . \$22.95

8-inch FLOPPIES  
Single-Density, FD34-1000 . . \$29.95  
Double-Density, FD34-8000 . . \$39.95

#### CALL FOR INFORMATION ON OTHER TRS-80™ PRODUCTS

### TRS-80™ PRODUCTS



- NEWDOS/80 by Apparat . . . . . \$149.95
- NEWDOS+ with ALL UTILITIES
- 35-track . . . . . \$69.95
- 40-track . . . . . \$79.95
- TRS-80™ DISK AND OTHER MYSTERIES . . \$19.95
- MICROSOFT™ BASIC DECODED & OTHER MYSTERIES for the TRS-80™ . . . . \$29.95

## THANK YOU for 1980 . . .

To show our appreciation for a very successful year, thanks to our thousands of satisfied customers, we are offering some great products at prices even lower than our regular low prices. We make an honest effort to deliver the best products at the lowest prices with the fastest service. The confidence you have shown in MTC is recognized and welcomed. Our mothers thank you, our fathers thank you, our children thank you . . . and we thank you.

All products guaranteed for replacement only. Prices, Specifications & Offerings subject to change without notice.

**MOST ORDERS SHIPPED WITHIN ONE BUSINESS DAY**

\*PRICES GOOD THRU NOVEMBER 30, 1980. Sorry, no dealer or quantity discounts. Allow for shipping delays for 1980 specials.

**WE ACCEPT**  
• VISA  
• MASTER CHARGE  
• CHECKS  
• MONEY ORDERS  
• C. O. D.

• Add \$2.50 for standard UPS shipping & handling  
• \$2.00 EXTRA for C. O. D.  
• Ohio residents add 5 1/2 % sales tax.

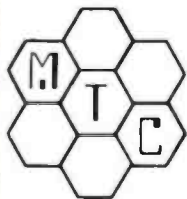

TO ORDER CALL TOLL FREE

**1-800-321-3552**

IN OHIO call (216)289-7500 (COLLECT)

## META TECHNOLOGIES CORPORATION

26111 Brush Avenue, Euclid, Ohio 44132



800917  
TRS-80 is a TM of Tandy Corp.  
PLAIN JANE is a TM of MTC.  
© 1980 by Metatechnologies Corporation, Inc.





# “GET A HEAD START ON TOMORROW WITH THE SOFTWARE THAT’S GOING PLACES. THE UCSD p-SYSTEM.™”

JULIE ERWIN, Director of Marketing, SofTech Microsystems



Our microcomputer software system's going places for good reasons: We're constantly expanding and developing it. We started with UCSD Pascal,™ added FORTRAN, and we'll be introducing more in the months ahead.

We offer a total development and execution environment, from operating system and cross assemblers to screen editor.

We run on most major micro-processors today: Z80, 8080, 8085, 6502, 6800, 6809, 9900 and LSI-11.™ And because the UCSD p-System's portable, you can be sure that what you invest in software today is a good investment in tomorrow.

We're going places and gaining in popularity with microcomputer manufacturers, applications developers, and demanding end users. Get a head start on tomorrow by working with a company that knows how to develop professional quality software, and that's committed to delivering it.

Our system's available for distribution licensing or for single-copy sales. With Pascal, it costs \$350... with FORTRAN, \$400... and with both languages, \$550. Documentation sets are \$50. Phone orders are welcome, and Visa and Master Card orders are accepted. Write or call for more details.

**SOFTech**  
**MICROSYSTEMS**  
A SUBSIDIARY OF SOFTECH

9494 Black Mountain Road, San Diego,  
CA 92126. (714) 578-6105  
TWIX: 910-335-1594

*UCSD p-System and UCSD Pascal are trademarks of the Regents of the University of California.  
LSI-11 is a trademark of Digital Equipment Corp.*

0212	CB23	589	SLA	E	MULTIPLY BY TWO	664	L	(POINTER)
0214	1600	590	LD	D,0	CLEAR POINTER	665	IY	(INDEX)
0216	FD217010	591	LD	(Y,STRUCT+S LINK	LOAD SLINK ADDRESS	666		
021A	FD19	592	ADD	IY,DE	ADD THE OFFSET	667	NONE	
021C	FD6E00	593	LD	L,(IY+0)	GET LOW BYTE OF ENTRY	668		
021F	FD6E01	594	LD	H,(IY+1)	GET HIGH BYTE OF ENTRY	669		
0222	DD5E41	595	LD	E,(IX+SOFF)	GET OFFSET	670		
0225	1400	596	LD	D,0	CLEAR POINTER	671		
0227	DD3641	597	INC	(IX+SOFF)	INCREMENT OFFSET	672		
022A	19	598	ADD	HL,DE	ADD OFFSET	673		
022C	1DE1	599	POP	IY	RESTORE IY	674		
022E	E1	600	POP	HL	RESTORE HL	675		
022F	D1	601	POP	DE	RESTORE DE	676		
0230	F5	602	POP	AF	RESTORE AF	677		
0231	DDC60F&	603	RES	Z,(IX+GDR15)	SAVE A AND F	678		
0235	DD7E0F	604	LD	A,(IX+GDR15)	RESET FETCH FLAG	679		
0236	D&2P	605	LD	A,(IX+GDR15)	GET GDR15	680		
023A	F8	606	OUT	(2),A	UPDATE THE STATUS	681		
023B	F1	607	EI		ENABLE THE INTERRUPTS	682		
023C	C9	608	POP	AF	RESTORE A AND F	683		
023E	C9	609	RET		RETURN	684		
610		610	EXEC	*****	*****	685		
612		612	EXEC	IS THE FIRST STEP IN EXECUTING A GRAPHICS		686		
614		614	PRIMITIVE, EXECUTE FIRST STEPS TO THE EXECUTE FLAG, THEN			687		
615		615	CALLS PRIMAT, WHICH JUMPS TO THE PRIMER FROM LIVE.			688		
616		616	AFTER A RETURN FROM THE PRIMITIVE ITSELF, EXEC.			689		
617		617	SETS THE EXECUTE FLAG AND RETURNS.			690		
618		618	CALLS	PRINT		691		
620		620	CALLS	BY	MAIN	692		
622		622	REGISTERS	A	(TEMPORARY)	693		
624		624	IX	IY	(INDEX)	694		
626		626	I/O	FOR	2: (STATUS)	695		
628		628	STRUCTURES	GDR15	(STATUS)	696		
630		630	EXEC:	PUSH	AF	697		
632		632	SET	S,(IX+GDR15)	SET EXECUTE FLAG	698		
634		634	OUT	(2),A	UPDATE THE STATUS	699		
636		636	POP	AF	RESTORE A AND F	700		
638		638	CALL	PRIMAT	CALL PRIMAT	701		
640		640	RES	S,(IX+GDR15)	RESET EXECUTE FLAG	702		
642		642	LD	A,(IX+GDR15)	GET THE STATUS	703		
644		644	OUT	(2),A	UPDATE THE STATUS	704		
646		646	RET		RETURN	705		
648		648	*****	*****	*****	706		
650		650	PRIMAT	IS THE SECOND STEP IN EXECUTING A PRIMITIVE.		707		
652		652	PRIMAT	FIRST DETERMINES THE PRIMITIVE NUMBER FROM THE		708		
654		654	OF CODE IN REGISTER A, AND PUTS A POINTER TO THIS			709		
656		656	ADDRESS IN IY, HL IS THEN LOADED WITH THE SUBROUTINE			710		
658		658	ADDRESS ITSELF, THEN PRIMAT JUMPS TO THIS LOCATION.			711		
660		660	NOTE THAT A RETURN FROM A PRIMITIVE SUBROUTINE			712		
662		662	ACTUALLY RETURNS TO EXEC.			713		
664		664	CALLS	NONE		714		
666		666	CALLS	BY	EXEC	715		
668		668	REGISTERS	A	(PRIMITIVE OF CODE)	716		
670		670	(POINTER)	D	(POINTER)	717		
672		672	E	E	(POINTER)	718		
674		674	H	H	(POINTER)	719		
676		676	IY	IY	(INDEX)	720		
678		678	I/O	FOR	2: (STATUS)	721		
680		680	STRUCTURES	GDR15	(STATUS)	722		
682		682	EXEC:	PUSH	AF	723		
684		684	SET	S,(IX+GDR15)	SET EXECUTE FLAG	724		
686		686	OUT	(2),A	UPDATE THE STATUS	725		
688		688	POP	AF	RESTORE A AND F	726		
690		690	CALL	PRIMAT	CALL PRIMAT	727		
692		692	RES	S,(IX+GDR15)	RESET EXECUTE FLAG	728		
694		694	LD	A,(IX+GDR15)	GET THE STATUS	729		
696		696	OUT	(2),A	UPDATE THE STATUS	730		
698		698	RET		RETURN	731		
642		642	*****	*****	*****	732		
643		643	GRAPHICS	PRIMITIVES	*****	733		
644		644	*****	*****	*****	734		
645		645	*****	*****	*****	735		
646		646	*****	*****	*****	736		
647		647	*****	*****	*****	737		
648		648	*****	*****	*****	738		
649		649	*****	*****	*****	739		
650		650	*****	*****	*****	740		
651		651	*****	*****	*****	741		
652		652	*****	*****	*****	742		
653		653	*****	*****	*****	743		
654		654	*****	*****	*****	744		
655		655	*****	*****	*****	745		
656		656	*****	*****	*****	746		
657		657	*****	*****	*****	747		
658		658	*****	*****	*****	748		
659		659	*****	*****	*****	749		
660		660	*****	*****	*****	750		
661		661	*****	*****	*****	751		
662		662	*****	*****	*****	752		
663		663	*****	*****	*****	753		
664		664	*****	*****	*****	754		
665		665	*****	*****	*****	755		
666		666	*****	*****	*****	756		
667		667	*****	*****	*****	757		
668		668	*****	*****	*****	758		
669		669	*****	*****	*****	759		
670		670	*****	*****	*****	760		

# FOLLOW THE LEADER.

**DataStar™** A general purpose key to disk data entry software package that's way ahead of the pack.

DataStar has two distinct phases. One allows you to actually design on the CRT the exact form you need. The other allows you to store and retrieve data. Quickly. And accurately. So, when it comes to data entry and verification, go with the leader.

Go with DataStar.

**WordStar™** The world leader in microcomputer word processing.

With so many advanced features, isn't it quite obvious? WordStar is a born leader. In fact, more than seven thousand people have purchased WordStar from over 300 dealers around the world. In just the first year! Proof positive that WordStar is *the* word processing software package for Z-80, 8085 and 8080 microcomputers.

**SuperSort™** It makes sorting so simple, it's simply in a class by itself.

There you are. With a *mountain* of tedious tasks. But don't panic. Here comes SuperSort to the rescue! SuperSort is faster, more powerful and able to sort 560 records in a single minute. Flooray for SuperSort, it makes molehills out of mountains.

**WordMaster™** It's everything you've ever wanted in a video text editor. And more.

WordMaster is so powerful and flexible it can actually double as a word processor. Yet it has all the capabilities you need to enhance your file management needs on a small budget. No wonder it's the path most programmers wish to take.

**I/O Master™** The economic route to quality printing.

Now you can get better input/output performance for less money because I/O Master's S-100 board

gives you the advantage of using lower cost O.E.M. letter quality printers. Plus you get so many extra features. Like two fully-buffered serial ports, so you'll never have to worry about keystrokes and data ever getting lost again.

So, when it comes to high quality/performance, look to MicroPro to lead the way. And then follow, follow, follow!

The logo for MicroPro, featuring the word "MicroPro" in a stylized, bold, sans-serif font. The letters are white with a black outline, set against a dark, rounded rectangular background.

Leads the way.

MicroPro International Corporation 1299 4th Street, San Rafael, California 94901 Telex: 340388  
Dealer/Distributor/O.E.M. inquiries invited.

Prices and specifications subject to change without notice.



```

0296 050F      AND 00001111B      ;AND ALL BUT SHR
0500 007740    LD  (JX+SPTR),A    ;UPDATE SPTR
02A0 00364100  LD  (IX+SOFF),D    ;UPDATE SOFF
0504 003442    JFC  (IX+GFC),D    ;JUMP TO GFC
02A7 003442    INC  (IX+GFC)      ;INCREMENT GFC
0700 C9       RET

743 ; LCRM *****
746 ; LCRM LOADS THE COLOR RAMS. LCRM FIRST DETERMINES IF
747 ; A SINGLE OR ALL COLOR RAMS ARE TO BE LOADED. IF A
748 ; SINGLE COLOR RAM IS TO BE LOADED, THE ENTIRE RAM OK
749 ; A SINGLE ADDRESS OF THAT RAM IS TO BE LOADED.
750 ; OTHERWISE, ALL THREE COLOR RAMS ARE EITHER ENTIRELY
751 ; LOADED, OR A SINGLE ADDRESS IN ALL THREE IS LOADED.
752 ;
753 ;
754 ;
755 ;
756 ;
757 ;
758 ;
759 ;
760 ;
761 ;
762 ;
763 ;
764 ;
765 ;
766 ;
767 ;
768 ;
769 ;
770 ;
771 ;
772 ;
773 ;
774 ;
775 ;
776 ;
777 ;
778 ;
779 ;
780 ;
781 ;
782 ;
783 ;
784 ;
785 ;
786 ;
787 ;
788 ;
789 ;
790 ;
791 ;
792 ;
793 ;
794 ;
795 ;
796 ;
797 ;
798 ;
799 ;
800 ;
801 ;
802 ;
803 ;
804 ;
805 ;
806 ;
807 ;
808 ;
809 ;
810 ;
811 ;
812 ;
813 ;
814 ;
815 ;
816 ;
817 ;
818 ;
819 ;
820 ;
821 ;
822 ;
823 ;
824 ;
825 ;
826 ;
827 ;
828 ;
829 ;
830 ;
831 ;
832 ;
833 ;
834 ;
835 ;
836 ;
837 ;
838 ;
839 ;
840 ;
841 ;
842 ;
843 ;
844 ;
845 ;
846 ;
847 ;
848 ;
849 ;
850 ;
851 ;
852 ;
853 ;
854 ;
855 ;
856 ;
857 ;
858 ;
859 ;
860 ;
861 ;
862 ;
863 ;
864 ;
865 ;
866 ;
867 ;
868 ;
869 ;
870 ;
871 ;
872 ;
873 ;
874 ;
875 ;
876 ;
877 ;
878 ;
879 ;
880 ;
881 ;
882 ;
883 ;
884 ;
885 ;
886 ;
887 ;
888 ;
889 ;
890 ;
891 ;
892 ;
893 ;
894 ;
895 ;
896 ;
897 ;
898 ;
899 ;
900 ;
901 ;
902 ;
903 ;
904 ;
905 ;
906 ;
907 ;
908 ;
909 ;
910 ;
911 ;
912 ;
913 ;
914 ;
915 ;
916 ;
917 ;
918 ;
919 ;
920 ;
921 ;
922 ;
923 ;
924 ;
925 ;
926 ;
927 ;
928 ;
929 ;
930 ;
931 ;
932 ;
933 ;
934 ;
935 ;
936 ;
937 ;
938 ;
939 ;
940 ;
941 ;
942 ;
943 ;
944 ;
945 ;
946 ;
947 ;
948 ;
949 ;
950 ;
951 ;
952 ;
953 ;
954 ;
955 ;
956 ;
957 ;
958 ;
959 ;
960 ;
961 ;
962 ;
963 ;
964 ;
965 ;
966 ;
967 ;
968 ;
969 ;
970 ;
971 ;
972 ;
973 ;
974 ;
975 ;
976 ;
977 ;
978 ;
979 ;
980 ;
981 ;
982 ;
983 ;
984 ;
985 ;
986 ;
987 ;
988 ;
989 ;
990 ;
991 ;
992 ;
993 ;
994 ;
995 ;
996 ;
997 ;
998 ;
999 ;

```

```

0300 CE27      ;SHIFT OFFSET
0302 6F       ;SAVE A IN L
0303 2600    ;CLEAR POINTER
0305 CDED01  ;GET OFFSET
0308 E40F    ;MASK ALL BUT OFFSET
030A 35     ;AND OFFSET
030B 6F     ;SAVE OFFSET
030C 11001C ;GET START ADDRESS
030F 19     ;ADD OFFSET
0310 CD7A08 ;GET DATA
0313 C9     ;RET

; LFTX *****
; LFTX LOADS PIXEL DATA ACCORDING TO THE GIVEN
; REFERENCE. LPIX CAN LOAD EITHER FULL FRAME, ONE
; PIXEL AT XY, OR AN ENTIRE VIEWPORT. THE PIXELS ARE
; LOADED IN EITHER THE PRIMARY COLOR, THE SECONDARY
; COLOR, OR AS SPECIFIED IN THE DATA WHICH FOLLOWS.
; LPIX FIRST CHECKS TO SEE IF ONLY A SINGLE POINT IS
; LOADED. IF SO, LPIX LOADS THE APPROPRIATE COLOR.
; OTHERWISE, LPIX SETS A FLAG IF THERE IS A FULL FRAME
; LOAD REQUESTED. NEXT, LPIX DETERMINES WHAT COLOR IS
; REQUESTED. IF THE COLOR DOES NOT FOLLOW, A FLAG IS
; SET, AND THE APPROPRIATE COLOR IS LOADED FROM THE
; GRAPHICS DISPLAY REGISTERS. NEXT, LPIX CLEARS BOTH
; X AND Y, AND PROCEEDS TO LOAD THE PIXELS FROM
; THE ORIGIN OF THE DISPLAY TO THE TOP, ONE LINE AT
; A TIME. CLIP IS CALLED IF THERE IS A VIEWPORT BE
; REFERENCE TO SEE IF THAT POINT WILL ACTUALLY BE
; LOADED. LPIX IS COMPLETED WHEN X AND Y RECYCLE TO THE
; ORIGIN.

; CALLS          FETCH
;                CASE
;                CLIP
;                POKE
;
; CALLED BY      PRIMAT (INDIRECTLY)
;
; REGISTERS      A (PRIMITIVE OF CODE, TEMPORARY)
;                B (CASE)
;                C (CLIP SUCCESS FLAG)
;                D (FULL FRAME FLAG)
;                E (COLOR FOLLOWS FLAG)
;                IX (INDEX)
;
; I/O            NONE
;
; STRUCTURES     GRD0 (X)
;                GR1 (Y)
;                GR2 (PRIMARY COLOR)
;                GR3 (SECONDARY COLOR)
;                REF (REFERENCE)
;
; LPIX:          LD  E,D      ;CLEAR COLOR FOLLOWS
;                LD  D,0     ;CLEAR FULL FRAME
;                AND 00001111B ;CLEAR OF CODE
;                LD  (IX+REF),A ;SAVE REFERENCE
;                SRL (IX+REF)  ;ADJUST REFERENCE
;                SRL (IX+REF)  ;TEST REFERENCE
;                BIT 3,A      ;JUMP IF VIEWPORT REF
;                BIT 2,A      ;TEST REFERENCE
;                JR  Z,LPIX4   ;JUMP IF FULL FRAME
;                JR  Z,LPIX3   ;TEST COLOR FOLLOWS
;                BIT 1,A      ;JUMP IF COLOR FOLLOWS
;                JR  NZ,LPIX1  ;TEST COLOR TYPE
;                BIT 0,A      ;JUMP IF PRIMARY COLOR
;                JR  Z,LPIX0   ;LOAD SECONDARY COLOR
;                LD  A,(IX+GR3) ;JUMP AROUND FETCH
;                JR  LPIX2    ;LOAD PRIMARY COLOR
;                LD  A,(IX+GR2) ;JUMP AROUND FETCH
;                JR  LPIX2    ;LOAD PRIMARY COLOR
;                CALL FEICH   ;GET THE COLOR DATA
;                CALL POKE   ;POKE THE COLOR AT XY

```

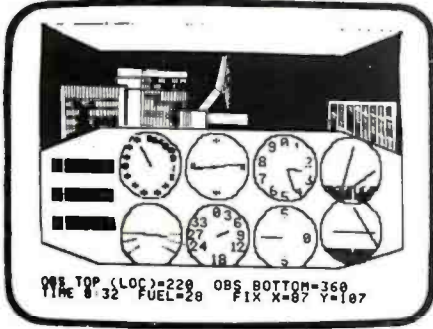

## APPLE II 24K IFR SIMULATOR FLIGHT TRAINER

The latest version of IFR SIM includes dual nav radios and allows the pilot to actually practice IFR landings and navigation. Features a HIRES plot of the flight that is flipped in & out with "ESC" key.

Smooth fluid real-time response gives your Apple more flight simulator power than most 10,000 machines on the market today.

\$25.00 for one on disk, three for \$37.50.

AVAILABLE FROM

### PROGRAMMERS SOFTWARE EXCHANGE

2110 N 2nd St  
Cabot AR 72023  
(501) 843-6037

## TERMINALS FROM TRANSNET

**PURCHASE PLAN** | **12-24 MONTH FULL OWNERSHIP PLAN** | **36 MONTH LEASE PLAN**

DESCRIPTION	PURCHASE PRICE	PER MONTH		
		12 MOS.	24 MOS.	36 MOS.
LA36 DECwriter II	\$1,695	\$162	\$ 90	\$ 61
LA34 DECwriter IV	1,095	105	59	40
LA34 DECwriter IV Forms Ctrl.	1,295	124	69	47
LA120 DECwriter III KSR	2,495	239	140	90
LA180 DECprinter I	2,095	200	117	75
VT100 CRT DECscope	1,895	182	101	68
VT132 CRT DECscope	2,295	220	122	83
DT80/1 DATAMEDIA CRT	1,995	191	106	72
T1745 Portable Terminal	1,595	153	85	57
T1765 Bubble Memory Terminal	2,595	249	146	94
T1810 RO Printer	1,895	182	101	68
T1820 KSR Printer	2,195	210	117	79
T1825 KSR Printer	1,595	153	85	57
ADM3A CRT Terminal	875	84	47	32
ADM31 CRT Terminal	1,450	139	78	53
ADM42 CRT Terminal	2,195	210	117	79
QUME Letter Quality KSR	3,295	316	176	119
QUME Letter Quality RO	2,895	278	155	105
HAZELTINE 1420 CRT	945	91	51	34
HAZELTINE 1500 CRT	1,195	115	64	43
HAZELTINE 1552 CRT	1,295	124	69	47
Hewlett-Packard 2621A CRT	1,495	144	80	54
Hewlett-Packard 2621P CRT	2,650	254	142	96

FULL OWNERSHIP AFTER 12 OR 24 MONTHS  
10% PURCHASE OPTION AFTER 36 MONTHS

#### ACCESSORIES AND PERIPHERAL EQUIPMENT

ACOUSTIC COUPLERS • MODEMS • THERMAL PAPER RIBBONS • INTERFACE MODULES • FLOPPY DISK UNITS  
PROMPT DELIVERY • EFFICIENT SERVICE



**TRANSNET CORPORATION**

1945 ROUTE 22  
UNION, N.J. 07083

201-688-7800  
TWX 710-985-5485

## SORCERER SOFTWARE

SYSTEM 2 by Richard Swannell, loads into the top of available RAM and becomes an integral part of the BASIC language. All commands are single keystroke. SYSTEM 2 is written in Z80 and provides the following features:

1. SCREEN EDITOR. Use the editor to insert, replace, delete or reformat characters in your BASIC program. Watch the line change on the screen! Gone are the days of typing in a whole line to change one character!
2. FUNCTION KEYS. SYSTEM 2 allows 12 keys to be programmed to represent one or more characters or up to several lines of text each! After a key is programmed, by simply hitting key, all the text is sent to the processor just as if you typed it in on the keyboard! Function keys may be used in all modes of operation, including the editor. This feature is handy for lengthy and/or often used commands and may include multiple statements.
3. RENUMBERING ROUTINE. With a single keystroke your program is renumbered. Starting line number and increment may be changed.
4. BASIC BUFFER PROTECTOR. SYSTEM 2 sends a (CR) when the BASIC BUFFER is full. This prevents BASIC from crashing.
5. PRINTER DRIVER. Simply hit CTRL P to direct output to Centronics printer.
6. REVIVAL ROUTINE. If NEW or CLOAD are typed, or RESET is hit by mistake, your program may be recovered. This is a safety device.

#### OTHER FEATURES

- RUNSTOP stops execution until any other key is hit.
- CLEAR clears screen then sends a (CR). Hit CLEAR to start on 'new page'.
- CTRL characters such as ESC, LF and CLEAR don't return ?SN ERROR.
- RUB doesn't require the SHIFT key to be depressed. This quickens editing.
- Includes a Real Time Random Number Generator.
- Returns automatically to BASIC after TAPE CRC ERROR while CLOADing.
- Suppresses premature CRLF. Normally, if RUB is used extensively while typing in a BASIC line, the cursor will drop down to the next line before reaching the end of the current line. SYSTEM 2 prevents this.
- SYSTEM 2 requires 2K of memory and is available in 8, 16, 32 & 48K versions. \$35.50

RS232 PRINTER DRIVER. Requires 250 bytes of memory and is relocatable. Suitable for MONITOR, STANDARD BASIC, WORD PROCESSOR PAC & DEVELOPMENT PAC. Stores each character in a buffer then sends the whole line at once, which solves timing problems. \$10.00

COMBINED SYSTEM 2 & RS232 PRINTER DRIVER. SYSTEM 2 with the RS232 printer driver instead of Centronics printer driver. \$40.00

LUNA LANDER. Written in Z80 and Basic and requiring 16K. LUNA LANDER uses graphics to the full. Land you craft on the moon in real time. But be careful to land softly, otherwise you will see your LANDER crumple before your very eyes! \$15.00



## SYSTEM SOFTWARE

1 Kent Street, Bicton, 6157 Australia

Program comes on cassette and includes full documentation. Specify size of RAM. Prices in Australian Dollars. Add \$2 for overseas airmail.  
SORCERER is a trade mark of EXIOY INC.

## GREAT FOR XMAS



ATTACHE STYLE CASES FOR CARRYING AND PROTECTING A COMPLETE COMPUTER SET-UP. CONSTRUCTED OF THE HIGHEST QUALITY LUGGAGE MATERIAL WITH SADDLE STITCHING WILL ACCOMMODATE EQUIPMENT IN A FULLY OPERATIONAL CONFIGURATION ALONG WITH MANUALS, WORKING PAPERS AND DISKS. NEVER A NEED TO REMOVE EQUIPMENT FROM CASE. SIMPLY REMOVE LID. CONNECT POWER AND OPERATE. LID CAN BE REPLACED AND LOCKED FOR SECURITY AND PROTECTION WITHOUT DISCONNECTING CABLES. FULLY TESTED.

- AP101S Apple and Single Disk Drive .....\$109
- AP102D Apple and Double Disk Drive .....119
- AP103M Apple, 9 inch Monitor and Double Drive .....129
- RS201 TRS-80, Expansion Unit and Double Drive .....109
- RS202 TRS-80 Monitor and Accessories .....84
- P401 Paper Tiger Printer .....99
- P402 Line Printer II-Centronics 730 .....89
- CC90 Matching Attache Case .....75



COMPUTER CASE COMPANY

5650 INDIANA MOUND CT COLUMBUS OHIO 43213

(614) 868-9464

MNEMONIC NAME

CALL	call subroutine
LCRAM	load color memory
LPIX	load pixel
LREG	load register
LSUB	load subroutine
LSYM	load symbol
MOV	move
RCRAM	read color memory
RET	return
RPIX	read pixel
RREG	read register
RSUB	read subroutine
RSYM	read symbol
SYM	display symbol
VEC	draw a vector
WAIT	wait

Table 2: Quick reference guide to the primitives defined for Micrograph. Although the minimum set of instructions need only include a point-positioning primitive and a vector-drawing primitive, added flexibility of extra functions is used to remove processing burden from the host system.

Listing 2 continued:

```

0345 C9 889 RET ;RETURN
0346 1601 890 LFIX3: LD D,1 ;SET FULL FRAME FLAG
0348 1603 851 JR LFIX5 ;JUMP AROUND CASE
034A CDA007 892 LFIX4: CALL CASE ;FIND VIEWPORT CASE
034D D0360000 893 LFIX5: LD (IX+GDR0),0 ;CLEAR X
0351 D0360100 894 LD (IX+GDR1),0 ;CLEAR Y
0355 CB4F 855 BIT 1,A ;TEST COLOR FOLLOWS
0357 200E 896 JR NZ,LFIX7 ;JUMP IF COLOR FOLLOWS
0359 1E01 897 LD E,1 ;SET COLOR FLAG
035E CB47 878 BIT 0,A ;TEST COLOR TYPE
035D 2805 859 JR Z,LFIX6 ;JUMP IF PRIMARY COLOR
035F D07E03 900 LD A,(IX+GDR3) ;LOAD SECONDARY COLOR
0362 1803 901 JR LFIX7 ;JUMP TO LOOP
0364 D07E02 902 LFIX6: LD A,(IX+GDR2) ;LOAD PRIMARY COLOR
0367 CB43 903 LFIX7: BIT 0,E ;TEST COLOR FOLLOWS
0369 2003 904 JR NZ,LFIX8 ;JUMP IF COLOR PRESENT
036E CDED01 905 CALL FETCH ;GET DATA
036E CB42 906 LFIX8: BIT 0,D ;TEST FULL FRAME
0370 2007 907 JR NZ,LFIX9 ;JUMP IF FULL FRAME
0372 CDEF07 908 CALL CLIP ;CHECK FOR CLIP
0375 CB41 909 BIT 0,C ;TEST SUCCESS
0377 2803 910 JR Z,LFIX10 ;JUMP IF CLIPPED
0375 CD390A 911 LFIX9: CALL POKE ;POKE THE DATA
037C D03400 912 LFIX10: INC (IX+GDR0) ;INCREMENT X
037F 20E6 913 JR NZ,LFIX7 ;JUMP IF X NOT ZERO
0381 D03401 914 INC (IX+GDR1) ;INCREMENT Y
0384 20E1 915 JR NZ,LFIX7 ;JUMP IF Y NOT ZERO
0386 C9 916 RET ;RETURN
917 ;
918 ; LREG *****
919 ;
920 ; LREG LOADS A GRAPHIC DISPLAY REGISTER. IF GDR15 IS
921 ; SPECIFIED, A RESET OCCURS, SINCE THIS IS ESSENTIALLY
922 ; A READ ONLY REGISTER. OTHERWISE, LREG SETS A POINTER
923 ; TO THE APPROPRIATE REGISTER AND READS IN THE DATA.
924 ;
925 ; CALLS FETCH
926 ;
927 ; CALLED BY PRIMA (INDIRECTLY)
928 ;
929 ; REGISTERS A (PRIMITIVE OF CODE, TEMPORARY)
930 ; D (TEMPORARY)

```

Text continued from page 278:

features, such as clipping and anti-aliasing, can be readily implemented at the primitive level without the addition of other instructions. Such features can be treated as system parameters, selectable through the load-register primitive. In figure 5, a sample of the images produced by these primitives is shown. (Also see listing 1.)

One last item that must be discussed is error processing. For any implementation of the primitives, the display processor must be able to detect, report, and possibly recover from errors such as invalid primitives or an error in a called user subroutine. Of course, this error processing is highly implementation-dependent, but does not affect the structures of our primitives. However, several of these primitives can be used to aid the host computer in error processing, such as the read-register and read-pixel primitives.

So far the characteristics of interactive computer-graphics systems have been examined, focusing on a comparison of the features of calligraphic and raster-scan display processors. A set of primitive instructions for the control of a color raster-scan display processor have been developed.

Next month, Part 2 of this article will concern the hardware design of Micrograph, a microprocessor-based peripheral which implements these primitives. ■

References

- "Chip Controls CRT Attributes." *Electronics*, June 1978.
- "Chip Generates 16 Colors." *Electronics*, November 1978.
- "Color Displays to Pace Computer Graphics Market." *Mini-Micro Systems*, February 1979.
- Computer*, IEEE Society, January 1979.
- Computer Graphics*, SIGGRAPH-ACM, June 1978.
- Course notes from "Computer Graphics" taught by Dr Steven Levine, Lawrence Livermore Laboratory, Anaheim CA, October 1978. They are available from Integrated Computer Systems Inc, 3404 Pico Blvd, Santa Monica, CA.
- Crow, Franklin W. "The Aliasing Problem in Computer Generated Shaded Images." *Communications of the ACM*, November 1977.
- Denning, P J. *ACM Computing Survey*, December 1978. This is a special issue on graphics standards.
- James, L P. "An Engineering Survey of Graphics Display Systems." An unpublished Computer Science Corporation (Vandenberg AFB) document, March 1979.
- Judice, Charles N. "Processing Signals for Digital Display." *Bell Laboratory Record*, Bell Telephone Laboratory, March 1976.
- Manufacturers' literature from "Computer Graphics" course taught by Dr Steven Levine. See reference 6 above.
- Newman, W, and R. Sproull, *Principles of Interactive Computer Graphics*. New York: McGraw-Hill, 1973.
- Schrack, G F. "Current Literature in Computer, Graphics and Interactive Techniques." *Computer Graphics*, SIGGRAPH-ACM, December 1978.
- Walker, B, S; Gurd, J, R; and Drawnek, E, A. *Interactive Computer Graphics*. New York: Crane Russak, 1973.



Feeling Listless

The performance of a program in the Technical Forum "Some More on Performance Evaluation," by Carl Helmers (July 1980 BYTE, page 216) suffered from one error of substitution and one error of omission.

Listing 1 on page 217, a program submitted by Charles Porter, should contain two lines as follows:

```

105 IF X = L THEN 120
110 IF A(X) = 0 THEN 100
    ELSE 90

```

Thanks to Martin Berman of Teaneck, New Jersey, for pointing this out. ■

# Omikron's Accounting Software

We made our reputation with our Mapper systems. One year ago we told TRS-80 Mod I owners that they could have standard CP/M, 8" drives, compatibility with the Mod II, the ability to transfer files from TRSDos to CP/M or run Newdos80, the TRSDos compatible operating system, with 8" and 5" drives all on line at once. Most of the readers said "too good to be true" and it was only the slowly spreading word (plus some excellent reporting —see August Byte column by Jerry Pournelle) that convinced you it worked.

Here we go again! **A field-proven, fully integrated accounting package with self-instructive documentation for \$350.00.** Too

good to be true? A General Ledger which has been running in the real world long enough to shake out the bugs and has sold for many times our price of \$100.00. Too good to be true? Ok, if we have to, we can wait for the word to spread. But just to get the ball rolling—let me give you the particulars:

#### REQUIREMENTS:

**Computer**— 48K z80/8080  
**Printer**— 132 columns  
**Video**— 80 x 24 or 16 x 64 w/scrolling  
**Storage**— 2 disk units 250 kbytes each  
**Language**— Microsoft Basic  
**O/S**— CP/M

**BENEFITS:** This is not another re-write of the Osborne packages but a professionally produced and marketed set of accounting software originally produced for the Mits/Altair machine. It has been tested and debugged in actual use. It comes with sample data and a manual designed for self-instruction. They are thoughtfully designed, interactive programs with clear prompts for ease of operation. Source code and documentation to aid in customization are also included.

**INTERESTED?** Write or call for our free brochure. It may sound too good to be true, but we've heard that before. Risk a stamp—our Mapper customers were glad they did.

## Too good to be true?



\*CP/M is a TM of Digital Research. TRS-80 is a TM of Tandy Corporation.

Circle 188 on inquiry card.

## Mark of the Unicorn

presents:

### Amethyst

a multi-faceted  
text processing system

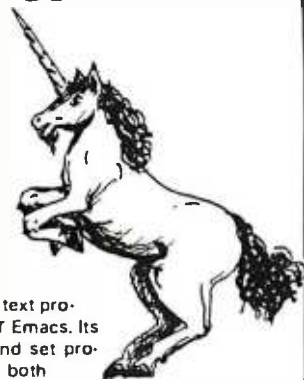

**A**methyst is a user-extensible text processing system based on MIT Emacs. Its powerful yet easy-to-learn command set provides convenient screen editing of both programs and documents. The Amethyst command set can be added to or modified to suit personal preferences.

**A**methyst, first of the Gemstones, is a professionally crafted program in a series that represents a firm commitment to user support. Ongoing program updates, a newsletter, and a telephone hotline for bug fixes and custom code modifications, are an integral part of each Gemstone. Documentation for Amethyst includes not just multiple user's manuals, but also a program logic manual and related theoretical materials.

**A** 48k CP/M® with a cursor addressable display is required. Amethyst is written in C, and the BDS C compiler is included to provide for simple reconfiguration of the system. Amethyst is available on 8" soft sector diskettes, other formats soon.

P.O. Box 423  
Arlington, Massachusetts 02174  
617-498-1387

\$350

CP/M is a registered trade mark of Digital Research

## 779 UPPER CASE/lower case "Conversion Kit I"

Expand the capabilities of your 779 line printer to include word processing!! Available to all Centronics 779 and TRS 80 Printer I owners is the option of lower case and changing slash 0 Zero to standard O. No etch cuts or soldering needed. Installs in minutes with a screwdriver. No program modification or additional interface is required.

**Price \$125.00**

**UPPER/LOWER CASE NOW AVAILABLE FOR THE FOLLOWING CENTRONICS PRINTERS:**

101AL, 102BL, 306, 500, 501, 503, 700, 701, 702, 703, 780, 781.

## Motor Control "CONVERSION KIT II" FOR ALL CENTRONICS 779 & TRS 80 PRINTER I LINE PRINTERS!!

Our "Conversion Kit II" Motor Controller gives your 779 the ability to turn the motor on and off automatically. Removes the annoying noise of constant run, increasing the life span of your 779 and TRS 80 line printer motor! No soldering, software or hardware changes needed. Installs easily.

**Price \$95.00**

**SAVE!** Buy Service Technologies "Conversion Kit I" and "Conversion Kit II" together for the single price of **\$199.00**

To order, please send check or money order in the proper amount to:



*Service Technologies, Inc.*  
32 Nightingale Rd.  
Nashua, N.H. 03062  
(603) 883-5369

Visa and Master Charge accepted (please include signature, expiration date and phone number).

# THE ORIGINAL MAGAZINE FOR OWNERS OF THE TRS-80™\* MICROCOMPUTER

SOFTWARE  
FOR TRS-80™  
OWNERS

## H & E COMPUTRONICS INC.

MONTHLY  
NEWSMAGAZINE  
FOR TRS-80™  
OWNERS

### MONTHLY NEWSMAGAZINE Practical Support For Model I & II

- PRACTICAL APPLICATIONS
- BUSINESS
- GAMBLING • GAMES
- EDUCATION
- PERSONAL FINANCE
- BEGINNER'S CORNER
- NEW PRODUCTS
- SOFTWARE EXCHANGE
- MARKET PLACE
- QUESTIONS AND ANSWERS
- PROGRAM PRINTOUTS
- .... AND MORE

**PROGRAMS AND ARTICLES PUBLISHED IN OUR FIRST 12 ISSUES INCLUDE THE FOLLOWING:**

- A COMPLETE INCOME TAX PROGRAM (LONG AND SHORT FORM)
- INVENTORY CONTROL
- STOCK MARKET ANALYSIS
- WORD PROCESSING PROGRAM (FOR DISK OR CASSETTE)
- LOWER CASE MODIFICATION FOR YOUR VIDEO MONITOR OR PRINTER
- PAYROLL (FEDERAL TAX WITHHOLDING PROGRAM)
- EXTEND 16-DIGIT ACCURACY TO TRS-80™ FUNCTIONS (SUCH AS SQUARE ROOTS AND TRIGONOMETRIC FUNCTIONS)
- NEW DISK DRIVES FOR YOUR TRS-80™
- PRINTER OPTIONS AVAILABLE FOR YOUR TRS-80™
- A HORSE SELECTION SYSTEM\*\*\*ARITHMETIC TEACHER
- COMPLETE MAILING LIST PROGRAMS (BOTH FOR DISK OR CASSETTE SEQUENTIAL AND RANDOM ACCESS)
- RANDOM SAMPLING\*\*\*BAR GRAPH
- CHECKBOOK MAINTENANCE PROGRAM
- LEVEL II UPDATES\*\*\*LEVEL II INDEX
- CREDIT CARD INFORMATION STORAGE FILE
- BEGINNER'S GUIDE TO MACHINE LANGUAGE AND ASSEMBLY LANGUAGE
- LINE RENUMBERING
- AND CASSETTE TIPS, PROGRAM HINTS, LATEST PRODUCTS COMING SOON (GENERAL LEDGER, ACCOUNTS PAYABLE AND RECEIVABLE, FORTRAN-80, FINANCIAL APPLICATIONS PACKAGE, PROGRAMS FOR HOMEOWNERS, MERGE TWO PROGRAMS, STATISTICAL AND MATHEMATICAL PROGRAMS (BOTH ELEMENTARY AND ADVANCED) . . . AND

**FREE**



WORD PROCESSING PROGRAM (Cassette or Disk) For writing letters, text, mailing lists, etc., with each new subscriptions or renewal.

LEVEL II RAM TEST (Cassette or Disk) Checks random access memory to ensure that all memory locations are working properly.

DATA MANAGEMENT SYSTEM (Cassette or Disk) Complete file management for your TRS-80™

CLEANUP (Cassette or Disk) Fast action Maze Game

ADVENTURE (Cassette or Disk) Adventure #0 by Scott Adams (From Adventureland International)

\* TRS-80™ IS A TRADEMARK OF TANDY CORP.

**FREE**

SEND FOR OUR NEW 48 PAGE SOFTWARE CATALOG (INCLUDING LISTINGS OF HUNDREDS OF TRS-80™ PROGRAMS AVAILABLE ON CASSETTE AND DISKETTE). \$2.00 OR FREE WITH EACH SUBSCRIPTIONS OR SAMPLE ISSUE.

## COMPUTRONICS

MATHEMATICAL APPLICATIONS SERVICE™

50 N. PASCACK ROAD  
SPRING VALLEY, NEW YORK 10977

ONE YEAR SUBSCRIPTION \$24 .....

TWO YEAR SUBSCRIPTION \$48 .....

SAMPLE OF LATEST ISSUE \$ 4 .....

START MY SUBSCRIPTION WITH ISSUE .....

(#1 - July 1978 • #7 - January 1979 • #12 - June 1979 • #18 - January 1980)

NEW SUBSCRIPTION ..... RENEWAL .....



**24 HOUR ORDER LINE**  
**(914) 425-1535**



**NEW TOLL-FREE ORDER LINE**  
(OUTSIDE OF N.Y. STATE)  
**(800) 431-2818**

**NEW!!!**  
**MOD-II NEWSLETTER**  
**\$12/year (or 12 issues)**

CREDIT CARD NUMBER \_\_\_\_\_ EXP. DATE \_\_\_\_\_

SIGNATURE \_\_\_\_\_

NAME \_\_\_\_\_

ADDRESS \_\_\_\_\_ CITY \_\_\_\_\_ STATE \_\_\_\_\_ ZIP \_\_\_\_\_

\*\*\* ADD \$6/YEAR (CANADA, MEXICO) . ADD \$12/YEAR AIR MAIL . OUTSIDE OF U.S.A.. CANADA & MEXICO \*\*\*



# H & E COMPUTRONICS INC.

## ...EVERYTHING FOR YOUR TRS-80™...

TRS-80 is a trademark of the Radio Shack Division of Tandy Corporation

★ All Orders processed within 24-Hours

★ 30-Day Money Back Guarantee on all Software (less a \$3 penalty for handling)

★ 10-Day Money Back Guarantee on Disk Drives and Printers PLUS 120-Days Free Service

**LEARNING LEVEL II** By David Lien  
The Original Author Of The Level Manual  
A Step By Step approach to Learning Level II  
especially geared to new TRS-80™ Owners  
**\$15.95**

**TRS-80™ DISK AND OTHER MYSTERIES**  
Over 100 pages of indispensible information for  
disk owners. Learn to recover information from  
bad disks, how to make Basic programs unlistable  
and 12 more chapters of never published tips and  
information. Written by H.C. Pennington.  
(For all Disk Owners). **\$22.50**

**NEW SBSG BUSINESS SYSTEM FOR MODEL I  
OR MODEL II - IN STOCK**

- General Ledger
- Accounts Receivable
- Accounts Payable
- Payroll
- Inventory Control with Invoicing
- Each module can be operated individually or as a  
coordinated SYSTEM. Turn-Key error catching  
operation for beginners.
- Complete manual and documentation  
accompany each program.
- Minimum System requirements 2-Disk Drives  
for Model I...1-Disk Drive for Model II
- Each module can be formatted to span data  
on up to 4-Disk Drives
- Free 30-Day telephone consultation
- Call for complete specifications
- Model I Version **\$125.00 Per Module**  
**\$495.00 Per System**
- Model II Version **\$225.00 Per Module**  
**\$995.00 Per System**

**DATA MANAGEMENT SYSTEMS**  
• DMS replace index cards or any data requiring  
longlists of information.

- TBS In-Memory Information System  
(For Cassette Systems) **\$39.95**
- TBS Disk Data Manager (Requires 1 or more disk  
drives)...Set up fast random access, files in  
minutes. Stores up to 320K of information on 4  
Drives. Up to 10 fields and 255 characters per  
record. Supports upper and lower case. RS-232 or  
TRS-232...Features complete editing **\$49.50**
- Personal Software CCA Data Management  
System...Completely user oriented, menu drive.  
130 page Step By Step Manual...Capable of  
inventory control, sorting data, reporting data in  
nearly any form (for reports and mailing labels).  
Sorts data by up to 10 fields for zip code, balance  
due, geographic location or whatever. Prints  
reports with subtotals and totals automatically  
calculated. Fast random access **\$75.00**

**FROM RACET COMPUTES**

- **REMODEL-PROLOAD** - Renumbers program  
lines, combines programs. The only renumber  
program that will renumber the middle of a  
program. Specify 16K, 32K or 48K. Works with  
Cassette or Disk **\$34.95**
- **GSF** - Use in your Basic Programs for Instant  
Sorting (will sort 1000 items in 9 seconds). Other  
commands include Compress and Uncompress  
Data, Duplicate Memory, Display Screen Controls  
and Fast Graphic Controls **\$24.95**  
(For Cassette or Disk, specify 16K, 32K or 48K).
- **DOSORT** - All G.S.F. commands plus special  
Multiple Disk Sorting Routines **\$34.95**  
(Specify 32K or 48K)
- **INFINITE BASIC** - Adds 70 commands to your  
TRS-80™ including Instant Sort, Matrix  
Commands, String Commands, Left and Right  
Justification, String Centering, Simultaneous  
Equations, Upper and Lower Case Reverse and  
more. (For Cassette or Disk) **\$49.95**
- **INFINITE BUSINESS** (Requires Infinite Basic)  
Eliminate Round-off error, 127-Digit Calculation  
Accuracy, Insert New Elements in Sorted Arrays,  
Automatic Page Headings, Footings and  
Pagination, Multiple Precision Arithmetic and  
more. (For Cassette or Disk) **\$29.95**
- **COPSYS** - Copy Machine Language Programs  
(For Cassette Only) **\$14.95**
- **DSM** (Disk Sort Merge) **\$75.00**

**FROM SMALL SYSTEM SOFTWARE**

- **RSM-2** Machine Language Monitor **\$26.95**
- **RSM-2D** Disk Version of RSM-2 **\$29.95**
- **DCV-1** Converts Machine Language Programs  
from tape to disk **\$9.95**
- **AIR RAID** - The ultimate TRS-80™ game converts  
your TRS-80™ into a real time shooting gallery  
**\$14.95**
- **BARRICADE** - A fast pong style game **\$14.95**
- **CPM** - (For Disk Only) **\$150.00**
- **TRS-232 INTERFACE** - Interface with Software  
driver RS-232 printers to your TRS-80™ **\$49.95**
- **TRS-232 FORMATTER** - Additional (optional)  
Software for TRS-232 owners. Adds many printer  
commands to your TRS-80™ **\$14.95**  
(With purchase of TRS-232) **\$9.95**
- **PENMOD** - Use the Electric Pencil with RS's lower  
case modification **\$19.95**

**FROM GALACTIC SOFTWARE**

- **MAIL PAC** - For Model I Disk Systems  
only **\$99.95**  
Quick-sorting full user control over mailing list  
from Galactic Software.
- **STOCK MARKET PAC** **\$99.95**

**FROM APPARAT NEW DOS +** **\$99.95**  
35, 40 and 77 Track Versions available.

- **NEW DOS/80** (With variable record length files,  
chainings and many other features) **\$149.95**

**FROM THE BOTTOM SHELF**

- **CHECKBOOK II** (For Cassette or Disk) **\$39.95**
- **SYSTEM DOCTOR** (A complete diagnosis of your  
TRS-80™...Checks memory, video, cassette, disk,  
ROM, and all other parts of your system)  
For Cassette or Disk **\$28.50**

- **CHECKBOOK REGISTER ACCOUNTING  
SYSTEM** (Requires 2 disk drives) **\$75.00**
- **LIBRARY 100** - 100 established business, game  
and educational programs plus FREE Tiny Pilot  
all for **\$49.50**
- **BASIC TOOL KIT** - Lists all variables, GOTO's  
and GOSUB's in your program **\$19.80**

- **SOUNDWARE** - Adds sound to your TRS-80™  
Just plus it in **\$29.95**  
Sample programs included.
- **TING TONG** - Can be used with Soundware for a  
Sound version of pong **\$9.95**

- **VIC - The Cartia Visual Instructional  
Computer Program** **\$19.95**  
The Level II 16K Cassette is designed to teach  
beginners the Basics of Machine Language and  
Assembly Language Programming. See every  
Machine Language Instruction Display on your  
video. VIC includes Step By Step 55 page manual

**VISTA V80 DISK DRIVE -**  
**110K of Storage** **\$395.00**  
Add \$29.95 for Cable (Free with purchase of  
2-Disk Drives). 10 day money back guarantee

**FROM HOWE SOFTWARE**

- **MON-3** - Machine Language Programming for  
beginners. MON-3 is a complete System Monitor  
with Users Manual **\$39.95**
- **MON-4** - Disk Version of MON-3 **\$49.95**

**FROM MICROSOFT**

- **LEVEL III BASIC** **\$49.95**  
Now Cassette owners can add Disk Commands  
to their TRS-80™ without owning a Disk Drive
- **MICROSOFT DISK ADVENTURE** **\$29.95**
- **TRSDOS BASIC COMPILER** **\$195.00**  
Run Basic Programs up to 15 times faster.

- **NEC BUSINESS QUALITY PRINTERS**  
(For MOD-I or MOD-II) **\$2,995.00**

**THE ELECTRIC PENCIL**

- Cassette **\$99.95**
- Disk **\$150.00**
- MOD-II Version **\$325.00**

- **HORSE SELECTOR II** By Dr. Hal Davis  
The TRS-80™ version updated for the TRS-80™  
and originally reviewed in Systems and  
Methods **\$50.00**

### ...EVERYTHING... FOR MOD-II OWNERS

**NEW MOD-II NEWSLETTER**  
MOD-II Catalog Free w/subscription **\$12/year**

**MAIL PAC** **\$199.95**

**MICROSOFT BASIC COMPILER** **\$395.00**

**MICROSOFT BASIC** **\$325.00**

**GSF SORT ROUTINE** **\$50.00**

**CP/M** **\$170.00**

**PEACHTREE BUSINESS SOFTWARE** **Call**

**WORD STAR** **\$495.00**

# COMPUTRONICS

MATHEMATICAL APPLICATIONS SERVICE™

50 N. PASCACK ROAD  
SPRING VALLEY, NEW YORK 10977

**HOURS: 9-5**

**Monday thru Saturday**

**48-Page Catalog \$2 FREE With Any Order**

Order By Phone Or Mail

Add \$1 Per Order For Shipping Within UPS Areas

Add \$3 For C.O.D.

Add \$3 For All Foreign And Non-UPS Shipments

Add \$3 For UPS Blue Label



**24 HOUR  
ORDER  
LINE**



**(914) 425-1535**

**NEW TOLL-FREE  
ORDER LINE**  
(OUTSIDE OF N.Y. STATE)  
**(800) 431-2818**

# A General Interpolating Graphics Package for the TRS-80

---

D K Cohen and Devon Crowe  
Bell Technical Operations Corp  
1050 E Valencia Rd  
Tucson AZ 85706

---

If you've ever tried creating graph displays with the Radio Shack TRS-80, then you know that the task can be time-consuming. If you haven't tried, you can look forward to the fact that axes must be generated and labelled, and data must be plotted using the awkward screen coordinates of Level II BASIC. After all this has been done, the resulting graph usually is not continuous, but has annoying *holes* in it. But don't despair, because with our simple package that may be implemented as a subroutine plotting X, Y coordinate relations or geometric figures is easy.

In order to use this plotting package effectively, we suggest that you work through each example given. After implementing this package, TRS-80 users should be able to plot any analytic function or set of  $x$  and corresponding  $y$  values efficiently. This package will allow you to draw axes in the correct quadrant(s) and label them with chosen titles. Tic marks displayed at user-determined intervals, and maximum and minimum values displayed at the correct positions on the graph are also easy to accomplish.

## Basic Plotting

The plotting package is divided into two subroutines. The interpolating subroutine (see listing 1)

---

With this package, TRS-80 users should be able to plot any analytic function.

---

plots the function (or coordinate pairs), interpolating between the points to produce a continuous curve. The resulting curve may be easily displayed at any position of the screen by changing at most four parameters. The program takes care of all scaling problems, and parameters are specified through the use of additional BASIC statements inserted at the front of the subroutine.

To begin this demonstration, suppose you desire to plot the cost of heating a home as a function of the monthly period, displayed in the upper right-hand corner of the screen.

(This is done to leave space for other information you may desire to display.) In order to have the graph confined to the desired position, you must specify a *viewport*. For this plotting routine, consider the screen to be divided into one hundred horizontal units and forty vertical units. The bottom left corner corresponds to the screen coordinate (0,0). (See figure 1.) To display the graph in the right-hand corner, the horizontal coordinates should be from 50 to 100, and the vertical coordinates should be from 20 to 40. Thus, to set this viewport, the reader must specify the four variables, Z1, Z2, W1, W2. For this example the viewport variables should be set as follows:

```
Z1 = 100  
Z2 = 50  
W1 = 40  
W2 = 20
```

The next step is to set up the  $x$  and corresponding  $y$  arrays. For example, if during the month of January the heating cost was \$80, the first  $x$  element would be 1 (for the month) and



the *y* element would be 80 (for the cost). Table 1 is a hypothetical set of data to be graphed. The arrays that will contain the data are AX and AY. Thus, for this example, the following BASIC statements should be inserted at the beginning of the subroutine:

```
FOR I=1 TO 12
READ AX(I)
READ AY(I)
NEXT I
DATA 1,80,2,90,3,75,4,50,5,
      45,6,45,7,50,8,80,
      9,70,10,65,11,70,12,80
```

The next variables specify the dimension of the arrays to be graphed. In this example, the minimum dimension TI is 1, the maximum dimension TA is 12, and the separation between the array points IN to be plotted is 1. (For example, if you wanted to plot the cost of heating for every other month, IN would be 2.) Therefore, you must include the following BASIC statements:

```
TI = 1
TA = 12
IN = 1
```

The final variable to be specified, S1, determines the *resolution*, or how well the points are connected in the graph. The value of S1 needed to fully connect all the points depends strongly on the size of the viewport and the number of array points to be plotted. A little experimentation with S1 is necessary to obtain the desired effect. For this demonstration: S1=0.01. After specifying the parameters above, the user is now ready to run the program.

After execution, the results should be as presented in figure 2. To change the viewport, simply change the values in the viewport variables. Figure 3 shows the result when the viewport variables are as follows:

```
Z1 = 100
Z2 = 0
W1 = 40
W2 = 0
```

If you desire to plot the cost of heating for every other month, simply change IN to 2. The results of this change are shown in figure 4.

You can extend the usefulness and data entry speed of your TRS-80 by giving it the graphics and menu capabilities of the Bit Pad One digitizer.

With the Bit Pad and proper software, you can generate schematic diagrams; describe sales curves to your computer; enter alphanumeric information by merely touching printed letters on a menu, or enter order or



inventory information by merely checking boxes on printed forms.

Bit Pad One, complete with stylus, specially designed plug-in TRS-80 interface and power supply cost just slightly over \$1,000.

If you don't have a digitizer, you are restricting your TRS-80's abilities. We'll gladly send you a list of distributors who have the Bit Pad One.



**Summagraphics**  
corporation  
35 Brentwood Avenue, Fairfield,  
CT 06430, (203) 384-1344

## Now, Bit Pad One™ digitizer makes it easy to add graphics capability to your TRS-80!

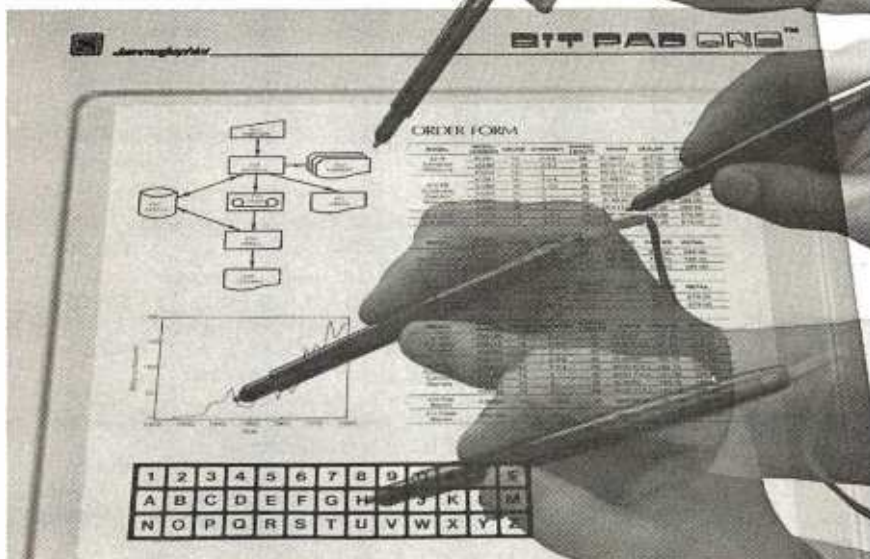

### Adding Axes

At this point, it would be nice to have the axes drawn and labeled. This can be done by specifying four axis parameters for use by the axis-drawing subroutine in listing 2. The first two parameters to be defined are the string variables AX\$ and AY\$, which define the *x* axis and the *y* axis labels respectively. For this example the *x* axis should be labeled "month" and the *y* axis should be labeled "cost." Thus, the two BASIC statements that must be executed are:

```
AX$ = "MONTH"
AY$ = "COST"
```

The final two parameters specify the separation of the tic marks on the axes. In the example, set C1 (the *x*-axis tic-mark-separation variable) to 1 for a tic mark every month. Set C2 (the *y*-axis tic-mark-separation variable) to 5 for a tic mark at every \$5.00 increment. Thus, the following BASIC statements must be executed:

```
C1 = 1
C2 = 5
```

After execution, the results should be  
*Text continued on page 310*

**A REFURBISHED ASCII TERMINAL OFFERED FOR THE FIRST TIME TO SMALL BUSINESS AND PERSONAL COMPUTER USERS.**

# The AJ 630. For just \$495\* you can have a quiet thermal printer terminal.

Now, for less than the price of a good electric typewriter, you can have your own personal ASCII printer terminal.

And the AJ 630 gives you a lot of features for interactive timesharing, data entry/retrieval, and communications.

- A wide carriage—up to 140 characters per line
- Built-in lamp for paper illumination

- Upper and lower case characters
- 128-character ASCII code set
- RS-232C interface
- Selectable 110, 150, or 300 bps operation
- Desktop portability
- 30-day warranty on parts and labor



Perhaps best of all, the AJ 630 is *quiet*. You can use it anywhere without disturbing anyone—in the office or at home. And we'll make it easy for you to pay—with cash, certified check, Master Charge, or Visa.

Call toll-free for more information and details on our 10-day money back guarantee:\*\*

**800/538-9721**

California residents call collect 408/263-8520, Extension 275.

\* Plus \$50 for transportation, terminal checkout, and one 15" four hundred foot roll of paper.

\*\*Excluding checkout charge of \$50.



## MARKET CHARTER TM



### STOCK CHARTING ON YOUR APPLE II\*

- High-Low-Close Bar Charts
- Simple, Exponential, Weighted Averages
- Trendlines, Resistance Lines, etc.
- Volume Charts with average volume
- Hard Copy of the Charts and Data
- Comparison Charts
- Weekly & Daily Stock Histories available
- User Oriented
- User can create and update the Data base
- Many Satisfied Users

MARKET CHARTER Retails for \$129.95. Manual, Demo Diskette and Stock Histories are available separately. Call or write for information on new offering in the financial field.

### RTR SOFTWARE, INC.

DEPT. B-11  
1147 BALTIMORE DR.  
EL PASO, TEXAS 79902  
(915) 544-4397



\*TRADEMARK OF APPLE COMPUTER, INC.

## DISCOUNT PRICES

Microcomputers & Peripherals

# B

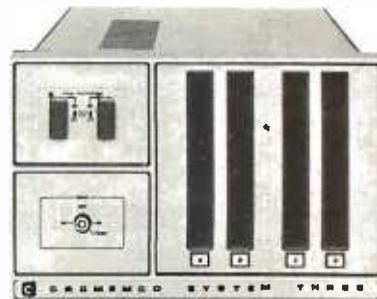
 ITS YTES LOOKS ARGAINS

Cromemco • SWTPC • Lear-Siegler  
Hazeltine • RCA • North Star  
Verbatim • Perkin Elmer and others

Fast, off the shelf delivery.  
Call TOLL FREE 800/523-5355

**MARKETLINE SYSTEMS, Inc.**  
2337 Philmont Ave., Huntingdon Valley, Pa. 19006  
215/947-6670 • 800/523-5355

Dealer Inquiries Invited

Listing 1: The interpolating subroutine. Written in TRS-80 Level II BASIC, this routine plots points on the screen from an array specified by the user. BASIC statements are inserted before the routine is run to create the desired array and, thus, the desired image.

```

10000 Z2=Z2+25
10005 W2=W2+5
10010 IF Z2>Z1 THEN Z3=Z2 ELSE GOTO 10025
10015 Z2=Z1
10020 Z1=Z3
10025 IF W2>W1 THEN W3=W2 ELSE GOTO 10040
10030 W2=W1
10035 W1=W3
10040 Y1=-1.0E38
10045 Y2=1.0E38
10050 X1=Y1
10055 X2=Y2
10060 FOR I=TI TO TA STEP IN
10065 IF Y1<AY(I) THEN Y1=AY(I)
10070 IF Y2>AY(I) THEN Y2=AY(I)
10075 IF X1<AX(I) THEN X1=AX(I)
10080 IF X2>AX(I) THEN X2=AX(I)
10085 NEXT I
10090 IF Y1=Y2 THEN Y1=1.001*Y1
10095 IF X1=X2 THEN X1=1.001*X1
10100 A=(X1-X2)/(Z1-Z2)
10105 B=(Y1-Y2)/(W1-W2)
10110 FOR I=TI TO TA STEP IN
10115 SET((Z2+(AX(I)-X2)/A),(47-((AY(I)-Y2)/B+W2)))
10120 Q=I+IN
10125 IF Q>TA GOTO 10165
10130 IF AX(I)>AX(Q) THEN SS=-S1 ELSE SS=S1
10135 FOR J=AX(I) TO AX(Q) STEP SS
10140 IF AX(I)=AX(Q) THEN AX(Q)=1.001*AX(Q)+.0000001
10145 Y3=((AY(Q)-AY(I))/(AX(Q)-AX(I)))*(J-AX(I))+AY(I)
10150 SET((Z2+(J-X2)/A),(47-((Y3-Y2)/B+W2)))
10155 NEXT J
10160 NEXT I
10165 RETURN
  
```

**FREE\***  
OSBORNE/McGraw-Hill  
Buy 2 get 1 free

**Ad #7**  
with new items

# DISCOUNT SOFTWARE

PS.—We want to be your software source. Give us the opportunity to beat any nationally advertised price!

- CP/M** DISK WITH MANUAL / MANUAL ONLY
- OSBORNE** †  
 General Ledger#... \$ 99/\$20  
 Acct Rec/Acct Pay#... \$ 59/\$20  
 Payroll w/Cost#... \$ 59/\$20  
 Buy 2 get 1 free... \$ 118/\$57  
 All 3 & CBASIC2... \$ 199/\$71
- DIGITAL RESEARCH** ‡  
 CP/M\* 2.2 Northstar... \$149/\$25  
 CP/M\* 2.2 Cromemco... \$189/\$25  
 CP/M\* (other versions) Call  
 PL/I-80... Call  
 Mac... \$ 85/\$15  
 Sid... \$ 85/\$15  
 Z-Sid... \$ 95/\$15  
 Tex... \$ 70/\$15  
 Despool... \$ 50/\$10
- MICROSOFT**  
 Basic-80... \$289/\$30  
 Basic Compiler... \$324/\$30  
 Fortran-80... \$384/\$30  
 Cobal-80... \$594/\$30  
 Mu Math... \$224/\$30  
 Mu Lisp... \$169/\$25
- MICRO DATA BASE SYSTEMS**  
 HDDBS... \$250/\$40  
 MDBS... \$750/\$40  
 Other... Call
- S.O.F.T.W.A.R.E.**  
 Microtax†‡  
 Federal individual... \$749/\$50  
 Federal corporate... \$249/\$25  
 State individual... \$249/\$25  
 C.P.A. Plus  
 Client Write-up... \$995/\$95  
 Time billing... \$995/\$95  
 Business Plus†  
 General Ledger... \$ 79/\$25  
 Accounts Receivable... \$ 79/\$25  
 Accounts Payable... \$ 79/\$25  
 Payroll... \$ 79/\$25  
 All 4... \$269/\$99
- SUPERSOFT**  
 Forth (8080 or Z80) †... \$129/\$25  
 Diagnostic I... \$ 49/\$20  
 Other disk software... less 10%
- SOFTWARE WORKS**  
 Adapt... \$69  
 Ratfor... \$86

- CP/M users: specify disk systems and formats. Most formats available.
- COMPUTER PATHWAYS**  
 Pearl (level 1) #... \$ 99/\$25  
 Pearl (level 2) #... \$299/\$25  
 Pearl (level 3) #... \$549/\$25
- MICROPRO**  
 Word-Star (Ver. 2.0)... \$349/\$40  
 Word-Star /Mail-Merge... \$489/\$65  
 DataStar... \$279/\$35  
 Word-Master... \$119/\$25  
 SuperSort I... \$199/\$25  
 SuperSort II... \$169/\$25  
 SuperSort III... \$119/\$25
- PEACHTREE** † ‡  
 General Ledger†... \$449/\$45  
 Accts Receivable†... \$449/\$45  
 Accts Payable†... \$449/\$45  
 Payroll†... \$449/\$45  
 Inventory†... \$499/\$45  
 Property Mgt.†... \$899/\$45  
 C.P.A. Client Write-up†... \$899/\$45  
 Mailing Address†... \$399/\$45
- STRUCTURED SYSTEMS**  
 General Ledger #... \$747/\$25  
 Accts Receivable#... \$747/\$25  
 Accts Payable#... \$747/\$25  
 Payroll#... \$747/\$25  
 Inventory Control#... \$447/\$25  
 Analyst#... \$197/\$20  
 Letterright#... \$167/\$20  
 NAD#... \$ 87/\$20  
 QSORT... \$ 87/\$20
- GRAHAM-DORIAN** †  
 Most packages... \$699/\$40
- MICRO-AP**  
 Selector III-C2 #... \$269/\$20  
 Selector IV #... \$469/\$35  
 S-Basic Compiler... \$229/\$25
- WHITESMITHS**  
 "C" Compiler\*... \$600/\$30  
 Pascal (incl "C")\*... \$750/\$45
- EIDOS SYSTEMS**  
 Kiss... \$299/\$25  
 Kbasic... \$529/\$50
- "OTHER GOODIES"**  
 Tiny "C"... \$ 69/\$40  
 CBASIC (Ver 2.06)... \$ 89/\$15  
 Pascal/Z (Ver 3)... \$369/\$35  
 Pascal/MT (Ver 3)... \$224/\$30  
 Pascal/M... \$149/\$20  
 Pascal/UCSD... \$299/\$25  
 FMS-80... Call  
 CBS... \$279/\$45  
 T.I.M.†... \$369/\$45  
 Vsort I... \$159/\$25  
 Siring/80... \$ 84/\$20  
 Whatsit?†... \$149/\$25  
 Postmaster... \$139/\$20  
 Textwriter III... \$111/\$20  
 Magic Wand... \$299/\$45  
 Spell Binder... \$349/\$45  
 Electric Pencil II... less 15%  
 CPAids... less 12%  
 Vulcan D.B.M.S... \$469/\$30  
 Nevada Cobol... \$89/\$25
- APPLE II®**  
 MICROSOFT  
 Softcard (CP/M)... \$292
- PERSONAL SOFTWARE**  
 Visicalc\*... \$122  
 CCA Data Mgr... \$ 84  
 Desktop/Plan... \$ 84
- PEACHTREE** † ‡  
 General Ledger†... \$224/\$45  
 Accts Receivable†... \$224/\$45  
 Accts Payable†... \$224/\$45  
 Payroll†... \$224/\$45  
 Inventory†... \$224/\$45
- MUSE**  
 Super-Text... \$ 84  
 Other disk software... less 10%
- Whatsit?... \$129  
 Apple PIE... \$ 69
- TRS-80® MODEL II**  
 CP/M 2.2... \$149  
 Electric Pencil II... less 15%
- TRS-80® MODEL I**  
 CP/M 1.4... \$129  
 CCA Data Mgr... \$ 68

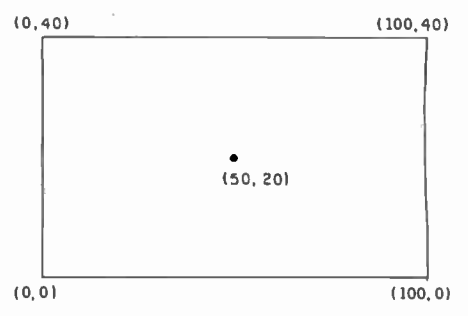

Figure 1: The TRS-80 video monitor screen is partitioned into one hundred units horizontally and forty units vertically. The bottom left corner of the screen corresponds to the coordinates (0,0). Coordinates are also used to specify viewports in which the plot is to be displayed.

Month	Cost(\$)
1	80
2	90
3	75
4	50
5	45
6	45
7	50
8	80
9	70
10	65
11	70
12	80

Table 1: This hypothetical set of data represents the heating costs incurred in a house. Plotted as in figure 2, the information may be limited to one area of the screen or may use the whole screen, as in figure 3.

Circle 199 on inquiry card.

Don't see it—CALL! Other software requirements—Call  
**"LIGHTNIN" service available! Just call and ask Diana.**  
**ORDERS ONLY—CALL TOLL FREE VISA • MASTERCARD**  
**1-800-854-2003 ext. 823 • Calif. 1-800-522-1500 ext. 823**  
 Overseas—add \$10 plus additional postage • Add \$2.50 postage and handling per each item • California residents add 6% sales tax • Allow 2 weeks on checks. C.O.D. ok • Prices subject to change without notice  
 All items subject to availability

For information write or call: **THE DISCOUNT SOFTWARE GROUP**  
 1610 Argyle Ave., Bldg. 102 • Los Angeles, CA 90028 • (213) 665-8280

\*—Special Bonus with order †—Requires microsoft BASIC ‡—Supplied in source code €—Requires CBASIC-2 ®—Mfgs. Trademark

Dealers: We can supply you with the industry's largest selection of quality business systems in our . . .

# \$245 Dealer Demo System.

You've got the hardware . . . we've got the software AND the total sales package to sell this rapid-growth market. Demonstration diskettes and documentation to quickly close the sale. (Kit includes: 14 diskettes, 20 users manuals and supporting Promotional Material.)

Check our complete list of systems. The source code is dealer-adaptable to run on any computer with disc capabilities in CBASIC II (CP/M).

GL, A/P, A/R  
 Payroll  
 Cash Receipts/Disb.  
 Job Costing  
 Fund Accounting  
 Student Scheduling  
 Mailing List Mgmt.  
**Medical/Dental**  
 Office Scheduler  
 Patient Billing & A/R  
 Insurance Forms

**Wholesale Distribution System**  
 Purchasing & Receiving  
 Inventory Control  
 Invoicing & Receivables  
 Salesman Comm. Reporting  
 Backorder Management  
**Manufacturing Inventory Control**  
 Finished Goods Inventory Mgmt.  
 Parts Inventory Mgmt.  
 Parts Purchasing & Receiving  
 Bill of Material  
 Production Scheduling

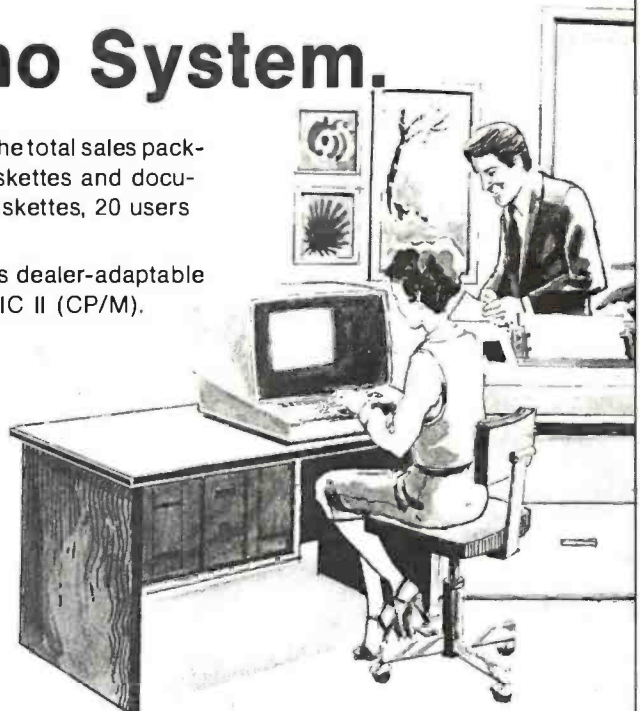

For details on our demo special, contact us at:  
 8425 Quivira Road, Lenexa, Kansas 66215  
 Phone: (913) 888-8330

THE STANDARD  
 OF EXCELLENCE  
 IN BUSINESS  
 SYSTEMS SOFTWARE

**I**NTERNATIONAL  
**M**ICRO  
**S**YSTEMS

## FORTH for CP/M\*

An enhanced version of FIG\*\* FORTH is now available on a CP/M\* disk, ready to run. Features include:

- EDITOR, WITH STRING COMMANDS
- Z-80/8080 ASSEMBLER
- RAPID DISK I/O VIA INTERLEAVING
- 8 DISK BUFFERS, 1024 bytes each

The price of \$75 includes documentation suitable for the beginning FORTH programmer, as well as the experienced user.

Available for immediate delivery. Send \$75 (includes shipping — CA residents add 6% sales tax) & your address to:

**Mitchell E. Timin Engineering Co.**  
 9575 Genesee Ave.  
 San Diego, CA 92121

\*TM Digital Research  
 \*\*FORTH INTEREST GROUP

## Desk Main/Frame Desk Main/Frame

LOW COST & ATTRACTIVE STYLING

- MAIN/FRAME INTEGRATED INTO FURNITURE QUALITY DESK
- ELECTRONICS PACKAGE SLIDE MOUNTED FOR EASY ACCESS
- SUPPORTS TWO 8" FLOPPY DRIVES FROM SEVERAL MANUFACTURERS (DRIVES NOT INCLUDED)
- 10 SLOT MOTHERBOARD INCLUDES CONNECTORS
- POWER SUPPLY FOR DRIVES AND CARDS
- DESK AND MAIN/FRAME AVAILABLE SEPARATELY
- MATCHING PRINTER DESK AVAILABLE

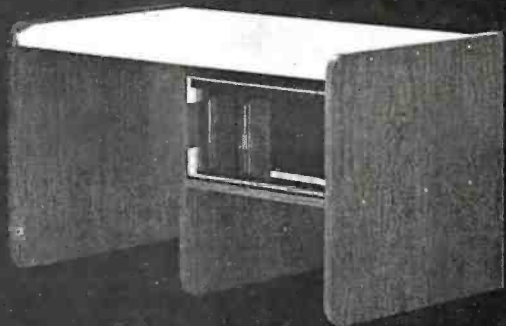

WRITE OR CALL FOR OUR BROCHURE WHICH INCLUDES OUR APPLICATION NOTE: 'BUILDING CHEAP COMPUTERS'

# INTEGRAND

8474 Ave. 296 • Visalia, CA 93277 • (209) 733-9288  
 We accept BankAmericard/Visa and MasterCharge

**"A triumph of cleverness."**

—Parabola

"Every few decades an unknown author brings out a book of such depth, clarity, range, wit, beauty and originality that it is recognized at once as a major literary event. This is such a work."

—MARTIN GARDNER,  
*Scientific American*

\$8.95, now in paperback, at your bookstore



**VINTAGE BOOKS**

A division of Random House

**WINNER OF THE PULITZER PRIZE**

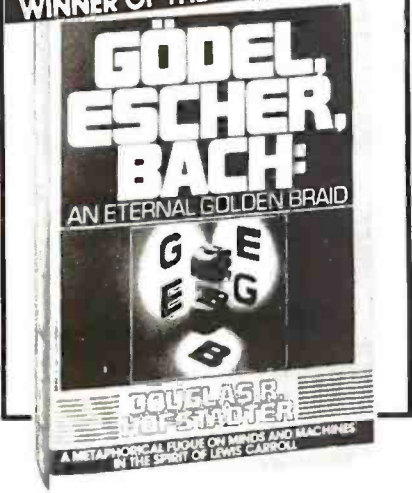

**"A rarity—a first-rate popular book about modern mathematics."**

—JEREMY BERNSTEIN,  
*The New Yorker*

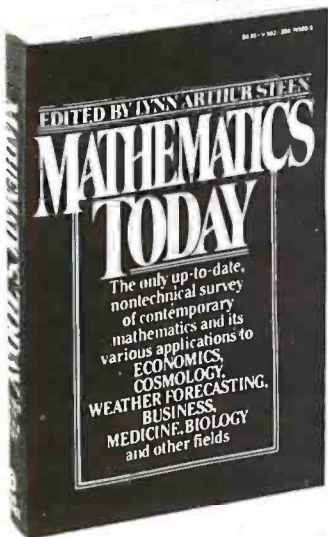

\$4.95, now in paperback,  
at your bookstore

**VINTAGE BOOKS**

A division of Random House

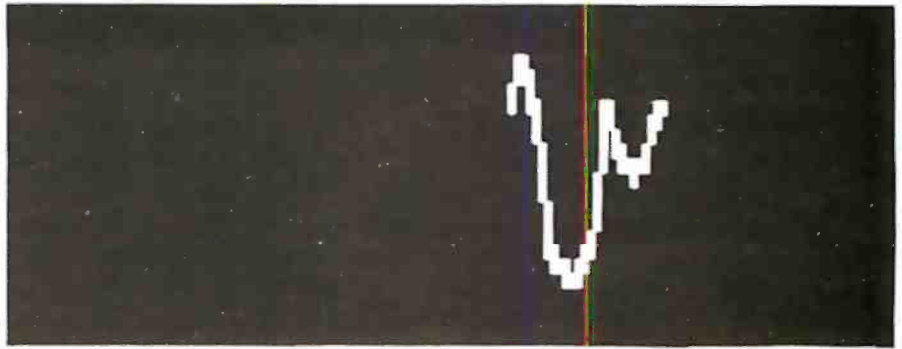

Figure 2: The information of table 1 is plotted as shown here. The size and location of the viewport used were specified by limiting the display area to the bounds of 50 to 100 and 20 to 40.

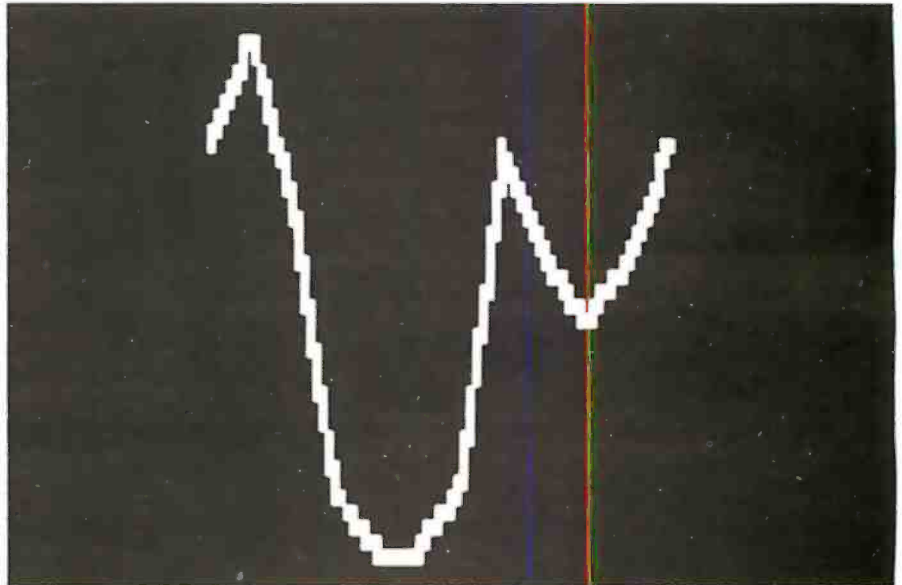

Figure 3: The information of table 1 is plotted again, with the viewport bounds set at 0 to 100 and 0 to 40 (whole screen).

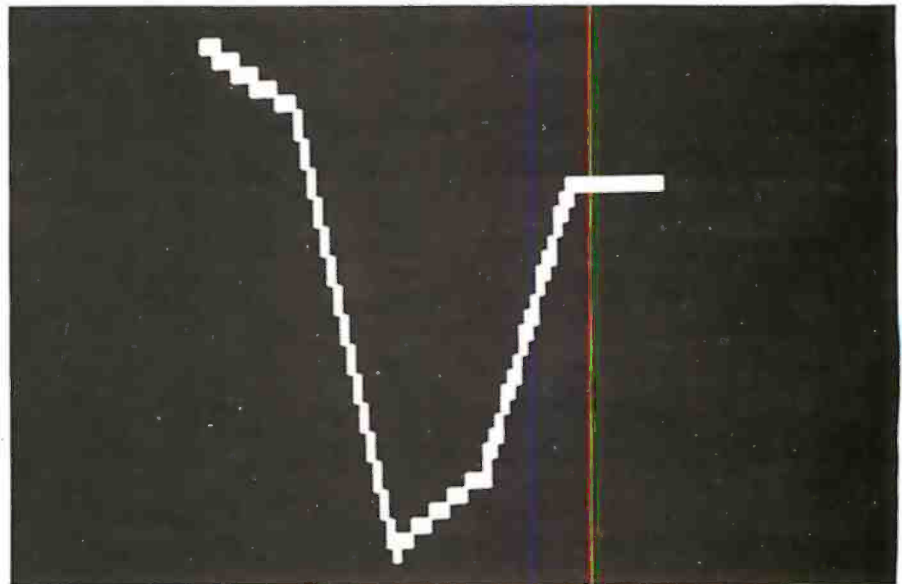

Figure 4: The information, as in table 1, may be condensed by changing the IN variable. The integer value specified allows the program to plot a reduced number of values from the array. Also, varying the S1 parameter may help to close gaps that occur between plotting points.



# New Produced and widely used in England and U.S.A. COMPLETE BUSINESS PACKAGE

**INCLUDES EVERYTHING FROM INVENTORY TO SALES SUMMARY  
PROMPTS USER, VALIDATES EACH ENTRY, MENU DRIVEN**

Approximately 60-100 entries/Inputs require only 2-4 hours weekly and your entire business is under control.

**PROGRAMS ARE INTEGRATED-**

- 01 = ENTER NAMES/ADDRESS, ETC
- 02 = ENTER/PRINT INVOICES
- 03 = ENTER PURCHASES
- 04 = ENTER A/C RECEIVABLES
- 05 = ENTER A/C PAYABLES
- 06 = ENTER/UPDATE INVENTORY
- 07 = ENTER/UPDATE ORDERS
- 08 = ENTER/UPDATE BANKS
- 09 = EXAMINE/MONITOR SALES LEDGER
- 10 = EXAMINE/MONITOR PURCHASE LEDGER
- 11 = EXAMINE/MONITOR (INCOMPLETE RECORDS)
- 12 = EXAMINE PRODUCT SALES

**SELECT FUNCTION BY NUMBER-**

- 13 = PRINT CUSTOMER STATEMENTS
- 14 = PRINT SUPPLIER STATEMENTS
- 15 = PRINT AGENT STATEMENTS
- 16 = PRINT TAX STATEMENTS
- 17 = PRINT WEEK/MONTH SALES
- 18 = PRINT WEEK/MONTH PURCHASES
- 19 = PRINT YEAR AUDIT
- 20 = PRINT PROFIT/LOSS ACCOUNT
- 21 = UPDATE END MONTH FILES MAINTENANCE
- 22 = PRINT CASH FLOW FORECAST
- 23 = ENTER/UPDATE PAYROLL (NOT YET AVAILABLE)
- 24 = RETURN TO BASIC

**WHICH ONE? (ENTER 1-24)**

**01 SUB. MENU EXAMPLE: 01 = EXAMINE: 02 = INSERT: 03 = AMEND: 04 = DELETE  
05 = PRINT (1,2,3): 06 = NUMERIC COMBINATIONS: 07 = SORT  
VERY FLEXIBLE. ADD YOUR OWN FUNCTIONS. EASY TO INTEGRATE.**

All programs in BASIC for CP/M. PET. 6800

**G. W. COMPUTERS LTD, the producers of this beautiful package in U.K.**

**WE EXPORT TO ALL COUNTRIES:  
BARCLAYCARD ACCEPTED  
CBM APPROVED**

**CALLERS BY APPOINTMENT ONLY  
89 Bedford Court Mansions  
Bedford Avenue  
London WC1, U.K.**

**CONTACT TONY WINTER 01-636-8210  
BARCLAYCARD ACCEPTED  
CBM APPROVED**

CPM Ver. 9.00 is one 16 K core program using random access releasing both drives for data storage, and 250 word vocabulary is translatable in any foreign language.

CPM Ver. 9.00 is one 16 K core program using random access releasing both drives for data storage, and 250 word vocabulary is translatable in any foreign language.

**PRICES: Programs 1-23 EXC (19,20,22,23) £475**

**£575 Stock Integrated Option + £100 Bank Integrated Option + £100**

**AT LAST!**

Mass production prices on this high quality software. Buy direct and save 50%. Now, also available for CBASIC on CP M and MBASIC on HEATH HDOS.

**DATA BASE MANAGER** Mod-I \$69 Mod-II \$199  
You can use it to maintain a data base & produce reports without any user programming. Define file parameters & report formats on-line. Key random access, fast multi-key sort, field arith., label, audit log. No time-consuming overlays. 500 happy users in a year. Mod-II version has over 50 enhancements including 40 fields max. 'IDM-M2 is great!' - 80-US.

**A/R** Mod-I \$69 Mod-II \$149  
Invoices, statements, aging, sales analysis, credit checking, form input, order entry. As opposed to most other A/R, ours can be used by doctors, store managers, etc.

**WORD PROCESSOR** Mod-I \$49 Mod-II \$49  
Center, justification, indentation, page numbering. Mod-I version features upper/lower case without hardware change!

**MAILING LIST** Mod-I \$59 Mod-II \$99  
The best! Compare and be selective. Form input, 5-digit selection code, zip code ext., sort any field, multiple labels. Who else offers a report writer?

**INVENTORY** Mod-I \$99 Mod-II \$149  
Fast, key random access. Reports include order info, performance summary, E.O.Q., and user-specified reports. Many have converted their inventory system to ours!

**GL, A/R, A/P, & PAYROLL** Mod-II \$129 each  
Integrated accounting package. ISAM, 100+ page manual, Uses 80 column screen, not 64. A \$1,000 value. Dual disk required.

**L216**, a cassette package of 10 business programs for Level II 16K systems, \$59. Includes word processor & data base. Poker game \$19.  
Most programs are on-line, interactive, random access, bug free, documented and delivered on disks. Mod-I programs require 32K TRSDOS. Don't let our low prices fool you! If still not convinced, send SASE (28c) for catalog.

**MICRO ARCHITECT, INC.,**  
96 Dothan St., Arlington, MA 02174



**TEXAS COMPUTER SYSTEMS**

**Radio Shack**

Authorized Sales Center, OFFERS

**LOWEST PRICES** on

**TRS-80  
COMPUTERS**

For the BEST prices on ALL TRS-80 computers, CALL our TOLL FREE NUMBER 1-800-351-1473. All Radio Shack computers are discounted 10%, 15% up to 20%! CALL for the latest prices on the items you need, or get advice from our consultant about your specific needs. CALL for prices on the Model I, II, and the new Model III, Color Computer and Pocket Computer.

SAVE up to 50% on accessories (non-Radio Shack). Need more disk space? Ask about single/DOUBLE DENSITY controller for the Model I. 300k in a 2-disk system 5 minute installation w/no modifications. Copies your single density data to DOUBLE for complete compatibility. Less than \$200.

40 track disk drives \$359 16k memory add on only \$58 w/instructions. Specify computer or expansion interface. CALL for information Programs available

- \* UPS prepaid insured delivery - FREE except some large items.
- \* No taxes on out-of-state shipments. Texas res. Add 5%.
- \* All merchandise is new, checked and guaranteed by manufacturer.
- \* Payment: Money Order, Cashier's Check, Certified Check, Personal Checks require 3 weeks to clear. VISA, MASTERCARD - Add 3%.
- \* Prices subject to change at any time.
- \* Delivery of merchandise is subject to availability.

**TCS, 106 East 10th, Brady, TX. 76825**  
An Authorized RADIO SHACK Sales Center F701

**TOLL FREE Order Number 1-800-351-1473**  
Texas Residents 915-597-0673

# CHOOSE...

## Choose an Apple Desk



A compact bi-level desk ideal for an Apple computer system. This 42" x 31 1/2" desk comes with a shelf to hold two Apple disk drives. The top shelf for your TV or monitor and manuals can also have an optional paper slot to accommodate a printer.

## Choose a Micro Desk



Get your micro computer off the desk top and into the micro shelf under our Designer Series desks. Suitable for the North Star, Dynabyte, Vector Graphics, and Altos computers. The desks come in a variety of sizes and colors.

## Choose a Mini Rack



Mini racks and mini micro racks have standard venting, cable cut outs and adjustable RETMA rails. Choose a stand alone bay or a 48", 60", or 72" desk model in a variety of colors and wood tones. A custom rack is available for the Cromemco.

## Choose a Printer Stand



The Universal printer stand fits the:

- |                    |                        |
|--------------------|------------------------|
| Centronics 700's   | Diablo 1600's & 2300's |
| Dec LA 34          | T.I. 810 & 820         |
| NEC Spinwriter     | Okidata Slimline       |
| Lear Siegler 300's | Anadex 9500's          |

Delivery in days on over 200 styles and colors in stock. Dealer inquiries invited.

### ELECTRONIC SYSTEMS FURNITURE COMPANY

17129 S. Kingsview Avenue  
Carson, California 90746  
Telephone: (213)538-9601

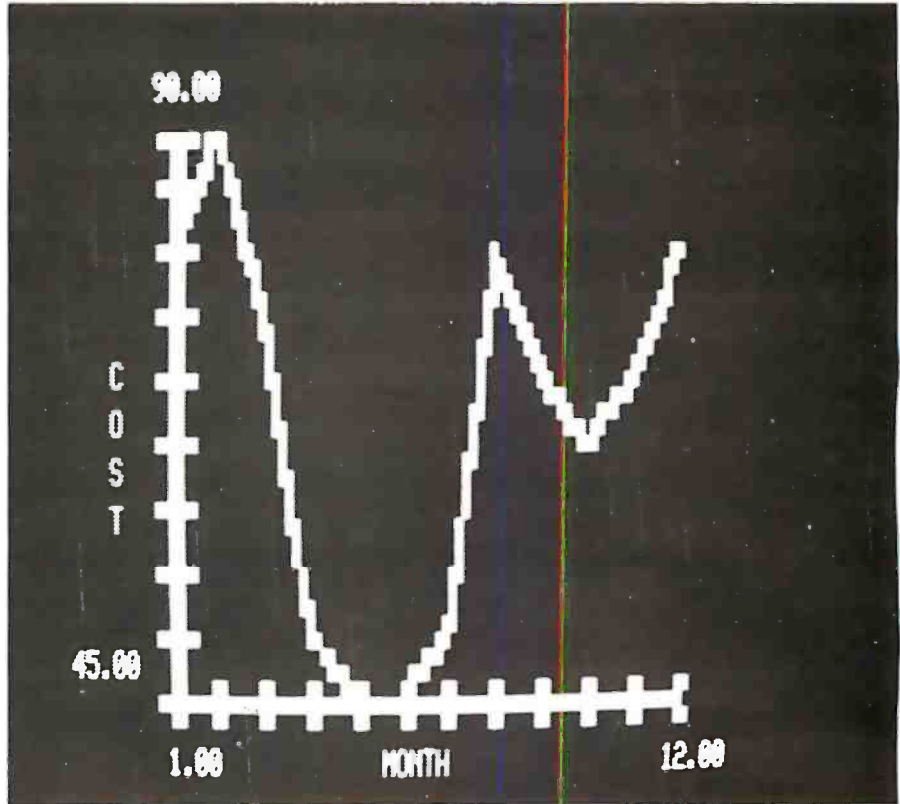

Figure 5: The axis-plotting subroutine provides for labeling and scaling of the display. The user only needs to specify increments for each scale.

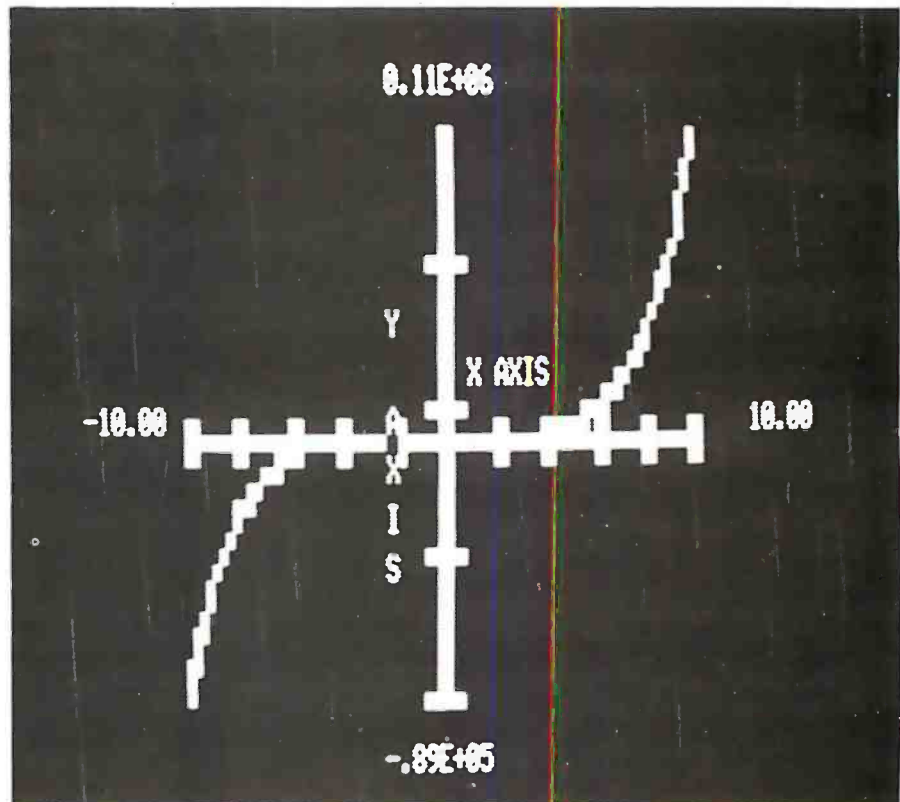
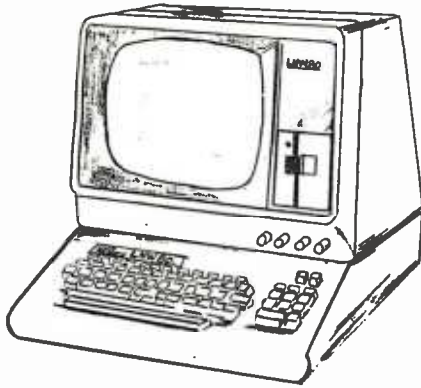

Figure 6: Analytic functions such as this may be plotted by transforming the function into an array. Usually, a short BASIC routine may be inserted before the plotting routines, depending on the complexity of the desired display.

# THE FIRST TRS-80<sup>®</sup> COMPATIBLE COMPUTER WITH HIGH DENSITY COLOR GRAPHICS!



## LNW80

PC BOARD **\$89.95**

Ask about our : Keyboard cabinet  
Leader VIDEO 100-80

## LNW RESEARCH

LNW RESEARCH 3183-E AIRWAY AVE COSTA MESA CA 92626 714-552-8948

\*Apple II is a Trademark of Apple Computer, Inc. IBM is a Trademark of International Business Machines Corp.

LNW RESEARCH introduces the LNW80, a high performance color computer, compatible with the TRS-80<sup>™</sup> Model I. The fully integrated LNW80 is a sophisticated and versatile microcomputer with the following powerful features.

### COMPATIBILITY

Hardware and software compatible to the Radio Shack TRS-80<sup>™</sup> Model I computer, provides the widest software base of any microcomputer. cassette interface; expansion bus

### DISPLAY

Quality upper and lower case display.

Two modes of color graphics, high resolution graphics, 384 x 192 in eight colors - higher density than the Apple II. Low density color graphics of 128 x 192 are also available in eight colors.

High resolution - black and white graphics - of 384 x 192 mixed with text and TRS-80<sup>™</sup> standard graphics.

Reverse video, composite video, RF output.

### PERFORMANCE

The LNW80 utilizes the fast 2-80A microprocessor which executes at a speed of 4 MHz - over twice the speed of the TRS-80<sup>™</sup> Model I.

**NEW**

**EXTERNAL DATA SEPARATOR**  
ASSEMBLED AND FULLY TESTED  
\$14.95  
SOME SOLDERING REQUIRED

### SYSTEM EXPANSION

AT **\$69.95** [PC BOARD & USER MANUAL]

- SERIAL RS232 C/20mA I/O
- FLOPPY CONTROLLER
- 32K BYTES MEMORY
- PARALLEL PRINTER PORT
- DUAL CASSETTE PORT
- REAL-TIME CLOCK
- SCREEN PRINTER BUS
- ONBOARD POWER SUPPLY
- SOFTWARE COMPATIBLE
- SOLDER MASK, SIK SCREEN

### ORDERING INFORMATION

Add \$3 for postage and handling. CA residents add 6% sales tax



## FOR SERIOUS USERS OF 8080, 8085, OR Z80 COMPUTERS

**PRINTER WIZARD** - Now add powerful capabilities to your printer. Free your computer for use while simultaneously printing backlogged output on a first-in-first-out basis. Transparent operation without noticeable slowing of the computer. Allows continuous computer and printer operation on programs having sporadic output. Will backlog up to 100 pages when used with a disk system. Adds optional automatic paging with numbers, adjustable margins on 4 sides, indented overflow lines. Occupies less than 2 1/2 K.

Documentation only	EX80M103	\$45.00
	EX80M103D	\$ 7.50

**DISASSEMBLER** - Disassemble machine code into standard source language. Modify or relocate existing programs such as DOS or BASIC using your existing assembler (not included). Disassembles any 8080, 8085, or Z80 code, including embedded data blocks and "trick" codes. Generates symbol and label tables.

Documentation only	EX80M217	\$75.00
	EX80M217D	\$12.50

ALL EXCOM products are fully supported and warranted indefinitely against original defects. Available on single or double density NORTHSTAR 5 1/4" diskettes, 300 or 1200 baud cassettes (specify). Washington residents add 5.3% tax.

## EXCOM

P.O. Box 1802 Bellevue, Washington 98009 U.S.A.  
Telephone (206) 641-6577

## LEAPAC SERVICES

- MAURO PROAC MP-250 PLOTTER - \$695
- with L2D Plot package - \$795
- with L2D & L3P packages - \$950

LEAPAC SERVICES

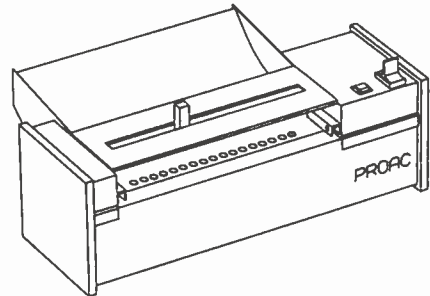

**MAURO PLOTTER** - Uses 11" by 8-1/2" or any length paper. Resolution is 200 steps per inch. 0.005" tracking error. Mauro X-Y vector software with pen control is available for 8080/Z80, 6502, & 6800 micro-processors. Requires 5 bits of a parallel output port. APPLE, TRS-80, and RS232 Interfaces are available as I/O Options.

**LEAPAC SOFTWARE** - Supports complete 2D & perspective plotting, including ASCII and curve generation. Available as relative linking libraries (L80) for MICROSOFT compatible software products, FORTRAN-80, COBOL-80, COMPILER BASIC, and MACRO-80 in CP/M compatible files on 8" IBM-3740 disks or 5-1/4" NORTHSTAR formatted disks.

**L2D** - X-Y plot package. Contains over 20 entries, including CALCOMP compatible calls such as PLOT and WHERE.

**L3P** - Perspective plot package. Contains over 70 entries. Capable of SCROLLING, PANNING, ANIMATION and much more. (See self portrait above).

LEAPAC SERVICES (916) 381-1717  
8245 MEDITERRANEAN WAY SACRAMENTO CA 95826  
DEALER INQUIRIES ARE INVITED

CP/M is a registered trade mark of Digital Research, Inc. MICROSOFT is a trade mark of MICROSOFT, Inc. COBOL is a trade mark of California Computer Products, Inc.

7a

```

W1= 40      AY(1)=0
W2= 0       AY(2)=1
Z1= 100     AY(3)=2
Z2= 0       AY(4)=2
S1= .005    AY(5)=0
            AY(6)=0
            AY(7)=2

AX(1)=1
AX(2)=2
AX(3)=2.1   TI=1
AX(4)=1     TA=7
AX(5)=0     IN=1
AX(6)=1
AX(7)=2.1   GOSUB 10000

```

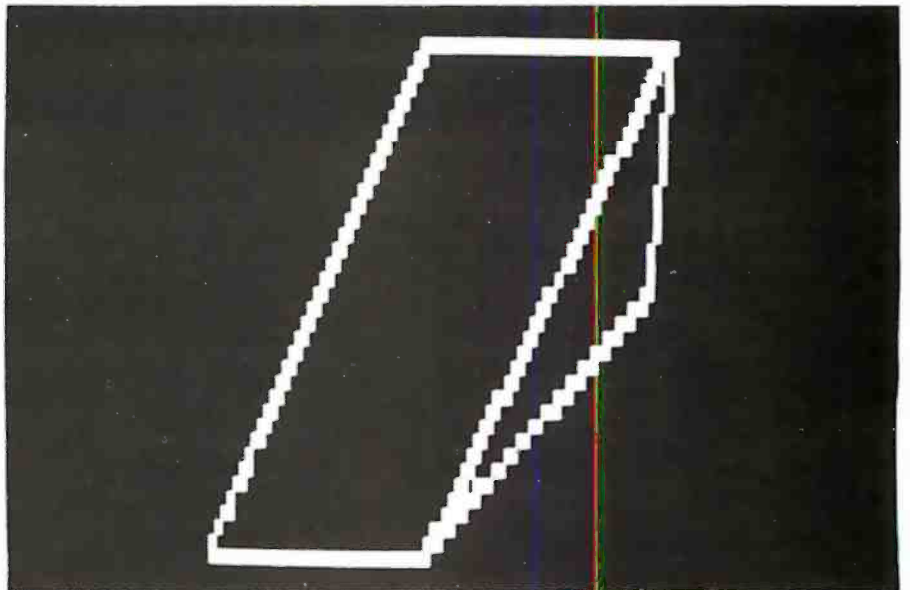

7b

```

W1= 40      AY(1)=0
W2= 0       AY(2)=0
Z1= 100     AY(3)=1
Z2= 0       AY(4)=2
S1= .005    AY(5)=2
            AY(6)=1
            AY(7)=0
            AY(8)=1
            AY(9)=1
            AY(10)=0
            AY(11)=1
            AY(12)=2

AX(1)=0
AX(2)=1
AX(3)=2
AX(4)=2.3
AX(5)=1.3
AX(6)=0.3
AX(7)=0
AX(8)=0.3   TI=1
AX(9)=1.3   TA=12
AX(10)=1    IN=1
AX(11)=1.3
AX(12)=2.3  GOSUB 10000

```

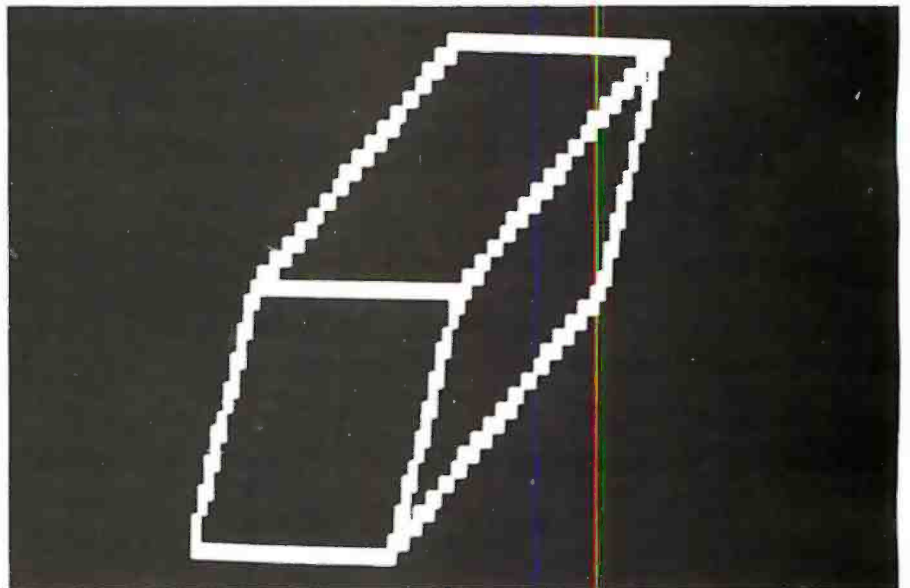

7c

```

W1= 40      AY(1)=1
W2= 0       AY(2)=0
Z1= 100     AY(3)=0
Z2= 0       AY(4)=1
S1= .005    AY(5)=.3
            AY(6)=0
            AY(7)=0
            AY(8)=.4
            AY(9)=.4
            AY(10)=.58
            AY(11)=.91

AX(1)=.5
AX(2)=0
AX(3)=1
AX(4)=.5
AX(5)=1.3
AX(6)=1
AX(7)=0
AX(8)=.2    TI=1
AX(9)=.8    TA=11
AX(10)=.98  IN=1
AX(11)=.6   GOSUB 10000

```

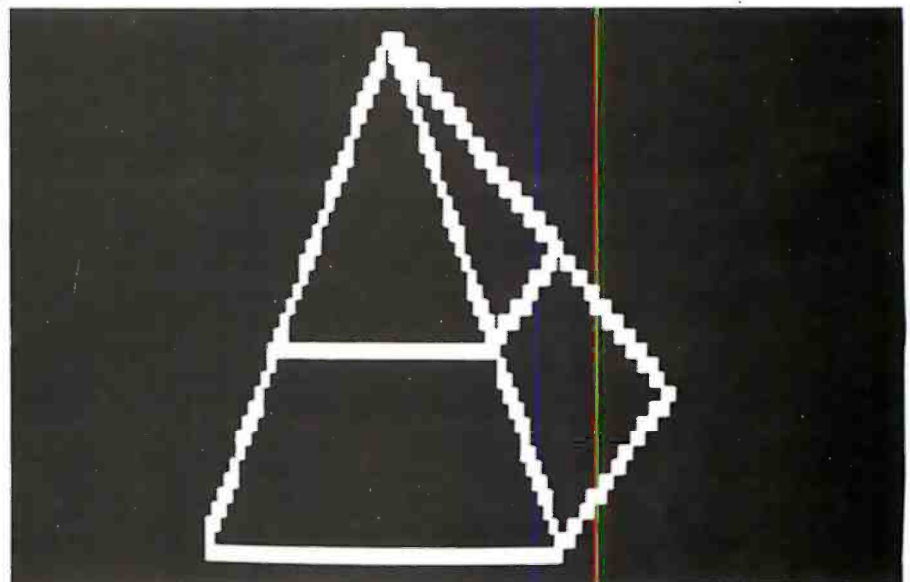
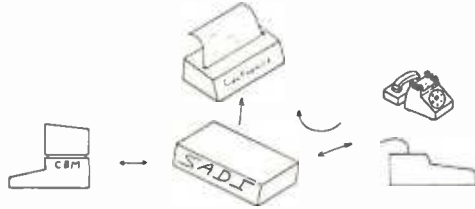

Figure 7: Three-dimensional displays are also achieved through the transformation to an array.

## PET TWO-WAY RS-232 and PARALLEL OUTPUT INTERFACE



SAOI - The microprocessor based serial and parallel interface for the Commodore PET. SADI allows you to connect your PET to parallel and serial printers, CRT's, modems, acoustic couplers, hard copy terminals and other computers. The serial and parallel ports are independent allowing the PET to communicate with both peripheral devices simultaneously or one at a time. In addition, the RS-232 device can communicate with the parallel device.

Special Features for the PET interface include:  
 Conversion to true ASCII both in and out  
 Cursor controls and function characters specially printed  
 Selectable reversal of upper and lower case  
 PET IEEE connector for daisy chaining  
 Addressable - works with other devices

Special Features for the serial interface include:  
 Baud rate selectable from 75 to 9600  
 Half or full duplex  
 32 character buffer  
 X-ON, X-OFF automatically sent  
 Selectable carriage return delay

Special Features for the parallel interface include:  
 Data strobe - either polarity  
 Device ready - either polarity  
 Centronics compatible

Complete with power supply, PET IEEE cable, RS-232 connector, parallel port connector and case. Assembled and tested.  
 SADla (110VAC) \$295  
 SADte (230VAC) \$325

Order direct or contact your local computer store.



Connecticut  
microComputer, Inc.

34 DEL MAR DRIVE, BROOKFIELD, CONNECTICUT 06804  
 TEL: (203) 775-4595 TWX: 710-456-0052

VISA AND MC ACCEPTED - SEND ACCOUNT NUMBER, EXPIRATION DATE AND SIGN ORDER. ADD \$3 PER ORDER FOR SHIPPING & HANDLING - FOREIGN ORDERS ADD 10% FOR AIR POSTAGE. MENTION THIS MAGAZINE WITH YOUR ORDER AND DEDUCT 2%.

## PET to NEC and CENTRONICS PRINTER ADAPTER

### LOWEST COST COMPLETE INTERFACE ON THE MARKET

Simple to use - low cost - designed for NEC 5530 Spin-writer and Centronics parallel printers. Works with WORDPRO and other software. Switch for upper-lower case conversion or upper case only.

Plugs into the PET and into the printer - all cables and connectors included - extra IEEE connector for Commodore disk drives.

Uses BASIC PRINT statements - no machine code needed.

Device address selectable - works with other peripherals.

\$129 complete - compare to others at \$225. Generous dealer discounts.

Assembled and tested. Our usual 30 day money back trial period applies.

Order direct or contact your local computer store.



Connecticut  
microComputer, Inc.

34 DEL MAR DRIVE, BROOKFIELD, CONNECTICUT 06804  
 TEL: (203) 775-4595 TWX: 710-456-0052

VISA AND MC ACCEPTED - SEND ACCOUNT NUMBER, EXPIRATION DATE AND SIGN ORDER. ADD \$3 PER ORDER FOR SHIPPING & HANDLING - FOREIGN ORDERS ADD 10% FOR AIR POSTAGE. MENTION THIS MAGAZINE WITH YOUR ORDER AND DEDUCT 2%.

# MICAH

## OSBORNE COMPATIBLE READY to RUN BUSINESS SOFTWARE in CBASIC2 or 16K BASIC

### \* features \*

- Four Complete Packages...
  - General Ledger
  - Accounts Receivable
  - Accounts Payable
  - Payroll with Cost Accounting
- Strong support from Osborne Manuals
- CBASIC2 runs under CP/M or under CDO5 version 1.07 on Cromemco computers
- 16K BASIC runs on Cromemco computers
- Cursor addressing routines from Hazeltine, Lear Siegler and Cromemco (Beehive) Terminals
- Source Codes and Installation Instructions provided along with disks
- Automatic Command Start-up
- Easy to apply to all of your business and systems needs

### \* hardware required \*

- One or more 8" or 5" Floppy Drives
- CRT with cursor addressing
- 132-Column Printer

**\$14500**  
per package

TO ORDER:  
Add \$5 for shipping  
Call add 6-1/2% Sales Tax  
CREDIT CARDS ACCEPTED  
Osborne Manuals \$25 each

\* DEALER INQUIRIES INVITED \*

- |  |   |  |
|--|---|--|
| • OSBORNE READY to RUN BUSINESS SOFTWARE | • EXPAND(Run Cromemco Software on CP/M) | • DUP 3(Disk Util- ition for Cromemco) |
| • SMO5(CP/M for Cromemco computers)      | • MICROPL0T(Versatile Printer Graphics) | • DUP 4(Double sided)                  |
| • X-105(MP/M for Cromemco Computers)     | • DRIVE(Customized Printer Drivers)     | • DUP 5(Disk Util- ities for CP/M)     |
|  |   | • DUP 6(Dbl. Density)                  |

\* Call or Write for Free Catalogue and More Information \*

\* We will Customize any of our programs at our Standard Consulting Rates \*

\* All orders usually shipped 8" For 5" disks add \$20.00 for downloading:

MICAH BOX 4987 WALTON CREEK CATH 9256 ph. 313/413-2783

MICRO Applications and Hardware

\* CONSULTANTS and SOFTWARE DEVELOPERS \*

## TRS 80-I TRS 80-II

TRSDOS®  
NEWDOS®

TRSDOS®  
P & T CP/M®

# EDITOR

EDIT ANY ASCII FILE/PROGRAM  
GLOBAL SEARCH/REPLACE

ABSOLUTELY THE BEST

**79<sup>95</sup>**      **99<sup>95</sup>**

### ALSO AVAILABLE

Osborne Accounting Model I & Model II CP/M Host program for Model II CP/M®

VISA  
or  
Money  
Order



## BYTES & FLIGHTS

7631 - St. Albans Rd.  
Richmond, B.C.  
V6Y 2K8  
(604) 278-5200

# Looking for the Lowest Prices

on



## TRS-80<sup>®</sup>

We have consistently offered the TRS-80 line at savings **up to 20%**, which means you can save \$150 to \$1500 by buying directly from Computer Discount of America.

**TRS-80 Model II, 64K System, with disc drive — only \$3385.00**

Other TRS-80 Model I, Model II, or Model III computers and systems, are in stock at similar savings.

## TRS-80<sup>®</sup>

Our savings are as big on stands, expansion interfaces, printers, diskettes — everything for your TRS-80 System. We also stock the new TRS-80 Color Computer, and Pocket Computer.

**ATARI<sup>®</sup>**

**400 - \$499.00**

**800 - \$799.00**



The computers, accessories, and hardware are brandnew, in factory sealed cartons, and carry a full factory warrant.

Most models are in stock for immediate delivery (usually within 7-10 days), and a price quote is as near as your phone.

So if you're looking for the **lowest prices in the U.S.A.**, for microcomputers and accessories, call Computer Discount of America, West Milford, New Jersey, 07480. 201-728-8080. **NO TAX ON OUT-OF-STATE SHIPMENTS.**

**TOLL FREE 800-526-5313**

**Computer  
Discount  
of America**

**Listing 2:** The axis-creating subroutine shown here produces properly scaled axes, complete with tic marks and labels, from a set of values specified by inserting BASIC statements.

```

20000 IF X1 <= 0 AND X2 <= 0 THEN A1 = Z1 ELSE A1 = Z2
20005 IF X1 >= 0 AND X2 <= 0 THEN A1 = Z2 - X2/A
20010 FOR I1 = 0 TO 1
20015 FOR J1 = W2 TO W1
20020 SET ((A1 + I1), (47 - J1))
20025 NEXT J1
20030 NEXT I1
20035 IF Y1 <= 0 AND Y2 <= 0 THEN B1 = 47 - W1 ELSE B1 = 47 - W2
20040 IF Y1 >= 0 AND Y2 <= 0 THEN B1 = 47 - W2 + Y2/B
20045 FOR I3 = Z2 TO Z1
20050 SET(I3, B1)
20055 NEXT I3
20060 FOR I5 = 1 TO 3 STEP 2
20065 FOR J5 = 0 TO 1
20070 FOR K5 = X2 TO X1 STEP C1
20075 SET(((K5 - X2)/A + Z2 + J5), (B1 - I5 + 2))
20080 NEXT K5
20085 NEXT J5
20090 NEXT I5
20095 FOR I6 = 0 TO 4 STEP 2
20100 FOR J6 = 2 TO 3
20105 FOR K6 = Y2 TO Y1 STEP C2
20110 SET((A1 + J6 - I6), (47 - ((K6 - Y2)/B + W2)))
20115 NEXT K6
20120 NEXT J6
20125 NEXT I6
20130 IF B1 < > 47 - W2 GOTO 20145
20135 IF A1 = Z2 - X2/A THEN P1 = -64 ELSE P1 = 64
20140 IF A1 = Z2 THEN P2 = -4 ELSE P2 = 4
20145 IF B1 < > 47 - W1 GOTO 20160
20150 IF A1 = Z2 - X2/A THEN F1 = 64 ELSE P1 = -64
20155 IF A1 = Z2 THEN P2 = -4 ELSE P2 = 4
20160 IF B1 < > 47 - W2 + Y2/B GOTO 20175
20165 P1 = -64
20170 IF A1 = Z2 THEN P2 = 4 ELSE P2 = -4
20175 Z3 = LEN(AX$)
20180 Z4 = (Z1 + Z2)/2
20185 I7 = 0
20190 FOR J7 = 3 TO 45 STEP 3
20195 IF B1 < J7 GOTO 20210
20200 I7 = I7 + 64
20205 NEXT J7
20210 Z5 = Z4/2 + I7 - Z3/2
20215 IF A1 = Z2 - X2/A AND B1 = 47 - W2 + Y2/B THEN DU = 5 ELSE DU = 0
20220 PRINT @ Z5 + P1 + DU, AX$,
20225 W3 = LEN(AY$)
20230 FOR I8 = 1 TO W3
20235 F$(I8) = MID$(AY$, I8, 1)
20240 NEXT I8
20245 W4 = (W1 + W2)/2
20250 J6 = 0
20255 FOR K8 = 3 TO 45 STEP 3
20260 IF 47 - W4 < K8 GOTO 20275
20265 J8 = J8 + 64
20270 NEXT K8
20275 W5 = J8 + A1/2 - (INT(W3/2) - 1) * 64
20280 L8 = 0
20285 FOR M8 = W5 TO (W5 + (W3 - 1) * 64) STEP 64
20290 L8 = L8 + 1
20295 PRINT @ M6 + P2, F$(L8);
20300 NEXT M8
20305 F1(1) = 47 - W1
20310 F1(2) = 47 - W2
20315 F1(3) = B1
20320 F1(4) = B1
20325 F3(1) = A1/2
20330 F3(2) = A1/2
20335 F3(3) = Z1/2
20340 F3(4) = Z2/2
20345 FOR I9 = 1 TO 4
20350 J9 = 0
20355 FOR K9 = 3 TO 45 STEP 3
20360 IF F1(I9) < K9 GOTO 20375

```

Listing 2 continued on page 310



Listing 2 continued:

```

20365 I9=I9+64
20370 NEXT K9
20375 F2(I9)=I9+F3(I9)
20380 NEXT I9
20385 IF ABS(Y1)>1E4 OR ABS(Y1)<1E-2 THEN D1$="#.###[|]"
ELSE D1$="#####.###"
20390 IF ABS(Y2)>1E4 OR ABS(Y2)<1E-2 THEN D2$="#.###[|]"
ELSE D2$="#####.###"
20395 IF ABS(X1)>1E4 OR ABS(X1)<1E-2 THEN D3$="#.###[|]"
ELSE D3$="#####.###"
20400 IF ABS(X2)>1E4 OR ABS(X2)<1E-2 THEN D4$="#.###[|]"
ELSE D4$="#####.###"
20405 IF B1 < >47 - W2 + Y2/B GOTO 20435
20410 D1=1
20415 D2=-9
20420 D3=-68
20425 D4=60
20430 GOTO 20505
20435 IF B1 < >47 - W1 GOTO 20475
20440 D1=-68
20445 D2=-68
20450 D4=60
20455 IF A1=Z1 THEN D3=65
20460 IF A1=Z2 THEN D3=54
20465 IF A1=Z2 - X2/A THEN D3=-68
20470 GOTO 20505
20475 D1=60
20480 D2=60
20485 D3=-68
20490 IF A1=Z2 THEN D4=-74
20495 IF A1=Z1 THEN D4=-62
20500 IF A1=Z2 - X2/A THEN D4=60
20505 PRINT @ F2(1)+D3,USING D1$,Y1;
20510 PRINT @ F2(2)+D4,USING D2$,Y2;
20515 PRINT @ F2(3)+D1,USING D3$,X1;
20520 PRINT @ F2(4)+D2,USING D4$,X2;
20525 RETURN
    
```

All scaling and other mundane functions are taken care of in the subroutine.

Text continued from page 298:

displayed as in figure 5. This is for a graph of the cost of heating for every month displayed in the total viewport.

Clearly, it is easy to plot any set of data that can be represented in array form. Remember that all scaling and other mundane functions are taken care of in the subroutines. You don't need to be concerned or irritated by the gyrations needed to create displays on the TRS-80.

### Analytic Functions

In order to plot any analytic function, be prepared to transform the function into array form. An example of this is best demonstrated in the plotting of the function:

$$Y = X^5 + X^4 - X^3$$

This is for X taking on values from -10 to 10. In order for this to occur the following BASIC initialization routine is needed:

```

FOR I=-10 TO 10
AX(I+10)=I
AY(I+10)=I5+I4-I3
NEXT I
TI=0
TA=20
IN=1
AX$="X AXIS"
AY$="Y AXIS"
C1=2
C2=49750
    
```

The result should appear as shown in figure 6. Note that the correct quadrants are displayed.

Another feature provided by this graphics package is the ability to create *three-dimensional* graphs. Figures 7a, b, and c give several examples of this, along with the array values used. The displayed figures are not necessarily functions, but may have more than one y value for each value of x.

So, creating graphic displays isn't as time-consuming as you might have once believed, and now there's less distance between the creative idea and its final realization on screen. ■

## TRS-80, PET, APPLE, SORCERER

### Communications Interface Systems



- Send & Receive Morse Code / Radioteletype
- Teaches Morse Code! / Copies wire services!
- Complete Hardware & Software Package
- Extensive User Manuals
- From \$129

**Write or call for complete catalog**



**MACROTRONICS, inc.®**  
1125 N. Golden State Blvd. / Suite G  
Turlock, CA 95380 (A)  
(209) 667-2888 / 634-8888



California residents add 6% tax

**We are experiencing telephone difficulties, please keep trying.**



# ZENITH

# BUSINESS SOFTWARE FOR THE Z-89!

S & M Systems, Inc., the "All-In-One" Software Company  
is offering a full line of Business Packages for the  
"All-In-One" Z-89 Microcomputer

Inseq-80(TM) Business Software Systems  
Industry Standard Osborne Based: Accounts Payable/Receivable,  
General Ledger, Payroll

S & M Software: Retail Inventory Control, Invoicing,  
Manufacturers Inventory Control, Customer Mail List

**PLUS MANY MORE!!**

All Systems have been Field Tested and are ready for shipment!  
CALL ABOUT OUR NATIONAL DEALER PROGRAM AND JOIN THE BEST  
IN SELLING THE FINEST SOFTWARE ON THE Z-80 MARKET!

**SYSTEMS ALSO OPERATE ON TRS-80 MOD I, MOD II, MOD III  
AND ALTOS MICROCOMPUTERS**

For Further Information, Contact: **S & M Systems, Inc.**  
P. O. Box 1225  
Haverhill, Massachusetts 01830

Or Dial Direct: 1-617-373-1599  
1-617-481-5231

# NEVADA COBOL

## For CP/M

Powerful subset of ANSI-74

Order now!  
All the elegant simplicity  
of COBOL is now affordable!

**\$99<sup>95</sup>**  
DISKETTE  
&  
MANUAL

**REQUIRES** only 16K RAM.  
**Available** on 8" CP/M  
standard single density or  
5 1/4" diskettes for North  
Star, TRS-80 Mod I and  
Superbrain. Other formats  
too! Manual alone \$24.95.

These powerful, easy to use  
**COBOL APPLICATION PACKAGES**  
are also available:

- BUDGET PLAN REPORT GENERATOR**  
Fantastic time saver and planning aid for beginning or established businesses.
- PERSONAL FINANCIAL REPORTING**  
Eye-opening insights of personal spending.
- LABELS** for mailing lists.
- PRECOCOL** (a preprocessor).

**ALL 4 in one BOOK!**  
73 pages with complete COBOL  
source code listings and super  
documentation.

**\$24<sup>95</sup>**

WE ACCEPT



**Ellis Computing**  
1480 17th Avenue  
San Francisco, CA 94122  
(415) 664-1534



**GO FOR IT!**

In CA add sales tax. CP/M trade mark of Digital Research. TRS-80 trade mark of Tandy Corp.

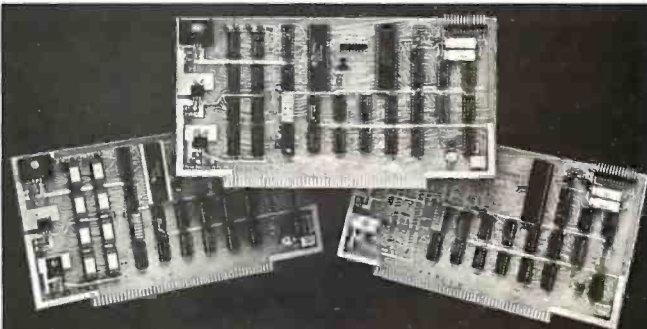

### COLOR VIDEO PROCESSOR

• Text, Graphics, Animation • 16 Colors • 256 x 192 Resolution  
• NTSC Composite Video Output • Uses TMS 9918 • Includes  
I/O Mapped 16K Video Memory • 3D Simulation with 32 Video  
Sprites • 2 Byte X-Y Positioning • Real Time Clock • 8 Level  
Interrupt Selection • Inexpensive RF Modulator allows easy  
connection to any color TV •

### PROGRAMMABLE SOUND GENERATOR

• Music, Sound Effects, Tone Signaling, Ultrasonics • 27 Hz to  
111 KHz Range • 3 Programmable Analog Channels with Separate  
Frequency, Volume and White Noise Control • 10 Selectable  
Envelope Wave Shapes under Software Control • Two 8-Bit  
Programmable I/O Ports for use as External Keyboard/Display  
Interface • Power Amplifier for driving External Speaker •

**INTRODUCTORY  
OFFER**

SINGLE BOARD COLOR VIDEO  
AND SOUND GENERATOR KIT . . . \$350  
COLOR VIDEO KIT . . . . . \$295  
SOUND GENERATOR KIT . . . . . \$195

Texas residents add 5% sales tax. Prices include complete documentation, manuals  
and programming examples. PC board is solder-masked with gold contacts. Add \$100  
for assembled and tested units. Send \$9.50 for documentation only, refundable with  
order. Compatible with Z80, 8085 and 8080 at 2 or 4 MHz on S-100 buss.



**ELECTRONIC DESIGN ASSOCIATES**

P.O. Box 94055 Houston, Texas 77018 (713) 999-2255

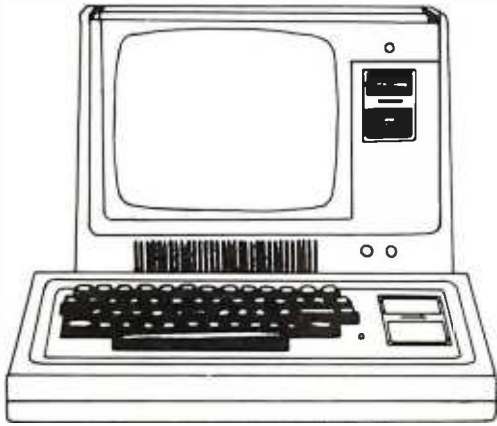

## MODEL I \$699

	LIST PRICE	OUR PRICE
Model-I, Level-II, 4K	\$649.00	\$619.00
Model-I, 16K no Keypad	\$768.00	\$669.00
Model-I, 16K w/Keypad	\$849.00	\$729.00
Model-II, 64K RAM	\$3899.00	\$3799.00
Model-III, 16K RAM	\$999.00	\$929.00
Model-III, 32K Dual Disk	\$2495.00	\$2299.00
Pocket Computer w/Interface	\$298.95	\$269.00
TRS-80 Color Computer	\$399.00	\$359.00
TRS-80 Color Computer Expanded	\$599.00	\$519.00
COMM-80 Interface	\$179.95	\$159.95
CHATTER BOX Interface		\$259.95
DISK-80 Interface	\$349.95	\$329.95
Expansion Interface, no RAM	\$299.00	\$279.00
Expansion Interface, 16K RAM	\$418.00	\$339.00
Expansion Interface, 32K RAM	\$537.00	\$399.00
RS-232-C Board	\$99.00	\$89.00



## MODEL III \$929



## POCKET COMPUTER \$269

with interface

	LIST PRICE	OUR PRICE
TRS-232 Printer Interface		\$59.95
16K Memory Kit, TRS-Keypad	\$119.00	\$59.00
16K Memory Kit, TRS-Exp. Int.	\$119.00	\$59.00
Upper/lower Mod Kit	\$59.00	\$24.95
Video Reverse Kit		\$23.95
CPU Speed-up Kit		\$24.95
Data Dubber		\$49.95
Percom Electric Crayon, w/cable		\$279.95
TRS-80 Dust Cover (3pc set)	\$9.95	\$7.95
TRS-80 Computer Case	\$109.00	\$99.95
TRS-80 Monitor Case	\$84.00	\$84.00

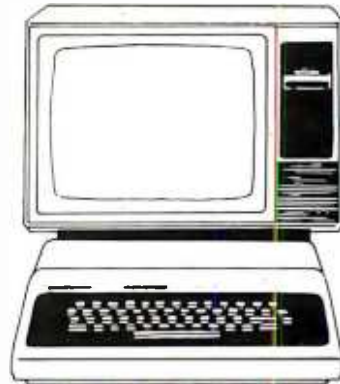

## COLOR COMPUTER \$359

	LIST PRICE	OUR PRICE
Percom, TFD-100, 40-track	\$429.95	\$399.00
Percom, Dual TFD-100 Drives	\$849.00	\$799.00
Percom, TFD-40, 40-track	\$399.95	\$379.00
Percom, TFD-200, 77-track	\$675.00	\$629.00
Hardside, 40-track Disk Drive	\$399.00	\$359.00
Percom Data Separator		\$29.95
Percom Extender Card	\$15.95	\$15.00
2-Drive Cable	\$29.95	\$29.00
4-Drive Cable	\$39.95	\$39.00

## TERMS:

TERMS: Prices and specifications are subject to change. HARDSIDE accepts VISA & MASTERCARD. Certified checks and Money Orders; Personal checks accepted (takes 3 weeks to clear). HARDSIDE pays all shipping charges (within the 48 states) on all PREPAID orders OVER \$100.00. On all orders over \$100 a \$2.50 handling charge must be added. COD orders accepted (orders over \$250 require 25% deposit) there is a \$5.00 handling charge. UPS, Blue Label, and Air Freight available at extra cost.

TO ORDER TOLL-FREE:  
**1-800-258-1790**  
 (In NH call 673-5144)

**HARDSIDE** 



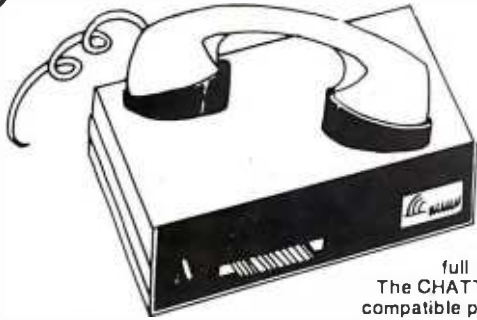

# The Chatterbox

## A TRS-80 Interfacing Alternative

The CHATTERBOX is a unique packaging combination of the presently available COMM-80 I/O Interface for the TRS-80\* and an acoustic modem. This one box is all that is required to turn even a barebones 4K TRS-80\* into a full time-sharing terminal.

The CHATTERBOX includes built-in programmable 50-19200 baud serial port, a Centronics compatible parallel printer port, a 300 baud acoustic originate modem, and a spare TRS-BUS expansion connector. It comes complete with power supply, ribbon cable and connector, user's manual, and terminal software for immediate operation. When the modem is in use, the complete data conversion is automatically routed to the serial output port where it can be logged on a printer.

The CHATTERBOX is the only peripheral needed to allow a TRS-80\* to communicate with time-sharing systems such as MICRONET and the SOURCE.

It is completely hardware and software compatible with existing TRS-80\* products and connects either to the keyboard connector or screen printer port on the RS Expansion Interface. Features: Full 8-bit parallel port; RS-232-C serial port (up to 19,200 baud); Acoustic modem; TRS-BUS connector for future expansion; Connects to Keyboard or E.I.; Includes terminal software; Users manual; Power supply. \$259.95

## PRINTERS

	LIST PRICE	OUR PRICE		LIST PRICE	OUR PRICE
Centronics 730	\$795.00	\$749.00	LRC to TRS-80		\$20.00
Centronics 730-3	\$895.00	795.00	LRC to PET, IEEE		\$59.00
Centronics 737	\$995.00	\$869.00	LRC to RS232C, male or female		\$65.00
Centronics 779	\$1395.00	\$1095.00	730 or 737 to TRS-80		\$29.00
Centronics 779 w/lower case	\$1595.00	\$1195.00	NEC or 779 to TRS-80		\$35.00
NEC 5510 SpinWriter	\$3195.00	\$2595.00	RS-232-C to RS-232-C, male to male		\$24.95
NEC 5520 SpinWriter	\$3395.00	\$2895.00			
NEC 5530 SpinWriter	\$3195.00	\$2495.00			
NEC Tractor-Feed Option	\$249.00	\$225.00			
LRC 7000* (64-col.)	\$405.00	\$299.00			
LRC 7000* (40-col.)	\$389.00	\$289.00			
Okidata Microline-80	\$800.00	\$699.00			
Tractor-Feed Option	\$140.00	\$129.00			
RS-232-C Option	\$299.00	\$279.00			

## GENERAL INTEREST

	LIST PRICE	OUR PRICE
BSR System X-10 Home Controller	\$124.95	\$109.95
BUSY BOX, TRS-80	\$114.95	\$99.95
BUSY BOX, S-100	\$119.95	\$114.95
AC-SFK-31 Line Filter	\$24.95	\$19.95
ISO-2 Line Filter & Isolator	\$56.95	\$49.95
ISO-2/CBS Line Filter-Isolator	\$70.95	\$59.95
ISO-7/CB Super Filter-Isolator	\$146.95	\$99.95
Mini-Flex Diskette File	\$24.95	\$19.95
CASIO C-80 Calculator Watch	\$49.95	\$44.95
BONE FONE	\$69.95	\$56.95
LOGOS-9 Printing Calculator	\$99.95	\$79.95

## SPECIAL



**BONE FONE**  
**\$56.95**

(plus \$2.50 postage and handling)

**CASIO**  
**C-80 CALCULATOR**  
**WATCH \$44.95**

(plus \$2.50 postage and handling)

**OLIVETTI**  
**LOGOS-9**  
**PRINTING**  
**CALCULATOR**  
**\$79.95**

(plus \$2.50 postage and handling)



**HARDSIDE** TO ORDER TOLL-FREE  
**1-800-258-1790**  
(In NH call 673-5144)



# Event Queue

November 1980

*November-February*  
**Courses from Integrated Computer Systems Inc.**, throughout the US. Courses are being offered on VIO—Voice Input/Output for Computers and Programming in Ada. The VIO course will teach par-

ticipants to apply voice-processing algorithms and software, utilize speech synthesis techniques, and design voice-recognition systems. There will be systems on which students can learn. Programming in Ada will cover language features, structured programming, interrupt handling, external I/O (input/output) inter-

faces, and more. This course is designed for programmers, systems analysts, software engineers, and for those in the aerospace and defense industries. For schedules of the times and cities, contact ICS Inc., 3304 Pico Blvd, POB 5339, Santa Monica CA 90405, (213) 450-2060.

*November-December*  
**Datapro Seminars**, throughout the US. Seminars on data communications, teleprocessing software, distributed systems, systems analysis design, word processing, and more, will be given. The enrollment fee is \$530 for current Datapro subscribers and \$580 for non-subscribers. For information on when and where the seminars are being held, contact Datapro Research Corporation, 1805 Underwood Blvd, Delran NJ 08075, (609) 764-0100.

*November-February*  
**Courses from Harvard**, throughout the US, and in London, England. Business graphics, digital-image processing, computer mapping, computer graphics, and information systems for natural resources, are some of the one- and two-day courses being sponsored by the Harvard Graduate School of Design Laboratory for Computer Graphics and Spatial Analysis. For a complete schedule, contact the Laboratory in Cambridge MA 02138, or contact Karen Smolens, Center for Management Research, 850 Boylston St, Chestnut Hill MA 02167.

*November 8*  
**Fall 1980 California Com-**



## Waiting On Delivery of A DEC LA120?

**Avoid the hassle by upgrading your LA36 for 1200 baud operation with a DS120 Terminal Controller.**

The Datasouth DS120 gives your DECwriter® II the high speed printing and versatile performance features of the DECwriter® III at only a fraction of the cost. The DS120 is a plug compatible replacement for your LA36 logic board which can be installed in minutes. Standard features include:

- 165 cps bidirectional printing
- Horizontal & Vertical Tabs
- Page Length Selection
- 110-4800 baud operation
- 1000 character print buffer
- X-on, X-off protocol
- Self Test
- RS232 interface
- 20 mA Current Loop interface
- Top of Form
- Adjustable Margins
- Double wide characters
- Parity selection
- Optional APL character set

Over 4000 DS120 units are now being used by customers ranging from the Fortune 500 to personal computing enthusiasts. In numerous installations, entire networks of terminals have been upgraded to take advantage of today's higher speed data communications services. LSI microprocessor electronics and strict quality control ensure dependable performance for years to come. When service is required, we will respond promptly and effectively. Best of all, we can deliver immediately through our nationwide network of distributors. Just give us a call for all the details.

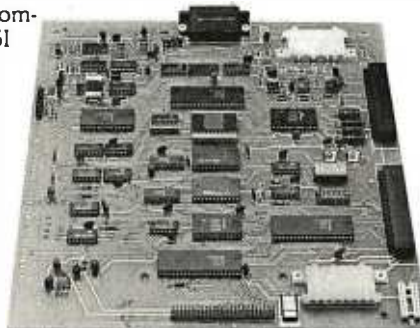

**DATASOUTH COMPUTER CORPORATION**

4740 Dwight Evans Road • Charlotte, North Carolina 28210 • 704/523-8500

*In order to gain optimal coverage of your organization's computer conferences, seminars, workshops, courses, etc, notice should reach our office at least three months in advance of the date of the event. Entries should be sent to: Event Queue, BYTE Publications, 70 Main St, Peterborough NH 03458. Each month we publish the current contents of the queue for the month of the cover date and the two following calendar months. Thus a given event may appear as many as three times in this section if it is sent to us far enough in advance.*

# CAT-100 FULL COLOR GRAPHICS

Complete line of color imaging systems with high resolution real time video **FRAME GRABBER** for the S-100 bus.

Capture and digitize a video frame in 1/60th of a second. Store up to 2 million bits of image data in on-board buffer. By software, select the best resolution for your application from 256 to 1280 pixels per TV line. Display your digitized image or your computer processed image with up to 256 gray levels or 65,536 simultaneous colors on standard B/W, NTSC or RGB color TV monitors.



480x512 Contoured digitized image



240x256 Digitized image. 16 levels

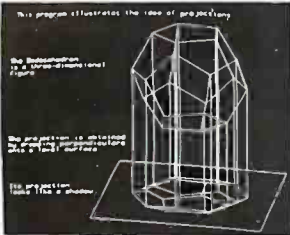

480x512 Computer generated

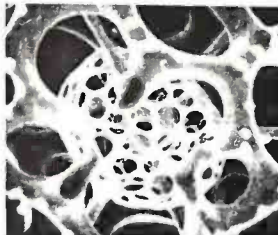

240x256 Digitized image. 16 levels

ROBOTICS-AUTOMATED COUNTING AND MEASURING-QUALITY CONTROL MONITORING-PATTERN RECOGNITION-IMAGE PROCESSING-MEDICAL AND SCIENTIFIC RESEARCH

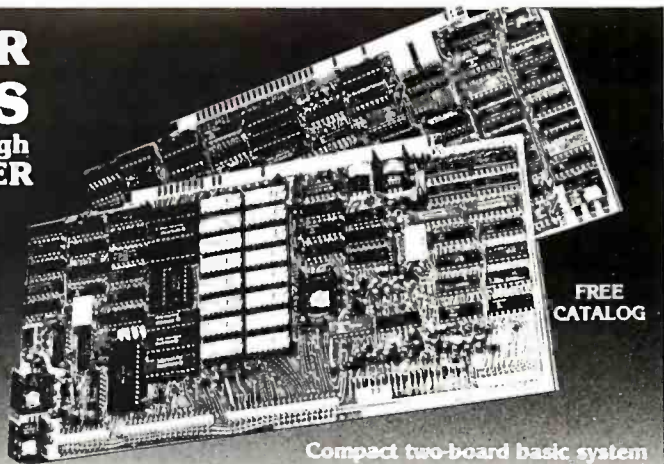

FREE CATALOG

Compact two-board basic system

### Features:

- Highest quality 480x512x8 digital video image
- Input capability from TV cameras or other sources
- Variety of synchronization choices
- 2 selectable video A/D conversion circuits
- Choice of 1, 2, 4, 8, 16 or 24 bits per pixel
- 32K-byte image memory on the basic system
- 64K, 128K, 192K and 256K-byte system capacity
- High resolution lightpen input
- Photographic trigger control input
- Software selectable system parameters
- Stand-alone intelligent graphics unit with universal interface

### Accessories:

- RGB color monitor
- High performance lightpen
- Hard copy printer/plotter
- Software packages available



441 California Avenue  
Palo Alto, CA 94306  
415/494-6088

## Disc/3 MART, INC.

# GO FOR IT!

FOR PRICE, QUALITY & RELIABILITY

ADDS REGENT 25 .....	\$ 875.00
ANACOM Printer (Ser./Par.) 150CPS .....	1095.00
ANADIX Printer DP-8000 .....	925.00
ANADIX Printer DP-9500/9501 .....	1425.00
BASE 2 Printer with options .....	599.00
CENTRONICS Printer 779 w/tractor .....	975.00
CENTRONICS Printer 730 (Parallel) .....	675.00
CENTRONICS Printer 737 (Parallel) .....	825.00
EATON Dot Matrix Parallel .....	399.00
EPSON TX80 Tractor Feed/Graftrax .....	Call
MICRO-TERMS .....	Call
NEC SPINWRITER 5510 R.O./forms tractor .....	2725.00
TELEVIDEO 920-B .....	795.00
TI99/4 Personal Computer/monitor .....	925.00
TRIMM—Printer Stand with basket .....	95.00

CALL FOR QUOTES ON ANY OTHER MICRO PRODUCTS  
We are dealers for BASF, DYSAN, 3M(SCOTCH) Diskettes, Cartridges, Mag Tape, etc. In addition we carry a complete line of Printer Ribbons and other data processing accessories.



1840 LINCOLN BLVD.,  
SANTA MONICA, CA 90404  
(213) 450-5911

## JOE COMPUTER\* Presents Exclusive Software: IT'S FOOTBALL SEASON!

### Pro and College Football from SDL:

A TRS 80† translation of Ken Perry's popular Apple programs. These programs predict point spreads with unbelievable accuracy. They are heuristic and require about 10 minutes a week to record the weekend's results into the data base from your local newspaper. You may predict any game within seconds from the data saved on cassette or disk. Pro Football contains all 28 pro teams. College football contains an unbelievable data base of 78 teams! Each program comes with the entire 1979 season data file on cassette or disk. You can display each team's record of scores or won-loss record. A record of 4-5 weeks is required before predictions are effective so you're just in time! Pro or College Football will be shipped U.P.S. blue label the same day order is received. Order C.O.D. by phone. \$1.00 blue label charge; C.O.D. fees added on.

Pro Football Cassette (32K TRS 80 Level II) .....	\$21.95
Disk .....	\$26.95
College Football Cassette (48K TRS 80 Level II) .....	\$21.95
Disk .....	\$26.95

### Horse Race Handicapping!

Probability Handicapping Device 1 was written by a professional software consultant to TRW Space Systems. This is a complex program carefully human factored for easy use. It is a comprehensive horse racing system for spotting overlays in thoroughbred sprint races. Your computer will accurately predict the win probability and odds line for each horse based on your entries from the racing form. The next day overlaid horses can be spotted on the track tote board. The users manual contains a complete explanation of overlay betting plus much more useful information. The appendix contains a detailed tab run of a 100 consecutive race system workout showing an amazing 50% return (\$50 returned for each \$1.00 flat wager). Includes many features such as error correction, bubble sort, line printer output, archiving, etc. The manual may be ordered separately for perusal for \$7.95 and credit. PHD-1 users manual and cassette for: BK Apple II Applesoft, BK Challenger (specify 1P or 4P), TRS-80 16K Level II .....

Apple or TRS-80 Disk .....	\$34.95
Brand new from SDL: <b>Win At The Races</b> another Ken Perry spectacular! This algorithm is based on a currently popular book representing the most ambitious multiple regression research on thoroughbred racing to date. The probable odds and win probability for each horse are displayed. Line printer output, error correction, descending sort: all the nketies!	
Win At The Races cassette (32K TRS-80 Level II) .....	\$34.95
Disk (48K TRS-80 Level II) .....	\$39.95

### THE BOOK for the Computerized Handicapper!

**WINNING AT THE RACES** by William Quirin Ph.D. Computer science has come to the rescue of the racing fan. This is the first major scientific study of handicapping available to the general public, detailing what the computer reveals about class, form, early speed, and more; plus special multiple regression computer systems. A Tom Alnsie — winners circle book. .....

Winning At The Races .....	\$21.95
	+ \$ 7.75 P & H

Order now to get on our list and receive back issues free!

Phone Orders: Mike (213) 992-0514 Systems Design Lab (213) 374-4471

Make Checks payable to: **JOE COMPUTER**  
22713 Ventura Blvd., Suite F, Woodland Hills, CA 91364

\*Get on the Computers & Gambling Products mailing list for \$3.00 & receive available back issues Calif. res. add 6% tax. †TRS-80 is a Registered Trademark of Tandy Corporation

puter Swap Meet will be held in the Gateway Hall at the Santa Clara County Fairgrounds 344 Tully Rd, San Jose CA. Show times are from 10 AM to 8 PM.

Manufacturers, stores, and individuals will display both top-of-the-line and used merchandise.

A special consignment table will be available for those who wish to drop off an item or two to be sold during the day. A free literature table is available to anyone within the industry. Admission to buyers

will be through the purchase of a redeemable \$5 purchase certificate. Sellers, both individuals and companies, should call (415) 966-6546 for booth prices, availability and reservations. Or, write to: California Computer Swap Meets, POB 52, Palo Alto CA 94302.

November 8-9

**Personal Computer Fair,** Pacific Science Center, Seattle WA. The theme of this year's fair is "Hands On." Both the booths and the

exhibits will reflect this idea, and the public will have access to as many computers and terminals as possible. Contact The Northwest Computer Society, POB 4193, Seattle WA 98119, (206) 284-6109.

November 10-13

**The Fourth Annual Data-Entry Management Conference,** Orlando FL. The theme of this conference is "Improving Productivity and the Quality of Working Life." This conference will cover data entry, dis-

tributed processing, and word processing with emphasis on data entry, including human-machine interface. Contact Data Entry Management Association, POB 3231, Stamford CT 06905, (203) 322-1166.

November 11-13

**Eleventh Annual Canadian Computer Show and Conference,** International Centre, 6900 Airport Rd, Toronto, Ontario. Computers and data-processing equipment, supplies and services, disk drives, terminals and printers, telecommunications equipment, software, and other related items will be displayed. Seminars and tutorials will also be included. Contact Industrial Trade Shows of Canada, 36 Butterick Rd, Toronto, Ontario M8W 3Z8, Canada.

November 12

**National Conference on the Use of On-Line Computers in Psychology,** St Louis MO. This conference is for computer users in psychology and related disciplines. These users will consider the use of computers in research, clinical practice, and teaching. Tutorial sessions will be included. Contact Dr Dominic Massaro, Program in Experimental Psychology, University of California, Santa Cruz CA 95064.

November 13-16

**The 1980 International Computer Music Conference,** Queens College, Flushing NY. This conference is for persons interested in computer applications in music. Conference activities include presentation of papers, concerts, workshops, panel discussions, meetings of special interest groups, demonstrations, and an exhibition of computer music equipment. For information, contact Dr Hubert S Howe Jr, Director 1980 International Computer Music Conference, Queens College, Flushing NY 11367, (212) 520-7342.

November 17-21

**Integrated Circuit Engineering,** Bergamo Center, 4435 E



## Marway has the AC Power Controller For Your System.

You'll find the ideal solution to AC power distribution needs in Marway's proven family of power controllers. From home audio visual centers to a time shared maxicomputer system. Marway products will stop "glitches", surges and unwanted line noises.

### MPD 110 Series of 3½" rack mount AC power controllers

- Low Price
- 10 outlets—8 switched (remote option), 2 unswitched (direct)
- 115 VAC and 230 VAC models
- 15 amp capacity
- High performance EMI filter
- Optional remote control



### MPD 115 Series of DEC Compatible Controllers

- Interchangeable with DEC model 861 and priced 40% less
- 12 outlets—8 switched, 4 unswitched (direct)
- 115 VAC and 230 VAC models
- Up to 30 amp capacity
- High performance EMI filter
- Optional delayed output and optional power fail restart

### MPD 117 low-cost AC power distribution

- Minimum cost
- 8 outlets—6 switched, 2 unswitched (direct)
- 10 amp capacity
- High energy EMI filter
- Transient suppressor

All Marway Power Controllers provide organized, noise-free power distribution of standard AC current to eliminate frequently experienced line transients and associated problems. They turn a single wall outlet into a controlled power source. Contact Marway today.

Marway can solve your power distribution problems and save you money.

## MARWAY PRODUCTS INC.

2421 South Birch Street, Santa Ana, CA 92707 (714) 549-0623

## Picture your data

with **x,y Genesis**

APPLESOFT® Subroutines Package . . . \$74.95

TURN THIS	HISTORY			PROJECTED	
	1977	1978	1979	1980	1981
SALES REVENUE	445.3	474.7	512.3	540.7	597.3
TOTAL EXPENSES	413.4	437.0	467.5	498.4	536.4
PROFIT BEFORE TAXES	31.9	37.7	44.8	50.3	61.0
FEDERAL TAXES	15.9	18.9	22.4	25.1	30.5
NET PROFIT	15.9	18.9	22.4	25.1	30.5

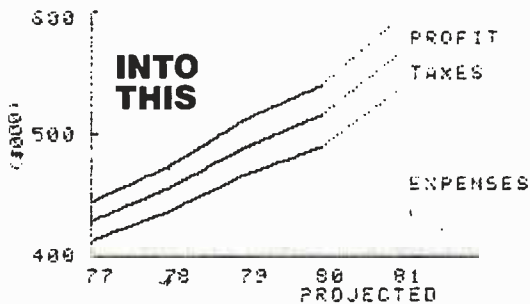

for the **total picture**  
of your business or scientific data.

- The most FLEXIBLE coordinate graphics package available for the APPLE II® Computer.
- Add a new dimension of meaning to your data. Graphics means your data will convey more information, faster, and it will be retained longer.
- Standard formats for PIE CHART, BAR CHART, SCATTER PLOT, and LINE PLOT are included.
- User-definable character sets.
- Hard copy - dump graphics screen to printer.

Custom OEM Licenses and Dealer Discounts Available.

### .....VisiCalc™ Models.....

For the APPLE II® Computer.

SAVE HOURS OF SETUP TIME.

#### VISIBLE BOOKKEEPER . . . . . \$59.95

Nine basic bookkeeping models with instructions for adapting to your own small business.

#### BUSINESS PROJECTOR . . . . . \$39.95

Basic one year projection with Cash Flow, P & L, Balance Sheet, and Common Ratios.

### .....Selected Software Tools.....

#### VISICALC . . . . . \$150.00

Throw away your pencil and paper with this Matrix Problem Solver from Software Arts, Inc.

#### INFORMATION MASTER . . . . . \$150.00

THE most powerful and easiest to use Data Management System from High Technology, Inc.

Software with a future from

## FUTUREWORLD

2514 UNIVERSITY DRIVE Dept. B-11  
DURHAM, NORTH CAROLINA 27707  
(919) 489-7486

\*Trademark of APPLE COMPUTER, INC.

# REFORMATTER™

Now There Are Three!

**REFORMATTER™** diskette conversion software now includes 3 programs for transferring information bidirectionally via floppy diskette medium:

**CP/M® ↔ DEC** gives the CP/M® user complete access to DEC formatted diskettes. Provides complete facilities for file reorganization and directory maintenance along with editing capabilities.

**TRSDOS ↔ IBM** gives the Radio Shack® Mod II user complete access to IBM 3740 formatted diskettes. Provides complete facilities for character translation, file reorganization and directory maintenance, along with editing capabilities.

**CP/M® ↔ IBM**, the original **REFORMATTER™** now available with enhanced features, gives the CP/M® user complete access to IBM 3740 formatted diskettes. Provides complete facilities for character translation, file reorganization, and directory maintenance, along with editing capabilities.

**REFORMATTER™** programs require a multiple drive system with at least one 8" single density drive.

**REFORMATTER™** is available at \$195.00 per program. For detailed information contact:

MicroTech Exports  
467 Hamilton Avenue, Suite 2  
Palo Alto, California 94301  
415/324-9114 ■ TWX: 910-370-7457 MUH-ALTOS

Dealer & OEM discounts available

CP/M is a registered trademark of Digital Research.  
Radio Shack is a registered trademark of Tandy Corp.

## Bridge the GAP in your Business Accounting.

**GENERAL ACCOUNTING PACKAGE.** This is a proven double entry accounting system with user definable accounts. The account numbers are made up of 7 4-digit fields allowing 7 levels of account classifications. With the use of the **Operator Report Selector Generator (ORSG)**, you can generate any type of report you desire, or use report programs in GAP-GL, GAP-AP, and GAP-AR.

**GAP-GL** Includes all basic GAP functions, plus entry of General Ledger transactions, prints General Journal, General Ledger summary and detail, Balance Sheet, Profit and Loss . . . . . Price \$124.95

**GAP-AR** Requires GAP-GL to run, allows adding A/R invoices, printing Sales Journal, detail A/R report, Account Aging, add/update Cash Receipts with register, Cash Receipts Journal, and A/R Billing . . . . . Price \$99.95

**GAP-AP** Requires GAP-GL to run, allows adding of A/P invoices, printing Purchase Journal, detail A/P report, Aging of Accounts, Check Writing, Check Printing, Cash Disbursements Journal . . . . . Price \$99.95

**SAVE NOW** by purchasing all three packages for only \$299.95. Simply mention this ad when calling in your order, or send the ad with you mail order.

Your BA/VISA or MasterCard is welcomed.

Call today to receive complete package specifications.

System requirements are 48K CP/M CP/M is registered trademark of Digital Research



**PROFESSIONAL DATA SYSTEMS**

318 E 18 St.  
BAKERSFIELD, CA 93305  
Telephone (805) 323-0891

Patterson Rd, Dayton OH 45430. This course is designed for engineers, scientists, managers, and others who need a broader understanding of the design, fabrication, and testing of integrated circuits. The fee is \$635. For information, contact the Director, Continuing Engineering Education, George Washington University, Washington DC 20052, (202) 676-6106, or toll free (800) 424-9773.

November 18-20

The Third Industrial Revolu-

tion, McCormick Place, Chicago IL. This show is an exposition and conference devoted to development by manufacturing companies of systems for information management. Information may be obtained from Banner & Grief Ltd, 110 E 42nd St, New York NY 10017, (212) 687-7730.

November 19-21

Comdex, Las Vegas Convention Center, Las Vegas NV. Comdex is a conference and exposition for independent sellers of small-computer

and word-processing systems, peripherals, media, and supplies. Address inquiries to The Interface Group, 160 Speen St, Framingham MA 01701, (800) 225-4620.

November 20-21

Western Educational Computing Conference, San Diego CA. This conference will feature papers and seminars on the use of computing in higher education for instruction, administration, and research. Contact Ron Langley, Director,

Computer Center, California State University, Long Beach, 1250 Bellflower Blvd, Long Beach CA 90840, (213) 498-5459.

November 20-23

Northeast Computer Show, Hynes Auditorium, Boston MA. This exposition is open to the general public. The admission will be \$5. Contact National Computer Shows, 824 Boylston St, Chestnut Hill MA 02167, (617) 739-2000.

November 21-23

National Home Entertainment Show, New York Coliseum, New York NY. Exhibits will cover video, photography, audio, games, and home computers. Seminars and demonstrations will be featured in this show. Contact United Business Publications Inc, 475 Park Ave South, New York NY 10016, (212) 725-2300.

November 24-25

Computer Equipment Registration, George Washington University, Washington DC. This course will review the FCC's Part 15 rules dealing with RF (radio frequency) emissions by computers. Technical considerations governing the classifications for computers, peripherals, and other related devices will be described. Contact the GWU Continuing Engineering Education Program, Washington DC 20052, (800) 424-9773.

November 25-27

Semiconductor International '80, Metropole Convention Centre, Brighton, England. This exhibition is devoted completely to production of semiconductor components, and displays will cover all areas of technology. A technical conference program will cover mask-making procedures, VLSI (very large-scale integration), crystal growth technology, thin film technology, bonding, memory testing, and more. Contact Kiver Communications SA, 171/185 Ewell Rd, Surbiton, Surrey, KT6 6AX, England.

		
Televideo 912 B . \$724 920 B . \$773 912 C . \$724 920 C . \$773	Okidata Microline 80 .. \$547	Zenith Z-19 ..... \$795 Z-89(48K)... \$2,225
		
Texas Instruments 810..... \$1,516	Soroc IQ120... \$688	Atari 800 (16K).. \$748 400 ..... \$445
	Scotch - 5 1/4" Qty. 10 ..... \$29 Verbatim - 5 1/4" Qty. 10 ..... \$26 Novation - Cat ..... \$150 Mattel - Intellivision ..... \$238	
Kurta Digitizer.. \$559		

## We Also Buy and Sell Used Micro Computers & Peripherals.

Prices reflect 3% cash discount. Add 3% for credit card orders.  
Product shipped in factory cartons with manufactures warranty.  
Add 2%, a minimum of \$5, for shipping and handling.



Call Collect

**602-954-6109**

**COMPUTER  
WAREHOUSE**

2222 E. Indian School Rd. • Phoenix, Arizona 85016

**We will try to beat any advertised prices!**

Prices & availability subject to change without notice.



StackWork's

# FORTH

A full, extended FORTH interpreter/compiler produces COMPACT, ROMABLE code. As fast as compiled FORTRAN, as easy to use as interactive BASIC.

## SELF COMPILING

Includes every line of source necessary to recompile itself.

## EXTENSIBLE

Add functions at will.

## CP/M\* COMPATIBLE

**Z80 or 8080 ASSEMBLER included**

Single license  
 Supplied with extensive user manual and tutorial:  
 \$150.00  
 Documentation alone: \$25.00

OEM's, we have a deal for you!

CP/M Formats: 8" soft sectored,  
 5" Northstar, 5" Micropolis Mod II,  
 Vector MZ, TRS-80 Mod II

Please specify CPU type.  
 Z80 or 8080

**All Orders and General Information:**  
**SUPERSOFT ASSOCIATES**

P.O. BOX 1628  
 CHAMPAIGN, IL 61820  
 (217) 359-2112

Technical Hot Line: (217) 359-2691  
 (answered only when technician is available)



*SuperSoft*  
**First in Software Technology**

\*CP/M registered trademark Digital Research

## Model EP-2A-87 EPROM Programmer



The Model EP-2A-87 EPROM Programmer has an RS-232 compatible interface and includes a 2K or 4K buffer. During the ON-LINE mode, another computer can down-load to the buffer. Only two easy-to-implement commands are available to an external computer. (Load buffer and read buffer.)

In the OFF-LINE mode, the EP-2A-87 will program, verify, test buffer, and load the buffer from the EPROM socket. During the programming cycle, the EPROM is checked before programming to insure that it is erased and after programming it automatically verifies that programming is correct. Power requirements are 115 VAC 50/60 Hertz at 15 watts.

Part No.	Description	Price
EP-2A-87-1	Programmer with 2K buffer	\$525.00
EP-2A-87-2	Programmer with 4K buffer	600.00
	Non standard voltage option (220 v, 240 v, 100 v)	15.00
PM-0	Personality Module, programs TMS 2708	26.00
PM-1	Personality module, programs 2708	26.00
PM-2	Personality module, programs 2732	31.00
PM-3	Personality module, programs TMS 2716	26.00
PM-4	Personality module, programs TMS 2532	31.00
PM-5	Personality module, programs 2716, TMS 2516	16.00
PM-6	Personality module, programs 2704	26.00
PM-7	Personality module, programs 2758, TMS 2508	16.00
PM-8	Personality module, programs Motorola MCM68764	34.00
MS-XX	Disk driver software	27.50

**Optimal Technology, Inc.**  
 Blue Wood 127  
 Earlysville, Virginia 22936  
 Phone (804) 973-5482

## VT-100 GRAPHICS



- Vector Plotting
- 1220 x 240 Dots/Screen
- Light Pen and Software Options
- \$1200

## DECwriter<sup>®</sup> GRAPHICS



- Vector Plotting
- Many DEC Options
- 1320 x 792 Dots/Page
- \$1060

**SELANAR (408) 727-2811**  
 CORPORATION  
 2403 De La Cruz Blvd., Santa Clara, CA 95050

*December 2-5*

**The Eleventh International Conference of the Computer Measurement Group**, Sheraton-Boston Hotel, Boston MA. This conference is entitled "Computer Performance Evaluation in the 80s." Contact Judith G Abilock, Price Waterhouse and Company, Office of Government Services, 1801 K St NW, Washington DC 20006, (202) 296-0800.

*December 3-5*

**The 1980 Winter Simulation Conference**, Orlando Marriott, Orlando FL. This conference will feature papers, panel discussions, tutorials, and review sessions on discrete and combined simulations. Contact Professor Tuncer I Ören, Chairman, Department of Computer Science, University of Ottawa, Ottawa, Ontario K1N 9B4, Canada, (613) 231-5420.

*December 3-5*

**Implementing Computer-Based Human Resource**

**Systems**, New York NY.

This is a seminar for planning, organizing, and implementing a comprehensive system for the human resources area. It will demonstrate ways to set up a useful personnel record-keeping system. The course fee is \$695. For information, contact The University of Chicago, Center for Continuing Education, MC Seminar Division, 1307 E 60th St, Chicago IL 60637, (800) 223-7450.

*December 4*

**California Computer Shows**,

**Hyatt-Palo Alto**, Palo Alto CA. Show hours are from 1 to 7 PM. OEM (original equipment manufacturers) and end-user computer and peripheral products will be exhibited and demonstrated by over sixty companies. Contact Norm De Nardi Enterprises, 95 Main St, Los Altos CA 94022, (415) 941-8440.

*December 10*

**1980 Computer Networking Symposium**, Gaithersburg MD. The symposium is sponsored by the IEEE Computer Society, Technical Committee on Computer Communications, and the Institute for Computer Sciences and Technology of the National Bureau of Standards. The focus is on office automation, office system components, and the computer networks required to interconnect them. For information, contact Executive Secretary, POB 639, Silver Spring MD 20901, (301) 439-7007.



## Our Newest Data Base Management System

Introducing CONDOR SERIES 20/DBMS, the relational data base management system for users who want powerful performance at reasonable prices.

For the special introductory offer of \$695, discover how easy it is to develop business or personal information systems with SERIES 20/DBMS.

- Create a Data Base in Minutes
- Full CRT Screen Management
- Use English-like commands. Host language not required.
- Computational, Statistical, and Sorting Capabilities

CONDOR SERIES 20/DBMS is compatible with many Z-80 microcomputers with at least 48K RAM running under CP/M® operating systems.

CP/M is a registered trademark of Digital Research, Inc.

### CONDOR SERIES 20/DBMS

\_\_\_\_ User's Manual (\$35, plus tax)    \_\_\_\_ Additional information.  
 \_\_\_\_ SERIES 20 package (\$695, plus tax)

Please Send To:

Name \_\_\_\_\_ Position \_\_\_\_\_  
 Company \_\_\_\_\_ Address \_\_\_\_\_  
 City \_\_\_\_\_ State \_\_\_\_\_ ZIP \_\_\_\_\_  
 Phone (    ) \_\_\_\_\_ Computer \_\_\_\_\_ CRT \_\_\_\_\_

**CONDOR COMPUTER CORPORATION**  
 3989 Research Park Drive, P. O. Box 8318  
 Ann Arbor, Michigan 48107 (313) 769-3988

Dealer inquiries welcome.

C 20-2

January 1981

*January 7-9*

**The Fourteenth International Symposium on Minicomputers and Microcomputers**, Hotel del Coronado, San Diego CA. The scope of the symposium will cover technology, hardware, software, engineering, languages, systems architecture, operating systems, numerical methods, computer networks, and other aspects of computing. Contact the Secretary, MIMI '81 San Diego, POB 2481, Anaheim CA 92804.

*January 13-15*

**Communications Networks 1981**, Albert Thomas Convention Center, Houston TX. This show will feature exhibits and seminars covering network policy and management for US and international users and carriers; network architecture, software, and hardware; new developments; information appliances; and more. This conference is aimed at communications professionals, carrier, service and

# APPLE II TRS-80

## QUALITY DISK SOFTWARE

**VISA** **Master Charge**

### HOME FINANCE PAK I: Entire Series \$49.95 (A) (T)

- BUDGET:** The heart of a comprehensive home finance system. Allows user to define up to 20 budget items. Actual expense input can be by keyboard or by automatic reading of CHECKBOOK II files. Costs are automatically sorted and compared with budget. BUDGET produces both monthly actual/budget/variance report and a year-to-date by month summary of actual costs. Color graphics display of expenses. . . \$24.95
- CHECKBOOK II:** This extensive program keeps complete records of each check/deposit. Unique check entry system allows user to set up common check purpose and recipient categories. Upon entry you select from this predefined menu to minimize keying in a lot of data. Unique names can also be stored for completeness. Rapid access to check files. Check register display scrolls for ease of review. 40 column print-out. Up to 100 checks per month storage. Files accessible by BUDGET program. . . \$19.95
- SAVINGS:** Allows user to keep track of deposits/withdrawals for up to 10 savings accounts. Complete records shown via screen or 40 column printer. . . \$14.95
- CREDIT CARD:** Keep control of your cards with this program. Organizes, stores and displays purchases, payments and service charges. Screen or 40 column printer display. Up to 10 separate cards. . . \$14.95

### UNIVERSAL COMPUTING MACHINE: \$39.95 (A) (T)

A user programmable computing system structured around a 2-Draw x 20 column table. User defines row and column names and equations forming a unique computing machine. Table elements can be multiplied, divided, subtracted or added to any other element. User can define repeated functions common to a row or column greatly simplifying table setup. Hundreds of unique computing machines can be defined, used, stored and recalled, with or without old data, for later use. Excellent for sales forecasts, engineering design analysis, budgets, inventory lists, income statements, production planning, project cost estimates-in short for any planning, analysis or reporting problem that can be solved with a table. Unique cursor commands allow you to move to any element, change its value and immediately see the effect on other table values. Entire table can be printed by machine pages (user-defined 35 columns) on a 40 column printer.

### COLOR CALENDAR: \$19.95 (A)

HI-RES color graphics display of your personal calendar. Automatic multiple entry of repetitive events. Review at a glance important dates, appointments, anniversaries, birthdays, action dates, etc. over a 5 year period. Graphic calendar marks dates. Printer and screen display a summary report by month of your full text describing each day's action item or event. Ideal for anyone with a busy calendar.

### BUSINESS SOFTWARE: Entire Series \$159.95 (A) (T)

- MICROACCOUNTANT:** The ideal accounting system for the small business. Based on classic T accounts and double-entry bookkeeping, this efficient program records and produces reports on account balances, general ledger journals, revenue and expenses. Screen or 40 column printer reports. Handles up to 1000 journal entries per month up to 300 accounts. Includes a short primer in Financial Accounting. . . \$49.95
- UNIVERSAL BUSINESS MACHINE:** This program is designed to SIMPLIFY and SAVE TIME for the serious businessman who must periodically Analyze, Plan and Estimate. The program was created using our Universal Computing Machine and it is programmed to provide the following planning and forecasting tools:  
 CASH FLOW ANALYSIS      PROFORMA BALANCE SHEET      SOURCE AND USE OF FUNDS  
 PROFORMA PROFIT & LOSS      SALES FORECASTER      JOB COST ESTIMATOR  
 Price, including a copy of the Universal Computing Machine. . . \$89.95

### BUSINESS CHECK REGISTER AND BUDGET: \$49.95

A combination of our CHECKBOOK II and BUDGET programs expanded to include up to 50 budgetable items and up to 500 checks per month. Includes bank statement reconciliation and automatic check search (48K). . . \$49.95

### ELECTRONICS SERIES: Entire Series \$159.95 (A)

- LOGIC SIMULATOR: SAVE TIME AND MONEY.** Simulate your digital logic circuits before you build them. CMOS, TTL, or whatever, it's digital logic, this program can handle it. The program is an interactive, menu driven, full-fledged logic simulator capable of simulating the bit-time by bit-time response of a logic network to user-specified input patterns. It will handle up to 1000 gates, including NAND, NOR, OR, inverters, FLIP-FLOPS, SHIFT REGISTERS, COUNTERS and user defined macros. Up to 40 user-defined, random, or binary input patterns. Simulation results displayed on CRT or printer. Accepts network descriptions from keyboard or from LOGIC DESIGNER for simulation. . . \$89.95
- LOGIC DESIGNER:** Interactive HI-RES Graphics program for designing digital logic systems. A menu driven series of keyboard commands allows you to draw directly on the screen up to 15 different gate types, including 10 gate shape patterns supplied with the program and 5 reserved for user specifications. Standard patterns supplied are NAND, NOR, INVERTER, EX-OR, T-FLOP, JK-FLOP, D-FLOP, RS-FLOP, 4 BIT COUNTER and N-BIT SHIFT REGISTER. User interconnects gates just as you would normally draw using line graphics commands. Network descriptions for LOGIC SIMULATOR generated simultaneously with the CRT diagram being drawn. . . \$89.95

### MATHEMATICS SERIES: Entire Series \$49.95 (A)

- STATISTICAL ANALYSIS I:** This menu driven program performs SIMPLE LINEAR REGRESSION analysis, determines the mean, standard deviation and plots the frequency distribution of user supplied datasets. Printer, Disk, I/O and edit routines included (32K mem.). . . \$19.95
- NUMERICAL ANALYSIS:** HI-RES 2-Dimensional plot of any function. Automatic scaling. At your option, the program will plot the function, plot the INTEGRAL, plot the DERIVATIVE, determine the ROOTS find the MAXIMA and MINIMA and list the INTEGRAL VALUE. . . \$19.95
- MATRIX:** A general purpose, menu driven program for determining the INVERSE and DETERMINANT of any matrix, as well as the SOLUTION to any set of SIMULTANEOUS LINEAR EQUATIONS. Disk I/O for data save. Specify 55 eqn. set (48K) or 35 eqn. (32K). . . \$19.95
- 3-D SURFACE PLOTTER:** Explore the ELEGANCE and BEAUTY of MATHEMATICS by creating HI-RES PLOTS of 3-dimensional surfaces from any 3-variable equation. Disk save and recall routines for plots. Menu driven to vary surface parameters. Hidden line or transparent plotting. . . \$19.95

### ACTION ADVENTURE GAMES: Entire Series \$29.95 (A)

- RED BARON:** Can you outfly the RED BARON? This fast action game simulates a machine gun DOG FIGHT between your WORLD WAR I BI-PLANE and the baron's. You can LOOP, DIVE, BANK or CLIMB in any one of 8 directions and so can the BARON, in HI-RES graphics. . . \$14.95
- BATTLE OF MIDWAY:** You are a command of the U.S.S. HORNETS' DIVE BOMBER squadron. Your targets are the Aircraft carriers, Akagi, Soryu and Kaga. You must fly your way through 2ERDS and AA FIRE to make your DIVE BOMB run. In HI-RES graphics. . . \$14.95
- SUB ATTACK:** It's April, 1943. The enemy convoy is headed for the CORAL SEA. Your sub, the MORAY, has just sighted the CARRIERS and BATTLESHIPS. Easy pickups. But watch out for the DE STROYERS - they're fast and deadly. In HI-RES graphics. . . \$14.95
- FREE CATALOG:** All programs are supplied on disk and run on Apple II w/Disk & Applesoft ROM Card & TRS-80 Level II and require 32K RAM unless otherwise noted. Detailed instructions included. Orders shipped within 3 days. Card users include card number. Add \$1.50 postage and handling with each order. California residents add 6% sales tax.

Make checks payable to:  
**SPECTRUM SOFTWARE**  
 P.O. Box 2084 142 Carlow, Sunnyvale, CA 94087  
 For phone orders - 408-738-4387  
 DEALER INQUIRIES INVITED

## DIGITAL COMPUTER CASSETTES

- Ideal for Apple, Pet or TR-S80 Users.
- Eight Special 50 Foot Cassettes.
- Unique Storage Album.

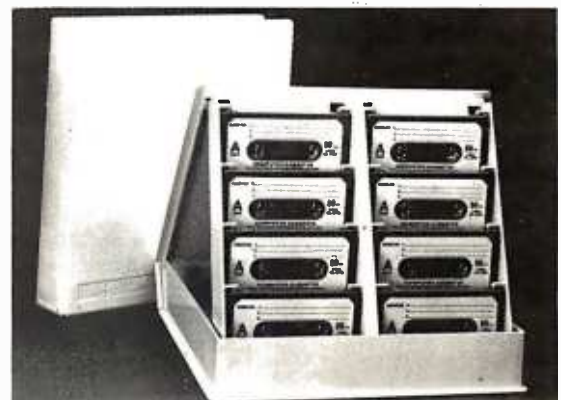

**\$9.<sup>95</sup> each or 3 for \$26.<sup>00</sup>**  
 Extra cases - \$4.<sup>95</sup>

No Sales Tax For Out Of State Customers  
 Price Includes Free Shipping In Continental U.S.

Dealer Inquiries Welcome

Sound Concepts  
 P.O. Box 299  
 Provo, Utah 84601

Call Collect  
 for Master Card  
 or Visa Orders  
 801-375-7333

## LOW COST IMPACT PRINTER

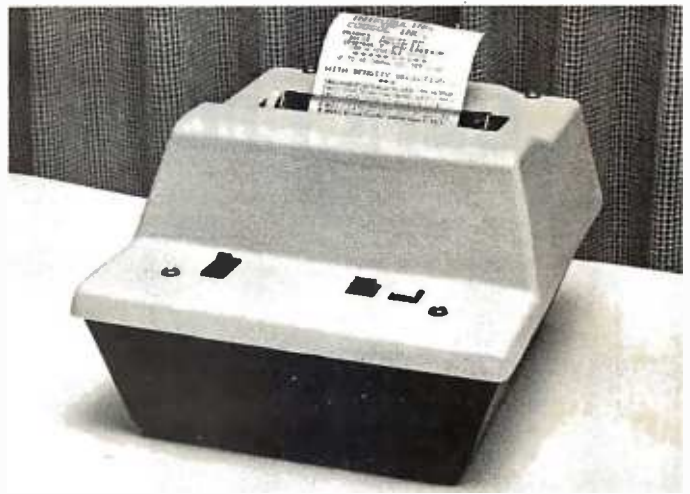

48 Column Impact Printer available in KIT form or ASSEMBLED and TESTED, ready to be connected to your computer. Primary features include: Microprocessor controlled and programmable with 32 system level software commands. 96 ASCII characters with upper and lower case, no eye straining print with 9 software selectable sizes from 5 x 7 to larger 10 x 7 and 10 x 14 character fonts, reverse font printing capability, standard parallel and serial interface, baudrate selectable from 110 to 9600 baud, plus many more functions at your command.

Prices for KITS are \$295 (101A-48K) without enclosure and \$325 (101A-48KE) with enclosure. KITS include all electronics, mechanical parts and detailed assembly instructions.

ASSEMBLED and TESTED Impact Printers—prices are: \$325 (101A-48) excluding enclosure, \$355 (101A-48E) with enclosure.

For further information, contact:

**COOSOL, INC.**  
 P.O. Box 743, Anaheim, Ca. 92805 Phone: (714) 545-2216  
 (7 days a week)

hardware vendors who are interested in combining voice, data, and message systems applications. Contact Communications Networks '81, c/o The Conference Company, 60 Austin St, Newton MA 02160, (617) 964-4550.

January 14-19

**42nd National Audio-Visual Convention and Exhibit**, Dallas Convention Center, Dallas TX. Over 300 manufacturers and producers of audio-visual, video and microcomputer hardware and software will be exhibiting their products. Seminars will cover marketing and production of audio-visual items. For more information, contact the National Audio-Visual Association, 3150 Spring St, Fairfax VA 22031, (703) 273-7200.

January 16-17

**Microcomputer Conference**, Arizona State University, Tempe AZ. The goal of this

microcomputer conference is to introduce educators to the applications of computers in the classroom. The emphasis of the conference is to provide an awareness of microcomputers and their impact on society. For further information, contact Dr Gary G Bitter, Arizona State University, Payne 203, Tempe AZ 85281.

January 27-29

**Advanced Semiconductor Equipment Exposition**, San Jose Convention Center, San Jose CA. Over 100 exhibitors will feature equipment at this trade show. The show's emphasis is on new products and emerging technology in the semiconductor processing and production fields. Contact Cartledge & Associates, 491 Macara Ave, Suite 1014, Sunnyvale CA 94086, (408) 245-6870.

January 28-31

**The Third IMMM/Data Comm International Japan**

**Exposition, Harumi Exposition Center, South Hall, Tokyo, Japan.** Over 15,000 scientists, design engineers, technical managers, applications engineers, and other specialists are expected to attend this show. Internecon Japan/Semiconductor International is held concurrently. A conference program will include talks on microcomputer-controlled data communications systems, peripheral interfacing, software management, and more. Contact Industrial and Scientific Conference Management Inc, 222 W Adams St, Chicago IL 60606, (312) 263-4866. ■



Correspondence on Correspondence

Thank you, BYTE, for

running the enlarged, corrected oscilloscope photographs in BYTE's Bugs on page 182 of the June 1980 issue. BYTE readers may wish to label these pictures in order to be sure of their correspondence with the original photographs on page 66 of the article, "A Computer-Controlled Light Dimmer" (January 1980 BYTE). The picture labels should be matched as follows:

Original Article (January)	Pictures in BYTE's Bugs (June)
00	a
40	b
80	c
C0	d
FF	e

Thank you again for your time and concern in publishing the corrections in BYTE's Bugs.

John H Gibson  
Department of Physics  
Ima College  
Alma MI 48801

Introducing

# THE BENCHMARK<sup>(TM)</sup>

WORD PROCESSING SYSTEM

THE BENCHMARK software system sets new standards in word processing. First, it can be delivered to run on the CP/M or the North Star DOS, so there may be no need to buy a special operating system. Second, it has all the features of systems costing thousands of dollars more. Third, the price is as low as, or lower than, most word processing systems.

Anyone can learn to run and use THE BENCHMARK in one day of self training. Completely self-prompting in English, THE BENCHMARK is a full capability word processor, has been thoroughly tested in an office environment and proved to meet the needs of the most sophisticated user.

- Multi-operating system
- Changes terminal drivers
- Customized to utilize all the features of terminal & printer
- Overtyping - erases, corrects
- Variable, electronic decimal tab
- Screen menus simplify operation
- Block move and get

**ONLY \$499** plus tax where applicable

THE BENCHMARK is distributed exclusively by R&B Computer Systems. Dealer inquiries are invited.

**R&B Computer Systems<sup>TM</sup>**

1954 E. University  
1-800-528-7385

Tempe, Arizona 85281  
AZ-602-968-7101

THE BENCHMARK is a trademark of Metasoft Corporation

## Incorrect STOIC Price

An incorrect price was reported in John James's article "What is FORTH?" in the August 1980 BYTE. On page 134, middle column, Mr James reported that the language STOIC was available from the CP/M User's Group (1651 Third Ave, New York NY 10028) for \$20. The membership fee of \$4 has been replaced by a one-time catalog fee of \$6, making the total \$22, not \$20 (\$8 each for two floppy disks plus \$6 for the catalog). Also, the above price is valid for the United States, Canada, and Mexico only. The price for all other countries is \$12 per disk, making a total of \$30 (\$12 each for two floppy disks plus \$6 for the catalog). The Group is filling orders that were received with insufficient funds, but they (and we at BYTE) request that the receivers of such orders pay the appropriate difference in price. ■

# WE DELIVER!

Osborne Business Software



Before you buy the programs that your company is going to depend on for its accounting, ask the following questions:

- Do I get the source code?** (Don't settle for less. You cannot make the smallest change without it.)
- Is it well documented?** (The Osborne documentation is the best.)
- Is it fully supported?** (If not, why not? What are they afraid of?)

The Osborne system is the industry standard accounting package, with literally thousands of users. We offer an enhanced version of that package that will run on most systems without recompiling.

**CRT INDEPENDENCE.** The original programs were designed to run on a Hazeltine terminal. To use a different CRT, you had to modify and test two modules — and recompile every program! With the Vandata package, you simply pick your CRT from a menu and run.

**FILE/DRIVE MAP.** The original package had all data files on the same drive as the programs. Ours allows you to dynamically specify the drive assigned to each file. In fact, you can change the drive assignments whenever you wish, to accommodate expanded file sizes or new hardware — all without recompiling!

**INTEGRATION.** The original AR and AP systems had to be changed and recompiled to feed journal entries to GL. Our installation program eliminates this hassle. It simply asks you if you want the systems integrated, and what your special account numbers are.

**SPEED.** The original programs used a binary search to access the GL account file. We use an enhanced technique that greatly cuts down on disk accesses, thus speeding up account lookups significantly in the GL, AR and AP systems.

**BUGS.** We have corrected a number of bugs in the original programs. If you find a bug in our programs, we'll fix it — and send you a \$20 reward! Our users are sent bug fixes in source form.

**MORE!** We have made many minor enhancements, and fixed many minor problems. We are committed to the ongoing support of our package. Vandata has been an independent software supplier for over seven years. Quality and support are our way of doing business.

General Ledger with Cash Journal .....	\$95
Accounts Receivable .....	\$95
Accounts Payable .....	\$95
Payroll with Cost Accounting .....	\$95
• All Four Packages (GL, AR, AP, PR) .....	<b>\$295</b>
Magic Wand (Super Word Processor!!) .....	\$345
Pearl/Level III (best prog. tool available) .....	\$645
CBASIC-2 .....	\$110
TRS-80 <sup>®</sup> MOD II CPM <sup>®</sup> 2.2 (Pickles & Trout) .....	\$185
H89/Z89 CPM <sup>®</sup> 2.2 (Magnolia inc. h/w mod) .....	\$295

Formats: Std. 8", 5" NorthStar DD, TRS-80 MOD II Im, H89/Z89. Manuals for GL, AR/AP, and PR are not included in price — add \$20 per manual desired (AR/AP are in one manual). CPM<sup>®</sup> and CBASIC-2 required to run accounting software. Users must sign licensing agreement. Dealer inquiries invited.

To order call: **(206) 542-8370**  
 or write: **VANDATA**  
**17541 Stone Avenue North**  
**Seattle, WA 98133**

VISA/MC Welcome — CP/M<sup>®</sup> is a registered trademark of Digital Research.  
 TRS-80<sup>®</sup> is a registered trademark of Radio Shack, Inc.

## 6502 MICRO MICROCOMPUTER

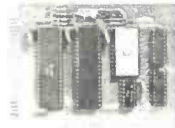

- This JBE micro-computer has the following:
- 1024 bytes of RAM (two 2114s)
  - 2048 bytes of EPROM (2716)
  - Uses one 6522 via (documentation incl.)
  - 2 8-bit bidirectional I/O ports
  - 2 16-bit programmable timer/counter
  - Serial data port
  - Latched output and input with handshaking logic
  - TTL and CMOS compatible

The 6502 microprocessor is particularly suited for control functions such as temperature control burglar alarm, electrical wheel chair, lights, etc. This micro-micro interfaces with the JBE Solid State Switch and A-D and D-A converter and uses JBE 5V power supply. 2716 EPROM is available separately. A 50 pin connector is included.

80-153 ASSM. **\$110.95** Kit **\$89.95** Bare Board **\$24.95**

### DIMMER CONTROL



The JBE Dimmer Control has 4 channels, 256 brightness levels on-board power supply and four 8-bit parallel input ports (not latched). This board interfaces with JBE Solid State Switch and Apple II Parallel Interface Card (documentation included).

80-146 ASSM. **\$89.95**  
 KIT **\$79.95**  
 BARE BOARD **\$25.95**

### APPLE II DISPLAY BOARD



This handy little board is ideal for teaching and troubleshooting. It has a run-stop single step switch which makes identification of shorted lines between address or data-bits easy & shows single step for teaching computer logic. The display board has 16 address LEDs, 8 data LEDs and 1 RDY LED. All lines are buffered.

80-144 ASSM. **\$49.95**  
 KIT **\$42.95**  
 BAREBOARD **\$25.95**



### JOHN BELL ENGINEERING

ALL PRODUCTS ARE AVAILABLE FROM: **JOHN BELL ENGINEERING**  
 P.O. BOX 338 • REDWOOD CITY, CA 94064 • (415) 367-1137  
 ADD 6% SALES TAX IN CALIFORNIA. FOR ORDERS OUTSIDE THE U.S.A.,  
 ADD 5% FOR SHIPPING AND HANDLING.

\*For complete product line, see John Bell Engineering full page ad in *Kilobaud*  
 \*Write for our new catalog

# Kill Surges Like Lightning!

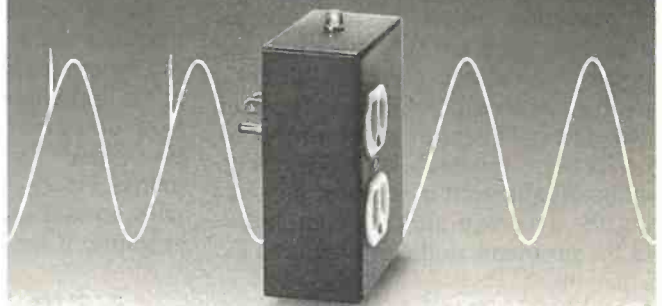

Surge Sentry 120 works in parallel with the power line to shunt destructive power surges in less than 1 nanosecond! Triggers at 10% above the nominal peak voltage. Plugs into any standard 120-volt outlet for immediate protection.

Ideal for small computers, communications, medical, and other sensitive electronic equipment. Suggested retail price \$89.50. OEM model also available. Call or write:

## R&K Enterprises

643 South 6th Street, San Jose, CA 95112  
 (408) 288-5565.

Dealer inquiries invited.

## The muSIMP/muMATH-79 Symbolic Math System

Gregg Williams  
Editor

Computers are very literal minded: ask one to add  $1/2$  and  $1/3$  and it will probably give you 0.833333 or some close approximation. Ask for  $40!$  (ie: 40 factorial) and you will get an answer like 8.1592E47, if you receive a reply at all. But what if you wanted the answer  $5/6$  for the first problem and an exact answer to the second problem, all forty-eight digits of it? Computers express everything in numbers, not symbols: that's the problem.

A software package called muMATH-79, created by the Soft Warehouse of Honolulu, Hawaii, does just what you want and more. The muMATH-79 package, billed as a *symbolic math system*, is to algebraic problem solving what the pocket calculator is to arithmetic problem solving. Like a pocket calculator, it cannot solve problems on its own, but muMATH-79 can be an invaluable tool in terms of increasing the accuracy and the complexity of the problems that can be solved by a person.

muMATH-79 is a modular system. It can be used for any one or a combination of the following: 611-digit arithmetic; matrix manipulation; algebraic manipulation and equation solving; logarithmic and trigonometric manipulation; integration and differentiation.

### Arithmetic and Algebra

muMATH-79 manipulates everything as a string of symbols, so it's no surprise that numbers are stored as strings of digits, with a

given number being up to 611 digits long. Given this situation, muMATH-79 has defined addition, subtraction, multiplication, division, and integral exponentiation as operations that work on two strings of numbers to give a third string as a result.

### Matrix operations in muMATH-79 are fast as well as exact.

When muMATH-79 is running, the computer prompts user input with a question mark and a space. (In our examples, computer-generated output is underlined here to distinguish it from user input.) All commands must be ended in a semicolon, and muMATH-79 precedes its answer with an ampersand and a space. For example, if we type in:

```
? 2!50;
```

muMATH-79 replies almost instantly with:

```
@ 1125899906842624
```

Similarly, a request for 40 factorial gets an immediate reply:

```
? 40!;  
@ 81591528324789773434  
561126959611589427200  
000000
```

We can assign strings (ie: numbers or symbolic expressions) to variable names using a colon:

```
? C1:2!50;  
@ 1125899906842624  
? C2:C1-1;  
@ 1125899906842623
```

Also, we can change the radix used to accept and display numbers. For example, to change to binary (also called radix 2 or base 2), we say:

```
? RADIX(2);  
@ 1010
```

and muMATH-79 replies that its base was base 10 (since it is now in base 2, it prints 10 in binary: binary 1010 = decimal 10). To check that we are in base 2:

```
? C1;  
@ 10000000000000000000  
00000000000000000000  
000000000  
? C2;  
@ 11111111111111111111  
11111111111111111111  
111111111
```

Sure enough, C1, being  $2^{50}$ , should be a 1 followed by fifty 0s in binary, and C2 should be fifty 1s.

Also, muMATH-79 is fast. It computed all the above answers in less than 1 second each (running on a Cromemco Z-2D at 4 MHz), and answered 250! (seven lines of numbers) in 31 seconds. (See listing 1.) When a number being computed

# Commercial Mailer

For your APPLE/CORVUS Computer System:  
Store up to  
**30,000 names**  
per mailing list!  
with an  
**unlimited number**  
of lists!

Unlimited potential is available now with this new mailing list program designed for commercial mailers, and written in Applesoft. With 6 lines per record, fully adaptable to your format, up to 30,000 names can be maintained on each list with no limit on the number of lists.

"Apple" and "Corvus" are registered trademarks of Apple Computer Inc. and Corvus Systems.



## Features of This Revolutionary Program:

- creates list
- selects list
- displays list
- reports list
- maintains list by zip code and alphabetical order
- finds entry
- browse thru entry
- change entry
- add to entry
- deletes entry
- search entries
- utility/code field

PRODUCES 1UP, 2UP, 3UP, 4UP CHESHIRE OR PRESSURE SENSITIVE LABELS

Fully Prompting • Easy To Run

## Requirements:

Requires 48K Apple, 80 or 132 column printer, Corvus 11AP Hard Disk. Optional: Corvus Mirror, Corvus Constellation.

## Complete Software

program with detailed user manual. Add \$3. for shipping. **\$250.**

All orders prepaid or C.O.D. N.J. firms add 5% sales tax.

**STONEHENGE COMPUTER CO.**  
89 Summit Avenue Summit, N.J. 07901

or call (201) 277-1020 for further information

DEALER INQUIRIES INVITED

# There's never been a better time to buy an Apple II.

48K APPLE II  
OR PLUS  
ONLY \$1095.

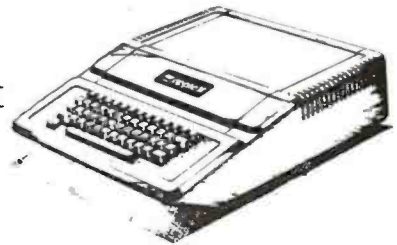

Visit our newly expanded showroom and see one of the original AppleIIs on display.

 **apple computer**  
Authorized Dealer



**FARNSWORTH  
COMPUTER CENTER**  
1891 N. FARNSWORTH AVE.  
(At the East-West Tollway)  
AURORA, IL. 60505  
(312) 851-3888  
Weekdays 10-8; Sat. 10-5

## MAIL ORDER DISCOUNTS

 **apple computer**  
Sales and Service

**APPLE II 48K**  
**\$1,059**



### ACCESSORIES

DISK II DRIVE & CONTROLLER .....	480	MICROSOFT Z-80 SOFTCARD SYSTEM .....	315
DISK II DRIVE ONLY .....	420	VIDEX 80 COLUMN BOARD .....	
INTEGER BASIC FIRMWARE CARD .....	149	W/GRAPHICS AND SWITCH .....	350
APPLESOFT II FIRMWARE CARD .....	149	DC HAYES MICROMODEM II .....	330
M&R SUR-R-MOD RF MODULATOR .....	25	SILENTYPE PRINTER W/INT CARD .....	510
CENTRONICS PRINTER INTERFACE CARD .....	185	LANGUAGE SYSTEM W/PASCAL .....	420
HIGH-SPEED SERIAL INTERFACE CARD .....	145	GRAPHICS TABLET .....	650
		ALF MUSIC SYNTHESIZER .....	235

### SOFTWARE

APPLE FORTRAN .....	165	THE CONTROLLER BUSINESS SYSTEM .....	515
DOS 3.3 .....	49	THE CASHIER RETAIL MANAGEMENT .....	199
APPLE DOS TOOL KIT .....	65	VISICALC .....	120
APPLE PLOT GRAPH & PLOT SYSTEM .....	60	APPLEWRITER TEST EDITOR .....	65

- WE WILL TRY TO BEAT ANY ADVERTISED PRICE
- WE PERFORM APPLE WARRANTY REPAIR

### TO ORDER:

Please phone using VISA and Master Card. Or send cashier's check, money order or personal check (allow 14 business days to clear). VISA and MC credit card service add 2%. Shipping, handling and insurance add 3%. California residents add 6% sales tax.

ORDER HOURS:

Monday thru Saturday 9-5 PST.

**computer age, inc.**

Authorized Apple Dealer & Service Center  
4688 CONVOY ST., SUITE 105  
SAN DIEGO, CA 92111  
(714) 565-4042

**Listing 1:** Extended-precision arithmetic in muMATH-79. As shown in the first two examples, muMATH-79 does not convert fractions, but rather reduces them to their lowest terms. As you can see from the 493-digit answer to 250! (250 factorial), muMATH-79 does all its arithmetic exactly. In this and all other listings, underlining denotes computer output.

? 4/20;

@ 1 / 5

? 352/283072;

@ 11 / 8846

? 250!;

@ 3232856260909107732320814552024368470994843717673780666747942427112823  
747555111209488817915371028199450928507353189432926730931712808990822791  
030279071281921676527240189264733218041186261006832925365133678939089569  
935713530175040513178760077247933065402339006164825552248819436572586057  
399222641254832982204849137721776650641276858807153128978777672951913990  
844377478702589172973255150283241787320658188482062478582659808848825548  
8000

exceeds the capacity of the system, muMATH-79 replies with the word FALSE:

? 300!;  
 @ FALSE

muMATH-79 also manipulates symbolic expressions (depending on the values of its control variables, described later). For example:

? 5\*X - 3\*Y!2 + 8\*X - 4\*Y!2  
 @ 13\*X - 7\*Y!2

Equations in muMATH-79 are often hard to read. It helps to write them out using pencil and paper; the above was  $5X - 3Y^2 + 8X - 4Y^2$ , which

simplified to  $13X - 7Y^2$ . Variables can be used in expressions, where they add their symbolic content to the expression being evaluated:

? EXPR1:B+4;  
 @ 4 + B  
 ? EXPR2:EXPR1+C+2\*B;  
 @ 4 + 3\*B + C

A variable name is called *bound* if it has a value and *unbound* if it does not. For example, the variable EXPR1, above, is bound because it has the value B+4. There are times, however, when we want a variable to simply be itself. We can change a variable from bound to unbound as follows (using the example of EXPR1):

? EXPR1;  
 @ 4 + B (EXPR1 is bound)  
 ? EXPR1:EXPR1  
 @ EXPR1 (EXPR1 is now unbound)

### Equation Solving

In addition, some equations can be solved. For example, to solve

$$X^3 + 2X^2 - 63X = 0;$$

? SOLVE(X!3 + 2\*X!  
 2 - 63\*X = 0,X);  
 @ {X = 7,  
 X = -9,  
 X = 0}

(muMATH-79 uses the double equal

## UCSD Pascal\* for the INTERTEC SUPERBRAIN™

Certified by Softech Microsystems

Our package includes:

- operating system
- compiler
- screen editor
- filer
- library
- Z80 assembler
- user manual
- Jensen & Wirth Pascal Reference Manual
- Bowles' Beginners Guide to UCSD Pascal

\$400 complete

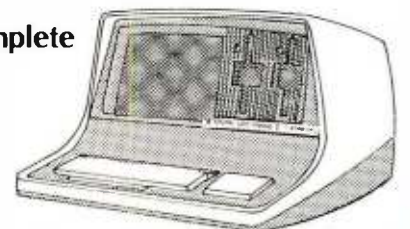

**NOESIS COMPUTING COMPANY**  
 615 Third Street, San Francisco, CA 94107  
 Telephone: (415) 495-7440

Master Charge Accepted

\*Trademark of the Regents of the University of California  
 \*\*Trademark of Inter-tec Data Systems



# Diagnostics I

for CP/M\* & TRSDOS\*

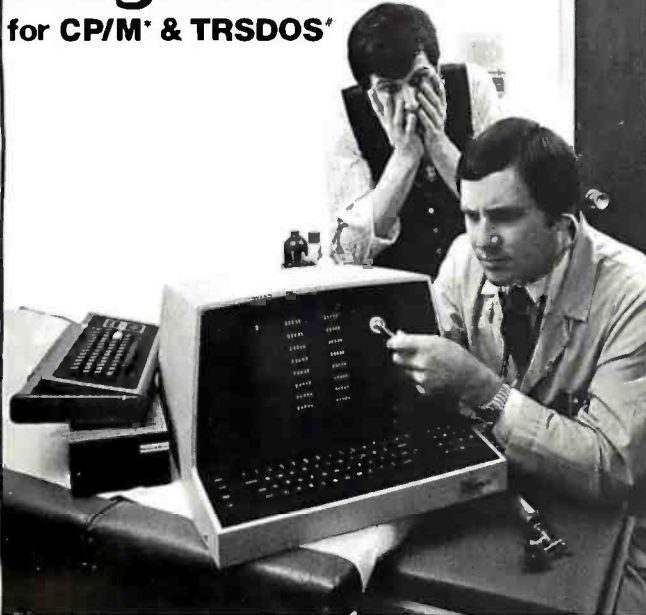

Someday your computer is going to break; even the most reliable computer systems "go down". Often, finding exactly what is wrong can account for the most time consuming part of repairing the system, and the longer the system is down, the more money you lose.

DIAGNOSTICS I is a complete program package designed to check every major area of your computer, detect errors, and find the cause of most common computer malfunctions, often before they become serious. For years, large installations have run daily or weekly diagnostic routines as a part of normal system maintenance and check-out procedures.

DIAGNOSTICS I is designed to provide that kind of performance testing for 8080/Z80 micro computers.

DIAGNOSTICS I will really put your system through its paces. Each test is exhaustive and thorough. The tests include:

- Memory Test
- CPU Test (8080/8085/Z80)
- Printer Test
- Disk Test
- CRT Test

To our knowledge, this is the first CPU test available for 8080/Z80 CPU's. Many times transient problems, usually blamed on bad memory, are really CPU errors.

A good set of diagnostics is an indispensable addition to your program library even if your system is working fine. Hours have been wasted trying to track down a "program bug" when actually hardware was to blame!

DIAGNOSTICS I also allows you to be confident of your system. This can be critical when file merges or sorts and backups are involved. You want to be as sure of your computer as possible during these critical times. Running DIAGNOSTICS I prior to these and other important functions helps to insure that your system is operating at peak performance.

DIAGNOSTICS I is supplied on discette with a complete users manual.

**DIAGNOSTICS I: \$60.00 Manual only: \$15.00**

**Requires: 24K CP/M; 16K disc for TRS-80**

**formats: CP/M 8" SOFT SECTORED, NORTHSTAR CP/M AND TRS-80 DOS**



All Orders and General Information:  
**SUPERSOFT ASSOCIATES**  
 P.O. BOX 1628  
 CHAMPAIGN, IL 61820  
 (217) 359-2112

**Technical Hot Line: (217) 359-2691**  
 (answered only when technician is available)

\*CP/M REGISTERED TRADEMARK DIGITAL RESEARCH  
 \*TRS-DOS 119 80 TRADEMARKS TAYSH CORP

FULL-VIEW 80™  
 by  
**Bit 3 COMPUTER CORPORATION**

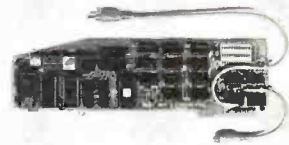

DESIGNED  
 FOR THE  
 APPLE II®

## 80 X 24 DISPLAY CARD

Permits selection of 80 column or Apple 40 column/graphics on a single monitor via keyboard or program control • Available character fonts include 7x9, 5x7, or EROM • 2K firmware on card • Lowest power requirement of any 80x24 card on the market • User definable character sets with the optional EROM Adaptor and a 2716 or 2732 (255 characters!) EROM • 7 keyboard function keys with pressure sensitive adhesive label provides HOME, HOME & CLEAR, CLEAR TO END OF LINE, CLEAR TO END OF SCREEN, CATALOG, LOAD and RUN • Works with Apple II, Apple II Plus, Apple Pascal, Z-80 Softcard®, and D.C. Hayes Micromodem™ • Compatible with all Apple II peripheral cards • Fast scroll—both scroll up and scroll down • Full keyboard editing • 127 upper/lower case characters • Individually selectable inverse or normal characters • Real time 1/60 second nonmaskable interrupt clock can be software enabled to permit timing of programs in background mode • READ screen capability • Light-pen connector and light pen firmware support • XY cursor positioning via GOTO X,Y command • Blank screen command to suppress video • Tab • 50/60 Hz • 80x24 display memory is contained on card • Keyboard Shift-Lock identified by blinking cursor: Un-shifted by non-blinking cursor.



Apple II, Z-80 Softcard, D.C. Hayes Micromodem registered trademarks of Apple Computer, Inc., Microsoft Consumer Products and D.C. Hayes Associates, Inc. resp.



List Prices: 5x7 or 7x9 \$395.00  
 Manual only \$15.00  
 See your Apple Dealer or contact:

**Bit 3 COMPUTER CORPORATION**  
 1890 Huron St. • St. Paul, MN 55113 • (612) 926-6997

## CFR Associates EXCLUSIVE! SURPLUS COMPUTER BARGAINS

### 8 INCH FLOPPY DRIVES

Used, removed from systems. Mfd. by MPI Division of Control Data. These are the CDC floppy! Includes schematics & I/O data. Sold 'As-Is' but complete and whole! An incredible BARGAIN, easy to interface with most commercial controllers. Features "hard" sectoring.

Special Price ..... **Only \$229.00 ea.**  
 Buy 3 and SAVE BIG!! ..... **3/\$599.00**  
 Plus Shipping



### DAISY TERMINALS

featuring the DIABLO HyType Daisy Printer. This exciting terminal features: RS232C ASCII, 110-1200 BAUD, KSR operation plus fantastic PLOTTER mode with bi-directional horiz. & vert'l movement, 1/60" H & 1/48" V increments, 15" platen, prints at 10, 15 & 30 cps! Uses plastic printwheel and has many more exciting features. Includes operator's manual & schematics. Used & refurbished.

CASE STYLE Now Only ..... **\$1499.00**  
 MAY DIFFER Add \$30.00 for Shipping Crat. Pay Shipping On Delivery

### \* SELECTRIC Typewriter Terminals

USED, off-lease. Features IBM Selectric Printer RS232 I/O. Takes BCD code type elements. Whole and complete. "AS-IS" (may need some adjustments). SEE OUR OCT. 1980 ADVERTISEMENT in this magazine. 15" carriage, type ball included. 110 VAC includes power supply. I/O and printer circuits and more.

Only ..... **\$469.00**  
 Add \$18.00 for Shipping Crat. Pay Shipping On Delivery  
 Maintenance Manuals Available... \$25.00



**2/\$750**

\*IBM Trademark

**GET YOUR COPY OF OUR LATEST FLYER!**  
 Circle the Bingo Card Number or Send a 1st Class Stamp for a Free Copy.

**CFR ASSOCIATES, INC.**  
 18 Granite Street  
 Haverhill, Mass. 01830

**617-372-8536**  
 Phone Orders  
 Welcome



# When You Have To Face A Deadline



Communication Arts. Huntington Beach, CA

## Arm Yourself With Pascal/MT+®

From

**MT Micro SYSTEMS**



1562 Kings Cross Drive  
Cardiff, California 92007 (714) 753-4856

We ship on 8" single density and 5-1/4" North Star single density.  
Other formats available. Ask us.

CP/M is a registered trademark of Digital Research MP/M is a trademark of Digital Research Pascal/MT+ is a registered trademark of MT Micro Systems  
Circle 248 on inquiry card.

# MT MicroSYSTEMS SOFTWARE ARSENAL:

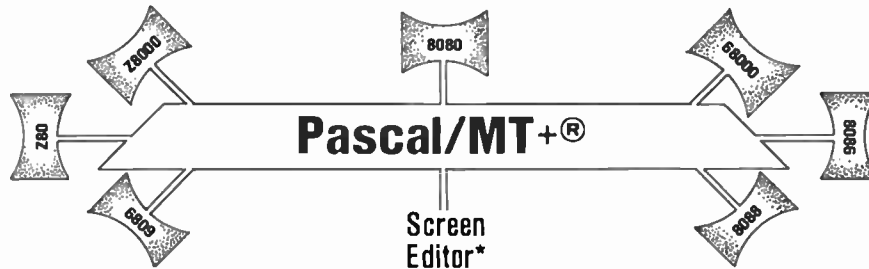

\*Contact us for the exciting news about this leap forward in state of the art technology.

Pascal/MT+® provides you with the power to meet your deadlines head-on! Compiling directly to native code without slowing down to generate P-code or assembly language, Pascal/MT+® generates ROMable, optimized native code and gives you the flexibility of modular compilation; and it does so at speeds up to 2000 lines per minute while the *others* are, at best, *one third* as fast! Even when you're *not* facing a deadline, Pascal/MT+® never wastes your time! Nobody likes to wait for a computer. The Pascal/MT+® won't keep you waiting! Your software written in Pascal/MT+® is totally portable to most 8 and 16 bit processors. The Pascal/MT+® system provides you with a powerful debugging tool. With Pascal/MT+® you *do* have an effective weapon against monstrous deadlines.

Pascal is the most popular programming language in use today. You can use Pascal/MT+® to replace assembly language in your ROM based applications, BASIC and COBOL in your business applications, FORTRAN in your scientific applications, or interpreted Pascal in all of your applications. Because Pascal programs are easy to write, read, and maintain; and because the Pascal/MT+® system contains all of the features you need for your applications, you can get your job done *on time!* In fact, you may never need assembly language or any other high level language again. Pascal/MT+® has the speed, extensions, and portability to stock your software arsenal for years to come!!!

## ISO STANDARD Pascal

Pascal/MT+® supports the ISO Standard. We send the results of our compiler's performance on the Validation Suite. Also, for portability the MT+ compiler can warn you when you are using non-standard extensions.

## Modular Compilation

Pascal/MT+® generates the same industry standard relocatable code used in FORTRAN and PL/I. Both Pascal and assembly language modules may be separately compiled and then combined to produce a final program. With modular compilation available, the run time overhead is as small as 256 bytes and is typically 1200 bytes.

## Native Code Generation

Pascal/MT+® native code is faster than interpreted Pascal and other native code Pascals in benchmark test programs. Optimization steps taken during compilation perform such enhancements as removing redundant PUSH/POP sequences and using single increment and decrement instructions when adding or subtracting small literal numbers. In addition, our disassembler interleaves your Pascal source code and symbolic assembly code to help you write more efficient programs.

## Extras

- Predeclared arrays INP and OUT directly access I/O ports.
- INLINE instruction for inserting assembly language between the Pascal statements. A built-in mini assembler translates the instructions at compile time. Constant tables may be generated using the inline facility.
- ABSOLUTE assembly language procedure declarations for using pre-assembled routines.
- INTERRUPT procedures.
- CHAINING for transferring control from one program to another.
- ELSE clause on the case statement.
- REDIRECTED I/O facilities allow user written character: level I/O drivers to be called via READ and WRITE statements.
- HEX literal numbers are supported.
- Built in procedures/functions:
  - bit test, clear, set.
  - byte swap.
  - return hi or lo byte.
  - Shift left and right.
  - Return the address of a data item or routine.
  - Return the size of a data item.
  - Enable, disable interrupts.
  - All standard file I/O plus random read and write to files.
- Include files supported.
- Source code for run-time package included.
- Business (18 digit) arithmetic.
- Scientific (6.5 digit) arithmetic.
- AMD 9511 hardware support.
- Transcendental functions.
- Full string capability (UCSD compatible).

## Symbolic Debugger

Our symbolic debugger is optionally linked into the final program. If you're tired of feeling like you're in the dark when using a higher level language, the Pascal/MT+® debugger lights up the darkness. The debugger traces one or more lines of Pascal code or executes the program until a line number or symbolic breakpoint is reached. To follow program flow the name of each procedure and function entered is displayed by the debugger. The contents of simple and complex variables may be displayed by name. The debugger may be used in a ROM environment so that program flow and variable contents are visible.

## Distribution disk contains

- BCD compiler configured for your target machine.
- Floating point compiler configured for your target machine.
- Linker.
- Interactive Symbolic Debugger.
- Run time package in source and object form.
- Pascal library and utility routines.
- Manual containing an Applications Guide and a Language Guide.
- Sample programs.
- Librarian program to manage libraries of modules.

## System Requirements

- Operating System: CP/M® (or equivalent such as CDOS, IMDOS, etc.) MP/M™, Intel ISIS II, Heath HDOS, and PDP-11 systems to be available soon.
- Memory requirements: 48K minimum.
- Host Machines: 8080 or Z80.
- Target Machines: 8080/Z80, 68000, Z8000, 8086/8088, 6809.
- Resident compilers for all processors will be forthcoming as operating systems become available.

MT MicroSYSTEMS has a very reasonable, graduated, one time royalty arrangement for free standing software generated by Pascal/MT+®.

## Ordering

8 bit processor target machines:  
 8080/Z80, 6809 ..... \$250.00 each

16 bit processor target machines:  
 68000, Z8000, 8086/8088 ..... \$500.00 each

User's guide alone  
 (refundable with system purchase): ..... \$30.00

Contact us for information about our automatic update service.

Note: Not all 16-bit CPU code generators are available at this time; contact us for information before ordering.

OEM and Dealer inquiries invited.

Circle 248 on inquiry card.



# FREE

**WORD PROCESSOR  
and  
REPORT WRITER  
when you buy this  
CADO COMPUTER!**

Now... own a *complete* CADO business computer and word processor for about the cost of IBM's computer-only 5120. It's the only low cost system that's multi-tasking: you can actually enter your payables or receivables at the same time you print perfect letters or documents.

CADO is the perfect way to keep track of things, too: personnel, sales, purchase orders... everything. And only CADO has JUST ASK II—the simple, programmerless English language inquiry system. It's free, too. JUST ASK II works with Word Processing to automatically insert names and facts in your standard letters. And CADO has an application package just for you.

Get all the facts on the only computer with *free* word processor and report writer... from the world's fastest growing computer company... sold and serviced in over 150 CADO offices worldwide.

Send in the coupon NOW!

## CADOSYSTEMS

CADO Systems Corporation  
2771 Toledo Street • Torrance, CA 90503  
(213) 320-9660 B11

Please rush me more information on the CADO System 20/22.

NAME \_\_\_\_\_  
TITLE \_\_\_\_\_  
COMPANY \_\_\_\_\_  
ADDRESS \_\_\_\_\_  
CITY \_\_\_\_\_ STATE \_\_\_\_\_ ZIP \_\_\_\_\_

The most impressive feature of muMATH-79 is its ability to do symbolic differentiation and integration.

sign to distinguish it from the single equal sign, which is used as a Boolean equality operator; the final X in the SOLVE command tells muMATH-79 to solve for the variable X.)

It is also aware of imaginary and complex numbers and uses the variable #I to represent the imaginary number i:

```
? SOLVE(X12+1==0,X);
@ {X = -#I,
   X = #I}
```

However, muMATH-79 is not intelligent; it cannot solve equations of order 3 or higher. (The example with the X<sup>3</sup> polynomial is seen by muMATH-79 as being of order 2, with a zero factor added.) Factoring is hard even for people, but muMATH-79 can aid you in factoring a higher-order polynomial.

### Trigonometric and Logarithmic Manipulation

With the addition of these packages to the muMATH-79 system, the user can manipulate logarithmic and trigonometric expressions. Manipulation of these expressions varies with the values of certain control variables.

For example, if the trigonometric expansion variable TRGEXPD is 0:

```
? SIN(5*Y);
@ SIN(5*Y)
```

But if TRGEXPD is -6 (denoting expansion of multiple-angle sine and cosine functions):

```
? SIN(5*Y);
@ -12*COS(Y)12*SIN(Y)
+ 16*COS(Y)14*SIN(Y)
+ SIN(Y)
```

The functions available are LN (logarithm to the base e), LOG (logarithms to other bases), SIN, COS, TAN, COT, SEC, and CSC. And muMATH-79 uses the variable #E (for e) and #PI (for π).

### Matrix Manipulations

The math system can also manipulate matrices. Matrices can be multiplied (or divided) by a matrix or a scalar, transposed, inverted, and taken to an integer power. If a matrix is nonsingular (ie: its inverse does not exist), muMATH-79 responds to an attempt to invert it with divide-by-zero error messages. If the matrix can be inverted, the coefficients of its inverse, if nonintegral, are expressed as fractions—that is, the inverse is algebraically exact. For an example of this, see listing 2.

Matrix operations are fast as well as exact. The inversion of matrix H in listing 2 took 5 seconds, and the inversion of a 5-by-5 matrix took 48 seconds. Since matrix entries are symbolic, the entries can be scalars or matrices. This allows the formation of complex data structures that can be manipulated by muMATH-79.

### Differentiation and Integration

The most impressive feature of muMATH-79 is its ability to do symbolic differentiation and integration. For example, if we differentiate 1/X<sup>3</sup> with respect to X, we get -3X<sup>-4</sup>. muMATH-79 accomplishes the task as follows:

```
? DIF(1/X13,X);
@ -3 / X14
```

Listing 2: Matrix inversion and multiplication in muMATH-79. Listing 2a shows the creation of the 2 by 2 matrix H. Listing 2b shows the creation of the inverse of H, HINV. Listing 2c shows the multiplication of two compatible matrices using a period (.) as the muMATH-79 matrix multiplication operator.

(2a)

```
? H: {[380, -115/2], [17, 109]};
@ {[380, -115/2],
   [17, 109]}
```

(2b)

```
? HINV:H^-1;
@ {[218/84795, 23/16959],
   [-34/84795, 152/16959]}
```

(2c)

```
? H.HINV;
@ {[1, 0],
   [0, 1]}
```

# DIGIAC MAPS 1000

MP/M'S  
HARDWARE  
PARTNER



*\*The Digiac MAPS-1000 MP/M\* Universal Support Module has been designed to meet the total demands required by Digital Research's MP/M multi-user, multi-tasking operating system. All input/output, interrupt generation for task switching, and disk bootstrapping are resident functions on the MAPS-1000.*

**\*The MAPS-1000 has been designed with all the following powerful features:**

- Four (4) independent RS-232C Serial Communication channels
- One 8 bit TTL parallel port
- On-board phantom controlled disk boot prom/monitor
- Power on jump capability
- Crystal controlled MP/M interrupt generation Logic
- On board extended memory bank switching Logic

\* MAPS-1000 fully assembled and tested introductory price... \$375.00

**DIGIAC CORPORATION**  
175 Engineers Road  
Smithtown, New York 11787  
Phone (516) 273-8600  
MP/M is a trademark of the  
Digital Research Corporation



## HEATH H9 OWNERS



**UPGRADE your H9<sup>®</sup> for a fraction of the cost of a new terminal with these features.**

### FLICKER FREE

\$69.95 KIT \$79.95 ASSEMBLED

If Columbus would have had to wait for his H9 operating at 600 baud, he might not have discovered America. At last your computer can communicate with your H9 eight times faster (4800 baud) without that annoying refresh interrupt that causes the screen to flash at rates greater than 600 baud. Faster listings. Faster program execution. Eight times faster.

### CURSOR CONTROL

\$29.95 KIT \$34.95 ASSEMBLED

Why limit your output to consecutive lines of your terminal? CURSOR CONTROL allows your computer to move the cursor anywhere on the screen. Add that professional touch to your displays by utilizing masking techniques. Functions included are: left, right, up, down, left and right 20 spaces, home and erase page.

### GRAFIX

\$59.95 KIT \$69.95 ASSEMBLED

Open a whole new world to your output. The graphical display capabilities of GRAFIX allow you to create displays never before possible on the H9.

### LOWER CASE ENTRY

\$28.88 ASSEMBLED

Now you can enter lower case characters from the keyboard. A Shift Lock key allows the keyboard to operate as the standard H9 keyboard or to generate upper and lower case depending upon the Shift key as per a normal typewriter.

### LOWER CASE DISPLAY

\$34.77 ASSEMBLED

Lower case capabilities greatly improve readability on terminals modified for 24 lines.

### KEY CAPS

\$12.50 SET 4 ARROWS \$1.00

These quality contour key caps have molded-in alphanumeric. For that professional feel.

**Full Six Month Warranty — 24 Line Compatible**

## NORTHWEST COMPUTER SERVICES, INC.

8503 N.E. 30th Ave.  
Vancouver, WA 98665  
(206) 573-8381

\*H9 is a registered trademark of Heath Co. MASTER CARD and VISA welcome.



### The Ultimate Application Development System

Our Selector-IV™ data base management system will let your micro-computer operate with the flexibility available (up to now) only on larger systems. You can create, maintain and report on files limited in size only by your CP/M™ compatible operating system or disk storage capacity.

The basis of the power of Selector-IV™ is our unique method of cross-indexing the information in your files. You can immediately recall records by the contents of any piece of information required — from account numbers to ZIP codes to the date of your last audit. You can update records, individually or all at once. You can create new, uniquely, selected sub-files from existing ones (in the same or a different format), and perform computations in the process. You can define procedures to generate computed invoices, personalized letters, or gummed labels with the information coming from several files at once, and invoke them whenever needed. You can add new items to a record definition and change or delete them at will.

We've come a long way since we released the first information management system in microcomputers. We've built screen editing functions into the system which make operating the system as convenient as possible. We've had Selector-IV's™ documentation produced by our experts emphasizing its use for the novice, the applications developer, as well as, the retailer. Our applications specialists can provide you with a "turnkey" Selector-IV™ system customized for virtually any requirement.

With Selector-IV™ and a good word processor program, chances are you won't need any other software. Look for Selector-IV™ at your local computer retailer, or call:

**MICRO\*AP, INC.**  
9807 Davona Dr., San Ramon, GA 94583  
(415) 828-6697

**MICRO\*AP**



\*CP/M is a registered trademark of Digital Research.

Circle 252 on inquiry card.



## BET, YOU DIDN'T KNOW!

OAE'S new PP-2708/16 PROM Programmer is the only programmer with all these features:

- Converts a PROM memory socket to a table top programmer: No complex interfacing to wire — just plug it into a 2708 memory socket\*
- A short subroutine sends data over the address lines to program the PROM
- Programs 2 PROMS for less than the cost of a personality module. (2708s and TMS 2716s)
- Connect 2 or more in parallel — super for production programming
- Complete with DC to DC switching inverter and 10

turn cermet trimmers (for precision pulse width and amplitude alignment)

- All packaged in a handsome aluminum case

PP-2708/16... A & T \$349.95

PP-2716 (Programs Intel's 2716... A & T \$324.95

# OAE

Oliver Advanced Engineering, Inc.  
676 West Wilson Avenue  
Glendale, Calif. 91203  
(213) 240-0080

## CROSS-ASSEMBLERS

WRITTEN IN ANSI FORTRAN IV

PACKAGE NO.	MACHINE(S)
XASM000	MC8000,02,08
XASM001	MC8001
XASM005	MC8005
XASM008	MC8008
XASM006	8000,8006
XASM1002	CDP1002
XASM0502	8600 FAMILY

Full instruction set, all addressing modes. Free-format input, relocatable listing and object modules, many user-selectable assembly options. 8-character labels, arithmetic expressions in operands, long error messages, high execution speed.

Full-capability assemblers run on almost any system supporting ANSI standard FORTRAN IV, 1988 or later, at a fraction of the cost of a separate development system.

FORTRAN SOURCE MEDIA	PRICE
MAGNETIC TAPE PACKAGE	..... \$75.00
PUNCHED CARD PACKAGE	..... \$50.00
MANUAL/LISTING ALONE	..... \$20.00

Packages include manual/listing, shipping in U.S.A. For cards, specify punch code. For tape, specify code, BPI, block size.

# IDM

P.O. Box 14538  
Minneapolis, MN 55414  
(612)-722-1702

Circle 254 on inquiry card.

# GET Paid

for using your Computer

FUN!

Easy

RUSH COUPON FOR  
FREE FACTS



GREAT SPARETIME



Send today to — DAR-B11  
209-5 Kenroy, Roseville, CA 95678

CASH

NAME \_\_\_\_\_

STREET \_\_\_\_\_

CITY \_\_\_\_\_

STATE \_\_\_\_\_ ZIP \_\_\_\_\_

Circle 255 on inquiry card.

Sales  
Installation  
Service  
of  
Computers

**JEPSAN, Group K**  
Incorporated

\* PERSCI DISK REPAIR \*

MINIMIZE DOWN TIME

BY  
CALLING

**(616) 698-8700**  
GROMEMCO Dealer

4180 44th Street S.E.  
Grand Rapids, MI 49508



Circle 256 on inquiry card.

Listing 3: Algebraic intergration in muMATH-79. Listing 3a shows the creation of the function FC1, which equals  $X^2 + \ln(X)$ . Listing 3b shows the calculation of the indefinite integral of FC1, while listing 3c shows the calculation of its definite integral from  $e$  to  $2e$ . (See the text for these two equations written in conventional form.)

(3a) ? FC1: X^2+LN(X);

@ X^2 + LN(X)

(3b) ? INT(FC1,X);

@ -X + X\*LN(X) + X^3/3

(3c) ? DEFINT(FC1,X,#E,2\*#E);

@ -2\*#E + 2\*#E\*LN(2\*#E) + 7\*#E^3/3

It works with the resources of whatever packages are loaded into it at the time. For example, if the trigonometric package is loaded, muMATH-79 can do the following:

? DIF(COT(2\*X),X);  
@ -2 \* CSC(2\*X)I2

which translates as:

$$\frac{d}{dx} \cot 2X = -2 \csc^2(2X)$$

Indefinite and definite integrals are also within muMATH's capabilities. The definite integral is calculated by simple substitution of the integral limits into the result of the indefinite integration, in much the same process a person performs. If muMATH-79 cannot do this, it simply returns the indefinite integral. Listing 3 shows its calculation of the following two integrals:

$$\int X^2 + \ln(X) dX = \frac{X^3}{3} + X \ln(X) - X + C$$

and

$$\int_e^{2e} X^2 + \ln(X) dX = \frac{7e^3}{3} + 2e \ln(2e) - 2e$$

### muMATH-79 Control Variables

The package does not exhibit artificial intelligence. (Although with some of its accomplishments, it seems to exhibit it.) Rather, it is a very sophisticated symbol manipulator

that rigorously applies a given set of rules to arrive at a transformed result. But achieving a desired algebraic manipulation is not always an exact process.

For example, consider the trivial example given in figure 1a. If the denominator is distributed over the numerator, the result is the expression in figure 1b. But if we factor the numerator first, the discovered factor of  $(X+1)$  in the numerator cancels the  $(X+1)$  in the denominator, leaving the simplified answer in figure 1c.

muMATH-79 cannot make these decisions; it is a tool, not a problem solver. So certain variables called *control variables* are introduced into its environment. Under human control, these variables are used to tell muMATH-79 what manipulations to make.

(a)  $\frac{X^3 + X^2}{(X+1)}$

(b)  $\frac{X^3}{(X+1)} + \frac{X^2}{(X+1)}$

(c)  $\frac{X^3 + X^2}{(X+1)} = \frac{X^2(X+1)}{(X+1)} = X^2$

Figure 1: Options in the transformation of an algebraic expression. The simple expression in figure 1a can be transformed to that of figure 1b by distributing the denominator over the terms of the numerator. A more useful transformation, however, is shown in figure 1c. By factoring out a term of  $X^2$  and cancelling out the  $(X+1)$  factor in both numerator and denominator, the expression can be considerably simplified.

# Payroll General Ledger Accounts Payable Accounts Receivable

Flexible and sophisticated business software that is of the highest quality. Originally developed by Osborne & Associates and rapidly becoming a standard. Accountants are pleased with our balance sheets and income statements. It has been tested and approved by secretaries.

- Complete instructions
- Up and running the same day of delivery.
- 100% guaranteed
- Unlimited free telephone assistance.
- Return within 30 days for complete refund if not satisfied.
- No licensing agreement — use as you want.

Accounts Receivable .....	\$145.00
Accounts Payable .....	\$145.00
Payroll-California .....	\$145.00
Payroll-Non California state income tax calculations (add to California payroll) .....	\$125.00
General Ledger .....	\$145.00
Multiple profit center option for general ledger .....	\$ 50.00
Manuals (each) .....	\$ 20.00

Formats: Any 8" single or double density, TRS-80 Mod II, Northstar DD, Vector Graphics, Super Brain, many others.  
Runs on Beehive, Soroc, Hazeltine, ADDS, Televideo, SOL, TRS-80 Mod II, HEATH, ACT V, Interube II, Altos, ADM and many other terminals. All programs in CBASIC under CP/M (includes source).

Synergetic Computer Products  
575 Middlefield Avenue Suite J, Palo Alto, CA 94301  
(415) 328-5391

VISA • Master Charge • COD • Company Check  
TRS-80 is a trademark of Radio Shack, Inc. CP/M is a trademark of Digital Research.

# NOBODY DOES IT LIKE SYNCHRO-SOUND!



**HAZELTINE  
1420  
VIDEO TERMINAL  
\$775<sup>00</sup>**

**HAZELTINE  
1500  
VIDEO TERMINAL  
\$849<sup>95</sup>**



**SYNCHRO-SOUND ENTERPRISES, INC.**

The Computer People  
193-25 Jamaica Avenue  
Jamaica, N.Y. 11423

PHONE ORDERS, CALL:  
New York—212/468-7067  
Los Angeles-213/628-1808  
Chicago-312/641-3010  
Dallas-214/742-6090

Multi-User Capabilities  
for MicroNOVA™

**Wild Hare Puts Muscle Into Your  
MicroNOVA™  
By Adding Multi-User Capabilities  
To DG's DOS!**

- Supports up to five users simultaneously executing jobs
- All Data General languages for MicroNOVA™ are supported
- User shared code support
- Independent user directories
- Record lockout facility
- Printer spooling package

Now Data General Users  
Have A Choice!

**A WILD HARE**  
COMPUTER SYSTEMS INC.

P.O. Box 3581, Boulder, Colorado 80307  
(303) 422-1182



MODEL PC-10: Finger Controlled

**Pacenter™  
Desoldering  
Systems**

**REMOVE ANY COMPONENT  
FROM ANY PCB  
... QUICKLY AND SAFELY**



MODEL PC-20:  
Footpedal Controlled

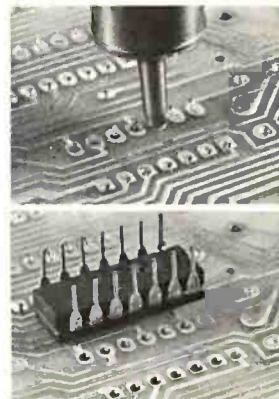

**STANDARD SYSTEM FEATURES**

- Lightweight and Portable
- Internal Vacuum Pump
- Sodr-X-Tractor Handpiece
- Variable Temperature Control

**PAGE**  
INCORPORATED

9893 Brewers Court ■ Laurel, Md. 20810 ■ phone (301) 490-9860

Although an explanation of the intricacies of control variables is beyond the scope of this review, the topic does deserve some explanation. Table 1 is a list of the control variables and their effects on algebraic expressions. Table 2 shows the effect of one control variable, NUMNUM, on expressions. (Most control variables behave similarly,

with positive values causing an expansion of terms to take place and negative values causing a combination of terms to take place.)

### Generating a muMATH-79 System

Because muMATH-79 can potentially use more than 64 K bytes of memory, the system is supplied as a

series of packages that can be combined to create an optimal environment for a given purpose. Figure 2 shows a *dependency diagram* from the muMATH-79 packages as they are supplied. To run a given package, you must load that package and all the packages above it. For example, to manipulate algebraic and logarithmic expressions, you must load the file named MUSIMP79 (which loads MUSMORE automatically), ARITH, ALGEBRA, and LOG, in that order. To solve equations that use logarithmic expressions, you would add to the above the files EQN and SOLVE.

Of course you would like to have all the packages available at once. Unfortunately, due to the large size of the packages, this cannot be done. A 32 K-byte system is necessary to run anything in muMATH-79, but more memory is recommended. It takes 40 K bytes, for example, to run algebra and 48 K bytes to run either calculus or matrix algebra.

A muMATH-79 system is first generated and then saved for future loading into the same system. Each package takes 1 to 5 minutes to load, given a Z80 system running at 4 MHz; loading time will be proportional to the speed of the processor being used.

Another method of loading, called *condensation*, takes from 10 minutes to 1 hour per module to load, but it has the advantage of loading the same module in just over half as much memory. At BYTE Publications Inc, we are running a condensed system in 56 K bytes that includes all the muMATH-79 packages except TRACE, ARRAY, and MATRIX. It took an afternoon to set up the system, but the time was well spent, because all the packages interact with each other. However, problem solution time decreases with increased unused memory. Decreasing the number of packages used would probably cut the solution times of problems, but so far the delays encountered have been hardly objectionable.

### The muSIMP-79 Language

An unexpected benefit of the muMATH-79 package is the inclusion of the muSIMP-79 language. muMATH-79 as supplied is actually a series of source files written in muSIMP-79. Inclusion of the source files allows you the very important

Control Variable	Result with Positive Value	Result with Negative Value
NUMNUM	$A(B+C) \rightarrow AB+AC$	$AB+AC \rightarrow A(B+C)$
DENDEN	$\frac{1}{A} \left( \frac{1}{B+C} \right) \rightarrow \frac{1}{AB+AC}$	$\frac{1}{AB+AC} \rightarrow \frac{1}{A} \left( \frac{1}{B+C} \right)$
DENNUM	$\frac{B+C}{A} \rightarrow \frac{B}{A} + \frac{C}{A}$	$\frac{B}{A} + \frac{C}{A} \rightarrow \frac{B+C}{A}$
NUMDEN	$\frac{A}{B+C} \rightarrow \frac{1}{\frac{B}{A} + \frac{C}{A}}$	$\frac{1}{\frac{B}{A} + \frac{C}{A}} \rightarrow \frac{A}{B+C}$
BASEXP	$A^{B+C} \rightarrow A^B A^C$	$A^B A^C \rightarrow A^{B+C}$
EXPBAS	$(AB)^C \rightarrow A^C B^C$	$A^C B^C \rightarrow (AB)^C$
PWREXP	$(A+B)^2 \rightarrow A^2 + 2AB + B^2$	$(A+B)^2 \rightarrow \frac{1}{(A^2 + 2AB + B^2)}$
	$(A+B)^3 \rightarrow A^3 + 3A^2B + B^3$	$(A+B)^3 \rightarrow \frac{1}{A^3 + 3A^2B + 3AB^2 + B^3}$
	(etc)	(etc)

**Table 1:** The effect of control variables on symbolic manipulation within muMATH-79. The values given to these control variables determine how muMATH-79 manipulates algebraic expressions. Other control variables not listed in this table are TRGSQ, TRGEXP, LOGBAS, PBRCH, and LOGEXP, which control trigonometric and logarithmic expressions.

Value of NUMNUM	Transformation	Example
0	do nothing	$3A(B+C)(D+E) \rightarrow 3A(B+C)(D+E)$
2 and its multiples	distribute constants over sums	$\rightarrow A(3B+3C)(D+E)$
3 and its multiples	distribute monomials over sums	$\rightarrow 3(AB+AC)(D+E)$
5 and its multiples	distribute sums over sums	$\rightarrow 3A(D(B+C)+E(B+C))$
6 (= 2*3)	distribute constants and monomials over sums	$\rightarrow (3AB+3AC)(D+E)$
10 (= 2*5)	distribute constants and sums over sums	$\rightarrow A(D(3B+3C)+E(3B+3C))$
15 (= 3*5)	distribute monomials and sums over sums	$\rightarrow 3(ABD+ABE+ACD+ACE)$
30 (= 2*3*5)	distribute constants, monomials, and sums over sums	$\rightarrow 3ABD+3ABE+3ACD+3ACE$
-2, -3, -6	same as 2, 3, 6, only factor out instead of distribute	NUMNUM = -3 causes $3AB+3AC \rightarrow A(3B+3C)$

**Table 2:** A detailed example of the effect of the control variable NUMNUM on algebraic expressions. NUMNUM is so named because it controls the distribution or factoring of a numerator expression with the numerator expression containing it. Positive values cause a factor to be distributed across a sum, while negative values cause factoring a common value from a sum.



# IEEE-488 BUS SYSTEM BUILDING BLOCKS

For Commodore PET/CBM and other computers...



TNW-2000

**TNW-1000** Serial Interface: \$129  
1 channel output only

**TNW-2000** Serial Interface: \$229  
1 channel input and output

**TNW-232D** Dual Serial Interface: \$369  
2 channels input and output plus RS-232 control lines

**TNW-103** Telephone Modem: \$389  
Auto answer/auto dial. Use with DAA

**SOFTWARE** PTERM: A program that turns your PET into a terminal (Use with TNW-2000, TNW-232D or TNW 103)  
SWAP: Allows storage of up to 8 programs in PET memory at once. Run them in any order.  
PAN: A sophisticated electronic mail program (use with TNW-103)



Write or call for information today:

TNW Corporation  
3351 Hancock Street  
San Diego CA 92110

(714) 225-1040

# DEC LSI-11 Components

Dependable service at discount prices

Domestic and Export

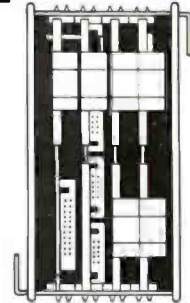

Mini Computer Suppliers, Inc.

25 Chatham Rd., Summit, N.J. 07901  
Since 1973

(201) 277-6150 Telex 13-6476

©Mini Computer Suppliers, Inc. 1979

# SPECTACULAR Offers

**BASF "FLEXIDISK"**  
Superior quality data storage medium, certified and guaranteed 100% error free.

5 1/4" or 8" Diskettes ..... 10/ \$24  
5 1/4" or 8" Vinyl Storage Pages ..... 10/ \$5

Write for quantity discounts  
\*Single sided / Single Density

**SFD CASSETTES**  
"Super Ferro Dynamic"  
Using the finest Agfa PE 611 tape in a professional quality housing.

**C-10 Cassette Sonic Weld Housing** ..... 10/ \$7  
Add 10¢ p/cassette for 5 screw housing  
**Cassette Album Page** ..... \$1.89  
Write for quantity discounts

**LIBRARY CASE**  
3-ring binder album. Protects your valuable programs on disks or cassettes. Fully enclosed and protected on all sides similar to Kas-sette storage box.

Library 3-ring binder \$6.50

5 1/4" mini Kas-sette 10/ \$2.49  
8" Kas-sette 10/ \$2.99

Write for quantity discounts

**DISKETTE DRIVE**  
head cleaning kits prevent head crashes and insure efficient error-free operation.

5 1/4" or 8" KIT  
**INTRODUCTORY PRICE**  
**\$19.50**

**HARDHOLE**  
reinforcing ring of tough mylar protects your disks from damage.

8" applicator ..... \$4.00  
5 1/4" applicator ..... \$3.00  
8" mylar hardholes (50) ..... \$8.00  
5 1/4" mylar hardholes (50) ..... \$6.00

**ABM PRODUCTS**  
631 "B" St.  
San Diego, CA 92101  
(714) 235-6602

VISA • MASTERCHARGE • MONEY ORDERS  
CERTIFIED CHECK • FOR PERSONAL CHECKS  
ALLOW 2 WEEKS • C.O.D. REQUIRES A 10%  
DEPOSIT • CAL. RES. ADD 6% SALES TAX  
MIN. \$2 SHIPPING & HANDLING • MINIMUM  
ORDER \$10 • SATISFACTION GUARANTEED  
OR FULL REFUND.

## The WORKSHEET Problem-Solving Language

Want to play "What-if"? Want to do Real Estate Analysis, Family Budgeting, Taxes, Company Cash Flow; want to evaluate the effect of changing assumptions on complex and interrelated processes? WORKSHEET is a powerful language designed for the purpose of writing programs to solve these and all other programs that involve a row-column "spreadsheet". Even non-programmers are solving complicated problems (e.g., the loads on a bridge as a train progresses across it) within the first day! For use with MicroSoft Basic or with North Star Basic under CP/M (please specify).

WORKSHEET Language disk (5" or 8" CP/M) \$99.95  
Manual only 19.95

## NORTH STAR BASIC—CP/M

Fabulous North star Basic Meets

The Industry Standard CP/M Operating System

North Star Basic users are switching to CP/M—all over the world—and we made it possible! The software professionals at the SoHo group present The MATCHMAKER, an easy-to-use conversion which enables North Star owners who also own the CP/M operating system to gain the full power of their North Star Basic, running under CP/M.

You'll have dynamic file allocation, automatic file creation and extension, and automatic reuse of deleted files, all under the control of the powerful instruction set of the outstanding North Star Basic interpreter.

Installation takes about 30 minutes and involves no dis-assembly or machine coding. Every powerful feature of both systems is maintained with this professional piece of software. And the instructions are COMPLETE and easy to follow.

The MATCHMAKER  
Manual only

\$89.95 ppd.  
9.95 ppd.

## The SoHo Group

140 Thompson St., Suite 4-B  
New York, NY 10012

Note: CP/M, Microsoft, and North Star are registered trademarks of Digital Research. Microsoft, and North Star Computers, respectively.

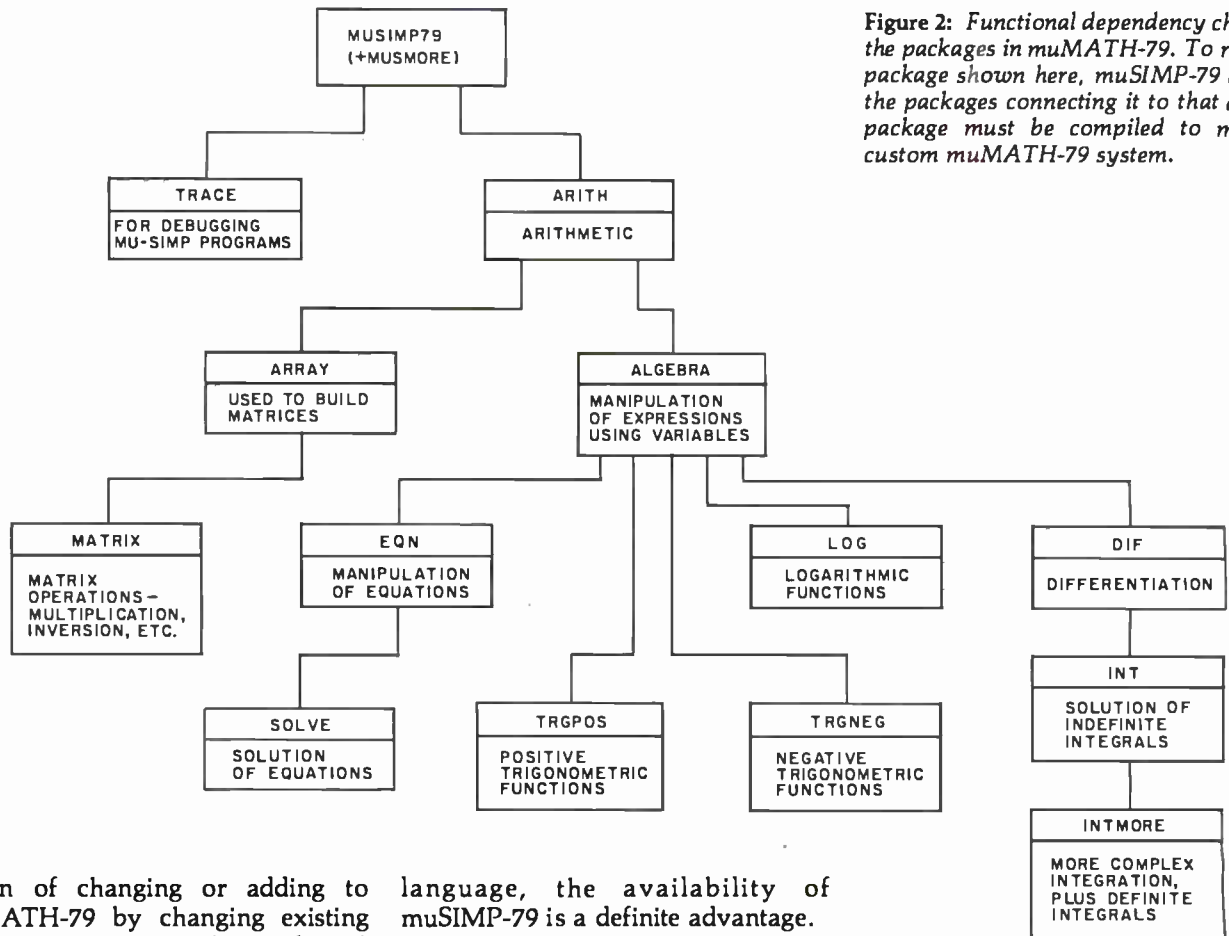

Figure 2: Functional dependency chart for the packages in muMATH-79. To run any package shown here, muSIMP-79 and all the packages connecting it to that desired package must be compiled to make a custom muMATH-79 system.

option of changing or adding to muMATH-79 by changing existing muSIMP-79 programs (ie: packages) or adding your own.

muSIMP-79 is a variation of the well-known list-processing language LISP; it has been adapted for readability and optimized for the manipulation of symbolic expressions. Considering that the entire capabilities of muMATH-79 are based on the use of the muSIMP-79

language, the availability of muSIMP-79 is a definite advantage.

### Documentation

The muSIMP/muMATH-79 Symbolic Math System comes with all its associated files on floppy disk and its printed documentation in a three-ring binder. There are about 175 pages of printed documentation in the reference manual, with tabbed sections marked General Information,

Calculator-Mode Lessons, Programming-Mode Lessons, muSIMP-79, Arithmetic, Algebra, Equation, Matrix, Log and Trig, and Calculus.

All of the sections consist of either documentation or source code for a particular package, both of which are

*Never so fast . . . Never so easy!*

# 3D Animation for the Apple II

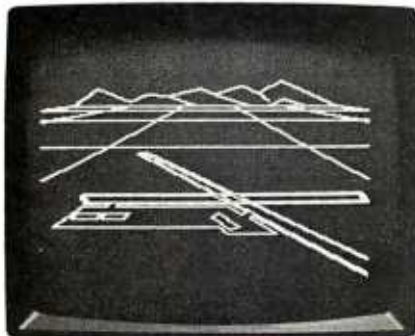

With SubLOGIC's A2-3D1 high-speed 3D animation package for your Apple, you can • generate scenes or drawings • view them from any distance or angle and, yes • even rotate them. All you need is 16K RAM and the creative urge.

116 pages of documentation included to guide the beginner through scene creation, storage, retrieval, movement, and advanced applications.

#### Special Features:

- 100-150 lines-per-second projection rate
- Dual page flicker free animation
- Scenes created with standard coordinates
- Easy use with BASIC programs

Cassette \$45 or disk \$55. See your dealer or order direct (include \$1.75 for UPS or \$2.50 for first class mail). Illinois residents add 5% sales tax. Visa and Mastercard accepted.

The engineering and graphics experts opening a new era in computer simulation.

**subLOGIC**  
Distribution Corp.  
Box V, Savoy, IL 61874  
(217) 359-8482

**X.25**  
**BISYNC**  
**SDLC/SNA**

IBM 2770 IBM 2780  
 IBM 3270 IBM 3741  
 IBM 3780  
 IBM 3767

Software for Your Microcomputer  
 8080 Z80 8086 Z8000

**WINTERHALTER & ASSOCIATES, INC.**  
 3825 N. Zeeb Road Dexter, Michigan 48130  
 313-426-3029 or 313-665-5582  
 SPECIALISTS IN DATA COMMUNICATIONS

**TRS-80**  
**LEVEL II**  
**\$685** COMPLETE SYSTEM  
 Limited quantity in stock

The world's most popular microcomputer, with 16K of memory and Level II basic for only \$685, complete with full 90 day Radio Shack warranty. We accept check, money order or phone orders with Visa or MasterCard. (Shipping costs added to charge orders).

Disk drives, printers, peripherals, software and games . . . you name it, we've got it (Both Radio Shack & other brands). Write or call for our complete price list.



Shown is Level I. Level II includes Alphanumeric keypad.

**C&S**  
**ELECTRONICS MART**  
 Ltd.

**AUTHORIZED DEALERSHIP** **Radio Shack**

32 E. Main Street • Milan Michigan 48160 • (313) 439-1400

**BYTE**  
 Back Issues for sale

The following issues are available:  
 1976: July and November  
 1977: March, May thru December  
 1978: February thru October, December  
 1979: January thru December except March  
 1980: January to current issue except February  
 Cover price for each issue through August 1977 is \$1.75 Domestic; \$2.75 Canada and Mexico; \$3.75 Foreign.  
 September 1977 through October 1979 issues are \$2.50 Domestic; \$3.25 Canada and Mexico; \$4.00 Foreign.  
 November 1979 to current is \$3.00 Domestic; \$3.75 Canada and Mexico; \$4.50 Foreign.  
 Send requests with payment to:  
**BYTE Magazine**  
 70 Main St, Peterborough NH 03458  
 Attn: Back Issues

**BUY COMPUTERS BY MAIL ORDER AND SAVE 16%**

<b>APPLE HARDWARE</b>	<b>SOFTWARE</b>
16K \$ 958.00	Controller (General Business System) \$ 519.00
32K \$1,040.00	Cashier (Retail Mgmt & Inventory System) \$ 199.00
48K \$1,099.00	Apple Post Mailing List \$ 45.00
Disk with Controller \$ 495.00	
Disk \$ 440.00	
Pascal \$ 445.00	
Graphics Tablet \$ 655.00	
Symtek Light Pen \$ 215.00	
Versawriter Digitizer System \$ 215.00	
Videx Videoterm 80 Column Card \$ 315.00	
with graphics-ROM \$ 335.00	
Apple Clock \$ 225.00	
Micro Soft Z-80 Software Card with CPM \$ 319.00	
Parallel Printer Card \$ 145.00	
Communications Card with connecting cable \$ 185.00	
Apple II Firmware Card \$ 149.00	
Integer Basic Firmware \$ 149.00	

<b>CROMEMCO</b>	<b>NORTHSTAR</b>
SAVE 16% ON ALL EQUIPMENT	Horizon-2-32KDD \$2,390.00
	<b>VERBATIM &amp; MEMOREX</b>
	5 1/4" \$ 27.50
	<b>PLASTIC BOXES</b>
	5 1/4" \$ 2.25
	8" \$ 3.50

Send certified check (regular checks require 2 weeks to clear) or charge to VISA or MasterCard. Customer pays shipping.

**MIRO COMPUTERS, INC.**  
 27 Long Meadow Place South Setauket, L.I., N.Y. 11720  
 (516) 423-7955 CALL MON-SAT., 10AM-6PM

available on the disk in machine-readable form. Included are sections on building, saving, and using a muMATH-79 *environment* (which is the muMATH-79 packages compiled plus all the variable and status assignments completed to date). In addition, ten files (five for each subject) that execute interactively on the host computer cover the topics of using muMATH-79 in what is called *calculator mode* and of programming in muSIMP-79.

The Soft Warehouse prints an occasional newsletter that contains updates, additions, and (very occasionally) corrections to its muSIMP/muMATH-79 and muLISP (another of its products) systems. The people at the Soft Warehouse have been friendly and informative every time I've called them.

### muMATH-79 for the TRS-80

Microsoft Consumer Products of Bellevue, Washington (a sibling company to the Microsoft of Microsoft BASIC fame) is marketing two versions of muSIMP/muMATH-79 for the TRS-80. The first version, equivalent to the one described in this review, will sell for \$250.

A slightly diminished version of the system will be available for \$75—a very reasonable price. Although I have not seen it, the manufacturer informs us that the system will come with two floppy disks (one for 32 K-byte systems, one for 48 K-byte systems) and an abbreviated manual. The floppy disk for the 32 K-byte system will include muSIMP-79, a precompiled module including the arithmetic, algebra, and equation-solution packages, and uncompiled logarithmic and positive and negative trigonometric packages.

The floppy disk for the 48 K-byte

At a Glance:	
Name of program	muSIMP/muMATH-79
Type of program	language/utility
Manufacturer	The Soft Warehouse POB 11174 Honolulu HI 96828 (808) 734-5801
Price	\$290
Format	5-inch or 8-inch disk
Language used	8080 machine language
Computer needed	an 8080, 8085, or Z80-based computer running CP/M, CDOS, IMDOS, or TRSDOS operating systems
Documentation	175 pages, 8½ by 11 inches, in three-ring binder
Audience	high-school and college students, educators, programming language enthusiasts

TRS-80 system will be the same but will add the differentiation package and most of the integration packages in the compiled module. Both versions have extensions that allow muSIMP to access the TRS-80 graphics.

### Conclusions

● The muSIMP/muMATH-79 Symbolic Math System is a very impressive tool. It fills a gap in the spectrum of problems solvable by a computer.

● Although it cannot work wonders, muSIMP/muMATH-79 *can* solve many of the problems encountered in algebra, trigonometry, and even calculus classes. (Educators need not fear: muMATH-79 does not provide a solution's derivation, only the final answer.)

● Educators from the high-school level up have used the package as an aid to teaching mathematics. And researchers have used it to keep track

of equations during complex manipulations. Other potential users include: engineers demanding exact numeric solutions of problems and matrices (the fractional answers can be divided out conventionally to give decimal answers of any accuracy); researchers interested in artificial intelligence; college professors studying programming languages, and all those in need of a calculator.

● Although this is no fault of the package, muMATH-79 occasionally behaves in a way that, although correct, leads to unexpected and seemingly mysterious results. (I, for example, was unable to save a compiled package to disk drive B because I had assigned an algebraic value to the variable B.) Some sophistication on the part of the user is necessary in such cases.

● The documentation is good, but a thorough knowledge of the system is gained only by lots of practical experience. ■



### AIM 65

AIM 65 is fully assembled, tested and warranted. With the addition of a low cost, readily available power supply, it's ready to start working for you. It has an addressing capability up to 65K bytes, and comes with a user-dedicated 1K or 4K RAM.

- Thermal Printer
- Full-Size Alphanumeric Keyboard
- True Alphanumeric Display
- Proven R6500 Microcomputer System Devices
- Built-In Expansion Capability
- TTY and Audio Cassette Interfaces
- ROM Resident Advanced Interactive Monitor
- Advanced Interactive Monitor Commands

**PRICE: \$389.00**

Plus \$4.00 UPS (shipped in U.S. must give *street* address), \$10 parcel post to APO's, FPO's, Alaska, Hawaii, Canada, \$25 air mail to all other countries

We manufacture a complete line of high quality expansion boards. Use reader service card to be added to our mailing list, or U.S. residents send \$1.00 (International send \$3.00 U.S.) for airmail delivery of our complete catalog.

**RNB** ENTERPRISES  
INCORPORATED

2951 W. Fairmount Avenue • Phoenix, AZ 85017 • (602) 265-7564

# MICROSTAT NOW AVAILABLE FOR CP/M\*

MICROSTAT, the most powerful statistics package available for microcomputers, is completely file-oriented with a powerful Data Management Subsystem (DMS) that allows you to edit, delete, augment, sort, rank-order, lag and transform (11 transformations, including linear, exponential and log) existing data into new data. After a file is created with DMS, Microstat provides statistical analysis in the following general areas: Descriptive Statistics (mean, sample, and population S.D., variance, etc.), Frequency Distributions (grouped or individual), Hypothesis Testing (mean or proportion), Correlation and Regression Analysis (with support statistics), Non-parametric Tests (Kolmogorov-Smirnov, Wilcoxon, etc.), Probability Distributions (8 of them), Crosstabs and Chi-square, ANOVA (one and two way), Factorials, Combinations and Permutations, plus other unique and useful features.

MICROSTAT requires 48K, Microsoft MBasic with CP/M and is sent on a single-density 8" Disk. It is also available on 5" diskettes for North Star DOS and Basic (32K and two drives recommended), specify which when ordering. The price for Microstat is \$250.00. The user's manual is \$15.00 and includes sample data and printouts. We have other business and educational software, call or write:



**ECOSOFT**  
P.O. Box 68602  
Indianapolis, IN 46268  
(317) 283-8883

\* CP/M is a registered trade mark of Digital Research.



- Quantity Discounts Available
- 90-day Warranty
- Ask about our unique "Guaranteed Custom Programming"

### ZENITH DATA SYSTEMS

	LIST	OUR PRICE
Z89 MICROCOMPUTER SYSTEM .....	\$2,895	\$2,495
48KB Memory		
Z19 Video Terminal (24 x 80)		
2 Serial EIA ports		
Single 5" Diskette Drive		
Z19 Smart Video Terminal .... SPECIAL ..	\$ 950	\$ 795
24 lines x 80 col		
Reverse Video		
Numeric keypad		
HDOS Operating System (with BASIC) ....	\$ 150	\$ 145
Microsoft Basic .....	\$ 150	\$ 145
Word Processing for Z89 System .....	\$ 395	\$ 375
Dual 5" Diskette Drive for Z89 System ....	\$1,195	\$1,095

To Order: Send Check or Money Order to: PK Systems, Inc., 113 North Center, Bloomington, IL 61701. Allow two weeks for personal checks to clear. For COD Orders, add 5% for handling and service charge. Rush orders, add \$50.00

Shipping: Freight collect, FOB Bloomington. We ship UPS, air freight, or motor freight.

PK Systems is an Authorized Zenith Data Systems Dealer and Zenith Service Center.



## A Message to our Subscribers

From time to time we make the BYTE subscriber list available to other companies who wish to send our subscribers promotional material about their products. We take great care to screen these companies, choosing only those who are reputable, and whose products, services, or information we feel would be of interest to you. Direct mail is an efficient medium for presenting the latest personal computer goods and services to our subscribers.

Many BYTE subscribers appreciate this controlled use of our mailing list, and look forward to finding

information of interest to them in the mail. Used are our subscribers' names and addresses only (no other information we may have is ever given).

While we believe the distribution of this information is of benefit to our subscribers, we firmly respect the wishes of any subscriber who does not want to receive such promotional literature. Should you wish to restrict the use of your name, simply send your request to BYTE Publications Inc, Attn: Circulation Department, 70 Main St, Peterborough NH 03458. Thank you.

## CATCH THE S-100 INC. BUS!



	LIST PRICE	OUR SPECIAL CASH PRICE
SSM I/O-4 2P+2S KIT	210.00	144.00
GODBOUT ECONORAM XX-16K UNKIT	319.00	272.00
S.D. SYSTEMS SBC-100 Z-80 KIT	295.00	219.00
MSAI "8080" FRONT PANEL COMPUTER W/MPU-A A & T	1,150.00	800.00
MORROW DESIGNS SWITCHBOARD I/O KIT	199.00	170.00
ITHACA INTERSYSTEMS DPS-1 W/MPU-80 A & T	1,795.00	1,499.00
SHUGART SA-800 BARE DRIVE	650.00	475.00
NORTH STAR MDS-A DOUBLE DENSITY DISK SYSTEM A & T	899.00	699.00

Subject to Available Quantities • Prices Quoted Include Cash Discounts. Shipping & Insurance Extra.

We carry all major lines such as  
S.D. Systems, Cromemco, Ithaca Intersystems, North Star,  
Sanyo, ECT, TEI, Godbout, Thinker Toys, SSM.  
For a special cash price, telephone us.

**S-100, inc.**  
7 White Place, Clark, N.J. 07066  
201-382-1318

Hours: Mon. - Fri. — 10 a.m. to 6 p.m.

# An 8088 Processor for the S-100 Bus

## Part 3

---

Thomas Woodward Cantrell  
2475 Borax Dr  
Santa Clara CA 95051

---

MON88 is a small system monitor for the single-board 8088-based processor described in parts 1 and 2 of this article (September and October 1980 BYTE, pages 43 and 62 respectively).

The current configuration of MON88 implements sixteen commands (expandable to twenty-six) and uses less than 1.5 K bytes of memory. This includes a "large" (approximately 256-byte) video driver required for my hardware environment and lengthy messages (about 128 bytes' worth) that make MON88 easy to use. No attempt was made to optimize the amount of memory used.

Stripping out the video-driver routine (that is, using a hardware *terminal*, rather than software, to create the same effect) and the messages, along with some optimization, can probably reduce code size to 1 K bytes. My plan is to expand the monitor until it fills the 2 K bytes of EPROM (erasable programmable read-only memory) in the 8755A-2 integrated circuit on the processor board. (See table 1 for a quick-reference guide to the MON88 instruction set.)

### MON88 Philosophy

The 8088 incorporates very powerful, mainframe-like architectural features such as segmented memory, pipelining, multi- and co-processing "hooks," etc. One key objective of the 8088 project has been to implement the hardware and software in as simple a fashion as possible. This will allow users familiar with traditional 8-bit processors to ease into an understanding of this powerful new machine.

Following the philosophy of simplicity, my 8088 design embodies what is known as the "small model of computation." This model assumes that a given task can be implemented using one set of segmentation register values:

- one 64 K code segment
- one 64 K data segment
- one 64 K stack segment
- one 64 K extra segment

A key feature of the 8088 is that, for many instructions, certain memory segments are used to determine an absolute memory address. This allows instructions to be implemented in fewer bits, contributing to the extremely

efficient use of memory in the 8088. This is not a restriction because the default segment can be overridden by using a *segment-prefix* for the instruction in question.

In fact, my decision was to initially use only sixteen of the twenty address lines available on the processor board. In this case, all segments (code, data, stack and extra) totally overlap in the 64 K-byte address space of the processor board. This means we need not concern ourselves with what segment is where, and what instructions assume which segments.

### MON88 Organization

The organization of MON88 in memory is shown in figure 1. I will briefly discuss each section. Note that modifications to MON88 for your own environment are discussed later in this article. The following paragraphs describe each section of the monitor.

*Storage allocation and constant definition:* This section defines commonly used constants and specific I/O (input/output) port addresses, etc. In addition, memory allocation is performed for needed buffer and variable space.

*User jump table:* This is the first actual code in MON88 consisting of two MON88 entry points (INIT and START) and three I/O entry points (KEYIN, KEYSTAT and VIDOUT). A user program could terminate by jumping to one of the two MON88 entry points. Similarly, a user program could call one of the I/O entry points. When the I/O is done, the return instruction of each I/O routine will give control back to the user program.

*Segment register and I/O initialization:* The code, data, stack and extra segments (CS, DS, SS and ES) are set overlapping at address 0. Environment-dependent I/O initialization is also performed by this routine.

*Main loop:* This is the overall control routine for MON88. It prints the prompt character and accepts a one-letter command from the console. The appropriate command-routine address is determined and control is transferred from this routine.

*Message storage:* Messages used by various commands are stored here. Note that each message is terminated by a 0.

*Command jump table:* The addresses for the twenty-six possible commands are stored here. Note that

# THIS YEAR CPAIDS

## COMPLETE INTEGRATED ACCOUNTING SOFTWARE

**MASTER TAX**—Professional tax preparation program. Prepares schedules A, B, C, D, E, F, G, R/RP, SE, TC, ES and forms 2106, 2119, 2210, 3468, 3903, 2441, 4625, 4726, 4797, 4972, 5695 and 6251. Printing can be on readily available, pre-printed continuous forms, on overlays, or on computer generated, IRS approved forms. Maintains client history files and is interactive with CPAids GENERAL LEDGER II (see below) . . . \$995/\$30 Annual Update Fee . . . . . \$350

**GENERAL LEDGER II**—Designed for CPA's. Stores complete 12 month detailed history of transactions. Generates financial statements, depreciation, loan amortizations, journals, trial balances, statements of changes in financial position, and compilation letters. Includes payroll system with automatic posting to general ledger. Prints payroll register, W2's and payroll checks. . . . . \$450/\$30

Runs with widely accepted CP/M operating system

Distributed by

**Lifeboat Associates**  
1651 Third Ave., New York, N. Y. 10028

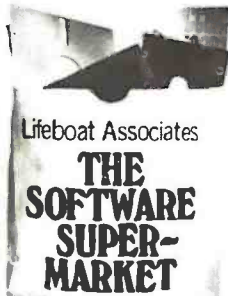

TM

# ZOBEX ZS-SYSTEMS

Complete computer on 3 S-100 boards with 32K RAM for \$1395.00  
Runs M/PM and C/PM

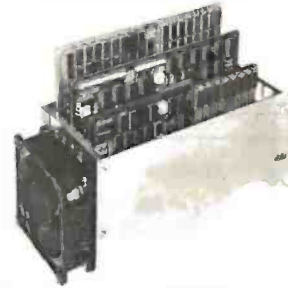

**64K RAM**  
4 MHz No WAIT States  
DMA operation,  
Bank select in 16K sections

**Z80CPU**                      **2-4 MHZ**  
2 or 4 serial ports, 3 parallel,  
one 4K EPROM, Vectored inter-  
rupts, real time clock, Software  
controlled baud rates, Drives  
daisy wheel printer directly

**DISK CONTROLLER**  
8" and 5" DRIVES  
All digital design for stable and  
reliable performance. No one-  
shots or analog circuitry. BIOS  
for C/PM available.

**CARD CAGE  
and Fan**

6 slot shielded motherboard for  
good cooling and low noise.

**SEND FOR FREE INFORMATIONS**  
6 months warranty on our boards with normal use

**ZS-SYSTEMS  
ZOBEX**

5333 Mission Center Rd., San Diego, CA. 92108  
P.O. Box 1847, San Diego, Ca. 92112  
(714) 447-3997, (714) 296-9182

To further improve  
service to our customers we  
have installed a toll-free  
WATS line in our  
Peterborough, New  
Hampshire office.

If you would  
like to order a  
subscription to  
BYTE, or if  
you have a  
question relat-  
ed to a BYTE  
subscription,  
you are invited  
to call\*

(800)258-5485  
between 8:00 AM and  
4:30 PM Eastern Time.  
(Friday 8 AM - Noon).

\*Calls from conti-  
nental U.S.  
only.

**BYTE's  
Toll-free  
Subscriber  
W.A.T.S. Line**

**(800) 258-5485**

We thank you and look  
forward to serving you.

9178

# Clipper<sup>TM</sup>

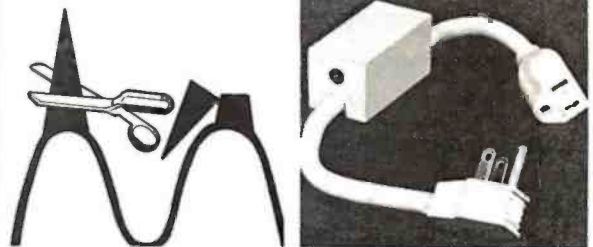

## LINE VOLTAGE TRANSIENT CLIPPING

Features Parallel Operation                      5000 Hits/Second

**PROTECTS:**

- Computers
- Micro-Computer Systems
- Word Processors
- Cash Registers
- Power Supplies

**PROTECTS AGAINST:**

- High Energy Voltage Transients
- On-Off Switching
- Lightning Induced Transients
- Inrush of On/Off Power

MFD. by Energy Electronic Systems, Inc.

Exclusively for:



7133 RUTHERFORD ROAD  
BALTIMORE, MARYLAND 21207  
**(301) 298-3130**

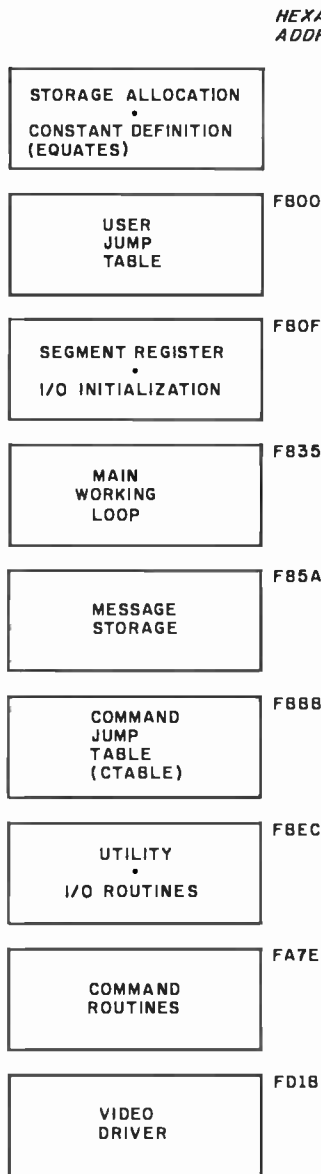

Figure 1: Memory map for the MON88 monitor.

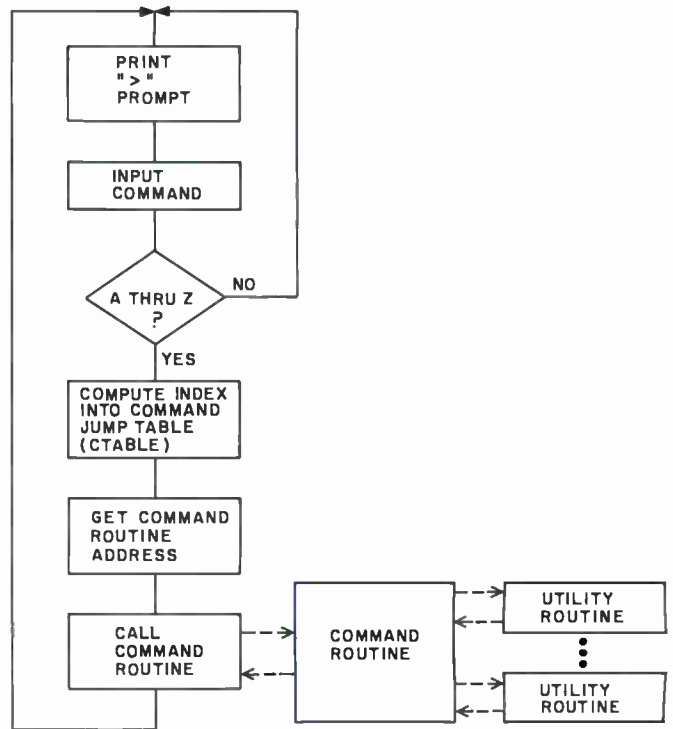

Figure 2: High-level flowchart for MON88 program. In general, the program decodes user input and, if valid, jumps to the appropriate command subroutine. Once the routine is finished, control is passed back to the command-input routine, and the program prints another prompt.

unimplemented commands are given the ERR (error) address.

**Utility and I/O routines:** This and the following (command routines) section make up the bulk of MON88. The utility routines are used by command routines. This allows command routines to be implemented largely as calls to various utility routines (see figure 2). For instance, many commands require the acquisition of a starting and ending address. The utility routine SETUP performs this function. Many of these utility routines may be useful in your own programming efforts.

**Command routines:** These are the routines that actually perform each command. Due to the extensive use of the above utility routines, most commands are easily implemented as a series of subroutines. A good example is the W (CWRITE) cassette-write command, which dumps a block of memory to tape (see listing 1, starting at line 576). Note that of the twelve "instructions" constituting the command, eight are calls to other routines.

The advantage of programming in this manner is that the command routines are easy to write. Should you

want to add commands, they can probably be implemented largely as a series of calls to already-existing, tested utility routines in MON88. This also saves memory space by eliminating redundant coding of essentially the same routine.

**Video driver:** My hardware requires a relatively lengthy software driver for the video board in my system. I converted this code from 8080 assembly language using Intel's CONV86 code converter. Briefly, the tradeoff is between the performance of the converted code versus a version rewritten for the 8088 and the associated time required for each process. Converted code may be somewhat larger than a rewritten version, but it will probably take only a small fraction of the time to implement as compared to a rewrite. Because the 8088 has a faster clock rate than the 8080, the converted program, even if larger, will probably run faster than the original 8080 version.

### Environment Dependence

The dependence of MON88 on a certain I/O or memory environment has been minimized. The following summarizes the changes you will need to make to adapt MON88 to your own system. Refer to listing 1, starting at line 14.

**Location of MON88:** The statement immediately preceding the EQUATES FOLLOW section sets MON88's origin. For my processor board, the origin is hexadecimal F800:

ORG F800H

Text continued on page 346



# GRAPHIC POSSIBILITIES

BY TOM SLOAN



I JUST WROTE A PROGRAM THAT WILL DISPLAY ANYTHING YOU THINK ONTO THE SCREEN, USING MY NEW REVOLUTIONARY "THINK SYSTEM."

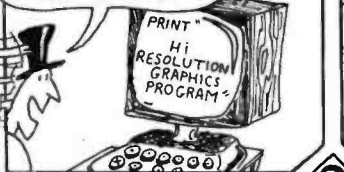

JUST HAVE A SEAT AND PUT ON THE THINKING CAP.



IS IT GOING TO HURT?



IT'S BLANK! ARE YOU THINKING?



I'M TRYING!

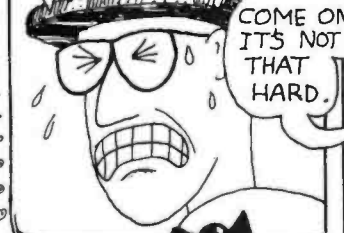

THERE YOU GO! GEE, YOU'RE THINKING OF ME.



IT'S A LIGHTNING BUG!

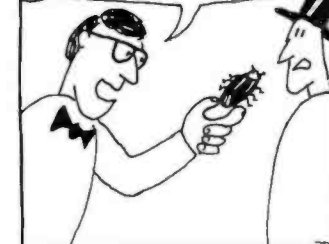

GREAT! PUT HIM UNDER THE MACHINE.



I'LL ASK HIM WHAT MAKES HIM EMIT LIGHT.

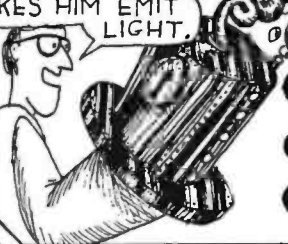

NEAT! AN L.E.L. LIGHT EMITTING LIGHTNING BUG!

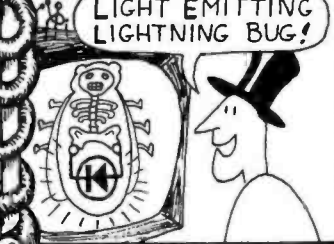

HEY, IT BOMBED!

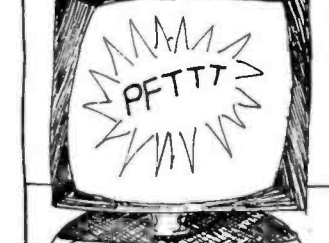

WHAT HAPPENED?

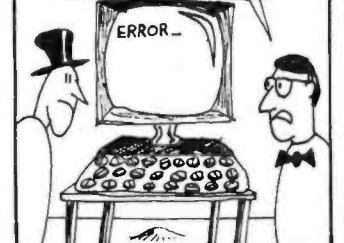

I GUESS THAT'S WHAT HAPPENS WHEN YOU HAVE A BUG IN YOUR PROGRAM.



## FOR SALE: OHIO SCIENTIFIC C2-8P SYSTEM

Do you want a lot of reliable computing power at a low price? Finances have forced me to sell my OSI C2-8P, which has the following:

- 6502-based OSI 500 processor board
- 540 video display board with graphics option
- powerful 542 polled keyboard
- 20K bytes of static programmable memory
- 8-slot motherboard with 5 empty slots
- cassette interface and two parallel ports
- hefty power supply
- all documentation, lots of reprints, OSI extended monitor and assembler tapes, some game and blank tapes.

My selling price is \$675, and I'll pay the shipping. Call me (603) 924-9281 days, or write: Gregory Williams, Shadow Lane Apts, #8, Peterborough NH 03458.

## Command Summary

Command syntax definitions:

[addr] = 16-bit address (or data) as four hexadecimal digits  
[data] = 8-bit data as two hexadecimal digits  
[cr] = carriage return

Note that [addr] and [data] entry routines accept the last four and two digits entered, respectively. For example, using the fill (F) command:

```
F0123456 789ABCD 0123456[cr]
```

is the same as

```
F3456 ABCD 56[cr]
```

Also note that [addr], [data] entries to commands can be separated by a blank or a comma, ie:

```
F3456 ABCD 56[cr]
```

is the same as

```
F3456,ABCD,56[cr]
```

Invalid hexadecimal digits and unimplemented commands always result in an error response. MON88 responds to errors by printing an asterisk (\*), carriage return/line feed sequence and redisplaying the prompt.

All entries to MON88 may be either upper or lower case.

Most commands can be halted temporarily with Control-S, restarted with Control-Q, and aborted with Control-C.

In the following examples, all user input to MON88 is underlined.

### Commands

**A** — Enter ASCII Text into Memory

Allows the direct entry of ASCII text from the keyboard into memory. The command is terminated with a Control-D [ctl-D]. At termination, the address following the last character entered is displayed:

```
A[addr][cr]
A100[cr]
This is a test of the 'A' command.[ctl-D]
@0122
D100 121[cr]
0100 54 48 49 53 20 49 53 20 41 20 54 45 53 54 20 4F
0110 46 20 54 48 45 20 27 41 27 20 43 4F 4D 40 41 4E
0120 44 2E
```

**B** — Not Implemented

**C** — Compare Cassette Input With Memory

Compares cassette input with the contents of

memory on a byte-by-byte basis. All tape-read operations display the length of the file being read when the header is found. In this case the length is hexadecimal 200 bytes. A heading line is displayed, and if a comparison fails, the address and differing inputs are displayed:

```
C[addr][cr]
C100[cr]
ADDR M T DIFF LENGTH (HEXADECIMAL)=0200
0102 77 76 00000001
```

In this example, the data coming from tape matched the data located starting at hexadecimal address 100 except for address 102, where a 1-bit error was encountered.

**D** — Dump or Display the Contents of Memory

Displays the contents of memory from [addr1] to [addr2] as sixteen hexadecimal values per line:

```
D[addr1] [addr2][cr]
D0 20[cr]
0000 01 33 43 56 A3D8 90 90 34 88 ACEE F0 99 5F 70
0010 86 45 10 3E D4 BB CDEE 42 4E 53 96 9F 88 53 40
0020 74
```

**E** — Enter Hexadecimal Data From the Keyboard into Memory

After you enter the E command and an address, MON88 will display the current contents of that memory address followed by a "-". The value at that address can be changed by entering a new value. Once a new value has been entered, or if no change to the contents is required, a space is entered. MON88 will then display the contents of the next location followed by a "-". The E command is terminated with a carriage return:

```
E[addr][cr]
D100 104[cr]
0100 01 02 03 05 06
E100[cr]
0100 01-02 02-03 03-04 05-__ 06-[cr]
D100 104[cr]
0100 02 03 04 05 06
```

**F** — Fill a Memory Block With a Constant

Fills a block of memory from [addr1] to [addr2] with a constant value:

```
F[addr1] [addr2] [data][cr]
F100 104 20[cr]
D100 104[cr]
0100 20 20 20 20 20
```

**G** — Go To and Execute a User Program

MON88 will vector to and begin executing a program in memory. Note that if the user program does not modify the contents of the segment registers, a

return instruction at the end of the program will transfer control to MON88. For this example, note that hexadecimal address F800 is the start address of MON88:

```
G[addr][cr]
GF800[cr]
(screen clears)
8088 Monitor [rev 0]
```

#### *H — Compute the Sum and Difference of the 16-Bit Hexadecimal Values*

MON88 will compute and display the sum and difference of two 16-bit arguments:

```
H[addr1] [addr2][cr]
H2000 1010[cr]
SUM DIFF
3010 0FF0
```

#### *I — Input a Byte From an I/O Port*

MON88 will read a byte from an I/O port and display the hexadecimal and binary values. Note that an 8- or 16-bit I/O port address may be specified. If boards in your system decode the upper (A8 thru A15) address lines, use a 16-bit I/O address:

```
I[addr][cr]
```

To input from I/O port hexadecimal 20 in the case that no I/O boards decode the upper eight address lines:

```
I20[cr]
23 00100011
```

To input from I/O port hexadecimal 20 in the case that any I/O boards decode the upper eight address lines for their 8-bit I/O port address:

```
I2020[cr]
23 00100011
```

#### *J — Not Implemented*

#### *K — Toggle Keyboard Upper/Lower Case*

For keyboards with only a "shift lock," the K command will result in teletypewriter-like uppercase capability. In this mode, the letters A thru Z will be automatically shifted to uppercase, while all other keys (ie: the numbers 0 thru 9, etc) will not shift:

```
K[cr]
```

#### *L — Not Implemented*

#### *M — Move a Block of Memory*

This command moves the block of memory between [addr1] and [addr2] (inclusive) to [addr3]. Forward or backward moves are acceptable. Overlapping moves can of course have strange results:

```
M[addr1] [addr2] [addr3][cr]
```

```
D0 F[cr]
```

```
0000 01 02 03 04 05 06 07 08 09 0A0B 0C 0D 0E 0F 10
M0 35 [cr]
```

```
D0 F [cr]
```

```
0000 01 02 03 04 05 01 02 03 04 0A0B 0C 0D 0E 0F 10
```

#### *N — Nondestructive Memory Test*

A block of memory may be nondestructively tested using a read-complement-write-read-recomplement-compare-write algorithm. This provides a quick check for easily detected failures. Failing bits will be noted in hexadecimal and binary along with the failing address. The memory block will be repeatedly tested until a Control-C is entered:

```
N[addr1] [addr2][cr]
```

```
N0 2000[cr]
```

```
12FF 02 00000010
```

```
12FF 02 00000010
```

```
12FF 02 00000010
```

```
[Control-C]
```

In this case, location hexadecimal 12FF has a bad bit (D1 on a scale of D0 to D7)

#### *O — Output to a Port*

This command outputs a byte to an I/O port. As in the Input (I) command, 8- or 16-bit I/O port addresses can be used. The same rule for dealing with S-100 I/O devices that decode their 8-bit I/O address on the upper eight address lines is used:

```
O[addr] [data][cr]
```

```
O2020 FE[cr]
```

This outputs hexadecimal FE to port hexadecimal 20 (old S-100) or port hexadecimal 2020 (new S-100)

#### *P — Write Continuous Sync Stream to Cassette*

A continuous stream of Tarbell format "sync" characters (hexadecimal E6) will be written to tape. The P command is terminated by pressing any key on the keyboard:

```
P[cr]
```

#### *Q — Not Implemented*

#### *R — Read from Cassette*

A file can be read from tape into memory, starting at [addr]. The length of the file is contained in the file header, so no length or ending address input to the R command is required. When MON88 finds the tape header, the file length will be printed on the console, informing the user that loading has been initiated. In this example, the file length is hexadecimal 200 bytes:

```
R[addr][cr]
```

```
R100[cr]
```

```
LENGTH (HEXADECIMAL) = 0200
```

S, T, U — Not Implemented

V — Verify the Equality of Two Blocks of Memory  
The block of memory from [addr1] to [addr2] will be compared with the block starting at [addr3]. Differences will be noted in hexadecimal and binary:

```
V[addr1] [addr2] [addr3][cr]
V20 3F 100[cr]
SRC M DEST M DIFF
0022 10 0122 11 00000001
0030 3E 0130 3F 00000001
```

In this case, the hexadecimal 20 bytes from hexadecimal addresses 20 to 3F are equal to those at address 100 except for two locations: hexadecimal locations 22 and 122 differ, as do locations 30 and 130.

W — Write to Cassette

The block of memory from [addr1] to [addr2] will be written to tape. MON88 will calculate the length of the block, display it, and write it to the tape header for use by the Read ("R") and Compare ("C") commands:

```
W[addr1] [addr2][cr]
W100 1FF[cr]
LENGTH (HEXADECIMAL) = 100
```

The block of memory from hexadecimal 100 to 1FF is written to tape.

X, Y, Z — Not Implemented

Command	Use
A	Enter ASCII text into memory.
B	Not implemented
C	Compare cassette input with memory.
D	Display memory.
E	Enter hexadecimal data into memory.
F	Fill memory with a constant.
G	Go To and execute user program.
H	Hexadecimal math.
I	Input from an I/O port.
J	Not implemented.
K	Toggle keyboard upper/lowercase.
L	Not implemented.
M	Move memory.
N	Nondestructive memory test.
O	Output to an I/O port.
P	Put a continuous 'sync' stream to tape.
Q	Not implemented.
R	Read a file from cassette.
S,T,U	Not implemented.
V	Verify equality of two memory blocks.
W	Write a file to cassette.
X,Y,Z	Not implemented.

Table 1: A quick reference guide to MON88 commands. Note that only sixteen of the possible twenty-six commands are implemented. While a stripped version of the present monitor can reside in 1 K bytes of memory, there is provision on the processor board for 2 K bytes of EPROM.

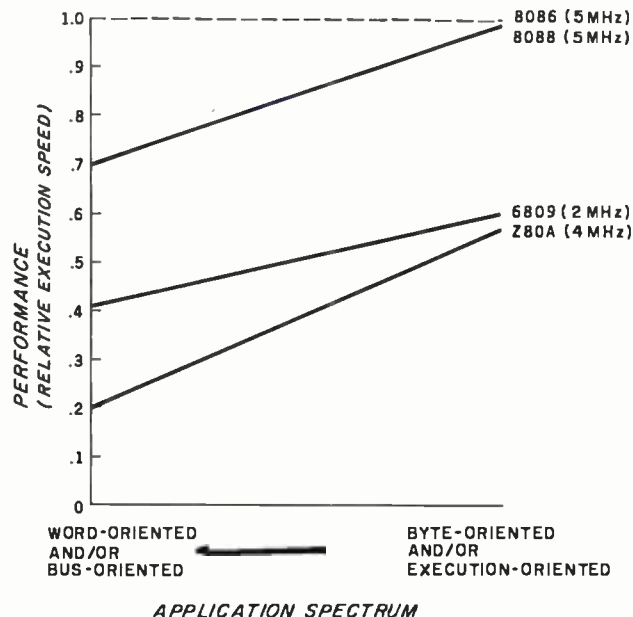

Figure 3: Relative performance of several 8- and 16-bit microprocessors. The types of programs a processor can run are divided into two groups: those that primarily move data around (word- or bus-oriented) and those that primarily manipulate byte-oriented data or perform many numeric operations. If the 16-bit 8086 microprocessor (dotted line) is defined as a performance figure of 1.0, the other three lines show the approximate relative performance of the three other microprocessors as influenced by the type of program being run.

Text continued from page 342:

**Scratchpad Allocation:** My video-board driver uses an 80-byte buffer and a 2-byte X,Y cursor-position variable. These, of course, can be removed or replaced according to your needs. Currently this storage is allocated in the processor boards, 1 K bytes of programmable memory in the (8185-2) device.

The only scratchpad memory required by MON88 is a 1-byte uppercase/lowercase flag variable. This is used by the K (keyboard toggle) command to allow emulation of uppercase-only peripherals in which letters are shifted, but numbers and special characters are not.

If you are not using the processor board described last month and don't have a dedicated scratchpad in the system, UCFLAG can be allocated at the top of memory:

```
UCFLAG EQU TOPMEM
```

where TOPMEM is the address of the top of memory.

**Stack:** My stack also resides on the scratchpad memory within the processor board. If you do not have scratchpad, allocate the stack 1 byte below the top of your memory (to leave room for UCFLAG). Note that the stack pointer is decremented before a PUSH operation is performed. Therefore, to allocate the stack 1 byte below the top of memory, set the stack pointer equal to the top of memory:

```
UCFLAG STACKP EQU TOPMEM
STACKP EQU TOPMEM
```

**Listing 1: Assembly listing of MON88.** The flowchart in figure 2 outlines the general operation of the program.

```

MCS-86 MACRO ASSEMBLER      VID88

ISIS-II MCS-86 MACRO ASSEMBLER V2.0 ASSEMBLY OF MODULE VID88
OBJECT MODULE PLACED IN :F0:VID88.OBJ
ASSEMBLER INVOKED BY: ASMB6 VID88.AB6

LOC  OBJ                LINE    SOURCE
-----
1      ;                *****
2      ;                *
3      ;                *           M O N 8 8           *
4      ;                *
5      ;                * A video oriented system monitor for the INTEL 8088 *
6      ;                *   written G1 1980 - revision 0   *
7      ;                *   by.. Thomas Woodward Cantrell *
8      ;                *
9      ;                *****
10     ;
11     ;                ASSUME DS:ABS_0,CS:ABS_0,ES:ABS_0
12     ----            ABS_0    SEGMENT BYTE AT 0
13     0000            M        LABEL  BYTE
14     FB00            ORG     OFB00H
15     ;
16     ;                *****
17     ;                *
18     ;                *           EQUATES FOLLOW           *
19     ;                *
20     ;                *****
21     ;
22     F400            VIDBUF  EQU    OF400H           ;video buffer
23     F450            XY      EQU    VIDBUF+80       ;holder for cursor position
24     F452            UCFLAG  EQU    XY+2           ;upper/lower case flag
25     000C            O00C    EQU    FF             ;form feed (clear screen)
26     000A            O00A    EQU    0AH           ;line feed
27     000D            O00D    EQU    0DH           ;carriage return
28     000B            O00B    EQU    0BH           ;backspace

```

*Listing 1 continued on page 348*

where TOPMEM is the address of the top of memory.

**Initialization:** I/O initialization is done in the INIT section of the monitor (see listing 1, starting at line 76). Starting at hexadecimal F81D, I initialize the Tarbell cassette interface and TDL Video Interface. Replace the section of code from hexadecimal F81D to F828 to suit your I/O needs.

### I/O Drivers

MON88 currently uses the following environment-dependent I/O routines (their hexadecimal addresses are given in parentheses):

- KEYIN (F90F)—Reads a byte from the console keyboard, strips off the parity bit, and returns the character in the AL accumulator.
- KEYSTAT (F922)—Reads the console keyboard's status and returns AL=0 if a key has not been pressed and AL = hexadecimal FF if a key has been pressed.
- CIN (F955)—Reads a byte from a mass-storage device (Tarbell cassette, in my case) and returns the byte in the AL accumulator.
- COUT (F964)—Writes the byte contained in the AL accumulator to the mass-storage device.
- CSTART (FB60)—Sets up the mass-storage device for a write operation. For the Tarbell interface, a start byte and a sync byte are required. Replace this code as necessary for your device.
- READINIT (FB9D)—Sets up the mass-storage device for a read operation. Replace the relevant code as necessary.
- PUTSYNC (FBBF)—Outputs a stream of sync bytes to

my cassette. This allows calibrating the interface. If your device has a similar feature, modify the PUTSYNC routine accordingly. If not needed, the whole P (PUTSYNC) command can be removed.

- VIDOUT (FCDA)—This routine outputs the character in the AL accumulator to the console display device. In my case, I converted an 8080 version of the video driver to 8088 code using Intel's CONV86 program. Using the code converter, it took only an hour or so to get the driver up and running. I will rewrite it as necessary to reduce the amount of memory used by MON88.

### Adding or Removing Commands

All commands are referenced through CTABLE (Command Jump Table) located at hexadecimal F8B8. Note that the commands are arranged in alphabetical order, A thru Z. To remove a command, simply replace its reference in CTABLE with ERR. For example, to remove the K command (uppercase/lowercase toggle), change:

```
F8CC DW KTOGGLE
```

to

```
F8CC DW ERR
```

then remove the KTOGGLE code (hexadecimal FCD1 to FCD9).

Similarly, to add a special memory test (for example) and call it using the letter T, first write the code (for example, starting label TESTMEM) for the command,

*Text continued on page 360*

Listing 1 continued:

```

E2E2      29  KSTAT  EQU  0E2E2H      ; keyboard status port
E3E3      30  KDATA  EQU  0E3E3H      ; keyboard data port
AEAE      31  CBSTAT  EQU  AEAEH      ; Terbell status port
BF&BF    32  CDATA  EQU  BF&BFH      ; Terbell data port
F7FF      33  BTACKP  EQU  0F7FFH      ; Stack address
0003      34  CTLC   EQU  03H        ; ascii ct)-r
0004      35  CTLD   EQU  04H        ; ascii ct)-d
0013      36  CTLE   EQU  13H        ; ascii ct)-e
0011      37  CTLO   EQU  11H        ; ascii ct)-q
0000      38  FALSE  EQU  0          ;
00FF      39  TRUE   EQU  0FFH       ;
40 +1    40  REJECT

```

MCS-86 MACRO ASSEMBLER VIDD0

```

LDC OBJ          LINE      SOURCE
                41      ;
                42      ;
                43      ; *****
                44      ; *                               *
                45      ; *                               *
                46      ; *                               *
                47      ; *                               *
                48      ; *                               *
                49      ; *                               *
                50      ; *                               *
                51      ; *                               *
                52      ; *                               *
                53      ; *                               *
                54      ; *                               *
                55      ; *                               *
                56      ; *                               *
                57      ; *                               *
                58      ; *                               *
                59      ; *                               *
                60      ; *                               *
                61      ; *                               *
                62      ; *                               *
                63      ; *                               *
                64      ; *                               *
                65      ; *                               *
                66      ; *                               *
                67      ; *****
                68      ;
                69      ;
                70      ;
                71      ;
                72      ;
                73      ;
                74      ;
                75      ;
                76      ;
                77      ;
                78      ;
                79      ;
                80      ;
                81      ;
                82      ;
                83      ;
                84      ;
                85      ;
                86 +1    REJECT

FB0F EB0D90      49      JMP      INIT      ;REBETS STACK, SEGMENT REGISTERS, CASSETTE INTERFACE
                50      ; ;ALBO PRINTS SIGN-ON MESSAGE
                51      ;
FB03 EB3090      52      JMP      START    ; 'WARM START'- REGISTERS NOT INITIALIZED
                53      ;
FB06 E91901      54      JMP      KEYSTAT ;RETURNS [AL]=0 IF NO KEYPRESS PENDING. ELSE [AL]=OFFH
                55      ;
FB09 E9E000      56      JMP      CONIN   ;WAITS FOR KEYPRESS. RETURNS [AL]=CHAR AND PRINTS IT.
                57      ;
FB0C E9CB04      58      JMP      VIDOUT  ;PRINTS CHAR IN AL DN CONSOLE
                59      ;
                60      ;
                61      ; *****
                62      ; *                               *
                63      ; *                               *
                64      ; *                               *
                65      ; *                               *
                66      ; *                               *
                67      ; *****
                68      ;
                69      ;
                70      ;
                71      ;
                72      ;
                73      ;
                74      ;
                75      ;
                76      ;
                77      ;
                78      ;
                79      ;
                80      ;
                81      ;
                82      ;
                83      ;
                84      ;
                85      ;
                86 +1    REJECT

FB0F FC          68      INIT:  CLD      ;direction flag points 'up'
FB10 FA          69      CLI      ;disable interrupts
FB11 BCC0        70      MOV     AX,CB   ;initialize
FB13 BEE0        71      MOV     DS,AX  ;segment
FB15 BEC0        72      MOV     ES,AX  ;registers
FB17 BED0        73      MOV     SS,AX  ;and set
FB19 BCF7F7      74      MOV     SP,STACKP ;stack pointer,
FB1C FB          75      STI      ;enable interrupts
FB1D B010        76      MOV     AL,10H ;Reset Cassette
FB1F BA6EAE      77      MOV     DX,CSTAT
FB22 EE          78      OUT     DX,AL  ; interface
FB23 BAEE00      79      MOV     DX,DEE0H ;Reset Video
FB26 B000        80      MOV     AL,B0H  ; interface
FB28 EE          81      OUT     DX,AL  ; inverse video w/cursor
FB29 C60632F400  82      MOV     BYTE PTR M[UCFLAG],0 ;0=lower case, FFH=U/C only
                83      ;
                84      ;
                85      ;
                86 +1    REJECT

FB2E BE3AFB90    84      MOV     SI,OFFBET SIGNON ;get sign on message
FB32 EB6301      85      CALL    PRINTMB ;and print it
                86 +1    REJECT

```

MCS-86 MACRO ASSEMBLER VIDD0

```

LDC OBJ          LINE      SOURCE
                87      ;
                88      ; *****
                89      ; *                               *
                90      ; *                               *
                91      ; *                               *
                92      ; *                               *
                93      ; *****
                94      ;
                95      ;
                96      ;
                97      ;
                98      ;
                99      ;
                100     ;
                101     ;
                102     ;
                103     ;
                104     ;
                105     ;

FB33 EB3D01      94      START:  CALL    CRLF      ;print CRLF
FB38 B03E        95      MOV     AL,'>' ;and prompt
FB3A EB9D04      96      CALL    VIDOUT
                97      ;
                98      ;
                99      ;
                100     ;
                101     ;
                102     ;
                103     ;
                104     ;
                105     ;

FB3D B400        99      MOV     AH,0    ;clear AH
FB3F EBAA00     100     CALL    CONIN   ;get a command
FB42 3C41       101     CMP     AL,'A'  ;check range for
FB44 72EF       102     JB     START   ; A
FB46 3C5A       103     CMP     AL,'Z'  ; thru
FB48 7FEB       104     JG     START   ; Z
FB4A 2C41       105     SUB     AL,'A'  ;calculate offset

```

```

FB4C D0E0      106      SHL      AL,1          ;and multiply by 2
FB4E 038BF890 107      ADD      AX,OFFBET CTABLE
FB52 8808      108      MOV      BX,AX
FB54 8807      109      MOV      AX,WORD PTR MEBXJ
FB56 FF00      110      CALL     AX          ;go do it
FB58 EBDB      111      JMP      START      ;start over
                112 +1 REJECT

```

MCS-86 MACRO ASSEMBLER VID88

```

LOC OBJ          LINE  SOURCE
                113  ;
                114  ; *****
                115  ; *
                116  ; *           M E S S A G E *
                117  ; *
                118  ; *****
                119  ;
FB5A 0C         120  SIGNON  DB      0CH
FB5B 38303B3820406F 121  DB      'BOBB Monitor Crav. 02'
        6E69746F72203C
        7265762E20303E
FB70 00         122  DBYTE   DB      0          ;dummy byte
                123  ;
FB71 41444452204020 124  COMHEAD DB      'ADDR M T DIFF
        20542020202044
        494646202020
FB85 00         125  DB      0
                126  ;
FB86 53554020204449 127  VHEAD   DB      'SUM DIFF'
        4646
FB8F 00         128  DB      0
                129  ;
FB9D 53524320204020 130  VHEAD   DB      'BRC M DEBT M DIFF'
        20204445535420
        40202020204449
        4646
FBA7 00         131  DB      0
                132  ;
FBA8 4C454E47544820 133  CHEAD   DB      'LENGTH (HEX) = '
        2848455829203D
        20
FBB7 00         134  DB      0
                135  ;
                136 +1 REJECT

```

MCS-86 MACRO ASSEMBLER VID88

```

LOC OBJ          LINE  SOURCE
                137  ;
                138  ; *****
                139  ; *
                140  ; *           C O M M A N D   J U M P   T A B L E
                141  ; *
                142  ; *****
                143  ;
FB88 80FC      144  CTABLE  DW      AENTER ;ENTER ASCII TEXT INTO MEMORY
FB8A A7F9      145  DW      ERR      ;B
FB8C 02FB      146  DW      COMPARE ;COMPARE CASSETTE INPUT WITH MEMORY
FB8E 00FB      147  DW      DUMP     ;DISPLAY MEMORY
FB90 78FC      148  DW      EBUBBT  ;ENTER HEX DATA INTO MEMORY
FB92 7EFA      149  DW      FILL    ;FILL MEMORY WITH A CONSTANT
FB94 4AFB      150  DW      GOTO    ;GO TO & EXECUTE A USER PROGRAM
FB96 1AFC      151  DW      HEXMATH ;COMPUTE SUM AND DIFFERENCE OF HEX #'S
FB98 2CFB      152  DW      INPUT   ;INPUT FROM A PORT
FB9A A7F9      153  DW      ERR      ;J
FB9C 01FC      154  DW      KTOGGLE ;TOGGLE KEYBOARD UPPER/LOWER CASE FLAG
FB9E A7F9      155  DW      ERR      ;L
FB90 E7FA      156  DW      MOVE    ;MOVE MEMORY
FB02 38FC      157  DW      NTEST   ;NON DESTRUCTIVE MEMORY TEST
FB04 3FFB      158  DW      OUTPUT  ;OUTPUT TO A PORT
FB06 2FFB      159  DW      PUTBYNC ;OUTPUT CONTINUOUS BYNC STREAM TO CASSETTE
FB08 A7F9      160  DW      ERR      ;0
FB0A 82FB      161  DW      READ    ;READ FROM CASSETTE
FB0C A7F9      162  DW      ERR      ;S
FB0E A7F9      163  DW      ERR      ;T
FB10 A7F9      164  DW      ERR      ;U
FB12 8DFA      165  DW      VERIFY  ;VERIFY EQUALITY OF TWO MEMORY BLOCKS
FB14 4FFB      166  DW      CWRITE  ;WRITE TO CASSETTE
FB16 A7F9      167  DW      ERR      ;X
FB18 A7F9      168  DW      ERR      ;Y
FB1A A7F9      169  DW      ERR      ;Z
                170 +1 REJECT

```

Listing 1 continued on page 350

Listing 1 continued:

MCS-86 MACRO ASSEMBLER VID88

```

LOC  OBJ          LINE      SOURCE
                                     ;
                                     ;
171  ;
172  ;
173  ; *****
174  ; *
175  ; *          U T I L I T Y  R O U T I N E S          *
176  ; *                                and                                *
177  ; *          I / O  D E V I C E  H A N D L E R S      *
178  ; *                                (except video driver)      *
179  ; *
180  ; *****
181  ;
182  ;
FBEC  EB2000      183  CONIN:  CALL    KEYIN          ;get a keyboard character
FBEF   50         184          PUSH   AX
FBF0  A052F4      185          MOV    AL, BYTE PTR M[UCFLAG] ;check for case conversion
FBF3  0AC0        186          OR    AL, AL                ;0?
FBF5  7405        187          JZ    CONNEXT          ;YES..no conversion
FBF7   58         188          POP    AX                ;restore character
FBF8  EB0900      189          CALL   UCCHEK          ;convert to UC
FBFB   50         190          PUSH   AX
FBFC   58         191  CONNEXT: POP    AX
FBFD  EBDA03      192          CALL   VIDOUT          ;and echo it on console
F900  EB0100      193          CALL   UCCHEK          ;always return UC
F903   C3        194  KQUIT:  RET
195  ;
F904  3C61        196  UCCHEK: CMP    AL, 'a'
F906  7206        197          JC    UQUIT
F908  3C78        198          CMP    AL, 'z'+1
F90A  7302        199          JNC   UQUIT
F90C  245F        200          AND   AL, 5FH
F90E   C3        201  UQUIT:  RET
202  ;
F90F   52        203  KEYIN:  PUSH   DX                ;keyboard device handler
F910  8AE2E2      204          MOV    DX, KSTAT
F913   EC        205  KEYLOOP: IN    AL, DX                ;check for keypress
F914  2480        206          AND   AL, 80H
F916  74F8        207          JZ    KEYLOOP          ;no keypress..then wait for one
F918   5A        208          POP    DX
F919   52        209  KIN:    PUSH   DX
F91A  8AE3E3      210          MOV    DX, KDATA
F91D   EC        211          IN    AL, DX                ;else get the character
F91E  247F        212          AND   AL, 7FH            ;and strip parity
F920   5A        213          POP    DX
F921   C3        214          RET
215  ;
F922  216        216  KEYSTAT:
F922  B400        217          MOV    AH, FALSE        ;RETURN [AL]=0 IF NO KEYPRESS ELSE [AL]=OFFH
F924   52        218          PUSH   DX                ;prepare for false
F925  8AE2E2      219          MOV    DX, KSTAT
F928   EC        220          IN    AL, DX
F929  2400        221          AND   AL, 00H
F92B  7402        222          JZ    KEXIT            ;return it if no keypress
F92D  F604        223          NOT   AH                ;otherwise make it TRUE
F92F  8AC4        224  KEXIT:  MOV    AL, AH

```

MCS-86 MACRO ASSEMBLER VID88

```

LOC  OBJ          LINE      SOURCE
                                     ;
F931  5A         225          POP    DX
F932   C3        226          RET
227  ;
F933  228        228  CTLCHEK:
F933   50         229          PUSH   AX                ;CHECK FOR CTL-S, CTL-Q AND CTL-C
F934  EBEBFF      230          CALL   KEYSTAT          ;keypress?
F937  3C00        231          CMP    AL, 0
F939  7418        232          JZ    CTLEXIT          ;no keypress so return
F93B  EBD8FF      233          CALL   KIN              ;if keypress then get the data
F93E  3C13        234          CMP    AL, CTLS        ;check for ctl-s
F940  750D        235          JNZ   CTLCHEK          ;if not look for ctl-c
F942  EBCAFF      236  KWAIT:  CALL   KEYIN          ;if ctl-s then wait for another keypress
F945  3C11        237          CMP    AL, CTLQ        ;is it ctl-q
F947  740A        238          JZ    CTLEXIT          ;YES..return
F949  3C03        239          CMP    AL, CTLC        ;abort?
F94B  745A        240          JE    ERR              ;YES
F94D  EBFF3       241          JMP    KWAIT           ;otherwise wait some more
F94F   242        242  CTLCHEK:
F94F  3C03        243          CMP    AL, CTLC        ;is it ctl-c
F951  7454        244          JZ    ERR              ;YES..ABORT!
F953  245        245  CTLEXIT:

```



```

F933 38          246          POP     AX
F934 C3          247          RET
                248
F935            249          ; GET BYTE FROM CASSETTE
F935 32          250          PUSH    DX
F936 BA6E6E     251          MOV     DX, CSTAT
F939            252          CINLOOP:
F939 EC          253          IN     AL, DX
F93A 2410       254          AND    AL, 10H          ;cassette ready to read?
F93C 73F8       255          JNZ   CINLOOP         ;NO wait
F93E BA6F6F     256          MOV     DX, CDATA      ;YES
F961 EC          257          IN     AL, DX          ;get the data
F962 3A          258          POP    DX
F963 C3          259          RET
                260
;
F964            261          ; WRITE A BYTE TO CASSETTE
F964 32          262          PUSH    DX
F965 30          263          PUSH    AX
F966 BA6E6E     264          MOV     DX, CSTAT
F969            265          COUTLOOP:
F969 EC          266          IN     AL, DX
F96A 2420       267          AND    AL, 20H          ;cassette ready for write?
F96C 73FB       268          JNZ   COUTLOOP       ;NO wait
F96E 3B          269          POP    AX              ;get char back
F96F BA6F6F     270          MOV     DX, CDATA
F972 EE          271          OUT    DX, AL          ;and send to tape
F973 3A          272          POP    DX
F974 C3          273          RET
                274
;
F975 30          275          ; CRLF:
F976 FBBAFF     276          PUSH    AX
F977 B00D       277          CALL   CTLCHK          ;CHECK FOR ABORT
F978 EB3C03     278          MOV     AL, CR          ;SEND CR AND LF TO CONSOLE
                CALL   VIDDUT

```

MCS-86 MACRO ASSEMBLER VIDEO

```

LDC OBJ          LINE      SOURCE
F97E B00A        279          MOV     AL, LF
F980 EB3703      280          CALL   VIDDUT
F983 38          281          POP    AX
F984 C3          282          RET
                283
;
F985            284          ; PRINT A BLANK, SAVE ALL REG.
F985 31          285          PUSH    CX
F986 890100      286          MOV     CX, 1          ;print 1 blank
F989 EB0200      287          CALL   TABS
F98C 39          288          POP    CX
F98D C3          289          RET
                290
;
F98E            291          ; PRINT # BLANKS IN CX..ON EXIT CX=0
F98E 30          292          PUSH    AX
F98F B020        293          MOV     AL, ' '
F991 EB4603      294          TLOOP: CALL   VIDDUT
F994 E2F8        295          LDDP   TLOOP
F996 3B          296          POP    AX
F997 C3          297          RET
                298
;
F998            299          ; PRINT THE MESSAGE (--- [SI] ON CONSOLE
F998 30          300          PUSH    AX
F999 AC          301          PHEBB: LDBS  OBYTE      ;END OF MESSAGE IS A ZERO (0)
F99A 3C0D        302          CMP     AL, 0          ;get a byte
F99C 7407        303          JZ     PQUIT          ;check for end of message
F99E 36          304          PUSH    SI            ;quit if zero
F99F EB3803      305          CALL   VIDDUT        ;otherwise save message pointer
F9A2 3E          306          POP    SI            ;and display byte
F9A3 EBF4        307          JMP    PHEBB          ;print more message
F9A5 38          308          PQUIT: POP    AX
F9A6 C3          309          RET
                310
;
F9A7 B02A        311          ; ERR:
F9A9 EB2E03      312          MOV     AL, 'e'       ;print error
F9AC BCFFF7      313          CALL   VIDDUT        ; message
F9AF E983FE      314          MOV     BP, STACKP    ;reinitialize stack
                JMP    START      ;and abort'
                315
;
F9B2            316          ; B[IN]OUT:
F9B2 31          317          PUSH    CX
F9B3 890800      318          MOV     CX, 0
F9B6            319          ; B[IN]OUT1:
F9B6 D0E0        320          SHL    AL, 1          ;get the bit
F9B8 7209        321          JB     BOUT1          ;output & 1
F9BA 30          322          PUSH    AX            ;otherwise
F9BB B030        323          MOV     AL, '0'       ;output
F9BD EB1A03      324          CALL   VIDDUT        ;& 0
F9C0 EB0790      325          JMP    B[IN]END      ;continue
F9C3 30          326          BOUT1: PUSH    AX
F9C4 B031        327          MOV     AL, '1'       ;output & 1
F9C6 EB1103      328          CALL   VIDDUT

```

Listing1 continued on page 352

Listing 1 continued:

```
F9C9 5B          329  BINEND: POP    AX
F9CA E2EA       330          LOOP   B INOUT1    ; do it eight times.
F9CC 59         331          POP    CX
F9CD C3         332          RET
```

MCS-86 MACRO ASSEMBLER VID88

```
LOC  OBJ          LINE  SOURCE
;
F9CE          333  ;
F9CE 30        334  HEXOUT:          ; OUTPUT [AL] AS 2 HEX DIGITS.. ALL REG SAVED.
F9CF 51        335          PUSH   AX
F9D0 8AE0      336          PUSH   CX
F9D2 B104      337          MOV    AH,AL      ; save AL
F9D4 D2EB      338          MOV    CL,4
F9D6 59        339          SHR    AL,CL      ; shift AL right 4 places
F9D7 E80700    340          POP    CX
F9D8 E80700    341          CALL  HEXDIGOUT   ; output upper nibble
F9DA BAC4      342          MOV    AL,AH      ; restore AL (now we do lower nibble)
F9DC E80200    343          CALL  HEXDIGOUT
F9DF 58        344          POP    AX
F9E0 C3        345          RET
;
F9E1          346  ;
F9E1 240F      347  HEXDIGOUT:      ; CONVERT NIBBLE TO ASCII HEX
F9E3 0490      348          AND    AL,0FH     ; mask upper 4 bits
F9E5 27        349          ADD    AL,90H     ; tricky conversion...
F9E6 1440      350          DAA          ; but
F9E8 27        351          ADC    AL,40H     ; it
F9E9 EBEE02    352          DAA          ; works!
F9EC C3        353          CALL  VIDOUT      ; print the result
F9ED          354          RET
;
F9ED 2C30      355  ;
F9ED 2C30      356  HEXCHK:          ; CHECK AL FOR VALID HEX DIGIT; CONVERT TO BIN
F9EF 720E      357          SUB    AL,'0'     ; IF INVALID RETURN WITH CARRY SET.
F9F1 3C0A      358          JB     HRET       ; Error..not alphanumeric
F9F3 F5        359          CMP    AL,0AH     ; check for 0-9
F9F4 7309      360          CMC
F9F6 2C07      361          JNB   HRET       ; return o.k. if 0-9
F9F8 3C0A      362          SUB    AL,7       ; adjust for A-F
F9FA 7203      363          CMP    AL,10
F9FC 3C10      364          JB     HRET       ; return error if > F
F9FE F5        365          CMC
F9FF C3        366          HRET:  RET
;
FA00          367  ;
FA00          368  ;
FA00          369  GETPARMB:        ; 16 BIT HEX VALUE TO BX. BX IS SHIFT REGISTER, ACCEPTS LAST 4
FA03 EBE6FE    370          ; ON ENTRY CX EQUALS NUMBER OF KEYPRESSES THAT CAN BE ACCEPTED.
FA06 3C30      371          ; ON EXIT AH CONTAINS TERMINATOR (I.E. CR, SPACE)
FA08 7210      372          ; UNLESS THE TERMINATOR IS INVALID (NOT EQUAL CR, SPACE OR ',')
FA0A 51        373          ; IN WHICH CASE AN ERROR IS GENERATED.
FA0B 8104      374  ;
FA0B 8104      375          MOV    BX,0       ; clear BX
FA0D D3E3      376  LOOPB:  CALL  CONIN    ; get a character
FA0F 59        377          CMP    AL,'0'     ; alphanumeric ?
FA11 3C30      378          JB     BEXIT      ; NO...quit
FA13 7292      379          PUSH  CX          ; YES...then
FA15 02DB      380          MOV    CL,4       ; shift BX to
FA17 E2EA      381          SHL   BX,CL       ; make room for
FA19 EBD0FF    382          POP    CX         ; latest addition
FA1B 7292      383          CALL  HEXCHK      ; check for valid hex and convert to binary
FA1D 7292      384          JB     ERR        ; if invalid then error!
FA1F 02DB      385          ADD   BL,AL       ; otherwise add it in
FA21 3C30      386          LOOPB             ; keep looking
```

MCS-86 MACRO ASSEMBLER VID88

```
LOC  OBJ          LINE  SOURCE
;
FA19 C3        387  RET
FA1A 3C20      388  BEXIT:  CMP    AL,' '   ; test for blank
FA1C 740B      389          JE     BGOOD
FA1E 3C2C      390          CMP    AL,', '    ; ..comma
FA20 7407      391          JE     BGOOD
FA22 3C0D      392          CMP    AL,CR      ; or carriage return
FA24 7403      393          JE     BGOOD
FA26 E97EFF    394          JMP    ERR        ; if none of the above the ERROR
FA29 8AE0      395  BGOOD:  MOV    AH,AL      ; save terminator
FA2B C3        396          RET
;
FA2C          397  ;
FA2C 53        398  GETPARMB:        ; 16 BIT HEX VALUE TO DX. USE GETPARMB
FA2D EBD0FF    399          ; save BX
FA2F 8BD3      400          CALL  GETPARMB    ; get the parameter
FA31 5B        401          MOV    DX,BX      ; put it where it belongs
FA33 5B        402          POP    BX         ; restore BX
FA35 C3        403          RET
;
FA37          404  ;
```

```

FA34          405      SETUP:          ;GET PARMs IN BX AND DX. ALL PURPOSE PARAMETER GETTER.
FA34 51       406      PUSH          CX          ;save CX
FA35 89FFFF   407      MOV          CX,OFFFHH ;allow 64K keypresses
FA3B EBC5FF   408      CALL         GETPARMB ;get first parameter
FA3B 3C0D     409      CMP          AL,CR      ;check for carriage return
FA3D 7406     410      JE          SET1       ;if so [DX] defaults to [BX]
FA3F EBEAFF   411      CALL         GETPARMD ;otherwise get second parameter
FA42 EB0390   412      JMP          SET2
FA45 8BD3     413      SET1:      MOV          DX,BX
FA47 59       414      SET2:      POP          CX
FA48 C3       415      RET
;
FA49          416      ;
FA49 52       417      CLENGTH:    ; [CX]<--[DX]-[BX]+1, IF[BX]>[DX] THEN ERR
FA4A 3BD3     418      PUSH         DX
FA4C 7303     419      CMP          DX,BX      ;if [BX] > [DX]
FA4E E956FF   420      JNB         CL1         ;then error!
FA51 2BD3     421      JMP          ERR
FA53 8B8CA    422      CL1:      SUB          DX,BX      ;else determine difference
FA55 41       423      MOV          CX,DX      ;and put in CX
FA56 5A       424      INC          CX         ;count ≠ difference + 1
FA57 C3       425      POP          DX
;
FA58          426      RET
;
FA58          427      ;
FA58          428      GETPARMAL: ; [AL]<-- ASCII HEX FROM CONSOLE
FA58          429      ; [AL] UNCHANGED IF NO PARAMETER ENTERED
FA58 53       430      PUSH         BX          ;save BX
FA59 51       431      PUSH         CX          ;save CX
FA5A 52       432      PUSH         DX          ;save DX
FA5B BADO     433      MOV          DL,AL       ;save AL
FA5D B9FFFF   434      MOV          CX,OFFFHH ;64 keypresses allowed
FA60 EB9DFF   435      CALL         GETPARMB ;get the parameter
FA63 81F9FFF  436      CMP          CX,OFFFHH ;how many parameters entered?
FA67 7502     437      JNE         GQUIT       ;if greater than zero then continue
FA69 BADA     438      MOV          BL,DL       ;if zero parms entered restore old value
FA6B BAC3     439      GQUIT:     MOV          AL,BL       ;otherwise put it where it belongs
FA6D 5A       440      POP          DX          ;restore DX

```

MCS-86 MACRO ASSEMBLER VID88

```

LOC OBJ          LINE      SOURCE
FA6E 59          441      POP          CX          ;restore CX
FA6F 5B          442      POP          BX          ;restore BX
FA70 C3          443      RET
;
FA71          444      ;
FA71 50          445      OUTBX:      ; [BX] OUTPUT AS FOUR HEX DIGITS
FA72 BAC7        446      MOV          AX          ;output
FA74 EB57FF      447      MOV          AL,BH       ; BH
FA77 BAC3        448      CALL        HEXOUT      ; BH
FA79 EB52FF      449      MOV          AL,BL       ; and
FA7C 58          450      CALL        HEXOUT      ; BL
FA7D C3          451      POP          AX
FA7E          452      RET
;
FA7E          453      ;
FA7E          454      +1 $EJECT

```

MCS-86 MACRO ASSEMBLER VID88

```

LOC OBJ          LINE      SOURCE
;
;
;
;
; *****
; *
; *      C O M M A N D R O U T I N E S
; *
; *****
;
;
FA7E          466      FILL:      ;FILL A BLOCK OF MEMORY WITH A CONSTANT
FA7E EB83FF      467      CALL        SETUP       ;get start and end
FAB1 EBC5FF      468      CALL        CLENGTH     ;compute the count
FAB4 EBD1FF      469      CALL        GETPARMAL   ;and get the constant
FAB7 8B07        470      FLOOP:     MOV          M[BX],AL ;... fill it...
FAB9 43          471      INC          BX
FABA E2FB        472      LOOP       FLOOP
FABC C3          473      RET
;
FABD          474      ;
FABD          475      VERIFY:   ;VERIFY EQUALITY OF TWO BLOCKS OF MEMORY
FABD EBA4FF      476      CALL        SETUP       ;GET SOURCE START AND END
FA90 EB86FF      477      CALL        CLENGTH     ;and compute the length
FA93 41          478      INC          CX

```

Listing 1 continued on page 354

Listing 1 continued:

```

FA94 B9F3          479      MOV     SI,BX          ;save source in B)
FA96 31           480      PUSH   CX
FA97 89FFFF       481      MOV     CX,OFFFH      ;64K addresses allowed
FA9A EB63FF       482      CALL  GETPARM0        ;get the destination
FA9D 59           483      POP     CX
FA9E 8BF8         484      MOV     DI,BX          ;into DI
FAA0 EBD2FE       485      CALL  CRLF            ;save source
FAA3 56           486      PUSH   SI
FAA4 8E90FB       487      MOV     SI,OFFSET VHEAD
FAA7 EBEEFE       488      CALL  PRINTHEB0       ;print header
FAAA 5E           489      POP     SI
FAAB            490
FAAB F3           491      VLOOP: REPE  CMPS     DBYTE,DBYTE ;do it'
FAAC A6
FAAD 83F900       492      CMP     CX,0           ;all done?
FAB0 7501         493      JNE    VERR           ;NO error
FAB2 C3           494      RET                    ; if done then return
;
FAB3 BBDE         495      VERR:  MOV     BX,SI    ;get the source addr
FAB5 4B           497      DEC     BX             ;adjust it
FAB6 E80CFE       498      CALL  CRLF
FAB9 EB83FF       499      CALL  OUTBX           ;output the addr
FABC E8C6FE       500      CALL  BLANK
FABF 8A07         501      MOV     AL,M(BX)      ;get what's there
FAC1 8A20         502      MOV     AH,AL         ;save it in AH
FAC3 EB86FF       503      CALL  HEXOUT          ;output the data
FAC6 E88CFE       504      CALL  BLANK
FAC9 EB89FE       505      CALL  BLANK
FACC 8BDF         506      MOV     BX,DI         ;get the destination addr
FACE 4B           507      DEC     DI             ;adjust it

```

MCS-86 MACRO ASSEMBLER VID88

```

LOC  OBJ          LINE  SOURCE
FACF EB9FFF       508      CALL  OUTBX           ;display it
FAD2 8A07         509      MOV     AL,M(BX)      ;get the data
FAD4 EBAEFE       510      CALL  BLANK
FAD7 EBF4FE       511      CALL  HEXOUT          ;output the data
FADA EBA8FE       512      CALL  BLANK
FADD 32C4         513      XOR     AL,AH         ;determine bad bits
FADF E8D0FE       514      CALL  BINOUT          ;display in binary
FAE2 E84EFE       515      CALL  CTLCHEK        ;check for abort
FAE5 E8C4         516      JMP     VLOOP         ;continue
;
FAE7            518      MOVE:  ;MOVE A BLOCK OF MEMORY
FAE7 EB4AFF       519      CALL  SETUP           ;get start and end
FAEA 3C0D         520      CMP     AL,ODM        ;if not enough data
FAEC 7503         521      JNZ    MI             ;then error'
FAEE E986FE       522      JMP     MI
FAF1 EB55FF       523      MI:    CALL  LENGTH         ;otherwise compute length
FAF4 53           524      PUSH   BX             ;save start address
FAF5 EB3CFF       525      CALL  SETUP           ;and get destination
FAFB 8BF8         526      MOV     DI,BX         ;[DI] ← destination
FAFA 58           527      POP     SI
FAFB 8BF3         528      MOV     SI,BX         ;[SI] ← source
FAFD F3           529      REP   MOVSB          ;... move it ..
FAFE A4
FAFF C3           530      RET
;
F800            531      DUMP:  ;DISPLAY MEMORY
F800 EB31FF       533      CALL  SETUP           ;get start and end
F803 EB43FF       534      CALL  LENGTH         ;and compute length
F806 EB1900       535      CALL  MUXLINE2        ;set up console
F809 8A07         536      DLOO1: MOV     AL,M(BX) ;get what's there
F808 E8C0FE       537      CALL  HEXOUT          ;print it
F80E EB74FE       538      CALL  BLANK           ;and a blank
F811 43           539      INC     BX
F812 F6C30F       540      TEST   BL,OFH        ;test for 16 byte boundary
F815 7503         541      JNZ    DNEXT         ;if not then continue
F817 EB0300       542      CALL  MUXLINE         ;otherwise set up console for new line
F81A E2E0         543      DNEXT: LOOP DLOO1    ;continue
F81C C3           544      RET
;
F81D 83F901       545      MUXLINE: CMP     CX,1
F820 7409         547      JE     MUXJIT
F822            548      MUXLINE2:
F822 EB50FE       549      CALL  CRLF           ;go to new line
F825 EB49FF       550      CALL  OUTBX          ;print address
F828 EB5AFE       551      CALL  BLANK          ;and a blank
F82B C3           552      MUXJIT: RET
;
F82C            553      INPUT: ;INPUT FROM A PORT
F82C EB05FF       555      CALL  SETUP           ;get port address
F82F EB43FE       556      CALL  CRLF
F832 B8D3         557      MOV     DX,BX
F834 EC           558      IN     AL,DX         ;read the port
F835 EB96FE       559      CALL  HEXOUT          ;print data in hex
F83B EB4AFE       560      CALL  BLANK          ; and

```

```

LOC  DBJ          LINE  SOURCE
F838  EB74FE      361          CALL  BINOUT      ; binary
F83E  C3          362          RET
363
F83F          364          ;
F83F  EBF2FE      365          OUTPUT:          ;OUTPUT TO A PORT
F842  BAC2        366          CALL  SETUP      ;get address
F844  FECB        367          MOV   AL,DL      ;and data
F846  88D3        368          DEC   AL         ;adjust data
F848  EE          369          MOV   DX,BX
F849  C3          370          OUT  DX,AL      ;output data
371
F84A          372          ;
F84A  EBE7FE      373          GOTO:          ;EXECUTE A PROGRAM
F84D  FFE3        374          CALL  SETUP      ;get the address
375          JMP   BX         ;GO!
;
F84F          376          ;WRITE:          ;WRITE TO CASSETTE
F84F  EBE2FE      377          CALL  SETUP      ;get the range
F852  EBF4FE      378          CALL  CLENGTH    ;compute the length
F855  EB10FE      379          CALL  CRLF
F858  EB9500      380          CALL  CPROMPT
F85B  EBF000      381          CALL  CSTART
F85E  EB5600      382          CALL  LENGTHOUT  ;cell length
F861  BA07        383          CLOOP: MOV   AL,[BX] ;get a byte
F863  EBF0FD      384          CALL  COUT       ;output
F866  43          385          INC   BX         ;next byte
F867  EBC9FD      386          CALL  CTLCHK     ;check for abort
F86A  E2F5        387          LOOP  CLOOP     ;continue
F86C  C3          388          RET
389
F86D  B03C        390          ;
F86D  B03C        390          CSTART: MOV  AL,3CH ;start byte
F86F  EBF2FD      391          CALL  COUT
F872  B0E6        392          MOV   AL,0E6H   ;sync byte
F874  EBEDFD      393          CALL  COUT
F877  BAC3        394          MOV   AL,CH     ;high length
F879  EBE8FD      395          CALL  COUT
F87C  BAC1        396          MOV   AL,CL     ;low length
F87E  EBE3FD      397          CALL  COUT
F881  C3          398          RET
399
F882          400          ;
F882  E9AFFE      401          READ          ;READ FROM CASSETTE
F885  EBEDFD      402          CALL  SETUP      ;get address
F888  EB2900      403          CALL  CRLF
F88B  EBF000      404          CALL  CPROMPT
F88E  EB2600      405          CALL  READINIT
F891  EBC1FD      406          RLODP: CALL  LENGTHOUT ;prompt when reading
F894  B807        407          MOV   [BX],AL   ;get a byte
F896  43          408          INC   BX         ;next byte
F897  EB99FD      409          CALL  CTLCHK     ;check for abort
F89A  E2F5        410          LOOP  RLODP     ;continue
F89C  C3          411          RET
412
F89D          413          ;
F89D  B01D        414          READINIT: MOV  AL,10H ;reset interface

```

```

LOC  DBJ          LINE  SOURCE
F89F  52          615          PUSH  DX
F8A0  BA6E6E      616          MOV   DX,CSTAT
F8A3  EE          617          OUT  DX,AL
F8A4  5A          618          POP  DX
F8A5  EBADF0      619          CALL  CIN
F8AB  BAE8        620          MOV   CH,AL     ;get high length
F8AA  EBABFD      621          CALL  CIN
F8AD  BAC8        622          MOV   CL,AL     ;and low length
F8AF  C3          623          RET
624
F8B0          625          ;
F8B0  BEABFB      626          CPROMPT:          ;CASSETTE PROMPT
F8B3  EBE2FD      627          MOV   SI,OFFSET CHEAD
F8B6  C3          628          CALL  PRINTMESS
629          RET
;
F8B7          630          ;
F8B7  53          631          LENGTHOUT:          ;OUTPUT RECORD LENGTH
F8B8  88D9        632          PUSH  BX
F8BA  EB84FE      633          MOV   BX,CX     ;get the count
F8BD  58          634          CALL  OUTBX     ;output it
F8BE  C3          635          POP  BX
RET

```

Listing 1 continued on page 356

Listing 1 continued:

```

636      )
637      PUTSYNC:                ;BEND SYNC STREAM TO CASSETTE
638      CALL                   CRLF
639      SYNCLOOP:
640      MOV                     AL,0E6H      ;sync character
641      CALL                   COUT        ;send it
642      CALL                   KEYSTAT    ;check for keypress
643      CMP                     AL,0       ;zero = no keypress
644      JE                      SYNCLOOP  ;no continue
645      CALL                   KIN        ;ignore the keypress
646      RET                       ;and quit
647
648      )
649      COMPARE:                ;COMPARE INPUT FROM CASSETTE WITH MEMORY
650      CALL                   SETUP
651      CALL                   CRLF
652      MOV                     SI, OFFSET COMHEAD ;print header
653      CALL                   PRINTMESS
654      CALL                   BLANK
655      CALL                   CPROMPT
656      CALL                   READINIT
657      CALL                   LENGTHOUT
658      COMLOOP:
659      CALL                   C!N         ;get char from cassette
660      CMP                     AL,M(CX)  ;compare with memory
661      JNE                     COMERR   ;not equal' error
662      INC                     BX        ;if equal
663      CALL                   CTLCHK    ;check for abort
664      LOOP                    COMLOOP  ;then continue checking
665      COMERR:
666      PUSH                    AX
667      CALL                   CRLF
668      CALL                   OUTBX     ;if error output memory address
669      CALL                   BLANK

```

MC8-86 MACRO ASSEMBLER V1088

```

LOC  OBJ          LINE      SOURCE
FC02  BA07        669      MOV     AL,M(BX)    ;get memory data
FC04  BAFO        670      MOV     DH,AL      ;save it too
FC06  EBC3FD     671      CALL   HEXDOUT    ;output what's in memory
FC09  EB79FD     672      CALL   BLANK
FC0C  58         673      POP    AX         ;restore cassette data
FC0D  E88EFD     674      CALL   HEXDOUT    ;output it
FC10  EB72FD     675      CALL   BLANK
FC13  32C6       676      XOR    AL,DH      ;determine bad bits
FC15  EB9AFD     677      CALL   BINOUT     ;and print in binary
FC18  E8D7       678      JMP    COM1       ;continue
679
FC1A  EB17FE     680      )
FC1A  EB17FE     681      HEXMATH:        ;COMPUTE SUM AND DIFFERENCE OF TWO HEX #'S
FC1D  53         682      CALL   SETUP     ;get the numbers
FC1E  52         683      PUSH  BX         ;save
FC1F  E833FD     684      PUSH  DX         ;them
FC22  E886FB     685      CALL  CRLF
FC23  EB70FD     686      MOV   SI, OFFSET MHEAD ;print the header
FC28  EB4AFD     687      CALL  CRLF
FC2B  030A       688      ADD  BX,DX       ;sum
FC2D  EB41FE     689      CALL  OUTBX
FC30  E832FD     690      CALL  BLANK
FC33  5A         691      POP   DX         ;restore
FC34  58         692      POP   BX         ;numbers
FC35  28DA       693      SUB  BX,DX       ;difference
FC37  EB37FE     694      CALL  OUTBX
FC3A  C3         695      RET
696
FC3B  EB66FD     697      )
FC3B  EB66FD     698      NTEST:          ;MEMORY TEST
FC3E  EB08FE     699      CALL  SETUP     ;get start and end
FC41  EB31FD     700      CALL  CLENGTH   ;compute length
FC44  53         701      CALL  CRLF
FC45  51         702      MTEST1:        PUSH  BX
FC46  BA07        703      PUSH  CX
FC4B  BAE0        704      MOV   AL,M(BX)  ;get what's there
FC4C  B807        705      MOV   AH,AL     ;save it
FC4E  BA07        706      NOT  AL         ;complement
FC4F  B807        707      MOV   M(BX),AL ;and store it back
FC50  F6D0        708      MOV   AL,M(CX)  ;read it again
FC52  3AC4        709      NOT  AL         ;re-complement
FC53  750C        710      CMP  AL,AH      ;is it a 1?
FC54  750C        711      JNE  SHORT TEND ;if not then error
FC56  B827        712      MOV   M(CX),AH ;restore previous value
FC5B  43         713      TNEXT:         INC  BX          ;next location
FC5D  EBD7FC     714      CALL  CTLCHK    ;check for abort
FC5E  E2EB       715      LOOP MTL00P    ;continue
FC5F  59         716      POP   CX
FC60  5B         717      POP   BX
FC60  EB8E2       718      JMP   MTEST1    ;test forever

```



Listing 1 continued:

```

783      ;          *
784      ;          *          DRIVES TOL VDB VIDEO INTERFACE          *
787      ;          *
788      ;          *          converted from BOBO Assembler with CUNV-B6          *
789      ;          *
790      ;          *
791      ;
792      ;
793      ;          VIDEO DRIVER
794      ;
FCDA 50      795      VIDOUT: PUSH      AX
FCDB 56      796              PUSH      SI
FCDC 57      797              PUSH      DI
FCDD E80400  798              CALL     VIDEO
FCE0 5F      799              POP      DI
FCE1 5E      800              POP      SI
FCE2 5B      801              POP      AX
FCE3 C3      802              RET
803      ;
804      ;***** CONVERTED CODE BEGINS HERE *****
805      ;
806      ; VDB DRIVER
807      ;
OOE1      807      VD      EQU      OE1H
OOE0      808      VC      EQU      OEOH
OOE0      809      XRD     EQU      OEOH
OOE1      810      YRD     EQU      OE1H
OOC0      811      YWR     EQU      OCOH
OOE2      812      MRD     EQU      OE2H
OOS0      813      MWR     EQU      OOH
OOSB      814      VMODE    EQU      OOH
OOSB      815      BMODE    EQU      OOH
OOSB      816      ;
OOSB      817      ;
FCE4 53      818      VIDEO: PUSH      BX
FCE5 B81E30F4 819      MOV      BX,WORD PTR MEXY)
FCE9 247F    820              AND      AL,7FH
FCE8 7403    821              JZ      SHORT L_2
FCED E80600  822              CALL     VDOUT
FCF0      823      L_2:
FCF0 B91E30F4 824      MOV      WORD PTR MEXY),BX
FCF4 5B      825      POP      BX
FCF3 C3      826      RET
827      ;
FCF6 3C20    828      VDOUT: CMP      AL,20H
FCF8 7303    829      JAE     SHORT L_3)
FCFA E87490  830      JMP     CNTI
FCFD      831      L_3:

```

MCS-B6 MACRO ASSEMBLER VID88

LOC	OBJ	LINE	SOURCE
FCFD	3C7F	832	CMP AL,7FH
FCFF	7501	833	JNZ SHORT L_4
FD01	C3	834	RET
FD02		835	L_4:
FD02	E6E1	836	OUT VD,AL
FD04	FECF	837	DEC BH
FD06	7401	838	JZ SHORT L_5
FD08	C3	839	RET
FD09		840	L_5:
FD09	8750	841	MOV BH,BO
FD08	FEC8	842	DEC BL
FD0D	7401	843	JZ SHORT L_6
FD0F	C3	844	RET
FD10		845	L_6:
FD10	FEC3	846	VD2: INC BL
FD12	53	847	;
FD12	53	848	SCROLL: PUSH BX
FD13	52	849	PUSH DX
FD14	51	850	PUSH CX
FD15	809B	851	MOV AL,BMODE
FD17	E6E0	852	OUT VC,AL
FD19	32C0	853	XOR AL,AL
FD18	E6E0	854	OUT VC,AL
FD1D	8A90C1	855	MOV DX,OC130H
FD20	BAC6	856	MOV AL,DX
FD22	E6E0	857	OUT VC,AL
FD24	8AEA	858	MOV CH,DL
FD26	8800F4	859	MOV BX,VIDBUF
FD29	E4E1	860	L1: IN AL,VB
FD2B	8807	861	MOV M[BX],AL
FD2D	9F	862	LAHF
FD2E	43	863	INC BX
FD2F	9E	864	SAHF
FD30	FEC0	865	DEC CH
FD32	75F9	866	JNZ L1
FD34	BAC6	867	MOV AL,DX



FD36	FECB	868	DEC	AL
FD3B	E6E0	869	OUT	VC, AL
FD3A	B300F4	870	MOV	BX, VIDBUF
FD3D	BAEA	871	MOV	CH, DL
FD3F	BA07	872	L2: MOV	AL, MIBXJ
FD41	E6E1	873	OUT	VD, AL
FD43	9F	874	LAHF	
FD44	43	875	INC	BX
FD45	9E	876	SAHF	
FD46	FECB	877	DEC	CH
FD4B	75F5	878	JNZ	L2
FD4A	FEC6	879	INC	DH
FD4C	BAC6	880	MOV	AL, DH
FD4E	3CD9	881	CMP	AL, OD9H
FD50	72D0	882	JB	S1
FD52	BAEA	883	MOV	CH, DI
FD54	B020	884	MOV	AL, 20H
FD56	E6E1	885	S2: OUT	VD, AL

MCS-86 MACRO ASSEMBLER

VIDBB

LOC	OBJ	LINE	SOURCE	
FD5B	FECB	886	DEC	CH
FD5A	75FA	887	JNZ	S2
FD5C	59	888	POP	CX
FD5D	5A	889	POP	DX
FD5E	5B	890	POP	BX
FD5F	B0BB	891	SETCAV: MOV	AL, VNODE
FD61	E6E0	892	OUT	VC, AL
FD63	B050	893	SETCUR: MOV	AL, B0
FD65	2AC7	894	SUB	AL, BH
FD67	E6E0	895	OUT	VC, AL
FD69	B0D9	896	MOV	AL, 25+OC0H
FD6B	2AC3	897	SUB	AL, BL
FD6D	E6E0	898	OUT	VC, AL
FD6F	C3	899	RET	
		900	,	
FD70	3C0D	901	CNTL: CMP	AL, CR
FD72	7422	902	JZ	SHORT CCR
FD74	3C0A	903	CMP	AL, I.F
FD76	7415	904	JZ	SHORT CLF
FD7B	3C0C	905	CMP	AL, FF
FD7A	741E	906	JZ	SHORT CFF
FD7C	3C0B	907	CMP	AL, BS
FD7E	7401	908	JZ	SHORT CBS
FDB0	C3	909	RET	
FDB1	B04F	910	CBS: MOV	AL, 79
FDB3	2AC7	911	SUB	AL, BH
FDB5	7901	912	JNS	SHORT L_B
FDB7	C3	913	RET	
FDB8		914	L_B: ,	
FDBB	E6E0	915	OUT	VC, AL
FDBA	FEC7	916	INC	BH
FDBC	C3	917	RET	
FDBD	FECB	918	CLF: BL	
FDBF	7503	919	JNZ	SHORT L_9
FD91	E97CFF	920	JMP	VD2
FD94		921	L_9: ,	
FD94	EBCD	922	JMP	SETCUR
FD96	B750	923	CCR: MOV	BH, B0
FD9B	EBC9	924	JMP	SETCUR
FD9A	B09B	925	CFF: MOV	AL, BMODE
FD9C	E6E0	926	OUT	VC, AL
FD9E	BBD007	927	MOV	BX, 25*B0
FDA1	32C0	928	CFF1: XOR	AL, AL
FDA3	E6E1	929	OUT	VD, AL
FDA5	9F	930	LAHF	
FDA6	4B	931	DEC	BX
FDA7	9E	932	SAHF	
FDA8	BAC7	933	MOV	AL, BH
FDAA	OAC3	934	OR	AL, BL
FDAC	75F3	935	JNZ	CFF1
FDAE	B31950	936	MOV	BX, 256*B0+25
FDB1	EBCAC	937	JMP	SETCAV
		938	,	
----		939	ABS_0 ENDS	

MCS-86 MACRO ASSEMBLER

VIDBB

LOC	OBJ	LINE	SOURCE	
FBOF		940	END	INIT

ASSEMBLY COMPLETE. NO ERRORS FOUND

# MARK GORDON COMPUTERS

DIVISION OF MARK GORDON ASSOCIATES, INC.

P.O. BOX 77, CHARLESTOWN, MASSACHUSETTS 02129  
(617) 242-2749 (617) 491-7505

## SD SYSTEMS COMPUTER KITS

- ★ EXPANDORAM I (No RAMS) ..... 169.00
- ★ VERSAFLOPPY CONTROLLER I .. 189.00
- ★ SBC-100 Single Board Kit ..... 239.00
- ★ Z80 Starter ..... 269.00

## OTHER SPECIALS

- ★ 16K Memory Kit ..... 49.00
- ★ CAT Modem ..... 151.00
- ★ Leedex Monitor ..... 109.00
- ★ Atari 400 ..... 499.00
- ★ Atari 800 ..... 779.00
- ★ Hazeltine 1410 ..... 699.00

To Order Call Toll-Free 1-800-343-5206

### ORDERING INFORMATION

We accept Visa and Mastercharge. We will ship C.O.D. certified check or money order only. Massachusetts residents add 5 percent sales tax.

The Company cannot be liable for pictorial or typographical inaccuracies.

# ATTENTION COMMODORE DISK OWNERS

Never sort another disk file!

With Creative Software's ISAM file handling routine, your files are always maintained in sorted order. 2K bytes of assembly language subroutines allow you to:

- CREATE a new ISAM file
- OPEN an existing file
- READ key and data from file
- WRITE key and data to file
- READNEXT key and data from file
- DELETE key and data from file
- CLOSE file
- SUPPORTS up to 5 open ISAM files simultaneously

Available for 16K or 32K CBM computers and 2040 disk units

**\$99.95 + \$2.50 shipping**

Soon to be available for CBM 8016 and 8032 computers with 8050 disk drive. Manual available separately for \$15.00

# Creative Software

P.O. BOX 4030, MOUNTAIN VIEW, CA 94040

Text continued from page 347:

followed by a RET (return) statement. Then replace:

```
F8DE DW ERR
```

with

```
F8DE DW TESTMEM
```

### Notes on Performance

How does the 8088 stack up in performance versus the popular 8-bit processors of the 1970s? To answer this question, we must develop at least a rough definition of what we mean by performance.

To evaluate performance I use three criteria:

- the execution speed for a set of applications,
- the amount of memory required to implement the applications, and
- the amount of software-development effort required for application implementation (as measured by lines of assembly-language code).

An appropriate set of applications will include a mix of mathematics, data-handling and process-control-type programs. In addition, both execution-bound (eg: heavy calculation) and bus-bound (eg: bubble sort) applications should be included.

This article is not meant to be a full-fledged benchmark report. Nevertheless, using my own background, manufacturer's documentation, and other sources, I have come to the following conclusions concerning the 5 MHz 8088, which on the average:

- is 1.5 to 5 times faster than the *fastest* versions of other popular 8-bit machines (ie: Z80B, 68B09, 6800, 8080A, etc).
- will typically require only 50% to 75% of the memory devoted to code by these other machines for a set of applications, and
- requires substantially less (as little as 50% or less) lines of code to implement a benchmark than these other machines.

Execution speed is the most visible measure of performance. Factors which contribute to the 8088's superiority are:

- *The high standard clock rate:* The standard 8088 runs at 5 MHz (in fact, possibly faster if you're willing to experiment). Intel claims that, next year, specially selected 8 MHz 8088s will be available. If 5 MHz 8088s are fast, 8 MHz 8088s will be *unreal*.
- *The pipelined architecture:* This architecture allows overlapped instruction fetch and execution, eliminating a traditional performance limitation present in other 8-bit machines.
- *The 16-bit internal data paths:* These enhance data movement and manipulation capability.
- *Its rich set of arithmetic instructions:* Math-oriented applications are served exceptionally well by the 8088. The 5 MHz 8088 can do most 16-bit integer math (add, subtract, multiply, divide) faster than a 9511 hardware math chip.

● *Powerful addressing modes:* The 8088 allows up to four address components to be used in calculating an absolute physical memory address. In addition, most instructions can operate *directly on a memory location*, eliminating the traditional accumulator bottleneck found in other machines.

The amount of memory required can have significant cost ramifications for an application. Here again, the 16-bit internal organization and powerful addressing modes of the 8088 reduce memory requirements. In extreme cases (heavily word- or math-oriented) the 8088 can implement applications in as little as 20% to 30% of the memory of other 8-bit machines.

The number of lines of code required to implement an application becomes more and more of an issue each day. For instance, the Department of Defense states that one line of debugged, documented code now costs close to \$60. Programming costs continue to rise, while productivity remains relatively fixed. This suggests a real "software crisis" in the 1980s.

The 8088 can require as little as 50% (average perhaps 75%) of the lines of code as compared to other 8-bit machines. This is because one assembly-language instruction can generate up to 6 bytes of code, and the instructions implemented are very powerful relative to other popular microprocessors.

A summary chart of my findings is shown in figure 3. The relative performance of the 8088 (5 MHz), 6809 (2 MHz) and Z80A (4 MHz) are shown, with an 8086 (true 16-bit machine) thrown in for reference. A differentiation between *word- or bus-oriented* and *byte- or execution-oriented* applications must be made here. Note that the bus-oriented versus execution-oriented differentiation does not apply to nonpipelined machines like the Z80A or 6809. The byte-orientation versus word-orientation differentiation *does* affect the performance of these machines.

Full-speed memories are assumed as shown below:

	Processor	Access Time (approximately)
5 MHz	8088, 8086	480 ns
2 MHz	6809	320 ns
4 MHz	Z80A	250 ns

As shown above, the 8088 can function at maximum speed but still use slower memory than the other microprocessors. In many cases (especially EPROMs), slower-memory-speed selected parts have much lower prices than faster selections.

Essentially, the 8088 has from 1.5 to 2.5 times the performance of the fastest 8-bit competition. Of course, the performance improvement over older 8-bit processors (ie: 6800s, 8080As, etc) is even higher.

### Finale

In the text box on pages 344 thru 346 you will find a full description of each MON88 command. A complete listing of the monitor program is given in listing 1.

The 8088 is not only the highest performance 8-bit processor available, but represents a "bridge" to the new architectures of the 1980s. I hope that you have found the 8088 project as challenging, educating and rewarding as I have. Welcome to the future! ■

# Add Macro Expansion to Your Microcomputer

## Part 2

---

David C Brown  
1704 Manor Rd  
Havertown PA 19083

---

Last month, I discussed the definition and use of the macro instruction and detailed a set of requirements for a macro processor. Part 1 also gave an overview in the form of text and flowcharts of how this macro processor would operate. Figures 1 thru 11 provide a more detailed flowchart of these processes and roughly correspond to the overview flowcharts in figure 1 of Part 1 of this article (October 1980 BYTE, page 162). Frequent reference should be made back to these overview flowcharts when reading the detailed flowcharts of figures 1 thru 11. A glossary of terms appears on page 371.

This completes the explanation of the macro definition and expansion. In the rest of the article I will discuss the interface of the macro processor to an assembler, as well as possible enhancements.

### Alternate Implementation Approaches

The last hurdle to clear is how to tie this macro facility into your assembler. Basically, there are two ways this can be done, *preprocessor* or *in-line*. The approach used depends upon your situation.

The simplest way to use your macro processor is as a preprocessor. This can be done in two ways. In the first way, the macro processor is a separate program, reading your source program and writing an output file of expanded code to cassette, paper tape, floppy disk, etc; it is this output file that is read into the assembler instead of the original source. While this is the easiest way to use the preprocessor, it is also the worst from the viewpoint of efficiency, requiring an intermediate file and a longer run time. However, if you cannot modify the assembler itself, this may be the only approach you can take.

A second, more efficient, preprocessor approach is to locate the read routine in the assembler and replace it

**Listing 1:** Example of keyword parameters. A change that can be made in the macro assembler involves the use of keyword parameters. These allow the user to specify variable symbol values in any order or by default. The macro definition for MOVE is given in listing 1a; two examples of a macro call and its resulting code are given in listings 1b and 1c. In listing 1b, both &TO and &FROM are assigned the default values given in the prototype statement of the macro definition. In listing 1c, the value for &FROM is specified by default. Note the absence of the ampersand in naming variable symbols within the macro call.

```
(1a)
1.      MACRO
2.  &JUMP MOVE  &TO=FIELD B,&FROM=FIELD A,&LENGTH=
3.      LXI    B,&TO
4.      LXI    D,&FROM
5.      MVI    H,&LENGTH
6.  &JUMP LDAX  D
7.      STAX  B
8.      INX  B
9.      INX  D
10.     DCR  H
11.     INZ  &JUMP
12.     MEND

(1b) LOOP  MOVE  LENGTH=10

        LXI  B,FIELD B
        LXI  D,FIELD A
        MVI  H,10
LOOP    LDAX D
        STAX B
        INX B
        INX D
        DCR H
        INZ LOOP

(1c) LOOP  MOVE  LENGTH=9,TO=NEW

        LXI  B,NEW
        LXI  D,FIELD A
        MVI  H,9
LOOP    LDAX D
        STAX B
        INX B
        INX D
        DCR H
        INZ LOOP
```

with a call to the macro processor. This is the direction taken in my flowcharts since it is a compromise between a separate program and making major revisions to the assembler.

Replacing the read routine is not as easy as it sounds, however. Microprocessor assemblers typically use character assembly rather than line assembly. They read the source statement one character at a time and process each character as it is read rather than reading an entire source statement and having the whole statement available to work on. My flowcharts are designed for line assembly in that a model statement is completely expanded before it is passed to the assembler.

If your assembler uses character-assembly processing, it will call the macro processor for each character. This will require the read routine to expand the model statement on the first call and pass it one character at a time to the assembler on successive calls until it is completely transferred, at which point the read routine will expand the next model statement. You can also modify the model-expansion routines to pass the statement a character at a time directly from the expansion routines, but this is a little more difficult.

The worst drawback of either preprocessor approach is that every operation code is looked up twice, once by the macro processor to check for macro calls and once by the normal assembler. This is quite time-consuming. Perhaps the most efficient way to incorporate macro processing is to put the macro processing in-line with the assembler's operation-code-lookup and read routines. This requires

*Text continued on page 366*

The worst drawback of the preprocessor approach is that every operation code is looked up twice.

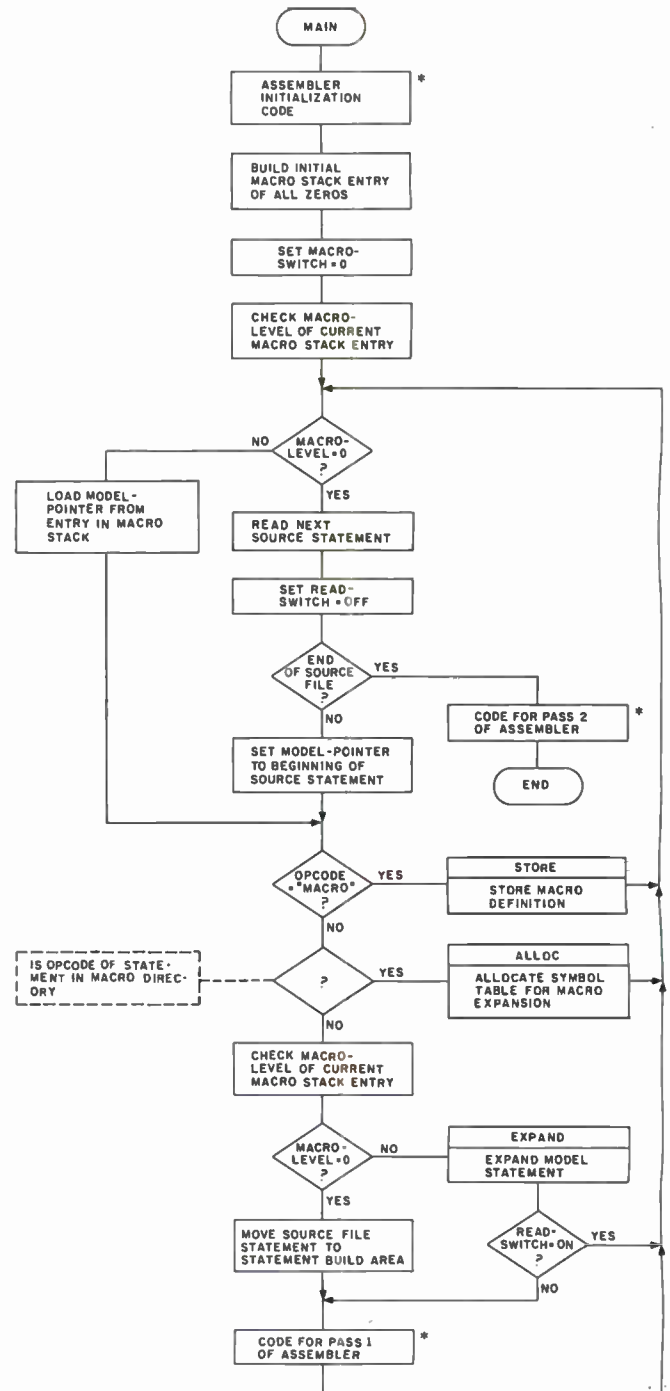

Figure 1: Overview flowchart for macro definition and expansion. This flowchart, MAIN, takes an assembly-language file containing both macro definitions and macro calls, stores the definitions, expands macro calls, and completes the work of a regular assembler. The boxes marked with asterisks represent the code that performs the assembler functions; the remaining boxes represent the code that is added through modification of the assembler's "read source" routine to implement the macro facility. Refer to the flowcharts in figures 2 thru 11 on pages 363 thru 370.

**FREE SOFTWARE\***

Unretouched photograph

- TEKTRONICS EMULATOR
- PRINTER INTERFACES
- CHARACTER GENERATOR

Designed to work with the CDL

**DYNAMIC BLACKBOARD**

High Resolution Graphics Interface

- 512 x 640 Matrix • High Speed • Gray tones and color
- Light pen • Fast delivery • 2-year field experience.

\*Offer good until January 31, 1981.

Send for brochure and data.

**CAMBRIDGE DEVELOPMENT LABORATORY**

36 Pleasant Street, Watertown, MA 02172  
(617) 926-0869

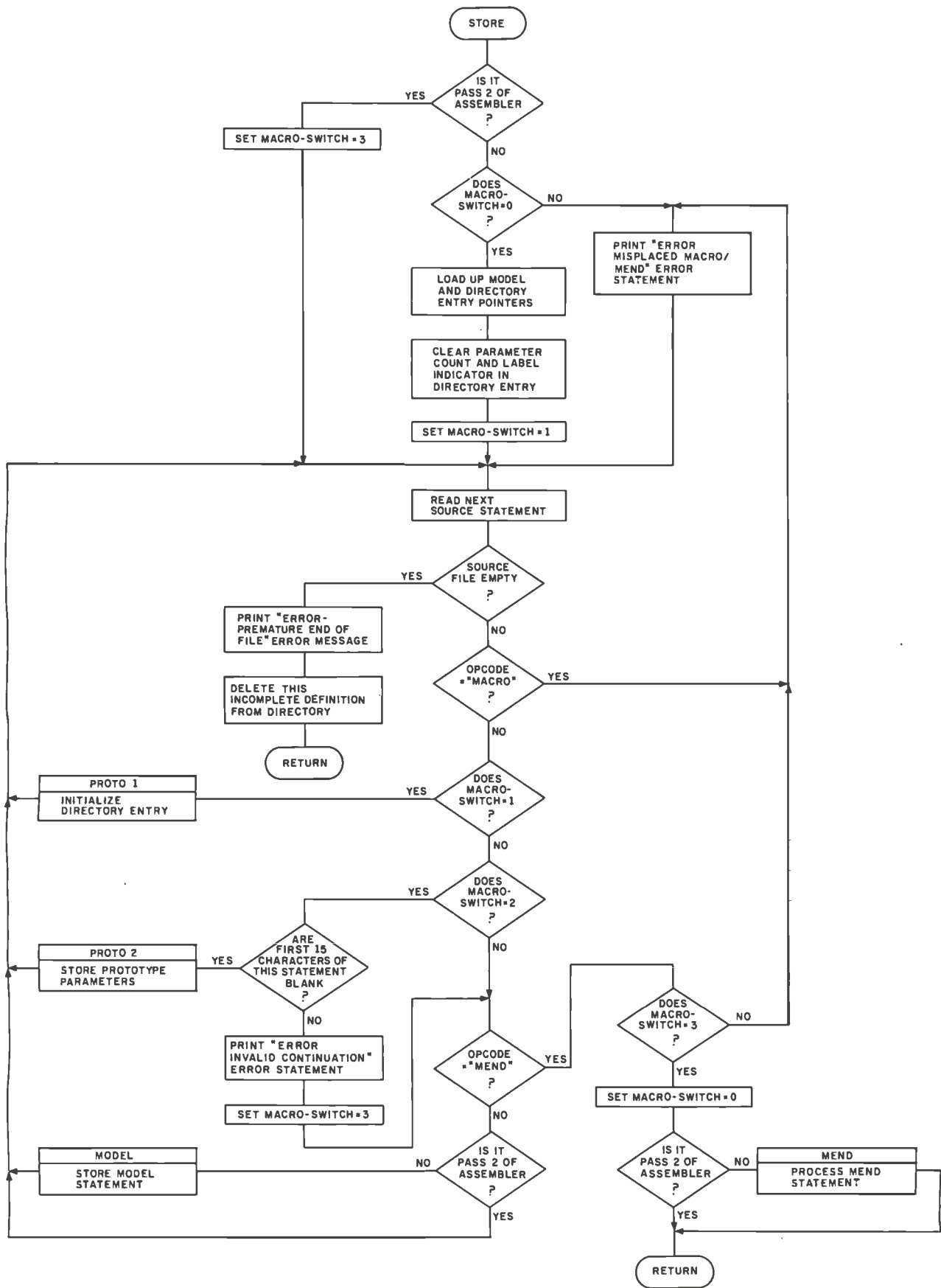

Figure 2: Flowchart for STORE subroutine. This subroutine stores an entire macro definition within the macro-definition storage area. MACRO-SWITCH is a flag that tells the program what kind of line the routine is expecting next. MACRO-SWITCH=0 means that the computer is ready to process a new macro definition. MACRO-SWITCH=1 means that the computer has found a MACRO statement and is looking for the prototype statement. MACRO-SWITCH=2 means that the computer is ready to process the second line of the prototype statement, if there is one. MACRO-SWITCH=3 means the computer is ready to process the body of the macro definition.

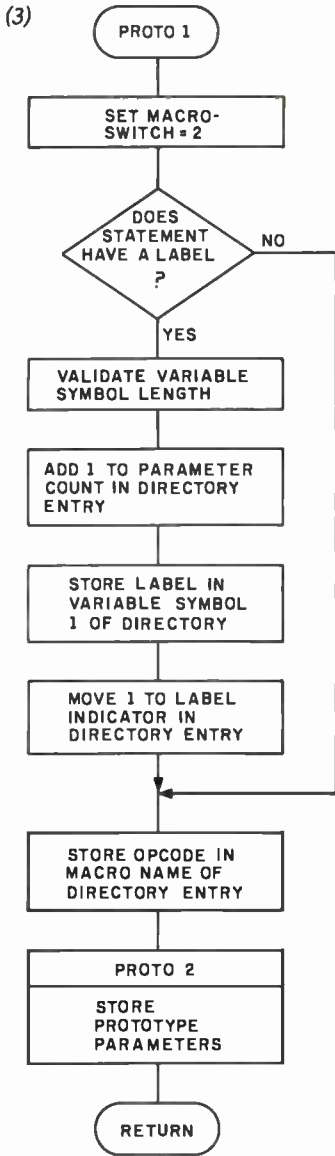
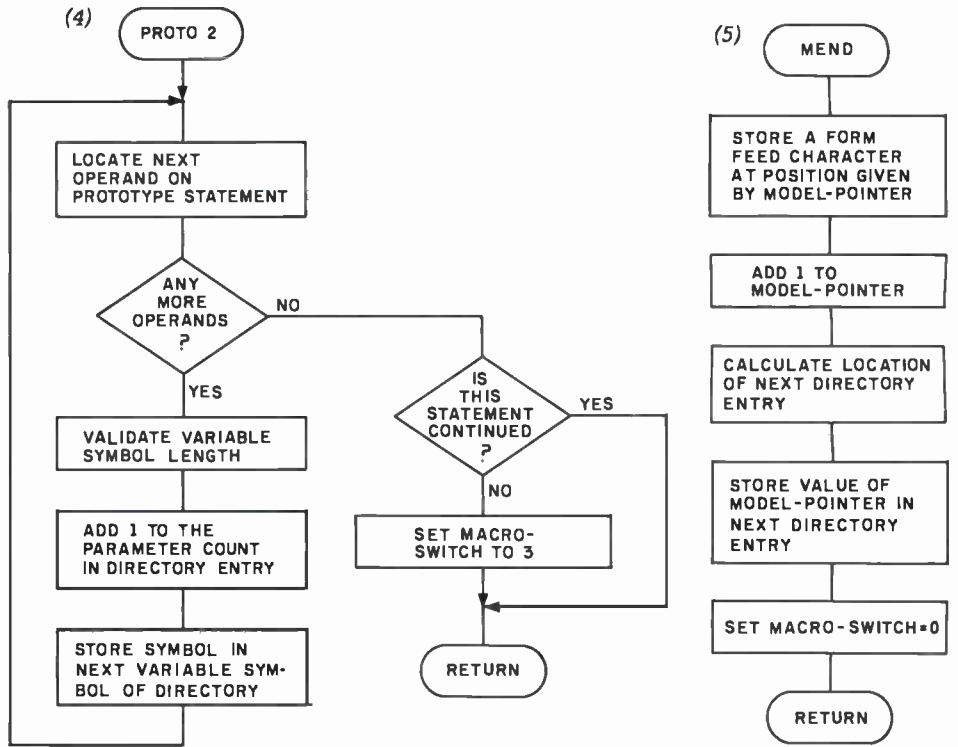

Figure 3: Flowchart for PROTO1 subroutine. This subroutine stores the prototype label, if any, the macro name, and calls PROTO2 to store the prototype variable symbols.

Figure 4: Flowchart for PROTO2 subroutine. This subroutine stores the variable symbols of a macro prototype statement in the directory.

Figure 5: Flowchart for MEND subroutine. This subroutine does several housekeeping chores associated with ending a macro definition.



## CALCULATOR MODULE SELECTOR

for Texas Instruments 59/58 Calculator



- Holds four Solid State Software™ libraries or a total of 20,000 program steps.
- Effectively quadruples the power of a TI 59 or 58 calculator by providing continuous access, under program or manual control, to any routine in any module.
- Four LED lamps on the selector can be activated to illuminate a prompting message or serve as a status indicator.
- Attaches to the calculator through the module port and can also be used with the PC 100 printer.
- Completely portable requiring no external power supply or batteries.
- Assembled, tested and warranted for ninety days.

**\$199.95**

**AMERICAN MICRO PRODUCTS, INC.**  
 705 N. Bowser  
 Richardson, TX 75080  
 (214) 238-1815

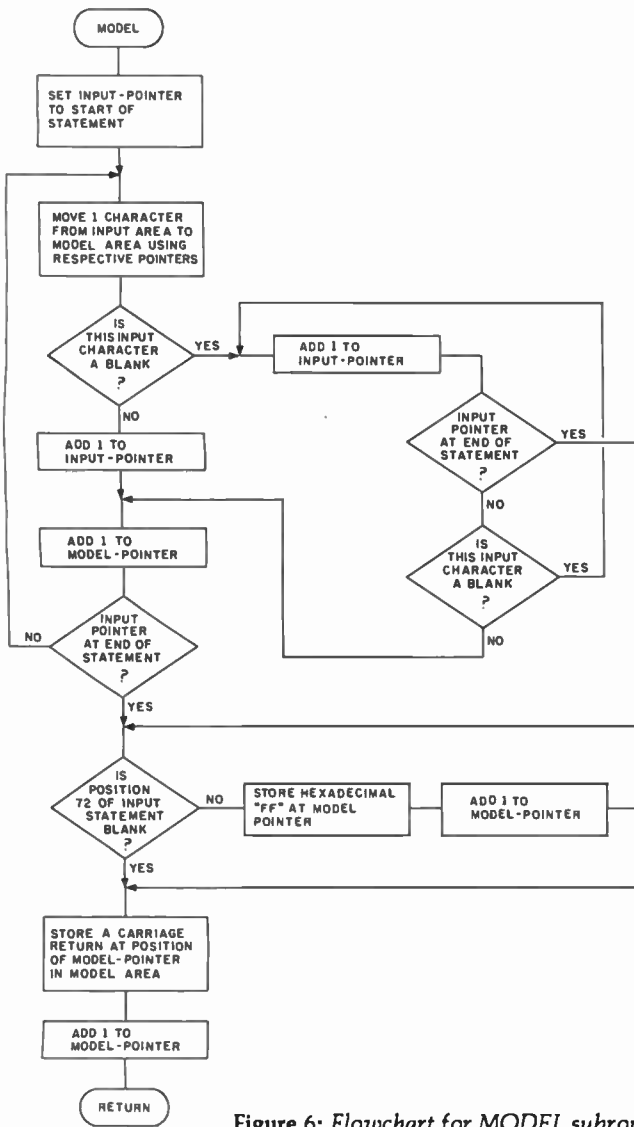

Figure 6: Flowchart for MODEL subroutine. This subroutine stores one model statement of a macro definition in the macro-storage area.

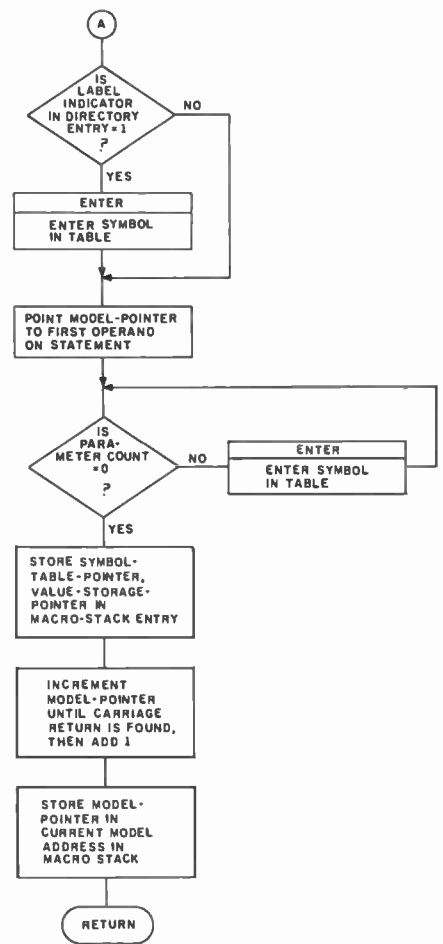
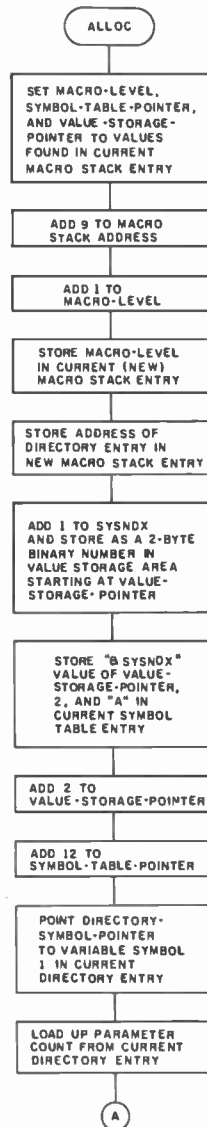

Figure 7: Flowchart for ALLOC subroutine. This subroutine is called when a macro call is found in the body of the assembly-language program; it sets up pointers in the macro stack and symbol table to identify the current values of the variable symbols as defined in the macro call.

# ARE YOU STILL PLAYING GAMES WITH YOUR COMPUTER?

## Get down to business with CBS.

THE CONFIGURABLE BUSINESS SYSTEM™ is a ready-made set of programs that lets you customize your computer without ever using a complex programming language.

- It makes accounting a 1,2,3 operation.
- It turns inventories into child's play.
- It makes mailing lists a zip.

In fact, CBS now makes the business of computers so easy, you might still think you're playing a game!

Disks and manual, \$395. Manual only, \$40.

CBS Disks can fit any 8080 or Z80 computer with CP/M.\* Your DMA representative can tell you about PDOS, our CP/M compatible operating system, and ASCOM, an Asynchronous Communication Control Program.

**DMA • WE SPEAK YOUR LANGUAGE**

CP/M\* is a Trademark of Digital Research Corp.

DYNAMIC MICROPROCESSOR ASSOCIATES • 545 Fifth Avenue • New York, New York 10017 • (212) 953-1721 • Master Charge and VISA accepted

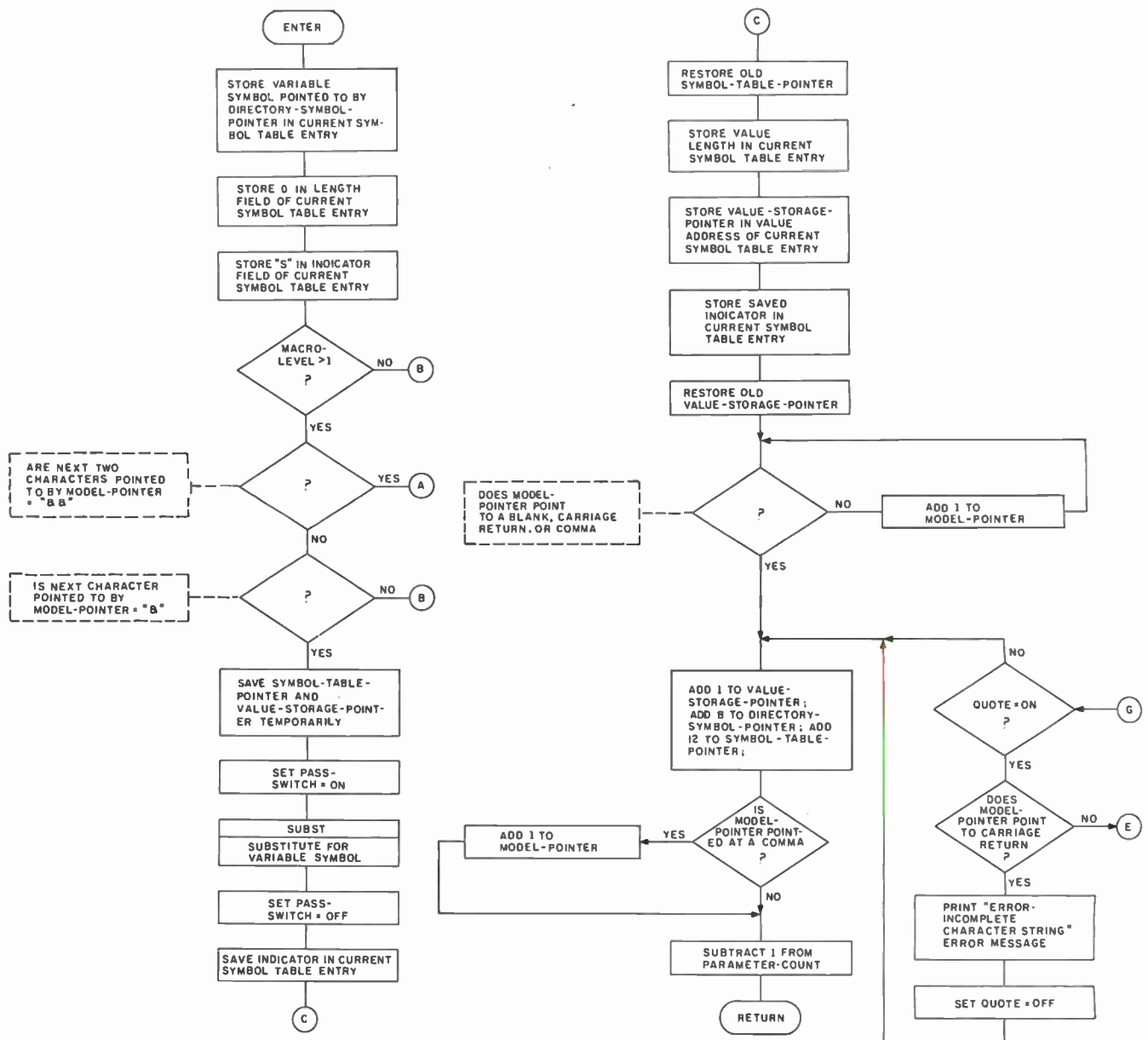

Figure 8: Flowchart for ENTER subroutine. This subroutine, called by ALLOC, stores the current value of a variable symbol in the symbol table.

Text continued from page 362:

source listings for your assembler and enough courage on your part to modify your assembler. The operation-code-lookup routine must be modified to first check for the identifier MACRO, at which point it stores the definition. If the operation code is not MACRO and is not found in the assembler's operation-code table, the assembler must then look it up in the macro directory and expand it if found.

In using this in-line approach, you also have to modify the read routines to make use of the macro-level counter, as is done at the beginning of the flowchart in figure 5. This approach, more ambitious than the others, is the best, and it should be taken if you have the assembler source and can take the time. It will result in an efficient, well-integrated assembler, rather than a patchwork creation. However, if this route cannot be taken, the power of macro facilities is probably worth the inefficiency of the preprocessor technique.

## Extensions

If you are really ambitious, there are several other facilities that you can implement. Many of these facilities require modifications to the assembler as well as to the macro processor; but if you are still reading at this point, maybe you feel up to the task.

A large improvement can still be made in print facilities. As detailed so far, the macro call itself never gets to the assembler for printing so that you do not know from looking at the intermediate source listing which statements are generated by the macro assembler and which are in the original source. Ideally, the macro call should print and all generated statements should be identified as such. One solution is to print the macro-level indicator, since this shows the level of nesting when nested macro calls are used. You can also add an assembler directive that tells the assembler whether or not to print the generated statements.

Another facility that you can implement is conditional



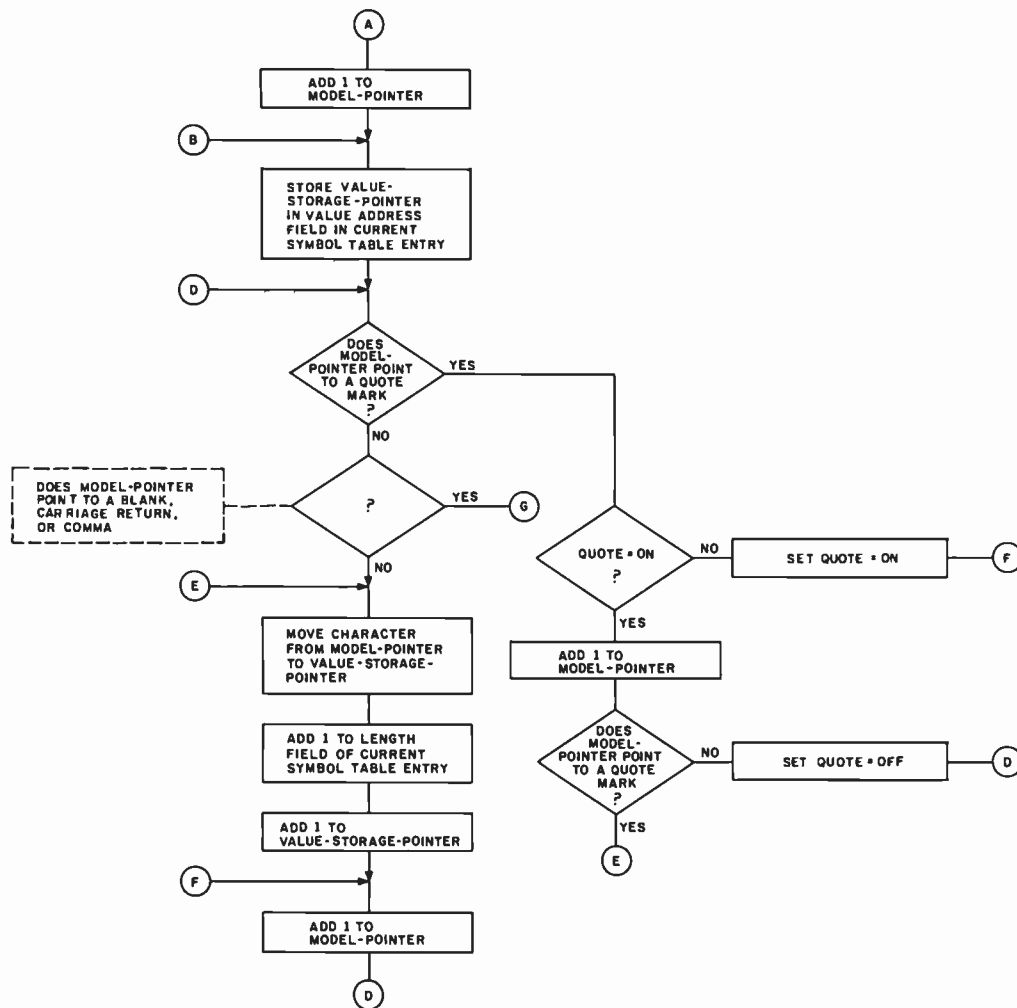

assembly, which was mentioned in Part 1 of this article. This would go along with the ability to define local variable symbols within the body of the macro definition; these local variable symbols would be used for loop control and arithmetic within the macro definition.

Another possible modification is the addition of global symbols and a global symbol table. This would allow you to pass variable symbols from one macro expansion to another. When a global symbol is encountered, you look it up in the global symbol table to get its value. If it is not found there, it is added to the global symbol table. This global table does not have its entries deleted at the end of the macro generation, so the information put there is still present whenever the next macro call is processed.

The method for handling variable symbols and their values detailed in this article is known as *positional parameters*. This means that the first variable symbol on the prototype assumes the first value on the macro call, the second variable symbol assumes the second operand value, and so on. A more flexible method is *keyword parameters*. With keyword parameters, the macro prototype might look like this:

```
&LABEL MOVE &FROM=FIELD A,
          &TO=FIELD B,&LENGTH=
```

The macro call would then be coded:

```
LOOP2 MOVE LENGTH=14, FROM=FIELD C
```

Keyword operands are distinguished by an equals sign and have several interesting properties. As shown in listing 1a, the `&FROM=` and `&TO=` variable symbols in the prototype specify a default value—`FIELD A` and `FIELD B`, respectively. If the `FROM` and `TO` operands are omitted on the macro call, the defaults are used as in listing 1b; otherwise, the value from the macro call is used, as in listing 1c. The `&LENGTH=` parameter on the prototype has no default, so it must be specified on the macro call. Also, since you specify the keywords on the macro call, they do not have to be in the same order as specified on the prototype. Otherwise, the keywords are used in the macro-definition statements just like the positional parameters I have been discussing.

Keyword processing requires a more complicated loading of the symbol table when the macro call is encountered; it also requires modifications to the routine that stores the macro definition, since the defaults will have to be stored in the value-storage area and the directory entries will have to be modified to point to the default values. It is a lot of work, but it is much more flexible.

These are just some of the enhancements you can implement. If you have access to the IBM Assembler Language manual (referenced at the end of this article), you will find that it gives much more detailed explanations of these facilities, plus others that I have not mentioned.

To those of you who are still interested, study of the text and flowcharts of this article is all you need do before you can write your own macro assembler. Once you understand the processes involved ("walking through" the flowcharts with pencil and paper will help), there is no reason why you cannot give it a try. After all, there's no magic to system software—it's just another program. ■

### References

1. Emmerichs, J. "Designing the 'Tiny Assembler'." BYTE, April 1977, page 60.
2. Fylstra, D. "Write Your Own Assembler." BYTE, September 1975, page 50.
3. Graham, R. *Principles of Systems Programming*. New York NY: Wiley, 1975.
4. Grappel, R and J Hemenway. "Jack and the Machine Talk." BYTE, August 1976, page 52.
5. Gries, D. *Compiler Construction for Digital Computers*. New York NY: Wiley, 1971.
6. IBM System 360/370 OS Assembler Language, Manual GC28-6514.
7. Jewell, G. "Simplify Your Homemade Assembler." BYTE, May 1976, page 74.
8. Wegner, P. *Programming Languages, Information Structures, and Machine Organization*. New York NY: McGraw-Hill, 1968.

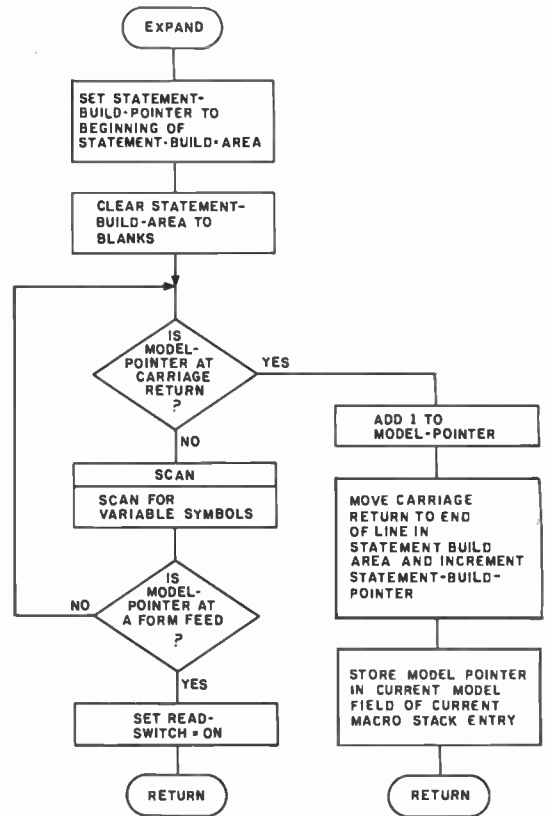

Figure 9: Flowchart for EXPAND subroutine. This subroutine expands a model statement using the current values of the variable symbols as found on top of the symbol table.

# FRIDAY SALE

## APPLE-TIME \$150

For Your **APPLE...** The Ultimate **CLOCK/CALENDAR** Board

### MORE FEATURES FOR LESS

- 12 or 24 HR Format
- Perpetual Calendar MM DD YY
- Crystal Controlled Time Base
- Ultra Fast Time/Date Setting
- 4 Interrupts Available
- Months Of On-Board Battery Backup

Set it & forget it.

## MANY MORE FEATURES

TSR80 & S100 MODELS AVAILABLE

**C/T Compu/Time**  
P.O. Box 5343  
Huntington Beach, Ca. 92646 (714) 536-5000

Dealer Inquires.

### Makers Of Quality Low Cost Microcomputer Components

# CP/M<sup>®</sup> USERS!

## The ED-80 TEXT EDITOR

- \$50,000 in Development Costs — Yours for Only \$99!
- For all CP/M, Cromemco, TRS-80 Mod II, and North Star Systems.
- Full Screen Text Editor w/Scrolling.
- For all CRT and Video Monitors.
- Features Found only on IBM, CDC, UNIVAC and DEC Systems.
- Forward or Backward Locate and Change Commands.
- Field Proven — More than 2 Years.

**A Terrific Value — \$99<sup>00</sup>** Write for **FREE Color Brochure**

**Software Development & Training, Inc.**  
Post Office Box 4511, Dept. B  
Huntsville, Alabama 35802

VISA or MC

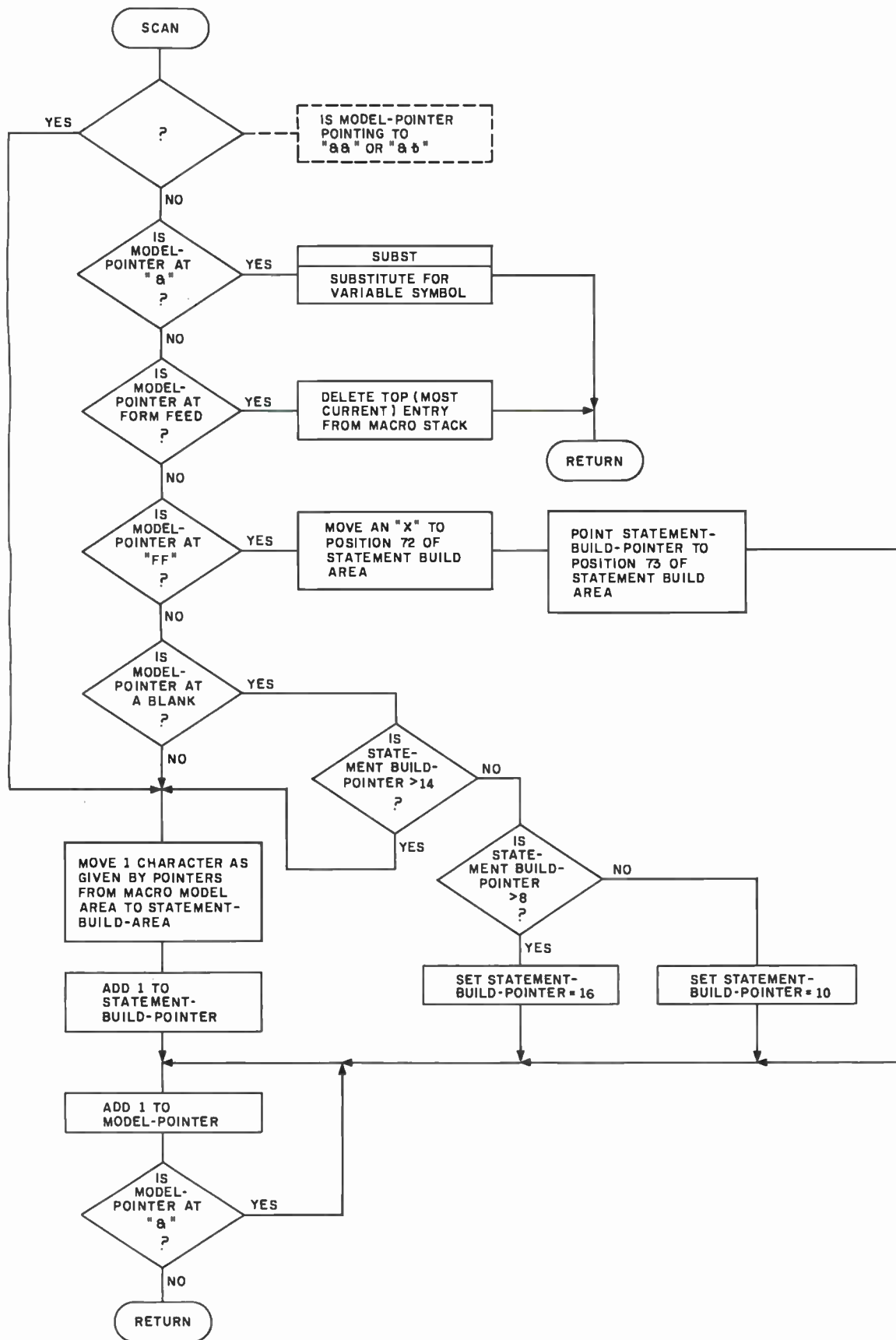

Figure 10: Flowchart for SCAN subroutine. This subroutine scans for variable symbols in the model statement and replaces them with their most recent values; it also restores blanks that were compressed out of the model statement.

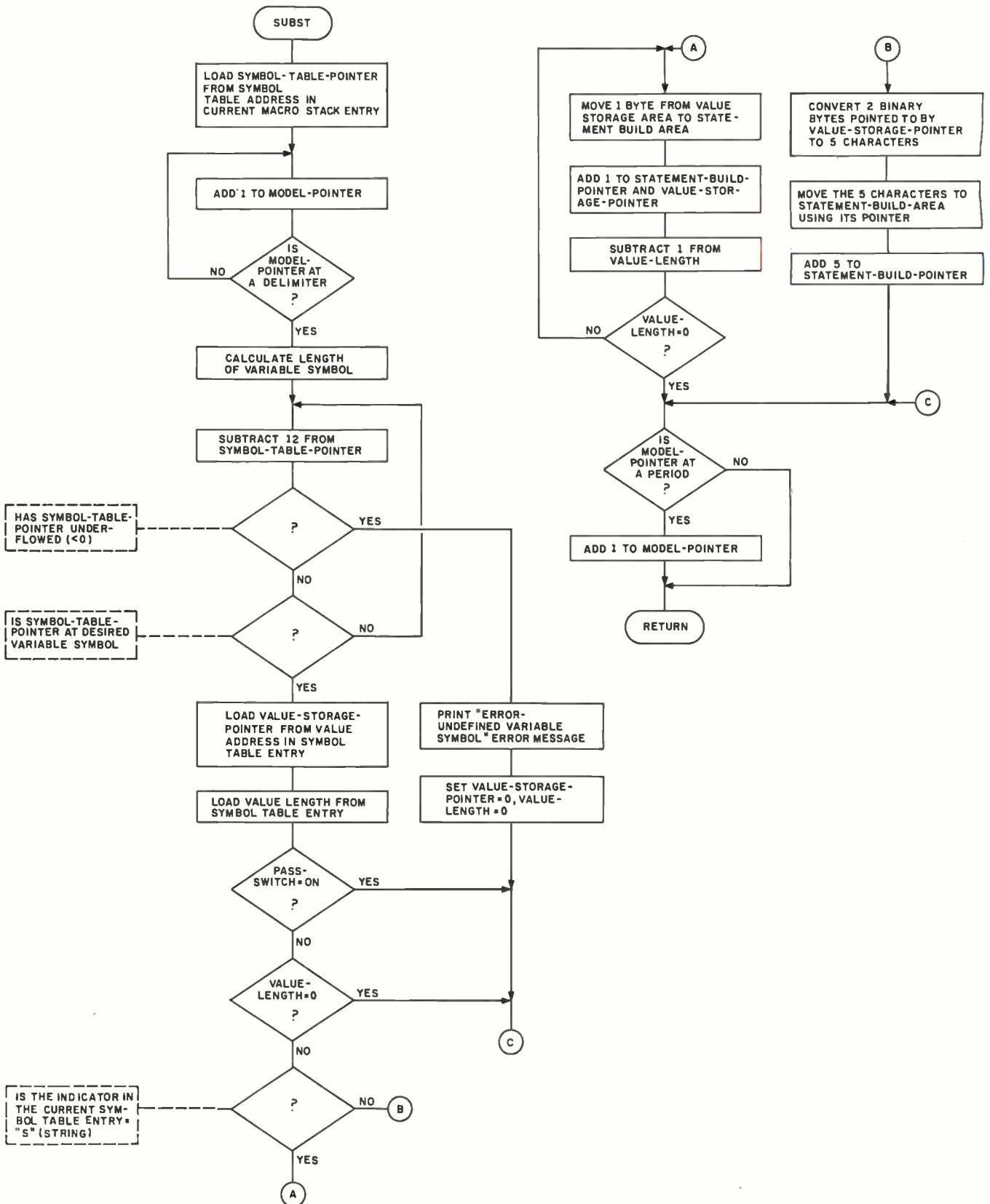

Figure 11: Flowchart for SUBST subroutine. This subroutine, called by SCAN, substitutes the appropriate value for its corresponding variable symbol in a model statement.

## GLOSSARY

**Conditional Assembly:** a feature of macro assemblers that instructs the assembler to generate or leave out certain lines of assembly-language code based on a given condition evaluated at the time of expansion.

**Descriptor:** useful when working with strings of characters. It is a fixed-length entry containing the length of the string and a pointer to where the string starts in the storage area. (Symbol-table entries can be considered descriptors.) Descriptors are used frequently in assemblers and in high-level language compilers.

**Directory:** it contains an entry for every macro defined, pointing to the start of the model statements and specifying the variable names (from the macro prototype) that must be entered into the symbol table before the macro is evaluated.

**Global Variable:** a variable whose value is in effect for the entire assembly and for every macro generation. Use of a given global variable name, even within different macros, refers to the same value (unlike local variable symbols, the values of which are lost at the end of the macro expansion). In this article, &SYSNDX is a global variable.

**Inner Macro:** a macro call specified within the model statements of another macro. When a macro referred to as the outer macro is generating statements and encounters an inner macro, it must stop, generate the statements from the inner macro call, add them to the statements belonging to the outer macro, then continue generating its own statements.

**Keyword Operand:** a variable symbol followed by an equals sign; it appears only on the macro prototype and the macro call. Unlike positional parameters, keyword operands can be coded in any order. They also allow the ability to specify default values in the macro prototype.

**Local Variable:** a variable, the value of which is in effect only for the macro in which it is defined. All variable symbols defined in macro prototype statements are local variables. The same local variable symbol name used in another macro is treated as a separate variable, even though the names are the same.

**Macro:** a user-defined assembly-language operation code that generates one or more assembler instructions.

**Macro Call:** a pseudoinstruction within an assembly-language program that refers to a macro definition of the same name. The eventual result is the replacement of the macro call statement with the expanded model statements of the macro definition.

**Macro Definition:** a sequence of statements that tell the macro processor what to generate when replacing the macro-call instruction. It is made up of a MACRO statement that signals the beginning of the macro, a prototype statement that defines the macro name and its operands, a series of model statements that replace the macro call, and a MEND statement that signals the end of the macro definition.

**Macro Stack:** a stack of certain information about currently incompleting macro calls; it is necessitated by the ability to call a macro within a macro. Each macro-stack entry points to the directory entry, the end of the symbol table, and the value-storage area for the macro.

**Model-Storage Area:** an area of computer memory set aside for storing the model statements of all macro definitions. The directory entry for each macro points to the start of that macro's model statements in the model-storage area.

**Pass 1:** the assembler's first reading of source statements. During pass 1, the assembler builds its symbol table, which includes every label in the program, and checks for duplicate symbols.

**Pass 2:** the assembler's second reading of the source statements. At this point, all symbols are known to the assembler as a result of pass 1, and the equivalent machine code can be generated from the source code.

**Positional Operands:** when the variable symbols in a macro prototype are defined as positional operands, they are assigned values from the list of operands in the macro-call statement in the order that they are defined in the prototype. The first variable symbol on the prototype gets the first operand value, and so on.

**Preprocessor:** a routine or program that processes and usually modifies the input before the main program gets it. Macro facilities are often written as preprocessors that replace macro calls with their expanded assembly-language statements before passing the source file to the assembler.

**Prototype:** the second statement in the macro definition. It defines the label entry, the operation code (macro name), and the allowable operands (in the form of variable symbols) for the macro call.

**Recursion:** a technique in which a called subroutine calls itself. A recursive function must be designed so that it eventually returns a value rather than calling itself again; otherwise, it calls itself in a loop that never finishes.

**Stack:** a last-in, first-out list that allows the user to remove only the value most recently placed onto the stack. Stacks are similar to the devices used to dispense plates in a cafeteria. Plates (values) are put on the top of the stack, pushing down all the others, and are removed from the top, causing the others to pop up. A stack in programming works the same way, giving rise to the terms PUSH and POP, which are commonly used when talking about computer stacks.

**Symbol Table:** a stack containing an entry for each variable in the macro prototype. The symbol-table entry specifies the variable name, the length of its current value, and the address where the value is stored in the value-storage area.

**Text Compression:** the process of removing all unnecessary blanks from a source statement in order to reduce the amount of space needed to store the text.

**Value-Storage Area:** an area of memory set aside for storing the values associated with a program's variables. The symbol-table entry for each variable points to the start of that variable's value and specifies the value length.

**Variable:** a variable (or variable symbol) is a character string that can have many different values assigned to it by either the programmer or the assembler. Variables can be either global or local; most references to variable symbols in this article actually refer to local variable symbols.

# What's New?

## PERIPHERALS

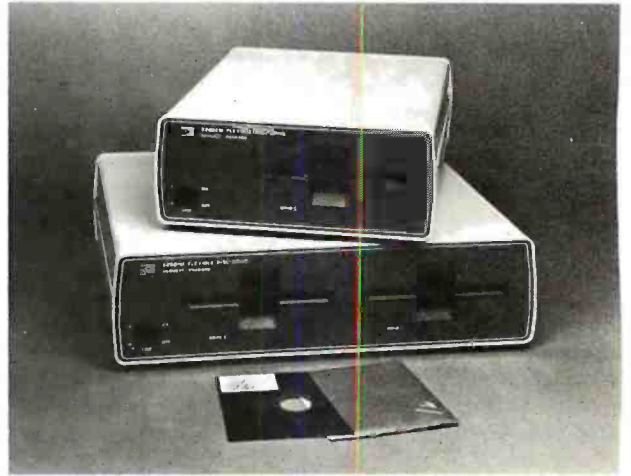

### Floppy-Disk Drive for the HP-85

The HP 82900 Series floppy-disk drives read double-sided, double-density, 5-inch floppy disks, and can be configured to provide from 279 K bytes to 1.08 megabytes of storage. The interface between the HP-85 and the disk drives is the HP-85 Mass Storage ROM (read-only memory). The ROM makes

available thirty additional BASIC commands including a Translate command, which upgrades written tape-based programs for use on the drives; the ability to store and retrieve the graphics display on the video screen; automatic default to the drive; and volume labeling, allowing users to refer to disks by name

and write programs independent of drive addresses. Prices for the floppy-disk drives start at \$1500 for a single-master drive and go to \$2500 for a dual-master drive. Contact the Inquiries Manager, Hewlett-Packard Co, 1507 Page Mill Rd, Palo Alto CA 94304.

Circle 662 on Inquiry card.

### Seven Spinwriter Thimble Fonts from NEC

NEC Information Systems Inc, 5 Militia Dr, Lexington MA 01273, (617) 862-3120, has introduced Pica 10 Multilingual, Elite 12 Multilingual, British Elite 12, Greek/Times Roman, Scientific Times Roman, Super Courier/Publishers, and Light Italic/Manifold type fonts. These fonts meet the special printing requirements of many industries. The multilingual fonts offer the capability of printing over thirty languages. The fonts are offered on the NEC Spinwriter series of 55 character per second impact printers which feature the "thimble" print element.

Circle 663 on Inquiry card.

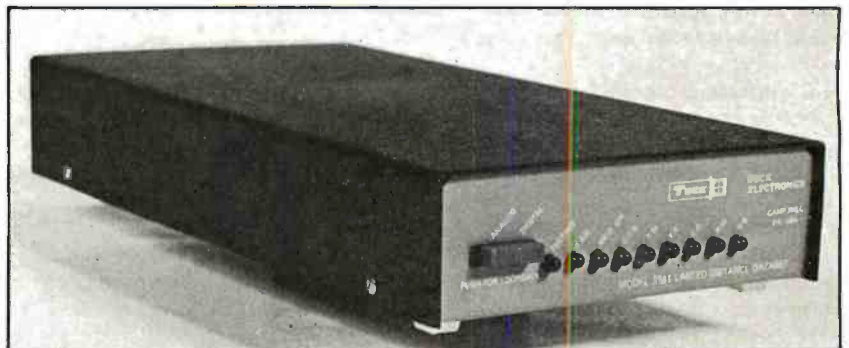

### Line Driver Meets Bell Metallic-Line Specifications

Tuck Electronics has announced a line-driver series for use on metallic

pairs from 0 to 9.6 kbs for 4-wire full-duplex service. The driver complies with Bell 43401 amplitude and line balance specifications, and features a floating receiver amplifier. The unit features analog and digital loop-back test facilities, and a blinking light which indicates when the driver is in the test mode. The driver supports an RS-232 interface. The unit is available in stand-alone and multiple units. Single unit price for stand-alone units is \$175, and multiple-unit cards are \$162. For more information, contact Tuck Electronics Inc, 3645 Industrial Park Rd, Camp Hill PA 17011, (717) 761-4354.

Circle 664 on Inquiry card.

### Where Do New Products Items Come From?

*The information printed in the new products pages of BYTE is obtained from "new product" or "press release" copy sent by the promoters of new products. If in our judgement the information might be of interest to the personal computing experimenters and homebrewers who read BYTE, we print it in some form. We openly solicit releases and photos from manufacturers and suppliers to this marketplace. The information is printed more or less as a first in first out queue, subject to occasional priority modifications. While we would not knowingly print untrue or inaccurate data, or data from unreliable companies, our capacity to evaluate the products and companies appearing in the "What's New?" feature is necessarily limited. We therefore cannot be responsible for product quality or company performance.*

# What's New?

## PERIPHERALS

### Large-Screen Color Monitor

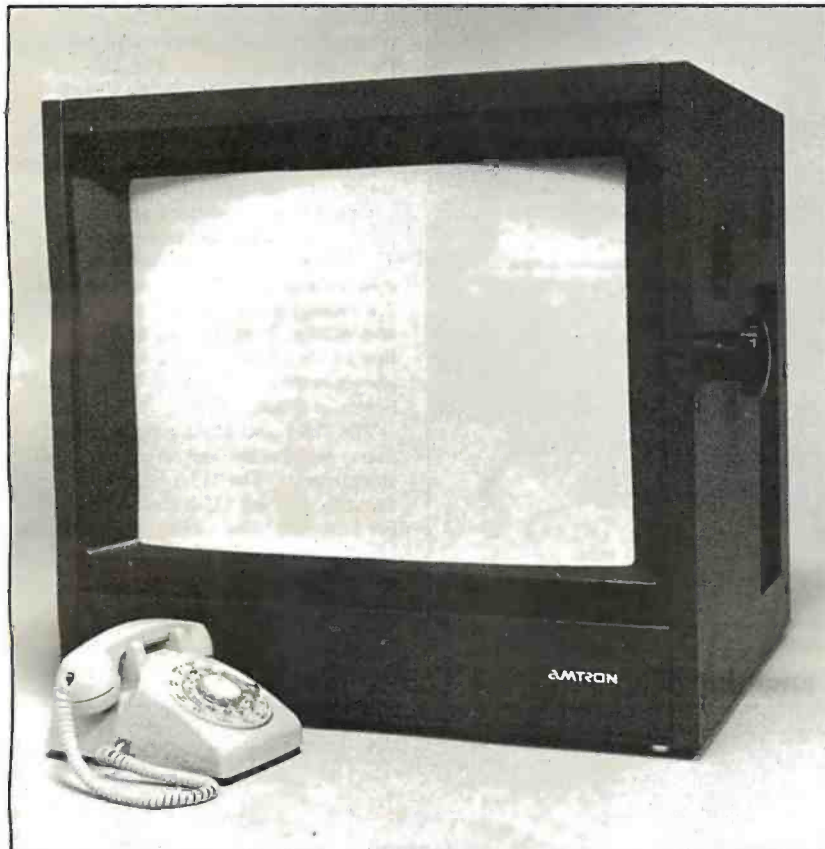

The AM-26, a 26-inch color monitor, with over 340 square inches of screen surface, combines Sony's Trinitron color system with switchable A/B inputs, switchable underscan, internal and external sync, and separate RGB (red, green, and blue) gun switches. Talley light,

separate horizontal and vertical scan delay are optional, and a separate tuner/audio amplifier and speaker section may be added. The Amtron AM-26 is priced at \$2395 from Amtron, Aptos CA 95003, (408) 688-4445. Circle 665 on Inquiry card.

### Digital Plotters from Houston Instrument

The DMP family of plotters comprises two standard and four intelligent models. All these models are available with plotting sizes of 21.5 by 28 cm (8.5 by 11 inches) and 28 by 44 cm (11 by 17 inches). The DMP-2 is a 21.5 by 28 cm plotter with an RS-232C and parallel interface. It has a pen speed of 2.4 inches per second and can plot at 100 or 200 increments per inch. The DMP-5 has a surface area of 28 by 44 cm and the RS-232C and parallel interface. The unit is plug-compatible with the DMP-2 and can utilize software developed for the DMP-2. The DMP-3 features a built-in microprocessor and pen speeds of 3 inches per second. Use of Houston In-

strument's Digital Micro/Plotter Language alleviates the software burden on the host computer. Self-test and pen positioning are accomplished via a computer or terminal keyboard. The DMP-3 comes with an RS-232C or Centronics-compatible interface. The DMP-6 is a 21.5 by 28 cm version of the DMP-3 and features a pen speed of 2.4 inches per second. The DMP-4 and the DMP-7 utilize electronic controls to facilitate positioning of the X and Y axes. Self-diagnostics are activated through front panel controls. Prices for the DMP Series plotters start at \$1085. For complete information, contact Houston Instrument, 1 Houston Sq, Austin TX 78753, (512) 837-2820.

Circle 666 on Inquiry card.

### Paper-Tape Reader

A paper-tape reader/transmitter, the Model 612, is available from Addmaster Corporation, 416 Junipero Serra Dr, San Gabriel CA 91776, (213) 285-1121. The 612 features the ability to read five- to eight-level tape and to transmit 7 to 11 frames per character at 50 to 9600 bps (bits per second). Other features include starting and stopping on character at all speeds; choice of manual or automatic control; 90 to 260 V, 50 to 60 Hz power sources; and even, odd, or no parity; with a choice of desk-top or rack mounting. The price is \$656 to \$779. Circle 667 on Inquiry card.

### Chatterbox from Micromint



The Chatterbox is a packaging combination of the presently available COMM-80 I/O (input/output) interface for the TRS-80 and an acoustic modem. This box can turn even a 4 K-byte TRS-80 into a full time-sharing terminal. The Chatterbox includes a built-in programmable 50 to 19 K bps (bits per second) serial port, a Centronics-compatible parallel printer port, a 300 bps acoustic originate modem, and a spare TRS-BUS expansion connector. It comes with a power supply, connection cable, manual, and smart terminal software. When the modem is in use, the data conversation is automatically routed to the serial output port for printing. The Chatterbox allows a TRS-80 to communicate with time-sharing systems such as Micronet and the Source. In addition, Chatterbox can be used simply to provide an address selectable serial and parallel port. It is completely hardware- and software-compatible with existing TRS-80 products, and it connects either to the keyboard connector or screen printer port on the Expansion Interface. It does not require the Expansion Interface for operation. The Chatterbox is available for \$259 from The Micromint Inc, 917 Midway, Woodmere NY 11598, (516) 374-6793.

Circle 668 on Inquiry card.

# What's New?

## SYSTEMS



### Systems from Wang

The Office Information Systems (OIS) Models 115-1 and 115-2 incorporate hard-disk drives located within the master control unit. The OIS systems can utilize the Wang Office-BASIC language, telecommunications and high-speed image printing capabilities, and Wang MAILWAY electronic mail software. These systems combine word-processing and data-processing capabilities in one device. The Model 105 supports two workstations and one printer, and contains a 2.5-megabyte hard disk. The addition of text editing, hyphenation, and justification to the 105 provides a complete photocomposition system. The 105 begins at \$9300.

The 115-1 and 115-2 support more users, peripherals, and larger hard-disk storage units. The 115-1 begins at \$13,400, and the 115-2 starts at \$15,400. For complete information, contact Wang Laboratories Inc, 1 Industrial Ave, Lowell MA 01851, (617) 459-5000.

Circle 669 on inquiry card.

### Casio Markets Its First Computer

The FX-9000P computer, priced under \$900, has been introduced by Casio Inc, 15 Gardner Rd, Fairfield NJ 07006, (201) 575-7400. It features instantaneous operation of the user system when the power is switched on. A graphic-display system makes it possible to display graphs, diagrams, and tables. The FX-9000P has all functions necessary to perform scientific and technical calculations and business analyses. The machine accepts memory packages to expand memory capacity.

Circle 670 on inquiry card.

### British S-100-Based Microcomputer

The Tuscan S-100 is based on the IEEE (Institute of Electrical and Electronics Engineers) standard S-100 bus. This single-board computer uses a Z80 microprocessor, can store 64 K bytes of programmable memory, is CP/M compatible, and includes a printer interface. Expansion capabilities include high-resolution graphics and speech synthesis cards. Transam offers application software packages that include BASIC and Pascal. Tuscan S-100 prices start at £195 for kits. For details, write Transam, 12 Chapel St, London NW1 5DH, England.

Circle 671 on inquiry card.

### Canon Introduces Its Desk-Top Computer

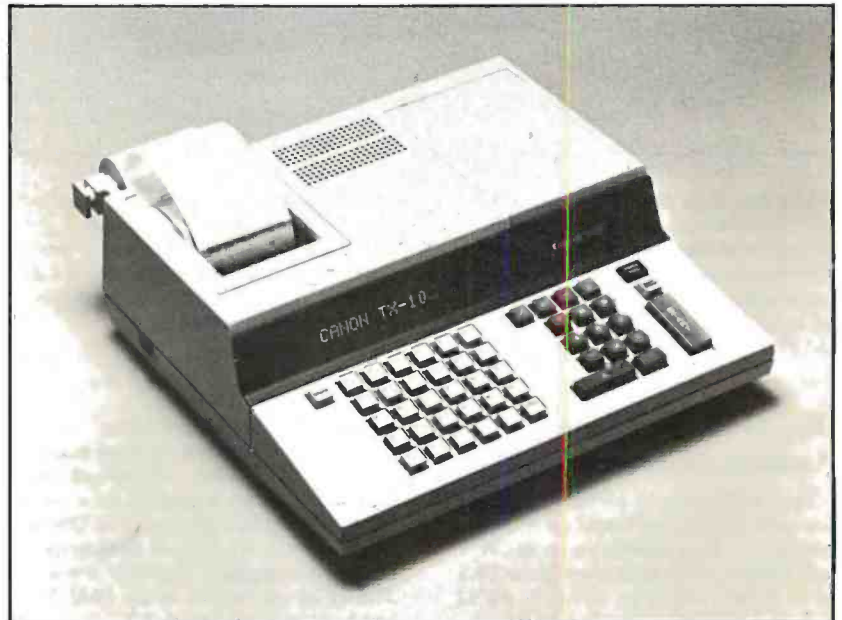

The TX Series microcomputers from Canon feature a 6809 microprocessor, extended BASIC and assembler language, a twenty-column alphanumeric video display, and a built-in twenty-six-column triple-copy impact printer. The models have 15 K bytes of user memory which can be expanded to 31 K bytes. Each model has an RS-232 interface port and a modem port. The TX-25 is a programmable machine with a full

typewriter keyboard and a built-in Canon floppy-disk drive. The TX-10 and TX-15 are nonprogrammable. The TX-15 incorporates a typewriter keyboard, while the TX-10 has a ten-key pad with twenty-six labeled keys. The price for the series is \$1295 from Canon Systems Division, 10 Nevada Dr, Lake Success, Long Island NY 11042, (516) 488-6700.

Circle 672 on inquiry card.



# What's New?

## GRAPHICS

### Colormaster Video and Graphics Board

The Colormaster allows users to program virtually any display format (eg: 64 by 32, 128 by 16, and 80 by 25). The board is designed for S-100 bus systems. Characters may be reversed, dimmed, flashing, underlined, and any of eight colors. Bit-mapped graphics or an optional PROM (programmable read-only memory) graphics set may also be displayed. Another option allows extension of the character set to include 128 user-defined characters. The Colormaster kit is \$399; assembled and tested, it is \$499; and the bare board is \$79. For more information, contact MicroDaSys, POB 36051, Los Angeles CA 90036, (213) 731-0876.

Circle 673 on inquiry card.

### Summagraphics Unveils Supergrid Digitizer

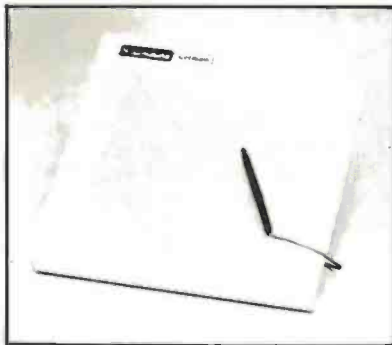

The microprocessor-based Supergrid utilizes a new technology—the Direct Magnetostrictive principle. This unit features high accuracy ( $\pm .005$  inch or 0.125 mm) and high-resolution (.001 inch or 0.025 mm) and eliminates the need for a biasing magnet. Supergrid is translucent with a flat surface; moreover, it supports a stylus and a cursor, and it permits simultaneous use of two digitizer tablets with the same driving electronics. The Supergrid comes in 11 by 11 and 20 by 20 inch forms, with larger versions to follow. RS-232C, IEEE, 8-bit parallel, and 16-bit parallel interfaces are supported. The technology behind the device is based on a principle that replaces a matrix of magnetostrictive wires with a matrix of plain copper wires and only one magnetostrictive wire per axis. For more information, contact Summagraphics Corporation, 35 Brentwood Ave, Box 781, Fairfield CT 06430, (203) 384-1344.

Circle 674 on inquiry card.



### Hard-Copy Unit for Video Images

The Tektronix 4634 Imaging Hard Copy Unit produces high-quality continuous tone copies from raster-scan video sources in seconds. Designed to provide photographic quality images, the device is aimed at digital image processing, pattern recognition, remote sensing, video-disk, and high-resolution display environments. The 4634 records on dry silver paper using a fiber-optic video display. The process requires no toners or developers. The copies have a twelve-tone gray-scale range. The approximate cost per copy is \$0.20. It prints 6 by 8 inch images on 8½ by 11 inch paper. It usually requires a single cable connection and can be interfaced to most raster-scan video sources, whether analog or digital. An automatic gain-control circuit tracks the input



signal. Paper is available in 8½ inch by 500 foot rolls. Paper length can be adjusted from 7 to 11 inches. For more information, contact Marketing Communications Department, M S 63-635, Tektronix Inc, POB 500, Beaverton OR 97077, (503) 682-3411.

Circle 675 on inquiry card.

### Digitizer for the Apple II

The DS-65 Digisector is a random access video digitizer for the Apple II. It converts a television-camera's output into digital information that the Apple can process. The Digisector features high-resolution reproduction, sixty-four levels of gray scale, and accepts interlaced or industrial video input. The unit has on-board software featuring full screen scans directly to the Apple screen, random access digitizing by BASIC programs, line-scan digitizing for

reading charts or tracking objects, and utility functions for clearing and copying the screen. BASIC programs include a burglar alarm and a graph reader. Complete source listings are included in the package. The DS-65 is used for digitizing pictures; security systems; moving-target indicators; computer portraits; reading paper tape, strip charts, bar codes, and more. The price is \$349 from The Micro Works, POB 1110, Del Mar CA 92014, (714) 942-2400.

Circle 676 on inquiry card.

# What's New?

## SOFTWARE

### A Mail-List and Data-Base System

SelectraSort is a mail-list, data-base management system. It can pull records from mail-list files on the basis of over sixty selection criteria. The mail-list-file maintenance module enters new records to the mail list and changes or deletes existing entries. The selection module pulls records from the files. The print module prints selected and master mail lists as well as mail labels. Sorts can be done by ZIP code, country, state, last activity date, amount purchased or sold last year and this year. SelectraSort is \$195, which includes CBASIC source code. It is available on 8-inch soft-sectored and 5-inch soft- and hard-sectored floppy disks. Contact Software Hows, a division of MicroDaSys, POB 36275, Los Angeles CA 90036, (213) 731-0877.

Circle 677 on Inquiry card.

### General Ledger for the Atari

MicroLedger, the Compumax general ledger program, has been converted to run on the Atari 800. The Atari MicroLedger performs trial balances and produces profit-and-loss statements and balance sheets. It features updating options, allowing the user to review and update records in the journal or chart of accounts; a running balance column in the journal listing; and error traps. The MicroLedger package retails for \$140, which includes the program, sample data, and a manual. BASIC source code is also included. Minimum hardware requirements are the Atari 800 with 24 K bytes of memory and a floppy-disk drive; a printer is offered as an option. Contact Compumax Inc, POB 1139, Palo Alto CA 94301, (415) 325-4503.

Circle 678 on Inquiry card.

### Data Manager for the Apple

Information Master is a data manager for use with the Apple and includes the ability to do calculations, totals, sub-totals, and more. The program lets the user define, enter, edit, sort, and retrieve data. Printed report formats using the report-generation features can be defined. Other features include screen formatting, error trapping, and the ability to add, multiply, divide, and do exponentiations. A program is included that transfers files from the Management System for use with the Information Master. For further details on the Information Master program, contact High Technology Inc, POB 14665, 8001 N Classen Blvd, Oklahoma City OK 73113, (405) 840-9900.

Circle 679 on Inquiry card.

### Vector Releases COBOL with Program Generator

Vector Graphic Inc has released a version of its ANSI-standard CIS COBOL, featuring program generation capability. Version 4.2 of CIS COBOL implements the eight modules necessary to meet the ANSI Level 1 standard at the low-intermediate level. The FORMS-2 utility generates data-entry screens and can create error-free data input programs without the programmer writing a line of code. It is available from Vector Graphic Inc, 31364 Via Colinas, Westlake Village CA 91361, (213) 991-2302.

Circle 680 on Inquiry card.

### Job-Costing Package Under CP/M

This job-costing package consists of a reporting facility, a job-costing accounts payable, and a job-costing payroll. These programs are designed to run on a Z80 or 8080 processor using the CP/M operating system. Other CP/M-like systems are also supported. The software will run on hard or floppy disks. The business applications are integrated, yet each will run singly. The price is \$700 for a system from Arkansas Systems Inc, Suite 206, 8901 Kanis Rd, Little Rock AR 72205, (501) 227-8471.

Circle 681 on Inquiry card.

### Business Application for the HP-85

Pro-Flow can figure sales analysis, forecast performance for products, evaluate material costs, and perform cash-flow analysis for a year's operation. By mixing initial raw data values with formulas, users can make projections about future operations. Pro-Flow is designed to run on the HP-85 micro-computer. It is available at a suggested retail of \$150 from Scelbi Publications, 20 Hurlbut St, Elmwood CT 06110, (203) 522-5515.

Circle 682 on Inquiry card.

### Disk-O-Tape

Disk-O-Tape is a utility program for the Apple II and Apple II Plus computers. It enables users to transfer the data from a floppy disk to cassette tape and back again. The program features sector-by-sector copy of a DOS 3.2 disk to tape, error detection, and a verification pass for reliability. Each tape produced by the program contains a bootstrap for easy loading on disk. The program allows user-assigned naming of tapes. Disk-O-Tape requires at least 32 K bytes of programmable memory. The program comes on a floppy disk with Testape, a program to aid in adjusting the cassette recorder for optimum performance. Disk-O-Tape costs \$12 from Dann McCreary, POB 16435-B, San Diego CA 92116.

Circle 683 on Inquiry card.

### Lifeboat Supports the Durango F-85

Lifeboat Associates has made available its 8080 software line formatted for the Durango F-85 computer. This software, which includes languages such as BASIC, COBOL, and Pascal; word-processing systems, such as Wordstar; communication software, such as BSTAM; and complete accounting packages, is available by the implementation of CP/M. The first version of CP/M supports the F-85 with up to four floppy-disk drives. This is priced at \$170. Later versions will support the 12-megabyte and 25-megabyte hard-disk systems. Contact Lifeboat Associates, 1651 Third Ave, New York NY 10028, (212) 860-0300.

Circle 684 on Inquiry card.

### RECLAIM "Hides" Bad Sectors and Tracks from CP/M

Lifeboat Associates, 1651 Third Ave, New York NY 10028, (212) 860-0300, has announced a CP/M 2.0 utility program that tests floppy-disk and hard-disk systems for error-prone parts of the disk and allocates those parts to files that are invisible to the user. RECLAIM maps the bad spots out of the file directory so that they cannot be used again. It safely tests the disk with or without data files. At the completion of the program, it announces the number of blocks hidden from the file system. RECLAIM is available on all CP/M media formats supported by Lifeboat Associates. The cost is \$80.

Circle 685 on Inquiry card.

# What's New?

## SOFTWARE

### Digital Synthesizer for the Apple

Mountain Computer Inc has developed the MusicSystem for the Apple II. This sixteen-voice digital synthesizer permits the creation of the sounds of real musical instruments utilizing the principle of additive synthesis. The generation of sounds is accomplished through programmable waveforms, envelopes, and amplitudes for each musical voice. Software is included for editing and playing of compositions. The editor program permits graphical input of sheet music utilizing standard music notation. The player program permits polyphonic performance of musical compositions. Stereo output is to user's stereo amplifier and speakers or directly off card with stereo headphones. For information, write or call Mountain Computer Inc, 300 Harvey W Blvd, Santa Cruz CA 95060, (408) 429-8600.

Circle 686 on Inquiry card.

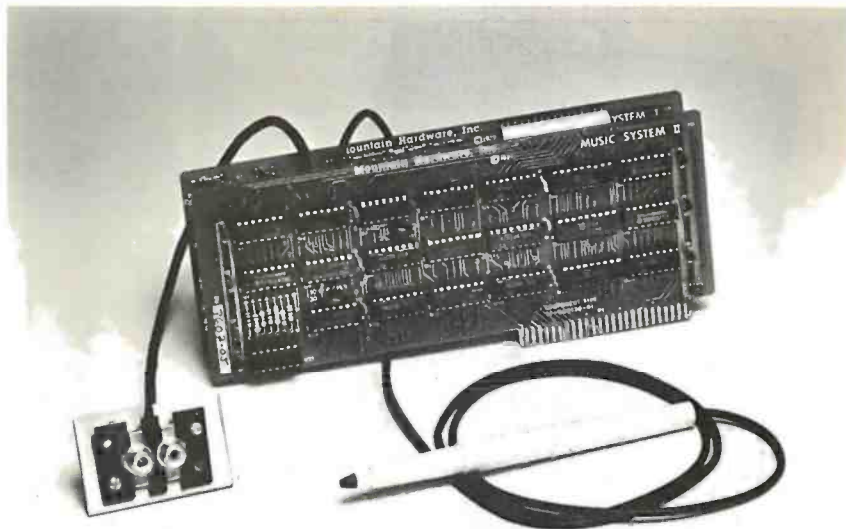

### New Business Software for the TRS-80

American Business Systems (ABS) has announced that its line of financial- and business-applications software packages are now available to users of Radio Shack TRS-80 computers. These seven new ABS packages offer the same full-scale features and capabilities as the company's software for larger minicomputers and microcomputers.

The packages include a complete series of financial systems, ranging from Accounts Payable and Receivable through Payroll, Order Entry and Inven-

tory Control to a fully automated General Ledger System. The application systems currently available include Financial Modeling and Real-Estate Sales Management. Additional packages soon to be released will offer a Client Accounting System and a Correspondence Management Package, which includes a letter writer, word processor and mailing-label generator.

Information is available from American Business Systems Inc, 439 Littleton Rd, Westford MA 01886, (617) 486-3509.

Circle 687 on inquiry card.

### TRS-80 CP/M 2.0 with 12 Megabytes

Lifeboat Associates, 1651 Third Ave, New York NY 10028, (212) 860-0300, has announced the release of CP/M version 2.0 for the TRS-80 Model II. The system features extended density format for each of up to four floppy-disk drives. Nearly 2.5 megabytes of storage is possible with floppy-disk drives alone. The Corvus 10 megabyte Winchester hard disk is suggested as a storage system, allowing CP/M to access 12 megabytes of memory. A menu-driven configuration program allows total control of the parallel printer port and both serial ports of the TRS-80.

The printer port software can be set to control a "dumb" printer that has no page control, or the software page control can be disabled for printing checks or mailing labels. The system includes

functions to set data rates of from 134.5 to 9600 bps (bits per second) for the serial ports. An ADM-3A emulation program is included which allows the TRS-80 to be used as a terminal through the serial ports. The system is offered with Corvus hard-disk capability for \$250 and floppy-disk capability for \$170.

Circle 688 on Inquiry card.

### Software for the Apple II

Softpoint, Dept C, 103 Clinton Ave, Terryville NY 11776, has announced cassette programs for the Apple II including Function Plot, Speed Reading, Road Race, and more. The programs utilize the Apple's high-resolution graphics capabilities. The prices range from \$5.95 to \$9.95.

Circle 689 on Inquiry card.

### Reformat for the TRS-80

Reformat is a programming aid to be used prior to compiling with the Microsoft BASIC compiler. The BASIC compiler allows the use of long variable names which can contain BASIC reserved words, making the format of a BASIC source file and the use of spaces critical. BASIC program files that are written as multistatement compressed lines will be rejected by the compiler in almost all cases. Bluebird's has developed this machine-language program which will reformat any TRS-80 BASIC source file into a format acceptable to the compiler. Reformat is available for \$24.95 from Bluebird's Company 2267 23rd St, Wyandotte MI 48192, (313) 285-4455.

Circle 690 on Inquiry card.

### Data-Base Program for Z80 Systems

Condor Computer Corporation, 3989 Research Park Dr, Ann Arbor MI 48104, (313) 769-3988, has announced Target/80 DBMS, a data-base system for Z80 microcomputers. Target/80 is designed for transaction processing applications. This version uses nineteen commands, including relational operations for selecting, sorting, appending, or posting data. Target/80 is compatible with most Z80 systems with at least 48 K bytes of programmable memory running under CP/M. The price is \$695.

Circle 691 on Inquiry card.

# What's New?

## MISCELLANEOUS

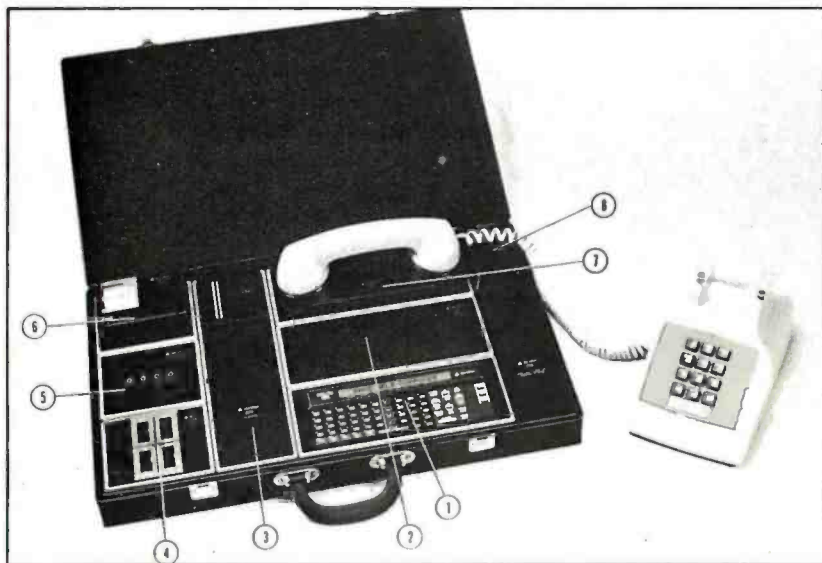

### Logic Timing Recorder from A P Products



A P Products, 1359 W Jackson St, Painesville OH 44077, (800) 321-9668, in Ohio (216) 354-2101—collect, has introduced the Logic Timing Recorder, a device for charting logic timing. The unit is an ABS plastic board with 320 slides arranged in eight horizontal rows. The slides represent the two logic levels of a circuit. After the slides are manually moved into position to represent the logic state in a circuit, the board is checked for proper design, then it can be placed on a copying machine to make a permanent record for your files. The recorder may be used over and over again to chart the logic timing of all circuits. The Logic Timing Recorder, P/N 923758, has a suggested price of \$44.95. Circle 694 on inquiry card.



### Computer in a Case

The Quasar Micro-Information System consists of a hand-held computer, video display, printer, modem, cassette deck, expandable programmable memory unit, I/O (input/output) driver—and it all fits in a briefcase. The hand-held computer fits in the palm of a hand, weighs less than a pound and con-

trols the peripheral devices. A library of memory capsules in ROM (read-only memory) for use in the computer include fourteen languages, calorie counter, bar/wine guide, phonetic pronunciation, and games. The system is available from Quasar Company, Franklin Park IL 60131. Circle 692 on Inquiry card.

### Nine-Voice Synthesizer

Vista Media Products has announced the Music Machine Nine. Using LSI (large-scale integration) technology, the device can produce nine voices on the Apple II computer. The board uses three AY3-8910 integrated circuits and requires one expansion slot. It can use software now available to produce and play back nine-voice music compatible

with other music boards. It will respond to commands for pitch, amplitude, duration, attack, delay, and more. Two high-impedance, low-level outputs are provided with six voices assigned to each channel. It is available through Advanced Computer Products, 1310 E Edinger, Santa Ana CA 92705, (714) 558-8813. Circle 693 on inquiry card.

### A/D Converter for S-100 Systems

The AIM-12 is a 16- or 32-channel 12-bit A/D (analog-to-digital) converter designed for laboratory and industrial applications. The card plugs directly into the standard IEEE S-100 bus. Features include an on-board resistor programmable instrumentation amplifier and operation of up to 25 ms with 12 bits of accuracy. The AIM-12 is I/O (input/output) mapped and can be used with either BASIC or assembly-language instructions. The module is designed for direct conversion of voltages from thermocouples, level sensors, pressure transducers, pH electrodes and other low-level signal sources. The device provides thirty-two single-ended or sixteen fully differential inputs; input impedance exceeds one billion ohms. It is fully compatible with North Star, Cromemco, and most S-100 system. Multiple boards can be employed, and BASIC and assembly-language programs are supplied. The price of the AIM-12 is from \$575, depending on options, from Dual Systems Control Corporation, 1825 Eastshore Hwy, Berkeley CA 94710, (415) 549-3854. Circle 695 on inquiry card.

**Speed up your PET programming with The BASIC Programmer's Toolkit™, now only \$39.95.**

Don't waste valuable programming time if there's an easier way to go. Here it is: The BASIC Programmer's Toolkit, created by Palo Alto ICs, a division of Nestar. The Toolkit is a set of super programming aids designed to enhance the writing, debugging and enhancing of BASIC programs for your PET.

The BASIC Programmer's Toolkit has two kilobytes of ROM firmware on a single chip. This extra ROM store lets you avoid loading tapes or giving up valuable RAM storage. It plugs into a socket inside your PET system, or is mounted on a circuit board attached on the side of your PET, depending on which model you own.

There are basically two versions of PET. To determine which Toolkit you need, just turn on your PET. If you see **\*\*\*COMMODORE BASIC\*\*\***, your PET uses the TK-80P Toolkit. If you see **###COMMODORE BASIC###**, your PET uses the TK-160 Toolkit. Other versions of the BASIC Programmer's Toolkit are available for PET systems that have been upgraded with additional memory.

# Increase your PET's IQ for \$39.95.



PET™ is a trademark of Commodore Business Machines, Inc. The BASIC Programmer's Toolkit™ is a trademark of Palo Alto ICs, a division of Nestar Systems, Inc.

**How Toolkit makes your programming easier:**

**FIND** locates and displays the BASIC program lines that contain a specified string, variable or keyword.

If you were to type **FIND A\$,100-500**, your PET's screen would display all lines between line numbers 100 and 500 that contain **A\$**.

**RENUMBER** rennumbers the entire program currently in your PET.

You can instantly change all line numbers and all references to those numbers. For instance, to start the line numbers with 500 instead of 100, just use **RENUMBER 500**.

**HELP** is used when your program stops due to an error. Type **HELP**, and the line on which the error occurs will be shown. The erroneous portion of the line will be indicated in reverse video on the screen.

These simple commands, and the other seven listed on the screen, take the drudgery out of program development work. And for a very low cost. The BASIC Programmer's Toolkit costs as little as \$39.95, or at most, \$59.95.

Get the BASIC Programmer's Toolkit and find out how quick and easy program development can be. See your local PET dealer or send this coupon in today.

**PALO ALTO ICs**  
A Division of Nestar Systems, Incorporated

The Toolkit is fully assembled. It is not a kit and requires no special tools to install.

I want to save programming time and money.

Send me The BASIC Programmer's Toolkit that will give my PET 10 new and useful commands. Fill in the appropriate line below:

Qty. \_\_\_\_\_ TK-160 Toolkit(s) @ \$39.95 each

Qty. \_\_\_\_\_ TK-80P Toolkit(s) @ \$59.95 each

Want to charge it? Call (415) 493-TOOL, or fill out the form below.

Enclosed is a  money order  check

(If charging):  Bill VISA  Bill Master Card.

Charge Card \_\_\_\_\_ Exp. Date \_\_\_\_\_

Master Card Interbank Number \_\_\_\_\_

Signature \_\_\_\_\_

Please include the amount of the Toolkit, plus \$2.50 for shipping and handling. Please allow 4-6 weeks for delivery. **SATISFACTION GUARANTEED, OR SEND IT BACK WITHIN 10 DAYS OF RECEIPT AND PALO ALTO ICs WILL REFUND YOUR MONEY.**

SEND TO:

Name \_\_\_\_\_

Address \_\_\_\_\_

City \_\_\_\_\_ State \_\_\_\_\_ Zip \_\_\_\_\_

Phone \_\_\_\_\_

MAIL TO: Palo Alto ICs  
A Division of Nestar Systems, Inc.  
430 Sherman Avenue  
Palo Alto, CA 94306  
(415) 493-TOOL

Dealer inquiries invited.

## OSI'ers!

OSI DIDN'T FILL YOU IN...  
WE WILL...



With the  
Complete,  
New OS-65D  
V3.2  
Disassembly  
Manual.

- 60 pages of listings
- Includes full cross-reference listing

Order today. Send check for \$24.95 to Software Consultants, 7053 Rose Trail, Memphis, Tenn. 38134. 901-377-3503. Postpaid. Allow 2-3 weeks.

Circle 282 on inquiry card.

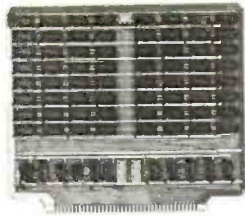

8K BYTE STATIC RAM MODULE FOR THE 6800. COMPATIBLE WITH THE MOTOROLA EXORCISER™ BUS AND 0-2 KIT. TWO SEPARATE 4K ADDRESSES; EACH MAY BE USED AS RAM OR TREATED AS ROM. SWITCHES SET ADDRESSES AND CONTROL RAM/ROM OPTION. ALL IC'S ARE SOCKETED; EACH IC HAS A BYPASS CAPACITOR. ACCESS TIME: 450 NSEC. DIMENSIONS: HEIGHT 8.425IN. WIDTH 9.750 IN. THICKNESS .062 IN. SIGNALS: R/W, VMA OR VUA (JUMPER), 0Z STATIC RAM: LOW POWER 2102AN 4L OR EQUIVALENT. THE AL1688K COMES ASSEMBLED AND TESTED.

PRICE \$175

APPLIED LOGIC, INC  
P.O. BOX 328  
JAMAICA, NEW YORK 11415  
(212) 459-4064

\*EXORCISER is a trademark of Motorola, Inc.

Circle 283 on inquiry card.

Now you can afford quality!

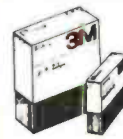

**Scotch®**  
DISKETTES

SAVE 30% TO 45%!

Possibly the LOWEST prices you'll find on quality SCOTCH Brand Diskettes in sizes to fit all Mini/Micro Computers. One box or by the case, all orders are processed quickly and shipped per your instructions.

Call COLLECT to Order!  
(805) 484-8146

QUALITY DATA SUPPLY  
P.O. Box 236, Camarillo, CA 93010

Authorized Distributor  
Information Processing Products



Circle 284 on inquiry card.

**NEW**

## S-100 A/D

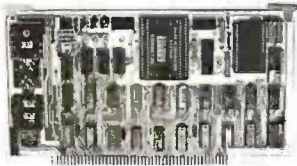

- S-100 Bus Compatible A/D Converter
  - 12 Bit Accuracy
  - 16 Channel Analog Input
  - Programmable Gain Amplifier with Sample-and-Hold
  - High Quality Commercial/Industrial Construction
- 2 and 4 Channel, 12 Bit D/A Boards also available.



CALIFORNIA DATA CORPORATION

3475 Old Conejo Road, Suite C10  
Newbury Park, California 91320  
(805) 498-3651

Circle 285 on inquiry card.

## 80X24 VIDEOTERM™ 7X9 MATRIX DISPLAY FOR

LOWER CASE W/ DESCENDERS **APPLE II®**



\*REGISTERED TRADE MARK OF APPLE COMPUTER, INC.

80 columns by 24 lines with easy to read 7x9 dot matrix, upper and lower case with descenders using shift lock feature • 1K firmware incorporates PASCAL and BASIC protocols so user is not required to enter machine language programs or change PASCALS, Misc. info, or Gotoxy files • Compatible with all APPLE II peripherals so user won't need new software patches for future software products • Crystal controlled dot clock for excellent character stability • VIDEOTERM is the same size as the Apple language card and power consumption is held to a minimum through the use of CMOS and lower power devices • Character set can be user definable up to a maximum of 128 symbols of 8x16 dot matrix font • Display control character mode and four standard display formats controlled by escape sequences • Built in light pen capability • Inverse display mode • 50/60 HZ operation • Sockets on all IC's.

PRICE: Without graphic EPROM \$345  
OPTIONS: Graphics EPROM line dwg. \$25  
VIDEO SWITCH PLATE, inserts  
Incase slot to choose between  
APPLE II\* and VIDEOTERM \$12  
MANUAL: \$15



VIDEX 3080 N.W. Thistle Pl. Corvallis, OR 97330 Phone (503) 758-0521

Circle 286 on inquiry card.

## APPLE II™

A/D INTERFACE BOARD

- 8 CHANNELS
- 8 BITS
- 65 μS CONVERSION
- ON BOARD REFERENCE

\$99.50 + \$2.50 SHIPPING  
(\$5.00 SHIPPING FOREIGN)

## TRENDCOM 100™ GRAPHICS UPGRADE KIT

- TGU1 - FOR PRINTERS WITH SELF-TEST JUMPER
- TGU2 - FOR PRINTERS WITH SELF-TEST SWITCH
- APPLE II HIRES DUMP SOFTWARE

\$59.95 + \$2.50 SHIPPING  
(\$5.00 SHIPPING FOREIGN)



STREET ELECTRONICS CORPORATION

8900 SW BURNHAM, #F9  
TIGARD, OR 97223 (503) 620-2713

Circle 287 on inquiry card.

## HARD DISC STORAGE FOR THE S100 BUS

PE100	• 100 HARD DISC CONTROLLER	\$695
833	33MB DISC SUBSYSTEM ADES 3310 Controller, Form 3350 Microstar Disc, Case, Power Supply & CMOS for CPU 2.2	\$4495
810	10MB DISC SUBSYSTEM ADES 1010 Controller, Form 1070 Microstar Disc, Case, Power Supply & CMOS for CPU 2.2	\$3495
PE100	USERS MANUAL	\$10
833	USERS MANUAL	\$15
810	USERS MANUAL	\$15
833CIB08	8108 CPU Diskette for use with CPU 2.2 and 333 Subsystem	\$25
810CIB08	8108 for CPU 2.2 and 810 Subsystem	\$25

FOR PRODUCT DATA SHEETS WRITE:  
ADAPTIVE DATA & ENERGY SYSTEMS  
2027 Pomona Boulevard  
Pomona, CA 91766  
Phone (714) 523-9553

DEALER INQUIRIES WELCOMED

REGISTERED CHARACTERS  
OF VARIOUS PATENT OFFICES

8887-118

Circle 288 on inquiry card.

## attention apple® owners

DOUBLE THE CAPACITY OF YOUR DISK

THIS KIT ALLOWS YOU TO WRITE AND  
READ ON BOTH SIDES OF YOUR APPLE  
FLOPPY DISK

DOES NOT AFFECT DISK DRIVE  
RELIABILITY

EASILY INSTALLED IN 15 MINUTES  
DOUBLE FLOPPY DISK CAPACITY FROM  
116K to 232K BYTES

SPECIAL INTRODUCTORY OFFER

ONLY \$9.95 plus \$1.00 postage



autometric.

8999 KINGS HILL DR.  
SANDY, UT. 84070

# TIME!

FOR YOUR  
S-100 COMPUTER!

The COMPUTIMER™ by rmi features

- 4 independent interval timers and calendar clocks
- all cascaded and synchronous
- 0 - 1/2 million year range with 1.0 microsecond - 10 second resolution
- vectored interrupts
- completely software controlled

• assembled, tested, and delivered with sample software and instruction manual. \$238

IDEAL FOR SCIENTIFIC, ENGINEERING,  
MEDICAL AND HOBBY APPLICATIONS!

rmi  
san carlos, CA

Circle 290 on inquiry card.



# MICRO BUSINESS WORLD™

# MAIL ORDER

Immediate response to your orders (verbal or written). toll-free (800) 421-0347



## apple II... Apple II plus and the NEW Apple III

The complete, ready to run computers... Connect to your color TV and start writing programs today. APPLE is faster, smaller, more powerful than it's predecessors. APPLE will change the way you think about computers. **Call for our Price.**

### INVENTORY CONTROL SYSTEM FOR Apple II

The first truly professional system that can tackle up to 8,100 items • Transaction register/audit trail • Inventory Status report • Re-order report • Keeps track of purchase orders automatically • Will handle multiple departments or divisions  
*Fast data retrieval.*

*Minimum hardware requirements: APPLE II Plus with 48K, one disk drive and 80 column printer.*  
Introductory Price: **\$99.00** Including comprehensive manual.

**ZENITH DATA SYSTEMS:**  
Smart Video Terminal



**Z-89 Computer System:**  
includes: Z19 Display, a built in 5 1/4" Floppy Disk, 2 serial ports, and 16K of memory. **2295.00** 48K Memory **2595.00**  
Also 48K Z-19 has a Z80 Micro -processor, numeric keypad and 8 function key. **895.00**

**ATARI 800** Personal Computer System  
Packed with: Computer Console, Basic Language Card, Education System Master Cartridge, Cassette Recorder, TV Modulator, 8K Memory (expandable to 48K), Power Supply & all Books and Manuals **\$799.95**

**ATARI 400** Personal Computer System for less  
Packed with: Computer Console, Basic Language Cartridge, Power Supply, TV Modulator, and all Books and Manuals **\$499.95**

**ATARI** Program Recorder **69.99**  
**ATARI** Software, Roms, Cassettes 25% off list price  
**ATARI** Expansion Memory 8K Module **99.99**  
16K Module **169.99**



## commodore the Great American Solution

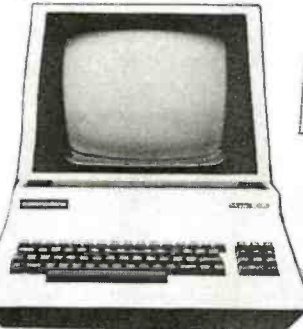

**CBM 8000 SERIES BUSINESS COMPUTER**



**CBM 2022 TRACTOR PRINTER**



**CBM 8050 DUAL DRIVE FLOPPY DISK**



**CBM 2001 SERIES BUSINESS COMPUTER**

**EPSON MX-80 DOT MATRIX PRINTER**

The new Model MX 80 is a high-speed bidirectional, impact printer capable of printing 9x9 dot matrix characters. Prints enlarged, condensed, condensed/enlarged, normal characters with 40,132, 66, 80 columns per line logical seeking function.

**\$645.**



**EPSON TX-80... DOT MATRIX PRINTER**  
with graphics **\$795.**

**DYSAN DISKETTES**  
THE CADILLAC OF THE FLOPPY DISKS AT LOW LOW PRICES

8" (BOX OF 10) • 3740/1 sgl side/ sgl density ..... 4.50 ea  
• 3740/1D sgl side/dbl density ..... 6.95 ea

5" (BOX OF 5) • 104/1 soft sector • 107/1 10 sectors  
• 105/1 16 sectors ..... 4.50 ea



**16K RAM** set of 8 4116's  
250 ns or better **\$59.00**

Prices subject to change without notice. VISA and MASTER CHARGE WELCOME. Allow 2 weeks for cashiers check to clear, 4 weeks for personal checks. Add 2% for shipping and handling. Calif. residents add 6% sales tax. (Sorry, no C.O.D.)  
**U.S. and International dealer inquiries invited.**  
Copyright 1980 • MICRO Business WORLD Circle 291 on Inquiry card.



**MICRO BUSINESS WORLD™**  
15818 Hawthorne Boulevard  
Lawndale, California 90260 (213) 371-1660

## 6800 Family Software



**SOFTWARE:** WIZRD multitasking DOS, editor, assembler, C, PL/W, PASCAL, FORTRAN, 12K BASIC  
**FIRMWARE:** FANTOM monitor/debugger, MATH long Integer and floating point, 4K Industrial BASIC

**CROSS SOFTWARE:** Assembler, PL/W, Inker, math/science, simulator



**WINTEK**

Wintek Corp.  
 1801 South Street  
 Lafayette, IN 47904  
 317-742-8428

Circle 292 on Inquiry card.

## H8 OWNERS

APU-H ARITHMETIC PROCESSOR CARD

- ADDS POWERFUL MATH CAPABILITY TO H8
- 32 BIT FLOATING POINT OPERATION
- 16 AND 32 BIT FIXED POINT OPERATION
- ADD, SUBTRACT, MULTIPLY AND DIVIDE
- TRIG, LOG, EXP, SQUARE ROOT AND MORE
- BASIC INTERFACE PROVIDED
- USES SINGLE H8 CARD SLOT
- FULL DOCUMENTATION
- ASSEMBLED AND TESTED
- VISA AND MASTER CHARGE ACCEPTED

\$389.00  
**CCM, INC**

P.O. BOX 2308 RESTON VA 22091  
 Phone orders (703) 620-3403

Circle 293 on Inquiry card.

## PRINTERS

**MICROTEK MT-80**

—S \$T \$895 **OUR PRICE \$775**

—P LIST \$795 **OUR PRICE \$685**

**OKIDATA MT-80**

LIST \$800 **OUR PRICE \$650**

**BASE<sub>2</sub> MODEL 800B**

LIST \$699 **OUR PRICE \$575**

\*PLEASE ADD 3% FOR S&M TO ORDER\*

**TECHNICAL INNOVATIONS**

P.O. BOX 803 DEPT. B

HILLSBORO, OR 97123

503-648-6423

Circle 294 on Inquiry card.

## PET music BOARD

At last! A music maker for your PET. Our system consists of a small circuit board which plugs into your PET's user port and connects either to a speaker or your hi-fi system (cable included). Our software (on cassette) lets you enter, save, and playback music in up to four voices, each with its own tone colour. Also included are several sample pieces to get you started. When ordering, please specify 8k, 16k, or 32k PET version.

\$49 without amp (plugs into your stereo)  
 \$54 with amp (connects to a speaker)  
 Please use certified cheque or money order.

Electronic Music Systems  
 45 Livingston Rd. Suite 501  
 West Hill, Ontario, Canada  
 M1E 1K8

\*PET is a trademark of Commodore B.M.

Circle 295 on Inquiry card.

## 16K DYNAMIC RAM

T1 4116 16Kx1 RAMS

8 FOR \$32.00 32 FOR \$120.00

**THIS IS A SPECIAL PURCHASE OF NEW T.I. 300 N.S. DYNAMIC RAMS.**

These are factory spec. parts, not surplus. These parts will work with most memory boards as well as memory expansion for TRS-80, APPLE, EXIDY, etc.

**HANLEY ENGINEERING**

P.O. BOX 21432  
 SEATTLE, WASH. 98111  
 (206) 633-3404

Circle 296 on Inquiry card.



**Dysan CORPORATION**

Solve your disc problems, buy 100% surface tested Dysan diskettes. All orders shipped from stock, within 24 hours. Call toll FREE (800) 235-4137 for prices and information. Visa and MasterCard accepted. All orders sent postage paid.



**PACIFIC EXCHANGES**

100 Foothill Blvd.  
 San Luis Obispo, CA  
 93401. (In Cal. call  
 (805) 543-1037.)

Circle 297 on Inquiry card.

## S-100 VOICE

The ARTICULATOR board allows you to record, store, and playback any vocabulary on your S-100 computer. Input speech is digitized by the ARTICULATOR and sent to the computer via an on-board port for storage at 1K to 2K bytes/sec. This data is then sent back from the computer to the ARTICULATOR for very high quality playback. On-board VOX switching minimizes memory storage requirements.

PRICE — \$319 A&T  
 AVAILABLE NOW

Quintrex, Inc., 9185 Bond  
 Shawnee Mission, Ks. 66215  
 (913) 888-3353

Circle 298 on Inquiry card.

**ATTENTION: Apple Users!**  
 WANT BETTER COLOR...MORE STABILITY?

Ever question the quality of your computer display. If so, you've probably been told "That's the best you can expect from an RF modulator...buy a color monitor".

**WE CHALLENGE THAT STATEMENT!**

DON'T BE SATISFIED WITH EXISTING QUALITY. See for yourself what our "new concepts" modulator can do for your picture...MICRO-VERTER Model MVX-500, \$35 PP. Phone orders welcomed.

**HOTLINE DIAL: 402-987-3771**

138 BROADWAY ATV Research DAKOTA CITY, NE. 68731

**DEALERSHIPS AVAILABLE**  
 CALL LOG UPON REQUEST

## FIFTY BUS SYSTEMS

32K 6800s from ..... \$1694.59

32K 6809s from ..... \$1844.69

Include: Chassis, CPU, 32K Static Ram, I/Os  
 Fully Expandable

2114L 300ns STATIC RAM CHIPS . . \$5.90

**FACTORY PRIME** From the same shipment we use in our professional quality boards.  
 Add \$5.00 Handling on Orders Under \$200.00

### 32K STATIC RAM BOARD

FOR THE SS50 AND SS50C BUS (SWTP etc.)

- SS50C Extended Addressing (can be disabled)
- 4 separate 8K blocks
- Socketed for 32K
- Gold Bus Connectors
- Low power 2114L RAMS
- Write Protect

16K ..... \$328.12

24K ..... \$438.14

32K ..... \$548.15

Phone, write, or see your dealer for details and prices on our broad range of Boards and Systems for the SS50/SS50C BUS including our UNIQUE 80 x 24 VIDEO BOARD, and our AC Power Control Products for all computers.

**GIMIX Inc.**



1337 W. 37th Place • Chicago, IL 60609  
 (312) 927-5510 • TWX 910-221-4055

**The Company that delivers.**

Quality Electronic products since 1975.

GIMIX® and GHOST® are Registered Trademarks of GIMIX INC.

Circle 300 on Inquiry card.



FOR APPLE II AND APPLE II PLUS COMPUTERS

# DoubleVision™

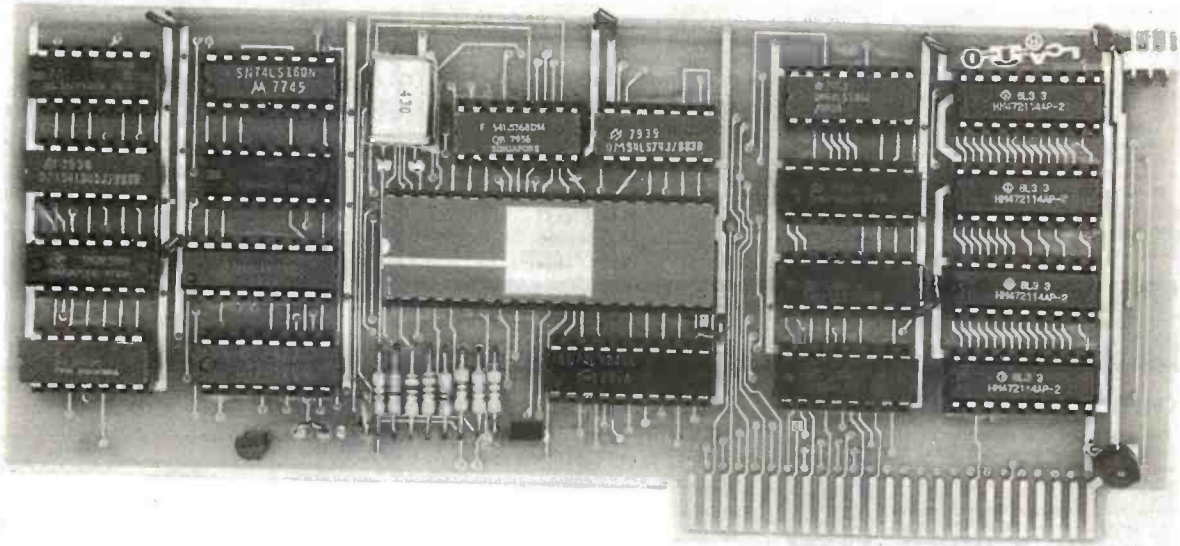

## 80 x 24 Video Display with Upper and Lower Case

COLUMNS LINES

• is a hardware board that may be plugged into any slot in Apple II or Apple II Plus 32K or 48K Disks • full 128 ASCII character set, including control characters • fully programmable cursor • built in light pen capability • inverse video • full cursor control • works with 50/60Hz • has 2k of its own screen memory • has its own video output jack that must be connected to a monitor (or a high band width black & white TV thru a good RF modulator). Color TV's produce a poor display and are not recommended. • permits you to connect another monitor (or a T.V. set thru RFmod) to the Apple video output jack • displays 24 lines of 80 column text — programmable for different values • permits you to have graphics on Apple video output • video output and Apple video output may be connected to one monitor thru optional video switch • is active only when addressed for reading from or writing to • accepts lower case input from keyboard by use of escape key. (no modification required) or direct use of shift key (1-wire connection from shift key pad to DoubleVision required). • is compatible with the latest version of various word processing software packages. Presently these include Apple-pie 2.0— Programma International, Easywriter Professional system—Informational Unlimited, Text Editor/Formatter—Peripheral's Unltd. (when ordering from these companies, please ask for versions compatible with DoubleVision). All software available from Computer Stop when released. • Peripheral's Unltd. B.I.T.S. and P.I.T.S. and Southeastern Software's "DATA CAPTURE" with Micromodem and communication card. These packages give ability to upload, transfer and download files from remote computers, and all at 80 columns! • Programma Int. latest assembler LISA V:20 will support full 80 column display • is transparent for use with Basic and Pascal • software on disk for easy modification and adaptation for different applications • completely commented source listing of software and hardware schematics available • PASCAL (optional) • becomes the console when installed in Pascal • Permits 80 column text processing with full upper/lower case while using Pascal's editor • must be plugged into slot 3 when operating with Pascal

Available now at your local computer store . . . . . **\$295.00**

Call Computer Stop for Store nearest you

Calif. Residents add 6% Sales Tax

Shipping, Insurance, Handling, extra

\*Apple Is a Registered TM of Apple Computers, Inc.

Dealer Inquiries invited.  
Contact:

**COMPUTER STOP CORP.**  
2545 West 237th St.  
Suite L  
Torrance, CA 90505  
539-7671

**The Computer Stop**  
16919 Hawthorne Blvd.  
Lawndale, CA 90260  
(213) 371-4010

**MON. - SAT.**  
**10-6**



Atari 800 ..... \$810.00 810 Disk Drive... \$525.00  
 16k RAM Module \$150.00 Controllers ..... \$16/Pk.  
 All ROM's, including STAR RAIDERS, 20% OFF!!

\*\*\*Bit Bucket software for the ATARI\*\*\*

Disassembler/dumper/  
 depositer/BASIC renumberer ..... \$30.00  
 Action Games... \$25.00 Brain Games... \$25.00  
 All above Bit Bucket software FREE with  
 purchase of ATARI 800.  
 Free utilities disk (disasm, renumber, etc.) with  
 purchase of 810 Disk.

**PET**

8K .... \$699.00 16K ... \$876.00 32K ... \$1140.00

CAT Modems ..... \$156.00!

Soroc IQ120 Terminals ..... \$775.00

All Centronics Printers 15% OFF!!

**The Bit Bucket**

168 North Beacon Street  
 P.O. Box 365  
 Newton Highlands, MA 02161  
 Phone: (617) 783-3144

See us at the Northeast Computer Show in Boston  
 November 20-23

All prices subject to change without notice.

Circle 302 on inquiry card.

**1802 USERS**

Original innovations from the other side  
 of the world.

1. Micro-basic for 1802 micro-systems. Uses only 1K of memory and HEX key pads. The world's smallest!
2. HUG 1802 microprocessor full color 7K on board memory. Unique original ultracompact design.
3. Also just developed PASCAL for 1802.
4. 1802 owners contact us for FREE data on Australasian developed innovations never before published.

Write to: **Kit Parts, Ltd.**  
 Dept B  
 Box 27037  
 Wellington,  
 New Zealand

Circle 303 on inquiry card.

**ATARI OWNERS  
 SCREEN PRINT  
 INTERFACE**

Obtain hardcopy of any screen image (graphics and/or text) on either a TRENDCOM 200 or IDS 440 Paper Tiger printer. Simply attach the supplied parallel printer cable and load the software from cassette (may be transferred to Disk). Obtain a "picture" of the screen on your printer under direct (CTRL?) or program (XIO) control. Works in all graphics/text modes as well as LPRINT and LIST "P."

Only **\$139**

California residents add 6% tax

**MACROTRONICS, inc.®**

1125 N. Golden State Blvd. / Suite G  
 Turlock, CA 95380 (A)  
 (209) 667-2888 / 634-8888

We are experiencing telephone difficulties, please keep trying.



Circle 304 on inquiry card.

**NORTHSTAR SOFTWARE**

**FUN ON THE HORIZON** is a collection of 40 games with average size over 200 lines. Includes Poker, Golf, Football, Biorhythm, Black-jack, Keno, Life and 33 more ..... \$24.00

**UTILITY** contains a Z80/8080 Disassembler for machine code programs resident in RAM or on diskette. It also includes a COMPRESS utility for BASIC program files which increases execution speed while decreasing program size as much as 35% ..... \$17.00

**SUPRTREK**, a space battle game, features action graphics and an updated play-by-play display map of the galaxy. Over 900 lines of code ..... \$11.00

All programs use the 64 character ASCII subset with max line length 64 characters. Available in double or single density on 1 or 2 (SD) specially modified double-sided diskettes. (SD, add \$4.00 per order)

**COMBINATION PRICE:** All three packages for \$36.00

Order now from S&S Computing, Inc.  
 64 Juniper Street  
 Allentown, Pa. 18106  
 (215) 398-1299

or circle our reader service number below to receive 4 pages of program abstracts and sample output.

Circle 305 on inquiry card.

**INVENTORY CONTROL SYSTEM  
 WITH PARTS EXPLOSION FOR  
 FINISHED GOODS AND ASSEMBLIES**

Parts requirements forecasting & Pull Sheets  
 Economic Order Quantities & Pull Sheets  
 1500 Items per single density 8" disk side  
**AVAILABLE FOR CROMEMCO, CP/M,  
 AND OASIS OPERATING SYSTEMS**

Hardware requirements: 64k RAM,  
 132 Column printer. Manual (Includes Source) and 8" floppy disk ... \$250.  
 Accounts Receivable, Accounts Payable, General Ledger, Payroll and Mailing List programs also available.

**FEITH SOFTWARE, INC.**  
 CEDARBROOK A-1103  
 WYNCOTE, PA. 19095  
 (215) 887-9780

Circle 306 on inquiry card.

**!! REAL TIME !!**

The TIME MACHINE from ALPHA OMEGA COMPUTER SYSTEMS isn't just another digital clock chip surrounded by interface circuitry. It's an intelligent microcomputer based peripheral device.

The TIME MACHINE communicates with your computer via a serial I/O port at a user selectable data rate between 300 and 2400 baud. RS-232, RS-422, or current loop communication may be used.

Battery protection against power loss is included. The TIME MACHINE automatically computes day of the week and leap year. Buffered output pulses at one second, one minute, and one hour intervals are provided.

Dimensions are 2.5 x 4.75 x 7.5 inches. Batteries, power supply, and communication cable are included.

Price is only \$450 single lot and quantity discounts are available. Dealer inquiries invited. Off the shelf delivery.

**ALPHA OMEGA COMPUTER SYSTEMS, INC.**  
 P.O. Box 2777 / Corvallis, Oregon 97330  
 (503) 754-1911



Circle 307 on inquiry card.

ARE YOU LOOKING FOR AN  
 ACOUSTIC MODEM?  
 THEN TEAR THIS OUT, YOU  
 WON'T SEE IT AGAIN!!!

BELL 103, 300 BAUD,  
 ORIGINATE MODE,  
 RS-232 INTERFACE,  
 BUILT FOR TI-733,  
 TESTED AND GUARANTEED.  
 LIMITED QUANTITY

CARD & COUPLER: \$ 89.00  
 w/CUSTOM CASE: \$109.00  
 w/CASE & POWER: \$124.00  
 ADD \$3.00 FOR SHIPPING.

**Creative Mind Businesses**  
 P.O. Box 18252 • Tucson, Az 85731

Circle 308 on inquiry card.

**FREE  
 CATALOGS**

**Software** (over 400 programs for Apple, Pet, TRS-80, Sorcerer, Sol, Challenger and CP/M systems)

**Books** (over 100 titles on personal, recreational and educational applications of small computers.

**Peripherals** (ALF music synthesizer and VersaWriter for the Apple II)

**Peripherals Plus**  
 119 Maple Avenue  
 Morristown, NJ 07960

Circle 309 on inquiry card.

**C C S INC**

1011 So Rancho Dr  
 Las Vegas, Nevada

(702) 384-0067

**TURNKEY SYSTEMS  
 AVAILABLE TODAY**

- \*MEDICAL BILLING\*
- \*WORD PROCESSING\*
- \*UNIVERSITY ADMISSIONS\*
- \*POINT OF SALES\*

**FREE TRAINING  
 CALL TODAY**

Circle 310 on inquiry card.

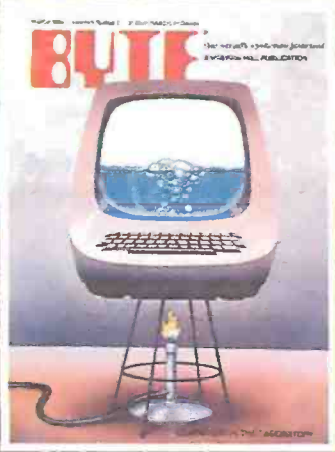

MAIL CARD OR CALL TOLL FREE  
**800-258-5485**  
**BYTE**

# THE MICROCOMPUTER MAGAZINE THAT'S READ 'ROUND THE WORLD.

Every issue of BYTE is filled with stimulating, timely articles on computer hardware, software, applications and reviews of computer products. There is also tutorial information for both the beginner and experienced computer user.

Read your first copy of BYTE, the Small Systems Journal. If it is everything you expected, honor our invoice. If it isn't, just write "cancel" on the invoice and mail it back. You won't be billed, and the first issue is yours at no charge.

Please print 4E80

Name \_\_\_\_\_

Address \_\_\_\_\_

City \_\_\_\_\_ State/Province/Country \_\_\_\_\_ Code \_\_\_\_\_

United States

One year \$18 (12 issues)       Two years \$32       Three years \$46

Canada or Mexico

One year \$20 (12 issues)       Two years \$36       Three years \$52

Foreign Rates (to expedite service, please remit in U.S. funds drawn on a U.S. bank)

Europe, one year,       All other countries, one year, surface delivered. \$32  
air delivered. \$32      Air delivery available upon request

Check enclosed (entitles me to 13 issues for price of 12, North America only)

Bill VISA       Bill Master Charge       Bill me (North America only)

Card Number \_\_\_\_\_ Expires \_\_\_\_\_

Signature \_\_\_\_\_

Allow 6 to 8 weeks for processing your subscription.

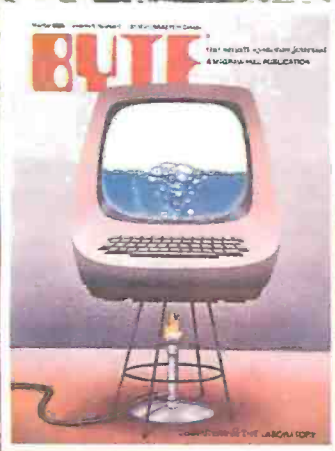

MAIL CARD OR CALL TOLL FREE  
**800-258-5485**  
**BYTE**

# THE MICROCOMPUTER MAGAZINE THAT'S READ 'ROUND THE WORLD.

Every issue of BYTE is filled with stimulating, timely articles on computer hardware, software, applications and reviews of computer products. There is also tutorial information for both the beginner and experienced computer user.

Read your first copy of BYTE, the Small Systems Journal. If it is everything you expected, honor our invoice. If it isn't, just write "cancel" on the invoice and mail it back. You won't be billed, and the first issue is yours at no charge.

Please print 4E80

Name \_\_\_\_\_

Address \_\_\_\_\_

City \_\_\_\_\_ State/Province/Country \_\_\_\_\_ Code \_\_\_\_\_

United States

One year \$18 (12 issues)       Two years \$32       Three years \$46

Canada or Mexico

One year \$20 (12 issues)       Two years \$36       Three years \$52

Foreign Rates (to expedite service, please remit in U.S. funds drawn on a U.S. bank)

Europe, one year,       All other countries, one year, surface delivered. \$32  
air delivered. \$32      Air delivery available upon request

Check enclosed (entitles me to 13 issues for price of 12, North America only)

Bill VISA       Bill Master Charge       Bill me (North America only)

Card Number \_\_\_\_\_ Expires \_\_\_\_\_

Signature \_\_\_\_\_

Allow 6 to 8 weeks for processing your subscription.



NO POSTAGE  
NECESSARY  
IF MAILED  
IN THE  
UNITED STATES

**BUSINESS REPLY CARD**  
FIRST CLASS PERMIT NO. 39 MARTINSVILLE, NJ

POSTAGE WILL BE PAID BY ADDRESSEE

**BYTE**

Subscription Dept.  
P.O. Box 590  
Martinsville, NJ 08836



NO POSTAGE  
NECESSARY  
IF MAILED  
IN THE  
UNITED STATES

**BUSINESS REPLY CARD**  
FIRST CLASS PERMIT NO. 39 MARTINSVILLE, NJ

POSTAGE WILL BE PAID BY ADDRESSEE

**BYTE**

Subscription Dept.  
P.O. Box 590  
Martinsville, NJ 08836

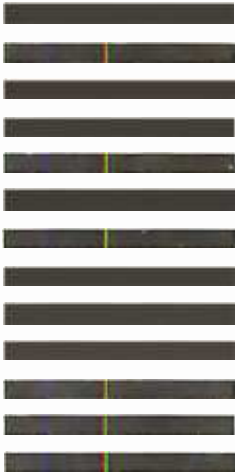



11542-1 KNOTT  
DEPT. C  
GARDEN GROVE,  
CA 92641  
(800) 854-6411  
(714) 891-2663

**ORDERING INFO**

NAME, ADDRESS, PHONE  
SHIP BY: UPS OR MAIL  
SHIPPING CHRG. ADD  
\$2.00 UP TO (5) LBS.  
\$25.00 Minimum Order

**TERMS**

WE ACCEPT CASH,  
CHECK MONEY ORDERS,  
VISA & MASTER CHRG.  
(U.S. FUNDS ONLY)  
TAX: 6% CALIF. RES.

**ATARI MODEL #800  
(NEW 16K VERSION)**

- COMPUTER CONSOLE
- ATARI BASIC 8K ROM
- 57 FULL STROKE ALPHANUMERIC KEYS PLUS 4 FUNCTION KEYS
- INVITATION TO PROGRAMMING CASSETTE
- OPERATORS MANUAL
- EDUCATION SYSTEMS MASTER

- JOYSTICKS
  - RF MODULATOR
  - POWER SUPPLY
- CALL FOR PRICE  
(IN STOCK)

**10% OFF SOFTWARE  
WITH PURCHASE**

**ANACOM GENERAL  
MODEL - 150 PRINTER**

- 9 x 9 Matrix
- Impact Dot
- 150 CPS.
- 10 CPI
- 136 Columns
- 94 ASCII Character

- 6 or 8 Lines per Inch
- Pin Feed & Dual Tractor Drive
- RS-232 or Parallel Interface

**CALL FOR PRICE**

**STATIC & DYNAMIC  
RAM CHIPS**

**2104's**  
(4K) DYNAMICS  
**\$2<sup>00</sup> ea.**  
**5257-3L**  
(4K) STATIC  
**\$5<sup>25</sup> ea.**

**ATARI OPTIONAL ACCESSORIES**

- MODEL #810 DISK DRIVE SYSTEM
  - MODEL #820 40-COL. DOT MATRIX PRINTER
  - MODEL #822 40-COL. THERMAL PRINTER
  - MODEL #825 80-COL. DOT MATRIX PRINTER
  - MODEL #830 ACOUSTIC MODEM
  - MODEL #850 INTERFACE MODULE
  - MODEL #CX853 16K RAM MODULE
- CALL FOR PRICE & AVAILABILITY

**2114L-3**

LO PWR./300NS  
1-16 . . . 4.25  
17-49 . . . 4.00  
50-99 . . . 3.80  
100 Up . . 3.60

**IN STOCK**

**4116's** ADD-ON  
MEMORY

APPLE, TRS-80, HEATH, ETC.

**(200NS) 8 for \$39.00**  
**16 for \$75.00**

**(250NS) 8 for \$37.00**  
**16 for \$70.00**

**2708's**

(450 ns.)

**\$7.50 ea.**

OR

8/ \$56.00

**ATARI SOFTWARE & ACCESSORIES**

- BASKETBALL ROM \$30.00
- SUPER-BREAKOUT ROM \$30.00
- STARRAIDERS ROM \$45.00
- CHESS ROM \$30.00
- VIDEO EASEL ROM \$30.00
- MUSIC COMPOSER ROM \$45.00
- 3D TIC TAC TOE ROM \$30.00
- JOYSTICKS \$18.00
- PADDLE CONTROLS \$18.00
- #410 CASSETTE RECORDER \$60.00

**S.D. SYSTEMS  
NOW AVAILABLE**

- EXPANDORAM I & II
- VERSAFLOPPY
- SBC100/SBC200
- VDB 8024 VIDEO BOARD
- PROM-100 PROGRAMMER

KITS & A&T CALL FOR PRICE

**MICROBYTE 32K  
STATIC RAM BOARD**

- IEEE/S-100 COMPATIBLE
- 4K BANK ADDRESSABLE TO ANY 4K SLOT WITHIN 64K BOUNDARY
- ON BOARD 8-BIT OUTPUT PORT
- NO DMA RESTRICTIONS
- 4 MHZ OPERATION

ASSEMBLED & TESTED **\$475.<sup>00</sup>**

**2716's**

5 VOLT ONLY  
450 ns.

**\$15.<sup>00</sup>**

(PRIME)

**CENTRONICS  
MODEL #737**

- 80 CPS Proportional Spaced
- Dot Matrix (7 x 9) or (7 x 8)
- 96 Character ASCII
- Parallel Interface

**\$825<sup>00</sup>**

**8080A**

(CERAMIC)  
**\$2.50 ea.**

**CAPACITORS  
.1 @ 12 VOLTS  
CERAMIC**

**11<sup>c</sup> ea.**  
100/\$10.00

**MICROBYTE  
(NEW PRODUCTS)**

- Z-80 CPU/IO BOARD
- DBL. DENSITY DISK CONTROLLER
- 64K DYNAMIC RAM BD.
- 4 PORT I/O BD.
- MICRO Z SYSTEM
- D<sup>2</sup> DISK SYSTEM

ALL ASSEMBLED & TESTED  
**CALL FOR PRICE & DELIVERY**

**ANADIX PRINTERS**

- MODEL #DP8000 CALL FOR PRICE
- MODEL #DP8000 (APPE) &
- MODEL #DP9500 DELIVERY
- MODEL #DP9501

**FEATURES ON DP8000:**

- 80 COLUMNS, 112 CPS, BI-DIRECTIONAL, SPROCKET FEED, 9x7 CHARACTER FONT, VARIABLE FORM WIDTH

**VERBATIAM**

**5 1/4" "**  
SOFT-SECTOR  
DISKETTS  
BOX OF (10)

**\$29.95**

**NEW PRODUCTS  
AVAILABLE**

- COMMODORE
  - GODBOUT
  - LEEDEX
  - PERSONAL SOFTWARE
  - SANYO
  - SOROC
  - TEXAS INST.
- CALL FOR PRICES

**RS232 CONNECTORS**

	1-9	10-24	25 Up
DB25P	2.99	2.75	2.45
DB25S	3.80	3.70	3.60

**IMSAI CONNECTORS**

100 PIN GOLD-SOLDERTAIL  
**\$2.50 ea.**  
OR  
**10/\$2.30 ea.**

**LO-PRO SOCKETS**

	1-99	100 UP
14 PIN	.10	.09
16 PIN	.12	.11
18 PIN	.15	.13
20 PIN	.23	.21
24 PIN	.26	.24
28 PIN	.30	.28
40 PIN	.42	.40

**Z-80A**

CPU CHIP  
NEC #D780C-1  
**\$10.<sup>00</sup> ea.**

**COMPONENTS**

- 74LS240 \$1.50
- 74LS241 \$1.40
- 74LS244 \$1.50
- 74LS373 \$1.60
- 74LS374 \$1.60

**QUME DT-8**  
DOUBLE-SIDED/  
SGL/DBL DENSITY  
8" DISK DRIVES  
CALL FOR PRICE

**SHUGART  
SA801R**

Bare Drives  
Single Sided/  
Sgl/Dbl Density  
**CALL FOR PRICE  
AND DELIVERY**

**SA 800/801 DISK DRIVE**

1 OR 2 DRIVES INSTALLED, SGL. OR  
DBL. DENSITY/SGL.-SIDED, METAL  
CABINET, & POWER SUPPLY  
(1) SA800/\$775.00 (2) SA800/\$1250.00  
(1) SA801/\$795.00 (2) SA801/\$1295.00  
1 YR. WARRANTY PARTS & LABOR

# Disk Based Word Processor

- A COMPLETE WORD PROCESSING SYSTEM FOR YOUR 8080/8088
- PROVIDES FULL EDITING CAPABILITIES INCLUDING FORWARD/REVERSE LINE DELETION, INSERTION AND CORRECTIONS
- STRETCHES TO 65536 BYTES, PRINTS UNLIMITED PAGES
- EDITING DONE ON DISPLAY AS BEGINS, ALL CHANGES TO TEXT ARE NOT LIMITED BY ANY AVAILABLE MEMORY
- REQUIRES 16K AND OUT OF MEMORY DATA FILES
- ONLINE COMPILER ON DISPLAYS WITH SOURCE TO OBJ. FILE
- ONLINE PASCAL/PL/SQL COMPILER WITH SOURCE TO OBJ. FILE
- ONLINE BASIC/ALGOL/INTERPRETER WITH SOURCE TO OBJ. FILE
- ONLINE FORTRAN/ALGOL/INTERPRETER WITH SOURCE TO OBJ. FILE
- ONLINE PASCAL/ALGOL/INTERPRETER WITH SOURCE TO OBJ. FILE
- ONLINE BASIC/ALGOL/INTERPRETER WITH SOURCE TO OBJ. FILE
- ONLINE FORTRAN/ALGOL/INTERPRETER WITH SOURCE TO OBJ. FILE

750

Available Now!  
Mailing List Option

750



4441 West First Ave.  
Vancouver, B.C.

VBR 4H9  
604-224-3107



Circle 312 on inquiry card.

# Apple II

## SOFTWARE ACCESSORIES SUPPLIES

ULTRA-CURRENT  
1000 ITEMS

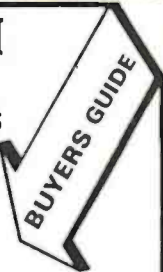

TO ORDER send \$3.00  
You receive current BUYERS GUIDE and a certificate worth \$3.00 off of your first purchase.

**Wcas** 2513 N. Sheridan Rd.  
Peoria, Illinois 61604

Circle 313 on inquiry card.

# JINSAM™ Data Manager

- ★ CUSTOM DATA FILES
- ★ FAST/EASY/MENU DRIVEN
- ★ HELP COMMANDS
- ★ KEYED RANDOM ACCESS
- ★ MULTIPLE SEARCH KEYS
- ★ PRIVACY ACCESS CODES
- ★ WILD CARD SEARCH

For 16K-32K PET, Dual Disk, and Printer

**FREE:** LABEL PRINTER MODULE  
**FREE:** REPORT GENERATOR MODULE  
Specify CBM 2040 or COMPU/THINK  
Package \$175 User's Guide only \$25  
Introductory Demo Tape \$5 Disk \$ 8

Check or Money Order plus \$2 Shipping  
(NY residents add 8% Sales Tax)  
-DEALER INQUIRIES WELCOMED-

**JINI MICRO-SYSTEMS, Inc.**  
P.O. Box 274-B • Bronx, NY 10463

Circle 314 on inquiry card.

## QUARTZ CRYSTALS

3218 0	52478 0	93336 0	20000 0	362866 0	42 8518 0	461828 0
5360 0	55110 0	93600 0	22 4968 0	36360 0	428168 0	473760 0
1000 0	5743 0	93600 0	221144 0	379628 0	429258 0	478330 0
18432 0	5955 0	10000 0	225258 0	38 3768 0	42 9628 0	48000 0
18437 0	5982 0	102458 0	26 3568 0	38 4448 0	43 0008 0	48 3006 0
2000 0	6000 0	104968 0	26 5008 0	38 6268 0	43 0378 0	48 5668 0
26974 0	6144 0	107755 0	26 5168 0	38 9258 0	43 0748 0	48 7006 0
2 4578 0	61600 0	108255 0	27 1000 0	39 3128 0	43 1858 0	48 8158 0
2 500 0	629180 0	10 8368 0	27 0008 0	39 5038 0	43 2598 0	49 7006 0
2 6657 0	6 400 0	11 1360 0	27 8568 0	39 6668 0	43 3338 0	49 7338 0
2 9950 0	6 5336 0	11 155 0	28 4008 0	39 7538 0	43 3708 0	49 8128 0
3004 0	6 7230 0	11 2185 0	28 6278 0	39 8768 0	43 4078 0	50 2505 0
3 057 0	6 7840 0	11 2800 0	28 7538 0	39 9628 0	43 4478 0	51 2566 0
3 200 0	6 9003 0	11 4778 0	29 8758 0	40 4448 0	43 4448 0	51 3128 0
3 2768 0	7 0063 0	11 6568 0	29 9378 0	40 5928 0	43 5868 0	51 7778 0
3 500 0	7 0336 0	11 6816 0	30 0968 0	40 8128 0	43 6298 0	51 8566 0
3 579 0	7 0916 0	12 440 0	30 3868 0	40 8338 0	43 6668 0	52 8928 0
4 000 0	7 1636 0	14 3192 0	30 5258 0	40 9158 0	43 7718 0	56 7506 0
4 1943 0	7 2585 0	14 4308 0	30 8168 0	40 8968 0	43 8128 0	56 5006 0
4 3476 0	8 000 0	15 000 0	31 4378 0	40 9258 0	43 8148 0	60 7508 0
4 4803 0	8 0556 0	15 4408 0	31 7538 0	41 0008 0	43 8518 0	66 7506 0
4 6103 0	8 1416 0	15 5006 0	31 9008 0	41 1665 0	43 8868 0	70 4006 0
4 6505 0	8 1818 0	16 000 0	32 000 0	41 3768 0	43 9258 0	75 0005 0
4 8303 0	8 3303 0	16 3368 0	32 2008 0	41 9378 0	44 0008 0	80 8338 0
4 9152 0	8 4998 0	17 2248 0	33 6258 0	42 0008 0	44 0378 0	99 5568 0
5 000 0	8 5766 0	17 2422 0	34 5558 0	42 5816 0	44 3768 0	100 6668 0
5 0688 0	8 6056 0	18 000 0	34 7538 0	42 6268 0	44 7778 0	101 4668 0
5 1205 0	8 9608 0	18 4300 0	34 9778 0	42 7008 0	45 1258 0	103 0668 0
5 1550 0	8 9906 0	19 4800 0	35 9258 0	42 7538 0	45 3006 0	103 6668 0
5 1656 0	8 47208 0	19 7508 0	36 000 0	42 8148 0	45 7006 0	104 918 0

ALL \$ - \$2.99 ALL "X" - \$1.99 100R MORE INDUSTRY.  
ADD \$1.00 SHIPPING  
CAL. RES. ADD 6% SALES TAX  
FREE OSCILLATOR SCHEMATICS  
WITH ANY ORDER  
QUALITY COMPUTER PARTS  
P.O. BOX 743 / CHATSWORTH, CA 91311

Circle 315 on inquiry card.

# MEMOREX Floppy Discs

Lowest prices. WE WILL NOT BE UNDERSOLD!! Buy any quantity 1-1000. Visa, Mastercharge accepted. Call free (800)235-4137 for prices and information. All orders sent postage paid.



**PACIFIC EXCHANGES**  
100 Foothill Blvd.  
San Luis Obispo, CA  
93401. (In Cal. call (805) 543-1037.)

Circle 316 on inquiry card.

# MICROCOMPUTERS and PHYSIOLOGICAL SIMULATION

James E. Randall, Indiana University School of Medicine, Bloomington

Foreword by Arthur C. Guyton, University of Mississippi School of Medicine, Jackson

This book provides microcomputer hardware and programs suited for teaching simulations such as nerve action potential, cardiac action potential, cardiovascular system mechanics, and the glucose tolerance test.

"Sorely needed for those of us who are just beginning to adapt microprocessors to teaching applications in Physiology. Dr. Randall is eminently qualified to do this special job. He has interacted for several years with his potential readers through his activities in the American Physiological Society."

Beverly Bishop  
SUNY at Buffalo, School of Medicine

Feb. 1980. 250 pp., illus. Paper 06128 \$14.50

Price is subject to change without notice.

**Addison-Wesley**  
Advanced Book Program  
Reading, Mass. 01867. U.S.A.

Circle 317 on inquiry card.

## Fine Software Tools in C



The Toolbox

- ref - cross reference C programs. Handles #include and #line
- sort - alphabetize by all or part of text line
- list - print source listing with date heading and line numbers. Handles #include and #line
- col - rearrange into variable number of columns.
- print - paginates text for hard copy.
- prt - spool through your files, a screen at a time.
- and more

All programs in Whitesmith C except date function of list and print in PDP-11 assembler. Source code on 8" floppies in RT-11(RX01) format. Documentation included. Available immediately for \$45 (includes shipping and sales tax) from:  
\*PDP-11 and RT-11 are trademarks of Digital Equipment Corporation.

The Toolsmith  
P.O. Box 22511  
San Francisco, CA 94122

Circle 318 on inquiry card.

## INTERTEC SUPERBRAIN SOFTWARE Available Now!

BUSINESS SOFTWARE	
INVESTMENT LEDGER	.....\$400
Takes care of Stocks, Bonds, CO's, M/A, Real estate, others - up to 250 investments	
GENERAL LEDGER	.....\$350
All general bookkeeping functions, major & sub accounts, comparative statements	
EXPENSE LEDGER	.....\$150
Designed to co-ordinate with the General Ledger for applications with multiple cost centers	
CHECK REGISTER/BANK RECONCILIATION	.....\$90
Relieve the worries of keeping up with cash disbursements - balances the checkbook	
FINANCIAL PACKAGE	.....\$65
Amortization schedule, balloon notes, effective interest, present/future value, etc.	
GAZES	.....\$5
* Muppet * Adventure * Escape * Bismark	
MISCELLANEOUS	
REPORT GENERATORS	.....\$25
Rentals, Automobiles, Insurance Policies, etc.	
ALL SOFTWARE EXCLUSIVELY DEVELOPED FOR THE SUPERBRAIN	
All prices include manuals, additional manuals \$25 ea.	
* Prices do not include media cost	



General Systems Consulting

69153 676-9612 2310 S 7TH, Suite 118, Abilene Texas 79605

Circle 319 on inquiry card.

# LOGIC PROBE

**CYBERTECH**  
CMOS / TTL  
HI 70%  
LO 30%  
PULSE  
ASSEMBLED AND TESTED:  
HI-Z or INVALID LEVEL

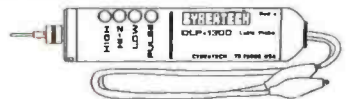

POWERED BY CIRCUIT UNDER TEST.  
SUPPLY LEADS AND INPUT ARE OVERVOLTAGE AND REVERSE POLARITY PROTECTED.

COMPARE TO UNITS COSTING 2 AND 3 TIMES AS MUCH!  
USE OUR 90 DAY GUARANTEE AS A TRIAL PERIOD.  
YOUR MONEY BACK IF NOT SATISFIED!

SEND \$19.95 TO: ORDER DLP-1300.  
**CYBERTECH**  
P.O. BOX 504  
ALLEN, TX 75002  
(214) 727-3900  
WE PAY POSTAGE. SORRY, NO C.O.D.s

Circle 320 on inquiry card.

# EXCITING MAIL ORDER DISCOUNTS

 **apple II**  
**16K computer**

Disk II with Controller \$479...without \$425

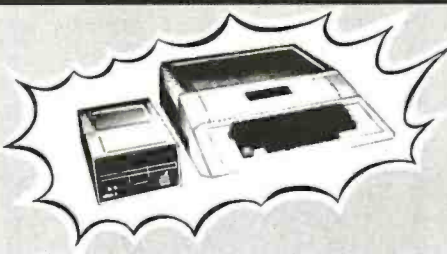

## \$899

**APPLE II 32K \$999**  
**APPLE II 48K \$1099**

DOS 3.3 with upgrade kit \$48

### APPLE II ACCESSORIES

Apple Joystick.....	47
AB T Numeric Input Keyboard.....	114
Brightpen Lightpen from Softape.....	32
Clear Cover for Apple Computer.....	25
CCS Programmable Timer Module.....	159
Dan Paymer Lower Case Kit.....	49
D C Hayes Micromodem.....	335
Extender Board.....	27
Graphics Input Tablet.....	649
Intral X-10 Remote Control System.....	239
Intral X-10 Controller Only.....	164
MGR Sup-R-Term 80 Column Board.....	325
Microsoft Z-80 Soft Card.....	299
Novation Cat Modem.....	159
Romwriter.....	149
Speechlink 2000/64 Word Vocabulary.....	215
Super Talker Speech Synthesizer.....	239
Sup-R-Mod RF TV Modulator.....	25
SVA 8" Disc Controller Card.....	329
Versa-Writer Digitizer Drawing System.....	209

**WE SHIP FAST!**

Adventure by Microsoft.....	27
Apple Bowl.....	14
Applebug Assembler/Disassembler.....	69
Applebug Debugger.....	27
Applepost Graph & Plot System.....	59
Applepost Mailing List System.....	44
Applesoft Utility Programs by Hayden.....	27
Apletwriter Word Processor.....	59
Ball Budge's Space Game Album.....	39
Bill Budge's Trilogy of Games.....	29
The Cashier Retail Management System.....	189
CCA Data Management by Personal Software.....	84
The Contributed Volumes 1-5 w/manuals.....	29
Desktop Plan by Personal Software.....	79
Dow Jones Portfolio Evaluator.....	44
Forth II by Programma Software.....	45
Fortran for use with Language System.....	159
Pascal Language System.....	395
Sargon II Chess Game-cassette.....	27
Sargon II Chess Game-disk.....	35
Shell Games.....	27
Space Invader-Cassette.....	18
Space Invader-disk.....	25
Sub-Logic FS-1 Flight Simulator Cassette.....	23

Sub-Logic FS-1 Flight Simulator-disk.....	29
Sybox Apple 80 8080 Simulator.....	17
Visicalc by Personal Software.....	115

### APPLE COMPUTER INTERFACE CARDS

Asynchronous Serial Interface #7710A.....	\$145
Applesoft II Firmware Card.....	149
CCS Arithmetic Processor Card #7811B.....	329
CCS Parallel Interface Card #7720A.....	155
Centronics Printer Interface Card.....	179
Apple Clock/Calendar Card by Mountain Hardware.....	229
Communications Card & DB25 Cable.....	179
Integer Basic Firmware Card.....	149
Parallel Printer Interface Card.....	139
Prototyping Hobby Card.....	22
Romplus Card with keyboard filter.....	169
Romplus Card without keyboard filter.....	159
SSM AIO Serial/Parallel I/O Assembled & Tested.....	169
Serial Interface Card.....	139
Symtec Light Pen Card.....	214

### PRINTERS, MONITORS, DISCS

Anadex DP8000.....	850
Anadex DP8000AP.....	850
Centronics without cable.....	819
Epson TX80-B w/Graphics.....	799
MPI 88T.....	650
NEC Spinwriter #5510.....	2695
Paper Tiger with Graphics.....	959
Sientype with Interface Card.....	495
Lexdex Video 100-12" B&W.....	139
Sanyo 9" B&W.....	169
Color Monitor 11".....	349
Dyson disks (pkg 10).....	50
Memorex (pkg 10).....	40
Verbatim (pkg 10).....	30

  
**IN STOCK, CALL FOR PRICES!**



**ATARI 800**  
PERSONAL COMPUTER SYSTEM  
**\$799**

- \*High resolution COLOR Graphics
- \*10K Basic in ROM
- \*8K user RAM expandable to 48K

- \*Built-in RF TV modulator
- \*High speed serial I/O port
- \*Includes ATARI 410 program recorder
- \*57 key full stroke keyboard

Atari 820 Printer.....	\$489
Atari 810 Disk Drive.....	569
Atari 410 Program Recorder.....	69
Atari 16K RAM Module.....	149
Atari 8K RAM Module.....	99
Atari Basic ROM.....	45
Assembler/Editor.....	45
Basketball.....	30
Video Easel.....	30
Super Breakout.....	30
Music Composer.....	45
Computer Chess.....	30
Star Raiders.....	39
3D Tic-Tac-Toe.....	30
Joystick.....	19

*THE AMAZING*  
**SORCERER II**  
16K **\$969** 



The SORCERER is a Z80 CPU based micro-computer internally expandable to 48K, 4K ROM resident monitor I/O connector for S-100 expansion. Parallel and serial interface. Dual cassette I/O. Graphic resolution of 240 x 512, 30 lines of 64 characters, 8 x 8 dot matrix. Full ASCII set (upper and lower case), plus standard graphic symbols. User may define up to 128 characters. Keyboard is 63-key data processing type, plus a 16 key numeric input pad.

S-100 EXPANSION UNIT.....	\$399
WORD PROCESSOR PAC.....	89
DEVELOPMENT PAC.....	89

WE ALSO SELL "QUALITY SOFTWARE" FOR SORCERER AT 10% OFF LIST.

TO ORDER: Phone orders invited using Visa, Mastercard, or bank wire transfers. Visa & MC credit card service charge of 2%. Mail orders may send charge card number (include expiration date), cashiers check, money order, or personal check (allow 10 business days for personal checks to clear). Please include phone number. Include 3% shipping, handling, and insurance (\$5.00 minimum) in USA. Shipments within Calif. add 6% sales tax. Foreign orders include 1% handling-shipped freight collect. Foreign orders over \$1000 allow 3 weeks extra and include \$25 license fee. All equipment is in factory cartons with the manufacturers warranty. Equipment is subject to price change and availability.



**MAIL TO: 1251 BROADWAY EL CAJON CA., 92021 (714) 579-0330**

AUTHORIZED  
APPLE  
SALES &  
SERVICE

# COMPUTER



# SPECIALTIES

DIVISION OF  
CMI



#### 64K BYTE EXPANDABLE RAM

DYNAMIC RAM WITH ON BOARD TRANSPARENT REFRESH GUARANTEED TO OPERATE IN NORTH STAR, CROMEMCO, VECTOR GRAPHICS, SOL, AND OTHER 8080 OR Z-80 BASED S100 SYSTEMS + 4MHZ Z-80 WITH NO WAIT STATES.

- \* SELECTABLE AND DESELECTABLE IN 4K INCREMENTS ON 4K ADDRESS BOUNDARIES.
- \* LOW POWER—8 WATTS MAXIMUM.
- \* 200NSEC 4116 RAMS.
- \* FULL DOCUMENTATION.
- \* ASSEMBLED AND TESTED BOARDS ARE GUARANTEED FOR ONE YEAR AND PURCHASE PRICE IS FULLY REFUNDABLE IF BOARD IS RETURNED UNDAMAGED WITHIN 14 DAYS.

	ASSEMBLED /	TESTED
64K RAM	.....	\$595.00
48K RAM	.....	\$529.00
32K RAM	.....	\$459.00
16K RAM	.....	\$389.00

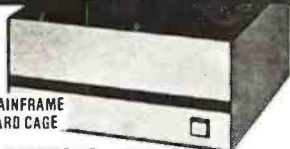

#### S100 MAINFRAME AND CARD CAGE

- \* W/ SOLID FRONT PANEL . . . \$239.00
- \* W/ CUTOUTS FOR 2 MINI-FLOPPIES . . . \$239.00
- \* 30 AMP POWER SUPPLY . . . \$119.00
- \* 8 SLOT MOTHERBOARD . . . \$149.00
- \* 19 SLOT MOTHERBOARD . . . \$199.00

#### 16K MEMORY EXPANSION KIT ONLY \$58

FOR APPLE TRS-80 KEYBOARD, EXIDY, AND ALL OTHER 16K DYNAMIC SYSTEMS USING MK4116-3 OR EQUIVALENT DEVICES.

- \* 200 NSEC ACCESS, 375 NSEC CYCLE
- \* BURNED-IN AND FULLY TESTED
- \* 1 YR. PARTS REPLACEMENT GUARANTEE
- \* QTY. DISCOUNTS AVAILABLE



#### VISTA V-200 MINI-FLOPPY SYSTEM

- \* S100 DOUBLE DENSITY CONTROLLER
- \* 204 KBYTE CAPACITY FLOPPY DISK DRIVE WITH CASE & POWER SUPPLY
- \* MODIFIED CPM OPERATING SYSTEM WITH EXTENDED BASIC \$695.00

# BETA

COMPUTER DEVICES

1230 W. COLLINS AVE.  
ORANGE, CA 92668  
(714) 633-7280

Call, residents please add 6% sales tax. Mastercharge & Visa accepted. Please allow 14 days for checks to clear bank. Phone orders welcome. Shipping charges will be added to all shipments.

#### 32K BYTE MEMORY RELIABLE/COST EFFECTIVE EXPANDABLE RAM FOR 6502 AND 6800 SYSTEM—AIM 65-KIM\*SYM\*PET\*\$44-BUS

- \* PLUG COMPATIBLE WITH THE AIM-65/SYM EXPANSION CONNECTOR BY USING A RIGHT ANGLE CONNECTOR (SUPPLIED) MOUNTED ON THE BACK OF THE MEMORY BOARD.
- \* MEMORY BOARD EDGE CONNECTOR PLUGS INTO THE 6800 S 44 BUS.
- \* CONNECTS TO PET OR KIM USING AN ADAPTOR CABLE.
- \* RELIABLE—DYNAMIC RAM WITH ON BOARD INVISIBLE REFRESH—LOOKS LIKE STATIC MEMORY BUT AT LOWER COST AND A FRACTION OF THE POWER REQUIRED FOR STATIC BOARDS.
- \* USES +5V ONLY, SUPPLIED FROM HOST COMPUTER.
- \* FULL DOCUMENTATION—ASSEMBLED AND TESTED BOARDS ARE GUARANTEED FOR ONE YEAR AND PURCHASE PRICE IS FULLY REFUNDABLE IF BOARD IS RETURNED UNDAMAGED WITHIN 14 DAYS.

ASSEMBLED WITH 32K RAM	.....	\$395.00
& WITH 16K RAM	.....	\$339.00
TESTED WITHOUT RAM CHIPS	.....	\$279.00
HARD TO GET PARTS (NO RAM CHIPS) WITH BOARD AND MANUAL	.....	\$109.00
BARE BOARD & MANUAL	.....	\$49.00

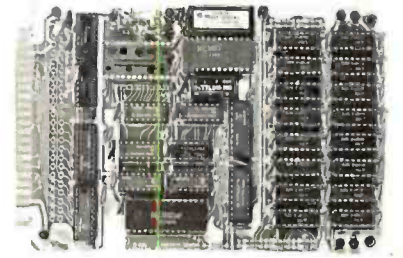

PET INTERFACE KIT—CONNECTS THE 32K RAM BOARD TO A 4K OR 8K PET. CONTAINS: INTERFACE CABLE, BOARD STANDOFFS, POWER SUPPLY MODIFICATION KIT AND COMPLETE INSTRUCTIONS. . . . \$49.00

U.S. PRICES ONLY



# Portable Oscilloscopes

15 MHz Triggered Miniscope Model MS-15

15 MHz Dual Trace Triggered Miniscope

Model MS-215

30 MHz Dual Trace Triggered Miniscope

Model MS-230



## New Touch/Test 20 Multimeter

A portable/bench-type meter that tests and measures 10 electrical parameters, 20 functions & 45 ranges.

#### MEASURES:

- AC and DC Voltage
- AC and DC Current
- Resistance
- Temperature
- °C & °F
- Conductance
- Capacitance
- Performs diode/transistor and continuity tests

#### FEATURES

- Touch selection and control of functions, ranges and power.
- Large (0.55" high) LED readout.
- In-circuit test capabilities.
- Size: 2.9" H x 6.4" W x 7.5" D.
- Weighs less than 3 lbs.

Order with Confidence and get the Fordham Advantage!

Call for our prices  
**TOLL FREE**  
**(800) 645-9518**

in N.Y. State call (516) 752-0050

# FORDHAM

855 Conklin St. Farmingdale, N.Y. 11735



- Master Charge
- BankAmericard
- VISA
- COD
- Money Order
- Check
- COD's extra



# The Supermarket for TRS-80\* Add-on Components (and other computers, too) In stock now. Immediate delivery.

## The Vista V-80/800/8000 Family Disk Drive System

- Fully compatible with TRS-80, Heath/Zenith
- 120 Day Warranty
- 40 Track Patch at NO CHARGE



V-80 Single drive system (102K)	.....	\$ 395.00
V-80 Two drive system (204K)	.....	\$ 770.00
V-800 Single drive, B52 Drive (204K)	.....	\$ 595.00
V-800-2 Double drive, B52 Drives (408K)	.....	\$1175.00
V-8000 Single drive, B92 Drive (408K)	.....	\$ 775.00
V-8000-2 Double drive B92 Drives (816K)	.....	\$1450.00

## The VISTA Model II

- Provides one, two or three drives.
- Adds up to 1.5 million bytes of on-line storage.
- 120 day warranty
- Does everything Radio Shack's expansion system will do... for less!

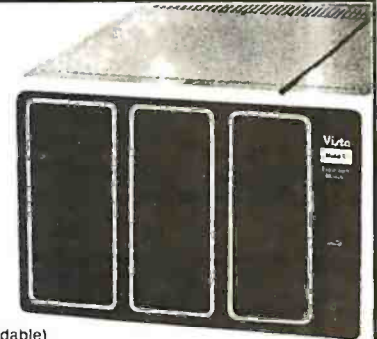

\$ 900.00	Single drive (non-expandable)
\$1000.00	Single drive Expansion System
\$1550.00	Two drive Expansion System
\$2100.00	Three drive Expansion System
\$ 525.00	Additional drives alone

## Vista's Add on Drives for Apple™

Speed . Capacity . Price

More for Less

- 30 to 60% cheaper per byte
- From 20 to 400% more capacity
- Twice as fast
- Compatible with Pascal
- Warranty 120 days

40-Track	\$365.00
80-Track	\$595.00
160-Track	\$825.00
Controller	\$100.00

## Printers

<b>Vista V300</b> .....	\$1895.00
Daisy wheel Letter quality	
<b>Base 2 Printer</b> .....	\$575.00 (includes: 2-K Buffer, graphics, high speed tractor feed)
Variable line spacing control 0 to 64 dots in half dot increments 100 cps — six densities Standard 96 character ASCII Up to 10 character fonts	
<b>Anadex DP8000</b> .....	\$895.00
9 x 7 dot matrix 80 column (112 cps)	
<b>Vista Printer</b> .....	\$745.00
5 x 7 dot matrix 80 column (125cps)	

## Add On Drives

MPI B51	40 Track, Double Density-204K	\$275.00
MPI B52	Dual Head, Double Density-408K	\$375.00
Siemens	FDD100-5 40 Track Double Density 204K	\$275.00
Siemens	FDD100-8 8" Single Sided Drive	\$448.00
Shugart	801R Single Sided Drive	\$448.00

## Other Products

1. VISTA Verbatim diskettes (hard or soft sector) Certified 40 track .....	\$ 38.95
2. 16K RPM upgrade kits, guaranteed for 120 days. <b>PRIME PRODUCT</b> .....	\$ 59.95
3. NEW! DOS + .....	\$110.00
4. LNW expansion bare board .....	\$ 66.95
5. H.C. Pennington book, TRS-80 Disk and Other <b>Mysteries</b> .....	\$ 18.95
6. DDT Disco-Tech disk drive timer .....	\$ 19.95

## The Vista MUSIC MACHINE 9

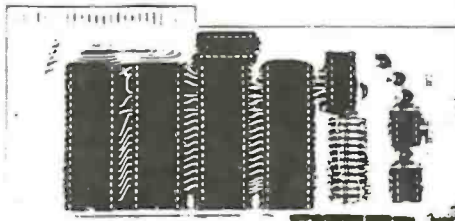

### WITH 9 VOICES!

- NEW! Uses latest State of the Art LSI Technology.
- Requires only one slot for 9 voices!
- Uses three Ay3-8910's to produce nine voices (Other competitive models have only 3 voices).
- Simulates three ALF Boards.
- Plays music generated by the ALF Board.
- APPLE™ II compatible.
- ALF™ software required.

**3 Times  
More Powerful  
Than ALF™  
\$129.95**

## The VISTA V-200 for Exidy

- Completely packaged system, tested and ready to plug in, includes: power supply, two 40 track drives, case, controller, all cabling and total CPM documentation.
  - Storage capacity from 400K to 1.2 meg.
  - System software-VISTA CP/M Disk Operating System and BASIC-E Compiler recorded on 5-1/4" diskettes.
- Price: Starting as low as **\$1199.00**

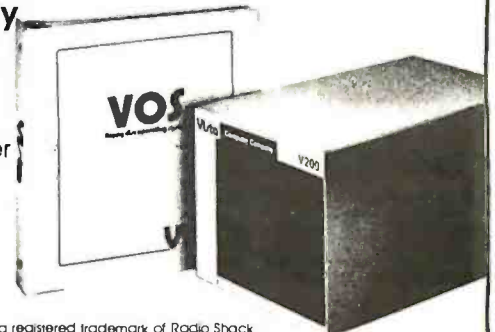

**CALL TOLL-FREE 800-854-8017**

\*TRS-80 is a registered trademark of Radio Shack

The Vista Computer Company 1401 Borchard Street • Santa Ana, California 92705 • 714/953-0523



# "COMPUTERS 'R' US"

A CONSUMER COMPUTERS SUBSIDIARY

## UNBEATABLE MAIL ORDER DISCOUNTS



**apple computer**  
Authorized Dealer

**NEW!**  
CALL FOR  
AVAILABILITY  
AND PRICES.

**\$925**  
FOR 16K

**48K**  
FOR ONLY  
**\$1049**

**apple ///**  
**APPLE II OR APPLE II PLUS**

**APPLE COMPUTER PERIPHERALS**

DISK II DRIVE & CONTROLLER card.....	485
DISK II DRIVE ONLY.....	425
GRAPHICS TABLET.....	655
SILENTYPE PRINTER w/int. card.....	515
SSM AIO SERIAL/PARALLEL kit.....	155
SSM AIO assembled & tested.....	190
SYMTEC LIGHT PEN SYSTEM.....	215
SYMTEC SUPER SOUND GENERATOR.....	225
SVA 8 INCH DISK CONTROLLER CARD.....	335
VERSA WRITER DIGITIZER SYSTEM.....	215
VIDEX VIDEOTERM 80 COLUMN CARD.....	315
VIDEX VIDEOTERM w/graphics ROM.....	335
LOBO DISK DRIVE ONLY.....	385
LOBO DRIVE w/controller card.....	465
DC HAYES MICROMODEM II.....	319
DAN PAYMAR lower case kit.....	55

**APPLE COMPUTER INTERFACE CARDS**

PARALLEL PRINTER Int. card.....	145
COMMUNICATION CABD w/conn. cable.....	185
HI-SPEED SERIAL Int. card.....	145
LANGUAGE SYSTEM with PASCAL.....	425
CENTRONICS PRINTER Int. card.....	185
APPLESOFT II FIRMWARE card.....	149
INTEGER BASIC FIRMWARE card.....	149

**MOUNTAIN HARDWARE ACCESSORIES**  
A Division Of  
**Mountain Computer**

APPLE CLOCK/CALENDAR card.....	225
SUPERTALKER SD200 SPEECH SYNTHESIZER SYSTEM.....	245
ROMPLUS w/keyboard filter.....	165
INTROLUX-10 BSR REMOTE CONTROL SYSTEM.....	245
INTROLUX-10 controller card only.....	165
ROMWRITER SYSTEM.....	155
MUSIC SYSTEM(16 voices/stereo).....	465
AD-DIA 16 CHANNELS.....	319
EXPANSION CHASSIS (8 slots).....	555

**PMC-80**  
COMPLETELY COMPATIBLE WITH RADIO SHACK TRS-80 LEVEL II SOFTWARE AND PERIPHERALS.

Features Include:

Level II BASIC	40 pin interface conn.
Video & Ch. 3 TV OUT.	16K User RAM Memory
Built in Cassette	Expandable to 48K

For more information, please call or write.

**APPLE ADD-ONS**

CORVUS 10 MEGABYTE HARD DISK DRIVE SYSTEM w/pwr supply.....	4395
CORVUS CONSTELLATION.....	595
16K MEMORY UPGRADE KIT (TRS-80, APPLE II, SORCERER).....	60
ABT NUMERIC INPUT KEYPAD (specify old or new kybrd).....	115
ALF MUSIC SYNTHESIZER.....	235
BRIGHTPEN LIGHTPEN.....	32
GPIB IEEE-488 (1978) Int.....	259
ARITHMETIC PROCESSOR card.....	335
SPEECHLINK 2000 (64 Word Vocab).....	215
M&R SUP-R-MOD TV MODULATOR.....	30
MICROSOFT Z-80 SOFTCARD SYSTEM w/CP/M & MICROSOFT BASIC.....	299
MICROWORKS-DS-65 DIGISECTOR.....	238
LAZER lower case adapter.....	50

**APPLE II or APPLE II PLUS SOFTWARE**

PASCAL with LANGUAGE SYSTEM.....	425
FORTRAN for use with LANGUAGE SYSTEM.....	165
CP/M for use with MICROSOFT Z-80 SOFTCARD (incl.).....	299
DOS 3.3.....	49
THE CONTROLLER General Business System.....	519
THE CASHIER Retail Management & Inventory System.....	199
APPLEWRITER Word Processor.....	65
APPLEPOST MAILING list system.....	45
APPLEPLOT Graph & Plot System.....	60
DOW JONES PORTFOLIO EVALUATOR.....	45
APPLE CONTRIBUTED VOLUMES	
1 thru 5 w/manuals.....	30
VISI-CALC by PERSONAL SOFTWARE.....	120
DESKTOP/PLAN by DESKTOP COMPUTERS.....	85
CCA DATA MANAGEMENT SYSTEM By PERSONAL SOFTWARE.....	85
APPLEBUG ASSEMBLER/DISASSEMBLER.....	75
APPLE DOS TOOL KIT.....	65



**THE TRS-80 'WORK-ALIKE'**  
**16K LEVEL II ONLY \$579**

**NEW!**



**ATARI**

**16K FOR \$799**

### ATARI 800 PERSONAL COMPUTER SYSTEM

**ATARI ACCESSORIES**

400 COMPUTER.....	479
820 PRINTER (40 col.).....	459
810 DISK DRIVE.....	559
410 Program Recorder.....	59
815 DUAL DISK DRIVE.....	1199
822 THERMAL PRINTER (40 col.).....	369
825 PRINTER (80 col. imp.).....	795
850 INTERFACE MODULE.....	175
ATARI 16K RAM MODULE.....	155



**16K \$969**  
**32K \$1049**  
**48K \$1099**

**Exidy SORCERER COMPUTER**

S-100 EXPANSION UNIT.....	375
WORD PROCESSING PAC.....	179
DEVELOPMENT PAC.....	89

### VIDEO MONITORS

LEEDEX VIDEO 100.....	129
SANYO 9" B&W.....	165
SANYO 15" B&W.....	245
PANACOLOR 10" COLOR.....	329
ZENITH 13" COLOR.....	399

**\$129**



**LEEDEX VIDEO 100**

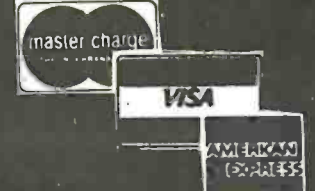

master charge  
VISA  
AMERICAN EXPRESS

## OHIO SCIENTIFIC Challenger

**OHIO SCIENTIFIC**

C1P MOD 2.....	429
C4P.....	399
C4PMF (1 disk drive).....	1589
AC-16P JOYSTICKS (2).....	39
ATV R F TV MODULATOR.....	35



**\$699**  
**C4P**  
8K ROM BASIC  
8K RAM EXPANDABLE TO 96K  
32x64 UPPER & LOWER CASE  
256x512 GRAPHICS POINTS  
PROGRAMMABLE TONES  
ANALOG INPUTS

**NEW!**



**\$429**  
**CIP MOD II**  
8K ROM BASIC  
8K RAM EXPANDABLE TO 32K  
COLOR EXPANSION  
48 LINE DISPLAY EXPANSION

### PRINTERS

ANADEX DP-8000.....	775
ANADEX DP-9500.....	1350
BASE 2.....	599
CENTRONICS 737.....	825
MPI 88-T.....	699
PAPER TIGER IDS-440 w/graphics.....	895
NEC SPINWRITER.....	2550
TRENDCOM 200.....	519
SILENTYPE w/int.....	515
EPSON TX-80 w/graphics.....	729
EPSON MX-80 132 col.....	620



**EPSON TX-80**

- FAST DELIVERY
- LOW PRICES
- COURTEOUS SERVICE
- KNOWLEDGEABLE STAFF
- LARGE VARIETY

**IN CALIFORNIA, OR FOR BACKORDER OR TECHNICAL INFO CALL: (714) 698-8088**

**TOLL FREE ORDER LINE: 1-800-854-6654**

CREDIT CARD USERS PLEASE READ TERMS OF SALE IN ORDERING INFORMATION

ORDERING INFORMATION: Phone Orders Invited using VISA, MASTERCARD, AMERICAN EXPRESS, or bank wire transfers. VISA & MC credit card service charge of 2%, AE credit card service charge of 5%. Mail orders may send charge card number (include expiration date), cashier's check, money order or personal check (allow 10 business days to clear.) Please include a telephone number with all orders. Foreign orders (excluding Military PO's) add 10% for shipping and all funds must be in US dollars. Shipping, handling and insurance in U.S. add 3%. California residents add 6% sales tax. Our low margins prohibit us to send COD or on account. All equipment subject to price change and availability. Equipment is new and complete with manufacturer warranty. We ship most orders within 2 days. Order desk hours are Monday thru Saturday 9-5 PST. Send for FREE 1981 Catalog. WE ARE A MEMBER OF THE BETTER BUSINESS BUREAU AND THE CHAMBER OF COMMERCE. RETAIL STORE PRICES MAY DIFFER FROM MAIL ORDER PRICES. PLEASE SEND ORDERS TO: CONSUMER COMPUTERS MAIL ORDER CRU Division 8314 PARKWAY DRIVE, GROSSMONT SHOPPING CENTER NORTH, LA MESA, CALIFORNIA, 92041

# At last...the Typewriter Interface!



**Turn your electric typewriter into a low cost, high quality hard copy printer. 1 Year Warranty**

Dynatyper—the patented\* RDI—I/O Pak is fast becoming the industry standard for typewriter output. Why? Because:

1. It takes 2 minutes to initially install and 5 seconds to remove or replace.
2. You *do not* have to modify your typewriter. All factory warranties and maintenance agreements on your typewriter will be honored.
3. You can use it with *all* powered carriage return typewriters that have U.S. keyboard. Our Model I works with all *non* Selectrics and our Model II works with Selectrics. Conversion between models takes 2 minutes and the kit (26 plungers) is available for a nominal charge.
4. You don't have to lug around a bulky printer when you travel. If there is a typewriter at your destination, you can install the light (3 lbs.) I/O Pak in just 2 minutes.
5. Same interface for TRS-80, Apple and GPIB. Centronics and Pet compatible interfaces are available in third quarter 1980. Electric pencil available.
6. Delivery: Stock to two weeks. Price: \$499. for the complete system, FOB Rochester, Domestic.

Over 1000 in operation today. VISA and MasterCard accepted. Call Ken Yanicky at 716-385-4336.

\*Patent Pending

**ROCHESTER DATA**

3100 Monroe Avenue, Rochester, New York 14618 incorporated

## The TRS-80 I/O solution

The COMM-80 is the only interface you need to turn your TRS-80 Level I or II into a timesharing terminal with provisions for a printer. The COMM-80 combines the most used features of the RS expansion interface in a low cost unit containing a built-in RS-232-C interface (50 - 19,200 baud software selectable), a full 8 bit parallel port (34 pin edge card Centronics compatible) and a TRS-BUS connector for future expansion. Up to 16 units can be chained together and addressed separately. Interface your TRS-80 to all standard RS-232-C devices including modems, CRT Terminals, printers and other computers. Smart terminal software (will run in 4K) is included at no extra cost.

**COMM-80™**

**Assembled and tested ... \$179.95**

Includes case, power supply, ribbon cable, parallel printer port, serial port and TRS-BUS connector plus smart terminal software (please specify Level I or II).



TRS-80 is trademark of Tandy Corp.

NY residents add 7% sales tax.

**To order call (516) 374-6793**

**or write:**

The MicroMint Inc.  
917 Midway  
Woodmere, NY 11598  
Dealer inquiries invited.



# EXECUPOINTS®

**Quiet, Portable, Reliable,  
Versatile Printing Data  
Terminals**

80 Print Position



Model 300

80/136  
Print Position  
Plotting



Model 3000

**FEATURES:**

- Built-In Acoustical Coupler/Modem
- 10, 15, 30 CPS
- Carrying Case

**SPECIAL PURCHASE PRICES**  
Remanufactured Units

**Model 300 \$795**  
(90 Day Factory Warranty)

**Model 3000 \$1,195**  
(One Year Factory Warranty)

**CALL NOW TO ORDER**

**Buy Direct From The Manufacturer • Maintenance Contract Available  
• Immediate Delivery •**



**Computer Transceiver Systems Inc.**  
East 66 Midland Avenue • Paramus, NJ 07652  
P.O. Box 15 • Phone: (201) 261-6800

# page

## PRE-CUT WIRE WRAP WIRE

Length	100/Bag	500/Bag	1K/Bag	Length	100/Bag	500/Bag	1K/Bag	Kit No. 1	\$9.95	Kit No. 3	\$32.95																								
2.5"	\$1.25	\$3.58	\$ 6.19	6.5"	\$1.92	\$6.44	\$11.81	250 3"	100 4½"	500 2½"	500 4½"																								
3.0"	1.30	3.86	6.78	7.0"	1.99	6.76	12.44	250 3½"	100 5"	500 3"	500 5"																								
3.5"	1.37	4.15	7.37	7.5"	2.08	7.07	13.09	100 4"	100 6"	500 3½"	500 5½"																								
4.0"	1.42	4.44	7.94	8.0"	2.14	7.38	13.73	<table border="1"> <thead> <tr> <th>Kit No. 2</th> <th>\$24.95</th> <th>Kit No. 4</th> <th>\$59.95</th> </tr> </thead> <tbody> <tr> <td>250 2½"</td> <td>250 5"</td> <td>1000 2½"</td> <td>1000 4½"</td> </tr> <tr> <td>500 3"</td> <td>100 5½"</td> <td>1000 3"</td> <td>1000 5"</td> </tr> <tr> <td>500 3½"</td> <td>250 6"</td> <td>1000 3½"</td> <td>1000 5"</td> </tr> <tr> <td>500 4"</td> <td>100 6½"</td> <td>1000 4"</td> <td>1000 6"</td> </tr> <tr> <td>250 4½"</td> <td>100 7"</td> <td colspan="2"></td> </tr> </tbody> </table>				Kit No. 2	\$24.95	Kit No. 4	\$59.95	250 2½"	250 5"	1000 2½"	1000 4½"	500 3"	100 5½"	1000 3"	1000 5"	500 3½"	250 6"	1000 3½"	1000 5"	500 4"	100 6½"	1000 4"	1000 6"	250 4½"	100 7"		
Kit No. 2	\$24.95	Kit No. 4	\$59.95																																
250 2½"	250 5"	1000 2½"	1000 4½"																																
500 3"	100 5½"	1000 3"	1000 5"																																
500 3½"	250 6"	1000 3½"	1000 5"																																
500 4"	100 6½"	1000 4"	1000 6"																																
250 4½"	100 7"																																		
4.5"	1.48	4.74	8.54	8.5"	2.18	7.69	14.36																												
5.0"	1.54	5.04	9.13	9.0"	2.24	8.11	15.01																												
5.5"	1.58	5.38	9.72	9.5"	2.30	8.32	15.65																												
6.0"	1.65	5.66	10.31	10.0"	2.39	8.71	16.28																												

Kynar precut wire. All lengths are overall, including 1" strip on each end. Colors and lengths cannot be mixed for quantity pricing. Choose from colors Red, Blue, Black, Yellow, White, Green, Orange, and Violet.

## ★ ★ Truckload SALE ★ ★

### FREE WIRE KIT

Kit #1 on orders over \$50  
 Kit #3 on orders over \$150  
 Kit #4 on orders over \$250

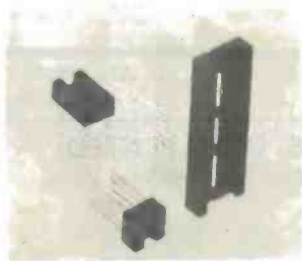

### RN WIRE WRAP IC SOCKETS

3-level Gold  
 Closed Entry  
 Design

\*Sockets sold at these prices by the tube only.

Size	Quantity/Tube	Price ea.*	Price/Tube
08 pin	52	.39	\$20.28
14	30	.46	\$13.80
16	26	.50	\$13.00
18	23	.68	\$15.64
20	21	.85	\$17.85
22	19	.92	\$17.48
24	17	.94	\$15.98
28	15	1.23	\$18.45
40	10	1.60	\$16.00

Above prices include gold up to \$800/oz.

## IDC CRIMP STYLE CONNECTORS

Card Edge Connectors	IDC Sockets	Cable Plugs	Right Angle Headers	CABLE								
IDE 10	\$3.25	IDS 10	\$1.25	IDP 14	1.25	Wire Wrap	Solder Tail	10 ft.	100 ft.			
IDE 20	\$3.50	IDS 20	2.02	IDP 16	1.40			10	2.90	17.00		
IDE 26	\$4.05	IDS 26	2.65	IDP 24	2.25	IDH10WR	1.75	IDH10SR	.80	14	3.40	23.80
IDE 34	\$4.85	IDS 34	3.50	IDP 40	3.65	IDH20WR	2.75	IDH20SR	1.25	16	3.70	27.20
IDE 40	\$5.65	IDS 40	4.05	DB25 Connectors	Male \$4.95 Female \$5.25	IDH26WR	3.60	IDH26SR	1.85	20	4.40	34.00
IDE 50	\$5.90	IDS 50	5.06			IDH34WR	4.15	IDS34SR	2.15	24	5.00	40.80
						IDH40WR	4.90	IDH40SR	2.50	26	5.40	44.20
						IDH50WR	6.15	IDH50SR	3.15	34	6.80	57.80
										40	7.80	68.00
										50	9.50	85.00

### ORDERING INFORMATION

- Orders under \$25 include \$2 handling.
- All prices good through cover date.
- All prepaid orders shipped UPS Ppd.
- Most orders shipped next day.
- Visa, MC & COD's charged shipping.
- Byte must be mentioned to get sale prices.

### Call or Write for 1980 Catalog:

- ★ IC Sockets
- ★ Vector Boards & Pins
- ★ Bishop Drafting Aids
- ★ OK Tools
- ★ RN IDC Crimp Connectors

page

1858 Evergreen, Duarte, California 91010 Phone (213) 357-5005

# WAMECO

## THE COMPLETE PC BOARD HOUSE EVERYTHING FOR THE S-100 BUSS

- \* **FPB-1A** FRONT PANEL BOARD FOR 8080A AND Z80 SYSTEMS IMSAI COMPATIBLE.  
PCBD ..... \$56.95      KIT ..... \$175.00
- \* **MEM-2** 16K RAM 2114's. ADDRESSABLE IN 4K BOUNDARIES.  
PCBD .... \$33.95      KIT (LESS RAMS) .... \$80.95
- \* **EPM-2** 16/32K ROM USES 2716 OR 2708. ADDRESSABLE IN 4K BOUNDARIES.  
PCBD .... \$33.95      KIT (LESS ROMS) .... \$74.95
- \* **CPU-1** 8080A PROCESSOR BOARD WITH VECTOR INTERRUPT.  
PCBD ..... \$33.95      KIT ..... \$124.95
- \* **IOB-1** I/O BOARD. ONE SERIAL, TWO PARALLEL WITH CASSETTE.  
PCBD ..... \$33.95
- \* **FDC-1A** FLOPPY DISC CONTROLLER BOARD USES 1771.  
PCBD ..... \$45.95
- \* **QMB-12** 13 SLOT MOTHER BOARD.  
PCBD ..... \$42.95      KIT ..... \$125.95
- \* **QMB-9** 9 SLOT MOTHER BOARD.  
PCBD ..... \$35.95      KIT ..... \$109.95
- \* **PTB-1** POWER SUPPLY AND TERMINATOR BOARD.  
PCBD ..... \$29.95      KIT ..... \$49.95
- \* **RTC-1** REAL TIME CLOCK BOARD WITH TWO INTERRUPTS.  
PCBD ..... \$29.95      KIT ..... \$79.95
- \* **MEM-1A** 8K RAM, USES 2102's.  
PCBD .... \$33.95      KIT (LESS RAM) .... \$71.95
- \* **EPM-1** 4K 170Z BOARD.  
PCBD .... \$29.95      KIT (LESS ROM) .... \$59.95

FUTURE PRODUCTS: 80 CHARACTER VIDEO BOARD.  
Z-80 CPU BOARD WITH ROM, 8 PARALLEL PORT I/O BOARD.

**DEALER INQUIRIES INVITED, UNIVERSITY DISCOUNTS AVAILABLE  
AT YOUR LOCAL DEALER**

MOST PRODUCTS FOR IMMEDIATE SHIPMENT. NO 4-8 WEEK DELAYS REQUIRED FOR OTHERS.



WAMECO, INC., P. O. BOX 877 • 455 PLAZA ALHAMBRA • EL GRANADA, CA 94018 • (415) 726-6378

### BECKIAN ENTERPRISES

ALL PRIME QUALITY — NEW PARTS ONLY  
SATISFACTION GUARANTEED.

#### EDGE CARD CONNECTORS: GOLD PLATED:

Abbreviations: S/E Solder Eye . S/T Sold Tail: W/W Wire Wrap.

PART # DESCRIPTION.	Row Sp.	1-9pc.	10-24pcs.	25pcs. Up.
<b>BRAND: TEXAS INST.</b>				
4070 50/100 Imsoil/Crom.	.250	\$3.95ea.	\$3.55ea.	\$3.15ea.
4090 50/100 Imsoil W/W	.250	4.30ea.	3.85ea.	3.45ea.
<b>BRAND: SULLINS: U.L. Reg.</b>				
129885 50/100 Solder Eye	.140	8.80ea.	8.10ea.	5.45ea.
129870 50/100 S/T Imsoil	.250	4.50ea.	4.10ea.	3.70
129875 50/100 W/W Imsoil	.250	5.25	4.75	4.20
129885 50/100 S/T Altair	.140	4.95	4.45	3.95
129990 50/100 S/T Cromem.	.250	4.75	4.25	3.80
<b>OTHER .125" CONTACT CTR CONNECTORS:</b>				
12305 22/44 S/E No Ears	.140	4.15	3.75	3.35
12759 38/72 S/T	.140	5.40	4.85	4.35
12790 40/80 W/W	.250	6.30	5.85	5.00
<b>.100" CONTACT CTR CONNECTORS:</b>				
10048 13/28 S/E No Ears	.140	3.40	3.05	2.15
10280 25/50 S/E TRS 80	.140	4.50	4.05	3.80
10175 20/40 S/E TRS 80	.140	5.85	5.35	4.75
10180 20/40 S/T TRS 80	.200	3.30	3.00	2.15
10190 20/40 S/T TRS 80	.140	3.20	2.90	2.55
10485 38/72 S/E Vector	.140	5.50	4.90	4.40
10490 38/72 W/E Vector	.200	5.80	5.25	4.85
10500 38/72 S/T Vector	.140	5.70	4.20	4.80
10535 40/80 S/E PET	.140	5.85	5.35	4.75
10540 40/80 W/W PET	.200	8.00	5.40	4.80
10550 40/80 S/T PET	.140	5.80	5.25	4.85
10585 43/88 S/E COS/ELF	.140	8.95	8.25	5.55
10805 43/88 S/T COS/ELF	.140	8.80	5.95	5.30
10595 43/88 W/W COS/ELF	.200	8.90	8.20	5.95
10815 43/88 S/T COS/ELF	.200	8.80	6.10	5.40

<b>.156" CONTACT CENTER CONNECTORS.</b>				
PART # DESCRIPTION.	Row Sp.	1-9pc.	10-24pcs.	25pcs. Up.
15105 8/12 S/E PET/NSC	.140	\$1.80	\$1.85	\$1.45
15110 8/12 S/T PET/NSC	.140	1.85	1.85	1.50
15137 8/12 S/T PET/NSC	.200	1.80	1.54	1.45
15175 8/ S/E Sgle Row	.140	1.70	1.50	1.30
15270 10/20 S/E	.140	2.15	1.95	1.70
15275 10/20 S/T	.140	2.00	1.85	1.60
15435 12/24 S/E PET	.140	2.60	2.35	2.10
15440 12/24 S/T PET	.140	2.65	2.40	2.15
15445 12/24 S/T PET	.200	2.75	2.50	2.20
15505 15/30 S/E GRI Key	.140	2.50	2.25	2.00
15510 15/30 S/T GRI Key	.140	2.40	2.15	1.95
15515 15/30 W/W GRI Key	.200	2.80	2.35	2.10
15800 18/38 S/E	.140	3.35	3.05	2.70
15810 18/38 S/T	.140	3.00	2.70	2.40
15815 18/38 W/W	.200	3.80	3.20	2.90
15700 22/44 S/E KIM/VEC	.140	2.98	2.90	2.75
15705 22/44 S/T KIM/VEC	.140	3.98	3.30	3.00
15710 22/44 W/W KIM/VEC	.200	3.49	3.20	2.85
15975 25/50 S/E	.140	4.85	4.20	3.75
15980 25/50 S/T	.140	4.55	4.10	3.65
15985 25/50 W/W	.200	4.85	4.35	3.90
18115 38/72 S/E	.140	6.50	5.85	5.20
18120 38/72 S/T	.140	6.55	5.90	5.25
18125 38/72 W/W	.200	6.75	6.10	5.40
18145 38/72 S/T	.200	6.50	5.85	5.20
18235 43/88 S/T Mot 8000	.140	6.80	5.95	5.30
18240 43/88 W/W Mot 8000	.200	7.80	7.05	6.25
18280 43/88 S/T Mot 8000	.200	6.50	5.85	5.20
18275 43/88 S/E Mot 8000	.140	7.20	6.50	5.75
K-1 Pol-Keys		.15	.12	.10

<b>D' TYPE SUBMINIATURE CONNECTORS.</b>				
PART NUMBER	DESCRIPTION.	1-9pcs.	10-24pcs.	25-99pcs.
DE 9P	Male	\$1.60ea.	\$1.40ea.	\$1.30ea.
DE 9S	Female	2.25ea.	2.00ea.	1.90ea.
DE 110983-1	2 pc. Gray Hood.	1.50ea.	1.35ea.	1.20ea.
DA 15P	Male	2.35ea.	2.15ea.	2.00ea.
DA 15S	Female	3.25ea.	3.10ea.	2.90ea.
DA 51211-1	1 pc. Gray Hood	1.40ea.	1.20ea.	1.15ea.
DA 51228-1	2 pc. Black Hood	2.50ea.	2.25ea.	2.00ea.
DA 110983-2	2 pc. Gray Hood	1.80ea.	1.35ea.	1.30ea.
DB 25P	Male	2.80ea.	2.60ea.	2.40ea.
DB 25S	Female	3.80ea.	3.40ea.	3.20ea.
DB 51212-1	1 pc. Gray Hood	1.50ea.	1.30ea.	1.10ea.
DB 51228-1	2 pc. Black Hood	1.90ea.	1.85ea.	1.45ea.
DB 110983-3	2 pc. Gray Hood	1.75ea.	1.50ea.	1.35ea.
DC 37P	Male	4.20ea.	4.00ea.	3.70ea.
DC 37S	Female	8.00ea.	5.75ea.	5.50ea.
DC 110983-4	2 pc. Gray Hood	2.25ea.	2.00ea.	1.75ea.
DD 50P	Male	5.50ea.	5.10ea.	4.75ea.
DD 50S	Female	9.40ea.	8.60ea.	8.00ea.
DD 51218-1	1 pc. Gray Hood	2.40ea.	2.20ea.	2.00ea.
DD 110983-5	2 pc. Gray Hood	2.80ea.	2.40ea.	2.10ea.
D 20418-2	Hardware Set (1 Hood Set)	.90ea.	.80ea.	.70ea.

<b>I.C. SOCKETS GOLD. W/WRAP 3 TURN</b>	
14 pin	\$0.40 ea.
18 pin	0.44 ea.
<b>8080A PRIME.</b>	
\$5.00 ea.	
<b>EIA 8 CONDUCTOR CABLES 8ft. Long. CLASS #1 Type Cables.</b>	
1 to 4 pcs.	\$22.00
5 to 9 pcs.	19.00

<b>I.C. SOCKETS TIN.</b>	
14 pin	\$0.15 ea.
18 pin	0.17 ea.
<b>CONNECTORS FOR CENTRONICS 700 SERIES. Amphenol 57-30380</b>	
1 to 4 pcs.	\$8.00 ea.
5 to 9 pcs.	6.00 ea.

<b>COOLING FANS. Extra Quiet.</b>	
1 to 4	\$18.00 ea.
5 to 9	17.00 ea.
<b>PHONE: 213-988-6196</b>	
<b>MAIL ORDERS TO:</b>	

TERMS: MINIMUM ORDER: \$15.00 ADD \$1.35 For Handling & Shipping. Orders over \$30.00 in the U.S.A. We Pay the Shipping. CALIF. RESIDENTS: Please Add 6% Sales Tax.

NOTE: NO C.O.D. OR CREDIT CARD ORDERS WILL BE ACCEPTED.

**BECKIAN ENTERPRISES**  
P.O. BOX #3089  
SIMI VALLEY, CA 93063

# THE STAR MODEM

From Livermore Data Systems



**RS232 MODEM  
SALE \$135**

**IEEE 488 MODEM  
SALE \$**

STAR Modem is the price performance leader with a full 2 YEAR FACTORY WARRANTY.

**FORTH + \$60.00**  
for APPLE or PET/CBM

A full-featured FORTH with enhancements. Fast and easy to use.

- conforms to FORTH Interest Group Standards
- cross compiler to produce either standard object modules or self contained ROMable modules
- built in macro conditional assembler
- complete string processing capabilities (including variable length strings)
- disk virtual memory for large programs (or small systems!)
- arrays (single or multiple dimensioned)
- full screen cursor controlled editor
- floating point and integer processing
- User's Guide and documentation

**A product of IDPC Company**

Requires 16K available RAM and one disk drive.

# Z80A System SPECIAL \$3500

- 64K memory
- 2.4 megabytes disk storage (2 8" 2D drives)
- 2 parallel and 2 serial ports
- CP/M 2.x included

## KMMM Pascal for PET \$75

A subset of standard Pascal with extensions

- Machine Language Pascal Source Editor
- Machine Language P-Code Compiler
- P-Code Interpreter (for debugging and learning)
- P-Code to machine language translator for optimized object code
- Run-time package
- User Manual and sample programs

Requires 16K minimum. Specify ROM version and disk or tape.



## FLOPPY DISKS

as low as \$1.85  
(write for price list)



Verbatim



maxell

## EARL for PET (disk file based) \$65

Editor, Assembler, Relocater, Linker

Generates relocatable object code using MOS Technology mnemonics. Disk file input (can edit files larger than memory). Links multiple object programs as one memory load. Listing output to screen or printer.

6502	7.45	10/6.95	50/6.55	100/6.15
6502A	8.40	10/7.95	50/7.35	100/6.90
6520 PIA	5.15	10/4.90	50/4.45	100/4.15
6522 VIA	6.90	10/6.50	50/6.10	100/5.70
6532	7.90	10/7.40	50/7.00	100/6.60
2114-L450	4.45	20/4.25	100/3.95	
2114-L300	5.65	20/5.35	100/4.95	
2716 EPROM	13.45	5/12.75	10/11.85	
<b>4116-200 ns RAM (NEC)</b>	<b>8 for 39</b>			
6550 RAM (PET 8K)	12.70			
S-100 Wire Wrap \$2.65	Solder Tail 2.15			

### CASSETTES - AGFA PE-611 PREMIUM

High output, low noise, 5 screw housing, labels.

C-10 10/5.65 50/25.00 100/48.00

C-30 10/7.30 50/34.00 100/66.00

All other lengths available. Write for price list.

## ATARI 800 \$777

All Atari Modules 25% OFF

**SPECIAL-purchase ATARI 800, receive extra 8K memory FREE.**

**EDUCATIONAL PLAN - buy 2 ATARI Computers, receive 1 ATARI FREE!**

## DISKS

(write for quantity prices)

SCOTCH (3M) 8"	10/3.00	50/2.85	100/2.75
SCOTCH (3M) 5"	10/2.95	50/2.80	100/2.70
Maxell 5"	10/3.65	50/3.40	100/3.15
Maxell 8" Double Dens.	10/4.10	50/3.95	100/3.80
Verbatim 5"	10/2.40	50/2.35	100/2.30
(add 1.00 for plastic storage box)			
BASF 5"	10/2.40	20/2.35	100/2.30
BASF 8"	10/2.40	20/2.35	100/2.30
Diskette Storage Pages		10 for 3.95	
Disk Library Cases	8" - 2.85	5" - 2.15	

## Commodore CBM-PET SPECIALS

**FREE** Up to \$235 free merchandise with purchase of one of following CBM-PET items!



8032 32K - 80 column CRT	\$1795	<b>235</b>
8016 16K - 80 column CRT	\$1495	<b>205</b>
8050 Dual Disk Drive - 950,000 bytes	\$1695	<b>220</b>
CBM Modem - IEEE Interface	\$395	<b>50</b>
CBM Voice Synthesizer	\$395	<b>50</b>
8N full size graphics keyboard	\$795	<b>100</b>
16K Full Size Graphics or Business Keyboard	\$995	<b>150</b>
32K Full Size Graphics or Business Keyboard	\$1295	<b>205</b>
2040 Dual Disk Drive - 343,000 bytes	\$1295	<b>205</b>
2022 Tractor Feed Printer	\$795	<b>100</b>
C2N External Cassette Deck	\$ 95	<b>12</b>
Used PETs (8, 16, and 32K)		<b>CALL</b>

**WRITE FOR SYSTEM PRICES**

### \*EDUCATIONAL DISCOUNTS\*

Buy 2 PET Computers, get 1 FREE

CBM Full Size Graphics Keyboard	\$ 74
WordPro I - for 8K PET	\$ 25
WordPro II - 16K CBM, disk, printer	\$ 85
WordPro III - 32K CBM, disk, printer	\$170
WordPro IV - 8032, disk, printer	\$255
VISICALC for PET (Personal Software)	\$170
BPI General Ledger, A/P, A/R for PET	\$270
Programmers Toolkit - PET ROM Utilities	\$ 36.90
PET Spacemaker Switch	\$ 22.90

Dust Cover for PET	\$ 7.90
IEEE-Parallel Printer Interface for PET	\$ 65.00
IEEE-RS232 Printer Interface for PET	\$149.00

Centronics 737 Proportional Spacing Printer	\$800
NEC Spinwriter - parallel	\$2450
XYMEC HI-Q 1000 Intelligent Daisy Wheel	\$
Leedex Video 100 12" Monitor	\$ 129
Zenith Z19 Terminal (factory asm.)	\$ 739
Zenith Z89 with 48K	\$2150
Strobe Model 100 Plotter	\$ 600

SYM-1	\$209
SYM BAS-1 BASIC or RAE-1/2 Assembler	\$ 85
KTM-2/80 Synertek Video Board	\$349
KIM-1 (add \$34 for power supply)	\$159
Seawell Motherboard - 4K RAM	\$195
Seawell 16K Static RAM - KIM, SYM, AIM	\$320

KL-4M Four Voice Music Board and Visible Music Monitor (4 voice) for PET	\$59.90
MICR-REVERSI for PET by Michael Riley machine language version - you can't win at Level 5.	\$ 9.95
PAPER-MATE 60 Command PET Word Processor \$29.95 full-featured version by Michael Riley	\$29.95

**A P Products 15% OFF**  
**A P Hobby-Blox 15% OFF**



### ALL BOOK and SOFTWARE PRICES DISCOUNTED

The 8086 Book (Osborne)	\$12.75
Z8000 Assembly Language Programming (Osborne)	\$10.60
PET Personal Computer Guide (Osborne)	\$12.75
PET and the IEEE-488 Bus (Osborne)	\$12.75
6502 Assembly Language (Osborne)	\$ 9.90
Programming the 6502 (Zaks)	\$10.45
6502 Applications Book (Zaks)	\$10.45
6502 Software Cookbook (Scelbi)	\$ 9.45

### WRITE FOR CATALOG.

Add \$1.25 per order for shipping. We pay balance of UPS surface charges on all prepaid orders. Prices listed are on cash discount basis. Regular prices slightly higher.

115 E. Stump Road  
Montgomeryville, PA 18936

215-699-5826 **A B Computers**



**Dual Trace Oscilloscope**  
**HITACHI 30 MHz**

- TV sync-separator circuit
- High-sensitivity 1mV/div (5MHz)
- Sweep-time magnifier (10 times)
- Z-axis Input (Intensity modulation)
- Signal delay line
- X-Y operation
- Trace Rotation

**\$945.00**

**More sensitive to your input**

**8080A**  
MICRO-PROCESSOR **\$5<sup>95</sup>**

**2114L**  
(350 nS) STATIC RAM **\$5<sup>95</sup>**

**CRT CONTROLLER**  
**5037P \$39<sup>90</sup>**

**EPROM 2708 \$9<sup>90</sup>**

**EPROM (5 Volt) 2716 \$14<sup>80</sup>**

**POWER SUPPLY**  
**5 Volt 3 Amp APS 5-3**

1-9 ..... \$42.50  
10 up ..... \$40.65  
25 up ..... \$38.85

---

**SD SYSTEMS**

**Z-80 STARTER SYSTEM**

The Z80 Starter Kit by SD Systems uses the powerful Z80 microprocessor as the heart of the complete micro-computer on a single board. Learn a step-by-step introduction to micro-computers with a keyboard and display, audio cassette interface, PROM programmer, wire-wrap expansion area, 4-channel Counter Timer and on Board RAM and PROM. Complete Operation and Instruction Manual included. Z80 Monitor in ROM.

**27004 kit . . . \$340 38007 assem/T. . . \$450**

**Low Cost EPROM Erasing Lamps**



- SIMPLE TO USE
- SAFETY INTERLOCK
- ERASES 4 CHIPS IN LESS THAN 20 MINUTES
- HIGH INTENSITY 6W LAMP
- TUBE RATED AT 5000 HOURS
- ERASES 8 CHIPS IN LESS THAN 14 MINUTES
- UNMATCHED INTENSITY AT 254 nm
- TUBE RATED IN EXCESS OF 10,000 HOURS
- ERASES 16 CHIPS IN LESS THAN 7 MINUTES

UVS-1E ..... \$95.00    UVS-54T ..... \$155.00    S-52T ..... \$355.00

**PLESSEY**

Metalized Polyester Capacitors

Series 160 MINIBOX SAMPLER **\$26.00**

**AP PRODUCTS**

923101 . . . \$ 79.95  
923102 . . . 124.95  
923103 . . . 124.95

**32K** Part No. DP1000-2 **\$1295**

**SORCERER COMPUTER** SPEAK YOUR LANGUAGE  
FEATURES: 280 - 4K ROM 32K RAM - Dual Channel I/O - 20 Lines of 64 Characters - 64 Defined Characters - 32 x 240 Graphic Resolution - Edge Card Connector - \$165.00 Box - Serial and Parallel I/O.

---

**SBC-100** SINGLE BOARD COMPUTER KIT

**27003 kit . . . . . \$295**

**PROM-100** BOARD KIT PROM Programmer

**27014 kit . . . . . \$200**

**VERSAFLOPPY I** FLEXIBLE DISK DRIVE Controller

**27002 assem/T. . . \$250 38005 assem/T. . . \$335**

**VDB-8024** VIDEO DISPLAY BOARD

**38013 assem/T. . . \$470**

**SD Systems EXPANDO RAM**

**27001 kit . . . . . \$220 38001 assem/T. . . \$480**

**Add-On RAM Kit**  
**27010 (16K, 8 devices) \$165**

**SYM-1** NEW LOW PRICE **\$239.00**

KTM-2 CRT/TV Kybd Term \$349

---

**MAIL ORDER**  
P.O. Box 22087  
Culver City CA 90230  
(213) 641-0868

**PORTLAND**  
1125 N.E. 82nd Ave  
Portland, OR 97220  
1503 254-9641

**SANTA ANA**  
1300 E. Edinger Ave  
Santa Ana, CA 92705  
1718 547-8426

**CULVER CITY**  
11080 Jefferson Blvd  
Culver City, CA 90230  
12131 390-3555

**TUCSON**  
4518 E. Broadway  
Tucson, AZ 85711  
1823 881-3348

**HOUSTON**  
2648 Richmond  
Houston, TX 77098  
17131 929-9489

**ATLANTA**  
3330 Piedmont Ave. N.E.  
Atlanta, GA 30305  
1606 261-7100

**SUNNYVALE**  
1254 E. El Camino Road  
Sunnyvale, CA 94087  
1081 263-1121

**★ 16% ★**

## DISCOUNT COUPON

Bring this COUPON into one of our stores or mail to our Mail Order address shown below and receive a **16% DISCOUNT** on purchases from this Ad of \$100.00 or more.

**Offer EXPIRES on November 30, 1980**

NAME \_\_\_\_\_

ADDRESS \_\_\_\_\_

CITY \_\_\_\_\_ STATE \_\_\_\_\_

ZIP \_\_\_\_\_ PHONE NO \_\_\_\_\_

Coupons accepted only with full name and address filled in

**ANCRONA**

Send check or Money Order to: P.O. Box 22087, Culver City CA 90230

California residents add 6% sales tax. Minimum Order \$10.00

Add \$2.00 to cover postage and handling. Master Charge and Visa welcomed.

Please include your charge card number, Interbank number and expiration date. **PHONE ORDERS: (213) 641-0864**

<b>MAIL ORDER</b> P.O. Box 22087 Culver City CA 90230 (213) 641-0868	<b>PORTLAND</b> 1125 N.E. 82nd Ave Portland, OR 97220 1503 254-9641	<b>SANTA ANA</b> 1300 E. Edinger Ave Santa Ana, CA 92705 1718 547-8426	<b>CULVER CITY</b> 11080 Jefferson Blvd Culver City, CA 90230 12131 390-3555
<b>TUCSON</b> 4518 E. Broadway Tucson, AZ 85711 1823 881-3348	<b>HOUSTON</b> 2648 Richmond Houston, TX 77098 17131 929-9489	<b>ATLANTA</b> 3330 Piedmont Ave. N.E. Atlanta, GA 30305 1606 261-7100	<b>SUNNYVALE</b> 1254 E. El Camino Road Sunnyvale, CA 94087 1081 263-1121

# apple II plus

+ With 48K of memory!

## \$1089<sup>00</sup>



Plexiglass cover as shown **\$24<sup>95</sup>**

**MODEL 800B**



- Dot resolution graphics in six densities
- 1920 character buffer
- Fully adjustable tractor to 9-1/2"

## \$649<sup>00</sup>

**base inc.**

**EPROMS**

**2708 1Kx8 \$6.75** (8 for \$49)  
**2716 2Kx8 14.95** (8 for \$110)  
**2732 4Kx8 54.95** (2 for \$100)  
SINGLE 5 VOLT FOR 2716 & 2732

**2114L** 1024x4 Static RAM \$4.50 450 nS

**8038C** VCO waveform Gen w/fine \$2.65

**LOGIC PROBE KIT**

**74LS Series**

74LS00	28	74LS158	113
74LS01	30	74LS159	75
74LS02	30	74LS160	80
74LS04	30	74LS161	80
74LS08	30	74LS162	80
74LS10	30	74LS163	80
74LS11	30	74LS164	80
74LS12	30	74LS165	80
74LS13	30	74LS166	80
74LS14	30	74LS167	80
74LS15	30	74LS168	80
74LS16	30	74LS169	80
74LS17	30	74LS170	80
74LS18	30	74LS171	80
74LS19	30	74LS172	80
74LS20	30	74LS173	80
74LS21	30	74LS174	80
74LS22	30	74LS175	80
74LS23	30	74LS176	80
74LS24	30	74LS177	80
74LS25	30	74LS178	80
74LS26	30	74LS179	80
74LS27	30	74LS180	80
74LS28	30	74LS181	80
74LS29	30	74LS182	80
74LS30	30	74LS183	80
74LS31	30	74LS184	80
74LS32	30	74LS185	80
74LS33	30	74LS186	80
74LS34	30	74LS187	80
74LS35	30	74LS188	80
74LS36	30	74LS189	80
74LS37	30	74LS190	80
74LS38	30	74LS191	80
74LS39	30	74LS192	80
74LS40	30	74LS193	80
74LS41	30	74LS194	80
74LS42	30	74LS195	80
74LS43	30	74LS196	80
74LS44	30	74LS197	80
74LS45	30	74LS198	80
74LS46	30	74LS199	80
74LS47	30	74LS200	80
74LS48	30	74LS201	80
74LS49	30	74LS202	80
74LS50	30	74LS203	80
74LS51	30	74LS204	80
74LS52	30	74LS205	80
74LS53	30	74LS206	80
74LS54	30	74LS207	80
74LS55	30	74LS208	80
74LS56	30	74LS209	80
74LS57	30	74LS210	80
74LS58	30	74LS211	80
74LS59	30	74LS212	80
74LS60	30	74LS213	80
74LS61	30	74LS214	80
74LS62	30	74LS215	80
74LS63	30	74LS216	80
74LS64	30	74LS217	80
74LS65	30	74LS218	80
74LS66	30	74LS219	80
74LS67	30	74LS220	80
74LS68	30	74LS221	80
74LS69	30	74LS222	80
74LS70	30	74LS223	80
74LS71	30	74LS224	80
74LS72	30	74LS225	80
74LS73	30	74LS226	80
74LS74	30	74LS227	80
74LS75	30	74LS228	80
74LS76	30	74LS229	80
74LS77	30	74LS230	80
74LS78	30	74LS231	80
74LS79	30	74LS232	80
74LS80	30	74LS233	80
74LS81	30	74LS234	80
74LS82	30	74LS235	80
74LS83	30	74LS236	80
74LS84	30	74LS237	80
74LS85	30	74LS238	80
74LS86	30	74LS239	80
74LS87	30	74LS240	80
74LS88	30	74LS241	80
74LS89	30	74LS242	80
74LS90	30	74LS243	80
74LS91	30	74LS244	80
74LS92	30	74LS245	80
74LS93	30	74LS246	80
74LS94	30	74LS247	80
74LS95	30	74LS248	80
74LS96	30	74LS249	80
74LS97	30	74LS250	80
74LS98	30	74LS251	80
74LS99	30	74LS252	80
74LS100	30	74LS253	80

**SOROC TECHNOLOGY, INC.**

**TRIS-80** 16K Memory Add-On **\$46<sup>66</sup>** KIT With jumpers and instructions

**10120** \$699<sup>00</sup>

**video 100** \$129 Loedex Corp. 12" BLACK & WHITE LOW COST VIDEO MONITOR

**CONCORD COMPUTER COMPONENTS**

1971 SOUTH STATE COLLEGE ANAHEIM, CA. 92806

VISA MASTERCHARGE (714) 937-0637 MINIMUM ORDER \$10.00  
CHECK OR M.O. NO COD. We stock and sell over 12,000 types of semi-conductors. ADD \$1.50 FOR FRIT. CAL RES ADD 6%



# 150,000 customers have noticed the difference

## At HOBBYWORLD, the difference is selection

In order to satisfy the needs of so many customers, you have to offer the widest possible selection of products. Hobbyworld does just that, and all under one roof! The Hobbyworld catalog offers hundreds of products to meet just about all of your electronics needs, including: Computer systems & accessories; Terminals, printers, disk drives & other peripherals; Computerized toys & games; Disks, diskettes & cassettes; Application boards; Integrated circuits and other electronics parts.

We also feature a comprehensive library of software and books.

Add to this the famous HOBBYWORLD quality guarantee, competitive prices, and superior service — and you've got selection that can't be beat!

### What are you waiting for?

Act now! Call us toll free to request your free catalog, or circle the readers service number in this magazine — or fill out the coupon and send to:

**HOBBYWORLD ELECTRONICS, INC.**  
19511 Business Ctr. Dr. Dept. B11  
Northridge, California 91324

### FREE HOBBYWORLD CATALOG

Name \_\_\_\_\_  
Company \_\_\_\_\_  
Address \_\_\_\_\_  
City \_\_\_\_\_ State \_\_\_\_\_  
Zip \_\_\_\_\_

*Selection makes the difference.*

**HOBBYWORLD  
ELECTRONICS, INC.**

Toll-Free: USA (800) 423-5387  
Toll-Free: Calif. (800) 382-3651  
Local & Outside USA: (213) 886-9200

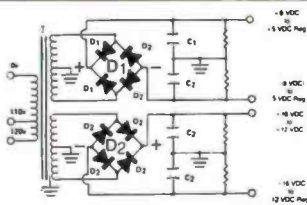

## BUILD YOUR OWN LOW COST MICRO-COMPUTER POWER SUPPLIES FOR S-100 BUS, FLOPPY DISCS, ETC!

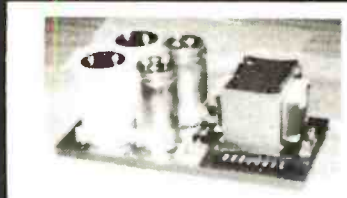

### POWER TRANSFORMERS (WITH MOUNTING BRACKETS)

ITEM NO.	USED IN KIT NO.	PRI. WINDING TAPS	SECONDARY WINDING OUTPUTS			SIZE W x D x H	UNIT PRICE
			2x 8 Vac	2x 14 Vac	2x 24 Vac		
T <sub>1</sub>	1	0V, 110V, 120V	2x 7.5A	2x 2.5A	—	3 3/4" x 3 5/8" x 3 1/8"	21.95
T <sub>2</sub>	2	0V, 110V, 120V	2x 12.5A	2x 3.5A	—	3 3/4" x 4 3/8" x 3 1/8"	27.95
T <sub>3</sub>	3	0V, 110V, 120V	2x 9A	2x 2.5A	2x 2.5A	3 3/4" x 4 3/8" x 3 1/8"	29.95
T <sub>4</sub>	4	0V, 110V, 120V	2x 4A	(28V, CT)	48V, CT, @ 3A	3 3/4" x 3 5/8" x 3 1/8"	22.95

### POWER SUPPLY KITS (OPEN FRAME WITH BASE PLATE, 3 HRS. ASSY. TIME)

ITEM	USED FOR	@ +8 Vdc	@ -8 Vdc	@ +16 Vdc	@ -16 Vdc	@ +28 Vdc	SIZE W x D x H	UNIT PRICE
KIT 1	15 CARDS SOURCE	15A	—	2.5A	2.5A	—	12" x 6" x 4 7/8"	51.95
KIT 2	SYSTEM SOURCE	25A	—	3A	3A	—	12" x 6" x 4 7/8"	58.95
KIT 3	DISC SYSTEM	15A	1A	2A	2A	4A	14" x 6" x 4 7/8"	66.95
KIT 4	DISC SOURCE	6A	1A	1A	1A	5A	10" x 6" x 4 7/8"	51.95

EACH KIT INCLUDES: TRANSFORMER, CAPACITORS, RESIS., BRIDGE RECTIFIERS, FUSE & HOLDER, TERMINAL BLOCK, BASE PLATE, MOUNTING PARTS AND INSTRUCTIONS. \*OPTION OF KIT 4: REPLACE +28V @ 5A BY +16 @ 6A.

**DISC DRIVE POWER SUPPLY "R3"** ASSY. & TESTED, OPEN FRAME, SIZE: 9"(W) x 6 1/4"(D) x 4 3/8"(H) ..... **66.95**  
 SPECS: +5V @ 5A REGUL, OVP, -5V @ 1A REG., +24V @ 5A REG., SHORTS PROTECT. OPTIONS: 1. REPLACE +24V BY +12V 2. ADD ±12V @ 1A, \$10.00 MORE.  
 IDEAL FOR 2 SHUGART 801/851 OR SIEMANS FDD 100-8/200-8 DISK DRIVES & ROCKWELL AIM-65.

SHIPPING FOR EACH TRANSFORMER: \$4.75. FOR EACH POWER SUPPLY: \$5.00 IN CALIF. \$7.00 IN OTHER STATES. CALIF. RESIDENTS ADD 6% SALES TAX. OEM WELCOME.



**MAILING ADDRESS:**  
 P.O. BOX 4296  
 TORRANCE, CA 90510

**SUNNY INTERNATIONAL**  
 (TRANSFORMERS MANUFACTURER)  
**(213) 328-2425 MON-SAT 9-6**

**SHIPPING ADDRESS:**  
 22129 1/2 S. VERMONT AVE  
 TORRANCE, CA 90502



# SOFTWARE LABS

735 LOMA VERDE, PALO ALTO, CA. 94303

PHONE: 415 493-8186

LSI-11 Z-80 8080 8085 6502

#### Database Management Systems

**HDBS** A hierarchical Database Management System featuring fixed length records, read/write protection at file level and one to many set relationships.

Z-80 Optimized	250.00
8080 Optimized	325.00
6502 Optimized	325.00

**MDBS** A large computer DBMS with hierarchical and full network data structures (CODASYL Oriented). Explicit representation of one to one, one to many, many to one and many to many sets. Routines are callable from BASIC, PASCAL, COBOL or Machine Language.

Z-80 Optimized	750.00
8080 Optimized	825.00
6502 Optimized	825.00

#### Communications

**BISYNC-80/3780** A full function IBM 2780/3780 emulator that provides one of the most widely used communications protocols. 550.00

**BISYNC-80/HASP** A full function Hasp Multi-leaving Workstation package. 800.00

**BISYNC-80/ASYNC** An asynchronous communications package that uses the full error correcting BISYNC protocol. 95.00

**BISYNC-80/3270** A full function IBM 3275 or 3271/3277 terminal emulator that converts a "dumb" terminal into a very smart one. 550.00

**Multiple License Pricing**  
 - Upon Inquiry -

\* LSI-11, PDP-11 TM DEC, UNIX TM Western Electric, CP/M TM Digital Research

#### High Level Languages

8080, 8085, Z-80 (Under OS-1 or CP/M)

**BASIC**  
 Microsoft Compiler 395.00  
 Microsoft "BASIC 80" 350.00

**FORTRAN**  
 Microsoft "FORTRAN 80" (Includes MACRO 80) 500.00

**COBOL**  
 Microsoft "COBOL 80" 750.00

**"C"**  
 Whitesmith's "C" 600.00

**PL/1**  
 Digital Research's PL/1 500.00

**PASCAL**  
 M.T. Compiler 250.00

Z-80 Optimized (Under OS-1 or CP/M)

**COBOL**  
 R-M Z-80 COBOL ANSI '74 750.00

**LSI-11\*/PDP-11\*** Under RT-11 or RSTS

**COBOL - ANSI '74** Introducing:

**RJ-11 Compiler** 1750.00

#### Applications in COBOL '74

Available in R-M COBOL, COBOL 80 and RJ-11. (Source Included)

**General Ledger** 995.00

**Accounts Receivable** 995.00

**Accounts Payable** 995.00

**Inventory Control** 995.00

**Order Entry/Invoicing** 995.00

**COMPLETE LEGAL** 4200.00

**COMPLETE DENTAL** 4200.00

Why COBOL?  
 It's portable (ANSI '74) it's universal!

#### OPERATING SYSTEMS

**Z-80 Optimized**  
**OS-1<sup>TM</sup>** A breakthrough in microcomputer software from Electrolabs! UNIX'-like OS with virtual I/O, bank-select memory control to 16 MBY and optional memory protection! Totally compatible with all CP/M programs. You will be amazed at the difference! Excellent brochure available. Includes editor, linker-loader, debugger, and one year update. 249.00

<b>8080, 8085 &amp; Z-80</b>	
CP/M Version 2.2	150.00
Manuals only	25.00
CP/M - MCZ Version 2.2. Runs on ZILOG MCZ and PDS-8000 systems.	
Only from Software Labs!	200.00
Manuals only	35.00

#### OUR CATALOGUE

Software Supplies Media  
 Storage Equipment Publications  
 - Upon Request -

#### TO ORDER

\* Price of manuals applied against software purchase.  
**By Mail:** Send check or money order (or P.O. from rated or institutional customers).  
**By Phone:** Use Master Charge or Visa No.  
**Important Note:** Please specify complete system hardware and software configuration with each order.

Contact us for new prices  
**Qume Datatrak 8**

Double sided floppy with NO HEADACHES. Although many think this an impossibility, seeing is believing, and this drive is really something! Shugart compatible, fully optioned, reliable, and rapidly becoming the standard in double-sided diskdom.

\$599. Two/\$549.



**Siemens FDD 100-8D**

Single sided 8" floppy drive, the latest & greatest revision. Features double density plus much more. An extremely reliable drive \$439 2/\$409

Hard sector option kit... \$9.95  
 Data separator option kit... \$9.95

The following 5 1/4" mini-floppies share most features with their 8" cousins, so without further ado...

- Siemens FDD 100-5D..... \$279.
  - Qume Datatrak 5 (double sided)... 399.
  - BASF Mini mini..... 279.
  - SA 400..... 299.
- All the above mini-floppies are fully SA400 compatible.

Manuals for all drives are \$10, refundable against future purchase of drives. Also, all 8" drives can be ordered with 220 v/50 hz for worldwide use.

**Accessories**



Cable kits for 8" drives with 10' 50 cond. flat cable, power cable, and all connectors. Assembled if desired. One drive 27.50, two 33.95, three 38.95 for mini floppies (34 cond): one 24.95, two, 29.95

CP-206 Power-one power supply. Powers two drives more than adequately, top quality. 2.8A/24V, 2.5A/5V, 5A/-5V. .... \$99.

mini-floppy power supply ..... \$79

**Hard Disk**

CII HB 10 MBY fully REMOVEABLE cartridge drive. Complete with controller, personality card, media, power supply, cabling, connectors and documentation. Highlighted by stylish & modern cabinetry. \$6995.

Shugart SA400B 20MBY fixed disk system. S-100, includes controller, power supply, and all that is necessary to run \$6995.



**Disk controllers**

- Delta Products double density \$349
- Micromation doubler 439
- Tarbell single density, A & T 225
- Tarbell single density, kit 184
- Tarbell double density, DMA 425
- Sorrento Valley 8" single density for Apple 375



**Electrolabs' Monthly Special!!!**

- TELEVIDEO 912C ..... \$745
- TELEVIDEO 920C ..... 812

Features typewriter keyboard, microprocessor controls, Upper/lower case, adjustable baud rates (75-9600 baud), special function keys, much more.

Second page memory option \$29.00

**Data Display Monitors**

used 12" Sylvania monitors. Composite video, 12 MHz, 120 VAC. with new P-39 or P-4 tube, \$79, used tube \$59, OEM style (without case), subtract \$12. U-fix model, 10/\$300.

**4116 dynamic RAM, 16K Bonanzall**

Set of 8, 16K, for Apple, TRS-80, Exidy, Heath & more. 200 Ns, prime parts, at the unheard of \$49/8. Large discounts available for quantity & dealers (500 & up). Offer limited while supply lasts, as these will vanish quickly!!!

**Media**



- 8" ...\$39.99 SS/SD
- 8" ...\$49.00 SS/DD
- 8" ...\$55.00 DS/SD
- 8" ...\$59.00 DS/DD
- 5 1/4" \$34.95 SS
- 5 1/4" \$59.00 DS

Verbatim, Memorex, Scotch, or equivalent name brand  
 Special Introductory Offer!!!  
 Wabash 8" diskettes \$29.00 SS  
 \$39.00 DS

Price is cheap, but they run like champs!!!!

Diskette head cleaning kit for 5 1/4" or 8" \$28.75 includes everything for 1 drive for 1 year. Alignment Diskette for Floppy Drives..... \$39.00

**Electrolabs**

POB 4436, Stanford, CA 94305

415-321-5601 800-227-8266

Telex: 345567 (Electrolab Pla)

Visa MC Am. Exp.



**ENCLOSURES**

Rackmount Mainframe MT-200. This gorgeous beast is so appealing that it can easily function also as stand-alone mainframe. Very modern styling with fully actively terminated S-100 bus.

With two 8" single-sided disk drives... \$1899.

With two 8" double sided disk drives in place of single-sided variety..... \$2499.

Desktop Mainframe MT-100. Contemporary styling, a handsome cabinet coated with durable epoxy finish colors (blue, beige, off-white & silver). Easy to fit into an office environment. The proper way to start your system.

Above plus two 8" single sided disk drives..... \$1599.

Above with two 8" double sided disk drives in place of single-sided variety..... \$2199.

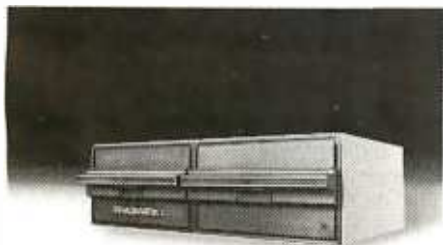

**PRAGMATIX 1**

Incredible!! - Two 8" Shugart compatible single sided floppy disk drives (double density), CP-206 power supply, in handsome color coordinated cabinet, with full cabling, connectors, and documentation, plus one box diskettes!!! All for an unprecedented \$1865. Up to one MBY of storage.

with Qume Datatrak 8" double-sided drive \$2495

\$25 min. order. Calif. residents add 6% sales tax. Orders under \$75, add 5% shipping and handling, over \$75 add 2.5%. All pricing subject to change without notice.

# Add-On Disk Drive Subsystems For Apple, TRS-80, S-100 Based Computers

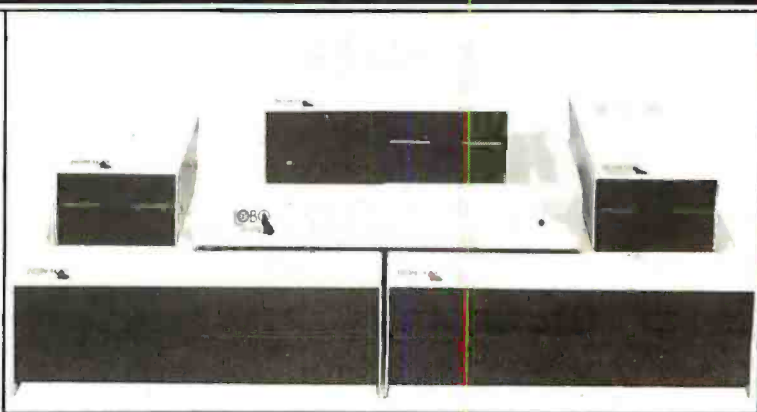

Expansion and enhanced capabilities are key words in achieving full utilization of your computer system. Our complete line of LOBO disk drive subsystems are the ideal, cost-effective way to provide the expansion capabilities you need to meet your system growth requirements. All of our subsystems are complete, thoroughly-tested, 100% burned-in, and feature a 1 year 100% parts/labor warranty.

## APPLE

3101	Minifloppy
3101I	Minifloppy w/interface card
8101CA	One SA800 in cabinet w/power, SVA Controller, cable and manual
8202CA	Two SA800 in cabinet w/power, SVA Controller, cable and manual
5101CA	One SA850 in cabinet w/power, SVA Controller, cable and manual
5202CA	Two SA850 in cabinet w/power, SVA Controller, cable and manual

## S-100 BASED COMPUTERS

MODEL NO.	DESCRIPTION
4101C	SA400 In cabinet w/power
8212C	Two SA801 in cabinet w/power
5212C	Two SA851 in cabinet w/power

## GENERAL

MODEL NO.	DESCRIPTION
8212	Two SA801 in cabinet
8212C	Two SA801 in cabinet w/power
5212	Two SA851 in cabinet
5212C	Two SA851 in cabinet w/power

## TRS80

MODEL NO.	DESCRIPTION	MODEL NO.	DESCRIPTION
4101C	SA400 in cabinet w/power	C808	Cable for TRS80 Eight-inch Floppy
8101C II	One SA800 in cabinet w/power for Mod. II	LX80	Double-density expansion interface
8202C II	Two SA800 In cabinet w/power for Mod. II	RS232	Dual Serial Port Option
C802	Cable for Mod. II	16K	16K Byte RAM for LX80 (32KB max.)
C805	Cable for TRS80 Minifloppy	VTOS	4.0 Disk Operating System

**JR**  
**INVENTORY CO.,**  
P.O. Box 185, Santa Yuez, Ca., 93640  
(805) 688-8781

1771 Junction Avenue  
San Jose, California 95112  
(408) 295-7247  
(408) 295-7171

**component supply, inc.**

## Yes! We supply **IMSAI** products...

**RAM III Assembled & Tested:** 64K Byte dynamic RAM BOARD— Utilizes the Intel 3242 refresh controller and a single delay line for total internal refresh. Uses time proven 4116 RAMS. Memory mapped I/O boards are allowed to coexist by the use of A16 buss pin 16.  
Assembled & Tested **Price \$350.**

**I8080 SYSTEM Assembled & Tested:** The basic 8080 based system. Includes CPA front panel, 22 slot motherboard (with all 22 edge connectors), MPU-A 8080 processor board, PS28 power supply (28AMP +8V 3AMP -16V), and chassis.  
**I8080** With MPU-A **\$650.** Without MPU-A **\$600.**  
**Options:** Thinker Toys Motherboard \$75 extra

**I8080 ENCLOSURE Sheet Metal Only:** THE ORIGINAL IMSAI: Mainframe with blue cover, cardguides and hardware spaced for 28A power supply, up to 22 slot motherboard.  
• Either jump start or front panel  
• Uses various motherboards  
**Price \$95.**

**IMSAI PS28D Parts Kit:** Mounts in the I8080 mainframe + 5V 28A, -/+16V 3A, kit includes board, transformer, and all components.  
**KIT \$95.50**

Terms: (1) **PREPAID**—Send check for merchandise amount only— We pay the shipping —or— (2) **UPS C.O.D.** and bank card orders by phone or mail. Shipping charges will be added. California residents add 6½% sales tax.

**WRITE FOR FLYER OR VISIT OUR STORE**



# DIGITAL RESEARCH COMPUTERS

(214) 271-3538

## 32K S-100 EPROM CARD

**NEW!**

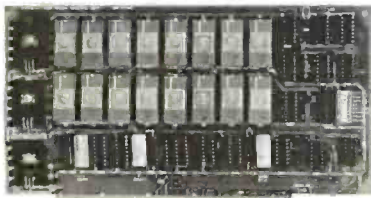

**\$74.95**  
KIT

USES 2716's  
Blank PC Board - \$34  
ASSEMBLED & TESTED  
ADD \$30

SPECIAL: 2716 EPROM's (450 NS) Are \$14.95 EA. With Above Kit.

**KIT FEATURES:**

1. Uses +5V only 2716 (2Kx8) EPROM's.
2. Allows up to 32K of software on line!
3. IEEE S-100 Compatible
4. Addressable as two independent 16K blocks.
5. Cromemco extended or Northstar bank select.
6. On board wait state circuitry if needed.
7. Any or all EPROM locations can be disabled.
8. Double sided PC board, solder-masked, silk-screened.
9. Gold plated contact fingers.
10. Unselected EPROM's automatically powered down for low power.
11. Fully buffered and bypassed.
12. Easy and quick to assemble.

## 16K DYNAMIC RAM PARTIALS

**LOOK!** INTEL 2108 8K X 1 RAMS **LOOK!**  
8 FOR \$9.95 32 FOR \$35  
**FACTORY PRIME!**

Huge special purchase of INTEL Dynamic RAM's. These are 2108-4, 300NS, 8K, Ceramic DIP. The 2108 is the INTEL 2116 (16K) tested for either upper or lower 8K only. These are factory prime. Full Spec. See INTEL 1978 Cat. for details or Memory Design Handbook for application data. Both IMSAI and EXTENSYS did mfg. S-100 RAM boards using these devices. — P.S. These devices will not work in the SD EPANDORAM™. Please specify upper or lower 8K. (S1626 or S1627). A super easy RAM to interface to a Z80, 16 PIN DIP.

FOR 4MHZ **PRICE CUT!** **LOW POWER - 300NS** 8 FOR \$37.50  
**2114 RAM SALE!**  
4K STATIC RAM'S. MAJOR BRAND, NEW PARTS.  
These are the most sought after 2114's, LOW POWER and 300NS FAST.  
8 FOR \$37.50

## 16K STATIC RAM KIT-S 100 BUSS

PRICE CUT!

**\$199.95**  
KIT

FOR 4MHZ  
ADD \$10

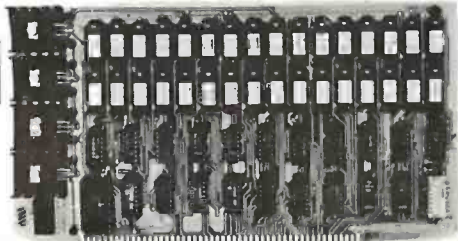

**KIT FEATURES:**

1. Addressable as four separate 4K Blocks.
2. ON BOARD BANK SELECT circuitry. (Cromemco Standard). Allows up to 512K on line!
3. Uses 2114 (450NS) 4K Static Rams.
4. ON BOARD SELECTABLE WAIT STATES.
5. Double sided PC Board, with solder mask and silk screened layout. Gold plated contact fingers.
6. All address and data lines fully buffered.
7. Kit includes ALL parts and sockets.
8. PHANTOM is jumpered to PIN 67.
9. LOW POWER: under 1.5 amps TYPICAL from the +8 Volt Buss
10. Blank PC Board can be populated as any multiple of 4K.

BLANK PC BOARD W/DATA-\$34  
LOW PROFILE SOCKET SET-\$12  
SUPPORT IC'S & CAPS-\$19.95  
ASSEMBLED & TESTED-ADD \$35

**OUR #1 SELLING  
RAM BOARD!**

## 16K STATIC RAM SS-50 BUSS

PRICE CUT!

**\$210** KIT

FULLY STATIC!

FOR 2MHZ  
ADD \$10

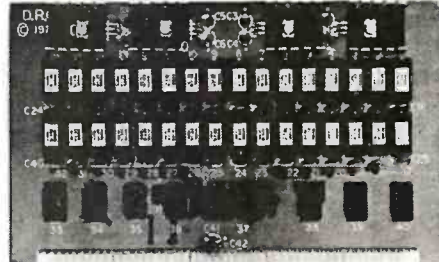

FOR SWTPC  
6800 BUSS!

ASSEMBLED AND  
TESTED - \$35

**KIT FEATURES:**

1. Addressable on 16K Boundaries
2. Uses 2114 Static Ram
3. Fully Bypassed
4. Double sided PC Board. Solder mask and silk screened layout.
5. All Parts and Sockets included
6. Low Power: Under 1.5 Amps Typical

BLANK PC BOARD—\$30 COMPLETE SOCKET SET—\$12  
SUPPORT IC'S AND CAPS—\$19.95

## NEW! STEREO! S-100 SOUND COMPUTER BOARD NEW!

At last, an S-100 Board that unleashes the full power of two unbelievable General Instruments AY3-8910 NMOS computer sound IC's. Allows you under total computer control to generate an infinite number of special sound effects for games or any other program. Sounds can be called in BASIC, ASSEMBLY LANGUAGE, etc.

**KIT FEATURES:**

- \* TWO GI SOUND COMPUTER IC'S.
  - \* FOUR PARALLEL I/O PORTS ON BOARD.
  - \* USES ON BOARD AUDIO AMPS OR YOUR STEREO.
  - \* ON BOARD PHOTO TYPING AREA.
  - \* ALL SOCKETS, PARTS AND HARDWARE ARE INCLUDED.
  - \* PC BOARD IS SOLDERMASKED, SILK SCREENED, WITH GOLD CONTACTS.
  - \* EASY, QUICK, AND FUN TO BUILD. WITH FULL INSTRUCTIONS.
  - \* USES PROGRAMMED I/O FOR MAXIMUM SYSTEM FLEXIBILITY
- Both Basic and Assembly Language Programming examples are included.

**SOFTWARE:**

SCL™ is now available! Our Sound Command Language makes writing Sound Effects programs a SNAP! SCL™ also includes routines for Register-Examine-Modify, Memory-Examine-Modify, and Play-Memory. SCL™ is available on CP/M™ compatible diskette of 2708 or 2716. Diskette—\$24.95 2708 - \$19.95 2716 - \$29.95 Diskette includes the source. EPROM's are ORG at E000H.

**COMPLETE KIT!**

**\$84.95**

(WITH DATA MANUAL)

BLANK PC  
BOARD W/DATA  
\$31

## 4K DYNAMIC RAM BLOWOUT!

SAME AS INTEL 2107B!

4K RAMS AT AN UNBELIEVABLE 50¢ EACH!!!

Prime, new, National Semi., 1979 date coded, full spec. parts. N.S. #MM5280-5N. Same as INTEL 2107B-4, T.I. TMS4060, NEC uPD411, etc. We bought a HUGE QTY. from a West Coast Distributor at truly DISTRESS PRICES! One of the most popular and reliable RAM's ever made. These parts have been used by almost all Major Computer Main Frame Mfg. the world over! Arranged as 4K x 1, 270NS Access Time, 22 Pin Dip. These units DO NOT use multiplexed addressing, thus making REFRESH and other timing very simple. See INTEL MEMORY DESIGN HANDBOOK for full application notes. The NAT. SEMI. MEMORY DATA BOOK is available at most Radio Shack Stores. Prime units in original factory tubes!

#5280-5N 4096 BITS x 1 270 NS ACCESS

8 FOR \$4.95 32 FOR \$16

FACTORY CASE (450 PCS) — \$180

Sockets Special: 22 Pin Low Profile (With Purchase of 5280's) 8 FOR \$1.

(With Pin  
Out Data)

## COMPUTER PARTS SPECIALS

- |                |                                    |
|----------------|------------------------------------|
| 74LS175 - .99  | 8035 Intel Single Chip CPU - 5.95  |
| 74LS240 - 1.79 | Signetics 2901 4 Bit Slice - 6.95  |
| 74LS241 - 1.79 | AMD 2903 4 Bit Super Slice - 12.50 |
| 74LS244 - 1.79 | AMD 29705 Dual Port RAM - 8.95     |
| 74LS373 - 1.99 |                                    |

## NEW! G.I. COMPUTER SOUND CHIP

AY3-8910. As featured in July, 1979 BYTE! A fantastically powerful Sound & Music Generator. Perfect for use with any 8 Bit Microprocessor. Contains: 3 Tone Channels, Noise Generator, 3 Channels of Amplitude Control, 16 bit Envelope PerIOD Control, 2-8 Bit Parallel I/O, 3 D to A Converters, plus much more! All in one 40 Pin DIP. Super easy interface to the S-100 or other busses. \$11.95 PRICE CUT!

SPECIAL OFFER: \$14.95 each Add \$3 for 60 page Data Manual.

**Digital Research Computers**  
(OF TEXAS)

P.O. BOX 401565 • GARLAND, TEXAS 75040 • (214) 271-3538

TERMS: Add \$1.50 postage. We pay balance. Orders under \$15 add 75¢ handling. No C.O.D. We accept Visa and MasterCard. Tex. Res. add 5% Tax. Foreign orders (except Canada) add 20% P & H 90 Day Money Back Guarantee on all items: Orders over \$50, add 85¢ for insurance.

### HEX ENCODED KEYBOARD

Four onboard LEOs indicate the HEX code generated for each key depression. The board requires a single +5 volt supply. Board only \$15.00 Part No. HEX-3, with parts \$49.95 Part No. HEX-3A. 44 pin edge connector \$4.00 Part No. 44P.

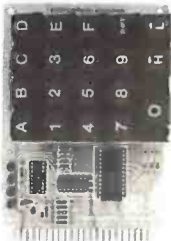

### ASCII TO CORRESPONDENCE CODE CONVERTER

This bidirectional board is a direct replacement for the board inside the Trendata 1000 terminal. The on board connector provides RS-232 serial in and out. Sold only as an assembled and tested unit for \$249.95. Part No. TA 1000C

### ASCII KEYBOARD

53 Keys popular ASR-33 format • Rugged G-10 P.C. Board • Tri-mode MOS encoding • Two-Key Rollover • MOS/DTL/TTL Compatible • Upper Case lockout • Data and Strobe inversion option • Three User Definable Keys • Low contact bounce • Selectable Parity • Custom Keycaps • George Risk Model 753. Requires +5, -12 volts. \$59.95 Kit.

### ASCII KEYBOARD

TTL & DTL compatible • Full 67 key array • Full 128 character ASCII output • Positive logic with outputs resting low • Data Strobe • Five user-definable spare keys • Standard 22 pin dual card edge connector • Requires +5VDC, 325 mA. Assembled & Tested. Cherry Pro Part No. P70-05AB. \$119.95.



### A-to-D D-to-A CONVERTER



Analog to Digital, Digital to Analog Converter. A-D conversion time 20µs. D-A conversion 5µs. Uses include speech and music synthesizing and slow scan TV. Single power supply (5V), 8 Bits wide, latched I/O, strobe lines. Part No. 792B7K Complete Kit \$49.95 • Part No. 792B7A Assembled \$69.95

### SOLID STATE SWITCH



Your computer can control power (120VAC) to your printer, lights, and other 120VAC appliances up to 720 watts (6AMPS at 120VAC). Input 3 to 15 VDC, 2-13 MA TTL compatible, isolation 1500V. Part No. 79000K 1 Channel Kit \$9.95 • Assm. \$12.50 • Part No. 79004K 4 Channel Kit \$34.95 • Assm. \$44.95.

### SUPER MODEM



Originate, RS-232 and 20 mA compatible, Full duplex, and half duplex, direct connect or acoustic coupled, on board power supply, carrier detect light, DB25 plug, 300 BAUD, Type 103 compatible frequencies, Bare board Part No. 2000, \$19.95, Kit Part No. 2000A, \$99.95.

### T.V. INTERFACE



• Converts video to AM modulated RF, Channels 2 or 3. So powerful almost no tuning is required. On board regulated power supply makes this extremely stable. Rated very highly in Doctor Dobbs' Journal. Recommended by Apple • Power required is 12 volts AC C.T., or +5 volts DC • Board only \$7.60 part No. 107, with parts \$13.50 Part No. 107A

### TAPE INTERFACE



• Converts a low cost tape recorder to a digital recorder • Works up to 1200 baud • Digital in and out are TTL serial • Output of board connects to mic. in of recorder • Earphone of recorder connects to input on board • No coils • Requires +5 volts, low power drain • Board only \$7.60 Part No. 111, with parts \$29.95 Part No. 111A

### T.V. TYPEWRITER



• Stand alone TVT • 32 char/line, 16 lines, modifications for 64 char/line included • Parallel ASCII (TTL) input • Video output • 1K on board memory • Output for computer controlled cursor • Auto scroll • Non-destructive cursor • Cursor inputs: up, down, left, right, home, EOL, EOS • Scroll up, down • Requires +5 volts at 1.5 amps, and -12 volts at 30 mA • All 7400, TTL chips • Char. gen. 2513 • Upper case only • Board only \$39.00 Part No. 106, with parts \$145.00 Part No. 106A

### UART & BAUD RATE GENERATOR



• Converts serial to parallel and parallel to serial • Low cost on board baud rate generator • Baud rates: 110, 150, 300, 600, 1200, and 2400 • Low power drain +5 volts and -12 volts required • TTL compatible • All characters contain a start bit, 5 to 8 data bits, 1 or 2 stop bits, and either odd or even parity. • All connections go to a 44 pin gold plated edge connector • Board only \$12.00 Part No. 101, with parts \$35.00 Part No. 101A, 44 pin edge connector \$4.00 Part No. 44P

### 44 BUS MOTHER BOARD



Has provisions for ten 44 pin (.156) connectors, spaced 3/4 of an inch apart. Pin 20 is connected to X, and 22 is connected to Z for power and ground. All the other pins are connected in parallel. This board also has provisions for bypass capacitors. Board cost \$15.00 Part No. 102. Connectors \$3.00 each Part No. 44WP.

### RS-232/20mA INTERFACE



This board has two passive, opto-isolated circuits. One converts RS-232 to 20mA, the other converts 20mA to RS-232. All connections go to a 10 pin edge connector. Requires +12 and -12 volts. Board only \$9.95, part no. 7901, with parts \$14.95 Part No. 7901A.

### SOROC IQ 120



Upper/lower case display • Numeric keypad & cursor keys • Protected fields, 1/2 intensity display • RS 232 interface & aux. port. IQ120—\$799.95 • IQ140 Detachable keyboard—\$1199.95

### MODEM



• Type 103 • Full or half duplex • Works up to 300 baud • Originate or Answer • Serial TTL input and output • connect B & speaker and crystal mic. directly to board • Requires +5 volts • Board only \$7.60 Part No. 109, with parts \$29.95 Part No. 109A.

### RS-32/TTL INTERFACE

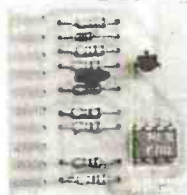

• Converts TTL to RS-232, and converts RS-232 to TTL • Two separate circuits • Requires -12 and +12 volts • All connections go to a 10 pin edge connector. kit \$9.95 Part No. 232A10P, edge connector \$3.00 part No. 10P.

### COMPCOLOR II



With reg. keyboard MOD3 BK \$1449.95 MOD4 16 K \$1495.95 MOD5 32K \$1699.95 Without disk drive subtract \$450.00. Add-on drives, \$495.00 With 101 key option add \$134.95. With 117 key option add \$179.95.

### DC POWER SUPPLY

• Board supplies a regulated +5 volts at 3 amps., +12, -12, and -5 volts at 1 amp. • Power required is 8 volts AC at 3 amps., and 24 volts AC C.T. at 1.5 amps. • Board only \$12.50 Part No. 6085, with parts excluding transformers \$42.50 Part No. 6085A



Send for FREE Catalog...a big self addressed envelope with 80¢ postage gets it fastest!

### To Order:

Mention part no., description, and price. In USA shipping paid by us for orders accompanied by check or money order. We accept C.O.D. orders (U.S. only) or a VISA or Master Charge no., expiration date, signature and phone no., shipping charges will be added. CA residents add 6.5% for tax. Outside USA add 15% for air mail postage and handling. Payment must be in U.S. dollars. Dealer inquiries invited. Prices subject to change without notice.



Order Line: (408) 448-0800

**ELECTRONIC SYSTEMS** Dept. B, P.O. Box 21638, San Jose, CA USA 95151

## Apple II Or APPLE II PLUS



16K \$975.95, Extra 16K E.S. RAM installed \$74.95, extra 32K E.S. RAM installed \$148.95.

**APPLE II HOBBY/ PROTOTYPING CARD**  
Part No. 7907 \$14.95

## APPLE II PARALLEL INTERFACE

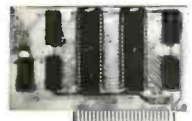

Interfaces printers, synthesizers keyboards, and JBE A-D D-A Converter & Switches. This interface has 4 I/O ports with handshaking logic, 2-6522 VIA's and a 74LS74 for timing. Inputs and outputs are TTL compatible. Part No. 79295K Complete Kit—\$69.95 • Part No. 79295A Assembled—\$79.95

## REAL TIME 100,000 DAY CLOCK

**MT. HARDWARE** Double the utility of your S-100 bus computer with a real-time clock that keeps time in 100µs increments for over 273 years. Program events for the entire period with real time interrupts...without derailing the system. Maintain a log of computer usage, time and date transaction printouts, callup lists. On-board battery backup. MHPX004—\$349.00

## 16K EPROM



Uses 2708 EPROMs, memory speed selection provided, addressable anywhere in 65K of memory, can be shadowed in 4K increments. Board only \$24.95 part no. 7902, with parts less EPROMs \$49.95 part no. 7902A.

## PET COMPUTER



With 16K & monitor—\$895.00 • Dual Disk Drive—\$1095.00

## OPTO-ISOLATED PARALLEL INPUT BOARD FOR APPLE II

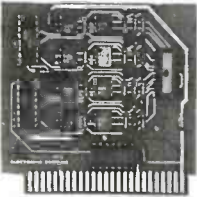

There are 8 inputs that can be driven from TTL logic or any 5 volt source. The circuit board can be plugged into any of the 8 sockets of your Apple II. It has a 16 pin socket for standard dip ribbon cable connection. Board only \$15.00. Part No. 120, with parts \$69.95. Part No. 120A.

## VIDEO TERMINAL



16 lines, 64 columns • Upper and lower case • 5x7 dot matrix • Serial RS-232 in and out with TTL parallel keyboard input • On board baud rate generator 75, 110, 150, 300, 600, & 1200 jumper selectable • Memory 1024 characters (7-21L02) • Video processor chip SFF96364 by Neculonic • Control characters (CR, LF, →, ←, ↑, ↓, non destructive cursor, CS, home, CL) • White characters on black background or vice-versa • With the addition of a keyboard, video monitor or TV set with TV interface (part no. 107A) and power supply this is a complete stand alone terminal • also S-100 compatible • requires +16, & -16 VDC at 100mA, and BVDC at 1A. Part No. 1000A \$199.95 kit.

## PARALLEL TRIAC OUTPUT BOARD FOR APPLE II



This board has 8 triacs capable of switching 110 volt 6 amp loads (660 watts per channel) or a total of 5280 watts. Board only \$15.00 Part No. 210, with parts \$119.95 Part No. 210A

## APPLE II\* SERIAL I/O INTERFACE



Baud rate is continuously adjustable from 0 to 30,000 • Plugs into any peripheral connector • Low current drain, RS-232 input and output • On board switch selectable 5 to 8 data bits, 1 or 2 stop bits, and parity or no parity either odd or even • Jumper selectable address • SOFTWARE • Input and Output routine from monitor or BASIC to teletype or other serial printer • Program for using an Apple II for a video or an intelligent terminal. Also can output in correspondence code to interface with some selectrics. • Also watches DTR • Board only \$15.00 Part No. 2, with parts \$42.00 Part No. 2A, assembled \$62.00 Part No. 2C

## 8K EPROM PIGEON

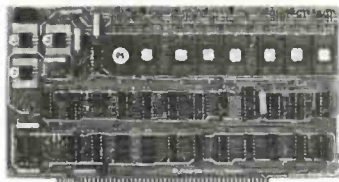

• Programs 2708's address relocation of each 4K of memory to any 4K boundary • Power on jump and reset jump option for "turnkey" systems and computers without a front panel • Program saver software in 1 2708 EPROM \$25. Bare board \$35 including custom coil, board with parts but no EPROMs \$139, with 4 EPROMs \$179, with 8 EPROMs \$219.

## WAMECO PRODUCTS

With ELECTRONIC SYSTEMS parts

- FDC-1** FLOPPY CONTROLLER BOARD will drive shugart, pertek, remex 5" & 8" drives up to 8 drives, on board PROM with power boot up, will operate with CPM (not included). PCB0 ..... \$42.95
- FPB-1** Front Panel, (Finally) IMSA1 size hex displays. Byte or instruction single step. PCB0 ..... \$42.95
- MEM-1A** 8KxB fully buffered, S-100, uses 2102 type RAMS. PCB0 ..... \$24.95, \$168 Kit
- QMB-12** MOTHER BOARD, 13 slot terminated, S-100 board only ..... \$34.95 \$89.95 Kit
- CPU-1** 8080A Processor board S-100 with 8 level vector interrupt PCB0 ..... \$25.95 \$89.95 Kit
- RTC-1** Realtime clock board. Two independent interrupts. Software programmable. PCB0 ..... \$25.95, \$60.95 Kit
- EPM-2** 2708/2716 16K/32K EPROM card PCB0 ..... \$24.95 \$49.95 with parts less EPROMS
- QMB-9** MOTHER BOARD, Short Version of QMB-12, 9 Slots PCB0 ..... \$30.95 \$67.95 Kit
- MEM-2** 16Kx8 Fully Buffered 2114 Board PCB0 ..... \$25.95, \$269.95 Kit

YOU MUST REFER TO THIS AD TO GET THESE PRICES.

## D.C. HAYES MICROMODEM



Fully S-100 bus compatible including 16-bit machines and 4 MHz processors. • Two software selectable Baud rates—300 Baud and a jumper selectable speed from 45 to 300 Baud. (110 standard). Supports originate and answer modes. • Direct-connect Microcoupler. This FCC-registered device provides direct access into your local telephone system, with none of the losses or distortions associated with acoustic couplers and without a telephone company supplied data access arrangement. • Auto-Answer/Auto-Call. The MICROMODEM 100 can automatically answer the phone and receive input; it can also dial a number automatically. • Automatic Reset and Disconnect. • Software compatible with the D.C. Hayes Associates 80-103A Data Communications Adapter. Micromodem-DCHA32625—\$379.95

## TIDMA



Tape Interface Direct Memory Access • Record and play programs without bootstrap loader (no prom) has FSK encoder/decoder for direct connections to low cost recorder at 1200 baud rate, and direct connections for inputs and outputs to a digital recorder at any baud rate. • S-100 bus compatible • Board only \$35.00 Part No. 112, with parts \$110.00 Part No. 112A.

## SYSTEM MONITOR

8080, 8085, or Z-80 System monitor for use with the TIDMA board. There is no need for the front panel. Complete with documentation \$12.95.

## RS-232/TTY INTERFACE



This board has two active circuits, one converts RS-232 to 20mA, the other converts 20mA to RS-232. Requires +12 and -12 volts. \$9.95 Part no. 600A Kit.

## SERIAL I/O



Four Serial I/O RS-232 ports. S-100 Bus, Software or jumper selectable baud rate (110, 300, 600, 1200, 2400, 4800, 9600, 19.2K), on board Xtal baud rate generator, Addressing, switch selectable, Parity or no parity (odd or even) switch selectable, 1 or 2 stop bits, 5 to 8 bits/character. Board only \$29.95, Part No. 7908. With parts (kit) \$199.95, Part No. 7908A.

## S-100 BUS ACTIVE TERMINATOR



Board only \$14.95 Part No. 900, with parts \$24.95 Part No. 900A

Send for FREE Catalog...a big self addressed envelope with 80¢ postage gets it fastest!

## To Order:

Mention part no., description, and price. In USA shipping paid by us for orders accompanied by check or money order. We accept C.O.D. orders (U.S. only) or a VISA or Master Charge no., expiration date, signature and phone no., shipping charges will be added. CA residents add 6.5% for tax. Outside USA add 15% for air mail postage and handling. Payment must be in U.S. dollars. Dealer inquiries invited. Prices subject to change without notice.



Order Line: (408) 448-0800

**ELECTRONIC SYSTEMS** Dept. B, P.O. Box 21638, San Jose, CA USA 95151

## 6502 USERS!

Upgrade your present 6502 system to 6809 capability with a 65-09 module.

Simple installation. No modification to existing hardware required. Software also available for most major systems.

65-09 Module Kit ..... \$110.00  
65-09 Module Assembled/Tested . . . 135.00  
2K Eprom Monitor ..... 59.95

Michigan residents add 4% sales tax.  
Send check, money order or COD to:

**MICRO PROCESSOR SYSTEMS, INC.**  
37060 Garfield, Suite C4  
Mt. Clemens, MI 48043  
(313) 263-9440

Circle 342 on inquiry card.

## OHIO SCIENTIFIC SYSTEMS

CALL FREE FOR OUR PRICES  
(800) 558-0870

or

WRITE FOR CATALOG

### FARAGHER & ASSOCIATES

7635 BLUEMOUND  
MILWAUKEE, WI 53213  
(414) 258-2588  
In Wisconsin

Circle 343 on inquiry card.

## HOLD THAT TIGER! (OR OTHER PRINTER)



**\$99.00**  
plus \$5.00  
shipping

- STAND WITH PAPER-TRAY
- MADE FROM 3/4" STURDY STOCK
- OFFICE-TYPE WALNUT FINISH
- COMPLETELY ASSEMBLED. NOT A KIT
- 18"W x 12"D x 27"H

5 1/4% sales tax for IL orders

**RMF PRODUCTS, INC.**  
P.O. Box 413 • Batavia, IL 60510  
Phone (312) 879-0020  
DEALER INQUIRIES INVITED

Circle 344 on inquiry card.

## dbis

YOUR HEADQUARTERS FOR

### OHIO SCIENTIFIC

SALES • SERVICE • SUPPORT

THE BEST NEW YORK AREA PRICES  
ON ALL OHIO SCIENTIFIC COMPUTERS  
- LOCAL USERS GROUP -  
BUSINESS AND PERSONAL SYSTEMS

PROFESSIONAL BUSINESS SOFTWARE:

Systems now available:  
Encumbered Budget Accounting  
Inventory/Invoicing Export Management  
Mailing List Payroll  
Accounts Receivable Accounts Payable  
Manuals available separately.....\$35

ALSO AVAILABLE:

\*Eaton LRC 7000+ Plain Paper Printer...\$356.  
\*Okidata Microline 80 Printer -  
upper/lower case, graphics, any paper,  
software selectable print size.....\$95.

MASTERCHARGE & VISA WELCOME

Designers & Builders of Information Systems, Inc.

One Mayfair Road - Eastchester, New York 10707

(914)779-5292 (212) 933-4170

Circle 345 on inquiry card.

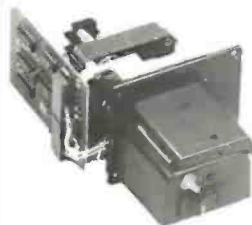

### 350 Char/Sec Low Cost Loader

Solid state photoelectronic components read all standard 5, 6, 7 or 8-level tapes. Smooth, quiet AC drive. Reliable high-speed paper tape data entry. Data amplifiers and "character ready" output available for CMOS or TTL interfaces. Standard interface or to your interface specifications. Fanfold boxes available.

**Addmaster Corporation, 416 Junipero Serra Drive, San Gabriel, CA 91776, Telephone: (213) 285-1121, Telex: 674770 Addmaster SGAB**

Circle 346 on inquiry card.

## The Software Toolworks

### H89/H8/Z89

SOFTWARE TOOLS THAT WORK

**MYCHESS - Now on H89 - \$34.95**

Winner-1980 West Coast Computer Faire

- FULL SCREEN EDITORS  
For Text Files; For Graphics
- TEXT PROCESSING:  
TEXT Formatter
- LANGUAGES: C, LISP, Z80 and  
8080 Macro Assemblers
- UTILITIES ● GAMES  
**Only \$19.95 - \$39.95**

All run under HDOS, some available for CP/M

Available at most Heathkit stores or from

THE SOFTWARE TOOLWORKS

14478 Gionetta Drive

Sherman Oaks, Calif. 91423

(213)986-4885

Heathkit is a registered trade mark of Heath Company  
CP/M is a registered trade mark of Digital Research

Circle 347 on inquiry card.

### COMPUTER EQUIPMENT & SOFTWARE BARGAINS



EVERY MONTH

BUY, SELL OR TRADE ALL TYPES OF COMPUTER EQUIPMENT AND SOFTWARE (pre-owned and new) among 20,000 readers nationwide in BIG (11x14") pages. Classified ads are only 10¢ per word and are indexed for easy and fast location. Subscription: \$10 a year/12 issues. Money back guarantee.

**COMPUTER SHOPPER**

P.O. Box F-14

Titusville, FL 32780

(305) 269-3211

MasterCharge or VISA orders only,

Call TOLL FREE 800-327-9920

Circle 348 on inquiry card.

add the sound dimension to your system  
**NOISEMAKER!**

Soundboard uses two GI AY 3-8910 I.C.'s to generate sound effects under software control. PCB only \$34.95.

Send for additional information, check or money order to:

**Ackerman**

**Digital Systems, Inc.**

110 North York Road • Suite 208

Elmhurst, Illinois 60126

Tel. 312-530-8992

(Illinois residents add 5% state sales tax.)

Circle 349 on inquiry card.

## BIRD™

Versatile Interface Peripheral Board  
Serial/Parallel I/O For The Apple II

**SERIAL FEATURES:** Software Baud Rate Select • 50-19.2 K Baud • Crystal Controlled • Partial 26 Pin Connector Strapping • RS232C

**PARALLEL FEATURES:** Centronics Compatible • Full 34 Pin I/O Connector Strapping • 16 I/O Lines + 4 Handshakes

**ALSO:** 256 Bytes On Board Ram • ALL GOLD Connectors/Seckets • 6 Foot 34 Conductor Ribbon Cable With Centronics Compatible Connector • 3 Foot Serial Ribbon Cable With Male DB25 Connector • 90 Day Limited Warranty • Documentation with Driver Software

SMS \* VIP \$169.95 ea A & T

Shipping Add 2.0% • Texas Residents Add 5% Sales Tax • Payment By Check or Money Order

BIRD \* BOARDS

Southwestern Management Services, Ltd.

Box 7277 Austin Texas 78712

Phone 512-327-1834

Circle 350 on inquiry card.



**DEALS □ DEALS □ DEALS**

OUR BUYERS ARE IN  
CONTACT WITH EVERY MAJOR  
SUPPLIER AND O.E.M.  
BUY HERE AT 1000 PIECE



# MICRO SALES

## QUANTITY PRICES

ALL MERCHANDISE 100%  
GUARANTEED! 15 DAY FULL  
CASH REFUND!

664 N. MICHIGAN AVE. • SUITE 1016 • CHICAGO, ILLINOIS 60611  
CALL TOLL FREE: 1-800-435-9357  
(ILLINOIS RESIDENTS CALL: 815-485-4002)

TERMS: Prepayment - C.O.D. up to \$100.00 - M/C, Visa  
Please allow personal check to clear before shipment.

## WRITE FOR FULL CATALOG!

### JUST HOT STUFF

#### POWER SUPPLIES

If you can beat these prices we will be truly amazed. OEM's at 500 lot pay more than this. Call or write for full spec. sheets.



DISK POWER SUPPLIES			
PRIAM - SHUGART - CENTURY - MICROPOLIS			
+5V @ 9A	-5V @ 8A	+24V @ 7A	US-384 89.00
SHUGART - SIEMANS - MPI 5 1/2"			
+5V @ 5A	+12V @ .9A		US-340 33.50
+5V @ 2A	+12V @ 4A		US-323 56.25
SHUGART - SIEMANS - CDC 8"			
+5V @ 1A	-5V @ 5A	+24V @ 1.5A	US-205 52.50
+5V @ 2A	-5V @ 5A	+24V @ 3A	US-206 69.00
+5V @ 3A	-5V @ .6A	+24V @ 5A	US-162 89.00
+5V @ 1.7A	-5V @ 1.5A	+24V @ 2A	US-272 69.00
+5V @ 2A	+12V @ .4A	-12V @ .4A	US-HTAA 37.50

#### TELEVIDEO 912C

**\$665.00**

Also have 920C, SOROC, HAZELTINE, etc. What we don't have is room on this page. Call Toll Free 800 number for prices.



#### C-ITOH PRINTER

**\$499.00**

Look closely at the photo and see other adds in this rag at \$995.00. Perfect units, warranted. Only 500 pcs. Same story, manufacturer had too many.



#### ATARI

800 - \$899.00

400 - \$499.00

As long as there is a price war, we will fight your battle. Compare at your local Dept. store and buy U\$ MICRO.



#### S-100 POWER

**\$49.50**

Simple Brute Force! S-100 Power Supply, 30A @ +8V, 6A @ +16V, 6A @ -16V, PC Board Design.



### SPECIAL OF THE QUARTER

#### DUAL DRIVE SUBSYSTEM

**\$995.00**

If this looks like a Lobo Drive System, don't be fooled. Just because it looks like one, works like one, smells like one, and tastes like one (?) doesn't mean it has to cost like one!

2 SHUGART 801R  
POWER SUPPLY



#### S1-MOD (KIT)

**\$239.00**

Complete S-100 12 Slot Computer. Ample system power with regulated power for drives. Excellent for Subsystem or Hobby use. 4 hours to build. (6 conn. incl., less fans)



#### EXPANDABLE RAM (KIT)

This is the best all around 64K board you can buy. If after you see it, you don't agree return (unassembled) for full refund. Bank Select by extended address lines.

32K - \$380.00 64K - \$450.00



#### 32K STATIC (KIT)

You have seen this well known board around for years. We bought 500 of them and plan on cornering the market! Bank Select on extended address lines.

**\$388.00**



#### Z-80 CPU (KIT)

The first time this world popular CPU offered in Kit. 2 serial, 3 parallel, CTC, EProm Z-80 at 4 mhz. Software buad rate, etc.(less Prom)

**\$212.00**



#### DMA DISK CONTROLLER (KIT)

How many DMA Disk Controllers are there on the market? Can't mention the name at this LOW, LOW, LOW, price.

**\$265.00**



#### 12 SLOT MOTHER

We have connectors and power supply too. Start your system with quality components. Terminated.

CONNECTORS \$3.50 ea.

**\$22.50**



### SPECIALS OF THE MONTH

**4116s \$4.25**

Expansion 16K Dynamic RAMs for Apple, TRS-80 S-100 systems. T.I., Mostek Intel, Call for manufacturer.

200 NS

**DIP-80 \$399.00**

Don't be misled by this LOW price. This is a rugged 100% Duty Cycle 7 by 7 Dot Matrix Printer. Brand new, factory warr.



• RS-232 ADD \$65.00  
• TRACTOR FEED ADD \$70.00

**2114s \$3.95**

One of the world's two most popular STATIC RAMs. Factory prime tested units. Sold in lots of 8 only. FUJITSU, HITACHI, etc.

200 NS

**TMS-4044 \$4.25**  
**MM-5257**  
**INTEL 2147 250 NS**

The other of the world's most popular STATIC RAMs. This one is 4K by 1 organization. Don't buy Gold, buy these, the price won't last!

**2716s \$13.50 (450 NS)**  
**2708s \$6.95 (450 NS)**

Remember when 2716s were \$50.00 and hard to get? These units are so beautiful it's hard to part with them. But we will, for a small price. Guaranteed!

#### SHUGART DRIVE

8" 851R \$585.00

**8" 801R \$385.00**

Manufacturer had too many, buys at 1000 piece rate, sales dropped, so we got 'em. Fantastic buy, get them while they last! Full warranty.

#### 5 1/4" MINI

**\$265.00**

Now is the time to expand that Trash-80 or Rotton Apple (no offense!) These go so fast. Quantities limited to those on hand. Hurry! No Junkers! Factory warranty.

SHUGART / SIEMANS / MPI

## Manufacturers, Dealers and Endusers

We buy, sell, trade and accept consignment on all new and used Micro Computers and Peripherals.

**(602) 954-6109**

**COMPUTER  
WAREHOUSE**

2222 E. Indian School Rd.  
Phoenix, Arizona 85016

Circle 362 on Inquiry card.

## CASH-FLOW ANALYSIS

PREDICTS CASH CRUNCH

DETERMINES OPTIMUM CASHFLOW  
USING PAYMENT PRIORITIES AND  
RECEIVABLE PROBABILITIES

MEASURES IMPACT OF POSSIBLE  
PURCHASES ON CASHFLOW

DOCUMENTS FINANCIAL ABILITY

**\$129** Ready to run  
on CP/M system.

ALPHA-OMEGA SYSTEMS, INC.  
1504 3RD AVE. SUITE 700  
SEATTLE, WA 98101

(206) 622-2719



Circle 363 on inquiry card.

**NEW!!!**  
32K Static Memory Board  
For Digital Group Systems

New Layout  
64K Addressing Decoded  
Dip Switch Selectable  
I/O Mapped Addressing to 256K  
On Board Battery Back Up  
Power Failure Inputs

VLSI COMPUTER SYSTEMS  
601 W. 5th Street, Suite 103  
Los Angeles, CA 90017  
213-623-8682

Circle 364 on inquiry card.

## LOW PRICES

HP 85	\$2925.
Atari 400	\$ 475.
Centronics 737	\$ 875.
Base 2 800 MST	\$ 629.
Diablo 630	\$2439.
NEC Spinwriter	\$2695.
MPI 88T	\$ 675.
Code-a-phone 1750	\$ 259.
Verbatim disks	\$ 30.
5" or 8" cases	\$ 3.
Novation D-CAT	\$ 165.

American Express, Master Card & VISA accepted. Checks require time to clear. CA add Tax. All add 3% for shipping. We carry most all brands micros, terminals, printers, drives, memory, software, disks, accessories, calculators, telephone equipment and more. Send for our catalog. Call 24 hours or mail order to:

## SP ELECTRONICS

P.O. Box 8265  
Sacramento, CA 95818  
**(916) 442-2323**

Circle 365 on Inquiry card.

C-10 SHORT 50 FT.  
CASSETTES



Premium tape and cassettes acclaimed by thousands of repeat order microcomputer users. Price includes labels, cassette box and shipping in continental U.S.A. VISA and M/C orders accepted. California residents add sales tax. Phone (415) 968-1604 24 hours.

MICROSETTE CO.  
475 Ellis Street  
Mt. View, CA 94043

Circle 366 on Inquiry card.

## PERTEC FD-200

Floppy Disk Drives

**35% OFF LIST**

Rebuilt, tested, like-new, with  
90-day Warranty

**\$235<sup>00</sup>ea.**

Any quantity, while supply lasts

Also available:  
New and like-new Pertec 24MB, 10MB,  
Cartridge Hard Disk Drives, Magnetic  
Tape Drives and Controllers.

Call, write or TWX for more info.  
**IBEX COMPUTER CORPORATION**  
18730 Oxnard St., Torrance, CA 91356  
(213) 705-2517  
VISA and Mastercharge accepted

Circle 367 on Inquiry card.

## MULTIMUSIC

PLAY MULTI-VOICE MUSIC ON YOUR APPLE II. NO HARDWARE CHANGES. MACHINE LANGUAGE MULTIPLEXES 1 TO 12 PARTS. OR MORE WITH REDUCED QUALITY. LO-RES GRAPHICS SHOWS VOICES CURRENTLY PLAYING. STANDARD NOTE NAMES WITH DIRECTIONS AND SAMPLES INCLUDED. REQUIRES APPLE II PLUS (OR ROMCARD), 32K, DISK II.

SC1408 - DISKETTE \$39.00  
VISA/MASTERCARD ACCEPTED.

**SONORA COMPUTING**  
P.O. BOX 4841  
ALBUQUERQUE, N.M. 87196

Circle 368 on Inquiry card.

## WE HAVE 8039

MICROCOMPUTERS  
NEW PRIME PARTS

- TIMER APPLICATIONS
- CLOCKS
- SYSTEM CONTROLLERS
- KEYBOARD ENCODING
- 5 VOLT SUPPLY 6MHz
- ETC.

SEND CHECK FOR  
IMMEDIATE DELIVERY

1-5 \$19 6-25 \$15

OVER 25 \$10

MARSHALL PHILLIPS

U.S.I., DEPT. 37

10324 S. DOLFIELD ROAD  
OWINGS MILLS, MD 21117  
(301) 363-3000 TELEX: 8-7675

Circle 369 on inquiry card.



OSI & TRS DOS  
SOFTWARE

## CIVIL ENGINEERS SURVEYORS

- Water Distribution  
Network Analysis
- Pressure Sewers
- Coordinate Geometry
- Matrix Algebra
- Roadway Alignment

**SYSTEK, INC.**

P. O. Drawer JJ  
Miss. State, MS 39762

Circle 370 on Inquiry card.

# WE WILL NOT BE UNDERSOLD

**16K MEMORY UPGRADE KITS** 2 for \$85 **\$45**  
for TRS-80\*, Apple II, (specify): Jumpers **\$2.50**

## PRINTERS

### NEC Spinwriter



**Letter Quality High Speed Printer**  
Includes TRS-80\* interface software, quick change print fonts, 55 cps, bidirectional, high resolution plotting, graphing, proportional spacing: R.O. **\$2550**

R.O. with Tractor Feed **\$2650** KSR with Tractor Feed **\$2950**

**779 CENTRONICS TRACTOR FEED PRINTER** **\$969**

Same as Radio Shack line printer I

**737 CENTRONICS FRICTION & PIN FEED PRINTER** **\$799**

9 x 7 matrix Same as Radio Shack line printer IV

**730 CENTRONICS FRICTION & PIN FEED PRINTER** **\$629**

7 x 7 matrix Same as Radio Shack line printer II

**P1 CENTRONICS PRINTER** Same as Radio Shack quick printer **\$269**

**PAPER TIGER (IP440)** Includes 2K buffer and graphics option **\$879**  
(IP460) Bidirectional, 160 cps, graphics and 2K buffer **\$1075**

**TI-810** Faster than Radio Shack line printer III. Parallel and serial w/TRS-80\* interface software w/u + 1 case & paper tray **\$1589**

Compressed print, vertical form control **\$1865**

**OKIDATA Microline 80** Friction and pin feed **\$549**

Tractor Feed, friction, and pin feed **\$649**

**Microline 83** Bidirectional, 120 cps, uses up to 15" paper **\$1050**

**EATON LRC 7000+** 64 columns, plain paper **\$299**

**ANADEX DP-9500** **\$1359** **DP-8000** **\$825**

**CAT MODEM** Works same as Radio Shack Telephone Interface II **\$148**

**LEEDEX MONITOR Video 100** **\$119**

**ZENITH Color Monitor** **\$379**

**SANYO Model VM 4509 9" Monitor** **\$155**

## DISK OPERATING SYSTEMS

**PATCHPAK #4** by Percom Data **\$ 8.95**

**CP/M®** for Model I, Zenith **\$145** • for Model II, Altos **\$169.00**

**NEWDOS Plus** 40track **\$ 99.00**

**NEWDOS 80** **\$135.00**

## ACCESSORIES

**HEAD CLEANING DISKETTE:** Cleans drive Read/Write head in 30 seconds. Diskettes absorb loose oxide particles, fingerprints, and other foreign particles that might hinder the performance of the drive head. Lasts at least 3 months with daily use. Specify 5 1/4" or 8". **\$20 ea/\$45 for 3**

**FLOPPY SAVER:** Protection for center holes of 5 1/4" floppy disks. Only 1 needed per diskette. Kit contains centering post, pressure tool, tough 7-mil mylar reinforcing rings. Installation tools and rings for 25 diskettes. **\$ 11.95 Re-orders of rings only \$ 7.95**

**EXTERNAL DATA SEPARATOR:** Eliminates data separation problems (crc). Improves reliability. This plug in unit comes fully assembled and tested. **\$ 29.95**

**RS232** **\$ 84.00**

**TRS232:** Teletype current loop output from cassette port **\$ 49.00**

**DISK-DRIVE EXTENDER CABLES:** Fits all mini-disk drives. **\$ 16.95**

**SIX (6) PRONG ISOLATOR:** ISO-2 **\$ 54.00**

**AC FILTER/6 PRONG POWER STRIP** **\$ 39.00**

**DISK DRIVE CABLES:** 2 drive **\$29.00** 4 drive **\$ 35.00**

**DUST COVERS:** TRS-80/Apple **\$ 7.95**

**PLASTIC DISKETTE HOLDER:** For ring binder, holds 20 **\$ 8.00**

**RF MODULATOR:** Adapts video to TV **\$ 35.00**

**TRS-80 & OTHER MYSTERIES** **\$ 18.95**

**NEC SPINWRITER THIMBLE** **\$19.95** **RIBBON** **\$ 6.95**

**CCS CARDS:** Parallel or serial **\$115.00**



## DISK DRIVES **\$314**

40 track, 102K Bytes. Fully assembled and tested. Ready to plug-in and run the moment you receive it. Can be intermixed with each other and Radio Shack drive on same cable. TRS-80\* compatible silver enclosure. 90 day warranty. One year on power supply. **External card edge included.**

**FOR TRS-80\*** **CCI-100** 5 1/4", 40 Track (102K Bytes) for Model I **\$314**

**CCI-280** 5 1/4", 80 Track (204K Bytes) for Model I **\$549**

**CCI-800** 8" Drive for Model II (1/2 Meg Bytes) **\$795**

**For Zenith Z89** **CCI-189** 5 1/4", 40 Track (102K Bytes) add-on drive **\$394**

**Z-87** Dual 5 1/4" add-on drive system **\$995**

**DISKETTES** — Box of 10 (5 1/4") — with plastic library case **\$24**

8" double density for Model II (box of 10) **\$36**

## COMPLETE SYSTEMS

**ALTOS 64K, DD, SS, 2-Drive, 1MB** **\$3995**

**APPLE 16K** **\$989**

**TRS-80\* Model II-64K** **\$3499**

**TRS-80\* LEVEL II-16K with keypad** **\$689**

**TRS-80\* Expansion Interface** **\$249**

**HEWLETT PACKARD HP-85** **\$2950**

**ZENITH Z89, 48K all-in-one computer** **\$2500**

**ZENITH Z19** **\$735**

**TELEVIDEO 912B** **\$745** **912C** **\$755** **920B** **\$769** **920C** **\$779**

**ATARI 400** **\$489** **ATARI 800** **\$749**

**APF Game Only** **\$99** **Complete System** **\$499**

**MATTEL INTELLIVISION** **\$229**

Software available for all Complete Systems

## SOFTWARE FOR THE TRS-80\*

Software w/Manual

**INTELLIGENT TERMINAL SYSTEM ST-80-III BY LANCE MIKLUS:** Enables a TRS-80\* to act as a dial-up terminal on any standard time sharing network. Provides a TRS-80\* with control key, ESC Key, Repeat Key, Run Out Key, Break Key, full upper and lower case support, selectable printer output and program-selectable transmission rates. **\$139**

**CCA-DATA MANAGEMENT SYSTEM:** Automate your information processing tasks. You can create a file of customer information, quickly and easily add, delete or update records; search a file; keep a file in order of the value in any field; and print records and labels in any desired sequence or from just a part of a file. Requires 32K TRS-80 and one drive. **\$72.00**

**S & M SYSTEMS INSE-80™:** Indexed Sequential Access Method (ISAM) for the TRS-80 Model I. A must for anyone writing business programs. Eliminate wasted disk space from direct record processing. Split second access to any record. Access data records instantly via alpha/numeric "key" eg. Part No. zip code or sequentially in ascending key sequence. Add/modify records in any order. Access up to three files per program—Files

may be spread over multiple disks. Machine language processing from your basic program. Utility program to convert direct files to INSE-80 format. **\$49.00**

**FULLY INTERACTIVE ACCOUNTING PACKAGE:** ISAM (INSE-80) based. Includes General Ledger, Accounts Payable, Accounts Receivable and Payroll. System runs "stand alone" or "co-ordinated G/L" at user's option. Based on Osborne accounting method. Requires 32K, TRS-80, 2 or 3 drives. N/A CA.

General Ledger **\$99**  
Accounts Receivable **\$99**  
Accounts Payable **\$99**  
Payroll **\$99**  
Osborne books: Req'd as additional documentation **\$20 ea**

**INVENTORY** Requires 32K, TRS-80, 1 drive **\$125**  
**INSORT-80:** Callable file BASIC via USA. Sorts "Random" Disk Files. "Disk" to "Disk" sort times—350 records in 35 secs, 1000 records in 6 minutes, 3500 records in 12 minutes. Machine language processing. Up to 35 sort keys ascending/descending. Utility to build BASIC program. Runs under NEWDOS. **\$49.95**

## CP/M® BASED SOFTWARE for Zenith, Altos, Radio Shack, Apple

Software w/Manual

**Z-80 SOFTCARD FOR APPLE:** Your key to future software expansion. Get the best of both worlds. Apple's 5502 and CP/M Z-80. Plug in the card and get a Z80. Supports Apple language card and all Apple peripherals. Comes with set of three manuals. **\$339**

**CCI-TELNET VERSION 3:** A communication Package which enables microcomputer users to communicate both with Large Mainframes and other microcomputers. Extensive commands make it useful in many applications where communication between computers is necessary. Powerful terminal mode enabling user to save all data from a session on disk. Completely CP/M compatible. Multiple communication

protocols supported. Able to transfer files in both directions without protocol where the other machine does not support any protocol. Extensive ON-SCREEN help. Source code provided. **\$149**

**MICROPRO-WORD-STAR:** Menu driven visual word processing system for use with standard terminals. Text formatting performed on screen. Facilities for text pagination, page number, justify, center and underscore. User can print one document while simultaneously editing a second. Edit facilities include global search and replace. Read/Write to other text files, block move, etc. Requires CRT terminal with addressable cursor positioning. **\$399**

DEALER (NATIONAL/INTERNATIONAL) INQUIRIES INVITED

Send for FREE Catalogue

# The CPU SHOP

TO ORDER CALL TOLL FREE 1-800-343-6522

Massachusetts residents call (617) 242-3361

For detailed technical information, call 617/242-3361

Hours: 10AM-6PM (EST) M-F (Sat. till 5)

\*TRS-80 is a Tandy Corporation Trademark

\*Digital Research

5 Dexter Row, Dept. B11M  
Charlestown, Massachusetts 02129

Massachusetts residents add  
5% sales tax

Quantities on some items are limited



# 3M DISKETTES

For record reliability and quality buy 3M Scotch Diskettes. All Diskettes are in stock for immediate shipment. Call TOLL FREE (800) 235-4137 for prices and information. Visa and Master Card accepted. All orders sent postage paid.



**PACIFIC EXCHANGES**  
100 Foothill Blvd.  
San Luis Obispo, CA  
93401 (In Cal. call  
(805) 543-1037)

Circle 352 on Inquiry card.

Close-  
Out!!

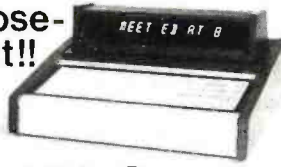

## Desk Top Computer

This unit is a computerized Electronic Secretary. It keeps time, date, calendar, message, and meeting files. Originally sold thru a major mail order house for over \$450.00.

Technically, it's a 8507 MICRO. ROM. Ram, Planaplex Alpha Display, Ni-cad Battery, Power Supply, Keyboard, Wood and Aluminum Case with Schematic and Instructions.

Most of these Computers are warranty returns. We are offering refurbished like new units for \$99.95 and as is (most have minor problems) units for \$44.95 Add \$4.95 per unit for shipping and handling per unit ordered. All units are complete as described. All sales are final. California Residents add 6.5% Sales Tax.

Send Payment and Order to:

**Solid State Surplus**  
P.O. Box 32418/San Jose, CA 95152

Circle 353 on Inquiry card.

FOR SALE:

Unused Polymorphic System 8813 with 32K Ram Memory with floppy disk drives, printer interface and Abern-Sopher Multiwriter III. System has Canadian import tax paid. Offers for complete system to:

**Bishop Management,**  
#8-825 McBride Blvd.,  
New Westminster, B. C.,  
Canada, V3L 5B5.  
(604) 525-8148.

Circle 354 on Inquiry card.

# OmniFORTH FOR NORTH STAR DOS

- Based on fig-FORTH
- 8080 Compatible (SOLS, IMSAI, etc.)
- Excellent users manual and installation documentation
- Includes the interactive OmniFORTH compiler, Text EDITOR, File system utilities, and 8080 + Z80 ASSEMBLER
- Requires North Star DOS and 24K memory
- Specify disk density (50 or DD/DD)
- Price \$64.95 plus \$2.00 S&H  
(Florida residents add 4% sales tax. U.S. Funds only. Additional shipping charges outside U.S.A.)



**INTERACTIVE  
COMPUTER SYSTEMS, INC.**

6403 DiMarco Rd. • Tampa, FL 33614

Circle 355 on Inquiry card.

*What?  
You own  
a PET and you  
haven't received this  
brand new catalogue?*



*Softwares,  
Peripherals, Books,  
Over 60 items. From  
\$1.00 to \$1,250. 24 Pages.  
Write to Skyles today for  
your FREE catalogue.*



## Skyles Electric Works

231 E South Whisman Road  
Mountain View, CA 94041

Circle 356 on Inquiry card.

## SURPLUS ELECTRONICS

ASCII



ASCII

TRS-80<sup>®</sup> COMPATIBLE, IBM  
SELECTRIC<sup>®</sup> BASED I/O TERMINAL  
with ASCII conversion Installed: \$645.00

Many Other Items Available: Tape Drives; Cable; Cassette Drives; Wire; Power Supplies (5 volt 35 amp, others); Displays; Cabinets; Transformers; Heat Sinks; Printers; Components.

Send for Free Catalog

**WORLDWIDE ELECTRONICS, INC.**  
130 Northeastern Blvd.

Nashua, N.H. 03062

Phone orders accepted using VISA or MC  
Toll Free 1-800-258-1036  
in NH 603-889-7661

\*TRS-80 is a trademark of the Radio Shack  
Division of Tandy Corporation.

Circle 357 on Inquiry card.

# J and S Computers

2247 Shetland Road  
Livermore, Ca. 94550

### Texas Instruments

99/4 Computer ..... \$1090.00  
810 Basic Printer (100) ..... \$1600.00  
810 Full ASCII (201) ..... \$1695.00

### Exidy

32K Sorcerer ..... \$1074.00  
48K Sorcerer ..... \$1205.00

### Lobo Disks

SA 400 in cabinet w/power supply .... \$410.00  
3101 | SA 400 for Apple w/interface ... \$487.00  
SA 801 in cabinet w/power supply .... \$780.00

### Centronics

730-1 Parallel ..... \$670.00  
730-3 Serial ..... \$715.00

and more... send \$1.50 for a catalogue  
California residents add 6% sales tax  
All orders, add 3% shipping and handling

Circle 358 on Inquiry card.

# ATARI OWNERS

## Parallel Printer Interface for the ATARI 400 / 800

Connects to controller jacks 3&4  
works with BASIC / DOS / ASSEMBLER  
Three printer connectors available:

**ATARI 400 / 800**  
TRENDCOM 100 / 200 A4P-1 ABP-1  
CENTRONICS 730 / 737 A4P-2 ABP-2  
CENTRONICS 36 PIN\* A4P-3 ABP-3

\*Fits all other parallel Centronics plus Anadex,  
Base 2, Epson, Comprint and Microtek.  
Order by part number, MC / VISA accepted.

**\$69.95**

◆ CA. sales add 6% tax



**MACROTRONICS, inc. ®**

1125 N. Golden State  
Turlock, CA 95380 (A)  
(209) 667-8888 / 634-8888

Circle 359 on Inquiry card.

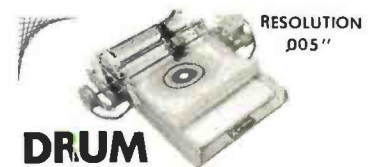

## DRUM DIGITAL PLOTTER

PRINTERS  
**COLOR GRAPHICS FROM  
SMALL PLOTTERS WITH  
BIG IDEAS.**

But draw the line on price. That's practical!

232 SERIAL IN

FROM \$310. SOFTWARE FURNISHED

WRITE FOR DETAILS TO  
X ... Y ENTERPRISES P.O. BOX 796  
HUNTSVILLE, ALA. 35804  
PHONE (205) 534-0177

Circle 360 on Inquiry card.



# Get the inside copy of CP/M\*

Just purchase a Jade Double-D or CCS double density disk controller this month and CP/M\* 2.2 is yours for free.

## S-100 Boards

### DOUBLE-D - Jade

Double density disk controller with the inside track  
 10D-1300K Kit & CP/M 2.2 ..... \$395.00  
 10D-1300A 8" A & T & CP/M 2.2 .. \$469.00  
 10D-1305A 5 1/4" A & T & CP/M 2.2 \$469.00  
 10D-1200B Bare board ..... \$55.00

### DOUBLE DENSITY - Cal Comp Sys

5 1/4" or 8" disk controller with free CP/M 2.2  
 10D-1400A A & T ..... \$374.95

### THE BIG Z\* - Jade

2 or 4 MHz switchable Z-80\* CPU with serial I/O  
 CPU-30201K Kit ..... \$145.00  
 CPU-30201A A & T ..... \$199.00  
 CPU-30200B Bare board ..... \$35.00

### SBC-100 - SD Systems

2.5 MHz Z-80\* CPU with serial & parallel I/O ports  
 CPC-30107K Kit ..... \$269.95  
 CPC-30109A Jade A & T ..... \$339.95

### SBC-200 - SD Systems

1 MHz Z-80\* CPU with serial & parallel I/O ports  
 CPC-30200K Kit ..... \$299.95  
 CPC-30200A Jade A & T ..... \$375.00

### CB2 - S.S.M.

2 or 4 MHz switchable Z-80\* CPU with RAM, ROM, & I/O  
 CPU-30300K Kit ..... \$239.95  
 CPC-30300A A & T ..... \$299.95

### 2810 Z-80\* CPU - Cal Comp Sys

2.4 MHz Z-80A\* CPU w/serial I/O port  
 CPU-30400A A & T ..... \$275.00

### ExpandoRAM I - SD Systems

2.5 MHz RAM board expandable from 16K to 64K  
 MEM-16130K 16K kit ..... \$245.00  
 MEM-16130A 16K Jade A & T ..... \$295.00  
 MEM-32131K 32K kit ..... \$275.00  
 MEM-32131A 32K Jade A & T ..... \$325.00  
 MEM-48132K 48K kit ..... \$305.00  
 MEM-48132A 48K Jade A & T ..... \$355.00  
 MEM-64133K 64K kit ..... \$355.00  
 MEM-64133A 64K Jade A & T ..... \$385.00

**64K RAM BOARD \$359.95**

### ExpandoRAM II - SD Systems

4 MHz RAM board expandable from 16K to 256K  
 MEM-16630A 16K kit ..... \$249.95  
 MEM-16630A 16K Jade A & T ..... \$299.95  
 MEM-32631K 32K kit ..... \$289.95  
 MEM-32631A 32K Jade A & T ..... \$339.95  
 MEM-48632K 48K kit ..... \$324.95  
 MEM-48631A 48K Jade A & T ..... \$374.95  
 MEM-64633K 64K kit ..... \$359.95  
 MEM-64633A 64K Jade A & T ..... \$409.95

**32K STATIC RAM BOARD \$299.95**

**16K STATIC RAM BOARD \$169.95**

### 32K STATIC RAM - Jade

2 or 4 MHz expandable static RAM board uses 2114L's  
 MEM-16151K 16K 4 MHz kit ..... \$169.95  
 MEM-16151A 16K 4 MHz A & T ... \$224.95  
 MEM-32151K 32K 4 MHz kit ..... \$299.95  
 MEM-32151A 32K 4 MHz A & T ... \$349.95

### S.P.I.C. - Jade

Our new I/O card with 2 SIO's, 4 CTC's, and 1 PIO  
 IOI-1045K 2 CTC's, 1 SIO, 1 PIO .. \$199.00  
 IOI-1045A A & T ..... \$259.00  
 IOI-1046K 4 CTC's, 2 SIO's, 1 PIO \$259.00  
 IOI-1046A A & T ..... \$319.00  
 IOI-1045B Bare board w/ manual ... \$59.95  
 IOI-1045D Manual only ..... \$20.00

### 16K STATIC RAM - Cal Comp Sys

2 or 4 MHz 16K static RAM - a real memory bargain  
 MEM-16160K 16K 2 MHz kit ..... \$249.95  
 MEM-16160A 16K 2 MHz A & T ... \$279.00  
 MEM-16162K 16K 4 MHz kit ..... \$279.95  
 MEM-16162A 16K 4 MHz A & T ... \$309.00  
 MEM-16160B Bare board ..... \$29.95

### PB-1 - S.S.M.

2708, 2716 EPROM board with built-in programmer  
 MEM-99510K Kit ..... \$159.95  
 MEM-99510A A & T ..... \$239.95

### PROM-100 - SD Systems

2708, 2716, 2732, 2758, & 2516 EPROM programmer  
 MEM-99520K Kit ..... \$175.00  
 MEM-99520A Jade A & T ..... \$225.00

### I/O-4 - S.S.M.

2 serial I/O ports plus 2 parallel I/O ports  
 IOI-1010K Kit ..... \$179.95  
 IOI-1010A A & T ..... \$259.95  
 IOI-1010B Bare board ..... \$35.00

### BIT STREAMER II - Vector Graphic

3 serial I/O ports plus 2 parallel I/O ports  
 IOI-1025A A & T ..... \$259.00

### 100K DAY CLOCK - Mtn Hardware

Crystal controlled S-100 clock with NiCad backup  
 10K-1400A A & T ..... \$329.95

### SB1 - S.S.M.

15 Hz to 25K Hz music synthesizer for S-100  
 IOS-1005K Kit ..... \$239.95  
 IOS-1005A A & T ..... \$299.95

### TB-4 - Mullen

Extremely versatile extender board with logic probe  
 TSX-180K Kit ..... \$55.00  
 TSX-180A A & T ..... \$75.00

### TERMINATOR & EXTENDER - C.C.S.

Can be used as both an S-100 extender and terminator  
 TSX-150K Kit ..... \$39.95

### S-100 EXTENDER - Cal Comp Sys

Puts problem boards within easy reach  
 TSX-160A A & T ..... \$24.95

### VERSAFLOPPY I - SD Systems

Versatile floppy disk controller for 8" or 5 1/4"  
 IOD-1150K Kit ..... \$219.95  
 IOD-1150A Jade A & T ..... \$269.95

### VERSAFLOPPY II - SD Systems

New double density controller for both 8" & 5 1/4"  
 IOD-1160K Kit ..... \$309.95  
 IOD-1160A Jade A & T ..... \$369.95

### S-100 PROTO BOARD - Jade

Universal design, plated thru holes, gold fingers  
 TSX-140B Bare board ..... \$24.95

### 2708/2716 EPROM BOARD - Jade

Holds up to 16 EPROMs, addressable on 1K banks  
 MEM-16230K Kit ..... \$69.95  
 MEM-16230A A & T, no PROMs ... \$99.95  
 MEM-16230B Bare board ..... \$30.00

\* Z-80, Z-80A, and the letter Z are recognized trademarks of Zilog, Inc.

### VDB-8024 - SD Systems

80 x 24 I/O mapped video board with keyboard I/O  
 IOV-1020K Kit ..... \$339.95  
 IOV-1020A Jade A & T ..... \$399.95

### VB3 - S.S.M.

80 x 24 or 80 x 48 memory mapped with graphics  
 IOV-1095K Kit, 4 MHz ..... \$399.95  
 IOV-1095A A & T, 4 MHz ..... \$464.95  
 IOV-1096K 80 x 48 upgrade, 4 MHz .. \$89.00

### VIDEO BOARD - Jade

64 x 16 assembled & tested S-100 video board  
 IOV-1050B Bare board ..... \$29.95  
 IOV-1050A A & T sale price ..... \$99.95

## Single Board Computers

### AIM-65 - Rockwell

6502 computer with printer, display, & keyboard  
 CPK-50165 1K AIM ..... \$374.95  
 CPK-50465 4K AIM ..... \$449.95  
 SFK-74600008E 8K BASIC ROM ... \$99.95  
 SFK-64600004E 4K assembler ROM \$84.95  
 PSX-030A Power supply ..... \$59.95  
 ENX-00002 Enclosure ..... \$49.95  
 4K AIM, 8K BASIC, power supply, & enclosure  
 Special package price ..... \$599.00

### Z-80\* STARTER KIT - SD Systems

Z-80\* computer with RAM, ROM, I/O, & keyboard  
 CPS-30010K Kit ..... \$319.95  
 CPS-30010A Jade A & T ..... \$399.95

## Video Monitors

### VIDEO 100 - Leedex

12" B & W video monitor with 12 MHz bandwidth  
 VDM-801210 ..... \$139.95

### VIDEO 100-80 - Leedex

81 x 24" version of Video 100 with metal cabinet  
 VDM-801230 ..... \$179.95

### 9" B & W MONITOR - A.P.F.

High quality, high resolution video monitor  
 VDM-750900 9" monitor ..... \$149.95

### 13" COLOR MONITOR - Zenith

The hi res color you've been promising yourself  
 VDC-201301 ..... \$449.00

### 12" GREEN SCREEN - NEC

20 MHz, P31 phosphor video monitor with audio  
 VDM-651200 12" monitor ..... \$249.95

## Software

### SDOS - SD Systems

DOS, CBASIC-2, Z-80\* assembler/editor/linker  
 SFX-55001000D Manual set ..... \$24.95  
 SFX-55001002M 5 1/4" disks & man \$199.95  
 SFX-55001006F 8" disk & manual \$199.95

### CP/M 2.2 - Digital Research

Latest & most powerful release of CP/M  
 SFC-52506000D Manual set ..... \$24.95  
 SFC-52506000M 5 1/4" disk & manual \$149.95  
 SFC-52506000F 8" disk & manual \$149.95

\* CP/M is a registered trademark of Digital Research Corp.

All royalties paid by Jade Computer Products and California Computer Systems.

# track and a free 2.2 to boot !!!

## Accessories for Apple

### 16K MEMORY UPGRADE

Add 16K of RAM to your TRS-80, Apple, or Exidy

MEX-16100K TRS-80 kit	\$39.95
MEX-16101K Apple kit	\$39.95
MEX-16102K Exidy kit	\$39.95

### PRINTER INTERFACE - Cal Comp

Centronics type I/O card w/ firmware

I/OI-2041A A & T	\$99.95
------------------	---------

### 8" DRIVES for APPLE

Controller, DOS, two 8" drives, cabinet, & cable

Special package price	\$1475.00
-----------------------	-----------

### AIO - S.S.M.

Parallel & serial interface for your Apple

I/OI-2050K Kit	\$159.00
I/OI-2050A A & T	\$199.00

### APPLE CLOCK - Cal Comp Sys

Real time clock w/battery back-up

I/OK-2100A A & T	\$125.00
------------------	----------

### SUPERTALKER - Mtn Hardware

Speech recognition/synthesizer w/speaker & mike	
I/OI-2015A A & T	\$275.00

### Z-80\* CARD for APPLE

Z-80\* CPU card with CP/M for your Apple

CPX-30800A A & T	\$298.00
------------------	----------

### MICROMODEM - D.C. Hayes

Auto answer/dial modem card for Apple or S-100

I/OI-2010A Apple modem	\$349.95
I/OI-1100A S-100 modem	\$375.00

## Printers

### BASE 2 - Impact Printer

132 cps, bi-directional, tractor feed, & graphics

PRM-13100	\$675.00
-----------	----------

### DP-9501 - Anadex

9 x 11 dot matrix, 220 column, 200 cps, & graphics	
PRM-10501 Standard DP-9501	\$1495.00
PRM-10511 with graphics & 2K	\$1595.00

### ANACOM 150 - Special

150 cps, 9 x 9 matrix, tractor feed

PRM-11150 Parallel interface	\$895.00
PRM-11151 Serial interface	\$895.00

### SPINWRITER - NEC

65 cps, bi-directional, letter quality with tractor

PRD-55510 with 2K buffer	\$2695.00
--------------------------	-----------

### NOVATION CAT

300 baud, auto answer/originate acoustic modem	
I/OI-5200A Special sale price	\$139.00

D-CAT 300 baud, direct connect modem

I/OI-5201A Special sale price	\$189.00
-------------------------------	----------

### EPROM ERASERS

L.S. Engineering UV eraser for up to 48 EPROMs

XME-3200 A & T	\$39.95
----------------	---------

Spectronics hi intensity industrial eraser

XME-3100 Without timer	\$69.95
XME-3101 With timer	\$94.50

### TV-1 - Best Buy

The inexpensive alternative to video monitors

I/OI-5040K Kit	\$8.95
----------------	--------

Call for your free 1980 catalog

Circle 372 on Inquiry card.

## Disk Drives

### JADE DISK PACKAGE

Double-D controller kit, two 8" double density drives  
CP/M 2.2, cabinet, power supply, & cables

Special package price	\$1395.00
-----------------------	-----------

### DUAL 8" DRIVES - Jade

A pair of double density Shugarts in a cabinet

MSF-12800R 2 single sided	\$995.00
MSF-125202 2 double sided	\$1425.00

### 8" DISK DRIVES

Highly reliable double density floppy disk drives

Shugart 801R single sided, double density	
MSF-10801R SA-801R	\$425.00
Special Sale Price	2 for \$800.00
Qume Datatrak 8 double sided, double density	
MSF-750080 851R compatible	\$625.00

### DISKETTES - Jade

Bargain prices on magnificent magnetic media

5 1/4" single sided, single density, box of 10	
MMD-5110103 Soft sector	\$27.95
MMD-5111003 10 sector	\$27.95
MMD-5111603 16 sector	\$27.95
5 1/4" double sided, double density, box of 10	
MMD-5220103 Soft sector	\$39.95
8" single sided, single density, box of 10	
MMD-8110103 Soft sector	\$33.95
8" single sided, double density, box of 10	
MMD-8120103 Soft sector	\$55.95
8" double sided, double density, box of 10	
MMD-8220103 Soft sector	\$57.95

### DUAL DISK CABINET Jade

Metal enclosure for 2 801R's, power supply & fan

END-000021 Bare cabinet	\$99.00
-------------------------	---------

## Motherboards

### ISO-BUS - Jade

Silent, simple, and on sale - a better motherboard

6 Slot (5 1/4" x 8 1/2")	
MBS-061B Bare board	\$19.95
MBS-061K Kit	\$39.95
MBS-061A A & T	\$49.95
12 Slot (9 1/2" x 8 1/2")	
MBS-121B Bare board	\$29.95
MBS-121K Kit	\$69.95
MBS-121A A & T	\$89.95
18 Slot (14 1/2" x 8 1/2")	
MBS-181B Bare board	\$49.95
MBS-181K Kit	\$99.95
MBS-181A A & T	\$139.95

## Mainframes

### MAINFRAME - Cal Comp Sys

12 slot S-100 mainframe with 20 amp power supply

ENC-112105 Kit	\$309.95
ENC-112106 A & T	\$349.95

### DISK MAINFRAME - NNC

Dual 8" drive cutouts with 8 slot motherboard	
ENS-112320 with 30 amp p.s.	\$699.95

**TRS-80 APPLE**  
16K MEMORY UPGRADE KIT  
**\$39.95**

### MICROPROCESSORS

Z-80	10.95
Z-80A	12.95
6502	11.50
6800	11.95
6802	17.95
6809	39.95
8035	24.00
8035-8	24.00
8080A	6.59
8085	15.95

### SUPPORT DEVICES

8212	4.95
8214	4.65
8216	2.95
8224	3.25
8224-4	10.95
8226	3.85
8228	4.95
8238	4.95
8243	8.00
8250	14.95
8251	6.50
8253	13.95
8255	6.50
8257	19.95
8259	17.95
8275	49.95
8279	15.95

### Z-80 SUPPORT

3881 PIO	9.50
3881-4 PIO 4 MHz	14.50
3882 CTC	9.50
3882-4 CTC 4 MHz	14.95
3883 SIO	29.50
3884 SIO	49.50

### BAUD RATE GENERATORS

MC14411	10.00
1.843 MHz xtal	4.95

### UARTS

6800	
SUPPORT	
6821P	5.95
6828P	11.95
6834P	12.95
6840P	18.75
6850P	4.80
6852P	5.79
6875L	7.40
68488P	25.00
AY5-1013A	5.25
AY3-1014A	8.25
TR1602B	5.25
IM6402	9.00

### RAMS

211A02 2 MHz	1.25
211A02A 4 MHz	1.50
211A1 2 MHz	3.75
211A1A 4 MHz	3.95
2147 70ns	39.95
2708 450ns	8.95
4116	4.95
2716 12.5v	14.95
2716 5v	14.95
2732 5v	59.95
2768 5v	19.95
4164 64K x1	175.00
5257 2 MHz	6.75
5257A 4 MHz	7.25
MK-4118	18.95

## PLACE ORDERS

### TOLL FREE

Inside California Continental U.S.  
800-262-1710 800-421-5500

For customer service  
or technical inquiries call 213-973-7707

Write for our FREE 1980 catalog

**JADE**  
COMPUTER PRODUCTS

4901 W. Rosecrans, Hawthorne, CA 90250

TERMS OF SALE: Cash, checks, credit cards  
money orders or from recognized institutions  
Purchase orders accepted. Minimum order \$10.00  
California residents add 6% sales tax. Minimum  
shipping and handling charge \$2.50. Prices are for  
U.S. and Canadian delivery only and are subject  
to change without notice. For export prices and  
information send for a JADE INTERNATIONAL  
CATALOG.









New Summer 1980  
**SEND FOR OUR FREE CATALOG**

## CompuMart lets you put 'em on trial



CompuMart has been selling computers by mail since 1971. Our thousands of satisfied customers rely on CompuMart for services not generally available from the others. Namely:

- Product Selection/Each product advertised by CompuMart has been evaluated by our in-house staff for best price, performance, and supplier reliability
- Return Privilege/After receipt of our products, you are protected by CompuMart's exclusive, 10-day return privi-

ledge- good for all products except software.

- Support/Our Customer Service Dept. and expert technicians are always there to assist you by phone or at CompuMart's outlets. Our knowledgeable phone sales force can provide you with detailed information and complete product specifications.
- Phone Ordering/For added convenience, CompuMart maintains a toll-free ordering number. 1-800-343-5504.
- Phones open M T W Th F 8:30 a.m. - 7:00 p.m. Sat. 11:00 a.m. - 4:00 p.m.

with 10 day free return

## Printers

### The Paper Tiger Printer From Integral Data

Uses standard 1/4 inch roll paper and ribbon  
 40 characters per line  
 Speed: 40 characters per second  
 UL approved

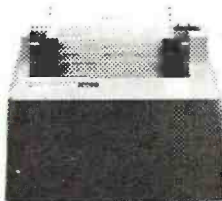

High resolution dot matrix impact printer

IDS Paper Tiger Printer ..... \$995  
 IDS Graphics Paper Tiger Printer ..... \$1,094

FREE Cable with your Paper Tiger.

### NEW! From Integral Data. The IDS 460.

We saw this new desktop printer at the NCC 80 and when we saw its features: Correspondence quality printing, High-resolution graphics capability, programmable print control functions, and automatic text justification—we knew that we had to offer this printer to our cost/features conscious customers \$1,295

### The Omni 810 Printer from Texas Instruments

TI Omni 820 Receive-Only (RO) Package. Includes machine-mounted paper tray and cable. A compressed print option and device forms control are standard features \$2,155

TI Omni 820 Keyboard Send Receive (KSR) Package Comes with full ASCII Keyboard with numeric Key- pad and an EIA cable with autospeed select. \$2,395

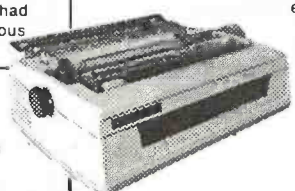

CompuMart will throw in a FREE fabric ribbon and Currier 72 element when you buy a NEC from us.

### CENTRONICS PRINTERS

New! The incredible Model 737- Correspondence and Draft Quality Printing for Under \$1,000. This is the first printer in its class to offer print quality suitable for text processing, plus the performance and application flexibility required for data processing.

737-1 (Parallel Interface)— \$899  
 737-3 (Serial Interface) \$1,045

Tractor Feed Printer- Centronics' Most Popular Model. Perfect for the needs of a small business system. Recommended by Apple and Radio Shack. \$1,079

FREE Cable with purchase of any Centronics printer.

### NEC The First Name in Letter Quality Printers.

CompuMart offers beautiful print quality with NEC Spinwriter terminals. The Spinwriters, both KSR and RO versions, give unsurpassed hard copy output. CompuMart offers a complete range of NEC Spin-writers—Call our expert salesforce

## Terminals

We've got the following Lear Siegler Terminals In Stock at prices too low to print—Call for quotes.

ADM-3A Industries favorite dumb terminal for some very smart reasons.

ADM-3A. + New from Lear Siegler. CALL!

ADM-31. The terminal that's too smart to be considered dumb.

ADM-42. Available with keyboard semi-intelligent terminal offering tremendous user flexibility. The optional configurations are amazing.

Call for details.



### HAZELTINE TERMINALS AT SPECTACULAR SAVINGS!

Hazeltine 1410.	List \$850	CompuMart \$749
Hazeltine 1420.	List \$995	CompuMart \$895
Hazeltine 1500.	List \$1095	CompuMart \$995
Hazeltine 1510.	List \$1395	CompuMart \$1325
Hazeltine 1520.	List \$1585	CompuMart \$1485
Hazeltine 1552.	List \$1395	CompuMart \$1295

Call CompuMart for complete specs and quantity discounts.

## Calculators

### A CALCULATOR, A SYSTEM, A WHOLE NEW STANDARD.

#### HEWLETT-PACKARD'S HP-41C

HP-41C Calculator ..... \$288.00

#### The System

Memory Modules. For storing programs or up to 2,000 lines of program memory ..... \$45.00  
 "Extra Smart" Card Reader. Records programs and data back onto blank mag-cards ..... \$199.00  
 The Printer. Upper and Lower case, High resolution plotting, Portable Thermal operation ..... \$355.00  
 Application Modules ..... \$45.00 EACH  
 Standard pac:

Statistics,  
 Math,  
 Financial &  
 Surveying



1/2 off Financial Decisions PAC with purchase of HP-41

### NOVATION CAT™ ACCOUSTIC MODEM

- Answer Originate
- Bell 108
- 300 Baud
- Low Profile Design

Looks good, works great! \$169.00



### Texas Instruments TI-99/4 Home Computer Save \$300 on this 16-Bit computer with monitor

TI-99/4 w/Monitor \$1250  
 TI-99/4 w/o Monitor \$ 950

## Monitors

### NEW FROM SANYO — Four Great Monitors at Low CompuMart Prices.

Sanyo's new line of CRT data display monitors are specifically designed for the display of alpha-numeric or graphic data

9" Sanyo Monitor	\$179
12" Sanyo Monitor	\$289
12" Sanyo Monitor with green screen	\$299
13" Sanyo Color Display Monitor	\$495

Free 6' Cable with purchase of any Sanyo

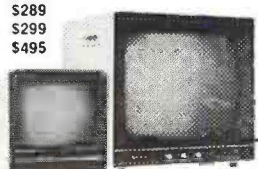

### EXCLUSIVE from CompuMart! Special Offer. Zenith Color Video Monitor for \$379!

The perfect monitor for Apple, Atari and Texas Instruments owners.

★ **COMPUTERMART NOW OFFERS THE ENTIRE DEC LSI-11 PRODUCT LINE. CALL FOR PRICES & DELIVERY.**

# Computers



**apple computer**

We carry the most complete inventory of Apple computers, peripherals, and software. CALL!

**Our Christmas Apple Special:** Save over \$250 on our most popular Apple System. System includes a 48K Apple II, Apple Disk & Controller, and a Sup R Mod RF Modulator.

List: \$2,020

CompuMart Sale Price: \$1,769

New from Apple for the Apple II:

DOS3-3 Convert disks to 16 sector format for 23% more storage and faster access **\$60**

Apple Plot. The perfect graphic complement for Visicalc. **\$70**

Dow Jones News & Quotes **\$95**

Adventure (Uses 48K) **\$35**

DOS Tool Kit **\$75**

Apple Fortran **\$200**

Silentype Printer w/Xface **\$595**

Visicalc **\$149**

Tax Planner **\$120**

From Symtech & Info Unlimited

Super Sound Generator (mono) \$159 (stereo) \$259

Light Pen **\$249**

X-10 Controller (plugs into paddle port) **\$49**

Apple Sync Controller **\$49**

From Personal Software

Visicalc **\$149**

Desk top plan **\$99**

New from Videx! — Video Term

80 Col. x 24 line

7 x 9 matrix, plug in compatible board for the Apple II. Price \$325 without graphics EPROM. With graphics EPROM \$350.

New from MUSE

The Voice **\$39.95**

Super Text **\$99.00**

Address Book **\$49.95**

Mountain Hardware — Expansion accessories for your Apple

Introl/X-10 System **\$289**

Super Talker **\$299**

The Music System **\$545**

ROM plus board w/keyboard filter **\$199**

Clock Calendar **\$280**

16 Channel A to D Converter **\$350**

Apple Expansion Chassis **\$650**

ROM Writer **\$175**

Miscellaneous Apple II Accessories:

EasyWriter (80 col. need Videx) **\$249**

EasyMover **\$ 49**

Easy Mailer **\$ 69**

Dysan Diskettes ea. **\$ 5**

S.S.M. Serial & Parallel Apple Interface **\$225**

ABT's Numeric Key Pad **\$110**



Preview of the Apple III

## THANKSGIVING SPECIAL



Buy \$1,000 worth of merchandise from this ad, including at our special sale prices and deals, and we'll ship you a Texas Instrument's Speak & Spell™ with your order. This is TI's famous talking and learning aid with the electronic voice and brain. It's an incredible electronic learning aid for children aged 7 and up. A \$69.95 Value Yours FREE with \$1,000 purchase.

### SUPER SALE PRICED TO MOVE!

We want to move our inventory of Zenith Z-89 and Exidy Computers. To do it, we've priced them so low you'll have to call us for prices. If you want either of these two great computers, call us now while supplies last for the best prices you'll find anywhere. Good selection of Zenith and Exidy peripherals as well.

### COMMODORE

Buy direct from the biggest — CompuMart has delivered more Commodore computers in the U.S. than any other dealer. We were Commodore's first dealer and carry everything Commodore manufactures. In stock for immediate delivery! Call us now for low prices and special deals.

#### NEW FOR PET:

Visicalc (Need 32K and a disk drive) **\$199**

Word Pro 1, \$29.95 • Word Pro 2, \$99.95 •

Word Pro 3, \$199.95 • Word Pro 4, \$299.95 •

### ROCKWELL AIM 65

The single board development system that's perfect in the classroom or lab.

Our AIM System Includes: 4K AIM with BASIC interpreter assembler, Power Supply, Cassette recorder & Enclosure **\$799.**

4K AIM — 65 **\$499**

PL65 High Level Language **\$125**

Paper for the AIM (roll) **\$ 2.50**

Rockwell's 4-slot Motherboard (SALE) **\$175**

CompuMart's Microflex 65 System for your AIM Includes: Adapter Buffer Module w/4-slot module stack, 8K RAM module, 16K PROM/ROM module, Asynchronous communications Interface, & Power Supply **\$1,299**

Call or write for our complete Microflex 65 brochure

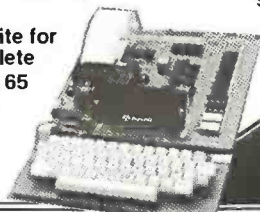

Introducing the HP-85 **\$3,250**

★ CompuMart stocks the COMPLETE LINE OF MATROX PRODUCTS. CALL FOR SPECS

Hewlett-Packard's Personal Computer for Industry. This extremely portable computer features extended BASIC to solve your problems quickly and efficiently along with an advanced graphics system to enhance communication.



NEW from Hewlett-Packard HP 82900-Series Flexible Disk Drives for the HP-85

These 4 new Flexible Disk Drives provide fast on-line storage using flexible disks

\* HP 82901M. Supplies approx. 540K bytes of on-line storage. **\$2,500**

\* HP 82902M. Approx. 270K bytes of on-line storage. **\$1,500**

\* HP 82901S. Supplies an additional 540K bytes when connected to an HP 82901M or an HP 82902M. **\$2,200**

\* HP 82902S. Supplies an additional 270K bytes when connected to an HP 82901M or an HP 82902M. **\$1,300**

The Hewlett-Packard 7225A. High Quality/Low Cost Graphics Plotter. **\$2,050**

Call our expert sales force for complete product specifications.

### COMPUMART'S EXCLUSIVE ATARI SPECIALS. (Pick one)

3 Ways to save when you buy the Atari 800 from us.

1) Free 8K of memory with purchase. (So your Atari will come to you with 24K.)

2) Free 4 10 program recorder with purchase (\$89.95 value).

3) \$100 off Atari Disk Drive purchase.

### ATARI 800 Personal Computer System —

Comes with 800 Operators Manual, 16K RAM Memory module, 10 K ROM Operating System, power supply, TV Switch Box. **\$1080.00**

#### PERIPHERALS

Atari 410 Program Recorder (FREE w/purchase of Atari 800) **\$ 89.95**

Atari 810 Disk Drive (\$100 off with purchase) **699.95**

New Dual Disk double density **1499.95**

825 Printer (Centronics 737) **995.00**

RS232 Interface w/Cable **249.95**

NEW! Light Pens **74.95**



Call for New Software

#### IMPORTANT ORDERING INFORMATION

All orders must include 4% shipping and handling. Mass. residents add 5% sales tax, Michigan residents 4% for sales tax.

Phones open from 8:30 a.m. to 7:00 p.m., Mon.-Fri.; 11:00 a.m. - 4:00 p.m. Sat. P.O.'s accepted from Dun & Bradstreet rated companies - shipment contingent upon receipt of signed purchase order. Sale prices valid for month of magazine date only - all prices subject to change without notice. Our Ann Arbor retail store is open 11:00 a.m. to 7:00 p.m. Tues.-Fri., 10:00 a.m. to 5:00 p.m. Saturdays. Stop by and visit.

**TO ORDER CALL: 800-343-5504**  
In Mass. call 1-617-491-2700

Circle 374 on inquiry card.

# COMPUMART

270 THIRD ST., P.O. BOX 568, DEPT. 111, CAMBRIDGE, MA. 02139



**LETTER  
QUALITY  
UNDER \$2200**



C. Itoh's Starwriter Daisy Wheel Printer is designed to fill a distinct gap in the peripheral market place. A speed of 25 cps and its low price make it the ideal choice for today's system designer interested in achieving superior price/performance ratios.

Incorporating the latest LSI technology, the STARWRITER is built by one of the world's most respected peripheral manufacturers. The printer is furnished complete and ready to use, requiring no changes in hardware or software. STARWRITER offers the industry standard parallel interface, as well as the RS-232 interface with voltage or current mode capacity. Total plug compatibility and a wide variety of interface matching capabilities help lower system integration costs and the 25 cps model is also easily upgraded to a 45 cps printer.

Using a 96 character wheel, the STARWRITER produces letter quality printing on 3 sharp copies with up to 163 columns. STARWRITER offers the highest degree of horizontal and vertical positioning, resulting in the most precise character placement in the industry. The easy-to-change character wheel also makes our printer a perfect choice for international applications. Compatible with sheet feeders, STARWRITER accommodates paper widths to 381 mm (15") and uses industry standard ribbon cartridges.

Along with a self-test capability and a programmable VFU (Vertical Format Unit), STARWRITER furnishes the operator with all desirable status functions, commands and program selectable switches. Panel lamps indicate the current Paper, Select and Power status.

The easy plug-in compatibility of STARWRITER and its outstanding print performance continue C. Itoh's tradition of providing reliable peripheral equipment to systems users the world over.

STARWRITER is backed by a one-year warranty (three months on parts and labor, 9 succeeding months on parts) and is supported by a strong, fully trained and technically proficient service organization.

A complete W/P package to add to your computer system now available. VR Data has integrated the C. Itoh Daisy Wheel Printer and the Magic Wand Word-Processing Program into a high-powered inexpensive word processing package. As an introductory offer we have the entire package for \$2295.00\* - a \$200.00 savings over the combined list price.

Printer specs:

- DIABLO® Wheels & Supplies
- Letter Quality
- 25 CPS - Rapid Seeking - Bi-Directional
- 45 CPS Optional
- Parallel Interface, Serial Optional
- Tractors Available

Priced Separately:

C. Itoh Starwriter	\$2195.00
options:	
45 CPS	600.00
RS232 interface	75.00
Tractors	250.00

\* Add \$75.00 for RS232 interface.



777 HENDERSON BLVD.  
FOLCROFT, PA 19032

**WE SERVICE MANY BRANDS OF COMPUTER EQUIPMENT.  
CALL FOR CONSULTATION AND ESTIMATE.  
DEALER INQUIRES INVITED • BIDS ACCEPTED • ABOVE PRICES  
ARE CASH DISCOUNTED, CALL FOR OTHER TERMS.**



ORDER NOW • TOLL FREE 1 (800) 345-8102 • IN PENNSYLVANIA (215) 461-5300

# VR DATA'S DISK DRIVE HEADQUARTERS

● SALE ●  
TRS-80  
Disk & Other  
Mysteries  
\$19.95  
reg. \$22.95

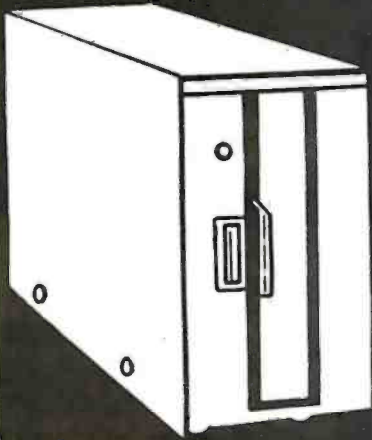

**77 TRACK DRIVES** \$ **545**  
NEW LOW PRICE

TRS-80 Model I compatible

**40 TRACK DRIVES** \$ **340**  
NEW LOW PRICE

TRS-80 Model I compatible

● ORDER NOW TOLL FREE 1 (800) 345-8102 ● IN PENNSYLVANIA (215) 461-5300 ●

**HARD DISK**  
for TRS-80 Model II

**\$5995**

10 meg. 5 fixed 5 removable

● SALE ●  
DISK HEAD  
CLEANERS

5-1/4" \$12.95

reg. \$14.95

8" 3M CLEANER

\$24.95 reg. \$30.00

**SUPERBRAIN™**

BY INTERTEC

**64K \$2995.00**

complete with  
5-1/4" disk drives • in stock



**TRS-80™**  
**64K MODEL II**

**\$3495.00**

NEW LOW PRICE

**Model II Drives**

1 Drive Single Enclosure \$ 899.00

1 Drive Multiple Enclosure 1069.50

Additional Drives for Mult. Enc. 540.00

● VR DATA Coupon ●

**\$5 Off!**

ANY ITEM OVER \$50.00

OFFER EXPIRES 12-1-80 ● ONE COUPON PER ITEM

● VR DATA Coupon ●

**\$10 Off!**

ANY ITEM OVER \$150.00

OFFER EXPIRES 12-1-80 ● ONE COUPON PER ITEM

**SOFTWARE**

	MOD. I	MOD. II		
Medical/Dental Patient Accounting		\$1500		
Word Processing (Magic Wand)		300	4K L II TRS-80	575.70
General Ledger	\$149.95	249	16K L II	789.60
Payroll	99.95	199	RS-232	92.10
Data Base	149.95	299	OK Expansion Interface	278.10
			16K Expansion Interface	376.10
			32K Expansion Interface	474.10
Upper/Lower Case Modification	\$19.95	\$24.95	Telephone Modem	179.95
Comprehensive Diagnostics	34.95	34.95	Emulator CRT by Intertec	895.00
CP/M		\$175.00	CRT Stands	139.00
New DOS + 40 TK		100.00	Anti-static Mats	11 00
New DOS/80		145.00		

Software Documentation Available • CALL FOR PRICES

● VISIT OUR NEW WAREHOUSE SHOWROOM AND REPAIR CENTER ●

**VR Data**

777 HENDERSON BLVD.

FOLCROFT, PA 19032

WE SERVICE MANY BRANDS OF COMPUTER EQUIPMENT.  
CALL FOR CONSULTATION AND ESTIMATE.

DEALER INQUIRES INVITED • BIDS ACCEPTED • ABOVE PRICES  
ARE CASH DISCOUNTED, CALL FOR OTHER TERMS.



ORDER NOW • TOLL FREE 1 (800) 345-8102 • IN PENNSYLVANIA (215) 461-5300

# DP/NET: Redefined

## INDIVIDUAL/NET

### WORD PROCESSOR



S-100, 7 Slot, 360K Double Density

## DUAL/NET

### SMALL BUSINESS APPLICATIONS



Up To 4 Terminals  
Can Be Slaved Off Master

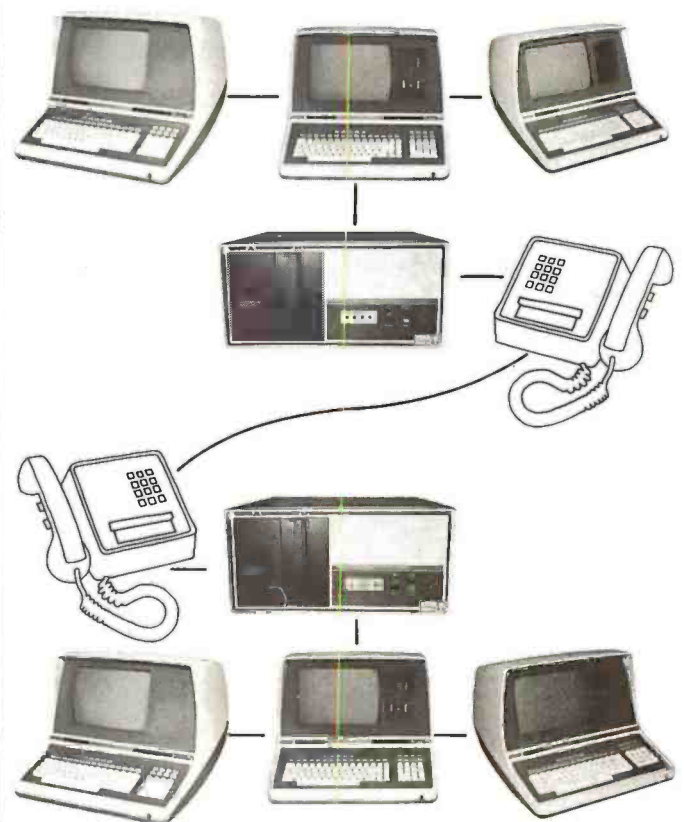
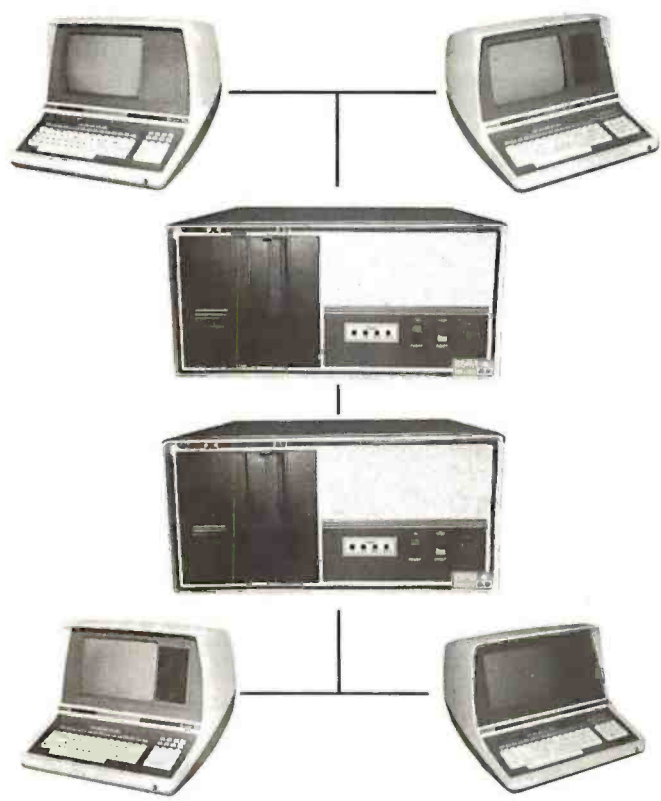

## LOCAL/NET

## TELEPHONE/NET

OVERSEAS

**AUSTRALIA**  
ASP MICROCOMPUTERS  
799 Dandenong Road  
East Malvern 3145  
Victoria, AUSTRALIA  
TEL: 2118855-2118344.

**UNITED KINGDOM**  
TERODEC (MICRO SYSTEMS) LTD.  
17 The Gallop, Yateley,  
Camberley, Surrey  
GU17 7SG ENGLAND  
TEL: 0252 874790

**CENTRAL EUROPE**  
HANNES KELLER AG  
Computer-Zentrum  
Eidmattstrasse 36  
CH-8032, Zurich  
SWITZERLAND  
TEL: 01 69 36 33

**SOUTH AMERICA**  
INVERSIONES URIMAN c.a.  
P.O. Box 1041  
Maracalbo 4001A,  
VENEZUELA  
TEL: 33015

**FAR EAST**  
MICROBOARDS  
1-7-1-1003 Salwai-Cho  
Chiba City, Chiba 260 JAPAN  
TEL: 0472(47)3081

# Configurability

## SYSTEM/NET

### LARGE SYSTEM NUCLEUS



Hard Disc and 8" Floppy  
Any Combination of Master or Slave

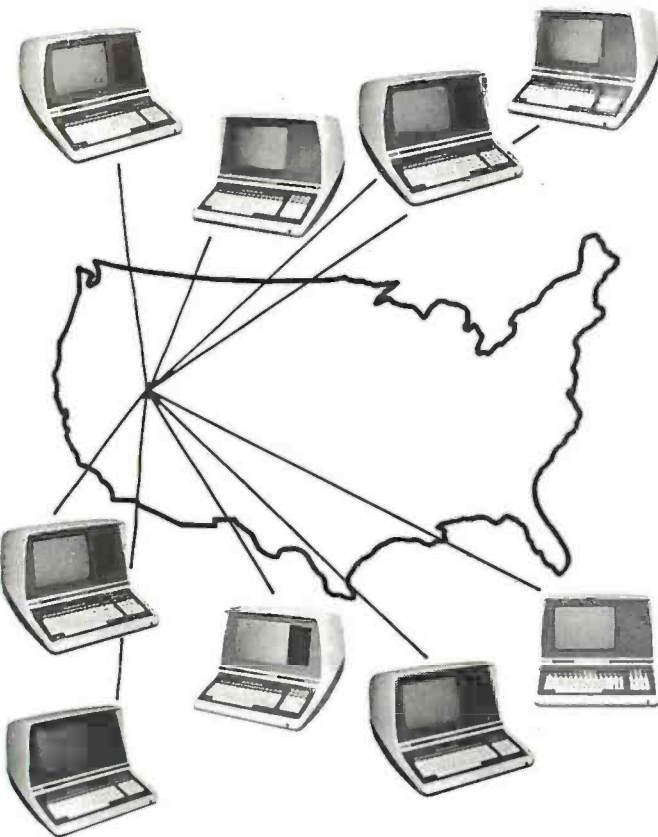

## MASTER/NET

CANADA  
CESCO ELECTRONICS LTD.  
4050 Jean Talon Street WEST  
Montreal, CANADA H4P 1W1  
TEL: (514) 735-5511

BENELUX  
MICROSPOT  
Postbus 564-3700 AN Zelst  
Verheulalaan 3-3971 RD Driebergen  
HOLLAND  
TEL: 03438-(1)8899

## "BUY" WORD FOR THE 1980's

*NETWORKING* is the newest 'buzzword' in microprocessors. Delta Products has produced a superior hardware system that cannot be matched in either cost or performance.

Don't buy a system that has "designed-in" limitations; check the following:

### PERFORMANCE

*This is where DP/NET® beats them all. Delta does multiuser and multitasking operations by using distributed processors. DIGITAL RESEARCH has provided a new operating system (CP/NET®) which combines MP/M® and CP/M 2.2® into the world's most powerful microcomputer system.*

*The system cannot be bogged down by adding more users. High-speed DMA transfers from Host to Slave, allow many processors to share workloads. (There can be 3 processors at EACH user terminal; a Z-80 for screen function, and a pair of 8085/8088 for main processing.)*

### FLEXIBILITY

*One of the most important advantages of DP/NET® is that you never have to purchase more system than you currently need. Your system can start with a 5" minifloppy 32K terminal for under \$3000.00. Adding a second terminal and additional mass storage is as simple as the original purchase. Networking up to 16 OR MORE intelligent and semi-intelligent work stations can follow in perfect step with the growth of your Company and requirements.*

### COST

*Since you never buy more computer power than you need, the system cost is matched to the demand to be placed upon it. DELTA PRODUCTS has a lot of experience in building micros, with over 2000 DELTA systems now in the field. DELTA component cost has always been extremely competitive. DELTA's new "networking system" is a natural and simple combination of the competitive "good deals" we have been offering for some time.*

### SOFTWARE

*A computer system to the end user IS THE SOFTWARE. All CP/M® compatible programs run perfectly on the DP/NET®. DELTA PRODUCTS is currently writing its' own high-performance custom data base, screen editor, order entry/inventory, and accounting packages in PL/1®. Target release date for the complete package is November, 1980.*

**SOLD ONLY THROUGH DEALERSHIPS  
CALL FOR YOUR NEAREST REPRESENTATIVE**

DELTA PRODUCTS

15392 Assembly Lane  
Huntington Beach, CA 92649  
TELEPHONE: (714) 898-1492



TELEX: 681-367 DELTMAR HTBH

MP/M, CP/M2.2, PL/1 & CP/NET ARE REG. TM. OF DIGITAL RESEARCH INC.

Circle 376 on Inquiry card.

# MICROPOLIS™

# OVERSTOCKS



**PRIORITY ONE ELECTRONICS**  
 16723B ROSCOE BLVD. • SEPULVEDA, CA. 91343  
 (800) 423-5633 or (213) 894-8171

## MICROPOLIS OVERSTOCK LIST

MODEL	DESCRIPTION	LIST PRICE	SALE PRICE
MCP-1053-2	<b>S-100 SUB-SYSTEMS</b>		
MCP-1043-2	630 KB DUAL	\$1895.00	\$995.00
MCP-1041-2	315 KB SINGLE	\$1145.00	\$695.00
MCP-1042-1	315 KB SINGLE, NO PS	\$1045.00	\$639.00
MCP-1041-1	143 KB SINGLE	\$795.00	\$625.00
	143 KB SINGLE, NO PS	\$695.00	\$595.00
	<b>COMPLETE W/S-100 CONTROLLER, CABLES, MANUALS &amp; MICROPOLIS MDOS &amp; BASIC</b>		
MCP-1033-2	<b>ADD-ON DRIVES</b>		
MCP-1023-2	630 KB DUAL		
MCP-1021-2	315 KB SINGLE		
MCP-1022-1	143 KB SINGLE, NO PS		
MCP-1021-1	143 KB SINGLE, NO PS		
MCP-1027-1	<b>REQUIRES ACCESSORY ADD-ON CABLES</b>		
MCP-1037-1	35 TRACK SINGLE	\$1395.00	\$895.00
MCP-1027-2	35 TRACK DUAL	\$645.00	\$495.00
MCP-1037-2	77 TRACK SINGLE	\$545.00	\$475.00
APP 395M	77 TRACK DUAL	\$445.00	\$375.00
VRB-MD 525-16	<b>DISK DRIVES</b>		
VRB-MD 577-16	NEW DOS/80 TRS-80® 35 thru 77 TRACK OPERATING SYSTEM	\$545.00	\$360.00
VRB-MD 577-01	Verbatim 16 Sector Diskettes Box of 10	\$1195.00	\$695.00
VRB-FD05	Verbatim 16 Sector 77 Track Cert Box of 10	\$645.00	\$495.00
PR1-34CEEE-2	Verbatim Soft Sector Diskettes Box of 10	\$1395.00	\$895.00
PR1-34CEEE-4	5 1/4" Disk Drive Cleaning Kit	\$149.00	\$100.00
	Two Drive Data Cable		\$29.95
	Four Drive Data Cable		\$48.00
			\$29.95
			\$48.00
			\$29.95
			\$29.95
			\$39.95

**ALL DRIVES NEW, IN FACTORY SEALED CARTONS WITH FULL MANUFACTURES WARRANTY.**  
 • Sale Prices are for prepaid orders only • Quantities are limited, subject to prior sale • CREDIT CARD ORDERS WILL BE CHARGED APPROPRIATE FREIGHT • PRICES GOOD THRU NOVEMBER, 1980



**ORDER TOLL FREE**  
**1-800-423-5633**  
 except CA., AK., HI., CALL  
**(213) 894-8171**

**FOR MORE INFORMATION SEE OUR 60 PAGE COLOR DETACHABLE ENGINEERING SELECTION GUIDE IN THE NOVEMBER BYTE MAGAZINE**

Terms: Visa, MC, BAC, Check, Money Order, U.S. Funds Only. CA residents add 6% sales tax. Minimum order \$15.00 Prepaid U.S. orders less than \$75.00 include 5% shipping and handling. MINIMUM \$2.50. Excess refunded. Just in case...please include your phone number. Prices subject to change without notice. We will do our best to maintain prices thru November 1980.



# SALE

NO PROBLEM BOSS ...  
PRIORITY ONE IS HERE NOW!  
BUT YOU'LL SLEEP BETTER IF  
YOU DON'T KNOW WHAT PRICES  
I'VE QUOTED .....

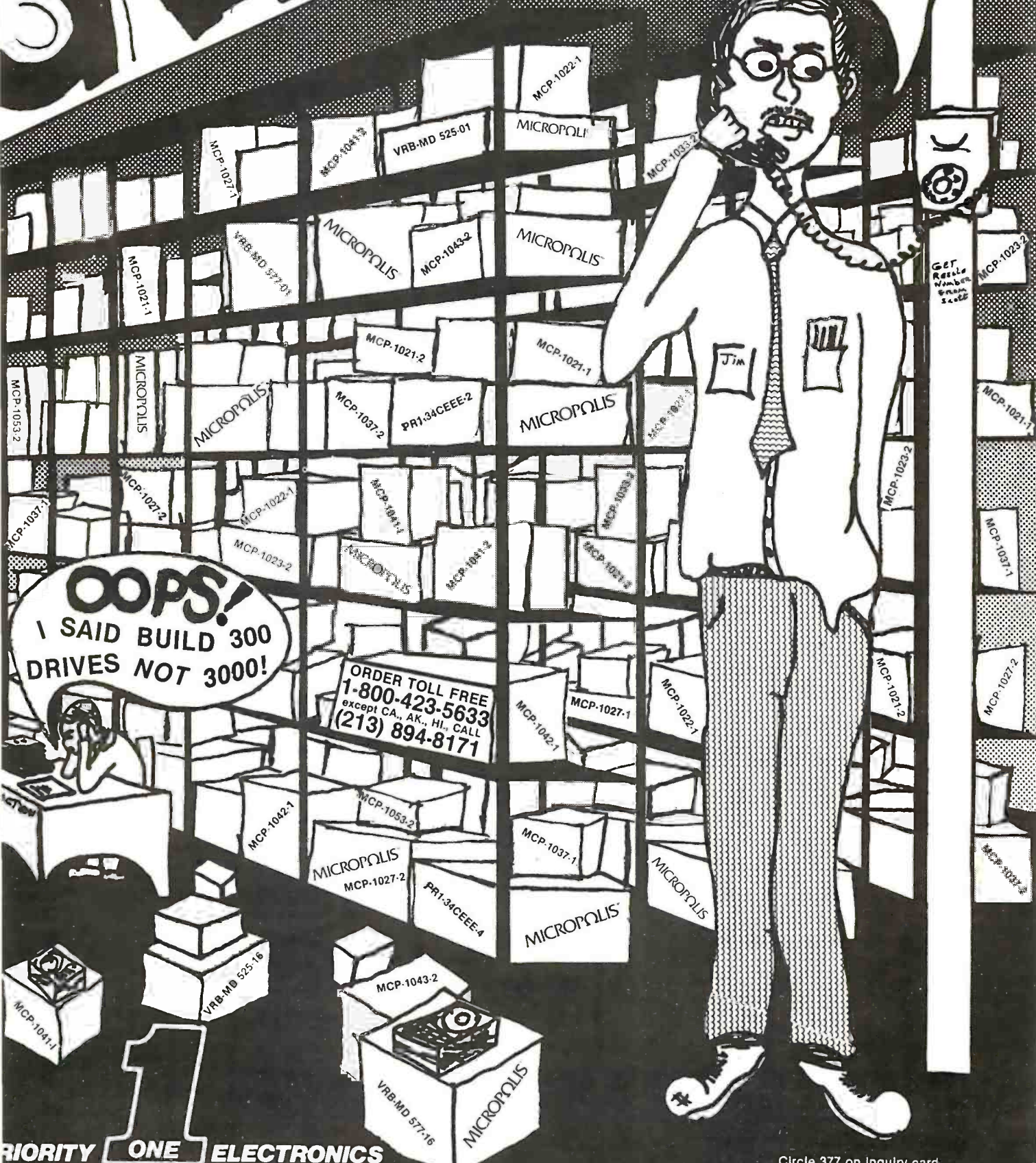

PRIORITY ONE ELECTRONICS

Circle 377 on Inquiry card.

# 7400 74LS00

SN7400N	19	SN74123N	69	74LS00N	35	74LS164N	4,19
SN7401N	22	SN74125N	69	74LS01N	28	74LS165N	89
SN7402N	22	SN74126N	44	74LS02N	28	74LS166N	2,48
SN7403N	22	SN74128N	59	74LS03N	28	74LS168N	1,89
SN7404N	22	SN74132N	69	74LS04N	39	74LS169N	1,89
SN7405N	23	SN74144N	65	74LS05N	39	74LS170N	1,15
SN7406N	23	SN74139N	95	74LS06N	39	74LS173N	89
SN7407N	23	SN74141N	69	74LS07N	39	74LS174N	99
SN7408N	26	SN74142N	2,95	74LS08N	28	74LS175N	99
SN7409N	23	SN74143N	2,95	74LS09N	39	74LS181N	2,20
SN7410N	23	SN74144N	65	74LS10N	39	74LS182N	1,15
SN7411N	29	SN74145N	62	74LS11N	47	74LS191N	1,15
SN7412N	29	SN74147N	1,95	74LS12N	47	74LS192N	98
SN7413N	39	SN74148N	1,20	74LS13N	39	74LS193N	98
SN7414N	39	SN74150N	99	74LS14N	26	74LS194N	1,15
SN7416N	29	SN74151N	67	74LS15N	38	74LS196N	89
SN7417N	29	SN74152N	67	74LS16N	39	74LS197N	89
SN7420N	22	SN74153N	67	74LS17N	39	74LS221N	1,49
SN7421N	35	SN74154N	1,19	74LS18N	39	74LS222N	1,59
SN7422N	39	SN74155N	89	74LS19N	39	74LS223N	1,59
SN7423N	29	SN74156N	69	74LS20N	26	74LS241N	1,90
SN7425N	29	SN74157N	69	74LS21N	39	74LS242N	1,55
SN7426N	29	SN74158N	1,65	74LS22N	39	74LS243N	1,95
SN7427N	29	SN74160N	95	74LS23N	39	74LS244N	1,95
SN7428N	45	SN74161N	95	74LS24N	26	74LS245N	4,35
SN7430N	23	SN74162N	89	74LS25N	79	74LS247N	1,10
SN7432N	29	SN74163N	87	74LS26N	79	74LS248N	1,10
SN7433N	29	SN74164N	97	74LS27N	79	74LS249N	1,69
SN7434N	29	SN74165N	97	74LS28N	79	74LS251N	1,79
SN7435N	29	SN74166N	1,20	74LS29N	79	74LS252N	1,79
SN7440N	24	SN74167N	1,95	74LS30N	35	74LS257N	98
SN7441N	79	SN74170N	1,69	74LS31N	35	74LS258N	98
SN7442N	79	SN74172N	5,95	74LS32N	35	74LS259N	2,95
SN7443N	79	SN74173N	79	74LS33N	68	74LS260N	69
SN7444N	79	SN74174N	89	74LS34N	68	74LS261N	69
SN7445N	79	SN74175N	89	74LS35N	65	74LS266N	59
SN7446N	79	SN74176N	85	74LS36N	65	74LS273N	1,75
SN7447N	59	SN74177N	85	74LS37N	1,19	74LS275N	4,40
SN7448N	79	SN74178N	1,80	74LS38N	45	74LS279N	2,59
SN7450N	23	SN74179N	1,85	74LS39N	75	74LS282N	1,10
SN7451N	23	SN74181N	1,75	74LS40N	75	74LS290N	1,29
SN7452N	23	SN74182N	1,75	74LS41N	75	74LS293N	1,29
SN7454N	23	SN74184N	1,95	74LS42N	75	74LS295N	1,10
SN7455N	29	SN74185N	1,95	74LS43N	88	74LS295N	1,29
SN7456N	29	SN74186N	1,95	74LS44N	88	74LS295N	1,29
SN7470N	39	SN74188N	3,90	74LS45N	88	74LS295N	1,29
SN7472N	34	SN74190N	1,15	74LS46N	88	74LS295N	1,29
SN7473N	38	SN74191N	1,15	74LS47N	88	74LS295N	1,29
SN7474N	38	SN74192N	1,15	74LS48N	88	74LS295N	1,29
SN7475N	38	SN74193N	1,15	74LS49N	88	74LS295N	1,29
SN7476N	38	SN74194N	1,15	74LS50N	88	74LS295N	1,29
SN7479N	4,60	SN74195N	85	74LS51N	88	74LS295N	1,29
SN7480N	59	SN74196N	85	74LS52N	88	74LS295N	1,29
SN7481N	1,10	SN74197N	85	74LS53N	88	74LS295N	1,29
SN7482N	1,10	SN74198N	1,39	74LS54N	88	74LS295N	1,29
SN7483N	55	SN74199N	1,39	74LS55N	88	74LS295N	1,29
SN7485N	65	SN74221N	1,39	74LS56N	88	74LS295N	1,29
SN7486N	39	SN74225N	3,90	74LS57N	88	74LS295N	1,29
SN7487N	1,75	SN74226N	1,39	74LS58N	88	74LS295N	1,29
SN7488N	39	SN74227N	1,39	74LS59N	88	74LS295N	1,29
SN7489N	39	SN74228N	1,39	74LS60N	88	74LS295N	1,29
SN7491N	65	SN74230N	2,15	74LS61N	88	74LS295N	1,29
SN7492N	65	SN74231N	2,15	74LS62N	88	74LS295N	1,29
SN7493N	65	SN74232N	2,15	74LS63N	88	74LS295N	1,29
SN7494N	65	SN74233N	2,15	74LS64N	88	74LS295N	1,29
SN7495N	65	SN74234N	2,15	74LS65N	88	74LS295N	1,29
SN7496N	65	SN74235N	2,15	74LS66N	88	74LS295N	1,29
SN7497N	3,10	SN74236N	68	74LS67N	88	74LS295N	1,29
SN7498N	3,10	SN74237N	68	74LS68N	88	74LS295N	1,29
SN7499N	3,10	SN74238N	68	74LS69N	88	74LS295N	1,29
SN7400N	19	SN74123N	69	74LS70N	88	74LS295N	1,29
SN7401N	22	SN74125N	69	74LS71N	88	74LS295N	1,29
SN7402N	22	SN74126N	44	74LS72N	88	74LS295N	1,29
SN7403N	22	SN74128N	59	74LS73N	88	74LS295N	1,29
SN7404N	22	SN74132N	69	74LS74N	88	74LS295N	1,29
SN7405N	23	SN74144N	65	74LS75N	88	74LS295N	1,29
SN7406N	23	SN74139N	95	74LS76N	88	74LS295N	1,29
SN7407N	23	SN74141N	69	74LS77N	88	74LS295N	1,29
SN7408N	26	SN74142N	2,95	74LS78N	88	74LS295N	1,29
SN7409N	23	SN74143N	2,95	74LS79N	88	74LS295N	1,29
SN7410N	23	SN74144N	65	74LS80N	88	74LS295N	1,29
SN7411N	29	SN74145N	62	74LS81N	88	74LS295N	1,29
SN7412N	29	SN74147N	1,95	74LS82N	88	74LS295N	1,29
SN7413N	39	SN74148N	1,20	74LS83N	88	74LS295N	1,29
SN7414N	39	SN74150N	99	74LS84N	88	74LS295N	1,29
SN7416N	29	SN74151N	67	74LS85N	88	74LS295N	1,29
SN7417N	29	SN74152N	67	74LS86N	88	74LS295N	1,29
SN7420N	22	SN74153N	67	74LS87N	88	74LS295N	1,29
SN7421N	35	SN74154N	1,19	74LS88N	88	74LS295N	1,29
SN7422N	39	SN74155N	89	74LS89N	88	74LS295N	1,29
SN7423N	29	SN74156N	69	74LS90N	88	74LS295N	1,29
SN7425N	29	SN74157N	69	74LS91N	88	74LS295N	1,29
SN7426N	29	SN74158N	1,65	74LS92N	88	74LS295N	1,29
SN7427N	29	SN74160N	95	74LS93N	88	74LS295N	1,29
SN7428N	45	SN74161N	95	74LS94N	88	74LS295N	1,29
SN7430N	23	SN74162N	89	74LS95N	88	74LS295N	1,29
SN7432N	29	SN74163N	87	74LS96N	88	74LS295N	1,29
SN7433N	29	SN74164N	97	74LS97N	88	74LS295N	1,29
SN7434N	29	SN74165N	97	74LS98N	88	74LS295N	1,29
SN7435N	29	SN74166N	1,20	74LS99N	88	74LS295N	1,29
SN7440N	24	SN74167N	1,95	74LS00N	35	74LS164N	4,19
SN7441N	79	SN74170N	1,69	74LS01N	28	74LS165N	89
SN7442N	79	SN74172N	5,95	74LS02N	28	74LS166N	2,48
SN7443N	79	SN74173N	79	74LS03N	28	74LS168N	1,89
SN7444N	79	SN74174N	89	74LS04N	39	74LS169N	1,89
SN7445N	79	SN74175N	89	74LS05N	39	74LS170N	1,15
SN7446N	79	SN74176N	85	74LS06N	39	74LS173N	89
SN7447N	59	SN74177N	85	74LS07N	39	74LS174N	99
SN7448N	79	SN74178N	1,80	74LS08N	28	74LS175N	99
SN7450N	23	SN74179N	1,85	74LS09N	39	74LS181N	2,20
SN7451N	23	SN74181N	1,75	74LS10N	39	74LS182N	1,15
SN7452N	23	SN74182N	1,75	74LS11N	47	74LS191N	1,15
SN7454N	23	SN74184N	1,95	74LS12N	47	74LS192N	98
SN7455N	29	SN74185N	1,95	74LS13N	39	74LS193N	98
SN7456N	29	SN74186N	1,95	74LS14N	26	74LS194N	1,15
SN7470N	39	SN74188N	3,90	74LS15N	38	74LS196N	89
SN7472N	34	SN74190N	1,15	74LS16N	39	74LS197N	89
SN7473N	38	SN74191N	1,15	74LS17N	39	74LS221N	1,49
SN7474N	38	SN74192N	1,15	74LS18N	39	74LS222N	1,59
SN7475N	38	SN74193N	1,15	74LS19N	39	74LS223N	1,59
SN7476N	38	SN74194N	1,15	74LS20N	26	74LS241N	1,90
SN7479N	4,60	SN74195N	85	74LS21N	39	74LS242N	1,55
SN7480N	59	SN74196N	85	74LS22N	39	74LS243N	1,95
SN7481N	1,10	SN74197N	85	74LS23N	39	74LS244N	1,95
SN7482N	1,10	SN74198N	1,39	74LS24N	26	74LS245N	4,35
SN7483N	55	SN74199N	1,39	74LS25N	79	74LS247N	1,10
SN7485N	65	SN74221N	1,39	74LS26N	79	74LS248N	1,10
SN7486N	39	SN74225N	3,90	74LS27N	79	74LS249N	1,69
SN7487N	1,75	SN74226N	1,39	74LS28N	79	74LS251N	1,79
SN7488N	39	SN74227N	1,39	74LS29N	79	74LS252N	1,79
SN7489N	39	SN74228N	1,39	74LS30N	35	74LS257N	98
SN7491N	65	SN74230N	2,15	74LS31N	35	74LS258N	98
SN7492N	65	SN74231N	2,15	74LS32N	35	74LS259N	2,95
SN7493N	65	SN74232N	2,15	74LS33N	68	74LS260N	69
SN7494N	65	SN74233N	2,15	74LS34N	68	74LS261N	69
SN7495N	65	SN74234N	2,15	74LS35N	65	74LS266N	59
SN7496N	65	SN74235N	2,15	74LS36N	65	74LS273N	1,75
SN7497N	3,10	SN74236N	68	74LS37N	1,19	74LS275N	4,40
SN7498N	3,10	SN74237N	68	74LS38N	45	74LS279N	2,59
SN7499N	3,10	SN74238N	68	74LS39N	75	74LS282N	1,10
SN7400N	19	SN74123N	69	74LS40N	75	74LS290N	1,29
SN7401N	22	SN74125N	69	74LS41N	75	74LS293N	1,29
SN7402N	22	SN74126N	44	74LS42N	75	74LS295N	1,10
SN7403N	22	SN74128N	59	74LS43N	88	74LS295N	1,29
SN7404N	22	SN74132N	69	74LS44N	88	74LS295N	1,29
SN7405N	23	SN74144N	65	74LS45N	88	74LS295N	1,29
SN7406N	23	SN74139N	95	74LS46N	88	74LS295N	1,29
SN7407N	23	SN74141N	69	74LS47N	88	74LS295N	1,29
SN7408N	26	SN74142N	2,95	74LS48N	88	74LS295N	1,29
SN7409N	23	SN74143N	2,95	74LS49N	88	74LS295N	1,29
SN7410N	23						



# California Digital

Post Office Box 3097 B • Torrance, California 90503



Introducing the  
**ANACOM 150**  
DOT MATRIX PRINTER

Mfg. suggested list \$1350  
California Digital Introductory Price  
**\$995**

**Full 136 Characters for the price of 80**

**DURABILITY...** is the key component of the new Anacom 150. No bells, no whistles, no problems, just consistent high quality output.

This nine wire dot matrix printer features a ballistic type print mechanism guaranteed for three million characters. Low count (16) integrated circuits add to the reliability of the printer.

Microprocessor controlled logic sucking bi-directional head allows the Anacom to print up to speeds of 190 characters per second. 136 columns wide.

Adjustable tractor and variable head permit the Anacom to accept fifteen inch wide multi-form forms.

Switch selectable: slip paper perforation, carriage return/line feed or 9/16 or eight lines per inch.

Lexan paper shield and enclosure sound proof add to the overall quality of the printer.

The Anacom 150 is definitely the best value in today's extremely competitive world of micro-printers.

If you are in the market for a "Quality Engineered" dot matrix printer, please consider the Anacom 150 before purchasing a less reliable machine.

Available either RS-232 serial 9600 baud, PRA-1505 or Centronics parallel PRA-130P. Field exchange. UPS shipping weight 20 pounds.

**IBM 3101 DISPLAY TERMINAL**

The new 3101 display terminal is the IBM entry into the plug compatible micro computer industry.

This modularly constructed CRT terminal has been engineered with the user in mind. The video display module swivels and tilts to provide the operator with a comfortable viewing posture.

Twelve inch 11-39 green phosphor screen boasts a crisp 7 by 11 character matrix.

Standard 80 by 24 line screen format with a 26th line to display machine status and aid in the diagnostics in the event of a system malfunction.

87 key scientific style keyboard arrangement, along with numeric entry pad. Eight user definable function keys.

The 3101 video terminal is RS232 compatible and displays all 128 ASCII characters including control codes.

Accessible customer setup switches aid in choosing such options as line speed, parity scroll, and reverse video.

But most of all, built into every 3101 terminal is the quality that you have learned to expect from the IBM Corporation. VDT-3101



IBM direct price \$1295  
**CALIFORNIA DIGITAL**  
discount price  
**\$1195** immediate delivery



**TEC V-300**  
Word Processing  
Daisy Wheel Printer  
**\$1595**

Finally a reasonably priced letter quality printer... Bi-directional printing at 25 characters per second. Full 136 print positions wide. Proportional spacing 1/120" horizontal, 1/48" vertical. Uses standard Diablo brand interchangeable easy print wheels. Intel 8085 CPU microprocessor controlled. Interfaces via Centronics parallel connector. Shipping 58 lbs. PRV-300.

**NEC Spinwriter**  
5510 P/S  
**\$2495**

The word processing quality Spinwriter prints at speeds up to 50 characters per second. The Model 5510 P/S is supplied with both parallel and RS-232 serial interfacing. Also included is the tractor feed mechanism, along with print thimble and ribbon. P/N-5510 P/S 79 lbs. Keyboard (K510) Model 5520 P/S available \$2995. P/N-5520 P/S 75 lbs.

**PRINTRONIX**  
**\$4500**

Forty-four separate print heads shuttle to provide overlapping dots. This unique feature allows a resolution of 60 dots per inch horizontal and 72 vertical. The Printronix P-300 has the capability of outputting pictures, bar codes and large labels, a feature not provided with hand or chain printers. PRP-300 290 lbs.

**Anadex**  
**\$1395**  
PRX9500  
**DP-9500**

**TI-810**  
**\$1495**  
List \$1895  
Save \$400

**CENTRONICS**  
730 \$595  
737 \$795

Both the Centronics 730 and the 737 are capable of accepting standard office letterhead or pin feed continuous forms. For higher resolution the 737 implements a nine wire dot matrix print head. Parallel interfacing. Add \$65 for RS232. PRC-130P (S). PRC-137P (S) 17 lbs.



**AMPEX**  
DIALOGUE 80  
CRT TERMINAL  
**\$995**

New from the Amplex Corporation. The Dialogue 80 features removable keyboard, displayable two pages (four optional) dual program keys, half intensity protected fields and status line. Transmits data either block, line or character mode. Excellent value. VDT-D80 shipping 47 lbs.



**ADDS**  
**HEWLETT PACKARD**  
**HP 85**  
**\$2650**

The Hewlett Packard HP-85 is a complete, low cost portable computer system. This self contained package includes CPU, keyboard, printer, CRT display and cassette tape drive. SYS-85S5 39 lbs.

**APPLE II**  
**\$988**

**ATARI**  
800 \$747  
400 \$695

**LOBO**  
Disk Drives

The package includes a durable steel enclosure. Power On/Off hard disk power supply, muffin exhaust fan and all the necessary harnessing cables. The Lobo package with: One Sugart SA801R disk drive... \$795 Two Sugart SA1601R disk drives... \$1195

**S-100 BOARDS**  
Assembled • Tested • Burned-in

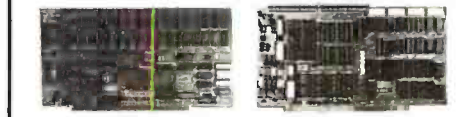

MEASUREMENT SYSTEMS	
Dynamic memory DAB-6400	\$770
Dynamic memory DAB-3200	900
GOBOUT/COMPUPRO	
Dual 8088/8085 16 bit CPU	375
Z-80 CPU 24 bit address 4 Mhz	239
Static RAM 32K (Alpha Micro)	375
Spectrum color graphics board	329
Interface II I/O board	199
SEATTLE COMPUTER PRODUCTS	
8086 16 bit CPU 2 card set/86 dos 595	
CALIFORNIA COMPUTER SYSTEMS	
S-100 Mainframe 2200A	329
Disk controller/2.2 CPM 2422	329
Z-80 CPU 4Mhz DMA 2810A	250
DIGITAL RESEARCH	
32K 2716 EPROM board	99
EPROM's for above 2716 16 reg. 13	
CALIFORNIA DATA CORPORATION	
A/D board 16 channel 12 bits	
QT COMPUTER SYSTEMS	
Real time clock/calendar	135

**S-100 Mother Board \$35**

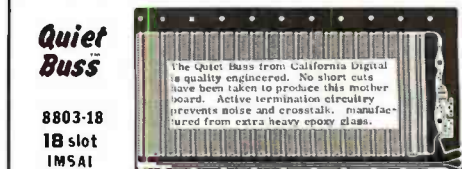

**Quiet Buss**  
8803-18  
1B slot  
IMSAI

**ACCESSORIES FOR THE APPLE COMPUTER**

CALIFORNIA COMPUTER SYSTEMS	
Arithmetic Processor 7811 B/C	\$319
Asynchronous serial interface 7710	129
Centronics interface card 7728	95
16 channel AD/DA 8 bit	319
12K PROM Module 7114	69
Calendar/ Clock. Back-up 7424	99
Parallel interface 7720A	99
Programmable Timer 7710A	99
Analog/Digital converter 7470A	99
NICHOSKOT PRODUCTS	
Apple to Z-80 CPU card	379
Microdotem for Apple	319
COMPUTER STOP PRODUCTS	
Double Vision / 80 Columns Video	250
INTER ACTIVE STRUCTURES	
16 Channel A/D card A10/2	275
MOUNTAIN COMPUTER PRODUCTS	
Inter X-10 system for BSR	\$239
Intrio X-10 card only	165
Apple Clock battery back-up	225
Serial-to-serial 52200	245
ROM Plus with filter	165
ROM Writer/Programmer	149
APPLE BRASID PRODUCTS	
Apple language card	450
Floppy disk with controller	590
Floppy disk without controller	495
Apple parallel interface	175
SSM MICROCOMPUTER	
Dual serial parallel interface A10	149
SORRENTO VALLEY ASSOCIATES	
8" Floppy controller (Pascal)	360

**direct connect**  
**MODEM**  
**Universal Data 103**

Connects directly to the new modular phone jack. Fully powered from your existing telephone line. No need to locate external AC power. Crystal control prevents frequency drift. Direct connect feature eliminates loss of information due to carbon compression that is associated with acoustic modems.



**\$169**



All merchandise sold by California Digital is premium grade. Shipping: First five pounds \$2.00; each additional add \$.40 Foreign orders 10% shipping. Excess will be refunded. California residents add 6% sales tax. COD's discouraged. Open accounts extended to state supported educational institutions and companies with a "Strong Dun & Bradstreet." Warehouse: 15808 Inglewood Blvd. Visitors by appointment.

**TOLL FREE ORDER LINE**  
**(800) 421-5041**  
**TECHNICAL & CALIFORNIA**  
**(213) 679-9001**

# California Digital

Post Office Box 3097 B • Torrance, California 90503

## NEW

from  
INTEGRAL DATA  
**460**  
Paper Tiger

\*\*\*\* All the features of the 440 and more \*\*\*\*  
The 460 uses a dot matrix character formation technique in which the placement of the dots overlap both horizontally and vertically to achieve a correspondence-quality printing.  
The printer's nine-wire print head uses staggered needle rows to create the vertically overlapping dots. The head is driven bidirectionally under microprocessor control by a stepper motor driven mechanism with logic-seeking look ahead capability.  
Standard "Two-K Byte" buffer allows the printer to accept the entire content of a 1.920-character CRT screen. Weight 27 lbs. suggested list price \$1,295. Calif. Digital price **\$1,076**

## S-100 POWER SUPPLY

Mfg. for California Digital by **\$59**  
**SIERRACIN**



Designed for on board regulation.  
8V./10A.; ±18V./2A.  
Input: 115/230VAC.  
80% efficiency.  
Same as above but:  
8V./20A.; ±18V./4A.  
11x5.4" PWS-20A  
\$95

## WESTERN UNION ENCLOSURE

These enclosures were manufactured for Western Union by Universal Technology. The exact purpose of the product is still a mystery but the enclosure is ideally suited for an S-100 motherboard with attached power supply. Remove the head and plastic from make this enclosure an attractive home for any hobby project. New surplus in factory boxes supplied with three 22/41 color connectors; DB25 communications connector; six foot grounded power cord and more. Inside dimensions: 18" x 10 1/2" x 6 7/8". Shipping weight 9 lbs. **\$24.95**



## TELETYPE MODEL 43

4320 KEYBOARD  
TTL ..... AAA **\$ 950**  
RS232 ..... AAK **1050**  
Friction ... AAE **1100** plus shipping  
103 Modem AAB **1575**

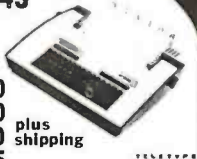

## FREE PLASTIC LIBRARY CASE

with purchase of each box of ...  
Memorex mini-diskettes, \$5 value.

**\$27** BOX of TEN DISKETTES  
10 Boxes **\$24.95**  
100 Boxes **\$22.25**  
forty track

### DB25

each 10+  
male \$2.50 225  
female 325 305  
hood-zp 125 98  
Centronic 695

### BCD Thumbwheel Switch 195

Ten Position  
Mfg. by Digiswitch  
1 7/8" high 1 1/2" wide

### Edge Connectors

**GOLD 100 PIN**  
IMSAI/ALTAIR

Imesai solder 125x 250 **\$2.95 3/4 7.50**  
Imesai w/w .125 centers **\$4.95 3/4 13.00**  
Altair solder/altair .140row **\$5.95 3/4 15.00**

**SPECIALS**  
22/44 Kim eyelet .156" **\$1.95 3/4 5.00**  
25/50 solder tab .156" **\$1.09 3/4 2.00**  
36/72 wide Post w/w .156" **\$1.95 3/4 5.00**

### Lear Seigler Inc. In Plant POCKET INTERCOM \$14.95

Another one of our mystery products. Manufactured by the Lear Seigler Company. The pocket intercom is supplied in a deep drawn blue anodized aluminum enclosure. Excellent for those special projects which require a touch of elegance. LSI list price \$145. Supplied with chrome pocket clip. 9W transistor battery required. Model 1160. New surplus. measures 3 1/2" x 2 1/8" x 1 1/2". SPC-LSI

### IEE Projection Module \$995 set of three \$25

Voltage applied to one of the twelve discrete miniature incandescent #28 lamps causes the module to display the selected character. (A-D thru G). Users may substitute the character film and display pictures and symbols of their own choosing. Manufactured by Industrial Electronic Engineers Inc. SPC-4. 12. Used excellent cond. 24 lamp modules also avail.

Authorized Distributor

740-0 IBM soft format.	\$39.00	\$3.50
740-2 Double side soft	65.00	6.00
741-0 Double density	53.00	4.90
743-0 Double/Double	70.00	6.60
740-32 8" Hard sector	39.00	3.50
744-(0)(10)(16) 5 1/4" mini	39.00	3.50
Library case for any above:	Add \$3.00	
834 A Data Cassette	5.50	
DC 100 Mini Cartridge	16.00	
DC 300 Data Cartridge	20.00	
920 ( ) Disk Cartridge	89.90	

### SA800-R Floppy Disk Drive \$449.50

Shugart Associates

### XEROX 800 WORD PROCESSING KEYBOARD ASCII ENCODED

This 77 key word processing keyboard was manufactured by Mergeswitch for use in the Xerox 800 word processing system. The keyboard outputs a seven bit ASCII code along with an eighth bit that allows most keys to shift and double function as special characters. Extra large "Tab A Return" keys are designed into the layout of the keyboard to emulate the IBM Selectric. 17 illuminated keys serve for special word processing codes. The keyboard is equipped with two thumbwheel switches for defining line width. Original Xerox acquisition over \$400.00. California Digital USED price only \$49.90. Excellent cond. Documentation included.

## MEMORY

### TRS-80 \$39

### APPLE II 39

16k memory (8) 4116's

Installation is simple. Anyone who has ever changed a spark plug should be able to up-grade his microcomputer.  
How can California Digital offer these memory up-grade sets at 25% below our competition? Simple, we buy in volume, wholesale to dealers and sell the balance directly to owners of personal micro-systems. These 16K dynamic memory circuits are factory prime and unconditionally guaranteed for one full year. NOW, before you change your mind, pick up the telephone and order your up-grade memory from California Digital. Add \$3 for TRS80 jumpers.

### DATA INPUT TERMINAL \$49

This Keystation terminal was recently acquired from the CMC division of the Perdec Corporation. The unit was originally designed for inputting data directly onto magnetic tape.  
The system is composed of a premium cast aluminum and fiberglass enclosure, along with a honeywell/microswitch hall effect keyboard. Thirty display lamps advise the operator of the systems status. Four inch loud speaker astrometrics acceptance of data and alerts the operator of pending problems.  
But most of all this "USED" terminal, with a little imagination, can be engineered to make the perfect home for an S-100 computer, and video display, or with slight modification will accept the lockwell Altai-65 microcomputer.  
Five volt regulated power supply is available for an additional \$20. (see June flyer)  
All units are in excellent condition. Original acquisition over \$700. 22 lbs.

### Scotch DISKETTE HEAD CLEANING KIT \$24.95

your choice  
**\$98**

SPDT Miniature Toggles  
7101 CK ON-NONE-ON  
7107 jbt ON-OFF(mnt.ON)  
7108 CK ON-(moment ON)  
7103 CK ON OFF ON  
Rotary 3P-4-Pos.  
Rotary 3P-6-Pos.  
Push B (N.O.) \$39ea. 4/51

STATIC	1-31	32-99	100-5C	999	1K+
21L02 450nS.	1.19	.99	.95	.90	.85
21L02 250nS.	1.49	1.39	1.25	*	*
2114 1Kx4 450	5.95	5.50	5.25	4.75	4.50
2114 1Kx4 300	8.95	8.50	8.00	*	*
4044 4Kx1 450	5.95	5.50	5.25	*	*
4044 4Kx1 250	9.95	9.50	9.00	*	*
4045 1Kx4 450	8.95	8.50	8.00	*	*
4045 1Kx4 250	9.95	9.50	9.00	*	*
5257 low pow.	5.95	5.50	5.00	4.80	4.60

### CONTROL DATA CRT Terminal? \$49

Frankly we made a mistake and are offering these terminals below our cost just to get them out of our warehouse. As far as we can determine the units are complete. But we are offering them on an "as-is" basis without any return privileges.  
The terminals were originally purchased from All State Insurance. At present we have been unable to locate any printed information on the units. If you have any doubts, please do not purchase one of these terminals. Shipped via truck. freight collect.

### KEYBOARD \$24.95

This classic Hitek keyboard is similar to the module used in the Deewetter Terminal. 62 non-encoded contacts three locking. Factory boxed Altair surplus. Shipping 3 lbs.

## 2716 EPROM SALE \$13

\*\*\* THOUSANDS \*\*\*  
We have slashed price in an effort to reduce our over stocked inventory. These are Single Five Volt. Eproms, manufactured by one of the Worlds largest producers of semiconductors. Please phone for volume pricing.

### IBM 2980 SELECTRIC BANK TERMINAL \$250

The IBM 2980 terminal was designed to be located at each tellers station in a branch bank. The terminal was on line to a master computer. Information entered into the terminal would instantaneously adjust the customers account at the computer. A record of the transaction would be entered into the customers passbook and simultaneously recorded onto a continuous 40 column paper roll located within the terminal.  
The heart of the 2980 is the IBM Selectric typewriter. Each unit is supplied with print ball, ribbon and full documentation.  
A potential use for this I/O terminal is in business applications where information must be entered onto ledger cards at the same time data is recorded at the computer. USED surplus, 77 lbs.

### BSR SYSTEM X-10

The new BSR timer runs your home like clockwork. Turns on lamps and appliances while your away from home. Completely compatible with your existing system X-10 devices.

BSR Timer **\$65.00**  
Master Console **34.95**  
Ultrasonic Controller **19.95**  
Modules: Appliance, Lamp or Wall Switch **13.95**

VISA  
master charge

Circle 379 on Inquiry card.

All merchandise sold by California Digital is premium grade. Shipping: First five pounds \$2.00; each additional add \$3.40 Foreign orders 10% shipping. Excess will be refunded. California residents add 6% sales tax. C.O.D.'s discouraged. Open accounts extended to state supported educational institutions and companies with a "Strong Dun & Bradstreet. Warehouse: 15608 Inglewood Blvd. Visitors by appointment.

TOLL FREE ORDER LINE  
**(800) 421-5041**  
TECHNICAL & CALIFORNIA  
**(213) 679-9001**

# Computers, Disk Systems

## SUPERBRAIN<sup>™</sup> By INTERTEC



32K or 64K (Double or Quad Density units available). Uses two Z-80 CPU's. Commercial-type terminal with 12" monitor. Dual double density minifloppies. Over 350 kilobytes of storage (twice that with quad density drives). Two serial RS232 ports, I/O ports standard. Expandable with optional S-100 S-100 interface. Comes with CP/M<sup>™</sup> 2.2 operating system. MiniMicroMart includes BASIC interpreter and can supply a wide range of CP/M Development and Application software.

w/32K Double Density, List \$2995 . **\$2685**  
w/64K Double Density, List \$3345 . . . . . \$2883  
w/64K Quad Density, List \$3995 . . . . . \$3595  
W/64K Quad — MiniMicroMart  
Upgrade Special. . . . . \$3395

## MICROMATION



A 64K complete computer with dual density 8" floppies (1 megabyte). Rack or vertical mounting. Systems with double-sided drives, hard disks, and multi-user (MP/M).  
Z+ 100 64K RAM, Computer, \$2495. . **\$2099**  
Z+ 120 Includes two 8" disks, \$4995. . . \$4199  
"Z" system features new distributed processing multi-user concept with one Z-80 per user, with Z-80 for MP/M (Master Satellite concept).

**AS LOW AS \$11,899!**

## SD SYSTEMS

SDS-100, w/32K RAM, \$6995 . . . . . **\$5945**  
SDS-200, List \$8995 . . . . . \$7645

## RADIO SHACK TRS-80<sup>™</sup>

**10% OFF!**



## INTERSYSTEMS formerly ITHACA AUDIO



DPS-1, List \$1795

**Call for Price!**

The new Series II CPU Board features a 4 MHz Z-80A CPU and a full-feature front panel. 20-slot actively terminated motherboard, with 25 amp power supply (50/60 Hz operation, incl. 68 cfm fan).

**COMPLETE SYSTEM** with InterSystem 64K RAM, I/O Board w/priority interrupt and double density disk controller board. Full 1-year warranty, List \$3595

**Call for Price!**

## HEWLETT-PACKARD HP-85A

Desk-Top  
Computer  
**Call  
for  
Price**



## MORROW THINKER TOYS<sup>®</sup> DISCUS M26<sup>™</sup>

26 megabytes of  
formatted storage  
List \$4,995

**\$4,199**



## THINKER TOYS<sup>®</sup> DISK SYSTEMS

Now includes CP/M<sup>®</sup> 2.2

Discus 2D, List \$1199. . . . . **\$1019**

Discus 2D, dual-drive, List \$1994 . . . . . \$1694

Discus 2+2, Assem., List \$1549. . . . . \$1319

Dual Discus 2+2, Assem., \$2748. . . . . \$2335

All Morrow systems now include CP/M<sup>®</sup> 2.2

Circle 380 on Inquiry card.

## NORTH STAR MDS-A Double Density Mini Floppy Disk System

Double Density, Kit

List \$799

**OUR PRICE \$669**

Assembled and Tested. . . . . \$719

Quad Version, Kit, List. . . . . \$836

Assembled, List \$1099. . . . . \$896

Above MDS-A units do not include cabinet or power supply.

Shipping and Insurance: Add \$7.50.

## NEW! CROMIX FROM CROMEMCO

A New UNIX Like  
Disk Operating System.

With true multi-user,  
multi-tasking capabilities

List \$295 . . . . . **OUR PRICE \$249**

## NEW! DOUBLE DENSITY CONTROLLER BOARD FROM CROMEMCO

With built-in diagnostics

16 FDC Controller, List \$595 **OUR PRICE \$505**



## NEW! CROMEMCO SYSTEM ZERO

List \$995 . . . . . **OUR PRICE \$849**

**NEW! CROMEMCO SYSTEM ZERO/O**

A complete 64K Computer with Double  
Density Disk Controller . . . . . List \$2995

**OUR PRICE \$2545**

Companion Disk drive for above —  
Quad Density — Total of 780 Kilobytes of  
storage on the two drives. . . . . List \$1295

**OUR PRICE \$1099**

Only \$3644 for a complete 64K Disk System

## MORROW Discus 2D's IN STOCK

# Terminals and Printers!

## TELEVIDEO TVI-912C



Upper and lower case, 15 baud rates: 75 to 19,000 baud, dual intensity, 24 x 80 character display, 12 x 10 resolution. Numeric pad. Programmable reversible video, auxiliary port, self-test mode, protect mode, block mode, tabbing, addressable cursor. Microprocessor controlled, programmable underline, line and character insert/delete. "C" version features typewriter-style keyboard. List \$950

**OUR PRICE \$789**

920C (with 11 function keys, 6 edit keys and 2 transmission mode keys, List \$1030)  
**ONLY \$849**

## Intertec EMULATOR

Software compatible with a Soroc IQ-120, Hazeltine 1500, ADM-3A or DEC VT-52. Features block mode transmission and printer port; 12" anti-glare screen; 18-key numeric keypad; full cursor control. List \$895

**OUR PRICE \$749**



## NEW INTERTUBE III

List \$995 **ONLY \$749**

12" display, 24 x 80 format, 18-key numeric keypad, 128 upper/lower case ASCII characters. Reverse video, blinking, complete cursor addressing and control. Special user-defined control function keys, protected and unprotected fields. Line insert/delete and character insert/delete editing, eleven special line drawing symbols.

## SOROC



**IQ-120**  
List \$995  
**SPECIAL \$729**

IQ-140 List \$1495  
**SPECIAL \$1149**

## HAZELTINE

1500  
**ONLY \$879**



1410 w/numeric keypad, List \$900 ..... \$749  
1420 w/lower case and numeric pad ..... 849  
1510, List \$1395 ..... 1089  
1520, List \$1650 ..... 1389

## NEC SPINWRITER™



Terminal/Keyboard as well as RO Printer Only models available.  
**CALL FOR PRICES!**

## CENTRONICS PRINTERS

NEW 730, parallel, friction, tractor ... **\$679**  
NEW 737 parallel, friction, tractor ... **\$849**  
779-2 w/tractor (same as TRS-80 Line Printer I), List \$1350 ..... 1049  
702 120 cps, bi-direct., tractor, VFU ... 1995  
703 185 cps, bi-direct., tractor, VFU ... 2395  
704 RS232 serial version of 703, \$2350 .. **\$1995**

Above prices reflect a 2% cash discount (order prepaid prior to shipment). Add 2% to prices for credit card orders, C.O.D.'s, etc. Prices are f.o.b. shipping point. Prices are subject to change and offers subject to withdrawal without notice. **WRITE FOR FREE CATALOG.**

## TI-810



TI-810 Basic Unit, \$1895 . **ONLY \$1695**  
TI-810 w/full ASCII (Lower case), vertical forms control, and compressed print . \$1895  
TI-745 Complete printing terminal with acoustic coupler, List \$1695 .... **\$1399**

## PAPER TIGER®



IDS-440 Paper Tiger, List \$995 . **\$895**  
w/graphics option, incl. buffer, \$1194 .. **\$989**  
TRS-80 cable ..... 45  
NEW IDS PAPERTIGER 460 List \$1295 . **\$1149**  
NEW IDS PAPERTIGER 460G List \$1394 **\$1199**

**NEW IDS 460**  
QUALITY PRINTING AT MATRIX  
SPEED—LOGIC SEEKING  
PROPORTIONAL SPACING  
w/auto text justification

## ANADEX

### DP9500 / DP9501 PRINTERS

DP-9500, List \$1650 ..... **\$1399**  
DP-9501, List \$1650 ..... **\$1399**

## OKIDATA

### Microline 80 **ONLY \$649**

Tractor Feed Option ..... \$99  
Serial interface ..... **\$89**

**AXIOM IMP I ..... \$699**

**COMPRINT 912 w/parallel interf. \$559**  
912 w/serial interface, List \$699 ..... **\$589**

**MICROTEK, List \$750 ..... \$675**

**ANADEX 80-Col. Dot Matrix. .... \$849**

# MiniMicroMart, Inc.

1618 James Street, Syracuse NY 13203 (315) 422-4467 TWX 710-541-0431

Circle 381 on Inquiry card.



**If North Star or Cromemco offer it . . .**

**WE HAVE IT!!**

**Immediate Delivery at Discount Prices**



**NORTH STAR  
Horizon<sup>®</sup> 2**

32K Double Density  
Assembled and Tested  
List \$3095

**ONLY \$2619**

**ASSEMBLED**

HORIZON 1, DD . . . . .	\$2279	32K, QD, List \$2995 . . . . .	2539
HORIZON 2, 32K, DD .	\$2619	48K, QD, List \$4090 . . . . .	3469
32K, QD, List \$3595 . . . . .	3049	64K, DD, List \$3830 . . . . .	3239
48K, DD, List \$3590 . . . . .	3039	64K, QD, List \$4330 . . . . .	3669

**NORTH STAR APPLICATIONS SOFTWARE**

*(Exclusive for use with North Star Disk Systems — specify Double or Quad Density)*

NORTHWORD, List \$399 . . . . .	\$339
MAILMANAGER, List \$299 . . . . .	249
INFOMANAGER, List \$499 . . . . .	419
GENERALLEDGER, List \$999 . . . . .	799
ACCOUNTSRECEIVABLE, List \$599 . . . . .	499
ACCOUNTSPAYABLE, List \$599 . . . . .	499

**NORTH STAR HARD DISK HD-18**

18 megabytes, plugs into parallel port of North Star Horizon. Utilizes tried-and-proven 14" Century Data Marksman. List \$4999.

**OUR PRICE \$4199**

**NORTH STAR MDS-A** — Double (or Quad) Density Disk System, Kit, List \$799 . **OUR PRICE \$669**  
Assembled and Tested, List \$899 **SPECIAL \$719**

**NORTH STAR MEMORY BOARDS**

16K Dynamic RAM (RAM-16-A/A), Assembled, List \$499 . . . . .	\$420
Kit, List \$449 . . . . .	<b>SPECIAL \$299</b>
32K (RAM-32/A), Assembled, List \$739 . . . . .	\$620
Kit, List \$669 . . . . .	<b>ONLY \$499</b>

**INTRODUCTORY SPECIALS ON ...  
PREMIUM QUALITY BASF DISKS  
CERTIFIED FOR QUAD SYSTEMS**

(Box of ten)

5 1/4" DOUBLE DENSITY DOUBLE SIDED	List \$57.50 . . .	<b>\$38.95</b>
8" DOUBLE DENSITY DOUBLE SIDED	List \$75.00 . . .	<b>\$47.49</b>

Shipping \$2.50 — Free Shipping in Multiple Or Two Box's

SHIPPING AND INSURANCE: Add \$15 or Horizons, \$2.50 for Boards and Software. Hard Disk Systems and Cromemco systems shipped freight collect. Advertised prices are for prepaid orders. Credit card and C.O.D. 2% higher. Deposit may be required on C.O.D. All prices subject to change and offers subject to withdrawal without notice.

— WRITE FOR FREE CATALOG —

**MiniMicroMart, Inc.**

1618 James Street, Syracuse, NY 13203 (315) 422-4467

TWX 710-541-0431

Circle 382 on Inquiry card.



**NEW System 3  
by CROMEMCO**

Now with Dual  
Double Sided  
Double Density  
(over 2 megabytes  
of Storage  
64K of RAM  
List \$7395

**LIMITED TIME  
INTRODUCTORY SPECIAL \$6199!**

**CROMEMCO SYSTEM 2** — Now double Density with Double Sided Drives, Quad Capacity mini floppy disc drives. List \$3990 . . . . . **Only \$3390**

**CROMEMCO Z-2H** Full 11-megabyte Hard Disk system. Fast Z-80A 4 MHz processor, two floppy disk drives, 64K RAM memory, RS232 special interface, printer interface, and extensive software available.  
List \$9995



**OUR PRICE \$8489**

**NEW DOUBLE DENSITY CONTROLLER BOARD  
From Cromemco**

With built-in diagnostics — 16 FDC Controller  
List \$595 . . . . . **OUR PRICE \$505**

Z-2 COMPUTER SYSTEM	List \$995 . . . . .	<b>\$845</b>
SINGLE CARD COMPUTER — SCC-W 4 MHz.	List \$450 . . . . .	<b>\$382</b>
NEW COLOR GRAPHICS INTERFACE — SOI	List \$595 . . . . .	<b>OUR PRICE \$505</b>
CROMEMCO HDD — 11/22-megabyte Hard Disk for use with existing systems. DMA controller. Transfer rate of 5.6 megabytes/second.		
HDD-11.	List \$6995 . . . . .	<b>OUR PRICE ONLY \$5939</b>
HDD-22.	List \$11,995 . . . . .	<b>\$10,189</b>





# Try to beat our prices!

## SUPERBRAIN<sup>™</sup> by Intertec



Self-contained computer with dual disks and two RS232C ports. Complete with CP/M<sup>™</sup> 2.2 and BASIC.

32K Double Density, List \$2995 . . . . . **\$2685**  
 64K Double Density, List \$3345 . . . . . \$2883  
 64K MiniMicroMart-upgraded  
 to Quad Density . . . . . **SPECIAL \$3395**

## VIDEO TERMINALS

**NEW EMULATOR** (Intertec), List \$895 \$ 749  
**NEW INTERTUBE III** List \$895 . . . . . **ONLY \$ 749**  
**SOROC 120**, List \$995 . . . . . **SPECIAL \$ 729**  
 1Q140, List \$1495 . . . . . **SPECIAL \$1149**  
**PERKIN-ELMER 550**, List \$997 . . . . . \$ 799  
 with anti-glare screen, \$1027 . . . . . \$ 829  
**HAZELTINE 1410**, List \$900 . . . . . \$ 749  
 1420 . . . . . \$ 849  
 1500, List \$1225 . . . . . \$ 879  
 1510, List \$1395 . . . . . \$1089  
 1520, List \$1650 . . . . . \$1389  
**ADDS R-20**, List \$995 . . . . . \$ 945  
**LEAR SIEGLER ADM3A**, Assembled . . . . . \$ 849  
**TELEVIDEO 912C**, List \$950 . . . . . \$ 789  
 920C, List \$1030 . . . . . \$ 849

## PRINTERS

**ANADEX DP-8000** . . . . . \$ 849  
 DP-9500, List \$1650 . . . . . \$1399  
 DP-9501, List \$1650 . . . . . \$1399  
**PAPER TIGER IDS-440**, List \$995 . . . . . \$ 895  
 w/graphics op., incl. buffer, \$1195 . . . . . \$ 989  
**NEW IDS PAPERTIGER 460** . . . . . List 1295 \$1149  
**NEW IDS PAPERTIGER 460G** List \$1394 \$1199  
**NEC Spinwriters** . . . . . Call for Price  
**TELETYPE 43 KSR** . . . . . \$1087  
**CENTRONICS**  
 730-1 parallel interface . . . . . **NEW LOW \$679**  
 737 parallel interface . . . . . **SUPER VALUE \$849**  
 779 w/Tractor, List \$1350 . . . . . \$1049  
 702 w/Tractor, VFU, List \$2480 . . . . . \$1995  
 703 w/Tractor, VFU, List \$2975 . . . . . \$2395  
 704 w/Tractor, VFU, List \$2350 . . . . . \$1995  
**TI 810 Basic**, List \$1895 . . . . . \$1695  
 810/serial & Centronics-style  
 parallel interface, List \$1940 . . . . . \$1735  
 810 w/full ASCII (U/LC), Vertical  
 Forms Control, Compressed Print . . . . . \$1895  
**TI 820 KSR**, List \$2165 . . . . . \$1895  
**TI 745 w/full ASCII**, List \$1695 . . . . . \$1399  
**COMPRINT 912 w/parallel interface** . . . . . \$ 559  
 912 w/serial interface, List \$699 . . . . . \$ 589  
**AXIOM IMP I** . . . . . \$ 699  
**MICROTEK**, List \$750 . . . . . \$ 675  
**OKIDATA Microline 80**, List \$949 . . . . . \$ 649  
 Tractor Feed Option . . . . . \$ 99  
**RS232 Serial Interface** . . . . . \$ 89

## NORTH STAR HORIZON<sup>®</sup>

**HORIZON 1 ASSEMBLED & TESTED**  
 32K, Double Density, List \$2695 . . . . . \$2279  
 32K, Quad Density, List \$2995 . . . . . \$2539

**HORIZON 2 ASSEMBLED & TESTED**  
 32K, Double Density, List \$3095 . . . . . \$2619  
 32K, Quad Density, List \$3595 . . . . . \$3049  
 48K, Double Density, List \$3590 . . . . . \$3039  
 48K, Quad Density, List \$4090 . . . . . \$3469  
 64K, Double Density, List \$3830 . . . . . \$3239  
 64K, Quad Density, List \$4330 . . . . . \$3669

LIMITED QUANTITY OF  
 HORIZON 2 KITS AVAILABLE

## FLOPPY DISK SYSTEMS

**NORTH STAR MDS-A**  
 Assembled, List \$899 . . . . . **SPECIAL \$ 719**  
 Kit Version, List \$799 . . . . . \$ 669  
**MORROW THINKER TOYS<sup>®</sup>** Discus 2D,  
 List \$1199 . . . . . **OUR PRICE \$1019\***  
 Discus 2D, dual-drive, List \$1894 . . . . . \$1694\*  
 Discus 2 + 2, A&T, List \$1549 . . . . . \$1319\*  
 Dual Discus 2 + 2, A&T, List \$2748 . . . . . \$2335\*  
 \*Now includes CP/M<sup>™</sup> 2.2  
**MICROMATION Megabox, DD w/**  
 8" drives, 1-megabyte, List \$2295 . . . . . \$1949  
 2-megabyte, List \$3095 . . . . . \$2629  
**MICROPO<sup>™</sup> IS 1041 MacroFloppy<sup>™</sup>**  
 w/enclosure (no P.S.), List \$695 . . . . . \$ 625  
 1042 MacroFloppy w/case & AC P.S. . . . . \$ 709  
 1053 Dual MetaFloppy<sup>™</sup> , List \$1895 . . . . . \$1695

## VIDEO BOARDS

I/O Mapped  
**SD COMPUTER VDB-8024**, kit, List \$370 \$319 †  
 Assembled, List \$470 . . . . . \$ 399 †  
**XITEX SCT-100K**, Kit . . . . . **ONLY \$154.95**  
 SCT-100A Assembled . . . . . \$174.95  
**SSM VB2 I/O**, Kit, List \$199 . . . . . Call  
 Assembled & Tested, List \$269 . . . . . Call  
 Memory Mapped  
**SSM VB1C**, 16x64, Kit, List \$179  
 Assembled & Tested, List \$242  
**SSM VB3**, 80-Char., 4MHz, Kit, List \$48! Call  
 4 MHz, A&T, List \$565 . . . . . Call  
**INTERSYSTEMS**, 16x64, A&T, List \$165 \$149

## ESCON CONVERSION FOR IBM SELECTRIC

Complete w/microprocessor controller and power supply. Factory built. User installs solenoid assembly or it can be done at Escon factory at nominal cost.

Parallel (TRS-80, Sorcerer, etc.): \$575 \$514  
 RS232 Standard Serial, List \$599 . . . . . 534  
 IEEE-488 (for PET), List \$660 . . . . . 584  
 TRS-80 Cable . . . . . 25

## CALIFORNIA COMPUTER SYSTEMS

280 CPU BOARDS List \$299 . . . . . \$269  
 DISK CONTROLLER 2422 List \$399 . . . . . \$359  
 32 CASE STATIC List \$710 . . . . . \$599  
 64K DYNAMIC BOARD List \$699 . . . . . \$589

## CPU BOARDS

(assembled unless noted)

**NORTH STAR 280A (ZPB-A/A)**, \$299 \$254  
**CROMEMCO 4 MHz (ZPU-W)**, List \$395 \$335  
 4 MHz (SCC-W), List \$450 . . . . . \$382  
**INTERSYSTEMS** (formerly Ithaca Audio)  
 new Series II Z-80, 4 MHz, List \$395 . . . . . \$349  
**SSM CB1 8080 A&T**, List \$252 . . . . .  
 CB1A Kit, List \$183 . . . . .  
 CB2 Z-80, A&T, List \$344 . . . . .  
 CB2 Kit, List \$260 . . . . .  
**DELTA Z-80**, with I/C . . . . . \$289  
**SD SBC-100**, List \$350 . . . . . \$298  
 SBC-100 Kit, List \$295 . . . . . \$250  
 SBC-200, List \$400 . . . . . \$332  
 SBC-200 Kit, List \$320 . . . . . \$272

## MEMORY BOARDS

**32K SD ExpandoRAM Kit**  
**ONLY \$249<sup>†</sup>**  
 ONLY \$159 without RAM chips

**NORTH STAR 16K Dynamic RAM Board**,  
 A&T (RAM-16-A/A), List \$499 . . . . . \$420  
 16K Kit Version, List \$449 . . . . . **SPECIAL \$299**  
 32K A&T (RAM-32/A), List \$739 . . . . . \$620  
 32K Kit, List \$669 . . . . . **SPECIAL \$499**  
**CROMEMCO 16KZ-W**, List \$495 . . . . . \$419  
 64KZ-W, List \$1795 . . . . . 1485  
**MEASUREMENT SYSTEMS & CONTROLS**  
 (Guaranteed performance, incl. labor/parts 1 yr)  
**DM6400 64K Board w/all 64K**, \$795 . . . . . \$659  
**DM4800 with 48K**, List \$695 . . . . . \$589  
**DM3200 with 32K**, List \$595 . . . . . \$509  
**DMB6400 64K Board w/all 64K** . . . . . \$859  
**DMB4800 with 48K** . . . . . \$789  
**MORROW SuperRAM** — all static, all A&T  
 16K, 4 MHz or 2 MHz, List \$349 . . . . . \$299  
 32K, 4 MHz, List \$699 . . . . . \$629  
 16K Memory Master, List \$399 . . . . . \$339  
 24K Memory Master, List \$549 . . . . . \$465  
**INTERSYSTEMS** (formerly Ithaca Audio)  
 8K Static 2 MHz, A&T, List \$165 . . . . . \$149  
 8K Static 4 MHz, A&T, List \$195 . . . . . \$176  
 16K Static 2 MHz, A&T, List \$475 . . . . . \$427  
 16K Static 4 MHz, A&T, List \$495 . . . . . \$445  
 64K Dynamic, List \$995 . . . . . \$895  
**CALIFORNIA COMPUTER**  
 16K Static, A&T, List \$349.95 . . . . . \$259

## FLOPPY DISK CONTROLLER BOARDS

**NORTH STAR, DD**,  
 Assembled, List \$499 . . . . . \$399  
**MORROW Disk Jockey 1**, A&T (\$213) . . . . . \$189  
 Disk Jockey 2D, A&T, List \$479 . . . . . \$429  
**SD Versafloppy 1**, Kit, List \$250 . . . . . \$212 †  
 Versafloppy II, DD Kit, List \$350 . . . . . \$297 †  
 Versafloppy II, DD, A&T, List \$430 . . . . . \$365 †  
**DELTA double density A&T** (\$385) . . . . . \$345  
**CONDUCTOR**, double density A&T . . . . . \$269  
**INTERSYSTEMS FDC-2**, A&T, \$495 . . . . . \$439  
**MICROMATION Doubler, DD, A&T** . . . . . \$399  
**TARBELL Floppy Disk Interface Kit** . . . . . \$199  
 double density, A&T, List \$495 . . . . . \$444

## NEW CROMEMCO DOUBLE DENSITY DISK CONTROLLER

List \$595 . . . . . **OUR PRICE \$505**

SHIPPING AND INSURANCE: Add \$2.50 for boards, \$6.10 for Selectric Converter or Floppy Disk Drives, \$7.50 for Floppy Disk Systems, \$15 for Horizon. SHIPPED FREIGHT COLLECT: SuperBrain, Centronics and T.I. printers. Contact us for shipping information on other terminals and printers.

Above prices reflect a 2% cash discount (order prepaid prior to shipment). Add 2% to prices for credit card orders, C.O.D.'s, etc. Prices are subject to change and offers subject to withdrawal without notice.

— WRITE FOR FREE CATALOG —

# MiniMicroMart, Inc.

1618 James Street, Syracuse NY 13203 (315) 422-4467 TWX 710-541-0431

# Unclassified Ads

**FOR SALE:** TRS-80 Model I Level 2, 48 K memory, expansion Interface, two disk drives, Emako-20 matrix printer with Centronics cable. Sell all or part at 80% Radio Shack list price. Also diskettes, game cassettes, etc. Phillip Crawford, 1720 E 1st St #10, Long Beach CA 90802, (213) 437-5475.

**EDUCATORS:** Small private school in central Connecticut (K-8) is considering implementation of microcomputers into curriculum. If you've previously experienced such an endeavor in this age group and would be willing to share an evening enlightening faculty and concerned parents, please contact us. We're eager to make this a successful program, and would be interested in learning how your program was launched and pitfalls to avoid. The Independent Day School, Laurel Brook Rd, Middlefield CT 06455, Attn: William Murdoch, (203) 238-3994.

**FOR SALE:** Voltage regulator, SOLA BASIC 750 VA Unit #63-13-175. Never used, output two outlets, 6.25 A maximum. \$300, shipping additional. Jane Greene, 1 Harmony Ct, Syosset NY 11791, (516) 921-4900.

**WANTED:** KIM-1 or similar microcomputer for dedicated real-time system. Must be like KIM-1: easily expandable but otherwise a bare single-board system. Needed for temperature monitoring system in a solar greenhouse. Robert Heller, Star Route Box 51A, Wendell MA 01379, (617) 544-6416 between 8:30 and 5.

**FOR SALE:** Standard Memories Ecom memory system including Ecom memory core (32 K), heavy-duty power supply, all interconnecting cables, interface firmware card, and documentation. Original cost of \$3500; will sell for \$1000. All in excellent condition, both main units are for relay rack mounting. Steve Garber, 3030 Polk St, San Francisco CA 94109, (415) 474-7081.

**FOR SALE:** Eaton LRC 7000 plus 64-character printer; \$250. Radio Shack Quick Printer II 32-character (Catalog #26-1155); \$150. Send certified check or money order. William R Spencer Jr, 5421 Grandin Rd Ext, Salem VA 24153.

**FOR SALE:** LSI-11 processor (KD11-F) mounted in a four-slot backplane with a serial interface (DLV11), paper-tape operating-system package including PAL-11S Assembler, LINK-11S, ODT, PTSP, and single-user BASIC, with full documentation. Entire system never used, in mint condition. Original cost \$1325, asking \$1000. Also for sale, Processor Technology VDM-1, \$100. M Wallin, 1607 Lauren Ct, Bensalem PA 19020.

**FOR SALE:** Hazeltine 1500 CRT terminal (less case, cable, XFMR); \$450, Anderson Jacobson acoustic coupler #242A; \$120, full ASCII keyboard; \$50. S Gladstone, 150 W Cedar St #6, Norwalk CT 06854, (203) 866-8930.

**WANTED:** Soft black leather case for the HP-45, 65, or 67. New or used. E King, 870 W 181 St, New York NY 10033, (212) 568-3309.

**FOR SALE:** Ithaca Audio 8 K, 250 ns static programmable-memory board for S-100 with protect; \$120. Ithaca Audio S-100 video-display board, 64-by-16 uppercase and lowercase with Greek symbols, normal or reverse video, 1 K on-board programmable memory; \$75. Mostek 4115N dynamic-programmable memories; eight for \$30. Ted Betz, Box 379A RD#1, Farmingdale NJ 07727, (201) 938-3722.

**FOR SALE:** DEC LSI-11 components: KD11-F processor board with FIS circuit and 4 K memory; DLV11 serial interface with remote data-rate switch. Also, Vadic two-speed modem: Bell 103/113 (300 bps) and 202 (1200 bps half-duplex) compatible. Sell both for half price. Bob Malahy, Mechanical Engineering Dept, Rice University, Houston TX 77001, (713) 664-8635 evenings.

**FOR SALE:** Color graphics board. Blotech CGS-808 with on-board microprocessor control for S-100 bus. Excellent condition, versatile, up to 256-by-192 resolution. Lots of software including 3D graphics. \$362 postpaid. John Peterson, 1820 Camino Dr, Forest Grove OR 97116, (503) 357-6310.

**FOR SALE:** Apple II computer with 36 K memory, AppleSoft Firmware Card, disk drive with controller, all manuals, plus extras. Everything is in excellent condition. \$1200 or best offer. David J Bauman, 249 Taft St, Wind Gap PA 18091, (215) 863-5736.

**WANTED:** S-100 system: Z80 processor, 48 thru 64 K programmable memory, 15-slot mainframe, 5 V at 15 A, ± 18 V at 1 A power supply, video-display board, serial and parallel I/O. Optional: keyboard, cassette interface, and read-only memory monitor. Fred Tydeman, 3901 Northfield Rd, Austin TX 78759, (512) 255-9292 evenings.

**FOR SALE:** New PP 2708/16 eeprom programmer by Oliver Audio Engineering, factory assembled; \$200. Double-sided printed-circuit board plated through with schematic for building small system using Motorola MC14500 single-bit controller; \$35 each. Charles Krasny, POB 57, Maple Falls WA 98266.

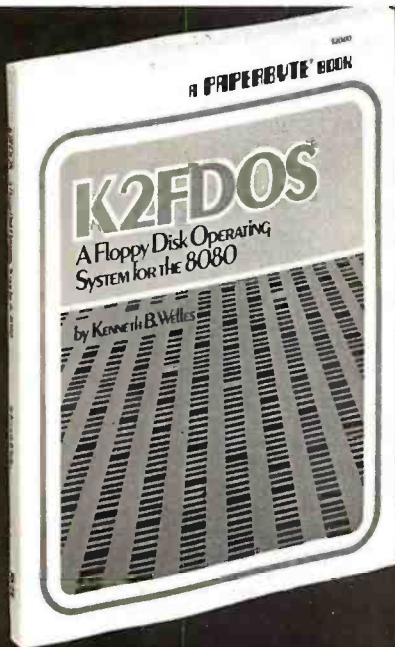

## A New Floppy Disk System for the 8080. Small (4K), but powerful!

K2FDOS is a complete software package. It includes all the specific routines necessary to bootstrap and run a powerful floppy disk operating system on an 8080 based microcomputer. K2FDOS features assembly language source code listings and object code in hexadecimal listings and machine-readable (PAPERBYTE®) bar code format.



This and other Byte/McGraw-Hill books are available from Byte Books or your local computer store.

ISBN #0-07-069206-8  
Price \$20.00

Please send  \_\_\_\_\_ copies of  
**K2FDOS A Floppy Disk Operating System for the 8080**

Name	Title	Company	
Street	City	State/Province	Code

Check enclosed in the amount of \$ \_\_\_\_\_  
 Bill Visa     Bill Master Charge  
 Card No. \_\_\_\_\_ Exp. Date \_\_\_\_\_

Add 75¢ per book to cover postage and handling.

Please remit in U.S. funds or draw on a U.S. Bank

Available in October

70 Main Street, Peterborough, N.H. 03458



**UNCLASSIFIED POLICY:** Readers who are soliciting or giving advice, or who have equipment to buy, sell or swap should send in a clearly typed notice to that effect. To be considered for publication, an advertisement must be clearly noncommercial, typed double spaced on plain white paper, contain 75 words or less, and include complete name and address information.

These notices are free of charge and will be printed one time only on a space available basis. Notices can be accepted from individuals or bona fide computer users clubs only. We can engage in no correspondence on these and your confirmation of placement is appearance in an issue of BYTE.

Please note that it may take three or four months for an ad to appear in the magazine.

**FOR SALE:** SwTPC 6800 computer with 12 K memory, CT-64 with Motorola monitor, 2 serial and 1 parallel interface, AC-30 cassette interface, GT-6144 graphics board—all working. Cost over \$1200; sell for \$600. Also, OSI Challenger with 16 K, cassette interface, video board, extra boards. Cost over \$1400; sell for \$700. J Chirigos, 4707 Larchmont NE, Albuquerque NM 87111, (505) 299-0378 after 5 PM.

**FOR SALE:** 64-word S-100 Model 50 Heuristics Speechlab; \$50, Morrow Speakeasy S-100 1P, 1S, and cassette interface; \$30, OAE paper-tape reader; \$20. All work fine. Micro-Term ACT-1 terminal, as is; \$30. Alex Begln, 7335 Deep Run, Birmingham MI 48010, (313) 642-7512.

**WANTED:** Three to six 8080 hackers to work with machine-language Monitor, Editor, and Assembler that I have developed. You will get free software in exchange for user comments and suggestions. First letter should give programming experience, computer type, and input format required. Robert G Durnal, POB 68, Junlor WV 26275.

**FOR SALE:** Radio Shack 16 K Level II TRS-80 microcomputer. With numeric keypad, expansion interface, cassette recorder, and several game cassettes including Microchess. List price is \$1200. I will sell for \$750. First cashier's check/money order takes it (I pay shipping). Include SASE for confirmation. Chris Willson, 8726 S Sepulveda Apt 91B, Westchester CA 90045.

**FOR SALE:** Xitan Z80 system. Mainframe, ZPU, SMB, VDB, 48 K programmable memory, 16 K read-only memory (12 K BASIC in read-only memory), keyboard, manuals, software. Complete system \$1600. Terry Young, 4 Alken St, Derry NH 03038, (603) 434-0257.

**FOR SALE OR SWAP:** KSR-28 Teletype (not ASCII, uses 5-bit code) with manuals. \$100 or will swap for an acoustic coupler, modem, or Radio Shack Voxbox. R L Reynolds, 30 Jordan St, Chelmsford MA 01863, (617) 251-8505.

**NEEDED:** Information, kit, schematics, or advice on turning ITEL word-processor typewriter Model 84101010 into computer terminal or printer. Gordon Dohle, 414-34 Kleisinger Cr, Regina Saskatchewan, S4R 7M4 Canada.

**FOR SALE:** IMSAI mainframe with 10-slot motherboard, Ithaca Audio Z80 processor board (with 2708), SSM VB1 video board, 32 K static-programmable memory, and Soroc 117-key professional keyboard. Best offer over \$600. Bob Watson, (602) 526-2312.

**WANTED:** Student experimenter wants integrated circuits, transistors, capacitors, resistors, LEDs, books, catalogs, magazines, diodes, switches, tubes, wire, printed-circuit boards, knobs, TTL circuits, keyboards, crystals, transformers, and parts-identification book. Please state price and what you have to offer in full detail. Judy Stapleton, POB 536, Pine Lake GA 30072.

**FOR SALE:** IMSAI 8080 with 16 K bytes, 3P plus S Teletype I/O board, Tarbell cassette interface, case, panel, and 22-slot motherboard, 8 K BASIC and all standard software. Panasonic cassette unit. Perfect condition. \$800 plus shipping, or best offer. Also available: ASR33 teletypewriter. Dick Aronson, 61 Morton St, New York NY 10014, (212) 243-0623 home, (212) 758-6500 work.

**WANTED:** Clever machines and ideas do not always advance the state of the art, but they are fascinating! Do you have or know about any unusual computing devices (mechanical, electronic, analog, digital, unclassifiable)? I am seeking information about such things, historical or recent, completed or not—even just crazy, ingenious ideas. I am also buying unusual machines, books, manuals, and documentation, and am building models of some of the machines. Dick Rubinstein, 15 Maugus Ave, Wellesley Hills MA 02181.

**FOR SALE:** Radio Shack TRS-80 Model I Level II. Equipped with 36 K programmable memory, 10-key pad, expansion interface. Unit is barely used, has been factory serviced, and can handle additional 16 K programmable memory. \$1000. Also, IBM Selectric Model 71-3 I/O device with TRS-80 printer-port interface. Gives letter-quality hard copy. \$650. Take both for \$1400. Doug Bowle, POB 3453, San Francisco CA 91449, (415) 861-6883.

**FOR SALE:** Diablo Hytype 1 Model 1200. Best of the daisy-wheel printers. Brand-new unit with in-feed friction platen and print wheel. Interface for Apple, TRS-80, and CP/M systems. Maintenance manual and additional interface information available. Scott Priester, 211 White Water Ct, Greer SC 29651, (803) 268-0678 after 6 PM.

**FOR SALE:** HP-41C calculator, card reader, two memory modules, and all manuals for \$425. All components essentially new. The system was replaced by an HP-85 before all HP-41C components were received. Ernest W Graham, POB 396, Shaw Island WA 98286.

**FOR SALE:** Fairchild PEP 3870 development board. In circuit emulation of 3870 series single-chip microcomputers. Programs 38E70 and 2716 PROM. Never used. Paid \$450; asking \$350. Ron Sutherland, POB 1147, Lawrence KS 66044, (913) 841-9433.

**FOR SALE:** Expando Black Box printer, 80-column, for connection to parallel port. Includes cable for connection to TRS-80 and maintenance manual with schematics. Cost over \$350 two years ago. Needs some attention, but otherwise in good condition. \$150 including UPS freight. Gary Taylor, Princeton Plasma Physics Laboratory, POB 451, Princeton NJ 08544, (609) 683-2573.

# BOMB

## BYTE's Ongoing Monitor Box

Article #	Page	Article	Author(s)
1	22	The Future of Computer Graphics	Brown and Levine
2	32	Home In on the Range! An Ultrasonic Ranging System	Ciarcla
3	64	Micrograph, Part 1: Developing an Instruction Set for a Raster-Scan Display	Booch
4	90	Language Control Structures for Easy Electronic Visualization	DeFanti
5	126	Graphic Color Slides, Part 1	Grogono
6	148	Three-Dimensional Graphics for the Apple II	Sokol and Shepard
7	180	A Simplified Theory of Video Graphics, Part 1	Watson
8	206	Getting to Know Your Monitor	Dalpiatz
9	220	Digital Storage of Images	Williams
10	244	Machine Problem Solving, Part 3: The Alpha-Beta Procedure	Frey
11	296	A General Interpolating Graphics Package for the TRS-80	Cohen and Crowe
12	340	An 8088 Processor for the S-100 Bus, Part 3	Cantrell
13	361	Add Macro Expansion to Your Microcomputer, Part 2	Brown

### FORTH Is First

John James' introductory article on FORTH won the BOMB first place in our fourth annual August language issue. Steve Ciarcla came in second with his construction article about a homemade modem for under \$50. Kim Harris' unique article, "FORTH Extensibility," ran a close third. The BOMB cards for this month were unusually enthusiastic in their rating of individual articles, affirming the overall positive reaction to this issue. Several BOMB cards expressed support for the article on Khachiyan's algorithm. First place for August was 1.70 standard deviations above the mean, followed by second place at 0.95. ■

# Reader Service

To get further information on the products advertising in BYTE, fill out the reader service card with your name and address. Then circle the appropriate numbers for the advertisers you select from the list. Add a 15-cent stamp to the card, then drop it in the mail. Not only do you gain information, but our advertisers are encouraged to use the marketplace provided by BYTE. This helps us bring you a bigger BYTE. "Correspond directly with company."

Inquiry No.	Page No.	
332	AS Computers 395	184
262	ASB Products 335	341
72	Ackerman Digital 118	130
349	Ackerman Digital 404	199
123	AEI 201	225
288	Adaptive Data & Energy Sys 380	140
317	Adkisson-Wesley Pub Co 388	168
344	Admaster 404	299
378	Advanced Comp Prod 422, 423	362
207	Ajuda Omega Comp Sys 384	288
383	Alpha Omega Systems 406	338
180	Am Comp & Telecom Corp 236	46
387	Am Micro Prod Inc 384	46
144	American Square Comp 228	296
333	Anrona 396	168
196	Anderson Jacobson 299	194
107	APF Electronics 178, 179	390
99	Apparel Inc 183	207
6	Apple Computer 12, 13	221
63	Applied Dig Data Sys 103	227
283	Applied Logic Inc 380	201
217	Arizona Comp Systems 309	93
3	Artec Electronics 6	114
311	ASAP 385	42
15	Atari Personal Computers 27	209
123	Automated Equip Inc 201	134
81	Automatics 389	4
28	Avant 129	343
331	base 2 inc 49	243
240	Beckman 38	306
354	John Bell Engineering 323	322
354	Bit Management Co Ltd 408	228
302	Bit 3 Computer Corp 327	319
165	Bit Special 384	300
161	Bitter-Schwartz & Assoc 256	137
374	Buss/Charles Photo 236	274
214	BYTE Back Issues 337	177
214	BYTE Books 148, 281, 430	204
286	BYTES & FLIGHTS 307	179
286	BYTE Subscriber 339	191
249	BYTE WATS 341	296
13	C & S Electronics 337	56
286	Card Systems 330	222
379	Card Comp Systems 20, 21	187
276	Card Data Corp 381	84
293	California Digital 424, 428	96
310	Cambridge Develop Labs 382	40
67	CCM Inc 384	7
247	CCS Inc 384	338
141	CCP Assoc Inc 327	53
111	Circle Computers 225	64
126	Circle Comp Sales 184	367
374	Cl Con Comp & Data 204, 205	254
244	CompMart 414, 415	34
107	Computer Age Inc 325	14
286	Computer Data Co 291	94
216	Computer Division Of Am 308	61
69	Computer Factory 237	202
75	Comp Furniture & Access 112	17
148	Computer Instant Ads 122	85
348	Computer Marketing Corp 233	133
321	Computer Shopper 404	365
73	Computer Specialist 387	200
91	Computers R Us 119	10
105	Computers R Us 145	60
325	Computers R Us 178	368
301	Computers R Us 391	118
49	The Computer Shop 383	372
11	Computers Wholesale 82	373
325	Computer Technology Assoc 18	43
231	Comp Trans Sys Inc 382	266
382	Computer Warehouse 318	314
18	Computer Warehouse 406	225
63	COMPUTIME 386	339
236	CompuView Products Inc 133	147
334	Comdex Computer Corp 320	303
211	Concord Comp Components 396	32
212	Con MicroCOMPUTER 307	90
149	Conrad 234	210
238	Conrad 381	181
162	The Corraff Group 282	68
31	Covet Systems 53	219
381	The CPU Shop 407	304
308	Creative Mail Businesses 384	389
275	Creative Software 389	127
1	Cromenco 1, 2	299
330	Cybernetics Inc 243	183
256	Cybernetics 386	189
256	DAT Sales 332	227
178	Data Display Center 74	60
223	Datadisk Systems 278	100
97	Datasouth Computer Corp 314	182
378	Deaton Model 181	213
346	Data Products 416, 419	168
165	Dea & Build Info Base 404	259
250	DE Electronics 243	118
224	Delta (Div Of Kern) 223	120
250	Delta Corp 201	37
164	Digital Graphic Systems 316	252
	Digital Marketing 245	168
	Digital Research (CA) 255	
	Digital Research Computers 401	
	DM Inc 211	
	The Data Software Group 300	
	Dial's Mart Inc 316	
	Dual Systems Control Corp 224	
	Dynacomp Inc 246	
	Dyn Microprod Assoc 385	
	Dynacomp 83, 81	
	Dyn Corp 188	
	Easoft 338	
	Electrolab 388	
	Electronic Control Tech 78	
	Electronic Design Assoc 311	
	Electronic Imaging Systems 382	
	Electronics Base Club 247	
	Electronics Specialists 297	
	Electronic Systems 402, 403	
	Electronic Sys Furniture Co 304	
	Elite Computing 311	
	Elite 148	
	Elite Publishing 189	
	Evation Inc 75	
	Execom 305	
	Executive Business Sys 215	
	Factory Direct 19	
	Fanlight & Assoc 404	
	Fanlight Comp Center 325	
	Fath Software 384	
	Fountain (Radio Supply) 388	
	Futureworld 317	
	General Systems Consulting 388	
	Gimix 382	
	Global Electronics 218, 219	
	Global Comput Computers 369	
	Global Electronics LTD 278	
	GM Computers 303	
	H & E Computerics 279	
	H & E Computerics 294, 295	
	Hanley Engineering 382	
	Hardhat Software 92	
	Hardside 312, 313	
	Hayden Book Co Inc 282	
	Hayes Microcomp Prod Inc 135	
	Hazeltine Corp 184, 185	
	Health Company 71	
	Health Company 113	
	High Technology Inc 14	
	Hobbyworld Electronics 387	
	Houston Instruments 89	
	Houston Instruments 89	
	Box Corp 406	
	OM 332	
	Image Resource Corp 67	
	Industrial Micro Systems 25	
	Industrial Micro Systems 151	
	Integral Data Sys 87	
	Integrant 301	
	Intel 121, 127	
	Intel 138, 137	
	Intelligence Systems 214	
	Interactive Comp Sys Inc 408	
	International Microsystems 301	
	Interlec Data Sys 17	
	Interlec Data Sys 127	
	Itaca Intersystems 8, 9	
	J & S Computers 408	
	Jade Computer Prod 193	
	Jade Comp Products 410, 411	
	Jamaico Electronics 412, 413	
	JDR MICRODEVICES INC 78	
	Jessen Group K Inc 332	
	Jini Microsystems 386	
	Joe Computer 316	
	JR Inventory Co 400	
	Kemco LTD 118	
	Kenyon Microsystems 232	
	Kit Parts LTD 384	
	Konan Corp 54, 55	
	Kurtz Corp 143	
	Leasec Services 306	
	Libri 36, 188, 187, 182, 230, 341	
	LJW Research 308	
	Lobo (Data Int'l) 111	
	Mastercomp Inc 310	
	Machinist Inc 384	
	Maprodata Inc 406	
	Melittu Electronics 207	
	Marketing 299	
	Marinchip Systems 171	
	Marot Software Systems Inc 253	
	Mark of the Unicorn 293	
	Marway Products Inc 318	
	Maryann Industries Inc 288	
	Maxell Data 165	
	McGraw-Hill Magazine 162, 163	
	Mass Sys & Controls 29, 95	
	Mata Technologies Corp 285	
	MICAH 307	
	MicroAce 259	
	MicroAmerica Distributing 194	
	MicroAmerica Distributing 195	
	Micro Age Computer Store 86	
	Micro Age Computer Store 169	
	Micro Ap 331	
	Micro Appl Group (MAG) 283	
	Micro Architect 303	
	Micro Business World 381	
	Micro Computer Products 217	
	Micro Comp Chipset Co 168	
	Microcomputer Tech Inc 183	
	MicroDataSys 89	
	Micro Data Base Sys 117	
	Micro Focus 108	
	Micro House 88	
	MicroMini 183	
	Micro Management Sys 173	
	Micro Mike 169	
	The Micro Mini 392	
	Micro Processor Sys Inc 404	
	Micro Pro International 289	
	MicroSoft 41	
	MicroStage 405	
	MicroSoft 123	
	Microsoft (Cons Prod Div) 231	
	MicroTax Software 94	
	MicroTech Exports 317	
	Microtek Inc 37	
	Microware 283	
	The Micro Works 124	
	Micro World 141	
	Mikos 390	
	Miller Microcomputer Ser 248	
	Minex Intelsystems 272	
	Mini Computer Suppliers 336	
	Mini Comp Mart 82	
	Mini Micro Mart 271	
	Mini Micro Mart 428	
	Mini Micro Mart 427	
	Mini Micro Mart 428	
	Mini Micro Mart 429	
	Mini Computers 337	
	Morrow/Thinker Toys 44, 45	
	Mountain Computer Inc 19	
	Mountain Computer Inc 100	
	mpi 221	
	MTI Inc 86	
	Mull Microsystems 328, 329	
	Mull Microsystems Comp Sys 38	
	Nat Microsystems Prod Inc 35	
	NEC 184	
	NEC 198	
	Nelson Systems Inc 379	
	Neltronics 81	
	Neltronics 128, 130, 132, 134	
	NHC Electronics 138	
	Norand Computing Co 328	
	North Star 33	
	Northwest Comp Serv Inc 331	
	Novation 80	
	NTI Schools 209	
	Ohio Scientific Instr 104, 105	
	Ohio Scientific Instr C IV	
	OK Machine & Tool 88	
	Oliver Advanced Eng 331	
	Olivetti 293	
	Omega Micro Computers 208	
	Omega Research 274	
	Omega Sales Co 177	
	On Computing 287	
	Optical Technology 319	
	Orange Micro 81	
	Organic Software 108	
	Orson McGraw-Hill 289	
	Owens Associates 278, 277	
	Page Inc 333	
	Pacific Exchanges 382	
	Pacific Exchanges 385	
	Pacific Exchanges 408	
	Page Digital 388	
	Pan American Elec 248	
	PCD Systems Inc 210	
	PDF Corp 388	
	Persodyne Comp Services 386	
	Percom Data 18	
	Percom Data 126	
	Percom Data 125	
	Peripherals Plus 384	
	Personal Micro Comp Inc 203	
	Personal Software 43	
	Phase One Systems 251	
	Phosco & Trout 238	
	pk systems Inc 339	
	Power One Inc 147	
	Priority One 182	
	Priority One 420, 421	
	Professional Data Sys 317	
	Professional Software Inc 63	
	Programs International 39	
	Prog Software Exch 291	
	The Purchasing Agent 217	
	QD Microsystems 191	
	QI Comp Systems 120, 121	
	Quality Computer Parts 388	
	Quality Data Supply 388	
	Quality Software 289	
	Quasar Data Products 199	
	Quest 409	
	Quintrix Inc 382	
	R & K Computer Systems 322	
	R & K Enterprises 328	
	Recat Computers 389	
	Radio Shack 47	
	RCA Solid State 213	
	RB Sales Co 18	
	RMP Products Inc 404	
	rm 380	
	RNB Enterprises 338	
	Rockwell Data 392	
	Rockwell International 102	
	RTE Software 289	
	S & M Systems 311	
	S & S Computing 384	
	S-100 Inc 339	
	Howard W. Sams Co 273	
	SD Digital 287	
	Solan Corp 5	
	SoftTools Inc 170	
	Soft Instruments 192	
	SoftWare Systems 212	
	Seattle Computer 107	
	Selena 319	
	Serise Technologies 293	
	Shenston Microsystems 250	
	Michael Shryver Software 110	
	Shugart 7	
	Sinclair Research 81	
	Solus Systems 185	
	Spice Gear Works 408	
	Small Business Appl 83	
	Smoke Signal Microcomputing 77	
	Smoke Sig Broad (Dealer) 77	
	Snop Inc 281	
	180	
	183	
	84	
	282	
	280	
	143	
	180	
	62	
	337	
	347	
	283	
	324	
	363	
	388	
	23	
	127	
	234	
	169	
	360	
	384	
	238	
	385	
	5	
	242	
	178	
	287	
	170	
	278	
	196	
	338	
	86	
	169	
	232	
	248	
	41	
	257	
	370	
	188	
	145	
	38	
	234	
	121	
	208	
	384	
	142	
	201	
	187	
	280	
	318	
	165	
	386	
	29	
	369	
	361	
	101	
	239	
	89	
	286	
	203	
	35	
	323	
	384	
	218	
	375	
	330	
	313	
	258	
	292	
	284	
	367	
	340	
	192	
	271	

For fastest service transfer mailer label from wrapper to coupon provided at the right. Requests cannot be honored unless zip code is given. This card valid for 90 days only.

NOTE—If label is missing or defaced fill out coupon carefully —PLEASE PRINT—this is only way to get requested material to you.

Name \_\_\_\_\_

(Title) \_\_\_\_\_

(Company) \_\_\_\_\_

Address \_\_\_\_\_

City \_\_\_\_\_ State \_\_\_\_\_ Zip \_\_\_\_\_

1 21 41 61 81 101 121 141 161 181 201 221 241 261 281 301 321 341 361 381 401 421 441 461 481 501 521 541 561 581 601 621 641  
 2 22 42 62 82 102 122 142 162 182 202 222 242 262 282 302 322 342 362 382 402 422 442 462 482 502 522 542 562 582 602 622 642  
 3 23 43 63 83 103 123 143 163 183 203 223 243 263 283 303 323 343 363 383 403 423 443 463 483 503 523 543 563 583 603 623 643  
 4 24 44 64 84 104 124 144 164 184 204 224 244 264 284 304 324 344 364 384 404 424 444 464 484 504 524 544 564 584 604 624 644  
 5 25 45 65 85 105 125 145 165 185 205 225 245 265 285 305 325 345 365 385 405 425 445 465 485 505 525 545 565 585 605 625 645  
 6 26 46 66 86 106 126 146 166 186 206 226 246 266 286 306 326 346 366 386 406 426 446 466 486 506 526 546 566 586 606 626 646  
 7 27 47 67 87 107 127 147 167 187 207 227 247 267 287 307 327 347 367 387 407 427 447 467 487 507 527 547 567 587 607 627 647  
 8 28 48 68 88 108 128 148 168 188 208 228 248 268 288 308 328 348 368 388 408 428 448 468 488 508 528 548 568 588 608 628 648  
 9 29 49 69 89 109 129 149 169 189 209 229 249 269 289 309 329 349 369 389 409 429 449 469 489 509 529 549 569 589 609 629 649  
 10 30 50 70 90 110 130 150 170 190 210 230 250 270 290 310 330 350 370 390 410 430 450 470 490 510 530 550 570 590 610 630 650  
 11 31 51 71 91 111 131 151 171 191 211 231 251 271 291 311 331 351 371 391 411 431 451 471 491 511 531 551 571 591 611 631 651  
 12 32 52 72 92 112 132 152 172 192 212 232 252 272 292 312 332 352 372 392 412 432 452 472 492 512 532 552 572 592 612 632 652  
 13 33 53 73 93 113 133 153 173 193 213 233 253 273 293 313 333 353 373 393 413 433 453 473 493 513 533 553 573 593 613 633 653  
 14 34 54 74 94 114 134 154 174 194 214 234 254 274 294 314 334 354 374 394 414 434 454 474 494 514 534 554 574 594 614 634 654  
 15 35 55 75 95 115 135 155 175 195 215 235 255 275 295 315 335 355 375 395 415 435 455 475 495 515 535 555 575 595 615 635 655  
 16 36 56 76 96 116 136 156 176 196 216 236 256 276 296 316 336 356 376 396 416 436 456 476 496 516 536 556 576 596 616 636 656  
 17 37 57 77 97 117 137 157 177 197 217 237 257 277 297 317 337 357 377 397 417 437 457 477 497 517 537 557 577 597 617 637 657  
 18 38 58 78 98 118 138 158 178 198 218 238 258 278 298 318 338 358 378 398 418 438 458 478 498 518 538 558 578 598 618 638 658  
 19 39 59 79 99 119 139 159 179 199 219 239 259 279 299 319 339 359 379 399 419 439 459 479 499 519 539 559 579 599 619 639 659  
 20 40 60 80 100 120 140 160 180 200 220 240 260 280 300 320 340 360 380 400 420 440 460 480 500 520 540 560 580 600 620 640 660

### MENTION **BYTE** WHEN WRITING TO ADVERTISERS

## BYTE SUBSCRIPTIONS

41B0

For a subscription to BYTE, please complete this card.

Name \_\_\_\_\_

Address \_\_\_\_\_

City \_\_\_\_\_

State \_\_\_\_\_ Zip \_\_\_\_\_ Country \_\_\_\_\_

USA Canada  
Mexico

- 1 year  \$18  \$20
- 2 years  \$32  \$36
- 3 years  \$46  \$52

- \$32 Europe (air freight) payment enclosed
- \$32 Elsewhere (surface mail) payment enclosed  
(Air mail rates available upon request)

*Please remit in US funds drawn on a US bank.  
Thank you.*

- Check enclosed (Bonus: one EXTRA issue  
— receive 13 issues for the price of 12)

-     Bill me (North America only)

Card No. \_\_\_\_\_

Expiration date \_\_\_\_\_

Four digits above name — Master Charge only \_\_\_\_\_

Signature \_\_\_\_\_ Date \_\_\_\_\_

Please allow eight weeks for processing.

Thank you

## BOMB: BYTE's Ongoing Monitor Box

41B0

BYTE's BOMB is your direct line to the editor's desk. Each month, the two top rated authors receive bonuses based on your votes. To use this card, refer to the list of authors, titles, and corresponding BOMB article numbers located in the Unclassified Ads section. Then rate each article on a scale from 0 to 10 below by circling the appropriate rating number to the right of each BOMB article number. Your feedback helps us produce the best possible magazine each month.

BOMB Article Number	Rating										
	Poor	Fair	Good	Very Good	Excellent	Wow!					
1	0	1	2	3	4	5	6	7	8	9	10
2	0	1	2	3	4	5	6	7	8	9	10
3	0	1	2	3	4	5	6	7	8	9	10
4	0	1	2	3	4	5	6	7	8	9	10
5	0	1	2	3	4	5	6	7	8	9	10
6	0	1	2	3	4	5	6	7	8	9	10
7	0	1	2	3	4	5	6	7	8	9	10
8	0	1	2	3	4	5	6	7	8	9	10
9	0	1	2	3	4	5	6	7	8	9	10
10	0	1	2	3	4	5	6	7	8	9	10
11	0	1	2	3	4	5	6	7	8	9	10
12	0	1	2	3	4	5	6	7	8	9	10
13	0	1	2	3	4	5	6	7	8	9	10
14	0	1	2	3	4	5	6	7	8	9	10
15	0	1	2	3	4	5	6	7	8	9	10
16	0	1	2	3	4	5	6	7	8	9	10
17	0	1	2	3	4	5	6	7	8	9	10
18	0	1	2	3	4	5	6	7	8	9	10
19	0	1	2	3	4	5	6	7	8	9	10
20	0	1	2	3	4	5	6	7	8	9	10

Comments \_\_\_\_\_

\_\_\_\_\_

\_\_\_\_\_

\_\_\_\_\_

PLACE  
FIRST  
CLASS  
POSTAGE  
STAMP  
HERE

**BYTE** READER SERVICE

PO Box 2114 GPO  
New York NY 10001  
USA

-----

**EDMB**  
BYTE's Engaging Monitor Box

**BYTE** Publications Inc  
70 Main St  
Peterborough NH 03458  
USA

**BYTE** SUBSCRIPTIONS  
PO Box 590  
Martinsville NJ 08836  
USA

PLACE  
STAMP  
HERE

PLACE  
STAMP  
HERE



# A COMPANY TO RELY ON... UNITED BUSINESS PRODUCTS



**UNITED BUSINESS PRODUCTS**  
20268 E. Carrey Rd.  
WALNUT, CA. 91789



UNITED  
BUSINESS  
PRODUCTS

(213) 448-4850

(714) 594-5966

NAME OF COMPANY \_\_\_\_\_

ADDRESS \_\_\_\_\_

CITY, STATE, ZIP \_\_\_\_\_

ATTENTION OR DEPT. \_\_\_\_\_

A  The swingline table top burster will separate single-ply continuous forms into individual sheets up to 15". Length 2 1/4" to 12". Paper weight 10 to 110 lb. bond. Speed is constant at 125 ft. per minute.

Wt. 95 lbs. Price \$ 899.00

B  Our custom forms have a guarantee that speaks for itself. Our time on forms range from two to five weeks for custom work and before we start a job we now give a guaranteed shipping date and price, depending on art work from two to five weeks and for every day we relate we give you a 10% discount. To get a quote just mail the detached portion of this ad with sample of form or layout and we will call you the day we get the information with a price and guaranteed day of shipment.

C  The swingline table top decollator is a portable unit which separates both carbon and carbonless continuous computer forms into stacks. The separated carbon is easily and neatly removed from carbon pick-up spool. Form size is up to 15" wide. Wt. is 10 to 110 lb. bond paper. and the speed is variable from 75 to 200 feet per minute and takes only 120 volts AC 60 hertz to operate.

Wt. 40 lbs. Price \$ 419.00

D  The Datatech Intimus 007 shredder works for Scotland Yard, for government authorities, for important corporations, banks and embassies. The cutting capacity is 12 to 14 sheets at one pass. Cross cut is 1/35 x 3/8. It has a 2 H.P. motor and runs off of 220/380 V 3 phase.

Wt. 320 Lbs. Price \$6799.00

E  The Intimus 306 is designed for trouble free operation and has a switch for forward and reverse rotation. It has 2 motors with terminal overload. Housing consists of coated steel, mounted on rubber cushions for noiseless shredding. The 306 can sit on a table or a stand. Cutting width is 1/4" or 1/2" and has two 150 watt 110 V 60 cycle, 1 phase motors.

Wt. 66 Lbs. Price \$1199.00

F  The Intimus Simplex is designed for security without problems in the office. One push of the button renders confidential information into five illegible paper strips 1/4" thin. The simplex has a wide opening in the middle for throw away of cans, etc. Even a paper clip is simply cut into pieces. The cutting capacity is 8 to 10 sheets at one time. It has a 1/5 H.P. motor and runs off of 110 volts.

Wt. 27 Lbs. Price \$ 599.00

G  Our catalog consists of more information on equipment in this ad. Other models are available plus a complete line of calculators and typewriters by Adler, Latham time recorders, several varieties of safes, and our disintegrator that destroys paper, aluminum, film and carbon to a complete loss of identity.

Price \$2.00

H  Free Brochures and more information:

1.  Business Forms
2.  Calculators
3.  Forms Handling Equipment
4.  Time Recorders
5.  Typewriters

Terms: Check or money order U.S. funds only. Prepaid orders add 3% S/H, COD's add 5% S/H (U.S. only). California residents add 6% sales tax.

Prices subject to change without notice.



# Ohio Scientific: The leader in Winchester based micro- computers.

Ohio Scientific produced the first large capacity fixed media hard disk (Winchester) based microcomputers in 1977. Since then we have shipped more of these systems than the rest of the microcomputer industry combined.

## Family Features

All standard C3 features including:

- 3-processor CPU with 6502, Z80 and 6800
- .7 MIPS 6502A
- 48K static RAM
- Dual 8" floppies
- Free standing rack for direct expansion capabilities
- 17-slot OSI 48 line BUS architecture for large system expansion
- Directly accepts up to 8 users with currently available memory boards, more with higher density boards in the future
- Directly expandable for use as Network data bases
- Slide-mounted subassemblies, removable side panels and locking rear door for easy expansions and service.

## C3-A

The floppy only rack based C3 for users who anticipate expansion to hard disk, multi-user and/or networking in the future.

**Under \$7000.**

## C3-B

The world's most powerful microcomputer (when GT equipped). Features the highly advanced and extensively field proven OKIDATA 3306 Winchester disk.

## Features

- System boots from floppies or hard disk on power up
- 74 megabytes end user workspace under OS-65U, 80 megabytes unformatted
- Ultra-high performance disk  
74 millisecc worst case access  
38 millisecc average  
10 millisecc access on cylinder (215K user workspace)  
8 megabits per second transfer rate
- Simple on/off disk operation with elaborate internal protection from improper temperature, line voltage and controller failures
- Features spindle brake and designated head landing areas for much longer operational life than the newer low-cost Winchester
- Highly advanced OS-65U operating system:  
Multiple level pass word security  
Multiple operating systems on disk  
Ultra-high speed "FIND" command for high speed string searches (Associative Access)  
Upward compatible with multi-user and network systems with full file, peripheral and communications arbitration between users



- Available factory configured for up to 8 users and network data base operation
- Expandable to CP/M operation by adding 4K (CM-2 memory)  
**Under \$14,000**

## C3-C

A medium performance Winchester disk based system which provides the ideal cost/performance ratio in typical small business applications. The C3-C uses the Shugart SA4008 29 megabyte Winchester disk.

Performance specifications, hardware configuration and software is identical to the C3-B with the following exceptions:

- 23 megabytes of end user workspace under OS-65U
- 29 megabytes unformatted capacity
- Medium performance Winchester  
240 millisecc worst case access  
87 millisecc average access  
10 millisecc access on cylinder (110K user workspace)
- Simple on/off disk operation  
**Under \$11,000**

**Ohio Scientific has a new OEM program that is easy to start with, and provides generous discounts for quantity purchases.**

**For literature and the name of your local dealer, CALL 1-800-321-6850 TOLL FREE.**

**OHIO SCIENTIFIC**  
1333 SOUTH CHILLICOTHE ROAD  
AURORA, OH 44202 • (216) 831-5600