

THE BROADCAST ENGINEERS' JOURNAL  
Ed. Stolzenberger, Editor  
116-03 91st Avenue Richmond Hill 18, N. Y.

Postmaster: If undeliverable for any reason,  
notify sender, stating reason, on form 3547,  
postage for which is guaranteed.

F A GENRES WGBF-WEDA  
2232 E POWELL  
EVANVILLE 14 IND  
5151

Sec. 562, P. L. & R.  
U. S. POSTAGE  
**PAID**  
New York, N. Y.  
Permit No. 2961

# THE BROADCAST ENGINEERS' JOURNAL

*Fay Schermer*  
NABET National Council

Meeting: Detroit

Oct. 4-8

Dept. of Labor Report on the Taft-Hartley Law

Papers of the West Coast I.R.E. Convention

Transformerless Voltage Multiplier Power Supplies

VOL. 15, No. 10

OCTOBER, 1948

**OFFICIAL PUBLICATION OF N. A. B. E. T.**

NAT'L ASS'N of BROADCAST ENGINEERS and TECHNICIANS

# Broadcast Radio Engineers

who want

this →

specify

this →

**because** the Shure Super-Cardioid Broadcast Dynamic Microphone has a super-cardioid pickup pattern which reduces the pickup of unwanted random noise energy by 73%. It is twice as unidirectional as the cardioid. In the super-cardioid pattern, the ratio of front-to-rear pickup is 14 to 1—in the cardioid, 7 to 1. There is a wide, useful pickup angle at the front of the microphone while the rear response is down of the order of 15 db over a broad range of frequencies. Reverberation energy pickup is decreased over two-thirds. The microphone can be placed close to the reflecting surfaces without objectionable effects if the rear side of the microphone is toward the reflecting surface.

The Shure "556" Dynamic Microphone has an Acousto-Mechanical circuit containing a single moving-coil element, which operates in conjunction with a high flux magnet and provides high efficiency and smooth peak-free response from 40 to 10,000 cycles. The super-cardioid pattern is achieved in a single unit, due to the "Uniphase" principle—a patented Shure development. The moving-coil unit is provided with a double wind-screen to permit quiet outdoor operation. As a precaution against mechanical vibration pickup, the unit is spring-suspended inside the microphone case, which in turn is floated in live rubber in the special Vibration Absorbing Unit, which eliminates reproduction of vibration transmitted through the stand. The microphone also has a standard 5/8"-27 thread which permits mounting on any Shure desk or floor stand. Adapters to other stands are obtainable when needed. Case dimensions: 4 1/4" high, 3 1/4" wide, 3 1/2" deep. Shipping weight, 4 1/2 lbs.

*Patented by Shure Brothers, Inc.*

## SHURE BROTHERS, Inc.

MICROPHONES AND ACOUSTIC DEVICES

225 W. Huron Street

Chicago 10, Illinois

CABLE ADDRESS: SHUREMICRO

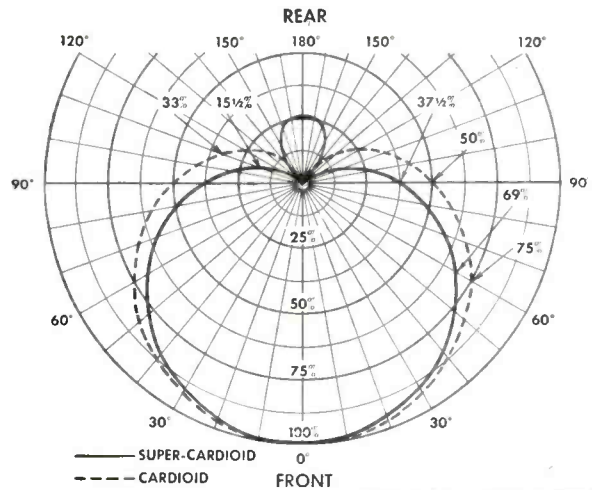

### SHURE SUPER-CARDIOID DYNAMIC MICROPHONE

MODEL "556"

Code: RUMUB • List price: \$87.50

MULTI-IMPEDANCE SWITCH ON MODEL "556"

IMPEDANCE TABLE	OUTPUT LEVEL
L—35-50 ohms	56.1 db below 1 Milliwatt per 10 microbar signal
M—150-250 ohms	56.8 db below 1 Milliwatt for 10 microbar signal
H—High Impedance	55 db below 1 volt per microbar

# THE BROADCAST ENGINEERS' JOURNAL

Ed. Stolzenberger

Editor and  
Business Mgr.

Editorial, Advertising and Circulation Offices:  
116-03 91st Avenue, Richmond Hill 18, N. Y.  
Telephone: Virginia 9-5553

Volume 15, No. 10

October, 1948

Contents copyright, 1948, by NABET Publications

## TABLE OF CONTENTS

	Page
NABET President McDonnell's Message .....	2
An Opinion on the Taft-Hartley Law .....	3
Transformerless Voltage Multiplier Power Sup- plies .....	6
Review of Current Technical Literature .....	10
Washington News .....	12
West Coast IRE Convention Papers .....	13
JTAC Request for High Frequency Data .....	15
RMA Report on TV Receiver Radiation and I.F. Frequency .....	16
Electronics Industry Mobilizes .....	17
Omaha News .....	20

## THE BROADCAST ENGINEERS' JOURNAL

OFFICIAL PUBLICATION OF THE N. A. B. E. T.

Trustees: D. J. MOLONEY, *Chairman*; CARL CABASIN, J. R. MC-  
DONNELL, A. G. POPPELE, C. WESTOVER.

Secretary-Treasurer ..... H. E. HILLER

### ASSOCIATE EDITORS

Baltimore .....	JOHN W. LAPPE
Boston .....	JAMES W. HUGHES
Chicago .....	MINOR J. WILSON
Cleveland .....	EARL HOLL
Denver .....	CONLEY HOLCOMB
Detroit .....	HARRY LEWIS
Dixie .....	SAM LILES
Engineering Chapter .....	
Hollywood .....	NORMAN DEWES
Hudson Chapter .....	AL KING
Mohawk .....	J. W. GAGNE
New York .....	
Omaha .....	LOUIS DE BOER, CY HAGRMAN
Philadelphia .....	
Pittsburgh .....	FRANK E. HENRY
Rochester, N. Y. ....	GEORGE WILSON, DONALD ANDERSON
San Francisco .....	EARL SORENSON
St. Lawrence, N. Y. ....	ALEEN A. CORBIN
Washington .....	WARREN D. DEEM

The Broadcast Engineers' Journal is a privately printed monthly publication issued by NABET Publications. Address all communications to Publication office: E. Stolzenberger, 116-03 91st Avenue, Richmond Hill 18, L. I., N. Y. Telephone Virginia 9-5553.

Advertising rates and information supplied on request. Subscription, \$2.50 per year; \$4.00 for two years. Single copies, except Christmas Yearbook, 35c; Christmas Yearbook, \$1.00. All remittances in advance Foreign: add postage. Back copies 50c, back Yearbooks, \$2.00.

Nothing appearing in The Broadcast Engineers' Journal shall be construed to be an expression of The Broadcast Engineers' Journal or the National Association of Broadcast Engineers and Technicians, but must be construed as an individual expression of the author or authors.

#### NATIONAL N.A.B.E.T. OFFICE

Room 501, 66 Court Street, Brooklyn 2, N. Y.

H. E. Hiller, Executive Secretary

MAIn 4-2855



## 25th ANNIVERSARY!

The world's finest  
precision disc  
recording machine —  
used and recommended  
wherever the finest  
recordings are made

«»

Today — Write, Phone, or Wire

your order for

SCULLY MASTER RECORDERS

«»

# SCULLY Machine Company

62 Walter Street

Bridgeport 8, Conn.

Telephone BRidgeport 4-5300



# National Association of Broadcast Engineers and Technicians

NABET is your democratic union, because  
NABET rank-and-file members control  
their union.

NABET means good trade-union practice.

NABET is the progressive union in the  
Broadcast Field.

Contact any of the following officers for further information:

**J. R. McDonnell, Pres.**  
375 O'Farrell St., Room 301  
San Francisco 2, Calif.  
Ordway 3-8484

**H. E. Hiller, Executive Secy.**  
**C. L. Gorsuch, Nat'l Rep.**  
66 Court St., Room 501  
Brooklyn 2, N. Y.  
MAin 4-2855

**Arthur Hjorth, Vice-Pres.**  
**Geo. Maher, National Rep.**  
80 E. Jackson Blvd. Rm. 543  
Chicago 4, Ill.  
Wabash 2462

## Chapter Chairmen

**Baltimore:**  
Royce I. Heintz  
5508 Wesley Ave.  
Baltimore 7, Md.

**Boston:**  
Elmer M. Lantz  
Concord Road  
S. Lincoln, Mass.

**Chicago:**  
Arthur Hjorth, Vice Pres.  
404 W. Evergreen, Apt. 51  
Chicago 10, Ill.

**Cleveland:**  
Harold V. Brandt  
19 Elm St.  
Brecksville, Ohio

**Detroit:**  
Roger K. Ellis  
820 University Pl.  
Detroit 30, Mich.

**Dixie:**  
J. Willard Dean  
217 E. North St.  
Raleigh, N. C.

**Engineering:**  
Carl A. Cabasin  
147-42 Elm Ave.  
Flushing, N. Y.

**Hollywood:**  
Ben M. Doty  
3330 Charleston Way  
Hollywood 28, Calif.

**Hudson:**  
Donald Hale  
1 Franklin Ave.  
White Plains, N. Y.

**Mohawk:**  
Donald P. Morey  
3 Circle Lane, Apt. 26-A  
Albany 3, N. Y.

**New York:**  
Clarence Westover  
1 Charles St.  
Oceanside, N. Y.

**Omaha:**  
F. A. (Bob) Rudd  
3676 Ida Street  
Omaha 11, Nebraska

**Philadelphia:**  
R. J. Wilke  
4718 Chestnut  
Philadelphia, Pa.

**Pittsburgh:**  
Elvyn M. Sollie  
Main St.  
Saxonburg, Pa.

**Rochester:**  
Edward Lynch  
109 Wolcott Ave.  
Rochester 11, N. Y.

**Rocky Mountain:**  
George Pogue  
2389 Birch St.  
Denver 7, Colo.

**San Francisco:**  
Richard T. Parks  
10 Leroy Place  
San Francisco, Calif.

**St. Lawrence:**  
David H. Lane  
119 Maple St.  
Black River, N. Y.

**Syracuse:**  
Donald Muir  
1200 W. Colvin St.  
Syracuse 7, N. Y.

**Washington:**  
John H. Hogan  
9312 Sudbury Rd.  
Silver Spring, Md.

## Section Chairmen

**Atlanta:**  
Broughton W. Benning  
2715 Stewart Ave.  
Atlanta, Ga.

**Connecticut Valley:**  
George R. Townsend  
44 Lakeside St.  
Springfield 9, Mass.

**Fairmont:**  
O. C. Swisher  
632 Orr St.  
Fairmont, W. Va.

**Louisville:**  
Kermit B. Smith  
1211 S. 6th St.  
Louisville, Ky.

**Richmond:**  
Ellmore Taggart  
2316 Floyd Ave.  
Richmond, Va.



## A Message to the Members of NABET

from

**JOHN R. McDONNELL**  
President, NABET

Events of the past few months demonstrate conclusively that NABET is *the* union which best represents the interests of the radio-television men. If you have been following the news and trade papers it should be obvious that where other unions who claim to represent the radio engineer have temporized—compromized—given ground—on such vital issues as jurisdiction, NABET has stood firm, and made its position stick.

The events referred to in the preceding paragraph are but a part of NABET's constant battle to protect the interests of the radio engineer. In order to continue this battle most effectively it is essential that we have a well informed, active membership. I urge every NABET member to acquaint himself with the affairs of his union, and to participate actively in the affairs of his Chapter. I invite, on behalf of NABET, every radio and television engineer and technician who has a stake in the future of the industry to get acquainted with our organization. Contact our Representative or Chapter Chairman nearest you, or our National Office. You will find an understanding of your problems—for the man you contact will also be a radio engineer.

Sincerely,

(Signed) J. R. McDONNELL, *President.*

## INITIATION AND ASSESSMENT CHECK-OFF HELD LEGAL

In response to a request by William S. Tyson, Solicitor of the Department of Labor, the Assistant Solicitor General, George T. Washington, has given an opinion dated May 13, 1948, that employees may authorize in writing the check-off of initiation fees and assessments as well as dues under the Labor Management Relations Act, 1947.

The opinion also stated that such authorization can continue irrevocably from year to year as long as the employee is permitted to revoke it during a specified period each year.

## DO WE HAVE YOUR ZONE NUMBER?

**DEADLINE** is 2nd OF EVERY MONTH. EXAMPLE: COPY RECEIVED MARCH 2nd APPEARS IN THE APRIL ISSUE, IN THE MAIL APRIL 1st.

*Heading Cuts* for Chapter news columns. Chapters without regular heading cuts and desiring same, should send in photo, cartoon, or drawing of subject matter that they wish used to identify and distinguish their column.

# An Opinion on the Taft-Hartley Law

By ACTING SEC. OF LABOR JOHN W. GIBSON

But a short time has elapsed since the death of the late Secretary of Labor Lewis B. Schwellenbach. During that time the responsibilities and duties of administering the affairs of the United States Department of Labor have fallen upon me.

I say that with a deep feeling of humility and not a little frustration, because the person who has to run the Department of Labor, or what is left of it today, has the responsibility, but not the tools, to carry out what is still one of the most important functions of the Federal Government:

"To foster, promote and develop the welfare of the wage-earners of the United States, to improve their working conditions, and to advance their opportunities for profitable employment."

All the people of our great country benefit when the workers enjoy full freedom to exercise their hard-won rights to organize, join unions of their own choosing, and bargain collectively. The prosperity which we enjoy today with its unprecedented level of national income and employment is the fruit of 16 years of free collective bargaining.

We in the Department did everything possible to give the people a good Department and we did our best to convince Congress this was so. But the powers of special privilege, the fat cats of special interests, were, after years of plotting, planning and propagandizing, again having their day.

The budget for the fiscal year which ended June 30 was cut 44 per cent by the House Appropriations Committee. We were successful in convincing the Senate that at least a part of our operating funds would have to be restored if we were going to provide wage-earners, employers, and the public with a bare minimum of services which they had come to regard as essential.

Nevertheless, our implacable foes in the House refused to go along with this restoration and a compromise had to be worked out in conference. As a result, the Senate restorations were cut 50 per cent, and many services had to be reduced or eliminated.

Failure to provide adequate funds made the following necessary:

The program of the Bureau of Labor Statistics to provide workers, employers and the public with the latest and most complete information about the rising cost of living had to be curtailed. The number of cities for which the Consumers' Price Index was issued monthly had to be cut from 21 to 10.

The BLS wage statistics program had to be substantially curtailed in scope. Comprehensive national industry surveys of wage rates in key occupations were greatly reduced.

Three regional offices of the Bureau of Labor Statistics where labor unions could come for facts and figures had to be closed.

Veterans who were unable to find jobs because of special problems and conditions were hit by these appropriation cuts. Four hundred field assistants of the Veterans Employment Service who devoted their full time and energies to these problems had to go out and find other jobs for themselves.

The Workers Education Service in the Bureau of Labor Standards which the previous year had been given a modest appropriation of \$35,000 to inaugurate its program was given nothing at all and its staff and operators were liquidated.

While the Bureau of Labor Standards was allowed \$200,000,

the expenditure of these funds was limited by the appropriations act to the "distribution of reports and material for information exhibits in connection with the promotion of health, employment stabilization, safety and amicable industrial relations."

Under its appropriation, the Wage and Hour and Public Contracts Divisions could not inspect more than 7 per cent of the 550,000 covered establishments in the United States during any year. In other words, the same Congress that passed the Portal-to-Portal Act which wiped out all back wage claims after two years made it impossible for the Divisions to visit any given establishment more than once every 12 to 14 years. This does not take into consideration the fact that approximately 50,000 new establishments started business each year and an equal number of establishments ceased business operations.

This year's appropriation was 13 per cent under budget requests which had been made for those services which were to remain in the Department.

The \$500,000 which the Congress "economized" will cost the people two field services. The Women's Bureau was forced to close its field offices in New York, Philadelphia, Boston, Chicago, St. Louis and San Francisco. And the Bureau of Veterans Reemployment Rights, given new duties under the Selective Service Act of 1948, had to close 20 of its 35 field offices and drop 50 of its 85 employees.

While the House cut the appropriation of the Bureau of Labor Statistics 53 per cent, the BLS finally got the same amount it had the previous year.

However, with the additional \$121,800 which it had requested BLS would have been able to expand its Consumers' Price Index to meet today's needs for the best possible information about retail prices. I believe that you will agree with me that this is a small price to pay for a service that plays so important a part in our economy and is used so widely by unions, employers, researchers, Government agencies, and the Congress itself.

As its final act of emasculation, the Congress overrode a Presidential veto of an appropriation rider kidnapping the United States Employment Service from the Labor Department and placing it in the Federal Security Agency.

This action, with unconscious irony, was taken as Lewis Schwellenbach was fighting a losing fight for life. He died without learning that this cause, like so many of the others on which he had been forced to spend his strength, was lost.

And the Department of Labor, which three years before, although it always has been the smallest executive department, had 7,000 employees, was finally reduced as of July 1 to barely 3,500 employees.

Surely this action cannot be explained away on the ground of economy or logic.

For what could be more logical, sound and practical than keeping within the Labor Department the responsibility for the promotion and development of the Nation-wide network of free employment offices which had been established at the time of our greatest economic distress for the purpose of finding jobs for workers and workers for jobs.

The Employment Service was conceived and founded in the Labor Department. There it was capably administered, pro-



protecting workers against discrimination. They were not only assured of equal opportunities for employment when they used its services, but also that jobs would be found for them at their highest skill and the best rates of pay.

Why, then, did Congress strip the Labor Department of one of its most important remaining services to the wage-earner? Why has the Department been subject to constant attack and dismemberment by the 80th Congress? Why have its appropriations been reduced by nearly 50 per cent so that it has been forced to halt or drastically curtail many of its vital services to workers?

Many smoke screens have been laid down by the perpetrators of these acts to cover their real objectives, and to mislead and confuse the public. But it seems to me that a careful and searching analysis of all the factors proves rather conclusively that the Labor Department is but one victim of a total, all-out attack on the gains of workers, organized and unorganized.

Even before the Congress could get around to passing the Taft-Hartley law, State legislatures were being whipped into an anti-union frenzy by the anti-labor lobby. As a result, there are now more than 22 States with laws prohibiting or restricting union security agreements in one form or another. Twelve States prohibit all forms of union security, and one more bars the closed shop. Several States have hedged in or eliminated the right of public utility workers to strike and have failed to provide other means by which they may obtain justice.

That brings us to the Taft-Hartley law, enacted by a *beneficent Congress* to protect the organized workers from themselves and their unions.

But, do the workers want this kind of "protection"? They have answered for themselves in the 13,325 union shop elections conducted by the National Labor Relations Board up to June 1. Of 1,250,000 workers voting in these elections, 95 per cent have expressed a preference for the union shop. When the workers are given a chance to speak for themselves, they are overwhelmingly in favor of the kind of protection that their union gives them: protection of their wage rates and earnings, union job security, and a continued voice through their union in these and other conditions of employment. It is worth noting that the number of union shop elections held up to June 1 was only half the number for which petitions have been filed.

In the face of these facts, the framers of the Taft-Hartley law have been telling the people that repressive measures against unions were necessary to prevent strikes. Here, again, the record speaks for itself. In 1919, after World War I, the number of workers involved in strikes was 20.8 per cent of the total number employed. In 1946, the number of workers involved in strikes was only 14.5 per cent of workers employed. In 1920, the percentage had dropped to 7.5 and last year it was only 6.5. I am convinced that the Taft-Hartley law was actually responsible for many of the strikes that occurred last year and that the figure would have been lower than 6.5 per cent if the law had not been enacted.

The fact-finding procedures set up by the Taft-Hartley law actually delay or prevent settlements because the panels cannot make a recommendation but only report on the facts. This is far different from the fact-finding boards established by the United States Conciliation Service when it was in the Labor Department. These boards made recommendations for a mutually satisfactory settlement of the issues. Under present procedures, after something like 80 days have elapsed, the parties are right back where they started from, confronted with a statement of the facts which they, of course, were intimately

acquainted with all the time.

Regardless of these facts, it is the propaganda line of the framers of the Taft-Hartley law that the workers of the United States want and need "protection" from their unions and that the law was necessary to prevent a wave of impending strikes. They are still working tooth and nail to keep the truth about this vicious, anti-labor, undemocratic law from the people.

Now, how does the Taft-Hartley law accomplish the noble purpose which has been ascribed to it; that is, protect American workers from their unions, from the men they elect and pay to act as their union officers, and, if you carry it to a logical conclusion, from themselves.

The first thing the Taft-Hartley law does, in Title I, is to reduce to a shambles the National Labor Relations Act of 1935, under which unionism was revived and membership has grown to 15½ millions.

The Wagner Act, often called the worker's Bill of Rights, proclaimed the right of workers to organize, join unions of their own choosing, and bargain collectively. Employers were guilty of an unfair labor practice if they interfered with the right to join unions or refused to bargain collectively.

Second, the Taft-Hartley law nullified some of the safeguards afforded workers by the Norris-LaGuardia Act of 1932, an Act which outlawed yellow-dog contracts and prohibited the irresponsible use of injunction in labor disputes, the latter a favorite strike-breaking device since 1806.

Next—and the point backs up what I've said about the drive against organized labor and the Labor Department being one and the same thing—it moved the U. S. Conciliation Service out of the Labor Department.

After 34 years of successful operation in the Department of Labor and with a record of 100,000 disputes settled, 90 per cent of them without a strike, the U. S. Conciliation Service as it existed in the Labor Department, was rubbed out by the Taft-Hartley Act.

This was a double blow, aimed at you and at us.

I have no quarrel with the independent Federal Mediation and Conciliation Service which was created by the Taft-Hartley law, nor the men who operate it. But I do believe that they functioned far more efficiently in the Department of Labor.

The Wagner Act equalized bargaining power between labor and management by requiring management to allow employees to join unions of their own choosing and to bargain with such unions on wages, hours and conditions of employment.

It reduced the power of brute economic force which was on the side of management. But it did not compel workers to join unions nor was it concerned with contract terms except to see to it that employers really bargained in good faith.

Now the balance of power had been heavily weighted in favor of management.

*Contract terms have become the subject of Taft-Hartley law prohibition and tabu.*

Before a union can fully organize his workers, an employer can so manipulate the situation as to defeat the organizing drive by asking for an election which is sure to result in defeat for the union, thereby preventing any union recognition in his plant for a period of 12 months.

He may delay bargaining by charging the union with unfair labor practices.

He may destroy a union by provoking a strike, replacing the union strikers with non-union workers, and then bring about an election that will exclude the union and give the

law's blessing to his union-busting tactics.

He may hire workers without regard to union affiliation, depriving union workers of genuine job security. In this way he can fight and undermine a union by placing on the pay roll, as long as they are willing to pay union dues or he pays dues for them, other assorted characters as company stooges, spies, troublemakers or strikebreakers.

These are a few of the ways in which the Taft-Hartley law "protects" workers from their unions.

In addition, it restricts the right to strike in many cases and outlaws it altogether in others. For instance, a union cannot strike during the duration of a contract for changes in its terms, without first satisfying certain notice requirements which have the effect of greatly weakening the effectiveness of the union in resisting the encroachments of an unfair management. Neither can it strike to compel an employer to recognize it where some other group has been certified by the NLRB solely as the result of an election secured by the employer long before the union completed its organizational drive in his plant.

Anyone with the slightest knowledge of the realities of labor-management relations knows that when employers commit unfair labor practices, time is of the essence. The remedy must be quick and complete to do justice and avoid industrial flare ups. But the Taft-Hartley Act has made rapidity of action against employers an administrative impossibility. When the act became effective in the summer of 1947, many unfair labor practice cases which had been initiated under the Wagner Act were pending before the NLRB in varying stages of incompleteness. This backlog has grown steadily to mountainous proportions. As of June 1, 30,493 cases of all kinds had been filed and 133,254 were still pending.

The General Counsel's Office finds that most of its time and energy are devoted to holding elections to determine if employees wish to authorize their unions to enter into union-security agreements. Despite the overwhelming approval employees have given to such agreements in the many elections already held, such elections continue, taking priority over almost all other aspects of the General Counsel's activities. Lucky is the union which can get an unfair labor practice charge processed in less than many, many months. In fact, the only phase of the General Counsel's work which gets acted on at once appears to be requesting injunctions against labor unions for alleged violations of the Taft-Hartley Act.

On this point there seems to be universal agreement. The union-security elections have proved not only a completely unnecessary measure—over 90 per cent of the elections have approved the union shop by overwhelming majorities—but such elections have diverted the Board from its primary function of eliminating unfair labor practices, and in effect made recourse to the Act a futile gesture on the part of unions.

What the law does with complete success is involve the delicate situations of labor-management relations in time-consuming and costly processes of hearings and litigation. It seriously interferes with free collective bargaining by subjecting contract provisions to legal restraint and interpretation, by providing penalties against unions, and by once again making it necessary for a worker to risk his job by joining a union.

It goes much further than first meets the eye in outlawing union security because it provides that its own provisions for the union shop or maintenance of membership are superseded in States making these forms of union security illegal.

Thus, by weakening the bargaining position of unions, harassing free union activity and collective bargaining, sub-

jecting unions to bankrupting fines and penalties, abridging the right to strike, permitting the hiring of spies and strikebreakers, and bringing the injunction back as an anti-union weapon, does the Taft-Hartley law "protect" American workers.

If the Congress really wants to do something constructive for the American workers, may I suggest the following program, in addition to repeal of the Taft-Hartley Act:

1. Strengthen the Labor Department and consolidate under its responsibilities all phases of those governmental functions having to do with labor-management relations, employment, manpower and the welfare of the wage-earners. Provide sufficient funds to maintain all these activities at adequate levels.

2. Enact immediate inflation controls and restore the balance between wages and prices. Wage-earners, especially those in the lower income brackets, have been faced with a grinding, endless fight to make their pay checks last out the week. In the end, they have been forced to use their savings, if they had any, or reduce their standard of living. As of May 15, the cost of living had risen more than 72 per cent since the beginning of World War II and more than 27 per cent since the end of OPA in June 1946. Advances in food costs are even more frightening, if possible. They have risen 125.6 per cent over the prewar level and 44.8 per cent since July food price comparisons between May 1939 and May 1948. Round steak, which then cost 34 cents a pound now sells for 85.3 cents a pound. Chuck roast prices have risen from 24.6 cents a pound to 64 cents a pound. The same can of corn that cost 12.3 cents in May 1939 retails for 20.2 cents today. Eggs 22.2 cents a dozen then—55.2 cents today and so on down the line.

As of today's prices, the cost of inflation to the American consumer is \$40 billion a year more than it was two years ago. That is an increase of about 30 per cent. American consumers, spending at an annual rate of \$177 billion in the second quarter of 1948, received fewer goods and services than they were able to buy in the second quarter of 1946 when they were spending at the annual rate of \$138 billion.

In May of this year, the average weekly earnings of factory workers was \$51.89, but the increased cost of living dipped into the pay envelope and took out \$21.63, leaving the workers with a purchasing power of only \$30.26 in terms of 1939 dollars.

3. Raise the minimum wage under the Fair Labor Standards Act to at least 75 cents an hour and increase the coverage of the Act to include millions of persons not now covered.

4. Increase the coverage of the Social Security Act to 20 million persons who are not now protected and raise the amount of benefits, including unemployment compensation, old age assistance, and survivor's insurance. Under the present provisions of the act the most an elderly couple, both of whom are eligible for old-age pensions, can receive is \$90 a month. A modest budget for a representative couple required, under living costs as they stood in June 1947, a cash outlay ranging from \$1,767 in Washington, D.C., to \$1,365 in Houston, Texas.

5. Enact legislation making it possible for the Department of Labor to carry out a program of labor education. The few thousands of dollars that were made available to the Department in previous appropriations were entirely eliminated two years ago. At the same time, the present session of Congress took no action on a labor education extension bill pending before it.

(Continued on page 8)



# An Investigation of Selenium Rectifier Transformerless Voltage-Multiplier Power Supplies

By ED STOLZENBERGER

We set out to make our own determination of the relative worth of selenium rectifier—voltage multiplying, transformerless power supplies, for high voltage applications.

The published material on the subject left many points in question insofar as voltage multiplication realizable under load. The literature seemed to us to imply that while voltage multiplication ad infinitum was theoretically attainable, that under load, poor gain per multiplier stage was already apparent when voltage-tripling, and that little more output voltage could be realized by adding a quadrupler section.

We were not satisfied that this subject had been adequately explored. A quick assembly of available parts was haywired into a voltage sextupler, and experimental load runs were made. This trial run readily indicated that a ten-stage multiplier would be capable of useful and predictable output (which may be interpolated from Fig. 2). However, it was also evident that a ten-stage multiplier was prohibitive in terms of cost and bulk, although it would still maintain a very favorable weight advantage. It was decided to thoroughly investigate a sextupler as a practical power supply. A load current of 200 ma DC was decided upon as a value high enough to determine the effectiveness of multi-doubling under relatively heavy load conditions that would be encountered in broadcast, TV, and amateur station applications. We would also determine the minimum bulk and weight of such a power supply, its percent ripple, and plot the regulation characteristics of the half-wave, doubler, tripler, quadrupler, quintupler, and sextupler stage, and demonstrate the disastrously bad regulation that results from inadequate capacity and increasing load (see dashed curves A and B in Fig. 2). The preliminary test runs indicated that it was necessary to use the maximum capacity permitted by the selenium rectifier ratings, which is approximately 40 mfd. per 100 ma rectifier unit. We planned to operate two of these 100 ma rectifiers in parallel (for 200 ma output) which meant that we could

use 80 mfd per stage. Selenium rectifiers form, deform, and reform similar to, but much more quickly than electrolytic condensers. Because of the low (5-ohm) internal resistance of selenium rectifiers, it is necessary to limit the ripple current during the forming of the electrolytic condensers, and also to limit the characteristic selenium rectifier ripple current. Excessive ripple current would ruin the condensers, and would exceed the peak current ratings of the rectifiers. A series limiting resistor is usually specified by the manufacturer, and varies between 20 and 50 ohms. We selected 30 ohm, 1 watt (Aerovox type 1098) resistors as a safe value to place in series with each rectifier. Aerovox condensers were supplied for each of the six voltage multiplying stages, as follows: an AF20D (100 mfd, 150 dcv); AF16H (80 mfd, 400 dcv); AF16H (80 mfd, 400 dcv); 3, PRS500 (16 mfd, 500 dcv); 3, PRS600 (16 mfd each, 600 dcv); 3, PRS 700 (16 mfd each, 700 dcv). The usual AC line "hash" condenser was not included in this unit since it has no bearing on the investigation. The twist-lug lower voltage condensers were mounted on a single sub-base, and the clamp-mounting higher voltage condensers were assembled on readily removable trays, to facilitate taking load runs with 48, 32, and 16 mfd in the quadrupler, quintupler, and sextupler stages, while maintaining 100, 80, and 80 mfd respectively, in the half wave, doubler, and tripler stages.

The six multiplier stages would require 6 selenium rectifiers, but to meet our requirement of a 200 ma load, two General Electric type 6RS5GH1 (100 ma rating) selenium rectifiers were paralleled thru individual series resistors, for each of the six stages, requiring a total of twelve rectifiers. Four rectifiers are mounted in a row, and the three rows may be seen in the photos. Because of the high voltages involved in this unit, each rectifier was insulated from the metal base with half-inch bakelite cubes. The six-inch ruler in one of the photos indicates approximate size. It is  $7\frac{1}{2}$ " long,  $5\frac{1}{2}$ " wide, and  $5\frac{1}{2}$ " high, and weighs only  $3\frac{1}{2}$  pounds! At

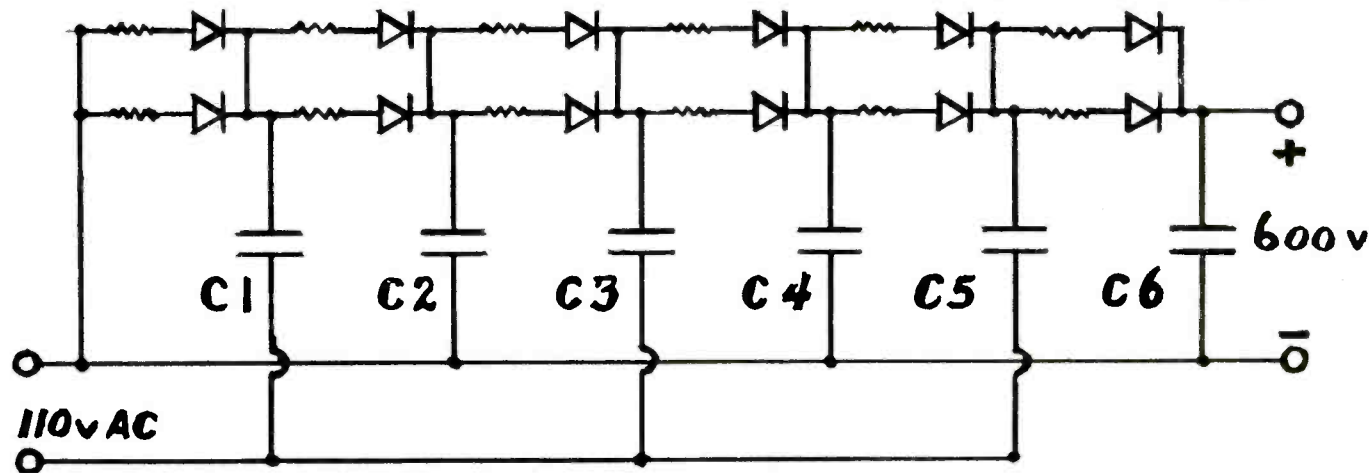

Fig. 1—Each of the G. E. Co. rectifiers indicated are rated at 100 ma DC output. The individual series resistors are 30 ohms 1 watt. The capacities of the Aerovox condensers are: C1, 100 mf; C2, 80 mf; C3, 80 mf; C4, 48mf; C5, 48 mf; C6, 48 mf. Additional multiplier stages may be added ad infinitum, by extending the circuit to include another rectifier, resistor, and condenser for each multiplier stage added. Note that alternate condensers return to alternate sides of the AC line. Doubler output is obtained across C2. Tripler output is obtained across C3. Quadrupler output is obtained across C4; etc.



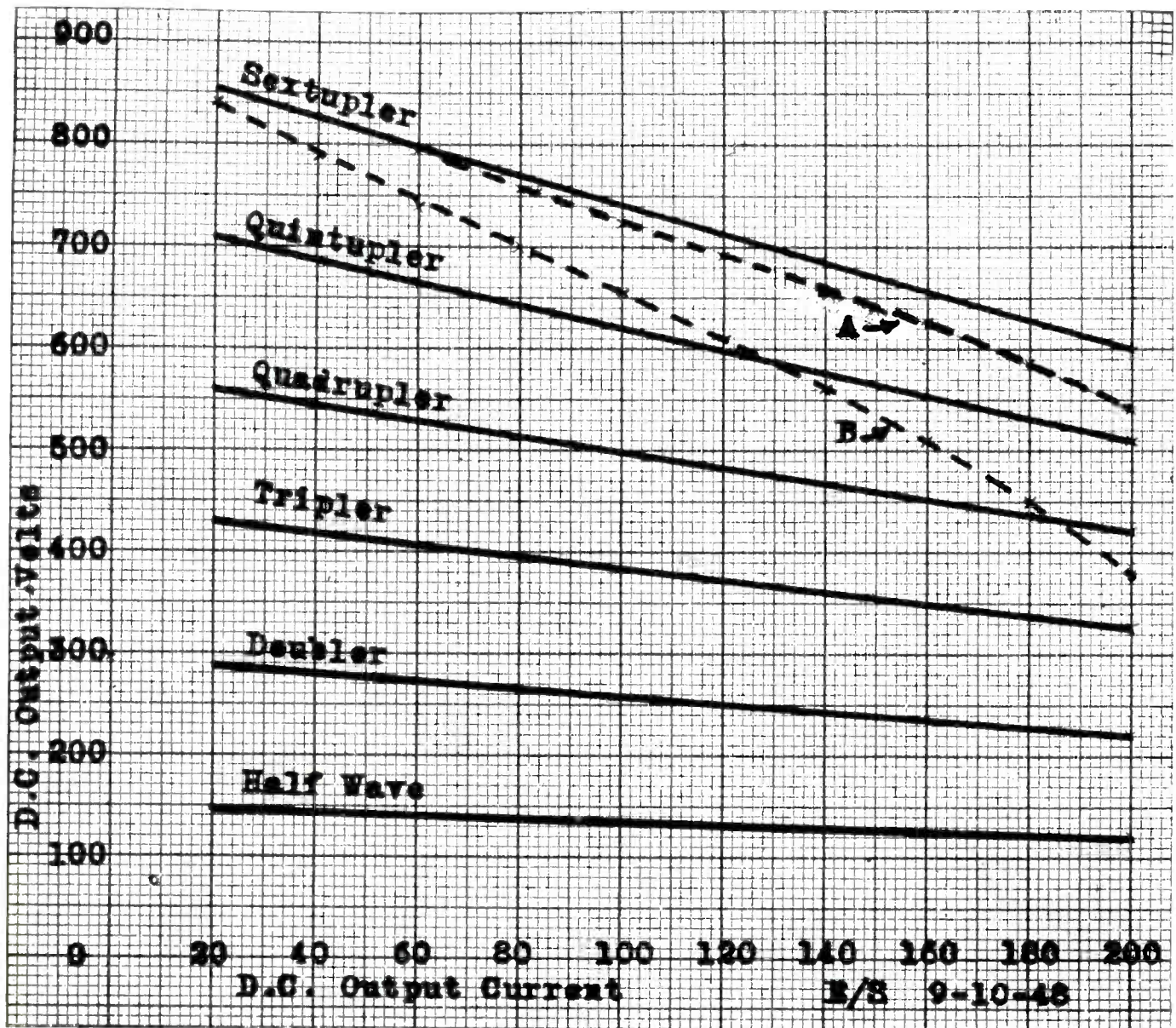

Fig. 2—The solid curves show the comparative regulation that may be expected from a doubler, tripler, quadrupler, quintupler, or sextupler, with capacities of C1, 100 mf; C2, mf; C3, 80 mf; C4, 48 mf; C5, 48 mf; C6, 48 mf, at 105 v AC line input. Dashed curve A shows the poorer regulation that results when C4, C5, and C6 are reduced from 48 mf each to 32 mf each. Dashed curve B is the result of further decreasing C4, C5, and C6 to 16 mf each. It is graphically demonstrated that a tripler with adequate capacity per section is more effective than an inadequately designed quadrupler, quintupler, or sextupler. At 117 v AC, the sextupler delivers 640 v DC at 200 ma with 7% ripple measured on a cathode ray oscilloscope. At 150 ma load, the ripple decreases to 4.4%.

117 v AC input, the sextupler delivers 200 ma DC at 640 volts. A low line voltage condition existed at the time the composite load runs of Fig. 2 were taken, which should be kept in mind when appraising the regulation curves. We preferred not to interpolate the complete load runs for 117 v AC, and Fig. 2 therefore is an indication of what may be expected from doublers, triplers, quadruplers, quintuplers, and sextuplers under poor line voltage conditions.

The results of this investigation are well demonstrated in the composite load runs of Fig. 2. At least 100 v DC gain at 200 ma load is realizable per multiplier stage, and there is no question that a ten-stage multiplier would deliver at least 1,000 volts at 200 ma. Additional output current in 100 ma

increments may be provided by adding additional 100 ma rectifiers and protective resistors. Additional capacity would be required to maintain the same regulation, of course. Note the dashed curves of Fig. 2. These curves indicate that a quadrupler with adequate capacity per multiplier stage will deliver a higher voltage under full load than a sextupler with 16 mfd each in the 4th, 5th, and 6th stages. The *cost cross-over point*, in comparison with transformer supplies occurs at or slightly after the tripler stage. In other words, a 200 ma tripler would approximate the cost of a 200 ma transformer supply delivering 340 v DC. (10.00 total cost), transformer supplies being cheaper above this point. The *bulk cross-over point* occurs at about the quintupler stage; i.e., multiplier sup-



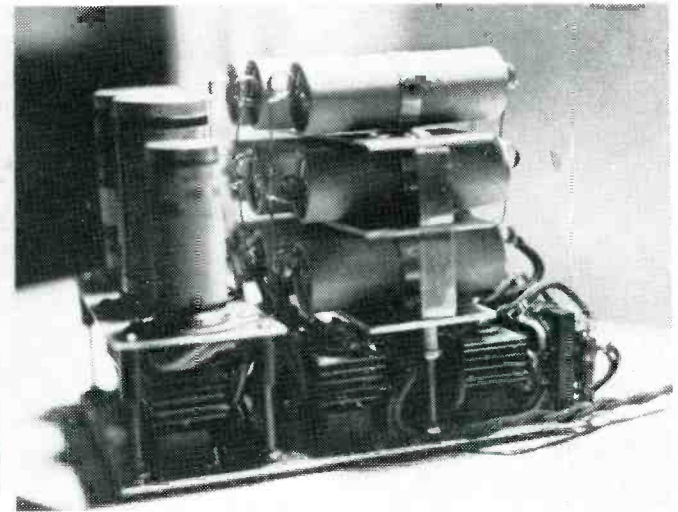
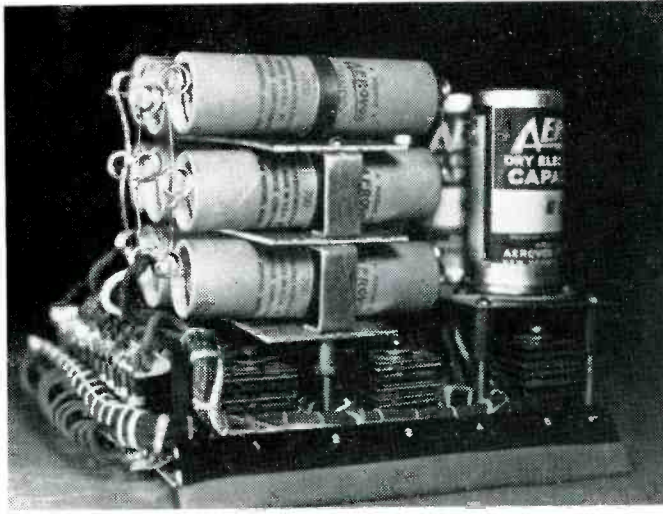

Fig. 3 and Fig. 4—These two views show the combined strip of twelve resistors and wiring terminal board. The three rows of four rectifiers each is shown, along with standoff assembly of C1, C2, and C3, and the three trays of clamp-mounted condensers that comprise C4, C5, and C6. The total weight is only 3½ pounds!

plies are bulkier beyond quintupling. The *weight cross-over point* can only be estimated to occur at about the 12th or 15th multiplier stage; the multiplier has a tremendous weight advantage; this unit weighs only 3½ pounds and delivers 125 watts of DC—640 v at 200 ma. In consideration of bulk, cost, and weight, the transformerless quadrupler is about optimum and would cost \$15, weigh 2¾ pounds, and would readily fit into a 4½ inch cube, and deliver 440 v DC at 200 ma output. Per cent ripple increases with load. At full 200 ma load delivering 640 v DC, the sextupler ripple was measured with a cathode ray oscilloscope and found to be 45 volts, or 7%. At 150 ma load, delivering 675 v DC, the ripple was 30 volts, or 4.4%. The usual smoothing choke and output condenser was not included in this unit, to avoid confusing the results of the multiplier investigation. On a two-hour load run, with the unit standing on end for vertical positioning of the rectifiers for maximum cooling, all selenium rectifiers, condensers, and series resistors were cool to the touch. The following tabular cost data may be of interest:

Stage	DC Volts at 200 ma	Sel. Rect. 80c ea.	30 ohm Resist. .20	Aerovox Cond. Type	Unit Cost	Total Cost
Half Wave	125.	\$1.60	\$0.20	1, AF20D	at \$1.17	\$3.00
Doubler	235.	1.60	.20	1, AF16H	at \$1.77	6.5c
Tripler	340.	1.60	.20	1, AF16H	at \$1.77	10.0c
Quadrupler	440.	1.60	.20	3, PRS500	at \$1.20	15.50
Quintupler	535.	1.60	.20	3, PRS600	at \$1.95	23.00
Sextupler	640.	1.60	.20	3, PRS700	at \$2.70	33.00

In general, selenium rectifier doubler supplies offer a number of advantages. The rectifiers are compact, about 1 cubic inch; they avoid typical heater power and heat loss; save transformer loss, heat, and cost; prevents hum trouble due to transformer field; mechanically rugged; no warm-up time, instant power; tremendously lighter in weight. The usual safety precautions should be observed, and care should be exercised that grounded side of the AC line corresponds to the negative output high voltage terminal. The prime limitation is operating temperature; this must be observed to avoid breakdown of the rectifiers.

Popular versions of the 100 ma selenium rectifier are 5-plate

stack assemblies, primarily intended for home receiver applications. They are nominally rated at 130 v AC rms input, 100 ma DC output, and must not be operated above 95° F. This temperature restriction precludes their use in auto radio and similar high ambient temperature applications. In consideration of this temperature limitation, selenium rectifiers should be mounted with their plates vertical to afford maximum cooling.

Selenium rectifiers are also available in higher and lower output current ratings. Unusually long life is claimed for them, and when used as rectifier tube replacements, changes may be necessary in dial light and tube-heater circuits. The higher output voltage from selenium rectifiers may require replacement of filter condensers with higher ratings, and the higher ripple output may require additional filtering.

This investigation proved amply justified in the results achieved.

## TAFT-HARTLEY From Page 5

6. Restore to the Department adequate appropriations to conduct a direct program and a State-aid program to reduce industrial accidents which last year caused two million lost-time injuries, killed 21,000 workers and permanently disabled 91,000. As pointed out by President Truman in his call for a National Conference on Industrial Accidents, which will be held in Washington September 27-29, the Nation cannot afford these human and economic losses.

7. Provide low-cost housing for wage-earners in the lower income brackets.

8. A national health program.

9. Laws to prevent unfair discrimination in employment.

This is an honest program to "protect" workers from the natural and economic hazards which they face every day. It is a program on which organized labor can unite for progressive action.

**NABET** — A UNION FOR  
RADIOMEN

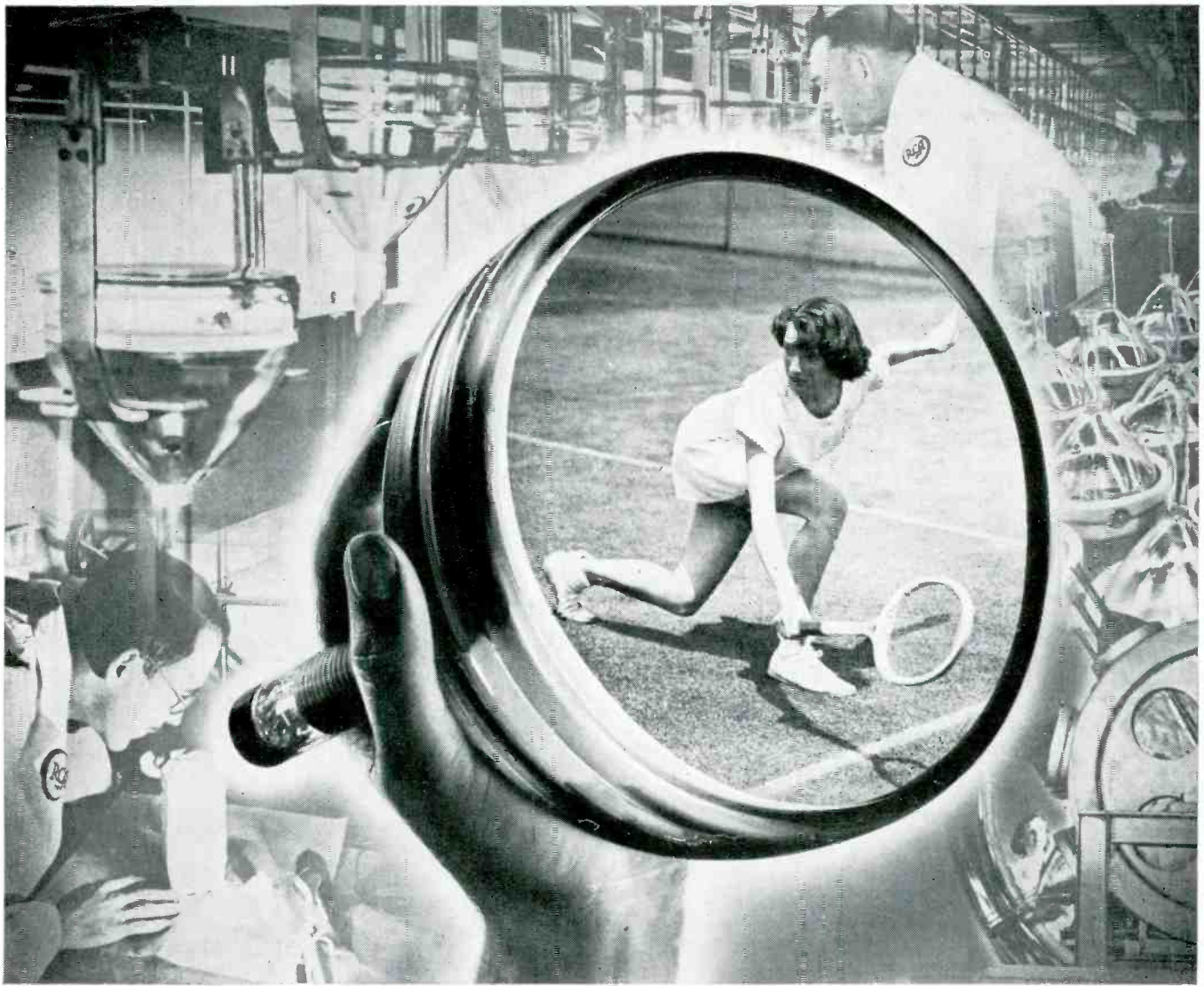

*Machines in RCA's Lancaster Tube Plant are designed for mass production of Kinescopes—television picture tubes—at lowest possible cost.*

## ***Behind the magic of a Television Tube***

Every morning, 14 tons of glass "bulbs" go down to the production lines at the RCA Tube Plant in Lancaster, Pa.

By evening, the bulbs are television picture tubes, their luminescent faces ready to glow—in television homes everywhere—with news, sports, entertainment, education, politics.

Born of glass, metals, chemicals, the picture tube comes to life through flame and heat. Its face is

coated with fluorescent material—forming a screen on which an electron gun "paints" moving images.

Each step is so delicately handled that, although RCA craftsmen are working with fragile glass, breakage is less than 1%.

Water, twice-distilled, floats the fluorescent material into place on the face of the tube, where it clings by molecular attraction—as a uniform and perfect coating.

Every phase of manufacture conforms to scientific specifications established by RCA Laboratories. **Result:** Television tubes of highest perfection—assuring sharp, clear pictures on the screens of RCA Victor home television receivers.

When in Radio City, New York, be sure to see the radio, television and electronic wonders at RCA Exhibition Hall, 36 West 49th Street. Free admission. Radio Corporation of America, RCA Building, Radio City, New York 20.



**RADIO CORPORATION of AMERICA**





# Review of Current Technical Literature

By Lawrence W. Lockwood

## **Audio Engineering—June, 1948**

**MAKING PHONOGRAPH RECORD MATRICES — H. Harris**

Presenting for the first time in any magazine complete data on this subject.

**GETTING THE MOST OUT OF A REFLEX TYPE SPEAKER—B. Orisko.**

Design data, constructional ideas, and simple tests for this type of loudspeaker.

**APPLICATIONS OF MAGNETIC RECORDING IN NETWORK BROADCASTING—R. Bigwood.**

Survey of ABC's recent expansion into the field.

## **Bell Laboratories Record—July, 1948**

**REPEATER BUILDINGS FOR THE FIRST RADIO RELAY SYSTEM—W. Tierney.**

Photographs and drawings with a description of the buildings in the new relay circuit between New York City and Boston.

## **Communications—July, 1948**

**MAINTENANCE OF PREAMP EQUIPMENT IN BROADCAST TRANSCRIPTION REPRODUCING SYSTEMS—R. Peters.**

Maintenance program, developed by NBC radio recording division, features tests which determine frequency response, distortion and operating levels of preamp units.

**TV TRANSMITTER DESIGN—G. Hamilton.**

Part III—Linear amplifier design features—output load considerations—testing the TV transmitter—testing DC restorer—RF pass band characteristic.

**NOISE MEASUREMENTS—R. Morgan.**

Concluding installment of two part paper covers measurements in rooms, studios and plants, and relationship of direct and reverberant sounds.

**COAXIAL AND SEPARATE TWO WAY SPEAKER SYSTEM DESIGN—H. Souther.**

Problems encountered in design and production—performance and cost considerations—advantages and disadvantages of ring and slab magnets—horn flare considerations—horn cells—crossover selection—HF and LF units—cabinetry.

## **Electronics—August, 1948**

**WHAT'S WRONG WITH U. S. FREQUENCY ALLOCATIONS—J. Courtney.**

Views on this subject by a former Assistant General Counsel of the FCC.

## **STEROPHONIC SOUND**

Magnetic tape carrying three simultaneous channels gives a striking illusion of presence when played back through properly oriented speakers.

**TELEVISION RECEIVER INTERMEDIATE FREQUENCIES—P. Holst.**

Recent experience indicates that the 21 mc and 26 mc intermediate frequencies now widely used in television receivers are too low. An exhaustive study of possibilities in the range from 20 to 50 mc, presented here, shows the superiority of values above 30 mc.

**FACSIMILE GOES COMMERCIAL—**

Simplex and multiplex transmissions on FM broadcast band using 8.2 inch width at 105 lines per inch are authorized by FCC.

**PICTURE MODULATED TELEVISION SIGNAL GENERATOR—A. Easton.**

Circuit data and performance characteristics of a signal source for production testing of receivers at points remote from telecasting stations. A mixing pad permits the combination of picture, sound and noise signals to simulate actual conditions.

## **Proceedings of the IRE—July, 1948**

**THEORY OF FREQUENCY COUNTING AND ITS APPLICATION TO THE DETECTION OF FREQUENCY MODULATED WAVES—E. Labin.**

The principles of detection of frequency modulated waves by the frequency counting type of circuit are studied as well as the subject of detection in general and also the methods employed for carrying into effect the electronic counting are explored.

**A DUPLEX SYSTEM OF COMMUNICATIONS FOR MICROWAVES—R. Pound.**

This paper discusses the properties of a communication system obtained by the use of a single microwave oscillator as both transmitter and beating oscillator of a superheterodyne receiver.

**THE FIELD OF A DIPOLE WITH A TUNED PARASITE AT CONSTANT POWER—R. King.**

Theoretical curves are shown of the electric field in the forward direction and in the backward direction for a center driven half wave dipole in the presence of parallel center tuned parasite of the same length and ratio.

**AVENUES OF IMPROVEMENT IN PRESENT DAY TELEVISION—D. Fink.**

Limited observations of the author on this subject.

**ADJUSTMENT SPEED OF AUTOMATIC VOLUME CONTROL SYSTEMS—A. Nolle.**

The behavior of an AVC amplifier following a sudden change of input level is analyzed. Overload may greatly increase the time required for gain readjustment. Equations for the overload case are developed and their application to a particular amplifier is illustrated.

## **Tele Tech—July, 1948**

**HOW HIGH IS HIGH FIDELITY?—M. Camras.**

Review of high fidelity reveals disagreement as to the value of extended frequency response; binaural system shows reproduction improvement.

**REDUCED STRAY INPUT PICKUP—P. Richman.**

Controlling unbalance of a differential amplifier minimizes undesired signal transmission.

**SALUTE TO WPIX.**

Practically the entirety of this issue of this publication is devoted to quite a thorough and well arranged study of the new "Daily News" New York television station WPIX.



# ADVANCE

to better recordings with

# ADVANCE

## RECORDING BLANKS



**Advance**  
Recording Products Company

36-12 34th STREET • STILLWELL 4-7837 • LONG ISLAND CITY, N. Y.

**All you want . . .**

**Available for immediate delivery**





## WASHINGTON

By Warren Deem

The "ham" in the Washington area we want to give mention to this month is SAM NEWMAN. He has been actively on the air since 1923. He started out at Richmond Hill, Long Island, New York with the call letters W2ACU. Dur-

ing the 25 years that SAM has been an active ham he has talked with fellows in 132 different countries and has made a lot of contacts and lasting friendships with other NBC engineers all over the U. S. who are active amateur operators. SAM's rig pictured here sports a pair of 250 TH's for the final, 900w input modulated by a pair of 810's. He has a band switch excitor and VFO control. His rig operates on 10, 20, 40, 75 and 80 meters, phone and CW, crystal, VFO on all bands. The receiver is a Hallicrafter SX28A with a DB-20 preselector; the antenna being remote controlled, Selsyn operated 3 element beam rotary. On the transmitter Sam has a builtin modulation monitor and a builtin carrier shift frequency monitor and has compression in the speech amplifier. SAM has been cited for his public service in handling traffic in connection with the Texas City disaster and in the Pennsylvania-New York floods and the Florida hurricane to mention a few. He has a public service certificate from ARRL proudly on display in his shack. SAM's most recent service was for the U. S. Army. He made 24 contacts in Ankara, Turkey, for General Hoage and the General in appreciation

presented SAM with a hand carved Meer-schaum pipe. SAM is at present the Assistant Station Engineer, WNBW Television and has been with the National Broadcasting Co. for 18 years. SAM's present amateur call letters are W3HN.

On August 30th, WRC celebrated at the Statler Hotel its 25th year on the air. Mr. FRANK RUSSELL presented DON COOPER and KEITH WILLIAMS with 20 year pins. Among the other engineers who belong to the 10 and 20 year clubs with NBC in Washington are the following: 20 year club—PATTY BIRGFELD (an official secretary who has been with NBC 20 years, but unofficially a wonderful helper and counselor to all the engineers). BART STAHL, BOB TERRILL, HAROLD YATES, and BILL CHEW.

The 10 year club includes, PAUL ANDERSON, SPEED CLARK, NICK CLOSE, CHARLES COLLEDGE, FRANK FUGAZZI, WALTER GODWIN, HOWARD GRONBERG, RALPH HAMMEL, JOHN HOGAN, and SAM NEWMAN. After a wonderful dinner came the entertainment. A riotous imitation of a 1923 studio orchestra included such artists as "Hot Lips MELINE on the trumpet, "Burp Horn" BRADFORD also trumpet, "Shifty" SHENTON on the sax and clarinet, "Cautious Joe" COLLEDGE was the guitar player and "Skinhead" HAMMEL on the banjo, "Slappy" HALLECK on the bass viol, "Bubbles" HATHAWAY on the piano and "Moose" MAY beating the drums. FRITZ BALZER was MCing with the aid of a cigar that could have been used as a walking stick as well as a "stogie." The trio, BOB SHENTON, JOE COLLEDGE and VANCE HALLECK as well as the rest of the boys and girls in the act should be working on both sides of the mikes instead of just behind them. They were good, but def.

VICK LEISNER is the proud father of a second son who weighed 6 lbs. 12 oz. VICK is an engineer at the WRC transmitter.

JACK BURRELL, the new Hollywood Field supervisor stopped over at WNBW on his way from New York to pick up a few tips on what he needed to get his new station started. He was the guest of "Joe" Colledge during his stay here. We are all hoping to see his pictures via cable shortly.

A new Group 12 with the WNBW crew is Steven F. Shubin. He has been married since last May and was a Civil Service employee with the Army Air Corps during the war. He is also a graduate of CREI here in D.C.

Mac MCGINLEY of the WRC record-

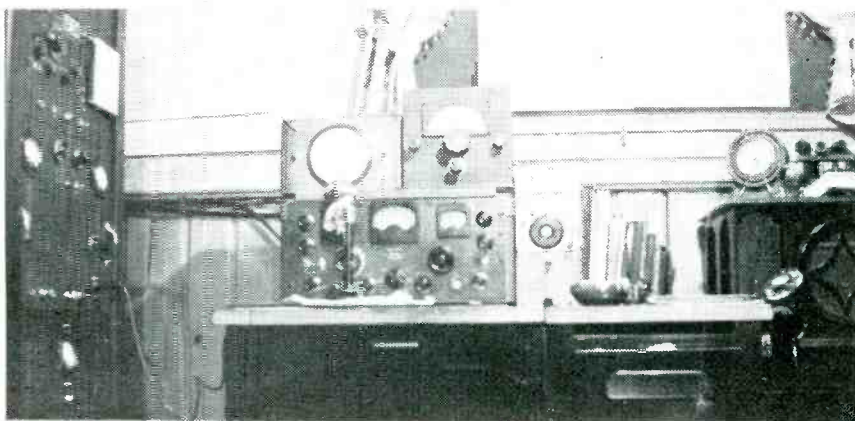
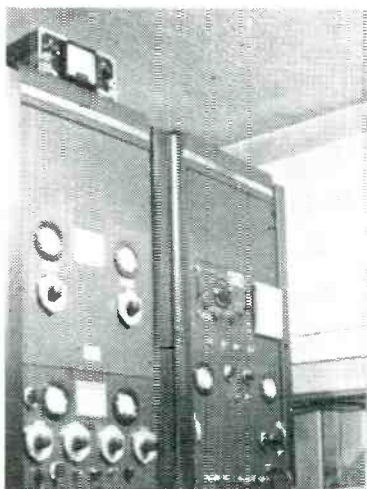



# WEST COAST IRE CONVENTION PAPERS

## A Low Cost Program Switching System

By I. GIFFORD and A. P. CHESNEY

This paper discusses a high quality program switching system of low cost unit construction for both large and small broadcasting stations.

This system is built in two sections,

one of which contains the master and individual control panels and the other contains the switching units and line reversal equipment.

The system is designed to expand, a unit at a time, as required by the growth of a station. Pushbuttons preset programs, two sets of lamps indicate both the existing and the preset program sources on the outgoing lines, a volume unit

meter indicates the level on the line and a potentiometer make individual line level adjustments possible. Provision is made for adding the equipment for automatic line reversal on any or all out puts with no additional manual controls. The switching units may be rack mounted at some distance from the master control desk to remove relay noise.

\* \* \*

## Problems in the Design of Megawatt Output Klystrons For Pulsed Operation

By MARVIN CHODOROW and E. L. GINZTON

Physics Department, Stanford University, Stanford, California

The design and construction of high power pulse klystrons has been undertaken to provide a source of power for the Stanford Linear Electron Accelerator. It is planned to build a 10 centimeter klystron with input of 100 megawatts and a pulse duration of  $10^{-6}$  sec. The anticipated power output will be in the vicinity of 30 to 50 megawatts. The attainment of such powers with klystrons seem somewhat more feasible than with megnetrons due to a more favorable geometry, i.e. the separation of the cathode-anode region from the inter-action space, and a separate collecting region for the un-utilized electrons. In addition, of course, a klystron can be used as an amplifier which is of major importance for the particular application mentioned.

Tentative design values for the tube are: beam voltage, 400 kv and beam current, 250 amperes. These voltages give electron velocities in the relativistic range and it was necessary to consider the effect on the behavior of the klystron. Calculations of relativistic efforts have been made with regard to the velocity modulation, electronic loading, focusing and space charge debunching. Since at these high voltages the electron has a greater mass, the per cent of velocity modulation produced by a given per cent of voltage variation is less than at non-relativistic voltages. However, the calculations indicate that for 400 kv. this decrease is not excessive and to get an adequate amount of velocity modulation, the increased driving power required is quite feasible. Calculations on the electronic loading indicate this is reduced in the same proportion as the velocity modulation since the effect arise from the same source.

With regard to space charge effects, all

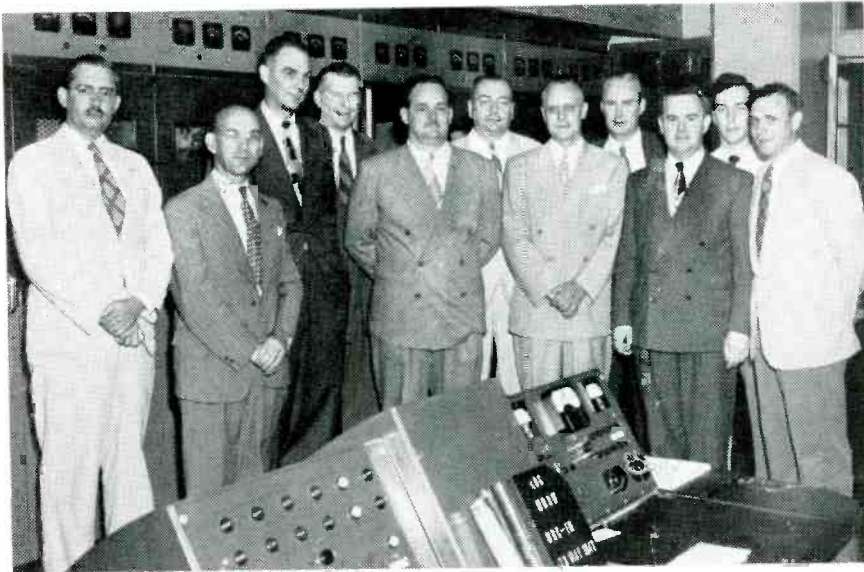

ing studios showed his folks around Washington and surrounding area during his vacation in August. Mac decided to get caught up on local Washington scenery instead of traveling a distance this year.

BOB SHENTON, W3LFN, recently purchased a new Collins 75A-1 receiver which set him back a pretty \$375. During his vacation he plans to get to work on his mobile transmitter and finish rigging his zepp endfed antenna and then he will be ready to start out on 40 meters in style.

WALTER GODWIN is also planning a mobile rig. He is putting his new lathe to work turning out an inducto-match stacked array antenna, (not for the mobile rig by the way).

FRANK FUGAZZI is giving SAM NEWMAN competition on 20. FRANK doesn't have a beam antenna and has only 150w input, but still gets Australia with remarkable clarity.

MARVIN COOPER, WRC studio engineer recently bought a Kaiser auto. Must have hit the hosses or had a rich uncle die.

YOURS TRULY is at long last a home owner (along with the holder of the

mortgage). Now I can join in on conversations centering around lawns, dogs and cats, raising tomatoes and interest on unpaid mortgages.

Congratulations to WALLY WARD WNBW Field Crew's councilman for making Group 13; and also to Al Argentieri and Mike Galvin for making Student Group 10.

A farewell party was given in honor of WNBW engineers JOHN KNIGHT and BOB BARNES prior to their departure to Station WNBH, Hollywood, California the last of July. The snap taken at the affair in front of the transmitter console at WNBW includes from left to right BOB BARNES, SAM NEWMAN, DON COOPER, MR. STETSON, JOHN KNIGHT, W. BOSTWICK, HOWARD GRONBERG, BILL SIMMONS, FONSO MORGAN, GENTRY STEVENS and ARCHIE DeVEAU. JOHN and BOB have assumed transmitter duties atop Mt. Wilson. Frank "Clag" SPAIN and JIM BUTTS, not pictured here, of WNBW field in all probability will have joined BOB and JOHN by this time. They expect to be in the field crew in Hollywood.

of these, in general depend on the pervance of the cathode. At relativistic velocities all the space charge effects are reduced by a slight factor for a cathode of given pervance. Therefore, all the problems of space charge spreading, debunching, and so forth are very similar to what they would be at lower voltages for the same cathode. For example, although magnetic focusing will be used to get the electron beam down the drift tube, actually the dimensions and operating conditions are such that it would be almost feasible to dispense with the magnetic focusing field.

In addition to these specifically relativistic problems it has been necessary to examine the behavior of cavities with large r-f gap voltages to determine if any peculiar non-linear effects occur, such as cold emission or other types of discharge. Tests of this sort have been made using a magnetron as a source of power. Special resonator and coupling hole design has also been necessary since the dimensions required for the contemplated tube are outside the range previously investigated.

\* \* \*

### Propagation Measurements At High Radio Frequencies Over Flat Desert Terrain

By J. P. DAY and L. G. TROLESE  
U. S. Navy Electronics Laboratory

This paper described an experimental investigation of the effect of relatively simple topography and meteorology upon the propagation of high frequency radio waves over an optical (26.7 miles) and a nonoptical (46 miles) path. Radiation from the ground at night from the desert terrain caused a temperature inversion which gave rise to a diurnal variation in field strength. The departure of the refractive index curve from standard was quite small in comparison to many meteorological situations found in other localities; however, the diurnal variation for the nonoptical path varied from less than one db. at 25 megacycles to over 50 db. at microwave frequencies. The experimental site enabled measurements to be taken at various transmitter and receiver height from 0 to 200 feet above the surrounding terrain. The measurements were performed on 25, 63, 170, 520, 1000, 3300, 9375, and 24,000 megacycles. The shape of the high frequency height gain curves for both the optical and non-optical paths was greatly modified by the temperature inversion, while the lower frequencies were but slightly affected.

\* \* \*

### Operation of AM Broadcast Transmitters Into Sharply Tuned Antenna Systems

By W. H. DOHERTY  
Radio Development Engineer  
Bell Telephone Laboratories, Inc.  
Whippany, N. J.

The impedance of some broadcast arrays varies so much over the transmitted band as to impair the performance of the radio transmitter. The impairment consists in clipping of sidebands and distortion of the envelope at high modulation frequencies. This paper reports on an experi-determination of the nature and magnitude of this impairment and on its substantial reduction by suitable coupling methods. An output circuit design is given which provides the required flexibility for achieving optimum performance in high-power broadcast transmitters with any impedance-frequency characteristics that may exist at the input terminals of the transmission line.

\* \* \*

### The VHF Omni-Directional Range

By R. E. McCORMICK  
Radio Development Division—C.A.A.

The VHF omni-directional range system provides a comprehensive aircraft navigation aid which permits manual or automatic flight with new standards of excellence in accuracy, simplicity, of operation, and presentation, and reliability. The paper enumerates the advantages of the ODR system, discusses briefly the basic theory of operation, considers the major development problems encountered, and outlines the present status of the project.

\* \* \*

### A New Method of Obtaining The Product of Two Voltages

By M. A. H. EL-SAID  
Paper Presented by D. B. Sinclair  
General Radio.

Operating conditions for multi-grid tubes have been found in which the plate current is proportional to the product of a linear function of the plate voltage and an exponential function of the grid voltage. Other operating conditions have been found in which the plate or cathode current varies logarithmically with the plate voltage. Two tubes, operating respectively under these two conditions, can be combined so that the output current varies accurately as the product of two voltages.

Over limited grid-voltage excursions a simpler one-tube version will accomplish

the same result. Grid rectification can be used to compensate the change in d-c plate current cause by the curvature of the exponential  $e/g-i/p$  characteristics. The remaining increment in d-c plate current is proportional to the average product of the grid and plate voltage. This arrangement is particularly suited for a simple electronic wattmeter.

\* \* \*

### Stratovision Development

By C. E. NOBLES  
Westinghouse Electric Corporation

A complete television broadcasting station operating on Channel No. 6 has been installed in a B-29 aircraft. A description of this equipment and a discussion of the flight test program will be given.

Television coverages over an area of 500 miles in diameter are being obtained from altitudes of 25,000 feet. A discussion of the reasons for this coverage and problems peculiar to airborne television will also be discussed.

\* \* \*

### Antenna Input Systems For Television Receivers

By D. E. FOSTER  
Hazeltine Research Inc. of California

The problem of meeting requirements of impedance matching, gain and bandwidth in antenna input systems for television receivers is a difficult one because of the 5 to 1 frequency range of assigned television channels and the finite input conductance of vacuum tubes particularly on the upper channels. In addition the input system should be compact, reliable and capable of economical manufacture by mass production techniques.

Several different tube and circuit combinations are considered in the light of these requirements and their advantages and limitations brought out.

\* \* \*

### "Design of Antennas For Optimum Directivity"

By THOMAS T. TAYLOR  
Electronics Department, Hughes  
Aircraft Company

The design of highly directive aperture-type antennas (parabolic reflectors, lenses, broadside arrays, etc.) has remained at a standstill for many years as far as any improvement in the beamwidth versus aperture relationships are concerned. In spite of this fact, theorists have from time to time calculated antenna current distributions which yield directivities arbitrarily higher than those met with in practice. Evidently the limitations to directivity are not to be found in the usual



approaches to the problems of calculating antenna patterns, and some additional theory must be used to reveal their nature. These limitations form the subject of this presentation. The ability of an antenna to produce a given field pattern is compared with the ability of a wave guide to sustain a given transverse field distribution. The ratio of dimensions to wavelength is shown to have similar effects in the two cases. Conclusions are drawn which definitely establish the size limitations of highly directive antennas applications to other types of antennas are indicated.

## JTAC Request For DATA

Dear Editor:

Any assistance you may give in bringing the following facts to the attention of your readers will be much appreciated by the members of the Joint Technical Advisory Committee, the policy advisory group recently established by the Institute of Radio Engineers and the Radio Manufacturers Association to advise the Federal Communications Commission and other bodies on matters relating to radio allocations and standards.

On September 20, 1948, the FCC will hold a hearing, docket 8976, on the utilization of the band of 475-890 megacycles for television broadcasting. The issues to be considered are as follows:

1. To obtain full information concerning interference to the reception of television stations operating on channels 2 through 13 resulting from adjacent channel operation of other services, from harmonic radiations, and from man-made noise.
2. To receive such additional data as may be available since the close of previous hearings (Dockets 6651 and 7896) concerning the propagation characteristics of the band 475 to 890 megacycles.
3. To obtain full information concerning the state of development of transmitting and receiving equipment for either monochrome or color television broadcasting, or both, capable of operating in the band 475 to 890 megacycles.
4. To obtain full information concerning any proposals for the utilization of the band 475 to 890 megacycles or any part thereof, for television broadcasting and the standards to be proposed therefor.

At the request of JTAC, members of

# Whether MICROPHONE or SPECIAL AMPLIFIER

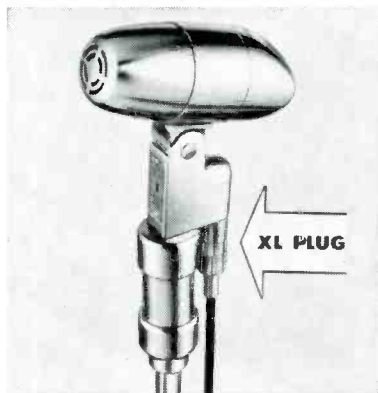

Photo Courtesy Electro-Voice, Inc.

Model No. 645 Broadcast Microphone made by Electro-Voice, Inc., Buchanan, Mich. used an XL Plug as standard disconnect equipment. This is only one of the several Electro-Voice microphones "XL"-equipped.

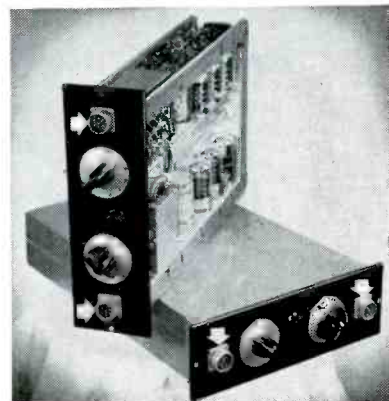
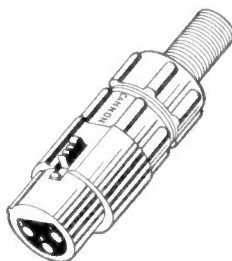

Photo Courtesy Brown Geophysical

Special amplifier used in oilfield geophysical exploration and survey by Brown Geophysical Co. of Houston, Texas uses K connectors for the circuits on this Amplifier equipment.

## Plug-in with CANNON PLUGS



**TYPE "XL" Series** is two plugs and several receptacle types, with two insert variations of 3 and 4 contacts, 10 and 15-amp. Latchlock type connection.

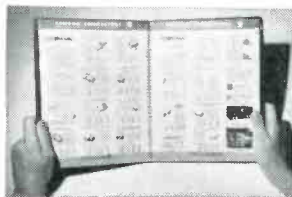

**TYPE "K" Series** is made in several shell types, including the "RK", and approximately 190 insert arrangements among the 8 shell sizes for a wide variety of wire sizes, including coaxials.

For a survey of Cannon Plugs, write for the C-47 Condensed General Catalog, covering the 13 major type series and electrical specialties. . . Details on Type "K" are found in the K-945 Bulletin. Address Department J-376.

# CANNON ELECTRIC



SINCE 1915

*Development Company*

3209 HUMBOLDT ST., LOS ANGELES 31, CALIF.

IN CANADA & BRITISH EMPIRE:  
CANNON ELECTRIC COMPANY, LTD.  
TORONTO 13, ONTARIO

WORLD EXPORT (excepting British Empire):  
● FRAZAR & HANSEN, 301 CLAY STREET  
SAN FRANCISCO 11, CALIFORNIA





# STANDARDIZED READY-TO-USE METAL EQUIPMENT

ADAPTABLE FOR EVERY REQUIREMENT

Par-Metal Equipment offers many features, including functional streamlined design, rugged construction, beautiful finish . . . plus ADAPTABILITY. Eliminate need for special made-to-order units on many jobs.

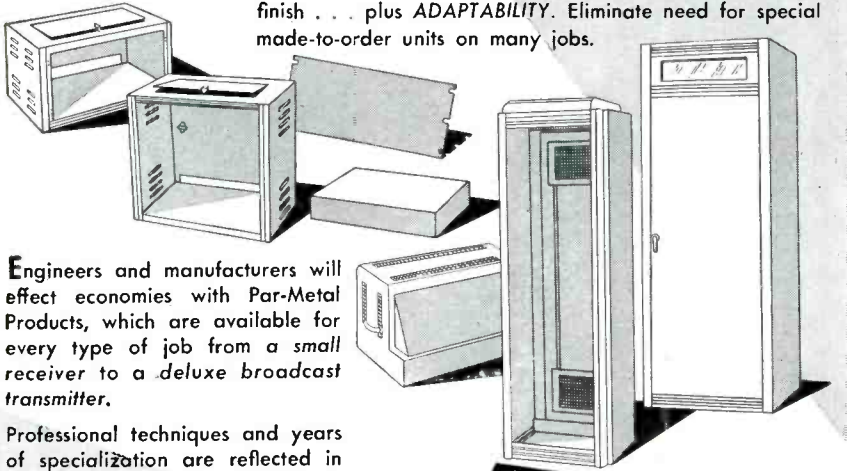

Engineers and manufacturers will effect economies with Par-Metal Products, which are available for every type of job from a small receiver to a deluxe broadcast transmitter.

Professional techniques and years of specialization are reflected in the high quality of Par-Metal. . .

**CABINETS • CHASSIS  
PANELS • RACKS**

*Write for Catalog*



## RMA COMMITTEE REPORT ON TV RECEIVER RADIATION AND I.F. FREQUENCY

With the aim of improving the operation of television receivers through the limitation of TV set radiation, the Executive Committee of the Receiver Section, RMA Engineering Department, has recommended to RMA members adoption of standard radiation rating of TV receivers, the Radio Manufacturers Association said today.

The proposed standard was recommended by the RMA Committee on Television Receivers, of which I. J. Kaar, of General Electric Co., Syracuse, N. Y., is chairman, and was approved by the Receiver Section's Executive Committee headed by Dorman D. Israel, of Emerson Radio & Phonograph Corp., New York.

The proposed standard defines the radiation rating of a television receiver as follows: "The radiation rating of a television receiver is related to the tendency of the receiver toward local oscillator radiation and, for operation on channels 2 to 6 inclusive, is defined as numerically equal to the value of the field strength laid down at 1,000 feet from the receiver under conditions especially favorable to oscillator radiation . . ."

The recommended "limits" of television receiver radiation, as stated in the proposed standard, are: "The rating of a television receiver on channels 2 to 6 inclusive, defined and determined as above, shall not exceed 25 volts per meter."

In explanation of the recommended proposal, which has not yet been passed upon by RMA members and therefore not adopted to date, Mr. Kaar said:

"In an effort to improve the operation of television receivers from the standpoint of image interference, direct IF pickup and other factors as well as oscillator radiation, it has become apparent that the use of a higher intermediate frequency is desirable. This fact was evidenced by the action of this committee in withdrawing its support of the previously recommended value (21.25 to 21.9 megacycles), as the operating frequency. Increasing the intermediate frequency will have the effect of placing oscillator radiation outside of the television bands, but leaves the possibility of interference to other services.

"While an active program is being instituted by members of this committee to determine the best choice of a new recommended intermediate frequency, it is be-

the Commission staff have prepared the following list of detailed questions:

1. What is the present state of development of equipment in the band 470 to 890 megacycles, in regard to
  - a) transmitters, tubes and components
  - b) receivers and components
  - c) antennas, transmission lines and related equipment for transmission and reception?
2. How much experimental work has been undertaken in television systems in this band, with respect to field operation (transmitter hours operated, number and distribution of receivers, and propagation tests) and laboratory work (development of receivers, transmitters and tubes)?
3. What consideration has been given to the costs of television systems for this band, particularly to the reduction of receiver costs, and the transfer of cost burdens to the transmitter?
4. What areas of service might be expected in this band, based on the following assumptions:
  - a) a particular system, using one of the following typical bandwidths: 6 megacycles, 13 megacycles, 20

megacycles

- b) radiated power, available now and expected to be available, say, 10 years in the future,
  - c) receiver sensitivity
  - d) at each of the following typical frequencies: 475 megacycles, 600 megacycles, and 890 megacycles?
5. What co-channel and adjacent-channel separations would be appropriate under the assumptions made in item 4, above?
6. How many channels would be available in the band 475-890 megacycles on the assumptions of item 4, above, and how might they be allocated among the 140 metropolitan districts of the United States?

"To assist the Committee in obtaining the widest possible contact with sources of information in the industry, it is requested that the foregoing questions be published in your journal, with a statement to the effect that any information related to these questions should be communicated directly to the Secretary of the Joint Technical Advisory Committee, Mr. L. G. Cumming, Institute of Radio Engineers, 1 East 79 Street, New York 21, New York."

lieved that the above proposal in regard to oscillator radiation is necessary and can be realized for the protection of other services. A corresponding proposal for the high television channels will be made as soon as more experience is gained with the higher frequencies."

## ELECTRONICS INDUSTRY MOBILIZES

Official presentation to the Munitions Board of the RMA plan for spreading military contracts throughout the industry was made by the RMA Industry Mobilization Policy Committee. The formal presentation was made to Lt. Gen. LeRoy Lutes, Deputy Chairman of the Munitions Board, executive committee, and other board members.

The RMA presentation, made for the RMA Industry Mobilization Policy Committee by Directors W. A. MacDonald and Frank M. Folsom, occurred on the eve of appointment of an official Electronic Industries Advisory Committee, jointly by the Munitions Board and the National Security Resources Board. Chairman F. R. Lack of the RMA committee was in Canada and unable to be present.

A number of the Munitions Board and other officials of the armed services were present at the RMA presentation. Following there were informal discussions with the Secretary of Defense James V. Forrestal, and other officials.

The communications and electronic equipment committee of the Munitions Board, which consists of four members from each of the armed services met to discuss both the RMA plan and the forthcoming formation of the official industry advisory committee by the two government boards.

The inter-agency group, headed by Col. Fred Kunesh, of the Signal Corps, named a four-man subcommittee to study the RMA plan. The subcommittee is expected to make a tentative report on the RMA plan.

In the appointment of the Electronic Industries Advisory Committee, the government agencies are following RMA committee recommendations to establish an exclusive committee for the electronic industry, eliminating communications and wire problems and representatives. It is planned to coordinate the procedures and activities of the RMA and the official electronic advisory committees.

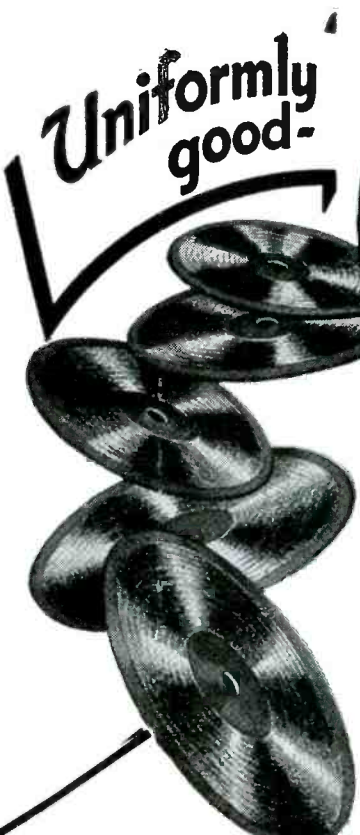

**Uniformly good-**

**ALLIED**  
PROFESSIONAL  
**RECORDING**  
**DISCS**

**FOR THE  
UTMOST IN  
HIGH FIDELITY  
REPRODUCTION**

**Allied Professional Recording Discs are manufactured to exacting standards by one of the pioneers in the field of instantaneous recording equipment. The accumulated knowledge of years of experience have been engineered into Allied Discs. TRY them.**

### **Also ALLIED RECORDING EQUIPMENT**

The Allied Recording Machine (illustrated) combines the Allied Transcription Turntable and Allied Overhead Cutting Assembly, which are also sold separately. Like Allied Discs, this equipment is of highest precision quality, good for long, trouble-free service.



**ALLIED**  
**RECORDING PRODUCTS CO.**

**21-09 43rd AVENUE**

**LONG ISLAND CITY 1, NEW YORK**

**WRITE FOR NEW DESCRIPTIVE BULLETIN**



AN  
IMPORTANT  
TECH LAB  
DEVELOPMENT

## New Type 1250 R. F. SWITCH

High r. f. current carrying capacity  
50 amps. max. intermittent load; 30  
amps. steady load. Low loss factor.

Sturdy mechanical design . .

Mycalex insulation.

Furnished in any

number of  
decks.

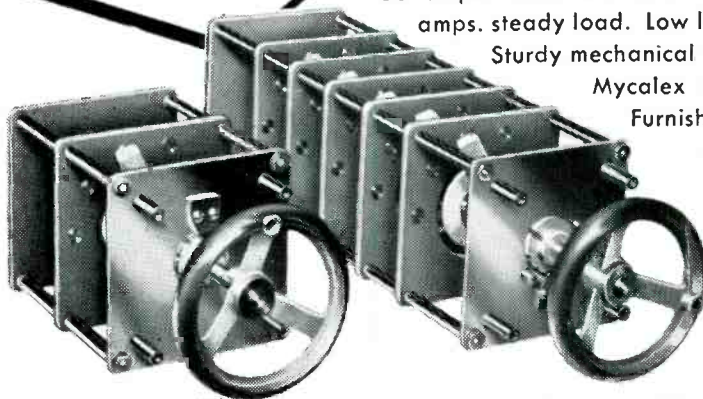

Write for Bulletin No. 472

**TECH**  
LABORATORIES, INC.

Manufacturers of Precision Electrical Resistance Instruments

337 CENTRAL AVE. • JERSEY CITY, N. J.

which features six overlapping ranges, giving continuous coverage from 5 to 125,000 cycles. It delivers a rectangular wave output voltage with a 25% negative pulse, and a rise time for the leading



edge of .3 microsecond. Includes a self-contained regulated power supply. Cabinet mounted, but can be removed for 19 inch rack mounting; weighs 44 pounds.

Shure Brothers Inc. manufacturers of acoustic devices, announces the appointment of Mr. E. L. Berman as their representative in the Northern California territory. Mr. Berman was Sales Manager of Shure Brothers from 1933 to 1939, and he served as an officer in the Signal Corps. during the war.

Aerovox announces a variable filter for readily and accurately determining the proper interference filter to use for any specific interference problem. A selector knob is turned thru a series of settings

## TRADE NEWS

General Electric Co. announces a new phono pre-amplifier, Cat. UPX003, with self contained ac power supply, designed to operate with the G. E. variable reluctance pickup.

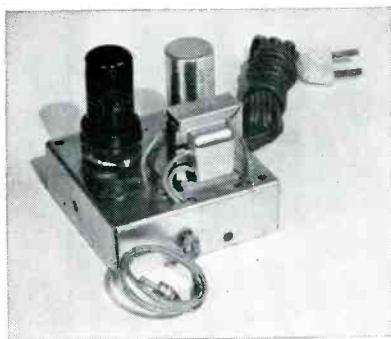

The device matches impedances between the pickup and the receiver's audio input, supplies the necessary pre-amplification, and provides tone compensation.

Cannon Electric Development Co. has issued a completely new edition of its

condensed catalogue, designated C-47. Consists of 32 pages covering the major multi-contact connectors for radio, communications, etc. Also included are data on solenoids and signal equipment and accessories. Catalogue available on request from Cannon, Humbolt St. and Avenue 33, Los Angeles 31, Calif.

Nomographs, Inc. of Lawrenceville, N. J. have assembled a number of solutions in graphical form which provide simple solution with the aid of a straight-edge. Group I, now available at \$1, covers conversion of DB to Nepers; DB ratios for current, voltage, and power; volume units versus volts, mils, and milliwatts; Peak, average, and RMS values; Surge impedance of air-filled coax lines and stubs; Minimum loss pads; etc., etc. Group II and III in preparation, will cover Electric Wave Filters, and Crystal Filters.

General Electric announces a new BFO-type audio oscillator, Type YGA-4, covering the range 25 to 16,000 cycles, features low distortion. The suitcase type weighs 21 pounds, ac operated.

General Electric announces a new Square Wave Generator, Type YGL-1,



corresponding to standard filter types; the type filter to use, as well as the best connections, are immediately known.

The AIEE has elected Everett S. Lee, General Electric engineer, as president for the 1948-9 term.

The Research Division of New York University is engaged in 20 projects supported by and available to industry and government agencies; they include: jet and rocket propulsion, water purification, sewage disposal, atmospheric energy and circulation, constant-level balloons, etc.

## JOB TRAINING

The RMA at its last Industrial Relations Seminar, brought out a number of interesting points which are contained in the published proceedings of the seminar. In a discussion of the effectiveness of aptness and fitness testing of new employees, this important point was made: "It is easy to credit failure to meet standards on the job to lack of desirable qualities in the employee, whereas inadequate job training, poor supervision, lack of proper motivation on the job, or any one of the many factors outside the employee himself may be responsible. Little is to be gained by improving selection techniques if necessary opportunities for proper development of new employees are not provided."

## OLD AGE AND SURVIVOR'S INSURANCE

The Social Security Administration recommends:

Coverage of all gainful workers, including agricultural and domestic employees, public employees and members of the armed forces, employees of nonprofit organizations, railroad employees, and self-employed persons, including farmers and small businessmen.

Changes in the average monthly wage and benefit formula to increase benefit amounts, particularly to low-paid workers.

Increase in the maximum amount of earnings taxable and counted in benefit computation, and expansion of the definition of taxable wages to include all tips, gratuities, and dismissal wages.

Increase in the amount of earnings a beneficiary may receive in covered employment without suspension of benefits.

Reduction of the qualifying age for all women beneficiaries from 65 to 60 years.

Greater uniformity in defining, for purposes of the insurance system, family relations and conditions of dependency that qualify members of an insured person's family for benefits.

Payment of a lump sum in the case of every deceased insured wage earner.

Payment of benefits during periods of extended or permanent total disability, similar to those for old-age retirement.

Provision for ensuring uniformity in coverage decisions relating to liability for contributions and eligibility for benefits, which are based on identical language in the Social Security and Internal Revenue Code but are made by two separate Federal agencies—the Bureau of Internal Revenue and the Social Security Administration.

Adoption of a long-range plan for financing old-age and survivors insurance which looks toward an eventual tripartite division of costs among employers, employees, and the Government.

### SUBSCRIPTION BLANK

**THE BROADCAST ENGINEERS' JOURNAL**  
116-03 91st Avenue, Richmond Hill 18, N. Y.

Gentlemen: Please enter my subscription to The Broadcast Engineers' Journal to start with the next issue.

Name..... (Station.....)

Address .....

City, P. O. Zone, State.....

Check attached for  \$2.50, 1 year;  \$4.00, 2 years.

## CAPPS\*

SAPPHIRE is, and has always been, the only material for making cutting styli for high class recordings.

CAPPS\* Patented Sapphire Styli (2187512) are the original and accepted standard for high class professional acetate recordings.

*Imitated but not equalled*

**FRANK L. CAPPS & CO., Inc.**

244 W. 49th STREET NEW YORK CITY

Telephone Circle 6-5285

\*Reg. U. S. Pat. Off.

**Engineers... like to SHOP at 'NEWARK'**

for ALL Their Needs in  
**RADIO and ELECTRONIC**  
• EQUIPMENT • COMPONENTS • ACCESSORIES

For all your personal or professional needs in Radio and Electronic equipment — save time, save MONEY, by shopping 'Newark' FIRST!

Engineers, who "live by the clock" have learned to depend on Newark's speedy, efficient service... our high geared organization of technically trained personnel know how important YOUR order is to YOU... mail and phone orders shipped same day! All standard makes of Tubes, Components, Receiving, Transmitting, Public Address, and Recording Equipment, in stock.

WIRE & TAPE RECORDERS — all makes now on demonstration at any of our THREE GREAT STORES, centrally located in New York and Chicago.

Speedy, Efficient Service AS NEAR AS YOUR PHONE! in NEW YORK Phone: CI. 6-4060 in CHICAGO Phone: STAte 2950

**NEWARK ELECTRIC COMPANY, INC.**  
NEW YORK: Offices & Warehouse, 242 W. 55th St., N.Y. 19  
CHICAGO: 323 W. Madison St., Chicago 6, Ill.  
New York City Stores: 115-17 W. 45th St. & 212 Fulton St.



---

# NABET

OFFERS ONE UNION FOR RADIOMEN

CONTACT ANY OFFICER. SEE PAGE 2.

---

## OMAHA NEWS

A very informative and instructive meeting was held by the Omaha Chapter at the home of our Chapter Chairman, Bob Rudd, during the first week of July. A discussion of the proposed contract for KSWI was held and several suggestions were made relative to clearing up the situation which exists there and it is hoped that a contract will soon be entered into which will benefit the engineers. Chairman Rudd together with Don Jepsen of the KSWI staff deserve an orchid for the time and energy expended to insure a workable contract for the boys across the muddy Missouri.

Correspondence received during the previous month was read by the Chairman and a discussion was held on all mail sent and received during the previous month.

At the conclusion of the business meeting, several of the boys took time to look over WØEUT (Bobs rig) and to partake of the delicious refreshments which had been prepared by Mrs. Rudd (Dean). Everyone thoroughly enjoyed the meeting and those present included Al Maller, Bill Dunbar, G. Flynn, Larry Sibilia, Cy Hagrman, Bob Rudd and Roy Glanton.

Television—Magic word to all radio minded people, is rapidly coming closer to Omaha and WOW. Latest and most interesting pieces of equipment to be received here are two micro-wave relay transmitters and receivers, with which we have been having several very successful experiments—sending pictures from one rooftop to another and relaying into our studios. Construction of the tele tower will start soon and we will then be one step closer to the dream we have had for more than two years.

The August meeting of the Omaha Chapter was held at the home of Al Maller. Those in attendance were Louis De Boer, Dick Peck, Bill Dunbar, Larry Sibilia, Al Maller, G. Glynn, Cy Hagrman, Roy Glanton, Bob Rudd, Johnny Brunken, Mark McGowan, and Don Jepsen. The most important item of business conducted was the presentation of the by-laws of the organization by Chairman Rudd and the accept-

---

## Join NABET

The NAB and its anti-labor attitude turns out to be the strongest answer to the broadcast engineer who would ask, "Why should I belong to a broadcast technicians' union?"

The solution to the broadcast engineers' problem of honest, competent, and highly specialized union representation requires a single national union, if their place in radio is to be bettered.

NABET is the *only* national union created expressly to serve the broadcast engineers and technicians.

## Switch to NABET

ance of them by the members. Chairman Rudd is to be congratulated upon this move and the thanks of the entire chapter go to him for his work in preparing these by-laws. After the business meeting, Mrs. Al Maller served a bounteous lunch and Larry Sibilia, who just returned from his vacation in Calif., had the foresight to bring four beautiful bottles of Vino to his brother Nabet members. Needless to say Larry is now in solid with the rest of the boys and when he is on duty, he need not worry whether or not the remotes will come around as scheduled. So with Mrs. Maller's lunch and with Larry doing the pouring, everyone had a wonderful time.

Vacations—Dick Peck is visiting relatives in Kansas City. Roy Glanton came back with a beautiful group of mountain color shots, and the boys are now awaiting a promise of their showing to be fulfilled at a future meeting. Bill Dunbar tried out a new convertible on foreign soil by nosing across the border into Canada and topped it off with a cruise at the Navy's expense in accordance with certain Naval reserve policies. The Cliff House may have been one of Larry Sibilia's hangouts—with Frisco on his list of this summer's travels. Louie DeBoer found that he was quite at home in Northern Iowa (you see there are a lot of Dutchmen around there). His only complaint was trying to name the Indian lakes he saw there.—No info on Mark McGowan's vacation, he being one of the strong silent clan. G. Flynn, Johnny Brunkin and Cy Hagrman, the deadbeats on this list, all stayed at home or at least within the confines of a one or two hundred mile circle.

Newest recruit at WOW is Roy Ekberg who is working a shift in the control room; Roy is a veteran of several years experience in radio and we are sure he will be a valuable addition to WOW and to Nabet.

That's all for now, see you next month.

LOUIS DE BOER and CY HAGRMAN.

---

## CONCILIATION AND MEDIATION

The role of conciliation in modern labor relations was also discussed, and we reprint this explanation from the Proceedings:

"Conciliation and mediation are almost synonymous terms. Actually, they are used synonymously not only by the general public but by the people who are in that line of endeavor. Mediation carries the connotation of a little more active participation in a labor dispute than conciliation. Two parties in dispute, an employer and an employee or a union, could get together and could conciliate their differences without the intervention of a third person, and very often they do conciliate their differences without the intervention of a third person.

"Mediation, of course, means that a third person does come in the middle and tries to bring the parties together. Either the conciliator or mediator acts as a friend of both sides in an attempt to resolve the dispute. One function of mediation, as distinguished technically from conciliation, is that a mediator very often makes suggestions as to what he thinks is a proper settlement of the dispute. Normally, a conciliator would not make any suggestions. He would simply get the parties together, see that they don't get mad at each other, tell them some pleasant jokes so that they will be amused and in a good humor, and try to keep them talking so that eventually they would resolve their differences. A mediator has a little more active role and may make positive suggestions for settlement of the dispute....."

# PRICES AND AUDIODISCS

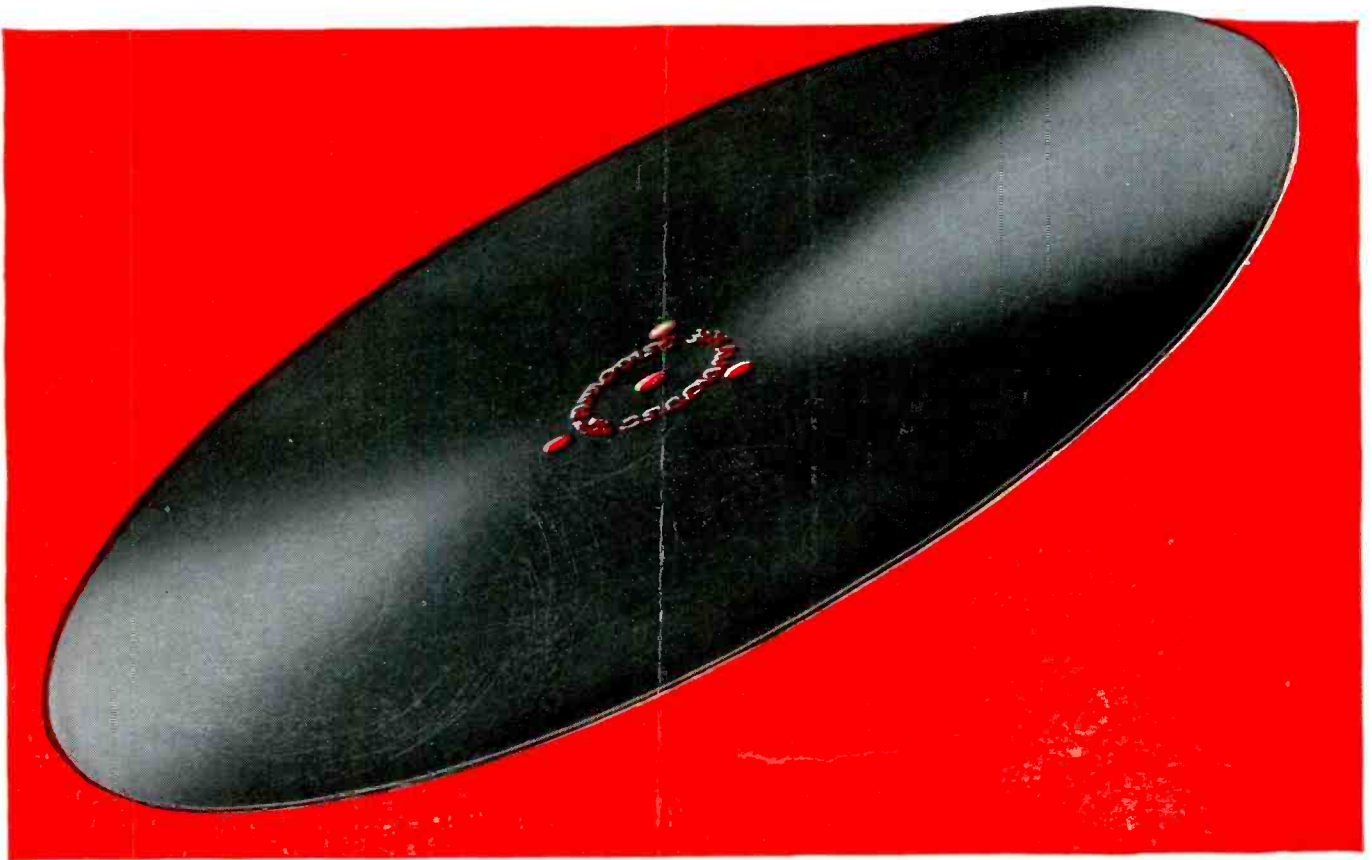

## *A Statement On Our Price Policy*

As of September 1st, aluminum prices are again increased. This means higher cost for the principal raw material used in the manufacture of AUDIODISCS. In fact, the cost of the aluminum base has always been the main item in the cost of production. Thus, any increase in aluminum prices is of major importance.

But beyond the cost of raw materials and labor there is a basic factor which determines the cost of manufacturing professional recording discs. This factor is the extent to which the particular process of manufacture enables the producer to turn out a large proportion of first quality discs. There are several methods of production used. None of these will give anything like a 100% yield. It is, however, obvious that as the percentage of yield increases there is a resulting drop in the average cost of aluminum, lacquer and labor.

Fortunately, our patented, precision-machine process—now used for over a decade and continuously improved—gives a more consistent yield of high quality discs than any method of production now used. And we have tested every other process in use.

So our position with respect to the present increase in aluminum prices is this:

1. We are *not* increasing prices of AUDIODISCS as of September 1st.
2. We shall make every effort to absorb this new aluminum price raise and thus continue our prices at the present level. Our calculations indicate that with some improved efficiency, now under way, and continued large volume production, we shall be successful in this hold-the-price effort.

*Audi discs are manufactured in the U.S.A. under exclusive license from PYRAL, S.A.R.L., Paris.*

**Audio Devices, Inc., 444 Madison Ave., N.Y. C.**

EXPORT DEPT: ROCKE INTERNATIONAL, 13 EAST 40TH STREET, NEW YORK 16, N. Y.



*they speak for themselves* **audi discs**



# DAVEN

## ENGINEERING LEADERSHIP

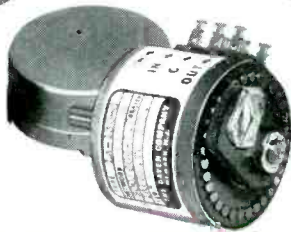

**MINIATURE ATTENUATOR — TYPE LA-130**  
30 STEPS — DIAMETER 1 3/4 INCHES

30 step ladder network, provided in a minimum of space . . . recommended for use in high quality equipment requiring a wide range of attenuation, where mounting space is limited.

Here are 4 of the more recent DAVEN "firsts". DAVEN long has been known for leadership . . . particularly in engineering and design. Many of our developments have been incorporated in the equipment of broadcasting stations, sound recording studios, and electrical laboratories throughout the world, and are specified as standard.



**FREQUENCY METER TYPE 838**

. . . frequencies read directly to 100,000 cycles with an accuracy of  $\pm 2\%$  of full scale in use . . . 7 ranges available . . . low input voltage requirements . . . large, easy-to-read illuminated meter . . . mounted on a 5 1/4" relay rack panel.

The DAVEN Engineering Department will be glad to discuss these new developments with you. Your inquiry is invited on the units shown or on any other DAVEN product.

THE **DAVEN** CO.

191 CENTRAL AVENUE  
NEWARK 4, NEW JERSEY



**TRANSMISSION MEASURING SET — TYPE 10A**

Direct reading instrument . . . meters and associated range controls . . . can be used independently as VU meters . . . range +26 to -100 DBM . . . total attenuation 111 DB in steps of 0.1 DB.  
(Pat. Pend.)

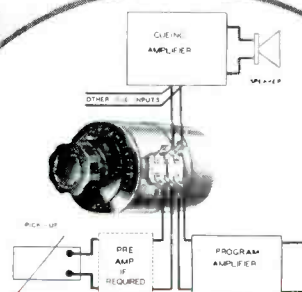

**ATTENUATORS WITH BUILT-IN CUEING CONTROLS**

. . . eliminate the need for auxiliary switching mechanisms . . . also available with built-in switchette for a pilot light . . . may be obtained on Ladder, "T", Potentiometer, and Ladder Fader controls.  
(Pat. Pend.)