

THE BROADCAST ENGINEERS' JOURNAL  
ED. STOLZENBERGER, EDITOR  
116-03 91ST AVENUE, RICHMOND HILL 18, N. Y.

POSTMASTER: IF UNDELIVERABLE FOR ANY  
REASON, NOTIFY SENDER, STATING REASON,  
ON FORM 3547, POSTAGE FOR WHICH IS  
GUARANTEED

F. A. GEHRES WGBF-WEOL  
2232 E. POWELL  
EVANSVILLE 14 IND  
\$148

Sec. 562, P. L. and R

U. S. POSTAGE  
**PAID**

New York, N. Y.  
Permit No. 2961

OFFICIAL PUBLICATION OF THE NATIONAL ASSOCIATION OF BROADCAST ENGINEERS AND TECHNICIANS



## The Broadcast Engineers' Journal

- Electron-Ray Tubes
- The Clamp Circuit — Part I
- ADP and KDP Crystals
- The Electropult

**VOL. 14**

**No. 1**

**JANUARY**

**1947**

SINCE 1934 . . . OF, BY AND FOR

**THE BROADCAST ENGINEER**

**A Major Advancement in the Recording Blank Field . . .**

*10 Year Guarantee*

**GOULD-MOODY PROFESSIONAL QUALITY "BLACK SEAL"  
ALUMINUM INSTANTANEOUS RECORDING BLANKS . . . .  
AT NO INCREASE IN PRICES!**

After prolonged research and experimentation, we have introduced technological improvements into "Black Seal" blanks that not only increase the life span, but materially enhance the other fine characteristics of these blanks. And so positive are we of the performance of these perfected "Black Seals" that we've placed an unconditional guarantee of ten years on each one of them.

***What Does This Guarantee Mean to You?***

It means that Gould-Moody "Black Seal" blanks will not rip up, disintegrate or powder after the first playing if kept in storage for any long period of time. It means that atmospheric conditions and changes, moisture and dampness, and old age will have no effect on blanks bearing "Black Seal" labels. It means that you'll be in no danger of losing valuable recordings in what, up until now, you have considered your safe library of recordings. And it means that you can expect the finest reproduction from the finest blank you have ever had on your turntable.

***You Can't Afford To Be A Recording Isolationist***

Whether you're a recording engineer in New York, Burbank or Wichita . . . no matter how well satisfied you are with your present blanks—you can't afford to be a recording isolationist now. Try these new Gould-Moody "Black Seal" blanks. Cut a few. If, for any reason whatsoever, you do not like them, you can return them at our expense.



**GOULD-MOODY'S PREFERRED RESHARPENING SERVICE  
restores the point on your precious recording needle  
SAPPHIRE! STELLITE!**

Exact workmanship assures lower surface noise and longer wear. In fact, needles and styli refinished by Gould-Moody are frequently reported to last longer than the original points. And the extreme accuracy with which that last 3/1000ths of an inch is shaped enables the needle to fit with microscopic perfection into the groove, thereby reducing record wear to minimum. This saving, in many cases, exceeds the cost of Gould-Moody resharpening.

**THE GOULD-MOODY COMPANY**

RECORDING BLANK DIVISION

395 BROADWAY, NEW-YORK 13, N. Y.

... do you know these important performance advantages of the SHURE Super-Cardioid?

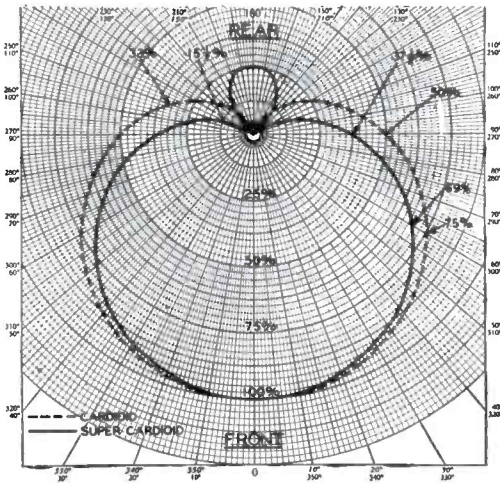

The improvement in unidirectional operating characteristics of the SHURE Super-Cardioid Microphone over the cardioid is indicated by the comparative pickup patterns shown above.

★ Maximum sensitivity (100%) is achieved by sounds entering the front of the Microphone.

★ A wide range of pickup is indicated by the fact that the Super-Cardioid is practically as sensitive as the cardioid at a 60° angle. (69% against 75%).

★ Beyond the 60° angle, the directional qualities of the Super-Cardioid become rapidly apparent. At 90°, the Super-Cardioid is 25% more unidirectional. At a wide angle at the back (110° to 250°) the Super-Cardioid is more than twice as unidirectional.

★ The ratio of front to rear pickup of random sound energy is 7:1 for the cardioid; 14:1 for the Shure Super-Cardioid.

*For critical acoustic use, specify the Shure Super-Cardioid Broadcast Dynamic.*

MODEL	IMPEDANCE	CODE
556A	35 ohm	RUDOM
556B	200 ohm	RUDOP
556C	High	RUDOR

List price . . . \$82.00

*Patented by Shure Brothers*

**SHURE BROTHERS, Inc.**

*Microphones and Acoustic Devices*

225 W. Huron St., Chicago 10, Illinois • Cable Address: SHUREMICRO





## 25th ANNIVERSARY!

The world's finest  
precision disc  
recording machine —  
used and recommended  
wherever the finest  
recordings are made

•  
*Today — Write, Phone, or Wire  
your order for*  
**SCULLY MASTER RECORDERS**

•  
**SCULLY  
Machine  
Company**

62 Walter Street

Bridgeport 8, Conn.

Telephone BRidgeport 4-5300

## THE BROADCAST ENGINEERS' JOURNAL

**Ed. Stolzenberger** Editor and  
Business Mgr.

Editorial, Advertising and Circulation Offices:  
116-03 91st Avenue, Richmond Hill 18, N. Y.  
Telephone: Virginia 9-5553

Volume 14, No. 1



January, 1947

Contents Copyright, 1946, by NABET Publications

### TABLE OF CONTENTS

	Page
NABET Activity .....	3
Electron-Ray Tubes .....	4
The Clamp Circuit—Part I .....	7
ADP and KDP Crystals .....	12
Meet: Clifford L. Gorsuch, NABET N'tl Rep. Ed Franke and Ray O'Neill, Jr., WOR ..	14
Rochester News .....	16
16,000 HP. Electropult Launches Planes ...	17
Baltimore News .....	19
Television News .....	20
Mohawk News .....	22
New York News .....	24

### THE BROADCAST ENGINEERS' JOURNAL OFFICIAL PUBLICATION OF THE N.A.B.E.T.

Trustees: A. T. POWLEY, Chairman; C. L. BENNIS, R. R. DAVIS,  
M. JACOBSON, W. L. PAYNE, G. RILEY

Treasurer..... H. E. HILLER

#### ASSOCIATE EDITORS

Baltimore .....	ALEC BEAUCHAMP
Boston .....	JAMES W. HUGHES
Chicago .....	D. R. FITCH
Cleveland .....	EARL HOLL
Denver .....	GEORGE POGUE
Detroit .....	DAVE STEWART
Dixie .....	D. GORDON MCCRARY
Engineering Chapter .....	E. B. BERLUND, JACK IRVING
Hollywood .....	NORMAN DEWES
Hudson Chapter .....	PAT MILLER
Mohawk .....	J. W. GAGNE
New York .....	GIL McDONALD
Omaha .....	CY HAGRMAN
Philadelphia .....	
Pittsburgh .....	FRANK E. HENRY
Rochester, N. Y. ....	GEORGE WILSON, DONALD ANDERSON
San Francisco .....	KEN MARTIN, JACK VAN WART
Washington .....	L. A. MCCLELLAND

The Broadcast Engineers' Journal is a privately printed monthly publication issued by NABET Publications. Address all communications to Publication office: E. Stolzenberger, 116-03 91st Avenue, Richmond Hill 18, L. I., N. Y. Telephone Virginia 9-5553.

Advertising rates and information supplied on request. Subscription, \$2.50 per year; \$4.00 for two years. Single copies, except Christmas Yearbook, 35c; Christmas Yearbook, \$1.00. All remittances in advance. Foreign: add postage. Back copies 50c, back Yearbooks, \$2.00.

Nothing appearing in The Broadcast Engineers' Journal shall be construed to be an expression of The Broadcast Engineers' Journal or the National Association of Broadcast Engineers and Technicians, but must be construed as an individual expression of the author or authors.

**NATIONAL N.A.B.E.T. OFFICE**  
Room 501, 66 Court Street, Brooklyn 2, N. Y.  
A. T. Powley, President

# NABET ACTIVITY

**W**E LEARN from the NABET News Bulletin of Dec. 17th that NABET won its unfair labor practices case against WSAY; credit for this victory goes to Mr. Charles Snyder, Chairman of the Rochester Chapter of NABET.

The latest addition to NABET's full-time staff is Mr. Clifford Gorsuch. He has gone through an introduction period at the National Office, and will make his permanent headquarters in Chicago. This will permit NABET to adequately service the mid-west area. The Chicago office address will be listed herein as soon as it becomes established. To permit all to get acquainted, Mr. Gorsuch's biography appears in this issue. He is now in Detroit negotiating a new contract at WWJ.

NABET negotiated a new contract at WGY, with the aid of Mr. Morey, Chairman of the Mohawk Chapter; top scale, \$90 after five years.

New contract at WMAL effective Jan. 1, 1947, includes three weeks' vacation, and \$536 per month after six years.

AFRA is reported in Variety to have secured a 20% across-the-board raise from all the networks.

With this issue, we are starting a regular "letters to the editor" page. It is through such letters that NABET and the Journal can keep a finger on the pulse of the NABET membership. A tear-out coupon appears elsewhere in this issue. Each NABET member is requested to fill in, and give the coupon to his Chapter Secretary, who in turn will mail to the Editor. The results of this poll will be published, and used as guidance in adjusting our Journal policies.

To comply with wishes of the National Council, we are at once inaugurating a "Who's Who in NABET" page. All members of the National Council, National Officers, etc., are directed to submit photos and biographical data.

## NABET Members Available for Employment

**Harry W. Schumacher**, 4852 N. Winchester Avenue, Chicago 40, Ill., studio and control engineer; ex-GI.

**Geo. Robinson**, 975 Midwood Drive, Rahway, N. J., was vacation relief at WJZ transmitter.

**Corby S. E. Stone**, 5312 Oregon Street, Detroit, Mich., in radio since 1934, broadcasting since 1941 with WIBM, WXYZ, WWJ; ex-full-time instructor, Electronics Institute, Detroit; high-freq. police transmitter, Mich.

\* \* \*

We have asked the National Office to provide us with the proper explanations of the "union shop," "closed shop," and "maintenance of membership" forms of labor contracts, with advantages, disadvantages, and operating differences of each type. We expect to be able to present this information in an early issue.

We have also requested information on the aims, purposes, and policies of ABUG—the Associated Broadcast Unions and Guilds. We have been besieged with requests for "more information," following many rumors and a brief report which appeared in a recent issue of the New York "Varity." We hope to be able to publish the National Office's comment on ABUG in an early issue.—Ed. S.

## National Association of Broadcast Engineers and Technicians

The only Union that is 100% Of, By and For the  
BROADCAST ENGINEER

### Attention Broadcast Engineers!

- NABET is a dignified union *worthy* of your support.
- NABET is an *effective* union, Of, By, and For the Broadcast Engineer *exclusively*, operated upon and dedicated to the principle that every member has a *right* to know what is going on in the union's "front office."
- NABET is controlled by its *members*; they have the right to vote on all matters of union policy. As a NABET member, you would have the *right* to Okay any actions which your President might take.

Contact any of the following officers for further information

- |   |  |
|---|--|
| <b>A. T. Powley, President</b>  | <b>Roger C. Ellis</b><br>820 University Place<br>Grosse Pointe, Mich.      |
| <b>Harry C. Hiller</b><br><b>Nat'l Sec'y-Treasurer</b><br>66 Court Street<br>Brooklyn 2, N. Y.  | <b>John H. Hogan</b><br>9312 Sudbury Road<br>Silver Springs, Md.           |
| <b>James H. Brown</b><br><b>Vice President</b><br>6000 Sunset Boulevard<br>Hollywood 28, Calif. | <b>William Justin Flanders</b><br>2 Holly Street<br>Hingham, Mass.         |
| <b>C. A. Allen</b><br><b>National Representative</b><br>1240 N. Utah<br>Arlington, Va.          | <b>C. Edward Jung</b><br>1405 Carswell Street<br>Baltimore 18, Md.         |
| <b>Charles L. Bennis</b><br>Apt. DA-2<br>117-14 Union Turnpike<br>Kew Gardens 15, N. Y.         | <b>John R. McDonnell</b><br>252 Oakdale Avenue<br>Mill Valley, Calif.      |
| <b>Harold V. Brandt</b><br>P. O. Box 68<br>Brecksville, O.                                      | <b>Mark L. McGowan</b><br>4550 N. 41st Street<br>Omaha, Neb.               |
| <b>Charles H. Colman</b><br>East Second Avenue<br>Parkersburg, Pa.                              | <b>Don Morey</b><br>Apt. 26-A, 3 Circle Lane<br>Albany 3, N. Y.            |
| <b>Reid R. Davis</b><br>18 Squirrel Hill Road<br>Roslyn Heights, N. Y.                          | <b>Donald A. Muir</b><br>1200 W. Colvin Street<br>Syracuse 7, N. Y.        |
| <b>J. Willard Dean</b><br>217 E. North Street<br>Raleigh, N. C.                                 | <b>Walter L. Payne</b><br>68-07 Colonial Avenue<br>Forest Hills, N. Y.     |
| <b>Garland S. Dutton</b><br>3132 E. 17th Avenue<br>Denver, Col.                                 | <b>Clyde M. Reed</b><br>363 Olancha Avenue<br>Brentwood, Pgh., Pa.         |
|   | <b>Frank C. Schnepfer</b><br>3508 West 97th Street<br>Evergreen Park, Ill. |
|   | <b>Charles Synder</b><br>106 Pembroke Street<br>Rochester 7, N. Y.         |

# ELECTRON-RAY TUBES

Principles of Operation, Types of Tubes, and Use in Circuits

By Jordan McQuay

**E**LECTRONS emitted from a heated cathode may be deflected or otherwise influenced by the presence of electric or magnetic fields, when such fields are located near the emitting surface or in close juxtaposition to the electron stream.

Also, electron bombardment of a phosphor-coated substance causes an emission of light or fluorescence, wherever electrons impinge upon the substance.

These two principles are utilized by the *electron-ray tube* to provide *visual* indications of certain voltage phenomena: either the presence of one or more voltages, or the relative magnitude of an existing voltage, or both.

These indications are displayed on a small, fluorescent screen known as the *target anode* of the electron-ray tube.

## Fluorescence

Certain phosphor chemicals have the property of emitting light waves when bombarded by electrons. This property is known as *fluorescence*.

If the target anode of an indicator tube is coated with one of these phosphor solutions, the anode becomes a photo-emitter. And whenever the anode is struck by electrons, the energy of the electron is converted into visible light.

All fluorescent materials are associated with a characteristic relationship between the intensity of the emitted light and the color contained in that light.

Most common phosphors used in electron-ray tubes are *zinc orthosilicate* or *zinc silicate*—*manganese* which emits a predominantly green light.

Efficiency, including visibility, is quite high. And the phosphors are used to coat the target anodes of practically all types of electron-ray tubes.

Of the several types of indicator tubes, marketed under various trade names, a description of a *basic* electron-ray tube will suffice for an explanation of all types—because of their great similarity in physical structure, electronic operation, and circuit function.

Essentially: *any kind of electron-ray tube is an electronic-controlled visual indicating device.*

## The Basic Tube

A *basic* electron-ray tube—typical of the type 6U5/6G5—consists of two interrelated sections: a triode amplifier and a cathode ray indicator, both enclosed within the same glass envelope.

The indicator section is actually a diminutive cathode ray tube consisting of three elements: a *cathode*, a *deflector* or *ray-control electrode*, and a *target anode*.

Electrons emitted from the heated cathode are attracted to the target anode because of its positive potential (with respect to the cathode). The target anode is a cone-shaped piece of metal, coated with a phosphor compound. And all electrons that manage to reach and bombard the anode cause fluorescence at the point of bombardment.

Because of the chemical content of the coating, the fluorescent color is green. And there is considerable after-glow or phosphorescence.

However, not all of the emitted electrons reach the target anode.

Some electrons are deflected from the screen by action of the ray-control electrode. When this electrode is negative with respect to the target anode, it tends to throw an electronic shadow on the anode screen. And the pattern of this shadow is dependent largely upon the position and shape of the ray-control electrode, as well as the contour of the fluorescent target area.

In the basic tube being described, the ray-control electrode is a thin vertical vein placed in close proximity to the emitting cathode, so that electrons can be easily deflected from their normal path toward the target anode.

There, the absence of bombarding electrons produces a wedge-shaped shadow on the illuminated surface of the screen.

The angular width of this shadow is determined by the relative potentials on the ray-control electrode and on the target anode. The degree of shadow-angle is a function of the triode grid voltage and the triode plate current, and is directly proportional to the magnitude of the voltage on the ray-control electrode.

## Circuit Theory

By reference to a conventional circuit used to indicate resonance (figure 3), the above relationship can be better understood in terms of voltage:

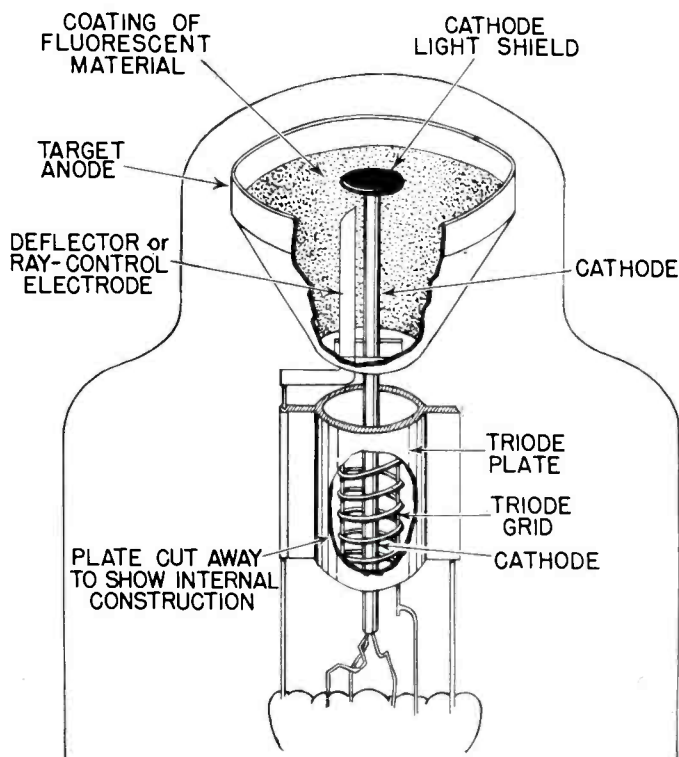

Figure 1—Structural view of a typical electron-ray tube.

With zero grid bias on the triode section of the tube, the ray-control electrode will also be negative with respect to the target anode—because the ray-control electrode derives its negative potential from the voltage drop across the plate load resistor  $R_L$ , and this voltage drop exists as long as triode plate current flows. Since the ray-control is negative with respect to the target anode, electrons are deflected from their normal paths causing a very wide-angle shadow to appear on the screen of the target anode. This shadow sector may often be as great as 90 or 100 degrees, as shown in figure 2 (A).

If the triode grid bias is permitted to become more negative, the triode plate current will decrease, and the voltage drop across the plate load resistor will also decrease. The potential of the ray-control electrode will become less negative with respect to the target anode. And the width of the shadow-angle will decrease, as shown in figure 2 (B).

Further decrease in the triode grid bias will again lower the relative potential of the ray-control electrode, causing a further decrease of the shadow-angle.

Only 7 to 10 volts of negative bias on the triode grid is sufficient to stop the flow of triode plate current altogether, and thus reduce the shadow-angle to an extremely small sector. See figure 2 (C).

Any additional negative bias voltage applied to the triode grid may cause the pattern to close completely. Or the shadow outlines may converge and overlap, resulting in a luminous line of considerable brilliance.

Normal angular range for the shadow pattern is from about 1 degree up to 100 degrees.

In the basic electron-ray tube (figure 1) there appears a dark round "spot" inside the envelope and over the center of the target anode. This "spot" is known as a *cathode light shield*. Mounted on but insulated from the cathode proper, the shield prevents loss of stray electrons that otherwise might fail to strike the target anode. It also makes any shadow deflection more noticeable, thus improving ease of vision.

The triode section of the electron-ray tube provides fairly linear voltage amplification of the input signal before it is applied to the ray-control electrode of the indicator section. Since the plate or output of the d-c amplifier is connected internally to the ray-control electrode, the voltage at the plate of the triode is always the same as the voltage at the ray-control electrode. And any variations in triode plate voltage (in accordance with a signal input) will appear as voltage variations of the ray-control electrode.

By supplying both amplification and control of the indicator section, the triode section thus greatly increases the over-all sensitivity of the tube.

Since variations of the shadow-angle on the target anode are controlled by the bias voltage on the triode, the

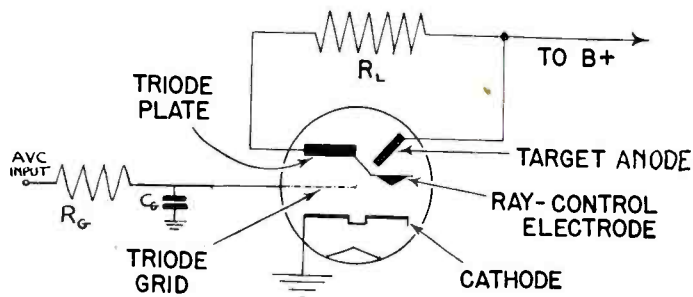

Figure 3—Electron-ray tube used in typical circuit as tuning indicator.

electron-ray tube draws no power from any external stage or circuit to which it is connected. Thus: the tube can be connected directly to high-impedance circuits with very little loading effect.

This characteristic is particularly useful when the tube is used as a resonance indicator for radio receivers, the original reason for development of the electron-ray tube.

### Resonance Indicators

Any superheterodyne radio receiver can be provided with a tuning or resonance indicator, enabling the user to tune the receiver accurately and visually to a desired station. Through the use of an electron-ray tube, an indication of resonance is obtained by visual examination of the pattern on the target anode.

Width of the shadow angle is controlled by the voltage on the ray-control electrode in conventional manner. But the controlling voltage is obtained from the automatic-volume-control system of the radio receiver.

A typical circuit of this nature is shown in figure 3 which can be connected to almost any superheterodyne circuit. A type 6U5 tube is used with a plate voltage of 250 volts. Plate load resistor  $R_L$  is 1 megohm; grid resistor  $R_G$  is 100,000 ohms; and grid condenser  $C_G$  is 0.05 microfarads. Operation is dependent upon only a small part of the total voltage of the a-v-c system.

When no r-f signal is being received by the superheterodyne, the a-v-c voltage is zero. And the bias on the grid of the triode amplifier is also zero, permitting relatively high conduction in the triode section of the tube. This high plate current produces a large voltage drop across the load  $R_L$ . And, as a consequence, the plate of the triode section is much less positive than the B supply voltage for the plate.

Since the target anode is directly connected to the B supply voltage and the ray-control electrode is internally connected to the triode plate, the ray-control is negative with respect to the target anode. And this produces a shadow having a wide angle. See figure 2 (A).

When the same receiver is properly tuned to a radio station, the a-v-c voltage is of a negative value and thus the bias on the triode grid is also negative. The resultant plate current is extremely small or even non-existent, and any voltage drop across resistor  $R_L$  is likewise small. In this condition the triode plate and the ray-control electrode are almost as positive as the target anode. Therefore the shadow-angle on the fluorescent target is extremely small, often merely a narrow slit of darkness.

Since the a-v-c voltage developed by the detector of a superheterodyne will change as the tuning of the receiver is varied around true resonance, the shadow-angle of the

(Continued on Page Ten)

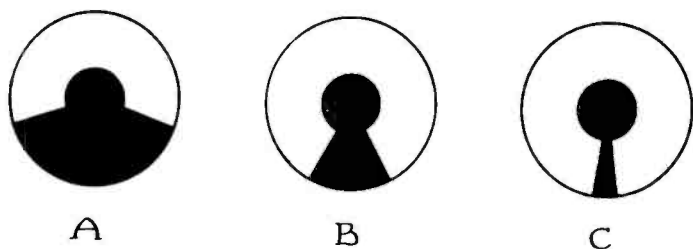
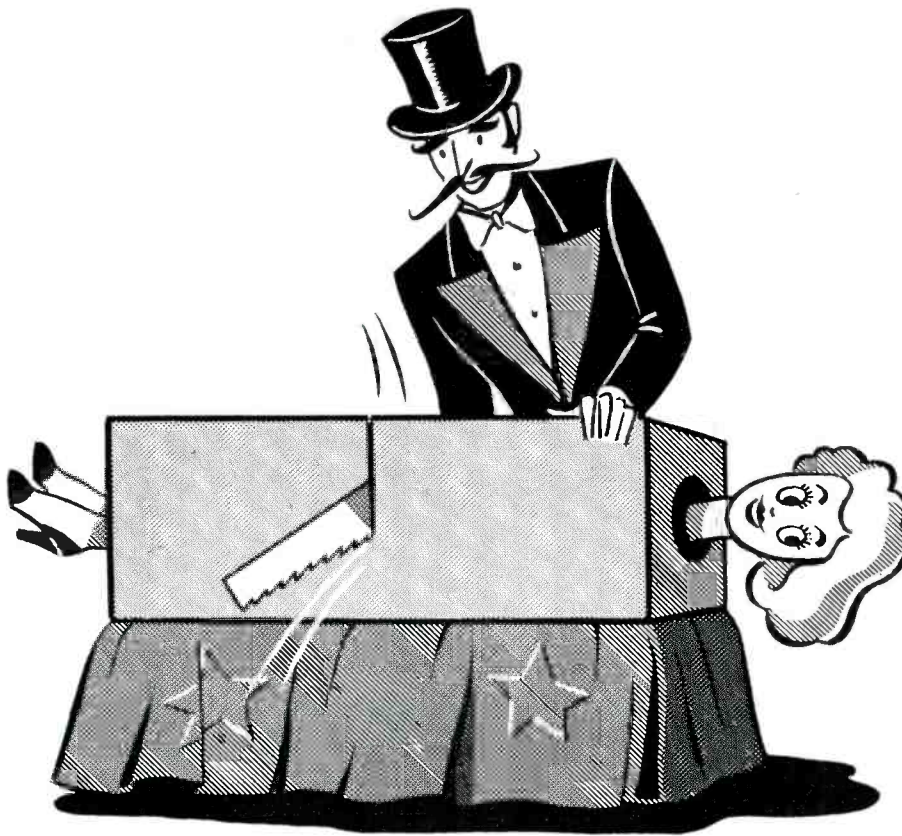

Figure 2—Shadow-angle patterns on screen of target anode.



## IT'S EASY TO FAKE THIS ONE...

There may be a trick to doing this (we're not telling), but you can't fool engineers of top broadcast stations and recording studios. When it comes to Advance Recording Blanks they know that there's no faking of tonal quality, cutting quality and length of service. So . . . for life-like reproduction, clear tone, and smooth, flat surfaces . . . join the ever-growing ranks of habitual Advance buyers and users!

## ADVANCE RECORDING BLANKS

**Advance**  
Recording Products  
Company

6-12 34th STREET • Stillwell 4-7837 • LONG ISLAND CITY, N. Y.

The Broadcast Engineers' **6** Journal for January, 1947



# The Clamp Circuit : Part I

By C. L. Townsend

Mr. Townsend is one of the country's outstanding television engineers. His twenty-odd years' experience includes Hollywood sound-movie engineering, and all phases of broadcast engineering. Since 1937, he has been wholly engaged in television development. During the war, he contributed all of his efforts to the military airborne television project "Ring." Mr. Townsend's original two-part article on the Clamp Circuit appeared in our February and March, 1945, issues, which are now out of print.—Ed. S.

## Summary

Electrical "clamp" circuits have long been used by a relatively small group of men mainly engaged in television and radar research. This article presents an informational discussion of the capabilities of such circuits, together with enough basic design information to permit construction and operation of satisfactory equipment.

## General

FOR many years equipment intended for television use has been built including as part of the electrical design certain circuits known in the laboratories as "clamps." Several articles have been published giving precise analyses of these circuits. However, they have had somewhat limited circulation, and because of their completeness and generality of exposition were somewhat difficult to use in practical circuit construction. This article, to the contrary, will concern itself primarily with simple circuit-designers' concepts, and experimentally obtained operational information.

It would be well to note that the term "clamp circuit" as used herein refers to pulse-driven switch type circuits and specifically excludes grid-current dc restorers of usual types.

## Capabilities of the Circuit

The clamp circuits to be discussed have many properties and abilities peculiar to themselves which should be understood as being the purposes for which the circuits were developed. The following is a partial list of the functions which may be expected of them.

Reproduction of complex wave shapes requiring wide-band amplifiers is greatly complicated if that band includes very low frequencies. In such a case, critical design of low-frequency compensation circuits is required, utilizing large coupling and filter capacitors, and usually based on low power-source impedance. If the wave to be reproduced includes a certain reference point, the use of a clamp circuit

will permit the complete elimination of the low-frequency portion of the pass band. The requirement that a reference be established is characteristic of the circuit. Such a reference would consist of any "flat" portion of the wave which recurs at a frequency which is high in proportion to the frequencies to be eliminated, and which is always at the same potential when the wave is accurately reproduced. An ordinary television horizontal line voltage-shape is such a wave, since "back-porch"—that portion of blanking immediately following supersync—fulfills the requirements. Thus a video amplifier intended to pass picture voltage after blanking has been added can be designed without regard for those frequencies well below line frequency, automatically removing the listed problems.

Since the frequencies controlled by clamp action are all those reasonably below the clamp frequency, the circuit may also be used to eliminate effects of switching surges, transients due to gain control movements, power line variations, and, where long cables are concerned, ground current fluctuations. Such a circuit design often permits the production of a good wave shape under conditions of interference which would make ordinary circuits useless.

The action of the clamp circuit is to force the "reference point" to a constant potential, irrespective of interference. Consequently, a clamp may be used to place a suitable wave on some certain portion of a vacuum tube characteristic, thus controlling the operating point of the tube, making the amplification of any particular part of the wave a quantity independent of shifts in its ac axis. Supersync can be held on a fixed point of amplification, for instance, establishing a stable black-level independent of amplifier saturation. And, since the blanking point is a definite potential, supersync may also be controlled as to amplitude independently of the picture changes. Voltages representing picture may also be processed independently of supersync on

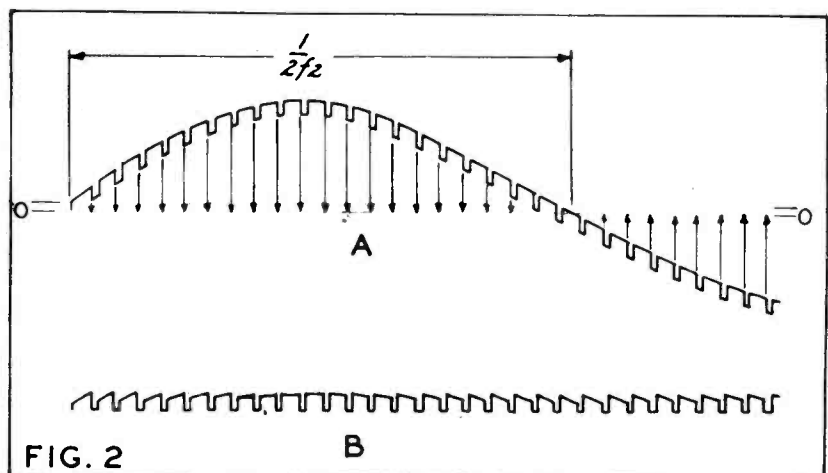
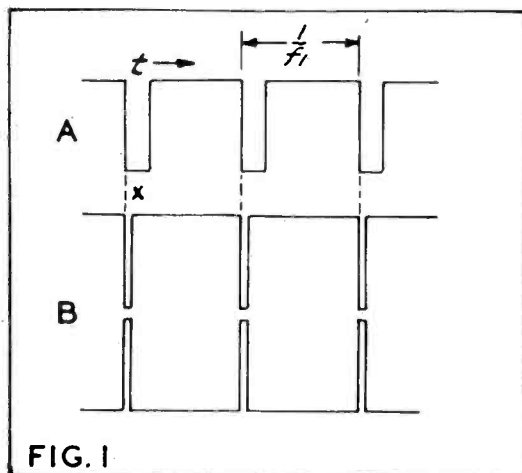

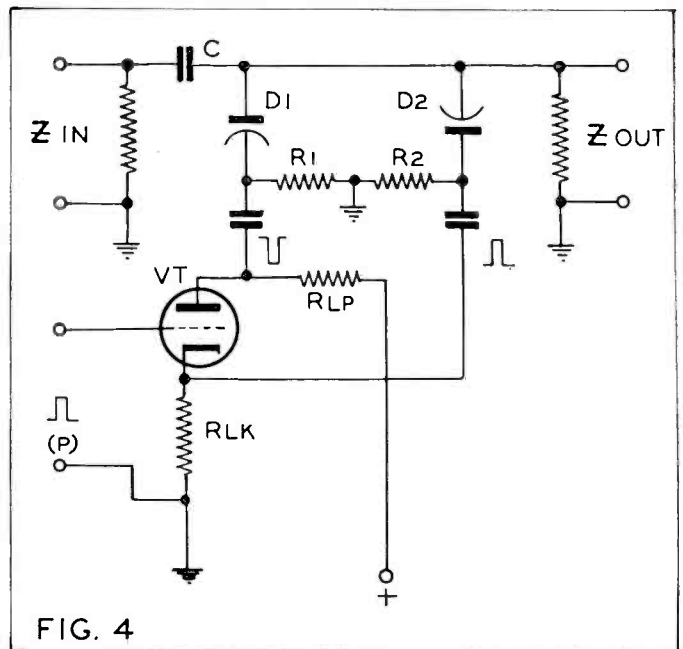
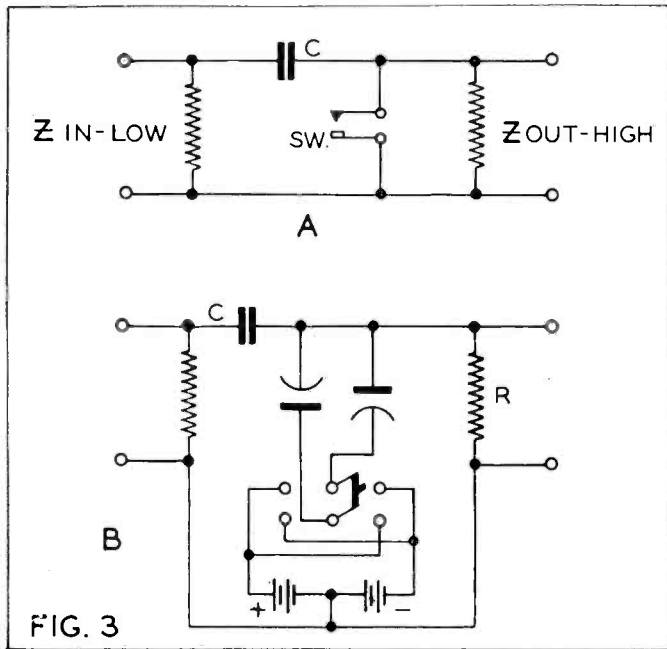

the same basis. Thus compensation for previous amplifier non-linearity and for improper sync-to-picture amplitude ratios may be effected through the aid of a clamp.

The use of a clamp as an accurate means for dc restoration in television circuits is immediately suggested by its action in holding blanking at a fixed potential. For those cases in which supersync is of varying amplitudes a clamp is far superior to ordinary grid-current, or diode current type dc inserters.

#### Circuit Development

Understanding of the basis upon which a circuit capable of producing the above results may be built is facilitated by reference to the diagrams of Figure (1). At (A) a simple wave of the type which can be treated successfully with clamp action is shown. It consists of a rectangular wave, drawn for convenience with a short-duration negative stroke. As generated, this wave contains no frequencies below  $f_1$ . In Figure (2-A) the same wave is shown with an interfering low-frequency,  $f_2$ , added. It is the purpose of the clamp to remove  $f_2$ .

If the beginning of each cycle of  $f_1$  (marked with an "x" in Fig. 1 "A," in this instance) could be brought to a constant voltage, action such as that indicated by the arrows in Figure (2-A) would take place. As  $f_2$  crosses its axis in a positive direction, the clamp action forces the "x" points of the wave down to the zero potential line. When the voltage of  $f_2$  swings negative, the clamp action forces all of the "x" points up to zero potential. Consequently, as shown in Figure (2-B), all that remains of  $f_2$  is that portion of its voltage change which occurs within the cycle of  $f_1$ . With  $f_1$  very high in proportion to  $f_2$ , this residual effect is vanishingly small, and usually can be neglected.

Consider the generic circuit shown at Figure (3-A). Across the input terminals the wave-shape of Figure (1-A) is impressed, and across the output terminals the wave is reproduced faithfully when the time-constant of R and C is long in proportion to the time of one cycle of  $f_1$ . If the wave of Figure (2-A) is impressed across the input terminals, it is likely that with RC long, some of  $f_2$  will appear in the output. However, if the switch (S) is closed at the instant (x) in each cycle of  $f_1$  only long enough to discharge (C)

through (Z-in), and then opened again, it can be seen that the flat portion of the wave following (X) will always be at ground potential. Following the opening of switch (S), the voltage changes applied to C will be reproduced across R. These are represented by the steep rise in positive direction, the long horizontal positive period, and the return negatively to point (X). The charge representing the wave  $f_2$  has been removed from (C) at point (X) by short-circuiting it through the switch. However, the  $f_1$  wave-form requires no charge on C during that period and is consequently unaffected by the switch action. It is this zero-charge period which is the reference point previously mentioned as being required in a wave to be clamped.

Since the operation of (S) in Figure (3-A) must occur at high frequencies, the use of a pair of diodes suggests itself immediately. The circuit of Figures (3-B) indicates the basic principle of diode switch operation. When the double-pole-double-throw switch is in the left-hand position, both diodes are biased open, and the RC time constant is unaffected by the presence of the diodes. When the switch is in the right-hand position, both diodes are conducting, and a low impedance path is provided from C to ground. If the charge on C has produced a positive potential to ground across R, the right-hand diode provides the path to ground, and if the signal potential is of the opposite sign, the left-hand diode provides the discharge path. Also, since the battery merely supplies polarizing voltage, it and the switch can be replaced by voltage pulses from an amplifier, provided that the pulses have the same polarity and duration of voltage as was previously obtained from the battery-switch combination.

The above reasoning results in the circuit of Figure (4). It is assumed that the input pulse (P) is timed as shown in A and B of Figure (1). All circuit elements can be used at high frequencies, and excessive shunt capacitance on the signal circuit is avoided. Such an instrument is therefore practical, and subsequent design modification will be in the nature of refinements rather than basic changes.

Consider the action of the circuit of Figure (4). When a positive pulse of short duration is applied to the triode grid, a similar pulse of smaller amplitude is generated across

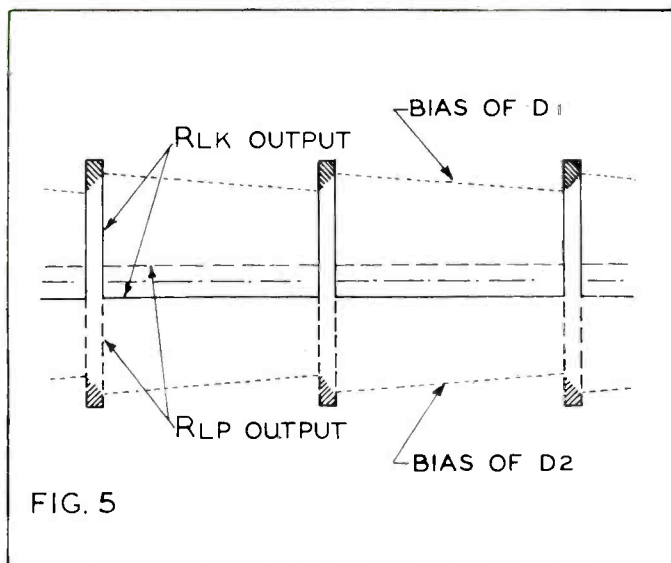

FIG. 5

RLK. Another pulse, identical except for reversed polarity, is produced in the plate circuit when RLP is of the correct value. These two pulses form the waves of Figure (1-B). The pulses are coupled into the diodes through blocking condensers, the diodes themselves being shunted by  $R_1$  and  $R_2$ , charging the blocking condensers in such a way as to reduce the diode current. Thus the  $D_1$  blocking condenser shows a positive dc voltage on the diode side, and the  $D_2$  blocking condenser shows a negative dc potential, with respect to ground. The pulse current, therefore, is only sufficient to supply the losses which have occurred in  $R_1$  and  $R_2$  during the cycle. This action is precisely similar to that occurring in the grid circuit of a vacuum tube which is self-biased.

Figure (5) is a diagrammatic representation of the clamp potentials. Diode current flows only when the pulse voltage exceeds the bias voltage. This portion of the cycle is shown as the shaded area of Figure (5). During the remainder of the cycle both diodes are non-conducting. The required switch action has therefore been obtained, since the diodes conduct precisely as in Figure (3-B).

The operation of the clamp of Figure (4) is the same as the generic types. If during the clamp period there is a charge on C, it is removed through the diodes. If the charge produces a positive potential at the output,  $D_1$  provides the discharge path, through its blocking condenser and the RLP and VT combination to ground. If the charge is of opposite sign,  $D_2$  provides the path through its blocking condenser, and the RLK and VT combination. Both of these paths are of low impedance as required for rapid discharge of C.

It was previously stated that the use of a clamp circuit such as has been developed should permit the elimination of the very low frequencies usually present in a television picture signal.

As an illustration of this action, consider the diagrams of Figure (6). At (A) a wave is represented which it is desired to reproduce. This wave has no reference point, since no part of it returns to a constant potential at a frequency high in proportion to the low frequencies of the wave. At (B), however, high-frequency pulses have been added to the wave of (A), and these pulses have been adjusted in length so that their negative tips are always at

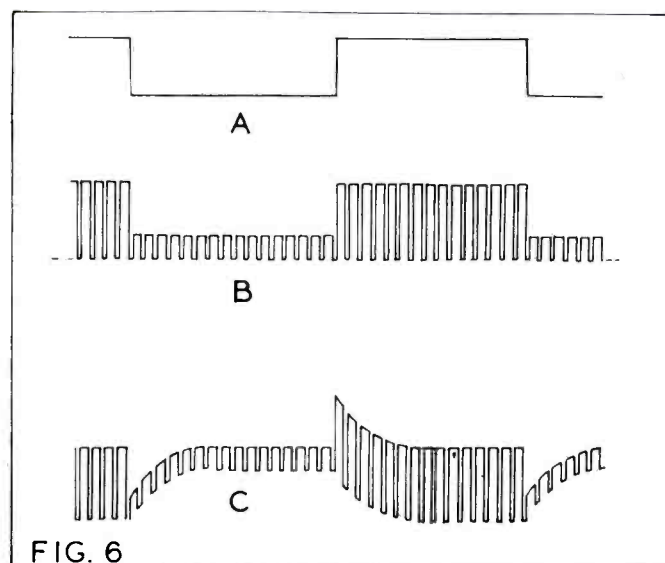

FIG. 6

the same potential, regardless of the amplitude of the (A) wave. This potential is represented by the line (X-X). These pulses do not destroy the basic shape of the wave to be reproduced, and are so timed as to avoid interfering with its usefulness. Now if the low-frequencies are eliminated from the wave of (B), the wave of (C) results. The long horizontal portions of the (A) wave have been lost, but the amplitudes of the reference pulses have not been changed. Therefore, if clamp action is applied to the (C) wave at the most negative point of each reference pulse, all these pulse tips will again be forced to a constant potential, and the wave of (B) complete with its original low-frequencies will again be produced.

Consider a television system operating at sixty fields and 525 lines per second. The low frequencies in question are those from 60 cps to approximately 1,000 cps. These frequencies provide information as to the average brightness of one line with respect to others, and define the slope and amplitude of vertical pedestal. In the early video amplification following the pick-up tube these frequencies are usually carefully preserved until blanking is added. Blanking is then "clipped" at a constant "blacker-than-black" potential. Since this level is constant, all brightness changes in the picture, whether line-to-line, or frame to frame, are produced by voltage changes with respect to the blanking level. It is, therefore, only necessary to clamp all horizontal blanking periods to the same potential to produce an accurate reproduction of the original picture. If the video amplifier used includes a coupling circuit such as that of Figure (4), the value of (C) may be made very small, and other stages of amplification preceding may be treated in the same manner, completely eliminating the normal-wave field structure, yet retaining all necessary information. Such a wave, properly clamped, will regain its vertical pedestal and blanking voltages in their original amplitudes. If the clamp circuit starts each line at the proper brightness, then the frame will also be at proper brightness, for variations in average brightness can only occur within the time of a line, and will be corrected at the beginning of the following line. Since both vertical and horizontal blanking were originally held at a fixed potential, clamping them to a fixed potential after variations have occurred will restore them to the original conditions.

(Continued Next Month)

# ELECTRON-RAY TUBES

(Continued from Page Five)

electron-ray tube provides a visual indication of current-resonance tuning in a radio receiver.

The a-v-c voltage will also vary according to the strength of the r-f signal received. And thus the shadow-angle of the tube can be used to indicate the relative strength of signals received.

High-fidelity receivers, designed to pass a wide frequency band, are often provided with a special control circuit having more selectivity than the normal signal channel. This selective control circuit is tuned to the center of the i-f pass band. And the minimum width of shadow-angle observed on the fluorescent screen of the tube thus accurately indicates when the receiver is in resonance with a desired r-f signal.

## Types of Tubes

The basic electron-ray tube heretofore described is typical of the type 6E5, first commercially developed tube of its kind. It was used for some time primarily as a tuning indicator for large radio receivers. But several years ago it was replaced generally by the type 6G5/6U5 which is used in a similar circuit (figure 3).

Principal difference between the tubes is that the 6G5/6U5 has a remote cutoff amplifier in the triode section, and thus can handle a wider range of input signal strength.

This popular tube replaced two other short-lived tubes: types 6H5 and 6T5, and was widely used.

However, a later and more improved indicator tube is the type 6AB5/6N5. It functions in identical manner as the basic electron-ray tube previously described. It has a remote cutoff triode, and requires relatively lower operating potentials for all electrodes.

An important variation of the basic electron-ray tube are the *twin-indicator* tubes: type 6AD6-G and type 6AF6-G.

These tubes have no provision for amplification within the same glass envelope, and contain a single cathode ray indicator section. Although functioning with one emitter and one target anode, the tubes have *two* ray-control electrodes mounted on opposite sides of the cathode.

The ray-control electrodes may be connected in parallel to produce symmetrically opposite shadow-angles on the screen of the target. Or, the electrodes may be connected separately to two individual signal sources to produce two unlike patterns on the same target anode.

External d-c amplification of all input signals is necessary for proper operation of the twin-indicator tubes. Usually a one-stage voltage amplifier will suffice for this purpose.

For the type 6AF6-G, a shadow-angle as wide as 100 degrees can be obtained by either of the two ray-control electrodes. For the type 6AD6-G, a shadow-angle as wide

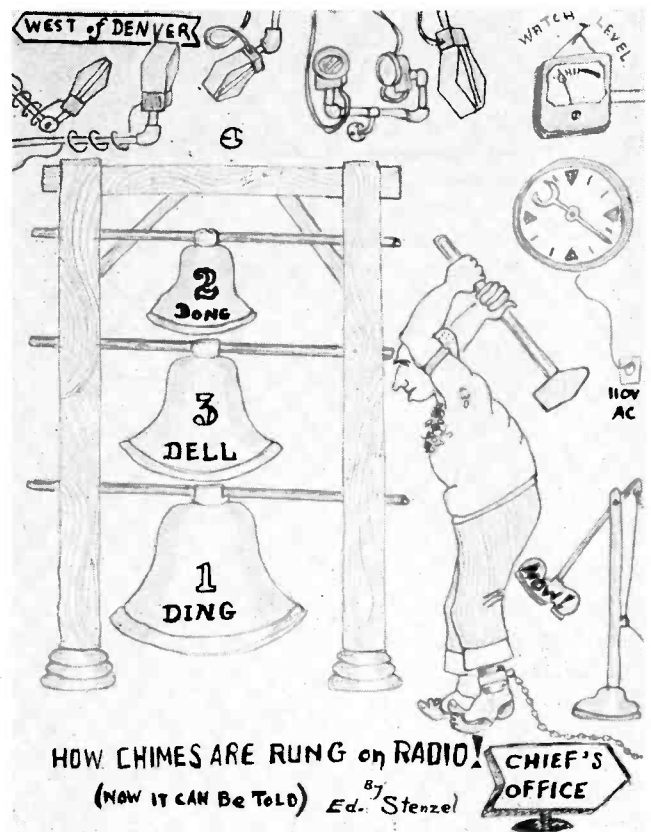

as 135 degrees can be obtained by either of the two ray-control electrodes.

Both tube types have extremely high sensitivity to input signals of proper amplitude.

Since there is no provision for amplification, twin-indicator electron-ray tubes have greater structural simplicity.

## Uses of Tubes

Although primarily developed as a tuning indicator for radio receivers, a number of other important applications have been found for electron-ray tubes.

Since the width of the shadow-angle on the target anode is always proportional to the voltage on the ray-control electrode and since the tube draws no power from associated circuits being investigated, it is possible *within limits* to calibrate the tube and use it for visual indications of voltage.

Such a voltmeter can be used for a variety of measurements in radio and electronics work. Electrode voltages of conventional, thermionic vacuum tubes may be checked with a considerable degree of precision. When radio receivers are in operation, the i-f and r-f stages may be checked by measurement of the r-f voltage across secondary windings of the transformers. As a check on rectifier operation, the peak plate current of a mercury-vapor rectifier can be measured by using an input resistor of suitable value to develop a measurable voltage. With an electron-ray voltmeter it's also possible to determine the ripple voltage of a high-potential power supply.

The electron-ray tube also finds considerable use as a null or balance indicator in many kinds of electrical bridge circuits.

### SUBSCRIPTION BLANK

THE BROADCAST ENGINEERS' JOURNAL  
116-03 91st Avenue, Richmond Hill 18, N. Y.

Gentlemen: Please enter my subscription to The Broadcast Engineers' Journal to start with the next issue.

Name..... (Station.....)

Address .....

City, P. O. Zone, State.....

Check attached for  \$2.50, 1 year;  \$4.00, 2 years.

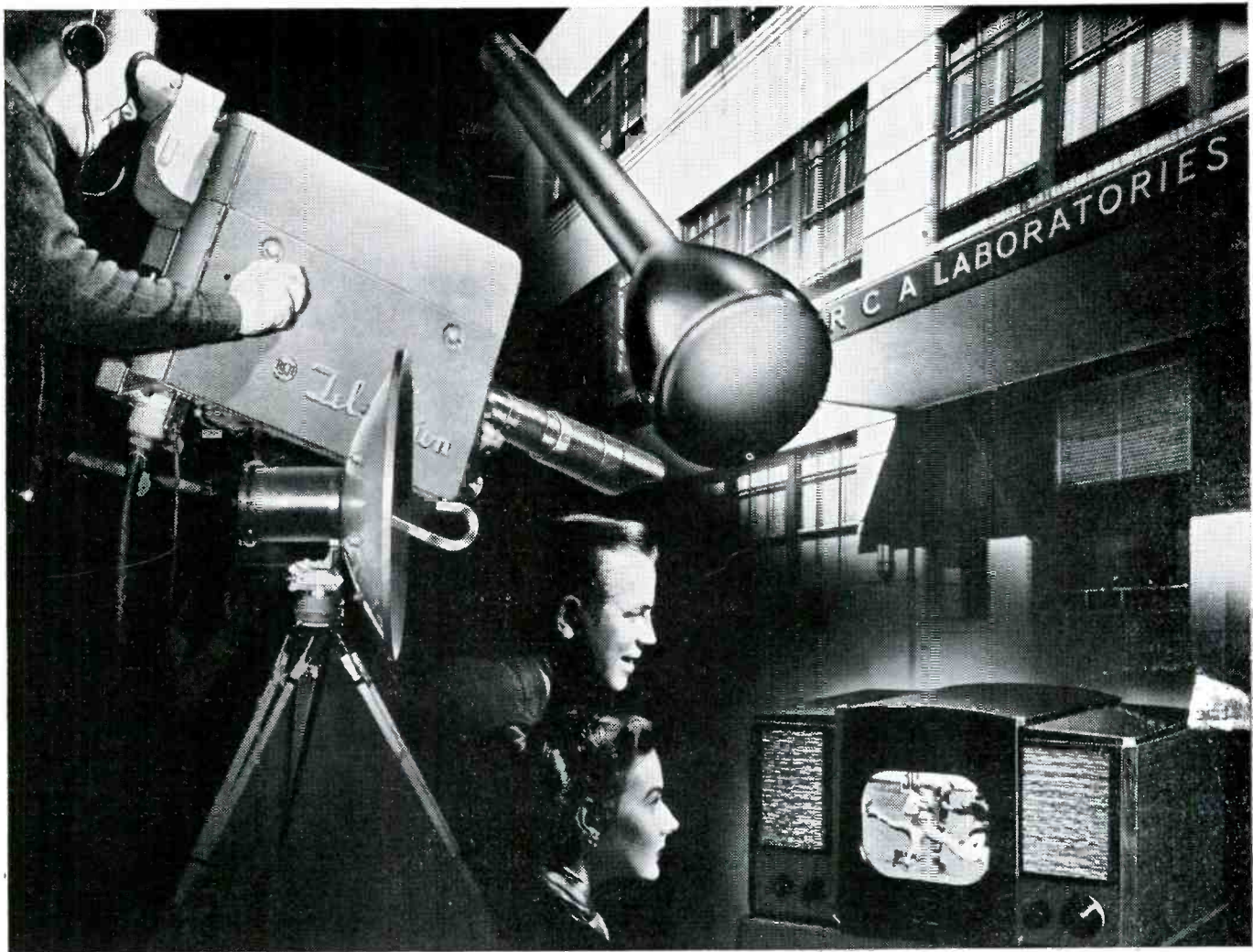

Television camera, receiving tube, all-electronic receiver and radio relay equipment —are the result of pioneering and research at RCA Laboratories.

## Behind every big stride in Television—RCA Laboratories!

From the scene of action—to your own living room—these RCA developments based upon research at RCA Laboratories mean *television at its finest*:

**RCA Image Orthicon Camera** sees whatever the human eye sees, even in the light of a match! Sports events on cloudy days or in twilight do not fade because this super-sensitive camera eliminates the need for strong lighting.

**RCA Mirror-backed Kinescope**—search-light brilliance for home television. All the lifelike realism and detail caught by the RCA Image Orthicon Camera is reproduced by this new receiving tube that loses none of the original brilliance.

**RCA Victor Television Receiver**—with the new RCA exclusive “Eye Witness” feature that “locks” the picture, keeps it bright, clear—as steady as a picture on the wall.

**RCA Radio Relay** equipment enables television stations to broadcast events taking place far from the studio, and eventually may link television networks. In television, as in radio, Victrola\* radio-phonographs, records, or tubes, if it bears the name RCA or RCA Victor, it is one of the finest instruments of its kind science has achieved.

*Radio Corporation of America, RCA Building, Radio City, New York 20 . . . Listen to The RCA Victor Show, Sundays, 2:00 P. M., Eastern Time, over NBC. \*Victrola® T. M. Reg. U. S. Pat. O. I.*



**RCA VICTOR** table model television receiver with the exclusive “Eye Witness Picture Synchronizer” that assures you *brighter, clearer, steadier* pictures. It is now available in some areas—see your local RCA Victor dealer.



**RADIO CORPORATION of AMERICA**

# ADP and KDP Crystals

By W. P. Mason

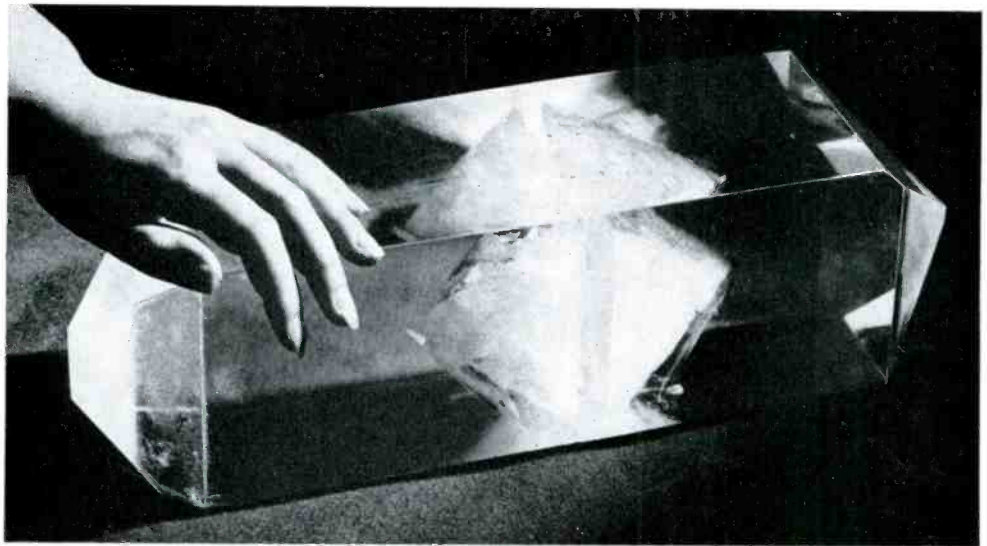

Physical Research, Bell Telephone Laboratories

(Reprinted by permission from the Bell Laboratories Record, July, 1946)

OVER a hundred crystals are known to have piezoelectric properties but only quartz and Rochelle salt had been used in practice to a large extent until the present war. Stimulated by war applications, there has recently been developed a third crystal which may displace both for certain peacetime applications. This crystal is ammonium dihydrogen phosphate and it has been given the abbreviation ADP.

When a constant voltage is applied to a piezoelectric crystal, the crystal is deformed mechanically and charged electrically. This results from a change in alignment, under the influence of the applied electric field, of separated charges of positive and negative electricity in the crystal which are called "dipoles." Energy is thus stored in the crystal both in mechanical and electrical form and the ratio of the mechanical energy stored to the total electrical energy applied is measured in terms of a constant characteristic of the material which is called its electromechanical coupling. This is a direct measure of the efficiency of the crystal for converting electrical to mechanical energy under static conditions.

If an alternating potential is used, all of the electrical energy can be transformed into mechanical energy, at the resonant frequency of the crystal, provided that its static capacity is tuned with an inductance. The electrical potential energy is converted into electrical kinetic energy and eventually into mechanical energy, if the mechanical load is the only source of dissipation. The frequency range over which the transfer can be made, however, is controlled by the electromechanical coupling in the crystal. If it is desired to transform electrical into mechanical energy, or vice versa, over a wide range of frequencies, electromechanical coupling is the most important factor.

ADP crystals provide high electromechanical coupling. They are free from non-linear response and hysteresis effects and are very stable with temperature. ADP has no water of crystallization and hence will not dehydrate. Furthermore, it is stable up to temperatures as high as 100 degrees C, whereas Rochelle salt dehydrates at humidities below 35 per cent and disintegrates at 55 degrees C. For these reasons,

ADP is largely displacing Rochelle salt in piezoelectric applications.

Crystals of ammonium dihydrogen phosphate were grown and their light transmission properties were studied as early as the middle of the last century. It was not until 1938, however, that the interesting dielectric properties of this and related crystals were realized. ADP crystallizes in the tetragonal scalenohedral class. A photograph of one of these crystals which was grown at our Murray Hill Laboratory is shown in the headpiece. It is sixteen inches long and four inches square. Still larger ones have been grown there.

The ADP plate of principal interest made from these crystals is the so-called 45-degree Z-cut whose major surface is normal to the Z axis of the crystal and whose length is at 45 degrees to the other two axes. Figure 1 shows the electromechanical coupling for these plates and those of

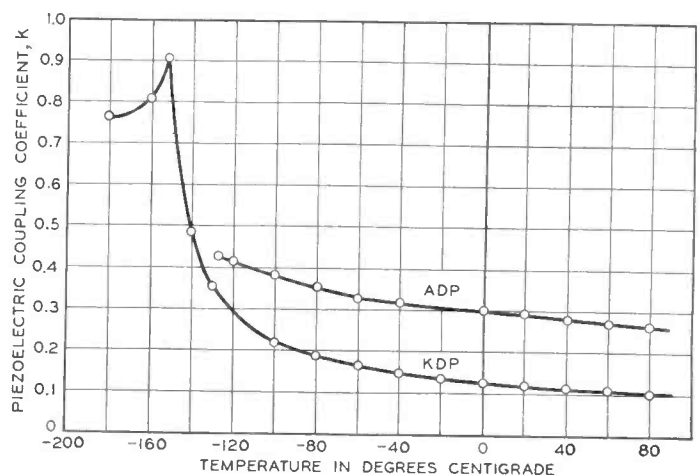

Fig. 1—The efficiency of a piezoelectric crystal as a direct-current converter of electrical into mechanical energy is measured by its coupling coefficient. For ADP this is approximately 0.3 at ordinary temperatures, which means that about 0.1 of the electrical energy reappears in mechanical form.

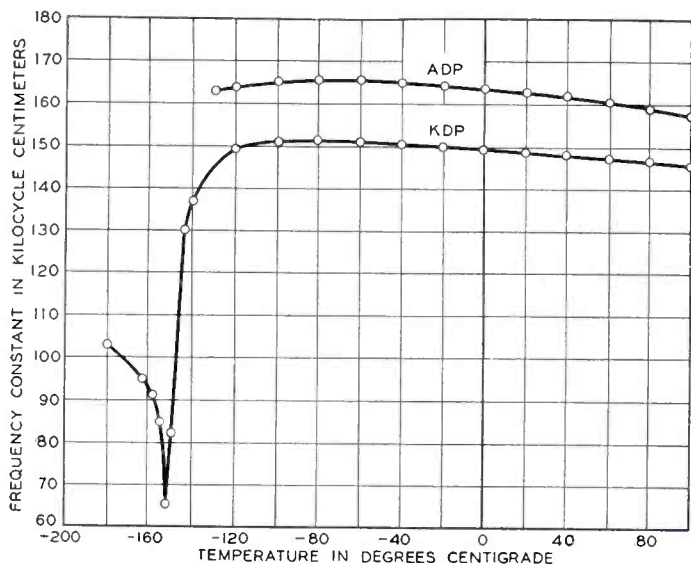

Fig. 2—Frequency constants of ADP and KDP plates, with variations in temperature. The dip in the KDP curve at  $-151$  degrees C. indicates the incidence of "Ferroelectric" coupling.

an isomorphous substance, potassium dihydrogen phosphate, KDP.

A different type of coupling, called ferroelectric from its analogy to ferromagnetism, appears in KDP at temperatures below  $-151$  degrees C. At this temperature the positive and negative charges of the crystal dipoles align themselves along one of the axes of the crystal like the elementary magnets of a ferromagnetic material. This makes it possible for a small applied field to cause a considerable mechanical distortion. As in ferromagnetism, the response is not proportional to the applied field because there is hysteresis between polarization, lattice distortion and the applied field. The increased coupling of KDP at low temperatures is obtained only at the sacrifice of the stability of crystal performance with changes of temperature and field strength. Rochelle salt also provides a similar and better known example of ferroelectric coupling between  $-18$  and  $+24$  degrees C.

ADP on the other hand suffers a transformation at  $-125$  degrees C. which causes the crystal to crack into minute fragments. This is not a ferro-electric transformation because, as is seen from Figure 1, the coupling coefficient does not change slope as the transformation temperature is approached. Figure 2 shows the frequencies of 45-degree Z-cut ADP and KDP plated crystals one centimeter long. Here again the elastic properties show a ferroelectric transformation for KDP but indicate no such change for ADP.

The ferroelectric properties of potassium dihydrogen phosphate have roused considerable theoretical speculation. Its crystal structure has been determined by X-ray analysis and the locations of the atoms in its unit cell are shown in Figure 3. The phosphate groups,  $PO_4$ , consist of a phosphorus surrounded tetrahedrally by four oxygens and are indicated by the tetrahedrons. Each phosphate group is surrounded tetrahedrally by four other phosphate groups. The positions of the potassium atoms in the crystal are indicated by the open circles. Those of the hydrogen atoms are not shown by X-ray analysis, but, according to Slater's theory, one is located somewhere on the connecting line between each pair of phosphate groups, forming what are known as hydrogen bonds. These bonds, as was first shown

by studies of the structure of ice, sometimes permit the nucleus of the hydrogen atoms to shift from one to the other of two positions along the bond.

However, recent work which shows that the dielectric constant is unchanged with frequency up to  $3 \times 10^{10}$  cycles indicates that the position of the hydrogen bonds may be along the edges of the  $PO_4$  tetrahedrons. In any case each  $H_2PO_4$  group forms not only a negatively charged ion but also a dipole, and the shift in the position of the hydrogen nuclei, which are positively charged, causes a change in the direction of alignment of the dipoles from the Z axis to directions perpendicular to Z. The dielectric behaviour of KDP indicates that the orientation of these dipoles along the Z (ferroelectric) axis must have a lower energy than at right angles to it. The spacing along the Z axis of the crystal is 6.97 Angstrom units, while that at right angles to it is 7.43 Angstrom units. This probably accounts for the lower energy along the Z axis. At very low temperatures all the dipoles must lie along the Z axis, since this is the position of lowest potential energy. The crystal is then spontaneously polarized in a region or "domain," although neighboring domains may have the direction of polarization reversed. As the temperature rises, the hydrogen ions acquire a more random arrangement and some of the dipoles assume direc-

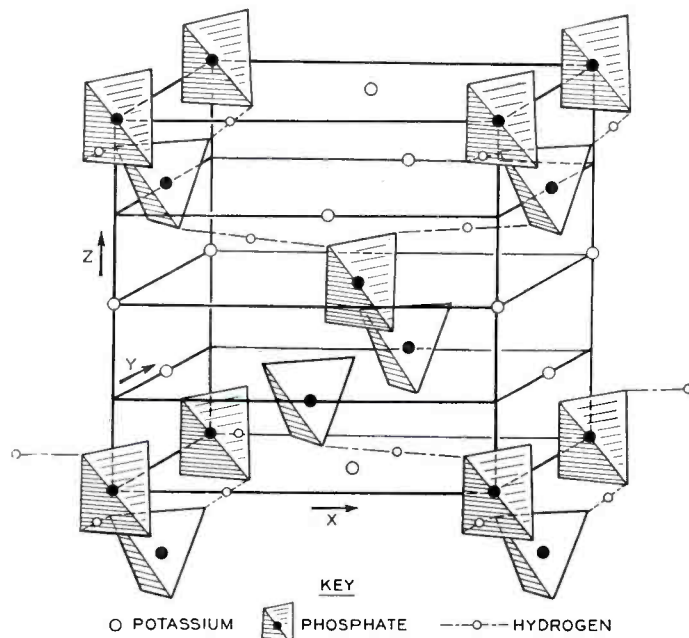

Fig. 3—Crystal structure of potassium dihydrogen phosphate. The dimensions of the unit cell are the same along the X and Y axes, 7.43 Angstrom units, and 6.97 Angstrom units along axis Z.

tions perpendicular to Z. When this condition occurs, the crystal loses its spontaneous polarization and is no longer ferroelectric.

Measurements made by the writer have shown that the piezoelectric distortion, which is a shear, is directly related to the position of the hydrogen ions. When all the dipoles are lined up along the Z axis, a spontaneous shearing distortion of large magnitude occurs as well as spontaneous electric polarization. Above the point where spontaneous polarization disappears, an electric field applied along the Z axis causes more dipoles to point along that axis than in

(Continued on Page Twenty-two)

## Clifford L. Gorsuch NABET National Representative

**C**LIFFORD L. GORSUCH was selected a National Representative of NABET at its recent National Council Meeting in Denver. As a means of introducing him to the membership



C. L. GORSUCH

and those with whom he will be doing business, we present herewith his brief biography.

Born April 27, 1917, in a Pittsburgh suburb. Educated at Swissvale Public and High Schools, followed by two years at Keystone Engineering Institute. He functioned as relief engineer at WWSW, Pittsburgh during 1937, and helped install WMBS at Uniontown, Pa., where he remained as studio and transmitter engineer until 1939. Gorsuch helped install WJLS, Beckley, W. Va., and remained as chief engineer. Next, to WCHS, Charleston, W. Va., as studio and transmitter engineer; helped install new 5 kw transmitter, and later set up the new WGKV in the same city. He then became chief engineer at WSLB, Ogdensburg, N. Y., until Nov., 1940. Then to Du Bois, Pa., to install the new WCED, which he supervised till June, 1941, when he left to install WISR, Butler, Pa., where he was chief engineer until he left to join Westinghouse, KDKA, in April, 1942. He was studio and field engineer until March, 1943. Gorsuch was commissioned in the Signal Corps, AUS; he was engineering officer on AAF ground installations, communications, etc. He was active in the Africa, Middle-East, and India-Burma theatres. He left the services January, 1946, and returned to KDKA

as studio and FM transmitter engineer. He left this post Nov. 15, 1946, to assume NABET National Representative post. Cliff is ex-W8PGC, married, has one son, and believes that broadcasting and NABET are here to stay.

—EdS.

## Ed. Franke and Ray O'Neill, Jr.

**E**D. "KAMIKAZE" FRANKE, and Ray "Cannonball" O'Neill, Jr., have led strangely parallel lives since first seeing the light of day in the early part of the century.

Both these worthies struck their first pay dirt working as druggist's helpers. Ray did his bit for a West Orange, N. J. Emporium, while Ed toiled for one in Erie, Pa.

Ray garnered his radio know how through self study, the CMTC Signal Corps and finally by joining the Naval Reserve in 1929. He topped off his efforts with the acquisition of a First Class Telegraph Ticket. Natch! he went to sea (1929-1931). But, as he says, "This was just a stepping stone to my heart's desire, a broadcast job."

1931 found his ambition realized with WOR pointing a beckoning finger. In 1934, after three years of studio and field work, an opportunity arose, enabling Ray to work at WOR's 5 kw transmitter at Kearny. Here he and "Kamikaze" Ed met and took up a tour of duty that, except for the war years, has kept them working side by side for over twelve years.

Ed was doing the same kind of Nip Ups on the road to success. That is to say during Ray's toe wiggling days he claims he learned his stuff at the Marconi Institute, but methinks he probably gave Marconi a few pointers. Having a roving and curious eye he honed up and obtained a First Class Ticket and off to sea for several years he went. During that period he girdled the globe twice.

1930 and the WMCA transmitter. Four years' toil in the 570 kc salt mines was enough for him and off he flitted to join WOR's lash up at Kearny.

A year after Ed and Ray joined forces, "Old Fifty," WOR's new transmitter at Carteret was born, nice, new and shiny like. Ray and Ed, of course, were right there pitching. They are symptomatic of the Cartet gang. If there is any department that works like a finely geared machine it's Carteret. Each and every one of the gang out

there has a set job but is able to take over the other fellow's duties on a moment's notice. The gang, as a whole, works like a well disciplined combat team. So, with Ray and Ed, they have developed an understanding of each other as any members within such a team must do.

1941 and old devil war came along to snatch Ray away for active duty in April. Here the parallel seems to end,



ED. FRANKE

but fate saw to it that their paths would cross during the war several times with neither of them realizing it.

Thriving, buzzing, Brooklyn Navy Yard took Ray into its maw and made a Radio Superintendent of him, testing and installing electronic equipment on board our various men of war.

1943 and the high seas as a Senior Assistant Communications Officer on the staff of the Commander of the Fleet Operations Training Command. Here he partook in shakedown cruises of new battlewagons and kept a weather eye on how the electronic equipment stood up.

1944 Iwo Jima. Shot and shell, Kamikaze's midget subs, and every form of Jap treachery and cunning were aimed at Ray's AGC (Command Ship). Then to Okinawa with more of same.

Finally in 1945, after "VJ" day, Ray bade good bye to battle while serving in another AGC which was part of a task force protecting mine sweeping operations in the East China Sea. Then stateside to continue the job from the Brooklyn Navy Yard.

The enemy did their best to make a casualty of Ray, but his closest call came when a badly aimed harpoon shot from a destroyer knocked his garrison cap off. He was in the process of ducking it, too. So, thanks to our stars, he is still intact.

(Continued on Page Sixteen)



## Four 807's Push-Pull Parallel

► The Presto 88-A is a 50-watt amplifier designed specifically to drive the modern wide range magnetic recording head, such as the Presto 1-D. Its very ample output stage—four 807's in push-pull parallel—provides adequate power at peak levels with a minimum of distortion. A selector switch provides a choice of:

1. Flat response 20 to 17,000 cycles per second,  $\pm 1$  db.
2. The NAB recording characteristic.
3. Rising characteristic for vertical recordings.

► The Presto 88-A is ideal for the most exacting recording requirements.

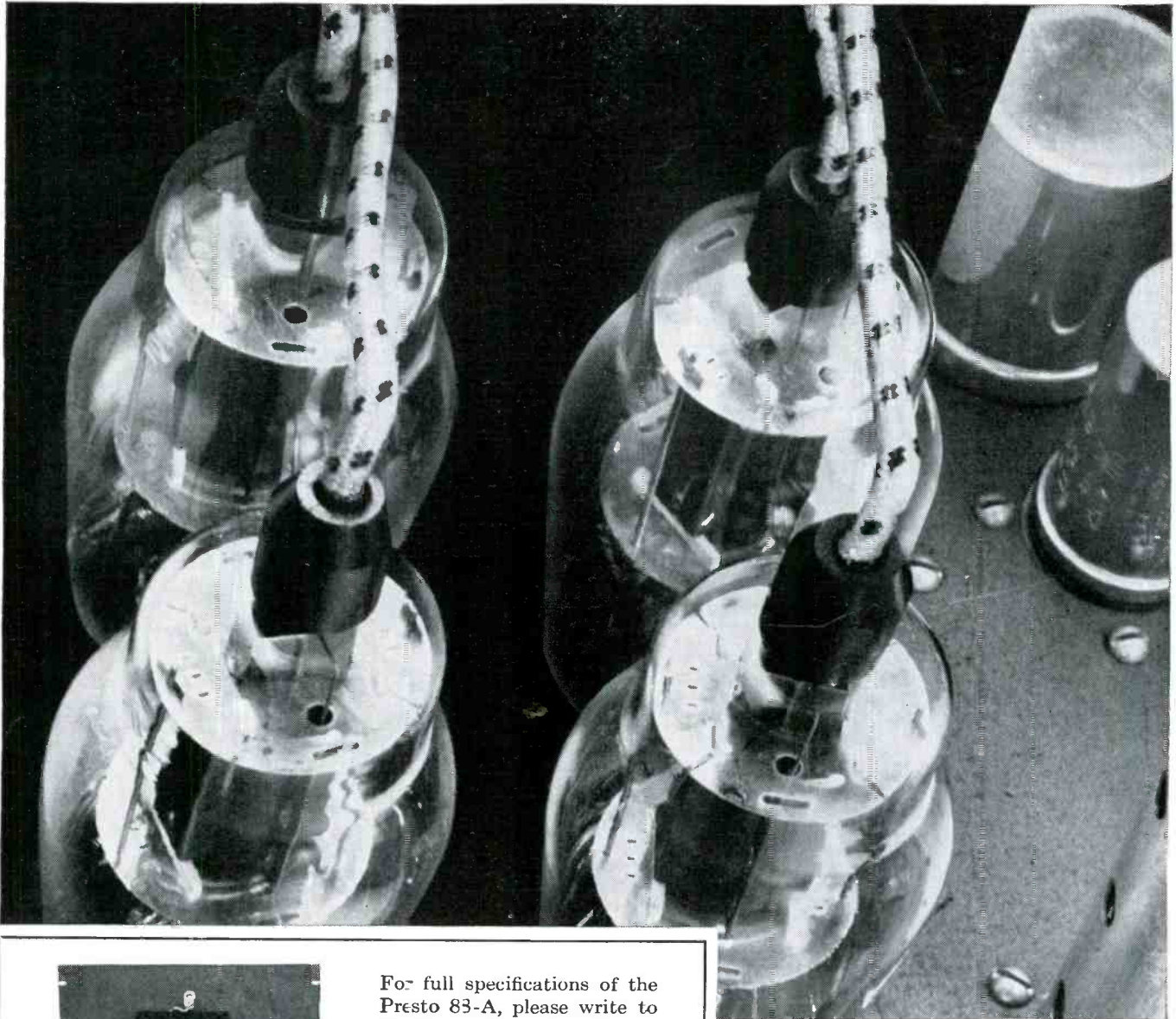

For full specifications of the Presto 88-A, please write to the Presto Recording Corporation, 242 West 55th Street, New York 19, N. Y. To insure future delivery within a reasonable time, we suggest that you place your order on our priority list since orders are considerably in advance of production.

**PRESTO**

RECORDING CORPORATION

242 WEST 55TH STREET, NEW YORK 19, N. Y.

Walter P. Downs, Ltd., in Canada

WORLD'S LARGEST MANUFACTURER OF INSTANTANEOUS SOUND RECORDING EQUIPMENT & DISCS



RAY O'NEILL, JR.

Franke & O'Neill (Continued from Page Fourteen)

Ed felt lonesome with his buddy away but added responsibility kept him well occupied. He became a junior supervisor during 1942. War seemed far off to him then. He little dreamed that early in 1944 he would be tendered a unique assignment acting as one half of a civilian reporting team representing the Mutual Broadcasting System on the active war fronts. When this occurred, life took on a dizzying pace with Ed off for London and high adventure. April, 1944, and a series of "dry runs" which were in reality wild goose chases that were supposed to take the enemy off the scent. He thought he was on one when he suddenly found himself along with his buddy, the correspondent, in an APA transport in the channel along with thousands of planes overhead. Out came his film recorder and the job of describing the Normandy Invasion was in process. "D" day plus seven saw him on Omaha beach.

Returning in a PT boat, the rough seas knocked him out of a chair, resulting in a three weeks' stay in an American naval hospital. Two weeks of buzz bombs in London and thence stateside for all too brief a time.

Off to the blazing blue Pacific via Pearl Harbor where he pitched in to help build radio studios in a Quonset hut for the Navy's CINCPAC. Thence to Manus Island where air travel from Pearl Harbor was over and a lumbering transport took over. At point "X" he picked up an Essex class carrier, a part of the third fleet. More grapeshot as the planes started to do their part in softening up the Jap defenses in the Philippines. A long swing into the South China Sea where bombardments of Indo China acted as a diversion. The same stunt was pulled fifty miles off Tokyo

Bay as we were really swooping on Iwo. When Tokyo was given a taste of carrier based bombing the force swung south to back up the Iwo operation. Here, without realizing it, Ray and Ed were within sight of each other.

From Iwo, Ed went back to Guam, and again aided in the construction of more Quonset studios.

Though Ed was classed as a civilian, he was not forgotten by the Navy. Admiral Nimitz sent him a signed photograph with a written commendation thereon. Secretary Forrestall also sent him a commendation.

Ray did well on the Fruit Salad front too, with: The Commendation Ribbon with Citation from the Commander, Amphibious Forces U. S. Pacific Fleet, American Defense Ribbon, American Theatre Ribbon, Asiatic Pacific Theatre Ribbon with two stars, World War Two Victory Ribbon, and Naval Reserve Medal.

June of '45 saw Ed's return to Carteret and a nice, new, shiny assistant supervisorship awaiting him. He became supervisor four months later. Ray and the Navy said au revoir in June of 1946, and he was a most welcome sight at Carteret. Once again "Old Fifty" felt at ease having two of her favorites on the scene.

Oyez, these fellows are both married. Ed made the fatal step in 1925 when he changed his Cathryn's name from Kuhn to Franke. Ray turned the trick for Carolyn in 1933.

Ed is an outdoor man with athletics being his forte. Ray, the proud possessor of two strapping sons and a tot of a daughter, is kept busy running a den of eight cub scouts. What little time he has left is given to model railroading and hamming under the call W2ALD.

With Stolzenberger's blue pencil staring me in the face, I must perforce, close. But I do want to say that both Ray and Ed are a swell pair and they have done their bit to make Carteret the show place that it is. I have not been out there since the late thirties but when I went there to interview the lads the place looked as shiny and spotless as ever. (They are not only good at applying their elbow grease but have done their bit towards making the fine record that "Old Fifty" has garnered as being one of the least often "off the air" transmitters in the country.)

I wonder what the fates have saved up for Ed and Ray? Will the strange parallel continue to tie their two lives together, or will it veer off into new and as yet, unseen fields of opportunity.

While we are waiting to find out,

keep up the good work Ed and Ray.

Next month, profile of Eugene Clark, of the WOR Studios.

## ROCHESTER

By George W. Wilson

WHAT'S in the books for 1947? Of course, we don't know, but at least we all have ideas and plans which will determine for the most part the nature of things to be. Our jobs and our NABET activities are always of first importance. An observation which serves to highlight the point of Bert Berg's letter to the Editor, printed in the November issue of the Journal. It's a challenge to those of us who write the news from our local Chapters to keep out of the Ham department, and stick to the Commercial side of radio engineering from which we earn our living. It's a constructive thought, and much as we enjoy our hobby of Amateur Radio, the material to be found in the Journal should be within the bounds of Commercial Radio and its relationship to NABET. At least this seems to be the opinion from Rochester.

At the present moment (the last of November), this city has been without a daily newspaper for almost four weeks. There are two dailies here, owned and operated by the same management, so when the boys walk out the natives must depend on the radio for their information on who does what and why. It's quite a job for the radio news boys, and has required a high degree of careful editing to maintain a position of strict neutrality. The position of WHEC has been a bit difficult, because WHEC is owned by the same person who owns the newspapers, and it was feared the printers might well take umbrage at aired statements. However, nothing has been said to hurt either side, and all concerned have done a good job in maintaining a sensible status quo.

In the not too distant past, the Rochester Chapter was in the process of organizing, and the problems at that time seemed almost too difficult to solve, yet they were with a high degree of success. Since then it has required constant effort to continue with a unity of purpose for the good of the entire membership, and that, at times has been none too easy. However, when we see the troubles confronting other Chapters, ours appears mighty small. The situation with the engineers at WENY in Elmira, N. Y., is one that none of us has had to meet, and it has taken more than unusual courage for the boys there to stick to their guns. One of our somewhat small problems has been that of getting a fair showing out to our meetings, and the fact that the Elmira members will drive the distance of 130 miles (a total of 260 miles round trip) to attend a meeting, rather makes some of the local members look silly who have been careless about attending. So, orchids to the WENY engineers. Good luck. This is all from Rochester for now. 73.

**A** LINEAR electric motor more than a quarter of a mile long is the latest answer to the problem of launching jet-propelled and robot planes and heavy bombers from shipboard or small landing fields without the initial impact of conventional catapults. This new device, called the Electropult, was designed and built by engineers of the Westinghouse Electric Corporation for the United States Navy.

The Electropult is essentially a huge electric motor laid out flat. The 1382-foot track corresponds to the rotor of a conventional machine and the small shuttle car which runs along it acts as

## 16,000 H.P. Electric Motor

—Laid Out Flat—Revolutionizes

## Plane Launching Technique!

By Ed. Stolzenberger

the stator. In operation, a plane is hitched to the shuttle car which speeds down the track and tows the plane into the air. In recent demonstrations at the Naval Air Test Center, Patuxent River, Maryland, the Electropult launched a jet-propelled plane at 116 miles an hour in four and one-tenth seconds after a

run of only 340 feet. Unassisted, the plane would have required a run of about 2000 feet for the takeoff. Running free, without load, the shuttle car has built up a speed of 226 miles an hour in slightly less than 500 feet.

Two Electropults have been built for the Navy, the first installed at Mustin

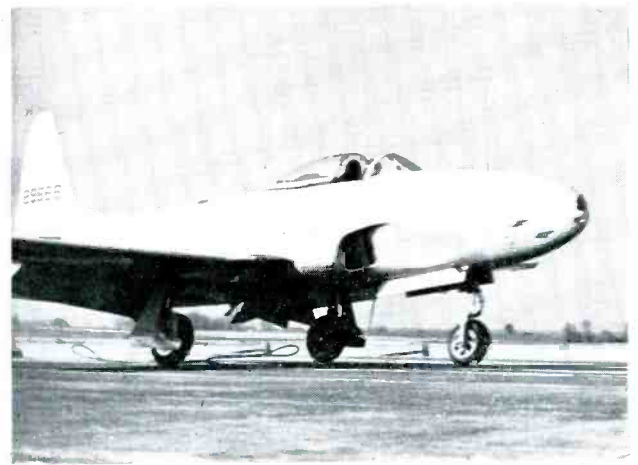

Westinghouse Photos

(TOP LEFT) Linear motor track of the Electropult . . . for assisting aircraft takeoff . . . at the Naval Air Test Center, Patuxent River, Maryland. About one-third of the 1382-foot track can be seen. Plane in background is at starting point being readied for launching. The central portion of the track is the core of the Westinghouse 1382-foot long linear induction motor. (TOP RIGHT) Naval mechanics ready a jet-propelled plane for launching by the Westinghouse Electropult. The plane is hitched to a small shuttle car by a steel cable bridle which will tow it down the "track." The plane can be launched at 116 miles an hour after a run of only 340 feet. (BOTTOM LEFT) Control room for the Electropult . . . electrical device to assist planes to takeoff . . . Power output during takeoff is 12,000 kw and is indicated by instruments on panel in center of room. (BOTTOM RIGHT) Here a jet-propelled plane takes off at 116 miles an hour after a run of only 340 feet on the Electropult. Developed by Westinghouse for the Navy, the Electropult is a 1382-foot linear induction motor to aid in launching plane from shipboard or small fields.

# HERE is a REAL VALUE in BROADCAST TYPE JACKS UNMOUNTED or MOUNTED IN STRIPS

We have a large quantity of standard broadcast jacks now ready for immediate shipment. Jacks have tip, normal, and sleeve connections, are individually inspected, and are sold with a money-back guarantee.

The jacks are available unmounted or already mounted in strips. These panels are of moulded bakelite, equipped with designation strips, and are ready to install on standard relay racks. Two sizes of jack strips are available: Type 111C, a single row strip with 24 jacks, and Type 121C, a double row strip with 48 jacks. Either size accommodates single or double patch cord plugs.

## IMMEDIATE DELIVERY

All jacks and jack strips are sold on a CASH basis. Prices shown are net prices with no discount permitted. We suggest that a check or money order accompany your order.

SINGLE JACK PANEL

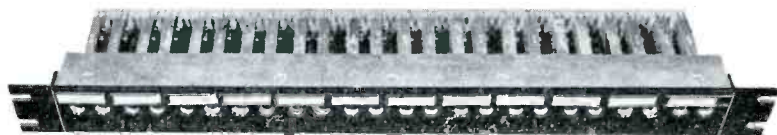

Please order by type number, indicating the quantity desired.

JACKS		JACKS MOUNTED IN STRIPS			
Type 101C		Single Strips		Double Strips	
Quantity	Price	Type 111C		Type 121C	
		Quantity	Price	Quantity	Price
1.....	.57	1.....	19.50	1.....	32.50
24.....	.47	20.....	17.40	10.....	29.40
500.....	.42	40.....	16.45	20.....	27.15
1,000.....	.38	80.....	15.20	40.....	25.20
1,900.....	.34	140.....	13.70	70.....	23.40
3,250.....	.31	200.....	13.00	100.....	21.25
5,000.....	.28	300.....	12.25	150.....	19.80
7,250.....	.25	400.....	11.55	200.....	18.40
10,000.....	.22				

DOUBLE JACK PANEL

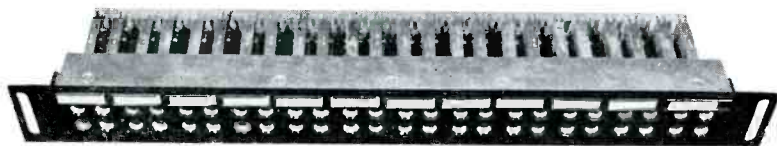

Jacks are offered subject to prior sale and jack strips are offered subject to availability. Order now!

**AUDIO EQUIPMENT SALES**  
923 EIGHTH AVENUE NEW YORK 19, N. Y.  
TELEPHONE CIRCLE 5-7798

Field, Philadelphia, and the other at the Patuxent River Base. The latter is the more advanced model although both are fundamentally the same. At Patuxent River the Electropult is installed on a 2800-foot concrete runway, 100 feet wide. The track is mounted flush with this runway above a concrete trench which contains the copper bus bars that carry current to the motor. Sunk into the concrete on both sides of the track are rails to carry the shuttle car.

The shuttle car itself is eleven and a half feet long, three and a half feet wide, and extends only five inches above the track. To harness the plane to the car a bridle of steel cable is used. The plane rides along the track on its own wheels and when flying speed is reached the car is stopped, the bridle drops off, and the plane takes to the air.

The power supply for the Electropult is housed in a sunken concrete vault beside the runway. A Pratt & Whitney 1100-horsepower aircraft engine starts the cycle. This engine drives a d-c generator which is connected to a d-c motor. This motor in turn is connected to an a-c generator and a 24-ton flywheel. The flywheel develops a tremendous amount of kinetic energy when accelerated to full speed of 1300 revolutions per minute. It is this energy stored in the flywheel that drives the a-c generator which supplies 12,000 kilowatts of electricity to the Electropult during the few seconds it takes to launch a plane.

The Electropult has no apparent limitations in speed or capacity within the range of requirements which are now foreseen. It gains in effectiveness as the size of the aircraft increases. With the ever-increasing speed and weight of aircraft it seems reasonable to expect that Electropults eventually may become the natural choice for the larger sizes of aircraft carriers.

Designs have already been completed for an Electropult capable of launching the largest existing airliners at 120 miles per hour with a take off run of 500 feet. Such airliners now need a run of about 4000 feet to accelerate to flying speed. Maximum acceleration would be about one "G" which would be built up during the first two seconds of the take-off run. This means that a passenger would be pressed back into his seat by a force about equal to his own weight.

Other possibilities for the Electropults besides aircraft carriers are floating airports or seadromes, barge-type airports on city water fronts, mid-city airports, and revival of outgrown airports.

## Another Letter to the Editor

JUDGING by the minutes of the National Council, that body put in a hard week's work at Denver, out of which came solutions to many of our problems. But it is obvious some things were done hastily and without the thought and consideration they merited. I have in mind a constitutional amendment using the meaningless phrase, "any special or general meeting of the Association." Similarly, many urgent problems were entirely ignored and too much time taken up by trivia.

A meeting of the National Council is an expensive investment. For better returns on that investment, why not standing committees to work throughout the year, the President's annual report be made several months before the meeting, a method of screening the business coming up before the Council and a committee to follow up on the enforcement of Council policies?

(Signed) Charles H. Thropp  
Hudson Chapter, NABET

## BALTIMORE

By Alex Beauchamp

I HAVE received a petition from the Te's of WITH, that they are not getting their names mentioned in the Journal. They feel they should take me to task, and get to the bottom of the situation. (Is my face red!)

WITH—F. M., went on the air commercially for the first time, on November 4, 1946, at 10:00 A. M. Otis R. (Alex) Beauchamp, was first Te to put the carrier on the air. John Lappe holds the same distinction for the A. M. transmitter that went on the air for the first time, March 1, 1941.

Bud Chell, an Ex-G. I., was on duty at the master control. Bud worked at WITH before the war, returning to his old job after serving in the Navy.

Due to the F. M. going on the air officially, Otts Claus has been reinstated at the controls, after a prolonged vacation—Otts worked the summer vacations.

It is a fact that you must study radio in order to get a ticket. But Ralph Carpenter has his own ideas. (Ed's note: What about the ticket Carpenter has held since 1943? A second class ticket is all that is necessary to operate police radio.)

Ralph, a former member of the technical staff at WITH, resigned to become a member of the Maryland State Constabulary. He is learning how to arrest drunken drivers, handle emergency births, catch murderers, reckless drivers and what have you. Ralph will have six months of this preliminary training before he can resume his radio career. We wish him luck.

In answering the question, why wasn't anything in the Journal about Lappe's and

The Broadcast Engineers' **19**  
Journal for January, 1947

# Unusual and Vital ELECTRONIC EQUIPMENT

PRODUCED BY

## TECH LAB

SUBCONTRACTING DEPT.

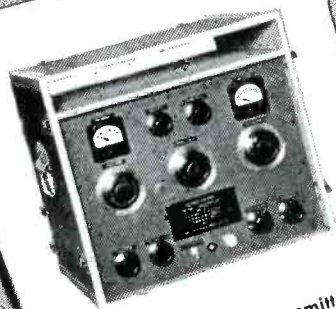

Special Short Wave Transmitter  
Range: 1-16 megacycles on  
one dial.



Development of special  
hearing aid analyzer for  
Western Electric Company.

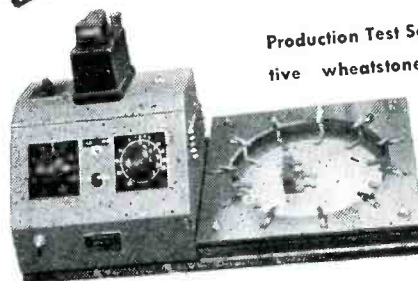

Production Test Set to test varistors. A sensitive wheatstone bridge arranged with switching means for quickly checking a number of varistors in rapid sequence.

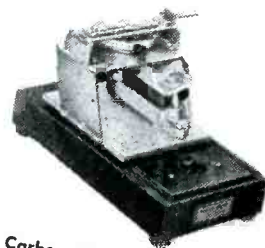

Carbon filling machines for  
precision filling of carbon  
microphones.

Manufacturers have continually called upon the modern facilities of Tech Lab Subcontracting Department to assist them in the production of unusual and vital electronic equipment. Our Engineering Department is ready to assist you with your production problems.

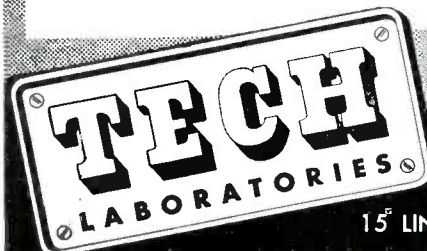

MANUFACTURERS OF PRECISION  
ELECTRICAL RESISTANCE INSTRUMENTS

15 LINCOLN STREET, JERSEY CITY 7, N. J.

FOR TRUE

SOUND REPRODUCTION

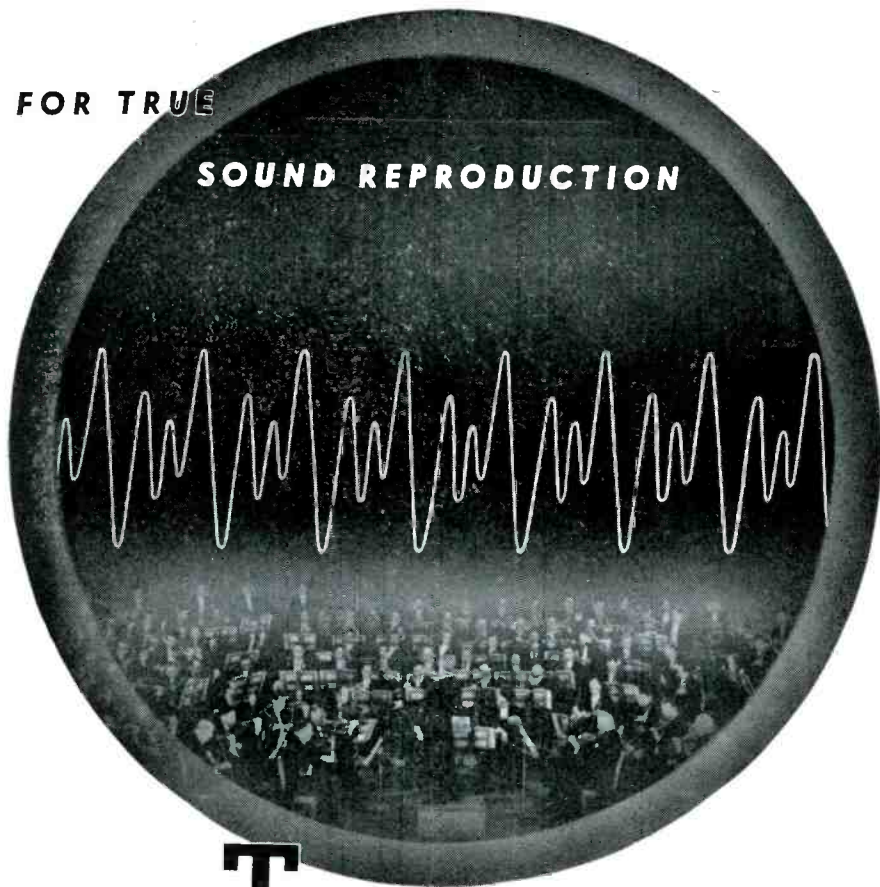

## TERMINAL

SPECIALISTS IN ALL HIGH QUALITY  
SOUND EQUIPMENT

It's results that count and that's why the **TERMINAL RADIO CORPORATION** is the leading supplier to broadcast stations, recording studios, sound engineers and other users of high quality sound equipment.

### Now Available for Immediate Delivery!

- **PICKERING** Pickups, Equalizers and Preamplifiers. Pickering's is the **only** pickup which satisfies FCC standards for FM broadcasting. Acclaimed by top-notch sound engineers as the finest reproducer for lateral-cut phonograph records and transcriptions.
- **ALTEC LANSING** Speakers, Cabinets and High Fidelity Amplifiers. Chosen by leading radio stations, motion picture studios and auditoriums, Altec Lansing is now available through the Terminal Radio Corporation to studios and high fidelity enthusiasts.
- **RADIOTONE** Portable Transcription Two-speed 16 inch Recorders. Radiotone Hollywood's new improved portable recording equipment is probably just what you've been looking for. Now available in several models for high quality disc recording and dubbing.
- **AUDIO DEVICES** Audiodisc aluminum and glass base Recording Blanks. **Audiodiscs** are high quality, precision-made instantaneous recording blanks which have won the praise of professional and amateur recordists. Designed for all high fidelity recording applications, available in sizes up to 16 inches.

As distributors for these and other high quality audio equipment, the **TERMINAL RADIO CORPORATION** can fill your high fidelity sound requirements.

Visit our Sound Studio to see and hear the newest equipment or write us for descriptive literature and prices.

**TERMINAL RADIO CORP.**

85 CORTLANDT STREET, NEW YORK 7, N. Y.  
PHONE WGRTH 2-4415

Hedrick's vacation, I have yet to receive one word from either of them, relating how, when, and where they spent their vacations. I would like to write about the things you do and the places you go, but I can not make up true facts out of the thin air.

Allen Hedrick has an odd hobby. He is starting to breed canaries. We are all waiting for his first offerings for sale. Bob Parks is back spinning controls again, thanks to the departure of Ralph Carpenter.

Butch Stockslager, Jr., seems to be dreaming of a white picket fence, (the house comes later). Butch had a date with a girl and so went out and bought an eight dollar orchid. He thought he would grab a bite to eat, so he left the orchid inside the studio street door. While he was eating, the WITH receptionist left to go home, and found the orchid. She went back and inquired of every one, who owned it, but no one did, and after deciding finders keepers, she took it home. Then, after all had gone home, things really exploded. Butch came back and wanted to know where his flower was. He found out, and had to pay a taxi driver about a buck to bring the flower back. All was peace and quite except for his being late for his date.

WITH engineers are, at this writing, waiting for Mr. Allen in order to start contract negotiations. Here's hoping.

On Saturday, December 21, WITH gave a Christmas party for the employees. Will give a report on the hang-overs along about next March, if the Anti-saloon League doesn't catch up to me in the meantime.

## TELEVISION

By Jack Irving

**N**OW that television field is large enough to rate some space on its own account, we would like to introduce those who have been added since the last column, lo, these many months ago. Here they are: Hal Bowden, Bob Galvin, Alan Henderson, Fred Squires, Andy Switzer, and O. Tamburri.

Ollie Fulton, formerly in the studio crew, and now one of the field's heaviest men, is back at his old eating stand after spending the Christmas holidays with his parents in Pittsburgh. Ollie swore that before he went home he would lose 20 pounds, but still tips the free scales at 200.

Bob Daniels, who recently was persuaded to pose for some nude pictures because of his Apollo-like build, was so pleased with the result, he has ordered two dozen prints. Many friends have called the field labs requesting these pictures.

Hal Bowdin, one of the new men, has taken up abode at 3 E. 73rd St., a lovely place very handy to St. Nick's Arena. Hal has thrown some mid-Victorian parties highlighted by the midnight dancing of the minuet. In recognition of Hal's talents, the field crew have christened the apartment

The Broadcast Engineers' Journal for January, 1947 **20**

"Propriety Plantation."

Burke Crotty, of production, who, according to Billboard, did such a fine job on camera at the Army-Navy game, is now practicing his camera technique for girls' hockey. Not quite as fast as ice hockey, the games have many similar points.

The field crew has been formally requested to chip in and buy one taxi on out-of-town trips instead of each member purchasing his personal cab. This request by Ed Wilbur, who incidentally, has a wonderful sense of humor, was enthusiastically received by the men who walked in the rain from the telephone building to their respective hotels.

Famous last words—"You can go anywhere in Baltimore for 35 cents"—you can, if you have a friend with a bicycle.

In recent months, the field, ready for the boom, received another unit with two more camera chains. The group was split in two groups, the green and the blue. The green does one type of show with the new equipment; the blue, another, with the old. Anything more specific on this subject would be highly inflammatory.

The NABET luncheon meetings have proven so satisfactory to "Waldo" Mullaney, our redoubtable councilman, that "Waldo" is not earnestly electioneering for another term. Good luck, Walter. The concensus is that you really deserve it.

The Christmas party at the Waldorf Astoria was an occasion for concern for Alfie Jackson, assistant field supervisor. Alfie was in charge of the fight show at St. Nick's Arena to be televised at 8:30 p.m. Jackson circulated among the different tables hending an anxious eye upon those with a drink in each hand. It can be said to Dr. Alfredo's credit—he didn't say anything. The show, incidentally, went off without a hitch; proving moderate drinking a moral trait of the blue division.

All of which brings up the Odyssey of the Astor Table. It seems that some time ago when the field equipment was transported by Mike's Gentle Trucking Service in lieu of the broad backs of the engineers, a small table on wheels was inadvertently packed by Mike's gentle helpers. Time and again, Wilbur has attempted to have the table returned, but something always seems to happen. Came a job at the Waldorf Astoria and time to leave, lo and behold, the table was missing. One of the waiters at the Waldorf had appropriated our audio table. After diligent search, it was discovered doubling in brass as a service table. Long argument finally convinced the waiter that we were not trying to steal a table from the Waldorf, but only attempting to return it to the Astor.

Our closing thought for the day—for video men—forget the front and back porch; if the light is burning in the window, go inside for a drink.

To those not in the field, many of these feeble passages may well appear without point. To those involved, the double entendre will not be lost. Soooo, if in doubt, punt.

A

A



# ALLIED

*The Name to Remember for  
Quality in Recording Discs*

**ORDERS SHIPPED PROMPTLY**

**ALLIED RECORDING  
PRODUCTS COMPANY**

21-09 43rd Ave., Long Island City, N. Y.

Phone STillwell 4-2318

Cable: Allrecord, New York

## CAPPS\*

SAPPHIRE is, and has always been, the only material for making cutting styli for high class recordings.

CAPPS\* Patented Sapphire Styli (2187512) are the original and accepted standard for high class professional acetate recordings.

*Imitated but not equalled*

**FRANK L. CAPPS & CO., Inc.**

244 W. 49th STREET NEW YORK CITY

Telephone Circle 6-5285

\* Reg. U. S. Pat. Off.

## C O P I E S

**BY DIRECT CUTTING  
OF YOUR RECORDINGS**

33 $\frac{1}{3}$  RPM transcriptions  
for broadcast or audition  
use.

**24 HOUR SERVICE**  
—packaged and shipped  
from Chicago.

Aluminum based material  
available for broadcast use.



Write for  
complete  
details and  
prices.

**L. S. TOOGOOD**

**RECORDING COMPANY**

221 N. LA SALLE ST. CHICAGO 1

## ADP-KDP Crystals

(Continued from  
Page Thirteen)

the other directions and polarization results. This is accompanied by a corresponding piezoelectric shear proportional to the number of dipoles aligned along the Z axis. The decrease of coupling with temperature, shown by Figure 1, is caused by the increased random arrangement of the hydrogen ions at the increased temperature, which makes it more difficult for an applied electric field to line up the dipoles along the Z axis.

In ADP an ammonium ion,  $\text{NH}_4^+$ , replaces the potassium ion of KDP and permits the possibility of a new set of hydrogen bonds, one, as in KDP, and the other formed by the hydrogens of the ammonium being shared between the nitrogen N and the oxygens of the nearest  $\text{PO}_4$  groups. On cooling to temperatures below  $-125$  degrees C. some change, probably a rotation of the ammonia group, takes place in ADP which causes the crystal to shatter.

The dielectric and piezoelectric properties of ADP are probably controlled by the same  $\text{H}_2\text{PO}_4$  bond system that is operative in KDP. The second set of hydrogen bonds in ADP more firmly knits the cell together and causes a larger change in shearing stress for a given dipole change than occurs in KDP which does not have the second set of bonds. The size of the unit cell has increased to 7.53 Angstrom units along the X and Y axes and 7.54 Angstrom units along the Z axis. This near equality of the edges of the unit cell indicates that the energy of the dipoles should be nearly equal for directions along Z and normal to it and hence the crystal should not be ferroelectric, a supposition that is borne out by the measurements. The principal piezoelectric distortion of ADP is a shear connected with an excess of dipoles along the Z axis and is directly proportional to the number of dipoles so aligned. Furthermore, the distortion for a given number of dipoles directed along the Z axis is over five times that for the same number of dipoles similarly directed in KDP. This accounts for the larger electromechanical coupling in ADP.

For ordinary temperature ranges, ADP has a larger electromechanical coupling than any other available non-ferroelectric crystal. It has already received large application in war equipment and will doubtless find extensive use in post-war commercial products.

## MOHAWK NEWS

By Joe Gagne

Not too much has transpired here in the past few months, so we are adding a few pictures to help out with the interest. To give you fellows who are unfamiliar with the weather here in the winter, here is a shot taken of the mobile unit out of "Pappy" Knapp's office last winter. Some heapum big snow eh?



This other shot shows some of the gang helping out Frank



Boudreau after the exchange broadcast between the BBC in London and WGY. This was a Youth Council bc between several Schenectady members and several of our British Cousins. The Stretcher bearers are just about ready to carry out the victim of nervous exhaustion.

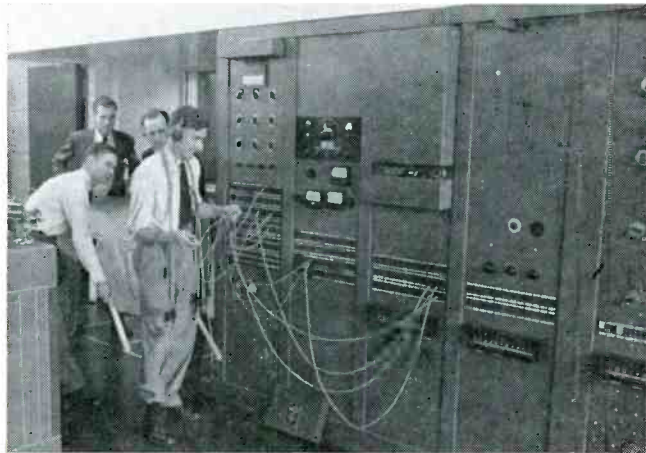

### BOUDREAU'S MASTERPIECE

Patching WGY Master Control for transatlantic broadcast. Left to right, Bob Vadney (bending over), Joe Gagne, Ralph DeGraff, and Frank Boudreau.

Now we were surprised to receive the following letter from one unsigned, but reading like the lingo of either Lewis or Durkee. So, here it is:

Dear Joe:

Having let you down on last month's edition from the Helderberg's "retreat," and I say that because winter is fast coming on—(we've already had one snowfall up here) we'll try to have this ready for you to tack on the chapter news for the coming issue.

Beginning with the first of this month, Television galloped up from 3 nights to 6 nights a week with the return of relaying WNBT in NY.

With this change, our staff, who have manned the Helderberg station since the time the Draft Act caught up with us, have two new additions—one being one of our pre-war members who was in the Naval Reserve and left us in '41 to see the world with the Navy to return as an Ensign—Maynard Cummings. For awhile after his return to being a "Civvy" he was out at South Schenectady. All of us here are glad to have him "back in the family."

Our other addition—Keith Mullenger, we have temporarily enticed from Tele Studio.

Speaking of winter, brings to mind several things. We had visions earlier in October, when our first snowfall looked like the real business of last year's. We expect heavy storms in November.

Last year Assoc. Ed's Note—I had to use an interpreter to get sense out of the following but I gather it goes something like this—) being well prepared, Ken Durkee and Ty Schumaker set off "as usual" in the Station Wagon from the studio. Our Winter precaution of chains and snow shoes were resting comfortably in the transmitting station on the mountain as previous winters the first snow fell around the early part of December.

As Ken and Ty drove along, the snow flew, and it also kept piling up. Finally about two miles in the Schenectady side of Thomson's Lake, the car just wouldn't go any further—not even the highway dept was prepared for that early storm.

Ken and Ty left the car by the roadside and began the mile-long hard trek a-foot for the station five miles away.

However, this year it was not so bad, as there was little snow. And besides, from now on the car will be fully equipped with winter stuff.

Perhaps the jeep—we've tried a sedan and a station wagon—with its four wheel drive and two speed transmission will take us where the others haven't when the winter going begins to get tough.

(Signed) "The Hill"

*for your work or hobby*

## NEWARK OFFERS YOU

Source of supply for all radio and electronic equipment and parts. Products of leading manufacturers in the industrial as well as home equipment fields. Complete stocks.

Through its Bargain Bulletins, the latest news about the latest developments in radio and electronic equipment. Get on the list to receive these valuable bulletins regularly.

Prompt, speedy delivery on orders. Expert and courteous advice on equipment and parts problems.

Complete stocks of all leading public address systems, plus able advice on setting up special installations.

Visit any one of our three large stores. You will find complete stocks of industrial equipment and parts as well as home appliance and radio equipment. Send us your name and address and ask for Bargain Bulletins.

★ MAIL ORDERS FILLED FROM EITHER NEW YORK CITY OR CHICAGO

NEW YORK  
Offices & Warehouse  
242 W. 55th St., N.Y. 19

**NEWARK**  
**ELECTRIC COMPANY, INC.**

CHICAGO  
323 W. Madison St.  
Chicago 6, Ill.

New York City Stores: 115-17 W. 45th St. & 212 Fulton St.

U1

## Tear This Off

Fill in completely, and give to your NABET Chapter Secretary along with your 1947 NABET dues; he will submit in bulk to the Editor. Other readers please mail directly to the Editor. This poll is being conducted for the guidance of the Journal's Editor and Trustees. (Fill in: more, less, same.)

- I want ..... NABET News and Activity.  
I want ..... news of activities of other unions, business news and trends that relate to broadcasting.  
I want ..... space devoted to Chapter gossip columns.  
I want ..... space devoted to technical articles.

To permit the Journal to comply with readers' requests that we publish a list of NABET members' ham calls, fill in:

Call ..... Ph/CW ..... Freq. .... Pwr. ....

Post Office Zone Numbers: The Zone number is here to stay. Look at the mailing stencil on the front cover of this magazine; if it is incorrect in any detail, let us know. Your local mail carrier will tell you your Zone number; write it here before you forget it: .....

Signature .....

(Chapter) (Group) (Station) Jan. /47



Photo by Joe Conn

# New York News

By Gil McDonald

ABC and NBC held their usual children's Christmas Party in Studio 8H, this Christmas Eve, and it was well attended by the wives and numerous offsprings of the New York engineering staff, many of whom remained after the party to visit behind the scenes. Gifts were distributed to the kiddies after a very entertaining show was presented in the studio.

**APPRECIATION**—The Three Suns sent over three cases of Xmas spirits for the Field-Studio gang as appreciation for their work during the past year on their Picadilly show. See "tag line" at end for further info.

**PROMOTION**—On Dec. 16th, Charles Bennis was promoted to the post of New York Recording Supervisor. Charlie, our erstwhile NY Chapter Chairman, came to NBC in Dec., 1928, as a field and studio engineer and since January, 1936, has served as Master Control Engineer as well as Transmission and Switchbanks engineer. We all wish him the best of luck in the new job and agree it couldn't happen to a nicer guy.

**MAINTENANCE**—The busy little beavers in maintenance are hard at work converting surplus radar equipment into television receivers. Several are under way and we are all awaiting the results. When the job is done, I'm going to try to get some of the boys to collaborate on an article for the BEJ. (Good!—Ed. S.)

**DOUGH**—A reminder from Bob Massell that dues for 1947 are now payable. The national dues are \$1.00 per month per \$1,000 of salary plus a 20% assessment on this figure plus \$10.00 local dues. He wishes to point out that dues must be paid by Money Order or check, payable to "New York Chapter, NABET," either in full or quarterly as in the past. Please note that cash will no longer be acceptable.

**ABC FIELD**—ABC Field no longer exists as a separate unit. Field men are now filling in on studio shows and the studio boys can now be expected to be handling more field assignments. Bill Trevarthen expects a flock of RF pickups during the coming year and as a result Messrs. Nilsen and Hornung are experiencing quite a business boom.

**NBC RECORDING**—Congratulations to Mr. and Mrs. Howard Firestone on the birth of Peter Glen Firestone, their first child. Mrs. Firestone will be remembered as Vicki Lazarek, formerly of Recording. Mother and son are doing fine. Pop, too. Welcome to an old friend in a new locale. Del Neutzman, formerly of ABC Studio, joined Recording this month as an engineer. Another new face on the seventh floor is that of Jack Kelly, who came over from Muzak. Welcome friend. Neil McCarrol and Hal Schneider really busy handling the Hi Jinx job. Hal did a great deal of work with the Swiss Broadcasting Service recording on paper tape. The machine was made by Brush and judging by the recording gang's enthusiasm, it must be a good deal.

**STEP UP AND MEET DEPARTMENT**—Step up and meet Mary Bell, fellers. Mary is the recording engineer with the fast up-take that floors most of us with a snappy come-back every time we get her on the TOE phone for a recording job. She claims Aberdeen, Wash., as her home town, although she hasn't lived there for quite some time. A graduate of the University of Michigan

where she studied radio engineering, production and acting, Mary has been an NBC recording engineer for the past three years. She gained most of her recording experience, previous to NBC employment, at The General Sound Corporation in New York. While living in Detroit, Mary earned her living by acting on WJR and WXYZ local and commercial shows.

**CONDOLENCES**—We wish to express our sorrow at the death of John Rodenbach's father, who passed quietly away on Dec. 18th. He was buried in the family plot in Buffalo, N. Y.

**TAG**—Next time it will be delivered by the FBI. . . . Gil.

## Another Letter to the Editor

KGO, Oakland, California.

Dear Ed:

Any resemblance between this communique and preceding communiques both living and dead is purely coincidental. Like H--- it is—but allow me to commiserate—might even sell a subscription. I understand a Circulation Manager will do almost anything to sell a sub.—well, almost anything!

Shall we open with a broadside? Have pity on the poor editor of a professional association or trade union publication—which after all is essentially what our magazine represents.

We hear from one side that it has degenerated into a meaningless rural gossip sheet; from another that it has become "hammy"; there are demands for emphasis on commercial broadcast technical articles and some intrepid white-corporuscled gentlemen have even gone so far as to protest against our beloved cheesecake! Ai yi YI, what next?

Meantime, the journal languishes thinner and thinner—might even be criticized into non-existence, which I'm sure is not the object of all this well-meant constructive criticism. Would you stand at the shoulder of a skilled surgeon directing his flashing scalpel? I think not. Somebody might lose some valuable appendages. Neither can Stolze slice here and lop there at every suggestion.

By godfrey no—the several good technical articles in each issue are enough. If anyone feels the crying need for more they can jolly well avail themselves of excellent current technical periodicals and texts for that purpose which heaven forbid reprinting in our Journal. QST exists solely for the inveterate ham, certainly, but there is some ham in all of us—this ranting for instance and some of the letters that have preceded it. I see no reason to froth at the fangs if a few casual remarks are thrown in about "amachoor activities". Aye, you can even take your cheesecake elsewhere to boot if your arthritis will no longer permit standing on windy corners. Try (ahem) Artists and Models, for instance.

Personally, I am convinced Stolze (Mr. Stolzenberger to you!) has his ear to the ground, is doing a fine job and keeps a fairly balanced book. Let's reflect upon the fact that this is a Union journal, wide-open for contributions along the lines of Union news, activities, organizational articles, trade-union educational material, aims and personalities of our Union and fellows—don't lose sight of the fact that our journal is out to sell our organization. NABET to outsiders—space in the book for plenty of such copy would not be wasted. Now, let's have your ideas!

Applause  Boos

Fraternally,  
(Signed) Kendrick Martin,  
TE-KGO; W6YDC.

*Original Recording For*

# BILLIONTH RECORD



... on **audiodiscs**

Recently in Camden, N.J., where the Victor Talking Machine Company was founded some 48 years ago, the billionth R.C.A. Victor Record was produced, thus marking a milestone in the history of the company, as well as the record industry.

For this history-making record, the Victor Division of the Radio Corporation of America chose two of John Philip Sousa's stirring marches, "Semper Fidelis" and "The Stars and Stripes Forever," played by the Boston

Symphony Orchestra under the direction of Serge Koussevitsky. And for the discs, on which the original sound recording was made, they chose Audiodiscs.

For the original sound recording in the phonograph record and electrical transcription industries—for master discs used in processing—for sound recording and reproduction in radio broadcasting and motion picture studios—Audiodiscs hold a place of eminent leadership.

**AUDIO DEVICES, INC.**, 444 Madison Avenue, New York 22, N.Y.

Export Department: Roche International Corp., 13 E. 40th Street, New York 16, N.Y.

Audiodiscs manufactured in the U. S. A. under exclusive license from PYRAL, Paris.



*they speak for themselves* **audiodiscs**

# Specify **DAVEN** TRANSMISSION MEASURING SETS

To accurately measure transmission characteristics of audio systems and their components

These transmission measuring sets are accurately designed instruments for the measurement of the transmission characteristics of audio frequency communication systems. This equipment may be applied to measure gains or losses through amplifiers, repeaters, attenuating networks or communication lines without the use of laborious calculations, complex setups, or sensitive meters.

The sets shown here are sturdy compact units built to exacting specifications. Your further inquiry is invited. Technical questions will be answered by our Engineering Department.



**TYPE 8A**

A portable battery operated set . . . weight 14 pounds.

**TRANSMITTING SECTION:** Contains an internal oscillator, operating at a frequency of 1000 cycles. Output impedance is 600 ohms either balanced or unbalanced to ground. Output levels are 0 DBM\* and -20 DBM\*.

**RECEIVING SECTION:** Frequency response is  $\pm 0.3$  DB from 30 to 10,000 cycles. Input impedance is 600 ohms terminating, and 6300 ohms bridging either balanced or unbalanced to ground. Will measure levels of -30 to +10 DBM\* at zero VU meter indication, when terminating a line.

**DIMENSIONS:** 9 3/8" high x 6 1/2" wide x 12 7/8" long.

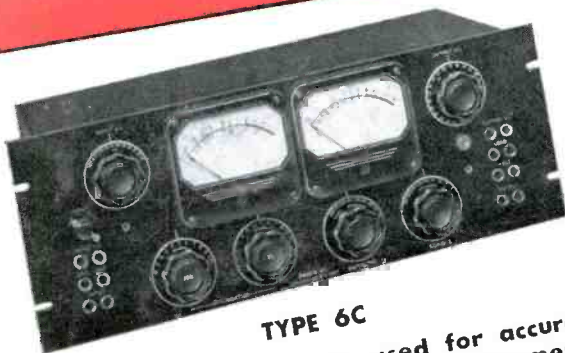

**TYPE 6C**

Primarily an instrument used for accurate gain and frequency response measurements. Must be used in conjunction with an external audio oscillator.

**TRANSMITTING SECTION:** Provides sending levels from -106 to +26 DB in steps of 1 DB for zero VU meter indication.

**RECEIVING SECTION:** Frequency response is  $\pm 0.3$  DB from 30 to 17,000 cycles. Will measure levels of +4 to +42 DB in steps of 2DB for zero VU meter indication. Input impedance is 600 ohms. Output impedance is 30, 50, 150, 200, 250, 500, and 600; 500 shunt and 600 shunt, either balanced or unbalanced to ground. Load impedance is 8, 15, 30, 50, 150, 200, 250, 500 and 600, either balanced or unbalanced to ground.

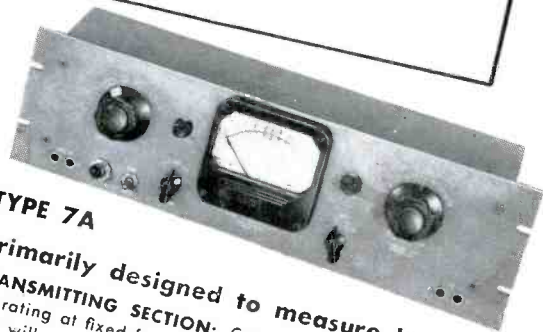

**TYPE 7A**

Primarily designed to measure losses.

**TRANSMITTING SECTION:** Contains an internal oscillator operating at fixed frequencies of 500, 1000, and 2500 cycles and will provide output levels of -13, 0, +4, and +10 DBM\*.

**RECEIVING SECTION:** Frequency response is  $\pm 0.3$  DB from 30 to 10,000 cycles. Will measure levels of -30 to +10 DBM\* at zero VU meter indication when terminating a line. Impedance is 600 ohms in both the transmitting and receiving sections.

\* DBM is based on a reference of 1 MW into 600 ohms.

THE **DAVEN** CO.  
191 CENTRAL AVENUE  
NEWARK 4, NEW JERSEY