

MARCH 1983

\$3.00

# BMUE

BROADCAST MANAGEMENT/ENGINEERING

KU0000099798-XM-2821 AJ1  
T W DENBRDOK DIR OF ENG  
KUOW RADIO  
326 CMU-II OF WASHINGTON  
-AD

# INAB '83

# THE SHOW STOPPER

is at Booth 1223

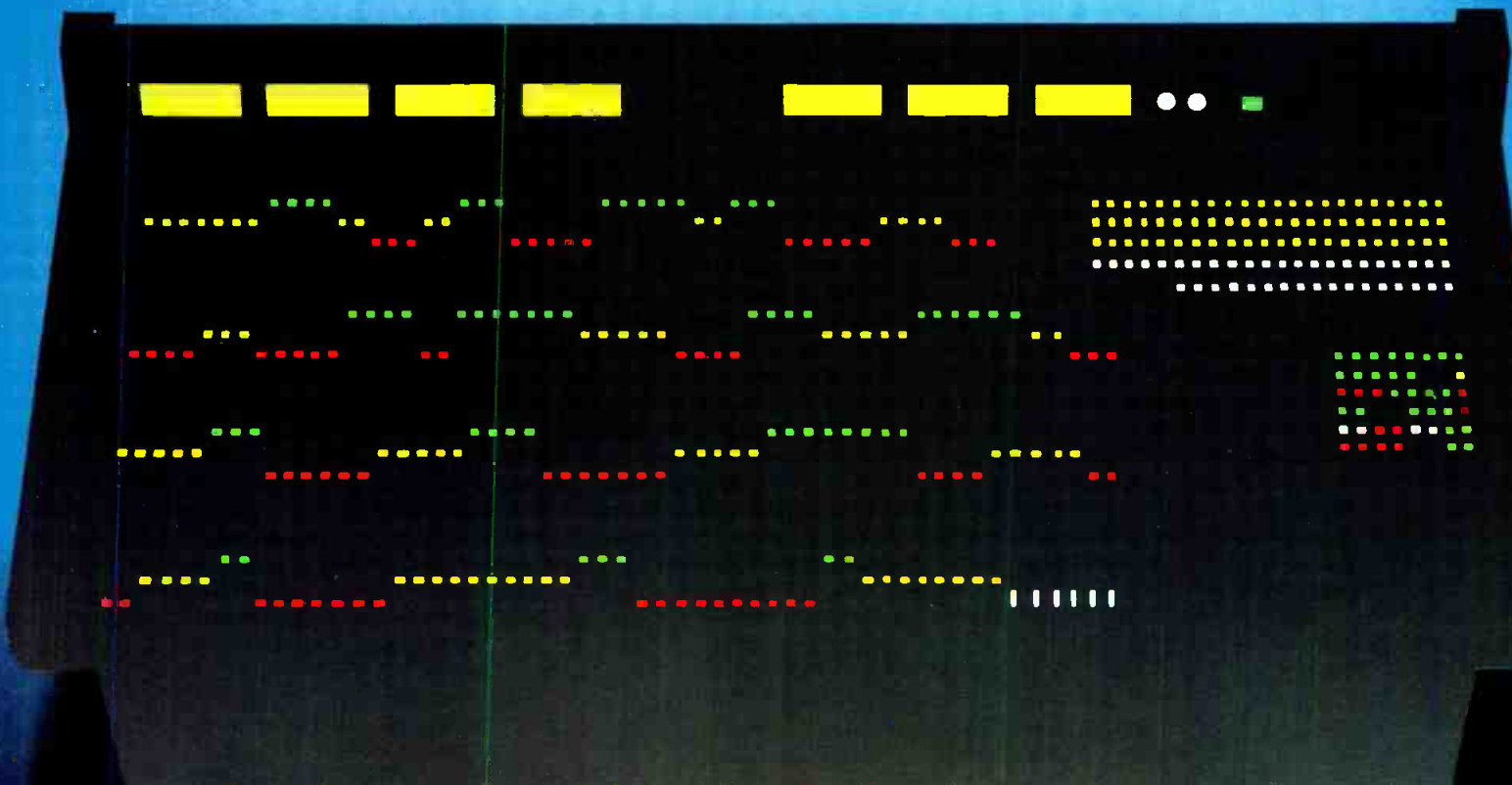

Introducing the newest,  
most advanced console  
in the industry.

# ADM

*The  
Audio  
Company*

MAIN OFFICE AND  
EAST COAST SALES  
(313) 524-2100

WEST CENTRAL SALES  
(817) 467-2990

WEST COAST SALES  
(415) 945-0181



# Image is Everything.



## **BARCO's CTVM Master Control Series lets you monitor your on-air look critically and confidently.**

The look of perfection.

Something every chief engineer, station owner and manager strive to achieve. The best available studio and control room equipment makes the difference.

Television stations all over North America with BARCO CTVM monitors in their master control rooms more than make the grade. They set the standard.

With CTVM monitors you see the picture as it really is, down to its finest detail or defect.

The sophisticated electronic design pays particular attention to stability, linearity, geometry and color fidelity. It ensures an accurate reproduction of the picture with distortion reduced to the absolute minimum.

CTVM monitors offer features you've come to expect from the world leader in broadcast monitors: pulse cross; underscan; standard, high or ultra high resolution CRT's; R minus Y, B minus Y outputs; RGB in and out. A choice of American standard or EBU phosphors assures color compatibility with other monitors. And the CTVM series is dependable and highly reliable, designed for continuous operation 24 out of 24 hours.

BARCO CTVM monitors are available in 14" or 20" models and feature modular PC boards for easy service and maintenance.

For the world's best engineered and most carefully built master control monitors, look to BARCO, where image is everything. Available in the U.S. only from ELECTOR.

### **ELECTOR USA, INC.**

NAB Booth 1131

In The U.S., Elector USA, Inc., 5128 Calle del Sol, Santa Clara, CA 95050 Phone: 408/727-1506 30 Chapin Road, P.O. Box 699, Pine Brook, NJ 07058 Phone: 201/882-0584 In Canada, Electro & Optical Systems, Ltd., 31 Progress Court, Scarborough, Ontario M16 3V5 Phone: 416/439-9333

Circle 100 on Reader Service Card

# COMING ATTRACTIONS FROM THE VISIONARY IN VIDEO.

Starting Sunday, April 10, for four days only, come see Sony Broadcast at NAB and you'll see technology so advanced it may be years before you see it from our competitors.

You'll see the industry's lightest, most compact and highest performance camera/recorder—the Sony Betacam™ system. With new accessories that make it the most complete and flexible system available. And Sony's genius makes it something else: the most affordable.

You'll see the latest advancements in U-matic® technology from the inventors of U-matic technology.

We'll unveil the state of the art in 1" type C systems, and the future of post-production systems.

You'll also get to explore Sony's three fully operational editing suites, the most complete line of portable ENG/EFP cameras in the industry, and the complete line of 1/2", 3/4" and 1" recorders they interface with.

And this year the visionary of video will show you a demonstration of high-definition TV, the promise of tomorrow.

See it all now from Sony, or see **SONY®** it all years from now from someone else. Broadcast

Sony and U-matic are registered trademarks and Betacam is a trademark of the Sony Corporation. © 1983 Sony Corporation of America, 9 West 57th Street, New York, New York 10019.



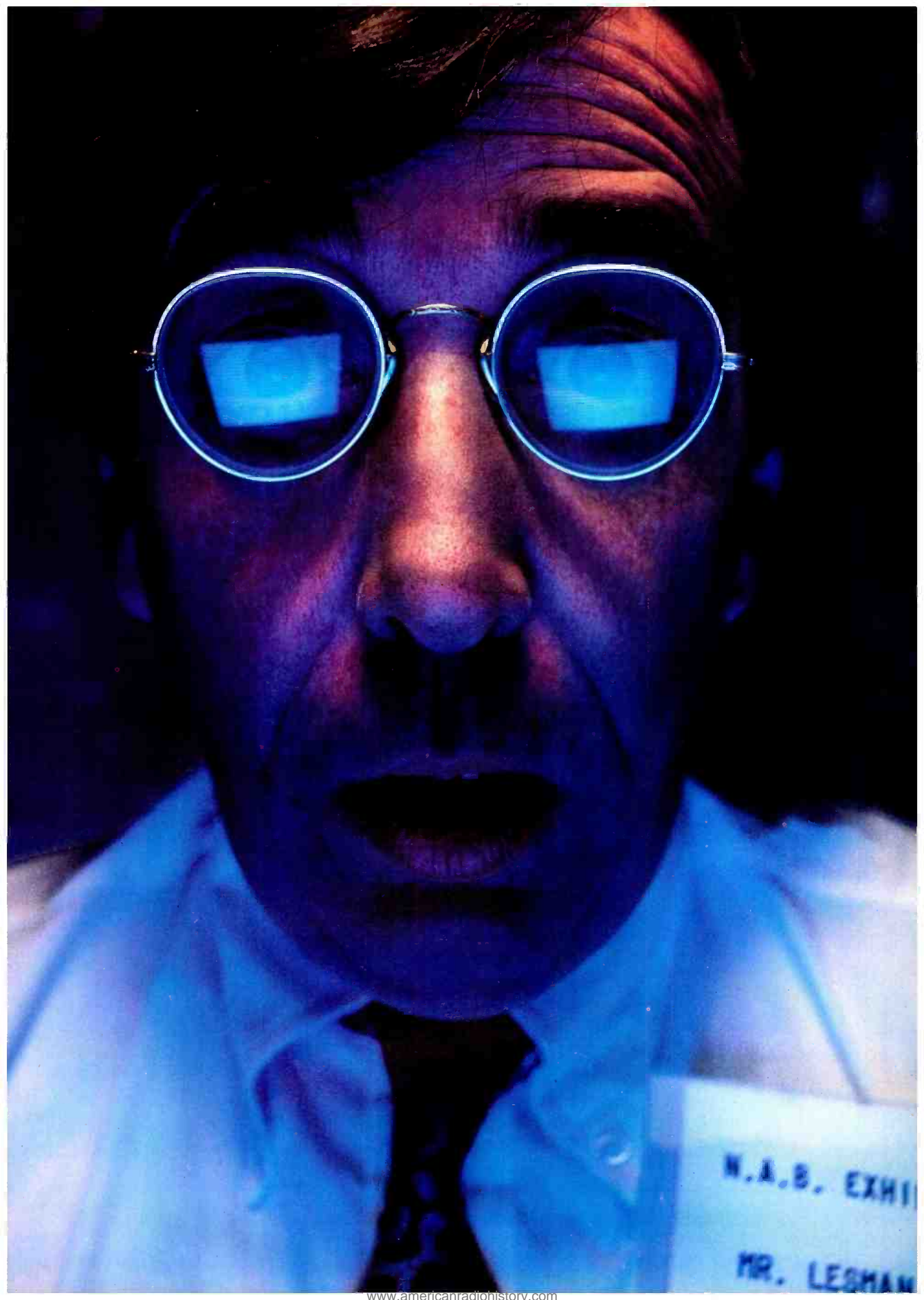

N.A.B. EXHIBIT

MR. LESMAN

# PORTA-PATTERN INCORPORATED



**NOW THE NAME  
YOU KNOW  
BECOMES THE  
COMPANY  
YOU TRUST.**

Telecommunications Industries Limited, the world's major supplier of Camera Test Charts, Chart Systems, Slides,

Films, Transparencies, Transparency Illuminators and Specialized Optical Test Media, has changed its name to Porta-Pattern Incorporated.

This is in recognition of the overwhelming acceptance of our Porta-Pattern® products as the standards by which others are judged within the industry. It also serves to redefine our ongoing commitment to leadership in the development of new, technologically superior products and techniques.

Porta-Pattern — in the future as in the past you can trust it to get the best out of your cameras and optical devices.

Please contact us for a copy of the current Porta-Pattern Incorporated Catalogue.

**PORTA-PATTERN**  
I N C O R P O R A T E D

P.O. Box 38945, 6822 Santa Monica Boulevard  
Los Angeles, California 90038, U.S.A., Telephone: (213) 461-3561  
TWX:910-321-4049 TV CHARTS LSA, Cables:TVCHARTS

See us at NAB in Las Vegas Booth 1427

Circle 101 on Reader Service Card

**BM/E**  
BROADCAST MANAGEMENT ENGINEERING

Publisher  
**Charles C. Lenz, Jr.**  
Editorial Director  
**Gerald M. Walker**  
Editor Emeritus  
**James A. Lippke**

Editor  
**Robert Rivlin**  
Senior Editor  
**Robin Lanier**  
Senior Associate Editor  
**Eva J. Blinder**  
Associate Editor  
**Tim E. Wetmore**  
Assistant to the Editor  
**Douglas Damoth**  
Editorial Production Assistant  
**Allene J. Roberts**  
Editorial Assistant  
**Toria Smith**

FCC Counsel  
**Farmer, McGuinn, Flood, Bechtel & Ward**  
Broadcast Financial Consultant  
**Mark E. Battersby**  
Special Projects Editor  
**C. Robert Paulson**

Associate Publishers  
**Djuna Van Vort**  
**Neal Wilder**  
Production Director  
**Janet E. Smith**  
Art Director  
**Mary McAdam Keane**  
Advertising Coordinator  
**Dana L. Kurtz**  
Marketing Assistant  
**Elaine Allmonti**  
Reader Service  
**Sharon Porges**

Controller  
**Michael J. Lanni**

**BROADBAND INFORMATION SERVICES, INC.**  
295 Madison Ave., New York, N.Y. 10017  
212-685-5320, Telex: 64-4001  
Publishers of:  
**BM/E—Broadcast Management/Engineering**  
**BM/E's World Broadcast News**

★**ABP**

▽**BPA**

BM/E BROADCAST MANAGEMENT ENGINEERING (ISSN 0005-3201) is published monthly by Broadband Information Services Inc. All notices pertaining to undeliverable mail or subscriptions should be addressed to 295 Madison Ave., New York, NY 10017. BM/E is circulated without charge to those responsible for station operation and for specifying and authorizing the purchase of equipment used in broadcast facilities in the U.S. and Canada. These facilities include AM, FM and TV broadcast stations, CATV systems, ETV stations, networks and studios, audio and video recording studios, telecine facilities, consultants, etc. Subscription prices to others \$24.00 one year, \$36.00 two years. Foreign \$36.00 one year, \$60.00 two years. Air Mail rates on request. Copyright 1983 by Broadband Information Services, Inc., New York City. Second class postage paid N.Y., N.Y. and additional mailing offices.





## Ikegami ITC-730 expands your ENG coverage, tightens your budget.

When Ikegami designed the ITC-730 ENG camera, we set out to create the world's finest modestly-priced, hand-held TV camera. And we succeeded.

Look at what the ITC-730 ENG gives you for under \$10,000\* (less lens). A lightweight, 3-tube prism optics camera featuring advanced Saticon II\*\* tubes, a 2H detail corrector, noise-free contrast compression circuitry, and a character generator in the viewfinder that indicates filter selection, gain selection, auto-white balance, VTR start/stop, gen-lock, and battery test.

The f/1.4 RGB prism beam-splitter delivers low-light performance (a standard sensitivity of 2000 lux at f/4), and a consistent 54 dB S/N ratio from the preamp.

And when you're out there shoot-

ing, you get even more. You can go farther and last longer because the ITC-730's unique circuitry makes it a miser on power consumption. Shoot up to three hours on one fully charged Nicad battery.

The ITC-730 is easy to handle. It has an excellent weight/balance ratio for smooth shooting from the shoulder. And its low profile makes it as easy to see over as it is to handle. A rugged magnesium alloy, die-cast housing takes the inevitable bumps in stride.

Equipped for EFP, the ITC-730 expands the limits of field production. It can be remotely operated up to 1000 feet from the CCU on AC; up to 300 feet on battery power from the camera.

ENG or EFP, you'll never have to accept anything less than an Ikegami again. Contact us for details.



**Ikegami** ITC-730

Ikegami Electronics (USA) Inc., 37 Brook Avenue, Maywood, NJ 07607

Northeast: (201) 368-9171  Midwest: (219) 277-8240  West Coast: (213) 534-0050  Southwest: (713) 445-0100  Southeast: (813) 884-2046

\*Manufacturer's suggested list price \*\*TM of Hitachi Ltd.

See us at NAB Booth #1013

Circle 102 on Reader Service Card

# BM/E

BROADCAST MANAGEMENT/ENGINEERING

MARCH 1983

VOLUME 19/NUMBER 3

EDITORIAL: Building the Digital Dream	10
LETTERS TO THE EDITOR	12
BROADCAST INDUSTRY NEWS: Divided FCC Proposes Revised Ownership Rules; Portable Murals Bring City Sights Into News Sets; VSA to Promote NABTS; Announces NBC Contract.	16
RADIO PROGRAMMING AND PRODUCTION: Programmers Tread Carefully Over Shifting Format Sands	29
TELEVISION PROGRAMMING AND PRODUCTION: WKOW-TV Scoops the Competition With Specialized Radio Communications	35

★ ★ ★ ★ ★ ★ ★  
**NAB '83**

43	<b>NAB '83</b>
45	<b>NAB '83: It's A Sure Bet!</b> Introduction and Program
57	<b>What's Hot in Video Products</b>
85	<b>Video Equipment Listing</b>
141	<b>What's Hot in Audio and Radio Products</b>
165	<b>Audio and Radio Equipment Listing</b>

203	<b>Development of the VPR-5</b>
213	<b>Eight-Track ATRs Bring Recording Studio Quality to Radio</b>
223	<b>DVTRs and the All-Digital Studio: A Long Wait in Store?</b>
245	<b>Cart Deck Automation Design</b>

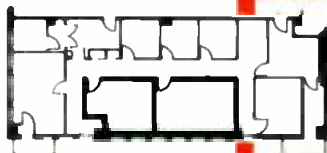

233	<b>FACILITIES DESIGN AND ENGINEERING</b>
	<b>Part 7: Building a Radio News-Talk Plant</b>
	How to build a news-talk plant to serve the needs of a staff making simultaneous demands on limited equipment.

253	<b>NEWS FEATURE:</b> AM Stereo Rolls Snake Eyes At Vegas Consumer Show
261	<b>FCC RULES AND REGULATIONS:</b> FM Allocations and LPFM: What's In Store?
265	<b>TAX TIPS FOR STATIONS:</b> Preventing Fires—With a Hand From the Tax Man
268	<b>GREAT IDEA CONTEST</b>
271	<b>BROADCAST EQUIPMENT:</b> <i>BM/E's</i> survey of new products
277	<b>ADVERTISERS INDEX</b>
278	<b>BUSINESS BRIEFS</b>

## ABOUT THE COVER

Pictured at right, artist and illustrator Joni Carter creates this month's cover on an MCI/Quantel Digital Paint Box graphics system set up at the recent SMPTE Winter Conference. The electronic image was then photographed through the courtesy of Dunn Instruments on its computer graphics camera system. The entire cover, with the exception of the *BM/E* logo, was created by Carter with the Quantel system.



COMING IN APRIL: Special Report Sports Production



SEE PRIMUS  
AT NAB BOOTH 415

# INTRODUCING THE NEW PRIMUS™ AUDIO COMPONENTS



**CERTIFIED  
PERFORMANCE**

**Powerful performance  
in the palm of your hand.**

PRIMUS (Pree-mus): an array of compact, performance-engineered audio electronics from Ramko Research.

The new PRIMUS components are unlike any professional audio equipment you've ever used. Never before has so much advanced performance been put into such compact and rugged packages. Rarely have you had available so many features and options to help get the job done. Never have you had a three-year warranty that's backed up by factory certified proof-of-performance.

PRIMUS is a comprehensive range of components that give you the flexibility to configure an audio system limited only by your imagination. Whether you choose from tabletop or rack mounting versions, there's hardly an audio job that can't be improved upon.

Here's a partial list of models currently available:

- Lab standard mono or stereo turntable preamplifiers.
- Dual and quad input, gain selectable microphone/line amplifier mixers.
- Audio distribution amps from three (3) stereo/six (6) mono up to eight (8) stereo/sixteen (16) mono outputs. All models feature individual recessed front panel adjustments or optional high resolution, conductive plastic potentiometers.
- Mic/Line equalizer amplifiers with balanced I/O and up to ±15 db of reciprocal equalization.
- Expandable audio console mixers with cueing, selectable EQ, metering phones and monitor.
- Voicegard™ combination limiter/compressor, noise gate with variable threshold and slope ratio; gain reduction metering.
- Signal processing VCA's with six (6) independently controlled channels. DC remote control with balanced outputs.
- R/P and playback, stereo and mono NAB cart machines.

Whichever combination of precision PRIMUS audio components you choose, you're guaranteed outstanding specifications. For example, our stereo turntable preamplifier measures:

- Signal-to-noise Ratio: -93 dB (A weighted)
- Total Harmonic Distortion: Below .0018%
- Frequency Response: 10 Hz to 20 kHz, ±.25 dB
- Stereo Separation: -70 dB @ 1 kHz
- Output Level: +25 dBm (10 Hz - 20 kHz)

The simplified and modular packaging of PRIMUS allows us to concentrate the quality where it belongs: in state-of-the-art circuitry. High slew-rate integrated circuits and extensive ground planes insure the highest RFI protection.

All IC's plug into gold plated sockets. All models feature quick disconnect I/O connectors and require only 1 1/4 inch standard rack height.

We've taken another important step, too.

When you invest in PRIMUS, you receive a *Certified Performance Gold Card* that instantly puts you in touch with our Technical Assistance Department on a toll-free line. Just call in your registered serial number and you're in touch with the advice you need.

To put PRIMUS audio components to task on a free two-week trial, call toll free (800) 821-2545 or contact your nearest Ramko Research sales representative or distributor. Put the powerful performance of PRIMUS in the palm of your hand.



PRIMUS audio components are an array of compact, performance-engineered rack mounting or tabletop packages.



**PRIMUS** is a division of Ramko Research, Inc. 11355-A Folsom Blvd., Rancho Cordova, California 95670

(916) 635-3600

Circle 103 on Reader Service Card

© 1983 Ramko Research

www.americanradiohistory.com



# Why ABC Sports selected Panasonic

ABC Sports demands uncompromising picture quality. Mt. Everest demands absolute portability. Panasonic Recam delivers both.

That's why Recam was the natural choice for ABC's "American Sportsman" to capture all the beauty

and danger of the U.S. expedition scaling Mt. Everest this Spring. John Wilcox, executive producer of "American Sportsman", said it best: "Recam's picture quality is as good as one inch...the 3-tube Plumbicon® camera and M-Format recorder give us the opportunity to shoot broadcast quality pictures in any location."

And perhaps no location is as demanding as Mt. Everest. As the expedition ascends the mountain, ABC will capture it all on Panasonic half-inch video equipment. Recam





# Recam to climb Mt. Everest.

recorder/cameras will transmit pictures via microwave to a base station specially outfitted with two Panasonic AU-300 source decks, an AU-A70 editing controller, an AS-6100 switcher and another AU-300 for mastering. These high-quality Recam pictures will then be

beamed via satellite to the U.S.

But this is just the beginning. Recam's picture quality and portability will be used by ABC Sports for future remote locations whenever the going gets rough.

Look into Recam for yourself and see why it's becoming the choice of demanding professionals whatever their EFP needs.

## Panasonic.

AUDIO-VIDEO SYSTEMS DIVISION

See Panasonic Recam  
at NAB Booth No. 1019



## Building the Digital Dream

IT HAS BEEN OVER A YEAR since worldwide standards for sampling the digital signal in studio applications were established at a 13.5 MHz frequency with a 4:2:2 (Y, R-Y, B-Y) ratio. The standard, achieved at considerable compromise, was hailed as the first step in a digital dream that would progress towards the all-digital plant, a single digital program production standard, even the digital videotape recorder.

Progress is being made in all these areas. Leading the way is the SMPTE Working Group on Digital Video Standards under Ken Davies of the CBC, working on standardization of the video interface. This group is on the verge of actually making a set of recommendations. Thus the possibility for an all-digital plant gains a step.

As for those working on a digital video recording standard, the future seems somewhat less clear. Organized so far as a study group (rather than a standards-recommending working group), the digital television tape recording committee chaired by William Connolly, CBS, is still far from reforming into a working standard-setting body. A new twist is the realization that it may not be practical in terms of cost or tape consumption to build a DVTR that can record a full-bandwidth component signal on standard videotape, using today's head technology. It may now be necessary to wait for the development of the new metal oxide tape formulations with their higher packing densities at some unknown future date.

We are concerned, however, for an industry that may be drawing up elaborate sets of blueprints for plants that will never be constructed.

The question that *must* be answered before further work takes place is exactly what the mandate is of digital technology in broadcasting. Other technologies are waiting in the wings, facing the ordeal of standardization and development into products—high definition television, to name but one. Yet HDTV technology has a clear advantage, a superior image that can be seen by the viewer and will therefore be economically justified. But who will be able to see the difference in the signal coming out of the all-digital plant recorded on the DVTR? As it is currently conceived, all-digital technology in broadcasting is little more than an engineering dream of what might be nice to have. The vision encompasses a technically marvelous system but not necessarily something that broadcasters *must* have.

The examples of an industry not yet ready to embrace the digital dream are everywhere apparent. Of the more than 30 companies currently manufacturing digital processing equipment for the U.S. market, we know of only one—the Ampex ADO—which is currently using 13.5 MHz sampling (albeit at a 4:1:1 ratio). Others will doubtless follow. But it is significant that a company such as Tektronix, entering the digital production area for the first time at this NAB, would do so with a four times subcarrier-based system. Meanwhile, U.S. broadcasters are in no rush to jump on the 13.5 MHz bandwagon. None of the network engineering executives we interviewed for our Industry Leaders profiles (January issue) said they had yet begun evaluating equipment based on the criterion of whether or not it was component coded. And why, in all honesty, should they? Despite the claims that a single A/D and D/A conversion would lead not only to lower cost but also to improved digital signal handling, is there a clear enough advantage to be gained over the ability to take an off-the-shelf digital processing system and plug it into the signal stream?

The many SMPTE groups are doing necessary yeoman technical work. Intrigued as we are with the directions being shown, we should not become over-anxious. Perhaps the clearest statement of American attitudes towards digital technology is represented by the elaborate five- and ten-year countdown plans which CBS has drawn up to move it from analog to digital. The transition looks smooth and the technology is almost in place that will allow it to happen. But the countdown clock hasn't been activated yet, and there is no telling when it will.



**\$29,900  
7-4 'SOLUTION'**

# It's a small price to pay for the 'SOLUTION'

Selecting a new audio console can be a problem if you are a busy executive engineer with broad responsibilities.

Your audio needs, however, are probably *not unique*.

We have identified several common needs in broadcast audio and have configured specific consoles to meet those needs.

One of the most common is 16 inputs with two program feeds (stereo or mono) and four auxiliary outputs. We have integrated a generous patchbay, space for two stereo-line input modules, and called the answer the 'Solution'. All interconnections are by way of XLR or easy to use DIN standard 30-pin connectors.



We also have many solutions to other needs, all at prices that will not compromise your budget or your requirement.

Now you get price,  
the solution,  
and, you get a Harrison.

 **Harrison**

HARRISON SYSTEMS, INC. • P.O. Box 22964, Nashville, Tennessee 37202 • (615) 834-1184 • Telex 555133

**SERIES 4 FEATURES:** All transformerless design • Thick-film resistor networks • 5532/5534/LF353 amplifiers • Minimum audio-path design • State-variable equalizer • +4 dB (or +8 dB) balanced outputs • Automated fader • Extensive patching • DIN (Tuchel) interconnects • DIN Eurocard internal connectors • Center-detent panpots • Center-detent ± EQ controls • All sends switchable main/monitor • All EQ sections switchable main/monitor • 4 mono sends, plus 1 stereo send • Automatic PFL • Optional non-interrupting stereo solo • New high RF-immunity transformerless mic preamplifiers • Dual switchable mic inputs to each module • 24 tracks, plus direct outs (MR) • 8 stereo groups, plus 4 stereo programs, plus 4 mono programs (TV) • Extensive internal and external communications • Multitrack interface from stereo groups (TV) • All-aluminum (lightweight) housing • Internal or external patching • Various meter options • P&G faders.

\*Prices shown are for direct factory sales in USA. FOB Factory, installation not included. Commissioning into a prepared facility is included. Prices outside of the USA are higher due to freight, duty, dealer service support, etc. Normal payment terms are 30% with order, 70% prior to shipment. Price, specifications, terms, and availability are subject to change and are determined only at the time of sale.

Circle 105 on Reader Service Card

[www.americanradiohistory.com](http://www.americanradiohistory.com)

# LETTERS

## COLLEGE STATIONS

### To the Editor:

As I was reading your December 1982 issue, I came across your story of Wesleyan University's radio station, WESU [p. 29]. If you had searched further, I think you might have come up with college stations much more out of the ordinary.

WDCR is a 1000 W daytime, 250 W nighttime AM station located in Hanover, NH. It is a commercial, CHR formatted station; we are major competitors in a slowly expanding market. Our license just happens to be owned by the Trustees of Dartmouth College. All management positions, air and news shifts, and technical positions are held by students. We are affiliated with the NBC Radio Network, and also carry such features as *American Top 40* and *Soundtrack of the 60s*. Our sales department can usually be relied on to bring in a net profit of \$20,000 to \$30,000 a year, all of which goes back into the station, as everyone (except our two sales reps and our secretaries) works on a volunteer basis.

WFRD-FM is a 3000 W commercial station, broadcasting a combination of AOR, classical, and jazz formats. It too is completely student-run. It just recently affiliated with the ABC Contemporary Network, which should add even more to its already top-quality programming.

As you can see, WDCR and WFRD are more than just normal college stations. We are proud of the work that we have done here, and we hope to continue serving in this capacity for a long time to come. Thank you.

**Lenwood K. Ivey**  
WDCR Programming Director

## AM STEREO

### To the Editor:

Recently I was visited by two engineers from Japan. I believe they have what may be the answer to our current AM stereo dilemma. The two engineers are employed by the Sansui Electric Co. and drove to the KFI studios in a car equipped with a very interesting AM stereo receiver. The receiver employed a universal AM stereo decoder that de-

codes all four stereo systems automatically without any manual switching. I enjoyed listening to KFI in Harris stereo and then tuning up the dial to KHJ in Kahn stereo. The engineers told me that the receiver does not favor one system over another but works equally well on each system. The receiver can be built for only a slight additional cost over a single-system receiver.

If all the receiver manufacturers will produce universal stereo receivers, our present chicken-or-egg dilemma will be solved. A universal receiver means the broadcasters are free to choose any AM stereo system they like, knowing that all receivers will receive all systems. This will surely encourage widespread AM stereo broadcasting soon. Congratulations to the Japanese and Sansui for leading the way. Now I hope the American manufacturers will do their part.

**Marvin Collins**  
Chief Engineer, KFI/KOST

*Editors's Note: See our article "AM Stereo Rolls Snake Eyes at Vegas Consumer Show," beginning on page 253 of this issue.*

Put your  
weather  
together  
with  
ESD

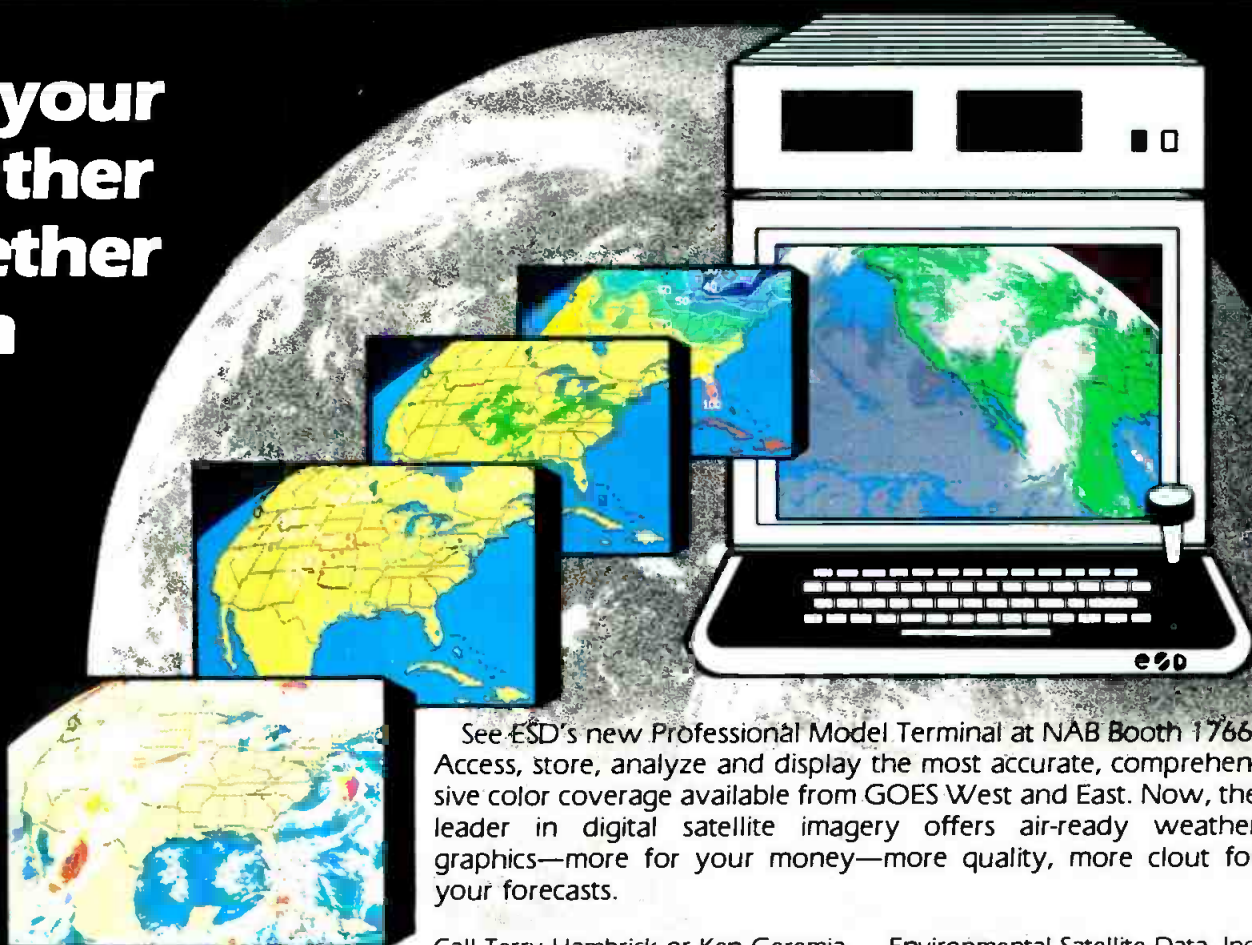

See ESD's new Professional Model Terminal at NAB Booth 1766. Access, store, analyze and display the most accurate, comprehensive color coverage available from GOES West and East. Now, the leader in digital satellite imagery offers air-ready weather graphics—more for your money—more quality, more clout for your forecasts.

Call Terry Hambrick or Ken Geremia. Environmental Satellite Data, Inc.  
World Weather Building 5200 Auth Road Suitland, MD 20746 (301) 423-8247/2113

Circle 106 on Reader Service Card



Now . . . remote, automatic control  
of your entire transmitting facility . . .



## Harris 9100 Facilities Control System

In its various configurations, the Harris 9100 Facilities Control System provides intelligent remote control; automatic transmitter control; automatic logging; plant protection through intrusion and fire alarms; and automatic control of tower lights and building temperature. It can even exercise your standby equipment...and operate up to three remote sites from a single location!

The Harris 9100 watches over your transmission system and physical plant. It makes decisions automatically, based on pre-programmed limits...with a minimum of operator interven-

tion. Quite simply, it is the most intelligent remote control system on the market.

Improve your manpower allocation. Increase plant protection. Maximize equipment life. The Harris 9100's automatic features are unmatched.

Whether you're AM, FM, TV or Satellite (or any combination), the Harris 9100 Facilities Control System is designed for you—for your security, efficiency *and* savings. For more information, contact Harris Corporation, Broadcast Division, P.O. Box 4290, Quincy, Illinois 62305-4290. 217-222-8200.

Visit Harris at the 1983 NAB,  
Las Vegas, in North Hall



# HARRIS

# TECHNOLOGY YOU CAN TRUST

For years, broadcasters have trusted that an Otari tape machine would perform to the highest specifications, day-in and day-out. Regardless of the age of their Otari machine, they have relied on a continuing commitment from the factory and dedicated dealer support. The Otari MTR-10 production recorder has maintained this tradition.

Broadcasters know they can trust the MTR-10 to provide uncompromised audio specifications and unique, useful features. In fact, the MTR-10 makes a broadcaster's life less complicated because it's faster to operate, easier to maintain and faster to service.

Broadcasters have discovered that investing in an Otari MTR-10 is an effective way to address today's

broadcast needs while preparing for tomorrow's.

The MTR-10 Series recorders are engineered with fully microprocessor-controlled transports and are available in four formats: 1/4" full-track; 1/4" two channel; 1/2" two channel and 1/2" four channel. Each version has a long list of sophisticated editing and production features: return-to-zero; 3 speed operation with individual equalization and bias; two master bias presets; controlled wind for library spooling; back timing; on-board test oscillator; user adjustable phase compensation; speed display in percentage or ips; cue speaker and headphone monitoring; shuttle edit control;  $\pm 20\%$  varispeed and an optional ten memory locator. All models easily





## The Otari MTR-10 Series 1/4" & 1/2" Mastering/Production Recorders

interface with any SMPTE-based video editing system.

All models come with the following typical specifications:

- Wow & Flutter: 0.03% (DIN 45507 Peak Wtd.)
- Frequency Response: 50Hz - 20kHz,  $\pm 0.5$  dB (Record/Reproduce)
- Signal to Noise Ratio: 75 dB (unwtd., 30Hz - 18kHz) (3%, Third Harmonic Distortion to Noise floor)
- Distortion: 0.15%, Third Harmonic (@ 1 kHz)

All specifications at 30 ips, 250 nWh/m Operating Level, Two Channel.

To receive your own comprehensive brochure or to arrange a hands-on evaluation, call us for the name of your authorized dealer.

The MTR-10 Series recorders are like no other tape machines: built with quality you can hear and feel, reliability that has made Otari the "Technology You Can Trust."

Otari Corporation, 2 Davis Drive, Belmont, CA 94002 Tel: (415) 592-8311 Telex: 910-376-4890



**OTARI**

*Technology You Can Trust*



## Divided FCC Proposes Revised Ownership Rules

The FCC overcame dissension within its ranks to approve a proposal that could significantly modify its multiple ownership attribution rules—the guidelines that determine how ownership of a broadcast company is defined. If adopted, the changes could bring additional capital into the broadcast industry, according to proponents; others, however, predict an adverse effect on ownership diversity.

As they presently stand, the FCC's attribution rules differentiate between widely held companies—those with 50 or more shareholders—and closely held companies, having fewer than 50 shareholders. Any shareholder, officer, or director of a closely held compa-

ny is considered to have a cognizable interest in the company—in other words, to be an owner subject to all ownership regulations, including the seven-seven-seven rule. In a widely held company, a shareholder must have a one percent or greater interest to be considered an owner; officers and directors are also considered owners. An exception is made for bank trust departments and investment and insurance companies, which must own at least five percent to have a cognizable interest.

The Commission's proposed amendments would raise the benchmark for ownership attribution to as high as 20 percent, allowing stockholders with a smaller interest to invest in a larger number of broadcast companies. Commissioner Henry Rivera was joined by

colleagues Joseph Fogarty and Anne Jones in criticizing the proposal, which he said could decrease diversity of ownership. After much debate, however, the three were persuaded to concur in the action.

Other proposed changes in the rules include ending the distinction between closely and widely held companies and dropping FCC forms 323 and 325. The Commission also asked for comments on whether its attribution rules should be linked to other legal or regulatory requirements; the advisability of treating all investors in a similar fashion; the degree to which indirect interests should be attributed; and the possible financial benefits to minority group members and new entrants.

## VSA to Promote NABTS; Announces NBC Contract

The new U.S. subsidiary of French videotex/teletext company Videographic Systemes, VSA-Videographic Systems of America, has launched itself into the U.S. broadcast market with the blessings of two of the three national television networks. VSA is a strong backer of the North American Broadcast Teletext Standard (NABTS), which it helped develop along with CBS, RCA, AT&T, and proponents of the Canadian Telidon system.

According to VSA board chairman and president Bernard E. Joseph, the formation of VSA moves French involvement in videotex and teletext from an exploratory role to an active business venture. Illustrating his point, NBC Television Network representatives described their newly signed contract with VSA, which will supply NBC with a full NABTS system for its national teletext magazine, scheduled to start in mid-1983. The advertiser-supported service will run on the net's five O&Os and be offered to affiliates. Representatives of CBS also reiterated their network's support for NABTS, agreeing with NBC that the high-resolution graphics of NABTS constitute a clear advantage over competing standards, especially for teletext advertising.

Vice president of VSA Gregory Harper said the FCC's reluctance to set teletext standards "is likely to be a disservice to you as the consumer." He predicted the eventual demise of the British format, spurred by the NBC/CBS acceptance of NABTS.

The U.S. subsidiary's French parent is 51 percent owned by Thomson-CSF; other partners include software manufacturers Cap Gemini Sogeti and Ster-

## Portable Murals Bring City Sights Into News Sets

An unusual imaging process is bringing the sights of the city into television news sets around the country. Developed by 3M, the computerized paint process scans a color original and programs micro-spray guns to paint an enlargement of the image, creating what the company calls a Scanmural.

According to 3M, the process differs from standard enlargement procedures in that it produces an image that is sharper than the original, with greater definition and reduced

graininess—giving viewers the impression that the Scanmural "view" is just over the anchors' shoulders. A Scanmural can be produced on any fabric, including canvas, which the company says is popular with station art directors because it is easy to light. In addition, the Scanmural can be rolled away for quick scene changes. Among the stations using Scanmurals as part of their sets are KSDK, St. Louis; WNGE, Nashville; KSL, Salt Lake City; WAVE, Louisville; and WLS, Chicago.

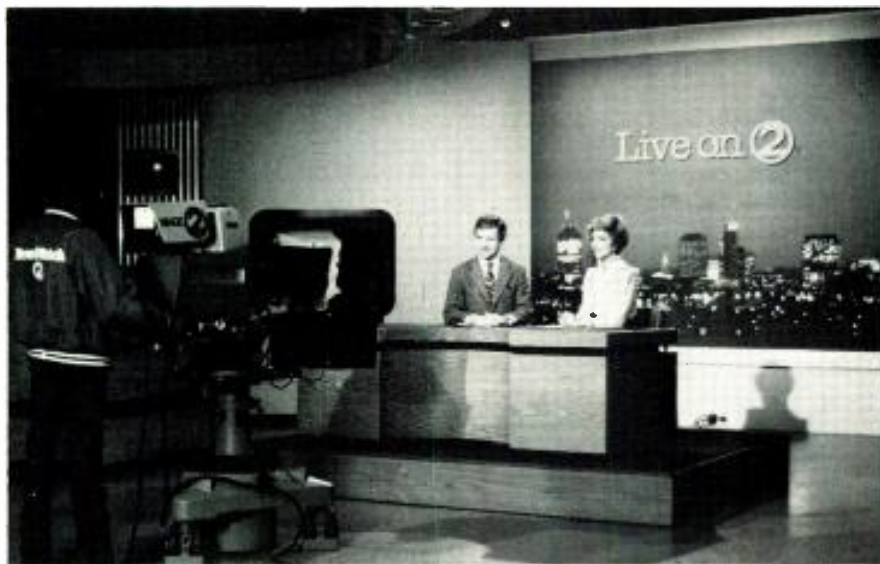

WNGE's news set, with Scanmural of the city. Art director Billy Pittard claims, "Most viewers would think we have a large window overlooking Nashville."



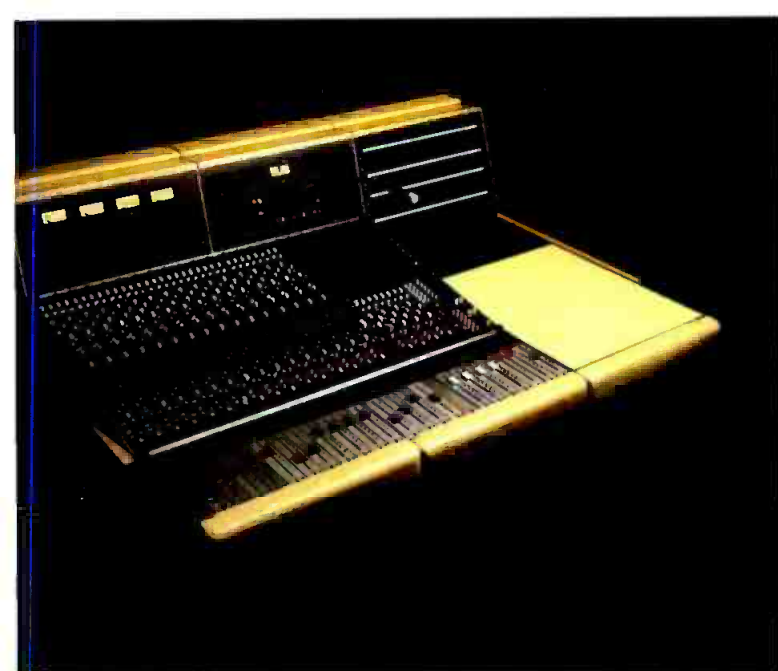

Model 5104 16 in/4/2/1



Model 5104 24 in/4/2/1

# YOUR REPUTATION,

The 5100 Series is a complete range of TV and broadcast audio consoles, from 16 in/4 sub-group to 48 in/8 sub-group, with optional multitrack facilities. A wide selection of standard facilities and options are available. Choose mono or stereo input modules, 2 or 4 band EQ, 4 or 8 Aux sends, limiter/noise gate and continuously variable high and low pass filters on every input, VCA sub-grouping or NECAM computerized audio editing and mixing, to mention a few. The audio performance and the mechanical engineering is in the best Neve tradition. Prices start at less than \$40,000.

When you choose a Neve 5100 Series Audio Console for your broadcast facility in 1983, you need not worry about being outpaced by new technologies. The 5100 Series is the absolute state-of-the-art in audio console technology, yet already proven in many North American installations and around the world. Take a close look at the others. Can you afford to choose outdated technology? After all, it's your reputation.

# AND OURS!

 **Neve**

Rupert Neve Incorporated Berkshire Industrial Park, Bethel, Connecticut 06801 Tel: (203)744-6230 Telex: 969638

Rupert Neve Incorporated 7533 Sunset Blvd., Hollywood, California 90046 Tel: (213)874-8124 Telex: 194942

Neve Electronics International Ltd. Cambridge House, Melbourne, Royston, Hertfordshire, SG8 6AU England Tel: (0763)60776

Rupert Neve GmbH 6100 Darmstadt Bismarckstrasse 114, West Germany Tel: (06151)81764

Circle 109 on Reader Service Card

ia, CFCT (Compagnie Francaise des Cable Telephoniques), Sofratev (engineering arm of Telediffusion de France), newspaper *Les Echos*, CCS (Compagnie Continentale de Signalisation), and teletext manufacturer Unitel. According to VSA, its ownership gives it a solid financial basis and the capability to produce and distribute its wares efficiently. VSA will absorb the technical and commercial activities of Antiope, Telematics Corp., and Alphatel, as well as the marketing activities of Intelmatique.

## NAB Cuban Task Force Suggests Tough Stance

Negotiation is the best means of dealing with the Cuban interference problem—but the U.S. will have better leverage in negotiating if it lifts its current protection of Cuban AM stations. So concluded the NAB's All-Industry Cuban Interference Task Force in an options paper it recently submitted to the FCC and the State Department.

The paper's second section outlines suggested regulatory changes the task

force feels would strengthen the U.S.'s bargaining stance against the Cubans, especially the lifting of restrictions on radiation toward Cuba. Specific proposals include removing power limits on U.S. stations, accepting applications eliminating protection of Cuban facilities, and compensating U.S. stations for costs they incur in modifying their facilities to counteract Cuban interference.

In its first section, however, the paper offers several "negotiating modes," including bilateral meetings between the U.S. and Cuba; regional meetings among area countries; brokered sessions in which another country would act for the U.S.; and intercession by international organizations. Cullie Tarleton, senior vice president, radio, of Jefferson Pilot Broadcasting and chairman of the task force, called a negotiated agreement between the U.S. and Cuba "the only long-term solution" to the interference threat.

The task force recommended that responsibility for international telecommunications policy should rest with a single senior State Department official. It also discussed the possibility of modifying station facilities perceived by the Cubans as problems.

Meanwhile, a Miami AM station, WKAT, has requested the FCC to let it raise its nighttime power to 2.3 kW from 1 kW, claiming that a Cuban station on its frequency (1360 kHz) is causing interference. The increase could cause some interference to another U.S. station, WSAI, Cincinnati, but is necessary if WKAT is to continue broadcasting at night, the station claimed.

## S-A, Plessey Announce European Joint Venture

In a complex agreement that will give Scientific-Atlanta a foothold in European communications markets, Plessey Co. of the U.K. will buy a piece of S-A and join the U.S. company in a European joint venture.

The joint venture, to be known as Plessey Scientific-Atlanta, Ltd., will be owned 49 percent by S-A and 51 percent by Plessey, an electronics manufacturer. Initially, it will sell largely products bought from S-A, but eventually will begin its own manufacturing operations under license from S-A. It also plans to develop new products, which S-A will sell in the U.S. under an exclusive U.S. marketing agreement.

At the same time, S-A agreed to allow Plessey to purchase three million shares—or 13 percent—of its common stock for an estimated \$71 million, with an option that will allow Plessey to buy

# THERE'S A VIDEO PATCHING SYSTEM THAT'S BETTER.

## HERE IT IS.

## HERE'S WHY.

Only THE DYNATECH COAXIAL PATCH Gives You All These Features: normal-thru connection, cross-patching, non-interrupting on-line monitoring of live circuits, AND Coterm's automatic termination of patched-out circuits *within the jack*.

All These DYNATECH Features Plus the least amount of noise pick-up, signal degradation and signal loss. This patented, shielded jack helps reduce interference due to EMI, RFI, hum, noise and cross-talk. Unbalanced line, coaxial equipment transmits signals in excess of 400 MHz with negligible insertion loss, cross-talk or VSWR.

Normal-Thru Connection eliminates patch cords or normalling plugs for dedicated circuits — you get less signal degradation and you get a clean, uncluttered patchfield — reducing the possibility of errors when a patch must be made.

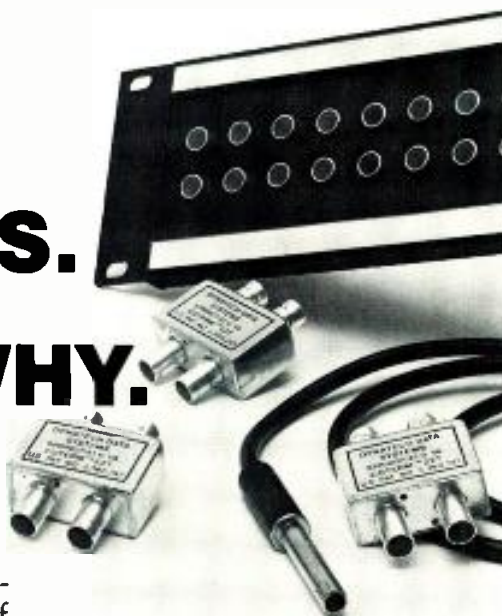

To Break The Normal-Thru Connection, you insert a patch cord that allows cross connections to be made. Sources that are patched-out are automatically terminated *within the jack in the proper impedance*. Test probes may be inserted in the jack to monitor a signal *without interrupting the live circuit*.

TO FIND OUT HOW Dynatech's coaxial patching/switching system can fulfill your requirements, CALL OR WRITE TODAY.

## Dynatech

Data Systems

7644 Dynatech Court  
Springfield, Virginia 22153  
800-368-2210  
In Virginia, (703) 569-9000



# PROGRESS

## ...the new High Resolution Studio 12A

Videotek's commitment to progress has resulted in the most versatile RGB/NTSC 12" broadcast color monitor on the market today. The Studio 12A employs an advanced fine-pitch CRT for 43% better resolution. Set-up Controls are now secured in an easy-access Slide-out Drawer; and Switchable Comb Filter, Notch Filter, and Analog RGB Inputs have been added to an already-impressive list of standard features found on monitors costing twice as much: High Voltage Regulation, A-B Split Screen, Selective H-AFC, ACC Defeat, Preset Controls, Pulse Cross, Underscan, and more.



TSM-5A Waveform Monitor / VSM-5A Vectorscope available in PAL Standard



## ...the TSM-5A Waveform Monitor & VSM-5A Vectorscope

New developments in the TSM-5A include: 30% less power consumption for increased efficiency and reliability; Dynamic Focus for critical waveform analysis; and a refined CRT for improved geometry and sensitivity.

Now that's Progress...

# BY DESIGN

125 N. York Street, Pottstown, PA 19464, (215) 327-2292, TWX: 710-653-0125  
9625 N. 21st Drive, Phoenix, AZ 85021, (602) 997-7523, TWX: 910-951-0621



**VIDEOTEK  
INC.**

Visit us at NAB Booth #1633

[www.americanradiohistory.com](http://www.americanradiohistory.com)

Circle 111 on Reader Service Card



## NEWS

an additional 17 percent of S-A stock for almost \$114 million. The agreement also offers the possibility of a merger of the two companies or a takeover of S-A by Plessey. A merger or takeover would have to be okayed by an investment banking firm and could not take place during the first 18 months of the agreement.

Scientific-Atlanta says its recent financial worries (the company lost heavily during the first quarter of this fiscal year and the last quarter of fiscal 1982) did not prompt the agreement

with Plessey. Rather, the move was designed to position S-A to sell its satellite and cable communications wares to European customers, who often prefer to deal with European companies, according to S-A.

### Tietjen Succeeds Inglis As RCA Americom Head

Dr. James J. Tietjen, a 20-year veteran of RCA, took over the post of president and chief operating officer of RCA Americom February 1, succeeding the



*Dr. James J. Tietjen, new head of RCA Americom.*

retiring Andrew F. Inglis. Inglis, president of RCA Americom since 1977, will serve as the company's vice chairman until his retirement becomes effective June 1. After that date, he will act as a consultant for the company.

Tietjen, who had held his previous post as staff vice president at RCA Laboratories since 1977, is a two-time recipient of the David Sarnoff Award for Outstanding Technical Achievement, RCA's highest technical honor. In announcing the appointment, RCA Corp. group vice president Eugene F. Murphy praised Tietjen for his "outstanding background of management capability and technological achievement."

### Cable Merger May Face Justice Dept. Scrutiny

The recently announced merger of two former rival cable services, Showtime and The Movie Channel, could become the object of a Department of Justice investigation if the department finds evidence of antitrust violations.

The department had already begun a look at the plan by MCA, Paramount Pictures, and Warner Brothers to buy shares of The Movie Channel—an agreement that has been tabled with the new move. Under its terms, the three movie companies and American Express agreed with Viacom to operate the two pay services as a joint venture. The movie companies and Viacom will share equally in the venture, with American Express owning a smaller piece. Viacom will receive \$75 million from the other principals.

In a significant difference from the ill-fated Premiere venture by Getty Oil and four movie companies, the partners have announced that they will license their movies to all pay TV services on a nonexclusive basis. The exclusivity clause in the Premiere plan, which

**THE  
BEST SOUNDING,  
MOST RELIABLE  
AUDIO CART  
EVER?**



**Judge for yourself when  
we take off the wraps at NAB  
BOOTH 665**

©1983 CAPITOL RECORDS INC

Circle 112 on Reader Service Card



# We Couldn't Have Said It Any Better Ourselves.

"We selected the SatCom Technologies 7 meter antenna because this antenna meets PBS's standards for sidelobe performance and mechanical reliability."

Mr. Ralph L. Mlaska  
Manager Systems Engineer  
PBS Washington, D.C.

"Excellent performance and easy to install."

Mr. Bill Baker  
V.P./Engineering  
KAMC-TV Lubbock, TX

"We are very pleased with this quality made 9.2 meter antenna."

Mr. Ray McMillan  
Chief Engineer  
KENS-TV San Antonio, TX

"The technical quality of our antenna is excellent and has brought new flexibility and a more competitive edge to our programming."

Mr. Dave Frasier  
Technical Operations Mgr.  
WVBT-TV Richmond, VA

"We purchased the SatCom Technologies 7 meter antenna because it is well designed and has the advanced features we need."

Mr. Charles W. Myers  
Chief Engineer  
WHO-TV Des Moines, IA(Iowa)

"Our 9.2 meter antenna gives us life-like pictures from the satellite. We believe this is the technology of the future and SatCom Technologies is in the forefront."

Dr. Hugh VanEaton  
President  
KVHP-TV Lake Charles, LA



**SatCom Technologies, Inc.**

2912 Pacific Drive, Norcross, GA 30071  
(404) 448-2116 Telex 70-8496

**an RSi Company**

Circle 113 on Reader Service Card

would have denied other program services the opportunities to show Premiere's offerings for nine months, was a major cause for the Justice Department's ruling against Premiere.

Home Box Office, which could face increased competition from the merger of the two services, commented that the joint venture could allow the movie companies "to gain control of the future development of pay television and thereby increase the prices for their movies to the cable operator."

The NAB has filed comments in support of the FCC's proposals to **add hours to daytime-only AM stations** through presunrise authorizations (PSAs) and post-sunset authorizations (PSSAs). The association also commented favorably on a proposal to grant preferences to daytimers seeking colocated FM or full-time AM licenses, but said daytimers should not be authorized to use local channels at night or broadcast with low power on their own frequencies at night . . . . The FCC's political editorializing

rules **discourage candidate endorsements** by broadcast stations, the NAB contends, citing a recent survey that shows only 3.1 percent of commercial stations endorsing candidates. More than 45 percent said they aired other editorials, however . . . . With NAB's **TV and radio code boards dissolved** by recommendation of the executive committee, the association has called for a study of "the future of industry self-regulation in the public interest."

An all-time one-year **record for new membership** has been reported by NRBA, with 475 joining in 1982. The association recently appointed Thomas McCoy senior vice president . . . . Aides of Senate majority leader Howard Baker (R.-TN) have told RTNDA that prospects for **electronic coverage of Senate proceedings** appear brighter . . . . A newly formed RTNDA committee, chaired by Lou Adler of WOR Radio, New York, will look into possible organizational changes to improve RTNDA's support of **radio news broadcasting** . . . . RCA Corp.'s Lee V. Hedlund has been elected a Fellow of the SMPTE. With the company since 1959, Hedlund is now manager of electronic recording equipment engineering for the Commercial Communications Systems Div . . . . **Sachtler Corp. of America** and **Panavision, Inc.**, have become sustaining members of SMPTE.

Outlet Company has agreed to purchase a Bethesda, MD, radio station, WHFS-FM, from High Fidelity Broadcasters, Inc., for \$2.1 million . . . . Meredith Corp. will sell its KCMO-AM and KCEZ-FM, Kansas City, MO, to Fairbanks Broadcasting Co. of Indianapolis for a reported \$7.5 million . . . . Blair Broadcasting Corp. has purchased a pair of Tampa radio outlets, WFLA-AM and FM, for a reported \$12 million.

The FCC has affirmed its third report and order on **subscription television**, which deregulated STV service. Responding to the action, Subscription Television Association chairman Jack Wyant said the provision allowing sale of STV decoders "is adverse to legitimate business interests" and "supportive of piracy" . . . . Overall **broadcast employment rose 3.22 percent** in 1982 over the previous year, according to recently released FCC figures. The report shows levels of female and minority employment staying generally steady, with slight rises or drops in some categories . . . . An analysis by Arlen Communications, Inc., predicts that U.S. videotex and teletext operations will create **as many as 5000 new jobs** by the end of this decade.

The FCC has proposed moving **pri-**

## NEW! Production Intercom from Clear-Com *The DLC\* Series*



### Features:

- party-line or point-to-point ("squawk") communications with visual signalling
- 4, 8, 12, or 16 channels - (8 channel shown)
- built-in Assignment Matrix
- standard functions include Stage Announce, Priority, Call Signalling, and Channel Isolation (ISO)
- locking and momentary push-to-talk buttons
- standard electret, noise-cancelling gooseneck mic with exclusive field-adjustable length
- modular design features plug-in Control Modules
- optional IFB plug-in modules & Talent Receiver
- each Control Module monitors 4 intercom channels
- mic limiter
- programmable talk/listen functions
- balanced program input
- compatible with all Clear-Com intercoms

*\*Digital Logic Control:  
all functions are programmable*

 **Clear-Com**  
intercom systems

1111 17th Street  
San Francisco, CA 94107  
415-851-6666 • TWX: 910-372-1087  
EXPORT DIVISION: P.O. Box 302  
Walnut Creek, CA 94596  
415-932-8134 • Telex: 176340

See us at the NAB, Booth #1502  
Circle 114 on Reader Service Card



# OPTIMOD-TV MODEL 8180A

## TV Audio Revolution.

There's a revolution going on. TV broadcasters are competing with VCR, videodisc, premium cable, and other services for the eyes *and ears* of a mass audience that's becoming more aware of good sound. In this audio war, '60's processing technology doesn't cut it.

Enter OPTIMOD-TV. It's the same second generation OPTIMOD-FM sound that's sweeping the country, with enhancements to adapt it to the specific needs of TV broadcasters. Smooth multiband compression teams up with our patented "Smart Clipper"<sup>TM</sup> and FCS overshoot corrector to create a tightly bandlimited, peak-controlled output that stays out of the video and is ready for TV stereo. And stereo processing is supplied standard.

The processor rides gain and peak-limits with remarkable subtlety, achieving superior consistency, openness, and naturalness on the finest master-quality audio or the poorest 16mm optical film.

OPTIMOD-TV gives you the potential to bring your audio up to the same quality as your state-of-the-art picture. Processing is no longer the limiting factor. So plan your audio strategy for the great war of the '80's around OPTIMOD-TV Model 8180A. Your Orban broadcast dealer can tell you more. Or contact us Toll Free (800) 227-4498. In California (415) 957-1067 for more information.

### orban

Orban Associates Inc.  
645 Bryant St.  
San Francisco, CA  
94107



Circle 115 on Reader Service Card

## NEWS BRIEFS

vate microwave radio operations into undeveloped spectrum of the 2, 6, 13, and 18 GHz bands. The microwave users now use the 12 GHz band, which has been allocated to the fledgling DBS service . . . . The television networks could turn to DBS as a distribution means in the future as a money-saving move. FCC commissioner Stephen A. Sharp told the recent convention of the Association of Independent Television Stations. "The response of conventional broadcasters," suggested Sharp, ". . . must be a reduction in operating

costs combined with an imaginative programming mix," with local programming and creative uses of new technologies giving independents an edge . . . . A major multi-client study on direct broadcast satellite systems will be undertaken by the Institute for Graphic Communication of Boston. The study will profile the proposed systems and look at issues of competition, markets, regulation, and future opportunities. The prospectus is available from Robert B. Entwistle, IGC, 375 Commonwealth Ave., Boston, MA

02115, (617) 267-9425.

England's Independent Broadcast Authority (IBA) has negotiated a nonexclusive **knowhow and patent-licensing agreement** with United States Satellite Broadcasting Corp. for USSB's MAC satellite transmission system. MAC, which has been accepted by the British government as the DBS system for the U.K., is also being proposed as the European standard . . . . Oak Media's **scrambled, national pay TV service**, ON TV, was scheduled to begin satellite delivery on Comstar D-4 February 28 . . . . The Supreme Court has heard arguments in Sony Corp.'s challenge of a California court's unfavorable decision in the **home videotaping case**. Final ruling is expected this spring.

March 1 was the target date for launch of Arbitron's **metered television ratings service** in Dallas. The Dallas hookup follows Arbitron's metering of Philadelphia, activated January 1 with five stations subscribing . . . . WRKO-AM, Boston, signed on as a Mutual Broadcasting System primary affiliate March 1 . . . . Gannett Broadcasting and Telepictures Corp. report that **two more stations** have signed for their Newscope satellite-delivered news/information service. KABC-TV, Los Angeles, and WCAU-TV, Philadelphia, bring the Newscope lineup to 52 stations.

Washington State University, Pullman, will sponsor this year's **Murrow Symposium**, ninth in the series, April 21 through 23. The program will address government censorship during crises, the balance of the press-government conflict, and the effect of technology on news content . . . . **Satcom '83**, sponsored by the International Association of Satellite Users, will meet April 25 through 27 at the Hyatt Orlando, Orlando, FL. For further information, contact Dr. Kerry Joels, program chairman, at (202) 357-2828 . . . . The Videotape Production Association has issued a **call for entries** for its Monitor Awards in categories including test commercials, national regional commercials, local commercials, and broadcast programming. All entries must be submitted on U-Matic cassettes; deadline is March 31. For entry forms, contact Janet Luhrs, VPA, 236 E. 46 St., New York, NY 10017, (212) 734-6633 . . . . Deadline for applying for the latest round of Society of Broadcast Engineers **certification exams** is April 29. The exams, for all certification levels, will be held June 17 through 25; for applications, write Mary Brush, Certification Secretary, SBE, P.O. Box 50844, Indianapolis, IN 46250.

# An easy switch

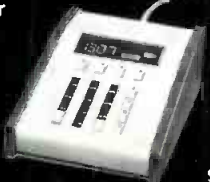
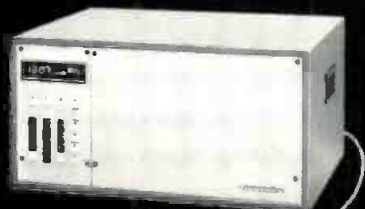

The BTI RS5000 routing switcher is a microcomputer based system which utilizes distributed processing to provide increased performance and reliability. Its flexibility, architecture and excellent specifications make it an ideal solution to your switching applications.

The microcomputer-based access terminals combine comprehensive control and status reporting functions with ease of operation. A two wire serial link is all that is required for connection to the mainframe, and there is provision for multiple access terminals to share the same link.

The RS5000 is compact and infinitely expandable. Because of its microcomputer control and modular add-ons, you will never again be confronted with obsolescence. The system can grow with your requirements whether your signals are analog or digital - audio, video or data - or a combination.

Beginning today, the RS5000 is the only switching system that you will ever need.

See and hear it at NAB, Las Vegas, April 10-13, Booth 1701

BTI...a concern for audio excellence.



**broadcast technology, inc.**

33 Comac Loop, Ronkonkoma, NY 11779 • (516) 588-6565



# The "Studio Optimod"



## The Orban 424A Gated Compressor/ Limiter/De-Esser

There are lots of production limiters out there. Old favorites. Pretenders to the throne. The competition is fierce. So, when Orban set out to design a new production limiter, we knew it had better be superior.

The result of our research is the "Studio Optimod"—a Gated Compressor/Limiter/De-Esser with versatile controls, simple set-up, and a natural, transparent sound that must be heard to be appreciated.

Try one and A/B it against your current favorite. You'll notice the **sound**—remarkably smooth and natural over a wide range of control settings—even at high compression ratios where apparent loudness and punch are significantly enhanced. It's no accident: The unit is a direct descendent of our super-popular, second-generation OPTIMOD-FM broadcast limiter. So it exploits our years of experience in making an AGC device sound natural on diverse program material without critical re-adjustments. Yet full versatility exists for special effects in production.

A bonus is a smooth, natural de-esser. It's independent of the compressor/limiter section so you can simultaneously compress and de-ess vocal material without compromise. You can even de-ess sibilant vocals which have been mixed with other program.

The icing on the cake is unique gating and "idle gain" functions which prevent unnatural noise-producing gain variations during pauses and abrupt gain changes when the unit is switched in.

Our new Model 424A (dual channel) and 422A (single channel) are destined to become the new industry standards in dynamic range control. Prove it to yourself. Contact your Orban dealer today.

## orban

Orban Associates Inc.  
645 Bryant Street  
San Francisco, CA 94107  
(415) 957-1067  
Telex: 17-1480

# FOR RENT.

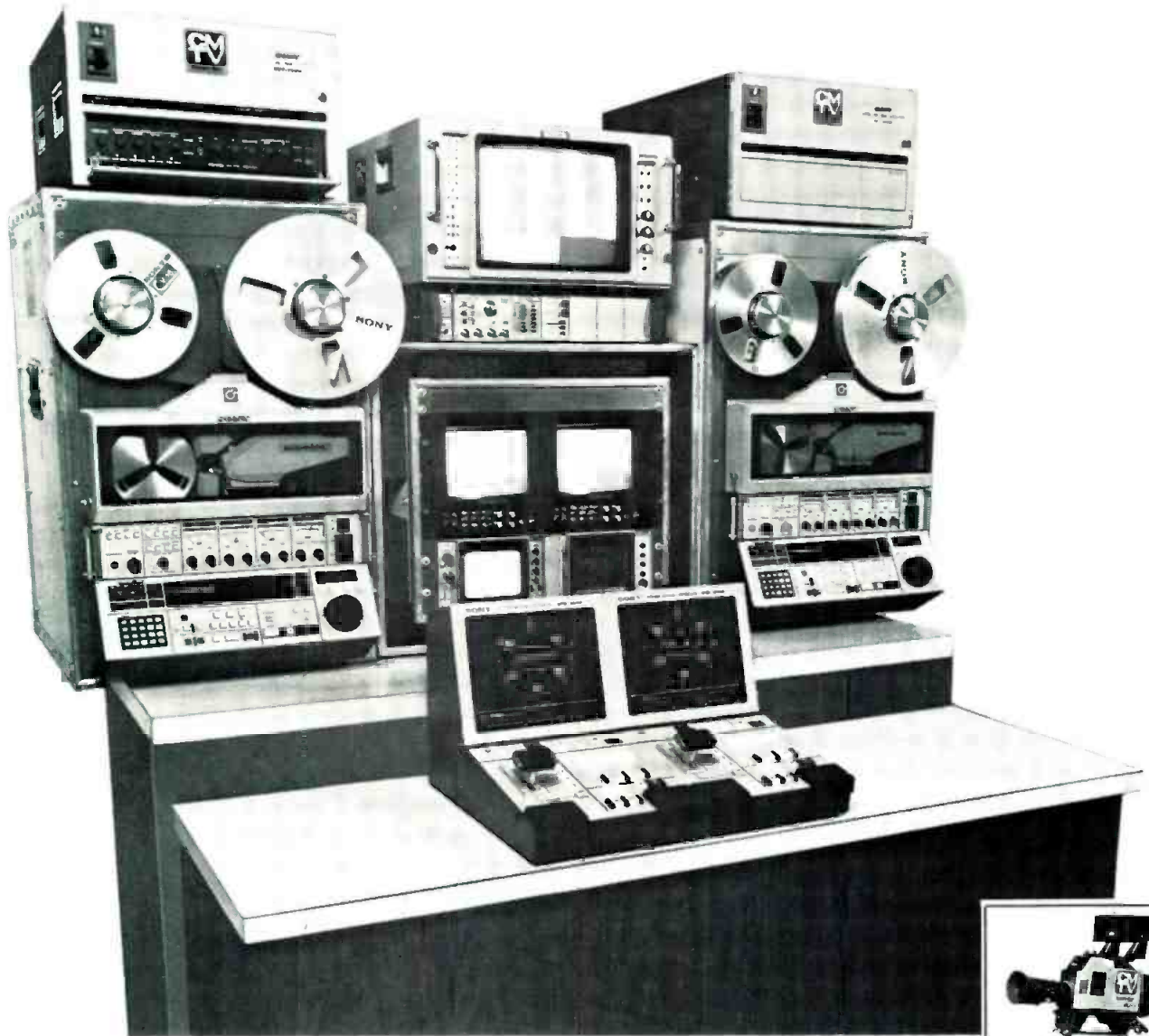

To keep up with the latest advances in video without breaking your budget, *rent* state-of-the-art equipment from Camera Mart. We carry the best names in video, with a complete line of the latest, most sophisticated equipment and we give you the finest service and support in the industry.

**The Camera Mart, Inc.**

456 W. 55th Street, New York, NY 10019 (212) 757-6977/Telex: 1-2078  
Video Rental Department: 800 Tenth Avenue

**Sales • Service • Rental**

See us at NAB Booth 1018

[www.americanradiohistory.com](http://www.americanradiohistory.com)



# FOR SALE.

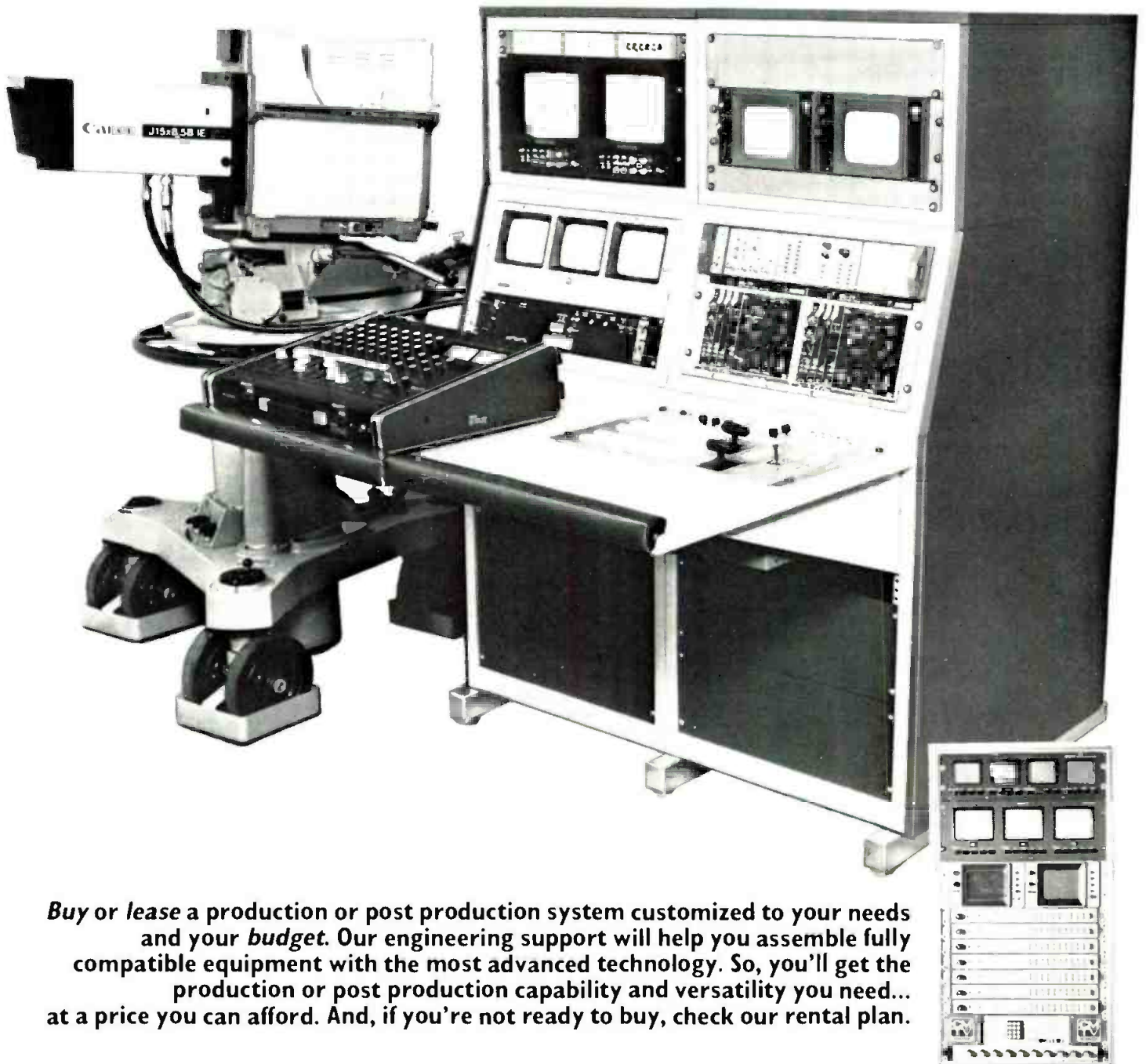

*Buy or lease a production or post production system customized to your needs and your **budget**. Our engineering support will help you assemble fully compatible equipment with the most advanced technology. So, you'll get the production or post production capability and versatility you need... at a price you can afford. And, if you're not ready to buy, check our rental plan.*

## The **Camera Mart**, Inc.

456 W. 55th Street, New York, NY 10019 (212) 757-6977/Telex: 1-2078  
Video Rental Department: 800 Tenth Avenue

**Sales • Service • Rental**

Circle 118 on Reader Service Card

See us at NAB Booth 1018

[www.americanradiohistory.com](http://www.americanradiohistory.com)

# **WHY ARE 50 RECEIVER MAKERS ASKING TO TEST MOTOROLA'S AM STEREO DECODER CHIPS?**

Is it because they've seen Delco choose Motorola's system as their standard?

Is it because Motorola has a breakthrough within a breakthrough — with not only a "basic" decoder chip, but an advanced anti-microphonic chip that's suitable for mechanically tuned radios?

Is it because Motorola has an inexpensive AM stereo chip that includes a pilot tone decoder and requires no manufacturing adjustments?

In a word, yes. And if you're not sure what it all means to you, here it comes:

To the broadcaster, it means that a ton of AM stereo receivers will be out there very soon. And that makes it important to order Motorola transmitting equipment right now.

To everyone attending the NAB show in Las Vegas starting on April 10, it means go see the Motorola booth, and take a pen with you.

To the makers and shakers of the broadcasting industry, it means call Dick Harasek at 312/576-2897 or Chris Payne at 202/862-1549 before your competition does.

See and hear Motorola's AM Stereo System at Booth #411 at the NAB.

**MOTOROLA AM STEREO. THE WINNING SYSTEM.**



Circle 119 on Reader Service Card



# RADIO programming & production

## Programmers Tread Carefully Over Shifting Format Sands

IN MOST MEDIUM and large markets the radio programmer is in a tougher spot than ever before to get the listeners the station needs. Economic recession, the threat of competing technologies, the aging of audience segments, are some of the problems the programmer must face. But above all it is the intensity of competition within radio itself that is demanding sharp new skills.

Every operator of a radio station is conscious of the rising tide of competition. For example, in some large markets, a high—and profitable—rating used to be an Arbitron share of 7 to 10. Today many stations in strongly competitive markets have to make out with a five-share. And many are economically sound with the smaller share, as station management has adapted the operation to the new imperatives. But profits are lower, compared to earlier periods, a fact reflected in the soft markets and falling prices for radio stations in a number of cities.

What are the new imperatives for the programmer? Among them are a more detailed understanding of demographic trends; careful, intensive use of audience research to fine-tune music choices; and a clear grasp of market situations. These have been parts of successful radio programming for a long time, but now these techniques must be used more thoroughly, more intelligently, than before.

The vital role of audience preference research got a nod in a recent published statement by Jim Schulke, a seminal figure in syndicated radio programming, extremely successful with his Beautiful Music format over two decades. Schulke acknowledged that a "gut approach" to music choices is no longer good enough: he is engaged with a number of associates in developing new program patterns that match better the audience tastes of the moment.

Beautiful Music has, in fact, shown softness, especially in larger markets. But the format is not through; in most cases the softening has meant that second or third stations using the music have had to switch to new formats, leaving one station still successful.

This is the situation in Los Angeles,

for example, where Bonneville's KBIG is still holding audiences with Beautiful Music. But KOST, formerly a competitor with the format, has switched to Adult Contemporary.

The staying power of the format can be seen in a recent survey by the National Radio Broadcasters Association. This survey, made late in 1982, shows Beautiful Music still the third most often used format, behind Adult Contemporary and Country, among more than a thousand FM stations.

What can the programmer learn from the softness of Beautiful Music? One factor often cited is that the older demographic group traditionally the mainstay of Beautiful Music has not been followed by the maturing youngsters who have grown up with other kinds of music. Another subjective factor noted by observers is the staid, often dull manner in which the programs are presented, compared with the more lively, more personal style that many young

adult radio listeners expect. This points to another important element of the programmer's skill: it is freshness in presentation, with something like a "one-on-one" style for announcers.

The more successful Beautiful Music programmers are in fact freshening the music with vocals, a more upfront character, new styles in announcing. Peters Productions, for example, calls their updated beautiful music "Easy Contemporary," to emphasize the new sound.

Some recent broadcast experiences with rock music also emphasize a sharper approach to programming. Rock, king for so many years, appeared to be dethroned or at least demoted when such long-running rock successes as New York's WABC had to abandon it.

It has been widely believed that basic to this change was the shift by listeners to FM. And further study of the AM-FM split has led to a new strategy on rock for a number of stations. Those going to

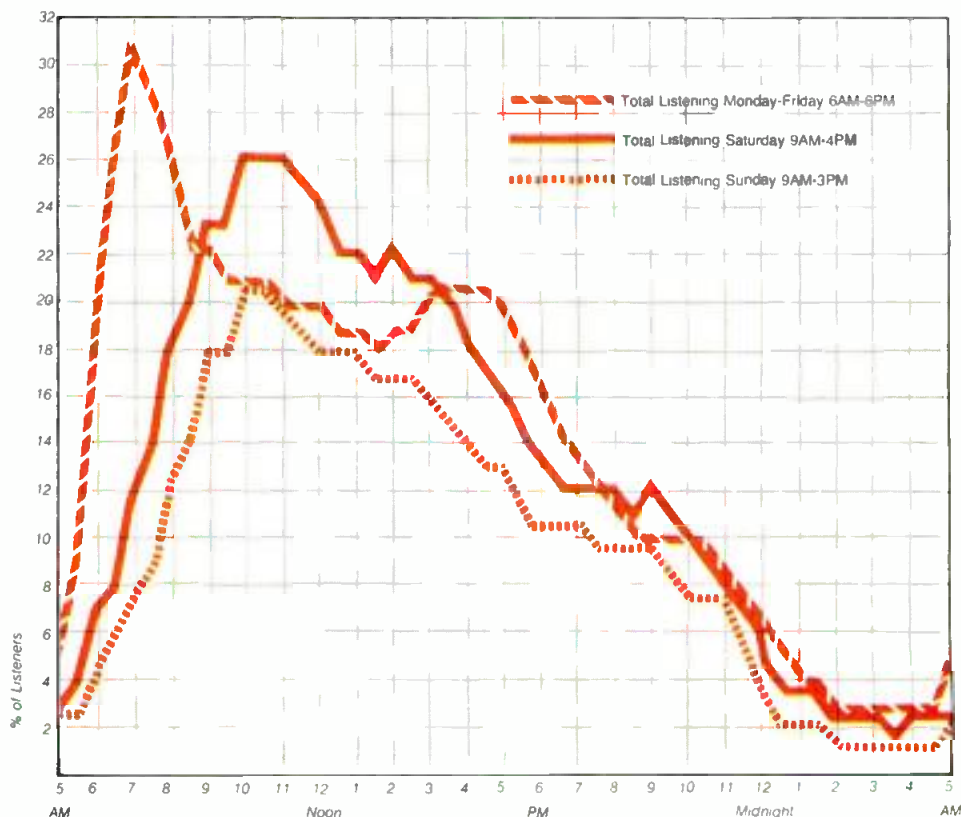



## Continental's 5 kW AM Power Rock: a sound winner that's ready for AM stereo.

The Power Rock is designed to give you the very best audio. Listen to the loud, clear signal, and you know you have a winner. The Power Rock is ready for AM Stereo and accepts sophisticated audio.

- Owners and managers like Power Rock's superior performance and outstanding on-air performance.
- Program directors like the crisp, clean signal and compatibility with the most sophisticated audio processors.
- Engineers like the proven design and conservative components: a safety margin for steady, reliable on-air performance.

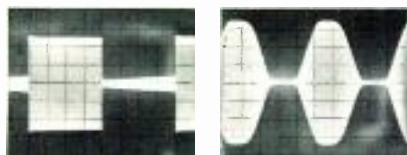

Left: Photo shows excellent dynamic response of Continental's 5 kW AM transmitter at 20Hz modulation. Right: photo of modulation wave form shows effect of Instantaneous Peak Limiter

For a copy of our brochure on the 315R 5 kW AM Power Rock, call (214) 381-7161. Continental Electronics Mfg. Co. Box 270879 Dallas, TX 75227.

© 1982 Continental Electronics Mfg. Co. /5101

**Continental**  
**Electronics**

Circle 20 on Reader Service Card

## RADIO PROGRAMMING

FM are overwhelmingly the younger listeners, as shown by "Listening to the Listeners," a study of 1800 people in a national, all-ages sample, carried out by McGavren-Guild and Robert Balon Associates. About 90 percent of the 18 to 24 age bracket voted for FM against AM, and more than 70 percent of the 25 to 34 bracket. In the oldest group tabulated, 45 to 54, 83 percent of the men and 68 percent of the women voted for AM radio.

This suggested to a number of program consultants and network programmers that an all-out rock format, carefully tuned to the current tastes of the youngest group, would have a chance on FM. The Columbia Broadcasting System has proved the truth of the proposition in its owned and operated FM stations, WCAU in Philadelphia, KHTR in St. Louis, and WBBM in Chicago. They are using "Hot Hits," made up mostly from current rock hit singles. Because Top 40 has lost its standing, it has become a nasty phrase. But these stations have been pulled up in the ratings by a format more thoroughly sales-oriented than Top 40.

Bob Hyland, CBS vice president in charge of the owned FM stations, explained it to *BM/E*: "We do not depend simply on published sales charts, but have our own active and continuing sales research in key cities all across the country. We are up-to-the-minute on what is happening in the rock music market."

Album-oriented rock, which uses many more pieces than a "Hot-Hit" program, some old, some new, has also been showing signs of wear lately. But CBS has recently been successful with a refurbished AOR format at KCBS-FM in San Francisco. Hyland reports that the other AOR outlets in the market seemed somewhat weak to CBS. Strong presentation, detailed audience research, and good promotion put KCBS up in the ratings. Filling an empty or weak slot in the market is an old technique that is more valid than ever, if skillfully done.

Another kind of rock success, possibly a key to the future, is at KROQ in Los Angeles. The programming here is devoted to the "rockiest-rock," the

farthest-out teen-and-young-adult music. The program director, for example, goes on the air as "Freddy Snakeskin" and the young listeners are tuning it in. Rick Carroll, former program director at KROQ and considered to be one of the originators of the style, is now a program consultant to other stations. So the idea may well spread to other large markets. It is not expected to win broad advertiser support in smaller markets.

There are a number of other new and old rock successes around the country. Two examples: KJYO in Oklahoma City went from Adult Contemporary to "Hot 100," and WQEZ in Birmingham

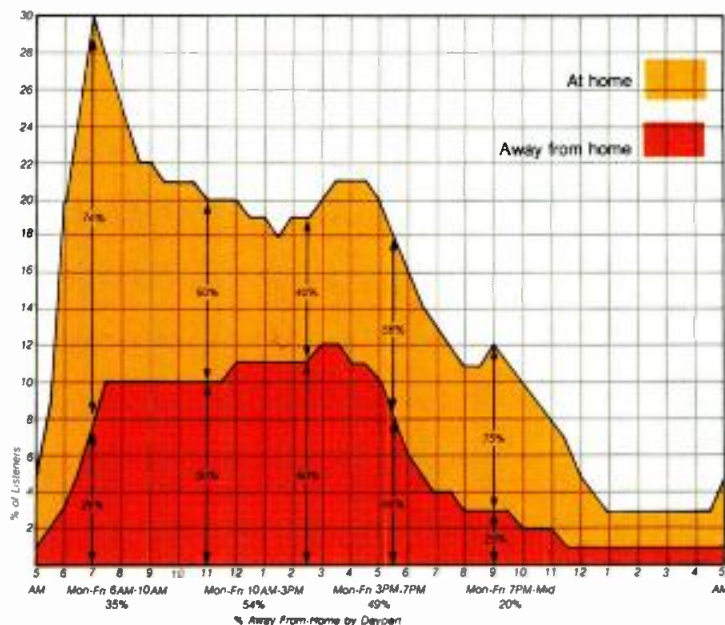

from Beautiful Music also to "Hot 100," both with good results.

But a common factor in the rock programming is its direction toward the young demographics. And the fact that the size of the young group is shrinking means that rock has to be used carefully. If a radio management wants the older listeners, the most common choice now is Adult Contemporary, current nonrock popular music. It is most widely acceptable to ad agencies and advertisers, and is the most-used format, as the NRBA survey quoted above has shown.

By the same token, Adult Contemporary is in many markets the most competitive format, and stations using it have to share the audience with one or more competitors. Or they have to reconstruct the programming to differentiate the station and get attention.

WYNY-FM, an NBC station in New York, is an example of the latter technique. They use noncurrent popular music, with Top-40s style in jingles. The mix is carefully made to produce a "foreground" sound, putting them very high in the ratings. **BM/E**



# EQUALIZATION

## A NEW CONCEPT

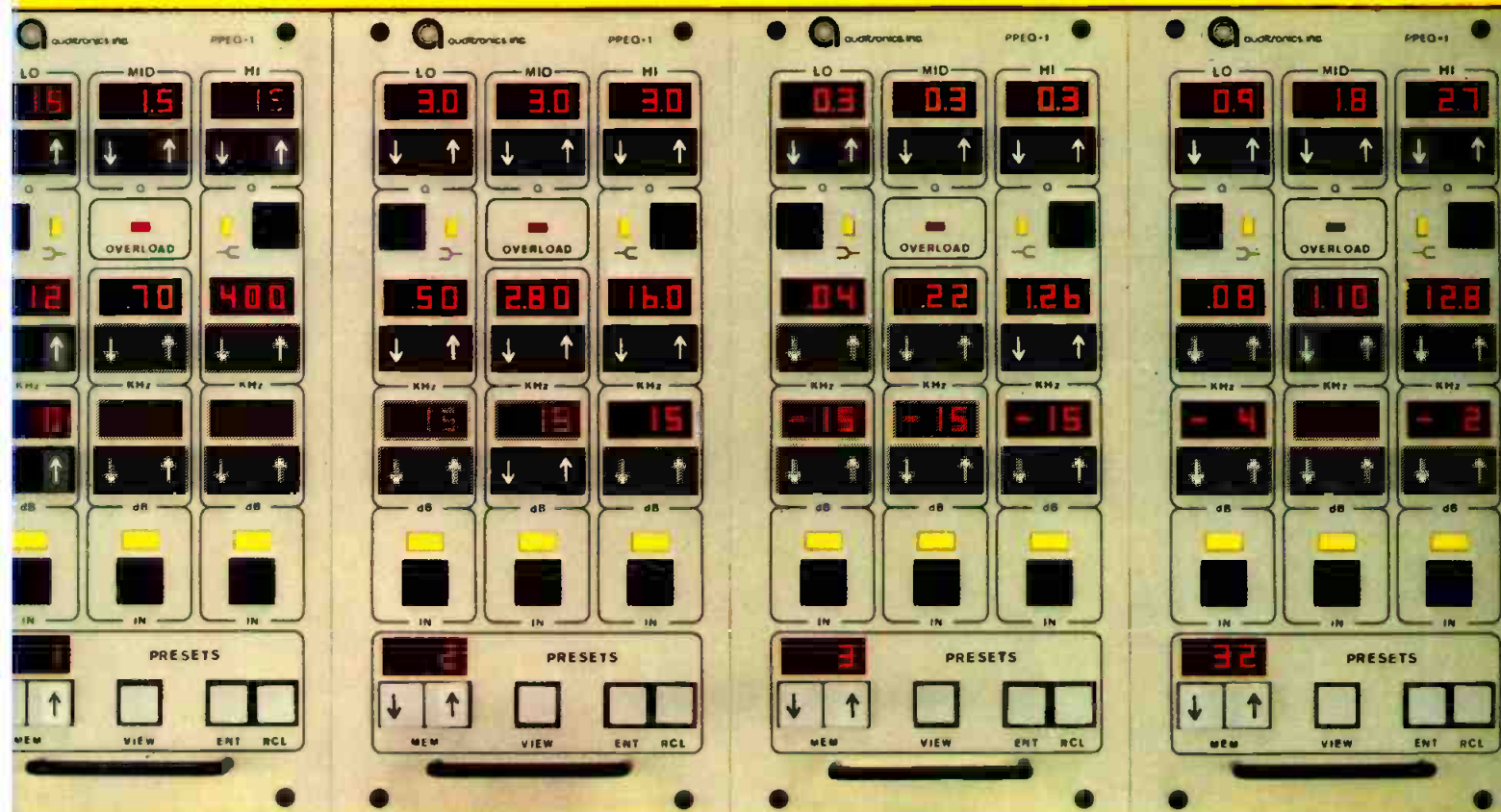

Development of the Auditrionics Model PPEQ-1 Programmable Parametric Equalizer marks another milestone in the evolution of master equalization. Carefully designed to provide the flexibility and expediency demanded by today's production methods, the PPEQ-1 is a totally new concept. Each equalizer is a self-contained unit, and up to four mono or stereo tracking equalizer units may be mounted in a compact 19" equip-

ment rack mounting package. Each unit includes three bands of equalization with variable frequency, variable boost/cut, variable Q, peak/shelf selection on the high and low bands, and a separate in/out switch for each band. An overload indicator is provided, and all parameters are accessible and visually indicated on all bands at all times. 32 on-board non-volatile memories are included, along with the ability to interrogate and display

the complete contents of any memory at any time without affecting current program material. Interface to computers or editors for external sequencing or programming as well as a full function remote control are available. The PPEQ-1, advanced technology from Auditrionics.



**auditrionics. inc.**

3750 Old Getwell Rd.  
Memphis, TN 38118 USA  
Tel: (901) 362-1350  
Telex: 533356

Circle 121 on Reader Service Card

# And that's the



*Meet the Press—NBC—11/20/47  
to present*



*John Cameron Swayze—NBC—  
Camel News Caravan 1948 to 1956*



*Dave Garroway—Garroway at Large  
1949, Today Show 1952 to 1961*



*Army vs McCarthy Hearings  
April 1954*



*Huntley/Brinkley Report NBC News  
10/15/56 to 7/5/70*



*Kennedy-Nixon Debates—ABC—  
10/3/60*



*Vietnam War*



*60 Minutes News Magazine 7/24/68  
to present*

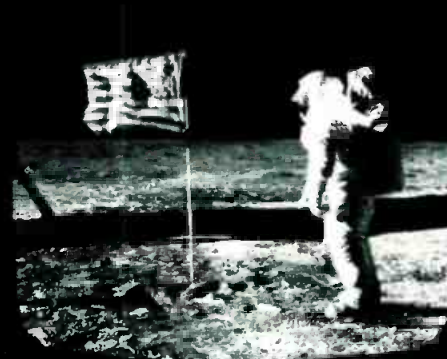

*U.S. Lands Men on the Moon July  
1969*

Garroway was introducing early risers to a show called *Today* and Conrac was introducing its first black and white monitor.

Swayze was anchoring network news, the McCarthy-Army hearings were being held in America's living rooms, and Conrac was introducing the first color monitor.

News and newspeople changed year after year, decade upon decade. All the while, Conrac was earning a position of trust and respect throughout the broadcast community.



# way it was.



*Senator Estes Kefauver Crime Hearings 1951*



*Edward R. Murrow—CBS—See It Now 4/20/52 to 7/5/55*



*Coronation of Queen Elizabeth June 1953*



*Walter Cronkite—CBS Evening News 1962 to 1980*



*John Kennedy Assassination 11/22/63*



*Lee Harvey Oswald Killed on Nationwide TV 11/24/63*



*Watergate 5/17/73 to 8/8/74 (Nixon Resigns)*



*Iran 11/4/79 to 1/20/81*



*Space Shuttle on a Model 6142 Conrac Monitor*

Today, Conrac is working on the next generation of broadcast monitors. To give you the highest resolution. The truest colors. The best value.

The first. And still number one.



CONRAC

# The new Philips LDK 6

**The first "total"  
automatic camera.**

Only the LDK6 provides 100% automatic control for all primary and secondary setup adjustments... plus it has multiple diagnostic systems and many other automatic and operating features.

The LDK6's advanced design provides unprecedented reliability and flexibility. It launches a new era for broadcast and production.

If you are interested in the most advanced studio/field camera available today, and the best investment for the '80s... put yourself behind the LDK6.

Call or write for details.  
Philips Television Systems, Inc.  
900 Corporate Drive  
Mahwah, New Jersey 07430  
201-529-1550

**At NAB... visit us at  
Booth 1409A**



Circle 123 on Reader Service Card

# PHILIPS



# TELEVISION

## programming & production

### WKOW-TV Scoops the Competition With Specialized Mobile Radio Communications

ONE OF THE MOST important considerations for the modern TV station is how new technology can improve the quality of the newsgathering effort and how, in turn, that quality ENG gives the station a boost in its image and ratings. To achieve this happy combination, a special rapport and a high level of communication needs to take place between the studio and the field.

With a new twist on an old theme, WKOW in Madison, Wisconsin has achieved this level of efficient communication with a new specialized mobile radio (SMR) system from Rogers Air-call. "Unlike conventional mobile radio-telephone systems with restricted channels and hundreds of subscribers on the same frequency clamoring for access and causing delays," declares David Wood, director of engineering for the ABC affiliate, "SMR eliminates these problems, which gives us an advantage and it makes us better."

"Better" means avoiding as many time delays as possible in getting the material back and staying ahead of the competition. Early one afternoon, the truck was 50 miles away, having shot a story for the evening news. Rather than wait an hour and a half for the truck to return, the piece was microwaved back to the station, with the engineers setting it up over the SMR. This could have been done on the old radios, but not

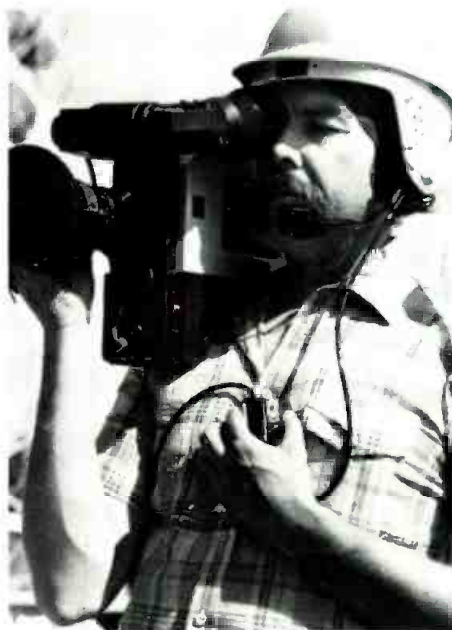

Photographer John Scapple communicates, through intercom interfaced to SMR, to the van or station engineer.

without alerting the competition to an exclusive story.

In another case, the SMR allowed WKOW to get to a story first. There was a fire reported on the police scanner. A team was dispatched to the area without knowing the exact location of the fire. Someone at the station called the police and got the exact location, sending it

out over the SMR. Having the SMR in place of the old system enabled the WKOW news team to get there first, and without doing the leg work for the competition by sending the location out over the 450 MHz band.

#### Gearing up for ENG improvements

The implementation of this unique communications system came about as a result of the station preparing to put its first microwave news truck on the road. Both management and engineering were aware that the key to operating an ENG truck effectively is good lines of communication between particular people in the truck and particular people in the station (field engineer to station engineer, camera operators or reporters to the studio director, and so forth).

At the time, the station had seven hand-held radios, which were inadequate and lacked privacy. The station was also forced to use a repeater on the 450 MHz band, which, of course, was extremely busy between the hours of 4 and 6 p.m.—when it was most needed. A lot of communication with field crews was done by pay phone!

The decision to go with private communications coincided with the approach by the Rogers Radio people who wanted to install a trunking system in Madison. In the new plan, WKOW has



Newscaster Myra Sanchick uses handset tied into SMR to speak to cameraman in the field.

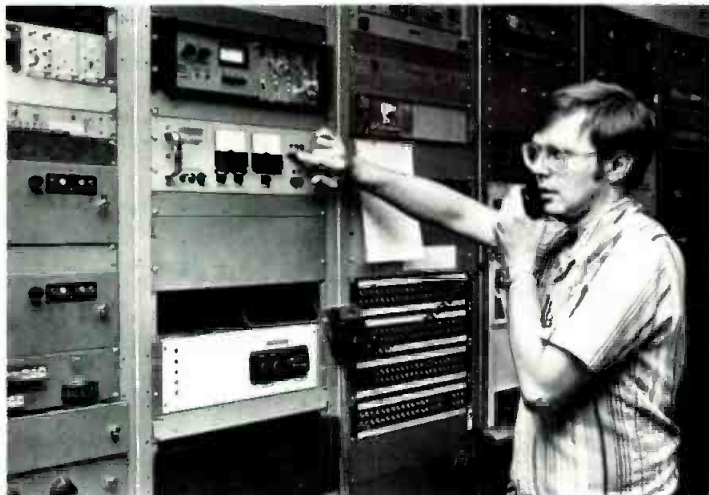

wkow technician Jim Buntrock lines up microwave receiver by SMR with news van in the field.

# TELEVISION PROGRAMMING

become a subscriber on the 800 MHz frequency, with the repeater on its own broadcast tower.

The system consists of Motorola's microprocessor-controlled trunking device, combined with custom interface units and communication stations. The system can provide up to 20 channels, but in the case of WKOW, only five are licensed. Of the five repeaters, four are used for radio communication and one, the control channel, carries digital data for constant updating of system parameters. The principle advantages to this configuration, according to Wood, are that "the range is increased considerably over the conventional radios we're phasing out. Besides, the old units cannot be tied into a total communications system that is possible with the SMR. And, of course, confidentiality is now provided."

Making the coordination of the total communications system possible is a computer in the repeater site. The computer activates the control channel so it can constantly update all channels of communication. If someone keys a microphone to access an open channel, a digital code is sent to the computer, which identifies who the subscriber is and routes it to the proper subfleet of ra-

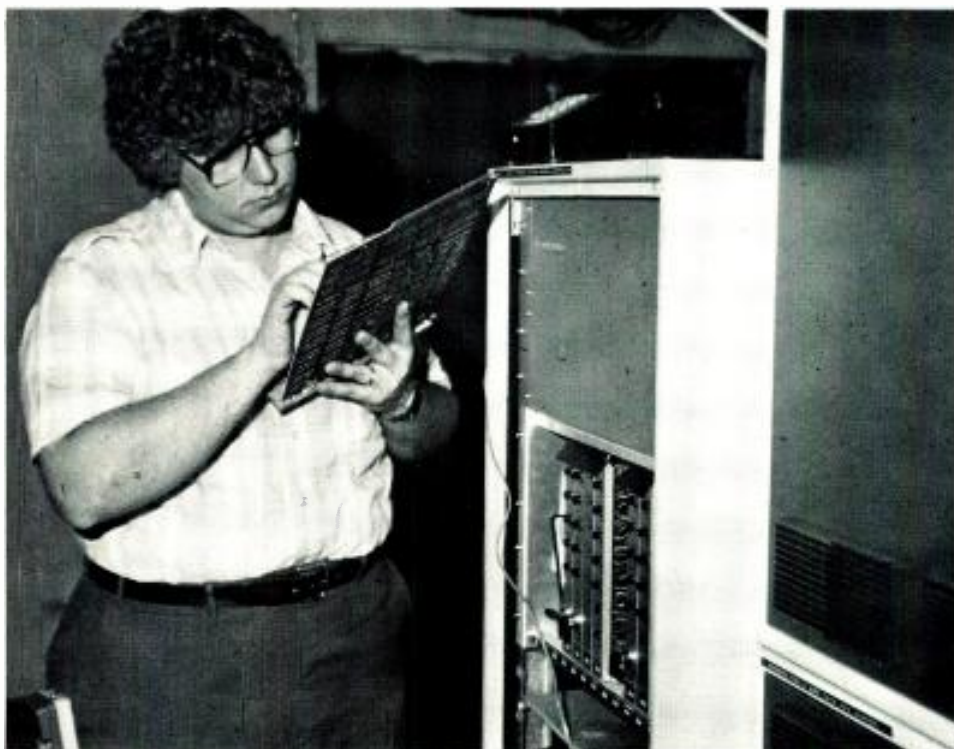

Director of engineering, David Wood, examines radio control unit circuit board.

dio channels, where it signals the transceiver to resynthesize itself to whatever that open channel is.

Specific hardware in the system consists of two base stations, four mo-

bile units, and 10 hand-helds. The components are set up so that the directional antenna for two-way communication from the truck is located on top of the pneumatic mast for the microwave so it

## THE 6112 IS BY FAR THE MOST ADVANCED SWITCHER IN ITS CLASS. NOTHING ELSE EVEN COMES CLOSE

Complete a mix or wipe on a 6112 (or any of our switchers for that matter), and there is **ABSOLUTELY** no **COLOR CHANGE** or **HORIZONTAL SHIFT**, we mean just that, absolutely none. That is because the 6112 has a blanking processor which replaces the sync and burst on all incoming video signals with a constant amplitude internally generated signal; completely eliminating the continuous problems caused by small drifts in your cameras and TBC's. **You never know the value of a blanking processor until you own a switcher that does not have one.**

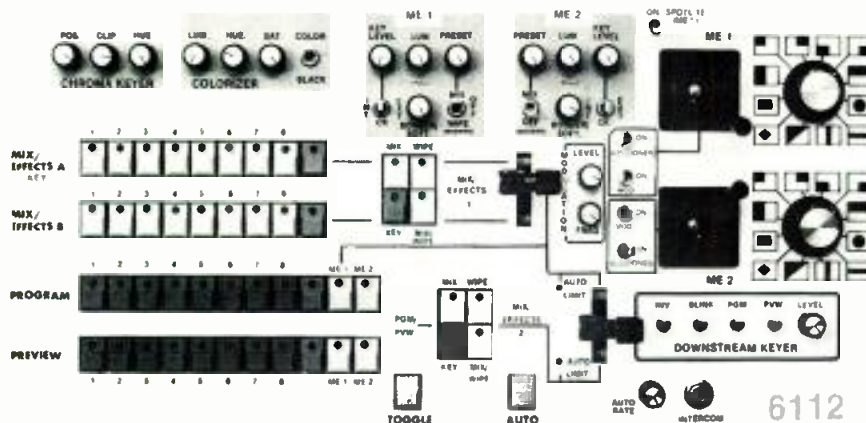

- TREMENDOUS PRODUCTION CAPABILITY
- EASE OF OPERATION
- TWO FULLY INDEPENDENT MIX-EFFECTS SYSTEMS
- AUTOMATIC MIX AND WIPE

- DUAL BACK PORCH CLAMPS
- ROCK STABLE CIRCUITRY
- DOWNSTREAM KEYS
- TWO ADDITIONAL KEYS

**MODEL 6112 NTSC \$7950 PAL \$8950.**  
**Chroma Keys Encoded or RGB \$1050.**  
**(Encoded chroma keyer not available in PAL)**

CROSSPOINT LATCH has the largest selection of compact switchers. All of them have blanking processors. Ask your local dealer for our very informative booklet "VIDEO POST PRODUCTION" which will be mailed to you free.

### OPERATE THE 6112 DIRECTLY FROM THE EDITOR KEYBOARD

The 6403 allows the 6112 to interface directly with most editors. No modification to the editor is required.

Under 6403 control the 6112 accepts commands such as duration times, pattern type, bus selection etc., directly from the editor keyboard. The 6403 also provides additional capability of accurate start and finish, size and position of pattern transitions.

Audio follow or split audio capability is provided by the 6800 mixer which has separate level controls for each stereo input. The 6803 can be driven either directly by the editor or via the 6403 interface unit.

**DELIVERY WITHIN TWO WEEKS**

**CROSSPOINT LATCH CORP.**

95 Progress St. Union, N.J. 07083  
 (201) 688-1510 Telex: 181160



# It's here! A still-store that titles.

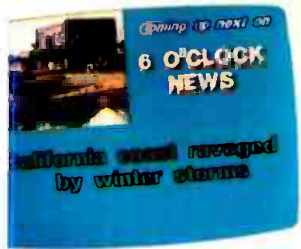

Harris' IRIS II Digital Still-Store now has DIGIFONT high resolution titling, built-in.

Now you can compose, store and retrieve title pages from anywhere in your facility using a standard IRIS keyboard. A down-stream

keyer even allows you to key titles over full-frame stills or compressed images.

The DIGIFONT option cost-effectively solves your titling problems with roll display, page store and recall, adjustable character spacing, italicized characters, and more. You can even choose font

types, border sizes and background colors!

DIGIFONT now — and more to come.

For a demonstration, call us at (408) 737-2100, or write Harris Video Systems, 1255 East Arques Avenue, Sunnyvale, CA 94086.

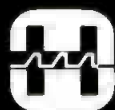

## HARRIS

**NAB  
Booth  
401**

Circle 125 on Reader Service Card  
[www.americanradiohistory.com](http://www.americanradiohistory.com)

is always oriented toward the repeater.

### Flexible design

The base stations are located in the newsroom and in the control room, each with an additional three hand-held units operating through the base. This was a modification made by Wood so that different people in these areas, while operating specific equipment, could contact the field units.

If, for example, the truck was preparing to microwave some video back to the station, the engineer at the microwave rack could talk to the engineer in the truck through the hand-held unit located next to the rack. Similarly, from the newsroom the director and other news personnel can talk with the reporter or cameraman in the field, all from a hand-held unit operating through the base station.

The hand-held unit at the anchor desk also operates through the base station in the newsroom, offering talkback before the news goes on the air or during commercial breaks.

To further integrate the SMR into the total communication spectrum of the news team, Wood interfaced the truck's Telex party line intercom system to the SMR unit in the microwave truck. There is an interface box which switches the SMR into the intercom PL so that both the reporter and camera operator can hear the studio director over the intercom. The cameraman also has a toggle switch which allows him to talk into the intercom.

In addition, the earpiece worn by the reporter is hooked to a hybrid audio mixer in the truck which allows him to hear the station from the off-air audio. Thus, both camera and reporter can hear the studio through a switch in the truck which connects the SMR transmission into the PL, and the director at the studio can hear the reporter through his microphone feed.

### Payoff in production value

Computerized communications and customized interfacing are all very nice, but the real question is whether or not the equipment results in more and better news coverage. The answer, in this case, is yes.

At WKOW, management likes it because it not only improved communications, but saved them from \$5000 to \$10,000 in expense for additional radios for the old system. The camera operators like it because it makes for an easy setup on location. The news director, Paul Pitas, and his staff like it because it makes the job smoother and increases efficiency. As Pitas concludes, "Any time you improve communication, you improve your product." **BM/E**



## Some important answers from Cipher Digital (and the people who wrote the industry reference 'Time Code Handbook')

**Q.** How can I improve the cost effectiveness of my next Longitudinal Time Code equipment purchase?

**A.** By purchasing your equipment from a company whose advanced engineering and manufacturing techniques provide quality, state-of-the-art products at half the usual cost.\*

\*(See our new #735 Series at NAB)

**Q.** Can I upgrade my existing longitudinal system to use Vertical Interval Time Code without the expensive duplication of hardware?

**A.** Yes, by purchasing translators\* that enable standard longitudinal products to generate and read Vertical Interval Time Code.

\*(See our new #9000 Series 'VITC' Translators at NAB)

For dramatic new products from the leader in Time Code technology — and your FREE copy of the 'Time Code Handbook' — visit us at NAB '83, Booth 1606. Or, write: Walter Hickman, Director of Marketing:

 cipher digital

Sales/Marketing Headquarters:  
150 Huntington Avenue • Boston, MA 02115  
Tel: (617) 267-1148 • Telex: 940536

Circle 126 on Reader Service Card



FROM THE SMALLEST EFP MOBILE VAN...

# TO THE LARGEST VIDEO PRODUCTION AND POST-PRODUCTION STUDIO...

**NOBODY DESIGNS AND BUILDS BETTER  
VIDEO SYSTEMS THAN AFA!**



**AFA Systems Division**

A Division of A.F. Associates, Inc.  
100 STONEHURST COURT, NORTHVALE, NJ 07647 (201) 767-1000

**PRODUCTION AND POST-PRODUCTION STUDIOS / SATELLITE AND  
NETWORK PLAYBACK CENTERS / DUPLICATION FACILITIES / MOBILE UNITS /  
SPORTS ARENA BROADCAST FACILITIES / CORPORATE VIDEO FACILITIES /  
SPECIAL-PURPOSE VIDEO FACILITIES.**

See us at NAB Booth 1609-1611

Circle 127 on Reader Service Card

[www.americanradiohistory.com](http://www.americanradiohistory.com)

# "TO RELIEVE MY CAMERAMEN'S BACKACHES AND MY



Art Biggs coordinates major engineering purchases for the six Corinthian stations. After careful evaluation of all the 1/2-inch camera/recorders on the market, he made a multi-million-dollar purchase of the Sony Betacam™ system.

"Betacam has several pluses. The most obvious of them are size and weight. We have one-man camera crews at all our stations. The camera/recorder that they take into the field is

right at 54½ pounds. Betacam will reduce this load by more than half—a significant reduction.

"As for quality of playback, you can see the difference with the naked eye. Its superiority is most apparent in scenes of fully saturated colors, particularly reds. It's cleaner. It doesn't have quite as much of the heavy, stringy-type noise we've grown to tolerate over the years.

©1983 Sony Corp. of America, 9 W. 57th St., New York, NY 10019. Sony is a registered trademark and Betacam is a trademark of the Sony Corp.



# CONTROLLERS' HEADACHES, I TOOK ALL OF THESE."

*-Art Biggs, Vice President, Engineering, Corinthian Broadcasting Corporation*

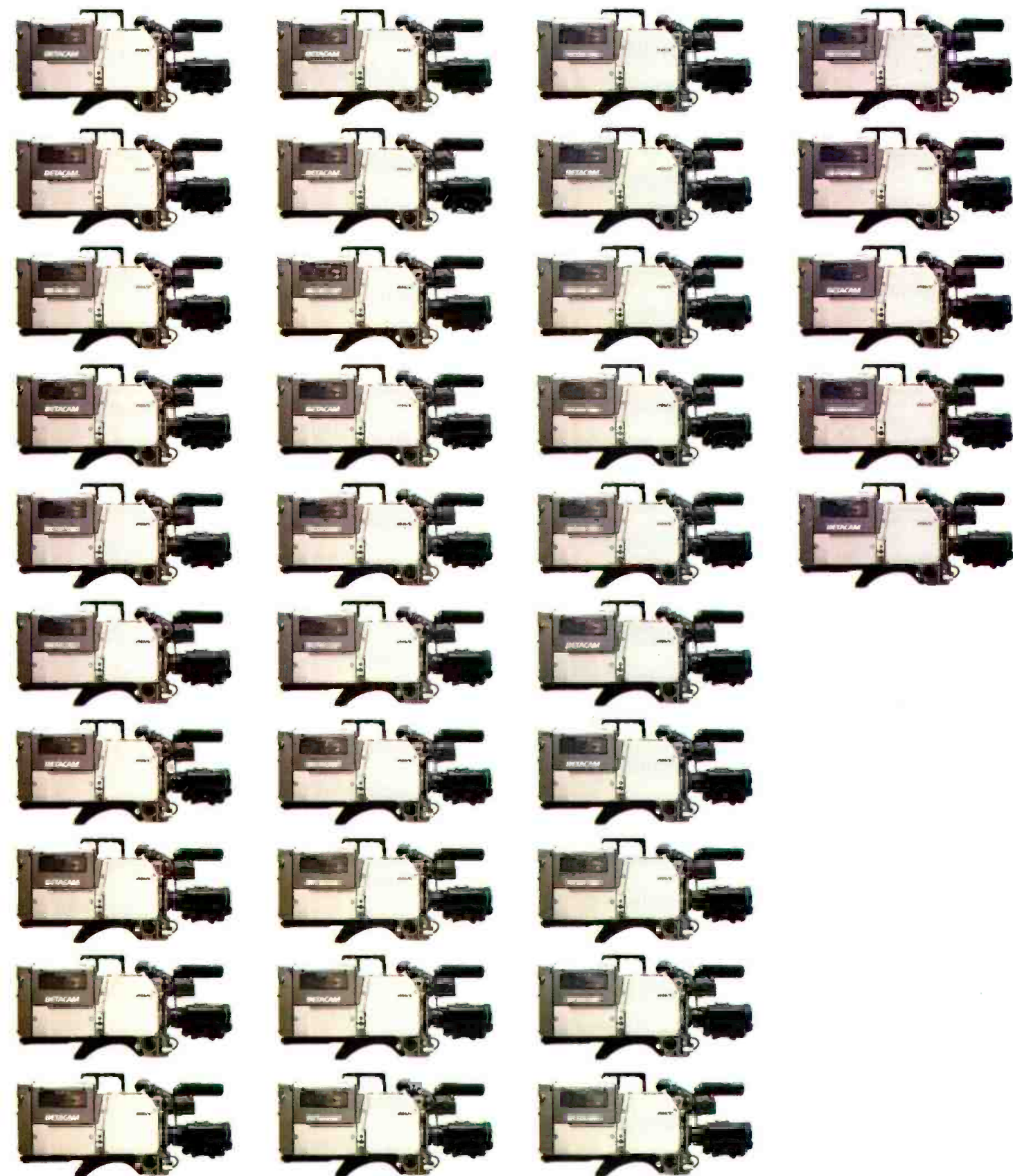

"Another Betacam plus is that it's not a patchwork approach. It's a total Sony system developed from the camera to the recorder to the player.

"Then there's the bottom line. Betacam is at a very attractive price. It would have cost me hundreds of thousands of dollars more to get the same amount of camera/recorders that even approach this kind of quality from someone else.

"I'll definitely be back for more."

For more information on the Sony Betacam system, and there's a lot more to know, contact Sony Broadcast in New York/ New Jersey at (201) 368-5085; in Chicago at (312) 860-7800; in Los Angeles at (213) 841-8711; in Atlanta at (404) 451-7671; or in Dallas at (214) 659-3600.

**SONY**  
Broadcast.



## VISIT NEC AT NAB. WHERE A LITTLE SLEIGHT-OF-HAND MAKES MORE VIDEO MAGIC THAN EVER BEFORE.

Take the controls of the new NEC E-FLEX Perspective Rotational Accessory. You can add it to your E-FLEX DVE® System to get pictures that compress, enlarge, tumble, spin and split. Images that rotate into perspective. Even pictures that roll or swirl like a whirlpool. Virtually any picture manipulation you can imagine, all with absolute fidelity...and all for a price that's more than magic—it's

a miracle. Plus something no other system offers at any price—future add-on flexibility.

See all the new NEC Imagination Machines, including the E-FLEX Perspective Rotational Accessory; portable 7GHz Short Range Microwave Link; and 3 Chip CCD Camera, at the NEC Imagination Theatre, Booth 1415, NAB, Las Vegas, April 10-13.

# NEC

### IMAGINE WHAT WE'LL DO NEXT

NEC America, Inc., Broadcast Equipment Division, 130 Martin Lane, Elk Grove Village, IL 60007 312/640-3792

VISIT BOOTH 1415 ■ FS-16 FRAME SYNCHRONIZER ■ DV-10 DIGITAL MULTIPLEX ■ TVL 807 ■ MNC-1 CCD CAMERA ■ MNC-10 CCD CAMERA ■ FBN 7000 SERIES FM TRANSMITTERS ■ E-FLEX OFFLINE EDITING SYSTEM ■ HPA-4536B FM EXCITER

Circle 128 on Reader Service Card

[www.americanradiohistory.com](http://www.americanradiohistory.com)





**45**

**INTRODUCTION, PROGRAM**

**57**

**WHAT'S HOT IN VIDEO PRODUCTS**

**85**

**VIDEO EQUIPMENT LISTING**

**141**

**WHAT'S HOT IN AUDIO AND RADIO PRODUCTS**

**165**

**AUDIO AND RADIO EQUIPMENT LISTING**



# When the action's hard-hitting, Midwest and Panasonic Video Systems will put you there!

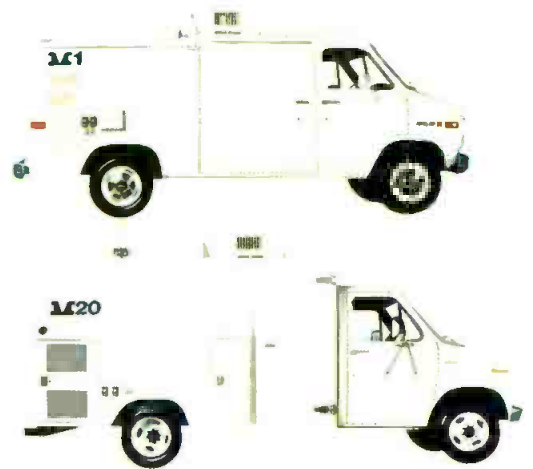

*Panasonic Gives You The Performance And Reliability You Need. Midwest Gives Them To You Fast ... And At A Super Price!*

You can depend on Panasonic Industrial video equipment to give you the performance you want and to take the hard-hitting action of mobile unit installations. That's why so many mobile production companies choose them.

If you need a mobile unit that can take in all the action ... and take all the punishment on-location shots hand out ... you need to talk to Midwest about their complete line of Panasonic-equipped mobile units. Midwest maintains a solid inventory of the complete Panasonic Industrial video line. The new WV-777 Camera shown here is but one of a wide range of components from the Panasonic Video Systems Division.

Let Midwest put you there when the action's best, with dependable Panasonic equipment in an M1 or M20 mobile unit. For information on the complete line of products at Midwest, call toll-free today. 1-800-543-1584

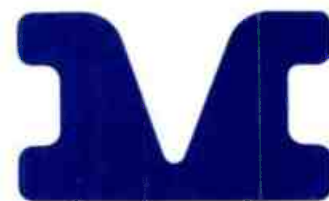

**MIDWEST**  
CORPORATION

**One Sperti Drive  
Edgewood, KY 41017**

Authorized Distributor  
for Panasonic Products

Dayton, OH 513-298-0421	Lexington, KY 606-277-49
Cincinnati, OH 606-331-8990	Nashville, TN 615-331-57
Columbus, OH 614-476-2800	Charleston, VA 304-722-29
Cleveland, OH 216-447-9745	Virginia Beach 804-464-62
Pittsburgh, PA 412-781-7707	Washington 301-577-49
Detroit, MI 313-689-9730	Charlotte, NC 704-399-63
Indianapolis, IN 317-251-5750	Atlanta, GA 404-457-43
Louisville, KY 502-491-2888	Miami, FL 305-592-53

Circle 129 on Reader Service Card





# NAB '83

## IT'S A SURE BET!

THE THOUSANDS OF BROADCASTERS who converge on Las Vegas April 10 through 13 will be betting on a sure thing—that the sixty-first annual convention of the National Association of Broadcasters will be filled with exciting equipment exhibits and informative, controversial sessions. Whether they're giving their shoes—and eyes—a workout on the exhibit floor or craning forward in their seats at the workshops, both managers and engineers will find plenty happening in an industry where the stakes are always high.

The "electronic supermarket" at NAB of everything that's hot in television and radio products will greet attendees Sunday through Tuesday, 9:00 a.m. to 6:00 p.m., and Wednesday, 9:00 a.m. to 2:00 p.m. With over 500 exhibitors, it's impossible to see everything—so find out what's hot in your area of interest by reading *BM/E*'s analyses of trends in audio and video equipment, plus the booth-by-booth rundown of all the exhibits. Both follow this introduction.

In addition to the regular convention program, NAB will sponsor a special two-day workshop for station counsel in conjunction with the American Bar Association's Forum Committee on Communications Law. Saturday and Sunday (April 9 and 10) at the Aladdin Hotel in Las Vegas, broadcast lawyers will learn about the status of FCC regulation and legislation, cable channel leasing and joint ventures, antitrust liability, and cellular radio, and attend a "newsroom for lawyers" session. FCC commissioners Mimi Dawson and Henry Rivera will speak at Sunday's closing luncheon.

This year's program opener, the annual State of the Industry address, will have special interest because it will mark Eddie Fritts's first NAB show as association president. Broadcasters will be anxious to hear Fritts's analysis of the state of broadcasting and his plans for NAB. Former NAB head Vincent Wasilewski, far from being absent from the proceedings, will be honored with the associa-

tion's Distinguished Service Award. Rounding out Sunday's welcome will be entertainment by the Oak Ridge Boys.

The program gets under way in earnest Monday morning, continuing right through Wednesday with a plethora

### ENGINEERING

#### Keeping Pace With the State of the Art

#### MONDAY

*Radio Sessions:*

- 8:00-9:45 a.m. AM-FM Allocations
- 10:10-11:55 a.m. Transmitters & Antennas
- 3:30-5:30 p.m. Cuban Radio Interference Workshop
- 6:00-7:00 p.m. Ham Radio Reception

*Television Sessions:*

- 8:00-10:10 a.m. UHF Transmission Systems
- 10:35-12:20 p.m. Satellite Systems
- 2:30-5:30 p.m. Television Audio
- 2:30-4:40 p.m. *Special Session:*  
Non-Ionizing Radiation

#### TUESDAY

*Radio Sessions:*

- 8:00-11:55 a.m. New Technology
- 2:30-5:30 p.m. AM Stereo: Users' Reports

*Television Sessions:*

- 8:00-11:50 a.m. Advanced Television Systems
- 12:00-2:15 p.m. Engineering Luncheon
- 2:30-5:10 p.m. Channel 6/FM Interference

#### WEDNESDAY

- 8:00-9:20 a.m. *Joint Engineering Session:*  
Spectrum Management



of vital sessions for both managers and engineers. For a complete listing of what's in store, see the accompanying boxes. At the show, of course, be sure to check NAB's own schedule for last-minute program changes.

"The Name of the Game is the Bottom Line" for radio managers, and NAB's offerings for radio broadcasters give plenty of hard advice on how to turn a profit. Several sessions, such as "SCA Spells Money," "The Golden Management Tool: Cost Cutting," "The Art of Buying, Financing, and Selling Stations," and "Countering Cable Advertising," will be held more than once to accommodate the large numbers of concerned GMs expected. Other sessions—such as "How You Can Capture More Co-op Dollars," "The 10 Most Common Training Mistakes and 10 Specific Ways to Correct Them," and "Don't Tell Me It's Impossible Until After I've Done It," focus on getting the most out of a sales staff.

A series of forums for radio managements includes Tuesday's all-day sales forum, conducted in cooperation with the Radio Advertising Bureau. The day will start with an all-market session in the morning, with small and large market stations separating for the afternoon's work. Monday morning will bring two exciting forums, "Winning Hand for Managers" (repeated on Tuesday) and "A Day in the Life of a Radio Station Manager," three hours of learning and problem solving. In the afternoon, forums will convene for two special interest groups, Spanish language broadcasters and daytimers.

Television is truly "An Industry in Transition," as NAB has dubbed it this year. NAB's TV program is geared toward helping managers keep up with—and profit from—the rapid changes. A long list of sessions will cover such diverse issues as crime and the media, new sales opportunities, expanding your present facility or planning a new one, copyright laws, deregulation, satellite services, the Fairness Doctrine, localism, and much more. Managers will be particularly interested in Monday's television luncheon, where featured speaker Senator Howard Baker will give an insider's update of the legislative scene. Another "must" for managers will be Tuesday afternoon's "One on One" session, with NAB president Eddie Fritts

## TELEVISION

### An Industry In Transition

#### SUNDAY

3:00-5:00 p.m. *General Session:*  
State of the Industry Address,  
followed by the presentation of the  
Distinguished Service Award and  
entertainment by the Oak Ridge Boys

#### MONDAY

8:00-9:15 a.m. Legislative/Regulatory Staff  
Breakfast

9:30-10:30 a.m. *Opening Session:*  
Growth through Change

0:45-12:00 p.m. *Workshops:*  
Strategic Planning & Venture  
Investment  
Saving Money on Legal Fees  
LPTV: Partner, Competitor, or New  
Opportunity  
New Sales Opportunities  
Employee Motivation

12:30-2:15 p.m. Television Luncheon  
Speaker: Sen. Howard H. Baker, Jr.

2:30-5:00 p.m. *General Session:*  
Government Relations

2:30-3:45 p.m. *Workshops:*  
Managing Organizational Performance  
Children's Television  
The Question of Space—Effective  
Planning of a Broadcast Facility  
Minority Programming on Television:  
Is It Working?  
Successful Promotion Campaigns for  
UHF Stations

4:00-5:00 p.m. *Workshops:*  
TV Deregulation...What and When?  
Through the Cable Copyright Jungle:  
A Broadcaster's Safari

The Question of Space, Continued—  
Effective Design, Redesign &  
Construction of Broadcast Facilities

#### TUESDAY

8:00-9:15 a.m. *Early Bird Workshops:*  
Making Money With Teletext  
Keeping Broadcast Spectrum for  
Broadcasters  
Taxes, Taxes, Taxes  
All Industry Music Licensing  
Committee

9:30-11:00 a.m. TvB Presentation

11:00-11:30 a.m. Conversation with James C. Miller  
(FTC) and William L. Stakelin (NAB)

11:45-1:00 p.m. *Workshops:*  
Taking Advantage of Cable  
Financial Management for the  
Nonfinancial GM  
MDS/SMATV  
Localism: The Key That's Being  
Overlooked  
The Hostage, the Terrorist, and the  
Broadcaster—The General  
Manager's Responsibility

2:30-3:45 p.m. One on One: Larry Harris (FCC) and  
Eddie Fritts (NAB)

3:45- *General Session:*  
The International Scene

#### WEDNESDAY

9:00-9:30 a.m. *General Session:*  
Speaker: Bob Packwood

9:30-10:30 a.m. *General Session:*  
FCC Questions and Answers

10:30-11:30 a.m. *General Session:*  
Productivity

11:30-2:30 p.m. Joint Luncheon with Mark Fowler,  
entertainment by Bill Cosby



# NEWSMAKER



## WKRG-TV makes news in Mobile, Alabama with a GVG 300/Mk II Digital Video Effects production system... tightly formatted using visually exciting digital effects.

The 300 System makes promos...with the high quality appearance of expensive outside services.

The 300 System makes commercials...at least eight hours a day for local and regional clients, who have come to WKRG because of 300/Mk II DVE capabilities.

Why did WKRG-TV purchase the 300/Mk II DVE production system? "Because of the capabilities, and the Grass Valley Group reputation for how their equipment stands up", says Don Koch, Assistant Chief Engineer.

WKRG-TV understands Grass Valley Group value...but if it's news to you, isn't it time you took a closer look at the 300 system?



DON KOCH

## THE GRASS VALLEY GROUP, INC.®

P.O. BOX 1114 GRASS VALLEY CALIFORNIA 95945 USA • TEL: (916) 273-8421 TWX: 910-530-8280

A TEKTRONIX COMPANY

Offices: **Eastern Regional:** 499 Thornall St, Edison, NJ 08817, (201) 549-9600 • **Southeastern District:** 1644 Tullie Circle N.E., Ste 102, Atlanta, GA 30329 (404) 321-4318 • **Midwestern Regional:** 810 West Bristol St, Elkhart, IN 46514 (219) 264-0931 • **Northwestern District:** 3585 North Lexington Ave, Ste 238, Arden Hills, MN 55112 (612) 483-2594 • **Southwestern District:** 316 Seminary South Office Bldg, Fort Worth, TX 76115 (817) 921-9411 • **Western District:** 1032 Elwell Court, Ste 244, Palo Alto, CA 94303 (415) 968-6680 • **Western Regional:** 21243 Ventura Blvd, Ste 206, Woodland Hills, CA 91364 (213) 999-2303

Circle 134 on Reader Service Card  
[www.americanradiohistory.com](http://www.americanradiohistory.com)



fielding questions to Larry Harris, head of the FCC's Mass Media Bureau. That session will be followed by a panel discussion on "The International Scene."

For television engineers, Monday will have sessions on UHF transmission systems and satellite systems, a three-hour meeting on television audio, plus a special session on nonionizing radiation. On Tuesday, sessions will include "Advanced Television Systems" in the morning and "Channel 6/FM Interference" in the afternoon. Wednesday morning will be devoted to a special joint session for radio and television engineers on spectrum management, with papers on FCC deregulation, RARC '83, and land mobile radio.

## RADIO

### The Name of the Game Is the Bottom Line

#### SUNDAY

3:00-5:00 p.m. *General Session:*  
State of the Industry Address, followed by the presentation of the Distinguished Service Award and entertainment by the Oak Ridge Boys

#### MONDAY

7:30-9:00 a.m. Syndicators Breakfast  
9:00-12:00 p.m. *Forums:*  
Winning Hand  
A Day in the Life of a Station Manager  
9:00-10:15 a.m. *Workshops:*  
What the FCC Did Not Deregulate  
Don't Tell Me It's Impossible  
SCA Spells Money  
Capturing Co-op Dollars  
10:30-11:45 a.m. *Workshops:*  
Correcting Sales Training Mistakes  
Sexual Harrassment, Discrimination, EEO  
Lifestyle Management  
Budgets, Income & Expense  
Projection  
12:00-1:15 p.m. *Workshops:*  
Record Retention and the Perfect Public File  
Secrets of Championship Collecting  
Capturing Co-op Dollars  
Don't Tell Me It's Impossible  
1:30-4:00 p.m. *Forum:*  
Spanish Language Radio  
2:30-4:00 p.m. *Forum:*  
Daytimers  
2:30-5:00 p.m. *General Session:*  
Government Relations  
4:00-5:15 p.m. *Workshop:*  
Radio Programming for Minority Markets

#### TUESDAY

7:30-8:45 a.m. *Workshop:*  
Cuban Interference

9:00-12:00 p.m. *Forums:*  
Sales Forum  
Winning Hand  
9:00-10:15 a.m. *Workshops:*  
Programming for Managers  
Sales and Motivation  
SCA Spells Money  
Budgets, Income & Expense  
Projection  
10:30-11:45 a.m. *Workshops:*  
Cost Cutting  
The Art of Buying, Financing, and Selling Stations  
Correcting Sales Training  
Lifestyle Management  
12:30-2:15 p.m. Radio Luncheon  
2:00-5:00 p.m. *Forums:*  
A Day in the Life of a Station Manager  
Large Market Sales Forum  
Small Market Sales Forum  
2:30-3:15 p.m. *Workshops:*  
Bits, Bytes, and What a Computer Can Do for You  
Countering Cable Advertising  
What the FCC Did Not Deregulate  
Cost Cutting  
3:30-4:45 p.m. *Workshops:*  
The Digital Revolution  
ARB/DST/Birch  
Sales & Motivation  
The Art of Buying, Financing, and Selling Stations  
Countering Cable Advertising

#### WEDNESDAY

7:30-8:45 a.m. Early Bird Roundtables  
9:00-9:30 a.m. *General Session:*  
Speaker: Bob Packwood  
9:30-10:30 a.m. *General Session:*  
FCC Questions and Answers  
10:30-11:30 a.m. *General Session:*  
Productivity  
11:30-2:30 p.m. Joint Luncheon with Mark Fowler, entertainment by Bill Cosby

Engineers will not find themselves left out, with NAB hosting a raft of important papers around the theme, "Keeping Pace with the State of the Art." Radio engineering sessions will include "AM-FM Allocations," "Transmitters and Antennas," and a Cuban radio interference workshop on Monday. Tuesday morning will see a radio session on new technology; the afternoon will be devoted to users' reports on AM stereo.

Wednesday morning will bring closing sessions of interest to all attendees, following the extra-early Early Bird Roundtables for radio. First will be a general session with Senator Bob Packwood, followed by a question-and-answer session with all FCC commissioners expected to attend. A meeting on productivity will precede the closing luncheon, featuring FCC chairman Mark Fowler as speaker and comedian Bill Cosby as entertainer. **BM/E**



# THE AMPEX COLLECTION

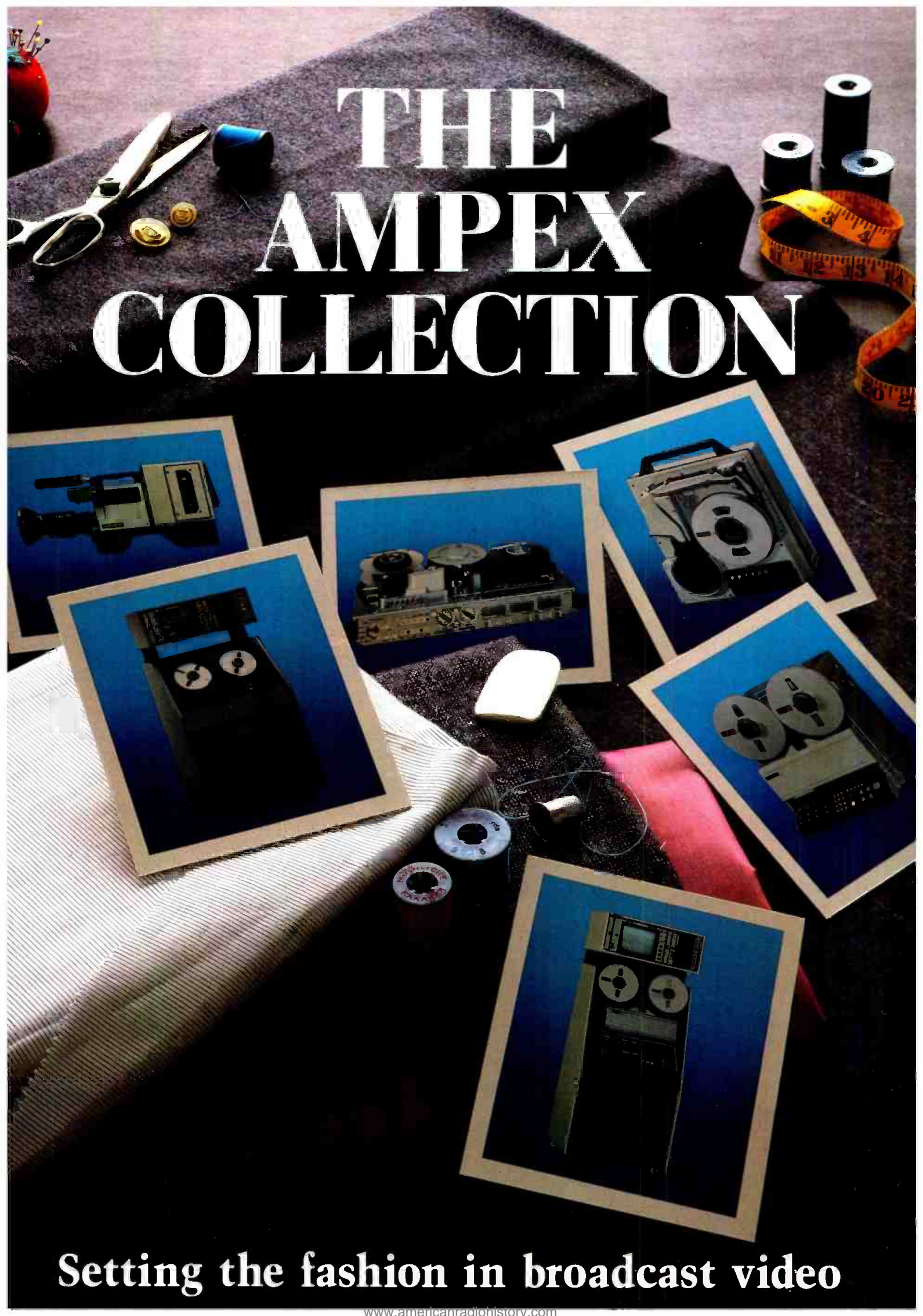

Setting the fashion in broadcast video





Quality. It goes with the Ampex label. It has for over 26 years now. You can count on us for the finest in American technology to give you more value for the money, and to do the job better and faster. That's our style. Ampex can offer you a family of top-of-the line VTRs that are the trendsetters in the fast-paced video world.

Ampex. In fashion today. In fashion tomorrow.

## VPR-3

### The classic choice in VTRs.

VPR-3. Sophisticated. Powerful. Efficient. It's the ultimate one-inch Type "C" video recorder. This truly revolutionary new VTR gives you what you've always wanted. In a single product. The VPR-3's uncompromising exclusive features include: far gentler air-guided tape handling, tape acceleration to full 500

inches per second shuttle speed in just one second on a one-hour reel, superior built-in audio features, plus automatic audio and video setup, "fail-safe" dynamic braking, fast editing without picture shift, simpler operation using a fluorescent status display window and soft-key-driven menus, and extensive, usable diagnostics.



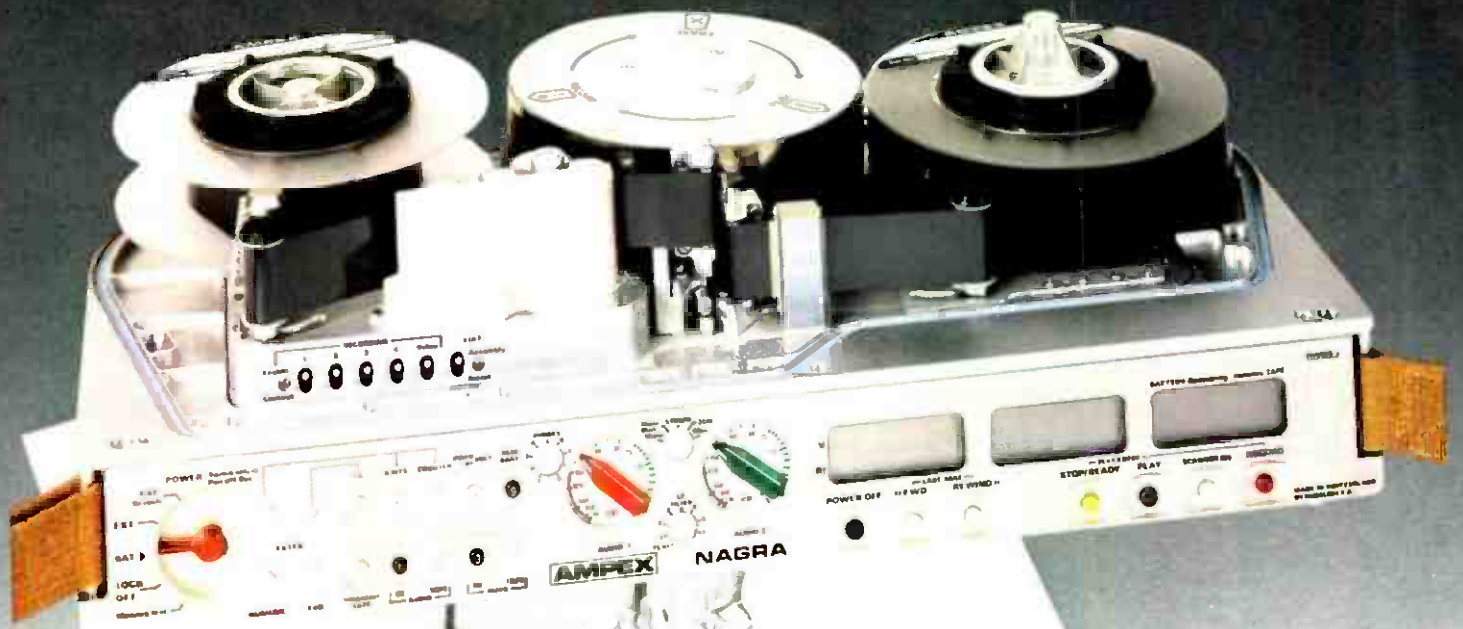

# VPR-5

**The world's lightest VTR.**

This sporty revolutionary fits in anywhere. It's the world's smallest, lightest portable Type "C" VTR — weighing under 15 pounds. Now, you can climb the highest mountain with ease, and come back with what you went after. The Ampex Nagra VPR-5. With rugged metal case, two high-quality audio channels, and comprehensive built-in editing capabilities, plus diagnostics.

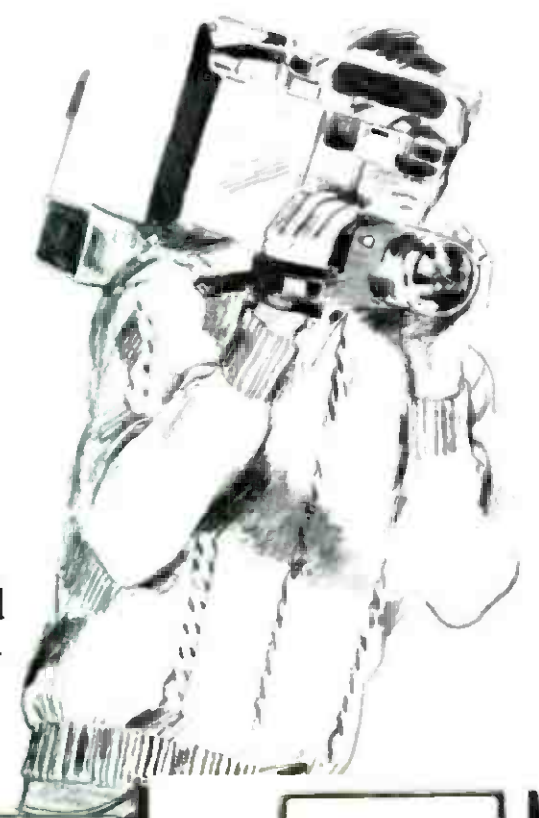

# THE ARC SYSTEM

**The perfect recorder/camera ensemble.**

Here's a fashion sensation for those in the broadcast world turning to the half-inch "M" format. Our versatile, lightweight recorder/system consists of a camera, a portable VTR, a studio editing VTR and an editing controller. Our rugged, self-contained ARC is well-suited to a variety of ENG/EFP situations. You can shoot quickly and easily. Then, all you have to do is edit and, using a TBC, go on the air without dubbing to another format. The ARC uses popular VHS videocassettes.





## VPR-20B

**The "looks-good-anywhere" VTR.**

The true indoor/outdoor stylesetter. VPR-20B. This on-the-go VTR is equally at home in EFP applications requiring portability with top quality, or working efficiently alongside your other VTRs back at the studio. VPR-20B is designed to operate in any position while in motion. And it also features dual-cue editing for studio-type control, and a simple plug-in power pack that replaces the battery.





## VPR-2B

**The perennial favorite VTR.**

Year-in, year-out fashion favorite. This recorder wears well. In fact, it's the world's most popular SMPTE/EBU one-inch Type "C" format production VTR, with over 5,000 sold and in use today. VPR-2B is the epitome when it comes to configuration versatility backed by a wealth of stylish accessories. Features include AST™ automatic scan tracking, accurate frame editing, and individual head replacement.



## VPR-80

**The highly affordable VTR.**

The perfect outfit for people who want Type "C" quality without compromise, at a lower cost than other Type "C" VTRs. Here's the stylish alternative to ¾" U-standard recorders. The VPR-80 gives you direct-color playback, excellent multi-generation picture quality, and flawless slow motion and still framing. This VTR's fashionable features include dual microprocessors, sophisticated editing, diagnostics, and a transport capable of superior tape handling of reel sizes from 6½" spots to two-hour 11¾" reels.



# JOIN THE AMPEX FASHION PARADE

AVC video production switcher

ACE Ampex Computerized Editing s

ATR-800 audio recorder

ATR-124 multitrack audio recorder

BCC-21 Digicam studio/field c

ADO Ampex Digital Optics system

For additional information about any Ampex VTR or other products created to set the fashion in the broadcast world, please contact your nearest Ampex office listed below

U.S. Field Offices: In: CALIFORNIA: Cupertino (408) 255-4800; Glendale (213) 240-5000 • GEORGIA: Atlanta (404) 451-7112 • ILLINOIS: Arlington Heights (312) 593-6000 • KENTUCKY: Louisville (502) 239-6111 • MARYLAND: Bethesda (301) 530-8800 • NEW JERSEY: Allendale (201) 825-9600 (in New York (212) 947-8633) • OHIO: Dayton (513) 254-6101 • TEXAS: Carrollton (214) 960-1162 • UTAH: Salt Lake City (801) 487-8181 • WASHINGTON: Tukwila (206) 575-0156

International Sales or Service Companies: ARGENTINA: Buenos Aires, 46-2776 • AUSTRALIA: North Ryde, NSW, (02) 887-3333 • BAHRAIN: Manama, 2741 • BELGIUM: Nivelles, 067/22 49 21 • BRAZIL: Rio de Janeiro, (021) 274-8122 • CANADA: Bramalea, Ont., (416) 791-3100 • COLOMBIA: Bogotá, 236-7855 • FRANCE: Paris, 270-55-00 • W. GERMANY: Frankfurt (Main), 60580 • HONG KONG: Kowloon, 3-678051 • ITALY: Rome, (06) 546991 • JAPAN: Tokyo (03) 767-4521/2/3 • MEXICO: Mexico D.F., 539-68-70/71/72 • NETHERLANDS: Utrecht, 030-612921 • SINGAPORE: Singapore, 2239241 • SWITZERLAND: Fribourg, (037) 81 31 11 • SPAIN: Madrid, 766.40.49 • SWEDEN: Sundbyberg, 08/28 29 10 • UNITED KINGDOM: Reading, Berks., (0734) 875200 • VENEZUELA: Caracas, 782-7122, Ext. 20

**AMPEX**

Ampex Corporation, Audio-Video Systems Division,  
401 Broadway  
Redwood City, California 94063





# WHAT'S HOT IN VIDEO PRODUCTS

## FIND IT FAST

- |  |   |
|--|---|
| <b>58</b> CAMERAS                          | <b>70</b> IMAGE PROCESSING                      |
| <b>59</b> LENSES                           | <b>72</b> ROUTING SWITCHERS                     |
| <b>59</b> PICKUP TUBES                     | <b>72</b> AUTOMATION SYSTEMS                    |
| <b>59</b> VTRs AND VCRs                    | <b>73</b> LIGHTING, POWER, AND SUPPORT          |
| <b>62</b> STILL AND SLOW-MO RECORDERS      | <b>76</b> TEST AND MEASUREMENT, MONITORS        |
| <b>62</b> PRODUCTION AND MC SWITCHERS      | <b>78</b> SATELLITE SYSTEMS                     |
| <b>64</b> IMAGE SYNTHESIS AND MANIPULATION | <b>78</b> TRANSMITTERS, ANTENNAS, AND MICROWAVE |
| <b>67</b> POST-PRODUCTION                  | <b>80</b> MOBILE UNITS                          |
| <b>70</b> TELECINES                        |   |

# ★ ★ ★ VIDEO ★ ★ ★ NAB '83

WHERE IS THE TELEVISION INDUSTRY headed this year? What will be the most crowded booths at NAB? What will be the most exciting new product introductions? Usually by this time the answers have become clear—industry trends are evident and new product information has been conveniently leaked to the press.

But this year something is different: None of the answers are clear. The results of our *Survey of Broadcast Industry Needs* published last January indicated major differences in what the industry is looking for. Heading the list of needs were 3/4-inch VCRs, video monitors, and TBCs—in fifth and sixth place the year before. Test equipment rose from tenth to fifth place. Lighting equipment, down in twenty-first place last year, this year was number 10. But studio cameras, which were number 11, became number 23. And down considerably in this year's list are those products which are still considered the "sizzle" products of the broadcast operation—single-piece recorder/cameras, switching automation, and even art/paint systems.

In short, inflation and the poor economic climate may have finally caught up with the television industry. Despite an apparent rash of new product introductions and considerable marketing efforts on the part of manufacturers to position themselves for an expanding market, broadcasters themselves are running scared. Rather than investing in new technology, the effort is to keep the existing technology around for a year or two more. And though there probably won't be crowds around the booths of T&M manufacturers, it's likely to be here that the most orders are taken.

There will be some excitement, of course. The graphics systems may be low on the list of purchasing priorities, but they always draw crowds—particularly this year with the MCI/Quantel Mirage and probably the Bosch FGS 3D systems making their first appearance on the exhibit floor.

Most exciting of all, however, are likely to be on-the-floor demonstrations of high definition TV systems. Sony is definitely bringing its playback system—the one that was demonstrated in the NHK/CBS presentation last year. But Sony may also bring its camera system along, helping to fill the mammoth exhibit booth that will be the largest at the show. Meanwhile Hitachi, too, will be demonstrating its HDTV camera system. And Merlin will have a wideband, higher-definition VTR to demonstrate.

## CAMERAS

The integrated recorder/camera market, at this point the hottest area of development in the camera field, will be swelled at this year's show with the official entry of Thomson-CSF and JVC. Thomson, of course, will show its version of the Betacam, which it previously endorsed. The company is entering the field full-blast, showing not only one- and three-tube versions of the camera but also the brand-new Sony player/recorder Betacam deck. JVC will unveil the HR-C3/GZ-S3U, a VHS-C unit, which has also been adapted and shown by other companies such as Frezzolini.



*Three-tube version of the Sony Betacam integral recorder/camera.*

As it promised at last November's SMPTE, Hitachi will bring its integrated half-inch recorder/camera in a new **three-tube version**, the SR-3. This becomes the latest member of a growing Hitachi family that includes both the quarter-inch SR-1/CV-One package and a complete RCA/Matsushita format system.

Other manufacturers will be back with their previously introduced recorder/cameras. RCA will show a complete **studio setup** for its **Hawkeye**, integrated with a TR-800 one-inch VTR and a CMX editor. The **Ampex ARC** and **Panasonic ReCam** will be back in force. And **Bosch** will once again show the KBF-1, its **quarter-inch system** introduced last year but now in a production version.

**Sharp**, which has been active in the low-priced ENG field, has promised unspecified developments in broadcast video for this year's show. A one-piece camera/recorder, perhaps? The answer will be at the booth.

Perhaps the greatest activity in cameras this year, however, will be in the EFP area, with several new entries in a field with increasingly blurry edges. For example, **Hitachi** will introduce what it describes as an auto setup, computerized, portable color camera for ENG, field production, or studio applications. This portable version was initially seen at SMPTE. Hitachi is also drawing considerable interest with its **SK-1**, an all-solid-state camera weighing but seven pounds which uses three CMOS sensors. The image is enhanced by a unique diagonal arrangement of diodes on the CMOS chips.

Harris will show the **TC-90** ENG/EFP camera unveiled last year.

At the **Ikegami** booth, visitors should check out the promised **new 2/3-inch prism optics ENG/EFP camera** system with 2-H detail enhancement, plus a new **auto setup EFP camera**, the HK-322. Ikegami will also bring a new portable microwave system for its established HL-79 and HL-83 cameras, plus its HDTV camera system.

News may also be made by the reemergence of **Bosch** in the lightweight ENG/EFP camera field with its **KCF-1**.

The **Philips** line of cameras for field and studio applications—including the advanced, computer-aided LDK-6, the LDK-25B and LDK-14S field/studio cameras, and the LDK-44, billed as an ENG/EFP "economy" camera—will all be back this year with entirely new electronics. The **LDK-6** will be shown in a production version. **Ampex's Digicam** series, the BCC-20 and BCC-21, will also be on view, with the company reporting healthy





A production model of the Bosch KBF-1 quarter-inch tape recorder/camera.

sales of both.

**CEI Panavision** will again be seeking to stake out its share of the market with the **Special Purpose** version of its 310—an extremely high resolution camera with features that can be defined as suited for electronic cinematography. The Foton, introduced last year, is CEI's entry into the microprocessor-controlled studio camera market—"at an affordable price."

In addition, look to both **Toshiba** and **Asaca** for other ENG/EFP camera developments.

## LENSES

As with cameras, much of the action in lenses will be in the ENG/EFP area—with notable exceptions. **Canon's** major work will be in the studio area, with **four new studio lenses**, 14X and 18X models for both 25 and 30 mm format cameras.

**Fujinon** will lay claim once again to the longest lens title with a brand-new **44X BCTV lens** designed for 25 mm tube cameras (13.5 to 200 mm focal length range with a 2X extender). Also new is a 17X16.5 lens for 30 mm tube cameras.

At the **Tele-Cine/Schneider** booth, however, the focus will definitely be on EFP and ENG. Among the promised developments are a line of lenses for the new recorder/cameras, including a **14X model**, and additions to Schneider's long focal length lenses for ENG and EFP.

**Century Precision/Cine Optics** promises new **0.7X wide angle attachments** for 2/3-inch camera zoom lenses, along with a new snorkel lens for ENG cameras. Lens manufacturer **Angenieux** will also display its complete line of lenses for ENG/EFP cameras.

In keeping with some of the HDTV demonstrations that will be taking place, **Fujinon** will show its special lenses designed for the Hitachi and Sony cameras. An interesting new development here will be shown by **Cinema Products**—what it calls "Todd-AO Video." The system consists of an anamorphic lens fitted to the NEC camera. The image is then displayed on a new **Barco** video projector which horizontally compresses the image and projects it onto a wide screen.

**Film/Video Equipment Service** will highlight its Wide Eye I and II wide-angle attachments for ENG/EFP lenses.

**Tiffen** will bring a new line of filters (also to be seen at the **Alan Gordon Enterprises** booth). And **Bush & Millimaki** promises the production model of its **tricolor video collimator**, seen last year in prototype. The device allows optical back-focusing of lenses.

## PICKUP TUBES

Of the tube manufacturers, both **Amperex** and **RCA** promise new **Plumbicons**. **Amperex's** entries will be **30 mm diode gun Plumbicons**, one a low capacitance version. **RCA** will show an 18 mm low capacitance diode gun **Plumbicon**, along with the new **Saticon III** for studio and field use.

**EEV** will offer several new tubes, among them a half-inch **lightweight Leddicon** designed for integrated recorder/cameras. The company's other entries will include a 30 mm diode gun Leddicon with ultra-high-resolution target and an 18 mm HOP/ACT Leddicon.

## VTRs AND VCRs

**Ampex** has already set abuzz two equipment shows—**IBC** in Brighton, England last September, and **SMPTE** in New York last November—with its new videotape recorders. Can the Redwood City, CA company do it again in Vegas? Chances are good that the crowds will gather again around the **VPR-5** lightweight portable, the **VPR-3** fast action unit, and the **VPR-80** low-cost machine—all one-inch, Type C VTRs—because of the impact they will have in EFP/ENG and in editing suites.

Not to be outdone, **Sony** promises a brand-new addition to its **BVH-2000 VTR**, already considered a major technological advance over previous Type C machines. **Sony**, sitting tight on information prior to the show, also promises "an optional accessory product to improve the picture quality of the 3/4-inch U-matic VCR."

But other exhibitors will be vying for a piece of the action with hot products of their own. **JVC** will introduce **three new 3/4-inch VCRs**, one for editing, one for record and play, and one for playback only. The new system is presumably intended to counter the **BVU-800** line from **Sony** which has been sweeping the market recently. **JVC** will also be demonstrating its half-inch **VHS-C** recorder—the extremely compact unit which can be attached to an ENG camera to form a "do-it-yourself" integrated recorder/camera. Both **Frezzolini** and **PEP** have adapted their snap-on power pack adaptors to accommodate the recorder unit.

A major demonstration of high-resolution recording technology will be made by **Merlin** which will be showing the product it developed in conjunction with the Compact Video Imagevision system demonstrated at last fall's **SMPTE** in Los Angeles. Based on a **Bosch BCN recorder**, the high-resolution system enables full-bandwidth recording with no bandwidth compression.



The complete RCA Hawkeye recorder/camera system with camera, recorder, editor.

# A frame synchronizer from Tektronix that sets a new standard of comparison.

**Now. Authentic reproduction from any signal source.** The Tek 110-S is the frame synchronizer with 10-bit resolution and accuracy. Performance that's every bit Tektronix! You get highest signal quality with correct SCH phase from any source. Resulting in the least signal degradation of any frame synchronizer on the market today.

**Ten-bit digital circuitry offers digital signal processing with negligible quantizing errors.** This 10-bit capability lets you cascade multiple units and depend on the 110-S for unexcelled performance. With four passes through the 110-S your signal is still better than with one pass through an 8-bit synchronizer. *Including quantizing effects,* the 110-S has the following specifications:

- 1% Diff Gain
- 1° Diff Phase
- 60dB Signal-to-Noise
- 1% Freq Response
- 0.5% 2T K-Factor

Compare these values to other frame synchronizers which omit quantizing effects from their specifications.

**Noise performance unmatched.** Signals can be tracked to low signal/noise ratios, such as those encountered during ENG Microwave fades. Or the operator can select field freeze or black. Adaptive clamping prevents streaking while quickly responding to hot switches.

**Accurate color framing.** With the adaptive decoder or optional four-field memory, field 1 to field 3 conversions can be accomplished without introducing 140 nanosecond picture shifts. With four-field memory (one complete color frame), accurate color framing can be obtained without decoder artifacts.

**Accurate RS-170A timing.** With the 110-S's 10-bit digitizer and full memory, your original sync and burst can be passed with the signal. Or you may choose to insert a new digitally generated sync and burst with RS-170A timing.

**Front loaded interchangeable boards.** Internal diagnostics allow you to quickly identify any impending problems. Circuit boards are calibrated individually so you can change boards quickly, minimizing downtime.

**Processing amplifier with remote control** provides adjustments for signal level, set-up, chroma gain and hue. Other controls such as field/frame freeze are also provided on the remote control.

The 110-S is built in our tradition of reliability, excellence and long-term value. And backed by a worldwide service network and proven technical support.

Call your nearest Tektronix Field Office (listed in major-city directories) for more information. Or call 1-800-547-1512 for descriptive literature. (In Oregon, 1-800-452-1877).

**Tektronix, Inc.,** P.O. Box 1700, Beaverton, OR 97075. In Europe: Tektronix Europe B.V. Postbox 827, 1180 AV Amstelveen, The Netherlands.

Tektronix 110-S SYNCHRONIZER



WORKING HARD FOR  
YOUR SIGNAL QUALITY



POWER  
SYSTEM  
STATUS

**Tektronix**  
COMMITTED TO EXCELLENCE

# ★ ★ ★ VIDEO ★ ★ ★ NAB '83

Less exotic fare can be seen at RCA, Hitachi, Marconi, Panasonic, and others.

3M, of course, will have its full line of Scotch videotapes and cassettes, as will Fuji, Maxell, Agfa-Gevaert, and TDK.

## STILL STORES, ANIMATION

As is the case with all broadcast equipment, new technology, involving everything from computers to lasers, has a profound effect on what is available in still stores and animation devices. In keeping with this, an exciting new development: **Panasonic** will unveil a laser disc-type still video recorder/playback system. The unit captures 15,000 frames of information on an eight-inch disc with access to any frame in 0.5 seconds.

Information is that 3M, too, will be introducing a new disk-based stills recorder, though there are no other details available.

There is also considerable excitement being generated over digital still stores. **MCI/Quantel** will be conducting full demonstrations of the central library system for its **DLS-6000** still store, which can accommodate up to seven DLS-6000s through its distributed processing system. The central unit can give or take information with titles from any or all of the separate units which have access to the over 100,000 picture capacity of the central library.

**Harris** will introduce a major modification to its **Iris II** still store system which permits the combination of a Chyron VP-1 into the still store to permit captioning of stills without tying up a full-blown character generator.

The **ESP** system from **ADDA** is also making a new push for customers. The highly reliable system is now being promoted for advanced production applications—married to a camera-input digitizer for creating animation-like effects of multiple-image stills.

**Asaca** will be making a move into the digital still store field this year with its **ADS-1000**, an extremely low-cost unit when married with the company's A/D converter. It stores 218 fields of video, which can be easily manipulated into multi-image effects.

The possibility for video animation is still attractive to



*Panasonic's brand-new optical laser disc record and playback system.*

many broadcasters, though the market is somewhat slow to get going and Convergence has abandoned its AniVid system. This leaves the well-established **Lyon Lamb** VAS system as the major contender for attention. Not to be forgotten, however, **Eigen Video** will show the **Frame Grabber**, DSR Series, to interface computer graphics with disk recorders for a variety of animation effects. The 10 MHz disk recorder, the 18-10 frame recorder, and the line of slow-motion equipment will fill out the needs in this area. Both Eigen and Lyon Lamb are also seriously exploring the interface between computer graphics and their recording systems, permitting true frame-by-frame animation effects.

The **Precision Echo** disk recorders will also be shown, though the company is now putting more effort into its digital manipulation products.

## PRODUCTION AND MC SWITCHERS

Among production switcher manufacturers, 1983 appears to be a time to market already introduced technologies rather than introduce new ones. This will be the case, for instance, with **Grass Valley**, which will be featuring the 1680 switcher—based on the popular 1600 series but with more extensive digital controls—introduced last year. The 300 switcher in two and three M/E versions will also be shown. According to company spokesmen, GVG will continue to actively market the **DVE** digital effects package with full support and development efforts.

New product will, however, be shown by **Central Dynamics** (now split off again from Philips, which is handling its camera line exclusively in the U.S.). The new product line is the **Series 80**, modeled after the CD-480 but with traditional features. As an added option for the Series 80 by CDL and the 3100 Series by American Data, the **Digital Services Corp.** Digifex special effects/graphics unit will be available.

**Bosch**, too, is planning to bring out a new switcher at the show, though no other details are available. Still another new switcher, with three M/E banks, is promised by **Digital Video Systems**.

**Vital**, another giant in the switcher business, will also be on hand with its 250 P/N digitally controlled switcher and its huge four M/E **Jupiter** line. **Crosspoint Latch** plans to have a new **production switcher with editor interface**—an eight-input, three-bus unit. Also new will be a 24-input computer-controlled switcher, and two other new production switchers with the M/E. **EchoLab**, too, will introduce a new editing interface for its **SE/3** switcher.

**ISI** will have the new **Model 903** computer interfaceable switcher with RS-232 serial interface optional as a replacement for the 902, making it automation-compatible with outboard systems as well as A.P.E. **Ross Video**, too, will bring a new production switcher, the **RVS-524**, with 12 or 20 inputs and a multilevel effects system. **Shintron** expects to unveil a new **390 YIQ** switcher for the RCA and Sony integrated recorder/camera formats, which is computer interfaceable with all editors. **Beaveronics** will also be on hand with its switcher line.

In the master control switching area, significant advances have been made by **American Data** (which still maintains its Central Dynamics links). ADC has developed a brand-new **master control switcher**, the **MC-4000**, with operating features for small, medium, and large



# The new digital generator that lets you access and configure the vertical interval any way you want it.

Now. Four external VITS inputs. Non-volatile memory. And 39 test signals. All wrapped up in one test signal generator with all-digital family features. The new 1910 from Tektronix gives you the most access offered to the vertical interval—for inserting and configuring the location of test signals, Teletext, closed captioning, source ID and more. No other generator gives you that kind of capability.

Plus, the proven performance of the leading family of digital test signal generators. With the 1910, Tektronix has combined its 1900 Series Transmitter, NTC7 and Studio Test Sets in one highly capable unit. You get a full signal complement, with the accuracy and stability of 10-bit digital signal generation. The digital code for each signal is stored in replaceable PROMs so your 1910 won't become obsolete. Its RS232 control port adds even more versatility to the 1910 by pro-

viding a means for automatic control from such devices as the Tektronix 1980 ANSWER Automatic Video Measurement Set, with added flexibility for programming VITS and VIRS in either field on lines 10 through 20, signal matrixing, VITS sequencing, redefining signal selection in the front panel or remote control unit—and more.

**Solid support completes the package.** The 1910 comes with a worldwide service network and proven technical support, plus the Tektronix reputation for reliability, excellence and long-term value. Contact your nearest Tektronix Field Office (listed in major city directories) for more information. Or call 1-800-547-1512 for descriptive literature. (In Oregon, 1-800-452-1877.)

Tektronix, Inc., P.O. Box 1700 Beaverton, OR 97075. In Europe: Tektronix Europe B.V., Postbox 827, 1180 AV Amstelveen, The Netherlands.



# ★ ★ ★ VIDEO ★ ★ ★ NAB '83

broadcast stations. The unit has full microprocessor control of all switching and analog control functions with over/under audio mixing, and single-event preroll for up to 10 VTRs and two film islands. Several models are available with up to 32 AFV inputs and up to eight audio-only inputs. **Central Dynamics** itself has added a single-event programmable memory to its MC switcher.

**Utah Scientific** will break ground with a new line of software-based master control switchers with full stereo audio capability and audio over/under; the matrices accommodate 30 video inputs. **Grass Valley's** automated MC switcher will also be strongly highlighted at its booth.

## IMAGE SYNTHESIS AND MANIPULATION

The most exciting products being developed from the broadcast industry are still often spillovers from other technologies—as is the case with the numerous digital art and graphics systems that will be on display. Among these, as mentioned, the **MCI/Quantel Mirage** and the brand-new **3D graphics system from Bosch**, both on the NAB floor for the first time, will certainly be show-stoppers. Both are capable of adding true z-axis special effects to a station's or facility's repertory.

In addition, **MCI/Quantel** will also probably have a brand-new product in a hospitality suite—as in previous years, the very latest in digital product developments. On the floor, the **DPE** special effects system will be demonstrated in its various manifestations—including the five-channel **DPE-5000+** with the dimensional effects package that allows rotation and 3D image processing, and a new two-channel version of the **DPE-5000SP** lower-cost system.

**Bosch**, in addition to the **FGS** system, will be introducing its **low-cost graphics system** to NAB for the first time—a drawing table-based device that can work independently or in conjunction with a character generator. Brand-new to NAB will be **Florida Computer Graphics** which is offering a system based on the **VBeacon** computer graphics system.

Several other companies will again be offering similar art/paint systems—being led by **Quantel**, whose **Paint Box** (used to create this month's cover of *BM/E*) is now apparently leading the field. Among lower-cost systems, those from **Via Video** are gaining acceptance, particularly in light of the company's development of its NTSC encoder line. **Thomson-CSF** continues its advances with its **Vidifont Graphics V** line. **Computer Graphics Lab** will again show its **Images** art system. And **Aurora** will be showing its multi-workstation system in a newly redesigned form, also with new software for automatic curve drawing, color edging, and so forth. **Interand**, one of the first companies to bring out a digitally based graphics system—using an interactive stylus to draw directly on the screen—promises a new model this year in addition to the popular "chalk board" being used more and more in sports coverage. **For-A** has a much lower-cost version of this kind of draw-on-screen system.

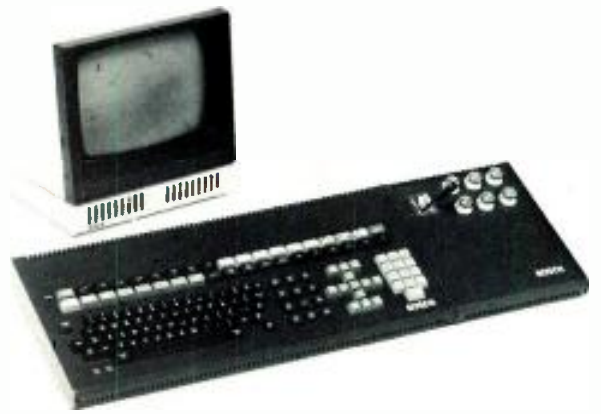

*Bosch will introduce the FGS-4000 3d computer graphics system.*

For those who already have Apple and similar computers in-house and want to use them for on-air graphics, **Video Associates Labs** will be showing its NTSC encoder cards that plug directly into the computer frame.

Likely to cause even more excitement is **Computer Graphics Lab's** decision to use this NAB to unveil its **Tween** computer program as a commercial product. Available for several years only at the facilities of the New York Institute of Technology, Tween is a computer graphics-based automated animation system in which the computer does large-scale, smooth-transition interpolations between animation key frames.

**Ampex**, too, promises something special with its **global combiner** for the ADO system. The unit will allow four channels to be combined into a single effect, permitting, for instance, a rotating cube effect to be produced with four channels of live video.

New software is promised for the **Vital SqueeZoom**, perhaps the addition of 3D effects to go along with the rotational effects introduced several years ago. **Grass Valley's** **Mk II** DVE effects generator is also undergoing some new developments, including the total interface with the E-MEM switcher automation device.

Some brand-new software will be available in **NEC's** **E-Flex** one- or two-channel effects system. Joining the ranks of the "big guys," E-Flex will now offer rotation and perspective effects.

A "dark horse" at the show will be **Toshiba**, which will again bring its **DPE-II** digital effects system introduced rather quietly at last year's show. The system, popular in Japan and the rest of the world, may make an impact in the U.S. market if its capabilities match the descriptions in the literature.

But the real surprise may be **Microtime's** first-time-ever entry into the digital effects arena. The extension of its digital processing system to incorporate effects is, of course, a natural extension of the product line and may make simple effects available to a host of producers who could not afford them before.

Other companies, of course, are already in the low-cost digital manipulation market. **Harris**, for one, offers compression and positioning with its digital framestore unit. **Precision Echo** introduced at SMPTE **The Squeezer**—an extremely low-cost compressor/positioner which offers discrete reduction stages, bordering of the compressed image, and joystick-controlled real-time manipulation of the compressed image.

Analog special effects have not totally disappeared, of course. **Graham-Patten** will be introducing a brand-new



# A completely automated audio analyzer package and advanced portable scopes to simplify your job.

Now, Four new products from Tektronix deliver more capability and performance than ever before.

## **SG 5010 Programmable 160 kHz Oscillator/AA5001 Programmable Distortion Analyzer.**

Two new members in our TM 5000 family of modular, IEEE-488 compatible instruments. The SG 5010 is the first oscillator to offer both GPIB programmability benefits and less than 0.001% (-100 dB) total harmonic distortion. Plus all the standard IMD test signals and high level, fully balanced, fully floating output. Together, the SG 5010 and AA 5001 make a completely automated audio analysis system with the highest performance available today. Fully automatic even when the oscillator and analyzer are separated, by yards or by miles.

## **2236 100 MHz Portable Oscilloscope.**

Measurements that had taken three or four instruments can now be done with one: the 2236 with integrated counter/timer/digital multimeter. It's a whole measurement system packed in a portable scope that's lightweight, versatile and easy

to use. Priced-right performance for tasks from circuit continuity testing to gated frequency, time and event counting. Standard features include TV field and TV line triggering.

## **2445 150 MHz Portable Oscilloscope.**

The new industry standard with more performance for the dollar than you've ever seen before. Four-channel capability. Auto level "hands-off" triggering. Standard  $\Delta$  time and delay sweep. 1 ns/div sweep speed. Overdrive aberration only 0.5%. Extensive CRT readout. Plus more. And state-of-the-art microprocessor design keeps the 2445 simple to operate. It's everything that a portable scope should be and the only one that is.

Contact your nearest Tektronix Field Office (listed in major city directories) for more information. Or call 1-800-547-1512 for descriptive literature. (In Oregon, 1-800-452-1877.)

**Tektronix, Inc.**, P.O. Box 1700, Beaverton, OR 97075. In Europe: Tektronix Europe B.V., Postbox 827, 1180 AV Amstelveen, The Netherlands.



# What You Should Know Before Buying a Character Generator:

## The Dubner CBG-1

There are scores of character generators on the market today. With so many manufacturers and models to choose from, it's hard to know what's important. Here's what to look for:



**Reputation:** Does the product have a proven track record? Are others using it successfully in a situation like yours? After delivery, can you count on the manufacturer for continued software updates?



**Ease of Use:** The system should be user-friendly. Can you select fonts and colors at the touch of a button, or are special "system modes" required? Are the prompts in plain English? Time spent battling the machine is time lost for production.



**Capacity:** Do you need hundreds of fonts and thousands of pages available on-line? If so, a high-speed, large-capacity disk is essential. What about colors? How many can be displayed at one time? How many do you have to choose from?



**Font Flexibility:** How many fonts are available from the manufacturer, and how easy is it to create your own? Can you change the size of an existing font? Create many types of edges? Type on an angle? Are there any limits to the size or number of colors in a character?



**Background Capability:** A "background" can be more than simple horizontal stripes. A good system will let you create complex images as backgrounds.



**Extras:** What does the system offer besides the standard rolls and crawls? Dissolves? Wipes? Zooms? Frame by frame animation?



**Expansion:** Can the system grow with you? Does it offer options that can make it more than a simple character generator? Can it do weather graphics? Election reporting?



When you consider these points, be sure to consider the Dubner CBG-1. The CBG-1 offers all the features you'd expect from a state of the art character generator, and one important extra—it can grow into the Emmy award winning CBG-2, with its animation capability, painting system and 3-D image creation. You get all of this and at a price that will surprise you.

For a free demonstration of the Dubner CBG-1 or CBG-2, call (201) 592-6500 or write:



**DUBNER COMPUTER SYSTEMS INC.**  
158 Linwood Plaza, Fort Lee, New Jersey 07024

Circle 136 on Reader Service Card



downstream keyer, joining American Data, which is already established here. Also check at the **Ultimate** booth for both the **Ultimate** and **Newsimate**—precise chroma-keying devices in which the key image is inserted without fringing into a "hole" cut in the background image.

Among character generator systems, considered here because they have in many cases become synonymous with art and graphics systems, the leader continues to be **Chyron**, with its **Chyron IV** software development program. Latest additions that will be on display include manipulation of the character generator output with digital effects capabilities, and a graphics tablet entry for multiplane, multicolored "painting" and drawing. Multiplane animation is also possible.

Another major company in this field is **Dubner**, whose **CBG** started the trend several years ago at the Winter Olympics. By creating effects on different planes and then weaving them into a unified image, highly complex images are created—including a font of astonishing 3D letters and numbers.

**3M** will of course feature its **D-8800** character generator with camera-based font compose. It is also possible that the company may come out with a new graphics software package to permit graphics tablet entry of images.

A new character generator, the **Marquee 4000**, will be introduced by **BEI**. The system is software-based, has a wide choice of fonts, and claims 27 ns resolution.

Brand-new from **Laird Telemedia** will be a **variable-font character generator**, Model 7200.

Another brand-new character generator can be seen at the **Quanta Corp.** booth—the **Q75**, designed as a completely modular teleproduction titler with three upgradable packages. It comes in both tabletop and rack-mount versions—ideal for mobile unit installation.

**Video Data Systems** will bring an updated version of its **T1000B** titler—a floppy-disk-based system with software programming for fonts, sizes, roll and crawl, bordering, and so on.

The low-cost **video typewriter** character generator line will again be shown by **For-A**.

Companies in the weather forecasting and display business are also finding applications for their graphics packages in a standalone mode. **Colorgraphics**, having purchased **Integrated Technologies**, will demonstrate a complete television station computer system. This will include the interfacing of **Colorgraphics'** computer weather systems with **Integrated Technologies'** news computers. There will be an introduction of a framestore with a video digitizer in conjunction with an automated sports scoreboard including animation.

**Kavouras** will be expanding its weather radar acquisition program with a graphics system featuring six-bit deep images with a 640x480 pixel structure and 32,000 color choices.

**McInnis Skinner**, whose graphics system is already in use at over a dozen stations around the country—either as a standalone graphics package or in conjunction with its **Newsan** and **Weathergraphics** packages—will mount a major exhibit.





The EECO IVES editor, one of a new generation of low-cost systems.

## POST-PRODUCTION

Although the trend in post-production—as in several other areas—has been toward smaller systems with increased capabilities, some movement is expected in the large editing system area with new (and as yet undescribed) editing advances from CMX—billed as something as important as the 340X itself. Far from bucking the trend, however, CMX will also show software improvements for its smaller editing system, The Edge, which will also have new interfaces for Sony and Ampex VTRs.

Videomedia plans to introduce a pair of systems in an inexpensive price range. The **Eagle I** has a 250-event memory; its sister, the **Eagle II**, features full list management capability. **Datatron** will also have its new **ST-3** editing system on display—a lower-cost version of the Vanguard which uses the same interface cards and which can be expanded into the larger system. **Convergence** says it will have new accessories for its **ECS-90**, such as built-in time code generator and decision lister.

EECO's new **IVES**, seen at SMPTE, will make its first NAB appearance this year; the low-cost system marks the first time EECO has marketed an editor under its own name in many years.

**Control Video**, in addition to its Lightfinger Plus editor, will have a new **cuts-only system**, the Spot Editor, designed for auto as two-channel effects system. Joining the ranks of the "big guys," E-Flex will now offer rotation and perspective effect video editors and also the **Translator system**—an audio editor based on SMPTE code that permits not only frame-accurate sound cuts but also completely automated automatic dialogue replacement in sync with the picture.

Other established editing systems will return to NAB, including **Bosch's** advanced **Mach One**, the **Ampex ACE**, and **Sony's** line of **BVE** editors.

Other advances in editing will be in the interface area, with **Jatex** unveiling a line of **control interfaces and software** for its A/B roll controller and **EchoLab** promising new **editing interfaces** for its SE/3 switcher. **Calaway Engineering** will also have a brand-new **editor interface** for VTRs, computers, and machine control.

Among time code system manufacturers, perhaps the most significant news will be made by **Cypher Digital**, whose owners have bought out the former **Datametrics** time code line. **Grey Engineering** will undoubtedly bring its field-updatable time code system, though it is not presently clear where the industry is going.

Vertical interval time code continues to draw attention, of course. EECO has a brand-new **VITC** system which uses unique processing to read code in still frame.

Other time code system manufacturers present at the show include **Skotel**, **For-A**, **Sony**, and **Convergence**,

# What You Should Know Before Buying an Animation System

## The Dubner CBG-2

Many companies are offering advanced video graphics and animation systems. But all are not alike. To make sure you're getting exactly what you need, ask yourself these questions:

**Reputation:** Is the manufacturer recognized as an industry leader? Do they provide adequate training and ongoing support? How do previous buyers feel about the product?



**Painting:** Electronic "painting" allows an artist to draw images directly on the screen. What kind of "brushes" are available? Can you create your own? Can you cut and paste?



**Geometrics:** Are there any aids for creating geometric objects? Straight lines? Circles and ellipses? Curves? 3-D objects? What about surfaces and hidden line removal?



**Text:** Letters and symbols are an important part of graphic design. How easy is it to enter text? Do you have a wide choice of fonts and colors? Can characters be typed and repositioned directly on the screen?



**Manipulation:** Once an image is in the system, can it be modified? Scaled? Tilted? Repositioned? Recolored? Rotated with perspective? Can you magnify the image and change it at the pixel level?



**Animation:** What sorts of animation possibilities does the system offer? Color animation? Simple motion? True cel animation? Can you transform one object into another? What kind of aids are available to speed the process?



**Storage and Playback:** How many frames can you store on-line? Does image quality degrade in successive generations? Can a series of images be played back in real time, or is an external single frame recorder required?

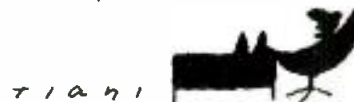

All advanced video graphic systems include some of these features, but only one has them all—the Dubner CBG-2. Dubner's industry leadership has been recognized by the 1982 Emmy award for outstanding engineering development.

For a free demonstration of the Dubner CBG-2, call (201) 592-6500 or write:



**DUBNER COMPUTER SYSTEMS INC.**  
158 Linwood Plaza, Fort Lee, New Jersey 07024  
Circle 137 on Reader Service Card



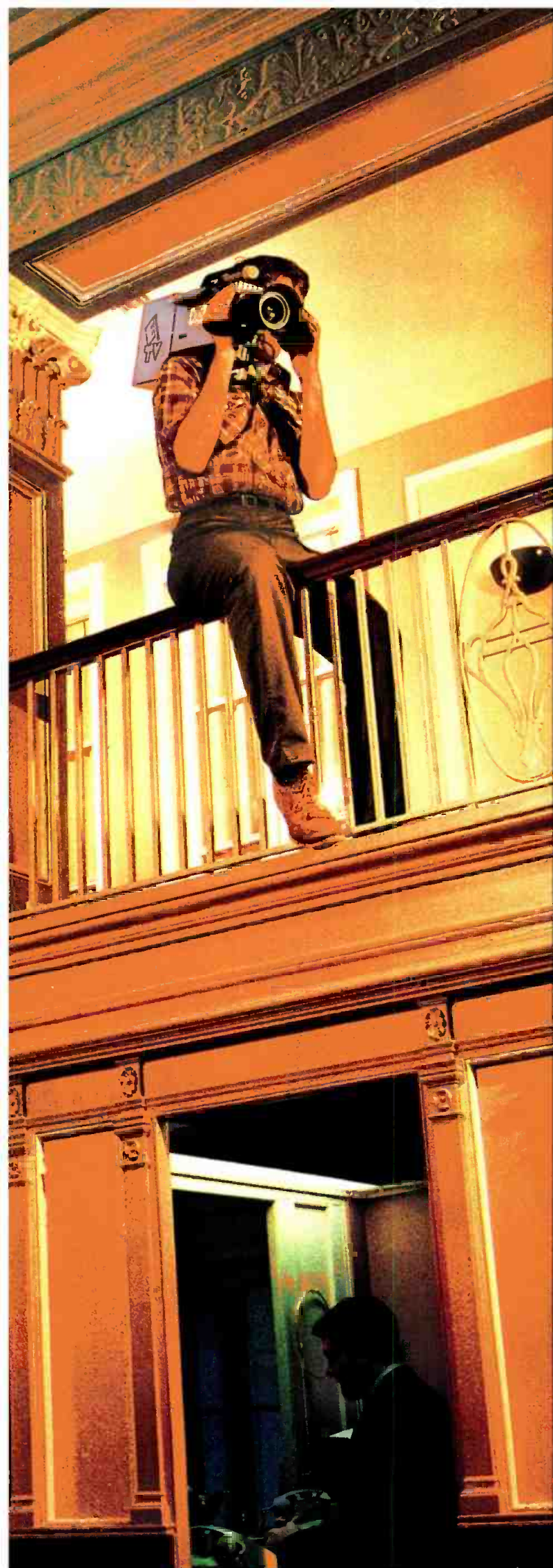



# HAWKEYE

## ONE-MAN GANG SHOOTS 25 SET-UPS IN 12 HOURS



Mississippi ETV has a one-man equipment gang on the road shooting and recording their new documentary series "Mississippi Roads". They're able to do it because of the versatility of HAWKEYE!

In a recent production covering the restoration of the Natchez Eola Hotel, the HAWKEYE recording camera and that one-man equipment gang were able to cover 25 different set-ups in 12 hours under a producer's direction.

"HAWKEYE gets into tough-to-shoot places," reports Larry Holden, director of production for Mississippi ETV. "It speeds our coverage and its small size puts on-camera individuals at ease. It gives us high quality productions in a cost-effective way."

### "Outstanding . . . Impressive"

"The camera video quality is outstanding and recorder performance is impressive. We've been putting HAWKEYE through a tough grind for nearly a year now and we haven't had any major problems."

Segments for "Mississippi Roads" are shot with the recording camera . . . a HAWKEYE studio recorder is used with existing 1" VTRs for multiple generation editing.

HAWKEYE is versatile. It can be easily integrated into your present equipment complement. Ask your RCA Representative for the HAWKEYE facts—camera, recorder, recording camera, or complete systems. Have HAWKEYE Your Way. RCA, Bldg. 2-2, Camden, NJ 08102.

Illustrations show HAWKEYE in a variety of locations and configurations at the Natchez Eola Hotel.

# ★ ★ ★ VIDEO ★ ★ ★ NAB '83

among others.

In the audio post-production area, look for a major development from **BTX**, which plans to introduce a full audio editing system based around a personal computer. The company had not revealed at press time what personal computer the editor would be built around, but says it will have the system up and running at its booth, interfaced with its synchronizer and Cypher generator. In addition, the company will bring some additions to its Shadow synchronizer, including a film table editing interface for flatbed editors or Moviolas and a computer-controlled keyboard (dubbed "Soft Touch") for sweetening and dialogue replacement. Soft Touch can control up to four machines. **BTX**, of course, will have its full Shadow synchronizing system and Cypher generator with all the options.

**Audio Kinetics** also plans advances in its Q-Lock synchronizer system in the form of a keyboard controller called Q-Link. Q-Link, designed for intelligent interface to automated audio boards, has user-definable keys and an internal subprocessor. Look for **Adams-Smith** to show its synchronizing systems, along with **EECO**, which will bring its Multique synchronizer.

## TELECINES

Film use in television is hardly dead, and the telecine area will see several new developments at this NAB. Those whose appetite was whetted by **Rank Cintel's** description of its **Amigo telecine color correction** at November's SMPTE show will find the device itself at NAB. **L-W International's Athena 4500** 16 mm film transport, seen in prototype last year, will arrive at Las Vegas in a full-fledged production model.

A completely new 16 mm telecine, the V-400, will be featured at the **Magnasync/Moviola** booth. The company says the compact V-400 is designed to replace TV studio film chains. The established V-1000 and V-500 telecines will also be on hand. **Laumic**, a major distributor of the Magnasync line, as well as the **CMX FLM-1** video-assisted film editor, will also be on hand.

No breakthroughs are expected in the high-technology telecine area. **Marconi** will return with its **B3410 CCD telecine**, **Rank** will again have its **Mk III-C flying spot scanner**, and **Bosch** will show the **FDL-60**.

A major show of confidence on the future of film in

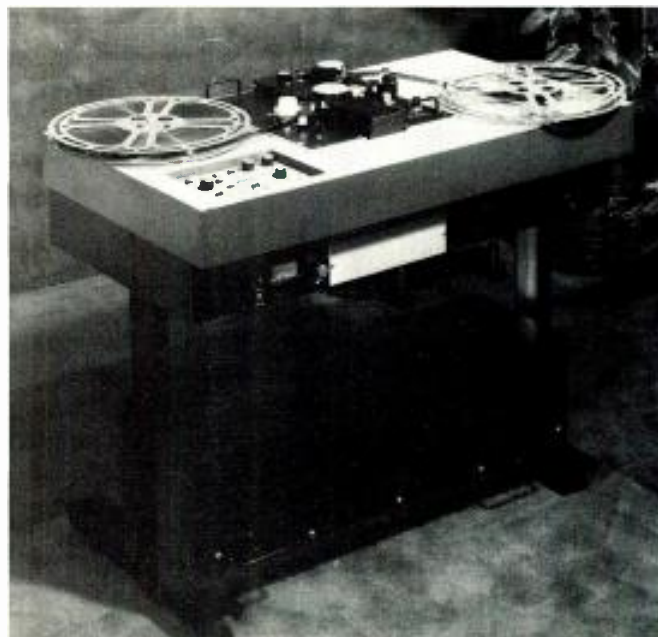

*New low-cost 16 mm telecine for broadcast from Magnasync/Moviola.*

television is expected from **RTI**, which plans to introduce a film editing system especially designed for the TV industry. The **TV-2000** inspects and cleans the film as well as previewing and editing. **Eastman Kodak**, ever vocal about its faith in film, will show NAB attendees the products it premiered at SMPTE—two new film stocks and **Datacode**, its "functionally transparent" magnetic coating for the underside of motion picture film, designed to allow recording of time code and other information.

Those looking for standalone color corrector systems should also check at the **Corporate Communications, For-A, Broadcast Video Systems (Cox)**, and **Asaca** booths. **Multi-Track Magnetics** will once again bring its sprocketed magnetic film dubbing systems.

## IMAGE PROCESSING

The hot news in this arena is the introduction by **Tektronix** of a brand-new **digital framestore synchronizer**, the first time the company has strayed outside its traditional T&M manufacturing role. The competitively priced system is unique in offering 10-bit processing (its nearest competitors, including units from **Harris** and **NEC**, offer only 9-bit depth). The unit is intended for applications such as synchronizing incoming satellite and microwave feeds and has features such as selectable freeze or fade-to-black when the image quality drops below a selectable threshold.

**Faroudja**, both at its own booth and at the booth of its

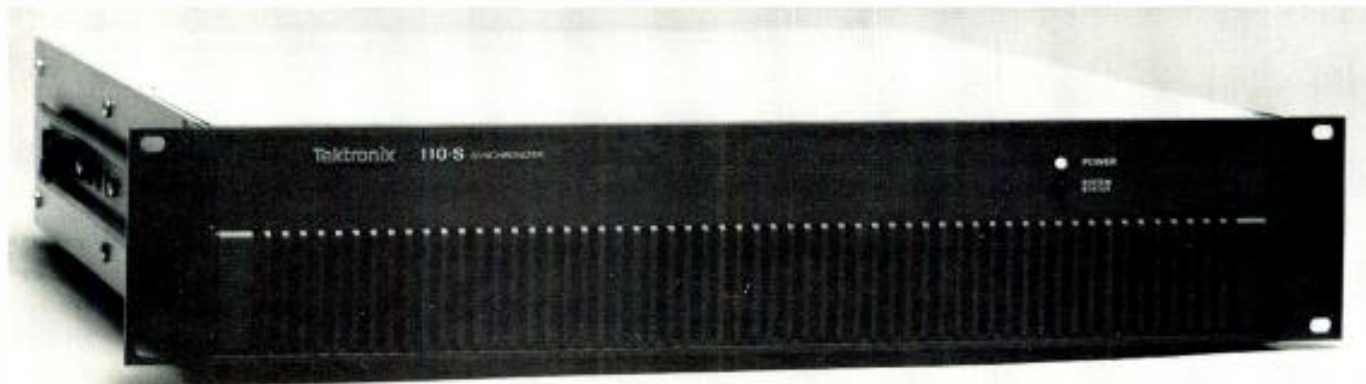

*The brand-new Tektronix frame synchronizer with 10-bit processing.*



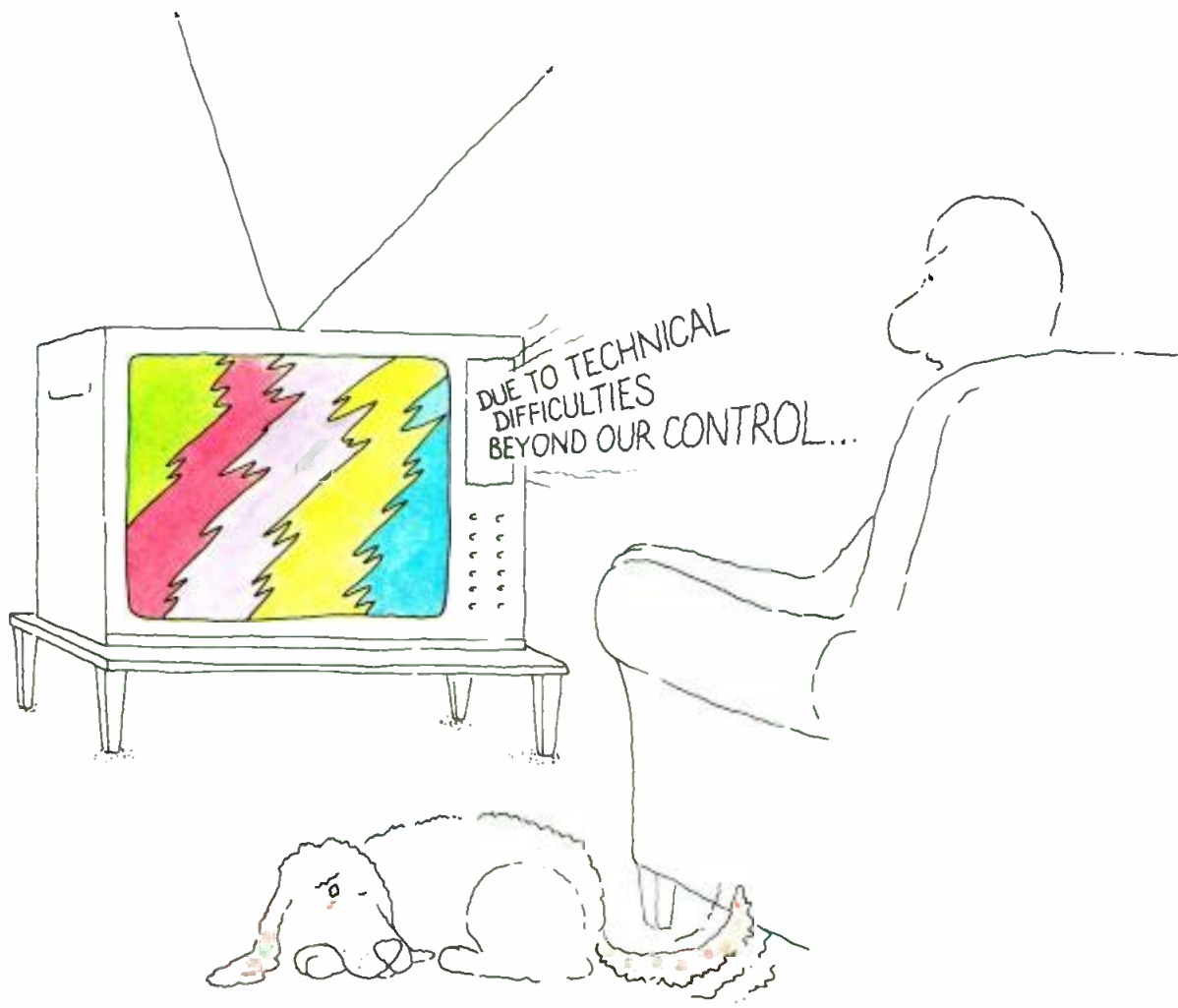

(Translation: The cassette broke.)  
 (Solution: Maxell U-Matic cassettes.)

If jammed U-Matics ever make you yearn for the days of live television something is wrong with the brand of U-Matics you're using. A lot of things are very right with Maxell U-Matic cassettes.

They're built to stand up to the toughest handling and editing conditions you can dish out. The unique Maxell Epitaxial™ tape formulation gives you an extremely dense magnetic coating that yields superior chroma and luminance. The proprietary Maxell binder system makes

sure the formulation, and everything you record on it, stays up to your standards, indefinitely.

That's why every one of the networks, hundreds of independent television stations and just about every major producer, director and cameraman in the business who tries Maxell U-Matic cassettes, buys Maxell.

Your Maxell supplier can make sure your programming isn't interrupted. Ask him for Maxell U-Matic cassettes. Or ask us for more information.



**maxell®**

PROFESSIONAL / INDUSTRIAL DIVISION

Our success is magnetic.

See us at NAB, Booth 1612, Las Vegas

Maxell Corporation of America, 60 Oxford Dr., Moonachie, N.J. 07074 (201) 440-8020

Circle 139 on Reader Service Card

# ★ ★ ★ VIDEO ★ ★ ★ NAB '83

exclusive North American distributor **Fortel**, will introduce a brand-new NTSC decoder, which uses chroma and luminance enhancement and active comb filtering technology.

There will, of course, be a whole new flock of digital processing equipment scattered in booths throughout the show. **Marconi** says it plans to introduce a brand-new TBC. A new single-clock TBC will be introduced by **Digital Video Systems** with switch-selectable freeze-field for heterodyne VTRs. **Fortel** will again highlight the **Digibloc**—its modular framestore synchronizer which can be expanded for two-channel operation. Brand-new from **Fortel** will be the CCDHPS, a solid-state TBC. **Microtime** promises some new developments in its TBC/synchronizer line.

A new exhibitor at NAB, **Hotronics** will exhibit a digital TBC/frame synchronizer. Other companies long established in this field include ADDA, NEC, MCI/Quantel, and now Sony.

Digital standards converters, meanwhile, are becoming more and more efficient thanks to modern IC circuitry. New at the NAB this year will be the **Video International**, whose three-way standards converter, the product of German engineering, fits into about two feet of rack space. Others who will have digital standards converters on hand will be Oki, MCI/Quantel, and McMichael.

## ROUTING SWITCHERS

EDCO will introduce two new routing switcher products. The first is a single bus unit with 16X1 stereo and audio-follow-video capability. The second new item will be a multibus unit, the IRS, intermediate routing switcher. There are two frame sizes, both 16-rack units: the IRS 24 can build to a 24X24, four-channel, or to a 48X48, one-channel in the same frame size.

**Image Video** promises the **Model 9100**, a brand-new routing switcher to be introduced this year. Other new products include the 7001 dual video mix amp and the 8200 master control switcher along with various new routing switcher control panels.

**Di-Tech** will demonstrate the new Model 5840-2 AFV switcher for providing two levels of audio per input with independent control for audio 1 and audio 2. **Datatek** will exhibit a routing switcher with video source ID.

**Bosch** will show the TVS-2000 routing switcher. **Grass Valley** will come with the 440, Ten-X, and other routing switchers.

Other companies to keep an eye on for important developments in this area are NEC, with digital, multiplexed units; **Dynair**, which will feature the Series 25 20X20 routing switcher; **Telemet**, which is introducing a computer-controlled routing switcher with new software options; and **Videotek**, whose new products include the RS-10A audio-follow-video rack-mountable unit.

## AUTOMATION SYSTEMS

There's certainly no lack of automation systems on tap at NAB '83. Ranging all the way from routine station traf-



*A new lighting head from Comprehensive Video.*

fic and accounting systems to elaborate newsroom operations, the offerings are numerous. One of the trends discernable in the latest generation of news services is the growing importance of accurate, well-presented weather information.

**Colorgraphics Weather Systems**, as mentioned, will feature a television station computer system interfacing its weather information with Integrated Technologies' news computers. **Environmental Satellite Data Inc.** plans to unveil its new **Portable Model Terminal (PMT)**, a low-cost weather graphics unit that a station meteorologist can use to pick up and analyze the satellite data that EDS provides. **McInnis-Skinner** has also streamlined the weather presentation system that it will demonstrate at the show.

But there's more to the automation systems than integrating the weather into the news. **Basys**, which has eight systems installed, will feature **News Fury** and **Mini Fury** newsroom automation systems. The company also has **Clip Fury**, a library program, and **Cart Fury**, a label printer for audio carts.

**BIAS/Data Communication Corp.** is going to demonstrate a new **newsroom management system**, complete with videotape morgue, cross indexing of slides, newspaper index, newscast lineup, and so forth. Also to be examined will be master control automation for on-air engineering activities management, moving BIAS among those companies offering complete station computer systems.

For its part, **Jefferson Data Systems** will have new additions for its **electronic news processing system** for handling wire services, script preparation, and related functions.

The lineup of business automation systems to be checked out is much longer. **Media Computing**, the Phoenix-based company which just underwent a name change to avoid the confusion of two "Computer Concepts" at the show, will offer new software for its Apple-based computer system. New or revised station business systems will be demonstrated by **Columbine Systems**, **Computer Concepts**, **Custom Business Systems**, **Generic Computer Systems**, **David Green Broadcast Consultants**, **Kaman Sciences**, **SNARR/Chase Systems**, **Station Business Systems**, and **WSI Corp.**

The real news in automation systems, however, is the push once again towards program automation systems, noticeably quiet for the past few years but likely to surface again in light of an industry push towards development of



a distribution system to replace quad carts. Thus far Lake Systems has taken an early lead with its La-Kart automated videocassette player which works with U-matic cassettes. Microtime, too, has a small automation controller originally developed for cable programmers but which might find applications in broadcasting as well. A system from IVC called Video Changer, presumably based on the multi-VTR controller shown last year by Cezar International, will also be on display.

There are also a large number of switching automation products and systems coming onto the market. Latest in the field is Vital, which last year introduced SAM and this year will present SANDI, a data communications system that links equipment with the automation controller. Grass Valley has, of course, been active in this area for a while and stands to gain a considerable share of the market if it ever really gets going. Meanwhile, other companies which manufacture large-scale routing switchers—such as Dynair with its System 21—and automated master control switchers—such as the various American Data and Central Dynamics models—are all eyeing these developments closely.

## LIGHTING, POWER, AND SUPPORT

In lighting equipment, Cinemills will come to its first NAB with Daymax high-intensity globes in 575 to 6000 W sizes, new Desisti HMI softlights in 575 and 1200 W sizes, and Desisti portable kits. Cine 60 will bring a new miniature 12 V, 100 W battery light for hand-held or camera-mounted use.

Cool-Light will introduce the new Tri-light unit consisting of three light strips arranged as a nine-light fay in a common frame. Also a new model of the Mini-Cool with redesigned air draft and dual filter slots. The Universal precision light framer is new and mounts directly to Mini-Cool and can be adapted to other lights providing complete control of projected light beam. These products will also be exhibited at the Alan Gordon Enterprises booth.

Cinema Products will have portable lighting systems in various complete exhibits, while Dynamic Technology will have studio manual, and memory lighting systems.

Kobold Of America is offering a new 1000 W halogen fresnel, and new 575 and 1200 W Brite Beam HMI fixtures. General Electric has designed a new multimirror reflector and Q-line lamps for lightweight camera fixtures. It also plans to show the complete line of Quartzline tungsten halogen and incandescent lamps for TV production.

Mole-Richardson will unveil 1000 and 2000 W eight-inch fresnel Solarspots and HMI Molepars. LTM will have the introduction of a new line of small incandescent location lights (100, 200, and 600 W). Also planned is the demonstration of the Cinepar 1200, a 1200 W HMI par light.

Arriflex will be on hand with its complete line of HMI lighting fixtures. New developments in lighting are also on their way from Colortran, which will also be demonstrating its lighting control units. Also look to Kliegl Bros. for additional lighting control systems. Belden Communications will be showing the complete line of Lee lighting control products. Rosco will also exhibit lighting control material.

# THE TRUE MEASURE OF PERFORMANCE

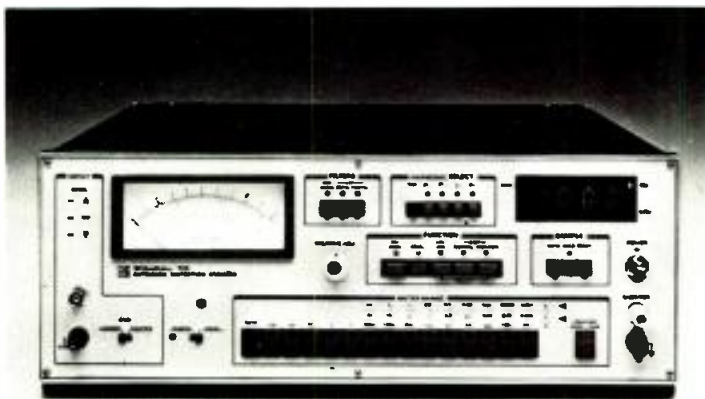

## ASACA/SHIBASOKU 725 Automatic Distortion Analyzer

This versatile instrument works both as a distortion analyzer and as a high performance distortion meter. You can use it to measure distortion ratios as low as .0001% (-120 dB) and analyze the 2nd to 5th harmonic distortion.

The 725 extracts only the harmonic components from various measured signals, including noise. By obtaining fundamental frequency rejection characteristics of more than 120 dB, it measures the small distortion which noise usually covers.

Input level adjustment, selection of measuring range and tuning of measured frequency are all automatic. The 725 connects to a general purpose interface bus (IEEE-488) and may be expanded into a fully automated instrumentation system.

- Harmonic analysis circuit measures 2nd to 5th harmonic distortion, including THD.
- Wide band distortion ratio measurement (5 Hz–110 kHz fundamental wave frequency).
- Distortion meter has 5 Hz–500 kHz frequency range and 30  $\mu$ V (-90 dB) full scale.
- All functions are remote controlled.

Measure your performance with the best. ASACA/SHIBASOKU 725. Tests lower with higher accuracy.

For complete specifications, write:

**ASACA**

ASACA/SHIBASOKU CORP. OF AMERICA  
12509 Beatrice Street, Los Angeles, California 90066  
Sales, Service: (800) 423-6347 • (213) 827-7144

Circle 140 on Reader Service Card

★ ★ ★ VIDEO ★ ★ ★  
**NAB '83**

Innovations in batteries include the introduction by **Anton/Bauer** of the **Lifesaver** line of battery chargers, a completely safe charging system featuring a logic-controlled battery charge monitor which maintains a fully charged battery indefinitely. There are three models available: fast-charge (one hour); eight-hour single-position; and eight-hour four-position. Also new is the 30/13 dual-voltage battery belt designed for lighting and/or camera power.

**Frezzolini** plans a display of a two-channel power supply as well as the VC-1 and VC-2 vehicle chargers and an on-board 50 W switcher power supply.

**Perrott Engineering** will introduce a new 30 V sun gun belt with a switchable connection for 30 V/4 A or 13.4 V/8 A operation, allowing dual use for light or cameras. Also new is a small 12 V light head.

**Arriflex** will introduce several new products in the power supply area, including NC TA-1, a nicad battery tester that can be connected to an x-y recorder for logging test data, and a new battery multicharger for multiunit, multivoltage applications.

**Christie Electric** will display the reFLEX-20 line of batteries and chargers for ENG and EFP and lightweight camera-mounted ac/dc power supplies.

**Cine 60** will introduce a new, two-pound battery for remote operation of Canon lenses, two-channel multichargers, and a lightweight switching mode power supply. New from **Bogen Photo** is a power pack that powers VTRs up to six hours or quartz lights up to 30 minutes.

Advances in grip and support equipment are evidenced

*The Chroma Meter II tricolor incident light meter from Minolta.*



*Autocue's ENGIEFP prompter being shown at the Listec booth.*

by this year's introduction from **Matthews** of 27 new products, including the Tulip, Tulip Junior, and Sky cranes which incorporate advanced camera remote control heads.

New also from **Arriflex** will be the **Arri Cinejib**—a portable crane for supporting camera and crew up to 570 pounds, which operates from below floor level up to 14.8 feet.

**Listec** will have the brand-new **Vinten digital remote-controlled studio color camera**, including preset, zoom, focus, iris, pedestal height, pan, tilt, and more. It also will introduce the **Vinten Merlin** remotely controlled crane arm for EFP. Other new equipment includes **Autocue**



*The Mini-Cool from Cool-Light produces maximum lumens with minimum heat.*



# SIGNAL COMPONENT ENCODING FOR



\$7,950  
NTSC Model

## PERFORMANCE PLUS!

This **DIGITAL TIME BASE CORRECTOR** combines 8-bit signal component encoding with an uncommon track record of innovation in video broadcast/production equipment. Result: State-of-the-art performance. State-of-the-economy price.

Such advanced signal processing is FOR·A's technology of choice because it insures gentler handling of the video signal and is quite forgiving of the many problems inherent in the world of video.

**Performance Plus!** That's what this new approach to time-base correction gives you. Significantly better signal-to-noise ratio for both chrominance and luminance than with any other system available. Greater stability • excellent pause and shuttle performance • optimized dropout compensation • lower differential phase and gain . . . plus

a built-in sync generator for even greater economy! Model FA-410 handles capstan or non-capstan ser-voed 3/4" and 1/2" VTR formats



Time base corrected signal input from SONY 820 VTR.

and operates in Standalone and VTR SC modes. It permits simple interface to any switcher; independent control of sync position and video timing with any setting of

system phase. A 16H window, Black Burst outputs, Proc Amp Pre-Set Functions and composite or non-composite outputs are standard. (NTSC and PAL TV standard models available.)

Comparing Apples and Oranges in TBC's and going Bananas? Who says there's no comparison? Play your tapes through this TBC and make up your *OWN* mind.

Arrange a demonstration by your FOR·A Representative or Dealer now by calling the nearest FOR·A Sales Office. Get complete information on our full line of Broadcast/Production equipments ranging from video typewriters and color synthesizers to SMPTE code generators and frame memories.

**FOR·A**<sup>®</sup>  
INNOVATIONS IN VIDEO

FOR·A CORPORATION OF AMERICA

East Coast: 49 Lexington St., Newton, MA 02165 (617) 244-3223  
West Coast: 1680 N. Vine St., Los Angeles, CA 90028 (213) 467-8412

Circle 141 on Reader Service Card

See us at NAB Booth 1306

# ★ ★ ★ VIDEO ★ ★ ★ NAB '83

Products 2000 memory prompter, and 15-inch on-camera prompter with trapezoidal mirror.

Excitement is being generated by the introduction of the **O'Connor Model 55 tripod**, a metal tripod built to the same specifications as wooden legs but more rigid. Also new will be a sideload adjustable platform for the Model 50 fluid head.

**Sachtler** will introduce several models of tripods and heads. The **Panorama 7 + 7** is a lightweight fluid head for ENG with a counterbalancing spring. **Bogen** will introduce the 3010 low-cost, **lightweight tripod** with micro-fluid head for small video cameras, and the 3040 heavy-duty tripod with mini-fluid head for cameras up to 10 pounds.

**Karl Heitz** will be showing a brand-new **fluid head** with 20-pound camera capacity. It will also have a line of tripods, spring and counter-balanced heads, leveling balls, mic booms, dollies, and light stands. **ITE** is introducing a new model **ENG tripod** with a load capacity of 25 pounds. Also new is the **ITE-T14 ENG remote** with Mitchell mount for loads to 100 pounds. **Quick Set** will be showing its line of tripods, pedestals, and dollies.

**K&H Products** will have new additions to the **Porta-Brace** line of cases, carts, and carriers for professional video equipment known as Quick Draw, a compact professional video camera case made of steel-reinforced and padded nylon that fits in the back seat or trunk of a car.

**Anvil** will present some innovations in interior case design, while **William Bal** will have the new Road Case for video gear. **Calzone** plans to introduce a new lightweight shipping case. Case users will find **Excalibur** displaying an 18-inch shock-mounted case with interlock option and will see **Fiberbilt's** new series of high-density polyethylene molded video units. A new equipment carrier from **Lee-Ray**, Model 6000, is a fold-up unit and carries video cameras, cases and VTRs. **Winsted** will display equipment racks, as will **Russlang** and **Stantron**.

A new 50 MHz oscilloscope from Leader Instruments.

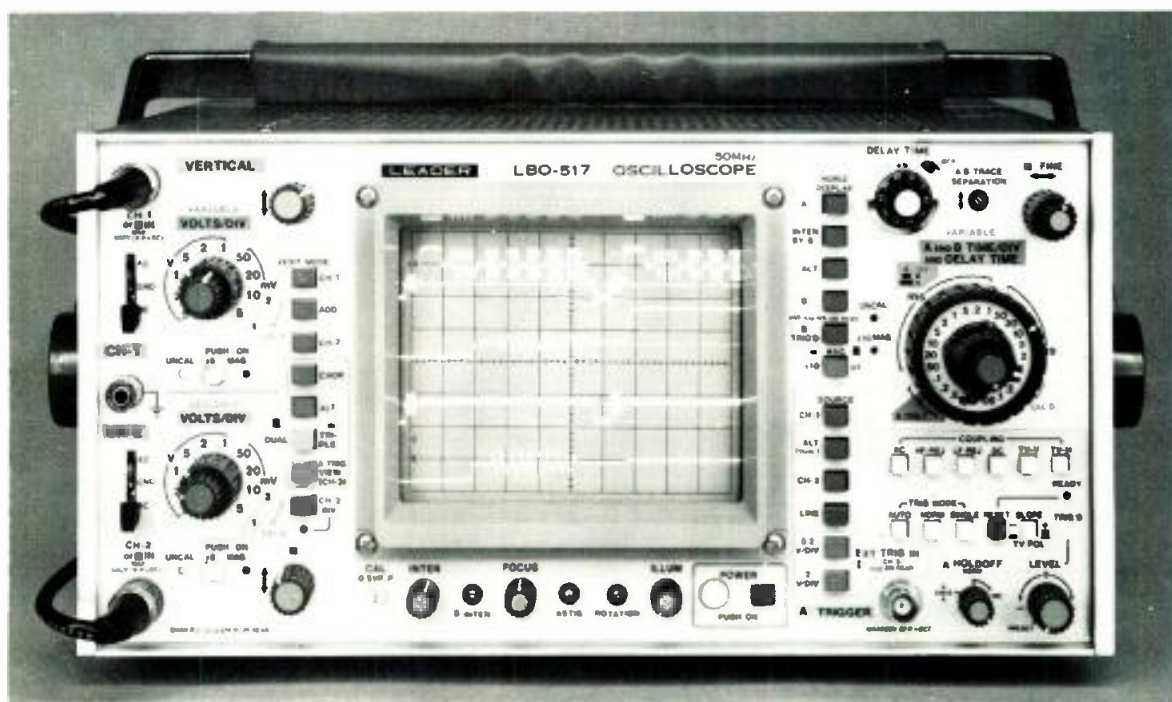

## TEST AND MEASUREMENT, MONITORS

While **Tektronix** will be drawing attention for its entry into the frame synchronizer market, it remains the leading test equipment source. Of note on this side of the Tek line is the new **Model 1910 digital signal test generator** and **VITS inserter**. It has four external VITS inputs to facilitate insertion of teletext, closed captioning, and source identification. Also on tap from Tek is the **Answer automatic video measurement set** with new Option 4 software.

Amid the large array of instruments gleaming in the **Asaca/Shibasoku** booth will be some newcomers. Look for the new **VHO1B2 digital dropout counter**.

**Leader Instruments** has put an appealing price—\$995—on its new **LBO-51MV x-y vector display unit** which it will introduce. Also leading the Leader list will be the new **LVS-5850A vectorscope** and the **LBO-518 100 MHz oscilloscope**.

Plugged into the **Rohde & Schwarz** line this year will be the new **LFM2 automated group delay measurement system** along with the **MUF2 TV sweep analysis system**. **Minolta** has an interesting instrument in store—the **Chroma Meter II** for measuring light source color such as lamps, CRTs, or color picture tubes. The firm will also have TV color analyzers.

**Marconi** will introduce the **B4624 monitoring unit** that can superimpose selected waveforms onto the VTR monitor. This makes it a similar product to the **Lenco Vectorscope** introduced several years ago. **NTI** will be showing its digital test signal generators and digital framestore device for test applications. **QSI** will show its direct-access TV demodulator as well as its color bar and SID generators.

Clock and timing systems can be seen at the **ESE** booth.

Other instrument makers on the scene will include **Philips T&M**, **Tennaplex Systems**, **Hitachi**, **Tentel**, **Electro Impulse**, **Lenco**, **Holiday Industries**, and **Amtron**. **Porta-Pattern** will have its full line of test charts and slides on hand.

**Amtron** will also display its high-resolution **RGB/NTSC color monitors**. **Conrac** will have additions to its **2400 Series** of 19-inch monochrome monitors and in-line gun



“I want the world.  
Consistent .05% corner registration  
and full auto-setup of up to 96  
cameras on computer command.”

# HITACHI HEARD YOU.



Don't want much, do you?

Dynamic registration not just at dead center but at all four corners.  
Plus 2-minute auto-setup of all those cameras.

You're asking for some smart camera system, networks  
of the world and top-drawer video production companies.

Well, Hitachi heard you, and has created an outright *genius*—  
the Hitachi SK-110 Camera System.

The computer registration capabilities of this camera system  
produce pictures of a  
clarity and resolution  
previously unheard of.

And you get auto-setup  
at the push of just one but-  
ton, and zero reference,  
too, where the computer  
sets the green channel and  
compares blue and red to  
it with absolute precision.

The SK-110 is not only self-correcting, but self-diagnostic  
as well. It gives both video screen display and hard copy print-  
out; can be hooked into the CRT for control room monitoring.

There's a high-performance contour corrector;  
5 automatic setup modes including quick check;  
5 data files; so many other unique features an ad  
can't begin to tell you about them.

The ultimate Hitachi SK-110. Contact the  
broadcast video division at any of the offices  
listed below. Hitachi Denshi America Ltd.,  
175 Crossways Park West, Woodbury, NY  
11797 (516) 921-7200. Offices also in  
Chicago (312) 344-4020; Los Angeles  
(213) 538-4880; Atlanta (404)  
451-9453; Cincinnati (513) 489-6500;  
Dallas (214) 233-7623; Denver  
(303) 344-3156; Seattle,  
(206) 575-1690; and Washington,  
D.C. (301) 459-8262.

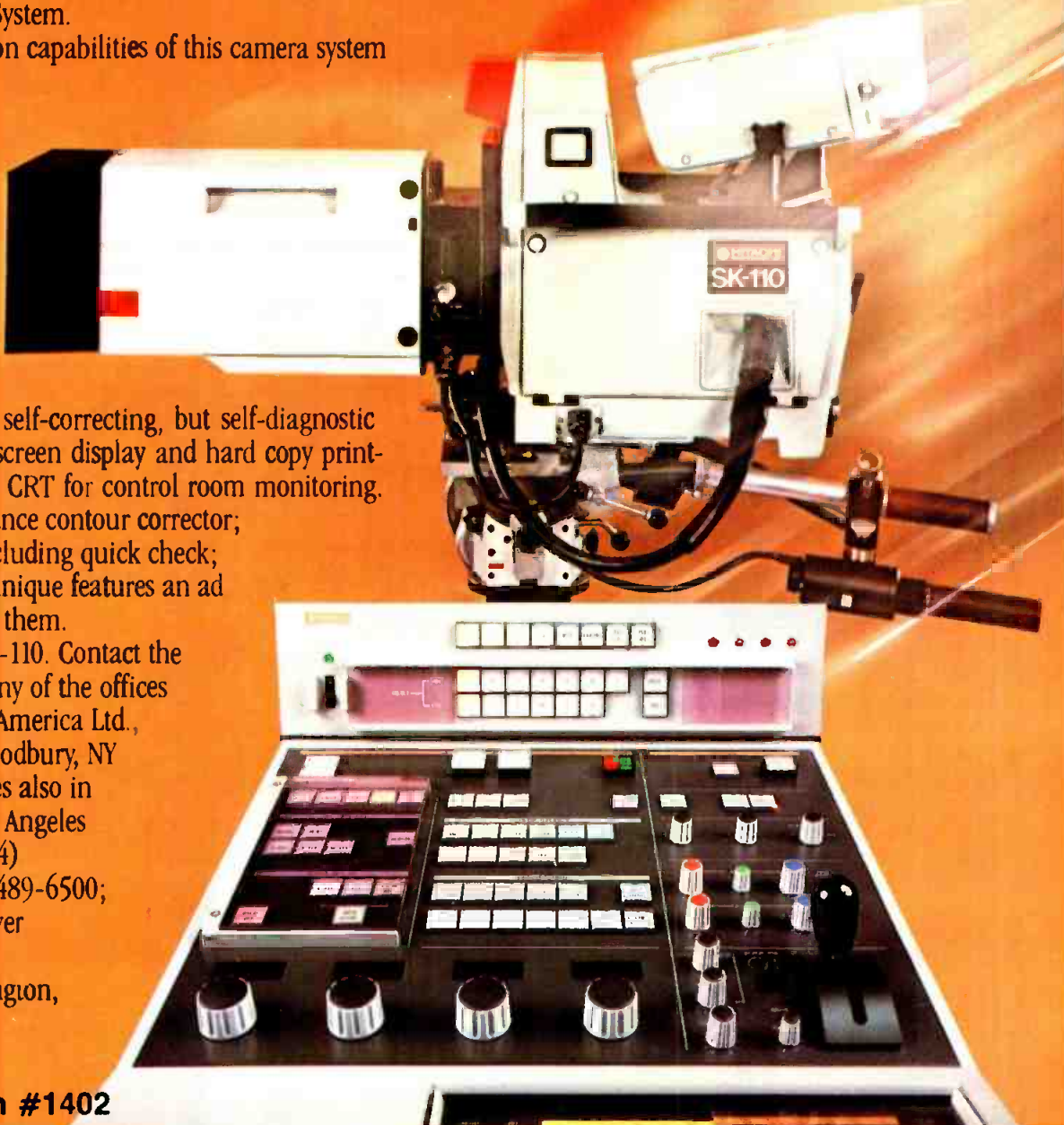

Circle 142 on Reader Service Card

See us at NAB Booth #1402

# ★ ★ ★ VIDEO ★ ★ ★ NAB '83

color studio monitors in the 2200 Series.

**Elector**, as usual, will have the **Barco monitors**, this year the CM22 nine-inch with switchable underscan; CM33 13-inch with pulse cross and red-green off; and a CM51 HRC 19-inch unit. A wide-screen, compressed-H video projector will also be demonstrated by **Elector**.

Attendees can also look for monitors from **Panasonic**, **Hitachi**, **Ikegami**, **Tektronix**, **Sony**, **JVC**, and **Sharp**.

## SATELLITE SYSTEMS

Amid the space-age atmosphere of the satellite dishes outside the convention center the theme will be evolution rather than revolution. **Scientific-Atlanta** will introduce a new **seven-meter antenna** and a satellite earth station uplink protection switch. These will be supplemented by a demonstration of a complete video earth station setup, and by the high-resolution transmission system developed in conjunction with its newly acquired subsidiary **Digital Video Systems**.

News will likely be made by **Harris** with the introduction of a **6.1-meter Delta Gain satellite antenna** along with a number of other antennas. **Comotech** will introduce satellite earth station equipment, featuring the new **24-channel frequency agile receiver**, the **Agile Modulator** and antennas, and complete new **TVRO** systems. **Microdyne** will unveil the **MSF-16** and **-23** multiple satellite feed systems for existing and new **Microdyne** five- and seven-meter antennas. In addition, **Microdyne** will have a complete line of satellite receiving equipment for video and **SCPC** motorized antennas from three to seven meters.

**Alcoa-NEC**, the newly formed partnership which made its first appearance last year, will again be on hand with its earth station antennas.

On the service side, **Wold Communications** will demonstrate live television and radio transmission. **RCA American Communications** will do the same with its digital audio transmission service (**ADDS**). And **Comsearch** and **Compucon** will promote a range of services for the bird users. Others sure to have satellite equipment are **M/A-Com** and, of course, **AT&T**.

## TRANSMITTERS, ANTENNAS, AND MICROWAVE

There will be plenty to see on the exhibit floor in transmitters, antennas, and microwave links.

In the former, **Larcan** will be showing its latest 12 kW VHF transmitter. At **RCA's** large booth will be three VHF transmitters; 12 kW, 50 kW high band, and 30 kW low band, as well as a 30 kW UHF unit. **EMCEE** will have a new **solid-state MDS transmitter** with separate aural and visual amplification, and a new single-bay UHF amplifier for **LPTV**. **Fiber optic systems** will be in evidence at several booths—noteably **Grass Valley (the Wavelink system)** and **Artel**.

**Bogner** will show its full line of TV transmitting antennas, as will companies such as **Cetec**. Those looking for



*New software options will be shown for the Tektronix ANSWER.*

transmitting tubes should check the **Eimac**, **Ceco**, and **Thomson-CSF** booths. The latter has several new models of klystrons.

**M/A-Com** will feature the **Super MX**, not a missile, but a self-contained transmitter, ac/dc, 2 GHz, 2 W switchable to 12 W unit. **Harris** will have transmitters, receivers, and antennas in 2, 7, and 13 GHz configurations.

For airborne **ENG Broadcast Microwave Services** will highlight its **GCA-1 gyro-controlled antenna system** and its omnidirectional receive antenna.

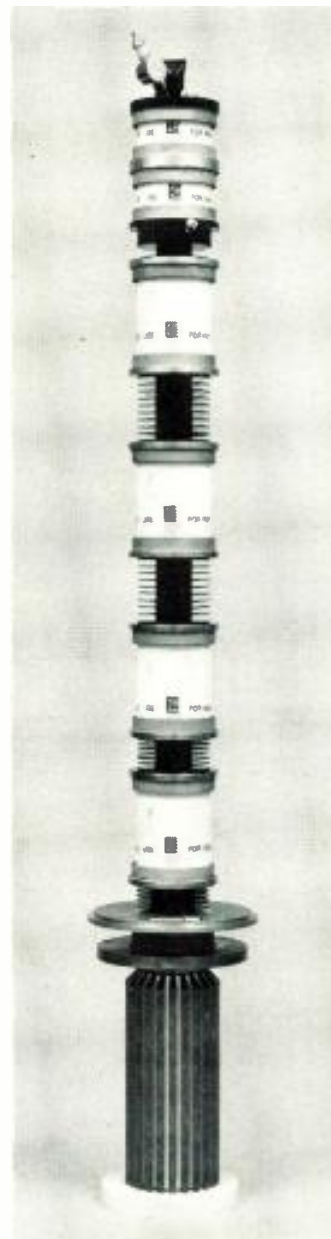

*The new K3270 BCD Klystron being shown at the EEV booth.*





# ★ ★ ★ VIDEO ★ ★ ★ NAB '83

Ikegami is to highlight a new HL-79E portable ENG microwave system for the HL-79 and HL-83 cameras, a popular item last year. NEC will let out of the bag a new TVL-807 7 GHz field pickup portable microwave unit, while Nurad will introduce a 2 GHz, 21-channel microwave receiver and a 7 GHz, 30-channel unit to go along with its 20PT1 2 GHz portable 21-channel transmitter. Rockwell too will display a microwave video transmission system.

Major developments in microwave can be expected from Harris Microwave, and also from RF Technology, which continues its innovations with state-of-the-art FET amplifiers in its microwave products.

Also on hand with UHF and/or VHF equipment will be TTCC, EMCEE, Shively Laboratories, Information Transmission Systems, and Comark. Comark, in addition, will tout the CCP-145 IF Corrector for use with new or existing IF modulated TV transmitters. Hipotronics, a newcomer to NAB, will promote its line of high-power voltage regulators and test sets to the broadcast industry.

## MOBILE UNITS

Vehicles for television production are always new because of customers' varied requirements, but technological breakthroughs are rare. This year's selection of vans, trucks, and helicopters is shaping up as expected—with plenty of interest, but few surprises.

Visitors to the Centro booth may be surprised, however, to find a 42-foot production trailer inside the convention center, rather than in the outside van area. The big truck was built for a Denver TV station. Centro will also have a smaller cable production truck in its booth.

Other big trucks will be outside—such as the 40-footer

*Television Engineering will show its small ENG van.*



*The fiber optic transmission system from Artel intended for production use.*

Lerro put together for North East Productions, and a TV production van built by Philips. Back inside, Shook will bring a new-design 22-foot van with rear-door access to the production area. The two-camera vehicle is fully equipped and has its own generator. MZB will have a cube truck with a 14-foot production area, called the MZB-14. Midwest Corp., maker of the standardized M-1 and M-20 vans, had not indicated what it would show at press time.

Other van companies will concentrate on smaller vehicles for EFP and ENG. Wolf Coach will bring what it describes as a "mini news room" for ENG/EFP, fitted with microwave. Television Engineering plans to bring a small ENG van—the company's specialty—and E-N-G Corp. will have two news production vehicles, a small van and a Suburban.

At press time, only two helicopter manufacturers—Bell and Hughes—had plans to show their birds, although a third, MBB Helicopter, will have a display featuring videotapes of BO-105. MBB claims this chopper, in service at KNXT-TV, is the only twin-jet helicopter in broadcast use at the present. Bell will once again have its big helicopters, the LongRanger and the JetRanger, while Hughes usually features smaller models. Next door to Hughes, ENG Helicopter Satellites will again bring its helicopter camera mounts, including the Model 50, suitable for installation in blimps. **BM/E**





Photo Courtesy Rouse Company

# A MILESTONE IN MICROWAVE TECHNOLOGY

The leader in microwave ENG/EJ systems has just redefined the performance standards. Introducing Nurad microwave transmitters and receivers. Combining Nurad's renowned quality and dependability with state-of-the-art design innovations, they represent a milestone in microwave technology.

With the advent of our new line of frequency-agile ENG/EJ central receivers, STL/ICR transmitters and receivers, and portable transmitters and receivers, Nurad offers the broadcaster complete microwave systems capability unparalleled in quality, performance, and reliability.

At Nurad we take pride in offering the finest, and being the leader. Nurad Microwave Systems.

**NURAD**  
MICROWAVE SYSTEMS

Circle 144 on Reader Service Card

2165 Druid Park Drive Baltimore Maryland 21211 Telephone (301) 462-1700 TWX/Telex (710) 235-1071

# OUR NEW 1/2" TAPE GIVES YOU COLOR

For professional tape users, it used to be that stepping down to half-inch video tape also meant stepping down in color quality.

But that was before Scotch® half-inch videocassettes with Color Plus oxide.

Now you can give your productions bright, brilliant color that no other half-inch tape can beat. Not even competitive high grade tapes.

3M's Color Plus oxide sets a standard for the industry for color signal-to-noise and broad-band signal-to-noise.

The result is better picture quality, more brilliant color and more realism. We've got the test results to prove it.

But the advantages of our half-inch tape go beyond color. You'll also get professional recording features like fewer dropouts, low headwear and extended

stop motion capability. The same characteristics that have made our 2", 1" and 3/4" tapes the leaders in the professional market.

New packaging plus a convenient labeling and hanger/storage system make our half-inch tape professional right down to the last detail.

But to get the true picture of our improved half-inch videocassettes you just have to try them. They're available in both Beta and VHS

formats from your authorized dealer of Scotch Video Tape.

Or ask your 3M Sales Representative for more information and test results on Color Plus half-inch tape. You'll get a free Color Plus painters hat as a bonus.

Magnetic A/V Products Division/3M



"Scotch" is a registered trademark of 3M. © 3M Company, 1982.

See us at NAB Booth No. 1002



**AS VIVID AS YOUR IMAGINATION.**



**SCOTCH HALF-INCH VIDEOCASSETTES.  
NOW WITH COLOR PLUS.**

3M hears you...

**3M**

Circle 145 on Reader Service Card

# 40 to 1

## Canon PV40 x 13.5B IE: THE OLYMPIAN

Canon moves you a giant step forward with a 40X broadcast quality zoom lens. An incredible new lens that allows you to cover a stadium at wide angle or fill the frame with the quarterback's eyes.

Never before has a single lens provided this much flexibility and sensitivity, with remarkably little change in effective aperture throughout its entire 13.5mm-540mm\* range. Built-in extenders let you go all the way to 1080mm and each lens is diascope-equipped for modern microprocessor-

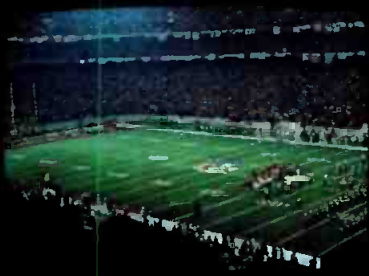

controlled cameras.

We call it The Olympian. Not only because it is ideally suited for sports coverage but also because of the dedication and team effort required of our optical and electronic engineers in making this lens a reality.

Enlarge a dollar bill forty times and it covers an area twenty feet long and eight feet wide. Now think about what you could do with the Canon PV 40 x 13.5B IE!

\*1" cameras. Also available in 30mm plumbicon.



# Canon®

Optics Division

Canon USA, Inc., Head Office: One Canon Plaza, Lake Success, N.Y. 11042 (516) 488-6700

Dallas Office: 11311 Stemmens Freeway, Suite 1, Dallas, Texas 75229 (214) 620-2641 Chicago Office: 140 Industrial Drive, Elmhurst, Ill. 60126 (312) 833-3070

West Coast Office: 123 Paularino Avenue East, Costa Mesa, Ca. 92626 (714) 979-6000

Canon Canada, Inc.: 3245 American Drive, Mississauga, Ontario L4V1B8, Canada (416) 678-2730

© 1982 Canon U.S.A., Inc.

See us at NAB Booth #1012

Circle 146 on Reader Service Card





# VIDEO EQUIPMENT LISTING

## **ABAKAS VIDEO SYSTEMS (1620-A)**

## **ACRODYNE INDUSTRIES (1228)**

Will highlight its line of translators and transmitters for LPTV applications.

## **ADAMS-SMITH (1704)**

Will show time code synchronizers with accuracy to 1/100th of a frame. Also time code generators and readers.

## **ADDA CORP. (1100)**

New products will be announced at show. Products from the standard line include the ESP digital still store/graphics system, the VIP digital effects processor, and framestone/synchronizer/TBCs.

*See ad page 79.*

## **ADVANCED VIDEO TECHNOLOGY (1420-A)**

## **A.F. ASSOCIATES (1609/1611)**

Will introduce the AVS-6000 **digital standards converter**, a unit from Marconi which may replace DICE. Other products will include the Marconi one-inch Type C VTR and CCD telecine, AFA's slate camera and joystick camera control, and a description of studio, mobile, and post-production facilities design and engineering services.

*See ad pages 39, 221*

## **AGFA-GEVAERT (1334)**

Will show a full line of videocassettes, including Beta packaged and bulk/duplicator tapes as well as VHS T30, 60, 90, 120 packaged and bulk. Also KCS mini and KCA standard packaged shelf box tapes.

*See ad page 129.*

*Booth numbers as supplied by NAB.*

## **ALCOA-NEC COMMUNICATIONS (1415)**

Will display satellite earth station antennas and transmit/receive earth station electronics.

## **ALEXANDER MANUFACTURING (1714)**

Demonstrating the complete line of battery packs for video cameras and other battery accessories.

*See ad page 124.*

## **ALLEN AVIONICS (1627)**

New **random noise measurement networks** will be introduced along with pre-emphasis and de-emphasis wave shaping networks and rack-mountable video and pulse delay lines. The standard line of equipment will include video filters, pulse, and delay lines and hum eliminators.

*See ad page 262.*

## **ALLIED BROADCAST EQUIPMENT (639)**

A complete new line of **Kustom Kraft control room furniture** will be introduced. **Handling new products** for over 160 manufacturers, including Modulation Associates' satellite receiver and Bonneville DA line.

## **ALLIED TOWER CO. (409)**

Will show microwave and broadcast transmitting towers.

## **ALLSOP (1177)**

Showing a new **U-Matic cleaner** as well as a number of computer, cassette deck, and digital cleaners for both VHS and Beta.

## **ALPHA VIDEO & ELECTRONICS (1722)**

Will show modified Sony type 5 **U-matic** for broadcast use and also custom equipment consoles and racks.

## **AMCO ENGINEERING (1218)**

General exhibit will contain communications consoles, styling options, computer desks, and complete desktop cabinets.

## **AMERICAN DATA CORP. (1409)**

Introducing a new **master control switcher** with operating features for small, medium, and large broadcast stations. The unit, the MC-4000, has full microprocessor control of all switching and analog control functions with over/under audio mixing, single event preroll for up to 10 VTRs and two film islands, a downstream keyer with master fade to black. Several models are available with up to 32 AFV inputs.

For effects capability in production switchers, American Data will announce its incorporation of Digital Services Corp.'s Digifex unit into the 3100 Series of switchers.

The 3104A and the DSK-3101-9 production switchers will be exhibited. The 800 Series of DAS will be on hand, as will the 900 routing switcher with various controls in a 20x10 format. The 860 downstream keyer with master fade to black and key edger, shadow and outline will also be demonstrated.

## **AMERICAN BELL (1429)**

(Formerly AT&T.) Will feature **System 85**, the newest member of its Dimension PBX system—offering voice, data communications, energy and security management, etc.

## **AMPEREX ELECTRONIC (1412)**

Will introduce two new **Plumbicon camera pickup tubes**: XQ2170, a one-inch diode gun Plumbicon; and XQ3170, a one-inch diode gun low-capacitance Plumbicon.

*See ad page 231.*

**AMPEX CORP. (1400)**

Under the banner "Setting the fashion in broadcast video," previously introduced products will include the VPR-3, VPR-5 portable, and VPR-80 low-cost one-inch Type C VTRs, the ARC single-piece recorder/camera, ADO digital special effects, ACE computerized editing system, AVC series production switchers, HPE-104 modular editing system, and the BCC-20 and BCC-21 Digicam camera line. Expect some new products, however, particularly in the digital effects area. (Also see listing in audio section.)

*See ad pages 49-56, 105-108, 210-211.*

**AMTEL SYSTEMS (1745)**

Will show time code equipment and clocks, including the 3700 and 3800A Edit Code Master SMPTE time code line.

**AMTRON CORP. (1104)**

Will unveil 8-, 13-, and 19-inch high-resolution RGB/NTSC color monitors to its studio monitor line. Also exhibited will be the safe title/safe area generator with pulse-cross, micro-rule, and blanking verifier.

**ANDREW CORP. (1202)**

New products will include an LPTV antenna and a circular waveguide for UHF TV transmitter applications. Also on display will be earth station antennas, STL microwave antennas, coaxial cables, and UHF transmitting antennas.

**ANGENIEUX (1201)**

Will be introducing lenses for half-inch, 2/3-, and one-inch, and 1/4-inch video cameras. Also showing brand-new Retro-Zoom, tele-attachments for the 15X9 ENG/EFP lens, along with the super wide angle adapter with accessories.

**ANTENNA TECHNOLOGY CORP. (1737)**

Showing a new simulcast 7-meter comparable multi-beam antenna for TV. The simulcast 5 will be exhibited for TV and cable. (Also see listing in audio section.)

**ANTON/BAUER (1337)**

Will introduce the Lifesaver line of battery chargers, a "completely safe" charging system featuring a logic-controlled battery charge monitor which maintains a fully-charged battery indefinitely. Also new is the 30/13 dual voltage battery belt designed for lighting and/or camera power, featuring a built-in overnight charger or optional Lifesaver fast charger. Also

new are snap-on ac and dc power supplies. Will also show camera remote control system—to 2000 feet.

**ANVIL CASES (1112)**

In a newly designed booth, Anvil will present some innovations in interior case design that allow for increased utilization while still maintaining strength and ruggedness. Will also introduce new case options, including locks, exterior colors, rack channel fastenings, rack glides, etc. Also unveiling brand-new pricing catalog.

**APERT-HERZOG (1703)**

Introducing a new 1X24 DA for reference and high-performance video distribution. Standard products will include the Model A digital frame sync, a travelling digital-to-analog converter, and the VBB-A, a hybrid video line driver.

**ARRIFLEX CORP. (1644)**

Will introduce several new products in the power supply area, including NC TA-1, a nicad battery tester that can be connected to an x-y recorder for logging test data, and a new battery multicharger for multi-unit, multi-voltage applications. Also some new additions to its line of professional cine products, including a brand-new six-plate editing table with individual phase-locked motors. New also will be the Arri Cinejib—a portable crane for camera + crew up to 570 lbs. which operates from below floor level up to 14.8 feet. These products round out the full line of professional motion picture and video equipment, including the SR-2 camera, Zeiss lenses, and a full line of HMI lights.

**ARTEL COMMUNICATIONS (1118)**

Will feature its baseband video fiber optic transmission system intended for production applications.

*See ad page 259.*

**ASACA/SHIBASOKU (1226)**

Will introduce the ADS-1000, a low-cost digital still store which works in conjunction with Asaca's video digitizer to provide freeze fields or freeze frames in full-screen and multi-image displays. Also at booth will be the new audio delay/synchronizer for synchronizing audio with microwave and satellite video. Other products include the ACV-100 color corrector and the ASW-50 ENG camera.

*See ad page 73.*

**ASSOCIATED PRESS (419)**

Will describe broadcast news services.

**ATLAS TOWER (617)**

Plans to introduce the international series of knock-down type tower along with new tower leases and lease-



*Fast charger unit for the new Anton/Bauer Lifesaver battery system.*

ing packages. Will also have towers to 2000 feet, guys, self-supporting towers, and tower-related products.

**AUBURN INSTRUMENTS (1711)**

Showing a two-wire machine control system, along with a new digital blanking meter.

**AUDICO (1343)**

Will promote its new videocassette and videotape loader/reloader/rewinder for all tape formats. Features reloading capability that removes old tape without opening cassettes, respooling that allows multiple shorter cassettes to be created from one longer one. (Also see listing in audio section.)

**AURORA SYSTEMS (1312)**

Demonstrating the Aurora 100 digital video graphics system with hardware and software improvements. These include automatic curve generation, color input, selectable directional edging, and newly designed work station. There will be demonstrations by several graphics artists.

*See ad page 243.*

**AUTOCUE PRODUCTS LTD. (1406)**

See listing under Listec.

**AVC SYSTEMS (616)**

Showing new control room furniture as well as existing line of products, including distribution in U.S. of Bayly/Telefunken transmitters. (Also see listing in audio section.)

**AYDIN CONTROLS (1642)**

**WILLIAM BAL CORP. (1614)**

Will have the new Road Case, a carrying/shipping case for video gear. Also plans to show standard lines of cases for equipment, shipping, and tools.

**BARTH ELECTRONICS (1122)**

Showing new UHF terminators.

**BASYS (1503)**

Will feature News Fury and Mini Fury full-function computer systems for news production; Clip Fury computer system for newsroom libraries; and Cart Fury label printer for audio carts.



# "Dimension" by Quantel.

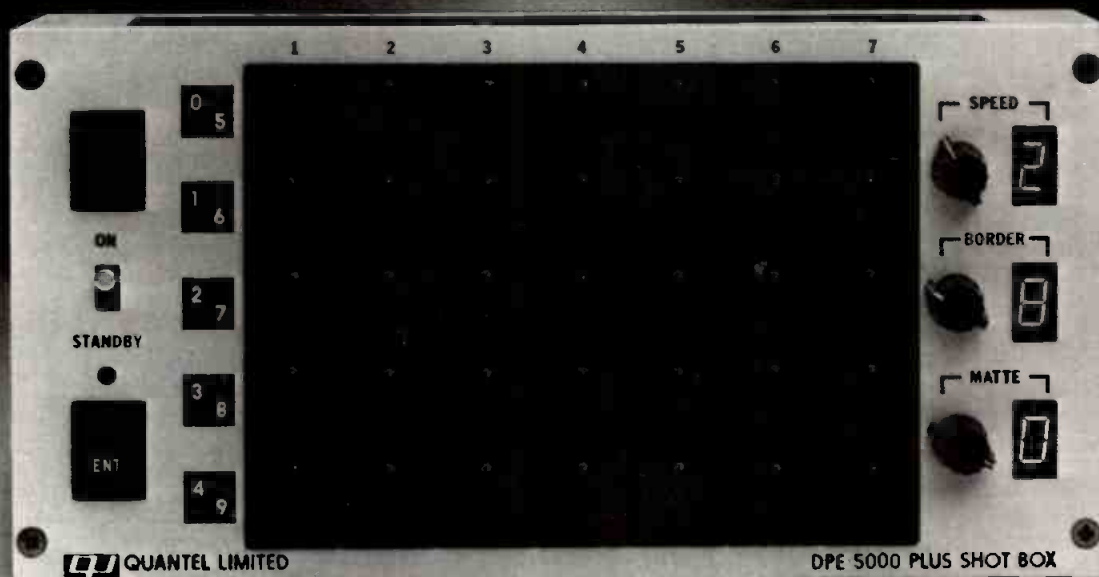

## Now you can have 3-D perspective effects at the touch of a button.

"Dimension" by Quantel. It lets you call up three-dimensional effects more dazzling and more powerful than any other system on the market. Any other system.

And you can do it on up to five channels of video. Simultaneously. With unsurpassed Quantel picture quality.

With our unique Shot Box control panel, you can have up to 70 move-sequences on-line. Each sequence can consist of several moves. Touch a single button and the sequence is executed. It's awesome.

You get all this with total creative freedom. You can use our standard pre-programmed catalog moves. You can modify the standard moves. Or you can create your own unique moves.

"Dimension" is a lot more than three-dimensional perspective. It also includes kaleidoscope, picture splits, trailing freeze, multi-freeze, custom shapes, "Autoflex" elastic shapes, and "Teletrack.\*"

If you already own our DPE 5000, you can add all the power of "Dimension," including multiple channels.

If you don't have a DPE 5000, don't make a move until you call Quantel.

Your local MCI/Quantel office has details. Or get in touch with us directly: Micro Consultants, Inc., P.O. Box 50810, Palo Alto, California 94303, 415/856-6226.



MCI/Quantel, "Shot Box," and "Dimension" are trademarks of Micro Consultants, Inc.

\*A BBC development.

**MCI/QUANTEL**  
The digital video people.

Circle 147 on Reader Service Card

**BEAVERONICS (1313)**

Will introduce new square version of Favag's **impulse slave clock**. Also plans to display Favag line of master clock systems, including the QMS-1 master with accuracy of better than one second/year, along with numerous types of analog slaves and digital displays activated by the Favag master. Also featured will be video production switchers, including the 154 and 712 systems, with various options such as downstream keyer, border line unit, quad split unit, and chromakeyer unit.

**BELDEN COMMUNICATIONS (1416)**

Will exhibit several new products in the **Lee Filter line**: brushed silk, HMI-, CSI-, and CID-to-tungsten color correction, etc. Also new **Lee resin filters**, unbreakable material with superior optical qualities.

**BELL HELICOPTER/TEXTRON (1175)**

Will show the JetRanger and the Long-Ranger ENG helicopters.

**BESTON ELECTRONICS INC./BEI (1620)**

Will introduce the BEI 4000, latest generation of its **character generator** line, with 27 ns resolution, priced under \$15,000. Basic system includes one selectable font in five sizes, row and page centering, roll, character edging/drop shadow, and eight-color background/characters. Software-expandable to 16,000,000-color palette, infinitely variable roll and crawl speeds, graphics system, etc.

**BIAS/DATA COMMUNICATIONS CORP. (1014)**

Will show new **BIAS newsroom management system** including videotape morgue, cross indexing of slides, newspaper index, newscast lineup, contact directory, and job costing. The product can function independently or as part of the Network Control System. Also on display will be the Master Control Automation for on-air management of engineering activities.

*See ad page 115.*

**BIRD ELECTRONIC (1625)**

Will show the new modload **RF calorimeter/load system** and the new dolly-mounted, water-cooled **load resistor series** for 10-80 kW transmitters. Also on hand will be self-cooled line terminations, water-cooled load resistors, RF power analysts, high-speed transmis-



Control panel for the Bosch Mach One multisource editor.

sion line monitor/alarm, and ThruLine ARF wattmeters.

**BIW CABLE SYSTEMS (1405)**

Will exhibit line of television camera cables, VTR and camera cable assemblies, triaxial cables, and fiber optic cable systems. Booth will feature demonstrations of advances possible with fiber optic systems.

**BLONDER-TONGUE LABS (1134)**

Will highlight its BTVision III fully addressable STV system in a live demonstration. Will also highlight its full line of products and services for LPTV systems.

**BOGEN PHOTO (1705)**

Will introduce 3010 low-cost, compact, lightweight **tripod** with microfluid head for small video cameras, and 3040 heavy-duty **tripod** with mini-fluid head for cameras up to 10 lbs. Also new is a **power pack** that powers VTRs up to six hours or quartz lights up to 30 minutes, and **VCR caddy** that attaches to two legs of any tripod.

**BOGNER BROADCAST EQUIPMENT (1319)**

Will show high-power UHF TV transmitting antennas, low and medium-power VHF/UHF slot and dipole antennas, and MDS and ITFS transmitting and receiving antennas. (Also see listing in audio section.)

**BOSCH (1207)**

Will introduce the FGS-4000, its **3D digital graphics and real-time animation system**. Will also introduce a working model of the **KBF-1 integrated quarter-inch recorder/camera system**, the **TVS-2000 routing switcher**, and a new entry into the **light-weight ENG camera** category with the **KCP-1**, the camera section of its recorder/camera unit.

Will also show the Mach One Series II computer editing system, the TVS-1000 and RKX routing switchers, as well as machine control systems, monitors, BCN tape recorders, FDL-60 telecines, and character generator systems.

*See ad page 97.*

**BRITISH VIDEOTEX & TELETEXT (1632)**

Showing teletext equipment and services.

**BROADCAST CARTRIDGE SERVICE (611)**

Will describe its new **videocassette loading service**. (Also see listing in audio section.)

**BROADCAST MICROWAVE SERVICES/BMS (1749)**

Highlighted products will include the **GCA-1**, a gyroscopically controlled antenna system for airborne ENG. The 16 dB directional antenna is mounted in a radome in the belly of a helicopter, together with a frequency agile transmitter and receiver; once the antenna is locked onto the receive site it automatically maintains the correct orientation no matter how the helicopter flies. Also **TBA-14 omnidirectional 14 dB gain receive antenna** with 360 degrees of coverage for low-cost "tracking" system.

**BROADCAST SYSTEMS (1500)**

Will describe its equipment rental service.

**BROADCAST VIDEO SYSTEMS (1326)**

Plans to introduce the **VIC-900, vertical interval indent and control system** as well as the **Cox 600J color corrector** with variable gamma and SMPTE time code interface. Will also show color signal monitor, line selector, dual standard encoder, and a complete range of **BVS video delay lines and filters**.

**BUSH & MILLIMAKI (1715)**

Will introduce a production model of **tricolor video collimator**, seen last year in prototype, that allows optical setting of back focus on video cameras. Also new is **collimated light box** that allows operator to perform electronic adjustments with a controlled light source, presenting every setup chart to the camera collimated to infinity. Will also show Universal line of tripod heads.

**B-W LIGHTING SYSTEMS (1733)**

Will exhibit its complete lighting package, including distribution, grid, cyc, track, curtains, control, and fixtures. Also portable lighting kits and miscellaneous lighting equipment.



Space shuttle image from Hewlett-Packard 45 computer recorded by LogE/Dunn 631 System

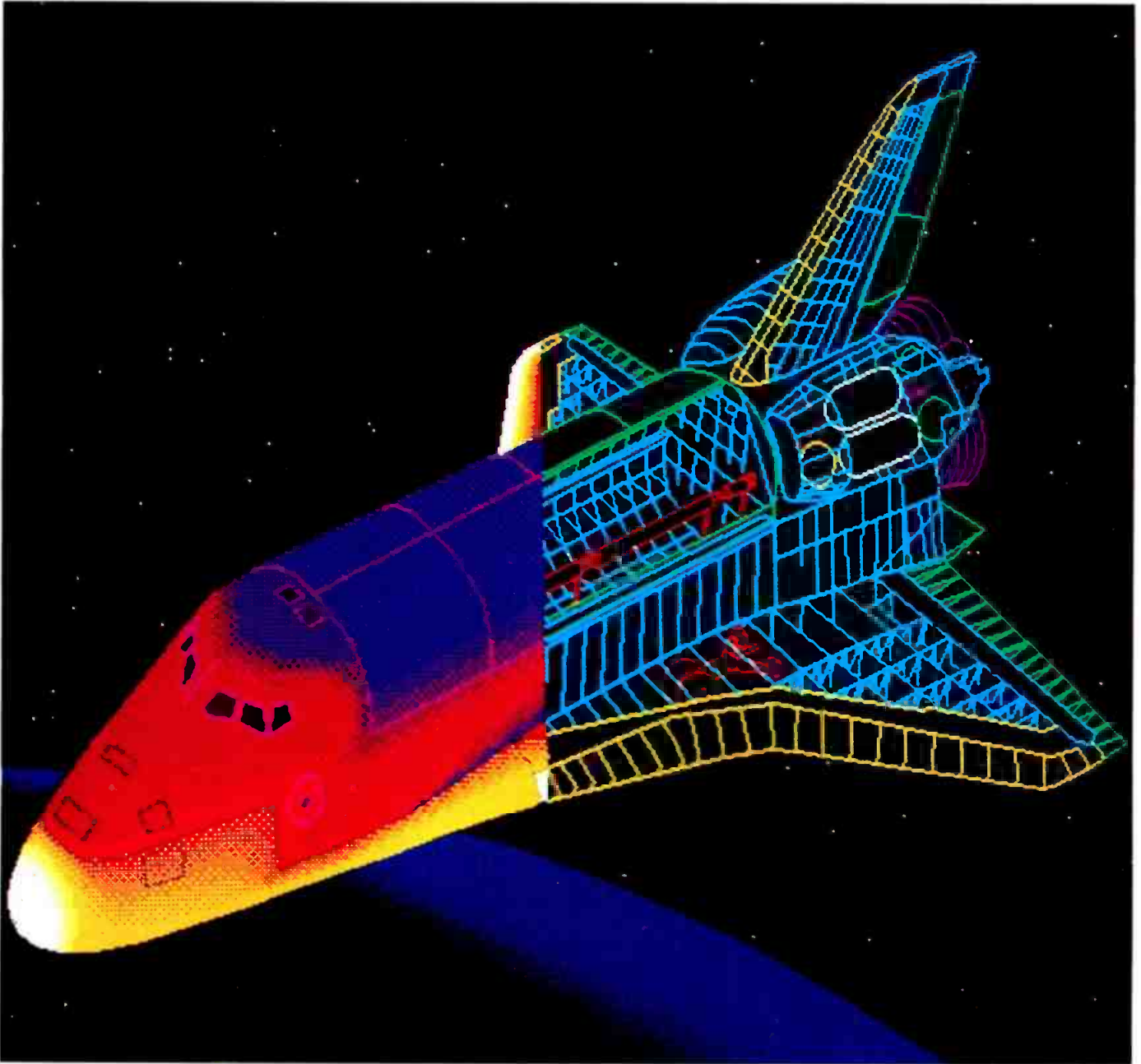

## Launching the color graphics recording systems of tomorrow.

Dunn Instruments' line of color graphics film recording systems offer today's... and tomorrow's... highest levels of user-friendliness and versatility in producing high quality photographic output from raster-based computer graphics systems. Note the wide range of camera options, film sizes and types available in these new Dunn systems: **CompactColor**, an 8x10 system with 35mm and Polaroid's Colorgraphic Instant Print and Overhead Transparency System capability. Includes intelligent keyboard for color corrections, enhancements, etc. **VersaColor**, designed for lower-cost 8x10 Ektaflex film. **ProColor**, for pin-registered accuracy in 35mm slide production. Add to these our industry-leading **Model 631**, with standard 8x10 plus our broadest range of camera and film options, and **Model 632**, ideal for 35mm slides, SX-70 and 4x5 Polaroid instant color prints, 16mm cine, and custom film formats. Be sure to watch for **UltraColor**, our soon-to-be-available (4096x4096) resolution system. For complete information on these systems, write or call today!

DUNN  
INSTRUMENTS

LogE/Dunn Instruments, Inc.

544 Second St., P.O. Box 77172 • San Francisco, CA 94107  
(415) 957-1600 • Telex: 340870

LogEtronics Inc. 7001 Laisdale Rd., Springfield, Virginia 22150 • LogEtec AG Fährlibuckstrasse 110, CH-8005 Zürich, Switzerland  
LogEtronics GmbH Frankfurterstrasse 16-40, D-6236 Eschborn/Ts./Germany



# KING OF THE

## IKEGAMI'S NEW HL-79E THE HEIR TO THE THRONE

Ikegami's latest technological triumph, the HL-79E, heralds a new generation of hand-held broadcast camera excellence.

Engineered to surpass the most rigorous standards of performance and introducing features that are masterpieces of innovative thinking, the HL-79E's picture quality even exceeds that of other manufacturers' top-of-the-line studio cameras.

In the fiercely competitive video market where others hope to be as good as the HL-79D, Ikegami is the unquestioned leader. And the HL-79E will soon ascend to a loftier throne as King of the Jungle. Only by seeing this remarkable camera in action can it be fully appreciated.

How great a camera is it? To begin with, it is smaller and lighter than the world's standard for comparison, the Ikegami HL-79D Series. And it has features as yet unknown to even sophisticated camera users: Dynamic Detail Correction, Chroma Aperture Correction, Highlight Aperture Correction and Auto Contrast Compression. Plus the HL-79E offers improvements in contrast range, S/N ratio, registration, accuracy, resolution viewfinder performance and more.

Optional accessories include the ADC-79E Auto Set-Up Digital Control, the RDC-79E Remote Digital Control and the VF 45-3 Large Viewfinder. The HL-79E is compatible for use with existing HL-79A and HL-79D lenses, power supplies, VTR cables, and other accessories. Plus, it can

be adapted to the MA-79 Multicore Base Station and TA-79/79C Triax Base Station.

The HL-79E is part of the great and proud family of Ikegami cameras and monitors serving many satisfied users worldwide. For a complete demonstration of Ikegami Cameras and Monitors, contact your local dealer or call Ikegami Electronics.



ADC-79E Auto Set-Up Digital Control

# Ikegami<sup>®</sup> HL-79E

Ikegami Electronics (USA) Inc. 37 Brook Avenue Maywood, NJ 07607

■ Northeast (201) 368-9171 ■ Midwest (219) 271-8240 ■ West Coast (213) 534-0050

■ Southwest (713) 445-0100 ■ Southeast (813) 884-2046



# THE JUNGLE



See the  
*King of the Jungle*  
at NAB  
booth 1013

Circle 149 on Reader Service Card





## **CABLEWAVE SYSTEMS (108)**

New products will be low loss, moisture block, annular copper corrugated **transmission line**. Phase temperature characteristics are excellent for sampling line systems in critical antenna arrays. Other products will include various diameter sizes of air and foam dielectric copper corrugated Wellflex transmission line, RF connectors, microwave parabolic antennas, mounting hardware, and pressurization equipment.

## **CALAWAY ENGINEERING (1167)**

Will show the new UPMC editor interface available for BVU-800, 2000, and VPR-2B and 80. The unit is also compatible with ISC superedit and CMX computer editing systems.

*See ad page 275.*

## **CALVERT ELECTRONICS (1761)**

Will show Eimac's Y 730 LPTV translator tube and its distribution inventory of tubes and components, including RCA power and camera tubes.

## **CALZONE CASE (1011)**

Will introduce a new **lightweight shipping case**, similar in appearance to Escort line but about 40 percent lighter and 30 percent lower in cost. Will also display established Convoy and Escort case lines.

*See ad page 120.*

## **THE CAMERA MART (1018)**

Will demonstrate full broadcast video lines from several companies, including ADDA, Ampex, Canon, Chyron, Digivision, For-A, Hitachi, Ikegami, JVC, Kangaroo, Listec, Microtime, O'Connor, Quanta, Sharp, Sony, 3M, and Videotek.

*See ad pages 26-27.*

## **CANARE ELECTRIC (1732)**

Will show bulk video cable. (Also see listing in audio section.)

*See ad page 230.*

## **CANON USA (1012)**

Will introduce four new **studio lenses**; the P14X16 and P18X15 for 30 mm tubes, and the PV14X12 and 18X11 for 25 mm tubes. In addition, will bring its full range of lenses for studio, field, and ENG applications, including the Olympian 40:1 studio zoom and 15X8.5 ENG lens, both introduced last year.

*See ad page 84.*

## **CAT SYSTEMS (1424)**

Will introduce two computerized

remote-control systems with color graphic display and synthetic voice capability. Both versions have auto start and prestart, as well as auto-logging. Will also demonstrate color graphic generator with bit pad, font generation and slide presentation.

## **CECO COMMUNICATIONS (118)**

New high-power **transmitting and receiving tubes** will be featured along with **new video and semiconductor departments**. Other products will include TV camera tubes, video monitors, and video camera equipment.

## **CEI/PANAVISION (1638)**

Will highlight its line of video cameras, especially the Foton-1, the newly introduced studio camera with "affordable automatics." Also the SP-3, a special purpose version of the CEI-310 for demanding applications such as electronic cinematography.

## **CENTRO CORP. (1101)**

Booth will feature 42-foot production trailer built for KWGN-TV, Denver, along with small cable production truck and information on complete range of services.

## **CENTRAL DYNAMICS (1409)**

Will demonstrate its new Series 80 **production switchers**, developed from the CD480, along with the 2300 video amps. Other new equipment includes the MC995, a **single event pre-roll system** for the MC990 master control switcher. CDL will also reveal the availability of Digital Services Corp.'s Digifex unit as an option on its Series 80 line of switchers. Displays from the standard line of products will include the VS10 and VS14 production switchers. (Also see listing in audio section.)

*See ad pages 116-117.*

## **CENTURY PRECISION/ CINE OPTICS (1781)**

Introducing the new 0.7X **wide-angle attachments** for 2/3-inch zoom lenses and **parascopic/snorkle lenses** for most 2/3-inch video cameras. Will also have the line of telephoto and wide-angle lenses and adaptors for video cameras.

## **CHRISTIE ELECTRIC (1016)**

Will introduce maxERASE-16, new **bulk tape/cassette degausser** for high coercivity audio, video, and audio/video formats. Will also display the reFLEX-20 line of batteries and chargers for ENG and EFP, and lightweight camera-mounted ac/dc power supplies, all featuring 20-minute burping charger, super nicad batteries.

*See ad pages 187, 258.*

## **CHYRON CORP. (1610)**

Will introduce the VP-2, a low-cost, high-resolution **character generator** with floppy disk drive standard. The new Chyron IV and RGU-2 **character generators** will be displayed, incorporating animation capability and Digital Service Corp. DigiFex digital effects.

*See ad page 232.*

## **CINEMA PRODUCTS (1221)**

New products include Steadicam Model III, J-6 **zoom control** for use with the EC-35 and EFP type cameras, **universal studio matte box**, and the new mini Worrall, a **precision geared head** offering whip pan capability. Standard line will include camraprompter, coax digital remote control system, Fresnel spot light series, portable location lighting systems, zip-pak ac power supply, and GSMO 16 mm camera with 100-foot quick change cassette-type magazine.

## **CINEMILLS (1140)**

Will come to its first NAB with Daymax **high-intensity globes** in 575, 1200, 2500, 4000, and new 6000 W sizes; new Desisti HMI **softlights** in 575 and 1200 W sizes; **Desisti portable kits** in 1000 and 2000 W ranges; Cine 60 battery belts; and complete line of Lee **video camera filters**, new to NAB.

## **CINE 60 (1423)**

Will introduce a new, two-pound **battery supply for remote operation of Canon lenses**, two-channel **multi-chargers**, and a **lightweight switching mode power supply**. Also new will be a miniature 12-volt, 100-watt **battery light** for hand-held or camera-mounted use. The established line of equipment will include sun-gun mounting brackets, sun-guns and kits, batteries, chargers, and battery power cables.

*See ad page 204.*

## **CMC TECHNOLOGY (1009)**

The Videomax, TD 800 **automatic bulk tape demagnetizer** is the new product for this year. The standard line will include refurbishing service for all video heads, available in alfesil or ferrite transducers.

## **CMX SYSTEMS (1639)**

Displaying a new **large-scale editing system** with details to be released at the show. The Edge with **upgraded software** will also be demonstrated, along with new **interfaces** for BVH-200 1/2-inch format and for the VPR-80.

*See ad page 123.*

## **COLORADO VIDEO (1222)**

Plans to show its slow-scan television system.



# Our monitors are worth looking into

## Ikegami 8-Series Standard and High Resolution Color Monitors

Once you look into an Ikegami monitor, chances are you may never look into buying a monitor from anyone else. And it's no wonder, since every Ikegami monitor is designed by the same demanding engineers who have succeeded in making Ikegami cameras synonymous with performance and reliability.

Look around. If you think you're seeing more Ikegami monitors at NAB, network and independent stations, professional studios, remote vans and corporate facilities in general, it's because you are.

Fact is, when you look into the Ikegami 8-Series standard and high resolution color monitors, you'll see more than 13V and 19V monitors (23V standard resolution monitor available). You'll see a host of standard features, from American Standard Matched Phosphors (not available on 23V) to a Shadow Mask Dot Matrix CRT to an Active Convergence Circuit to Delta Gun tubes and more. And you'll see a product name that says exceptional quality—every time.

That's something worth looking into.



TM14-8R



TM14-2RHA



TM20-8R

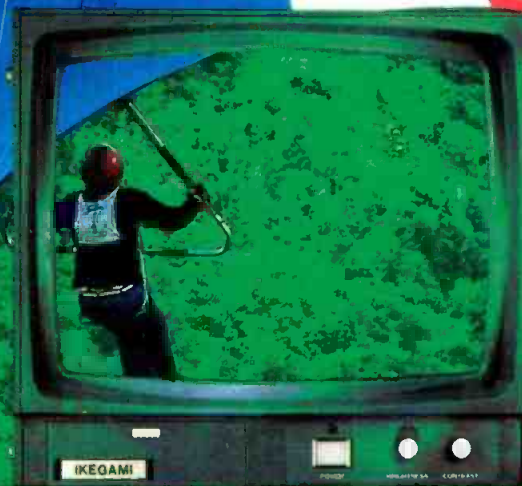

TM20-8RH

# Ikegami

## Delta Gun Standard and High Resolution Monitors

*Ikegami is the supplier of Color Monitors to ABC for its coverage of the 1984 Winter and Summer Games.*

Ikegami Electronics (USA) Inc., 37 Brook Avenue, Maywood, NJ 07607 • (201) 368-9171 • Northeast: (201) 368-9171  
West Coast: (213) 534-0050 • Southwest: (713) 445-0100 • Southeast: (813) 884-2046 • Canada: (201) 368-9179

Circle 150 on Reader Service Card



**COLORGRAPHICS WEATHER SYSTEMS (1116)**

Will introduce its complete television station computer system. This will include the interfacing of Colorgraphics' computer weather systems with Integrated Technologies' news computers. There will be an introduction of a **framestore with a video digitizer** in conjunction with an automated sports scoreboard including animation. This allows on-air manipulation of scores and animated efx, with the computer generating information with any font required, any animation required, and any combination of these functions.

**COLORTRAN (1205)**

Will have the new Patchman small lighting control console as well as a full line of fresnels from 1 to 5 K and high-density dimmers.

**COMARK (1226)**

Will introduce a new line of high-efficiency UHF transmitters and new broadband UHF exciter. Also new will be a universal anode pulser, envelope delay correction system, and a new square wave guide. Demodulators, filters, coaxial switches and wave guide switches will also be on hand.  
*See ad page 119.*

**COMPACT VIDEO SERVICES (1142)**

See listing under RTS.

**COMPREHENSIVE VIDEO (1315)**

Will introduce the Quartz Beam video lighting line. Standard products will be the PAG line of power and lighting equipment, and Bilora tripods. (Also see listing in audio section.)

**COMPUCON (1616)**

Plans to introduce new radiation hazard measurements designed to docu-

ment levels from existing common carrier, private microwave, or earth station transmitting facilities. Other services include earth station frequency analysis and coordination and engineering, cellular and land mobile engineering, and frequency protection.

**COMPUTER GRAPHICS LAB (1143)**

Will introduce Tween keyframe animation system, which enables the artist to input key frames of animation; the computer then extrapolates the in-between frames to form a complete animation sequence. Will also feature IMAGES (Image Manipulation And Graphic Enhancement System) electronic art/paint system.

**COMSEARCH (1136)**

Will demonstrate as new products a digital termination system for frequency coordination, Ku-band earth station services, and FCC testing. Also on display will be LPTV engineering, point-to-point terrestrial microwave planning, and earth station frequency coordination. (Also see listing in audio section.)

**COMTECH (314)**

Introducing satellite earth station equipment, featuring the new 24-channel frequency agile receiver, the Agile Modulator and antennas, and complete new TVRO systems. The existing line of products will include demodulators.  
*See ad page 200.*

**CONNOLLY LEGATE LTD. (1159)**

**CONRAC (1401)**

Two new additions will be displayed this year: the 2400 Series of 19-inch monochrome broadcast monitors, and the Inline Gun studio monitor which can be added to the 2200 Series. Will also have its line of computer graphic color monitors and the complete line of professional color monitors in varying price ranges and with different features.  
*See ad pages 32-33.*



*Touch-activated editing system from Control Video—the Lightfinger Plus.*

**CONTROL VIDEO (1157)**

Will demonstrate Lightfinger Plus, video editor with floppy disk memory, list management A/B roll editing, and mix/effects and switcher interface. The new Spot Editor for cuts-only editing for the auto assembly of spot reels will be introduced, along with a new feature for the intelligent controller which makes editing and pre-programmed single-event playback possible.

**CONVERGENCE CORP. (1430)**

Will feature the ECS-90 edit controller accessories, including a built-in time code generator, time code reader, and edit decision lister. Standard products on display will consist of the complete line of video editing products and accessories. The ECS-103B A/B roll unit, list management Model ECS 104, the ME-110 mix effects system, the DD-100 dual disc drive, and other broadcast products will also be displayed.

**COOL-LIGHT (1322)**

Will introduce the new Tri-light unit consisting of three light strips in a common frame. Also a new model of the Mini-Cool with redesigned air draft and dual filter slots. The Universal precision light framer is new and mounts directly to Mini-Cool and can be adapted to other lights, providing complete control of projected light beam.

**CORPORATE COMMUNICATIONS CONSULTANTS (1611)**

Will introduce the System 60XL B equipped with the ABC digital command module designed to reduce time in scene-to-scene color correction of features and long duration material. Will also show the System 60C, XL, and THOR with a low-cost version of ABC module.

**COX DATA SERVICES (1165)**

Will bring its line of TV business automation hardware and software.



*One of the computerized color correction systems from Corporate Communications.*



# Now there's even more to look into



TM14-9RH



TM20-9RH

## Ikegami's new Broadcast Color Monitors

Ikegami has just made it impossible for any quality-minded high resolution color monitor user not to consider looking into an Ikegami monitor.

They call it the 9-Series, two new monitors (13V and 19V) with standard features that include a High Resolution Shadow Mask CRT with a Self-Converging In-Line Gun; American Standard Matched Phosphors; a Comb Filter to preserve luminance resolution; pulse cross and R-Y/B-Y outputs. We think you'll call it just what you've been looking for.

Along with its streamlined design and easily serviced modules, Ikegami's new monitors follow in a tradition of excellence. Each offers high stability, exceptional performance and proven reliability. Together with Ikegami's Delta-Gun Series, the 9-Series provides yet another reason to look into the monitors that more and more video users are spending their time looking into.

Isn't it time you looked into Ikegami monitors?

# Ikegami

9-Series monitors

*Ikegami is the supplier of Color Monitors to ABC for its coverage of the 1984 Winter and Summer Games.*

Ikegami Electronics (USA) Inc., 37 Brook Avenue, Maywood, NJ 07607: (201) 368-9171 • Northeast: (201) 368-9171  
West Coast: (213) 534-0050 • Southwest: (713) 445-0100 • Southeast: (813) 884-2046 • Canada: (201) 368-9179

Circle 151 on Reader Service Card

[www.americanradiohistory.com](http://www.americanradiohistory.com)



# ☆☆☆☆☆☆ NAB '83

**MICHAEL COX ELECTRONICS, LTD.** (1326)

See listing under Broadcast Video Systems.

**CROSSPOINT LATCH** (1321)

Will introduce an 8-input, 3-bus **production switcher** with editor interface, a 24-input computer-controlled switcher, a level switcher, and two new **production switchers** with three mix

effects. The full line of established products will be displayed, including 6, 8, 9, and 12 input switchers, editor-switcher interface, and computer controller for three different switchers. (Also see listing in audio section.)

*See ad page 36.*

**CIPHER DIGITAL** (1606)

This newly formed company will show **time code equipment** formerly in the Datametrics line as well as new introductions. Among the new units will be a modified Datametrics 710, the 710-A **time code reader**. Completely new will be the 9050 and the 9010 **time code translator** and **generator/translator**

for converting VITC into SMPTE time code and vice versa. The 735 Series features new **SMPTE time code readers** and a **coincidence detector** with control over eight items based on coincidence to time code.

*See ad page 38.*

**PETER W. DAHL CO.** (612)

Will show its line of heavy-duty plate, power, filament, and modulation transformers and reactors. Replacement transformers for many manufacturers are available from stock. Lightning and transient protectors and suppressors will also be displayed.

**BILL DANIELS CO.** (1333)

**DATA COMMUNICATIONS CORP.** (1014)

See listing under BIAS.  
*See ad page 115.*

**DATAMETRICS/DRESSER** (1606)

See listing under Cipher Digital.

**DATATEK** (1428)

Will show line of routing switchers, including model with video source identification. Also video processors; distribution amplifiers for video pulses, subcarriers, audio, and SMPTE time code. (Also see listing in audio section.)

**DATATRON** (1005)

Showing the ST-3, first seen at SMPTE. This advanced **editing system** is positioned midway between the company's Tempo and Vanguard systems and can be upgraded to the full Vanguard five-machine system; it controls most one-inch, 3/4-inch, half-inch, and quad machines. Also showing the lines of off-line editing systems and editing peripherals, using microprocessor, LSI, and VLSI circuitry.

**DATUM** (1708)

Will introduce a unit for **video source identification**. Also bringing a new model of the **vertical interval data transmission system** encoding 97 bits per line, eight lines per field, using 8-bit parallel computer interface with outputs, for printout and display. Will also show the line of character generators, digital time display, automatic videotape searcher using time code, earlier data transmission system encoding 48 bits per line.

**DELCOM** (1507)

Showing a post-production system, and the design and installation of complete television systems.

**DIGITAL VIDEO SYSTEMS** (1017-A)

Will introduce a **satellite transmission system** which is a refinement of MAC technology and provides secure scram-

# MINOLTA INDUSTRIAL METERS

SEE US AT BOOTH #1113 AT THE NAB SHOW

Remarkable versatility combined with superb accuracy—Minolta meters conform to CIE Spectral Response Standard.

**MINOLTA TV COLOR ANALYZER II**

Used for on-line quality control in the manufacture of TV sets, and for monitor set-up in TV control rooms.

- Analyzer mode for white balance
- Chroma mode for setting white standard
- Matrix system eliminates cross-over interference
- Four white-memory channels; four CRT memory channels



**MINOLTA CHROMA METER**



**MINOLTA ILLUMINANCE METER**



**MINOLTA LUMINANCE METER 1**



**MINOLTA HAND-HELD INDUSTRIAL METERS ARE:**

- Lightweight and compact
- Battery powered for portability
- Rugged—ideal for field use



MINOLTA

For more information, write Minolta Corporation, Scientific/Industrial Meter Div., 101 Williams Drive, Ramsey, NJ 07446. Or call (201) 825-4000  
© 1982 Minolta Corp. Product appearance and/or specifications subject to change without notice.

Circle 152 on Reader Service Card



# The most advanced editor now costs less than stripped-down units.

Mach One® Series II from Bosch-Fernseh. The fastest, easiest-to-use, and most powerful videotape editor on the market.

Now, we're making it the most affordable editor.

## Less is more.

Series II is our second generation Mach One system—with a combination of advanced features no other computer-assisted editor can match. Regardless of cost.

Features like **dual-channel audio control** to give you independent control over two separate audio tracks plus the video channel.

**Variable speed control** to let you select any of 16 shuttle-jog speeds in either direction.

**Programmable slow motion** to let you program your selected speeds in the edit list—with the sequences completely repeatable.

**Updated edit list formatting** to give you 6-digit alphanumeric reel numbers and various other edit list features.

**Cluster-event programming** to let you program complicated multiple events in a "cluster" treated as a single event—and preview or record in one pass rather than event-at-a-time.

**Screen highlighting** to brighten the edit line you're working on while dimming the rest of the screen—so you'll never strain your eyes or your nerves, and never lose your place.

## There's no comparison.

Despite all its power, all its speed, all its capability, Mach One Series II costs less than many stripped-down editors. And *far* less than any remotely comparable system.

## Second best—or second generation?

Now you don't have to settle for less editing power than you need because your budget can't handle your first choice. We're making the choice easy. You can have the second generation instead of the second best.

Your local Bosch-Fernseh office has full details. Call them. Or get in touch with us directly: Fernseh Inc., P.O. Box 31816, Salt Lake City, UT 84131, (801) 972-8000.

# BOSCH

Circle 153 on Reader Service Card



# THE BROADEST TELEPRODUCTION IN THE WORLD.

Choose Your Solution from the Shapes and Strengths of Quanta Technology.

Priced from \$3,000 to \$50,000.



## QUANTAFONT® Q8

- 26 nanosecond resolution
- Instant character sizing
- 16 million colors

Q8 instant sizing  
 Q8 instant sizing  
 Q8 instant sizing  
 Q8 instant sizing  
 Q8 instant sizing  
 Q8 instant sizing  
 Q8 instant sizing  
 Q8 instant sizing  
 Q8 instant sizing  
 Q8 instant sizing  
 Q8 instant sizing  
 Q8 instant sizing

MILWAUKEE		ATLANTA	
1-1	1-1	1-1	1-1
1-2	1-2	1-2	1-2
1-3	1-3	1-3	1-3
1-4	1-4	1-4	1-4
1-5	1-5	1-5	1-5
1-6	1-6	1-6	1-6
1-7	1-7	1-7	1-7
1-8	1-8	1-8	1-8
1-9	1-9	1-9	1-9
1-0	1-0	1-0	1-0

**CHAMPIONSHIP SERIES**  
 Game One

Milwaukee Brewers  
 021 000 000 3 7 2

California Angels  
 104 210 00X 8 90 0

ATTORNEY GENERAL	
Williams (A)	128,612
Jefferson (D)	104,077
Adams (H)	21,445

QUANTAFONT Q8

QUANTAFONT SELECT 7



# LINE OF GRAPHIC TITLERS

**MICROGEN™**

- Quanta's price/performance leader
- 256 colors
- Off-line editing capability



**Introducing the  
QUANTAFONT SELECT 7**

**The mid-range international  
standard now in a new configuration.**

- Completely modular and updatable
- Multiple resident fonts
- Multiple graphic symbols

©Registered trademark of Quanta Corporation

SCOREBOARD			
WASHINGTON	105	NEW YORK	98
INDIANA	111	CLEVELAND	103
NEW JERSEY	107	ATLANTA	99
SAN ANTONIO	88	HOUSTON	78
MILWAUKEE	115	BOSTON	112
DENVER	123	CHICAGO	124
LOS ANGELES	115	PORTLAND	100



**QUANTA™**

2440 So. Progress Drive, Salt Lake City, Utah 84119  
(801) 974-0992 TWX 910-925-5684

Sales Offices: California, San Jose (408) 985-8888  
Connecticut, Danbury (203) 797-1179  
Georgia, Atlanta (404) 493-3913  
Ohio, Cleveland (216) 692-3410  
Oklahoma, Tulsa (918) 627-4151  
The Netherlands, Aalsmeer  
(31) 2977-23473

**MICROGEN**

# ★ ★ ★ VIDEO ★ ★ ★ NAB '83

bling. A new single-clock TBC with switch-selectable freeze field for heterodyne VTRs, and a new **special effects mixer** with a three-bus structure. Other products will include the DPS-103 component TBC which yields instantaneous correction at the output and provides locked video at 40 times normal speed in forward and reverse.

## **DIRECT-CUE (1424-A)**

## **DRUMMEX (1760)**

Displaying mobile shelving units.

## **DUBNER COMPUTER SYSTEMS (1630)**

Will be demonstrating an updated version of the CBG-2 **video graphics generator** with an expanded color palette option, and added fade, dissolve, translucence capability between both display planes. Also showing its color corrector computer, Model CCC-12, for the first time.

*See ad pages 66, 67.*

## **DYNACOM ELECTRONICS (1163)**

Is introducing a new **multichannel MDS down-converter**. Will also show the line of video scrambling encode-decode equipment, for low-power TV, STV, etc.

*See ad page 220.*

## **DYNAIR ELECTRONICS (1404)**

Four new series of products will be introduced: Series 1600, 16x1 **switching modules**; Series 25, 20x20 **routing switcher**; Series 5300, **audio pulse and DA modules**. Also on display will be the System 21 routing switcher, machine control, data control switching, and distribution equipment.

## **DYNAMIC TECHNOLOGY (1719)**

Studio lighting control units with both manual and memory systems will be exhibited as well as remote machine control and data transmission equipment in the VIMACS range of products. Distribution equipment will be shown as well as video patch panels. (Also see listing in audio section.)

## **EASTMAN KODAK (1214)**

Will display its Datacode "functionally transparent" magnetic undercoating for motion picture film, designed to allow automation of various aspects of film post-production. Will also feature its recently introduced color film stocks, including 7294/5294 320 ASA negative.

## **ECHOLAB (1510)**

New editing **interfaces** for the SE/3 switcher featuring customized serial interfaces with proposed SMPTE protocol will be introduced. A PAL version of the SE/3 switcher/special effects generator will also be introduced.

*See ad page 121.*

## **EECO (1314)**

Will introduce the new **IVES Intelligent Video Editing System**. Showing the line of SMPTE and vertical-interval time code generators and readers, with the new PTG-560 **portable time code generator**; and the Multique synchronizer system for control and syncing of video/video, video/audio, and audio/audio tape machines.

## **EEG ENTERPRISES (1155)**

Will introduce a **dual-line encoding system** which encodes line 21 and any other line in the vertical interval with digital data for special transmission. Will have standard closed-captioning encoders and decoders and encoding systems for captions and text, along with EDAC-1 processing system.

## **EEV (1335)**

Will introduce the new 1/2-inch Type P8470 **Leddicon** with a 13 mm diameter designed for 8 mm scan diagonal. Also new is the P8440 30 mm **diode gun Leddicon**. Will be showing the established line of Leddicons and Vidicons as well as the new range of high-efficiency klystrons for UHF TV. The monochrome CCD hand-held camera, power tubes for AM and FM transmitters, and liquid crystal displays for static or multiplex operation will be exhibited.

*See ad pages 162-163.*

## **EG&G (1327)**

Demonstrating FAA-approved high-intensity obstruction lighting equipment.

*See ad page 182.*



*Datatron's new ST3 video editor uses the same interfaces as its Vanguard system.*

## **EIGEN VIDEO (1227)**

Will show the Frame Grabber, DSR Series, to interface computer graphics with disc recorders for a variety of animation effects. Also showing the 10 MHz disc recorder, the 18-10 frame recorder, and the line of slow-motion equipment.

## **EIMAC (1605)**

See listing under Varian.

*See ad pages 113, 257.*

## **ELECTOR (1131)**

Will unveil its new line of Barco **video monitors**, including the CM 22 nine-inch with switchable underscan, the CM 33, 13-inch with pulse cross, red-green off, and the CM 51 HRC 19-inch. Will show existing line of CTVM grade I studio monitors and 26-inch CM/CTM 66 monitor series.

*See ad page 1.*

## **ELECTRO CONTROLS (1103)**

Will show new **lighting control systems**, including the updated Lite Cue system, as well as studio grip and rigging equipment.

## **ELECTRO IMPULSE (117)**

Showing its line of RF loads, calorimeters, wattmeters, attenuators, and baluns.

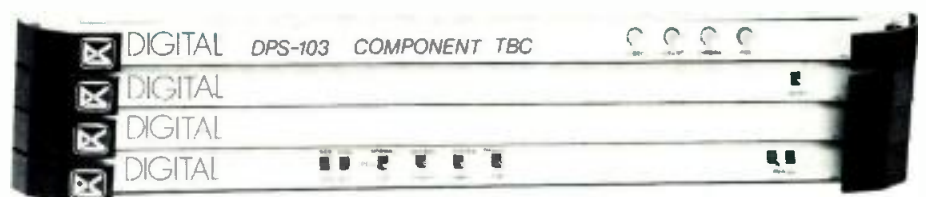

*Digital Video Systems is taking an early lead with its digital component tbc.*





**VIDIFONT® GRAPHICS V.** The excitement radiates through your creative staff. Reaches out. Grabs your audience. Vidifont Graphics V™ refines the art of electronic graphics. From often-needed name supers to story highlighters to full animated sequences. Imagine the added impact!

You start with distinctive graphic composition capabilities. With digitizing tablet or keyboard, design and create character fonts, logos, weather symbols and other graphics.

Add color. Over 4,000 colors for those multi-colored characters, extended edges, banners, backgrounds and graphics you could never before create in-house.

Now get things moving. With animation, color cycling and mix effects, including wipes, fades, mixes and merges. Our multiple plane frame-store means freedom of movement for rolls, crawls, character-by-character ripples and diagonals and full-screen animations.

Graphics V is a multi-channel system that welcomes simultaneous multiple-user access. Two high resolution channels and six off-line entry channels provide enough operating positions to custom fit your needs, including elections and other special programs.

For all its features and flexibility, Vidifont Graphics V is user-friendly. In the studio or on the road, operation is easy and efficient. Real-time productivity is the result.

Call or write Thomson-CSF Broadcast, Inc., 37 Brownhouse Road, Stamford, CT 06902. Tel. (203) 327-7700. TWX: (710) 474-3346.

 **THOMSON-CSF BROADCAST, INC.**

# Generate excitement!





**ELLIS TOWER CO. (461)**

Will show communications towers, earth station installations, equipment buildings for cable, and access roads.

**EMCEE BROADCAST PRODS. (1621)**

New products are a solid-state 10 W MDS transmitter with separate visual and aural amplification, and a new single-bay 1 kW UHF amplifier for LPTV. Other equipment on display will be the Model TTU-100RM 100 W UHF LPTV transmitter, and the TTU-5000, 5000 W UHF transmitter.  
*See ad page 238.*

**EMCOR PRODUCTS (429)**

Will have for the first time at NAB a new line of RF-immune enclosures for electronic equipment. Will also introduce the "Instant Emcon," enclosures in modular form for easy transport of electronic equipment, available in many sizes and five colors. Also new will be the "ESQ" Emcor enclosures.

**E-N-G CORP. (1022)**

Displaying a broadcast news van and a news Suburban.  
*See ad page 126.*

**ENG HELICOPTER SATELLITES (1517)**

Will show Model 25 camera mount for helicopters and cars, and Model 50, developed for Goodyear blimps, adaptable to larger helicopters.

**ENTERPRISE ELECTRONICS (1329)**

Will exhibit color weather radar equipment.

**ENVIRONMENTAL SATELLITE DATA INC. (1667)**

Plans to introduce the PMT, portable model terminal, a low-cost display terminal for meteorologists to receive, store, and display all ESD satellite and weather data. Also showing dial-up digital weather satellite images from GOES.  
*See ad page 12.*

**E.R.A. (1711-A)**

**ESE (116)**

Will demonstrate the new ES207 video DA, the new ES232 time calculator,

and the new ES256 SMPTE time code smart reader. Will also have digital clocks, timers, master clock systems, programmable timers, and time code generators/readers. (Also see listing in audio section.)

**EXCALIBUR INDUSTRIES (1106)**

Is introducing an 18-inch shock-mounted case with case interlock option—segments can be shipped as small units, fastened together on site to form a rack for video equipment. Will also have new units in the line of cases for in-case operation of various electronic units. Showing in addition the line of in-case designs for video and other electronic units.

**FAROUDJA LABS (1753)**

Will be introducing a new NTSC comb filter decoder with active comb filtering and enhancement of the chroma transition by way of the luminance transition with RGB output. Other products will include The Image System with the Record One processor, and the Playback One automatic playback enhancer. Also on hand will be the RecordEX, the ColorEX chroma noise reducer, and comb filter separators as plug-in boards for monitor applications.

**Eventide's BD955 Broadcast Audio Delay Finally Has Some Serious Low-Priced Competition...**



**EVENTIDE'S BD931 (MONO) PRICED AS LOW AS \$1795**  
**EVENTIDE'S BD932 (STEREO) PRICED AS LOW AS \$2595**

Now there's a worthy low-cost alternative to Eventide's BD955 – the world's best-selling digital obscenity delay. Eventide's new BD931/932 series is priced to be cost-effective even for stations that air only limited talk programming. Available in mono or stereo, with 3.2 or 6.4 seconds of delay, these new units feature specs that far exceed the performance of other economy delays:

**FREQUENCY RESPONSE: 40Hz to 16kHz ± 1dB.**  
**DYNAMIC RANGE: Greater than 90dB.**  
**DISTORTION: Less than 0.2% at 1kHz & 100Hz.**

So now stations on a tight budget can say goodbye to the problems of trouble-prone tape loop delays without sacrificing audio quality. Eventide's BD931/BD932 series is the low-cost, high quality alternative.



**OUR BD955 SERIES—NOW A GREATER VALUE THAN EVER.**

For the ultimate in operating convenience, Eventide's BD955 is still in a class by itself. Only the BD955 has the patented AUTO CATCH-UP feature that automatically rebuilds the delay after objectionable material is dumped. There's no need to fill the delay period. Now increased production and lower memory chip prices have enabled us to substantially reduce prices on all BD955 models – you save up to \$2400!

**Eventide**  
the next step

265 West 54th Street  
New York, N.Y. 10019  
(212) 581-9290

Circle 156 on Reader Service Card





ForTEL will unveil this brand-new solid-state time base corrector.

**FARRTRONICS (1159)**

Will introduce a new **video patch field**; also a new **belt pack system** for its intercom. (Also see listing in audio section.)

**FELDMAR WATCH CO. (651)**

Will show stopwatches, chronographs, timers, timing boards, and timing systems.

**FIDELIPAC CORP. (103)**

Plans to demonstrate a new tabletop **bulk tape eraser** for 3/4-inch videocassettes. (Also see listing in audio section.)

*See ad page 160.*

**FILM/VIDEO EQUIPMENT SERVICE (1153)**

New products will be the Wide Eye I

and II **wide angle attachments** for ENG/EFP lenses, and new video camera and recorder cases from Kangaroo Video. Also demonstrating its optical repair service.

**FITZCO SOUND (1514)**

Showing the line of video equipment consoles. (Also see listing in audio section.)

**FLASH TECHNOLOGY (1619)**

Displaying its antenna-top beacons, high-intensity aviation warning lights, including the L866 replacement for twilight lights.

**FLORIDA COMPUTER GRAPHICS (1632)**

Will show Beacon **color computer graphics system**, with software appli-

cations such as word and data processing, business systems, and charting.

**FOR-A CORP. (1340)**

Introducing a multiple-input **title keyer**, low-cost **character generators**, a **time code reader** with video display function, and a **color interface module** for the video typewriter line. The **computer video display synchronizer** and a PAL TBC with image enhancement will also be new. The line of low-cost digital TBCs and full line of character generators and accessories will be featured.

*See ad page 75.*

**FORTEL (1323)**

Will introduce the CCD-HPS digital TBC especially designed to work in conjunction with the BVU-800 and other

# A GRAPHICS AND ANIMATION SYSTEM THAT GATHERS ALL THE WEATHER...

## before the Weatherman even arrives at the studio.

### TRITON X

It's all here. And it's all automatic. The Triton X Graphics & Animation System is the complete single-source meteorology machine. It'll gather radar, satellite, national weather circuit data or special weather packages... all in real-time... all the time. And Triton X updates the weather information, archives it, animates it, or manipulates it any



way you want... automatically. The Triton X display is always perfect too—no jaggies, never. That's just on its own. You should see what Triton X can do with a little encouragement. Give us a call today and find out how affordable Triton X can be for you. And tell your weatherman he can sleep in... Triton X is covering for him.

**Kavouras INC**

**800-328-2278**

Federal Aviation Building, 6301 34th Ave. So., Minneapolis, MN 55450  
In Minnesota call 612-726-9515

See us at NAB Booth 1635

new-generation VCRs. Other products will include the Model CCD-HP time base corrector, the Y-68832 total error corrector, the Digibloc frame synchronizer, the Faroudja automatic image corrector (exclusive to Fortel in North America), and other digital processing systems.

See ad page 227.

**FORT WORTH TOWER (1010)**

Showing towers, earth stations, and prefabricated equipment buildings.

**FREZZOLINI (1107)**

Featured product will be the half-inch VHS-C on-cam VTR. Also two-channel power supply, VC-1 and VC-2 vehicle chargers. Will also display the low-cost 12 V, 75 W light and the Model RPS3 on-board 50 W switcher power supply.

See ad page 271.

**FUJINON (1411)**

Will introduce its brand-new 44X studio 300 mm lens, the longest at the show. Also displaying its full line of television lenses and optical systems for half-, 2/3-, one-, and 1/4-inch formats. These include the larger 14X HDTV, 16X, and 17X which combine extenders and optional pattern projectors. The 28X studio lens is a wide angle. The full line of ENG/EPF lenses includes the 12X, 14X, 17X, 22X, and 30X with built-in extenders.

See ad page 145.

**FUJI PHOTO FILM (1413)**

Introducing a fire-retardant plastic shipper for 14-inch reel of one-inch tape, and the Beta Super Hygrade videocassette. Also showing two-inch and 3/4-inch tape as well as VHS Super Hygrade for 1/2-inch.

See ad page 151.

**GAGNON LAFOREST (1717)**

Will bring its Vertilift mechanized theater rigging system.

**GARNER INDUSTRIES (1233)**

Display will include videotape erasers and 1/4-inch tape duplicators. (Also see listing in audio section.)

**GENERAL ELECTRIC (1109)**

New products will be a multi-mirror reflector and Q-line lamps for lightweight camera fixtures. Will show its complete line of Quartzline tungsten halogen and incandescent lamps for TV production. The 220 and 240 Quartzline units were introduced at SMPTE.



Fuji Photo Film's line of one-inch videotapes.

**GENERIC COMPUTER SYSTEMS (308)**

Will show the Applelog software for radio and TV traffic and billing on the Apple II+ computer, using hard disk for storage. The system manages logs, bills, affidavits, availabilities, sales projections, and the entire Apple software.

**GLENTRONIX (1318)**

Displaying lines of switchers, character generators, video monitors, scopes, and time code equipment from such companies as Ross Video, Telcom Research, Conrac, Porta-Pattern, Torpey Controls, Hitachi, Bal, Pentronics, and Scientel.

**ALAN GORDON ENTERPRISES (1726)**

Stressing its role as a supplier of accessory and support equipment for television producers, AGE will exhibit new products including a mini crab dolly; the Cool-Light Mini-Cool and three-strip lights; the Super-grip clamp; and the video test charts and slides.

**GRAHAM-PATTEN SYSTEMS (1227-A)**

Introducing the Model 1231 downstream keying system with simultaneous keying of multiple key sources, key bordering, and post-production interface. Also new is the Model 612 post-production audio mixer with 12 inputs, two out. Other equipment will include the 9400 Series and the 1200 Series of DAS.

**THE GRASS VALLEY GROUP (1207)**

Plans to show the 300+ MK II video production system, the 1600/1680 Series of production switchers, and the 440, Ten-X, and other routing switchers. Fully complete M208 master control automation system will be displayed, as will the Wavelink fiber optics system. Rounding out the dis-

play are processing amps, sync generators, Sc/H phase meters, and the 3400 Series of DAS.

See ad page 47.

**GRAY COMMUNICATIONS CONSULTANTS (1618-A)**

See ad page 218.

**THE GREAT AMERICAN MARKET (1108)**

Showing Stick-Up, a compact single-source fill light, and Colormax Far Cyc, the rolling color changer to light a cyclorama. Also on display will be patterns, the Scene Machine, Diamond Light Curtain, Quik-Chase, SPE-2, and Instaset RDS/HMI lights.

**DAVID GREEN BROADCAST CONSULT. (417)**

Showing the Sperry weather radar, the IBM System 23 broadcast business system with Dexel software.

**BOBBY GRIFFIN INC. (432)**

Will display signs and other advertising specialties.

**GRUMMAN AEROSPACE (1644)**

The 701-000 is a new machine control system with microprocessor design expandable for large applications. The company will return with its Sync-Proc, video source ID, VITS/VIRS, and color encoder equipment. (Also see listing in audio section.)

See ad page 132.

**HALLIKAINEN & FRIENDS (306)**

Plans to introduce the DRC190 remote control system at \$3000. System is expandable to 100 sites, and with addition of A/D boards, allows expansion to 100 channels per site. Also showing TVA series audio equipment and TEL series of digital telemetry adapters for adding digital metering to Moseley analog remote controls. Process control computers will also be displayed for automation of transmitter logging.



**Now, there's a  
new meaning to  
'broadcast-quality.'**

# Introducing Ampex 197, that's broadcast.





# the new 3/4" videocassette quality in every way.

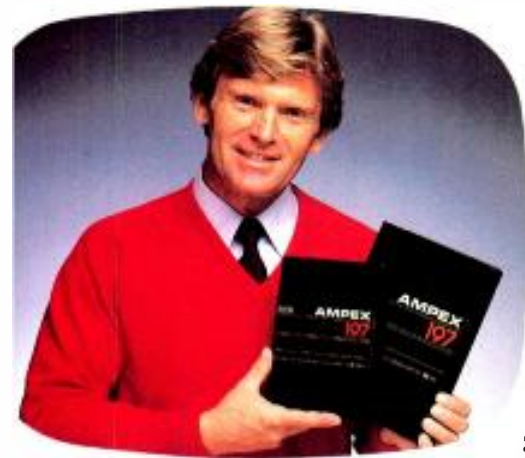

## Broadcast-quality sound.

Ampex award-winning sound has been an industry leader for a quarter of a century. Now Ampex 197 brings this award-winning expertise to video.

Ampex 197 offers superior signal-to-noise and low distortion characteristics. This translates into crisper, cleaner audio performance under heavy editing conditions and multiple generation dubbing. It also delivers excellent stereo fidelity when used for music recording.

AUDIO MULTIPLE GENERATIONS

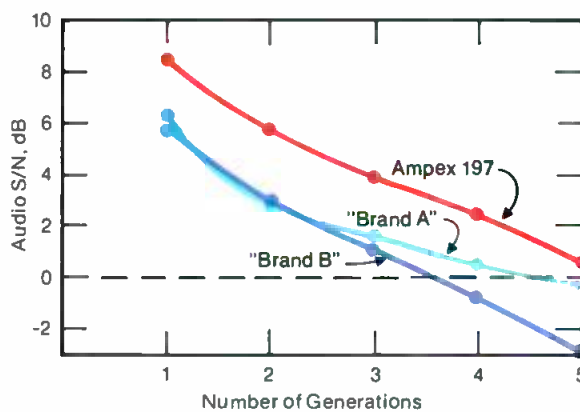

Even after five generations, Ampex 197's audio signal-to-noise ratio exceeds the BVU series machine specifications (the red line at 0 dB).



## Broadcast-quality reliability.

This new 3/4" videocassette is a blend of the finest broad-

STILL FRAME DURABILITY

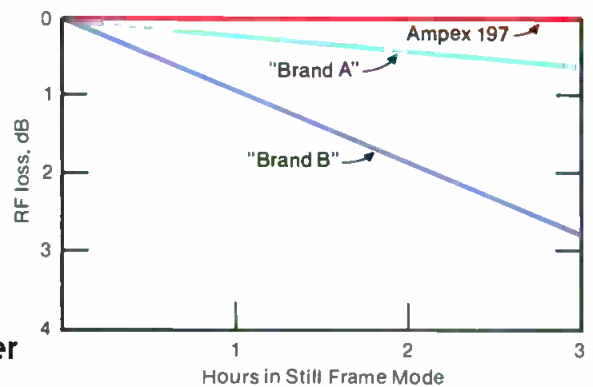

Laboratory tests proved that Ampex 197 held up for three full hours with no RF loss.

cast materials and Ampex's unique technical expertise. In blind field testing, Ampex 197 got the highest marks from broadcast professionals for its picture quality, stability, and durability.

In laboratory trials, Ampex 197 held up in the still-frame mode for three full hours and showed no dropout increase or RF loss.

Ampex Corporation,  
Magnetic Tape Division,  
401 Broadway, Redwood City,  
CA 94063

# AMPEX

Ampex Corporation • One of The Signal Companies

Quality worth broadcasting.

# Ampex 197: Quality worth broadcasting.

- Outstanding chrominance and luminance performance
- Excellent durability and mechanical reliability
- Superior audio output, signal-to-noise and low distortion
- Designed to optimize performance of Sony BVU's
- Ideal for ENG, EFP and on-line editing
- Available in all popular 3/4" play lengths



## Ampex Regional Sales Offices

5 Pearl Court  
Allendale Industrial Park  
Allendale, New Jersey 07401  
(201) 825-9600

10215 Fernwood Road  
Bethesda, Maryland 20817  
(301) 530-8800

3135 Chestnut Drive  
Suite 101  
Atlanta, Georgia 30340  
(404) 451-7112

3353 Earhart Drive  
Carrollton, Texas 75006  
(214) 960-1162

719 West Algonquin Road  
Arlington Heights, Illinois 60005  
(312) 593-6000

500 Rodier Drive  
Glendale, California 91201  
(213) 240-5000

401 Broadway  
Redwood City, California 94063  
(415) 367-4611

Ampex International  
Europe, Africa, Middle East  
Acre Road  
Reading, Berkshire  
RG2 0QR England  
(44) 734-875200

Ampex International  
Americas and The Far East  
550 Broadway  
Redwood City, CA 94063  
(415) 367-4603

# AMPEX

Ampex Corporation • One of The Signal Companies 

## Quality worth broadcasting.



**HARRIS CORP. (401)**  
**BROADCAST DIV.**

Introducing a 6.1-meter Delta Gain satellite antenna, a UHF-TV transmitting slot antenna with waveguide construction, and the TC-90 EFP camera.

*See ad pages 13, 168, 173, 263.*

**HARRIS CORP., (401)**  
**BROADCAST MICROWAVE**

New product will be a high-performance 7 GHz solid-state relay system. Also will display a complete line of television microwave products, including 2, 7, and 13 GHz transmitters, receivers and antennas, power amps, Global IX portable radio and accessories. (Also see listing in audio-section.)

*See ad page 217.*

**HARRIS, SAT. (401)**  
**COMM. DIV.-ANTENNA**

Will show its satellite earth stations, including antennas, frequency agile receivers, and electronics, and the 9165 earth station facilities controller.

**HARRIS VIDEO SYSTEMS (401)**

Will introduce a major modification to the Iris II still store system. The Digifont is a combination of a Chyron VP-1 into the still store system, along with software enhancement of previous Iris II programs, allows direct keyboard access to the character generator from the still store location. Line of TBCs, including a new PAL/SECAM digital TBC, will also be displayed.

*See ad page 37.*

**HARVEY PROFESSIONAL (1122-A)**  
**AUDIO/VIDEO**

**HEDCO/HUGHES (1516)**  
**ELECTRONIC DEVICES**

HEDCO will introduce two new products, both routing switchers. The first is a single-bus routing switcher with 16X1 stereo and audio-follow-video capability. The second new item will be a multi-bus unit, the IRS, intermediate routing switcher. There are two frame sizes, both 16-rack units: the IRS 24 can build to a 24X24, four-channel, or to a 48X48, one-channel in same frame size.

**KARL HEITZ, INC. (1115)**

Showing a brand-new fluid head with 20-pound camera capacity. Will also have a line of tripods, spring and counter-balanced heads, leveling balls, mic booms, dollies, and light stands.

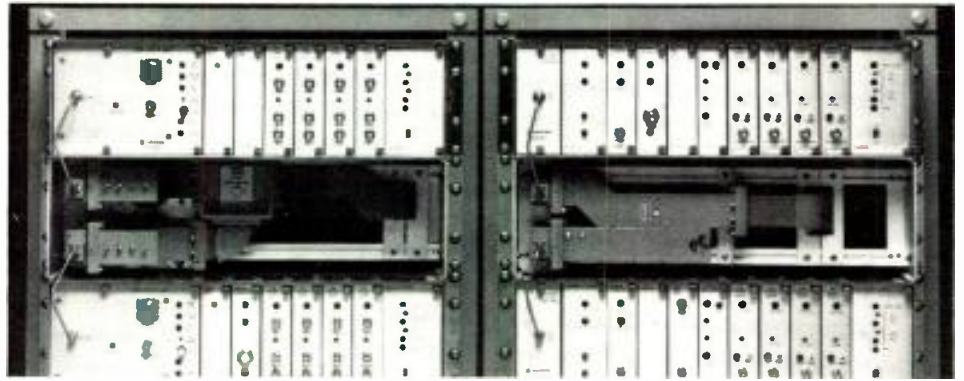

*Harris Broadcast Microwave will unveil this monitored hot standby system.*

**HILOMAST (339)**

Plans to show its pneumatic and winch-operated teletropic masts, including four series of pneumatics with extended heights from five to 28 meters. The NX series will be featured as a specially designed group for larger antennas and heavier windloads.

**HIPOTRONICS (1779)**

First-time NAB exhibitor will introduce the Peschel automatic voltage regulator. Also showing ac/dc high voltage test sets.

*See ad Cover 3.*

**HITACHI DENSHI (1402)**

Introducing an automatic set-up computerized, portable color camera for ENG/EFP/studio. Other new equipment includes the SR-3 ENG/EFP three-tube prism optics recorder/camera, the ECR-5 and -50 quarter-inch playback deck for editing, and the FP-11 and -15 ENG/EFP color cameras. Will also have the complete line of existing cameras, recorders, and test and measurement products on exhibit.

*See ad page 199.*

**HOLADAY INDUSTRIES (1517-B)**

Will show its battery-powered field or in-plant instrumentation for measuring radiation.

**HOTRONIC INC. (1782)**

First-time NAB exhibitor will show digital TBC/frame synchronizers.

*See ad page 137.*

**HUGHES HELICOPTERS (1518)**

Will bring its ENG helicopters, including the two-seater 300C.

**IKEGAMI ELECTRONICS (1013)**

Plans to introduce a new 3/8-inch prism optics camera system with 2-H detail enhancement for ENG/EFP, a new HL-79E, portable ENG microwave system for HL-79 and HL-83 cameras, and the HK-322 EFP auto setup camera. Also showing new HDTV camera and monitor system, Series 9 in-line gun CRT, color monitors and Series 3 monitors.

Existing products on display will include the EC-35 electronic cinematography camera, the HLL Series of ENG/EFP cameras, the HM-100 and 300, and the HK studio camera systems. The full line of monitors and DAS will be on hand as well as the TKC-970 telecine camera system.

*See ad pages 5, 90-91, 93, 95, 260.*

**IMAGE VIDEO (1341)**

The Model 9100 is a brand-new routing switcher to be introduced this year. Other new products include the 7001 dual video mix amp and the 8200 master control switcher along with various new routing switcher control panels. Complete selections of routing switchers and control panels, border and status generators, video DAS, serial data readers, and machine interface equipment will also be demonstrated.

**INDUSTRIAL (1232)**  
**SCIENCES, INC./ISI**

Model 903, new for the NAB, is a computer-interfaceable production switcher with RS-232 serial interface optional. It serves as a replacement for the 902 and has dual mix effects amps with soft/hard border wipes, shared pattern generator, and microprocessor control. Other products will be the 200-3 video production switcher, the 1100 and 982 Series routing switchers, and the 899-25 master control switcher.

**INFLIGHT SERVICES, INC. (1316)**

Introducing the V Star 4-C, a large-screen video projector system for computer application. Also showing its standard V Star 4.

**INFORMATION (1765)**  
**TRANSMISSION SYSTEMS**

Will show ITSS and NDS transmitters, UHF exciters for full-power TV transmission. Data subcarrier systems for UHF exciters for digital data, second audio and stereo TV applications.

**INNOVATIVE TELEVISION (1215)**  
**EQUIPMENT/ITE**

Introducing a new Model ITE-T3 ENG tripod with a load capacity of 25 pounds. Also new is the ITE-T14 re-



mote with Mitchell mount for loads to 100 pounds, the ITE-P2 **studio pedestal**, and other **grip and support equipment**, including fluid heads with pan and tilt control, counterbalanced. The entire line of dollies, tripods, pedestals and pan/tilt heads will also be displayed.

**INTERACTIVE MARKET SYSTEMS (310)**

Showing Radio Spectrum, a system to analyze spot radio, network, and the entire radio medium as well as a computer color graphics system. This includes GraphPac, an on-line system for generating computer color graphics, and PicturePac, a standalone computer graphics system for producing color xerox or slides. Also on hand will be a data base management system.

**INTERACTIVE SYSTEMS (1167)**

Introducing the Model 41 **videotape editing systems** as well as interfaces for VTRS and editing systems, and **software and accessories** for videotape editing.

**INTERAND (1622)**

New product for this year's show will be the **Telestrator 440** with multiple pages of video memory with up to 250 preprogrammed symbols and multiple colors. Also on hand will be the Telestrator 100.

**INTERNATIONAL VIDEO CORP. (1509)**

Showing the Video Changer, a **VCR-based automation system** with central microprocessor control of 16-32 videocassettes with switching through the IVC digital framestore.

**JAMIESON & ASSOC. (1718)**

Will describe its services, including radio and TV station design, turnkey installations, and engineering consultation.

**JATEX (1132)**

Introducing **control interfaces and software** for A/B roll editing controller in company's line of editing equipment.

**JEFFERSON DATA SYSTEMS (1629)**

New **program management system** for inventory and control of syndicated materials and program cost analysis. Also a new **electronic news processing system** for computerized handling of wire services, story, and script preparation. The System 90 sales, traf-

fic, and general accounting system will be on hand for both radio and television.

**JENEL CONSULTANTS (1338)**

Offering consulting, engineering, and design of broadcast television facilities and systems, interactive cable systems, computer controlled/assisted systems, and post-production facilities. Acoustics, mobile facilities design, and engineering software will also be handled.

**JENSEN TOOLS (1169)**

Introducing the new JTK-99 **service technician's kit** with more than 85 tools. Also complete new **kits for installation and service engineers** with specialized test equipment and hand tools for broadcast and cable operations.

*See ad page 271*

**JVC CO. OF AMERICA (1234)**

Introducing three new 3/4-inch **videocassette decks**, one for editing, a recorder/player, and a player only. The VE-90A is a new **time code editing controller** and the BR-6400U VHS 1/2-inch is a **recorder/player**. Also new is the CR-4700U portable 3/4-inch VCR with videoconfidence heads and the KM-2000U **special effects generator**. Along with the brand-new HR-C3/GZ-S3U VHS-C **recorder/camera combination** will be the full line of video equipment for the broadcast industry.

*See ad page 111.*

**KAMAN SCIENCES/ KAMAN BROADCASTING (1607)**

Introducing a new **in-house computer system** for TV and radio stations, including traffic, billing, accounting, films, news, and interfacing with automated switch gear.

*See ad page 244.*

**KAVCO (1706)**

Showing the new Kavcart **videotape station break automation system** for either half- or 3/4-inch machines and featuring the Kavtrol microprocessor control system. Also will show TIP, the Tape Identification Process, which encodes a 40-character data message on unused audio or cue channel of videotape.

**KAVOURAS (1635)**

Plans to introduce the Triton X **graphics and animation system** with resolution of 640x480x6 pixels and 32,000 color choices. The Radac Satellite **data acquisition system** is also new and introduces a new **satellite acquisition system** to the Radac Color Weather Remoting System, which will also be on hand.

*See ad page 103.*

**KEYLITE RENTAL CO. (1220)**

Showing new lightweight **flexible rigging systems and expandables** for location setup.

**KING INSTRUMENT CORP. (1794)**

Will show its line of video and audio cassette loading equipment.

**KLIEGL BROS. (1604)**

Will display the Entertainer, a hands-on **memory control console** and the Performer III console. The Command Performance memory lighting console, the K96 digital dimming system, TV studio packages, cyc lights, fresnels, and scoops will also be displayed.

**KOBOLD OF AMERICA (1725)**

Introducing a new 1000 W **Halogen Fresnel**, new 575 and 1200 W Brite Beam HMI fixtures. Also showing full line of HMI and Halogen lamp fixtures.

**K&H PROUCTS, LTD. (1746)**

New additions to the Porta-Brace line of cases, carts, and carriers for professional video equipment will be Quick Draw, a compact professional **video camera case** made of steel-reinforced and padded nylon that fits in the back seat or trunk of a car; a line of Cordura nylon **rain covers** for professional video cameras; and a **video waist belt** for carrying VTRS that works in conjunction with a shoulder strap.

**LAIRD TELEMEDIA (1721)**

Introducing the brand-new Model 7200 **communicator graphics system** for creating multiple font sizes and characters. Other new models will be the 1500 **character generator**, the 3300/3302 **message generator**, and the 4410 Telop **telecine input source** to be used with Laird multiplexers. Will also show the 1060A video pointer, electronic control and light boards, slide projectors, multiplexers, and the 6000 Series control consoles and equipment racks.

*See ad page 127.*

**LANDY ASSOCIATES (1747-A)**

Will bring a line of new equipment from Interphase, including the System Three microprocessor **machine control system**, which conforms to the SMPTE's proposed RS-422 standard; a digital **countdown/slate border generator** offering safe title, safe picture area, and crosshatch, digitally generated for extreme stability; a 10X1 video, stereo audio, vertical interval **switcher** with remote control; and two **video DAS**. Will also show George Kelk Ltd. voltage regulators and hand out the Landy catalog.



**What's  
Red &**

**Gray**

**& soon to be seen  
all over?**

**Find out from JVC at NAB Booth 1234**

**JVC<sup>®</sup>**

JVC COMPANY OF AMERICA  
Professional Video Division

Circle 159 on Reader Service Card

© 1983 JVC COMPANY OF AMERICA

**LARCAN (1626-A)**

Demonstrating a new 12 kW VHF high-band transmitter, the TTC 12000 FH. The standard line of equipment will include the 30 kW VHF two-tube transmitter, the TTC 30000 FH and a paralleling rack used for control of parallel transmissions.

See ad page 266.

**LAUMIC (1774)**

Will show portable, rental CMX Edge video editing system and Videola film-to-tape transfer system.

See ad page 275.

**LEADER INSTRUMENTS (1702)**

Will introduce Model LBO-51MV, an x/y vector display that lists for \$995. Also new are the LVS-5850A vector-scope and the LBO-518 100 MHz oscilloscope. Existing line of products to be shown are waveform monitors and vectorscopes, video generators, CATV level meters, and the LFR-5600 frequency response recorder, as well as other products.

See ad page 212.

**LEBLANC & ROYLE (1149)**

Showing broadcast towers.

**LEE-RAY INDUSTRIES (1151)**

Will introduce the new Model 6000 equipment carrier, which folds with all equipment on it. Will also bring its established line of carriers.

**LEITCH VIDEO (1024)**

Plans to introduce new vertical interval processor which adds up to nine



Listec will introduce Vinten's Avocet tripod and head.

pieces of information into the vertical interval with a self-contained proc amp. Also new will be a DA video equalizer, the EA 662, the SCH 731 SCH monitor and H timing measurer, as well as the standard broadcast terminal equipment.

**LEMO USA (1171)**

Showing the line of electrical circular connectors, multicontact coax and triax connectors.

**LENCO (1419)**

New products at this year's show will include a digital chroma decoder for converting a composite NTSC video to RGB, a PAL standalone sync generator, and new low-cost 14- and 19-inch color monitors using the PIL CRT. Full line of sync and distribution equipment, as well as decoders, noise meters, video-scopes, monochrome and color monitors.

**LERRO (Van Area)**

Will exhibit a fully equipped 40-foot van engineered and assembled for North East Productions (NEP).

See ad pages 130-131.

**LIGHTING ELIMINATION ASSOCIATES (302)**

Introducing two new models for power source, the CPS-1K continuous and the PP-9K3. Also on display will be the power line surge eliminators, dissipation arrays, Kleanline electronics filtering systems, guy charge dissipation chokes, coaxial surge eliminators, and transient eliminators.

See ad page 256.

**LINK ELECTRONICS (1216)**

See listing under Television Equipment Associates.

**LIPSNER-SMITH (1626)**

Will be showing new ultrasonic film cleaning machines for cleaning of negatives, prints, broadcast films, opticals, and films for transfer to videotape.

**LISTEC (1406)**

Introducing the brand-new Vinten digital remote controlled studio color camera, including preset, zoom, focus, iris, pedestal height, pan, tilt, and more. Also will introduce the Vinten Merlin remotely controlled crane arm for EFP. Other new equipment includes Autocue Products 2000 memory prompter, and 15-inch on-camera prompter with trapezoidal mirror. Standard equipment includes full line of Vinten camera mounting equipment, titlers, and Electrohome EVM video monitors.

See ad page 118.



An uninterruptable power supply from Lightning Elimination Associates.

**LOGICA (1632)**

Plans to show full line of teletext hardware.

**LOWEL LIGHT (1309)**

Exhibiting its complete line of location lighting and support equipment, including the DP and Omni-light focusing spot lights, the Tota broad light, the Softlight 2 folding unit, light reflectors, and clamping and rigging systems.

See ad page 242.

**LTM AMERICA (1516)**

The introduction of a new line of small incandescent location lights (100, 200, 600 W) is planned, as is the demonstration of the Cinepar 1200 W, a 1200 W HMI par light and the unveiling of a line of portable lighting kits. Also on display will be the full line of HMIs and the newest fiber optic lighting and a line of portable battery-operated equipment.

**L-W INTERNATIONAL (1305)**

Will show the new Athena 4500 telecine film chain projector, along with the existing Athena 6000.

**LYON LAMB VIDEO ANIMATION (1414)**

Will display the VAS 4, a microprocessor-based VTR controller for recording single-frame video animation from camera or computer graphics input.

**3M, A/V PRODUCTS (1002)**

Showing the full line of Scotch videotapes including 1/2, 3/4, one-inch, and two-inch versions. Line of graphic and character generators will be on display with one-inch VTRs and switching equipment. Booth will feature a demonstration of videodisc capability.

See ad pages 82-83, 156, 255.

**M/A-COM VIDEO SYSTEMS (1004)**

Several brand-new products will be introduced. The Super MX is a self-contained transmitter, ac/dc, 2 GHz, 2 W switchable 12 W. The 2MR is a



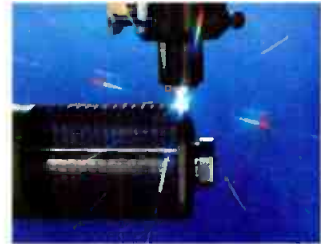
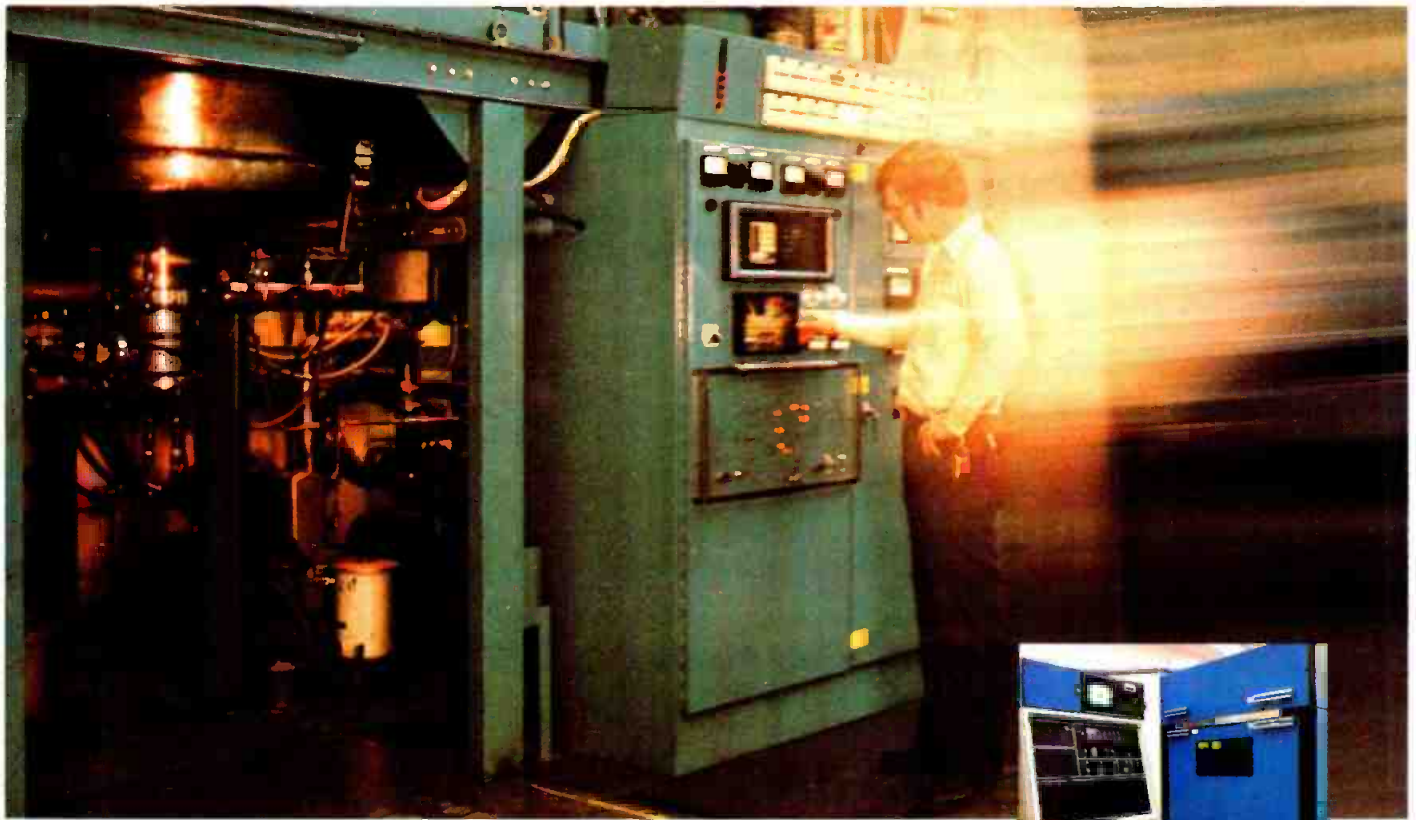

# EIMAC—moving toward higher frequency and performance in the 1980s.

Varian EIMAC, the world's leading power grid tube manufacturer, proves its expertise with almost 50 years of know-how in state-of-the-art manufacturing techniques.

Continuing in its tradition of providing customers with maximum operating frequency and high gain, EIMAC designs and manufactures superior tubes for broadcast service.

Close tolerance control and modern manufacturing techniques provide improved life and uniform performance, tube after tube.

Consider the new EIMAC 4CX40,000G. This 40 kW tube is full-power rated to 220 MHz. The tube features laser-cut, high sta-

bility Pyrolytic graphite grids and a new internal structure combining low RF losses and high operating efficiency.

For more information on Varian EIMAC tubes and high power VHF cavity amplifiers, call or

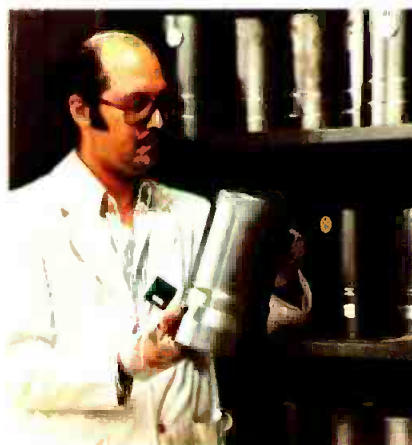

write today. Or contact the nearest Varian Electron Device Group sales office.

Varian EIMAC  
301 Industrial Way  
San Carlos, California 94070  
415 • 592-1221

Varian AG  
Grienbachstrasse 17  
Post Fach  
CH-6300 Zug, Switzerland  
Tel: (042) 31 66 55  
Telex: 845-78789



Circle 160 on Reader Service Card

# Americ

## Central Dynamics and American Data announce 3 major new price/performance products.

**CDL's new Series 80 Switchers**... the most versatile and powerful video production switchers available today... featuring...

- New Program Processor... another first from CDL... is equivalent to adding a SFX type M/E to the Program Bus with Sequential Background/Foreground transitions, Video or Matt Keys, Mix, Wipe or Cut and an independent downstream Fade-to-Black.
- New SFX power... with Dual Luminance Keyers, Dual Matt Generators, plus SuperSoft and Super Bordered wipes.
- 3 models are available now! The 480, 680 and 1080... these 4, 6 and 10 bus switchers provide a new artistic freedom for your creative talent.

**American Data's new SDS-2**... a totally new concept in Signal Distribution Systems... featuring...

- RS-2000 Hi-Density, 4 signal level, microprocessor controlled switching array... with 2048 crosspoints in a self-powered 6 RU frame!
- A compact cost that compares with the SDS-2's compact design.
- MicroPatch... the most efficient and sophisticated software and hardware signal control and distribution system available today.

**American Data's MC-4000**... the newest Master Control Switcher with the freshest operating concepts to protect your quality programming and profits... featuring...

- A switching system priced for any budget... up to \$15,000 less than presently available designs.
- A system for any requirement... models are available with up to 32 AFV and 8 separate audio inputs. The largest system requires only 7 RUs!

For full details... call or write Central Dynamics Corporation/American Data  
Research Park, 401 Wynn Dr., Huntsville, AL 35805 205-837-5180



**CENTRAL DYNAMICS  
CORPORATION**



*The Broadcast Company for* **CDL** • **American Data**

# CENTRAL



# an Data



**CDL's Series 80  
Production  
Switchers**



**American Data's  
MC-4000  
Master Control  
Switcher**



**American Data's  
SDS-2  
Signal Distribution  
System**

These are only 3 of the many  
new products being introduced by  
the combined engineering teams of  
American Data and Central Dynamics.

**See them all at NAB... Booth 1409.**

Circle 162 on Reader Service Card

# DYNAMICS

★ ★ ★ VIDEO ★ ★ ★  
**NAB '83**

circular and rectangular waveguide transmission lines, UHF TV and MDS diplexers, and transmission line spring hangers.

**MICRODYNE (1129)**

Will unveil the MSF-16 and -23 **multiple satellite feed systems** for existing and new Microdyne five- and seven-meter **antennas**. Also a complete line of satellite receiving equipment for video and SCPC motorized antennas from three to seven meters.

**MICROTIME (1230)**

Exhibiting its lines of digital video and video processing equipment for NTSC, PAL, PAL M, and SECAM standards. Frame synchronizers, TBCs, automatic VTR machine controllers, and signal synchronizers will be demonstrated, along with video image processors.

*See ad page 125.*

**MIDWEST CORP. (1710)**

Will bring its line of standardized mobile vans, including the M-1 and M-20 models.

*See ad page 44.*

**MINOLTA (1113)**

Plans to introduce a new Chroma Meter II **incident light meter for measuring light source color** such as tungsten or fluorescent lamps, CRTs, or color TV picture tubes. Will also have TV color analyzer for objective white balance measurement, a luminance meter, a foot lambert meter, CRTs, and foot-candle meter.

*See ad page 96.*

**MODULIGHT SYSTEMS (1103-A)**

**MOLE-RICHARDSON (1006)**

Introducing 1000 W and 2000 W eight-inch **Fresnel Solarspots** and type 6221 1200 W HMI **Molepar**, type 2791 6000 W **Molepar**, and the Molepar Superquartz **cyc strip**. The 1000 W **baby Solarspot** is a new pole-operated unit. Will also show the complete line of other lighting equipment and kits.

**MULTI-TRACK MAGNETICS (1712)**

Will introduce a new **ultra high speed magnetic film recorder/reproducer** designed especially to interface with solid-state telecines and one-inch VTRs with their higher speeds. The unit incorporates a capstan servo motor and a "loading puck" for rapid threading.



*One of the new transportable microwave systems being introduced by Nurad.*

**MZB & ASSOCIATES (1507-A)**

Will show its MZB-14 custom-built mobile TV production truck. Built on a Chevrolet chassis with a 14-foot aluminum cube box, the truck has four-camera capability, dual generators, dual air conditioners, custom cabinetry, and sophisticated voltage and current regulation to protect against power fluctuations.

**MODEL 2000 DIGITAL PROMPTING**

**SCRIPT DISPLAY**



**NEW**



- Collate and store on-air script from single or multiple inputs.
- Text editing with preview right up to air time.
- No more anxiety over illegible scripts.
- Display is equal to character generator.
- 80x24 preview display is automatically formatted to 24x5 for prompter presentation.
- Even the most difficult recognition problems are overcome and talent will thank you!



**LISTEC TELEVISION EQUIPMENT CORPORATION**

39 CAIN DRIVE / PLAINVIEW, NEW YORK 11803 / (516) 694-8963 / Telex: 640470

**LISTEC (WEST) CORP.**

1619 COSMIC WAY / GLENDALE, CALIFORNIA 91201 / (213) 247-9247 / Telex: 182686

**NAB  
 Booth 1406**



# COMARK TV EXCITER SYSTEMS

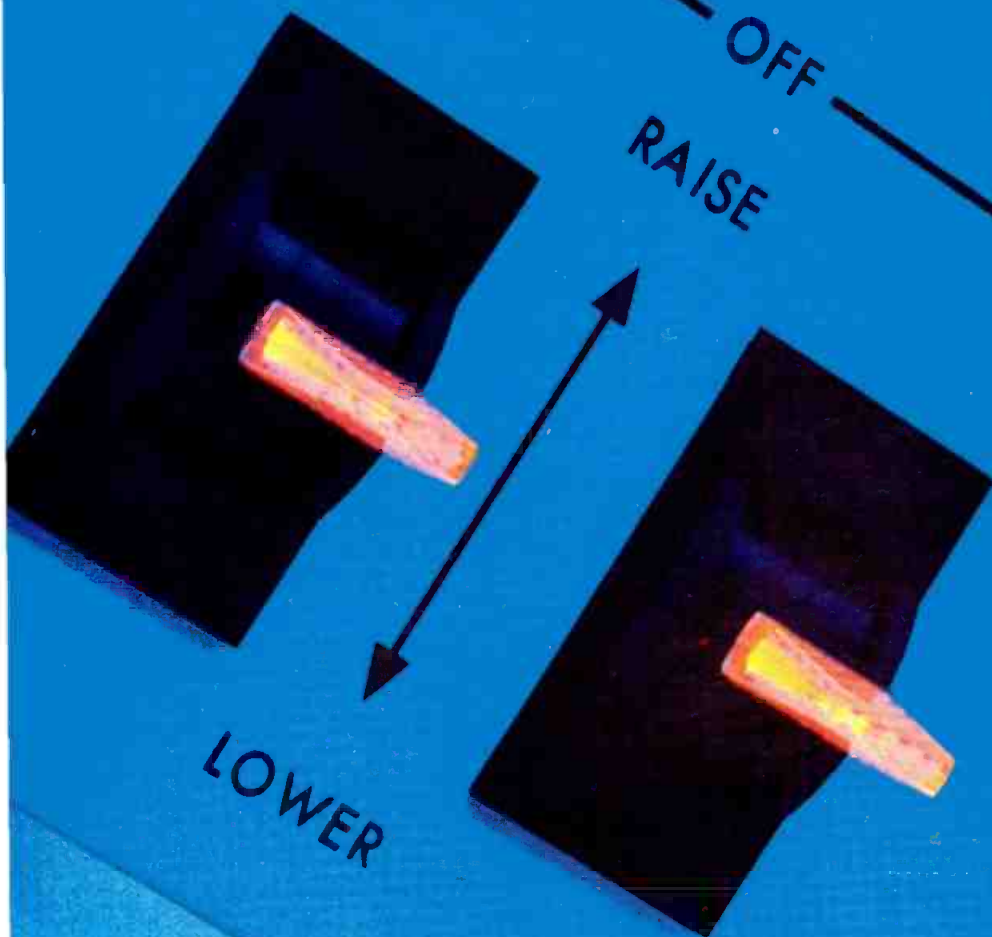

See the **NEW**  
30/60/120 kW  
Transmitters at our  
NAB Booth 1217



## Component Exciter Systems Only from Comark

Comark introduces a truly new concept in television exciter design—the “component” exciter system. With Comark exciters you get the versatility to upgrade your existing RF plant one piece at a time as your needs require.

All of these unique features are available only with the Comark exciter concept.

- Totally broadband operation from 460 MHz to 890 MHz eliminates all tuning adjustments in any amplifier or multiplier stage.
- Parallel signal path design and redundant power supplies insure highest on-air reliability.

■ Identical ultra-linear vision and sound chains permit instantaneous emergency multiplexing through both channels by remote control.

- Plus, you can choose to incorporate these options:
  - output power ranges from 15 to 100 Watts, vision and sound
  - separate drawers for System Envelope Delay Corrector, ICPM Corrector, Linearity Corrector and Mod Anode Pulser

In addition, Comark exciter systems include full front-panel meter monitoring and complete remote control capability. Plug-in modular RFI construction permits ease of maintenance, while insuring maximum system stability.

These systems are available for upgrading existing transmitter plants and are standard on all current Comark high powered UHF broadcast transmitters.

For a free copy of our Universal Exciter Systems brochure, write or call today.

## COMARK

Engineering and Sales Offices  
Rt. 309 and Advance Lane  
Colmar, PA 18915  
(215) 822-0777 Telex: 846075

International Headquarters  
Rt. 57, Feeding Hills Rd.  
Southwick, MA 01077  
(413) 569-5939

Circle 164 on Reader Service Card

**NEC AMERICA (1415)**

Will introduce E-Flex digital effects system enhancements, including 3D rotation perspective adaptors, off-line editing capability, and a chromakey generator. Other new products will be the TVL-807, 7 GHz field pickup portable microwave unit, and the MNC-1/10 three-chip CCD color camera. The standard line will include the BV10 digital video multiplex system and

Type C VTRs. (Also see listing in audio section.)

See ad pages 42, 242.

**NEILSON-HORDELL LTD. (1744)**

Will introduce its new broadcast-quality video animation stand with computer-controlled motion control motor.

**NEWSCAN (1349)**

See listing under McInnis-Skinner & Associates.

**NTI AMERICA (1105)**

The DSS-11 still store will be shown at NAB for the first time, designed for use

with the company's digital test signal generator.

**NURAD (1426)**

Introducing a 2 GHz, 21-channel microwave receiver and a 7 GHz, 30-channel unit, along with STL/ICR transmitters and receivers. Other new products are the 20PT1 2 GHz, 21-channel portable transmitter, the ITFS/MDS transmitter and receiver, the MC4 digital remote control unit, and the Silhouette receive and transmit antenna systems. Standard line offers antenna systems, remote control, microwave, and the Mini Pod airborne ENG system.

See ad page 81.

**NYTONE ELECTRONICS (1135)**

Plans to show a flying spot scanner camera for 35 mm reproduction.

**OAK COMMUNICATIONS (1331)**

Exhibiting an overview of the subscription TV, satellite scrambling, and program services.

**O'CONNOR ENGINEERING LABS (1229)**

Will introduce the new Model 55 metal legs tripod in dark smoke color and a new sideload adjustable platform for Model 50 fluid head. Will show the full line of fluid camera heads and wooden and aluminum tripods and accessories, including the Hydroped.

**OKI ELECTRIC (1505)**

The LT 1210 digital portable TV standards converter will be demonstrated. See ad page 241.

**OLESEN (1307)**

Showing will include lighting fixtures from Altman, Colortran, and Strong Electric, curtain tracks from ADC, and rigging from J.R. Clancy. Dimming controls from TTI will be on hand, as will cyclotrons and flooring from Rosco.

**OMNIMOUNT SYSTEMS (510)**

Plan to introduce three new lines of products: the 200 Series of 19-25-inch video monitor mounts, cable mounting assemblies, and a new quick-release mounting head assembly for video cameras. Also on display will be the 50 and 100 Series of mounting devices.

**J. OSAWA & CO. (1716)**

Will demonstrate the complete line of YEC/Photron video signal equipment including the VS-1000 sync/test signal generator and the DA-1000 video/pulse signal DA.

**PANASONIC AV SYSTEMS (1019)**

Will introduce a disc-type still video recorder/playback system using sem-

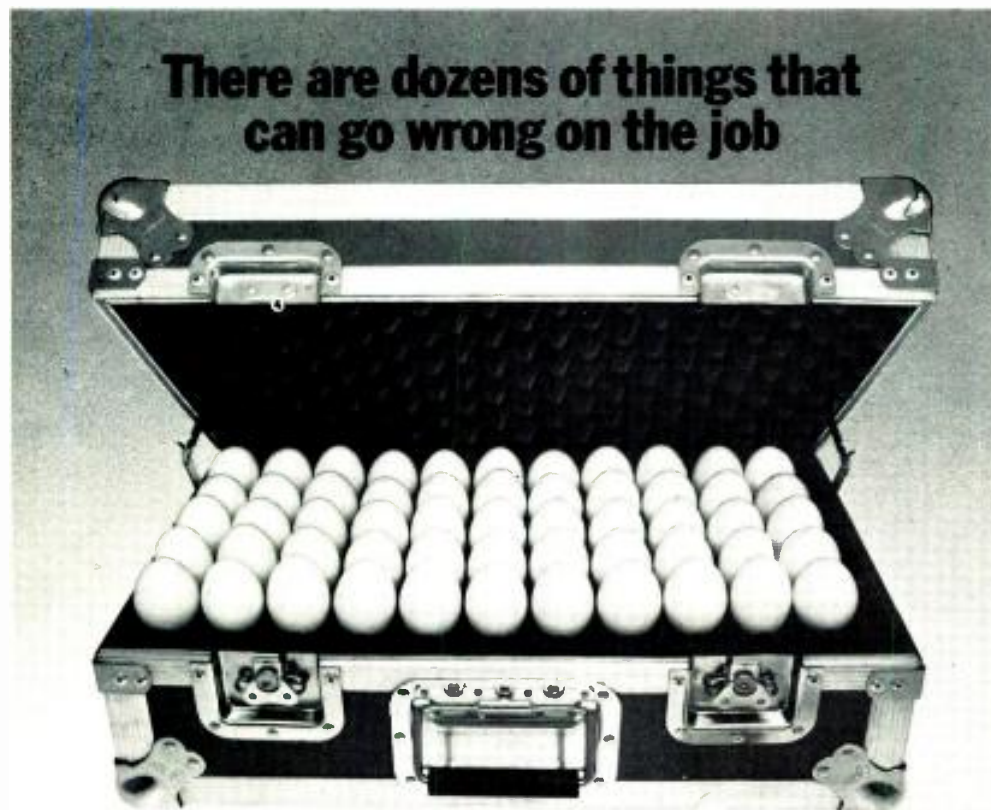

**Getting there shouldn't be one of them**

Even though all "flight cases" may look similar, there are real differences between them.

Calzone Escort cases are designed to protect expensive and delicate equipment from the most punishing travel conditions. Our patented Double-Angle construction provides ultimate strength and protection for rack-mounted equipment, mixing boards, lighting, speakers, cameras, VTR's, cables or anything that must endure the torture of heavy travel. Our cases are already being used

by many of today's production companies, sound contractors and radio/television crews whose living depends on getting their gear to the job in perfect working order.

Calzone also makes tough Convoy road cases for short hauls. We make dozens of different models to fit most any kind of job or equipment. Or, we can custom-build virtually any type of case in a hurry. When your sophisticated equipment requires high-tech protection, Calzone handles with care.



P.O. Box 862, So. Norwalk, CT 06856 1-800-243-5152

Circle 165 on Reader Service Card



iconductor laser technology. The unit captures 15,000 frames of information on an eight-inch disc with access to any frame in 0.5 seconds. Other new products to be exhibited are the AT-190 and -130 high-end video monitors. Also will exhibit the complete line of ReCam recorder/cameras and 3/4-inch video recorders and editing equipment.  
See ad pages 8-9, 225.

**PATCH BAY DESIGNATION CO. (1773)**

Will come to its first NAB with its line of patch bay labeling strips.

**PEP (1208)**

Featuring the Model OCI on-cam VTR for mounting onto the battery bracket and the 64/200 playback unit which handles the TC20 cassettes. The full line of PEP and Christie batteries and chargers and other ENG accessories will be on display.

**PERROTT ENGINEERING LABS (1729)**

A new 30-volt sun gun belt is scheduled to be introduced in Las Vegas with a switchable connection for 30 V, 4 A or 13.4 V, 8 A operation, allowing dual use for light or cameras. Also new is a small 12 V light head. The full line of snap-on batteries and power equipment will also be on hand.

See ad page 208.

**PHELPS DODGE COMMUNICATIONS (1007)**

Will show rigid coaxial transmission line, patch panels, FM antennas, and directional couplers. Harmonic filters and mobile communication antennas will also be shown.

See ad page 147.

**PHILADELPHIA RESINS (126)**

Exhibiting complete synthetic tower guy systems for broadcast, including proper electrical protection against corona, as well as mechanically optimized and fittings.

See ad page 133.

**PHILIPS TELEVISION SYSTEMS (1409-A)**

Will show production models of the LDK-6 in 25 and 30 mm tube configurations. Other products include the LDK-25B and -14S field/studio cameras, and the LDK-44 ENG/EFP economy camera. A mobile television production van will be displayed in van area. The new LDH-6200 14-inch color monitor will be demonstrated, along with the new LDM-3001 digital noise reduction unit and new LDK-4210 sync pulse generator. In transmitters, new equipment will include the 25 kW UHF as well as remote control and telemetry systems and an-

Panasonic will introduce a new NV-1310 videocassette recorder.



# TEACH YOUR EDITOR NEW TRICKS

Here is a simple, cost-effective way to add a full range of special effects to your post-production editing routines.

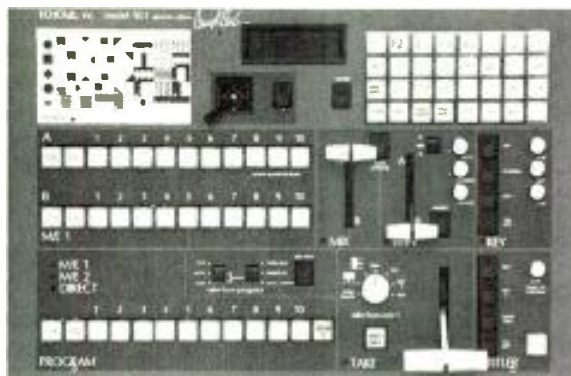

Now, directly from the keyboard of your editing controller, you can mix, wipe, dissolve, key and produce complex transitions. Through either standard or optional interfacing, ECHOLab's SE/3  $\mu$ P-controlled production switcher can add a new level of sophisticated capability to virtually any inexpensive editor.

**Contact Closure Interface** — Permits your editor to initiate a wide range of mix, wipe, key and transition effects.

**Customized Serial Interfaces** — Available for many editing controllers, including Videomedia Z6000, Convergence 103, 104 Series, United Media Commander II and Sony BVE 800. Gives your editor complete functional control of the switcher. You can create complex animation sequences and/or access complex multiple transitions previously

stored in the SE/3's 5000 steps of programmable memory — all directly from your editor.

**The SE/3 is the only switcher in its class with serial-editing interfaces completely self-contained. There are no costly, external boxes or computers to purchase.**

**External Computer Interface** — In addition to the editing interfaces, a general-purpose serial interface protocol is available for full remote control of the SE/3 by an external computer.

**Future Interfacing Capabilities** — ECHOLab is rapidly expanding its line of editing interfaces and is dedicated to supporting the full SMPTE editing standard when it becomes available in the final form.

<b>SE/3 with Contact Closure Interface</b>	<b>\$14,000</b>
<b>Serial Interface Option</b>	<b>\$2,225</b>

For details, write or call:

## ECHOLab, Inc.

175 Bedford Road, Burlington, MA 01803 (617) 273-1512

Circle 166 on Reader Service Card

# ★ ★ ★ VIDEO ★ ★ ★ NAB '83

nular beam control high-efficiency klystron systems.

See ad page 34.

## PHILIPS TEST & MEASURING (1408)

Will bring its range of video test equipment and TV exciters, including the PM5565 waveform monitor, PM5567 vectorscope, PM5539 color analyzer, and PM5534 color pattern generator.

See ad page 209.

## PORTABLE ENERGY PRODUCTS (1153)

New products will be a 30 V, 10 AH battery pack that provides 50 minutes of running time for operating 250 W lights, a new BP90 nicad replacement battery, and solar chargers for 12- to 30-volt sealed lead acid or nicad batteries. Established products on exhibit will include the complete line of sealed lead acid battery packs and belts for cameras, recorders, and portable lights.

## PORTA-PATTERN TELECOMMUNICATIONS (1427)

Will introduce an extensive number of new chart series for color bars, gray scales, test charts, calibrations, and pocket test chart systems. Also bringing the existing line of test charts, transparency illuminators, ENG/EFP test charts, and specialized test patterns.

See ad page 4.

## PRECISION ECHO (1417)

The new Budget Squeezer will be demonstrated for its ability to compress a video image and place it anywhere in the raster area. It can compress live action or freeze the image and is capable of additional effects. The existing line of equipment on exhibit will include the EFS-1B still store, the EFS-2 real time, effects and animation disc recorder, and the EFS-1A P/S video disc recorder for PAL/SECAM systems.

## PROCOMMOTION (434)

Displaying a radio and TV promotion item which is a plexiglass chamber constructed with a fan in the bottom for blowing money or discount coupons in the air as a station promotion.

## PROGRESSIVE BUSINESS SYSTEMS (631)

## QSI SYSTEMS (1325)

The Demod 105 is a direct-access TV demodulator for 82-channel broadcast and will be introduced this year. Also new are a lower-cost color bar genera-

tor with ID and a new serial time-to-video decoder designed to produce a time display in video. The standard line will include various models of color bar generators including the 9000V Series, and also DAS, frame and field counters, and ID systems.

See ad page 237.

## Q-TV (1206)

Plans to exhibit video prompter systems, mini Q prompter systems, and various prompter accessories.

## QUANTA CORP. (1432)

The Quantafont Q7S teleproduction graphic titler series is new with a totally modular three-stage update configuration in both tabletop and rack-mount units. Will bring the standard Quantafont Q8 graphic titler, the QST automatic subtiting system, and the Microgen MG100 teleproduction graphic titler. Also on display will be the Quantanews computer-assisted newsroom processing system and the Quantatrak videotape evaluator.

See ad pages 98-99.

## QUICKSCAN SYSTEMS (1516)

Will display its indexed video electronic publishing system, designed as a practical means of delivering high-volume text and image via a broadband network for local search and readout.

## QUICK-SET (1009)

Will be exhibiting tripods, pedestals, dollies, grip and support equipment.

## RANK CINTEL (1219)

Introducing the new AMIGO VDU-based programming system for use with all MK III series telecines. A new slide file will be introduced, a digital still store with integral Winchester disc drive with a capacity of 80 stills. Also plan to exhibit the MK III-C flying spot telecine for film/tape transfers in international standards and from slides to 35 mm film.

See ad page 222.

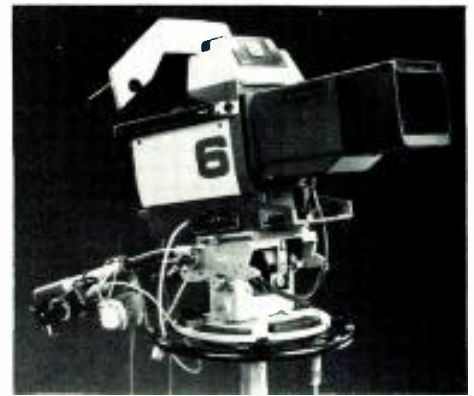

The Philips LDK-6 automatic camera will be shown as a production model.

## RCA AMERICAN COMMUNICATIONS, INC. (1000)

Will feature television channel service with RCA leasing satellite transponder time for TV syndication, news, sports, or video conferencing through individual TV studios. (Also see listing in audio section.)

## RCA COMMERCIAL COMM. SYSTEMS DIV. (1000)

Will be showing the Hawkeye with in-camera VTR and studio setups that integrate with the TR-800 one-inch and CMX editing systems. The TK-290 telecine will be exhibited, as will the TR-800 one-inch VTR, the TCR-100 quad cart machine, and the TH-50 one-inch portable machine.

Three VHF transmitters will be displayed, a 12 kW and 50 kW highband, and a 30 kW lowband, as well as a 30 kW UHF unit. Complete lines of antennas, transmission line, and waveguide displays will also be on hand.

See ad pages 68-69.

## RCA SOLID STATE DIV., TUBE OPERATIONS (1000)

This new division, which combines the former Electro Optics and Solid State divisions, will introduce new 18 mm, 2/3-inch low capacitance diode gun camera tubes and a new Saticon III tube

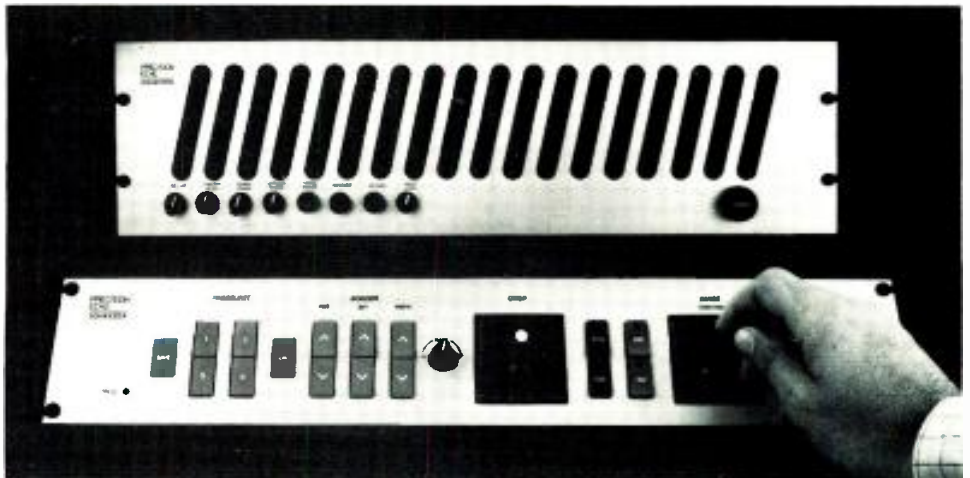

The Squeezer from Precision Echo offers low-cost digital compression.



JOIN  
THE CMX  
EVOLUTION  
REVOLUTION.

NAB BOOTH #1639

for studio, ENG/EFP cameras. In power tubes, a 1 kW UHF for LPTV translator applications will be introduced, featuring a nominal gain of 16.5 dB with in-band IM of -54 dB.

The full line of 15-30 kW power tubes will be on hand, along with broadcast and industrial camera tubes, including Vistacons, Saticons, and Vidicons.

*See ad page 247.*

**REAL WORLD TECHNOLOGIES GROUP (1637)**

**RECORTEC (1209)**

Plans to show videotape evaluators and videotape control equipment.

**REES ASSOCIATES (1727)**

Showing a recently developed LPTV building package in association with Star Manufacturing Co. Will show examples of broadcast facility projects involving planning, design, engineering, and consulting services.

**RELIABLE MEASUREMENT SYSTEMS (1762)**

**RESEARCH TECHNOLOGY INTL./RTI (1626)**

Plans to introduce the new TV-2000 film editing system designed for the TV industry. It previews, edits, inspects, and cleans the film. Also introducing the Data-Film 820 film condition analysis system and the VT3100 videotape evaluator/cleaner. Standard products will include the Cinescan fast talking 16 mm film viewer.

**RF TECHNOLOGY (1306)**

Will bring its line of ENG microwave, STLs, and RF amplifiers, including the RF-1300 Series portable 13 GHz microwave system, the pathfinder tracking antenna, and the RF-700 power amplifier.

**ROCKWELL INTL. (1512)**

Will show its microwave video transmission systems.

**ROHDE & SCHWARZ (1203)**

The new LFM2 automated group delay measurement system will be introduced along with the MUF2 TV sweep analysis system. Existing products include the EUF2/D precision TV demodulator and the UPS F2 video noise meter.

*See ad page 178.*

**ROHN (110)**

Showing new modular fiberglass equipment shelters of standard design or by custom order. Will also exhibit line of towers.

**ROSCO LABS (1235)**

New equipment will include a series of lighting and lighting control material kits for both film and video. Also will show Cinegel products.

**ROSCOR CORP. (1181)**

**ROSS AMERICAN LOGIC SYSTEMS (1332)**

Will introduce an alphanumeric, light bulb array-type readout system for game shows, elections, telethons, etc., along with its established product, a computerized control light wall for theater backdrops and light shows and its custom system design services.

**ROSS VIDEO (1110)**

Will introduce the RVS 524 video production switcher, which is available with either 12 or 20 inputs and features a multilevel effects system and several options. Also on display will be the RVS 508 production switcher with 20 or 24 inputs.

# ALEXANDER TECHNOLOGY SCORES AGAIN WITH THE NEW BP90 BATTERY

Replace those worn-out Sony BP90 or Alexander BP40 batteries with the new Alexander BP90 rechargeable nickel-cadmium battery pack.

The Alexander BP90 features a taped case to provide easy access for on-the-spot repairs. There is an internal fuse, a greatly improved, rugged plug and cord, and a pull tab for quick removal from the equipment. And the BP90 is unconditionally guaranteed for six months.

**SPECIAL NAB CONVENTION OFFER!** Buy three BP90 battery packs, get charger free. See us at Booth 1714, NAB Show, Las Vegas. (Offer expires June 1, 1983)



**ALEXANDER**

Alexander Manufacturing Co.  
 Box 1645  
 Mason City, IA 50401 515-423-8955

Circle 168 on Reader Service Card



# UNDERPAID OVERACHIEVER

The MICROTIME T-120 Time Base Corrector.

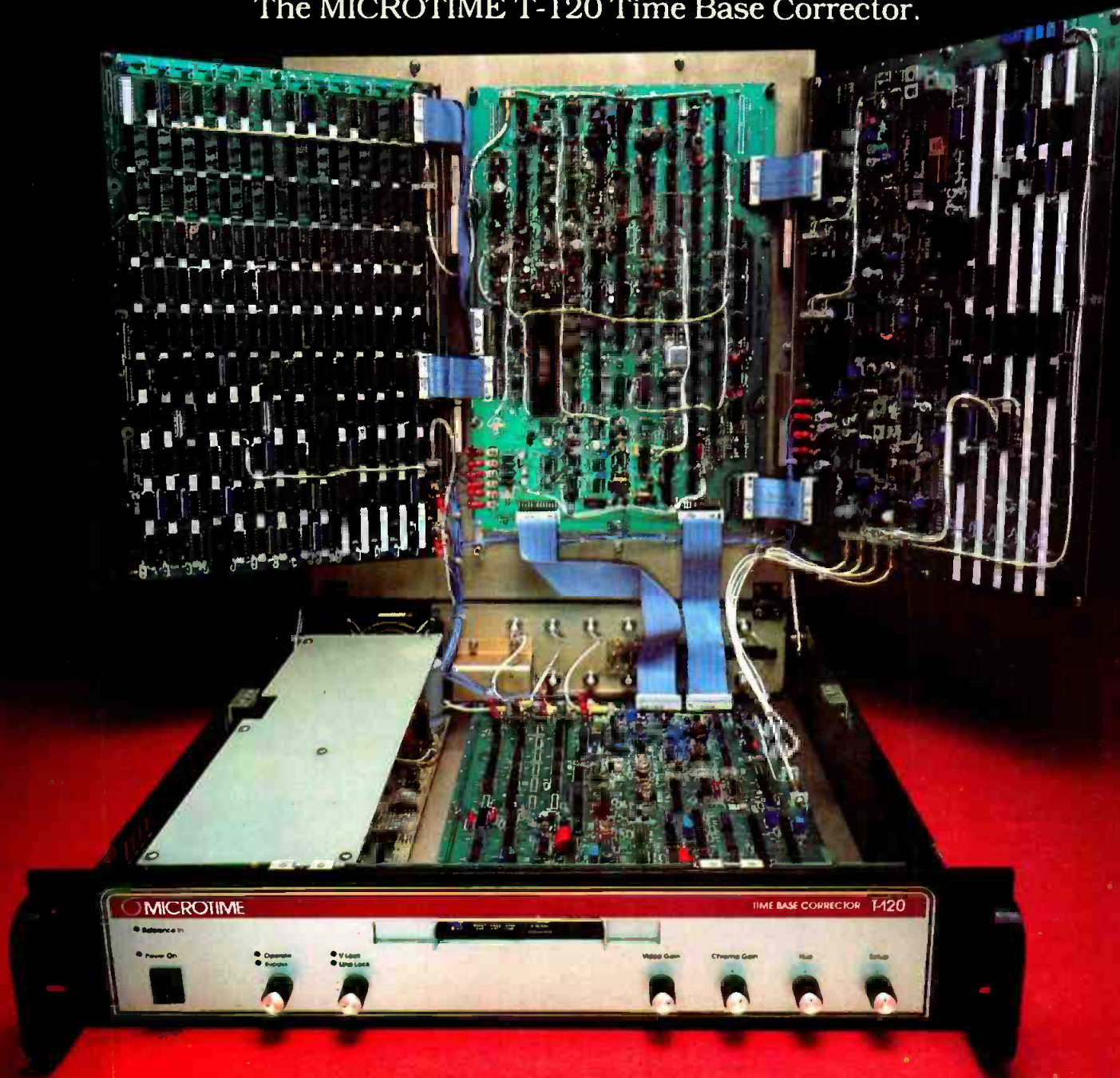

It does everything but cost a lot:

- 8 bit, 4x subcarrier digital design for high reliability and transparent performance
- Wide range, 16-H line memory allows correction of large gyro errors
- 3.58 MHz feedback for full bandwidth processing
- Averaging Velocity Correction for best color performance

- Chroma/Luminance delay compensation adjustment for smear-free pictures
  - Built-in RS-170A Sync Generator will operate genlock or standalone if reference is lost.
- For full information contact: MICROTIME,  
1280 Blue Hills Avenue Bloomfield, CT 06002.  
(203)242-4242 TWX 710-425-1165

Circle 169 on Reader Service Card

 **MICROTIME**

SEE ALL THE NEW MICROTIME PRODUCTS AT NAB BOOTH #1230

[www.americanradiohistory.com](http://www.americanradiohistory.com)



**JOHN B. RUDY CO. (1175)**

Will show its line of custom-manufactured video cables. (Also see listing in audio section.)

**SACHTLER CORP. (1648)**

Will introduce several models of **tripods and heads**. Panorama 7+7 is a lightweight fluid head for ENG with a counterbalancing spring. Video 25 is a medium-sized fluid head for ENG/EFP, with a dynamic counterbalancing system. Video 30 and 35 are larger fluid head models designed for EFP and studio work.

See ad page 251.

**SATT ELECTRONICS (212)**

Will show their line of SAM 82 and 42 portable mixers with either eight or four inputs, RF filter, two-band EQ, and phase reverse on each input.

See ad page 150.

**SCIENTIFIC-ATLANTA (1017)**

Current plans are the introduction of a new 7-meter **antenna**, and a **satellite**

**earth station uplink protection switch**. These will be supplemented by a demonstration of a complete video earth station setup. (Also see listing under **Digital Video Systems**.)

**SHARP ELECTRONICS (1102)**

Promises "a number of new technologically advanced **broadcast video products**," but no details available yet. Will also show the XC800 camera, XC80RPA remote operation panel, and a full line of lenses, batteries, chargers, and related products.

**SHINTRON (1421)**

Expects to unveil a new 390 YIQ **switcher** which is computer-interfaceable with all editors, and a new Series 200 DA system. Also its **time code line**, adding the 646 reader and the 647 generator. The standard line will have switchers, time code products and character generators.

See ad page 228.

**SHIVELY LABS (623)**

Shively has entered into a joint marketing and manufacturing agreement with SIRA, an Italian manufacturer of broadcast products. Brand-new from the company will be a line of **UHF and VHF TV transmitting antennas**, both full-power and LPTV. Other products in-

clude coax transmission line, RF patch panels, directional couplers, pressurization equipment, and antenna optimization services. (Also see listing in audio section.)

**SHOOK ELECTRONIC ENTERPRISES (1310)**

Will feature its new-design 22-foot **mobile production facility** with rear-door entrance into the production area. The van has a 6.5 kW generator, air conditioning, and roof deck, and is equipped with two Hitachi cameras, Crosspoint Latch production switcher, two 3/4-inch VCRs, and audio mixing.

**SIGMA ELECTRONICS (1125)**

Will add two new **sync generators** to its line, one for RS-170A and the other for test signals plus 170A. Also new will be BBG-144, a **system timing module** with four adjustable outputs.

**SKOTEL (1126)**

Plans to show the character generator option for its TCR-TCG time code reader/generator series. Also to be displayed will be a VITC time code reader and generator, digital metronome, and portable time code readers and generators.

**SNARR/CHASE SYSTEMS (609)**

Under its new name, the former Chase

**BEST** ★ QUALITY  
★ PRICES

**Custom engineered electronic news gathering vehicles**

E-N-G vehicles and equipment were originally designed with direct input from Chief Engineers, News Directors, and the Technicians who use and service the electronic journalism equipment. In the ensuing years since the first unit was built in 1973, all modifications, improvements, and design changes incorporated into the vehicles have been tested by the hard knocks of field experience. The result is ever-increased reliability that only the combination of proper engineering and field testing can produce.

All E-N-G vehicles are feature-rich with standard equipment, and can be custom designed or modified to suit any conceivable broadcaster's need. The country's most successful syndicated magazine shows use our units all across the country. We manufacture a "PM Magazine" special edition which is very popular.

Each vehicle comes pre-wired to receive your equipment, eliminating lengthy delays. If desired, E-N-G can supply a complete turn-key van or suburban, with all equipment, cameras, cables, microwave, etc. ready for immediate use.

You'll find no better quality, and prices are thousands of dollars below the competition. Our delivery is faster than any coach builder we know of.

**\$32,900 includes vehicle**

**E-N-G UNIT**  
The famous E-N-G Suburban. The largest selling news vehicle in the U.S.A. Tough, reliable, and a pleasure to operate. 4WD takes you anywhere. Diesel available.



**\$34,500 includes vehicle**

**E-N-G/EFP UNIT**  
The combination E-N-G/EFP Van. When tight budgets specify one vehicle for both news and production, this van combines the best of both.



**\$28,850 includes vehicle**

**EFP UNIT**  
The new EFP Van. Feature-filled vehicle for both remotes and commercial production. Ask about the special cable operator turnkey system.



For a quote, call us with your specifications.

**ENG — We gave our name to the entire industry!**

**ENG** ELECTRONIC NEWS GROUP  
CORPORATION  
2930 Cloverdale Ave., Concord, CA 94520 (415) 798-4060

Circle 170 on Reader Service Card



Media will display business automation and traffic systems for radio and TV broadcasters.

**SONY BROADCAST PRODUCTS (1200)**

Highlight of the exhibit this year will be the complete **Betacam** system, featuring a **production version of the three-tube Betacam** introduced last year, plus the brand-new **Betacam editing recorder** to complete the line. Another major highlight of the booth (the largest in the entire show) will be Sony's **high-definition TV system** including the Sony/NHK-developed HDTV camera and the Sony three-VTR record system. Sony will also unveil "a new product based on the BVH-2000," the latest generation of its one-inch VTRS. Also promised are a new system for improving the image quality of the BVU-800. A full line of BVP cameras, BVH one-inch VTRS, and BVE editors will also be shown.

On the pro-audio end, news will be made by the introduction of a prototype model of Sony's **compact audio disc player** designed specifically for professional and broadcast use. The Sony RF mic will also receive attention.

*See ad pages 2-3, 40-41, 205, 224*

**SPECTRUM PLANNING (128)**

Plans introduction of LPTV FCC filing



*The TV-2000, a complete film editing and inspection system from RTI.*

system as well as the exhibition of standard services such as microwave, satellite, and television coordination. (Also see listing in audio section.)

**STAGE LIGHTING DISTRIBUTORS CORP. (1128)**

Will show its line of studio lighting equipment.

**STAINLESS, INC. (1347)**

Will describe its line of broadcast towers and antenna arrays.

**STANTRON (1123)**

Will introduce a number of new metal consoles, cabinets, and racks for video production, post-production, and

# 7200 COMMUNICATOR

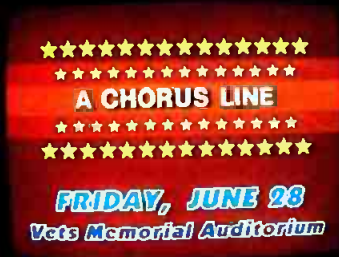

Certainly our 7200 Communicator produces high-resolution, proportionally spaced characters from a multitude of undistorted standard and special fonts. Instant italics, font intermix, animated graphics, and auto sequence are also included. These are all features you would expect to find in any Broadcast-class Graphic Generator.

What wouldn't you expect? How about a choice of 32,768 background and character colors, a 100-line resident text memory, four 128-character resident fonts. How about a full-screen status/preview display and a basic PROM alternative to RAM/disk memories.

What you will come to appreciate the most, however, is that our imagineering has made the operation and maintenance of the 7200 simplified.

SEE US AT NAB BOOTH #1721

**LAIRD TELEMEDIA INC.®**  
2424 SOUTH 2570 WEST • 801 972-5900  
SALT LAKE CITY, UTAH 84119

NAB Booth 1721

dubbing operations, including modular video center sloping-front consoles.

**STATION BUSINESS SYSTEMS (311)**

Has added new capability to the BAT 1700 **management systems plan**. Will also show computer-based systems for billing, accounting, and traffic. (Also see listing in audio section.)

**STOREEL CORP. (1008)**

Will feature instant-access and modular rapid transit storage systems for tape, cassettes, and film, rack storage system for Ampex and RCA carts and cassettes, and setup trucks for transferring tape and film.

*See ad page 149.*

**STRAND CENTURY (1418)**

Will bring its lighting systems, including the light palette console and mantrix control system.

**SYLVANIA/GTE (1204)**

On display will be the complete line of energy-saving lighting products, including Brite-Arc and Brite-Beam lamps, both producing less heat than standard bulbs.

**SYSTEM ASSOCIATES (1121)**

Will discuss the supply and services provided by the company in used broadcast equipment.

*See ad page 272.*

**TAMRON (1640)**

**TDK ELECTRONICS (1707)**

Will introduce videocassettes with the Super Avilyn tape, which claims advantages in S/N and frequency response. Initial cassettes available will be VHS TK-20 Beta L-500, and VHS compact TC-20. Also showing line of professional videotape. (Also see listing in audio section.)



*TDK's new TC-20 Super Avilyn formulation for the vhs-c compact cassette recorder.*

**TECCOM (1785)**

**TECHNICAL PROJECTS (440)**

**TECHNOLOGY SERVICES CORP. (1103-B)**

Will display a low-cost weather radar system with four-picture storage expandable to 16 with plug-in boards. The addition of an optional disk will increase the storage capacity to in excess of 100 pictures.

**TEKTRONIX (1604)**

Has revealed it will enter television studio operation for the first time with a **frame synchronizer**, Model 110-S, with 10-bit processing and accuracy. The unit has selection for signal pass-through or creation of RS-170A sync burst. Will also introduce the new Model 1910 digital **signal test generator** and VITS inserter with four external VITS inputs to facilitate insertion of teletext, closed captioning, and source ID. In addition, the Model 1980 automatic video measurement set will be shown with the new Option 4 software.

Other products on exhibit will be the complete lines of audio and video testing and measurement equipment.

*See ad pages 60-61, 63, 65.*

**TELEASE (1752)**

Will show MAAST (Multiple Application Addressable Secure Television), an **encryption/decription system** for cable, DBS, STV, and other pay services that can transmit up to five audio signals per video channel, allowing multi-

ple language or stereo transmissions. Audio security is extremely high. System also offers a means for the operator to provide pushbutton impulse purchase capability for pay-per-view on a one-way system.

**TELE-CINE/SCHNEIDER (1403)**

Will introduce new **ENG/EFP lenses** for integrated camera/VTRs, including the Schneider 14X9 lens. Also showing new improved lenses for automatic setup cameras. There will also be additions to the line of lenses of long focal length for ENG/EFP use. Also showing the full line of Schneider zoom lenses for half-, 2/3-, and one-inch tubes, and a custom-designed remote-control for lenses.

**TELE-COM PRODUCTS (1728)**

Will show office and personal products, including telephone answering machines, calculators, dictation and transcription equipment, and cordless telephones.

**TELEMET/GEOTEL (1003)**

Introducing computer-controlled **routing switcher** with new software options and a new standalone **Multiburst generator** with built-in power supply and sync. Will also have demodulators, fiber optics with sound, isolation amps, thermal EQs, repeaters, pulse DAS with variable delay, chroma keyers, and chroma keyer decoders. Also plan to exhibit a complete line of test equipment.

*See ad page 208.*



*A new version of the Tektronix 1910 digital test signal generator.*





## BROADCAST U-MATIC VIDEOCASSETTES A NEW DIMENSION OF COLOR BRILLIANCE

Producers, engineers, performing artists—choose Agfa Professional Performance Videocassettes for one reason—they deliver. They deliver a new dimension of color brilliance and definition to your masters with 3dB more video signal-to-noise, 3dB more color signal-to-noise and 2dB more RF output. Drop-out rate is exceptionally and consistently low when compared to the industry standard.

In addition to superior video characteristics, Agfa U-Matic Cassettes feature a black anti-static backcoating which provides better tape transport and winding properties. Our proprietary formulation delivers unsurpassed durability in Agfa Videocassettes. Even with excessive editing, repeated playbacks and conditions unfit for other videocassettes, Agfa will perform flawlessly.

The Agfa cassette is precision molded and assembled under the most stringent and uncompromising quality control standards. It all adds up to unsurpassed professional mastering performance.

CASSETTE TYPE	PLAYING TIME
KCS 20 (Mini)	20 min.
KCA 30	30 min.
KCA 60	60 min.



**MAGNETIC TAPE DIVISION**

Agfa also offers High Color 1/2" VHS and Beta Videocassettes.

**AGFA-GEVAERT, INC.** 

275 North Street, Teterboro, NJ 07608 • 201/288-4100

See us at NAB Booth #1334

**40ft. &  
PICTURE  
PERFECT.**





The Lerro organization of Philadelphia is proud to have engineered and completely assembled "The Super Shooter III", a 40 foot production van for North East Productions.



# LERRO

ELECTRICAL CORPORATION

3125 N. Broad Street, Philadelphia, Pa. 19132

For more information, call  
Bob McTamney at (215) 223-8200

For NEP production services, call John Glawe (800) 233-4777.



# SUPER SHOOTER III



Circle 173 on Reader Service Card

See you at NAB.

**WE'VE DEVELOPED  
A WAY TO  
ELIMINATE  
HORIZONTAL SHIFT.  
AUTOMATICALLY.**

Grumman has solved the problem of horizontal shift caused by improper SCH timing. And solved it in a way that's not only economical, it's automatic. With our SYNC PROC™ unit you won't waste time, people and test equipment establishing SCH. And editors won't have to use trial and error to get the correct matched frame edit between two video signal sources.

SYNC PROC™ solves the problem in a simple way. It generates a color field identification signal that's positioned on the "front porch" of the TV signal. The ambiguity with RS-170A is thereby ended; you get positive identification for one field of the four-color field sequence. With color field identification, the SYNC PROC™ automatically maintains proper SCH timing, eliminating horizontal shift.

SYNC PROC™ provides the

most economical method of maintaining an SCH timed plant.

And it comes packaged with normally required features: a processing amplifier and sync generator and other optional features. Our expanding line of unique process and control products for the broadcast industry include color encoding, satellite transmission processing, machine control and many other state-of-the-art developments, and beyond.

For more information, write Business Development, Mail Stop A24-43, Grumman Aerospace Corporation, Great River, NY 11739, or call (516) 435-6001.



See us at NAB Convention, Booth #1631, April 10-13, Las Vegas, Nevada



Circle 174 on Reader Service Card



**TELESCRIPT (1407)**

New Model MPS-E electronic prompting system will be introduced with facilities for writing, editing, and storing scripts. Will also show the MPS system with 15- and 17-inch monitors of 1000-line resolution in light aluminum chassis, along with the Telecue and Telescriptor transports.

**TELESOURCE COMMUNICATIONS (1616-A)**

Will introduce a new election reporting system for broadcast newsrooms, using a standalone computer. Also showing computerized newsroom management and editing systems.

**TELEVISION ENGINEERING (1700)**

A new model ENG van will be displayed, illustrating methods for reducing customer vehicle replacement costs.

**TELEVISION EQUIPMENT ASSOCIATES/TEA (1216)**

Introducing the Matthey Dip Delay boxes and back packages and the new Matthey passive cable equalizers. Elcon tape cleaners for one-inch, the VG teletext system, and Link video DAS will also be exhibited, as will the JRT color monitor. (Also see listing in audio section.)

**TELMAR CORP. (1520)**

**TENNAPLEX SYSTEMS (1127)**

The standard line of equipment on display includes three-panel UHF antennas, the Elcom network analyzer, and the field strength meter Model MFK-42.

**TENTEL CORP. (1613)**

New product will be a head protrusion gauge for measuring VHS. Beta, and U-Matic cassette recorders. Also show-

ing Tentelometer tape tension gauges for VTRS. (Also see listing in audio section.)

**TERMINAL SYSTEMS (1768)**

Will premiere its ACORN (Automatic Compilation Of Radio-TV News) turn-key newsroom computer system for radio and television. Both hardware and software are produced by the company; system includes word processing.

**THEATRE SERVICE & SUPPLY (1513)**

Will display its studio cyclorama curtains and tracks as well as lighting equipment.

**THEATRICAL SERVICES (1759)**

Plans to introduce a modular system of connector strips for stage and studio lighting systems which can be assembled on-site. Will show studio cycloramas, curtains, and tracks.

**THERMODYNE (1637)**

Will exhibit the Shock-Stop and Rack-Pack shipping and operating cases.

**THOMSON-CSF BROADCAST (1001)**

Will mark entry into the recorder/camera arena with the latest version of the Betacam. The Microcam MC-611, one-tube and the MC-613, three-tube cameras will be exhibited, both coupled with 1/2-inch recorders. Also on display, the new videotape player and editing system, VT-615. Also introducing the TTV-5305 special effects generator with freeze frame, viditrac, zoom in/out, image dissolve by jamming, and memory for 32 effects combinations. The Vidifont Graphics V character graphics system with new software for news, weather and sports interface, plus new animation capability will also be exhibited. The Microcam, the TTV-1525B studio camera, video processors, TBCs, and the full complement of TV transmitters will be exhibited. (Also see listing in audio section.)

*See ad page 101.*

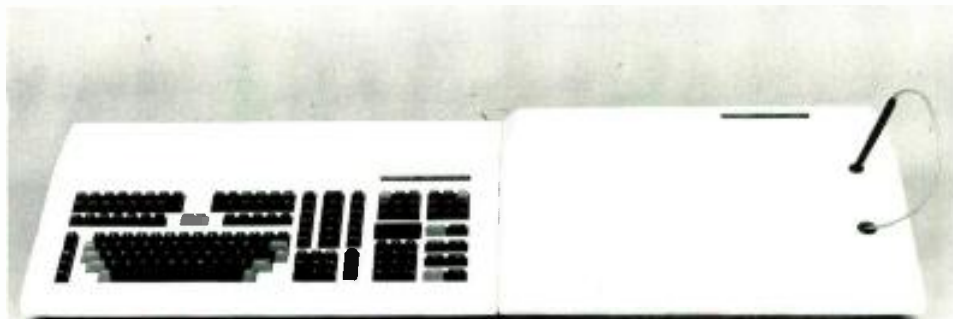

Thomson-csf Vidifont Graphics v as standalone system without console.

"No-Stretch"  
 Phillystran® HPTG

**the only  
 flexible  
 FIELD  
 PROVEN  
 electrically  
 transparent  
 tower-guy system**

1. eliminates EMI and RFI at broadcast sites
2. simplifies installation of AM, FM, AM directional and TV towers. Made with DuPont's Kevlar®. Lightweight, flexible, yet as strong as extra-high-strength galvanized steel\* . . . negligible creep, negligible elongation with new HPTG\* for tension-once and walk-away installations.
3. maintenance free. Non-conducting, non-corroding, nonmetallic. No internal corrosion. No white-noise arcing across insulators. No insulators required.
4. no more expensive re-buying.

\*Comparative stress-strain data and information about other physical properties available on request.

**Call/write for:  
 10 REASONS WHY  
 YOUR BEST BUY IS  
 PHILLYSTRAN®  
 and the new  
 PHILLYSTRAN® HPTG**



*Philadelphia  
 Resins Corporation*

P.O. Box 454  
 20 Commerce Drive  
 Montgomeryville, PA 18936  
 Telephone (215) 855-8450  
 Telex: 84-6342

Circle 175 on Reader Service Card



**THOMSON-CSF (1145)**  
**ELECTRON TUBES**

New products will include the TH-347 **tetrode** for 1 kW LPTV, the TV-18363 **cavity** for 1 kW LPTV, and the TH-382 6 kW **tetrode** for aural UHF. The TH-3591 600 W travelling wave tube for Ku-band satellite ground stations will be exhibited, along with two different versions of C-band Klystrons. The THX-31133 CCD for miniature TV cameras will be displayed, as will other products in the line of high-power tubes for UHF and VHF TV.

**TIFFEN (1422)**

Is introducing a new set of **lens filters**, soft net—in red, skintone, black, white, each in four densities. Also showing soft contrast filters in five densities; sepia filters in two densities; other lens filters in complete line; the line of video effects units; the Model 933 high-impact case, which holds nine filters; and the 445 case which holds 18 filters.

**TOSHIBA (1631-A)**

Will again return with a broadened product line that includes the AS-II audio synchronizer for delaying audio on complex transmissions and due to video frame synchronizer delay; the DS-IV digital video frame synchronizer; the DPE-III digital video effects system; and the PK-60 ENG and PK-41 automated setup studio cameras. New this year may be a complete station automation system.

*See ad page 135.*

**TOWNSEND ASSOC. (1420)**

Will have on the floor a new **turnkey low-power TV system**, including a transmitter building, all test equipment, the satellite receiver, and the TV transmitter. A mock-up of antenna tower and satellite dish will be exhibited, along with a complete "packaged" low-power TV transmission system. Also showing the line of other TV transmission systems and accessories.

*See ad page 215.*

**KEVIN TRACY PRODUCTIONS (645)**

**TRUE TIME INSTRUMENTS (643)**

Will introduce **automatic synchronization of analog clocks** to the National Bureau of Standards time signals and a new **option** for the Model 60-DC, 468-FPC and 468-E **satellite synchronized clocks** for interface of simplex-

type analog clocks. Also showing line of phase comparators and a line of NBS time and frequency receivers.

**TTC (305)**

Showing equipment from its three divisions: TT, Wilkinson Radio, and Satellite Technology. Will have LPTV translators and UHF and VHF transmitters. (Also see listing in audio section.)

**TV CUE COMPUTER (1747)**

**TVI (1730)**

Showing the Strand Century Mantrix memory lighting control consoles and die-cast 6- and 8-inch Fresnel lens spotlights. Other products include the CD-80 dimming systems, curtains, tracks, and cycloramas.

**ULTIMATE CORP. (1624)**

The Postmatte will be introduced, a **video matting device** for post-production. Ultimatte and Newsmatte video compositing units for production, commercials, and live broadcast will be exhibited.

**UNIDYNE TECHNOLOGIES (616)**

Will describe services for designing and executing direct mail campaigns for broadcast stations, using targeted zip code lists from automated lists in 36 states, with specially created contests, audience research, program analysis. Lists reach nontelephone subscribers. Will show a number of successful direct mail campaigns.

**UNI-SET (1023)**

Will introduce a new modular system of **three-dimensional settings** for the TV newsroom.

**UNITED MEDIA (1300)**

The new item will be the Model 500 **sequencer**, a computer-controlled comparator designed for switch closure for up to 16 channels. Other products include the Commander II computer-assisted editing system, the Director looping controller, and the Translator cue writer for preparing the cue list for the looping controller. (Also see listing in audio section.)

**UNITED PRESS INTERNATIONAL (1015)**

Will describe its broadcast news services.

**UNR-ROHN (110)**

See listing under ROHN.

**U.S. TAPE & LABEL (602)**

Adding concert patches to the line of bumper strips and window labels for the broadcast industry.

**UTAH SCIENTIFIC (1114)**

Will introduce a new line of software-based **master control switchers** with full stereo capability and audio over/under while the matrices accommodate 30 video inputs. A new station automation system will be demonstrated in conjunction with master control switchers. The full line of routing switchers and audio/video DAS will be on display.

*See ad page 193.*

**UTILITY TOWER (200)**

Displaying standard tower sections and base insulators.

**VARIAN/EIMAC (1605)**

Showing 40, 100, and 300 kW graphite grid tetrodes, triodes, and the Y-831 200 kW tube. The microwave division will have an external cavity UHF klystron and an aural as well as a visual coupler. Also shown will be a 500 W Ku-Band travelling wave amplifier.

*See ad pages 113, 257.*

**VIA VIDEO (1225)**

Will show major new advances in its **digital art/paint system** including multi-plane animation, high-resolution graphics, and many software mode expansions.

**VIDEO ASSOCIATES LABS (1303)**

Will introduce Microkey Systems **boards for personal computers** (e.g., Apple) converting them into graphics generators, titlers, effects units. Will also introduce light pens to draw on TV screens. Showing peripheral software for effects systems.

**VIDEO DATA SYSTEMS (1506)**

Will show an updated version of the T1000B **production titler**, with disc memory, roll and crawl, adjustable height characters. Also showing the line of character generators and titlers.

**VIDEO INTERNATIONAL (1524)**

Will introduce a **digital standards converter** that converts all systems both ways, in a portable, 19-inch rackmount model.

*See ad page 136.*

**VIDEOMEDIA (1308)**

Will show new moderate-priced **editing systems**, Eagle I and Eagle II. Also introducing new **automation control systems** using twisted-pair wire for interconnects. Will also bring the new VMC-200, for **computerized station automation control**. Other new systems: the STC1 and STC2 **computer-**



# TOSHIBA Color TV Camera PK-41

**Our PK-41 is a microprocessor-controlled fully automatic color camera with digital circuit reliability.**

Controlled by a microprocessor with a non-volatile memory and over 100 controllable items, the fully automatic PK-41 can do practically everything for you. It also holds a data filing function for over 400 items.

The thinking PK-41 not only offers a fully automatic setup, it also displays the control and diagnostic data of the camera operating conditions on the picture monitor. Experience our incomparable 58dB high broadcast quality pictures.

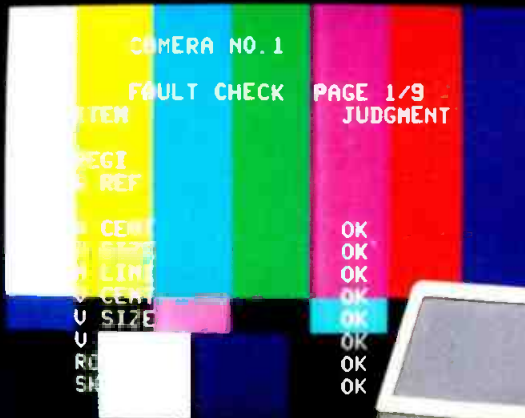

**See us  
at NAB Exposition.**

**A name that communicates.**

## TOSHIBA

TOSHIBA CORPORATION

ELECTRONIC SYSTEMS DEPARTMENT 1-6, UCHISAIWAICHO 1-CHOME, CHIYODA-KU, TOKYO, 100, JAPAN  
TELEX: J22587 TOSHIBA CABLE: TOSHIBA TOKYO PHONE: 501-5411

Circle 176 on Reader Service Card

# ★ ★ ★ VIDEO ★ ★ ★ NAB '83

ized remote control for VTR functions using twisted-pair interconnects, shown with switchers. There will be **new features for the ADDA AC-20 TBC**, including interface to Z-6000 switchers, for multiple source inputs, scene-by-scene color correction.

## VIDEOTEK (1633)

New products include the RS-10A audio-follow-video rack-mountable **routing switcher**, a new series of DAS, and the Studio-12A 12-inch color **monitor** with 400 lines of resolution.

See ad page 19.

## VINTEN (1406)

See listing under Listec.

## VITAL INDUSTRIES (1212)

Will have production models of SAM, **automation system for TV**, interfacing cart machines, etc., with business systems. Will introduce the new SANDI general-purpose **data communications system**, for sending command

and control signals to TV stations' equipment; can transmit data to automation manager, can be assigned to automation manager, or can be assigned to control one piece of equipment. Will have some **new options for SqueezeZoom**, and a full line of production switchers, with multiple mix effects to single mix effects on-air switchers. Also introducing the PSAS **production automation system**, controlling data from production switcher and from SqueezeZoom.

## WEATHERMATION/ (1179) SATELLITE BROADCAST NETWORK

Will bring its weather radar systems.

## WILKINSON/TELEVISION (305) TECHNOLOGY

See listing under TTC.

## WINSTED CORP. (1238)

Will have new **shelf units** for front-loading 3/4-inch Sony VTRs, the 5850 and 800 Series. Also showing the general line of cases, shelves, and cabinets for all varieties of broadcast equipment.

See ad page 226.

## WIREWOKS CORP. (1511)

Will show coaxial cables and audio/video multicables. (Also see listing in audio section.)

## WOLD COMMUNICATIONS (1515)

Point-to-point and multipoint television and radio program transmission and network interconnection systems will be demonstrated with a live, nation-wide syndicated television broadcast.

## WOLF COACH (1317)

Revealing the Mobile Mini News Room microwave-equipped ENG/EFP vehicle as well as other production vans, along with literature displaying the line of production bodies.

## FRANK WOOLLEY & CO. (1731)

Showing the Motionmaster video animation system, Polarmotion animation materials, and the Motionmaster color tinting sheets.

## WORLD TOWER (519)

Will show the regular line of antenna towers in sections and photographs.

## WSI CORP. (1777)

Will feature its weather and sports databases, providing real-time sports and weather information via satellite distribution or on a request/reply basis.

## ZENITH RADIO CORP. (1517-A)

Will bring its line of STV encoders and decoders.

Digital TV Standard Converter STC 2003!

# Converts all TV Systems!

If you see the quality and hear the price  
you'll forget the others!

new

Includes 3 systems for professional applications:

- freeze frame synchronizer for PAL, Secam, NTSC
- time base corrector for PAL, Secam, NTSC
- test pattern generator for PAL, Secam, NTSC

Full broadcast quality at your finger tip.

Made in Western Germany

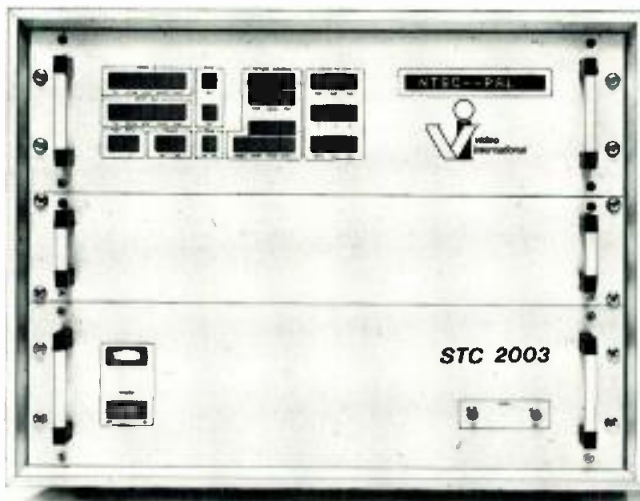

Visit us in Las Vegas on NAB Convention '83, Booth 1524 from April 10th-13th.



Please contact for North and South America  
Video International  
1280 Sunrise Highway  
Copiague, N.Y. 11726  
Tel.: (516) 842-1815  
Telex: 645537

Please contact for Europe  
G.F. Video Technik  
Ulmenweg 11  
D-3013 Barsinghausen  
W-Germany  
Tel.: (5105) 8 11 44  
Telex: 923397 GF

Circle 177 on Reader Service Card



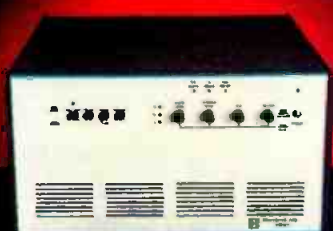
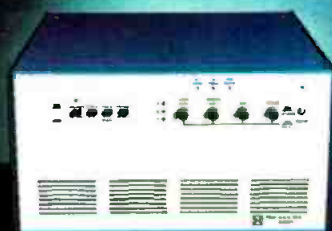
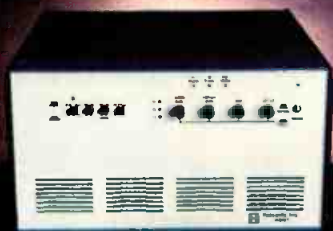
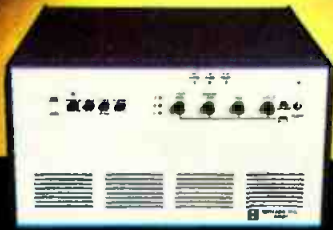

# FLEXIBILITY, PERFORMANCE,

In adaptability, state-of-the-art technology, and price the Hotronic AD 51 leaves other TBC/frame synchronizers in a blur.

The AD 51 series gives you a full range of options and budgets. Start at the TBC with a full 525 line correction window. Or the frame synchronizer. Or the TBC + freeze field-freeze frame. Or the TBC + frame synchronizer. Or the complete TBC + frame synchronizer + freeze field-freeze frame. Or any of the above with a convenient remote control option. But, for real adaptability, you can pick any of the current configurations which fit your current needs and budget, and upgrade later all the way to the top of the line. Incidentally, *all* upgrades are done by your technician at your facility.

The AD 51 series uses the newest digital signal processing with a full bandwidth comb filter. And yes, you get the digital noise reduction inherent in the comb filtering process. Check the rest of the AD 51 specs . . . All are full professional video quality.

And this comes at a surprisingly low price. Compare Hotronic's AD 51 with any TBC/frame synchronizer on the market today and you'll find it offers the flexibility for your future, the performance you demand, and the affordability you need. Call Hotronics today at (408) 292-1176, or see us at NAB booth 1782 for more information.



# and CHANGE.



**HOTRONICS, INC.**  
1210 South Bascom Ave. #128  
San Jose, California 95128  
(408) 292-1176

Circle 178 on Reader Service Card

Circle 179 on Reader Service Card

# THE RESULT OF SEVEN YEARS OF INNOVATION AND EXPERIENCE



## The RTS Systems' Model 802 Master Station

For almost a decade, RTS Systems has been quietly and effectively advancing the quality and scope of professional intercommunications. Innovating. Refining. Perfecting. Our research, experience and continuing success have resulted in a remarkably sophisticated and powerful communication control center... the new RTS Model 802 Master Station.

The 802 is a unique, *microprocessor-assisted* communications network providing 22 independent signal paths operating in up to six separate modes. It offers an impressive array of features including intercom, squawk, IFB/SA, station-iso and signaling. An intelligent combination

of hardware and software programmability allows the user to conveniently structure an individualized operating format. The Model 802 does not require space-consuming central electronics, yet it features a sensible front panel layout, unique momentary/latching action buttons, individual channel listen level controls, and stereo headset source assignment. The RTS Model 802 can mark the beginning of effective, efficient, smooth intercommunications.

For more information, please call Bob Tourkow, Sales Manager. The Model 802 Master Station... imagine the possibilities.



**RTS**  
**Systems**  
INC.





# WHAT'S HOT IN AUDIO AND RADIO PRODUCTS

## FIND IT FAST

- |  |   |
|--|---|
| <b>142</b> AUDIO CONSOLES                | <b>152</b> TEST AND MEASUREMENT         |
| <b>143</b> MODULATION DENSITY PROCESSING | <b>157</b> TELCO/STUDIO COUPLING        |
| <b>146</b> SPECIAL EFFECTS, REVERB       | <b>157</b> PROGRAM AUTOMATION           |
| <b>146</b> NOISE REDUCTION               | <b>157</b> RPU, REMOTE CONTROL, AND STL |
| <b>146</b> OTHER PROCESSING UNITS        | SATELLITE SYSTEMS (See Video Section)   |
| <b>146</b> ATRs, CART DECKS              | <b>158</b> RADIO TRANSMITTERS           |
| <b>150</b> AUDIO PRODUCTION EQUIPMENT    | <b>160</b> RADIO SYNDICATION            |
| <b>152</b> INTERCOMS                     |   |

# ★ ★ ★ AUDIO ★ ★ ★ NAB '83

BROADCASTING USED TO BE divided into two simple categories: Radio and Television. But times and technology have changed. The truth is that revolutions in the industry are pointing to a brand-new way of dividing things: Audio and Video. And this year for the first time we are organizing our NAB coverage into these two sections.

The main reason for the change is the tremendous push towards more and better quality audio for television—everything from advanced consoles to advanced processors. NAB '83 is going to see an unprecedented number of new products in the audio area, many designed for the audio-for-video market.

There won't be more products, but the emphasis is shifting away from strictly traditional radio-related equipment. Transmitters, STLs, remote control systems and the like are always going to be enormously important. But there's a new push on now towards increasing the importance of **audio production**—because neither radio nor television is content any more with the same old recorders, mics, intercoms, and so on that it has been using for years. There's something new happening out there—a technological push that is going to take the industry by storm.

## CONSOLES

The clearest indication of the change will be in the audio console area. Many console manufacturers are aiming at the audio/video production houses as well as at TV and radio stations. ADM will highlight a brand-new **console for video post-production** with VCA control, direct outputs, and remote control from a switcher or editor. Also new will be a “**high tech**” console incorporating a random-access audio routing switcher.

New at NAB '83 from **Rupert Neve** will be the 8128, 32-input, 24-track **post-production/recording console**. The board is divided into two sections, one for track recording and the other for mixdown, with 32 channels available to each section.

*The 248  
Component  
Series from  
Quad/Eight can  
be seen at booth  
1636.*



*Neve's 5104 24-track console will be at booth 1410.*

Digital control will be in evidence everywhere as manufacturers use the new technology to advance the state of the console-maker's art. A prime example will be **Broadcast Audio**, which will announce its **System 14** digitally controlled audio console as well as an analog stereo version. Also shown will be the **System 5** news console, as well as new studio cabinetry.

**Solid State Logic** is also making a major assault on the TV station and teleproduction market with its **4000E** and **6000E** consoles—huge automated consoles with built-in computers.

**Autogram** will debut a brand-new, fully **micro-processor-controlled** console with up to 60 inputs, three stereo program outputs, a mono program output, and interface with a TRS-80 Model III for two channels of automation and logging.

Meanwhile, three new models of **Harrison's TV-4**, all variations on the same frame, will be displayed. The consoles range from small broadcast to complicated post-production units, varying in sophistication and price. Also on display will be the **TV-3** multitrack and post-production console.

A newcomer to the TV audio field will be **Sound Workshop**, which will introduce a version of its **Diskmix** computer automation system designed especially for the station and facility market. The automation system interfaces with any manufacturer's console, in addition to Sound Workshop units.

**Ward-Beck** is also expanding its line with a new





Booth 437 will house the Ramsa WR-8118 audio mixers.

console designed for TV audio—supplementing its existing line of TV and radio consoles. Also new will be a **transportable mixer**, T1202A.

From **Harris**, look for the addition of a DJ assist on the Micro Mac all digital console. Small market/budget stations will be especially interested in the UREI 1650 and 1680 Series. **Yamaha** will also be on hand with its line of consoles.

**Graham Patten** will introduce the new Model 612 **post-production audio mixer** with 12 inputs and two outputs.

Among the **mid-range mixers** look for a new line of consoles from **Gregg Labs** which have few extra goodies, but plenty of basic, useful features. The 14-channel consoles have, as standard, Penny & Giles faders.

**Howe Audio** plans to offer newly packaged **7500 Series consoles** as well as the 7000 Series with the addition of Daven step attenuators. **McCurdy 8000 Series audio consoles** will be displayed, and **Datatronix** will introduce the new **Gold Seal 4024 consoles** and post-production mixers. **Farrtronics** has planned to exhibit the M70 audio console with DC-controlled interface to the CMX editor.

Mixers that are not getting larger and more complex are getting smaller and more complex. **MCI/Sony** will feature the **Broadcast Production Package** and the newest console, the **JH-800 Series**, which is the company's first entry into the compact mixer market. The unit has 12 inputs accepting mic or line level signals, four VCA groups, four sends, and three echo returns. The broadcast package features a JH-618 console with 10 mic inputs and five stereo line inputs.

New equipment from **Interface Electronics** will include the Model 200B version of the eight-input, ac/dc stereo **portable mixer**, and the Model 550J TV **broadcast mixer** with built-in EQ, input selectors, monitor logic, and cueing. **Audio Developments** will again bring the **ADO 62 portable mixer**.

Versatility in size and capability is another aim of console suppliers. In this category, **Micro-Trak** will have two new **dual bus consoles**, the 6509dB and the 6510dB. **Trident** will introduce the **VFM Series** of low-cost modular mixing consoles with four-band EQ on each input, three auxiliary sends, and .12-segment metering.

**Ramsa** will introduce the Model WR-8616 **compact mixing console** compatible with either a four- or 16-track recorder. The unit contains 16 balanced mic inputs, and can also accommodate 16 line-in inputs, and 16 direct line outputs.

**TEAC/Tascam** will show the new **Series 50 mixer/**

**recorder** combinations, including the M-50 mixer, the M-52 half-inch two-track recorder, and the M-58 half-inch eight-track recorder.

**Shure** will feature its **AMS (Automatic Microphone System)**, an integrated system in which mic and mixer act as one. Each mic/mixer channel contains logic circuits enabling that mic to act independently. Each mic also continuously monitors its own local acoustic environment, allowing each channel to adjust independently.

**JBL** will demonstrate the **710 Series** of mic mixers, while **Ramko**, as a part of the Primus line, will show small mixers as well. The **Clyde Electronics Alpha Series** and **Delta** news mixers will be displayed.

To help bring the audio equipment together for both production and post-production there is the new **McCurdy Model ARS-5020 audio routing switcher** based on a 50X1 switcher card with 20 cards per frame. The **AVS 100** is an a/v routing switcher with a new **alpha-numeric** control.

**Broadcast Technology** will demonstrate a micro-processor-controlled **audio routing switcher** with multiple control stations. **Datatronix** plans to bring the **Telepath** audio routing switcher. In addition, **Audio Kinetics** will have a new, compatible keyboard controller, the **Q-Link**, for the Q-Lock system, containing its own sub-processor, user-definable keys, and intelligent interface to automated consoles. For other audio/video synchronizers, see the discussion in the Video Products section.

## MODULATION DENSITY PROCESSING

Manufacturers in this department are clearly responding to the pressure, higher than ever, for the densest possible on-air modulation, hopefully with low distortion. This pressure is closely related to the intensifying competition in radio broadcasting. It brings new makers into the field and stimulates old ones to enlarge and diversify the capacities of their equipment.

**Audio + Design** adds new flexibility to compressor/limiter design with the new **S27 four-band cross-over and combining amplifier**. This allows single processing units to be assembled into a variety of multiband systems.

**Broadcast Technology's** new **10-band processor** opens a fresh line for this firm, known before largely for card-mounted plug-in units covering separate audio system functions. The new system illustrates the complexity hardware makers believe to be necessary to make an impact in the area.

**Dorrough Electronics** shows the trend by adding to the long-used **Discriminate Audio Processor** a programmable EPROM that automatically sets attack and release times. Programmability is making a strong appearance in several other brands, too. **Inovonics** has made it central in a new **multiband system**, Model 250, which can be programmed in a simple way for AM, FM, or TV, and for the



**Dorrough Electronics** booth 312 will display the Model 610 processor.

# ★ ★ ★ AUDIO ★ ★ ★ NAB '83

precise action wanted.

And another programmable system from a firm with a strong track record, **Gregg Laboratories**, is the new **AM processor** which can be set for mono or stereo operation.

**Audio Technologies** is another entrant in the field, bringing the **Emph-A-Sizer**, a name that suggests strong

action on modulation density. **Orban**, one of the pioneers in modulation processing, continues forward with a new **Optimod-TV** that includes a loudness controller.

**Circuit Research Labs** moves into TV audio processing with a **two-band system** using gate control to prevent hole punching. CRL is also responding to the increasing interest in SCA operation for FM stations with a signal generator/processor for that service. The new CRL **AM stereo limiter**, SMP-1000A, is another clearly aimed for developing needs.

Firms that will be on the floor with established systems are **Elcom-Bauer**, **McMartin**, **Symetrix**, **Thomson-CSF**, **UREI**, and **Kahn Communications**.

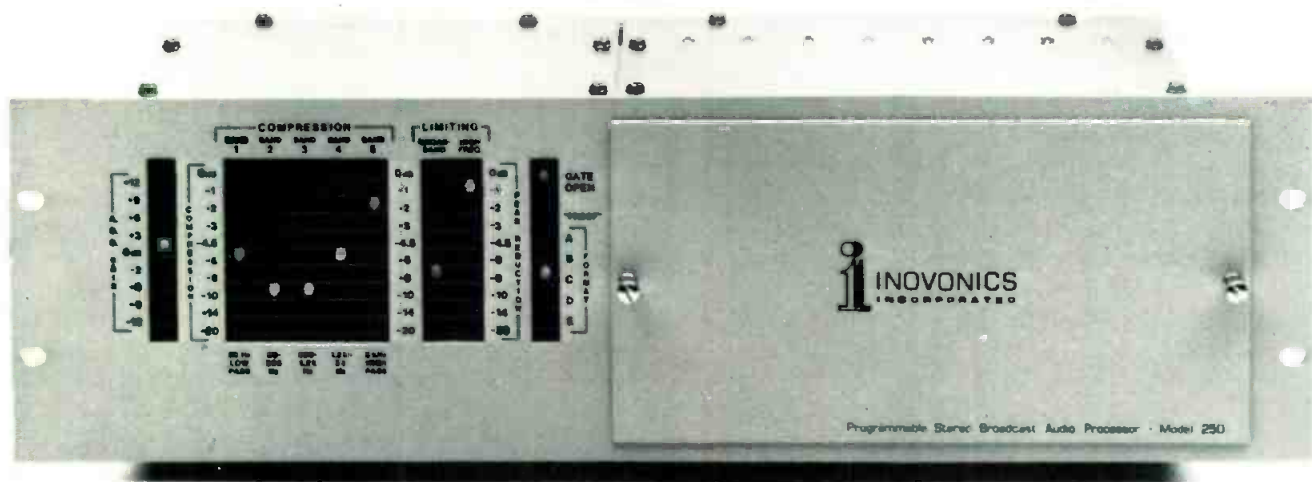

*Inovonics Model 250 can be viewed at booth 304.*

## UNCOMPROMISING WIRELESS MICROPHONES

Finally, you can choose a wireless mic to fit the application. The Telex WHM-300, the electret wireless transmitter mic for uncompromising speech clarity. Or a Telex WHM-400 dynamic wireless transmitting mic for vocal entertainment with rich, full bodied audio quality. Both elegantly tapered and without trailing antenna wires. Or select the miniature electret WLM-100 lavalier mic (or any standard dynamic mic) with our belt-pack transmitter.

Combined with the superb Telex dual diversity\* FM receiver, you'll have a wireless system that is as good as any hard wired mic, and at a reasonable price. Write us today for full details.

Quality products for the Audio Professional

# TELEX

TELEX COMMUNICATIONS, INC.

9600 Aldrich Ave. So. Minneapolis, MN 55420 U.S.A.  
Europe: Le Bonaparte - Office 711 Centre Affaires Paris-Nord 93153 Le Blanc-Mesnil, France

\*U.S. Patent No. 4293955. Other patents applied for.

Circle 181 on Reader Service Card



See the longest shot in Las Vegas

# The New FUJINON

# 44X

The lens that  
breaks the barriers on focal length,  
shatters the limitations on performance  
and gives you the shortest distance  
between any two points!

See why the new 44 is the  
surest winner in Las Vegas.  
Play the 44 for yourself  
at FUJINON, Booth 1411.

In the field of long lenses, no  
single lens covers the field  
tighter and wider.

- 594mm at full tele . . . doubles to 1188mm with the built-in 2X extender
- 13.5mm wide angle for better than a 65° horizontal field of view
- F1.7 maximum aperture . . . with Fujinon's traditionally better ramping characteristics

Fujinon Inc.  
672 White Plains Road  
Scarsdale, NY 10583  
(914) 472-9800 Telex: 131642

Fujinon Inc.  
2101 Midway, Suite 350  
Carrollton, TX 75006  
(214) 385-8902

West Coast Division  
Fuji Optical Systems, Inc.  
118 Savarona Way  
Carson, CA 90746  
(213) 532-2861



FUJINON

Circle 182 on Reader Service Card

[www.americanradiohistory.com](http://www.americanradiohistory.com)

## SPECIAL EFFECTS, REVERB

These two functions, closely related technically, make up another expansion area. **Advanced Music Systems'** new RMX-16 reverb system, part of a range of new devices for this firm, joins the "pre-set" ranks with nine different reverb programs built in.



Digital reverb from AMS will be demonstrated at booth 1330.

**Eventide** will show its programmable system with an extremely flexible and varied capacity in the SP2016 system, introduced last year, and now in production. The plug-in software modules for this system can provide a nearly endless list of programs, both in special effects and reverb. Many new ones, developed by Eventide in the course of the year, will be described at the show. Eventide will also show time compression and spectrum analyser systems.

**Lexicon**, another stalwart in this field, will have the 224X reverb system, introduced earlier, which also allows a wide choice of programming, with some new ones developed. **Quad Eight** has an upgrading of the System 5 reverb, the System 5LC, again with added versatility. **Ursa Major's** already widely used 8x32 reverb system, now with remote control, and the very popular Space Sta-

tion special effects system, will also be there.

**MicMix** will come forward with the new XL-404 "plate synthesizer" reverb.

## NOISE REDUCTION

There won't be any radical new approaches to audio noise reduction, but a number of tried and true systems will be on hand, some in new, more convenient forms.

**Dolby**, for example, is expanding the line of plug-in modules for adding Type A Dolby to videotape recorders. Introduced earlier were plug-ins for the Sony BVH-1000 and the Ampex VPR-2. New at the show is the **Model 234 for the Sony BVH-2000**.

**Deltamod** will again feature its CNR-6 Dolby noise reduction for cart decks.

The **MicMix Dynafex system**, new last year, is a "sliding filter" system and so does not need encoding and decoding. In the new modular form brought by MicMix, with matching rack and power supply, it should be easier to use in many applications.

**Gotham Audio** will have the **Telefunken multiband system, C-4**, popular in Europe. **Straight Wire Audio**, which announced last year the exclusive license in the U.S. for the **Telefunken single-band "High Com"** system, will demonstrate the system and show the production models produced here.

**dbx** will have a new noise reduction unit, **Model 321**, aimed at the burgeoning satellite transmission circuits.

## OTHER PROCESSING UNITS

Equalizers for broadcast audio are going digital for more accuracy and versatility. An early entry on the digital side is the **new equalizer** from NEC. **Auditronics**, best known for its consoles, comes into this field with the new **PPEQ-1 parametric equalizer**, which features 32 on-board nonvolatile memories for settings. **Sphere** expands the digital audio control ranks by introducing a **digital attenuator** series for the digital audio console.

## ATRS, CART DECKS

Digital recording is definitely on its way for both radio and TV, but activity seems to have slowed temporarily,



Booth 318 will contain the Valley People exhibit of effects processors.



# Out of 4000 stations, 1700 chose our antennas.

**Phelps Dodge FM antennas were purchased for more applications from 10 watt educational to high power 25 kw class C stations.**

We believe no one else even comes close to that record, and no wonder.

Performance is the overriding reason. Our antennas are less susceptible to corona. You get proper phase relationship between the vertical and horizontal components. They are available with any combination of null fill and

beam tilt. And, remember, only Phelps Dodge antenna elements are fabricated of hard drawn, high conductivity copper.

Whatever your needs may be, we can probably meet them with a range of 25 different types from which to choose; low power, high power or super high power. Use an



element as a single bay antenna for limited coverage or use multi-element arrays. We also have circularly and horizontally polarized stainless steel educational antennas. Directional couplers and low pass filters complete the line.

Whichever model you choose, your Phelps Dodge antenna arrives complete, ready for installation, with a tunable input transformer to match the antenna to the location. Deicer kits and radomes are optional.

Write, telephone or TWX for Catalog 779 with all the details: Phelps Dodge Communications Company, Route 79, Marlboro, NJ 07746, (201) 462-1880, TWX: 710-722-3861.

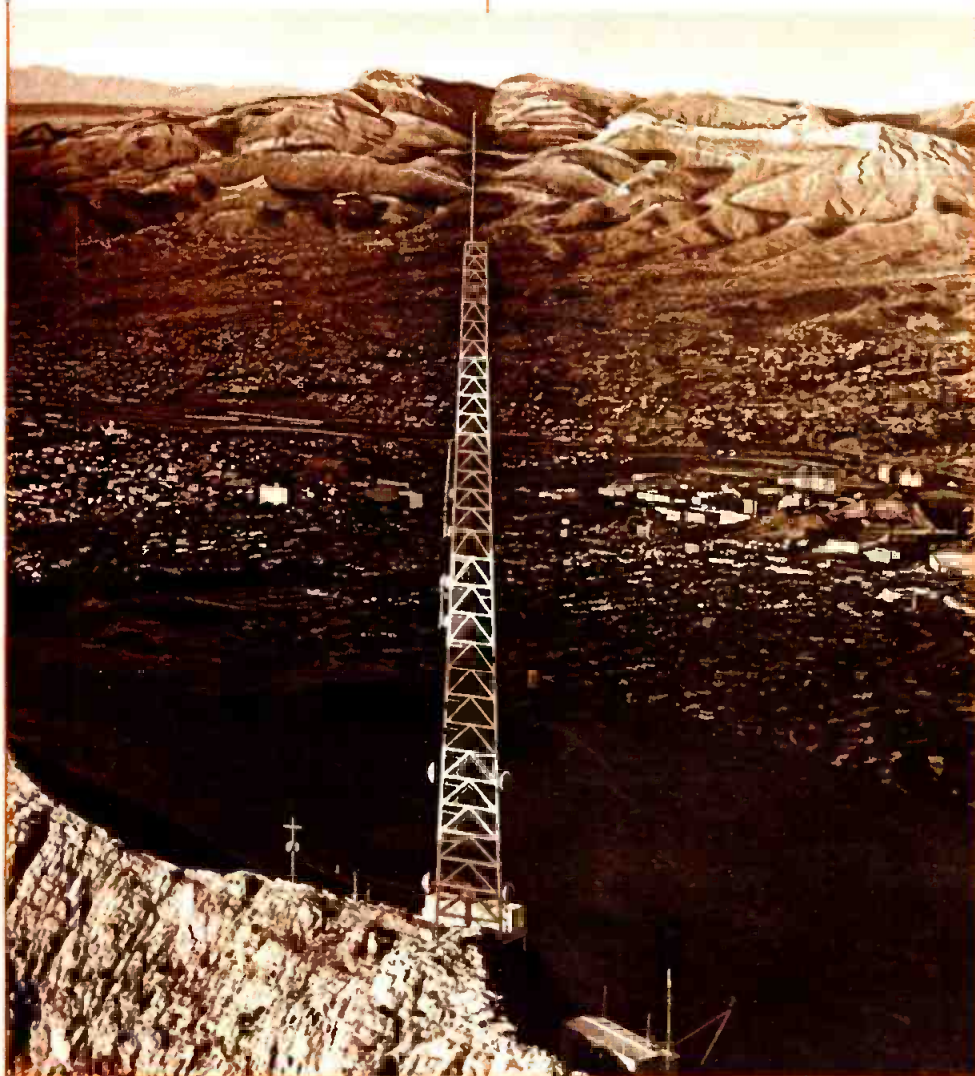

**phelps  
dodge**  
*Communications Company*  
A Division of Phelps Dodge Industries, Inc.

See us at Booth 1007, NAB Convention

Circle 183 on Reader Service Card

# ☆☆☆ AUDIO ☆☆☆ NAB '83

perhaps awaiting the digital video recorder. An interim solution is being offered by **dbx**, however, in the form of its Model 700 **low-cost digital audio processor** intended for creating a two-channel digital recording system when used with a videocassette recorder.

**Nagra**, which has gained considerable respect in the video community as the co-developer of the Ampex/Nagra VPR-5 videotape recorder, will again bring its popular audio recorder—with an addition of a **SMPTE time code head**, positioned at the apex of the head stack, providing a SMPTE time code center stripe. Nagra will also bring a SMPTE editing system for ATRs with controller and synchronizer/resolver.

**Otari** expects to light up the exhibit with the showing of the brand-new 5050 MK-III-2, a **two-track quarter-inch deck** in a tabletop console with editing features for production applications. Also new is the **MTR-12**, a quarter- or half-inch, two- or four-track recorder capable of handling reel sizes from seven to 12.5 inches. It can be rack-mounted or installed in a console, and the transport is microprocessor-controlled. The CB-116 auto-locator accessory is for Otari BQ II and all MK-III machines.

Production versions of the **Studer A810** will be new at NAB '83. The U.S. version has four speeds, selectable from the front panel.

**Gotham Audio** will introduce the **Telefunken M21 audio tape machine** with microprocessor control of transport functions. **Quantum Audio** will display at the same booth the Series 22 **modular audio console** for broadcast applications. **Ampex** will show its full line of ATRs. And **Fostex** will again show its low-cost multitrack recorder line. Those looking for replacement heads for ATRs should check at the **Nortronics** and **Saki Magnetics** booths.

There seem to be few revolutionary developments in cart machines this year, although it is possible that ITC may follow the lead of Pacific Recorders' TomCat and introduce a non-NAB standard.

There are, however, several modifications and improvements in cart decks. **Ramko** plans to unveil a major new professional series called **Primus**, which includes over 40 products. The features of this line of DAS, consoles, and cart equipment are slide-out modules, rack or tabletop configurations, and extended warranty.



*Soundcraft multitrack reels and audio equipment at booth 1724.*

ITC/3M will be introducing the **Delta Series** of audio tape cart reproducers and recorder/reproducers, designed to offer the same quality as the Premium Line but in a more compact package.

IGM will unveil the **MARC Manual Assist Remote Control** for Instacarts, as well as a new System Design Group for custom systems using microprocessors and IGM hardware or software.

**Broadcast Electronics** plans a complete demonstration of the line of **cart decks**. **Audi-Cord** will have the

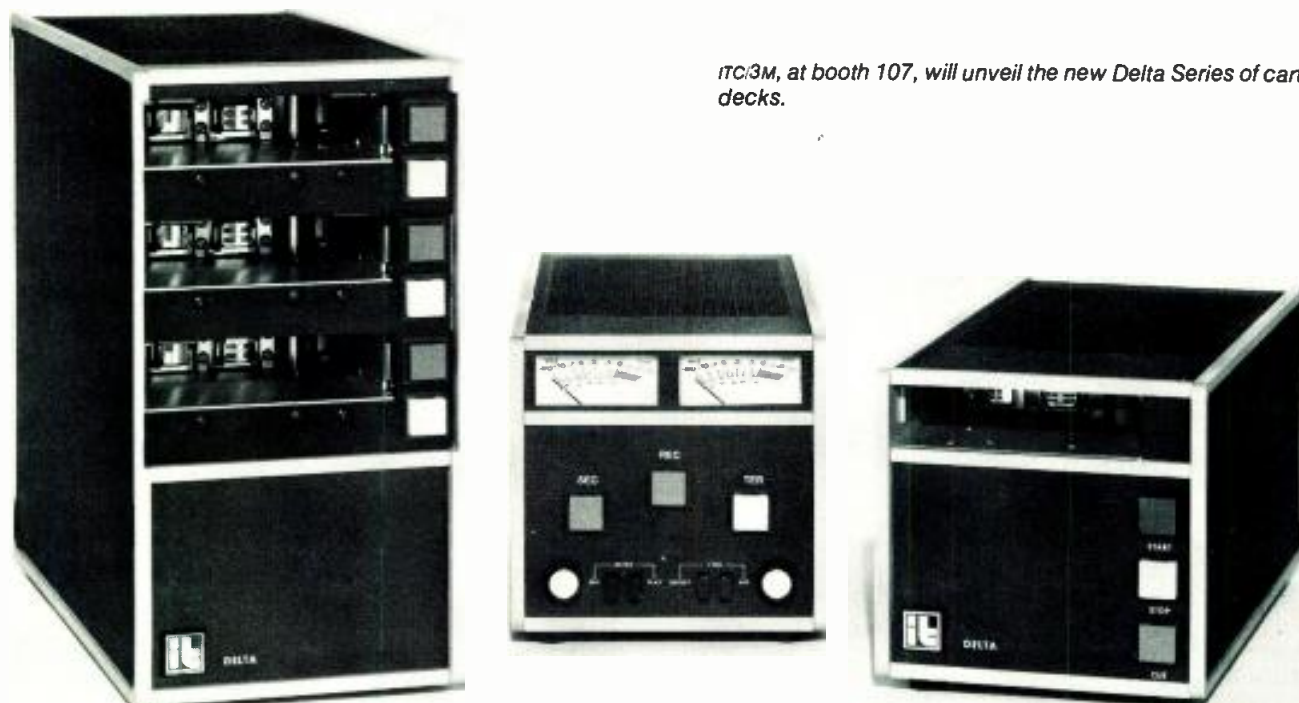

*ITC/3M, at booth 107, will unveil the new Delta Series of cart decks.*



# Storeel is dedicated to conserving energy. Yours.

Energy conservation is much in the news these days. Like the weather, many talk about it but few do anything about it. We haven't figured how to change the weather, but we do have several systems specifically engineered for broadcasters that both conserve energy and add efficiency. The very latest (shown installed) is called **STOR-MAX™**

Save energy (yours) by converting your overcrowded film and VTR libraries to the new "Instant Access" high-density systems engineered and distributed only by Storeel. Modular **Rapid Transit Storage™** maximizes units stored per square foot of floor space, minimizes retrieval time, optimizes energy efficiency.

Our many years of design and engineering pay off in solutions to your storage problems.

Call or write "The Railriders" at Storeel today for free estimate. No obligation, of course.



*Illustrated catalog of Storeel's "confusion eliminators" available upon request. Write on your letterhead or telephone for your free copy.*

See us at NAB Booth #1008

# STOR

**The  
Space-Saving  
Engineers**

2050-C Carroll Avenue • Atlanta, Georgia 30341 • Telephone (404) 458-3280



# SAM82

**SATT**  
**Electronics**

ac operated

Size: 17.5"x13.2"x3.2"  
445x335x80 mm

Weight: 17.9 lbs  
8 kgs



# SAM42

dc operated

Size: 11.3"x10.4"x3.1"  
287x263x78 mm

Weight: 8.5 lbs  
4 kgs



Made in Sweden by  
**SATT Electronics AB**

P.O. Box 32006  
S-126 11 Stockholm/Sweden  
Phone: +46 (8) 81 01 00 Telex: 10884 SATTELS

**April 10-13 · Las Vegas**

Booth No. 212

### International distribution:

**Benelux:** TransTec BV, Rotterdam **Canada:** Gerr Electro Acoustics, Toronto **Denmark:** AEG Dansk Elektricitets A/S, Copenhagen **Finland:** Sähköliikkeiden OY, Vantaa **France:** Publison Audio Professional, Paris **Japan:** Hoei Sangyo Co. Ltd., Tokyo **Norway:** Siv.ing. Benum A/S, Oslo **Switzerland:** Biesse Elettronica SA, Lugano **USA:** Martin Audio Video Corp., New York.

Circle 185 on Reader Service Card

# ★ ★ ★ AUDIO ★ ★ ★ **NAB '83**

new S Series, which replaces the 100 Series of cart machines. The medium-priced A Series will be shown from the existing line.

From the established line of **Fidelipac** products, the display will include a complete line of **NAB tape cartridges** and accessories, as well as audio tape carts. **Audico** will have its bulk tape loaders and erasers on hand. **NAB-type** carts can be seen at the **Capitol Magnetics** and **UMC (Beucart)** booths.

## **AUDIO PRODUCTION EQUIPMENT**

The audio production work horse, the microphone, will as usual get a lot of attention at the show. And once again **NAB** will bear witness that the wireless mic has established itself. **HM Electronics** will introduce **System 85**, a light-weight hand-held model incorporating **Shure SM85** mic electronics in a package three inches shorter than its previous model. In addition, **Swintek**, **Cetec Vega**, **Nady**, **Sony**, and **Comrex**, among others, will expand their wireless lines.

**Sennheiser** will be on hand with the **MKE-2 ultra-miniature electric lavalier mic**. **Crown International** will expand its **PZM** line with **three new mics**—**PH4**, **3LVR**, and **2.5 PZM**. And **Beyer Dynamics** will show its line of dynamic and condenser mics, as will **Electro-Voice**. **Shure Brothers** plans to highlight its unusual **Automatic Microphone System (AMS)** described in the **Audio Processing** section. **Audio-Technica** will introduce **AT-835**, a small **shotgun mic** especially designed for **ENG**. **Countryman Associates** will show its widely accepted **directional lavalier mic**. Mics from **Neumann**, **KMR82** and **82 shotgun** and **KMF4 minis**, can be found at the **Gotham Audio** booth.

**Gotham** will also have the new **EMT 938 broadcast turntable**. **Russo Electronics** will show a **direct drive turntable** and a new **phono preamp**. And **United Re-**



*EMT 938 turntable can be seen at Gotham Audio's booth 503.*





# No surprises.

See us at NAB Booth #1413

Available in 2", 1", 3/4" and 1/2" Beta and VHS.

Circle 186 on Reader Service Card



© 1981 Fuji Photo Film U.S.A., Inc., Magnetic Tape Division, 350 Fifth Avenue, NY, NY 10118

# ★ ★ ★ AUDIO ★ ★ ★ NAB '83

search Lab will display the Auto-Tec MP101 solid state mic preamp for professional recorders. Stanton and Shure will feature their pickups.

## INTERCOMS

Intercom developments at NAB this year will be led by the surprising entry of HME into the hardwired intercom arena—moving away from its traditional stance as a wireless systems manufacturer. It claims the market in RF systems, except for occasional special-purpose systems, is becoming saturated. This brings it head-to-head with both Clear-Com and RTS, both of which will also be taking a strong stance at the show.



The HME wireless intercoms will be at booth 1130.

Among these companies the movement appears to be towards the digitally controlled base station which allows switchboard-like assignment of channels and remote-control capabilities. Both Clear-Com and RTS will have new systems on display. The market leader here is apparently Ward-Beck, whose large-matrix MicroCom promises several new features.

Wireless systems still remain popular, of course. Some companies such as Telex offer both wireless and

hardwired systems, while others such as R-Columbia will feature only RF-based systems—specifically, several models of its popular wireless headset. Nady will arrive with a new Model PRC-3 duplex radio communicator and a new line of base stations. All the manufacturers mentioned above who offer RF mics will also have their RF intercoms available.

An exciting new product from Alan Gordon Enterprises is an extremely small wireless cueing device which fits inside the ear and is activated by an induction loop. Stanton will introduce an announcer's ear set, especially designed to be inconspicuous for on-camera work.

## TEST AND MEASUREMENT

The news in studio monitors is the arrival of Belar's low-distortion AM and FM units. The company will also have new AM stereo monitors. Electro Voice will be heard with its Sentry 505 and Logitek will introduce the Pyramid Met 11. For its part, James B. Lansing will highlight the 4401 two-way and the 4411 three-way monitors.



Amber Electro Design Model 3501 will be on display at booth 427.

Multipurpose test equipment is catching on in audio. For example, the 1510A is an all-in-one unit from Sound Technology that does ac volts, phasing, second and third harmonic distortions-versus-level, frequency response, channel separation, and so forth. Amber Electro Design's entry is the Model 4400A multipurpose audio test set. Amber is introducing Model 3501 portable distortion and noise measuring system with modular options.

Leader Instruments, a first-time NAB exhibitor, will arrive with a strong showing of a complete line of measuring equipment, especially scopes.



Booth 1142 will highlight RTS Model 802 intercom station.





JH-618-10-GO/VU

JH-800

# INSIDE. OUTSIDE. OR BOTH.

MCI's years of experience building the world's finest consoles has led us to the development of two new console configurations designed specifically for broadcast audio production. On the road, take studio performance with you in the new JH-800 compact console with user programmable broadcast signal flow, built-in communications functions and 12 mic or line inputs. Back in the

studio, make creative productions possible with our JH-618 console in its broadcast configuration with 10 mic inputs and five stereo line inputs.

Inside and outside, Sony Broadcast has the answer... with audio equipment from MCI. The choice of today's professionals.

Call Sony Broadcast in New York/New Jersey at (201) 368-5085; in Chicago at (312) 860-7800; in Los Angeles at (213) 841-8711; in Atlanta at (404) 451-7671; or in Dallas at (214) 659-3600.

MCI products are also available at: Control Technology, Inc., Ft. Lauderdale, Florida (305) 587-2716; Pro Audio General Store, Coral Springs, Florida (305) 752-0330; Pacific Recorders & Engineering Corp., San Diego, California (619) 453-3255; or Bennett Engineering Associates, Inc., Mercer Island, Washington (205) 232-3550.

**SONY**  
Broadcast

# If you're ready to move up to a specialized mixer, you're ready for Ramsa.

## The Sound Reinforcement Specialist: Ramsa WR-8716

When your sound says you're professional but your mixer doesn't. When you're wasting your subtlety and style on "make-do" boards. When you're creating compromises instead of clear-cut distinctions. Then you're ready for Ramsa—the mixers that are specialized so you won't have to compromise.

The WR-8716 is a fully modular sound reinforcement console with 16 input

modules, 4 group modules, and 2 masters. It features 16 input pre-fader solo buttons, 4 group modules with pre-fader insertion patch points, and lockable post-fader solo buttons. There are 6 illuminated VU meters with peak LED's for easy outdoor

reading and a separate stereo variable frequency EQ for monitor sends. Pan pot controls allow panning to the left or right masters while level controls permit 16 x 6 board operation. The left and right direct channel assign function lets you bypass the group modules for individual sources. Portable operation is a snap with easy access connectors.

And the WR-8716 features plastic conductive faders for greater reliability and smooth, low-noise operation; external power supply for light weight, and switchable 48V DC phantom power for condenser mics.





# RAMSA

## The Recording Specialist: Ramsa WR-8816

The WR-8816 recording console includes the same modular construction, input modules, power supplies, and faders as the WR-8716 plus many important recording advantages. Like direct outputs for 4, 8, or 16 track recording and peak-reading LED meters that let you monitor any 4 out of 24 signals with clear, quick response.

You'll command a variable frequency EQ section with 3 frequency settings for the high and low frequencies plus continuously variable

midrange. Stereo echo send replaces the separate mono controls you'll find on competitive boards. And you get two independent stereo monitor controls—one for musician's headphones, one for control room monitors—a special feature for any mixer in this class. And there are other important features

like low noise electronically balanced mic inputs with high-speed IC's, 16 switchable post-fader solo controls and XLR-type mic connectors.

Ramsa offers a full line of specialty mixers including the more compact WR-8210 recording mixer and WR-130 sound reinforcement mixer. So don't hold down your professional sound, call (201) 348-7470, because you're ready for Ramsa.



**Panasonic**  
PROFESSIONAL AUDIO DIVISION

Circle 188 on Reader Service Card

**GET YOUR HANDS  
ON A FREE  
SCOTHCART  
AT BOOTH 203**



**AND YOUR EARS  
WILL NOTICE  
THE DIFFERENCE.**

Our new Scotchcart Broadcast Audio Cartridge offers some dramatic improvements that are absolutely unheard of. So to make sure you hear these improvements, we're offering you a free Scotchcart. Just stop in and listen at booth 203 of the NAB show.

Scotch is a registered trademark of 3M

3M hears you...

**3M**



# ★ ★ ★ AUDIO ★ ★ ★ NAB '83

Among Potomac Instruments' line of test gear will be a new introduction, the MPC-11 modulation and power level controller for AM stations. Bird Electronics will feather its nest with RF test gear, including the Thruline RF wattmeter. Other exhibits to look for are TFT with AM and FM equipment, Asaca/Shibasoku with its extensive line, and Pinzone with its diagnostic system RCD-100P.

## TELCO/STUDIO COUPLING

This function continues to grow in interest, with new equipment both for the in-studio interface and the remote pickup function. (See the Facilities Design and Engineering article in this issue.)

ITC moves into the field with the FB-1 telephone interface unit. Comrex will bring new models of the frequency extender series (now handling both low and high frequencies), and the complete talk show system introduced last year.

Symetrix moves into the area with new telephone interface units. Studer will have the telephone hybrid and processor that it put on the market earlier.

## PROGRAM AUTOMATION

Further refinement has been the story of audio automation for some time.

Cetec, one of the standards, will have a new addition to the VIC automation, and will show the Series 7000 and 7000GLS, introduced last year, the latter particularly useful for handling syndicated programs that come in via satellite.

Autogram will introduce a new audio console with an interface to a TRS-80 computer, for automation and logging. Sono-Mag will have the line of control and manual assist systems.

IGM Communications will demonstrate the new MARC (Manual Assist Remote Control) for Instacarts. Also new for IGM will be the System Design Group, prepared to

The MRC-1600 remote control from Moseley can be seen at booth 301.

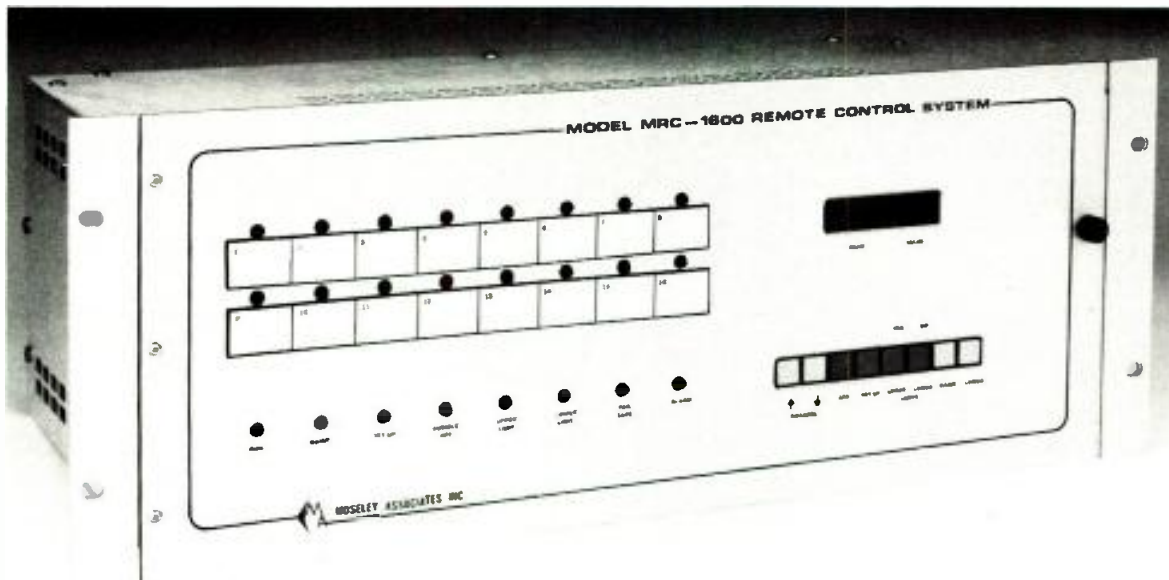

create custom automation systems for individual needs. Harris's long-established System 90 will also be on the floor.

## RPU, REMOTE CONTROL, AND STL

The companies strong in these areas in the past will again be the ones to watch for innovations. TFT, for example, will have a new high-density FM STL, Model 9300, aiding and abetting the trend to audio quality in FM. TFT also moves into a function just opening up: SCA for television, with the Model 1834 SCA system. TFT will have its line of modulation monitors, STLs, remote-control systems, and E-Alert receivers for the EBS alarm function.



Marti's RPT-2 unit will be on display at booth 501.

Delta's new option for the RCS-IV remote-control system, dual-site operation, is aimed for broadcasters who have widely separated AM and FM transmitter plants. Delta's modulation and power controllers, RF measurement and switching equipment will also be on display.

CAT Systems, whose microprocessor-based RC system features a color video monitor display, now has a synthetic voice capability to announce changes.

Hallikainen & Friends will bring its microprocessor-based remote control systems.

Moseley Associates, with a line of microprocessor-controlled remote control systems introduced in the last few years, is another pushing ahead from a strong base. The new MRC-1600 remote control system will bring further facility and refinement to this function.

Marti, a leader in broadcast-quality RPU systems, will show its coverage with the RPT-2 hand-held transmit-

# ★ ★ ★ AUDIO ★ ★ ★ NAB '83

ter, and others in this widely used line. New from Marti is the TSL-15-2 telemetry line with automatic switching, and the ATS-15 automatic transmitter switcher.

Motorola continues its broad coverage of two-way talk operations with a microprocessor-controlled repeater. Also shown will be studio communications systems, and Motorola's very extensive line of mobile and hand-held two-way radio systems.

MCA/Powerpak Systems, a reorganization of Micro Control Associates seen last year, will bring refinements on the heterodyne STLs introduced in 1982, and will add remote control systems and remote pickup equipment, FM exciters and generators, moving into a broader line in the transmission field.

## RADIO TRANSMITTERS

There will be a solid array of excellent radio transmitters on the floor, with the new ones filling out lines so that virtually every important maker can show a complete power range in both AM and FM. No sharp change in transmitter technology is now in sight, but both AM and FM models will generally be on the top of the steady trend of recent years to higher refinement—AM with much better handling of heavy modulation with lower distortion, FM

with extraordinary performance in the generator and exciter sections with respect to noise and distortion.

Solid-state designs will spread moderately, continuing the gradual but broad forward movement of last year. AM stereo equipment is going to turn up in some booths, but there is so far no sign of a wide-scale industry move in that direction. Motorola, however, plans to make an elaborate demonstration of its AM stereo system (the one chosen by Delco).

QEI will show several of these trends. They will have a new high-performance FM exciter, Model 695; a new all-solid-state 1 kW FM transmitter; and a new 3.5 kW FM model using a power tube.

Nautel Maine created some excitement last year with the Amfet solid-state AM transmitter line, and will revive that with a new member of the line, the Amfet I, a solid-state 1 kW AM. Singer is another with a new exciter, a 30 W direct-FM model, with digital phase-lock AFC. Singer will also have a new stereo generator and new 3 kW and 25 kW FM transmitters that solidify the line of top-grade models.

Broadcast Electronics, already strong in high-performance exciters and generators, will add three new transmitters: the FM-5, a 5 kW model; and the FM-3.5 and FM-1.5.

CSI promises a move to high power with photos of a 50 kW AM model now in development. The firm will also be one of the few with AM stereo equipment: a new synthesized AM exciter.

Continental Electronics, active in very-high-power AM for a long time, will have a line of AM units from 1 kW to 50 kW, and an FM line from 10 kW to 50 kW. New



**T-Audio Nagra won't make audio production easy. Just better.**

The re-entrant, servo-controlled two-track recorder by Nagra features a totally isolated transport system with twin capstans and servo-controlled motors with interhead tape tension sensors, as well as the kind of performance you'd expect from Nagra. Available with Time Code and features you won't find on any other machine. For more details about this extraordinary recorder, write to Nagra Magnetic Recorders, Inc., 19 West 44th Street, Room 715, New York, N.Y. 10036 (212) 840-0999. 1147 N. Vine St., Hollywood, Ca. 90038 (213) 469-6391

**NAGRA KUDELSKI**

A PASSION FOR PERFECTION  
Circle 190 on Reader Service Card



# LISTEN TO THE DIFFERENCE.

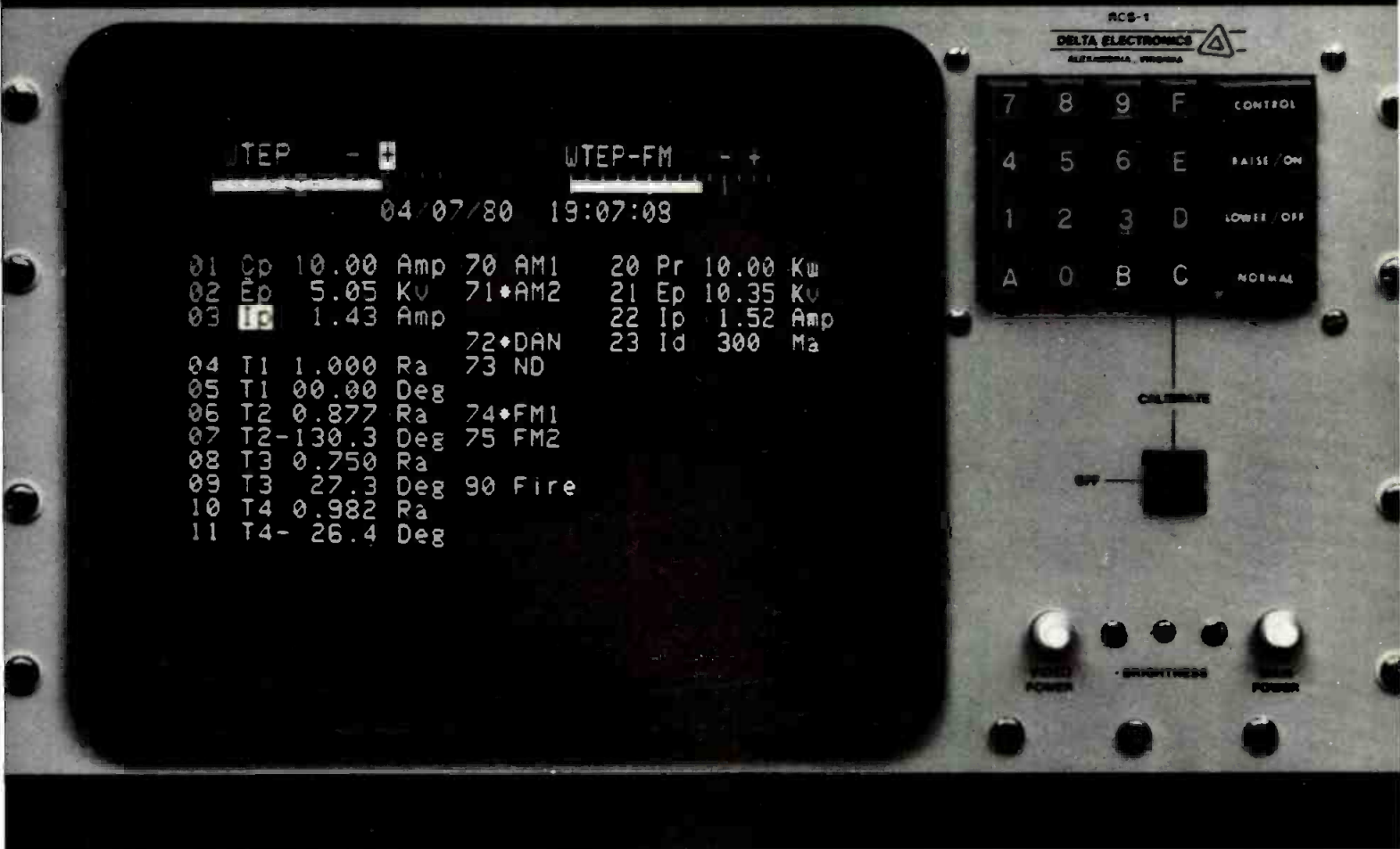

## THE DELTA RCS-1 REMOTE CONTROL SYSTEM

*A simple, yet sophisticated approach to AM, FM and TV Remote Control*

### SIMPLE.

- All parameters are displayed for the operator.
- Hands-off operation until an actual control function is required.
  - Automatic logging option ends the nightmare of forgotten or incorrect log entries.

### SOPHISTICATED.

- Features not found on other remote control systems:
- Modulation bargraph with peak flashers.
  - Direct antenna monitor interface.
  - Telephone coupler with speech synthesizer providing telephone interrogation.

The RCS-1 is designed to grow with your plant. Additional control, input, and alarm boards can be added to the systems, thereby meeting any new station requirements. In addition, the RCS-1 contains the fundamental building blocks for ATS, permitting conversion to a combination Remote Control/ATS System at a later date.

Write or call for a descriptive data sheet and pricing.

**DELTA ELECTRONICS**



5730 General Washington Drive, Alexandria, VA 22312 703-354-3350 TWX 710-832-0273

Circle 191 on Reader Service Card

[www.americanradiohistory.com](http://www.americanradiohistory.com)

# ★ ★ ★ AUDIO ★ ★ ★ NAB '83

will be an AM stereo exciter, adjustable to the various systems.

Harris, in bringing a new demodulator for the Harris AM stereo system, clearly hopes to encourage potential users to come in. Harris will emphasize the line of solid-state AM transmitters brought last year.

LPB will continue with the line of low-power modular AM transmitters, from 50 W to 250 W.

The ranks of all-solid-state systems will include the transmitters in this class introduced last year and earlier by Elcom-Bauer and RCA. Also welcome will be the McMartin and Wilkinson transmitters. The latter are now owned by Television Technology Corp. and will be shown by that firm.

Hipotronics, a new exhibitor at NAB and making a major push into the broadcast market, will demonstrate its high-power voltage supplies and voltage regulators.

## RADIO SYNDICATION

The syndicators of radio programming are not due on the floor in full force, with their number limited to eight or ten. Most of those on hand will reflect the unrest and competitiveness of radio programming today with new and remixed formats intended to pull together fragmented audiences. However, it must be remembered that by and

large the successful syndicators of the last five years are mostly still doing very well; virtually everyone present will be able to point to many stations attracting good audiences with one or more of the syndicator's programs.

BPI, with about a dozen active formats, will add another, **Country Oldies**, obviously an attempt to combine some of the pull of country music with the phenomenal strength lately of "nostalgia" music. Similar format-mixing for wider appeal is evident in **Toby Arnold's** promise to show **MOR Oldies**, **Adult Hot Hits**, and **Countdowns**, the last reflecting a contest slant.

Another great success area for radio programmers is music specials, an old idea but one stronger every year. **Drake-Chenault**, an old hand at long-running specials, has a new one in an obvious slot, **The History of Country Music**, which runs 52 hours.

**Live Sound** will demonstrate how its Country programs maintain freshness on an automation system. **Century 21** is introducing **Good Ol' Rock and Roll**, a marriage of rock and nostalgia (for better or worse). **The Musicworks** will emphasize a new blend of easy listening-MOR. **Peters Productions** has created **Easy Contemporary**, an updating and freshening of Beautiful Music for a more foreground, vocal-carried blend.

Others on the floor concerned with radio programming will include the makers of jingles and musical IDs, and the representatives of another large growth industry, the music libraries. The latter have multiplied lately and quite a few are evidently successful. Some present will be the **Network Production Library**, **Valentino Music Library**, **De Wolfe Library**, and now **Comprehensive Video**.  
BM/E

# ONLY FIDELIPAC GIVES YOU A CHOICE

## FOR MONO, STEREO...AM, FM, TV



**Master Cart II** For the modern stereo broadcaster satisfied with nothing less than the ultimate in performance.

**Model 300** The most popular NAB cartridge...performance and price make it the mono broadcaster's first choice.

**Model 350** For use in stereo machines with inadequate tape guidance. The precision is provided by adjusting the cartridge.

and, for extended play...Fidelipac Model 600 and 1200. For details, contact your Fidelipac Distributor or



## FIDELIPAC BROADCAST TAPE CARTRIDGES

Fidelipac Corporation  
P.O. Box 808 • Moorestown NJ 08057 • USA  
609-235-3511 • TELEX II: 710-897-0254

See us at NAB Booth #103

Circle 192 on Reader Service Card



# Studer Re-States the Art



With the new A810, Studer makes a quantum leap forward in audio recorder technology. Quite simply, it re-states the art of analog audio recording.

By combining traditional Swiss craftsmanship with the latest microprocessor control systems, Studer has engineered an ATR with unprecedented capabilities. All transport functions are totally microprocessor controlled, and all four tape speeds (3.75 to 30 ips) are front-panel selectable. The digital readout gives real time indication (+ or - in hrs, min, and sec) at all speeds, including vari-speed. A zero locate and one autolocate position are always at hand.

That's only the beginning. The A810 also provides three "soft keys" which may be user programmed for a variety of operating features. It's your choice. Three more locate positions. Start locate. Pause. Fader start. Tape dump. Remote ready. Time code enable. You can program your A810 for one specialized application, then re-program it later for another use.

There's more. Electronic alignment of audio parameters (bias, level, EQ) is accomplished via digital pad networks. (Trimpots have been eliminated.) After programming alignments into the A810's memory, you simply push a button to re-align when switching tape formulations.

The A810 also introduces a new generation of audio electronics, with your choice of either transformerless or transformer-balanced in/out cards. Both offer advanced phase compensation circuits for unprecedented phase linearity. The new transport control servo system responds quickly, runs cool, and offers four spooling speeds.

Everything so far is standard. As an option, the A810 offers time-coincident SMPTE code on a center track between stereo audio channels. Separate time code heads ensure audio/code crosstalk rejection of better than 90 dB, while an internal digital delay automatically compensates for the time offset at all speeds. Code and audio always come out together, just like on your 4-track. Except you only pay for 1/4" tape.

If you'd like computer control of all these functions, simply order the optional serial interface. It's compatible with RS232, RS422, and RS422-modified busses.

More features, standard and optional, are available. We suggest you contact your Studer representative for details. Granted, we've packed a lot into one small package, but ultimately you'll find that the Studer A810 is the most versatile, most practical, most *useable* ATR you can buy.

The Swiss wouldn't have it any other way.



**STUDER REVOX**  
PRECISION FROM SWITZERLAND

Studer Revox America, Inc. • 1425 Elm Hill Pike, Nashville, TN 37210 (615) 254-5651  
Offices: Los Angeles (213) 780-4234 • New York (212) 255-4462 • Dallas (214) 760-8647 • Canada: Studer Revox Canada, Ltd.

Circle 193 on Reader Service Card

[www.americanradiohistory.com](http://www.americanradiohistory.com)

# The definition of the best color camera

No matter how you define your color camera needs, you will want to be certain you have chosen the best tube for the job. And no technical appraisal can be complete without EEV Leddicons.

## Highest picture quality

Lag or smearing under low-light conditions is a common effect with most tubes - but less with EEV Leddicons! Instead of the twin-light pipe used by some competitors, Leddicons incorporate a unique light bias arrangement with a 10-hole and sintered quartz diffusing disc system for minimal shading. Differential lag is minimised by balancing the response speeds of the green, red and blue channels; so a football in flight will always look like a football - not a flying saucer! Light biasing is variable on 30mm and 25mm Leddicons. On 30mm types, biasing is integral so there is no need for a clumsy adaptor.

## High resolution

EEV is the only manufacturer to make three different target layers to optimise resolution for each color channel. The advantage of this unique feature can be clearly seen in the Leddicon's much better performance.

## Faithful color imagery

Faithful color imagery is all about reproducing what the eye sees. And that is exactly what Leddicons do. Extended reds have a precisely-engineered response and a matched infra-red filter is incorporated to provide cut-off where you want it.

## Reduced highlight image retention

Highlight image retention can be a production team's nightmare - the wrong choice of tube and highly polished orchestra instruments can end up looking like the aftermath of an aerobatics display. With EEV Leddicons, the problem is minimised by a unique target manufacturing process. The result is you can rely on Leddicons, even in the very difficult extended red channel where other tubes are simply unable to cope.

## Better tube quality - plus longer life

At long last a manufacturer who is prepared to talk about blemishes - but then we know Leddicons average less spotting than other tubes! The secret lies in the fact that all Leddicons must satisfy the most exacting manufacturing, testing and quality control standards. These not only preclude loose particles from the inside of the tube but also ensure longer tube life.

## Optimised geometry and registration

The optimised electron optical design of Leddicon ensures the best possible geometry without distortion. Registration too is equally distortion free - we can, in fact, supply computer-matched sets for all three channels.

# LEDDIC

## Unique anti-microphonic features

Nothing tests a tube more rigorously than the range of frequencies generated by an orchestra. With EEV's unique anti-microphonic mesh assembly, Leddicons provide the cleanest pictures - even from cameras operating in areas of high ambient acoustic noise.



FOR FURTHER INFORMATION ON LEDDICONs, CALL US TODAY.

**IN USA** Toll free 800 431 1230 (except for NY State).

**EEV Inc Corporate Office**, 7 Westchester Plaza, Elmsford, NY 10523.

Tel: 914 592 6050. Telex: 646180. **Mid. Western Sales Office**, 2073 Arleen Court, Schaumburg, IL 60194. Tel: 312 843 8417. **North-Eastern Sales Office**, 250 Hamilton Drive, Snyder, NY 14226. Tel: 716 839 5959. **Southern Sales Office**, Route 1, Anna, TX 75003. Tel: 214 837 2464. **South-Eastern Sales Office**, Suite 100E, 15 Dunwoody Park, Atlanta, GA 30338. Tel: 404 394 9201.

**Tri-State Sales Office**, 7 Westchester Plaza, Elmsford, NY 10523. Tel: 914 592 619

**Western Sales Office**, 19001 40th Place, N E Seattle, WA 98155. Tel: 206 363 220

**IN CANADA** EEV Canada Ltd, 67 Westmore Drive, Rexdale Ontario M9V 3Y6.

Tel: 416 745 9494. Telex: 06 989 363.

**REST OF THE WORLD** English Electric Valve Co Ltd, Waterhouse Lane, Chelmsford, Essex CM1 2QU, England. Tel: 0245 61777. Telex: 99103.



# tubes in the world.

## First for customer service

EEV is not only concerned with manufacturing the best tubes but also ensures the best delivery and after-sales service. Our reputation in this respect, like that of our Leddicons, is second to none.

To serve the needs of our broadcast customers in the USA and Canada best, we sell direct from our centers in New York and Toronto where we maintain a large inventory as well as full test facilities.

When you add up all the facts about EEV Leddicons, there is only one conclusion - namely, the definition of the best tubes for your camera. But don't leave it at that. Next time specify Leddicons for your new equipment and as replacements. Then find out what that definition really means in practice.

## Comprehensive range

EEV Leddicons are specified throughout the world for virtually every type of studio, EFP and ENG camera. The range covers 30mm (1 1/4 in), 25mm (1 in), 18mm (3/4 in) and 12mm (1/2 in) sizes. And the comprehensive choice of front- and rear-loading types includes diode gun, low output capacitance (LOC) diode gun, triode gun and tetrode gun highlight overload protection (HOP).

EEV Leddicons are fully interchangeable in most types of camera including:

BCC10/20/21	HL79/81/83	MNC80	TC80/85
BVP300/330	HK312/322	MKVIII/IX	TK47
CEI310	KCU/KCK 40	SK91/96	TK76
FOTON 1	LDK5/15/25	SK110	TTV1515/1516

# LEDDICONS<sup>®</sup>

®Leddicon is the Registered  
Trademark of EEV Lead Oxide Camera Tubes



**EEV** Camera Tubes 

See us  
at **NAB**  
on Booth  
**1335.**





**Amid the hostility, the confusion, the competition,  
one microphone stands above the crowd.**

## The SM63.

No matter how rough things get in the field, the Shure SM63 Omnidirectional Dynamic Microphone gives your crew the whole story with a lot less handling noise than any microphone in its class. When Shure's engineers developed the SM63 and SM63L (with longer handle), their objective was to create a high-output, lightweight microphone perfect for the needs of electronic news journalists.

With the SM63's patented internal mechanical isolation system reducing undesirable handling noise, its high output and smooth extended frequency response lets your story come through crisp and clear. Its omnidirectional polar pattern prevents boominess that is often encountered during close miking situations. And its overall lightness makes continuous hand-held ENG/EFP assignments less fatiguing, without sacrificing ruggedness. Even its profile is small and elegant so it won't obscure faces on camera.

The output of the SM63 is a full 6 dB higher than comparable hand-held interview microphones.

And there are even more precision-engineered refinements. A highly effective internal humbucking coil rejects strong magnetic fields encountered around lights and other broadcast situations. And when things get really tough, the Shure-developed *VERAFLEX*<sup>®</sup> grille is virtually impervious to rust, moisture and dents. This system includes a highly effective internal anti-wind and -pop filter; and for more adverse conditions, a dual-density two-layer windscreens also is supplied.

The Shure SM63. The hard-working microphone for the working press.

For more information on the complete line of professional broadcast products, call or write Shure Brothers Inc., 222 Hartrey Ave., Evanston, IL 60204, (312) 866-2553.

# SHURE<sup>®</sup>

**THE SOUND OF THE PROFESSIONALS<sup>®</sup>...WORLDWIDE**

Circle 195 on Reader Service Card

[www.americanradiohistory.com](http://www.americanradiohistory.com)

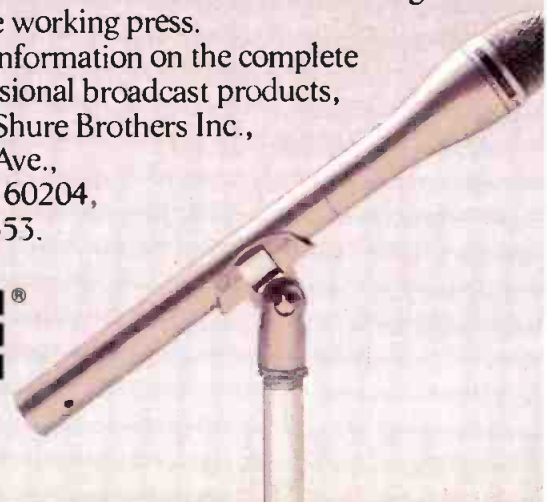





# AUDIO AND RADIO PRODUCTS LISTING

## ADAMS-SMITH (1704)

Will show time code synchronizers with accuracy to 1/100th of a frame. Also time code generators and readers.

## ADC MAGNETIC CONTROLS (1320)

Will add new coaxial jacks and panels, switching coax, humbuckers, and "an exciting new concept in audio patching systems" to its line of jackfields and patching equipment.

## ADM TECHNOLOGY (1223)

Will highlight a brand-new audio console for video post-production with VCA control, direct outputs, and remote control from a switcher or editor. Also new will be a "high tech" console incorporating a random-access audio routing switcher. These round out a complete line of consoles designed for radio and TV applications.

*See ad Cover 2.*

## ADVANCED MUSIC SYSTEMS/AMS (1330)

Will show a complete range of digital audio processing systems, including the DMX 15-80S stereo digital delay with dual pitch changers, the new RMX 16 digital reverb system, which has nine different reverb programs, and the A/V sync audio delay compensator for video synchronizers.

*See ad page 229.*

*Booth numbers as supplied by NAB.*

## ALCOA-NEC COMMUNICATIONS (1415)

Will display satellite earth station antennas and transmit/receive earth station electronics.

## ALLIED BROADCAST EQUIPMENT (639)

A complete new line of Kustom Kraft control room furniture will be introduced. Handling new products for over 160 broadcast lines, including Modulation Associates' satellite receiver and Bonneville DA line.

## ALLIED TOWER CO. (409)

Will show microwave and broadcast transmitting towers.

## ALPHA AUDIO (422)

Will again feature Sonex, the open-cell urethane plastic foam designed to control reverberation time, eliminate stray reflections, and kill standing waves. Employing the "anechoic wedge" principle, the material optimizes noise dissipation through its spectral geometric shape and offers a 450 percent increase in surface area over flat material.

*See ad page 183.*

## AMBER ELECTRO DESIGN (422)

Will introduce Model 3501 distortion and noise measuring system, a portable instrument with modular options and competitive pricing. Will also have the Model 4400A multipurpose audio test set on display, along with a com-

plete line of audio test and measurement products.

## AMCO ENGINEERING (1218)

General exhibit will contain communications consoles, styling options, computer desks, and complete desktop cabinets.

## AMERICAN BELL (1429)

(Formerly AT&T.) Will feature System 85, the newest member of its Dimension PBX system—offering voice, data communications, energy and security management, etc.

## AMPEX CORP. (1400)

Will display its established ATR-100, ATR-700, ATR-800, and ATR-124 professional audio recorders. (Also see listing in video section.)

*See ad pages 49-56, 105-108, 210-211.*

## ANCHOR SYSTEMS (443)

Will show the new 100 and 200 Series of powered speakers for mini-P.A. system or as monitors and mobile units with batteries.

## ANTENNA TECHNOLOGY CORP. (1737)

Showing a new simulstat 3-meter antenna for radio. (Also see listing in video section.)

## APHEX SYSTEMS (515)

Showing the new Type B aural exciter, an economic sound enhancement device. The Aphex II aural exciter and

the EQ-2 sweep EQ/filter will also be demonstrated.

**ARBITRON RATINGS (802)**

Plans to show the new Prizm AID, a feature of the "Information on Demand" applications package. Will also have all other applications packages.

**TOBY ARNOLD & ASSOC. (321)**

Offering new radio programming such as MOB oldies, adult hot hits, countdowns, and a new contest and promo library. Also offering MOB nostalgia and two production libraries.

**ARRAKIS SYSTEMS (121)**

Demonstrating four console lines, the 150SC, the 500SC, 2000SC, and 2000R. Will also have one routing switcher, the 100RS.

**ASACA/SHIBASOKU (1226)**

Introducing the new AA-100 digital audio synchronizer. (Also see listing in video section.)

*See ad page 73.*

**ASSOCIATED PRESS (419)**

Will display its broadcast news services.

**ATI/AUDIO TECHNOLOGIES INC. (420)**

Will introduce the DA 10,000 audio distribution system which has up to 10 interchangeable plug-in amp modules combined with dual plug-in power supplies in a small rack frame. Showing a series of audio equipment, including dual microphone, line, phono and monitor amps as well as DAS, and a brand-new audio processor, the Emph'a Sizer.

**ATLAS TOWER (617)**

Plans to introduce the international series of knock-down type tower along with new tower leases and leasing packages. Will also have towers to 2000 feet, guys, self-supporting towers, and tower-related products.

**AUDICO (1343)**

Will promote its new videocassette and videotape loader/reloader/rewinder with capacity for audio tape as well. (Also see listing in video section.)

**AUDI-CORD (123)**

The new S Series which replaces the 100 Series of cart machines will be introduced. The medium-priced A Series will be shown from the existing line.

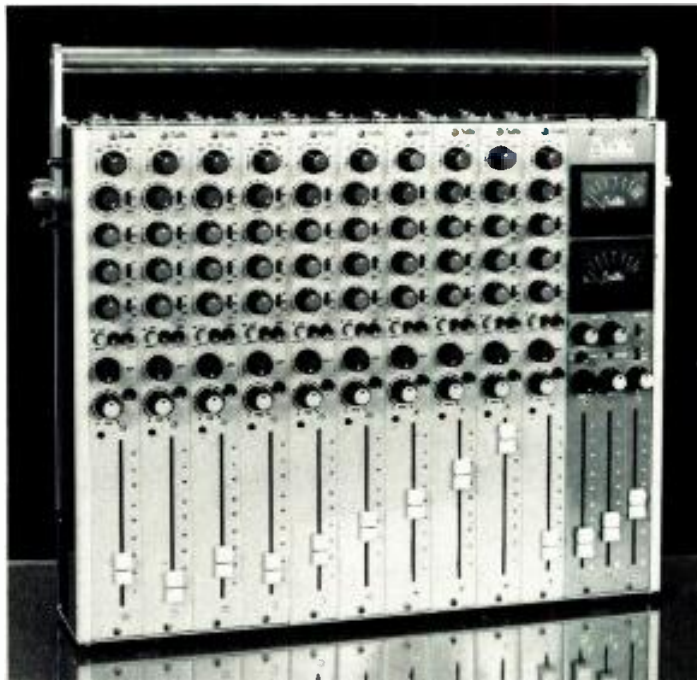

Audio Developments, at booth 1709, will demonstrate the AD145 Pico mixer.

**AUDIO + DESIGN (402)**

Will premiere two new modules for its SCAMP (Standardized Compatible Audio Modular Package) system. S27 is a four-band phase coherent crossover and recombining amp allowing SCAMP to be used as a multiband processor for either broadcast or sound reinforcement. S28 is a dual VCA module combining two A+D VCAs. These products round out the complete line of audio processing equipment.

**AUDIO DEVELOPMENTS (1709)**

Featuring three products, the AD 062 multimixer for portable applications containing a comprehensive EQ section and high-pass filtering; the AD 145 Pico mixer; and the AD 160 ENG mixer with battery test, built-in charging meter for nicad batteries, and switchable monitoring between output and line.

**AUDIO KINETICS (1173)**

A new, compatible keyboard controller, the Q-Link, for the Q-Lock synchronizer will be introduced at the show. It contains its own subprocessor, has user-definable keys, and is equipped for intelligent interface to automated consoles. The Q-Scan will be shown as a modified HP microprocessor that stores edit information with optional augmented memory.

**AUDIO-TECHNICA (1141)**

Will introduce the AT835 short shotgun mic for hand-held ENG applications. It features 100 Hz switchable high-pass filter and is powered by a single AA penlight battery. Exhibiting the complete line of professional microphones, mixers, headphones, tone arms, cartridges, and record care products.

**AUDIO TECHNOLOGY (512)**

Showing line of LED level meters and a small portable mixer, the Mk III. Also displaying the Keith Monks line of mic booms, stands, and cables.

**AUDITRONICS (505)**

Plans to introduce the PPEQ-1 programmable parametric equalizer, which will accept up to four mono or stereo tracking equalizer units, each containing three bands of EQ with variable frequency. Standard unit includes 32 on-board nonvolatile memories. Will also show the complete line of broadcast, production, and recording consoles and accessories as well as the RTW peak program meters.

*See ad pages 31,184,185,218.*

**AUTOGRAM CORP. (120)**

Will debut a brand-new fully microprocessor-controlled audio console, featuring up to 60 inputs, three stereo program outputs, a mono program output, and interface with a TRS-80 Model III for two channels of automation and logging.

**AVC SYSTEMS (616)**

Showing a new broadcast console and control room furniture as well as existing line of products, including distribution in U.S. of Bayly/Telefunken transmitters. (Also see listing in video section.)

**AYDIN CONTROLS (1642)**

**BASYS (1503)**

Will feature News Fury and Mini Fury full-function computer systems for news production; Clip Fury computer system for newsroom libraries; and Cart Fury label printer for audio carts.



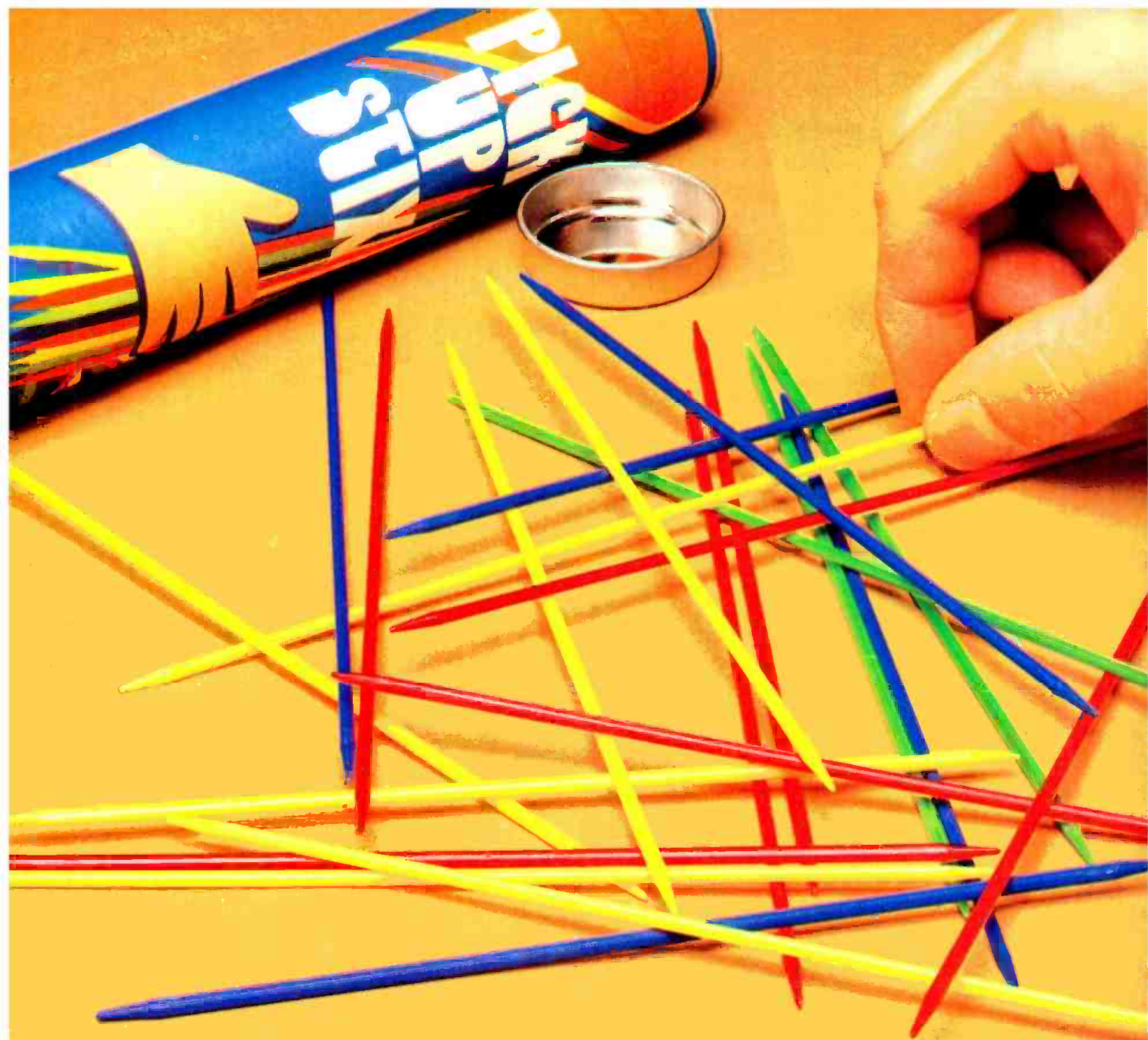

# WHEN YOU NEED ONLY ONE...

Now you can extract just one channel from a T1 carrier multiplex system without disturbing the other channels. And without decoding and re-encoding through back-to-back channel banks! Inserting a channel is just as easy. Our new Intraplex system makes all this possible and cost effective. Intraplex works with voice frequency telephony, data circuits, and full-fidelity audio program channels.

If we've touched on your area of operation, we invite you to send for our Intraplex brochure.

**tau-tron**

A UNIT OF  
**GENERAL SIGNAL**

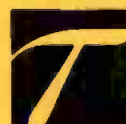

©1982  
Tau-tron Inc.  
27 Industrial Ave.  
Chelmsford, MA 01824  
(617) 256-9013

Circle 196 on Reader Service Card

# Dramatically improve your FM performance . . .



## The New Harris MX-15 Exciter

Unequaled audio performance and specifications. Wideband input FM Noise (S/N) is 80 dB! Equally impressive are CCIF Intermodulation Distortion measurements. Using 14/15 KHz test tones, distortion products are over 60 dB down in stereo mode...over 80 dB down through the wideband mode! Wideband 60 Hz/7KHz 1:1 Intermodulation Distortion is .02%.

A truly balanced, floating composite input eliminates ground hum pickup. The exclusive adjustable hum bucker nulls out extraneous magnetic fields

unique to your installation. New construction techniques reduce susceptibility to microphonics. And at maintenance time, you'll appreciate the ease of accessibility to modules.

The Harris MX-15 outperforms *any* other FM exciter in these and other key performance areas. And it's the heart of Harris' complete line of FM transmitters. For more information, contact **Harris Corporation, Broadcast Division, P.O. Box 4290, Quincy, Illinois 62305-4290. 217/222-8200.**

Visit Harris at the 1983 NAB,  
Las Vegas, in North Hall



# HARRIS

Circle 197 on Reader Service Card





**BEAVERONICS (1313)**

Will introduce new square version of Favag's **impulse slave clock**. Also plans to display Favag line of master clock systems, including the QMS-1 master with accuracy of better than one second/year, along with numerous types of analog slaves and digital displays activated by the Favag master. (Also see listing in video section.)

**BELAR ELECTRONICS LAB (300)**

Will add new **FM monitors** and new **AM stereo monitors** to its established line of AM, FM, FM stereo, and TV monitors.

*See ad page 276.*

**BEYER DYNAMIC (426)**

Will highlight its full line of microphones, including dynamic mics with both moving coil and ribbon electronics, and electret condenser mics in mini-omni and shotgun models. Also the line of professional headphones.

*See ad page 201.*

**BGW SYSTEMS (421)**

Will display its audio monitors, power amps, and crossovers.

**BIRD ELECTRONIC (1625)**

Will show the new Moduload **RE calorimeter/load system** and the new dolly-mounted, water-cooled **load resistor series** for 10-80 kW. Also on hand will be self-cooled line terminations, water-cooled load resistors, RF power analyzers, high-speed transmission line monitor/alarm, and ThruLine RF watt meters.

**BOGNER BROADCAST EQUIPMENT (1319)**

Will show circularly polarized FM antennas, and MDS and ITFS transmitting and receiving antennas. (Also see listing in video section.)

**BPI/BROADCAST PROGRAMMING INTL (122)**

Will add new **Country Oldies** format to established radio syndication products.

**BRAND REX/CONNECT-AIR INTL (1764)**

Showing cables and cable assemblies, connectors and back shells.

**BROADCAST AUDIO CORP. (213)**

Will unveil System 14 **analog stereo console** and System 5 **news console**, as well as new **studio cabinetry**. Also showing System 8/12/16 stereo audio

consoles, System 14 digitally controlled audio console, System 20 advanced stereo audio console, plus full line phono preamps, distribution amps, and MOSFET power amps, all featuring plug-in amplifier cards.

**BROADCAST CARTRIDGE SERVICE (611)**

Will offer a new **stereo meter**. Company also supplies Aristocart, Audiopak, Fidelipac, and 3M Scotchcart audio carts. (Also see listing in video section.)

**BROADCAST ELECTRONICS (303)**

Will introduce three brand-new FM transmitters: FM-5 (5 kW), FM-3.5, and FM-1.5. These complement the FM-30, and the full line of FM stereo generators, SCA generators, the Control 16 microprocessor-based automation system, and a full line of cart decks.

**BROADCAST MUSIC, INC./BMI (124)**

Will describe BMI's services for broadcasters.

**BROADCAST SYSTEMS (1500)**

Will describe its equipment rental service.

**BROADCAST TECHNOLOGY, INC. (1701)**

New product introductions will include 10-band **signal processor**; remote, portable, self-powered **program interrupt system**; compact, self-powered 1X10 audio DA with XLR connectors; and microprocessor-controlled **routing switcher** with multiple control stations. Will also show complete range of audio PC cards and rack-mounting frames from mic preamps to power amps, including equalizers.

*See ad page 24.*

**BRYSTON LTD. (517)**

Introducing the new 2B **cue foldback and monitor amplifier**, 50 watts occupying one rack space. Will also have new 2B **line amp**. Standard equipment includes the 3B, 100 W, and the 4B, 200 W amplifiers.

**THE BTX CORP. (1124)**

Will introduce a personal-computer-based full **audio editing system** designed specifically for audio. The BTX synchronizer and Cypher will be interfaced with the editor. Also new will be a **film table editing interface** to the Shadow system that will allow flatbed editors or Moviolas to interface with the Shadow. A new **computer-controlled keyboard** for Shadow, Soft Touch, will support up to four machines for audio sweetening and auto-

matic dialogue replacement operations for film, video, or audio post-production. Will also introduce an **interface from the Shadow synchronizer** to fill dubbing equipment, notably Magna-Tech.

**CABLEWAVE SYSTEMS (108)**

New products will be low loss, moisture block, annular copper corrugated **transmission line**. Phase temperature characteristics are excellent for sampling line systems in critical antenna arrays. Other products will include various diameter sizes of air and foam dielectric copper corrugated Wellflex transmission line, RF connectors, microwave parabolic antennas, mounting hardware, and pressurization equipment.

**CAMBRIDGE PRODUCTS (1328)**

Will display right-angle BNC, TNC coaxial connectors, including the company's Fastfit/Twist-on construction.

**CANARE ELECTRIC (1732)**

Showing five-conductor mic cable and portable cable reels with pre-made junction boxes as well as bulk audio cable. (Also see listing in video section.)

*See ad page 230.*

**CAPITOL MAGNETIC PRODUCTS (665)**

Will demonstrate the AA-3 broadcast cart and will unveil an updated version of the AA-3 with significant sound improvement.

*See ad page 20.*

**CBS RADIO STATIONS NEWS/BYLINE (606)**

Offering *BYLINE Magazine* with 13 news and information broadcasts in national syndication. The 90-second features cover several topics from music to medicine.

**CENTRAL DYNAMICS (1409)**

Will introduce its new 2350 Series **audio DAS**. Displays from the standard line of products will include the AFM 10 audio-follow-video mixer and the VG2210 digi-sync. (Also see listing in video section.)

*See ad pages 116-117.*

**CENTURY 21 PRODUCTIONS (204)**

Will premiere new **nostalgia rock format**, "Good Ol' Rock and Roll," along with The Motivators, new **production library**. Will also feature 15 established radio formats and rebuilt broadcast automation equipment.

**CETEC BROADCAST GROUP (601)**

Will introduce a completely new **addition to the VIC automation**, along with

# MICROPROCESSORS = MACRO RESULTS

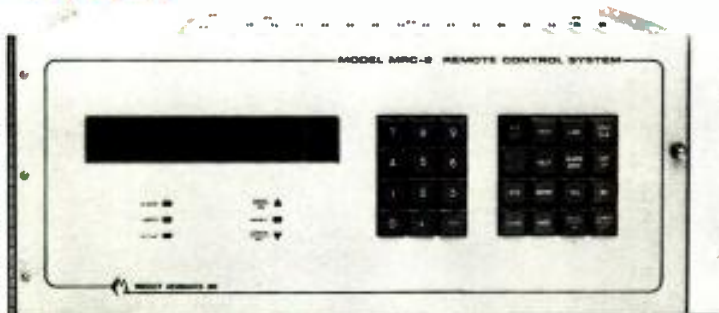

## MRC-2

- MULTI-REMOTE AND MULTI-COMMAND SITE CAPABILITY
- MULTIPLE TRANSMISSION CHANNELS
- USER DEFINED SOFTWARE
- CLEAR ENGLISH DISPLAY

Leading Moseley's ever-growing family of microprocessor-based remote and supervisory control systems, the MRC-2 offers the user the most flexible and complete method of controlling and monitoring up to 99 remote sites available. With dual data link capability, 32 control lines, 32 status, and 32 telemetry channels standard; expansion capabilities allow for up to six data links, up to 255 control lines, and 255 status and 255 telemetry channels. User-defined dual upper and dual lower telemetry limits alarm when exceeded. Status channels can be programmed to alarm on rising, falling, or rising and falling waveforms. The MRC-2 offers a choice of six calibration modes for telemetry inputs; all setup data is preserved in non-volatile memory. Multiple CRTs, Loggers, and Automatic Control Units for automatic transmitter operation are available at both command and remote terminals.



## MRC-1

- MULTIPLE REMOTE SITE CAPABILITY
- AUTOMATIC TELEMETRY MUTING
- USER DEFINED SYSTEM SETUP
- UP TO 64 COMMAND LINES PER SITE

Closely following the MRC-2 in performance, Moseley's MRC-1 is the leading Microprocessor Control System in the industry today. Up to 64 command outputs at each of up to nine remote terminals gives the user outstanding system flexibility. System setup is tailored by the individual user. Telemetry channels may be keyboard-calibrated for linear, indirect power, or direct power scaling. The MRC-1 features modular design, upper and lower telemetry limits, automatic telemetry muting, and a set of 32 LEDs that display all status inputs from any site simultaneously. In case of extended shutdown, the Moseley Memory Option stores setup data for up to ten years. Optional CRT and Logging terminals simplify operator interface with the MRC-1. The Multiple Direct Command options offers ten preselected command functions to give the operator quick control of critical parameters at any site.

For further information please contact our Marketing Department.

## MOSELEY ASSOCIATES, INC.

A Flow General Company · Santa Barbara Research Park

111 Castilian Drive . . . Goleta, California 93117  
(805) 968-9621 · Telex: 658-448 · Cable: MOSELEY



the Series 700 and 700GLS program automation systems introduced last year. Also new is the complete line of IBM business systems designed for broadcasters. The standard line of equipment will include the 2000 and 8000 Series of audio consoles and the MAPS system for station business management.

### CETEC VEGA (1210)

New additions to the line of wireless microphones will be shown in conjunction with the complete line of established wireless mic and intercom systems.

See ad page 176.

### CHRISTIE ELECTRIC (1016)

Will introduce maxERASE-16, new bulk tape/cassette degausser for high coercivity audio, video, and audio/video formats. (Also see listing in video section.)

See ad pages 187, 258.

### CIRCUIT RESEARCH LABS (106)

Will introduce a new TV audio processor with gated gain control circuits to prevent unwanted background noise. Audio is split into two bands to prevent unwanted pumping and holepunching. Features alignment-free internal circuitry and absolute peak control. Also introducing a new SCA processor/generator for subchannel communications. Showing for the first time the SMP-1000A AM stereo limiter. Also bringing line of audio processors for AM and FM stations, multiband AGCs, dynamic equalizing compressors, and precision limiting.

### CLEAR-COM INTERCOM SYSTEMS (1502)

Will introduce the DLC Series (digital logic control), with a solid-state design feature that combines the reaction of analog switch functions with digital circuitry. First DLC product is the MS-800 eight-channel main station. Other new products are KB-115A remote intercom station, a compact, self-contained rackmount model, the KB-112 remote intercom station, and revised versions of the MR-103, a KB-11A remote intercom station.

See ad page 22.

### CLYDE ELECTRONICS LTD. (106-A)

Showing the Alpha Series of modular mixing consoles as well as Delta Series pushbutton news presentation mixers, and a number of specialized 19-inch rack-mounting broadcast products.



**COLUMBINE SYSTEMS (1122)**

Sales analysis, traffic billing, accounts receivable, film inventory and amortization, and music inventory and rotation products and services will be on display. Cash management programs, automation interface, payroll, and media inventory will also be offered.

**COMEX (1508)**

Will display its digital audio delay products.

**COMPACT VIDEO SERVICES (1142)**

See listing under RTS.

**COMPREHENSIVE VIDEO (1315)**

The new comprehensive production music library, the PML-8, will be introduced along with a new line of microphones. (Also see listing in video section.)

**COMPUCON (1616)**

Plans to introduce new radiation hazard measurements designed to document levels from existing common carrier, private microwave, or earth station transmitting facilities. Other products on display will include earth station frequency analysis and coordination and engineering, cellular and land mobile engineering, and frequency protection.

**COMPUTER CONCEPTS CORP. (404)**

The TSA, Total System Automation, will be introduced, offering a communication link between the business automation and program automation functions of a station. Other products include the Broadcast System business computer, word processing, Music Management System for generating playlists and controlling inventory, and Coop Management, a word processing system for billing and cooperative advertising.

**COMREX CORP. (400)**

Under the theme of "Remote Broadcast Audio Transmission," will show new models of frequency extender system, plus full line of frequency extenders, talk show system, ENG Q systems, and wireless mics. Will also show the complete line of Itame, STL, RPU and FM exciter lines.

**COMSEARCH (1136)**

Will demonstrate as new products a digital termination system for frequency coordination, paging services, FCC testing, and cellular radio engineering services. Also on display will be point-to-point terrestrial microwave planning and earth station frequency

**\$3,695.00**

**NEW**

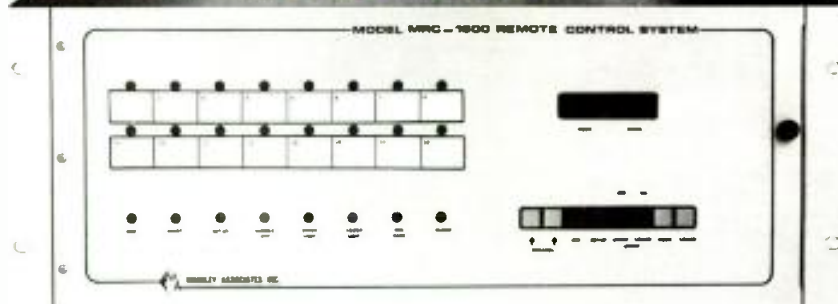

**MRC-1600**

- 16 RAISE AND 16 LOWER COMMAND LINES
- 16 CHANNELS EACH, STATUS AND TELEMETRY
- ADAPTS TO ANY INTER-CONNECTION NETWORK

Microprocessor sophistication and economical price unite in Moseley's newest Microprocessor Remote Control, the MRC-1600. A full 16 status channels, 16 telemetry channels, and 16 raise and 16 lower, relay-isolated command lines provide flexible, dependable and noiseless operation between the control and remote site. Plug-in modules adapt the MRC-1600 to any interconnection network, 2-wire or 4-wire telephone lines, subaudible, FM subcarrier, or a combination of these.

System setup and calibration are easy. In each channel, telemetry data may be calibrated in one of four modes; millivolt, power, indirect power and linear. Upper and lower telemetry

limits may be set or disabled independently. Status inputs may be muted for no alarm, or set to alarm on rising, falling, or rising and falling waveforms. They may display direct or inverted. Set up data entered at the remote terminal is automatically backed up at the control terminal which ensures that a temporary power down of either terminal does not mean loss of set up data.

In operation, telemetry data is checked against upper and lower limits. Visual and audible alarms are enabled upon any excursion beyond preset limits. ACKnowledging the alarm gives the operator all needed information to bring telemetry back within limits. The MRC-1600 maintains special channels that monitor A/D ratios and data link conditions. It also has full control Fail-Safe features and a Maintenance Override mode to lock out command signals to the remote unit, yet maintains status and telemetry updates.

- SETUP DATA BACKED UP AUTOMATICALLY
- ALL TELEMETRY LIMITS MAY BE SET OR DISABLED INDEPENDENTLY

For further information, please contact our Marketing Department

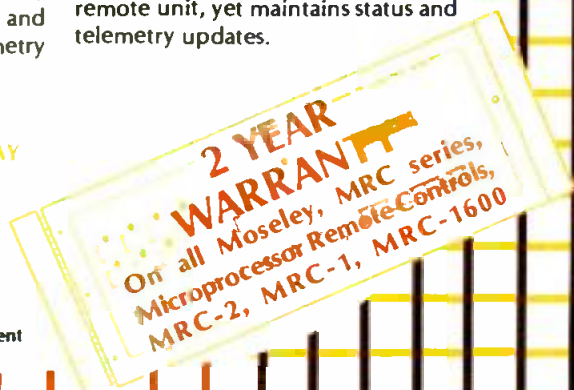

**MOSELEY ASSOCIATES, INC.**

A Flow General Company . Santa Barbara Research Park

111 Castilian Drive . . . Goleta, California 93117  
(805) 968-9621 . Telex: 658-448 . Cable: MOSELEY

Circle 199 on Reader Service Card

coordination. (Also see listing in video section.)

**CONCEPT PRODUCTIONS (423)**

Will specialize in voice-track programming and concept programming for automated radio stations with four different formats including country, AOR, and adult contemporary.

**CONNECTRONICS CORP. (608)**

Formerly Canford Audio, will exhibit the new ACCESSIT budget priced line of audio signal processors including compressors, EQs, reverbs, noise gates, preamps and stereo power amps. Will also have a wide range of colored wire and cable.

**OTIS CONNER PRODUCTIONS (414)**

A new production library for TV and radio, The Sound System, will be introduced. Also new is ID product, "This Is It" urban contemporary package. Other packages include full-service radio ID series and adult contemporary ID packages.

**CONNOLLY LEGATE LTD. (1159)**

**CONTINENTAL ELECTRONICS (101)**

Plans to display AM transmitters of 1, 5, 10, and 50 kW, and AM stereo exciter. Also FM transmitters of 10, 20, 25, 40, and 50 kW, and FM exciters, antennas and studio consoles.  
*See ad page 30.*

**CONTINENTAL RECORDINGS (333)**

Introducing a new adult contemporary ID package, a country ID package, and several new commercial jingles. Will have a complete selection of commercial jingles and station ID packages as well as music effects library.

**CROSSPOINT LATCH (1321)**

Will show its audio mixer. (Also see listing in video section.)  
*See ad page 36.*

**CROWN INTL (428)**

Plans to unveil its new line of microphones, the PH4, 3LVR, and the 2.5 PZM. Will also show the line of amplifiers and preamps.

**CSI ELECTRONICS (507)**

Showing the new synthesized AM exciter and photos of the T50A 50 kW

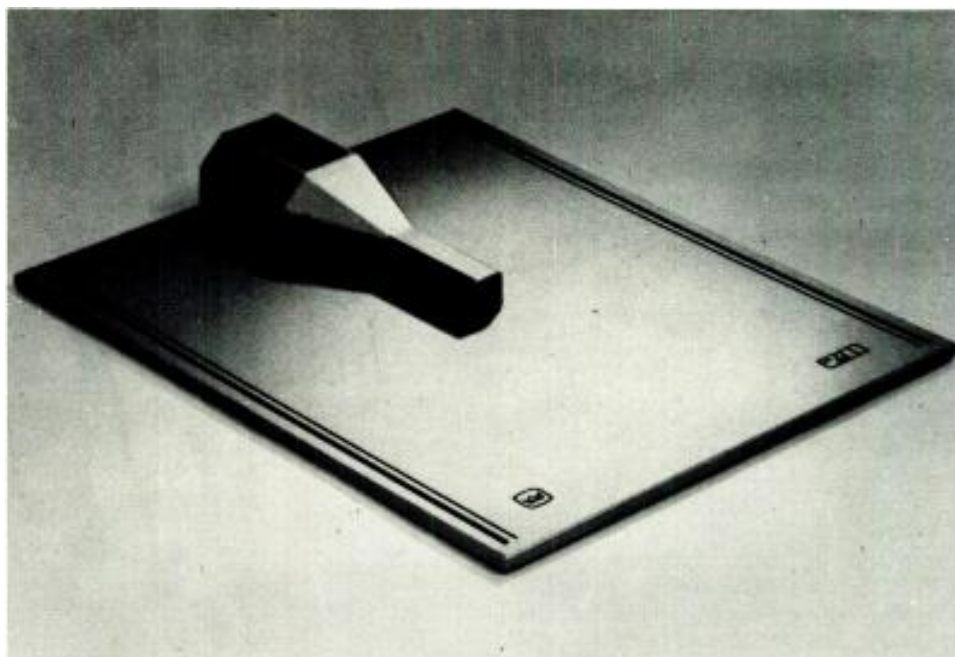

*The Crown PZM mic can be viewed at booth 428.*

AM transmitter. The standard line will include a 1 and a 10 kW AM transmitter as well as a 25 kW single-ended transmitter. A total of four FM transmitters from 1 kW to 25 kW, and an FM exciter will also be exhibited.

**CUSTOM BUSINESS SYSTEMS (317)**

Demonstrating a complete broadcast business computer system with improvements over previous models.

**PETER W. DAHL CO. (612)**

Will show its line of heavy-duty plate, power, filament, and modulation transformers and reactors. Replacement transformers for many manufacturers are available from stock. Lightning and transient protectors and suppressors will also be displayed.

**BILL DANIELS CO. (1333)**

**DATATEK (1428)**

Will show line of audio preamps, line amps, and monitor amps. (Also see listing in video section.)

**DATATRONIX (1504)**

Will introduce the new Gold Seal Series 4024 consoles, post-production mixers, the new Model 318 DAs, and the new Telepath audio routing switchers and intercom system. The existing line of equipment includes mixing consoles and modular audio system components.

**dbx (621)**

The dbx Model 700 is a new low-cost digital audio processor, creating a two-channel digital recording system when used with a VCR as the storage medium. Also on display will be the 900 Series modular signal processors,

160 Series compressor/limiters, 500 Series signal enhancers, the dbx type I and II noise reduction, and the 321 Series satellite/cable noise reduction cards.

**DELTA ELECTRONICS (105)**

Will have the Model RCS-IV remote control system with a new option, dual-site operation, for example with an AM transmitter in the valley, FM on the mountain. Also showing the line of modulation and power controllers, antenna monitors, RF measurement and switching equipment, impedance bridges.  
*See ad page 159.*

**DELTAMOD (614)**

New cable-related products will be introduced, and the standard line of equipment, including the CNR-6 Dolby noise reduction unit, the multichannel modular N/R unit, auto-control for cart machines, and microwave products will be exhibited.

**DE WOLFE MUSIC LIBRARY (1120)**

Showing the 600 plus LP album production music library, and the 21-album sound effects library.

**DICTAPHONE CORP. (211)**

Will display its tape-based loggers.  
*See ad page 249.*

**DIRECT-CUE (1424-A)**

**DI-TECH (1304)**

Will demonstrate the new Model 5840-2 AFV switcher for providing two levels of audio per input with independent control for audio 1 and audio 2. Also at the exhibit will be audio/video/pulse DAs, audio/video routing switchers, video equalizers, mono and stereo



# A major breakthrough in satellite antenna performance... Harris' 6.1 meter Delta Gain\*

Harris has developed a revolutionary new design for satellite antennas...with direct benefits for broadcasters, such as high gain and exceptional sidelobe suppression. A special reflector shape and unique feed design combine to deliver service comparable to larger antenna systems...at a convenient 6.1 meter size and price.

The Harris Delta Gain concept is based on Gregorian optics, near field Cassegrain theory, and a deep-dish reflector design. A "monopod" subreflector support eliminates support spars and the troublesome 5 to 10 dB increase in sidelobe levels that occur along spar contours.

The feed position also rejects noise and interference from

all directions beyond the antenna edge. This improved sidelobe performance is of particular benefit to the SNR capability of TVRO systems in crowded terrestrial RF spectrum environments. In many cases, this advantage may save you the expense of remote siting or settling for compromised performance.

Future 2° or 3° spacing requirements are met, ensuring solid SNR performance even with worst case adjacent satellite C/I contributions. Future Ku Band operation is accommodated by the 6.1 meter size and a design based on convertibility.

The Harris Kingpost pedestal is designed for repositioning of the antenna to any domestic satellite in 60 seconds or less! 110° of azimuth

travel is standard from a universal  $\pm 70^\circ$  arc referenced from a non-critical foundation centerline.

Everything needed for local or remote site TVRO operation is available as an integrated system from Harris...your single-source supplier. From Delta Gain antenna, to micro-processor based facilities control, to microwave interconnect, to all the satellite equipment required, Harris provides the means to better broadcasting. And it's all backed by Harris' 24-hour-a-day service...the most responsive in the industry.

Contact Harris Corporation, Broadcast Division, P.O. Box 4290, Quincy, Illinois 62305. 217/222-8200.

\*Patent Pending



## HARRIS

Visit Harris at the 1983 NAB,  
Las Vegas, in North Hall

Circle 200 on Reader Service Card

# HEAR AND NOW.

## Yamaha at NAB

Booth #1340

- AUDIO CONSOLES
- RECORDING MIXERS
- POWER AMPLIFIERS
- SIGNAL PROCESSORS
- SPEAKER SYSTEMS AND COMPONENTS



Yamaha International Corporation • P.O. Box 6600 • Buena Park, CA 90622

Circle 201 on Reader Service Card

[www.americanradiohistory.com](http://www.americanradiohistory.com)



★ ★ ★ AUDIO ★ ★ ★  
**NAB '83**

audio monitor amps, and touch-tone control systems.  
*See ad page 252.*

**DOLBY LABS (1311)**

A replacement audio module for one-inch VTRs has been a standard item from Dolby. The current modules fit the Sony BVH-1000 and 1100, and the Ampex VPR-2. Audio improvement and type A noise reduction are the benefits of the add-on module. A new module, Model 234, designed for the BVH-2000, will be introduced at the '83 show, and research and development is under way for a unit to accommodate the VPR-3. Will also be exhibiting the entire product line of audio and video N/R units with separate power supplies and electronically controlled output protection.

*See ad page 191.*

**DORROUGH ELECTRONICS (312)**

New introduction will be the Model 610, a digitally controlled tri-band audio processor with attack and release times a function of a programmable EPROM. Other products include loudness meter 40-A, an LED meter with simultaneous display of peak and persistence functions.

**DRAKE CHENAULT (408)**

Plans to demonstrate radio programming including "The History of Country Music," a 52-hour special.

**DRUMMEX (1760)**

Displaying mobile shelving units.

**DYNAMIC TECHNOLOGY (1719)**

Will show remote machine control and data transmission equipment in the VIMACS range of products, as well as audio jackfields. (Also see listing in video section.)

**EG&G (1327)**

Demonstrating FAA-approved high-intensity obstruction lighting equipment.

*See ad page 182.*

**ELCOM BAUER (412)**

Plans to show its standard line of AM and FM transmitters, 10 and 250 W solid-state exciters, audio processors, AGC systems, and audio consoles.

**ELECTRO IMPULSE (117)**

Showing its line of RF loads, calorimeters, wattmeters, attenuators, and baluns.

**ELECTRO-VOICE (511)**

New products to be introduced are various microphone and speaker products, including the Sentry 505 wall-mounted studio monitors. The existing line of products on display will be broadcast mics, both dynamic and condenser, as well as Tapco mixing consoles, amps, and signal processors and Sentry monitors.

*See ad page 219.*

**EMCOR PRODUCTS (429)**

Will have for the first time at NAB a new line of RF-immune enclosures for electronic equipment. Will also intro-

duce the "Instant Emcor." enclosures in modular form for easy transport of electronic equipment, available in many sizes and five colors. Also new will be the "ESQ" Emcor enclosures.

**EMERGENCY ALERT RECEIVER (610)**

Plans to show EBS receivers.

**E.R.A. (1711-A)**

**ESE (116)**

Will demonstrate the new ES232 time calculator. Will also show digital clocks, timers, master clock systems,

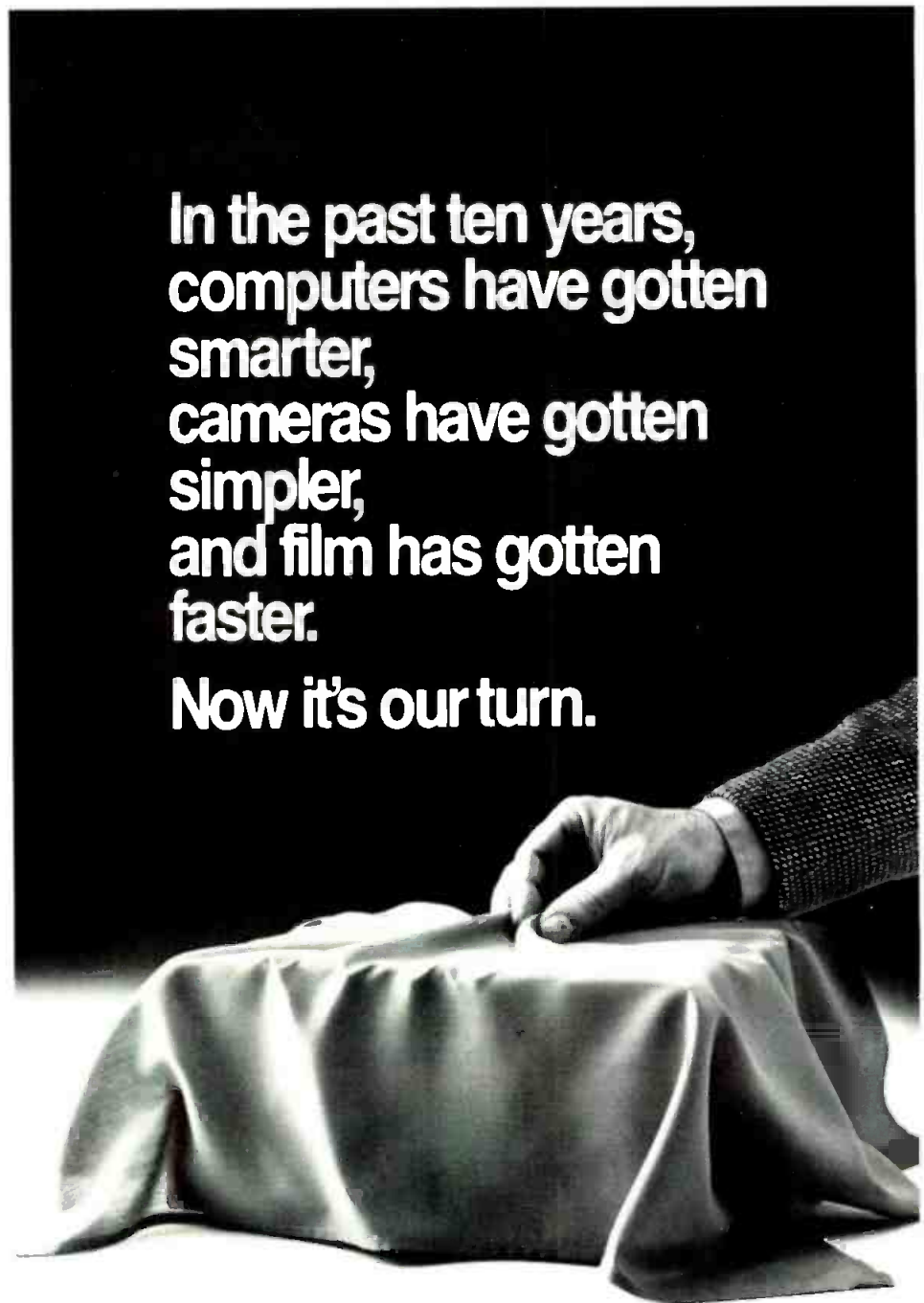

In the past ten years,  
 computers have gotten  
 smarter,  
 cameras have gotten  
 simpler,  
 and film has gotten  
 faster.  
 Now it's our turn.

INTERNATIONAL TAPETRONICS CORPORATION

3M hears you...

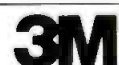

Circle 206 on Reader Service Card

# Brilliant performer.

**NEW  
WIRELESS**

## Model 82 Wireless Condenser Hand-Held

The Model 82 condenser wireless microphone has been added to Cetec Vega's professional hand-held line. The Model 82 incorporates the popular Shure SM85 condenser element and attractive black windscreen to provide:

- Minimal handling noise, reduced mechanical vibration, and virtually no "boominess" (by means of controlled low-frequency rolloff).
- Clean reproduction of close-up vocals with moderate proximity effect.
- "Crispness" and presence with high-definition midrange.
- Clear, scintillating highs with crisp upper register.
- Cardioid pickup pattern for effective rejection of off-axis sounds.

All Cetec Vega hand-held wireless microphones (including the Model 80 with the Electro-Voice EV-671 dynamic element and the Model 81

with the Shure SM58 dynamic element) have an attractively contoured black case with internal antenna.

Used with Cetec Vega professional wireless receivers, the FM systems operate on any crystal-controlled frequency between 150 to 216 MHz, at a range up to 1000 feet or more. Transmit-to-receive frequency response is almost perfectly flat from 100 Hz to 12 kHz with gentle rolloffs to 40 Hz and 15 kHz. Total harmonic distortion is typically 1/2 percent. System dynamic range is 90 dB when "Dynex" (transmit compression and receive expansion) is incorporated, with a resulting low noise floor.

Cetec Vega hand-held wireless microphones are newly redesigned for 20 to 30 percent additional battery life, using a commonly available 9-volt alkaline battery (Duracell recommended). Microphone sensitivity is easily adjustable with an audio

gain control on the bottom, with an adjacent LED indicator to verify optimum setup. Power and audio on/off switches are also conveniently located on the bottom.

Write or call for further information and location of your nearest dealer: Cetec Vega, P.O. Box 5348, El Monte, CA 91731. (213) 442-0782  
TWX: 910-587-3539

*In Canada: A.C. Simmonds & Sons Ltd.*

 **Cetec Vega**  
Division of Cetec Corporation



Circle 203 on Reader Service Card

[www.americanradiohistory.com](http://www.americanradiohistory.com)



★ ★ ★ AUDIO ★ ★ ★  
**NAB '83**

and programmable timers as well as audio level indicators. (Also see listing in video section.)

**EVENTIDE (323)**

Will display a production unit of the SP2016 totally programmable effects processor/reverb, featuring plug-in software modules. The H949 Harmonizer, the Timesqueeze Jr., a range of digital audio delay lines, as well as the APX252 real-time analyzer with SPECSYSTEM software will be on display.

See ad pages 102, 250.

**FARRTRONICS (1159)**

Will introduce a new intercom system with tally lights. Also showing the M70 audio console with DC-controlled interface to CMX editor; M76 audio and time code distribution amplifier; M750 audio patch field; the M81 intercom; and the M82 intercom, party line, eight-channel. (Also see listing in video section.)

**FELDMAR WATCH CO. (651)**

Will show stopwatches, chronographs, timers, timing boards, and timing systems.

**FIDELIPAC CORP. (103)**

Plans to demonstrate a complete line of NAB tape cartridges and accessories, as well as audio tape carts, studio warning lights, storage racks, alignment and calibration tapes and gauges, and wow and flutter meters. (Also see listing in video section.)

See ad page 160.

**FINNTEK (1646)**

Will display its consoles and test signal generators.

**FIRSTCOM BROADCAST SERVICES (219)**

Will introduce several syndicated TV spots for radio stations. Two continuing offerings are "The Creative Department" and "The World's Best" commercial services.

**FITZCO SOUND (1514)**

Showing the line of audio equipment consoles, speakers, amps, and other audio products. (Also see listing in video section.)

**FLASH TECHNOLOGY (1619)**

Displaying its antenna-top beacons, high-intensity aviation warning lights, including the L866 replacement for



Booth 323 will contain Eventide's H949 Harmonizer.

twilight lights.

**FORT WORTH TOWER (1010)**

Showing towers, earth stations, and prefabricated equipment buildings.

**FOSTEX (1739)**

Demonstrating new multitrack recording products as well as playback, amplifying, and audio signal processing equipment.

**In the past ten years,  
 beer has gotten  
 lighter,  
 bodies have gotten  
 leaner,  
 and blue jeans have gotten  
 classier.  
 Now it's our turn.**

INTERNATIONAL TAPETRONICS CORPORATION

3M hears you...

Circle 206 on Reader Service Card

# THE ONLY FULL CAPABILITY VIDEO NOISE METER IN THE WORLD

THE FUTURE  
IS IN STEREO  
SOUND TV...  
AT NAB BOOTH 1203

AVAILABLE NOW!

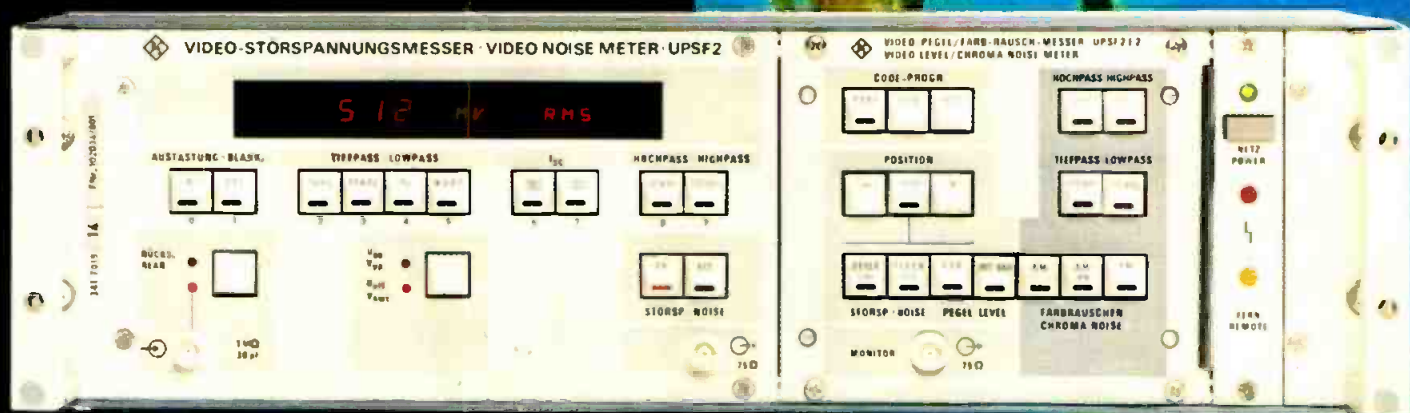

- **DUAL-STANDARD:**  $\mu$ P automatically determines standard (525 / 625 lines), identifies it on the display, and performs the appropriate measurement.

- **Measurement Domain:** Full-field, any individually selected line, any individual "spot" ( $4 \mu$ s x 10 lines)

- **IEEE-488 (GPIB) Bus Compatible**

- **Video Level Measurement:** Luminance-bar amplitude, or individual test-points selectable in steps of  $1 \mu$ s (range: -500 to +1500 mV)

- **Noise Measurement:** Luminance (peak or rms) or Chrominance (AM or  $\phi$ M). Range: 0-80 dB, referenced to 714 mV (525 lines), 700 mV (625 lines), or actual luminance-bar amplitude.



**ROHDE & SCHWARZ**

13 Nevada Drive, Lake Success, New York 11042 • (516) 488-7300

Circle 205 on Reader Service Card



**GARNER INDUSTRIES (1233)**

Display will include audio tape erasers and quarter-inch tape duplicators. (Also see listing in video section.)

**GENERIC COMPUTER SYSTEMS (308)**

Will show the Applelog software for radio and TV traffic and billing on the Apple II+ computer, using hard disk for storage. The system manages logs, bills, affidavits, availabilities, sales projections, and the entire Apple software.

**GORMAN-REDLICH (506)**

Will introduce the new EBS encoder with stereo option. The standard line will include EBS encoder/decoder, NOAA weather radio and digital antenna monitors.

**GOTHAM AUDIO (503)**

Will show the new EMT 938 broadcast turntable and will introduce the Telefunken M 21 analog audio tape machine with microprocessor control of transport functions. From the standard line of Neumann equipment will be the KMR 82 and 81 shotgun mics and the KMF 4 mini mic system and the full Neumann line of mics. Quantum Audio will display at this booth the Series 22 modular audio console for broadcast applications.

**GRAY COMMUNICATIONS CONSULTANTS (1618-A)**  
 See ad page 218.

**DAVID GREEN BROADCAST CONSULT. (417)**

Showing the Sperry weather radar, the IBM System 23 broadcast business system with Dixel software.

**GREGG LABS (455)**

The biggest new item will be the AM stereo audio processor. The main frame of the processor can have mono or stereo cards and the company has put in place a card exchange program to make it easy to upgrade or change the system. Also new at the show will be a line of consoles which have few extra goodies, but plenty of basic, useful features. The 14-channel consoles have, as standard, Penny & Giles faders.

**BOBBY GRIFFIN INC. (432)**

Will display signs and other advertising specialties.

**GRUMMAN AEROSPACE (1644)**

Will introduce the 601-000 Rainbow Sound system for encoding audio into video, and will also have a stereo TV demonstration. (Also see listing in video section.)  
 See ad page 132.

**HARRIS CORP. BROADCAST DIV. (401)**

Will introduce a new 10-channel dual stereo audio console, a DJ assist feature on the Micro Mac console, and a 28-pin demodulator for the Harris linear AM stereo system will be new. The

MSP-90, and MSP audio processors will also be demonstrated. (Also see listing in video section.)  
 See ad pages 13, 168, 173, 263.

**HARRIS CORP., BROADCAST MICROWAVE (401)**

Will display a complete line of AM products, including SX solid-state transmitters, AM stereo exciter and modulation monitor. FM products will be the MX-15 exciter, line of transmitters and antennas. (Also see listing in video section.)  
 See ad page 217.

**In the past ten years,  
 radio has gotten  
 stronger,  
 cars have gotten  
 shorter,  
 and outer space has gotten  
 closer.**

**Now it's our turn.**

We're about to unveil our first major change in ten years. For a sneak peek, visit Booth 107 at the NAB Show.



INTERNATIONAL TAPETRONICS CORPORATION

3M hears you...



Circle 206 on Reader Service Card

# Anyone Could Put the Phone Jack in the Correct Place...

## The UREI Broadcast Consoles

At UREI, we believe details and solid construction make the difference between a good product and an excellent one. For instance, headphone cords are on the left side. But virtually all on-air boards put the jack on the right side of the console. On the new UREI boards, we give you two jacks, one on the left, where it should be, and another on the right to let two people monitor simultaneously.

Before we started designing the new Series 1650 and 1680 consoles, we talked to you... engineers, jocks, announcers and consultants. Then we went to the drawing boards to plan a line of on-air boards with the



features you wanted.

The result is a fresh answer to the operational requirements of the broadcaster of the '80's. Six all-new on-air boards... choice of 5 mixers (1650 Series) or 8 mixers (1680 Series)... choice of Penny & Giles slide pots, Shallco or conductive plastic rotary attenuators.

## High Output, Low Distortion, Low Noise

The Series 1650 and 1680 Consoles can easily handle today's dynamic program material with +24 dBm output into 600 ohms. Signal to noise is better than 90 dB. At normal operating levels of +4 to +8 dBm, THD is typically less than 0.02%.

## Flexible, Simple Operation

Each mixer position has two inputs selected by a gold contact rocker switch. Two banks of four push-buttons each may be assigned to any mixer input for additional sources such as remote or network feeds.

All channel on/off switching is performed by reliable FET switches; extra contacts are provided for activating cart machines or turntables.

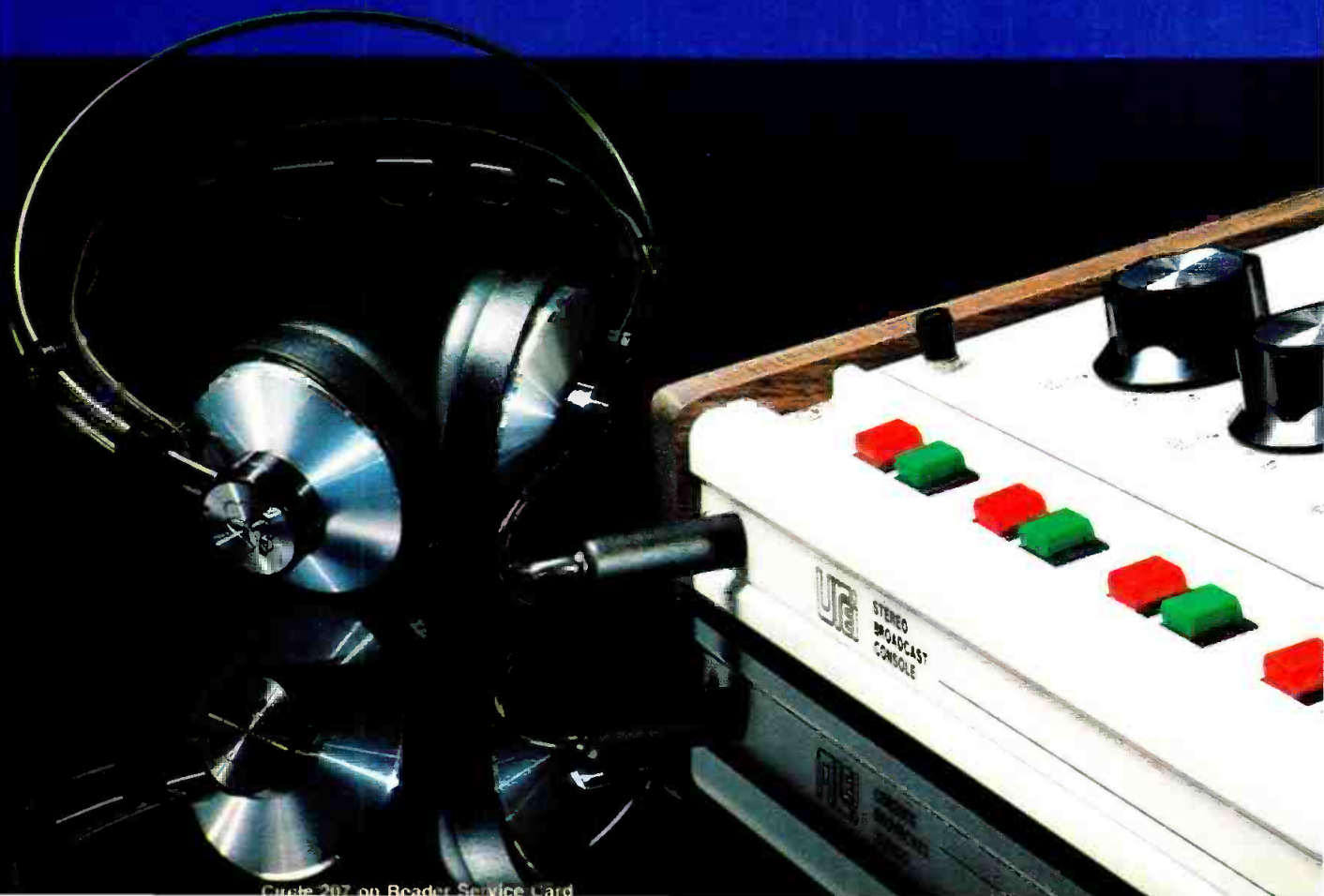



# Only UREI Did.

Monitoring is easy. Four-position pushbutton selectors connect Program, Audition, Air or External input to an internal 8 W stereo power amp (or to a line output for a larger external amp). Another four-position selector sends Program, Audition, Air or Cue to an internal 1 W stereo amp and the two stereo phone jacks.

The three independent mute busses can be activated by any mixer position. Each buss drives one of three mute relays. Mute buss 1 electronically mutes the cue amp and speaker without affecting the headphone output.

## Durable and Reliable

A special plastic overlay on the console surface makes it virtually impervious to marks. The electronics are built to rigid UREI standards using MIL-SPEC glass epoxy circuit boards

and highest quality components. The meter box and front panel are hinged to allow easy access to all interior circuitry and modules for rapid maintenance.

## Ready to Go

You can customize the new UREI consoles, but no accessories are required to put a stock console on the air. The Series 1650 consoles are supplied with one monaural, transformer isolated mic input and four stereo line input preamps. The 1680 Series comes with one mic preamp and seven line preamps. All preamps are interchangeable in all positions.

The line inputs can accept nominal

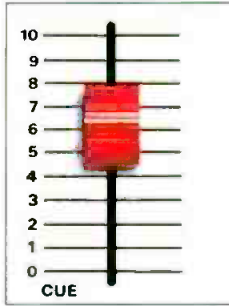

+4 dB or +8 dB (ref. 0.775 V) professional sources or may be adjusted for use with -10 dB equipment. These inputs are differentially balanced and referenced to ground; input transformers are an available option.

## The Modern Ones

You've been asking for a new line of UREI on-air consoles for years. We took the time to make them "the modern ones"... the ones that will meet your requirements through the 80's and beyond. For more information on the UREI Broadcast Consoles, see your authorized UREI dealer, or write:

From One Pro to Another 

United Recording Electronics Industries  
8460 San Fernando Road  
Sun Valley, California 91352  
(213) 767-1000 TLX 472 0889 UREI SNVY  
Canada: E. S. Gould Marketing, Montreal





ranging in sophistication and price. Also on display will be the TV-3 multitrack and post-production console.

*See ad page 11.*

**HARRIS CORP., SAT. (401)  
COMM. DIV.-ANTENNA**

Will describe its satellite earth stations.

**HARVEY PROFESSIONAL (1122-A)  
AUDIO/VIDEO**

**HARRISON SYSTEMS (1324)**

Will have three new versions of the TV-4 console, all variations from the same frame, from small broadcast to complicated post-production units

**HIPOTRONICS (1779)**

Will introduce the Peschel automatic voltage regulator. Also showing ac/dc high voltage test sets.

*See ad Cover 3.*



*Production modules for the Harrison tv-3 console can be seen at booth 1324.*

# STROBEGUARD®

HIGH INTENSITY  
OBSTRUCTION  
LIGHTING SYSTEMS\*  
FOR TELEVISION AND  
RADIO TOWERS AND  
SIMILAR SKELETAL  
STRUCTURES.



TECHNICAL PRODUCTS GROUP — BEDFORD DIVISION  
35 CONGRESS ST., SALEM, MASSACHUSETTS 01970  
TEL: (617) 745-3200  
ATTENTION: GEORGE MANDEVILLE, PRODUCT MANAGER

\*FAA APPROVED as meeting or exceeding the requirements of Advisory Circular AC 150/5345-43 and FAA/DoD Specifications L-856 plus FAA AC 70/7460-1

See us at Booth 1327

**HM ELECTRONICS (1130)**

Plans to introduce the new System 85 hand-held wireless mic, the PAL Precision Audio Link, and the 700 Series cabled intercom. Will display a wide range of wireless mics and diversity systems, as well as full-duplex wireless intercom systems.

**HOLADAY INDUSTRIES (1517-B)**

Will show its battery-powered field or in-plant instrumentation for measuring radiation.

**HOWE AUDIO (406)**

Plans to offer a newly packaged 7500 Series console, a slide fader and VCA controlled console. The 7000 Series of consoles will now be available with Daven step attenuators. Also on display will be the Phase Chaser, phono pre-amps, telephone couplers, and monitor amps.

**IGM COMMUNICATIONS (403)**

Introducing MARC. Manual Assist Remote Control, for Instacarts, as well as a new System Design Group for custom systems using microprocessors and IGM hardware or software. Also showing the Instacart 12, 24, 48 and Go-Cart 24, 42, 78.

**INDUSTRIAL ACOUSTICS (322)**

Will show acoustic structures and acoustic elements as complete packages or parts for doors, walls, floors,

Circle 208 on Reader Service Card



ventilation, and will have sample structure at booth.

**INOVONICS (304)**

Will introduce the Model 250 **digitally programmable stereo audio processor** for AM, FM, and TV which interfaces with most small computers for on-line control of program dynamics. Also shown will be the full line of recorder replacement electronics, audio signal processors, and instrumentation equipment for acoustic analysis.

**INTEGRATED SOUND SYSTEMS (327)**

Will show its consoles, mics, audio processing, speakers.

**INTERACTIVE MARKET SYSTEMS (310)**

Showing Radio Spectrum, a system to analyze spot radio, network, and the entire radio medium as well as a computer color graphics system. This includes GraphPac, an on-line system for generating computer color graphics, and PicturePac, a standalone computer graphics system for producing color xerox or slides. Also on hand will be a data base management system.

**INTERFACE DATA SYSTEMS (1517)**

Will show its program and business automation systems.

**INTERFACE ELECTRONICS (215)**

New equipment includes the Model 200B version of the eight-inch battery/ac **stereo portable mixer**, and the Model 550J TV **broadcast mixer** with built-in EQ, input selectors, monitor logic, and cueing.

**INTERNATIONAL TAPETRONICS CORP./3M (107)**

Introducing the Delta Series of **audio tape cart reproducers** and **recorder/reproducers**, designed for the same quality as the Premium Line but in a more compact package. Standard products will include the Series 99B audio tape cart machine, the 770 reel-to-reels, the PD-II reproducers and recorder/reproducers, and the ESL-III eraser/splice locator. The FB-1 telephone interface will also be on display. *See ad pages 175, 177, 179.*

**ITAME (400)**

See listing under Comrex.

**JAM CREATIVE (206)**

New radio station **ID jingle packages** will be demonstrated, including those for WNBC, WABC, WYNY New York, KIMN Denver, and WMAL Washington. Also displayed will be "The Answer," a commercial production library.

**JAMIESON & ASSOC. (1718)**

Radio and TV station design, turnkey installations and engineering consultation.

**JEFFERSON DATA SYSTEMS (1629)**

New **program management system** for inventory and control of syndicated materials and program cost analysis. Also a new **electronic news processing system** for computerized handling of wire services, story, and script preparation. The System 90 sales, traffic, and general accounting system will be on hand for both radio and television.

**KAHN COMMUNICATIONS (625)**

Will be showing AM stereo receivers in a stereo receiving demonstration.

**KAMAN SCIENCES/ KAMAN BROADCASTING (1607)**

Introducing a new **in-house computer system** for TV and radio stations, including traffic, billing, accounting, films, news, and interfacing with automated switch gear.

*See ad page 244.*

**KING INSTRUMENT CORP. (1794)**

Will show its line of video and audio cassette loading equipment.

**SONEX**  
**FOR KILLING BACKGROUND NOISE**

SONEX is a special sound-absorbing acoustical foam with a sculptured anechoic design that absorbs noise four times better than acoustical tile or carpeting. It emulates the sound quality of a professional recording studio at a low cost, so your voice-over sounds rich and clean. Or use it when mixing to hear the real sound on tape. Or use it on location to trap the sound you want and to kill the noise you don't want.

Get the facts today. SONEX is manufactured by Illbruck/usa and distributed exclusively to the pro sound and A/V Industries by Alpha Audio, 2049 W. Broad Street, Richmond, VA 23220.

**Alpha Audio**  
804/358-3852  
*Acoustic Products for the Audio Industry*

Circle 209 on Reader Service Card

# ☆☆☆☆☆ NAB '83

## KINGS ELECTRONICS (1623)

Demonstrating new **patch panels and jack fields** along with standard line of coaxial RF connectors.

## JAMES B. LANSING/JBL (615)

The new 7510 **automatic microphone mixer** will be displayed along with the 4401, two-way, and the 4411, three-way **studio monitors**. The full line of JBL loudspeakers will be exhibited.

## LEBLANC & ROYLE (1149)

Showing broadcast towers.

## LEXICON (1139)

Demonstrating the Model 1200 audio time compressor/expander allowing faster or slower playback of tape by manipulating audio frequencies. Also on display will be the 224X, a digital reverb with remote console and the Model 97 Super Prime Time digital audio delay processor/mixer.

## LIGHTNING ELIMINATION ASSOC. (302)

Introducing two new models for **power source**, the CPS-1K continuous and the



At booth 615, JBL will show the 7510A automatic mic mixer.

PP-9K3. Also on display will be the power line surge eliminators, dissipation arrays, Kleanline electronics filtering systems, guy charge dissipation chokes, coaxial surge eliminators, and transient eliminators.  
*See ad page 256.*

## LOGITEK (613)

Introducing the new **studio monitor speaker**, Pyramid Met 11, and a line of **modular DAS, AGC amps, compressor and power amps**, all rack-frame oriented. The existing line of products to be presented includes Audiorack news console, the line of modular consoles, and audio accessories.

## LPB (405)

The new **Highway Advisory Radio and Travelers Information transmission system** will be introduced. Other equipment being exhibited includes the Monogram Series of audio consoles, along with the Signature and Citation console series. AM50/250 Series modular AM transmitters will feature 50, 100, 150 and 250 W capability.  
*See ad page 198.*

## 3M/SCOTCHCART (203)

Scotchcart radio broadcast tape cartridges will be displayed.  
*See ad page 156.*

## MAGNAVOX (603)

Centering the exhibit around the PMX AM stereo equipment.

## MAGNUM TOWERS (119)

Showing its standard line of towers.

## THE MANAGEMENT (627)

Featuring SimpleLog, a computer traffic and billing system with different software available. Other broadcast-related computer software products will be shown, such as an AM/FM proof of performance package.

## MARCOM (306)

Introducing BAX, a new **extended bandwidth system**, and the Motorola/Magnavox compatible **AM stereo generator**. A new **audio monitor/switcher** will be presented, as will the stereo programmable **broadcast audio processor** for AM. The standard line includes the SC-203 stereo generator with digital overshoot corrector.

## MARTI ELECTRONICS (501)

The new TSL-15-2 full back-up **telemetry link** with automatic switching will be introduced, along with the ATS-15 automatic **transmitter switcher** using pin diode RF switching. Also the RPT2 hand-carried RPU transmitter and other

## AUDITRONICS AUTHORIZED DEALERS

**Allied Broadcast Equipment**  
635 South E Street  
Richmond, IN 47374-8487  
(317) 962-8596

**Audio Broadcast Group, Inc.**  
2342 S. Division Avenue  
Grand Rapids, MI 49507  
(616) 452-1596

**Broadcast Services Co.**  
Rt. 3, Box 45-E  
Four Oaks, NC 27524  
(919) 934-6869

**Doug Brown Enterprises**  
1703 East Skelly Drive  
Tulsa, OK 74105  
(918) 747-3618

**Control Technology, Inc.**  
2322 Davie Blvd.  
Fort Lauderdale, FL 33312  
(800) 327-4121  
(305) 587-2716 FL only

**Phase Audio, Inc.**  
151 N. Angelus  
Memphis, TN 38104  
(901) 726-1900

**Pro Audio General Store**  
1378 N.W. 100th Ave.  
Coral Springs, FL 33065  
(305) 752-0330

**PRS Inc.**  
1616 Soldiers Field Rd.  
Boston, MA 02135  
(617) 254-2110

**Robert Slye Electronics**  
3415 N. Washington Blvd.  
Arlington, VA 22201  
(703) 525-7272

**Sonics Associates, Inc.**  
237 Oxmoor Cl. Suite 101  
Birmingham, AL 35209  
(205) 942-9631

**Sound Genesis**  
2001 Bryant Street  
San Francisco, CA 94110  
(415) 285-8900

**Westec Audio Video, Inc.**  
1841 Broadway, Suite 1203  
New York, NY 10023  
(212) 586-1662

**Westlake Audio**  
7265 Santa Monica Blvd.  
Los Angeles, CA 90046  
(213) 851-9800



## auditronics. inc.

3750 Old Getwell Rd.  
Memphis, TN 38118 USA  
Tel: (901) 362-1350  
Telex: 533356

Circle 210 on Reader Service Card



transmitters, repeaters, STLs and TSLs will be shown.

See ad page 204.

**MAXELL (1612)**

Demonstrating its full line of blank audio and video recording tape for broadcast applications.

See ad page 71.

**MCA/POWER PAK SYSTEMS (206-A)**

Formerly Micro Control Associates, will be showing brand-new aural STLs, transmitter remote control systems, remote pickup equipment, FM stereo exciters and generators, and FM translators.

**McCURDY (207)**

Digitally controlled intercom will be introduced at NAB; Model CS-9400 is totally programmable from master control panel, self-programmed to four locations. Only a single pair of wires from each control panel is necessary for operation.

Model ARS-5020 is an audio routing switcher based on 50X1 switcher card with 20 cards per frame. The AVS 100 is an a/v routing switcher with a new alpha-numeric control. Existing product lines include the 8000 Series of audio consoles and a full selection of audio and video equipment.

**MCI/SONY (605)**

Demonstrating its complete line of professional recording systems for studio, broadcast, and teleproduction applications. Will feature the Broadcast Production Package and the newest console, the JH-800 Series, which is the company's first entry into the compact mixer market. The unit has 12 inputs accepting mic or line level signals, four VCA groups, four sends, and three echo returns. The broadcast package features a JH-618 console with 10 mic inputs and five stereo line inputs.

See ad page 153.

**McMARTIN INDUSTRIES (701)**

Will have new audio amps, a compander, and a new version of the 30 kW FM transmitter. The standard line of products will include the entire line of transmitters, monitors, consoles, and other audio and transmission equipment. (Also see listing in video section.)

See ad page 254.

**MEDIA COMPUTING (1522)**

New NAB exhibitor (formerly Computer Concepts of Phoenix) will display software modules for station automation designed to be implemented on Apple computers.

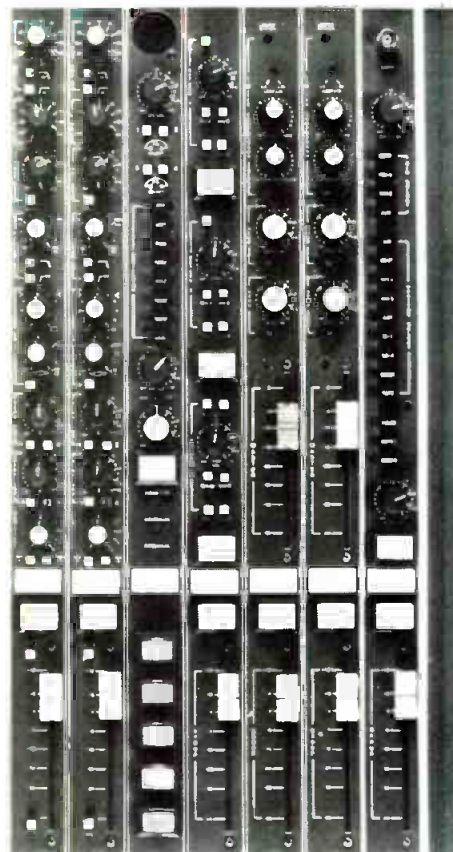

The MCI/Sony JH-800 will be exhibited at booth 605.

# Sound quality.

## 200 Series On-Air Broadcast Control Console

The Audiotronics 200 Series represents the culmination of latest technology applied for broadcast use. Standard features include Penney & Giles linear VCA controlling faders for reliability and precise tracking accuracy even on stereo channels, noiseless hall effect/CMOS on/off switching, local power regulation on every module to prevent mass failure, built-in Control Room Monitoring controls, a comprehensive logic system and headphone amplifier with local equalization. Available in 4 mainframe sizes for up to 24 mono or stereo inputs, a full line of accessories is provided for custom tailoring to individual requirements.

- Monitoring and Communications for Two Studios
- Equalizers
- Telephone Interface
- Remote Controls
- Redundant Powering
- Clock & Timer

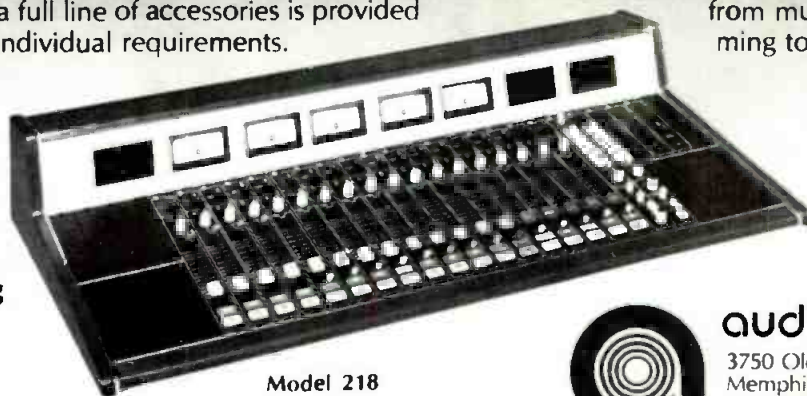

Model 218

**Voice Controller Accessory:** A mono or stereo compressor/limiter/noise gate utilizing the VCA circuitry built into the 200 Series.

The 200 Series, the logical choice for on-air operations from music programming to newsrooms.



**audiotronics. inc.**

3750 Old Getwell Rd.  
Memphis, TN 38118 USA  
Tel: (901) 362-1350  
Telex: 533356

Circle 211 on Reader Service Card

**MICMIX AUDIO PRODUCTS (604)**

Introducing modular signal processing system, the MC-Series, containing the MC card frame with power supply along with the MC-101 Dynafex N/R system. Also new will be the Master Room XL-404 "Plate Synthesizer" reverb unit. Included in the exhibit will be other reverb units and noise reduction equipment.

**MICRO CONTROLS (104)**

Will introduce the PTS-10CD three-channel microwave system for AM stereo and satellite communications from the satellite station to the broadcast station. Will also bring its line of microwave and remote control equipment.

**MICRO-TRAK (619)**

Two new dual-bus consoles will be introduced, Models 6509 dB and 6510 dB. A repackaged version of the Telefile, the Telefile II will also be new. From the standard line of equipment, the company will display the 6618 audio console, three distribution amps, phono preamps, and the Sport III and IV.

**MODULATION ASSOCIATES (639)**

Introducing an optimized SCPC audio satellite receiver for use in state and regional radio networks. Designated the RSAT, the unit is designed for networks of less than 100 affiliates. It has a 3.7-meter antenna and allows satellite power to be cut from 80 W to 10 W. Also showing complete satellite radio communication system uplink and downlink facilities, along with electronic satellite systems with full turn-key capabilities.

**KEITH MONKS AUDIO (512)**

Standard line of equipment on display will include mic stands, cable drums, record-cleaning machines, impedance and phase testers.

**MOSELEY ASSOCIATES (301)**

Will introduce the MRC-1600 microprocessor remote control system for AM and FM. Also on display will be the MRC-1 and -2 systems, the aural STLs and stereo demodulator and generators, subcarrier demods and generators, and the TRL-1 telemetry return link.

*See ad pages 170, 171.*

**MOTOROLA C&E (411)**

The AM stereo system will be highlighted. A portable microprocessor-controlled repeater will be demonstrated



*Nagra, located at booth 1213, will demonstrate the T-Audio recorder.*

along with studio communication systems, lines of mobile and hand-held radios, as well as communication system analyzers and intercom trunking mobiles.

*See ad page 28.*

**MULTI-TRACK MAGNETICS (1712)**

Dubbers, audio heads, alignment gauges will be displayed. (Also see listing in video section.)

**THE MUSICWORKS (209)**

Introducing Showcase, an easy listening/MOR blend music programming service. Other products include programming for automated or live assist radio stations featuring their three country, one pop adult, and one Hispanic music formats.

**NADY (1133)**

Planning introduction of the new

PRC-3 full duplex personal radio communicator and new base stations and interface systems for wireless units. Will also bring the RT-201A intercom, receivers, wireless microphones, and a full complement of wireless communications equipment.

**NAGRA (1213)**

Introducing the T-Audio ATR with a new center stripe SMPTE code, with the new head mounted on the apex of the headstack. Also new will be a SMPTE audio editing system with controller and synchronizer/resolver. The full line of tape recorders will be exhibited, including the 4.2, E, 4/S, and SNN models.

*See ad page 158.*

**NAUTEL MAINE (216)**

A totally solid-state 1 kW AMPFET I AM broadcast transmitter will be introduced. Also plans to bring complete



*MicMix Audio, at booth 604, will show the mc Series of processors.*



# NO OTHER BATTERIES EVEN COME CLOSE!

ReFLEX®-20—the only battery charging system that gives a full charge in 20 minutes with longer battery life and requiring fewer batteries to buy—now brings you 4 more vital reasons to use Christie camera-mounted, belt-mounted, and VCR batteries.

## NEW Batteries Fit Most Mounts

Christie "burping" KS and KR batteries now fit virtually all factory camera battery mounts.



## NEW Slow-Charger and 20-Minute Burp Charger

Every Christie battery can now be fully charged in 20 minutes on the patented ReFLEX-20 "burping" charger (now available from under \$1,000) or when on the road with our inexpensive, compact, lightweight slow-charger. Meet minimum battery order requirements and receive our slow-charger *free*.



## NEW Extra Reliability, Convenience, and Ruggedness



Most of our batteries now feature *overload protection* with automatic reset (*no thermal fuses to blow*). No flimsy shrink tubing on our BP90 equivalent batteries—you get a *rugged hard case*. And now you won't be caught dead with a Christie battery because our new *discharge indicator light* tells you when to recharge.

## NEW 12-Month Super-Warranty

Incredible but true. Under normal use, Christie will repair or replace a defective battery free of charge for a full year. (Copy of complete warranty available on request.)

### LIMITED WARRANTY (ABSTRACT)

#### ReFLEX-20 BATTERIES

Any battery pack which becomes defective, or has permanently lost more than 1/3 of its rated capacity, under proper (normal) use within one (1) year of delivery to the user, but not to exceed eighteen (18) months from the date of shipment from Christie, will be repaired or replaced at no charge upon return to the Christie factory, transportation paid and properly insured. Batteries must not have been tampered with or cells replaced.

For the complete Christie battery story, contact Steve Heller today at Christie Electric Corp., 20665 Manhattan Place, Torrance, California 90501, 800-421-2955 (in California 213-320-0808), TWX 910-349-6260.

You Can Depend On Us

# CHRISTIE

Since 1929

See the new Christie batteries and the industry's most powerful bulk tape degausser at NAB Booth 1016.

Circle 212 on Reader Service Card

[www.americanradiohistory.com](http://www.americanradiohistory.com)

line of existing AMPFET AM transmitters from 1 kW to 50 kW.

**NEC AMERICA (1415)**

Will introduce a digital **audio disk player** and **digital audio equalizer**, and the new FM exciter transmitter. The standard line will include the FS16 synchronizer. (Also see listing in video section.)

*See ad pages 42, 242.*

**NEILSON-HORDELL LTD. (1744)**

**NETWORK PRODUCTION MUSIC (1138)**

Making available its library of contemporary music adaptable to commercials, feature films, industrial and educational films, and other productions. Will introduce a 50-volume **sound effects library** this year.

**RUPERT NEVE (1410)**

New at NAB '83 from Rupert Neve will be the 8128, 32-input, 24-track **post-production/recording console**. The board is divided into two sections, one for track recording and the other for mixdown, with 32 channels available to each section. The entire 51 Series of broadcast consoles will be demonstrated along with the 542 range of compact units for portable or small studio applications.

*See ad page 17.*

**NOBLE BROADCAST CONSULTANTS (441)**

Will describe its radio station formats, including AOR, Top 40, Adult Contemporary, Beautiful Music, and a **new format** to be announced at the show; also consultancy and research services for radio.

**NORTRONICS (205)**

The new professional **head degausser**, the PF 208, will be introduced as the

strongest in its line with a field strength at the tip of 1000 gauss. Also on display will be the complete line of maintenance products and replacement heads.

**ORBAN ASSOC. (607)**

Will introduce a new **Optimod-TV** with loudness controller, a new **digital programmable parametric equalizer** capable of storing up to 32 EQ curves. Exhibiting the Optimod-AM and the FM, the compressor/limiter/de-esser, EQs, stereo synthesizer, and spring reverbs.

*See ad pages 23, 25.*

**J. OSAWA & CO. (1716)**

**OTARI (601)**

Brand-new is the 5050 MK-III-2, a two-track **quarter-inch deck** in a tabletop console with editing features for production applications. Also new is the MTR-12, a quarter- or half-inch, two- or four-track **recorder** capable of handling reel sizes from seven inches to 12.5 inches. It can be rack-mounted or installed in a console, and the transport is microprocessor-controlled. The CB-116 auto-locator accessory is for Otari BQ II and all MK-III machines. Other products on display will be the MTR-90 multitrack ATR, the MTR-10 mastering ATR, the full 5050 Series, and the ARS/BGM Series of compact ATRs for automation systems.

*See ad pages 14-15.*

**PACIFIC RECORDERS & ENGINEERING (113)**

Will show the Tomcat cart recorder/players as well as audio DAS, routing switchers and control room cabinetry. Also demonstrating complete lines of broadcast audio consoles and cartridge tape machines.

**PANASONIC PRO AUDIO (412)**

See listing under RAMSA.

*See ad pages 154-155.*

**PATCH BAY DESIGNATION CO. (1773)**

Will come to its first NAB with its line of patch bay **labeling strips**.

**PETERS PRODUCTIONS (315)**

Will make available an all-new **production music library**, "The First National Music Bank." Will also demonstrate its complete range of music formats.

**HELPS DODGE COMMUNICATIONS (1007)**

Will show rigid coaxial transmission line, patch panels, FM antennas, and directional couplers. Harmonic filters and mobile communication antennas will also be shown.

*See ad page 147.*

**PHILADELPHIA RESINS (126)**

Exhibiting complete synthetic tower guy systems for broadcast, including proper electrical protection against corona, as well as mechanically optimized end fittings.

*See ad page 133.*

**POTOMAC INSTRUMENTS (100)**

Plans to introduce the MPC-11, a **modulation and power level controller** for AM stations. Also set to show line of field strength meters, antenna monitors, ATS equipment, and audio test equipment.

*See ad page 196.*

**PROCART (115)**

Exhibiting the Procart tape cartridge and the AA mono/stereo cartridge.

**PROCOMMOTION (434)**

**PROGRESSIVE BUSINESS SYSTEMS (631)**

**QEI (307)**

Introduction will be made for the new 695 low-distortion exciter, the 695T 1 kW solid-state FM transmitter, and the 695T 3.5 kW tube FM transmitter. A full line of modulation monitors, FM exciters, and transmitters will be displayed.

**QUAD-EIGHT ELECTRONICS (1636)**

Introducing System 5 LC **digital reverb unit** as well as recent develop-

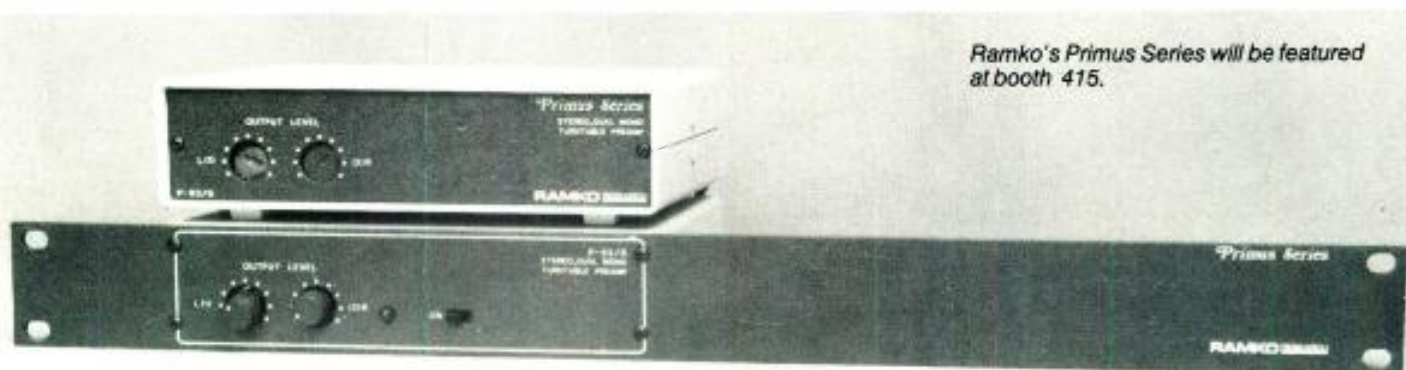

Ramko's Primus Series will be featured at booth 415.



ments in the 248 console modules, including VCA fader modules. Will bring the 248 consoles for television and radio production and post-production.

**QUANTUM AUDIO LABS (134)**

Will be displaying the Series 22 modular audio consoles.

**RADIO COMPUTING SERVICES (510)**

Will introduce a new Stormcenter, a software school and business bad weather closing system. Other products will be a music selection system, callout research analysis, and the Traffic 2000 traffic system.

**RADIO SYSTEMS, INC. (341)**

Will introduce a new broadcast audio console with 10 channels, linear, VCA controlled with clocks and timers as standard features. Also showing the Audio-Metrics line of timers and amps.

**RAMKO RESEARCH (415)**

Plans to unveil a major new professional series called Primus which includes over 40 products. The features of this line of DAS, consoles, and cart equipment are slide-out modules, rack or tabletop configurations, and extended

warranty. Will also show the Phase-master tape cartridge equipment and the DC-38 Series of audio consoles. See ad pages 7, 194-195.

**RAMSA/PANASONIC PROFESSIONAL AUDIO (437)**

Will introduce the Model WR-8616 compact mixing console compatible with either a four- or 16-track recorder. The unit contains 16 balanced mic inputs, and can also accommodate 16 line in inputs, and 16 direct line outputs. The WR-8118 will also be displayed and is designed as a PA mixer for up to 18 mic and line inputs. Also on exhibit will be the full line of audio consoles, Technics turntables, and audio studio and control room monitors. See ad pages 154-155.

**RCA AMERICAN COMMUNICATIONS, INC. (1000)**

Plans to show the digital audio transmission service for radio stations. (Also see listing in video section.)

**R-COLUMBIA (1111)**

Will introduce two models of the Teleheadphone which plugs directly into a telephone. Also new will be the line-powered intercom headphone, the single-ear FM wireless intercom,

and the broadcaster's headphone. Plans to exhibit its complete line of communication products for TV and radio, both wired and wireless intercom systems, and stereo and mono headphones.

**REAL WORLD TECHNOLOGIES GROUP (1637)**

**RELIABLE MEASUREMENT SYSTEMS (1762)**

**ROH CORP. (1634)**

Audio amplifiers and intercom systems, will be displayed.

**ROHN (110)**

Showing new modular fiberglass equipment shelters of standard design or by custom order. Will also exhibit line of towers.

**ROSCOR CORP. (1181)**

**RTS SYSTEMS (1142)**

Introducing the new RTS 802, a microprocessor-assisted master intercom station with up to 12 channels of two-wire, conference line intercom. The unit offers front-panel programmability using a Z80 type microprocessor to control selection and operation of all functions. Will also exhibit the TW intercom system, the 4000 Series IFB sys-



# SOUND MANAGEMENT.

The Model 610 Dual Compressor/Expander from Valley People is the total sound management device with an internal system of checks and balances.

The interactive compressor/expander circuitry of the 610 places either mode under the watchful eye of its counterpart.

Therefore, "Expanded Compression" actually reduces the noise boosted by compression during quiet passages. While "Limited Expansion" maintains a disciplined level of expansion to avoid clipping and distortion. And, of course the VCA section of the 610 controls the action with sensitive and distortion-free performance in any mode.

The Valley People 610. A perfect combination of versatility, control and performance. And that's not the half of it. Get the full picture from your Valley People representative.

**Signal Processing from Valley People. Pure and Simple.**



**VALLEY PEOPLE, INC.**  
P.O. Box 40306/2820 Erica Place  
Nashville, Tenn. 37204  
615-383-4737

TELEX 558610 VAL PEOPLE NAS

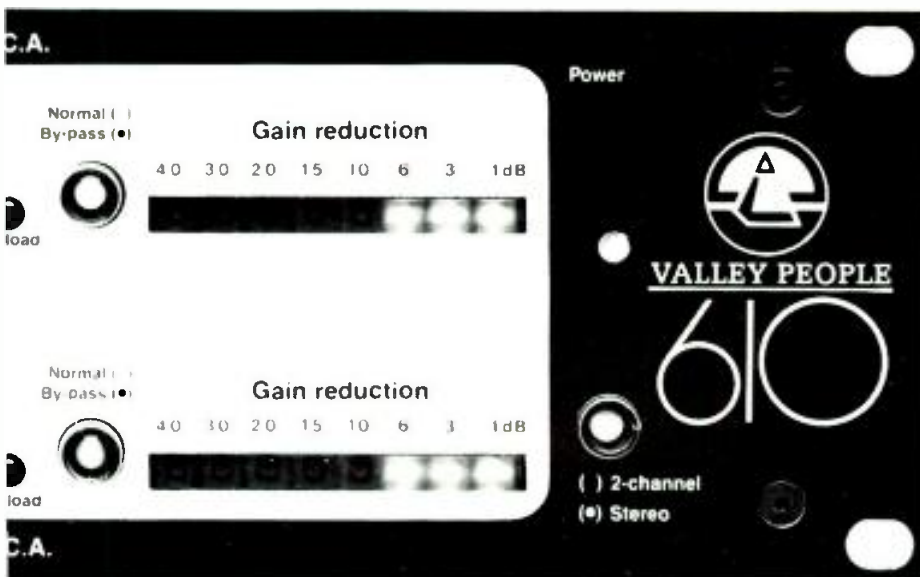

Export: GOTHAM EXPORT CORPORATION  
NY, NY/TLx: 129269

Series IFB system, and lines of pro audio equipment.

*See ad page 140.*

**JOHN B. RUDY CO. (1175)**

Will show its line of custom-manufactured audio cables and its distribution catalog of mics, audio boards, amps, and various audio supplies. (Also see listing in video section.)

**RUSSCO ELECTRONICS (413)**

New equipment for this year's NAB will include a direct-drive turntable and a new phono preamp. From the standard line, expect to see a remote mixer designed to interface with a dial telephone and an EQ/coupler to improve audio on phone lines. A mic/line driver and Mark VI turntable will also be shown, as well as the full line of turntables, consoles, and phono preamps.

**SAKI MAGNETICS (416)**

Will introduce a new line of long-life metal cartridge heads constructed of an amorphous core material. Will also be showing the new ferrite one-inch audio posts for Sony VTRs and the standard line of ferrite heads for Ampex, MCI, Minicom, Otari, Revox, Studer, and Technics machines.

**SANSUI ELECTRONICS (130)**

Will introduce two brand-new products. B-2301 is a 300-watt-per-channel basic power amplifier with "Super Feedforward" circuitry. PC-XI is a tricode PCM digital processor designed to work in conjunction with a VCR's extended play capability.

**SATT ELECTRONICS (212)**

*See ad page 150.*

**SCRIBE RECORDERS (214)**

Will premiere a production model of NewsCorder, the battery-operated, lightweight audio cassette recorder designed for radio field recording.

**SENNHEISER (1137)**

New products planned for the show are the MKE-2 ultra-miniature electret lavalier mic, plus the full line of professional microphones and headphones for the broadcast and film industry.

*See ad page 272.*

**SESCOM (412)**

Mic mixers, audio amps, and other audio equipment will be displayed.

**SHIVELY LABS (623)**

Will show FM antennas, coax transmission line, RF patch panels, directional couplers, pressurization equipment, and antenna optimization services. (Also see listing in video section.)

**SHURE BROTHERS (1602)**

Will introduce AMS (Automatic Microphone System), an integrated system in which mic and mixer act as one. Each mic/mixer channel contains logic circuits, enabling that mic to act independently. Each mic also continuously monitors its own local acoustic environment, allowing each channel to adjust independently. Also new will be SM6 3L, an omnidirectional mic with streamlined, shock-mounting handle to minimize handling noise.

*See ad page 164.*

**SIFAM (683)**

Will feature high-specification VU and PPM meters as well as low-cost audio level meters and a complete line of control knobs and sliders.

**SIERRA AUDIO CORP. (1618)**

**SINGER BROADCAST PRODUCTS (309)**

The new 30 W direct FM exciter with digital phase-lock AFC system will be introduced. Other new products include a new stereo generator with transformerless audio stages, new 3 kW and 25 kW FM transmitters, and a new 5 kW AM transmitter with solid-state circuitry on plug-in cards.

*See ad page 258.*

**SNARR/CHASE SYSTEMS (609)**

Under its new name the former Chase Media will display business automation and traffic systems for radio and TV broadcasters.

**SOLID STATE LOGIC (1723)**

Exhibiting the 4000E and 6000E Series of audio production and post-production consoles with in-board computers and video monitoring of system parameters.

*See ad pages 138-139.*

**SONO-MAG CORP. (202)**

Automation systems and cart machines will be displayed.

**SONTEC ELECTRONICS (335)**

Will show the completely reworked DRC-FM dynamic range controller, especially for FM broadcast use. The three-band processor works in feed-forward and includes a three-band compressor, expander, noise gate, peak limiter, and 19 kHz filter.

**SONY BROADCAST PRODUCTS (1200)**

On the pro-audio end, news will be made by the introduction of a prototype model of Sony's compact audio disc player designed specifically for professional and broadcast use. The Sony RF mic will also receive attention.

*See ad pages 2-3, 40-41, 205.*

**SOPER SOUND MUSIC LIBRARY (1620B)**

In addition to its production music library, will show for the first time to the broadcast industry the "Music Selector" music selection system, which works with an undedicated micro-computer to help producers select music cues from a music database.

**SOUNDCRAFT (1724)**

Will demonstrate its line of audio on-air, production and post-production consoles. Also its Model 762 multi-track ATR.

**SOUND IDEAS (647)**

At its first NAB, will show its library of taped sound effects, more than 100 reels of effects available at 7½ or 15 ips to the professional market only.

**SOUND TECHNOLOGY (502)**

New this year will be the Model 1510A "all-in-one instrument" for audio and ATR testing featuring automatic measurement and display of ac volts, phasing, second and third harmonic distortions versus level, frequency response, channel separation, etc. Also on view will be the 1710A distortion measurement system, and the 1500A tape recorder test system.

**SOUND WORKSHOP PRO. AUDIO PRODUCTS (1734)**

Will show its range of audio mixing consoles, designed for operation in vid-

*Model AMS 8000 mixer can be viewed at the Shure booth, 1602.*





# Dolby

## Plug Better Sound Into Your Picture

The Dolby® Cat. No. 221 or 226 module allows you to plug the benefits of a Dolby A-type noise reduction directly into your Sony® BVH-1000/1100 or Ampex® VPR-2 1" VTR\*. Operation is fully automatic. And at long last the audio performance of your VTR will rival that of professional audio tape recorders.

Dolby A-type noise reduction has been accepted for years throughout the world for high-quality tape recording and other audio transmission and storage media. It provides 10 dB of noise reduction from 30 Hz upwards, increasing to 15 dB at 9 kHz and above, without the audible side effects (such as noise modulation and overshoot distortion) associated

with more conventional techniques. Dolby noise reduction can also lead to lower distortion, as it permits more conservative recording levels to reduce the risk of tape saturation.

Today wide audio bandwidth and low noise are becoming commonplace in many parts of the television origination/transmission chain. Contact us to find out how Dolby noise reduction can prevent the VTR audio track from being one of the weak links.

\*Outboard Dolby noise reduction units are available for use with virtually any other video or audio recorder.

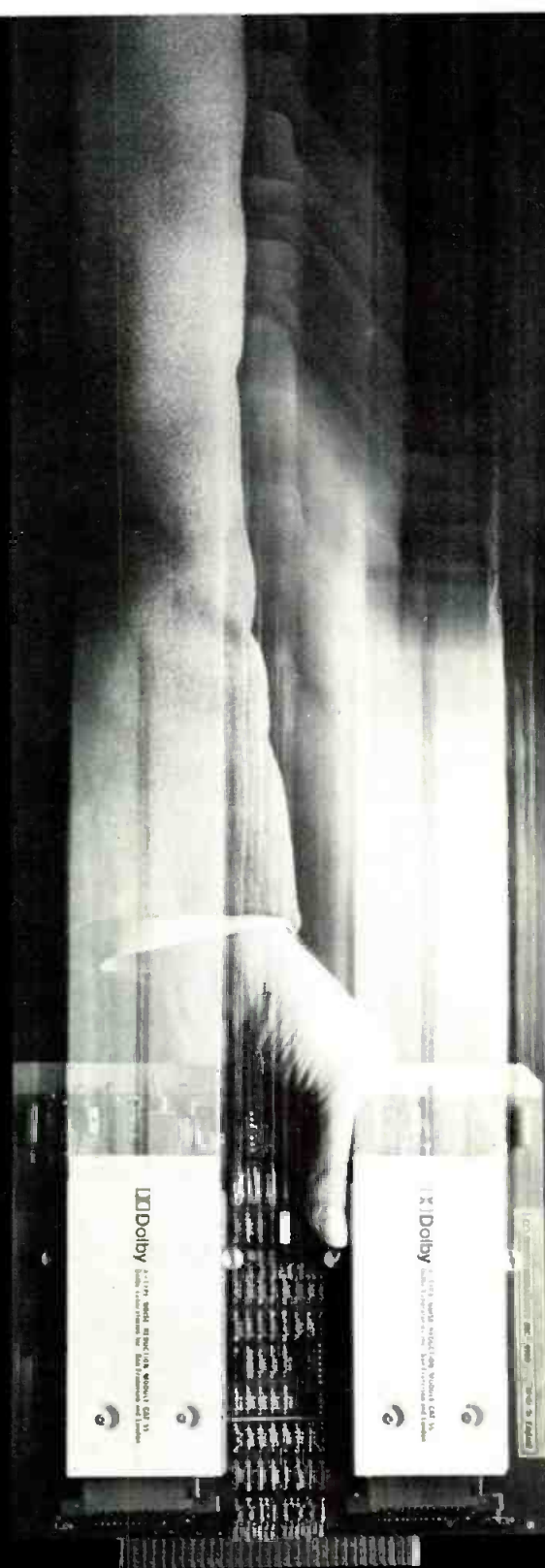

# Dolby®

**Dolby Laboratories Inc.**

731 Sansome St.  
San Francisco,  
California 94111  
415-392-0300  
TELEX 34409

346 Clapham Road  
London SW9 9AP  
England  
01-720-1111  
TELEX 919109

# ★ ★ ★ AUDIO ★ ★ ★ NAB '83

eo and broadcast production environments and capable of interfacing with video editors either directly or through RS-232 ports. Will also display Diskmix, a floppy disk-based automation storage system driven by SMPTE time code that can interface with audio consoles from various manufacturers.

## **SPECTRUM PLANNING (128)**

Will describe standard services such as microwave, satellite, and FM radio coordination. (Also see listing in video section.)

## **STAINLESS, INC. (1347)**

Will describe its line of broadcast towers and antenna arrays.

## **STANTON MAGNETICS (102)**

Brand-new product will be an **announcer's earset** specifically designed to be inconspicuous for on-camera work. The miniature driver element requires only minimal operating power, permitting the announcer to listen while holding a live mic. Other products will include mic preamps, magnetic phono cartridges, and record cleaning/care products.

*See ad page 266.*

## **STATION BUSINESS SYSTEMS (311)**

Have added new capability to the BAT 1700 **management systems plan**. Will also show computer-based systems for billing, accounting, and traffic. Also available is music playlist and inventory, program package inventory, and media cartridge inventory systems.

## **STEENBECK (1769)**

Will show the ST-1 magnetic film recorder, capable of transfer from Nagra and of time code transfer or recording, interlocked with the ST-1B film-to-videtape transfer machine.

## **STEPHENS ELECTRONICS (1757)**

Will show its ATRs and audio synchronizers.

## **STOREEL CORP. (1008)**

Will feature instant-access and modular rapid transit storage systems for tape and cassettes, and rack storage system for Ampex and RCA carts and cassettes. (Also see listing in video section.)

*See ad page 149.*

## **STRAIGHT WIRE AUDIO (130)**

Display will center on a demonstration

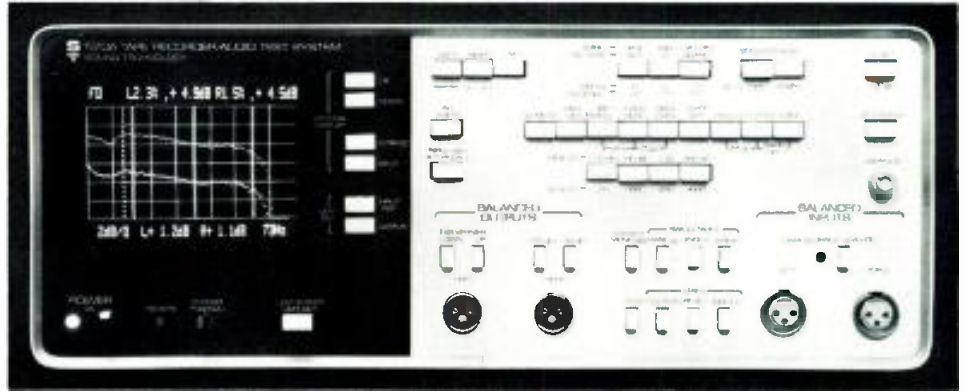

*The Sound Technology 1510A audio test system will be at booth 502.*

of the High Com N/R system, which incorporates an exclusive license from Telefunken. Also will show a preamp card for ITC cart machines and cards for the output transformer stage which are compatible with ITC or Straight Wire preamp card. Also on display will be the UA-2 universal line amplifier with THD of less than 0.001 percent and IM less than 0.002 percent.

## **STUDER REVOX (201)**

Production version of A810 will be new at NAB '83; last year had only prototype; U.S. version is four-speed front-panel selectable, while European version is two speeds. The domestic price of the unit is \$6200. A 800 Mk III is a multichannel tape machine, totally transformerless record and reproduce. Available in 8, 16, or 24, all with same transport.

The Series of 900 and 169/369 consoles will be shown, as will the Revox pro line, including the PR-99 and B77 and B-710 cassette deck.

*See ad page 161.*

## **SWINTEK ENTERPRISES (1345)**

Will introduce its new RFS **multi-antenna switching diversity system** for use with most VHF/UHF wireless receivers. Other products on display will be the all-weather QAC VHF/UHF receivers and the full line of wireless mics.

## **SYMETRIX (641)**

The new display at this booth will be the DCS-16 **remote control system** for transmitter sites via telephone or microwave, able to monitor and control 16 lines at once. Also on display will be telephone interface units, compressor/limiters, stereo amps, and parametric EQs.

## **SYSTEM ASSOCIATES (1121)**

*See ad page 272.*

## **TABER MFG. & ENGINEERING (624)**

Will feature its Taberaser bulk tape eraser, audio recording heads, and Taberamp stereo replacement electronics.

## **TAMRON (1640)**

## **WILLIAM TANNER CO. (410)**

Will describe its music library and radio programming.

## **TASCAM (1304)**

See listing under TEAC.

## **TDK ELECTRONICS (1707)**

Will show line of professional audio tape. (Also see listing in video section.)

## **TEAC/TASCAM PRODUCTION PRODUCTS (1304)**

Will show the new Series 50 mixer/recorder combinations, including the M-50 mixer, the M-52 half-inch two-track recorder, and the M-58 half-inch eight-track recorder. Also showing the full line of consoles and tape recorders, including the 8516B 16-track recorder and the M16 mixer, 24-in, 12-out.

## **TECCOM (1785)**

## **TECHNICAL PROJECTS (440)**

## **TELE-COM PRODUCTS (1728)**

Will show office and personal products, including telephone answering machines, calculators, dictation and transcription equipment, and cordless telephones.

## **TELEVISION EQUIPMENT ASSOCIATES/TEA (1216)**

Introducing the Matthey Dip Delay boxes and back packages and the new Matthey passive cable equalizers. Link audio DAS will also be exhibited, as will Racal headsets and intercoms. (Also see listing in video section.)

## **TELEX COMMUNICATIONS (600)**

New wireless headsets will be introduced. Other new products include the Model 6120 **high-speed duplicating system** and the new Caramate 4000 **audio cassette slide projector**. Also plan to show the line of cartridge and reel-to-reel audio tape machines, the Audio-com closed circuit intercom system, and the lines of wired and wireless mics. Reel-to-reel loggers, headphones, and high-speed audio cassette





## A NEW DIMENSION IN MASTER CONTROL SWITCHING

*Utah Scientific, the industry's number 1 supplier of routing switchers, has now applied its talents to an allied area—Master Control Switching. Designed for immediate conversion to stereo and / or station automation, Utah Scientific Master Control Switchers are designed to deliver superior performance today while accommodating your future needs as well.*

- Two models: two bus and three bus
- The industry's best performance specs
- Full preset capability with "goof-proof" single-button execution
- Integral edge, shadow, outline and color matte
- 28 direct inputs plus two assignable from panel
- Alphanumeric readouts on assignable inputs
- All-digital interconnect via RS-422 lines
- Top quality switches
- Stereo-ready—just add the matrix and one card
- All panel functions software controlled
- Machine control for two telecines and ten VTR's included
- Available with or without station automation system
- Preroll times individually assignable and user alterable
- Full audio over / under capability
- Separate 8 x 3 audio only matrix included
- Four large LED VU meters

**US** **UTAH SCIENTIFIC**  
a DYNATECH company

1685 West 2200 South  
Salt Lake City, Utah 84119

Telephone: (801) 973-6840  
Toll Free: (800) 453-8782  
TWX: 910 925 4037

**See us at NAB Booth #1114**

Circle 215 on Reader Service Card



  
**CERTIFIED  
PERFORMANCE**

TEST OSC.  
0 REF  
OFF -10db  
12.5K 250  
10K 500  
HZ 8K 4K 1K

METER  
TELE



SEE PRIMUS  
AT NAB BOOTH 415

# TAKE A CLOSE LOOK AT THE NEW PRIMUS<sup>TM</sup> CART MACHINES.

**Introducing the PRIMUS (pree-mūs) cartridge recording/reproduction system from Ramko Research.**

These new cart machines are engineered to be demonstrably and dramatically better than any other cart machines in the industry. They deliver signal-to-noise, distortion and frequency response specifications that are unrivaled. They set a new standard for the lowest wow and flutter. They're built rugged throughout to guarantee adherence to specifications.

**COMPARE THESE SPECIFICATIONS: YOU BE THE JUDGE.**

roller is engaged by an adjustable air-dampened solenoid with a Teflon-coated plunger for friction-free, quiet operation. Optical sensors start the motor when a cart is inserted. This not only eliminated start-up wow, but it means there are no mechanical switches to break or jam. Bearings have a longer life too because the motor doesn't need to run continuously. A crystal-controlled, brushless D.C. servo motor insures timing accuracy to within 0.05%. The minimal motor heat is kept away from your tapes by a high traction, ceramic capstan. Tape speeds (7.5 & 15 ips) are field selectable.

With PRIMUS, you have three cue tones with sharp, error-free digital sensing. Solidstate bar graph meters and dynamic noise reduction are standard. An

sistently repeatable, accurate electronic phase alignment. A front panel phase meter and internal diagnostics are added for operating ease.

PhaseMaster works flawlessly with any cartridge and eliminates the compromise of unreliable and inconsistent electromechanical schemes. The trade-offs imposed by noise-inducing and non-compatible matrixing approaches are now history. Complex, inexact cross-correlation techniques have been discarded. With PhaseMaster you're positively guaranteed compatibility with all your previously recorded carts. Here's a cart machine truly ready for superior FM & AM Stereo applications — a machine that rivals the performance of an open reel recorder.

	PRIMUS <sup>TM</sup>	ITC RP SERIES	AUDICORD #128	BE SERIES 3280	PhaseMaster	TOMCAT	ITC SERIES 99B	ATR-880* (Reel-to-Reel)
Signal-to-Noise Ratio:	-60 dB	-50 dB	-47 dB	-52 dB	-65 dB	-59 dB	-56 dB	-60 dB
Distortion (System):	0.9%	2.0%	1.0%	2.0%	0.9%	0.9%	0.8%	0.3%
Frequency Response: 50 Hz - 15 kHz	±1.5 dB	±2.0 dB	±2.0 dB	±2.0 dB	40 Hz - 15 kHz ±1.5 dB	40 Hz - 15 kHz +5, -1.0 dB	31.5 Hz - 15 kHz ±1.0 dB	40 Hz - 15 kHz ±2.0 dB
Wow & Flutter:	0.095%	0.2%	0.15%	0.15%	0.08%	0.05%	0.15%	0.06%
Real time Phase Correction:					locks to 5° @ 15 kHz	none	none	none
Price:	\$2,550	\$2,810	\$1,979	\$2,450	\$3,850	\$5,280	\$5,330	\$6,230

All measurements referenced to 160 mW/m, distortion is THD @ 1 kHz. All models are R/P stereo, priced with three cue tones. All prices are based on latest available manufacturers' information 3/83.

All measurements referenced to 250 mW/m, distortion is THD @ 1 kHz. All models are R/P stereo, priced with three cue tones (excepting ATR-880). \*Measurements referenced to 370 mW/m.

## A CLOSER LOOK AT BETTER ENGINEERING

Mono or Stereo, R/P or playback, here are more reasons why the PRIMUS cart machines are the industry's most advanced.

The PRIMUS transport deck is 5/8" thick cast alloy for superior stability. It's covered with stainless steel for wear resistance and EMI shielding. The machined headmount allows easy and precise adjustments. In addition, the heads are internally illuminated for cleaning and inspection. For smoother insertion and withdrawal and to prevent distortion, carts are securely held at the edges by spring-loaded rollers, rather than friction springs. To prevent tape skew, pinchroller parallelism is adjustable with the motor running. The pinch

automatic 4 1/2 digit timer is optional. All electronics are on plug-in modules and rear panel connectors are quick disconnect type.

In summary, the PRIMUS cart machines have been engineered to be the most sophisticated broadcast reproduction system you can buy for under \$3,000.

**COMPARE THE PHASEMASTER<sup>TM</sup>: YOU'RE THE JUDGE AGAIN.**

If you're in the market for the ultimate Stereo phase-correcting cart machine, look to our PhaseMaster, the broadcaster's premier phase-correcting, stereo cart machine.

The PhaseMaster has all the features as PRIMUS plus, the advantages of con-

## THE CERTIFIED PERFORMANCE GUARANTEE

Whether you invest in PRIMUS or PhaseMaster, you'll receive a two year warranty\* and a Certified Performance Gold Card that instantly puts you in contact with our Technical Assistance Department over our toll-free hotline.

To put PRIMUS or PhaseMaster to task call (800) 821-2545 or contact your nearest Ramko Research sales representative or distributor. Ask about our two week free trial.

Take a close look at how the Certified Performance of PRIMUS or PhaseMaster can make your job a whole lot easier.

**PRIMUS**

PRIMUS is a division of Ramko Research, Inc.

copiers will also be exhibited.  
 See ad page 144.

**TELMAR CORP. (1520)**

**TENDEL CORP. (1613)**

Will show the Tentelometer tape tension gauges for audio recorders. (Also see listing in video section.)

**TERMINAL SYSTEMS (1768)**

Will premier its ACORN (Automatic Compilation Of Radio-TV News) turn-key newsroom computer system for radio and television. Both hardware and software are produced by the company; system includes word processing.

**TFT (109)**

Will bring the new Model 8300 high-density FM STL; and the Model 1834 SCA equipment for TV. Also showing the line of other STLs for FM and AM; telemetry return links; remote-control systems; data acquisition systems; monitoring equipment for AM stereo, FM and TV, for modulation and frequen-



Booth 600 will house the Telex 6120 tape duplicating system.

cy; SCA monitors; FM-SCA receivers; radio-controlled load management; E-Alert receivers for EBS signals.

**THOMSON-CSF BROADCAST (1001)**

Will show the Volumax audio processor for AM and FM, along with complete lines of DAs, automatic level controllers, dynamic presence equalizers, and FM transmitters. (Also see listing in video section.)

See ad page 101.

**KEVIN TRACY PRODUCTIONS (645)**

**TRIDENT (633)**

Introducing the VFM Series of low-cost modular mixing consoles with four-band EQ on each input, three auxiliary sends, and 12-segment metering. Will also show the line of recording consoles at varying size and price levels.

**TROMPETER ELECTRONICS (1211)**

Will show the regular line of coaxial cable, patch panels, etc., with many accessories.

**TRUE TIME INSTRUMENTS (643)**

Will introduce automatic synchronization of analog clocks to the National Bureau of Standards time signals and a new option for the Model 60-DC, 468-FPC and 468-E satellite synchronized clocks for interface of simplex-type analog clocks. Also showing line of phase comparators and a line of NBS time and frequency receivers.

**TTC (305)**

Showing equipment from its three divisions: TT, Wilkinson Radio, and Satellite Technology. Will have AM and FM transmitters and a 10 W FM translator. (Also see listing in video section.)

**TWEED AUDIO (313)**

Will highlight its services as a designer and manufacturer of customized audio systems for the broadcast market.

**UMC ELECTRONICS (114)**

An all-new splice finder with bulk eraser, the SPE-100, is planned for introduction along with the SF-100 splice finder. Full line of broadcast cart machines and on-air consoles will be displayed. The Beaucart II economy cart machines and the Monitor II cart playback machines will be exhibited.

See ad page 274.

**UNIDYNE TECHNOLOGIES (616)**

Will describe services for designing and executing direct mail campaigns for broadcast stations, using targeted

**THE NEW STANDARD  
 COVERS AM BAND PLUS HARMONICS TO 5 MHz**



The Model FIM-41 Field Strength Meter has many more features —

- Measures Harmonics to -80 dB
- High Adjacent Channel Rejection
- Ganged Oscillator/Receiver Tuning
- Stable Operation over wide Temperature Range
- Low Battery Drain Circuits
- Front Panel Speaker
- Large illuminated Meter and Tuning Dial
- Indicates field strength accurately down to 10  $\mu$  volts/M
- RF input jack for tuned voltmeter applications

CONTACT US NOW FOR COMPLETE DETAILS ON OUR LINE OF FIELD STRENGTH METERS

**POTOMAC INSTRUMENTS**  
 932 PHILADELPHIA AVE.  
 SILVER SPRING, MARYLAND 20910 (301) 589-2662

Circle 217 on Reader Service Card





## SUPERB VIDEO, ELEGANT SIMPLICITY.

INTRODUCING THE VIDEOLA® V-500 . . . for broadcast-quality Film/Video Synthesis™ in a new, compact form.

Offering all of the quality and convenience features of the widely-accepted V-1000, this new model is for applications which don't require sep-mag facilities, but do need the capacity for films up to 6,000 feet in length.

Built around the unique Flickerless Prism® optical system, Videola produces superb images with no sign of flicker, jitter or frame lines . . . at any frame rate. Because the Videola optics merge adjacent frames into a continuously-moving image, TV synchronization is no longer a consideration. Video transfers can be made at crystal-controlled sound speed or at any speed forward or reverse up to 6x (35mm) or 10x (16mm) sound.

Video output will stay state-of-the art for years to come, because the Videola optics deliver their

image to the pickup tube of a high-quality ENG/EFP camera . . . readily exchanged for a future high-resolution model.

Please write or call for full information on the V-500 and V-1000, and for the names of happy Videola users. In the east, contact Laumic Co. Inc., New York.

Magnasync/Moviola Corporation, A Subsidiary of Craig Corporation, 5539 Riverton Avenue, North Hollywood, CA. (213) 763-8441. Cable: MAGNASYNC. Telex: 67-3199 MAGNA/MOVIO.



Circle 218 on Reader Service Card

zip code lists from automated lists in 36 states, with specially created contests, audience research, program analysis. Lists reach nontelephone subscribers. Will show a number of successful direct mail campaigns.

**UNITED MEDIA (1300)**

Will feature the Model 425 audio router/dissolver for interfacing audio with videotape editors. (Also see listing in video section.)

**UNITED PRESS INTERNATIONAL (1015)**

Broadcast news services.

**UNITED RECORDING ELECTRONICS IND./UREI (513)**

UREI will have the Series 1600 consoles. The 1650 is a five-input and the 1680 an eight-input board with three choices of attenuators for each model. Featured are clipping LED indicators, front panel switches from program to audition, and there is an ac reference to ground. To go along with the broadcast consoles, a new line of preamps will



UREI's Music Mixer Model 1620 can be seen at booth 513.

be introduced. Model 1101 is an out-board turntable preamp matched with the specs of the two consoles.

A full line of audio signal processing equipment, including EQs, filters, limiters, compressor, power amps, and control room monitors will be shown. There will also be displayed test equipment for audio products.

*See ad pages 180-181.*

**UNITED RESEARCH LAB (406-A)**

Introducing the Auto-Tec MP 101 solid-state mic preamp for professional recorders. Also exhibited will be the Auto Tec C-5 amps and replacement

parts for professional recorders and Ampex, Saki, Nortronics, IEM head-stacks and alignment tapes.

**UNR-ROHN (410)**

See listing under ROHN.

**URSA MAJOR (418)**

Unveiling the 8X32 digital reverbator with remote console. Also showing the Space Station SST-282 digital reverb unit.

**U.S. TAPE & LABEL (602)**

Adding concert patches to the line of bumper strips and window labels for the broadcast industry.

**4 Models—8 and 10 mixer dual stereo with rotary or linear faders • Transformer Balanced Inputs and Outputs • 3 Inputs Per Mixer—internal pads allows mic/line selection on the same mixer • Two 4-Input Auxiliary Input Selectors—may be assigned to any mixer • Pre-fader Pushbutton Cue—in addition to normal CCW fader cue position • LED Status Indicators—color coded to aid in instant identification of function selectors • Momentary or Continuous Remote Control Contacts—internally selectable, also controls optional digital timer reset/start • Full Metering Capability—two meters standard, up to four meters and/or digital clocks and timers optionally available, all meters provided with LED peak indicators • Gain Selectable Microphone Preamps—provided with center tap access for phantom condenser microphone power, processor input/output port with buffer amplifier for outboard compressors, limiters, etc. • Programmable Muting Logic—internal pin-programmed matrix allows any selection of monitor and cue muting for the first five mixer positions • Pushbutton Aural Phase Test • Announcer's Microphone Intercom-Air Selector • Full Dual Channel Operation—-independent program and audition assignment push-buttons • Five Monitor Driver Outputs—four muted, one non-muted • All Mixers Switch-Selectable to Mono or Stereo • Ground-Plane Techniques Used Throughout for Increased RF Immunity • Selectable Internal or External Master Level Controls • Accessories and Options—mono mixdown, high impedance (cassette) line input plug-ins, reference oscillator/line input plug-in, additional microphone input plug-ins, digital clock, digital timer, linear faders.**

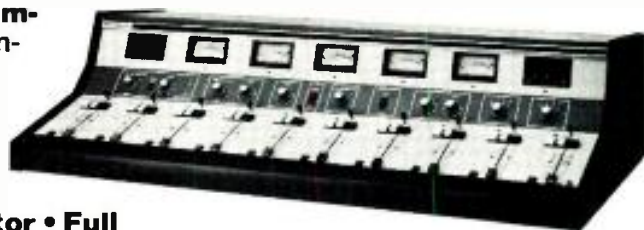

**LPB® citation series** Everything you want in an audio console  
 LPB Inc. • 28 Bacton Hill Road • Frazer, PA 19355 • (215) 644-1123  
 Manufacturers and Distributors of Broadcast Equipment since 1960  
 © 1981 LPB Inc.

See us at NAB Booth #405

Circle 219 on Reader Service Card





# All Others Lag Far Behind

SATICON\* is the odds-on favorite among pickup-tube brands. Offering cleaner, clearer, more realistic images. And available in a variety of sizes to meet your exact specifications.

## SATICON-III

Developed by using Hitachi's own techniques for high-precision evaporation and doping that allows only infinitesimal amounts of impurities, this new generation of SATICON tubes provides minimal highlight sticking and low-lag characteristics.

## New Diode Gun SATICON

Two models incorporate the SATICON series' first electron gun: the H9386B and the H9386D. Activation is achieved by an innovative "five-electrode" diode-operated gun, opening new vistas for TV cameras by breaking the resolution performance limits imposed by conventional camera tubes. The H9386D is rated for low output capacity.

\*US Registration No. 1047050

Specifications	H9879A 1-inch SATICON-III	H9386B and H9386D* 2/3-inch New Diode Gun SATICON-III
Focusing method	Magnetic	Magnetic
Deflection method	Magnetic	Magnetic
Maximum diameter	28.9 mm	19.8 mm
Overall length	163 mm max.	105 mm max.
Rated heater voltage	6.3 V, 95 mA	6.3 V, 95 mA
Amplitude response (at the center of screen, 400 TV lines)	70%	60%
Limiting resolution (TV lines)	1,200 lines	1,000 lines
Lag (50 msec after, 5 nA equivalent bias light)	1.5%	0.8%
Applications	Studio cameras	ENG and EFP cameras

\*Low output capacity type



Head Office: Hitachi, Ltd. Electronic Devices Group, 6-2, Otemachi 2-chome, Chiyoda-ku, Tokyo 100, Japan  
 Tel: Tokyo (03) 270-2111 Cable: HITACHY TOKYO Telex: J22395, J22432, J24491, J26375 (HITACHY)  
 For more information contact: Hitachi America, Ltd. Chicago Office, 500 Park Boulevard, Suite 805, Itasca, Illinois 60143 Tel: (312) 773-0700

Circle 220 on Reader Service Card



**UTAH SCIENTIFIC (1114)**

Will introduce a new line of software-based **master control switchers** with full stereo capability and audio over/under while the matrices accommodate 30 video inputs. A new station automation system will be demonstrated in conjunction with master control switchers. The full line of routing switchers and audio/video DAs will be on display.  
*See ad page 193.*

**UTILITY TOWER (200)**

Displaying standard tower sections and base insulators.

**VALENTINO MUSIC LIBRARY (1231)**

A **sound effects library** for radio and television with over 2000 different effects on 30 LPs will be introduced. The Production Music Library with over 3000 selections will also be on hand.

**VALLEY PEOPLE (318)**

Introducing Model 610 **compressor/expander** and a new TR806 10-

position one-piece metal rack for 800 Series products, and new **600 Series product**. Standard equipment will feature the 810 Kepex II expander/noise gate keyer, a parametric EQ, a full line of preamps, and the HH 2x2 level-matching interface.  
*See ad page 189.*

**WARD-BECK SYSTEMS (1224)**

The transportable T1202A audio consoles will be displayed, along with the R1000, R1200, and R2000 radio boards, as well as the M1204B production consoles. The L-Series of television mixers and various custom designed consoles will also be displayed along with the MicroCOM communications systems.  
*See ad Cover 4.*

**WEATHERMATION/ SATELLITE BROADCAST NETWORK (1179)**

Will describe its weather radar systems.

**WEGENER COMMUNICATIONS (628)**

**WHIRLWIND MUSIC (329)**

Showing interface cables for audio and video, as well as matching transformer systems and multipair cables.

**WIREWOKS CORP. (1511)**

Hardwired microphone multicables will be the center of the show, along with the TE-2 mic cable tester and other professional mic cables. Coaxial cables and audio/video multicables will round out the exhibit.

**WOLD COMMUNICATIONS (1515)**

Point-to-point and multipoint television and radio program transmission and network interconnection systems will be demonstrated with a live nationwide syndicated television broadcast.

**WORLD TOWER (519)**

Will show the regular line of antenna towers in sections and photographs.

**WSI CORP. (1777)**

Will feature its weather and sports databases, providing real-time sports and weather information via satellite distribution or on a request/reply basis.

**YAMAHA INTERNATIONAL (1340)**

Will feature its sound reinforcement consoles and recording mixers, along with a full line of audio equipment, including amplification gear, speaker systems, and audio signal processing.  
*See ad page 174.*



**For state & regional radio network systems,**

**COME TO COMTECH FOR THE PERFECT SOLUTION.**

Comtech's engineering excellence, cost-effective manufacturing and sustained inventory will assure you prompt delivery of high-quality systems. Just look at the features:

- 3.8 meter antenna/2° spacing
- Optional built-in SCPC demodulator
- Optional composite video baseband for MCPC applications
- Antenna mounted LNC allows single low-cost coax interconnect
- Remote three-channel select
- Broadcast quality audio

For details and prices, call Comtech Antenna Corp., P.O. Box 428, St. Cloud, FL 32769, (305) 892-6111, TWX 840-870-0220. Or Comtech Data Corp., 350 North Hayden Rd., Scottsdale AZ 85257, (602) 949-1155, TWX 910-950-0085.



**COMTECH** Comtech Data Corporation  
 Comtech Antenna Corporation  
 Creative solutions Subsidiaries of  
 in satellite communications. Comtech Telecommunications Corp.

Circle 221 on Reader Service Card

**NEW! BOOK VIDEOTAPE EDITING**

**Videotape Editing-Communications With Pictures And Sound answers every videotape editing question:**  
 When to edit? When to (and when not to) use a dissolve or wipe? How to cut? How to use complex sync role editing and audio sweetening? How to affect the mood and pace of a show? Why and how to perform computer editing without losing creative control? It even takes the mystery out of time code and user bits.

Beginning editors, experience pros, film editors, and media managers will all appreciate Videotape Editing. This new book is your guide through the world of computer assisted videotape editing.  
**Videotape Editing-Communications With Pictures And Sound** By Michael D. Sbetter  
 • 165 pp • 1-1/4 illus. • 6" x 9" • Hardbound  
 Order Today!  
 Brochure Available  
 (312) 364-1900 Ext. 825  
 Major Credit Cards Accepted

**SE Swiderski Electronics Inc.**  
 Audio Video Engineers  
 200 Greenleaf Ave. • Elmhurst, Ill. 60120

Circle 222 on Reader Service Card



# Why Beyer mics represent a viable alternative to the usual choices in Broadcast.



Beyer MCM Condenser System



Beyer MCE 5 Lavalier



Beyer M 260

Now there's another high-tech German condenser system.



Until recently, film and broadcast engineers thought only Sennheiser and Neumann made high-quality condenser microphone systems. Now the Beyer MCM Series offers the same German excellence in design and construction, the same kinds of accessories (windscreens, pistol grips, shock mounts) and facilities for 12V and 48V "phantom" powering.

And since the MCM Series studio condenser mic is part of a system which combines power modules and different mic capsules (long shotgun, short shotgun, unidirectional, omnidirectional and figure eight), you get more microphone potential for dollar output.

Like all Beyer microphones, the MCM Series is a truly professional instrument system suited to the widest range of applications in Broadcast/Film and Video post-production.

With lavalier mics, small is not enough.



Electret condenser lavalier mics like SONY's ECM-50 have proven useful for on-camera miking situations because of their reduced size. And while many of these mics offer good performance in a compact size, the Beyer MCE5 also provides extended frequency response (20 to 20,000 Hz) and durability in an even smaller format (diameter: 7 mm / length: 23 mm).

To optimize its compatibility with a variety of broadcast and film applications, the tiny black MCE5 is available in different configurations for powering interface and includes a system with accessories like windscreens, expansion mounts etc.

At Beyer Dynamic's ultra-modern manufacturing facility in West Germany, we hand-build virtually all of our microphones in the most evolved state of fine German engineering.

There's more than one way to bring out the warmth in an announcer's voice.



Broadcast engineers choose the E-V RE20 for many vocal announcing situations because of its wide frequency response (45-18,000 Hz)\* and smooth sound. Beyer Dynamic's M 260 also provides the extended frequency response (50-18,000 Hz) and warmth required for critical vocal applications with one distinct advantage: its reduced size. Its compact and efficient ribbon element captures the warmth traditionally provided by this type of mic. And because it is considerably smaller than a mic with a large moving-coil diaphragm, the M 260 provides a natural, balanced sound image in a portable format that won't obscure copy or take up valuable space in the studio.

The Beyer M 260 has its own custom-designed ribbon element to optimize the mic's performance based on its Broadcast applications.

The Dynamic Decision

beyerdynamic

\*Extracted from competitive promotional literature or advertising.

\*\*Documentation supporting specific comparative claims available upon request.

See us at NAB Booth 426

Beyer Dynamic, Inc. 5-05 Burns Avenue, Hicksville, New York 11801 (516)935-8000

Circle 223 on Reader Service Card

www.americanradiohistory.com

Now, I can program, air and control station breaks, local commercials—in fact totally automate my station's scheduling needs 24 hours a day with just the touch of a finger.

Unlike costly 2" video cart machines—this automatic multi-deck random-access video cart system developed by Lake is compact, modular and has the flexibility I need.

It was a turn-key system.

I had a choice of formats: U-Matic/Type M/Type C. La-Kart is expandable and capable of controlling up to 30 machines. It features automatic frame accurate switching—plus, total redundancy. Best of all, it reduces tape costs, programming time—and even cuts my overhead by freeing

operators to perform other duties.

La-Kart. It's the affordable system for the cost-conscious station manager.

For the La-Kart representative nearest you please contact: Lake Systems Corporation, 55 Chapel Street, Newton, MA 02160 (617) 244-6881

**LAKE**  
LAKE SYSTEMS  
CORPORATION

TWX 710 335-1639.  
The La-Kart Series I shown is \$94,500.

The Systems Company

# "La-Kart™ Does Everything Except Bring Me My Coffee"

Jim Boaz, Station Manager  
WXXA-TV/New York

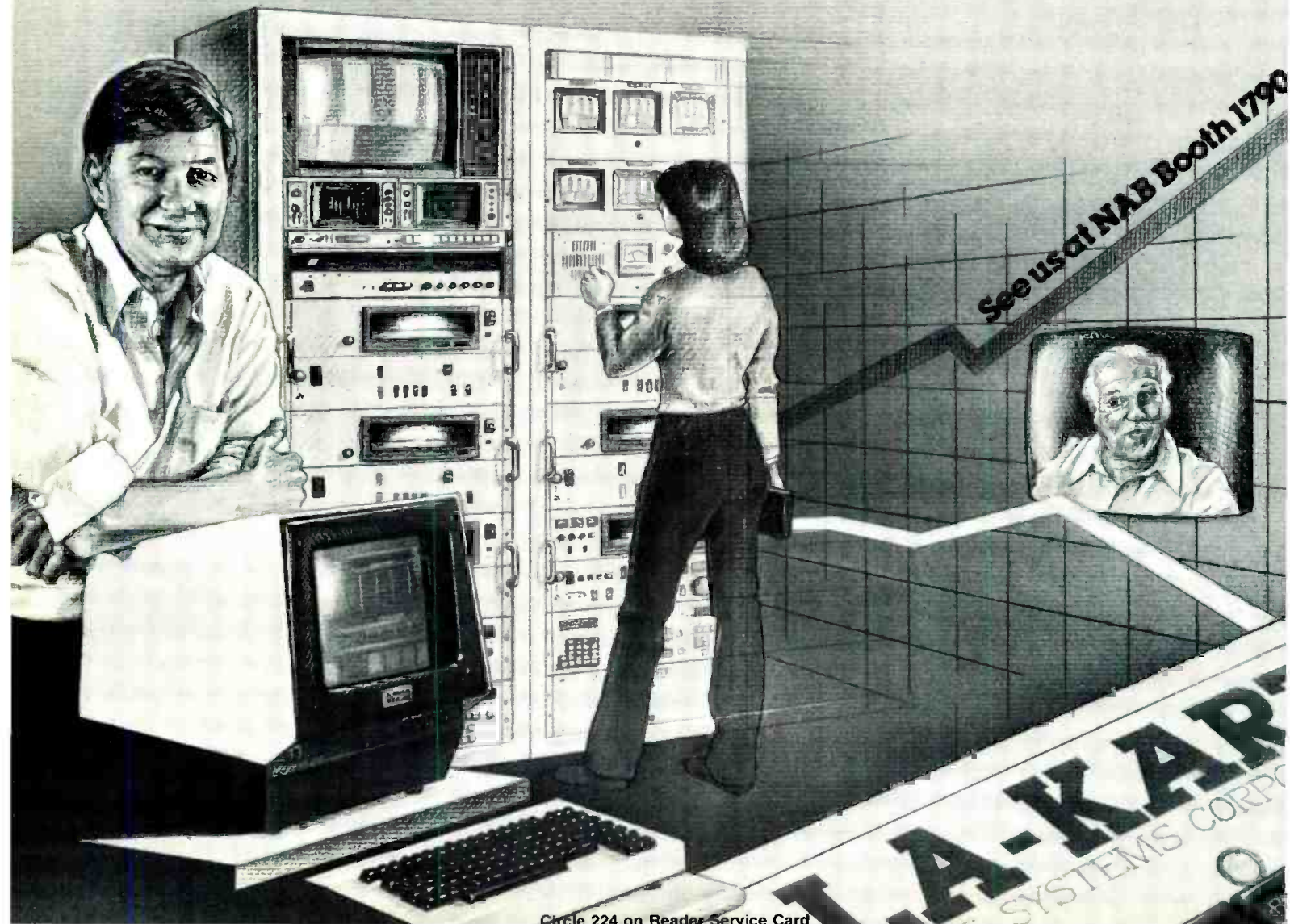



# Development of the VPR-5

By C. Thomas Hasty

***Joint design of the compact Ampex/Nagra VPR-5 one-inch Type C VTR is being hailed as a major technological advance. How was it engineered and developed so successfully into a broadcast product?***

THE C-FORMAT ONE-INCH videotape recorder has provided all users of high-performance video with a new combination of production/post-production utility, special effects, economy, and quality in creating the final program product. The field-per-scan characteristic of the C-format, with its inherent still and variable speed playback, has encouraged the development of a new video editing art. And video productions, whether programs for education, travelog, news, sports, or entertainment features, are taking on a new look due to the unique contribution of the C format.

However, to date, the C format has not had a truly portable VTR for high-quality field acquisition of editable program material. The best efforts of VTR manufacturers to supply full-performance recording units for EFP in the C format have resulted in units that weigh a minimum of 40 to 55 pounds; they are transportable, but certainly not humanly portable. To acquire field material from remote or difficult terrain, the producer of quality productions has been forced to rely on the lower-performance 3/4-inch video format or to mix film from field production with his video format, and go through tedious translation into the C format to be properly edited with all the finesse available with the studio C-format VTR and supporting equipment.

Until recently, VTR technology in the portable area has not kept pace with the available EFP camera packaging. The smallest, lightest weight VTRs available are the 3/4-inch and half-inch tape formats, but they are no match for the camera performance now available in this size and

C. Thomas Hasty is senior product manager for the VTR group of Ampex's A/V Systems division, and was a key member of the VPR-5 design team.

weight class. It is no question that a C-format VTR of under 18 pounds, in a size complementary to these full-performance cameras, is desirable and necessary.

Ampex Corporation and Kudelski, S.A., recognizing this user need for a truly portable C-format VTR, entered into a joint development program in early 1981 to produce such an innovative product. The merging of the Kudelski/Nagra expertise in rugged, portable audio recorders with Ampex video knowledge led to the world announcement at the International Broadcast Convention in September 1982 of the Ampex Nagra VPR-5. Full C-format record performance was realized in a VTR weighing under 15 pounds.

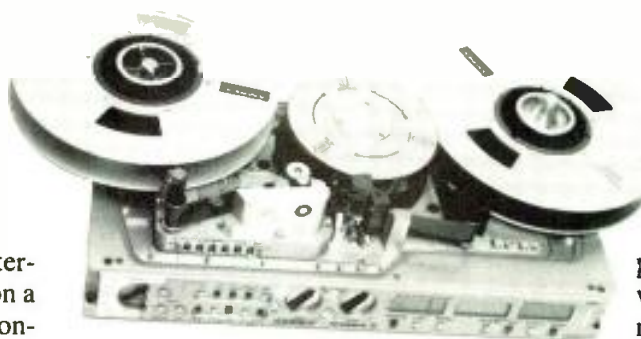

*The Ampex/Nagra VPR-5.*

## **The design task**

Imagine the task of producing such a C-format VTR! In attacking a 15-pound design goal for this VTR, the weight reduction required was a staggering 4:1. Where would one start to produce a design with such a significant saving in weight?

There was, of course, the necessity to attack directly packaging structures and the VTR mechanism to effect overall weight decreases. However, since emphasis on minimum power leads to efficient, minimal component circuits, and this pays double benefits in reduced battery size and weight, power efficiency was given first priority in the design project.

Major changes to the basic electronic organization of the recorder were not necessary since the C-format parameters are fixed and the design implementation of the record/playback is well known. However, analog video integrated circuits, now widely used, are quite power-hungry, and so the VPR-5 VTR design reverted to discrete component circuit design so that power may be saved.

# cine 60 Nicads

Pure and Simple,  
The Power to Rely On.

## Booth #1423, NAB

Belts, Packs, BP-60, BP-90, BP-20 Nicad Batteries

... Our 23rd Year.

630 Ninth Ave., New York, NY 10036 (212) 586-8782  
6430 Sunset Blvd., Hollywood, CA 90028 (213) 461-3046

Circle 225 on Reader Service Card

## Telemetry Problems?

Many subcarrier and telco telemetry circuits are shakey, making telemetry return the weakest link in broadcasting. The Marti TSL-15 is solving these problems.



TSL-15

This link consists of a 15 watt type accepted transmitter, a narrow band receiver and Yagi Antennas designed for 450-456 MHz. group P channels. This system will provide continuous-duty operation, and can handle data and voice in a 20Hz.-3000Hz. band. Test meters are provided on both transmitter and receiver. Automatic station identification is available and external DC operation is provided for.

**MARTI** MARTI Electronics, Inc.  
1501 N. Main • P.O. Box 661  
Cleburne, Texas 76031  
(817) 645-9163 • Telex 794 835

Circle 226 on Reader Service Card

## Development of the VPR-5



The VPR-5 weighs less than 15 lbs.

Much of this circuit design is implemented in the newest miniature, leadless components and, where possible, in hybrid circuit modules.

The SO, or "small outline" component package is just now becoming available in multiple products from a number of manufacturers, and these are used extensively in the design to yield smaller electronic modules, less power consumption, and an overall VTR weight reduction.

Another way of saving power was in the use of digital logic. Of course, extensive use of CMOS, which is inherently low power, is to be expected; however, only recently have semiconductor manufacturers turned their attention to low-power microprocessors. The VPR-5 uses the NSC 810 CMOS computer to implement all system control and diagnostics. Internal time code generation and processing is implemented by another NSC 810 processor, rather than by one of the available special-purpose time code generator chips.

Being microprocessor controlled, the VPR-5 also has intelligent power control, so that internal power can be carefully switched on and off to each VTR module only as needed. To this end, the VTR circuits are carefully partitioned by function, with appropriate power dispatching by the computer.

One area in which VTRs are inefficient is in the re-use of stored, inertial energy. Inertial energy in scanner, reel motors, and capstan is usually dissipated by the servo systems as heat. If one could return some part of this energy as regenerated dc to the batteries, total power requirement and, therefore, battery weight, could be reduced. In the VPR-5 design, the high stored energy of the spinning



# NOW YOU CAN HAVE THE BEST IN WIRELESS WITHOUT GOING PENNILESS.



When we asked sound engineers which wireless was superior for sound, quality and design, the overwhelming choice was Sony.

And now, the wireless system unequaled by any of our competitors in quality is highly competitive in price.

Which means, for about what you pay for an ordinary system, you can have the most flexible system you can buy. A modular system that can be set up and rearranged in the greatest possible number of configurations in a mere fraction of the time it takes to set up any other system. So it's suitable for any production requirement—studio or field.

Then there's the performance. The dynamic range is 96dB. The frequency response is 100-15000kHz. And signal-to-noise is greater than 60dB.

And because the wireless system is based on the Sony theory of total system technology, it's compatible with all standard professional audio and video systems on the market today. For all the facts on how you can have the state of the art in wireless without going into a state of bankruptcy, contact Sony Professional Audio Products, Sony Drive, Park Ridge, New Jersey 07656.

**SONY**  
Professional Audio

Sony Communications Products Company, Sony Drive, Park Ridge, New Jersey 07656. © 1983 Sony Corp. of America. Sony is a registered trademark of the Sony Corp.

Circle 227 on Reader Service Card

[www.americanradiohistory.com](http://www.americanradiohistory.com)

## Development of the VPR-5



◀ A pluggable input/output video "personality module."

The upper drum with head/electronics assembly. Heads are field replaceable.



The simple direct drive configuration of the tape leaves the interior of the VPR-5 totally free for electronics.

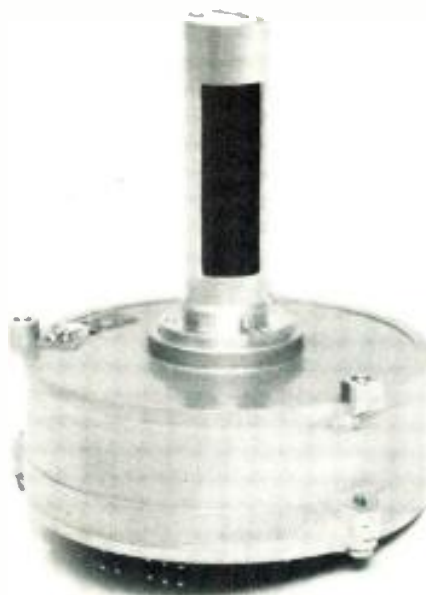

To save weight, an aluminum capstan was used in the drive assembly. A carbon fiber composite surface was added to increase friction and minimize wear.



Reel motors release and reposition to accommodate one-hour reels.

C-format scanner is dynamically braked when not recording, and this energy is returned to the battery to extend battery life.

Another consideration was a coaxial reel configuration. Besides being complex, however, they are somewhat inefficient in power transmission. Also the longer tape path required has more turnarounds and guides. All this would have meant more power consumption. Therefore, it was decided the VPR-5 must "regress" to a reel-to-reel configuration, with the shortest tape path possible. To keep the VPR-5 physical size reasonable, the reel-to-reel aspect dictated a tape capacity of 20 minutes maximum in the portable configuration with the weather-tight cover in place. With the cover off, the VPR-5 can accommodate one-hour tape reels.

### Mechanical design

Probably the most innovative aspect of the VPR-5 is that all conventional techniques of packaging and mechanical parts fabrication were abandoned. One would think casting and forming of aluminum would lead to the optimum strength-to-weight desired for all metal parts of such a VTR. However, most aluminum sheet material that is malleable enough for forming is also only mildly strong in ultimate tensile strength. Also, aluminum alloys able to be cast do not produce the strongest piece parts. Although careful use of these conventional processes could result in lower VTR weight overall, the crossover point between

ruggedness and weight savings would still leave us with an unnecessarily weighty production.

The solution was to start with solid stock of the aircraft machine aluminum alloy 7075, with a tensile strength rivaling steel. All parts are machined to precise strength-to-weight dimensions, including the control panel, case parts, latches, connector shells, and so on. Where large nonprecise surface areas preclude flat machining, the same 7075 alloy in sheets is formed much as the skin of modern jet aircraft. In this way, every gram of superfluous material not required to work either as part of the structure or as a functioning item is deleted from the VPR-5.

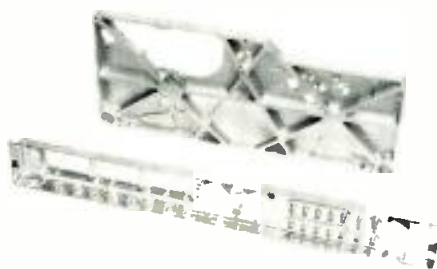

The top plate and front panel. No castings and almost no sheet metal is used in the recorder.

Computers were used extensively in this design for maximum strength-to-weight, and the most modern of computer-controlled manufacturing machined tools used for production. On some parts, the final grams of weight are removed by precise chemical machining. As a case in point, the VPR-5 transport top-plate starts out as a 15x34x15 cm plate of aluminum and ends up looking as if it were a precise, complex die-casting but with less weight than an equivalent cast part.

Another marvel of machining precision is the VPR-5 C-format scanner. Portable VTRs of the previous generation typically used the same scanner as produced for the studio VTR; the VPR-5, however, has a special scanner containing no castings. Since bulk means extra weight, every effort was exerted to reduce the scanner to the mini-



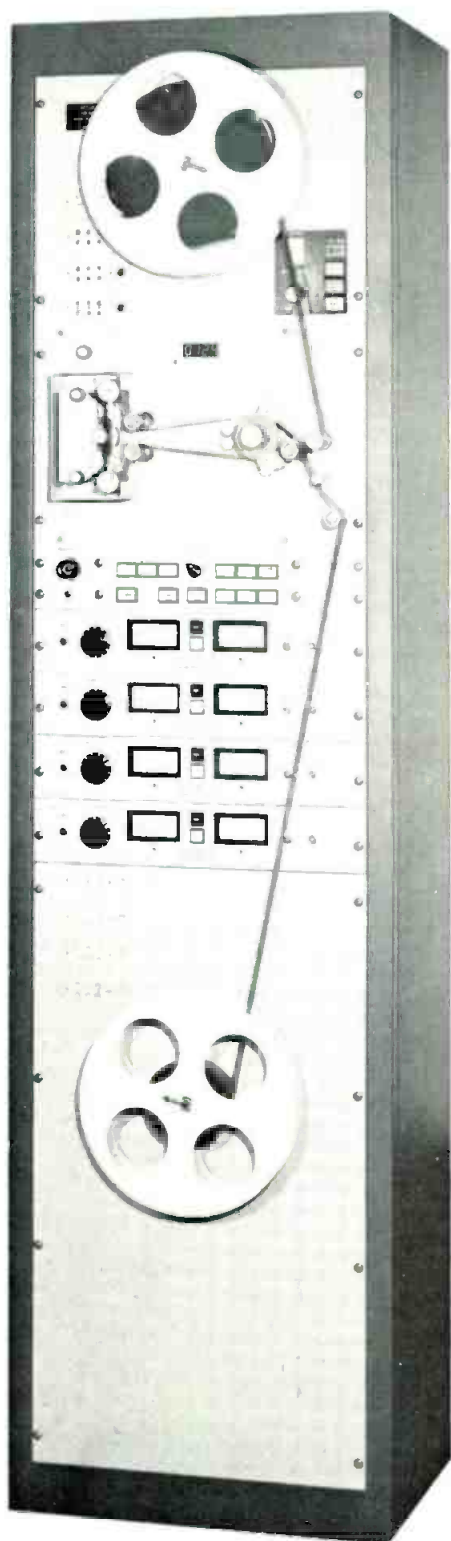
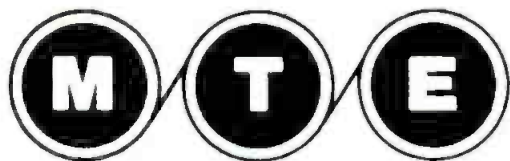

# **MAGNA-TECH**

## **THE SOUND HEARD AROUND THE WORLD**

**Magnetic Film  
Recorders and Reproducers  
for Television and Film  
Sound Post-Production**

### ***HIGH SPEED***

Telecine Magnetic Followers  
Video Tape-Film Interlock  
Electronic Looping  
Dubbing Systems  
16 and 35mm Electronic Projectors  
Total Facility Engineering

#### **WORLDWIDE SALES OFFICES**

**Paris**  
Hi-Fidelity Services  
4 Rue Semard  
75009 Paris, France

**Sydney**  
Magna-Techtronics (Aust.)  
PO Box 150  
Crows Nest NSW 2064  
Australia — Telex 24655

**Johannesburg**  
General Optical Co., Ltd.  
15 Hulbert Road  
Johannesburg 2001,  
South Africa

**Rome**  
Alberto Sciarretta  
Via Sliria 24  
Rome 00179  
Telephone 7943618

**Brussels**  
A.R.C.  
Rue de Boisdé Linthout 45  
1200 Brussels Belgium

**Hong Kong**  
Paul Yang and Associates  
901 Star House  
3 Salisbury Road  
Kowloon, Hong Kong

**Bombay**  
Capt. P.K. Vishwanath  
234/4 Rama Baug,  
Deodhar Road  
Bombay 400 019, India

**Kehl West Germany**  
Zenon GMBH  
Postfach 1743  
Hauptstrasse 128  
Kehl am Rhein  
Tel: 07851/2991  
Telex: 753537

**London**  
Branch & Appleby  
42 High Street  
Harrow-on-the-Hill  
Middlesex HA1 3LL,  
England

**Kuala Lumpur**  
Kinematronika Sdn. Bhd.  
2852, Jalan Selangor/  
Persekutuan,  
Federal Hill  
Kuala Lumpur, Malaysia

**Caracas**  
Cine Materiales srl  
Apartado Postal 61.098  
Caracas 106 Venezuela

# **MAGNA-TECH ELECTRONIC CO., INC.**

630 Ninth Avenue, New York, N.Y. 10036

Telephone (212) 586-7240

Telex 126191

Cables "Magtech"

Circle 228 on Reader Service Card

[www.americanradiohistory.com](http://www.americanradiohistory.com)

When **YOU** want  
**NICKEL CADMIUM**

**PE 52**  
Lighting or  
Camera

28.8 volt 4 AH  
or  
14.4 volt 8 AH  
in one unit

dual output belt



**Versatile • Rugged • Economical**

**YOU** want Booth 1729 NAB  
**PERROTT**  
a name you can depend on

7201 Lee Highway, Falls Church, Va. 22046 (703) 532-0700

Circle 229 on Reader Service Card

## Development of the VPR-5

mum volume commensurate with the mechanical dimension of the C format. The ultimate goal reached was to package the complete functioning scanner, including motor, tachometer, heads, rotary transformers, and necessary shielding, within the drum dimensions.

This produced a scanner with no parts protruding below the top-plate, allowing more VTR electronics to be packaged just below the top-plate and reducing the overall height of the VPR-5. It has a brushless dc drive motor of extreme efficiency and compactness that uses rare-earth magnets of super strength. To have such a motor in close proximity to low-level video signals and the precious information recorded on tape required careful shielding in the compact scanner design.

As for the reel drive mechanisms, the same design goal—to mount totally above the top-plate—was attacked. To package a powerful drive motor within the standard hub of a videotape reel again required the exotic design of a rare-earth-magnet-based dc brushless motor, aided by a noiseless gear system. An additional requirement of including parking brakes within the same volume made this design as challenging as the scanner. The single capstan motor design benefited from the same motor and packaging approach. The resulting transport configuration, with the major items being direct drive and self-contained, makes for an elegantly simple VTR.

### Electronics packaging

To complement the exotic, lightweight mechanical packaging previously described, the electronics underwent the same treatment. Thin printed wiring board material is used and electronic components are of the SO type, as previously mentioned. Automated manufacturing techniques have been installed for such circuit modules. Soldering of these leadless components cannot be accomplished by current production techniques, so the new process of vapor phase soldering has been adopted, where the circuit modules are immersed in a fluorocarbon liquid that has a vapor phase precisely at the required soldering temperature. The resulting soldered connections have lower contamination and have proven to be reliable in operation. The resulting electronic modules are two to three times lighter and more reliable than those produced by conventional techniques, with the added benefit of having low power consumption.

These features of the VPR-5 design only address those portions where radical thinking prevailed. Many other portions required meticulous attention to the overall design theme of weight and power savings so as not to squander the gains made.

However, by meeting the design goal of a 4:1 reduction in weight over the conventional portable C-format VTR, the design team of Ampex and Kudelski were able to add features not available on previous units. Such desirable EFP features as full video and audio confidence playback, Nagra-featured audio processing, and a more sophisticated camera/VTR/operator interface have been included in the VPR-5 design.

In addition, with the compact size, rigidity, and precise fit of the machined case parts, more positive sealing of the VPR-5 and tape from severe environments was made possible. With the weight, size, C-format performance, additional EFP features, and severe duty capabilities, the VPR-5 is truly a revolutionary design. **BM/E**

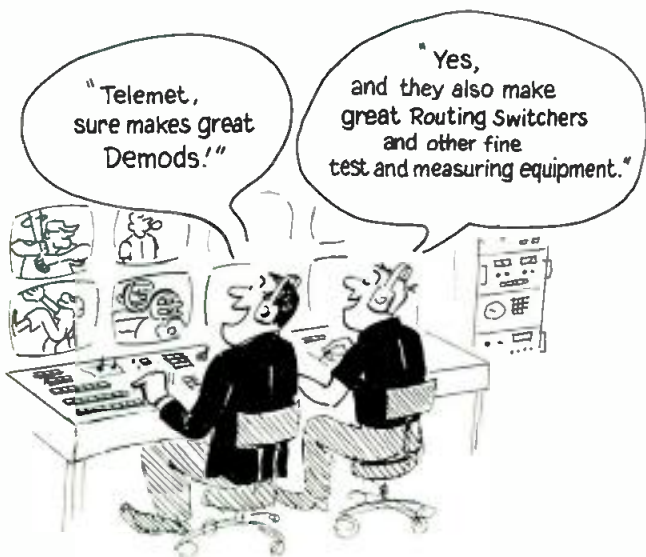

**Telemet**

A Geotek Company

185 Dixon Avenue, Amityville, L.I., New York 11701  
(516) 842-2300 TWX 510-227-9850  
Eastern Area Office—(914) 279-3231

Circle 230 on Reader Service Card





FROM THE INVENTORS OF THE PLUMBICON™ TUBE

## Objective Color Monitor Balance

At last, a practical solution to the age-old problem of color balancing your picture monitors—the PM5539 color analyzer.

Working directly off the screen with three color-sensitive photodiodes, the PM5539 gives you quick and easy readings of the three primary colors—separately or simultaneously—referred to a previously-set white standard.

This means that in a matter of minutes every color monitor you need to watch can be set up to have the

same color temperature and intensity.

Once the PM5539 matches all your monitors, you'll see all the difference in the world. The PM5539 is the quantitative way to eliminate the qualitative "calibrated eye-ball."

For nationwide sales and service information call 800-631-7172, except in Hawaii, Alaska and New Jersey. In New Jersey call collect (201) 529-3800, or write Philips Test & Measuring Instruments, Inc., 85 McKee Drive, Mahwah, NJ 07430.

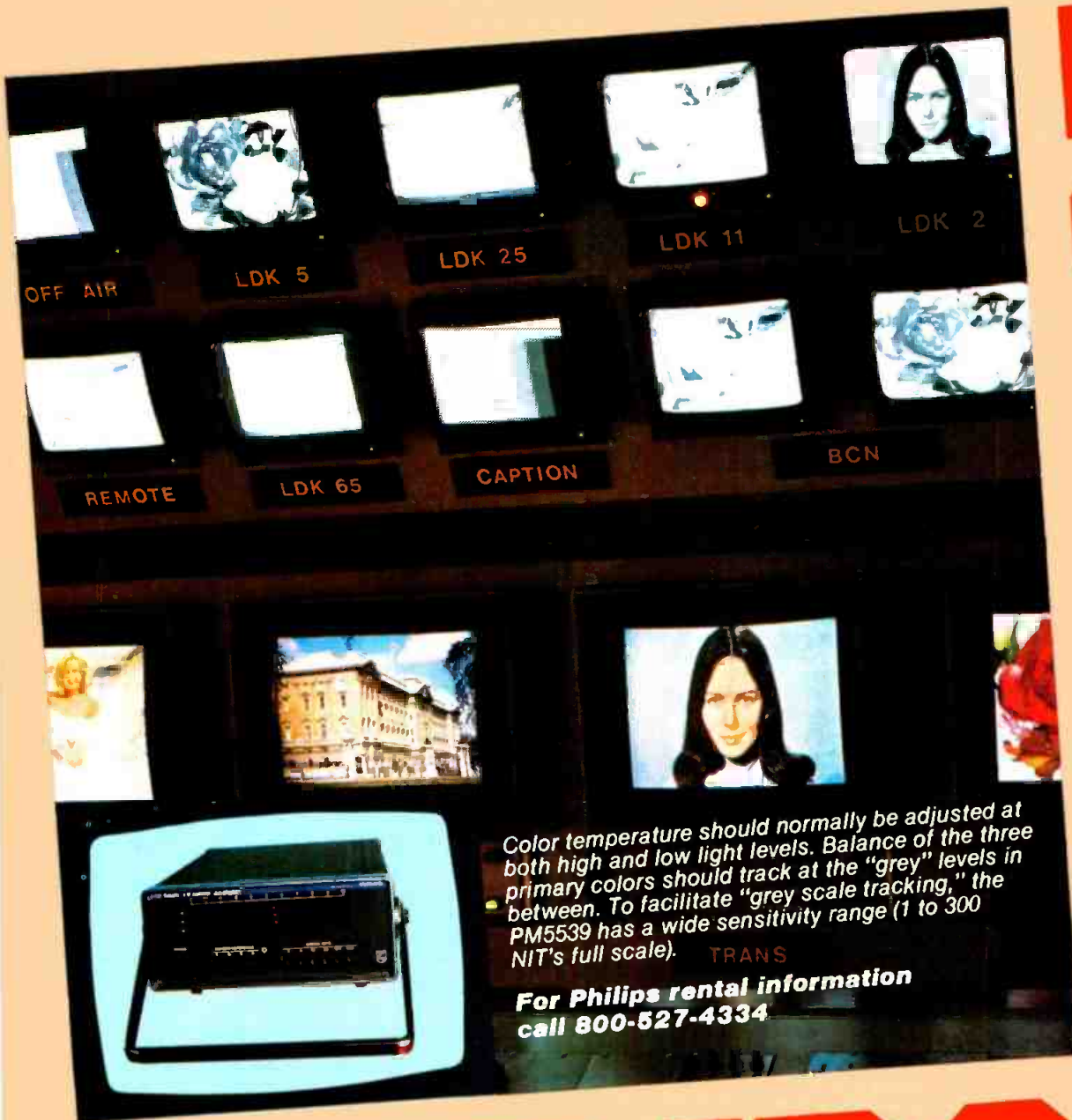

*Color temperature should normally be adjusted at both high and low light levels. Balance of the three primary colors should track at the "grey" levels in between. To facilitate "grey scale tracking," the PM5539 has a wide sensitivity range (1 to 300 NIT's full scale). TRANS*

**For Philips rental information call 800-527-4334**

# WESCAM

# PHILIPS

# AMPEX 196 ONE-IT'S NOT JUST ANO



## Beautiful pictures generation after generation.

The high energy formulation of Ampex 196 has been designed to give you pictures of perfection time after time. With clarity and color rendering that's truly amazing even after many generations.

Recent laboratory tests comparing signal loss after multiple generations demonstrated Ampex 196 is measurably superior in chroma signal-to-noise, audio distortion and video signal-to-noise. These tests put Ampex directly against all other leading brands in multi-generation uses.

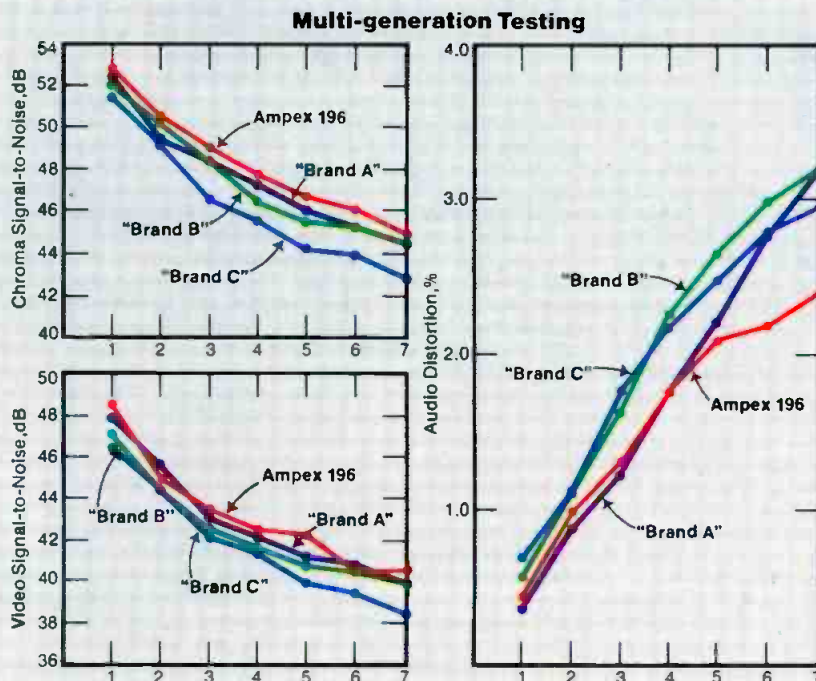



# INCH VIDEO TAPE. THEIR PRETTY TAPE.



Even troublesome shades of red hold up brilliantly after seven generations with Ampex 196. And audio distortion is insignificant.

But don't take our word for it. Check the charts that show the test results. Better yet, give Ampex 196 your own test. You'll quickly realize why so many video professionals use Ampex 196 for mastering, editing and duplication.



To find out more about how Ampex 196 One-Inch Video Tape can make your productions look brilliant over and over again, call your Ampex representative.

## AMPEX

Ampex Corporation • One of The Signal Companies

**QUALITY WORTH BROADCASTING.**

AMPEX CORPORATION, MAGNETIC TAPE DIVISION  
401 Broadway, Redwood City, California 94063 (415) 367-3809

Circle 232 on Reader Service Card



# The fastest rising stars in video test instruments.

Video engineers, studio managers and station managers can now agree. Only Leader offers outstanding performance and reliability with more features, plus immediate delivery, economy and two-year warranties on all parts and components, CRT's included! Chances are the video cameras, recorders and monitors you are using today were built by companies using Leader's NTSC, PAL and SECAM test equipment.

## The first half-rack waveform monitor with a line selector.

Leader's LBO-5860 has many more features than higher priced half-rack waveform monitors.

- Front panel line selection for displaying VITS and VIRS.
- Lines 14 through 21 on fields 1 or 2 can be individually selected.
- Output blanks vectorscope to display selected line vector only.
- Compatible with existing racks.

## The only vectorscopes with etched or electronic graticules.

Only Leader's LVS-5850/A gives you a choice of standard graticule, or electronically generated targets which are easily read from afar or in the dark...

- Compensates for non-linearities caused by CRT aging.
- Compensates for improper horizontal and vertical set-up.
- Compatible with existing racks.

## The video engineer's oscilloscope.

Video engineers will reach for the 100 MHz Leader LBO-518, first. It's the better way to troubleshoot systems and equipment.

- 2 independent active sync separator trigger inputs.
- 4-channel, 8-trace capability.
- PDA CRT, with 20 kV potential.

## Low cost vector display.

A direct low-cost replacement for the Tektronix 602A, the Leader LBO-51M-V delivers outstanding performance.

- Driven by R-Y and B-Y video signals from a precision chroma decoder or Tektronix 650HR picture monitor.

## Get the generators with every important feature...immediately!

Compare the LCG-400M/S to any other sync/test generators. Feature for feature, dollar for dollar, they can't be beat!

- Seven primary test signals with many auxiliary outputs.
- Genlock with adjustable horizontal delay and subcarrier phase.
- Sync, set-up, burst, luminance, and chrominance levels, all front panel adjustable.

**Call toll free (800) 645-5104**  
In Canada call Omnitronix Ltd.  
(514) 683-6993

Ask for an evaluation unit, our 1982/83 full line catalog, special video brochure and the name of your nearest Leader distributor.

For video engineers who know the difference.

**LEADER**  
Instruments Corporation

380 Oser Avenue  
Hauppauge, NY 11788 (516) 231-6900

Regional Offices:  
Los Angeles, (213) 618-0695,  
Chicago, Dallas, Dayton, Boston.

LEADER VECTORSCOPIES,  
WAVEFORM MONITORS,  
SYNC/TEST GENERATORS  
AND OSCILLOSCOPES  
PHOTOGRAPHED AT REEVES  
TELETAPE, NEW YORK CITY.

See us at NAB '83,  
Booth #1702.

Circle 233 on Reader Service Card



# Eight-track ATRs Bring Recording Studio Quality To Radio

By Eva J. Blinder, Senior Associate Editor

**Formerly the exclusive province of recording studios, eight-track ATRs are finding their way into the production rooms of radio stations—increasing creativity and reducing production time.**

ALTHOUGH MULTITRACK AUDIO RECORDERS have been moving into broadcasting for several years, those with eight or more tracks have largely been restricted to television stations and the largest radio operations. With the softening of the recording studio market, however, manufacturers of multitracks have started to explore how much farther their radio business can be expanded. Radio stations, meanwhile, are taking a closer look at the eight-track ATR—and many are finding the investment can pay off, both in creativity and profitability.

Once a station management has decided to acquire a top-quality eight-track machine such as those from Otari, MCI/Sony, Ampex or Studer Revox, additional equipment decisions follow, based on the need to preserve the recorder's quality throughout the audio chain. The produc-

*Detail of WAXY's MCI 618 console. ▶*

*In WAXY's spacious production studio, advanced MCI 618 console is flanked by MCI eight-track and two-track ATRs (far right) and turntables (left).*



## Eight-track ATRs

*Program director for WVOY/WKHO Jim Owen operates the turntable in the production room. Twelve-track Quantum Audio board is at left.*



tion studio at WAXY-FM, Ft. Lauderdale, FL, is a case in point.

"Everything in our studio complex was done right, from the acoustics to the interior decorating to the equipment," asserts chief engineer Wayne Dilucente. WAXY had a four-track operation in place for several years before making the move to eight-track, and when the station rebuilt three years ago, eight-track seemed the logical step.

The WAXY production studio is built around an MCI 618 recording studio quality audio console with full computer automation assistance, an unusual feature to find in a radio station. The board's internal computer can remember and play back a mix exactly as it was set up.

"When we purchased the board from MCI," Dilucente relates, "we understood that it was the first of its kind in a broadcast facility." Originally built two and a half years ago, the production room was considered "experimental" until just a few months ago, according to Dilucente. WAXY, as the technical flagship of the RKO radio network, often has the opportunity to experiment with new equipment and ideas.

"We were out in the jungle there with our machetes trying to figure out the rules of the game," Dilucente laughs. "Radio stations rarely get into this kind of operation. We feel that we've been able to attack it and approach it properly, and it's paying off right now."

Dilucente sees the recording industry affecting broadcasting in several ways. "I do believe that the recording studio industry is having a tremendous impact on the broadcast industry," he comments, pointing out that several WAXY staffers, including music director Kenny Lee, have recording studio experience. Besides talent, the recording industry has given both broadcasters and the public a finer ear for sound, necessitating a better quality

product.

The advanced MCI board interfaces with the station's eight-track recorder, an MCI JH-110C, and two JH-110B half-track machines. While most stations that consider multitrack recording opt for four-track machines, at WAXY the choice was between eight and 16 tracks.

"We chose eight-track as opposed to 16-track partially because of cost," explains Dilucente, "but more importantly because we didn't want to overwhelm the programming people."

The programming people at WAXY, however, seem to have had little problem getting used to the eight-track machine. Don Bruce, director of creative services at the station, points out that the station hires only production people with previous experience in producing commercial material for broadcast, so it is not in the position of having to train novices in the work.

"A person with good experience is capable of going the extra step that eight-track work requires," Bruce asserts. The ATR itself is not difficult to operate, according to Bruce, especially for staffers who are working with the 16-input MCI console. Besides, Bruce says, the benefits of the equipment make any transition period worth while.

Its sophisticated production facility has enabled WAXY to set up a "mini ad agency" in-house for its clients, producing regional as well as local spots. (The station has plans to produce some of its own programming in the future, but has not yet allocated staff for any specific projects.) The capabilities of the decks and the board are enhanced by such additional gear as a Micmix reverb unit, cassette machines, mics and turntables. Dilucente says the station will be buying additional effects gear this year, perhaps the new Eventide SP-2016 special effects generator, which "can do just about anything."



# TOWNSEND

## The Television Transmission Specialists

**Running a straight course keeps Townsend a step or two ahead of the competition.**

The many opportunities in television have attracted several of today's largest corporations into our industry from a variety of backgrounds. Since the beginning, Townsend Associates has been dedicated to the design, development, and manufac-

ture of television transmission equipment exclusively. It's not a sideline with us. And we're not someone else's subsidiary. From transmitters to components, everything we develop and produce is mainstream to the transmission of television.

### **INNOVATIONS THROUGH SPECIALIZED R&D High Power UHF & VHF Television Transmission**

**FIRST** solid state exciter.

**FIRST** to employ emergency klystron multiplex circuitry for UHF.

### **Low Power UHF And VHF Transmission Systems**

**FIRST** manufacturer of High Power transmitters for L.P.T.V.

**FIRST** integrated antenna and amplifier transmission system for low power UHF.

### **Satellite Rebroadcast Systems**

**FIRST** transmitter manufacturer to introduce satellite system concept through a cooperative effort with a TVRO manufacturer.

**FIRST** to have a complete line of transmitters for satellite rebroadcast systems. We design and build rebroadcasting systems for UHF and VHF and each is available in either low or high power configurations.

### **Multipoint Distribution Service (MDS) And ITFS**

**FIRST** 100% solid state transmitters in both 10 watt and 100 watt.

**FIRST** with intermod free external diplexing of the aural and visual carriers.

### **Custom Engineering**

**FIRST** and only manufacturer with hardware and the know-how to up-power all major brands of T.V. transmitters.

### **Major Components**

**FIRST** solid state pulser.

**FIRST** to introduce external cavity klystrons.

**FIRST** to provide a regulated and adjustable power supply...PERVEAC.

**FIRST** to manufacture and employ plug in vacuum contactors for T.V. transmitters.



### **The R & D Group Our "FIRST" Team,**

The many transmission innovations developed by the Townsend R & D group have often involved technologies borrowed from other fields. Their singular purpose is to find ways to measurably raise the state-of-the-art in just one field...television transmission.

# TOWNSEND

ASSOCIATES, INC.

79 Mainline Dr., Westfield, MA 01085 Tel. 413-568-9581 TWX #710-356-1521 • West Coast: 1080 Los Molinos Way, Sacramento, CA 95825 • Bangkok: Box 11-1240, Nana, Thailand 10112 • Canada: Comad Comm., 91 Kelfield St., Rexdale, Ontario M9W 5A3 • Australia: TBC PTY. Ltd., 6 Chilvers Rd., Thornleigh, N.S.W. 2120

**NAB Booth 1420**

Circle 234 on Reader Service Card

## Eight-track ATRs

Bruce and Dilucete agree that the eight-track recorder has produced significant savings in time and generations for their in-house production. "Before, we might have put a record on and had someone read the copy over it," Bruce says, "but now we record the music bed, voices, and sound effects on separate tracks and then mix them." The multitrack capability allows producers to add to the production or correct errors without additional generations. For example, the station recently produced a spot for a travel agency. The spot was based on an outside-supplied music bed, with local singers adding the words.

With the flexibility of the multitrack deck, if the client decides to change the lyric, the station can bring back the singers to rerecord the words, eliminating the need to produce the commercial again from scratch. "You find yourself doing more creative work with the eight-track," Bruce adds. "There's less you have to do to make magic."

### Multitrack: a production necessity

"To do any complex or sophisticated production you need a multitrack machine," insists Lee McCormick, chief engineer at KGW, Portland, OR. McCormick feels an eight-track machine is a minimum for any station that is involved in stereo broadcasting—as KGW hopes to be soon. KGW and its FM sister KINK each have an eight-track MCI JH-110.

In an unusual operation for a radio station, KGW and KINK regularly use the eight-tracks to produce programming. On the AM side, the station sponsors a yearly Fourth of July celebration, billed as the largest Independence Day bash west of the Mississippi. For its one-hour live broadcast from the celebration site, the station produces a soundtrack that is synchronized with the fireworks display. As McCormick describes it, the producers lay down a basic music track, then overlap on other tracks for segues to the music, laying in the voices on additional tracks.

"That way, we can segue right off the tape machine," McCormick explains. "It takes a little while to lay down all the tracks, but you get a much smoother program that way than by punching things in off different machines." KGW uses a similar technique in broadcasting a station-sponsored Neighborfair.

On the FM side, KINK regularly produces music programming, recording live broadcasts of local musicians onto the multitrack machine and mixing down for later stereo broadcast.

In all, the stations have 13 JH-110s: the two eight-tracks, one four-track, and the rest either stereo or mono decks. KGW has two production rooms—one eight-track and one four-track—each with two stereo machines and a mono deck in addition to the multitrack. The eight-track room has an MCI 16-track console, the four-track room a



Otari MX-7800, seen at right in WKHQ production room, is flanked by the station's Addy awards for production. Otari two-tracks are at left.

Pacific Recorders BMX. The station also has special effects capability in the form of an Eventide Harmonizer, along with various limiters and equalizers.

The station also does a great deal of outside production, especially slide-synced programs, for which the multitrack recorders are essential.

"If you're dealing with a stereo soundtrack, for instance, you need at least four tracks just to do segues, plus a fifth track for your synchronization to the slide program," McCormick says. Additional tracks are needed for effects. In addition, the station does work for clients and ad agencies, producing spots for its own air and for other local stations. McCormick says that the days when broadcast production facilities were looked down upon as "quick and dirty" are drawing to a close. These days, he says, "A lot of broadcast stations have production facilities as good or better than a lot of the commercial production houses."

### Main motivator

WVOY, Charlevoix, MI, and its FM counterpart, WKHQ, have also found their eight-track ATR has changed their way of working.

"I don't know what we would do if we didn't have it," chief engineer Bob White says of the Otari MX-7800 eight-track. Both White and station manager Jim Owen echo their counterparts at WAXY in asserting that they use the eight-track deck on a daily basis.

"We do just about all our production on the eight-track," Owen states. "We use our two Otari two-tracks for recording separate voice tracks and ABC feeds, and to make dubs for other stations, but the eight-track is the main motivator." Owen observes that the WVOY eight-track seems somehow easier to use than the four-track machine at his last station. Although he's not certain why that should be, the operating setup in the station's production studio may give some clues. The Otari eight-track is located behind the producer's position in the studio. A remote control unit, to the producer's right, has controls for all tracks and variable speed functions. According to



# Advanced technology in a new, compact television relay system...

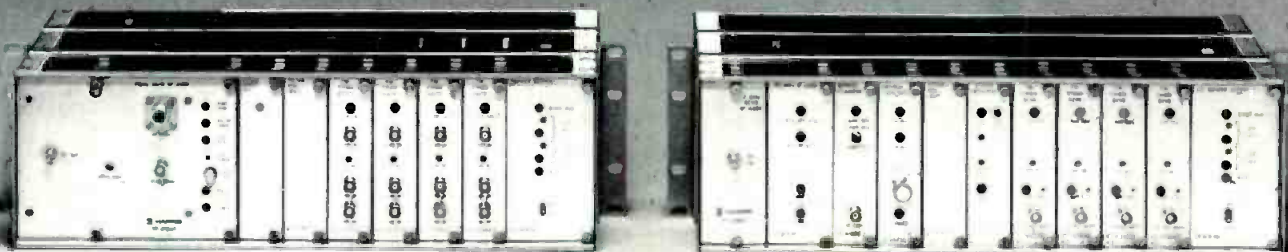

## Harris 7FB Solid-State Microwave for Television Relay

### Designed for STL, TSL and Multi-Hop Systems

Introducing a new, compact baseband radio from Harris Broadcast Microwave. Designed for easy installation in existing equipment racks, each receiver or transmitter uses only six rack mounting spaces. Yet this compact television relay system offers superior transmission performance for single-hop STL/TSL systems and for many multi-hop intercity systems.

### FET Technology... Low- Noise Figure

The transmitter uses a phase locked source to assure precise transmit frequency and a power-efficient, state-of-the-art broadband FET output amplifier. Use of a thin film LNA and an Image Rejection Mixer result in a receiver noise figure of only 7 dB.

### Video Clamper is a Standard Feature

Some manufacturers call this a luxury option. We call it built-in quality. Our 7FB receiver includes a clamper which stops picture bounce, reduces low frequency noise and eliminates hum from the video signal.

### Expandable System

You can easily expand your 7FB system, in the field if you wish, to a fully protected version. The monitored hot standby protection arrangement is offered as a factory option or as a field installed add-on. And you can equip the system with up to four audio subcarrier channels—in the same shelf as the radio.

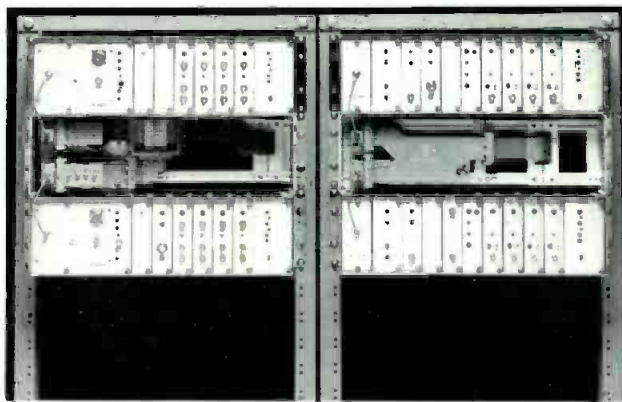

In this fully protected system, the audio and video signals automatically switch to a second system in the event of service interruption to the main receiver and transmitter.

### Simplified Maintenance

To save maintenance time and cost, the 7FB is designed with modular plug-in units. This design allows each unit to be quickly and easily removed for servicing.

### Quality, Service & Technology Leadership

Farinon Video—now Harris Broadcast Microwave—built its reputation by supplying top quality television transmission equipment for STL, ICR and portable systems.

You can continue to expect exceptional quality and the finest service-after-the-sale from the industry's technology leader...Harris Broadcast Microwave.

For all your microwave equipment and accessories, contact HARRIS CORPORATION, Broadcast Microwave, 1680 Bayport Avenue, San Carlos, CA 94070. Phone (415) 595-3500.

Visit Harris at the 1983 NAB,  
Las Vegas, in North Hall



Circle 237 on Reader Service Card

[www.americanradiohistory.com](http://www.americanradiohistory.com)

## VITC ENCODE-DECODE PROVIDES THE BEST OF BOTH CODES



MODEL VIE 224 ENCODER



MODEL VID 225 DECODER

- Decodes longitudinal and/or VITC and outputs a SMPTE longitudinal code at a rate proportional to either input to provide an automatic interface with most edit controllers.
- Encodes VITC on any combination of vertical interval lines from 10 through 20 on either or both fields.
- Two separate modular instruments for maximum flexibility and economy.
- Works in conjunction with your existing SMPTE longitudinal code equipment.

SEE THESE AT NAB, BOOTH 1755



GRAY ENGINEERING LABORATORIES

504 W. Chapman Ave. Suite P  
Orange, Ca. 92668 714-997-4151

Circle 235 on Reader Service Card

## RTW Peak Meter

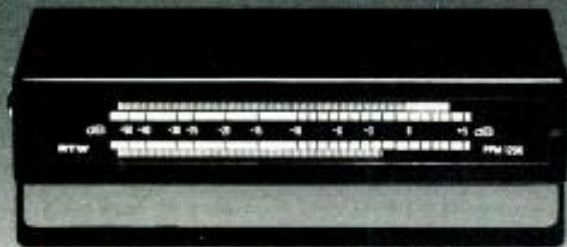

Stereo Peak Program Meter  
Model 1206

- 101 segment display permits precise peak level metering
- Automatic ON/OFF switching dependent on signal presence
- Auxiliary input for full scale metering of low level inputs

Available exclusively through



auditronics, inc.

3750 Old Getwell Rd.  
Memphis, TN 38118, USA  
Tel.: (901) 362-1350  
Telex: 533356

Circle 236 on Reader Service Card

## Eight-track ATRs

Owen, the only reason to turn around is to cue up the machine for dubbing.

The audio console in the WVOY production room is a Quantum Audio board with 12 slide pots, all with equalization. Owen says that the board is set up so that tracks five through eight on the deck have to be patched in manually if they are needed. The station seldom requires all eight tracks, but, as Owen puts it, "We use half the machine, but to full capacity."

Of course, the station does use all eight tracks if the occasion calls for it—such as recording bands or doing work for the Young Americans singing group, which is based in California but spends summers in the Charlevoix/Petoskey area. The primary use of the deck, however, is commercial production, and White says the time savings have been "incalculable." In fact, Owen says having the eight-track "has eliminated the need to pick up the razor blade."

"Several of our clients have singing jingles," White adds. "And maybe they'll have three pieces of copy, so you can lay down the musical image on one track and then come back and do the donuts on separate tracks. That way, if any one person makes a fluff, you don't have to do the whole thing over again. Also, with sound effects you don't have to worry as much about initial levels, since you can go back and adjust them."

Owen comments that multitrack production, because it requires a different way of thinking than many producers are used to, can take a little while to learn. For example, many producers tend to think in a more linear fashion than that appropriate for multitrack work. Another initial problem, according to Owen, is that "every now and then" an operator will forget to flip a key out of record and accidentally erase a track. Once the new habits are learned, however, operation becomes simple.

"On the surface, buying an eight-track recorder seems extravagant for a radio station," Owen notes, "but it's invaluable for production." The faster operation the eight-track offers enables the station's four-person production staff to work to the limits of their creativity. Even in a fairly small market (Charlevoix will become a metro market with this spring's rating book), stiff competition demands a top-notch operation.

Another benefit of good equipment, Owen says, is the boost in staff morale when producers can be proud of the equipment they work on. "Your mind is set right," he explains. "You know you don't have to fight with the equipment." Owen believes second-hand equipment is no longer acceptable in radio production rooms as quality sound becomes more and more of a necessity at radio stations. To help achieve that quality, the studio also includes, in addition to the Quantum board and Otari eight-track and two-tracks, three ITC cart machines, Sennheiser mics, a Shure studio mic that Owen says has cut down on some of the acoustical problems from glass walls in the studio, and Technics turntables.

Both the AM and the FM use syndicated programming—Al Hamm's *Music of Your Life* on WVOY and TM Stereo Rock on WKHQ—so in-house program production is not on schedule, at least at the moment. The eight-track is used occasionally to produce *Staff Meeting*, WKHQ's morning interview show, parts of which are used on WVOY's Sunday night *Focus*. Normally the show is produced on the two-track machines, but if several people are



# “The Electro-Voice Sentry® 500 is a monitor by design.”

## Greg Silsby talks about the New Sentry® 500 studio monitor...

Everyone expects a studio monitor system to provide a means of quality control over audio in production.

True, other audio test equipment can supply you with valuable data. But that data by itself is incomplete and only displayed in visual form.

Only a true studio monitor speaker system can deliver an accurate indication of audio quality in... audio! After all, this is the language of the trained ear and doesn't require a complex interpretation process.

I believe the Electro-Voice Sentry 500 Studio Monitor System will meet your every expectation.

### What's a “studio monitor?”

The term “studio monitor” is often a misnomer. It's easy to tack a label on a box and call it a “studio monitor” without including the best precision engineering available, and careful attention to application design. Too often, these all-important considerations are traded-off for such marketing reasons as high cosmetic appeal, a particular type of popular sound, and low component manufacturing cost. While all of this may translate into high profit margins for the manufacturer it does nothing to produce a reliable standard for audio testing and evaluation.

### Linear frequency response

The Sentry 500 follows the well-established Electro-Voice tradition of combining the most advanced engineering and manufacturing technology available. The Sentry 500 has been carefully thought-out and built to meet the specific needs of the audio professional. Like the smaller Sentry 100A, the Sentry 500 provides linear response throughout its range (40-18,000 Hz  $\pm$  3dB). In fact, because the two systems share this linearity, program material may be mixed on one, sweetened on the other, with



complete confidence in quality. Acoustic “Time Coherence” (the synchronous arrival of acoustic wave fronts from both high and low-frequency drivers) has been maintained through careful crossover design and driver positioning.

### Constant Directivity

The Sentry 500 is a Constant Directivity System, benefitting from years of EV experience in the design and application of constant directivity devices. Utilizing a unique EV-exclusive high-frequency “Director”, the Sentry 500 provides essentially uniform coverage over a 110° angle from 250 Hz on up to 10 kHz and 60° dispersion from 10 kHz clear out to 18,000 Hz! And it does this on both the vertical and horizontal axes. This means the “sweet spot”, once a tightly restricted area large enough for only one set of ears, has been broadened to allow accurate monitoring by the engineer, producer, and talent—all at the same time. That's what we call Constant Directivity.

### A monitor by design

To qualify as a truly accurate test device, a monitor speaker system must faithfully reproduce the wide dynamic range required by today's music and current digital recording techniques, and do it with low distortion. This is no problem for the Sentry 500 which combines the high efficiency of an optimally-tuned Thiele-aligned cabinet to the brute power handling of Electro-Voice Sentry components. Consider what you get with proven

EV components in the Sentry 500: the Sentry 500 will deliver 96 dB at one meter with only one watt and yet will handle 100 watts continuous program material with 6 dB of headroom. That's 400 watts on peaks! The same Super-Dome®/Director combination which maintains uniform dispersion of linear response out to 18 kHz also handles a full 25 watts of program power or 5 times the power handling capacity of most “high powered” tweeters. After all, tweeters should convert electrical energy to acoustical energy—not to smoke and fire.

The Sentry 500 is another no-nonsense Electro-Voice Sentry design with the incredible performance and credible price you've learned to expect from EV. I'd like to tell you the rest of the Sentry 500 story and send you the complete Engineering Data Sheet. Write to me: Greg Silsby, Market Development Manager/Professional Markets, Electro-Voice, Inc., 600 Cecil Street, Buchanan, Michigan 49107.

  
Market Development Manager,  
Professional Markets



See us at Booth #1159

a **gulton** company

Circle 238 on Reader Service Card

www.americanradiohistory.com

# A WINNING TEAM!



RENTALS · SALES · SERVICE

**VICTOR DUNCAN, INC.**

CHICAGO  
661 N. LaSalle  
Chicago, IL 60610  
(312) 943-7300

DALLAS  
Four Dallas Communications Complex  
Irving, TX 75039  
(214) 869-0200

DETROIT  
32380 Howard  
Madison Hgts., MI 48071  
(313) 569-1900

Circle 239 on Reader Service Card

## YOUR SUCCESS... IS OUR BUSINESS

Regardless of your pay television mode (LPTV/MDS/STV) Dynacom has a secure scrambling system for you which is low in cost and high in reliability. We have provided our scrambling system to small International markets and fully addressable systems to larger U.S. markets. Recent deliveries include an STV operator in Lima, Peru and an LPTV operator in Mullin, Texas.

Having been in the Subscription Television since 1976, we know that our success is based upon your success.

Some key features to our system are:

- Low Cost addressable head-end
- Effective, secure, scrambling technique
- Multi-channel decoders covering any VHF or UHF channel
- Available in all television formats, NTSC, PAL and SECAM



**Dynacom Telecommunication Systems, Inc.**  
590 Commerce Park Drive, Suite 125  
Marietta, Georgia 30060  
Telephone (404) 428-3100  
Telex: 54-2161 DYCOMINTL MARA

Circle 240 on Reader Service Card

## Eight-track ATRs

being interviewed, the station sometimes decides to put each voice on a separate track of the eight-track so that levels can be adjusted later.

### Borrowing from the recording industry

Just now, in the process of upgrading from four to eight tracks, WKQX, NBC's AM O&O in Chicago, is building a production studio that will incorporate many pieces of "recording studio" equipment. Scheduled for probable completion this month, the new room will incorporate either three or four MCI recorders, according to chief engineer Joel Hodroff—a JH-110B eight-track one-inch, the station's current JH-110 four-track, and either one or two quarter-tracks. The console will be an MCI 618, also a recording studio-quality item.

"I think there's a definite increased awareness at broadcast stations—at least certain broadcast stations—of state-of-the-art technology that was formerly the domain of recording studios," Hodroff says. "More and more stations are striving for an increased flexibility in the production area and putting more effort, and more money, for that matter, into in-house production." The MCI machines are not the only recording studio influence on the WKQX project, according to Hodroff, who reports that the studio will include an Echo Plate 2 reverb system from Studio Technology and dbx Type 1 noise reduction. The station uses dbx Type 2 noise reduction for the rest of its operation, but felt that the more critical equipment in the new studio deserved the wider detection range of Type 1.

Other equipment scheduled for installation will probably include Eventide special effects, such as a flanger or Harmonizer, and White equalizers. Hodroff sees the room's primary use as an expansion of the station's current four-track operation, producing spots and in-house promos. With approval from NBC, the station would also like to lease the studio to outside concerns.

An additional production studio was needed by WKQX because of the heavy time demands on its first, but the decision to do everything at the recording studio level developed gradually. "We didn't set this as our goal from the start," Hodroff comments. "It just evolved. We chose the console first because it seemed to be high-performing and a good value. Then, with such a good console, we wanted a good tape deck, and then it seemed a shame to put anything else but the best noise reduction with it. Before we realized it, we were looking at a top-notch studio.

"When you get right down to it—and this is the funny thing—the equipment isn't that much more expensive than you would think of to build a standard broadcast studio with probably a lesser capability." Once the initial investment had been made, Hodroff says, the remaining decisions followed naturally.

As the experiences of these stations indicate, the current malaise of the recording industry is serving as a quality push to radio stations that are ready to take advantage of the available talent, techniques, and equipment. Multitrack recorders may be difficult to justify to a budget-conscious management, but their high initial cost can bring leaps in staff morale and creativity, sound and production quality of produced material—with an ensuing increase in station business. Looking at it that way, the multitrack recorder could be a bargain.

BM/E



# THE WORLD'S ONLY FULLY DIGITAL TELECINE IS NOW IN AMERICA!

It's the MARCONI LINE ARRAY TELECINE B3410—the telecine that not only delivers a new standard of quality for film-to-tape transfers but can appreciably add to your productivity and profits!

The reasons are simple. The Marconi B3410's fully digital processing and CCD image sensors deliver an extraordinarily true video picture. And the Marconi B3410 does not require time-consuming tweaking, day-to-day adjustments and set-up arrangements that rob you of valuable hours of productive work.

The Marconi B3410 delivers full performance within two minutes from the time you switch on. Moreover, there is no registration

drift and no tubes to replace. It interfaces with all available color correctors, converts into all international standards and—by its very digital nature—is designed to have an exceptionally long life.

And, because the Marconi B3410 is distributed and supported by A.F. Associates—America's largest designers and builders of video systems—there is no lack of engineering backup and spares on both the East and West coasts!

For more information on specifications, costs and delivery, contact Richard Lunniss in New Jersey (201) 767-1000 or Noel Parente in California (213) 466-5066.



## THE MARCONI LINE ARRAY TELECINE B3410

Now in America and only from

# AAA

A.F. Associates

100 Stonehurst Court, Northvale, NJ 07647  
1438 N. Gower St. Box 47, Hollywood CA 90028

See us at NAB Booth 1609-1611

Circle 241 on Reader Service Card

whole new ballgame must be played.

A 4:2:2 DVTR design is being developed by RCA, which is not ready to see a standard set around regular tape, although the driving force that will bring on metal tape may not be the broadcast market but either the computer market or the audio disc market. Sid Griffin, chief engineer, Video Products, says economics alone argues for waiting to see what develops in metal tape or vertical recording. Higher density vertical recording need not be of the pass-through-the-medium kind, and extensive work is being done in vertical recording using ring heads.

Ampex, which is also engaged in research that will lead to a "practical" recorder using 4:2:2 coding standards, affirms there are many exciting new areas that need to be investigated, including metal tape, new heads, and other recording techniques. Dave Fibush, chief engineer, Video Tape Recording Engineering Group at Ampex, says a number of factors will slow progress towards a DVTR built to 4:2:2 standards. Cassettes, using regular commercial tape playing at 10 square inches/second, are large. "Hence, development of metal tape is a critical factor," he says.

And when Sony's Takeo Eguchi was asked his opinion at the SMPTE conference, he said, speaking personally, that he would wait perhaps even longer for evaporated metal tape (which permits shorter wavelength recording, and therefore higher density, than particle metal tape).

Even when lower tape consumption becomes practical vis-à-vis metal tape, there are many design parameters

that will have to be pinned down, since they are so interactive. Fibush thinks the 4:2:2 recorder "is still on the horizon, not around the corner." Because of the expense of building a digital plant, Ampex suspects the initial demand for such a recorder will be low. Fibush further questions whether the analog component route is a suitable bridge, because that, too, is a costly route for a broadcaster to take.

### DVTR format standard proposal

Nonetheless, significant developments are taking place. Eguchi's paper at the 124th SMPTE gave an update on Sony's work, and he proposed a format, as he put it, "for comment." Although this was the sole paper presented at SMPTE, Sony's efforts are significant, since they have long been involved with the DVTR effort, beginning with the early 3x fsc NTSC composite machine and progressing up to the latest 4:2:2 component unit. (A 4:1:1 recorder was used in the famous tests run in San Francisco in 1981 when SMPTE sought to determine what the sampling rate should be. A further revised 4:2:2 component recorder was shown in Europe in April 1982 to the Magnum group and others.)

The format being proposed by Sony is based on the premise that there has to be commonality between 525- and 625-line machines, as per Magnum requirements. This means there has to be a 5:6 ratio of picture segmentation. Consistent with earlier "recommendations" by RCA, Ampex, and Bosch, two channels are necessary to

# GET THE SAME VIDEO TRAINING THE PEOPLE AT SONY GET.

Now you can be trained by Sony even if you aren't employed by Sony.

Because we're making our vast library of training videotapes available to you. The very tapes that teach our own engineering, service and sales personnel.

The tapes cover the products and concepts of video and its related technologies. You can learn the basics of video recording. Color systems. Digital video and electronics. Television production. And more.

Plus you can learn how to service cameras, VTR's, and other video products. As professionally as Sony does.

The tapes are produced entirely by Sony and contain up-to-the-minute information. They communicate clearly and simply. And some of them are even programmed for interactive learning.

And learning through video can be done at your own pace, in the convenience of your home, shop or school. Reviewing is quick and easy. And the tapes are always available for reference.

Send for your catalog, which lists more than 250 titles. In your choice of 3/4" or 1/2" formats.

Write Sony Video Products Company, Tape Production Services, 700 W. Artesia Boulevard, Compton, California 90220. Or call (213) 537-4300.

Of course, there's no obligation. Except the obligation you have to yourself: to find out about the best training available in one of the country's fastest-growing, most lucrative fields.

**SONY**

Video Communications  
Sony is a reg. trademark of Sony Corp.

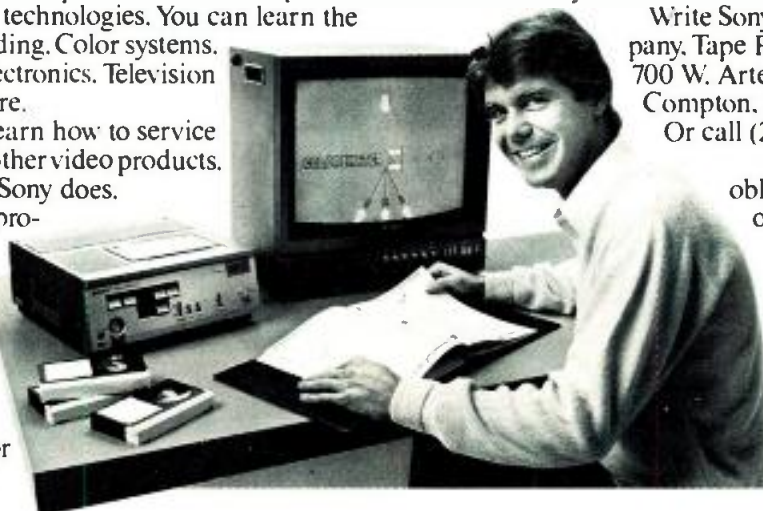

Circle 243 on Reader Service Card





## Introducing the Panasonic AT Series. The natural choice for accurate color reproduction.

Video is changing right before your eyes. With more sensitive cameras, more advanced recorders and more sophisticated production techniques. Now Panasonic introduces two shining advances in video technology. The AT Series Color Broadcast Monitors.

The AT Series consists of the 13" AT-H130G and the 19" AT-H190G (screen sizes meas diag). Both incorporate high-resolution delta gun shadow mask CRTs with a dot pitch that's 1/3 finer than conventional CRTs. The result is more

than 600 lines resolution with an NTSC signal and a picture with excellent colorimetry and geometry.

The AT Series goes on to show its sophistication with its switchable comb filter decoder. Unlike subcarrier notch filters in conventional decoders, the AT Series uses an ultrasonic switchable comb filter. It not only maintains the full luminance bandwidth, it also prevents loss of color resolution.

For accurate phase demodulation, both AT monitors incorporate automatic frequency phase control.

Black level clamp circuits to reduce hum. Plus LF tilt and pulse cross display with separate vertical and horizontal delay.

The AT Series looks even better with RGB inputs, active convergence and pushbutton degaussing. There are also lockable side-mounted drawers on the 13" model and lockable bottom-mounted drawers on the 19" unit.

So whatever field you're in—broadcast production, computers, medicine or education—whenever accurate reproduction of

color and detail is crucial, the choice is natural. The AT Series from Panasonic.

**Panasonic**  
AUDIO-VIDEO SYSTEMS DIVISION

For additional information on the Panasonic AT Series Color Broadcast Monitors mail to:  
Panasonic Industrial Company  
Audio-Video Systems Division  
One Panasonic Way  
Secaucus, NJ 07094

Name \_\_\_\_\_  
Title \_\_\_\_\_ (Please Print)  
Company \_\_\_\_\_  
Address \_\_\_\_\_  
City \_\_\_\_\_  
State \_\_\_\_\_ Zip \_\_\_\_\_  
Phone (\_\_\_\_) \_\_\_\_\_

BME-383

Circle 244 on Reader Service Card

www.americanradiohistory.com

capture the 216 Mbits/second data rate (108 Mbits per channel). Further, segmented recording is required; five segments of two channels are proposed for 525-line countries, six for 625-line systems. Sony's segmentation scheme is compatible with a 2:1:1 approach.

Since it is desirable not to record both horizontal and vertical blanking lines—to keep bit rates as low as possible—Sony proposes to keep only part of the vertical areas for VITS, other test lines, and teletext. Fifty-one lines per scan—all video lines except the vertical sync pulse area—were chosen for the experimental machine, even though 50 is probably adequate (for a saving of two percent of the bit rate).

Sony chose a wrap angle of 220 degrees and a drum diameter of 109 mm as the best compromise. Eguchi said a wrap angle of 180 degrees (the easiest to thread) would have too big a diameter for 9000 rpm rotation. The smallest drum (lowest g forces) of 69.5 mm, could support a wrap angle of 346 degrees, but the threading problem would dictate against cassettes. Further, the diameter is nearly too small to incorporate the heads.

Faced with numerous coding schemes with no clear favorite, Sony chose, for its experimental machines, the 8-8 NRZ mapping code with alternate word inversion and the scrambled NRZ code. The previously used 8-10 block code was rejected because it adds the 25 percent to required track length, which in turn requires a larger drum diameter and a higher frequency (for a given wrap angle). The track length need not have been increased if the re-

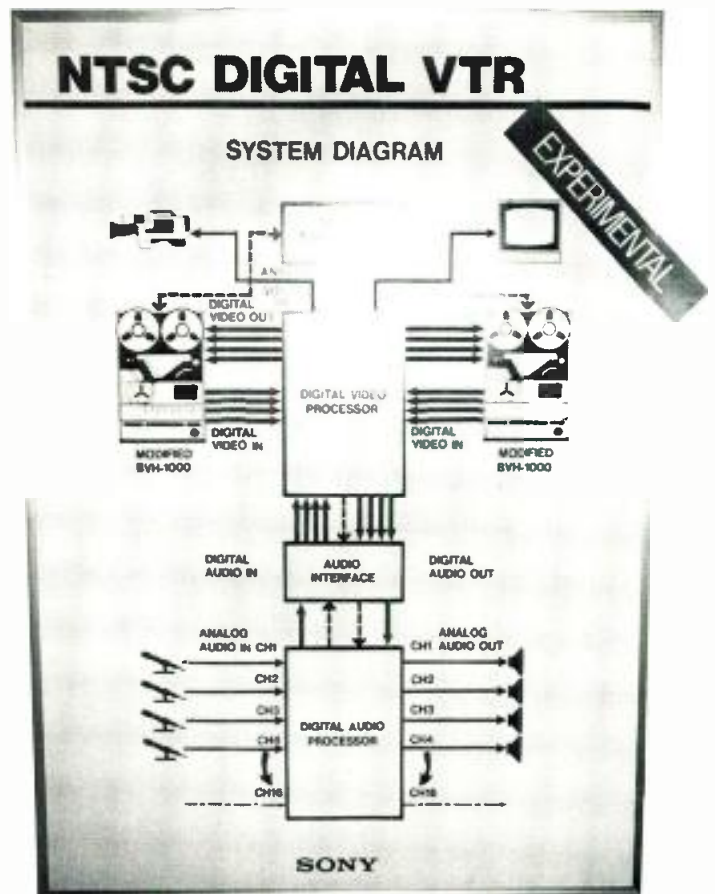

Experimental DVTR design shown by Sony at the 1980 NAB.

corded wavelength were shortened, but Sony decided not to go below 1 μm as the shortest wavelength in accordance with the SMPTE DVTR and Magnum study group's recommendations.

Determination of the optimum coding scheme calls for more evaluation, Eguchi said. How the signal should be processed in light of the error protection plan, channel coding scheme, and so on awaits further study. Processing is interdependent on the coding scheme selected, Eguchi said.

The Sony machine that was shown to the Magnum group offered these features:

- Compatibility for 525/60 and 625/50.
- Compatibility for 4:2:2 and 2:1:1.
- One-inch open reel with same tape consumption as Type C format at 4:2:2 and half at 2:1:1.
- Possibility for still, slow-motion and color shuttle up to 25 times normal speed.
- Two-channel digital audio, 16-bit linear/48 kHz sampling with possibility for four channels.
- Separate edit between video and audio.
- Possibility for cassette loading.

The recording head assembly includes four heads for the two parallel channels. Writing speed is 52 meters/second. The data rate per channel works out to be 100 Mbits/second. Total track length is 210 mm.

Eguchi concluded his paper with the observation that many possibilities have still to be tested before standards can be written. Nonetheless, the Sony proposal seems in line with recommendations coming out of user groups, and particularly the EBU Magnum group. Included in Magnum's requirements, as outlined by its chairman, Aleksandar Todorovic of Televisija Beograd, Yugosla-

**Winsted** THE PERFECT MATCH  
for your video equipment

MODEL 900LC

**LOW PROFILE EDITING CONSOLE**

This new low-profile editing console combines operator convenience and over-the-top viewing. Generous 31" rack space. Pullout VTR shelves and editor shelf bring editing equipment into easy reach. Walnut woodgrain paneling blends with any decor.

Winsted traditional rugged construction features provide for safe support of valuable video equipment. Many models and configurations available.

For full-line catalog of editing, production and dubbing consoles, tape and film trucks, film and videotape storage systems, call or write.

**THE WINSTED CORPORATION**  
9801 James Circle • Minneapolis, MN 55431

PHONE TOLL-FREE **1-800-328-2962**  
See us at NAB Booth #1238

Circle 245 on Reader Service Card





4th generation conventional TBC

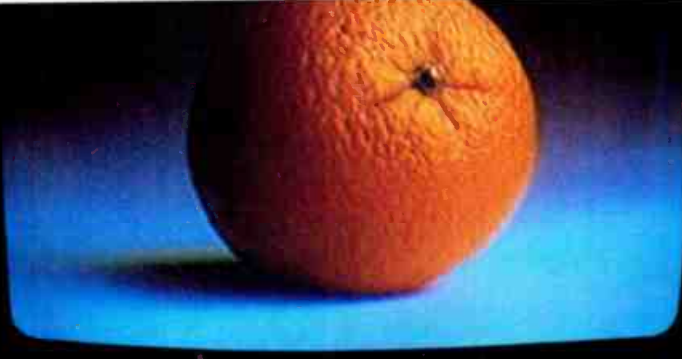

4th generation Y-688 Total Error Corrector

# NO COMPARISON

Comparing video from a conventional TBC to video from a Y-688<sup>32</sup> Total Error Corrector is like comparing apples to oranges. A time base corrector, as the name implies, corrects timing errors. The Y-688<sup>32</sup> Total Error Corrector corrects timing errors and virtually all VTR induced errors.

The major cause of video quality loss in 3/4 VTR's is inherent in the color under process. This process separates the input color video signal into its luma and chroma components, converts the chroma frequency for recording and playback and recombines the luma and chroma for color video output. The worst part is that this quality loss is cumulative, in that it is compounded with each pass through a VTR or conventional TBC.

## Total Error Correction

The Y-688<sup>32</sup> TEC is designed specifically to overcome multiple

generation quality loss from color under VTR's. The Y-688<sup>32</sup> TEC utilizes "dub" (Y-688) input and output as well as encoded video. The "dub" mode allows processing of component (Y-688) video bypassing the separation, frequency conversion and recombination cycle. "Dub" signals processed through the Y-688<sup>32</sup> TEC are better than encoded video signals because they contain more information and are less degraded.

The Y-688<sup>32</sup> TEC also utilizes advanced signal processing techniques, some manufactured under exclusive license from Faroudja Laboratories. These techniques reduce chroma noise by up to 20dB, correct luma/chroma timing automatically, reduce luma noise by up to 10dB, improve chroma rise times, reduce second order ringing and eliminate luma/chroma crosstalk. Some processing is used during each pass through the Y-688, while

the balance of the processing is used for the last copy or for broadcast to correct any minor degradations which have occurred.

## A Difference You Can See

The improved quality of Y-688<sup>32</sup> TEC video can be seen in first generation playback. It becomes more obvious in successive generations. It is particularly noticeable in third and fourth generations because conventional TBC video has gotten worse with each pass, while fourth generation Y-688<sup>32</sup> TEC video approximates original quality.

The Y-688<sup>32</sup> TEC is simply the most powerful tool available for extending multi-generation quality from color under VTR's.

For more information on the Y-688<sup>32</sup> TEC or an on-site demonstration, circle the reader's card. For immediate response write or call Fortel today.

Fortel Incorporated  
6649 Peachtree Industrial Boulevard  
Norcross, Georgia 30092-9990  
Telephone (404) 447-4422  
Telex 804822 Circle 246 on Reader Service Card



**Y-688<sup>32</sup>**  
Total Error Corrector

## DVTRs

via, is the demand for the "largest possible commonality" between 525- and 625-line recorders. Specifically, this means the same data rate, the same linear packing density, the same track length, the same number of recording heads, and the same number of video channels. Magnum's other requirements include variable slo-mo, still pictures of broadcast quality, ability to recognize pictures at shuttle speed, and frame-by-frame editing. Audio requirements include four audio channels, separate track for time code and independent erase and edit functions.

The Sony-proposed machine did not strive for a superhigh recording density since it decided not to go below a one-micron wavelength as mentioned. Thus its physical characteristics in terms of drum diameter and speed is in line with those suggested earlier by C. R. Thompson of RCA, Pohl of Bosch and Fibush of Ampex in 1981. It would appear, therefore, that the range of possibilities are narrowing, as pointed out by Connolly of the SMPTE study group.

A clear picture of what has to be standardized and what does not has been set forth in an article on that subject by Jurgen Heitmann of Bosch appearing in the March 1982 *SMPTE Journal*. Heitmann says the goal is not a DVTR that is a dual-standard device suitable for both 525/60 and 625/50, but one that can use the same tape deck, and much the same electronics. Use of the same tape deck requires that the length of individual tracks be identical. It might be assumed that 525 and 625 systems require the same number of segments for transport compatibility. If this is so,

linear density must be different. But linear density can be kept constant, Heitmann argues, and adjustment to different TV standards can be made by changing the number of segments per field (the approach taken by Sony). Such things as wrap angle, drum diameter, and head configurations need not necessarily be standard from machine to machine if signals are time compressed by means of buffer memories.

Because channel coding methods are controversial, and are likely to remain so for a while, Heitmann says that the first effort of standardization should be to reach agreement on a percentage of redundancy for channel coding and synchronization.

At IBC '82, Heitmann said Bosch has "rediscovered" 8-bit NRZ code as having a superior operating margin and dc-free. Bosch's current experimental machine is 4:2:2, using a recorded data rate of 200 Mbit/second with the smallest recorded wavelength being one micron. Head-to-tape speed is 50 meters/second, very close to Sony's. Heitmann reminded the IBC attendees that the design of any DVTR hinges on linear packing density and bit rate.

### Studio Implementation

Meanwhile, the form of the all-digital studio is beginning to take shape, based not so much on what is happening in the U.S., but in the U.K. The British are keen to move forward for several reasons. They were, of course, the first to think about a conversion to digital techniques, and the DVTR in particular, primarily because of their de-



**... Shintron's New  
Edit Code Generator  
Edit Code Reader/Raster Display**

The Shintron Model 646 reads SMPTE or EBU code, displays data in eight digit, half inch high LED numerals and lets you key in data on the video raster in black or reverse letters. Readable tape speed is from 1/16 to 40 X. Front panel selection switch displays user code.

The Model 647 generates SMPTE/EBU code either independently or in sync with incoming video. Time data is easily reset and user bits are set by thumb wheels on the front panel.

Circle reader service card or call (617) 491-8700 for information.

## SHINTRON

144 Rogers Street, Cambridge, MA 02142 • Tel: (617) 491-8700 Telex: 921497  
Shintron Europe • 198 Avenue Brugmann, 1180 Brussels, Belgium • Tel: 02-347-2629 Telex: 61202

Circle 247 on Reader Service Card





Digital video processing and recording equipment shown in the 1980 Sony demonstration.

sire to make multiple-generation recordings without degradation. Both the BBC and the IBA in Britain do a great deal of their own production work and are therefore able to focus in on production weak links. Convinced that digital is the way to go, both groups are exploring the means of implementation in earnest.

Reporting on progress in the U.K., John Baldwin's paper at the 124th SMPTE described implementing digital component standards at the IBA. The present problem, as seen by Baldwin, is interconnecting the different digital

devices—TBCs, still stores, special effects manipulators—without using codexes which impair the picture considerably. Baldwin says that as soon as a digital interface is agreed upon, a great deal of equipment will be able to be cabled together without codices, and even more digital equipment will come on the market. The consequence is that a rudimentary component system will have come into being.

An accommodation can be made if the analog signal is in component form. Baldwin is trying to achieve a good compatibility by multiplying the analog component signal

## AUDIO/VIDEO SYNCHRONISER



The A/V Sync is a digital audio delay system which automatically ensures that the audio signal remains in synchronisation with video after passage of the video through a video synchroniser.

The unit provides up to three independent audio delay channels, controlled by decoding looped input and reference composite video signals, and is housed in a compact 1U rack-mounting case.

Audio specification of each channel is 18kHz bandwidth and 90dB dynamic range.

Additional delay of up to 1.27 seconds is possible.



Advanced Music Systems  
 England: Tel. (0282) 36943  
 U.S.A.:  
 Quintek Tel. (213) 980-5717  
 Trident Tel. (203) 357-8337

Australia A.M.S. (Intl) Pty Ltd. Sydney  
 Switzerland ABQ Zurich  
 Norway Pro Technic A/S Oslo  
 Canada Octopus Audio Toronto  
 Japan Continental Far East Inc. Tokyo  
 Spain Singleton Productions Barcelona  
 Hong Kong Audio Consultants Kowloon

Finland Into Oy Helsinki  
 France Lazare Eqpt Paris  
 W.Germany Elmus GmbH Berlin  
 Italy Professional Eqpt Milan  
 Singapore Auvi Private Singapore  
 Denmark Sweet Silence Copenhagen  
 Holland Audio Script Loosdrecht

# Japan's LEADING CABLES are NOW AVAILABLE in the U.S.A.

- Superior quality cables used by NHK (Japan broadcasting system) and leading equipment manufacturers for over a decade.
- Double balanced mic cables have 4 inner conductors and very high shield density for exceptional rejection of hum and SCR noise.
- Tough polyvinyl chloride jacket resists abrasion yet remains flexible below -50°F.
- Available in 10 colors, pre-wired with Cannon XLR's or in bulk.

Stop by our NAB booth #1732 for a  
**FREE 16' MIC CABLE**  
sample. Also see our complete line of  
Audio/ENG cables, cable reels, snakes and  
junction boxes.

## CANARE

6733 Vineland Avenue  
N. Hollywood, CA 91606  
(213) 506-7602

Circle 249 on Reader Service Card

## The Perfect Commercial

### Now Perfect Timing Is Easy With The TDM 8000 TIME COMPRESSOR

Now you can compress commercials for television or radio, time programs to fit standard tape lengths or available time slots, and vary the tempo of music material — without changing the original pitch!

The TDM 8000 Time Compressor features proprietary patented technology that allows recorded audio material to be played back at faster rates, but still achieve the performance demanded by broadcast and professional applications.

Even stereo programs can now be compressed without the phasing problems inherent in other systems. Just add the TDM 8200 Stereo Slaving Unit.

In all audio timing applications, the TDM 8000 offers high definition, wide bandwidth, superior dynamic range and the lowest distortion. It's the optimum way to compress the message.

TDM 8000 Time Compressor



TDM 8200 Stereo Slave



Come see and hear us at NAB Booth 327.

**VSC** Corporation 185 Berry Street, San Francisco, CA 94107  
(415) 495-6100 — TELEX 340-328

Circle 250 on Reader Service Card

## DVTRs

and then multiplexing it into the system. Analog equipment with a increased bandwidth of about 50 percent can handle the multiplexed luminance and chrominance signals, and Baldwin's approach has been to multiply the luminance by 1.5 and color difference signals by 3.

The IBA has been building some equipment of its own to test this approach. Constructing one's own equipment is expensive, but Baldwin sees an orderly progression taking place. More and more analog component equipment will become available, until one day it will be possible to convert to the all-digital plant.

The early emergence of agreed digital interfaces is the hope of A. Howard Jones of the BBC, who spoke at another SMPTE session. He said that within the studio these interfaces will, for the time being, be in a parallel form, since that is how the signals are normally handled within the digital equipment itself. Another matter that must be decided, says Jones, is the manner in which the signal sources should be clocked so that signals can be brought into synchronism.

Baldwin and Jones speak as representatives of 625-line users; at SMPTE, Ken Davies of the CBC outlined the steps that he sees necessary for 525-line users. The task before the NTSC countries is to convert to component processing pretty much as Baldwin suggests. Although a serial format would appear to be the simplest, 230 MHz bandwidths would be necessary and that, says Davies, is out of the question. Hence the need for a practical parallel-word approach.

Davies envisions ribbon cable good for 20 feet, twisted pairs running 50 to 60 feet, and round multipair cable (as developed in the U.K.) running as far as 750 feet.

Davies points out that the digital standard is related to RS-170. Digital blanking will be less than in analog and will make possible tight control of the digital width throughout the production chain. He says discussions in the digital standards group propose centering digital blanking over analog blanking so that getting from the digital signal back to the analog form for a production release should eliminate "many of the production hassles we currently have."

The studio digital signal will go out as a synchronous data stream which includes the RGB signal matrixed to  $C_R$ ,  $C_B$ , and  $Y$  multiplexed so that inside the studio there is a single signal with these components, plus synchronization data. The work of the SMPTE standards group is to come up with a datastream block, decide what can be eliminated in the horizontal blanking period, and so on.

Davies foresees less switching equipment in the digital TV studio compared to an analog studio because there can be more "iterative multigenerational steps. . . ." Although switchers handling parallel bits may seem more complex, current LSI devices are being used in 10x10 matrices for computers, Davies says.

Interface to common carriers seems quite far off, in Davies' view. The digital post-production suite will come first, with the development of a practical DVTR.

In short, the industry seems to know what must be done in getting to the all-digital studio, but progress will come more slowly than was thought a few years ago. We will reach more international agreement on standards, but the digital era may not fully take over until the next decade.

BM/E





# If you want Plumbicon\* picture quality from your next TV camera buy— insist on Amperex Plumbicon tubes.

If it's a professional TV color camera—it's available with Amperex Plumbicon tubes.

When you're paying top dollar for a professional TV camera, it is assumed by the manufacturer of the camera that you will specify the pickup tubes for your system. Obviously, the camera manufacturer wants to sell you *his* camera, and since he knows that the overwhelming majority of knowledgeable video purchasers will specify Plumbicon tubes, virtually every professional TV camera system produced for today's market is designed to use the Plumbicon tube.

The crucial factors of sensitivity, resolution and burn-in that affect the "total in-system performance" of ENG and EFP cameras and the consistent record of singularly brilliant performance of the one-inch and the 30mm Plumbicon tubes in studio cameras are generally credited for the professional's continued preference for Plumbicon tube-equipped cameras: that is why an estimated ninety percent of all network color broadcasting originates in Plumbicon pickup tubes.

Visit us at NAB,  
Booth 1412

\*Registered trademark of  
N.V. Philips of the Netherlands.

Whatever your application—ENG, EFP or Studio; whatever the origin of your next camera—American-made or imported; and regardless of the camera salesman's personal persuasion (or his own compensation scheme)—you will get Plumbicon quality pictures only by specifying, insisting, demanding Plumbicon tubes in your camera.

Yours for the specifying, the full line of Plumbicon tubes— $\frac{1}{2}$ ",  $\frac{2}{3}$ ", 1" and 30mm diameters, including low capacitance Diode Gun™ and special anti-comet-tail types—is available in the professional TV camera of your choice and is in demand today as never before by camera users in every segment of broadcast and corporate television.

There is only one Plumbicon, and that famous Emmy-award-winning pickup tube is available for the asking in every three-tube professional TV color camera sold today. For more information, contact: Amperex Electronic Corporation, Slatersville Division, Slatersville, Rhode Island 02876. Telephone: 401-762-3800.

## Amperex®

...dedicated to product excellence  
A NORTH AMERICAN PHILIPS COMPANY

Circle 251 on Reader Service Card





THE NEW

# CHYRON IV MAKES MAGIC

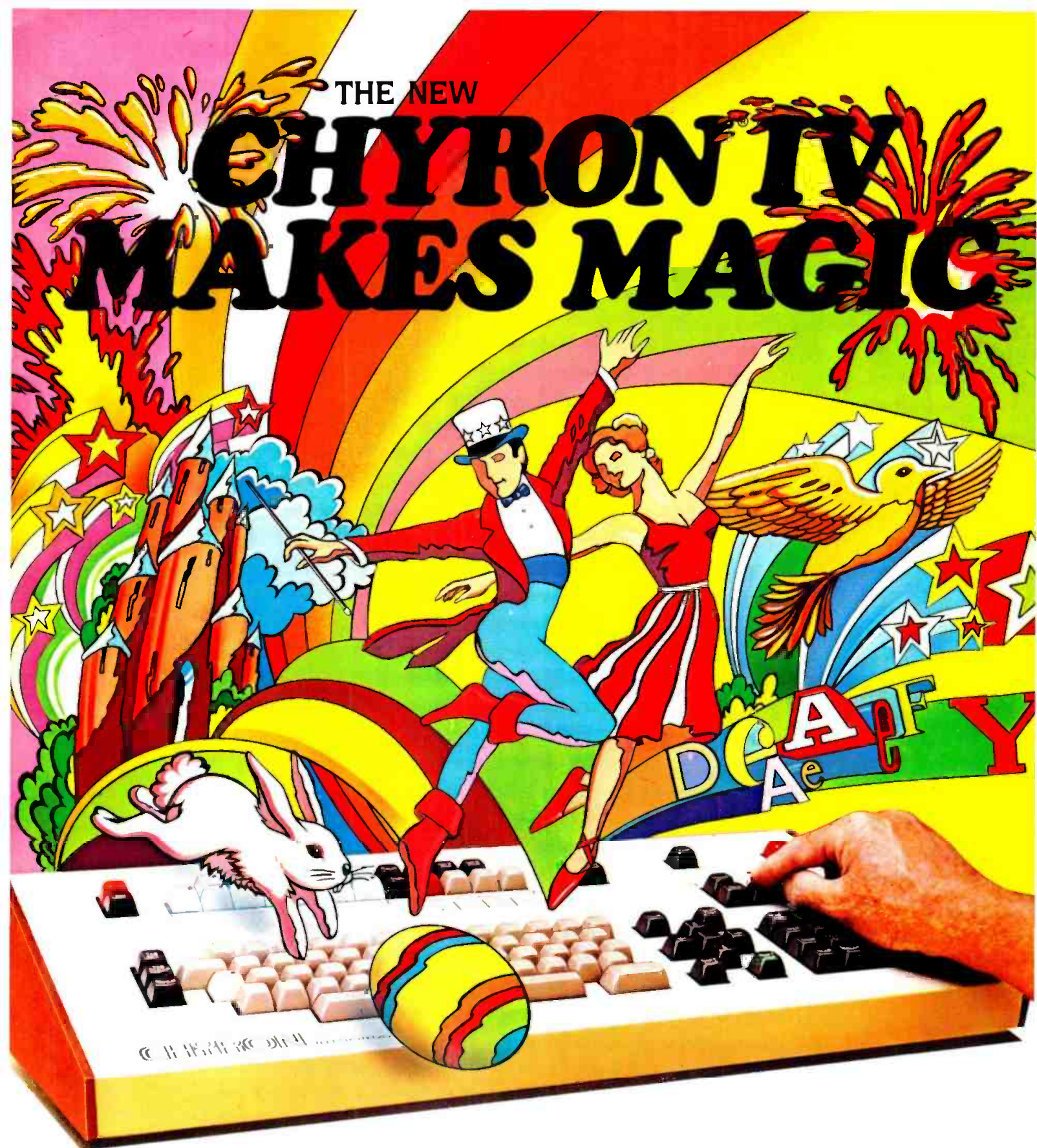

The electronic magic of the new CHYRON IV is at your fingertips: 512 color choices...animation...multi-color characters...independent background graphics...advanced camera font compose...digital drawing tablet...special effects...as well as the widest assortment of font styles and sizes available. And you don't have to be a magician to work the magic. CHYRON IV is still easy to use, totally versatile, and provides unsurpassed resolution. Perhaps best of all, earlier models of CHYRON IV

can be retrofitted to provide all of the features of the new CHYRON IV.

So, isn't it time to bring a little magic into your television production? Call or write for all the details on today's most sophisticated and versatile electronic graphics system. CHYRON IV. The magician's choice.

Follow the Leaders with

**CHYRON**  
TELESYSTEMS

A DIVISION OF CHYRON CORPORATION  
265 Spagnoli Road, Melville, New York 11747  
• 516-249-3296 • Telex: 144522 Chyron Melv  
Ampex International is exclusive distributor for  
Chyron Graphics Systems outside the U.S.A.

Circle 252 on Reader Service Card



**NEW!**

# THE DEMOD 105 OFF-AIR DEMODULATOR HELPS YOU CLEAN UP YOUR ACT

- Replace sync and burst at a touch of a button - locks 3/4" machines.
- Varactor tuning - tunes mid, super, and standard broadcast bands
- Front panel speaker
- Balanced 600 ohm audio
- LED VU meter
- Optional remote control

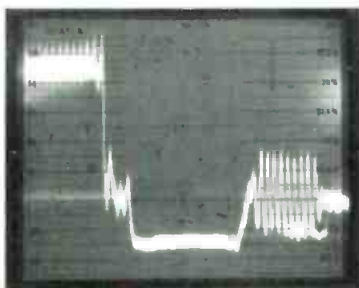

UNPROCESSED

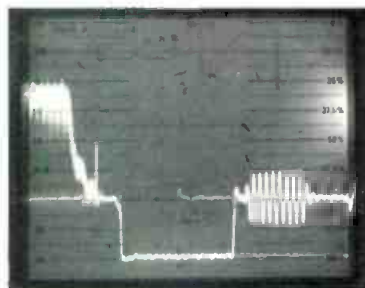

PROCESSED

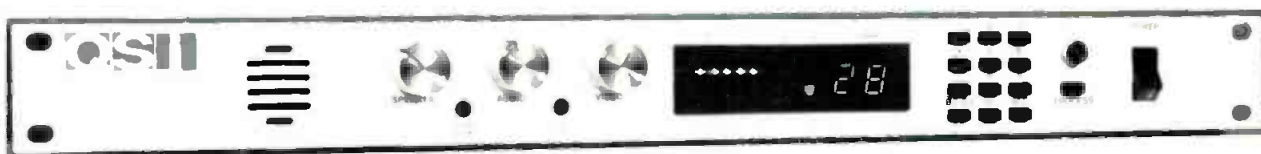

Try the QSI DEMOD 105. More features . . . and less rack space, only 1-3/4 in. high.

Dealer Inquiries Welcomed



**systems, inc.** ®

12 LINS COTT ROAD • P.O. BOX 2176, WOBURN MA, 01888 • (617) 938-1403

**SEE US IN LAS VEGAS • NAB '83 • BOOTH 1325**

## SERIES 9000V LIVE VIDEO IDENTIFIER AND SOURCE IDENTIFIED COLOR BAR GENERATORS

**NEW!**



Photo by Stanley Forman  
Courtesy Boston Herald American

The CB-9000V Series, in the color bar mode, allows you to test your audio and video links, and the split field identification indicates who is out there. When the color bar is dropped for the live feed, the identification is automatically transferred to the vertical interval of the live video.

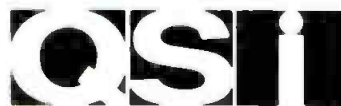

**systems, inc.** ®

12 LINS COTT ROAD • P.O. BOX 2176, WOBURN MA, 01888 • (617) 938-1403

# With EMCEE® TV transmission equipment, you'll have to find something else to worry about



## **You won't have to worry about reliability**

TV transmitters and translator/transposers serve towns and villages, not test benches surrounded by engineers. So we design and build for reliable performance. With straight-forward, proven circuitry descended from EMCEE equipment on the air for more than twenty years.

## **You won't have to worry about support**

To help keep you on the air, EMCEE provides complete training for technicians at your station. In most cases, we can also provide needed spares within twenty-four hours. And even design, build, install and thoroughly check-out a complete transmitter or translator site in as little as thirty days.

## **You won't have to worry about selection**

EMCEE TV equipment includes 10, 100, 1000 and 5000 watt Band I and III VHF transmitters and 10, 100 and 1000 watt Band IV and V UHF transmitters. All EMCEE equipment is available for either NTSC or CCIR standard applications. And is a sure way to take a lot of worries out of your operation.

## **You won't have to worry about anything**

Transmitters

- Television
- Instructional Television Fixed Service Microwave
- Multipoint Distribution Service
- Operational Fixed Service

Television Translators/Transposers  
Tower Erection  
Complete Turnkeys

*For more information, including data sheets in English or Spanish, please contact:*



**BROADCAST  
PRODUCTS**

a division of  
**ELECTRONICS, MISSILES  
& COMMUNICATIONS, INC.**

P.O. Box 68  
White Haven, PA 18611 U.S.A.  
Call toll free: 800-233-6193  
(In PA: 717-443-9575)  
TWX: 510-655-7088  
Ans: EMCEE WHHV

*It's not just how it works.  
But how long it works.*

**See us in Las Vegas, Booth #1621**

Equipment manufactured in U.S.A.  
©EMCEE Broadcast Products  
©1983 EMCEE Broadcast Products

Circle 255 on Reader Service Card



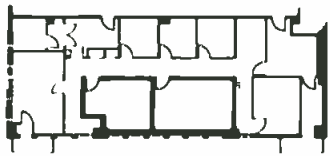

## FACILITIES DESIGN AND ENGINEERING

control surface must be as simple as possible. It should have good tactile feedback, proper control lighting, and tally lights that show settings at every instant. The control system should not confuse the talent and take his or her mind away from the show.

- Have a more complicated control center somewhere near the producer if necessary, but duplicate the simpler panel somewhere else in another studio or a newsroom—both for redundancy and for use by persons other than talk show talent during emergencies. You don't want to be in the position of having spent \$25,000 for a super-slick talk system, only to have it inaccessible to the newsroom when an emergency occurs during nontalk hours.
- Plan for at least two good-sized video monitors in plain view of the talent. Don't skimp on the size of the screen, especially if they are on a wall at some distance. One of these screens should display an "electronic producer" computer program that gives information about callers: names, locations, time waiting on hold, the order they're in, what they want to talk about, and so on. This information should be continuously updated and available to talent, producer, and engineer. In addition, a printer should make a hard copy of this and other demographical information for the sales department to compile listener profiles. The second monitor is used for in-house information, accurate time, weather forecasts, promo one-liners, instructions from producer or program director, and so forth.

- Install a private and immediate communications link between talent/producer and talent/engineer. Use a muted chime, very low level, when you need to break into a talent's phones while he or she is on-air. And provide talent with means to block out your message if he doesn't want to be disturbed at that moment. Provide some sort of signalling for talent to use while on-air such as a DTMF (touch-tone) pad that allows the talent to send a dozen different signals to the control room.
- Provide the talent with one NEXT EVENT button, clearly lit. This may start a cart deck or tape machine but it gets him out of the show at the exact instant he wants, even when the engineer isn't quite ready for the break.
- Label all phone lines clearly and make sure they appear the same all over the complex. It's usually not necessary to put the actual phone numbers on the buttons; in fact, that's adding unnecessary data. Label them by single number or letter.
- Provide a simple, direct, two-way communications path to the newsmen on duty.
- Add a "caller-override" button to push down the irate callers level, or to give the guest on another trunk a chance.
- In an operation where the producer is also the engineer, talent often helps out by screening some calls, particularly in setting up an important newsmaker. Provide the ability for the talent to talk off-air to a telephone trunk, using his mic and headphones.

### THE NEWSROOM

Newsroom work areas are divided into two general categories: the make-up or assembly work station, and the air or delivery station. Judicious planning allows all work stations to be used for both tasks—the key is flexibility and human engineering. Remember, newsrooms are

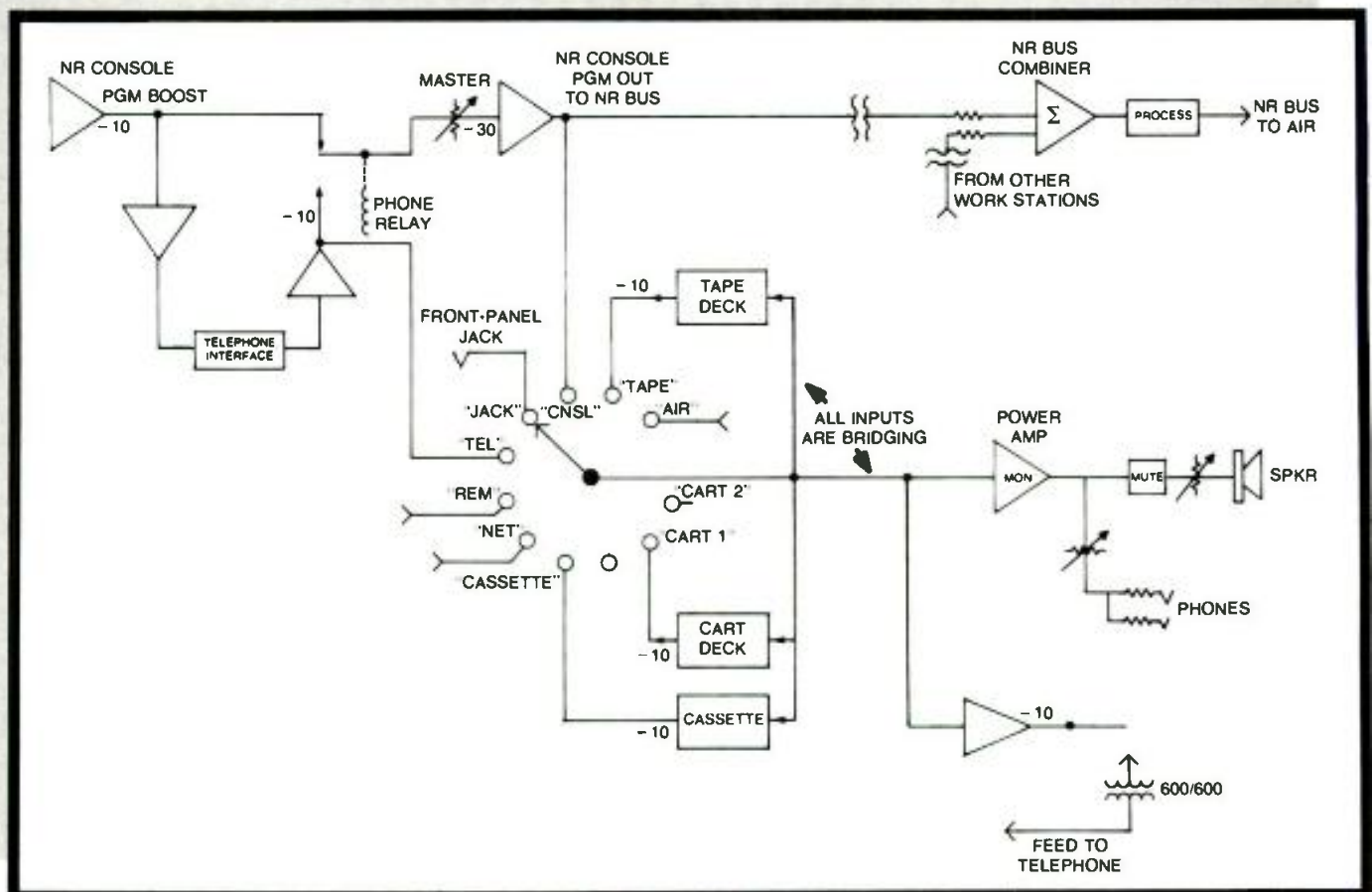
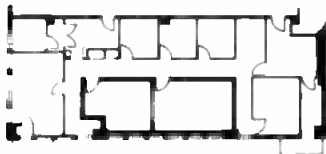

Figure 4. Newsroom work station allows recording and editing of program material, and going on air, from one spot.



## FACILITIES DESIGN AND ENGINEERING

occupied by nontechnical people who want simplicity and reliability, as in the newsroom record center illustrated in Figure 4, which integrates the telephone and which can go directly to air. Equip these record centers with tape erasers, a mic and headphones, tape machines, and a couple of cart decks, and you have the facility to produce and deliver a full newscast from the same chair.

Electronic editing is a must in any fast-paced newsroom. No one has the time, and few newsmen the aptitude, for tape splicing. A large step toward record/playback consistency is to provide the newsmen with high-quality portable cassette decks with pause, cue, and timers. This machine is brought to the work station with actuality recorded on it to become one of the two edit/assembly machines.

Newsroom telephones are another area of major concern. You can modify the usual push-to-talk handset, but have it wired release-to-talk. This makes it much easier for a newsmen who likes to type a story with the handset on. Imbalance between the local handset transmitter and the incoming call can be slightly relieved by installation of a small bypass resistor across the mouthpiece terminals in the handset. But remember that this slightly upsets the network in the phone and you are lowering the level of the newsmen's voice as heard by the caller.

At least one of the work stations should be left after-hours with a full load of tape, on a machine connected to a telephone recorder-coupler (commonly used for listen-lines). This device answers an unlisted number at night, puts the recorder into record mode, and allows the newsmen to feed in a story for the morning crew without having to return to the station.

### THE CONTROL ROOM

The operation comes together in the control room, quite obviously the heart of any news-talk operation. Figure 5 is

a block diagram of a control room master telephone interface which will handle all telephone remotes and provide limited capacity for conferencing. It is a recording interface, has a range-extender, provides options for reverse cue, and acts as a standby on-air talk system. The main talk-show system should be duplicated in the control room as a backup, ideally a separate system, fed from the same mix-minus sources.

Warning: Don't even think of combining two sources on one fader! It simply doesn't work with a news-talk format where inevitably a switch will be forgotten in the frenetic pace. It means more money, but every input used at all regularly must have its own fader.

A solid news block will flow more smoothly when the news announcers are seated in the control room with the engineer. Assign at least three cart slots to them; ideally a two-headed show means three cart slots per person with another triple-decker used for breaks and commercials. Communications are improved tenfold when everyone involved in the air side of a news block works from the same room.

Engineer-assists will include automatic recording devices for network cue-tone detectors to arm and start a recorder; a cassette machine might be used as a "skimmer," starting in record whenever a mic comes on. A cart recorder can be the slave of a cue-tone detector to record traffic or weather reports from outside the studio. Once a report is recorded, logic cues up the cart but won't let it be re-recorded.

The only processing needed in the control room (unless you want to invest in noise-reduction for cart machines) is some sort of level control and noise gating on the mics. By a combination of any of the many popular processors available, you can easily put the lid on mic levels, while at the same time providing expansion for noise-gating. In effect, even though a number of mics may be on in the same room, each mic is "quiet" until the closest mouth opens up. An expander set for the 10 dB range will make a world of audible difference when several mics are on.

Networks and remotes must be treated separately, because satellite-delivered network audio is going to far out-class that delivered by all but the best local phone loops or

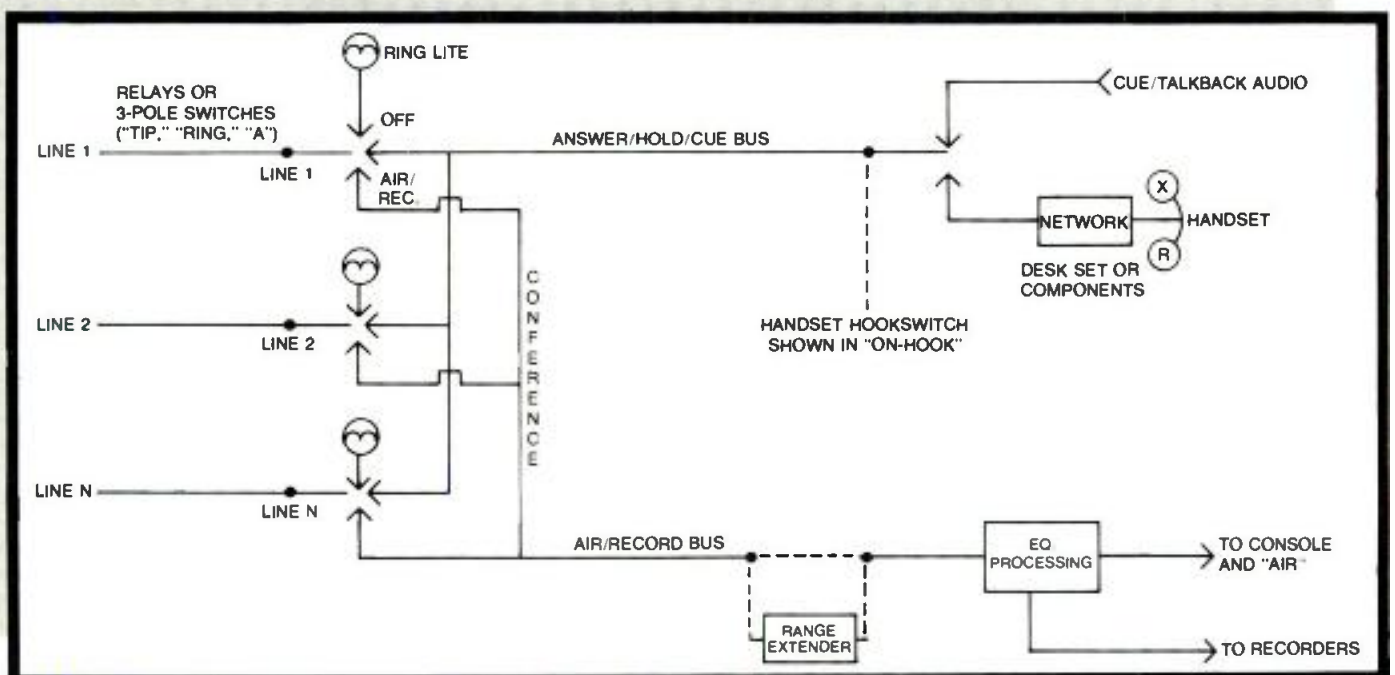
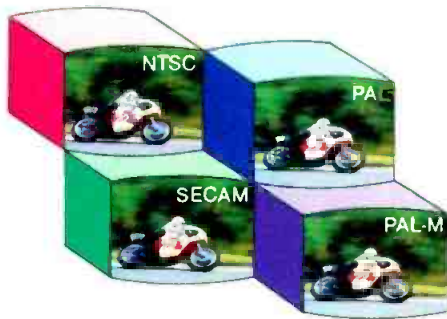

Figure 5. Control room telephone interface provides some conferencing and recording and is a stand-by on-air talk system.



# Where You Need It, When You Need It.

Oki Portable Digital TV  
Standards Converter  
**LT1200**



The need for TV standards conversion doesn't stop at the studio door. That's why Oki developed the portable LT 1200 Digital TV Standards Converter. The cost performance of this system sets the industry standard. And its reliability in the field as well as in rugged use in broadcast stations has earned the LT 1200 a reputation for dependable performance. Operation is totally automatic and totally simple. For converting NTSC, PAL, SECAM, or PAL-M, leave it to the LT 1200. Wherever you are.

Oki also produces the high-end LT 1015Σ Digital TV Standards Converter.



LT 1015Σ

*In the U.S.A. and Canada, contact:*

Oki Electric Overseas Corp.  
One University Plaza.  
Hackensack, New Jersey  
07601 U.S.A.  
Tel: 201-646-0011—0015  
TWX: 7109905004 OKI ELEC HAK

*In other areas, contact:*

Head Office:  
Overseas Marketing & Sales  
10-3, Shibaura 4-chome,  
Minato-ku, Tokyo 108, Japan  
Tel: (03) 454-2111  
Telex: J22627  
Cable: OKIDENKI TOKYO

**OKI**  
electric  
industry  
company, Ltd.

Circle 256 on Reader Service Card

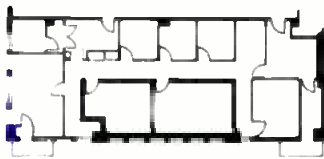

## FACILITIES DESIGN AND ENGINEERING

RPU systems. If you can afford to go that final mile, install an equalizer in each remote channel to make up for deficiencies; the result will be a very uniform air sound.

One other feature you'll want to design into the control room is the RPU interface. Two-way RPU is absolutely essential; the vest-pocket reverse-cue system is probably the best approach, with the control room and newsroom operators able to access this half of the two-way circuit. The field reporter should have his choice of pre-delay program cue or order-wire cue information. The reverse-cue transmitter should also be accessible from a telephone; by dialing an unlisted number, another reporter should be able to access this repeater through a VOX (voice-operated-control) to provide switching logic.

Separate intercom and headphone cue facilities are a must when the newsmen are in the control room. The engineer/producer may be monitoring a half-dozen sources in addition to program, so stereo headphones in a split-cue arrangement are great; selected cue is in one ear while program remains in the other.

The engineer/producer can also have a keypad tied to a small computer with which to call up different pages of information for his own use—spot schedules, program information, phone numbers of newsmakers, and so on. In addition, the news announcers can have an array of video

monitors: one a duplicate of the talk system, the second a display of weather and programming data, the third an output of a newsroom channel or a word processor. Depending on the amount of continuous updating a story might need, it might well be that a newsroom producer could type a story on his own word processor to be read directly by the announcer from a screen in the control room.

A successful news-talk operation will gain acceptance as the station to turn to during weather alerts, emergencies, and other quick-information situations. So it's important to stay on the air at all times. For about \$1000 you can purchase battery-powered ac, enough to run the console, mics and several tape decks without interruption. Because most of these inverters use standard 12-volt batteries sitting beneath a trickle charger, emergency operation can go on indefinitely as long as you can keep hauling in batteries. It is also a good idea to purchase several emergency lanterns which come on when the power fails. And it is wise to establish a dial-up back-up STL circuit so that if you lose a phone line or microwave STL link you can immediately dial the transmitter and feed program via voice-coupler.

The news-talk station is probably the most exciting format left to many AM stations. It's also the most expensive to program, but if it's done well, it becomes the salvation for many an operation whose music listeners have gone to FM. As the guidelines presented here make clear, it takes a lot of thought and money to set up. But the investment in a talk-news operation can be returned many times over by a successful operation. **BM/E**

### The first 9-bit frame synchronizer is still the best.



When we introduced the FS-16 in 1980, we expected our competitors would rush to copy it.

But while all of them have copied some of the FS-16's features, none of them have matched it.

So, we still offer the only 3"x19" rack-mounting frame synchronizer with the unsurpassed clarity of 9-bit quantization. As well as features like full proc-amp controls. Integral freeze-frame field. Data rotation and a built-in memory analyzer, to keep you on the air. And a price that's surprisingly low.

## When you want the best, call NEC.

# NEC

NEC America, Inc.  
Broadcast Equipment Division  
130 Martin Lane  
Elk Grove Village, IL 60007

Call toll-free: 1-800-323-6656.  
In Illinois, call (312) 640-3792

Circle 257 on Reader Service Card



LOWEL OMNI & LOWEL TOTA ARE VERY DIFFERENT LIGHTS, BUT THEY WORK TOGETHER BRILLIANTLY. YOU CAN USE EVERY TOTA ACCESSORY WITH THE OMNI-LIGHT. PROFESSIONALS ♥ THEM.

LOWEL-LIGHT MFG., INC., 475 TENTH AVE. N.Y., N.Y. 10018. 212-947-0950.  
LOWEL WEST, 3407 W. OLIVE AVE. BURBANK, CA. 91505. 213-846-7740

lowel 

Circle 258 on Reader Service Card



# Freedom of Expression



*The Aurora/100 digital videographic and animation system.  
Creativity limited only by your imagination.*

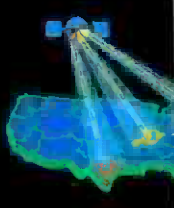
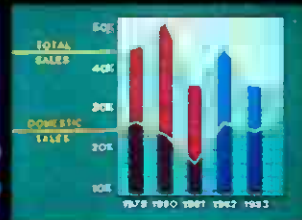
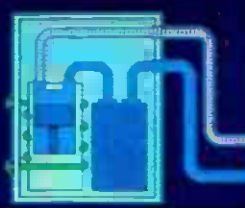

The Aurora/100 is the most powerful television artist's tool ever developed. We've taken the time to do it right. In fact, our people pioneered in the design and application of digital videographic and animation systems starting in the early 70's.

The Aurora/100 was designed first and foremost to permit real artistic flexibility. It's not just an extended character generator but a complete graphic and animation system built from the ground up by creative people for creative people.

This is an extraordinarily powerful system. Yet it is simple to learn. Easy to use. And it requires absolutely no computer experience.

You will be amazed at the speed with which ideas and concepts can be transformed into exciting, colorful visual images.

The Aurora/100 features real-time animation, freehand painting, powerful graphic editing tools, character generation, video input and many other capabilities.

Digital videographics has come of age. Aurora systems are already in use in NTSC and SECAM broadcast, post production and industrial applications in the U.S., France, Japan and Canada.

The Aurora/100. Limited only by your imagination.

**AURORA**

# IN-HOUSE. INTERACTIVE. INCREDIBLE.

## INTRODUCING THE NEW KAMAN BROADCASTING SYSTEM.

KBS is a totally new computer system for the broadcasting industry. It's not a rewrite or an adaptation of any existing system. KBS was created from scratch by broadcasters, from a broadcaster's point of view, to meet broadcasters' needs—now and for decades to come.

### Incredible power, capacity and flexibility.

KBS gives your station or group awesome information handling and communication capability: A single system that can handle traffic, sales, billing, accounting, autoswitching, word processing, films, news writing, and news archiving.

A single system that can accommodate up to 80 work stations (CRTs or tabletop printers), two high-speed line printers, up to eight remote lines with as many as eight displays or printers per line—all simultaneously, if need be.

KBS was designed for IBM System/38 hardware to give broadcasters a system with almost unlimited capacity and growth potential,

unequaled availability of hardware and maintenance,

simplicity of programming and operation and the choice of hardware lease or purchase.

### The incredible speed and utility of a completely interactive system.

KBS links together every department in your station to form an integrated information network of unsurpassed usefulness. Information generated in Sales, for example, instantly becomes part of the database for Traffic and Accounting. Enter a contract and it immediately goes into the avails and logs.

Sensitive data, such as financial reports and payroll can, however, be restricted to authorized parties. And KBS can be networked with other IBM systems for corporate reporting and electronic mail.

### The incredible economy and convenience of an in-house system.

KBS eliminates the need for expensive and frequently unreliable phone lines tying your station to a computer hundreds of miles away. It does away with waiting for avails, logs or reports. Because KBS is completely in-station, it is always under the control of station staff. And, even though the system is designed to give you complete independence, you're not left totally on your own: KBS customer service representatives, themselves experienced broadcasters, are available at all times to help you get the most from your KBS system.

For more information on the incredible new Kaman Broadcasting System, call Kaman today.

### **Kaman Broadcasting Systems**

 a product of

### **KAMAN SCIENCES CORPORATION**

1500 Garden of the Gods Road (303) 599-1500  
Mailing Address: P.O. Box 7463, Colorado Springs, CO 80933-4763

Circle 260 on Reader Service Card

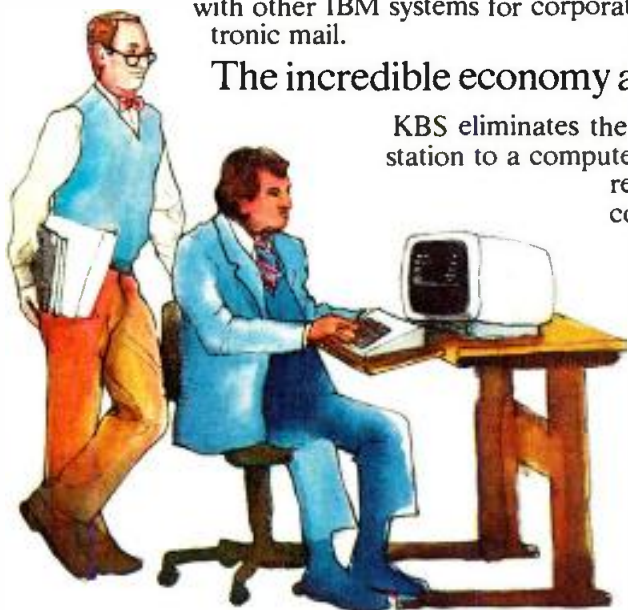
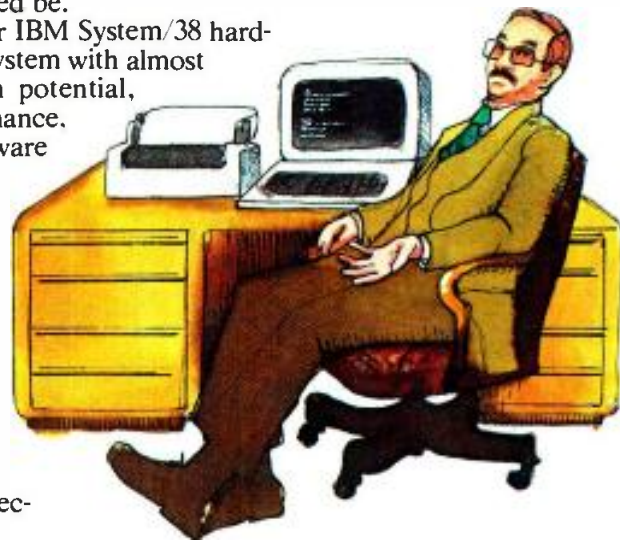



# Cart Deck Automation Design

By Bob Lafferty

ONE OF THE MOST ENJOYABLE aspects of station engineering is the opportunity to design and build those "bells and whistles" gadgets that can add so much to the station operation. But all too often, the engineer gets caught up in complex design and fails to follow the basic rule: keep it simple!

An excellent example can be found in the solutions to the "Great Ideas Contest" Cart Automation problem in the November 1982 issue of *BM/E*. All three were too complex for their intended use, would create more problems than they would solve, or both.

The contest called for a way to automatically sequence three dissimilar cart machines. The rules specified the use of pushbutton switches and relays which unnecessarily complicated the design—in its simplest form, only four single-pole, double-throw switches are needed.

Reducing a design to the lowest common denominator cuts construction time, parts costs, and projected failure rate. A working knowledge of logic gates or SCRs is great, but they should be used only when absolutely needed. On the other hand, finding the simplest possible design is often more difficult than a complex one.

Another important design consideration is Murphy's law: "If something can go wrong, it will." If three or more cart machines are being sequenced and one in the middle can't be bypassed when it breaks down, the system has little value. Or, if relays used in the audio path between the cart decks and the console are opened when the sequencing unit fails, the operator can be left with useless cart decks.

Projects such as these usually begin with a suggestion that the station's efficiency or on-air sound can be enhanced by doing things in a different way. Before diving headlong into design, however, the engineer should first carefully define the purpose and expected results of the project. This requires not only a knowledge of the station equipment, but also a complete understanding of how that equipment is used. A relay

system that cuts the audio from one deck as it starts the next may look good on paper to the engineer, but would be rejected by the air staff because it would lack segue capability and create a choppy on-air sound. Think of the problems if this were discovered only after the unit was built and installed.

In the project described here, the definition of purpose

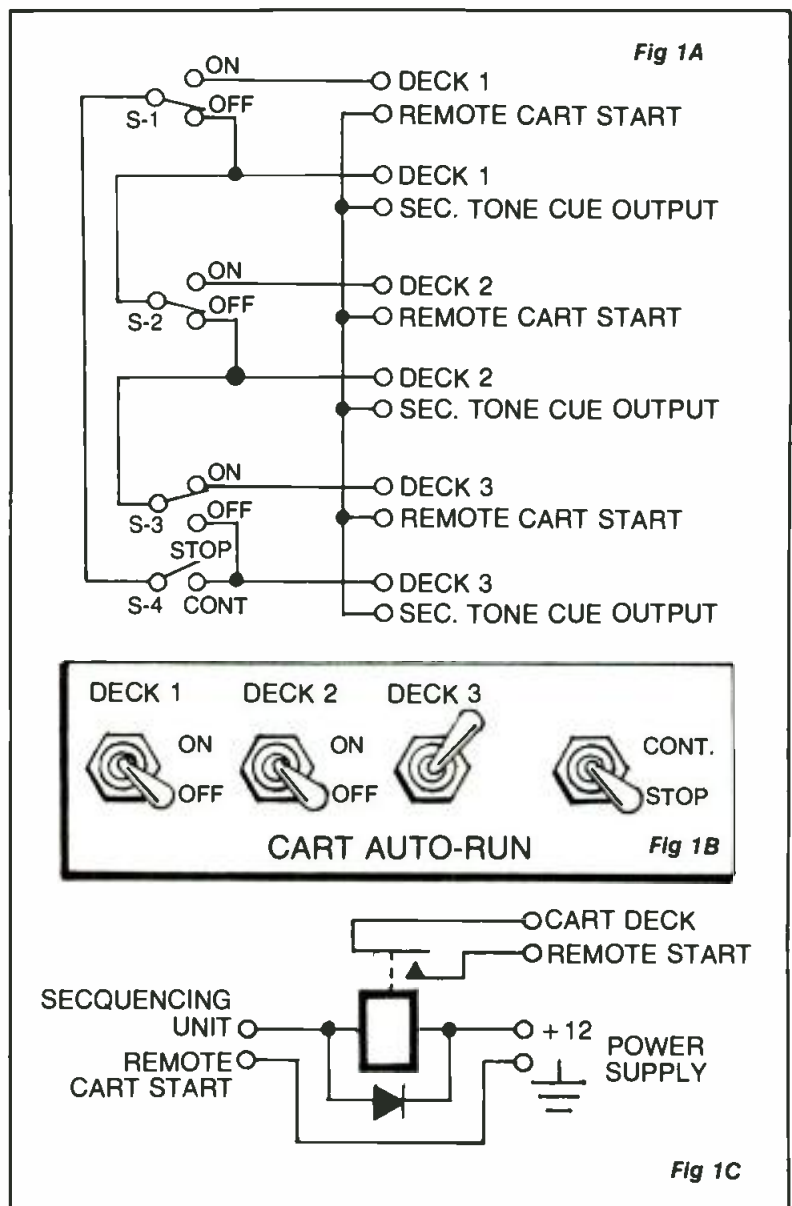

Bob Lafferty is chief engineer of KKJO/KSFT, St. Louis, MO.

## Cart Deck Automation Design

might be, "We need a circuit that will automatically sequence the cart machines in the main studio, cut the audio output of any deck not actually airing audio, allow for overlapping segues, run unattended with little chance for error, and not interrupt station operation if it or one of the cart machines fails." When the purpose is clearly in mind, the engineer can look for the very simplest design that will do the job.

### Multistep design

If the problem involves two or more separate but interconnected operations, it is often helpful to use a multistep design process. This is done, as illustrated in the accompanying diagrams, by concentrating on the cart machine sequencing first and adding the audio switching later. In this way, the simplest sequencing system can be determined before cluttering the design with the more complex switching circuit.

Now let's take a look at a workable solution to the cart sequencing problem and see how these design considerations can be met. Any simple sequencing design should be based around use of the secondary (or tertiary) tone capability of the cart machines. This tone can be placed on the cart cue track at the end of the audio and thus be used to start the next cart before the first one cues up.

A check of five cart machine designs from three different manufacturers shows all pull in an internal relay during secondary tone detection to provide a closed circuit "secondary tone cue" output. If one or more of the decks to be used was purchased without the optional secondary tone detection circuitry, an external detector can be added.

In four of the five cart machines, remote start involves the use of an external contact closure to pull in a 12 or 24 VDC relay. The fifth requires a TTL logic low to start the deck. In every case, however, the secondary tone cue output of any cart machine would trigger the remote start of any other simply by connecting them together.

Based on this information, the simplest cart sequencing system involves interconnecting properly equipped decks with SPDT switches, as shown in Figure 1-A (see preceding page). To illustrate its operation, let's assume deck two is out of service and the operator wants the cart in

deck one to start deck three and then have the automatic sequence stop. He sets the switches as shown in Figure 1-B and starts the first cart. The secondary tone cue from deck one bypasses deck two through S-2 and starts deck three through S-3. If deck two is operating, three carts can be sequenced by flipping up S-2. Continuous sequencing is enabled by setting S-4 at CONTINUE. Note that more cart machines can be included by adding a switch for each additional deck.

Although most cart machine remote start circuits require a ground closure to pull in the run relay, some switch the supply high side instead. These can be isolated from the other decks by using a relay between the sequencing unit remote cart start output and the cart deck, as shown in Figure 1-C.

The circuit shown in Figure 2 can be added to any cart machine lacking a secondary tone detector. It connects to the cart deck logging output or, lacking that, to a point between the deck cue tone amplifier and the primary tone detector. The circuit uses an inexpensive LM567 tone decoder IC with the variable resistor adjusted for operation at 150 Hz. Three methods are shown for interfacing the IC with the sequencing switches: a TTL compatible relay, two NPN transistors with the second capable of carrying the current needed to enable any cart run relay, or a PNP transistor plus a 12 or 24 V SPST relay. Other variations of these circuits are possible.

If any of the cart machines uses a secondary tone output other than a relay (TTL logic, optocoupler, transistor switch) which won't carry the current necessary to pull in another deck's run relay, it can be interfaced in the same manner as the IC in Figure 2.

### Adding audio switching

Now that we have the simplest possible sequencing design, we can add an audio switching section. Because it is likely that an operator will leave the studio while carts are sequencing, it is wise to include a circuit that connects a cart deck's audio output to the console only during the audio portion of a cart being run in that deck. This eliminates airing noise during cue-up of poorly erased carts, cue-up "burps," or two carts on the air at the same time if one misses a stop cue.

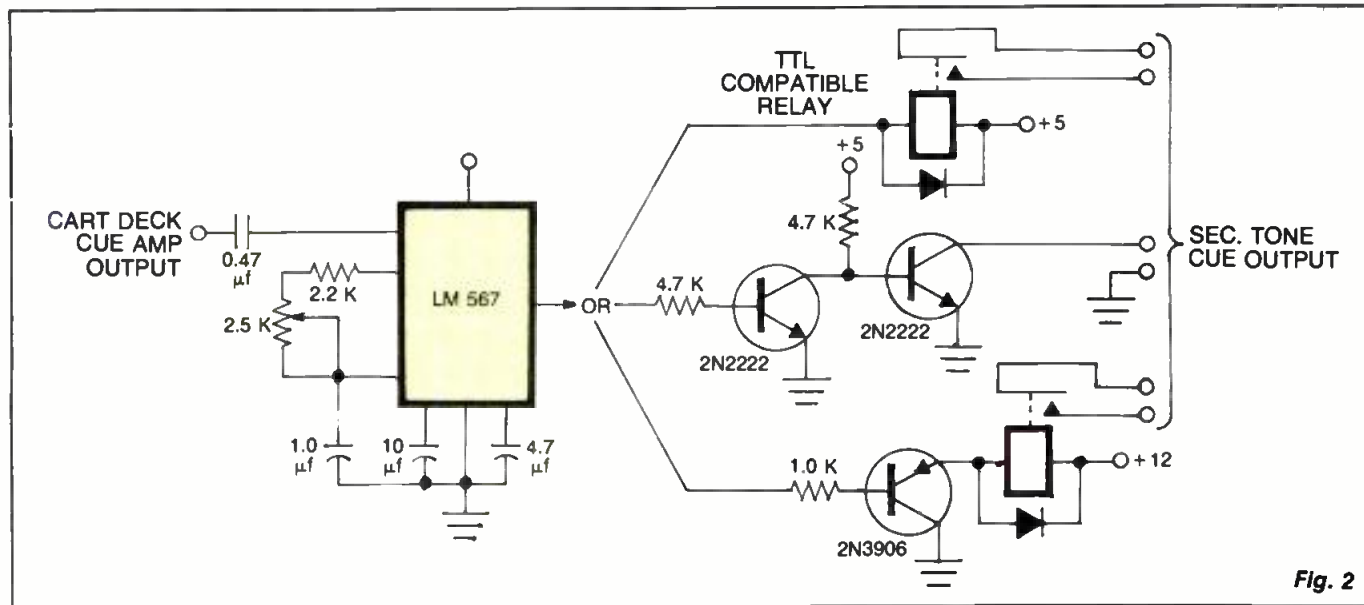

Fig. 2



# The new Saticon II camera tube. Clearly superior to lead oxide.

Compare the unretouched photos below and see for yourself how the new RCA Saticon\* II camera tube reduces specular highlight memory, without red trail.

You no longer have to choose between lead oxide's good handling of highlights and Saticon's well known superiority in other critical performance factors. Now it's a whole new ball game.

Computer-aided deposition and advanced material purification technologies have given Saticon II a considerably improved photoconductor. Your benefits: less highlight trail, reduced highlight memory (as much as 75% less than that experienced with earlier Saticon tubes), improved resistance to image burn.

What's more, you still get all of the recognized advantages of Saticon: high resolution,

distortion-free colors, very low lag, and extremely long tube life. And Saticon II is backed by a warranty that's second to none. RCA offers full replacement for any failure in normal use for six months, compared with only two months for Plumbicon™.

Your choice is now clear. For more information on the complete Saticon line, contact your RCA distributor or write to RCA Camera Tube Marketing, New Holland Avenue, Lancaster, PA 17603. Or call (800) 233-0155. In Penna., phone collect to (717) 397-7661. Overseas, contact RCA Brussels, Belgium. Sao Paulo, Brazil. Sunbury-on-Thames, Middlesex, England. Paris, France. Munich, W. Germany. Hong Kong. Mexico 16 DF, Mexico.

\*Used by permission of trade mark owner.

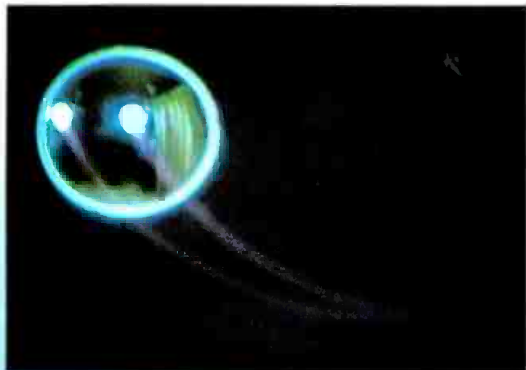

**Good. Plumbicon XQ1427.**

*Photograph of direct reflection of flood lamps, produced by camera with CTS circuitry. Note highlight memory with red trail.*

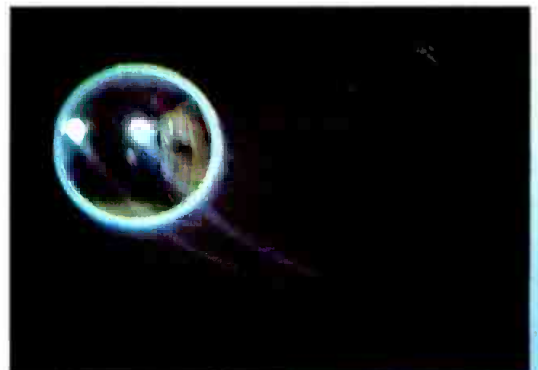

**Better. Saticon II BC4390.**

*Same subject and conditions as in photograph at left. Note reduced highlight memory without red trail.*

BOOTH NO. 1000

**RCA**

Circle 261 on Reader Service Card

[www.americanradiohistory.com](http://www.americanradiohistory.com)

# Cart Deck Automation Design

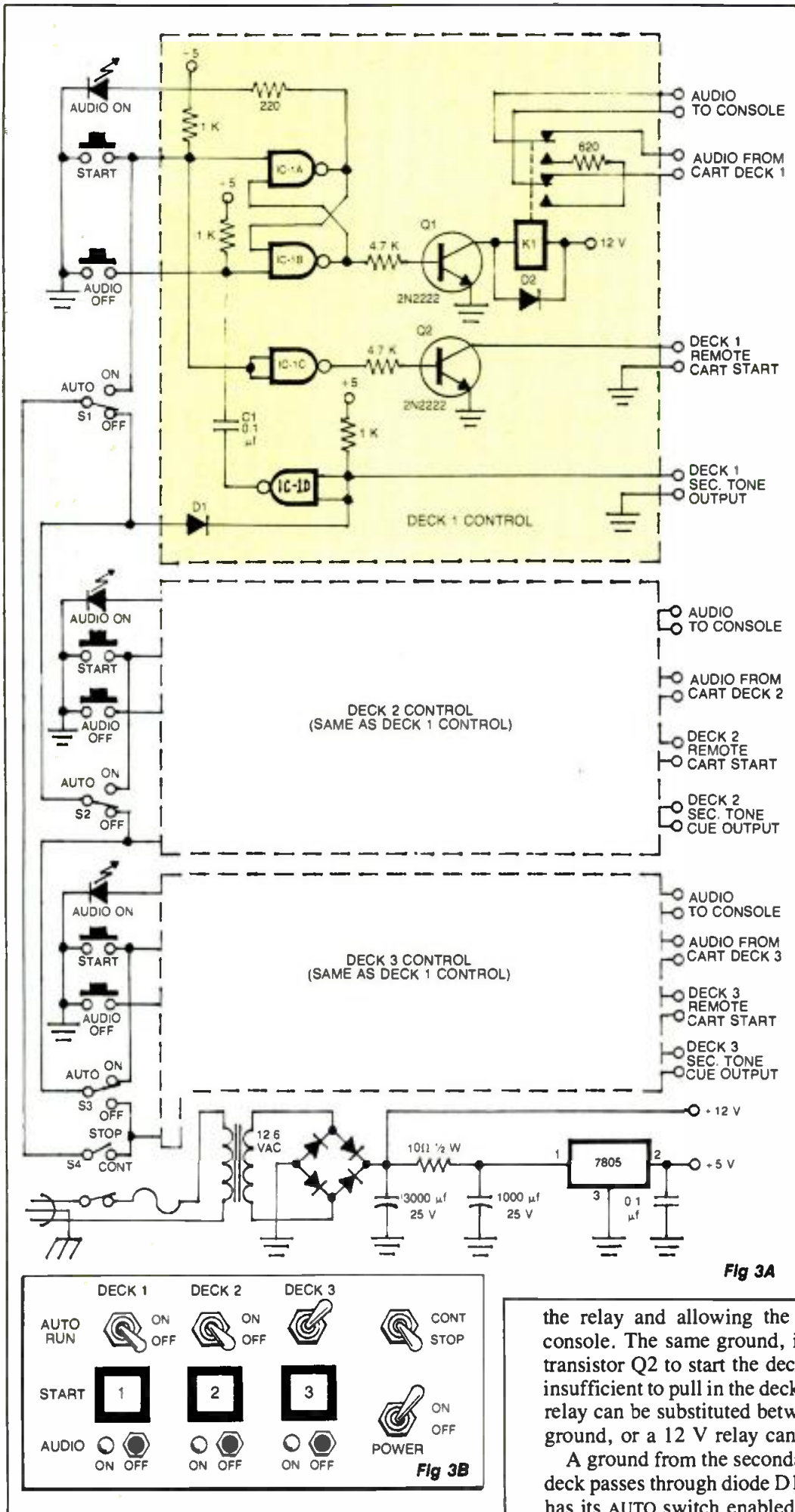

The circuit of Figure 3 is designed to start the next cart at the beginning of the secondary tone and remove the audio of the first deck when the secondary tone ends. Thus two carts can be segued with the second starting over the fading ending of the first. It requires that the secondary tone be applied to the cart at the point where the next cart would normally be started and remain on until all audio is over.

Note that the circuit of Figure 3-A provides the sequencing in the same manner as Figure 1-A using SPDT switches S-1 through S-4. Two SPST momentary switches and an LED are added per deck to the operator's panel, as shown in Figure 3-B. This circuit requires the use of the remote switches when manually starting any cart deck. Because all audio paths are completed when the relays are relaxed, the operator can, in an emergency, bypass the unit by turning off the power supply. Then the cart machine start switches would be used.

The circuit uses one 7400 quad NAND gate per deck. The audio relay is operated by an RS latch made up of gates IC-1A and IC-1B. The ground from the START switch or a secondary tone ground from a preceding deck sets the latch so that the base of Q1 goes low, relaxing

the relay and allowing the deck audio to pass to the console. The same ground, inverted by IC-1C, turns on transistor Q2 to start the deck. If the transistor switch is insufficient to pull in the deck run relay, a TTL compatible relay can be substituted between the output of IC-1C and ground, or a 12 V relay can be added as in K1.

A ground from the secondary tone relay of the running deck passes through diode D1 and starts the next deck that has its AUTO switch enabled. The ground also sends the



# The first 8-days-a-week logger.



## The Dictaphone Veritrac SL.

Whether charting the hits or checking the spots, Dictaphone's new Veritrac SL voice communications recording system is practically indispensable. Here, in a package you can lease for as little as \$99 a month, is recorded testimony to what you've aired. Uninterrupted by tape changes. 24 hours a day.

What's more, the Veritrac SL is modular. It can be configured to meet your station's specific needs. Providing recording time of up to 8 days. And it has something else going for it. Dictaphone reliability and service.



**Dictaphone**

A Pitney Bowes Company

Circle 262 on Reader Service Card

[www.americanradiohistory.com](http://www.americanradiohistory.com)

For more information on the Dictaphone Veritrac SL system, fill in the coupon or call toll-free:

**800-431-1708**

Except in Hawaii and Alaska  
(in New York call 914-967-2249)

Name

Title  Phone

Station

Address

City  State  Zip

**Mail to: Dictaphone Corporation  
120 Old Post Road  
Rye, New York 10580**

Dictaphone and Veritrac  
are trademarks of Dictaphone Corp. Rye, N.Y. PBME-33

## Cart Deck Automation Design

output of IC-1D high. When the ground is removed at the end of the secondary tone, IC-1D's output will return low, resetting the RS latch through capacitor C1. This drives the base of Q-1 high, turning it on, pulling in the relay, breaking the audio path, and bridging the console input with a 620-ohm resistor.

The AUDIO ON LED indicates when the latch is set and the AUDIO OFF switch can be used to reset the latch when the unit is first turned on or when a cart does not have a secondary tone. The circuit of Figure 2 can be connected directly to the secondary tone cue input of the unit if a cart deck does not have a secondary tone detector. And, if stereo decks are being used, a 4PDT relay can be substituted for the one shown.

Another advantage of this circuit is that it allows the audio of all cart decks to be brought into one console input. Many cart decks switch from a low impedance output (600 ohms) when running to high impedance when stopped. This impedance change causes level shifts if two or more decks are paralleled into one input or if a resistive combiner is used. Because each audio relay of this circuit drops a 620-ohm resistor across the output when pulled in, it effectively retains a constant impedance and allows the use of the circuit, Figure 4, that combines the outputs of as many as ten cart machines into a single console input.

It is interesting to speculate on other functions that could be added to this circuit. For instance, how about one that would lock out the start circuit of a used cart deck until another cart is inserted? This might appear to be a wel-

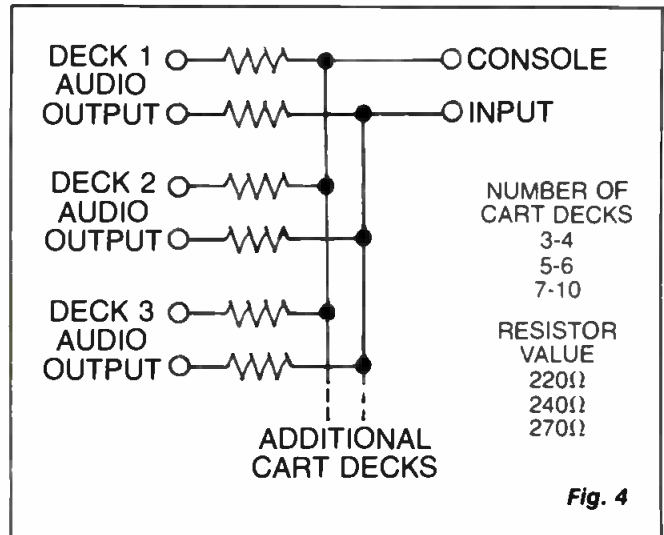

Fig. 4

come addition, especially if the operator enables the CONTINUE switch and leaves the studio. However, it would be necessary to determine which would be worse, the dead air that could result, or repeating a cart or two until the operator returns.

The brings up another possibility—designing a silent sense circuit to sound an alarm and/or skip to the next enabled cart if there is no audio for three to five seconds. But, we'll leave that to another article—or another "Great Ideas" contest. In the meanwhile, keep in mind Murphy's First Law of Failure and the Keep It Simple Rule when designing your next "bells and whistles" device. **BM/E**

## Why Your Radio Station Should Own An Eventide H949 Harmonizer.<sup>®</sup>

### • IT'S A COMPLETE AUDIO TIME COMPRESSION SYSTEM AT A FRACTION OF THE PRICE

The \$3500\* H949 gives you the same audio time compression and expansion capabilities of competitive single-purpose units costing well over twice as much. You get the power to control time itself...with no editing, no program material deleted and no abnormal pitch effects.

### • IT'S A COMPLETE SPECIAL EFFECTS DEPARTMENT

The Eventide H949 Harmonizer\* special effects unit gives you an almost endless variety of effects. There's variable delay, echo and reverb. Feedback level and equalization controls let you "custom-tune" the audio. Pitch change capability can create new voices. Mix input with pitch-changed output for chorus and harmony effects. Want the distinctive sound of flanging? The H949 offers the best flanging ever. There's time reversal and repeat too. For even more versatility, many more effects can be created from combinations of the basic effects.

### WHAT CAN THIS MEAN FOR YOUR STATION?

#### • IT CAN HELP YOU MAKE MORE MONEY

Go after those co-op dollars! The H949 can easily compress an existing national spot to accommodate a local retailer tag. Local advertisers who deliver their own ad copy will love what the H949 can do. Endless retakes to correct

the non-professional's timing errors are eliminated. Use pitch-change to make that local retailer sound more like an announcer (He'll love that!) Time compression with the H949 can bring order out of chaos when running back-to-back religious or political programs which are often mistimed. And, you'll find yourself doing more and better station-produced local spots—with those special audio effects that make for a more professional custom production. Your advertisers will notice and appreciate the difference.

#### • IT CAN GIVE YOUR STATION A MORE DISTINCTIVE, TIGHTER SOUND

The H949 Harmonizer can really make a difference. Use its special effects capabilities to produce really distinctive promos, intros and custom jingles. For a brighter, fast-paced sound, some stations choose to speed up their music by a few percent, utilizing the Harmonizer to maintain normal pitch. Using pitch-change, you can even create new voices to populate your air.

**MOST EVENTIDE DEALERS HAVE EVALUATION UNITS AVAILABLE. CALL EVENTIDE TODAY FOR THE DEALER NEAREST YOU.**



**Eventide**  
the next step

265 West 54th Street  
New York, N.Y. 10019  
(212) 581-9290

\*List price in domestic U.S.



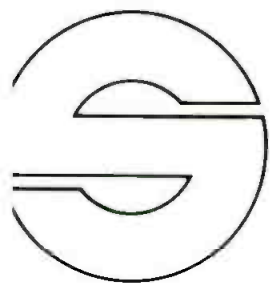

# sachtler

## THE PERFECT HEADLINE

for your ENG- or EFP-camera

**sachtler**  
**camera supporting systems**  
offering

drag-in – up to seven – steps of drag,  
independently adjustable for pan and tilt,

built-in compensation for center of  
gravity displacements,

camera-adequate or dynamic counter-  
balancing, adjustable on the spot  
for all your possible requirements,

extreme positive, operational locks,  
for effecting camera orientation  
when operated,

leak-proof by design fluid system  
with guaranteed (for years) trouble free  
operation,

an all-in-one piece unit for easy handling  
and transport,

that is available when and where you need it  
worldwide.

As the Sachtler headline offering all  
these features, don't ask for less!

Call on your nearest Sachtler dealer

or write to

Sachtler Corporation of America  
100 Oser Avenue, Hauppauge NY 11788  
Phone (516) 231 0033, Tx 140170,

a subsidiary of Sachtler GmbH  
Hieselstr. 16  
D-8046 Garching/München  
Phone (89) 320 4041, Telex 5215 340  
Circle 264 on Reader Service Card

Panorama

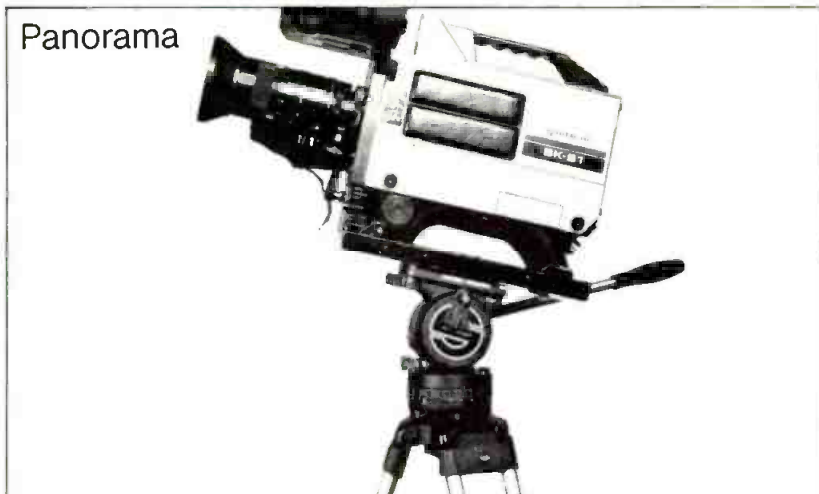

Video 20

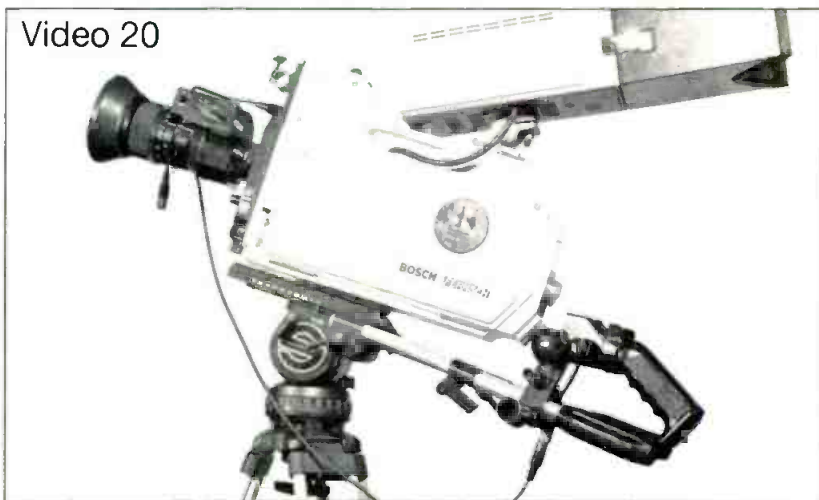

Video 25



Video 30



# Imagine The Features That Will Answer Your Present And Future Needs ... Then Call **Di-Tech**

Audio/video routing switchers come in many different shapes and sizes, offering a variety of features. Since your requirements change from year to year, shouldn't you select the one that fits today's budget AND can meet your present and future needs? Then try **Di-Tech**. We've got that small 4 x 1 matrix switcher and the 200 x 200 switchers. We've even got a selection of in-between sizes for audio only, video only or audio follow video with 1, 2 or 3 channels of audio per input.....

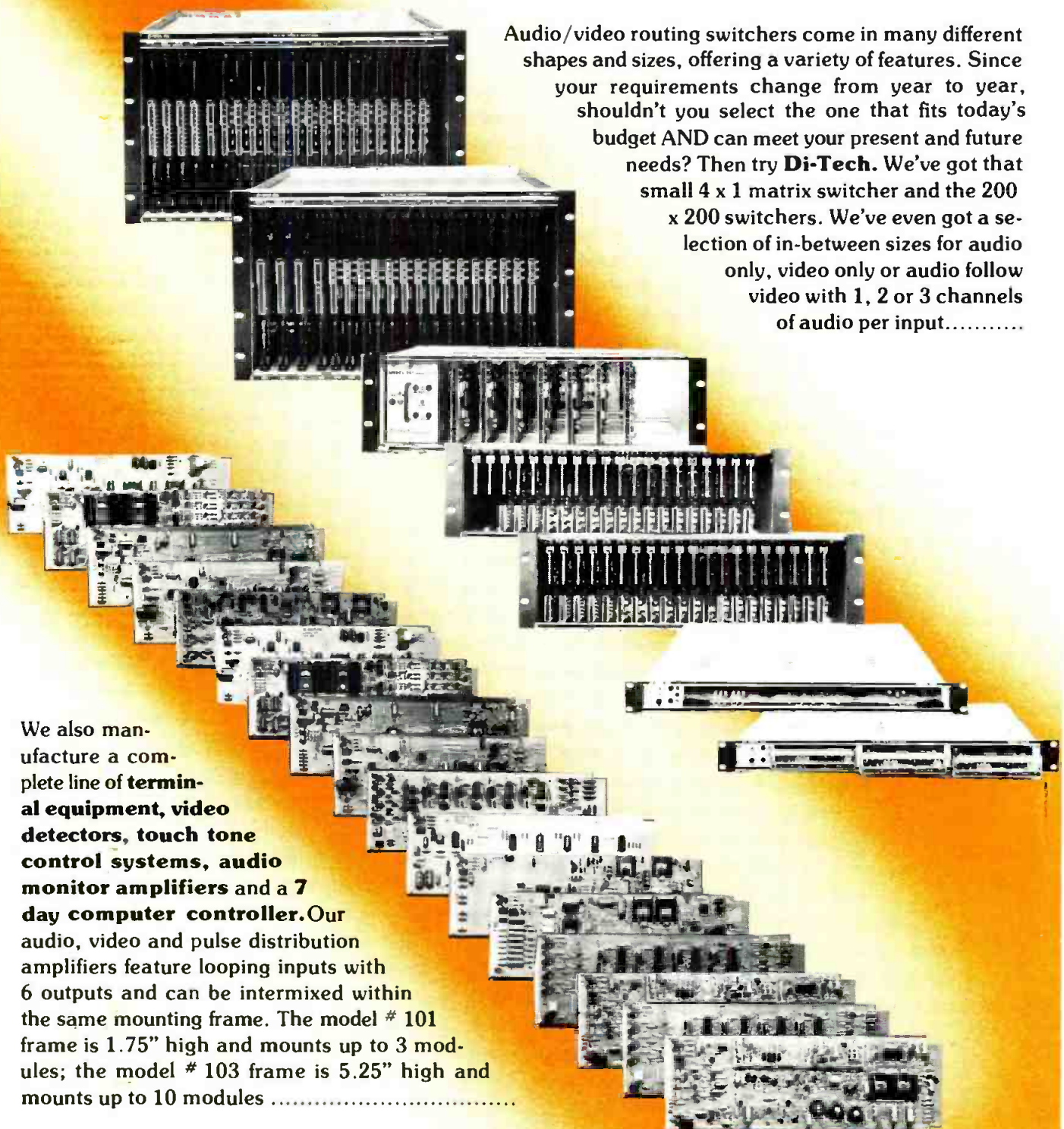

We also manufacture a complete line of **terminal equipment, video detectors, touch tone control systems, audio monitor amplifiers** and a **7 day computer controller**. Our audio, video and pulse distribution amplifiers feature looping inputs with 6 outputs and can be intermixed within the same mounting frame. The model # 101 frame is 1.75" high and mounts up to 3 modules; the model # 103 frame is 5.25" high and mounts up to 10 modules .....

Whatever your present or future needs are, call **Di-Tech** for the high quality, reliable, easy-to-operate answer.



# di-tech

our **NEW**, bigger location:  
**48 JEF RYN BOULEVARD**  
**DEER PARK, N.Y. 11729**  
**TEL. # (516) 667-6300**



# NEWS FEATURE

## AM Stereo Rolls Snake Eyes at Vegas Consumer Show

ONCE AGAIN it appears that the marketplace choice of an AM stereo system will rest with the receiver makers, not with the broadcasters. But it may be the end of the year before any radios actually reach consumers. That was the message at the January Consumer Electronics Show (CES) in Las Vegas where over 78,000 manufacturers, retailers, executives, and engineers gathered.

While professional broadcast presence there is traditionally thin (most saving their plane fares and gambling stockpiles for the NAB expos that clog the same hotels and casinos several months later), this year's show was being carefully watched for a consumer direction on the AM stereo front. Of particular note was the fact that Delco had selected the Motorola C-Quam standard only several weeks before, a decision that had been anticipated to be a weather vane of an industry-wide direction.

However, a series of interviews with key AM stereo executives and receiver manufacturers at CES revealed that no immediate consumer trend is in the offing. In fact, AM stereo played a seemingly insignificant role in a consumer electronics pageant that found audio in general pushed aside to the upper floors of the convention center and to the nearby Riviera and Hilton hotels. Even video, more recently the technology darling of the electronics moguls, was comparatively abandoned.

The center aisles were dominated by the maddening bleeps of the videogame manufacturers (with initials like CBS), the clicking keyboards of the personal computer-makers (with more initials like IBM), and the snapping buttons of the telephone dealers (with still more initials like AT&T). The big names (and initials) in audio receivers were there nevertheless, and the current AM stereo standard-bearers (Magnavox, Motorola, Harris and Kahn) worked the floor and hotel suites like political conventioners to court them into their particular camp.

Motorola, which drew a lot of interest, occupied a 30-foot-long booth at the Hilton with a GM car equipped with a Delco modified AM stereo dashboard radio, a modified Technics SA-222 receiver and a 10-watt mini-transmitter



*Motorola's AM stereo system developers Norm Parker (left) and Frank Hilbert show off Compatible Quadrature system exciter and monitor along with testing components. Company demonstrated the system with modified receivers at the Consumer Electronics Show.*

for demonstrations. While reportedly several major receiver manufacturers, including Sony and Panasonic, stopped by for "talks," no official announcements were forthcoming.

Explained Motorola AM stereo/broadcasting manager Chris Payne, "We were encouraged by the reaction to the Delco decision, but they [the manufacturers] were all worried about leaking their plans. Any announcement would automatically render obsolete their monoaural AM radios. I don't think you are going to get many 'official' announcements until their inventories are exhausted. It would be foolish to expect anyone to jump aboard as quickly as even they themselves may want to."

Part of the delay, obviously, was the fact that Motorola had not been able to tool up its IC production as quickly as it had hoped to take full advantage of its Delco boost. Payne said the company had "hundreds" of sample chips available at CES and anticipated having

"thousands" available in February, followed by "tens of thousands" in March. He added that the company was in the process of licensing talks with leading broadcast equipment manufacturers to build their patented AM stereo exciters for domestic sales, with the hope that other companies would be able to bring the existing price tag below the current \$10,000 mark.

Another factor was the impressive show presence of Sansui, which displayed an AM stereo car tuner that automatically receives all the "approved" AM stereo broadcast systems. The so-called Model ST-7 incorporates a patent-pending PLL synchronous detector circuit that had been introduced by the company in 1981 at the seventieth AES convention. The hard-wired prototype has been field tested at a variety of radio stations throughout the country, including WIRE in Indianapolis, where the Delco tests were first held (see *BM/E*, January 1983, p. 12). A company spokesman indicated that a

## NEWS FEATURE



*Kahn Communication's hope in the AM stereo sweepstakes is the Stereo, Stereo receiver unveiled at the CES in January.*

production model could be available as early as June.

The market viability of such a device will depend on whether or not Sansui's engineers can convert this hard-wired prototype to microchip reality at a reasonable price. Sansui management was reported to be in "serious" conversation with several AM stereo manufacturers and the possibility of a "switchable" AM stereo receiver was also voiced by company representatives.

According to Sansui spokesman Arnold Singer, "A system such as this [Model ST-7] will naturally be more expensive to make. We will be showing it again at NAB, but if the market has settled by then, there is a chance the

product will never see reality."

At least one company involved in the AM stereo sweepstakes was encouraged by the Sansui display. Kahn Communications president Leonard Kahn remarked, "If indeed they do come out with it, it would be a pretty good thing. In my book it would be good to have universal receivers. In fact, we proposed a universal system to the FCC. Such a decision would have allowed all broadcasters to make their own choice."

At CES Kahn still played favorites with the debut of its first consumer product, Stereo, Stereo (about \$179), designed, obviously, to be compatible with the Kahn/Hazeltine system. The

receiver uses a multi-section, high-selectivity filter providing an IF bandwidth of 14 kHz, so that audio response of 7 kHz will be provided. Kahn also plans to develop a top-of-the-line tuner which will incorporate the patented asymmetrical sideband selectivity and provide 8 to 9 kHz audio frequency response. At CES the company announced that 30 radio stations will participate in the initial evaluation of 1000 samples of its Stereo, Stereo receiver.

However, a more significant vote of confidence in the Kahn system came from the company's Long Island neighbor, Mura, which was making primarily a telephone push on the convention floor. The Mura AM stereo radios will be part of the company's "Hi-Stepper" personal portable line that will be introduced this spring with an expected retail price of under \$60. Initial sales will be made only in retail outlets where Kahn system stations are currently on the air. Thirty-two radio stations in the U.S. are now equipped to broadcast AM stereo with this format, most recently WQXI in Atlanta, which was the first to go on the air with the Harris system last year.

If one was equipped with a Harris-chip radio in Las Vegas, the sound of

## McMartin *broadcast*

"Our transmitters are so good we want you to try our other products.

We not only manufacture a complete line of AM and FM transmitters, but also produce audio consoles, monitors and amplifiers, FM/SCA equipment and satellite receivers. We have over 300 products.

We have 27 years of experience, and in broadcast, experience counts!"

*Ray B. McMartin*  
Ray B. McMartin  
President  
McMartin Industries, Inc.

McMartin Industries, Inc. • 4500 S. 76th St. • Omaha, NE 68127 • (402) 331-2000

Circle 266 on Reader Service Card

## BROADCAST BEST BUY!



...from  
audiotechniques



FOR SERVICE & PRICE  
WE'RE THE BEST!

**audiotechniques inc.**

NEW YORK CITY  
212/586-5989  
STAMFORD, CT  
203/359-2312

Circle 267 on Reader Service Card



**IF YOU PUT  
ONE-INCH TAPE  
THROUGH A LOT  
OF PASSES,  
DON'T PASS BY  
NAB BOOTH 1002.**

Magnetic A/V Products Division/3M

3M hears you...

**3M**

Circle 268 on Reader Service Card

[www.americanradiohistory.com](http://www.americanradiohistory.com)

# FACT!

## No one can match The Complete Lightning Protection Systems from LEA.

- ANTENNA DISSIPATION ARRAYS FOR AM, FM, TV, MICROWAVE TOWERS
- SURGE ELIMINATORS FOR MAIN POWER LINES TO HANDLE ENERGY LEVELS OF 50,000 JOULES PER PHASE
- COAXIAL TRANSMISSION LINE SURGE ELIMINATORS 1Kw to 25 Kw
- KLEANLINE ELECTRONIC FILTERING SYSTEMS TO PROTECT AGAINST LIGHTNING STRIKES AT 50,000 JOULES PER PHASE PLUS AN RF/EMI FILTER TO HANDLE RF INTERFERENCE FOR SENSITIVE SOLID STATE EQUIPMENT.
- TRANSIENT ELIMINATORS FOR DATA LINES, PHONE LINES, COMMUNICATIONS EQUIPMENT WITH A FREQUENCY RESPONSE FROM D.C. TO 1 GIGAHERTZ.
- LIGHTNING WARNING SYSTEMS PROVIDING ½ HOUR ADVANCE WARNING OF AN APPROACHING STORM.
- SURGE AND TRANSIENT GENERATORS
- GROUND SYSTEMS
- CONSULTING SERVICES
- PERFECT POWER SOURCE VOLTAGE REGULATION
- CONTINUOUS POWER SOURCE

### LIGHTNING ELIMINATION ASSOCIATES



12516 Lakeland Road  
Santa Fe Springs, CA 90670  
(213) 944-0916  
TWX: 910-586-1381

Perfect Power Source  
See us at NAB Booth 302

Circle 269 on Reader Service Card

## NEWS FEATURE

AM stereo could be heard during the course of the show. KORK had purchased the appropriate Harris equipment prior to the influx of consumer electronics mavens and was expected to remain on the air with the system thereafter.

Whether or not anyone will be able to pick up the AM stereo signal in that gambling town during the four-month hiatus between CES and NAB is doubtful. Harris first began shipping evaluation samples of the ICs used for decoding their system's signal in December. Additional samples were handed out like party favors at the company's hotel suite while the tones of

dual-channel AM stereo could be heard on a modified Sansui TU-S9 receiver.

The Harris camp had received a show boost due to the recent announcement that pedigree car stereo manufacturer Jensen would be inserting the Harris IC into its dashboard models later this year. However, no new pledges of format allegiance were made.

According to Roger Burns, Harris director of strategic planning, "AM stereo wasn't played up at the show. The market is obviously confused. They just don't know which way things are going." While he had been quoted in consumer trades previously that the Delco announcement would settle the

### On the Receiving End

All was not AM stereo at CES—far from it. Though the influx of videogame and personal computers has no immediate impact on the broadcast industry (other than their drain on public discretionary dollars) audio and video developments that *will* impact broadcast professionals included:

- Pioneer Electronics introduced the successor to its Supertuner series of car stereo radios, the Supertuner III, which improves FM tuning sensitivity, multipath rejection, pulse noise suppression and, most importantly, three signal intermodulation (TSI), commonly experienced in metropolitan areas where strong stations near a desired FM channel combine to interfere with the signal. The system makes use of a digital direct decoder which Pioneer recently described in a paper at the Audio Engineering Society (AES) convention at Anaheim, CA.
- At the same time as RCA Selecta-Vision was celebrating a sales surge of its CED videodisc players as well as a soon-to-be-added feature of "interactivity," Zenith Radio Corp. announced it was abandoning the videodisc business and, instead, entering into a five-year agreement with the Taft Broadcasting Co. to produce teletext receivers. The agreement will become effective when the FCC gives the go-ahead to commercial teletext service. In the meantime Zenith will produce receivers for Taft's experimental teletext project in Cincinnati.
- The big audio news at CES was, as had been expected, the compact disc (CD) that is scheduled for a spring entry in the U.S. marketplace. At the show, audio software manufacturer

Polygram (a division of Philips) made its CES debut, offering attendees a chance to AB a dozen players that will soon be available. Displayed on the booth walls were nearly 300 album titles that will hit the record racks along with the hardware. The applications of digital playback for radio broadcast have already been widely discussed, though CES featured no professional compact disc players like the Sony unit that was demonstrated privately at AES last fall.

- If anything was video "big news" at CES, it was the unveiling of Sony and its Beta family's latest generation of VCRs known as Beta Hi Fi which, unlike its VHS stereo competitors, offers superior stereo sound with dynamic range of 80 dB and frequency response from 20 Hz to 20 KHz. The improved audio requires new playback heads, though the new players are compatible with existing Beta software. No professional applications were announced.
- New dimensions in television technology were few and far between outside of the Toshiba booth which showcased a new picture tube known as FST (full square tube) which features a new four-lens design resulting in a fuller picture from corner to corner. One inch is added to a standard picture size, and distortion in the corners of the tubes, as a result of a flatter surface, is eliminated. A look at TV tubes of the future was given at the General Electric exhibit, where the potential of high resolution was made a reality to conventioners, the added sharpness and brightness made possible through a prototype high-resolution chassis.





# EIMAC cavities cover 54 to 970 MHz at power levels to 30 kW —our design or yours

Varian EIMAC has complete cavity design and production capability. We make sure that tube and cavity are compatible. If it isn't an off-the-shelf-item, we have the designers and engineers for any specific job.

EIMAC has expertise in all disciplines including pulse, CW, FM, and TV. We match tube, power,

bandwidth and operating mode to achieve optimum performance.

More information on EIMAC cavities and tubes is available in our Cavity Capability brochure from Varian EIMAC. Or for prompt consideration of your special design requirements, contact Product Manager, Var-

ian EIMAC, or the nearest Varian Electron Device Group sales office. Call or write today.

**Electron Device Group**  
**Varian EIMAC**  
 301 Industrial Way  
 San Carlos, California 94070  
 415-592-1221

**Varian A.G.**  
 Steinhäuserstrasse  
 CH-6300 Zug, Switzerland  
 Tel: (042) 23 25 75  
 Telex: 78 841

EIMAC Cavity	Matching EIMAC Tube	Tuning Range (MHz)	Power Output
CV-2200	4CX20,000A	86-108	30 kW
CV-2220	3CX1500A7	86-108	1.5 kW
CV-2225	4CX3500A	86-108	5 kW
CV-2240	3CX10,000U7	54-88	10 kW†
CV-2250	3CX10,000U7	170-227	10 kW†
CV-2400	8874	420-450	300/1250 W*
CV-2800	3CX400U7	850-970	225 W
CV-2810	3CX400U7	910-970	190 W

\*pulsed power

†peak sync, or 2.5 kW combined in translator service



**varian**

# NEW VIDEO TAPES FROM OLD

If you're using video or audio tapes, you want to erase them and use them over. But with today's high tape coercivity you've got problems. With every erase/record pass, the signal-to-noise ratio gets worse. Or your cleaner/evaluator leaves a tough RF signal embedded.

Either way, you probably end up with increasing control track and time code miscuing, or other difficulties.

Only maxERASE-16, successor to the widely proven Optek 8000 bulk tape degausser, can make your tapes like new with its 16KW, vertically concentrated magnetic field, which delivers many times the erasing power of other machines. Usually, one fully automatic 30-second pass is all that's needed.

Only maxERASE-16 can degauss every format regardless of whether it is 3/4-inch video cassette,

1- or 2-inch cassette or reel, audio tape, or 35mm magnetic film.

Only maxERASE-16 can be used with most tapes on a continuous basis without overheating and shutdown.

You won't have to degauss many tapes before maxERASE-16 pays for itself.

For full details contact Steve Heller at Christie Electric Corp., 20665 Manhattan Place, Torrance, California 90501, 800-421-2955 (in California 213-320-0808), TWX 910-349-6260.

**CHRISTIE**  
Since 1929



Circle 271 on Reader Service Card

## THE ONLY NEW AM & FM TRANSMITTER LINE AT NAB WILL BE SINGER BROADCAST

Completely new, inside and out. Quietly, we've been developing transmitters that benefit from 40 years' manufacturing experience. We've improved on technology already trusted by more than 2,000 customers.

The new Singer Broadcast transmitters are something to get excited about.

See them at NAB Booth 309.

**SINGER BROADCAST PRODUCTS, INC.**

P O BOX 5500 · CHERRY HILL, NEW JERSEY 08034 · TEL 609-424-1500

Circle 272 on Reader Service Card

## NEWS FEATURE

AM stereo battle once and for all, following the CES encampment Burns seemed far from satisfied that a winner had finally been tapped. To help things along the Harris way, the company announced it had lowered its royalty fee to 10 cents per radio, lower than any of its competitors.

Everyone's AM stereo competitor at CES was Magnavox, which had the largest floor presence due to the display of radios equipped with the appropriate ICs by manufacturers from Hong Kong and Korea. A total of 13 manufacturers from the Orient had signed up to hawk their PMX receivable wares, though, by opening day, only four appeared; from Hong Kong there were CosmoTime (with a mini-portable with headphones), Lloyd's Electronics (with a clock radio), and Leewah Electronics (with a car radio); the only Korean representative was Taihan Electric Wire (with a boom box). Each had made the trek to Las Vegas anticipating that, at least in the first year of AM stereo broadcast in the U.S., the biggest sales would be made to radio stations themselves wishing to boost interest in the new technology by giving away the receivers as promotional items to their listeners.

Magnavox received a promotional boost as well from the local commercial station KMJJ-AM, a 10-kilowatt station which conveniently began broadcasting in PMX stereo in late 1982. The installation utilized a Continental stereo exciter, a Moseley composite stereo aural studio transmitter link, and a CRL stereo matrix processor limiter.

National Semiconductor had as much to gain from Magnavox's reception as the North American Philips (NAP) company did itself, since it is their chip that makes the system receivable. Said Dan Shockey, product marketing manager for the Silicon Valley concern, "Once the public begins to hear and becomes aware of AM stereo, it will look for this benefit as purchase decisions are made." However, Shockey said that he was "disappointed" by AM stereo's presence at CES and added that his company is not married to any single format. "We're trying to help everyone," he remarked. "We're backing all the horses."

The statement was particularly appropriate in Las Vegas, where picking a winner is as much a part of life at the crap tables as it is on the convention floor. And while AM stereo is only a small part of a burgeoning consumer electronics industry, its outcome is more uncertain than even the bigger stakes gambles that currently dominate the profile of home entertainment.

BM/E



# Communications

---

## **Fiber Optics Bring Broadcast TV To EPCOT**

Walt Disney World's EPCOT Center now has broadcast video/audio capability in its extensive fiber optic communications network. Vista-United Telecommunications, which is tasked with providing communications facilities for the resort complex, has installed Artel's SL-2000 and EN-1000 systems for the long distance trunking of broadcast quality video and audio signals on the complex. Vista-United first used the Artel fiber systems in the live opening coverage of EPCOT on network TV.

## **SL-2000 Gets Low Cost Video/Audio Addition**

A new low cost fiber optic video/audio plug-in transmission module set is now available for Artel's widely used SL-2000. Designated the T-2020/R-2020, this new transmitter/receiver module set combines broadcast quality video and audio on a single card module set. The result is a compact, economical system that, for the first time, makes fiber optics cost effective in shorter distance video/audio applications. Maximum distance of the T/R-2020 is one kilometer (3281 ft.), compared to the 7 km range of other SL-2000 module systems.

## **Longest F.O. System Brings Cable Network On Air**

The Weather Channel, a 24-hour cable network devoted exclusively to weather forecast and reports, has begun operations through the longest studio-quality fiber optic video/audio/data installation in the country. The system employs Artel's SL-2000 fiber optic transmission system to span the 2.18 miles (3.5 km) from The Weather Channel studios to the RCA Earth Station in Atlanta.

## **ABC Approves, Uses Fiber Optics**

The American Broadcasting Company Engineering Lab has approved the Artel EN-1000/SL-2000 fiber optic systems for use by ABC. One of ABC News' first use of these systems was in a live New York-Plains, GA, interview of former President Jimmy Carter on ABC's "Nightline" program.

## **Free RGB Application Note**

A free application note on how to use and specify fiber optics in high resolution RGB computer graphics is available from Artel. Application Note CG-1 describes the use of the SL-2000 system in remoting RGB graphics monitors to achieve longer distance, higher resolution and elimination of interference.

See Us At NAB Booth 1118

**ARTEL** COMMUNICATIONS  
CORPORATION

P.O. Box 100, West Side Station, Worcester, Mass. 01602 (617) 752-5690 - Cable: ARTEL

Advertisement

Circle 273 on Reader Service Card



# Ikegami ITC-730 takes you farther in EFP, and costs you less.

The ITC-730 is probably the most versatile low-cost, high-quality EFP camera available today. To start with, a newly developed digital multiplex system gives you real operational freedom. Using 13.5 mm diameter flexible cable, the camera head can be separated by 300 feet from the CCU using battery power at the camera head, and up to 1000 feet using AC power at the CCU.

Look what else the ITC-730 EFP gives you for \$11,950\* (less lens and accessories). 3-tube prism optics with advanced, dependable Saticon II\*\* tubes, an extra sharp 5-inch viewfinder, and a full roster of automatics. And there's more—a 2H detail corrector, a noise-free contrast compression circuit and a char-

acter generator in the viewfinder that indicates filter selection, gain selection, auto-white balance, VTR start/stop, gen-lock and battery test—all standard.

The f/1.4 RGB prism beam-splitter delivers excellent low-light performance (a standard sensitivity of 2000 lux at f/4) and a consistent 54 dB S/N ratio from the pre-amp. And the ITC-730's unique circuitry makes it a miser on power consumption. One fully charged Nicad battery provides over two hours of shooting time.

There's also an ENG version that we believe is the world's finest modestly priced, hand-held TV camera. EFP or ENG, you'll never have to accept anything less than an Ikegami again. Contact us for full details.

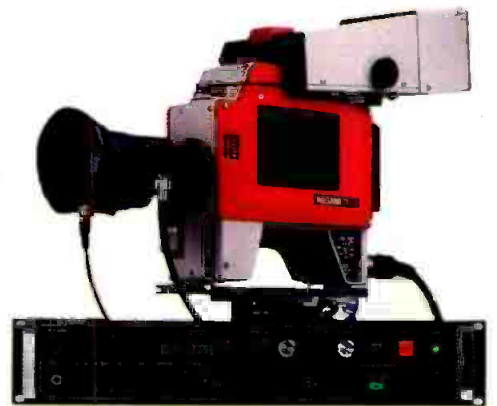

**Ikegami ITC-730**

Ikegami Electronics (USA) Inc., 37 Brook Avenue, Maywood, NJ 07607.

Northeast: (201) 368-9171 □ Midwest: (219) 277-8240 □ West Coast: (213) 534-0050 □ Southwest: (713) 445-0100 □ Southeast: (813) 884-2046

\*Manufacturer's suggested list price \*\*TM of Hitachi Ltd.

See us at NAB Booth #1013

www.americanradiohistory.com

Circle 274 on Reader Service Card



# interpreting the FCC rules & regulations

## FM Allocations and LPFM: What's In Store?

By Harry Cole  
FCC Counsel

RECENT RUMBLINGS at the Commission have suggested that the next "new" developments in broadcast allocations policies could occur in the FM area. These developments could include action on the proposals included in BC Docket No. 80-90, and possibly even action on a proposal to create a new "low-power FM" service based on FM translators. We wrote about BC Docket No. 80-90 in this column in the July 1982 issue of *BM/E* and, at the time, we noted that it appeared to be going nowhere fast. The factors that were then slowing it down have not changed much in the intervening eight months, and thus there is a good possibility that it will continue to go nowhere fast. However, recent interest in the establishment of a low-power FM service may provide the impetus necessary to overcome the stumbling blocks that held back 80-90 throughout 1982. Of course, those stumbling blocks are substantial, and it is best not to get your hopes up too high. The following discussion is intended to provide some perspective on the overall situation.

As we wrote last July, BC Docket No. 80-90, which was initiated in 1980, has been ripe for action since early last year. The proposals under consideration in that proceeding are aimed at overhauling the 20-year-old standards governing FM channel allocation, primarily by establishing new minimum mileage separations, creating two new station classes and permitting stations with only Class A facilities to use Class B and C channels. Obviously, such changes would lead to a significant, and perhaps staggering, amount of channel allocation and FM application activity. Apparently fearing the administrative impact that this increased burden would have on its staff—a staff already depleted as a result of budgetary cutbacks—the Commission held off on considering the

proposals at all in 1982, despite repeated rumors that a decision in the proceeding was imminent. This inaction pleased many broadcasters who were concerned about any adverse effects the proposed standards might have on the technical quality of their existing signals, not to mention any adverse effects those standards might have on the competitive position of existing licensees. On the other hand, the FCC's inaction frustrated many others who saw the possible opportunity to squeeze in new FM stations, or possibly to upgrade their existing facilities. This clear division of opinion was yet another factor likely contributing to the Commission's reluctance to grapple with the BC Docket No. 80-90 proposals.

In the meantime, a religious broadcasting organization filed, in May 1981, a petition for rulemaking proposing that FM translators be permitted, in effect, to originate programming. As you know, FM translators are extremely low-power (maximum 10 W) operations that are prohibited from originating more than one 30-second announcement per hour. The idea underlying the translator service as originally conceived was to permit the extension of existing FM service to small communities that needed radio service, but were unlikely to be able to sustain an independent, full-service station. Translators are intended to operate on a nonprofit basis, although "advertisements" acknowledging the receipt of financial support may be broadcast in the single 30-second announcement that translators may originate each hour. On the technical side, translators are restricted to rebroadcasting signals they receive over the air. It was this requirement which was the central target of the 1981 proposal. Essentially, the proposal suggested that translators be permitted to transmit programming from other than over-the-air sources.

While the petition for rulemaking was restricted to a discussion of potential, non-over-the-air programming

sources, it is easy to see that such a change in the fundamental identity of translators could entail additional changes that would ultimately lead to the creation of a whole new service. Indeed, some observers viewed the translator proposal to be little more than an effort to adapt and apply to FM service the concepts governing low-power television. Thus, for example, it would be conceivable that the allocation standards restricting FM translators primarily to remote rural areas could be lifted, as could the restrictions against making a profit. The result would be the creation of a substantial number of mini-broadcast stations that would, in all likelihood, be "dropped in" wherever they could fit, and that would compete with full-power stations for audiences and revenues, subject to the same general regulatory restrictions as full-power stations.

Not surprisingly, the Commission was not eager to embrace such a proposal, particularly in mid-1981. At that time the low-power television proceeding was in substantial disarray, and probably the last thing the Commission wanted was a repetition of the headaches it was then experiencing as a result of LPTV. Accordingly, the petition for rulemaking was placed squarely on the back burner, where it has simmered since. However, by late 1982 there were indications that the concept of low-power FM had not been forgotten completely. In its proposals to ease the plight of daytime-only AM licensees, for example, the Commission suggested that one possible measure might be to offer daytime-only licensees the opportunity to acquire low-power FM licenses. We discussed the Commission's proposals in this column in the October 1982 issue of *BM/E*. Further, discussions with members of the Commission's staff indicated that serious thought has been given to the LPFM concept, perhaps because of the apparent belief that the low-power television morass had finally been corrected by late 1982. In addition, reports circu-

# FCC RULES & REGULATIONS

lated that pressure was being exerted by representatives of groups looking to benefit from LPFM authorizations. Thus, despite the Commission's apparent initial reluctance, the LPFM movement seemed to be gathering momentum.

Notwithstanding this momentum, a number of factors still stand in the way of LPFM as of this writing. First, there is the matter of BC Docket No. 80-90. Before the Commission begins to tinker with FM allocations standards so as to permit low-power FM service, particularly on a drop-in basis, it would make sense for it to define the allocation standards applicable to full service stations. In other words, not only is Docket No. 80-90 "riper" than LPFM—since the Docket 80-90 proposals have been under formal consideration significantly longer than LPFM—but, from the conceptual standpoint, it only makes sense for the Commission to settle its full-power allocations criteria before attempting to factor multiple low-power stations into the established full-power framework. However, the staffing shortages that have given the Commission pause all along with respect to the changes proposed in Docket No. 80-90 still exist

and, in some areas, have worsened. Since LPFM, if ever adopted, would likely place even greater strain on the Commission's resources, the real limitations of the Commission's staff cannot be ignored.

A second factor impeding LPFM is the fact that low-power FM service might be harder to fit in than was low-power television simply because, unlike full-service television, the FM service is still in a growth period, constantly expanding into new areas. Since a low-power FM service could very likely be created on a "secondary" basis relative to full-service stations, as was the case with LPTV, the continued expansion of full-power FM service could create some problems.

A third factor to consider is that the FCC has already had direct experience with a low-power, program-originating FM service allocated on a drop-in basis, and it has concluded, within the last few years, that such a service represents an inefficient use of the spectrum. As you may recall, as part of its overhaul of the noncommercial educational FM service, the Commission eliminated Class D, 10 W educational stations, forcing such stations to boost their power at least tenfold. Having done

that, the FCC will have to explain what differences, if any, exist between the Class D service it eliminated and the proposed LPFM service before the Commission can properly adopt the latter.

The bottom line on this is that, while potentially desirable developments in the FM band may appear close at hand, the Commission must be cautious in approaching those developments, lest it find itself plunged back into an LPTV-like maelstrom of technical problems, staff shortages, tremendous processing backlogs, and the like. The FCC may think it has learned enough from its LPTV experience to keep it from making the same mistakes again. It may also think that, as it computerizes the processing of LPTV applications, it will be able to increase the efficiency of its staff enough to be able to handle the load that would surely be generated by adoption of docket No. 80-90 or by the creation of an LPFM service. And, in both instances, it may be right. But then again, it may not be. It is best to consider *all* of these factors in determining what, if any, plans to make with respect to the possible developments in the FM band. If you need further information, consult with your communications counsel. **BM/E**

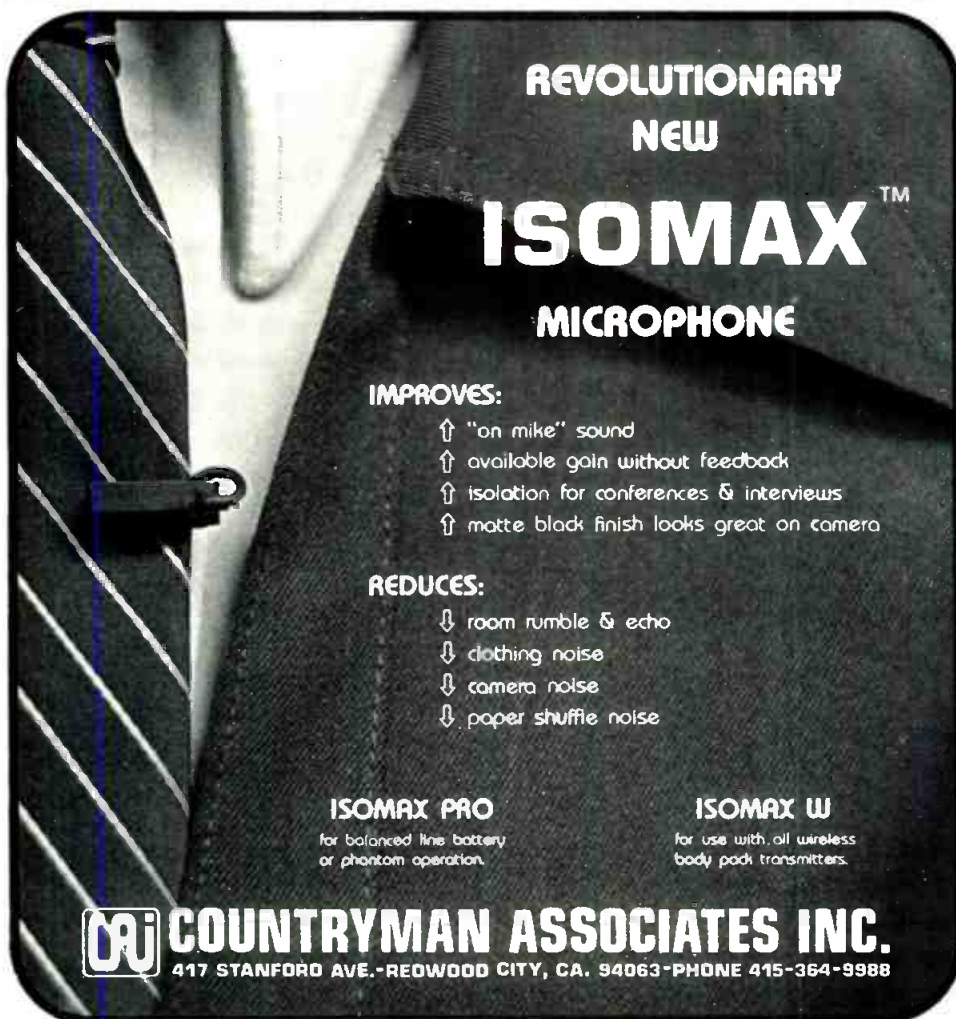

**REVOLUTIONARY  
NEW**

## ISOMAX™ MICROPHONE

**IMPROVES:**

- ↑ "on mike" sound
- ↑ available gain without feedback
- ↑ isolation for conferences & interviews
- ↑ matte black finish looks great on camera

**REDUCES:**

- ↓ room rumble & echo
- ↓ clothing noise
- ↓ camera noise
- ↓ paper shuffle noise

**ISOMAX PRO**  
for balanced line battery  
or phantom operation.

**ISOMAX W**  
for use with all wireless  
body pack transmitters.

**COUNTRYMAN ASSOCIATES INC.**  
417 STANFORD AVE.-REDWOOD CITY, CA. 94063-PHONE 415-364-9988



### VIDEO L-C DELAY LINES

A complete line of passive switchable and strappable Variable Delay Lines manufactured specifically for the video industry. Also available in a rack mountable configuration. Finest specifications available anywhere. Lowest pricing. Delivery from stock.

**REQUEST VIDEO CATALOG**



### VIDEO L-C FILTERS

NTSC Delay Equalized Lowpass, Band Reject and Bandpass Filters, Random Noise Measurement Networks, Pre-Emphasis & De-Emphasis Wave Shaping Networks are available from stock. Sub-Miniature Filters from 5 to 500MHz. Hum Eliminator (HEC1000) in stock.

**SEE US AT NAB SHOW, BOOTH 1627**

**ALLEN AVIONICS, INC.**  
224 E. 2nd St., Mineola, NY 11501  
Phone: (516) 248-8080

Circle 275 on Reader Service Card

Circle 276 on Reader Service Card





New Harris Wavestar™...

# The most reliable UHF slot antenna ever designed... because it's waveguide!

The new Harris Wavestar is the only slotted waveguide UHF antenna now available...the ultimate in design simplicity. No center conductor. No couplers. No insulators. Fewer parts mean fewer problems. And that means less off-air time and lower maintenance costs.

Additional advantages of waveguide over coax antennas include higher power handling capabilities and greatly increased safety margins to prevent arcing.

The Wavestar pattern performance is excellent by any standard. Cardioid and peanut directional patterns are currently available, and a highly circular omnidirectional pattern will follow soon. All of these Wavestar configurations provide the smooth elevation patterns necessary for high signal strength and minimum ghosting over the entire coverage area.

The Wavestar is a low windload design for tower top or side mounting. High mechanical strength and rigidity minimize picture variations caused by wind sway.

Every Harris antenna is completely assembled and tested at the Harris antenna test range...the largest, most comprehensive facility of its kind.

The range is located in an area far from the pattern-distorting clutter of urban development. Situated atop a 230-foot bluff, with test transmitters located up to 3 miles away on flat, unobstructed bottom lands, the range offers ideal conditions for testing, approaching the "free space" situation of an installed antenna.

Here, theoretical azimuth and elevation patterns are verified with the most accurate and sophisticated test instruments available—translating the theory of a calculated pattern into the reality of actual antenna performance.

You can depend on Wavestar for top reliability. And you can be confident that your Wavestar antenna will be thoroughly tested by Harris to meet your exact pattern requirements.

Contact Harris Corporation, Broadcast Division, P.O. Box 4290, Quincy, Illinois 62305-4290. 217/222-8200.



## HARRIS

Visit Harris at the 1983 NAB,  
Las Vegas, in North Hall

# Setting A New Pace For The Industry We Pioneered!

**...RCA Broadcast Systems**

Current 3/4-inch video recording system performance falls below the performance of 3 tube, portable cameras. In developing the Hawkeye broadcast quality camera/recording system, RCA engineers closed the performance gap between cameras and recorders. By developing a new method to record chrominance and luminance on standard 1/2-inch VHS cassettes, they were able to improve overall picture quality while reducing weight and the number of moving parts.

Virtually any picture you encounter on your home screen has been touched by RCA engineering. As America's largest supplier of commercial video equipment, we are involved in every step: studio cameras, portable cameras, video recorders, editing equipment, telecine equipment, transmitters and broadcast antennas. As you read this, we are moving ahead with advanced development programs in digital video equipment and the creation of a completely solid state color television camera.

Our commitment is to continue to set the pace for the industry we pioneered. If you are an engineer who is interested in furthering the development of advanced broadcast technology, we invite you to share this adventure with us. For career details, please write to: **RCA Broadcast Systems Division, Joy K. McCabe, Dept. PR-3, Front & Cooper Sts., Building 3-2, Camden, New Jersey 08102.**

Equal Opportunity Employer

**Setting The Pace In  
Broadcast Engineering!**

# RCA

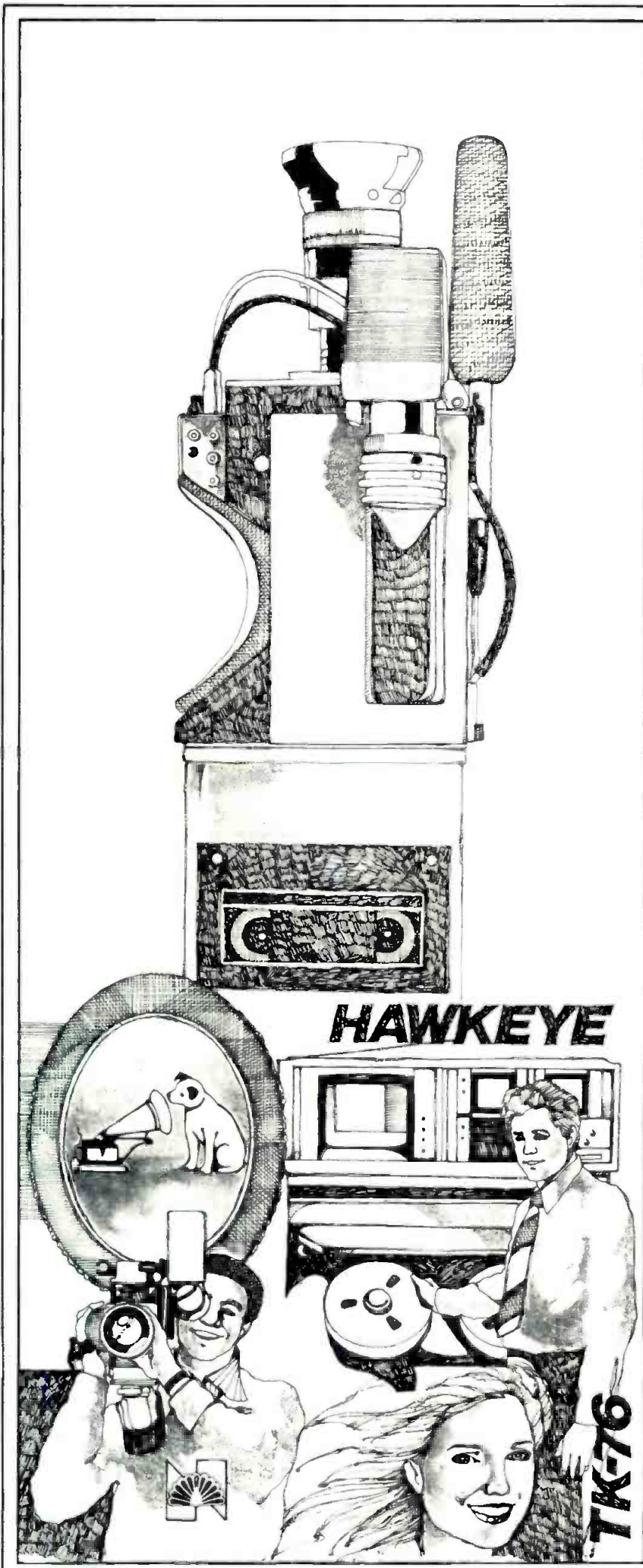



## Preventing Fires—With a Hand From the Tax Man

By Mark E. Battersby, Financial Consultant

EVERY 10 MINUTES, on an average, warns the National Fire Prevention Association (NFPA), there will be a fire in some business. The total dollar loss is pegged at a whopping \$250 million each year, which brings two questions immediately to mind: Do you know how to prevent fire losses in your own broadcasting facility? And, just as important, do you know how to use the tax rules to help offset those losses?

Witness the record. Of the firms struck by fire, 42 percent never resume operations. Twenty-eight percent fail within three years and only 23 percent fully recover after a fire. (There is a 6 percent undetermined loss according to NFPA.) It is useful to find out what causes fires and how to prevent them. The three most frequent causes of fires are smoking; defective electrical wiring; and accumulated trash.

Now let's look at those preventive measures that are going to cost your station money—and how the tax laws can help reduce the actual out-of-pocket expense.

Statistics reveal that 42.7 percent of all commercial fires start in storage areas or basements. For this reason, the entrance to your basement should have a fireproof door as well as a sprinkler system over the stairs. Also, a smoke detector should be installed at the entrance to the basement and obviously should be battery-powered, since a fire could knock out the electrical system.

Additional considerations in fire prevention are the four basic types of fires: (1) ordinary materials such as wood, paper, cloth or similar materials; (2) flammable liquids; (3) electrical; and (4) combustible metals, such as magnesium. The all-purpose dry chemical fire extinguisher is one of the best retar-

dants, as it puts out types 1, 2 and 3 fires. Your local fire department can give you an opinion before you buy any type of fire extinguisher and it won't cost you or your business a penny.

### The cost of protection

While both smoke detectors and fire extinguishers are not really big-ticket items, their purchase will mean that your station will have to part with some money. The chances are that your insurance carrier demands at least this minimal protection, but the out-of-pocket expenditure is going to be reduced by the taxes saved.

Suppose, for instance, you decide that your studio building requires \$5000 of smoke detectors and fire extinguishers. That \$5000 will result in an immediate \$500 reduction in your tax bill as the investment tax credit rules come into play. Depreciation under last year's rule changes can be taken over a five-year period, utilizing the 150 percent double-declining balance method, producing a reduction of taxable income of \$750 in the first year. Or it might be more advantageous to make use of the immediate write-off those changed rules permit for up to \$5000 in newly acquired assets and use the entire \$5000 to offset taxable income. Of course, taking that path eliminates the investment tax credit benefits.

As far as equipment investment is concerned, it will pay you to check with your fire insurance agent and a good sprinkler company for details before installing sprinklers. You might also ask your fire insurance agent just what reduction you might obtain by installing fire extinguishers, smoke detectors, fireproof files and alarm systems. Another item to check is the so-called "In-

terruption Insurance" that covers certain expenses if your station is closed down because of a fire.

Fire prevention authorities claim that a good sprinkler system can pay for itself within three and one-half to five years by the reduction in fire insurance premiums alone. Factor in the same tax benefits we mentioned for smoke detectors and fire extinguishers, and the out-of-pocket expenditure is further reduced and the payback accelerated even more.

One of the most important points in any review of fire prevention is the value of your records. After all, just how fireproof are those business records?

In four out of 10 fires in business establishments, the broadcaster was drastically hurt financially because vital records had been destroyed and they could not provide proof of loss. Your fire insurance is 100 percent effective only if you have the records to prove the loss. The same holds true for any tax-deductible casualty loss.

If, despite your best efforts and preventive measures, fire does hit your broadcasting business, all is not lost if you have insurance. And backstopping that all-important insurance are those awesome tax laws. Fortunately, those tax laws, at least those sections governing the deduction of fire losses, are neither as complex nor as tough as you may have been led to believe.

Take, for instance, the many pages of regulations that define just who is permitted to claim a casualty loss. Quite simply, a property damage loss is not ordinarily deductible unless the property actually belongs to the taxpayer claiming the deduction. In other words, you cannot claim a loss for a

# The Professionals



**A complete new line of cartridges built to the exacting standards of professional requirements...**

The famous Stanton 881S set a new standard of performance for world professionals and audiophiles alike. Now built to the same careful standards, Stanton introduces three new cartridges—881E, 880S and 880E. The 881E includes the calibrated perfection of the 881S but with an elliptical stylus. The 880S and 880E maintain the same high standards of performance, in applications where calibration is not of prime importance.

Visit us at Booth 102

The "Professionals" a series of four cartridges featuring all the famous Stanton performance features at different price levels, designed for every budget requirement.

For further information write to Stanton Magnetics Inc., Terminal Drive, Plainview, N.Y. 11803



**STANTON**

THE CHOICE OF THE PROFESSIONALS™

Circle 278 on Reader Service Card

## TAX TIPS

fire-damaged studio that is owned by your landlord. Nor can you claim a loss for equipment which you only lease, never actually taking title to the equipment.

The voluminous rules for determining the actual amount of loss can be similarly simplified. Start with the decrease in fair market value of the property as a result of the fire or the adjusted basis/book value, whichever is less (adjusted basis includes a reduction for the amount of allowable depreciation). This amount is then reduced by any insurance or other compensation received or recoverable.

A special rule applies when there is a complete destruction of business or income-producing property as a result of a fire or any other casualty. In this situation, the full adjusted book value minus the salvage value and any insurance or other compensation is deductible.

### Determining value and loss

In determining the actual amount of a casualty loss, the fair market value of the property immediately before and immediately after the casualty is generally determined by means of a competent appraisal. The appraisal fees themselves are not a part of the loss, but they can be deducted as an expense incurred in determining tax liability.

When determining the value immediately after the fire, consideration can be given to damages that are an indirect result of the casualty as, for example, destruction of doors and windows by firemen.

For tax purposes, a casualty loss is usually determined item by item. Thus, the damage to your business would involve equipment losses, supply losses, perhaps the loss of the roof (if you own the station building), and so on.

Finally, the cost of repairs is acceptable as evidence of loss of value of property due to a casualty. However, it is usually up to the broadcaster to show that the repairs do not do more than repair the damage suffered. In other words, the value of the property after the repairs cannot (as a result of these repairs) exceed the value of the property immediately before the fire or other casualty.

The direct dollar loss of a fire in your business is incalculable and not likely to be fully covered by insurance or made up with tax deductions. How, then, do you measure the loss of competitive position, seasonal opportunities missed or even station failures? Obviously insurance and taxes cannot cover all losses, which brings us to the principal rule that, in this case, prevention is better than deduction. **BM/E**

## A product of years of refinement

Our well-known Model "F" VHF television transmitter is a sixth-generation design. With solid-state circuits, modular construction and our control logic bypass system, it has proven reliability and cost-effectiveness. Offered in power ratings from 250 W to the 30 kW model shown here, it's available from:



**LARCAN**

**LARCAN COMMUNICATIONS EQUIPMENT INC.**

396 Attwell Drive, Rexdale, Ontario, Canada M9W 5C3 Telephone (416) 675-7517 Telex 06-989302  
In USA: Lewis F. Page, 323D Washington Blvd., Laurel, Maryland 20707 Telephone (301) 490-6800

Circle 279 on Reader Service Card





# 1983 International Broadcast Equipment Exhibition in Japan.

*October 25 ~ 27  
Tokyo Ryutsu Center (TRC)*

## A STAR WAS BORN

In its first performance as an international exhibition, after seventeen years as a national, InterBEE 82 was acclaimed the newest star on the broadcasting horizon.

Visitors from every broadcasting company in Japan and from forty other countries in every part of the world—a total of 15,038—came to marvel at the displays of the latest audio and video equipment. Included were computerized and digital models and the newest systems for television and radio stations and production houses developed by companies in the United States, Canada, England, Germany, France, Belgium, Holland, Switzerland, Sweden, Denmark, Austria and of course Japan.

Planning is already underway for InterBEE 83 to be held in Tokyo from October 25 to 27. Join us as an exhibitor or a visitor and be part of the continuing success of InterBEE.

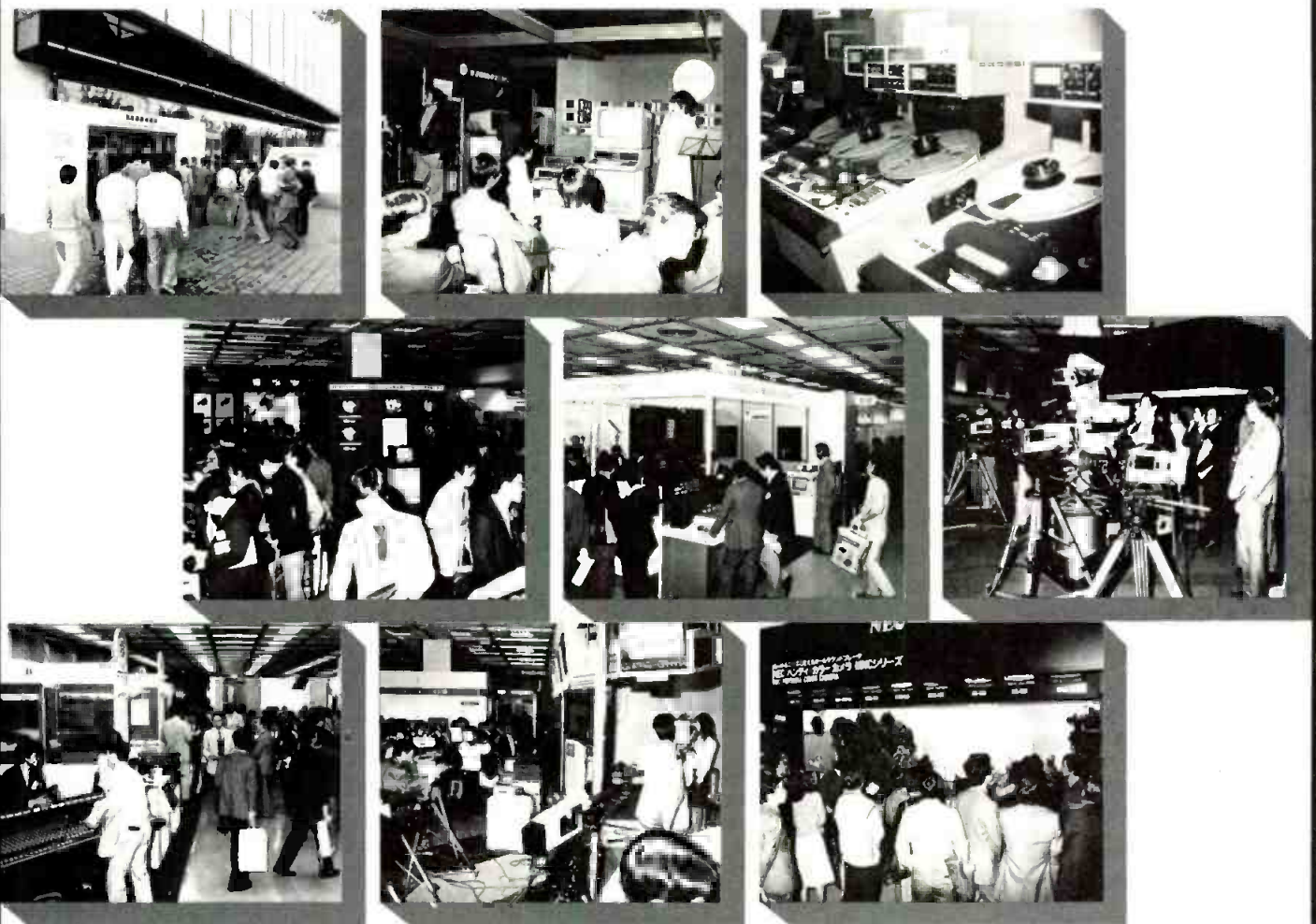

**Sponsor:** Electronic Industries Association of Japan  
**Co-Sponsor:** The National Association of Commercial Broadcasters in Japan  
NHK (Japan Broadcasting Corporation)  
**Management:** **JAPAN ELECTRONICS SHOW ASSOCIATION**  
No. 24 Mori Bldg., 3-23-5, Nishi-Shimbashi, Minato-ku, Tokyo, Japan

Circle 280 on Reader Service Card

# GREAT IDEA CONTEST

Here's a chance to share your own personal solutions to some of broadcasting's most vexing engineering needs . . .

Each month, *BM/E* presents two engineering problems and invites you to submit solutions complete with diagrams. *BM/E's* editors will read the entries and select the best for publication—giving readers an opportunity to vote for the idea they consider best by using the ballot area on the Reader Service Card.

We will pay \$10 for each entry printed. In addition, the solution in each month's competition receiving the most votes on our Reader Service Card will win \$50.00. So put on your thinking cap and submit an answer to either of the problems outlined below . . . and be sure to watch this section for the solutions.

**NEW, BIGGER PRIZE:  
\$50.00 FOR  
EACH CONTEST WINNER!**

## Problem 16: Cart Ready/ Not Ready Indication

Many older audio cart machines lack a blinking *ready* light that indicates whether a cart in the machine has already played. Design a circuit that indicates, with lights or otherwise, if a cart is ready, playing, or finished playing.

**Solutions to Problem 16  
must be received by  
March 21, 1983, and will be  
printed in the May, 1983 issue**

## Problem 17: Preventing Echo in Cart Recording

In a radio production studio the main console at all times feeds the record channel on the cart machine. A second channel on the console is connected for playback from the cart machine. If the pot on this second channel is left open while recording is in progress, the feedback/crosstalk puts an echo in the recording. What is needed is an alarm signal, activated when recording is in progress, that operators are trained to recognize as the signal to turn down the playback pot. It should be inactivated when the pot is down. Alternatively, an automatic switching system could close the playback channel when recording starts.

**Solutions to Problem 17  
must be received by  
April 21, 1983, and will be  
printed in the June, 1983 issue**

### CONTEST RULES

- 1. How to Enter:** Submit your ideas on how to solve the problems, together with any schematic diagrams, photographs, or other supporting material. Entries should be roughly 500 words long. Mail the entries to *BM/E's* Great Ideas Contest, 295 Madison Avenue, New York, NY 10017. Use the official entry form or a separate piece of paper with your name, station or facility, address, and telephone number.
- 2. Voting and Prizes:** *BM/E's* editors will read all entries and select some for publication; the decision of the editors is final. Those selected for publication will receive a \$10 honorarium. Each month, readers will have an opportunity to vote for the solution they consider the best by using the Reader Service Card. *BM/E* will announce the solution receiving the most votes and will award the winner of each month's competition a \$50.00 check.
- 3. Eligibility:** All station and production facility personnel are eligible to enter solutions based on equipment already built or on ideas of how the problem should be solved. Consultants are welcome to submit ideas if they indicate at which facility the idea is in use. Manufacturers of equipment are not eligible to enter. Those submitting solutions are urged to think through their ideas carefully to be certain ideas conform to FCC specs and are in line with manufacturers' warranty guidelines.

Mail Official Entry Form to:

#### **BM/E's Great Ideas Contest**

295 Madison Avenue, New York, NY 10017

**Solution to Problem #** \_\_\_\_\_

Your Name: \_\_\_\_\_

Title: \_\_\_\_\_

Station or Facility: \_\_\_\_\_

Address: \_\_\_\_\_  
\_\_\_\_\_

Telephone: ( \_\_\_\_\_ ) \_\_\_\_\_

I assert that, to the best of my knowledge, the idea submitted is original with this station or facility, and I hereby give *BM/E* permission to publish the material.

Signed \_\_\_\_\_

Date \_\_\_\_\_



# BM/E READER SERVICE CARD March, 1983 Issue

NAME \_\_\_\_\_  
 TITLE \_\_\_\_\_  
 STATION OR COMPANY \_\_\_\_\_  
 ADDRESS \_\_\_\_\_  
 CITY \_\_\_\_\_ STATE \_\_\_\_\_ ZIP \_\_\_\_\_  
 PHONE # ( ) \_\_\_\_\_

**SEND ME ADDITIONAL FREE INFORMATION  
 ON EACH ITEM CIRCLED**

Tell us what you like or dislike about the issue

\_\_\_\_\_

\_\_\_\_\_

What articles would you like to see?

\_\_\_\_\_

\_\_\_\_\_

100	101	102	103	104	105	106	107	108	109	110	111	112	113	114	115	116	117	118	119
120	121	122	123	124	125	126	127	128	129	130	131	132	133	134	135	136	137	138	139
140	141	142	143	144	145	146	147	148	149	150	151	152	153	154	155	156	157	158	159
160	161	162	163	164	165	166	167	168	169	170	171	172	173	174	175	176	177	178	179
180	181	182	183	184	185	186	187	188	189	190	191	192	193	194	195	196	197	198	199
200	201	202	203	204	205	206	207	208	209	210	211	212	213	214	215	216	217	218	219
220	221	222	223	224	225	226	227	228	229	230	231	232	233	234	235	236	237	238	239
240	241	242	243	244	245	246	247	248	249	250	251	252	253	254	255	256	257	258	259
260	261	262	263	264	265	266	267	268	269	270	271	272	273	274	275	276	277	278	279
280	281	282	283	284	285	286	287	288	289	290	291	292	293	294	295	296	297	298	299
300	301	302	303	304	305	306	307	308	309	310	311	312	313	314	315	316	317	318	319
320	321	322	323	324	325	326	327	328	329	330	331	332	333	334	335	336	337	338	339
340	341	342	343	344	345	346	347	348	349	350	351	352	353	354	355	356	357	358	359
360	361	362	363	364	365	366	367	368	369	370	371	372	373	374	375	376	377	378	379
380	381	382	383	384	385	386	387	388	389	390	391	392	393	394	395	396	397	398	399

Use until June 30, 1983

# BM/E READER SERVICE CARD March, 1983 Issue

NAME \_\_\_\_\_  
 TITLE \_\_\_\_\_  
 STATION OR COMPANY \_\_\_\_\_  
 ADDRESS \_\_\_\_\_  
 CITY \_\_\_\_\_ STATE \_\_\_\_\_ ZIP \_\_\_\_\_  
 PHONE # ( ) \_\_\_\_\_

**SEND ME ADDITIONAL FREE INFORMATION  
 ON EACH ITEM CIRCLED**

Tell us what you like or dislike about the issue

\_\_\_\_\_

\_\_\_\_\_

What articles would you like to see?

\_\_\_\_\_

\_\_\_\_\_

100	101	102	103	104	105	106	107	108	109	110	111	112	113	114	115	116	117	118	119
120	121	122	123	124	125	126	127	128	129	130	131	132	133	134	135	136	137	138	139
140	141	142	143	144	145	146	147	148	149	150	151	152	153	154	155	156	157	158	159
160	161	162	163	164	165	166	167	168	169	170	171	172	173	174	175	176	177	178	179
180	181	182	183	184	185	186	187	188	189	190	191	192	193	194	195	196	197	198	199
200	201	202	203	204	205	206	207	208	209	210	211	212	213	214	215	216	217	218	219
220	221	222	223	224	225	226	227	228	229	230	231	232	233	234	235	236	237	238	239
240	241	242	243	244	245	246	247	248	249	250	251	252	253	254	255	256	257	258	259
260	261	262	263	264	265	266	267	268	269	270	271	272	273	274	275	276	277	278	279
280	281	282	283	284	285	286	287	288	289	290	291	292	293	294	295	296	297	298	299
300	301	302	303	304	305	306	307	308	309	310	311	312	313	314	315	316	317	318	319
320	321	322	323	324	325	326	327	328	329	330	331	332	333	334	335	336	337	338	339
340	341	342	343	344	345	346	347	348	349	350	351	352	353	354	355	356	357	358	359
360	361	362	363	364	365	366	367	368	369	370	371	372	373	374	375	376	377	378	379
380	381	382	383	384	385	386	387	388	389	390	391	392	393	394	395	396	397	398	399

Use until June 30, 1983

## COMPLIMENTARY SUBSCRIPTION QUALIFICATION CARD

- 1 I would like to receive BM/E (Broadcast Management Engineering)  
 YES                       NO
- 2 Please check your business classifications
 

<input type="checkbox"/> AM Station Network Group <input type="checkbox"/> FM Station Network Group <input type="checkbox"/> TV Station Network Group <input type="checkbox"/> Non-broadcast TV <input type="checkbox"/> Campus Limited Radio <input type="checkbox"/> CATV Facilities <input type="checkbox"/> Microwave Telephone <input type="checkbox"/> Satellite Company	<input type="checkbox"/> Recording Studio <input type="checkbox"/> Teleproduction Facility <input type="checkbox"/> Government <input type="checkbox"/> Consultant <input type="checkbox"/> Lawyer <input type="checkbox"/> Manufacturer/Distributor/Dealer <input type="checkbox"/> Other (please specify) _____
---	---
- 3 Are you responsible for more than one station or facility?  
 YES                       NO
- 4 My primary area of responsibility is (please check one)
 

<input type="checkbox"/> Corporate Management	<input type="checkbox"/> Board Chairman, President, Owner, Partner, Director and VP or General Manager (other than in charge of engineering or station operations management)
<input type="checkbox"/> Technical Management & Engineering	<input type="checkbox"/> VP Engineering, technical engineering director, chief engineer, engineering supervisor, other engineering or technical titles
<input type="checkbox"/> Operations & Station Management, Production & Programming	<input type="checkbox"/> VP operations, operation manager, director, general manager, station manager, production manager, program manager, news director, and other operations titles

5 Signature \_\_\_\_\_ Date \_\_\_\_\_

Name \_\_\_\_\_

Title \_\_\_\_\_

Station Call Letters or Company \_\_\_\_\_

Street \_\_\_\_\_

City \_\_\_\_\_ State \_\_\_\_\_ Zip \_\_\_\_\_

Is this your business address?                       YES                       NO

If not, please give us your business address below so that we can avoid sending duplicate copies

Name \_\_\_\_\_

Station Call Letters or Company \_\_\_\_\_

Street \_\_\_\_\_

City \_\_\_\_\_ State \_\_\_\_\_ Zip \_\_\_\_\_

Place  
Postage  
Here



*Broadband Information Services, Inc.*  
*P.O. BOX 6058*  
*Duluth, Minnesota 55806*

Place  
Postage  
Here



*Broadband Information Services, Inc.*  
*P.O. BOX 6058*  
*Duluth, Minnesota 55806*

Place  
Postage  
Here



*Broadband Information Services, Inc.*  
*P. O. BOX 6056*  
*Duluth, Minnesota 55806*



# broadcast EQUIPMENT

## Digital Video Announces Single-Clock TBC 295



Designed to operate with 3/4- and half-inch VTRs, the new TBC has changed a basic principle of time base correction. By eliminating the input clock, which must precisely track unstable video sources, the DPS-103 Digital Processing System introduces a microprocessor sync separator and an all-digital time base correction interpolator to reduce analog circuitry.

With video stored in a buffer memory, the microprocessor examines the position and length of each TV line (phase and frequency) on a line-by-line look-ahead basis to correct both time base and velocity errors. Error data is

stored, examined, compared with prior and upcoming lines, and then applied to the video data for time base correction in the digital interpolator.

The new unit also provides locked video at 40 times normal speed in forward and reverse. It will hold color to 10 times normal speed. The 16-line memory handles gyro errors often associated with portable VTRs. The unit is designed for 3/4- and 1/2-inch VTRs.

Luminance and chroma components are processed separately, providing RS 170A outputs which are automatically color-framed to house sync. The DPS-103 is priced at \$8950.

## Gotham Audio's EMT Turntable 296

The EMT 938 is a complete turntable system consisting of a direct drive turntable, a shock/isolation mount, the EMT 929 tonearm, and built-in EQ amplifiers for line level audio output. The platter accelerates to speed in less than 0.5 seconds, while audio output is



muted during startup to allow accurate cueing in the middle of program material.

The three standard, fixed speeds are referenced to an internal quartz oscillator and variable speed is available through an external potentiometer via rear panel connections. The same connections allow remote start/stop and remote stereo/mono output switching.

Specifications for the 938 include wow and flutter weighted per DIN 45 a maximum of 0.075 percent, while rumble is a minimum of 70 dB. The design used to achieve the specs is called the "stiff ring" concept, which is a suspension system that eliminates rotational oscillations while providing isolation from vertical and lateral forces.

The motor drive circuitry and audio amplifiers are built into the base and swivel out for servicing. Audio output is +4 dB nominal into 200 ohms with a maximum output capability of +21 dB. The 938 is available both with a 47

## New "Frezzi"™ ON-CAM™ VTR system mounts on your own cameras.



N.A.B.  
Booth 1107

- compact 5 lb VCR
- mounts on battery bracket
- 1 BP-90 powers camera/VCR
- VHS-C FORMAT / 20 minutes
- no modifications required

For information call (201) 427-1160

 Frezzolini Electronics Inc.

7 Valley St. Hawthorne, N.J. 07506 • TWX: 710-988-4142

Circle 281 on Reader Service Card

## Adopt This Mean Little Kit



Take home this 24-piece kit of electronic tools designed for engineers, scientists, technicians, students. Includes 7 screwdrivers, adjustable wrench, 2 pair pliers, wire stripper, knife, alignment tool, stainless rule, hex key set, scissors, 2 flexible files, burnisher, soldering iron, solder aid, coil of solder, and desoldering braid. Highest quality padded zipper case measures approximately 6 x 9 x 1-3/4" inside. Satisfaction guaranteed. Send check, company purchase order or charge VISA or Mastercharge. We pay the shipping charges to your door.

JTK-6 Tool Kit ..... \$95.00

## Free Catalog!

Page after page of hard-to-find precision tools. Also contains complete line of tool kits and tool cases. Send for your free copy today!



**JENSEN TOOLS INC.**

7815 South 48th St., Phoenix, AZ 85040  
Phone: 602-968-6241 TWX: 910-950-0115

Circle 282 on Reader Service Card

# BROADCAST EQUIPMENT

kohm input for magnetic cartridges (priced at \$2490), and a low-impedance version with active input transformer for moving coil cartridges for \$2470.

## Datamax Presents 297 New Graphics Computer

The new UV-1R is a graphics computer for creating animated titles, charts, graphs, maps, and other artist-generated images for video production. The computer, incorporated into the Zgrass graphics system, allows the artist to work on an electronic tablet, while the images can be recorded directly on videotape through the unit's composite video output.

A palette of 256 colors is available, four of which can be displayed at one time. The images and animation sequences can be stored externally on disk. The system uses the Zgrass graphics computer language, designed specifically for producing graphics. This allows the artist, with programs such as "paint," to create graphics and animation without knowledge of computers.

The UV-1R contains a 16-screen memory of 256K, permitting images to be created on several screens and dis-



played in quick succession. The unit will interface to a printer and plotter, while other options include a Winchester hard disk drive, RGB output, gen lock, and a video digitizer. The basic system, which includes the UV-1R, terminal, monitor, graphics tablet, and floppy disk drive, costs \$12,000.

## Lake Systems 298 Develops Video Cart Unit

La-Kart is a microprocessor-based random-access video cart system allowing programmable station breaks and promotions, commercials, programming, and animated IDs. The system can handle 3/4-inch, half-inch, or one-inch Type C video formats.

The Broadcast Software Package prepares videocassettes by recording a four-digit reel ID number at the head of the tape, and segments to be aired are defined with a start/finish time according to their location on the tape by reference to SMPTE time code.

Once the tape is inserted for playback, it automatically rewinds to the head, reads the directory and cues to the first segment or any segment programmed in a sequence. The system is capable of controlling up to 30 machines, has modular design, and offers automatic frame-accurate switching.

## Cinema Products 299 Has New Steadicam

The new Steadicam Universal Model III is a streamlined, lighter weight, and more compact version of the original device. In the new unit, the integral monitor is fully adjustable up and down the main support post. It also revolves 180 degrees around the post and pivots up and down. The monitor can be flipped upside-down for "low mode" viewing operation.

The sled portion of the system has been redesigned so that the new battery housing can pivot vertically. The cam-

# YOU ONLY NEED ONE OF OURS.

No reliability problems from microphone or cable with the subminiature Sennheiser MKE-10 electret. Not only better-sounding, it's better looking—because you *don't* see it.

## SENNHEISER

ELECTRONIC CORPORATION  
10 West 37th Street, New York, NY 10018  
(212) 239-0190



Manufacturing Plant: Bissendorf/Hannover, West Germany  
© 1980, Sennheiser Electronic Corporation (N.Y.)

See us at NAB Booth #1137

Circle 283 on Reader Service Card

272 BM/E MARCH, 1983

# STOP PLAYING DIRTY TAPES

Use the N.O.V.A. Block.  
A Sapphire Tape  
Cleaner.



For all formats,  
Attaches to  
your present  
VTR.

Patent Approved

**N.O.V.A.** Corporation  
See us at Booth 1722

Circle 284 on Reader Service Card





various modes of shooting for precise repetition of shot setups.

### FAX Audio Has 300 Interphone Transceiver

The FA-1B interphone transceiver is designed to replace the Daven CBS-1B type unit. It is a low-noise, low-distortion device with a high input impedance permitting the use of a 150-ohm bus impedance for up to 32 interconnected units. It is also capable of being connected to standard low-impedance units.

Other features include a thermally stable circuit design, a receive signal limiter, and an optional solid-state power source that replaces the need for a retard coil.

### DataVoice Provides 301 Synthesized Speech Device

A completely self-contained speech synthesizer, the CT-200 is a small module that holds up to three seconds of speech or sounds. Total playback time may be partitioned into one, two, four, or eight equal intervals in order to hold multiple words, phrases, or sounds. Several boards may be cascaded to



achieve longer recordings.

The 3x3.25-inch board requires switches or TTL control logic. Signals are provided to interface with a microprocessor as well, and a volume control and I W audio amp are included on-board, but may be bypassed if exter-

era can also rotate 180 degrees.

The patented support arm system now features an articulated elbow hinge, freeing the arm to move 360 degrees horizontally. Compensating angle scales on all system components permit documentation of adjustments made for different cameras and for

## Broadcast Technician II

Salary \$1509-\$1932 monthly

Expanding television station that nationally has the 15th largest market is currently recruiting qualified maintenance engineers. Required: 2 years of full-time experience/training in television technician work to include repair, maintenance of state-of-the-art broadcast television equipment, and an FCC first phone OR/general telephone license.

Official University of Washington applications must be received by 5 PM or post-marked by midnight, Monday, April 4, 1983.

University of Washington Staff Employment Office, 1320 N.E. Campus Parkway, Seattle, WA 98195. (206) 543-6969.

An equal opportunity and affirmative action employer.

## 100 hours of uninterrupted recording.

The Tandberg TD 20A-L tape recorder is designed for continuous long-time logging. It's ideal for use in radio and tv stations or wherever logging of music or voice is required.

The TD 20A-L utilizes Tandberg's patented recording system DYNEQ and ACTILINEAR to achieve a superior sound quality at a tape-saving 15/32 inches per second.

One logger permits uninterrupted recording for up to 50 hours. With two units operating you can log 100 hours of material. And you can add additional units for an infinite number of hours of uninterrupted recording.

The TD 20A-Ls auto start capability enables any one logger to start another at the end of the tape. Or start up one in event of power failure.

For further details, contact:  
Tandberg of America  
1 Labriola Ct., Armonk, NY 10504  
(914) 273-9150.

## TANDBERG Low-Speed Logger

See us at NAB Booth #632



Circle 285 on Reader Service Card

## EQUIPMENT

nal amplification is necessary.

Phrases may be selected from a standard vocabulary or custom boards with specific messages can be made in one week, costing \$100. The voice can be ordered in any male or female speech, and custom users can specify emotions, attitudes, or intonations.

The TTL-compatible phrase select lines are addressed for multiple phrase boards. A start line initiates speech in the normal mode but a continuous line may be used to achieve a 50 percent duty cycle operation. A done line indicates the end of speech and may be used to initiate additional speech boards or delay timers.

A factory-calibrated clock is included on-board. Operating power is +5 V at 200 mA for the logic. If the power amp is used, an additional +12 V at 800 mA is required. Single units are \$185 each.

### RCI Introduces 302 Remote Mixer

Recording Consultants, Inc. has just introduced the MX-84, a remote broadcast mixer for radio and TV ENG/EFP applications. The unit features an 8X12 mix via pan pots and two 8X1 utility mixes for IFB, mix-minus, or local PA.

All main inputs and outputs are transformer-balanced with XLR connectors and allow 20 dB of headroom. Line outputs and telco inputs have binding posts for connection to phone lines, and the intercom and talent IFB system is built in for party line communication with the studio phone line.

The three headphone output sections each has a 2 W power amp, and each output for talent, producer, and engineer is switch-selectable to any of four main outputs with IFB for checking program levels.

Up to four hours of continuous operation is possible on internal battery power and no interruption of programs occurs when the unit switches from ac to battery. The internal cue speaker is muted when a headset is used. The MX-84E version features 100 Hz and 10 kHz EQ on each input. Separate units may be combined for full-function expansion to 16 or 24 inputs. Single unit price is \$4500.

### Tektronix Adds 303 to Signal Generator

The introduction of the SG 505 option 2 adds new features to the standard 505. The new option provides a high-level, fully balanced output from a selection of three source impedances: 600 ohms, 150 ohms, and 50 ohms.

The option was introduced because

THE MARK OF  
*Integrity*



Our reputation (and success) is a result of providing client service of the same quality as the products we sell. Perhaps it's time you consider that the people you buy from are at least as important as what you buy...

**Professional Products, Inc.**  
4964 Fairmont Avenue, Beltsville, Maryland 20814  
Richmond, Virginia (804) 794-2585  
Baltimore, Maryland (301) 298-7111

**Sales • Design • Installation  
To Broadcast  
Industrial  
Government  
CATV**

Circle 286 on Reader Service Card

## We stand out from the crowd.

Thanks to the unique design of the patented Beau pancake motor, our Type 100 Recorder/Reproducer gives you *space* economy (it's only 3 5/8" high and stackable) and *power* economy, too. Also cool-running and compact, there's the inexpensive Beaucart II Reproducer.

Simple design means greater efficiency. Our versatile Model SFE-1 Automatic Splice Finder and Bulk Eraser combines two machines in *one*.

A common-sense approach makes Beau-Master Stereo Console and its companion Beau-Pro easy to operate—with the performance you demand.

Simple functional design makes UMC stand out from the crowd.



UMC Electronics Company  
460 Sackett Point Road  
North Haven, Connecticut 06473  
Phone (203) 288-7731

**UMC**<sup>®</sup>

Outside Connecticut, toll free, (800) 243-6178

See us at NAB Booth #114

Circle 287 on Reader Service Card



# LAUMIC HAS THE EDGE IN VIDEO EDITING EQUIPMENT

Now you can  
**RENT**  
a CMX Portable  
3 machine system  
from Laumic Company

"THE EDGE"™ computer assisted editing system offers some editing capabilities found only in large scale systems—multi-event memory, floppy disk, printer read out, re-edit and list rippling. Off line support goes directly to on-line auto assembly with events in sequential order for final post production assembly.

It's yours for short or long term rental. Call today.



**SALES, SERVICE AND RENTALS OF BROADCAST AND INDUSTRIAL VIDEO EQUIPMENT. SYSTEMS DESIGNED AND INSTALLED.**

## LAUMIC COMPANY, INC.

306 EAST 39th STREET, NEW YORK, N.Y. 10016 • TEL. (212) 889-3300

Isn't it nice to know we'll be around to service your equipment...**AFTER THE DEAL IS CLOSED?**™

See us at NAB Booth #1771

Circle 288 on Reader Service Card



most broadcast systems have 600 ohms as their standard line impedance, while proper mic input testing requires the 150-ohm source, and 50 ohms is a common source impedance in generalized signal applications without impedance matching, such as audio amp design and two-way radio.

This development provides a fully balanced, fully floating output with a maximum calibrated amplitude of +22 dBm from 600 ohms into 600 ohms, and +28 dBm from 50 into 600 ohms. Into 150 ohms, more than +30 dBm can be achieved. More than 100 dB attenuation of the output level can be achieved with the built-in step and variable attenuators.

The standard features of the SG 505 unit itself are 0.0008 percent maximum THD from 20 Hz to 20 kHz and  $\pm 0.1$  dB flatness from 10 Hz to 20 kHz.

## Newsroom Switcher 304 from Modular Audio

The Model 7301 newsroom switcher is designed to offer a record/edit facility for recording and monitoring of wire news services, station remotes, and cassette-recorded interview duplication. The unit has a 10-position high level input selector, bridging transformer input, and a separate selectable mic input for intros or news packaging.

Three separate outputs are standard, including program for recording, monitor, and headset jack with level controls. A high level input sensitivity control is incorporated for levels of -10 to +8 dBm and all output levels are balanced +8 dBm/600 ohms.

The unit contains an integral power supply with indicator and fused on/off switch. The switcher is housed in a 1.75-inch-high by 9-inch-deep case.

**Today's Interface  
For Today's Machines**

Available For

VPR-2B*	VPR-80*
BVU-800*	BVH-2000*
BVW-10*	BVH-1100*

Compatible with ISC Superedit\*  
and CMX\* Computer Editing Systems

CALAWAY ENGINEERING

P.O. Box 323, Sierra Madre, CA 91024  
49 South Baldwin, Sierra Madre, CA 91024  
(213) 355-2094

SEE US AT NAB, Booth 1167

\*Registered Trademarks of Ampex, Sony, Ortofon Corporations & Interactive Systems Company

Circle 289 on Reader Service Card

# BROADCAST EQUIPMENT

## Klark-Teknik 305 Introduces Digital Delay

The DN700 digital delay unit is the first of a series of products designed for ma-

nipulation of audio signals. The unit is a single-input device with three independently adjustable outputs. All operations are controlled by a micro-processor, and the delay time for each

output can be varied from 0 to 435 ms, in 26.5-microsecond steps.

The DDL has a perpetual memory of all delay settings and features a lock-out system to prevent tampering with front panel controls. In-house designed AD/DA converters provide a 15 kHz bandwidth at maximum delay, with a dynamic range greater than 86 dB.



## When accuracy counts... Count on Belar for AM/FM/TV MONITORS



**BELAR**  
AM MODULATION MONITOR

**BELAR** CALL ARNO MEYER (215) 687-5550  
**ELECTRONICS LABORATORY, INC.**  
LANCASTER AVENUE AT DORSET, DEVON, PA. 19333 • 80X 826 • (215) 687-5550

Circle 290 on Reader Service Card

## Modulation Sciences 306 Composite Line Driver

Model CLD-2500 is a stereo composite line driver which breaks the 6- to 12-foot cable limit on transmission of the stereo composite baseband signal between the stereo generator and the

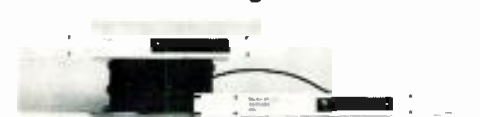

transmitter. The unit is designed to transmit the stereo composite over 3000 feet of cable without ground loops, loss of stereo separation, or other signal degradation.

This development allows the stereo processor to be located in the studio instead of next to the transmitter. The high-current, balanced, impedance-matched driver is coupled to twinax line, and is terminated at a receiver whose active circuit translates the balanced twinax circuit to a coax drive suitable for the short run to the exciter.

The CLD-2500 can drive two independent twinax cables, each driving a different exciter. Cable lengths can be independent of each other and reach up to 3000 feet. Input is a floating BNC connector. The receiver, which terminates the twinax, features isolation amplifiers and low-impedance floating output. A special-order CLD-2500 can be modified to drive as much as 10,000 feet (two miles) of cable.

## Millidyne Offers 307 Digital Modulator

The new Ladd DM-100 digital modulator accepts a digital input and provides an output suitable for modulating an FM transmitter without the use of any other SCA generating equipment. The unit can be used for RF data communications using the FM band at a data rate of 7200 bits per second. The unit is fully compatible with either mono or stereo broadcast equipment.

Digital filters and a crystal-controlled oscillator are used to achieve stable operation, high data rates, and low spurious emissions. The RF-tight enclosure reduces interference with low-level RF and audio stages of other equipment.

## COLOR PRODUCTION SWITCHERS

FOR MORE DETAILS  
CALL OR WRITE

105 EAST 69th AVENUE  
VANCOUVER, B.C.  
CANADA V5X 2W9  
PHONE (604) 327-9446  
TELEX 04-508605

MODEL  
1107  
AC OR DC POWERED

**ISCOUNT**  
INDUSTRIES INC.

Circle 291 on Reader Service Card



# ADVERTISER'S INDEX

**ADDA Corp.**..... 79  
**ADM Technology, Inc.**..... C-2  
**Advanced Music Systems** ..... 229  
**A.F. Associates, Inc.**..... 39,221  
**Agfa-Gevaert, Inc.**..... 129  
**Alexander Manufacturing Co.**..... 124  
**Allen Avionics, inc.**..... 262  
**Alpha Audio** ..... 183  
**Amperex Electronics Corp.** ..... 231  
**Ampex-AVSD.**..... 49-56  
**Ampex-MTD**..... 105-108, 210-211  
**Artel Communications**..... 259  
**Asaca Corp. of America** ..... 73  
**Audio Techniques**..... 254  
**Audtronic Inc.** ..... 31, 184, 185, 218  
**Aurora Imaging Systems** ..... 243  
  
**Belar Electronics Lab. Inc.**..... 276  
**Beyer Dynamic, Inc.**..... 201  
**Bosch (Fernseh)** ..... 97  
**Broadcast Technology, Inc.**..... 24  
  
**Calaway Engineering** ..... 275  
**Calzone Communications**..... 120  
**Camera Mart, Inc.**..... 26-27  
**Canare Electric Co., Ltd.**..... 230  
**Canon USA, Inc.**..... 84  
**Capitol Magnetic Products** ..... 20  
**Central Dynamics Corp.** ..... 116-117  
**Cetec Vega** ..... 176  
**Christie Electric Corp.** ..... 187, 258  
**Chyron Corp.** ..... 232  
**Cine 60, Inc.**..... 204  
**Cipher Digital** ..... 38  
**Clear-Com Intercom Systems** ..... 22  
**CMX/Orox**..... 123  
**Comark Communications, Inc.** ..... 119  
**Comtech Data Corp.**..... 200  
**Conrac Corp.**..... 32-33  
**Continental Electronics Mfg. Co.** ..... 30  
**Countryman Associates** ..... 262  
**Crosspoint Latch Corp.**..... 36  
  
**Data Communications Corp.**..... 115  
**Delta Electronics**..... 159  
**Dictaphone Corp.** ..... 249  
**Di-Tech, Inc.** ..... 252  
**Dolby Laboratories, Inc.** ..... 191  
**Dubner Computer Systems Inc.**..... 66, 67  
**Victor Duncan**..... 220  
**Dunn Instruments, Inc.** ..... 89  
**Dynacom International, Inc.**..... 220  
**Dynatech Data Systems** ..... 18  
  
**Echoiac, Inc.**..... 121  
**EEV, Inc.**..... 162-163  
**EG & G** ..... 182  
**Elector**..... 1  
**Electro-Voice** ..... 219  
**Emcee Broadcast Products** ..... 238  
**E-N-G Corp.**..... 126  
**Environmental Satellite Data Inc.**..... 12  
**Eventide Clockworks, Inc.**..... 102, 250  
  
**Fidelipac**..... 160  
**For-A Corp.**..... 75  
**Fortel Inc.**..... 227  
**Frezzolini Electronics, Inc.**..... 271  
**Fujinon Optical, Inc.**..... 145  
**Fuji Photo Film USA, Inc.**..... 151  
  
**Grass Valley Group, Inc.**..... 47  
**Gray Engineering Labs** ..... 218  
**Grumman Aerospace** ..... 132  
  
**Harris Broadcast Division**..... 13, 168, 173, 263  
  
**Harris Broadcast Microwave Operation**..... 217  
**Harris Video Systems**..... 37

**Harrison Systems** ..... 11  
**Hipotronics, Inc.**..... C-3  
**Hitachi Denshi American Ltd.**..... 199  
**Hitachi Pro-Video**..... 77  
**Hotronic Inc** ..... 137  
  
**Ikegami Electronics USA, Inc.**... 5, 90-91, 93, 95, 260  
**International Tapetronics Corp.**... 175, 177, 179  
  
**Japan Electronics Show** ..... 267  
**Jensen Tools, Inc.**..... 271  
**US JVC Corp.**..... 111  
  
**Kamen Broadcasting Systems** ..... 244  
**Kavouras, Inc.** ..... 103  
**KCTS/9** ..... 273  
  
**Laird Telemedia, Inc.** ..... 127  
**Lake Systems Corp.**..... 202  
**Larcam Communications Equipment, Inc.** ..... 266  
**Laumic Co., inc.**..... 275  
**Leader Instruments**..... 212  
**Lerro Electrical Corp.**..... 130-131  
**Lightning Elimination Assoc.** ..... 256  
**Listec Television Equip. Corp.** ..... 118  
**Lowell Light, Inc.**..... 242  
**LPB, Inc.**..... 198  
  
**3M/Magnetic Tape Div.**... 82-83, 156, 255  
**Magnasync/Moviola Corp.** ..... 197  
**Magna-Tech Electronic Co., Inc.**..... 207  
**Marti Electronics** ..... 204  
**Maxell Corp. of America** ..... 71  
**MCI (Div. of Sony America)** ..... 153  
**MCI/Quantel**..... 87  
**McMartin Industries, Inc.**..... 254  
**Microtime, Inc.**..... 125  
**Midwest Corp.**..... 44  
**Minolta Corp.** ..... 96  
**Moseley Assoc., Inc.**..... 170, 171  
**Motorola, Inc.** ..... 28  
  
**Nagra Magnetic Recorders, Inc.**..... 158  
**NEC America, Inc.** ..... 42, 242  
**Rupert Neve, Inc.**..... 17  
**Nurad, Inc.**..... 81  
  
**Ok Electronic Industry Ltd.**..... 241  
**Orban Associates, Inc.** ..... 23, 25  
**Otari Corp.**..... 14-15  
  
**Panasonic Matsushita**..... 8-9, 225  
**Panasonic Ramsa** ..... 154-155  
**Perrott Engineering** ..... 208  
**Phelps Dodge Communications Co.**... 147  
**Philadelphia Resins Corp.** ..... 133  
**Philips Television Systems, Inc.**..... 34  
**Philips Test & Measuring Instruments** ..... 209  
**Porta-Pattern**..... 4  
**Potomac Instruments**..... 196  
**Professional Products, Inc.** ..... 274  
  
**QSI Systems, Inc.**..... 237  
**Quanta Corp.**..... 98-99  
  
**Ramko Research**..... 7, 194-195  
**Rank Cintel** ..... 222  
**RCA Broadcast Systems** ..... 68-69  
**RCA Electro-Optical** ..... 247  
**RCA Recruitment**..... 264  
**Rohde & Schwarz** ..... 178  
**RTS Systems** ..... 140  
  
**Sachtler GmbH**..... 251  
**Satt Electronics** ..... 150  
**Satcom Technologies**..... 21  
**Sennheiser Electronic Corp.**..... 272

**Shintron** ..... 228  
**Shure Bros., Inc.** ..... 164  
**Singer Broadcast Products Inc.**..... 258  
**Solid State Logic**..... 138-139  
**Sony Broadcast** ..... 2-3, 40-41, 205  
**Sony Video Products**..... 224  
**Stanton Magnetics, Inc.**..... 266  
**Storeel Corp.**..... 149  
**Studer Revox America, Inc.**..... 161  
**Swiderski Electronics, Inc.**..... 200  
**System Associates** ..... 272  
  
**Tandberg** ..... 273  
**Tau-tron, Inc.** ..... 167  
**Tektronix, Inc.**..... 60-61, 63, 65  
**Telemet**..... 208  
**Telex Communications, Inc.**..... 144  
**Thomson-CSF Broadcast**..... 101  
**Toshiba America, Inc.** ..... 135  
**Townsend Assoc., Inc.** ..... 215  
**Transtector Systems** ..... 235  
  
**UMC Electronics Co.** ..... 274  
**UREI** ..... 180-181  
**Utah Scientific, Inc.**..... 193  
  
**Valley People, Inc.**..... 189  
**Variable Speech Control**..... 230  
**Varlan, Elmac Div.** ..... 113, 257  
**Video International** ..... 136  
**Videotek, Inc.** ..... 19  
**Viscount Industries Ltd.** ..... 276  
  
**Ward Beck Systems Ltd.**..... C-4  
**Winsted Corp.**..... 226  
  
**Yamaha Combo** ..... 174

## SALES OFFICES

# BM/E

**Broadcast Management/Engineering**

295 Madison Ave.  
 New York, New York 10017  
 Telex: 64-4001  
 Vice President, National Sales Manager  
**James C. Maywalt**

### Eastern & Central States

295 Madison Avenue  
 New York, New York 10017  
 212-685-5320  
**James C. Maywalt**

### Western States

1021 South Wolfe Road, Suite 290  
 Sunnyvale, CA 94086  
**Neal Wilder**: Associate Publisher  
**Charleen Kennedy**

5015 Birch Street, Office One  
 Newport Beach, CA 92660  
 714-851-1461  
**Neal Wilder**

### United Kingdom/Europe

Chilberton House  
 Doods Road  
 Reigate, Surrey, England  
 Telephone, Reigate (7372) 43521  
**Bronwyn Holmes**  
**Derek Hopkins**

### Japan/Far East

Eiraku Building  
 1-13-9, Ginza,  
 Chuo-Ku, Tokyo 104 Japan  
 03 (562) 4781  
**S. Yasui**  
**K. Yamamoto**

# BUSINESS BRIEFS

**Line One Video** recently began full-service operation in New York City for broadcast production and post-production services. . . . **Leader** has expanded its headquarters in New York by 10,000 square feet for increased production space. . . . **Pyramid Video** in Washington, DC has signed a long-term agreement that includes provisions for leasing office and studio space with the **National Press Building Corp.** to facilitate delivery of news communications.

**Plastic Reel Corp.** will open a new divisional office in North Hollywood, CA to accommodate its west coast operations. The 30,000-square-foot building will house sales, administrative, and warehousing departments.

**Sony** has opened its Burbank offices as a means of improving customer service for its west coast regional office. . . . The Syracuse University Audio Archives for the **Thomas Edison Re-recording Laboratory**, a facility devoted exclusively to the preservation and restoration of recorded sound, has added **Sony/MCI** recorders and automated mixing consoles for installation in the new facility.

**VCA/Teletronics** has begun construction on its advanced audio post-production facilities in New York City which include a **Solid State Logic** console and **Studer** audio tape recorders.

The adult contemporary service of **CBS, Radioradio**, has contracted with **Osmond Entertainment** for a network weekly countdown show premiering in July. . . . **Radio Arts** has added another 14 stations to its country and rock formats.

**Videostar Connections** of Atlanta has contracted with **Satellite Business Systems** to lease Ku-band transponder capacity for use by occasional commercial video users.

**EFP Video** now operates the only five-meter transportable downlink in the Chicago area as a representative for the **Satellite Downlink Service**. . . . **American Satellite and Television** recently formed a subsidiary to operate and market satellite uplink services called the **Telasat Network**, operating throughout the southeast.

**Plessey** and **Scientific-Atlanta** have formed a company to exploit international markets in satellite and cable communications. **Scientific-Atlanta** has completed its acquisition of the assets and business of **Digital Video Systems** of Toronto.

In a comarketing venture between **Lyon Lamb** and **Oxberry**, the com-

panies will combine resources for marketing film and video animation hardware both domestically and internationally.

The **Schneider** lens manufacturing reorganization is complete as of December 1, 1982. The new company will be known as **Jos. Schneider Optische Werke Kreuznach GmbH & Co. KG**, a



*Proud owner of the 5000th VPR-2 one-inch helical VTR, Reeves Teletape president Caddy Swanson (right) accepts congratulations from Willie Scullion, national sales manager of Ampex's Audio-Video Systems Div. Looking on is Reeves' director of engineering, Ralph Mensch. Purchase brings the number of VPR-2s at Reeves to 30.*

West German limited partnership which is now the parent company of **Tele-Cine Corp.**

**Video Components, Inc.** has been appointed as the national sales and marketing representative for **Taber Manufacturing and Engineering**. . . . **RCA Commercial Communications Systems** division has announced a nonexclusive marketing agreement with **SatCom Technologies** under which RCA's broadcast sales network will sell satellite earth stations provided by **SatCom**.

**WVSB-TV** in West Point, MS bought a 55 kW UHF transmitter and STL equipment from **Harris** valued at over \$1.2 million. . . . **ADDA** has shipped TBC number 1000, this one to **CNN** in Atlanta.

**Harrison Systems** appointed **Everything Audio** as manufacturer's sales representative for Southern California. . . . **L. Matthew Miller Associates** has been appointed by **Agfa-Gevaert** as a distributor for its videotape products.

**DJM**, a New York City-based post-production facility, has placed an order for a second **CBG 2** video graphics unit from **Dubner**. . . . **RKO General** radio station **WOR** has agreed to purchase the **News Fury** system from **Basys** to interconnect nine terminals spread about the newsroom.

**UNR-Rohn** set a record for sales for the month of October 1982, showing a 15 percent increase.

**Zenith Radio Corp.** and **Taft Broadcasting** have announced the first U.S. agreement between a TV set manufacturer and a broadcaster to enter into a five-year venture in the teletext service.

**Skirpan Lighting** has appointed **Midland Technology Corp.** as the representative for New York, New Jer-

sey and Connecticut. In a personal development, **Stephen Skirpan**, founder of the lighting company, has opened operations as an independent technical consultant in Canyon Country, CA.

Other industry personnel developments come from **Fujinon**, where **Hiroaki Minoshima** has been named president. . . . **Michael Sipsey** has joined **BTX** as VP of marketing, a new position in the company.

**Frank Alioto** is now the national marketing manager for the **ESP** system at **ADDA Corp.**. . . . The board of directors for **For-A Corp.** announced the appointment of **David Acker** as president. . . . **Ron Haig**, after 50 years in the television and film industry, announced his retirement in December 1982. He was acting VP of the **British Kinematograph Sound & Television Society**.

**M/A-Com DCC** has reorganized, including changes of **Pradman Kaul** to senior VP, and **J. Lou Peeler** to senior VP and corporate secretary. . . . **Gary Persons** has joined **Cetec Broadcast** as radio systems sales manager.

**Clare Simpson**, with a background in television programming and independent production, has been named VP of program development for **United States Satellite Broadcasting Company**, the DBS division of **Hubbard Broadcasting**. . . . Two developments at **CMX**: **H. Ward Gebhardt** is the new director of marketing, and **Gary Schultz** is now the product manager.



# Leading transmitter manufacturers are switching to automatic voltage regulators made by Hipotronics\*

They are switching for improved:

- EFFICIENCY
  - RELIABILITY
  - CUSTOM DESIGN
  - DELIVERY AND SERVICE
- plus:*
- SIZE REDUCTION
  - WEIGHT REDUCTION
  - COST REDUCTION

To learn more call our sales department at (914) 279-8091

\*HIPOTRONICS' REGULATORS INCORPORATE THE PATENTED PESCHEL VARIABLE TRANSFORMER™.

Circle 292 on Reader Service Card



REGULATOR SHOWN WITH COVER PANELS REMOVED.

**Hipotronics**

P.O. Drawer A, Route 22, Brewster, New York 10509  
Phone (914) 279-8091  
Tlx: 710-574-2420 HIPO BRWS NY; Tlx: 178915-HIPBNY



# When you didn't think you could!

To the imaginative broadcaster whose engineering appetite appears to exceed the limitations of his budget, we say, "Take heart!"

This versatile broadcast console is based on a standard L3242A design, modified to include an integral routing switcher. An excellent example of a Ward-Beck standard product that has been customized and delivered to WHIO-TV for substantially less than the cost of a purely custom system.

Talk to us about your needs. We have a broad range of surprisingly affordable standard consoles and there's a good chance we can move you up to Ward-Beck quality for much less than you might expect.



First by Design.

Ward-Beck Systems Ltd.,  
841 Progress Avenue, Scarborough,  
Ontario, Canada M1H 2X4.  
Tel. (416) 438-6550.