

JUNE 1975

# BME

BROADCAST MANAGEMENT ENGINEERING

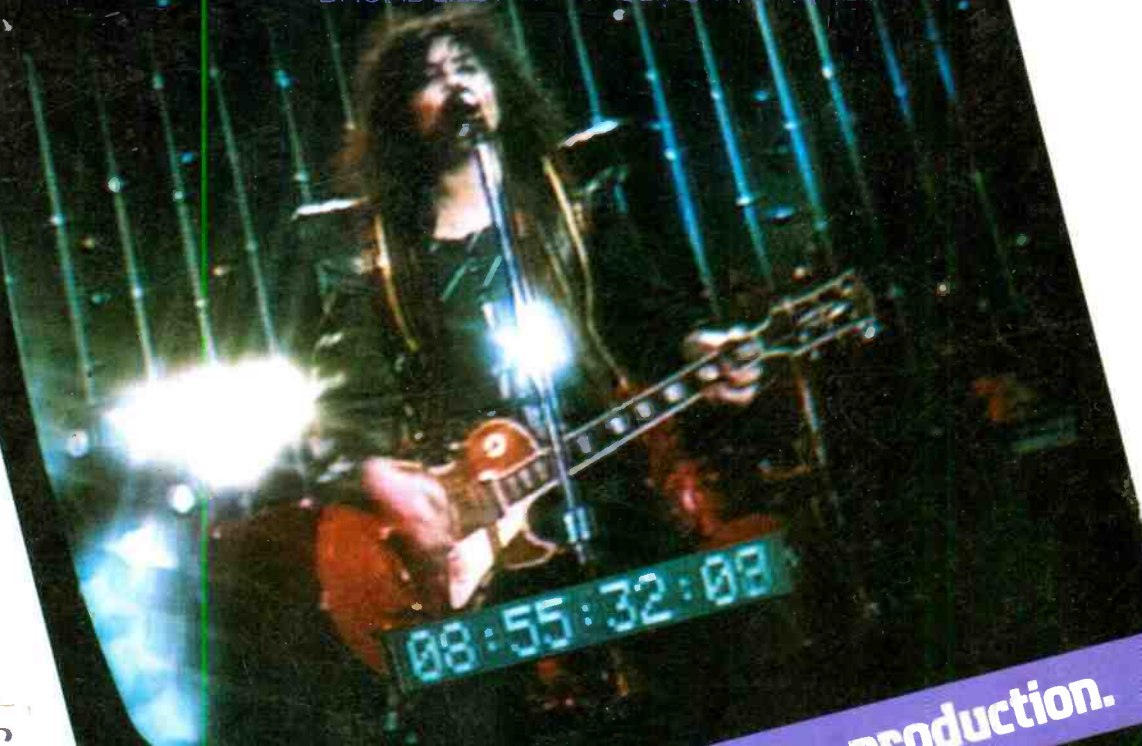

Editing and effects enhance production.

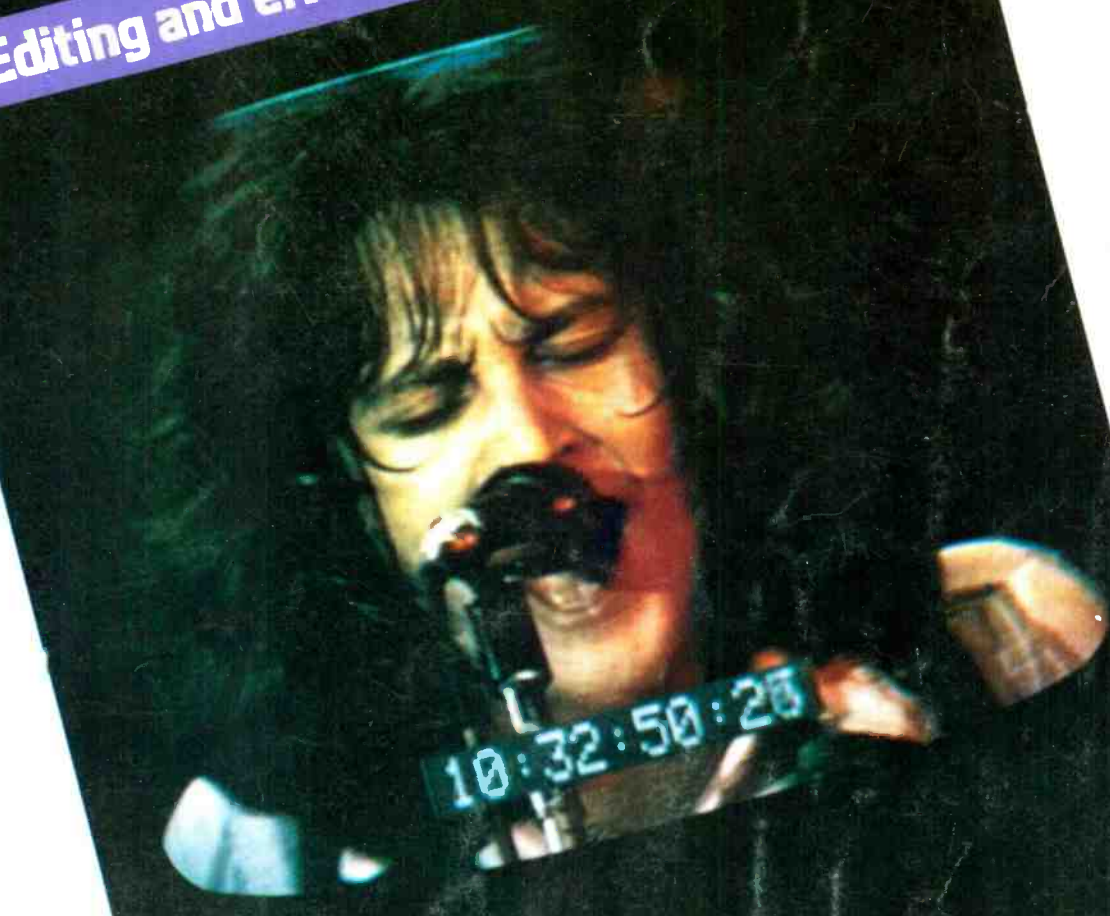

CARD 8557893-XM#1752-DL1 -  
 RECORD PLANT T/DIR - X AD  
 8456 W 3RD ST  
 LOS ANGELES  
 CA 90048



STEREO PACKAGE SHOWN: WHDH — RADIO, BOSTON



The McCurdy approach to engineering and construction of a packaged system allows the user to easily locate his new equipment without the added burden of wiring to auxiliary equipment.

All aspects of the broadcast function, from news booth to music production center, can be assembled into a unique and functional package.

Each system is fully pretested as a total functional unit and will meet or exceed all broadcast specifications.

For further information, see us at Booth #408, North Hall at NAB

**McCURDY RADIO INDUSTRIES INCORPORATED**

1051 CLINTON STREET, BUFFALO, N.Y. 14206 (716) 854-6700

108 CARNFORTH RD., TORONTO, ONT. M4A 2L4 (416) 751-6262

Circle 100 on Reader Service Card

PSC "PROFESSIONALIZES" . . .

SUPER 8

. . . announcing  
our new

# ACME MINIPRINTER

PSC now brings low  
cost, professional  
quality optical  
printing to Super  
8 mm and 16 mm film  
duplicating with  
the  
**ACME  
MINIPRINTER . . . .**

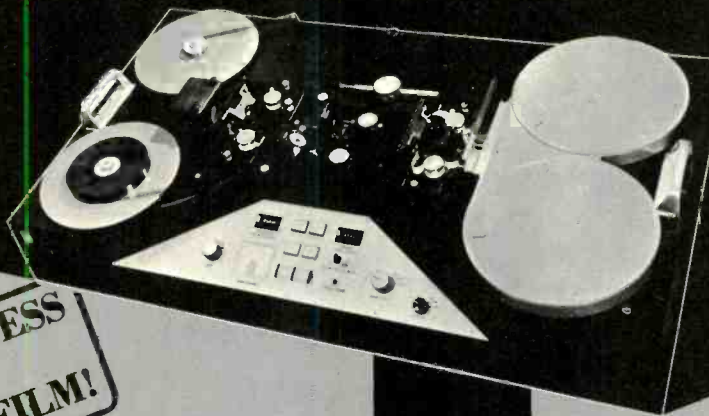

**OUR BUSINESS  
IS  
MOVING FILM!**

## FEATURES

- Camera/Projector Forward Reverse
- 1200' Camera Magazine Capacity
- 1000' Projector Magazine Capacity
- Variac Lamp Brightness Control
- Lamp Meter in Amperes
- Stop Motion
- Freeze Frame
- Speeds from 80 to 960 Frames/Minute
- Interchangeable Movements & Lenses   
1-1, Blow-up & Reduction
- Eyepiece for Camera Line-up
- .001 Dial Indicators for Focus Placement
- Daylight Operation
- Professional Quality Lenses
- Filter Holder for Color & Density Correction
- 5-Digit Frame Counter, Camera & Projector
- Fades & Dissolves
- Operates from 115 volt, 10 amp Circuit
- Portable
- Ruggedized for Heavy Use

## ADVANTAGES

- Professional quality prints.
- Low cost, easy to operate.
- Does not require dedicated space.
- Has same features as most \$45,000 optical printers.
- Excellent return on investment.
- Perfect as a teaching tool in colleges and universities.
- Within budgets of colleges & universities
- Excellent unit for labs and special effects houses which specialize in Super 8mm.

Want more information?

*Call, cable or write to D. E. Stults  
or N. J. Mastrogianni.*



**PSC** (formerly Producers Service Corporation)  
**TECHNOLOGY**  
**INC.** Acme Products Division

1200 Grand Central Avenue,  
Glendale, California 91201

**(213)245-8424**

Cable: PRODUSERV Telex 69-8231

Circle 101 on Reader Service Card

# BM/E

BROADCAST MANAGEMENT/ENGINEERING



If you don't like what you see or hear, it's an easy job to edit it or doctor it with today's production aids.

**BROADBAND INFORMATION SERVICES, INC.**  
274 Madison Ave.  
New York, N.Y. 10016  
212-685-5320

Editor  
**James A. Lippe**

Associate Editor  
**Robin Lanier**

Washington Editor  
**M.L. Hollowell**

Contributing Editor  
**Robert Wollins**

Editorial Assistant  
**Karen Goudket**

Art Director  
**Gus Sauter**

Manager Publication Services  
**Djuna Zellmer**

Circulation Manager  
**Barbara Connolly**

FCC Counsel  
**Pittman Lovett Ford and Hennessey**

Publisher  
**Charles C. Lenz Jr.**

---

## JUNE 1975/VOLUME 11/NUMBER 6

---

**6 Broadcast Industry News**  
*ABC gets set for 1976 Olympics*

**22 Interpreting the FCC Rules and Regulations**  
*Guidelines on Obscenity*

**29 Creative Chroma Key**  
*Design developments can give you a more imaginative product*

---

**34 Teleproduction Aids**  
*New ideas and products to help solve production problems*

<b>Encoded &amp; RGB chroma keying compared</b>	<b>34</b>
<b>Creative teleproduction via new editing system</b>	<b>39</b>
<b>Capabilities of Vitals' VIX 114-3 switcher</b>	<b>40</b>
<b>Burst phase meter substitutes for vectorscope</b>	<b>41</b>
<b>"Instant Flanger"</b>	<b>42</b>
<b>Creating with "Synthavision"</b>	<b>42</b>

---

**45 One O'Clock, Two O'Clock, Three O'Clock . . . Rock!**  
*How live original rock shows for TV are produced—and the problems involved.*

**50 The Great Idea Contest**  
*5 more ideas from our readers*

**55 Broadcast Equipment**  
*New and significant products*

**61 New Literature**  
*Useful reading materials*

**62 Letters/Feedback**

---

**CM/E: A supplement for those with cable interests following page 54—Report on NCTA Convention**

---



BM/E, BROADCAST MANAGEMENT/ENGINEERING, is published monthly by Broadband Information Services, Inc. All notices pertaining to undeliverable mail or subscriptions should be addressed to 274 Madison Ave., New York, N.Y. 10016. BM/E is circulated without charge to those responsible for station operation and for specifying and authorizing the purchase of equipment used in broadcast facilities. These facilities include AM, FM, and TV broadcast stations; CATV systems; ETV stations; networks and studios; audio and video recording studios; consultants, etc. Subscription prices to others: \$15.00 one year, \$25.00 two years. Foreign: \$20.00 one year, \$35.00 two years. Foreign Air Mail: additional \$24.00. Copyright © 1975 by Broadband Information Services, Inc., New York City. Controlled circulation postage paid at East Stroudsburg, PA.

# 1600 SERIES 7J PRODUCTION SWITCHER

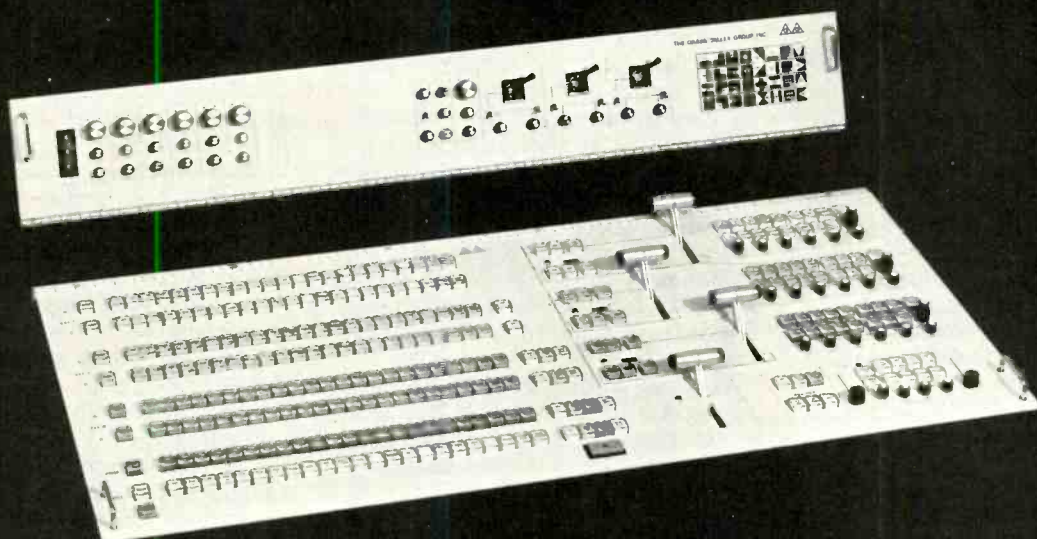

Model 1600-7J, introduced at NAB 1975, provides increased flexibility by the inclusion of preset and program buses. A cut-bar operating between these buses provides both flip-flop and flip-only transitions. In addition, a mixing amplifier allows dissolves or fades to be made between the buses.

The special effects pattern selector, positioners, and color background generator, as well as controls for accessory quad split generator and chroma keyers, are located on a separate auxiliary panel designed to mount in a sloping console for easy operator access.

Other accessories available include borderline generators, a downstream keyer system, and a shadow key option for the chroma keyers. The latter device, also introduced at NAB 1975, allows lifelike shadows to be added to chroma keyed inserts for the first time.

Model 1600-7J is also available in a 16-input format, the Model 1600-3J. Both models can be supplied in NTSC, PAL, and PAL-M versions.

For additional information, please call or write your nearest Grass Valley Group field office.

**THE GRASS VALLEY GROUP, INC.**   
A TELEXONIX COMPANY

Station Plaza East  
GREAT NECK, NY 11021  
(516) 487-1311

4419 Van Nuys Blvd, Ste 307  
SHERMAN OAKS, CA 91403  
(213) 990-6172

1644 Tullie Cir, NE  
ATLANTA, GA 30329  
(404) 634-0521

P.O. Box 482  
MABANK, TX 75147  
(214) 887-11E1

810 W Bristol Street  
ELKHART, IN 46514  
(219) 264-0931

# BROADCAST INDUSTRY NEWS

## Thomson-CSF Buys CBS Labs Professional Products

In another significant penetration of the American electronics industry by ownership from abroad, Thomson-CSF of France has bought, effective May 1, 1975, the professional products activity of CBS Laboratories, Inc., and will operate it as a wholly-owned subsidiary with the name Thomson-CSF Laboratories, Inc. Headquarters will be in Stamford at 37 Brownhouse Road, one of the locations formerly used by CBS Labs.

At the same time CBS announced that the research activities of CBS Labs in broadcasting and audio recording will be taken over by a new division, the CBS Technology Center, with headquarters in the CBS Labs facilities on High Ridge Road, in Stamford.

Thomson-CSF Laboratories will continue and expand the production

and sale of CBS Labs' broadly used line of audio and video processing equipment: the Volumax, Audimax, image enhancers, color correctors, etc. The top management of Thomson-CSF Laboratories, as well as most of the operating personnel, have come over from CBS Labs: President of Thomson-CSF Labs is Renville McMann, formerly president of CBS Labs; and executive vice president of Thomson-CSF Labs is Langdon Cooke, formerly General Manager of CBS Labs.

Heading up the new CBS Technology Center will be Benjamin B. Bauer, as vice president and general manager. There will be four divisions under him: Advanced Television Technology, directed by J. Kenneth Moore; High Density Recording, Robert A. Castrignano; Audio Systems, Emil L. Torrick; and Sound Reproduction, Louis A. Abbagnaro.

## NAB Asks FCC to Bar Cable Sports Importation

Continuing the war over cable TV's use of sportscasts, the National Association of Broadcasters late in April urged the Federal Communications Commission to prohibit uncontrolled importation of sports programs by cable systems. The NAB said that such importation would take away control of the sports telecasts from the sports leagues, and would "fragment the viewing audience and saturate the sports market to such a degree that local and regional advertising support for sports broadcasts will diminish . . ." This would reduce the amount of sportscasting available on television, said the NAB, directly contrary to the cable industry's contention that their coverage will not affect the quantity of sports telecasts on television.

## NCTA Protests Proposed Blackout on Sports

And firing from the other side of the cable-sports battle line, the National Cable Television Association passed a resolution at its convention in New Orleans calling on the FCC not to pass a proposed rule barring cable operators from importing a professional game on the same day a local team is playing at home. (The Convention is covered in detail elsewhere in this issue). The NCTA said it would soon file a report with the FCC showing the massive adverse effect the rule would have on cable subscribers across the country.

## FCC Opens Inquiry On Automatic Transmitters

As noted briefly in BM/E's NAB show-in-print-coverage in the May issue, the Federal Communications Commission has opened an inquiry to determine the rules and regulations needed for operation of automatic transmitters for AM, FM and television. Noting that the automatic transmitter will be a "go—no go" device, automatically going off the air, or applying correction, if any important pa-

continued on page 8



**New ABC Vans—Mobile High-Grade Pick-up for Sports, Etc.** The American Broadcasting Company has put into service a two-van "fleet" that comprises a mobile TV origination system of very high grade, probably the most elaborate such system now in use. Slated for the Olympics in Austria later this year, as well as for many other sports and non-sports location assignments, the system includes a production/control van and a videotape/support van each weighing 30 tons. The first has the most elaborate video switcher in mobile use (photo, right, designed by Grass Valley); and a multi-channel audio console by Ward-Beck. Up to 21 cameras can be accommodated. The videotape/support van has a bank of Ampex VTR's (photo, left); disc recorders for slow motion replay; space for production.

# New Sony U-matic news team... from action to broadcast in 30 minutes.



Or even less time. With less equipment. And at less total cost than you're probably paying now for news-gathering and teleproduction.

The major networks, ABC, CBS, and NBC, and many stations nationally are using the new Sony U-matic VO-3800/2850 Videocassette System.

All your work is done on economical, reusable videocassettes. After location taping, either microwave the signals or send the cassette to the studio for quick and accurate editing. Or go right on the air with the use of a time base corrector.

You eliminate film cost and processing time, especially when important events break close to air-time deadlines.

You start with the Sony VO-3800 portable VideoRanger™ recorder and a color camera, such as the Sony hand-held DXC-1600. The VO-3800 can record three 20-minute cassettes on a single battery charge. It has NTSC color and EIA monochrome standard signals, remote control, two separate audio tracks, automatic power shut-off, and on-the-scene playback capability.

Accurate electronic editing is achieved with two Sony VO-2850 mastering recorder/editors and the Sony RM-400 Remote Automatic Editing Controller. The RM-400 provides search, pause, and automatic back-spacing. The VO-2850 has a signal-to-noise ratio in excess of 45 dB for video and audio, also separate editing capability for video and two audio tracks.

Of course, the VO-3800 portable VideoRanger™ or the VO-2850 editor can be used independently of each other. In addition to electronic news gathering, these versatile new videocassette units can add new capability and economy in production of documentaries, on-site retail spots, and general studio use.

For complete information and/or a demonstration write us today.  
Sony Corporation of America  
Video Information Center, BME-065-210  
P.O. Box 1594, Trenton, N.J. 08607

## Sony. The proven one!

### Sony U-matic Color Videocassette System

TV reception simulated.

Circle 102 on Reader Service Card  
for a demonstration  
Circle 106 on Reader Service Card  
for literature



## NEWS

parameter is out of tolerance, the FCC questioned the role of the operator in automated installations. Some of the other questions the FCC asked the industry for help in resolving were: How about AM stations with directional antennas? What about manual override? FCC inspections? Records and logging? What about safety provisions? The request posed a number of other specific questions and asked for comment on them and on general issues, by July 11, 1975.

### CTIC Members Analyze Cost of FCC Cable Rules

The cable industry must spend about \$185 million more to move into substantial compliance with the FCC cable rules which go into effect March 31, 1977, report W. Bowman Cutter executive director, and E. A. Deagle, Jr., director of analysis, of the Cable Television Information Center.

The study, issued by the two individuals and not by CTIC as a body, further says that about \$106 million of the remaining total must be used to replace old cable and obsolete electronics equipment.

### FCC Amends Renewal on Children's Programs

To get data that will help determine whether or not the industry is living up to its own regulations on children's programming, the Federal Communications Commission has amended the TV license renewal form by rewording some old questions and adding new ones. For example, Question 6 is amended from "programs . . . primarily directed to children 12 years and under" to "programs . . . designed for children 12 years and under." New Question 13 asks for a list of all children's programs in which commercial material exceeded the new agreed-on limits. A new Question 16 asks the station for a projection of commercial matter in future programs along the same lines. The new limits on children's commercials apply to programs aired after January 1, 1976. The new renewal forms should be ready in the near future, the FCC said.

### No Ban on Cable, News Cross-Ownership

After a study of existing licensees, the Federal Communications Commission announced late in March that it would not issue any rules against cross-ownership of cable systems and newspapers, at least for the time being.

continued on page 12

# The AMM-3 is the best AM Monitor available.

## Ask Arno Meyer: (215) 687-5550.

FCC Type Approval No. 3-231

\$1300.

Belar Electronics Laboratory, Inc., Lancaster Ave. at Dorset, Devon, PA 19333.

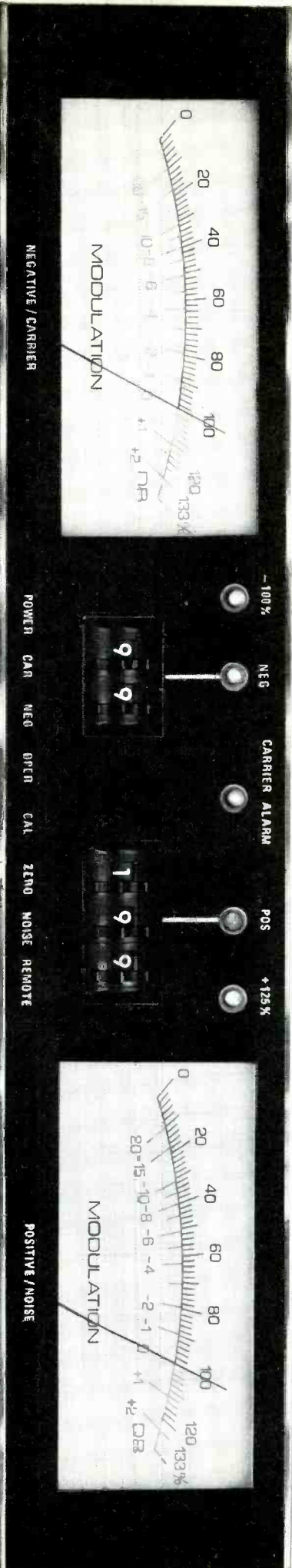

**BELAR**  
AM MODULATION MONITOR



MODEL C



V30

Today, More Than Ever...

# DITCH WITCH TRENCHERS Make \$ense!

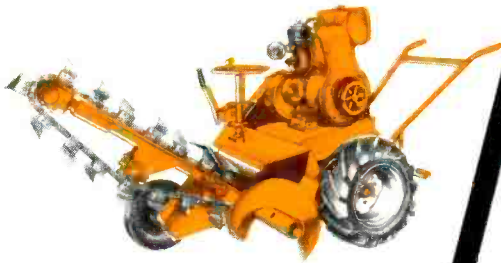

MODEL M

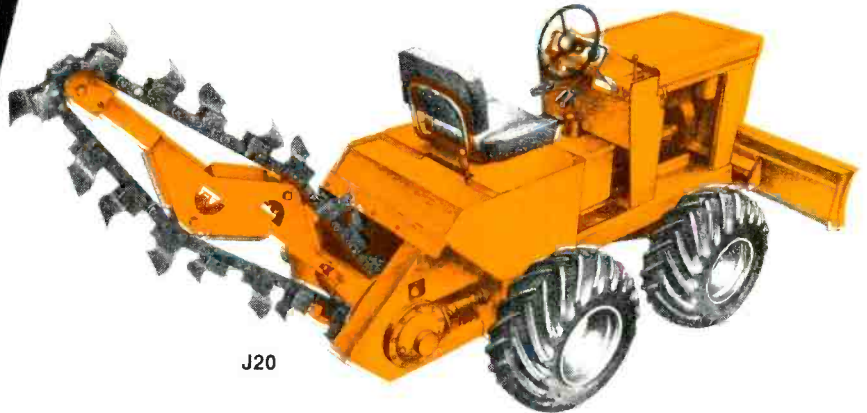

J20

If your job calls for trenching, it makes sense to look to the people who have the most experience in the industry: Ditch Witch. Ditch Witch built the world's first service-line trencher more than 25 years ago and today offers the most complete range of trenching equipment available. The Ditch Witch Trencher Series is designed strictly for trenching. It includes two compact handlebar units and two four-wheel-drive models — the 18-HP J20 and 30-HP V30. If you require larger equipment, outfit one of the four Modularmatic vehicles as a trencher. The power range is from 30-HP to 100-HP. From 7-HP compact to 100-HP main-line equipment, Ditch Witch has the right machine for your trenching job. That's why today, more than ever, Ditch Witch makes sense.

*Ditch Witch . . . equipment from 7 - to 195-HP.*

**CHARLES MACHINE WORKS, INC.**  
P.C. Box 66  
Perry, Oklahoma 73077



Circle 105 on Reader Service Card

# Picture a new high performance,

One picture couldn't begin to tell the whole story of how our new TR-600 compares with other "new" VTR's.

Nor would a hundred.

But, we felt that a number of different views would give you a good idea of what we mean when we say totally new tape technology.



Like the drop-on reels for instance.



Then there's our unique straight line threading. It not only speeds loading, but once the tape reaches the take-up reel, the operator is also assured that threading has been accomplished properly.



The TR-600 utilizes a standard headwheel (featuring long-life Alfecon II poletip material) that's compatible with all other RCA highband recorders. You'll find this really keeps down the expense of spares.

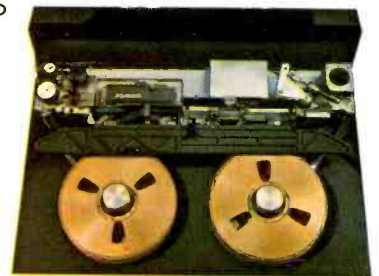

# tape technology, medium price.

We've added an electronic LED readout tape timer. And LED diagnostic indicators.

At the first sign of certain malfunctions or nonstandard modes, a control panel light flashes a warning, while individual lights inside direct you to the module that's in question.



We've simplified the control panel for easy operation.



These module cards have the reliability advantages of computer assembly printed circuit wiring and automatic insertion of components.



Another TR-600 innovation is the copper backplane which assures precise resting of modules.

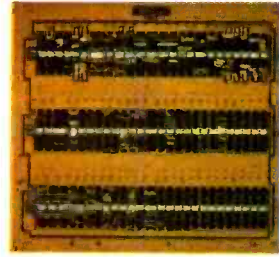

The backplane is wire wrapped under computer control replacing the past practice of using dense, bulky internal wiring harnesses.

Chimney cooling eliminates the need for blowers and a Venturi vacuum system replaces normally noisy vacuum pumps.

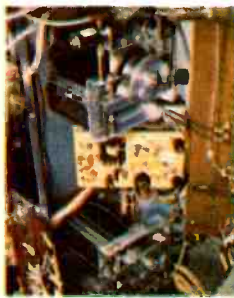

And for optimum playback performance our tape tension servo system features fast rewind and is gentle in handling of tape.

**Unfortunately, there are so many things we can't show you. Like all the TR-600's automatics. Because they're all built in. Like the splicer, too. Or the fact that its new integrated design reduces the number of components by 40%.**

**Nor can we show you the time and money the TR-600 will save you.**

**But, if what we've shown you so far looks good, we'd be glad to send you a more complete picture of the TR-600.**

**Write RCA Broadcast Systems, Bldg. 2-5, Camden, N.J. 08102. Get the picture, then compare.**

# RCA

## NEWS

There is no present evidence, the FCC said, of anti-competitive abuses arising from such combinations. But the FCC said that a continuing watch would be kept for any future abuses.

### FCC Invites Views of Educators on Cable

In a full-day Advisory Conference at the Federal Communications Com-

mission Offices recently, the Commission participated with twenty leaders in educational communications in an attempt to pin down what cable could and should be doing for education in this country. The FCC called the conference as an aid to the development of rules for cable television, described as an ongoing process.

### "ACCESS," New Newsletter, Offered by Johnson Group

A new newsletter covering the field of

"media reform" (challengers to broadcast licensees, etc), titled "access," is offered in a letter signed by Nicholas Johnson, former gadfly member of the FCC and now chairman of the National Citizens Committee for Broadcasting. The newsletter is the publication of NCCB headquartered in Washington. "Access" has been recommended by Dr. Everett Parker of the United Church of Christ, which has stopped publishing the "Broadcasting-Cable Consumer Newsletter," formerly the "house organ" of media reform advocates.

### NAB Sets Separate Radio Workshops for Fall

Separate radio programming workshops have been set for the 1975 Fall Conferences of the National Association of Broadcasters, Burns Nugent, executive vice president for station relations, announced recently. He said the workshops would deal with actual programming problems and solutions, with such session titles as How to Program to Today's Different Audiences; What Makes Your Listeners Tune In; Identifying the Hit Elements In Any Format; etc. The sessions will be directed by Bob Henabery, now operating his own program-development firm and before 1974, long-term program director for the ABC owned AM stations. The Fall Conferences are slated for Atlanta, October 12-14; Boston, October 15-17; New Orleans, November 9-11; Chicago, November 12-14; Denver, November 16-18; and San Francisco, November 19-21.

### FCC Asks Comment on New Radio Renewal Form

The Federal Communications Commission has issued for comment by the industry a proposed new renewal form for radio broadcast stations, Form 303-R. It has only 33 questions rather than the 61 relating to radio on the now-used Form 303, which is for both radio and television stations. The new form would be for radio only. The FCC said that even more questions might be eliminated as the result of ongoing studies of ownership reporting requirements and of automatic transmitters. (See preceding story on the latter inquiry.)

Radio broadcasters who would like to see the proposed new form and comment on it should ask the FCC for a copy.

### Television Effective in Patient Education

A program supplying a wide variety of health education topics to hospital patients continued on page 14

There are **2** great CHIRON systems

*providing titling...graphics for television production*

the

## CHIRON II Electronic Graphics System,

unquestionably the most advanced and versatile system available today... the one system that offers the highest character resolution and do-it-yourself capability for unlimited type font and logo preparation, plus more features than any other TV graphics equipment.

the

## CHIRON III Electronic Titling System,

only \$19,500. At this price, CHIRON III provides more flexibility and quality than higher priced units, including unlimited font and logo interchangeability, large message storage capability, and character resolution exceeded only by CHIRON II.

*For complete information and demonstration, call or write:*

# CHIRON telesystems

A Division of The Computer Exchange Inc.

11 Grace Avenue, Great Neck, New York 11021 • 516 829-5666  
235 Montgomery St., San Francisco, Calif. 94104 • 415 788-0600

Circle 106 on Reader Service Card

# Fernseh means television.

And television means bringing the best to the most. Even if you're not ABC, CBS, or NBC.

Take a look at camera number 3 in the picture.

It's our KCP-40, a straightforward, lightweight camera that offers performance equal to the finest broadcast camera system available (which happens to be our own KCU-40, camera number 1).

With remote operating controls as standard equipment, the KCP provides the incredible picture quality and lightness of weight that make broadcast applications such as 34 to 1 zoom shots from the Goodyear airship possible.

What's more, with a simple lens change, the KCP-40 camera head can be directly mounted on a Fernseh multiplexer for telecine applications.

Whether you're a broadcaster or a professional user, for the money you can't do better.

Because Fernseh *means* television.

We'd welcome the opportunity to demonstrate the superior capabilities of Fernseh television equipment. A call to your nearest office will bring any further information you require.

Saddle Brook, Headquarters (201) 797-7400

Chicago (312) 681-5000 Houston

(713) 688-9171 Los Angeles (213) 649-4330

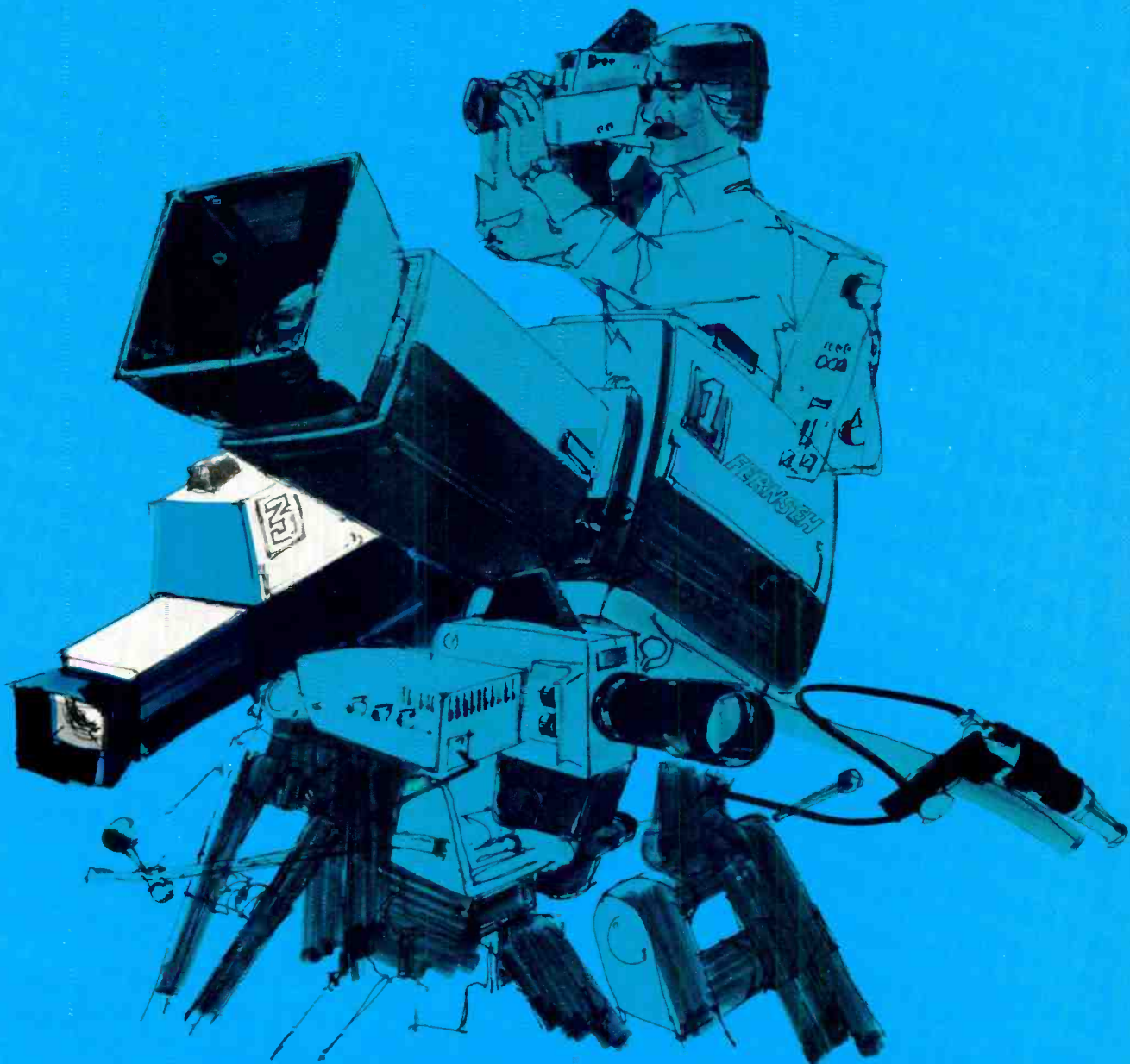

**FERNSEH** Robert Bosch Corporation

# Big Markets

Colorado Springs, Fort Myers, Sarasota, Tallahassee, Columbus, Elgin, Springfield, Belleville, Elkhart, Peru, Owensboro, Golden Meadow, Shreveport, Lewiston, Beacon, Jamestown, Utica, Asheville, Greensboro, Bismarck, Medford, Salem, Lebanon, Scranton, Wilkes-Barre, Austin, Everett, Fond du Lac . . .

# Small Markets

Los Angeles, San Francisco, San Jose, Hartford, Miami, New Orleans, New York, Raleigh, Tulsa, Portland, Seattle, Toronto, Windsor/Detroit, Sydney, Australia.

# BAT Systems Are Working!

They do all the Billing, Accounting, Traffic and Payroll work for AM's, FM's, AM/FM's, TV's, Radio/TV's, and Groups. And they do it faster, more accurately, and at less cost.

Get more information on these in-house, complete mini-computer systems. Write or call . . .

**PSI** *PAPERWORK*  
**systems inc.**

P. O. Box 38 2000 "A" St., Bellingham, WA 98225 (206) 733-8510

Circle 108 on Reader Service Card

## NEWS

tients via the hospital MATV system has been highly effective in transmitting the data to viewers, and in motivating them to watch the programs, says a report from the Wells National Services Corporation of New York. The program was carried out in five Indiana Hospitals in conjunction with the Indiana University School of Medicine. The program was evaluated for Wells by Throckmorton/Satin, New York marketing research firm. Among the topics patients liked best were: diabetes; sodium-restricted diet; rheumatoid arthritis; mouth-to-mouth resuscitation; VD; periodic health exam; self-examination of the breast. Wells is a subsidiary of the American Hospital Supply Corporation, concerned with communication systems in hospitals.

### Jones Intercable to Receive Satellite HBO Programs

Glenn R. Jones, president of Jones Intercable, Inc., Colorado cable management firm operating systems in Asapahoe and Jefferson Counties, Colorado, said recently that his firm would install a satellite earth station to receive programs from Home Box Office, in New York. Jones Intercable is the second system to sign up for the HBO satellite-transmitted programs; as reported in BM/E last month, UA-Cablevision will take the programs in a number of mid-west and western cities. Jones said that his firm is negotiating with Scientific-Atlanta for the construction of the earth station. "Home Box Office is to be commended for . . . supplying their programming via satellite," said Jones. "It is exactly what the CATV industry needs and the public . . . wants."

### Wall St. Journal To Use Satellite for Print Delivery

The Dow Jones Company, publishers of the Wall Street Journal, will transmit copy from Chicopee Falls, Mass., to a new printing plant in Orlando, Florida, via the satellite data service of the American Satellite Corporation, the latter company announced recently. An earth station will be built at each location. The daily copy will be sent initially at a rate of about 3 minutes per page. Dow Jones plans to print a part of the Wall Street Journal's eastern circulation at the Orlando plant.

### NBS To Show New Frequency Calibration

A new frequency calibration service developed by the National Bureau of

Standards will be explained and demonstrated by NBS at a one-day meeting June 10th, at the Sheraton-Boulder Inn, Boulder, Colorado. The new method uses color television signals to provide NBS-traceable calibration of oscillators quickly and easily. NBS will monitor the signals, compare them with atomic standards, and publish an average frequency offset for various periods, in the NBS Time and Frequency Services Bulletin.

NBS will also show at the meeting plans for two instruments that implement the calibration method. One is a color bar comparator, which can be constructed for about \$100 in parts, to produce an accuracy of one part in  $10^9$  in five minutes. The other, called the System 358 Frequency Measurement Computer, will allow calibration to less than three parts in  $10^{11}$  in fifteen minutes. NBS estimates that the FMC can be manufactured and sold for \$1500 to \$2000, including the color TV set.

Registration for the meeting, with a fee of \$15, should be addressed to NBS, Section 277.01, Boulder, Colorado, 80302.

### CBS Network Radio Goes To Alaska Via Satellite

Four more radio stations in Alaska joined the CBS Radio Network as affiliates in May, and began getting regular network broadcasts via the Canadian Anik II satellite, CBS announced in New York. The programs go to the satellite from Point Reyes, California, and come down to earth stations at Bartled, Juneau, and Nome.

The stations are KICY, in Nome; KJOB, in Juneau; KIFW, in Sitka, and KLAM, in Cordova. Added to KBYR, Anchorage, and KFRB, Fairbanks, which had earlier started carrying the CBS net broadcasts, the new stations will reach about 90% of the listeners in Alaska, CBS said. Programs being carried by all the stations include the CBS news of the hour, news features, and sports broadcasts. All but KLAM (which is daytime only) will also carry the CBS nightly Radio Mystery Theatre.

In addition, in the summer, 18 new 50-watt stations serving the construction camps along the Alaska pipeline will also carry the CBS network programs, brought in by microwave from Anchorage or Fairbanks.

### SMPTTE Open For Exhibits, Papers, for Fall Meeting

The Society of Motion Picture and Television Engineers opened booth space to applicants, and extended the deadline for papers to June 10th, both

continued on page 16

# IKEGAMI

## Portable Color Camera Systems

### Now Affiliates are joining the trend to real-time news...and higher ratings!



Model shown above is HL-33

### All four networks, dozens of independents and now the affiliates

are replacing film cameras with the Ikegami Camera System. Its NTSC video signal can go directly on the air. Or be taped and played without film delays. Your station gets a priceless "first with the news" image . . . and it shows up in the ratings. Proof: VARIETY reports the Ikegami is the first piece of hardware to have a substantial effect on news ratings in Chicago.

This is the only micro-mini electronic news gathering system that delivers the picture quality, reliability and ruggedness of film cameras. And it's truly portable . . . only 12 lbs. with an auxiliary backpack of 22 lbs. Operating costs are much lower than film, too. Join the trend. Be the first "instant news" station in your market. With the Ikegami Portable Color Camera System.



Ralph L. Hucaby  
Vice President  
Director of  
Engineering  
WLAC-TV, Nashville  
(CBS affiliate)

"Our Ikegami cameras deliver better picture quality than we got with color film . . . live! We're broadcasting four or more real-time news feeds a day from remote vans, via microwave links. Color is strictly broadcast quality. These little portables have surpassed all my expectations in stability, quality and ruggedness."

"Our switch to live news has created more talk in town than any technical programming change we've ever made!"

For more information or a complete demonstration write to Ikegami today.



### IKEGAMI ELECTRONICS (USA) INC.

29-19 39th Avenue ■ Long Island City, New York 11101 ■ Telephone: (212) 932-2577

Circle 109 on Reader Service Card

# The ALL FOCUSING Quartz Location Lighting Kit

The AERO-KIT  
... ideal for  
on-location  
filming  
and still  
photography.

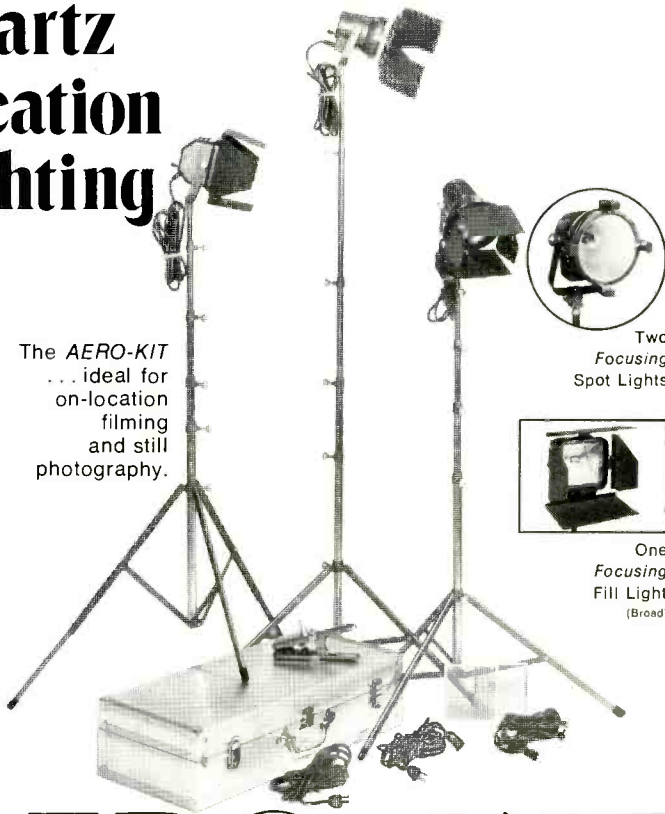

Two  
Focusing  
Spot Lights



One  
Focusing  
Fill Light  
(Broad)

## AERO-KIT

Compact enough to slide under an airplane seat or fit easily in the trunk of a small car.

The compact AERO-KIT, which weighs less than 31 lbs., includes two focusing spot lights with two detachable rotating four-way barndoors; one focusing fill light with integral four-way barndoors; two scrims; three 10 ft. long three-wire cables (with in-line switches); three 15 ft. long three-wire extension cables; one gator grip; three professional-type stainless steel light stands; and a sturdy aluminum carrying case, measuring only 6½" x 12" x 26½".

The light stands (10 ft. high when fully extended, and 24" high when telescoped) are specially designed with adjustable legs which permit easy and stable placement of the light stands on uneven ground surfaces.

The two focusing spots and focusing fill light (equipped with new and improved quartz lamp sockets which are extremely heat resistant) operate at 120-volts AC/DC with 600-watt lamps, and can also be used with 250-watt lamps for 30-volt battery operation.

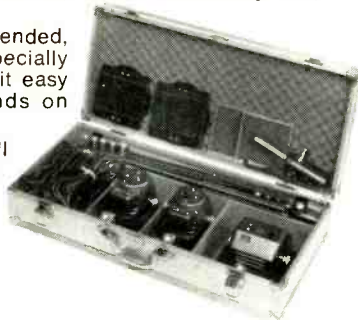

For further information, please write to:

**Cinema E products**  
CORPORATION

Technology In The Service Of Creativity

2037 Granville Avenue, Los Angeles, California 90025  
Telephone: (213) 478-0711 ■ Telex: 69-1339 ■ Cable: Cinedevco

## NEWS

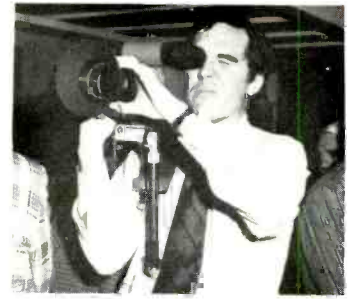

### Mini News Camera— A "Game Saver"

The Ikegami portable mini news camera demonstrated its all-around flexibility at the Houston Astrodome recently. WTCG-TV Operations Manager, Bob Doty, was getting ready to carry the season's opener between the Houston Astros and the Atlanta Braves to the 10-station Braves TV network when he discovered the afternoon prior to the opener that their mobile equipment had been sidetracked somewhere outside Houston.

A quick check of the Houston TV stations revealed that there was no other local mobile equipment available with the exception of an Ikegami portable mini-news camera at station KPRC-TV, the NBC affiliate in Houston.

Doty tried to contact Jack Harris, proxy of KPRC-TV, who happened to be at the NAB convention in Las Vegas. Then he tried Jack McGrew, number two man at the stations who, ironically enough, had left for the ball game. Finally, Doty located Ray Miller, KPRC-TV New Director, who gave the OK to use his highly prized mini-news camera as a pinch-hitter for the regular equipment.

A two man KPRC-TV team made all the necessary hook-ups and when the umpire cried "Play Ball," the video arrangements had been made to feed the WTCG-TV-Atlanta Braves network. Perhaps the first time in TV history that a season's opener had been covered by a single camera—and a mini-portable electronic camera at that.

The results of the one-camera coverage were "excellent" according to station executives in Atlanta and the two-man crew managed to catch most of the highlights of the action packed opener which was won by Houston. The Atlanta Braves audience thought the coverage fine as there were no complaints from viewers.

for the upcoming 117th Technical Conference which will run September 28 through October 3rd at the Century Plaza Hotel in Los Angeles.

continued on page 18



Signal in  
Signal out  
as simple as that. . .

## NEC Frame Synchronizers

The basic reasons might be different, but finally, everyone will agree — REMOTE SIGNALS need NEC frame synchronizers.

For station management, there is long-term cost reduction and saving . . . and improved broadcast quality with resultant increased revenues. For production, there is the simplicity of automatic synchronization. PLUS, there is the optional "joy stick" remote control that allows reducing the key shot to a fourth of its original size and then freezing it . . . anywhere in the raster. And for station engineering, there is the pleasant realization that disruptive genlocking and the limitations of rubidium standards are things of the past.

The NEC frame synchronizer, whether it is the standard sized FS-10 or the portable FS-12 model, allows a broadcast station to accept and handle a remote, asynchronous signal as an in-plant/in-time source for broadcasting . . . as simple as that.

*Nippon Electric Company, Ltd., extends its appreciation to the Academy of Television Arts and Sciences for the award of Outstanding Achievement in Engineering Development, which was presented 19 May 1975 at the Academy's Annual Awards Ceremony. This is a highly appreciated recognition.*

*Thank you.*

TeleMation is the North American Representative for Nippon Electric Company, Ltd., frame synchronizer products. For complete details, call (801) 487-5399.

 **TeleMation**  
P. O. BOX 15068, SALT LAKE CITY, UTAH 84115, (801) 487-5399

Circle 111 on Reader Service Card

# AUDIOWAVES

Programming by the numbers.

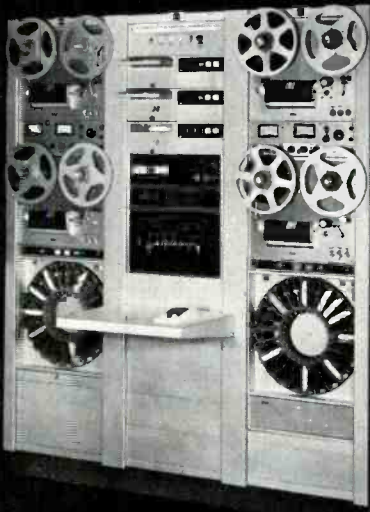

An RCA audio automation system lets you put up to a week's programming in operation by pressing one button.

Because of the latest digital approaches like an MOS memory and full use of FET's, you get a system that can program anywhere from 2000 up to 8000 random events. From up to 92 sources.

And RCA systems sound live because of our voice track synchronization, announceover and fadeout capabilities.

Your RCA representative can help you plan your system. RCA Broadcast Systems, Camden, N. J. 08102.

## RCA

Microphones • Consoles • Tape and Transcription Equipment  
Automation Systems • Amplifiers and Speakers

Circle 112 on Reader Service Card

## THE NEW STANDARD COVERS AM BAND PLUS HARMONICS TO 5 MHz



The Model FIM-41 Field Strength Meter has many more features —

- Measures Harmonics to -80 dB
- High Adjacent Channel Rejection
- Ganged Oscillator/Receiver Tuning
- Stable Operation over wide Temperature Range
- Low Battery Drain Circuits
- Front Panel Speaker
- Large illuminated Meter and Tuning Dial
- Indicates field strength accurately down to 10  $\mu$  volts/M
- RF input jack for tuned voltmeter applications

CONTACT US NOW FOR COMPLETE DETAILS  
ON OUR LINE OF FIELD STRENGTH METERS

## POTOMAC INSTRUMENTS

932 PHILADELPHIA AVE.  
SILVER SPRING, MARYLAND 20910 (301) 589-3125

Circle 113 on Reader Service Card

## NEWS



### They Recondition, Guarantee "Used" Videotape (Women Run the Company, Do Most of the Work)

Do you want 92 minutes worth of quad videotape, with a guarantee of no edge damage and no area defects, for \$175? Obviously it is used tape, but just as obviously it should perform satisfactorily—if the guarantee is an accurate indication of the tape's condition.

Evidently, the guarantees of STE (Studio Tape Exchange), which has offices in New York and Studio City, Calif., have been convincing, because the firm has recently hit a \$1 million-a-year sales rate, and confidently hopes for \$2 million in 1975. The outfit uses a Recortec Videotape Evaluator, now in operation three shifts a day, to clean tape thoroughly as it comes in, and to spot tape defects with a paper read-out showing exactly what and where the defects are.

The tape is then classified according to its condition. There are several classes below the "Certified Master," or AA, with no defects, noted above; prices go down as defects go up. In every case the customer knows exactly what he is getting.

Now, as to those women in the headline: president of STE is Carole Dean, and the growth of the operation is all the testimony she needs to her effectiveness. Among the other nine women in the small company are the three shown with Ms. Dean in the accompanying photograph. STE's ballooning repeat orders for tape mean, of course, that these staff members are all working with care.

Since the SMPTE will hold only one technical conference this year rather than the two of recent years, a heavy demand for exhibit space is expected and exhibit chairman Warren Strang, of Hollywood Film Company, advised manufacturers who want exhibit space to apply soon. A sell-out, he said, is probable.

To submit a paper, the author should forward to SMPTE by June 10th a 500-750 word summary, with the final manuscript due no later than August

continued on page 20

# THE ADC 553

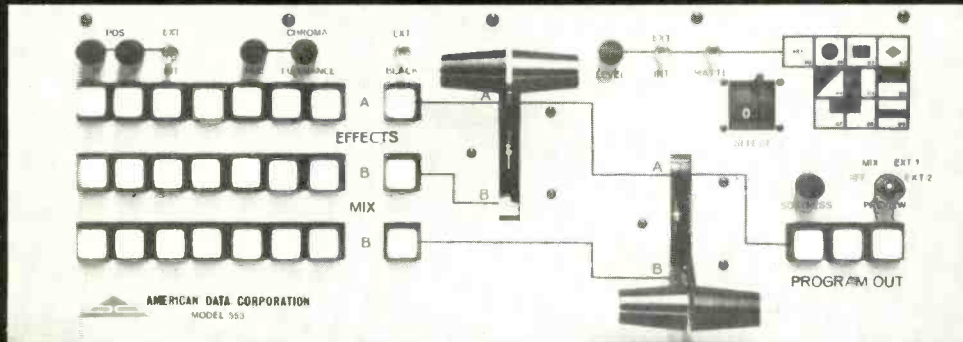

## A TOTALLY NEW PACKAGE DESIGNED ESPECIALLY FOR:

- ★ THE LARGE MARKET
- ★ THE SMALL MARKET
- ★ THE MEDIUM MARKET
- ★ CABLE, CCTV, MOBILE
- ★ ONLY \$3,950

The ADC Model 553 Vertical Interval Color Production Switcher is designed to provide small studio and remote van operators with a broadcast quality switching system that incorporates the latest state-of-the-art advances. SOFT WIPE and LINEAR KEY are standard features, but a new development from ADC allows the combining of two 553 systems for a system of unmatched capability and economy.

The special effects generator provides nine wipes, including a circle, square, diamond, diagonal, H&V splits and corner inserts. In key mode, the special effects generator provides a choice of self or matte key on internal or external sources, and an external chroma keyer may be used on the external input. True SOFT WIPES are provided, with control for degree of softness. The keying system is LINEAR in nature so that edge crawl and key breakup are minimized.

The Model 553 is self-contained and designed to mount in a standard 19 inch console or rack housing. Input selector buttons are momentary contact, illuminated with relegendable lens caps. A blackburst and color background generator is included in the switcher to provide fades or wipes to any color or black, and in conjunction with the matte keyer, will provide colored insert keying.



**AMERICAN DATA CORPORATION**

AN **AIRPAX** COMPANY

315 WYNN DRIVE, N.W. P. O. BOX 5228 HUNTSVILLE, ALABAMA 35805 TEL. 205-837-5130

1729 WILMONT DRIVE  
ATLANTA, GA. 30329  
404-633-2100

5500 WATERWAY  
ROCKVILLE, MD. 20853  
301-480-1454

3250 WILSHIRE BL. STE 900  
LOS ANGELES, CA. 90010  
213-387-7756

2908 MULBERRY  
PASADENA, TX. 77502  
713-941-7272

**AIRPAX ELECTRONICS**

Cambridge Division  
Cambridge, Md.

Circuit Breakers & Switches

Controls Division

Ft. Lauderdale, Fla.

Telemetry & Control Instrumentation

50 db

55 db

60 db



65 db

# DYNASCIENCES Image Enhancers

## SPECIFICATIONS

Random Noise:	better than 60db rms below 1V p-p
% Enhancement:	0 - 175%
Differential Gain:	1% maximum
Differential Phase:	1° maximum
Frequency Response:	flat within $\pm 1/2$ db from 60 Hz to 4.3 MHz, $\pm 1$ db to 6 MHz
Maximum Gamma Change:	from zero to maximum detail - 2%
Low Frequency Tilt:	less than 1% with standard window

For further information, write or call:

# DYNASCIENCES

A SUBSIDIARY OF

# Whittaker

## video products

TOWNSHIP LINE ROAD • BLUE BELL, PA. 19422

Telephone: (215) 643-0250 • Telex: 84-6358

## NEWS

8th. Applications for exhibit space and summaries of proposed papers should both be sent to SMPTE at 862 Scarsdale Ave., Scarsdale, N.Y. 10583.

## News Briefs

**Microwave Associates** have put into operation a mobile van for demonstrating their remote pickup equipment, to customers and at conventions, and supply emergency remote pickup service . . . **Conrac Corp.** will install in a new 18,000-seat sports arena, the Summit, in Houston, a Telescreen display system with two 15' x 20' screens, one at each end, for game close-ups, each flanked by two 12' x 12' screens, for advertising . . . **Cinema Products Corp.** will hold a maintenance training seminar for their CP-16 cameras on September 26-27, in Los Angeles, just prior to the SMPTE fall meeting in that city (info from CP at 2037 Granville Ave, Los Angeles 90025).

**Sony Corp.** got a Technical Achievement Award from the International Industrial Television Association for the Model 2850 U-Matic recorder/player . . . **MarketDyne International**, Philadelphia, announced a program of supplying film distributors with U-Matic versions of their material, and distributing them to cassette-equipped users.

**Stanford Research Institute** will issue an up-dated version of their forecast of cable growth through 1985; the new report is due in July, 1975 (address: Menlo Park, CA, 94025)

. . . **Scientific-Atlanta** announced sale of their line of terrestrial microwave antennas to Cablewave Systems, Inc; the latter firm will immediately make available the UDA, DA, and DAX antennas developed by Scientific-Atlanta . . . **Shintron Company** has opened a West Coast facility at Thousand Oaks, CA, for complete sales and service of its lines of video equipment.

The **Society of Broadcast Engineers** have moved their editorial office to Washington, with Mrs. Jeanne Smith, of Smith and Powstenko, as editor, to whom all releases, reports, etc should be sent (address: 2000 N Street, NW Washington 20036) . . .

**Marconi Electronics** has sold one of their model B3404 telecine units to the Student's International Meditation Society, at Livingstone Manor, New York; the SIMS already has five Marconi Mark VIII studio cameras, used to aid the dissemination of Trans-

continued on page 66

# If you're editing just one half-hour show a week, our off-line System/50 will cut your costs in half.

Many System/50 video editing systems are installed at the networks, teleproduction houses and television stations in Hollywood, Burbank, New York and elsewhere.

Their performance is now a matter of record. Their cost effectiveness/efficiency is also a matter of record. It's impressive.

As an example, the average half-hour show requires about 16 hours of on-line editing at a cost of \$300 per hour. That's \$4,800. Our CMX System/50 off-line editing system will accomplish the same job averaging 18 hours per show at \$100 per hour plus \$600 for auto assembly. The total: \$2,400... a 50% reduction.

Another interesting fact. These savings for a year's production would more than pay for the total cost of a System/50.

Applicable to electronic journalism? Naturally.

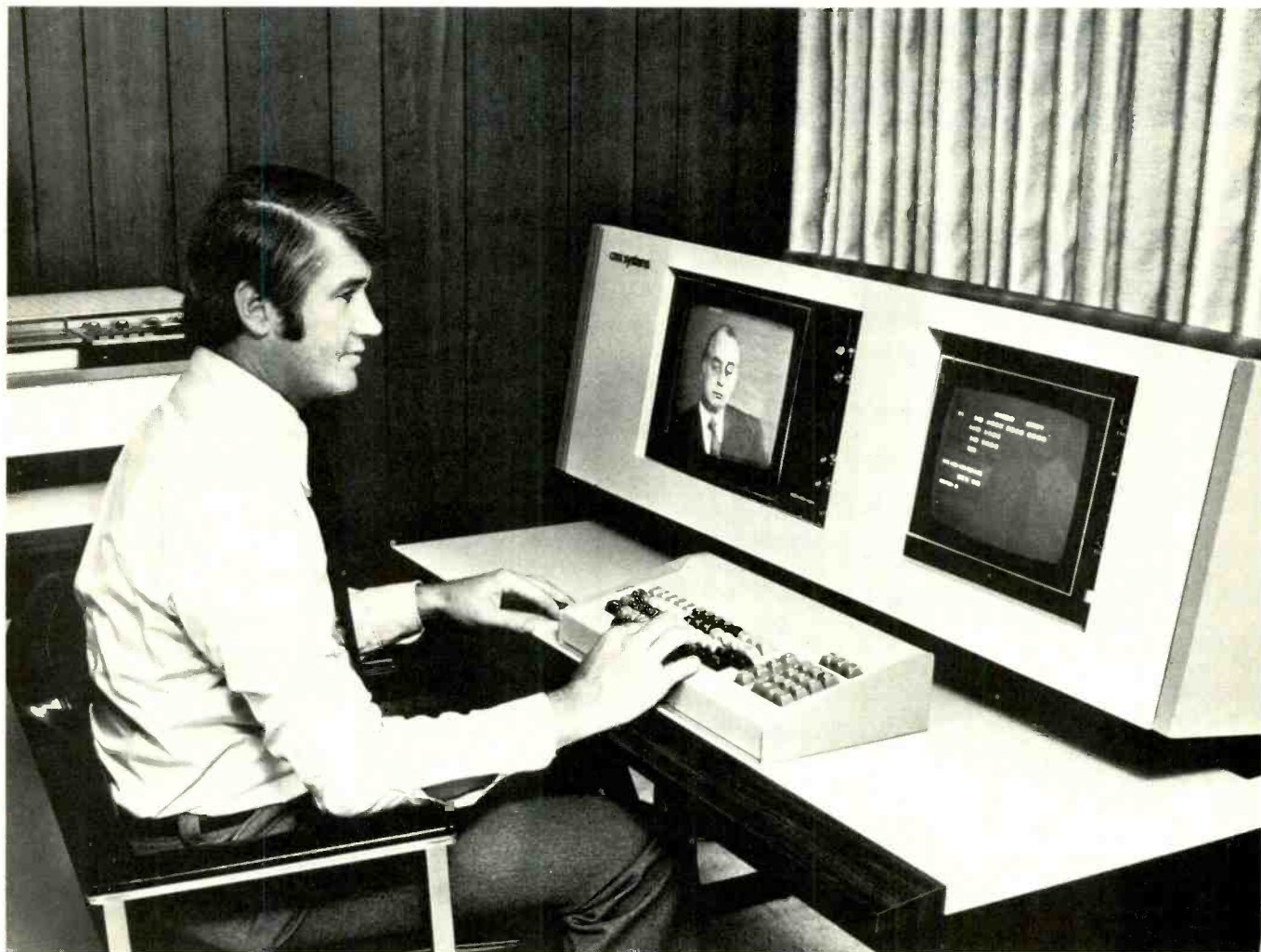

**SALES AND SERVICE**  
New York (212) 371-1122  
Los Angeles (213) 980-7927  
Dallas (214) 242-2690

**cmx systems**

CMX Systems, an ORROX company,  
635 Vaqueros Avenue, Sunnyvale,  
California 94086, (408) 245-8450

Circle 116 on Reader Service Card

# INTERPRETING THE **FCC** RULES & REGULATIONS

## Programming Of Violent, Indecent And Obscene Material

Since the first of the year, certain significant steps have been taken to more clearly define the troublesome parameters of programming which falls into the "indecent" and "obscene" categories prohibited by Federal law. First, the Commission issued (1) its *Report on the Broadcast of Violent, Indecent, and Obscene Material*,<sup>1</sup> and (2) a declaratory order in the *Citizen's Complaint Against the Pacifica Foundation Station WBAI (FM), New York*.<sup>2</sup> Second, the U.S. Court of Appeals for the D.C. Circuit issued an important supplemental opinion in the *Illinois Citizens Committee for Broadcasting, et al. v. FCC and U.S.* case.<sup>3</sup> Each of these Federal actions sheds new light on the ever-changing boundaries of what programming and speech is prohibited or permitted to be broadcast over the public airwaves. A brief background and discussion of same and its effect on individual broadcasters follows.

### Background

In 1948, the U.S. Congress passed legislation which prohibited the dissemination of "obscene, indecent, or profane language by means of radio communication" and imposed a punishment of up to \$10,000 fine or imprisonment of up to two years.<sup>4</sup> Its language was derived from Section 326 of the 1934 Federal Communications Act which expressed that this prohibition was *not* to be construed as giving the Commission the power to censor or interfere with programming content. Recognizing its obligation to enforce Section 1464, the Commission stated that, upon finding violations, it was empowered to

(1) revoke a station's license, (2) issue a cease and desist order, or (3) impose a monetary forfeiture. (It should be noted in this context that the Commission will ask Congress for a law which will eliminate any uncertainty as to whether the agency has statutory authority to proceed against video and cable depiction of obscene or indecent material.) Thus, pursuant to congressional directive and its own enforcement powers, the Commission has struggled over these past few years to define an objective standard for broadcasters and cablecasters of "obscene, indecent, or profane" language and programming. The Commission's *Report on the Broadcast of Violent, Indecent and Obscene Material* and its action in *Pacifica* are natural steps in this progression.

### FCC Report

Spurred by an increase in citizen complaints about violent or sexually-oriented programming from 2,000 in 1972 to 25,000 in 1974, the Commission undertook a study of specific solutions to these programming problems. This focused upon two essential questions: (1) what steps might be taken to prohibit the broadcasting of obscene and indecent material and (2) what steps might be taken to protect children from sexually-oriented or violent material which might be inappropriate for them. Pursuant to meetings and policy recommendations from the three networks and the NAB Television Code Review Board, the Commission established the following guidelines, equally applicable to *broadcasters* and *cablecasters*, for the Fall 1975 television season:

(1) *Scheduling*. A "Family Viewing" period is designated to include the first hour of network entertainment pro-

<sup>1</sup>32 RR 2d 1367.

<sup>2</sup>32 RR 2d 1331.

<sup>3</sup>33 RR 2d 117.

<sup>4</sup>18 U.S.C. §1464.

continued on page 24

# remote or studio?

JVC's complete color recording system...

BUY A JVC COLOR PORTABLE NOW!  
**CASH REBATES**  
 FOR NAME OF LOCAL DEALER CALL  
 NEAREST JVC OFFICE OR USE COUPON  
 offer expires June 30, 1975

On the spot video coverage or preparing a program in the studio . . . the JVC PV/GC 4800 system keeps you ready for any situation. Grab the camera and 1/2" EIAJ-1 recorder and go into the field with only 28 pounds of equipment and record audio and video in color under battery power.

Or use the same equipment to set up under the lights in your studio for program taping. Add the color camera adaptor provided and tape directly into a 3/4"U video cassette recorder or other video equipment. Either way you'll have a complete system offering high resolution . . . low power consumption . . . and simple operation. Call your video dealer for a demonstration.

JVC Industries, Inc., 50-35 56th Road, Maspeth, N.Y. 11378, Tel.: (212) 392-7100. In Chicago: 3012 Malmo Dr., Arlington Hgts., IL. 60005, Tel.: (312) 593-8997. In Los Angeles: 1011 W. Artesia Blvd., Compton, CA. 90220, Tel.: (213) 537-8230.



PV/4800 EIAJ-1 tape deck for use with camera.

*JVC Best by Design*

# JVC

## JVC INDUSTRIES, INC.

Circle 117 on Reader Service Card for demonstration  
 Circle 118 on Reader Service Card for more information

JVC Industries, Inc. • 50-35 56th Road  
 Maspeth N.Y. 11378 • (212) 392-7100

**BM/E75**

Please send me information on:

- Complete system
- Camera
- VTR
- Please arrange a demonstration

Name \_\_\_\_\_

Title \_\_\_\_\_

Organization \_\_\_\_\_

Address \_\_\_\_\_

City \_\_\_\_\_

State \_\_\_\_\_

Zip \_\_\_\_\_

Telephone \_\_\_\_\_

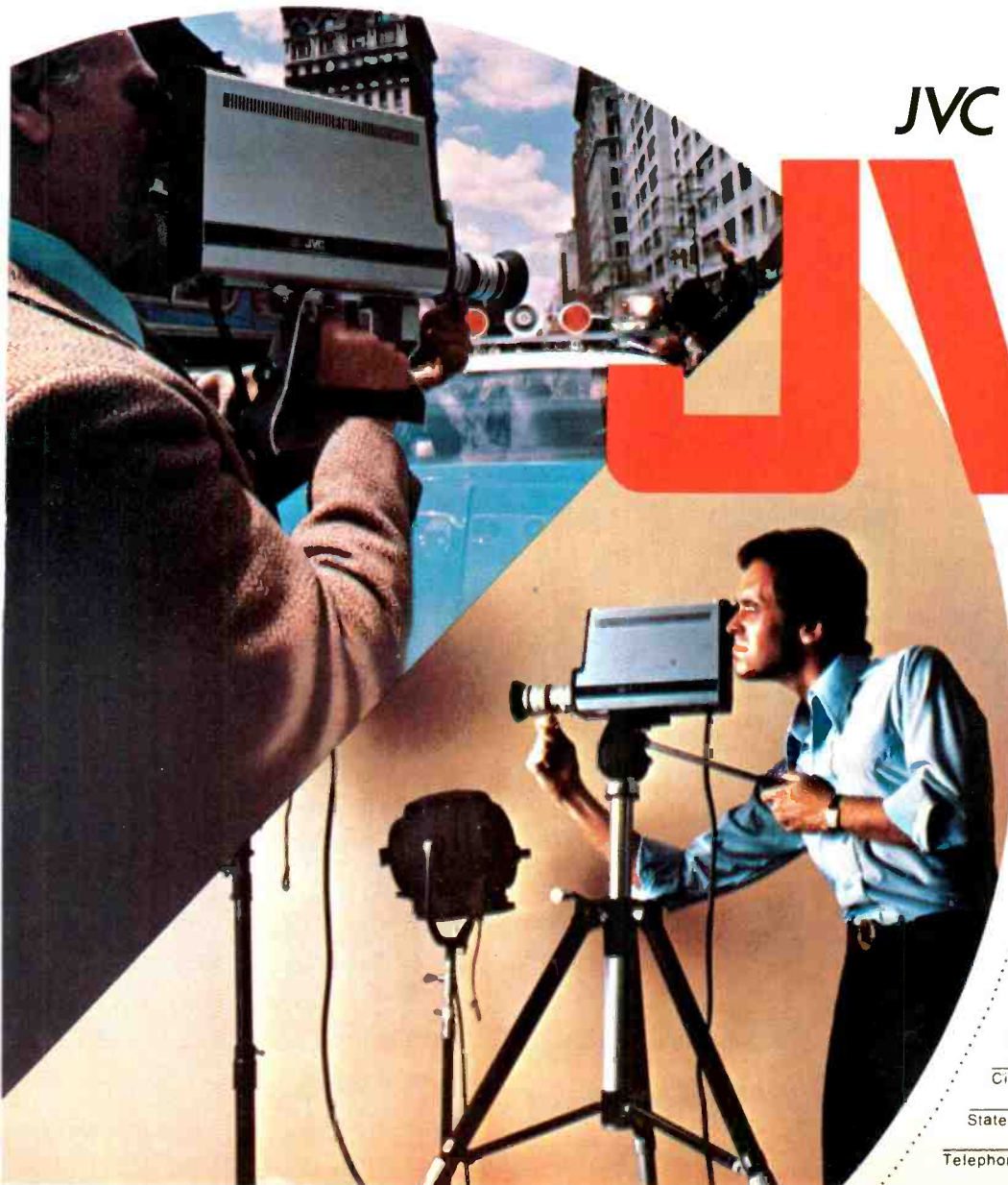

## FCC RULES AND REGS

gramming in prime time and the immediately preceding hour. In effect, this would include the period between 7 pm and 9 pm Eastern time during the first six days of the week. (This special period would also ordinarily end at 9 pm in Los Angeles, at 8 pm in the Midwest, and as early as 7 pm in portions of the Mountain Time Zone.) On Sunday, the "Family Viewing" period will begin and end a half-hour earlier, for the obvious reason that network programming typically begins at a different time.

(2) *Warnings.* In the occasional case when an entertainment program broadcast during the "Family Viewing" period contains material which may be "unsuitable" for viewing by younger family members, licensees shall broadcast in audio and video form "viewer advisories" to warn viewers of same. In addition, "viewer advisories" shall be used in later evening hours for programs which contain material that might be "disturbing" to significant portions of the viewing audience. Naturally, the determination of what programming might be "unsuitable" or "disturbing" is a matter of judgment on the part of the licensee.

(3) *Advance Notice.* Licensees are also directed to notify publishers of television program guides as to programs which will contain advisories. Responsible use of "advisories" in promotional materials is also advised. The Commission takes special care to urge licensees not to commercially exploit or use in a titillating fashion the "program advisories" and "advance notices" that function as a notice or warning that violent or sexually-oriented material will be presented. In addition, licensees are advised not to be "unreasonably expansive" in their choice of programming suitable for family viewing.

Hence, the Commission's Report promotes industry self-regulation over the straight-jacket of restrictive

rules, thus obviating encroachment into constitutionally-protected areas and avoiding a labyrinth of confusing and difficult enforcement problems.

### Pacifica Case

The Commission used a citizen complaint against Pacifica Foundation Station WBAI (FM), New York, to clarify its applicable standards on "indecent language." In *Pacifica*, the Commission found that the broadcaster's playing of an album by comedian George Carlin during an afternoon programming hour, in which Carlin satirized certain sexual expletives ("f . . .," "m.f.," "s . . .," etc.), fell within the 1464 prohibition. The Commission premised its decision on the finding that such language was not so much "obscene" as it was "indecent." "Indecent" language is distinguished from "obscene" language in that (1) the former lacks the element of appeal to the prurient interest<sup>5</sup> and (2) when children may be in the audience, it cannot be redeemed by a claim that it has literary, artistic, political, or scientific value.<sup>6</sup> Hence, the Commission is employing an "indecency" definition which comports with the realities of both radio transmission and constitutional law.

Despite the fact that Pacifica had specifically announced, immediately prior to the broadcast of the Carlin album, that it included language that listeners

<sup>5</sup>WUHY-FM, 24 FCC 2d, at 412.

<sup>6</sup>See *Ginsberg v. New York*, 390 U.S. 629 (1968).

## Profitable programming begins with Automated Systems from SMC

Make the most profit possible. Automate with a complete system from SMC—world's largest maker of broadcast automation equipment.

Choose from digital or sequential systems, or a customized system built and designed to meet your specific needs to help you realize more profit plus greater format control.

SMC can help you plan and finance an automated system that fits your budget and operation. SMC also has information on every major music format. Phone us today—or return the coupon below.



### Systems Marketing Corporation

1019 West Washington Street  
Bloomington, Illinois 61701  
(309) 829-6373

*Broadcast Automation—our only business*



**YES! I want to profit through automation.**

Send complete information  
and have your Representative call me.

Name \_\_\_\_\_

Station \_\_\_\_\_

Address \_\_\_\_\_

\_\_\_\_\_ Zip \_\_\_\_\_

Phone (area code) \_\_\_\_\_

75-102

Circle 119 on Reader Service Card



might regard as offensive, the Commission stated that such did *not* relieve the station of its burden. Stating that broadcasting required special treatment under the concept of "variable obscenity," the Commission cited four specific reasons for holding the station in violation of Section 1464: (1) children had access to radios and in many cases were unsupervised by parents; (2) radio receivers are in the home, where people's privacy interest is entitled to extra deference; (3) unconsenting adults might tune in a station without any warning that offensive language was being broadcast; and (4) with the scarcity of spectrum space, the government must license in the public interest. In a word, because of the "intrusive" nature of the broadcast medium, the Commission is attempting to *channel*, rather than *prohibit*, language that "describes in terms patently offensive (as measured by contemporary community standards for the broadcast medium) sexual or excretory activities and organs, at times of day when there is a reasonable risk that children may be in the audience."

For the *radio* licensee, the lessons of *Pacifica* are well worth noting:

(1) If the broadcaster has an interview or album containing objectionable language on tape or film, he'd be wise to refrain from broadcasting same. That the performer or interviewee has spoken spontaneously no longer prevails as the issue; the *broadcaster* has had time to consider the interview's contents and, unlike the interviewee, has a *choice* of whether or not to air it.

(2) Although the broadcaster's *forewarning* his audience that an interview or album includes language that may be regarded as offensive may help mitigate Commission sanctions, such will not, alone relieve him of his "public interest" responsibilities. "Warnings" are no substitute for the exercise of sound judgment and discretion which reasonably comports to the interests of the listening audience and children.

(3) If a broadcaster desires to program "marginal" material, he would be wise to schedule such programming for the late evening hours (after 10 pm), when the number of children in the listening audience is at a minimum. However, this, alone, will not insulate him from possible Commission sanction if his judgment is in error.

#### Illinois Citizens Case

The District of Columbia Circuit Court of Appeals issued a supplemental opinion in *Illinois Citizens Committee for Broadcasting v. FCC* making it clear that representatives of the *public* have a role in FCC proceedings concerning obscenity determinations. The Court directed the Commission to adopt, in its deliberations leading to any substantive determination of "obscenity," approaches that provide the functional equivalent of a jury determination of a "clear community consensus that the material is lewd and offensive."

Hence, taken together, the *Pacifica* and *Illinois Citizens* cases underscore the right of listeners who consider themselves aggrieved, or who wish to call additional factors to the Commission's attention, to *petition* the Commission and have their complaints heard. Such obviously places an even greater burden on the licensee to program in the "public interest" in the larger and more effective use of the broadcast media. Thus, with the Commission reacting to strong citizen and Court pressure, and drawing more clearly objective standards for television, cable and radio programming, the broadcaster would be wise to seek the advice of counsel whenever a 1464 problem is anticipated, or when it arises. **BM/E**

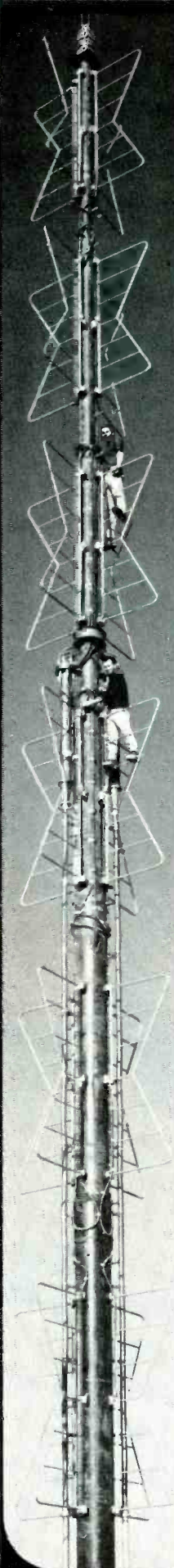

**800  
VHF**

**Broadcasters  
can't be wrong!**

Here's the time-proven favorite television antenna of over 800 VHF broadcasters in the United States, Canada and Mexico, improved by Jampro, using galvanized steel poles and beryllium copper feed straps. Available in low and high power versions to meet your power and budget requirements. Copper heliax inter-bay cables provide trouble-free service in salt laden air, sulphuric and other corrosive atmospheres.

Jampro has delivered these turnstiles for dual channel use, with 70 KW total power. For example channels 4 & 5 Mexico City, deliver 100 KW on each channel. The best costs no more. Compare before you buy or specify your next batwing turnstile for FCC channels 2-13 or CCIR band I and III.

Accessory items for these antennas include medium to high power quadrature diplexers with over 30 DB isolation. Electrical deicers are also available, together with coaxial transmission line and supporting towers.

J  
A  
M  
P  
R  
O

**JAMPRO  
ANTENNA  
COMPANY**

A DIVISION  
OF COMPUTER  
EQUIPMENT  
CORPORATION

Phone  
(916) 383-1177

6939 Power  
Inn Road

Sacramento,  
California  
95828

Circle 120 on Reader Service Card

# OHIO OR OKLAHOMA...IT'S

**WKY-TV at the game in Oklahoma  
Bowling Green State University, the**

The Marconi Mark VIII-B Camera is in wide spread use in the U.S. and around the world. Marconi, innovators in camera technology since 'Day One.' First with automatics—complete line up—even a self-diagnostic check-out facility.

**BEST PERFORMER**

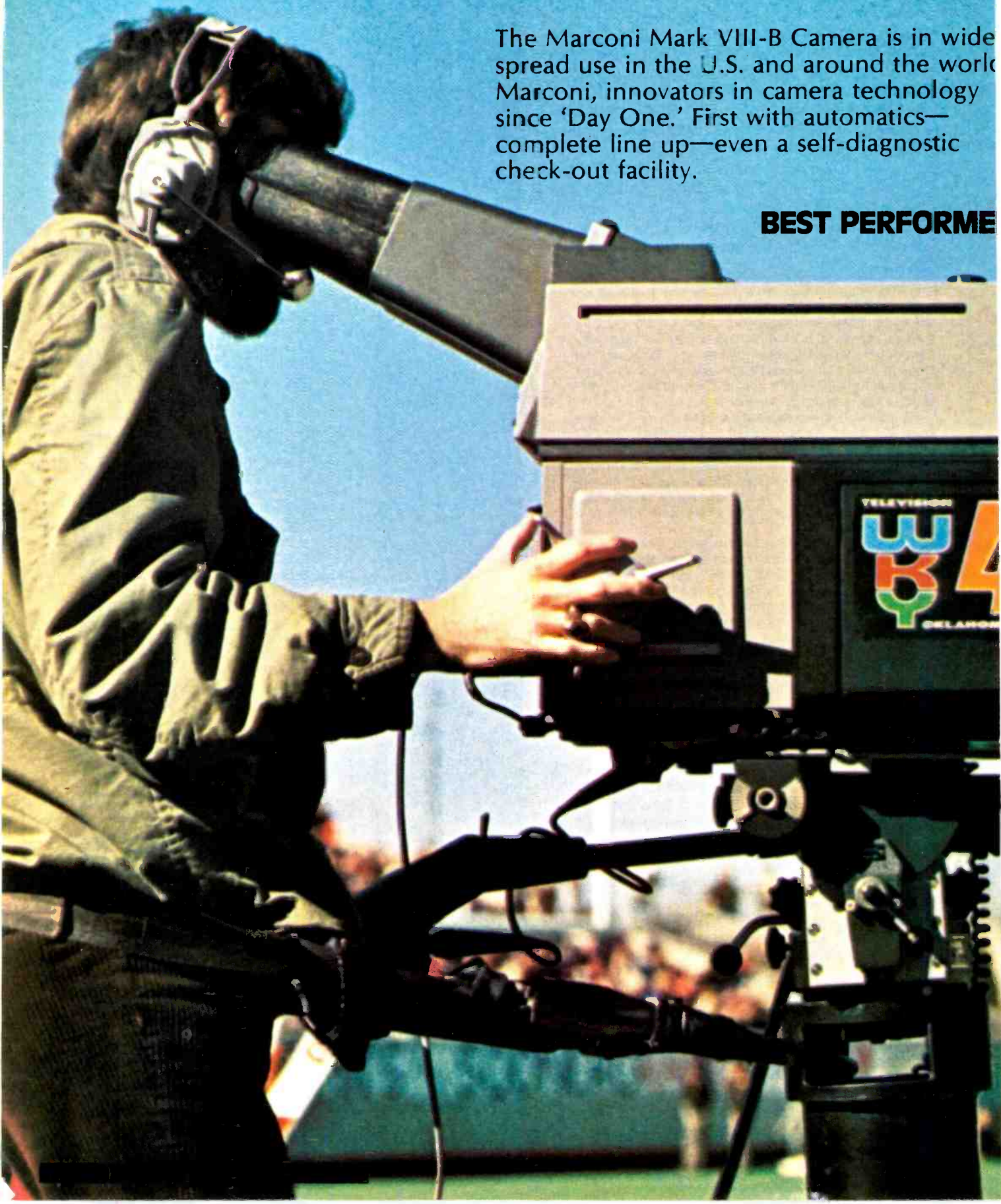

# MARK VIII-AUTOMATICALLY

For WBGU-TV programming at  
Mark VIII-B Camera wins every time.

- World's first fully automatic color camera
- Super-Sensitive. Saving studio energy by operating at f/4.0 in 75 f.c. Or operating on remotes when others quit
- Small and lightweight, using 1/2-inch cable
- Always making 'Big-Picture' pictures

**AUTOMATICALLY**

**AND NOW, MARK VIII  
QUALITY IN A PORTABLE!**



**Marconi  
Electronics Inc.**

1309-J Stone Mill Court,  
Stone Mountain, Ga. 30083. (404) 469-7471

Executive Office: 100 Stonehurst Court  
Northvale, N.J. 07647. (201) 767-7250

Programming WBGU-TV

Circle 121 on Reader Service Card

# Small is sometimes BIG ENOUGH!

Central Dynamics Introduces  
the New VS-10  
TV Color Production Switcher  
for Mobile, CATV, Industrial  
and Educational Applications

Priced at Only \$3350,  
we believe it represents  
a major value break-  
through for professional  
programming with true  
broadcast quality

You don't always have to be big and sophisticated to make it as a TV Color Production Switcher. The low cost VS-10 is an 8-input, 3-bus, compact, self contained, vertical interval, solid state switcher with ample sophistication for professional programming with true broadcast quality. Impressive special effects, mix amplifier, wipe/key amplifier, output selector and broad operational capabilities provide real production talent. A unique automatic special effects preview allows presetting keys and wipes for smooth, dramatic transitions to effects. The VS-10 lets you chroma key, matte key, wipe or dissolve to keys, dissolve or wipe between program sources, dissolve to special effects, or insert titles. Other standard features include a Cut Bus and true On-Air tally system. The VS-10 is compatible with NTSC, PAL-M and PAL color systems. All this... plus the proven reliability of the largest and most sophisticated Central Dynamics Production Switchers.

Sometimes . . .  
**SMALL is Big Enough!**

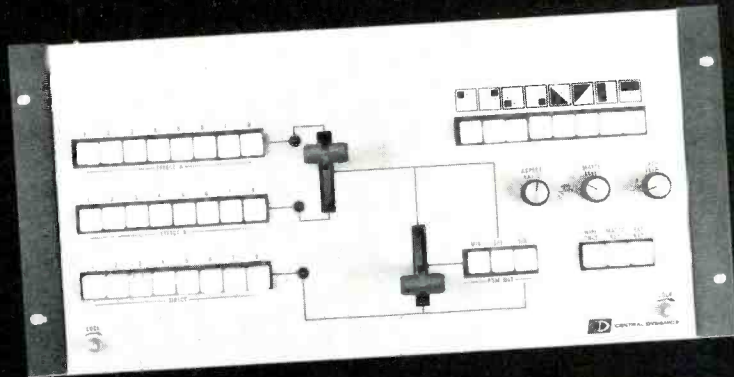

## Control Features

- Wipe** - Fader positions A & B signals. Aspect Ratio Control varies configuration of 4 corner patterns.
- Keys** - Wipe Keys on or off. Key Level Control adjusts slicing level of key signals. Matte Level Control adjusts luminance value
- Mix** - Fader proportionally controls output signals from the Direct Bus and the Key/Wipe Amplifier.
- Switches** - Crosspoint and Output Selection switched in vertical interval with illuminated momentary pushbuttons. Wipe, Key Mode & Pattern switches are mechanically interlocked pushbuttons. Tally lights on each input bus indicate "on-air" signal.

## Specifications

- Video** - 8 loop through inputs (BNC) externally terminated.  
1 V p-p composite or 0.7 V p-p non-composite synchronous signals.  
1 External/Chroma Key input terminated internally. (CDL Chroma Keyer Module is optional)
- Pulse** - 1 Sync input (BNC) externally terminated, 2 to 6 V p-p.
- Tally** - Relay interface with 14-pin Amphenol connector with mating connector.

**Power** - 115 VAC  $\pm 10\%$  60 Hz or 230 VAC  $\pm 10\%$  50 Hz (switchable). 50 VA.

**Mounting** - Rack frame mountable with hinged front panel. 19" (483 mm) W x 8-3/4" (22 mm) H x 7" (178 mm) D. All external connections are on rear of frame. 18 lbs. (8.5 Kg)

Unit includes module extender, Operating & Maintenance Manual.

Central Dynamics has earned a reputation as one of the unquestioned leaders in TV Broadcast Equipment. Our standard line of production switchers are priced from \$11,000 to \$70,000.

The VS-10 is the first of a series to be engineered and priced to fill the gap between inexpensive, inadequate switchers and the more sophisticated expensive ones.

Solid-state technology, and volume production techniques allow the VS-10 to be offered at this remarkable price.

However, you purchase the VS-10 with complete confidence that it is backed by the engineering experience, integrity and reputation of Central Dynamics.

We are convinced, as you will be, that the VS-10 Broadcast Quality, TV Color Production Switcher is the best value available on the market. We're delivering production units now.

**Order yours today . . . at only \$3350.**



**CENTRAL DYNAMICS LTD**

Canada:  
147 Hymus Blvd., Montreal, Que., H9R-1G1  
514-697-0811

U.S.A.  
230 Livingston Street, Northvale, N.J. 07647  
201-767-1300

# Creative Chroma Key

By Leonard Watson

Improvements in chroma key design plus a little logical thought can open creative doors

The uses for chroma key are almost endless. Unfortunately, what we're normally hit with is a barrage of announcers keyed over winter scenes, summer scenes, unfinished basements and paint-blistered, peeling homes. While this type of use does help pay the bills, it is rather unfortunate that the true capability of the effect is seldom seen on the air.

The problem really stems from the fact that most creative personnel think of chroma key as a means of putting a person into a scene. If they were to think of it as it operates electronically, the chances are good that its uses would be expanded greatly.

The first thing to realize is that chroma key is not a technique for inserting an announcer over a scene. Rather it is the technique for electronically switching from one video signal to another according to the "color" present in various parts of a keying signal. This is done by processing unencoded red-green-blue (RGB) video through a matrix network. The network develops a switching signal based on a selected hue.

The classic example was mentioned before . . . the red-suited announcer against an ultramarine blue background. When this is fed to the chroma keyer, a different video source is inserted where blue is present in the original scene; the keyer switches from one source to another according to the hue, brightness, and saturation in the shot of the announcer.

It is important to note that there are two basic types of chroma keyers—RGB and composite. The RGB keyers are so named because they require discrete red, green and blue signal inputs. Composite chroma keyers operate on standard NTSC encoded video.<sup>1</sup> Composite units can key on nearly any source including VTRs and remotes (synchronous) while the RGB keyer is limited to studio gear that provides separate Red, Green and Blue signals. While this may seem to be a distinct advantage in favor of composite keyers, one must consider some other factors:

- There is often no need to key with sources other than studio cameras.
- To install composite key, the complete video system must be fitted with delay lines to match the delay of the decoder and comb filter. This increases the chance of differential phase and gain errors. Disregard for delay will cause misregistration of the keyed information or timing errors.<sup>2</sup>
- Composite key adds a rather large extra expense.

Technology has eliminated the need to use "ultramarine blue" as a keying color. Instead, the hue on which the keyer operates is made variable, as is the brightness or "clip" level. The effect has been refined further to make the switching waveform developed be-

tween the keying backdrop and the foreground available at the switcher. This allows an external keying effect . . . the ability to use either the "background" (normal mode) or "foreground" (key invert mode) to key in a third signal. An obvious example of this would be a blue-on-yellow title card. The blue lettering can be used to key a different signal say, flashing lights, over a program's opening scenes. By reversing the inputs (or inverting the key), the lights appear where the blue isn't . . . surrounding the titling. Source "A" is being keyed over source "B" according to course "C". While this may seem to be a technical explanation, logical thinking can add a great deal to the creative use of chroma key. Take transitions for example. A program title fades up then the lettering begins to shimmer and the film comes in behind it. Next the letters disappear and the film is seen straight. This is accomplished by having the graphic shot straight first. Then the lettering is used to key in a shimmer effect (film, acetate, etc.) in place of itself. This shimmer effect would appear over the blue background of the card. A simple dissolve on a mix bus could add scenes from the program "behind" the shimmering title. Or, scenes from the show could appear through the title letters. If the letters are made very bold, a simple zoom in on the card, combined with a dissolve to the film itself is a pleasing transition.

Sometimes it's necessary to spice up a transition. For a "billowy" wipe between sources, fill a small white tray with water, and shoot from overhead. Using the external key mode, make it the keying signal for a transition between the two desired sources. At the proper moment, pour a bottle of ink into the tray.

Chroma key can also be used to effect a pushoff. A pushoff is somewhat different from a wipe. With a wipe, the picture remains stationary while the switching point moves across the screen; with a pushoff, the pictures themselves move, one "pushing" the other off the screen.

A semi-pushoff can be accomplished by using camera one in the self-key mode, shooting the scene it is desired to push from. Camera two is set up as the keyed source, the scene you wish to push to. A colored card is set up next to camera one, just outside the shot. When the pushoff is desired, camera one simply pans or tilts off the scene onto the card. What appears on the screen is a semi-pushoff, scene one moving during the transition, but not scene two. By panning both cameras at approximately the same rate, a "full" pushoff can be accomplished.

A note about camera movement. As a transition, zooming or panning on a key works well. But at other times it can be very disconcerting to the viewer. All of us have been taken on a roller coaster ride when the cameraman on a crowd shot keyed behind a sports commentator suddenly zooms in on a young female.

**Author Watson** is a member of the staff of Leo Burnett, U.S.A.

# CREATIVE CHROMA KEY



1.

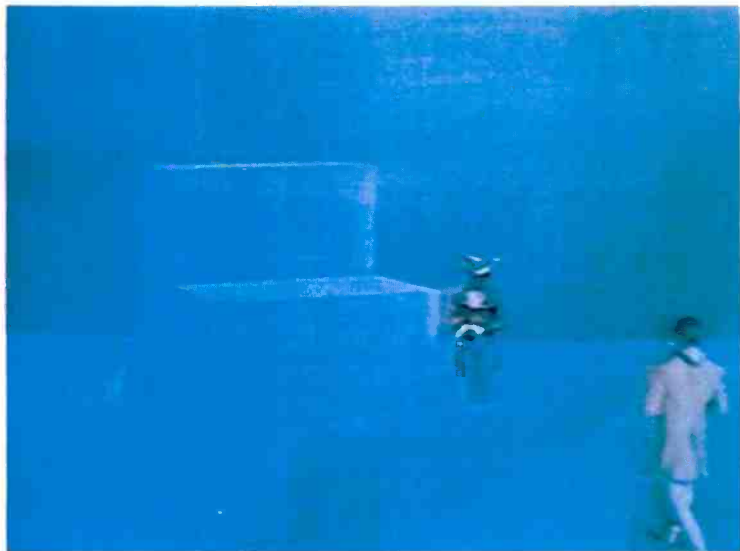

2.



3.



4.

An animated background of artwork and moving clouds (1) combined with set pieces for chroma keying (2) allow dancers to descend the rocks (3) or even walk "behind" them (4).



5.



6.

Blue tape on floor allows dancer to jump from one cliff to another. Note flat in far right background, allowing dancers to emerge from "behind" rocks.

Technique developed by, and courtesy of, Norman Campbell and Robert Lawson, Canadian Broadcasting Company, Toronto.

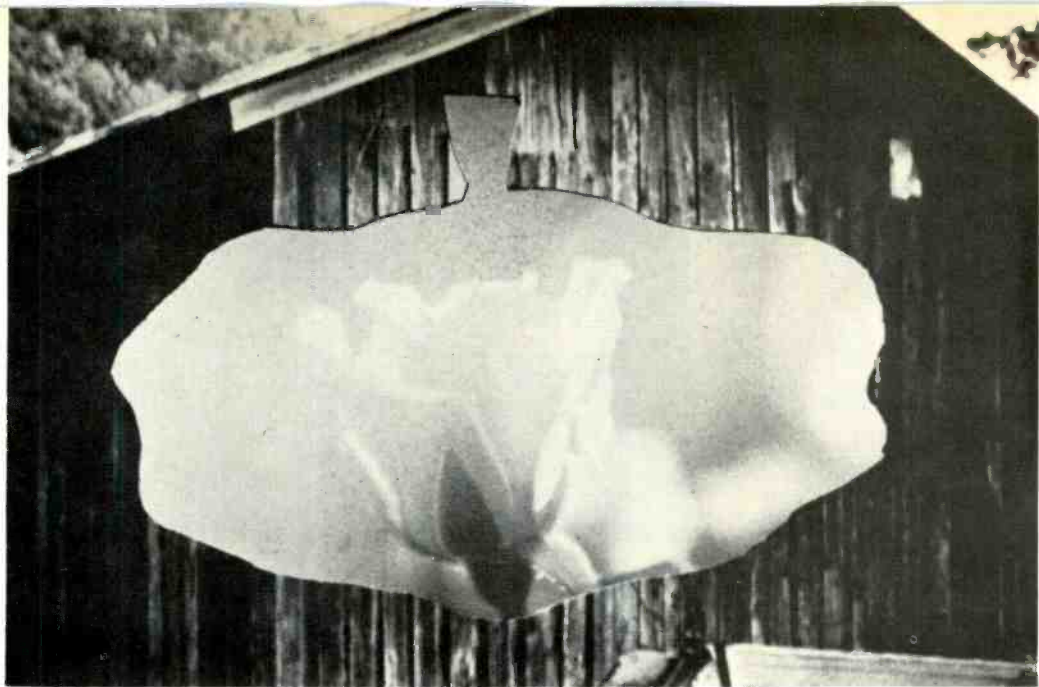

The "billowy" or water-wipe as it appears on the monitor. The drawing shows setup, including card which keeps the container from keying.

One way to avoid this annoyance is to restrict keys to static shots. Another is to coordinate the moves of both cameras. Often, they needn't move at the same rate . . . just in the same general direction . . . to alleviate the problem. Obviously, the optimum, and most expensive, solution is servo'd cameras.

What about effects for effects sake? While I don't agree that effects should be used "because they're there," I do admit to the need for attention-getting video. Rotating effects can be made by designing a wheel which is painted in varying colors. A simple one might be painted yellow on one half and blue on the other. By rotating the wheel, in the external key mode, a rotating transition from one source to another can be accomplished. This appears as two scenes, each rotating about one another. With multiple chroma keyers (or tape generations with composite key), a number of wedges could be used, varying in color, to "spin-in" a variety of scenes.

Another possibility is design of a graphic employing multi-colored letters. In this case, the graphic could be keyed over a camera and at the same time, the "hue" control rotated on the chroma keyer. As this is done, various parts of the graphic will be keyed into the picture as their color is selected by the keyer itself.

The key invert mode offers the ability to insert a new source in place of "foreground objects." Instead of an image appearing "behind" an announcer, it can appear within his outline . . . a waterfall can be made to appear in the outline of a beer bottle or dollar bills in the outline of a bankbook. Zooming in full-screen on the foreground object can effect a complete transition. Also, temporary use of the key invert mode can show any "holes" in a key shot prior to air or taping.

Finally, consider a third dimension. Almost all chroma keying is done for the sake of a two-dimensional effect, but it's easy to add the illusion of a third dimension by allowing the talent to walk behind part of his keyed background . . . appearing truly as part of the scene. Simple enough. With the keyer operating on the desired color, all that is necessary is to provide a foreground piece (cut out of wood and painted the keying

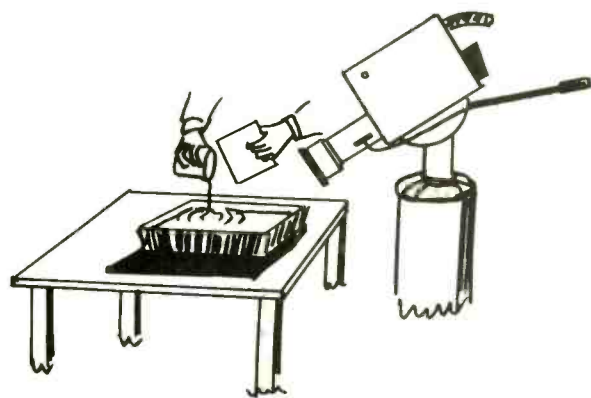

color) behind which the talent can walk. This piece is cut to match the size and shape of the item in the background scene that the talent is to walk "behind." (Be sure to pay close attention to camera position when cutting the set piece.) During production, the talent simply walks behind the piece, which causes that portion of the desired scene to be keyed in.

This can be carried one step further through the use of multiple keying. For example, an announcer keyed over a football scene in which the quarterback is to pass the ball in front of him to a receiver. If the ball is colored in such a way that it can be differentiated from the rest of the scene, you can key the announcer over the scene, and re-key the football over the whole thing (announcer included) as it moves. The football will appear to pass in front of the announcer rather than behind him. If the color of the football appears elsewhere in the picture, mask key or pattern generator and joystick can be used to isolate the football from the rest of the scene. (see below)

A final thought concerns the technical quality of chroma key. Chroma key today is a completely different effect from the "in the camera" key of a few years ago. But the way to get optimum quality from it is to remember that it operates on the basis of being able to differentiate one hue from another. Hopefully, items close in color to the keying color can be kept out of the scene. The ideal key is present when the part of the scene

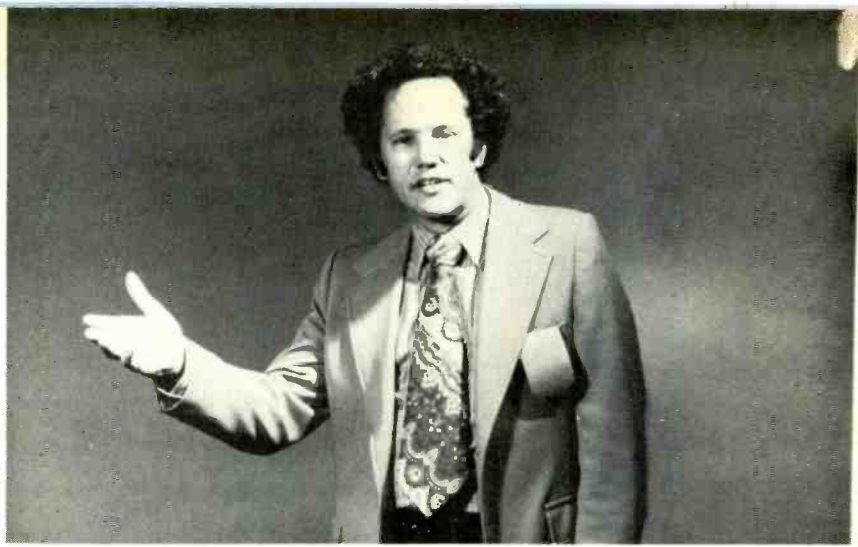

*Studio shot shows actor against keying backdrop. Note material attached to his pocket is same color as drop. Keyed shot shows no evidence of background in pocket area. Special effects were used to "reinsert" it.*



## CREATIVE CHROMA KEY

to be keyed out is complementary to the rest of the scene. For example, blue on yellow, or red on cyan (blue-green).

If colors close to the key color are present in other parts of the scene, an additional effects bus can be used to circumvent the problem. As a simplified example, if an announcer has a green patch on his pocket, and you are keying on green, a diamond pattern can be pulled through and positioned around the pocket area. Then, while chroma keying on one effects bus, another is used to "insert" the "pocket" back into the picture . . . a type of mask key. Tricky, it's true, but if the effects banks are top notch, it'll work.

Fringing can be caused by a number of problems. The use of older 4-tube cameras may cause problems. The frequency response of the chroma channels is rolled off on the high end, causing a loss of resolution at the chroma keyer. The keyer has a hard time deciding exactly when to switch,<sup>3</sup> and the edges of the key are degraded. Peaking of the chroma channels (if permissible) or use of 3-tube cameras (if available) will reduce the problem. Fringing can also be caused by poor lighting or color coordination. For example, by amber-

ing the backlight used on an announcer, (assuming the use of blue key), some of the fringing may be eliminated.

Colors close in hue to the keying color, or including the keying color should be kept away from the keying surface. An announcer wearing a cyan coat standing near a green keying surface might fringe heavily if he moves too close. This is because cyan material reflects both blue and green light and the green from the keying surface illuminates the coat. This green is re-reflected by the edges of the coat back to the camera. The chroma keyer, not knowing any better, keys on the edges of the coat, which appears as fringing. Results are usually improved by choosing a secondary color (yellow, magenta, cyan) for the keying surface and a primary color (red, blue, green) for the performer's coat. Then, even if the coat is brought near the keying surface, it will reflect only one of the components of the keying color, reducing the tendency to fringe. State-of-the-art units help reduce fringing, but only good lighting and proper choice of colors can eliminate it.

**BM/E**

<sup>1</sup>A composite keyer is really an RGB keyer preceded by a demodulator and comb filter.

<sup>2</sup>CBS Laboratories is currently marketing a "zero-delay" unit which, in many cases, eliminates much of this problem.

<sup>3</sup>Time constants employed in state-of-the-art switchers soften the switching waveform allowing a softer, cleaner transition. However, this is done after the switching point has been established.



Puzzle:

# How do you get a lot of SWITCHER for a little MONEY?

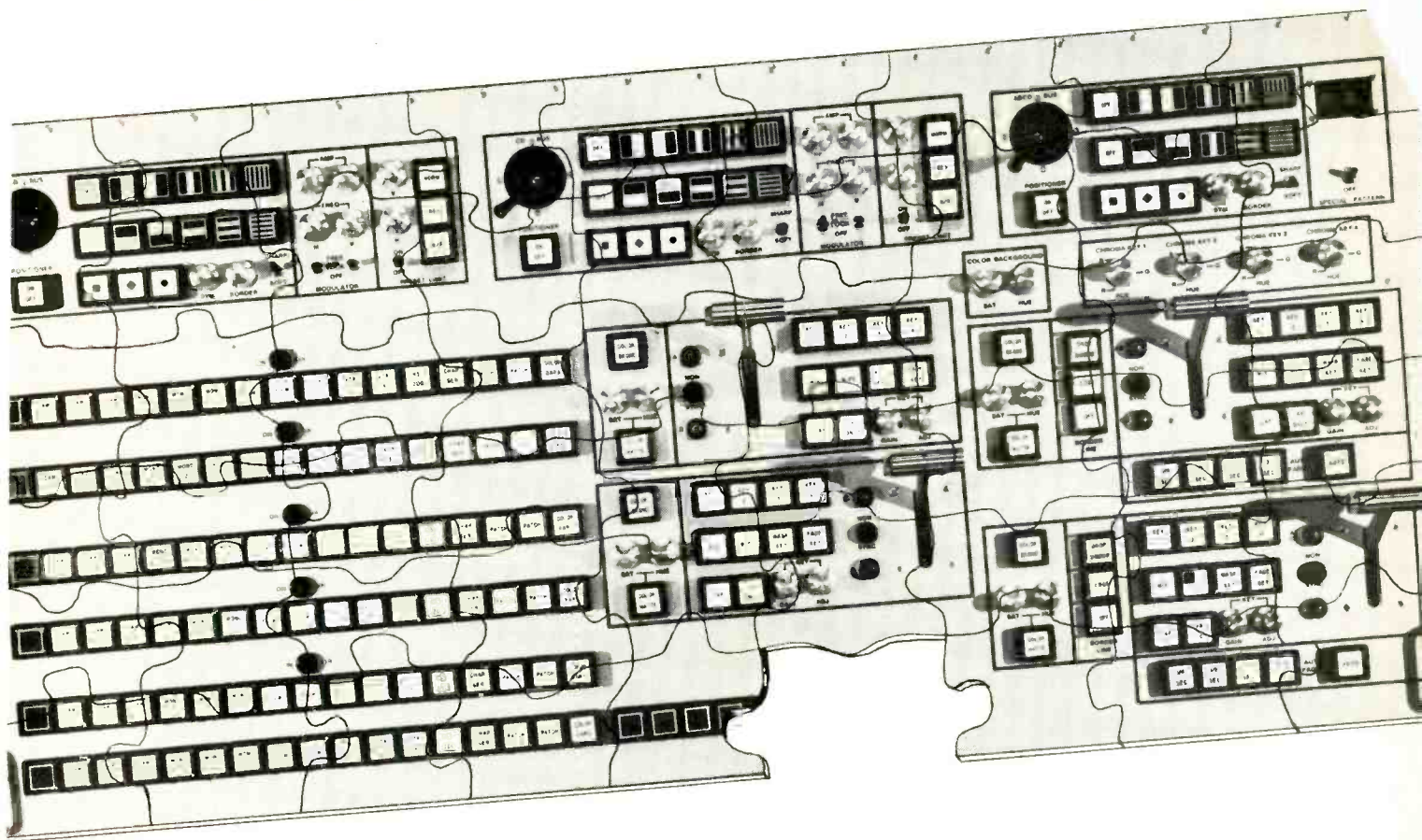

## Answer: The Computer Image "Pre-wired" Modular Video Controller System.

### Represented nationally by:

**Broadcast Communications Devices, Inc.**  
5526 East LaPalma Avenue  
Anaheim, California 92807  
(714) 528-9505

**Broadcast Communications Devices, Inc.**  
1850 Warburton Avenue, Suite 203  
Santa Clara, California 95050  
(408) 954-6614

**Didier/Denver**  
P.O. Box 1599  
Evergreen, Colorado 80439  
(303) 674-6000

**H. M. Dyer Electronics**  
31185 Ten Mile Road  
Farmington Hills, Michigan 48024  
(313) 478-2154

**Landy Associates**  
12 Buxton Road  
Cherry Hill, New Jersey 08003  
(609) 424-4660

**Landy Associates, Inc.**  
20 Winslow Street  
Plymouth, Massachusetts 02360  
(617) 326-6050

**Radford Associates**  
3203 Lanier Drive  
Atlanta, Georgia 30319  
(404) 237-6097

**The Gene Sudduth Company**  
2809 Raintree Drive  
Carrollton, Texas 75006  
(214) 242-2690



For further information call or write:  
Vice President, Marketing, Video Controller Division



**COMPUTER IMAGE CORPORATION**  
2475 West 2nd Avenue, Denver, Colorado 80223  
(303) 934-5801

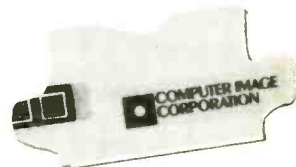

Now there is a way to plan for the ultimate in switching potential with the least initial outlay.

If you can afford the industry's finest broadcast quality switcher with all the latest state of the art techniques and capabilities... fine! Computer Image will deliver a Model 7243 with 7 buses, 24 inputs, four mix/effects amplifiers, preview and program buses with computer compatible control, and save you money!

If however, your budget is tight, then you may choose a Computer Image Model for as low as \$10,000 — have it pre-wired for options you know you'll need and have a broadcast quality switcher today that will not soon be obsolete.

Computer Image Video Controllers are designed with circuit-element building blocks... to give you every advantage of add-on capabilities, and reliability of functions. Your basic purchase can be pre-wired for the options found in the most complete switching system.

If your future requirements can be estimated at the time of ordering a basic unit, all the add-on options can be pre-wired for only 10% of each option. And, any options ordered within six months of initial delivery will be credited that 10% pre-wire charge! The installation of any option, because it's pre-wired and completely modular, is almost as simple as plugging in the morning coffee pot!

COMPARE THE VIDEO CONTROLLER WITH ANY OTHER SWITCHER... AT ANY PRICE! Ask about price, performance, versatility, reliability, guarantee and delivery... and ask about some very happy Video Controller users!

Computer Image, 1972 emmy winner for outstanding achievement in engineering development for its unique electronic animation systems for television.

Circle 123 on Reader Service Card

# Production Aids You Can Use

On the following pages are a series of ideas/reports describing what's possible in audio and video production using editing equipment, chroma keyers, switchers with M/E flexibility, standard tape leaders, a burst phase meter, the computer, the "flanger," and character generators. For more help you can join the Production Manager's Association described below.

## Encoded and RGB Chroma Keying Compared

The introduction of chroma keying several years ago initiated a quiet revolution in television production. Highly dramatic formats have since been generated that contain a true audio-visual approach toward creative programming. Unfortunately, as with any unique and specialized device, an information gap resides in effective utilization. Chroma keying is currently being accomplished with two types of devices, RGB and Encoded keyers (with Encoded keyers recently becoming more popular).

### Encoded chroma keying is most versatile

Encoded chroma keying is, by far, more versatile when compared directly to RGB chroma keying when properly integrated into a video switcher. It permits using VTR's, network sources and cameras (without direct access to RGB signals) to function as key sources. Chroma keying from tapes gives the added flexibility and freedom of assembling chroma key effects in a true *post* production environment.

Production applications must, however, take into account certain theoretical constraints when encoded chroma keying. The narrower bandwidth utilized (1 MHz for encoded versus 2 to 4 MHz for RGB) is a constraint, but fortunately, this is not a serious limitation in most program formats. High noise level on the key source signal is another important consideration when encoded chroma keying is utilized. This noise often results in break-up and jitter of keyed edges. Every possible precaution to reduce noise should be taken. A key source camera should be operated with minimum acceptable horizontal and vertical aperture correction and should have its notch filter turned on to reduce luminance noise from falling within the encoded chrominance band.

When considering the addition of an encoded chroma keyer to a video switcher, system timing cannot be overlooked. Provisions must be made in the video system to compensate for the electrical delay of the keyed waveform (approx. 400 to 700 ns). Encoded chroma key systems are classified as "keyers" or "generators."

A "keyer" will combine both the A&B signals (foreground and background) relative to the key signal. This type of keyer is sometimes referred to as a "0" delay keyer. The two signals processed through the keyer do

have "0" video delay relative to one another; however, there is a 1 line video delay relative to other undelayed video signals processed through a switcher. Consequently cuts, wipes and dissolves between the "keyer" output and primary switcher inputs result in undesirable transitions.

A "generator" supplies only the key signal waveform to the Mix/Effects amplifier. The foreground and background signals are processed, with the waveform signal, and combined in the Mix/Effects amplifier for the chroma key effect.

For the maximum flexibility, lowest cost and best picture quality the encoded chroma keyer generator should be installed and integrated into a video switcher as shown in the diagram on page 39.

For lower cost and greater flexibility the input sources to the encoded chroma keyer generator should be derived from individual bus output amplifiers. This eliminates the need for delaying all input signals to the switcher primary matrix, and permits selection of any input source as the key source (VTR's, film, network, cameras, etc.). Delays are only required within the switcher so the foreground and background video sources (A&B inputs) are "in time" with the key signal at the Mix/Effects amplifier (400-700 ns depending upon the "generator" used). A second encoded chroma keyer generator can be easily added and the outputs switchable between M/E 1 and M/E 2 amplifiers.

The best picture quality becomes apparent when an analysis of the diagram is made. *All* video signals and *pulse* signals are "in time" with one another which is truly a "0" delay encoded chroma keying system. (The total system delay is equal to the electrical length of the switcher plus the delay of the key generator).

### RGB chroma keying has better S/N ratio

RGB chroma keying, with its principles based on selective information matrixed from 3 separate channels, operates with a wider bandwidth (2-4 MHz) and a distinctly higher s/n ratio than encoded chroma keying. Its low susceptibility to signal noise on the keying waveform yields keying effects of superior quality in a direct comparison to encoded chroma keying. The obvious production handicap of this keying system is that it can only be used where RGB signals are conveniently available.

Technical considerations are minimal with RGB chroma keying. An internal variable delay network should be  
continued on page 39

**“From those wonderful folks who made my face clear up.”**

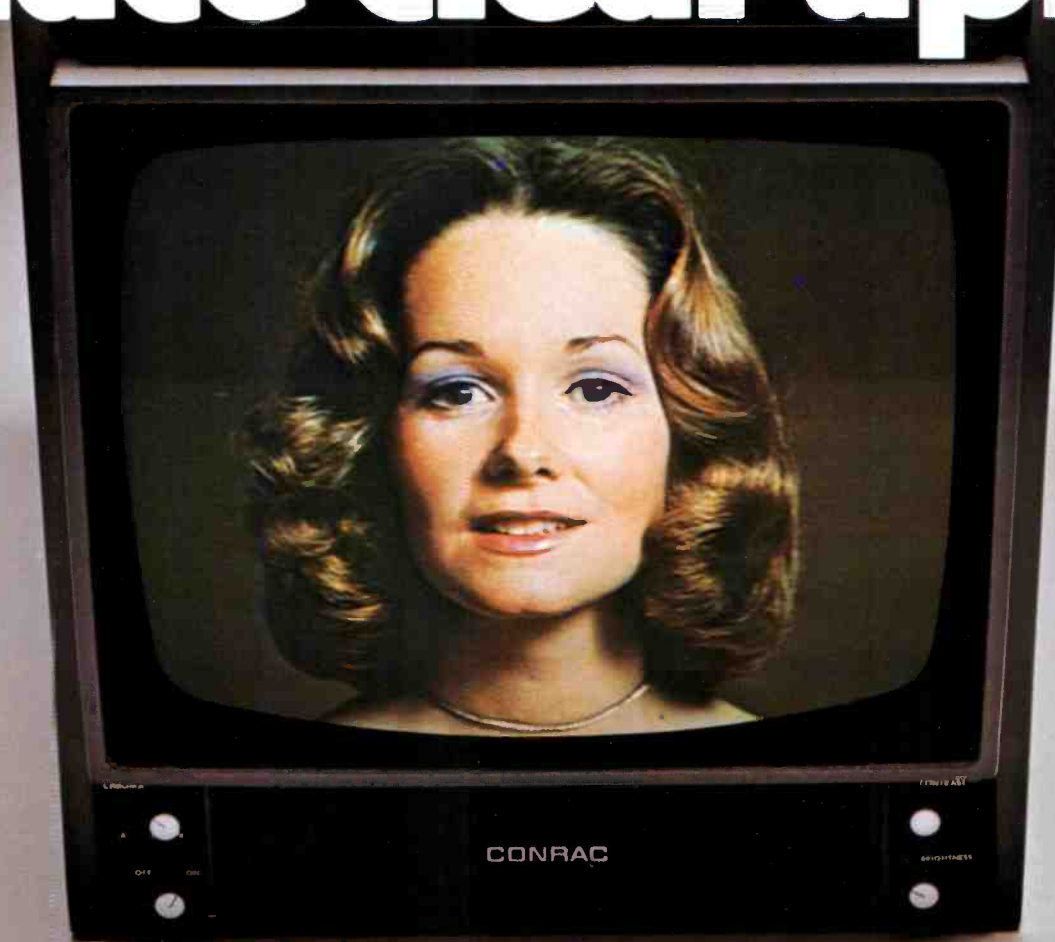

In 1965, 3M introduced a quadruplex color drop-out compensator that has since become the standard of the industry. Today, all three networks and thousands of television stations across the country rely on 3M Brand color DOC's to bring viewers better picture quality.

But what have we done for you lately?



# We don't quit when we're ahead.

Introducing five new video products for broadcast, educational and industrial uses.

We could have rested on our laurels after developing our quad color DOC. But we didn't. Instead, we've developed five new low-cost products to help you produce the very best professional-quality video with your existing equipment.



## 3M Mini Processing Amplifier

This unit, designated P-50, has an important exclusive feature: A built-in pulse-cross generator with automatic brightening that allows the use of any inexpensive monitor to examine the critical head switch area for tracking and skew adjustments during on-line operation through an auxiliary monitor output. Other features include front panel controls for six video signal parameters; horizontal and vertical blanking generator for precise timing, plus a reconstituted sync system to allow stable operation with random interlaced video; operation with both color and monochrome inputs. Burst or chroma can be switched out to accommodate unacceptably noisy color recordings; and input clamping for excellent low frequency and 60-cycle hum rejection.

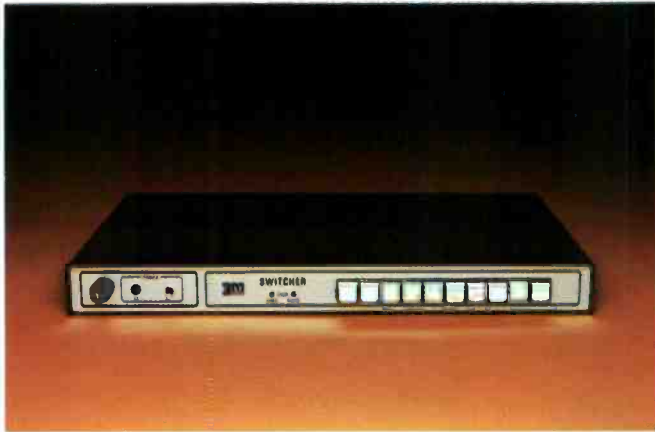

### 3M Bridging Video Switcher

This is a broadcast-quality unit. It is a highly-sophisticated 10-input switcher with momentary-contact illuminated buttons. There is an audio D. A. to eliminate loading, and this unit also provides remote capability.



### 3M Color Bar and Sync Generator

Now your studio can have a color reference for a surprisingly modest cost. This unit produces an NTSC 8-bar pattern and all sync signals just like the very expensive units used in professional broadcasting studios.



### 3M Digital Videc AGC

This digital unit is a new concept. There is none other like it. It can be used in any application where sudden and undesirable signal level changes occur without incurring the unacceptable effects usually associated with AGC circuitry. There is no overshoot with large duty cycles. And calibration/setup is simple and straightforward. Other important features include a peak white or VIR reference signal; fade-to-black recognition circuit for gain memory; selectable attack and release time; and a total AGC range of 15 db, with unity gain under no-input conditions. Suitable for broadcast, industrial, educational and cable TV applications.



### 3M Video Distribution Amplifiers

This complete line of products suitable for any video application includes a Pulse D. A. that reforms distorted incoming sync pulses, and if your application requires, will accept composite video and separate and distribute sync as needed. Then mate this unit with our Subcarrier D.A. that has four independently phaseable outputs, and our totally reliable four-output Analog D.A. with cable equalization.

**Turn the page for six more 3M professional-quality products.**



### Quadruplex Color DOC

The 3M dropout compensator is the industry standard for broadcast VTR use. It replaces color dropouts in videotape recordings with the correct color video, avoiding the problems of other types of signal compensation.



### Helical DOC and Processing Amplifier

Our 3M DP-100 is a complete video processing system designed to clean up, correct and stabilize helical scan VTR signals for any VTR format. Corrects for high or low contrast, inaccurate or washed-out colors, picture jump and roll.



### Video Source Identifier

The VSI inserts a preselected, 8-character identification code into any 525/625 composite video signal which appears on your picture monitors to help keep your switching straight and locate video path failures.

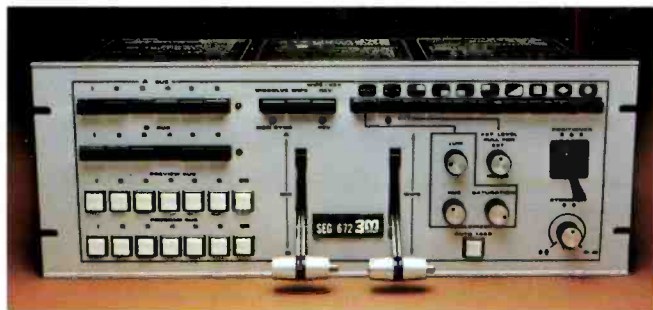

### Special Effects Generator and Program Switcher

This 3M SEG 672 performs vertical interval program switching, dissolves and wipes between six video inputs. The key and mat key feature can be used to produce many imaginative special effects. Joy-stick positioner. Many features of more expensive units.



### Dropout Profile Recorder

The DPR evaluates video dropout rate and annoyance factor during normal on-line playback, and provides a permanent strip chart of the resulting profile. The logical companion to the 3M dropout compensator.



### Color Video Encoder

This supplies a standard NTSC color signal from either a three or four-channel camera source, and is compatible with live color cameras and film chains. The resulting signal meets all applicable EIA and NTSC specifications.

**We don't quit when we're ahead.**

Your dealer is:

Attn: Bill Curtis, Mincom Division, 3M Company,  
350 South Lewis Rd., Camarillo, Calif. 93010

Please send me more detailed information, including  
technical specifications, about your video products.  
I am interested in \_\_\_\_\_ applications.

Name \_\_\_\_\_

Title \_\_\_\_\_

Address \_\_\_\_\_

City \_\_\_\_\_

State \_\_\_\_\_ Zip \_\_\_\_\_

Phone number (\_\_\_\_\_) \_\_\_\_\_  
Area Code

## Creative Teleproduction Boosted by New Editing Systems

There's been the film camp and the videotape camp and never the twain shall meet. That's more-or-less been the situation for some time. There *have been* creative editors who have learned tape editing and have done great things for their clients but the majority of the film editors have put the medium down—and advertisers, to get their talents, have had to use film or wait in line at the tape production house.

The problem has not only been getting film editors to learn electronic editing, but to get them to adopt the "now" TV philosophy—i.e. editing on-line, editing with a crew standing by for a retake, etc. Recently this last barrier has been overcome—with reasonably-priced off-line editors that function "like a Movieola." Editors can afford the luxury of rocking video tape reels back and forth when they are on low priced helical machines and Television Research International has earned a place in history by introducing a \$5000 editor that is as easy to operate as a Movieola and quite precise for non-SMPTE time code editing. Another company to take the route of tape editing using film techniques is CMX with the introduction of the System 50. System 50 is a relatively low cost off-line

system using a computer assist. It offers SMPTE time code frame accurate editing. The source material is on videocassette (which non-experts can handle) and the edited workprints are on cassette—a convenient form for client viewing. This means the editor works alone in a quiet environment. When editing is completed (and approved), a decision list can be turned over to a post-production house for auto assemble on 2-inch high band tape. The System 50 offers complete creative control; audio only, video only, or audio/video manipulation—cuts, dissolves, keys, wipes or fades.

The first organization to use the CMX-System 50 in New York City was Forum III Films, a highly creative film-editing group headed by Hy Goldman, president. Acquisition of a System 50 gave Forum III the ability to work in the tape medium (now preferred by some agencies for its quality of realism) at a cost less than that demanded by on-line systems. Goldman offers his award-winning creative talent for \$100 an hour—not \$300 typical for on-line editing facilities. On top of this, Forum III's approach allows for client revisions at a later date—a procedure that adds costs significantly when using more expensive on-line techniques.

To further keep client costs down, Goldman edits only for scene cuts, meaning standard dissolves, wipes, etc. can be added automatically during the final conforming stage—after all of the marketing executives have made their personal inputs.

## Chroma Keying Compared

continued from page 34

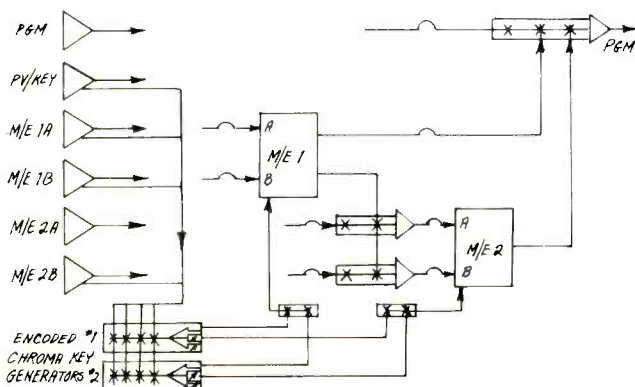

Diagram showing where to locate encoded chroma keyers.\*

\*Material for this section was prepared by Bob Hueffed, Central Dynamics Corp.

supplied with the keyer to compensate for the electrical delay of the camera encoder. This insures that the keying signal and background information arrive in time coincidence at the video switcher Mix/Effects amplifier. Calibration requirements for camera sources generally consist only of standard operating procedures.

### Soft Keying performs miracles

Soft chroma keying (also referred to as linear keying) has recently surfaced as a member of the latest generation of production devices. Hard chroma keying requires no introduction, since it has been the traditional chroma key mode to date. Soft keys provide a major and often unbelievable improvement to encoded or RGB chroma keying. As soft keys are subject to far less noise, the ragged and tearing effects often encountered when keying very small objects are virtually eliminated. Minute details, such as wisps of hair, are successfully handled, since soft keying provides a gradual blend at the edges of the keyed object, rather than an abrupt outline characteristic, as in traditional hard keying. Additional dimensions in chroma keying are also possible with this new technique. Translucent keying, where a keyed background scene may be shown through a glass of water, is possible with soft keying. A variation on this effect is the keying of a subject—with its shadow—to provide a striking degree of naturalness in dimension.

In the technical sense, soft keying is not totally accomplished from within the chroma key device. The key source waveform, either encoded or RGB, is processed from within a Mix/Effects amplifier to achieve the softness effect. Special technical considerations should be taken to preserve the original rise-times of chroma key waveforms into a Mix/Effects amplifier. The key waveforms into the Mix/Effects amplifier should not be preceded by any "stretch-then-clip" circuitry when soft keying.

### Other application notes

The aesthetic part of chroma keying, beyond the camera lens, has suffered many ambiguities. It is generally accepted that a flat, ultra-marine blue cyclorama affords the most versatile backdrop for keying purposes. This selection is, of course, dependent on the hue present in the foreground subject to be chroma keyed. When utilizing the same blue cyc for encoded and RGB chroma keying, differences in keying quality have resulted in a direct comparison. Tests have indicated that encoded chroma keying typically produces improved results with a cyc of a higher luminance value than RGB. This difference attributes itself to improving the s/n ratio of encoded chroma keying.

Chroma keying is an illusion that, even with today's sophisticated devices, requires careful control and consideration.

### WIS-TV Excited Over Capabilities Of The Vital VIX 114-3 Switcher

In the recent past, WIS-TV, Columbia, S.C. had to rely on the result of multiple tape generations to create commercial productions. This was because of the limited flexibility of its old switcher—an ancient General Communications one-effects, one-mixer switcher that had been modified many times. Now it has the first unit of Vitals VIX 114-3 series and is ecstatic over the new possibilities. "This is probably the world's best switcher," says Henry Goldman, WIS-TV producer/director. Goldman is undoubtedly somewhat biased because his station also takes some credit for influencing the design of the 114-3.

Goldman reports, "Our news shows use many chroma keys, name supers and weather, sports, and stock market information. By assigning one M/E unit to chroma keys, one to visual displays (weather, stocks and sports scores), and the downstream keyer to name supers, we can switch the entire program without re-setting or re-clipping any effects unit."

For commercial production, many new possibilities became available to WIS-TV. The linear chroma keys are particularly valuable. The soft wipe effects have added new dimensions to soft transitions, without the use of dissolves, in much the same way that a border enhances the wipe. WIS-TV finds new uses every day. Just recently it created a tunnel effect for a commercial. This was done by setting up a two box wipe alternately fast between the two and adding changing brightness. The intermixed digital effects and wipe and key functions give WIS-TV 62 pattern partner selections (most with soft edge, hard edge, or border).

WIS-TV likes the layout of its switcher. All controls associated with each M/E unit are in a group (and even color coded). This switcher is human-engineered for ease of operation and the control panel is logically layed out in that two hands can be used simultaneously. Goldman points out some switchers have functions that can't be used because one operator physically can't manipulate it.

The VIX 114-3 selected by WIS-TV has four keyers,



*With M/E systems, many patterns are possible.*



*A good switcher is human engineered for easy operation.*

each with a matte generator and a choice of type key—normal edge, shadow, or outline. Three of the keyers can be used with any of four chroma keys, each having a 4-camera input switcher. The downstream keyer features include means to cut or dissolve a key in or out and fade the whole system to black, and, as with all the keyers, off line monitoring is possible.

Another feature is quadsplit with input switchers for each quadrant. Each quadrant size is adjustable, as is the border.

### Production Managers Association Formed to Improve Teleproduction

The Production Managers Association got underway in late April with 56 charter members. Its purpose is to contribute to the improvement of television production by providing a forum for the discussion of ideas and the exchange of information concerning commercial production and related fields.

The plan of the organization, according to Ralph T. Kuehn, WISN-TV, Milwaukee, is to have each member put together a videotape which shows a sample of his best work—commercials, promos, openings for shows and any special effects or techniques he has come up with. This

tape is then bicycled among the members who may use this tape for ideas or direct copy. At the end of each reel is a work tape that may be dubbed off by the members for their own use.

Since more and more local broadcasters will be doing commercials—as they compete with newspapers for local retail ad dollars—Kuehn sees heavy demand on tape machines and tie ups in time. Thus the ability to lift from demo tapes should be especially helpful to PMA members. In the illustrations included on this page are some samples of a movie lead-in as photographed from a monitor. The local station could insert its own titles. Another sample shows a visual that could be used behind a title frame.

PMA will give its members other ideas, through future seminars and a quarterly newsletter to be edited by Alvin



*The scenes here are from a stock lead in of tape about to announce a movie . . .*



## Inexpensive Burst Phase Meter Substitutes For A Vectorscope

Keeping the color burst phase within 10 degrees of the 3.58 MHz sub-carrier reference is an FCC requirement—and a necessity for acceptable color. Monitoring the burst phase is commonly done with a vectorscope. But, it can also be done in many teleproduction applications, at considerably less cost and with higher accuracy, with the Burst Phase Meter, Model BPM-1 produced by Video Aids Corp. of California.

The BPM-1 (small unit on top of waveform monitor, at right in photo), has an input for a reference signal to which the color burst is to be compared in phase. The meter is nulled to the reference, and the video from a switcher, a camera, a VTR, or other source can then be connected to the video input, and the phase difference read directly on the meter. Accuracy is rated at 1/2 degree; typical vectorscope accuracy is 2 degrees. Video Aids Corp. recommends monthly calibration of the burst phase meter (against the daily calibration common for vectorscopes).

The vectorscope is mandatory, VACC says, for color bar and encoder set-up. For virtually all other applications, the burst phase meter is a valid, more accurate alternative.

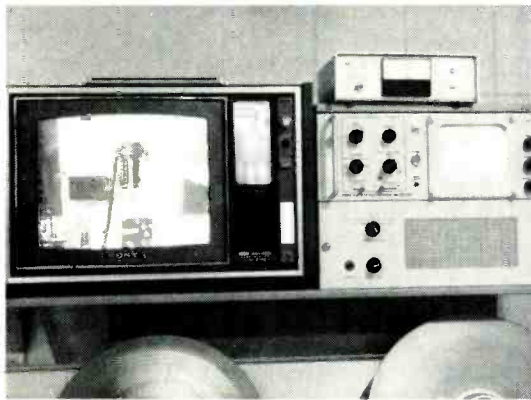

Burst phase meter in use at Colorado State Univ.

## Some Stand alone Production Aids To Improve Production Quality

The blue screen travelling matte system has been in use in various forms in the motion picture industry for many years. Chrome-key, the electronic blue screen system, has been widely used in commercial television production in spite of certain limitations.

Some of the top of the line production switches from Central Dynamics, Grass Valley and Vital feature shadow key—a feature that gives production that high quality rich look. Now you can get a standalone device that will give you the best of keying and matting systems *plus* full noise-free shadows. An RGB matte amplifier, the R-Matte from Sonex International Corp., has the most natural edges without any sacrifice to the shadow.

All electronic travelling matte systems have certain common characteristics. The foreground scene is photographed or televised against a color background of high saturation. The background scene is photographed or televised separately.

In a recent commercial set-up, Sonex had the requirement of matting a clear glass coffee pot with coffee and a girl into a still photo of a kitchen. After setting up the girl and coffee pot in front of the blue cyc, a remarkable composite was achieved: fine detail in the hair, glass reflections on the coffee pot, no matte line or edge separation to give you the feeling of a paste-on. The real bonus of the R-Matte was the ability to carry the shadows of both lady and coffee pot *and* the reflections on the blue from the coffee. With the dancing liquid reflections carried on the still photo background plate, the ultimate realism was achieved. Just for experiment, we then gave the lady a cigarette and the smoke looked sensational.

With the improved detail of the R-Matte, greater attention is necessary in the pre-planning and production stages. Lighting and background consistency are of primary importance.

Because it is RGB, the R-Matte is compatible not only with NTSC but PAL, PAL-N and SECAM. It can also be applied to other systems such as an electronic optical printer. The R-Matte can be remote controlled and used with or without a switcher.

Another Sonex production aid is Lum-A-Key which keys off of black or white. It does all that a standard chroma-keyer will do only cleaner because it, too, is RGB. It is a hard keyer and because it keys RGB there is *no* chroma crawl. The Lum-A-Key was developed for situations where all the colors of the rainbow may be keyed onto a background to light if you use black—as you normally would in a studio situation.

Lum-A-Key is ideal for animation. White paper instead of cells can be used or cells on black background filmed and then Lum-A-Keyed onto tape combined with live action or used as videotape animation. Even a standard chroma-keyer can be run through the Lum-A-Key to clean up the edges. Lum-A-Key is a highly flexible, time saving production tool which can expand the capabilities of any switcher or production studio. The Lum-A-Key can also be remote and a switcher is not necessary for its function.

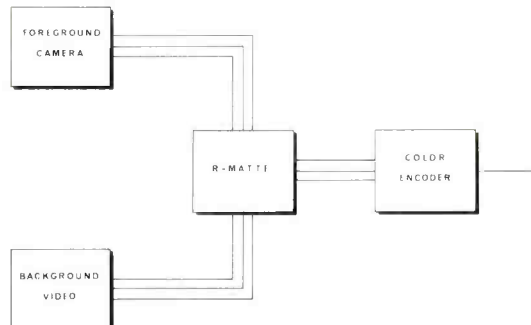

Diagram depicting use of the R-Matte.

Dompke, WBNS-TV, Columbus, Ohio. Kuehn, for example, has shared an idea successful for his station. WISN-TV sends out a piece of videotape worth \$25 to local non-TV advertisers. With the return of the videotape, plus an additional \$75, that station offers one hour of production time in its studio. The station also offers to write commercial copy free of charge. The creative staff of the station is available to produce a commercial using sight, sound, color, motion and "emotion" says Kuehn. This promo has helped dispel the idea that commercials cost a lot of money to produce.

Membership in PMA is open to all production managers of commercial or educational stations and production tape houses. Contact Ralph T. Kuehn, WISN-TV, 759 N. 19th St., Milwaukee, WI 53233 or secretary Ray Drago, WBRZ-TV, Box 2906, Baton Rouge, LA 70821.



... the title can be inserted in this standard frame.



A willowy effect is available for insertion behind the title.

## "Instant Flanger" For Those Swimming "Jet Plane," Beat Effects In An Audio Signal

As other articles in this issue describe, teleproduction has its special generators that can "process" video signals in a hundred different ways. Audio, too, has its array of processors that can turn out creative sounds in enormous variety. There is the music synthesizer, which we covered in detail in the February, 1974 issue. And there is a growing number of units that can be put in an audio line to alter the program in highly expressive and varied ways.

"Flanging" results from the combination of two versions of the same audio signal, with one delayed by various amounts and in various strengths. The resulting "swimming," "shifting mulls" and other effects can be highly distinctive. A new unit which is designed to produce a very wide range of flanging effects, from flexible front-panel controls, is the "Instant Flanger," Model FL201, introduced recently by Eventide Clockworks, Inc., of New York.

The Model FL201 uses charge-coupled electron devices to produce a delayed version of the signal, with delays in the range around 5 milliseconds, electronically

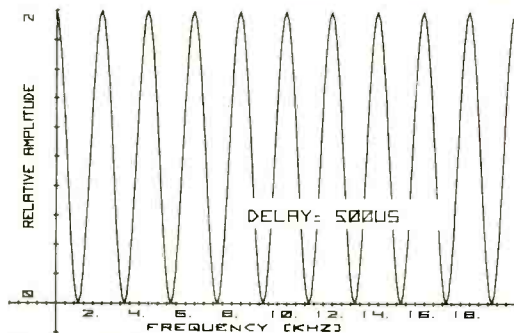

controllable. The delayed signal is combined with a straight-through, or direct signal, at the output of the device.

The unit is tremendously resourceful. A few representative things the user can do with it are: a "depth" control varies the ratio of direct signal delayed signal, and with time-delay variation can produce a great variety of changes in frequency balance, various Doppler and vibrato effects, changes in apparent source distance, and other numerous aural variations; a "bounce" control substitutes a damped sine wave for the flange depth control, producing a variety of damped-reverberant, swimming effects; an oscillator-rate control activates the flange control with a triangular waveform, with a period that can be varied from 20 seconds to 50 milliseconds—an LED lights up when the oscillator is connected; an envelope follower ties the flange control to the amplitude of the audio signal, with an adjustable "threshold" level and release time, the latter variable from several milliseconds to several seconds.

The unit has a number of other capabilities, well laid out in an instruction manual that also covers the theory of flanging in some depth. A number of radio stations are using it in production of commercials, which can be made to stand out sharply in the listener's consciousness.

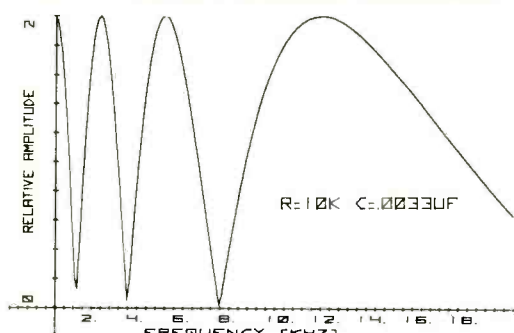

Signal to left is simply processed through a delay as shown. At right, signal is processed through 8 identical networks with R-C constants as shown.

## Synthavision Creates Pictures of Objects, Moves Them, Turns Them Inside Out, Etc., Etc.

The creation of graphics by computer is carried to a very high degree of resourcefulness, flexibility and production ease, with a process developed by Computer Visuals, Inc., of Elmsford, N.Y., called "Synthavision." The object or picture to be created—anything the user can imagine, draw, or provide in photographic form—is first analyzed on a spot-by-spot basis with the data put onto IBM cards. The IBM 360 computer used in the process reads the cards, has a powerful program that will direct the computer in doing *anything* (besides reproducing it exactly) with the object in the picture: move it at a specified rate of speed, spin it, assemble or disassemble it, etc., etc. The sequence is recorded onto magnetic tape, and can be delivered on motion picture film by photographing a display

on a 100-line CRT; or can be transferred to NTSC color videotape.

This system allows the user to do such things as try out a new "car," see how it will look from every angle, before building it; "drive" on a highway before it is built; manipulate mathematical shapes for teaching programs; show the workings of machines more clearly than pictures of the real thing. And, of course, the system can create new art forms in endless variety, for advertising, ID's, art teaching, or pure self-expression.

For broadcasters, the system has been most useful for commercials and ID's. The accompanying pictures show one example: a radio station commercial made for television showing in Detroit.

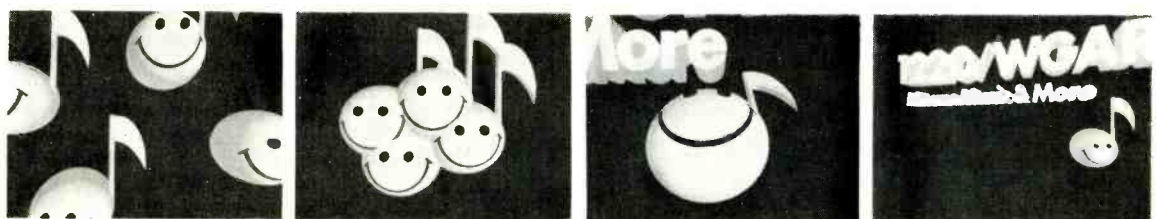

Four successive monitor shots showing how the station ID for WGAR develops.

# The COHU 1550

Compare features of telecines available in today's market and you will quickly see why Cohu's 1550 "Performer" is proclaimed the standard in the industry and stands as a GIANT in terms of performance.

SMPTE slides look great on the 1550, but more importantly its superior performance can be verified by its ability to handle the typical everyday quality of program source material.

Technically, the 1550 gives you 700-line center and 600-line corner resolution, manual Instant Paint, automatic black and white color balance, response for 2 to 1 increase in light is 70 milliseconds to within 90% of final value with zero overshoot, gamma control continuously variable from 0.4 to 1, less than 1% geometric distortion, 52 dB minimum signal-to-noise ratio, unsurpassed colorimetry, and fully sealed electron beam coated optics.

Cohu's new color encoder/image enhancer/auto balance unit, the Model 9900, is standard equipment on the 1550. It provides automatic two-level horizontal and vertical detail enhancement and adjustable detail coring with both manual and automatic detail gain including remote control of level. The encoded color signal meets all applicable NTSC, EIA, and FCC specifications. Other user advantages are vertical interval reference insertion, full or split color bars, plus remote control of color burst, color bars and chroma.

Don't buy any telecine until you have seen the GIANT. Contact your local Cohu sales office or Cohu, Inc., Electronics Division, P.O. Box 623, San Diego, CA 92112. Telephone (714) 277-6700. TWX 910-335-1244.

# A GIANT

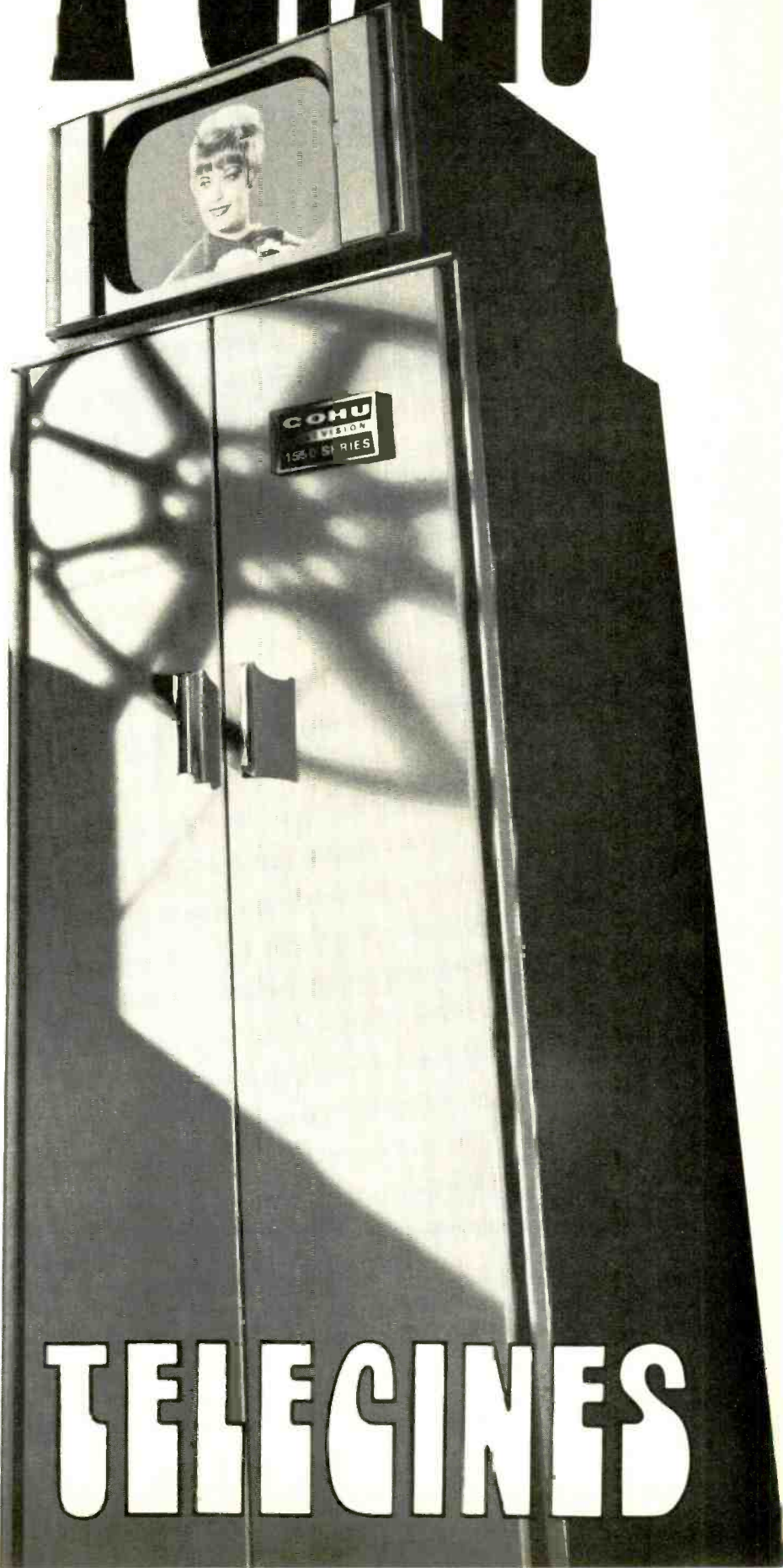

YOU EXPECT  
MORE FROM  
...AND  
YOU GET IT.



#### COHU SALES OFFICES:

**NEW ENGLAND** Bedford, MA 617-275-0370 • **NEW YORK** Florham Park, NJ 201-377-6636 • **WASHINGTON, DC** 301-656-3061 • **PENNSYLVANIA** Wayne 215-688-7325 • **GREAT LAKES** Michigan City, IN 219-874-3333 • **NORTH CENTRAL STATES** Lincoln, NE 402-467-2900 • **SOUTHEAST** Orlando, FL 305-896-4881, Huntsville, AL 205-881-8220, Greensboro, NC 919-273-1918 • **ROCKY MOUNTAIN** Denver, CO 303-573-8835 • **TEXAS** Arlington 817-461-1707 • **CALIFORNIA** San Diego 714-278-8931, Costa Mesa 213-869-5884, Cerritos 213-926-7002, Palo Alto 415-326-0280

# AMONG TELECINES

Circle 125 on Reader Service Card

# a standard switcher from CDL?

only 120 day  
delivery?

only \$34,000?\*

that's right!

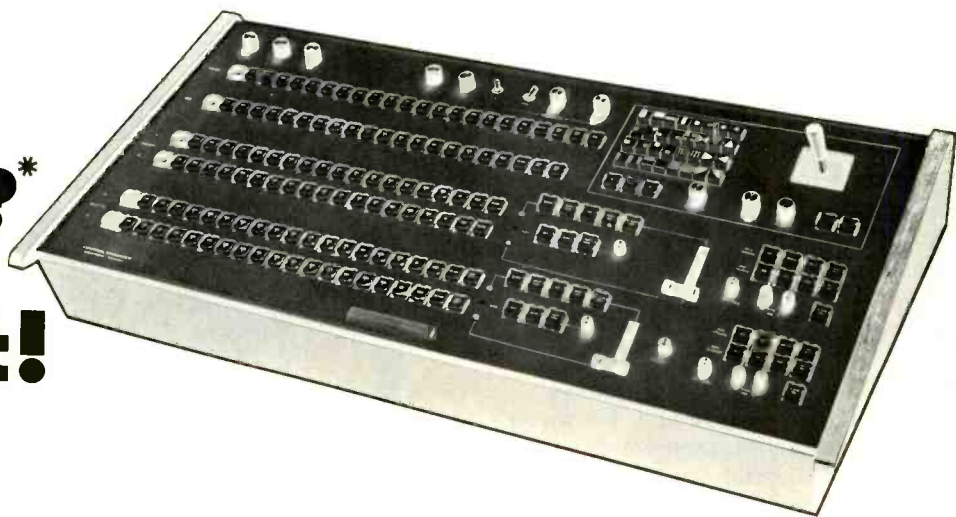

And in addition...  
loaded with  
"custom" features  
and CDL Quality

it's the  
**VSP-1260S!**

When you need a "Big" Video Production Switcher there are only a few manufacturers who make them. You've been accustomed to a "Big" delivery (6 months and longer), and at a "Big" price.

That's how it has been ...

**Here's how it is NOW!**

- We've taken your most wanted "Custom" options and made them STANDARD.
- Standardizing features and production have reduced costs, and delivery schedules to less than 4 months.
- The VSP-1260S also has all the other original features of Central Dynamics' VSP-1200 Series Switchers.

You get these most wanted "Custom" features:

- 20 inputs
- 8 Busses including 2 Mix/Effects, Preview/Key, Program AND 2 prewired Utility busses for a variety of applications.
- VK-2140 Encoded Chroma Keyer integrated and timed into switcher and including 4x1 input selector.
- Dual 2x1 Chroma Key Switcher to delegate VK-2140 or RGB Chroma Keyer to either M/E amplifier.
- 1 Key Border Module: can be used with either Mix/Effects bus.
- 32 Non-Repeating Effects Patterns
- Soft Edge Key
- Soft Edge Wipes and Vignettes
- Spotlight & Mask Keys
- Non-Add Insert on each M/E
- Fade to Black from nonsynchronous sources
- Automatic Color Black system

Following options can be added any time on a plug-in basis:

- RGB Chroma Keyer and input selector
- Utility Bus Control Panels
- Additional Key Border Module

To see the effects of VSP-1200 Series Switchers in color, request our "On-with-the-Show" Brochure.

You can also see the effects "Live". VSP-1200 Switchers are operating in most major cities across the country.



**CENTRAL DYNAMICS LTD**

Canada:  
147 Hymus Blvd., Montreal, Que., H9R-1G1  
514-697-0811

U.S.A.  
230 Livingston Street, Northvale, N.J. 07647  
201-767-1300

# One O'Clock, Two O'Clock, Three O'Clock . . . Rock!

By Pepe Lobo

Producing original live rock shows for TV—and stereo for record making—is not easy. There's the problem of working with five groups a night, getting rid of hum on 30 mike setups per group (each with a three way splitter), doing a visual edit that conforms with the music (and audience reaction), then letting the performer do the final mix.

Some say rock music causes headaches; and they're right. Musical taste aside, taping rock music causes every kind of headache. Precisely because of its technical complexity, only recently has rock-and-roll music become a viable television commodity distinct from its cousins, variety and traditional pop. The teleproduction of rock and roll is one of the frontiers of the technology, the methods and equipment are constantly changing as producers in the field strive to meet the demands of the audience.

Several shows with live-audience, concert formats now vie for King of the Mountain. They are intended to be, and in truth are, live concerts. Don Kirshner's *Rock Concert* was one of the first in the field to successfully teleproduce and distribute rock music. *Rock Concert*, distributed by Viacom, is seen in over 100 markets across the United States. Remote production is provided by Trans American Video (TAV) of Hollywood. Typically, Kirshner Entertainment, through TAV, produces a ninety minute show every week for television. Jim McElroy, video editor at TAV, found himself working as much as eighty to one hundred and twenty hours a week on these shows.

"Figure you're cranking out a ninety minute show a week," said McElroy. "Some people take six weeks on a ninety minute show. It's a monumental task. I just sit back and shake my head sometimes."

## Recording sound to please the performers

Sound recording has been the key to the success of this format. The highest level of sound reproduction was necessary; not, as one might suppose to please the audience, but to please the performers. Rock musicians are, in general, serious artists concerned with the quality of their performances; most groups would not participate if the quality of the sound reproduction was inferior. In order to sell the groups on this kind of show, it was necessary to implement multitrack recording.

Jerry Clemans, recording engineer for TAV who claims a doctorate in Patch-Bay, explains. "What they were trying to get away from was the Dick Clark Saturday afternoon stuff where everybody came in and lip-synced to their 45. We grew up on the stuff. It's bee on since the beginning of television."

*American Bandstand* was lip-sync all the way and for some very good reasons. The budget of the show did not allow for musicians, rehearsal time, or mistakes. Indeed,

**Pepe Lobo** is a free lance writer/photographer from Los Angeles, Ca.

there is some question as to whether many of the performers could reproduce their sound away from their producers and sound engineers. Popular music is in many ways a collaborative medium.

In order to tape a live concert using studio techniques on one track, the performance has to be done over and over and over until the musicians, the mixer, the recording engineer, everybody gets it right. There goes the concert. What is the audience supposed to do while the band goes through its rendition of "Blue-Green Kisses" one more time?

The answer, reasoned executive producer Don Kirshner, was multitrack recording of the original performance in a one-shot, concert atmosphere before (hopefully) a frenzied live audience. "It's the real thing," was to some extent the theme he and producer David Yarnell used to sell the talent. The groups were allowed to come in and mix down their own material in order to insure that as closely as possible it was *their* show. This is a case where talent and its correspondent technology could not be separated. It worked. The show looks and feels like a live concert, which for the most part it is; but what a technical headache it caused.

## TV Recording for broadcast and the record industry

"It was really long and involved," says sound engineer Jerry Clemans, "and came down to selling our

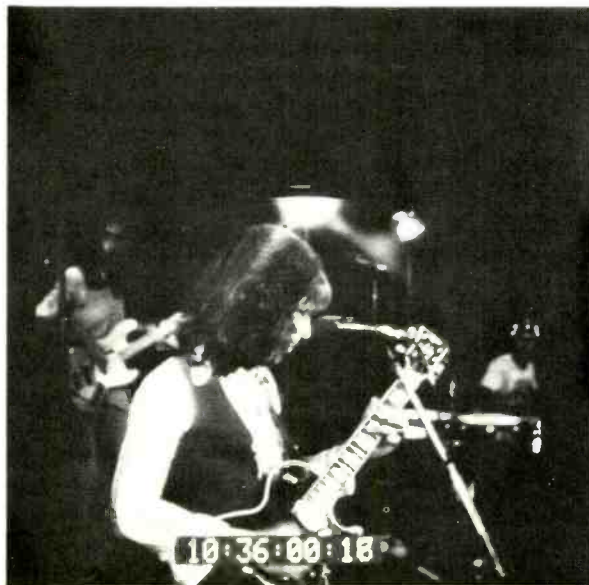

Typical Rock Concert frame.



At the editing console, Jerry Clemens, left, and Jim McElroy, right.

Helical tape decks associated with editing equipment.

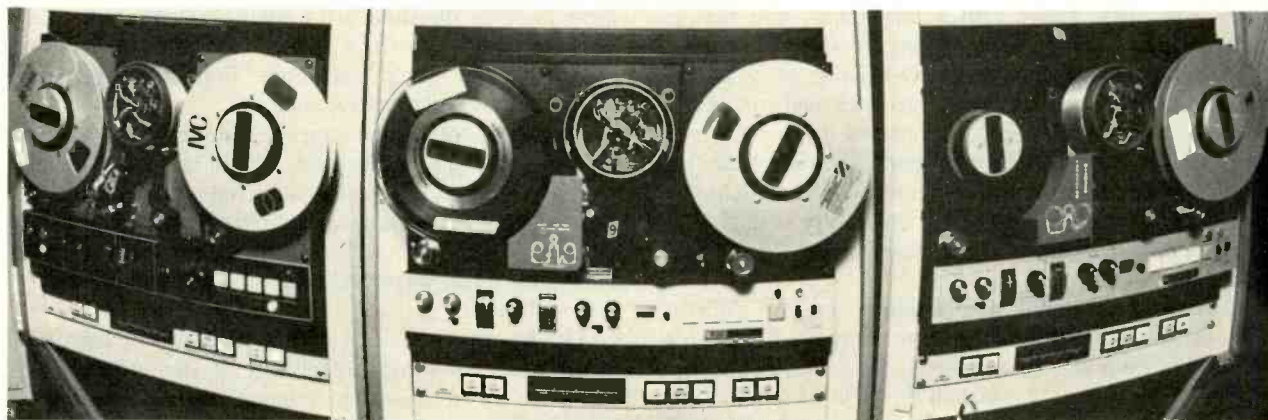

media to the record industry." All of the recording is done on a 16 or 24 track equipment using Wally Heider Sound Productions of Hollywood. This allows the shows to be mixed to a stereo mix for simulcast and mono for the network tapes. "We had to start dealing with their industry," Clemans goes on, "to bring their credibility and expertise to our pictures."

Artistically, it works; but the technical complexity increases by a power of ten. Instead of going on location and simply shooting with all the normal problems, add the problems of making a professional sound recording which must reproduce the band's well-known sound at the same time. In other words, take a sound studio and a television studio on location and marry the two technically.

"It's a multifaceted problem," understates Clemans.

The show tapes three days in a row. After a two day set-up period for light and stage personnel, the remote crews arrive and taping begins. For three days they will tape five or six acts a night before a live audience of about two thousand persons. Audiences are recruited from local schools and surrounding areas. The logistics are horrendous.

"Just think about taping five or six acts a night," exclaims Jerry Clemans. "Getting their instruments delivered to wherever we're going to tape it. Get them unpacked and set up on stage and make them work." To speed set-up, the show uses three movable stages pre-setting the groups before their turn comes up, then rolling them before the cameras. Too much down-time kills the audience and the feel of the show. The drums are set-up on risers, then lifted into place. Determining how best to move talent on and off-stage smoothly and

quickly was a trial-and-error process. What about the electronics?

At the talent technological interface the techniques remain the same as for any on-location sound recording. "The problems are just exactly like the problems you'd run into miking a live concert," says Clemans, "and then some. They'll use a direct box and mike from the amps just like in the studio. Except that you have to remember you're working with a lot of high-level PA. It becomes very tricky mixing this stuff down."

The basics are the same, but there are differences. A crew of technicians will remain on the floor just to remike. There were visual problems to work out. The crew had to learn to keep a mike from hiding a performer's face. The Wally Heider sound people had to learn that their goal was not to make a record, but to lay down good clean tracks for TV. It was an educational process. Some of the problems were simply habits which had to be changed.

Clemans explains that, "you have to have roll-up time in order to edit. The recording people were used to reaching over and pushing "stop" as soon as there was a die-off at the end of a song. You can't do that." It was leaving Jim McElroy, the editor, short of track.

All of these problems had to be worked out, but some things could not be avoided. The sound configurations alone are staggering. Each mike runs to its own splitter box where the signal is split three ways. One line runs to a house P.A. mixer board where the signals are mixed and run to a house P.A. for the audience. Another line runs to the stage P.A. mixer where a different mix is returned to the stage monitors for the performers. the third line

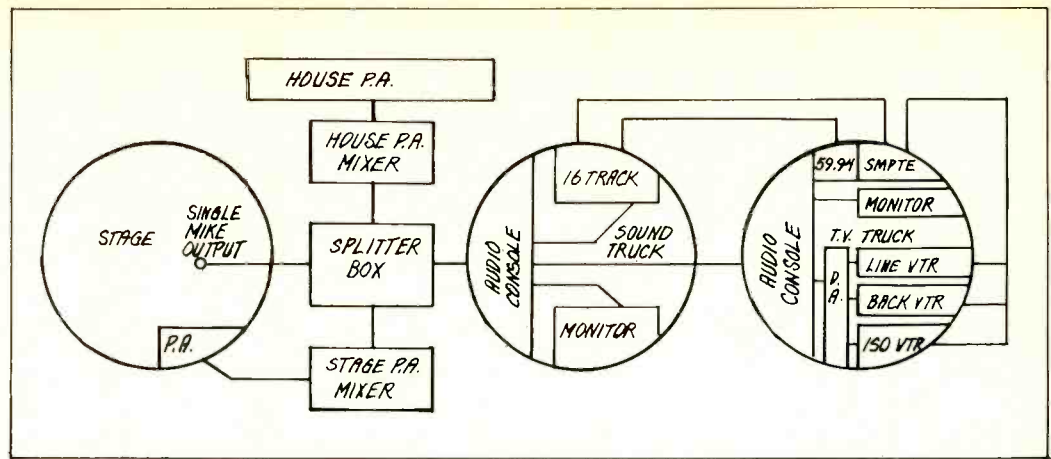

Sound configuration for single mike output.

runs out to the Wally Heider sound truck and into the 16-track mixing console. As there may be as many as thirty mikes on an act, each doing the same three way split, the palce gets to be a mess rather quickly.

The hum and buzz problems of doing a rock-and-roll show for television are incredible. Remember, those ninety odd cables just get the sound off the stage and out the door. This says nothing for the lighting and the sets . . . and all the guitar amps. "Pretty soon you've got this mass of lines that just go everywhere. The physical aspects are just unbelievable," says Jerry Clemans. So unbelievable in fact that Associate Producer Bonnie Burns began charting cable runs for each show to be sure the cable was dressed properly.

"Every group you've got a problem," says Clemans. "Every group has a different set of amps. It's tremendous. Lighting dimmers . . . there's a certain type of SC lighting dimmer that will induce noise in the track. If all the P.A. systems in the audio truck and the TV truck are not on the same ground potential you have hum. All you need is for one leg of the audio truck or the TV truck to be two volts above ground and you've got buzz. Not only do you have buzz in the P.A. board, but it goes right back down the line into the audio truck, the TV truck, the house P.A. and back into the guitar amps. Then you get all this lighting cable thrown on top of it. All these little things just drive you up the wall."

Chasing down buzz is one of those rock-and-roll migraines. "You never know what you're getting into," complains Clemans. "It could be something very simple, or it could be major. It can take a couple of minutes or it can take an hour. Meanwhile, the taxi meter's running . . . that's when the heat's really on. A lot of times it's a connector that has a broken wire in it, or one that's turned over. We have gear from all kinds of different companies. Not everybody uses the same pin assignments. If you go into those you're turned over in phase and that generates buzz. Sometimes it'll be coming from a bad dimmer in the (lighting) dimmer board. The SC lighting dimmers will transmit a spike. It's almost impossible to notch or filter out, like trying to filter out flurescent buzz. It's very broadband."

Sleuthing for buzz requires a certain regimen. You simply start working back from the front of your set-up all the way to the board. You know which mike input its on. You start working at the mike and work back. It might go over a whole stack of ac cord. A lot of times it's just cable, the way it's dressed; it could be a bad

plug, or a mike even. Most of the time it's ground loops, bad cables, or connectors.

### Several mixes during the show

Once all those hopefully buzz-free mike inputs reach the Wally Heider 16 track in the audio truck, the signals are amplified and several mixes are made. One mix goes to the monitor in the sound truck and another is piped to the TAV remote truck. In the Wally Heider truck the inputs from the stage are cleaned up and equilized, then laid down at the proper level on the 16 track recorder. Several submixes will be made at this time. The drums will be mixed down to one or two tracks, while the vocals and guitars will probably be laid down on a track apiece. Audience response will be laid down on one or two tracks and several tracks are needed for sync and time codes.

The two monitor mixes in the sound truck are necessary as Jerry Clemans explains. "The recording engineer in the recording truck must have the ability to monitor what he wants to . . . to keep very close tabs on the vocals to be sure they are correctly modulated. You've got to be able to hear it for buzz, distortion, and things like that. With all his punching in and out, you can't let the director hear that, so the director has to have a separate monitor mix. It must be a monitor mix of the performance so he can tell what the talent is really doing."

The TV monitor mix runs to the TAV remote truck where it is split by the audio console. One feed goes to the monitor for the director, and another goes to the distribution amp. The D.A. feeds three video tape machines, a line, a back-up, and an iso. This monitor mix, the "scratch track," is necessary for editing.

In addition, the TAV remote truck has a SMPTE time code generator which lays SMPTE time code on all of the VTRs, then locks the system together by feeding SMPTE time code back to one of the free tracks on the 16-track recorder. To make sure that the editor can always sync up picture with sound, 59.94 cps the TV color sync frequency, is laid down on another of the tracks of the 16 track.

"As long as we have 59.94," says Jim McElroy, "we can go back and sync it visually. Without it, that tape recorder is running wild."

### The editing process, visual then audio

Conforming all the input from this work falls to Jim  
continued on page 48

## ROCK

McElroy. All the tape, and whatever supplemental visuals are available, come to him for editing. The work of the director is recorded by the line and back-up VTRs while an iso mix has also been recorded. All of this goes into the final McElroy-cut version under the direction of the director or an assistant, like Associate Producer Bonnie Burns or Associate Director Lou Horvitz.

Everything is first transferred to one inch as all of the workprint editing is done in this format. The material to be used in the show having been decided, McElroy builds visual sequences to match the scratch track. *He makes no edits in the music.* This is the province of the musical group involved. He likes to keep the edits true to reality, even the audience.

"I try to keep the audience looking like it sounds," says McElroy. "If there's not a big audience, I try to find microscopic shots."

The editing of this show is arduous because of the need to turn out one ninety minute show every five days. That's three or four days of off-line editing akin to producing work prints and then at least 24 hours of two inch editing. Says McElroy, "I was working 24 hours straight on that. I was putting in an extra day into the week. It takes a lot of concentration . . . and it's all so particular. Start splitting frames at a thirtieth of a second."

McElroy produces a one-inch insert-edited work tape. This one-inch edited master is the basis for the computer punch tape which will direct the CMX control machinery to create the two-inch edited master. Since the one-inch

edited master is an insert-edited tape, it contains its own SMPTE time code. The punch tape relates the old SMPTE time code as recorded during the performances to the new one as found on the one-inch edited master. McElroy delivers his one-inch edited master and the CMX punch tape, but it still only contains the "scratch" track laid down from the director's monitor mix.

At Wally Heider's in Hollywood, the rock groups mix and modulate until they have created the best sound they can. The original 16-track recording is mixed down to stereo. Then at Glen Glenn Sound Co. an eight-track "conforming" tape is made. This eight track contains two tracks of stereo product, two tracks of audience, the "scratch" track, and the new SMPTE time code as laid down from McElroy's edited master. In addition, one track carries 59.94, the back-up sync frequency.

When the conforming tape is played in conjunction with the two-inch edited master, the old scratch track is stripped from the master and the new, mixed sound is laid down. The new SMPTE time code locks the whole thing together.

The process of merging on-location television production with multi-track recording has not been easy and is by no means complete. There are still some problems, and some conflicts in this work. The final mix-downs, while perhaps correct for disc pressing may still not be quite so suitable for TV with its four-inch speakers and under-designed amplification. The hard work is completed though, and these techniques have been tested week after week as Don Kirshner's *Rock Concert* airs some of the most dazzling and technically exciting footage available.

BM/E

# End the Identity Crisis in your videotape library! Model 367 Post Production Switcher for the 'Videotape Generation' \$3,780.00 List

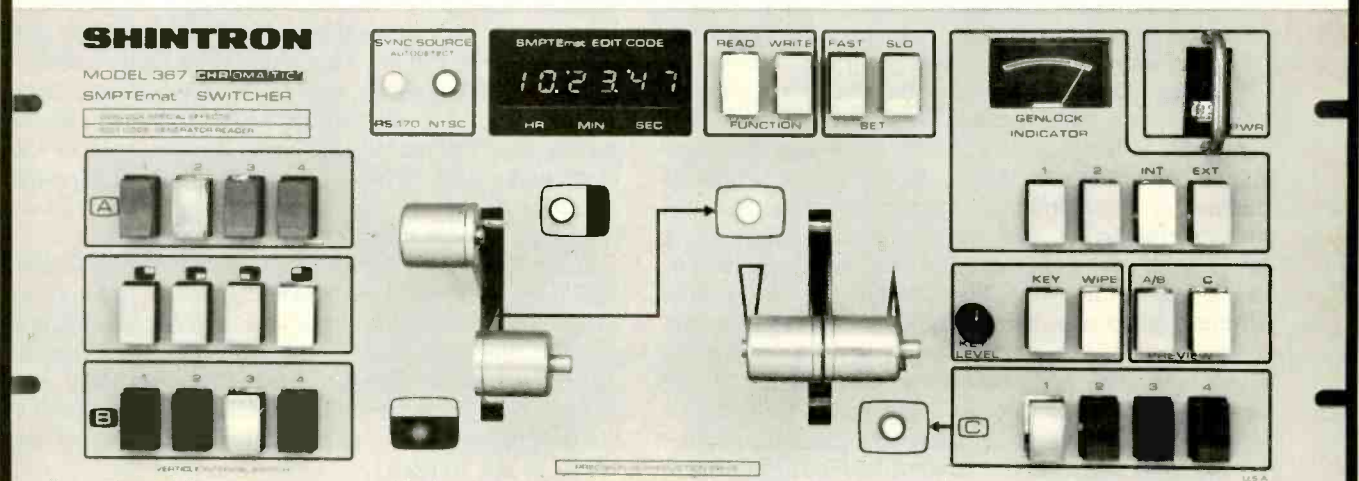

- total color switcher + SMPTE edit code generator/reader
- + color count-down genlock (to Helical VTR)

**SHINTRON**  
Cambridge, MA 02142 (617) 491-8700

**...The Precision People**



# If we didn't make a better refurbished quad head than either Ampex or RCA and with a better price/performance ratio we'd have been out of it a long time ago. (And that's the truth)

Videomax began to make refurbished quad heads 5 years ago. We were convinced a better job could be done and that you should have a choice. We were also convinced that a small company of specialists could offer a better product than the large multi-product manufacturers. Nothing since has changed our minds or the minds of our **more than 600 customers.**

Today, no one in the business comes close to our level of cost/performance. No one in the business exceeds our warranty protection. No one in the business offers a wider variety of

refurbished Ampex and RCA heads. And no one, according to our long list of customers, has a more respected manufacturing and Q.C. history.

So, if you need a Mark X or a Mark III quad head in our "L" or "M" Series ... or an RCA High Band or Low Band quad head in our "M" Series ... contact Videomax.



Videomax, an ORROX company  
154 San Lázaro Avenue  
Sunnyvale, CA. 94086  
(408) 739-5391



MARK X



MARK III

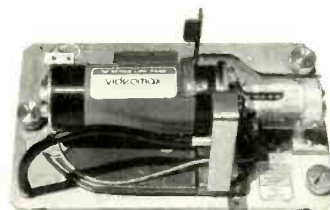

RCA LOW BAND

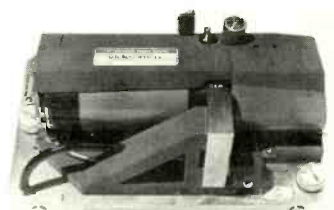

RCA HIGH BAND

#### SALES & SERVICES

New York Los Angeles Washington, D.C.  
(212) 947-8031 (213) 980-7927 (301) 384-4733

Circle 128 on Reader Service Card

# GREAT IDEA CONTEST

## 12. Waveform Generator Synthesizes Steady-State Tones.

*Jerry E. Shepherd, Transmitter Engineer, KCPX-TV, Salt Lake City, Utah*

**Problem:** To duplicate sound by artificially generating its characteristic waveshape. I developed a circuit which allows the user to obtain a signal which can be adjusted to any desired waveshape. The circuit was developed to fill a need for a combination test signal generator, digital-to-analog converter, and an AM or FM modulator.

**Solution:** The circuit divides the period of the input signal into 16 segments. By means of the 16 control pots, the user can adjust the amplitude of each segment to the desired amplitude while observing the output signal on an oscilloscope. If a dual-trace scope is used, it is possible to match the reference waveform very closely.

A square wave is applied to the input of a SN7493 binary counter connected to count from 0 to 15 in 16 steps. As the counter proceeds through the 16 counts, its status is transferred to a SN74154 4-line to 16-line demultiplexer. The SN74154 has 16 separate output lines; with each of the states of the counter the corresponding output line is grounded while the re-

maining lines remain at a high level. As the input pulses arrive at the input of the chip, and the counter advances, each successive output line is grounded in turn. Each potentiometer is

momentarily connected in series with resistor R1 while the remaining ones are floating and isolated from the circuit.

continued on page 52

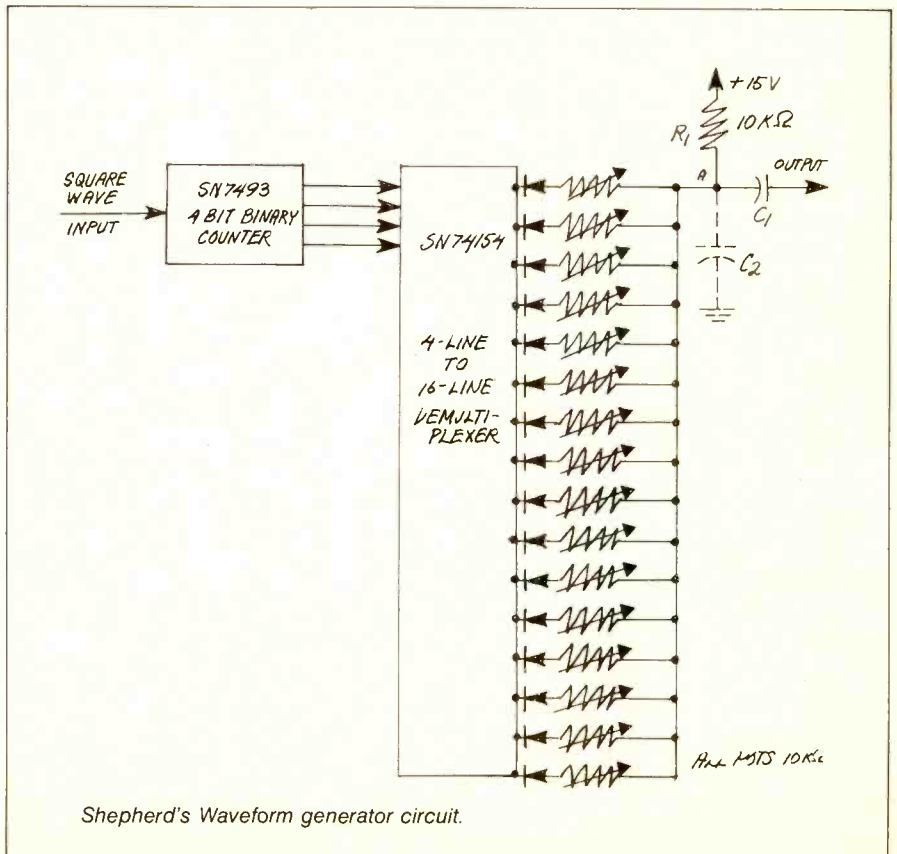

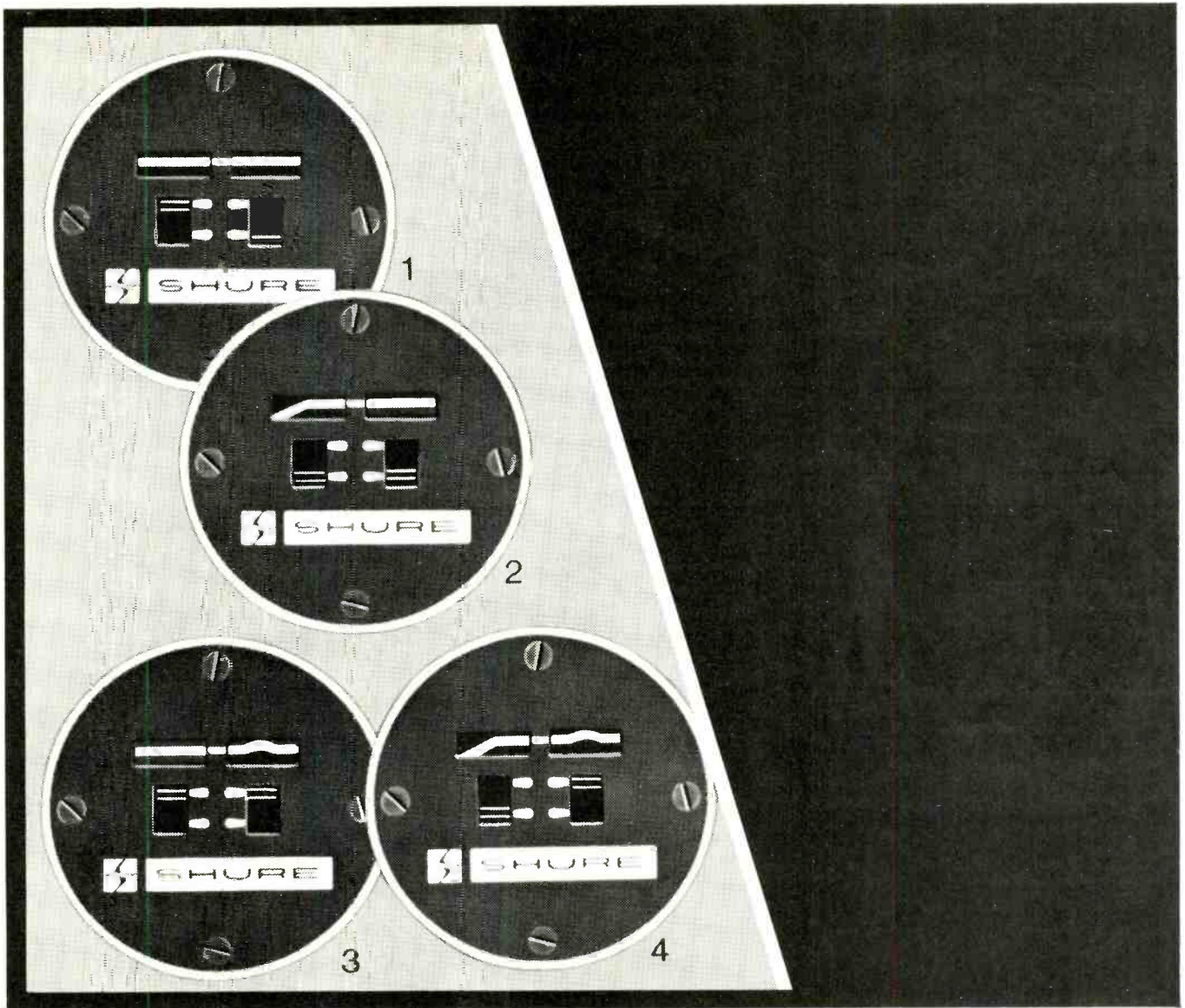

What you see is what you get.

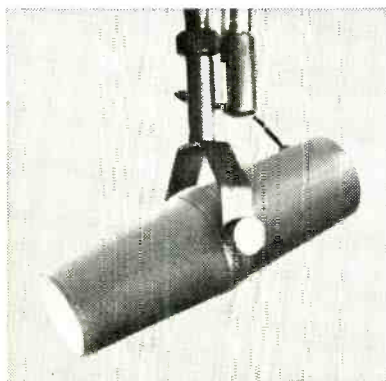

The extraordinary Shure SM7 professional microphone features something you've never seen before: a *built-in Visual Indication Response Tailoring System* that offers you four different frequency response curves—and shows you the curve you've selected with a graphic readout (see above) at the back of the microphone! Choose: 1. flat response; 2. bass roll-off; 3. presence boost; 4. combination of roll-off and presence. And there's more: the SM7 delivers exceptional noise isolation with a revolutionary pneumatic suspension mount . . . an ultra-wide, ultra-smooth frequency response . . . an integral "pop" and wind filter . . . and a cardioid pickup pattern that looks "text-book perfect." The Shure SM7 Studio Microphone was extensively field-tested in recording studios and broadcasting stations! Write:

Shure Brothers Inc.  
222 Hartrey Ave., Evanston, Ill. 60204  
In Canada: A. C. Simmonds & Sons, Ltd.



Circle 129 on Reader Service Card



the first  
reel to reel  
with the rugged  
reliability of  
**itc**

The makers of premium quality tape cartridge equipment in the reel-to-reel market? It had to happen! The result is what you, Mr. Broaccaster, have been looking for. All the features you demand plus a few innovative optionals of our own. And all with the rugged reliability inherent in the International Tapetronics' name. Check out these plusses in your own studios. We offer a 30 day guarantee of satisfaction plus a one year warranty. Just call collect and say you want to try the "850" series. We'll do the rest.

Phone 309-828-1381



**INTERNATIONAL  
TAPETRONICS CORPORATION**  
2425 South Main Street Bloomington, Illinois 61701

Marketed exclusively in Canada by  
McCurdy Radio Industries Ltd., Toronto

## GREAT IDEAS

Resistor R1, connected in series with the potentiometer which is grounded at any given instant, forms a voltage divider. The value of voltage at point A is determined by the setting of the respective potentiometer. Since each of the pots is selected in turn, the voltage at point A continually varies through each complete sweep of the signal. Since the circuit continues this operation until the input signal is removed, a signal of the desired waveshape is generated.

The output frequency of the generated waveshape is 1/16 of the frequency of the input signal. It is neces-

sary therefore to apply a signal 16 times the desired output frequency to the input.

Capacitor C1 is used to block DC. Capacitor C2 is used if a step-type signal is not required and a smooth-changing waveform is required.

Amplitude modulation can be obtained from the circuit by replacing the 15 VDC with a sinewave of appropriate amplitude and frequency. In this case the sinewave signal will be amplitude-modulated with a waveshape determined by the setting of the controls.

Frequency modulation can be obtained by applying the output signal to a voltage-controlled-oscillator. The frequency of the oscillator will then swing in a manner determined by the setting of the pots.

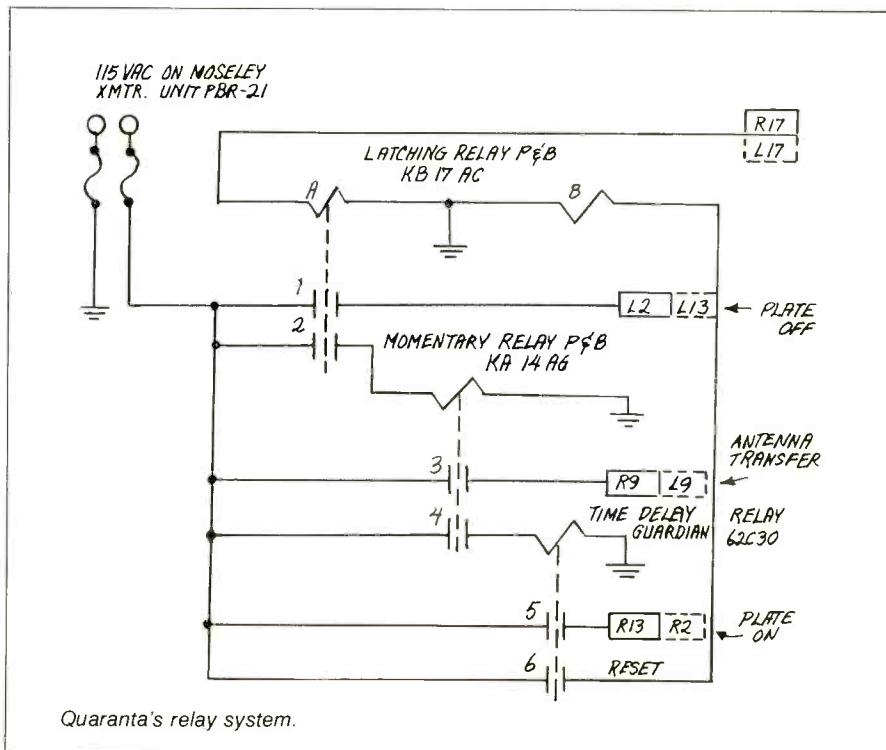

### 13. Six Relays Speed Transmitter Changeover.

Don Quaranta, Supervisor, WNYC, New York, N.Y.

**Problem:** To upgrade the existing studio-transmitter remote control system for quicker switching of main and alternate FM transmitters.

**Solution:** Initially, whenever switching transmitters on our Moseley PBR-21 remote control unit, the single pushbutton approach of plate off-antenna transfer-plate on took at least 10 seconds to accomplish. A quick automatic step relay system was designed to work in conjunction with the PBR-21.

This auto-switching unit now trans-

fers transmitters in 2 seconds. It uses six relays; three for switching main to alternate transmitters, and three for switching alternate to main.

We made use of one unused pushbutton on the PBR-21 control for the auto-step switching. We picked contact 17 to start the command sequence in the system. Before initiating the sequence, though, the PA filaments of the transmitter to be switched must be receiving power.

When the pushbutton is pressed, and the Raise command is held down, latching relay A is activated and closes its contacts 1 and 2. Contact 1 puts 117 VAC across Lower command L2 and cuts the plate voltage of the "on" transmitter. Contact 2 activates the momentary relay KA14. Contact 3 on this relay puts 117 VAC across Raise command R9; this activates the an-

tenna transfer switch. Contact 4 triggers the time delay relay. After about two seconds, contact 5 on this relay closes and activates Raise command R13. Plate voltage now is applied to the alternate transmitter. Contact 6 shuts off the system by activating coil B of the latching relay.

For switching from alternate to the main transmitter, a duplicate triple-relay system was also built. Now contact 17 (Lower command) switches transmitters. This auto-switching unit was built on a five-inch rack panel. The total cost for the six relays was less than \$100.

## 14. Tape Cart Helps Third Phone Operator in a Jam.

Robert R. Groome, Director of Engineering, WERE, Cleveland, Ohio

**Problem:** To enable third class operators to correct problems affecting on-air audio and modulation outages.

**Solution:** WERE, An AM station, has a phone line (LMC circuit) between the studio and transmitter. Audio phantomed from our modulation monitor drives a Maritel V1005

VOX adjusted to trip for loss of audio for more than 5 seconds. The VOX has two dry relay contact sets; one operates a flashing off-air light, the other operates relay K1. The operating sequence follows:

The normal path for automatic logging of program material is broken between the Gates SSC switching center and the logging decoder equipment. The modified Spotmaster is coupled to the decoding equipment and is started. Playback of an instruction tape starts the ASR33 teletype which immediately begins to print out a com-

continued on page 54

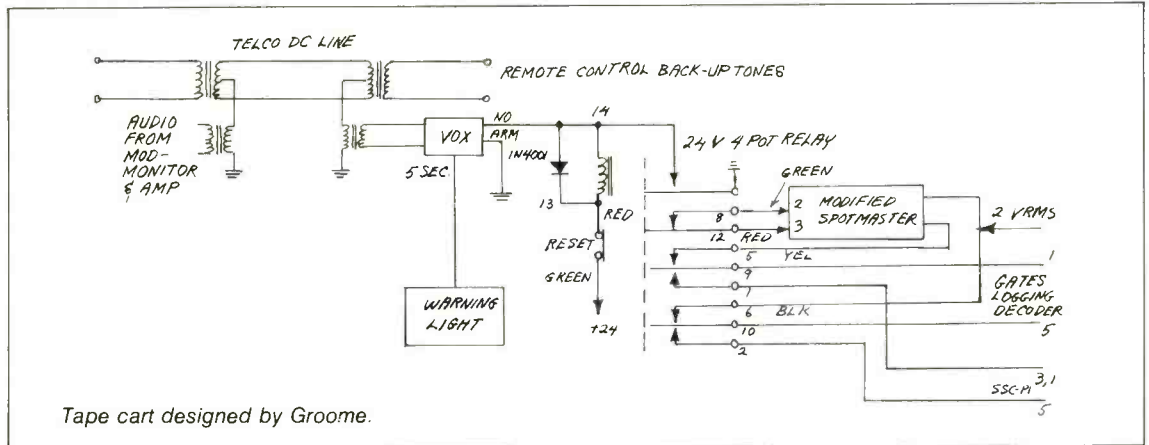

## Our CP-16 Camera/Lens Package Deals Are Guaranteed To Give You More.



Package Order Code: #1P121

Figure it out yourself.

Take for example the package deal illustrated in this ad. You get a CP-16 reflex camera — the most outstanding news/documentary camera on the market today — *plus* a set of three superb Angenieux lenses. The extreme wide angle 5.9mm f/1.8; the high speed 28mm f/1.1; and the all around favorite "workhorse" 12-120mm f/2.2 zoom. All CP reflex mounted. A perfect combination for the news/documentary cameraman on the go.

**And you save \$700 on the package.**

Or, you can choose any of our other CP-16 reflex and non-reflex camera/lens package deals designed to save you hundreds of dollars.

**Without compromising on quality.**

So, visit your local CP-16 dealer. Ask for our new CP-16 illustrated price list. Pick the one package deal that suits you best. And save!

For further information, please write to:

**cinema E products**  
CORPORATION

Technology The Service Of Creativity

2037 Granville Avenue, Los Angeles, California 90025  
Telephone: (213) 478-0711 ■ Telex: 69-1339 ■ Cable: Cinedevco

Circle 131 on Reader Service Card

## GREAT IDEAS

plete step-by-step procedure giving instructions to correct the audio and/or RF problems. All the necessary personnel phone numbers also appear on the sheet.

We needed 15 minutes of tape to handle all the necessary instructions. For shorter messages, it would be possible to use the tape reader on the ASR-33 triggered by a contact closure, or by the code on a short tape cartridge. We needed the much longer time which fits the tape format better.

The instructions print over and over until action is taken. Then the Reset button is pushed. The device is tested each time we run an EBS test, or have very low or no audio for more than 5 seconds.

The modification to the Spotmaster was the simple addition of a small audio amp to get the level up to 2 volts. When making the message cart, we recorded 1000 Hz on the program channel of the tape for about 1/2 second. The Spotmaster head leads were swapped to use the normal program amp to amplify the logging information; the Spotmaster cue circuit will cue up to the 1000 Hz tone placed on the other track. We no longer have to worry about losing phone numbers

and remembering what to do. In addition, commercials and PSA's that were aired when we were off the air are not logged.

### 15. Modified Cart Integrates Network News into Auto Format

Vern Argo, KYLT-FM, Missoula, Montana

**Problem:** To automate recording and playing back network radio newscasts. KYLT-FM recently began broadcasting with an automated format. One of the problems encountered was the programming of network newscasts. Three methods were available to integrate network news into the automation equipment: use a backfill, fade out the selection playing, or have an operator record the news and then program the automation gear to run it. We integrate the news into an auto format without the problems encountered with the above methods.

**Solution:** A Sparta record/playback cart machine was rebuilt by adding a bias amp, a 150 Hz and 8 kHz detector card, and a Nortronics type 6126

erase/record head. The cart machine was rewired so it is always in the record mode. As the cart runs, the tape passes the playback head, then the erase head, and finally the record head. Only the program track is erased. The cue tones are detected on the program head. The cue track is prerecorded on another machine with the 150 Hz, 1 kHz and 8 kHz tones. The 150 Hz tone is recorded 5 minutes into the tape for a period of three seconds. This length allows the newscaster to give the network news close over music, which is the next event following news.

ABC Contemporary News is used at the station. At 54:30 the automation clock sends out a pulse; this activates a relay which starts the cart machine and records the newscast. The cart machine stops at the 1 kHz tone and is cued and ready to play back the newscast. At approximately 2 minutes past the hour the automation calls on the cart machine for news playback. The cart machine stops at the 1 kHz tone and is ready to record again at 54:30.

Using this method, no one is required to record the news. This gives a tighter, more professional sound on the air. At this time, it is understood that an equipment manufacturer has developed a system similar to this one.

continued on page 65

## Flexible, solid-state audio switching NOW under \$10 per crosspoint

Input-output configurations are virtually unlimited with this modular, building-block solid-state, audio switch. And . . . this flexibility comes at reduced cost.

Starting with a single 8 3/4-inch by 19-inch rack frame assembly, the user can build to a 20-input by 20-output configuration through selection of plug-in switching and amplifier boards.

Still using the same basic frame assembly, other configurations such as 20 by 5, 10 by 20 or combinations in between can be assembled. Greater capacities, including dual inputs or outputs, are just as easy . . . just add.

Control? . . . a snap! pushbuttons, thumbwheels, dials, touch pads . . . even a computer.

Performance is outstanding. Using field effect transistor switching and integrated amplifiers, the Series 8100 handles -6 to +8 dBm levels through its balanced transformerless inputs. Flat within  $\pm 0.15$  dB (20 Hz to 20 kHz)  $\pm 1.0$  dB (1 Hz to 50 kHz), crosstalk (better than 70 dB below output), harmonic distortion (less than 0.15%) and hum and noise (85 dB below maximum output) the 8100 compromises nothing for its flexibility.

Best of all, users will really appreciate the economy. By specifying the initial capability for any remotely-controlled, switched audio distri-

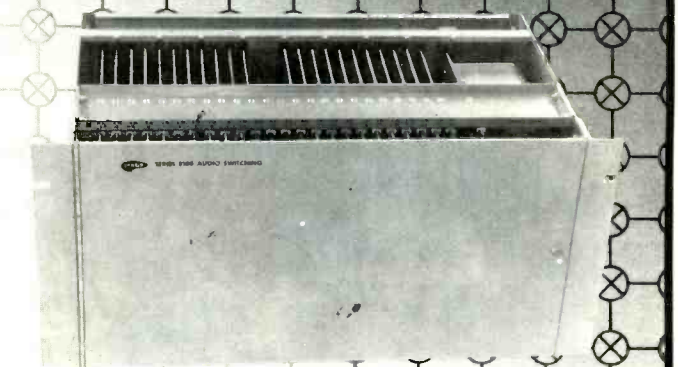

bution network, the buyer saves now and isn't penalized later. High reliability solid-state audio switching costs can be cut to as little as \$10 per crosspoint . . . significantly less than competitive switching systems.

**DYNAIR ELECTRONICS, INC.**  
6360 FEDERAL BLVD., SAN DIEGO, CA. 92114  
PHONE: (714) 582-9211; TWX: (910) 335-2040

DYNAIR

# BROADCAST EQUIPMENT

For more information  
circle bold face numbers  
on reader service card.

**Modulators** add closed-circuit TV programs into Master Antenna systems or CATV systems. Model AVMT 4923 provides both a modulated visual and modulated aural RF carrier output on any single VHF channel. It has LED aural modulation lamp and adjacent channel operation without external filters. Other models are for visual or aural modulation alone, and for high-resolution (8 MHz) operation. BLONDER-TONGUE LABORATORIES. **300**

**Cleaner** for all audio equipment is aimed to penetrate iron oxide buildup on tape recorder heads. Audio Pro is



also designed for general cleanup of tape decks, electronic panels, mike stands, keyboards and consoles. AUDIOTECHNIQUES, INC. **306**

**Automatic iris control** unit samples video signal and drives iris to the correct setting. Model V107AC can be used with Inraspot fixed-focal length-

lenses and a sensitive camera for operation from bright sunlight to partial darkness. VICON INDUSTRIES. **301**

**Connectors for .085 and .141 semi-rigid coaxial cable** fasten without soldering on the outer conductor. Two-piece connectors use a slotted collar and clamping nut, with a captive pin. They are available in all standard configurations. TROMPETER ELECTRONICS. **302**

**Signal generator** includes micro-processor for high degree of automaticity. Model 6010A has a keyboard control for free-form entry of frequency in Hz, KHz or MHz. Range is from 10 Hz to



11 MHz. Up to 10 preset frequencies, modulation, and attenuator settings can be stored and recalled by pushbutton. The seven-digit readout is autoranging. \$2495. JOHN FLUKE MFG. CO. **303**

**Videocassette deck** for the 3/4" U-Matic format provides both assembly and insert editing. Model VT-6000 also has stop motion, remote control, automatic repeat, counter program stop. It is built with IC chips to a large extent. \$6000. TEAC. **304**

**FM program audio diplexer** can provide full fidelity stereo or mono TV sound on microwave and satellite TV nets. Model SBC-418 incorporates an active HF receive tracking filter which gives high immunity to noise on long-haul microwave and satellite links. Other features are a linear, low-noise VCO, and digital discriminator handling wide FM deviation corresponding to more than 75 dB of audio dynamic range. COASTCOM. **305**

**Radiation field monitor** for 200 KHz through 500 MHz is mounted in weather-tight case for use on antenna towers. The AFM gives absolute accuracy of modulation display when connected to an ordinary audio oscillo-



scope, thru any length of RG-58 coax cable. It requires no external power or batteries and is held on the tower by one  
continued on page 56

## PRODUCTS

mounting screw. \$29.50. D.R. CORBIN MFG. CO. **307**

**Character generator** produces 512 black or white characters in 16 lines of 32 characters each. Model 72 has a single-line or full-page operating mode, with roll-down in the single-line mode, and insert-delete capability.



Characters are formed by a 7 x 8 dot matrix. Keyboard is standard 64-character ASCII type that can be interfaced to a computer. \$1995.00. MOXON, INC. **309**

**"Noise loader"** allows simple performance checks of microwave system. Model AT-9003 is designed for use with any good general purpose selective level meter, or with a noise re-

ceiver. The test system includes an accurate white-noise generator, covering 6 KHz to 12.5 MHz, two plug-in band-limit filters, three plug-in bandstop filters, and a pre-emphasis network. Suitable noise bands for test are selected by front-panel pushbuttons. By changing plug-ins the system can be adapted to a broad range of microwave requirements. The band-stop filters allow the noise signal to be blocked out, so noise and distortion products can be measured. \$2290. W&G INSTRUMENTS, INC. **308**

**Delay lines** are for use in broadcast equipment in which video is modulated onto 27 MHz carrier. The 27 Series have nominal delay time of 64 microseconds, but can be specified for the user's system. Minimum bandwidth is 12 MHz or 14 MHz (in various models), delay tolerance is ±10 nsec, and delay temperature stability is 5 nsec. \$195 to \$225. WALTHER M.A. ANDERSEN AND ASSOCS. **310**

**Audio mixing console** series has modular construction, up to 16 input and 8 outputs. Allen and Heath Modulares have full TT series patch bay, three range equalization with parametric mid-range, separate monitor-mix section with overdub sync capability, echo and cue sends, many other operating

flexibilities. \$4695 to \$6795. AUDIO-TECHNIQUES, INC. **314**

**Low-cost digital signal generator** produces frequencies from 0.1 Hz to 1 MHz. Jiskoot DG2 uses CMOS and low-power TTL integrated circuits for very low power consumption. Read-



out is to three significant digits. Accuracy from internal reference source is ±20 pm at 25°C. \$330. JIGSKOOT AUTOCONTROL, LTD. **311**

**Sub-miniature coax connectors** are for DC to 6 MHz range. ALC-5 series are for 50-ohm cable, are fully crimpable to both inner conductor and outer shield (no soldering). Accessory crimping tool fastens both inner conductor and shield. \$0.50 a matched pair (in quantity). AMPHENOL. **312**

**Lightweight open-air stereo headphones** have foam cushions. Model W674 uses a high-velocity principle allowing the wearer to hear outside sounds with no loss of program perception. Weight is 2.2 ounces, in-

## Beau...the best replacement motor for Ampex and Scully units.



More and more broadcasters are coming to UMC for Ampex and Scully replacement motors because they realize that the famed Beau inside-out design provides maximum performance as well as rugged construction and compact size. Beau motors are fully factory repairable, too. All standard tape speeds are available. Those are just a few of the reasons why all of the finest new broadcast cartridge machines incorporate the Beau hysteresis synchronous drive as original equipment.

Here's how to order Beau replacement drive motors, direct from the factory. 1) Specify tape speed. 2) Choose from the table below:

Type and Models	Beau Prices
Ampex — Model 440	\$180.00
Ampex — Models 350, 351, 354	\$195.00
Scully — Models 270, 275, 280, 282	\$180.00

Six page catalog available on request.

**UMC**® BEAU MOTOR DIVISION  
UMC ELECTRONICS CO.  
460 Sackett Point Rd. North Haven, CT 06473

Circle 133 on Reader Service Card

## hard as nails.

No wonder it's the No. 1 rugged DMM ■ That's the Fluke 8000A—the only 3½ digit multimeter really built to survive a rough and tumble field service life. ■ Reliable, solid-state LED readout ■ High impact plastic case ■ Few parts to jar loose, thanks to LSI technology ■ -10°C to +55°C operating range ■ 8-hour rechargeable battery option ■ It has the versatility that you need in the field. ■ 26 ranges of volts, amps, and ohms with 0.1% basic accuracy ■ 0.001 ohm resolution (optional) ■ 100 and 500 MHz probes. 40 KV high voltage probe. ■ Other options include 20 amps AC/DC current and 600 amp AC current probe. ■ Plus Fluke's world-wide 48-hour turnaround service to make sure your 8000A is always earning its keep.

**FLUKE**

For data out today,  
dial our toll free  
hot-line: 800-426-0361.

John Fluke Mfg. Co., Inc., P.O. Box 7428, Seattle, WA 98133

Circle 134 on Reader Service Card



cluding the cable. \$49.95. UHER OF AMERICA. **315**

**Stand-by power source** for cable trunk amplifiers uses gelled electrolyte lead acid batteries that are sealed and need no maintenance. Model SPS is in a weatherproof cast housing for strand mounting near the amplifier. It is con-

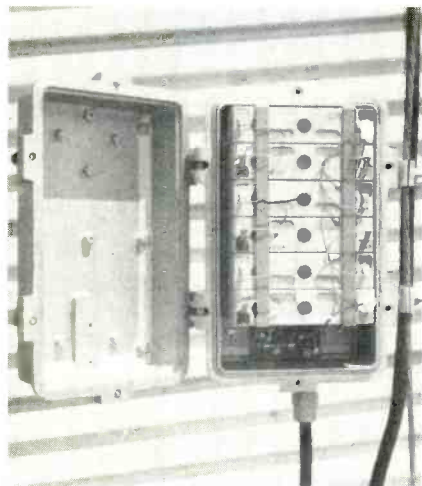

nected to the raw DC power and instantaneously takes over, thru solid state switches, if the regular power fails. C-COR ELECTRONICS. **313**

**New line of cable amplifiers** is aimed at the need for 20-channel systems with add-on reverse capability, for small and medium-sized cable systems. PHOENICIAN II series are hybrid amplifiers, with push-pull circuitry, for trunk applications, and may also be used as drop-in replacements, fitting the standard Pheonician housing. THETA-COM. **316**

**Calibrated light source** and test pattern projector for TV incorporates new high-resolution optics. Spectra TV Optoliner provides up to 52% square wave modulation transfer at 1000 TV lines,



with geometric distortion of the projected pattern  $\pm 1\%$  and uniformity of illumination  $\pm 1\%$ . Weight is 3 lbs, 6 oz. PHOTO RESEARCH DIV., KOLLMORGEN CORPORATION. **318**

continued on page 58

# Video Tape Timer

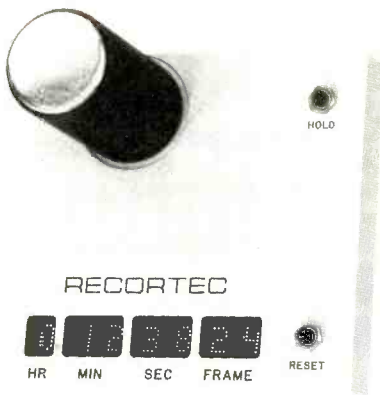

**REPLACES  
MECHANICAL TIMER  
ON  
AMPEX  
AND  
RCA VTR'S**

- Hour-minute-second-frame display
- Bright LED readout
- All solid state
- Direct replacement on VTR
- Remote display option

**AVAILABLE FOR  
TR4 ★ TR60**

## RECORTEC, INC.

777 PALOMAR AVENUE • SUNNYVALE, CALIFORNIA 94086 • (408) 735-8821

Circle 135 on Reader Service Card

# AUDIOWAVES

The choice is practically infinite...  
RCA Audio Consoles



Start with 30 off the shelf models, including mono, dual and stereo.

Next consider our custom consoles where we combine money-saving standard modules in practically limitless ways. They all offer quality performance at affordable prices.

Details? See your RCA representative. RCA Broadcast Systems, Camden, N.J. 08102

## RCA

Microphones • Consoles • Tape and Transcription Equipment  
Automation Systems • Amplifiers and Speakers

Circle 136 on Reader Service Card

Quick-change reflectors: standard diffuse; specular, for high intensities, long throws (6400 f.c. at 40 feet!); gold reflector, for warmer tones—all compatible with other accessories.

Choice of 500, 750 or 1000-watt single-ended lamps—1000W 220/240V lamps available.

Extremely smooth, efficient light pattern, spot to flood. Continuously-variable focusing—7:1 ratio.

Extremely light-weight rugged head with 16-foot neoprene cable.

Unusually compact—only 5" deep.

Convection cooling for virtually maintenance-free heads and extended lamp life.

Oversize, cool pan-tilt handle and focus knob.

Constant-tension tilt system for fast, one-hand operation.

## Lowel Quartz D

The Workhorse that doesn't say no.



Complete accessory system including 4-way barn doors, dichroic filter, full and half-screens, cookaloris and snoot.

Flexible mounting system, including taper-up/nail-on wall bracket and extremely sturdy, lightweight stand.

Fully compatible with Tota and Link System components, for greater range of mounting and control.

Workhorse Kits for a variety of production and budget requirements.

Proven performance—thousands of Quartz D lights and kits in use throughout the world.

For more information, see your Lowel dealer or send for our brochure.

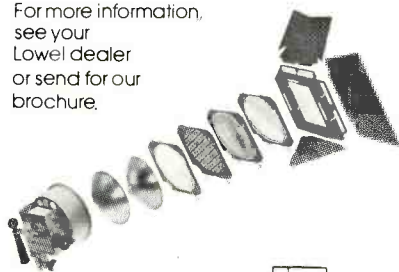

**lowel** 

421 West 54th Street, New York, N.Y. 10019 (212) 245-6744  
West Coast: 3407 West Olive Avenue,  
Burbank, Ca. (213) 846-7740

Circle 137 on Reader Service Card

## PRODUCTS

**Sequential color TV test pattern generator** develops a complete set of test patterns including resolution, gray scale, color bar, window, flat field, bar, and dot. Signal Source 512 can produce fields for various scan rates, (125/150, 441/180, etc.), and includes an internal sync generator with either crystal, free run or AFC line-lock oscillator control. A multiburst pattern has the reference bar plus a burst at each density from 100 to 600 lines. VISUAL INFORMATION INSTITUTE, INC. **317**

**Operational power amplifier** has output of dual-50-watts for stereo or 100 watts for mono over audio range. Model SM-100 is available in a kit (complete with power supply) for \$175; or wired for \$225. OP-AMP LABS, INC. **319**

**"Signal stopper"** is a fitting to dead-head a coaxial cable, installed in the same way as a standard F fitting. SST Signal Stopper cuts off contact between drop wire and tap; the would-be program thief is baffled by a connector that doesn't connect. \$0.22. IIT CANON, DISTRIB. BY ANIXTER-PRUZAN. **321**

**Digital metronome** is for accurate pre

or post music scoring for movies and television programs. Model 964 produces accurate tempos from one frame per beat to 40 frames per beat in



1/8-frame steps. It is operated from front panel or by an external start signal. Less than \$500. UREI. **320**

**Auto-slate edge marker**, plus bloop tone and sync pulse output, are provided by new modification for CP-16R reflex cameras. "Crystaslate" modification can be used with Nagra 3 and 4 recorders and other similar professional tape recorders. It is ordered when ordering the camera. \$650.00. CINEMA PRODUCTS. **322**

**Isolated switch driver** accepts inputs from timers and programmers, drives up to 12 diode switches independently. Model ISD-1212 driver can be remote from programmer and from switches, suitable for CATV headends, emergency override, and general video, RF, or IF test applications. Each driver is on a separate plug-in logic card; user can choose any number up to 12. Assembly

## MCMARTIN / BA-1K 1000/500/250 watt AM

**BA 1K**—the perfect transmitter for your new AM station or updating your existing operation

FCC TYPE ACCEPTED

unique interior accessibility front and rear

all solid state except for four 4-500A power tubes

125% positive peak capability

pushbutton Hi-Lo power operation

full remote control/metering capability

power driven vacuum variable tuning/loading controls

built-in dummy load

from the "FULL-CHOICE" line

**McMartin**

McMartin Industries, Inc. 4500 South 76th Street, Omaha, Nebraska 68127 (402) 331-2000

Circle 138 on Reader Service Card

transmitters

## CARTRIDGE TAPE EQUIPMENT

- Compact Modules
- Multiple Units
- Single Units
- Record/Playback
- Playback Only
- Monaural
- Stereo

INFORMATION  
ON REQUEST



GARRON ELECTRONICS INC.™  
**RAPID-Q**

SUNNYVALE, CALIF. 94086 (408) 736-8737

1216 KIEFER ROAD



THE BLOCKS TO BUILD ON! RAPID-Q!

Circle 139 on Reader Service Card

## Matthey LOW PASS VIDEO FILTERS



with phase equalization

Impedance.....	75Ω	
Frequency range	0.5MHz to 10MHz	
Supplied in metal box with BNC connectors or PCB		
Basic Loss Approx.....	0.5dB	
Insertion Loss:		
Frequency	3dB@	≤45dB@
4.5mHz	4.56mHz	5.63mHz
5.5mHz	5.65mHz	6.92mHz
Price.....	\$ 121.00	

Television Equipment Associates, Inc.

BILL PEGLER 516 • 628-8068  
Box 1391 • BAYVILLE, N. Y. 11709



Circle 140 on Reader Service Card

JUNE, 1975—BM/E

## PRODUCTS

comes complete with power supply and diode switches. \$1099, for 12 drivers, 12 switches. PECA, INC. **323**

**Encoders for SECAM** are newly-designed with IC technology. Matra Model M380R is a rack-mount version accepting standard RGB or Y,RGB camera signals and a composite sync signal; outputs are two separate 1-volt composite SECAM signals into 75 ohms. Model M380 is two plug-in circuit boards for installation in IVC, Philips, Fernseh, and other similar color cameras. INTERSECAM. **324**

**Wind screen** for Sennheiser 815, 415 and 435 and other similar microphones has aero-dynamic design sending wind around it, with a dead-air space around the microphone. "Zeppelin" screen has outer lattice of polyethelene, inner layers of foam between laminated nylon. ALAN GORDON ENTERPRISES, INC. **325**

**New videotape editing system** can be purchased for two-machine mode, later expanded to three machines; to on-line, off-line capability; and to computer control. Viduic Model 5050-200/300 has visual display of tape position and all edit points; "Jam Sync" which automatically sets the time code generator during preroll; simple keyboard entry; A/B rolls; color framing; special effects switching; time base correction. DATATRON, INC. **326**

**Broadcast audio cartridge** is 100% pre-screened for phasing reliability, to eliminate high frequency loss from phase error. Model A-2SP is guaranteed to be within ±90 degrees of phase coincidence up to 12.5 KHz. One-piece housing makes permanent the phasing and azimuth; guides are fixed and immobile, no user adjustments are needed. CAPITOL MAGNETIC PRODUCTS. **327**

**A synchronizer/code generator** provides interlock between any two audio multi-track machines, or an audio-video or video-video pair. "Minimag II" generates the SMPTE standard time and control code, records it on both machines at the time original material is recorded or later. The unit thereafter compares the code signals from the two recordings as played back, uses any error signal to issue a capstan control signal for perfect sync. Thumbwheel offset control allows for lip sync or delay effects. \$4950. AUTOMATED PROCESSES, INC. **328**

**Digital up/down counters** have four-digit readout, cover 100 minutes, display running to 99:59. Models ES-301 and ES-302 have controls for count up, continued on page 60

## Now! Monitor audio channels visually— the easy way

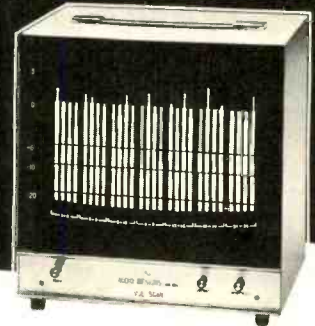

## ADM VUE-SCAN

Eliminates  
"head-swiveling"—  
replaces up to  
28 VU meters

You keep your eyes on a single TV-type screen instead of eyeballing a whole string of VU meters. VUE-SCAN displays each analog channel as an easily-read illuminated bar. The bars are always present as a background reference. As the voltage level of a channel increases, the bar representing it increases in height and color intensity. Blue represents a normal operating condition—red immediately signals an overmodulated condition. VUE-SCAN can be used as a self-contained accessory with any Audio Designs or competitive console. Write us for details.



ADM Consoles are built to the most exacting quality standards. Unique plug-in modules provide exceptional flexibility for expansion.

AUDIO DESIGNS AND MANUFACTURING, INC.

16005 Sturgeon, Roseville, Michigan 48066  
Phone: (313) 778-8400, Cable: AUDEX

In Canada: TELAK, Scarborough, Ont.  
(416) 438-3804

Circle 141 on Reader Service Card

# Change Sound to Silence with a **TABERASER**



This rugged, heavy duty bulk tape eraser wipes sound from all magnetic tapes, cartridges, cassettes and magnetic film stock; handling up to 2".

It erases with minimum residual noise because the field automatically diminishes at the end of each 30-second cycle.

A thermal control and blower keeps the unit below 71° C.

Available for 60Hz or 50Hz operation.

For the distributor in your area—Call or write:

**TABER** Manufacturing & Engineering Company  
2081 Edison Ave. • San Leandro, Ca. 94577 • (415) 635-3831

Circle 142 on Reader Service Card

## the **NEW McMARTIN FM TRANSMITTER • BF-3.5K**

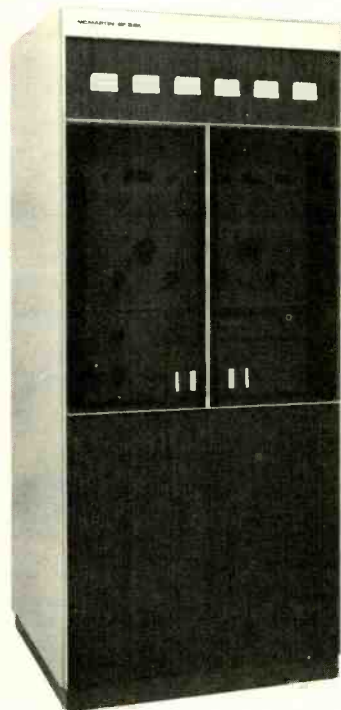

traditionally, McMARTIN engineering has supplied the AM/FM broadcaster with the finest professional equipment. The new BF-3.5K is one of those products.

excellent efficiency for power output levels from 2000 to 3500 watts.

the high performance solid state B-910 exciter, is the heart of the system

superb bandwidth characteristics and operating stability

optimum stereo and SCA performance — zero bias, grounded grid PA — no neutralization . . . no screen grid or bias voltage supplies are needed

standard features include illuminated pushbutton switch controls, output reflectometer, memory-type LED status indicators, built-in harmonic filter, remote control capability of metering and operating functions

### *McMartin.*

McMartin Industries, Inc. 4500 South 76th Street, Omaha, Nebraska 68127 (402) 331-2000

Circle 143 on Reader Service Card

## PRODUCTS

count down, stop, minutes advance, seconds advance, re-set. The counters can be pre-set to a desired number, and timing activated up or down from there. ESE, INC. **329**

**New memory option** for System/50 off-line videotape editing system provides storage for up to 999 edit decisions in mini-computer. Improvements in the standard system include a re-edit function allowing operator to scan the list of edit decisions; and also a new frame advance, or "jogging" function allowing editor to "jog" through a scene virtually on a frame-by-frame basis. CMX SYSTEMS. **330**

**High-speed tape duplicator** designed for program syndicators takes ¼", 7½ ips or 15 ips masters, and produces 3¾ ips, 7½ ips or 15 ips copies. Model ES-2001 can be configured with a master and up to ten slaves. Output of a 30-minute, 7½ ips program through an 8-hour shift is about 100 copies per slave, based on automatic master rewind and Cueing. ELECTRO SOUND, INC. **331**

**New attenuator design** for audio mixing consoles combines advantages of a sealed rotary with convenience of a slide design. Model RS1000 attenuator has two miniature, rotary resistive controls driven by a common slide mechanism; both are sealed against dust, dirt. Unit is available with all values and tapers provided by high-quality rotary units. ROBINS/FAIRCHILD. **332**

**Voltage regulator for mini-computers** and other similar units maintains supply voltage within ±3% for line-voltage variations of ±15%; the NEMA-recommended tolerance of ±5% is maintained for voltage drops to 65% of nominal. Output has less than 3% of harmonic distortion. SOLA ELECTRIC. **333**

**New frequency extender/equalizer** has successively sharper adjustable tuned equalizers from 150 Hz to 16 Hz and from 3.3 KHz to 24 KHz. Model 3200 also has a set of five adjustable equalizers for gradual tilt of frequency response up or down, with half gain or loss points at 50, 200, 700, 2,000 and 8,000 Hz. Combined action of all controls gives up to 40 dB boost or loss at 20 Hz and 20 KHz. LED indicators show peaks anywhere in system that are less than 3 dB below clipping level, for adjustment to avoid overload. Unit claims less than .05% harmonic distortion from 20 Hz to 10 KHz, noise is -94 dBm. \$1095; professional rack-mount model with active transformer input, \$1245. BURWEN LABS. **334**

# NEW LIT

For copies of these literature offerings, circle number for appropriate items on Reader Service Card.

Article defines when a **standby power system** is needed, and how to decide which system to use for various applications. Globe Battery Division, Globe-Union, Inc. **250**

**Single output and dual output DC modular power supplies** are illustrated and described in new four-page catalog. Sorensen Power Supplies. **251**

Comprehensive line of **CATV test equipment** and test accessories is covered in new 16-page illustrated catalog, including signal generators, spectrum analyzers, oscilloscopes, frequency counters, etc. Jerrold/Texscan. **252**

Telecommunications Products Catalog shows **microwave receivers and transmitters**, coaxial cable transmission systems, multiplex systems, cable carrier systems, multiplex systems, many others. GTE Lenkurt. **253**

Catalog of **transformers** for TV, hi fi and radio lists several hundred replacement transformers, with original mfg's number and number of Triad replacement. Triad-Utrad. **254**

Short-form catalog lists complete line of **broadcast television** products, including broadcast color film cameras, optical multiplexers, video switcher, sync generators, color encoder/decoder, video multiplexer, etc. Cohu Electronics. **255**

**Satellite antennas** from 15 to 42 feet in diameter are described in a new bulletin, and also standard antenna reflectors in sizes from 12 to 30 feet. RF Systems, Inc. **256**

"**Cinema Perspectives**" is available in a Winter, 1975 edition, with 24-pages of feature articles on recent events in news/documentary and studio-type film making. Cinema Products. **257**

**Cassette recordings** of all sessions at the NAB convention, Las Vegas, are available \$5.95 for one, lower prices on larger quantities. Write Convention/Seminar Cassettes, 13356 Sherman Way, North Hollywood, CA 91605.

**Instructional videotapes** on electronic subjects are listed in new 24-page catalog, showing several hundred

continued on page 62

## Canon IOX UNIVERSAL ZOOM

One-Inch Plumbicon Color Camera Zoom



N. V. PHILIPS

PV 10X15

### 15 mm to 150mm; f/2.0

- Wide Angle
- Close Focusing 3.9'
- Bayonette Mount
- Adjustable Back Focus
- "Macro Focus" Operation
- Small Size
- Lightweight
- Light Transmission Over 80%
- For All One-Inch Color Cameras

**Canon**

BROADCAST OPTICS

CANON U.S.A., INC., 10 NEVADA DRIVE, LAKE SUCCESS, N.Y. 11040

(516) 488-6700

Circle 144 on Reader Service Card



# VALUE

... LPB's S-15, 8-Channel, Dual-Output Mono Signature Line Audio Console with 19 inputs (shown) is one giant value. So is LPB's S-14, 5-Channel, Dual-Output Console with 15 inputs. In addition to moderate prices and excellent performance, both consoles feature:

- Step attenuator mixers.
- Plug-in fiberglass printed circuits.
- Individual plug-in program, 12-watt monitor, cue and headphone amplifiers.
- Remote line talkback.
- Input transformers.

There are many other plus features you'd expect to find only in higher priced units. And, speaking of price, other LPB consoles start in the low hundreds!

LPB offers a complete line of broadcast audio equipment. Call or write us for all your audio needs, from tape recorders to frequency and modulation monitors.

**LPB**

LPB Inc.  
520 Lincoln Highway, Frazer, Pa. 19355  
(215) 644-1123

Circle 145 on Reader Service Card

**If you want to see, touch and ask questions about the newest in television equipment, visit the SMPTE Equipment Exhibit.**

If you're interested in the latest in television equipment, there's no better place to find it than at the SMPTE Exhibit. Representatives of most major manufacturers and suppliers of professional equipment will be on hand to show you their equipment, let you handle it, and of course, answer all your questions. You'll find TV cameras, lenses, videotape recorders, editing equipment, film cameras in all formats, sound recorders and lighting equipment. Everything there is for television and film production. Everything. All under one roof. And the nice thing about it is that it's absolutely free. Just fill out the coupon below and send it to us and we'll mail you your free pass to the equipment show.



The Exhibit, where you can see and touch new TV equipment.



The Technical Sessions always draw large numbers of broadcasting people.

**If you want to hear about the latest developments in television technology, come to the SMPTE Conference Technical Sessions.**

During the five days of Conference week, the SMPTE holds technical sessions with special emphasis on television technology. The range of subjects is wide, with presentations touching virtually every aspect of television, from news gathering to digital television, from satellites in broadcasting to videotape recording. There are also session topics relating to both TV and film, with sound recording and lighting as good examples. Each session opens with a short film of interest to the film or TV professional. Additional features on the SMPTE program include a special Sunday night social event, the Monday noon Get-Together luncheon, and the Wednesday evening banquet, plus a full week's activities for spouses. For details on the technical program and other Conference activities, please fill out and mail the coupon below.

**The SMPTE Conference & Equipment Exhibit  
Century Plaza Hotel, Los Angeles  
September 28-October 3, 1975**

SMPTE  
862 Scarsdale Ave., Scarsdale, NY 10583



- Please send me a free pass to the SMPTE Equipment Exhibit.
- Please send me information on the technical program, and registration forms.
- I won't be able to attend the Conference, but I'd like to read about it. Please put me on your list to receive a free report.

Name \_\_\_\_\_  
 Title \_\_\_\_\_  
 Company \_\_\_\_\_  
 Address \_\_\_\_\_  
 City \_\_\_\_\_ State \_\_\_\_\_ Zip \_\_\_\_\_

- While you're at it, please send me information on the SMPTE and how to become a member.

**NEW LIT**

tapes covering basic electronics, electronic mathematics, theory and use of test instruments, theory and application of transistors, etc. Hewlett-Packard. 258

**"Cable Handbook, 1975-76:** A guide to Cable and New Communications Technologies," is a new publication of Publi-Cable, Inc., public-interest group; the book describes the technology of cable and its application in various areas. Available at \$6.95 from Communications Press at 1346 Conn. Avenue, Washington, D.C. 20036.

A 262-page report, **"1975 Eastern European Electronic Equipment and Components Market,"** charts the prospects for electronic sales in nine Eastern European countries; it costs \$35 from Fred Glynn Marketing Research, 2200 Sacramento St., San Francisco 94115.

**LETTERS**

**Sexism at the NAB Convention**

Dear Editor:

For an industry that prides itself on the advancement of highly sophisticated technology, which was celebrated in your May issue, it is disturbing to see so little sophistication in the marketing. The NAB, held in Las Vegas this year, demonstrated a drastic and puzzling breach between the levels of product lines and the people who sell them. Case in point: What is the relationship between equipment and sexy models?

Most of us agree there isn't any real relationship. Yet, there are many die-hards in this industry who still believe everyone coming to the NAB is a "small-time" buyer, vulnerable to glamor . . . Broadcast marketers apparently believe the rumor that no one in the industry watches television. I mean, really! What would Maude say about the sex sell at NAB?

While the sex sell has been a constant in marketing, maybe it's about time to evaluate its effectiveness, even for those die-hards. For instance, has it ever occurred to anyone that a buyer may well wonder at the attempt to draw his (obviously "his," because it is the male buyer the sex sell attempts to capture) attention away from the product itself. Let's suppose for a moment that a customer does feel this way. Can any company in today's market afford such a cavalier attitude toward their equipment? Another minus is the ever present political

in some circles as sexism. Politically speaking, any company that hires women to dress seductively to embellish their booth, i.e. low cut evening gowns at 9 a.m., is inviting criticism, not only toward their own company, but also toward the entire industry. Perhaps if those involved are so fond of feminine faces at NAB, they might ask their companies to break down and hire some women engineers.

Companies unmoved by possible customer and feminist wrath might want to consider the effect of the sex sell on their own sales force. How effectively can a salesperson explain the technology and establish rapport with a customer when the customer is being bombarded with tasty ladies? Better yet, what does the sex sell say about the faith a company has in its salespeople when, at the BIG show, the company brings in "Ringers"? From all appearances, the booths I visited where models were used, I found a genuine uneasiness, especially when I began asking questions about their marketing techniques.

In the case of one company, the sales force came out en masse to divert my attention away from their customers, and the correlation between the amount of sex sell and the deficiency of their equipment was predictably in-

continued on page 66



## The manual for the third revolution

In the 50's the quad VTR was invented and every station had to have at least two. In the 60's color TV blossomed and b & w cameras became obsolete. In '75 Electronic News Gathering is here. It's already pushed film out at scores of stations and is now invading the domain of commercial production.

Contents will include: *Chapter 1*—Handhelds and Shoulder-mounted TV Cameras Challenge 16mm; *Chapter 2*—Video Tape Recorders That Are Truly Portable and Battery-operated; *Chapter 3*—Instant Broadcast Means Microwave Feeds; *Chapter 4*—Systems in Use: How Broadcasters and Production Houses Are Putting It All Together; *Chapter 5*—Meanwhile, Back At The Studio: Editing Tape; *Chapter 6*—Getting It On

The Air Via Time Base Correctors; *Chapter 7*—The Future.

### Join The Revolution NOW

BM/E  
274 Madison Avenue  
New York, NY 10016

Please send ( ) copies of  
ENG/Field Production Handbook  
at \$7.95 each.

Name \_\_\_\_\_

Address \_\_\_\_\_

City \_\_\_\_\_ State \_\_\_\_\_ Zip \_\_\_\_\_

Total Amount \$ \_\_\_\_\_

N.Y.S. Residents  
add 7% Sales tax \_\_\_\_\_

Total enclosed \$ \_\_\_\_\_

Foreign orders add \$1  
Postage and Handling \_\_\_\_\_

Made in U.S.A.  
**FREZZOLINI**

GRL/HL-33NC Battery Pack fits Ikegami backpack perfectly.

**Battery Pack HL-33NC for Ikegami HL-33 or 35**

Mounted in case ready for use. NiCad reliability, 4AH, 24 "D" cells. Includes patented Charge Control Method. Recharges in less than 3 hours . . . . User Net \$575.00

GRL/HL-33NCT Single Channel Charger . . . User Net \$812.50

Delivery: 2 weeks from stock.

Call Jim Crawford, (201) 427-1160

General Research Laboratories

DIVISION OF  
**Frezzolini Electronics Inc.**  
7 Valley St., Hawthorne, N. J. 07506

Circle 147 on Reader Service Card

# VISCOUNT 1150B PRODUCTION SWITCHER

**PROFESSIONAL...  
and... AVAILABLE**

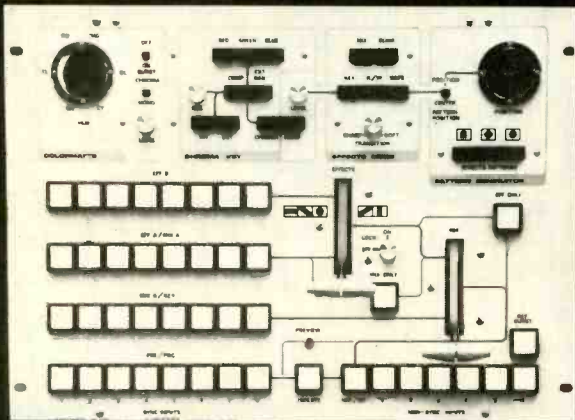

## KEY FEATURES:

- \* 14 inputs - 8 sync, 6 non
- \* 4 busses
- \* 27 std. wipe patterns
- \* int., ext., chroma key
- \* composite, ext. RGB
- \* soft key, wipe of key
- \* mix-blink on wipe-key
- \* spot light effect
- \* black burst, clr. mat. gen
- \* 'on-air' inputs indication
- \* full preview
- \* colour timed, any path
- \* vert. int. switching
- \* processing amplifier
- \* remote control panel

\* **\$9250 - '1150 B'**  
(shown above)

also available:

**\$ 7500 - '1150 A'**

**VISCOUNT INDUSTRIES LTD.**  
105 EAST 69th AVENUE  
VANCOUVER, BRITISH COLUMBIA  
CANADA V5X 2W9  
PHONE (604) 327-9446 TELEX (04) 508-605

## Today's Character Generator Can Be A Teleproduction Tool

"Character generator" used to mean simply a unit that would put on the screen a limited number of alpha-numeric characters, which had notched curves because they were formed by a dot matrix or similar method. Many broadcasters and cable operations need no more than that from a character generator and they can, or course, still get it at moderate cost.

But the broadcaster willing to spend quite a bit more can get a character generator today that is a flexible, resourceful teleproductions tool. CBS, Chiron and RCA showed outstanding systems of this highly flexible variety at the recent NAB Convention in Las Vegas.

Station WREC-TV, in Memphis, Tennessee, for example, has put into use the new RCA Video Graphics IV. Cal Crowell, program manager, is delighted with the many things he can do. The system can be programmed, *from the keyboard*, for a very large variety of font styles—the range extends to such exotics as Arabic, Hebrew, Japanese, Chinese. Once on the screen, the characters can be made to roll (at any speed), crawl, flash, appear in any of eight colors, perform the other gyrations familiar on the current high-flexibility CG's.

Beyond that, WREC-TV is making good use of the ability of the system to produce many kinds of graphics, again directly from the keyboard: charts, logos, animated figures, even an American flag, (photo) which can be "rolled up" from the bottom. "Very useful," Crowell says, "with the National Anthem and for other occasions—and easy to make."

Any material created at the keyboard can be stored on a floppy-disc memory, with 3000 lines of storage per disc. Since a new disc can be inserted in a few seconds, the system has virtually unlimited memory: ID's, logos, etc. are repeatable at any time. WREC-TV, for example, repeats the weather graph (photo) daily, up-dated for current info; each bar is in a different color.

In the standard phrase, what you can do with a CG today is limited only by the imagination of the user.

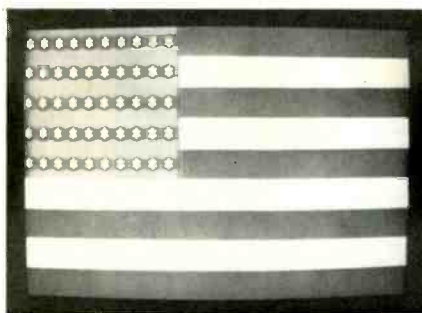

*American flag as generated on Video Graphics IV.*

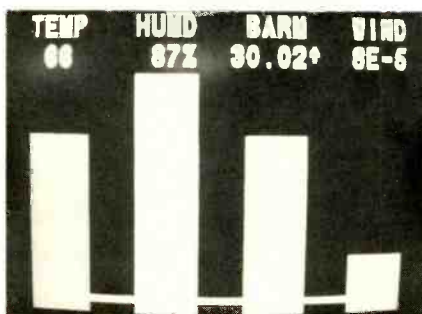

*Weather graph used daily at WREC-TV and updated as needed. Bars are different color.*



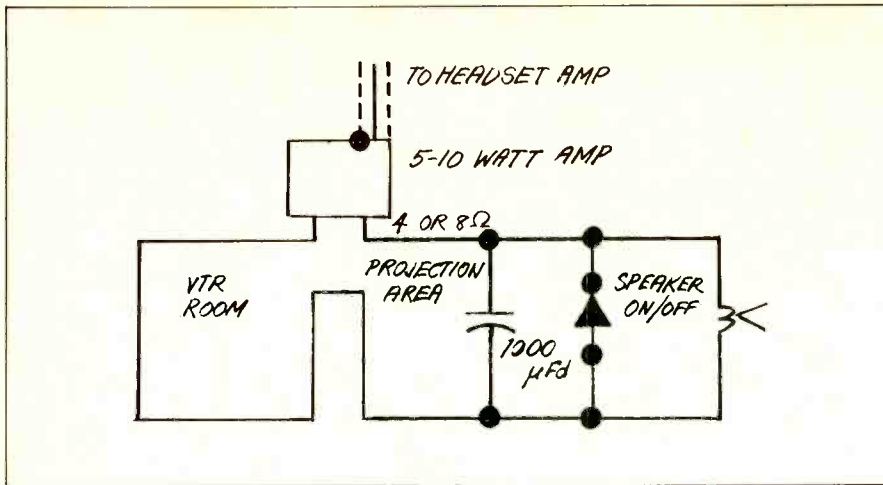

## 16. Wired/Wireless Intercom Always Keeps the Crew in Touch

*Al Szablak, WKTV, Utica, N.Y.*

**Problem:** To provide continuous intercommunication between the Technical Director and the operations crew member staffing more than his own work station. In smaller markets, when an operations position becomes vacant, some member of the crew is going to have to fill in for a while. Quite often, for instance, a projectionist is required to cue up videotapes, or the video operator has to keep his eye on the film chain. Problem is, the staffer doing double duty may miss a cue from the TD as he travels from one work station to another. Most installations use either conventional loudspeaker- or wireless-type inter-

coms in the work area. Our system, however, uses both.

**Solution:** Low-level audio feeding the director's cues is taken from the station headset intercom and fed into an audio amplifier. The 4- or 8-ohm amplifier output tap is connected to a single-conductor wire looped around the required areas. The loop can be broken anywhere and connected in series with the room intercom speaker. A constant-impedance pad can be wired across the voice coil. Terminate all wire runs to the audio amplifier common. Lampcord wire works well. It should be at ear level, or directly on top of a suspended ceiling.

Besides the 5- or 10-watt audio amp, the only other part needed now is a pair of induction (wireless) headsets, available from many audio-visual dealers who sell to schools. When wearing these sets, don't go near a bulk tape eraser—induced hum is strong enough to obliterate cues shouted by the TD.

## GREAT IDEA CONTEST 1975: RULES

- Eligibility:** All station personnel are eligible. Consultants to the industry may enter if the entry indicates the specific station or stations using the idea or concept. Manufacturers of equipment or their representatives are not eligible.
- How to Enter:** Use the Official Entry Form on this page or simply send *BM/E* a description of your work. State the objective or problem and your solution. Include diagrams, drawings, or glossy photos, as appropriate. Artwork must be legible but need not be directly reproducible but not exceeding three in number. Camera reproducible material is preferred. Length can vary, but should not exceed 500 words. *BM/E* reserves the right to edit material. Entry should include: Name, title, station affiliation, and the class of station—TV, FM, AM. Indicate if idea is completely original with you.
- Material Accepted for Publication:** *BM/E* editors will make all decisions regarding acceptability for publication. If duplicative or similar ideas are received, *BM/E* editors will judge which entry or entries to accept. A \$10 honorarium will be paid for each item published.
- Voting:** Every reader of *BM/E* is entitled to rank the ideas published. This can be done on the Reader Service Card in the magazine or by letters or cards sent to the *BM/E* office. To vote, readers should select the three ideas they like best and rank them 1, 2, or 3.
- Winners:** Relative ranking of each month's entries will be published periodically. Top-rated entries for various categories will be republished in late 1975 for a second and final round of scoring. Final winners will be picked in February 1976 and notified by mail. Winners will be published in the March 1976 issue of *BM/E*.
- Prizes and Awards:** Three top prizes will be awarded: a color TV set for the entry receiving the most votes in the respective categories of AM, FM and TV. Ten AM-FM radios will be awarded as secondary prizes for the highest voted entries in the following additional categories (except the three top winners): audio (three prizes one each in categories AM, FM, TV); (three prizes one each in the categories of AM, FM, TV); Control (three prizes one each in the categories of AM, FM, TV); Video (one prize in TV).

See April or May for Entry Form

# FIDELIPAC® ACCESSORIES & CARTRIDGES

## CART-A-ROUND CARTRIDGE STORAGE RACKS

Each WR-25 Modular Rack holds 25 Type A Cartridges... eight can be mounted on our Mobile Carousel Base to make up the MR-200.

WR-25 \$13.25  
MR-200 \$145.95

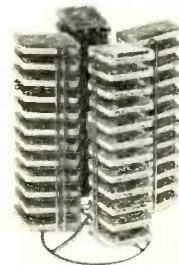
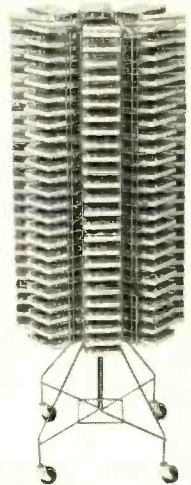

## TABLE TOP CARTRIDGE RACK

Model TR-96 holds 96 Type A cartridges, Model TR-48 holds 48.  
TR-96 \$73.85  
TR-48 \$38.55



## STUDIO ON AIR LIGHT

brilliant red lettering on jet black background can be seen even in the brightest ambient light conditions. \$29.95



## CART-E-RASE DEMAGNETIZER

can be used for erasing cartridges, reel-to-reel tape, film sound stripping, etc. \$34.50

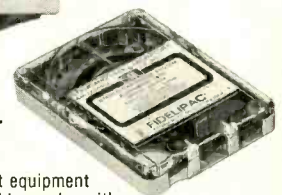

## ALIGNMENT PROBLEM?

Keep your cart equipment in perfect working order with:

- 350 STA Alignment Cartridge \$38.50
- 350 STF Wow and Flutter Cartridge \$24.50
- 350 STQ Cue Test Cartridge \$35.00
- Head Insertion Gage \$3.35
- Height Gage \$12.95



Contact your Fidelipac Distributor or

# FIDELIPAC®

A Division of TelePro Industries Incorporated  
109 Gaither Drive, Mt. Laurel, NJ 08057  
(609) 235-3511

® Trademark of TelePro Industries Incorporated

Circle 149 on Reader Service Card

**Gets  
to go.**

Over 5,000 Rosco color sheets and rolls of reflective, diffusing, color-correcting media always in stock—plus all the newest, like new super-thin 2-mil for TV and ¼-inch 4' x 8' panels for display. Everything for the professional—ready for immediate off-the-shelf delivery!

*In NY, come use our unique new color media Test Lounge. Discover, innovate, experiment, consult, relax—on us!*

Nationwide service for over 25 years.  
Same-day shipment anywhere in US.  
Rush delivery in Manhattan.

(212) JUDSON 6-1620  
**BARBIZON ELECTRIC**

426 W. 55, NYC 10019  
Circle 150 on Reader Service Card

## VERSA CONSOLE



- Compact rack mount single channel mixer ideal for CATV, CCTV, film studios, commercial sound installations, dubbing facilities and remote broadcasts.
- Accepts 10 inputs — 7 externally switchable for microphone or line level sources.
- Balanced 600 ohm line output and high impedance PA output.
- Internal 1 KHz test oscillator.
- Sealed mixer pots with cue detents.
- FET muted cue amp and speaker.
- Headphone jack for program or cue.

*Spotmaster*  
ALSO CARRY  
MACHINES AND  
AUDIO CONSOLES



BROADCAST ELECTRONICS  
8810 Brookville Road  
Silver Spring, Maryland 20910  
Phone: 301-588-4983

Circle 151 on Reader Service Card

## LETTERS

cont. from page 63

verted. In this type of situation I can hardly blame the effort of the firm involved. It's just unfortunate that many companies with finer reputations place their sales people and their equipment under the same compromise.

O.K., let's say, for the sake of argument, a company doesn't care about the taste of its customers, the pressures from women libber's, or the capabilities of their salespeople, can they then be sticklers about the company image? Need I say more? Any company that has ignored all of the above has no company image. Wait, that's not true. They do have an image—a bad one.

But fair is fair. There were many companies which did not employ the sex sell. What distinguished these booths was a sense of unity among the salespeople, the equipment, and the customers; it was out of deference to these companies that I chose not to write an article called, "The \$200,000 Boobs From The People Who Bring You The 6 O'clock News."

Kate Ahearn  
Sunnyvale, California

*Editor's comment: Readers of our May NAB Show-In-Print issue may be wondering where all those "tasty ladies" were. In our focus on equipment features, we overlooked such attractions. Is correspondent Ahearn right? Were there exhibitors who ended up with a poor image because of their sexy models?*

## NEWS

cont. from page 20

centennial Meditation, aimed at full mental and physical development of its devotees.

**Radio station WJW**, Cleveland, will join the CBS radio network on or before September 13th . . . **United Tapes of America** has moved to new enlarged recording studios in Grand Junction Colorado, for production of their automated radio programming.

**Coastcom**, Concord, California firm specializing in multiplex systems, has sold FM program audio duplexers to GTE International for use in a satellite system being installed in Algeria by the latter firm . . . **WYOO (AM and FM)**, Fairchild radio stations in Richfield, Minnesota, raised more than \$24,000 in a radiothon for the St. Jude's Children's Research Hospital in Memphis, Tenn. . . . **RCA Corp.** sold more than \$1.5 million of color studio equipment to Pakistan Television Corp., as part of that country's preparation for installation of color later this year.

**Ampex Corp.** has a contract with Metromedia Television for delivery of about \$1.6 million worth of videotape recording equipment, for use at Metromedia stations . . . **Douglas Video**, a new direct television communications service firm, has been created by E. Douglas Gratton and Paul M. Douglas for videotape and film productions, contract video publishing, videotape "networks," conference television; headquarters is 711 Third Avenue, New York . . . **Belden Communications** of New York will distribute in eastern and central states, **Roy Low Enterprises** of Burbank, CA, will cover Western states, for **Lee Filters**, English light control systems.

**Martin Audio/Video**, New York Electronics distributor, has formed a division specifically to supply the professional broadcast, recording and sound reinforcement markets with parts and construction materials . . . **GTE Sylvania** celebrated the production of their 60-millionth TV picture tube; as Tylvania, the company's vacuum tube production and development of course go back to the early 1920's, with a long list of innovations in every sector of the field.

**AEL Communications Corp.** has sold new cable electronic systems to cable operators in Success, Ark., Albany, Georgia; Calmore, Oklahoma; Marcelline, Missouri; and Hutchinson Texas . . . **Skirpan Lighting Control** sold to the American Broadcasting Company a computerized light control system for ABC's Studio TV-1 in New York, for about \$431,000 . . . **TelePrompTer Corp.** sold its subsidiary, National Security Systems, Inc., to John W. Walter, who was founder and president of NSS; the latter firm will continue and expand its production and installation of security and alarm systems for industry, homes and police systems.

**Infonics**, makers of high-speed tape and cassette duplicators, was sold to **Phoenix Enterprises**, which began manufacturing the products in a new facility in Michigan City, Indiana . . . **C-Cor Electronics** has instituted a complete cable amplifier repair and testing service for units of all brands, with normal turnaround of two weeks, shorter times in emergencies; info from C-Cor at 60 Decibel Road, State College, PA.

**Broadcast Communications Industries** of Philadelphia is the exclusive sales representative of CSI Electronics, new firm which introduced a complete line of AM and FM transmitters at the recent NAB convention in Las Vegas . . .

## People

**George Rosol** became director of en-

gineering, and **George Fike** manager of special projects, both for Nurad, Inc., antenna system manufacturer . . . WSNL, Channel 67, Islip, Long Island, made the following engineering appointments: **Frank Cambria**, studio/transmitter supervisor; **Ted Gosman**, maintenance supervisor; **John Hunter**, studio supervisor; **Jack Kanakarlis**, studio/VTR supervisor; and **John Monteleone**, field shop supervisor.

**Brian C. Mitchell** was appointed field service engineer for Conrac video products . . . **Gordon H. Schutte** became marketing manager of 3M Company's magnetic audio/video products division . . . **Lowell Bates** is national sales manager (the company's first) for Advance Board Circuits, Inc., Florida maker of printed circuit boards.

**Ron Sheets** was named general manager of KXOA-FM, Sacramento, Cal.; he had been sales manager of KROV, Sacramento . . . **Carl De Simone** is outside sales representative for Anixter-Pruzan's Southwest district, based in Santa Ana, California . . . **Barney Keep** celebrated his 30th anniversary as a "personality" on radio station KEX, in Portland, Oregon; Governor McCall proclaimed the anniversary, December 28th, to be "Barney Keep Day in Oregon."

**Patterson N. Hyndman** was elected chairman of the Cohu, Inc., board of directors; the position had been vacant since the 1970 resignation of Lt. Gen K.B. Wolfe . . . **Wm. L. Harvey** became station manager; and **E. Adrian Smith** became sales manager and sports director, both for station KICO, Calexico, Cal.

**Bengt-Arne Vedin** was named secretary-general of Nord-Video, Scandinavian group of video publishers . . . **Robert W. Chambers** became Chairman of the Board of Cox Broadcasting Corp., to succeed James M. Cox Jr., who died . . . **Charles T. Morey** became general manager of WNDE and WFBQ, Indianapolis; his last previous position was general manager of WBES, Charlestown, W. Va.

**Sam Cook Digges**, CBS radio president, and **Himan Brown**, producer-director of the CBS Radio "Mystery Theatre," both got certificates of appreciation from the American Federation of Television and Radio Artists, for contributions to the nation's culture and "to the welfare of AFTRA members," with the reestablishment of radio drama . . . **Audrey M. Sculthorpe** was appointed personnel manager of Teleprompter Corporation . . . **Paula Conley** became associate

continued on page 68



# PROTECT your broadcast equipment against lightning surges with WILKINSON AC LINE SURGE PROTECTORS

Excessive voltage surges caused by lightning, transformer arcing and induced transients are everyday occurrences that cause heavy damage to valuable broadcast equipment.

Now through the use of WILKINSON voltage sensitive Line Surge Protectors you can protect your equipment from line surges that may exceed even twenty times the normal line voltage.

A WILKINSON pulse compensated Line Surge Varistor, is placed across a line of its rated voltage. Should a surge or increase of voltage occur, the resistance of the varistor decreases at log scale as the voltage increases, thus acting as a momentary load or short circuit to the surge. WILKINSON Line Surge Protectors draw little or no current and are capacitor compensated for microsecond surges, thus damping all line disturbances as well as excessive voltage increase.

A small investment in WILKINSON Line Surge Protectors is your assurance that your valuable broadcast equipment will not be damaged due to line surges.

Model SIA-1	110 V.	Single phase	\$175.00
Model SIA-2	220 V.	Single phase	\$295.00
Model SIA-3	220 V.	Three phase	\$395.00
Model SIA-4	440 V.	Three phase	\$495.00

For complete details write to:

## WILKINSON ELECTRONICS, INC.

1937 MacDADE BLVD. • WOODLYN, PA. 19094  
• TELEPHONE (215) 874-5236 874-5237

## COLORBARS & a VECTORSCOPE GO HAND IN HAND



HAS THE LOWEST  
COST ARRAY EVER

The VM3 NTSC VECTORSCOPE	\$995
★ R/BS9 Complete NTSC SYNC GEN. (2 sets of outputs) with Genlock & COLORBARS GEN.	\$795
★ R/DB8 Driven Encoded COLORBARS GEN.	\$645
★ R/GB8 Standalone Encoded COLORBARS GEN.	\$695
★ R/CS2 NTSC SYNC GEN. (2 sets of outputs) with Genlock	\$595

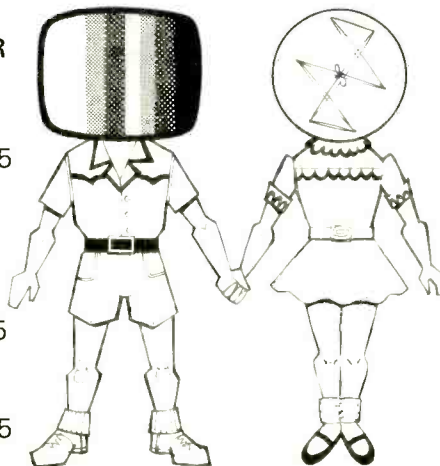

Prices subject to change  
without notice. All products  
are portable (power supply  
included) and rackmountable.

### Ultra Audio Pixtec

Box 921  
Beverly Hills, CA 90213  
(213) 849-1433

Circle 152 on Reader Service Card

Circle 153 on Reader Service Card

# STOP DON'T BUY EBS

DON'T SIGN THAT EBS ORDER YET!

Alpha brings ten years of experience with tone equipment in the two-way radio industry to broadcasting with better performance and a realistic price in EBS two-tone monitor/generator systems.

**NO. 1 IN TONE SIGNALLING**

CIRCLE BINGO NUMBER OR CALL FOR DETAILS



ALPHA ELECTRONIC SERVICES INC  
8431 MONROE AVE., STANTON, CA. 90680  
714-821-4400

Circle 154 on Reader Service Card

## the new TWO-TONE EBS generator

the TG2/EBS—available when you need it, meets the new FCC requirements effective January 15, 1976. Precise, crystal-derived 853 and 960 Hz tones, manual, or automatic 22 sec. output duration with remote "start" provision delivery late 1975

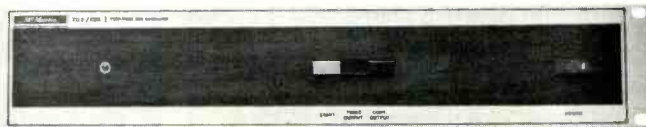

TG2/EBS

**McMartin**® McMartin Industries Inc., 4500 South Seventy-sixth Street Omaha, Nebraska 68127 Phone (402) 331-2000

Circle 155 on Reader Service Card

### AUTOMATIC RELEASE



## SERIES 3000 CART MACHINES

**LOW POWER CONSUMPTION** — less than 45 watts; no damage to your tapes.

**STANDARD FEATURES** — headphone jacks, transformer output, FET switching, remote control socket.

**OPTIONS** — all tape speeds, secondary and tertiary Cue tones, fast forward, mike input.

**FULL RANGE OF MODELS** — available in mono and stereo, record and playback, all cartridge sizes, desk and rack mounting.

*Spotmaster*®



**BROADCAST ELECTRONICS, INC.**  
8810 BROOKVILLE ROAD  
SILVER SPRING, MD. 20910  
PHONE 301-588-5983

Circle 156 on Reader Service Card

### NEWS

director of marketing services for Kliegl Brothers, lighting suppliers.

**Alf W. Olsen** returned from retirement to assume duties as president of Gunnar A. Olsen Corporation, tower constructors who have put up many of the tallest antenna towers around the country. . . . **Garo W. Ray**, veteran broadcast engineer and currently executive-in-residence in the Communications Department at the University of New Haven, was given the honorary degree of Doctor of Engineering at the January mid-year commencement of the University. **Frank J. Deighan**, president of Strand Century, resigned at the end of 1974 for personal reasons; the year was the most prosperous in the company's history. . . . **Raymond S. Rajewski** was named assistant controller of Kaiser Broadcasting Corporation. . . . **Robert Sherman** became vice president, CBS Radio Division, and general manager of WCAU, Philadelphia; and **John A. Lack** became vice president, CBS Radio Division and general manager of CBS Radio Spot Sales.

**Jack Keyes** was appointed national sales manager for broadcast optics, Canon Inc. . . . **Giulio G. Masullo**

is the new operations manager for the Amperex Electro-Optical Devices division. . . . **Charles E. Baker** was named vice president, engineering and research, of Malco, Chicago maker of connectors and installation hardware.

**Larry S. Alt** is assistant station manager of WSJV, Channel 28 in Elkhart, Indiana. . . . **Sam Dress** became director of the news center for the 6 pm and 11 pm daily airing, at station WRC-TV, Washington. . . .

**M. Christopher Derick** won appointment as vice president and general manager of Television Signal Corporation.

**Joseph Ciccone** became northeastern regional sales manager for Electro Sound, Inc., with headquarters in the Boston area. . . . **A.W. Trueman** is the new Director of Engineering for CCA Electronics Corporation. . . .

**Thomas B. Watson** was named general manager of station WLCY AM/FM in St. Petersburg, Florida.

**Christopher J. Hall** was appointed chief engineer of WWEL, AM/FM, in Boston; he had been CE at WIVY, in Jacksonville, FL. . . . **E.F. Murphy**

was elected president of RCA Global Communications, Inc. . . . **Steve Shannon** was named vice president and general manager of KCMO-AM and KCEZ-FM, Kansas City; and **Jim Eddens** became vice president and

general manager of WOW-AM and KEZO-FM, Omaha, all Meredith stations.

### Financial Briefs

**Scientific-Atlanta:** For six months ended 12/31/74, record sales of \$16,058,000, (Up 30%), and profits of \$515,000, (up 19%). . . . **Cox Broadcasting Corporation:** for year ended 12/31/74, record operating revenues of \$100,407,000 (up 11%), and net income of \$12,736,000 (up 20%)

. . . . **Conrac Corporation:** for year ended 12/31/74, record sales and earnings of \$81,129,000 and \$3,093,000, respectively.

**Fairchild Industries:** for year ended 12/31/74, sales of \$252,392,000 and earnings of \$6,022,000. . . . **Telemation, Inc.:**

announced a 25-year \$1,600,000 loan from New York Life Insurance Co. . . . **Anixter Brothers:** announced a quarterly dividend of four cents per common share, raising yearly rate to 16 cents, against earlier 10 cents.

**Warner Communications Inc:** for the year ended 12/31/74, revenues of \$720,076,000, net income of \$48,470,000. . . . **Oak Industries, Inc:** for the year ended 12/31/74, sales were \$130,140,783, net income \$4,774,355, both increases.

# BM/E CLASSIFIED MARKETPLACE

## CLASSIFIED ADVERTISING RATES

DISPLAY CLASSIFIED ADVERTISING: \$32.50 per inch 1x; \$30.00 per inch 6x; \$27.50 per inch 12x. ALL OTHER CLASSIFIED ADVERTISING 35¢ per word; minimum \$3.50. BLIND BOX NUMBER: \$1.00 extra charge. Replies sent to address below will be forwarded to you. PAYABLE IN ADVANCE; send check with order. CLOSING DATE: 5th of 2nd month preceding issue date.

**BM/E, Monterey and Pinola Avenues, Blue Ridge Summit, Pa. 17214 Phone 717/794/2191**

## EMPLOYMENT OPPORTUNITIES

### FIELD SERVICE ENGINEER

Extensive Travel. All Benefits. Experience in Color video and switching systems preferred. Contact: **Mr. Buzan, Vital Industries, Inc., 3700 N.E. 53rd Avenue, Gainesville, FLA. 32601 Phone: (904) 378-1581.**

Downstate Illinois. Maintain excellent facilities and do some production. Announcing ability helpful. Please send resume. Reply to box 575-1, c/o BME, Blue Ridge Summit, PA. 17214.

### HELP WANTED

Opportunity for talented, ambitious broadcast engineer with computer programming skills to work in expansion of large Statewide Television system, remote controlled transmitters using computer techniques, extensive microwave expansion. Excellent challenge. Paid hospitalization, 3 weeks vacation plus 12 holidays per year. Salary range \$9,000 to \$12,000. An equal opportunity employer. Send detailed resume to Gerald H. Warr, Transmission Engineer, P.O. Drawer L, Columbia, S.C. 29250.

WANTED: Committed Christian television engineer qualified in VTR, color camera and microwave maintenance for studio and remote truck operations. Christian production center in southeast. Salary commensurate with experience and ability. Send resume to P.O. Box 25328, Charlotte, N.C. 28212.

Broadcast Automation Engineer Strong on programming, Digital, Challenging position with manufacturer. Some travel Box 575-2 c/o BME, Blue Ridge Summit, Pa. 17214.

## EQUIPMENT FOR SALE

Solid-state audio modules-console kits, power amplifier kits, power supplies, Octal plug-ins, mic. eq. line, disc, tape play, tape record, amplifiers, Audio & tape bias oscillators. Over 50 audio products. Send for free catalog and applications. Opamp Labs, Inc. 1033 N. Sycamore Ave. Los Angeles, Calif. 90036. (213) 934-3566.

SPOTMASTER, FIDELIPAC, RUSSCO, ROH, ELECTRO-VOICE, OTARI, RAMKO, SCOTH, STANSON, NORTONICS, SHURE, SENNHEISER, TELEX, MAGNACORD, AND VIKING are all items distributed and serviced by COMMUNICATION MEDIAS/BROADCAST COMPONENT DISTRIBUTORS, P.O. Box 54, Allentown, PA. 18105. (215) 437-0607. "Sudden Service" — our specialty.

SPOTMASTER PARTS — 24 hour service — repairs and rebuilding of your equipment. Franchised SPOTMASTER repair service. COMMUNICATION MEDIAS/BROADCAST COMPONENT DISTRIBUTORS, P.O. Box 54, Allentown, PA. 18105. (215) 437-0607.

CCA AM250D Transmitter. Excellent. Low Hours. Now in use. \$2900.00 FOB, San Bernardino, California. LaVern Garton, (714) 885-6555.

SYLVANIA LAMPS 50% OFF! Quartz, Projection, Studio, Enlarging, Movie Lamps, in stock for immediate delivery. Write or call for price list. SAWYER CAMERA COMPANY, 6820 Santa Monica Blvd., Hollywood, California. 90038. (213) 466-6113.

AMPEX, SCULLY, TASCAM, all major professional audio lines. Top dollar trade-ins. 15 minutes! George Washington Bridge. PROFESSIONAL AUDIO VIDEO CORPORATION, 342 Main Street, Paterson, N.J. 07655. (201) 523-3333.

## EQUIPMENT FOR SALE (Cont'd)

Broadcast mixer for remote out of studio programming. Can be used as inexpensive second console for college and small radio stations. D.J.'s can now originate programming at home. Simultaneous mixing of two stereo phonographs, a tape machine and a microphone. Precue for all inputs with built-in monitor headphone amplifier. Send for literature. \$325. Professional discount, use letterhead. G.L.L. Box 2076, DEPT BM/E, Brooklyn, N.Y. 11201 Phone: (212) 875-6992.

BROADCAST AND RECORDING EQUIPMENT: Scully, V.I.F. International, Metrotech, Langevin, Electrodyne, Q.R.K., Micro-Trak, MRL, Nortronics, McMartin, U.R.E.I., E.V., A.K.G., Stevenson, Gately, D.B.X., Advent, Altec, Fairchild, Audio Designs, 3M, Magnecord, Telex, Inovonics, Nagra, Uher, Tape-Athon, Package Deals, Installations, Service, Request Flyer. Weigand Audio, Middleburg, PA. 17842. (717) 837-1444.

One stop for all your professional audio requirements. Bottom line oriented. F.T.C. Brewer, Box 8057, Pensacola, Florida 32505.

MICA AND VACUUM transmitting capacitors. Large stock; immediate delivery. Price lists on request. SURCOM ASSOCIATES, 1147 Venice Boulevard, Los Angeles, Calif. 90015. (213) 382-0985.

4-650 ft. towers \$6500.00 each. Many more. Ground wire 85¢ per xx. lb. Bill Angle, Box 55, Greenville, N.C. 27834. Tel. 919-752-3040.

DELTA RG-1 Receiver Generator for sale. New condition. \$1,275. McClanathan and Associates, P.O. Box 750, Portland, Oregon. 97207.

WHATEVER YOUR EQUIPMENT NEEDS—new or used—check us first. We specialize in broadcast equipment. Send \$1.00 for our complete listings. Broadcast Equipment and Supply Co., Box 3141, Bristol, TN 37620.

## EQUIPMENT WANTED

WANTED TO BUY — Equipment. WWCO requires new or used AM guyed tower 480 feet above base insulator. Contact Peter Marcus — (203) 758-2468 or (201) 944-8817.

WE NEED USED 250, 500, 1KW, 5KW AM Transmitters, 250, 1000 Watt FM transmitters. No junk. Guarantee Radio Supply Corp., 1314 Iturbide St., Laredo, TX. 78040.

## INSTRUCTIONS

First phone-through-tape recorded lessons at home plus one week personal instruction in Washington, D.C., Atlanta, Boston, Detroit, New Orleans, Minneapolis, Seattle, Denver, Portland, Los Angeles. Proven results. Our 17th year teaching FCC license courses. Bob Johnson Broadcast License Training, 10001 Duncan, Manhattan Beach, Calif. 90266. 213-379-1461.

## PROGRAM SERVICES

"FREE" CATALOG ... Everything for the Deejay! Custom I.D.'s, Promos, Airchecks, Wildtracks, Books, FCC Tests, Comedy, and more! Write: Command, Box 26348-A, San Francisco 94126.

Deejays! New Comedy! 11,000 classified one-line gags. \$10. Catalog FREE! Edmund Orrin, 2786-M West Roberts, Fresno, CA. 93705.

## PROFESSIONAL CARDS

### COHEN & DIPPEL, P.C.

#### CONSULTING ENGINEERS

527 Munsey Bldg.  
(202) 783-0111  
Washington, D. C. 20004  
Member AFCEE

## PROFESSIONAL CARDS (Cont'd)

RALPH E. EVANS ASSOCIATES  
Consulting Telecommunications  
Engineers  
AM-FM-TV-CATV-ITFS  
3500 North Sherman Boulevard  
MILWAUKEE, WISCONSIN 53216  
Phone: (414) 442-4210  
Member AFCEE

### Midwest Engineering Associates Consulting Engineers

F.W. Hannel, P.E.  
BSEE; MSEE

7304 N. Oxford, Peoria, Illinois 61614  
(309) 691-3426

## MISCELLANEOUS WANTED

BACK ISSUE MAGAZINES WANTED by collector. Donald Erickson, 6059 Essex, Riverside, CA. 92504. (714) 687-5910.

## FRANCHISES AVAILABLE

### PUBLIC NOTICE

The City of Columbia, Missouri hereby gives notice of request for applications to construct and operate a cable television system to serve the City.

Applications must be received by 5:00 p.m., CDT, August 15, 1975.

Applications will be accepted only if they follow the form specified in the application package. Application packages, which include a copy of the application form, the regulatory ordinance, pertinent charter sections, the feasibility study and the selection criteria, may be obtained from the City Counselor, Municipal Building, Sixth and Broadway, Columbia, Missouri 65201.

All applications will be publicly opened on August 18, 1975. Communications should be addressed only to the City Counselor and should be limited to those of a contractual nature. Public hearings will be held subsequent to August 18, 1975 at which time applicants will be given an opportunity to make a public presentation.

## SERVICES

### RCA Microphone Repair and Reconditioning Service

RCA Professionals can repair, rebuild and test your RCA Broadcast Microphones to like-new condition and certify them to meet original performance specifications. For details and prices, write Technical Services, RCA, Bldg. 2-8 Camden, N.J. 08102.

## ADVERTISERS INDEX

Alpha Electronic Services Inc. ....	68	Taber Mfg. & Engrg. Co. ....	60
American Data Corp. ....	19	TeleMation, Inc. ....	17
Audio Designs & Mfg. Inc. ....	59	Television Equipment Associates, Inc. ....	59
Barbizon Electric Co. ....	66	UMC Electronics Co. ....	56
Belar Electronics Laboratory, Inc. ....	8	Ultra Audio Products ....	67
Broadcast Electronics, Inc. ....	66, 68	Videomax ....	49
CMX Systems ....	21	Viscount Industries, Inc. ....	59
Canon U.S.A. Inc. ....	61	Ward Beck Systems, Ltd. ....	Cover IV
Central Dynamics Ltd. ....	28, 44	Wilkinson Electronics, Inc. ....	67
Charles Machine Works, Inc. ....	9		
Chiron Telesystems ....	12		
Cinema Products Corp. ....	16, 53		
Cohu Electronics, Inc. ....	43		
Computer Image ....	33		
Datatron, Inc. ....	Cover III		
Dynair Electronics, Inc. ....	54		
Dynasciences Video Products ....	20		
Eastman Kodak Co. ....	CM/E 3		
Fernseh Group, Robert Bosch Corp..	13		
Fidelipac Div. Telepro Industries, Inc. ....	65		
Fluke Mfg. Co., Inc., John .....	56		
Frezzolini Electronics Inc. ....	63		
Garron Electronics Inc. ....	61		
General Cable ....	CM/E 5		
Grass Valley Group ....	5		
Ikegami Electronic Industries, Inc. ....	15		
International Tapetronics Corp. ....	52		
JVC Industries, Inc. ....	23		
Jampro Antenna Co. ....	25		
LPB, Inc. ....	61		
Lowel Light ....	58		
McCurdy Radio Industries, Inc. ....	Cover II		
McMartin Industries, Inc. ....	58, 60, 68		
Marconi Instruments, Inc. ....	26, 27		
Mincom 3M Co. ....	35, 36, 37, 38		
Oak Industries, Inc. ....	CM/E 7		
PSC Technology Inc. ....	3		
Paperwork Systems ....	14		
Potomac Instruments ....	18		
RCA Broadcast Systems .	10, 11, 18, 57		
RCA Community Television Systems ....	CM/E 8		
RCA Service Co. ....	70		
Rapid Q ....	59		
Recortec, Inc. ....	57		
SMPTE ....	62		
Shintron Co. Inc. ....	48		
Shure Bros., Inc. ....	51		
Sony Corp. of America ....	7		
Systems Marketing Corp. ....	24		

## SALES OFFICES

Broadband Information Services, Inc.  
274 Madison Ave.  
New York, New York 10016

**EASTERN & MIDWESTERN STATES**  
274 Madison Avenue  
New York, New York 10016  
212-685-5320  
Kenneth F. Luker, Jr.

**WESTERN STATES**  
1212 Hearst Building  
San Francisco, California 94130  
415-495-0990  
William J. Healey

P.O. Box 49206  
Los Angeles, California 90049  
213-476-6451  
Art Mandell

**JAPAN**  
Nippon Keisoku Inc.  
P.O. Box 410  
Central Tokyo, Japan  
Tokyo (03) 667-7681  
Yoshi Yamamoto

**COMING:  
BM/E'S ANNUAL  
UPDATE ON RADIO  
AND TELEVISION  
AUTOMATION—  
JULY & AUGUST  
ISSUES**

**USE BM/E's CLASSIFIED  
MARKETPLACE TO  
REACH OVER 28,000  
BROADCASTERS!**

To find a job or fill one, to sell a product or service . . . send your ad (along with a check) to:

**BM/E**  
Classified Advertising Dept.  
Blue Ridge Summit, Pa. 17214  
717-794-2191

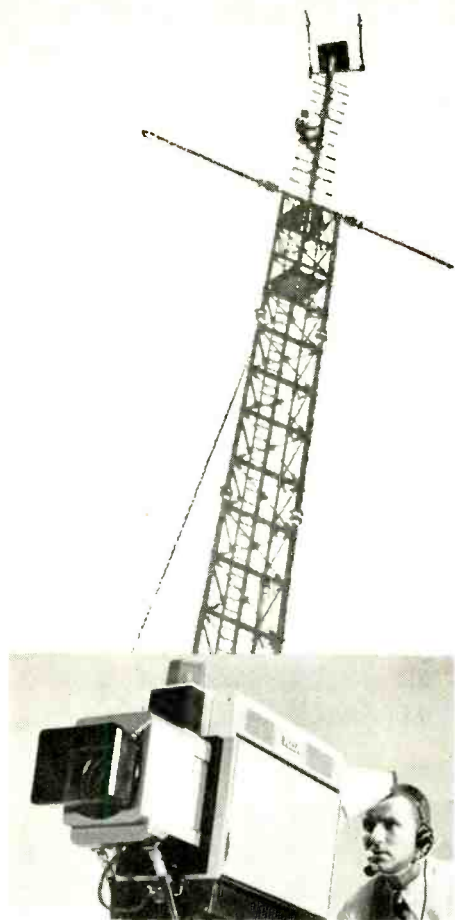

## Command Performance? RCA SERVICE DELIVERS Expert Repair and Overhaul Service

FOR:

- Video tape recorders
- TV Cameras
- Antennas
- Microphones
- Transmitters
- Installation
- Console
- TV Projectors
- Microwave

Dial either of these offices for full information about fast, dependable broadcast equipment maintenance service from RCA:

Chicago (312) 298-7980  
Philadelphia (215) 467-3300

Or contact:

RCA Service Company  
A Division of RCA  
Technical Products Service  
Bldg. 204-2, Camden, N. J. 08101  
Phone (609) 779-4129

# RCA

Circle 157 on Reader Service Card

## BM/E READER SERVICE CARD June 1975 Issue

*Use this FREE postpaid Card for more information on the products described.*

NAME \_\_\_\_\_  
 TITLE \_\_\_\_\_  
 STATION OR COMPANY \_\_\_\_\_  
 ADDRESS \_\_\_\_\_  
 CITY \_\_\_\_\_ STATE \_\_\_\_\_ ZIP \_\_\_\_\_  
 PHONE # ( ) \_\_\_\_\_

GREAT IDEA BALLOT Rank Ideas of interest to you 1, 2 or 3					
No.	Rank	No.	Rank	No.	Rank
—	—	—	—	—	—

**100-249: ADS      250-299: LITERATURE      300-399: EDITORIAL**

100	101	102	103	104	105	106	107	108	109	110	111	112	113	114	115	116	117	118	119
120	121	122	123	124	125	126	127	128	129	130	131	132	133	134	135	136	137	138	139
140	141	142	143	144	145	146	147	148	149	150	151	152	153	154	155	156	157	158	159
160	161	162	163	164	165	166	167	168	169	170	171	172	173	174	175	176	177	178	179
180	181	182	183	184	185	186	187	188	189	190	191	192	193	194	195	196	197	198	199
200	201	202	203	204	205	206	207	208	209	210	211	212	213	214	215	216	217	218	219
220	221	222	223	224	225	226	227	228	229	230	231	232	233	234	235	236	237	238	239
240	241	242	243	244	245	246	247	248	249	250	251	252	253	254	255	256	257	258	259
260	261	262	263	264	265	266	267	268	269	270	271	272	273	274	275	276	277	278	279
280	281	282	283	284	285	286	287	288	289	290	291	292	293	294	295	296	297	298	299
300	301	302	303	304	305	306	307	308	309	310	311	312	313	314	315	316	317	318	319
320	321	322	323	324	325	326	327	328	329	330	331	332	333	334	335	336	337	338	339
340	341	342	343	344	345	346	347	348	349	350	351	352	353	354	355	356	357	358	359
360	361	362	363	364	365	366	367	368	369	370	371	372	373	374	375	376	377	378	379
380	381	382	383	384	385	386	387	388	389	390	391	392	393	394	395	396	397	398	399

Tell us what you like or dislike about the issue

\_\_\_\_\_

\_\_\_\_\_

What articles would you like to see?

\_\_\_\_\_

\_\_\_\_\_

Use until September 30, 1975

## BM/E READER SERVICE CARD June 1975 Issue

*Use this FREE postpaid Card for more information on the products described.*

NAME \_\_\_\_\_  
 TITLE \_\_\_\_\_  
 STATION OR COMPANY \_\_\_\_\_  
 ADDRESS \_\_\_\_\_  
 CITY \_\_\_\_\_ STATE \_\_\_\_\_ ZIP \_\_\_\_\_  
 PHONE # ( ) \_\_\_\_\_

GREAT IDEA BALLOT Rank Ideas of interest to you 1, 2 or 3					
No.	Rank	No.	Rank	No.	Rank
—	—	—	—	—	—

**100-249: ADS      250-299: LITERATURE      300-399: EDITORIAL**

100	101	102	103	104	105	106	107	108	109	110	111	112	113	114	115	116	117	118	119
120	121	122	123	124	125	126	127	128	129	130	131	132	133	134	135	136	137	138	139
140	141	142	143	144	145	146	147	148	149	150	151	152	153	154	155	156	157	158	159
160	161	162	163	164	165	166	167	168	169	170	171	172	173	174	175	176	177	178	179
180	181	182	183	184	185	186	187	188	189	190	191	192	193	194	195	196	197	198	199
200	201	202	203	204	205	206	207	208	209	210	211	212	213	214	215	216	217	218	219
220	221	222	223	224	225	226	227	228	229	230	231	232	233	234	235	236	237	238	239
240	241	242	243	244	245	246	247	248	249	250	251	252	253	254	255	256	257	258	259
260	261	262	263	264	265	266	267	268	269	270	271	272	273	274	275	276	277	278	279
280	281	282	283	284	285	286	287	288	289	290	291	292	293	294	295	296	297	298	299
300	301	302	303	304	305	306	307	308	309	310	311	312	313	314	315	316	317	318	319
320	321	322	323	324	325	326	327	328	329	330	331	332	333	334	335	336	337	338	339
340	341	342	343	344	345	346	347	348	349	350	351	352	353	354	355	356	357	358	359
360	361	362	363	364	365	366	367	368	369	370	371	372	373	374	375	376	377	378	379
380	381	382	383	384	385	386	387	388	389	390	391	392	393	394	395	396	397	398	399

Tell us what you like or dislike about the issue

\_\_\_\_\_

\_\_\_\_\_

What articles would you like to see?

\_\_\_\_\_

\_\_\_\_\_

Use until September 30, 1975

## COMPLIMENTARY SUBSCRIPTION QUALIFICATION CARD

1. I would like to receive BM/E       Yes       No  
 I would like my copies to include CM/E       Yes       No

2. My company is: (Please check ALL items which pertain to your firm.)

- |  |  |
|--|--|
| <input type="checkbox"/> AM Station(s)<br><input type="checkbox"/> FM Station(s)<br><input type="checkbox"/> TV Station(s)<br><input type="checkbox"/> Instructional TV or CCTV<br><input type="checkbox"/> Campus Limited Radio<br><input type="checkbox"/> CATV Facilities<br><input type="checkbox"/> Telephone Company | <input type="checkbox"/> Program Sources<br><input type="checkbox"/> Recording Studios<br><input type="checkbox"/> Government<br><input type="checkbox"/> Consultant<br><input type="checkbox"/> Lawyer<br><input type="checkbox"/> Distributor/Manufacturer dealer<br><input type="checkbox"/> Other (please specify) _____ |
|--|--|

3. Are you responsible for more than one station or facility?  
 Yes       No

4. My primary area of responsibility is: (Please check one)

- |  |  |
|--|--|
| <input type="checkbox"/> Corporate Management<br><input type="checkbox"/> Engineering & Engineering Management<br><input type="checkbox"/> Operations Management | <input type="checkbox"/> Station, Production or Program Management<br><input type="checkbox"/> Other (please describe) _____ |
|--|--|

5. Your signature \_\_\_\_\_

Title \_\_\_\_\_ Date \_\_\_\_\_

Name \_\_\_\_\_ Title \_\_\_\_\_

Station or Co. \_\_\_\_\_

Street \_\_\_\_\_

City \_\_\_\_\_ State \_\_\_\_\_ Zip \_\_\_\_\_

If this is an address change, affix label

Is this your business address?       Yes       No

If not, please give us your business address below so that we can avoid sending duplicate copies.

Name \_\_\_\_\_

Station or Co. \_\_\_\_\_

Street \_\_\_\_\_

City \_\_\_\_\_ State \_\_\_\_\_ Zip \_\_\_\_\_

**FIRST CLASS**  
Permit No. 665  
Duluth, Minnesota

**BUSINESS REPLY MAIL**

NO POSTAGE STAMP NECESSARY IF MAILED IN THE UNITED STATES

POSTAGE WILL BE PAID BY



*Broadband Information Services, Inc.*  
P.O. BOX 6058  
Duluth, Minnesota 55806

**FIRST CLASS**  
Permit No. 665  
Duluth, Minnesota

**BUSINESS REPLY MAIL**

NO POSTAGE STAMP NECESSARY IF MAILED IN THE UNITED STATES

POSTAGE WILL BE PAID BY



*Broadband Information Services, Inc.*  
P.O. BOX 6058  
Duluth, Minnesota 55806

**FIRST CLASS**  
Permit No. 665  
Duluth, Minnesota

**BUSINESS REPLY MAIL**

NO POSTAGE STAMP NECESSARY IF MAILED IN THE UNITED STATES

POSTAGE WILL BE PAID BY



*Broadband Information Services, Inc.*  
P.O. BOX 6056  
Duluth, Minnesota 55806



# The Editor-In-Chief!

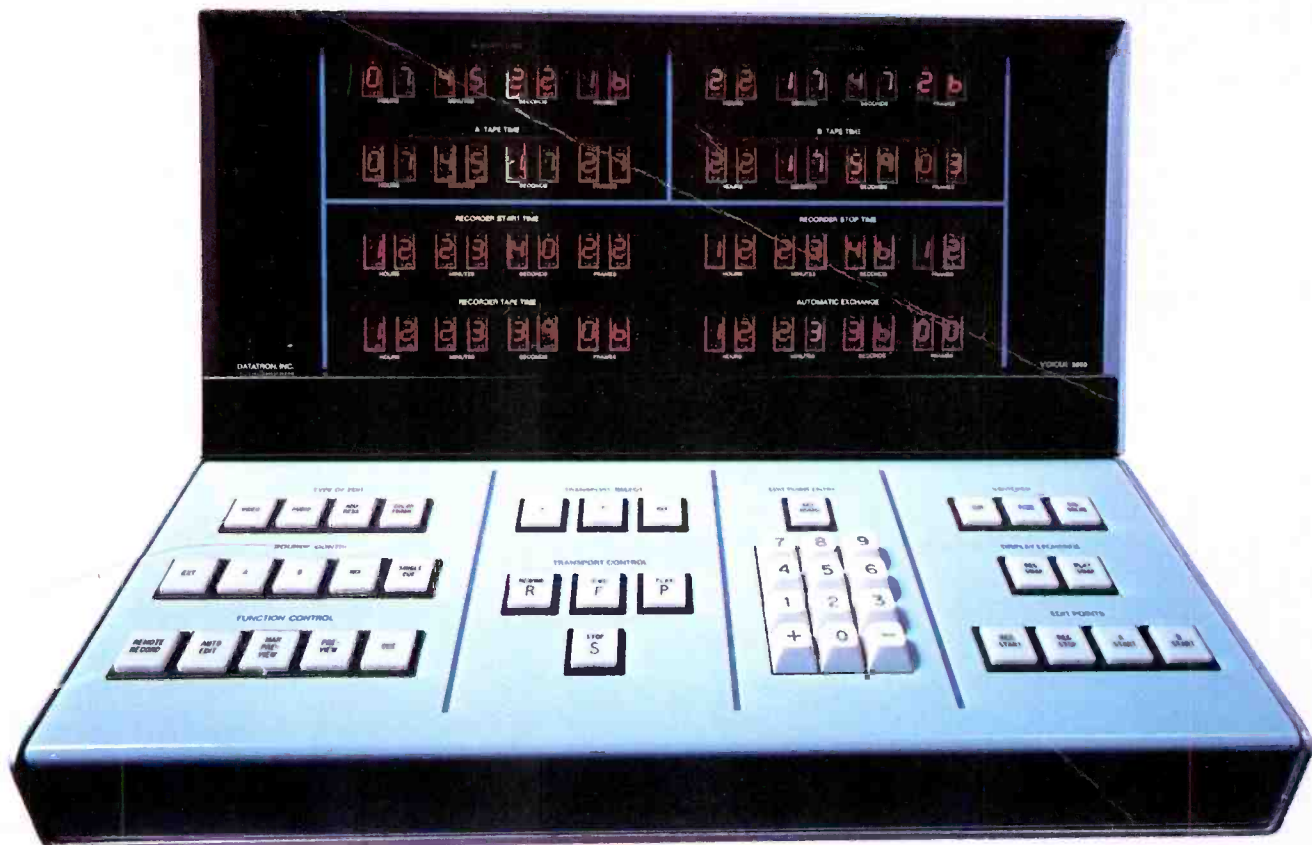

## Now you can economically edit on helicals and automatically transfer in minutes to quads

The editing system you've been waiting for.

Meet the Editor-In-Chief. Our thrifty new Vidicue 5050.

It defies obsolescence. You can expand from two to three machines at will. Or move up in logical steps to a completely automatic on-line, off-line system where editing is done on low cost helicals and transferred in minutes to quads.

Easy to learn, and to operate too. Simple keyboard entry. Visual display of tape position and all edit points.

Exclusive jam sync, eliminating forever the need to pre-record SMPTE edit code on tape. A/B rolls, color framing, special effects switching, time base correction. The works!

Yet this remarkable video tape editing system is priced far below competition. In fact, there is none.

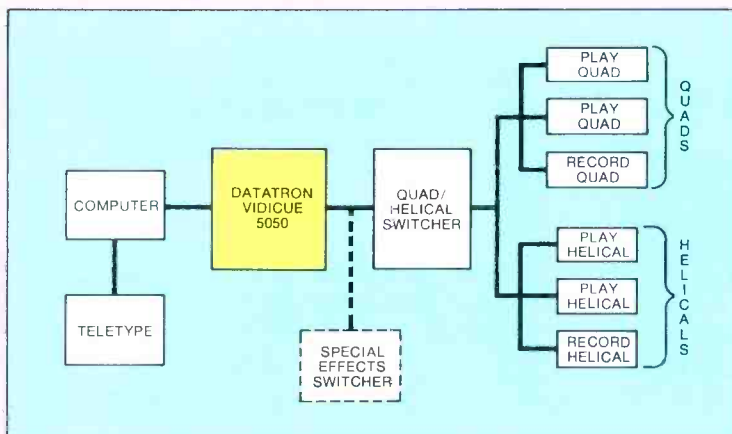

### The importance of Jam-Sync.

Our exclusive jam-sync eliminates the need to pre-lay-down the SMPTE edit code on an entire length of fresh tape being used to assemble a show from other tapes. Instead, during pre-roll, the system time code generator is automatically set and sync'd so that time picks up exactly where it left off — to

the frame. This saves quad head wear. Tape wear, too. And is also a great time saver on stop-and-go live production by generating a continuous uninterrupted elapsed time on the tape.

**Save your expensive quads for other jobs.**

The block diagram tells the story. You can edit on-line or off-line. Do time consuming edits on low cost helicals. Edit event times are stored in the computer

and a punched tape prepared. Using this tape, a precisely edited show can be automatically transferred to quads in minutes.

Your quads have never had it so good. Or your pocketbook either. We'd like to tell you the whole story of our Editor-in-Chief. Why not write or phone today.

**datatron, inc.** EDITING SYSTEMS DIVISION

1562 Reynolds Ave., Santa Ana, California 92705 (714) 540-9330 • TWX 910-595-1589  
Mailing Address: P.O. Box 11427, Santa Ana, California 92711

Circle 158 on Reader Service Card

# The Art of Sound

Experience new dimensions in sound. With console configurations embodying a comprehensive series of new high performance modules. Trend setting systems combining operational flexibility with aesthetic appeal.

Ward-Beck continues to move ahead with dynamic designs, performance standards approaching theoretical limits, and uncompromising quality, to bring you the kind of equipment that you always hoped might happen.



Tomorrow's Technology Today.

Ward-Beck Systems Inc.,  
290 Larkin Street,  
Buffalo, N.Y. 14210

Ward-Beck Systems Ltd.,  
841 Progress Avenue, Scarborough,  
Ontario M1H 2X4  
Telephone (416) 438-6550. Telex 06-23469