

BMEP

BROADCAST MANAGEMENT/ENGINEERING



RECEIVED FEB 6 1969

**WE INTERRUPT YOUR HOLDING PATTERN
TO BRING YOU SIX HOURS
OF LOCAL NEWS**



SUDDUTH

KAAY-022221 PEXX009 4681
F 0007 HLT CUE 1300
KAAY
BOX 1796
LITTLE ROCK, AR 72203

SCA: for Special Captive Audiences

RIKER VIDEO

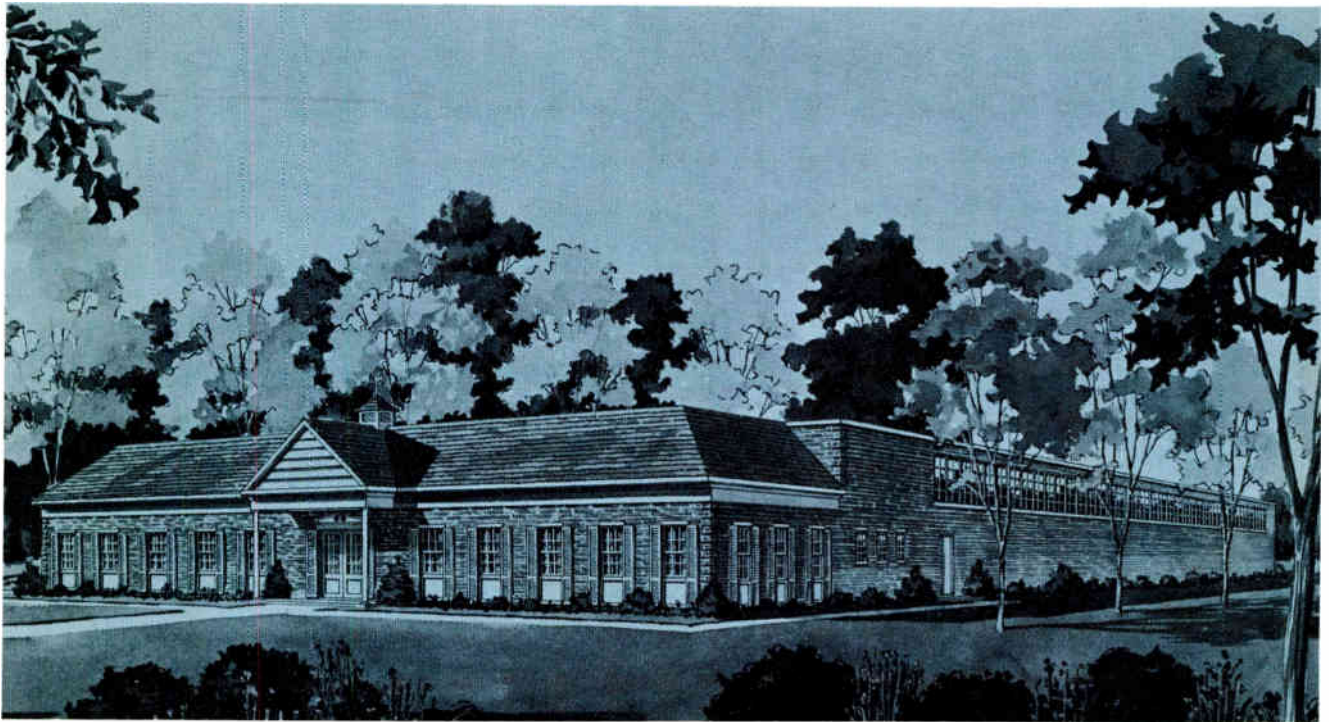

MAIN OFFICE AND PLANT

A. W. Malang, President

HEADQUARTERS

Abe Jacobowitz
National Sales Manager

T. K. Chapman
Manager of Marketing Admin.

Charles Green
Manager of Quality Assurance

CENTRAL REGION

Herbert N. Didier
Riker Video
2550 Denver Merchandise Mart
451 East 58 Avenue
Denver, Colorado 80216
(303) 534-3995
Telex 45-784

WESTERN REGION

George Ray Walker
Riker Video
7811 Le Mona Avenue
Van Nuys, California 91405
(213) 785-1005

NORTHEAST REGION

Roger C. Jakobs
Riker Video
100 Parkway Drive South
Hauppauge, New York 11787
(516) 543-5200

SOUTHEAST REGION

Lewis L. Parson
Riker Video
3127 Maple Drive, N.E.
Suite 210
Atlanta, Georgia 30305
(404) 233-2557

RIKER VIDEO Inc.

100 PARKWAY DRIVE SOUTH
HAUPPAUGE, L.I., NEW YORK 11787

TELEPHONE (516) 543-5200

TELEX 96-1356

CABLE—RIKERVERVIDEO

One-of-a-kind antenna system takes unique skills

You couldn't ask for a more complex TV antenna system than this one-of-a-kind installation—with five RCA antennas on-air from twin masts on John Hancock Center in Chicago next fall. Only the Empire State antenna system by RCA paralleled it in technological involvement.

The John Hancock Center has: Two UHF Polygons. A VHF Zee Panel. A VHF Superturnstile. A VHF Butterfly. Each one is designed to handle maximum authorized ERP. All five can radiate maximum power with minimum inter-reaction. And that's not all: There are provisions in the system for future expansion to a total of 10 antennas!

Did you know that almost all multiple antenna installations in the business were RCA-engineered—planned—tested—built—and installed? And that the basic principles of multiple array antenna operation were first evolved at RCA's Gibbsboro Center—world's best equipped and most advanced Antenna Engineering facility. Or that Gibbsboro maintains the industry's largest and most complete computerized store of reference data. RCA's experience and intelligence are readily adaptable to solutions of every kind of antenna problem.

Your antenna is your bridge to business. Call your RCA Broadcast Representative when you begin to think about that installation. Or write RCA Broadcast and Television Equipment, Building 15-5, Camden, N.J. 08102.

RCA Broadcast
Equipment

Owner/Developer:
John Hancock
Mutual Life
Insurance Company

Circle 102 on Reader Service Card

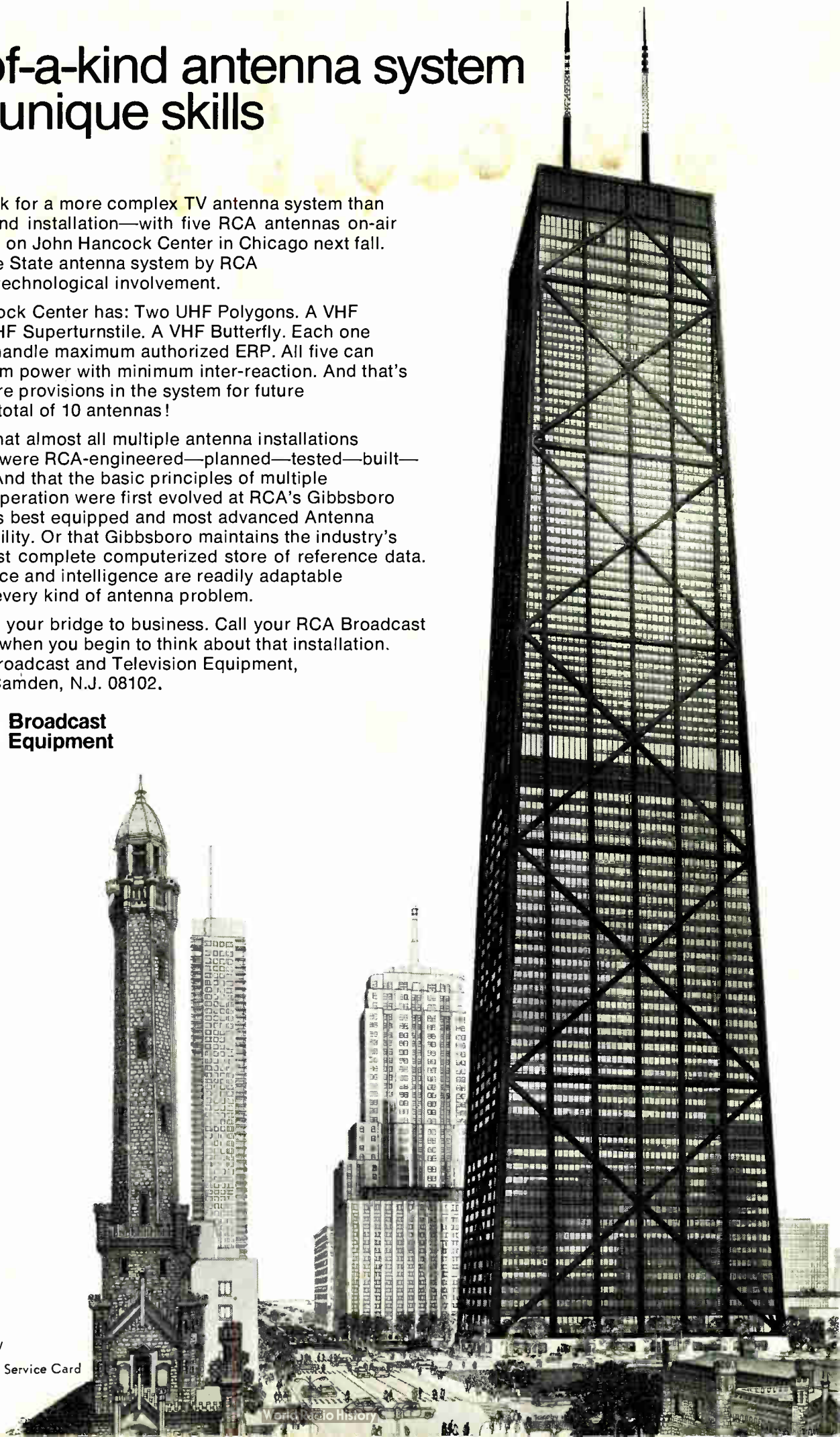

BM/E

BROADCAST MANAGEMENT/ ENGINEERING

Editor:
JAMES A. LIPPKE

Managing Editor:
WALTER G. SALM

Assistant Editor:
ALBERT P. LAHNDT, JR.

Editorial Assistant:
HILARY E. ABRAMSON

Art Director:
KAREN WEINSTEIN

Editorial Director:
GEORGE ROSTKY

Production and Reader Service Manager:
ARLINE G. JACOBS

Circulation Director:
KEEFE G. WERNER

Sales Promotion Manager:
RHODA GLENNER

Research Manager:
IRENE CHERVIN

Marketing Services Manager:
JACK LOW

President:
RALPH E. RICHARDSON

This month's cover: Ever sit in a holding pattern and wonder what's going on down there on the ground? Now you'll be able to find out from Newsrad, a capsule news summary transmitted to incoming airliners via an fm/SCA subchannel. While the air may look a bit jammed in Art Sudduth's cover design, that's nothing compared to the spectrum crowding that SCA may help alleviate. For more on fm/SCA, see pages 22-36.

- 6 **Broadcast Industry News**
- 12 **Focus on CATV**
- 14 **Interpreting FCC Rules & Regulations**
FCC acts on pay-TV.

SPECIAL SECTION: FM/SCA

- 22 **SCA Spells More \$\$ for Fm**
Once the province of a handful of background music services, SCA subchannels are coming into their own.
- 26 **Education at Home via SCA**
Educating is bold concept for programmed instruction which puts a classroom in everyone's home.
- 28 **Fax to Get the Facts there Fast**
Newly formed facsimile network will criss-cross the country on SCA subchannels.
- 30 **Fm: Free Music, Faithful Market**
Fm radio is no longer the poor stepchild it once was, but it still hasn't found its true niche.
- 34 **Successful Fm'er Wears Many Hats**
It's hard to think of KTRT/Telaudio as simply a radio station. Its many services add up to \$\$\$.

-
- 40 **Anti-Trust vs. CATV—Part I**
Underlying new developments in CATV is the lurking shadow of that Ole Devil of U.S. industry—Anti-Trust.
 - 44 **Low-Cost Radar Adds Zip to Weather Reports**
It's possible to set up fast and economically for your newscast rainmaker slot for CATV weather channels.
 - 46 **'Dip and Dunk' for Newsfilms—Color it Cheap**
If you're in a small-to-medium-size market, have a limited budget and want color newsfilm, this could be for you.
 - 52 **Broadcast Equipment**
Reports on newly introduced products and equipment.
 - 62 **Names in the News**
 - 68 **Management Q&A**
Have questions on station management? Ask Si.
 - 71 **Literature of Interest**
Valuable data you can obtain by using Reader Service Card between pages 70 and 71.
 - 75 **Classified Marketplace**
 - 77 **Index to Advertisers**
 - 78 **Editorial**
Fm Turns the Corner.

Mactier Publishing Corp.
820 Second Ave., New York, N.Y. 10017, 212 661-0450

Also publishers of:
BROADCAST EQUIPMENT BUYERS GUIDE
EEE
ELECTRO-PROCUREMENT



BM/E, Broadcast Management/Engineering, is published monthly by Mactier Publishing Corp. All notices pertaining to undeliverable mail or subscriptions should be addressed to 820 Second Ave., New York, N.Y. 10017.

BM/E is circulated without charge to those responsible for station operation and for specifying and authorizing the purchase of equipment used in broadcast facilities. These facilities include a-m, fm, and TV broadcast stations; CATV systems; ETV stations, networks and studios; audio and video recording studios; consultants, etc. Subscription prices to others are: U.S., its possessions and Canada—\$10.00 one year, \$18.00 two years; elsewhere—\$15.00 one year, \$25.00 two years.

Copyright © 1969 by Mactier Publishing Corp., New York City. Controlled Circulation postage paid at Duluth, Minn.



Broadcasters— Feeling the Freeze?

Defrost with Audimax and Volumax! We guarantee to increase your effective radiated power.

Are your plans for increasing power on ice? Well, here's a quick way to beat the cold: call us collect: (203) 327-2000! We'll send you Audimax and Volumax FREE for 30 days. No obligation.

Audimax is an automatic level control years ahead of the ordinary AGC. It automatically maintains appropriate volume levels and eliminates distortion, thumping and pumping.

Volumax outmodes conventional peak limiters by controlling peaks automatically with-

out side effects. It's unconditionally guaranteed to prevent overmodulation. Volumax alone has typically provided a 4 to 1 increase of average program power.

With this winning combination, we guarantee increasing your maximum program power as much as 8 to 1. You reach a bigger audience with a more pleasant sounding program.

Why wait? Defrost with Audimax and Volumax . . . the powerful pair from CBS Laboratories.

PROFESSIONAL
PRODUCTS
CBS LABORATORIES
Stamford, Connecticut 06905
A Division of Columbia Broadcasting System, Inc.

Circle 103 on Reader Service Card

NEWS

Jerrold president predicts CATV future

During 1969, the growth of CATV will exceed the 900,000 homes linked to the cable during 1968, according to Robert H. Beisswenger, president of The Jerrold Corporation and chairman of the National Cable Television Association.

Beisswenger says that given freedom from major government restraints and considering advances in cable technology, 90 percent of the homes in this country will be wired for CATV ten years from now.

Four additional trends are predicted by Beisswenger:

- CATV systems operators should realize about \$300-million an-

nually by the end of 1969.

- Participation by established broadcasters in CATV systems will increase.

- Further advances will be made so that 12-channel and 20-channel CATV systems will become commonplace throughout the country.

- Accompanying expansion of the number of channels in CATV systems will be a substantial increase in local programming.

Beisswenger adds that he looks forward "to an increase in understanding and cooperation between the broadcasting and CATV industries . . . both broadcasters and CATV systems operators have come to realize that cooperation and understanding are necessary ingredients which spell a bright future for both our industries."

Zenith Radio chairman praises FCC for move

Joseph S. Wright, chairman of Zenith Radio Corp., has praised the FCC for authorizing nationwide subscription TV.

"The chairman and members of the FCC are to be congratulated for taking this favorable action approving subscription TV, in face of all the pressures from the powerful interests who have opposed this decision. This decision will, I believe, stand with such FCC actions as approval of the industry color standards in 1953 and the allocation of uhf TV channels as landmarks in the progress of broadcasting."

Wright said that the success of STV "rests squarely on the availability of the best productions and the employment of the most advanced creative techniques from Hollywood, Broadway and all the performing arts."

According to Wright, "only the American people, by making a free choice in an open market, can ultimately decide the future of STV."

FCC authorizes ITT, RCA to start service abroad

ITT World Communications Inc. and RCA Global Communications Inc. have been authorized temporarily by the Commission to provide the first leased channel service of 48-kHz bandwidth overseas.

The FCC has also ordered an investigation of the two companies' tariffs for the service and of one filed by Communications Satellite Corp., which will provide circuits to the carriers.

The tariff revisions apply to a channel that could be used either as a broadband data channel or subdivided into voice channels. ITT's revision, which became effective Dec. 20, is for a 48-kHz channel between Washington, D.C., and the theoretical midpoint between the U.S. and Spain. Its customer is the National Aeronautics and Space Administration.

RCA's revision, which became effective Dec. 21, is for service to

Spread-out CATV system fires up six-channel microwave service

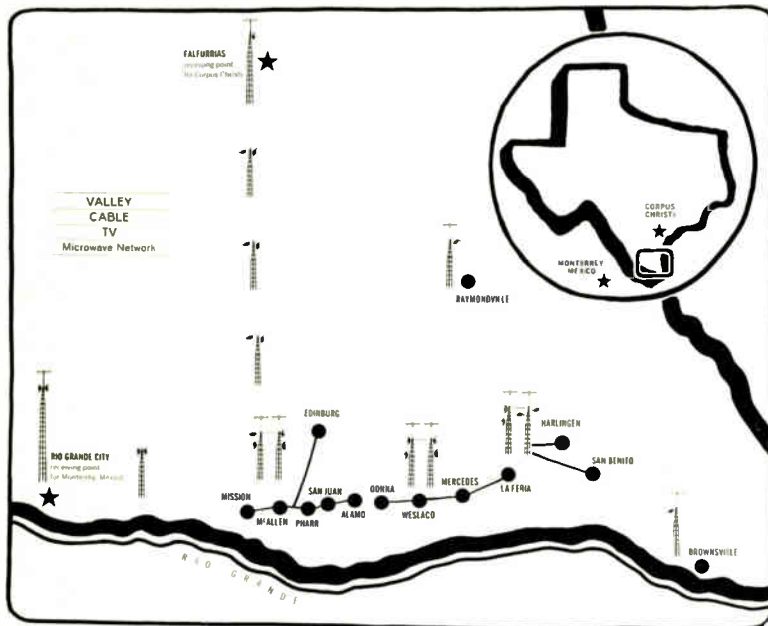

Valley Cable TV, a subsidiary of the Jerrold Corp., and geographically the world's largest CATV system, has installed microwave service 200 miles around the Rio Grande Valley. Cable TV via microwave (relayed point-to-point in the new 12 MHz CARS band to the hub of the system at Pharr, Texas,) is allowing more varied programming and better reception than previously possible: channels in Monterrey, Mexico, can be received and retransmitted; ten-channel reception allows selective reception of all three major networks; six distant channels can be added to present local channels. Equipment includes 37 transmitters and 37 receivers.

Slip the end of a video tape around the hub of one of our new Plio-Magic reels and it won't slip off. An exclusive Tape-Tac coating keeps the tape in place—perfectly flat, snug and secure—until you unwind it. Without slippage, ripples or wrinkles, or damage, either.

Our high-impact reels resist cracking, bending and breaking. And each reel,

available in 8"x2", 6½"x2", 8"x1" and 6½"x1", comes in its own metal-core shipping carton, so tape can't shift in transit.

With all this going for it, you would think our new Plio-Magic Tape-Tac video tape reel would be expensive. Think again. It's the *most* economical on the market. Call or write for details.



**PLASTIC REEL
CORPORATION OF AMERICA**

Manufacturers of
PLIO-MAGIC®

Film Reels, Cans, Shipping Cases,
Reel Paks, Tape Reels, Processing
Rollers, Cores and Bushings.

640 SOUTH COMMERCIAL AVE.,

CARLSTADT, N.J. 07072, (201) 933-9125

Direct N.Y.C. Phone No. (212) 524-5055

West Coast: 905 NORTH COLE AVE.,

HOLLYWOOD, CALIF. 90038, (213) 467-3107

THE LATEST EDITION OF OUR TV GUIDE IS GRIPPING

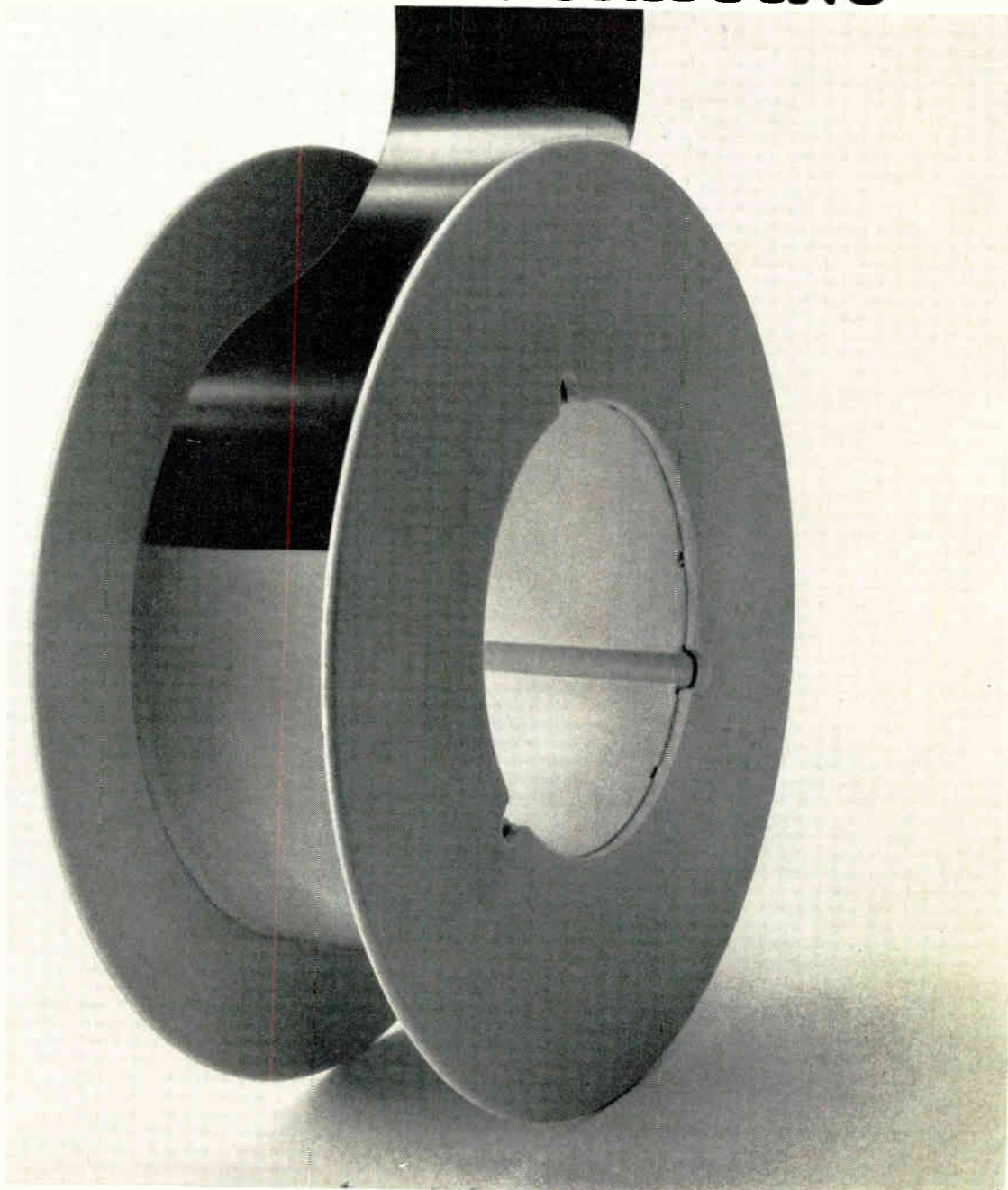

Circle 104 on Reader Service Card

the Department of Defense between San Francisco, Calif., and Honolulu, Hawaii. Comsat's tariff covers broadband channels for authorized common carriers between Andover, Maine, and a satellite to be used in conjunction with the channel to Spain and between earth stations on the West Coast and Paumalu, Hawaii.

The Commission cited opposition filed by Hawaiian Telephone Co. to earlier applications by RCA and Comsat to test and line up a 48-kHz channel before service started. Hawaiian Telephone characterized Comsat's broadband offer as a disguised rate reduction for voice channels. It said it had been advised by Defense that it is discontinuing leases on 12 voice circuits between the mainland and Hawaii.

FCC amends ITFS rules

Amendment of Section 74.951 (a) (1) of the rules governing the Instructional Television Fixed Service to permit substitution without application and approval of one similar, type-accepted transmitter for another, has been ordered by the FCC.

The present rule permits only identical, rather than similar, type-accepted transmitters to be exchanged without application. The amended rule is similar to the rules for the a-m, fm services and TV translator service in requiring notification of the exchange of transmitters to the Commission and the engineer-in-charge of the district where the station is located.

The Commission said that it felt the change in the rule was warranted in the ITFS where transmitters are of low power and no substantial problems will ordinarily be presented.

1968 sales exceed \$5 billion rise in 1969

The Electronic Industries Association Consumer Products Division has announced that total U.S. sales, including domestic factory sales and imports, will exceed \$5 billion in 1968, up 10 percent from 1967, and sales by domestic manufacturers will reach \$4.5 billion.

According to the EIA marketing Services Department:

- TV sales will account for almost 50 percent of the \$5 billion.
- Total U.S. color television market to dealers will approach 6 million units.
- Radios will be up 5 percent

over 40 million units per year.

- Fm radio sales will rise.

Within the next five years, color TV, video tape equipment, cassette and cartridges and integrated home communication centers will be the major growth product areas.

Minnesota offers first radio service for blind

First full-time radio broadcast service for the blind and partially seeing people offered anywhere in the U.S. has been established in Minnesota.

A joint project of St. John's University Broadcasting, Inc., Minnesota State Services for the Blind and the Hamm Foundation of St. Paul, the service consists of 17 hours of daily broadcasts with short periods of broadcasting and expanding rapidly to the full schedule over facilities of St. John's radio stations KSJR-FM and KSJN-FM. The former of these stations reaches 150 outstate cities and towns in Minn.; the latter covers metropolitan Twin Cities area.

The new service uses a system of multiplex transmission which permits broadcasts of several programs simultaneously. Total cost of the project is set at \$90,000. Content of the programs is the responsibility of the State Services for the Blind.

Jerrold covers U.S., Puerto Rico, Canada

The Educational and Communication Systems Division of Jerrold Electronics Corp., recently completed organization of a continent-wide network of franchised electronics firms representing Jerrold in the educational market.

With the naming of 35 Jerrold engineering contractors to special-

ize in Instructional Television Fixed Service, the Jerrold ITFS organization covers every station of the U.S., Puerto Rico and Canada.

According to the Bureau of Higher Education of the Department of Health, Education and Welfare, the government has allocated some \$1.5 million annually for the past three years for communications equipment.

A.T.&T. tariff provides ETV interconnections

The American Telephone and Telegraph Company's revisions to its private line tariff to provide for interconnection of educational television stations at reduced rates became effective December 1.

Revisions furnish, during prime time, occasional television service on a six-month trial basis to the Corporation for Public Broadcasting for use by noncommercial educational broadcast stations.

A.T.&T. says that special use will be made of otherwise temporarily idle channels to interconnect 57 stations or locations. Under the new tariff, a basic charge of \$43.50 for each station connected for each occasion of use will apply to the intercity channels and station connections provided by the telephone company, with the possibility of additional consecutive hours at \$10.00 per hour per connected station.

FCC specifies retention period

The Commission has decided that records identifying officers of groups that sponsor material for programs other than commercially sponsored programs be retained two years. A rule covering records on use of low-power broadcast auxiliary stations was similarly amended.

Affected are Sections 73.119 (f), 73.289(f), 73.654(g), 73-789(f) and 74.437(j). They cover respectively a-m, fm, TV, international and low-power broadcast auxiliary stations.

NAB asks FCC to set 3-year limit on files

The National Association of Broadcasters has asked the FCC to set a three-year retention period for public file records which broadcasters are required to maintain.

NAB said it surveyed a substantial number of radio and tele-

WOR Pilot Killed

Frank McDermott, relief helicopter pilot for New York's WOR-AM, crashed to his death Friday, January 10. This is the first fatality for the station's high-flying traffic commentators, long noted for their excellent safety record.

WOR's regular helicopter pilot, Fred Feldman, would alternate with McDermott, who would fill in for him on weekends and alternate Fridays. McDermott, who was 37, is survived by his wife, Mary, and two children.

Q. what video distribution amplifier has all these features...

- Lowest cost per output
- Six identical source terminated outputs
- Cable equalizing for LF and HF compensation
- Hum bucking input for 46 db ground loop rejection
- Available with sync adding facility
- Built in power supply
- BNC source-terminated test output on front panel
- Plug-in module; silicon semi-conductors throughout
- Excellent performance characteristics



A. only Ward video distribution amplifier

Type TA-901

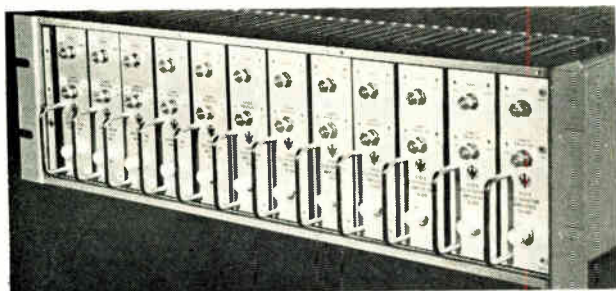

Your best buy—feature for feature, dollar for dollar . . . 72 outputs in 5-1/4" rack space—at less than \$45 per output.

The Ward TA-901 Video Distribution Amplifier is a high performance, multi-purpose amplifier for distributing color or monochrome video signals in TV systems. Each TA-901 plug-in module, with built-in power supply, provides six source-terminated outputs. Twelve TA-901 amplifiers can be accommodated in a standard F-800 5-1/4" rack frame. Write or call for complete details.



WARD ELECTRONIC INDUSTRIES

142 CENTRAL AVE., CLARK, NEW JERSEY 07066 • (201) 382-3700

Circle 105 on Reader Service Card

vision stations and found that the extent to which the public made use of these files during 1967 was "only token." Of 1286 stations surveyed, NAB said only 50 had received '67 inspection requests.

Examiner awards commercial applicant

In an initial decision, FCC Hearing Examiner Basil P. Cooper proposed SRC Inc. for grant of a new TV permit for Channel 6 and denied a competing application by the San Angelo Independent School District No. 226903.

Cooper said that SRC Inc. is to be preferred for several reasons:

- SRC Inc. programming is diversified and is designed to serve the needs of residents.
- Programs proposed by the School District are based on opinions and observations of teachers and educators, rather than a survey of the community at large.
- SRC station will be on the air not less than 103½ hours per week, whereas the School District station would be on the air 57½ hours per week and remain silent on Saturdays and Sundays.
- SRC station would bring the first and second television service

to larger areas than would the School District's proposed station.

- SRC station will give a third national television network a regular San Angelo outlet.

Although there is an unoccupied San Angelo allocation, Channel 21, for noncommercial educational use only, the School District said that not enough sets capable of receiving a uhf signal were in the hands of those it sought to reach.

SRC Inc. proposes to operate with effective radiated power of 100 kW, antenna height above average terrain of 585 ft. It will seek an ABC affiliation.

FCC receives 1596 complaints in November

The FCC received 1596 complaints from the public during Nov.—a decrease of 694 from October. Comments and inquiries totaled 2471, a decrease of 176 from October.

A number of complaints were received concerning NBC's failure to show the end of a professional football game. Others alleged the broadcast of offensive and suggestive remarks on certain network comedy programs. A number of writers objected to the

broadcast on election night of predictions based on projections made after the polls had closed in the East while they were still open in the West.

The Commission's staff sent a total of 2026 letters in response to complaints, comments and inquiries.

Membership reaches all-time high in NAB

Membership in the National Association reached an all-time high on Dec. 1 with 4188 members—an increase of 152 over last year.

Included in NAB are 3391 radio stations, 537 television stations, 253 associate members, all four national radio and all three national television networks.

FCC refuses Hawaiian licensees

Requests by licensees of three commercial vhf TV satellite stations in Hilo, Hawaii, for rules waivers to allow conversion of their stations to vhf translators have been denied by the Commission.

Licensees included Western Telestations, Inc., Pacific and Southern Broadcasting Co., Inc.,



and Pacific Broadcasting Co.

The FCC said that it did not believe public interest would be served by replacing a TV station capable of originating local programming with a translator station incapable of origination; and that converting a television station into a translator service was not consistent with the FCC's policy of encouraging development of high-power translators into regular TV broadcast stations.

Puerto Rico to receive live color television

Live color television originating anywhere in the world will be seen soon in Puerto Rico due to an agreement between Telemet, a division of Geotel, Inc., and ITT World Communications, Western Union International and RCA Communications.

Telemet, manufacturers of TV broadcast processing equipment, TV test equipment, switching and telephone transmission equipment, will install equipment that will receive TV color transmission via satellites in Cayez, Puerto Rico, fully process the signals and transmit them to the International Transmission Center at San Juan.

The transmission center will be alternately operated by three carriers and will make the live color TV available for local TV broadcast stations in Puerto Rico.

Competing applications filed for Channel 6

Two mutually exclusive applications for television Channel 6 in Pocatello, Idaho, have been designated for hearing by the Commission.

Involved are KBLI, Inc., licensee of TV station KTLE for renewal of license, and Eastern Idaho Television Corp. for a construction permit for a new television station.

KBLI proposes to operate with erp of 70.8 kW visual and antenna height above average terrain of 990 ft, and Eastern Idaho with erp of 100 kW visual and antenna height above average terrain of 1307 ft.

Hearing set on requests for Channel 68, Newark

Mutually exclusive applications of two New Jersey companies, Atlantic Video Corp., and Vikcom Broadcasting Corp., to operate a television station on Channel 68, Newark, have been set for hearing

by the FCC.

Atlantic Video, which proposes erp of 1000 kW visual and antenna height of 491 ft, asked modification of construction permit to specify operation on Channel 68. Atlantic Video is permittee of television station WRTV, Channel 58, Asbury Park, N.J.

Vikcom Broadcasting, which hasn't any broadcast interests, proposes erp of 1000 kW visual and antenna height of 616 ft.

FCC approves new Prescott vhf translator

The Commission has granted a construction permit to Prescott TV Booster Club, Inc., for a new one watt vhf TV broadcast translator station to rebroadcast programs of educational television station KAET, Channel 8, Phoenix, Arizona.

In the same action, the FCC denied a petition by H&B Communications Corp., operator of a CATV system in Prescott, opposing the Prescott request.

Prescott TV Booster Club, a nonprofit community organization, operates four vhf translators in Prescott, and the Commission said its present request for a fifth trans-

Continued on page 66

FM main channel and Stereo/SCA off-the-air monitors and re-broadcast receivers are now combined into one neat little package

we call the
TBM-
1000A.

New products always upgrade a station's operation, make the work more efficient and faster. Here are some of the features that make the TBM-1000A a device that all up-to-date stations will want to have:

- All-transistorized receiver.
- Uses same circuitry as the TR-66A multiplex receiver with FET's in the front end and integrated circuits.
- Has composite signal output. Provides left and right audio when used with the TBM-0380 stereo demodulator.
- Will provide SCA audio if two optional plug-

in circuit boards are added. No wiring needed.

- Has true peak-reading meter.
- Monitor speaker can be switched to either main channel or SCA.
- Simultaneous recovery of main and SCA channels in audio form — 600 ohms.
- Crystal controlled to one frequency within the 88-108 mc band.
- Rack-mounted; only 3½" high.
- Optional wooden cabinet for use in executive offices as an off-the-air receiver.

McMartin®

McMartin Industries, Inc. 3104 Farnam Street Omaha, Nebraska 68131
Circle 106 on Reader Service Card

TAPE-ATHON STATION EQUIPMENT

*increases
operating
profits*

- *By minimizing initial investment*
- *By dependable, around-the-clock operation*
- *By reducing personnel attention time*



Model 900 Station Logger—A high-capacity solid state logger equipped with automatic reel reversing and self-seeking system for correct track playback. Up to 8 tracks and 8 channels per track available. Speeds of 17/8, 15/16 and 15/32 ips provide up to 400 hours of broadcast logging per 10½" reel. Price: from \$1390.00. Details in Bulletin TA-255.

Model 5000 Automatic Broadcasting System—Expansion feature permits economic initial installation and addition of more capacity at later date. Systems include Carousels for commercials, ID's, etc. (up to 9), tape playback units (up to 14), recorder/reproducers, loggers, master timer, and exclusive program board for establishing Carousel interject time. Other options include ratio switching, time announcer, cartridge recorder, cartridge playback. Price: from \$6000.00 Details in Bulletin TA-371.

Model 900 Professional Recorder/Reproducer—All solid state electronics, with dual-capstans for split-second timing, "automatic" tape threading, and the field-proven Tape-Athon drive system. Available in 2, 4, or 8 track versions, with 7 or 10½ inch reels, speeds to 15 ips, and options for automatic reversing, remote control, and editing mode. Price: from \$1200.00. Details in bulletin TA-250.

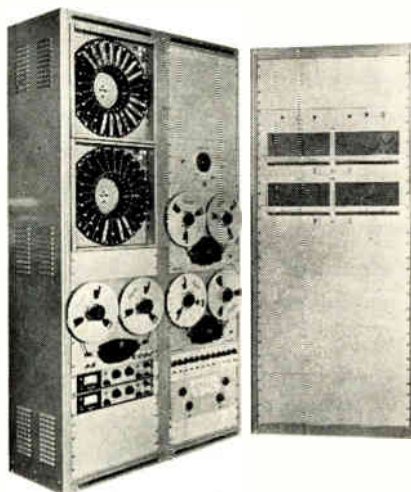

WE INVITE COMPETITIVE COMPARISON OF BOTH QUALITY AND COST.

Tape-Athon®

Tape-Athon Corp. 502 S. Isis
Inglewood, Calif. 90307 • (213) 776-6933

See Tape-Athon at the NAB Convention, Shoreham Hotel, Booth 514

Circle 107 on Reader Service Card

FOCUS ON CATV

Schizophrenia: cable TV's FCC-induced malady

For cable TV, the Commission's end-of-year release of its compendium of proposed rules made nearly as much stir in communications circles as NASA's flight around the moon, though not as much glee. A flight is shaping up in Congress under the leadership of Lionel Van Deerlin (D-Calif). The congressman says that he does not "pretend to know all—or any—of the answers to the CATV dilemma." He even admits that it is possible the FCC may have "prescribed exactly what is needed to permit CATV and broadcasters to . . . coexist." Nevertheless he predicts "A penetrating look by the Congress at the rulemaking and inquiry proposal by the FCC could well be just a necessary preliminary to a thorough revision of the Communications Act to cover the now potent medium of cable television."

In the meantime, cable manufacturers and NAB are exuding gloom while CBS is busy buying cable systems to the tune of \$17 million, mainly in Vancouver, B.C.

Manufacturer reaction was mixed, ranging from Jerrold's lay-off of 30 percent of its work force to Ameco's wait-and-see attitude.

Despite the fact that NAB's official stand with respect to the FCC's proposed CATV rules, opinions expressed by NAB staffers indicate that they believe the rules are good neither for broadcasters nor CATV.

McClellan et al persist in copyright efforts

Early January meetings in Washington among lawyers and legislators participating hopefully in what result in the formulation of a copyright law acceptable to the manifold interests involved thus far have been about as fruitful as the Paris peace talks.

NAB is haggling for a 40- to 45-mile circle of nonduplication protection, rather than the 35-mile version proposed by the FCC. NAB also wants individual broadcast and CATV agreements on copyright, but broadcasters appear to be reluctant to grant retransmission rights they're not sure belong to them in the first place.

Continued on page 66

Even during a power failure, the routing path of the RLS-100 stays memorized by use of magnetic latches.

Compact (1 3/4" high) and extremely low cost, the Telemet RLS-100 Routing Switcher can be expanded ... and expanded ... and expanded again ... simply by adding modules. This

versatility makes the RLS-100 ideal for both the smallest stations and the largest networks.

Thoroughly tested PC board type plug-in relays insure highest reliability; and audio and video can be switched on the same relay. The plug-in feature also allows easy access for simplified maintenance.

Telemet's Routing Switcher never forgets. And don't **you**. Call or write us today for complete specifications.

T E L E M E T

a division of **GEOTEL, INC.**

185 Dixon Avenue, Amityville, New York 11701
Telephone (516) 541-3600

Telemet's routing switcher never forgets.

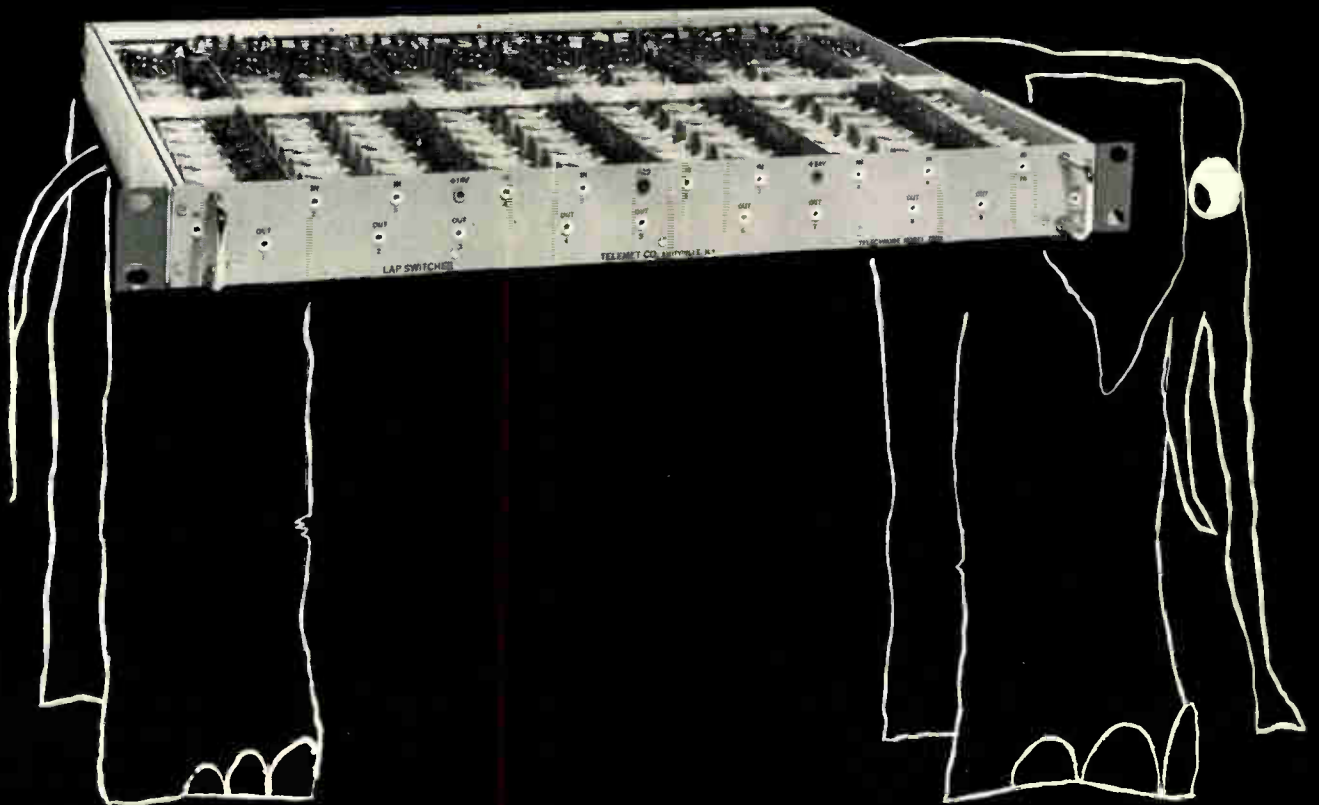

Circle 108 on Reader Service Card

INTERPRETING THE **FCC** RULES & REGULATIONS

FCC acts on pay-TV

CONTRARY TO THE SPECIFIC REQUESTS of numerous leaders of the U.S. Congress to delay action on pay-TV, on December 13, 1968, the Commission released the attached Third Further Notice of Proposed Rule Making (FCC 68-1175) and a Fourth Report and Order (FCC 68-1174) in Docket No. 11279. Therein, the Commission authorized over-the-air subscription (pay) television (STV) as a supplemental broadcast service. Thus, pay-TV service will be permissible after a six-month waiting period (on June 12, 1969). This Notice and Order culminate a proceeding commenced in 1955. The Third Notice and Fourth Report are related to the Commission's far-reaching CATV actions of the same date.

Before the effective date (of June 12th) the Commission will issue technical standards for STV systems. No applications for station authorizations will be accepted prior to June 12th.

Over-the-air STV will be permitted only on one station in "a community" and only in communities that currently receive service from four conventional TV stations.

Third notice of Rulemaking

The Third Notice, in sum, states or clearly implies: (1) Pay-TV is a *broadcast* (not CATV) service. (2) Grade B or better signals from STV stations, when operative, must be carried (pursuant to 74.1103 carriage requirements) by CATV. (3) Those within the Grade A contour of a STV station will be permitted to subscribe to STV service; those within the Grade B contour may be permitted to subscribe. (4) CATV's will not be permitted to extend restriction of STV program content, the Commission will preclude duplication of free TV fare by STV stations.

Comments on the Third Notice are due on January 24, 1969, and replies on February 14, 1969. The necessity of comments in this proceeding is negligible and, suffice it to say, if (1) you operate a CATV system and you would like to be able to extend the Grade B of an STV to reach your CATV system, (2) you would like to apply for such an STV station in June 1969, or (3) if you wish to oppose the advent of pay television, you should consider filing comments.

Fourth report and order

The Fourth Report, *supra*, considered some very basic questions:

This section, providing broad interpretation of FCC rules and policies, does not substitute for competent legal counsel. Legal advice on any given problem is predicated on the particular facts of each case. Therefore, when specific problems arise, you would be well advised to consult your own legal counsel.

(a) Whether STV would provide a beneficial supplement to the program choices now available.

(b) Whether STV would provide an increase in financial resources which would facilitate significant increases in the numbers of services available to the public under the present system.

(c) The degree of acceptance and support which STV might be able to obtain from members of the public in a position to make a free choice.

(d) Whether STV would seriously impair the capacity of the present system to continue to provide advertiser-financed programming of the present or foreseeable quantity and quality, free of direct charge to the public. This is closely related to the question of whether STV would result in significant audience diversion from conventional television and siphoning of programs and talent away from free television into STV service.

Of course, subparagraph (d) embodies the very heart of the problems decided, and in order to obtain justification for its actions, the Commission referred to the tests authorized in Hartford.

In sum, the Commission decided (1) STV is broadcasting (not cablecasting). (2) To give Pay-TV to CATV would be to discriminate against those who do not subscribe to CATV service. (3) STV should be authorized on a permanent basis. (4) STV will not seriously impair the capacity of the present free-TV system to continue to provide advertiser-financed programming nor will it significantly divert, siphon off, or fractionalize existing TV audience (away from free-TV stations). (5) Feature films (run on the basis of no reserved seats in U.S. theaters more than two years before a proposed STV showing) may not be carried on STV. (6) Sports events, regularly carried by free-TV, may not be shown on STV. (8) STV's must carry at least 28 hours per week (after three years of operation) of nonsubscription programming (e.g. local news, local talent, panel shows, etc.) and a lesser amount of non-subscription fare of STVs during their first three years of operation. (9) STV is permitted over both uhf and vhf stations. (10) STVs, like free-TVs, may not relinquish control of program choice or fees. (11) A fourth network of STVs was not foreclosed by the Commission, and, probably will be required to be uniform. (13) STV service must be made available to all those residing within the STV's Grade A; service to those in the Grade B may be required. (14) STVs will be limited to operation in within the Grade A contours of at least five commercial stations (including the STV station) to assure adequate amounts of free TV programming to the public. (15) Only one STV will be permitted per community. (16) The FCC

run the MARATHON and win



The patented differential hub on this MARATHON continuous tape cartridge provides constant tension at any speed — without special winding. If you're already using high-speed equipment, you can fast-forward wind MARATHON cartridges with no fear of spew-out.

This, plus a precision guide path which assures the best possible handling of your tape, guarantees maximum broadcast quality every time you use the tape, not merely "most of the time." And you'll get considerably greater tape life.

MARATHON cartridges meet all NAB specifications and exceed them where it counts. NAB specifications call for a maximum drive force of 6 ounces. MARATHON cartridges never exceed ½ ounce!

Major cartridge users are running the MARATHON. They're under constant tension, and they love it. In every detail of design and performance, MARATHON cartridges demonstrate quality which assures MARATHON performance. Can we send you complete engineering specifications and prices today?

MARATHON

BROADCAST EQUIPMENT SALES CORPORATION
57 NORTH PUTNAM ST. • DANVERS, MASS. 01923 • (617) 774-6066
Circle 110 on Reader Service Card

will permit different technical systems (e.g., types of scrambling pictures, etc.) for the time being but warns of possible standardization later. (17) The FCC states: "... nationwide STV—using multiple systems—should begin with a minimum of delay" (Fourth Order, para. 220).

The information set forth disclosed that an average of about 1500 hours of STV programming (consisting of about 300 separate programs) was presented each year. The programs were not available on free television either in Hartford or elsewhere in the United States. The breakdown of the programs is as follows:

Category	Approx. number of programs	Approx. number of showings	Av. number of showings per program	Percentage of total showings
Feature films	216	768	3.55	86.5
Sports	40	40	1.0	4.5
Special entertainment	18	49	2.7	5.5
Educational	26	32	1.2	3.5
Totals	300	889	2.96	100.0

Of the 216 feature films shown during each year, one was a first-run U.S. film, 58 (27 percent) were first-subsequent-run U.S. films (i.e., films shown several weeks after their first showing in theaters, which corresponds to the time when pictures are released to neighborhood theaters), about 149 (69 percent) were U.S. films of over 6 months in theater release, and 9 (4 percent) were foreign language films with English titles or dialogue dubbed in. The sport programs were live broadcast events not carried on conventional television—such as championship boxing, high school, college, and professional basketball, college football, and professional hockey. The special entertainment included plays, opera and ballet, concerts and recitals, variety, and nightclub programs. Educational features included, among other programs, three for doctors only.

Conventional TV Programming. Opponents of STV devoted many pages of their comments attempting to show that the STV programming of the Hartford station did not provide a beneficial supplement since it was of the same general type as that shown on conventional television, i.e., motion pictures, sporting events, special entertainment, and educational presentations. Illustrative of the mass of data submitted to document their case is the following material:

(a) **Feature Films.** Of the 73½ hours of network programming between the hours of 7:30 and 11:00 p.m. each week over the three networks combined, 10 hours are feature films (CBS-2 films, NBC-2, ABC-1). Such films are available five nights per week. (The figures are now 14 hours of films available seven nights per week, because since the record was made herein, ABC has begun to show 2 films per week in this time period, and NBC now shows 3.)

(b) Of the 432 films shown during the first two years of the trial at Hartford, only 116 (27 percent) were first subsequent run, and the remaining 297 were over six months old—the average release date of those films having been 1960. Of the films shown during that period in the Hartford trial, over 60 percent have already been made available to free TV (some as soon as five months after their showing on STV)—the aver-

Need tubes...technical facts...fast delivery?

Join the Big Phone in!

Call your RCA Industrial Tube Distributor.
He sells the leading brand — RCA. And RCA
is the company that makes more kinds
of tubes than anyone.

- Receiving
- Power
- Vidicons
- Image Orthicons
- Microwave
- Photomultipliers
- Cathode-Ray/Storage

RCA Electronic Components,
Harrison, N. J. 07029



RCA

age being less than two years after STV showing. Of the remaining ones, many have already been purchased or are under option.

(c) **Sports.** Opponents of STV stated that there is virtually no major sports attraction that is not presently being broadcast on free TV. They listed in overwhelming detail the kinds of sports and sports programs that free TV carries.

(d) **Special entertainment and educational programs.** As with sports, opponents described at length the great variety and quality of special entertainment programming carried by free TV to who that it is of the same type that STV offered at Hartford.

STV opponents, in connection with the foregoing data submitted by them, made the argument that the Hartford trial did not provide a beneficial supplement because the programming of the same general type appears on free TV. With regard to feature films, the only possible advantage of STV is that of reducing the time lag between theater release and TV viewings. The promise of STV was that it would provide viewing for members of the public interested in the fine arts, opera, educational and informative programming, and similar programming (i.e., programming for minority tastes and not for mass appeal); however, Hartford has not fulfilled that promise. Its programming was largely of a mass appeal type, directed at those who watch free TV the most.

Other arguments offered were that (1) STV promised quality program and that most of the films shown at Hartford were run-of-the-mill films; (2) STV would deter the formation of a

fourth national TV network; and, (3) the game-of-the-week and black-out restrictions imposed by college and professional sports are a reasonable accommodation of conflicting economic and social interests; and to the extent that STV would derogate from these policies, it would undermine amateur and professional sports.

The proponents, while not conceding that there is no demand, maintained that nothing in the Act indicates that establishments of a new service must be preceded by absolute proof that it will be viable, and that authorizing a new service does not require evidence of a widespread public demand. Such proof, they say, was not made when the Commission allocated for uhf in 1952 or when it reserved channels for educational TV in 1952; and there was not great demand for fm or TV services when they were commenced. The Hartford trial, they state, provided useful information on which to make projections.

Conclusion

The Commission concluded that the results of a single trial cannot be projected into the future to indicate with complete accuracy the nature of a new service. With nationwide STV more (and in some respects better) program product might be available, and it is not unreasonable to expect that subscribers might spend more on programs because of this. In any event, the Commission wants to give it a try. If you have any interest in supporting, opposing, or participating in, this new entertainment medium, contact your counsel for the details. **BM/E**

YOUR STEREO SIGNAL ON A SINGLE STL*

ONLY *Moseley* OFFERS IT . . .

SCG-3T
STEREO
GEN.
NEW



PCL 303/C
COMPOSITE
STL

The sounds of pure stereo — and profits — are dependably yours when you use the solid-state STEREO MATES in place of leased program lines. No longer is the conventional two-link stereo STL always needed. Deliveries are now well underway on the PCL-303/C single-link stereo STL and the SCG-3T Stereo Generator. They're available mated or singly, even with remote control. Contact our Marketing Manager for full details, or see us in **Booth 328 at the N.A.B. Show, Sheraton Park Hotel.**

* Stereo Mates — SCG-3T (shown above) and PCL-303/C



MOSELEY ASSOCIATES, INC.
SANTA BARBARA RESEARCH PARK

111 CASTILIAN DRIVE
GOLETA, CALIFORNIA 93017
(805) 968-9621

Circle 111 on Reader Service Card

Circle 112 on Reader Service Card →

The General Electric guide to explaining your unfair advantages over competition





World Radio History

Part 1: antennas

Face it. Eventually, at a club or charity meeting, you'll run into a fellow broadcaster and he's going to want to know some things. Like why your market coverage is better. Why you get sharper picture detail. And better color. And a higher profit. All the unfair advantages a General Electric antenna can give you.

To keep your unfair advantage, it's important to know how to handle these questions. Three examples should get you on the right track.

QUESTION: Did you have to do a lot of figuring to get that coverage pattern?

ANSWER: "We made the standard calculations." Understatement is important. No need to tell him about the GE computers that figure the vertical and horizontal radiation patterns. Don't bother to mention the sharp GE engineers that work with you and the computer, either.

QUESTION: Did you do very much antenna testing?

ANSWER: "Just the standard test you'd expect." Being a little devious like this doesn't hurt. GE's *standard* tests go a couple of steps further than the rest of the industry's. The natural "free space" test site at Cazenovia, N.Y. is unmatched for checking patterns and giving predictable performance. And GE can pretest to an alternate pattern, then adjust helical and

zigzag antennas *after* installation—something your competition (and ours) has never heard of.

QUESTION: You were pretty lucky last winter, weren't you?

ANSWER: "Pretty much so." Modesty helps here. You don't have to tell him how GE antennas are designed to stand up in all kinds of weather. Just let him guess why GE antennas are on Mt. Wilson and the Empire State Building—transmitting to the country's two major markets where missing a minute of air time would be disastrous.

In fact, don't overtalk at all. You don't have to remind him that GE was the first to develop a high-gain TV transmitting antenna. First with helical and zigzag VHF and UHF installations. The industry leader in super-power.

If he doesn't know, don't tell him.

If by some chance you don't know, someone may be taking unfair advantage of you. Today, ask your General Electric Broadcast Sales Representative for a copy of the GE antenna story, "The High and Mighty." Or ask us. It could give you the unfair advantage you're looking for.

General Electric Company,
Visual Communication Products
Department, Electronics Park,
Syracuse, New York 13201.

GENERAL  ELECTRIC

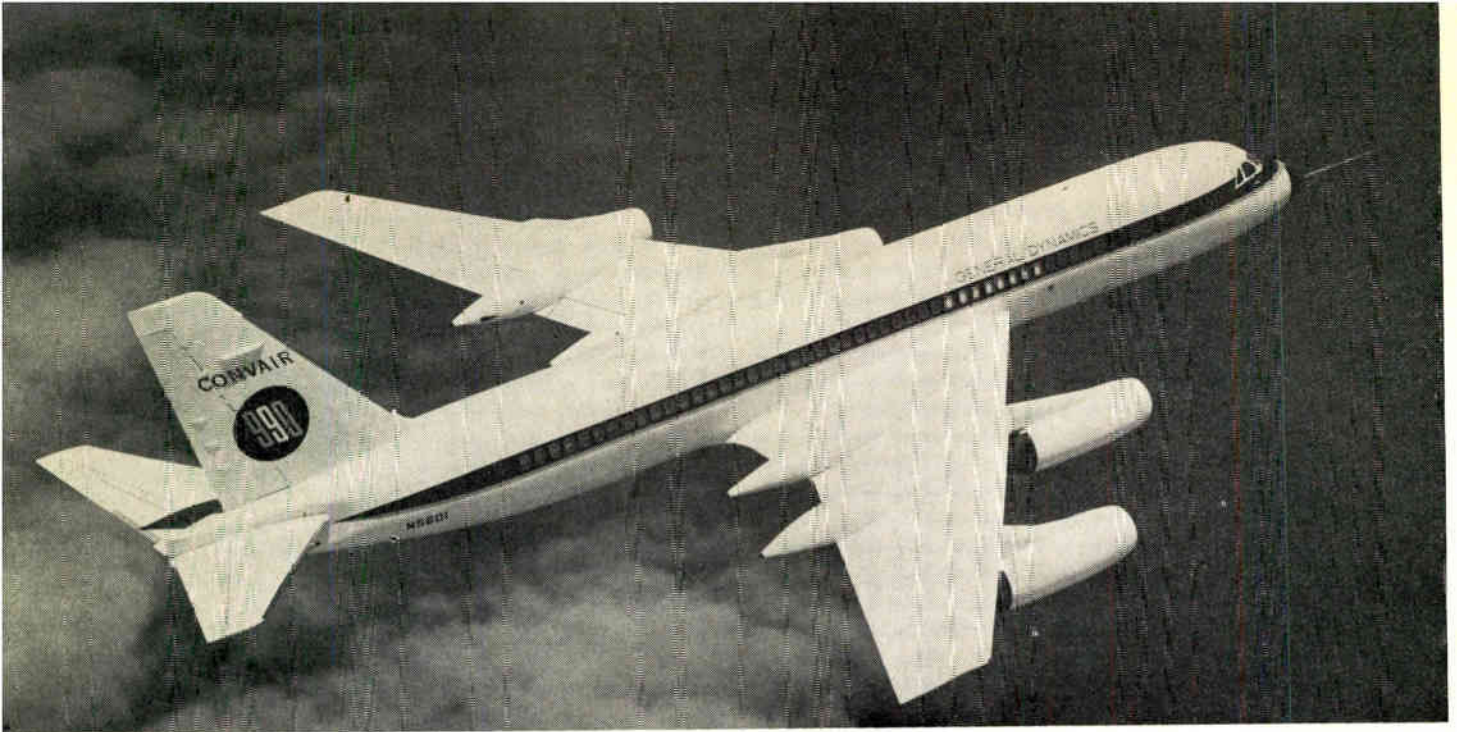

Airline passengers approaching major U.S. cities soon will receive local commercial-free news and weather reports aboard the plane ten minutes from touchdown. The system that provides this unusual service makes use of SCA channels at fm stations near airports. The black box marked "Newsrad" shown near center of photo below is an SCA receiver installed in an airline communications equipment rack.

SCA Spells

Once the province of a handful of background music services, SCA subchannels are at last coming into their own as diversified, imaginative, and big-income producing adjuncts to the fm'er's main operation.

WITH THE EXCEPTION OF UHF television, nearly every segment of the operating communications services has felt the pinch of a lack of spectrum space. In particularly crowded spots on the frequency allocation chart there are as many as seven different services sharing the same channel.

Doing what it can to alleviate the situation, the FCC makes it a standard practice to offset carrier assignments and generally get the most mileage from each kilohertz of available spectrum space. Recently, the Commission whittled down the guard bands on land mobile frequencies—a particularly congested portion of the spectrum. Communications manufacturers too, are developing and/or refining equipment for more efficient spectrum use. Speech compression is increasingly emphasized. Modulation limiters ride the gain for a-m and fm transmitters. Television lower sidebands are attenuated and more squeezing has spurred development and use of such transmission modes as single sideband.

Despite all these efforts by the Commission and manufacturers, there are segments of the market with special requirements that until relatively recently, have been shortchanged because of a lack of spectrum space. This is where SCA can move in and do a job. SCA is attractive to fm'ers where it really counts—the pocketbook.

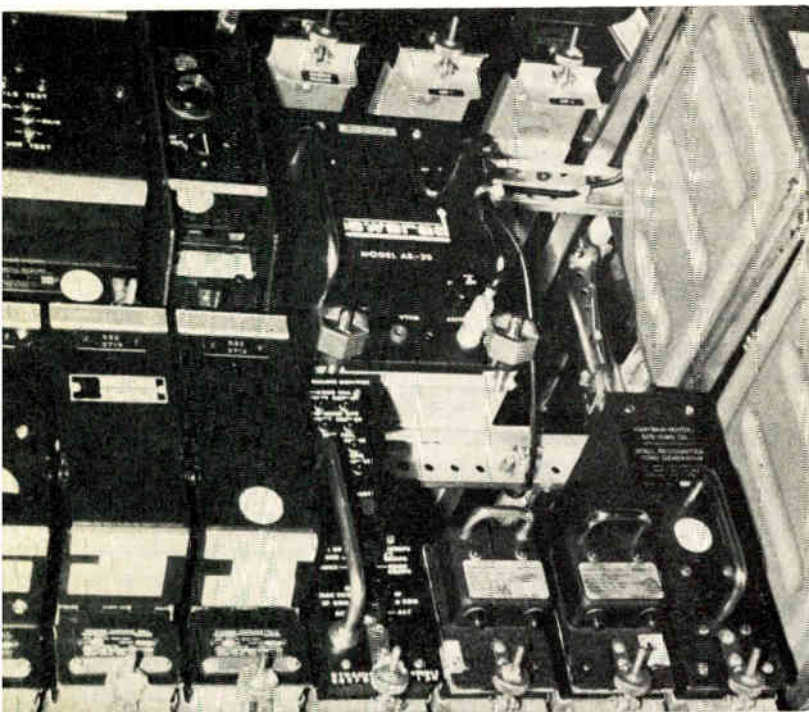

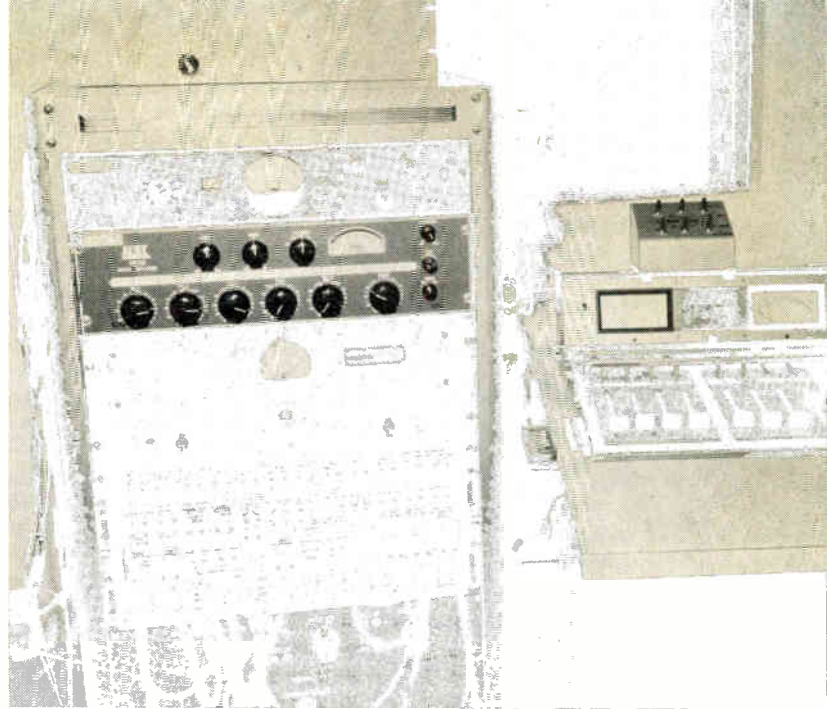

Two views of the University of Wisconsin's SCA control room. Bottom view shows a conference discussion being transmitted via SCA for the Educational Telephone Network. The telephone network permits listeners to ask questions which lecturers answer on the air. The arrangement maximizes the exchange of information and saves on travel time and expense for conference participants.

More \$\$ for Fm

In some instances SCA is supplying the marginal revenue to put fm stations in the black.

According to the latest FCC data, there are well over 600 fm stations who have discovered how easy it is to get a subcarrier authorization. Of these, 15 are using SCA for educational purposes (authorized in 1961) and six are authorized to use as many as four channels simultaneously.

Despite the fact that SCA has been around almost since the time that Major Armstrong invented fm in 1934, it has been a retarded child, its development slowed by legal and regulatory difficulties. Only in the past few years has SCA's potential begun to capture broadcasters' imaginations. Lying beyond SCA's traditional role of background music is bright future of specialized communications services. A list of new areas of application would include: medical radio, weather forecasting, news, facsimile and data transmission, aircraft newscasting, programmed learning, broadcasts for the blind and radio paging services.



SCA and Education

Use of SCA in the educational field is getting a big boost with Triangle Publishing's Educating system and the efforts of WHA-FM at the University of Wisconsin (see pages 26-27 for more details).

Poised on the launching pad, Educating is about to go into orbit with international agreements with four or five African governments, the U.S. Armed Forces and other contracts, principally with European governments who will underwrite Educating costs. Domestically, the system is presently operating in only two markets:

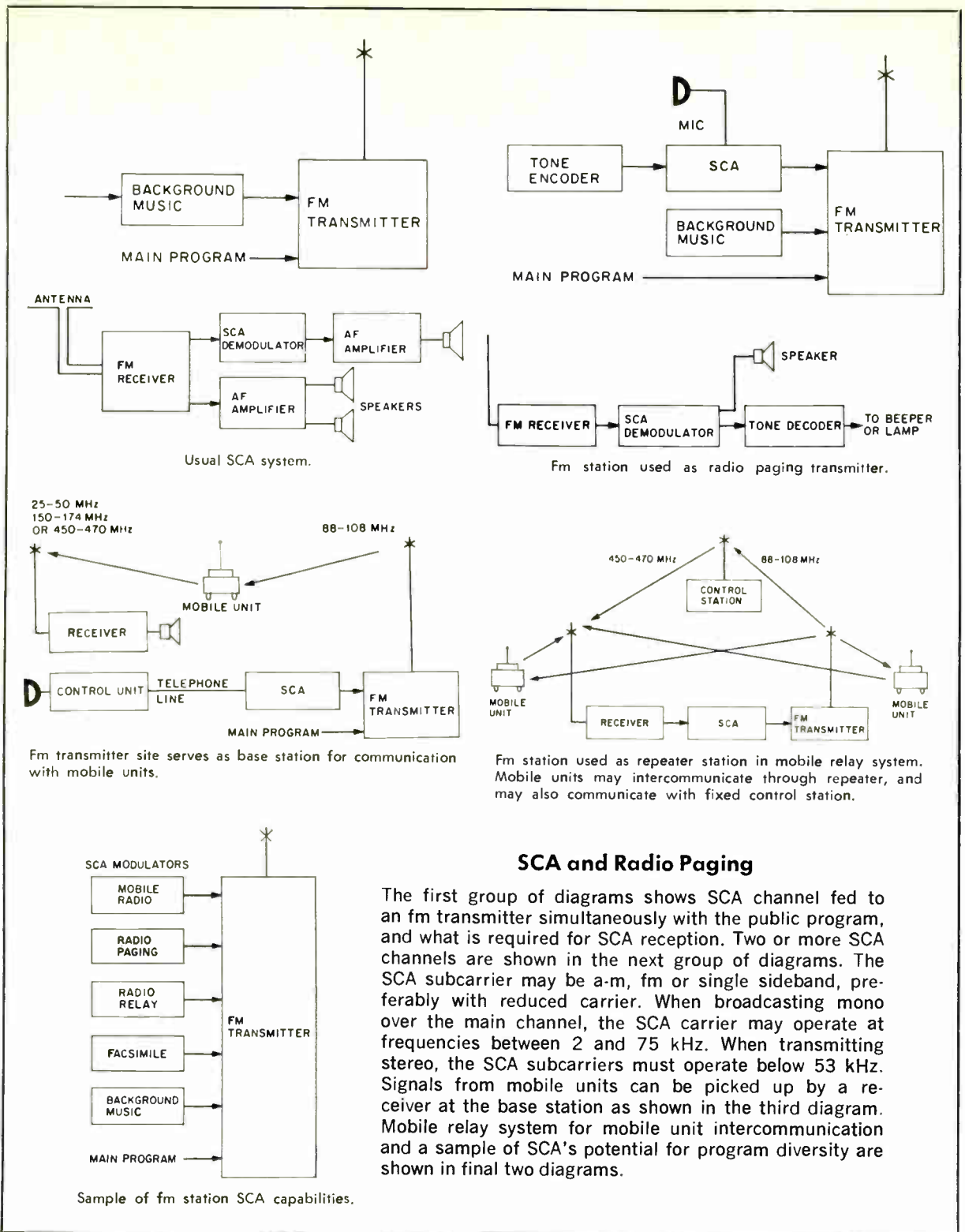

SCA and Radio Paging

The first group of diagrams shows SCA channel fed to an fm transmitter simultaneously with the public program, and what is required for SCA reception. Two or more SCA channels are shown in the next group of diagrams. The SCA subcarrier may be a-m, fm or single sideband, preferably with reduced carrier. When broadcasting mono over the main channel, the SCA carrier may operate at frequencies between 2 and 75 kHz. When transmitting stereo, the SCA subcarriers must operate below 53 kHz. Signals from mobile units can be picked up by a receiver at the base station as shown in the third diagram. Mobile relay system for mobile unit intercommunication and a sample of SCA's potential for program diversity are shown in final two diagrams.

WFIL-FM in Philadelphia and WNB-FM, Binghamton. The plan for 1969 is to sell franchise rights on a market-by-market basis. In the meantime, Educasting's catalog of courses is growing. Gary Player has already taped 30 lessons of golf instruction, and other celebrities are doing tapes in their respective fields. It's Triangle's plan to change to videotape after the Educasting market has been established.

WHA-FM and the Wisconsin fm network—

the first educational stations to carry SCA programming on a regularly scheduled basis—are providing unusual educational and community services. The SCA service is the result of a cooperative arrangement between the University of Wisconsin Extension and the State Coordinating Council for Higher Education. Two hours of third- and fourth-year Spanish and an hour of fourth-year French are broadcast each week to high schools where teacher shortages or class

enrollment don't permit the usual method of instruction.

WHA also uses SCA for conferences and special captive audiences of all kinds. Frequently the audience and those in the studio conference are members of specialized government agencies or professional groups. Listeners are able to telephone questions to be answered by the on-air conference participants. WHA, because of its financial position as a part of the University of Wisconsin, is able to provide SCA air time on request at no charge.

SCA Network for Airline Passengers

A new and exciting development is an SCA network for airline passengers. Newsrad, the company organizing this new operation, is based in New Rochelle, N.Y. Studios at Newsrad headquarters receive local, national and international news, sports, stock reports and weather in 3-minute-plus-ten-second capsules, revised hourly by UPI. Newsrad inserts cue tones at the beginning and end of each tape and transmits audio via telephone lines directly to the SCA generators at fm stations near airports in New York and Chicago. This year, the list of cities served by the SCA network will increase by fourteen, to include Washington, Boston, Philadelphia, Los Angeles, San Francisco, Miami and Dallas.

Aboard the airliner, passengers will hear no commercials. A stewardess will push a button about 10 minutes' flying time from the airport, keying an onboard receiver. The cue tones inserted by Newsrad (77 Hz at the beginning and 67 Hz at the end) will key the aircraft's public address system, preventing passengers from being tuned in on the middle of a newscast. The cue tone at the end of the loop of tape being played at the New Rochelle studio turns off the airplane's PA at the end of the newscast. An override allows the plane's crew to cut in for announcements of transcending importance. Although, thus far, only one airline has installed SCA receivers, others are expected to follow suit once the 16-city network is established.

SCA Paging

Leading proponent of SCA radio paging, Leo Sands, a New York-based communications consultant, has labored mightily, though as yet unsuccessfully, to make the FCC see things his way. The problem is that fm'ers are licensed by the broadcast bureau while radio paging is a common-carrier service. The FCC is not currently in favor of licensing one transmitter to perform two different services.

Sands sees SCA as a way out, at least temporarily, of the spectrum squeeze. Land mobilers, who see themselves as probably the most short-changed group of spectrum users, would benefit most if the Commission were to approve SCA paging. As Sands sees it, the paging system would be used by police to contact walkie-talkie-

equipped patrolmen on their beats. Talkback would be on land mobile frequencies. Emergency broadcast system alerts could be piped through the system, providing instant civil defense information to police in the field. Despite the fact that a petition was filed in 1951 for rulemaking, no action has been taken by the Commission to

Continued on page 48

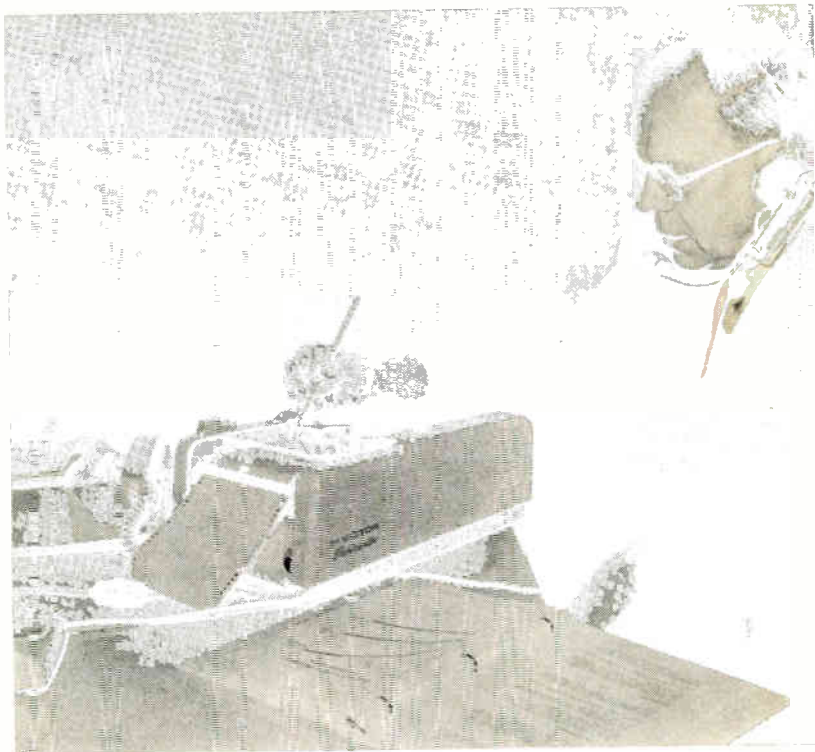

Hardware for transmission of visual material via SCA or telephone lines. The Victor Electrowriter Remote Blackboard (VERB) shown above transmits handwritten notations. Sylvania's ECS-100 blackboard-by-wire system (below) has the additional capability of storing visual material for up to one hour.

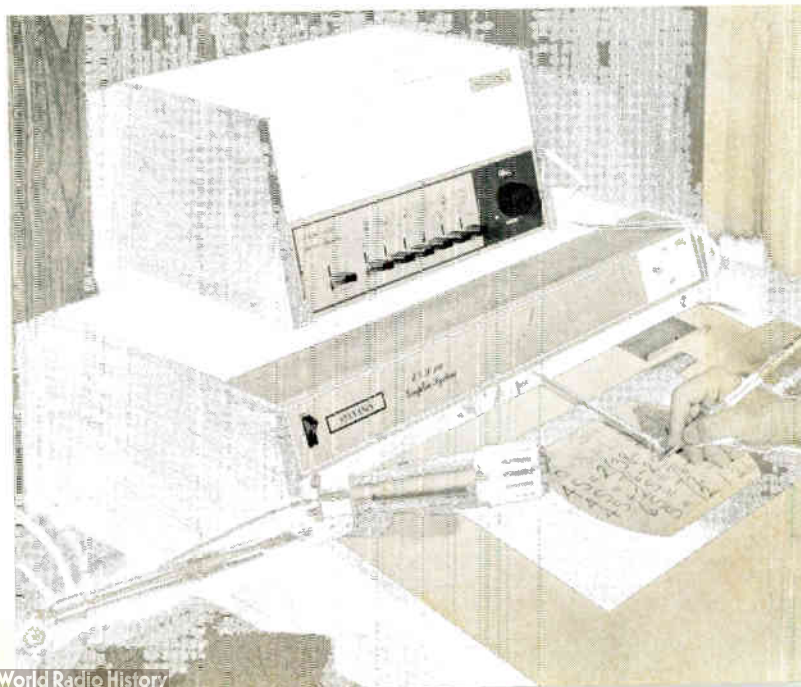

Educasting receiver has four pushbuttons for selecting answer. Student works with special "Edu-text" provided with the course.



Education at Home via SCA

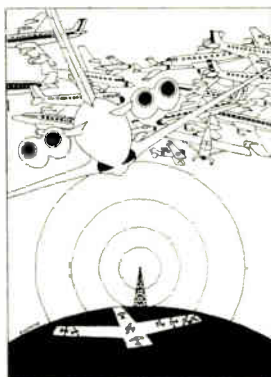

By Ira Kamen

Educasting is a bold concept for programmed instruction. It puts a classroom in everyone's home, and can put lots of revenue dollars into the participating fm broadcaster's coffers.

PROGRAMMED EDUCATIONAL INSTRUCTION via the widely available SCA subchannels is on the threshold of becoming a major element in at-home learning. Being offered by Triangle Educational

Ira Kamen is vice president of Educasting Systems, Inc., New York, N.Y.

Services, "Educasting" not only makes this highly sophisticated form of instruction available on a widespread basis—it is also a vast potential revenue source for the fm broadcaster.

The system uses four subcarriers, running independently of the main program carrier. A special receiver has four numbered pushbuttons so the student can "answer" questions posed by the radio instructor. The entire program is on 4-track tape, and although only one channel is used the greater part of the time, all four subchannels are in use during the "answer" period.

Subscribing fm stations pay Triangle an annual fee for special transmission equipment to be used with their regular fm transmitters. The main fm carrier is multiplexed with four subcarrier channels that can't be picked up by conventional home fm receivers.

Special Receiver

The small, specialized receivers are made by Sylvania. These are available to participating stations on an annual fee/per 100 units basis. These sets are then provided to students who pay for them with part of the course enrollment fee. The major share of the course fee paid by the student goes directly to the fm station.

The Educasting fm radio not only lets the

The Kamenland Called SCA

A burgeoning figure in the emergence of SCA's many possible uses, Ira Kamen is fast becoming the Sol Hurok of the world of fm subchannels. Kamen is vice president of Educasting Systems, Inc., and chairman of the board of newly formed Comfax Communications Corp.

During World War II, Kamen made major contributions to shipboard communications systems, and his work won him two U.S. Navy citations. His concepts and ideas are at work in tropo scatter systems, DEW and BMEWS early warning sys-

tems. He holds 23 patents and is the author of six texts—one of them the only authoritative work on scatter communications. At press time, he is president or director of Laser Link Corp., Charger Electronic Systems, Inc., DuoVision, Inc., First Illinois Cable TV, Louisiana Cable TV, Dwight Perfect Picture TV, Inc., and vice president of First National Planning Corp.

Kamen forms new corporate entities almost as often as he gets into his Rolls Royce. His ideas and influence will likely be guiding factors in the emerging world of SCA for some time to come.

student listen and answer questions, it provides for an instant response from the instructor every time a question is answered.

In operation, the student tunes in each lesson when it is scheduled. Each lesson is repeated; if it's missed the first time, the student still has another shot at it. Using time-tested and highly effective training fundamentals, a skilled professional instructor teaches his subject using the dramatic potential of fm radio. Each step is covered clearly and completely. At intervals, the instructor will ask a question about the material he has just presented. By using one of the response buttons on the Educating radio, the appropriate answer to each question is selected. The instructor's voice will then tell the student: whether or not the answer is correct, and why; what the correct answer is; the reasoning behind the correct answer.

In addition to learning by listening and by answering questions, the student works with a combination textbook, notebook and workbook. Called an "Edu-text," this book contains text, pictures and diagrams, where appropriate, and charts, tables and other printed materials—plus plenty of room to take notes. Some Educating courses consist of 30 one-hour lessons, three weekly for 10 weeks. Many people cannot afford the time or money for conventional classroom instruction, but Educating is potentially within the reach of all fm station listeners who want it.

Extensive Course Catalog

New courses are constantly being added by Triangle to the Educating catalog: general knowledge; career improvement; leisure time activities. All of these courses are presented at times convenient to the subscriber, and lessons are repeated for their benefit in case they miss one, or if they want to repeat.

The Educating transmitting and receiving equipment was product-designed and is being manufactured by the Commercial Electronics Division of Sylvania Electric Products, Inc. The equipment installed at the fm broadcasting station uses a four-track audio tape machine to feed the four subcarrier generators which drive the exciter of the fm transmitter. This permits transmission of four subcarrier audio messages without interfering with the main carrier and its scheduled entertainment program.

The subcarrier frequencies are approximately 25 kHz, 40 kHz, 55 kHz and 70 kHz from the main carrier. The deviation of each subchannel is nominally 3.5 kHz. With a maximum modulating frequency of also 3.5 kHz with 15kHz separation between subcarriers, a guard band of 8 kHz is provided.

FCC regulations limit the modulation baseband to ± 75 kHz for broadcast fm service. There are varying specifications outside the U.S.; other countries have different standards or no standards at all, and may assign other frequencies for these subcarriers.

FCC regulations also require that interference by a subcarrier to the main channel must be down

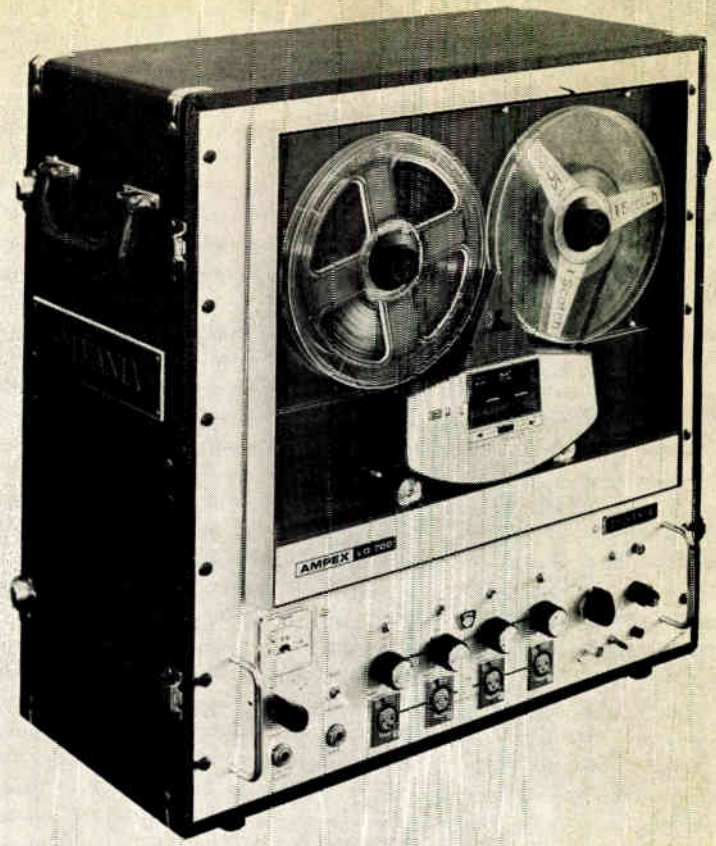

Modified Ampex recorder plays back four tracks simultaneously for the four concurrent programs going out on SCA channels.

at least 60 dB. In the Educating receiver, the objective for the main-to-subchannel crosstalk is down at least -40 dB.

The Receiver

The fm receiver is pretuned to the main carrier and can be used practically anywhere within listening range of the fm transmitter. It has a sensitivity of approximately $10 \mu\text{V}$ for 20 dB of quieting on the main channel. In most environments the subcarrier signal is usable when there is $30 \mu\text{V}$ of signal available at the receiver input.

The compact unit contains a complete transistorized fm receiver chassis plus a four-transistor subcarrier circuit board which "responds" as the student presses the multi-color buttons on the set. The chassis also contains four simple stagger-tuned three-stage filters which are alternately inserted in the circuit when the student makes his selection. In receivers designed for classroom use, the subcarrier filters operate simultaneously, enabling each of 40 or more students to listen to any one of the outputs he selects by pressing one of four buttons mounted on his chair.

The set may be designed to accommodate a paper tape or computer card punch built into the set. The unit can be time-sequenced to record the student's response to testing. The tape or card could then be fed to a computer to help determine the results of an overall study program. Ancillary units could pump out coins as rewards for correct answers; they could indicate the number of correct answers. Other accessories could advance film in a slide viewer, when triggered by tone signals.

BM/E

Fax to Get



Facsimile machine is easily loaded by secretary. New system could put a fax unit in any office.

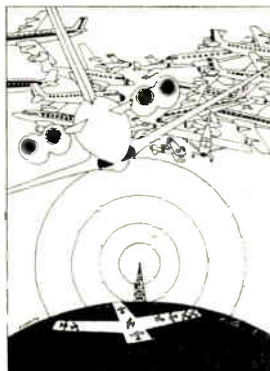

By John Porterfield

Instant daily newspapers on the home TV screen (in color), detailed medical histories from central files for hospital emergency cases, stolen credit card bulletins—all are possible aspects of a newly formed facsimile network that will criss-cross the country on SCA subchannels.

A NATIONWIDE FACSIMILE NETWORK via SCA is beginning to take shape. It may have far-reaching benefits to broadcasters and the public alike—increased revenue for the broadcaster; convenience, financial, medical and other benefits for the public.

John Porterfield is vice president of Comfax communications Corp., New York, N.Y., a company devoted to fax/SCA systems.

Last summer, a new facsimile transmission system called “variable velocity scanning” was demonstrated to the industry. This new mode of facsimile increases the transmission speed depending on message content. The system will have a three-fold meaning to fm broadcasters who will participate in the fax network now being planned.

Fm subcarriers will be able to carry pages of facsimile newspapers to satellite printing plants at the rate of one page per minute. This can mean income for broadcasters offering this service during periods when the station is not transmitting stereo.

Another possibility will be transmission of home newspapers using the “Sonic Vee” system’s narrow bandwidth techniques, operating within the frequencies assigned for subcarrier fax transmission—again, at times in the broadcast day when the subcarriers aren’t being used for anything else. The system will establish broadcasters as communications centers, supplementing their income while using existing overhead and facilities.

Fax Systems Already Running

February is startup month for a network of facsimile systems via SCA and the ink is barely dry on contracts covering a major radio network and member stations throughout the United States—the first to ink with Comfax. This new arrangement will open the door for broadcasters to get into the growing business of graphic communications service. Documents will be transmitted and received by graphic transceivers.

The first graphic transceivers to be used are the compatible Xerox and Magnavox units. Advanced devices using high-speed transmission will be available later from Chromalloy American Corporation, under the brand name of Comfax Communications Corp. Documents to be handled include both handwritten and typed correspondence, printed documents, graphs, maps, reports, charts, contracts, engineering drawings, bank signatures and checks, photographs and security validations such as fingerprints and other identification materials. Transmission time for an 8½ x 11” document sent over the Xerox or Magnavox equipment will be about six minutes. The Comfax equipment will be faster.

Plans call for Comfax communications centers in all major markets in the U.S., and on the premises of franchised radio and TV broadcasters who may or may not be part of a common network.

Advantages over the classic telegram are cited as the ability to transmit pictures, drawings and

the Facts there Fast

illustrations and messages in non-Roman alphabets such as Japanese and Hebrew. Error-free transmission of copy containing medical logic and price and shipping information, is seen as another important application.

The Cost Factor

Cost savings of facsimile over telegrams can be significant. Lengthy telegrams are transmitted error-free and at low cost. When Comfax's high-speed equipment becomes available and telephone charges are further reduced, the average facsimile transmission will cost less than a 50-word telegram.

The broadcaster is considered the best outlet for distributing this vital new communication medium. He has rapport with the community and can offer a profit-making public service.

New Uses for Fax

Medical information, stored in computerized libraries in major cities, will on demand, be fed across the country on the fax system's existing telephone lines. A hospital treating an emergency case for an out-of-town visitor can have his complete medical history available via facsimile in a matter of minutes. This will reduce emergency medical errors, and may well save lives.

Comfax will be used by any nationwide organization which occasionally finds itself needing the ability to put out its own kind of All Points Bulletin. The credit card industry may be an early subscriber. Criminals who steal charge plates generally buy virtually all they want with the cards for up to three days. After that, they feel the word has been put out and the card is hot. Using broadcasters as com centers could cut that down to less than two hours after a credit card theft is discovered. Affiliated fm radio stations will serve as cooperating relay points along the coast-to-coast network. They'll use messenger services and local store facsimile units when needed to make sure major outlets are properly notified of a credit card in wrong hands.

This same technique can apply to pharmaceutical houses which might want to remove medicines from drugstore shelves for safety or marketing reasons, automobile manufacturers who need to recall an entire line of models, and food packaging or distribution firms when a product must be kept out of the public reach. Currently, such tasks are preformed by an expensive and often image-damaging combination of hundreds of telegrams and use of the public news media.

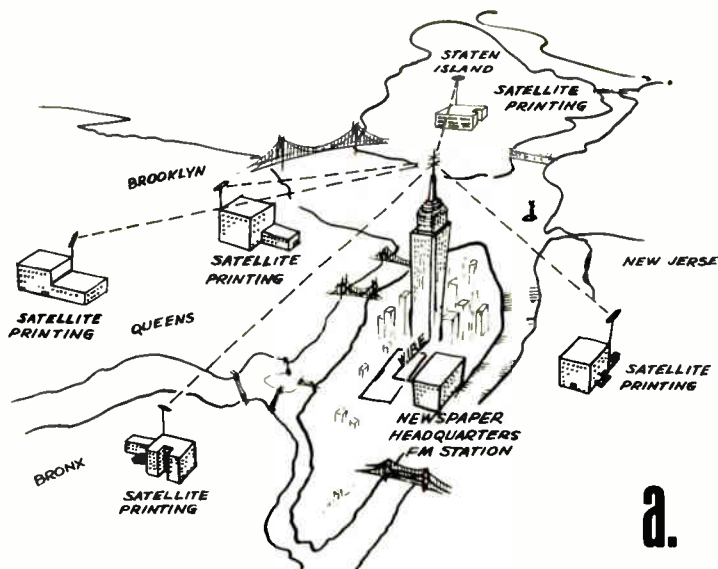

a.

Satellite printing plants (a) can be served simultaneously by a single fax SCA subchannel in a centrally located point, such as the Empire State Building. In home fax newspaper service (b), special receiver would pick out fax signals, putting them on tape for later recall on TV screen.

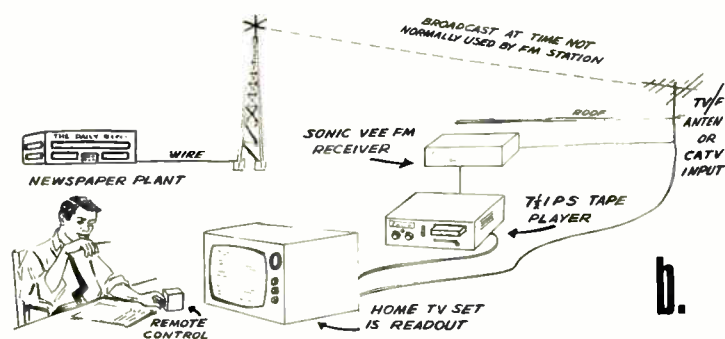

b.

Another application, scheduled for experimental use this year, will be the electronic newspaper in the home. The facsimile system will not provide hard copy. Instead, it will transmit the newspaper to a low-cost Sonic Vee magnetic tape unit in the subscriber's home. This will store the frames or pages as they come off an fm subcarrier. The subscriber could then, at his convenience, turn on the TV set and punch up, for example, *The New York Times* index button. Individual pages would appear on the TV screen as called for. This system would eliminate the delay in the hard copy readout. Small-screen TV sets might not work too well, but the TV sets of the mid-1970's will probably be wall-screen units, providing a newspaper in color.

BM/E



BM/E Photo

Veteran WQXR announcer Loy Moss is fm personality of type on the wane in the face of new formats and schedule changes.

Fm: Free Music,

By Harry Maynard

Fm radio is no longer the poor stepchild it once was. As it grows and garners an increasing share of the market, fm flexes its muscles and shows off a bit, but still hasn't found its true niche. It's time for fm'ers to beware and not rush off headlong into a carbon copy of successful a-m programming. There's lots of room for innovation and true public service while running firmly in the black.

THE MUCH-DEBATED FCC 50-percent programming ruling has at last borne a rich harvest. The final sales figures for 1968 are coming in, and they place fm home receiver dollar volume at a staggering 50 percent of all radio sales. In actual listening audience coverage, according to figures from the Electronic Industries Association, more than one-third of all sets sold in 1968 were fm or fm/a-m units. Current estimates of nationwide radio audiences show more than 25 percent listening to fm.

Some broadcasters have said that they'll face a horrible dilemma if the FCC ever asks them to divest themselves of either their a-m or fm station in a given market. The FCC is studying this possibility as part of its multiple-ownership rules, and group owners are nervously wondering "what if . . ." Not too long ago, this wouldn't have posed

Harry Maynard is publisher of *FM Guide* and has his own weekly stereo show, "Men of High Fidelity," on New York's WRFM.

such a serious problem; the poor stepchild called fm would have gone out the window with scarcely a twinge of regret.

The Stepchild Grows

The recently attained success of the fm'er had led some broadcast industry executives to predict that fm will eventually surpass a-m, both in audience and revenue. Survey and industry-wide studies point to the mid-1970's as the time of the golden crossover.

There are several reasons for this "instant success" of a medium that's been around since 1934. Probably the biggest single factor has been the advent of stereo broadcasting. Stereo, coupled with high fidelity frequency bandwidth has made fm the medium for the man in the street as well as the audio buff. It's no longer enough to have an ordinary radio/phone combination in the living room; the quality stereo system has become at once a status symbol and a necessary part of everyday life.

Fm broadcast stations are converting to stereo at a rate of about five per week across the country. At this rate, by the end of 1969, more than 1000 stations will be stereocasting in the U.S. This stereo-awareness is reflected by the record industry, which has virtually stopped producing any monophonic discs. A listening public that has grown accustomed to quality stereo sound from discs and tapes is embracing fm stereo with enthusiasm.

Although fm is no longer the sole province of classical music, it still offers the broadcaster the opportunity to bring the live concert hall into the listeners' living rooms, and in full stereo. Concert halls traditionally lose money and must be subsidized by recording companies, civic groups and



(Left) One-man band operation at WPIX-FM features ambidextrous deejay Tom Mercein. Newscaster shares his microphone every hour. Production control room (above) at WQXR features Gates console and two Ampex recorders. Station music director and engineer edit taped musical program for later presentation.

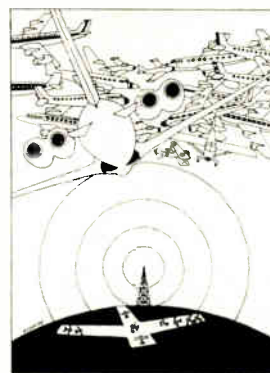
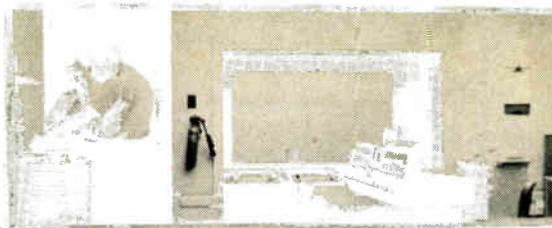

Faithful Market

patrons of the arts. Yet, attendance in the major cultural centers continues to soar. There is a ready-made listening audience here for live or taped stereocasts of local or distant concerts.

But fm programming has itself changed drastically in the last couple of years. Fm once meant fine classical music—mostly recorded—with very few commercials. Today, fm simply isn't a classical juke box. Instead, it contains virtually the entire gamut of musical and dramatic tastes. As an example, a big-audience station, WOR-FM, programs rock and roll. Its public appeal is devastating—garnering as it does more listeners than the next 70 a-m and fm stations in the New York metropolitan area. In fact, there are only five New York stations that exceed WOR-FM in listening audience size, and all five are a-m operations.

Fm obviously does something for music that most listeners like—regardless of content. Fm stereo has already demonstrated its technical versatility, and is no longer viewed as a gimmick. People apparently prefer to listen to sound the way they would in a live environment—with two ears, and with the full frequency range of normal live sound.

Stereo has a very definite effect on an fm station's rating. Bob Richer, vice-president and general manager of Quality Media, Inc., states, "It's very difficult for a station to achieve a top-rated position without the benefit of stereo." Add to this the fact that the nature of a-m radio is continuing to change, and it becomes crystal-clear that fm is definitely the wave of the present and the future.

A great deal of credit for this burgeoning market must be given to the FCC 50-percent programming ruling. Widely criticized at first, it soon became apparent that having 50-percent different programs on a station's a-m and fm outlets was an income-builder. It wasn't too long before many

stations changed to 100-percent different programming for their two outlets.

Also growing out of the 50-percent rule has been the trend toward talk shows on a-m. Fm is rapidly becoming *the* medium for music—all kinds of music—while a-m is fast-becoming pretty much a voice vehicle. Talk programs are invading every market. All-news formats have been incredibly successful in many markets, with some cities supporting more than one all-news station (WINS and WCBS-AM in New York). In some major cities (Chicago for one) there is no longer a single all-classical music station on a-m.

Stereo's Importance

In addition to its high fidelity sound, fm's stereo capability is a major selling point for music-lovers. Even the most sonically illiterate have opted for stereo, once they've become acquainted with it. A good performance is not only enhanced, but becomes real and alive in stereo. Musician and leading music critic Edward Tatnall Canby is a great believer: "I myself am a music lover and a musician so thoroughly convinced of stereo's values in purely musical terms, that I rarely hear any recorded music in any other form these days. When I listen to a monophonic disc now, it honestly sounds strange to me; it sounds false and lacking in realistic impact until I've readjusted my ears solely to its musical values."

Research and sales figures clearly indicate that the mass audience is going for stereo's better sound. And yet the versatility of fm as a broadcast medium has barely been explored and exploited by the industry or by advertisers. There have been few live international satellite broadcasts in stereo, even though the hardware is readily available. Why shouldn't the serious listener in this

An All-Channel A-m/Fm Receiver Bill?

The next session of Congress may consider the so-called all-channel radio receiver bill. Bills have been introduced already. The House bill is H.R. 16523, introduced by Rep. Alvin E. O'Konski (R-Wis.), a one-time fm operator and now licensee of WAEO (TV) Rhinelander, Wis. On the Senate side is S. 3622, introduced by Sen. Frank Moss.

Should hearings be held, opposition is likely to be vigorous. Support is growing, however. Only a year ago the idea was dismissed as too radical—even for the National Association of FM Broadcasters at its convention in March.

Later in the summer, however, the NAFMB Board gave the measure its wholehearted support and Sen. Moss introduced the Senate bill. The governing board of the National Educational Radio, at year's end, endorsed the principle.

The bill is patterned after the 1962 act which required all television sets shipped in interstate commerce to be capable of tuning the 70 uhf channels in addition to the 12 vhf channels. It would give the FCC "authority to require that apparatus designed to receive any amplitude modulated (a-m) or frequency modulated (fm) broadcast be capable of adequately receiving all frequencies allocated by the Commission for a-m and fm broadcasting when such apparatus is shipped in interstate commerce, or is imported from any foreign country into the United States,

for sale or resale to the public."

A champion of the proposed legislation is Bruce F. Elving, manager of the educational fm station at Syracuse University, WAER-FM. Elving has researched the subject and is quick to come up with a number of arguments on behalf of all-channel radio sets. For one thing, Elving feels that fm set sales, despite their growth, are leveling off at about 35 percent of a-m production (when auto radios are added the figure is about 22 percent.)

For another, Elving cites about 175 small towns to which only fm stations are licensed. In 21 major cities fm stations outnumber a-m's. Although some studies show that 70 percent of the homes in some areas have fm sets, Elving points out that this can mean only one fm set while a-m sets usually number four or five per home.

Such a radio set law would force large station owners, who promote their a-m outlets heavily, to regard fm seriously. Advertisers would thus be attracted and commercial fm stations might begin to fully contribute to the main stream of American broadcasting. Without legislation, Elving feels this won't happen.

Elving acknowledges that the public could lose its freedom to choose either a-m or fm, but feels it would gain a greater freedom in eventually having more programming choices.

country be treated to live stereo concerts from Salzburg, Bayreuth, Glyndbourne and the major concert halls of Vienna, Berlin, London and Moscow? Why shouldn't Europeans have the same privilege of listening to live stereocasts from Tanglewood, Ellenville and Saratoga?

At one time, Ford sponsored New York Philharmonic concerts carried live over hundreds of network stations on the vastly inferior (for music) medium of a-m. Such forward-looking subsidies and sponsorships are needed in today's fm stereo marketplace. The listening audience for such broadcasts is potentially awesome in size compared to the halcyon days of a-m radio.

Next on the list of unexplored areas is the simulcast concert. The marriage of color TV and fm stereo offers the serious music listener the visual treat of watching the Detroit Symphony in full color, while listening to the concert in full-frequency stereo over his fm rig. These simulcasts are completely feasible, and have already been transmitted in the Boston area over the combined facilities of WGBH and WGBH-FM (see Nov. 1968 *BM/E*, page 35).

And where are the stereo commercials? James La March, associate media director of Wells, Rich, Greene, Inc., in admonishing the advertising fraternity, has pointed out, "Surprisingly, the technical ability of fm to broadcast stereophonically hasn't been exploited commercially. Commercials in stereo, if done imaginatively, could heighten audience awareness and create a level of interest and commercial recall not possible monophonically. There would be less of a tendency for

the commercial to melt into its surroundings."

Fm radio is still an infant that has been afraid to pioneer in programming ideas. In the memorable days of a-m radio, we had personalities, live entertainment and symphony orchestras maintained by the broadcasters themselves. Today's Chicago's WGN is the only station that still maintains its own full-time orchestra. This is a disturbing trend, and the point has been reached where there is very little innovative difference between a-m and fm.

But this touches on other problems—mainly of finances—for the fm'er. The fm broadcaster today hardly has the cash to spare for such niceties as an in-house symphony orchestra or an expensive and imaginative programming experiment. Too often, the broadcaster has simply moved successful a-m formats *in toto* from a-m to fm. Perhaps that explains why over 50 percent of all fm programming is some variant of middle-of-the-road (MOR) material. "Play it safe" is the motto.

Going after the mass audience has increased fm penetration to as much as 70 percent in major markets. On weekends, fm does spectacularly well. The adults of the family are home and they're spending time with their fm equipment. Stations such as WNEW (New York) have found that their fm outlet has a larger audience than their a-m counterparts on weekends and often during weekday evening hours as well.

All isn't peaches and cream on the programming front. Fm seems to be suffering from what might be called the "Hollywood Syndrome." When a successful program format is discovered, there's



WQXR studios include 300-seat Studio H—once the home of live stereocasts, now seldom used. Note a-m/fm division of studios.

a herd-like rush to meet the need. Result: the need is quickly saturated. There simply isn't enough long-term planning to meet anticipated programming gaps and needs. Radio—including fm—deals mainly in tonnage. Stations seem to create programming that reaches the maximum number of people regardless of demographics—and then sell at the lowest cost per thousand. Such stations don't

spend money researching the audience, since rating services will tell where the station stands in relation to its competitors—the number of warm bodies reached. These stations simply haven't learned the lesson that magazines had to learn so long ago—the idea of going after specific demographics and special interests which can then be

Continued on page 44

Format Additions at WQXR

Tradition dies hard at the *New York Times*, and that includes its radio stations, WQXR (a-m and fm). For years, one of the few spots on the dial where classical music devotees could depend on hearing a variety of major (and minor) classical works, WQXR is riding the winds of change. Beginning with a new Saturday program on January 18, staid WQXR has added such recording artists as the Beatles, Simon and Garfunkle and the Tijuana Brass to its traditional programming.

Walter Neiman, the station's general manager says, "The format change was made to keep pace with the times and to make the station attractive to young people of taste, culture and substance." Behind those words stand some stark financial realities. Although 1967 had been a record year, 1968 revenue was down markedly.

For openers, WQXR-AM will feature Gene Lees, freelance music writer and lyricist right after the 12 midnight news on Saturday nights. His two-

hour stint will give him leeway to program as he sees fit—even hard rock if he likes.

Feature attractions on another new program, "Woody's Children," Saturdays from 7:07 to 8 P.M., are Judy Collins, Pete Seeger and Tom Paxton. Late Saturday and Sunday evening fare from 11:20 to midnight will consist of philosophical and other readings against a background of classical music. From 10:07 to 11:00 P.M. Mondays, guest hosts from the musical world will discuss their particular specialties.

WQXR-AM partially duplicates the fm programming. Simultaneous broadcasts are limited to early mornings and evening fare. Much of the fm station's daytime programming is duplicated on a-m one week later. Although changes are the order of the new year, Neiman flatly states that such recordings stars as Frank Sinatra and Frankie Laine will never waft from WQXR's antennas—not even with this "new" sound.



Station manager Michelle Danielle has somehow managed to focus lots of local industry and public attention on KTBT.



Successful FM'er

By Oliver Berliner

Brand-new on the broadcast scene, KTBT/Telaudio offers so many special services and facilities, it's hard to think of it as simply a radio station. Among other things, a mobile TV van for hire sits out front in the parking lot, not far from the station's transmitting tower. Other services include TV off-the-air checks and a specialized audio equipment distributorship. It all adds up to extra revenue \$\$\$.

THE MAGIC SUCCESS FORMULA for the fm-only broadcaster can be summed up in two words: imagination and diversification. Sometimes this diversification can go rather far afield from the traditional fm station's boundaries, as in the case

Oliver Berliner heads SounDesign Engineers, a specialized design group responsible for putting together KTBT's studios and mobile TV van.

of Garden Grove, California's KTBT. A combined business operation, KTBT/Telaudio Centre calls a shopping center its home, and its main transmitting antenna sits in front of the building in a parking lot.

Located five minutes from Disneyland and forty minutes from Hollywood, KTBT/Telaudio Centre complex is actually five separate, allied operations functioning under two distinct companies.

One of the firms is Audio International, Inc., which operates Radio KTBT, a 2-kilowatt fm'er, transmitting 24 hours a day in stereo. In the less than two years that Audio International has owned this station, it has risen from last place among the county's broadcasters to become the pace-setting, most watched and most copied broadcaster in the area. KTBT was the first in the county with dual-polarized antenna for both automobile and home reception, the first to automate, the first to use the latest style fm antenna, the first with a female station manager.

The manager is a glamorous creature named Michelle Danielle, who's garnered more national and local industry and public attention for KTBT than has been given to any other radio station in

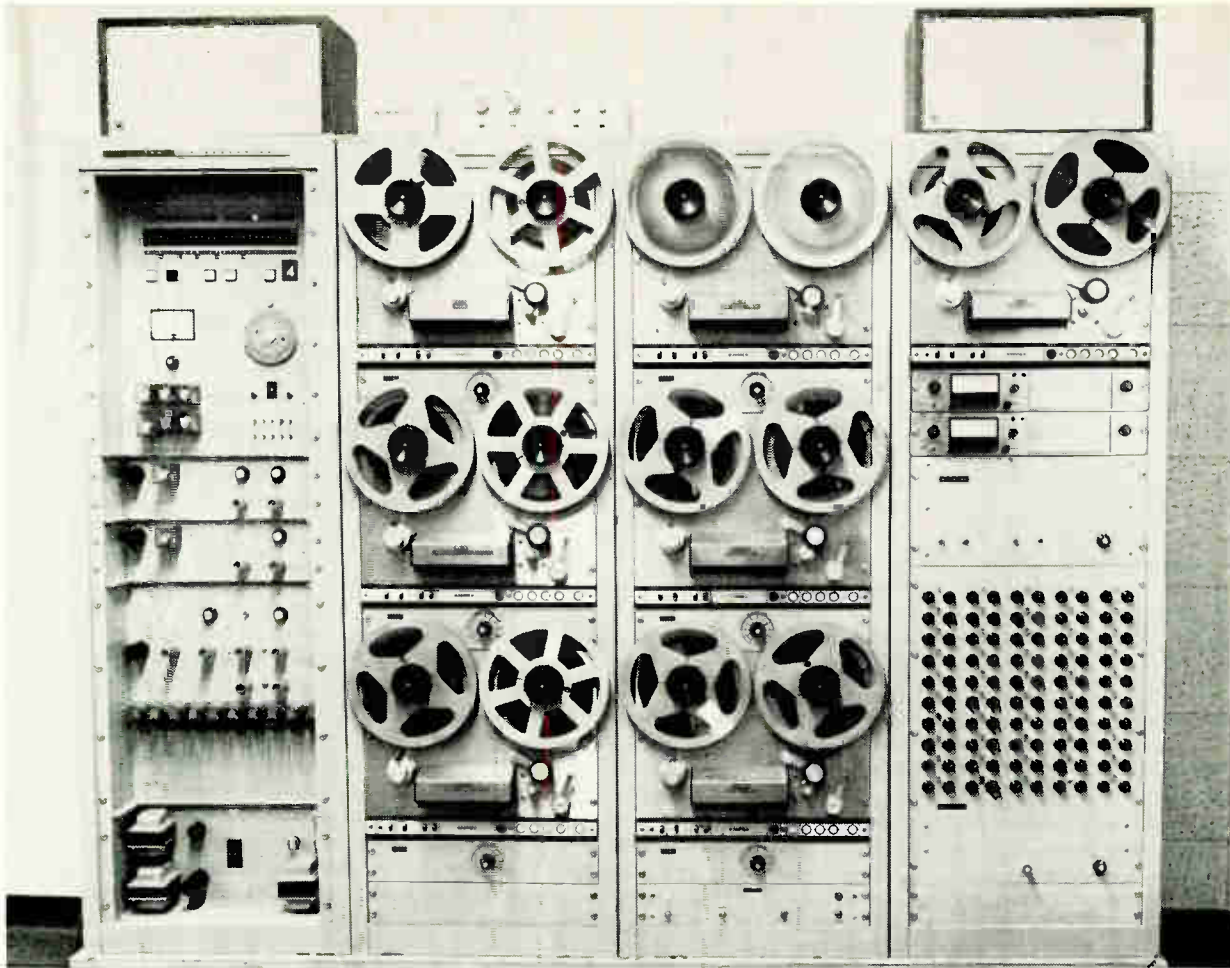

Custom-made automation rack covers control room wall.

Wears Many Hats

the country, regardless of size or age.

KTRF was also first in the area to run the famous old *Green Hornet*, *The Shadow*, *The Third Man* and *Lone Ranger* dramas. The station further pioneered with the introduction of the group sales concept for Orange County, permitting an advertiser to make one buy with just one contract for saturation advertising in the entire county. This has simultaneously served to awaken national advertisers to the fact that the chauvinistic million-and-a-quarter Orange County folk prefer local radio to the nearby Los Angeles County stations.

Shared Facilities

Sharing the same location is sister Telsudio Centre, whose four areas of endeavor form a rare but very logical adjunct to the broadcaster. These include: a commercial and consumer audio and video products distributorship; the county's newest and most advanced recording studio; an elaborate mobile television unit available for rental; a television air check service—audio only or audio and video.

The high esteem in which Telsudio is held is



Well-tanned deejay pretapes his show using Ampex four-track recorder. Show will be aired from automation rack.



Sophisticated custom-built recording console gives KTBT flexibility plus facilities for extra-income recording.

illustrated by the fact that it has furnished equipment to keep one of KTBT's competitors on the air; its studios prepare commercials broadcast by all the county's stations; and one of its engineers has more than once provided emergency service for various KTBT competitors.

The building is located in the Orange County Plaza Shopping Center. In addition to KTBT's antenna, the parking-lot tower supports a radiophone antenna and also various uhf and vhf receiving antennas for Los Angeles and San Diego TV stations. The building's physical layout and the responsibility for all facilities design and equipment specification, were handled by SoundDesign Engineers.

Just inside the main door is the audio-video products distributorship. The display area is small, but adequate for the limited number of lines handled by Telsudio. The areas of activity are: home, industrial and broadcast video products; hi-fi tuners, amplifiers, turntables and tape recorders; broadcast audio tape recorders; commercial sound systems; accessories and tape for all of these departments. KTBT's Studio A, now used only for production work and some special shows, is also in this area. This permits visitors to get an easy look at the radio equipment from the hallway. The considerable glass area also makes it possible for those in Studio A and in the Telsudio sales office to see any visitors who enter unannounced.

Next down the hall is Studio B control room. Here, a window provides a view of the recording studio mixing console and the KTBT automation equipment. One of the automation racks is located in Studio A for production convenience. The remainder sit on a dolly in Studio B control, which permits the entire assembly to be rolled away from the wall for servicing.

One unusual innovation is the wall of glass between the control room and the studio. It extends from the floor to approximately six feet above floor level. A saloon-type foot rail prevents visitors from leaning or putting their feet on the window-wall.

A small window lets visitors see from the hallway into the studio, but curtains can prevent this

if necessary for "closed" recording sessions. These hallway windows give visitors an eyefull while reducing unauthorized and unnecessary interruptions of studio and control-room activity.

A receptionist sits at the end of the hall and has a clear view of the main entrance and the entire hallway.

Near the rear of the building and away from unnecessary traffic is Studio C—the disc-cutting room—where tapes and discs are edited, equalized and dubbed, as needed. In addition, television air checks for clients are made here, which is also possible in the showroom and Telsudio office. Equipment repair is also done in Studio C, where extensive test equipment is available.

Studio B itself measures approximately 18×32 feet. Its control room is disproportionately large to accommodate the automation system and to allow VIPs to watch sessions from floor level between the window-wall and the operating platform. There are tape and microphone storage cabinets along most of two of the studio's walls. A duct at platform surface level runs all the way from the microphone plug-in panel, past the automation system to the console, console rack and transmitter room and terminates in Studio A. All audio and video lines are easily accessible here.

A conduit links Studio C with Studio B. Very high current ac power lines are provided in Studios C and B and in the Telsudio display and office areas to accommodate a large number of video tape recorders. Extra ac wiring is provided in Studio B for lights for small television productions. Special ports into the hallway are located in the walls of Studio B and its control room for running camera cables down the hall and out the front of the building for hookup to the Video Tape Mobile.

Video Tape Mobile

This latter service is one of the most exciting of the many facilities offered by Telsudio Centre. The van (see September, 1968 *BM/E*, pp. 31-32) is a compact, complete mobile video tape recording unit providing broadcast quality at modest rental rates for custom clients such as schools, low-budget TV stations, the military, independent television producers, advertising agencies and industrial accounts. The van, which uses a director and basic crew of three, plus up to three cameramen depending on client requirements, houses a 3-camera video system with all necessary monitoring and processing equipment, broadcast-grade video tape recorder, plus full audio and interphone equipment. In spite of its elaborate nature, the walk-in van is one of the smallest of its type made. Three men (director, video, audio) operate comfortably inside, and it also functions as a mobile unit for Radio KTBT's remote broadcasts. The van is normally parked next to KTBT's tower, where ac power is available for equipment testing and to charge batteries. Since all of the audio and video equipment in the van draws less than a kilowatt, its equipment can be run on a battery/inverter combination.

BM/E

All Solid State Television Microwave Relay Systems For High Quality Color and Monochrome TV Links

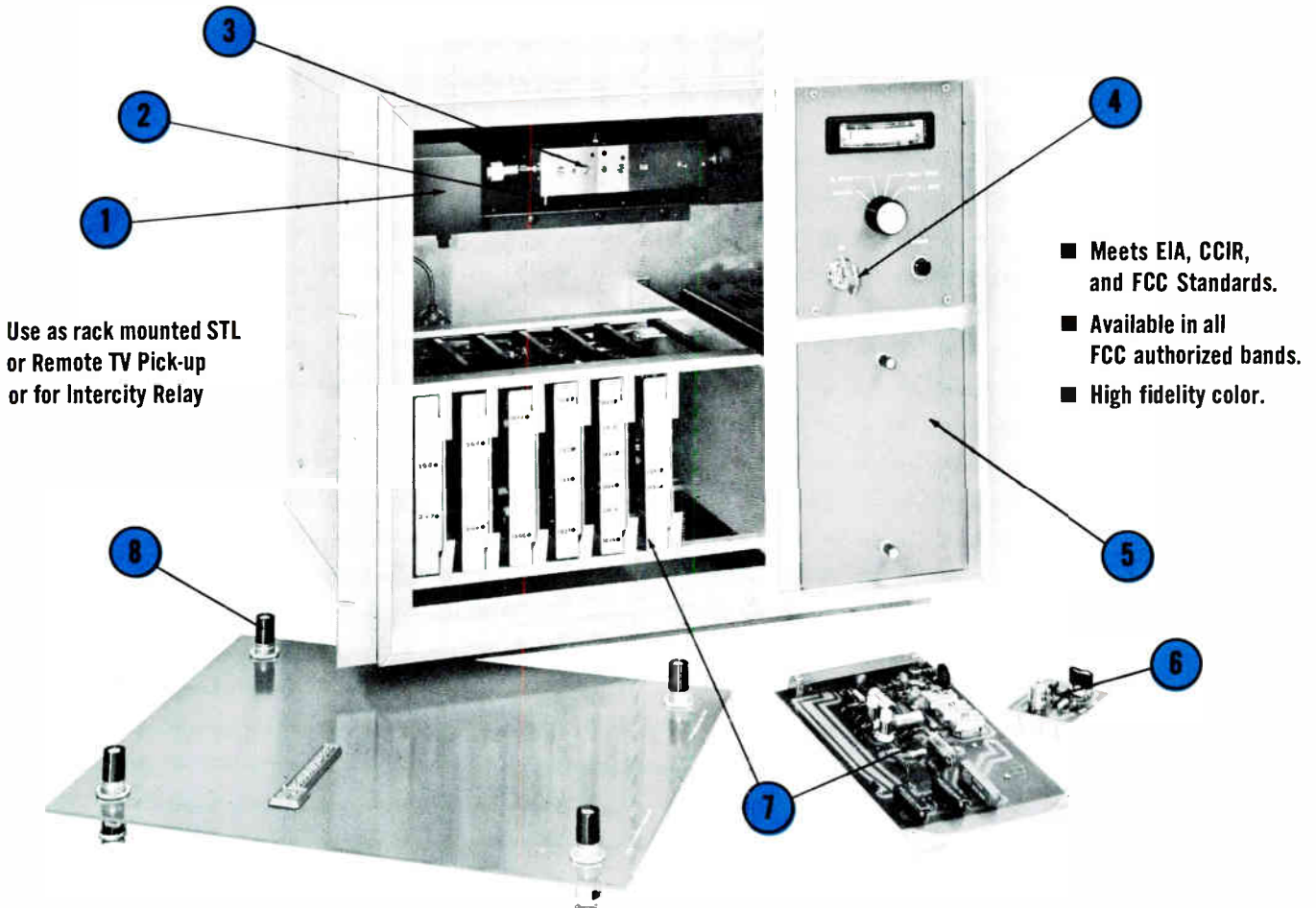

1 Built-in ferrite isolator

2 All Solid State — easily replaceable RF Module

3 High efficiency varactor multipliers

4 Key lock for secure unattended operation

5 Removable power supply module

6 Plug in pre/ de-emphasis

7 Plug in printed circuit cards

8 Instant panel removal by finger tip fasteners

RHG, a leading supplier of military TV relay links, now offers Series MRS to the broadcast industry. Transmitters and receivers, with advanced field proven designs provide solid state reliability, no warmup, and low power drain.

To improve your color transmission quality and to insure trouble free operation specify RHG equipment fully described in Bulletin 69C. Call for "no obligation" demonstration.



RHG ELECTRONICS LABORATORY, INC.

See operating link at the NAB Show Booth 544 — Shoreham

94 MILBAR BOULEVARD
FARMINGDALE, LONG ISLAND
NEW YORK 11735 (516) 694-3100

Circle 113 on Reader Service Card

It's easy to sell sellers on color

SELL YOUR CAR SELLER.

SELL YOUR HOME SELLER.

SELL YOUR
FASHION SELLER.

SELL YOUR BEVERAGE SELLER.

SELL YOUR MEAL SELLER.

There's a retail color explosion going on right now in hundreds of markets. Loan companies. Dairies. Department stores. Car dealers. They're all producing color spots. And for a good reason: they move the merchandise.

You undoubtedly know how many color sets there are in your market. You've certainly seen some of the research about the reach and recall-ability of color vs monochrome spots. Well, now's the time to start cashing in locally on color.

Our VR-1200B videotape recorder is the easiest and most flexible way to get on the highband wagon. Built

for highband color from the ground up, the VR-1200B lets you get into color commercial production immediately, then add performance options as you grow. And you can choose the configuration most suited to your needs with overhead monitor or "sidecar" console.

We've gathered some interesting case histories that show how color has helped local retailers. We think you will find their experiences most helpful in selling your local retailers on color. If you'd like a packet, drop a line to *Sell the Sellers* at our world headquarters, 401 Broadway, Redwood City, Calif. 94063.

with a VR-1200B.

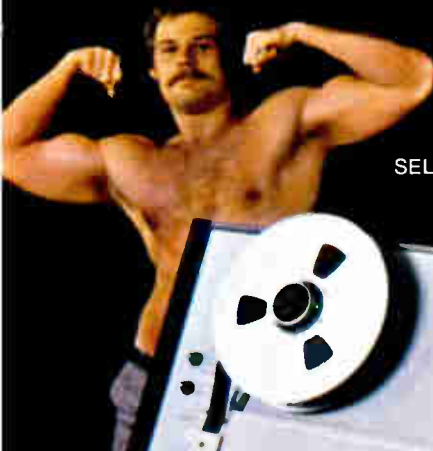

SELL YOUR HEALTH SELLER.



AMPEX



SELL YOUR LOAN SELLER.

Anti-Trust vs. CATV—Part I

In last month's editorial, we hinted at a possible, albeit complex, solution to the knotty dilemma of CATV regulation. Basically, what is needed here is an accommodation—a mutually beneficial and mutually profitable arrangement between broadcasters and CATV operators.

While this idea may sound fine in theory, in practice the solution may run afoul of myriad anti-trust legislation. Ironically, this legislation was originally conceived to foster competition and may now be squelching it instead.

Ultimately, new Congressional action may be required, but can it happen without raising a hue and cry from hundreds of other special-interest groups? The solution may yet be years off; yet however it is resolved, this problem will demand a complex formula that will please no one fully. Some of the knotty problems of anti-trust vs. CATV and some possible answers are presented here by Leo Drachsler, an attorney who has made anti-trust a subject of lifelong specialization.

The Editors

By Leo M. Drachsler

Is CATV competition for the broadcaster? How are the FCC proposed rules going to affect CATV? Is a CATV/broadcaster accommodation possible? What pitfalls lie ahead? Lots of questions, a dilemma that deepens daily, and a half-century-old federal law that looks after private enterprise are all contestants in this latest round of troubles for the cable industry.

DECEMBER WAS REPORT MONTH for cable TV. Two official documents vitally affecting the industry came out of Washington. The first, issued on December 10, was the Report of the *Rostow Commission* (President's Telecommunications Task Force). It urged the need for diversifying communications so that low-cost service could reach more homes. The report recommended more rapid growth of cable TV, but complained that the Federal Communications Commission had been unduly restrictive against this young industry; "Accommodation" between over-the-air TV and cable TV was needed as a basic policy.

On December 13, the FCC announced proposed changes in permissible cable operations, authorized subscription TV in six months, and suggested a variety of new rules to govern cable TV in the top 100 markets as well as smaller markets and made program origination a requirement. Some cable interests hailed the FCC proposals as favorable; others denounced them as "harshly and unfairly restrictive." Comments were invited for filing no later than June 16, 1969.

Does Anti-Trust Help Competition?

But underlying these new developments, and barely mentioned, is the lurking shadow of that Ole Devil of American industry—Anti-Trust. The immediate *short-term* concern of the two Reports is a change in *regulation*. "Anti-Trust" evokes the long-term (and more grim) image of "*competition*" and "*monopoly*." Anti-trust problems will inevitably arise as CATV makes incursions into the established markets of the older segments of the communications industry.

While the *commercial* prospects of CATV are

Leo Drachsler is a member of the New York bar.

dazzling, the *anti-trust* prospects are baffling. FCC Commissioner Nicholas Johnson stated in his opening remarks at the Federal Bar Association's Washington Symposium in May, 1968, on 'Anti-Trust and Monopoly in the Communications Industries,' ". . . we haven't the slightest notion where we're going (or, indeed, where we want to go)—but we know we're getting there a whole lot faster than ever before." A fast-growing, husky youngster, *Community Antenna Television* is the latest and most aggressive member of the vast communications family. Envious and greedy glances are being cast in its direction by its older brethren—broadcasters, telco, newspapers and the movie industry.

Cable Started Small

It had an unheralded birth in 1949. Yet, today CATV's future role is described as "limited only by one's imagination." It began as a simple communications device in rural areas to pluck TV signals from the air and pipe them into a set by wire, to eliminate distortion and interference. Now it's exploding into a brash and swiftly proliferating collection of about 2200 systems in operation, serving over 11 million viewers in 3300 communities. More than 400 systems are under construction and over 2000 permits have been granted for future systems. More than 1300 cities have applications pending, while 2400 others are waiting to file. Thanks to CATV, countless smaller communities are beginning to get TV reception, either where none existed, or where there were only one or two channels.

Late in June, 1968, with FCC approval, CATV began *program origination*—in addition to AP or UPI news, weather, local news and community events. Soon CATV will offer subscribers full-length films and documentaries. Spot advertising time is being sold by CATV systems on local origination programs at very low rates. CATV cable service can now carry *simultaneously*, color as well as black and white telecasts, fm radio, as well as signals for facsimile teletypewriter and other input/output devices.

The amazing growth of CATV is recapitulating the experience and struggles of American industries as they emerged from the inventor's shop. The steamboat, railroad, telegraph, telephone, motion picture (silent and sound), radio, airplane, conventional TV broadcasting—all the basic industries suffered the same labor pains as CATV.

The "elders," who were well-entrenched in an industry, were always on the alert for newcomers, competitors with better methods, improved technology, more attractive or cheaper products. Similarly, established oligopolies today are quick to pay lip service to the ancient American myth—"Competition is the life of trade. True—competition for the other fellow is fine—but not for *my* company. If *we* are to survive, we must combat competition, eliminate it, if necessary by methods which graze the thin line of legality . . ."

Do we face a period of involved, anti-trust prosecution and/or private litigation among contenders struggling to expand and swallow up CATV? Or will there be (as there has been in other industrial areas) some economic *modus vivendi* established with the blessing of the FCC, Congress, local governments, the Supreme Court, and ultimately, the American viewing public? Something "has to give," because at stake is the free competitive development of forms of communications of *expression* in all their variety.

It is not surprising that the most vociferous opponents of CATV, while deploring the "inroads" of this pushy newcomer as "unfair competition," are hedging their bets. NBC, CBS, Time-Life Broadcast, RKO-General and many others already have considerable investments in CATV. This ambivalent, love-hate relationship leans more and more to the time-worn, practical attitude of expediency in war, politics and business—"If you can't lick 'em, join 'em" (or merge, buy up CATV systems and put them into larger units under your control and domination). Presently, about 25 percent of CATV systems are controlled by independent telephone systems like General Telephone and Electronics, or are leased from the Bell System; 33 percent are controlled by TV or radio broadcasting interests and 15 percent of the operating CATV systems are owned by newspapers and magazine publishers.

Landmark Decisions

CATV tried fighting off a flock of the most powerful adversaries during 1968. Two landmark decisions surfaced on June 10, when the Supreme Court upheld the authority of the FCC to regulate CATV (this was the *San Diego vs. Col. Cable TV* case). KFMB-TV San Diego protested when certain local San Diego CATV systems imported programs from Los Angeles stations, adding to those relayed by signals from local TV stations, whose

Multimedia Togetherness—A Topic of Increasing Concern in Washington

With multimedia mergers being announced practically on a weekly basis, it has become evident that although broadcasters and CATVers began their relationship on a note of animosity, they have since found large areas of common interest. The problem with cross-ownership in the communications industry is that it's under close scrutiny by both the FCC and the Justice Department. The communications industry will long remember the ill-fated attempted merger between ITT and ABC. Any tendency on the part of one communications medium to absorb or merge with another is subject to a very thoroughgoing review.

In the Commission's proposed new rules on CATV, cross-ownership of CATV and television stations in the same area (within a station's Grade-B contour or a 35-mile zone) will be prohibited. On a nationwide basis, the total number of subscribers, the size of the communities and the regional concentration and the other broadcast interests of the CATVer will be limited.

CBS, Reeves Broadcasting, Time-Life and the

Metromedia-Transamerica mergers now awaiting FCC approval are perhaps the leading examples of multimedia combinations. Those involved may be required to make certain divestitures because of the new rules. Call it what you may (control of mass-media monopoly in the eyes of the FCC or anti-trust action on the part of the Justice Department), the effect is the same—delayed or disallowed license renewals, applications and mergers.

Latest example of the FCC and Justice Department crackdowns on multimedia combinations is Frontier Broadcasting's pending application for license renewal (KFBC-TV). Frontier's broadcast holdings include Cheyenne, Wyoming's only full-time a-m station, a CP on an fm'er and the town's only cable system. Moreover, Frontier's management controls the only morning, afternoon and Sunday newspapers in Cheyenne.

The probable effect of this regulation on CATV will be to depress system prices, to slow appreciation and to eliminate many affluent buyers. In general, growth of CATV can be retarded.

“economic health” was allegedly jeopardized. The Court held that the FCC had broad responsibilities under its Congressional mandate for orderly development of local television and that regulatory authority over CATV was imperative, since it is “ancillary” to FCC's general responsibility for the regulation of the whole TV field. CATV accepted the inevitable. The FCC can now challenge any plans of a CATV operator to import TV signals from one city to another. The Commission now has greater authority to regulate all CATV activities. It can now act as a watchdog over this relatively new medium.

A week later, on June 17, 1968, CATV had a victory. In the *United Artists Television, Inc. v. The Fortnightly Corp.* (W. Va. CATV Systems), the Court held that CATV systems *do not infringe copyrights* when they lift movies and other copyrighted programs from the air and retransmit them to their subscribers. CATV systems are “viewers” and not “performers in public,” the Court stated. Broadcasters (not CATV systems) “perform” programs and are liable to copyright fees. “*But CATV falls on the viewers' side of the line,*” the Court announced, and accordingly need not pay copyright fees. There was a prompt demand for a rehearing made by United Artists to

clarify the basic question as to what constitutes a “performance.” And on June 18, 1968, the FCC ruled that although CATV systems in the San Diego area could *originate* programs, they were prohibited from selling advertising commercials for those programs.

Basic Anti-Trust Problems

While important, these Supreme Court decisions are primarily *administrative* in effect. Later developments begin to pose true anti-trust problems. Some of the basic anti-trust problems taking the fore of the legal stage in the duel between CATV and its enemies include:

- Anti-competitive practices by phone companies which overcharge CATV systems for the use of pole and cable facilities.
- Delaying unaffiliated CATV systems in obtaining cable service (thus eliminating competition from these smaller systems).
- Obtaining stock control over many CATV systems, giving the phone companies a monopolistic position. Characteristic legal problems are precipitated by violations or potential violations of the oldest federal statutes (dating from 1890), governing economic activity. Among the basic are: (a) Sections 1 and 2 of the Sherman Act, (b) the

Clayton Act, particularly Section 7, (Celler-Ke-fauver Act), the “anti-merger” provision.

Section 1 of the Sherman Act strikes at combinations in restraint of trade, typically price-fixing, division of territories among competitors, obstructions to new entrants and other anti-competitive practices.

Section 2 condemns “monopolies” or combinations or activities which tend to create monopolies.

Section 7 of the Clayton Act clamps down on mergers. It prohibits, with certain exceptions, purchases of stock or assets of companies by others with results that would substantially lessen competition in a given line of commerce in a given area of the country, or that would tend to create a monopoly.

No Decisions Yet

It is not surprising that in this early stage, when all the elements in the complex CATV-Communications duel are maneuvering for favorable economic and legal positions, no purely anti-trust *judicial* decisions have yet been announced. The warring groups are still probing, experimenting, pressing applications before the FCC, or local government agencies, such as the New York City Board of Estimate, for licensing. “Combinations” or “compromises” are proposed between CATV’s thrusts into the huge communications markets and the established segments of the industry. Early in November 1968, ABC urged that the FCC adopt severe restraints on cable TV before Congress rewrites the Copyright Law. “There is certainly no urgent public need for greater program diversity,” said ABC. There was, of course, an outcry of protest by cable interests, who asserted that ABC’s proposals would effectively bar any threat of competition to the networks and in so doing, would perpetuate the public’s already limited choice of program sources. The Rostow Report and the

FCC’s proposed new cable TV regulations are partly in response to these pressures.

Until the Supreme Court acts, no reliable “law” will exist. The total picture, with CATV as the “eye of the storm” is in violent flux. Surely the administrative regulations of the FCC, the economic turmoil stirred up by mergers into larger units and numerous anti-competitive practices will have to be examined and ruled on by the Court. And once more the Court will be compelled to apply the anti-trust laws in specific cases, mark out the path of permitted growth, strike down combinations or practices which violate the basic precept underlying the dynamics of American industrial growth—competition.

Outlines of bitter anti-trust confrontations to come are foreshadowed in some recent developments. In November, 1968, the FCC instituted a rule-making proceeding on whether cable systems should be permitted to transmit CATV program originations in CARS (Community Antenna Relay Service). Commenting on this proposal, NCTA (National Cable Television Association) urged that if CATV originations are to have restrictions imposed on them logically, the FCC should undertake *complete regulation of programming of all media* it regulates—especially the networks. Opponents of CATV asserted the FCC can regulate cable organizations in any way it sees fit. The cable group replied that enemies of its industry were attempting “to fix the present oligopolistic marketing structure with the result that the public would be deprived of multiple channels of communication. It was asserted that CATV’s opponents argued that “a (television) *system of scarcity* is plenty for the American public.” Cable interests retorted that the FCC was being asked to sacrifice the public interest to insure “private financial interests against speculative competition from CATV.” Opposition to CATV organizations

The Future for Cable

Cable is the ideal interconnection for future business, school and home information services like retail and classified advertising, facsimile newspapers, library and educational services in the home. Its diversification potentials seem endless. By 1985 it is estimated that 46 out of 70 million American homes will have cable TV. Air transmission may well become obsolete by 2000.

It’s understandable that the prospect of pay television has aroused vehement opposition in the entertainment and broadcast industries. CATV’s phenomenal expansion into the great world of commercial entertainment spells sharp competition for the Big Boys who have for so long dominated the air-waves spectrum and the screen.

“strikes at the heart of the announced design to encourage the development of *independent* and *competitive* program sources and the *free flow of programming* to the public.” Failure of FCC to adopt the CARS rule, NCTA contended, would leave the cable industry “unable to effectively and economically reach its full potential.”

Thus the issues are being sharply drawn between the new entrant, CATV and the giants of communications. The same fundamental, anti-trust questions are appearing as we saw in the evolution of other great American industries. Shall the Big Three (or Big Four) be permitted to block the penetration of their rich markets by “new entrants” like CATV? Shall the Big Boys be allowed to engage in anti-competitive practices against the newcomers? Shall secret understandings to fix rentals to discriminate as to services, leases or licensing be exposed and rooted out? How far can mergers of unaffiliated CATV systems into the broadcasters, newspaper, movie or telco corporate structures be allowed? (It is known, of course, that Bell is prohibited by a consent decree from buying affiliated CATV companies).

What answers to the immensely complicated, intermingled problems of communications economics, administrative and anti-trust laws, and ultimate constitutional law might emerge by 1975 or 1980, no one can presently foretell. **BM/E**

FM Market

Continued from page 33

sold to advertisers at a high cost per thousand. Some stations do make careful market studies; too many simply don't bother.

Advertisers are beginning to spend their money more judiciously by going after special-interest groups. They're also beginning to realize that fm offers a great opportunity to go after people who are traditionally difficult to reach with most other media, except for prestige magazines. Fm offers the possibility of going after new markets, low-cost test marketing, and special-interest appeals. But fm broadcasters must learn once and for all that such desirable ad revenue can be theirs only if they embark on imaginative and *different* programming formats—not only different from one another, but different from the old, tried-and-true a-m formula that still looks so appealing. Segmented marketing will effect all media, especially with marketing costs escalating every day.

Fm is a new medium in a profound sense, but its newness will soon lose its luster and appeal if it simply follows in a-m's footsteps. Those early fm stations that went stereo 24 hours a day gained a clear advantage and have generally led the pack since. But this is just one aspect of daring and innovative programming and formatting. Fm is a medium that demands appropriate inventiveness and a long, hard look at the future, and that doesn't mean just next month! **BM/E**

Budget

By Rod Maddison

Want to add the radar dimension to a low-budget weather forecasting operation? With a little ingenuity and a bargain-basement-priced maritime radar system, it's possible to set up fast and economically for your newscast rainmaker slot or for CATV weather channels.

GROUND-BASED RADAR is not a U.S. Weather Bureau, airline or RCA Building exclusive—local broadcasters and CATV systems doing local origination can provide weather radar screen service for relatively low cost.

The Wisconsin-Michigan Power Company, for example, has been granted a radio station license to operate a radar facility at Appleton, Wisconsin. The radar, which scans local weather patterns, is licensed in the Industrial Radio Location Service in the 9320 to 9500 MHz band. The power company uses a Kaar Raymarc LN 101 radar rated at 20 kW peak output. With the rotating antenna only 45 feet above the ground, it's possible to view the skies within a radius of 55 miles. The radar provides advance information about impending storms, allowing company officials to dispatch emergency crews to possible trouble areas and to determine anticipated changes in load requirements.

CATV Radar

A similar radar system has been installed by a Louisiana CATV operator. The rotating radar antenna is mounted about 30 feet above ground on a platform supported by four utility poles. The 12-inch radar screen is located in the head-end building, and a standard low-cost vidicon CATV camera is focused on it. The radar image, which scans a 50-mile radius, is fed into the CATV system on a vacant TV channel and can be seen by all subscribers.

The view of the radar screen is transmitted continuously. To make it easy for viewers to find

Rod Maddison is vice president and general manager of Kaar Electronics Corp., Linden, N.J.

Weather Radar on Camera

their own locations on the screen, an etched overlay has been placed over the radar screen instead of a graticule.

Weather radar can be used by TV broadcasters to liven up weather news broadcasts. The radar can be installed at the studio, transmitter site or other location where the radar beam will not be obstructed. When the radar is not located at the studio or transmitter site, a video circuit or microwave link between the studio and the radar site must be provided. If a really creative effect is desired, program material can be transmitted simultaneously with the weather radar image by split image techniques, through a conventional effects generator.

FCC Approval

FCC Form 400 is used for applying for a station license to operate a radar in the Industrial Radiolocation Service. At item 15, or on the second page of the form in the space left open for "additional information," the applicant should state the nature of his business and the purpose for which the radar is to be used. A map should be attached to the application which shows the area covered by the radar, and the height of the beam at the maximum range.

A supplemental statement should be included in which the applicant should state: (1) that he is financially able to install, operate and maintain the equipment proposed to be installed; (2) that he has licensed electronic technicians on his staff who will be responsible for maintenance of the equipment (or will employ a qualified maintenance firm); (3) that the radar will be used to monitor weather changes and that the information obtained will be used in the interest of public safety and in particular for warning the public of severe weather changes; and (4) a technical description of the equipment to be used.

A weather radar like the type used by the U.S. Weather Bureau is costly. Much lower-cost marine radars, priced at about \$5000 installed, can be modified for weather observation use. Exclusive of maintenance and electric power costs, a TV station or CATV system can provide weather radar facilities for less than \$1.50 per day, based on 10-year equipment life. **BM/E**

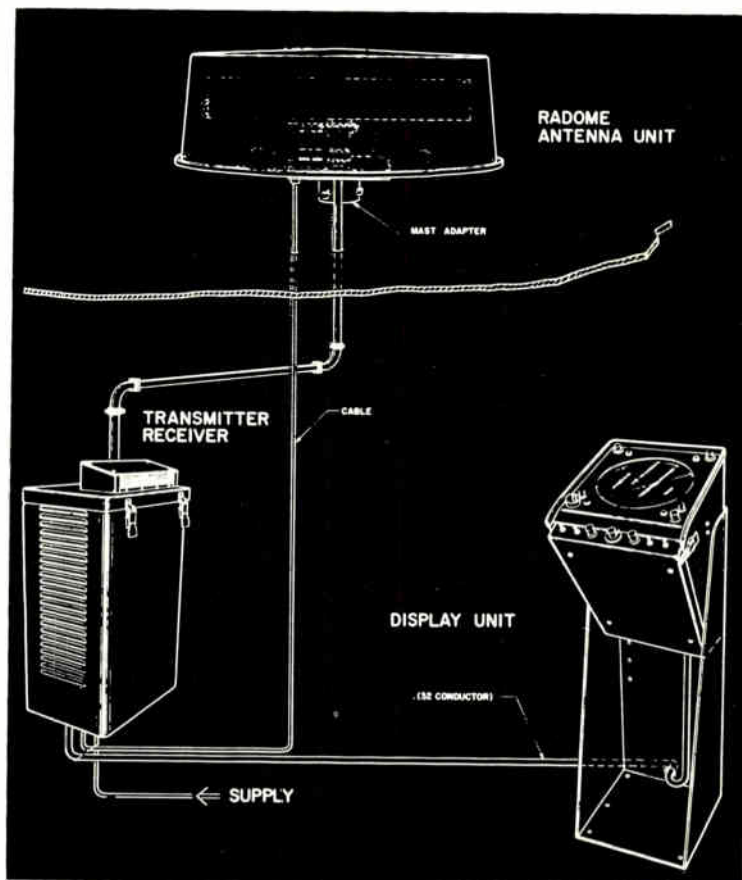

Basic setup for the marine radar as modified for weather watch includes an antenna radome on the building roof or tower, and an indoor display unit.

'Dip and Dunk' for

By Howard E. Russell

If you're in a small-to-medium-size market, have a limited budget and feel you need color newsfilm to stay ahead of the competition, a "dip and dunk" system could help build audience ratings.

COLOR NEWSFILM DOESN'T HAVE to be prohibitively expensive. A simplified, semi-manual processing lab setup can put your station on the air with its own color films almost as fast as the big, costly automatic processors can. Called "dip and dunk," this method does have its drawbacks, but will let you take a giant step forward in the increasing color news market. About 3 to 3½ hours of afternoon processing will permit you to hit the tube with at least five minutes of solid video for your early evening newscast.

The idea was originally conceived at KAUZ by news director Larry Sledge. The tanks and water jacket were patterned after those at KLBK, Lubbock, Texas. Our first color newsfilm was strung up in the studio to dry in February, 1967. Many improvements have been made since then in processing, handling, drying and quality.

We decided on Anscochrome film for many reasons. We were already using the D-100 and T-100 emulsions for our slides. The AR-1 color film chemical process was familiar to us. Temperature requirements were manageable. All in all, the film and chemicals seem to be a bit more forgiving of temperature variation than other color emulsion types are.

For convenience, we used T-100 only for 16mm; and we originally started with a straight AR-1 process. We're still with the tungsten film, but we use a much modified process now.

Our total wet time is 30½ minutes; drying a full 110 feet requires 35 minutes in our dry box, and with practice, about 20 minutes is required for handling time and re-exposure. For a late-breaking story we could run 30-40 feet through in about 70 minutes for a minute of color video. On a few occasions we have single-reeled a 5:00 P.M. accident and have run it before our 6:30 news was over.

The first question usually is, "What does the film look like? How is its quality?" The best answer came from Bill Hobbs, our vice president-general manager, and severest critic. A commercial lab opened that promised 2—2½ hour service on Ektachrome; after the first few days of seeing the results on the tube, Hobbs decided

Howard Russell is chief of photographic services for KAUZ-TV, Wichita Falls, Texas.

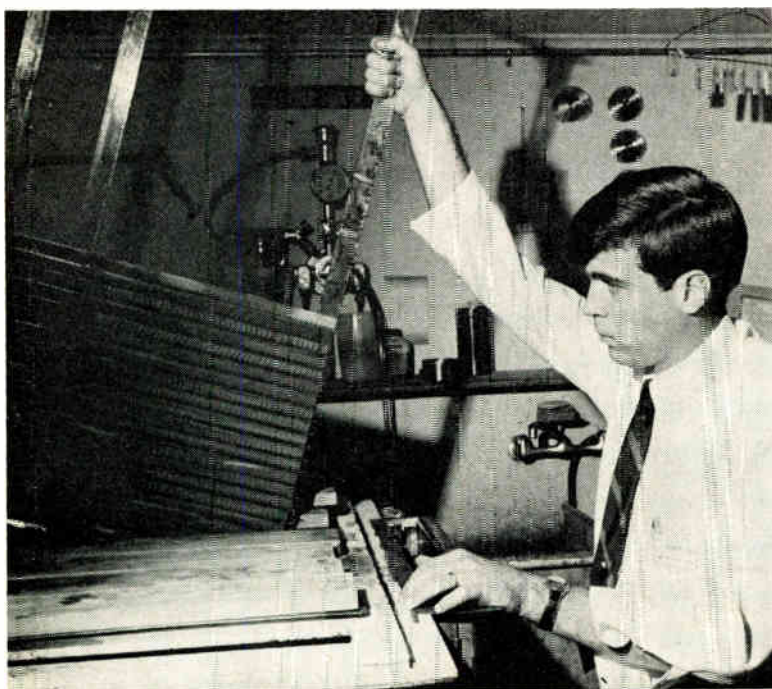

Lab chief lifts film rack holding 70 feet of Anscochrome from bleach tank—ready for next step.

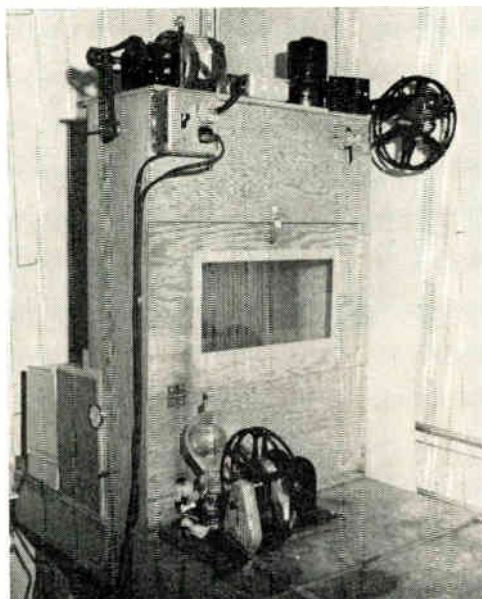

Homemade drying cabinet holds 75 feet of leader, will dry 100 feet of film in 30-35 minutes.

Newsfilms—Color it Cheap

to use Anscochrome exclusively, since it provides better saturation and contrast.

Why use this system rather than Nikor or similar reels and tanks? Temperature control is fairly simple in our water jacket, and we did not have room to shelve all those round tanks. Our tanks only have a surface solution area of 2×23 inches; so aeration and oxidation are minimized.

What would it cost to duplicate a system such as ours? The answer depends on what type of craftsmen you have and how much of the work they can do. Our stainless steel tanks and sheet steel water jacket were made on the "outside," but I designed and made the expanding film rack and the drying cabinet. For us, the only purchases were the plexiglass and the heater; the other parts were from our "junk piles."

Replenishing the Chemicals

General Aniline and Film may not endorse some of our methods, but we've found they will work—under our conditions. For instance, their instructions say keeping qualities for the chemical solutions is two weeks; we have always run at least two months, and right now I'm pushing them to the time limit just to see. Chemicals have been in our tanks for three months and we are not out of control.

We watch our lineal footage and usually dump the tanks after about 8000 feet; but once we ran nearly 11,000 feet before getting too far out of control. A schedule is used to pump the tanks out and filter the solutions as we return them; this is done on a rotating basis and seems to work better than trying to do all the tanks at one time.

Replenishers are used. Because of our film chain and its automatic iris controls, we strive for nine steps on the Ansco test strip. To do this, we will run about 2000 feet before replenishing and then replenish every 1000 feet.

Without replenishment, chemistry cost would exceed 3 cents a foot—twice our cost now. Seven gallon solutions are used in the tanks, and it runs around \$42.00. Except for the developers, we use the ten-gallon sizes, mixing them to replenisher strength and then diluting to working strength when fresh chemistry is needed.

We had down time only once. After five months leaks developed in the conduit boxes holding the heaters. We had to dump the tanks, pump out the water jacket, reseal the boxes and replace the heaters.

If you feel you need color newsfilm, have no local lab to process it, and do not have the \$10,000 plus for a processor, dip and dunk could be your answer.

BM/E



Water jacket holds seven deep tanks, uses coffee-pot heating elements to keep solutions at proper temperature.

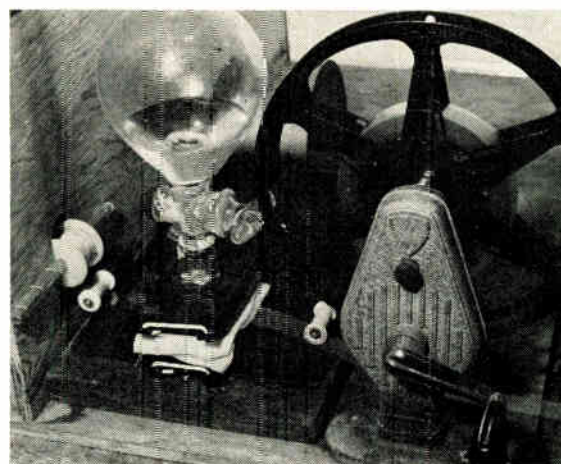

Modified film cleaner squeegees film before it goes to drying box. Cleaner pads were replaced with foam rubber.

SCA Spells More \$\$

Continued from page 25

allow SCA paging. A paper on the subject was delivered by Sands before the IEEE in Dec., 1967.

Closely paralleling musicasting or storecasting, SCA is going into doctors' waiting rooms to entertain patients and provide news to medical personnel on the latest developments in medicine. Developed 9 years ago by the National Broadcasting Co., the system mutes only waiting room speakers as periodic medical news is broadcast to doctors.

An increasing variety of visual media is being transmitted via SCA. Displays of news headlines, time, weather reports, stock market averages and sports information are being conveyed to hotel and motel lobbies, restaurants, and other public locations. Facsimile and blackboard remoteing are other modes of transmission suitable for SCA. Victor Comptometer Corp. and General Telephone are both making systems which transmit graphics and audio via phone lines or SCA. Victor's unit, called an Electrowriter, was introduced at NAB '68 in Chicago. GT&E's ECS-100, which sells for \$7000, bowed in February '68.

New and more efficient facsimile transmission systems are being developed, and can be used on SCA for sending copy and page makeup to satellite printing plants from editorial offices. The system also can be used to provide home TV set readout to subscribers (see pages 28-29).

The FCC recently announced the third and final extension of its deadline for installing type-approved SCA monitors to April 1, 1969. Collins Radio, Belar, RCA and McMartin recently introduced type-approved monitors meeting the new requirements (see page 39, October, '68 *BM/E*).

Although SCA multiplexer specs indicate they're all pretty much the same, major SCA manufacturers discourage mixing breeds of SCA

multiplexers and main carrier generators. Even where circuits are compatible, modular construction and plug-in units make breed-mixing impractical and inconvenient.

Of the half-dozen leading manufacturers in the field, five modularize their fm equipment. The main idea appears to be to sell customers the modular concept, with components designed from the ground up to work well together. Even if a broadcaster buys only a direct fm generator, that's 90 percent of the battle for an eventual complete system sale.

None of the modularizing manufacturers seems willing to admit that somebody else's multiplexer will work with his fm generator. Besides, it's impossible to fill the holes in a modularized box with anything but a same-family plug-in. Marti is the holdout for generally compatible, directly rack-mountable SCA equipment. An added feature on Marti's SCG-67 SCA multiplexer is a provision for remote telemetry monitoring of transmitter functions on 950-MHz STL.

In spite of the basic sameness in SCA circuitry, there is an order of sophistication, taking the form of an active-component pre-emphasis network in some units. In one particular model, pre-emphasis can be set for flat, 50-, 75-, or 150- μ s response. Typical crosstalk specifications are on the order of 42- to 45-dB down from main to subchannel or vice versa. Reports from the field indicate that this well may be insufficient, and might be an area where SCA multiplexer and receiver manufacturers could do a little homework.

SCA as a Revenue Producer

According to one source,* SCA is an industry with a \$15-million potential gross for receiver rental alone. This figure is based on an estimate that the average number of subscribers per town is 400, with actual numbers of SCA receivers varying from 100 in smaller communities to 3000 or 4000 in major cities. Multiplying communities by the average number of subscribers per town produces a figure of nearly 50,000 receivers. Based on an average monthly charge of \$25 per receiver for background music, the national rental income per month works out to \$1.25 millions.

Because of its ability to satisfy the communications requirements of small, select groups, SCA broadcasters are in a good position to request funds from state and federal agencies. Speaking at NAEB's session on ways and means of improving the economic base of educational radio, Albert P. Fredette, manager of WAMC-FM, Albany, N.Y., explained that his station receives one-third its total revenue in the form of a grant. The grant pays for a special subcarrier service for the blind. Fredette feels that station operators often overlook possibilities for such grants by seeking revenue only in the obvious areas of technology and education.

BM/E



RCA's BTX-1B SCA multiplexer mounted in direct fm system offers deluxe features but is typical in its modular construction. The Marti SCG-67 (below) is directly rack mountable.

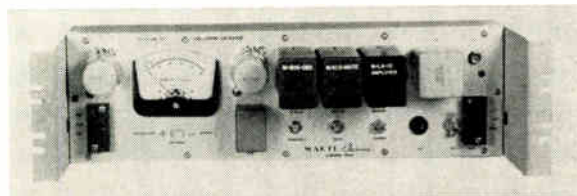

*"The Development and Utilization of the Subsidiary Communications Authorization 1900-1967," by Lorne A. Parker, MS thesis (Speech), University of Wisconsin.

ONE MAN; ONE CAMERA, THE IVC-100 □ Internet Television Productions, Inc. of Laguna Beach, California in association with San Clemente Cable TV Co. and Leisure World (a Rossmore development) desired to produce live pick-up of the San Clemente Surf Club Competition, the Hollywood Hackers Golf Tournament, plus an award banquet for later cablecast to 15,000 Southern California homes. □ Problem? You bet. □ This meant surf, turf and filet mignon—lighting conditions from one extreme to the other—fixed and remote camera positioning—indoor, outdoor and studio locations. □ The IVC-100 color camera and IVC-800 video tape recorder was the only system that could do the job and deliver top-notch color fidelity and registration at realistic costs. □ In three days of bouncing from truck-to-turf, not a single operating adjustment had to be made by the lone operator. Now, this same performance is in pocketbook range of every cablecaster, large and small. See the reverse side for details on the IVC-100 color camera and IVC-800 video tape recorder.



SURF...TURF...AND FILET MIGNON



**IVC's INNOVATIONAL
DESIGN BRINGS THE
VIDICON TO LIFE IN THE
IVC-100 COLOR CAMERA.**

New design ideas in optics and electronic design have maximized performance. Reduced "lag", high stability, and better registration are the result. The IVC-100 with built-in sync generator and encoder is transportable (one man); easy to maintain and set up. It can be used for remote taping, multiple camera pick-up and film chain functions with proper options. Price—\$14,000.

**IVC's DESIGN ECONOMY
MAKES IVC-800 SERIES
RECORDERS THE ONLY SELF-
CONTAINED, PORTABLE VTR's
THAT EDIT IN COLOR.**

Frugal design engineering by IVC not only cuts cost but delivers more equipment capability for the investment. The IVC-800's built-in electronic editing feature, for instance, contributes to operating efficiency without affecting compactness, mobility and versatility. The IVC 1" format allows an hour of recording time on a small 8" NAB reel tape—30% less tape is used at an average savings of \$15 an hour. The IVC-800 reproduces high-resolution NTSC-type color pictures, or, wideband monochrome pictures with bandwidth exceeding 5MHz. Stop motion is standard. Slow motion is optional. Price—\$4,200 to \$6,200 depending on options.



675 Almanor Avenue,
Sunnyvale,
California 94086
Phone (408) 738-3900

690 North Broadway,
White Plains,
New York 10603
Phone (914) 761-7820

2200 East Devon Avenue,
Des Plaines,
Illinois 60018
Phone (312) 297-5160



Digital Video Review:

Digital technology is rapidly moving, beyond its original wide-spread application in computers, into the communications field. Major advantages of using digital techniques in communications are the inherent reliability and intelligibility of digital devices in the presence of noise. A whole series of new commercial television products utilizing digital techniques has been developed by the Broadcast Equipment Division of Sarkes Tarzian, Inc.

SELECTEC II is an unusually flexible, universal switching system. Tarzian engineers designed the system to fulfill a variety of military and commercial requirements. The equipment can be used as a high capacity distribution switcher: 1,000 video plus 1,000 audio inputs can be distributed to 1,000 independent video and audio outputs. SELECTEC II can also be used as a studio production switcher or master control switcher. And, it can be operated as a fast lap or Vertical Interval switcher. The modular plug-in design will fit any configuration requirement. Remote control is accomplished through use of digital circuits.

A new digital encoding and decoding process from Sarkes Tarzian, Inc. reduces the complexity of pulse distribution in television stations. ComPPulse encodes six separate pulse signals into a single complex pulse which is distributed throughout the station over a single coax cable.

A Sync Generator System with computer precision is now available to commercial broadcasters. DIGIPULSE--another product of Tarzian digital technology--is actually a small computer that reduces color lock-in time to a single back porch interval. Extra no-cost options include Black Burst and Mono Black output video signals from the Sync Generator.

SYNCOM--a multiple channel, synchronous detection system with digital sensing--has been introduced by Tarzian for use in Network, VTR, Studio Production, and Master Control switching applications. SYNCOM prevents errors resulting from attempts to dissolve, fade, or super synchronous and non-synchronous video sources. Sensitivity is adjustable to less than 50 billionths of a second.

Sarkes Tarzian, Inc. has openings for engineers in several major programs. Especially for circuit designers, TV system specialists, and field engineers. Requirements: proven ability in television engineering with competence in Color TV maintenance. A BSEE degree is preferred but not mandatory. Send resume to Mr. B. Presti, Sarkes Tarzian, Inc., Broadcast Equipment Division, Bloomington, Indiana 47401.

Advanced circuit developments at Tarzian--utilizing Op Amps, Integrated Circuits, and Thick Film techniques--have produced a number of unique, highly reliable circuit configurations. A recent example is a new camera sweep circuit with more precise linearity than previously possible, that eliminates adjustment controls. This circuit will find its first application in a new color camera to be unveiled by Sarkes Tarzian, Inc. at NAB '69.

Other new products in Tarzian's line of Digilogic Television Equipment are METRIK, a new concept in Video Effects Control, and DATAPROC, a Video Signal Processor. DATAPROC completely regenerates the video information, re-establishing Burst, Chroma, Sync, Set-Up, and Blanking. Only the original picture content is left intact.



SARKES TARZIAN SYSTEMS/DIGILOGIC BROADCAST EQUIPMENT

BROADCAST EQUIPMENT

Orthicon camera tubes

3-inch image orthicon camera tubes have a new electron gun structure which reduces noise component so that signal-to-noise ratio is increased by more than 60 percent. Dynode background interference is elimi-



nated. Optical screening eliminates extraneous light. Tubes are interchangeable with other image orthicons of same size. Available in color matched sets. Visual Electronics Corporation, New York, N.Y. 10018.

Circle 146 on Reader Service Card

Slide projector for TV broadcast chain

Model SLR-TV forward/reverse sequencing 2x2 slide projector is de-

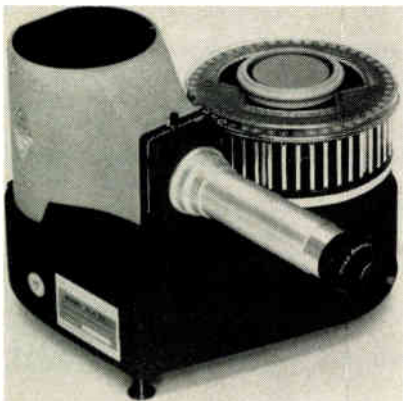

signed for TV chain integration—for use with black and white or color multiplexers or direct projection onto TV camera tube face. Slide change time is one second. Rotary 48-slide magazine accepts all types of slide mounts. Features include automatic housing during slide change, continuous cooling of lamp and both sides of projected slide, uniform illumination over slide area, 500-line resolution minimum, and choice of 200- or 500-watt projection lamps. Slide gate gives 1/5 wear. Spindler & Sauppe, Inc., Glendale, Calif. 91201.

Circle 147 on Reader Service Card

Cylindrical CCTV camera

PK-501 closed-circuit, monochrome camera weighing eight pounds is



housed in compact tubular shape especially designed for use by law enforcement, educational and manufacturing establishments. Concealment is achieved by one-inch vidicon pickup tube and circuitry being encased in four-inch-diameter cylinder,

13 in. long. Featured is automatic light compensation over brightness range of 4000 to 1; horizontal resolution in center measures 600 lines. \$1195. RCA Commercial Electronic Systems Division, Camden, N.J.

Circle 148 on Reader Service Card

Soldering iron holder

Model HC-7 holder/tip cleaner accommodates ESICO and other miniature offset soldering irons. Tip

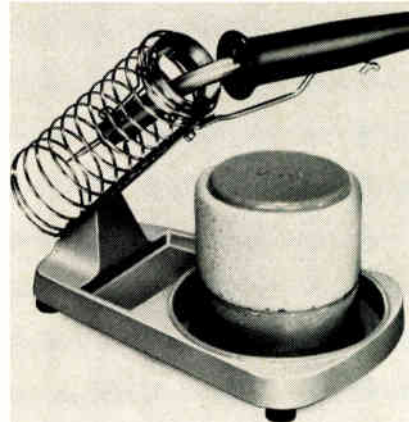

cleaner uses vertical sponge wrapped around water reservoir; soldering iron tips are stroked against the sponge to remove residues which fall into base tray. \$16.00. Electric Soldering Iron Co., Deep River, Conn. 06417.

Circle 150 on Reader Service Card

5-kW follow spot dimmer

The 5-kW follow spot dimmer consists of lightweight, compact and portable 120/150 volt solid-state



dimmer, a dimmer controller and a boost transformer (accessory). Convection cooled dimmer includes

CCTV system

Alpha II is closed circuit TV system featuring 4- X 3.5- X 2-ft PC-1 compact control console. Console is



designed to handle STV-1, STV-2 and STV-4 cameras and to record on DP-1 videotape recorder using 1/2-in. tape. Components of Alpha II's instructional training system include: two STV-4 cameras, two DPZL-41 zoom lenses and two DPM-1 8-in. monitor receivers. The system is self-contained in five compact carrying cases which can be assembled to function as mobile console. System will be marketed to industry, business, schools, medical institutions and government agencies. \$9445 for two-camera system. Diamond Power, Lancaster, Ohio 43130.

Circle 149 on Reader Service Card

maximum performance package

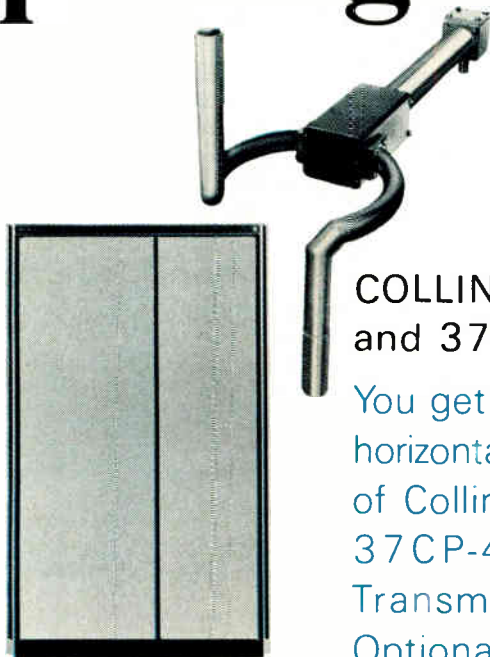

COLLINS 2-kw FM Transmitter and 37CP-4 Antenna

You get economy in Class A vertical and horizontal polarization with these features of Collins' 831D-1 FM Transmitter and 37CP-4 Antenna: **831D-1** 2-kw Transmitter • All solid-state exciter.

Optional stereo and/or SCA generator available as plug-in modules. • Local or remote control and monitoring. • Adaptable for fully automated broadcast facility. • Self-monitoring. Automatic control and protection circuits for power output, fault, overload, and start/stop cycle. • One-tube design. • Front-of-cabinet access for easy maintenance. • Small, free-standing cabinet (40-13/16" wide x 69" high x 22-1/4" deep). **37CP-4** Circularly Polarized Antenna • 4-bay clockwise circular polarization. • Minimum windloading. • Low VSWR. For additional information on the most advanced 2-kw transmitter and antenna in the industry, contact a Collins sales engineer or Collins Radio Company, Broadcast Sales, Dallas, Texas 75207. Phone: (214) AD 5-9511.



COMMUNICATION / COMPUTATION / CONTROL

Circle 116 on Reader Service Card

Canon has a 45X zoom range.



Divided six ways, that gives you your choice of 4X, 5X, 6X, 8X, 10X and 12X zoom ratios—more tv zooms than anybody else can offer you.

All six have interchangeable rear drives for any Vidicon camera (if you have more than one kind of camera, you can swap your Canon zooms around the studio as needed). All six are available in motorized remote-control versions, too.

Need zooms for Plumbicon or Image Orthicons? We have them, too. Plus fixed focal length lenses for every "C" mount application. All with the optical precision for which Canon is famous. Write for full information.

The lens you need is made by

Canon

Canon U.S.A., Inc.
64-10 Queens Boulevard
Woodside, N. Y. 11377

Please send information on
 manual zooms,
 remote-control zooms,
 fixed focal length lenses
 for Vidicon, Image
 Orthicon, Plumbicon
 TV cameras.

Name _____
 Title _____
 Company _____
 Address _____
 City _____
 State _____ Zip _____

Circle 117 on Reader Service Card

hanger brackets and built-in filter which reduces I=A filament "sing" and rf interference. Boost transformer is equipped with power tap selector switch for voltage control which permits operation of a follow spot at more than 120 volts. Dimmer is priced at \$365 and boost transformer at \$225. Berkey-ColorTran, Inc., 1015 Chestnut St., Burbank, Calif. 91502.

Write on company letterhead.

Microphone mixer

Model M67 microphone mixer/remote amplifier for studio and remote broadcasting and recording and sound reinforcement applications provide four low-impedance bal-

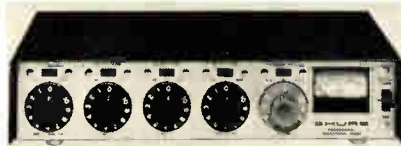

anced microphone inputs, one line input and line and microphone outputs. Size is 11 3/8 in. X 7 1/2 in. X 2 1/2 in. Weight is four lb, three ounces. \$147. Battery supply is \$12.60 additional. Shure Brothers, Inc., Evanston, Ill. 60204.

Circle 151 on Reader Service Card

Television demodulator

TD-2200 television demodulator is capable of accepting any vhf or uhf input. (TD-2200V is vhf model and TD-2200U is uhf model.) Front end is available with standard solid-state printed circuit board or with tuner for flexibility. Demodulator is



self-contained, all silicon and controlled by crystal local oscillator. Age action produces 1-dB change at output for a 60-dB swing on the input. Packaged in 5-1/4 in. high cabinet that mounts in standard 19 in. rack, the unit is 12 in. deep and weighs about 10 lb. Catel Corp., Belmont, Calif. 94002.

Circle 152 on Reader Service Card

Sync generator

Model ST 600 for broadcast, ETV, CATV or Industrial Television systems is self-contained and generates composite sync, mixed blanking, horizontal drive and vertical drive pulses. It is capable of operating in

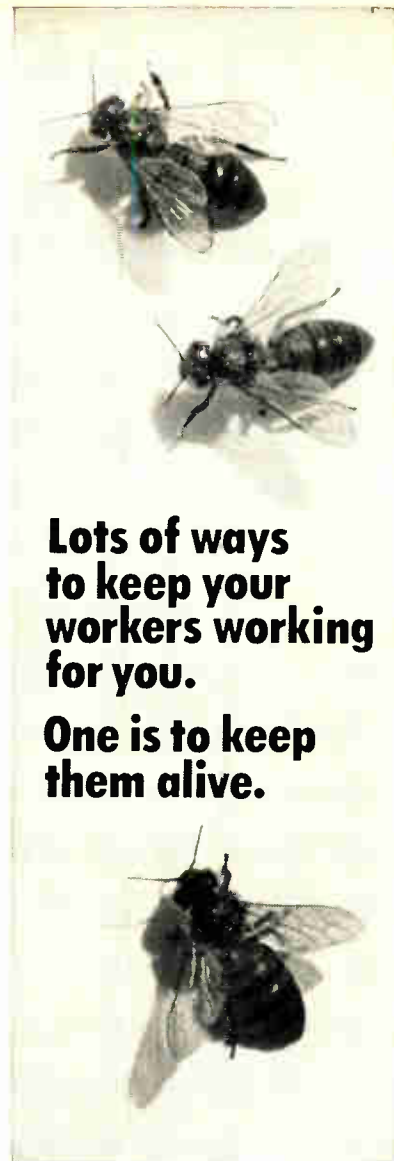

**Lots of ways
to keep your
workers working
for you.**

**One is to keep
them alive.**

And we want to help. With a comprehensive employee education program. That tells your people life-saving facts about cancer. And how their doctors can spot it early—when most cancer is beatable.

We have free films, exhibits, speakers, booklets, articles for your house organ. Tell your local American Cancer Society Unit your plans, and they'll work with you.

Because we want you to keep your workers. By keeping them alive.

**american
cancer
society**

This Space Contributed by the Publisher





*no credibility
gap*

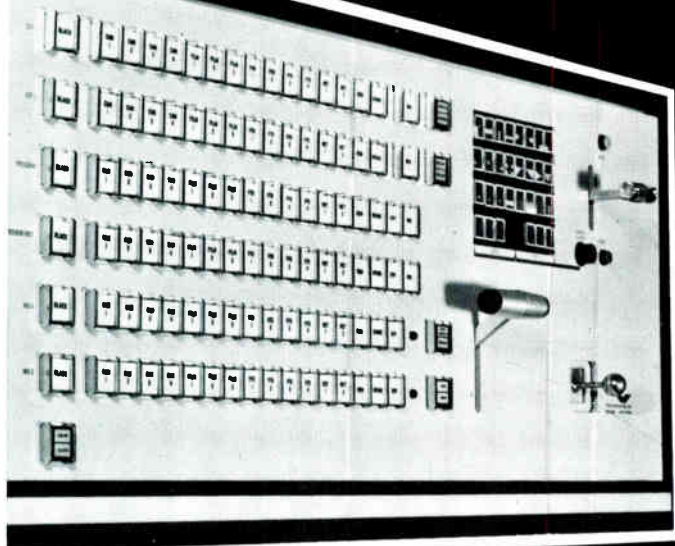

FIRST VIDEO SWITCHER
TO USE DIGITAL
COMPUTER TECHNIQUES

in a Vital
**VERTICAL
INTERVAL
SWITCHER**



it keeps performing and outperforming

Give your production people a Vital Industries switcher and make them feel like "Cecil B. De Mille". The VIX-108 vertical interval switcher is like a computer... a real money-making production tool. You no longer have to search and wonder if your video is composite or non-composite, synchronous or not, equalized re-entry or not, burst on black or not, etc. The VIX-108 thinks for you and minimizes errors caused by the unfamiliarity of the operator with color electronics.

FEATURES:

- Extensive use of integrated circuits with solid state cross points for long term stable performance.
- Basic matrix housing 108 crosspoints and associated logic and output electronics, comes in 5¼" of rack space and has no coax inter-connections. This means no delays of signals in any path and no crosstalk.
- Production oriented design with automatic sync and clamping on all inputs for bounce-free switching of video with varying luminance levels.
- True composite additive/non-additive mixer with automatic inhibit of non-synchronous dissolves.

- Fade network color to network black burst with automatic inhibit.
- Fade to monochrome, maintain color burst or choose to drop color burst. Only one reshaped burst and constant level sync during all dissolves.
- Custom built production or routing switching with the latest state of the art accessories designed as an integrated system are all furnished by Vital Industries, Inc.

OTHER VITAL PRODUCTS:

- VI-1000 video proc. amp. with automated features.
- VI-500 stab. amp. with AGC.
- Video and pulse distribution equipment.

Selecting the right switcher is Vital

GOOD ENGINEERING IS VITAL

Play it safe... Call N. Donoyan



VITAL INDUSTRIES, INC.

3614 SOUTHWEST ARCHER ROAD
GAINESVILLE, FLORIDA 32601 - PHONE (904) 378-1581

Circle 119 on Reader Service Card

THE NEW AMPEX BC-210 is the first two-Plumbicon* tube color camera that gives you an easy answer to your need for full studio performance plus fast-action field portability—at a price that makes it easy to buy.

The BC-210 color camera can do both studio and remote colorcasting easily. It weighs less than 50 lbs. without lens. The cable, which severely limits other cameras, is less than 1/2 inch in diameter and weighs only 12 1/2 lbs. per 100 feet. A technician can easily

Give your crew a break

STATION MANAGER EXULTS:

The easiest thing about the new BC-210 is owning it. For the price of two big heavy cameras we can get three of these and have some cash left over. We should be able to get more work done in a lot less time and with fewer people, thanks to that new light-weight cable.

SALES MANAGER SAYS:

We can't work any harder, we've got to work smarter. That's why we invested in the BC-210. It puts out color pictures advertisers can admire for themselves. Plus it has easy portability for location work which opens up all kinds of new business.

FLOORMAN SAYS:

I'm sure looking forward to working with that new light cable the BC-210 uses. It's hard to believe that 3000 feet weigh only 375 pounds—compared to 3000 pounds for conventional cable.

And for remotes, the camera lifts right off the tripod with its own handle and sits on a clear, smooth underside. It's plenty rugged because it's all solid state.

shoulder 300 or 400 feet of cable for fast-reaction coverage of local news or sports. And maintenance is easy too—kept easy by the simple design. If you want to lift your station to the top of your market, do it the easy way: the BC-210 color camera.

For complete information, call your Ampex man or write the Video Products Sales Manager at our world headquarters: Ampex Corporation, 401 Broadway, Redwood City, California 94063.

with our new BC-210...the easy color camera

CAMERAMAN SAYS:

Think of it—a color camera with only three little knobs under the big bright viewfinder (which is removable!) At last I'll be able to concentrate on being creative with my camera instead of being its slave.

VIDEO ENGINEER SAYS:

Talk about easy! Set-up time on the new BC-210 should let me get home without a wilted collar once in a while. All major controls are at the CCU. Give it a five minute warm-up, register one channel, and you're ready to go.

CHIEF ENGINEER SAYS:

It will be a great change to see my crew go home once without looking like they've gone five rounds—with less griping about heavy this and complicated that.

AMPEX

Hickok CRO 5000 25 MHz Oscilloscope (all solid state)



\$650⁰⁰

This high-precision laboratory oscilloscope equals the basic performance of higher priced, sophisticated 'scopes, yet meets the industry need for such performance in the \$600 price range. Emphasis has been placed mainly upon those characteristics most important in precise measurements, eliminating some of the more exotic and somewhat superfluous functions found in higher priced instruments. The result is an all-solid-state instrument in the medium price range with extraordinary stability, sensitivity, bandwidth, sweep-speed range, trigger capability, reliability, and ruggedness.

- 25MHz vertical bandwidth (to 3db down points)
- Usable to 50MHz
- All solid state for high stability and reliability
- 12 calibrated vertical attenuator ranges
10 mv/div to 50 volts/div ($\pm 3.0\%$ accuracy)
- 24 calibrated sweep ranges
0.05 microseconds/div to 2 sec/div ($\pm 3.0\%$ accuracy)
- Vertical delay line assures viewing of full leading edge of pulses
- "Sweep Delay" of up to 40 divisions
- Sweep speed continuously variable between ranges
- X-axis channel bandwidth DC — 5MHz
- 4" flat-faced CRT, 6 x 10 division graticule
- 3.8 kv HV provides sharp, bright trace
- Vertical amplifier will handle overloads, with negligible distortion of waveforms increased to 5 times screen height
- Internal 1.0% calibration squarewave
- Fast, convenient push-button selection of trigger modes
- Positive, solid triggering on all displays
- Small — 11 $\frac{1}{4}$ " W, 6 $\frac{7}{8}$ " H, 19" D; 24 pounds

HICKOK ELECTRICAL INSTRUMENT COMPANY, 10514 Dupont Ave., Cleveland, Ohio 44108
Circle 122 on Reader Service Card

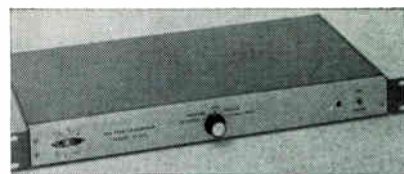

INT., CRYSTAL, LINE, or SYNC LOCK modes. The unit uses integrated circuits, all voltages are electronically regulated and all outputs are short circuit proof. Models are available for 525/625/729/873/945 and 1029 line TV-systems. \$595. Semcotronics, Belmont, Calif. 94002.

Circle 153 on Reader Service Card

Tool kit

Industrial tool kit (25-piece) in 6- $\frac{1}{2}$ x 6 x 19 in. steel box is primarily useful for electrical, sound and communications maintenance and installation work. Optional tools that can be added to the kit include a $\frac{3}{8}$ -in. electric drill and a set of 14



high-speed drills in metal case. \$90 (complete with drills). Jensen Tools and Alloys, Phoenix, Arizona. 85018.
Circle 154 on Reader Service Card

Vhf power tetrodes

The 7527A and 8438A power tetrodes for vhf amplifier, oscillator and modulator service in broadcast and communications systems are the first tubes in this power class to have mesh cathode and graphite anode. Mesh cathode provides greater strength, eliminates noise caused by vibration, reduces hum to better than -60 dB and operates at lower cathode loading factor; graphite anode prevents temporary overload damage. They differ from each other by use of metal shell on base of 8438A. Amperex Electronic Corp. Professional Tube Division, Hicksville, N.Y. 11802.

Circle 155 on Reader Service Card

Uhf wattmeter and matching indicator

Type NAU uhf wattmeter and matching indicator provide simultaneous measurement of incident and reflected power on two meters, eliminating need for switching or

New QUALITY LOCAL-ORINATION PROGRAMMING

Just \$220 starts you on your way



LOW COST... FIELD-PROVEN DESIGN... EXTREME FLEXIBILITY

If you are planning a local origination studio, you'll need all three. And you get all three in DYNAIR equipment, which provides professional quality and professional effects in your local-origination distribution and programming at true budget prices.

Want to start small? For just \$220 you can use the VS-220A MINI-FADE (above) to mix or fade between the outputs of two cameras or other non-composite video sources. Or for only \$550 more, you can add the SE-260A MINI-SPLIT (left) for professional effects like the inserts or wipes shown below.

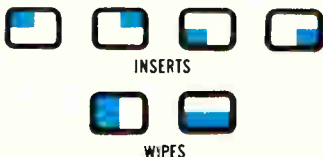

Or would you like complete color-compatible facilities for any degree of fade-in, fade-out, lap dissolve or superimposition, with up to 12 inputs and preview buss? The solid-state VS-121B-RS Remote-Controlled Broadcast Switcher-Fader (below) will do it all for just \$2250.

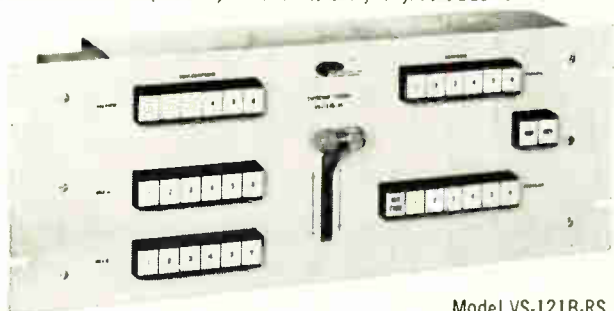

Model VS-121B-RS

FOR THE IMPORTANT EQUIPMENT BETWEEN CAMERA AND MONITOR...

Switches... Sync Generators... Video and Pulse Distribution Amplifiers... Screen Splitters... Audio/Video Modulators...

LOOK TO DYNAIR

HERE'S WHAT TO DO:

First: Send today for a set of DYNAIR Application Engineering IDEAS. Second: Outline your requirements. Third: look over our firm quote on a programming system designed specifically for your job. Finally: just turn on the equipment and send your subscribers programs equal to the best.

TAKE
STEP
ONE
NOW



MS

DYNAIR
ELECTRONICS, INC.
SAN DIEGO, CALIFORNIA

6360 Federal Blvd., San Diego, Calif., Zip 92114
Phone (714) 582-9211

Name _____

Title _____

Company _____

Address _____

City _____

State _____ Zip No. _____

Circle 123 on Reader Service Card



MAGNE-TRONICS, a program service of the very finest quality for transmission via FM multiplex, wire line, CATV, or for on-location music systems.

for complete details; write or call **MAGNE-TRONICS INC.**
 212 532-3832 21 East 40th Street, New York, N.Y. 10016
 Circle 124 on Reader Service Card

DIGILOGIC

Discover how digital computer techniques have revolutionized television broadcast equipment.

From:

 **SARKES TARZIAN SYSTEMS**
 Bloomington, Indiana

Circle 125 on Reader Service Card

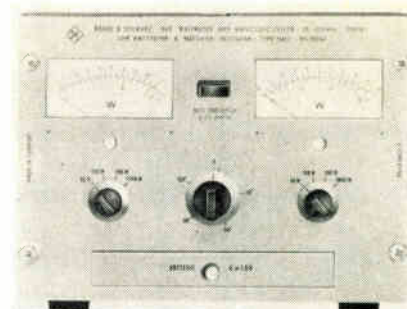

replacement of plug-in elements. Meter frequency range is 25 MHz to 500 MHz, available in two models—one from 50 mW to 31.6 W; the other from 2 to 1000 W. Unit's VSWR of less than 1.02 percent permits measurement of reflective coefficients as low as 5 percent. Special features include power consumption of less than 0.15 dB maximum at 500 MHz and automatic cutoff by timer. Fully transistorized instrument is ready for operation five seconds after turn-on. Price is \$1295. Rohde & Schwarz.

Circle 156 on Reader Service Card

Terminated tap

Model TTM-4-7 terminated tap unit features directional coupling, hybrid design for flat response and a band-



pass of 50 MHz to 300 MHz. Tap has attenuation figure of 6-1/2 dB. \$14. C-Cor Electronics, State College, Pa. 16801.

Circle 157 on Reader Service Card

Dual-cable CATV switch

Type 300-10100 switch mounts on the rear of cable subscriber's TV receiver with the pressure sensitive adhesive panel provided; or it may be mounted with screws on a nearby wall. It is connected between the dual-cable leadin and the antenna terminals of the set, enabling subscriber to switch between two sets of 12 CATV channels. Crosstalk specification for switch is -55 dB at 216 MHz; impedance is 75 ohms. Type 300-10100 measures 2 1/2 x 1 1/2 in., including connectors. Switch is priced at \$4.25 in quantities of 5000. Amphenol RF Division.

Circle 158 on Reader Service Card

**"Look, fellows, if you want
to get ahead
in this business,
you've gotta have
the right connections."**

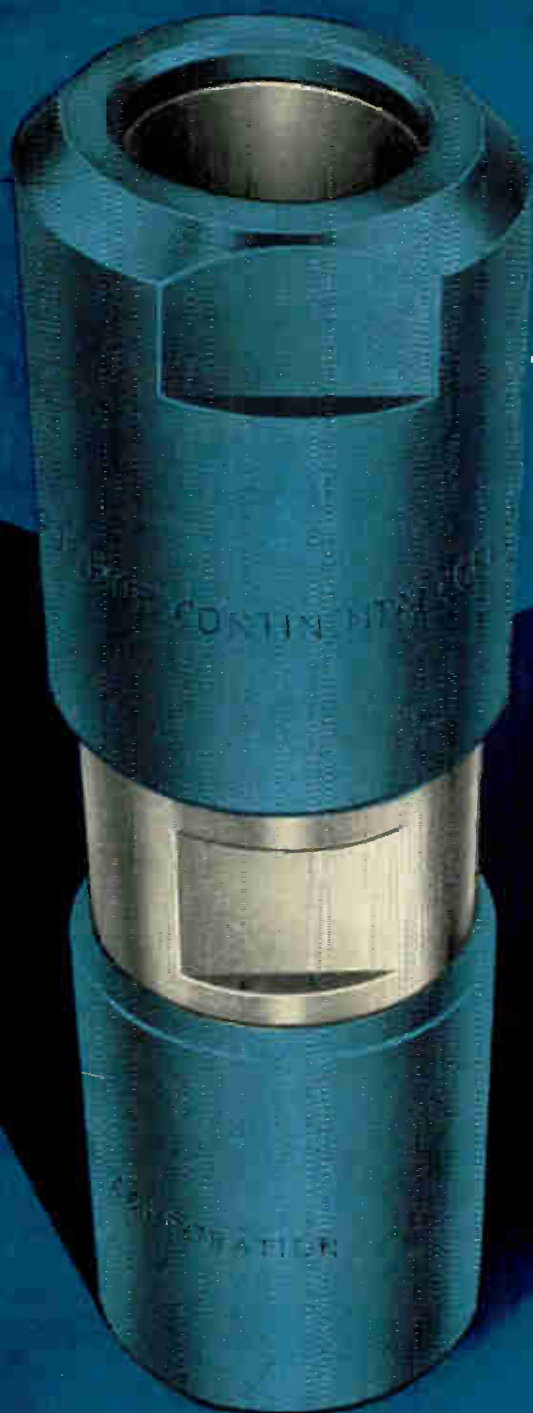

That's a fact of life. If you want to go anywhere in the TV world, your future is in the grip of your connections.

Take Superior Continental Connectors, for instance.

They really snuggle up to you. Keep out the weather. Prevent conductor pull-out. And if you're concerned about your outer conductor,

they'll maintain its integrity.

Like I say, fellows . . . if you're gonna go anywhere, go first class. Insist on quality. Things like silver-plated contacts. Teflon* insert. Iridized body. Anodized grip nut. And a heavy-duty weather seal that protects your backside.

That's what you get when you pick the right connections. But,

then, who would know more about coaxial connectors than the leading producer of coaxial cables? And that's Superior Continental.

Get the connection?

For information and prices, write or call:
Superior Sales and Service Division
P. O. Box 2327 Hickory, North Carolina 28601
Phone 704/328-2171



*DuPont Trademark

Circle 126 on Reader Service Card

Fujinon F 1.8/20-100 push rod type



Fujinon F 1.8/20-100 motor zoom type



Fujinon F 1.8/20-100 standard type

FUJINON the sharpest eye for CCTV or CATV cameras

Vidicon cameras go sharp via Fujinon lenses. With focus and zoom extremely smooth and noiseless. Image remaining constantly in focus throughout the

zooming range. And compact and streamlined design to simplify, while enhancing, the operation of every CCTV or CATV camera. To be sure yours are... specify Fujinon.

FUJI PHOTO OPTICAL CO., LTD.

No. 324 1-chome, Uetake-machi, Omiya City, Saitama Pref., Japan CABLE ADDRESS: FUJIKOKI OMIYA
Circle 127 on Reader Service Card

HAVING A PROBLEM MATCHING STEREO CARTRIDGES TO YOUR MONO CONSOLE???

THE 602-I.M.P. . . .

**IMPEDANCE MATCHING
PRE AMP MAY BE THE
ANSWER . . .** The 602-I.M.P. is a self-contained FET solid state pre-amp designed to match a 47, K stereo cartridge to your 602-C equalizer or similar 600 Ω input device.

With distortion of less than 0.5% with 20 MV of input signal and noise levels lower than -70 DB, it offers Gray's typical

**"Truly
Professional
Performance."**

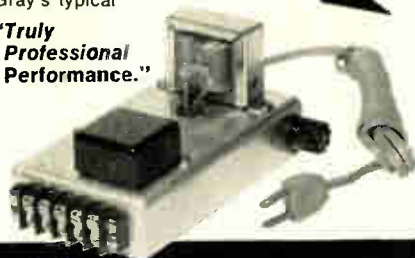

**GRAY RESEARCH &
DEVELOPMENT DIV.**
155 Park Ave.
East Hartford, Conn. 06108

Circle 128 on Reader Service Card

FAIRCHILD

FAIRCHILD'S PRECISION MAKES 57 OF THE WORLD'S FINEST PROFESSIONAL AUDIO COMPONENTS

. . . Fairchild's complete Series of Attenuators: 10 models with new packaging plus Slide Wire Fader / The Integra I Series: an automatic Attenuator, 3 Preamplifiers, 3 Compressors, 3 Program Equalizers, 4 Dynalizers, De-Esser / 692 Remote Card Series: over 12 inputs with extensive switching capacity / Integrated Control Module Series: Input-Output-Monitor Modules / 7 Audio Control Devices including the well known Conax, Limiter and Reverbertron Systems / 2 Gain Shifter Intercom Systems / 7 Power Supply Models / over 24 Accessories. Contact your Fairchild Distributor or write **FAIRCHILD RECORDING CORPORATION** Dept BM2, 10-40 45th Ave., L.I.C., N.Y. 11101.

Circle 129 on Reader Service Card

NAMES IN THE NEWS



Dr. Dennis Gabor



Sam T. Aed

The Royal Society—Britain's oldest scientific institution—has awarded the annual Rumford Medal to **Dr. Dennis Gabor**, staff scientist for CBS Laboratories, for his contributions to the optics field and for his discovering holography.

Sam Aed, engineering director of WABC radio, has joined the National Broadcasting Company as director of engineering for WNBC radio.



Jerry B. Minter

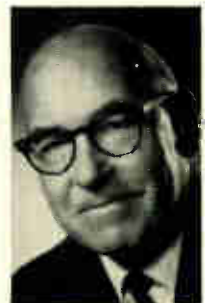

Raymond F. Guy

President of Components Corp., **Jerry B. Minter**, has been awarded the Armstrong Medal from The Radio Club of America.

Raymond F. Guy, employed in radio since 1916, has been named consulting engineer for Fort Lauderdale television station WSMS-TV, Channel 51.

FCC Commissioner **H. Rex Lee** has announced the appointment of **Ernest Theleman** as engineering assistant, **Fred M. Cohen** as special assistant and **Mrs. Mary Mulroe** as secretary.

Recipient of the National Association of Broadcasters' annual Engineering Achievement Award is **Jarrett L. Hathaway**, senior project engineer for NBC television network.

Continued on page 64

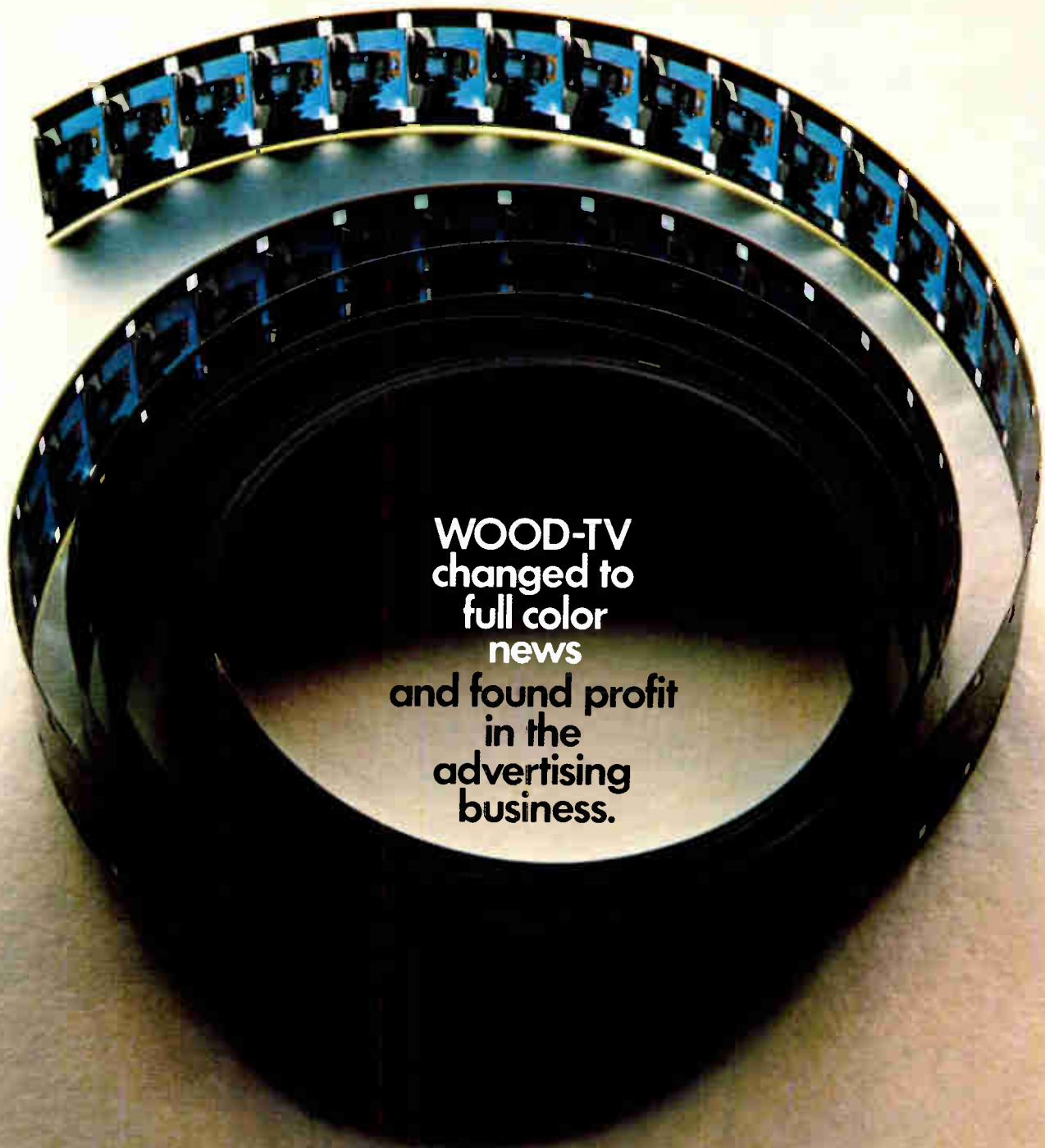

**WOOD-TV
changed to
full color
news
and found profit
in the
advertising
business.**

"We invested in the Kodak ME-4 Process for two reasons," says Del Blumenshine, Film Laboratory Supervisor for Grand Rapids' WOOD-TV. "One, we wanted the dramatic impact of color for our news coverage. And, two, we wanted to keep pace with our industry where the move is to full color.

"When we found we couldn't keep the processor busy with news, we started doing a bit of local commercial processing. Now we're working with local advertising agencies, local producers, and one independent syndicated television show which originates locally.

"The quality of our processing is what sold the commercial side of our business. The processor now works a

shift-and-a-half every day. The commercial work is paying our color processing bills and then some. It's made our switch to color film a lot more livable."

The Kodak ME-4 Process is a great investment. Processors are available

in many sizes, at many different prices. Chemicals come from Kodak packaged for easy use. And, Kodak experts help set the system up and are available to assist when needed. Call one of our Regional Chief Engineers for more detailed information. In Chicago, call Dick Potter. In New York, Ray Wulf is your man. John Waner is the one to call in Hollywood. Get with it.



World Radio History

EASTMAN KODAK COMPANY

ATLANTA: 404/GL 7-5211
CHICAGO: 312/654-0200
DALLAS: 214/FL 1-3221
HOLLYWOOD: 213/464-6131
NEW YORK: 212/MU 7-7080
SAN FRANCISCO: 415/776-6055

Kodak

Bauer AM Transmitter. Aft view.

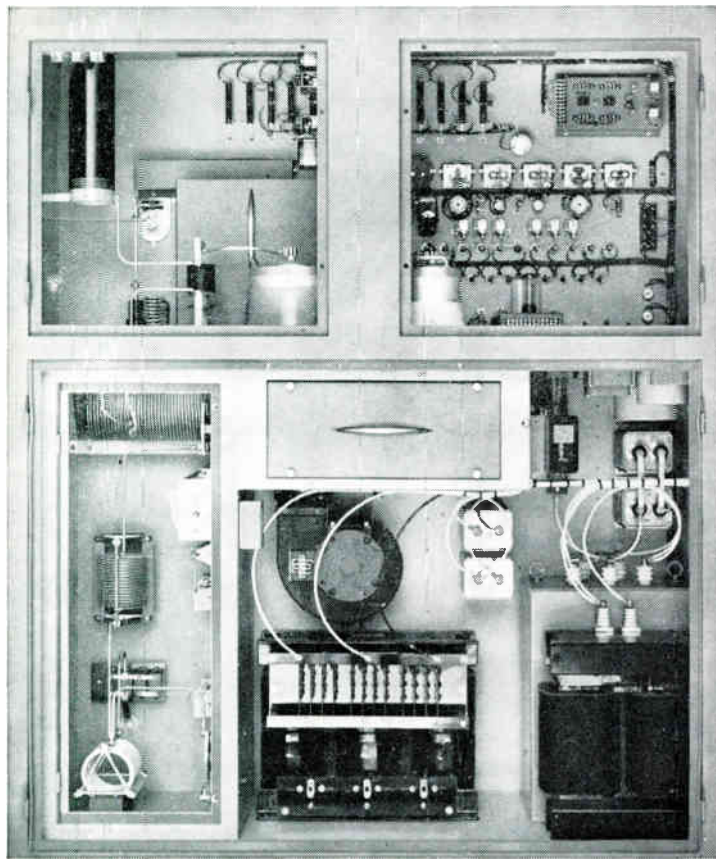

Clean.

This is the aft end of the all-new Bauer AM Transmitter from Granger. The 5 Kw Model FB-5V.

Look at its well-engineered mechanical layout. Clean. All components are arranged within easy reach for quick inspection and servicing. □ Model FB-5V is compact. Measures only 75"H x 60"W x 30½"D. In fact, it's the most compact 5 Kw AM transmitter on the market. □ Around in front, full metering shows all functions simultaneously. Tally-light system provides instant warning of any malfunction or momentary overload, permits fast reset to back-on-the-air status, and pinpoints the cause for later servicing. □ Compare its performance. Low distortion, wide frequency response and 6,000-watt power-plus capability. Excellent modulation capability — boosts signal in fringe areas and provides "clean" sound. □ Consider the cost-savings. The output tube's operating level has a service capability of more than 20,000 hours, proved in actual use. Save hundreds of dollars per year in operating costs. □ Need a higher kilowatt model? Ask us about the all-new 10 Kw Model FB-10J. It has the same clean, compact features as the FB-5V, with 12,000-watt power-plus capability. □ Write for complete data.



Granger Associates / **Bauer**
BROADCAST PRODUCTS DIVISION

1601 California Avenue, Palo Alto, California 94304

Circle 130 on Reader Service Card

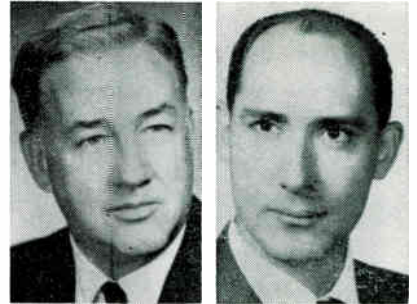

Maurus C. Logan

Anthony N. English

President of Thomas & Betts Corp., Robert McK. Thomas, has announced the appointment of **Maurus C. Logan** as vice president, product research.

Anthony N. English has been named vice president and general manager of United Recording Electronics Industries.

John S. Auld has been elected president of Philips Broadcast Equipment Corp. Auld succeeds Matthew Dornbosch.

Promoted to Jerrold Electronics Corp.'s three recently created positions are: **Jerry Hastings**, director of marketing for entire company; **Robert L. Toner**, administrative assistant to the executive vice president; **John Dieckman**, manager, systems development, of Community Operations Division.

James H. Smith has joined General Recorded Tape, Inc., as senior mechanical engineer.

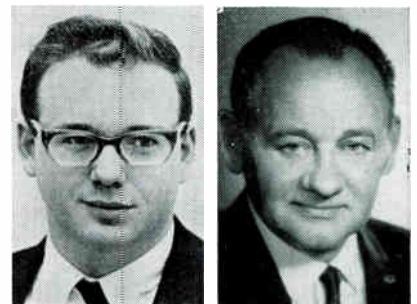

Robert Johnson

J. L. Shimansky

Robert Johnson has assumed the post of project engineer in newly formed CATV Division of Aqua Instrument Co.

Frank A. Gunther, president of Radio Engineering Laboratories, has announced the appointment of **John J. Shimansky** as vice president of manufacturing.

**This was the E-V Model 635.
It started a tradition
of excellence in
dynamic microphones.**

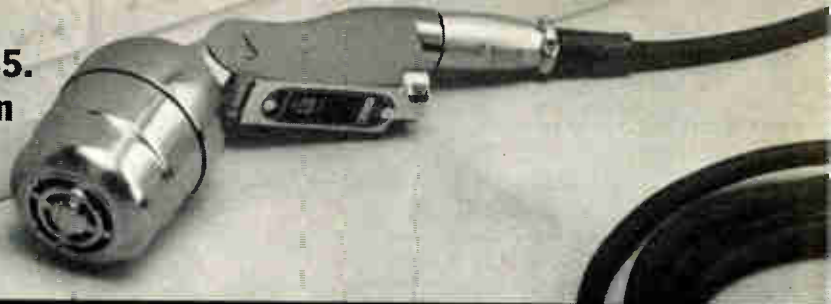

**This is the new
E-V Model 635A.
It's better
in every way!**



Model 635A Dynamic Microphone \$82.00 List. (Normal trade discounts apply.)

E-V How can a microphone as good as the E-V Model 635 be made obsolete? By making it better! It wasn't easy. After all, professional sound engineers have depended on the 635 since 1947.

During this time, the 635 earned a reputation for toughness and dependability that was unrivalled by other omnidirectional dynamics. And internal changes through the years have kept the 635 well in the forefront of microphone design.

But now the time has come for an all new 635: the Electro-Voice Model 635A. It's slimmer, for easier hand-held use. Lighter, too. With a slip-in mount (or accessory snap-on Model 311 mount) for maximum versatility on desk or floor stands. The new, stronger steel case re-

duces hum pickup, and offers a matte, satin chromium finish perfect for films or TV.

The new 635A is totally new inside, too—and all for the best. A new four-stage filter keeps "pops" and wind noise out of the sound track, while guarding against dirt and moisture in the microphone, completely eliminating any need for external wind protection. Of course you still get high output (—55db) and smooth, crisp response. And you can still depend on the exclusive E-V Acoustalloy® diaphragm that is guaranteed against failure for life* (it's that tough)!

We expect to see plenty of the "old" 635's in daily use for years. But more and more, the new 635A will take over as the new standard. It's easy to find out

why: just ask your E-V Professional Microphone distributor for a free demonstration in your studio. Or write us today for complete data. We'll be proud to tell you how much better the new Model 635A really is!

*The E-V Professional Microphone Guarantee: All E-V professional microphones are guaranteed UNCONDITIONALLY against malfunction for two years from date of purchase. Within this period, Electro-Voice will repair or replace, at no charge, any microphone exhibiting any malfunction, regardless of cause, including accidental abuse. In addition, all E-V microphones are GUARANTEED FOR LIFE against defects in the original workmanship and materials.

ELECTRO-VOICE, INC., Dept. 291EM
614 Cecil Street, Buchanan, Michigan 49107

Electro-Voice®

A SUBSIDIARY OF GULTON INDUSTRIES, INC.

Circle 131 on Reader Service Card

World Radio History

NEWS

Continued from page 11

lator would bring Prescott the same services off-the-air as are provided by H&B.

H&B contended that the translator would cause interference to reception by subscribers on cable Channel 2 and would also cause adjacent channel interference to the system's reception of signals of TV Channel 3, Phoenix.

FCC grants licenses renewal, modification

In an initial decision, the FCC has granted the applications of Potomac Valley Telecasting Corp., Irons Mountain, Maryland, for modification and renewal of licenses of point-to-point microwave common carrier stations KGO-30 and KOX-32.

The grant is subject to the condition that the common carrier stop serving one of the CATV systems, Potomac Valley TV Co., if the CATV system doesn't give carriage and nonduplication protection to station WJAC-TV, Johnstown, Pa., in areas which are

penetrated by the measured Grade B contours of WJAC-TV.

The four TV stations had asserted rights to carriage and nonduplication protection under Section 21.712 of the rules. The CATV customers filed petitions asking waiver of 21.712 on the ground that their areas are not within the "measured, as distinguished from the predicted" Grade B contours of the stations.

Distributors group formed in Washington

The Master Systems Distributors Association, a group of prominent video equipment distributors from across the country, was formed at the convention of the National Association of Educational Broadcasters in Washington, D.C., last Nov.

Officers were chosen and objectives were set at the group's first meeting late in Nov. John B. Klindworth, president of K&M Electronics, Minneapolis, indicated that among the objectives are promoting professionalism among member firms and users providing television equipment users with a nationwide organization of competent distributors.

CATV

Continued from page 12

The new rules don't clearly spell this out although it's been the Commission's recent strategy to encourage or even force the granting of such rights. Perhaps Senator McClellan and his colleagues and advisors in the Hill will be able to clear up this sticky point in the not-too-distant future.

N.Y.C. grants permission for limited originations

New York city's Board of Estimate granted the city's three cable systems the right to originate programming late last year, provided that they refrain from showing "pure entertainment movie films" and professional sporting events normally excluded from transmission on on-air television.

Reacting to the Board's decision, Charles F. Dolan, president of Manhattan Cable Television said: "We are delighted that the Board of Estimate has authorized Manhattan Cable Television viewing more interesting and more rewarding."

TAPECASTER®

T C M

Tapecaster models are head and shoulders above the rest

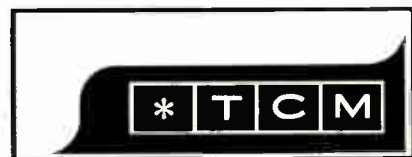
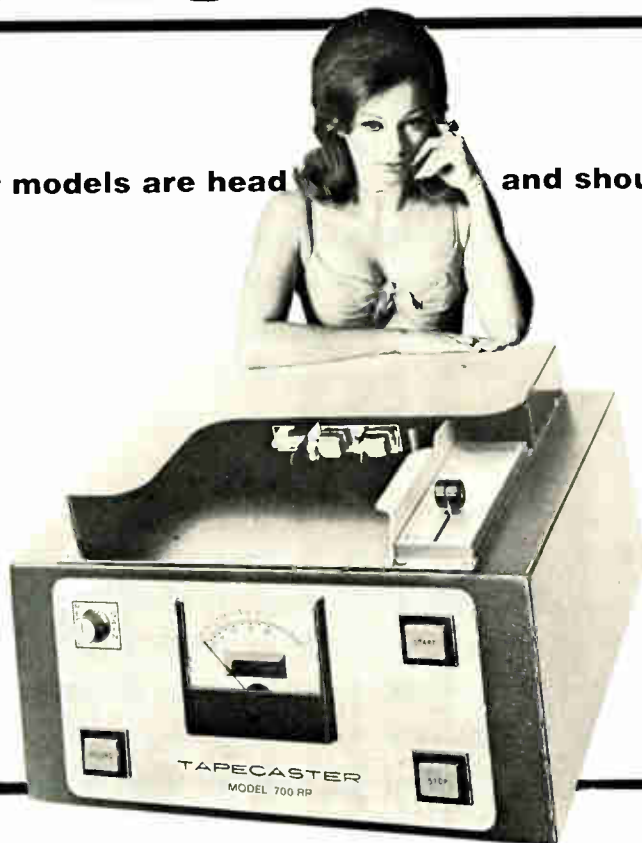

TAPECASTER

Box 662 — 12326 Wilkins Avenue
Rockville, Maryland 20851
Phone: (301) 942-6666

Circle 132 on Reader Service Card

3 ALL NEW AUDIO CONSOLES from GATES

Plug-in silicon amplifiers • 20-20,000 cycle response

Solid state, all new – inside and out. Featuring 100% silicon transistors. All amplifiers and DC power supplies plug in. All three consoles feature 20-20,000 cycle frequency response, with less than 1 db variation. At all frequencies, distortion is less than 0.5% at rated output. Write for complete details. You'll wonder how we could build so much into such compact, handsome packages.

Stereo Statesman

The Gates Stereo Statesman features 5 full stereo mixing channels from 11 inputs. Full logic audio switching. New illuminated program keys... exciting new packaging concept.



Dualux II

The Dualux II provides monophonic and stereophonic mixing facilities separately or together. Designed to control AM and FM, FM Stereo and SCA from one control point. Features 8 mixing channels, 13 mono sources and 6 stereo sources... a total of 22 audio inputs, plus inputs for automatic programming equipment and an SCA audio signal.



Gateway II

The Gateway II with 8 monaural mixing channels from 18 inputs features in-built cue/intercom system; provision for remote announcer operation of studio microphone channels, and a novel variable equalizer for special effects or line correction.



GATES

GATES RADIO COMPANY
QUINCY, ILLINOIS 62301, U.S.A.
A subsidiary of Harris-Intertype Corporation

Circle 133 on Reader Service Card

February, 1969—BM/E

MANAGEMENT Q&A

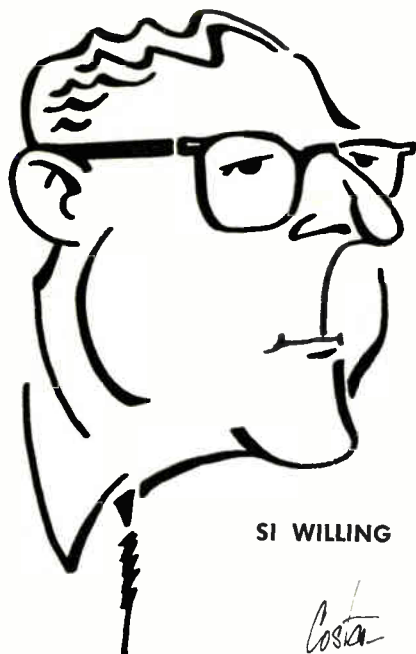

SI WILLING

Costa

Have questions on station management and sales? Ask Si. He'll draw on his many years of experience managing successful radio stations in a variety of markets. Si Willing

is president of KMAR (Winnsboro, Louisiana) and of KNNN Broadcasting Corp. (Friona, Texas). He's also chief exec of brand-new KCRF-FM (Winnsboro, La.) due to go on the air in May. Send your questions to: Si Willing, BM/E, 820 Second Ave., New York, N.Y. 10017.

Q. A sponsor caught me completely off guard. After running some very successful schedules and admitting to me that he was pleased with the response, our station's service, etc., he said, "Advertising on your station is eating into my profits." This was in response to my suggesting a bigger weekly schedule. When I asked him to explain what he meant he said, "Advertising is a *real* cost while the results add up to a *probable* gain." Now what?

A. Often what a man says and what he means are two different things. Sorry that I don't know what kind of an account you are referring to, but I'll bet he's the manager of a store that pays a yearly bonus. These stores usually deduct all costs before letting their managers share in the bonus; the bonus is computed based on the *net profit*. Since this man has already admitted that he was pleased with the response, he actually was telling you that he had made some sales as a result of his advertising. Remember, the *primary* effort of a sales campaign is to make *im-*

mediate sales. The *ultimate* result is to get new, steady customers. If this man spent \$100 with you and he sold an equivalent amount of merchandise, then he's even-up. If he sold \$200, then he's 100% ahead and so on. Now, don't cave in when he tells you that his sales are not all profit, because neither are yours or anyone else's. We must talk in terms of *gross* income. He received \$200 as a result of \$100 spent with you; forget the margin of profit. Carefully and cleverly explain to him that if he gained even just one steady customer as a result of his campaign, his one-time will continue to reap dividends indefinitely. If your man can scent the prospect of a bigger bonus for himself as a result of increased business that your station can create for him, he'll soon agree that you're right. The catalyst in this sales effort is your honest appraisal of his budget as it relates to the customer response.

Q. My problem is that I really *don't have* a problem. I've been in this market for over ten years, seeing the same sponsors, getting almost the same schedules, and have leveled off my gross to maximum potential, give or take a few hundred dollars every month. In the beginning, it was a challenge to get

new from Lipsner-Smith

LSC VEDETTE

16 mm and 35 mm
PROFESSIONAL
PROJECTORS

for fast, safe, high speed
viewing and inspection
of motion picture film

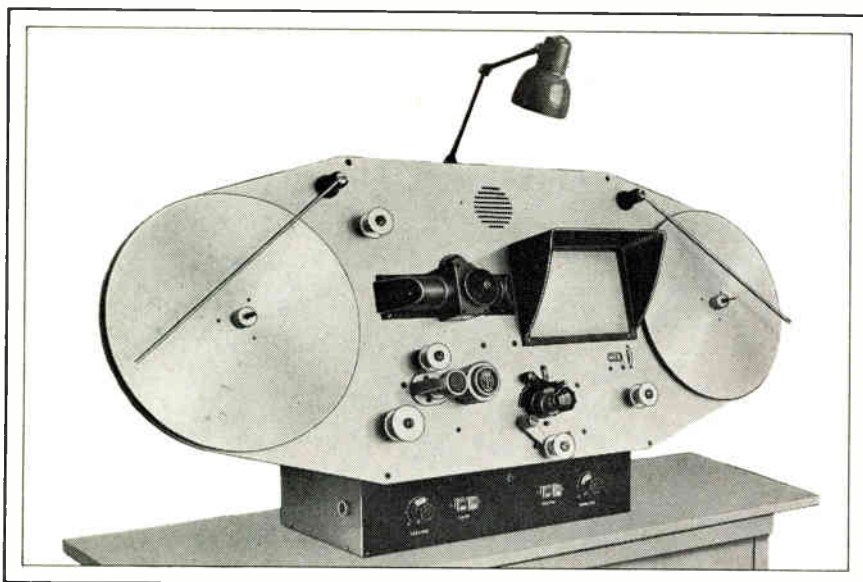

- The ideal machine for film quality control, timing and correction, and release print inspection. Handles negatives, fine grains and prints.
- Designed for visual inspection of both picture and optical sound track. Solid state amplifier for simultaneous monitoring of picture and sound.
- Features compare favorably with much more costly machines. Efficient revolving prism shutter and sharp optics produce bright, clear images in moderately lit rooms, without overheating film.
- Smooth, gentle film handling at up to 400 ft./min., without intermittent movement of usual claw or Geneva gear drive. Stable, positive focus. 2,000 foot film capacity.
- Designed by lab experts for day in-day out performance with minimum maintenance.

Write today for the LSC Vedette Bulletin or for a demonstration of this versatile projector.



LIPSNER-SMITH CORP.

7334 North Clark Street,
Chicago, Ill. 60626 312 • 338-3040

9635

Circle 134 on Reader Service Card

Circle 135 on Reader Service Card →

Look at the Difference



Unretouched photographs of 21" studio monitor. Photographic data: Rolleiflex C-3, CPS color negative film — ASA 100, 1/15 second at f/5.6

...after 3M Color Dropout Compensation

Here's what 3M's Color Dropout Compensator does for your VTR reproduction:

Look at this unretouched composite photograph of a studio monitor. It shows, at the left, a videotape playback with 13 electronically recorded-in dropouts. These dropouts were created by a special test generator which attenuates the RF level to the record driver. On the right, these dropouts have been completely restored by the DOC.

The black dropouts shown on the left are followed by a complete loss of color-lock in the direct color recovery equipment. Since these dropouts include horizontal sync and color burst, they cause transient color flashing not ordinarily attributed to the dropouts themselves. Even shallow dropouts can create a similar problem due to loss of side-band information.

Only the 3M Color DOC corrects all these effects.

After compensation, note the precise color match and complete freedom from switching transients. Also, the dropout disturbance to the time correction unit has been eliminated. Proc amp and

servo stability are improved to such a degree that it is possible to play this tape in full intersync or pixloc mode.

In the compensated half of the photo, compare the replacement material with the original signal two scan lines above the dropout due to a *complete* frame being photographed. Try to find the 13 switching transients.

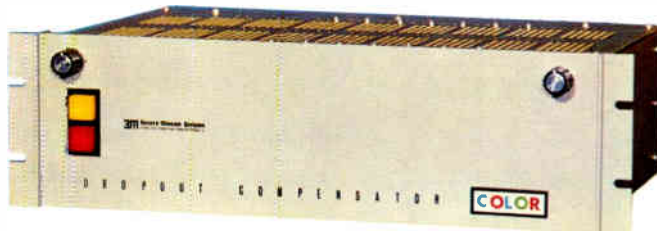

The 3M Color Dropout Compensator is the only system available that can provide proper color and luminance replacement. For details write for the booklet, "Compensating for Dropouts in Color Television Recording."

Mincom Division **3M**
COMPANY
300 SOUTH LEWIS ROAD • CAMARILLO, CALIFORNIA 93010

new accounts, but now I feel like an order taker. How can I stimulate sales, what should I do? I am in a small market where new sponsors seldom move in. I like this place, the station and everything else, but I'm getting bored. Please advise.

(Name withheld on request)

A. Yours is a common problem so don't get into a feeling of depression. *Do something about it!* Carefully examine the list of your sponsors. Find out what percentage of their gross they should be using for advertising. For example, grocery stores should spend 0.9 percent of their annual gross for advertising; hardware stores, 2.0 percent; department stores, 5.8 percent; etc. These suggested budgets are recommended by the various industry trade organizations. Now do a little arithmetic. Are your sponsors spending what they *really* should spend for advertising? Mind you, the percentages that I quoted apply to *total* advertising budgets. But here's where market research comes in and here's where you can start a new ball game.

Check the newspapers, circulars,

etc., and estimate the costs of this kind of advertising. Then find out from your chamber of commerce or local state government how much retail trade is being done in these categories. This information is readily available from any agency that handles sales taxes. You can get a breakdown by county. Yours is a small town and you are probably in the largest town of your county so you can make a pretty good guess about how much money your merchants are grossing. With this information, you can also make a pretty accurate estimate about whether they're spending what they should for advertising. Then get to the fine point about whether you're getting your share of their budget. Now, determine how much more the merchants should be spending with you.

If you have a sponsor on a spot schedule, figure out a program to go along with his advertising or prepare some good reasons why you think he should increase his spot campaign. An advertising schedule can become static only if you let it! *Increase existing schedules if you have no new merchants to call on.* If you can't expand, you

build upwards. And while we're on the subject, I bet you haven't changed your programming much either. If you make changes, it will automatically affect your commercial advertising. From here, it looks like you have a real challenge to not only bring a fresh, new sound to your listeners but also use those program changes as sales tools when you figure out how to increase sponsor's schedules. If you're bored, that feeling is communicated to your staff and ultimately to your listeners and to your sponsors. So right now, start checking those budgets and pay more attention to the sound of your station. This isn't easy and you'll need help. Have staff meetings; get ideas and suggestions from your personnel. Ask listeners to become program directors and offer a dollar for each letter received with an acceptable programming idea. Then, take all of those letters and have some impartial judges select the best letter written in and give that person fifty dollars. That'll get action and also make your listeners feel as if they belong to your station. Audience participation is important. Don't ever become detached from your audience. **BM/E**

Russco
PROFESSIONAL QUALITY **Broadcast Turntables**

Heavy Duty, Quiet!

- Single lever controls 33, 45, speeds
- Plays 45 RPM's without adapter
- Illuminated speed indicators
- Sold with or without arm (GREY or REK-O-KUT)
- Instant acceleration
- Competitive low price
- Call or write for folder

SEPARATE TONE ARM MOUNTING PLATE — EASY TO INSTALL

PRICED FROM \$149.50 to \$179.50

SOLD DIRECT — OR TO DEALERS

RUSSCO Electronics Mfg.
6879 N. SUNNYSIDE, CLOVIS, CALIF.
PH. 299-4692

Circle 136 on Reader Service Card

Unlocking the Future

Electrical Electronics Engineering

4 FLOORS OF EXHIBITS
NEW YORK COLISEUM

48 TECHNICAL SESSIONS
NEW YORK HILTON

Monday through Thursday

- 48 TECHNICAL SESSIONS at the New York Hilton. Hours: 10:00-12:30; 2:00-4:30.
- FOUR FLOORS OF EXHIBITS at the N. Y. Coliseum including over 600 firms. Hours: 10 a.m.-8 p.m. 4 Days.
- GALA ANNUAL BANQUET—Wednesday 7:15 p.m. N. Y. Hilton Grand Ballroom — \$18.00.
- FREE SHUTTLE BUSES between the Hilton and the Coliseum — every few minutes.
- REGISTRATION — Good all days — Technical Sessions and exhibits. In and out privileges. — IEEE Members \$3.00. Non-members \$6.00. Ladies \$1.00. High School Students \$3.00 if accompanied by an adult — One student per adult; Thursday only — limit of 3 students per adult.
- REG-IDENT CARD speeds request for exhibitors' literature. Ask for one when registering.
- ESCALATORS/EXPRESS ELEVATORS to the Fourth Floor.

IEEE '69 INTERNATIONAL CONVENTION & EXHIBITION
MARCH 24-27, 1969

Circle 137 on Reader Service Card

February, 1969—BM/E

BUSINESS REPLY MAIL

NO POSTAGE STAMP NECESSARY IF MAILED IN THE UNITED STATES

FIRST CLASS

Permit No. 665
Duluth, Minnesota

POSTAGE WILL BE PAID BY



BROADCAST MANAGEMENT/ENGINEERING

Mactier Publishing Corporation

P.O. Box 1105

Duluth, Minnesota 55802

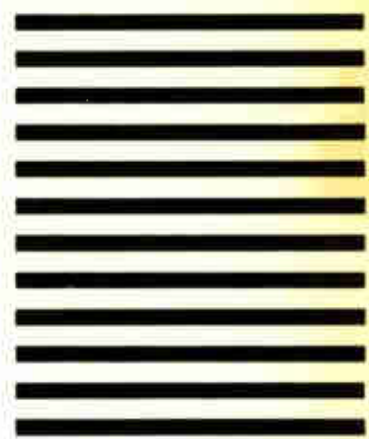

BUSINESS REPLY MAIL

NO POSTAGE STAMP NECESSARY IF MAILED IN THE UNITED STATES

FIRST CLASS

Permit No. 665
Duluth, Minnesota

POSTAGE WILL BE PAID BY



BROADCAST MANAGEMENT/ENGINEERING

Mactier Publishing Corporation

P.O. Box 1105

Duluth, Minnesota 55802



BUSINESS REPLY MAIL

NO POSTAGE STAMP NECESSARY IF MAILED IN THE UNITED STATES

FIRST CLASS

Permit No. 665
Duluth, Minnesota

POSTAGE WILL BE PAID BY



BROADCAST MANAGEMENT/ENGINEERING

Mactier Publishing Corporation

P.O. Box 1105

Duluth, Minnesota 55802

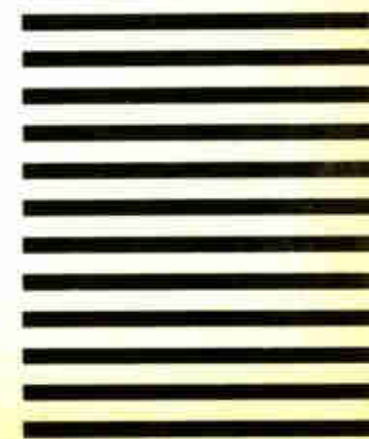

READER SERVICE CARD

BM/E - Broadcast Management/Engineering

Good until 4/30/69

GET MORE INFORMATION on products, free of charge. Just circle appropriate number below and mail card today.

Tell us what you like or dislike in this issue.

Pages # _____
Comments: _____

101	112	123	134	145	156	167	178	189	200	211	222	233	244	255
102	113	124	135	146	157	168	179	190	201	212	223	234	245	256
103	114	125	136	147	158	169	180	191	202	213	224	235	246	257
104	115	126	137	148	159	170	181	192	203	214	225	236	247	258
105	116	127	138	149	160	171	182	193	204	215	226	237	248	259
106	117	128	139	150	161	172	183	194	205	216	227	238	249	260
107	118	129	140	151	162	173	184	195	206	217	228	239	250	261
108	119	130	141	152	163	174	185	196	207	218	229	240	251	262
109	120	131	142	153	164	175	186	197	208	219	230	241	252	263
110	121	132	143	154	165	176	187	198	209	220	231	242	253	264
111	122	133	144	155	166	177	188	199	210	221	232	243	254	265

The information requested is for Immediate Use Future Use

YOUR NAME AND ADDRESS:

Name: _____
Title _____
Station or Company _____
Street _____
City _____ State _____ Zip _____

COMPLIMENTARY SUBSCRIPTION QUALIFICATION CARD

1. I would like to receive BM/E — Broadcast Management/Engineering Yes No

2. I specify purchase Capital Equipment
 approve the purchase of: Replacement Parts
 Services
 None of the above

AM FM TV Station(s)
 CCTV (Educational-Theatrical-Industrial)
 CATV Facility
 Telephone Company
 Government
 Other _____

3. My company is _____

4. I am responsible for Multiple Facility
 Single Facility

5. Your signature _____ Title _____ Date _____

6. The address below is correct

7. For Address Change — Give OLD Address below

NAME TITLE

Is this your business address?
 Yes No
If not your business address, please give us your business address below so that we can avoid sending duplicate copies.

STATION or CO.

STREET

CITY, STATE, ZIP

Firm Name _____ Business Address _____ City _____ State _____ Zip _____

READER SERVICE CARD

BM/E - Broadcast Management/Engineering

Good until 4/30/69

GET MORE INFORMATION on products, free of charge. Just circle appropriate number below and mail card today.

Tell us what you like or dislike in this issue.

Pages # _____
Comments: _____

101	112	123	134	145	156	167	178	189	200	211	222	233	244	255
102	113	124	135	146	157	168	179	190	201	212	223	234	245	256
103	114	125	136	147	158	169	180	191	202	213	224	235	246	257
104	115	126	137	148	159	170	181	192	203	214	225	236	247	258
105	116	127	138	149	160	171	182	193	204	215	226	237	248	259
106	117	128	139	150	161	172	183	194	205	216	227	238	249	260
107	118	129	140	151	162	173	184	195	206	217	228	239	250	261
108	119	130	141	152	163	174	185	196	207	218	229	240	251	262
109	120	131	142	153	164	175	186	197	208	219	230	241	252	263
110	121	132	143	154	165	176	187	198	209	220	231	242	253	264
111	122	133	144	155	166	177	188	199	210	221	232	243	254	265

The information requested is for Immediate Use Future Use

YOUR NAME AND ADDRESS:

Name: _____
Title _____
Station or Company _____
Street _____
City _____ State _____ Zip _____

LITERATURE OF INTEREST

For additional data, circle number shown on Reader Service Card.

Model 22-1187 ac power supply for CATV is the subject of Sola Basic Industries' four-page bulletin. Heart of the supply is constant voltage transformer. **200**

Closed-cell synthetic rubber sample is offered in a folder by Armstrong Cork Co. Rubber is recommended for ornament gaskets, sight glass seals and nonskid pads. **201**

Six-pound Packard Bell Model PB911 CCTV camera is featured in data sheet. **202**

"The FCC in Fiscal 1968, A Summary of Activities," includes a review of actions and statistical tables of stations in the services. **203**

Sample kit of emi/rfi shielding material used on electronic enclosures is available from Tecknit. **204**

Four printed circuit connector families—bifurcated bellows contacts, tuning fork contacts, preloaded cantilever contacts and modular plate assemblies—are described in 24-page catalog from Amphenol Industrial Division. **205**

Selection of relays is subject of 12-page brochure from Cornell-Dubilier Electronics. **206**

Magnetic reed switches' specifications are offered in 8-page, 2-color catalog from Gordos Corp. **207**

Six-channel model TAU-1 tolerance alarm unit for automatic transmitter loggers is described in bulletin from Moseley. **208**

3-dimension plotting system model 501-3, which automatically prepares multiuse 3-D models from digital magnetic tape, is available from Special Data Systems. **209**

Model G centraxial blower from Rotron is detailed in 4-page technical bulletin. **210**

104 ultrahigh purity elements and compounds for vacuum deposition and sputtering applications, listed according to chemical symbol, price per gram and purity in "nines," is the subject of Semi-Elements' brochure. **211**

TV camera lenses for educational, industrial and government closed circuit TV applications (**212**) and

portable closed-circuit videotape recorder are delineated in two brochures from Ampex. **213**

Underwater television is the subject of Cohu Electronics' eight-page, two-color treatise which includes 18 photographs. **214**

Deep-drawn aluminum boxes and covers and deep-drawn aluminum instrument housings are described in Zero Mfg.'s 48-page catalog. **215**

Five-channel plus audio auxiliary channel unit for small-to-medium markets—Autogram—is the subject of a brochure from Day Mfg. **216**

"Recording Basics" is the title of 3M Co.'s 24-page guide book for better use and understanding of magnetic recording tape. **217**

Low cost cold cathode display tubes—Datecon CT Series—are detailed in data sheet from Integrated Circuit. **218**

400 cycle ac brushless generator (219), ac generator brush type or brushless, class 720 (**220**) and belt drive motor-generator set (**221**) are subjects of bulletins from Kato Engineering Co.

High trackability "Easy Mount" phono cartridges, tone arms, styli and head-phone amplifiers highlight eight page catalog from Shure Brothers. **222**

Harmonic suppression filters, series FSW, are described in I-Tel's bulletin, 1929-25. **223**

Product file folder on Raytheon's infrared detectors and semiconductor lasers is available. **224**

Thermoformed cases, various dimensional changes and special hardware are detailed in Skydyne Inc.'s seven-page catalog. **225**

Large Scale Integration text of 105 pages is available from Integrated Circuit Engineering Corp. **226**

Nagra IV line of portable, synchronous tape recorders is featured in brochure from F&B/Ceco. **227**

QSA series of modular, convection cooled dc power supplies for system applications is the subject of eight-page catalog from Raytheon. **228**

"Television Display System, Fixed-Head Parallel Digital," and **"Servo Drive System,"** are titles of data sheets from Data Disc. **229**

2600 Series Video Multiplexer, new from Cohu Electronics, is detailed in technical data sheet 6-497. **230**



**THE
LEADER
IN
CATV
TOWERS**

*"Quality—Service
and Price!"*

Yes, quality, service and price on CATV systems are the reasons for Fort Worth Tower's position as the industry's leading supplier. Experience gained as a pioneer supplier of CATV enables Fort Worth Tower to provide you with a quality product at a price that is reasonable and attractive.

Take advantage of our experience. For assistance in systems planning, engineering and complete systems quotations . . .

CALL OR WRITE TODAY

Fort Worth Tower
COMPANY, INCORPORATED
P. O. Box 8597, Fort Worth, Texas
(817) JE 6-5676

— Associated Companies —
Tommy Moore, Inc.
Big State Engineering, Inc.
Tower Construction Finance, Inc.

Circle 138 on Reader Service Card

Cases—103 sizes of aluminum military transit and combination types are detailed in Zero Mfg. Co.'s 16-page catalog. Dimensional drawings included. **231**

Antenna and rf transmission line products are featured in Prodelin's General Catalog 688. **232**

Power amplifier, Model AA-80, is discussed in Data Sheet A297 released by Ampex Corp. Features and specifications are given. **233**

"Coaxial Cables for Cable TV" and **"CATC Cables for Buried Plant"** are the titles of cable TV brochures

which include detailed information about trunk, distribution and drop cables for cable TV. **234**

Fused-in-glass silicon diodes, rectifiers, zeners and high voltage assemblies are described in Unitrode's 16-page catalog C-146. **235**

Air-moving devices for commercial, industrial and military applications are detailed in Rotron's latest catalog, "Quick Reference Catalog." **236**

Cases—103 sizes of aluminum military transit and combination types are detailed in Zero Mfg. Co.'s 16-page catalog. Dimensional draw-

ings included. **237**

Model 3444-A tube analyzer is described in Triplet Electrical's two-page data sheet. **238**

"Inductors For Electronics" is a catalog released by J.W. Miller Co. Over 40 items are discussed from adjustable padding condensers to wave traps. Specs are given. **239**

New, recommended standards are available from EIA. They include RS-355, "Standard Dimensions for Unrecorded Magnetic Sound Recording Tape" and "Type B Plastic Reel for Magnetic Tape." **240**

Adhesives, coatings and sealers classified by official U.S. government specifications are basis of catalog available from 3M Company. Catalog also lists federal stock number descriptions, intended application and the corresponding 3M adhesive, coating or sealer that meets the specifications. **241**

Wires and cables are topic of catalog put out by ITT Wire and Cable Div. of International Telephone and Telegraph Corp. Military and U.L. style hookup wire, airframe wire, coaxial and CATV cables, audio and marine cables, and commonly used wire insulations are described. **242**

Neon glow lamps as replacements for digital readout tubes are discussed in illustrated, one-page bulletin from Signalite Inc. Such topics as how the Signalite A261 neon lamp is used and its advantages over the common readout are included. **243**

"Instrumentation Handbook" (308 pages) is title of hardbound guide published by Honeywell, Inc. All topics are covered from metrology service to data acquisition systems to instrumentation cabinets. The book is replete with photos, graphs and diagrams. For a copy of the handbook, send your request on your company letterhead. **244**

Passive tubular (Series 21 and 22) filters for i-f applications are featured in I-Tel, Inc.'s catalog supplement 1929-24. **245**

Semiconductor pressure transducer which is low-cost and has high-output is described in data sheets from Endevco Laboratories. **246**

Solid-state power conversion equipment is the subject of a catalog released by Topaz, Inc. **247**

MIC 0201 integrated circuit audio driver amplifier for entertainment and industrial communications equipment is detailed in P.R. Malory Co.'s eight-page booklet. **248**

Stereo cassette record/playback deck literature is available from Auricord Illustrated. **249**

Specify exactly the kind of HI-Q INDUCTOR COILS* you really need.



Conventional Designs for Broadcast Phasors and Transmitters

- Fixed Edgewound Ribbon, 15 amp.
- Fixed Edgewound Ribbon, 20 amp.
- Variable Edgewound Ribbon, 15 amp.
- Fixed Tubing, 30 amp.
- Fixed Tubing, 40 amp.
- Fixed Tubing, 60 amp.
- Variable Tubing, 30 amp.
- Variable Tubing, 40 amp.

New MULTIFILAR designs that handle more current in a smaller package

- Fixed BIFILAR Edgewound Ribbon
- Variable BIFILAR Edgewound Ribbon
- Fixed TRIFILAR Edgewound Ribbon
- Fixed QUADRIFILAR Edgewound Ribbon
- CAT-Line (Continuous Adjustable Transmission-Line) 2-30 MHz, also ideal as a broadcast filter component.

*All MULTRONICS coils offer these important design advantages:

- 1/ Silver-plated Copper "windings" with anti-tarnish finish and hard soldered terminations,
- 2/ Non-breakable Support Bars of G9 MELAMINE which combines minimum loss resistance (dissipation) with superior arc resistance,
- 3/ TEFLON insulation to prevent closed loops, and
- 4/ Numbered Support Bar for easy identification during tune up.

Use this whole ad as a coupon, if you wish. Indicate your basic needs, including inductance and space limitations. If you want combinations of fixed and variable inductors, chances are we have them off the shelf. Special requirements we can probably handle quickly and economically. But please remember to include your name and address . . . or use the Reader Service Card.

NAME

ADDRESS

Mail to:

MULTRONICS, INC.

5712 FREDERICK AVENUE, ROCKVILLE, MARYLAND 20852

Circle 139 on Reader Service Card



**THIS
FEATURE-FILLED
MIXER/REMOTE
AMPLIFIER
HAS AN
UNEXPECTED*
PRICE TAG**

*Unexpected? Judge for yourself: the Shure M67 Professional Mixer/Remote Amplifier has virtually every important feature asked for by broadcasting and recording studios and sound installers. It can be used as a complete, compact console for studio, remote, or original installation use—or as an "add-on" mixer for expanding existing facilities and providing additional microphone inputs with tape recorders and VTR's.

It features 600 ohm line and microphone level outputs; an illuminated VU meter calibrated for +4 and +10 dbm; four low impedance microphone inputs, each with individual low-frequency filter inputs—plus one input convertible for line bridging, or 600 ohms; built-in tone oscillator to provide calibration signal to set signal levels; extremely low noise

and RF susceptibility (noise level -126dbv); female Cannon connectors, two-level headphone monitor jack and many other features.

Its distortion level is UNDER 1% from 20 to 20k Hz at +10 dbm out! Clipping level is +18 dbm. It also features a unique *noiseless* automatic switchover to battery if the AC line fails. (Battery pack optional.)

It is not much larger than two cartons of cigarettes (11 $\frac{3}{8}$ " x 7 $\frac{1}{2}$ " x 2 $\frac{1}{2}$ ") and weighs just 4 lbs. 4 oz.

Incredibly, this truly professional, compact, complete mixer/remote amplifier has a professional net price of only \$147.00!

Write Professional Products, Shure Brothers, Inc.
222 Hartrey Ave., Evanston, Illinois 60204

SHURE M67 new
PROFESSIONAL MICROPHONE MIXER/REMOTE AMPLIFIER

© 1968 SHURE BROTHERS, INC.

OTHER SHURE PROFESSIONAL MICROPHONES... FOR SUPERIOR AUDIO



**MODEL SM5
CARDIOID BOOM DYNAMIC**

Because its cardioid directional pattern is uniquely uniform with frequency and symmetrical about its axis, the SM5 is singularly independent of the effects of environment. Even in extreme shooting situations (such as with tight sets, low ceilings, hard walls, low microphone angles, traffic or air-conditioner noise and rumble and changing distance) the SM5 minimizes sound coloration and ambient noise pickup.



**MODEL SM76
3/4" OMNIDIRECTIONAL
DYNAMIC**

Ideal for interviews and audience participation, yet unusually smooth wide range response (40-20 KC) for critical music reproduction. Instantly detachable from stand. Steel case with Cannon connector.



**MODEL SM50
OMNIDIRECTIONAL
DYNAMIC**

Self-windscreened and pop-free for news, sports, remotes, and interviews. Also ideal for many studio and control room applications. Comfortably balanced for hand or stand use. Natural response.

Circle 140 on Reader Service Card

TWO OF A KIND



THIS ONE

is a complete broadcast facility for use in recording or production studio, plus versatile portability for remote broadcast assignments. Rugged and compact, yet professional in every respect!

Exclusive features include:

- Two 3 speed custom turntable systems
- Removable solid state console
- Monitor and cue system
- Lift-Leaf work surface

A variety of optional accessories:

- Matching bench lid
- Removable equipment shelf
- Dynamic cardioid microphone

Send for detailed information on the
AC-155 Studio Control & Remote Unit.

Only \$1195

AND THIS ONE!

A complete audio center designed for master control use. Rich, scratch resistant wood grain finish cabinets add that custom furniture look to your studio at a surprising low cost. Plenty of storage or equipment rack space, too!

Standard features include:

- 8 Channel solid state console
- Dual 3 speed custom turntable systems
- Complete cartridge record/playback system
- Cartridge storage hutch
- Shipped completely assembled



Write for complete information on **Sparta SHOWCASE CONTROL ROOM CABINERY**
All cabinetry & equipment shown (except chair) — under \$4000.



SPARTA

ELECTRONIC CORPORATION

5851 FLORIN-PERKINS ROAD SACRAMENTO, CALIFORNIA 95828

A DIVISION OF COMPUTER EQUIPMENT CORPORATION (916) 383-5353

Circle 141 on Reader Service Card

BM/E CLASSIFIED MARKETPLACE

CLASSIFIED ADVERTISING RATES

DISPLAY CLASSIFIED ADVERTISING: \$22.50 per inch 1x; \$22.00 per inch 3x; \$21.00 per inch 6x; \$20.00 per inch 12x. ALL OTHER CLASSIFIED ADVERTISING 25¢ per word; minimum \$3.00. BLIND BOX NUMBER: No extra charge. Replies sent to address below will be forwarded to you. PAYABLE IN ADVANCE; send check with order. CLOSING DATE: 5th of 2nd month preceding issue date.

BM/E, Monterey and Pinola Avenues, Blue Ridge Summit, Pa. 17214 Phone 717/794-2191

BUSINESS OPPORTUNITIES

"Representatives wanted

to sell complete line of A.M. and/or F.M. Fixed Tune radios only to stations. Immediate delivery from New York stock."

Box 269-1, c/o BM/E,
Blue Ridge Summit, Pa. 17214

HELP WANTED

Field Service Engineers

Immediate openings for field service personnel on the East Coast, in the Midwest and in California.

Experience is required on either VTR's, color cameras or switching systems.

Your inquiry will receive an immediate reply. Please forward it, in complete confidence, to Mr. R. E. Rutman, 2655 Bay Road, MS 2-20, Redwood City, California. Ampex is an equal opportunity employer.

AMPEX

Radio Station Manager for Oklahoma daytimer. Excellent town, good market. Want all-around man, oriented on sales. Salary \$750.00 a month plus car, and bonus. Ownership possibility to right man. Give full details including references. All replies confidential. Don't phone—write John Morris, The Free-Lance, Henryetta, Okla. 74437.

Engineer with good maintenance background. Some switching required. Full color operation. Good equipment well maintained. Full employee benefits plus good area to live in California. Good man will make over 10M first year. Contact Chief Engineer, KLYD-TV, Bakersfield, Calif.

Assistant chief engineer with diversified experience can qualify at new Channel 19 TV, color ABC affiliate, Kingsport, Tennessee. Now under construction. Send resume including salary requirements to Harold Dougherty, Holston Valley Broadcasting Company, P.O. Box 569.

HELP WANTED (cont'd)

VIDEO SALES ENGINEER

If you are experienced in layout of video switching and distribution systems, we would like to talk to you . . . in strictest confidence. You could become an important part of one of the most aggressive manufacturing firms in the television industry. Call or send your resume to: R. L. Paullus, Vice-President, Marketing, DYNAIR ELECTRONICS, INC., 6360 Federal Blvd., San Diego, California 92114 (714 582-9211).

Announcer for 5KW full-time Pennsylvania adult music station with heavy accent on news and sports. No. 1 in medium market. Modern operation with top sound. No maintenance or selling. Good salary and fringe benefits. 215-696-3690.

First Class technician for east Pa. 5,000 watt full-time station. Well-established clean operation offers profit-sharing plan, other good benefits. Box 269-5, c/o BM/E, Blue Ridge Summit, Pa. 17214.

Engineering position available to work with PC-70's, VR-2000's and TK-27's in outstanding metropolitan VHF operation. First Class license required. Write Box 269-4, c/o BM/E, Blue Ridge Summit, Pa. 17214.

#1 and #2 technicians wanted for 125-mile 20-channel CATV system. Construction beginning. Penna. Box 269-6, c/o BM/E, Blue Ridge Summit, Pa. 17214.

Sales minded station manager. Salary and bonus plus chance to earn part ownership. Small market in Carolinas. Box 269-7, c/o BM/E, Blue Ridge Summit, Pa. 17214.

POSITIONS WANTED

Educational Communications, Audio-Visual Aids, Administrative and/or Technical Position Desired. Married, 29 years old, B.S., M.S., Degrees. First-Class F.C.C. License, Several Publications, Several Years Experience, Currently Hold University Faculty Position. Box 269-2, c/o BM/E, Blue Ridge Summit, Pa. 17214.

Trouble Shooting husband and wife managerial team. Familiar all phases AM radio. Prefer New England or Atlantic Coastal area. Available early 1969. Permanent. Box 269-8, c/o BM/E, Blue Ridge Summit, Pa. 17214.

Female—40—December grad of Broadcast school. Desire work in copywriting, commercials or production commercials. Relocate. 3rd. Box 269-9, c/o BM/E, Blue Ridge Summit, Pa. 17214.

Black personality disc-jockey . . . program variety show and jazz. Best radio ratings in the country. Dependable, married. Resume, tape upon request. Box 269-10, c/o BM/E, Blue Ridge Summit, Pa. 17214.

Manager/Comm. manager, best references, small, medium markets. Full responsibility, 36 years old/civic leader. Experienced all phases. Box 269-11, c/o BM/E, Blue Ridge Summit, Pa. 17214.

Your attention please: Are you looking for a news man? Married, draft exempt. Age 44. Ed Osborn, 214-528-1109. 3223 Cambrick, Apartment #106, Dallas, Texas 75204.

Top 100 DJ-announcer, newscaster, 2½ yrs. experience, 19, draft exempt, live remotes, relocate immediately. 3rd endorsed. Box 269-3, c/o BM/E, Blue Ridge Summit, Pa. 17214.

Negro dj, N.Y. trained. Best jazz in town. Strong on news. Good board. 3rd endorsed. Box 269-12, c/o BM/E, Blue Ridge Summit, Pa. 17214.

POSITIONS WANTED (cont'd.)

Disc jockey, newscaster, salesman, third-endorsed, tight board, experienced, dependable, versatile, creative, and Negro. Box 269-13, c/o BM/E, Blue Ridge Summit, Pa. 17214.

Have FM CP? Let me put it on the air and in the money. First, Family, require 1 year contract, \$175. Box 269-14, c/o BM/E, Blue Ridge Summit, Pa. 17214.

Negro announcer—dependable—experienced. Reliable—can work any type station. Third endorsed. Box 269-15, c/o BM/E, Blue Ridge Summit, Pa. 17214.

24. married, 10 years experience, military complete March 1. Resume available. A. Stevens, 2613 Second Rd., North Arlington, Va. 22201.

EQUIPMENT WANTED

TK-21 RCA monochrome film chain for educational ctv facility. Good condition with or without vidicon, power supply, lens. Educational price consideration appreciated. Paul Tharp-Audiovisual Service, Loma Linda University, Loma Linda, California 92354. AC 714-796-7311, X2035.

EQUIPMENT FOR SALE

REBUILT AND MODIFIED BROADCAST EQUIPMENT

We are now accepting for overhaul, rebuilding, modification FM-AM-TV transmitters

FOB our laboratory

For stations—manufacturers—military and governmental agencies

Modification to CCIR—PAL—CCIR—SECAM standards—customizing by contract, acceptance at laboratory

Richard R. Hayes

President

(214) 231-5511

TELDEX CORPORATION

747 S. Central Expressway

Richardson (North Dallas) Texas 75080

Best deals—Spotmaster, Scully, Magnecord, Crown, Omega film equipment, CBS Audimax/Volumax, Metron Modulation Monitor, Langevin, Pultec, Fairchild, Universal Audio, Rek-O-Kut, Gray, Russco, other top brands. Write for information. Finance, trade, lease. Audiovox, Box 7067-55, Miami, Florida, 33155.

EQUIPMENT FOR SALE (cont'd.)

QTY.	DESCRIPTION	PRICE
1—	GE Image Orth Studio Camera Chain, including: PC-11 Camera, 10 Tube, Zoom Lens, 100 Foot cable, TV-41 Channel Amp, Control Panel.	\$3000*
1—	GE Image Orth Portable Studio Camera Chain, including: PC-4 Camera, 10 Tube, 50-100-150 mm Lenses, 100 foot cable, TM-35 Portable Control unit and Monitor	\$3000*
*Above two items available as a package for \$5500		
1—	RCA TRT-1B VTR Complete in Operating Condition.	\$2900
1—	GE TV 86C Optical Prism Multiplexer	\$ 450
1—	GE TV-31H Pulse Distribution System, including four Pulse D-A's and Bias Supply.	\$ 300
1—	Tektron Automatic target control unit for use with GE or RCA Vidicon camera.	\$ 100
18—	19½ foot lengths of 3/8-inch 50-ohm, Prodelin coax transmission line. (Make Offer)	
Contact Ellis Feinstein, Director of Engineering KMED-TV, Medford, Oregon (97501)		

TRANSLATOR POWER now put your translator where antenna should be for best coverage not where power line happens to be. Use a TELAN thermoelectric generator. No moving parts, simple to operate, leave unattended 6-12 months. General Instrument Corp., Thermoelectric Division, Dept. BM, 65 Gouverneur St., Newark, N.J. 07104, 201-485-2100 ext. 481.

21-Mod 24B-2 M/W Collins Video Amp, with clamp and polarity reversal with 3 video outputs 1 volt 24 volt DC powered. Purchase one or all at \$75.00 each. Contact Bill Little, Cable TV, 445 Broadway, El Centro, Calif.

Tower—212 ft., self-supporting. Extra heavy duty construction, galvanized steel, complete with lights, insulators and photocell transmission line 100 ft long. WL1B, 310 Lenox Ave., New York, N.Y. 10027. Phone: 212-831-1000.

Brand new remote amplifiers, 2 channel remote microphone amplifiers, 2½ inch VU, battery operated, 9 transistors \$95.00 FOB Kokomo. **GREDCO, INC.** 1830 S. Webster, Kokomo, Ind. 46901. Area 317-883-5688.

Collins 737 amplifier converted to 4CX5000A tubes, \$1750, f.o.b. Los Angeles. Good condition. Also Moseley SCG-4, 67kc. Generator like new. \$450. Write or phone Adams, KUTE Radio, Occidental Center, Los Angeles 90015.

4 self supporting heavy duty 130' foot towers. Four leg, federal aviation standard. Bolted construction. Reasonable. Ray Gard, 54132 Quince Rd., South Bend, Ind. Call CE-43014.

Ampex 300 Mastering recorder. Mono Console. Excellent condition. \$975.00. Barbara Allan Productions, Inc., Box 207, Kalamazoo, Michigan. Phone 327-6746.

100 ft. tower \$200.00, 200 \$800.00, 300 \$1500.00, 400 \$2400.00. Groundwire new 68¢ per lb. Bill Angle, 917/752-3040, Box 55, Greenville, N.C. 27834.

Broadcast and recording equipment, new and used, bought-sold-traded. New items listed daily. Maze Corporation, Box 6636, Birmingham, Ala. 35210.

One TBM-3500 black McMartin FM modulation monitor like new. Highest offer. Make yours. Box 269-16, c/o BM/E, Blue Ridge Summit, Pa. 17214.

TRY US FIRST. New and used Broadcast equipment and supplies. Package discounts. **VHSA**, Box 616, Warrenton, N.C. 27589.

Complete kit audio proof forms \$3.50 postpaid. Specify AM/FM. Box 2605, Corpus Christi, Texas 78403.

Whatever your equipment needs . . . check first with Broadcast Equipment and Supply Co., Box 3141, Bristol, Tennessee 37620.

Towers, broadcast, microwave, CATV, TV, new and used. Phone 224-9922, Tower Maintenance, Inc., 2408 Old St. Rd., Tallahassee, Fla.

EQUIPMENT FOR SALE (cont'd.)

BARGAINS: CCTV Cameras, monitors, send for free list. Box 269-17, c/o BM/E, Blue Ridge Summit, Pa. 17214.

Protect your records. Send for our free LP supply lists. Record Supplies, Hillburn, N.Y. 10931.

MISCELLANEOUS FOR SALE

Japanese Electronics. New products monthly! \$1.00. Money-back guarantee. DEE 10639 BM Riverside, North Hollywood, Calif. 91602.

SIGNS, NAMEPLATES, LABELS, Decals, Badges, Trophies, Plaques. Seton Corp., Dept. BM/E, New Haven, Conn. 06505.

TECHNICAL SERVICES

IN CANADA...
 for CATV SYSTEM: ENGINEERING —
 PLANNING — CONSTRUCTION —
 TECHNICAL SERVICES — MAINTENANCE

DEPEND ON EXPERIENCE
NORAM CABLE
CONSTRUCTION, LTD.

1770 Albion Road • (416) 741-0566
 Rexdale, Ont., Canada

VIDEO TAPE RECORDER
AUDIO HEAD ASSEMBLY SERVICE

Precision relapping of all heads and supporting posts, includes cleaning and testing. **AMPEX VTR** audio assembly . . . \$75.00 complete. Brand new shelf stock replacement heads of our manufacture available when relapping not advisable. **LIPPS, Inc.** 1630 Euclid St., Santa Monica, Calif. 90404 (213) EX 3-0449.

DON'T BE AN AUDIO DROPOUT in your market area. Let **BROADCAST EQUIPMENT REBUILDERS** take care of your tape cartridge rewinding needs. Call or write **Quin Morrison** for further information. Route 8, Box 718, Fayetteville, N.C. 28304. B-E-R . . . **THE SPECIALISTS!**

PROGRAM SERVICES

16mm CATV
SOUND PROJECTORS
(synchronized for TV)
\$650.00

American Diversified Services
 Box 975, Kingsport, Tennessee 37662
 Phone area 615 239-9301

"DEEJAY MANUAL" is a folio of Gags, Ideas, Breaks, Gimmix, Fun for the working deejay. Special \$3.00 with this ad. Write for free "Broadcast Comedy" catalog. Show-Biz Comedy Service (Dept. E) 1735 E 26 St., Brooklyn, New York 11229.

35,000 professional comedy lines! Forty speakers' joke books plus current comedy, a topical humorous service period. Catalog free. Sample selection, \$5. John Rain Associates, Inc., 232 Madison Avenue, New York City 10016.

DEEJAYS! 6000 classified gag lines for radio, \$5.00! **COMEDY CATALOG FREE!** E. Orrin, Boyer Rd., Mariposa, Calif. 95338.

INSTRUCTION

R.E.I.'s famous (5) week course for the First Class Radio Telephone License is the shortest, most effective course in the nation. Over 98% of R.E.I. graduates pass F.C.C. exams for 1st class license. Total tuition \$360.00. Job placement free. Write for brochure **Radio Engineering Incorporated Schools**, 1336 Main Street, Sarasota, Florida 33577—or 3123 Gillham Road, Kansas City, Missouri 64109—or 809 Caroline Street, Fredericksburg, Virginia 22401—or 625 E. Colorado Street, Glendale, California 91205.

FCC License in six weeks from the nation's largest license school. Compare reputations and success rates before you invest. Professional announcing training on the nation's only fully school-operated commercial station used solely for training. School locations in Dallas, Houston, Atlanta, Chicago, New Orleans and Minneapolis. Write **Elkins Institute**, 2603 Inwood Road, Dallas, Texas 75235.

INSTRUCTION (cont'd)

First phone in six to twelve weeks through tape recorded lessons at home. Sixteen years FCC license teaching experience. Proven results. **Bob Johnson Broadcast License Training**, 1060D Duncan, Manhattan Beach, Calif. 90266.

Learn Avionics (Aviation Electronics)—Jobs galore, G.I. approved; literature, Academy Avionics, Reno/Stead Airport, Reno, Nevada 89506.

CONSULTANTS

ROSNER TELEVISION
SYSTEMS

ENGINEERS	CONTRACTORS
120 E. 56 St.	29 South Mall
New York	Plainview
N. Y. 10022	N. Y. 11803

JANSKY & BAILEY
BROADCAST-TELEVISION DEPARTMENT
 Atlantic Research Corporation
 A Division of
 The Susquehanna Corporation
 1812 K Street N.W.
 Washington, D.C. 20006
 Member AFCCE (202) 296-6400

USE BM/E's CLASSIFIED
MARKETPLACE TO
REACH OVER 22,000
BROADCASTERS!

Please run the ad below in **BM/E's CLASSIFIED MARKETPLACE** in your next:

- | | |
|------------------------------------|-----------------------------------|
| <input type="checkbox"/> 12 issues | <input type="checkbox"/> 6 issues |
| <input type="checkbox"/> 3 issues | <input type="checkbox"/> 1 issue |

in a space of inches
 words under the Classification of:

.....

Check enclosed

Name

Station or Co.

Address

City State

BM/E, Classified Advertising Department, Blue Ridge Summit, Pa. 17214. 717/794-2191.

*Ampex Corp.	38, 39, 56, 57
*CBS Laboratories, A Division of Columbia Broadcasting System, Inc.	5
Canon U. S. A., Inc.	54
*Collins Radio Co.	53
Crown International	77
Dynair Electronics, Inc.	59
Eastman Kodak Co.	63
*Electro-Voice, Inc.	65
Fairchild Recording Equipment Corp.	62
Fort Worth Tower Co., Inc.	71
Fuji Photo Optical Co., Ltd.	62
Gates Radio Co., A Sub. of Harris- Intertype Corp.	67
General Electric Co., Visual Communication Products Dept.	19, 20, 21
Granger Associates, Bauer Broadcast Products Div.	64
Gray Research & Development Co.	62
Hickok Electrical Instrument Co., The	58
I.E.E.E.	70
International Nuclear Corp.	Cover 3
International Video Corp.	49, 50
Jampro Antenna Co.	78
Lipsner-Smith Corp.	68
McMartin Industries, Inc.	10, 11
Magne-Tronics Inc.	60
Marathon Broadcast Equipment Sales Corp.	16
3M Co., Mincom Div.	69
Moseley Associates, Inc.	18
Multronics, Inc.	72
Plastic Reel Corp. of America	7
RCA Broadcast & Television Equipment	3
RCA Electronic Components	17
RHG Electronics Laboratory, Inc.	37
*Riker Video, Inc.	Cover 2

Russco Electronics Mfg.	70
Sarkes Tarzian	51, 60
*Shure Brothers Inc.	73
*Sparta Electronic Corp.	74
Superior Continental Corp.	61
Tape-Athon Corp.	12
Tapecaster TCM	66
Tektronix Inc.	15
*TeleMation, Inc.	Cover 4
Telemet, a div. of Geotel, Inc.	13
Vital Industries, Inc.	55
Ward Electronic Industries	9

ADVERTISING SALES OFFICES

Charles C. Lenz Jr.
Manager, Advertising Sales

EAST COAST

820 Second Avenue
New York, New York 10017
212-661-0450

Mid-Atlantic
Shanton Granger

Southeast
Charles C. Lenz, Jr.

NEW ENGLAND

41 Stevens Lane
Cohasset, Massachusetts 02025
617-383-0029
Donald B. Kennedy

MIDWEST

612 North Michigan Avenue
Chicago, Illinois 60611
312-642-3774
Charles E. Moodhe
Ralph Bergen

WEST COAST

1245 East Walnut Street
Pasadena, California 91106
213-795-1528
213-684-0590 (Los Angeles)
Lawrence C. Papp
Thomas Boris
Jules E. Thompson Co.
1111 Hearst Building
San Francisco, California 94103
415-362-8547
William J. Healey

JAPAN

Nippon Keisoku Inc.
P.O. Box 410
Central Tokyo, Japan
Yoshi Yamamoto

"phenomenal performance . . .
numerous refinements . . .
place Crown CX822

IN A CLASS BY ITSELF"

-- AUDIO MAGAZINE



CROWN CX822 reviewed by Audio

To Crown owners, Audio's evaluation comes as no surprise. They know that every Crown meets or exceeds its specifications. Your own Crown CX822 will deliver the same "phenomenal performance" as the one tested by Audio magazine. You will find, as Audio's engineers, that "the new Crown CX822 is capable of providing the most faithful reproduction of sound through the magnetic recording medium. . . to date." You will also agree with Audio, that "to truly appreciate this machine, you must use it." Your Crown dealer will help you select the Crown model to meet your exact needs.



CX822

To receive the 4-page Audio test report, free literature and the name of your dealer, write Dept. BM-2



Crown

Box 1000, Elkhart, Indiana 46514
MADE ONLY IN AMERICA

Circle 142 on Reader Service Card

the new

JAMPRO

uhf

ZIG ZAG

offers greater
flexibility
and lower cost!



The ZIG ZAG Television Antenna offers more pattern & gain per dollar than any other uhf antenna.

High power gains are available with many computerized vertical patterns. Omnidirectional and cardioid patterns are available which will provide power gains from 8 to 56 and directional gains as high as 215! Power capabilities of 60 or 120 KW.

Fiberglass radomes are available.

Write for complete catalog and prices.

JAMPRO

ANTENNA COMPANY

6939 POWER INN ROAD SACRAMENTO CALIFORNIA

A DIVISION OF COMPUTER EQUIPMENT CORPORATION

Circle 143 on Reader Service Card

FROM THE EDITOR

Fm Turns the Corner

Once the poor, misbegotten stepchild of the broadcasting industry, fm radio is rapidly coming into its own as a prime moving force and as a profitable medium. Part of this new-found success can be laid directly at the FCC's doorstep, with the 50-percent programming rule forcing fm'ers into new areas that have miraculously produced profits.

These profits aren't entirely due to improved program formats and aggressive selling. Many fm'ers get into other, sometimes related businesses simply as a matter of survival. Biggest single money-maker in this area is SCA. Traditionally the vehicle for a limited number of background music systems, SCA is now riding the wave of fm's enhanced popularity, with new uses for subchannels emerging regularly. Many of these new uses are still experimental. Many still need more investigation for true profit potential.

But the fact that these subchannel authorizations can be turned into dollars while stretching limited spectrum space deserves close scrutiny by every fm broadcaster. New program formats and experimentation should follow. There's too much sameness about today's fm. It's being invaded by program formats that are fugitives from a-m with little or no change. A-m affiliates in the meantime are going into solid talk programs and their music formats are being moved whole cloth into the fm side.

This type of programming begs the question of providing new and different fm ideas. "Follow the leader" seems to be the battle cry, and if the leader has a successful formula in a large market, then legions of competitors will follow suit. A metropolitan area certainly doesn't need four hard rock fm stations. Two would be far better with the other two working out some new experimental formats. Revenue? There's simply not a big enough piece of it to slice up into many tiny pieces. The number four hard rock would do well to explore more selective audiences, while hedging its bets with an SCA channel.

The 50-percent rule was intended to open up new vistas for fm. Instead, a-m has had its format revamped, while popular musical programs moved into the new fm land.

What's the answer? It's obviously going to be different for each station and for each market. There are no magic success formulas that will work for everybody. But do ask yourself these questions: "Do we have a forceful and readily identifiable station image? Do we disdain following the leader? Are we innovators? Are we getting as much ancillary revenue as we should be? Do we sell our image? Do we reach a select clientele?" If the answer to any of these questions is "no," then you've got room for some instant improvements. One other thing—when you answer these questions, don't cheat!

Walter G. Salm
Managing Editor



Looking for a good video stabilizing amplifier?

International Nuclear's TVA1 is certainly one of the best on the market today. The TVA1 with its associated series of plug-in units offers high level performance and versatility for studio or transmitter use. It removes all low frequency disturbances such as hum, bounce and tilt by sync-tip clamping. This back porch level is precisely stabilized without affecting color signals in any way. Sync is stretched after back porch stabilization and then clipped accurately to desired level. This level may be set by means of a front panel control which can be extended to a remote location. Stripped sync is provided at one 75 ohm internally terminated output connector, at a 4 volt level. The TVA1 chassis contains a plug-in compartment which accepts up to 4 plug-in units. Among these plug-in units is the TVA1-E, providing a stripped color video channel, and the TVA1-D which provides the means of adjusting peak-white clipping, white stretch and differential phase. Other plug-in units are listed below.

PRICES F.O.B. NASHVILLE, TENNESSEE

Model TVA1 Stabilizing Amplifier (less plug-ins) . . . \$1,380.00
 Model TVA1-A, Manually Operated Input Amplifier Unit . . . \$310.00
 Model TVA1-B, Input Amplifier Unit, with Remote Master Gain and Chroma Panel . . . \$425.00
 Model TVA1-C Monitor Amplifier Unit . . . \$265.00
 Model TVA1-D White Stretch and Clip Unit . . . \$240.00
 Model TVA1-E Stripped Video Unit . . . \$450.00
 Model TVA1-S Remote Sync Level Control Panel . . . \$25.00



For more complete information write or phone:

INTERNATIONAL NUCLEAR CORPORATION
"Transistorizing the Television Industry"

608 NORRIS AVENUE • NASHVILLE, TENN. • PHONE 615-254-3366

You're
looking at
television's most
versatile
camera...

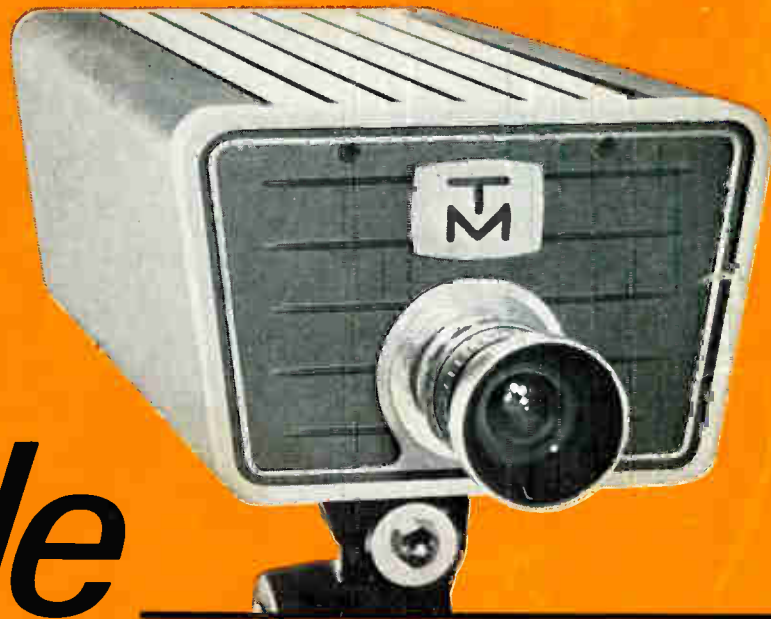

TeleMation's TMC-2100:

- Operation may be self-contained or driven from external control equipment. Select mode of operation with the flip of a switch.
- Six different TeleMation control devices to work with the TMC-2100.

- Four internal sync options (plug-in modules) including: crystal/ drive, 2:1 interlace, and EIA.
- Separate-mesh vidicons may be installed without modification. 800-line resolution guaranteed.

- Portability — Easy (permanent) conversion to viewfinder model — Custom mounting equipment — Single-cable operation.

Versatility is only one characteristic of the TMC-2100. Performance, Reliability, Quality are a few of the others. A full broadcast viewfinder camera (less lens) costs as little as \$2,495.00. Basic random interlace viewfinder camera is \$1,895.00; non-viewfinder camera \$1,295.00.

Find out more about our low-cost, versatile television camera. Write or call for free brochure.



TELEMATION, INC.

2275 South West Temple
Salt Lake City, Utah 84115
Telephone (801) 486-7564

Circle 145 on Reader Service Card