

Broadcast ENGINEERING®

THE JOURNAL OF DIGITAL TELEVISION™

AC POWER QUALITY

Secrets to clean
and reliable power

A LOOK AT COMPRESSION

Serial compression could
destroy your digital quality

OLYMPIC PREVIEW

Inside the '98 Olympics
broadcast center

FIRST INSIDE LOOK:
KITV, first on-air
DTV station
How they did it!



#BXNCFHL AUTO ***** 5-DIGIT 08034
#00070128# 0000 30 13 BE Q 0081
O LYTTLE HOOVER OPS MGR
OLH- TV PROD
38 PLYMOUTH DR
CHERRY HILL NJ 08034-3643

The New *TV-1000* Audio Console

LIVE TV – The Way It Has to Be

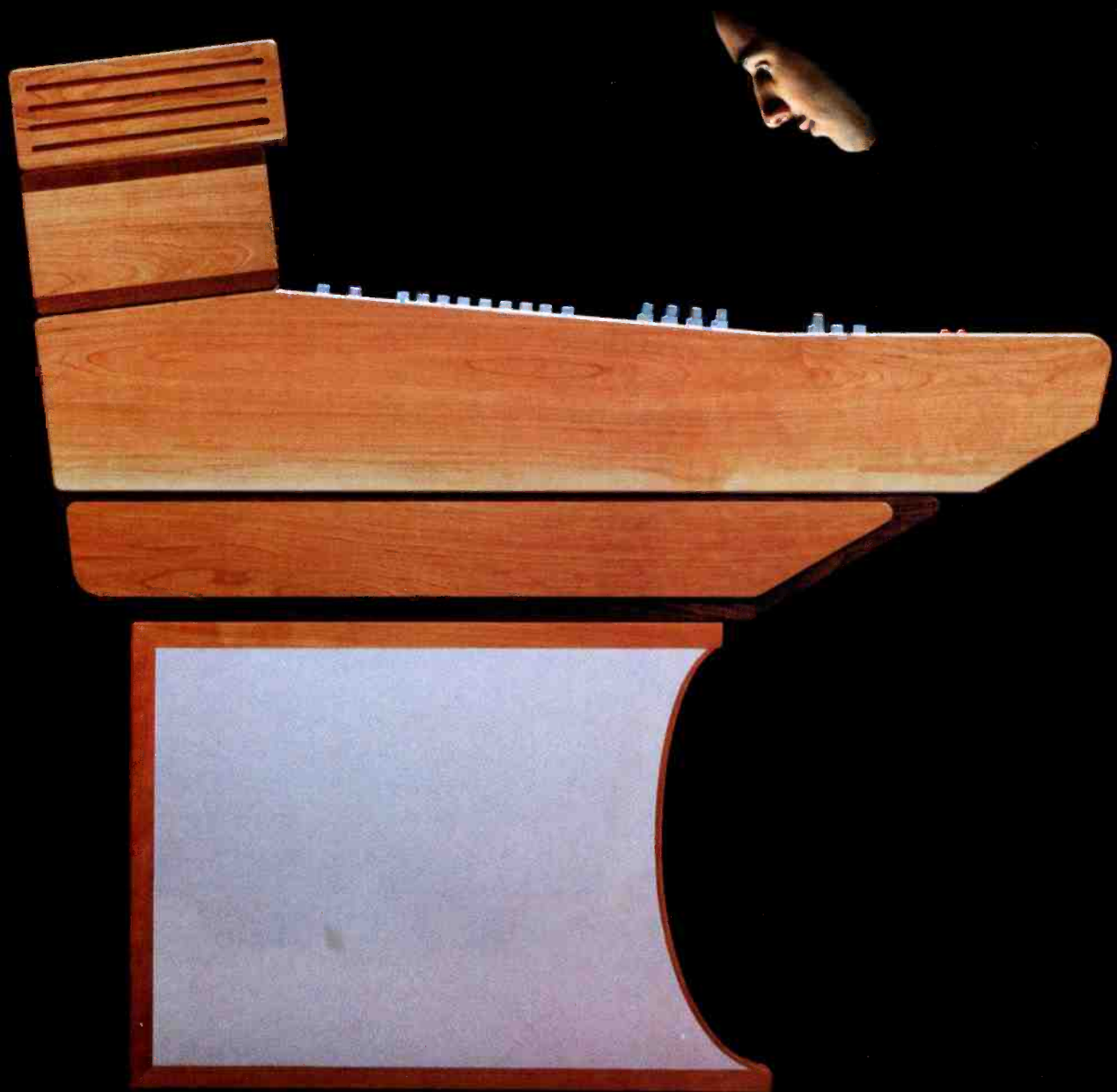

315-452-5000

 Wheatstone[®] Corporation

Circle (1) on Free Info Card

www.americanradiohistory.com

DIGITAL TELEVISION SYSTEMS



“Harris created an all-digital facility that let us double saleable inventory, and they did it at a near-analog cost.”

Robert Allbritton, Chief Operating Officer, Allbritton Communications

When Allbritton Communications wanted to reach two television markets from a single location, Harris incorporated a centrally located all-digital studio with microwave links to three transmitters over 100 miles apart, two remote news bureaus and 3 additional microwave repeater sites. This solution enables Alabama's ABC 33/40 to blanket the state with city-grade signals.

“Harris' digital solution gives us multichannel capabilities which allow

us to offer four distinct channels to advertisers,” Robert Allbritton notes. “Not only do we now have twice the product to sell; we have the ability to broadcast DTV as soon as we're ready. What's more, Harris designed and implemented our digital solution faster than we ever thought possible – and at a cost only 10-15% greater than analog.”

From an all-digital studio and C-/Ku-band teleport facility...to a fleet of Harris ENG and SNG vehicles that



proudly bear the ABC 33/40 logo, Harris met Allbritton's unique challenge with state-of-the-future technology.

Whether your needs call for digital-ready analog, or digital right now, call Harris today. We'll show you how digital is more of a practical reality than you may think.

HARRIS CORPORATION BROADCAST DIVISION

7920 Kentucky Drive
Florence, KY 41042 USA
TEL: +1 606 282-4800
FAX: +1 606 283-2818



A new world of broadcast solutions

Systems: Electronic News Gathering — Fly-away Satellite — Mobile Production — Radio Studio — Satellite News Gathering
Satellite Uplink — Television Production — Television Transmission — Terrestrial Microwave

©1997 Harris Corporation

Circle (4) on Free Info Card

www.americanradiohistory.com

We'll cover Nagano better than the snow.



1/2" FIT-3CCD Camera/Recorder
AJ-D700

Lap-Top Editor AJ-LT75

© AKIRA TAKAHASHI/AFLO FOTO AGENCY

The moment of concentration before the gate slams open. The turn of a ski that determines the race. The spin. The soar. The gasp. With Panasonic DVCPRO cameras covering every game at Nagano, there's not much drama our lenses will miss.

But it's more than just the coverage that will make you feel like you're right in the middle of it. DVCPRO digital cameras are so lightweight, they allow broadcasters to keep pace with the athletes, even at 140 kilometers per hour, even at 138

meters above ground. And that's important when the difference between a national hero and a silver medalist is measured in .001 second increments.

There are over 30,000 DVCPRO units in use at broadcast facilities around the world, offering super-sharp digital images, pin-drop sound quality and minimal dubbing degradation. DVCPRO won't just bring the action to your home, it will bring you to Nagano. Panasonic will offer state-of-the-art broadcasting

systems, such as DVCPRO in our role as the Official Supplier and prime contractor for the International Broadcast Center [IBC] and all the venues.

As an Official Worldwide Olympic Partner participating with superior digital technology, we believe it's also important to cover the true spirit of sport. Something we do with our hearts, not just our cameras.

See you in Nagano for the snow.

Argentina	Tel. 54-1-308-1610	Canada	Tel. 1-905-624-5010	Egypt	Tel. 20-3938151	Iran	Tel. 98-21-2271463	Norway	Tel. 47-22658400
	Tel. 54-1-954-2010	Chile	Tel. 56-551-9571	Finland	Tel. 358-9-521-5253	Italy	Tel. 39-2-67881	Panama	Tel. 507-229-2955
Australia	Tel. 61-2-9887-6222	China	Tel. 86-10-6836-4788	France	Tel. 33-149464388	Kuwait	Tel. 965-481-2123	Peru	Tel. 51-145-29470
	Tel. 61-2-986-7400		Tel. 86-10-6515-8828	Germany	Tel. 49-611-18160	Malaysia	Tel. 60-3-755-0511	Philippines	Tel. 632-722-7490
Austria	Tel. 43-1-61080-337	Colombia	Tel. 507-229-2955	Greece	Tel. 30-1-9899300		Tel. 60-3-757-6622	Poland	Tel. 48-3912-3173
Bahrain	Tel. 973-252292		Tel. 57-1-616-8373	Hong Kong	Tel. 852-2313-0888	Mexico, D.F.	Tel. 52-5-488-1000	Portugal	Tel. 351-1-424-8660
Belgium	Tel. 32-2-481-0481	Czech Republic	Tel. 42-02-2166-4120	Hungary	Tel. 36-1-344-2614	Netherlands	Tel. 31-73-6402-505	Puerto Rico	Tel. 1-787-750-4300
Brazil	Tel. 55-11-889-4000	Denmark	Tel. 45-43-200-800	Indonesia	Tel. 62-21-801-5666	New Zealand	Tel. 64-9-272-0100	Singapore	Tel. 65-390-3699



4x Non-Linear Editor AJ-DE77



DVCPRO

Official Worldwide Olympic Partner



Panasonic

T-103 36 USC 380 (m) Official Mark of the Canadian Olympic Association

<http://www.panasonic.co.jp>

South Africa	Tel. 27-11-313-1400	U.K.	Tel. 44-118-902-9210
Spain	Tel. 34-3-425-9300	U.S.A.	Tel. 1-800-528-8601
Sweden	Tel. 46-8-680-8238	Venezuela	Tel. 58-2-93-3022
Switzerland	Tel. 41-41-259-9090		Tel. 58-2-285-6440
Taiwan, R.O.C.	Tel. 886-2-725-9100		
Thailand	Tel. 66-2-731-9527		
Turkey	Tel. 90-216-416-0150		
U.A.E.	Tel. 971-4-719000		

IN THIS ISSUE



86

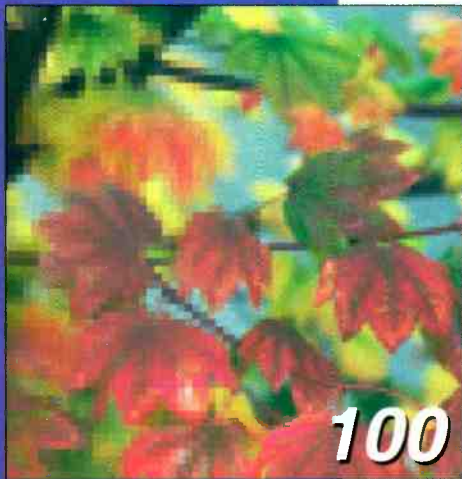

100



106

Features

86 Power quality and grounding

By Warren H. Lewis

Many of the older methods of grounding, bonding and shielding must be abandoned for reliable operation of today's digital equipment.

100 MPEG compression issues

By Keith Dunford

Concatenation, digital turnaround and interoperability are the keys to MPEG transportability.

Beyond the Headlines

NEWS

- 14 TCI has "different" HDTV
- 18 Is lip sync in HDTV going to be a problem?
- 20 A new chip for cameras
- 22 Show me the graphics
- 22 CEMA unveils new logo
- 22 Blazing trails in DTV
- 27 Harris and Lucent form DTV alliance

FCC UPDATE

- 28 Reallocating TV Channels 60-69

DTV UPDATE

- 30 DTV: Broadcasting or datacasting?

EXPERT'S CORNER/ VENDOR VIEWS

- 34 What speed — a digital infrastructure?

Digital Handbook

TRANSITION TO DIGITAL

- 50 Testing CCIR-601 serial digital distribution

COMPUTERS AND NETWORKS

- 54 Networking basics, Part 2: Faster is better

ASK DR. DIGITAL

- 58 Bringing a scope back to life
- 60 Doing the dishes

Special report

- 106 Winter Olympics: Putting on the Games in Japan

(Continued on page 8)

AES

DA's

A to D's

D to A's

Sample Rate
Converters

Mix / Minus

Delays

Transmission
Protection
Switches

Reference
Generators

Synchronous/
Asynchronous
Routers from 8²
to 2048²

Time Code

Delays

Routers From
8 x 32 to 512²

Data

RS422 / 232
Routing

64 Port to
256 Port

Is the uncertainty of HDTV keeping you from buying the digital audio equipment you need today? Are you afraid that what you buy today will be obsolete tomorrow? With NVISION you can buy now and buy with confidence, because these products are 100% HDTV compatible. Each one is designed to perform in today's demanding environment as well as tomorrow's.

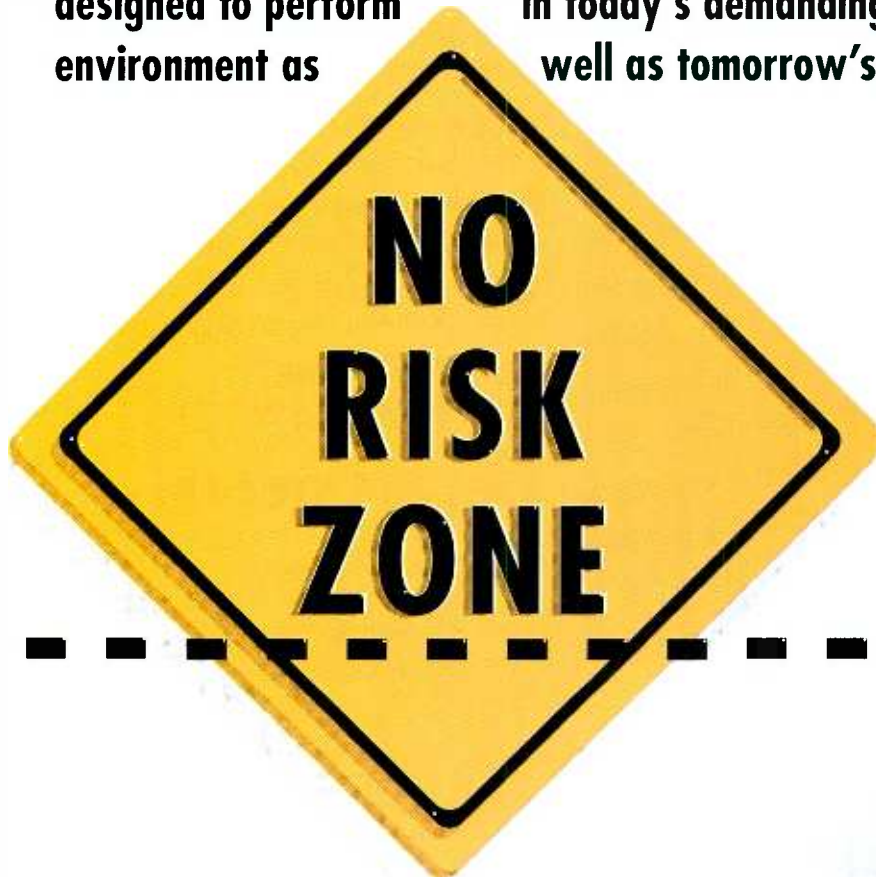

 **FR1000** 2RU frame and power supply (with redundant option) - plug in any combination of up to 12 NV1000 Series modules

 **NV1035** Reference quality 20 bit AES A to D converter

 **NV1045** Reference quality 20 bit AES D to A converter

 **NV1025** AES DA with reclocking and EQ

 **NV1080** AES reference generator for efficient digital audio synchronization

 **NV3064SA** Synchronous AES router 32² to 64² error-free, on-air digital audio

Circle (9) on Free Info Card

For more information on these and other high performance audio products, call us at 1-800-719-1900. www.nvision1.com



22



74

ON THE COVER: Cover design by Intertec art director, Michael O'Keefe.

WEB SITE DIRECTORY

www.broadcastengineering.com

Feature Articles

Departments

New Products & Reviews

Classifieds/Jobs

Marketing/Advertising

Reader Resources

- Editorial calendar
- Article archives

Contact the Editors

Questions? Contact:

Deanna Rood
deanna_rood@intertec.com
 913/967-1905 fax

Systems Design & Integration

TRANSMISSION & DISTRIBUTION

62 Predicting DTV coverage

PRODUCTION CLIPS

68 Field accessories

SYSTEMS DESIGN SHOWCASE

74 KITV-TV First on-air DTV station

New Products & Reviews

APPLIED TECHNOLOGY

- 112 Telect: Router technology: Bigger isn't always better
- 116 NUCOMM: Digital video systems for 2GHz applications
- 124 Acrodyne: Adjacent-channel DTV/NTSC Diacrode transmitters

FIELD REPORT

134 Kramer Electronics: Color my world

TECHNOLOGY IN TRANSITION

136 Wireless microphones — Complete update

NEW PRODUCTS

140 Digital cameras, HDTV waveform monitors and more

BUSINESS WIRE

150 Canon lenses used at Super Bowl XXXII

Departments

- 10 Editorial
- 12 Reader Feedback
- 104 Management
- 157 Classifieds
- 161 Advertisers' index
- 162 EOM

FREEZE FRAME

A look at the technology that shaped this industry.

Do you remember?

How far we've come! In February of what year was this ABC engineer shown operating a "new" device for sports coverage, and what was it?



Answer: The year was 1969 and the "new" device was the Ampex HD-100 disc recorder. Record time as 1 minute on a 16-inch disk. Cost was \$100,000. (That's about \$500,000 today!)



Graphics



at

the



speed



of

news

PAINTBOX® & PICTUREBOX®

The graphics team

In a world dominated by deadlines and ratings, the ability to create great news graphics fast, is vital. The united forces of Paintbox®, Picturebox® and Picturenet® Plus gives you all the creative power, assured stills handling performance and efficient networking you need. It's the team you can count on.



Call our 24 hour Graphics Hotline now: 1 800 218 0051 Ext.481

Quantel Inc., 28 Thorndal Circle, Danvers, CT 06820 Tel: (203) 656 3100 Fax: (203) 656 3459 <http://www.quantel.com>

Circle (82) on Free Info Card

Marching to the DTV drummer

Ever heard the line “If you build it, they will come” from the movie *Field of Dreams*? Recently it’s been uttered by a variety of pundits from Wall Street to Sesame Street when referring to HDTV, but they have added a new twist, “If you build it, *will* they come?” Trouble is, after it’s asked, few seem willing to answer the question. Well, I think the question has been answered.

I recently spent several days at the January Winter Consumer Electronics Show (CES). I attend the show infrequently, but when I heard that Harris Broadcast was going to host a special DTV event, I decided it was time once again to check it out.

What I learned was more than a little surprising. Although it’s no secret that TV set makers need something new to sell, I didn’t expect as much excitement and visible support for HDTV from them as I saw. From the set makers to DirecTV, to broadcasters, everyone’s onboard the HDTV train, and this baby is ready to roll.

The show had plenty of set makers showing off their new TV sets. In the past, we mostly saw recorded clips of flowers or fish, much of which wasn’t even real HDTV. However, this time, the images were live, off-air HDTV feeds from two Las Vegas stations, KLAS and KLVW. There was lots of material, some designed to stress the receivers, but all of it looking great. There were plenty of flat-panel displays, new projection systems and lower predicted prices. Sets will be available by the third quarter of this year. And, if you think all this won’t matter because there won’t be any images to view on these sets at your local Radio Shack or Best Buy, think again. DirecTV announced that it will soon begin delivering two channels of HDTV programming.

Before concluding, I want to give a “Well done,” to the folks at Harris. I’ve been to a lot of press events (most could have been neglected without missing anything), but this one was different.

The company hosted a session the day before CES opened to highlight its research supporting the conversion to DTV. Although you might question the research the company conducted, Harris also had independent sources there presenting their own data on the subject. Company officials promoted HDTV and the technology; they did not promote their products.

Later that evening, Harris hosted what had to be the most upbeat, no-holds-barred, rousing kick-off for DTV (or any other broadcast technology) ever. While I expected a typical snoozer, complete with company talking heads spouting the advantages of “their” solutions, what I, and more than 200 others, got was a fantastic evening’s entertainment, in addition to some great facts and demonstrations of HDTV and DTV.

Congratulations to Harris for supporting DTV at CES. It helps not only broadcasters, but also our partners in this endeavor, the consumer electronics industry.

So to the question I first posed: Will they come? Well, I’ve seen it and when you build it — they will come.



Brad Dick

Brad Dick, editor

direct: brad_dick@compuserve.com
 website: www.broadcastengineering.com

Trinity™

The Golden Age of Television is Back

The One Box That Changes Everything
It took eight years to create. It's driven by 22 radically advanced custom chips and one million lines of hand-coded software. It's the stunning new technology everyone's whispering about. There's never been anything like it: all real-time, all D1 digital, all perfect network-level broadcast quality. A lot of people didn't think it was possible. They were wrong.

MADE IN U. S. A.

RANCHO CORDOVA, CALIFORNIA

TRINITY IS THE FUTURE OF TELEVISION AND A TRADEMARK OF PLAY INCORPORATED. PATENTS PENDING. COPYRIGHT © 1997

- 8 Input Live Production Switcher
- Real-Time 3D Digital Video Warp Effects
- On-Line Non-Linear/Linear Editor
- Live 4ns Character Generator
- Dual Channel D1 Still Store
- Two Time Base Correctors
- Real-Time Animated Paint and Compositing

Experience Trinity Now

at your

Local Dealer



PLAY
INCORPORATED

800-306-PLAY www.play.com

YOUR SECRET NUMBER IS: 49-002-0

re: the October 1997 "Digital Basics"

Dear Paul,

Yes, the 2.4GHz digital wireless sender really works! I just bought the Wavecom Jr. brand (it cost \$95) from one of our distributors for video products (Petra) and frankly, I was skeptical. I am surprised to report that the quality is satisfactory and better than expected!

I needed to transmit a PrimeStar signal to another part of the house, approximately 40 feet away and downstairs. Yes, the receiving antenna must be pointed in the general direction of the transmitter, but the transmitter did not need to be pointed at the receiver. I have not noticed any interference due to other equipment operation, nor does walking between the units cause any signal degradation.

You might want to purchase one to experiment with and see for yourself all of its possible uses. I also plan to use it with my camcorder for times when I want the signal to transmit to a monitor or recorder at a close distance where wire would be impractical. It also transmits quality stereo sound and can be used for audio applications, as well.

I have also been trying some wireless speakers around my house with excellent results, solving some wiring problems with a simple solution.

Yes, it truly is a TV station for \$150.

DONALD D. FLINT
PRESIDENT/CEO
DF&A WIRELESS
CORPUS CHRISTIE, TX

Another roadblock for DTV?

Brad Dick wrote in his December 1997 Editorial: "In November, I again reminded readers how stupid rules seem to be the normal course of action by

elected officials (and bureaucrats)." Here is yet another example:

Dear Brad,

I know most *Broadcast Engineering* readers are more concerned, understandably, about having to implement ad-



vanced TV and how to finance advanced television, however . . .

The Copyright Royalty Tribunal recommended increasing direct-to-home (DTH) network copyright fees by 900%, more than cable's fees for the same network signals. When the Library of Congress approved that raise, I realized that whether intentional or not, another roadblock had been put in place to block the road leading to smooth growth, development and implementation of ATV-DTV in the one area of program distribution that can most easily embrace network ATV-DTV technology, the DTH industry!

Can anyone provide a detailed explanation of either the Copyright Royalty Tribunal's or the Library of Congress' logic and reasoning for the disparity between past and new DTH copyright liability vs. cable's copyright liability?

Cable advertisements compare (promote) their service vs. DTH. The ad touts cable's ability to carry multiple channels (multiplexed) on one coaxial

cable. Each TV connected to cable in one dwelling, can display any of 20 to 45+ channels all at the same time — while DTH receivers can only tune and output one channel at a time. So, without multiple DTH receivers (and modulators), off-air broadcast reception, cable, or other signals (modulated onto channels other than 3 or 4) DTH owners must watch the same channel on any/all TV sets in the dwelling that are connected to the DTH receiver.

To date, no one in Congress or the broadcast or cable industries can explain the logic. If you can, I'd like to hear it.

ROBIN ADAIR, CET
THE VIDEO LADIES
DULCA SCENES
2471 MONTPELIER RD.
COLUMBIA, KY 42728
DULCA@DUO-COUNTY.COM

re: the November 1997 Editorial "Stupid Rules"

If you want to know about DTV or HDTV ask your Congressman or Senator! (Particularly those on the Communications Committee, i.e., former Senator Hank Brown from Colorado — "I can't answer that question, but I will certainly ask my office advisor about that issue." My answer was — Wait a minute, I didn't ask about an issue, I just asked a simple question.

JACK E. MCKAIN
ITELCO
DENVER, CO



READER FEEDBACK
INTERNET: brad_dick@compuserve.com
FAX: 913/967-1905

You can buy a discontinued 2465B for more or a new IWATSU for less.



Model SS7840H

Decisions, decisions.

How often does it turn out that your only choice is your best choice?

While you can still buy a **used** Tek 2465B 400 MHz oscilloscope for as much as \$8,300, our **new** \$8,000 470 MHz not only costs you less but you get a whole lot more.

Besides the extra 70 MHz of bandwidth and all of the functionality that you've come to expect from a superior analog oscilloscope, you'll also enjoy...

- Our auto calibration feature that cuts your calibration time down to 30 minutes or less.

- Our 'ghost-free' IWATSU 6" meshless CRT display that assures bright and sharp traces.
- Our full TV triggering function that is a standard feature and not a costly option.

Each of our 100, 200, 400 and 470 MHz analog oscilloscopes comes with a three year warranty and IWATSU's 43 year history of analog oscilloscope experience.

For more information, product literature or to arrange a demonstration call us toll free at **888-637-4513** or visit our web site at <http://www.iwatsu.com>.

IWATSU AMERICA, inc

430 Commerce Boulevard, Carlstadt, NJ 07072 Tel: 201-935-8486 Fax: 201-935-8533
WebSite: <http://www.iwatsu.com> e-mail: iwatsu@access.digex.net

Circle (11) on Free Info Card

TCI has "different" HDTV

BY LARRY BLOOMFIELD



"TCI May Deny HDTV to its Subscribers" and "TCI Cable Service May Provide Only Low-Resolution Digital Television" were headlines that blazed across the wire services recently.

Last month, while speaking to the National Association of Television Production Executives (NATPE) in New Orleans, Consumer Electronics Manufacturers Association (CEMA) president Gary Shapiro said, "Manufacturers and broadcasters have committed to bringing Americans the astounding picture resolution of HDTV, but now TCI's 14 million customers may never have the chance to see it. This is a huge tragedy for the American consumer."

TCI plans to downconvert broadcaster transmission of 1,080 interlace (1,080-I) HDTV and then pass it on to its subscribers in a lower resolution, 480 progressive (480-P) format. Under

these circumstances, TCI's subscribers may suffer a loss of more than 80% of their spatial resolution when compared to the 1,080-I signal were they to receive it directly.



Gary Shapiro



Leo Hindery, Jr.

"This highlights the importance of the FCC's upcoming must-carry proceeding," continued Shapiro. "The FCC must ensure that if broadcasters transmit programming in high-definition, cable companies are required to pass the programming through to the consumer in the same manner. Otherwise,

cable subscribers will be involuntarily downconverted to a picture resolution no better than today's TV."

Although the next generation of TV receivers will be able to receive and decode the lower-resolution 480-P as one of the 18 formats available, the lower-resolution 480-P, just isn't HDTV. "Any effort to label 480-P as true HDTV is an attempt to fool American consumers, who want the highest level of resolution they can get. HDTV could have a wonderful future, but it won't if Americans aren't allowed to see it," Shapiro concluded.

The cable industry has always had the charter to pass along to their subscribers exactly what they received from their various sources. Case-by-case exceptions have been made when it has been impractical to pass on some program material in stereo.

To present the other side of the story, Leo J. Hindery, Jr., president of TCI, said, "CEMA's information is incorrect and it was extremely irresponsible of them to mislead the public. The truth is, TCI has provided for additional choices and flexibility for all involved. The technology in TCI's advanced digital set-top devices allows a TV signal in any HDTV format to be transmitted to a customer's high-definition TV set. Second, customers who do not own a high-definition TV set can receive 480-P HDTV signals, translated into a standard-definition format, with the set-top device as currently configured. As the market for HDTV evolves, TCI will continue to respond to the needs of its customers. Any accusation that we are impeding this process is dead wrong."

Hindery continued, "We believe strongly that the marketplace will drive this business and determine which HDTV format will be used. The dialogue continues in the broadcast indus-

FRAME GRAB

A look at the issues driving today's technology.

Why won't you buy a satellite TV dish in the next 12 months?

Broadcaster's greatest friend may be DBS-equipped homes. A Yankee Group's survey on satellite TV dish ownership showed that relatively few consumers cited the fact that DBS does not carry local TV stations as a reason to not buy a dish.

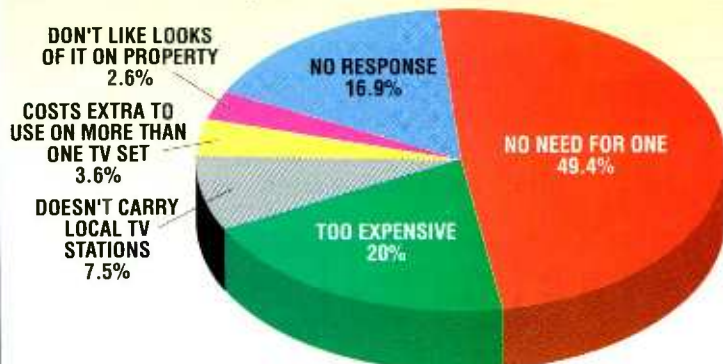

Source: SCRI International. For more information on broadcast and production industry trends, contact www.scri.com or e-mail: scri@scri.com.

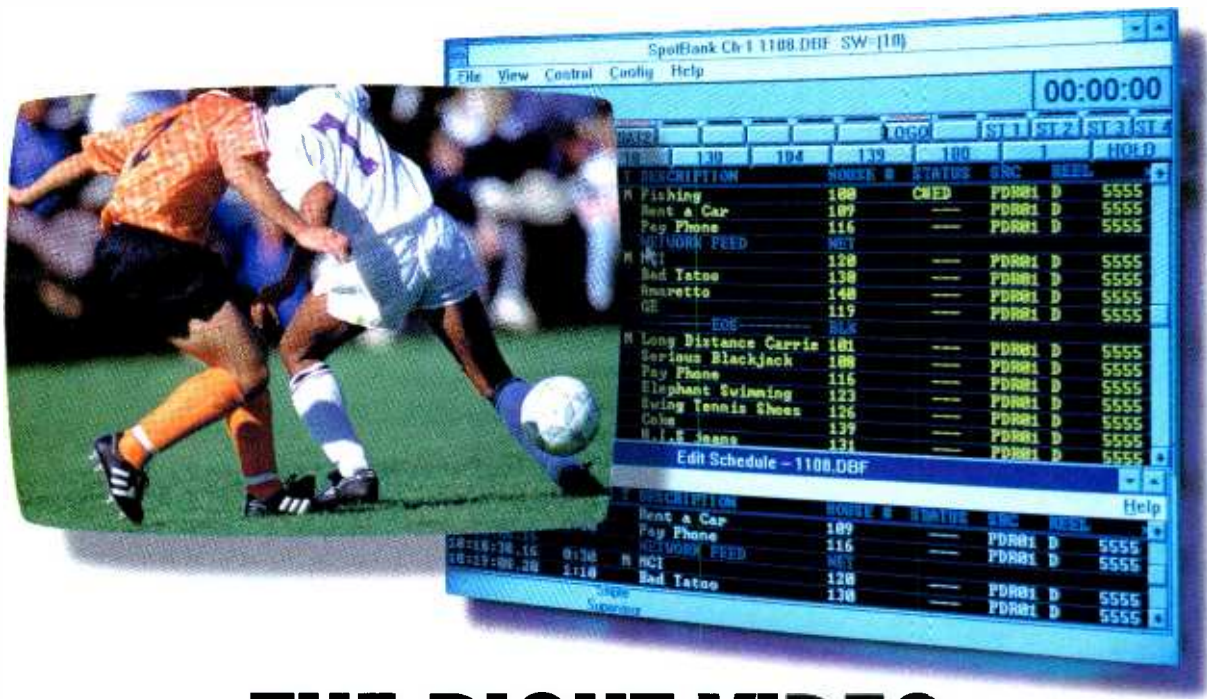

THE RIGHT VIDEO MANAGEMENT COMPANY MAKES EVERY SECOND COUNT.

And every dollar, franc, pound, or peso too! That's why you need a company that offers more than just shrink-wrapped software and board sets. One that has an ongoing history of customer satisfaction and field-proven system solutions. A company like Odetics Broadcast. We understand your station automation needs and have systems to meet those requirements. Like SpotBank, a complete on-air automation system that provides smart management of video server storage. SpotBank is a flexible system that supports multiple on-air channels. And SpotBank uses RAID servers for maximum data protection, so you can count on every spot.

To assure a smooth transition, Odetics includes system installation, training and round-the-clock customer support. Clearly, the SpotBank family makes every second count.



Odetics SpotBank™ family, a plug and play automation solution.

The SpotBank family of format-independent disk-based disk automation systems covers all your on-air needs. From single-channel MicroSpot™ to multichannel SpotBank configurations, the SpotBank family includes a configuration that will meet your on-air requirements. SpotBank systems can be expanded to control up to 24 external devices including a variety of VTRs, routing switchers and master control switcher. SpotBank is compact, affordable, field-proven and available today.



The Automated Storage Management Company

USA Tel (714) 774-2200 EUROPE Tel +44 (0) 118 927-4600 ASIA Tel +65 324-0636
WWW <http://www.odetics.com/> E-mail broadcast_sales@odetics.com

© ODETICS INC 1996 11067

Circle (5) on Free Info Card

**Contrary to popular belief,
engineers and physicists are
quite capable of celebration.**



3-color skin tone detail

Noise reduced to 65db

Switchable between
16:9 and 4:3

©2009 Sony Electronics Inc. Sony, the Sony logo, and the DTV Ready logo are trademarks of Sony. From all the... www.americanradiohistory.com

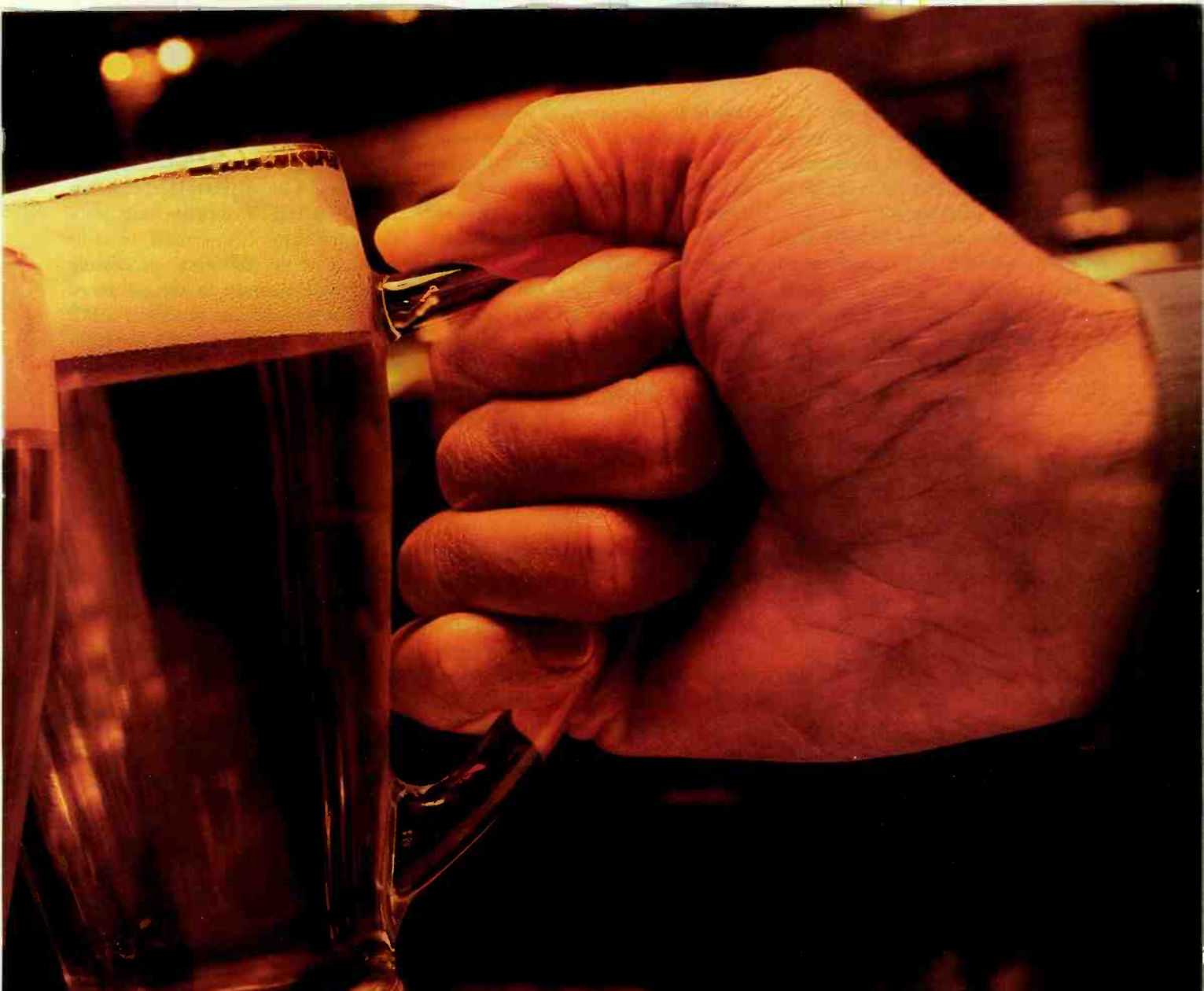

Engineers and physicists don't celebrate like the rest of us.

They wait for a truly special occasion.

Like developing the finest 12-bit digital camera on the market.

And then they really cut loose.

Our engineers designed an advanced 12-bit Digital Signal Processor.

Our physicists developed a revolutionary 16:9 CCD imager.

Working together, they figured out how these innovations
could give you the best picture available.

And if that weren't enough to cheer about,

they made our camera SDTV-ready, with the
flexibility and reliability you've come to expect from Sony.

After you see what our new camera can do,

you'll understand what all the celebration is about.

www.sony.com/professional and 800-635-SONY ext. ADSP



BVP-900/950

80% horizontal depth of
modulation at 400 TVL

16:9 CCD

12-bit DSP

SONY

try surrounding HDTV formats and digital multiplexing. The outcome of this dialogue will help determine the HDTV product ultimately available in the consumer marketplace.”

A few days after CEMA's Gary Shapiro addressed NATPE, TCI countered by saying, “TCI unequivocally affirms that its advanced digital set-top devices will indeed have the capability to pass through, to high-definition TV sets, HDTV signals in the 1,080-I format or

any other proposed HDTV format that may be selected by broadcasters and the consumer marketplace. Furthermore, since the introduction of high-definition TV sets into consumers' homes will happen over time, TCI has taken the extra step of incorporating the ability to translate 480-P HDTV signals into the standard NTSC format for display on consumers' standard-definition TV sets.”

It is my understanding that only the

720-P and the 1,080-I have ever been referred to as high-definition television.” TCI also stated, “Based upon the demands of the marketplace, translating other HDTV formats into standard-definition TV signals remains possible with additional processing speed and memory in the advanced digital set-top devices. In no way is TCI planning to “downconvert” any higher-format HDTV signal to a lower HDTV format.” ■

Is lip sync in HDTV going to be a problem?

Much space has been given to the 18 different video formats that are part of the new DTV standards, but not much has been said about audio. You need to look at what you'll be working with, because there may be potential problems, if you are not aware of what's going on.

Dolby Digital AC-3 is Dolby's third and next generation of surround sound and is the audio system adopted for HDTV. AC-3 is also the digital film format and is used on the audio tracks of the latest-generation digital video disc (DVD). That's not all. With the recent changes to the PAL DVD specification, the AC-3 encoders are used in most parts of the world, including Europe, making it, for the most part, the worldwide format on audio tracks. This makes the techniques for encoding/decoding the same for DTV, DVD and HDTV.

AC-3 provides five full-bandwidth channels and a 120Hz bandwidth low-frequency effects channel (hence the 5.1 channel term) that provide extra headroom for special effects. The full-frequency range channels consist of right-front, center-front, left-front, right-surround (rear) and left-surround (rear).

The trick comes in carrying 5.1 channels of audio information, which would normally require close to 5Mb/s of data in a 384kb/s stream. Perceptual coding methods that take advantage of the human ears' tendency to respond to only the loudest of several closely spaced components of a sound are used to do

this trick.

AC-3 also includes provisions for sending information about the audio in multiple auxiliary datastreams, such as language identifiers, copyright protection, time stamps and control information.

According to Louis D. Fielder of Dolby Laboratories in San Francisco, in a technical paper published by the Audio Engineering Society entitled Collected Papers on Digital Audio Bit-Rate Reduction: “A distinguishing feature of the AC-3 is that it processes multiple channels as an ensemble. It uses an oddly stacked TDAC transform and is designed primarily for single-point to multi-point consumer applications.”



Louis Fielder

With that in mind, what do we do with AC-3 when it gets to our station? There could be some potentially undesirable side effects lurking in the corners ready to bite you when you're not looking.

It will help to understand the impending quagmire if we approach this from the standpoint of a station getting a feed in HDTV. The station will receive encoded AC-3 along with normal network HDTV video feeds. Dolby addressed this issue and said, “Most of the networks, except for PBS, are planning to distribute a mezzanine level rate-reduced datastream to their affiliates. The audio and video will run at a high enough data rate to allow several decode-re-encode processes to happen without losing any significant amount of quality. The final rate-reduction process that produces the 384kb AC-3

datastream and the video data that will be combined to make up the 19.39Mb/s ATSC transport stream, will happen at the transmitter.” Now that should put some minds to rest.

But what about the network or other feeds that may be distributed, like PBS will be doing. According to Dolby, “PBS will distribute the 19.39Mb/s per ATSC transport stream to all affiliates just to get a system-wide HDTV presence from day one. The company realizes that for the HD programming, it won't have the freedom to brand its programs, but is willing to forego this to get the service started. I'm guessing that it will also go to the intermediate level of compression that will allow them the operational freedom it has now in the future.”

There is some concern that decoding delays in AC-3 may raise their ugly heads. Dolby reassured me that “normally, the video is processed, when it goes through master control and has to be decoded and re-encoded in the same manner as the audio would have to be to add a voice-over.” The saving factor here is that the video decoding, processing and re-encoding takes longer for the video than it does for the audio. The result is that we will still have to delay the audio to match the video, as we do today.”

It appears that any station, especially the PBS affiliates, will have to decode the AC-3 back into all six channels, add what it needs to and then re-encode all six channels back to AC-3. According to Dolby, AC-3 decoders will have the ability to decode and reproduce any of a number of different configurations “from one to 5.1 channels from a com-

The Short/cutTM Editor is your next tape recorder, edit block and digital delivery system.



It's Un-Reel. So is our free test drive offer.

Discover for yourself why the Short/cut Personal Audio Editor is the perfect replacement for generations of reel-to-reel tape recorders.

It delivers massive hard disk storage, provides true cut and paste waveform editing, and makes low-cost copies to the popular ZipTM drive.* It even has built-in speakers.

Short/cut is powerful enough

for production, yet easy enough for fast on-air editing. All this in one compact, portable and sexy unit.

If you've got a lot to do, and not enough time to do it in, it's time for a Short/cut.

So here's our offer. Take it out for a test drive on our nickel. We're that sure that after you test drive it, you'll want to park it at your place.

Drive it Hard!



Attention call letter stations.** You're only a phone call away from a free 10-day Test Drive.

So try it out. We'll understand if you don't give it back.

(818) 991-0360

360 Systems[®]

PROFESSIONAL DIGITAL AUDIO

For more information call (818) 991-0360 / Fax (818) 991-1360 / e-mail: info@360systems.com / Website: www.360systems.com

Circle (6) on Free Info Card

*Optional accessory. **Offer good in U.S. and Canada only.
© 1997-360 Systems

mon 5.1 channel bitstream.” The channel playback configuration is the X/Y mode, X being the number of front channels and Y the number of surround channels. Thus, the AC-3 coding algorithm supports 3/2, 3/1, 3/0, 2/2, 2/1, 2/0 and 1/0 playback modes.

Also keep in mind that it takes time to decode and encode digital signals.

Fielder said, “AC-3 is a single algorithm with a high degree of flexibility with regard to data rate and other operational details.”

In speaking with Brink’s Intasys’s Pe-

ter Burinskas who was involved with the audio codec concept and associated compression issues said, “Where the Grand Alliance’s selection of the AC-3 scheme gets dicey is in live feeds that need to be VO’d. The problem, even when sending the original 5.1 signal out as 2/0, is the encoder delay. If you are feeding a digital transmitter with an uninterrupted compressed digital signal, and all of the boxes along the way “speak” AC-3, all is wonderful in TV land. The moment the signal is decoded for enhancement of any kind, it must be

fed to the transmitter as uncompressed or recompressed using AC-3. The encoder/decoder chain total processing delay averages 100ms. Most of this is in the encoder, with only 5ms to 27ms delay resulting from the decoding process. This means that at best, ‘walking up to the post’ is gonna be tough.

Two questions. Is there a simpler way of doing it? How can we do our local audio business, such as inserts without screwing up the incoming signal? If you think about it, we’re sure you can think of several more concerns. ■

A new chip for cameras

Looking to buy new cameras in the not too distant future? Well hold on to your hat and those budget dollars too. It looks like you could get much more for your money and better pictures to boot from a new generation of cameras, if they use a recently developed chip from the Sarnoff Corporation. Sarnoff, the former RCA Laboratories, has developed an image sensor based on complementary metal oxide semiconductor (CMOS) technology. The new CMOS active pixel sensor (APS) has a dynamic range that is nearly 100 times that of standard charged-coupled device (CCD) sensors, at comparable resolutions. This means better shadow and highlight detail. What’s more, the APS-CMOS can control exposure without the need for a mechanical iris. The on-board electronics also eliminate the need for external analog-to-digital converters and other circuitry normally required in CCD-based cameras.

The chip is designed to give full TV resolution with video output in analog and 12-bit digital form. The temporal noise is as low as 10 elec./pixel for demanding applications, with a dynamic range better than state-of-the-art CCDs (more than 110dB), to preserve image detail in highlights and shadows. APS-CMOS chips have lower power consumption than CCDs, making it attractive for battery-pow-

ered applications. The chip is also compatible with color filter technology.

The design incorporates breakthrough technology that virtually eliminates the performance limitations associated with previous CMOS-based image sensors. The design of the internal circuitry reduces fixed pattern noise to <0.01% of full signal, below the

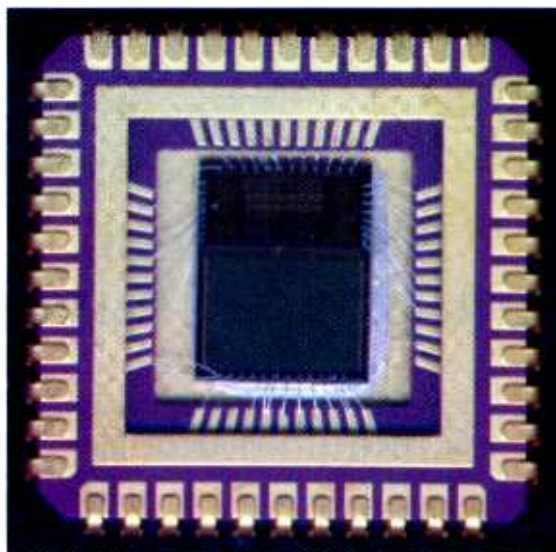

threshold of visibility.

Michael Ettenberg, senior vice president of Sarnoff’s solid-state division said, “The CMOS APS is virtually a ‘camera on a chip,’ and we believe it will revolutionize the way cameras are made and used. Not only can it replace CCDs in many current camera applications — it will help create new applica-

tions. Its low cost allows engineers to add vision capability to products where it would once have been too expensive. Complete cameras based on the CMOS imagers will be cheaper right from the start, because they’ll need fewer electronic parts and consume less power.”

It came as no surprise when Ettenberg commented, “We expect the quality of the resolution to eventually overtake what you can do with film. As we move forward and improve the technology, we’ll be able to have the same quality as pictures from high-definition TV sets and beyond.”

The cost of the chip is low enough to make the digital camera as inexpensive as a computer mouse and just as common. Ettenberg predicts that the CMOS APS chips will start at prices comparable to those of equivalent CCDs and then drop as volume increases. Unit costs for the chips could be in the \$6 to \$10 range.

The company will license the technology to camera makers and provide engineering support to modify the sensor’s design to fit specific cameras and applications. The company has already approved two foundries to fabricate the chip, and will supply design tapes for manufacturers who wish to produce it in other foundries.

For additional information, check out www.sarnoff.com. ■

LEARN TO SHARE...

WITNESS
CROSS-PLATFORM SHARING
NAB 98
BOOTH 9384



ALL OVER AGAIN

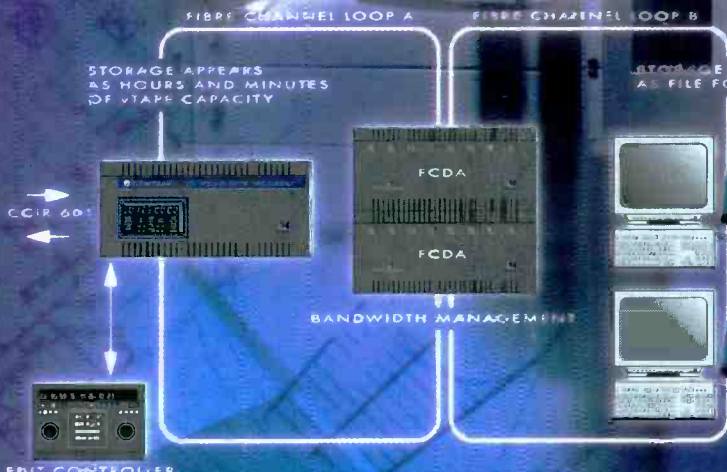

CENTRAVISION SHARING

In more innocent times, we discovered the joy of sharing an experience. We found out that accomplishment and creativity flourished more fully when we cooperated and worked in teams. It's time to get back to basics.

The CentraVision™ Fibre Channel Network and Storage System is founded on the fundamental lesson of sharing. Now, multiple workstations in your facility can all access the same pool of source material, even work on the same projects at the same time. And the CentraVision VDR lets you bridge the world of the on-line suite with the non-linear, easily transferring source material between the two. It's a secret: the only VDR that grows up with you, providing expandable storage that's shared on the CentraVision network.

It's a whole new way of working together. Just like it used to be.

Call 800-556-0222 or 702-851-9393 and visit our website at www.mountaingate.com.

SHARED MEDIA SOLUTIONS



© 1998 MountainGate Data Systems, Inc. CentraVision and CentraVision VDR are trademarks of MountainGate Data Systems, Inc. No credit was taken during the making of this ad.

Circle (7) on Free Info Card

Show me the graphics

If you weren't one of the estimated 130 million plus who watched Super Bowl XXXII, you missed some of the hottest graphics seen on television. To make spectacular graphics happen, NBC Sports enlisted the help of Silicon Graphics (SGI) to provide game analysis using SGI's Onyx2 Infinite-Reality graphics computers to render and deliver live, real-time, 3-D graphics.

The goal of NBC and SGI was to present complex statistics in a way never before seen on network television, while providing an informative, entertaining interpretation with a new look.

As the football game progressed, several on-site engineers used SGI's O2, desktop workstations to input data, play by play, so it could render the results live on the Onyx2 systems when needed. An NBC spokesperson said, "There was a separate machine for every category or separate graphic they built. This SGI equipment and software and a live set where the commentator made his presentation were all housed in a separate trailer near the remote truck.

At the conclusion of each quarter, Randy Cross, NBC Sports commentator used statistical charts created by the Silicon Graphics Onyx2 systems to provide viewers with a live, 3-D animations of key game elements from the graphics trailer. "Statistics are a necessary part of football, but numbers are boring. Pictures excite people. The capabilities of real-time live, instead of a pre-made packaged piece made my job as a commentator much easier."

The 3-D model of the stadium was created by MultiGen, Inc., using its real-time, 3-D modeling tool, MultiGen II Pro. Also working with Silicon Graphics was Boston Dynamics who had developed Football-Guy, a special version of its DI-Guy (software which was created to visualize football defense formations).

The equipment was, for the most part, off-the-shelf SGI gear, but the software was a joint effort custom modified or designed specifically for this particular event.

The current price tag for this "solution," including the custom software and hardware, is pretty stiff. The approximate cost for everything in this particular solution was about \$250,000. However, like everything else, the price should come down for these packages as they come into more common use.

For more information, check out www.sgi.com. ■

Blazing trails in DTV

When you want to do a job right the first time, you start by getting the best people you can. That is what Hughes did when it put together its subsidiary, DirecTV. To lead the team, the company nabbed Dave Baylor, NBC's Skypath wizard.

Because DirecTV delivers TV programming digitally, it might give us some insight as to what terrestrial broadcasters will be getting into. My first step was to get a direct broadcast satellite (DBS) receiver. If there were any faults, I'd see them on my 50-inch TV set. The difference in picture quality over any of the cable services or off-the-air signals exceeded my expectations.

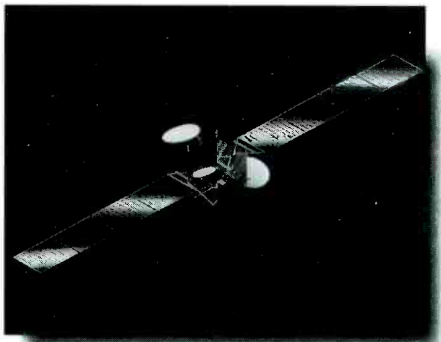

Step two was to give the engineers at DirecTV a call. I asked Jeffrey Crosby, senior vice president in charge of engineering, what DirecTV had planned. He said, "There are 18 different formats all separate from NTSC. Given the large established market, we will continue to transmit NTSC for many years to come. DirecTV will most certainly want to offer digital TV formats to the consumer that will be consistent with these (other) new formats."

DiracTV broadcasts from satellites some 22,300 miles out in space. "We currently have three satellites flying in close formation. Each satellite has 16 transponders. DirecTV uses 11 transponders on DBS-1 and USSB uses the remaining five transponders. DirecTV operates all of the transponders on each of the other two satellites." DirecTV's uplink site is in Castle Rock, CO, and a second site is being built in southern California.

To get the number of channels to the viewer's receiver, I was curious about

CEMA unveils new logo

At the International Consumer Electronics Show in Las Vegas last month, the Consumer Electronics Manufacturers Association (CEMA) and the Advanced Television Systems Committee (ATSC) unveiled a new logo for the DTV Receiver Certification program.

This new logo will be displayed on TV sets, computers and other consumer devices to signify to consumers that the product they are about to purchase will be capable of receiving

and presenting for display all ATSC video formats.

The CEMA/ATSC certification program, which will be administered by



CEMA, will allow manufacturers to assess their products for conformance to the ATSC standard. ATSC will establish the conformance standards and compliance testing procedures.

For more information, contact CEMA at www.cemacity.org or ATSC at www.atsc.org. ■



SNELL & WILCOX



DTV. ADAPT OR DIE?



Circle (12) on Free Info Card



www.americanradiohistory.com



YOUR SURVIVAL

SDTV? HDTV? Both? – Managing the Evolution

How easily can you adapt to the digital television future? Snell & Wilcox has many of the answers you need. Especially on the question of HDTV. After all, we've been developing High Definition technology for the past ten years.

Can I use my existing facility for production and then upconvert to HDTV for transmission and still adhere to the FCC requirements?

Yes. FCC regulations only require the transmission of a digital signal, but don't specify the digital transmission or production format. Standard Definition (SD) formats such as 480i can be upconverted to higher quality formats, and component digital signals from clean sources upconvert fairly well to HDTV. NTSC is not so good because of its limited bandwidth. D-2 and D-3 digital signals are better than analog because of the reduced noise. The ideal pictures for this purpose are those downconverted from HD.

So the best solution of all is to use HDTV cameras for acquisition and downconvert to SDTV for post production prior to up-converting. This also means you get continuing value out of your existing SDTV hardware investment.

Can I downconvert a signal so that I can do local production?

Yes. Studio quality baseband HD feeds just require a suitable downconverter set to the required aspect ratio. If the source is an ATSC MPEG bitstream, it's got to be decoded back to baseband video with the highest possible quality before downconversion.

How do I deal with all

Easy. Compared with clean 601 digital signals, archive material typically suffers from problems such as tape noise, film grain, poor quality transfer, motion weave and sometimes the degradation of old age.



GUIDE TO HDTV



Is it time to transfer my facility to a 601 type production at the very least?

Maybe. 601 isn't HD and will still require upconversion, but the output quality will be much better than upconversion from other sources. If your NTSC quality is good, you could use a high grade decoder and an upconverter to output HDTV in the short term. If it isn't, you should fix it because upconversion reveals poor quality and MPEG encoders don't like noise.



Can I pass through an HDTV signal if I'm not doing any local HD production?

Yes. The HDTV signal you pass through will be MPEG encoded and provided you don't modify it in any way, it's a cinch.

my archive material?

Careful noise reduction and pre-processing of these SD signals prior to upconversion will tackle each of these problems and enable you to maximise the value of your archives.

What kind of quality can I expect when I upconvert my local production for transmission in HD?

Best results are from a 601 digital source. Then analog component is the next best, finally the least good results come from a composite NTSC source. When you have no choice but to use composite, you will need the best decoder. With less than excellent decoding, residual NTSC color subcarrier can remain in the decoded video signal. This is then treated as video by the MPEG encoder, wasting valuable bandwidth.





THE DEFINITIVE HD RANGE FROM SNELL & WILCOX

Up and downconversion allows existing equipment to complete its life cycle into the HD era.



HD5100: HDTV Upconverter

Fully featured provider of high quality upconversion from SD to all current HD formats.

10 bit Transmission/Production



HD3100: HDTV Cross/Downconverter

With PhC motion compensation option for total conversion transparency across field rates. Perfect for international syndication of sports etc.

10 bit Transmission/Production



HD2100: HDTV Downconverter

Excellent quality pictures, particularly suitable for dual SD/HD production.

10 bit Transmission/Production



HD200: Compact HDTV Downconverter

Economical solution for dual format studios.

8 bit General Purpose



HD50: HDTV Upconverter

Economical analog upconversion.

Ideal for monitoring.

8 bit General Purpose



HD6000: HDTV Field Rate Converter

Converts both ways between previous 1125 HD formats and US 1080 standard.

Enables incorporation of legacy hardware and archive programming.

10 bit Transmission/Production

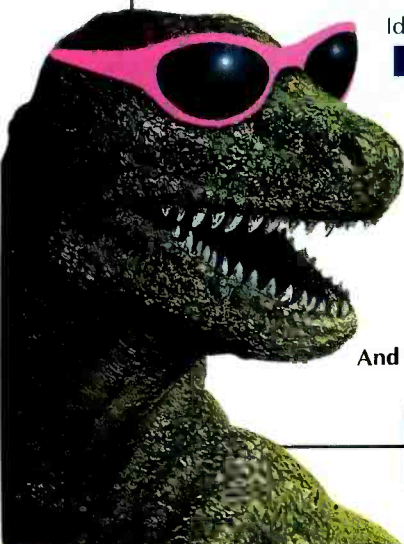

For more information and product details call us on 408 260 1000 or fax us on 408 260 2800. e-mail: info@snellusa.com. [www: snellwilcox.com](http://www.snellwilcox.com).

And to see DTV solutions in action visit our booth #9876(LVCC) at NAB '98

Circle (14) on Free Info Card



what kind of compression it used. When pressed, Crosby said, "We're using MPEG-2. The world of digital video compression is similar for everyone right now. We're dealing with

the same issues trading off the number of channels vs. the image quality for those channels."

Crosby went on to indicate that when it comes to formats, the consumer will

not decide. It will be up to the broadcasters. Ultimately, Crosby felt that if the broadcast industry narrows down to just a few of the 18 formats, they would become de-facto formats. ■

Harris and Lucent form DTV alliance

On Jan. 21, Harris Corporation and Lucent Technologies announced the formation of a strategic alliance to provide digital TV encoding equipment for broadcasters. The Harris FlexiCoder (tm) will use MPEG-2 encoding technology developed by Bell Labs, the R&D arm of Lucent Technologies.

The FlexiCoder is an expandable, modular, ATSC-compliant digital video and audio compression system. It will allow flexible, transparent switching between multiple channels of standard-definition video or a single channel of high-definition video, each with Dolby stereo digital audio. A data input module will accept EIA708 captioning data and will support an external Dolby Digital encoder. All video

modes and formats in the original ATSC Table 3 will be supported, subject to ongoing standard-setting issues.

Four SD channels in a single ATSC transport stream (one TV channel) were demonstrated, with a target of six HD programs or one HD program to be available by NAB '98. For the target HD operation, six encoding engines are combined for increased horsepower. Of the six encoder engines used in the HD mode, four are required and two are configured as redundant standbys. For additional reliability, multiple modules of the same type can be installed as redundant pairs, with automatic change-over. The modules are hot-swappable, although redundant units must already be installed to allow

seamless replacement of a failed unit.

ATSC transport stream outputs are available in a variety of formats, including ATM and SMPTE 310M. (310M is the new SMPTE standard for the link between the ATSC encoder and the 8VSB exciter. It is in the final stages of standardization.) A unique feature of the FlexiCoder and 8VSB exciter combination is a transport stream frame synchronizer. This decouples the timing reference of the transmitter from the transport stream clock rate, allowing the transmitter frequency stability to be determined by an external frequency reference (GPS, WWV, etc.) if desired. ■

Larry Bloomfield is a former chief engineer, industry consultant and author, located in Bend, OR.

Who has the best wireless microphone systems?



Systems Wireless is proud to offer and support the **NEW** Lectrosonics 200 Series wireless microphone systems for demanding field production needs. This is the most advanced wireless in the world, with the most frequencies available to the user, period. When wireless microphones are a part of your life's work, don't take a risk. Depend on the folks who have made wireless their life's work.

- SALES
- RENTALS
- SERVICE

The Lectrosonics 200 Series wireless microphone system offers 256 selectable frequencies to alleviate interference problems in traveling applications.



systems wireless, ltd.

Specializing in Professional Communications Solutions
swl@swl.com • www.swl.com • PH (703) 471-7887 • FAX (703) 437-1107

Circle (15) on Free Info Card



Reallocating TV Channels 60-69

BY HARRY C. MARTIN

In a year-end action, TV Channels 60-69 (the 746-806MHz band) were re-allocated to other services. Specifically, 24MHz at 764-776MHz and 794-806MHz were allocated to the fixed and mobile services for public safety use. The remaining 36MHz at 746-764MHz and 776-794MHz were allocated to the fixed, mobile and over-the-air DTV broadcasting services.

A proposal has been issued to develop rules for the public safety services that will operate in the Channel 60-69 spectrum and includes criteria for protecting analog TV and future DTV stations against interference.

Channel assignment update

In December, broadcasters responded to filings by the Association for Maximum Service Television (MSTV) and the

Association of Local TV Stations (ALTV), which asked the FCC to revise the DTV table of channel allotments.

MSTV requested 357 changes to the table saying they were designed to reduce projected adjacent-channel interference among stations operating on the DTV channels and alleviate interference to existing NTSC service and new DTV service. MSTV changes included 32 additional allotments on Channels 60-69.

ALTV addressed the disparity in authorized power between UHF DTV channels assigned to stations operating on UHF channels and UHF DTV channels assigned to stations operating on VHF channels. ALTV suggested allowing DTV stations to increase power to 1,000kW if they use beam-tilt antennas or other technologies to prevent additional interference.

Fees for ancillary DTV signals

The FCC plans to impose fees on stations that use digital spectrum for non-broadcast services and other uses that are supplemental to stations' over-the-air DTV signals. In an NPR, the FCC asked what methodology should be used to determine the fees. The rationale for imposing fees on ancillary use of DTV spectrum is that the commission does not wish to provide a competitive advantage to broadcasters over wireless licensees who purchased their spectrum at auctions.

The FCC proposed three alternatives to calculate the fees: 1) a percentage of gross revenues, 2) a percentage of net revenues or 3) a combination of both. ■

Harry Martin is an attorney with Fletcher, Heald & Hildreth, PLC., Rosslyn, VA.

Wherever you are...

GSC3000 with Voice Interface* Radio Transmitter Remote Control

- With any phone or by computer & modem
- Dial in to check transmitter
- Access and correct from anywhere
- Program unit to take its own corrective action
- Notification by phone, pager or computer
- Full time access or periodically check multiple transmitter sites from anywhere

* Available end of summer 97



800.945.4397
http://www.gentner.com • 801.975.7200
Try our conference call service 1.800.LETS MEET

Approvals: CE, FCC, P 15 & P 68, CSA NRTL/C



You're in control.

Circle (16) on Free Info Card

TRAVEL
AT
THE
SPEED
OF
THOUGHT

Think

Done.



YOU'VE GOT 15 MINUTES. WITH A STRATASPHERE™ NONLINEAR EDITING SYSTEM YOU CAN DO 33 LAYERS, 19 DVEOUS™ EFFECTS WITH DROP SHADOWS, 26 WIFES, 17 ALPHA KEYS, 44 DISSOLVES, 3 TITLE ROLLS, COMPOSITE IT ALL, MIX YOUR AUDIO, FINISH 4 DIFFERENT VERSIONS, AND STILL HAVE TIME TO CHANGE YOUR MIND. IMAGINE WHAT YOU CAN DO WITH 20 MINUTES.

STRATA SPHERE



The Ultimate Drive Machine.™

THE KEY TO UNLEASHING YOUR CREATIVE POTENTIAL IS WITHIN REACH. EXPERIENCE REALTIME CREATIVITY IN THE FAST LANE.

CALL US NOW TO SET UP A TEST DRIVE.
TOLL FREE [888-846-7017]

scitex 
DIGITAL VIDEO

WEB: WWW.SCITEXDV.COM

Circle (17) on Free Info Card

www.americanradiohistory.com



DTV: Broadcasting or datacasting?

BY LOUIS LIBIN

There are now more opportunities for broadcasting data and it is the new catch phrase for those who want to take advantage of the digital capacity of the new DTV channel. According to some estimates, the potential revenue from datacasting will ultimately run a close second to broadcasting revenue. In the beginning of the DTV era, however, datacasting has an even higher potential for stations to earn money than even broadcasting premier HDTV programming. To date, there is no conclusive research or evidence to prove the business model of the various datacasting schemes and plans that broadcasters are currently evaluating.

The new digital transmission technology will allow broadcasters to deliver high-definition pictures, CD-quality

audio and additionally, data transmissions. The FCC adopted the standard, leaving open the video formats. This means that full flexibility is available to broadcasters for different video formats, all the way from high-definition pictures to low-resolution images. The digital broadcaster will be transmitting only data through its network, leaving it to make the choice of services to occupy the almost 20Mb/s. The use of data broadcasting will allow broadcasters and others to apply part of the 6MHz channel for other services, and these uses may prove to be a significant revenue stream, even at the beginning of the DTV service.

The DTV system owes much of its power and flexibility to the packetized transport technology employed for the

broadcast delivery of the multimedia service.

Along with packetization, the transport technology provides two other important functions: multiplexing and synchronization of the services that comprise a program. The transport technology creates a stream of fixed-length information packets from a variety of elementary bitstreams. Each packet contains only one type of data: video, audio or ancillary. Because there is no fixed mix of packet types, the transport mechanism can dynamically allocate the available channel bandwidth for complete flexibility. Each transport packet consists of a four-byte packet header followed by 184 bytes of payload. The header includes means for synchronizing packets and identify-

"Very few things happen at the right time, and the rest don't happen at all..."

Herodotus

The Time Is Right For DTV



To make DTV happen for you, it's critical you find an experienced supplier with proven products and services ready to satisfy your unique DTV challenges. It's time you talked to Andrew. We're experts at delivering the custom solutions you'll need for DTV. Take tower loading, for example. To cut windload for Phoenix's KTVW-TV, Andrew recently supplied a new pressurized, slot covered TRASAR[®] antenna and our new 5" HJ9HP-50 high power HELIAX[®] transmission line. These design innovations significantly reduced tower loading: 32% lower weight, 14% lower windload. Time and time again, we deliver the right answer, at the right time. Don't wait. Call today for more information.

Andrew Corporation
10500 W 153rd Street
Orland Park, IL 60462
Visit our Web Site at
<http://www.andrew.com>

1-800-DIAL-4-RF

ANDREW[®]

*In A Communicating World,
Andrew Is Everywhere*

Circle (18) on Free Info Card

Tiger

144 x 144 Routing Switcher

Introducing
the largest
scaleable routing
switcher...with the
smallest footprint.



- A Digital/Analog Routing Switcher scaleable from 8 x 16 to 144 x 144. Low cost expansion to 288 x 288, or beyond.

- Compact 12RU video chassis handles both 60MHz analog and SMPTE 259M digital cards *in the same frame*. The audio chassis provides two analog, or two AES/EBU digital levels in 8RU. Both frames include redundant power supplies.

- Two outputs/bus with equalization.

- WIN3500 System Controller with Tieline Management supports a wide selection of control panels. Single or dual controllers can be installed inside the video chassis.

Grab hold of a Tiger...
a smart investment for
the DTV transition.

You can do it!

Call... 1-800-328-1008

Circle (8) on Free Info Card

Corporate Sales • Melville, NY 11747

www.pesa.com

NAB Booth 12970

LVCC—South Hall



PESA
Switching
Systems



NEWS. FLASH.

Now you can turn a single lightning bolt into a hundred different stories. In a broadcast second. Fact is, Tektronix® News Solutions can help you produce more news, better news, in less time — with more control. As integrated video solutions, they can help you automate all the news gathering, editing and organizing. At the same time, they can streamline your entire news production — from assignments to on-air scheduling. But before you start to feel any gigavolt jolts, know this: Tektronix News Solutions can be integrated with tape systems as easily as disk. So you can set your own migration pace on the way to disk. They're scalable. So you can grow from newsrooms of 20 people all the way to 200. And, of course, you can rely on Tektronix' long-running support of these "mission critical" applications. Just so you know, you'll get maximum impact for every broadcast watt — without the risk of natural disaster. See, if you can dream it up, we've got a way to get you there.

For the whole story, call 1-888-TEK-VIDEO, dept. 606 or visit us at www.tek.com/VND

Tektronix®

ing payload service. The sync byte, always the first byte of the packet header, contains a fixed, pre-assigned value. A 13-bit field called the packet identifier, also found in the packet header, affords a way of multiplexing various elementary bitstreams. Because the location of the packet identifier field is fixed, packets corresponding to a particular elementary bitstream are simple to extract once packet synchronization

has been established. The simplicity of this approach is extremely significant.

An example of a solution for the multiplexing/datacasting problem can be seen with the Philips 4.0+1 DTV compression system. This is a modular system, capable of flexible designs. A station may choose to transmit four SDTV signals in one ATSC datastream. HDTV programming may be added by using an HDTV encoder. External data sources

can be inserted, even replacing an SDTV source. One of the primary purposes for this device is an STL replacement, to allow the NTSC and the HDTV or multiple DTV channels to be multiplexed together for transmission on a single channel. This is but an example of the types of equipment we will see in the coming months and years. ■

Louis Libin is a broadcast consultant in New York and Washington.

Expert's Corner/Vendor Views

Planning for DTV

Within any facility, there are infrastructure issues that once implemented are difficult to change. As stations move toward DTV broadcasts, these infrastructure issues must be revisited. *BE* contacted two readers and two vendors and posed the following questions:

- 1) *What type of infrastructure would you recommend stations build if they have to convert within the next two years? Is a mezzanine approach adequate today, how about for tomorrow?*
- 2) *What if stations don't have to convert until five years from now? Would the answer be different?*

EXPERT



Charlie Goode, vice president of engineering, Smith Broadcasting, St. Petersburg, FL.

Group perspective:

All of our stations are in the 30+ tier and do not need to convert until the end of the FCC's timetable. Therefore, we will be doing only minimal conversion over the next two years. Our facilities consist of a composite analog infrastructure, however, within that infrastructure are other formats, made necessary by color-under and component tape equipment and RGB-based graphics systems. These signals are converted to the house format (analog composite) as needed, and we expect conversion to the house format to remain a staple of our operations. What will change will be the house format.

Facility upgrades and purchases are made with an eye toward a serial digital infrastructure. For example, we are no longer installing 8281 cabling. Wiring is being done with true 75Ω connectors and cabling that supports data rates in excess of 270Mb/s. Fiber is not used unless it is required. Routing switcher frames compatible with serial digital are used, but are being configured with analog crosspoints. As our complement of serial digital equipment grows, so too will the router crosspoints to support it. As our existing cameras are replaced, we are providing them with switchable aspect ratio cameras. In this manner, we hope to preserve our current investment and extend the equipment's useable lifetime.

The concept of local pass-through of network signals is unworkable. Local branding, EAS and local commercial insertion are all required in our current and future operations. A mezzanine level of some type might be supportable, but our anticipation is that incoming and locally produced signals will be converted to a serial digital house format and handled accordingly. We do not expect to support a high-definition infrastructure, but rather to upconvert standard-definition as needed. It does not make economic sense to invest \$4 or \$5 million in a station that is only worth \$4 or \$5 million. ■

EXPERT

Scott G. Griffin, principal and director of engineering, The Systems Group, Hoboken, NJ.

System integrator perspective:

The choice of infrastructure needed to support DTV programming is primarily a business decision. It is based more on a station's market competition, network affiliations, fiscal capacity and programming content than on a subjectively chosen transmission or production standard. The mezzanine approach of a 270Mb/s routing and distribution scheme, with upconversion and "mole"-aided bitstream splicing for network insertion, is the most cost-effective approach for most stations that need to convert within two years. Once transmitting in DTV, a close monitoring of the competition, and an assessment of the *actual* financial impact of the new technology will lend clarity to a prudent next step, whether it be further technological upgrade or expanded programming. ■

SONY

Business and Professional Group

Technical Brief: Studio Camera Technologies and Systems for the DTV Era



By Laurence J. Thorpe

Vice President, Acquisition Systems, Business & Professional Group
Sony Electronics, Inc.

The era of DTV has arrived. A gigantic private sector undertaking has finally forged its way through a long and sometimes difficult process to shape the new American broadcasting landscape. Television is about to change dramatically, and it will change for the better.

All facets of the gigantic television "food chain" are already being touched. From program origination through post-production, distribution, and traversal of the broadcast network infrastructure, to the local station's final program preparation and—finally—transmission to the home, the new DTV agenda is affecting every element of the television system. And, it is affecting the system in ways we would not have dreamed of only a short five years ago.

The DTV agenda of the United States encompasses a new freedom never before known through all of the decades of analog NTSC transmission. DTV can be a digital HDTV (high-definition television) service, or it can be a digital SDTV (standard-definition television) multichannel service. Perhaps most important, it can be any combination of these two. In other words, broadcasters have been assigned a new and separate 6 MHz RF channel through which they can transmit a single channel of HDTV, or multiple channels of SDTV, or any combination of these two services—throughout different portions of a given day or night. The "payload" carried by the mandated digital transmission standard has been effectively deregulated.

It is probably true to say that the new freedom broadcasters now have, in terms of the DTV service that they might ultimately offer, is presently a cause for some confusion and anxiety. The difficult decision of how to start the service, and then how to evolve it to a successful new broadcast business, confronts every broadcaster.

The leading edge of this total television system, namely, the camera or camcorder that originates the DTV pictures and sound, will play a major role in the system that follows. Just the decision of whether to start with digital HDTV, or one, two, three or more widescreen or 4:3 digital SDTV services, poses a basic question as to the appropriate camcorders for the news crews, the cameras for the news studio, and cameras for a production studio or mobile outside broadcast (OB) truck.

In this Technical Brief, Sony will examine the central technical issues confronting the producer and broadcaster when acquiring the program origination equipment that will support their first venture into an embryonic DTV service, while facilitating further flexible migration. What is unique about this DTV era is that different broadcasters may elect to pursue quite different migration strategies to their final service. This poses special challenges to the studio/OB camera manufacturer. Sony's design strategies underlying the new BVP-900/950 digital SDTV studio/OB cameras and the new

HDC-700/750 high-definition cameras will be outlined as contemporary solutions to these challenges.

DTV Requirements in Studio Camera Systems

What are the key requisites for acquisition systems supporting program origination in this looming era of DTV? What are the essential technical imperatives, in contrast with those of the former analog-only NTSC period? There are four such requirements, given below:

- **Aspect ratio management.** The need to service both the standard 4:3 aspect ratio and the new 16:9 widescreen image format introduces the most difficult challenge of all for the program originator. Aspect ratio conversion entails difficult choices in terms of preserving or discarding precious picture content.
- **Highest picture quality.** In anticipation of DTV, an entirely new yardstick of picture quality will soon be appearing in the living room. This will be propelled by a plethora of new digital delivery media that bring MPEG-2 digital component video directly into the home.
- **Highest signal/noise performance.** There is now an entirely new industry need for the very lowest in picture source noise. Noise is the enemy of compression. Television program masters will henceforth be subjected to increasingly frequent digital compression in order to service distribution via DTV broadcasting, digital satellite and cable, and digital packaged media ranging from CD-ROM to DVD. A formerly benign noise interference (in the analog NTSC context) can, in an era of heavy digital compression, be easily translated into new and disturbing picture artifacts.
- **System flexibility.** The diversity of services that any given broadcaster may ultimately deliver, coupled with the still unclear migration to a full widescreen DTV operation (while still maintaining an ongoing standard 4:3 analog NTSC service for some years), augur for particular care in the choice of program origination equipment that is suitably flexible.

The implications of each of these issues are complex, and need to be carefully evaluated against the contemporary technologies available to camera equipment manufacturers. In particular, the ability to deliver full HDTV and a choice of either the 480I or 480P SDTV formats will become more important.

Section I: Camera Technology for SDTV

HDTV and SDTV are both usually distinguished from current analog NTSC by their aspect ratio. HDTV is always presented in a widescreen 16:9 aspect ratio, compared to the standard 4:3 of NTSC. SDTV, on the other hand, while expected to be largely 16:9 widescreen, *can* also be standard 4:3.

As shown in Figure 1, the very essence of the future simulcast broadcast operation will dictate a great deal of program material flow between the ongoing analog 4:3 NTSC service and the new DTV service. Archive 4:3 material will be regularly accessed for the developing digital DTV channel; new material specifically originated for the widescreen DTV channel may well also be used at times on the analog NTSC channel; widescreen film-originated programming may sometimes service both channels; and so on. There are many variations that will constitute a normal daily programming dynamic in the multiple DTV scenarios that will surely evolve in the anticipated competitive and innovative DTV marketplace.

The management of aspect ratio is a significant new production issue, dealing in a world that will encompass two quite different image formats: the widescreen 16:9 format and the standard 4:3 format. Here we are dealing with the very troublesome issue of *picture content*, as illustrated in Figure 2. The 16:9 image has 33 percent more horizontal picture content than the 4:3 image.

There is no good way of moving program material in a bidirectional manner between two such formats. Simply put, you can derive an often-times excellent (or at least satisfactory) 4:3 image from a 16:9 original, but there is no way of deriving a satisfactory 16:9 picture from a 4:3 original.

Figure 3 summarizes a novel Sony approach to the entire issue of implementation of dual 16:9 and 4:3 aspect ratios in a studio/OB camera (the BVP-900/950). The essential point the illustration conveys is Sony's recognition that this implementation would vary considerably between customers. No one implementation would meet all the needs of a broadcast and production industry that will see different approaches to both the initial start-up and the ultimate migration of DTV services. There are a number of primary variables, including:

- The timetable of the end-user. Being able to upgrade to 16:9, in *their* time frame, can be very important.
- Some innovative users will start immediate production in 16:9, but would still like to have the ability to also produce in 4:3 if the need arises.

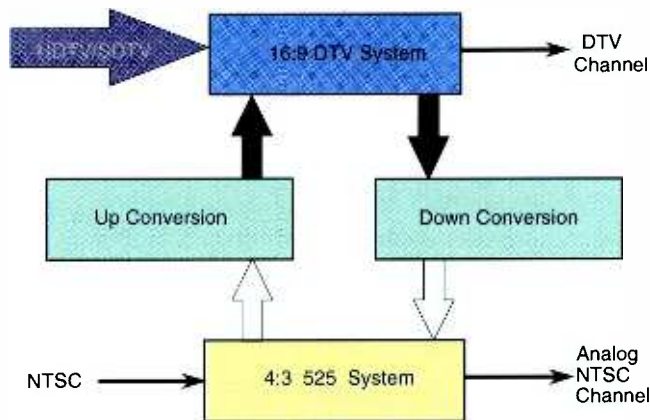

Figure 1. The flow of program material between the existing analog NTSC service and the new DTV service.

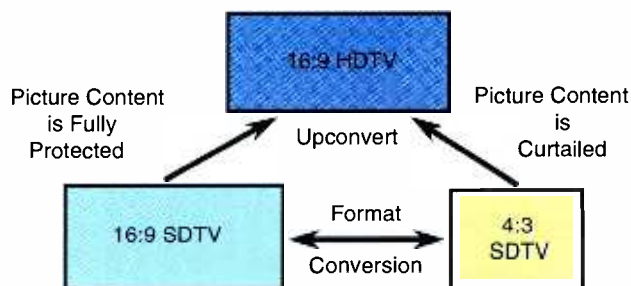

Figure 2. Exchanging program material between two different image formats is not symmetrical in terms of protecting picture content.

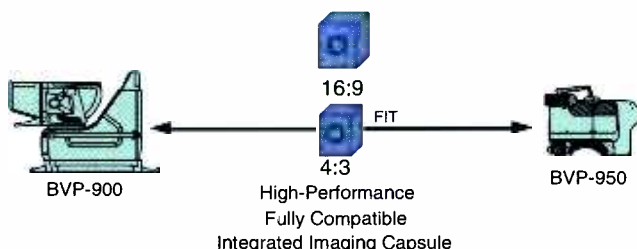

Figure 3. The *Integrated Imaging Capsule* allows rapid configuration of a camera with a 16:9 or a 4:3 CCD imaging system.

At first glance, it would seem that the switchable 16:9/4:3 camera would meet all requirements. That is not, however, the case in the real world.

Widescreen is fully expected by the marketplace to produce a picture that can be clearly distinguished from traditional 4:3 images, and for that reason alone there can be no short-changing the initial 16:9 image capture. It is for this reason that Sony always employs a full-format, true widescreen 16:9 CCD imager, whenever it images for widescreen.

The suggested approach of using a basic 4:3 imager and electronically altering the vertical spatial sampling structure to implement 16:9—in Sony's view—is, unfortunately, badly flawed. Sony disagrees with the concept of attempting to synthesize any form of credible widescreen image from switching a 4:3 imager into a 16:9 mode, for the following reason.

Spatial sampling can only be optimized for *one format* or the other. The all-important optical low-pass filter is a fixed entity that *cannot* be optimized for two different vertical spatial sampling formats. Vertical aliasing is inherently troublesome in the 525-line SDTV domain, and this is worsened by such an approach. Sony strongly favors the use of a true 16:9 imager and the employment of DSP signal processing to derive a quality 4:3 video format from the widescreen original.

For a television station today, three approaches to dual 16:9 and 4:3 camera operation are useful:

- Configurable
- Simultaneous
- Switchable

We will look at each in turn.

Configurable

This approach exploits the innovative Sony concept of the plug-in *Integrated Imaging Capsule*. It uses two optimized CCD Integrated Imaging Capsules—one being a full-diagonal 2/3-inch standard 4:3 format, and the other a full-diagonal widescreen 2/3-inch 16:9 format.

This approach works exceedingly well for those customers who, by the very nature of their business, are regularly reconfiguring studio/OB and companion portable cameras. Mobile truck operators, who alternate between different sports coverage and high-visibility entertainment events, are a classic example of this type of user.

They also fully expect to be reconfiguring their cameras for different events that will be defined by widescreen or standard 4:3. Having an appropriate pool of 16:9 Integrated Imaging Capsules will readily facilitate the transfor-

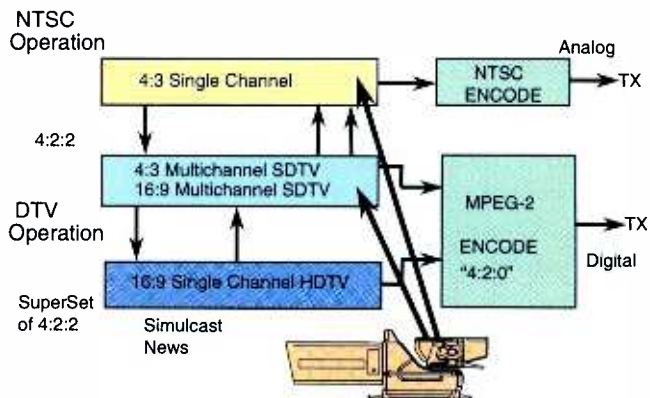

Figure 4. The evolving simulcast broadcast plant and the servicing of NTSC and DTV with multipurpose studio/OB/EFP cameras.

mation of the appropriate mix of studio/OB and portable cameras to 16:9 operation.

Simultaneous

This is a very important operational situation. Figure 4 depicts a macro-view of the evolving broadcast station (or production facility) of the near future. Depending upon the agenda of the customer, they will ramp-up some form of DTV while continuing to broadcast 4:3 NTSC. It is expected that these agendas will be widely variable. HDTV may or may not figure into the agenda in the early years. Widescreen 525-line SDTV surely will play a role for most.

Within the dual simulcast NTSC/DTV operation, there will constantly arise the need to service *both* channels from a single live source. Broadcast news is a prime example. Here, a widescreen camera will directly originate the live 16:9 pictures for the new DTV service, but those same images may also be required for the analog 4:3 NTSC news program.

Sony's novel (and still unique) ARU-701 aspect ratio converter can take an analog component video output, or the serial digital component video output, from the widescreen 16:9 camera CCU and *simultaneously* deliver the two required live feeds—each via serial digital interfaces. (See Figure 5.) A switchable camera alone cannot do this.

Switchable

As DTV broadcasting becomes more routine, the need to deploy cameras between 4:3 and 16:9 operation will, for many customers, become almost a daily event during the simulcast years (at least until NTSC goes away, many years from now). Now, the switchable camera becomes more attractive.

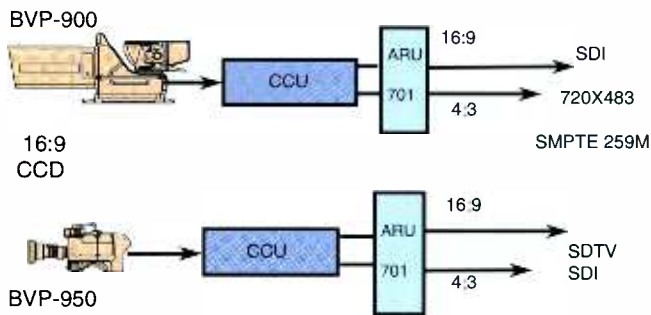

Figure 5. Use of the ARU-701 digital processor produces simultaneous 16:9 and 4:3 outputs.

The switchable camera will require a DSP camera head and a true 16:9 Integrated Imaging Capsule. This provides the high-performance true widescreen image origination, delivered via a serial digital interface of 16:9 at the output of the CCU. Alternatively, via a remote control switch at the master setup unit, a 4:3 derivative can be digitally created from the widescreen capture and provided as a serial digital stream at the CCU output.

Highest Picture Quality

The overall performance of a television camera can be divided into two distinct categories:

- Those separate imaging attributes that collectively contribute to overall picture quality (that is, the aesthetics and beauty of the picture).
- Those separate artifacts of the camera system that collectively detract from the overall picture quality.

The name of the game in high-end television camera design is to optimize *all* of the picture quality factors while minimizing *all* of the picture artifacts.

The New Importance of Picture Quality

As the transition begins to digital component video origination and post-production—and all-digital transmission to the home—it is very important to take stock of how we specify the true overall performance of picture sources. Widescreen MPEG-2 digital 4:2:0 component 525-line video that is virtually artifact and noise-free will look dramatically different from analog NTSC when viewed in the living room. As a

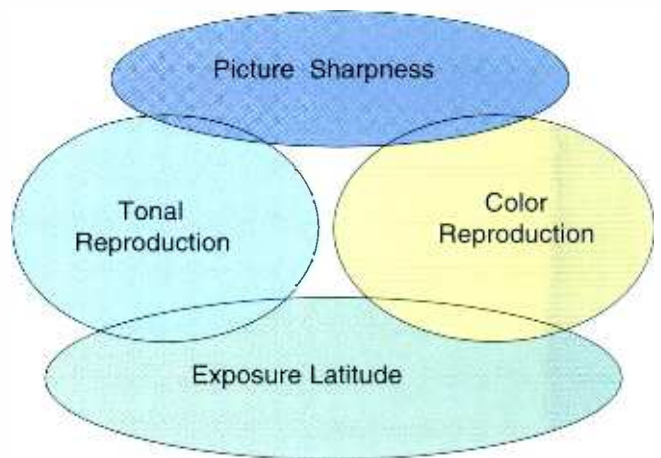

Figure 6. The multiple dimensions that contribute to image quality.

consequence, new criteria for source picture quality will invariably emerge.

In describing the overall aesthetics of the DTV picture, it is essential to re-examine the multidimensional aspect of image quality and to reassign some priorities to the contribution of each of those picture dimensions.

Quantifying the Separate Dimensions of Picture Quality

There are four core attributes of picture quality, as illustrated in Figure 6. They can be separately considered (and separately specified) as the key contributing dimensions of picture quality:

- **Picture sharpness**—the overall resolution of the image.
- **Tonal reproduction**—the accuracy of reproduction of the gray scale.
- **Color reproduction**—the total color gamut that can be captured, and the accuracy of reproduction of the luminance, hue and saturation of each color.
- **Exposure latitude**—the total camera dynamic range, or the ability of the camera to simultaneously capture picture detail in deep shadows and in areas of the scene that are overexposed.

The overall performance of a camera is largely determined by the front-end imaging system, namely the combination of optics and imager. These elements predetermine the four core attributes, earlier defined, of a television picture. The image quality must be fully retained and—where possible—en-

CCD Imager		Video Processing
Pixel count Super EVS	Picture sharpness	Detail enhancement system Skin tone detail system
Sensor design	Tonal reproduction	Video dynamic range management system - Gamma precorrection - Black gamma
	Exposure latitude	Variable overexposure - Knee control
Manufacturing quality control	Color reproduction	Linear matrix Variable linear matrix Secondary color vector

The New CCD Imager

We unceasingly refine the core technologies of CCD imaging. These refinements are not merely isolated advances in semiconductor physics. Rather, they constitute carefully planned development programs targeted at improving specific picture attributes that have been clearly identified by Sony's camera design teams. These engineers are a formal part of design reviews for any new CCD development programs.

The award-winning *HyperHAD™* technology was spawned from this synergistic coordination of

Table 1. System linkage between the CCD imager characteristics and the video DSP processing in determining overall camera performance.

hanced within the complex RGB video processing system that follows the imaging system.

Thus, the operational picture performance of a camera is totally determined by the combination of the CCD optics, the imaging system and the RGB video processing system. Table 1 shows the relationship between the CCD imaging parameters and the associated video processing that together contribute to each of the four primary dimensions of picture quality.

Achieving the Highest Picture Quality: The Pivotal Technological Linkage of a New CCD and ADSP

What is different about the Sony approach to *Advanced DSP* (ADSP) is that it was not born of an isolated technological advance in RGB video signal processing. Rather, Sony's ADSP was part of a larger *advanced imaging* strategy that carefully coordinated two important, but separate, development programs. It comprised no less than a strategic mobilization of the separate technologies of CCD imaging and DSP processing to enhance the multidimensional aspects of a number of important imaging parameters.

The specific goal was to advance digital video imaging simultaneously, on two fronts, with the intent to produce the highest performance SDTV camera in the industry. These two development programs included:

- The introduction of an advanced new CCD imager that would simultaneously improve dynamic range and S/N.
- The move to the long-sought 12-bit DSP, which would simultaneously facilitate a better match with the high dynamic range of contemporary CCDs, and higher S/N.

a focused program to make a significant breakthrough in television camera dynamic range, actually thrusting its imaging capability—in this respect—beyond the legendary capabilities of motion-picture film. Sony did not stop there.

The company, some time ago, elevated the priority of imaging sensitivity, S/N, and dynamic range as a system “imaging troika” that Sony would optimize *in concert*. This imaging troika is illustrated in Figure 7. Equally important, when Sony attempts to optimally reproduce the superb CCD imaging capability at the lower end—toward optical black—as well as the overexposed signal ability, it speaks of a total imaging dynamic range in excess of 70 dB! As much priority needs to be assigned to this crucial lower region of the exposed signal as to the higher signal level region. Clearly then, care must be exercised in the priorities assigned to the A/D amplitude scaling applied to this unprecedented level of video signal [1]. This is the very essence of the Sony strategy to significantly improve overall picture quality.

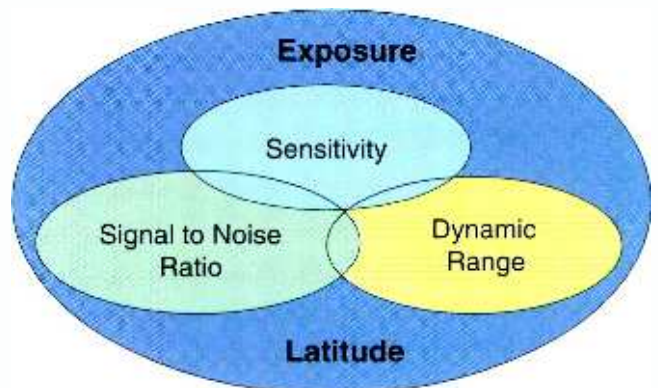

Figure 7. The three core performance attributes of the CCD imager that combine to expand the *exposure latitude* of the studio camera.

Sony's Approach to 12-bit ADSP

The analog-to-digital (A/D) quantizing levels have a direct bearing on the S/N performance of the DSP processing circuits in a camera system. Over the linear video A/D output range from black to nominally exposed reference white level, the video S/N is given by the well-known formula,

$$S/N = 10.8 + 6N \text{ (dB)}$$

Where N = the number of bits assigned to that range.

Table 2 summarizes the quantization S/N ratios of various levels of DSP amplitude sampling.

The significance of this DSP S/N quickly emerges when the concatenation of this S/N with that of the CCD itself is examined. Sony set as a central design target, for the new BVP-900/950 cameras, that the amplitude sampling of the video representation of a nominally exposed signal (capped black to nominal 100% exposed reference white) must be *at least* 10 bits. The remaining bits would be delegated to handling the overexposed signal.

To ensure the highest S/N camera for the era of SDTV, it is essential that the *CCD imager* be the defining element of that noise level. This demands that the DSP quantization noise be of a far lower level than the CCD imager noise. In this respect, a rule of thumb is that the DSP quantization noise will have less than a 1 dB effect on overall camera S/N if the DSP S/N is about 6 dB higher than that of the CCD. Figure 8 illustrates this critical issue by examining two cases: one where the CCD and the DSP have the same S/N, and a second where the DSP has an S/N approximately 10 dB higher than that of the CCD.

The 12-bit DSP Camera: The New BVP-900/950

It is in recognition of this major S/N system optimization that Sony's design approach to 12-bit digital video processing is markedly different from that of some competitive 12-bit DSP cameras. This difference is significant. Figure 9 shows the contemporary approach used for the assignment of the 12 bits to the full CCD linear output signal. Here, priority has been given to a *linear* quantization, based upon a plausible argument that handling the compression of the overexposed signals entirely in the digital domain constitutes the achievement of a goal of the true digital processing camera [2].

The resulting 9.2-bit amplitude scaling applied to the nominally exposed signal produces a DSP quantization noise in the vicinity of 65 dB, which, if concatenated with a 62 dB CCD, would produce an operational S/N of about 60.5 dB.

Number of Bits	DSP Quantization Levels
8 bits	$S/N = 10.8 + 6 \times 8 = 58.8 \text{ dB}$
9 bits	$S/N = 10.8 + 6 \times 9 = 64.8 \text{ dB}$
10 bits	$S/N = 10.8 + 6 \times 10 = 70.8 \text{ dB}$
11 bits	$S/N = 10.8 + 6 \times 11 = 76.8 \text{ dB}$

Table 2. The quantizing S/N associated with various DSP quantizing levels.

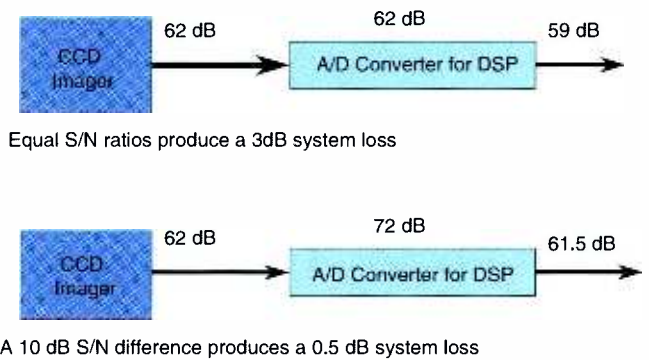

Figure 8. The critical separation required between the CCD and the DSP S/N contributions.

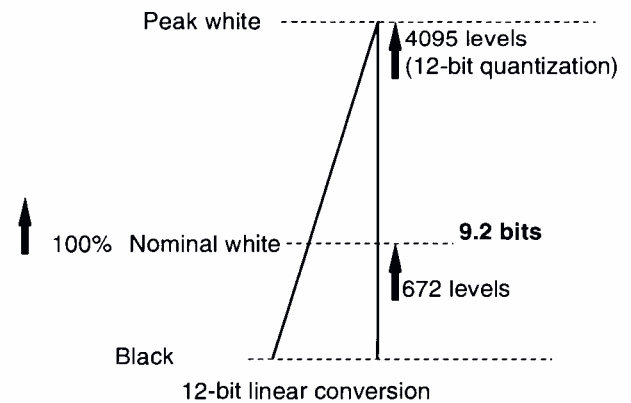

Figure 9. 12-bit linear quantization of the total CCD output signal capability results in a 9.2-bit amplitude scaling for the 100% nominally exposed signal.

In the case of the BVP-900/950, Sony has a new CCD producing a remarkable *66 dB S/N*, so it was important to elevate the DSP S/N as far beyond this point as possible. The starting premise was an unequivocal assignment of at least

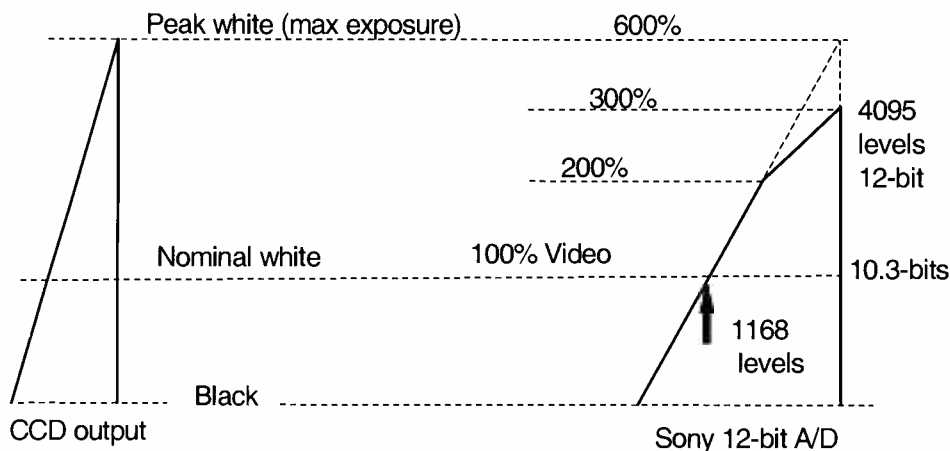

Figure 10. The amplitude scaling of the BVP-900/950 DSP cameras, which uses a fixed analog pre-compression to optimize the bit allocation for both maximum S/N and preservation of a wide exposure latitude.

10 bits to the nominally exposed (reference white chip of gray scale chart at 100% video level) signal.

Accordingly, Sony uses an analog *pre-knee* processing technique before the 12-bit A/D converter. This is a careful compromise—a fixed and accurate analog compression of highlight information—one that facilitates unique and sophisticated downstream digital processing of the important over-exposed highlight information. The results of this approach are shown in Figure 10.

This scheme produces an effective operational S/N performance for the camera of 65 dB, a number that sets a new yardstick for the industry and assures the requisite ultra-low noise source that will be important in the era of compressed SDTV transmission. Table 3 shows how this S/N is produced, being a concatenation of the 66 dB of the new CCD and the 10.3-bit allocation to the quantization of the nominally exposed video.

The issue of S/N, however, is only the first key performance issue. The second is the effective dynamic range of the CCD/DSP combination, which—in turn—will determine the operational exposure latitude of the camera itself.

It must be emphasized that 12 bits are still not sufficient to properly quantize the extraordinarily high *linear* dynamic range signal that a contemporary CCD can produce. Today, Sony typically talks in terms of overexposed CCD linear signal output capabilities in the vicinity of 600 percent! At least 16-bit *linear* quantization is required to do justice to such an extraordinary signal range if it is to be handled entirely in the digital domain, as shown in Table 4.

Unfortunately, 16-bit high-speed A/D and video processing is beyond today's technology. Various techniques for pre-processing the linear analog output from the CCD imaging system have, therefore, been utilized to optimally match this extraordinarily wide video signal dynamic range to the capabilities of a given A/D converter. Given this limitation, Sony carefully deploys the 12 bits to optimize *both* S/N and dynamic range. True optimization of exposure latitude (this

Signal to Noise Ratio and Bit Sampling S/N = 10.8 + 6N dB
BVP-900/950 = 10.8 + 6 × 10.3 (ADSP) = 10.8 + 61.8 = 72.6 dB
With a 66 dB S/N FIT CCD imager Camera S/N = 66 dB + 72.6 dB = 65 dB

Table 3. How the new CCD and 10.3-bit quantization of the nominally exposed signal combine to produce an operational S/N of 65 dB.

Video Control Function	Number of Bits
Nominally exposed video (100% reference white)	9
Gamma correction (X4 gain at black)	2
White balance gain (color temperature adjustment)	1
Black gamma (X2 gain)	1
Overexposed signal handling (600% of nominal white)	3
Total	16

Table 4. The allocation of minimum bits to each of the core functions of the DSP camera.

is bound up in issues of CCD sensitivity, dynamic range, and noise floor) is the primary goal.

Section II: Camera Technology for HDTV

The nature of the U.S. DTV agenda suggests that the majority of broadcasters will inevitably become involved in providing *both* digital HDTV and digital SDTV services. This duality poses a serious dilemma to the broadcaster and program producer in terms of planning their capital outlays over the early years of DTV. In recognition of this fact, and of the quite unpredictable nature of the overall migration from 4:3 analog NTSC to widescreen DTV, Sony has adopted a core strategy to make HDTV program origination equipment as *multipurpose* as possible. Multipurpose, meaning the flexibility for one studio/OB camera system to deliver *both* HDTV and SDTV outputs. The latter one available as a choice of the ubiquitous ITU R601 4:2:2 480I standard, or the new 480P version of that basic format.

A flanking strategy was to design that camera to be as cost-effective as possible, so that the HDTV premium paid above the typical cost of a present-day, high-end, 525-line equivalent camera system would be well-justified by this dual format capability. The center of the strategy was to firmly embed the new HDVS (*High-Definition Video System*—the

logo used by Sony for its line of products to support HDTV program production) cameras within the existing BVP series of SDTV/NTSC studio and portable systems. Maximum system compatibility would be maintained; lens interfaces (optical, mechanical and electrical) would be maintained; and—to the degree possible—all physical components would be common between the two camera families.

The HDC-700 is a full-featured studio/outside broadcast camera utilizing Sony's two million pixel Hyper-HAD *frame-interline transfer* (FIT) CCD imager. The HDC-750 is a companion portable HDVS camera that perfectly matches the performance and operational features of the HDC-700. It can, however, be used in a stand-alone portable configuration for highly mobile field acquisition. It can also be configured for full studio operation with the same CCU and control panels as the HDC-700. Figure 11 illustrates the integrated camera HDTV/SDTV system.

The cameras utilize the same housings and chassis as the contemporary BVP-900/950 and BVP-500/550 SDTV camera families. The unique high-speed digital control sys-

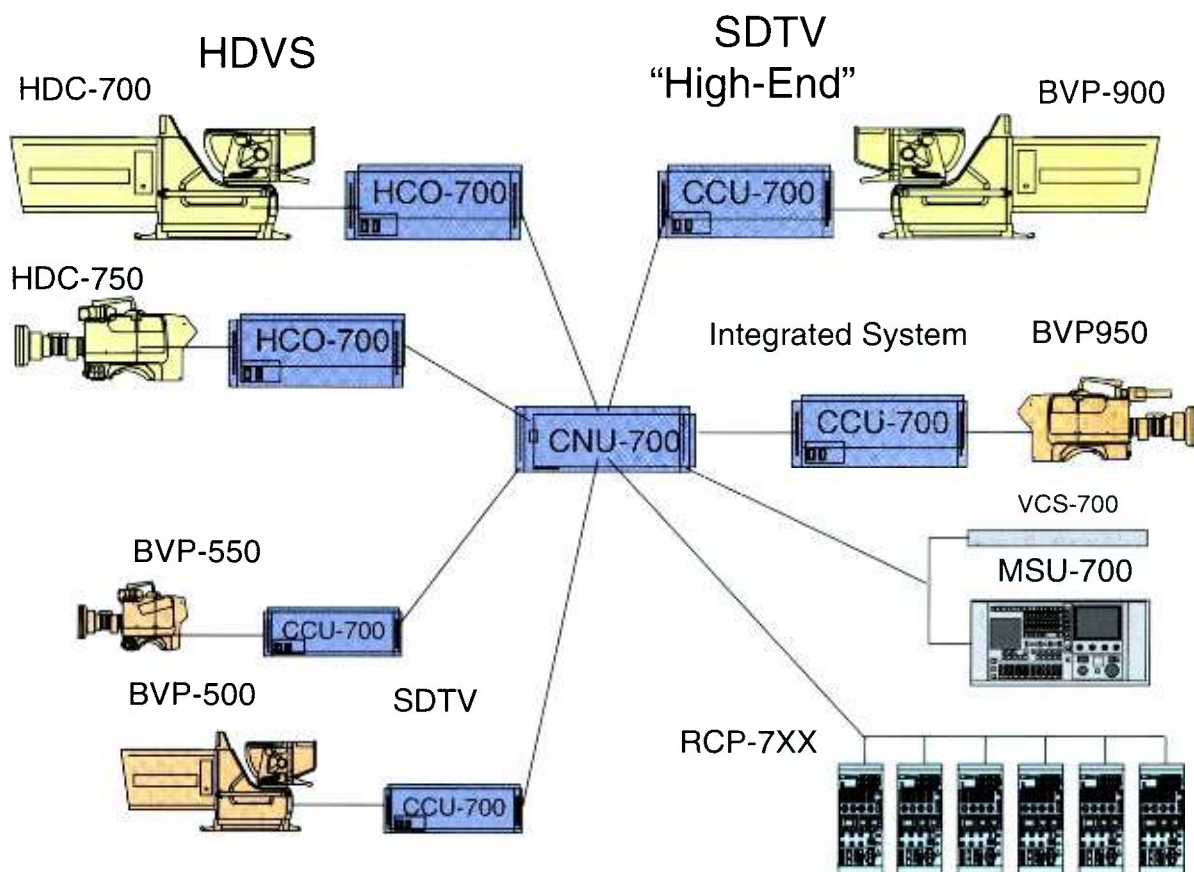

Figure 11. The master design strategy to integrate SDTV and HDTV studio and portable camera systems.

tem is common to all of these HDTV and SDTV cameras. They also share the same remote video control panels and the same master setup units.

The benefits of this master design plan are twofold:

- Migration from the present analog 4:3 525-line world to widescreen digital SDTV or full HDTV is made easier with a variety of transition paths.
- Important manufacturing economies of scale were gained that dramatically lowered the price of the new HDTV camera systems.

Having set the stage for the transition to HDTV, the HDC-700 studio camera and its portable companion HDC-750 will next be outlined in terms of the four key criteria earlier defined for DTV.

Management of Aspect Ratio

The HDC-700/750 cameras originate in 16:9 widescreen HDTV. Both of the cameras also provide a simultaneous feed of downconverted 525-line SDTV. The cameras are, thus, *multipurpose* in that they simultaneously deliver serial digital outputs of both HDTV and SDTV. This “two for one” capability offers broad operational flexibility in that it enables the servicing of both forms of DTV (for those who will offer both HDTV and SDTV), or it allows a paced migration from an initial SDTV program service to full HDTV at a later time.

The troubling conversion of widescreen SDTV to a standard 4:3 format can be a creative decision requiring some production flexibility. The HDC-700/750 provide remote control (from the MSU or the RCP video panels) of a variety of aspect ratio conversion choices. These include:

- *Widescreen* 16:9 525-line SDTV.
- *Standard* 4:3 derived from the 16:9 downconversion, with remote variable control of pan-and-scan.
- *Letterbox* version of the full widescreen image within the standard 4:3 format.

Picture Quality

Just as with the SDTV camera, the front-end CCD imager goes a long way toward the ultimate determination of the HDTV camera picture quality. And again, the criteria of picture sharpness is directly related to the pixel sampling structure, while the remaining key criteria of tonal reproduction, color reproduction and exposure latitude are all largely bound up in the quality of the individual CCD sensor.

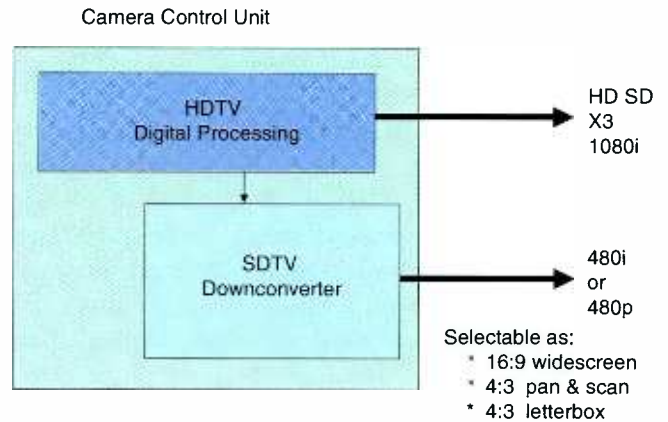

Figure 12. A built-in downconverter within the CCU makes the HDTV camera multipurpose in delivering both HDTV and one of the SDTV alternatives.

Sony expended enormous resources in perfecting the HDTV CCD imager. It first introduced the 1920 x 1035 pixel CCD to the U.S. market in 1992 with the HDC-500 camera [3]. Refinement of the HD CCD technology has been ongoing since that time. At NAB in 1997, Sony introduced the 2/3-inch, two million sensor CCD using Hyper-HAD and FIT technologies.

A distinct advantage of such a multipurpose camera is that the downconverted SDTV video is of a highly technical quality. The original HDTV imaging effectively constitutes a “super-sampling” system in both the horizontal and vertical domain (with a 1920 x 1080 sampling lattice), both of which are subsequently interpolated down to the 4:2:2 SDTV structure of 720 x 480 samples using very sophisticated digital techniques. In the vertical direction, this means a higher overall *modulation transfer function* (MTF) and much less aliasing than that created by a 525-line camera. In the horizontal direction, it also allows a higher MTF and less aliasing for the downconverted SDTV signal.

As illustrated in Figure 12, the CCU delivers three outputs of serial digital HDTV and two outputs of serial digital 525-line SDTV. In the case of the progressive scan SDTV output, each 540-line *Field* of HDTV is digitally converted to a high-quality 480-line *Frame*.

Signal to Noise

The HDC-700/750 cameras employ a new 2/3-inch, two million pixel CCD for each of the RGB video channels. These Sony-developed CCD imagers (FIT technology) are the culmination of a decade of technical development. They utilize the latest in Hyper-HAD techniques in the sensor design, which yields a high luminance S/N performance of 54 dB (measured unweighted over a 30 MHz bandwidth). While it is difficult to directly relate this specification to contempo-

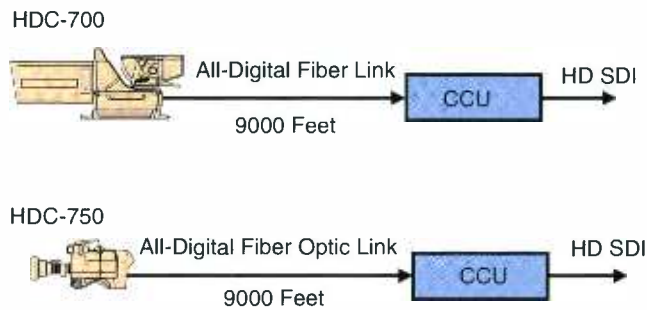

Figure 13. The all-digital fiber link for the HDC-700/750.

rary S/N specs for 525-line cameras (which are measured over the much more restricted 4.2 MHz bandwidth), suffice to say that it subjectively represents an extraordinarily low noise level. This greatly depressed noise floor contributes to the extended dynamic range that endows these cameras with an operational exposure latitude in excess of 10 *f*-stops.

System Flexibility

The HDC-700/750 cameras were designed to meet all needs for outside broadcast in HDTV. In particular, long cable connections between the camera heads and their CCUs are the key to system flexibility for large sports and entertainment event coverage. Both cameras utilize two-way, *all-digital* transmission of video, audio, intercom, control and status signaling. These are 1.5 Gbits/s serial digital transmissions (both directions), according to the SMPTE 292M standard. Such transmission data rates negate the possibility of multicore or triax cable. Accordingly, a new fiber-optic interface has been developed to facilitate this transmission over a 3,000-meter (>9,000 feet) length, as shown in Figure 13. This camera fiber interface is presently in the final stages of standardization by SMPTE.

The technical advantage of this approach is enormous, providing a digital link of high signal integrity, which ensures that the full quality of the HDTV image created in the camera head is made available at the CCU output interface. Perennial problems associated with triax transmission on long cable lengths are a thing of the past in HDTV: no more electromagnetic or RF interference, no timing skewing, and minimal equalization problems.

A New Era for Camera Technology

The dawn of DTV, and especially HDTV, promises to reshape the television industry in short order. New digital devices and systems are rapidly replacing important elements



The Sony HDC-700 HDTV camera in action. Designed for studio and OB use, this camera features simultaneous HDTV and SDTV outputs.

of the NTSC-based analog past. Cameras are, of course, a crucial element in the chain that will bring crystal-clear images to consumers. New advances in imaging and digital signal processing developed by Sony have given broadcasters, content producers and production houses the tools they need to succeed in the DTV revolution.

References

1. Thorpe, Laurence J., "HDTV and Film—Digitization and Extended Dynamic Range," *SMPTE Journal*, SMPTE, White Plains, NY, pp. 486-497, June 1993
2. Van Rooy, J., and B. Voet, "Twelve-Bit Acquisition, the Next Step in Digital Broadcast Cameras," *SMPTE Journal*, SMPTE, White Plains, NY, Vol.106, No.10, October 1997.
3. Thorpe, Laurence J., F. Nagumo, and K. Ishikawa, "A Comparison Between HD Hyper-HAD CCD Camera and Color Film for Television Program Production," *SMPTE Journal*, SMPTE, White Plains, NY, pp. 364-376, June 1994.

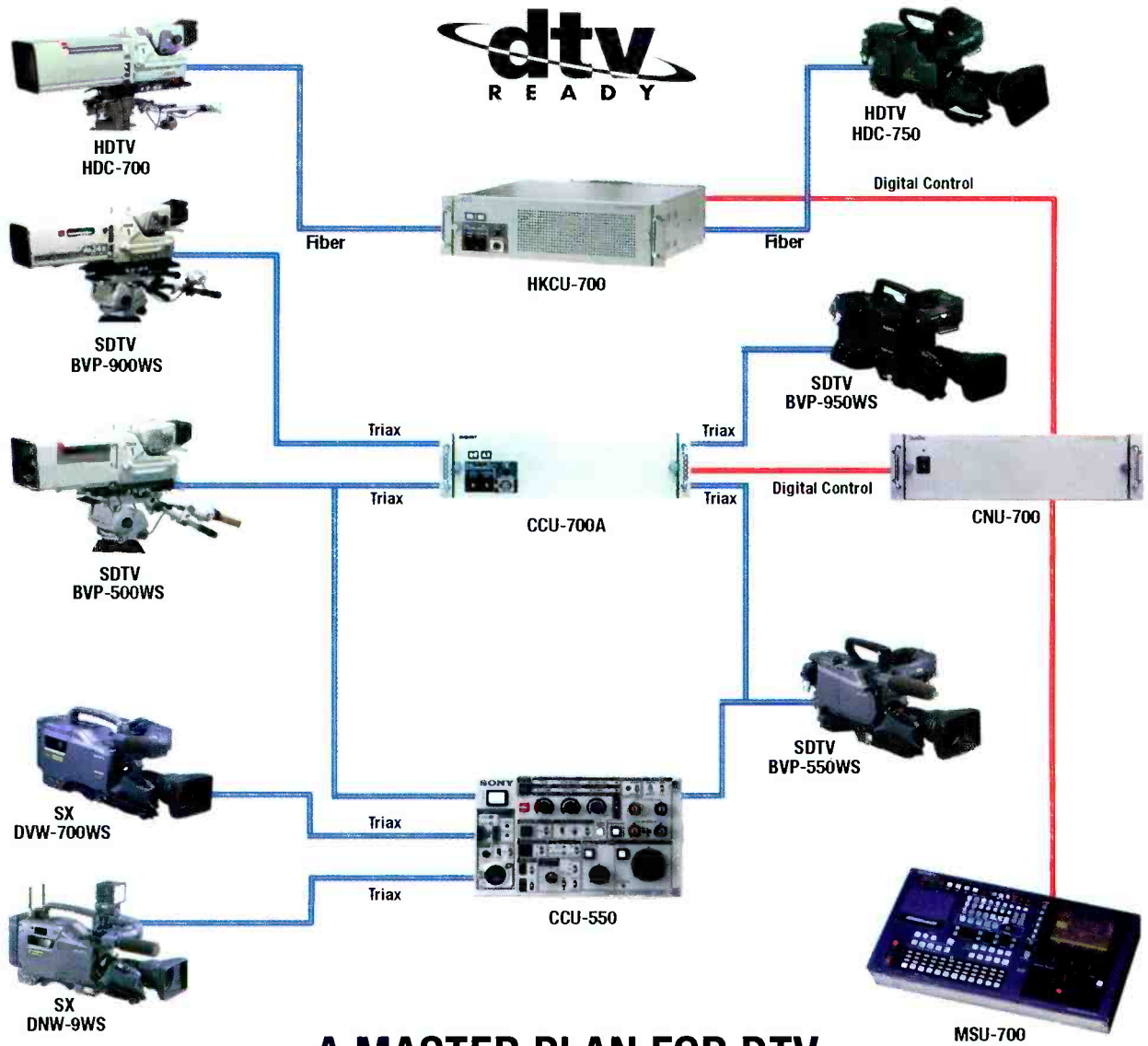

A MASTER PLAN FOR DTV

For more information, contact your Sony Account Manager:

NORTHEAST REGION	123 West Tryon Avenue, Teaneck, New Jersey 07666 (201) 833-5200
MID-ATLANTIC BRANCH	9901 Business Parkway, Lanham, Maryland 20706 (301) 577-4850
SOUTHEAST REGION	3175A Northwoods Parkway, Norcross, Georgia 30071 (770) 263-9888
MIDWEST REGION	1200 N. Arlington Heights Road, Itasca, Illinois 60143 (630) 773-6000
SOUTHWEST REGION	8400 Esters Boulevard, Suite 500, Irving, Texas 75063-2214 (972) 915-3100
WEST REGION	10833 Valley View Street, Cypress, California 90630 (714) 220-9100
SAN JOSE HEADQUARTERS	3300 Zanker Road, San Jose, California 95134 (408) 432-1600

www.sony.com/professional

BC-00645

Copyright 1998 Sony Electronics©. All rights reserved. Specifications subject to change without notice.

SONY

The same two questions were posed to vendors familiar with infrastructure issues.

VENDOR



Bruce Penney,
Tektronix, Inc.

One of the most basic questions a broadcaster faces in planning for DTV is whether to go single-program high-definition or multiprogram standard-definition. Many broadcast stations still have analog NTSC facilities. If broadcasters elect to jump all the way from NTSC to HDTV, but consumers don't buy into HDTV, they could find themselves sitting on a high-tech elephant. If, on the other hand, broadcasters bet on multichannel SDTV and convert their NTSC facility to component digital 601, they might be at a competitive disadvantage if HDTV is a hit. What's needed is a strategy for converting an analog NTSC facility to digital, while preserving the flexibility to later use the facility for either HDTV or SDTV.

Proper application of compression in a DTV facility can provide this flexibility. If we use 270Mb/s or 360Mb/s serial digital routing and distribution within a facility, we can support lightly compressed HDTV or non-compressed SDTV. Broadcasters can safely convert to digital now, implement 16:9 widescreen operation at the appropriate resolution for their market and know that the basic infrastructure is future-proofed to handle SDTV or HDTV.

But what if a broadcaster doesn't have to convert to digital until five years from now? Because 16:9 widescreen is a key part of DTV, the sooner broadcasters convert to 16:9 digital, the sooner they can start building their library. By choosing the right balance of 16:9 SDTV, lightly compressed HDTV and full 1.5Gb/s HDTV, broadcasters can be sure that their investment in digital television has immediate and long-term value regardless of whether DTV means SDTV, HDTV or both. ■

VENDOR

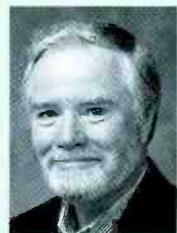

Larry Thorpe,
vice president of
Acquisition Systems,
Sony Electronics' Business
and Professional Group.

The DTV infrastructure will inevitably encompass the *duality* of routing/distributing and networking. This duality includes routing and distributing uncompressed base-band SDTV and HDTV video and multichannel audio, in addition to networking digitally compressed SDTV/HDTV/ audio signals. For high-definition production, the base-band network will encompass digital "islands" largely using the SMPTE 292M HD SDI interface.

Sony has embraced the international MPEG 4:2:2 P@ML compression standard as the basis for production, transmission and distribution (via the new SMPTE SDTI transport interface standard) of SDTV. An extended family of MPEG levels will serve the HDTV applications.

Four imperatives form the underpinnings of the approach being taken by Sony: 1) highest possible picture quality based upon the 4:2:2 digital component set for all broadcast applications — *adequate data*; 2) highest possible storage efficiency on disk (realize cost-effective DTV servers) — *minimum data rate*; 3) utilization of the installed base of digital routers — *attempt to maintain the maximum DTV data rate below 270Mb/s*; 4) utilization of existing digital VTRs for tape streaming — *data rates commensurate with those VTRs*.

An 18Mb/s implementation of such a system has already been brought to the marketplace. ■

Razor Sharp Video

Catalyst™ CV

All the switching and keying power you need in a traditional environment. Plus ethernet connectivity for workstation interface and one-step graphics keying.

- Perfect for Telecine and Post
- Additive, Chroma, Linear and Luminance keying
- Direct computer graphics keying over live video
- Built-in framebuffers

For a sharper image call Ensemble today!

ENSEMBLE

DESIGNS

530.478.1830
Fax 530.478.1832
info@endes.com
www.ensembledesigns.com
PO Box 993 . Grass Valley, CA 95945

Circle (19) on Free Info Card

ON AIR

The new Origin
video computing
platform.
It's about time.
It's about



money.

Introducing the Origin™ video computing platform from Silicon Graphics. It's time you had everything you wanted, everything you needed and everything your competitors didn't want you to have in one, rack-mountable, digital broadcast platform.

Time will tell which digital video formats become the standards of our industry, so the Origin platform supports them all. From the biggest uncompressed formats to the most multi-channel playout streams, from HDTV to low bit-rate MPEG, run them all today.

Time also changes everything, so we've

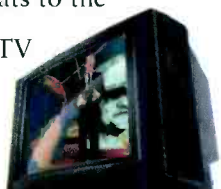

AD INSERTS NVOD PROGRAM PLAYBACK ASSET MANAGEMENT	SDI DVCPRO™ MPEG1 MPEG2	ORIGIN VIDEO COMPUTING PLATFORM www.sgi.com	HDTV ↔ SDTV UP TO 100 MPEG2 STREAMS
---	----------------------------------	---	--

given the Origin platform more scalability and flexibility than any dedicated box. Store months of on-line video, fast-network to any local desktop, run world-class applications, support standard automation systems and StudioCentral™ asset management environment. Want advanced graphics? Origin will let you add it. That's power and flexibility.

When you're ready to see what the best system in the industry can do, visit us on the Web. But don't wait too long. Time is money and of the two, we can only make you more of the latter.



Circle (20) on Free Info Card



Transition to Digital

Testing CCIR-601 serial digital distribution

BY MICHAEL ROBIN

The need to satisfy the complex signal distribution patterns typical of large teleproduction centers led to the development of the bit-serial distribution concept. For this type of distribu-

ing signal can then be transmitted on a single coaxial cable. This signal has a high bit rate (270Mb/s) and an associated spectrum on the order of 1GHz. When properly installed, this system

on the cable loss equalization capability of the receiver, are typical.

Figure 1 shows a block diagram of a bit-serial digital signal distribution model. The source encoder is a conventional

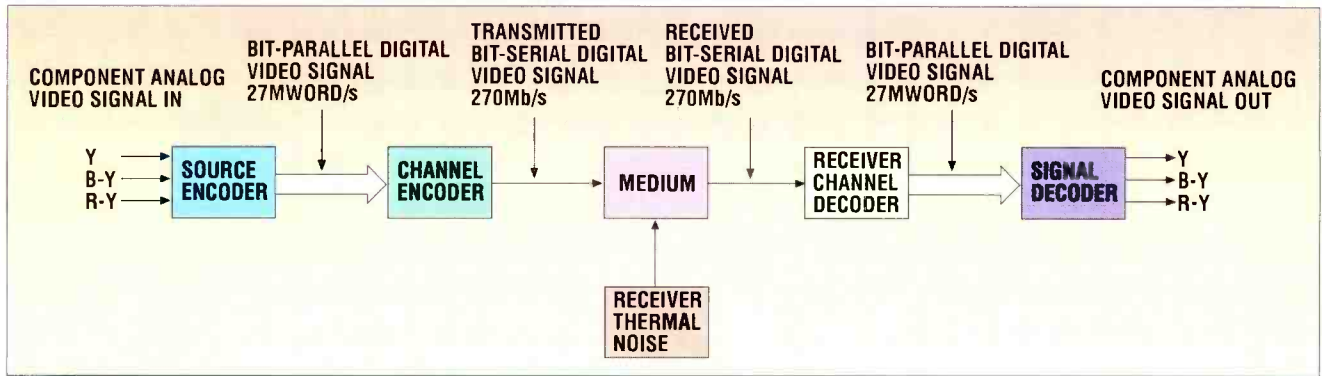

Figure 1. Bit-serial digital video signal distribution model.

tion, 10-bit parallel data is read out sequentially, starting with the least significant bit (LSB) and ending with the most significant bit (MSB). The result-

can provide unambiguous and error-free signal regeneration at the end of long coaxial cables. Lengths up to between 200 and 300 meters, depending

group of three A/D converters whose outputs are multiplexed into a 27Mword/s bit-parallel datastream. The channel encoder transforms the bit-parallel datastream into a bit-serial digital signal suitable for transmission through the chosen medium (e.g., coaxial cable). The receiver channel decoder deserializes the received bit-serial signal and recovers the bit-parallel digital video signal, which can be converted back to analog, if necessary, by a set of three D/A converters. Problems can arise due to excessive cable losses, that result in a low signal-to-noise ratio (SNR) and a high bit error rate (BER). Additionally, interference caused by thermal noise contributed by the receiver input stage, can corrupt the signal.

Standard interface characteristics and performance

SMPTE 259M describes the bit-serial interface for 525/59.94 and 625/50 equipment. It has applications in video facilities using coaxial cable. Cable lengths must not exceed the amount specified by the equipment manufac-

FRAME GRAB

A look at tomorrow's technology.

How soon do TV stations expect to have in-house HDTV production facilities?

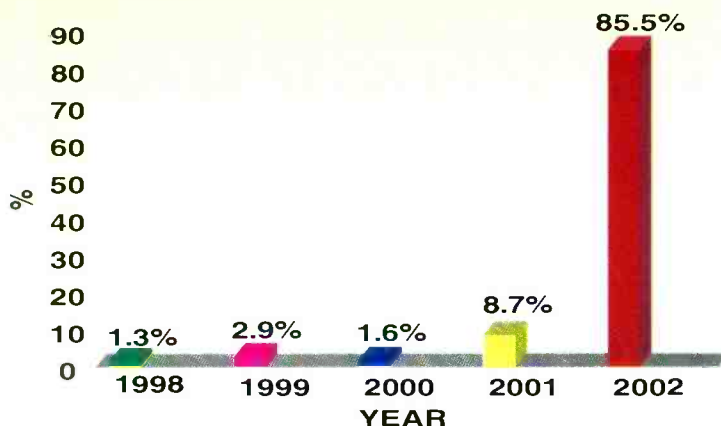

Source: SCRI International. For more information on broadcast and production industry trends, contact www.scri.com or e-mail: scri@scri.com.

turer (typically 300 meters). A signal loss of 30dB at the clock frequency is normally acceptable. The interface characteristics are summarized in Table 1. The typical eye diagram of the bit-serial digital signal and some significant characteristics are shown in Figure 2.

Figure 3 shows a classification of bit-serial performance indicative of parameters related to the transmitter, distribution medium and the receiver of the bit-serial signal. Three areas of performance-related engineering concerns are as follows:

1. evaluation of equipment and technology;
2. post-installation acceptance tests; and
3. maintenance tests.

Measuring signal parameters

For SDI, measuring signal characteristics requires accuracy, speed and reproducibility. It is advantageous to use

a digitizing oscilloscope with a bandwidth on the order of 2GHz, which can be programmed to measure a set of parameters and display the results. Parameters to be measured include ampli-

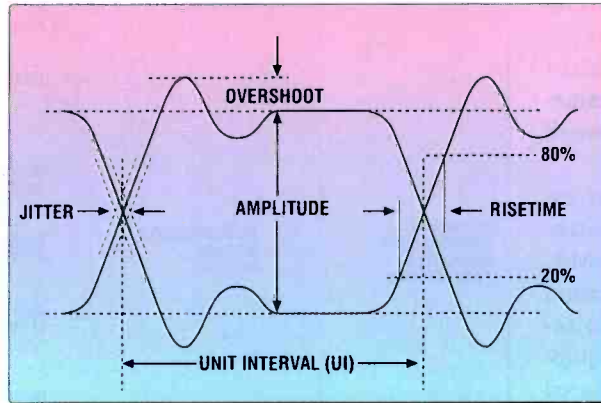

Figure 2. Eye diagram measurement dimensions.

tude, rise time and fall time, jitter, overshoot and undershoot.

Jitter measurements require a suitable reference. The reference can be external to the equipment to be tested, resulting in absolute jitter measurements, or derived from the signal to be

measured, resulting in relative measurements. The bandwidth of the relative jitter measurement depends on the clock recovery method used, because the recovered clock signal will contain some of the signal jitter characteristics. A jitter measurement bandwidth of 10Hz to 27MHz yields *timing jitter values*, whereas a measurement bandwidth of 1kHz to 27MHz yields *alignment jitter values*. When measuring jitter, it is important to mention the reference clock source.

Waveform monitors belonging to the Tektronix WFM601 family can be used to carry out signal characteristics measurements. However, many of these instruments have a measurement bandwidth on the order of 300MHz, which affects the rise time/fall time and overshoot/undershoot measurements. This requires the use of a correction formula (check with the

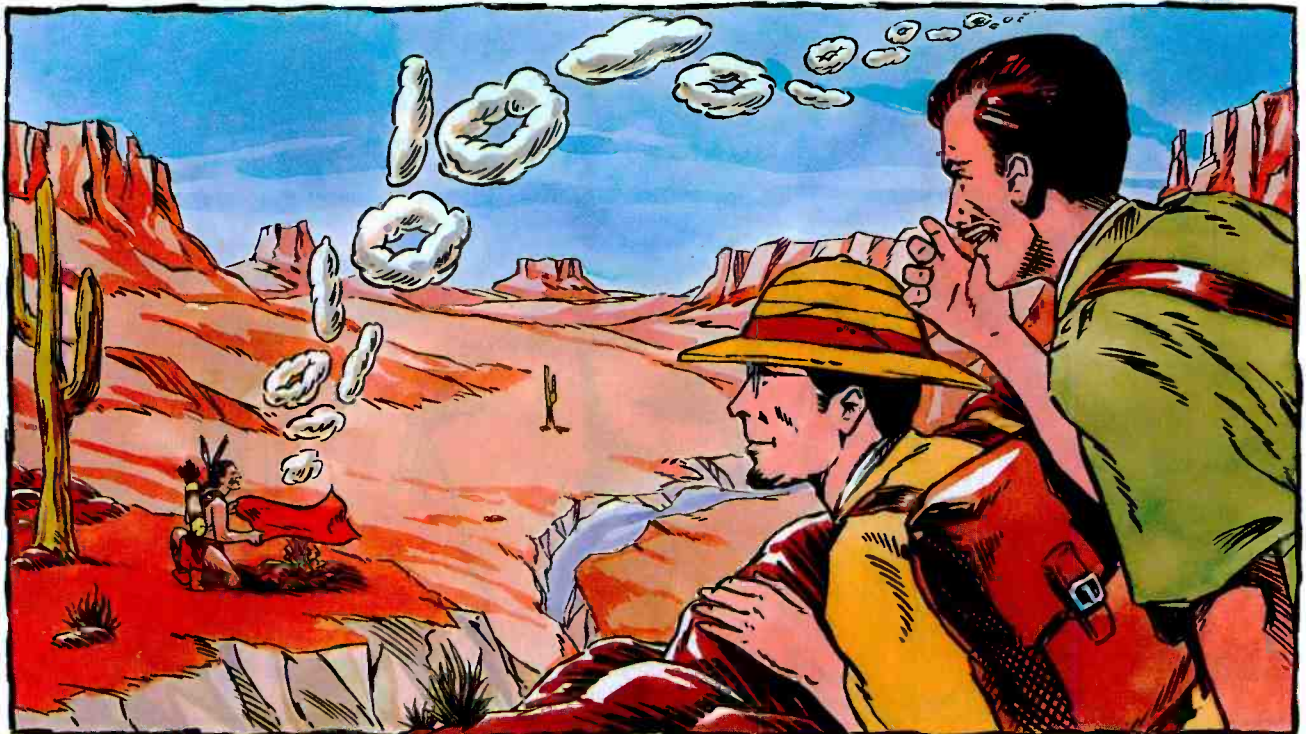

“LOOK WILCOX, THE DIGITAL COMMUNICATIONS TREND IS CATCHING ON EVERYWHERE,” WHISPERED SNELL.

manufacturer) to obtain credible results. Some waveform monitors offer a choice of derived reference clock band-pass allowing the user to determine the dominant frequency of jitter.

Transmitter output return loss is an important performance indicative parameter, especially for relatively short cable runs. Measuring this parameter, however, requires special network analyzers.

Bit-serial digital video equipment, especially large-capacity routing switchers, may generate high levels of EMR. Equipment design and safe installation practices can help reduce EMR to acceptable levels. EMR levels of equipment and installations can be measured using a calibrated antenna and a spectrum analyzer.

For receivers, in addition to the input return loss, several other characteristics should be measured. These have to do with the receiver's ability to extract the original data from a noisy and jittery input signal. Two special test signals have been developed to meet

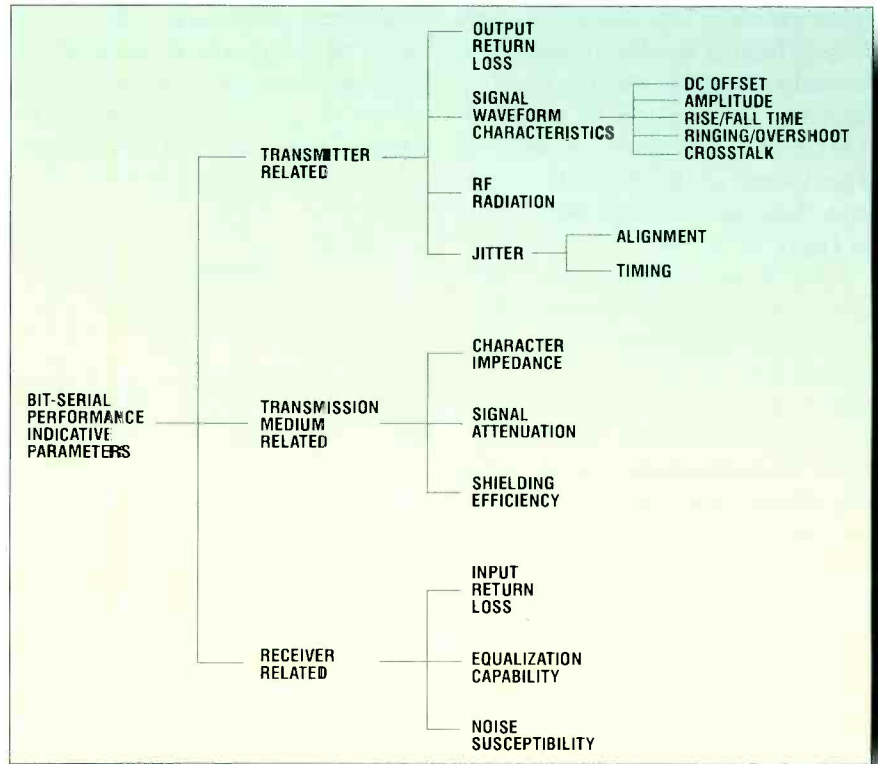
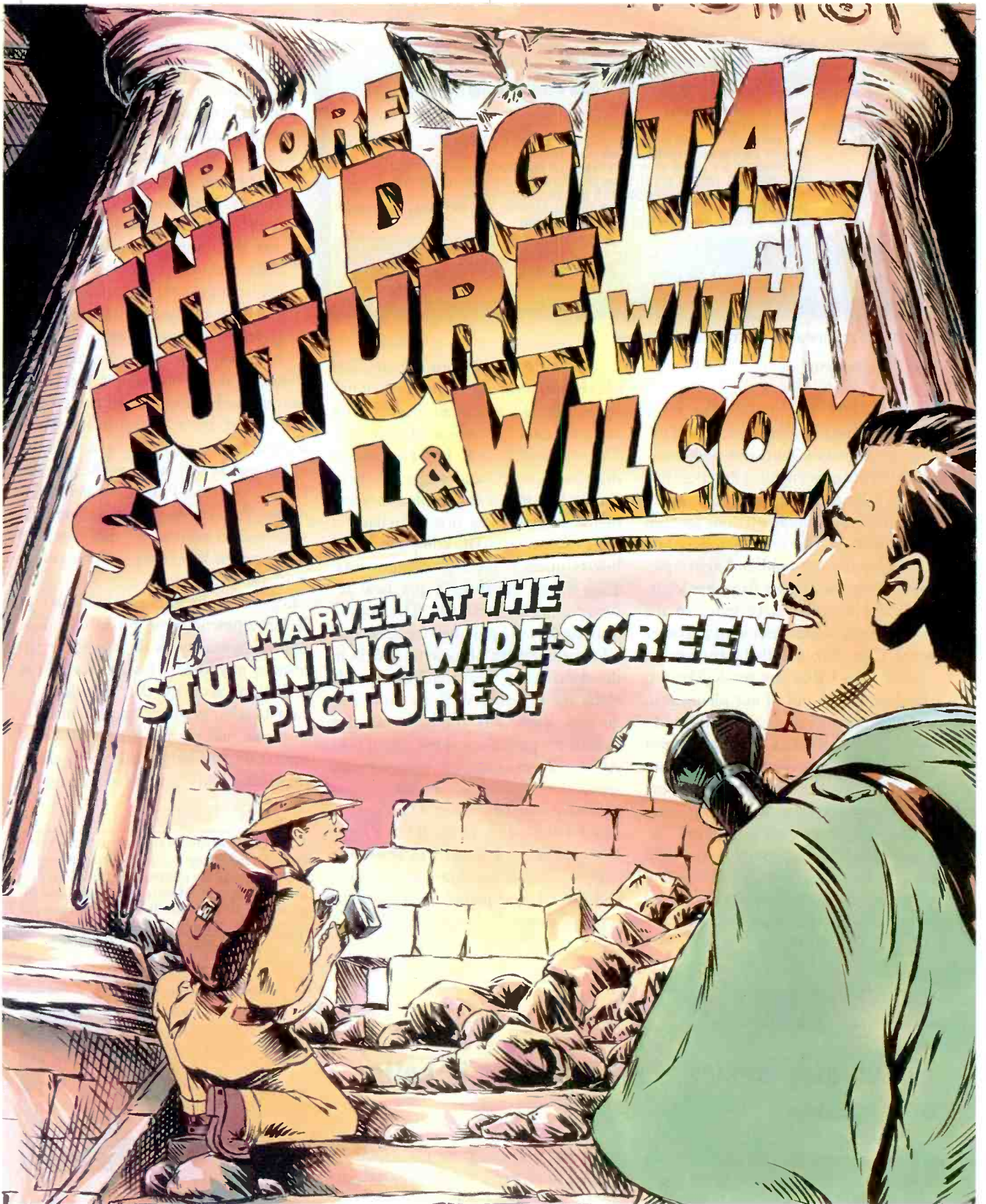

Figure 3. Classification of bit-serial signal performance indicative parameters.



“CLEARLY THE RESULT OF AN EARLY EXPERIMENT IN COMPRESSION...” MUSED WILCOX.



ち SNELL & WILCOX ㊦

Engineering with Vision

Circle (27) on Free Info Card

www.americanradiohistory.com

CHANNEL CODING	SCRAMBLED NRZI INPUT SIGNAL POLARITY: POSITIVE LOGIC DATA WORD LENGTH: 10 bits TRANSMISSION ORDER: LSB OF ANY DATA WORD TRANSMITTED FIRST
TRANSMITTER CHARACTERISTICS (see figure 2)	UNBALANCED OUTPUT SOURCE IMPEDANCE: 75Ω NOMINAL RETURN LOSS: ≥ 15dB (5MHz TO CLOCK FREQUENCY OF SIGNAL) OUTPUT SIGNAL AMPLITUDE: 800mV p-p ± 10% DC OFFSET: 0.0 V ± 0.5V WITH REFERENCE TO MID-AMPLITUDE OF SIGNAL RISE AND FALL TIME: 0.4ns TO 1.5ns BETWEEN 20% AND 80% OF SIGNAL AMPLITUDE POINTS. DIFFERENCES NOT TO EXCEED 0.5ns OVERSHOOT OF RISING AND FALLING SIGNAL EDGES: <10% OF SIGNAL AMPLITUDE JITTER: 0.2 UI (0.74ns) BETWEEN 10Hz AND 27MHz
RECEIVER CHARACTERISTICS	UNBALANCED INPUT INPUT IMPEDANCE: 75Ω NOMINAL RETURN LOSS: ≥ 15dB (5MHz TO CLOCK FREQUENCY OF SIGNAL) OPTIONAL CABLE-LOSS EQUALIZATION: 30dB AT CLOCK FREQUENCY OF SIGNAL

Table 1. Characteristics of bit-serial interfaces.

this requirement.

1. *The EDH test signal:* The error detection and handling concept (EDH) was developed by Tektronix and issued as SMPTE Recommended Practice (RP) 165. It is based on making cyclic redundancy code (CRC) calculations for each video field at the serializer. Separate CRCs for the full field and active picture, along with status flags, are located in the ancillary data space of the vertical interval and sent with the other serial data through the transmission system. The CRCs are recalculated at the deserializer and, if not identical to the transmitted values, an error is indicated. EDH is used as an in-service test to pinpoint automatically and electronically any system failures. Depending on the sophistication of the EDH monitoring and measuring equipment, errors can be indicated as a warning light or as a complex report of errors and their sources. Each flag is set or cleared on a field-by-field basis.

2. *The pathological test signal (SDI checkfield):* Proper performance of bit-serial digital equipment depends on accurate data recovery at the receiver. The interface signal has two major drawbacks that require special attention in the design and implementation of the receiver. The first drawback is the existence of a DC component and low-frequency spectral components. This makes designing a practical receiver equalizer difficult. The second drawback is the possible occurrence of a long run length of logic 0s and 1s in the datastream. This requires a stable clock regenerating VCO to avoid frequency drifts. The fundamental idea behind the pathological test signal is to stress the transmission channel and assess the effects. Two special test signals have been developed. One consists of a 1 followed by 19 0s. It has a large DC content and is used to stress the cable-loss equalizer. The second signal consists of a sequence of 1s and 0s repeated every 20 bits, that provides a

minimum number of crossings for clock extraction. SMPTE RP 178 describes a recommended pathological test signal called the serial digital interface (SDI) checkfield. It consists of one half field of each of the two stress signals described previously. This test signal is fed to the input of the equipment under test and the output is monitored on a color monitor. Bit errors affecting the top of the picture are a result of equalizer malfunction. Usually, this is due to excessive lengths of coaxial cable. Shortening the cable can

eliminate the problem. Bit errors affecting the bottom half of the picture are caused by a malfunction of the receiver clock regenerator and could indicate a condition where the free-run frequency of the PLL-controlled VCO in the receiver has drifted from the specified frequency. In this case, re-adjusting the VCO frequency may eliminate the problem.

Because of the high reliability of digital equipment using bit-serial ports, many organizations do not carry out tests of any kind. This creates a false feeling of security that can lead to catastrophic results. Implementing a program that verifies proper bit-serial operation can help reduce and eliminate bit errors and avoid complete failure. ■

Michael Robin, former engineer with the Canadian Broadcasting Corporation engineering headquarters, is an independent broadcast consultant located in Montreal, Canada, and the co-author of "Digital Television Fundamentals" published by McGraw-Hill.

Computers & Networks

Networking basics, Part 2: Faster is better

BY BRAD GILMER

If you are building a network from scratch, you might be asking yourself, "Should I be looking into something faster than 10Mb/s?" "How much more will it cost to install a faster network?"

The cabling, connectors, patch panels and wall plates will cost you exactly the

same for 100BaseT as for 10BaseT. The labor cost associated with installing these components is the same too — about \$125 per desktop. The pieces at the ends of the cable — the network interface card (NIC) and the hub — are the only price difference. The NIC plugs into your PC. The hub is at the

center of the star and serves as a central connecting point. (See Part 1 in January.) Even the NIC and hub costs are similar between 10BaseT and 100BaseT. A six-pack of 10BaseT NICs can be purchased for about \$200 — about \$34 per card. A totally dumb



Serious SDI Testing

Tests both active video and auxiliary data portions of SDI signal and displays embedded audio stream numerically or as a waveform for easy recognition of proper test tones. 'Stop on Error' trigger catches auxiliary data embedding errors and embedded audio errors.

Jitter injection, amplitude attenuation, and error injection tell you if interconnections have enough headroom.

Confirms strict compliance with SMPTE and EBU standards.

Edge diagram of digital waveform. Clearly displays waveform shape and jitter. Fast, automatic eye-diagram waveform measurements are readable from remote control port.

Long-term digital error logging can grab 400 complete errored frames for unattended burn-in and overnight testing.



The DVA184C

Advanced jitter features include FFT analysis with automatic measurements, output BNC connectors for demodulated jitter and reference clock to identify 'fingerprints' of jitter sources.

Built-in test pattern generator provides stimulus and analyzes results conveniently. You get 32 test patterns and the ability to grab, create and store up to 400.

It's all here. Complete digital SDTV and widescreen testing at 270 and 360 Mbps, all in one very serious instrument that's also easy to use. The DVA184C is so accurate, fast and conclusive, you can bring systems up in much less time, ship product on schedule, and nail equipment incompatibilities before they nail you. Plus, the DVA184C has been well-proven, with demanding folks like HBO, ABC and SGI. Give us a call at 650-364-1853, or hit our web site today.

SYNTHESYS
RESEARCH, INC.

www.synthesysresearch.com

Circle (28) on Free Info Card

See us at NAB April 6-9 in the
Sands Convention Center, Booth S4920

Available from:
 Television Equipment Associates, Inc
 Bill Pegler.
 PO Box 499
 South Salem, N.Y. 105900499
 Tel. 914-763-8893 Fax. 914-763-9158



**VIDEO A-D/D-A
 CONVERTERS**

**DISTRIBUTION
 AMPLIFIERS**

**AUDIO
 MUX/DEMUXES**

**PAL/NTSC
 DECODERS**

**FIBRE OPTIC
 LINKS**

SDI ROUTERS

10BaseT hub will cost about \$100. A six-pack of 10/100 cards that will run either 10BaseT or 100BaseT costs \$350, and a dumb 100Mb hub costs approximately \$400.

Dumb hubs or smart hubs?

Hub prices vary greatly, ranging from \$400 to \$2,500 for a 10/100 Ethernet hub. So, why is there such a big difference in price? Quality of components may have something to do with it, but the larger reason is differences in functionality.

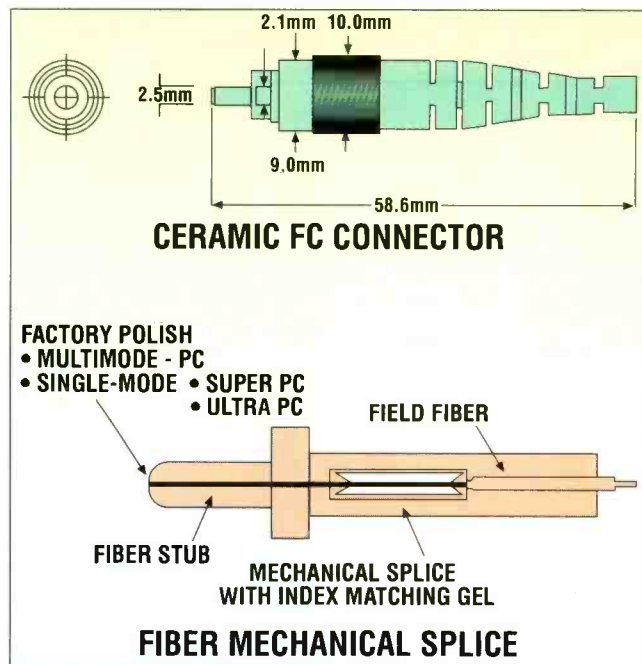

Figure 1. Fiber connectors are becoming more common and easier to use. Terminating a fiber cable into a connector typically involves a mechanical splice at or near the connector.

Dumb hubs serve as a central connecting point for the network — and that's it. Smart hubs serve that function, but many also perform protocol conversion and allow connection to a backbone running at a much higher speed. Most also contain network management software that tracks the network performance and reports this information to a central point. The decision of a dumb hub vs. a smart hub depends on the criticalness of your network, its size and your personal preference. When it comes to connecting a small group of computers together, both hubs will work fine.

How can I go even faster?

One way to go faster is to purchase faster cable. There are cable technologies on the horizon that promise connectivity over wire at rates up into the gigabit range. Standards for some of these technologies have not been set, and equipment availability is constantly changing. One thing is certain — faster wire-based technology will be available soon. The best thing is to speak with someone knowledgeable about networking when you are ready to begin work, and purchase the fastest wiring available at that time. Once the cost of installation, NICs and a hub are considered, cable cost becomes much less significant.



**LIKE OTHER TOP PERFORMERS,
THE LONGEST LASTING BATTERY USES A STAGE NAME.**

Around the house, DURACELL® batteries go by the name The Copper Top®. But on the job, the longest lasting batteries answer to PROCELL® PROFESSIONAL™ BATTERIES. PROCELL batteries are DURACELL® batteries. The longest lasting professional alkaline batteries you can buy. You get the same DURACELL performance. The same DURACELL dependability. The same DURACELL value, and more, because PROCELL Professional Batteries are specially priced and packaged for professional use. Now that's one act that's hard to follow. For more information or a distributor near you, call 1-800-4PROCELL. Ext. 33.

When it matters the most.

DURACELL®
PROCELL PROFESSIONAL™ BATTERIES

Circle (30) on Free Info Card

www.americanradiohistory.com

What about fiber?

What about running fiber to the desktop for the ultimate in speed? Fiber connectivity provides the greatest potential for high-speed networking to the desktop. But, fiber has found its true niche in connecting hubs together behind the scenes. Here are some of the reasons. The first is installed cost. It costs about \$250 per line for fiber line, terminations, wall plates and jumpers. A fiber hub costs anywhere between \$1,500 and \$3,000, depending on the features. Fiber NICs are also more expensive — a six-pack of FX fiber NICs is about \$2,000. Second, fiber media can be easily damaged. The cables are better than they used to be, but it is difficult to protect a fiber cable in an office environment. The big killer of fiber cables is not crushing, it is bending the fiber too tightly. Third, fiber terminations are sensitive to dirt. If you leave a fiber termination uncovered and reconnect the cables before you clean both surfaces, you may end up with a connection that is noisy at best. On the positive side, gone are the days of the old biconic fiber connectors where alignment was a real problem. The new FC connectors always mate correctly with little problem. Once you connect the fiber, dirt is

no longer a problem. Taken together, these three issues have relegated fiber to the back room where it is a better fit in the computer network environment.

Fiber has a big advantage over wire in areas of high electromagnetic interference, impulse noise and lightning. If you continually have a problem with lightning destroying the NICs, you might try switching to fiber. Another advantage is distance. Fiber can be used in runs up to 412 meters. 10BaseT and 100BaseT are limited to 100 meters.

If you have ever tried terminating fiber cables in the past, you probably still have nightmares about sanding little figure eights. All that has changed. 3M, Siecior and others now make crimp connectors and splices for fiber that allow you to terminate fiber easier and cheaper. (See Figure 1.) If you were not all that great at making splices in the past, you can probably do better with these. Losses will be in the one-half to one decibel per connector range. A connector kit costs about \$350 and connectors are about \$6 each.

Although it is difficult to make a single recommendation that is right for everyone, here are some thoughts. Let's assume that you are going to install a small network with 10 workstations.

Given that the cost of 10BaseT and 100BaseT is about the same, and given that you can purchase equipment that runs at 10Mb and 100Mb, then you should probably purchase 10/100 cards and wire your facility with the fastest wiring system available. Minimize your initial hub investment and plan on replacing it in a few years as your network grows. ■

Brad Gilmer is president of Gilmer & Associates, Inc., a technology and management firm.

FURTHER READING

The following sites on the web contain more information on 100BaseT and fiber:

- * "Data Communications Cabling FAQ" compiled by readers of the comp.dcom.cabling newsgroup.
www.hostots.utexas.edu/ethernet/descript-100quickref.html
- * www.cis.ohio-state.edu/hype-test/faq/usenet/lans/cabling-faq/faq.html

Brad Gilmer left a 14-year stint at Turner Broadcasting Systems, Inc. to start Gilmer & Associates, Inc. Brad's consulting company specializes in designing and implementing multi-channel and DTV broadcast facilities — especially those facilities that employ high-speed video networking. You can reach Brad at 770-414-9952 or on the Internet at bgilmer@atlnet.com.

Ask Dr. Digital

Bringing a scope back to life

BY STEVE EPSTEIN



As promised last month, we're here to help. Along those lines, one of my assistants recently received a plea for help from Brian Hoover, chief engineer at WNIT, the PBS affiliate in Elkhart, IN. It seems Brian was in the middle of rebuilding a Tek 529 and needed some information that ran many years back in *Broadcast Engineering* magazine.



Well, we dug deep in the archives and it turns out that the article Brian was looking for was written by Ken Dixon and ran in our December 1978 issue. It

discussed modifying the 529 to replace the 7788 tubes (yes, tubes) used for vertical output with 2N3439 transistors. Now, I've repaired a few 529s in my time, and most of them had already been modified. Why anyone would want to keep one of those beasts alive is beyond me, but hey, I just spent my entire weekend rebuilding/restoring a 50-year-old micrometer (ACE Hardware sells them for \$29.95, but it was my wife's grandfather's). So, who am I to say? Regardless, we sent Brian the information he needed.

Shortly thereafter...

Received your fax with the magazine article and schematic diagrams. Repaired the scope and it works great.

Please have lunch on us grateful WNIT engineers!

*Brian L. Hoover, Chief Engineer
WNIT-TV, Elkhart, IN*

Enclosed in the letter were some fast food lunch coupons (hint, hint).

Thanks, Brian.



Now with Special Pricing on Betacam SP, guess what the SP stands for?



Now's the time to take
advantage of Sony's highest

quality Betacam SP format. BVW series list

BVW Series

prices have been lowered by 15%. Key part prices
have been lowered by 30% on average. And there is a
new, extended warranty. The BVW series recorders and
players deliver robust, solid performance under critical
conditions, using either metal or low-cost oxide media.

Expand and enhance your production capabilities with
Betacam SP. There's never been a more affordable
time to own Betacam SP. For more information
on these special prices, call 1-800-635-SONY, ext. SP.

www.sony.com/professional

Well, I don't think that Tektronix has to worry too much about a warranty claim on that scope. We're here to help you. So, if you've got a technical prob-

lem, complaint or question, send it to dr_digital@intertec.com. Include as many pertinent details as possible, such as what you've done already and who

you have talked to at the manufacturer and I'll see what I can do.

Steve Epstein



Several years ago I was hired as the chief engineer at a station in southern Illinois. Included in the station's equipment complement was a 10-foot satellite dish that was

dish was moved too far east or west, the motor (which was basically designed for a six-foot mesh dish) was not strong enough to lift the dish back up.

After doing a little research, it became apparent why a larger (stronger) jack wasn't used; it simply wasn't available in the necessary size for a reasonable amount of money. For the most part, there were consumer units and models for five-meter and larger dishes — but nothing that was in between. Another solution was needed. Because I couldn't

counterweight. Using mostly two-inch pipe, a local machine shop fabricated the "iron cross" and the necessary mounting hardware. The end of the long pipe was threaded to accept a standard pipe cap. Removing the cap allowed the counterweights to be added as necessary.

The counterweights (two large and one small) were made from six-inch steel sleeves large enough to fit around the two-inch pipe. Four "spikes" (three-inch carriage bolts) were welded to the outside of the sleeve to provide some additional grip for the concrete. The spiked sleeves were placed in the center of a wooden form and the concrete was poured around them and allowed to harden.

When everything was assembled (except the jack) and the counterweights adjusted, the dish could be moved from horizon to horizon with little more than finger pressure. The jack was then remounted and with some adjustment, provided full coverage of the arc. At that point, the dish could be aimed at any satellite. However, one small problem became obvious over the next few weeks. It seemed that when the dish was pointed nearly due south, the signal strength would bounce around a bit. Looking at the dish, I noticed it was being blown around by the wind! The problem was mechanical "slop" in the jack. Re-adjusting the counterweights added some load (25 to 50 pounds) to the jack, eliminating the dish blowing in the wind.

Manufacturing the "iron cross" ran about \$300, but it eliminated the majority of the wear and tear on the motor/jack assembly. It also improved the functionality of the dish by more than 300%. Other than an occasional tune-up, that dish required no additional maintenance the rest of the three years I was there. ■



The counterweights were mounted on a five-foot lever arm and provided enough weight to offset the weight of the dish.

used daily for a variety of feeds. Apparently, it was designed for use at a cable head-end because it was not motorized. Two hand-operated jacks allowed it to be aimed at the desired bird. Sometime before I arrived, one of the hand jacks was replaced with a motorized unit. After I was on board several weeks, I found out the dish could only be aimed at the birds in the center of the arc. It seems that once the

use a bigger jack, maybe I could lighten the dish. Counterweights are fairly common in many applications, I figured one could help here as well.

A series of calculations led me to believe that 150 or so pounds of counterweight on about a five-foot lever arm would offset the weight of the dish. Luckily, the metal and fiber-glass dish assembly had a metal frame that provided support for the rather massive

DBMAX

- FIVE BAND DIGITAL BROADCAST MAXIMIZER



Maximize your footprint and get the impact you need with the cleanliness you deserve!

Years of research and experience in digital compression and limiting techniques for CD mastering have led TC Electronic to the development of the five-band DBMAX processor.

The DBMAX was brought to life in close cooperation with chief engineers at broadcast facilities world-wide,

resulting in a powerful broadcasting tool, that easily interfaces with all analog and digital audio broadcast formats.

Used as a Transmission Processor, the DBMAX ensures a louder and more consistent signal, thereby enhancing the signal within the actual coverage area.

Better coverage means you get better ratings, which in turn makes the DBMAX a *sound investment!*

The DBMAX doubles as a great Production Tool at all resolutions and sample rates, offering optimized program material without the sacrifice of sound quality.

Radio, TV & Film Post Optimizer:

- ◆ Ultimate mastering processing: Louder, crisper, warmer, punchier, more subtle, more spectrally-balanced production
- ◆ 5-band Eq, Dynamic filtering of spot/trouble frequencies, 0 or 90 degree mono summing, MS-decoder etc
- ◆ AES/EBU I/O and sync-Input as well as 24 bit AD and DA-converters
- ◆ Full 24 kHz audio bandwidth at 48 kHz sampling frequency

Transmission Processor:

- ◆ Transparent 5-band on-air dynamics processing
- ◆ Presets available for DAB, FM and AM transmission
 - all pre-programmed and easy to set up
- ◆ Simultaneous AGC, Compressor, Limiter and Soft Clipper
- ◆ Enhanced signal within the broadcast coverage area
- ◆ Various versatile OB-tools (for unattended operation etc)

The DBMAX allows transmission-settings to be copied to the production suites, enabling engineers with a DBMAX to listen to the final transmitted signal during the production phase. For easy transfer and back-up of these transmission settings we've equipped the DBMAX with a PCMCIA-slot.

Finally you can be confident your listeners receive the signal you intended them to!

Put Yourself in the Place of Your Listener

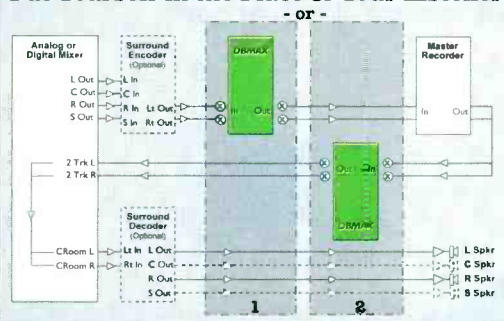

TV or Radio Production & Transmission Emulation

Example of production for DAB, Digital TV and FM

- 1) Production: DBMAX inserted pre-master to optimize production.
- 2) TX Emulation: DBMAX inserted post-master for transmission emulation

t.c. electronic
ULTIMATE SOUND MACHINES



TC ELECTRONIC INC., 790-H HAMPSHIRE ROAD, WESTLAKE VILLAGE, CA 91361, USA · PHONE: (805) 373 1828 · FAX: (805) 379 2648
EMAIL: INFOUS@TCELECTRONIC.COM · HTTP://WWW.TCELECTRONIC.COM/DBMAX
TC ELECTRONIC A/S, SINDALSVEJ 34, DK-8240 RISSKOV, DENMARK · PHONE: + 45 8621 7599 - FAX: + 45 8621 7598

Circle (21) on Free Info Card

Predicting DTV coverage

BY DON MARKLEY

Some months ago, this column touched on filing requirements for DTV. In part, the procedure described was correct, but more needs to be added to fully cover the filing requirements and the ability to predict the DTV service area. The problem comes about as the result of the commission's determination of a new antenna pattern that is meant to duplicate the NTSC Grade B service area.

The table of allotments that was contained in Appendix B of the FCC's sixth Report and Order identifies a maximum ERP and HAAT for each DTV allocation. What isn't clear from that document is that the ERP is the maximum allowable using the directional pattern determined by the commission. In preparing a DTV application for a construction permit, it is necessary to refer to that directional pattern and to propose an antenna that will not ex-

ceed the limits of that pattern at any azimuth value. This is discussed further in documents that can be found on the web page for the Association of Federal Communications Consulting

A standard "omni" antenna will fit by simply checking the actual pattern for the antenna and rotating it.

Engineers (AFCCE) at www.afcce.org. In particular, the comments filed by AFCCE concerning petitions for reconsideration in that docket are of in-

terest as is an excellent paper by Oded Bendov concerning the construction permit process.

More on directional patterns

Of particular concern are the new directional patterns. The patterns are available from the FCC web page at www.fcc.gov. An easier way is to use the link through the author's web page at www.dlmarkley.com. That page also includes a link to the AFCCE. The actual file is "dadb" and contains all of the notified patterns for all manufacturers, the directional antenna patterns as filed by all existing or proposed stations and the calculated DTV patterns. The DTV patterns are at the end and are identified by the city, state and channel number. Here is where the first of the problems lies.

For many stations, the DTV patterns are near non-directional. Many are sufficiently close to non-directional that a standard "omni" antenna will fit by simply checking the actual pattern for the antenna and rotating it as needed to keep it under the limits. It must be realized that no antenna is truly omnidirectional. They all have a little variation from a perfect circle. It may be possible to use that variation to meet the commission's requirements. In such a case, the simple check list application is a reality. In addition, an application for an ERP less than that shown in the allocation table will often work with a simple omnidirectional antenna as the maximum ERP values of the DTV directional antenna will not be exceeded. The problem comes with trying to file for the maximum permissible ERP.

The directional antenna patterns for many stations are unrealistic. Some of the patterns are simply unobtainable in the real world. In fact, some of the antenna patterns don't even comply with the commission's rules. The rules



FRAME GRAB

A look at the consumer side of DTV.

So what's a set gonna cost?

This chart shows that in today's dollars, the first color TV sets were very expensive. However, as quantities shipped increased and technology improved, prices dropped dramatically. Experts believe that a similar, but far more rapid, price drop will be evident with HDTV sets.

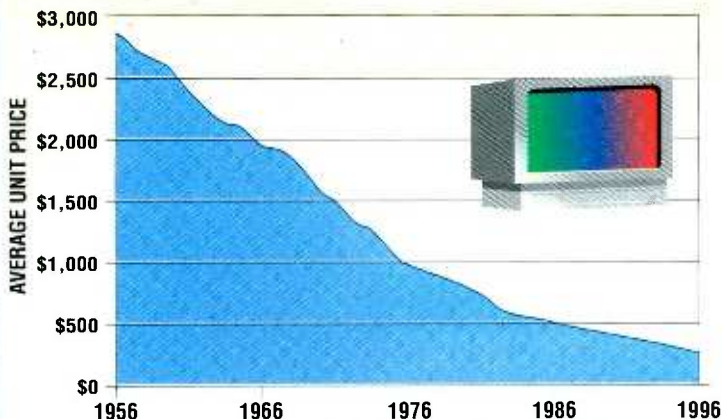

Source: Consumer Electronics Manufacturers Association market research department. www.cesweb.org

COMPARE

Why risk your future with any other DTV transmitter company?

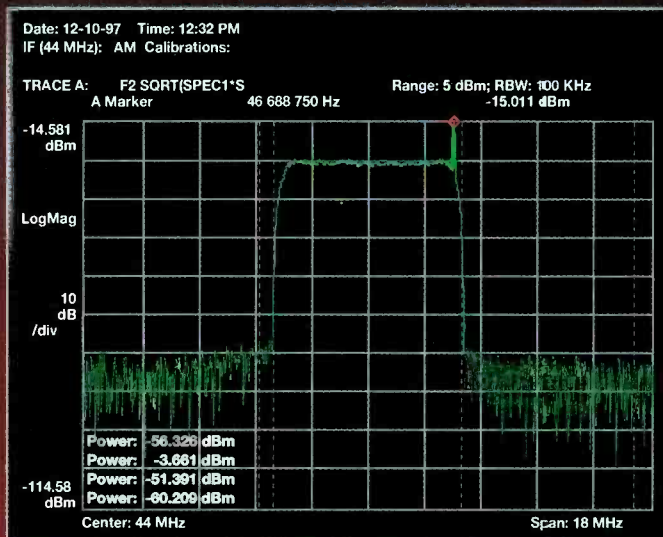

ACRODYNE's DTV Modulator
IF Output

52 dB down at the band edges.

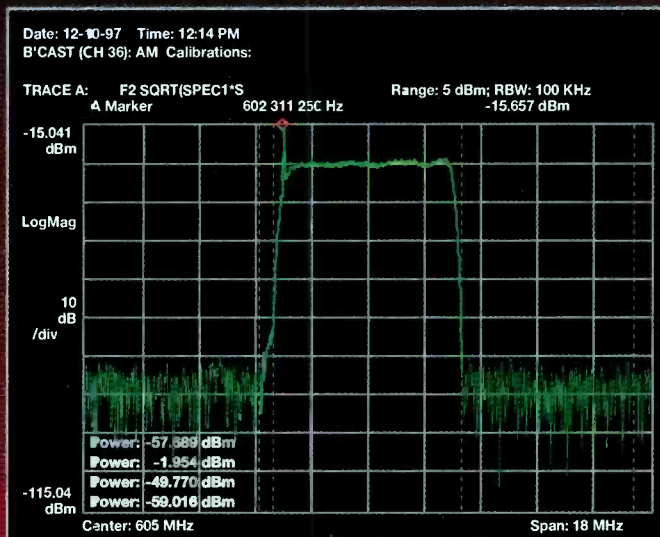

ACRODYNE's AuD25D 25 kW
UHF DTV Transmitter Output

50+ dB down at the band edges.
Count 'em! The rest is noise floor.

The numbers PROVE the difference between occupying one channel or three!

We always knew that the Diacrode® and Advanced Tetrode were good! We just didn't know *how* good. The answer to the out-of-band problem is obvious. Just look at the wave forms. It's too late to ask for an ACRODYNE transmitter after you've interfered with your neighbor.



Making the right decision in the first place is in your best interest. Can you afford to risk your DTV future with anything less than ACRODYNE performance?

Suddenly, the UHF TV band just got a lot less crowded! Visit us. See for yourself.

ACRODYNE

Leading Edge Television Transmitter Technology!

Acrodyne Industries, Inc. ■ 516 Township Line Road ■ Blue Bell, Pennsylvania 19422

Phone: 800-523-2596 / (215) 542-7000 ■ Fax: (215) 540-5837 ■ E-Mail: acrodyne@pond.com ■ www.acrodyne.com

NAB
Booth #13420

LOOKING FOR A WAY TO TEST

THERE'S ONLY ONE



HP ESA-L1500A Portable Spectrum Analyzer:
Low cost, high dynamic range, spectrum analyzer for return path and ingress maintenance.



HP 8594Q QAM Analyzer:
Transition smoothly to digital RF testing with comprehensive RF, modulation and data quality measurements.



HP E6277A MPEGscope DVBplus:
Real-time measurements and monitoring of MPEG streams.



HP 8591C Cable TV Analyzer:
The industry's only one-box tester for all non-interfering RF and video measurements.

Your subscribers depend on you—you can depend on Hewlett-Packard. HP has dedicated itself to keeping your broadband system at peak performance by providing a complete range of test solutions for:

- R & D • Manufacturing • Headend • Field

Be Prepared for the Interactive Technology of the Future.

To stay competitive, you have to be prepared for new digital technologies—including interactive services. And you have to know that the products you buy

YOUR NETWORK FROM END TO END?

ROAD TO TAKE.



HP E6000A Mini-OTDR:

Fast, easy and accurate optical fiber analysis during cable installation, maintenance and restoration.



HP 89440 Digital Video Modulation Analyzer:

Lets you characterize QAM signals in cable systems and VSB signals used in broadcast transmissions.



HP E4480A SONET/ATM/T-Carrier Test Set:

A field-portable test set for installation, qualification and maintenance of optical networks.



HP CaLan 3010R/H Sweep/Ingress Analyzer:

Install and maintain forward and return paths quickly and accurately, all in the presence of ingress.

today will meet your needs well into the future. HP gives you a unique range of products to make sure your cable system always delivers quality service to your subscribers.

Performance from End to End.

There's only one way to go for broadband test products: HP. No one offers a more complete range of test equipment to keep your entire broadband system up and running today—and down the road.

For more information, call: 1-800-452-4844, Ext. 5663

©1998 Hewlett-Packard Co. TMMID730.2/BE

www.hp.com/go/catv



Circle (23) on Free Info Card

www.americanradiohistory.com

for directional antennas limit the ratio of the maximum to minimum value of the pattern to 15dB for UHF stations and as little as 10dB for VHF stations. Although waivers of those limits have been granted on a case by case basis in

ally done in the real world. Therefore, it won't be possible for some stations to duplicate their existing NTSC Grade B contours. In some cases, they can't even come close. You wonder if anyone actually looked at the DTV patterns before

calculation, the maximum ERP and HAAT can be obtained from the table contained in the sixth Report and Order. Then, the transmitting antenna must be designed to provide the best match to the commission's directional antenna for that station without exceeding the directional pattern at any azimuth. Then, the distance to the noise-limited contour can be determined from the F (50, 50) curves modified to F (50, 90). Even better, an improved propagation model, such as Longley-Rice, can be used to obtain a more accurate evaluation of the service area based on actual terrain.

It won't be possible for some stations to duplicate their existing NTSC Grade B contours.

the past, it seems unusual for the commission to specify patterns that do not meet their own rules. A brief study of the patterns reveals max to min ratios of as much as 32dB. Get serious. That ratio is difficult to achieve with a dish, let alone a TV transmitting antenna. That really means that the maximum ERP shown on the table is a joke. Even if a ratio of 20dB could be achieved, the maximum ERP would have to be reduced by as much as 12dB to have an application that would be acceptable by the FCC.

Let's look at some real numbers. WGBO-TV is licensed to Joliet, IL, on Channel 66. The station is located on the John Hancock Building in downtown Chicago and operates with a directional antenna and an ERP of 5,000kW. The null on its DTV pattern ala the commission's computations is -32dB from the peak. The authorized DTV ERP is 128.7kW. Let it be assumed that an antenna with nulls 20dB down could be reasonably built and further assumed that the commission would grant a waiver for that antenna. That would limit the station's maximum DTV ERP to 9.89kW to avoid exceeding the commission's pattern at any azimuth. The commission's tables indicate that the station's DTV/NTSC coverage match is 100%. Let's see now. That would mean that 9.89kW for DTV will provide the same service area as 5,000kW for NTSC at the same height. Those pigs must be flying again.

In addition, the lobe shapes themselves are a little bit strange. Rates of change on the side of lobes of as much as 10dB over a 10° azimuth change are shown for some stations. That can't be realisti-

cally done in the real world. Therefore, it won't be possible for some stations to duplicate their existing NTSC Grade B contours. In some cases, they can't even come close. You wonder if anyone actually looked at the DTV patterns before

they were published or if the output of the computer was treated as the mouth-ing of some great deity as untouchable and absolute. Now, on to the height above average terrain. The value shown in the allotment table is a maximum HAAT. Unless the DTV operation is to be on the same antenna as the NTSC station, which should be possible for some stations, the two stations cannot operate with the same HAAT unless a candela-bra structure is used. There is no provision in the DTV rules for reducing

With luck, this will change. Numerous petitioners have requested the commission to revisit this process and to correct some of the obvious problems. It is felt by many that the problem results, at least in part, from using one model to calculate the location of the NTSC contour, a different model to determine the location of the DTV contour and a third method to determine interference. This is not comparing apples and oranges — it is comparing apples and cows. The commission's staff has indicated that changes are

In the meantime, to answer the question of what your DTV coverage will be — who the hell knows.

power with an increase in HAAT. For example, some manufacturers propose stacked antennas with, usually, the DTV antenna on top of the NTSC antenna. That would call for a decrease in the HAAT for the NTSC system so that the height for the DTV antenna doesn't exceed the limit. In the past, the commission has allowed the ERP to be reduced to compensate for an increase in height. That is still acceptable for NTSC stations as well as for FM broadcast stations. An equation is contained in the rules for each band of DTV stations for new allocations, but no provision exists to modify the limits in the allocation table.

Revisiting the contours

So, what will the DTV service area look like for a given station? To start the

coming — perhaps some by the time this article is published. In the meantime, to answer the question of what your DTV coverage will be — who the hell knows. The answer concerns what model you want to believe and how much you have to give up to match the commission's patterns. ■

Don Markley is the president of D. L. Markley and Associates, Peoria, IL.

WEB SITES

- www.afcce.org (Association of Federal Communications Consulting Engineers)
- www.fcc.gov (Federal Communications Commission)
- www.dlmarkley.com (Don Markley web page with links to the above)



in the television
industry's race toward
digital transition,

think of us as your
c r a c k p i t c r e w .

Broadcast technology is on the fast track as stations across the country begin converting their technology to digital. If you're not on track for this important transition, the time to begin is now. And *Professional Communications Systems* is here with the tools to help.

Professional Communications Systems is a reliable, cost efficient source in the design and integration of today's digital technology. From turn-key studios for new television and cable operations, to up-upgrades for existing broadcast facilities.

Technology can be the difference between winning and losing. *Professional Communications Systems* will help you stay in front.

Technology Evolves. We Take You There.™



PROFESSIONAL COMMUNICATIONS SYSTEMS

5426 Beaumont Center Blvd.
Tampa, FL 33634
(800) 447-4714

Circle (31) on Free Info Card

www.americanradiohistory.com

Field accessories

BY BENNETT LILES

When a shooter grabs a camera bag and heads for the field, he or she can always count on one thing. That is, that you can't count on anything. A camera, a microphone and a batt light will equip you for home movies, but today's field shoots demand a toolbox full of widgets to instantly convert a number of tasks from impossible to easy. When selecting gear for a field package — *accessorize!*

There is a virtually endless array of small tools that are forgettable until the moment you need them. Clamps and C-stands can hold lights, masks, goboes, reflectors and shades. These are best kept in good condition with all three pads on the stand legs. One missing pad can cause the clamped equipment to sway back and forth in the wind like an annoying restaurant table with one short leg. Before the equipment goes out, always check the tripod for loose legs. One that slowly lets go can cost you a camera and a lens. A frequent question asked as the smoke clears and the damage is cleaned up is — “Why weren't those light stands sandbagged?”

Lighting gear can fill a large truck, but if you carry a batt light, at least have a barn door, some scrims, diffusion material and a solid stand and a sandbag for it. Still on the mechanical side, one item that no shooter should ever walk out the door without is gaffer's tape. It is used everywhere for everything. Take plenty.

If you get lucky and AC power is available, extension cables with adapters will be needed. The adapters should include stage/Edison and pig-tail/Edison. Although they are heavy and cumbersome, AC power isolators can cure headaches for you *and* others using common power on the shoot; especially when that mysterious audio hum gets into everything like sand on a beach trip. Although Nickel/Cadmium

(NiCad) batteries still rule the roost, the newer Nickel Metal Hydride (NiMH) batteries are the heir apparent, with greater capacity per size and without the memory effect commonly found in older NiCads not allowed to fully discharge before recharging.

That brings us to the fleet of audio adapters. Isolation transformers with ground lifters can help cure hum situations when you can't select another power source. Splitters of every kind are also a must. RCA, XLR, quarter-inch, mini and even submini splitters are good to have. There are still occa-



The Tektronix WFM 90 is a hand-held video monitor that can show audio and video waveforms, vector displays and picture-in-picture.

sions when a 70V PA feed is all that's available. That's one more audio transformer to throw in.

Every kind of connector including last-resort alligator clip leads have a place in the well-stocked field kit. Line/mic pads with adjustable levels are also useful as are adapters to mix and match all of these various connectors. Turnarounds should also be included in every connector type. You never know when you'll have to take a feed from a high-impedance source so add impedance-matching transformers to the list. The type of connector that you encounter on the source will give you a clue to the characteristics of the signal. The high-impedance sources will usually

have mini or RCA connectors while 150Ω to 600Ω sources will be XLR. Even binding posts for banana connectors are sometimes found at the rear of a PA mixer or pre-amp. One frequently home-made item is a phase reverser housed in an XLR audio turnaround. Just make sure that these are clearly labeled “phase reverse.”

Extremely long audio cables can attenuate the sound signal until it is far below the originally advertised level. One little black box that's worth its weight in gold is a battery-powered pre-amplifier. Many of these have a selectable amplification level calibrated in power decibels and sport a range of 3dB to 64dB of amplification. Among other places, these have been used in cramped skyboxes at political conventions to boost individual mic lines to much higher levels so that they can be sent downstairs and across the street to the production truck in the press area and mixed there. The closer to the microphone that these pre-amps are located, the cleaner the amplified signal will be. A stereo field mixer is worth the extra money. The post people

may want three mics on three separate tracks and a mix on the fourth. If you are mixing mics onto a common track in the field, a stereo mixer can allow you to easily mix any combination of sources to any combination of sound tracks. This is valuable because producers may not consider these options until things are hooked up and tape is about to roll. The stereo field mixer gives you maximum flexibility at a moment's notice.

Live from anywhere

In recent years there has been a new remote shoot animal added to the zoo — the ENG satellite uplink live shot. When your video and audio signal is

Meet the *new* company with *decades* of experience.

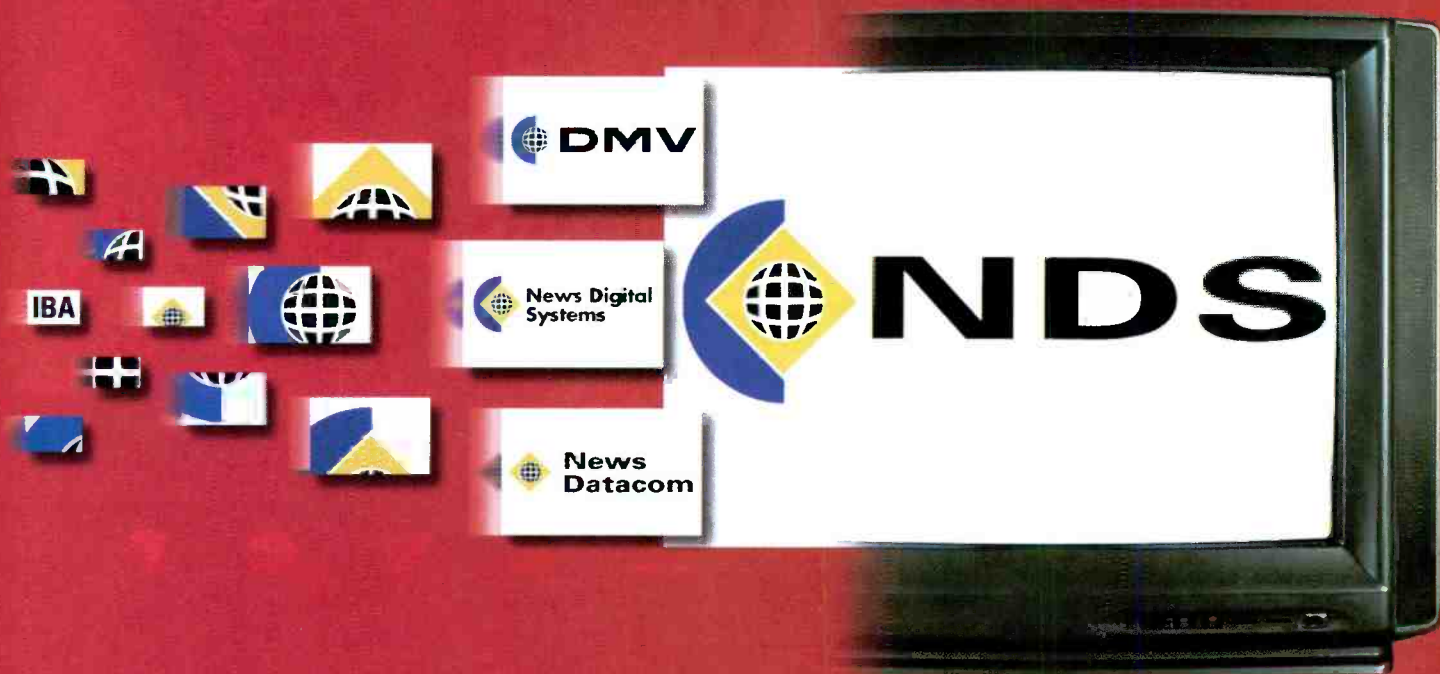

Once broadcasters looked to DMV (formerly the Advanced Products Division of NTL) for compression, and News Datacom for conditional access. Now DMV and NDC have come together to create NDS.

Your one clear choice for digital broadcast solutions. Whether you're involved in contribution, distribution, digital terrestrial, satellite, private networks, or cable, NDS has everything you need to be successful.

NDS has already provided systems to leading broadcasters worldwide such as: DIRECTV, EBU, Fox, Galaxy Latin America, NBC, PanAmSat, Reuters, CBC, and others.

Call NDS today. Because with NDS, the future of digital broadcasting never looked clearer.

NDS Americas Inc.
3501 Jamboree Road Suite 200
Newport Beach, CA 92660
714.725.2554

www.ndsworld.com

©1998 NDS America Inc. NDS, DMV, and NDC are trademarks of NDS. All other trademarks are the property of their respective holders. All rights reserved.

Circle 32 on Free Info Card

www.americanradiohistory.com

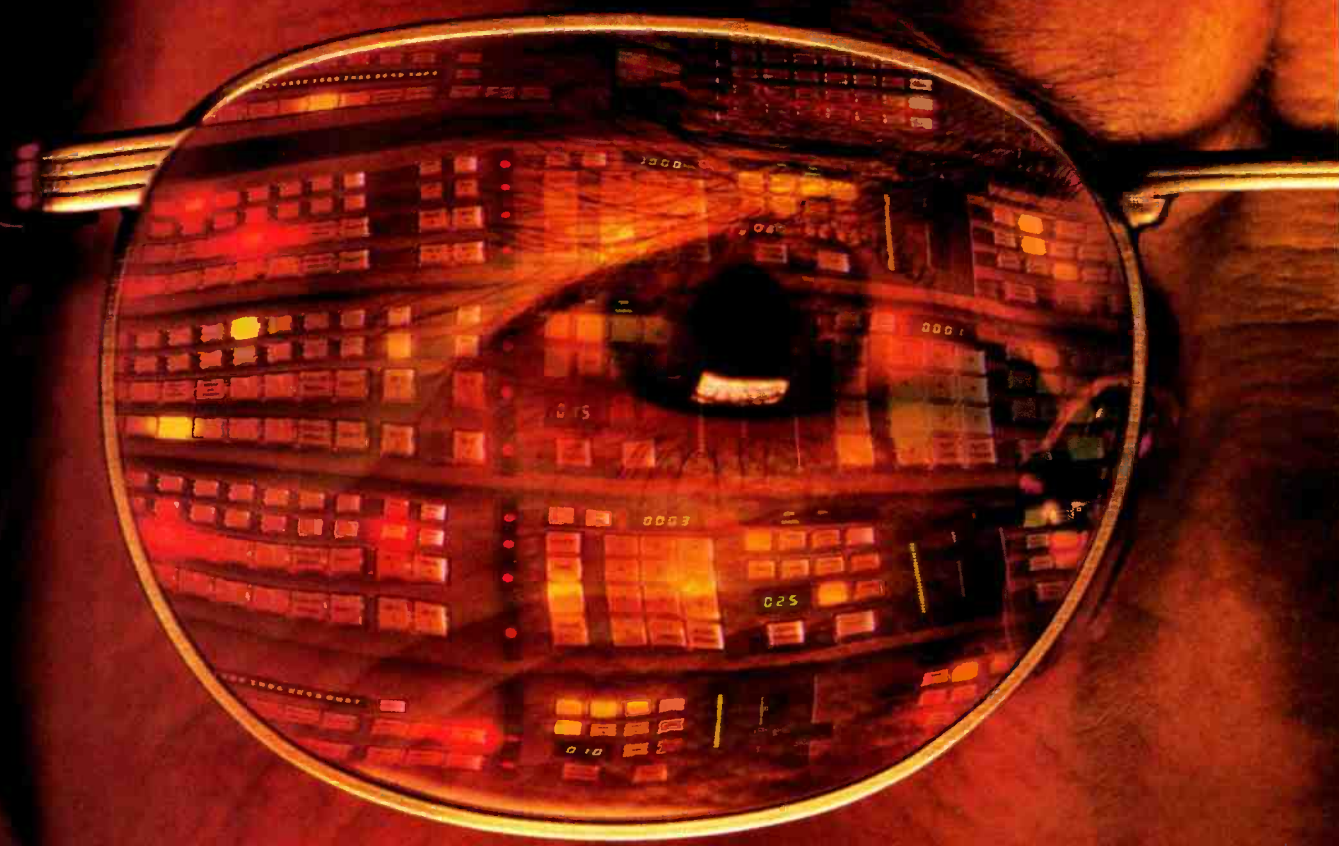

We'll never
leave you alone
in the dark.



DVS-7350 System

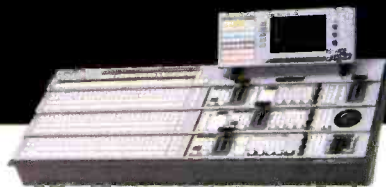

DVS-7250 System

©1998 Sony Electronics Inc. All rights reserved. Reproduction in whole or in part without written permission is prohibited. Sony, SHIPNET, SOFTWARE_{plus}, the Sony logo, and the DTV-Ready logo are trademarks of Sony.

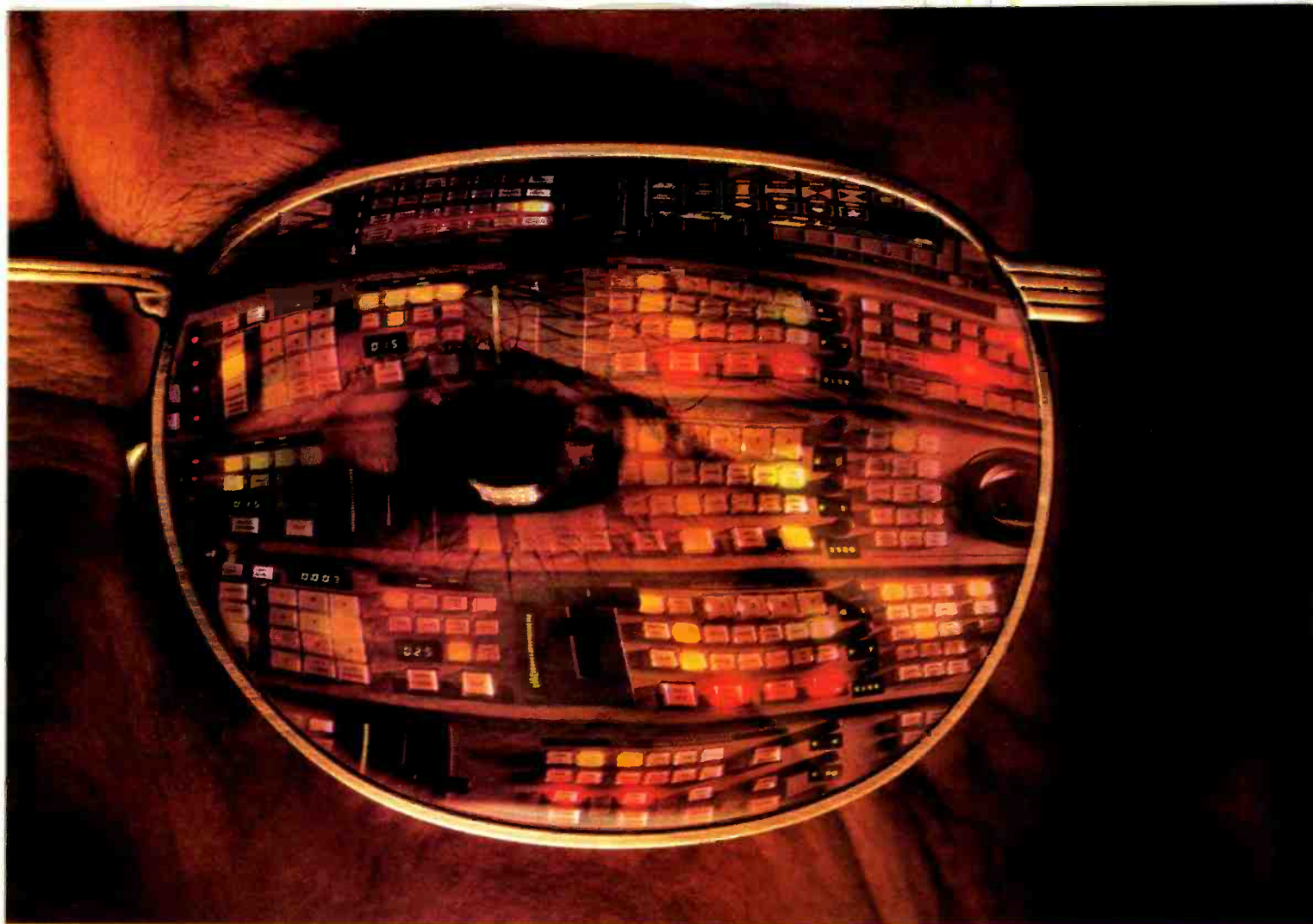

Sometimes the only thing that can turn a crisis into a creative opportunity is the company you keep. At Sony, your performance is our priority. Whether you're on-air or on-line, Sony has the features **dtv** READY you want and the critical support you need to beat the clock. The Sony DVS-7000 series of digital video switchers can help you handle anything from a large studio production to a small mobile application. Choose from four models with 18 panel styles-or custom configure your switcher with drop-in panels. We'll do whatever it takes to get you through the night. Extensive training, on-going SUPPORTNETSM services, SOFTWARE^{PLUS}[®] upgrades, and on-call technical support 24 hours-a-day, every day, just for starters. To arrange a demonstration, contact your Sony Account Manager, call 1-800-635-SONY, ext. DVS, or visit our website at www.sony.com/professional.

SONY

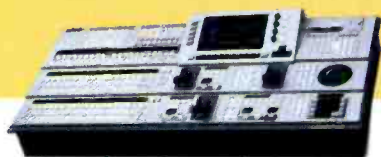

DVS-7200 System



DVS-7300 System

Features and specifications are subject to change without notice.

being uplinked as part of a program originating elsewhere, several new tools are needed in the field kit. These items interface the telephone line with the IFB earpiece and the shooter's communication headset.

Typically, one side of these telephone couplers will have an RJ-11 jack and a loop-through RJ-11 for connection of a standard handset. The other side will have an XLR and/or quarter-inch jack to connect the IFB earpiece or the camera op's high-impedance headset connector. Many now sport dialer pads and some even have an auto-answer feature. Of course, there have been telephone sets around for years that have parallel headset outputs incorporated into the case, but these are generally too bulky for a field kit.

Here again, the stereo field mixer can be used to mix mics on one channel and monitor mix-minus program sound on the other, by way of a pair of stereo headphones so that the camera op can hear both sides of the conversation. One channel carrying the mic mix is fed

to the uplink, while the other channel carrying the mix-minus is fed into the talent's IFB earpiece by way of the second output channel on the mixer. Some of these telco interface units are powered by the wet phone line, but some use 9V batteries or external power in the range of 15-24VDC at around 50mA. Lately, cell phones have begun to augment telco interfaces for connecting to remote intercom and IFB.

Check that cable

Bad cables are a fact of life on field shoots and the task is to diagnose and replace them quickly. Many new tools have surfaced to help spot sick lines. Some consist of nothing more than small, mic-to-headphone amplifiers that can be clipped to a belt and worn for instant line monitoring. Others tell a more complete story, with LEDs that light to show which if any conductors are carrying DC. This will identify phantom-powered mic lines and IFB cables.

The nicer boxes have built-in microphones, speakers and tone oscillators

with selectable output levels at -50dB, -20dB and +4dB. With one at each end of an audio cable, an instant intercom is created and powered on a 9V battery in each unit. Microphones can be handily checked at the mic end of the line. On the video side, new hand-held multifunction monitors have made field video measurements and monitoring easier than ever. Some of these units enable adjustments to video, sync and blanking levels anywhere along the signal path while displaying a vectorscope or waveform in the corner of the picture. All vital video and audio parameters can be checked at any location along the line, allowing the field operator to quickly isolate a trouble spot and make corrections. As field accessories have gotten smaller and smarter, jobs that used to take an hour or more can now be done in seconds. Using these tools more, the modern field shooter may use his running shoes and antacids less. ■

Bennett Liles is audio engineer at Georgia Public Broadcasting, Atlanta.

MPEG-2

Test and Measurement

DVB
ATSC



Whatever your requirements for *real time* MPEG-2 test and measurement, we have the system solution:

- *Transport Stream Analyzer (TSA™)*
- *Transport Stream Generator (TSG™)*

For powerful and affordable solutions worldwide, the Digital Transport Systems/Wandel & Goltermann team is your single source. Contact us today.



Digital Transport Systems

Wandel & Goltermann
Communications Test Solutions



Digital Transport Systems: www.dtsys.com
Wandel & Goltermann: www.wg.com



Circle (33) on Free Info Card

See us at NAB Booth # S12145

LEITCH

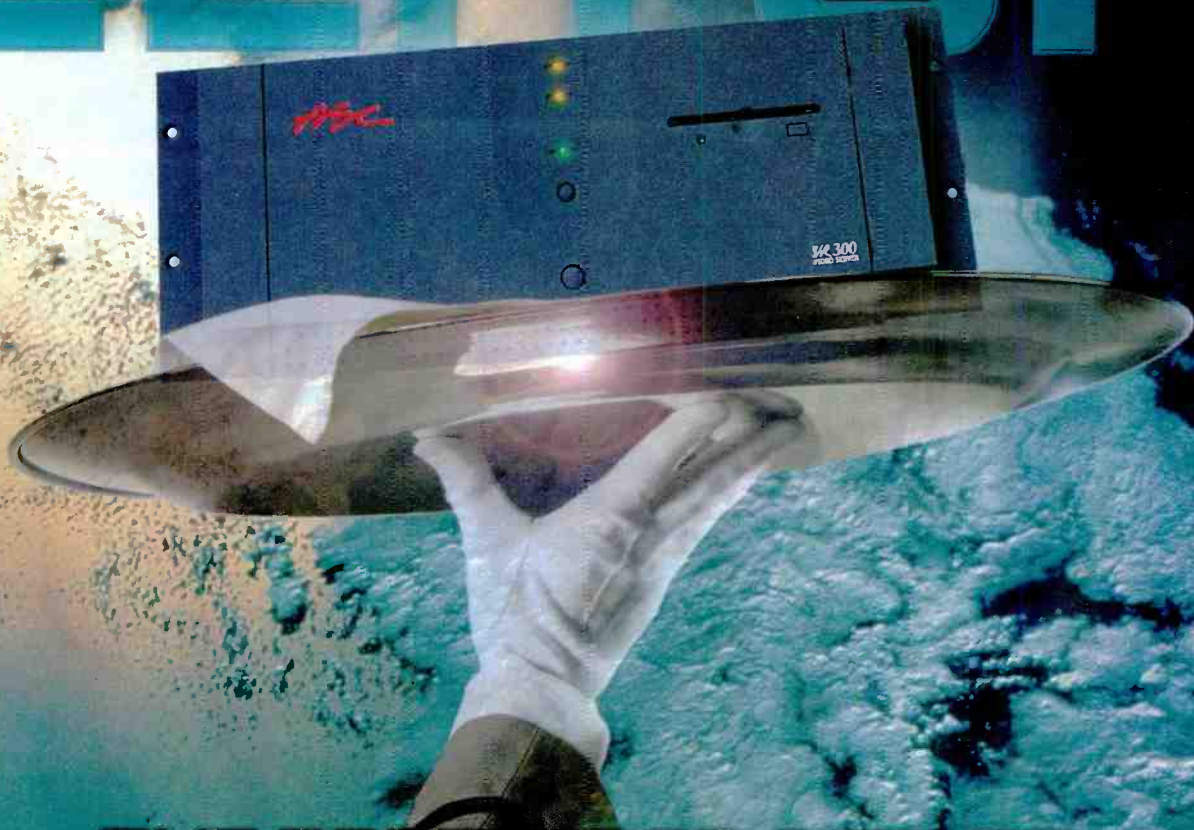

THE BEST VIDEO SERVER IN THE BUSINESS JUST MOVED UP IN THE WORLD.

7echnically speaking there's no better broadcast video server than ASC's VR300.™ With 1 Gb/sec bandwidth, it serves up to 24 simultaneous channels and 96 hours of online digital storage.

FIBREDRIVE. ALL THE DIFFERENCE IN THE WORLD.

The VR300 is the only on-air server with FibreDrive,™ ASC's exclusive Fibre Channel technology. FibreDrive is the only server architecture that gives all users true simultaneous random access to Fibre Channel RAID storage.

SERVE UP FASTER, BETTER LOOKING NEWS.

For a completely tapeless newsroom, integrate the VR300 with ASC's NEWSFlash,™ a powerful full-featured

news editing solution. Record satellite feeds, edit news stories, and play directly to air – all at the same time with the same media. No tapes. No local buffers. No file transfers.

THE WORLD'S MOST ADVANCED VIDEO SERVER IS NOW PART OF THE LEITCH FAMILY.

Recently, ASC's innovative server technologies became part of the Leitch family of digital broadcast solutions. Now the leader in video servers is backed up by Leitch's global support network and world-class customer service.

ASC and Leitch. The best just got better. Visit us on the web at www.leitch.com/asc.

USA & Canada call (888) 843-7004

ASC
A LEITCH COMPANY
Circle (34) on Free Info Card

International call (416) 445-9640

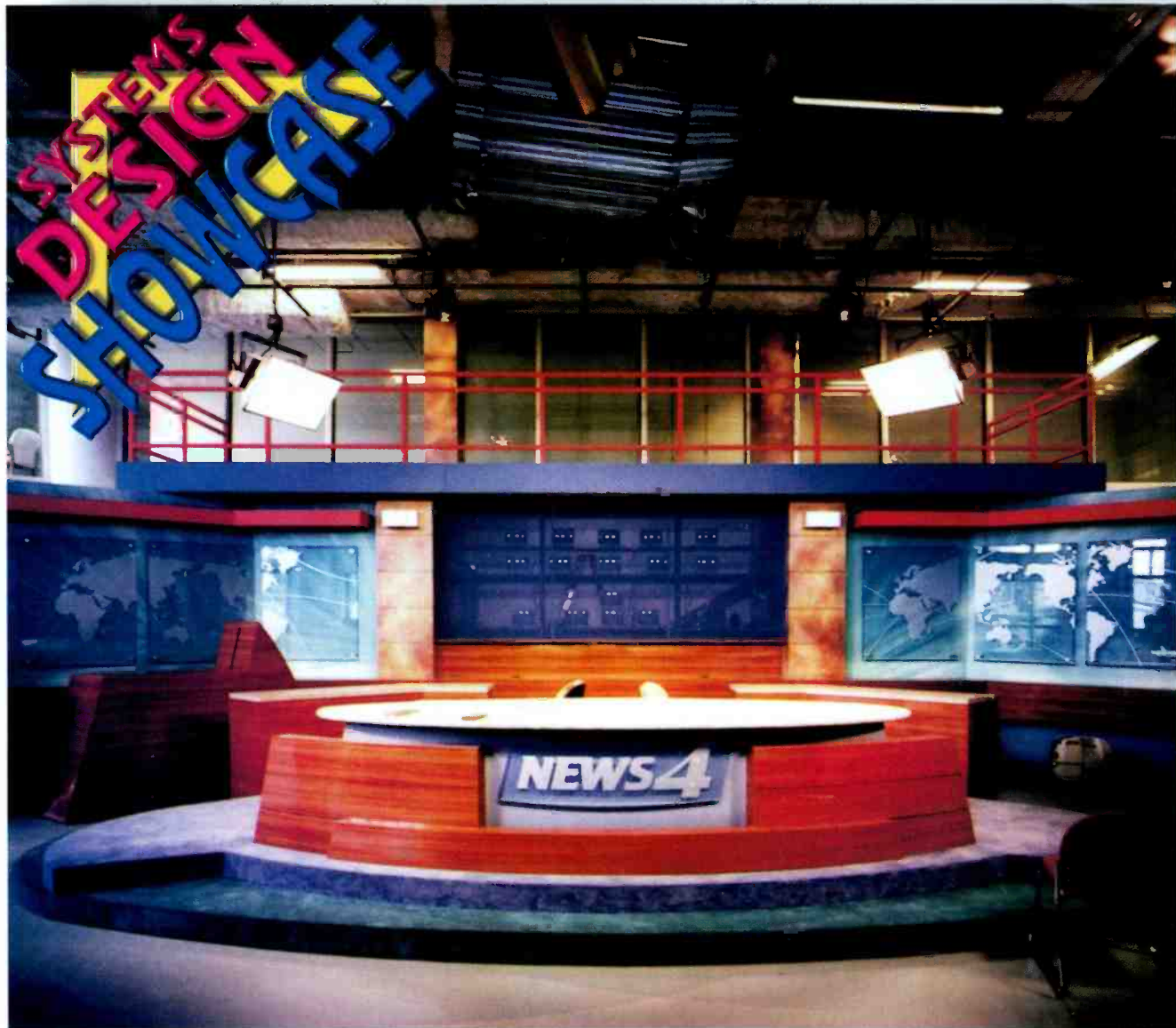

KITV: First on-air DTV station

BY JT DUGGIN

When Argyle Television did its due diligence inspection visit at KITV in Honolulu in December 1994, Tom Mann, then Argyle's vice president for engineering and new technologies, discovered that upon purchase, the company would have to begin a fast-track plan to find and equip new studio facilities for Channel 4. The present building was an owned building on leasehold land, with the lease expiring in three years. The old facility was extremely crowded, contained in just 15,000 square feet. Preliminary space planning studies by the previous owner revealed the need for double the space. A 35,000-square-foot commercial space at the

One Archer Lane condominium complex was selected to be the site of KITV's new facility.

The technical facility was straight out of the early 1970s with poor growth planning and insufficient technical capital. Almost no equipment would be valuable enough to move and the rest was in questionable repair. A facility would need to be designed from the ground up. Although no regulations were on the books to require ATV and no technical standards existed for ATV, it was to be a reality within the next several years. An analog design, whether component or composite, would be a poor choice for new construction.

ROSS

SYNERGY SERIES

DIGITAL PRODUCTION SWITCHERS

POWERFUL

HUGE input/output matrix with up to 64 Inputs & 12 Aux Busses

Add MLEs and a larger control panel as your needs grow

Squeeze & Tease
Freeze, Zoom, Reposition & Push Keys. 2 per MLE

Full function keyers have dedicated push buttons, flying borders for every key type. Squeeze & Tease, chroma keying, key over transition, quick preview & take, and bi-color on-air status

Chroma Keyers with chroma suppression, hue rejection, natural & simulated shadows and transparencies

Direct control of VTR transport with timecode

32 Custom Control Hot Buttons recall any combination of switcher memories, button pushes and external device control

All MLEs have full effects capability, their own memory system keypad, two pattern generators, live comprehensive matte generators and dual chroma keyers

Preview Monitor Overlay Display including VTR timecode, count up/down timer, source ID, safe title area

DVE Effects from all popular DVEs are seamlessly integrated as switcher transitions

11 RU frame
Redundant power
500 W, 1/4 line delay

Excellent price

3 year transferable warranty

Ross has combined the latest digital technology with a firm understanding of video production and over 20 years of switcher design experience to develop a series of production switchers which will be the standard that all digital switchers will be compared to for years to come

Synergy Series
Digital Production Switchers
by Ross.



2 MLE



3 MLE



4 MLE

And all the **ROSS Gear** to go with them

TERMINAL

EQUIPMENT

- **Conversion Gear**
A-D & D-A Converters
- **Distribution Gear**
Audio, Video, and Digital Video
- **Video Keying Gear**
Analog and Digital Keyers

- **Master Control Gear**
Mini Master Control Switchers
- **Telecine Gear**
Telecine Switchers



**Switchers, Keyers,
& Terminal Gear**

As well as the complete line of Ross Analog Video Production Switchers

NAB Booth 9635

Tel: (613)652-4886 Fax: (613)652-4425 Web: www.rossvideo.com eMail: solutions@rossvideo.com

We're bringing
tomorrow
together.



NAB '98, Las Vegas, April 6 to 9, Booth #12701



At **Philips Digital Video Systems** we're focused on the future and ready with the solutions that will get you there fast. From camera to reception in the home, our technology covers every link in the digital chain. And we back it with the kind of knowledge you only get by spending 70 years pushing the boundaries in broadcasting technology. No one is in a stronger position to help you migrate to DTV.

Be there.



Our multi-format approach frees you to move ahead in the most cost-effective way at the pace that suits you best, while respecting your existing investments. Visit us at NAB '98 and we'll show you a host of innovations. We'll be delighted to welcome you—and to demonstrate how Philips Digital Video Systems can put the power of digital to work for you. To learn more, call us toll free at **1-800-962-4287**.

Circle (25) on Free Info Card



PHILIPS

Let's make things better.

www.americanradiohistory.com

Putting the system together: **Invention**

KITV did not have a large engineering staff. The goal was to efficiently construct a new station without adding to the station's engineering staff. John Duggin Sr. and Digital System Technology, Inc. (DST) presented a unique solution. We had supplied routing switchers, master control and machine control systems packaged pre-wired to Argyle Television for other stations in the past. Duggin and Mann had coined the term *palletization* several years prior, to describe a process that wasn't stick-built and wasn't turnkey.

Digital System Technology, Inc. assembled multitrack modules pre-wired to patch panels, configured and tested. The racks were bolted together on a shipping pallet so that the installation team could drop it in place, con-



The master control room with a Philips Media Pool that is used for spot payout.

nect the inputs and outputs and let it fly. The station gets a finished, tested system, ready for implementation into its existing technical fabric. Digital System Technology, Inc. extended this mod-

ular design and packaging of palletization to larger more complete systems, including the entire technical facility at KITV. Because of its modularity, the palletization process is particularly suited to the ATV conversion of TV stations. Many stations will not need a complete redesign of their facility, just a conversion in key areas.

Working closely with Mann and KITV station chief, Greg Johnson, Dwight Crumb engineer at Digital System Technology, Inc. began the task of designing KITV's new digital facility. Once the technical design was completed DST's president John Duggin Sr. oversaw the procurement of the specified equipment for the project. Simultaneously, DST began pre-building the core of the station at its facility in Irwindale, CA. The

Wherever you are...

GSC3000 with Voice Interface*

Television Transmitter Remote Control

- With any phone, or by computer & modem
- Dial in to check transmitter
- Program unit to take it's own corrective action
- Notification by phone, pager or computer
- Access and correct or periodically check multiple transmitter sites. anytime from anywhere.

* Available end of summer 97

Gentner

We put the world on speaking terms™

800.723.4075

<http://www.gentner.com> • 801.975.7200

Try our conference call service 1.800.LETS.MEET

Approvals: CE, FCC, P 15 & P 68, CSA NRTL/C

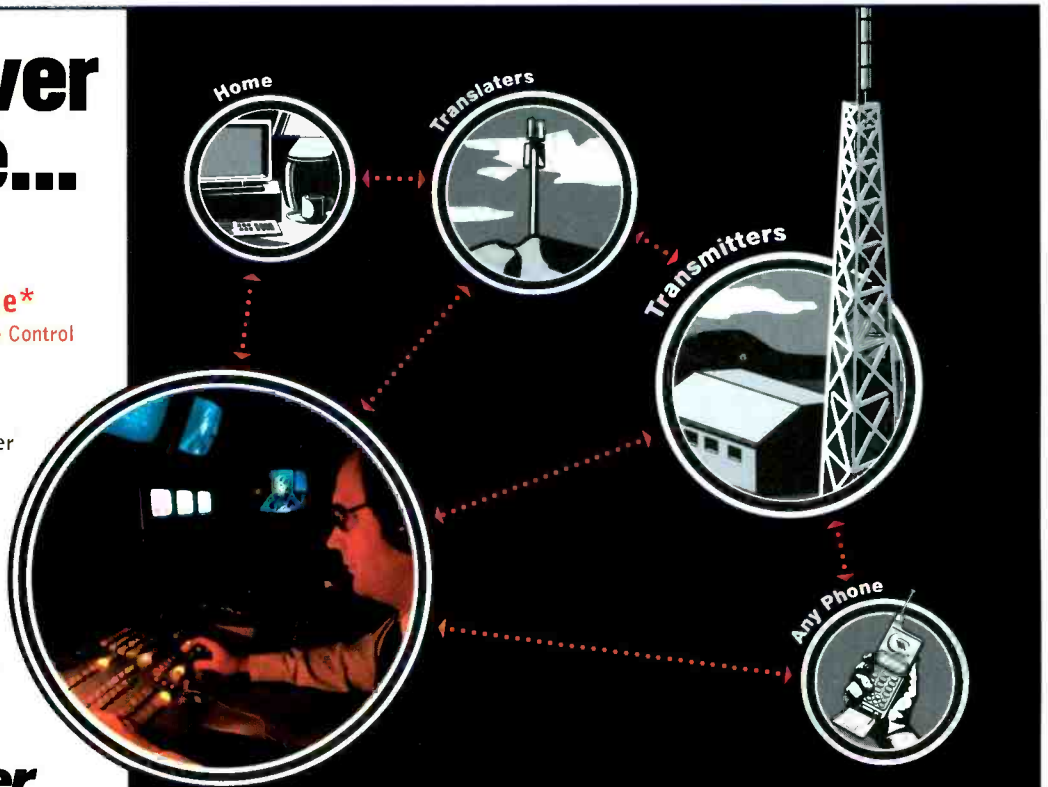

You're in control.

Circle (26) on Free Info Card

Meet The Digital Detectives

Video's First Serial Digital Analyzing System
That Captures Signals, Injects Test Errors
& Helps Bridge The Gap.

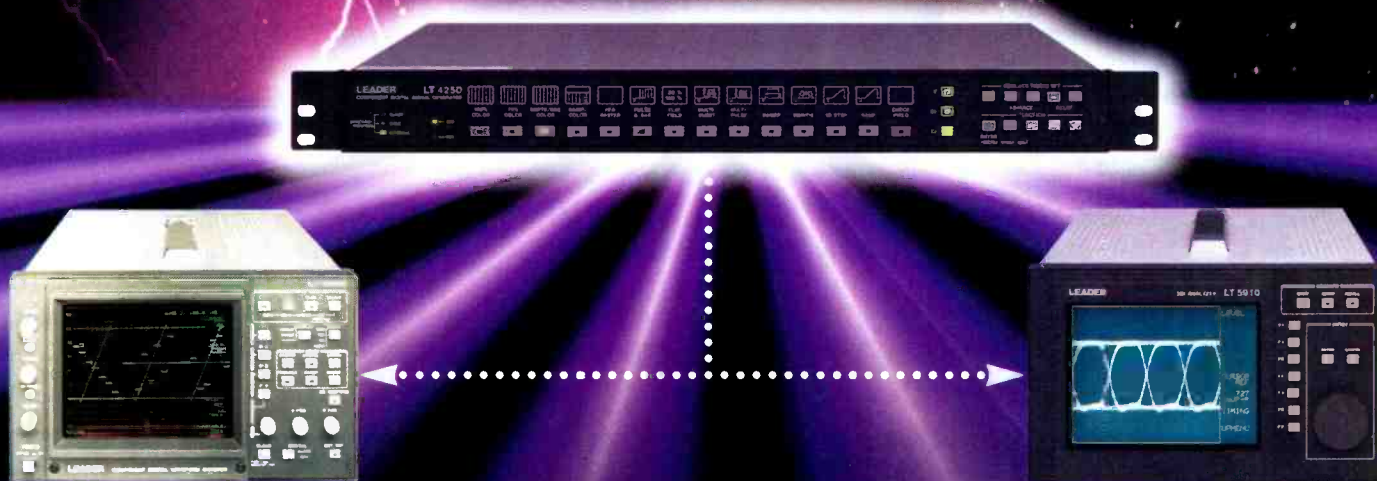

Whether you are testing SDI transport path, verifying digital video protocol or performing quality assurance checks on program material, Leader's new "Digital Detectives" are a dynamic solution for meeting SDI testing needs. Designed to operate in today's "transition" environment where analog and digital are present, these advanced design instruments provide superior flexibility and ease of use for quick, painless transition from analog to digital. Yes, each "Digital Detective" is a stand-alone product, but...the sum is greater than the parts!

For example, the LT 5910 SDI Analyzer delivers every capability for routing path and protocol analysis. What's more, it acts as a signal source to permit deliberate introduction of digital video errors into the data stream in order to test your system's ability to identify and deal with errors. Error capture and an extensive set of alarms facilitate

24 hour monitoring. Simultaneously, error capture permits detailed troubleshooting of intermittent faults.

Monitoring actual video signals is the job of the versatile LV 5100D. It has 2 serial and one analog (3-wire) inputs and works well in multi-format environments. Extensive cursors and data readouts facilitate quick, error-free analysis using familiar analog displays to ease the transition to digital. The LT 425D generates all the signals and test patterns needed to become a precise master source for digital component reference and signal testing. Multiple SDI and analog black outputs simplify use with multi-formats. Compression test patterns include provisions for future test needs, while the built-in AES/EBU (separate and embedded) satisfies audio test requirements.

For a close-up look at the "Digital Detectives," or for further details, call Leader's system integration specialists...

1-800-645-5104 / www.leaderusa.com

See us at NAB Booth #6415

LEADER
FOR PROFESSIONALS WHO KNOW
THE DIFFERENCE

Circle (35) for Product Information only
Circle (36) for Product Information
& Demonstration

Leader Instruments Corporation, 380 Oser Avenue, Hauppauge, New York 11788
Regional Offices: Chicago, Dallas, Los Angeles, Atlanta. In Canada call Omnitronix Ltd., 905 828-6221

equipment was pre-wired in five rack modules, powered up and tested prior to shipment. Taking into consideration the high cost of on-site labor, everything that could be completed prior to shipment was addressed. On Sept. 10, 1997, 3.2 million dollars of crated and palletized equipment was sent via air cargo to Honolulu. Digital System Technology, Inc. remained on site for 14 weeks with its installation crew. The entire install took place at KITV's new home, One Archer Lane, while the building was under construction. This alone presented some interesting challenges. In order to meet the specified deadlines for transmission we began the install under temporary lighting with no air conditioning or windows in the middle of a construction zone. Painstaking efforts were taken to protect the equipment from dust and damage.



The master control room with an Itelco transmitter remote control shown in the background.

2. production system; and
3. news gathering and editing.

The Philips Venus digital routing switcher, Jupiter router and machine

er as a system. KITV's master control was specifically designed to do HDTV and SDTV multicasting. It is designed to originate up to eight program streams simultaneously, and is presently equipped to output two SDTV streams. Additional SDTV streams are largely a matter of plugging in cards. Insofar as possible, HDTV is also a plug-in. Although KITV is not automating as part of the move, automation is part of the design and will be implemented as soon as it is necessary to originate additional program streams.

Hawaiian TV stations have a unique problem in that the network (ABC in KITV's case) has to delay two or three hours (depending on the season; Hawaii does not have daylight savings time). KITV was a pioneer adopter of



The newsroom area under construction.

Technical islands for island television

It might be said that the station has three separate technical islands:

1. master control and the core technical facility;

control, Saturn digital master control and Diamond digital production switcher system were chosen as key core technical equipment, principally because the components all work together

Philips Media Pool disk-based storage system for this net delay back in 1994. A second Media Pool has been added for spot playback in the new technical facility. The great advantage of Media



Power up

At Best Power, everything points up, because our **uninterruptible** power systems keep you up and running.



Best Power products are **reliable**, with a field-proven mean time between failure up to 300,000 hours. That's why Best Power was **voted #1** in product **quality**.^{*} If **uptime** matters, demand the most reliable UPS solution.

Demand Best Power.



**Best
Power**
UNINTERRUPTIBLE
POWER SYSTEMS

When it comes to reliability,
Best Power never stops.

1.800.356.5794 • www.bestpower.com

* VARBusiness 1997 APEX Study conducted by Charles River Strategies.

Circle (37) on Free Info Card



The newsroom area under construction.

Pool over competing products for spot applications is that it inherently has variable compression as part of its original design. Figuratively, a K-Mart spot could be compressed 10:1 or even 22:1 if there was no motion, but a Rolls Royce spot could be stored in uncompressed form. The Media Pool is the short-form storage engine for the sta-

tion. There is planning for the addition of near-line storage to the Media Pool this year.

The long-form storage engine for KITV is JVC Digital S tape. This format was chosen after evaluation of Digital S and DVC PRO, both of which got high marks for quality in subjective tests. The following factors carried the

most weight in the decision-making process:

Digital S is 4:2:2 with a 50MB/s data rate from inception.

The half-inch tape in the Digital S format was thought to be more physically stable than the 8mm tape in DVC PRO in the high humidity environment of Honolulu, because tape is hydro-

THE ULTIMATE IN DIGITAL.

(PRICES START AT JUST \$6,995)

OMEGA™

DIGITAL VIDEO RECORDERS

- Series available in three versions:
 - ◊ OMEGA Deck - Single channel
 - ◊ OMEGA Double Deck - Dual channel version
 - ◊ OMEGA RAID Deck - Dual channel recorder with built-in RAID controller
- Plug-in replacements for most commonly used broadcast analog tape decks
- Random access, looping
- Non-linear and A/B roll editing

- Instant replay with dynamic tracking
- Program automation, commercial insertion
- Clip and still storage
- NTSC & PAL
- CD quality stereo balanced audio
- Motion-JPEG compression as low as 2:1
- Front panel controls with LCD touch screen
- Uses standard SCSI fast & wide disk drives

1 (800) 755-8463 • (714) 852-8404 • fax: (714) 852-1226 • www.ffv.com

Circle (38) on Free Info Card



Color Pattern Generator

16:9 Pattern Generator

Digital Sync Generator

Waveform Monitor

Vectorscope

Digital Video Analyzer

Color Analyzer

VITS Generator

OFDM

TV Digital Sound Modulator

NICAM Monitor

TV Monitoring Receiver

TV Modulators

Central Test Transmitters

Distribution System

Quality Control System



PHILIPS

Philips TV Test Equipment



PTV

New owners - new name

Philips TV Test Equipments is today owned by PANTA Electronics from the Netherlands, a company in which Advent International holds the majority of the shares.

Philips TV Test Equipment's new name is ProTelevision Technologies - PTV, delivering to our customers the same high quality products and services they have come to expect.

PTV is poised to meet the challenge of tomorrow's digital innovation. In close co-operation with our customers, we will expand our expertise within digital technology. Your wish is our command.

Our goal? To make things even better!

Circle (43) on Free Info Card

PTV



PROTELEVISION TECHNOLOGIES, 85 McKee Drive, Mahwah, New Jersey 07430. Tel. 201-529-2188 or 1-800-421-0888. Fax 201-529-2109
E-mail: ptna@compuserve.com, Website: <http://www.ptv.dk>

www.americanradiohistory.com

scopic and there had been reports of problems with hi-8 tape in humid environments. This was circumstantial, but Hawaii is a unique, tropical environment.

The station had been using JVC SVHS for news gathering, had a good maintenance and support history with JVC and could retain the KY-27 cameras for a couple more years of use in the news department field service.

The production studio system was designed to be SDTV component digital 16x9/4x3 aspect ratio switchable, based on Philips LDK-10 cameras, the Philips DD-30 production switcher and a Neve 55S analog audio console. This straightforward control room/studio pair provides daily service for the production of news shows, as well as special production for the unique identity of the sta-



Shown on the right in the master control room are the JVC Digital S decks, the station's house format.

tion's trademark, Island Television.

Post-production editing is accomplished on three Avid Media Composer 8000 systems, one of which is exclusively dedicated to station promotion production to keep KITV's image and

programs fresh in the Hawaiian public's eye.

News footage is shot on Digital S with JVC KY-27 cameras, then transmitted or carried back to the station and spooled into six Avid News Cutters. Ninety percent of the station's news product is non-linearly edited. The edited product is streamed to an Avid Air Play, which also stores interstitial components of the news and serves the station's affiliation on local cable with CNN 24/54 news. News stories are played out of Air Play into the

5:00 newscast from the production control room. Long-form news programs (specials, series pieces, etc.) often start out in News Cutter and migrate to the Media Composers via Avid's Media Dock docking hard drives.

NEW FROM PARKERVISION

EXPERIENCE THE POWER OF

LIVE VIDEO

PRODUCTION

IN

STUDIO AUTOMATION

Transmitting advanced television

On April 2, 1997, the FCC authorized the commencement of digital TV broadcasting and assigned channels for that purpose. In June 1997, Argyle Television made a strategic decision to be first in the Hawaiian market to actually transmit ATV signals. Thus, began a fast-track project to license, provision and construct KITV-DT, KHVO-DT and KMAU-DT (Honolulu, Hilo and Maui, respectively). They became the first commercial TV stations to receive an FCC construction permit to build digital TV transmitters.

The DTV transmitters were the longest lead item in the RF group. After discussions with most of the major transmitter manufacturers, Itelco S.p.A., was selected because it was the only manufacturer who could deliver a solid-state design before the third quarter of 1998. Itelco-USA was able to deliver two 800W DTV transmitters and one 7.5kW transmitter in late November 1997. The transmitters are, in

at least one aspect, unusual for a solid-state design, because the power amplifiers are liquid cooled. The liquid is distilled water, although other liquids could easily be used. This cooling method allows the transistors to operate 20°C cooler than air-cooled designs. Thus, allowing much greater linearity and stability in conventional bipolar transistor designs, without having to resort to bleeding-edge technology before it may be ready.

The Honolulu transmitter began transmitting on Nov. 28 at 3:34 p.m. Honolulu time. Hilo followed several days later on Dec. 3 at 8:00 p.m. As far as is known, this was the first commercial digital TV transmission in the United States. ■

JT Duggin is the vice president of Digital System Technology, Inc., Irwindale, CA.

Equipment list

JVC 22 BRD-85U Digital S VTRs; 19 BRD-750U Digital S VTRs; 11 BRD-40U Digital S docking recorders; KY-27 cameras; 70 racks from GKM; ADC audio/video patch panel; Philips Venus 128x128 SDV router; Venus 128x128 analog audio router; Jupiter control system; Saturn digital master control; DVS Token mux and multiplexer; three LDK 10 studio cameras; Media Pool eight-channel video server; Diamond Digital DD30 production switcher; \$300,000 of Leitch Digibus conversion and distribution equipment; five Ikegami 32-inch 16x9 color monitors; 40 Link D-to-A monitor converters; RTS intercom system; Chyron Infnit with Liberty paint system; six Nigel B edit consoles; Pinnacle Extreme DVE; Neve 55s audio console; Tektronix test and measurement equipment; Hewlett-Packard test and measurement (ATV).

CameraManSTUDIO™ from ParkerVision is the world's only fully integrated live video production automation system.

For the first time, one person, from one graphical user interface, has complete manual or automated control over multiple robotic cameras, as well as video switching and effects, audio mixing, VTR's and other machines, production graphics, keying and more.

CameraManSTUDIO's powerful Transition Macro™ automation technology allows you to be more creative and efficient by:

- **Pre-producing each show in real time;**
- **Seeing it all before it goes to air;**
- **Going "live" with the touch of one button.**

See us at
Booth M6268 in the
Sands Convention Center
at NAB '98, April 6-9
in Las Vegas.

CameraMan STUDIO™



Directors and Station Managers agree...
CameraManSTUDIO delivers:

- **Greater Creative Control...**
the power to produce **your vision** - every time
- **More Accurate, Polished Programs...**
air shows with confidence and pride
- **One Fully Integrated System...**
all from a single supplier
- **Affordable Production Automation...**
for less money than traditional systems
- **12-Month Payback...**
maximizes your existing resources
- **Competitive Advantage...**
air higher-quality shows at a lower cost

CameraManSTUDIO is the one solution to today's live video automation needs. And it's available now for demonstration and delivery!

For more information and a demonstration
Call: 1-800-532-8034, Fax: 1-904-731-0958
Email: cameraman@parkervision.com
Website: <http://www.parkervision.com>

CameraManSTUDIO, The Power To Produce Your Vision...

**The Power
of One**

PARKER VISION®
Visibly Better.™

8493 Baymeadows Way, Jacksonville, FL 32256-9886

Circle (44) on Free Info Card

www.americanradiohistory.com



Power quality and grounding

Many of the older methods of grounding, bonding and shielding must be abandoned for reliable operation of today's digital equipment.

By Warren H. Lewis

Times change, and so does equipment. Analog power supplies and electronic circuitry have been steadily giving way to digital switching and logic-based designs. Although most of us have noticed this progress, are we aware of what this change means regarding the reliable operation of digital-based equipment? Also, what happens when newer equipment is connected into the typical AC power and signal wiring systems used for the old analog equipment?

To begin with, most analog audio mixers used potentiometers to directly vary the input signal level. The potentiometers could be rotary or slide types, and either type could get noisy over time. Newer digital-based circuits use the same types of controls, but with a difference. Channel gain is step-variable in accordance with the binary value of the number produced via A-to-D conversion of the potentiometer's resistance. Noise is filtered out prior to and during the A-to-D conversion process.

Some controls for mixing and gain are no longer even potentiometer-based. Optically or magnetically coupled digital encoders are used. Shaft rotation or slide position is directly converted to digital pulses and hence, binary numbers. Then, of course, there are systems such as audio and video mixers controlled via a digital link to a laptop or desktop personal computer. Links are often of the RS-232 or RS-422 type, although fiber-optic links with even better

performance are coming on strong. Wireless systems also exist, and they may also use control and signal links involving infrared (IR) or radio frequency (RF) for the wireless portion of the path, but still wind up using wiring to get the signal into and out of the equipment to which these links are connected. The wired portion of these devices may use these types of digital-format signal protocols or other proprietary types.

Once we get to the actual control, audio and video signals that newer equipment deals with, we find the signals are fully digital. They are no longer neatly phase-shifted or amplitude-varied AC waveforms or DC-referenced sine or analog-shaped waves. Rather, they are streams of square-wave-shaped, pulse-width-modulated (PWM) signals or packets of encoded binary numbers representing a fully digitized control, sound or video signal. Even looking into AC-to-DC power supplies, there are typically only two places where DC exists (the input filter capacitor and the logic or utilization voltage output buses); the rest of the circuit handles square waves of one sort or another. Frequencies into the tens of kHz and PWM schemes are now encountered inside power supplies. In contrast, analog power supplies had only 50Hz or 60Hz AC on the line input to the rectifier and everywhere else was either pulsating 120Hz DC or some "pure" level of DC — stable or changing, but nevertheless DC.

Power quality and grounding

Ground rules

In the analog equipment world, we typically lusted after the much-discussed single-point ground (SPG) system and quiet earth-grounding electrode, usually of a mystical 1Ω character and not connected to anything except our equipment. This practice has been and re-

of an SRG and related equipment is shown in Figure 1. We will cover the SRG in detail later in this article.

Digital equipment is different and also immune to some of the problems associated with analog equipment. However, new problems have emerged relative to digital equipment. Some old rules of installation used with analog equipment must be thrown out and new rules applied. Luckily, these

Power quality and performance problems

No practical difference exists between a logic circuit used in a computer system to represent a numerical bit value (0 or 1) and that used in digital circuit-based sound and video equipment. Therefore, a lot of information that has been successfully developed for use in the computer world is directly applicable to digital audio and video equipment. Don't forget this also involves computer equipment. Nowhere is this more true than when considering the CBEMA curve.

CBEMA (pronounced See-B-Mah) stands for an old mainframe computer manufacturer's organization called the Computer Business Equipment Association. The curve developed by CBEMA's Power Interface Subcommittee No. 3 (SC-3) can be used to characterize the general relationship between AC power quality and the reliable performance of most digital logic-based equipment. (See Figure 2.)

The x-axis is constructed in terms of time and the related number of cycles per second of the standard U.S. 60Hz power-line frequency. The y-axis is constructed as a plus-and-minus reference for voltage. The reference point on the y-axis is set to equal 100% of the chosen nominal rms voltage of the AC line being considered. For example, 120VAC is at the 100% line; when the voltage increases, go up on the curve's y-axis (marked by double, triple and so on increments of the AC line's nominal voltage as set to 100%). When the line

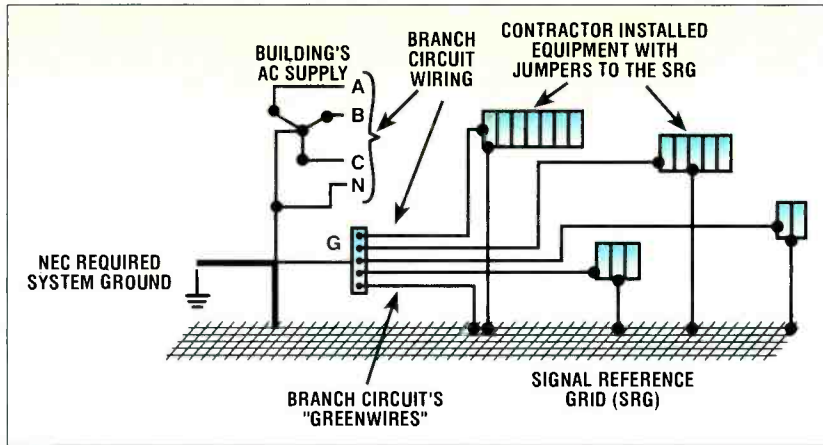

Figure 1. Diagram of a typical signal reference grid (SRG) and equipment grounded or bonded to it for reduction of common-mode noise.

mains a serious NEC violation per Article 250 — Grounding. All earth-grounding electrodes on the premises are required for fire, shock and lightning safety purposes to be made by means of bonding conductors, electrically common to all other electrodes and to the building's electrical systems equipment (safety) grounding conductor (EGC) system. The system consists of metal conduit raceway, metal equipment enclosures and the famous green-wire on the power cords.

This situation has changed completely. The modern recommended practice for grounding analog and digital-based equipment is to use a multipoint grounding (MPG) design, accept connection to the AC power system's equipment grounding greenwires and ignore special connections to earth of all types.

For example, where we have rooms full of equipment in racks and where this equipment is interconnected by signal-level cables, a signal reference grid (SRG) is used to ensure that broadband grounding capability is achieved and common-mode noise is attenuated among interconnected units. A diagram

rules generally apply to analog equipment as well. For example, some equipment grounding rules have undergone significant revision. Some cable shielding rules have been similarly affected. Lightning and electrical surge-protection requirements have also emerged as being poorly understood and more important than ever when using electronic load equipment and, in particular, digital-based equipment.

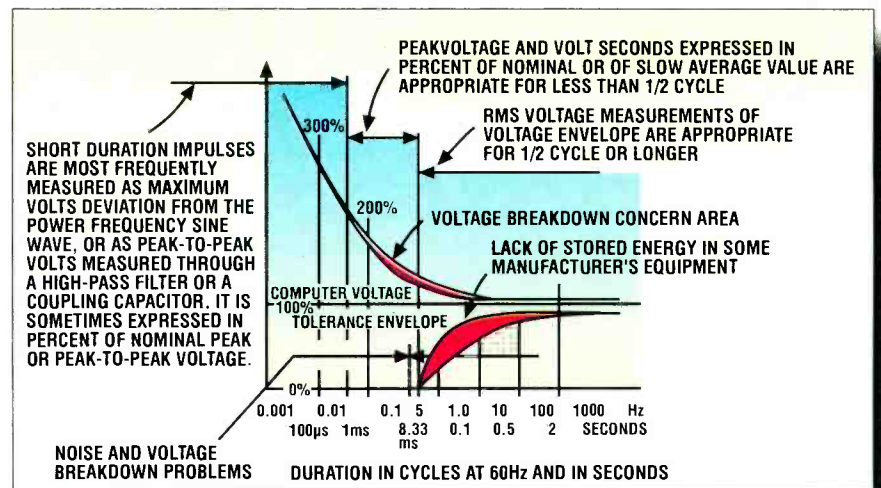

Figure 2. CBEMA curve (original form).

voltage goes down, go down the y-axis all the way to zero, as in a complete power loss. The logarithmic x-axis determines the duration of the event being tracked. For example, if the AC power line went to zero voltage for one minute (in addition, the y-axis line

on its way to the next half cycle and a polarity reversal. We all hope that our equipment will continue to work while the AC line does this; otherwise, we will have to provide for a DC power distribution system.

To the left of the 8.33ms or half-cycle point is the subcycle, impulse or transient-surge voltage realm. To the right, is the longer-term or rms voltage event realm. For example, voltage swells or voltage sags are found here if these events last only a few cycles. After that, we might be discussing problems such as a long-term, high or low nominal rms line voltage or loss of voltage. In general, impulses are to the left and high or low rms voltages are to the right of the 8.33ms mark. The former lasts for less than one-half cycle; the latter lasts for more than one-half cycle and can continue indefinitely.

Sags

One of the most commonly encountered power-quality problems is called a sag. The sag has been variously described as being a dip, dive or something similar, but sag is the official term, according to the IEEE's Emerald

results in a noticeable decrease in rms voltage for more than one and over a period of several cycles.

The typical sag event is often caused by the sudden application of loads that have a high momentary starting or inrush current. Such loads are typically represented by whole panel boards, motors, large rectifiers and AC-DC power supplies that have an internal large-value input capacitor. The capacitor is charged directly across the line via a rectifier. With a big, empty capacitor, a large charging current can exist on the first half cycle, with progressively lessening currents on subsequent half cycles until the capacitor is charged to near the peak line voltage.

Swells

As might be expected, the swell is the exact opposite of the sag condition. The swell has also been called a surge voltage, but this phrase is not correct. The term surge is more properly applied to shorter-duration events involving momentary high voltages, such as those produced by lightning. The term swell is the IEEE's official description of the described event. An idealized view of a swell is shown in Figure 4, where a nominal voltage exists before and after the swell event, which resulted in a noticeable increase in rms voltage for more than one and over a period of several cycles.

The typical swell event is often caused by the removal on an electrical system or circuit of large loads that have a high running current. Such loads are typically represented by panel boards, motors, rectifiers and large groups of AC-DC power supplies that can be disconnected at the same time by a single power-off control.

The impulse voltage condition

The typical impulse event has many names, such as glitch, spike, notch, whisker, zot, transient and, of course, impulse. These events are characterized as being subcyclic events of either polarity and any amplitude. They are

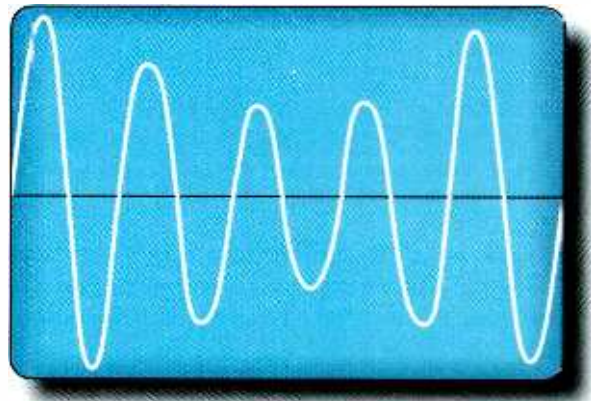

Figure 3. Simplified illustration of an AC line voltage sag.

would be drawn along the bottom of the curve from the far left and at 0V until the one minute point (3,600 cycles) was reached on the x-axis, then it would be restored to the 100% line. This assumes the voltage did go back to 120VAC and, therefore, 100%. If it did not, then the line would be restored to whatever level to which it returned.

The CBEMA curve has an overlaid funnel-shaped set of lines on it. The inside area represents that set of time periods and voltage levels over which typically well-designed digital logic-based equipment should operate reliably with respect to the quality of the AC line's input power. However, if the conditions on the AC power line find themselves outside of the funnel, an increasing level of trouble will occur. Ultimately, the equipment will fail, and component damage is possible. The area above the funnel's top line represents the area of increased line voltage for whatever reason, while the area below the funnel's lower line represents the area of decreased line voltage.

Note the AC line voltage is shown as reaching zero at the 8.33ms point. All this means is that once every half cycle, the 60Hz voltage waveform passes through the zero voltage point

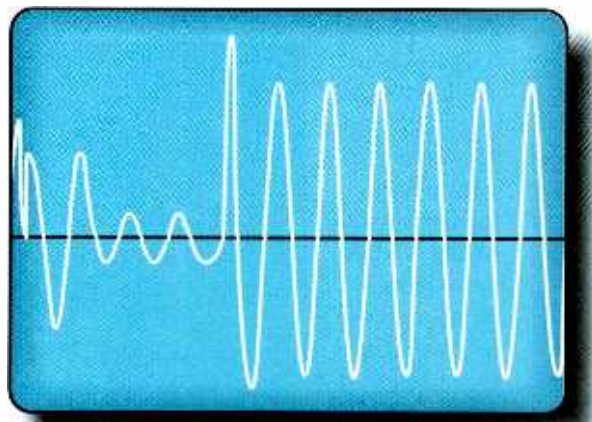

Figure 4. Swell after AC system fault recovery.

Book (Std. 1100-1992). An idealized view of a sag is shown in Figure 3, where a nominal voltage exists before and after the sag event. A sag event

Power quality and grounding

generally of a singular nature, but can occur in trains or strings of impulses that may or may not all be related to a single cause. The impulse may be synchronous or asynchronous with the amplitude of the AC line's voltage or current with which it is being compared. The impulse will typically appear in that portion of the CBEMA curve to the left of the 8.33ms point and in the subcyclic area. The impulse may remain fully above or below the 100% line or part of it might be above and part below that line. It may also be of a

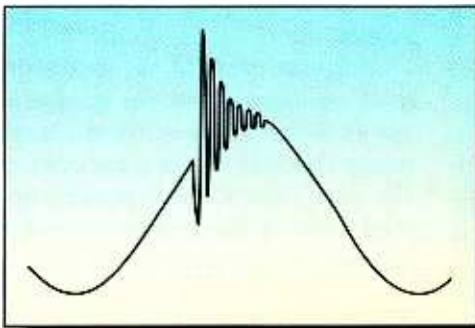

Figure 5. Impulse waveform (as impressed onto AC voltage waveform).

decaying oscillatory nature.

A fast transition time is also typically associated with an impulse event, but the term fast is not always clear except in comparison to the rate of change for the AC power system's fundamental frequency. Generally, impulses have a transition time expressed in terms of less than a millisecond or several microseconds. Faster transition times are typically seen only when the source of the impulse is close to the point at which the measurement is being undertaken. This is because at high frequency, AC power circuits are lossy transmission lines and tend to attenuate signals rapidly with distance. An idealized impulse is shown in Figure 5.

Decaying oscillatory voltages

The impulse event may also involve a decaying oscillatory current or voltage waveform, depending upon how it was generated and transmitted through the AC power system. AC systems contain reactances and are LC circuits resonant at a fundamental frequency and har-

monically related ones. Therefore, oscillatory events are common. The degree of damping of these oscillations is variable, but in general, only a few decaying repetitions of the higher-frequency impulse will be seen. Lower-frequency events may take longer to damp out and can be propagated over longer wiring paths. The typical decaying oscillatory event is found to the left of the 8.33ms point on the CBEMA curve and in the subcyclic disturbance area.

However, sometimes the 8.33ms line is crossed by the oscillatory waveform's tail.

An example of this type of event is when banks of power factor capacitors are switched in (and sometimes out). These events have some energy behind them and contain a lot of low-frequency content. Together, these things allow the resulting disturbance to be propagated

without much attenuation up to several miles. Generally, the closer the capacitor bank is to the affected electronic equipment, the worse the potential disturbance will be and vice-versa. Most power factor correction capacitor banks are installed on three-phase distribution circuits for the electrical supply system itself, within a facility on its main feeder system or at both locations. In either case, their unwanted effects reach down the building's secondary feeder and branch circuit system to electronic load equipment.

The commutation notch

Voltage waveforms on the AC line are

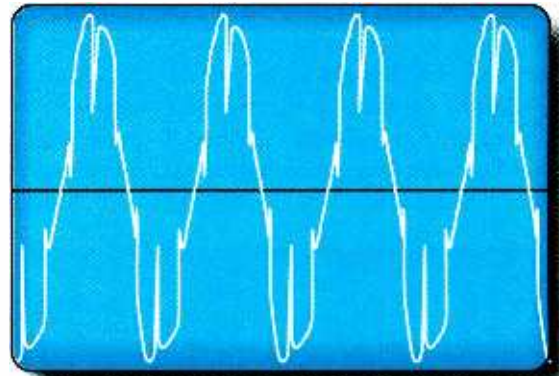

Figure 6. Waveform notching (typical commutation notches caused by rectifiers).

also sometimes seen to exist with what is best described as one or more notches having been taken out of the waveform. (See Figure 6.) These notches may appear anywhere along the time base and may move around in starting time and duration. They are called commutation notches and are generally caused by the momentary short circuit placed across the AC line during the time that one controlled rectifier is turning off and another is turning on. With SCRs that are phase-shift fired, it is easy to see the notches move around on the x-axis. Notches generally stay on the left side of the 8.33 ms line on the CBEMA curve and in the subcyclic area.

Multiple zero crossings on the voltage waveform

In the extreme case of a capacitor's decaying oscillatory event, the zero-voltage line may be crossed multiple times.

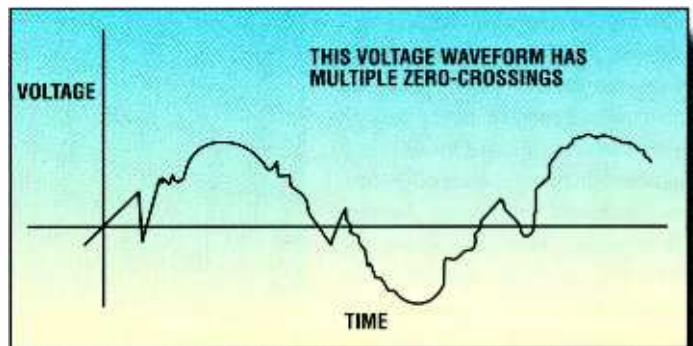

Figure 7. Voltage waveform distortion from rectifier-type load on an alternator.

(See Figure 7.) This can also occur if some oscillation exists on a deep notch's edge and crosses the zero-voltage line. In either case, the result is multiple zero crossings. This can significantly affect

any equipment that depends upon the 60Hz line voltage's zero-crossing point for timing, SCR commutating or both. Some SCR-based lighting control systems are seriously affected by this kind of problem. Also, some digital clocks and timers that count zero crossings on the voltage waveform can really speed up if they get more than one voltage zero crossing every 180° on the 60Hz circuit.

Harmonic voltage waveform distortion

With non-linear loads, such as rectifier power supplies of all types (linear and SMPS), current is taken from the power line at frequencies harmonically related to the 60Hz fundamental. In general, all current is taken in the form of an impulse near 90° and 270° as opposed to being linearly taken all along the applied voltage waveform. A typical input current waveform for a switched-mode power supply (SMPS) is shown in Figure 8. This waveform can involve a high peak current on the affected circuit with a concurrently large voltage drop occurring across the AC supply circuit's impedances. These impedances include the wiring, the impedance of the supply transformer and an alternator's windings or any other AC power source's internal impedance.

Of special note and interest, the above impedance can be largely provided by the flexible power cord sets used with temporary AC power distribution systems. Long branch circuits are another contributor, and if they are used in conjunction with an extension cord, good luck! Also, placing a power-conditioning device, such as a line voltage regulator, between the non-linear load and the AC supply can sometimes make things worse. This is because the typical power-conditioning device has considerable internal impedance, adding directly to the voltage waveform distortion problem.

The typical non-linear load, such as an SMPS connected to a 120VAC line, requires fundamental frequency cur-

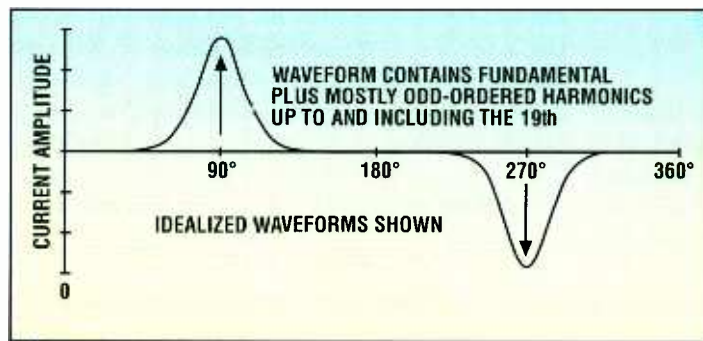

Figure 8. Typical high-peak current waveform for switch-mode power supply input on 120VAC circuit.

rent and harmonic currents up to about the 19th order ($19 \times 60\text{Hz}$ or 1,140Hz). Mostly, the currents are drawn from odd-ordered harmonics (3, 5, 7, 9 . . .) and from the lower orders (particularly the third, fifth and seventh harmonics). Once a harmonic current is demanded by the non-linear load, it produces voltage drops across any of the impedances in the series path. Thus, if a third-harmonic current of a given amount produces a 10V drop in the upstream circuit, this condition will be seen as 10V at 180Hz algebraically added to the 120V, 60Hz fundamental voltage. (See Figure 9.) It is important to understand that because of the total amount of inductive reactance $X_{L=2\pi fL}$ in the current's path, 1A at 180Hz (third harmonic) produces three times the voltage drop that would be produced per amp at the current's fundamental frequency of 60Hz. This relationship also holds true for each higher order of harmonic current because the

connected linear power supply than for an SMPS design. The former loses regulation headroom and runs hotter. It sees what it interprets as a low-voltage condition on its input and reacts accordingly. The SMPS has more headroom available and compensates by drawing a higher peak-charging current for its main energy storage capacitor at 90° and 270°. With enough distortion, both supplies will eventually lose regulation, but the linear supply will almost always go first and by quite a bit.

Here's an important bit of advice. If you are attempting to make an accurate voltage or current measurement on an AC power conductor that is not carrying a sinusoidal waveform, you cannot use anything other than a true rms instrument. The typical analog or digital current or voltmeter is not true rms, but is an average-actuated, rms-calibrated device. In other words, it is a full-wave-rectified DC instrument that

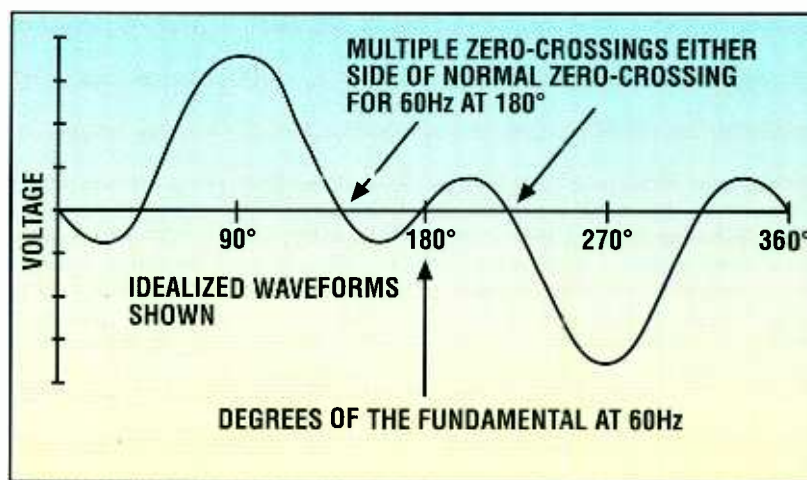

Figure 9. Multiple zero crossings of a 60Hz voltage waveform distorted by third-harmonic voltage (180Hz).

inductive reactance increases proportionally with frequency.

Harmonically distorted voltage waveforms typically have less total area under the curve than an undistorted sine wave and the peak voltage may also be lower. This spells more trouble for a

Power quality and grounding

has its scale fudge-factored to make it agree with the rms value of 0.707 on a pure sine wave. On a typically harmonically distorted waveform, the area under the curve is insufficient to allow this kind of instrument to give accurate readings. The result is typically a reading that may be off as much as 50%, making a 20A rms current read around 10A. This could mislead the user into believing that the circuit is not heavily loaded. Similar problems occur on the voltage waveform, where the user is

mislead into thinking the AC line voltage is too low and needs to be raised. Computations involving voltage and current are, of course, really fouled up by this situation.

Mitigating problems

Choosing the AC power source: Proper AC power for electronic equipment definitely involves more than just plugging it into the nearest available wall outlet. It also involves avoiding the common mistakes made when attempting to get special or dedicated AC power. The task of obtaining truly proper AC power, therefore, starts with the

AC source itself.

Go upstream: The best advice to follow is to originate the AC power from a point on or as close upstream to the service equipment (SEQ) for the building as is practical. This means a dedicated feeder into the SEQ that is routed to the electronic equipment room, where it can be interfaced to one or more panel boards via an isolation transformer (IT) or another suitable power-conditioning device.

The rationale for this advice is simple. No matter where you get the AC power in the building, whatever affects the SEQ will similarly affect all

Switch mode vs. linear power supplies

Another perspective on the CBEMA curve is to view the area below the 100% line on the y-axis and to the left of the 8.33ms point as being the area where the lack of good energy storage in the typical SMPS' input filter capacitor comes into play. In well-designed SMPS units, this relatively large-valued capacitor is fed from a full-wave bridge rectifier connected directly across the input AC line, and can be charged to nearly the AC line's peak line voltage (169VDC on a 120VAC line). It can store a lot of charge ($Q=CE$), which can then be drawn off by the supply's inverter prior to use in the logic voltage regulation circuits.

SAG EVENTS

A poorly made SMPS or a good one that is overloaded, could be susceptible to a lack of stored energy in its main input capacitor once during a sag event. In an SMPS, this occurs anytime the peak AC line voltage out of the full-wave rectifier is equal to or less than the voltage level on the capacitor for that half cycle. In linear AC-DC supplies, the filter capacitors are operated at a low voltage obtained from an input step-down transformer. Not much voltage difference exists between what the capacitor is charged to and what the linear voltage regulators constantly work against. This difference is called head room, and there is no comparison between the two designs — the SMPS wins this contest hands down.

Because $Q=CE$, it can be seen that for the same size capacitor, the amount of available energy stored at 170 peak volts from a 120VAC line is a lot more than what might be stored at 40 peak volts from a 25VAC transformer secondary. Also, just think about the additional energy that could be stored in an SMPS that is operated at 240VAC input. In a linear design, there is no difference. The secondary voltage from the step-down transformer doesn't change, only the primary voltage does; hence no change in headroom results either.

The idealized effect of a typical line voltage sag on the DC output of an analog supply and SMPS of similar output rating is compared in Figure 1. (See page 96.) A line voltage sag does little to the connected SMPS when compared to an equivalent linear AC-DC power supply. The digital difference provides better performance in a less-expensive, smaller volume and lighter weight supply.

Not surprisingly, most AC power-quality studies (IBM,

Bell, et al.) have identified the AC line voltage sag event as being the most commonly experienced power-quality problem by most electronic and computer equipment users. Even though the SMPS-based digital equipment type is better than analog equipment at ignoring AC line power-quality problems, there is still some point at which the sag can produce performance problems.

SWELL EFFECTS

When a swell arrives at the input to a typical SMPS, the result is predictable. It tries to charge the input energy storage capacitor after the full-wave rectifier as quickly as possible. The capacitance in the typical SMPS is fairly large, making the task difficult. Adding to the difficulty is the RLC time constant based on the input capacitor and the reactances and resistance of the whole upstream wiring system. It is hard to get the capacitor filled up; instead it just absorbs what is available and stores it for use. If it results in a voltage higher than the AC line's peak, the capacitor will not accept any new charge until after the SMPS' inverter load has depleted the capacitor's voltage to below the AC line's peak voltage.

SMPS inverters are high-frequency (usually in the tens of kilohertz) switched circuits involving alternately cut-off and saturated devices supplied from the main input energy storage capacitor. The inverter transformer's secondary is then full-wave rectified and used to charge a secondary energy storage capacitor at a voltage (with headroom) near that used by the connected loads. By pulse-width modulating the inverter (controlling its duty cycle), the capacitor's charge level can be precisely controlled.

The final result is a stable voltage on the inverter-served secondary energy storage capacitor, even though the main input energy storage capacitor may have considerable voltage variation across its terminals. The inverter may even be temporarily held cut off by the pulse-width modulation circuit if too much voltage begins to appear across the secondary energy storage capacitor. This automatically resetting protective action works quite well, keeping input line overvoltages from reaching the load.

In linear power supplies, swells often cause the main energy storage capacitor (on the input transformer's low-voltage secondary) to become overcharged. Ultimately, the

Continued on page 96

levels of power distribution in the building. For example, a momentary low voltage (sag) at the SEQ will also be seen at all electrical outlets in the building. However, if you are obtaining power from an outlet far downstream in the distribution system, then anything affecting the feeders or panel boards between the selected outlet and the SEQ can affect the power quality at the selected outlet. Statistically, power quality is best at the SEQ and becomes progressively worse as you move down through the distribution system, where the building's own loads can create problems.

Get a low-impedance power source: All power sources have an internal impedance. This is what limits the short-circuit current available across the terminals of a battery or a transformer, for example. Internal impedance is, therefore, unavoidable and beneficial unless you fail to account for it and get in trouble from its predictable effects.

Typical electronic load equipment power supplies involve rectifier inputs. These kinds of inputs require non-sinusoidal and high peak currents on each half cycle and cause a significant voltage drop across the internal impedance of a power source. This then causes a harmonic distortion of the available voltage waveform from the source. Harmonically distorted voltage waveforms thus created cause numerous problems with the basic operation of normal and electronic types of load equipment.

Harmonics on power circuits can be strong and, therefore, can usually get into telephone and electronic equipment's signal level circuits and cause a lot of mischief. For example, simple voltage waveform harmonics on the AC power system are serious because they also cause the involved AC power wiring to propagate wideband audio-frequency interference into nearby control or signal cables. For example, the interference from simple AC-DC power supplies may range from 60Hz to around 2kHz. Where higher-frequency notching is present on the voltage waveform, the available harmonics can extend upward into the tens and hundreds of kilohertz, potentially affecting

video or digital switching processes.

Harmonic voltages are reduced to reasonable levels by ensuring that the chosen AC power source is of sufficiently low internal impedance. For the typical service transformer (ST), this correction is not a problem. But it can easily become a problem where dry-type transformers or other types of power-conditioning equipment are subsequently installed within a building, and from which equipment is being powered. Recommended practice is to employ building AC power sources of larger kilovoltampere capability than the load requires and with internal impedances in the range of 2.5% to 5% to avoid

The newest way to provide AC power system wiring and grounding is to use a 120VAC center-tapped AC system.

most of these problems.

Note that most voltage regulators and UPS types of power sources cannot meet the foregoing internal impedance recommendations. This compromise is sometimes still acceptable. The trick is to make certain that the chosen regulator or UPS has an internal output voltage feedback circuit that looks at the output voltage waveform and sends an error-correction signal back into the control circuit. This signal will keep the output waveform distortion and rms voltage level under simultaneous control. Thus, an active method can be used to compensate for the high internal impedance.

If the power-conditioning equipment does not have good output voltage waveform control, then it is common for the distortion of the output voltage waveform to be significantly worse than when it is being supplied directly from the building's power system. Sometimes, this problem gets so bad that the electronic load equipment won't even work

properly when connected to a power-conditioning unit, but will work when connected directly to building power. In the trade, this is known as an expensive lesson.

NEC wiring methods for electronic loads

Historically, the NEC did not allow much flexibility when wiring the AC power branch circuit supplying electronic load equipment. Only two ways were allowed: solid grounding (SG) and isolated or insulated grounding (IG). The AC system supplying the equipment typically could only be a solidly grounded system. (This means bonding the supply transformer's neutral to the equipment grounding conductor system and to the nearest NEC-acceptable earth-grounding electrode to the transformer for AC systems of 150VAC to ground. See Sections 250-5 and 250-26.) Anything else was not permitted on the branch circuit, even if it might be a good idea from an equipment performance standpoint, such as decreasing hum and other noise problems.

Because the product safety testing and listing services (such as UL) were completely aware of this point, it should be apparent that all of the equipment that they tested and the standard for safety to which it was tested had to meet the NEC's requirements as they were written, not as someone would like them to have been written. Together, the NEC and UL made it impossible to try anything else until the NEC was changed. This was done for the 1996 edition of the NEC.

AC system and branch circuit grounding

The two traditional ways of grounding an AC system and its branch circuits used to support typical installed electronic load equipment that is subject to noise and hum problems are shown in Figure 10 for the SG design and in Figure 11 for the IG design. Until the NEC's 1996 edition, these were the only two permitted designs.

There are two important points to be aware of relative to these grounding methods. First, on a typical 120Vrms branch circuit, the hot wire is at a

Power quality and grounding

potential of nearly 170 peak volts to anything grounded or to ground itself. Second, because of common-mode noise current flow in the grounding conductor system, an unequal common-mode (CM) noise current can occur on the neutral and hot conductors of the branch circuit. This unequal current subsequently gets partially converted to normal-mode current on the AC power wires to the load (the hot and

into the audio cable. This point is important for high-impedance circuits because they are voltage driven. If the voltage to ground on the AC wiring was lowered, so would the amount of coupled interference from the e-field into nearby signal-level conductors. This is important because the e-field is a near-field phenomenon that is proportional to the voltage and tends to fall off rapidly with increasing distance between the involved conductors.

The second situation means that the

frequency range and above, not just at 60Hz and 120Hz. This implies special considerations for the filtering system following the rectification process. These might include the use of low series-resistance leakage value capacitors and low-leakage inductors.

For example, a linear power supply might pass this noise voltage onto its DC output, where it could affect the regulation circuit's performance. The noise voltage might even pass through or around the regulation circuits and gain access to the final DC bus structure directly connected to the

electronic circuits. This is especially vexing when these are low-level mixers or amplifiers that are analog in nature and have a bandpass that ranges across the audio range.

However, with the typical SMPS, this is not much of a problem because the interstage inverter transformer provides a sufficient amount of attenuation between stages and keeps the noise out of circuits, such as the regulator circuits.

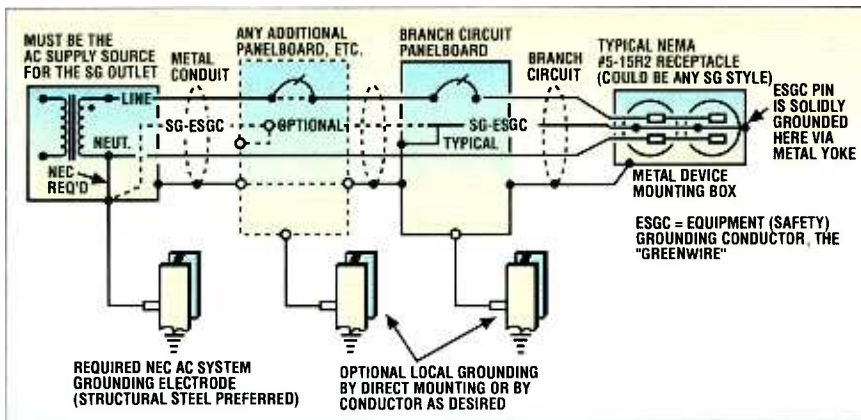

Figure 10. Solidly grounded (SG) AC system and branch circuits.

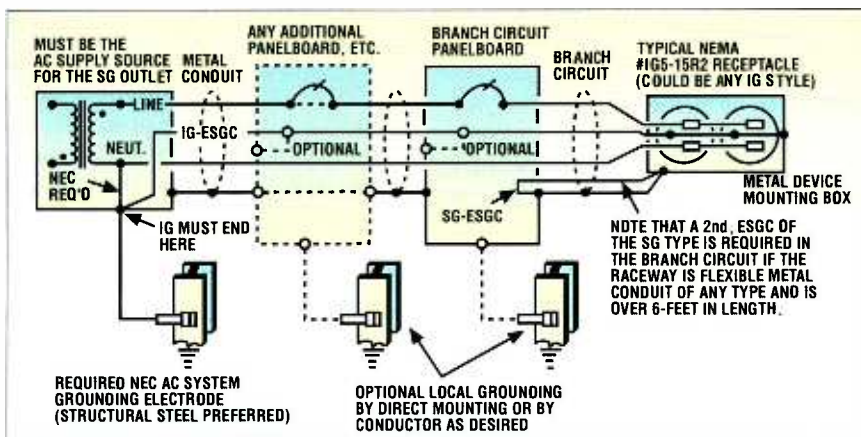

Figure 11. Solidly grounded AC system and isolated or insulated grounding (IG) of the served branch circuit.

neutral conductors).

The first situation means the electric field (e-field) is quite high nearest to the hot conductors and in relation to anything grounded, such as a shield on an audio cable installed near power wires. This high e-field maximizes the electrostatic coupling between the AC wires and the grounded shield, which then introduces hum and other noise

normal-mode converted common-mode (CM) noise current becomes algebraically additive to the expected power current on the circuit and, after interaction with the circuit's impedances, becomes a normal-mode noise voltage impressed upon the AC voltage waveform. Thus, the load equipment must have an AC input circuit immunity to noise voltage across the entire audio

The new way

The newest way to provide AC power system wiring and grounding is to use a 120VAC center-tapped AC system for a single-phase AC power source and to establish the branch circuit system with all of the conductors symmetrically arranged to ground. The nominal AC voltage to ground must be one-half of what it was before, for example, 60Vrms instead of 120Vrms. This type of AC system and the subsequent wiring and grounding requirements are called out in NEC Article 530 — Motion Picture and Television Studios and Similar Locations, Part G; Separately Derived Systems with 60V to Ground. A typical wiring design using the solid grounding (SG) method with the new AC system grounding method is shown in Figure 12; the design for the insulated-isolated grounding (IG) method is shown in Figure 13.

The operative section within the NEC for a 60VAC to ground system is

530-70, General, where it states that the "use of a separately derived 120V, single-phase, three-wire system with 60V on each of two ungrounded conductors to a grounded neutral conductor shall be permitted for the purpose of reducing objectionable noise in A-V production or other similar sensitive electronic equipment locations provided that its use is restricted to electronic equipment only and that all of the requirements in Sections 530-71 through 530-73 are met. The new requirements call for the addition of a ground-fault interrupt (GFI) on either the receptacle or the branch circuit breaker used on the new type of AC system grounding.

Three important changes occur when the new 120/60VAC system is used. First, the voltage to ground on the hot conductors is one-half of what it would be if it were a standard form of circuit. This drops the e-field to ground level proportionally. Second, the grounding system is fully symmetrical, limiting the ability of a common-mode noise current in the grounding system to be converted to normal-mode current and hence normal-mode noise voltage on the circuit. This change reduces the ability of the noise to get through the equipment's power supply and to the subsequent circuits. Finally, the requirements prevent the use of any equipment other than electronic equipment equipped with the required special connector. This prevents a great deal of unwanted interference from other types of equipment that might otherwise share the same AC system and branch circuit wiring.

What to do?

For best results, install a separate transformer, secondary overcurrent and disconnect device, feeder and branch circuit — all at the new 120/60VAC level. This system needs to meet the requirements of the NEC for use on such a system. This will be a separate AC system from the building's other systems, but it will still need to be AC system grounded. This is done via a grounding electrode conductor (GEC) to an NEC-acceptable earth-grounding electrode that is electrically common to the building's nor-

mal earth-grounding electrode system used by the service equipment and other separately derived AC systems.

Please note that one small glitch exists in the whole process of using the 120/60VAC system arrangement. It involves locations that do not restrict access to qualified persons only. Per the NEC, when the 120/60VAC system is used in areas of general access, it will need to be uniquely configured and identified

by cutting off the existing 120VAC plug on its line cord and replacing it with one of the new plugs. This latter action makes for another problem: you generate another NEC situation because of the combined effects of Sections 110-2, Approval and 110-3, Examination, Identification, Installation and Use of Equipment; Paragraph (b), Installation and Use. For example, you cannot modify listed or labeled

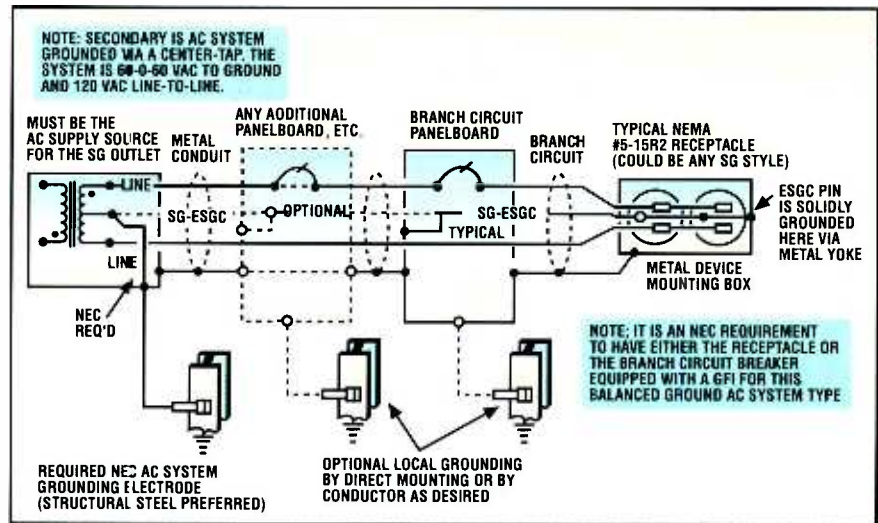

Figure 12. Article 530 — Motion Picture and Television Studios or Similar Locations, Part G; Separately Derived Systems with 60V to Ground (Solid Ground Receptacle).

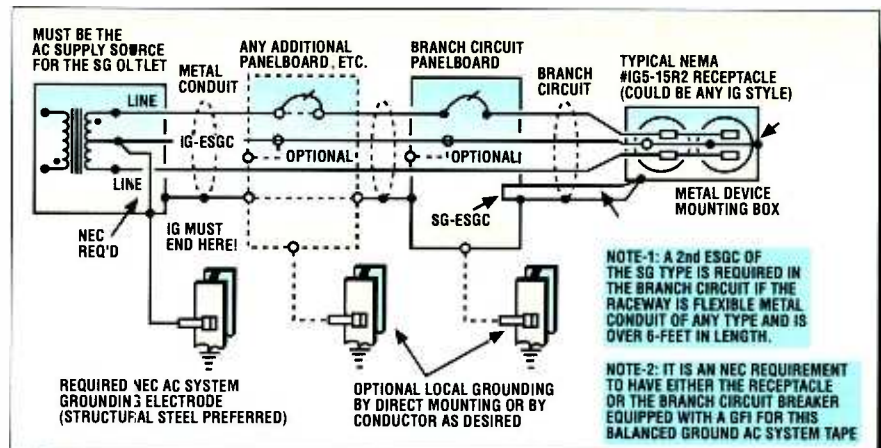

Figure 13. Article 530 — Motion Picture and Television Studios or Similar Locations, Part G; Separately Derived Systems with 60V to Ground (Insulated-Isolated Ground).

for use with this system.

The problem involving this unique configuration requirement is two-fold. First, you have to obtain the special receptacles and plugs, which are not necessarily in-stock at all suppliers; second, you must modify already produced safety listed and labeled equipment

in any way without invalidating its listing or label process. This then causes the equipment to no longer be in listed or labeled condition, which then creates a problem with the two sections just identified. The only out on this is to get the electrical safety inspection authority having jurisdic-

Power quality and grounding

tion at the location to provide a written waiver that permits the installation and operation of such modified equipment. If this is not done and a fire or shock occurs, the lawyers will have a field day in assigning liability to those involved in the modification process at all levels. A change in the NEC is needed in this area to permit equipment already listed and labeled for use on standard NEMA-5-15 or-20 types of receptacles to be so modified without losing either the listing, labeling or any other NEC compliance benefits.

Equipment grounding for hum and noise control

When equipment is installed together in a room, such as for audio or video editing, there are typically several racks of equipment involved with a number of signal-level cables routed among them. This type of installation often has hum and other noise problems, all originating in the common-mode (CM).

Common-mode currents and voltages on the equipment grounding system can cause operational problems with digitally based equipment when the impulses interfere with clocking and related set-reset operations of the logic elements. Once converted into

normal-mode current or voltage by the circuit's impedance imbalances, it mimics the desired signals and can directly affect control, audio or video signal processes.

Common-mode currents and voltages classed as noise are problem areas usually addressed by marginally and randomly effective or hazardous practices. These generally involve creating electrical safety problems via equipment grounding methods that violate the NEC or employing grounding-bonding schemes that are based in unreliable art as opposed to predictable engineering practices. A good example of this is the use of the

Continued from page 92

linear voltage regulator circuit cannot withstand the applied voltage and regulation is lost. Too much DC voltage on the power supply's output can upset or damage the connected loads. Alternately, the regulator circuits themselves can

and output. This is especially true when higher frequencies in the tens to hundreds of kilohertz are involved, and where small amounts of stray reactance can create significant coupling between circuits. The usual problem

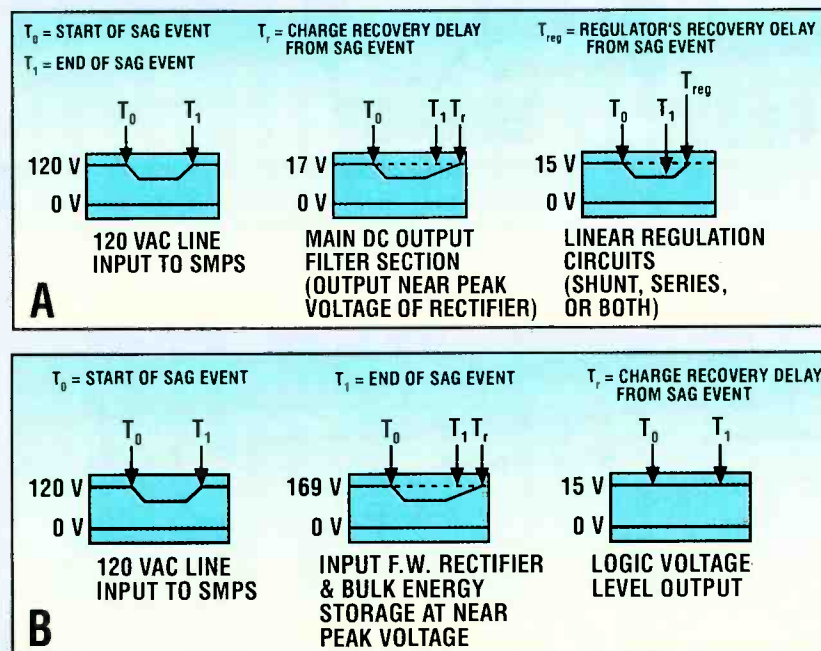

Figure 1. (A) Idealized effect of an input voltage sag on an AC/DC analog power supply, (B) Idealized effect of an input voltage sag on an AC/DC SMPS.

become damaged. A DC level crowbar circuit is sometimes the only protection from this kind of problem. It is not an elegant solution, especially if it is not automatically resetting or can be triggered by electromagnetic interference (EMI).

OTHER EFFECTS

Because impulses and most oscillatory events contain high-frequency components, they can affect the power supply that they are impressed upon because of EMI effects. EMI problems involving AC line propagated electrical disturbances generally involve power supply designs that provide unwanted coupling between the input

within a power supply involves H-fields as opposed to e-fields. This is because the currents are relatively high and circuit impedances and voltages are relatively low. Thus, most problems involve stray magnetic fields and the routing of, for example, wiring harnesses and PC board traces.

Regarding EMI immunity, the SMPS wins hands down because it is already a prolific generator of EMI in its own circuits. Thus, the SMPS must be well-designed from an EMI and electromagnetic compatibility (EMC) standpoint or it will not work and will also generate interference for the equipment with which it is being used. Making the SMPS immune to its own poison has the desirable effect of also rendering it pretty much immune to externally applied EMI. This is not the case with the typical linear power supply, which is fairly quiet by itself, but is often not well-designed from an EMI immunity standpoint.

As an example, often, when equipment with a linear power supply is being affected by AC line EMI problems, a compatible uninterruptible power supply (UPS) is placed between it and the offending AC line.

This change typically cures the problem, but how? Simple. The problem has been fixed by putting an SMPS between the AC line and the linear power supply in the "victim" equipment. After all, what's the real difference between an AC power UPS and the SMPS in equipment except that the UPS is higher power, doesn't have a rectified inverter output and supplies 60Hz instead of DC to its loads? The similarity between the UPS' battery and the SMPS' main input energy storage capacitor is pretty obvious, so I won't elaborate.

single-point grounding method. This produces marginal and unpredictable performance for analog-based equipment and is useless for digital-based equipment. In addition, it is a lightning damage-prone grounding design for the attached equipment, and an NEC equipment and AC supply system grounding violation when implemented in its clas-

The typical SRG consists of a network of bare copper conductors with bonded intersections every one or two feet, completely covering the floor area where the equipment is installed. The SRG is typically installed on the floor and all of the equipment is jumpered to and from it via grounding-bonding straps. All electrical conduits, the equip-

tural subflooring or suspended just below the floor's pedestal post's top cap by SRG wire-holding and bonding clamps. Either way, it works well. Materials used generally involve bare copper wire AWG 6 or a copper strap about 0.1 inch thick and two inches wide. The crossover points where the junctions are made are typically at 2x2 feet. They can be made a little larger or smaller, because the differing effects are not too noticeable.

For carpeted or uncovered floor surfaces, a flat copper foil is generally used. The foil is typically 0.030 inches thick and two inches wide, with all of the crossovers soldered together. This type of SRG can be directly applied to a floor's surface and then either walked directly on or covered with an anti-static electricity carpet. (You do use this kind of carpet in equipment rooms, don't you?) T-shaped access slots cut into the carpet allow grounding straps or jumpers to be passed through and then soldered to the underlying SRG foil, after which the carpet's edges are folded back down.

A ground plane is typically difficult to implement and somewhat costly in practical forms.

sic form.

However, an effective methodology does exist to deal with all of these problems and also to keep the AC supply system and equipment grounding safe. This method is called a signal reference grid (SRG) and it involves AC power and signal-level surge protectors being employed along with some special rules for the termination of cable shields. Taking these items in order, let's start with the SRG.

The signal reference grid

It is generally agreed that if all the electronic equipment is grounded to an underlying ground plane (a flat, wide-area solid sheet of copper), then the best form of grounding available across the broadest range of frequency can be obtained. However, a ground plane is typically difficult to implement and somewhat costly in practical forms. If, instead of a plane, a grid is installed, all the benefits of the ground plane can be had except that the upper effective operating frequency limit will be lower.

Remember, topologically speaking, a grid is just a plane with some openings in it. For the typical grid installation, having openings in the plane is not a problem. The recommended practice designs for SRGs are effective from DC to approximately 25MHz to 30MHz. This is good broadband grounding effective across the entire frequency range needed by analog and digital logic-based commercial audio and video equipment.

ment ground and the isolation transformer (IT) serving the equipment room are grounded or bonded to the SRG, making it the commonly shared ground reference for everything. Yes, everything. The idea of isolation is long gone; it has too many problems, including electrical safety ones. (The neutral terminal on the secondary, the metal case or enclosure and the greenwires are all tied together within the transformer. The junction point for these items is then grounding-bonding jumpered to the SRG. The isolation transformer is typically placed directly atop the SRG and is not remotely installed.)

Typical construction

Generally, the construction of the SRG involves the use of a cellular raised

Surge protection

The biggest threat to electronic equipment from a physical damage standpoint is from lightning-related transient voltages, commonly called surges. Although somewhat related to the geographical location of the equipment, surges are a real threat almost everywhere in the United States. How

Common-mode currents and voltages classed as noise are problem areas usually addressed by marginally and randomly effective or hazardous practices.

floor (computer-room-style flooring) under which the SRG, electrical power and signal wiring can be routed. The underfloor volume is also often used for an air-handling space for the supply of HVAC process cooling air into the room above.

Cellular raised floors allow the SRG to be installed directly atop the struc-

ture. Much of a threat can be estimated by consulting ANSI/NFPA-780, the National Lightning Protection Code 1992.

A direct strike to the building or the incoming AC supply conductors is not necessary to create a damaging surge current and voltage for the equipment installed in the building. A cloud-to-cloud overhead or a nearby

Power quality and grounding

strike is sufficient to do the trick.

Because many typical installations involve routing cables throughout a facility, there is ample opportunity for damaging lightning currents to be near-field coupled into them. This is an e-field (electric-field, capacitive coupled) and H-field (magnetic-field, inductive) set of phenomena that is unavoidable. However, they can be mitigated by employing proper grounding, bonding, shielding and surge-protection techniques.

The surge is coupled into the building wiring system and the various control or signal process cables of the affected electronic load equipment. The amount of surge coupled is proportional to the amount of area enclosed by the affected wiring. Big areas mean larger surge currents and voltages are developed from the lightning discharge.

From the victim equipment's standpoint, there are two ports from which the surge threat arrives: the AC power input and the signal or control cable connectors. Therefore, a surge current arriving from one port's conductors is passed into the victim equipment and out the other port and into its conductors. The victim equipment is in the center of a loop into which a surge impulse has been coupled.

This explains why adding surge protection to only one of the two ports does not do much to protect the equipment from lightning-coupled damage.

With the increased use of computers, the control or signal-level port is generally configured to use one of the computer industry's standard protocols, and this is fortunate, as we will see. This is true unless problems arise because of some special interface plug-in card being installed, which may use a non-standard signaling protocol or other configuration.

Proper surge protection needs to be installed on the equipment itself and on the AC power and control or signal

cable ports using performance-coordinated surge-protective devices. Typically, this is a metal-oxide varistor-based form of protection on the AC power input port. The signal level port may use a combination of Tranzorbs, gas tubes, series resistances or impedances and common-mode chokes in a specially designed protection circuit particular to the signal port's characteristics and coordinated with the performance of the associated AC power port's protection.

For example, an RS-232 signal port needs a surge protector specifically designed for the RS-232 protocol. It must be used with an AC power port surge protector with which it has been performance tested and rated to work. Anything else will most likely fail to do the job, and the signal port will most likely be the one damaged. The best protection is provided when the AC power and signal protectors are mounted onto and grounded-bonded to the

A direct strike to the building or the incoming AC supply conductors is not necessary to create a damaging surge current and voltage.

protected equipment's metal frame or enclosure. In most cases, using a rack's metal framework is adequate for this purpose, and this practice is necessary for larger groupings of equipment in any case.

Surge protector units are generally available for any industry-standard signaling protocol, but not for proprietary signal protocols. These need to be specially engineered for the specific application.

The building's AC power system also must be surge protected so that the level of the surge arriving at the electronic load equipment is as low as possible. The protection provided at the electronic load equipment is not usually capable of doing the whole protection job involving high-energy

surges, but is rated to do a good job with lower-level surges. By today's means, you cannot provide top-notch performance and high energy level handling in the same package as installed at the victim equipment's level.

The recommended practice is to start with the building's SEQ and to install a device called a secondary lightning protector (or arrestor) on the service conductors. The metal frame or enclosure of the SEQ must be used for the surge current's reference point. Generally recommended practice is to parallel this protector with an AC capacitor connected from each line to equipment ground. This is often properly referred to as a wavefront modification capacitor. It is sometimes built in as a part of the overall protector chosen to do the job. Most of these protectors are rated for 600VAC systems and are available for single- and three-phase services.

Next, recommended practice encourages the application of surge protectors similar to the one used at the SEQ on each level of switchboard and panel board that exists between the SEQ and the victim electronic load equipment on the branch circuit. In each case, the protector is applied in shunt between each line and equipment ground, such as the metal frame or enclosure of the switchboard or panel board.

The final level of surge protection ahead of the equipment's port protection is applied at the end of the branch circuit itself. The recommended practice is to install a surge-protected receptacle or to plug in a protector to the normal receptacle into which the victim electronic load equipment is then plugged.

Taken together, all of these measures serially shunt and progressively attenuate the level of surge that arrives at the SEQ from the power distribution system. What is left is mopped up by the device-specific and coordinated protection applied at the AC power port for the electronic load equipment, coordinated with that equipment's signal port's protection.

Cable shield terminations

With analog circuits and lower-frequency signal processes, the golden rule was always to ground the shield at one end only. However, this is not recommended with digital signal circuits because of the higher-frequency nature of the circuits. It is not recommended for analog circuits either, if you are concerned with the shield attenuating H-field coupled interference, such as from lightning.

With digital circuits, the requirement is to ground the cable's shield at both ends to obtain H-field protection and to preserve the integrity of the high-frequency signal on the cable. Worries about cable shield current combining with the digital signal on the cable are minimized because, at the involved frequencies, the two currents are separated by flowing on the inner and outer surfaces of the shield with little or no overlap. This is an e-field and a skin-effect function. In fact, most digital signal cables, such as coaxial cables, can have the shield grounded at multiple points along the way with no ill effects and much improved lightning protection.

The telephone company has always grounded the cable shield at both ends between the subscriber loop station and the subscriber's premises. This was done for lightning safety reasons and is required under NEC regulations. A twisted-pair arrangement is used inside the telephone cable's shield, and each of the contained pairs is protected by a surge-protective device (SPD) connected from line-to-line and line-to-ground or chassis. Unwanted cable shield currents caused by conducted common-mode currents are typically dealt with by isolating one end of the shield from ground via a capacitor of a few microfarads. This blocks DC and most audio frequencies (including AC power system harmonics), but lets high-frequency surge-type currents flow with ease. As a result, the shield can function as a means of attenuating H-field-coupled noise and surge cur-

rents, but is relatively unaffected by DC and AC power system-related common-mode currents resulting from ground potential offset between the two ends of the circuit.

Shield current problems can also be dealt with via a number of other recognized techniques, such as using Transorbs between the shield and ground, opto-couplers at the cable's ends, common-mode chokes on the cable and transformer isolation of the signal.

Proper surge protection needs to be installed on the equipment itself and on the AC power and control or signal cable ports using performance-coordinated surge-protective devices.

Finally, if you simply must have the cable's shield grounded at one end only, you can still have the benefits of grounding the shield at both ends (for H-field protection) by pulling the cable into a grounded-at-both-ends metal conduit raceway. This practice provides a two-level shielding system. The design also improves the e-field shielding capability of the circuit. The best types of conduit or raceway to use in this role are electrical metallic tubing (EMT), intermediate metal conduit (IMC) and rigid metal conduit (RMC) in ascending order of effectiveness. Note that galvanized steel conduit is markedly better than aluminum conduit in attenuating common-mode noise currents and that tightly made joints and terminations are necessary for the best effect.

Digital logic and SMPS-based equipment is replacing or has replaced the analog circuit-based equipment of yesterday. These newer designs have great advantages, but are still somewhat susceptible to electrical noise arriving on the AC power input, the grounding system and the attached signal level cables used to interconnect items into a system. Equipment of the new and old design types are still susceptible to the

damaging effects of lightning-induced surge currents and voltages that are impressed upon the equipment's AC power input wiring, the signal cables and the grounding system being used.

By understanding how AC power problems affect electronic load equipment, you can determine the types of power-conditioning equipment needed. The CBEMA curve was developed to aid in this process and is useful with the analog design equipment and digital logic-based designs.

When using the newer digital-based equipment, abandon many of the older methods of grounding, bonding and shielding. This means strictly following the NEC. Avoid the use of isolated earth-grounding electrode connections. Eliminate single-point grounding systems, instead use broadband signal reference grid (SRG) designs.

Ground signal cable shields at both ends — a requirement for digital signals. Pay strict attention to providing proper surge-protective devices on the AC power and signal circuits if there is a risk of lightning damage at the location. Following these guidelines will ensure a ground system that is safe for the electronic equipment you install and for the people who will use it. ■

Warren H. Lewis is with Lewis Consulting and Engineering, Julian, CA.

For more information:

1. IEEE Emerald Book entitled "Recommended Practice for Powering and Grounding of Sensitive Electronic Equipment"
2. Federal Information Processing Standard Publication No. 94 [i.e.; Fips-PUB-94]
3. "Guideline on Electrical Power for ADP Installations," U.S. Department of Commerce, National Institute of Standards and Technology [NIST], National Technical Information Service, U.S. Department of Commerce, Springfield, VA 22161.)

NEC sections:
Grounding
250-5, 250-26

Balanced power systems:
530-70. General
530-71. Wiring Methods
530-72. Grounding
530-73. Receptacles

MPEG transmission issues

Concatenation, digital turnaround and interoperability are the keys to MPEG transportability.

By Keith Dunford

The use of MPEG-2 compressed digital TV signals is expanding rapidly throughout the world for terrestrial and satellite video networks. Although the digital technology does bring significant operation and cost savings to users, it also has created challenges for equipment manufacturers as the transition from analog to digital is implemented. The top challenges have been *interoperability* of MPEG-2 encoders and decoders from various manufacturers, *concatenation* of signals and *digital turnaround* of compressed video between satellite and terrestrial networks.

Interoperability

Compressed digital television has been around for more than a decade, bringing new capability and flexibility to TV program contribution and distribution networks. The past five years has seen an order of magnitude improvement in performance, efficiency and size of MPEG-2 compression products, largely brought about by the development of RISC technology.

Standards that were developed in the early 1990s for compressed digital TV signals have played an important role in the utility of the new technology. The International Standards Organization (ISO) MPEG-2 digital TV standard brought digital television closer to widespread use in network TV operations. This standard provides a degree of

confidence that users can buy equipment from an array of manufacturers and know those digital encoders and decoders would interoperate. This was substantially proven in tests conducted by the industry, but they left the satellite modulation and demodulation standards open, reducing the chance for guaranteed interoperability. The European digital video broadcasting (DVB) standard developed quickly to help solve the problem. Because MPEG-2 and DVB standards have since been adopted by all manufacturers of compressed digital TV systems, interoperability has to a large degree been achieved. Even so, there remain isolated instances where a manufacturer's MPEG-2 encoder or integrated receiver decoder (IRD) does not interoperate with others.

Companies that tested their MPEG-2 encoders, DVB modulators and MPEG-2/DVB IRDs for interoperability at the Intelsat and ISOG trials include Tiernan Communications, News Data Systems (NDS), Scientific Atlanta, General Instruments, Divicom, Wegener, Thomson and Tadiran/Scopus. These companies proved their interoperability in accordance with parameters set by Intelsat and ISOG, designed to meet primary requirements of digital TV broadcast applications. Interoperability will be an ongoing issue as new products are released, such as the new high-performance encoders and IRDs supporting the MPEG-2 4:2:2 studio profile.



The issue of interoperability allowing exchange of digital TV programs between users of different manufacturers' MPEG-2 equipment is no longer a key issue in making the decision to convert from analog to digital technology. CBS Inc. was the first among U.S. networks to adopt the advantages of digital satellite news gathering (DSNG), when in 1995, it began with a single-channel MPEG-2 system for fixed and mobile applications. CBS went further when covering the 1996 Republican Convention in San Diego, by uplinking six channels of MPEG-2 compressed digital TV coverage on a single transponder. This provided extensive coverage of the event to CBS affiliates and international networks using other manufacturers' receiving equipment. European news networks, including the 25 member stations of European News Exchange (ENEX), were faster to adopt the benefits of DSNG and are considered ahead of U.S. deployment.

This is likely to change in 1998 as the major U.S. networks plan a significant increase in the use of MPEG-2 compressed digital TV technology for their contribution and distribution requirements. This demonstrates the increased confidence in MPEG-2 technology that has without doubt improved substantially over the past couple of years. This was clearly seen at NAB '97 when most of the leading players rolled out new and substantially improved products over those seen a year earlier, including some with the long-awaited 4:2:2 studio profile.

Concatenation

The need for concatenation or multiplexing of MPEG-2 compressed digital TV signals must be considered in designing program contribution networks. Concatenation of MPEG-2 datastreams can generate unacceptable errors resulting in visual artifacts in the TV image. Signal jitter and tim-

ing problems can also be introduced in the multiplexing environment. In networks where concatenation is necessary, the problem can be lessened by running the originating encoder at higher video data rates. The use of a 4:2:2 studio profile @ main level encoder offering video data rates up to 50Mb/s will improve digital post-production tools and provide a degree of protection in multiplexing situations, above that possible with 4:2:0 encoding.

Experience has shown that broadcast-quality video can be achieved in single and multihop circuits using satellite or terrestrial links with video bit rates of between 5Mb/s and 8Mb/s (more on this in the next section). However, where post-production editing or re-encoding is necessary, artifacts are likely to overrun when more than three or four concatenations take place at these highly compressed data rates. Higher video data rates help protect against errors that can be

MPEG transmission issues

introduced in multiprocessing environments. In concatenated MPEG-2 applications, video data rates from 8Mb/s up to the 15Mb/s limit of MPEG-2, ML@MP must be considered. Unfortunately, higher data rates reduce the efficiency of a network and require more bandwidth, which results

news interviews and other less aggressive video, resulting in only slight degradation of quality. However, low data rates are not advisable when heavy concatenation is likely.

In adverse conditions, such as a satellite circuit operating at close to threshold, a low data rate video signal will be less robust than one operating at a higher data rate. This will likely result in disturbing artifacts being visible at

concatenations when coded at 8Mb/s or higher using MPEG-2 compression. There is no accurate measurement of the effect that concatenation is likely to cause, other than the measurement of errors in the datastream, which may not be consistent even within the same category of compressed program material. There is always the potential for a video signal to create processing problems in MPEG-2 compression and this

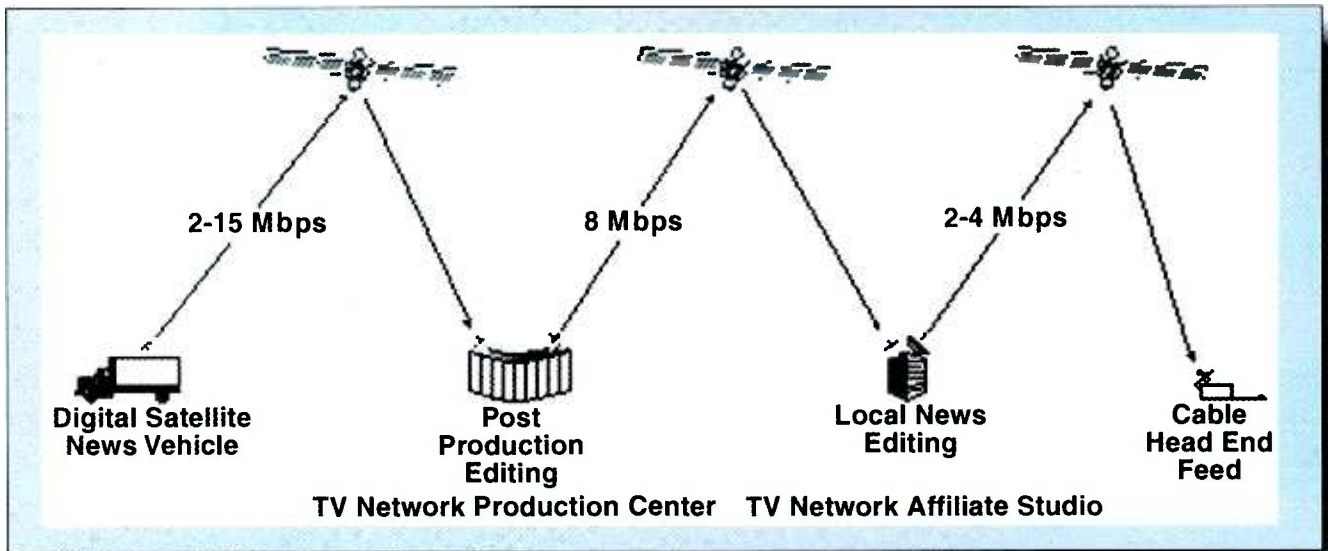

Figure 1. Concatenation of MPEG-2 encoding/decoding in digital satellite news gathering.

in fewer channels per transponder or terrestrial circuit.

MPEG-2 relies on high compression ratios, reducing the required video data rate by 90% or more. These

high compression ratios and low data rates are inevitable for network efficiency, but data integrity is always of prime importance in digital TV networks. Specific attention must

be directed to error-free decoded video and audio signals, comparable to uncompressed analog video, while still gaining the benefit of digital transmission. MPEG-2 has been proven adequate and sufficiently robust to render broadcast-standard video at around 8Mb/s. Lower video data rates in the order of 4Mb/s to 6Mb/s are possible with some less complex video, such as

an earlier state of link decay with low data rate video, than signals composed of higher rate video. The problem of possible decoded artifacts with high

gets more problematic in concatenated operations.

Digital turnaround and ATM networks

In the world of analog television, turnaround of network signals in program contribution and distribution networks was a relatively easy task. All you had to do was simply re-

modulate a baseband signal or even better, do it at the IF frequency.

However, noise gets added at each turn-

around and there will be signal degradation to varying

degrees, which can reach the point where a broadcast-quality picture is not possible.

Many problems were encountered in the early days of multihop digital TV networking, largely caused by the continuation of analog network practices, such as IF turnaround. This technique often resulted in the generation of er-



TE6 encoder and the TDR600 decoder.

compression ratios must be balanced against the type of program material and the degree of concatenation expected in network operations.

Tests show that a high proportion of broadcast program material, including much with high motion, like sports events, can withstand at least two con-

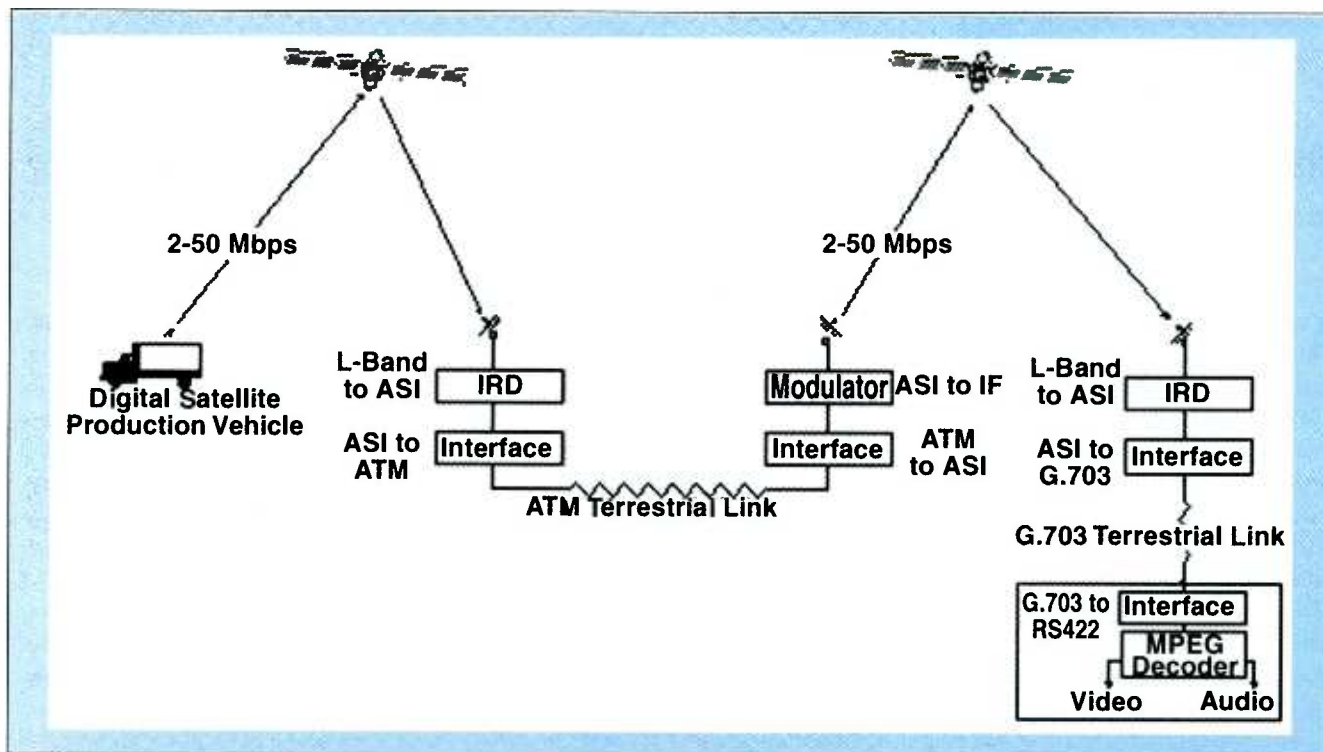

Figure 1. Digital turnaround in a satellite/terrestrial DSNG network.

rors and timing problems in the MPEG-2 datastream that were outside the MPEG tolerance. It was soon discovered that digital TV turnarounds had to be done at digital baseband and not involve multiple encoding.

Digital turnaround has now become commonplace with the major TV networks and common carriers. Global circuits can be used with MPEG-2 digital television offering little or no loss of video performance. British Telecom (BT) was among the early adopters of the digital turnaround technique. BT provides digital video transmission services to and from the main switching center at London's BT Tower over a standard G.703 terrestrial fiber and microwave link to the Madley satellite teleport. The G.703 link supports an 8Mb/s or 34Mb/s link to the BT Teleport where the datastream is converted from G.703 to the asynchronous serial interface (ASI) format required as input to the satellite uplink.

The attractiveness of asynchronous transfer mode (ATM) technology in digital turnaround of MPEG-2 signals is well recognized and offers another step in efficient bandwidth-on-demand circuits for a growing digital TV mar-

ket. ATM will add another dimension to MPEG-2 digital TV networking in terrestrial and satellite media. The addition of this new networking tool has come just when global TV networks need added bandwidth and flexibility to meet the demand for program contribution and distribution.

Digital turnaround has become commonplace with the major networks and common carriers.

Teleglobe International was the first major carrier to offer digital TV service over an ATM terrestrial network using newly available MPEG-2 4:2:2 studio profile equipment. The service was inaugurated in December 1997. The ATM link was established between Teleglobe's Lake Cowagan, British Columbia teleport to Laurentides

teleport near Montreal, terminating at Waterfront Communications New York teleport.

NHK was the first to use the new MPEG-2 4:2:2 ATM service from Teleglobe International. NHK was well satisfied with the video and audio quality of the service. Teleglobe is initially offering two levels of MPEG-2 ATM service to its users: 8Mb/s at either 4:2:2 or 4:2:0 profiles and 18Mb/s at 4:2:2 only.

Finally, trials by Intelsat and ISOG have convinced manufacturers and users that interoperability is no longer a major issue. It has been proven that any manufacturer's equipment conforming to the MPEG-2 and DVB standards can be made to interoperate with another manufacturer's similarly compliant product. Continued cooperation is needed between manufacturers to ensure that the new products, including those supporting the new 4:2:2 studio profile will maintain the required interoperability. ■

Keith Dunford is vice president of Tiernan Communications, Inc., San Diego.



Make it easier for others to reach agreements with you

BY KARE ANDERSON

Are you far enough along into the new year to find that you are already backsliding on your goals for 1998? Want to try on some bite-size “behavioral change” goals instead? These small habits may reap big rewards in reducing stress and friction when trying to reach better agreements more easily.

Tell me which of the following 12 habits you find the most difficult to adopt, the easiest or the most rewarding. E-mail me at kareand@aol.com.

1. Anticipate what you want out of a situation before you go into it. Before you enter into a conversation with someone, consider your main goal. The more you can keep your goal in mind, especially if you have strong negative or positive feelings about the person you are talking to, the more you will remain focused on what is being said and you will be less reactionary to issues that don't relate to your bottom line. In some cases, your main goal may change in mid-conversation, but having a goal gives you a context for the conversation.

2. Demonstrate goodwill upfront. Be willing to compromise and be genial, even if you don't like the person or the situation. This is the best way to keep the channels of communication open.

3. Make the other people feel safe before you try changing their minds. Being right or smart or good is often of no help in protecting your interests. Acting in mutual best interests is more valuable. All agreements involve asking people to change, which we initially resist. In almost every situation, people are first influenced by their fears more than their opportunities. Calm their fears, even if they may be unstated, and you will open people up to hearing your needs. Align your goals with their picture of positive possibilities and you may move them more quickly to agreement. Once fears are allayed, they can

hear about others who have already done something similar to what you propose.

4. Understand that problems seldom exist at the level at which they are discussed. When you are involved in any argument lasting more than 10 minutes, ask yourself, “Are we arguing about what our disagreement is really about or is there a deeper conflict not being discussed?” Probe for the underlying concern and find a direct or indirect way to address it.

5. Make it a habit to refer to other people's interests first. Refer to the other person's interests first (you), then how the topic relates to your mutual interests (us) and finally, how the topic relates to your interests (me). Research shows that others will listen sooner, longer, remember more and assume you have a higher IQ than if you were to address your interests first.

6. Honor commonalities more frequently than bringing up the differences. It is a habit to bring up our concerns more than our agreements with someone else. Whatever you refer to most often and most intensely will be the center of your relationship. Keep referring to the part of them and their points that you can support and want to expand upon. If you want more from other people, wait until they have invested more time, energy, money or other resources to ask for it.

7. Don't assume that other people see the picture you are presenting. Do not presume that others recognize all the benefits of what you are proposing. Take time to describe them in their terms, relating your suggestions to their most pressing interests and situation. Many seemingly tough “negotiators” are simply acting to prevent looking foolish later on. The best peacemakers work hardest to allay the other people's worries.

8. Use time, rather than letting it control you. Plan and act early to avoid last-minute rushing and thinking. As you go forward in your discussions, remember that the allure of a successful agreement often clouds our perceptions of whether we can cover all the elements of the agreement in the time we have allotted to discuss it. Do not panic when you have unavoidable outside time constraints. Use the pressure to get more accomplished in less time.

9. Look to your long-range interests and your better side. Even though it is human to gloat in the face of imminent victory or vindication, do not make a victim of the underdog. You will never have their complete attention or trust again; some will retaliate and you will be diminished in the eyes of others who witness your behavior.

10. Recognize your blind spots and your hot buttons. When you get angry with someone, look first to your vulnerable points before you lash out.

11. Be a “synthesizer leader” (SL). The emerging synthesizer leaders have some behaviors in common. They listen to others before voicing an opinion. They ask probing and follow-up questions. They refer to the previous comments of other people with whom they agree as a way of prefacing the idea they advocate. They display consistent values. They offer and keep commitments, without being reminded. Consequently, even if others may not agree with “SLs,” they are likely to respect and work with SLs more than others who may be closer to their beliefs, but who are unreliable in keeping commitments.

12. Aim humor at yourself. The best way to deflect is to poke fun at yourself. Make reference to a situation when you did something foolish. ■

Kare Anderson is a speaker and author. Visit her web site at www.sayitbetter.com.

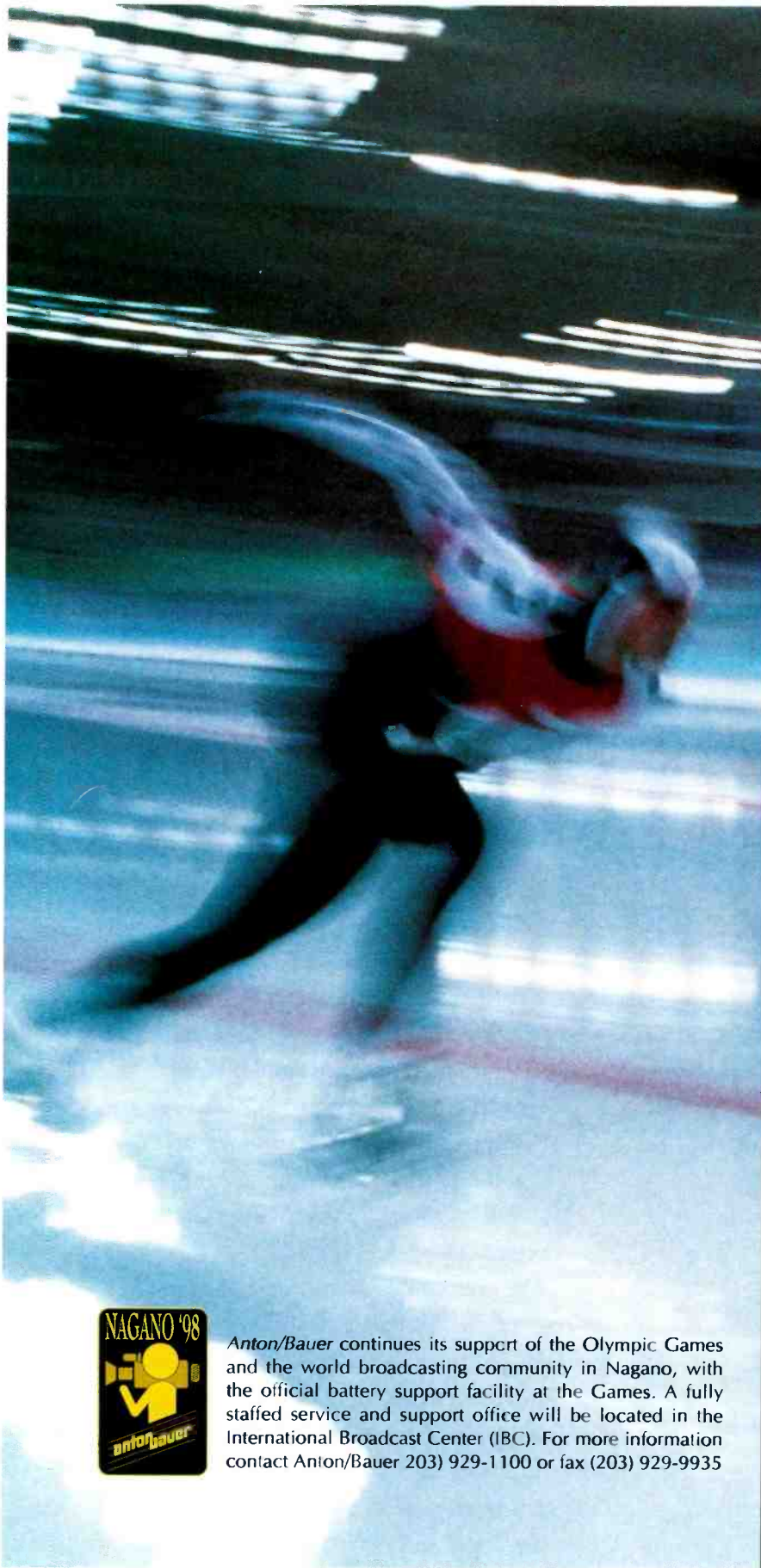

Anton/Bauer continues its support of the Olympic Games and the world broadcasting community in Nagano, with the official battery support facility at the Games. A fully staffed service and support office will be located in the International Broadcast Center (IBC). For more information contact Anton/Bauer 203) 929-1100 or fax (203) 929-9935

In February, over
3000 athletes from
83 countries will
compete in *64 events*
in the *16 days* of the
**1998 Winter
Olympic Games**
in Nagano, Japan.

35 broadcasters will
deliver *thousands*
of broadcast hours,
using *hundreds*
of cameras . . .

and
**one
worldwide
standard.**

antonbauer



Circle (45) on Free Info Card

Winter Olympics: Putting on the Games in Japan

ORTO'98 served as the host broadcasting organization at the 1998 Nagano Olympic Winter Games. ORTO'98 was responsible for producing the radio and TV international signals of the Games, including events held at the 17 venues, the opening and closing ceremonies, the victory ceremony and the main press center.

BY TAKASHI
MIYAMOTO

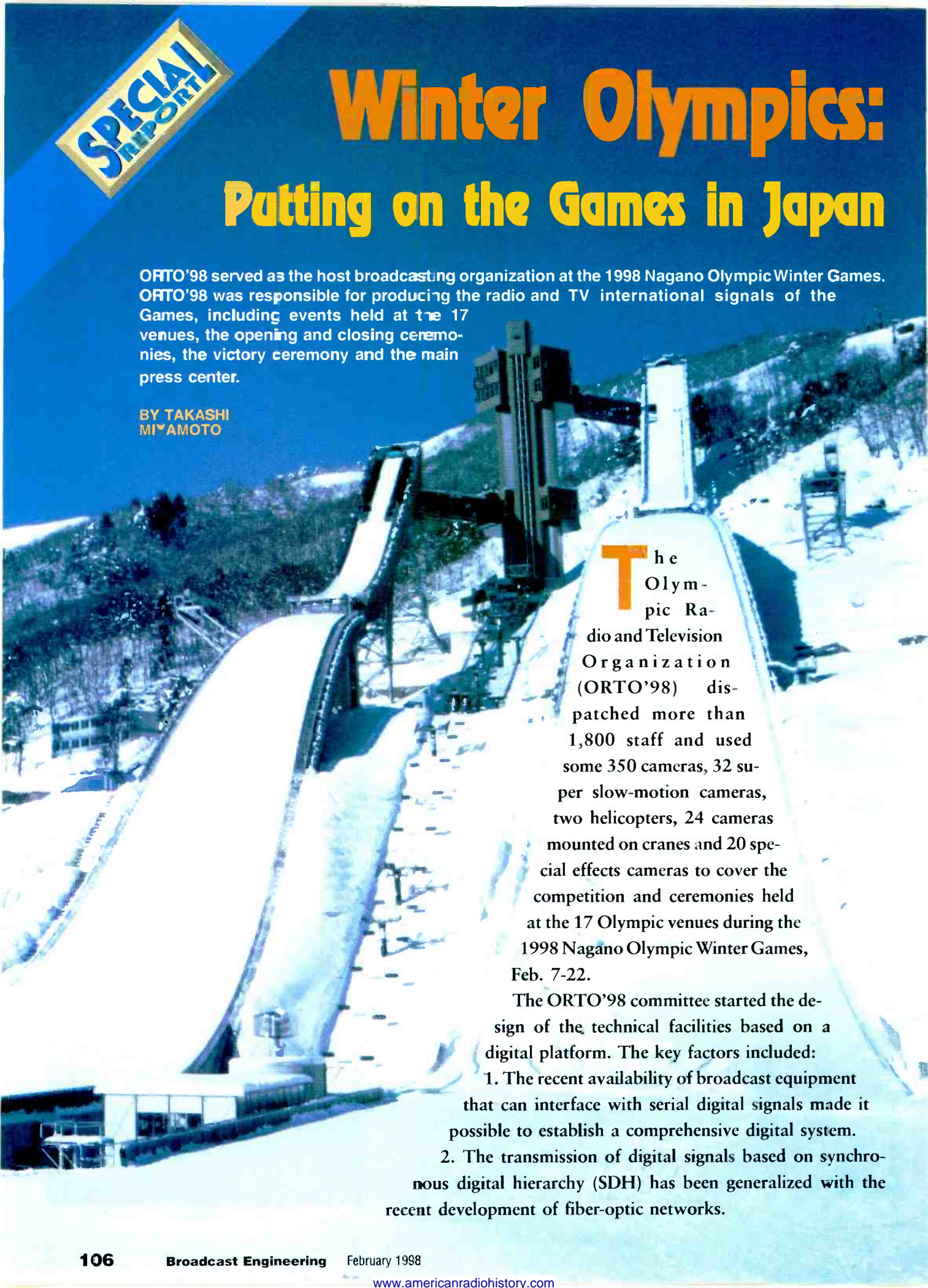

The Olympic Radio and Television Organization (ORTO'98) dispatched more than 1,800 staff and used some 350 cameras, 32 super slow-motion cameras, two helicopters, 24 cameras mounted on cranes and 20 special effects cameras to cover the competition and ceremonies held at the 17 Olympic venues during the 1998 Nagano Olympic Winter Games, Feb. 7-22.

The ORTO'98 committee started the design of the technical facilities based on a digital platform. The key factors included:

1. The recent availability of broadcast equipment that can interface with serial digital signals made it possible to establish a comprehensive digital system.
2. The transmission of digital signals based on synchronous digital hierarchy (SDH) has been generalized with the recent development of fiber-optic networks.

Finally, a place to stick the FCC's DTV requirements.



Introducing the world's only video jacks to surpass SMPTE® 292M specifications for uncompressed HDTV.

You're looking right up the business end of the SVJ-2 Super Video Jack from ADC Telecommunications. A breakthrough jack that can do far more than help convert your station to digital television — it will take you all the way to HDTV. ■ That's because ADC Superjacks don't just pass SMPTE 292M specs, they blow them out of the water. Our standard-size SVJ-2, for example, can handle bandwidths up to 2.4 GHz. And our mid-size MVJ-3 can go to 3.0 GHz and beyond. Which means these jacks could realistically outlive your entire network. That's why we call them "future proof." No matter what DTV format your station adopts now, you won't have to upgrade again. ■ ADC Superjacks. The

best place in the world to stick FCC requirements for DTV. ■ As you'd expect, ADC is innovating the broadcast industry.

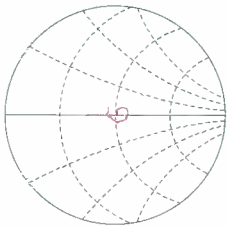

No other jacks on the market come close to the performance of ADC's Superjack family.

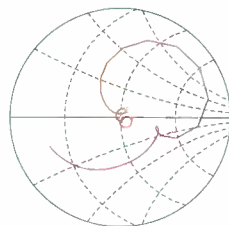

The impedance performance of the nearest competitive jack spirals out of control.

Call for a **free** Tech Brief on the DTV story and complete product information on ADC Superjacks

1-800-726-4266

Or visit us at
[www.adc.com/
Products/AVproducts/
index.html](http://www.adc.com/Products/AVproducts/index.html)



Cabling Solutions from Gepco

Gepco supplies audio cable, video cable, cable assemblies, breakout boxes and more.



Gepco distributes ADC, Kings, Neutrik, Switchcraft, EDAC and more.

Innovative, Quality Audio and Video Cable Products

1-800-966-0069

Chicago • Los Angeles



www.gepco.com

Circle (41) on Free Info Card

Winter Olympics: Putting on the Games in Japan



Video workshop room for CG work at IBC.

3. In order to ensure superior signal quality, conversion from analog to digital and back was minimized.

4. Standard digital multiplexing techniques allowed digital video and audio to be combined on one coaxial cable, which reduced the amount of cables and work required when building large broadcast facilities.

ORTO'98 established a digital system that conformed to NTSC composite digital format SMPTE 259M/272M standard that specifies a serial digital interface with embedded digital audio. In order to secure the host broadcast equipment at the International Broadcasting Center (IBC), Panasonic was selected to be the key system integrator for the Nagano Games in September 1996. The Panasonic installation included digital broadcast equipment, including D-3 format videotape machines with serial digital (SDI) and embedded audio interfaces.

International signals

The international TV signals were handled by SMPTE 170M (NTSC, 525 lines/59.94Hz) with stereo audio in-

Switch On

to the new wave of switcher for the new demands of post and broadcast.

The PC-based PVS-2 and PVS-4 compact switchers are loaded with features and can be driven from a familiar format control panel or your own workstation.

Applications include:

TELECINE AND HIGH END GRAPHICS

The PVS-4 is a true 4:4:4 switcher capable of handling both 4:4:4 and 4:2:2 sources.

EDIT SUITES & GRAPHICS

For both M/E and key layering applications, the PVS-2 is ideal for graphics compositing as well as auto conforming.

MASTER CONTROL & PRODUCTION

For applications requiring a compact control panel for preview to air operation, the PVS-2 provides a perfect solution.

Call PSP Digital, the makers of the Alpha switcher range. To find out more, please call +44 (0) 1635 522534



PSP
DIGITAL

PSP Digital Limited
6 Votec Centre, Hambridge Lane,
Newbury, Berkshire RG14 5TN U.K.

Tel: +44 (0) 1635 522534
Fax: +44 (0) 1635 551995
Web: www.psp-digital.co.uk

Circle (40) on Free Info Card



NOJC (Japan Pool) monitoring room using compact DVCPRO VTRs (AJ-D-230) IBC.

A few new additions...



LECTRO™

Recent additions to the 200 Series Synthesized UHF wireless family...



All new 250mW belt-pack transmitter

For extreme operating range.
256 frequencies in 100 kHz steps.
Adjustable low frequency roll-off.



All new synthesized plug-on transmitter

Converts hand-held microphones to
wireless operation. 256 frequencies
in 100 kHz steps.



The best sounding hand-held transmitter

The new VariMic™ electret element offers adjustable bass, midrange and treble to suit individual taste or to match other microphones, plus an attenuator for high sound pressure levels.

*Controls are
located
underneath the
windscreen*

**For more information and a
free 50 page wireless guide:**

Call (800) 821-1121

Circle (42) on Free Info Card

Made with pride in the USA

The most advanced wireless systems in the world.



LECTROSONICS

581 Laser Road, Rio Rancho, NM 87124 USA

FAX (505) 892-6245 - PH (505) 892-4501

E-mail: sales@lectro.com - http://

Winter Olympics: Putting on the Games In Japan

terfaces. In order to transmit the digitized TV signals with a data rate of 143Mb/s through fiber-optic circuits based upon STM-1 (155.52Mb/s),

As international signals were distributed to world broadcasters on an analog system, digital and analog facilities coexisted in the ORTO'98 central facilities. All video and audio signals transmitted through contribution networks from the Olympic venues were terminated at the distribution center in

the venues and the IBC were NTSC composite analog with associated stereo sound. Signals were identified, equalized and synchronized in the distribution center. ORTO'98 also handled 73 permanent unilateral circuits from venues to the broadcast suites at the IBC.

Transmission center

The transmission center served as a final supervising point of outgoing signals to be transmitted via terrestrial or satellite circuits in cooperation with telecommunications companies. ORTO'98 handled 51 permanent outgoing circuits from the IBC to overseas and domestic destinations.

Outgoing signals were transmitted via telecom KDD's uplink facilities as follows: Yamaguchi earth station accessible to Indian Ocean Region (IOR); Ibaraki earth station accessible to Pacific Ocean Region (POR), PanAmSat and Intersputnik; and IBC earth station accessible to IOR, POR and PanAmSat. In addition, a transoceanic fiber-optic link at Ninomiya was used.



VTR room for archiving/library (IBC).

ORTO'98 introduced a codec with serial digital interface that was capable of carrying serial composite digital signals on SDH. The codecs, supplied by Grass Valley, accommodated two times AES3 channels in addition to one times serial digital video input. No bit reduction was used on any channel.

Technical facilities

ORTO'98 secured a space of approximately 1,800 square meters, with the IBC as the technical area, to perform the host broadcaster's responsibilities. Installation of ORTO'98 technical facilities at the IBC started in September 1997 in association with Panasonic. The technical area included the following facilities:

- distribution center;
- transmission center;
- codec room;
- VTR room;
- video workshop;
- quality control room;
- seven edit suites;
- RF communications control room;
- viewing/copying room; and
- radio studio.

the IBC before being distributed to the world broadcasters' areas. The contribution networks consisted of 15 sports venues, a venue for the opening and closing ceremonies, plus main press center and a venue for the victory ceremony, the Olympic village and the panoramic camera feeds.

Distribution of the signals produced by ORTO'98 to world broadcasters at



Distribution center inside of IBC.

VTR and post-production facilities

ORTO'98 was responsible for non-stop recording of all the international signals transmitted live from the venues. In the VTR room, all international TV signals were recorded in digital format conforming to SMPTE 259M/272M standard without any conversion to analog signals.

More than 100 D-3 videotape ma-

EASY PATCH

The Analog/Digital patch bays for today and tomorrow...from Neutrik®

Two choices to "wire up" Easy Patch for fast termination.

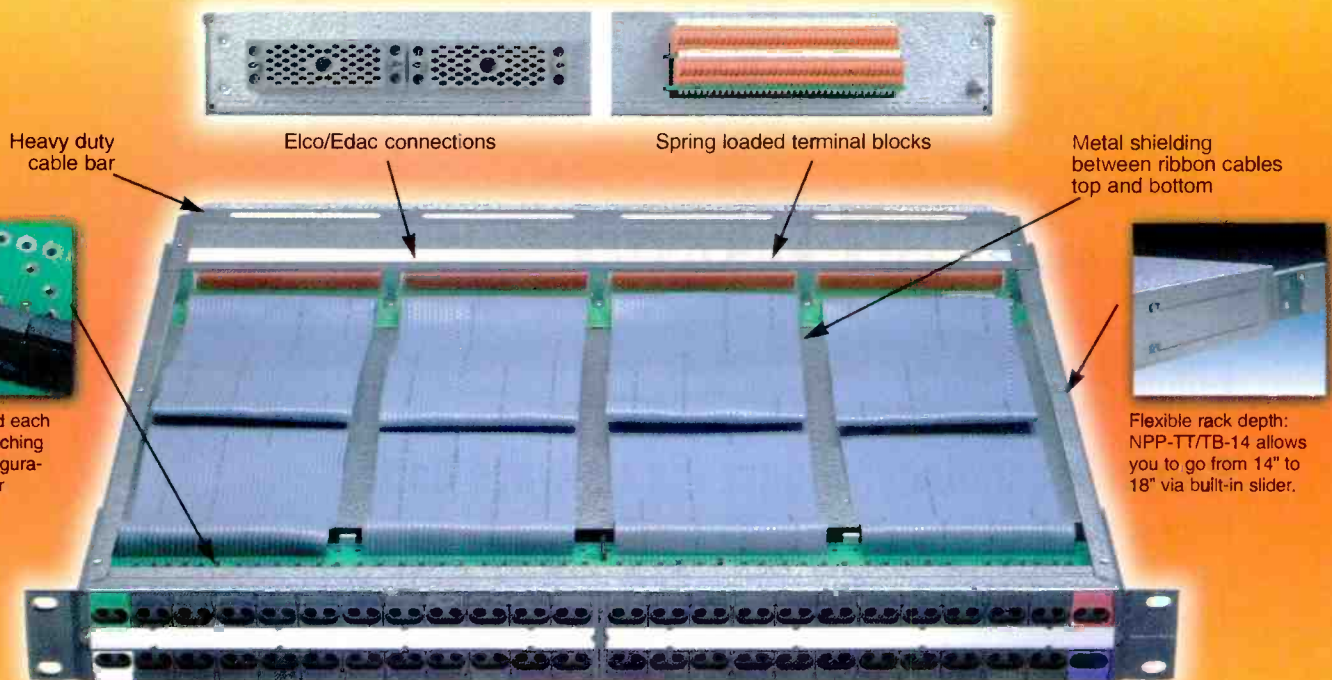

The Easy Patch series of easy to use patchbays eliminates signal degradation and offers excellent crosstalk performance required in today's broadcast facilities, mobile trucks, recording studios and audio installations.

Their analog/digital signal capability, reduced wiring time and quality workmanship are unmatched by competitors' patchbays.

The Easy Patch gives you features and options no other patchbay provides:

- Galvanized, heavy duty metal housing.
- Flexible depth from 14" to 18".
- Hard gold plated contacts designed specifically for A/D signals.
- Six jumper switching configurations.
- Ten color coded ID tabs - optional.

You asked for innovation, productivity and value in a patch bay series and Neutrik listened.

Demo Easy Patch for yourself. Call **732-901-9488** and ask for our NEW product guide and the name of your nearest Neutrik representative.

Neutrik... your one stop source for all your audio connector needs...today and tomorrow.

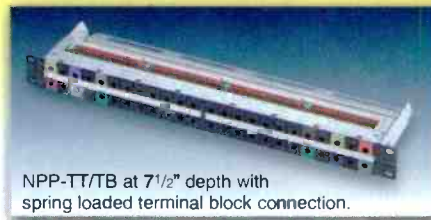

NPP-TT/TB at 7 1/2" depth with spring loaded terminal block connection.



 **NEUTRIK USA**
CONNECTING THE WORLD

195 Lehigh Avenue, Lakewood, NJ 08701-4527
Phone: 732-901-9488 Fax: 732-901-9608
E-Mail: neutrikusa@aol.com Web Site: www.neutrikusa.com

Circle (46) on Free Info Card

Winter Olympics:

Putting on the Games in Japan

chines were installed at the venues and at the IBC for recording and editing purposes. Also, DVCPRO machines were available at the venues for insertions.

Commentary switching center

In order to provide commentators with the best possible operational environment, ORTO'98 introduced a newly developed commentary system that incorporated advanced digital technology. The commentary equipment was supplied by Aplicaciones Electronicas Quesar (AEQ), which is headquartered

in Spain.

Transmission of wideband commentary audio from the venues to the IBC were conducted via digital circuits equipped with codecs that featured short delay times. The source coding technologies were adopted to 7kHz transmission (G722) and 15kHz transmission (apt-X100).

Graphics

Taking into account the large and differing audiences that watched the 1998 Winter Games on television, ORTO'98 designed the graphics for the international signals to be simple and viewer friendly. In order to gain high-speed operations and uniformity of the international pictures,

ORTO'98 installed the "Video Work Station" developed in cooperation with FOR-A Company Ltd. in Japan as a graphics/character generator. The graphics/character generator system was linked with data/result/timing systems at each venue.

The graphics information, such as the athletes' names, countries, starting numbers and running times, were always inserted and placed in an exact location on the screen, giving uniform and stable images to the viewers.

Takashi Miyamoto is director, IBC Operations, ORTO'98, Nagano, Japan. ■

New Products & Reviews

Applied Technology

Router technology: Bigger isn't always better

BY DAVE TEWEL

In today's world of rapidly evolving technology, stations and production houses need to make careful decisions when selecting new routers. No longer can it be assumed that one central legacy router is the best way to manage audio and video signals. Sometimes, bigger is not better.

This concept has been proved beyond a doubt in the computer industry. During the past two decades, the era of the mainframe computer as the only source of computing power has passed away. Today, every organization has decentralized its computing into a mix of smaller computer systems tailored for specific applications. This distributed processing approach has great applicability in the broadcast industry as well.

Advantages

There are some significant benefits to distributed routing configurations. They are compact in size and can be

located in that new edit bay with only a limited number of cable runs back to the legacy router. In addition, these routers simply don't require the care and feeding of the products of old; no longer do you need a climate-controlled environment and raised floors.

However, the biggest advantage by far is the cost savings associated with buying only the capacity that you need. When large router configurations are installed or expanded, an enormous amount of capacity and costs are added to the system, while in all probability, the majority of this new capacity is simply not needed.

The effective cost of the distributed routers is much lower because the crosspoint use is so much higher. The larger the router, the more crosspoints, but the fewer of them in use at any given time. On the other hand, a decentralized design provides for a much greater utilization level, meaning the cost per crosspoint will actually be

much less in smaller routers. This is true even though there is a natural economy of scale realized when building mainframe routers; if the crosspoints are never used, however, there is simply no cost savings to be gained by having them available.

The other similarity to the computer industry is that every year, routers get smaller, faster and less expensive. The lesson here is to buy only what you need to meet today's requirements.

The VersaFrame

Telect's VersaFrame products fit well into the distributed routing environment. The VersaFrame is a three-rack unit chassis and power supply into which up to 10 modules may be inserted. These may be scalable router input and output modules, as well as a number of other application modules. The routers are scalable by performance level, as well as by total configuration size.

The VersaFrame uses a building-block

PORTABLE ONE DUAL DOMAIN

Digital + Analog + Interface Audio Test



True Dual Domain Audio Testing at an Attractive Price Point

The Portable One Dual Domain is the complete portable test solution for analog and digital audio and the AES/EBU/SPDIF serial digital interface. As the first portable Dual Domain® audio analyzer, it includes separate and independent hardware for analog, digital and interface signal generation and measurement.

- Comprehensive analog audio analyzer
- True digital domain analyzer with -140 dB residual noise
- Independent analog & digital audio generators and analyzers
- Generate and measure interface jitter
- Digital interface analyzer
- View AES/EBU status bits

- Internal save and recall of 30 test setups
- Loudspeaker monitor for digital & analog audio signals

Audio precision

PO Box 2209
Beaverton, Oregon 97075-3070
Tel: (503) 627-0832 Fax: (503) 641-8906
US Toll Free: 1-800-231-7350
Email: sales@audioprecision.com

Our worldwide force of Audio Precision representatives will be pleased to demonstrate the many advantages of the Portable One Dual Domain

INTERNATIONAL DISTRIBUTORS: Australia: VICOM Australia Pty Ltd., Tel: 3 9563 7844; Austria: ELSINCO GmbH, Tel: (1) 815 04 00; Belgium: Trans European Music NV, Tel: 2 466 5010 Brazil: INTERWAVE LTDA, Tel: (21) 325-5351; Bulgaria: ELSINCO Rep. Office Sofia, Tel: (2) 956 12 45; Canada: GERRAUDIO Distribution, Tel: (613) 342-8999; China, Hong Kong: A C E (Int'l) Co. Ltd., Tel: 2424-0387; S&V Instruments Co. Ltd., 2833 9987; Croatia: ELSINCO Rep. Office Zagreb, Tel: 1 615 34 50; Czech Republic: ELSINCO Praha spol. s r.o., Tel: (2) 49 66 89; Denmark: npr Elektronik aps, Tel: 86 57 15 11; Finland: Genelec OY, Tel: 17 813 311; France: ETS Mesureur, Tel: (1) 45 83 66 41; Germany: RTW GmbH & Co. KG, Tel: 221 709 13-0; Greece: KEM Electronics Ltd., Tel: 1 6748514/5; Hungary: ELSINCO Budapest KFT, Tel: (1) 339 0000; Israel: Dan-El Technologies, Ltd., Tel: 3-647 8770; Italy: Audio Link s.n.c., Tel: 521 648723; Japan: TOYO Corporation, Tel: 3 (5688) 6800; Korea: B&P International Co., Ltd., Tel: 2 546-1457; Malaysia: Test Measurement & Engineering Sdn (Selangor), Tel: 3 734 1017; Test Measurement & Engineering Sdn (Penang), Tel: 4 6422088; Netherlands: Heynen B.V., Tel: 485 55 09 09; New Zealand: Audio&Video Wholesalers, Tel: 9 279 7205; Norway: Lydconsull, Tel: 47-69-178050; Poland: ELSINCO Polska sp. z o.o., Tel: (22) 39 69 79; Portugal: Acultron Electroacustica Lda, Tel: 1 940 1785; Singapore: TME Systems Pte Ltd., Tel: 747-7234; Slovakia: ELSINCO Slovensko, s.r.o., Tel: (7) 784 165; Slovenia: ELSINCO d.o.o., (61) 133 62 79; South Africa: SOUND FUSION MFG., Tel: 11 477-1315; Spain: Telco Electronics S.A., Tel: 1 531-7101; Sweden: TTS Tal & Ton Studioteknik AB, Tel: 31 52 51 50; Switzerland: Dr. W.A. Gunther AG, Tel: 1 910 41 41; Taiwan: R.O.C.: Double Advance Tech., Tel: 2-596 0696; Thailand: Massworld Company Ltd., Tel: 2-294-4930; United Kingdom: Thurby Thandar Instruments, Ltd., Tel: (1480) 412451 (11-12-97)

Circle (47) on Free Info Card

www.americanradiohistory.com

approach of either eight-input x eight-output or 8x16, which provides a granularity sufficient for inexpensive expansion in cost-affordable increments. It allows the station to select more closely the actual router size required, knowing that expansion can be easily performed later. With the VersaFrame, a station no longer has to buy a router with enormous headroom, instead it can buy a router with the capacity to grow.

Room for growth

Each VersaFrame module is made of two components: the electronics portion for input and crosspoint on one module and the output on a second. Each of these is mated with an I/O card that attaches to the back of the VersaFrame. This provides the versatility to configure the router to fit the customer's needs. Signal isolation within the module is assured by the steel plate that backs each module,

separating it from all others. The power supply, an optional redundant power supply and all other VersaFrame modules may be positioned in the VersaFrame for optimal access, particularly for cable routing. Output modules

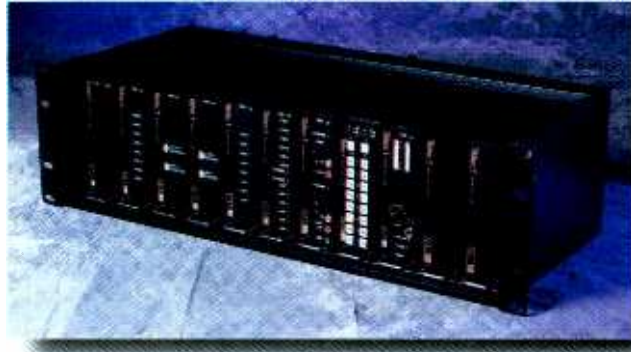

Telect's VersaFrame 2000.

include gain adjustment pots for each output. An optional audio input gain adjustment module is available when working with a mix of balanced and unbalanced sources.

All units may be hot-swapped for ease

of maintenance. With Telect's building-block strategy, only a limited number of spare input and output modules are required to be maintained on site or in the dealer's location for quick repair. This saves cost and storage space.

Telect offers a variety of video performance levels, ranging from 50MHz to 150MHz to 400MHz. The 50MHz and 150MHz products target NTSC, YC and YUV applications, while the 150MHz and 400MHz products target mid- to high-end RGB applications. With Telect's ability to place various performance products in the same VersaFrame, a user can specify 50MHz video

routers for managing external sync signals in combination with a 400MHz RGB router to reduce cost. Each router may have its own unique router address so that controllers to individual routers may all share the same daisy-chained cable. A router may be set up to run component, as well as composite, in order to accommodate a limited number of NTSC signals in a predominantly component environment without requiring a separate router. Each of the scalable routers can grow from their base size up to 72 input x 128 output. This same set of building blocks can be used in a number of sizes and applications within the station, all according to current requirements.

Those stations that installed Telect routers last year have a choice when expanding to meet this year's requirements. Last year's 16x16 router that needs to grow this year to a 32x32 router may be expanded with more of the 50MHz eight-input x eight-output modules that are currently installed. However, if users choose to upgrade with the new 150MHz eight-input x 16-output modules, their total configuration will be less expensive and require fewer VersaFrame slots, even though the performance level is greater. The same holds true for the audio router counterparts. If the new routers are backward-compatible with routers already installed, the justification to grow in small increments only gets stronger.

The New Strip in Vegas!

new from: canare

5 in 1



TS100E COAXIAL CABLE STRIPPER

- 5 strippers in 1 easy to use hand tool
- Rotary knob selects 5 different cable setups
- Usable cable O.D. range: .173"~.402"
- Replaceable circular steel blade cassettes
- For all Canare 75Ω BNC, RCA & F crimp plugs

SEE US AT THE SHOW

Booth 10976

LVCC, Hall S-5

CANARE

531 5th Street • Unit A San Fernando, CA 91340 USA
tel: (818) 365-2446 • fax: (818) 365-0479
w w w . c a n a r e . c o m



Circle (48) on Free Info Card



SMALL PACKAGE

BIG PICTURE

This is the digital solution chosen by broadcasters around the world including CNN, NBC, and TV Globo. After evaluating digital video quality and built in features, major broadcasters are choosing Wegener.

Making the upgrade from analog to digital is easy with Wegener. Its all in one package:

- Broadcast Quality MPEG-2 Video Encoder
- Broadcast Quality MPEG Audio Encoder
- Integral QPSK Modulator

You can dial in video rates from 2MB to 15MB instantly via front panel control. Higher data rates for maximum picture quality. Lower data rates to utilize less transponder capacity.

Your needs may change throughout the day. The DVT2001 will change with you. Just enter in the configuration you need - all the flexibility is at your fingertips via the front panel control. Preset configurations make channel changing on the DVT2001 a snap.

And you won't need much space. This package is just 3 rack units high.

The DVT2001 includes RS-422 transport stream data output interfaces for network or multiplexed MCPC applications. The transmitter accepts either NTSC or PAL analog video, and serial D1. The DVT2001 is DVB compliant and may be interoperated with other manufacturers compliant products. It can also run in scrambled mode to prevent unauthorized reception.

What about MPEG 4:2:2? Designed for expansion, the DVT2001 can be upgraded to 4:2:2.

This technology was developed by the teamed efforts of COMSAT Labs & Wegener Communications. And it is available now. For more information call 770-814-4000, or email info@wegener.com

**READY FOR
4:2:2 UPGRADE!**

Compel[™]Control
The Advanced Network Control System

DVB
Digital Video
Broadcasting

**WEGENER[®]
COMMUNICATIONS**
11350 Technology Circle, Duluth GA 30097

Phone (770) 814-4000 Fax (770) 623-0698
Email info@wegener.com
World Wide Web www.wegener.com

Circle (57) on Free Info Card

www.americanradiohistory.com

Analog audio and video routing are only a small part of how the VersaFrame can be used. In a distributed processing concept, space typically is at a premium, whether it's in the edit bay, the news room, in the production area or in a mobile unit. The VersaFrame leads the industry in configuration flexibility and packaging density. In addition to scaleable routers, Telect builds audio and video DAs, serial digital DAs, serializers and deserializers, stereo audio amplifiers, color bar/black/sync/tone generators, router controller modules for small-

er configurations and 16x16 serial digital routers.

All of these applications modules may be positioned in the open slots not occupied by the routers. The combination of analog and digital, audio and video, routing and distribution, conversion and control provides the ultimate in space conservation.

Looking ahead

Digital transition appears inevitable, but the future of many stations is still uncertain. The strategy of distributed

routing, which uses smaller routers like the VersaFrame, can be a valuable tool during this transition phase. As the migration begins, users can install the serial digital modules in the same VersaFrame next to their analog counterparts. By doing so, they'll be easing into the digital world while protecting their current router investment. ■

Dave Tewel is the eastern region account manager for Telect, Inc., Liberty Lake, WA. He can be reached at davet@telect.com.

Applied Technology

Digital video microwave systems for 2GHz applications

BY DR. JOHN B. PAYNE

The FCC's new rules on HDTV create new opportunities for TV broadcasters. Unfortunately, for some stations, even getting the signal to the transmitter may be a task. In addition, recent FCC actions reducing the amount of ENG spectrum have resulted in severe shortages of new channels for news operations. Fortunately, there are some new digital techniques that can bring solutions to these pressing problems.

Transmission architecture

The modulation and type of microwave radio required to transmit digital video information is considerably different from that used for analog video transmission. In a digital system, the encoder digitizes then compresses the video and audio signals, then multiplexes the compressed bitstream with the digital data inputs to produce a digital transport stream. The encoder output data rate is typically in the range of 1.5Mb/s to 34Mb/s, depending on the amount of compression and forward error correction (FEC). The digital modulator converts this baseband signal to a 70MHz RF signal.

Typical digital modulation techniques include QPSK, multiple-level PSK and QAM, which use a combination of phase and amplitude to modulate the 70MHz signal. The modulator's output is upconverted (heterodyned) to the RF microwave frequency, amplified in a linear-type RF amplifier and output

to an antenna or diplexer with other microwave signals.

At the receiver, the reverse process takes place. The RF signal is received, downconverted to 70MHz and demodulated to produce the compressed datastream. The decoder then decompresses the signal to generate the final video, audio and data. The receiver, digital demodulator and decoder functionalities are generally combined into a single unit called an integrated receiver decoder (IRD). These units typically accept either a 70MHz or L-band RF signal.

The system is easily scaleable to compress and transmit multiple channels on a single carrier. To support multi-channel transmission, only additional encoders and a multiplexer are added. The multiple encoder outputs are combined by a multiplexer that outputs a digital stream at a rate equal to the sum of the input datastreams. Thus, if two encoders output 15Mb/s and 10Mb/s respectively, then the multiplexer output will be 25Mb/s. The multiplexed datastream is fed to the digital modulator. In this manner, multiple channels can be fed on a single carrier, as long as the multiplexed datastream does not exceed the maximum data rate of the system.

NTSC/HDTV dual-channel STL

Figure 1 shows how an NTSC and an HDTV transport stream can be simul-

taneously transmitted over a single microwave link from the studio to the transmitter. The NTSC composite signal is digitized and compressed to the desired output rate, 17Mb/s in this example. The 17Mb/s compressed NTSC signal is combined with the 19.39Mb/s HDTV transport stream to yield a muxed output rate of 36.39Mb/s. Using a QPSK modulator, the required transmission bandwidth is approximately 22MHz. Using 16-QAM, the bandwidth is further reduced to 11MHz.

At the receiver, the signal is demodulated and applied to two decoders. The NTSC decoder decompresses and outputs the composite video and audio signal to be applied to the NTSC transmitter. The other decoder demultiplexes and passes through the HDTV transport stream to the HDTV transmitter. NUCOMM offers a complete turnkey system for this application that is available now.

DIGALOG — digital and analog microwave system

To meet broadcasters immediate need for continued transmission of analog signals, but to also be ready for the transition to digital, NUCOMM has developed the DIGALOG FT6/FR6 radio system for STL applications (and the DIGALOG MMPT6 for ENG applications). The DIGALOG radio is highly configurable and can operate in

**"These broadcasters needed
a CG solution.
Here's what
they found."**



Character
generator
for Win NT 4.0



Paul Doughty & David Munde

INSCRIBER & DIGISUITE

**"One of the main things for us
was that the CG is PC-based and
not proprietary."**

**Inscriber & DigiSuite:
Broadcast CG, animation,
still store, and live titling
solutions on a powerful,
flexible platform.**

"We looked carefully at the quality of the output. Inscriber was equivalent to anything out there. I'm happy with it and would buy another one. We are also satisfied with Matrox; they have a strong reputation, offer good web support, and seem to offer the whole package.

"Cost was also a factor in our decision. Inscriber and DigiSuite fill a void in the mid-range, offering good functionality at a reasonable price."

David F. Munde

DAVID MUNDEE • CHIEF ENGINEER
WCSH6/NBC • PORTLAND, MAINE



"We ran Inscriber through some tests and found it would accomplish the tasks we needed quickly and easily. The fact it was PC-based was also important for integrating files from other workstations in our network.

"Inscriber and DigiSuite met all our needs. The price was in our ballpark, and our editors have been very happy with the program."

Paul A. Doughty

PAUL DOUGHTY • DIRECTOR OF NEWS
WCSH6/NBC • PORTLAND, MAINE



inscriber
TECHNOLOGY

Contact Inscriber for a free demo CD-ROM of Inscriber CG-Supreme.

FOR MORE INFORMATION ON INSCRIBER CG-SUPREME
please call 1.800.363.3400 or +1.519.570.9111, or visit our website at www.inscriber.com
Circle (58) on Free Info Card

either analog or digital mode. Depending on the existing system configuration, optional analog and digital modulators can be added to the 2RU unit. If the input is already a 70/140MHz modulated IF signal, the IF signal can be directly upconverted and amplified for transmission. Using a single switch located inside the front panel, the power amplifier can either operate in analog mode for maximum power output or in digital mode for linear power output. The corresponding receiver is the DIGALOG FR6 analog/digital microwave receiver. Two IF bandwidths, 30MHz and 45MHz, are provided in the IF amplifier. The 30MHz bandwidth filter can be used for analog or low data rate digital operation. The 45MHz bandwidth filter is switched in for data rates of 45Mb/s or higher.

Data rate vs. bandwidth

The equation defines the bandwidth required to transmit an encoded bit-stream at a given data rate. The transmission bandwidth is a function of input

data rate (Z_a), modulation coding (M), FEC and spectrum shape factor (a).

$$\text{Bandwidth (MHz)} = \frac{(1+a) \sum Z_a \text{ Mb/s}}{\text{FEC} * M}$$

where $\sum Z_a$ = sum of data rates from one or multiple encoders (Mb/s)
 FEC = forward error correction = $VC * RS$; if no FEC is used, then $\text{FEC}=1$
 VC = Viterbi coding: typical 1/2, 2/3, 5/6, 3/4, 7/8
 RS = Reed-Solomon: typical 188/204, 192/208
 M = coding level of the modulator
 a = spectral shaping factor

Table 1 shows the spectrum efficiency in bits/hertz and carrier-to-noise level (C/N) for various modulation techniques. As M increases, the required transmission bandwidth for a given data rate decreases proportional to bits/hertz (assuming $\text{FEC}=1$) and the required receive C/N level must increase for a given bit error rate (BER). This is the trade-off

for better transmission efficiency.

The most robust and common form of digital modulation is QPSK, which has a spectrum efficiency of 1.66 bits per hertz. In cases where more bandwidth reduction may be required, higher-order modulation, such as 16-QAM or 64-QAM, provides a spectrum efficiency of 3.33 bits/hertz or five bits/hertz, respectively. However, as the coding number increases, the modulation is less robust and becomes susceptible to RF interference and multipath effects. Also, system gain decreases substantially because of lower available output power and the requirement for higher receive carrier levels increases for a given bit error rate.

In an STL link where signal levels tend to be high and the transmission link reliable, the higher forms of modulation can usually be justified. However, in ENG links where multipath

Type of Modulation	M	Bits/Hertz M / (1+a)	C/N (dB)
PSK	1	.833	10
QPSK	2	1.66	10
8-PSK	3	2.50	14
16-QAM	4	3.33	17
64-QAM	6	5.00	23
256-QAM	8	6.66	28

Notes: 1-Normalized C/N corresponds to a BER of 1×10^{-6} .
 2-Assumes No FEC and a = .20

Table 1. Types of modulation.

and weak signals are the norm, a robust modulation such as QPSK is needed. To fit the digital video data rate within the allocated bandwidth, the encoder data rate and FEC need to be adjusted according to the type of modulation technique used. Reducing the data rate with current encoders has little effect on the picture quality. Therefore, it becomes a judgment call on the part of the ENG management to assess the picture quality for given bandwidths. There may be no other option if the 2GHz allocated bandwidths are further reduced by the FCC.

Analog vs. digital performance

The analog link and a comparable digital link for those system configurations discussed earlier show a video signal-to-noise (S/N) ratio of 70dB for high receiver input signal levels. As the



BOGEN MANFROTTO

WE CAN TAKE THE HEAT

3141-510 VIDEO TRIPOD

Whether you're covering a three alarm fire, or a heated political debate, you need equipment that can stand up to a rigorous pace. Made of lightweight high-tensile aluminum alloy, the 2-stage 3141 Professional Video Tripod equipped with the Bogen/Manfrotto 510 Video Head can withstand the rigors of everyday filming no matter how hot it gets.

bogen

We don't sell anything we wouldn't buy ourselves.

565 East Crescent Avenue, Ramsey, NJ 07446-0506
 (201) 818-9500 FAX (201) 818-9177
 e mail: info@bogenphoto.com web: www.bogenphoto.com

3141 PROFESSIONAL VIDEO TRIPOD
 Lightweight 2-stage high-tensile aluminum alloy and high strength plastic composite (weight savings up to 50% versus ordinary aluminum tripods) Complete with 100mm bowl, spiked feet and spreader

510 VIDEO HEAD
 An advanced three-step drag system, zero freewheel setting and a return to center variable balance spring adjustment

360° pan and -75° to -70° tilt control with effortless starts and stops
 Weighs 8 lbs. and can handle cameras up to 19 lbs. (Model 510) or 23 lbs. (Model 510-10)

Circle (59) on Free Info Card

If You Want To Appreciate The Incredible Design and Construction of Sennheiser Lavalier Microphones, You Have To

LOOK CLOSELY

ME104
The world's
smallest
true-cardioid
microphone

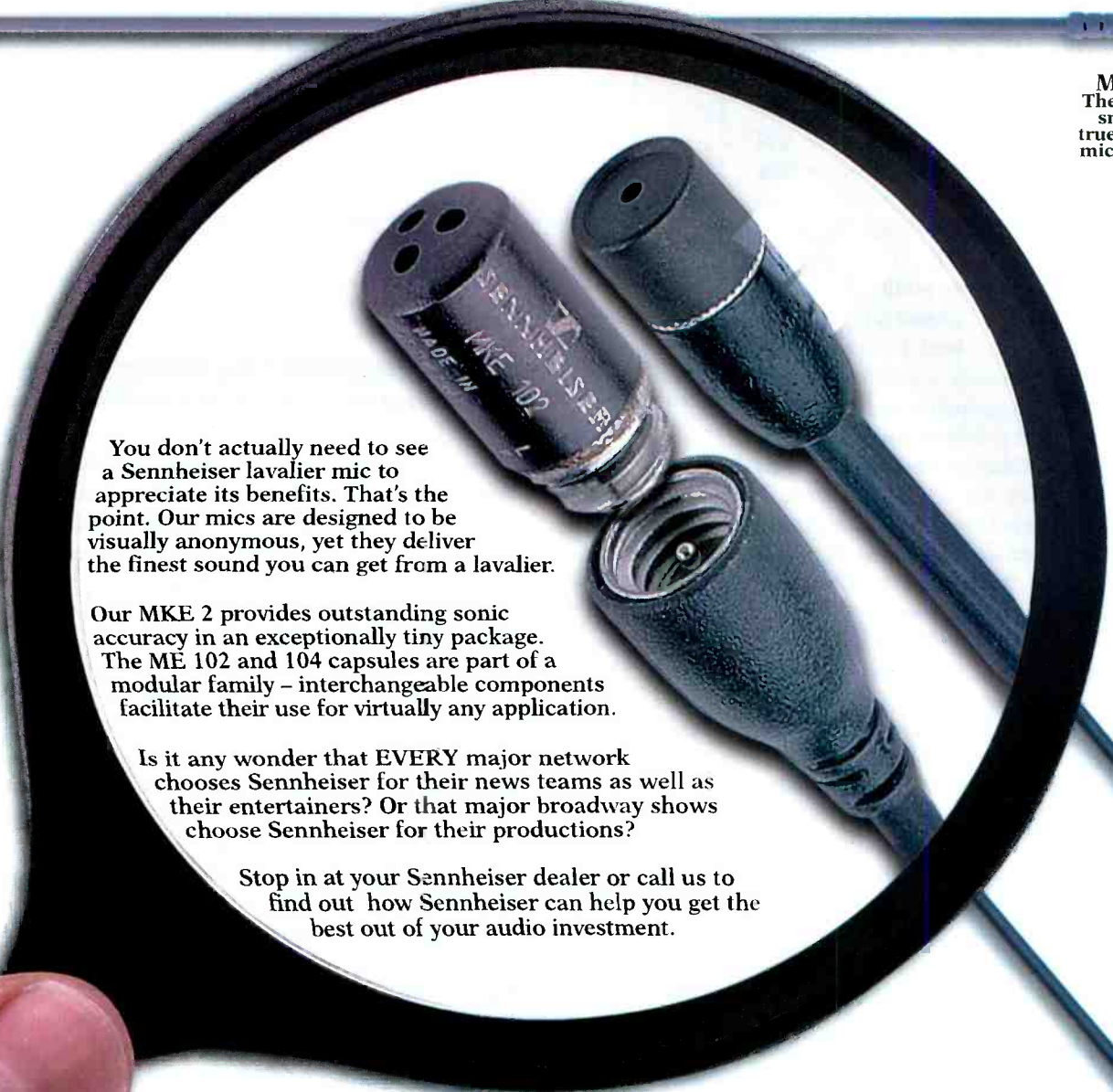

You don't actually need to see a Sennheiser lavalier mic to appreciate its benefits. That's the point. Our mics are designed to be visually anonymous, yet they deliver the finest sound you can get from a lavalier.

Our MKE 2 provides outstanding sonic accuracy in an exceptionally tiny package. The ME 102 and 104 capsules are part of a modular family - interchangeable components facilitate their use for virtually any application.

Is it any wonder that EVERY major network chooses Sennheiser for their news teams as well as their entertainers? Or that major Broadway shows choose Sennheiser for their productions?

Stop in at your Sennheiser dealer or call us to find out how Sennheiser can help you get the best out of your audio investment.

To Appreciate Our Incredible Fidelity and Performance

JUST LISTEN

THE EVOLUTION OF AUDIO



SENNHEISER ELECTRONIC CORPORATION
P.O. BOX 987, DEPT: 213, OLD LYME, CT 06371 • TEL: 860-434-9190 EXT: 213 • FAX: 860-434-1759 • CALIFORNIA: TEL: 818-845-7366 • LATIN AMERICA: TEL: 525-639-0956
SENNHEISER CANADA: 221 LABROSSE AVE., PTE-CLAIRE, PQ H9R 1A3 • TEL: 514-426-3013 FAX: 514-426-3953

World Wide Web: <http://www.sennheiserusa.com>

Manufacturing Plant: Am Labor 1, 30900 Wedemark, Germany

Circle (60) on Free Info Card

www.americanradiohistory.com

signal level drops, the video S/N becomes linearly proportional to the input signal level. When the receiver threshold is reached (typically -85dBm at 7GHz in current video receivers), the video S/N drops much more rapidly than the receiver input signal level. In a typical analog system, threshold is defined when the video S/N reaches 37dB. At a receive level of about -82dBm, the audio channels become noisy and unusable.

The digital link shows a lower S/N than the analog link for strong receive signal levels. This lower S/N is due to the limitations of the digitizer in the encoder. Typically, a 10-bit digitizer gives a S/N of about 60dB. The advantage of the digital system is that even as the input signal level is reduced, the video S/N remains constant at 60dB. This S/N is maintained until the error correction capabilities are exceeded, at which point the transmission fails. This failure point for a QPSK system is generally at or below the analog threshold point and depends primarily on the amount of error correction and the type of modulation used.

A 45Mb/s QPSK digital signal with error correction was passed through the NUCOMM 7GHz FT6/FR6 DIGALOG transmitter and receiver. The digital threshold for QPSK (-89dBm) was 4dB lower than the systems analog threshold (-85dBm). Using 16-QAM, the digital threshold (-82dBm) was higher than the analog threshold by 4dB. This 7dB threshold increase using 16-QAM instead of QPSK essentially enables the transmission of twice the data within the same bandwidth.

Field tests at 2GHz

When the subject of digital video being applied to 2GHz ENG microwave systems is suggested, oftentimes the response is that digital video will never work for ENG. Operators are typically faced with non-engineered paths where shots are made using multiple bounces in high multipath environments. We recently completed field testing of our 2GHz ENG digital video microwave system in New York City. This city was chosen because it represents one of the most severe and challenging environments for ENG operation.

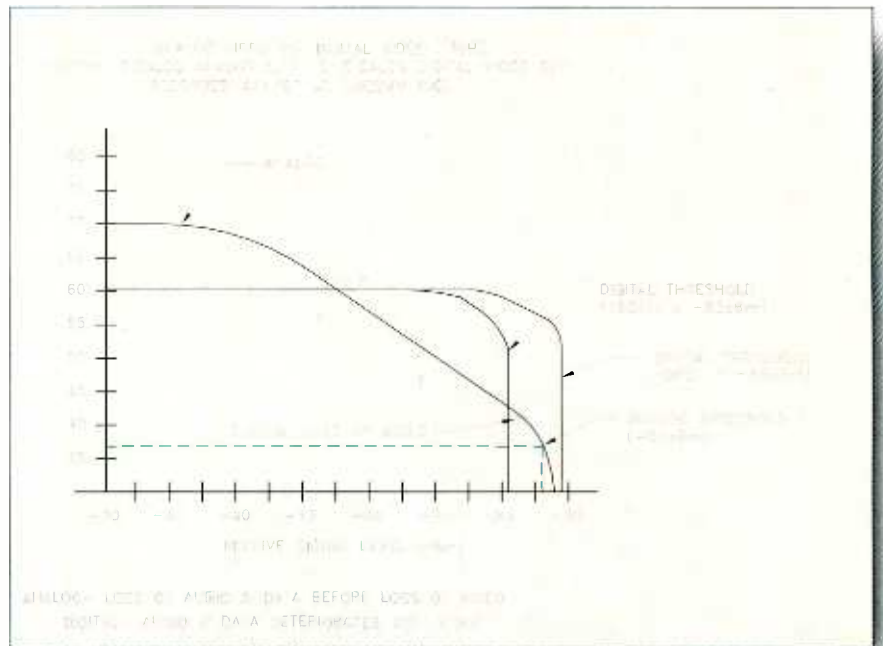

Figure 1. Video S/N vs. receiver signal level for analog and digital ENG/STL systems.

For this test, the analog transmitter was a NURAD 10W model PT1 that was padded down for an output of 3W. The digital transmitter was a NUCOMM DIGALOG FT6. Its power output was 1.5W. The antenna was connected directly to the transmitters through 50 feet of Andrew half-inch flexible coax and had a measured loss of 3dB. The antenna was a NURAD silhouette antenna mounted on a pan and tilt. To ensure stress testing the digital encoder, a difficult 2.5-minute video clip of a pre-recorded hockey game on Betacam SP was used as source material because it included fast camera panning, fast action, high color contrast and saturated colors.

At the Empire State Building, the output from a steerable Super Quad antenna was divided to feed the NURAD analog receiver and the NUCOMM DIGALOG FR6 digital receiver simultaneously. The 70MHz output from the digital receiver was upconverted to L-band for input into the IRD decoder. Each of the composite outputs from the analog and digital receive systems was transmitted back to the studio over an analog fiber link where the outputs were recorded on Betacam SP tape. Both transmitters operated on the same 2GHz channel.

The first three case tests compared the audio and video quality of the 2GHz

analog FM signal with the quality of the digital MPEG-2 compressed and QPSK modulated signal under the following three environments:

1. direct line-of-sight transmission;
2. moderate multipath transmission; and
3. extreme multipath transmission.

The ENG truck was located at E. 90th St. and 5th Ave., and the receive site was the Empire State Building. The procedure for setting up each test was to first establish the analog shot geometry and picture quality. The resultant analog video picture was recorded for 2.5 minutes. Then, without moving the antennas, the digital transmitter was connected and the test repeated. Each digital case tested data rates ranging from 9Mb/s to 15Mb/s and two FEC rates of 3/4 and 7/8.

The first test was a line-of-sight shot to make sure that the system was working properly. Analog and digital transmissions produced overall good pictures for each configuration. Although the analog signal was strong, there were still some multipath and ghosting artifacts. The digital picture showed no sign of multipath or ghosting.

The second case, moderate multipath transmission, is representative of typical ENG operating conditions in major urban cities. The ENG truck was in the same location as in the first case, but

ROSS

TERMINAL

Gear

EQUIPMENT

Rugged Dependable Quality

Count on Ross for all your terminal gear needs.

The RossGear family includes Converters, Audio and Video Distribution Products, Video Keyers, Telecine Switchers, and a Mini Master Control Switcher.

The Ross name, known for quality video production switchers, is rapidly becoming *the* name in terminal equipment.

Ross has released over 100 terminal gear products in the last three years.

GVG* and Leitch** Compatible Frames

*GVG is a trademark of Tektronix Inc.
**Leitch is a trademark of Leitch technology Corporation

Conversion Gear
A-D Converters
D-A Converters

Distribution Gear
Analog Video
Analog Audio
Digital Video

Video Keying Gear
Analog Keyers
Digital Keyers

Telecine Gear
Telecine Switchers

Master Control Gear
Mini Master Control Switchers

And a Complete Line of Ross Video Production Switchers

Digital Switchers



Analog Switchers

- RVS 210A 1 MLE, 10 Inputs
- RVS 216A 1 MLE, 16 Inputs
- RVS 316 1 MLE, PGM/PST, 16 Inputs
- RVS 416 2 MLE, 16 Inputs
- RVS 424 2 MLE, 24 Inputs
- RVS 630 2 MLE, PGM/PST 30 Inputs



Switchers, Keyers, & Terminal Gear

NAB Booth 9635

Tel: (613)652-4886 Fax: (613)652-4425 Web: www.rossvideo.com eMail: solutions@rossvideo.com

Circle 61 on Free Info Card

www.americanradiohistory.com

the antenna was moved to 45° off true North so that at least one bounce was introduced in the path. The received signal measure was lower than the first case, but still quite strong. The resulting analog signal showed noticeable ghosting artifacts and color shifting. The quality of this analog signal was considered a borderline usable picture for broadcasting. The digital signal, on the other hand, had no problem locking up and performed perfectly with no ghost or indication of multipath in the picture.

The third case tested extreme multipath interference comprised of multiple reflections and scattering from buildings and possibly even moving vehicles. Here, the ENG truck antenna was aimed toward the west side of Central Park. The resulting transmitted analog

signal was severely degraded to the point where it was not usable and was so bad that a frame synchronizer had to be used to receive the picture. The analog video had significant ghosting artifacts and the audio had severe break-

perfect picture.

In the presence of extreme multipath, a 7/8 FEC was not enough and the resulting errors can be observed by occasional slow-picture motion, checkerboarding and drop outs. As predicted, an FEC rate of at least 3/4 was required to adequately recover from random errors induced by multipath interference, and in our tests, an FEC rate of 3/4 seemed sufficient to recover from most errors. This test shows the importance of forward error correction.

The results of these tests surprised all concerned and clearly showed that

The results of these tests clearly showed that digital ENG video transmitted in the 2GHz band consistently produced a picture equal to and, in most cases, superior to the analog transmission system.

up. The studio reported that the picture quality was too poor to broadcast. When the digital signal used an FEC of 3/4, the IRD decoder had no problem locking on the signal and it produced a

digital ENG video transmitted in the 2GHz band consistently produced a picture equal to and, in most cases, superior to the analog transmission system.

Applying digital video compression, QPSK modulation and forward error correction for STL and ENG systems can conserve frequency spectrum and yield superior quality and performance equal to and better than analog systems under fading and multipath types of environments. Although QPSK worked well for the STL and ENG tests, there are other digital modulation techniques available that can be used for these applications. For STL, higher-order modulation than QPSK can be applied because their transmission links are fixed and tend to be reliable.

The tests were performed without the use of adaptive equalization in the digital demodulators. Equalization was purposely not used so as to measure the uncorrected multipath effects on such a system. The use of adaptive equalization can only further improve the performance of digital video systems. ■

Dr. John B. Payne is president of NUCOMM, Inc., Hackettstown, NJ.

Acknowledgment: The author wishes to thank New York City FOX station WNYW-TV and Rich Paleski for providing the ENG truck and its Empire State Building central receive site, as well as studio recording equipment and personnel. I would also like to thank the WEGENER Corporation/COMSAT Labs, which supplied the encoder and IRD equipment.

OUR MAST GETS IT UP FAST

TELESCOPIC PNEUMATIC MASTS

HILOMAST

Applications

- Remote ENG Communications
- Field Strength Measurements
- Pop-up Jamming
- Remote Surveillance
- Noise Level Measurements
- Temporary Floodlighting
- Environmental Sensors
- Military Communications

COMPETITIVE PRICING

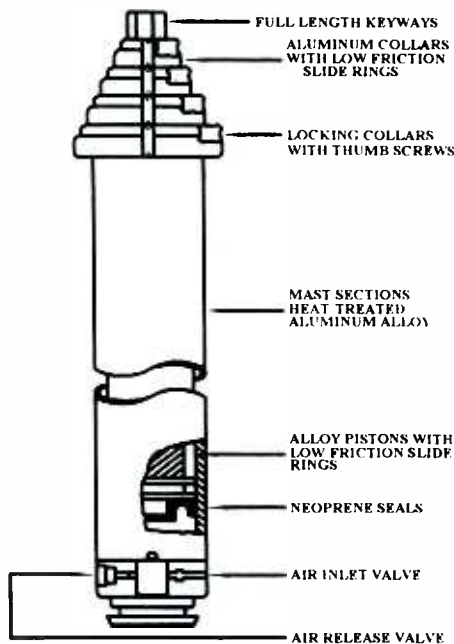

for Further Information Contact Jim Osborne
ALLEN OSBORNE ASSOCIATES, INC.

756 LAKEFIELD RD.
 WESTLAKE VILLAGE, CALIFORNIA 91361
 Tel: (805) 495-8420 Fax: (805) 373-6067

See us at our website: www.aoa-gps.com
 E-mail address is: aoa@aoa-gps.com



Circle (62) on Free Info Card

Tiernan produces the most comprehensive range of MPEG-2 equipment:

- ✓ High-performance MPEG-2 Encoders for 4:2:2 and 4:2:0 profiles
- ✓ MPEG-2/DVB IRDs for broadcast, professional and industrial applications

- ✓ Satellite Modulators for QPSK and 8PSK
- ✓ Interface products for satellite and terrestrial networking (including ATM)
- ✓ Conditional access for simple and complex networks
- ✓ Network management and control systems

Tiernan products *are* the cutting edge of technology.

Contact us for an MPEG-2 compression solution that can put you on the crest of the digital wave.

GUESS WHO'S LEADING THE DIGITAL WAVE WITH PROVEN 4:2:2 MPEG-2 RIGHT NOW?



Others promised. We delivered the
TE6 Encoder and TDR600 IRD.
The first. The best. Only from Tiernan.

TIERNAN
Communications

5751 Copley Drive, San Diego, CA 92111 USA
TEL: +1 619 587-0252 • FAX: +1 619 587-0257
EMAIL: info@tiernan.com • WEB: <http://www.tiernan.com>

Leaders in Digital Television

Circle (49) on Free Info Card

See us at NAB '98:
Sands Booth T5159 and
our LVCC Outdoor Booth.

Adjacent-channel DTV/NTSC transmitters using Diacrodes

BY TIMOTHY P. HULICK, PH.D.

The FCC's new TV broadcast channel allocations have resulted in many TV stations being assigned a DTV channel adjacent to their NTSC allocation. In the case where the DTV channel is adjacent and below the NTSC channel (n-1), little guard band is present to design and build a channel-combining filter system enabling the user to pipe both signals to a common antenna. A second transmitter, a DTV transmitter, is still needed, however. For the n+1 case, the solution isn't simple. There is virtually no guard band between the channels, rendering the filter combiner solution impractical. Even where a filter combiner is to be used, in this case, the visual and DTV signals enter the combining filter, then go through a notch diplexer where they are com-

bined with the aural signal. This means three transmitters are needed: visual, aural and DTV. Acrodyne has developed an alternative



approach called *adjacent channel technology* (ACT).

Common NTSC/DTV amplification

The answer to both situations may lie in using a common high-power amplifier for the NTSC and DTV signals. If this can be successfully accomplished, a combiner will not be needed. However, this approach does require a linear amplifier and one that is capable of sufficient peak envelope power.

Common amplification of the entire NTSC signal became popular in the mid-1980s when UHF tetrodes were developed for higher power and the klystrone/IOT devices were introduced. The tetrode and its derivative, the Diacrode, along with the IOT, are the UHF choices today because all three offer sufficiently linear performance for amplifying the combined visual and aural signals. Properly designed intermodulation and cross-modulation correction circuits are used to prevent any one carrier from contaminating the other.

The specific circuit and technique used is tube-type dependent. If common amplification of the visual and aural signals is possible, what happens when a DTV signal is added to the mix? Surprisingly, it isn't all bad. This technique is only an extension of methods already used.

Only the tetrode and Diacrode cavities can be tuned wide enough to accommodate side-by-side channels, however. More than 12MHz of flat bandwidth is needed to allow both channels to be included. The TH-680 Diacrode cavity can be tuned for a 1dB bandwidth of 14.6MHz, putting the tuning bandpass sufficiently far enough away from the channel edges so that group delay is not a problem. Flatness is within 1dB across both channels. Input return loss is sufficiently low so that the driver sees an adequately matched load.

The amplifying device type must have sufficient bandwidth and be able to provide the desired power. The TH-680 Diacrode is capable of at least 104kW of unsaturated peak envelope

IN STOCK
Ready to Ship!

ZERO Stantron's most popular vertical welded cabinet is now in stock!

Standard Features

- Same day shipment
- Aggressively priced
- 78 3/4" usable panel space (45 rack units)
- 87 1/4" overall height and 30 7/8" overall depth
- Manufacturing facilities in California, Indiana and Massachusetts

ZERO Stantron's STOCK 200 vertical equipment cabinets lead the industry in design and construction. We offer the industry's most comprehensive line of standard accessories. Make the smart choice - Call ZERO Stantron today at 800-821-0019!

"the neat idea people"

Stantron
A ZERO Corporation Company

12224 Montague Street
Pacifica, CA 91331
Tel: (800) 821-0019
Fax: (818) 890-4460
Website: <http://www.zerocorp.com>

Open bottom for ventilation or cable management

Raised partition base with center option

Ships Fully Assembled

STOCK 200

Circle (50) on Free Info Card

Ready for your

DTV STL?

With the MRC

DAR45

it's as easy as

plug'n play

CALIFORNIA
MICROWAVE
MICROWAVE
RADIO
COMMUNICATIONS

While some companies have been talking digital futures, MRC has been:

- integrating the industry's first 2-channel digital STL at the Model HDTV station,
- working with codec and multiplexer manufacturers,
- building alliances with DTV transmitter manufacturers,
- serving on industry committees, and
- developing a full-line of MRC digital microwave solutions.

MRC's digital microwave systems are optimized for DTV transport applications, such as studio-to-transmitter links, satellite backhauls, and intercity relays. And, they're built with all of the ease of installation and high reliability that you expect from Microwave Radio Communications.

Let MRC make your digital microwave the easiest part of your DTV conversion. Call 1-800-490-5700 today.

CALIFORNIA
MICROWAVE
MICROWAVE
RADIO
COMMUNICATIONS

20 Alpha Road
Chenitsford, MA 01824
Tel: 1-978-256-1110
Fax: 1-978-256-6225
Email: sales@cm-mrc.com

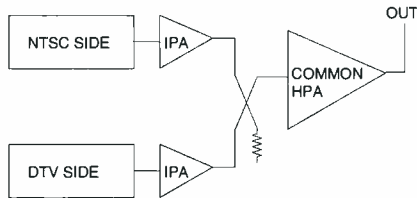

Figure 1. A simplified ACT system block diagram. By keeping the NTSC signal separate from the DTV signal until they are power combined, near-perfect clean drive is obtained.

power, giving it a rating of 60kW peak of sync along with simultaneous provision of 6kW of aural power.

The actual output power levels derived may be doubled, tripled or quadrupled according to need by using two, three or four Diacrodes. A single TH-563 tetrode offers half the power with a PEP limitation of 52kW.

Performance considerations

Peak envelope power limits and tuning bandwidth are not the only considerations in selecting a high-power amplifying device or method. Other considerations also include:

- linear distortion;
- non-linear distortion; and
- how to make the driver clean.

Of all of the types of distortion in all TV transmitters, regardless of tube type, only relatively simple correction for a Diacrode or UHF tetrode is needed to make the combined output signal competitive in the world of performance specifications. In-band intermodulation distortion, probably the most difficult one to achieve, is routinely recorded at -60dB from peak of sync across all picture levels. Uncorrected IM output from these tubes is about -49dB with a 10% aural signal.

Figure 1 illustrates the block diagram of the approach taken by Acrodyne to provide near perfect drive. The NTSC driver and all of its lower-level stages back to the modulator and video processor are kept separate from the DTV side. Likewise, the DTV side is kept separate from the NTSC signal. They are brought together only at the driver outputs through a 3dB coupler or hybrid combiner. Although half of the drive power is lost to the combiner reject load, this is a small price to pay for the resulting signal integrity. System details, such as input filters, circulators and correction circuits, are not shown for clarity.

Using a TH-680 or TH-563 tetrode in common amplification has the follow-

ing advantages for the n+1 situation:

- It is not necessary to use a channel combiner, nor is it necessary to have a separate aural transmitter.
- Split drivers allow for generating the cleanest possible drive for the HPA.
- A single transmission line and antenna may be used for both broadcast channels.
- At a future date, the NTSC side may be turned off and its driver used to work with the DTV side to come to full DTV power.

Using a common amplification Diacrode or tetrode approach to solve the n+1 problem has these following disadvantages:

- If the HPA fails, the power output of both signals is reduced to the drive level in HPA bypass mode.

- The tube is not perfect and some additional intermodulation distortion products are introduced because of the presence of the added DTV signal. With a clean drive, it all happens in the tube, but these products are quite low in power and easily dealt with.

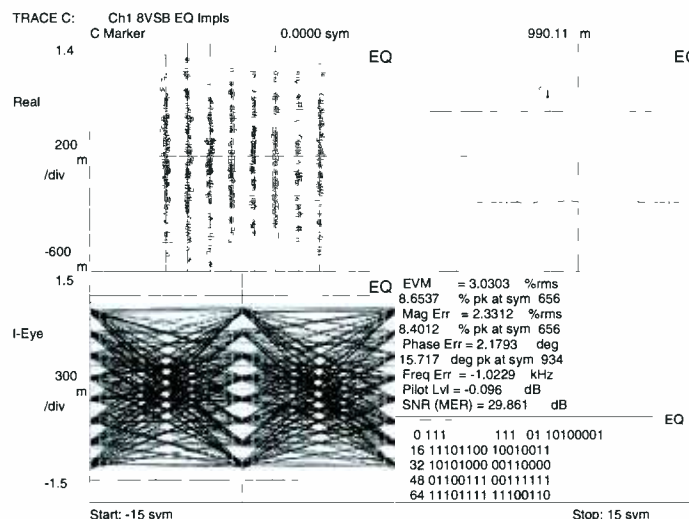

Figure 2. With the NTSC side off, the DTV results out of the HPA are shown. Eye opening is good with an EVM of 3.03%. SNR is 29.861 dB. Power output is 2.5kW average.

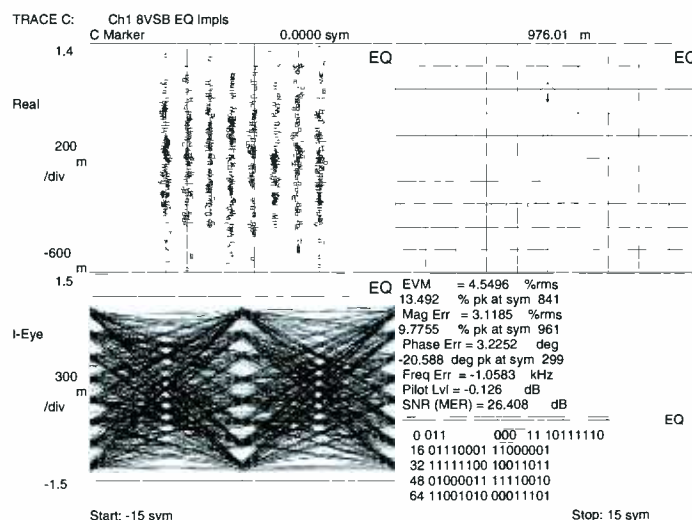

Figure 3. The NTSC side is turned on and brought to 25kW peak of sync with 2.5% aural power. DTV power remains at 2.5kW. Only slight degradation is seen in the EVM and SNR. The eyes are still widely open.

Test results

The following data represents test results acquired as of Nov. 21, 1997. Although not every idea has been exploited to date, the results indicate that the common amplification approach ACT works well.

The major equipment used for these tests included:

- An Acrodyne Au60D 60kW 10% aural NTSC transmitter on Channel 27 for NTSC and Channel 28 for DTV.
- A Zenith version 2 8-VSB modulator with FIR filter linear correction and supporting linear correction software. Non-linear correction software is not available as of yet.

It Takes the Whole Team...



And score big in the digital age.

To win at the digital game, you've got to assemble your whole team—everyone from managers to engineers—and go to **NAB98**. With so much to see, do, hear and learn, every player counts as you map out your game plan at the most comprehensive broadcasting and e-media convention in the world! Start assigning your key players to test drive and learn about the latest technologies. Register now and enter the digital age like a Hall of Famer!

Don't turn this page until you've contacted us for more information!

- ▶ Visit www.nab.org/conventions/
- ▶ Call Fax-on-Demand at 732.544.2888
- ▶ Call 800.342.2460 or 202.775.4970

Spotlighting DTV— in the sessions, on the exhibit floor and at special events!

- ▶ Explore more than **1,300 exhibits** and uncover hundreds of new products that will change the rules of the game
- ▶ Examine critical issues that will lead your station to victory in more than **150 sessions** and workshops
- ▶ Take a look at the play books of the convergence markets to see how they impact your business



EXHIBITS: April 6–9, 1998 CONFERENCE: April 4–9, 1998

Las Vegas, Nevada USA

ANALOG CLOCKS

"5100" Series

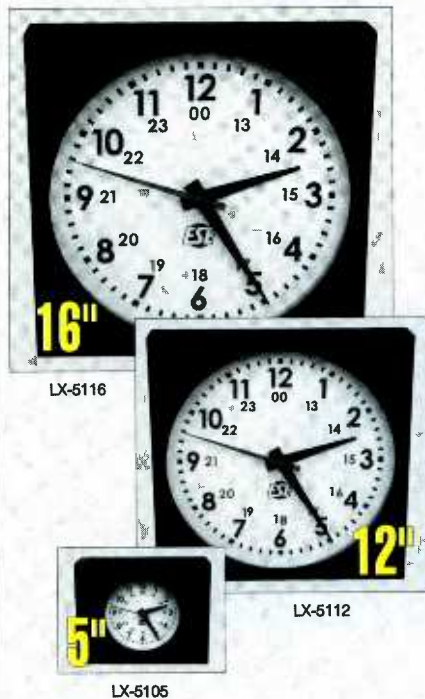

The LX-"5100" Series can read Time Code (ESE, SMPTE/EBU & ASCII), as well as operate as Stand-Alone or Impulse Clocks. These clocks are loaded with many features, here's just a few...

FEATURES:

- Self-setting time code readers
- 5", 12" & 16" models
- Sweep & Step second hand modes
- Lighted Dial and Rack Mount options
- Time Zone Offset
- 3 Year Warranty



www.e-se-web.com

310-322-2136 • FAX 310-322-8127
142 SIERRA ST., EL SEGUNDO, CA 90245 USA

Circle (52) on Free Info Card
See us at NAB Booth #8130

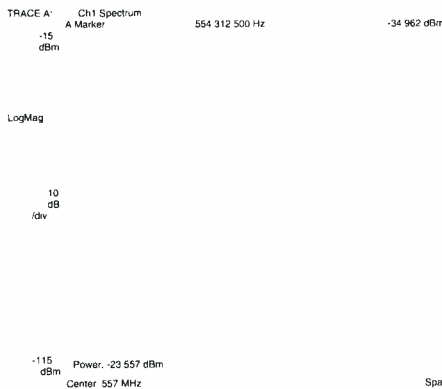

Figure 4. A spectral plot of the DTV signal with full NTSC (25kW) and 2.5% aural power is presented. Linear correction at the DTV modulator is on. The NTSC aural carrier is seen to the left of the DTV pilot with the color subcarrier at the extreme left.

- An HP-89441A vector modulation analyzer with adaptive equalizer.

Figure 2 represents the data as displayed on an HP-89441A for the driver output with the NTSC driver off. The important measurements to watch throughout this discussion are the error vector magnitude (EVM) and the signal-to-noise ratio (SNR), shown in the box at the lower right part of the display.

The EVM is a measure of all that is wrong with the transmitter because it indicates the relative magnitude of the vector at the tip of the desired one pushing it away from its intended position. The smaller this measurement, the less distortion of the DTV signal. Although SNR will be obvious to the reader, it's important because tests have shown that this number must be greater than 15dB at the receiving point for the signal to be decoded.

The eye opening is a qualitative measurement and it is shown that the eyes are widely open. The plot at the upper left shows the symbols lying generally on the eight I or in-phase levels. Departure from these levels is due to the error vector. Closing of the eyes is also a function of the EVM. It must be mentioned that the measured EVM and SNR for the modulator alone with the FIR correction off is 2.01% and 33.1dB, respectively.

Figure 3 shows the same results when the NTSC signal is on at 25kW peak of sync power with 2.5% aural power. DTV power remains at 2.5kW average. The EVM has increased

slightly to 4.55%, while the SNR has decreased to 26.408dB. Eyes are still widely open.

The presence of the NTSC signal, even though the aural power is low, has only minimally affected the DTV signal. It must be remembered that for all of these tests, the FIR filter linear correction coefficients are determined by the HP-89441A and fed to the DTV modulator. Linear

correction is on.

A spectral plot of the setup condition for Figure 3 is shown in Figure 4. The DTV pilot carrier is shown at the left edge of the upper channel, while the aural carrier is seen just below the pilot. At the extreme left is the NTSC color subcarrier. Closest to the DTV signal is the aural carrier. The high side band edge is awaiting a band edge filter from the vendor.

These results show the out-of-band performance of the Diacrode, without help. The flatness of the DTV spectrum shows the linear correction circuits of the DTV modulator at work. The cavity bandpass response has an upward tilt of 1dB toward the right side of the DTV channel. This is corrected by the linear correction of the FIR filter in the DTV modulator. The result is the flat DTV spectrum displayed.

A full two-channel spectral display is

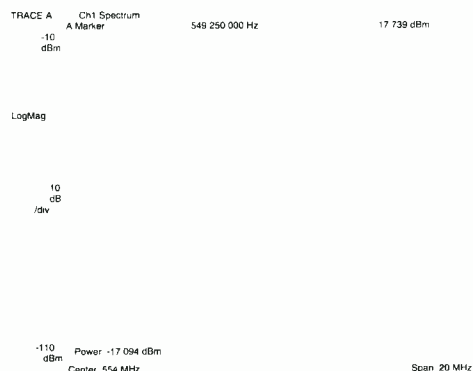

Figure 5. The spectral content of the two side-by-side channels with 25kW peak of sync power and 5% aural power on Channel 27 and 2.5kW of DTV power on Channel 28 is shown. The -4.5MHz and -3.58MHz components are easily taken care of with a conventional bandpass filter, while the upper DTV edge is fixed with a mask corrector circuit.

WIRELESS FOR THE YEAR 2000... AND BEYOND!



It's a tough RF world out there – and it's getting tougher. Fewer open TV channels. More wireless everywhere. And advanced digital television will soon be coming to a city near you.

Vega's EMP (Embedded Micro-Processor) Series takes these challenges in stride, while giving you the Emmy award winning audio quality you've come to expect from Vega.

EMP technology in the transmitters offers "intelligent" frequency agility and audio control, allowing you to reprogram UHF frequencies as often as needed, along with precise digital control of mic gain.

The receiver's embedded microprocessor is intelligent enough to shut itself off when it's not needed, removing any possibility of digital interference with itself or other units.

Of course, the EMP Series also has all the performance, features and reliability needed for the toughest applications.

Vega's EMP Series – specifically designed to meet the challenges of the year 2000 and the coming century.

For more information on the EMP Series, see your Vega dealer or call us at 1-800-877-1771.



Vega Wireless Technology, named winner of the 1996 Emmy® for Pioneering Achievement in the Development of Wireless Microphone Technology for Broadcast.

© NATAS/ATAS

EMP
SERIES
VEGA
SYNTHESIZED UHF WIRELESS
MAKING HISTORY BY DEFINING THE FUTURE.

Circle (53) on Free Info Card

VEGA
9900 East Baldwin Place
El Monte, CA 91731
(800) 877-1771
(626) 442-0782



Figure 6. The out-of-band intermodulation components at +9MHz and +8.08MHz, which lie under the DTV signal are responsible for the degrading EVM as aural power is increased. They are 31dB below the average power of the DTV signal.

shown in Figure 5, with the 25kW NTSC channel on 27 and the 2.5kW DTV signal on Channel 28. The -4.5 and -3.58 IMD components may be removed by a conventional bandpass filter, while the upper DTV channel edge will be suppressed by a mask corrector. Notice the close proximity of the DTV pilot and the aural carrier only 25kHz below the upper channel edge.

Figure 6 shows the spectral output of the Diacode operating at 25kW peak of sync with the DTV driver turned off. The +9 and +8.08MHz out-of-band intermodulation components, which lie underneath the DTV signal, are responsible for the decreasing EVM with increased aural power. The peaks of the +9MHz component is only 31dB below the average power of the DTV signal. These out-of-band components are easily taken care of with an anti-intermodulation component adjusted for best cancellation. The cancellation circuit under development is a modification of the +/-920kHz cancellation circuit in extensive field application. It will allow the EVM and SNR values to return to 3+% and 29+dB, respectively.

Conclusions and further work

This work shows common amplifica-

tion of an NTSC and DTV signal at meaningful broadcast power levels may be accomplished using a TH-680 Diacode for adjacent n+1 or n-1 situations. The secret is in knowing the PEP limits of the tube and the ability to tune a Diacode (or tetrode) cavity wide enough to accommodate both signals.

This means that when station engineers are searching for RF solutions to an n+1 or n-1 configuration, the common amplification method presented should be considered. It is the only viable solution unless you have unlimited tower space and site resources. If common amplification works for combining aural and visual, why shouldn't it work for combining NTSC with DTV? The answer is that it does. ■

Dr. Timothy P. Hulick, Ph.D., is vice president of engineering, Acrodyne Industries, Blue Bell, PA. For more information on ACT, contact the company's web site at www.acrodyne.com or circle reader service number 180.

Field Report

Color my world

BY GARY FREEDLINE

Until recently, only extremely expensive (\$4,000 and up) component color correctors existed. For broadcast stations purchasing \$70,000 BVW Betacam SP machines, these expensive add-on color correctors were already part of the budget. The introduction of

ever, by running component, hue control was lost.

If the picture was green, it stayed green. If it was too red, it remained red. It was uncertain how hues could be adjusted when normal hue controls or subcarrier phasing controls wouldn't do the trick.

A component color corrector was needed between the Betacam SP decks and a switcher. Unlike composite devices, where the chroma signals are recorded together, component

independently. There is no easy, one-knob control to adjust the hue or subcarrier phasing. A device that controls the Y, R-Y and B-Y levels independently is called a component color corrector.

Color correctors can cost approximately half as much as a UVW 1600 machine. However, we could not justify spending thousands of dollars just to correct colors. At NAB '97, we discovered that Kramer Electronics was shipping a low-cost component color corrector, the 3001 component video processor.

At a glance

- Three looping component video inputs
- Nine outputs, three for each component
- Full-color control of component video signals
- Can also serve as component distribution amplifier
- Screen splitter for all channels



the PVW and UVW series of Betacam SP decks and camcorders allowed budget-restrained production companies to enter the Betacam SP market. How-

ever, by running component, hue control was lost. If the picture was green, it stayed green. If it was too red, it remained red. It was uncertain how hues could be adjusted when normal hue controls or subcarrier phasing controls wouldn't do the trick. A component color corrector was needed between the Betacam SP decks and a switcher. Unlike composite devices, where the chroma signals are recorded together, component

independently. There is no easy, one-knob control to adjust the hue or subcarrier phasing. A device that controls the Y, R-Y and B-Y levels independently is called a component color corrector. Color correctors can cost approximately half as much as a UVW 1600 machine. However, we could not justify spending thousands of dollars just to correct colors. At NAB '97, we discovered that Kramer Electronics was shipping a low-cost component color corrector, the 3001 component video processor. It has a Y input, R-Y input and B-Y input, with individual unprocessed looping for each.

The outputs are well-designed and incorporate a distribution center accommodating three independent outputs per color channel. In addition, the front

LIGHTNING FAST IMAGES



Pinnacle Systems Introduces

LIGHTNING™

Image Storage for News and Sports

LIGHTNING FAST

The Lightning Video Image Storage System recalls and plays images in less than 1/2 second. And you can add our ShotBox for your most demanding on-air applications.

BUILT-IN 3D DVE

Our unique built-in DVE lets you instantly size and rotate an image, add borders, a drop shadow, and 3D perspective.

OPEN NETWORKING

Lightning lets you browse and move images on *all* your network drives. You can even convert images to and from TGA, TIFF, BMP and JPEG formats in order to import and export images to and from graphic design and paint programs.

INCREDIBLY EASY IMAGE MANAGEMENT

Use our picture-based database to view over 100 thumbnail images at a time, or search by number, date, title, user, subject, and other fields. And you can drag-and-drop any image directly from the picture database into preview or on air.

SEE FOR YOURSELF

Call Pinnacle Systems today for a Lightning brochure. Better yet, if you have a PC with Windows® 95 or a Power

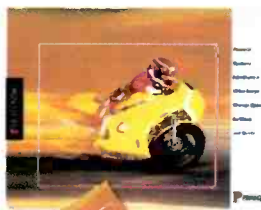

Macintosh®, with a CD drive, ask for the Lightning CD-ROM. It will show you everything that's in the brochure, and more.

Call 1-800-4PINNACLE ext. 91 for a Brochure or CD-ROM.



Pinnacle Systems, Inc. • 280 N. Bernardo Avenue • Mountain View, CA 94043
Phone: 415-526-1600 • Fax: 415-526-1601 • Fax Back: 415-237-1973 • BBS: 408-933-8630 • Web Site: <http://www.pinnaclesys.com>
Europe: 44-1895-442003 • Latin America & Caribbean: 954-349-6745 • Asia Pacific: 65-3243207 • N. E. Asia: 81-3-3221-9710

© 1997 Pinnacle Systems

™Lightning is a trademark of Pinnacle Systems, Inc. ®Windows is a registered trademark of Microsoft Corporation, and Macintosh is a registered trademark of Apple Computer, Inc.

P PINNACLE
SYSTEMS

Circle (63) on Free Info Card

www.americanradiohistory.com

panel has a variety of controls for processing independent signals, while all the inputs and outputs are in the rear of the unit. All of these features come in a unit that is only one rack space in height.

Although the documentation is sparse, the device is simple to use. There are gain and black level controls for the B-Y, R-Y and Y channels independently

The Y channel has an additional contrast and definition control. There's a front-panel splitter control that performs split screening, which allows comparison of the original picture to the processed signal. Once in the process mode, signal phase can be adjusted.

The R-Y and B-Y signals can also be adjusted via gain control and black

level controls, maintaining level ratios. The Y signal can be adjusted to the correct IRE level. Another useful Y signal item is the definition control. In the middle position, the picture is processed normally. A counterclockwise rotation of this control allows the image to become soft or defocused and a clockwise rotation sharpens the image. Even though there was noise associated with sharpness control, it didn't negatively affect any products.

To create an image that looks like it was shot on film, adjust the contrast and definition controls. The definition control can sharpen a soft-focus camera shot and closely match the look of multiple cameras. An ideal situation for Kramer's 3001 component video pro-

cessor is in a non-linear environment. By placing the 3001 between the source machine and the non-linear input, color correction can be done in real-time, before it is recorded on the hard drive.

This saves countless hours of color correction from software filters that need to be applied and rendered, especially when applying other effects to the clip. The 3001 can also be used to apply special-effect color filters and to detail clips in real-time before digitizing, thus cutting color-filter rendering time completely out of the non-linear process. The picture quality was clear with minimal signal loss in either the processed or unprocessed modes. ■

Gary Freedline is a director and editor at Virtual Studios in North Miami.

Technology In Transition

Wireless microphones

There's no doubt about it, audio equipment used for studio and field production is getting lighter and more compact. This advancement in equipment portability without sacrificing audio quality has created a steady acceptance of wireless microphones.

Wireless systems were fraught with complexity, dropouts and noise. For years, the complaint about wireless mic systems was interference, or unwanted signal reception caused by poor receiver selectivity or intermodulation distortion.

Manufacturer's have, for the most part, solved these problems. The solution was to move up in frequency. Higher radio frequencies mean shorter wavelengths, which mean smaller components and better filtering. Another solution was the development of diversity receiving circuits to address signal dropout.

Replacing an old system or adding a system where one didn't exist should be approached carefully. If you are adding a system in an area already congested with RF signals, check with the local frequency coordinator to determine which frequencies are available. When buying a system determine whether you need a hidden system or want to plug in a transmitter to a microphone. A hidden system usually relies on a

lavaliere, in-the-ear or headset microphone and a bodypack transmitter. Receivers can be mounted in racks, on cameras or set on desks, depending on the length of use.

Diversity reception is one area that needs a lot of consideration. There isn't enough space to cover this area, however, refer to the following back issues for a discussion of diversity and wireless microphones:

"Unraveling the Mysteries of Wireless Mic Operation," 7/97; "Understanding Wireless Microphones," 10/96; "Wireless Microphones in the Studio," 5/95; "Solving Wireless Microphone Interference Problems," 9/94; "Using Wireless Microphones," and "Diversity Reception for Wireless Microphones," 1/93.

See summarized details of microphone features in Table 1 on page 138.

Special features

Azden:

Audio distortion of less than 0.1% @ 15k deviation; dynamic range of better than 100dB; an operating range of 100m under ideal conditions

Sennheiser:

Frequency range of 450-960MHz; switching bandwidth of 24 MHz; HiDyn Plus noise reduction system

Shure:

797 fully selectable, user-programmable frequencies; up to 20 systems can be used simultaneously; all Shure UHF components are interchangeable

Vega:

Microprocessor-controlled; 100 channel synthesis; controlled by embedded microprocessor

Telex:

Tone squelch

Systems Wireless:

UDR200B features PC control for selecting frequencies, monitoring system operation and performing spectrum analysis; can operate any one of 256 available frequencies; systems operate in UHF band 470-608 and 614-806.

AKG Acoustics:

Multiple frequency bands available; simultaneous operation of up to 11 frequencies in WMS60; 16 in WMS300; and 40 in WMS800/900; in WMS800/900 two receiver sections provide true receiver diversity

Lectrosonic:

User-adjustable low-frequency roll-off; dual-band compandor; fit microphones with XLR jacks

COMTEK:

Switchable EQ circuit; dual-tracking preselector front end; helical resonator for front-end RF selectivity

Make the Switch

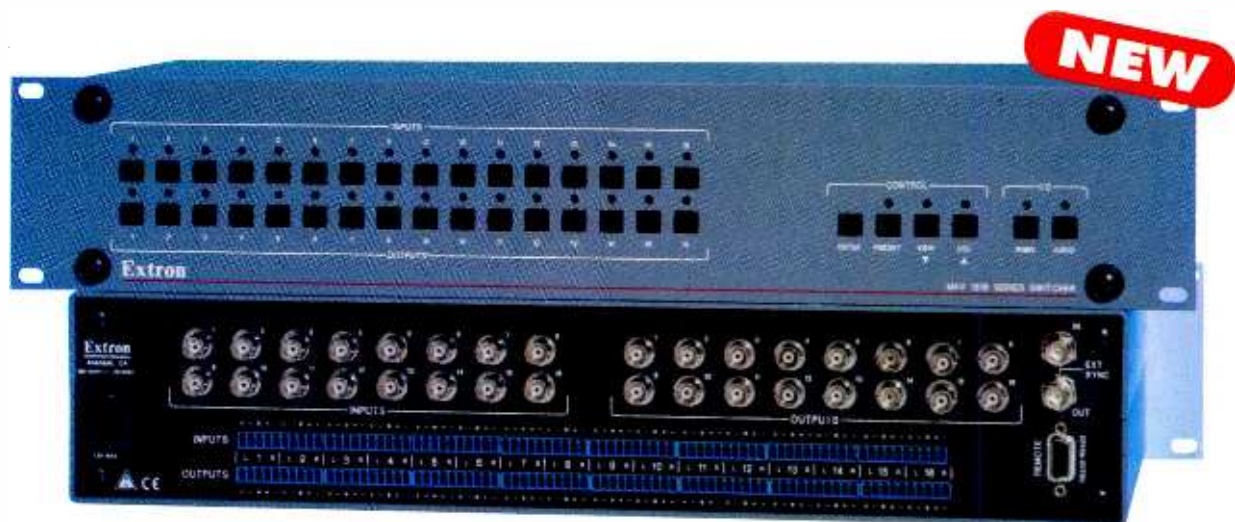

More 16 x 16 Solutions

Extron introduces the new MAV 1616 series matrix switchers. There are three switchers in this series: the MAV 1616 (matrix for audio and video); the MCV 1616 (matrix for composite video only); and the MSA 1616 (matrix for stereo audio only). Each of these models is capable of switching up to sixteen independent video and/or stereo audio sources to sixteen independent outputs.

All of the high performance features come standard. The MAV 1616s not only fit your large-scale matrix switching needs, they fit your budget: MAV 1616 \$5,850; MSA 1616 \$3,250; MCV 1616 \$2,750.

The MAV 1616 series switchers provide:

- 16 x 16 configurations
- 80 MHz (-3 dB) video bandwidth, fully loaded
- Audio gain/attenuation settings for each input from the front panel (MSA 1616, MAV 1616)
- Stereo audio is standard and included in one 2U high enclosure (MSA 1616, MAV 1616)
- 16 memory presets
- Simple Instruction Set™ with basic ASCII commands for RS-232/422 controls
- Vertical interval switching
- QuickSwitch Front Panel Control™
- Internal 100-240 volt, 50/60 Hz power supply
- Windows® based control program software

Extron Electronics

Circle (64) on Free Info Card

800.633.9876

See us at NAB Booth #M7219



EXTRON ELECTRONICS/RGB SYSTEMS, INC.
1230 South Lewis Street, Anaheim, CA 92805
800.633.9876 714.491.1500 FAX 714.491.1517
U.S.A.

EXTRON ELECTRONICS, EUROPE
Beeldschermweg 6C, 3821 AH Amersfoort
+31.33.453.4040 FAX +31.33.453.4050
The Netherlands

EXTRON ELECTRONICS, ASIA
41B Kreta Ayer Road, Singapore 089003
+65.226.0015 FAX +65.226.0019
Singapore

EXTRON ELECTRONIC INFORMATION
EXTRONWEB™: www.extron.com
EXTRONFAX™: 714.491.0192
24-hour access—worldwide!

COMPANY	OPERATING BAND	CASE TYPE	TYPE OF DIVERSITY	TRANSMITTER OUTPUT	FREQUENCY POWER CONTROL	RS #
Azden (516-328-7500) 411 systems	UHF	-	true diversity	10-15mW	PLL controlled	290
Sennheiser (860-434-9190) EM1046	UHF	multichannel receiver	true diversity	-	PLL controlled	291
EM3032	UHF	2-channel	true diversity	-	PLL controlled	292
EK4015	UHF	miniature receiver	true diversity	-	PLL controlled/ 32 switchable freqs.	293
SKM 3072-u	UHF	hand-held	-	50mW	PLL controlled	294
SKM 5000	UHF/VHF	hand-held	-	50mW	PLL controlled	295
5K50	UHF/VHF	bodypack transmitter	-	50mW	PLL controlled/ 16-channels	296
SK250	UHF	bodypack, transmitter	-	250mW	PLL controlled/ 16 channels	297
SHURE (708-866-2200) U14S/83 - 98	UHF	bodypack	-	-	-	298
U14S/16	UHF	bodypack	-	-	-	299
U14S58/87	UHF	hand-held	-	-	-	300
U14S/beta58/87	UHF	hand-held	-	-	-	301
Vega (800-877-1771) R-672	UHF	studio receiver	true diversity	-	synthesized	302
T-772	UHF	bodypack	-	50mW	synthesized	303
T-690 family	UHF	hand-held	-	50mW	synthesized	304
U2020 family	UHF	receiver, bodypack, hand-helds	true diversity	40-50mW	synthesized	305
Telex (612-884-4051) ENG-500/ ut-500	UHF	portable receiver & plug-in transmitter	posi-phase	50mW	2 channel crystal	306
USR-100L	UHF	lapel system	posi-phase	10/1 select.	100 channels	307
USR-100H	UHF	hand-held system	posi-phase	10/1 select.	100 channels	308
Systems Wireless (703-471-7887) UDR200B	UHF	receiver	true diversity	-	-	310
UT200	UHF	hand-held	-	-	-	311
UM200B	UHF	bodypack	-	-	-	312
UH200	UHF	plug-in transmitter	-	-	-	313
UCR200D	UHF	compact receiver	-	-	-	314
AKG Acoustics (615-360-0499) WMS60	VHF	hand-held, bodypack	antenna diversity	10mW	freq. agile	315
WMS300	UHF	hand-held, bodypack	true diversity	10mW	freq. agile	316
WMS800/900	UHF	metal construction, hand-held, bodypack	true diversity	10mW	freq. agile	317
Lectrosonics, Inc. (800-821-1121) UM200B/250b	UHF	beltpack	-	100/250mW	synthesized 256 freqs.	318
UCR200D	UHF	machined	antenna phase/switching	-	synthesized 256 freqs.	319
UH200	UHF	plug-in	-	100mW	synthesized 256 freqs.	320
UM195B	UHF	beltpack	-	70mW	crystal	321
UH195	UHF	plug-in	-	70mW	crystal, wide deviation	322
UCR195D/195	UHF	machined	antenna phase/ single antenna design	-	crystal	323
UM190B	UHF	beltpack	-	70mW	crystal	324
UH190	UHF	plug-in	-	70mW	crystal, narrowband	325
UCR190	UHF	machined	single antenna design	-	crystal, narrowband	326
COMTEK (800-496-3463) BST-25	VHF	metal	-	50mW	crystal	327
M-72	VHF	bodypack	-	50mW	crystal	328
PR-25	VHF	bodypack	-	-	syn. agile, crystal	329
MRC-82C	VHF	camera-mount	-	-	crystal	330
MR-182	VHF	base type	-	50mW	crystal	331
M-182	VHF	hand-held	-	50mW	crystal	332
Beyerdynamic (516-293-3200) V200/300	VHF	bodypack, hand-held	true diversity	50mW	freq. agile	333
U400/500/600	UHF	bodypack, hand-held	true diversity	50mW	freq. agile	334

Table 1. Summarized details of microphone features — (-) indicates missing information or that the category is not applicable. To receive more information, use the Reader Service Numbers shown in column 7.



DIGITAL-S Acquisition

To get the most out of today's digital editing systems, you need to begin with the best raw footage possible. And that means shooting in 4:2:2. With DIGITAL-S, you get 4:2:2 color sampling with perceptually lossless compression. This produces an image that remains free of annoying artifacts that could build up through various steps in post production and digital distribution.

DIGITAL-S also offers superior chroma resolution, producing more well-defined colors, chroma keys and effects. In fact, all high-end systems, including the best non-linear editors, require 4:2:2 to achieve these benefits. The result is performance and quality that can stand up through each phase of digital video production. Shooting in a 4:1:1 DV format compromises your image, and you can't bring back the quality once it's lost.

COMPONENT DIGITAL

4:2:2

Take your first step into high performance. Make it DIGITAL-S. For more information call:

1-800-JVC-5825
www.jvcpro.com



BR-D40
Dockable Recorder &
KY-D29 DSP Camera -
package under \$18,000
(with viewfinder, less lens)

DY-700 Camcorder
under \$12,000
(with viewfinder
and 13:1 lens)

Every step
in video production
affects the next.

Your first is the
most critical -
start with 4:2:2!

Circle (65) on Free Info Card

www.americanradiohistory.com

JVC
PROFESSIONAL

New Products

SERIAL DIGITAL INTERFACE OPTION FOR VIDEO MEASUREMENT SET

Tektronix VM700T video measurement set with serial digital interface (SDI) option: the VM700T video measurement set is a highly accurate, multiformat serial digital video analyzer; the SDI option is a comprehensive and affordable upgrade for professional video manufacturers and terrestrial broadcast engineers that are beginning the transition to full-bandwidth digital applications while still requiring precise analog testing; 503-627-7111; fax 413-448-8033. www.tek.com
Circle (273) on Free Info Card

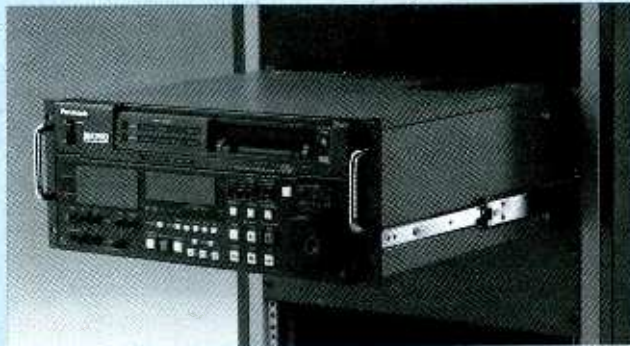

DVCPRO RACK-SLIDE KIT

Winsted rack slide kit model F8203: this kit is the latest addition to Winsted's line of rack slide kits designed specifically for Panasonic, JVC and Sony VTRs (the line also includes models for Vicon and Barco monitors); model F8203 features heavy-duty chassis support brackets, Accuride ball-bearing slides for smooth pulling action, and pivoting rear finger brackets to allow mounting in sloping, vertical racks; 612-944-9090; racks@winsted.com
Circle (274) on Free Info Card

DIGITAL CAMERA SYSTEM

Thomson Broadcast's 1657D camera system: based on the portable 1657D, the Thomson Broadcast camera system provides many different configurations, such as Microcam and Sportcam; the 1657D is a digital camera with 12-bit quantization combined with intermediate processing stages of up to 20 bits providing the type of contrast ratio only previously available in film; it accepts a full range of accessories, including triax and multicore adapters, Betacam SP and Betacam SX recorders; other standard features include the switchable 16:9-4:3, dynamic pixel correction, video noise slicer, sensors, and shutter and clear scan; 201-569-1650; fax 201-569-1511
Circle (272) on Free Info Card



ONE- AND TWO-LINE VIDEO DISPLAY

Matthey Electronics 2550 broadcast-quality delay: the 2550 broadcast-quality video delay was designed for applications where one line or more of analog video delay is required; the 2550A delays the video signal and compensates for errors, such as large timing errors that can occur when new production equipment is installed; the Matthey 2550 has a fully variable range of two microseconds up to one or two lines, with two 75V outputs — NTSC or PAL; the 2550A also provides front-panel

toggle switching of the delay range in 1ns steps; internal processing and Matthey filtering expertise to full CCIR-601 recommendation optimize all standard video measurements; 914-763-8893; fax 914-763-9158

Circle (275) on Free Info Card

Take 10% off your next BASF video tape purchase through March 31, 1998!

Professionals AROUND the WORLD Rely on **BASF** Video Tapes

No matter how extreme the conditions, BASF professional video tapes are designed to deliver first rate video and audio playback every time. With over sixty years experience as innovators in the formulation and manufacturing of magnetic media, BASF sets the world standard for video performance and reliability. That's why BASF media is in use throughout the world today at hundreds of leading broadcast and post production facilities.

Now, for a limited time, your local authorized BASF dealer is offering a special 10% discount on all BASF professional video tapes purchased before March 31st, 1998. This includes BASF Betacam SP Mega, Digital Betacam, the entire range of S-VHS and VHS products and 1" C-format tape. Act now to take advantage of this special offer and experience BASF's legendary quality.



EMTEC Magnetics



Distributed in North America by EMTEC Pro Media, Inc. ☎ US 1-888-295-5551 Canada 1-800-205-0070 or visit our web site at www.emtec-usa.com

Circle (66) on Free Info Card

www.americanradiohistory.com

HIGH-SPEED DATA TRANSMISSION OVER RING NETWORKS

ADC Telecommunications Fast EtherRing

switch: ADC's first product based on its new EtherRing technology that enables data to be transmitted over fiber rings for the first time in native Ethernet format; the Fast EtherRing switch allows high-speed, high-capacity transport of data, Internet Protocol (IP) video and IP voice over telephony and MPEG digital video over fiber-optic rings of virtually unlimited distances; it initially uses a dedicated fiber or works in conjunction with ADC's DV6000 high-speed digital transport system; 800-366-3891 (ext. 3475); www.adc.com

Circle (276) on Free Info Card



INTERFACE FOR BROADCAST MEDIACLUSTER AND OMNIBUS SYSTEMS

SeaChange International and OmniBus Systems broadcast

development effort: SeaChange is developing an interface between its Broadcast MediaCluster video server and OmniBus Systems' broadcast network operation system; the interface will allow the Broadcast MediaCluster to be efficiently used in TV transmission systems that have selected OmniBus Systems as their broadcast vendor; OmniBus is a real-time network operating system that enables distributed control of a wide range of broadcast TV equipment from simple intuitive user interfaces; 508-897-0100; fax 508-897-0132

Circle (250) on Free Info Card

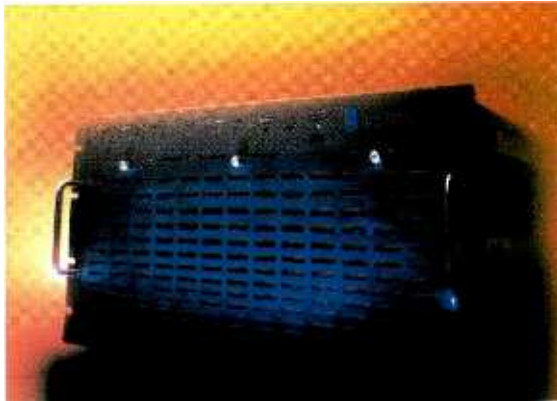

Back in the days when the .(dot) was known as a period, you had to actually visit the NAB convention in Las Vegas to get the latest news.

Broadcast Engineering is going beyond the printed page to bring you direct coverage from the NAB show floor.

Visit our homepage at www.broadcastengineering.com for your link to the 1998 NAB Internet Show Daily. Broadcast Engineering's editorial staff is doing the leg work to bring you up-to-the-minute updates from NAB...all on-line. With a click of your mouse you can stroll through the convention centers at your own pace. Check out the new product releases. Sit in on a press conference or two. Catch up on the latest industry news.

Just because you're not going to the show, doesn't mean you have to miss the show. Log on to www.broadcastengineering.com for complete coverage from the NAB show floor.

Contact your marketing manager for advertising opportunities on the Internet Show Daily. See page 161 for the marketing manager nearest you.



Now
you
can
get
there
with
the
click
of a
mouse.

www.broadcastengineering.com

**Broadcast
ENGINEERING**
THE JOURNAL OF DIGITAL TELEVISION™

PRODUCTS NOW SHIPPING



SADIE OWNERS CAN ADD PORTIA RANDOM ACCESS VIDEO

SADiE Portia NTSC: Portia, a random access video system, eliminates the need for a VTR during sound-for-picture processes by providing instant access to the visual elements; with the release of V3.03 software, all Portia functionality is now available in NTSC video format; when Portia is installed into a SADiE or Octavia DAW, video can be recorded into the EDL along with the audio; the video appears as a dedicated stream in the playlist, and audio and video can be scrubbed simultaneously; editing functions such as cut, copy and paste, can be performed on the video clips, as well as placement of the original recorded time code; 615-327-1140; fax 615-327-1699

Circle (287) on Free Info Card

ADVANCED VERSION OF EMULATOR OPERATING SYSTEM



E-mu Systems EOS 3.0: the latest version of E-mu software developed specifically for the Emulator 4 line of products is now available; EOS 3.0 has several new features, including 48-track sequencer with loop record and performance control features such as arpeggiator, split mode and layer mode; the advanced version also offers new modulation sources and destinations; EOS 3.0 ships with Emagic's EOS SoundDiver, a preset editor that is designed for EOS products; 408-438-1921; fax 408-438-8612; www.emu.com

Circle (288) on Free Info Card



INTEGRATION OF SEAGATE'S STORAGE TECHNOLOGY WITH ANDATACO'S APPLICATION-SPECIFIC ARCHITECTURE

Andataco GigaRAID Application-Specific Architecture (ASA) product line shipping with Seagate Technology's 10,000 RPM 9GB Cheetah disk drives: combining Seagate's advanced storage technology with Andataco's application-specific architecture (ASA) allows you to match the attributes of specific data structures to receive maximum levels of performance, availability and scalability in heterogeneous UNIX and NT computer environments; Andataco's GigaRAID high availability series offers extensive RAID and RAID-ready storage for ASA-targeted applications; new products in the series include Ultra SCSI and Fibre Channel solutions, as well as advanced new data sharing, remote mirroring and disaster recovery software that will soon be released; 800-335-9191; fax 619-453-9294; www.andataco.com; inquire@andataco.com

Circle (289) on Free Info Card

(math. Sym = any number)

*It's Coming And It's Going To Change
Everything You Do. In Any Number Of Ways.*

Circle (54) on Free Info Card



WIDE-POWER LENS

Fujinon A10X4.8B-10: this wide cine-style lens features a 90° horizontal field of view in the 16:9 format and over 85° in the 4:3 format with less than 1% distortion at a wide angle; it has a two-foot MOD that is measured from the object plane, unlike other TV production lenses that traditionally have measured MOD from the lens front; other benefits include a newly designed inner focusing system that reduces image size change to a minimum when focusing, zoom and focus gearing that accommodates most cine-style controls, and large orange numerals for focal length and "T" stop that are visible from both sides of the lens; 800-553-6611; fax 201-533-5216

Circle (259) on Free Info Card

MINI-M SAT PHONES FOR VEHICLES

LandSea Systems Mini-Ms: LandSea Systems is offering the latest of Thrane & Thrane's satellite communications products, the TT-3062A and TT-3062B INMARSAT phones for vehicles; both phones use spot beam technology allowing them to be more compact and use less power than their predecessors; the TT-3062A vehicular Mini-M Satphone uses a rod antenna and is fully omnidirectional; the TT-3062B model uses a stabilized disc antenna that uses steered beam technology and its internal components constantly move to locate the satellite as the vehicle moves; both antennas can be mounted to vehicles magnetically; 757-468-0448; fax 757-468-0625; www.LandSeaSystems.com

Circle (263) on Free Info Card

QUIET SWITCH AES ROUTER

Leitch ASR-16x16: this router includes the new synchronous quiet switch (SQS) process that guarantees quiet switching of AES digital audio; the SQS provides two processing steps — synchronous switching and user-selectable crossfade; the synchronous switching maintains AES framing during and after crosspoint switches, so that the downstream equipment does not lose lock during a switch; the crossfade guarantees a quiet switch between any two sources by fading the two signals near the switch point; the fade duration is user adjustable and the fade can be enabled or disabled; 800-231-9673; fax 757-548-4088

Circle (255) on Free Info Card

TLM103



Large diaphragm capsule derived from the famous U87 transformerless circuit, 7dBA self noise figure. **LIST \$999.00**



5700 E. Loop 820 S. - Ft. Worth, TX 75460
Phone: 817-483-7474 - Fax: 817-483-9952
E-mail: pas@lights-audio.com
www.lights-audio.com

CALL TODAY 1-800-433-7668

Circle (56) on Free Info Card

HDTV DIGITAL WAVEFORM MONITOR

Leader LV 5150D: a monitoring unit that handles serial digital and analog components for HDTV signals in the 1125/60 (59.94) format; it provides full waveform monitoring functions including line select, cursors and memory presets of test setups; picture display of the Y or G component, with a line select strobe provided; the unit offers a vector display of chroma component, as well as a Lissajous display for stereo audio; 800-645-5104 or 516-231-6900

Circle (254) on Free Info Card



PRODUCTS NOW SHIPPING



EDIT MPEG-2 FILES DIRECTLY

Applied Digital Technology AD-net MPEG editing station: Greenway Ltd. announced the release of the

ADnet MPEG editing station from Applied Digital Technology that allows you to edit MPEG-2 files directly; it provides frame-accurate editing of first-generation MPEG-2 files, and in the edit mode, beginning and end points can be marked to create an EDL in the same manner that videotape is edited; edits can be previewed and modified and the final EDL, in industry-standard format, can be exported for further editing; this release allows simple cuts and dissolves, with additional functions scheduled for implementation later this year; +44 1635 528700; rcrosoer@greenway.co.uk

Circle (281) on Free Info Card

NEW VERSION OF ARGUS MPEG-2 ENCODING SYSTEM

Vela Research's Argus 3.0: now shipping, this Windows NT-based MPEG-2 encoder system is designed for a broad range of applications that need broadcast-quality digital video; the Argus 3.0 is a full-featured MPEG encoder on the Windows NT platform; new features include variable bit-rate encoding, caching FTP, improved API and inverse telecine; available as a rack-mount or desktop configuration, it creates streams at MPEG-1, SIF, MPEG-2 Half D-1, MPEG-2 D-1 (DOE) and MPEG-2 D-1 (AFF) resolutions; 813-572-1230; fax 813-573-2508; www.vela.com

Circle (282) on Free Info Card



WIDESCREEN CAMCORDER

Sony DNW-9WS: this widescreen digital Betacam SX camcorder is shipping to news operations migrating to widescreen digital TV production; it uses a new, high-performance widescreen Power HAD IT CCD designed specifically for ENG environments; the DNW-9WS offers superb video and audio acquisition, direct digital recording according to MPEG 4:2:2 P@ML, high-speed field-to-station transmission, networking within a non-linear disk-based system; with the ability to switch between 16:9 and 4:3, the 13-pound camcorder features an extraordinary sensitivity capable of making full level in-scene illumination of only 0.7 lux (new Turbo Gain function); 800-686-SONY; www.sony.com/professional

Circle (283) on Free Info Card

vision

(vision = foresight, visual resolution)

*It's Coming Closer And Becoming More Defined.
Can You See It? We Can. We've Seen It For Years.*

VISION

Circle (55) on Free Info Card



DELAY CANCELLOR
Avocet Instruments
delay cancellor: this product eliminates

delayed audio or echoes of remote audio from the off-air return heard at remote sites; unlike the mix-minus systems that require a dedicated return path to the remote site, the delay cancellor allows the remote talent to use the air feed as their return audio from the station; a special DSP program compares audio that is transmitted to the studio with audio that is being received at the remote site via the on-air signal, satellite line or microwave path; the delay cancellor will compensate and correct for transmission delays of up to 800ms; 800-443-0728; fax 503-671-9626; www.avocetinst.com
 Circle (265) on Free Info Card

DIGITAL CONSOLE

Studer D950 digital mixing system: featuring a fully scalable and configurable central DSP core, the D950 allows you to configure exactly the right console design for a given application; up to four control surfaces can share a single DSP core for maximum flexibility in multiroom installations; the maximum DSP configuration (20 hot-swappable DSP cards) allows for as many as 256 fully-featured channels, while a 40-channel console can be provided with as few as three or four cards; the console is controlled from a central PC-compatible system running on Microsoft Windows NT; 615-399-2199; fax 615-367-9046
 Circle (262) on Free Info Card



TEST SOLUTION FOR DIGITAL TV TRANSMISSION STANDARD

Hewlett-Packard HP 89441V VSB/QAM signal analyzer: this analyzer tests 8VSB TV signals providing comprehensive radio frequency (RF) and modulation test capabilities in addition to powerful troubleshooting features; it provides a visual display of VSB constellation and eye diagrams, allowing TV system designers to identify design errors quickly; TV broadcasters can conduct reliable transmission power-level measurements and generate accurate statistical measurements for peak-to-average power; this instrument also provides a statistical percentage of the time transmission power that exceeds a user-specified level; 800-452-4844 (ext. 5522); www.hp.com/go/tmdir
 Circle (260) on Free Info Card

REAL-TIME VIDEO EDITING

Pinnacle Systems Reel-Time: a dual-stream desktop video capture card with on-board real-time special effects; ReelTime supports dual audio and video stream playback, and data rates as high as 13.4Mb/s (per stream) for lossless M-JPEG compression; with its dual-stream engine, ReelTime eliminates the performance limitations imposed by conventional video capture products, enabling Adobe Premiere to operate render-free in real-time editing; ReelTime allows for the playback and scrub of three tracks, including titles and keying at a lower cost; 650-526-1000;
 www.pinnaclesys.com
 Circle (258) on Free Info Card

12 PRECISION VIDEO TEST SIGNALS, AUDIO TONE \$469



- TSG-50 generates 12 composite video test signals plus 1Khz or 400Hz audio tone, and composite sync.
- All test signals computer calculated and digitally synthesized for perfect RS 170A accuracy with no drift or SCH adjustments required.
- Convenient 12 position rotary switch for quick, easy pattern selection. 13th signal of 100% white field can be substituted for full field color bars.
- 30/60 second timer switches from pattern to black after timeout. • Ref Frame Pulse/59.97 Hz output.

• 9-14 volts DC powered for portable use. AC adapter included. • TSG-50B model adds 5 black outputs or 4 black plus subcarrier - \$628. • Also available in rackmount version.

HORITA

Unconditional Guarantee.

P.O. Box 3993, Mission Viejo, CA 92690 (714) 489-0240

Circle (67) on Free Info Card

DTV

Fiber Optic Transport and Distribution

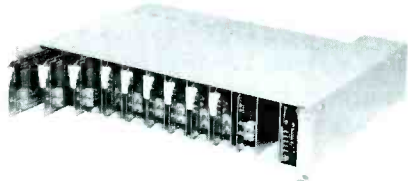

DTV-200 Series of Modular Digital Products

- Supports SMPTE 259M, 4:2:2 Component and Wide Screen, 540Mbps 4:4:4:4, SONET and ATM.
- Distribute and transport data from DC to 650Mbps up to a 10Km distance.
- Coaxial and Fiber Optic interfaces.

MULTIDYNE

Web <http://www.multidyne.com>

Email info@multidyne.com

1-(800)-4TV-TEST Fax 1-(516)-671-3362

Visit NAB #8116. Call for a FREE pass.

Circle (74) on Free Info Card

Shively Labs

Series 2000 UHF Broadcast Antennas B-LINE Transmission Line

Shively Labs offers superior engineering support and accessibility from your first contact through the life of your Shively UHF broadcast system.

Offering Complete Solutions for Your DTV Requirements!

UHF & FM Antennas and Related RF Equipment

P.O.Box 389, Bridgton, Maine 04009 USA
Tel.: +1-207 647-3327 FAX: +1-207 647-8273
NUEVO web site: www.shively.com
- An Employee-Owned Company -

Circle (75) on Free Info Card

The GALLERY

The results are in...

WinMasterCG™

is the leading Master Control application for the Chyron Codi



LOGOS



TV RATINGS



EAS



SCHOOL CLOSINGS



TIME & TEMP

Finally a Master Control Character Generator Program with the Master Control Operator in mind. WinMasterCG has the new 44 TV Guidelines Ratings Icons Manually or with timed display fade accomplished with a click of the mouse. WinMasterCG has an incredible list of features for the Chyron Codi and supports 36 file formats which are translated to Codi format within WinMasterCG. Simply click on the desired icon and your MC task will be accomplished in seconds.

"WinMasterCG is the simple solution for Master Control"

The Chyron
codi

For more information:

1-800-273-4033

FAX (561) 776-8464

BSS Broadcast Software Solutions
Systems For Broadcasters By Broadcasters

See our web site at broadcastsoftware.com for a free demo and additional features

Circle (72) on Free Info Card

PRODUCTS NOW SHIPPING



HIGH-PERFORMANCE STORAGE DRIVES

Avid's iS Pro Series: this powerful line of storage drives includes 9G and 18GB storage drives in a 3.5-inch format; ideal for digital video and audio applications, the iS9 Pro and the iS18 Pro are available in fixed and removable formats and offer increased performance, reliability and investment protection; these ultraSCSI drives are designed to work with Avid's MediaDock removable storage systems and in Avid MediaDrive fixed storage devices; using iS18 Pro drives in a fully loaded MediaDock (eight drives) allows storage of 140GB of digital media; 978-640-6789; fax 978-640-1366; www.avid.com

Circle (284) on Free Info Card

NEXT-GENERATION NEWSROOM COMPUTER SYSTEM

Avid's AvidNews Newsroom Computer System:

the first component of AvidNews newsroom and control system, the AvidNews Newsroom Computer System, is now available; it streamlines news production with tools that enable text, video and audio management on your desktop; built on three core systems — AvidNews Newsroom Computer system, Media System and Broadcast Control System — AvidNews allows you to access and share video, scripts and rundowns; 800-949-AVID; www.avid.com

Circle (285) on Free Info Card



NT VERSION OF ITS IMAGING CONTROL PANEL SOFTWARE

Miranda Windows NT version of ITS ICP-S remote-control software:

the Windows NT version of its ICP-S software control panel is now shipping; the Imaging Control Panel (ICP) software allows you to remotely control and monitor Miranda's line of digital encoders, decoders, converters, frame syncs and more from a software environment; ICP-S offers three menu levels that allow you to continuously monitor the status and control of all Imaging family modules connected to a particular workstation via a given RS-422 daisy chain; 514-333-1772; fax 514-333-9828; www.miranda.com

Circle (286) on Free Info Card

PROFESSIONAL MULTICHANNEL DECODER

Tandberg TT1100: a state-of-the-art, cost-effective multichannel IRD that simultaneously decodes one to six video channels in one unit; major CA systems are implemented, and the TT1100 receives and transcodes components of a digital TV signal into the preferred format; it transcodes to PAL/NTSC and offers MPEG-2/DVB conformance and interoperability; other features include closed captioning (NTSC), flexible conditional access handling, test signal (VITS) generation and automatic language selection for sound, subtitling and teletext; +47 67 11 62 00; fax +47 67 11 62 01; sales@tandbergtv.no

Circle (277) on Free Info Card

HDTV DIGITAL DISK RECORDER

Digital Video Systems' ProntoVision: new I/O features are now available on the ProntoVision HDTV disk recorder products; concurrent storage of virtually all interlaced and progressive HDTV and SDTV formats is provided in a single ProntoVision system; some of the enhancements include the ability to switch from HDTV to a multichannel SDTV server, record/play of the Panasonic HD360 compressed stream format and a frame doubler playout option that allows any material recorded in progressive-30 format to be played out in progressive-60 or interlace-60 formats; ProntoVision is compatible with all major edit controllers using the Sony RS-422 protocol and it easily emulates or replaces the traditional VTR in edit suite applications; 818-846-9444; fax 818-846-7444; www.digitalvideosystems.com

Circle (271) on Free Info Card

LARGE-CONFIGURATION MATRIX SWITCHERS

Extron Crosspoint 1616 series switchers: RGBS/RGBHV, 16x16 matrix switchers offer new options for large-scale routing; available in four models — 1616, 1616A, 1616HV and 1616HVA; each model has 16 memory presets and can switch S-Video and composite video for easy use with any large-screen projector and monitor currently available; when fully loaded, the switchers deliver 200MHz (-3dB) video bandwidth; the inputs and outputs are each isolated and buffered, allowing any single input or combination of inputs to be switched to any outputs with virtually no crosstalk; 714-491-1500; fax 714-491-1517; www.extron.com

Circle (266) on Free Info Card

The

GALLERY

SPLIT IT!

HENRY ENGINEERING

503 Key Vista Drive
Sierra Madre, CA 91024 USA
TEL (626) 355-3656 FAX (626) 355-0077
FAX-on-Demand Doc #103 (626) 355-4210
<http://www.henryeng.com>



USDA is a handy 2-in, 4-out stereo "mini-DA" that can combine or split audio signals for distribution. Mix stereo to mono, get both stereo and mono outputs from a stereo source. Gain trims for each output. Great specs with lots of headroom. *Keep one on hand!*



We Build Solutions.

Circle (73) on Free Info Card

Slow Motion Controller for Demanding Sports Production



NEW!

ST300

Slow Motion Controller, \$3000

- All the features and functions you would expect to find on an \$8,000 to \$12,000 slow motion controller!
- Control up to 4 VTRs
- Simple and easy to use. Small space-saving footprint.
- Quickly and easily store and recall up to 100 cue points per VTR,
- T-Bar or detented wheel provide fast & easy slomo control
- Can be customized for your specific application

Another Control
Solution From . . .



DNF Industries
9970 Glenoaks Blvd., Suite D, Sun Valley, CA 91352
Phone: (818) 252-0198 FAX: (818) 252-0199

Circle (77) on Free Info Card

QUALITY. RELIABILITY. EASE OF OPERATION.



ENG, SNV and EFP
trucks, vans and trailers

BAF Broadcast Vehicles

TOLL FREE (800) 633-8223

WEB www.bafcom.com

FAX (407) 324-7860 SAT. SPACE (800) 966-3822
E-MAIL baf@gate.net WORLDWIDE +(407) 324-8250

Circle (76) on Free Info Card

They got their
machines under
control... so what
are you waiting for?



The Secret is Out!

Two of the world's largest DBS operators
have our OmniJET™ Machine Control Server
and DTx-800™ DTMF transceiver systems.

Check out these features:

OmniJET™

- LAN/WAN TCP/IP
- RS-422 Ports
- Sony S-BUS interface
- VSYNC/LTC input
- Web Browser set-up

DTx-800™

- DTMF cue tones 8 channel receive AND transmit
- Built-in GPIO and Relay, with LTC reader option...

And that's only the beginning. How about independent router control, advanced digital ad insertion, client server machine control, router protocol conversion and much more for your scalable system automation requirements.

Don't wait... get yours NOW!



pacific
computing

133 Mission St., Suite 103
Santa Cruz, CA 95060
Tel: (408) 427-4280
Fax: (408) 427-4282
pacific@netcom.com
www.pacific-computing.com

Circle (80) on Free Info Card

Business

More than 14 **Canon** DIGI-SUPER 70 lenses were used in Superbowl XXXII. Canon's 70X zoom lens DIGI-SUPER 70 provides the longest telephoto and widest angle combination of any lens, and is engineered to incorporate internal focusing and IF+ technologies for long-range telephoto applications.



Already a fixture at sporting events, Canon's breakthrough DIGI-SUPER 70X lens is also gaining attention as a valuable tool in the entertainment business. Black Entertainment Network (BET), Washington, DC, purchased four Canon 70 lenses for use at entertainment productions, as well as sports events. Because the DIGI-SUPER 70 provides extremely high performance without regard to object distance, the cameras can be placed in the back of a concert hall or large theater and still get good close-ups, without obstructing the audience's view. At BET, the 70X lens has been able to get tighter shots from a greater distance, than they normally get

with a 45X lens that is closer to the object.

Cinetel Studios, Knoxville, TN, installed an **AMS Neve** 24-fader Libra fully automated digital music console. The console will help in Cinetel's production of programming for networks, such as Home & Garden, The History Channel, A&E and The Nashville Network. The installation represents the final stage of a facility-wide upgrade to digital.



AMS Neve 24-fader Libra digital music console.

The Associated Press was awarded the contract for the new newsroom computer system at CBS-owned, KUTV-TV in Salt Lake City. KUTV-TV uses NewsCenter on 35 workstations to manage all areas of its news operations, including program management and timing, on-air control, prompting, captioning and assignment planning.

Boston University's College of Communication also awarded a contract for its newsroom computer system to The Associated Press. It will use NewsCenter on more than 40 workstations for production of local cable newscasts and for classroom training. Since its introduction, more than 160 stations, networks, cable programmers and broadcast bureaus have chosen AP's NewsCenter.

Hitachi announced that four of the CBS mobile trucks sent to Nagano, Japan for production of the 1998 Winter Olympics were equipped with Hitachi cameras. Three expandable units with a total of 18 SKF-710s, nine SKF-3s and three SKF-300 cameras were used to cover the games. This was the third time the expandable units (MU1, MU11, MU12) were used to cover the Winter Olympics and the units were also used at the Daytona 500.

Acrodyne Industries was awarded a contract to manufacture and install an adjacent-channel technology (ACT) transmitter at KBLR-TV, Las Vegas. The ACT transmitter enables KBLR to operate two channels, NTSC Channel 39 and DTV Channel 38, through a single transmitter, transmission line and antenna.

In related news, Acrodyne was awarded contracts by Pappas Telecasting Companies to manufacture and install Diacode-equipped UHF transmitters at WWSW-TV in Opelika, AL, and Channel 63 in Merced, CA.



An Hitachi camera in use at the Daytona 500.

Panasonic announced that Warner Bros. will invest in high-definition recording systems from Panasonic Broadcast for high-resolution film-to-tape transfers of its movies. The initial purchase will be for two Panasonic AJ-HD2000 high-definition recording systems, but the station plans to buy several more over an 18-month period. Warner Bros. will standardize on Panasonic's D-5 format for high-resolution masters that will be used in creating products for DTV, NTSC and PAL delivery.

* Receive FREE Gift With Catalog *

FREE
1997 H.L.
DALIS
CATALOG
OVER 350
PAGES



Since 1925

Audio, Video & Broadcast Engineering Supplies

Authorized Distributor for over 250 major lines including Kings Broadcast, Belden, Neutrik, Canare, John Fluke and Motorola.

Call, Fax or E-mail **Stanley Marks** for your Free Copy
(NY) Ph.: 718-361-1100 • Fax: 718-392-7654
Nationwide: 1-800-HLDALIS
E-mail: Hldalis@aol.com

H.L. DALIS Inc.
35-35 24th St., Long Island City, NY 11106
TRIED THE REST? NOW TRY THE BEST!

Circle (70) on Free Info Card

CONVERGENCE

of high quality sound and low cost



Enhanced Betacam VCRs

- ◆ 4 audio channels for any PVW or UVW Betacam VCR
- ◆ AFM kits are easy to install in your UVW or PVW VCR



Los Angeles 1840 Flower Street Glendale, CA 91201 818.551.5858	New York 500 W. 37th Street, 2nd Floor New York, NY 10018 212.268.8800
---	---

www.broadcaststore.com
Dealer inquiries welcome.

Circle (81) on Free Info Card

The GALLERY

LEIGHTRONIX, INC.

MVP-2000



- MPEG video and audio player with built-in hard drive storage
- Built-in 4x3 video and stereo audio matrix switcher
- PRO-BUS VCR control for up to 16 VCRs
- Stand-alone, full-featured Event Controller operation
- Manageable via network, modem or direct serial connection
- Only one rack unit in height!

Contact **LEIGHTRONIX** for your communications control solution!

- In-house communication networks/CCTV
- Kiosks/information centers ■ LPTV/MATV
- Public/educational/government access cable television

LEIGHTRONIX, INC.

2230 Janco Drive ■ Holt, MI 48842
517-694-8000 ■ fax: 517-694-1600
e-mail: info@leightronix.com ■ www.leightronix.com

Circle (79) on Free Info Card

NEMAL

Cable & Connectors
for the Electronics Industry

(800) 522-2253 • Fax (305) 895-8178
Email: info@nemal.com • Internet: www.nemal.com
Brazil (011) 535-2368

MANUFACTURER AND SUPPLIER OF:

***CABLE**
Audio
Video
Composite
Custom



***CABLE ASSEMBLY**
No minimum
24 hour service
printed shrink tubing
snakes/stage boxes

***CONNECTORS**
BNC
Audio
Triaxial
RF

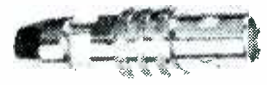

*No minimum order on standard products.

Please call for your copy of our 1998 Cable and Connector Selection Guide and Corporate Video.

PATCH PANELS - REELERS - TOOLING - ASSEMBLY

Immediate shipment worldwide on more than 3000 interconnect products. We also design and manufacture custom cable and assemblies to your specifications.

NAB'98 • Booth 12643

Circle (71) on Free Info Card

8-VSB MODULATOR

- For HDTV Terrestrial Broadcast System
- Conforms to ATSC Specification
- All Solid State Construction for High Reliability
- Digital Implementation for High Performance
- IF or RF Output Options
- Accepts MPEG2 Source Input
- 8-bit Byte Wide Parallel Input Format
- Phase Locks Clock to the MPEG2 Source
- Clock Lock Indicator
- Made in the U.S.A.



KTech Telecommunications, Inc.

15501 San Fernando Mission Blvd.
Suite 100
Mission Hills CA 91345
PH (818) 361-2248 FAX (818) 270-2010
INTERNET: www.ktechtelecom.com
Email: skuh@ktechtelecom.com

Circle (78) on Free Info Card



THE PROFESSIONAL'S SOURCE FOR PHOTO,

FOR ORDERS CALL:

800-947-9928

212-444-5028

OR FAX (24 HOURS):

800-947-9003

212-444-5001

Store & Mail Order Hours:
Sun 10-4:45 • Mon & Tues 9-6
Wed & Thurs 9-7:15
Fri 9-1 • Sat Closed

On the Web: <http://www.bhphotovideo.com>

QUICK DIAL 72

MILLER

Fluid Heads and Tripods

The silky, smooth action of each Miller Fluid Head is the product of the finest quality cast and machined parts functioning together in a fluid environment. They are engineering masterpieces, built to operate under extreme conditions. They're engineered to exceptionally fine tolerances and their mechanisms are protected effectively against ambient moisture and dust.

Miller 20 - Series II Fluid Head

- Dynamic fluid drag control
- Sliding quick release camera platform
- Weights 4 lbs. - handles up to 22 lbs.
- Counterbalance system compensates for nose heavy or tail heavy camera configurations and permits fingertip control of the camera throughout the tilt range
- Includes independent pan and tilt locks, bubble level, dual pan handle carries and integrated 75mm ball leveling



Miller 25-Series II Fluid Head

- 100mm ball level fluid head - Robust, lightweight, low profile design
- Quick release camera platform - Weights 7 lbs. - handles up to 25 lbs.
- Multi-stage fluid drag system and integrated counterbalance system provide ultra-smooth, repeatable pan-and-tilt fluid control and finger-tip camera balance for ENG camcorders, industrial CCD cameras or small studio cameras

#601-Lightweight Tripod

- Weights 4.5 lbs., supports up to 30 lbs.
- Minimum height down to 24", maximum height to 57"
- Extremely portable, folds down to 35"
- Engineered from thermoplastic moldings, diecast alloy and hard anodized tubular alloy.
- Fast, one turn, caprive leg locks
- Includes 75mm (3") ball leveling bowl

#649-2-Stage Tripod

- Two extension sections on each leg. Operates at low levels as well as normal heights without the use of mini legs
- High torsional rigidity, no pan backlash
- Weights 6.8 lbs., supports 50 lbs. • Very portable, folds to 27"
- Includes 75mm (3") ball leveling bowl

- System 20 #338**—Miller 20 Head, 601 Lightweight Tripod, On Ground Spreader
- System 20 ENG #339**—Miller 20 Head, 649 2-Stage Aluminum, On Ground Spreader
- System 25 #500**—Miller 25 Head, 611 Lightweight Tripod, On Ground Spreader
- System 25 ENG #502**—Miller 25 Head, 641 2-Stage Aluminum, On Ground Spreader

Vinten

Vision SD 12

Pan and Tilt Head with Serial Drag

The Vision SD 12 head features "Serial Drag" pan and tilt system. Vision consists of a unique, permanently-sealed fluid drag and an advanced lubricated friction drag. You achieve the smoothest pans and lifts regardless of speed, drag setting and ambient temperature.

- Patented spring-assisted counter-balance system permits perfect "hands-off" camera balance over full 180° of tilt
- Instant drag system breakaway and recovery overcome inertia and friction for excellent "whip pans"
- Consistent drag levels in both pan and tilt axis
- Flick on, flick off pan and tilt capacitor disc brakes
- Greater control, precision, flexibility and "touch"
- Touch activated, time delayed illuminated level bubble
- Working conditions from as low as -40° up to +60°C
- SD 12 weighs 6.6 lbs and supports up to 35 lbs.

Vision 20 Stage ENG and LT Carbon Fibre ENG Tripods

The ultimate in lightweight and innovative tripods, they are available with durable tubular alloy (Model #3513) or the stronger and lighter, axially & spirally wound carbon fiber construction (Model #3523). They incorporate torque safe clamps to provide fast, safe & self-adjusting leg clamps

- "Torque Safe" requires no adjustment. Its unique design adjusts itself when required, eliminating manual adjustment and maintenance and making for a much more reliable clamping system
- New hip joint eliminates play and adds rigidity
- They both feature 100mm leveling bowl, fold down to a compact 28", and support 45 lbs.
- #3513 weighs 6.5 lbs. - #3523 CF (Carbon Fibre) weighs 5.2 lbs.

Vision 12 Systems

Vision 12 systems include #3361-3 SD 12 dual fluid & lubricated friction drag pan/tilt head, single telescoping pan bar & clamp with 100mm ball base

SD-12A System	SD-12D System
SD-12 pan and tilt head	SD-12 pan and tilt head
3518-3 Single stage ENG tripod with 100mm bowl	3513-3 Two-stage ENG tripod with 100mm bowl
3363-3 Lightweight calibrated foot spreader.	3314-3 Heavy-duty calibrated foot spreader

VIN-5ST and VIN-10ST

- Compact & lightweight, they maintain Vision performance and quality
- Provide total stability and durability with payloads up to 33 lbs
- VIN-5ST includes Vision 5LF head, single stage toggle clamp tripod, spreader, and soft case.
- VIN-10ST includes Vision 10LF head, single stage toggle clamp tripod, spreader, and soft case.
- Ideal for the latest generation of dockable and one-piece camcorders
- Compatible with all Vision accessories

QUICK DIAL 74

Canon

IF+ Series 1/2-inch & 2/3-inch Zoom Lenses

Canon's IF+ family of lenses are engineered to meet the needs of the next generation of broadcasting while meeting the standards of today. Besides having the widest wide angle lens available, the IF+ lens series have wider angles at shorter M.O.D. (Minimum Object Distance), provide higher MTF performance and incorporate Hi-UD glass for reduced chromatic aberration. In addition to superb optics they're all designed with Canon's Ergonomic Grip for fatigue-free shooting over an extended time. IF+ lenses are your assurance of unsurpassed quality and performance for today and tomorrow.

J15ax8B

A next generation internal focusing lens with the shortest MOD and widest angle of any standard lens, the J15ax8B IRS/IAS is a standard ENG lens that lets you shoot in tight or restricted areas at the closest minimum object distance ever possible and capture more of the subject. It incorporates all the great features of IF+ lenses including a built-in 2X extender, high MTF performance, Hi-UD glass, square lens hood and Canon's Ergonomic Grip.

J20ax8B IRS/IAS

Excellent for ENG sports and production, the J20ax8B IRS/IAS lets you squeeze in shots from 8mm and still take you all the way out to 320mm with its built-in extender. Incorporates all IF+ features, plus is the only lens (besides the J9Ax5 2B IRS/IAS) with a Vari-Polar lens hood, enabling rotation of attached filters.



JVC GY-X2B 3-CCD S-VHS Camcorder

- Newly designed three 1/2" CCD image sensors deliver 750 lines of horizontal resolution and superb signal-to-noise ratio of 82dB
- Micro-Lens technology provides exceptional sensitivity of F8.0 at 2000 lux and LD.LUX mode lets you shoot with almost no light! Shoot superb footage with excellent color balance at a mere 1.5 lux
- Variable Scan allows flicker-free shooting of a computer screen
- Full Time Auto White circuit lets you move from incandescent to fluorescent to outdoor lighting without changing white balance or the filter wheel
- Quick Record Mode - when turned on the camera is set to the auto iris even if variable shutter
- Shoat continuously from dark room to bright outdoors without having to adjust gain, iris or ND filter
- Dual output system allows camera output to be connected directly to an external recorder

KY-D29 3-CCD Color Video Camera

One of the most sensitive cameras ever developed, the KY-D29 sets the standard for 3-CCD cameras and is also ideally suited for today's digital recording formats. With a sensitivity F11 at 2 000 lux, the KY-D29 can shoot in light as low as a remarkable D 35 lux. It also offers a signal-to-noise ratio of 65 dB (with its DNR function on), and delivers 850 lines of horizontal resolution. The exceptional resolution and sensitivity of the KY-D29 are achieved by three new 760,000 pixel 2/3" interline transfer (IT) CCDs, the highest pixel count in the industry.

All-New Digital Signal Processing

Advanced 14-bit Digital Signal Processing (DSP) and 3-dimensional Digital Noise Reduction (3D DNR) circuitry make this camera ideal for acquisition with today's popular digital formats, especially JVC's revolutionary new Digital-S.

DSP within the camera provides astonishingly crisp, high-quality images, while minimizing analog distortions and noise. DSP also makes the camera more flexible and easy to use. It even smooths the transitions between gain and white balance settings so that viewers won't notice sudden changes of settings while the tape is rolling.

Digital signal processing is enhanced with new 3D digital noise reduction circuitry to make it even more practical. By mixing multiple frames to cancel out random noise, they're using motion detection to minimize lag. JVC's exclusive 3-D DNR produces dramatic results far superior to any other DSP camera.

Super LoLux for Extremely Low Light Shooting

Incredible new Super LoLux technology allows you to obtain a broadcast-quality picture in light as low as 0.35 lux. This extraordinary low light capability is the best ever achieved and is made possible by utilizing JVC's exclusive LoLux dual pixel readout technology (increasing gain by 6dB without introducing noise) while at the same time doubling the pixel readout integration time to 1/30 second.

Versatile Docking Capability

Extremely high quality 4 2/2 digital recordings can be made by docking the KY-D29 to JVC's Digital-S BR-D40 dockable recorder. This digital combo produces recordings far superior to any component analog camcorder or 4 1/1 digital camcorder. The KY-D29 also docks directly to JVC's BR-DV10 DV-format and BR-S425 S-VHS dockable recorders and dock to Betacam SP recorders using an adapter.

Features for a Wide Range of Applications

- The KY-D29 is loaded with a wealth of high-performance features, making it ideal for a wide range of broadcast and professional applications.
- The KY-D29 is continuously takes a black balance setting, and full-time auto white for continuous compensation of color temperature changes, balance the camera in real time, all the time. This allows you to concentrate on getting the shot, and not on adjusting the camera.
- Because different shooting situations require flexibility, the KY-D29 offers selectable vertical resolution. In the Standard Mode, the camera produces 380 TV lines of vertical resolution. However, in the V-Plus high vertical resolution mode, the camera puts out 420 TV lines of vertical resolution, allowing you to increase vertical resolution without sacrificing sensitivity or lag, while maintaining 850 TV lines of horizontal resolution.
- Focusing is easier than ever with Accu-Focus. By momentarily decreasing depth of field, fast & critical focus is achieved instantly.
- Commonly used features can be activated without having to scroll through layers of menus. Features such as shutter control, variable scan, black stretch, black compress, CAB, iris modes, Accu-Focus, DNR and zebra are all menu-free. And for those times when events move so fast it prevents you from making any settings whatsoever, the KY-D29's Full Auto Shooting (FAS) mode controls all of the camera's requiring you control only the focus, zoom and trigger.
- Other camera features include a built-in time/date, built-in zebra level selection switch, an I-stop display in the viewfinder, and a battery remaining display on Anton Bauer battery packs. A Special Black Stretch/Black Compression circuit is also included.



\$500 Rebate thru 12-31-97

Panasonic Broadcast & Television Systems

AG-DP800H UPERCAM

S-VHS 3-CCD Digital Signal Processing Camcorder

- Three high-density 380,000 pixel CCDs with half-pitch pixel offset achieves 750 lines of horizontal resolution, S/N ratio of 60dB and sensitivity of f8 at 2000 lux. Additionally the Frame Interline Transfer (FIT) CCDs minimize vertical smear, even in very bright illumination.
- Digital Signal Processing circuitry provides four valuable benefits:
 - Consistently reliable up-to-spec performance
 - Fine adjustment of a wide range of parameters
 - Memory storage and instant recall of specific settings
 - More flexible and higher quality image processing, easier maintenance
- Two Hi-Fi stereo audio channels with a dynamic range of 80 dB as well as two linear audio channels with Dolby NR
- Has a 26-pin connector for convenient backup recordings using an additional VCR equipped with a 26 or 14-pin connector
- Phantom power can be supplied to an optional mic. Power can be switched off to prevent battery drain when not in use.

Super High Gain mode allows shooting under illumination as low as 2 lux while retaining detail and color balance

Synchro Scan function allows flicker-free shooting of computer monitors. Electronic shutter increments can be set variably from 1/61 seconds to 1/2563 of a second

Built-in internal time code generator lets you record with SMPTE LTC/VTC (Longitudinal/Vertical Interval) time code

wDP-800H "LS" Package:

- DP-800H Supercam 3-CCD camera head with 1.5" electronic viewfinder and Anton Bauer Gold Mount battery plate
- Fujinon 134x7.5 BRM 14:1 servo zoom lens
- CC-S800 soft carrying case
- WV-Q1700 tripod mounting plate

DP-800H "XL" Package:

- DP-800H Supercam 3-CCD camera head w/1.5" electronic viewfinder and Anton Bauer Gold Mount battery plate
- Fujinon 134x7.5 BRM 14:1 servo zoom lens
- CC-H800 Thermodyne hard shell carrying case
- WV-Q7700 tripod mounting plate
- Two Anton Bauer Digital Tripack 14 batteries
- Anton Bauer 2-position quick charger



QUICK DIAL 72

sachtler

VIDEO 14/100 FLUID HEAD

- Sachtler Touch and Go System
- Integrated sliding battery plate
- Strengthened dynamic counterbalance in 2 steps
- Frictionless leak proof fluid damping with three levels of drag
- Vibrationless vertical and horizontal brakes
- Built in bubble for horizontal leveling

HOT POD TRIPOD SERIES

Especially developed for use in ENG, the Hot Pod tripod is the fastest in the world. The central locking system is activated on all three legs at the same time, while the pneumatic center column easily makes it possible to have the lens at a height of over 7 feet. The elevation force of the center column is factory set and doesn't require any setup. When moving to another location it can be carried by its handle located at the center of gravity.

ENG TWO-STAGE TRIPOD SERIES

Sachtler two-stage tripods have an enlarged height range (lower bottom and higher top position) so they are more universal. Legs can be locked in seconds with Sachtler's quick clamping. There are also heavy duty versions for extra stability. The heavy duty aluminum has a 40mm diameter tube vs. 16mm and the heavy duty carbon fiber has a 24mm diameter tube vs. 22mm. All heavy duty two-stage tripods have a folding tripod handle.

NEW! Sachtler CADDY systems

Now Sachtler quality is available to low budget users. The price of a CADDY system includes the new 7-step damped CADDY fluid head, ultra-light but rugged carbon fiber tripod, lightweight spreader and either a soft bag or cover. The CADDY fluid head features an adjustable lens arm, 7-step adjustment for quick counter balance and the self-locking Sachtler Touch and Go System.

- CAD 01 Single-Stage ENG Carbon Fiber System:** CADDY Fluid Head • ENG Single-Stage Carbon Fiber Tripod • SP 100 Lightweight Spreader • Transport Cover 100
- CAD 2A 2-Stage ENG Carbon Fiber System:** CADDY Fluid Head • ENG 2-Stage Carbon Fiber Tripod • SP 100 Lightweight Spreader • Soft padded ENG Bag

Libec MATTHEWS

P100 Portable Pneumatic Pedestal

The P100 is a small size pedestal that offers great flexibility without taking up too much space. Featuring an advanced air pressure system, the P100 smoothly handles loads up to 60lbs., easily accommodating professional cameras used in a studio, ideal for CATV, small studios, event and wedding video as well as all kinds of industrial and institutional applications.

Air Pressure System:

- Air pump attached to the main body frame allows air to be pumped into a column anywhere and anytime - even when the camera is mounted on the pedestal. This allows you to check and adjust the air pressure while using the pedestal and avoid over-tilting of air.
- Air pressure can be gradually adjusted by discharging air through a bleed valve when too much air has been pumped into the column.
- There is also a relief valve that automatically lets air out when air pressure inside the column exceeds the uniform value, bringing it below the uniform value.
- Large double wheel 5 casters allow the P100 to move smoothly and quickly. Wheels and caster axles are easily fixed by the double stopper system.
- A track lock mechanism locks the wheels of the pedestal so that it only moves in a desired position.
- Cable guards prevent the casters from rolling over and becoming tangled in camera cables when the tripod is moved around in a studio.
- Large steering wheel affords greater ease in handling when shifting columns up and down or when moving the pedestal.
- Maximum and minimum height is 31" to 61". By attaching the optional LA-100 Low Angle Adapter to the dolly for shooting at low angles (height from the ground to mount is only 10").
- The column and dolly can be quickly disassembled for convenient transport. The column weighs 18 lbs. and the dolly 16 lbs.

H80 Professional Fluid Head

A premium fluid head, the H80 incorporates a patented drag control system that provides the smoothest pan and tilt available.

- Unlike conventional drag systems that have click stops at predetermined points, Libec's Continuous Drag Control System provides infinite control of drag tension allowing smooth, rapid movements as well as very slow movements.
- Continuous Counter Balance Control System provides optimum camera balance with tilt angles of +90° or -90°.
- Designed to withstand the most demanding environments, the H80 is fully operational even in temperatures as low as -22°F.
- H80 supports up to 37 lbs. and has a 100mm claw ball to simplify camera leveling.



H70 Professional Fluid Head

The H70's patented counter-balance mechanism supports various operating configurations including stand alone cameras, camcorders and studio cameras with large viewfinders. Perfect balance can be obtained with settings from 0 to 3, depending on camera weight (from 15 to 33 lbs.) and tilt angle.

- Sliding balance plate features a locking mechanism and allow a total of 4" (100mm) of travel for camera balance. Has a 100mm claw ball.

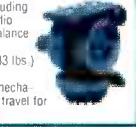

FOR A FREE MONTHLY CATALOG, CALL 800-947-6933, 212-444-6633 OR WRITE



TO INQUIRE ABOUT YOUR ORDER:
 800 221-5743 • 212 239-7765
 OR FAX 24 HOURS:
 800 947-2215 • 212 239-7549

New Address:
 420 Ninth Ave. (Bet. 33rd & 34th St.)
 New York, N.Y. 10001



QUICK DIAL 74 NRG

POWER VEST SYSTEM

The Power Vest combines the comfort and convenience of a photo-journalist style vest with the power of NRG's highest capacity power belt. Available in two styles, the **Field** model is designed for use in a field production environment while the **Event** model is for shooting events where style is everything. The Field model is ruggedly constructed from black high density weatherized ballistic nylon and has an open-cut style that makes it comfortable to wear in a variety of climates. Also has a highly adjustable design to fit almost any physical proportion.

- Internal and external pockets for blank tapes and accessories, a clear insert window for a press pass or business card, D-rings for cables and microphones, and an integral padded camera rest on the right shoulder.
- Cleverly concealed inside the vest is your choice of 12-volt 86 watt hour or 13.2-volt 95 watt nicad cell packs.
- A control box on the front features dual power outputs (dual cigarette, dual XLR or mixed).
- 7-stage "fuel-gauge" charge status indication and auto-reset short-circuit protection.

The **Event** model is very similar to the **Field** except in place of rugged fabric and pockets it features shoulder to sternum black satin like fabric. Work surfaces of black, the **Event** model is indistinguishable from a formal dress vest and it still retains interior and low exterior pockets. Both vests include 300-series charger (12 hrs.) and can be used with the optional Intelliclick Fast Charger (2 hrs.)



POWER CAN SERIES

For powering single or multiple pieces of 12V DC equipment for extended periods of time, nothing beats the power and convenience of NRG's Power-Can Series. It integrates an ultra-high capacity, high-temperature-curable UPS type lead acid power cell, a world-wide fast charger, and computer-controlled monitoring system with display in a single, rugged package. Connect up to four pieces of equipment simultaneously. From a midnight emergency scene to a wedding reception in the park, the Power-Can delivers ample power for extended running time.

- Recharge in 8-10 hours by simply plugging the Power-Can into standard AC power (90-250V AC).
- LCD display shows charge status, voltage etc.
- An optional "Power Dial" allows the Power-Can to be rolled for easy transport.
- Available in 18, 28 and 40 amp versions, each Power-Can has either four cigarette lighter connectors, four 4-pin XLR connectors or two of each.



HORITA

BSG-50

Blackburst/Sync/Tone Generator

The BSG-50 provides an economical means for generating the most common RS-170A video timing signals used to operate various video switchers, effects generators, TBCs, VCRs, cameras and video edit controllers.

- 6 BNC video/pulse outputs
- Now available, 6 blackburst, 4 sync, 2 subcarrier
- Each sync output individually settable for composite sync, composite blanking, H-drive, or V-drive
- Separate buffer for each output—maximum signal isolation
- 1KHz, 0dB sinewave audio tone output, locked to video
- Outputs can easily be configured to meet specific user and equipment needs.

*269

CSG-50

Color Bar/Sync/Tone Generator

Generates full-SMPTE color bars, blackburst and composite sync signals.

- Built-in timer can automatically switch video output from color bars to color black after 30 or 60 seconds. Easy and convenient for producing tape leaders and stripping tapes with color bars and black.
- Front panel selection of full-field or SMPTE color bar patterns or colorblack (blackburst) video output.
- Includes crystal-controlled, 1KHz, 0dB audio tone output.
- Outputs video, sync, ref frame, 1KHz, 0dB.
- Audio tone switches to silence and color bars change to black when using 30/60 second timer.
- Fully RS-170A SC/PH phased and always correct.
- No adjustment required.

*349

WE STOCK THE FULL LINE OF HORITA PRODUCTS INCLUDING:

- WG-50 - Window Dub Inserter
- TG-50 - Generator/Inserter
- TRG-50 - Generator/Inserters/Search Speed Reader
- TRG-50PC - Has all of the above plus RS-232 control.
- VG-50 - VITC Generator, LTC-VITC Translator
- VLT-50 - VITC to LTC Translator
- VLT-50PC - VITC to LTC Translator / RS-232 Control
- RLT-50 - Hi8 (EVD-9000-9500) to LTC Translator
- RTS-50 - NTSC Test Signal Generator
- SCT-50 - Serial Control Titrer "Industrial" CG Time-Date Stamp, Time Code Captioning
- SAG-50 - Sale Area, Convergence Pattern and Oscilloscope Line Trigger and Generator

QUICK DIAL 72 GLIDECAM INDUSTRIES

V-16 AND V-20

Professional Camera Stabilization Systems

The GLIDECAM V-16 and V-20 Camera Stabilization Systems allow you to walk, run, go up and down stairs, shoot from moving vehicles and travel over uneven terrain without any camera instability or shake. Designed primarily for professional video and 16mm motion picture cameras, the Glidecam V-16 stabilizes cameras weighing from 10 to 20 pounds and the V-20 from 15 to 26 pounds. They are both perfect for shooting the type of ultra-smooth tracking shots that take your audience's and client's breath away — instantly adding high production value to every scene. With either of the "V" series stabilizers you'll be able to offer the type of professional shooting techniques that were previously available only to clients with full budgets.



The Glidecam Support Vest

The lightweight and comfortable Support Vest can be adjusted to fit a wide range of operators. High endurance, closed cell, EVA foam padding and integral T6 aluminum alloy create a vest which can hold and evenly distribute the weight of the Glidecam V-16 and V-20 systems across the operator's shoulders, back, and hips. For safety, quick release, high impact buckles allow the vest to be removed quickly.

The Three Axis Gimble

A free floating, precision Gimble incorporating Integrally Stilted Bearings creates the super-smooth and pivotal connections between the front end of the Dyna-Elastic Arm and the Camera Mounting Assembly. The Three Axis Gimble provides the operator with finger tip control over fluid tilting, panning and rolling. A locking mechanism allows the Gimble to be placed at varying positions on the Central Support Post. Moving the Gimble effectively adjusts the Systems Center of Gravity. The upper portion of the Sled's central support post includes guide markings. These markings allow for accurate gimble positioning.

The Dyna-Elastic Arm

The Exoskeletal, Dyna-Elastic Support Arm is designed to counteract the weight of the combined camera and Camera Mounting Assembly by employing high carbon alloy springs. The arm may be boomed up and down, as well as pivoted in and out, and side to side. It is the combined booming and pivoting action of the arm which creates the shock absorption necessary for ultra-smooth camera movement and mobility. The spring force is field adjustable to allow for varying camera weights. For safety, a Dual-Spring design is employed to reduce spring failure damage.

QUICK DIAL 74

lowel

ViP Video Lighting System

Designed for video, ViP systems provide 55 to 500 watt capabilities, powered by AC or DC. Mount one on-camera, on-stand, or hand hold it. Some ViPs feature adjustable beam angles. All are light weight and convention cooled.

V-light

Efficient enough to light a small room yet small enough to fit in a large pocket, the V-light provides a broad key light, back light or fill light (with umbrella or gel).

- Extreme wide-angle multi-use halogen source
- Mounts on stand, clamps, boom, wall, window, door-top
- 500 watt AC powered (lamps not included)

i-light

Battery powered light provides excellent fill light, eye-light, or high-lights, with good contrast control for news and documentary shooting.

- Small and lightweight (18 oz.) for on-camera use
- Multi-use 6.1 focusing range with 1100 lamp (lamps not included)
- 55 or 100 watt (12/14 volts DC)
- Includes cig. lighter connector or optional 4-pin XLR

Pro-light

Can be used as a low-level key or accent light, fill light (with diffusion), backlight or background light.

- Multi-use halogen, focusing/tilting controlled with one hand
- 125 or 250 watt AC, 100 watt 12 volt, or 200 watt 30 volt DC
- Optional cigarette, 4-pin and 5-pin XLR connectors
- Lamps not included

Complete line of Lowel lights, lighting kits and accessories in stock... Call

antonbauer

Logic Series DIGITAL

Gold Mount Batteries

The Logic Series DIGITAL batteries are acknowledged to be the most advanced in the rechargeable battery industry. In addition to the comprehensive sensors integral to all Logic Series batteries, each DIGITAL battery has a built-in microprocessor that communicates directly with Anton/Bauer InterActive chargers, creating significant new benchmarks for reliability, performance, and life. They also complete the communications network between battery, charger and camera. With the network in place, DIGITAL batteries deliver the feature most requested by cameramen: a reliable and accurate indication of remaining battery power.

DIGITAL PRO PACS

The ultimate professional video battery and recommended for all applications. The premium heavy duty Digital Pro Pac cell is designed to deliver long life and high performance even under higher current loads and adverse conditions. Its size and weight creates perfect shoulder balance with all camcorders.

- **DIGITAL PRO PAC 14 LOGIC SERIES NICAD BATTERY**
14.4 v 60 Watt Hours 5 1/8 lbs. Run time: 2 hours @ 27 watts, 3 hrs @ 18 watts
- **DIGITAL PRO PAC 13 LOGIC SERIES NICAD BATTERY**
13.2v 55 Watt Hours 4 3/4 lbs. Run time: 2 hours @ 25 watts, 3 hours @ 17 watts

DIGITAL TRIMPAC

Extremely small and light weight, the Digital Trimpac still has more effective energy than two NiPc style slide-in batteries. High voltage design and Logic Series technology eliminate the problems that cripple conventional 12 volt slide-in type batteries. The professional choice for applications drawing less than 24 watts.

- **DIGITAL TRIMPAC 14 LOGIC SERIES NICAD BATTERY**
14.4 v 43 Watt Hours 2.3/4 lbs. Run time: 2 hours @ 20 watts, 3 hours @ 13 watts

InterActive 2000 Power/Chargers

Four-Position Power/Chargers

The lightest (and simplest) full featured four position chargers ever. They can fast charge four Gold Mount batteries and can be expanded to charge up to eight. They also offer power from any AC main, all in a package the size of a notebook computer and weighing a mere four lbs! The 40 watt 2401 can charge ProPacs in two hours and Trimpacs in one. Add the Diagnostic/Discharge module and the QUAD 2401 becomes an all purpose power and test system. The 70 watt QUAD 2702 bundles all Power/Charger features in the ultimate professional power system.



Dual 2702/2401 Two-Position Power/Chargers

The QUAD 2701 (70 watt) and 2401 (40 watt) are sleek, rugged and economical two position Power/Chargers that have all the features of InterActive 2000 technology including DC camera output and LCD display. The DUAL 2701 will charge any Gold Mount battery in one hour. The DUAL 2401 charges ProPac batteries in two hours and Trimpacs in one. Their compact, lightweight package design makes them the ultimate travel Power/Chargers. They can also be upgraded with the Diagnostic/Discharge Module and/or with the Expansion Charge Modules to charge up to six batteries of any type.



PROFESSIONAL VIDEO TAPES



Professional Grade VHS

PG-30	2.39	PG-60	2.59	PG-120	2.79
Superior Grade Double Coated VHS					
SG-30	3.39	SG-60	3.99	SG-120	4.49
H4715 S-VHS Double Coated					
ST-30	6.99	ST-60	7.49	ST-120	7.99

M221 Hi 8 Double Coated

Metal Particles		Metal Evaporated	
P630HMP	4.99	E630HME	8.39
P660HMP	6.49	E660HME	10.49
P6120HMP	8.49	E6120HME	13.99

M3215P Metal Betacam (Box)

05S	17.95	10S	18.49	20S	19.95
30S	22.95	60L	31.95	90L	49.95

DP121 DVC PRO

12M (Med)	8.29	23M	9.99	33M	12.99
63M	22.49	64L (Lg.)	23.99	94L	33.99
123L					43.99

maxell

Hi8 Metal Particle (XRM)

P6-120 XRM				6.59
------------	--	--	--	------

Broadcast Quality Hi8 Metal Particle

P6-30 HM BQ	5.39	P6-60 HM BQ	6.09
P6-120 HM BQ			7.99

P/1 PLUS VHS

T-30 Plus	1.69	T-60 Plus	1.99	T-90 Plus	2.09
T-120 Plus			2.19	T-160 Plus	2.69

HGX-PLUS VHS (Box)

HGXT-60 Plus	2.69	HGXT-120 Plus	2.99
HGXT-160 Plus			3.99

BQ Broadcast Quality VHS (Box)

T-30 BQ	5.49	T-60 BQ	6.19	T-120 BQ	7.39
---------	------	---------	------	----------	------

BQ Professional S-VHS (In Box)

ST-31 BQ	7.19	ST-62 BQ	7.99
ST-126 BQ	8.39	ST-182 BQ	17.49

Betacam SP

B5MSP	15.75	B10MSP	17.75	B20MSP	19.75
B30MSP	20.75	B60MLSP	29.75	B90MLSP	46.45

Panasonic

Mini DV Tape

AY DVM-30	9.99	AY DVM-60	11.99
-----------	------	-----------	-------

DVCPRO

AJ-P12M (Medium)	8.49	AJ-P23M	9.99
AJ-P33M	13.49	AJ-P63M	22.99
AJ-P64L (Large)	24.99	AJ-P94L	34.99
AJ-P123L			44.99

Hi-8 Professional Metal Video Cassettes

P6-30 HMPX	4.59	P6-30 HMEC	7.99
P6-60 HMPX	6.59	P6-60 HMEC	11.49
P6-120 HMPX	8.89	P6-120 HMEC	15.49

Hi-8 Metal Evaporated Editor (HMEAD)

E6-30 HMEAD	10.49	E6-60 HMEAD	14.89
E6-120 HMEAD			20.19

PR Series Professional Grade VHS

T-30PR	2.39	T-60PR	2.59	T-120PR	2.78
--------	------	--------	------	---------	------

PM Series Premier Grade Professional VHS

T-30PM	3.49	T-60PM	3.99	T-120PM	4.79
--------	------	--------	------	---------	------

BA Series Premier Hi-Grade Broadcast VHS (In Box)

T-30BA	3.59	T-60BA	3.99	T-120BA	4.79
--------	------	--------	------	---------	------

MD Master Quality S-VHS (In Box)

MOST-30	7.49	MOST-60	7.99	MOST-120	8.39
---------	------	---------	------	----------	------

BRS 3/4" U-matic Broadcast Standard (In Box)

KCS-10 BRS (mini)	8.29	KCS-20 BRS (mini)	8.99
KCA-10 BRS	8.19	KCA-20 BRS	8.69
KCA-30 BRS	9.69	KCA-60 BRS	13.39

BRS 3/4" U-matic Broadcast Master (In Box)

KCS-10 XBR (mini)	8.29	KCS-20 XBR (mini)	10.19
KCA-10 XBR	9.29	KCA-20 XBR	10.69
KCA-30 XBR	11.99	KCA-60 XBR	15.69

KSP 3/4" U-matic SP Broadcast (In Box)

KSP-S10 (mini)	9.59	KSP-S20 (mini)	11.09
KSP-10	10.09	KSP-20	11.59
KSP-30	12.99	KSP-60	16.99

BCT Metal Betacam SP Broadcast Master (Box)

BCT-5M (small)	14.99	BCT-10M (small)	15.99
BCT-20M (small)	17.99	BCT-30M (small)	18.99
BCT-30M (1/4)	21.99	BCT-60M	27.99
BCT-90M			41.99

Mini DV Tape

DVM-30EXM w/Chip	15.99	DVM-60EXM w/Chip	19.95
DVM-30EX "No Chip"	12.99	DVM-60EX "No Chip"	14.99
DVM-30PR "No Chip"	9.99	DVM-60PR "No Chip"	12.99

Full Size DV Tape with Memory Chip

DV-120MEM	29.95	DV-180MEM	34.95
-----------	-------	-----------	-------

PVD Series Professional DVCMC Tape

PDVM-12ME (Mini)	24.95	PDVM-22ME (Mini)	26.95
PDVM-32ME (Mini)	29.95	PDVM-40ME (Mini)	31.95
PDV-64ME (Standard)	39.95	PDV-94ME (Standard)	44.95
PDV-124ME (Standard)	49.95	PDV-184ME (Standard)	59.95

SEVEN DAY CUSTOMER SATISFACTION GUARANTEE

Circle (68) on Free Info Card

FOR ORDERS CALL:

800-947-9928
212-444-5028

OR FAX (24 HOURS):

800-947-9003
212-444-5001

**MOST ORDERS SHIPPED
WITHIN 24 HOURS**

OVERNIGHT SERVICE AVAILABLE

On the Web: <http://www.bhphotovideo.com>



Panasonic

WJ-MX50 Digital A/V Mixer

- Four input switcher and any two sources can be routed to the program buses
- Two-channel digital frame synchronization permits special effects in each A/B bus
- Combination of 7 basic patterns and other effects creates 287 wipe patterns
- External edit control input for RS-232 or RS-422 serial controls. Also has GPI input
- Wipe boundary effects: soft/border (bold, 8 background colors available)
- Digital effects: strobe, still, mosaic, negative/positive, paint, monochrome, strobe, trail, and AV synchro
- Real-Time compression - entire source image is compressed inside a wipe pattern
- Scene Grabber - move a pattern while upholding the initially trimmed-in picture integrity

- Non-Additive Mix (NAM) - selects between A and B sources, passing only the signal with the highest luminance value
- Fade-in and fade-out video, audio, titles individually or synchronously faded
- Down stream keyer with selectable sources from character generator or external camera
- Eight separate memories enable instant recall of frequently used effects
- 8 preset effects including: Mosaic Mix, Position Stream, Corkscrew, Bounce, Flip, Shutter, Vibrate, and Satellite
- Audio mixing capability of 5 sources with 5 audio level adjustments



BT-S1360Y

13" Color Video Production Monitor

The BT-S1360Y is a full-function, professional 13" production monitor with a wealth of features. They include: superb 420-line horizontal resolution, S-Video input and output, advanced automatic white balance circuitry, blue-only mode, underscan and pulse-cross. All this, housed in a rugged, rack mountable metal-hybrid cabinet. So, for long-term reliability in any professional application, the BT-S1360Y is the ideal choice.

- Incorporates advanced, proprietary white balance circuitry that stabilizes white balance to provide outstanding picture performance automatically
- S-Video input and advanced video circuit technology provides a remarkably sharp picture with over 420 lines of horizontal resolution
- External sync inputs and outputs provide for synchronization with other equipment fed with the same sync signal
- Blue Only mode plus Chroma selection provide a monochrome image for fine adjustment of contrast, brightness, chromance & hue
- Pulse Cross - displays horizontal and vertical intervals at the center of the screen so you can examine data in the blanking area and also sync/burst timing
- Two sets of video/audio inputs and outputs

- Underscan - Strikins the scanned area of the picture tube approximately 5% enabling the entire active picture area to be displayed. Let us detect intruding cameras and mike booms
- Switchable color temperatures of 6500°K (broadcast standard) or 9300°K (for pleasing picture)
- Built-in speaker and headphone jack
- Rack-mountable with optional BA-131 brackets.



BT-S 1360Y Olympic Demo Special!
We have a limited stock of BT-S1360Y monitors that were used by Panasonic exclusively at the 1996 Olympics in Atlanta. Used only by Panasonic engineers in broadcasting the summer games, these monitors are like new.
Demo Special \$599
(\$400 less than our regular selling price on this monitor)

SONY

PVM-14N1U/14N2U & 20N1U/20N2U 13" & 19" Presentation Monitors

With high quality performance and flexibility, Sony's presentation monitors are ideal for any environment. They use Sony's legendary Trinitron CRT and Beam Current Feedback Circuit for high resolution of 500 lines as well as stable color reproduction. They also accept worldwide video signals, have a built-in speaker and are rack mountable. Four models, the PVM-14N1U/20N1U are designed for simple picture viewing, the PVM-14N2U and 20N2U add RGB input and switchable aspect ratio for more sophisticated applications.

- They Feature:**
 - 500 lines of resolution to match DV, DVCAM and DVCPRO recording capabilities
 - Beam Current Feedback for color temperature stability
 - They handle four worldwide color systems: NTSC, NTSC 4.43, PAL, and SECAM
 - On screen display in five languages: Picture adjustments (chroma, phase, contrast, brightness) and setup adjustments (volume, aspect ratio) are displayed as easy-to-read on screen menus
 - Built-in speaker for small audiences without the expense of an external sound system

- Closed captioning is available with the optional BKM-104 Caption Vision Board
- Designed with a sturdy metal cabinet for stability, durability and rack mounting. The 13-inch series mount on a 19-inch rack with the MB-502B Rack Mount Bracket. The 19-inch monitors with the SLR-103A Slide Rail Kit
- PVM-14N2U/20N2U Only:**
 - Remote Control (Last Input Switch) - Contact closure remote control allows you to wire a remote to an existing system so that the monitor's input can be remotely controlled to switch between the last previously selected input and the current input
 - With the PVM-14N2U and PVM-20N2U Series, the aspect ratio is switchable between 4:3 and 16:9 simply by pressing a button.



PVM-14M2U/14M4U & 20M2U/20M4U 13" & 19" Production Monitors

Sony's best production monitors ever, the PVM-M Series provide stunning picture quality, ease of use and a range of optional functions. They are identical except that the "M4" models incorporate Sony's state-of-the-art HR Trinitron CRT display technology and have SMPTE C phosphors instead of P22

- HR Trinitron CRT enables the PVM-14M4U and 20M4U to display an incredible 800 lines of horizontal resolution. The PVM-14M2U and 20M2U use an aperture grille dot pitch of 0.25mm to offer 600 lines of resolution. M4 models also use SMPTE-C phosphors for the most critical evaluation of any color subject.
- Dark limit for a higher contrast ratio (black to white) and crisper, sharper looking edges
- Beam Current Feedback Circuit + 4.3/16.9 switchable aspect ratio
- Each has two composite (BNC), one S-Video and component input (R-Y-B-Y, analog RGB) for flexibility. For more accurate color reproduction, the component level can be adjusted according to the input system. Optional serial digital interfaces kit BKM-101C (video) and BKM-102 (audio) for SMPTE 259M component serial input
- True multi-system monitors: they are equipped to handle four color system signals: NTSC, NTSC 4.43, PAL, and SECAM

- External sync input and output for synchronization with other equipment. Can be set so that it will automatically switch according to the input selected
- Switchable color temp: 6500K (broadcast), 9300K (pleasing picture). User preset: 3200K to 10000K
- Underscan and H/V delay capability in underscan mode: the entire active picture area is displayed, allowing you to view the entire image and check the picture edges. H/V delay allows viewing of the blanking area and sync/burst timing
- Using color bars as a reference. Chroma/Phase setup mode facilitates the complex, delicate procedure of monitor adjustment. Especially convenient when used with computer-based editing systems
- On-screen menus for monitor adjustment/operation
- Parallel remote control and Tally via 20-pin connector
- Sub control mode allows fine, on-screen adjustment of the center "defeat" value of the contrast, brightness, chroma and phase knobs
- PVM-14M2U/M4U mount on a 19-inch rack with the MB-502B Rack Mount Bracket. The 20M2U/M4U monitors mount with the SLR-103A Slide Rail Kit



SENNHEISER

Condenser Microphones

Unlike traditional condenser microphones, the capacitive transducer in Sennheiser condenser microphones is part of a tuned RF-discriminator circuit. Its output is a relatively low impedance audio signal which allows further processing by conventional bi-polar low noise solid state circuits. Sennheiser microphones achieve a balanced floating output without the need for audio transformers, and insure a fast, distortion-free response to audio transients over an extended frequency range. The RF-design yields exceptionally low noise levels and is virtually immune to humidity and moisture. The comparatively low RF-voltage across the elements of the transducer also eliminates arcing and DC-bias creeping currents. Sennheiser employs RF-technology to control residual microphone noise. Optimizing the transducer's acoustic impedance results in a further improvement in low noise performance. Sennheiser studio condenser microphones operating according to this RF-principle have proven their superior ruggedness and reliability in the past decades under every conceivable environmental condition.



MKH 40 P48U3

Cardioid

- Highly versatile, low distortion push-pull element
- Transformerless RF condenser, high output level
- Transparent response, switchable proximity EQ. Recommended for most situations, including digital recording, overdubbing vocals, percussive sound, acoustic guitars, piano, brass and string instruments. Mid-Side (M-S) stereo, and conventional X-Y stereo. Vocals when used with a pop-screen.

MKH 60 P48U3

Short Shotgun

- Short interference tube RF condenser
- Lightweight metal alloy, transformerless, low noise, symmetrical capsule design
- Smooth off-axis frequency response. Handles extremely high SPL (135 dB) ideal for broadcasting, film, video, sports recording, interviewing in crowded or noisy environments. Excellent for studio voiceovers

Digital Multi-Track Recording TASCAM DA-88

- ATF system ensures no tracking errors or loss of synchronization. All eight tracks of audio are perfectly synchronized. It also guarantees perfect tracking and synchronization between all audio tracks on all cascaded decks - whether you have one deck or sixteen (up to 128 tracks!)
- Incoming audio is digitized by the on-board 16-bit D/A at either 44.1 or 48KHz. The frequency response is flat from 20Hz to 20KHz with the dynamic range exceeds 92dB
- Execute seamless Punch-ins and Punch-outs. This feature offers programmable digital crossfades, as well as the ability to insert new material accurately into tight spots. You can even delay individual tracks to generate special effects or compensate for poor timing.



SONY PCM-800

- Flawless sound quality, outstanding reliability and professional audio interfacing with AES/EBU digital I/O and XLR analog I/O connections.
- Combines audio functions such as precise auto punch in/out, digital cross fade technology, external synchronization with SMPTE/EBU time code and selectable sampling frequencies of 44.1 and 48KHz
- Shuttle dial for precise tape control, variable speed playback of 6% to 0.1% increments and a flat frequency response from 20Hz to 20KHz
- Operate up to 16 PCM-800's in perfect sync with optional RCC-S1 sync cables for up to 128 channels of digital audio recording
- Optional DABK-801 Sync Board provides SMPTE/EBU time code generation and chase sync. It locks to the incoming time code with subframe accurate offset - ideal for audio-follow-video applications. Also synchronizes to external video reference signal
- Optional RM-D800 provides comprehensive remote control over all PCM-800 functions. The RM-D800 can control up to six units for up to 48 channels of digital audio.



ALESIS adat xt

8-Track Digital Audio Recorder

- An incredibly affordable tool, the ADAT-XT sets the standard in modular digital multi-track recording. With new features and enhanced capabilities, the ADAT-XT operates up to four times faster than the original ADAT, offers an intelligent software-controlled tape transport and provides onboard digital editing and flexible automation
- Onboard 10-point autolocate system provides quick access to multiple tape locations. Four specialized locate points make your recording sessions quicker and easier
- Includes remote control with transport and locate functions offers a footswitch jack for hands-free punch-in
- Advanced transport software continuously monitors autolocate performance and the head constantly reads ADAT's built-in sample accurate time code - even in fast wind modes
- Dynamic Braking software lets the transport quickly wind to locate points while gently treating the tape
- Servo-balanced 56-pin ELCO connector operates at 44dB to interface with consoles with +4 dB ball/unbalanced inputs/outputs. Also unbalanced -10dB inputs/outputs (phono connectors)
- Has an electronic patch bay built-in so it can be used with stereo and 4-bus consoles
- Make flawless copy/paste digital edits between machines or even within a single unit. Track Copy feature makes a digital clone of any track (or group of tracks) and copies it to any other track (or group) on the same recorder. This allows you to assemble composite tracks for digital editing.



ANTEX

StudioCard

4-Channel Digital Audio Card for Windows

- The next generation in digital audio for the desktop, StudioCard is a premium-quality digital audio adapter with advanced features, studio-quality specs and professional connections. Unmatched in quality, flexibility and expandability, it features 4 tracks of audio sound and real-time digital mixing capability making it the ideal board for musicians who want digital multi-tracking and mixing on their PC, or producers looking for a versatile board for post-production digital audio editing and uncompromised audio quality. StudioCard is Windows 95' plug and play compatible plus includes drivers for Windows NT as well.
- Key to StudioCard's amazing sound is the marriage of a low noise analog I/D section and high quality A/D and D/A converters. A PCI-based 32-bit memory mapped board, it delivers less than 0.003% total harmonic distortion and 92dB dynamic range. Plus, a PLL-based sample clock generator that can be locked to an assortment of clock sources
- Incorporates a programmable 32-bit 40 MHz DSP and pro connections like 4 independent balanced analog I/Os (4+4bu or 10 rBv) and AES/EBU or S/PDIF digital I/O. It also offers a MIDI port with deep buffers and time stamping. No matter which type of equipment you have StudioCard will integrate into standard studio environments
- Compatible with film, video or MIDI. StudioCard offers synchronization via SMPTE, LTC, word and pixel clocks, and composite video. Plus, the StudioCard not only reads SMPTE timecode, but generates it as well
- Unique to the Antex design is StudioCard's multiple adapter capability. This means you can install multiple StudioCards in a single computer for up to 16-track recording. Start with one StudioCard today - add more StudioCards tomorrow. Also included is an on-board SPx expansion connector for plugging in optional daughtercards for compression or enhanced DSP operations



VIDEO and PRO AUDIO



TO INQUIRE ABOUT YOUR ORDER:
 800 221-5743 • 212 239-7765
 OR FAX 24 HOURS:
 800 947-2215 • 212 239-7549

New Address:
 420 Ninth Ave. (Bet. 33rd & 34th St.)
 New York, N.Y. 10001

KNOX VIDEO

RS4x4/8x8/16x16/16x8/12x2 Video/Audio Matrix Routing Switchers

Knox's family of high performance, 3-channel routing switchers are extremely versatile easy-to-use and very affordable. Housed in an ultra-thin rackmount chassis they accept and route (on the vertical interval) virtually any video signal, including off-the-air and non-timebase corrected video. They also route balanced or unbalanced stereo audio. The audio follows the video or you can route the audio separately (breakaway audio). Each of the switchers offers easy manual control via front panel operation. They can also be controlled remotely by a computer, a Knox RS Remote Controller, or by a Knox Remote Keypad via their RS-232 port. Front panel LEDs indicate the current routed pattern at all times, and an internal battery holds and restores current patterns in case of power interruption. Totally versatile, Knox switchers are ideal for applications such as studio-feed control and switcher input control, plus they have an internal timer allowing timed sequence of patterns for surveillance applications as well.

- Accept and route virtually any one-volt NTSC or PAL video signal input—including off-the-air and non-timebase corrected—to any or all video outputs
- Accept and route two-volt mono or stereo unbalanced audio inputs to any or all audio outputs
- Video and audio inputs can be routed independently (breakaway stereo audio). They don't need to have the same destination
- Can store and recall preset cross-point patterns. (Not available on RS12x2.)
- Front panel key-pad operation allows easy manual operation.
- Can also be controlled via RS-232 interface with optional RS Remote Controller or Remote Keypad.
- Internal timer allows manual or automatic timed sequence of patterns—ideal for surveillance applications.
- Front panel LED indicators display the present routing patterns at all times.

- An internal battery remembers and restores the current pattern in case of power failure.
- Internal vertical interval switching firmware allows on-air switching
- Housed in a thin profile rackmount 1" chassis
- Also except the RS12x2 are available in S-Video versions with/without audio.
- Models RS16x8 and RS16x16 are also available in RGB/composite version
- With optional Remote Video Readout, the RS16x8 and RS16x16 can display active routes on a monitor at remote locations, via a composite signal from a BNC connector on the rear panel.
- The RS4x4, RS8x8 and RS16x16 are also available with balanced stereo audio. They operate at 660 ohms and handle the full range of balanced audio up to +4 dB with professional quick-connect, self-locking, bare-wire connectors.

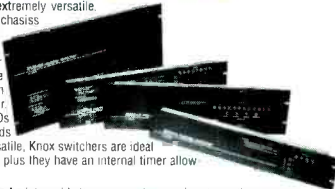

VIDEONICS POWER™ Animated Postscript Character and Graphics Generator

The most advanced character generator ever designed for video production, multimedia and industrial applications, PowerScript delivers the huge range of titles and graphics supported by PostScript display technology, plus animation, effects, transparency and color keying. It features two GPI inputs, anti-aliasing, 17.5 ns (nanosecond) pixel resolution and 4.2.2 broadcast-quality video. It also offers high-speed RISC processing to provide real-time Level 2 PostScript imaging and fast rendering—even with the most complex images. The PowerScript works stand alone or with a computer, has a built-in TBC, offers a powerful and intuitive interface, and is suitable for the desktop or can be rackmounted.



- Powerful Character Generator**
 - Choose from 35 built-in fonts or download PostScript fonts from your PC. PowerScript's high-speed RISC processor provides real-time PostScript imaging.
 - Characters can be rotated at any angle, scaled to any size, stretched horizontally or vertically.
 - Styles include variable bold and italic; underline and shadow (drop shadow, variable displacement and opacity). Each character can be adjusted separately.
 - Text can be positioned anywhere on the screen or automatically centered, vertically or horizontally. Left, right, top, bottom and center justification is also provided.
 - Characters are automatically kerned, using the font's standard kerning information. Spacing is highly flexible with variable word and letter spacing and line spacing (leading).
- Intuitive User Interface**
 - Built-in real-time object-based drawing tool and text editor—no computer or software required. Design can be done ahead of time and displayed later, or can be done on the fly.
 - Supplied keyboard and mouse are used with easy on-screen menus to place and modify graphics and text.
 - Change fonts, colors, and other characters instantly.
- Transparency and Colors**
 - Characters can be made transparent (0-100%) over video, other characters and graphics with 64 levels of transparency.
 - Opaque characters can use over 8,000 colors.
 - Different colors can be used for fill and outline (variable width) as well as each letter and each graphic.
- Expansion Capabilities**
 - Although PowerScript operates on its own, you can still add peripherals and connect to a computer or network. Two PC-card slots allow the addition of non-volatile flash-RAM and Ethernet cards. RS-232 port allows connection to desktop computers for folder storage and downloading of fonts or graphics from a PC.

- Roll, Scrawl, Animation, Effects**
 - Variable speed roll, crawl and push (slide) in all directions.
 - Every text object, graphic and logo can be animated. Complex animations include having elements follow paths, bounce, etc.
 - Elements can change outline and/or fill color, transparency, position as they move and results are displayed in real time.
 - Move individual characters in different directions, make colors change, flash words, make letters and words bounce spin a letter across the screen. Use fades and wipes to transition between titles and video or between two pages of titles.
- Backgrounds and Graphics**
 - Titles can be placed on solid color, patterned or graduated backgrounds, or they can be locked to incoming video.
 - Lines, squares, rectangles, ovals and circles can be created and placed anywhere on the screen. Each graphic object can use a different color, transparency, rotation, size, fill and outline.
- Imported Logos and Graphics**
 - Accepts most PostScript or PCX format graphics without modification. Imported images can be any size and can be scaled, skewed, and rotated when placed on screen. Transparency and anti-aliasing can be defined when graphic is generated.



StudioFrame Modular Video Processing System

The Nova StudioFrame Series is a modular, flexible, digital/analog signal processing system. It is designed to efficiently and effectively combine a wide variety of individual function (or processor) boards such as A-D and D-A converters, video signal encoders and decoders, audio and video distribution amplifiers and frame synchronizers into more complex function groups, all in one equipment mainframe. The scalable nature of the StudioFrame design allows it to be easily reconfigured and/or upgraded as today's video standards and requirements continue to evolve. The system is based on two rackmount frame models (the SF-3 and SF-1) allowing up to thirteen front loading processor boards and thirteen rear mounted passive interface cards to be accommodated in a single chassis. Both the StudioFrame SF-1 and SF-3 chassis are designed to meet the most stringent broadcast requirements. The SF-3 is a thirteen slot, 3RU chassis while the SF-1 is a 4 slot, 1RU chassis. All studio cards as well as the two chassis are backed by a two year warranty on parts and labor with guaranteed 24-hour turnaround service. The units are ruggedly constructed to endure studio rackmount, production van and OB (Outside Broadcast) mobile applications. A universal power supply operates at either 110 or 240 VAC, 50/60 cycle. DC operation is optionally available as is a redundant supply with automatic switchover. Dual exhaust fans maintain proper airflow and cooling. "Hot swappable" front card loading allows power-on removal/insertion of individual processing modules without disturbing others in the system. All cabling can remain in place while you service any module. An intelligent "centerplate" provides power, sync, timing and data distribution, facilitating expansion to more complex, more cost-effective signal processing functions.



NovaASD/NovaSDA Analog to Serial Digital & Serial Digital to Analog Converters

Components of the Nova StudioFrame series, the NovaASD and the NovaSDA incorporate the latest digital signal processing techniques for high speed A-D and D-A signal conversion. They are designed to meet the most stringent broadcast requirements and their "hot swappable" front card loading facilitates servicing without disturbing other cards in the system. The NovaASD is ideal for interconnecting analog signals with digital video formats and the NovaSDA for interfacing serial digital signals with

- | | | |
|--|---|---|
| <p>SDA-1 Serial Digital Component to Analog Composite Converter</p> <ul style="list-style-type: none"> • SMPTE 259M 4:2:2 Serial Digital Component (D1) input. • Equalized and relocked serial digital component output • Analog component video (Y, R-Y, B-Y/YUV), RGB or RGB/S outputs • 10-bit D/A converters • Output level control • NTSC and PAL compatible | <p>SDA-2 Serial Digital Component to Composite and S-Video Converter</p> <ul style="list-style-type: none"> • SMPTE 259M 4:2:2 Serial Digital Component (D1) input. • Equalized and relocked serial digital component output • Dual composite & dual S-Video outputs • Color bar output selectable • 10-bit D/A converters • Output level control • NTSC and PAL compatible | <p>SDA-3 Serial Digital Component to Analog Video Converter</p> <ul style="list-style-type: none"> • SMPTE 259M Serial Digital Composite (D2/D3) input. • Equalized and relocked serial digital component output • Four analog composite video outputs • Color bar output selectable • 10-bit D/A converters |
| <p>ASD-1 Analog Component to Serial Digital Component Converter</p> <ul style="list-style-type: none"> • Analog component video (Y, R-Y, B-Y/YUV), RGB or RGB/S input • Dual SMPTE 259M 4:2:2 Serial Digital Component (D1) outputs • 10-bit D/A converters • Picture positioning control • NTSC and PAL compatible | <p>ASD-2 Analog Composite and S-Video to Serial Digital Component Converter</p> <ul style="list-style-type: none"> • Analog composite and S-Video input • Dual SMPTE 259M 4:2:2 Serial Digital Component (D1) outputs • 10-bit D/A converters • NTSC and PAL compatible | <p>ASD-3 Analog Composite to Serial Digital Component Converter</p> <ul style="list-style-type: none"> • Analog composite video input • Dual SMPTE 259M 4:2:2 Serial Digital Composite (D2/D3) outputs • 10-bit D/A converters • Input gain adjustment |

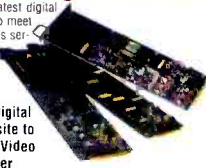

NOVAMNR Median Noise Reducer

The NovaMNR is a StudioFrame card that eliminates impulse and transmission noise, cleans up satellite, microwave and fiber feeds and fills in CODEC and time-based corrected videotape drop-outs. It features full bandwidth, uncompressed 10-bit digital processing for ultimate video transparency as well as analog composite inputs and outputs.

- Eliminates "sparkles" those black and white dots that sometimes appear on remote video feeds.
- The NovaMNR incorporates a proprietary adaptive three-dimensional median filter that analyzes pixels from several fields of video and replaces the impulse noise with uncontaminated, clean video.
- Universal drop-out compensation replaces missing video information, whether it is from a time-base-corrected VCR source or the decoded output of a CODEC feed. The NovaMNR effectively fills in drop-outs with replacement video from the surrounding pixels and previous video field.

NC-8 RGB/Component to Composite/S-Video Encoder

- 10-bit processing, 8-bit D/A conversion
- Zero insertion delay, frame of memory
- Two composite and one S-video output.
- Analog RGB (Sync on Green or all three), RGB/Sync and YUV (BetaCam) inputs. Also available with looping inputs.
- Variable luminance notch filter
- Y and C pre-comb filtering for maximum encoding performance
- Remote serial control • Output level control
- Color bar output selectable
- Designed to meet the most stringent broadcast requirements
- "Hot swappable" front card loading facilitates servicing without disturbing other cards.
- Available in PAL and PAL-M versions

LEADER

Manufacturing test and measurement equipment for over 40 years, Leader Instruments is the standard which others are measured against for reliability, performance, and most important—cost effectiveness. Before a product is brought to market, an exceptional degree of energy and effort go into its design. Prototypes are built and tested to withstand environmental and other factors far exceeding actual operating conditions. These include high humidity, extremes of heat, cold, shock and vibration. Manufacturing quality is built in every step of the way and only the finest parts are used. At each production run, subassemblies are separately tested before they are integrated into the finished product, then each product is tested again. This is why less than 1% of all Leader products are ever returned for warranty repair or adjustment.



- 5860C WAVEFORM MONITOR**
 A two-input waveform monitor, the 5860C features 1H, 1V, 2H, 2V, 1.5/div and 2V mag time bases as well as vertical amplifier response choices of flat, IRE (low pass), chroma and DIF-STEP. The latter facilitates easy checks of luminance linearly using the staircase signal. A PIX MDN output jack feeds observed (A or B) signals to a picture monitor, and the unit accepts an external sync reference. Built-in calibrator and on-off control of the DC restorer is also provided.
- 5850C VECTORSCOPE**
 The ideal companion for the 5860C Waveform Monitor, the 5850C adds simultaneous side-by-side waveform and vector monitoring. Featured is an electronically-generated vector scale that precludes the need for fussy centering adjustments and eases phase adjustments from relatively long viewing distances. Provision is made for selecting the phase reference from either A or B inputs or a separate external timing reference.

- 5100 4-Channel Component / Composite WAVEFORM**
 The 5100 handles three channels of component signals, plus a fourth channel for composite signals, in mixed component / composite facilities. Features are overlaid and parade waveform displays, component vector displays, and automatic bow-tie or "shark fin" displays for timing checks. Menu-driven options select format (525/60, 625/50, and 1125/60 HDTV), full-line select, vector calibration, preset front-panel setups and more. On-screen readout of scan rates, line-select, preset numbers, trigger source, cursor line and volts.

- 5100D Digital Waveform/Vectorscope**
 The 5100D can work in component digital as well as component analog facilities (and mixed operations). It provides comprehensive waveform, vector, timing and picture monitoring capabilities. Menu driven control functions extend familiar waveform and vector observations into highly specialized areas and include local calibration control, the ability to show or blank SAVE/AV signals in both the waveform and picture, the ability to monitor digital signals in GBR or YCBCR form, line select (with an adjustable window), memory storage of test setups with the ability to provide on-screen labels, flexible cursor measurements, automatic 525/60 and 625/50 operation and much more than.

- 5870 Waveform/Vectorscope w/SCH and Line Select**
 A two-channel Waveform/Vector monitor, the microprocessor-run 5870 permits overlaid waveform and vector displays, as well as overlaid A and B inputs for precision amplitude and timing/phase matching. Use of decoder 1R allows relatively high-resolution DG and DP measurements. The 5870 adds a precision SCH measurement with on-screen numerical readout of error with an analog display of SCH error over field and line times. Full-raster line select is also featured with on-screen readout of selected lines, a strobe on the PIX MDN output signal to highlight the selected line, and presets for up to nine lines for routine checks.

- 5872A Combination Waveform/Vectorscope**
 Models 5872A offers all the operating advantages of the 5870, except for the following: SCH is deleted from the 5872A (line select retained), making it ideal for satellite work.

- 5864A Waveform Monitor**
 A two-input waveform monitor that offers full monitoring facilities for cameras, VCRs and video transmission links. The 5864A offers front panel selection of A or B inputs, the choice of 2H or 2V display with sweep magnification, and flat frequency response or the insertion of an IRE filter. In addition, a switchable gain boost of X4 magnifies setup to 30 IRE units, and a dashed graticule line at 30 units on screen facilitates easy setting of master pedestal. Intensity and focus are fixed and automatic for optimum display. Supplied with an instruction manual and DC power cable. Designed for EFP and ENG (electronic field production and electronic news gathering) operations, they feature compact size, light weight and 12 V DC power operation. Thus full monitoring facilities can be carried into the field and powered from NP-1 batteries, battery bolts and vehicle power. Careful thought has been given to the reduction of operating controls to facilitate the maximum in monitoring options with the operating simplicity demanded in field work.
- 5854 Waveform Vectorscope**
 A dual channel compact vectorscope, the 5854 provides precision checkout of camera encoders and camera balance, as well as the means for precise genlock adjustments for two or more video sources. Front panel controls choose between A and B inputs for display and between A and B for decoder reference. Gain is fixed or variable, with front panel controls for gain and phase adjustments. A gain boost of 5X facilitates precise camera balance adjustments in the field. Supplied with a DC power cable. Designed for EFP and ENG (electronic field production and electronic news gathering) operations, they feature compact size, light weight and 12 V DC power operation. Thus full monitoring facilities can be carried into the field and powered from NP-1 batteries, battery bolts and vehicle power. Careful thought has been given to the reduction of operating controls to facilitate the maximum in monitoring options with the operating simplicity demanded in field work.

CORPORATE ACCOUNTS WELCOME
 Circle (69) on Free Info Card

www.americanradiohistory.com

Dielectric Communications signed an agreement with NBC for the purchase of DTV and NTSC TV station equipment. Under the agreement, Dielectric will be NBC's supplier for its current and future O & O TV stations nationwide. The agreement covers all passive RF components including, but not limited to, antennas, transmission lines, filters, combiners, switches and dehydrators.

Comark Digital Services (CDS) and the WGBH Educational Foundation are teaming up to develop strategies for the implementation of DTV. Comark and WGBH will develop plans for digital television, including HDTV, SDTV, multicasting and data broadcasting, as well as access services such as closed-captioning and descriptive video. WGBH plans to have a digital signal on the air by the end of 1998.

Avid Technology Inc. announced that FOX Television Stations, Inc. will incorporate its new AvidNews newsroom system in each of its 22-owned stations. The AvidNews newsroom system increases news production by streamlining all text processes. With the integration of Avid's newsroom computer sys-

tem, Fox plans to have 200 seats installed by this June.

Avid also announced that WSB-TV, Atlanta's ABC affiliate, will also install AvidNews; the sale will involve the installation of 171 seats.

Sony announced that the Washington Redskins' home stadium, the Jack Kent Cooke Stadium, is now equipped with the TX-7 component triax system and DXC-D30 DSP cameras. Professional Products of Bethesda, MD, integrated and installed an advanced A/V system that is used to feed game action and crowd shots to the Sony JumboTron system during games and for the stadium's commercial and promotional video production. In addition to allowing for quick camera setup and multiple camera direction by a small crew, the triax system is designed for high-quality component video and extensive control of DSP functions.

More than 20 of its DV6000 Universal Digital Transport Systems from **ADC Broadband Communications** are being used by WorldCom in the United Kingdom. With the DV6000 system, TV stations no longer need an on-site truck to do post-production work, instead the

signal is sent directly to the production studio to be edited and transmitted.

In an effort to consolidate regional operations, the WIC-Television Group in Alberta has chosen the **Louth Automation** ADC-100 to provide comprehensive solutions for automated satellite recording, program timing, media preparation and multichannel commercial and program playback. The two main centers, CICT Calgary and ITV Edmonton, originate the five signals. Calgary's CICT provides a second feed for CISA Lethbridge, while CITV in Edmonton provides a total of three on-air channels.

Hewlett-Packard installed eight HP MediaStream broadcast servers at the FOXTEL Management, Pty., Ltd. facility. Based in Sydney, Australia, the FOXTEL facility went operational with the new servers in October and presently is running more than 16 channels to air. The installation consists of seven HP MediaStream servers connected via a fiber channel network. Each server delivers one input channel and five output channels and will accommodate up to 15 hours of spot and promotional insertion material.

People

Dr. Yeshwant Kamath was appointed president of Videonics, Campbell, CA, and will serve on the board of directors.



Inscriber Technology, Ontario, Canada, has appointed **Hugh Smyser** as director of U.S. operations. Smyser will be responsible for strengthening the U.S. dealer network, expanding U.S. marketing and support systems and leading all operations in the U.S. marketplace.

Dan Ambauen was promoted to Harmonic Lightwaves' director of sales for the Western United States, Sunny-

vale, CA. Ambauen will oversee the sales team responsible for servicing Harmonic's customers west of the Mississippi River.

Tan Yee Tiang was named director of operations and engineering at Asia Broadcast Center, New York.



Telemetrics, New York, has appointed **James D. Wolfe** to the position of sales director for the company's lines of camera control and robotics systems.

Romolo Magarelli has been named president and chief science officer of the Everetz Corporation, Burlington, Ontario, Canada. Everetz also an-

nounced **Douglas A. DeBruin** as chief financial officer and **Alan Plaunt** as technical director.

Harris Broadcast division, Richmond, IN, announced that **Chuck Maines** has added the role of radio and TV audio advisor to his other duties.



Rajnish Babbar has been appointed program manager, network management for the Broadband Communications Division, Meriden, CT.

Professional Services

HDTV Doesn't have to mean
High Dollar TeleVision™.

Check us out at
www.AstreSystems.com

"Say It Better"

See more than 300 tips
(and related books and tapes)
from "gut instincts" expert,
Emmy-winner and former Wall
Street Journal reporter **Kare Anderson** at
www.sayitbetter.com

JOHN H. BATTISON P.E.
CONSULTING BROADCAST ENGINEER,
FCC APPLICATIONS AM, FM, TV, LPTV
Antenna Design, Proofs, Fieldwork
2684 State Route 60 RD #1
Loudonville, OH 44842
419-994-3849 FAX 419-994-5419

CHAN ASSOCIATES

Strategic Marketing • Public Relations • Advertising
1307 Shadow Lane, Suite C
P.O. Box 5509
Fullerton, CA 92838-0509
Phone: (714) 447-4993
Fax: (714) 578-0284
Pager: (714) 506-1357
Email: cjchan@ix.netcom.com
CompuServe: 74601,2707

Curtis Chan
President

H&E HAMMETT & EDISON, INC.

CONSULTING ENGINEERS
RADIO AND TELEVISION

DANE E. ERICKSEN, P.E.
Box 280068
San Francisco, CA 94128
707/996-5200 707/996-5280 Fax

D.L. MARKLEY & Associates, Inc.

CONSULTING ENGINEERS

2104 West Moss Ave.
Peoria, Illinois 61604
(309) 673-7511
FAX (309) 673-8128
Member AFCC

NETCOM

STATE OF THE ART ENGINEERING
FOR AUDIO AND VIDEO
ENGINEERING DESIGN • CAD DRAFTING SERVICES
CABLE FABRICATION • PRE-WIRED PATCH PANEL RACKS
SYSTEM INSTALLATIONS • EQUIPMENT SALES

(201) 837-8424

FAX: (201) 837-8384
1465 PALISADE AVE. TEANECK NJ 07666

REID BROADCAST COMM. INC.

ED REID - PROJECT ENG. SERVICES
RADIO-FM / AM TV-ANALOG / DIGITAL
P.O. BOX 170476
Arlington, Texas 76003

(817) 496-6142
E-MAIL RBCI@NKN.NET

(FAX) 496-5835



Stainless, Inc.

50 Years of Broadcast Tower
Design - Fabrication - Construction

210 S. Third St. Voice 215-699-4871
North Wales, PA 19454 Fax 215-699-9597

**Why not run your
business card here?
Promote your services
and increase business!**

**Only \$151⁰⁰ per insertion.
Frequency discounts
available.
Call 1-800-896-9939**

East Coast Video Systems

consultants • engineers • systems integrators

3 Mars Court
Boonton, NJ 07005
973.402.0104
Fax: 973.402.0208
www.ecvs.com

on line **in time**

Classifieds

For Sale

<http://www.broadcastexchange.com>

The new way to buy and sell preowned broadcast video gear. Free listings. Online database.
1-888-FAX-GEAR Toll-free 24-hour
Fax-on-Demand
Dial toll-free or call +1.310.442.8481 to have the latest hot list sent to your fax!



Broadcast
Exchange, Inc.
tel. 310.442.8481
fax 310.442.8480
email: broadcast@ax.com

TRON-Tek Microwave

Video Equipment

Miniature S-band 2 and 2.5 GHz Links

- Fixed Frequency - Selectable Output
- Tunable - Continuous
- Remotely Tunable - Via RF or Phone
- Tower Cams - Various Configs
- Repeaters - In-band Available

Call for Free Catalog

918-663-4877

TRON-Tek, Inc.

6570-B East 51st Street
Tulsa, OK 74145

(FCC TYPE ACCEPTED)

FREE 44pg Catalog & 80 Audio/Video Applic.



144 Pages!

VAC Hirose Mogami Neutrik Covid Edac

Bi-Tronics Manufactured & Distributed Products

FREE CATALOG!

BI-TRONICS
Voice: 800-666-0996
Fax: 800-569-4244
E-mail: info@bi-tronics.com
www.bi-tronics.com

WhisperRoom INC. PH: 423-585-5827
SOUND ISOLATION ENCLOSURES FAX: 423-585-5831

Vocal Booths
Broadcast Booths
etc...

E-MAIL: whisper@lcs.com
WEB SITE:
www.whisperroom.com
116 S. Sugar Hollow Road
Morristown, Tennessee 37813

CLEARLY PRUDENT.

For video duplication, demos, audition reels, work tapes, our recycled tapes are technically up to any task and downright bargains. All formats, fully guaranteed. To order call:

(800)238-4300 **CARPEL**
VIDEO

Advertise in Broadcast Engineering Classifieds!

BROADCAST PRODUCTS

CONSULTING • ENGINEERING

BECK ASSOCIATES

INSTALLATION • FURNITURE

2403 HOWARD LANE
AUSTIN • TX • 78728
1-800-728-3725
FAX: (512) 388-1833

NEW!!

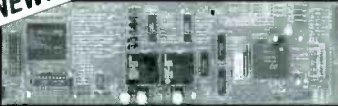

SDV 4-4 - Serial Digital and Analog Video Monitoring DA - 4-2-2/270 mbps. Four relocked SDV outputs, plus four CVBS or RGB outputs. 10 bit DACs. Fits GVG 8500/8800 DA frames. **\$895**



TBC-RMT - TBC Remote Control Unit
Remote control of up to 3 TBC's. For use with internal TBC's on BVW, DVW, PVW, UVW, and BVH Beta machines or any machine using Sony BVR-50 controller. Purchased with 1, 2, or 3 modules. With 3 modules. Now available for JVC machines - Series 22, 80, 85. **\$960**



SCR-4X8 - Serial Machine Control Router - Input/Output Twelve rear mounted DB9-F connectors (four controllers, eight devices). EIA RS-422 send and receive. Controls: Twelve lighted pushbuttons for channel assignment. **\$980**



SCP-10 - Serial 422 Patch Panel
10x10 passive non-normalizing serial data patch panel. Two rack units high. Legend strips and 10 patch cords included. **\$350**



VU2-P - VU/Peak Meter with Phase Indicator - Simultaneous peak and VU display. Solid state phase indication. Highly readable LED arrays. Adjustable headphone output. Hi-impedance looping inputs. **\$890**



SPK-2 - Two Channel Audio Monitor
Two channel audio confidence monitoring. Accepts both balanced and unbalanced inputs. Five switchable listening modes. Headphone output with speaker mute. **\$650.**

Circle (100) on Free Info Card

Classifieds

For Sale

Buy Consign Sell		90 Day Warranty Labor, One Year on Parts
<p>All Major Brands, Featuring:</p> <p>DIGITAL S Night Suite</p> <p>FAST Pinnacle</p> <p>JVC PROFESSIONAL</p> <p>SONY</p>	<p>Special this month!</p> <div style="display: flex; align-items: center;">  <div style="margin-left: 10px;"> <p>AVID MC 1000</p> <p>2-9 gig drives 2-20" monitors #86124</p> <p>\$25,000 (one only)</p> </div> </div>	
LA 818.551.5858 Fax 818.551.0686 www.broadcaststore.com	NY 212.268.8800 Fax 212.268.1858	

Circle (101) on Free Info Card

TAPE ERASERS

**The World's Leader
In Degaussers**

ERASES
ALL VIDEO
FORMATS



The Eliminator 4000

There's nothing better than the Model 4000 to completely erase metal particle media in just seconds, including the hard to eliminate audio and control tracks. It's the one degausser approved by major television networks and production facilities across the world. Join the owners of the Eliminator 4000 and see what a Gamer Degausser can do for you.



4200 N. 48th Street
Lincoln, NE 68504
1-800-228-0275
TEL (402) 434-9100
FAX (402) 434-9133

Circle (102) on Free Info Card

Just Think...

...if this had been your
ad, you'd have a
prospect right now!

**Call 1-800-896-9939 to
place your ad today.**

THE 5D VIRTUAL TELEPORT

Serving USA and Canada
Digital and analog video, data

- C Band Transponders available on GEI
- Occasional Space
- 24hr booking
- Worldwide Service
- Call 1-800-565-1471

Program Playout and Uplink Facility
located in Ottawa, ON, CAN.

Uplink installed at your location, remote
controlled and monitored from ours

KU Band Transportable
Hire/Lease/Sell

Engineering and Technical Services

Call: Grahame Fournier
1-800-267-1221 x152
email: gfournier@5d.com

*** Studio Exchange ***

Burbank

(818) 840-1351 Fax (818) 840-1354

New and Used Video Equipment

Audio/Video Dealer

Starring

Panasonic & Sony

BUY, SELL, TRADE & CONSIGN

*816 N. Victory Blvd.
Burbank, CA 91502*

email: studioex@ecom.net
www.studio-exchange.com

Place your business on **top** of the world with 32,000+ worldwide circulation!

Advertise in *Broadcast Engineering!*

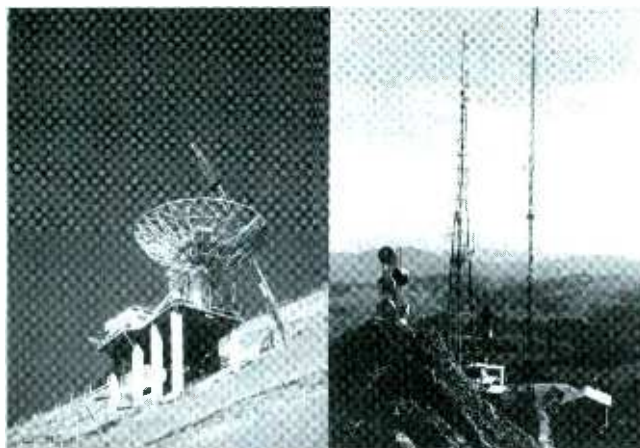

the FANTOZZI
company, inc.

Ground Facilities
Earth Stations
Towers
Civil Works
Testing/Inspections
Tall Towers

Structural Studies
Static/Dynamic Analyses
Failure Analyses
Risk Assessments
Location/Height Verification
Surveying/GIS

Engineers/Constructors

Design/Build

PROVIDING TURNKEY ENGINEERING AND CONSTRUCTION SERVICES TO THE COMMUNICATIONS INDUSTRY

93 Devine Street San Jose CA 95110
(408)297-2700 FAX:(408)297-2766

Circle (103) on Free Info Card

WE PLACE TV ENGINEERS, GENERAL AND SALES MANAGERS



KEYSTONE INT'L, INC.
16 Laffin Road, Suite 900
Pittston, PA 18640, USA

Phone (717) 655-7143
Resume/Fax (717) 654-5765

1/98

ENGINEERING SUPERVISOR/ASSOCIATE DIRECTOR The University of Central Florida's Office of Instructional Resources is seeking an Engineering Supervisor/Associate Director with knowledge of television and radio broadcasting and cable delivery, video and audio engineering, microwave systems, fiber-optic and digital compressed video, audio and data communications, satellite transmission, multimedia hardware systems, and data and computer networking. A Master's degree and four years of directly related professional work experience or a Bachelor's degree in an appropriate area of specialization and six years directly related professional work experience are required. A Master's degree in an appropriate area of engineering specialization is preferred. A FCC general broadcast license is preferred. Candidate screening will begin on January 5, 1998 and will continue until the position is filled. <http://www.oir.ucf.edu/jobs> To apply, send resume to: University of Central Florida, OIR Engineer Search Committee, P.O. Box 162800, Administration Building, Room 326, Orlando, Florida 32816-2800. Affirmative Action, Equal Opportunity Employer.

Equipment Wanted

WANTED Parabolic Audio Dish, Sony PBR-300, 14 inches. Contact WQED, Alan Lawyer, 4802 Fifth Avenue, Pittsburgh, PA 15213. Phone: 412-622-1455; Fax 412-622-1488

Want more information on advertised products?

Use the Reader Service Card.

Diversity Miniature Broadcast Microwave



- ▶ Eng. Remote Camera to Eng Van for Live Hits
- ▶ Full Motion Colour Video/Audio
- ▶ Video Signal Processing
- ▶ 470 Lines @ 45+ db

Miller Wireless

3212 NW Ave. Suite C, Box 221
Bellingham, WA 98225 USA

tel: (360) 715.3328 fax: (360) 715.1239
e-mail: milwire@televar.com

Help Wanted

MAINTENANCE ENGINEER: Top 50 market television station seeking a qualified maintenance person. This person must have a strong background in Beta, Macs and PC computers, Digital electronics and be a good trouble shooter. Must be a self-starter and highly motivated. Send resume to the following address. WSMV-TV Attn: Mike Nichols, 5700 Knob Rd., Nashville, TN 37209. EOE

ENGINEERING TECHNICIAN NBC network affiliate in 79th market now accepting applications for a technician to maintain VHF transmitter, microwave systems and studio equipment. Must be a graduate of an accredited technical electronics school or possess equivalent maintenance experience. No phone calls, please. Send resume to: Dan Steele, Operations and Program Manager, WPSD-TV, P.O. Box 1197, Paducah, KY 42002-1197. EOE/M/F/ADA.

COMMERCIAL EDITOR Post production facility seeking editor for supervised work. Three years experience with Sony 8000 Digital switcher, Sony 5000 DME, Sony 9100 editor. Must work well with clients. Mail resumes to Jamie Politz, Director of Human Resources, WBRZ-TV, P.O. Box 2906, Baton Rouge, LA 70821. Fax: 504-336-2246 Email: jamie@wbrz.com Internet: <http://www.wbrz.com> Smoke free facility. EOE.

MAINTENANCE ENGINEER: TV station seeks full time Maintenance Engineer. Position requires maintenance and repair of broadcast equipment to the component level. UHF transmitter experience helpful. FCC or SBE certification a plus. Send resume and salary requirements to Trinity Broadcasting Network, WDLI CH-17, 6600 Atlantic Blvd. N.E., Louisville, Ohio 44641. EOE

MAINTENANCE ENGINEER Immediate full time position in broadcast television. Must have studio and transmitter maintenance experience. If you can trouble shoot all aspects of a television station and solve the problems, send your resume to Chief Engineer, KAYU-TV, PO Box 30028, Spokane, WA 99223. EOE.

STAFF ENGINEER INFRASTRUCTURE AND ENGINEERING SERVICES Bradley University Infrastructure and Engineering Services seeks to fill the position of Staff Engineer. The successful candidate will support the broadcast operations of WTVP-TV, WCBU-FM and the instructional technologies of Bradley University. This is an exciting opportunity for the individual who is ready to work in a diverse technical and cultural environment. Required qualifications: Associates degree in electronics technology and/or 3 years of electronics repair experience; Ability to obtain an Illinois class B Commercial Drivers License with air brake endorsement and drive a 30 ft. straight truck; Lift equipment weighing up to 33 lb. to the work bench top; Limited evening and week-end work required. Some overnight travel. Desired qualifications: Experience in the repair of broadcasting equipment; FCC General Class License; Society of Broadcast Engineers Certification; Experience with computers in a networked environment. Submit letter, resume and three professional references to Chairman, Staff Engineer Search Committee, Bradley University-Infrastructure and Engineering Services, 223 Jobst Hall, 1501 West Bradley Avenue, Peoria, IL 61625. This position will remain open until filled. Bradley University is committed to diversity in the work force and is an Equal Opportunity/Affirmative Action Employer.

Classifieds**Help Wanted****LEADER IN COMPUTER GRAPHICS****FAST-FORWARD YOUR CAREER
WITH THE VIDEO/TV INDUSTRY**

We're Pro-Bel America, a premier supplier of signal distribution and signal products for over 25 successful years, and a division of the Chyron Corporation—always on the cutting edge of product development for the broadcast and multi-media industries. We are seeking broadcast technical professionals with excellent communication skills for the following opportunities:

TECHNICAL SUPPORT ENGINEER-LOS ANGELES, CALIFORNIA

You will be responsible for accurately defining operations and product issues to field service and support personnel, plus serving as key contact with the engineering, maintenance, and operations staff at TV stations. You should have basic technical knowledge of television station operations.

PRODUCT SPECIALIST-ATLANTA, GEORGIA

We will thoroughly train you in hardware and software products relating to routing, master control, and automation, with a concentration in hardware. You will then be responsible for oral and written presentations plus supervise development of large-scale proposals. You should have solid understanding of the television process (acquisition through transmission) and an eagerness to expand your technical knowledge.

We offer excellent compensation and benefits packages including relocation allowance plus room for growth. For strictly confidential consideration, please send/fax/e-mail your resume, indicating salary requirement and position of interest, to: HR Department-BE, Chyron Corporation, 5 Hub Drive, Melville, New York 11747; FAX #: (516) 845-2090; e-mail: careers@chyron.com. We are an equal opportunity employer dedicated to affirmative action.

To learn more about CHYRON and our employment opportunities visit our website: www.chyron.com

pro-bel AMERICA*A Chyron company*

CHIEF ENGINEER WUAB-TV, Cleveland, has immediate opening for Chief Operator. Requires knowledge of FCC regulations. FCC license or SBE certification a plus. Minimum 5 years experience in television broadcast engineering, including working with UHF transmitters. Must be solutions oriented, able to lead and work on team and individual projects, and have excellent communication and interpersonal skills. Fax resume and cover letter to: (216) 348-0614, or mail to: Cannell Cleveland, Attn: Station Manager, 1717 East 12th St., Cleveland, OH 44114. EOE; women and minorities encouraged to apply.

IMMAD+ECVS, (www.immad.com/www.ecvs.com) one of the North America's largest combined system integration companies, is seeking both Senior and Mid-level Television System Engineers for our new Boonton, NJ facility. Our growing public company is currently designing and building DTV solutions for the broadcast community and have positions open for the right candidates. The Senior Engineering candidate should have the following: a E.E., and/or P.E.; a strong background in Television engineering; departmental management experience; financial management skills at the project level; computer literate and a working knowledge of Office97/AutoCAD. The Mid-level Engineering candidate should have the following: a good background in television engineering; extensive knowledge of AutoCAD; and computer networking and management skills. An EE or PE would be a plus. Please send all info to Rich Bisignano, at rbisign@immad.com.

EASTERN CONN STATE UNIVERSITY POSITION ANNOUNCEMENT Engineering/Studio Support: Leading Connecticut State University seeking highly motivated studio professional. Experienced in maintaining and calibrating University TV Studio, Satellite system, cable channel and editing facilities. Systems include Grass Valley 200, Panasonic S-VHS, DVC-Pro and Media 100 Non-linear. Repair and trouble shooting of all Media equipment required. Administrative staff position, B.S. degree required and SBE certification a plus. Salary negotiable, full benefits including tuition waiver for self and dependents. Interested candidates should send resume and three references to: Jack Boyko, Associates Director of Media Services, Eastern Connecticut State University, 83 Windham Street, Willimantic, CT 06226-2295. ECSU is an AA/EEO employer. Women, members of protected classes and people with disabilities are encouraged to apply.

MAINTENANCE ENGINEER - VACATION RELIEF Responsibilities include the maintenance of Studio, Video Tape, and Electronic News equipment, including Cameras, Video Tape Recorders, Video Switchers, Editing and Transmitting equipment. Digital Video and Audio experience a plus. FCC license or SBE certification preferred. Broadcast or related professional experience required. Please send resume to: Bill Beam, WABC-TV, 7 Lincoln Square, New York, NY 10023. No telephone calls please. We are an equal opportunity employer.

CNN ENGINEERS
THE WORLD'S NEWS LEADER

Turner Broadcasting System has career opportunities for experienced television engineers. These career positions demand an extensive background in equipment maintenance, digital video and audio, and knowledge of computer systems and networks. Please mail or fax your resume and cover letter to:

Jim Brown
Assistant Vice President
of Engineering Services

Turner Broadcasting System, Inc.
One CNN Center • P.O. Box 105366
Atlanta, GA 30348-5366

Fax: 404-827-1835
Phone: 404-827-1638

CNSI
THE SPORTS NEWS NETWORK

TBS is an equal opportunity employer.

KCPM TV IS SEEKING an Assistant Chief Engineer to fill hands on role in broadcast TV. This individual will be a hard working, self-motivated person who possesses UHF knowledge and experience. Come and join our team, we offer competitive wages and benefit package. E.O.E. Mail or fax resume and cover letter to KCPM-TV, Attn: Human Resources-MR, 180 E. 4th Street, Chico, CA 95928. Fax #(530) 893-1033.

KXLY BROADCAST GROUP has openings for two Broadcast Engineer positions. Excellent benefits package, ideal surroundings and lifestyle. Requirements include electronics degree, exp. in broadcast industry, computer knowledge. Must be physically fit and flexible with schedule. Send resume to EEO Coordinator, KXLY Broadcast Group, 500 W. Boone Ave., Spokane, WA 99201. EOE. No phone calls.

MAINTENANCE ENGINEER If you're versed in NTSC & PAL, understand 601 Digital, speak in GHz, can change an upper drum, and trouble shoot to component level, we'd like to talk to you. Immediate opening. SBE Certification preferred. Send resume, compensation requirements, and professional references to: Human Resources, Eyemark Video Services, 310 Parkway View Drive, Pittsburgh, PA 15205. (EEOC) Satellite/Syndication/International distribution.

SALES ENGINEER FOR HELICOPTER ENG Seattle area: Geneva Aviation is a leading manufacturer of a full range of electronic equipment designed to produce the most capable news gathering helicopters. Geneva is interviewing for a sales engineer to meet with potential customers. Fax resume to Cherie Hasson at 800-546-2220.

ELECTRONIC TECHNICIAN NBC 25 has an excellent opportunity for an experienced television maintenance engineer to join our growing operation. Primary job responsibilities include component-level repair of video tape recorders, cameras, switchers, eng. equipment, etc. A minimum of 2 years of broadcast equipment maintenance experience is required for this position. SBE certification and FCC general class license and/or prior transmitter maintenance experience a plus. Drug screen required. NBC 25 is a small market NBC affiliate. We offer a comprehensive benefit package, including 401(k) and section 125 plans. Send resume to NBC 25, Dept. Z, 13 East Washington Street, Hagerstown, MD 21740. Faxes or email are also accepted. (fax#301-733-1735) (email to jstanley@nbc25.com.) EOE. No phone calls please.

PICTURE AN EXCITING FUTURE WITH THE

FOR TELEVISION & GRAPHIC SYSTEMS PRODUCTS

Ad Index

	Page Number	Reader Service Number	Advertiser Hotline		Page Number	Reader Service Number	Advertiser Hotline
Acrodyne Communications	63	22	800-523-2596	Multidyne Electronics	147	74	800-4TV-TEST
ADC Telecommunications	107	39	800-726-4266	NAB'98	131		800-288-8606
Andrew Corporation	30	18	708-349-3300	NDS America, Inc.	69	32	714-725-2500
Antony Bauer	105	45	800-422-3473	Nema Electronics	151	71	305-899-0900
ASC Audio Video Corp.	73	34	818-843-7004	Neutrik USA	111	46	732-901-9488
Audio Precision	113	47	800-231-7350	NVision Inc.	7	9	916-265-1000
BAF Communications Corp.	149	76	407-324-8250	NVision Inc.	143, 145	54, 55	916-265-1000
BASF/EMTEC	141	66		Odetics, Inc.	15	5	800-243-2001
Beck Associates	158	100	512-388-9777	Allen Osborne Assoc.	122	62	805-495-8420
Best Power Technology	81	37	608-565-7200	Pacific Computing	149	80	408-427-4280
B&H Photo-Video	152-155	68, 69	800-947-9928	Panasonic Broadcast	4-5		800-528-8601
Bogen Photo	118	59	201-818-9500	Parker Vision	84-85	44	800-532-8034
Broadcast Software Solutions	147	72	800-273-4033	Pesa Switching Systems	31	8	800-328-1008
The Broadcast Store	151	81	818-551-5858	Philips Broadcast TV	76-77	25	800-962-4287
The Broadcast Store Inc.	158	101	818-551-5858	Pinnacle Systems	135	63	415-526-1600
Canare	114	48	818-365-2446	Play, Inc.	11		916-631-1865
Digital Transport Systems	72	33	619-675-1410	Professional Communications Sys.	67	31	813-888-5353
DNF Industries	149	77	818-252-0198	Professional Audio Supply	144	56	903-737-8478
Duracell USA	57	30	800-548-5489	PSP Digital Ltd.	108	40	
Ensemble Designs	47	19	916-478-1830	PTV	83	43	201-529-2188
ESE	132	52	310-322-2136	Quantel	9	82	203-656-3100
Extron Electronics	137	64	714-491-1500	Ross Video Ltd.	75, 121	24, 61	613-652-4886
Fantozzi Company, Inc.	159	103	408-297-2700	Scitez Digital Video	29	17	650-599-3081
Fast Forward Video	82	38	800-755-TIME	Sennheiser Electronics	119	60	860-434-9190
Garner Industries	158	102	800-228-0275	Shively Labs	147	75	207-647-3327
Gentner Communications	28, 78	16, 26	800-945-7730	Silicon Graphics	48-49	20	800-636-8184
Geppo	108	41	312-733-9555	Snell & Wilcox Ltd.	23-26	12-14	408-260-1000
Harris Corp./Broadcast Div.	3	4	606-282-4800	Snell & Wilcox Ltd.	51-53	27	408-260-1000
Henry Engineering	149	73	818-355-3656	Sony Electronics	16-17		408-955-5493
Hewlett Packard	64-65	23	707-577-2265	Sony Electronics	35-46		408-955-5493
H.L. Dalis, Inc.	151	70	718-361-1100	Sony Electronics	59		408-955-5493
Horia	146	67	714-489-0240	Sony Electronics	70-71		408-955-5493
Inscriber Technology	117	58	519-570-9111	Synthesys Research	55	28	415-364-1853
Iwatsu America	13	11	201-935-8580	Systems Wireless Ltd.	27	15	703-471-7887
JVC Professional Products	139	65	800-JVC-5825	T C Electronic	61	21	805-373-1828
KTech Telecommunications	151	78	818-361-2248	Tektronix Inc.	32-33		800-998-3588
Leader Instruments	79	35, 36	800-645-5104	Tieman Communications	123	49	619-587-0252
Leitronics	109	42	800-821-1121	Vega Wireless	133	53	
Leighttronix Inc.	151	79	818-361-5589	Videotek, Inc.	163	2	800-800-5719
Leitch Incorporated	164	3	800-231-9673	Wegener Communications	115	57	770-623-0096
Matthew Electronics Ltd.	56	29	914-763-8893	Wheatstone Corporation	2	1	315-452-5000
Microwave Radio Corp.	125	51	978-250-1110	Zero Stantron	124	50	800-821-0019
Mountaingate	21	7	800-556-0222	360 Systems	19	6	818-991-0360

Sales Offices

WEST
Duane Hefner
 5236 Colodny Ave., Suite 108
 Agoura Hills, CA 91301
 (818) 707-6476
 Fax: (818) 707-2313
 E-Mail address:
 dnhefner@worldnet.att.net

Susan Simon
 3046-3 Lakemont Drive
 San Ramon, CA 94583
 (510) 735-7616
 Fax: (510) 735-7626
 E-Mail address:
 ssmimon@pacbell.net

Sue Horvitz
 809 South Orange Drive
 Los Angeles, CA 90036
 (213) 933-9485
 Fax: (213) 965-1059
 E-Mail address:
 76345.2624@compuserve.com

EAST
Josh Gordon
 210 President Street, Suite #4
 Brooklyn, NY 11231
 (718) 802-0488
 Fax: (718) 522-4751

EAST/MIDWEST
Joanne Melton
 1775 Broadway, Suite 730
 New York, NY 10019
 (212) 641-5270
 Fax: (212) 459-0395

INTERNATIONAL
Richard Woolley
Tory Chapman
 P.O. Box 250
 Banbury, Oxon OX16 8YJ U.K.
 +44 (0) 1295 278407
 Fax: +44 (0) 1295 278408

JAPAN
Orient Echo, Inc.
Masby Yoshikawa
 1101 Grand Maison
 Shimomiyabi-Cho 2-18
 Shinjuku-ku, Tokyo 162, Japan
 (3)+81 3235-5961
 Fax: (3)+81 3235-5852

CLASSIFIED ADVERTISING
OVERLAND PARK, KS
Jeff Utter
 P.O. Box 12901
 Overland Park, KS 66282
 (800) 896-9939 (913) 967-1732
 Fax: (913) 967-1735

US/RENTAL SERVICES
Lori Christie
 9800 Metcalf
 Overland Park, KS 66212-2215
 (913) 967-1875
 Fax: (913) 967-1897

Broadcast ENGINEERING

EDITORIAL

Brad Dick, *Editor*
 Steve Epstein, *Technical Editor*
 Dawn Hightower, *Senior Associate Editor*
 Deanna Rond, *Associate Editor*
 Jennifer Lowe, *Group II Editorial Assistant*
 Tom Cook, *Senior Managing Editor*
 Carl Bentz, *Directories Manager*

ART

Stephanie L. Masterson, *Art Director*

BUSINESS

Raymond E. Maloney, *President*
 Cameron Bishop, *Senior Vice President*
 Dennis Triola, *Publisher*
 Eric Proffitt, *Marketing Coordinator*
 Kathy Lewis, *Advertising Coordinator*
 Annette Hulsey, *Classified Advertising Coordinator*
 Doug Conrod, *Corporate Art Director*
 Barbara Kummer, *Circulation Director*
 Leann Sandifar, *Circulation Manager*
 Customer Service: 913-967-1711 or 800-441-0294

TECHNICAL CONSULTANTS

Jerry Whitaker, *Contributing Editor*
 Eric Neil Angevine, *Broadcast Acoustics*
 John H. Battison, P.E., *Antennas/Radiation*
 Dale E. Erickson, P.E., *Systems Design*
 John Keane, *Subcarrier Technology*
 Donald L. Markley, *Transmission Facilities*
 Harry C. Martin, *Legal*

MEMBER ORGANIZATIONS

Sustaining Members of:

- Acoustical Society of America
- Society of Broadcast Engineers
- Society of Motion Picture and TV Engineers
- Society of Cable & Telecommunications Engineers

Member, American Business Press

Member, BPA International



Affiliate Member,

International Teleproduction Society



BROADCAST ENGINEERING is edited for corporate management, engineers/technicians and other management personnel at commercial and public TV stations, post-production and recording studios, broadcast networks, cable, telephone and satellite production centers and networks. Qualified persons include consulting engineers and dealer/distributors of broadcast equipment.

SUBSCRIPTIONS: Non-qualified persons may subscribe at the following rates: United States and Canada; one year, \$55.00. Qualified and non-qualified persons in all other countries; one year, \$70.00 (surface mail), \$130.00 (air mail). Subscription information: P.O. Box 12937, Overland Park, KS 66282-2937.

Authorization to photocopy items for internal or personal use, or the internal or personal use of specific clients, is granted by Intertec Publishing, provided that the base fee of U.S. \$2.25 per copy, plus U.S. \$0.00 per page is paid directly to Copyright Clearance Center, 222 Rosewood Drive, Danvers, MA 01923. The fee code for users of the Transactional Reporting Service is ISSN 0361-0942/1997 \$2.25+00.00. For those organizations that have been granted a photocopy license by CCC, a separate system of payment has been arranged. Prior to photocopying items for classroom use, contact CCC at (508) 750-8400. Organizations or individuals with large quantity photocopy or reprint requirements should contact Cherie Wood, (913) 967-7212. Microfilm copies of *Broadcast Engineering* magazine are available by calling or writing UMI, 300 North Zeeb Rd., P.O. Box 1346, Ann Arbor, MI 48106-1346. Phone: (313) 761-4700 or (800) 521-0600.

© 1998 by Intertec Publishing **INTERTEC PUBLISHING**
 All rights reserved.

BROADCAST ENGINEERING (ISSN 0007-1994) is published monthly (except semi-monthly in May and December) and mailed free to qualified persons by Intertec Publishing, 9800 Metcalf, Overland Park, KS 66212-2215. Periodicals postage paid at Shawnee Mission, KS, and additional mailing offices. Canada Post International Publications Mail (Canadian Distribution) Sales Agreement No. 0956295. POSTMASTER: Send address changes to *Broadcast Engineering*, P.O. Box 12902, Overland Park, KS 66282-2902. CORRESPONDENCE: Editorial and Advertising: 9800 Metcalf, Overland Park, KS 66212-2215. Phone: 913-341-1300; Edit. fax: 913-967-1905. Advert. fax: 913-967-1904. © 1998 by Intertec Publishing. All rights reserved.



When is an organization not an .org?

BY PAUL MCGOLDRICK

I was ruminating the other day about NAB; the annual event that some of us wish would never be repeated, and yet, we would be broadcasting hermits if we ignored it. Over the last 30 years I have been on the exhibitor side of the aisle for five companies and on the looking-in side with three organizations. Don't ask which is the most fun.

The change in the show over the years has been incredible; not just the growth, but the change in the people, the locations and the attitudes. It was decided years ago that the exhibition should always be in Las Vegas. Not a surprise. Although it is not the largest production in Las Vegas (CES and COMDEX are), it actually makes the utility meters run faster than any other show. There is no other show floor in North America that can provide the power needed.

NAB sells

It is also a practical show for the exhibitors. Visitors come to make purchasing decisions. Compare NAB with Montreux (a chance to spend a few comfortable days at the lake with your spouse) or SMPTE (where the papers and technology are wonderful, but you are prohibited from talking money) or some SBE shows of recent years (that were compared to bowling alley parties). Whenever I hear the phraseology quoted by an exhibitor in the show's press, "We were able to spend some real quality time with the visitors," I start to squirm. Broadcast is not the only industry with exhibitions and conferences that should be euthanized; I can think of electronics shows, like Wescon, which really died a few years ago, but people forgot to notice.

No, NAB has not been in those categories. The technical program has never been the centerpiece, but it is respectable. I always thought a five-day exhibition/conference with NAB running the exhibits and SMPTE running the papers would

be a not-to-be missed show.

Although buyer and seller meet well at NAB, it is not a cheap way to go. Even the smallest company (a three- or four-person operation in a 10'x10' booth) will end up spending \$15,000 for NAB. A 40- to 50-person company will have to budget about \$75,000 and be committed to a custom-made booth on a 20'x20' space. "Have to" because if you don't look big in the broadcast business, customers won't believe you ever will be.

What does all this money buy? NAB '98 will cost exhibitors \$29 per square foot — if you are a member of NAB —

I have watched the NAB exhibition go from being run marginally close to Mafiosi, to squeaky clean, to greedy.

and \$35 per square foot if you're not. Other costs include freight of the booth and equipment (and any booth refurbishing, new graphics, etc. since its last outing), drayage at the show floor, set-up labor, power, special rentals, airfare, hotels and meals for the staff, special advertising, promotional and collateral pieces. Also, company sales people better be out there entertaining every moment while they have so many customers in one place.

Earning \$75,000 to pay for such a mid-sized venture means having to sell about \$750,000 of equipment or services.

As of the beginning of January, according to its web site, NAB had sold more than 750,000 square feet of exhibit space to more than 1,200 exhibitors

with another 200 exhibitors expected. The "sold" space, if you assumed it was all sold at member rates, represents about \$22 million of revenue. But wait, there is more.

Hype, glorious hype

Around Christmas, every NAB exhibitor and, presumably, every PR company involved with those accounts, received a box by Priority Mail from NAB. It contained a marketing extravaganza the likes of which I've never seen — a three-ring binder with laminated cover containing 74 sheets (148 pages) of "It's a Mad, Mad, Mad, Mad Advertising Rate Card." At least 50 sides were four-color, with a lot of special photography, and the remainder were at least two-color with spot varnish. For about a 2,000-piece circulation, my guess is this piece of work was upward of \$40 a copy — that's exhibitors' money.

Some of the advertising is genuine; the remainder is covering NAB's costs of events, from the Amateur Radio Reception to the International Leadership Dinner where 300 of the world's finest — no doubt including the NAB board — get invited to a \$60,000 bash that exhibitors are paying for! The granddaddy of them all is sponsorship of the Internet Theater on the floor of the Sands: A cool \$150,000 . . . oh, plus expenses. What broadcasting equipment company do you think could afford that? Microsoft? Intel? H-P? Are we seeing a progressive image here?

I have watched the NAB exhibition go from being run close to Mafiosi, to squeaky clean, to greedy. As one of the most powerful lobbying bodies in the nation, NAB does not need this greed; if it feels it does, then it should change its web site from www.nab.org to www.nab.com.

Paul McGoldrick is an industry consultant based on the West Coast.

Matrix Routers

by Videotek.



The difference is control!

The entire SDR family of digital and analog matrix routing switchers was designed from an operator's point of view.

The power is in the control, and control is yours to take... by name, by number, by "From" and "To", by input and output, and also by salvos. Identify sources, destinations, and salvos with alphanumeric characters that are easily configured from the front panel, or simply download the information from a PC.

See us at NAB '98 Booth 10761!



With a wide range of sizes,

types, and levels, the compact and expandable SDR series meets your needs for today and in the future at a surprisingly affordable price.

Take control... contact Videotek for more information on the SDR series and single bus routing switcher family today. **With Videotek, you control the router...it doesn't control you.**

Premium Quality, Intelligent Design, Smart Price...That's Videotek.

VIDEOTEKTM
A Zero Defects Company

Five Year Warranty
ISO-9001 Certified

243 Shoemaker Road, Pottstown, PA 19464 Toll Free: (800) 800-5719 (610) 327-2292 FAX: (610) 327-9295
Visit us on the Worldwide Web: www.videotek.com

Circle (2) on Free Info Card

www.americanradiohistory.com

The Difference Is NOISE



DES-6801

Leitch can handle it

Most decoders can't handle noisy feeds, but you can count on Leitch decoders to transform noisy satellite signals into useful, synchronized, 4:2:2 signals. Leitch's DES-6801 has a 3-line adaptive comb filter decoder, analog genlock, a full frame synchronizer and infinite H & V phasing.

The decoder fits the FR-6801 frame and is the world's most compact decoding/synchronizing combination. The DES-6801, like the DEC-6801 for A to D conversion and the VFS-6801 for 4:2:2 digital frame sync, is just one of many digital solutions in Leitch's Digital Glue family of products.

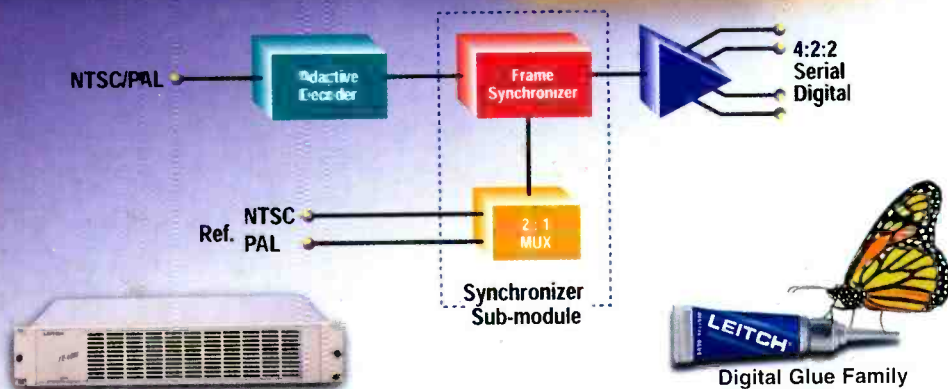

LEITCH

<http://www.leitch.com>

Circle (3) on Free Info Card

International Canada
Tel : + 1 (416) 445-9540
Fax: + 1 (416) 445-0595

U.S.A
Tel : + 1 (303) 231-9673
Fax: + 1 (757) 548-4088

Europe
Tel : +44 (0) 1256 880088
Fax: +44 (0) 1256 880428

Eastern Europe
Tel : +49 (89) 4900-2042
Fax: +49 (89) 4900-2043

Japan
Tel : +81 (3) 5423-3631
Fax: +81 (3) 5423-3632

Australia
Tel : +61-2-9999-2355
Fax: +61-2-9999-2366

Brazil
Tel : +55 (11) 867-0218
Fax: +55 (11) 867-0408