

BROADCAST[®] ENGINEERING

March 1987/\$3

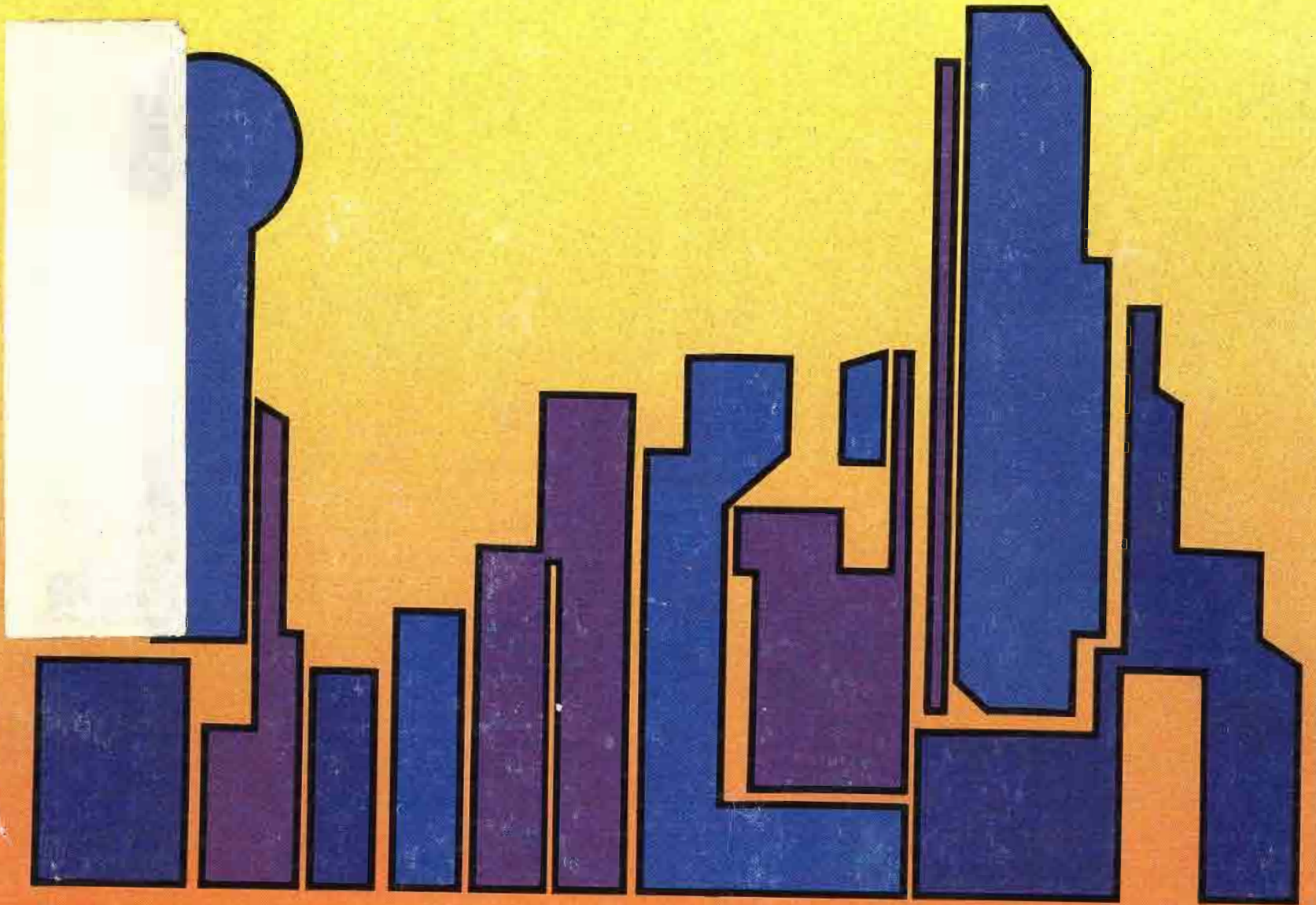

NAB '87

DALLAS

TELEVISION SUPERSTATION, AFFILIATE OR INDEPENDENT... ADM MAKES YOUR CHANGE TO STEREO EASY

When you're making the transition to stereo TV, make the move to ADM. In addition to stereo, you can have the traditional ease of operation, reliability and quality available only with ADM consoles.

ADM's top of the line BCS has proven to be a best seller at major networks, affiliates and independents. The console features input pre-selection and bussing, dual cue, group mute and Slidex® VCA control of all main program paths provide superior stereo tracking... making ADM your logical choice.



BCS SERIES

For any broadcaster who needs ADM quality at a price that will be gentle on your equipment budget, the S/TV fills the bill.

With the ADM five year warranty on parts and labor you can buy it and forget it. It will handle your stereo needs now and in the future. Call us, we like to make life easier for our friends.



S/TV SERIES

Visit us at Booth 3266

ADM®
The
Audio
Company

ADM Technology, Inc.
1626 E. Big Beaver Road, Troy, Michigan 48084
Phone: (313) 524-2100 • TLX 23-1114
Circle (1) on Reply Card

Cross-Country Communication



With the antenna
that works!
In Brownsville,
In Seattle,
In Miami,
Everywhere!

Midwest combines its mobile production unit experience with the latest antenna technology to bring you the S-23, a mobile satellite communications system that enables you to uplink a story from virtually anywhere.

The S-23 incorporates a Vertex 2.6M antenna with 50db gain into a unit that is spacious enough for full production capability, yet has excellent weight distribution and a wide GVW safety margin.

An integral deployment and positioning system ensures antenna accuracy, even in heavy weather. You

can choose from a variety of equipment configurations and several domestic and foreign chassis models.

Call for specifications and antenna patterns on the S-23, S-18, S-1 Fly-away or any of our mobile satellite communications systems.

The Midwest S-23. The mobile satellite communications system that works. Everywhere.

- 2.6M Vertex Antenna
- >50db Gain at 14.25 GHz
 - >35db Cross Polar Isolation
 - Meets 29-25 log E.FCC 2° Spacing Curves



See Midwest at Indoor Booth #3210
and at Outside Booth #10.

MIDW
Communications
One Spert Drive
Edgewood, KY 41
606-331-5990

Circle (3) on Reply Card

Contents

March 1987 • Volume 29 • Number 3

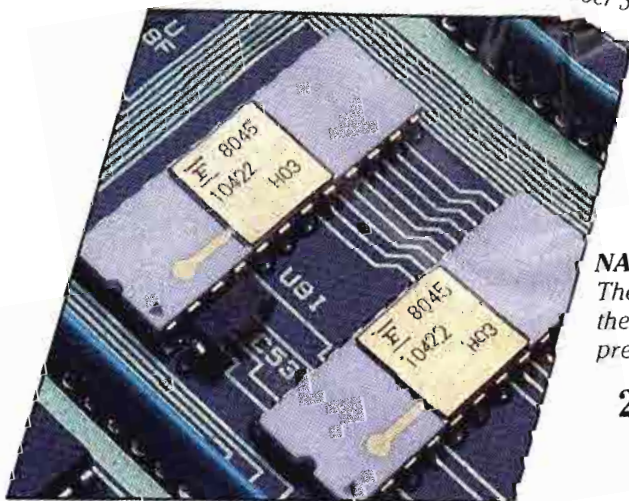

Page 36



Page 86

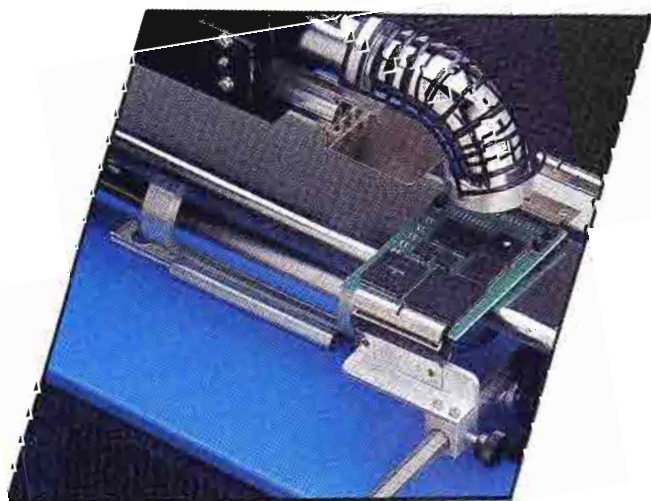

Page 116

ON THE COVER

The big event is about to begin. The 1987 NAB Convention (March 28-31 in Dallas) promises to be another record show. The Dallas setting is the inspiration for our cover this month. The distinctive Dallas theme was developed by BE graphic designer, Kristi Sherman. Airbrush by Intertec designer, Tim Lynch.

NABcast ENGINEERING

NAB SPECIAL ISSUE

The annual National Association of Broadcasters convention is the clock that drives the industry. Use our show preview to plan your convention.

26 NAB Engineering Conventions
By Ed Williams, NAB Office
A summary of the major technologies presented at NAB's premier engineering convention is presented at NAB's premier engineering convention.

141 NAB Convention Floor Map
Your complete guide to exhibitors at the convention.

154 Exhibitor Listings
A rundown of the companies exhibiting at NAB, organized by types of products they will have on display.

214 New at NAB
A detailed summary of the new products to be introduced at NAB, organized by product categories. Your best source for new product information.

35 RELIABILITY AND MAINTAINABILITY SPECIAL REPORT

36 The Mechanics of Component Failure
By Jerry Whitaker, editorial director
A detailed analysis of why parts fail and how problems in the field can be avoided. The article is the most detailed look at component and system reliability ever published for the broadcast industry.

86 Troubleshooting Transmission Equipment
By Jerry Whitaker, editorial director
How to repair failures in radio and TV transmitters.

116 Repairing Surface-Mount PC Boards
By Christopher Fenton, Western Reserve Tool
Guidelines on how to remove and install surface-mount components found in many broadcast systems today.

OTHER FEATURES

130 Planning for Audio Post-Production
By Richard Maddox, recording engineer

262 A Design Approach to Lighting
By Eric Neil Angevine, BE acoustics consultant

272 Audio Equalization for Cartridge Recording
By Douglas Fearn, WKSZ Radio

276 Coping with Solar Outages
By John Loeffler, Mannamedia

284 LCD Display Technology
Adapted by Conrad Persson, BE electronics editor

DEPARTMENTS

4 News	20 Management for Engineers
6 Editorial	22 SBE Update
8 FCC Update	302 Applied Technology: Dolby Deltalink
10 Strictly TV	308 Field Report: Ampex AVA-3
12 Where: Radio	316 Station-to-Station
14 Satellite Technology	320 Business
16 Circuits	326 People
18 Troubleshooting	330 New Products

HOW THE SK-110D PUTS AN END TO THE REIGN OF ERROR.

With the SK-110D, Hitachi has created a studio broadcast camera with microprocessor technology so accurate that registration errors and time-consuming setup are things of the past.

Using a single button, now you can automatically set up RGB, color balance, and analog and digital registration—along with complete fault diagnosis—for up to 42 cameras simultaneously in just two minutes. And while you're shooting, the SK-110D keeps correcting realtime zoom and focusing errors, as well as registration changes caused by fluctuating prism temperatures.

The SK-110D performs magnificently.

Here's why: The 30-mm LOC diode gun Plumbicons and electronics yield 750 lines horizontal resolution, and greater than -56dB S/N. Dynamic focus provides for superb corner resolution. And detail signals are generated from both red and green.

The SK-110D is also today's most technologically advanced and versatile camera system. It offers iris and auto-setup by external chart. It has a high-resolution viewfinder with electronic markers.

The battery-backed head and CCU store up to four full-function files, eight lens files and 64 scene files. And add a smart RCU that controls those files, and you've got a camera that can precisely remember the "look" of every production shot you'll take.

Put an end to the reign of error in your studio today. And usher in a new era of image quality with the Hitachi SK-110D. For a demonstration in your studio contact Hitachi Denshi America Ltd., Broadcast and Professional Division, 175 Crossways Park West, Woodbury, NY 11797; (516) 921-7200 or (800) 645-7510. Canada: Hitachi Denshi, Ltd. (Canada), 65 Melford Drive, Scarborough, Ontario M1B 2G6; (416) 299-5900.



 **HITACHI**

Circle (4) on Reply Card

1987 SBE call for papers

Abstracts are being accepted for proposed engineering papers for the 1987 **Broadcast Engineering** conference of the SBE national convention. The technical conference will address the hands-on needs of engineers and technical managers at radio and TV stations. The conference is being organized again this year by John Battison, well known through his work at the annual WOSU seminars.

If you would be interested in preparing a technical paper for presentation at the conference, submit an abstract outlining the scope of the paper and its importance to the industry, to Battison no later than May 31. If you are interested in participating in a panel discussion or serving in some other capacity, please submit a letter to Battison stating your desire. Because of the number of contacts required to organize a program as large as the '87 SBE convention, only written abstracts

and letters of interest can be accepted.

The SBE will again publish a *Proceedings* of the conference, which will be distributed at the convention. Authors should be prepared to submit a camera-ready manuscript by August 31. Send your correspondence to: John Battison, conference chairman, 890 Clubview Boulevard North, Columbus, OH 43085.

NAB backs elimination of origination rules

The National Association of Broadcasters supports an FCC proposal to eliminate its main studio and station program origination rules for radio and TV stations. However, NAB said steps are needed to ensure that the public has access to a station licensed to its community.

The association suggested that the commission require a broadcaster that chooses to locate its studio outside its community of license to maintain a local or toll-free telephone number for local

residents. Also, the public file should be maintained in a place that is reasonably accessible to residents of that community.

The rules were implemented in 1950 to provide a fair, efficient and equitable distribution of a station's service to every state and community. However, NAB feels that with competition and technological advances the rules are obsolete.

NTC invites participation

The Network Transmission Committee (NTC) is inviting representatives of the broadcasting and telecommunication communities to join in the committee, which previously had its membership limited to the Bell System and the major TV networks. The committee was established in 1954 to facilitate the transmission of color television. It has developed operational guidelines for transmission personnel, such as the well-known NTC

Continued on page 351

BROADCAST engineering

Editorial and advertising correspondence should be addressed to: P.O. Box 12901, Overland Park, KS 66212-9981 (a suburb of Kansas City, MO); (313) 883-4664. Telex: 42-4156 Intertec OLPK. Circulation correspondence should be sent to the above address, under P.O. Box 12937.

EDITORIAL

- Jerry Whitaker, *Editorial Director*
- Brad Dick, *Radio Technical Editor*
- Ned Soseman, *TV Technical Editor*
- Carl Bentz, *Special Projects Editor*
- Paula Janicke, *Associate Editor*
- Dawn Hightower, *Associate Editor*
- Dan Torchia, *Group Managing Editor*
- Irma Adread, *Group Associate Editor*
- Ailsa Carter, *Editorial Assistant*
- Pat Blanton, *Directory Editor*

ART

- Kristi Sherman, *Graphic Designer*

EDITORIAL CONSULTANTS

- Fred Ampel, *Audio*
- Nils Conrad Persson, *Electronics*
- Tom Cook, *Video*
- Mel Lambert, *Professional Audio*

BUSINESS

- Cameron Bishop, *Group Vice President*
- Duane N. Helmer, *Publisher*
- Stephanie Fagan, *Promotions Manager*
- Cynthia Sedler, *Promotions Coordinator*
- Dee Unger, *Advertising Supervisor*
- Mary Birnbaum, *Advertising Coordinator*

ADMINISTRATION

- R. J. Hancock, *President*
- Doug Riemer, *Circulation Director*
- JoAnn DeSmet, *Circulation Manager*
- Kevin Callahan, *Art Director*
- Dre Manies, *Reader Correspondent*

TECHNICAL CONSULTANTS

- Eric Neil Angevine, *Broadcast Acoustics*
- John H. Battison, *Antennas/Radiation*
- Elair Benson, *TV Technology*
- Dennis Ciapura, *Radio Technology*
- Dane E. Ericksen, *Systems Design*
- Howard T. Head, *FCC Rules*
- Wallace Johnson, *FCC/Bdct. Engineering*
- John Kean, *Subcarrier Technology*
- Donald L. Markley, *Transmission Facilities*
- Harry C. Martin, *Legal*
- Robert J. Nissen, *Studio/Communications*
- Hugh R. Paul, *International Engineering*
- Art Schneider, *A.C.E., Post-production*
- Elmer Smalting III, *Cable/Satellite Systems*
- Vincent Wasilewski, *Communications Law*

MEMBER ORGANIZATIONS

- Acoustical Society of America
- Society of Broadcast Engineers

- Member, Association of Business Publishers
- Member, Business Publications Audit of Circulation



SUBSCRIPTIONS: BROADCAST ENGINEERING

is mailed free to qualified persons within the United States and Canada in occupations described above. Non-qualified persons may subscribe at the following rates: United States and Canada: one year, \$25.00. Qualified and non-qualified persons in all other countries: one year, \$30.00 (surface mail); \$108.00 (air mail). Back issue rates, \$5, except for the Buyers' Guide/Spec Book, which is \$20. Rates include postage. Adjustments necessitated by subscription termination at single copy rate. Allow 6-8 weeks for new subscriptions or for change of address. Second class postage paid at Shawnee Mission, KS.

BROADCAST ENGINEERING Volume 23, No. 3 (USPS 338-130) is published monthly (except in the fall, when two issues are published) by Intertec Publishing Corporation, 9221 Quivira Road, P.O. Box 12901, Overland Park, KS 66212. Second Class Postage paid at Shawnee Mission, KS and additional mailing offices. POSTMASTER: Send address changes to BROADCAST ENGINEERING, P.O. Box 12983, Overland Park, KS 66212.

Photocopy rights: Permission to photocopy for internal or personal use is granted by Intertec Publishing Corporation for libraries and others registered with Copyright Clearance Center (CCC), provided the base fee of \$2.00 per copy of article is paid directly to CCC, 21 Congress St., Salem, MA 01970. Special requests should be addressed to Cameron Bishop, group vice president, ISSN 0007 1794 \$2.00 + \$0.00.

© 1987 All rights reserved.

Advertising offices listed on page 361.



Cross-Country Communication

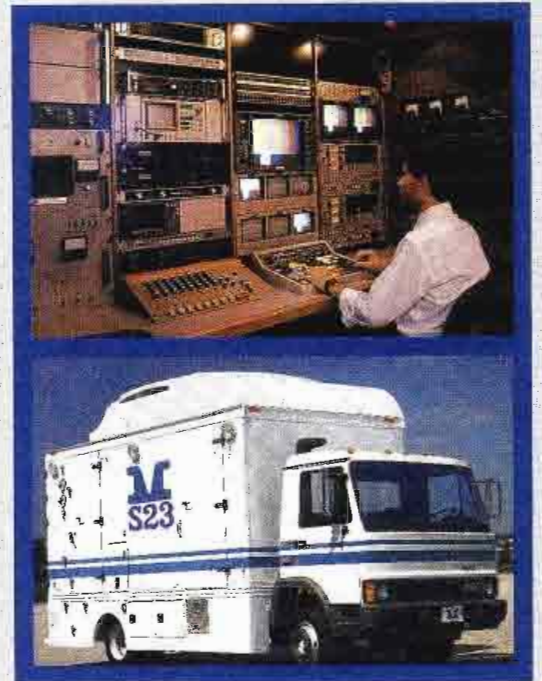

With the antenna
that works!
In Brownsville,
In Seattle,
In Miami,
Everywhere!

Midwest combines its mobile production unit experience with the latest antenna technology to bring you the S-23, a mobile satellite communications system that enables you to uplink a story from virtually anywhere.

The S-23 incorporates a Vertex 2.6M antenna with 50db gain into a unit that is spacious enough for full production capability, yet has excellent weight distribution and a wide GVW safety margin.

An integral deployment and positioning system ensures antenna accuracy, even in heavy weather. You

can choose from a variety of equipment configurations and several domestic and foreign chassis models.

Call for specifications and antenna patterns on the S-23, S-18, S-1 Fly-away or any of our mobile satellite communications systems.

The Midwest S-23. The mobile satellite communications system that works. Everywhere.

- 2.6M Vertex Antenna
- >50db Gain at 14.125 GHz
 - >35db Cross Polar Isolation
 - Meets 29-25 log θ FCC 2° Spacing Curves



MIDWEST
Communications Corp.

One Sperti Drive
Edgewood, KY 41017
606-331-8990

See Midwest at Indoor Booth #3210
and at Outside Booth #10.

Circle (3) on Reply Card

Contents

March 1987 • Volume 29 • Number 3

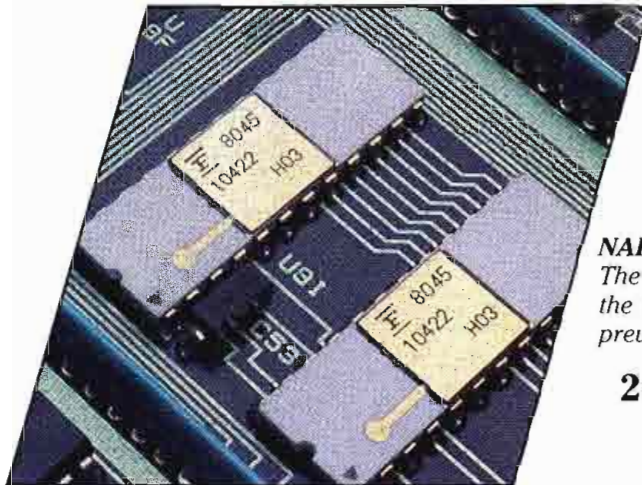

Page 36

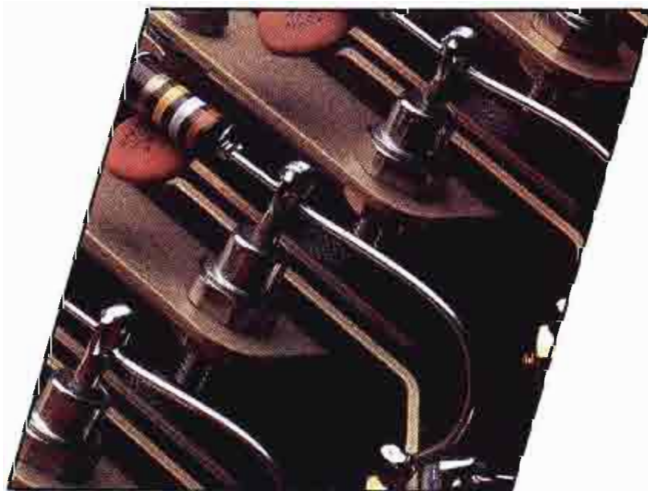

Page 86

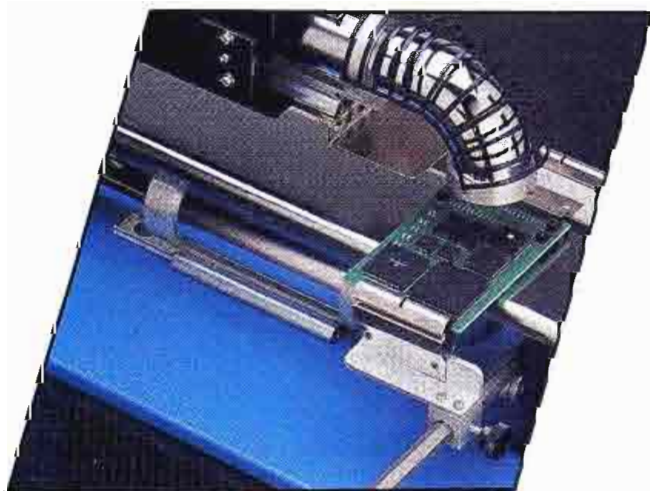

Page 116

ON THE COVER

The big event is about to begin. The 1987 NAB Convention (March 28-31 in Dallas) promises to be another record show. The Dallas setting is the inspiration for our cover this month. The distinctive Dallas skyline was developed by **BE** graphic designer, Kristi Sherman. Airbrush work by Intertec designer, Tim Lynch.

BROADCAST engineering

NAB SPECIAL ISSUE:

The annual National Association of Broadcasters convention is the clock that drives the broadcast industry. Use our show preview to plan your convention activities in Dallas.

26 NAB Engineering Conference Preview

By Ed Williams, NAB Office of Science and Technology
A summary of the major technical papers to be presented at NAB's premier engineering gathering.

141 NAB Convention Floor Map

Your complete guide to exhibitors at the show.

154 Exhibitor Listings

A rundown of the companies exhibiting at NAB and the types of products they will have on display.

214 New at NAB

A detailed summary of the new products to be introduced at NAB, organized by product categories. Your best source for new product information.

35 RELIABILITY AND MAINTAINABILITY SPECIAL REPORT

36 The Mechanics of Component Failure

By Jerry Whitaker, editorial director
A detailed analysis of why parts fail and how problems in the field can be avoided. The article is the most detailed look at component and system reliability ever published for the broadcast industry.

86 Troubleshooting Transmission Equipment

By Jerry Whitaker, editorial director
How to repair failures in radio and TV transmitters.

116 Repairing Surface-Mount PC Boards

By Christopher Fenton, Western Reserve Tool
Guidelines on how to remove and install surface-mount components found in many broadcast systems today.

OTHER FEATURES

130 Planning for Audio Post-Production

By Richard Maddox, recording engineer

262 A Design Approach to Lighting

By Eric Neil Angevine, BE acoustics consultant

272 Audio Equalization for Cartridge Recording

By Douglas Fearn, WKSZ Radio

276 Coping with Solar Outages

By John Loeffler, Mannamedia

284 LCD Display Technology

Adapted by Conrad Persson, BE electronics editor

DEPARTMENTS

4	News	20	Management for Engineers
6	Editorial	22	SBE Update
8	FCC Update	302	Applied Technology: Dolby Deltalink
10	Strictly TV	308	Field Report: Ampex AVA-3
12	re: Radio	316	Station-to-Station
14	Satellite Technology	320	Business
16	Circuits	326	People
18	Troubleshooting	330	New Products

HOW THE SK-110D PUTS AN END TO THE REIGN OF ERROR.

With the SK-110D, Hitachi has created a studio broadcast camera with microprocessor technology so accurate that registration errors and time-consuming setup are things of the past.

Using a single button, now you can automatically set up RGB, color balance, and analog and digital registration—along with complete fault diagnosis—for up to 42 cameras simultaneously in just two minutes. And while you're shooting, the SK-110D keeps correcting realtime zoom and focusing errors, as well as registration changes caused by fluctuating prism temperatures.

The SK-110D performs magnificently.

Here's why: The 30-mm LOC diode gun Plumbicons and electronics yield 750 lines horizontal resolution, and greater than -56dB S/N. Dynamic focus provides for superb corner resolution. And detail signals are generated from both red and green.

The SK-110D is also today's most technologically advanced and versatile camera system. It offers iris and auto-setup by external chart. It has a high-resolution viewfinder with electronic markers.

The battery-backed head and CCU store up to four full-function files, eight lens files and 64 scene files. And add a smart RCU that controls those files, and you've got a camera that can precisely remember the "look" of every production shot you'll take.

Put an end to the reign of error in your studio today. And usher in a new era of image quality with the Hitachi SK-110D. For a demonstration in your studio contact Hitachi Denshi America Ltd., Broadcast and Professional

Division, 175 Crossways Park West, Woodbury, NY 11797; (516) 921-7200 or (800) 645-7510. Canada:

Hitachi Denshi, Ltd. (Canada), 65 Melford Drive, Scarborough, Ontario M1B 2G6; (416) 299-5900.



 **HITACHI**

Circle (4) on Reply Card

1987 SBE call for papers

Abstracts are being accepted for proposed engineering papers for the 1987 **Broadcast Engineering** conference of the SBE national convention. The technical conference will address the hands-on needs of engineers and technical managers at radio and TV stations. The conference is being organized again this year by John Battison, well known through his work at the annual WOSU seminars.

If you would be interested in preparing a technical paper for presentation at the conference, submit an abstract outlining the scope of the paper and its importance to the industry, to Battison no later than May 31. If you are interested in participating in a panel discussion or serving in some other capacity, please submit a letter to Battison stating your desire. Because of the number of contacts required to organize a program as large as the '87 SBE convention, only written abstracts

and letters of interest can be accepted.

The SBE will again publish a *Proceedings* of the conference, which will be distributed at the convention. Authors should be prepared to submit a camera-ready manuscript by August 31. Send your correspondence to: John Battison, conference chairman, 890 Clubview Boulevard North, Columbus, OH 43085.

NAB backs elimination of origination rules

The National Association of Broadcasters supports an FCC proposal to eliminate its main studio and station program origination rules for radio and TV stations. However, NAB said steps are needed to ensure that the public has access to a station licensed to its community.

The association suggested that the commission require a broadcaster that chooses to locate its studio outside its community of license to maintain a local or toll-free telephone number for local

residents. Also, the public file should be maintained in a place that is reasonably accessible to residents of that community.

The rules were implemented in 1950 to provide a fair, efficient and equitable distribution of a station's service to every state and community. However, NAB feels that with competition and technological advances the rules are obsolete.

NTC invites participation

The Network Transmission Committee (NTC) is inviting representatives of the broadcasting and telecommunication communities to join in the committee, which previously had its membership limited to the Bell System and the major TV networks. The committee was established in 1954 to facilitate the transmission of color television. It has developed operational guidelines for transmission personnel, such as the well-known NTC

Continued on page 351

BROADCAST engineering

Editorial and advertising correspondence should be addressed to: P.O. Box 12901, Overland Park, KS 66212-9981 (a suburb of Kansas City, MO); (913) 888-4664. Telex: 42-4156 Intertec OLPK. Circulation correspondence should be sent to the above address, under P.O. Box 12937.

EDITORIAL

Jerry Whitaker, *Editorial Director*
Brad Dick, *Radio Technical Editor*
Ned Soseman, *TV Technical Editor*
Carl Bentz, *Special Projects Editor*
Paula Janicke, *Associate Editor*
Dawn Hightower, *Associate Editor*
Dan Torchia, *Group Managing Editor*
Irma Allread, *Group Associate Editor*
Alisa Carter, *Editorial Assistant*
Pat Blanton, *Directory Editor*

ART

Kristi Sherman, *Graphic Designer*

EDITORIAL CONSULTANTS

Fred Ampel, *Audio*
Nils Conrad Persson, *Electronics*
Tom Cook, *Video*
Mel Lambert, *Professional Audio*

BUSINESS

Cameron Bishop, *Group Vice President*
Duane N. Hetner, *Publisher*
Stephanie Fagan, *Promotions Manager*
Cynthia Sedler, *Promotions Coordinator*
Dee Unger, *Advertising Supervisor*
Mary Birnbaum, *Advertising Coordinator*

ADMINISTRATION

R. J. Hancock, *President*
Doug Riemer, *Circulation Director*
JoAnn DeSmet, *Circulation Manager*
Kevin Callahan, *Art Director*
Dee Manies, *Reader Correspondent*

TECHNICAL CONSULTANTS

Eric Neil Angevine, *Broadcast Acoustics*
John H. Battison, *Antennas/Radiation*
Blair Benson, *TV Technology*
Dennis Ciapura, *Radio Technology*
Dane E. Ericksen, *Systems Design*
Howard T. Head, *FCC Rules*
Wallace Johnson, *FCC/Bdct. Engineering*
John Kean, *Subcarrier Technology*
Donald L. Markley, *Transmission Facilities*
Harry C. Martin, *Legal*
Robert J. Nissen, *Studio/Communications*
Hugh R. Paul, *International Engineering*
Art Schneider, A.C.E., *Post-production*
Elmer Smalling III, *Cable/Satellite Systems*
Vincent Wasilewski, *Communications Law*

MEMBER ORGANIZATIONS

Acoustical Society of America
Society of Broadcast Engineers

Member,
Association of Business Publishers
Member,
Business Publications
Audit of Circulation



SUBSCRIPTIONS: BROADCAST ENGINEERING

is mailed free to qualified persons within the United States and Canada in occupations described above. Non-qualified persons may subscribe at the following rates: United States and Canada: one year, \$25.00. Qualified and non-qualified persons in all other countries: one-year, \$30.00 (surface mail); \$108.00 (air mail). Back issue rates, \$5, except for the Buyers' Guide/Spec Book, which is \$20. Rates include postage. Adjustments necessitated by subscription termination at single copy rate. Allow 6-8 weeks for new subscriptions or for change of address. Second class postage paid at Shawnee Mission, KS.

BROADCAST ENGINEERING

Volume 29, No. 3 (USPS 338-130) is published monthly (except in the fall, when two issues are published) by Intertec Publishing Corporation, 9221 Quivira Road, P.O. Box 12901, Overland Park, KS 66212. Second Class Postage paid at Shawnee Mission, KS and additional mailing offices. POSTMASTER: Send address changes to BROADCAST ENGINEERING, P.O. Box 12983, Overland Park, KS 66212.

Photocopy rights: Permission to photocopy for internal or personal use is granted by Intertec Publishing Corporation for libraries and others registered with Copyright Clearance Center (CCC), provided the base fee of \$2.00 per copy of article is paid directly to CCC, 21 Congress St., Salem, MA 01970. Special requests should be addressed to Cameron Bishop, group vice president. ISSN 0007 1794 \$2.00 + \$0.00.

© 1987. All rights reserved.

Advertising offices listed on page 361.



LEADER

2-YEAR WARRANTY!
 All Leader Test Instruments have the highest level of accuracy and reliability. Durable enough to withstand intensive 3-shift production demands, Leader Instruments are the benchmark of quality and performance.

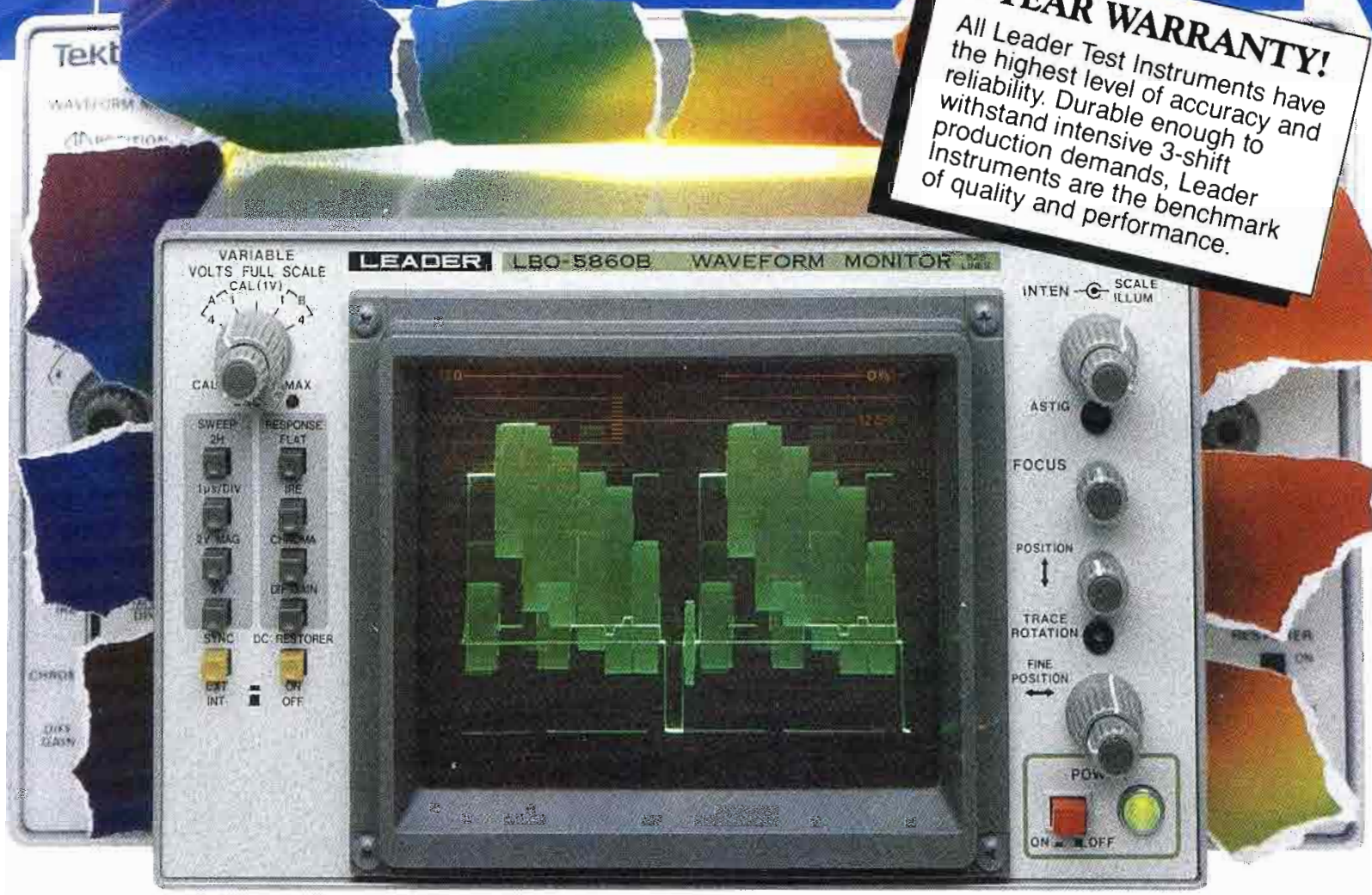

Goodbye old standard!

Leader's new LBO-5860B Half-Rack Waveform Monitor delivers all its features for \$590* less!

As good as you were, old standard, your time has passed-The Leader LBO-5860B is better because it's easier to use and delivers all your features for only \$1,740 list. In fact, video pros who swore by you for years will be delighted to have me around.

The LBO-5860B sets new standards.

Compare the LBO-5860B to any other half-rack unit—be it the Tek[†] 1730 which lists for \$2250*, or even the old standard, Tek[†] 528A, at \$2,330*. You'll agree the high-performance LBO-5860B has no equal in ease of use and value:

- RGB at no extra cost; optional YRGB
- Rack-mounts alongside LVS-5850B or any other half-

rack vectorscope • Bright, PDA CRT with internal, etched graticule

- 4 sweep speeds (2-line and 2-field displays, regular and expanded)
- Flat response, IEEE and chroma filters
- Switchable dc restorer clamps blanking at zero IRE
- Switchable internal/ext. sync
- Excellent stability and reliability
- PAL, SECAM and line selector (5860H) models available
- 2-year warranty.

Raise your vectorscope standards.

LVS-5850B reduced \$200 to only \$1,995.

- Easy to use
- Rack-mountable with LBO-5860B or any other half-rack waveform monitor
- Electronically generated CRT targets, and error limits
- Electronic targets eliminate parallax and readout is independent of centering controls.



Buy both for \$3,735. Less than any other high-quality, half-rack pair.

Call toll-free
(800) 645-5104
 In NY State
(516) 231-6900

Ask for an evaluation unit, our latest Catalog, more information, or your nearest "Select" Leader Distributor.

For professionals who know the difference.



380 Oser Avenue, Hauppauge, New York 11788
 Regional Offices:
 Chicago, Dallas, Los Angeles, Boston, Atlanta
 In Canada call Omnitronix Ltd. (514) 337-9500

For Product Demonstration Circle (5) on Reply Card

For Product Information Circle (6) on Reply Card

*All prices are manufacturer's suggested list prices as of 9/3/86. Actual savings may vary since prices are set by the retailer.

†Trademark of Tektronix

Broadcast quality ... use it or lose it!

Remember when the words *broadcast quality* were synonymous with the highest level of development for transmission and reproduction of pictures and sound? These days, *state of the art* is used to characterize the leading edge of studio and RF equipment. Does broadcast quality lag behind the state of the art?

As radios evolved from a box with a speaker to thundering component systems, FM broadcasters were among the first to address a growing segment of the audience that was listening on better sound systems than those in charge at the station. As a result, FM broadcasting has evolved from simply transmitting the loudest signal on the dial to broadcasting the cleanest.

With the introduction of MTS, many TV broadcasters have suddenly been thrust into the position of fulfilling demands for premium-quality stereophonic sound, in a medium where undistorted monaural audio was always unquestionably sufficient. In the near future, similar demands will be made on video quality.

Since television was introduced to the public, TV set marketing, like old radio marketing, emphasized the style and size of the cabinet over the technical capabilities of the unit. Until recently, broadcast monitors clearly offered a far more critical display of video information than any consumer TV set.

A walk through this year's Winter Consumer Electronics Show in Las Vegas illustrated how rapidly the game is changing for the TV industry. Yes, there were still a couple of French Provincial TV consoles on the floor, but they were vastly outnumbered by a new generation of high-tech component-style TV receiver/monitors. These new televisions are designed to be the single, ultimate display device for all video sources within a home. Many of the new televisions approach 600 lines of resolution and use digital frame storage to routinely accomplish futuristic magic such as noise reduction, progressive scanning conversion, picture-in-picture, ghost rejection and perfect freeze frames.

Over the last couple of years, consumer-level CRT and digital video technology has mushroomed. The TV industry can thank (or blame) the computer industry for many of these advancements.

Only a decade has elapsed since broadcasters were standing in line to order a Squeezzoom for \$175,000. Today, you can drop by your local appliance store and see a new television or VCR, with digital picture manipulation features built in, for under \$1,000. While you're there, compare the new consumer camcorders to the original TK-76. And then there are the broadcast spin-offs of 1/2-inch consumer video. Where will we be in 10 years? Or next year? Who is leading whom?

The incorporation of new technology has created consumer televisions that approach and sometimes exceed the picture quality of many expensive broadcast monitors. Granted, their colorimetry may not be as accurate as a good broadcast monitor, but their picture detail and resultant sensitivity to noise and picture artifacts is astonishing.

The technology that continues to improve state-of-the-art video, audio and computer displays also will be the vehicle for increased awareness of technical quality by the audience. On the new televisions, good video looks better, poor video looks worse, heterodyne artifacts and chroma noise stick out like a sore thumb.

Broadcasters must address the fact that the rules in the game of home entertainment are changing, rapidly. Today, the technical quality of a presentation is becoming as important as the content to attract and hold an audience. If you question whether the market for high quality is there, consider the unprecedented proliferation and success of compact discs.

In this age of increasing options for video screen and sound system sources, the purest broadcast pictures and sound are no longer a luxury. Improvement lies not with simply passing proof-of-performance tests, but with uncompromising technical production values, and comprehensive lens-to-antenna system transparency. The *broadcast quality* technical leadership our industry worked so hard to establish must be revived to survive.

!:-:~)))]]

THE BLUE CHIPS.

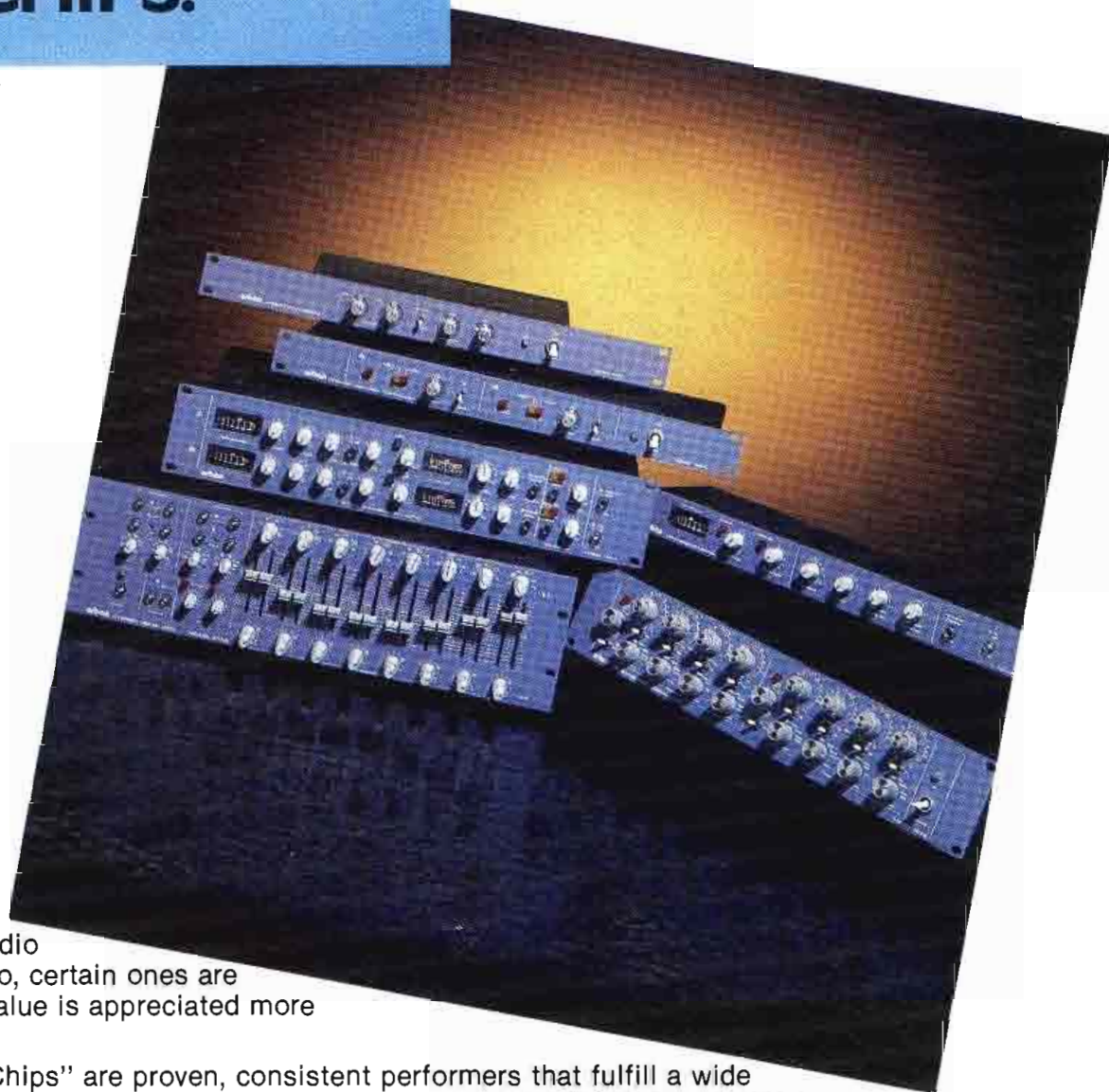

While trendy audio products come and go, certain ones are timeless. Their true value is appreciated more year after year.

Orban's "Blue Chips" are proven, consistent performers that fulfill a wide variety of essential production and system requirements in top facilities worldwide.

622B Parametric Equalizer: The standard by which all others are judged. Sonically and musically pleasing. Can be used as combination 4-band EQ and notch filter. A real job saver.

672A/674A Graphic Parametric Equalizers "The Paracrossalizer": Combines eight bands of parametric EQ with tunable high and lowpass filters. A uniquely versatile production tool. Also quickly becoming the smart choice for room and system tuning because it eliminates ringing and phase shift problems. Can be used as full electronic crossover plus EQ in one cost-effective package.

536A Dynamic Sibilance Controller: Around the world, Orban de-essers are the salvation of vocal sessions. Quick set up and easy operation.

422A/424A Gated Compressor/Limiter/De-Esser "The Studio Optimod": The most flexible, cost-effective level control system available. Orban compressors are known and appreciated for their smoothness. No pumping, no breathing; they work for you, not against you in tough applications.

412A/414A Compressor/Limiter: Transparent level control delivers the punch without the bruise. Very cost-effective. Ideal for installations and reinforcement work.

245F Stereo Synthesizer: Magical stereo effects from mono synths, drum machines, or any mono source. Perfect for extending capability of smaller format multi-track systems—the 5th, 9th, 17th, or 25th track. Inexpensive.

Orban also manufactures the reliable 111B Dual Spring Reverb as well as attractive acrylic security covers which fit all standard 19" rack mount products.

Orban Associates Inc.
645 Bryant St. San Francisco, CA 94107
(415) 957-1067 Telex: 17-1480

Circle (7) on Reply Card





Commission stays must-carry rules

By Harry C. Martin

The FCC, on its own motion, stayed the Jan. 15 date of its recently adopted must-carry rules for cable TV systems. The new rules require cable systems to provide all new subscribers, at no cost, an input selector (A/B) switch for receiving off-the-air signals. Additionally, the cable operator must offer to supply and install the switch, for a fee, to all existing subscribers. The new rules also establish mandatory carriage requirements for local TV signals depending on the channel capacity of the cable system.

The stay applies to all aspects of the new rules. It will remain in effect until 30 days after the release of an order by the commission addressing the petitions for reconsideration that were filed.

Proposed changes in multiple ownership

The commission has proposed relaxing the multiple ownership rules to allow certain radio-TV combinations that are now prohibited by the one-to-a-market rule and to lessen the requirements of the duopoly rule as it applies to commercial radio stations.

- One-to-a-market rule: Under the proposed rule, restrictions on cross-ownership of radio and TV stations would be changed to allow a party to own (a) one AM/FM/UHF TV combination or (b) one AM/VHF TV combination or (c) one AM/UHF TV combination in a market. The commission asked for comments on whether such combinations should be allowed in all markets or only in the larger or well-served markets.

- Duopoly rule: Under the current rule, parties are prohibited from owning two or more commercial AM stations whose 1mV/m contours overlap or two or more commercial FM stations whose 1mV/m contours overlap. The commission has proposed relaxing the 1mV/m benchmark to 5mV/m for AM stations and 3.16 mV/m for FM stations. These contours are proposed because they are the minimum signal strengths that AM and FM stations are required to place over their respective communities of license.

Deletion of reservation of 20 Class A FM channels

The commission has eliminated its power and height restrictions on the 20 FM frequencies previously reserved for Class A use. Stations operating on those frequencies now may petition to have them upgraded to higher classes where spacing permits.

The reservation, which was contained in Section 73.206 of the rules, was intended to ensure that FM allotments would be available for smaller communities. The commission has concluded there is no longer any need to reserve channels because a large number of the allotments made in the Docket 80-90 proceeding went to small communities.

In the same proceeding, the commission refused to consider amending its rules to permit an increase in power to 4kW and an increase in antenna height to 125m above average terrain for all Class A stations.

Plan of action for AM

The commission has outlined a series of present and future possible actions with regard to AM broadcast regulation. The commission's proposal comes in the wake of a 1986 report, prepared by the Mass Media Bureau, on the status of AM broadcasting. The report recognized that the future of AM broadcasting rests on broadcasters' entrepreneurial initiative and identified steps to remove government intrusion upon such initiative.

Based on the 1986 report and public comments filed in response, the commission has outlined a tentative course of action with regard to AM broadcast regulation. That course includes present steps, longer term initiatives now under consideration and potential actions that will be deferred pending the outcome of other proceedings. The specific actions initiated or proposed are as follows:

Near-term actions

The commission has:

- Begun an inquiry into the use of synchronous transmitters to improve AM coverage.
- Issued a notice of proposed rulemaking to relax or eliminate its main studio and program origination rules.

- Begun a proceeding to examine certain multiple ownership issues, including the duopoly rule.

- Taken under consideration interference limits for RF lighting devices and also may issue a notice of inquiry concerning interference from incidental radiation devices, such as appliances and electrical motors.

Longer-term actions

The commission is also considering:

- An inquiry proceeding to examine the technical parameters of interference protection, including protection ratios, protected contours, RF bandwidth limitations and calculation methodologies. Based on the results of this proceeding, the commission might be able to take future action in order to relieve current restrictions on station power.

- Action to permit daytime-only stations to operate at night, using a power level below the current minimum if necessary. The commission noted that many daytime-only stations are unable to meet minimum power requirements without causing objectionable interference to existing full-time stations.

Deferred subjects

The commission has deferred consideration of:

- Action on new antenna design needs, until sufficient test data has been obtained. The commission stated it will continue to encourage the development of new antenna designs in the meantime, through issuance of experimental authorizations for their study and testing.

- Changes in channel and station classifications and current limitations on station power, pending resolution of the issues in the technical parameters proceeding.

- The development of a uniform standard for AM stereo, pending completion of a study being conducted by the NTIA on the functioning of the marketplace in the selection of a uniform standard.

The commission stated that interested parties are invited to develop information concerning the proposals that have been deferred, in order to assist the commission in formulating future actions.

Martin is a partner with the legal firm of Reddy, Begley & Martin, Washington, DC.

In the year 2003, this system will be less obsolete than any other master control system available today.

Not even Grass Valley Group knows all the features you'll need in your master control system in 2003.

But we *do* know you'll need stereo audio, second audio program and still store interface. And the only

master control system that has them all today — plus BETACART™ interface — is the Grass Valley Group 1600-4S/M200.

As your needs grow, so will your system — because it's designed,

built and backed by Grass Valley Group.

Check out the 1600-4S/M200. In 2003, you'll still be glad you did.

Grass Valley Group[®]
A TEKTRONIX COMPANY

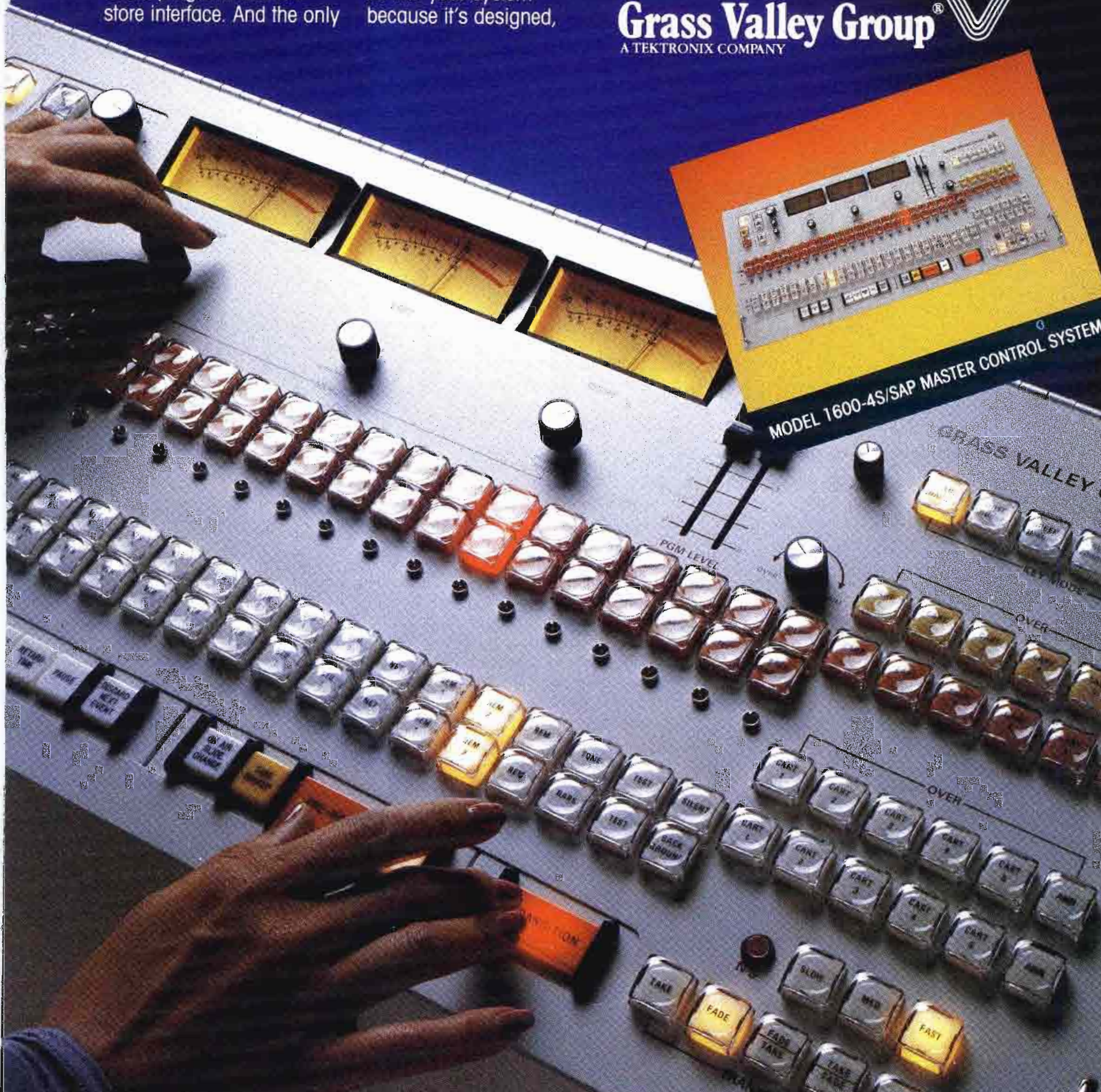

Circle (8) on Reply Card

THE GRASS VALLEY GROUP, INC.® — P.O. Box 1114 — Grass Valley, CA 95945 USA — Telephone (916) 273-8421 — TRT: 160432
OFFICES: Edison, NJ (201) 549-9600; Atlanta, GA (404) 321-4318; Elkhart, IN (219) 264-0931; Arden Hills, MN (612) 483-2594;
Fort Worth, TX (817) 921-9411; Woodland Hills, CA (818) 999-2303; Palo Alto, CA (415) 968-6680.

TM — BETACART is a registered trademark of Sony Corporation

Comparing similar video products

By Ned Soseman, TV technical editor

When the time comes to purchase new equipment, how do you decide which product to buy? Do you "kick tires" at trade shows, generate detailed spread sheets from sales brochures and the annual **BE** Spec Book, or ask others for advice? These methods are frequently employed to arrive at a purchasing decision. But with equipment prices higher than the station's payroll, a misinformed decision could put you directly behind the 8-ball. Take advantage of the influence and tools you have at your disposal by organizing a side-by-side shoot-out.

There is a good chance, if you're at work, that there is a manufacturer's sales brochure for some piece of equipment on your desk. On the back of that literature, there are probably some performance specifications.

It would seem that comparing price, features, performance specs and a reassuring testimonial or two would be adequate. However, there are few, if any, well-defined multilateral agreements between manufacturers to ensure that all broadcast equipment specs are derived by exactly the same procedures and criteria.

The trade show

Whether you visit local dog-and-pony shows, or international trade show exhibits, comparing products in a sales en-

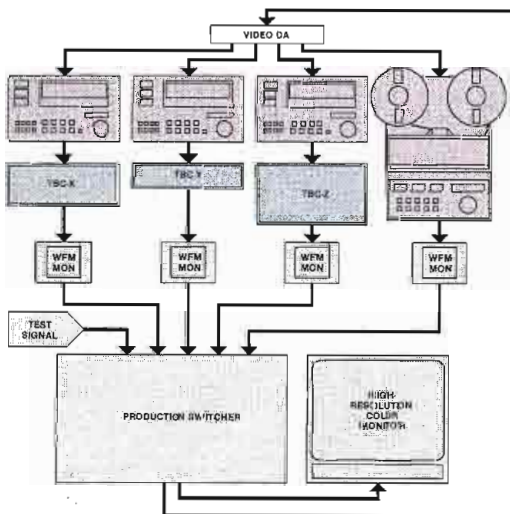
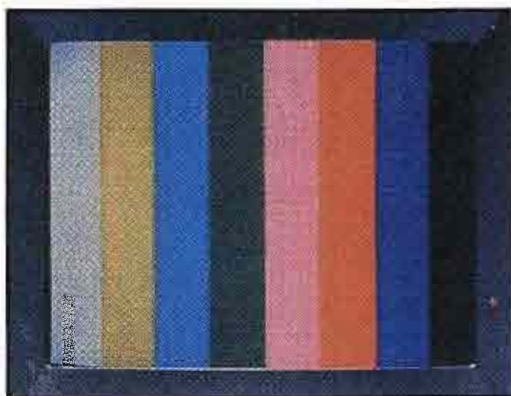

Figure 1. There is no better venue for comparative evaluation than at your station. Shown here is a system to assess the multigeneration performance of three TBCs.



vironment seldom provides the control necessary to reach undisputable conclusions. Product shows offer an opportunity for sensory experience and sales discussions, but they are typically limited to subjective comparisons of products from booth to booth.

Organizing a shoot-out

A shoot-out is an on-site, side-by-side demonstration under actual operating conditions, of two or more competitive products. As the buyer, you decide who gets your order, so organize your shoot-out to reveal the most valuable information. The initial stages of organizing may seem to be a formidable task, but the education, satisfaction and virtual elimination of buyer's remorse will make your efforts profitable. The participants will appreciate your decision-making criteria, and everyone may be surprised at the results.

To establish and maintain control, inform the sales managers of each product you want to test side by side. Schedule a day and time that will be the best for you, your station and the manufacturers' representatives. Plan and coordinate all cable, ac and physical requirements with your maintenance department, and block out studio switcher time with your production department. To increase enthusiasm, you may want to invite a few other prospective customers to witness the shoot-out.

Let's say, for example, that you need to purchase several time base correctors. These TBCs will be used for 3/4-inch playback of ENG and production materials. Your research indicates most 3/4-inch material that airs on your station is at least third or fourth generation. You have invited three TBC manufacturers to participate in a shoot-out. How will you comparatively evaluate their products with fairness and objectivity?

Designing your own test

The best method to directly compare the electronic output of video devices, without elaborate laboratory setups and equipment, is to use split-screen special effects, displayed on a single, large, high-quality monitor and a waveform moni-

tor. By using your station's production switcher, this can easily be accomplished. In the TBC shoot-out example, each 3/4-inch VTR feeds one of the test TBCs at its output, as shown in Figure 1. A separate waveform monitor is connected to the output of each TBC to observe and eliminate level discrepancies.

Feed a test video source such as a studio camera or color bars from the output of the studio production switcher to the inputs of the three 3/4-inch VTRs and a 1-inch VTR simultaneously. Record this signal on all four machines to establish a first generation reference.

Next, simultaneously play back the first generation recordings through the production switcher, configured to simultaneously display all the TBCs in a split-screen pattern, for easy comparison, and record the split-screen output on the 1-inch machine. Then select the 1-inch machine direct on the switcher and play back the 1-inch recording of the split screen, while simultaneously recording this playback (showing the split screen) again on the 3/4-inch machines. You now have second generation signals on your 3/4-inch tapes.

Simultaneously play back the 3/4-inch second generation recordings via the split screen and again record the split screen on the 1-inch machine. Perform this cycle again until you have arrived at the desired number of generations. Use a character generator to identify which TBC is which, and how many generations are shown on each cut.

The finished results are now on your 1-inch tape. If you recorded the generations end-to-end, you now own a 1-inch tape that documents the differences between the picture quality of each TBC, at each generation.

Regardless of what product you're buying, if it is small enough to easily ship, a well-planned shoot-out will help you make the right decision.

Video Graphic Courtesy of:
Abel Image Research/Cinecommunications,
Malaysia/KHK/Needham, Malaysia



NOW, A 1-INCH VIDEO TAPE THAT LOOKS GREAT TO EDITORS. AND ENGINEERS.

Introducing 1-inch EASTMAN Professional Video Tape, EVT-2000 (Broadcast Quality). With the durability to satisfy the toughest editor, and the signal characteristics to brighten the eyes of the most demanding engineer.

The latest advances in binder technology have produced a highly durable video tape that runs smoothly and withstands the ravages of heavy editing and still-framing without increasing headwear.

New EASTMAN Professional Video Tape, EVT-2000, is formulated to deliver clean, crisp, brilliant pictures and excellent audio performance. Chrominance and luminance are superior. Dropouts are minimal. EVT-2000 is recommended for production, post production, and heavy editing, while our economical EVT-1000 video tape is suggested for duplicating and syndication. EASTMAN Professional Video Tape, EVT-2000, is available in

C-format lengths from 34 to 188 minutes and B-format lengths from 34 to 126 minutes.

For details, write to Eastman Kodak Company, Dept A3067, 343 State Street, Rochester, NY 14650. Or call toll free 1 800 44KODAK (1 800 445-6325), Ext 864.



EASTMAN KODAK COMPANY
Motion Picture and
Audiovisual Products
Division.

EVT-2000
PROFESSIONAL VIDEO TAPE (BROADCAST QUALITY)

© Eastman Kodak Company, 1986

Circle (9) on Reply Card

Augmentation in practical operation

By John Battison, P.E.

Last month's "re: Radio" column discussed MEOVs, standard patterns and augmentation. This month we'll continue to look at the subject and demonstrate how the augmented pattern is used in a practical application.

As you may know, a non-directional proof of performance is required before testing the directional pattern. Normally, an engineer expects a directional station's non-directional pattern to be circular—just as it would be for a regular non-DA station. In many cases the pattern is circular, but in some cases, external factors distort the pattern's shape.

Readers may recall that we have stressed the importance of checking unexpected building or tower construction adjacent to an antenna site. Such construction can distort not only a station's directional pattern, but also its non-directional pattern.

Parasitic tower

Figure 1 shows the non-DA pattern for one station. When the construction permit was issued several years ago, a communications tower, about 1,000 feet away, did not exist. Indeed, there was no reason to suspect one would be built. Un-

Battison, BE's consultant on antennas and radiation, owns John H. Battison & Associates, a consulting engineering company in Columbus, OH.

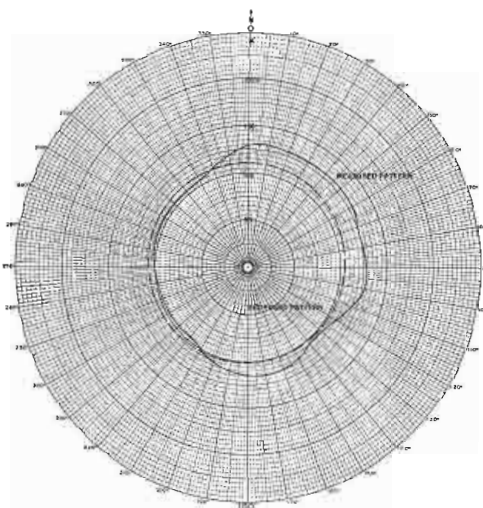
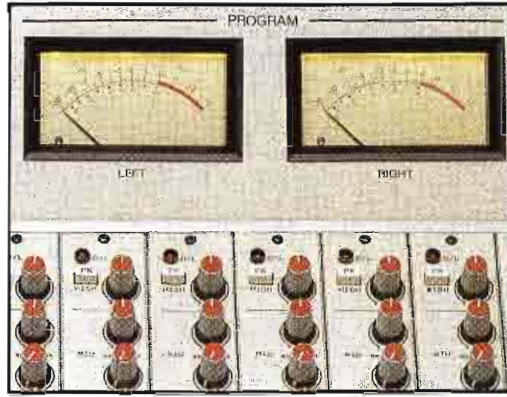

Figure 1. The dotted line represents the proposed pattern. The solid line represents the distortion produced by a communications tower.



fortunately, the tower was constructed in the major lobe of the 500W station. And, as might be expected, the new tower caused problems for the AM station.

The dotted line in Figure 1 represents the anticipated non-DA pattern. The solid line shows the actual measured non-DA pattern. This is the pattern that developed as a result of the nearby communications tower. The adjacent tower is about 260 feet high. The station's towers are 120 feet high. Thus, the intruding tower became a good radiator and affected the station's pattern.

The resulting, albeit distorted, pattern is not a bad non-DA pattern. There are plenty of similar non-DA patterns in the FCC's files, some much more distorted. However, this station's engineer was faced with trying to bring the pattern in to meet the CP requirements.

As might be expected, the communications tower affected more than the non-DA pattern. It also distorted the directional pattern. In this case, the distortion in the DA pattern followed more or less that of the non-DA pattern. The radials to the north and southeast each showed higher fields than anticipated. In some cases, the DA pattern may not be distorted in the same areas as the non-DA pattern. The phenomenon often depends upon the pattern complexity, the number of broadcast towers and the lo-

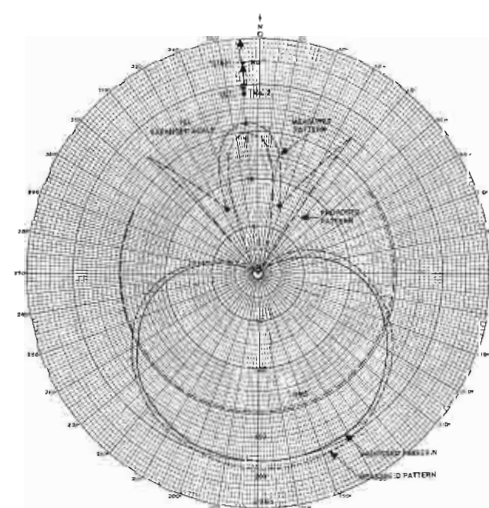

Figure 2. Note the distortion caused in the DA pattern.

cation of the parasitic radiators.

When this station's directional pattern was measured, the results shown in Figure 2 were obtained. The solid line is the proposed pattern. The dotted line is the major lobe's measured pattern. In the minor lobe, the dotted line represents the measured pattern and the broken line represents the proposed pattern.

In this example, the two critical directions are 355° and 17° . The commission had specified not-to-be-exceeded values for these azimuths. Although these values were not exceeded, the measured values were quite close to the permitted limits.

Note the two nulls shown in the proposed pattern. Contrast this with today's standard pattern in which the commission's equations produce a minimum of about $6mV/m$ in the nulls. The MEOV's usefulness is shown here because the measured value is less than the MEOV. The results therefore conform with the proposed pattern.

If the MEOV had not been shown in the CP application, then the consulting engineer would have two options: either file for a modified CP to document the discrepancy or detune the parasitic radiator. With the latter option, modifying the parasitic radiator would result in additional expenses.

In this particular example, the consultant filed a short modifying statement with the commission. This statement clarified the actual field situation and the pattern was accepted.

This is a good example of where the consultant was not at fault. It was actually the commission's error for failing to attach a rider to the communications tower's CP, requiring the owner to detune the tower. If the AM station had known of the proposed tower, it could have requested such a rider on the CP. This example emphasizes again the importance of keeping tabs on the area surrounding your tower site. You don't want to find out too late that someone is planning to construct something that may affect your pattern, without first having a chance to protect your station.

||:~:~)))))

THREE WAYS TO STEREO TV

the Superior Generator and More

A Stand-alone System

- Digitally synthesized signal generation
- Factory dbx encoding
- Improved noise reduction
- Full range, gated gain riding AGC
- Exclusive program-controlled stereo enhancement
- Multiband pre-emphasis limiting
- On-board Bessel tone calibrator
- Independent balanced and unbalanced output
- Selectable L/R or L + R/L - R Inputs



TVS-3002

the Ultimate MTS System

Add the TVS 3001 Audio Controller to the TVS 3002 to complete the system.

- Control of entire audio transmission path
- Loudness control that works well on voice and music
- Gated linearized multiband gain reduction
- Automatic stereo phase reversal correction
- Audio asymmetry controller
- Input sync suppression filtering
- Built-in pink noise generator



TVS-3001

TVS-3002

the Unequaled Processing Upgrade

Improve your current system with the latest in processing. Incorporates all of the features of the TVS 3001 plus:

- Extended-range AGC capability
- Exclusive program-controlled stereo enhancement
- Multiband pre-emphasis limiting
- Complete metering system for easy setup
- Loudness control that works well on voice and music
- Selectable L/R or L + R/L - R outputs
- Full remote control capability
- Compatible with any MTS generator



TVS-3010

**A
GENERATION
AHEAD**



CRL Systems

2522 West Geneva Drive
Tempe, Arizona 85282
(800) 535-7648 (602) 438-0888
TELEX: 350464 CRL TMPE. UD.

Circle (10) on Reply Card

Spring check list

By Elmer Smalling III

It's that time of year again: time to check your earth-station equipment for any damage or wear caused by the past season's weather extremes, regardless of where in the world your earth station might be located. Rain, ice, snow, wind and high humidity can greatly reduce the effective life as well as the long-term operation of a TVRO or earth-station facility. The first part of the check list is categorized by weather to aid operators whose facilities have been subject to particularly severe conditions throughout the entire winter season.

✓ Ice and snow

- 1. Examine the surface of the dish for dents, rust or rippled mesh. Treat where necessary.
- 2. Check the LNA and feed support structure for damage, twists or off-axis position.
- 3. Clean the de-icer heater filter(s) and examine ducts for dirt and obstructions.
- 4. Check the elevation and azimuth positions as well as the offset angle.
- 5. Examine cableways or catenaries for torn or stressed cables and broken supports.

✓ Wind

- 1. Check LNA and support structure for twists, bends or off-axis position.
- 2. Check the antenna for proper azimuth position, particularly king-post base units.
- 3. Check for debris in the feedhorn or offset feed aperture.
- 4. Examine cableways or catenaries for torn or stressed signal cables and broken supports.
- 5. Tighten all bolts and nuts. Do not over torque.

Smalling, BE's consultant on cable/satellite systems, is president of Jenel Systems and Design, Dallas.



- 6. Check for loose dish segments or stiffeners.

✓ Rain

- 1. Check all connections for corrosion or dampness and reseal if necessary.
- 2. Check the plumb of the standard antenna base or king-post antenna mounts.
- 3. Check the integrity of underground cables through resistance checks.
- 4. Remove all rust or corrosion and treat mount or antenna surfaces where required.

✓ High humidity

- 1. Check all connectors for corrosion or dampness.
- 2. Remove all rust and corrosion and treat surfaces where required.

✓ General

- 1. Lubricate all joints and bearings where indicated by the manufacturer.
- 2. Tighten all bolts and nuts. Do not over torque.
- 3. Check feed assembly for insects and foreign objects.
- 4. Check dry air or nitrogen if pressurized cable or waveguide is used.
- 5. Check the integrity of lightning-protection systems.

MSN units

Spring is a good time to perform the annual check of each mobile satellite news vehicle. They are susceptible to much more wear and tear than a fixed earth station. In addition to a thorough engineering inspection, MSN units should have a mechanical check, tune-up and replacement of worn parts such as fan belts, hoses and filters. The annual engineering check list should consist of:

✓ Antenna system

- 1. Clean and inspect all surfaces and treat with anti-oxidant where required.
- 2. Lubricate all bearings, hinge joints and thrusters where indicated by the manufacturer.
- 3. Check hydraulic fluid levels.
- 4. Check the operation of all limit and safety switches.
- 5. Inspect the LNA, feed aperture and waveguide or coaxial lead-in. If possible, check the SWR of the antenna system and compare with the manufacturer's specifications.

- 6. Check the azimuth and elevation drive system for proper operation.

- 7. Check the dehydrator for proper operation.

✓ Power/HVAC

- 1. Check generator for proper operation and output.
- 2. Clean filters, housing and lubricate generator where indicated by the manufacturer.
- 3. Check for tight and corrosion-free connections throughout the power-distribution system.
- 4. Check all lighting and replace where necessary.
- 5. Clean the filters and coils of air-conditioning units.

The annual inspection check list covers only the satellite-systems hardware. It is equally important to perform checks of all associated electronic equipment, particularly equipment that is mounted in the MSN vehicle. If the MSN vehicle is active throughout the year, the 3/4-inch VTRs and any other electromechanical equipment should be replaced or completely overhauled annually. [:-?~))]]

ONE LESS ALLIGATOR

The Broadcast Engineer works with time-line responsibilities few of us will ever experience. He knows that equipment problems can wreck production schedules.

That's why the Otari BII audio machine is so widely used for broadcast, news editing, and production.



Three speed operation, front panel record calibrations, a microprocessor controlled tape counter with LED display, and variable speed control, coupled with "bulletproof" reliability and high level product support all add up to one less alligator snapping at your heels. From Otari: The Technology You Can Trust.

Contact your nearest Otari dealer for a demonstration, or call Otari Corporation, 2 Davis Drive, Belmont, CA 94002 (415) 592-8311 Telex: 910-376-4890

OTARI®



Circle (11) on Reply Card

© Otari 1984

Inside digital technology

By Gerry Kaufhold II

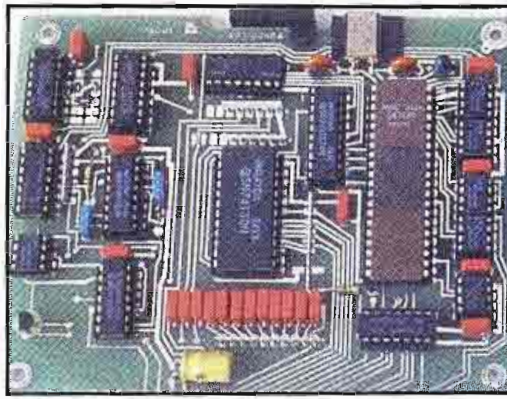

Thus far in this series, discussion has been limited to exploring the basic building blocks of digital electronics. Truth tables for the simple gates were presented in the November 1986 "Circuits" column, and these gates have been combined to create a one-of-sixteen decoder for addressing memories (February "Circuits" column). Once a memory address has been selected, data can be written into or out of the selected memory cell. How is this accomplished?

Recall that flip-flop circuits are used to store the *state* of a digital signal. Memory cells are made up of numerous latching flip-flops. Latching flip-flops are driven by the edge-transitions of digital pulses (December 1986 "Circuits" column).

The clock cycle

To prevent errors caused by unequal switching speeds of transistors in a memory array, the signals that control memory-access operations must be synchronized to a *master clock* signal. This master clock is the primary timing signal for all data transfers, and its unit of time is called the *clock cycle*. The top line of most timing diagrams shows the clock cycles for the master clock, and all of the other timing signals are referenced to this basic clock. (See Figures 1 and 2.)

Because the clock cycle is the unit of time, and not absolute frequency, timing diagrams for many digital circuits may

Kaufhold is staff engineer at KAET-TV, Tempe, AZ.

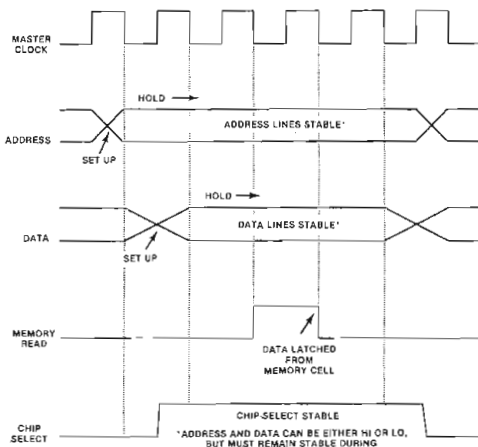

Figure 1. Typical MEMORY WRITE cycle. Pulses are synchronized with the master clock. Data is latched into memory at the end of the write pulse.

appear to be similar, even though there may be orders of magnitude difference between their absolute clock frequencies. When studying timing diagrams, note the actual times of signals in micro- or nanoseconds, especially if using an oscilloscope or logic analyzer for in-circuit analysis.

Also note that the timing diagram for a digital circuit illustrates the timing relationships between the useful parts of digital pulses, and does not show the actual waveforms of those pulses. A timing diagram is a conceptual tool, whereas the actual waveform of each digital pulse will contain harmonic distortion (because it is not a sine wave), noise and components due to transmission ringing or crosstalk from adjacent lines.

The WRITE cycle

In order to store a byte or word of information into memory, four operations must occur in proper sequence.

First, the MEMORY ADDRESS must be presented to the inputs of the address decoder circuits. The address decoder, made up only of gates, will hold the correct cell select signal TRUE only while the address-select bits are active. Therefore, the device driving the address bus must set up the address, and hold it on the bus during the entire length of the memory address cycle.

Next, the DATABITS to be stored into the selected memory cell must be pres-

ent and stabilized on the DATA inputs of the memory device. (See Figure 1.)

Now that the address and the data have had time to set up and hold, a MEMORY WRITE pulse occurs, which toggles the data into the selected memory cell. During the time that this MEMORY WRITE pulse is active, whatever data-bits appear on the data bus are ready to store into the memory cell. The data actually gets latched into the memory cell on the ending transition of the MEMORY WRITE pulse.

Finally, the ADDRESS SELECT lines and the DATABITS must still hold for a short while after the MEMORY WRITE pulse has completed, to prevent errors in storing the data.

Digital bus as transmission line

Digital circuits typically operate with a master clock in the range of several megahertz. The wires that interconnect digital circuits must be treated as transmission lines, and any time a LO-to-HI (or HI-to-LO) transition occurs, some ringing will be observed due to the imperfect terminations of the interconnected circuits. The timing requirements for setup and hold times for the ADDRESS, DATA and MEMORY WRITE signals are dictated by the characteristics and speed requirements of the circuit. ECL (emitter-coupled logic) is the fastest, followed by TTL (transistor-to-transistor logic), and the slowest is CMOS (complementary-metal-oxide-semiconductor logic).

Reading from memory

Similar to the MEMORY WRITE access cycle, four operations must occur for MEMORY READ. First, the ADDRESS SELECT lines must set up and hold (see Figure 2).

Next, when the MEMORY READ signal appears, DATA is read out from the selected memory cell and placed onto the DATABUS. This DATA must set up and hold until the next clock cycle, when the device requesting DATA latches the DATA off of the bus.

Finally, the MEMORY SELECT, MEMORY READ and DATA signals remain active for a short time after the DATA has been read, to prevent problems from transmission line ringing.

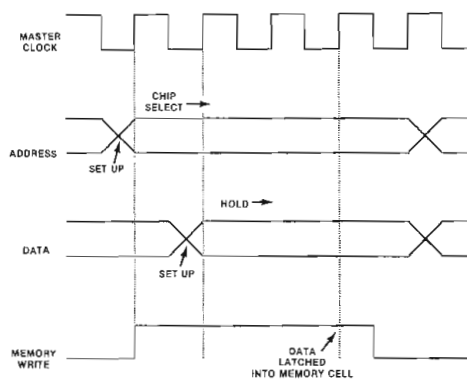
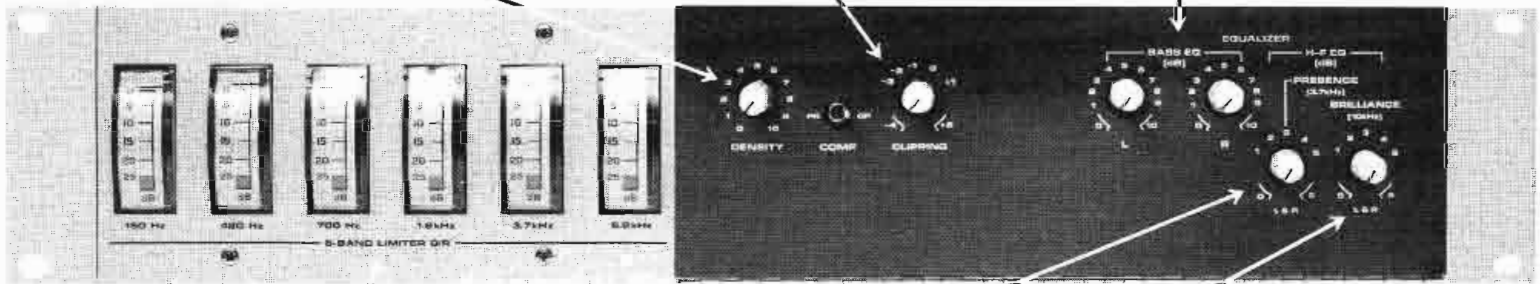

Figure 2. Typical MEMORY READ cycle. The MEMORY READ signal appears prior to the data, and the device requesting data latches itself while the MEMORY READ signal is holding.

DENSITY determines the input drive level to the Six-Band Limiter. Lets you have it your way—open and transparent, or solid and dense.

CLIPPING adjusts the drive level into the multi-band clippers, determining the loudness/distortion tradeoff.

BASS EQ provides peaking boost at 65Hz, making it easy to get the solid punch you need for many contemporary music formats.



Gain reduction meters for each band: they provide the information you need for accurate setup.

PRESENCE boosts the 3.7kHz band to achieve midrange balances right for your format.

BRILLIANCE boosts the 10kHz band. Use it to increase the sense of "air" and "transparency" in your music.

THE NEW ORBAN 6-BAND FM LIMITER. (WE LISTENED.)

Many FM stations perpetually seek "the perfect sound". OPTIMOD-FM alone does it for many. The OPTIMOD XT Accessory Chassis improved results for some. Still, some seek even more from OPTIMOD-FM.

We listened.

Our **NEW 8100A/XT2 Six-Band Limiter Accessory Chassis** (which works with any 8100A OPTIMOD-FM) features two new high-frequency equalizer controls: PRESENCE and BRILLIANCE. They complement the original 8100A/XT's bass EQ controls, and give you *twice the flexibility* of the single HF EQ control typical of other add-on multiband processors.

With an XT2, your OPTIMOD-FM system is totally immune to operator gain-riding errors because the dual-band compressor in the main unit is converted into a smooth, slow AGC to ride gain ahead of the XT2. Any reasonable input level operates the XT2 in its "sweet spot," so there's never any need to add external, potentially incompatible compression.

This is good news because the time-constants and other processing parameters in a pure, integrated Orban system have been carefully harmonized to achieve an overall sound that's *loud* and *bright*, yet remarkably *open* and free from audible side-effects.

The XT2 also excels in the most difficult of processing tradeoffs—delivering loudness on music while keeping speech free from clipping distortion. Credit this uniquely capable performance to Orban's patented multiband distortion-cancelled clipping system—which we were able to implement in the XT2 system because the XT's circuitry is fully *integrated* into the processing system, not just tacked onto the front.

The XT2 lets you have it all: natural sound, source-to-source consistency, loudness, clean voice, and adjustability that lets you tailor bass and treble to your taste and format requirements. And thanks to its efficient single-chassis construction and its use of the main 8100A power supply, it lets you have the next step in Optimod processing at an exceptionally reasonable price: \$2075 (suggested list).

We listen to our customers. Listen to our new XT2. We think you'll like what you hear.

Orban Associates Inc.

645 Bryant Street, San Francisco, CA 94107
(800) 227-4498 or (415) 957-1067 Telex 17-1480

orban

Circle (12) on Reply Card

A failure to communicate

By Ned Soseman,
TV technical editor

When a data system fails, whether the printer for a desktop personal computer won't respond, or the master control automation system suddenly develops a mind of its own, the fault lies in one of three areas. If the system *never* worked correctly, the problem may be bugs in the software. If the system *used* to work but simply failed, the fault is either in the hardware or communications between devices.

The question is, how do you determine which device is at fault? Before you spread the hardware across your bench, consider the fact that a large percentage of data system failures involve communications between devices.

A simple and effective tool used to observe serial communications signals is the breakout box. Breakout boxes are equipped with connectors and indicators configured for the specific communications protocol to be tested (such as RS-232C, RS-422 and RS-449). The breakout box is connected to both sides of an interface. For this discussion, the model problem is a printer that fails to respond to a computer, although it easily could be a VTR that fails to respond to editor commands. The interface is RS-232C.

A breakout box is inserted in the interface between the devices. One side of the box is connected to the computer; the other side is connected to the printer. All communication lines flow through the breakout box. Typically, red and green LEDs on the box indicate whether positive or negative signal voltage is present on each pin, on each side.

The wiring of the model interface is shown in Figure 1. A simple protocol between the PC and a printer might be:

- *Step 1:* Complete the input of data and depress the *enter* key to print the information entered.
- *Step 2:* The computer sends out a signal on pin 4, called *request to send* (RTS).
- *Step 3:* The computer expects a return signal from the printer on pin 5, called *clear to send* (CTS). In this situation the CTS signal would signify that there is paper in the printer, and that it is not busy printing.

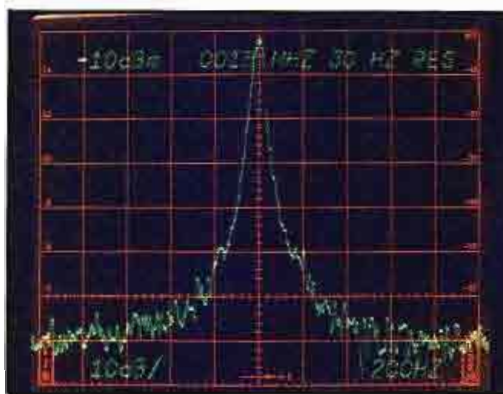

- *Step 4:* After a CTS signal is received, data is sent by the computer on pin 2 to the "other device," such as a printer or modem.
- *Step 5:* The "other device" receives transmitted data on pin 3, per RS-232C standards.

A breakout box will illuminate a specific LED when the computer transmits the RTS signal on pin 4. Did the computer receive a CTS signal on pin 5? If so, another LED should have illuminated. If the computer sends out an RTS, but doesn't receive a CTS, the data is not transmitted. A breakout box allows immediate visual recognition of the problem. The maintenance engineer can then deduce which device is at fault and proceed accordingly.

The breakout box is essentially a passive test device; that is, it detects signals that are present in the circuit under test. An exception is *jumpering*, by which you can place a positive or negative voltage at a specific pin location to trigger a response from one of the devices under test.

If, for example, your first test showed a missing CTS signal on pin 5, you might run a jumper from pin 4 to pin 5. This would force a positive signal on pin 5, telling the computer to transmit data. Then the question would be whether the printer would respond.

Special features

Most breakout boxes, when connected into the interface, give the user some type of access to all data lines. An access point is typically a pin to which a jumper wire can be connected. This allows pin-to-pin jumpering of signals, such as a pin 2-to-pin 3 crossover.

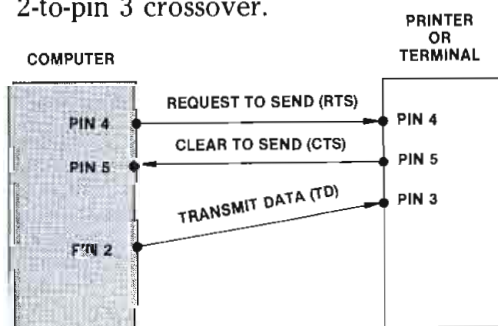

Figure 1. A cable wiring configuration like this is used in many PC-to-printer interfaces.

Indicators are usually LEDs and they may indicate positive voltages only or separate LEDs may be provided to display positive and negative voltages. Tristate LEDs may be used to indicate the polarity of voltage on a single LED.

For many maintenance engineers, an important consideration is how the pin LEDs derive their power. Breakout boxes may be powered by the voltages on the data line, or they may be battery-powered.

The consequences of degradation of the signal under test are a significant consideration. With an unpowered box, the power consumed by the LED causes a slight voltage drop in the signal. If you are attempting to simulate a long cable run, this may be a desirable effect. On the other hand, a powered box will not affect the signal voltage, thus increasing the accuracy of marginal signal readings.

Some breakout boxes include *test voltages* and *signal traps*. On powered boxes, a test voltage may be provided by positive and negative jacks on the faceplate. Through these jacks, nominal power may be drawn from the internal battery for use in applying a signal to test points, or in forcing a signal positive or negative.

The trap feature is a special circuit within the breakout box that captures signals of short duration that might occur too quickly to be visible. The trap detects sudden, momentary voltage drops, sudden shorts and high-speed pulses. The trap is good for catching intermittent problems such as spikes and transients.

Dual gender connectors are also a handy feature, allowing the user to set up quickly, regardless of interface cable gender.

Some experienced maintenance engineers have never used a breakout box. Because they've survived without one, they assume it's not necessary. Many others, after having been introduced to the breakout box, would not loan you theirs on a bet!

Editor's note: This information was adapted with permission from "Testing Serial Communication With a Breakout Box" by Doug Swain of Beckman Industrial Corporation. The article first appeared in *Electronic Servicing & Technology* magazine (an Intertec publication), February 1987.

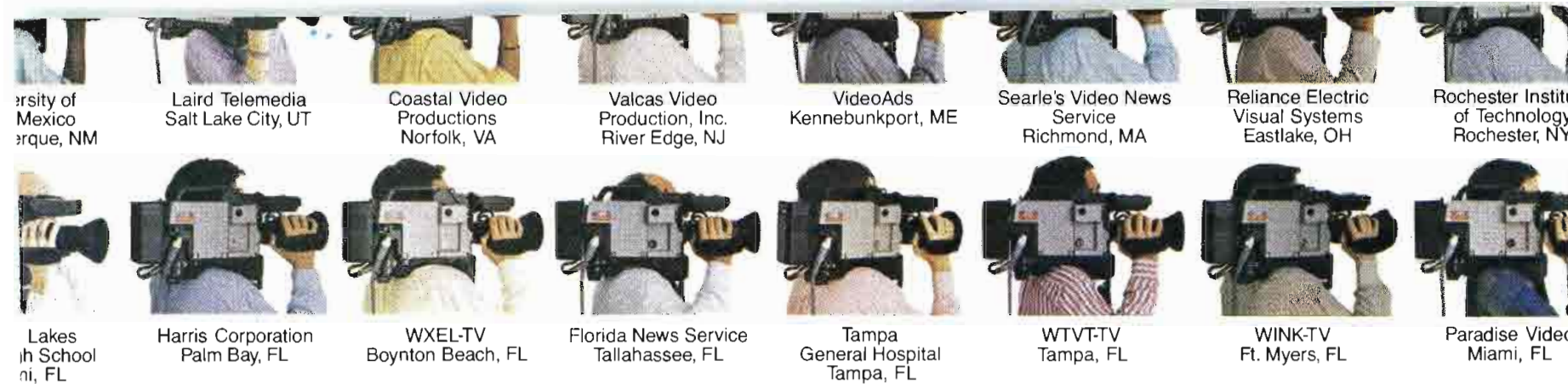

PROCAM[®]

The choice of hundreds in high-end teleproduction.

High-end users are closing ranks solidly and fast behind PROCAMS as THE choice... for the industry's BEST performance and sheer overall value.

The KY-950B. The KY-320B. The PROCAMS. A crowning achievement even for JVC, long identified with ultra-reliable performance in compact, affordable, 3-tube cameras.

Plumbicon* tubes, of course, for high sensitivity, low lag, and minimized image retention, yet always with the highest possible resolution for each image format. They prevent the build-up of microphonic vibrations at high audio levels, too, and help maintain a high S/N ratio.

PROCAMS have Triaxial capability permitting extension to almost a full mile! And JVC's is the ONLY Triaxial System in its price range to offer chroma key.

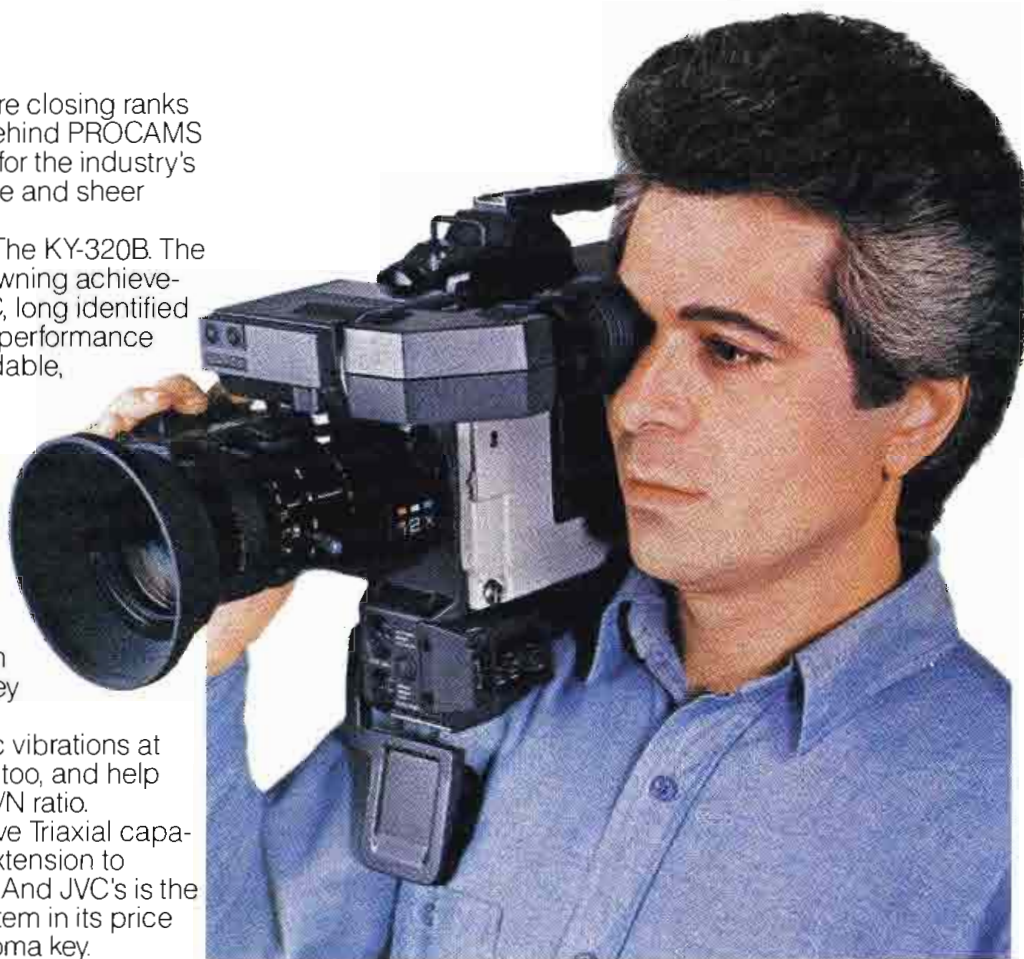

Component Video? Of course. JVC's KA-3 Component Adaptor makes you compatible with the increasingly popular M-II format as well as all other 1/2" component formats, and lets you record color signals in component form.

The PROCAMS. KY-950B. KY-320B. Penetrating dozens of new markets. Out-performing the competition in scores of imaginative applications in the hands of demanding professional users.

For a demo, call us toll-free for the name of your PROCAM Rep.

1-800-JVC-5825

JVC COMPANY OF AMERICA
Professional Video Communications
Division, 41 Slater Drive,
Elmwood Park, NJ 07407
JVC CANADA, Scarborough, Ontario

©1986 JVC COMPANY OF AMERICA



*Plumbicon is a registered trademark of North American Philips Corp.

Circle (13) on Reply Card

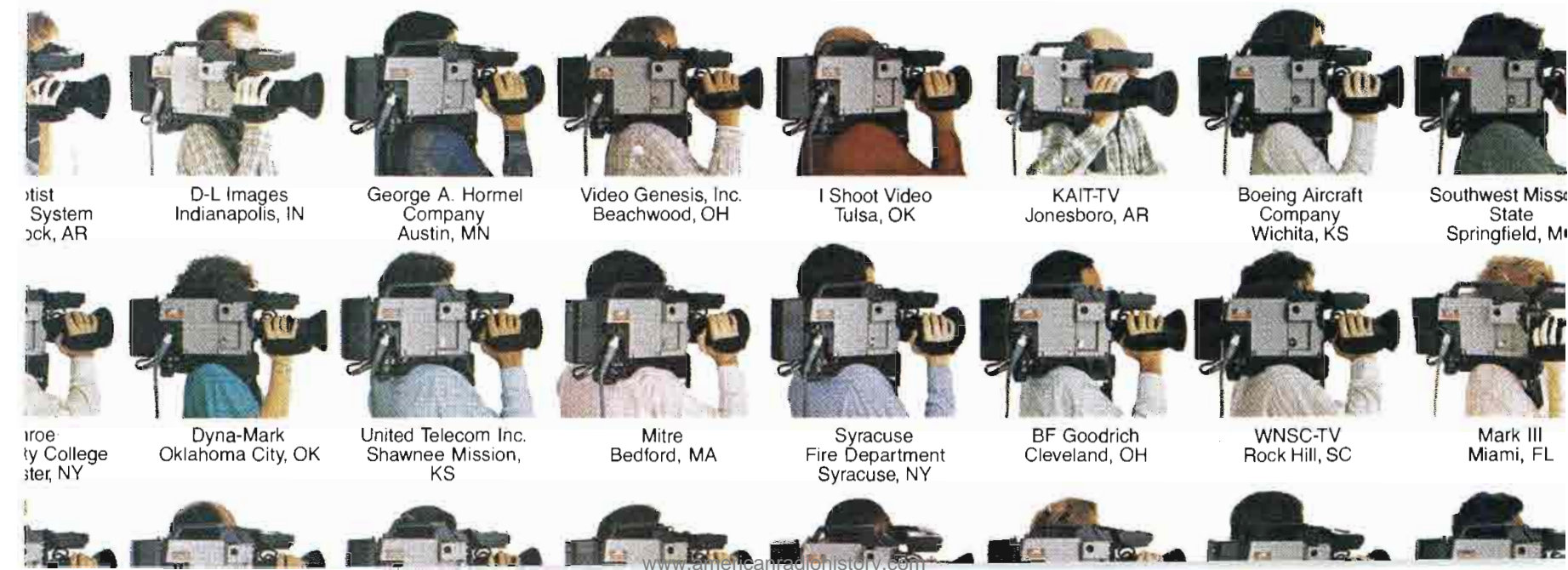

Management for engineers

Study theories before you implement one

By Brad Dick, radio technical editor

To some engineers, the thought of studying different management theories sounds about as exciting as watching a rock lie in the sun. Big deal—right? Granted, the subject may sound boring, but behind all the theory there may be some useful and practical techniques.

There is no single managerial solution to the many problems faced by managers and supervisors. There are, however, a number of different philosophies or theories of management that might provide some insight into effective managerial practices. Reviewing the basic theories is only the first step. The second step is to use these practices for developing new leadership skills.

Management by objectives

Management by objectives (MBO) is one of the most highly touted ways to effectively manage a company. The approach was developed by Kurt Lewin and later made famous by Peter Drucker in his 1954 book, "The Practice of Management" (Harper & Row). MBO quickly became known as a planning effort in which senior and subordinate managers jointly identify the organization's common goals, each individual's major area of responsibility and the expected results. Although the system sounds relatively easy to implement, it requires a great deal of effort.

First, MBO requires that managers and workers develop *mutually* agreeable goals. The goals must be specific, with agreed-upon performance criteria target dates and results. Second, specific evaluation standards must be developed. These measurement standards might be based on production quantity in pounds, in sales projections, number of make-goods, mean-time-between-failure or turnaround time.

As the process begins, periodic reviews and appraisals are conducted. MBO is cyclical in terms of developing plans, goals and performance evaluations. A standardized form is typically used to track the iterative process.

Although Drucker's work has received much praise, the implementation of his research into practical solutions has not been as well received. Many early MBO

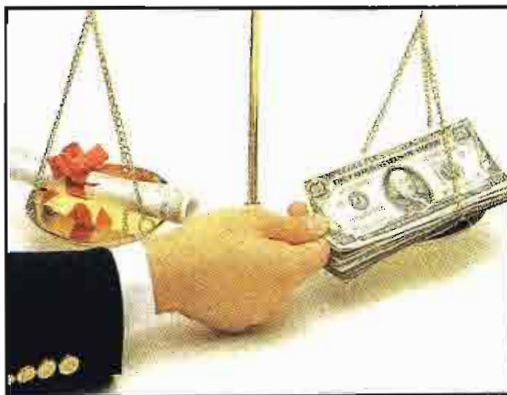

proponents failed to recognize Drucker's observation that effective goal-setting occurs naturally as a result of trust. This trust, mutual understanding and integrity must already exist within the organization. If it doesn't, then passing around MBO forms that outline objectives, goals and evaluation criteria won't solve the problem.

Improperly implemented, MBO can create a host of problems. Supervisor-subordinate conflicts may increase because of the rigid expectations and standards imposed from higher powers. Because the reward system is highly dependent upon meeting group-specified goals, managers may not want to risk taking unusual steps or developing unique approaches to problem solving. Instead, they may take the safe approach to solving problems and meeting quotas.

Although MBO can help focus an organization's staff on common goals, it also can force a certain level of mediocrity upon people. This is especially true if middle managers lack specific skills. Instead of strengthening those skills, MBO can force the manager to "lock-step" with others, thereby inhibiting professional growth.

The appearance of clarity and objectivity in goals and responsibilities may, in fact, be illusory. Although MBO is touted as a way to provide workers and managers with clear and distinct organizational goals, the actual effect may be less company planning and coordination. MBO can even become a strait-jacket at lower operating levels.

MBO is not an unsound management philosophy. The principles are solid and can provide dramatic results. What often happens though, is that those charged with implementing MBO fail to thoroughly understand the potential pitfalls.

Quality circles

Quality circles (QC) became the great hope for many American manufacturers in the 1970s. The idea behind QC is based on Japanese management techniques. QC reduces a society's entire culture down to smaller groups or circles. A circle can be composed of almost any group with related tasks or goals. A sta-

tion might have quality circles composed of ENG team members, an engineering department, sales department or other function-related group.

First developed by Wayne Rieker in 1974, QC was seen as a way to encourage *participative* management. By allowing workers to interact with managers to develop solutions to problems, effective solutions would hopefully be found.

One often-mentioned QC problem concerns line-level employees. Quite often, these employees are in the best position to offer suggested changes in the workplace. However, management may be in a better position to evaluate the potential overall improvements. For instance, providing each ENG camera operator with a vehicle might improve response time to fast-breaking news events. The bottom line, however, might be that the extra cost of the trucks or cars far outweighs the programmatic advantages.

There are many other popular management theories than the two that have been presented here. Although you may never be asked to help implement an official company management policy, the more you know about different management systems, the better equipped you will be to deal with change.

Readers' response

If you would like to share your personal experience with MBO or quality circles, write to **BE**, in care of the technical editor. Letters may be used in a future column as examples of broadcast applications of these management techniques.

Remember Kate, the tardy videotape operator? (See the December 1986 "Management" column. A number of readers took the time to offer their own suggestions on how her supervisor should have dealt with the problem. Next month we'll look at some of those suggestions and, perhaps, learn where Jim failed.

Editor's note: Information for this article was obtained from the following: "Electronic Media Management," by William E. McCavitt and Peter K. Pringle, Focal Press, Boston, London; "Broadcast Management," by Ward Quaal and James Brown, Hastings House, New York; and "Fad In, Fad Out," *Computer Decisions*, May 21, 1985.

[:(-)]]

WHAT'S NEW IN ARRAKIS SYSTEMS



5000 SERIES MODULAR CONSOLE \$9,999 Complete

- 16 CHANNEL MAINFRAME
- PROGRAM, AUDITION & MONO
- TELEPHONE MIX-MINUS
- CONTROL ROOM MODULES
- PROCESSING/EQ MODULES
- CLOCK AND TIMER STANDARD

Advanced engineering brings the radio industry its first no-compromise under \$10,000 audio console.



600SC DELUXE AUDIO CONSOLE \$4,399 Complete

- PENNY AND GILES ROTARY FADERS
- VCA ELECTRONICS
- 8 CHANNELS - 28 INPUTS
- PROGRAM AND AUDITION
- TELEPHONE MIX-MINUS
- REMOTE START
- ESE CLOCK & TIMER STANDARD

A timeless combination of classic reliability and modern, high-tech, distortion free sound.



MODULUX STUDIO FURNITURE

- MODULAR, KNOCK DOWN FURNITURE
- UPS SHIPPABLE FOR LOW FREIGHT COSTS
- IN STOCK FOR FAST SHIPMENT
- MODULARITY MEANS FLEXIBILITY
- EASY TO ASSEMBLE
- EXPANDABLE

A major new step in the evolution of studio furniture for radio. From \$1000.

**COME SEE US AT
NAB CONVENTION BOOTH #2742**
(LOWER LEVEL • MIDDLE ISLE • EXACT CENTER OF THE HALL)

Circle (14) on Reply Card



(303) 224-2248

MS-DOS permits remote access to databases

By Bob Van Buhler

Five years ago, the SBE conducted a computer and telecommunications equipment survey to see what was being used by SBE frequency coordinators. Although Apple was the most common brand, the survey revealed that a bewildering assortment of equipment was being used by the SBE frequency coordinators. Because of the need to exchange data and software between coordinators and end-users, the society concluded at that time to wait for a consensus in hardware to develop. Only then could data be properly maintained on a national and regional basis.

Computer standard

Since that time, MS-DOS has emerged as the favored operating system. At the Jan. 14 National Frequency Coordinating Council (NFCC) meeting, Gerry Dalton, SBE national frequency coordination chairman, presented a standardized software program for frequency coordination. The program will permit uniform remote access to databases across the country.

The software is an authorized modification of Fido Net, which permits remote access and retrieval through an MS-DOS computer-operating system. The data files also are dBASE compatible, which should make them easy to manipulate by most coordinating committees. Although the local coordinators can add more information if desired, the first 35 fields are reserved for use by the national database system.

Plans are to disseminate the program first to several coordinating committees for trial use. The trial period will help eliminate any problems before widespread use. The new frequency coordination database will be demonstrated at the society's booth at the NAB convention. Broadcasters are encouraged to view the presentation.

UNICOM

An important, although unresolved, problem for the NFCC is a uniform calling frequency. The current plan calls for a 450MHz-band FM repeater frequency

Van Buhler is chief engineer for WBAL-AM and WIYY-FM, Baltimore.

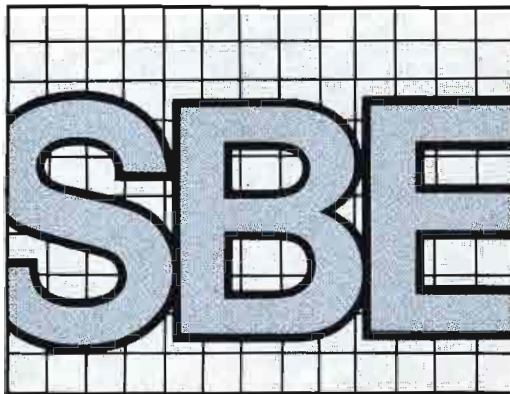

Conference help instructions

To access the help menus, follow these instructions:

- When you arrive at the BP forum, a function menu will be displayed. Select DL (Data Libraries).
- Select Forum HELP files from the data library. Then select BROWSE THRU FILES. Select the keyword CONFERENCE.
- On the Disposition Menu, select 1 to read the instructions or 2 if you wish to download instructions and protocol for the conference.

pair to be reserved for real-time frequency coordination throughout the United States. A uniform calling frequency (UNICOM) is necessary so microwave users can share information with others as links are established.

Richard Rudman, SBE president, speaking at the January SBE executive board meeting, commended Gerry Dalton for his loyal and tireless efforts to the society over the past five years. Dalton has played a major role in the implementation of the computer program for frequency coordination. Dalton, Rudman and board member Van Buhler are members of the industrywide National Frequency Coordination Council.

Certification

At its January meeting in Washington, the SBE executive board discussed the mounting certification program costs. The board decided that in spite of the rising costs, current broadcast industry conditions dictate holding the fees at current levels for the remainder of the year. Because of the program's intrinsic value to the industry and SBE members, the society will continue to underwrite any financial losses the program incurs.

The certification committee was instructed to develop a special safety module as a part of the certification study guide and testing program. The commission's shift away from regulation makes the operator safety issue more important than ever. The new safety module will help operators and engineers better understand the essentials of transmitter and plant safety, interlocks,

grounding and equipment. The study guide will help educate people who may not be aware of previous commission safety regulations, many of which have been deleted.

CompuServe forum

As many members know, a proposal has been made to modify the SBE bylaws. The proposal mandates a regional representation system and would replace the current system of electing directors at large. Under the proposal, the country would be divided into regions, each region to elect a single board member.

The proposal was originally submitted to the board by Charlie Hallinan. However, it could not be acted upon because the proposal violated current SBE bylaws and District of Columbia corporate regulations. The proposed change, which was presented as a single-vote package, would actually have required 15 separate ballot proposals, each requiring a separate vote.

Rudman urged Hallinan to rewrite his proposal and resubmit it in a form that could be voted upon by the membership. Hallinan felt that it was the national organization's responsibility to modify the proposal. To accommodate his request, Chris Imlay, SBE attorney, rewrote the bylaws proposal in a form that meets DC and SBE requirements.

If adopted, these proposals will have a far-reaching impact on the society. Therefore, each member should become familiar with them. The text for each motion for change can be inspected on CompuServe's SBENET in DL7 (Data Library 7). Members can inspect or download the information for review.

In order to stimulate discussion, an SBENET bylaws forum will be held on March 17, at 9 p.m. Eastern time. All members are invited to participate and to share their comments.

Prior to participating in the forum, members should study the CompuServe HELP menus. Data library DL1 contains information on how to access and participate in forum discussions. Additional information is available in CompuServe handbooks.

[:?=:))]]

Alden Color Radar: All The Extras At No Extra Cost.

A color radar system should include certain features as standard. Because while the base price may look OK, it can be a shock when you put together the options that make it perform the way you want.

That's why you should look at the Alden C2000R. We've just redesigned it to include more features than ever—and kept the price the most competitive around.

Our radar network has expanded. You can access any NWS radar in the country, over 120 of them nationwide. And each has its own customized 4-color background—you don't pay extra for it.

We've also added four built-in range displays, from 25 to 200 miles, so you can focus on your local weather, or display the entire region—at the push of a button.

Our image memory has been expanded so you can store up to 16 images with the standard system, or add another 48 frames if you want. You can loop combinations in time-lapse sequences to emphasize the drama of storm movement.

And now you can collect your time-lapse sequences more easily than ever. Our new auto-dialer can be programmed to automatically



Waycross, GA: 200-nautical mile range.

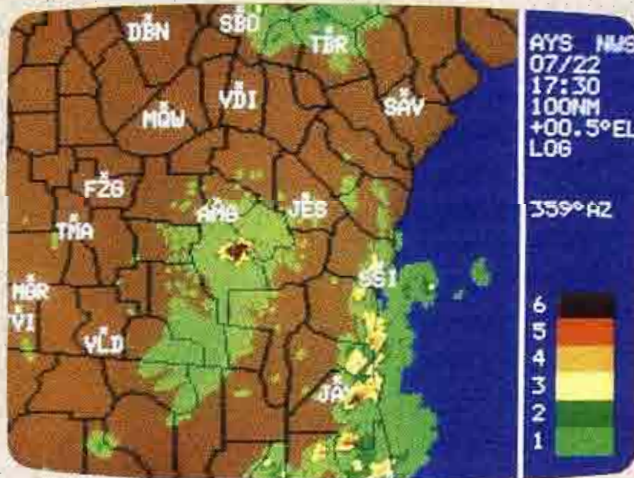

Same storm, 100-NM range (with county lines).



Close-in, 50-NM range (same storm).



Our C2000R/S System adds weather graphics such as these from major private databases.

call the radar at preselected intervals—freeing you up for other important tasks.

We still include the wide variety of standard features that make Alden the most flexible system you can buy. Zoom, pan and scroll, range rings and sweep line. And NTSC and RGB compatibility that make it usable for broadcast.

In addition to the C2000R radar system, Alden offers the C2000S weather graphics system, which lets you access a variety of private databases. Our "building-block" design lets you add either system to an existing C2000 model at any time in the future, with minimal additional cost.

For more information on Alden's weather radar and weather graphics systems, call or write Alden Electronics, 135A Washington Street, Westborough, MA 01581. (617) 366-8851.

Please send information on:

- C2000R Color Radar System
- C2000R/S Radar and Color Weather Graphics System
- C2000M Single Picture (radio version)

Name _____

Company _____

Address _____

City _____ State _____ Zip _____

Phone _____

ALDEN ELECTRONICS

For a live demonstration, visit booth 2759.

Circle (15) on Reply Card

Betac

is here. So is a new Type C machine, a new editor, and lots

amSP



of other news. All evolutionary, all from Sony.

SONY[®]
BROADCAST

NAB '87 Engineering

By Ed Williams

The 65th annual National Association of Broadcasters' Convention and 41st annual Broadcast Engineering Conference will be held March 27 through March 31, at the Dallas Convention Center. This year's theme is *Broadcasters . . . serving local America*. It represents the commitment and responsibility all radio and TV stations share: to provide the quality of sound, pictures, reliability and services the public has come to expect.

The challenge to provide local radio and TV audiences with ever-increasing programming diversity, and increased quality, places unique demands upon the broadcast engineer. Rapidly advancing electronics technologies require that station engineers and managers examine their priorities, look over the competition and create opportunities by improving local service. Upgrading facilities and improving production techniques will maintain and build the local audience. Preparing for future technology while cutting costs through more efficient facilities will ensure that the local audience and station profitability is not lost to the proliferation of new programming services.

This year, the NAB Broadcast Engineering Conference begins Friday,

March 27, a day earlier than the convention, which starts on Saturday, March 28. Plan to arrive Thursday evening or early enough Friday morning to attend the AM Improvement and TV Cameras and Recorders Technical sessions which begin after registration at 11 a.m.

Radio

So much has happened to benefit AM broadcasting since last year, it's hard to keep track of everything. The FCC issued a series of proposed rulemaking proceedings, the National Radio Systems Committee agreed upon a transmission standard and numerous ideas for other improvements for the AM service have been developed.

In the all-day *AM Improvement* technical session on Friday, March 27, you can find information on analyzing your modulation, understanding how splatter is caused, methods for improving fidelity, a tutorial on synchronous transmitters, a detailed report on the work of the NRSC on the AM pre-emphasis and band-limiting voluntary standard, and finally a panel on the implementation of the standard itself. With implementation of the standard by stations, receiver manufacturers will be motivated to improve receiver fidelity.

Friday evening, take a tour of Dallas, visit a local radio station or enjoy a leisurely dinner and rest up for the main event.

Following a good night's sleep, you'll be ready for Saturday and the *Radio Broadcast Engineering* technical session, which begins at 9 a.m. This session will feature presentations on AM and FM transmission subjects such as: planning new antenna systems, selecting FM-SCA frequencies, designing low-cost directional arrays, putting more than one AM station on the same tower, and a report from the newly formed NAB FM transmission subcommittee and its tasks.

Saturday also is the opening day for the world-famous equipment exhibit, with the largest selection of broadcast equipment in the world. Visit the exhibits for a few hours after the engineering session and then get set for the convention grand opening at 2:30 p.m., featuring presentations of awards for outstanding contributions in the field of broadcasting and sensational top-name entertainment.

Saturday evening is open to visit exhibitor's hospitality suites and resting up for the days ahead.

Sunday morning brings the popular *Radio Station Maintenance* technical session and panel featuring experts in

Williams is staff engineer for the NAB.

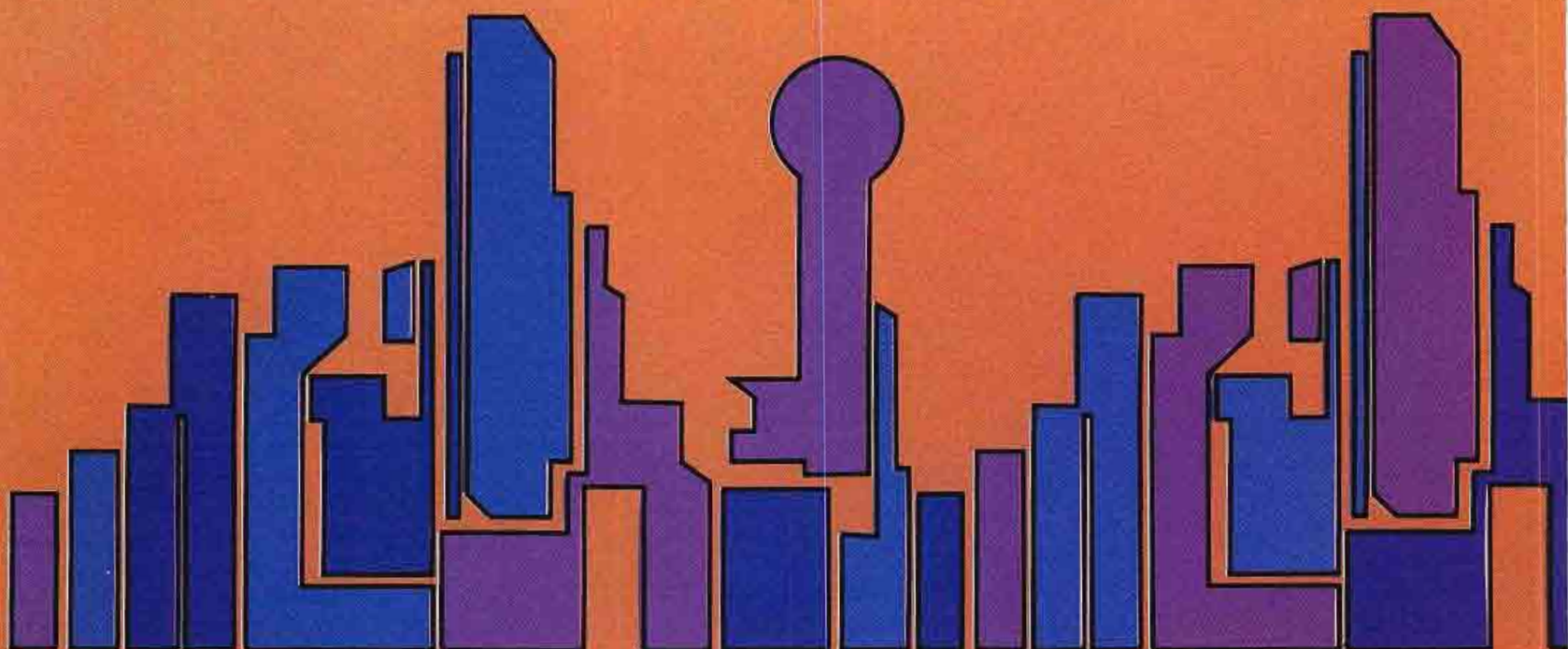

preview

transmitter, tower, studio, digital, tape and other broadcast facility maintenance. This is an excellent opportunity to bring out your most difficult maintenance problems for the experts or others in the audience to solve.

The *Engineering Luncheon* will be held Sunday, March 29 at 12:30 p.m. in the convention center arena. We'll have the arena all to ourselves for the annual presentation of the industry's highest engineering honor, the Engineering Achievement Award. This year, Renville H. McMann of the CBS Technology Center is being honored for the work he conducted on audio processing, digital video effects, the mini-cam, HDTV systems and many other major contributions to broadcast technology.

Speaking at the engineering luncheon will be U.S. Rep. Dan Ritter, R-PA, who is a member of the House Committees on Science and Technology and Energy & Commerce.

Other luncheons scheduled during the convention include Monday's TV luncheon and Tuesday's radio luncheon.

Of interest to all broadcast engineers are two special technical sessions to be held Sunday afternoon.

Satellite Systems will be discussed at 2:30 p.m. Presentations include site prob-

lem solutions by computer, a systematic approach to video uplink design, trade-offs in MSN system design, evaluating Ku-band antennas, network news systems and improved communications systems. A panel devoted to satellite operations will follow the formal technical presentations with a Q & A session.

A special engineering session on *Studio Construction and Acoustics* will be held Sunday at 3 p.m. This session is devoted to presentations on the new PBS technical facilities, building the largest radio studio in New York, making equipment decisions, improving existing studio acoustics and a panel of experts on studio construction and acoustics.

Sunday evening, the annual *Engineering Workshops* will be held at 7 p.m. in the Hyatt Regency Hotel near the convention center. The workshops are small, shirtsleeve working groups, led by experts on various specific topics, to discuss common problems and find answers to your questions. Tentatively, you'll have to choose between HDTV tutorial, TV measurements, contract engineers, RF radiation regulation compliance, AM antenna tuning and acoustic workshops.

Monday morning brings the *AM-FM Allocations* technical session in which an

FCC engineer will review the various international agreements made during the past year and how they affect U.S. broadcasting. Other reports will cover FM interference to the Aeronautical Radio Service, and how the CCIR defines a reference radio receiver (which is used as a guide by radio manufacturers). Finally, we'll hear ideas about raising the power and antenna height for Class A FM stations.

Right after AM-FM allocations is the *Radio Production* technical session featuring presentations on solving stereo phase problems, multitrack production, enhancing local production and special-event planning.

Monday afternoon brings a special engineering session on the *Environmental Aspects of Broadcasting* at 2:30 p.m. This session will address such topical issues as PCBs and RF radiation. Time will be allowed for questions from the audience. This session is of serious concern to both engineers and managers.

Spectrum use issues will be examined at the *Broadcast Auxiliary* session, held at 4 p.m. Of interest this year are several presentations on how to use the 23GHz band as an alternative to the 950MHz band for radio STL. A panel of experts on frequency coordination for both radio

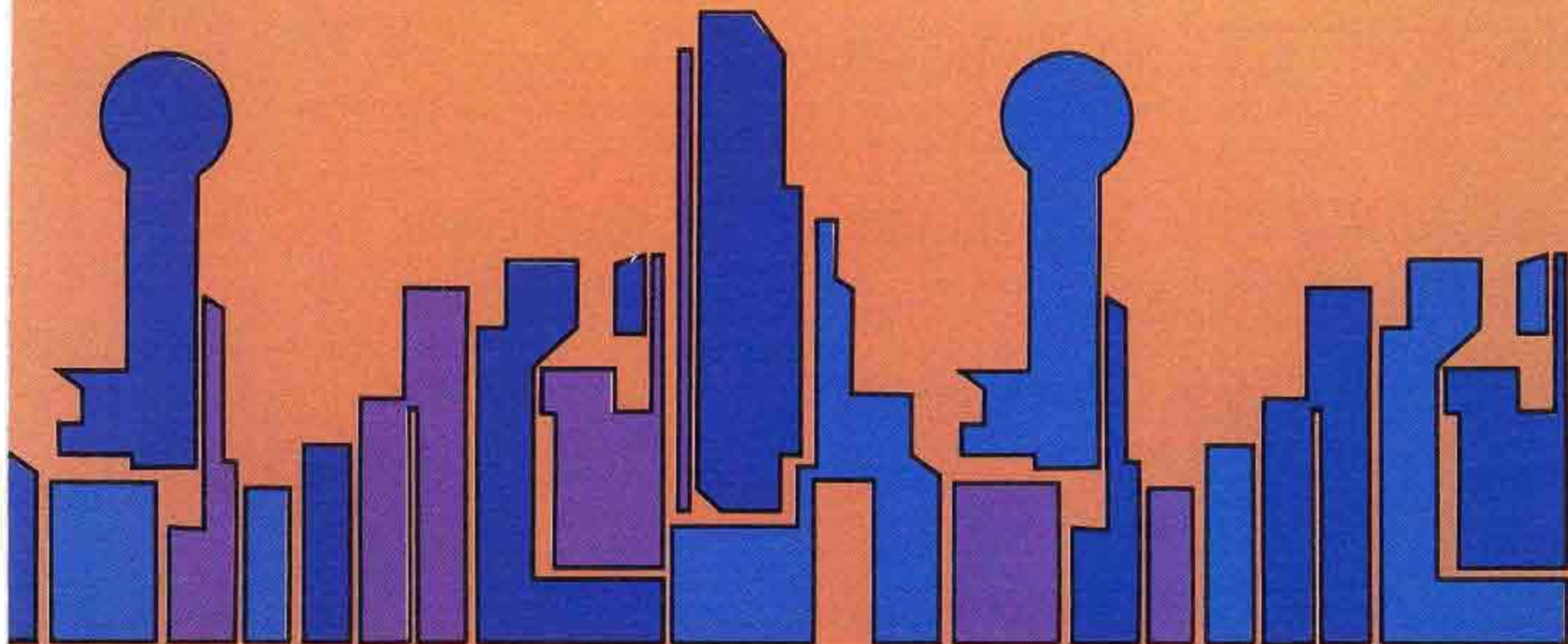



TV **NEW 8185A TV Stereo Generator**

The *first* second-generation Stereo Generator, with the features and specs you always wanted. From the company with more first-generation units in service than all other manufacturers combined. Works with your current processing or (preferably) with the Orban 8182A OPTIMOD-TV Audio Processor.

AM **NEW 9100B OPTIMOD-AM Audio Processing System**

The industry-standard 9100A, updated to add the newly-announced NRSC-standard modified 75us pre-emphasis and 10kHz low-pass filtering. (Upgrade kits available for current owners of Model 9100A.)

FM **NEW XT2 Six-Band Limiter**

Out just a few months, the XT2 is already the new "hot box" for that "major-market" audience-grabbing FM sound. Listen for yourself.

PRO **NEW 787A Programmable Mic Processor**

AUDIO
BLUE
CHIPS
Multi-function microphone processing system, ideal for optimizing on-air DJ mics and studio production chores. 32 programmable presets!

NEW 464A Co-Operator™

An integrated easy-to-use level control system with outstandingly transparent control action. Includes slow AGC leveling, compression, gating, HF limiting, and peak clipping. Just the ticket for production work, or for protecting SCAs and STLs.

Orban Associates Inc.

645 Bryant Street, San Francisco, CA 94107 USA
(800) 227-4498 or (415) 957-1067 Telex: 17-1480



urban *at NAB*

Circle (16) on Reply Card

and television will be included.

After the exhibits close, ham radio operators, and those aspiring to be, should head for the Hyatt Regency Hotel near the convention center at 6:30 p.m. for the 8th annual *Ham Radio Operator's Reception*. This event is sponsored by the NAB in special recognition of the expertise, talent and service "hams" bring to their job and community. Enjoy an "eyeball QSO" with old friends and new acquaintances in your industry, and bring your QSL card for posting or exchange. There'll be fun, refreshments, snacks, special guests and, of course, door prizes!

Now give those hospitality suites one last fling before the last day of the convention. Be careful, no driving after those visits!

The best is yet to come on Tuesday, March 31. First thing in the morning is the *Radio New Technology* technical session. Topics feature tape cart phase correction, routing switchers, news-gathering techniques and remote-control systems in the latest radio broadcast technology.

Then, it had to happen . . . *The Digital Radio Studio* technical session will be held, in which presentations will be made on digital tape, error correction, a new concept in audio consoles and how to put digital equipment to work in your studio.

The radio luncheon will be held at 12:30 p.m. After lunch, and the FCC Commissioners Forum, the *FCC engineers Q & A Forum* technical session offers station engineers and managers an ideal opportunity to interface directly with FCC engineers. The latest technical rule changes and where the commission is headed in deregulation will be discussed by top FCC engineers from the Mass Media Bureau, Field Operations Bureau and the Office of Science and Engineering. Specific issues scheduled to be addressed include AM daytime regulations, operator requirements, FM station class changes, TV stereo, station inspections and interference. This session is the one in which station engineers may talk with FCC engineers to ask questions on technical rules and regulations, discuss station problems, and let them know what it's like outside Washington, DC.

FCC field van open for inspection

Have you ever wanted to know what's inside one of those field units used by the FCC field engineers during inspections or finding interference? Well, they're well equipped to examine the spectrum from "DC to daylight," in detail. Here's your chance to tour one of the units and talk with the field engineers to find out how they measure modulation, frequency and spurious signals. They also have excel-

lent direction-finding equipment for solving interference problems. See the unit in operation during the day, Monday and Tuesday, directly in front of the convention center.

Television

Friday, March 27, is a goodie for TV engineers with technical sessions on *Television, Cameras and Recorders* in the morning, followed by *Trends in TV Audio*. In the first session, there will be presentations on adapting the M-II format to station automation, solving Type C interchange problems, new CCD camera pickup devices and cameras, more and better uses for video cart machines, and a new play and record optical disc video recorder.

The TV audio session will include such subjects as digital transmission systems, development of satellite and terrestrial stereo links and the new surround-sound technique with demonstrations. Between the two sessions, there will be more than 12 technical presentations.

Now assuming you didn't over do it Friday night in the Big D, and you're wide awake on Saturday morning, the *TV Graphics* technical session will begin at 9 a.m. with lots of glitzy graphics, animation and just plain good information. A station's personality is expressed in its graphics presentations on the air; learn how to sort out all the systems for your own station's use. Also, find out how to manage still store pictures and learn new developments in weather graphics systems in this session, too.

Take Saturday afternoon off and tour the exhibit halls, which will be open all day. This is a good time to bring your manager along to look at (and possibly purchase) much needed equipment. Get some rest Saturday night after visiting some manufacturer's hospitality suites because Sunday will be a busy day.

We'll hold the *TV Maintenance* technical session on Sunday morning, with interesting presentations on maintaining ACR-25s, using automatic VITS analyzers, and finish up the session with a panel of manufacturers and station engineers. They'll answer audience questions and discuss transmitters, videotape and other video maintenance topics.

Last year, the interest in high-definition television (HDTV) was overwhelming. Therefore, this year we're organizing an entire session on the subject. The *High-Definition Production* technical session will run all day Sunday and consists of presentations by HDTV production centers from all over the world. Interspersed with these presentations will be papers on various HDTV production equipment such as cameras, recorders, special effects, editing, displays and more. Large screen projectors will show

just how good HDTV can be, and why broadcasters are so interested in it.

Sunday evening brings the engineering workshops (discussed earlier) in the Hyatt Regency Hotel including TV measurements, acoustics, RF radiation measurements and others.

The *Advanced TV Systems* technical session begins Monday morning and features reports from the Advanced Television Systems Committee, new developments in compatible HDTV, how the Japanese will transmit HDTV to the home via satellite, and a special report on the first-ever terrestrial UHF-TV HDTV tests, conducted in Washington, DC in January.

Monday afternoon, after the TV luncheon, the *UHF-TV Transmission Systems* technical session will feature presentations on new higher power transmitters, circular waveguide technique, modifying older UHF transmitters for newer tubes, and what the 21st century UHF transmitter will be like.

And finally, on Tuesday, March 31, you won't want to miss the *TV Engineering and New Technology* technical session at 9 a.m. This session features presentations on fiber optics for video, digital transmission, multichannel TV antennas, computer-aided design (CAD), transmitter specifications and remote-controlled camera systems.

Then have lunch, visit the exhibits and return for the *FCC Engineers Forum* where your questions on technical rules will be answered by the top FCC Mass Media Bureau and other FCC engineers.

Tuesday evening is reserved for the great convention closing event featuring a good dinner and super entertainment.

You'll find a complete list of the sessions beginning on page 260 to let you set your overall personal schedule. For a list of the papers and times of presentations, check the convention program.

Conference proceedings

As always, many of the papers to be presented will be available in the conference proceedings. More than 60 papers will be contained in the *Proceedings* and can be purchased at the NAB store during the convention.

In summation, planning ahead for transportation, lodging, attending the exhibits and attending the technical sessions requires some homework and some hard decisions. Although you will run across a few conflicts, we hope we've put together an engineering conference you will find interesting and useful to you and your station's operations. Who knows? Maybe next year you'll have an idea for a topic for the conference. We look forward to seeing you in Dallas, where we'll be helping you as broadcasters, to help serve local America.

CONSIDERING NEW HIGH QUALITY 2/3" STUDIO/FIELD CAMERAS?



AVOID THE GENERATION GAP.

While camera manufacturers were developing new high-performance 2/3" studio cameras, Fujinon was busy designing new lenses to go with them. Not conversions, modifications or quick fixes, but totally new lenses. And they're available here and now.

Starting with the premise that the CCD is the wave of the future, Fujinon's new generation lenses are the first — and only — lenses built to be compatible with the higher registration specifications. The new A15x8ESM and A18x8ESM studio lenses and A44x9.5ESM (F1.4) field lens exhibit the industry's lowest longitudinal chromatic aberration. Which means unprecedented color and focus-tracking accuracy with all the new generation cameras.

For studio use, the new A15x8ESM zooms from 8mm out to 114mm, while the *F1.5 maximum aperture remains absolutely flat!* At 120mm, it's F1.7. That means

no changes in your present studio lighting. And you can fill the screen with an 11' x 8' subject from only 10' away.

Weight and size are reduced, reliability and serviceability are increased. Major components are modular and interchangeable. Controls and adjustments are accessible *with the shroud in position*. These include back focus adjustment and lock, servo/manual switch for the built-in 2X extender, and pattern projector color levels and chart positioning. Focal length and aperture are reported through LEDs on the side of the lenses. And options include the full array of Fujinon accessories including remote demands and shot boxes.

To learn more about Fujinon's new generation of 2/3" studio/field lenses, you'll get more information or a demonstration by calling the Fujinon location nearest you.

See Us At NAB Booth #3410

Circle (18) on Reply Card

FUJINON INC. 10 High Point Drive, Wayne, N.J. 07470
SOUTH 2101 Midway, Suite 350, Carrollton, Texas 75006
MIDWEST 3 N. 125 Springvale, West Chicago, Ill. 60185
WEST 118 Savarona Way, Carson, Calif. 90746

(201) 633-5600 Telex 6818115
(214) 385-8902
(312) 231-7888
(213) 532-2861 Telex 194978



Think about last year's NAB and how exhausted you felt when it was over. (Fade in the violin music.) Your feet were killing you. You missed a few exhibits that you really needed to see. Your billfold and expense account didn't exactly balance. And you lugged a bulging suitcase stuffed with literature halfway across the airport parking lot. What are you going to do to make your trip more comfortable and profitable this year?

Consider the challenge. This year's indoor exhibits alone will cover more than 300,000 square feet. If you were to walk in a straight line down each aisle of the convention floor, without deviating from your course to visit a booth on either side of the aisle, you will walk more than 3.6 miles. That's more than seven miles of booth frontage. Incidentally, the power requirements for the equipment to be displayed at this year's show total more than 6.5 megawatts.

Consider the time. There are about 630 exhibits at the show. The show is open for a total of 36 hours. Therefore, if you were to spend all of your time just visiting indoor exhibits (no lunch, breaks or seminars), you'll have about three minutes to spend at each booth.

The NAB comfort check list:

✓ The road kit: Bring your favorite remedies from home. Antacids, aspi-

Feet— don't fail me now!

By Ned Soseman, TV technical editor

rin, instant coffee and a reliable alarm clock can make your mornings easier to deal with.

✓ Shoes: Most attendees find their feet can't keep the pace of their itinerary. Foot pads might help, but they make shoes tighter, restricting circulation. Those that are truly experienced will carry an extra pair of comfortable shoes and change shoes when the pain sets in. It's one of the most instantly refreshing feelings you will ever experience.

✓ Literature: Use the post office and package express services to ship your literature directly to your office. It is impossible to select the exact literature that may be useful in the future. Pick up what you think you need, ship it and forget about it until you are back in your office. Don't pass up literature simply because you don't have room.

✓ The bag: If you have a canvas over-the-shoulder bag, suitable for literature (and shoes) bring it! Remember how those little string handles on the bag you picked up last year cut through your fingers? If you pick up

four ounces of sales material at each booth, you'll haul off 157 pounds of literature.

✓ Your itinerary: Plan ahead. With all the simultaneous activities and the size of the convention, you must set priorities, state your collective goals and develop a plan ahead of time. If you're not visiting alone, meet with others in your group to develop an hour-by-hour daily written itinerary for each individual, and do your best to stick to it.

✓ Scheduling: Plan who to see and where to meet. Choose a central rendezvous location and exchange itineraries. Use the telephone to schedule meetings with others before arriving in Dallas to secure time.

✓ Expenses: Count your cash before leaving home. Count it when you return. Including charged expenses, your expense reimbursement should equal the total of cash before leaving, minus cash left over, plus charges. Demand a receipt from everyone you give cash to. Keep a running itemization of cash spent on a separate piece of paper. Document every dollar you spent on your expense account form so there will be no raised eyebrows back at the office.

✓ Procrastinators' note: There are only two weekends between the end of the show and April 15. [:-)]!!!

Hear the great wireless sound.

Consider the size advantages...

Cetec Vega's R-33 PRO PLUS wireless microphone receiver mounts inconspicuously on a camera. Or on a tiny corner of your sound cart. Or in your pocket. Or on your belt, providing you with program-quality headset audio.

With the R-33 you have a wide choice of transmitters...any Cetec Vega DYNEX® II bodypack or handheld. A full complement of useful accessories is included.

The R-33 provides 8 hours of operation on a single 9-volt battery. Audio is studio-quality (e.g., over 100 dB S/N).

All this, in a rugged package less than 12 ounces, and only 3/4 x 3-1/4 x 5-5/8 inches (HWD). Available in two colors... PRO Brown/Cream or Camera Black.

 **Cetec Vega**

... the professional's wireless
9900 Baldwin Place
El Monte, CA 91731-2204
(818) 442-0782

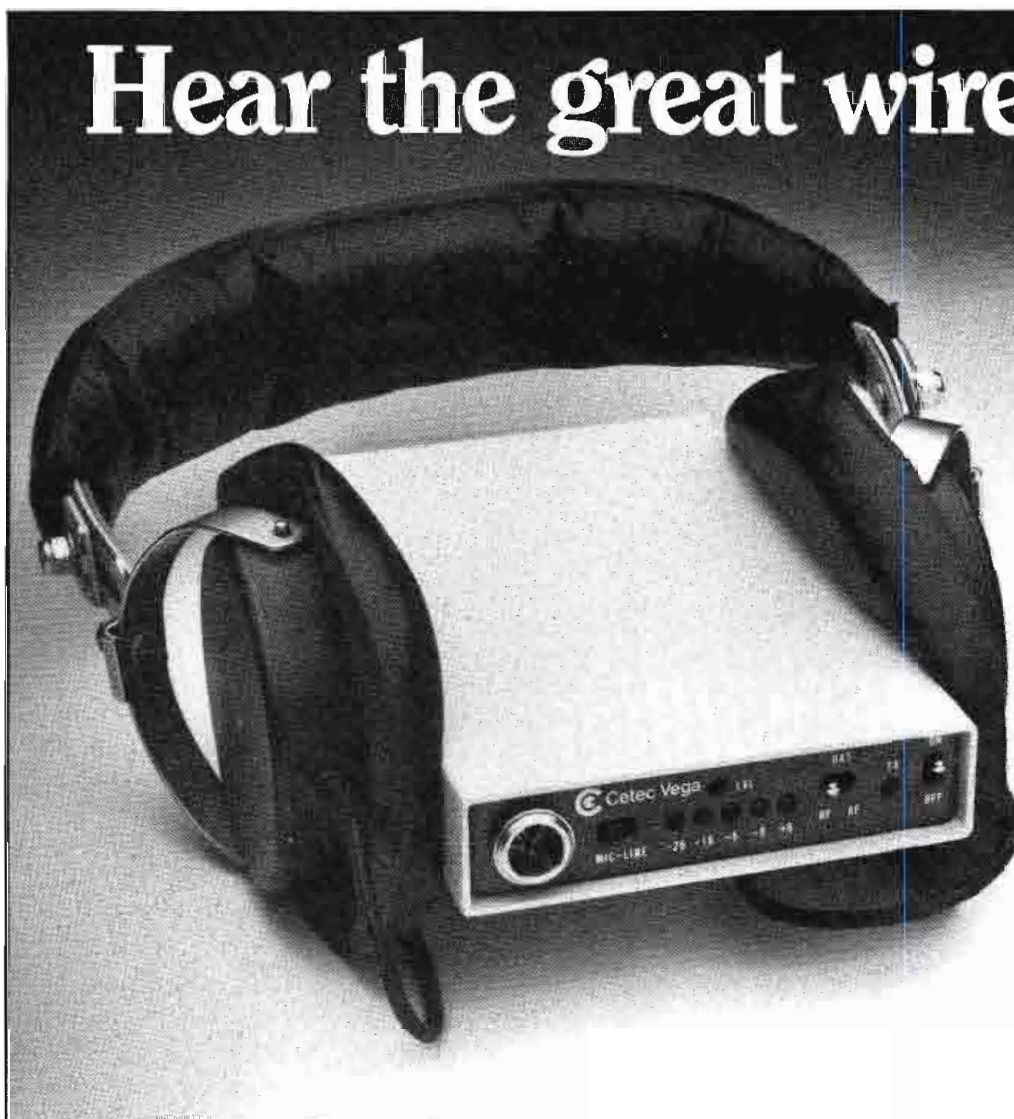

Circle (19) on Reply Card

Anything less than a Neve is just a lot of...

Bells and whistles may be all you need for New Year's Eve...or a birthday celebration. But is a desk full of bells and whistles enough for the demanding art and science of broadcast production? You need the Neve difference.

At Neve, the first name in audio mixing control and distribution systems, we offer you all the bells and whistles your creativity demands...as well as the sonic quality, reliability, and ease of operation that sets Neve apart from the rest.

Neve's versatile 51 Series, for example, gives you the full range of advanced facilities you want, plus the virtually unlimited versatility you require...to let your creativity soar. With features that include:

- 16-to-60 inputs
- Custom configurations

- Stereo or mono modules
- A choice of 4 standard consoles
- Up to 8 auxiliary outputs
- Multitrack recording capability
- 4-band Neve Formant Spectrum Equalization

Hear the Neve quality difference for yourself. Find out firsthand how Neve advanced engineering gives you "a touch of the future."

Circle the bingo card for a literature pack. Or call (203) 744-6230 for a demonstration of Neve sound at your location.



- Nothing sounds as good as a Neve... because nothing else is.

Rupert Neve Incorporated

Berkshire Industrial Park
Bethel, Connecticut 06801
Telex 969638
Facsimile (203) 792-7863
(203) 744-6230

Neve Electronics Int'l Ltd.

Cambridge House, Melbourn, Royston
Hertfordshire SG8 6AU, England
ph (0763) 60776 fax (0763) 61886
telex 81381

7533 Sunset Blvd.
Hollywood, California 90046
(213) 874-8124
Facsimile (213) 874-1406

P.O. Box 40108
Nashville, Tennessee 37204
Telex 786569
(615) 385-2727

Neve

A Siemens Company

See us at
the NAB
Booth #3318

NOISE

Circle 50 on Reply Card

NEVE 00-004 WLM 467

NEC'S NEW EFFECTS PACKAGE REALLY LETS YOU MAKE WAVES, AND CURLS, AND ROLLS...

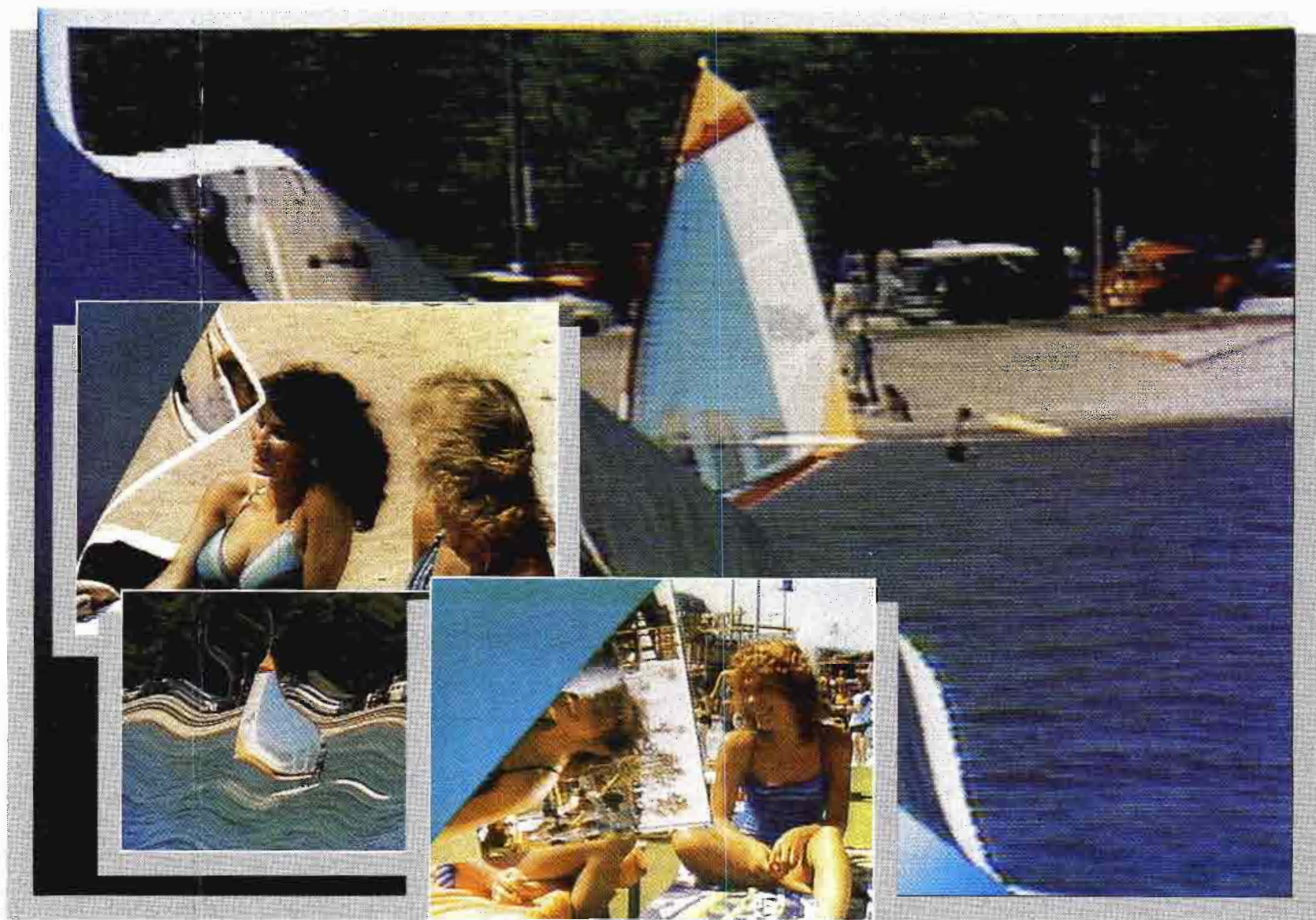

Nobody knows better than NEC America how fast digital video effects technology can change. That's why we built the DVE® System 10 with "soft keys" — keys that let you access disk-based effects just as fast as we could produce them.

Now you can put those keys to work with our new Transition Effects Package.

Get three dimensional looks out of a two dimensional effect. Curl up the image. Peel it right off the screen. Roll it. Create looks that were limited to systems costing over twice as much. Until now.

Push a button and manipulate with the joystick. It's that easy. Just add the option to your DVE System 10 and go to work.

But if you haven't already bought a DVE System 10, you can buy it complete with the option now, or pick up the option later. And the DVE System 10 is now also available in a component version.

The new Transition Effects Package from NEC America. The newest way to get hard work out of your "soft keys."

Photographs appearing above are actual unretouched photographs of video images.)
DVE® is a registered trademark of NEC Corporation.

NEC

NEC America, Inc.

Reliability and maintainability special report

A chain is only as strong as its weakest link. This familiar saying is especially applicable to electronic systems used by broadcasters today.

Back in the good old days (whenever that was) reliability of broadcast equipment was an elusive goal. Racks full of vacuum tubes did not lend themselves to long-term stability and dependable operation. In actual circuit complexity, the systems were generally simple compared with today's broadcast hardware. However, the primary active devices that made the equipment of 30 years ago operate—tubes—were fragile components with a more-or-less limited lifetime.

Enter solid-state electronics and the wonders that it has provided. We have been blessed with increased reliability and performance, reduced space requirements and heat generation, and practical, affordable systems that were little more than dreams 30, or even 20, years ago. However, in our march ahead with technology, broadcast engineers have acquired new problems in the areas of preventive maintenance and troubleshooting. We can no longer fix a video switcher, TV transmitter, audio control board or cart machine with a Simpson 260, an oscilloscope and a bag full of tubes.

Our industry has grown up in a technical sense. And the point we have reached in equipment sophistication requires new approaches to reliability and maintainability. This month, in the following special report, **Broadcast Engineering** examines the critical questions of why systems fail and how failures can be prevented. We look at the following topics:

- "The Mechanics of Component Failure" page 36
 1. "Why Parts Fail" 38
 2. "Semiconductor Failure Modes" 48
 3. "Vacuum Tube Life" 58
 4. "Support Component Reliability" 62
 5. "The Transient Overvoltage Threat" 76
 6. "The Quest for Reliability" (includes glossary and bibliography) 80
- "Troubleshooting Transmission Equipment" page 86
 1. "Plate Overload Faults" 90
 2. "RF System Faults" 98
 3. "Power Control Faults" 110
- "Repairing Surface-Mount PC Boards" page 116

Reliability is the primary concern of any equipment user. The best graphics system in the world is useless if it doesn't work. The most powerful and sophisticated transmitter is of no value if it won't stay on the air.

Maintainability ranks right behind reliability in broadcasting. When equipment fails, the user needs to know that it can be returned to service within a reasonable length of time.

Reliability and maintainability is not just an esoteric concept developed by the aerospace industry to satisfy government dictates. It is a science that has fostered the continued improvements in components and systems that we enjoy today. It is a science that we, as broadcast engineers, need to understand.



Jerry Whitaker,
editorial director

The mechanics of component failure

By Jerry Whitaker, editorial director

It's 5 p.m., the early news program is about to begin and the STL microwave system kicks off the air. Repairs are made in 15 minutes or so, and the program resumes. Life goes on.

The next morning, however, the vice president for engineering calls a meeting to determine what happened, and how a recurrence can be prevented. In the discussion, someone comes up with the brilliant observation that *one of the parts just failed*. How many times have you heard that? It implies that component failures occur more or less at the whim of the component itself.



You can prevent failures in broadcast equipment if you thoroughly understand why parts go bad.



There is a much better explanation for equipment problems than the conventional, simplistic answer. By understanding what parts are prone to failure—and why—the engineering department can increase the reliability of any system.

Critical systems

Radio and TV engineers tend to view the reliability of their *critical systems*—that is, systems that are required to operate properly in order to remain on the air—as being more demanding than just about any other profession. Think for a moment, however, about the reliability

demands inherent in the operation of a nuclear power plant, avionics control system or missile guidance unit. The subjects of reliability and maintainability have been studied in great detail, but the findings have not been generally communicated to broadcast engineers.

The science of reliability and maintainability matured during the 1960s with the development of sophisticated computer systems and complex military and spacecraft electronics. It is a science that we, as broadcast engineers, can learn a great deal from. Much of the information contained in this article is

based on research conducted by members of the IEEE Reliability and Maintainability Society. (References listed on page 84.) As you will see, there is a much better explanation for equipment failure than, "One of the parts wore out."

Components and systems never fail without a reason. That reason may be difficult to find, but determination of failure modes and weak areas in system design or installation is fundamental to increasing the reliability of any component or system, whether it is an integrated circuit, aircraft autopilot or broadcast transmitter.

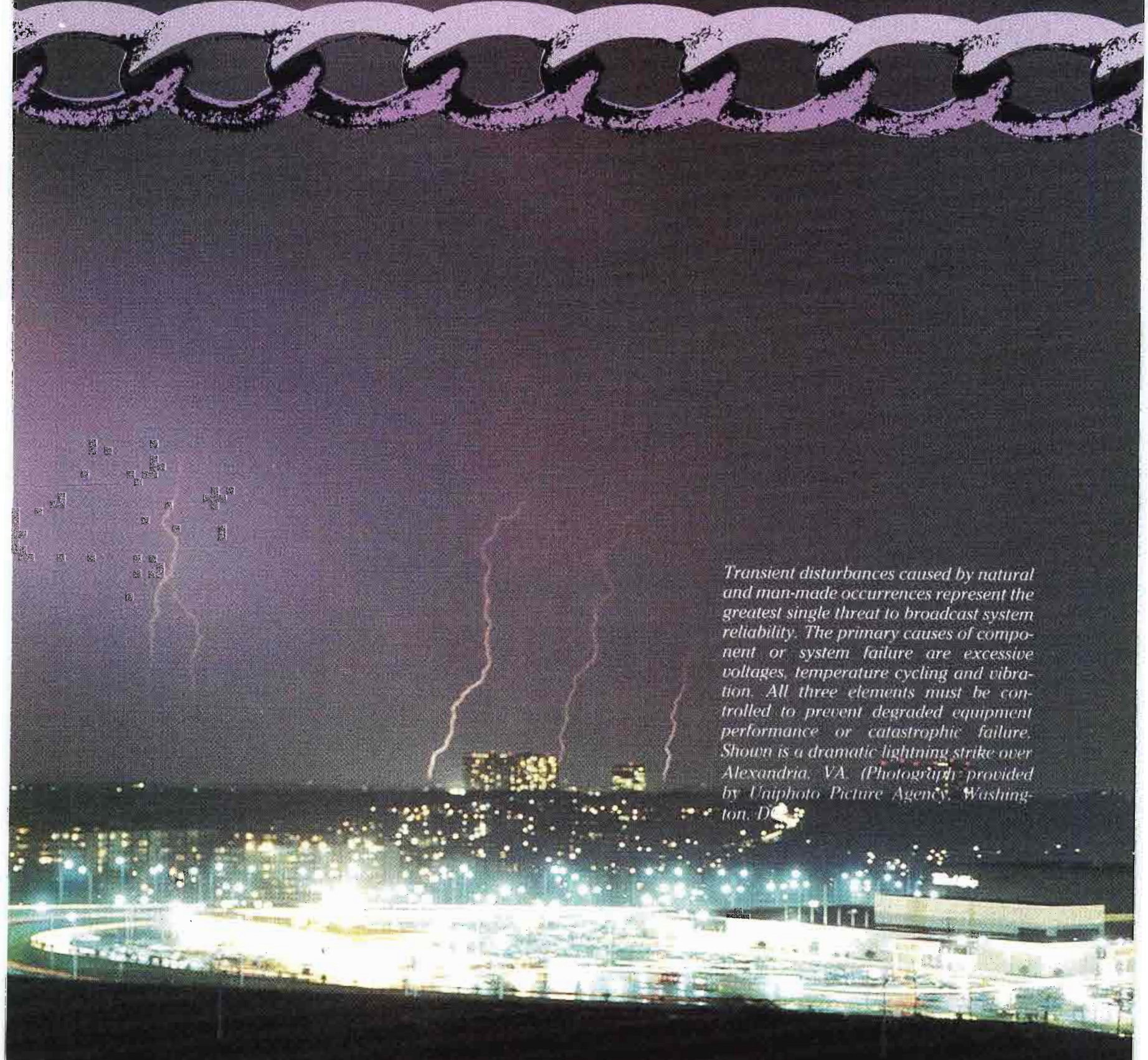
A photograph of a city at night, likely Alexandria, VA, showing a dramatic lightning strike over the city. The city lights are visible in the foreground and middle ground, with a large, bright lightning bolt striking down from the dark sky. The image is framed by a decorative border at the top.

Transient disturbances caused by natural and man-made occurrences represent the greatest single threat to broadcast system reliability. The primary causes of component or system failure are excessive voltages, temperature cycling and vibration. All three elements must be controlled to prevent degraded equipment performance or catastrophic failure. Shown is a dramatic lightning strike over Alexandria, VA. (Photograph provided by Uniphoto Picture Agency, Washington, DC.)

1

Why parts fail

All equipment failures are logical and some are predictable.

When a system fails, it is usually related to poor-quality components or to abuse of the system or a part within, either because of underrating or environmental stress. Even the best-designed components can be badly manufactured. A process can go awry, or a step involving operator intervention can result in an occasional device that is substandard or

likely to fail under normal stress. Hence, the process of *screening* and/or *burn-in* to weed out problem parts is a universally accepted quality-control tool for achieving high reliability.

Statistical reliability

Figure 1 illustrates what is commonly known as the *bathtub curve*. It divides

the expected lifetime of a class of parts into three segments: infant mortality, useful life and wearout. A typical burn-in procedure consists of the following steps:

- The parts are electrically biased and loaded (*i.e.*, they are connected in a circuit representing a typical application).
- The parts are cycled on and off (power

Continued on page 42



Avionics hardware, particularly equipment intended for space applications, has been the driving force behind the science of reliability and maintainability. There is much that we, as broadcast engineers, can learn from the successes and failures of NASA and the defense department. (Photo courtesy of NASA.)



*The choice of
Radio Station KGLT*

David Peters, Assistant Engineer KGLT Radio Station, Bozeman, Montana.

THE EIMAC 5CX1500B FOR LONG LIFE, QUALITY AND ECONOMY

Varian EIMAC has been in the business of broadcasting for over 50 years, producing durable, reliable and long-lasting tubes that a non-profit radio station like KGLT in Bozeman, Montana, can afford.

Longevity

KGLT engineers use the EIMAC 5CX1500B tube in their transmitter, reporting a life span of 18-19 months—approximately 13,000 hours of service!

Quality and Savings

This would be impressive under ideal conditions, but KGLT operates under rugged and adverse mountain-top conditions. Just as important is the 40% cost

savings attributable to the 5CX1500B's extended life.

In FM broadcasting, EIMAC tubes are customer-proven.



EIMAC's 5CX1500B broadcasting tube in KGLT radio station's transmitter.

Varian EIMAC offers a 5,000-hour warranty on 5CX1500B tubes.

For more information, contact:

Varian EIMAC
1678 South Pioneer Road
Salt Lake City, Utah 84104
Telephone: 801-972-5000



Circle (20) on Reply Card

Five!

FOUR ARBITRONS IN A ROW.* THE #1 MARKET... THE TOP THREE FM STATIONS.



Step up to digital control! The digitally-controlled TEXAR AUDIO PRISM™ breaks the old quality-versus-loudness tradeoff of analog audio processors. The AUDIO PRISM delivers unsurpassed modulation power for maximum cumes but with a

clarity that keeps listeners quarter-hour after quarter-hour.

Digital control delivers ratings and revenues. The AUDIO PRISM has been the audio processor of choice for the top 3 rated FM stations in America's

largest market, New York City...for five Arbitrons in a row.*

Step into the future. Put the power and clarity of digital control to work for you today! Call Barry Honel at (412) 85-MICRO or visit us in booth #2571 at the Dallas NAB Convention.

TEXAR

616 Beatty Road • Monroeville, PA 15146-1502 • 412/856-4276 • 412/85-MICRO

*Summer & Fall '85, Winter & Spring '86 and Summer & Fall '86 ARBITRON Ratings. Total Persons 12+ Share. Mon-Sun, 6A-12M. (Used with permission.)

Circle (365) on Reply Card

www.americanradiohistory.com

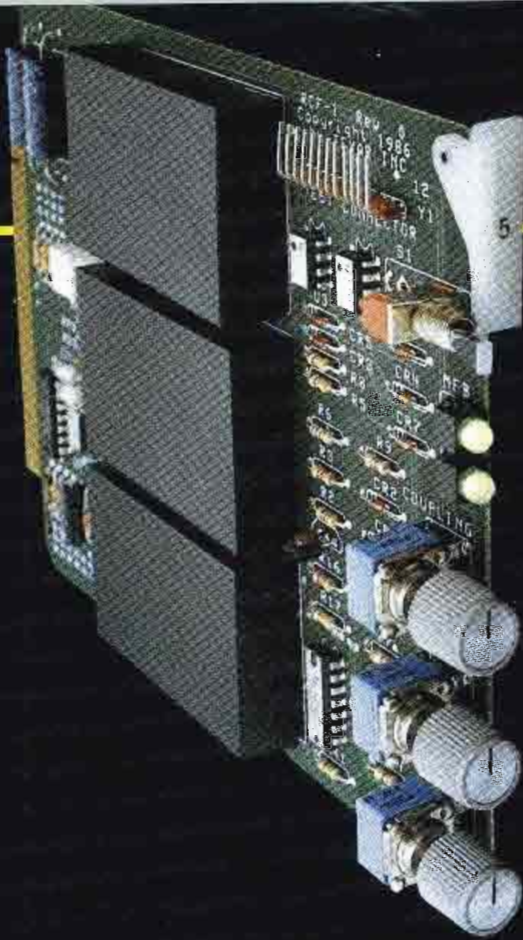

TEXAR

For FM

For FM broadcast, the digitally-controlled, TEXAR AUDIO PRISM™ is designed to be used in conjunction with your high-quality FM limiter/stereo generator. For most PRISM users, that means the Orban Optimod 8100*. In fact, so many PRISM owners use them in conjunction with the Optimod 8100, that TEXAR has developed the Replacement Card Five (RCF-1) for the Optimod. The TEXAR RCF-1 plugs into the Optimod in place of the original Orban card number five.

The RCF-1 delivers every last inch of performance from the AUDIO PRISM/Optimod combination. It's more open, but up to 1½ dB louder.

Converting over to CD digital discs for source material? The RCF-1 is definitely for you! (Present, state-of-the-art, FM exciter is *strongly* recommended.) Come hear the RCF-1 in Booth #2571 at the Dallas NAB Convention. Have a favorite CD you'd like to hear through the TEXAR system? Bring it with you! We'll be happy to play it for you.

*Optimod 8100 is a registered trademark of ORBAN ASSOCIATES INC., San Francisco, CA.



TEXAR

For AM

Bring FM-like fidelity to your AM station. The TEXAR EAGLE™ series of AM processors implements the new National Radio Standards Committee (NRSC), voluntary standard for pre-emphasis and frequency response. The NRSC is a joint effort of the National Association of Broadcasters (representing radio broadcasters) and the Electronics Industries Association (representing receiver manufacturers). The NRSC standard, approved January 10, 1987

after nearly a year in development, promises to bring fidelity to listeners, never before heard on the AM band.

For single-side AM, use the TEXAR EAGLE™, AMC-2, Am Modulation Controller. The AMC-2 circuit board mounts inside the AUDIO PRISM enclosure. For split-site AM, use the TEXAR SUPER EAGLE™ stand-alone AM Modulation Controller (shown above) at the transmitter, and the AUDIO PRISM at the studio. Both

the EAGLE™ and SUPER EAGLE™ have variable-asymmetry and low-frequency tilt-correctors. The SUPER EAGLE also has separately adjustable outputs to drive two transmitters, and a unique subsonic telemetry circuit to eliminate the need for phone lines on the remote control.

See both EAGLE's and pick up a free reprint of the NRSC standard in Dallas at the NAB Convention - Booth #2571.

Circle (21) on Reply Card

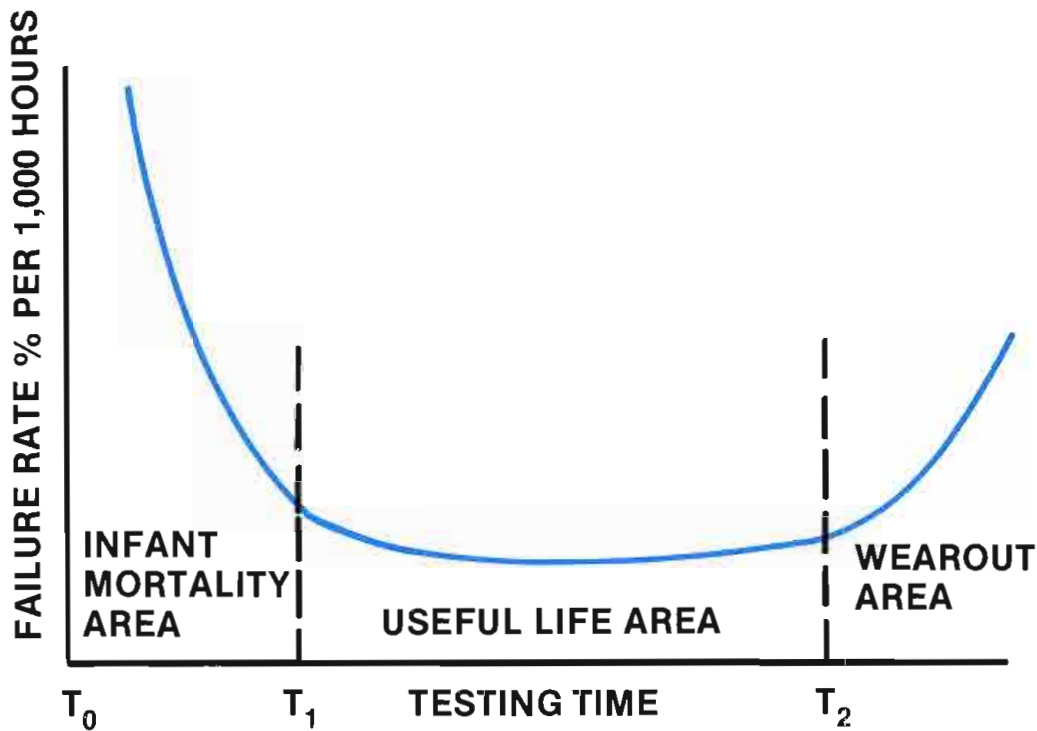

Figure 1. The statistical distribution of equipment or component failures vs. time for electronic systems and devices.

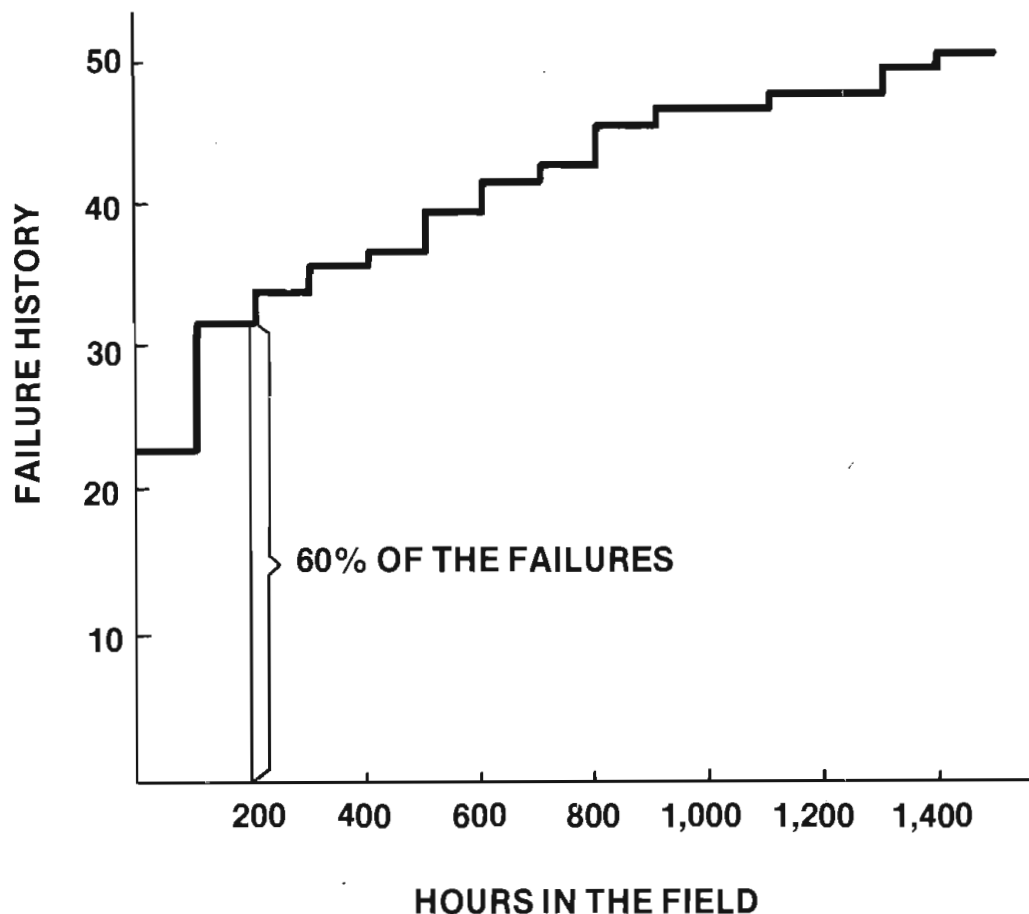

Figure 2. The failure history of a piece of avionics equipment vs. time. Note that 60% of the failures occurred within the first 200 hours of service. (Source: Reference 9.) ©IEEE

Continued from page 38

applied and then removed) for a predetermined number of times. The number of cycles can range from 10 to several thousand during the burn-in period, depending on the component under test.

- The components under load are exposed to a high temperature (typically 125°C to 150°C) for a selected time (usually 72 to 168 hours). This represents an accelerated life test for the part.

An alternative approach involves temperature shock testing in which the product is subjected to temperature extremes, with rapid changes between the hot-soak and cold-soak conditions.

- After the stress period, the components are tested for adherence to specifications. Parts meeting the established specs are accepted for shipment to customers. Parts that fail to meet specs are discarded.

The goal of burn-in testing is to ensure that the component lot is advanced past the infant mortality stage to point T_1 . This process is used for individual components and for entire systems such as broadcast transmitters, videotape recorders and routing switchers.

This approach to reliability is effective, but not foolproof. The burn-in period is a function of statistical analysis. And, like anything else in the world of electronics, it brings no absolute guarantees. The natural enemies of electronic parts are heat, vibration and excessive voltage.

Figure 2 documents failures vs. hours in the field for a piece of avionics equipment. The conclusion is made that a burn-in period of 200 hours or more will eliminate 60% of the expected failures. However, the burn-in period for another system using different components may not require the same number of hours.

So, what does this mean to you, the end-user? Simply that infant mortality is a statistical fact of life in the operation of any piece of equipment—including broadcast hardware. Most of you can relate to the problems of "working the bugs out" of a new piece of equipment.

Because the goal of burn-in testing is to catch system problems and potential faults before the device or unit leaves the manufacturer, the longer the burn-in period, the greater the chances of catching additional failures.

The factors involved with extended burn-in, however, are time and money. Longer burn-in translates to longer delivery delays and additional costs for the equipment manufacturer, which are like-

Stop by AL's and have one on us.

AL's is the first, fully Automated Library System
that really works.

Stop by the NAB Booth 3532 for a beer mug
and a demonstration.

ly to be passed on to the user. The point at which a product is shipped is based largely on experience with similar components or systems and the financial requirement to move products to users.

Environmental stress screening

In an effort to catch greater numbers of failures during qualification testing

(burn-in) at the factory while reducing the required burn-in time, the concept of *environmental stress screening* (ESS) has come into widespread use for aeronautics and military products. To date, however, ESS has not been widely implemented in qualification testing of broadcast products.

ESS takes the burn-in process a step

further by combining two of the major environmental factors that cause parts or units to fail: heat and vibration. Qualification testing for products at a factory practicing ESS involves a carefully planned series of checks for each unit off the assembly line. Units are subjected to random vibration and temperature cycling during production (for subassemblies and discrete components) and upon completion (for systems). The concept is designed to catch product defects at the earliest possible stage of production.

ESS also can lead to product improvements in design and manufacture if feedback from the qualification stage to the design and manufacturing stages is implemented. Figure 3 illustrates the improvement in reliability that typically can be achieved through ESS over simple burn-in screening, and through ESS with feedback to earlier production stages. It is possible to significantly reduce equipment failures in the field.

Designing an ESS procedure for a given product is no easy task. The environmental stresses imposed on the product must be great enough to cause *fallout* of marginal components during qualification testing. The stresses must not be so great, however, that they *cause* failures in *good* products. Any unit that is stressed beyond its design limits eventually will fail. The proper selection of stress parameters—generally random vibration on a specially designed vibration generator and temperature cycling in an environmental chamber—can, in minutes, uncover product flaws that might take weeks to occur in the field. The result, therefore, is greater product reliability for the user.

The ESS concept requires that every product undergo qualification testing before implementation into a larger system or shipment to an end-user. The flaws uncovered by ESS vary from one unit to the next, but types of failures tend to respond to particular environmental stresses, as illustrated in Table 1. The levels of stress imposed on the product during ESS should be greater than the stress to which the product will be subjected during its operational lifetime, but should remain within the maximum design limits.

The types of products that can be economically checked through ESS break down into two categories: high-dollar items and mass-produced items. Because broadcasting is not a high-volume business (compared to the consumer industry) don't expect to see ESS practiced on

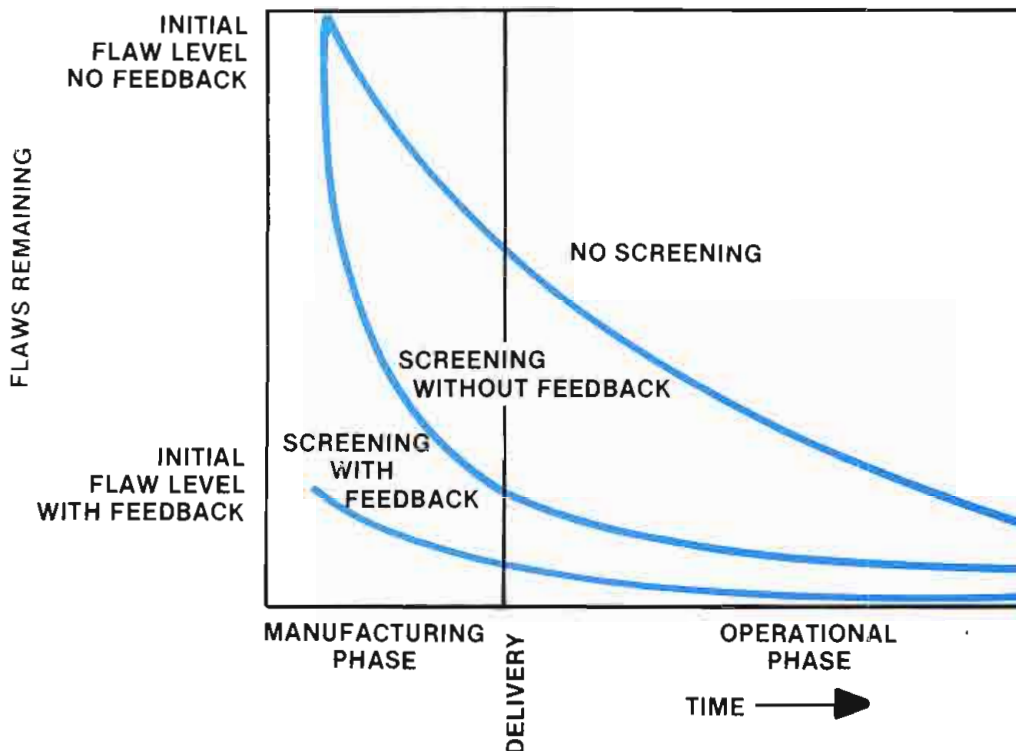

Figure 3. The effects of environmental stress screening on the reliability bathtub curve. (Reference 31.)

TYPE OF DEFECT	FAILURE REVEALED THROUGH	
	THERMAL SCREENING	VIBRATION SCREENING
COMPONENT DEFECTS	X	X
IMPROPERLY INSTALLED PART	X	
FAULTY SOLDER CONNECTION	X	X
FAULTY ETCHING	X	X
LOOSE CONTACT		X
BAD WIRE INSULATION	X	
LOOSE WIRE TERMINATION	X	X
IMPROPER CRIMP	X	
CONTAMINATION	X	
DEBRIS WITHIN ASSEMBLY		X
LOOSE HARDWARE		X
MECHANICAL FLAW		X

Table 1. System failure modes that typically are uncovered by environmental stress screening. (Reference 31.) ©IEEE

What'll you have?

Beta, Beta SP, M, M2, U-matic or Digital 19mm formats? AL'S serves them all. And will even mix them up so you can run two formats at once--full length programming or commercials, it makes no difference to AL.

How big is your tape library? AL'S can serve 500, 1000, 1500 at a time--all in the right order, with no mistakes, automatically. Digital technology has given AL a flawless memory and real knack with names. He even recognizes newcomers and ejects tapes who've overstayed their welcome. At AL'S, all tapes are current and inventory is always kept up to date. Not bad, eh?

What's more, AL is not one for fancy, exotic, altered machinery. Plain and simple suits him just fine. So, stock VTRs are all you'll find at AL'S place. Out of the box and into the rack makes for easy maintenance as far as Al is concerned.

But don't misunderstand. AL is not lazy. He'll work when there's not a soul around. In fact, give him a set of chores to do, then turn out the lights, lock the door and he'll work alone all weekend. Think of the man-hours (and payroll) that saves!

There is no doubt. For performance, service, for sheer ability, there's no place like AL'S. If you're in the neighborhood--NAB Booth 3532--stop by and have one on us. If you can't make it, call us at: (617) 244-6881 and we'll be glad to send you more information.

Automated
Library
System

LAKE

THE SYSTEMS COMPANY

Lake Systems Corporation

287 Grove Street

Newton, MA 02116

(617) 244-6881

Circle 122 on Reply Card

products costing less than several thousand dollars anytime in the near future. High-priced computer-based systems, on the other hand, are candidates for such screening.

Units that are physically large in size, such as transmitters, are not candidates for ESS in the finished state. The cost for a vibration table or environmental chamber for a transmitter would total many times more than the transmitter under

test (if you could find somebody to build one). ESS for larger systems must rely on qualification testing at the subassembly stage.

The basic hardware complement for an ESS test station includes a thermal chamber shaker and controller/monitor. A typical test sequence includes 10 minutes of exposure to random vibration, followed by 10 cycles between temperature minimum and maximum. To save time, the two tests may be performed simultaneously.

Field experience

Research conducted by the aerospace industry has shown that components account for the vast majority of equipment failures in the field, as Figure 4 illustrates. The exact percentage breakdowns for broadcast equipment will probably vary from those shown for avionics hardware. However, in the absence of any better data, we will assume these statistical breakdowns to be projectable.

As the chart illustrates, the generalization can be made that the failure of a piece of equipment is most likely to be caused by the failure of an individual component. Workmanship and other factors account for a relatively small per-

centage of failures.

One potential cause of component and system failure is that the operating environment of the unit—resulting either from external environmental conditions or unintentional component underrating—may be significantly more stressful than expected by either the system manufacturer or the component supplier. Unintentional component underrating represents a design fault, but unexpected environmental conditions are possible for many applications, particularly in locations that are popular broadcast transmitter sites, such as remote mountain tops.

Conditions of extreme low or high temperatures, high humidity and vibration during transportation may have a significant impact on long-term reliability of the system. It is, for example, possible—and probable—that the vibration stress of the truck ride to your transmitter site will represent the worst-case vibration exposure of the transmitter and all components within it during the lifetime of the product. We must realize that *the field* is the final test environment and burn-in chamber for the equipment that we use.

Failure modes

An understanding of how electronic parts fail is important to maintenance engineers because it allows them to focus on potential areas of vulnerability within a system. Consider the distribution of catastrophic failure modes for various types of components shown in Table 2. Note that types of components tend to fail in predictable ways. This information is critical to an engineer troubleshooting a fault or analyzing the possible consequences of device failure in a system.

There are really no big surprises in the table. Your experience, for example, probably confirms that most capacitors fail in a short circuit and that connector pins almost always fail in an open circuit. The exact failure percentages shown in the table, developed to study the reliability of electromagnetic pulse (EMP) suppressor circuits in aircraft, are not directly transferable to components used in broadcast equipment.

A device can fail in a catastrophic, intermittent or degraded mode. Such failures are usually opens, shorts or parameters out of specifications. For electrical components, the three most destructive stresses are excessive temperature, voltage and vibration.

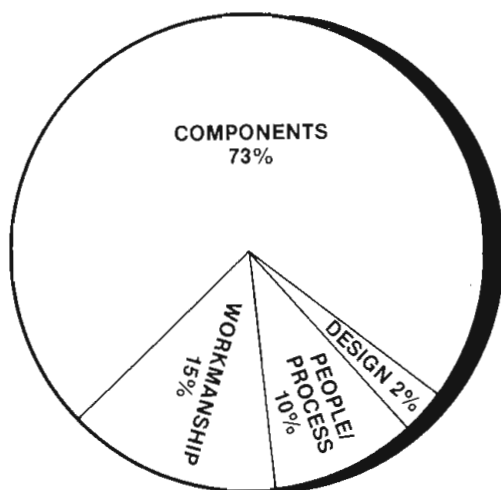

Figure 4. The distribution of failure modes in the field for an airborne avionics system. (Reference 9.)

COMPONENT	MODE OF FAILURE	DISTRIBUTION
CAPACITOR (ALL TYPES)	OPEN	.01
	SHORT	.99
COIL	OPEN	.75
	SHORT	.25
DIODE (ZENER)	OPEN	.01
	SHORT	.99
GE-MOV	OPEN	.01
	SHORT	.99
TRANSZORB	OPEN	.01
	SHORT	.99
CONNECTOR PIN	OPEN	.99
	SHORT TO GND	.01
SOLDER JOINT	OPEN	1.00
LUG CONNECTION	OPEN	1.00
SURGE PROTECTOR	OPEN	.99
	SHORT	.01

Table 2. Statistical distribution of component failures in an EMP protection circuit. Note that types of components tend to fail in predictable ways. (Reference 8.) ©IEEE

Dynamic Performer

The FOR-A PVM-500 Production Video Mixer delivers a powerful combination of performance and value for professional production and post-production video systems.

At just \$8,950, this compact switcher performs a series of dynamic functions typically found in products costing considerably more:

- 6 separate program inputs plus black and color backgrounds
- 24 programmable wipe patterns
- 4 independent automatic transition rates for effects, program, downstream keying and fade to black
- Generation of border, drop-shadow and outline for downstream keying
- 3 independent colorizers for background, effects border and downstream keying
- Built-in gen-lock sync generator
- 6 independently adjustable black burst outputs
- Two program and preview output lines
- Serial and parallel editor interfaces

An optional EXKEY Component Chroma Keyer (CCK-500) and EXTROL Effects Memory (FXM-500) that can store up to 40 effects commands further extend its capabilities.

For a fast moving demonstration of the PVM-500 Switcher, call your FOR-A dealer today.

See FOR-A's exciting new products at NAB Booth 3599.



FOR-A[®]
INNOVATIONS IN VIDEO
and AUDIO TECHNOLOGY

FOR-A CORPORATION OF AMERICA • Nonantum Office Park • 320 Nevada Street • Newton, MA 02160
Boston (617) 244-3223 • Chicago (312) 250-8833 • Los Angeles (213) 402-5391

Circle (23) on Reply Card

www.americanradiohistory.com

2

Semiconductor failure modes

Integrated circuits are among the most vulnerable components in broadcast hardware.

Active components are the heart of any broadcast product, and most—except high-power transmitter stages—employ semiconductors. Other component types exhibit their own unique failure modes, but share similar interconnection and packaging problems.

Although very reliable, integrated circuits are particularly vulnerable to damage because of environmental and electrical forces. The circuit density of an IC can have a direct relationship on its survivability under adverse conditions in the field. The problem of IC reliability is of great concern today as device complexity increases with the use of more LSI and VLSI components in broadcast hardware.

Failure mechanisms

Semiconductor failure modes can be broken down into two basic categories: mechanical (including temperature and vibration) and electrical (including electrostatic discharge and transient overvoltage). Semiconductor manufacturers are able to increase device reliability by analyzing why good parts go bad.

Figure 5 shows an example of failure because of mechanical stress. The two diodes failed as a result of temperature cycling that led to a cracked die and fractured metallurgical die bond. The underlying reason for the failure was off-center die placement and axial misalignment during diode assembly. The arrows show the mechanical stresses that were present on the diode structure.

Even though misalignment during assembly was the root cause of failure, thermal cycling triggered the failures. There are, in fact, a frightening number of mechanical construction anomalies that can result in degradation or catastrophic failure of a semiconductor device. Some of the more significant threats include:

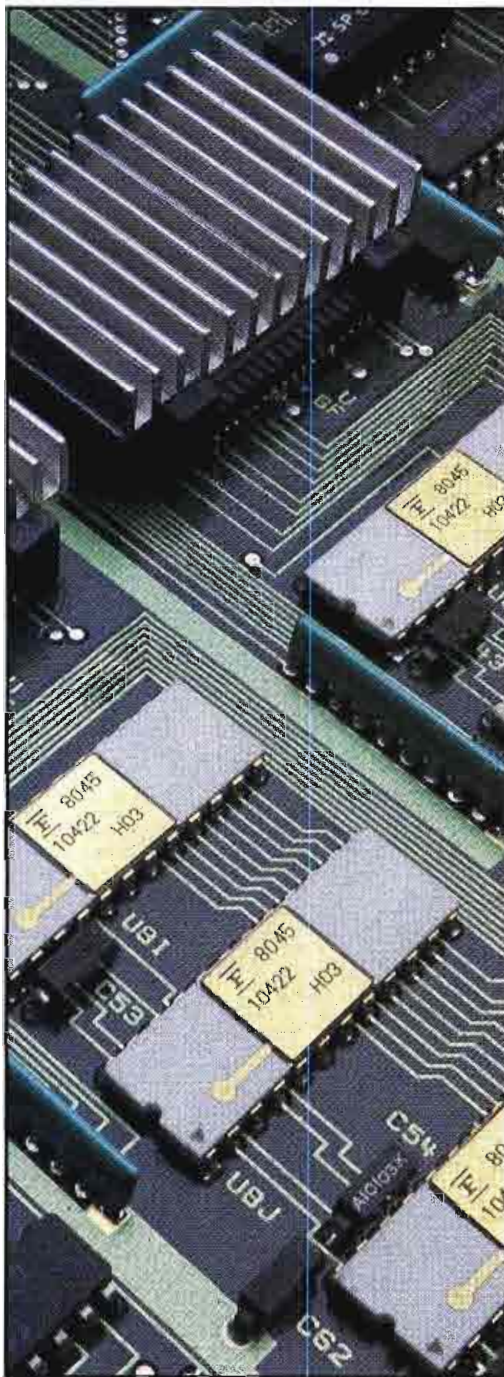

The increased use of LSI and VLSI devices in today's broadcast equipment places additional importance on component reliability analysis.

- Encapsulation failures caused by humidity and impurity penetration, imperfections in termination materials, stress cracks in the encapsulation material and differential thermal expansion coefficients of the encapsulant, device leads or chip.
- Wire bond failures caused by misplaced bonds, crossed wires and oversize bonds.
- Imperfect chip attachment to the device substrate, resulting in incomplete thermal contact, stress cracks in the chip or substrate and solder or epoxy material short circuits.
- Aluminum conductor faults caused by metalization failures at contact windows, electromigration, corrosion and geometrical misalignment of leads and/or the chip itself.

The principal failure modes for semiconductor devices include the following:

- An internal short circuit between metalized leads or across a junction, usually resulting in system failure.
- An open circuit in the metalization or wire bond, usually resulting in system failure.
- Variation in gain or other electrical parameters, resulting in marginal performance of the system or temperature sensitivity.
- Leakage currents across P-N junctions, causing effects ranging from system malfunctions to out-of-tolerance conditions.
- A shift in turn-on voltage, resulting in random logic malfunctions in digital systems.
- A loss of seal integrity through the ingress of ambient air, moisture and/or contaminants. The effects range from system performance degradation to complete malfunction.

Aluminum interconnects in a semiconductor device are the nerves that make possible the integration of complex circuits onto blocks of silicon. The integrity

PERFECT FIT, ANY FORMAT.

Tek know-how at work in component television!

When it comes to maintaining performance and enhancing signal quality—in a world of changing formats—Tektronix is your one *complete* solution for test and measurement needs. Tek has what you need, when you need it.

650HR-C Series Component/Composite Input Picture Monitors. Multiple formats with direct analog component inputs — competitively priced.



TSG-300 Component Television Generator. With signals for multiple formats and standards, plus new test signals for component video.

WFM-300 Component Television Waveform Monitor. A complete measurement set featuring Bowtie timing and Lightning displays. Tek innovations.

Get the Tek solution now. For complete details and fast delivery contact your Tektronix Sales Manager today.

See us at NAB. Booth 3214.

Behind the scenes in quality component television

Tektronix
COMMITTED TO EXCELLENCE

Circle (24) on Reply Card

These products available for SMPTE/EBU, M, MII, BetaCam and GB. BetaCam® is a registered trademark of Sony Corporation. Copyright © 1987, Tektronix, Inc. All rights reserved. #TVG-076

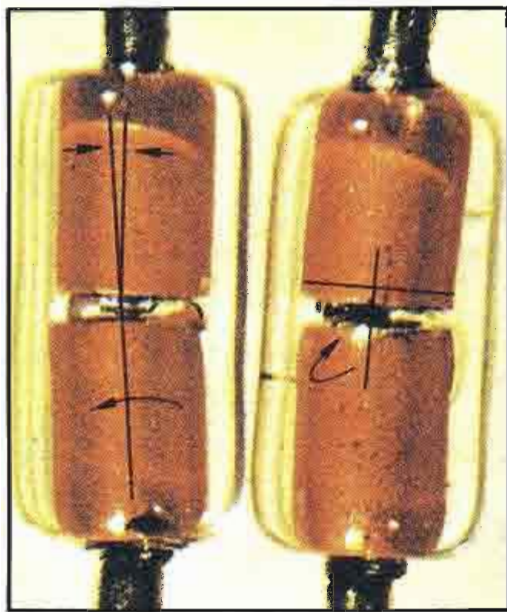

Figure 5. These diodes failed as a result of temperature cycling. The arrows show the mechanical forces at work that ultimately led to the failures. The root cause of the failures was off-center die placement and axial misalignment during assembly. (Reference 10.) ©IEEE

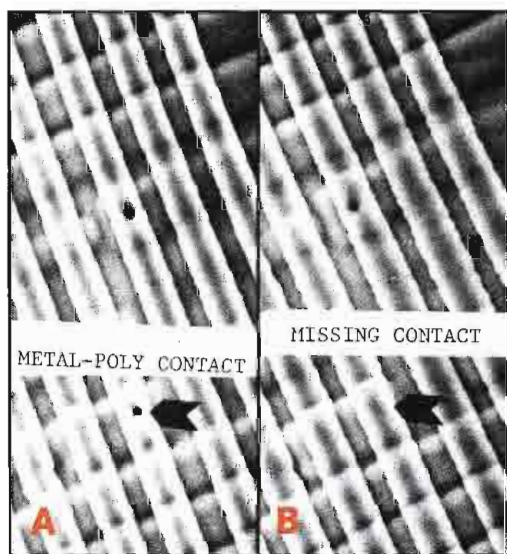

Figure 6. Die photos of two 16K EEPROM devices. Photo (a) shows a good part (note the connection dot shown at the arrow) and photo (b) shows a bad part (the aluminum interconnect is missing). (Reference 15.) ©IEEE

of these interconnects is of critical importance to reliable operation of a device. Figures 6(a) and 6(b) show a failure mode discovered in a common 16K EEPROM device.

Of equal importance are the bonding connections from the integrated circuit package to the die. Each step of the packaging process creates stress on the IC, and the bonding operation accounts for much of the threat to reliability. Bonding has been known to result in damage to the underlying pad region of the chip. Problems range from cracks on the pad to *cratering*, in which the bond breaks away some of the silicon substrate. Figure 7(a) shows a cross section of a typical IC bond pad. The thin layers of *grown* oxides or deposited glasses insulate the bonding pad from the silicon substrate.

Stress-induced failures

Thermal fatigue represents a threat to any semiconductor component, especially power devices. This phenomenon results from the thermal mismatch between a silicon chip and the device header under temperature-related stresses. Typical failure modes include voids and cracks in solder material within the device, which results in increased thermal

resistance to the outside world and the formation of *hot spots* inside the device. Catastrophic failure will occur if sufficient stress is put on the die. Although generally considered a problem just for power devices, thermal fatigue also affects VLSI ICs because of the increased size of the die. Figure 7(b) illustrates the deformation process that results from excessive heat on a semiconductor device.

As a case in point, consider the 2N3055 power transistor. The component is an NPN power device rated for 115W dissipation at 25°C ambient temperature. The component can handle up to 100V on the collector and 15A. Although the 2N3055 is, obviously, designed for demanding applications, the effects of thermal cycling take their toll. Figure 8 charts the number of predicted thermal cycles for the 2N3055 vs. temperature change. Note that the lifetime of the device increases from 9,000 cycles at 120°C to 30,000 cycles at 50°C. From these estimations, it can be seen that device failure for a semiconductor often results from the adverse (and irreversible) effects of thermodynamics.

The microphotographs in Figures 9(a) through 9(c) show a hybrid voltage regulator that failed because of high-voltage breakdown. Failure analysis of several units in a power supply system found that the regulator pass transistor was overstressed because of excessive input/output voltage differential. The manufacturer determined that during testing of the system the regulator's load would be removed, causing the unregulated supply voltage to rise and exceeding the input/output capability of the pass transistor.

Discrete transistors

It is estimated that as much as 95% of all transistor failures are directly or indirectly the result of excessive dissipation or applied voltages in excess of the maximum design limits of the device.

There are at least four types of voltage breakdown that must be considered in a reliability analysis of discrete power transistors. Although each type is not strictly independent, you can treat them separately, keeping in mind that each is related to the others.

- **Avalanche breakdown:**

Avalanche breakdown is a voltage breakdown occurring in the collector-base junction, similar to the *Townsend effect* in gas tubes. This effect is caused by the high dielectric field strength that

occurs across the collector-base junction as the collector voltage is increased.

The high-intensity field accelerates the free-charge carriers so they collide with other atoms, knocking loose additional free-charge carriers that, in turn, are accelerated and have further collisions.

This multiplication process occurs at an increasing rate as the collector voltage increases until at some voltage, V_a (avalanche voltage), the current suddenly tries to go to infinity.

If enough heat is generated in this process, the junction can be damaged or destroyed. A damaged junction will result in higher-than-normal leakage currents, increasing the steady-state heat generation of the device, which may ultimately destroy the semiconductor junction.

- **Alpha multiplication:**

This type of breakdown is closely related to the avalanche effect. Alpha multiplication is produced by the same physical phenomenon that produces avalanche, but differs in circuit configuration. This effect is generally responsible for collector-emitter breakdown when base current is equal to zero.

- **Punch-through:**

Punch-through failure is a voltage breakdown occurring at the collector-base junction because of high collector voltage. As collector voltage is increased, the *space charge region* (collector junction width) gradually increases until it penetrates completely through the base region, touching the emitter. At this point the emitter and collector are effectively shorted together.

This type of breakdown occurs in some PNP junction transistors but generally alpha multiplication breakdown occurs at a lower voltage than punch-through. Because this breakdown occurs between collector and emitter, punch-through is more serious in the common emitter or common collector configuration.

- **Thermal runaway:**

This breakdown involves the avalanche effect, and is dependent upon circuit stability, ambient temperature and transistor power dissipation. Thermal runaway is a regenerative process by which an increase in temperature causes an increase in the leakage current that results in an increased collector current. This, in turn, causes increased power dissipation. This action raises the junction

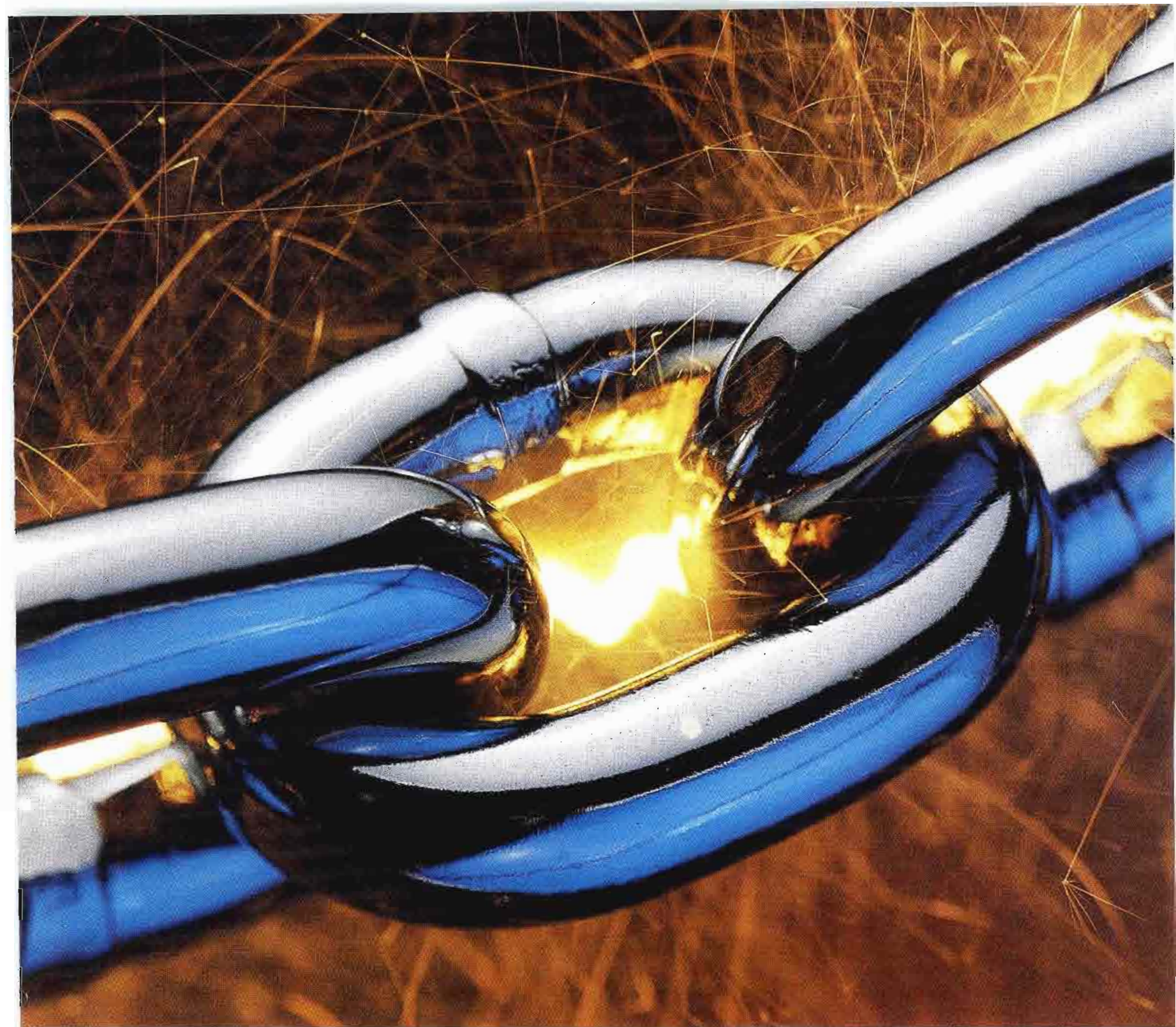

BTS Forges A New Link *to its chain of switcher products*

BTS forges a new link to its chain of distribution switching equipment by introducing the most advanced television automation system available today.

This BTS system gives you total automated control combined with ease of operation by using state of the art computer technology.

The new BTA-2300 automation system, the TAS/TVS-2000 Distribution Switcher, the MCS-2000 Master Control Switcher and TCS-1 Machine



Control link directly to your existing equipment, eliminating the need for non-standard control systems, special interfaces or custom black boxes.

WGBH-TV, PBS, the Armed Forces Radio & Television Service (AFRTS) and over 2,000 other
Circle (25) on Reply Card

users have linked up with BTS distribution switching equipment. Let us send you our free booklet, "The Switcher Network." Write or call today. BTS Broadcast Television Systems, PO Box 30816, Salt Lake City, UT 84130-0816, (801) 972-8000.

"Customer satisfaction is our satisfaction"

BTS

**Broadcast
Television
Systems**

A joint company of Bosch and Philips

March 1987 *Broadcast Engineering* 51

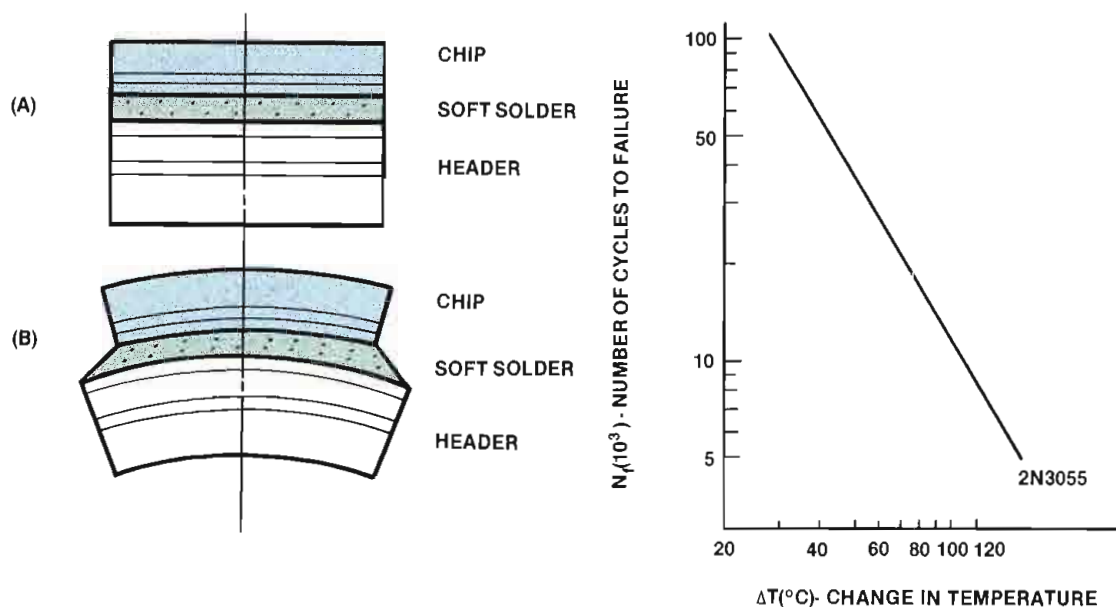

Figure 7. The mechanics of thermal stress on semiconductor devices. Diagram (a) shows a normal chip/solder/header composite structure; (b) shows the assembly subjected to a change in temperature. (Reference 17.)

Figure 8. The effect of thermal cycling on a 2N3055 power transistor. (Reference 17.)

cific upper limit. This is accomplished primarily by conduction from the junction through the transistor material to a metal mounting base that is designed to provide good thermal contact to an external heat dissipator or heat sink.

Because heat transfer is associated with a temperature difference, a differential will exist between the collector junction and the transistor mounting surface. A temperature differential also will exist between the device mounting surface and the heat sink. Ideally these differentials will be small. They will, however, exist to one extent or another. It follows, therefore, that an increase in dissipated power at the collector junction will result in a corresponding increase in junction temperature. In general, assessing the heat sink requirements of a device or system (and the potential for problems) is a difficult proposition.

Figure 10 shows some of the primary elements involved in thermal transmission of energy from the silicon junction to the external heat sink. An electrical analog of the process is helpful for illustration. The model shown in Figure 10(b) includes two primary elements: *thermal capacitance* and *thermal resistance*. The energy storage property of a given mass, expressed as C , is the basis for the transient thermal properties of transistors. The thermal transmission loss from one surface or material to another, expressed as Θ , causes a temperature differential

temperature, causing a further increase in leakage current.

If the leakage current is high enough (caused by high temperature or high voltage), and the current is not adequately stabilized to counteract increased collector current because of increased leakage current, the process can regenerate to a point that the temperature of the transistor and power dissipation rapidly increase, destroying the device. This type of effect is more prominent in power transistors where the junction is normally operated at high temperatures and where high leakage currents are present because of the large junction area.

Effects of voltage breakdown

The effects of the breakdown modes previously outlined manifest themselves in various ways on the transistor. Avalanche breakdown usually results in destruction of the collector-base junction because of excessive currents, which, in turn, results in an open between collector and base.

Breakdown due to alpha multiplication and thermal runaway most often results in destruction of the transistor because of excessive heat dissipation that shows up electrically as a short between collector and emitter. This condition, most common in transistors that have suffered catastrophic failure, is not always easily detected. In many cases an ohmmeter check may indicate a good transistor. Only after operating voltages are applied will the failure mode be exhibited.

Punch-through breakdown generally does not permanently damage the transistor. It can be a self-healing type of breakdown. After the overvoltage is removed, the transistor will usually operate satisfactorily.

Heat sinks

Heat generated in a power transistor (primarily at the collector junction) must be removed at a sufficient rate to keep the junction temperature within a spe-

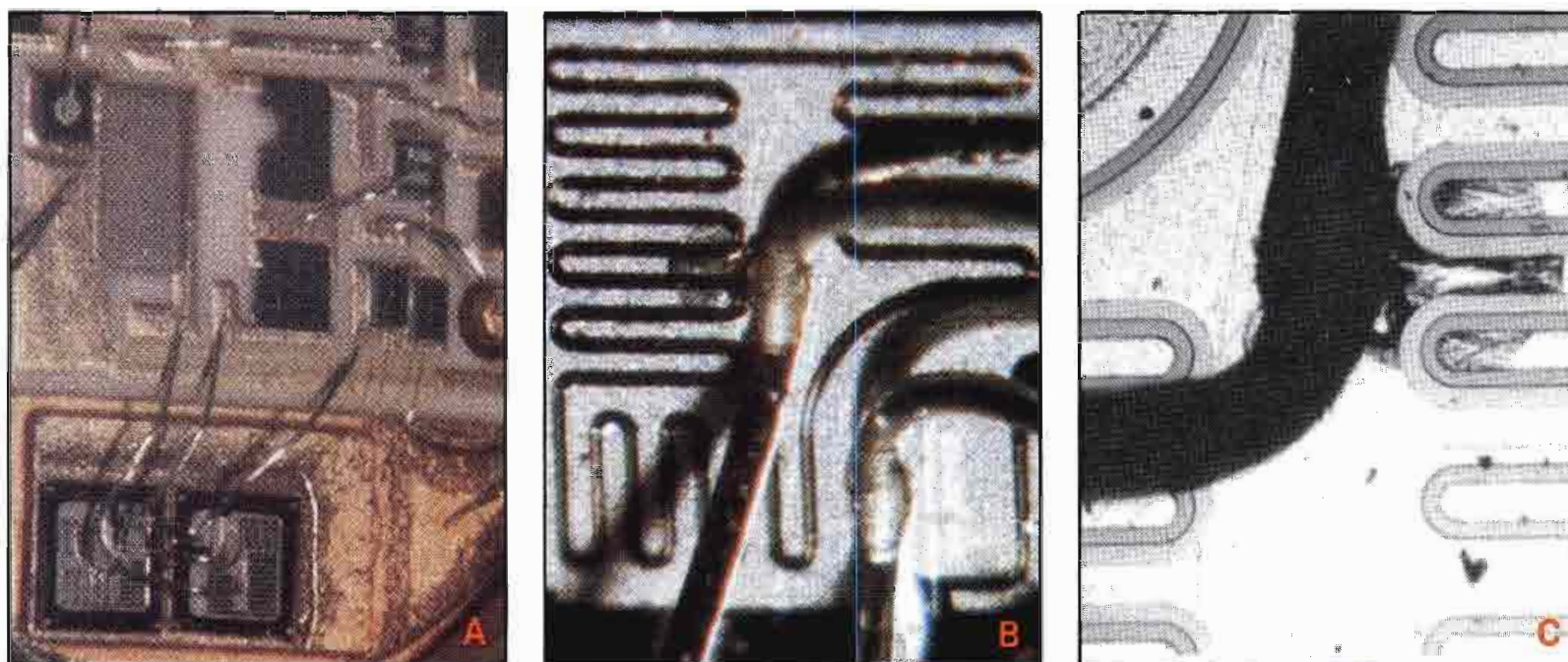

Figure 9. Three views of a hybrid voltage regulator that failed because of a damaged pass transistor. Photo (a) shows the overall circuit geometry. Photo (b) shows a close-up of the damaged pass transistor area. Photo (c) shows an enlarged view of the damage point. (Reference 29.)

ANNOUNCING A TAPE SO ADVANCED, IT DEMANDED A NEW GENERATION OF VIDEO EQUIPMENT.



FUJI'S NEW M401 MII 1/2-INCH METAL VIDEOTAPE.

Fuji introduces the world's first 1/2-inch metal videotape, Fuji M401. M401 technology is so advanced, it's taken three years for the broadcast world to develop a compatible system of video equipment.

With M401, your picture quality is comparable to 1-inch tape at considerably less cost. You also get a tape that can withstand the rigors of the broadcast environment, in the editing room as well as in the field.

And if the idea of metal videotape surprises you, the fact that it's from Fuji shouldn't. We've been making breakthroughs in broadcast technology for more than 25 years.

So ask your Fuji representative about the tape the world has finally caught up with. Fuji M401.

 **FUJI** PROFESSIONAL
VIDEOTAPE

© 1987 Fuji Photo Film U.S.A. Inc., Magnetic Products Div., 555 Taxter Rd., Elmsford, NY 10523

Circle (320) on Reply Card

FOAM FILTERS				
	WITHOUT FILTER	40PPI-¼ THK	20PPI-¼ THK	10PPI-¼ THK
ROOM AMBIENT TEMPERATURE	71°	73°	75°	77°
EQUIPMENT AIR TEMPERATURE	81°	97°	94°	93°
TEMPERATURE RISE	10°	24°	19°	16°

NOTE: The more pores per inch, the greater the pressure drop. Density of material is not related to pore size.

Table 3. Temperature measurements (in °F) on an electronic system showing the differences in cooling performance without fan filters, and with filters, of various PPI (pores-per-inch) ratings. (Reference 29.)

thermal resistance of the insulator itself, however, can represent a significant problem. Unfortunately, materials that are good electrical insulators are usually good thermal insulators. The best materials for such applications are mica, beryllium oxide and anodized aluminum.

The fans and filters used in an electronic system are important criteria to be considered. Depending on the pores-per-inch (PPI) rating of the material used, fan filters can cause a significant difference in ambient temperature vs. internal equipment air temperature, even when clean. Table 3 documents typical measurements taken on a piece of electronic equipment. Clearly, the porosity (and thickness of the filter material selected) influences the best-case internal temperature of an electronic system. The cubic foot-per-minute (CFM) rating of the fans or blowers used in a system must provide for operation under a wide variety of operating conditions and temperatures.

ESD failures

Semiconductor failures caused by high-voltage stresses are becoming a serious problem for system users as integrated circuit density increases. Connection leads have been reduced from 5 microns a few years ago to 1.5 microns or less. Spacing between leads has been reduced by a factor of three or four. In the past, the overvoltage peril was primarily to semiconductor substrates. Now, however, the *metalization* itself—the points to which leads connect—is subject to damage.

Figure 11 shows an electron microscope photo of a semiconductor device that failed because of out-of-tolerance electrical conditions. An ESD (electrostatic discharge) to this metal-oxide field-effect transistor damaged the metalization connection point of the device, resulting in catastrophic failure. Note the places where damage occurred. The objects in the photo that look like bent nails are actually gold lead wires with a diameter of 1 mil. By contrast, a typical human hair is about 3 mils in diameter. The photo was originally shot at 200X magnification.

In Figure 12 we see another view of the MOSFET damage point, but at 5,000X magnification. The character of the damage can be observed. Some of the aluminum metalization has melted and can be seen along the bottom edge of the hole.

Continued on page 58

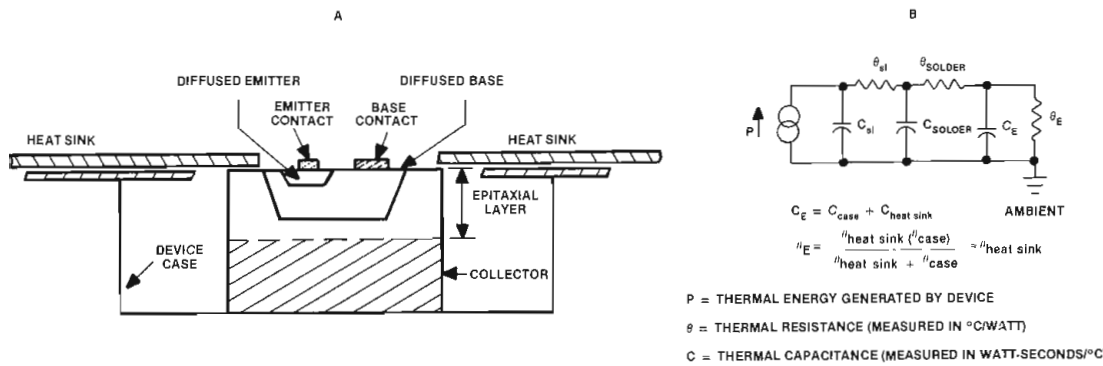

Figure 10. A simplified model of thermal transmission from the junction of a power transistor (TO-3 case) to a heat sink. The structure of a double-diffused epitaxial planar device is shown in (a). A simplified electrical equivalent of the heat transfer mechanism is shown in (b). (Reference 30.)

between the various components of the semiconductor model shown in Figure 10(a).

Although this model may be used to predict the rise of junction temperature that results from a given increase in power dissipation, it is an extreme oversimplification of the mechanics involved. The elements considered in the example include the silicon transistor die (Si); the solder used inside the transistor to bond the emitter, base and collector to the outside-world terminals; and the combined effects of the heat sink and transistor case. This model assumes the transistor is mounted directly onto a heat sink, not through a mica (or other type of) insulator.

The primary purpose of a heat sink is to increase the effective heat-dissipation area of the transistor. If the full power-handling capability of a transistor is to be

achieved, there must be zero temperature differential between the case and the ambient air. This condition exists only when the thermal resistance of the heat sink is zero, requiring an infinite heat sink. Although such a device can never be realized, the closer the approximation of actual conditions to ideal conditions, the greater the maximum possible operating power.

In typical power transistor applications, the case must be electrically insulated from the heat sink (except for circuits using a grounded-collector configuration). The thermal resistance from case to heat sink, therefore, includes two components: surface irregularities of the insulating material, transistor case and heat sink; and the insulator itself. Thermal resistance resulting from surface irregularities can be minimized through the use of silicon grease compounds. The

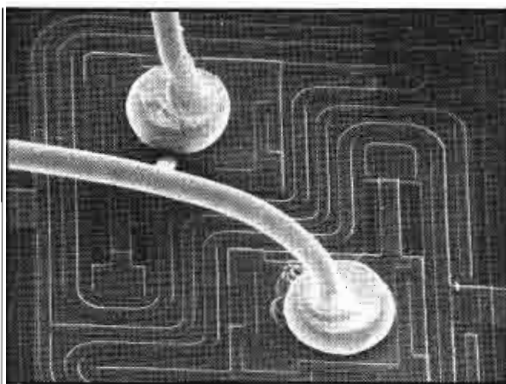

Figure 11. A scanning electron microscope photo illustrating ESD damage to the metalization of a metal-oxide semiconductor field-effect transistor, or MOSFET. (Reference 7.)

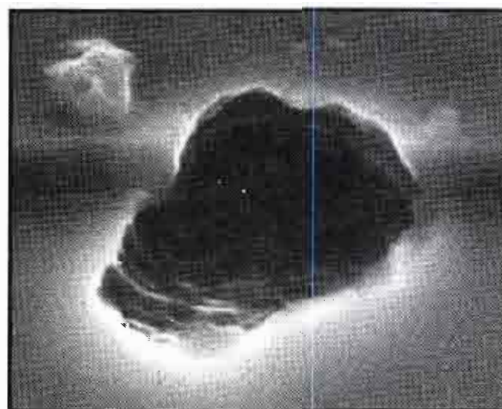
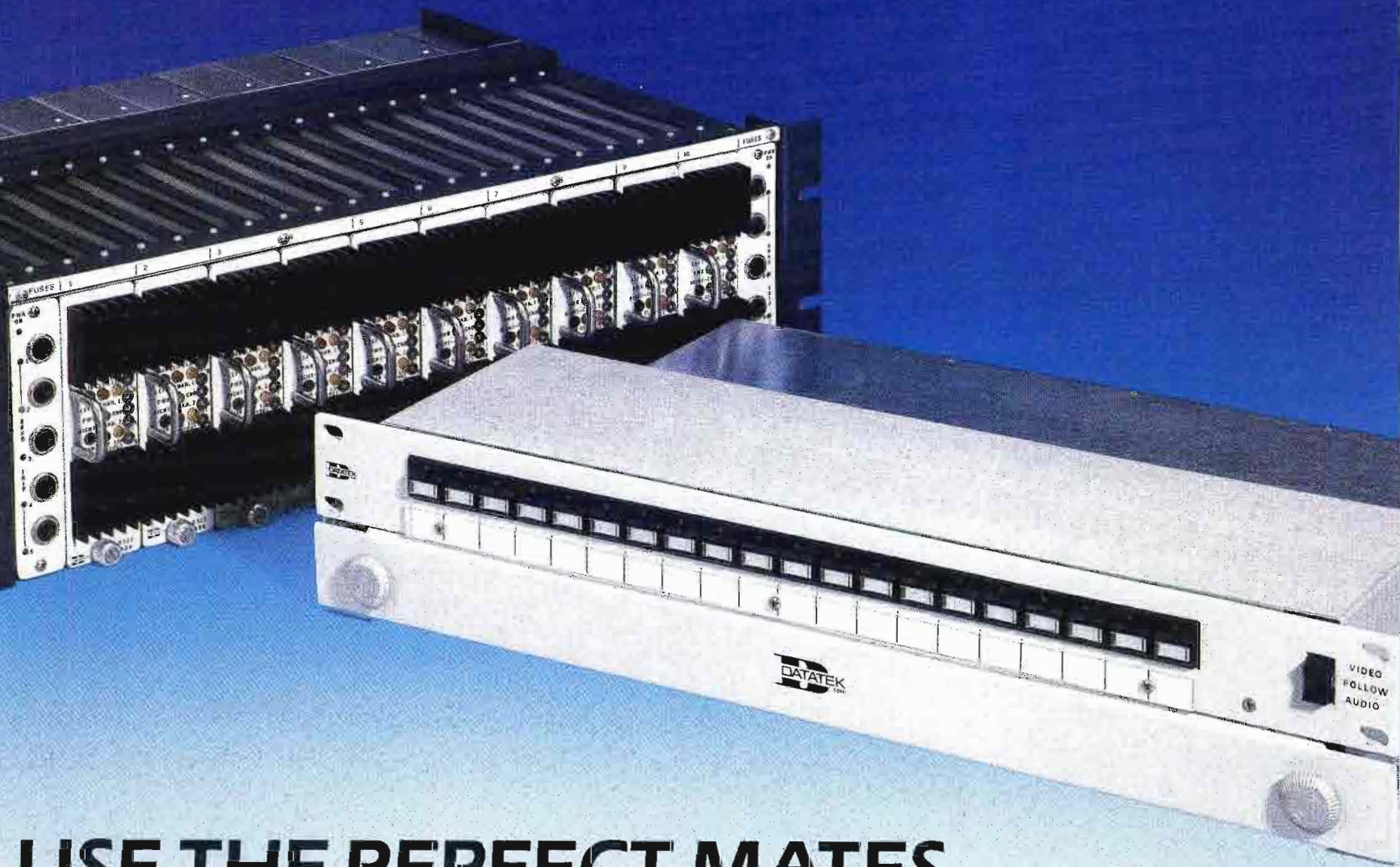

Figure 12. The device shown in Figure 11 at 5,000X magnification. The character of the damage can be observed. (Reference 7.)

YOU KNOW DATATEK'S REPUTATION FOR QUALITY.
NOW COMPARE US FOR VALUE.



USE THE PERFECT MATES FOR YOUR STEREO SWITCHING AND DISTRIBUTION NEEDS.

- The D-525 is a 2-channel Audio D.A. with 6 balanced outputs per channel. It can be used for one monaural input with 12 outputs, two monaural inputs with six outputs each, or one stereo input with 6 stereo outputs.
- Ten D-525 amplifiers fit in one DF-609 5¼" Rack Frame, providing 120 balanced monaural or 60 balanced stereo outputs in only 3 rack units.
- Front panel gain controls and clip level indicators.
- Individual power supply.
- The D-4317A is a 20x2 Monaural or 20x1 Stereo Audio Switcher, self contained in a 1¾" Rack Frame. It can be used with a D-4304A 20x1 Video Switcher, for 20x1 video/stereo audio switching.
- Maximum audio output is +30dBm balanced for excellent "headroom" and audio dynamic range is in excess of 100dB.
- Remote control panels operate over a single coax line.

See us at the NAB Show, Booth 3547



We will be happy to assist in the selection of Datatek products to meet your exact needs.
Call toll free: 1-800-882-9100.

1121 BRISTOL ROAD • MOUNTAINSIDE, N.J. 07092
(201) • 654-8100 • TELEX 833 541

Circle (27) on Reply Card

www.americanradiohistory.com

3M

480



One Tape for True Picture and Sound.

To all those who have to get it on the air without fail, you need a tape you can turn to without fear. 3M 480 1" Videotape. Designed to deliver exceedingly low video dropout levels—and extremely high audio fidelity. To give you a true picture—and true sound.

TO THOSE WHO ARE ON THE LINE TO GET IT ON THE AIR, ONE TAPE IS TRUE.



One Tape Stands True.

Getting you on the air without fail...that's what we've been doing since we invented videotape 30 years ago.

That's why we stand by you—with the largest support force in the field.

And we stand behind you—with some of the most advanced research in the industry. All to keep our standing—as number one in the world of the pro.

NUMBER ONE IN THE WORLD OF THE PRO

3M

Worldwide Sponsor
1988 Olympic Games



Circle (28) on Reply Card

3

Vacuum tube life

Power transmitting tubes present special reliability problems.

Failures in semiconductor components result primarily from deterioration of the device caused by exposure to environmental fluctuations and voltage extremes. The vacuum tube, on the other hand, suffers wearout because of a predictable chemical reaction.

Failure mechanisms

A power grid tube wears out when the filament emission is inadequate for full power output or acceptable distortion levels. Three primary factors determine the number of hours a tube will operate before reaching this condition: the amount of carbon originally processed into the filament, the quality of the tube vacuum and the filament temperature.

The maximum amount of carbon that can be burned into the filament assembly is limited by the increased fragility that results from high carbon-processing levels. The carbon concentration is also limited by the reduction in filament temperature below the level required for ad-

equate emission at the rated filament voltage that occurs with high carbon percentages.

The residual envelope vacuum affects tube life because the *decarburation rate* (the rate at which carbon is burned out of the filament assembly) is a function of the partial pressures of the active gases, primarily oxygen compounds, reacting with the carbon. Good vacuum processing and proper *gettering* in the tube result in the lowest residual gas levels.

The decarburation rate is closely related to the filament operating temperature. This temperature is determined by the power delivered to the filament and, therefore, is controllable by proper filament voltage management.

These factors taken together determine the wearout rate of the tube. Catastrophic failures because of interelectrode shorts or failure of the vacuum envelope are considered abnormal and often result from some external influence.

The design of the transmitter can have a substantial impact on the life expectancy of a vacuum tube. Protection circuitry must remove the applied voltages rapidly to prevent damage to the tube in the event of a failure external to the device. Sufficient cooling air must be directed toward the base of the tube and the anode cooling fins whenever voltage is applied. The filament turn-on circuit also can have an effect on PA tube life expectancy. The surge current of the filament circuit must be maintained at a low level to prevent thermal cycling problems. This consideration is particularly important in medium- and high-power PA tubes.

When the heater voltage is applied to a cage-type cathode, the tungsten wires expand immediately because of their low thermal inertia. However, the cathode support, which is made of massive parts (relative to the tungsten wires) expands more slowly. The resulting differential expansion can cause permanent damage

to the cathode wires. It also can cause a modification of the tube characteristics, and occasional arcs between the cathode and the control grid. Design considerations such as these are the domain of the transmitter manufacturer, not the end-user. However, during the selection process for a new transmitter, consider the finer points of system design, such as filament voltage control.

Examining tube performance

Examining a power tube after it has been removed from a transmitter can tell a great deal about how well the transmitter-tube combination is working. Contrast the appearance of a new power tube (see Figure 13) with a component at the end of its useful life. If a power tube fails prematurely, examine the device to determine if an abnormal operating condition exists within the transmitter. Consider the following examples:

- *Figure 14:* Two 4CX15,000A power tubes with differing anode heat-dissipa-



The useful operational lifetime of a power tube is determined by the filament structure, shown here. The mesh construction of this filament provides a rugged structure that is resistant to shock and vibration.



Figure 13. A new, unused 4CX15,000A tube. Contrast the appearance of this device with the tubes that follow.

9-BIT VERSION
NOW AVAILABLE



UNWANTED FRAME GRABBING STOPS HERE



DFS-3000N Digital Frame Synchronizer

If your video synchronizer lets you down on a noisy feed, you need the new Leitch DFS-3000N. This digital frame synchronizer incorporates input processing circuitry that uses the latest in digital auto-correlation techniques to prevent intermittent frame grabbing or switching to black. Only Leitch offers this capability.

Now you know one of the features of the Leitch DFS-3000N. But the advantages don't stop there. Neither should you. Write or call (toll free) for further information.

In U.S.A. 1-800-231-9673
In Canada 1-800-387-0233

LEITCH

Progressive Concepts in Television Technology

Leitch Video of America, Inc.
825k Greenbrier Circle
Chesapeake, VA 23320
(804) 424-7920

Leitch Video International Inc.
10 Dyas Road, Don Mills
Ontario, Canada M3B 1V5
(416) 445-9640

See you at the
NAB Show, Dallas,
Booth #3559

Circle (29) on Reply Card



Figure 14. Anode dissipation patterns on two 4CX15,000A tubes. Tube (a), on the left, shows excessive heating and tube (b), on the right, shows normal wear. (Tube photos courtesy of Econco Broadcast Service.)

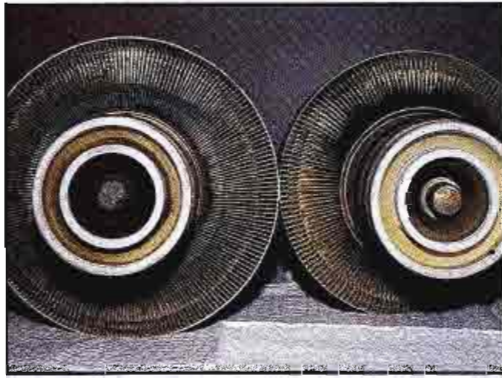

Figure 15. Base heating patterns on two 4CX15,000A tubes. Tube (a), on the left, shows excessive heating and tube (b), on the right, shows normal wear.



Figure 16. A 4CX5,000A tube that appears to have suffered socketing problems.

tion patterns. Tube (a) experienced excessive heating because of a lack of PA compartment cooling air or excessive dissipation because of poor tuning. Tube (b) shows a normal thermal pattern for a silver-plated 4CX15,000A. Nickel-plated tubes do not show signs of heating because of the high heat resistance of nickel.

- **Figure 15:** Base heating patterns on two 4CX15,000A tubes. Tube (a) shows evidence of excessive heating because of high filament voltage or lack of cooling air directed toward the base of the device. Tube (b) shows a typical heating pattern with normal filament voltage.

- **Figure 16:** A 4CX5,000A with burning on the screen-to-anode ceramic. Exterior arcing of this type generally indicates a socketing problem, or another condition external to the tube.

- **Figure 17:** The stem portion of a 4CX15,000A that had gone down to air



Figure 17. The interior elements of a 4CX15,000A tube that had gone to air while the filament was lit.



Figure 18. A 4CX15,000A tube showing signs of external arcing.



Figure 19. A 4CX10,000D tube that experienced severe overheating. (Bill Barkley of Econco describes this example as a 4CX10,000D briquet. He suggests that someone stole either the PA blower or the antenna!)

while the filament was on. Note the blue and yellow deposits of tungsten oxide formed when the filament burned up. The grids are burned and melted because of the ionization arcs that subsequently occurred. A failure of this type will trip overload breakers in the transmitter. It is indistinguishable from a shorted tube in operation.

- **Figure 18:** A 4CX15,000A that experienced arcing typical of a bent finger-stock, or exterior arcing caused by components other than the tube.

- **Figure 19:** A 4CX10,000D that was subjected to cruel and unusual punishment. Because all of the contact surfaces are burned and overheated, the tube probably continued to operate after it lost cooling air. If only the anode were overheated, a loss of antenna coupling would have been suspected. It also is conceivable that this tube was in a fire.

Proper cooling of the tube envelope

and seals is a critical parameter for long tube life. Deteriorating effects that result in shortened life and reduced performance increase with increasing temperature. Excessive dissipation is perhaps the single greatest cause of catastrophic failure in a power tube.

Tubes that operate in the FM and TV frequency bands are inherently subject to greater heating action than devices operated at AM frequencies. This condition is the result of larger RF charging currents into the tube capacitances, dielectric losses, and the tendency of electrons to bombard parts of the tube structure other than the grid and plate at higher frequencies. Greater attention, therefore, must be given to tube cooling at higher frequencies.

Tube construction

Traditionally, the vacuum envelope of multigrad tubes was constructed of glass with metal—usually copper—for the anode at higher power levels. In recent years, however, the trend has been toward the use of ceramic in place of glass for the external insulating portions of such devices. The advantages of ceramic over glass include:

- Reduced radio-frequency loss in the seals. In glass-to-metal seals, the metal is normally made of a magnetic material such as Kovar. Because Kovar has high resistivity and permeability, the radio-frequency losses at the seals are high, and at high frequencies cracking and/or glass suck-in near the seals can result. With ceramic-to-metal seals, this problem is minimized because the radio-frequency circulating currents at the seals flow through the metalizing and plating on the ceramic. The resistivity is low, and the permeability is unity.

- A lower dielectric loss than glass. Furthermore, the loss factor of glass rapidly rises with temperature. This can lead to a runaway condition and glass suck-in. This places a limitation on the maximum frequency of operation of glass tubes.

- The safe operating temperature of a ceramic-to-metal seal may be between 220°C and 250°C, compared with 180°C for Kovar-glass seals.

- The high bakeout temperature of ceramic envelope tubes during evacuation increases reliability and life.

- Ceramic tubes withstand higher thermal and mechanical shocks than those with glass envelopes. They also can be manufactured to closer dimensional tolerances.

The World's First
4:2:2 Telecine
on booth 3966 at NAB Dallas

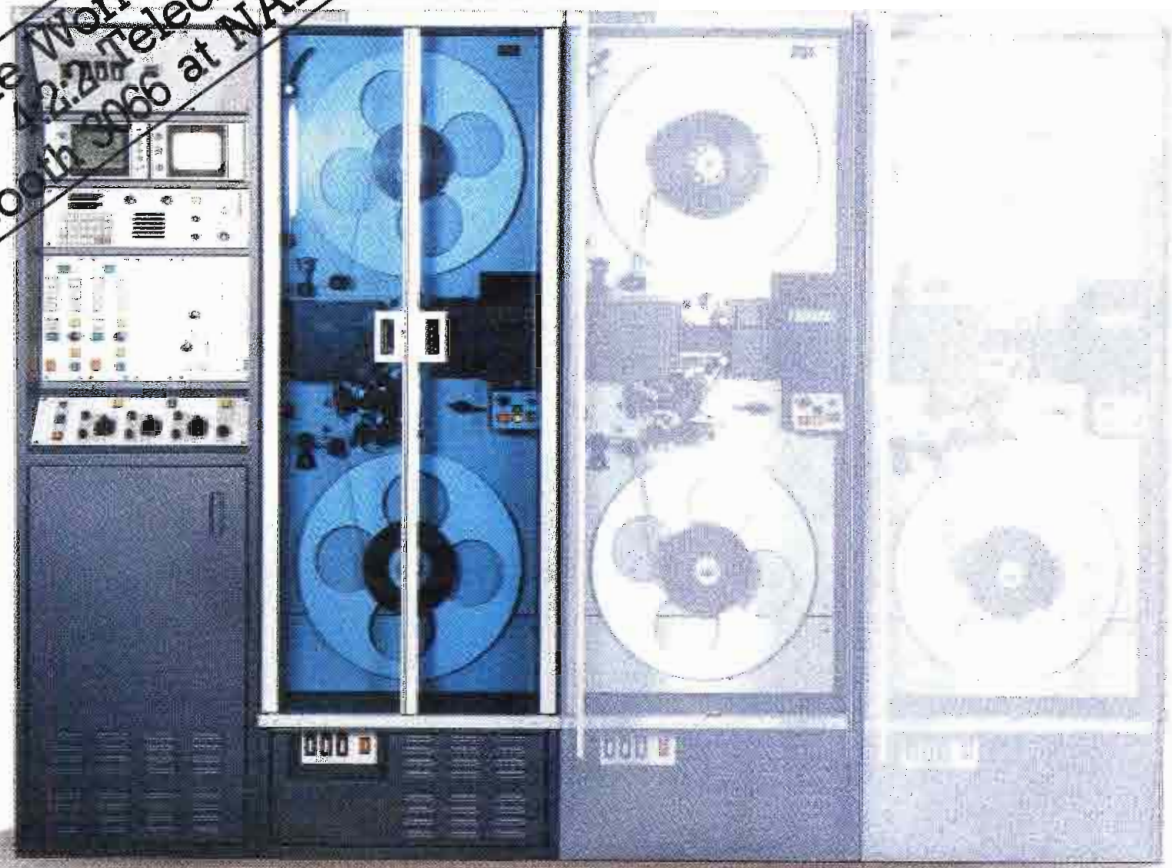

The no hassle broadcast telecine

ADS 1 Advanced Digital Scanner

With ADS 1, Rank Cintel has applied its unique film-scanning experience to the specific needs of the broadcaster.

Developed in close co-operation with the British Broadcasting Corporation (BBC), this CCD multiplexed broadcast-telecine is designed for easy 'on-air' operation and transfer of film to tape prior to transmission.

The incorporation of solid-state imaging technology is an example of Cintel's continuing development philosophy.

Latest component technology, cost-conscious design and modern manufacturing techniques have been

exploited, without compromising performance and reliability. The result is a telecine system which is technically advanced while at the same time being economical to operate. That is not all, ADS 1 also features a unique electronic dirt and scratch concealment system. Add all this together and you have the ideal broadcast-telecine package.

Take the hassle out of film broadcasting — call us at 914-353-1914.



Rank Cintel Inc. East Coast
New York 10994, U.S.A.
260 North Route 303, West Nyack,
Tel: 914-353 1914 Telex: 726441



Rank Cintel

Rank Precision Industries Inc. 411 East Jarvis Avenue, Des Plaines, Chicago, Illinois 60018, U.S.A. Tel: 312-297 7720 Telex: 646998 Fax: 312-6990581
Circle (30) on Reply Card

West Coast
13340 Saticoy Street, North Hollywood,
California 91605, U.S.A.
Tel: 818-765 7265 Telex: 182694 RPI LSA
Fax: 818-765 3315

4

Support component reliability

The failure modes for capacitors, transformers, resistors and circuit breakers are usually predictable.

The circuit areas of equipment most vulnerable to failure are those exposed to the outside world. In most broadcast hardware, the greatest threat generally involves the ac-to-dc power supply. The power supply is subject to high energy surges from lightning and other sources. For this reason, failure modes involving power supply components are important to consider.

Capacitors

Experience has shown that capacitor failures are second only to semiconductors and vacuum tubes in components prone to malfunction in broadcast equipment. Of all the various types of capacitors used today, it is estimated that electrolytics present the greatest potential for problems.

Electrolytic caps are popular because they offer a large amount of capacitance in a small physical area. They are widely used as filters in low-voltage power supplies and as coupling devices in audio and RF stages. An aluminum electrolytic capacitor consists of two aluminum foil plates separated by a porous strip of paper or other material soaked with a conductive electrolyte solution. (See Figure 20.) The separating material between the capacitor plates does not form the dielectric, but instead, serves as a spacer to prevent the plates from mechanically shorting.

The dielectric consists of a thin layer of aluminum oxide that is electrochemically formed on the positive foil plate. The electrolyte conducts the charge applied to the capacitor from the negative plate, through the paper spacer and into direct contact with the dielectric. This sandwich arrangement of foil-spacer-foil is then rolled up and encapsulated.

Capacitor failure modes

Problems with electrolytic capacitors

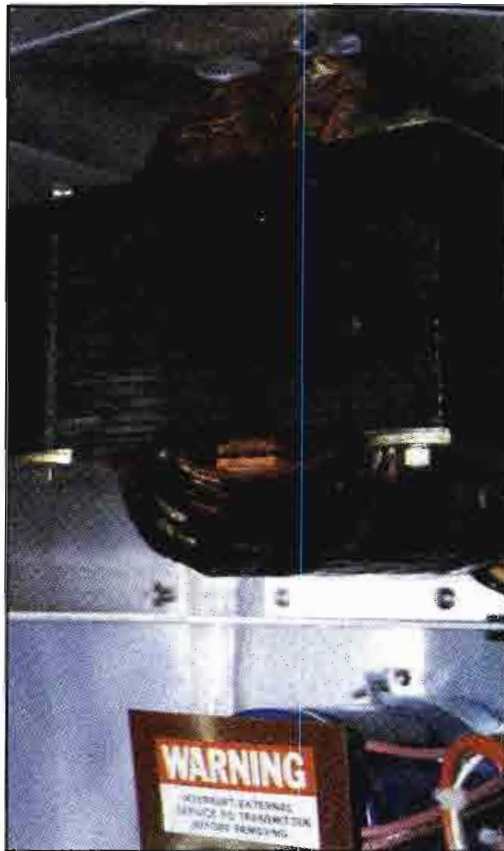

Component reliability is a particular concern for devices that are subject to elevated temperatures during normal operation, such as this power transformer.

fall into two basic categories: mechanical failure and electrolyte failure. Mechanical failures relate to poor bonding of the leads to the outside world, contamination during manufacture and shock-induced shorting of the aluminum foil plates. Failure of the electrolyte can result from application of a reverse bias to the component or a drying of the electrolyte itself.

As a capacitor dries out, three failure modes may be experienced: leakage, a downward change in value or *dielectric absorption*. Any one may cause a system to operate out of tolerance or fail

altogether. The most severe failure mode for an electrolytic is increased leakage (see Figure 21). Leakage can cause loading of the power supply or upset the dc bias of an amplifier circuit. Loading of a supply line often causes additional current to flow through the capacitor, possibly resulting in dangerous overheating and catastrophic failure.

A change in value for a capacitor has a less devastating effect on system performance. A typical tolerance range for an aluminum electrolytic is $\pm 20\%$. A capacitor suffering from drying of the electrolyte can experience a drastic drop in value (to 50% of rated value or less). This phenomenon occurs because after the electrolyte has dried to an appreciable extent, the charge on the negative foil plate has no way of coming in contact with the aluminum oxide dielectric. (See Figure 22.) Remember, it is the aluminum oxide layer on the positive plate that gives the electrolytic capacitor its large rating. The dried-out paper spacer, in effect, becomes a second dielectric, which significantly reduces the capacitance of the device.

The loss of capacitance in a circuit can result in increased ripple in power supply applications or a loss of low-frequency response in multistage circuits coupled using electrolytics.

Dielectric absorption is another effect of drying of the electrolyte. Dielectric absorption refers to a capacitor's inability to completely discharge when its terminals are shorted. When a voltage is applied to an electrolytic capacitor, the dipoles in the dielectric become polarized and line up in an organized fashion. After the applied voltage is removed from the device and the terminals are shorted, the dipoles should return to their random state, resulting in full discharge.

A device experiencing the phenome-



**Hector Munoz,
Distribution Services
Manager**

“Our purpose is to keep you on the air.”

Our extensive inventory of broadcast tubes, RF transistors and related components ensures delivery of the product to you on time—even if I have to run the package to the airport myself. Last year our company made over 7500 overnight deliveries, so we take emergencies seriously!”



**\$30 Million Inventory—
98% Same Day Shipment**



Technical knowledge to help you save time and money by choosing the right component.



PRODUCTS: Cathode Ray Tubes ■ Diodes ■ Klystrons ■ Monitor Tubes ■ Plumbicon® Tubes ■ Receiving Tubes ■ RF Ceramic Capacitors ■ RF Transistors ■ Saticons ■ Solid State Replacements ■ Transmitter/Power Tubes ■ Tube Sockets ■ Accessories ■ TV Linear Devices ■ Vacuum Capacitors ■ Vidicons ■ Vistacons

MANUFACTURERS: Acrian ■ Amperex ■ Cetron ■ EEV ■ Eimac ■ GE ■ Hitachi ■ ITT ■ Jennings ■ Machlett ■ National ■ Philips ■ RCA ■ Raytheon ■ Thomson CSF ■ Varian ■ Westinghouse

See us at NAB Booth #3343

Circle (31) on Reply Card



800-323-1770

Richardson Electronics, Ltd.

Broadcast Division—Calvert Electronics, Inc

Convenient Sales Offices: Franklin Park, IL ■ Woodland Hills, CA ■ Belmont, CA ■ Dallas, TX ■ Norwell, MA ■ Rockville Centre, NY ■ East Rutherford, NJ ■ Winter Park, FL ■ Brampton, Ontario, Canada ■ Lincoln, England ■ Gennevilliers, France

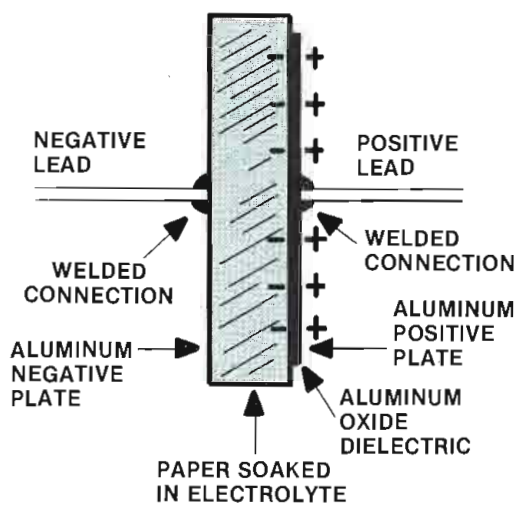

Figure 20. The basic design of an aluminum electrolytic capacitor. (Reference 32.)

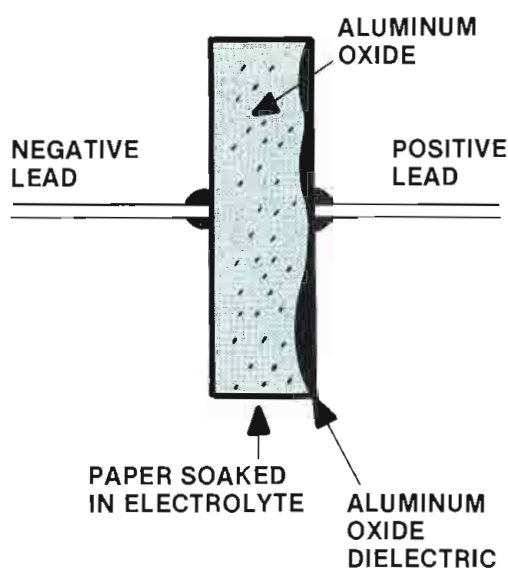

Figure 21. As an aluminum electrolytic capacitor ages, the aluminum oxide dissolves into the electrolyte, causing the capacitor to become leaky at high voltages. (Reference 32.)

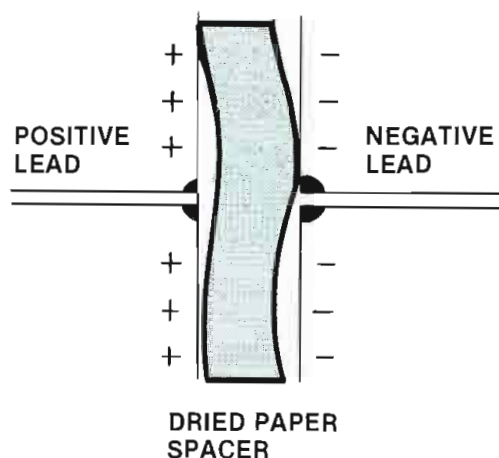

Figure 22. After the electrolyte dries, the electrons can no longer come in contact with the aluminum oxide. The result is a decrease in capacitor value. (Reference 32.)

tion of dielectric absorption, however, will return to a percentage of its original charge when measured with a high-impedance electrostatic voltmeter. This *battery effect* results from dipoles remaining in their polarized positions after the applied voltage has been removed and the capacitor has been discharged.

The effects of dielectric absorption are similar to those resulting from loss of capacitance value—specifically, poor filtering in power supply applications and distorted waveforms in stage coupling applications.

Aluminum electrolytic capacitors are also susceptible to corrosion damage caused by halogenated hydrocarbon cleaning solvents. (Table 4 lists safe and unsafe solvents.) The unsafe solvents can penetrate the elastomer end seals of the capacitor, resulting in a long-term corrosion failure mode. The degree of degradation is dependent upon operating time, temperature and applied voltage. Excessive dc leakage, electrical open circuits or internal gassing are the failure symptoms. Figure 23 shows the effects of anodic corrosion on a capacitor.

Like semiconductor components, capacitors are subject to failures induced by thermal cycling. Dimensional changes between plastic and metal materials may result in microscopic ruptures of termination joints, possible electrode oxidation and unstable device termination (changing series resistance). The highest-quality capacitor will fail if its voltage and/or current ratings are exceeded. Appreciable heat rise (20°C during a 2-hour period of applied sinusoidal voltage) is considered abnormal and may be a sign of incorrect application of the component or impending failure of the device.

Physical shock also can damage capacitors. Figure 24 shows dipped tantalum capacitors with cracks in the encapsulating epoxy. The failures were caused by forcibly spreading the device leads during PC card insertion. These cracks can allow moisture to penetrate the units and lead to intermittent operation. The cracks also provide a crevice that could trap particulate matter, leading to a long-term corrosion failure mode.

Capacitor life

The life expectancy of a capacitor—operating in an ideal circuit and environment—will vary greatly, depending upon the grade of device selected. Typi-

cal operating life, according to capacitor manufacturer data sheets, range from a low of three to five years for inexpensive electrolytic devices to a high of more than 10 years for computer-grade products. You get what you pay for.

The shelf life of a stored electrolytic capacitor (according to several manufacturers) is about two years, regardless of whether the device is an inexpensive or computer-grade part. The storage temperature is important, with room temperature (about 25°C) being typical. When the storage conditions are unknown, manufacturers recommend that capacitors be reconditioned every six months or before they are put into service.

Like other devices discussed in this report, a capacitor's life expectancy can be shortened by operation at high ambient temperatures, as Figure 25 shows. Note that operation at 33% duty cycle is rated at 10 years when the ambient temperature is 35°C, but the life expectancy drops to just four years when the same device is operated at 55°C.

Transformers

Transformer failures are all too familiar to many broadcast engineers. The failure of a power transformer is almost always a catastrophic event that will cause the system to fail, and leave you with a messy cleanup job. The two primary enemies of power transformers are heat and transient overvoltages.

Temperature rise inside a transformer is the result of losses in the windings and the core. The load current passing through the resistance of the windings causes a fixed power loss (I^2R). This power loss is dissipated as heat, which combines with losses in the iron core caused by *eddy currents* and *hysteresis*. The insulation within and between the windings tend to blanket these heat sources and prevent efficient dissipation of the waste energy, as illustrated in Figure 26. Each successive layer of windings, shown as A, B and C in Figure 26, acts to prevent heat transfer from the hot core to the local environment (air).

The hot spot shown in Figure 26 can be dangerously hot even though the outside transformer case and winding are relatively cool to the touch. Temperature rise is the primary limiting factor in determining the power-handling capability of a transformer. To ensure reliable operation, a large margin of safety must be designed into a transformer. Design

**Ever
Wonder
Why We
Paint QEI FM
Transmitter
Cabinets
Red?**



**It's Simple.
QEI
transmitters
are *so reliable*, if
we didn't paint
the cabinet red,
you might forget
it was there!**

Case in point: Our new 20/30KW FM Transmitter. One of the QEI "New Reliables." Everything about it is designed for maximum efficiency and ultra-dependability. Its single tube design uses a grounded grid triode for greater stability.

QEI FM transmitters employ no troublesome sliding contacts. And to go a step further toward perfect reliability, we found a way to eliminate the conventional plate blocker, along with all the problems it can cause.

The QEI 20/30KW units back you up in another important way, too. Their drivers can be operated as self-contained transmitters, and can go directly to air in minutes.

QEI includes the directional coupler and a 100% semi-conductor spares kit with every transmitter. And our ARC-27 Automatic Remote Control system (including studio control unit) is the envy of the industry.

Our 15,000 hour tube warranty is enviable too. No one else offers anything like it.

Whether your station's power level is 1KW or 60 KW — or anywhere in between — QEI has a "New Reliable" FM transmitter you can count on.

One Airport Drive P.O. Box D
Williamstown, NJ 08094
Phone: 609-728-2020
Toll Free: 800-334-9154
Telex: 510-686-9402



The New Reliables

Circle (32) on Reply Card

See Us At NAB Booth 3336 (upper level)



SAFE (ACCEPTABLE) CLEANING SOLVENTS	
ACETONE	METHYL ALCOHOL
TOLUOL-HEXANE-ETHYL-ACETATE	MINERAL SPIRITS
BUTYL ALCOHOL	PROPYL ALCOHOL
ETHYL ALCOHOL	XYLENE
LACQUER THINNER	
UNSAFE (UNACCEPTABLE) CLEANING SOLVENTS	
CARBON TETRACHLORIDE	METHYLENE CHLORIDE
CHLOROFORM	PERCHLORTHYLENE
CHLOROTHENE	TRICHLOROETHANE
FREON	TRICHLOROETHYLENE

Table 4. A listing of safe and unsafe cleaning solvents that may be used with aluminum electrolytic capacitors. (Reference 29.)



Figure 23. Internal view of an aluminum electrolytic capacitor that failed because of anodic corrosion. (Reference 29.)

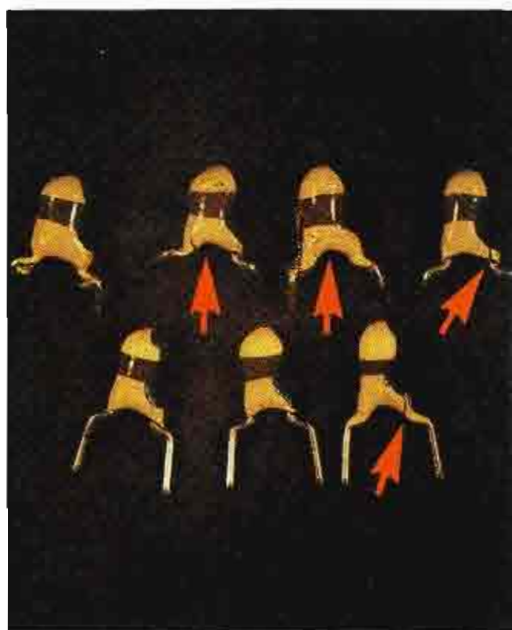

Figure 24. Tantalum capacitors damaged during insertion in a printed circuit board. The arrows indicate where cracks occurred in the epoxy-clad units. (Reference 29.)

criteria include winding wire size, insulation material and core size.

Transformer failures resulting from transient overvoltages typically occur between layers of windings within a transformer. (See Figure 27.) At the end of each layer where the wire rises from one layer to the next, zero potential voltage exists. As the windings move toward the opposite end of the coil in a typical layer-wound device, however, a potential difference of up to twice the voltage across one complete layer exists. The greatest potential difference exists at the far opposite end of the layers.

This voltage distribution applies to continuous 60Hz signals. When the transformer is first switched on or when a transient overvoltage is impressed upon the device, the voltage distribution from one hot layer to the next can increase dramatically, raising the possibility of arc-over. This effect is caused by the inductive nature of the transformer windings and the inherent distributed capacitance of the coil.

Insulation breakdown in a transformer may occur because of puncture through the insulating paper of the device, tracking across the surface of the windings or flashing through the air. Any of these failure modes may cause catastrophic failure of the transformer.

Fixed resistors

Long-term reliability for fixed resistors depends primarily upon three conditions: device dissipation, working voltage and hot-spot temperature. The wattage rating of a device is based on the maximum power that the resistor can dissipate (assuming a standard ambient temperature), stated long-term drift from the no-load value, and expected device lifetime. Increasing the ambient temperature or reducing the allowable deviation from the initial value (yielding a more stable resistance) requires derating the typical dissipation of the device. Re-

sistors are usually derated linearly from full wattage at rated ambient temperature to zero wattage at maximum ambient temperature.

The maximum working voltage that may be applied across the resistor is a function of the materials used, the allowable resistance deviation from the no-load value, and the physical configuration of the device. Carbon composition resistors are more voltage-sensitive than other types.

The hot-spot temperature is the maximum permissible temperature on the resistor caused by internal heating and the ambient operating environment. The allowable hot-spot limit is determined by the thermal capability of the materials used in the device and the resistor design. The ambient temperature for a resistor is greatly affected by surrounding heat-producing devices. Resistors stacked together do not experience ambient temperature except when forced cooling is provided. Resistors are usually rated for maximum wattage at an ambient temperature of 70°C, with a maximum hot-spot temperature of about 130°C to 150°C.

Good engineering practice dictates operation at one-half the allowable wattage dissipation for the expected ambient temperature. An adequate heat sink or forced-air cooling must be provided for power devices. No other heat-dissipating parts should be mounted within one diameter of a resistor.

Failure modes for fixed resistors typically involve one of two defects: a significant change in value or an open circuit (either permanent or intermittent). Both failures are usually the result of over-dissipation or excessive heating from other components in the circuit. The symptoms are usually charring or deformation of the device, often accompanied by a characteristic odor.

Adjustable resistors

Adjustable resistors may be divided into three separate categories: potentiometers, trimmers and rheostats.

Potentiometers are used when the frequency of adjustment is high. They may be operated manually or mechanically. Potentiometers are designed for long mechanical life, generally from 10,000 to 100,000 cycles. Certain types have life capabilities in the millions of cycles. A

Continued on page 70

**THE
NEW
MICROMAX™
RECORDER.**



**NOW
EVERY
STATION
CAN
AFFORD**

THE STATE-OF-THE-CART.™

Our new Micromax Recorder is for those who want the high performance sound of a Tomcat,™ but don't need its elaborate, exotic features – or its price.

In fact, the same performance, the most popular features and renowned reliability can be in your studios for about half the cost of the best. So, what's the catch?

NO COMPROMISES. JUST STATE-OF-THE-CART.

The Micromax is loaded with clever engineering. We integrated some of the Tomcat's best features with the latest technology into a single, compact and sleek unit.

For example, Micromax is equipped with Maxtrax™ heads, our exclusive wide-track recording format which puts more punch on today's better tapes. An innovative tape drive system with a 40 millisecond start-time helps make the Micromax Series the fastest and coolest-running machines made (only 14 watts!).

PERFORMANCE LIKE A TOMCAT

Tomcat has big meters, lighted buttons, M-S matrix operation, an instantaneous-start motor, 7.5/15 ips tape speeds, 30 ips recue and a host of logic-controlled options.

Micromax has smaller VU meters, LED tally lights and Tomcat's more popular logic features. As far as the most important feature, performance, both machines are practically identical.

DOLLARS AND SENSE

Think of it this way: why pay for a Mercedes when a BMW will do quite nicely.

Whether equipped with NAB heads or with Maxtrax, the new Micromax Recorder is only \$2,980.* There's only two options: an attractive desktop case with a hinged service lid, \$85* and a rack-mount housing, \$105.*

Compare Micromax's performance and quality with any other machine. You'll quickly see why the new Micromax Recorder & Reproducer Series are the "digital-ready" machines ready to cart-up the best tape, vinyl and CD source material you can throw at 'em.

Contact us now for full technical information.

*Suggested Professional List Price, 9/86

Circle (33) on Reply Card

Side-by-side Micromax Reproducers in only 3 1/2" height; with our new Recorder, a complete "State-of-the-Cart" system.



Pacific Records & Engineering Corporation
2070 Las Palmas Drive
Carlsbad, CA 92008
(619) 438-3911 Telex: 181777

Hands Down, the #1 Choice.

© 1986 Pacific Records & Engineering Corporation

Classic beauty is unmistakable. You know it when you see it.

Like the beauty you get with Ampex 196. Clean, clear pictures that capture every sparkling moment of your production.

No other video tape delivers such consistent low-dropout performance. Or such dynamic picture quality.

By focusing on critical dropouts, especially in the area not compensated for by your VTR, we developed a video tape you can rely on for all your applications.

The secret behind our success is Ampex Process Management. APM is a unique manufacturing concept enabling us to control the consistency of the entire production process. From raw materials to finished products.

So you always get the cleanest, sharpest pictures time after time, reel after reel, carton after carton. That's why top professionals around the world specify Ampex 196.

If you'd like to know more about how APM contributes to beautiful pictures, call or write Ampex today for a free brochure.

B E



Ampex Corporation, Magnetic Tape Division, 401 Broadway, Redwood City, CA 94063, 415/367-3809.

A U T Y

AMPEX

Circle (24) on Reply Card

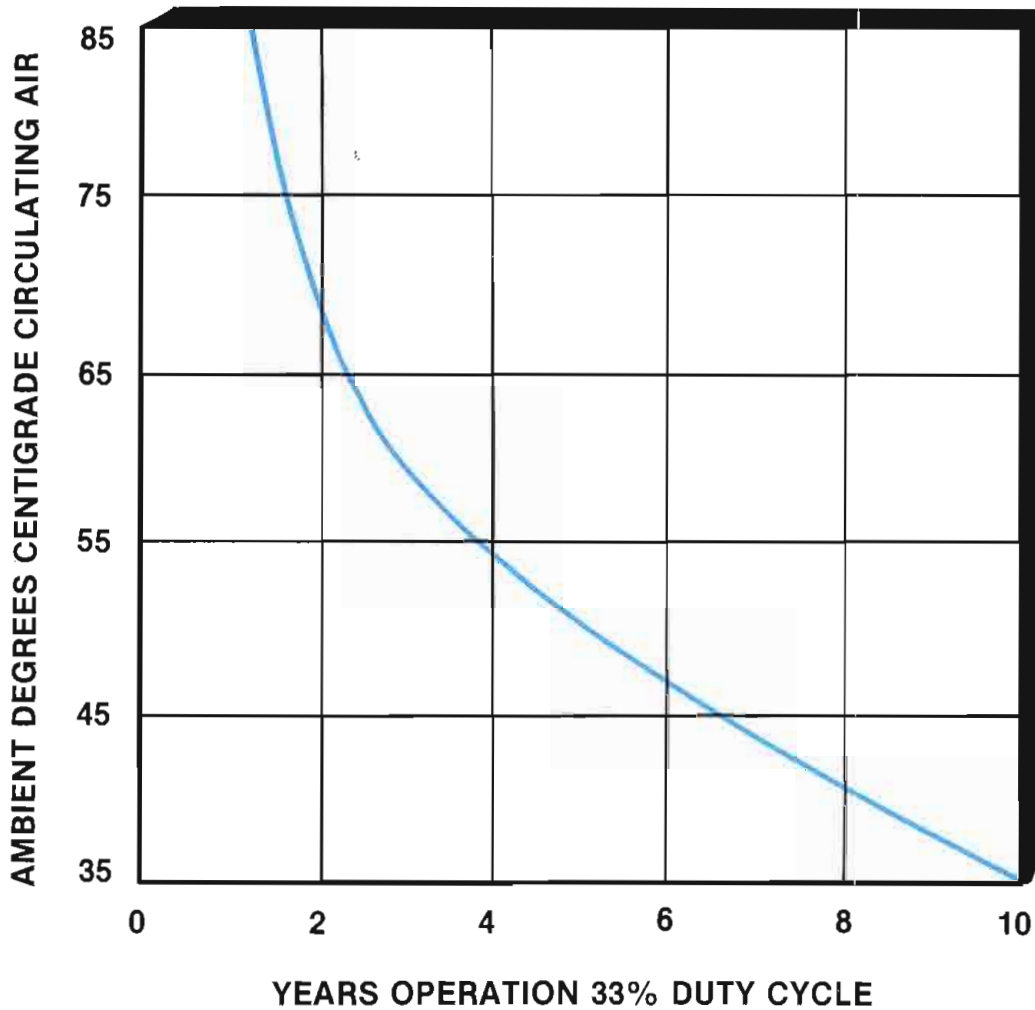

Figure 25. Life expectancy of an electrolytic capacitor as a function of operating temperature.

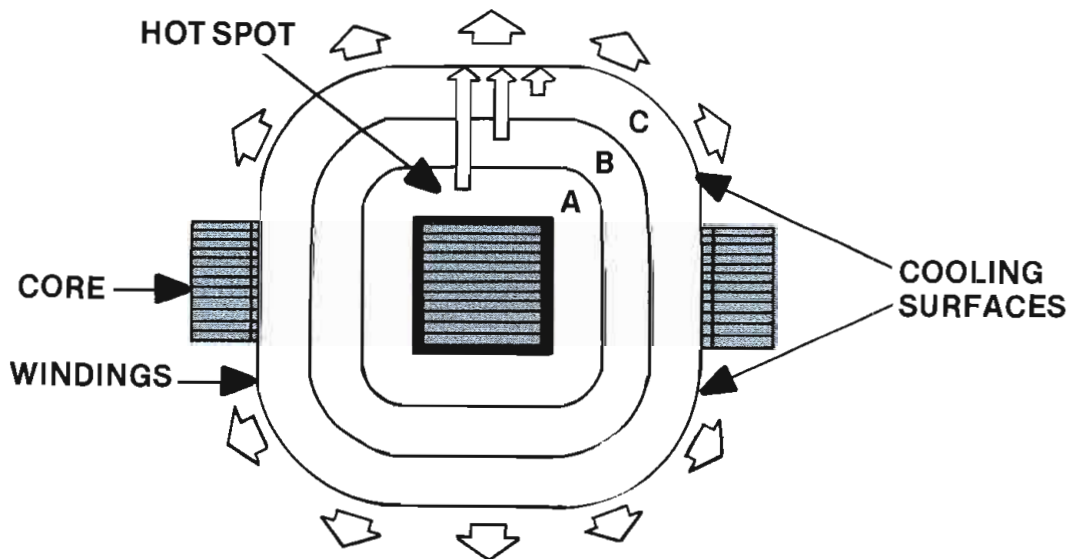

Figure 26. The dynamic forces of heat generation in a power transformer. (Reference 22.)

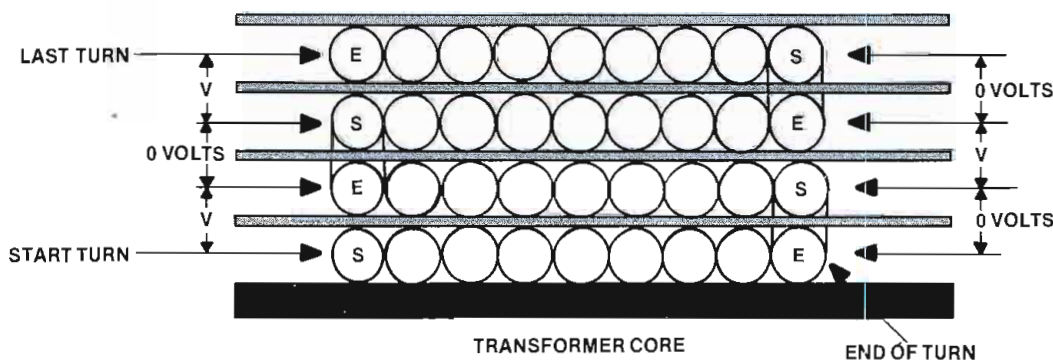

Figure 27. The voltage distribution between the layers of a typical layer-wound power transformer. (Reference 22.)

Continued from page 66

cycle, or excursion, consists of wiper traverse from one limit of travel to the other limit and back.

Trimmers differ from potentiometers in that they are designed to be adjusted infrequently, sometimes only once, and normally exhibit greater setting stability. Their employment eliminates the use of expensive precision components and provides an easily retunable vehicle to compensate for drift or aging in related parts. Normal life designs are rated at approximately 200 excursions.

Unlike potentiometers and trimmers, whose primary functions are to control voltage, the rheostat is basically a current-controlling device. Rheostats are designed with attention to wiper current-carrying capability and power ratings.

Wattage ratings of adjustable resistors apply only when all the resistance is in the circuit. To avoid overloading any section, never exceed the maximum rated current based on total resistance.

The most prevalent failure mode for a variable resistor involves intermittent loss of contact between the wiper arm and the resistive element. Typically described as a *dirty contact*, such problems are disruptive to proper equipment operation. Repairs can sometimes be made (on open-frame devices) by cleaning the contact surface and the wiper arm. Sealed units, used in most professional hardware, must be replaced if intermittent problems develop. Other failure modes include a change in value or open circuit in the resistive element. The causes of these failures are similar to those outlined previously for fixed resistors.

Fault protectors

The two most common methods used in broadcast equipment to prevent system damage in the event of a component failure are fuses and circuit breakers. Although they are hardly new technology, there are still a lot of misconceptions about fuse and circuit breaker ratings and operation.

Fuses are rated according to the current they can pass safely. This may give the wrong idea—that excessive current will cause a fuse to blow. Actually there is no amount of current that can cause a fuse to blow. It is, rather, power dissipation in the form of heat. Put in more familiar terms, it is the I^2R loss across the fuse element that causes the linkage to melt.



NEWS FROM THE OUTER LIMITS IN MINUTES

When news breaks in a remote location, the farther away you are from your station, the longer it takes to get the story back to your newsroom.

The Networker from Centro is designed for ease and speed of set up. Your crew can easily have the Networker linked up with the proper satellite with all systems operating and transmitting live news back to the newsroom within minutes.

ONE-OF-A-KIND DISH OPERATING SYSTEM

This capability for fast action is made possible, in part, by a computer engineered dish mounting structure. This unique system not only allows for fast link-up but it eliminates the possible 2-degree uplink tolerance problem and stabilizes the dish even in heavy weather.

INDIVIDUALLY EQUIPPED TO YOUR SPECIFICATIONS

Before building an SNV, we

listened to people who needed them. And we learned that a standard SNV product could not meet everyone's varied needs.

That's why every Networker starts out with the basic aerodynamic shell and ends up as the perfect SNV for your specific needs by integrating each individual component you need in your Networker.

If you need production capability, you get it. Editing capability? It's yours. More monitors or a character generator? Just say the word.

And it's all assembled according to Centro's demanding quality standards utilizing sound human engineering principles. That means everything you wanted is right where you need it so effort goes down and productivity goes up.

STANDARD FEATURES DELIVER OPTIMUM PERFORMANCE

Every custom designed Networker is complemented by features most often mentioned by users we surveyed:

- A van-style vehicle which is easy to drive and easy to get into, and out of, tight spots.
- Sturdy Ford chassis for service and parts availability virtually anywhere.
- A powerful gasoline engine to ensure easy fuel access at any service station.
- A 2.3 meter dish with 49.5 Dbi gain and selectable-adjustable vertical and horizontal polarization from inside the vehicle.
- Six equipment racks for maximum equipment complement and future system expansion.
- Abundant storage area over the driver's compartment which can also be utilized for a co-driver bunk.

The Networker's easy set-up and custom design let you get news from the scene to the station no matter where you are. If that's the performance you look for in an SNV, look to Networker by Centro.

SEE THE NETWORKER AT OUR BOOTH AT NAB

Visit booth #3181 inside or #34 outside

NETWORKER

Centro Corporation 369 Billy Mitchell Drive
Salt Lake City, Utah 84116 (801) 537-7779

Centro is a subsidiary of Skaggs
Telecommunications Service, and
American Stores Company.



Circle (35) on Reply Card

www.americanradiohistory.com

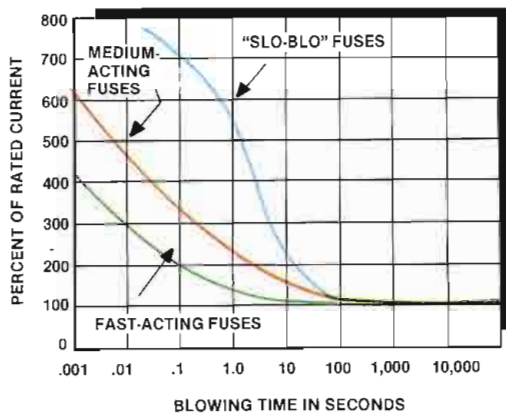

Figure 28. The relationship between the rated current of a fuse and its blowing time. Curves are given for three types of devices (fast-acting, medium-acting and slow-blow).

One of the surprising discoveries you will make if you examine literature from fuse manufacturers is that the current rating of a given device is not the *brick wall* protection value that you may think it is. Consider the graph shown in Figure 28, which illustrates the relationship of rated current across a fuse to the blowing time of the device.

Fuse characteristics can be divided into three general categories: *fast acting*, *medium-acting* and *slow-blow*. As you can see from the three traces of Figure 28, circuit protection for each type of device is a function of both current and time. For example, a slow-blow fuse will allow six times the rated current through a circuit for a full second before opening. Such delay characteristics offer protection against nuisance blowing because of high inrush currents during system start-up. This feature, however, comes with the price of possible exposure to system damage in the event of a component failure in the load.

Circuit breakers are subject to similar current let-through constraints. Figure 29 illustrates device load current as a percentage of breaker rating vs. time. The "A" and "B" curves refer to breaker load capacity product divisions. Note the variations possible in trip time for the two classifications. The minimum clearing time for the "A" group (the higher classification devices) is one second for a 400% overload. Similar to fuses, these delays are provided to prevent nuisance tripping caused by normally occurring current surges from (primarily) inductive loads.

Most circuit breakers are designed to carry 100% of their rated load continuously without tripping. They are normally specified to trip at between 101% and 135% of rated load after a period of time specified by the manufacturer. In this example, the must-trip point at 135% is one hour.

The need for a greater level of protection for semiconductor-based systems led to the development of semiconductor fuses. Figure 30 shows the *clearing* characteristics of a typical fuse of this type. The total clearing time of the device, designed to be less than 8.3ms, consists of two equal time segments: the *melting time* and the *arcing time*. The

rate of current decrease during the latter period must be low enough that high induced voltages, which could destroy some semiconductor components (mainly thyristors), are not generated.

Application considerations

Although fuses and circuit breakers are key links in preventing equipment damage during the occurrence of a system fault, they are not without some built-in disadvantages. Lead alloy fuses work well and are the most common protection devices found, but because the current-interrupting mechanism is dependent on the melting of a metal link, their exact *blow point* is not constant. The interrupting current can vary depending on the type and size of fuse clip or holder, conductor size, physical condition of the fuse element, extent of vibration present and ambient temperature. Figure 31 illustrates the effects of ambient temperature on blowing time and current-carrying capacity.

Circuit breakers are available in both thermal and magnetic designs. Magnetic protectors offer the benefit of relative immunity to changes in ambient temperature. Typically, a magnetic breaker will operate over a temperature range of -40°C to $+85^{\circ}\text{C}$ without significant variation of the trip point. Time delays usually are provided for magnetic breakers to prevent nuisance tripping caused by start-up currents from inductive loads. Trip-time delay ratings range from instantaneous (under 100ms) to slow (10s to 100s).

Trip delays for fuses and circuit breakers are necessary because of the high start-up or inrush currents that occur when inductive loads or tungsten filament lamps are energized. The resistance of a tungsten lamp is high when hot, but low when cold. A current surge of as much as 15 times the rated steady-state value can occur when the lamp is first energized (pulse duration approximately 4ms).

Transformer inrush currents can measure as high as 30 times the normal rated current for newer types of transformers that have grain-oriented high-silicon steel cores. These transformer designs are becoming popular because of their favorable size and weight characteristics.

Older transformers of more conventional design typically exhibit an inrush current approximately 18 times greater than the steady-state value. This transient current surge reaches its peak in

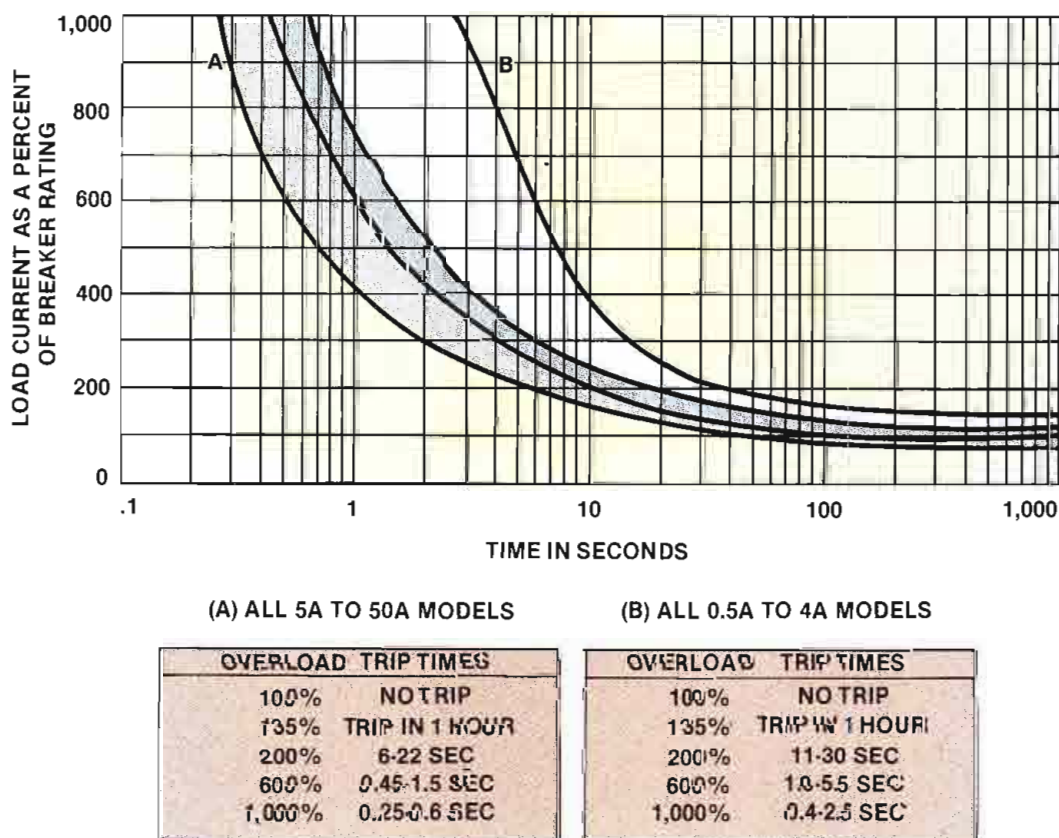

Figure 29. The relationship between the rated current of a circuit breaker and its blowing time. Curves (a) and (b) represent different product current ranges, as shown.

Yamaha's newest musical instruments.

For years, Yamaha has been making musical instruments that allow performers to express what they feel. Our new line of MZ Series professional dynamic microphones continues this tradition.

The three-layer laminated beryllium film used in the diaphragms of the MZ102Be, MZ103Be and MZ105Be offers greater control over piston movement for heightened presence and accuracy throughout the entire frequency range.

Throughout the entire line, a superior acoustic damping system makes use of a mesh screen and photo-silkscreen technology. The benefits are extraordinary long-term stability and absolute uniformity. This uniformity can be especially important when matching pairs of mics for stereo.

A tight cardioid pattern provides excellent off-axis rejection for superior feedback suppression.

To reduce handling noise, all MZ mics have a unique three-point floating suspension system. And a special windscreens with three times the impact resistance of conventional types. So you know it can take a pounding.

We even use gold-plated audio connectors.

But when you listen to Yamaha MZ mics, you hear more than the result of advanced technology. You hear a one-hundred-year tradition of making music.

For complete information, write Yamaha International Corporation, Professional Audio Division, P.O. Box 6600, Buena Park, CA 90622.



YAMAHA[®]

Engineering Imagination

Circle (39) on Reply Card



Gold-plated Connectors

Three-point Suspension System

Acoustic Resistors

Protective Grill

Beryllium Diaphragm
(“Be” models)

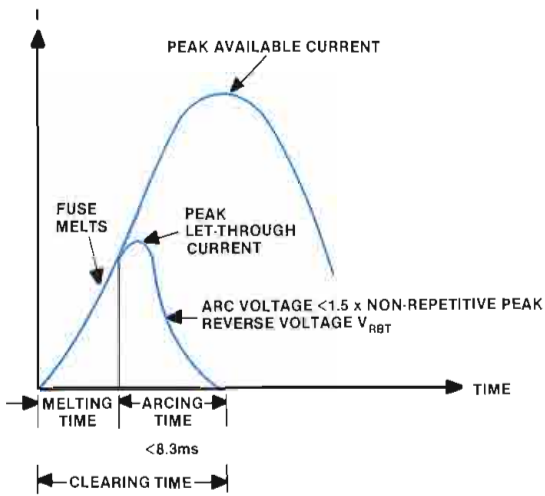

Figure 30. The current let-through characteristics of a semiconductor fuse. Note that the clearing time of the device is less than 8.3ms. (Reference 26.)

the first half-cycle of applied ac power and decreases with each successive half-cycle. The transient is relatively insensitive to the load placed on the secondary. The transient may, in fact, be smaller when the transformer is loaded than unloaded.

A worst-case turn-on current surge will not occur every time the transformer is energized, but rather, in a random fashion (perhaps one in every five or 10 turn-ons). Among the determining factors in-

volved is the magnitude of the applied voltage at the instant the load is connected. Minimum transient energy occurs when the transformer is switched on at the zero-crossing point of the sine wave.

The turn-on current surge of an ac-to-dc power supply is affected by the transformer transient and the capacitive load placed after the rectifier elements. Large filter capacitors commonly found in low-voltage high-current supplies can place severe stress on the rectifiers and transformers. A fully discharged capacitor appears as a virtual short circuit when power is applied. Some form of surge-limiting circuit is often provided for power supplies containing more than 10,000 μ Fd total capacitance.

The surge current of an ac motor is spread over 10ths of a second, rather than milliseconds, and varies considerably with the load connected to the unit. Table 5 lists typical motor surge currents for various types of devices. Note that the single-phase induction motor has the highest surge rating (seven times the running value for a period of 750ms). Three-phase motors exhibit a relatively low surge current during start-up (350% for 167ms).

The occurrence of turn-on surges for inductive loads, ac-to-dc power supplies and tungsten filament lamps requires the installation of protective devices that exhibit delayed-trip characteristics that match the given load. The problem is, however, that high surge currents of brief duration—not related to turn-on activities—can occur without tripping the circuit breaker or opening the fuse element. Damage can subsequently result to other circuit devices, such as semiconductors. In order to provide full protection to an electronic system, the overload withstand characteristics of all components should match. This is not always an easy goal to accomplish.

For example, consider a simple SCR-controlled ac-to-dc power supply. The transformer will set the upper limit on surge current presented to the protective device and the SCR (assuming light capacitive loading). If that surge is 18 times the normal steady-state current for a period of 8ms, then a protective device must be selected that will allow the surge to pass without tripping. An SCR must be selected for the circuit, therefore, that can withstand at least 18 times the normal rated current for 8ms. If not, the SCR will become the weak link in the system, not the protective device.

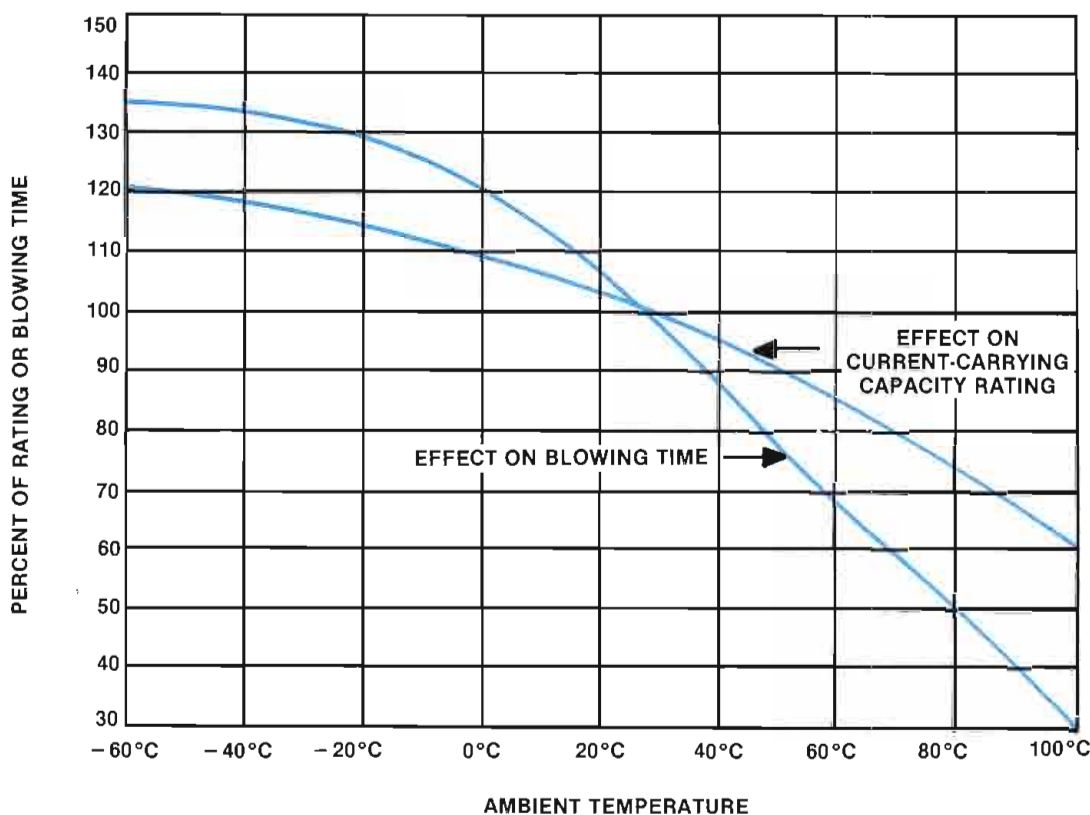
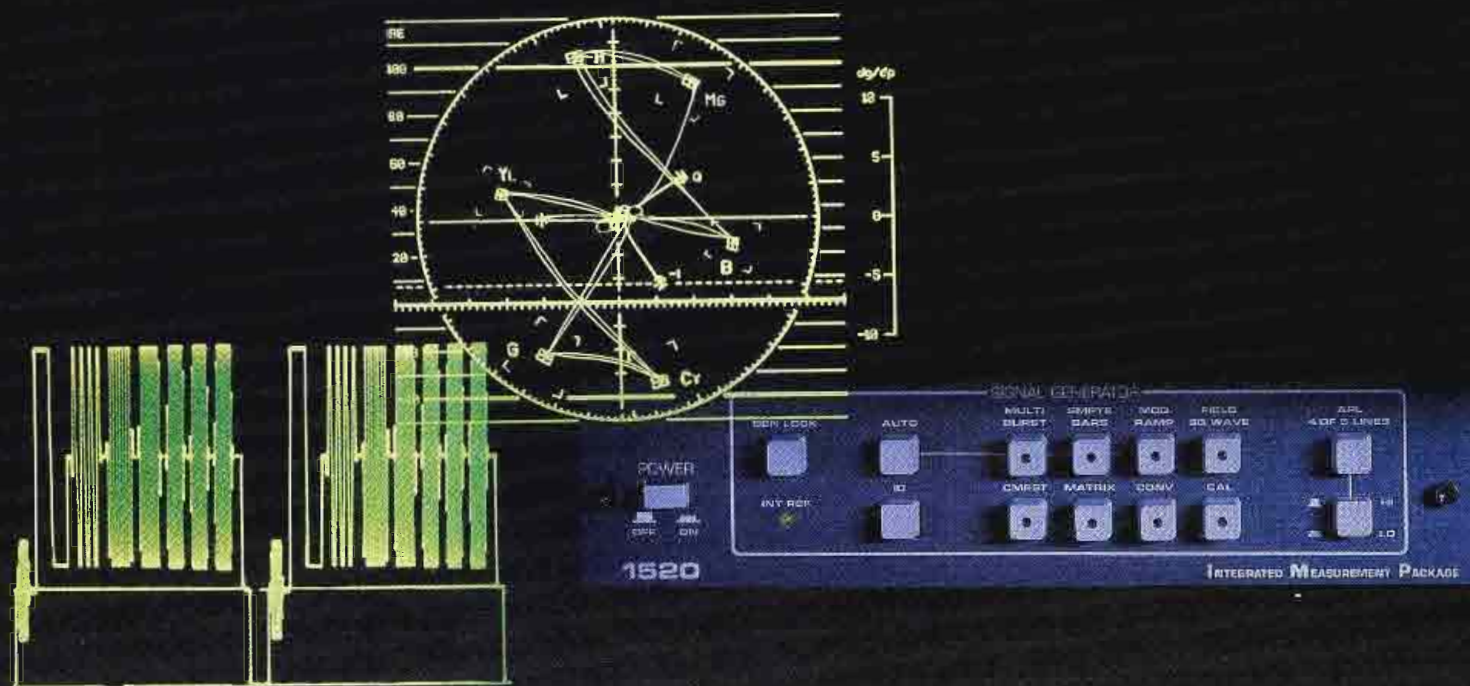

Figure 31. The effects of ambient temperature on fuse blowing time and current-carrying capacity. (Reference 34.)

MOTOR TYPE	START CURRENT PEAK AMPL. rms	DURATION OF START SURGE IN SEC.	LOAD-SECOND % $i \times t$ SEC.
SHADED POLE	150%	2.0	0.3
SPLIT PHASE #1	600%	0.116	0.7
SPLIT PHASE #2	425%	0.500	2.0
CAPACITOR (LOADED) #1	400%	0.600	2.4
CAPACITOR (NO LOAD)	300%	0.100	0.3
CAPACITOR (LOADED) #2	420%	0.500	2.1
INDUCTION 3 PHASE	700%	0.750	5.0
CAP. START SPLIT PHASE RUN	350%	0.167	0.6
	290%	0.083	0.24

Table 5. The starting surge current characteristics for various types of ac motors selected from a random test group. (Reference 34.)



WINNING COMBINATION.



Up until now if you needed a signal generator, vectorscope and waveform monitor, you had to buy three different instruments, or at the very least, two.

Not any more. With the Magni 1520/25 you get all three in one easy to use package, with the same quality and performance you'd expect from the best in the industry. All for only \$5750.*

And that's not all. Since we set out to put as much functionality as possible into one small package, we've also included a character generator overlay and differential phase and differential gain measurement, at no additional cost.

We also offer the Magni 1527/25 which includes all of the above, plus the first SCH phase measurement that can look at DEMOD out of a video tape recorder.

At Magni Systems we think it's time your test and measurement equipment was designed and packaged to do the job. So if you're tired of buying a piece here and a piece there, call us. We've put it all together.

MAGNI
Video Measurement

Magni Systems, Inc.
9500 S.W. Gemini Drive, Beaverton, OR 97005 USA
Phone: 800/237-5964 or 503/626-8400

*FDB Beaverton, Oregon USA
See Magni at NAB, Booth 2827
Circle (37) on Reply Card

5

The transient overvoltage threat

High-voltage spikes are a serious threat to system reliability.



Disturbances on the ac power line into a broadcast facility can latch up or damage complex, sensitive equipment.

Transient protection is important in a modern broadcast facility because of the widespread use of high-speed logic systems, sensitive analog integrated circuits and low-voltage discrete semiconductors. These devices require a clean supply of power in order to perform correctly. The first line of defense in the protection of broadcast equipment from damaging transient overvoltages is the ac-to-dc power supply.

Failure mechanisms

The power supply components most vulnerable to damage from an ac line spike are generally the rectifier diodes and filter capacitors. Diodes will occasionally fail from one large transient, but many more fail because of smaller, more frequent spikes that punch through the device junction. Such occurrences explain why otherwise reliable systems fail "without apparent reason."

The oscillating and decaying tail of some transient voltage disturbances also can subject semiconductor devices to se-

vere voltage polarity reversals, forcing the components into or out of a conducting state. This action can damage the semiconductor junction or result in catastrophic failure of the component. The position of the transient on the waveform (for ac or RF circuits) can have a significant effect on the damaging potential of a disturbance. This explains, in part, why identical spikes do not always cause identical damage.

Thyristors (SCRs) and diodes are subject to damage from transient overvoltages if the device peak inverse voltage or instantaneous forward voltage (or current) rating is exceeded. Thyristors face an added problem from transient occurrences because of the possibility of device misfiring. A thyristor can break over into a conduction state regardless of gate drive if either a too-high positive voltage is applied between the anode and cathode or a positive anode-to-cathode voltage is applied too quickly (dv/dt rating). If the leading edge is sufficiently steep, even a small voltage pulse

can turn on a thyristor. This represents a threat not only to the device, but also to the load that it controls.

Capacitors are vulnerable to damage from transients because the working voltage of a given device may be exceeded during the occurrence, punching a hole in the dielectric and leaving the capacitor useless at its normal operating value. The most damaging conditions result from an operational change with the "right" amount of residual magnetism in the power supply transformer or dc reactor, or an operational change with the "right" amount of energy in the filter capacitor(s). Although these situations may be rare in normal operation, the possibility of such *worst case* conditions cannot be disregarded.

Problems can be caused in a broadcast facility by transient overvoltages not only through device failure, but also because of logic state upsets. Studies have shown that an upset in the logic of typical digital circuitry can occur with transient energy levels as low as 1×10^{-9} J.

When You Have to Get it Right the First Time—Reach for HME.

There are very sound reasons why professionals reach for HME when the show goes on.

Dependability. HME knows the vital need in your business for reliable equipment. We think we build the best wireless microphones, as well as the best wireless intercoms and cabled intercoms available anywhere. They're rugged, built from top quality components, and assembled with HME's Pride in Excellence.

Performance. You'll please the most demanding performers with an audio quality that's second to

none. Dynamic range and immunity to interference are unsurpassed.

Service after the sale. No one reacts like HME in the event you need assistance. Now we have direct telephone lines to Customer Service—the people with the answers. Should your system ever require repair we'll turn it around faster than anyone in the business.

Call us today for all the details. See why more professional sound engineers rely on HME when performance is on the line.



HME manufactures:
Wireless microphones
Wireless intercoms
Cabled intercoms

h m e
HM ELECTRONICS, INC.

9675 Business Park Avenue, San Diego, CA 92131, U.S.A.
Phone (619) 578-8300 Telex: 350-771

Circle (38) on Reply Card

JOULES

DEVICE FAILURE

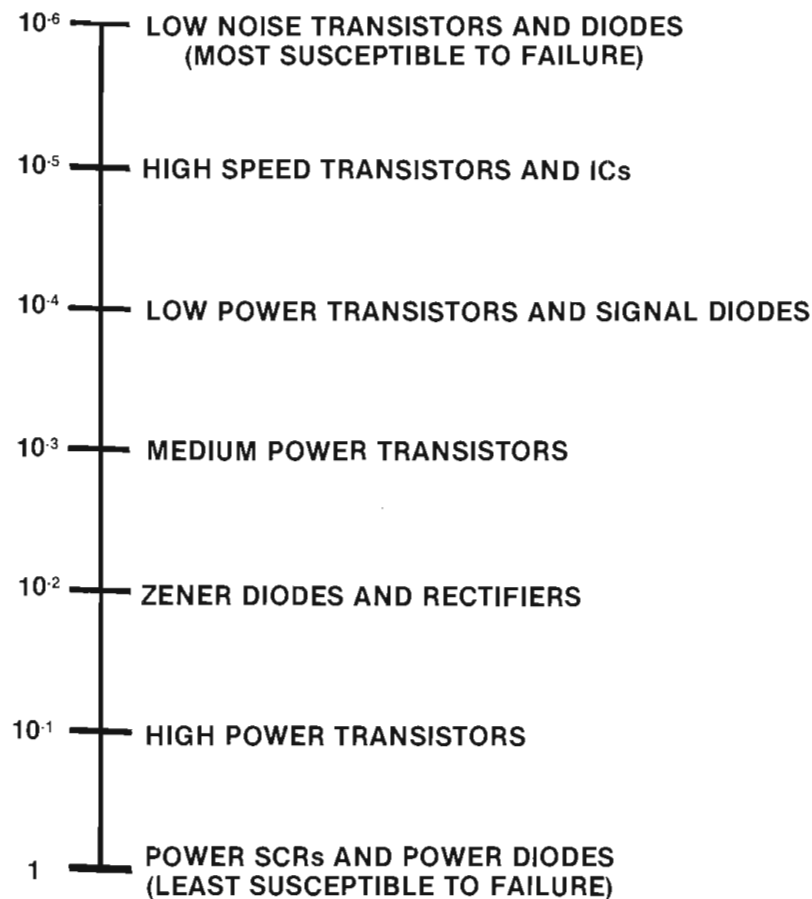

Figure 32. An estimate of the susceptibility of semiconductor devices to failure because of transient overvoltages. The estimate assumes a transient duration of several microseconds.

Such logic state upsets can result in microcomputer latch-up, lost or incorrect data, program errors and control system shutdown.

In addition to the single-occurrence logic upset, exposure of semiconductors to a high-transient environment can cause degrading, which can eventually result in total failure. Figure 32 shows the energy-vs.-survival scale for several types of semiconductors.

Other components

Effective transient suppression can significantly reduce the amount of energy dissipated during the operation of switch or relay contacts. This reduction in dissipated energy will result in a corresponding increase in switch life. In applications in which relay contacts are acting as power-switching elements, the use of effective transient suppression techniques will reduce the amount of maintenance (contact cleaning) required for the device.

The actual wear (or failure) of a mechanical switch is subject to many factors, including the contact construction and type of metal used, amount of contact bounce that typically occurs with the particular switching mechanism, the atmosphere, temperature, steady-state and in-rush currents and whether ac or dc voltages are being switched by the mechanism. Another significant factor in

switch contact wear is the amount of energy that is dissipated in each operation of the device.

Transient overvoltages can also result in insulation breakdown. The breakdown of a solid insulating material usually results in localized carbonization, which may be catastrophic, or may simply result in decreased dielectric strength of the material at the arc-over point. The occurrence of additional transients will often cause a breakthrough at the weakened point in the insulating material, and eventually result in catastrophic failure of the insulation.

Printed circuit board arcing can result in similar system failure modes. A breakdown induced by high voltages along the surface of a PCB can create a conductive path of carbonized insulation and vaporized metal from the printed circuit wiring traces or component leads.

The greatest damage to equipment from insulation breakdown because of transient disturbances generally occurs after the spike has passed. The follow-on steady-state current that can flow through fault paths created by a transient often causes the actual component damage and system failure.

Transient-generated noise

The computer-based electronic systems widely used in broadcast equipment today are particularly susceptible

to logic state upsets caused by transient activity. Switch contact arcing and other repetitive transient-generating operations can induce significant amounts of broadband noise into an electrical system, possibly disturbing the operation of nearby CMOS or TTL devices.

Noise generated in this fashion is best controlled at its source, almost always an inductive load. Switch contact arcing generates an effect known as "showering," a low-current, high-voltage series of brief discharges of a damped oscillatory nature (frequencies of 1MHz or more are common). This "shower" of noise can travel through power lines and create problems for microcomputer equipment either through direct injection into the system's power supply, or through coupling from adjacent cables or printed circuit board wiring traces.

SCR power controllers also can contribute to noise-induced microcomputer system problems. Each time a thyristor is triggered into its active state in a resistive circuit, the load current goes from zero to the load-limited current value in less than a few microseconds. This step action generates a broadband spectrum of energy, with an amplitude inversely proportional to frequency. Electronic equipment using full-wave thyristor control in a 60Hz ac circuit can experience this noise burst 120 times per second.

In a broadcast or industrial environment, where various control systems may be closely spaced, such noise bursts can cause latch-up problems or incorrect data in microcomputer equipment, or interaction between thyristor control units in machine control equipment. Power line cables within a facility can couple thyristor noise from one area of a plant to another, further complicating the problem.

The solution to the thyristor noise problem is found by looking at both the source of the interference and the susceptible equipment. The use of good transient-suppression techniques in the application of SCR power control equipment will eliminate noise generation in all but the most critical applications.

As further insurance, sensitive electronic equipment should be adequately shielded against noise pickup, including metal cabinet shields, ac power line filters and input/output line feedthrough RF filters. Fortunately, most broadcast equipment is designed with RF shielding as a primary concern.

Islatron.

Strong enough to protect your equipment against powerful lightning-induced voltages.

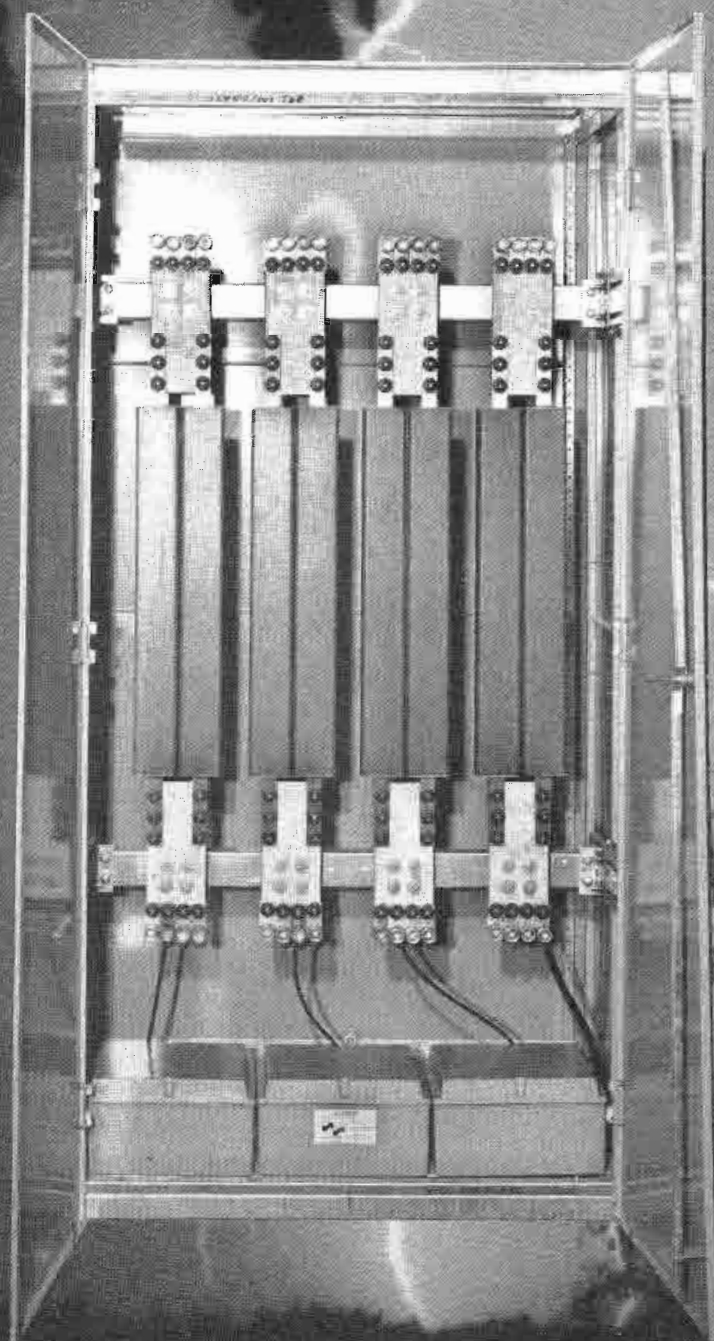

If **Islatron** can protect your facility against lightning induced voltages, it can protect against any harmful disturbance that comes down the powerline. That means longer life and less deterioration for your sensitive electronic equipment — transmission or studio.

Islatron works like no other device can. Its unique patented design actually absorbs extraneous energy to deliver only clean, safe power. The **Islatron** bottom line is fewer repairs, less equipment maintenance and less expense!

Get the facts on the exclusive **Islatron** "active tracking" system from small studio units through complete facility protection. Call or write for a free brochure. Or visit NAB Booth #2687.



**CONTROL
CONCEPTS**

"We Make Pure Power"

Circle (36) on Reply Card

CONTROL CONCEPTS BROADCAST GROUP
328 WATER STREET • BINGHAMTON, NY 13902 • (607) 724-2484

6

The quest for reliability

Make the best of our imperfect world.

The ultimate goal of any maintenance department is zero downtime. This is an elusive goal, but one that can be approximated by examining the vulnerable areas of plant operation and taking steps to prevent a sequence of events that can result in system failure. In cases in which failure prevention is not practical, a reliability assessment should encompass the stocking of spare parts, circuit boards or even entire systems. A large facility can often cost-justify the purchase of backup gear that can be used as spares for the entire complex. The cost of backup hardware is expensive, but so is downtime.

Failures can, and do, occur in broadcast systems. The goal of product quality assurance at every step in the manufacturing and operating chain is to ensure that failures do not produce a systematic

or repeatable pattern. The ideal is to eliminate failures altogether. Short of that, the secondary goal is to end up with a random distribution of failure modes. This situation indicates that the design of the system is fundamentally correct and that failures are caused by random, unpredictable events. In an imperfect world, this is the best we can hope for.

The recognition of reliability as an integral part of product performance is more than simply a matter of early prediction of in-service behavior. It also identifies a number of major economic and safety implications. The realization that failures are inevitable adds an extra dimension to conventional design. Consideration must be given to the consequences of failures and to the actions that must be taken to mitigate them. One

possible action is to provide redundant or standby systems. Another is to implement aggressive preventive maintenance programs for critical equipment.

The equipment used in broadcasting today is more reliable than ever before. It is also more complex, and more sensitive to external threats. The science of reliability and maintainability is one that we as broadcasters can learn a great deal from. Reliability and maintainability must be built into products or systems at every step in the design, construction and maintenance process. It cannot be treated as an afterthought.

The need for maximum uptime, a universal requirement in broadcasting, can only be met through a systems approach to problems and their solutions.

Your job depends on it.

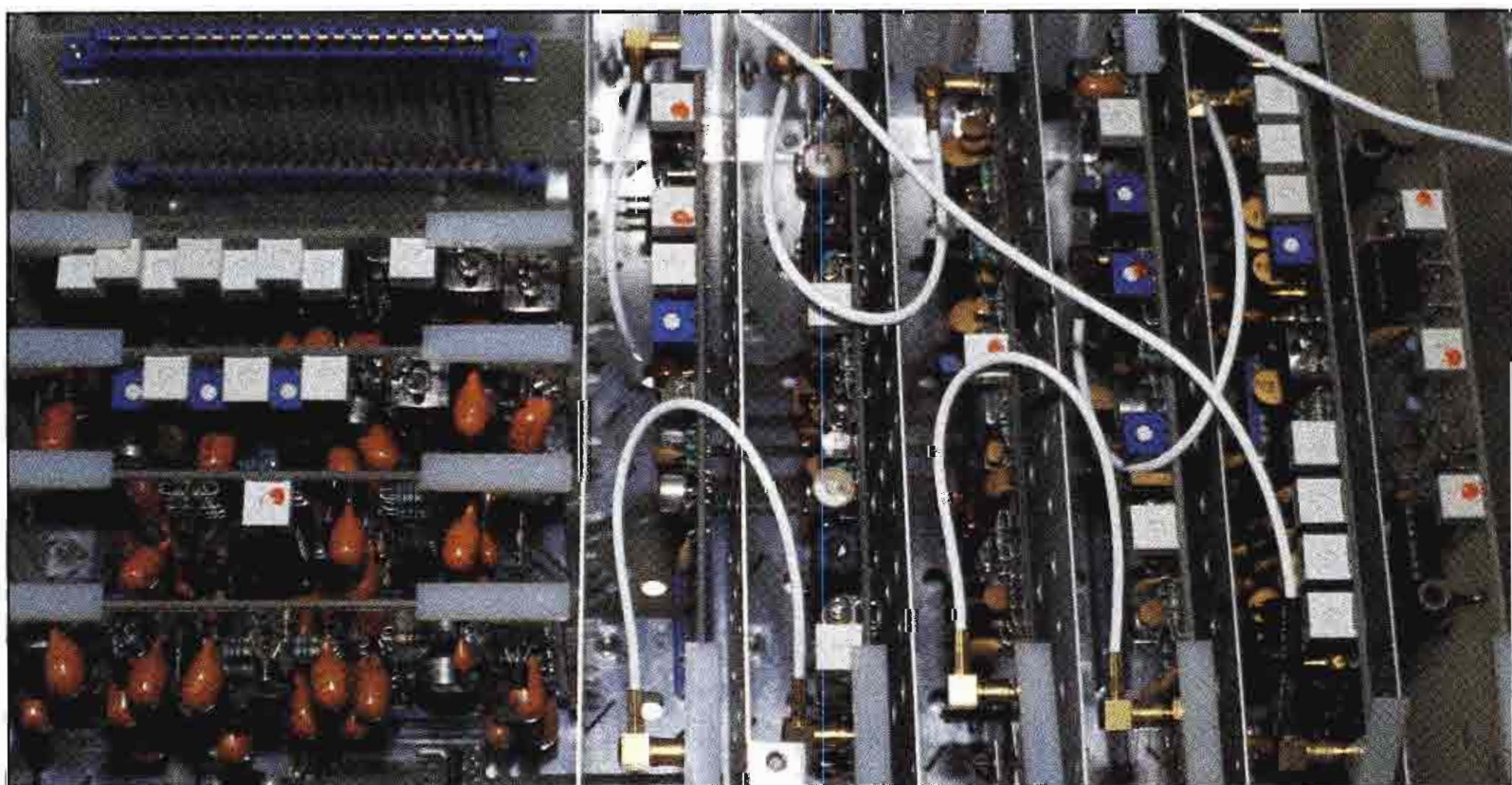

Achieving high reliability for broadcast equipment requires attention to all details of system design, operation and maintenance.

EEV KLYSTRONS

SO MUCH MORE TO OFFER

The most comprehensive range of External Cavity UHF TV Klystrons

<u>WIDEBAND SERIES</u>	Transmitter output power	Frequency range	Typical Sync efficiency
K3672BCD	55-60 kW	470-810 MHz	44% to 48%
K3572BCD	40-55 kW	470-810 MHz	43% to 46%
K3272WBCD	40-55 kW	470-860 MHz	42% to 45%
K3271BCD	15-30 kW	470-860 MHz	42% to 47%
K3270BCD	5-15 kW	470-860 MHz	42% to 47%

<u>STANDARD SERIES</u>			
Low Band			
K3276HBCD	40-55 kW	470-596 MHz	38% to 43%
K3382BCD	40-55 kW	470-590 MHz	38% to 42%
K3217HBCD	30-45 kW	470-590 MHz	40% to 42%
K3282BCD	30-45 kW	470-610 MHz	30% to 40%
K3230BCD	10-30 kW	470-596 MHz	40% to 42%
K376L	10-30 kW	470-610 MHz	34% to 40%
K370/W series	5-10 kW	470-606 MHz	29% to 35%
Mid Band			
K3277HBCD	40-55 kW	590-710 MHz	38% to 43%
K3383BCD	40-55 kW	590-702 MHz	38% to 42%
K3218HBCD	30-45 kW	590-702 MHz	40% to 42%
K3283BCD	30-45 kW	590-720 MHz	30% to 40%
K3231BCD	10-30 kW	590-704 MHz	40% to 42%
K377L	10-30 kW	590-720 MHz	38% to 45%
K371/W series	5-10 kW	606-742 MHz	32% to 35%
High Band			
K3278HBCD	40-55 kW	702-860 MHz	38% to 43%
K3384BCD	40-55 kW	702-860 MHz	38% to 42%
K3219HBCD	30-45 kW	702-860 MHz	40% to 42%
K3284BCD	30-45 kW	700-860 MHz	30% to 40%
K372/W series	5-10 kW	740-860 MHz	32% to 35%

See us at NAB
Booth 2626.

AVAILABLE TODAY **EEV** Klystrons

USA: EEV Inc., 4 Westchester Plaza, Elmsford, NY 10523, USA Telephone: 914 592 6060 Telex: 6818096 Fax: 914 592 8342
 UK: EEV, Waterhouse Lane, Chelmsford, Essex CM1 2QU, England Telephone: (0245) 261777 Telex: 99103 Fax: (0245) 50424
 CANADA: EEV Canada Ltd, 67 Westmore Drive, Rexdale, Ontario M9V 3Y6 Telephone: 416 745 9494 Telex: 06 989363 Fax: 416 745 0618
 Circle (40) on Reply Card

Definitions and terminology

- **Availability:** Probability of a system subject to repair operating satisfactorily on demand.

- **Average life:** The mean value for a normal distribution of product or component lives. (Generally applied to mechanical failures that are the result of "wearout.")

- **Burn-in:** Initially high failure rate encountered when first placing a component on test. Burn-in failures usually are associated with manufacturing defects and the debugging phase of early service.

- **Defect:** Any deviation of a unit or product from specified requirements. A unit or product may contain more than one defect.

- **Degradation failure:** A failure that results from a gradual change in performance characteristics of a system or part.

- **Downtime:** Time during which equipment is not capable of doing useful work because of malfunction. This does not include preventive maintenance time. In other words, downtime is measured from the occurrence of a malfunction to the correction of that malfunction.

- **Failure:** A detected cessation of the capability to perform a specified function or functions within previously established limits. It is beyond adjustment by the operator by means of controls normally accessible during routine operation of the system. (This requires that measurable limits be established to define satisfactory performance.)

- **Failure rate:** The rate at which failure occurs during an interval of time as a function of the total interval length.

- **Lot size:** A specific quantity of similar material or collection of similar units from a common source; in inspection work, the quantity offered for inspection and acceptance at any one time. It may be a collection of raw material, parts, subassemblies inspected during production, or a consignment of finished products to be sent out for service.

- **Maintainability:** The probability that a failure will be repaired within a specified time after the failure occurs.

- **Mean time to failure (MTTF):** The measured operating time of a single piece of equipment divided by the total number of failures during the measured period of time. This measurement is normally made during that period between early life and wearout failures.

- **Mean time to repair (MTTR):** The measured repair time divided by the total number of equipment failures.

- **Mode of failure:** The physical description of the manner in which a failure occurs and the operating condition of the equipment or part at the time of the failure.

- **Part failure rate:** The rate at which a part fails to perform its intended function.

- **Quality assurance (QA):** All those activities, including surveillance, inspection, control and documentation,

aimed at ensuring that the product will meet its performance specifications.

- **Reliability predictions:** Compiled failure rates for parts, components, subassemblies, assemblies and systems. These generic failure rates are used as basic data to predict a value for reliability.

- **Sample:** One or more units selected at random from a quantity of product to represent that product for inspection purposes.

- **Sequential sampling:** Sampling inspection in which, after each unit is inspected, the decision is made to accept, reject or inspect another unit. (Note: Sequential sampling as defined here is sometimes called *unit sequential sampling* or *multiple sampling*.)

- **System:** A combination of parts, assemblies and sets joined together to perform a specific operational function or functions.

- **Test to failure:** Testing conducted on one or more items until a predetermined number of failures have been observed. Failures are induced by increasing electrical, mechanical and/or environmental stress levels, usually in contrast to life tests in which failures occur after extended exposure to predetermined stress levels. A life test can be considered a test to failure using age as the stress.

Source: Reference Data for Engineers: Radio, Electronics, Computer and Communications, Seventh Edition. Edward C. Jordan editor-in-chief. Published by Howard W. Sams & Company, Indianapolis, IN.

Tough as Sony.



Pound for pound, Sony videotape is the toughest you can buy.

One word sums up everything we tried to achieve with VI-K one-inch videotape: durability.

It was perfected for the world where rugged dependability counts every bit as much as dazzling picture quality.

Its strength comes from a truly tough, cross-linked binder system, a very strong adhesive base film and our carbon black anti-static back coating.

This durable foundation protects an ultrafine Vivax™ magnetic particle

formulation, which delivers astonishing picture quality, higher stability and optimum S/N ratio.

Amazingly enough, VI-K also has the lowest headwear rate of any major one-inch videotape. Our efforts have benefitted BCT Betacam® and the BRK U-matic® videocassettes, too, with trouble-free still frame editing, totally reliable repeated playback and worry-free long-term storage.

So, after all, Sony professional videotape is just like any other Sony: standard-setting video and audio with a "tough as nails" reputation. That's why it's the only videotape you can treat like a Sony.



SONY
THE ONE AND ONLY®

© 1986 Sony Corporation of America. Sony Vivax, Betacam, U-matic and The One and Only are trademarks of Sony.

Circle (160) on Reply Card

Bibliography

1. Spradlin, B.C. "Reliability Growth Measurement Applied to ESS." Proceedings of the 1986 Reliability and Maintainability Symposium of the IEEE.
2. Devaney, John. "Piece Parts ESS in Lieu of Destructive Physical Analysis." Proceedings of the 1986 Reliability and Maintainability Symposium of the IEEE.
3. DesPlas, Edward. "Reliability in the Manufacturing Cycle." Proceedings of the 1986 Reliability and Maintainability Symposium of the IEEE.
4. Frank, Donald. "Please Keep Your EMC Out of My ESD." Proceedings of the 1986 Reliability and Maintainability Symposium of the IEEE.
5. Cameron, David, and Rod Walker. "Run-In Strategy for Electronic Assemblies." Proceedings of the 1986 Reliability and Maintainability Symposium of the IEEE.
6. Pantic, Dragan. "Benefits of Integrated Circuit Burn-In to Obtain High Reliability Parts." IEEE Transactions on Reliability, Vol. R-35, No. 1, April 1986.
7. Kanarek, Jess. "Protecting Against Static Electricity Damage." *Electronic Servicing & Technology*, March 1986.
8. Nenoff, Lucas. "Effect of EMP Hardening on System R&M Parameters." Proceedings of the 1986 Reliability and Maintainability Symposium of the IEEE.
9. Capitano, Joseph, and Jerold Feinstein. "Environmental Stress Screening Demonstrates Its Value in the Field." Proceedings of the 1986 Reliability and Maintainability Symposium of the IEEE.
10. Doyle, Edgar Jr. "How Parts Fail." *IEEE Spectrum*, October 1981.
11. Smith, A., R. Vasudevan, R. Matteson and J. Gaertner. "Enhancing Plant Preventative Maintenance via RCM." Proceedings of the 1986 Reliability and Maintainability Symposium of the IEEE.
12. Wilson, Sam. "What Do You Know About Electronics?" *Electronic Servicing & Technology*, September 1985.
13. Product and background information from the following companies: Sencore, Component Research, Littlefuse, Heinemann, Potter & Brumfield and Mallory Capacitor Company.
14. Pearman, Richard. "Power Electronics." Reston Publishing Company, 1980.
15. King, Randy, and John Hiatt. "A Practical VLSI Characterization and Failure Analysis System for the IC User." Proceedings of the Reliability Physics Conference, April 1986.
16. Koch, Tim, Wayne Richling, John Witlock and Dave Hall. "A Bond Failure Mechanism." Proceedings of the Reliability Physics Conference, April 1986.
17. Guang-bo, Gao, Chen An and Gui Xiang. "A Layer Damage Model for Calculating Thermal Fatigue Lifetime of Power Devices." Proceedings of the Reliability Physics Conference, April 1986.
18. Koyama, H., Y. Mashiko and T. Nishioka. "Suppression of Stress Induced Aluminum Void Formation." Proceedings of the Reliability Physics Conference, April 1986.
19. Kenett, Ron, and Moshe Pollak. "A Semi-Parametric Approach to Testing for Reliability Growth, With Application to Software Systems." IEEE Transactions on Reliability, August 1986.
20. Correspondence with John Sullivan. Econco Corporation, Woodland, CA.
21. Sydnor, Alvin. "Voltage Breakdown in Transistors." *Electronic Servicing & Technology*, July 1986.
22. Lowdon, Eric. "Practical Transformer Design Handbook." Howard W. Sams Publishing, 1980.
23. "Power Grid Tubes for Radio Broadcasting." Thomson-CSF publication No. DTE-115, 1986, Dover, NJ.
24. Gloer, H. Niles. "Voltage Transients and the Semiconductor." *The Electronic Field Engineer*, 2, 1979.
25. General Electric Company MOV Varistor Data and Applications Manual. General Electric Company, Auburn, NY.
26. SCR Applications Handbook. International Rectifier Corporation, El Segundo, CA, 1977.
27. SCR Manual, Fifth Edition. General Electric Company, Auburn, NY.
28. Reference Data for Radio Engineers, Sixth Edition. Howard W. Sams & Company, Indianapolis, IN.
29. Meeldijk, Victor. "Why Do Components Fail?" *Electronic Servicing & Technology*, November 1986.
30. "RCA Power Circuits: DC to Microwave." RCA Electronic Components, Harrison, NJ, 1969.
31. Tustin, Wayne. "Recipe for Reliability: Shake and Bake." *IEEE Spectrum*, December 1986.
32. Sencore News, Issue 122. Sencore Corporation, Sioux Falls, SD.
33. Reference Data for Engineers: Radio, Electronics, Computer and Communications, Seventh Edition. Edward C. Jordan, editor-in-chief. Howard W. Sams & Company, Indianapolis, IN.
34. Davis, William. "Selecting Circuit Protective Devices." Plant Electrical Systems, March 1980.

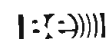

Strong as Sony.

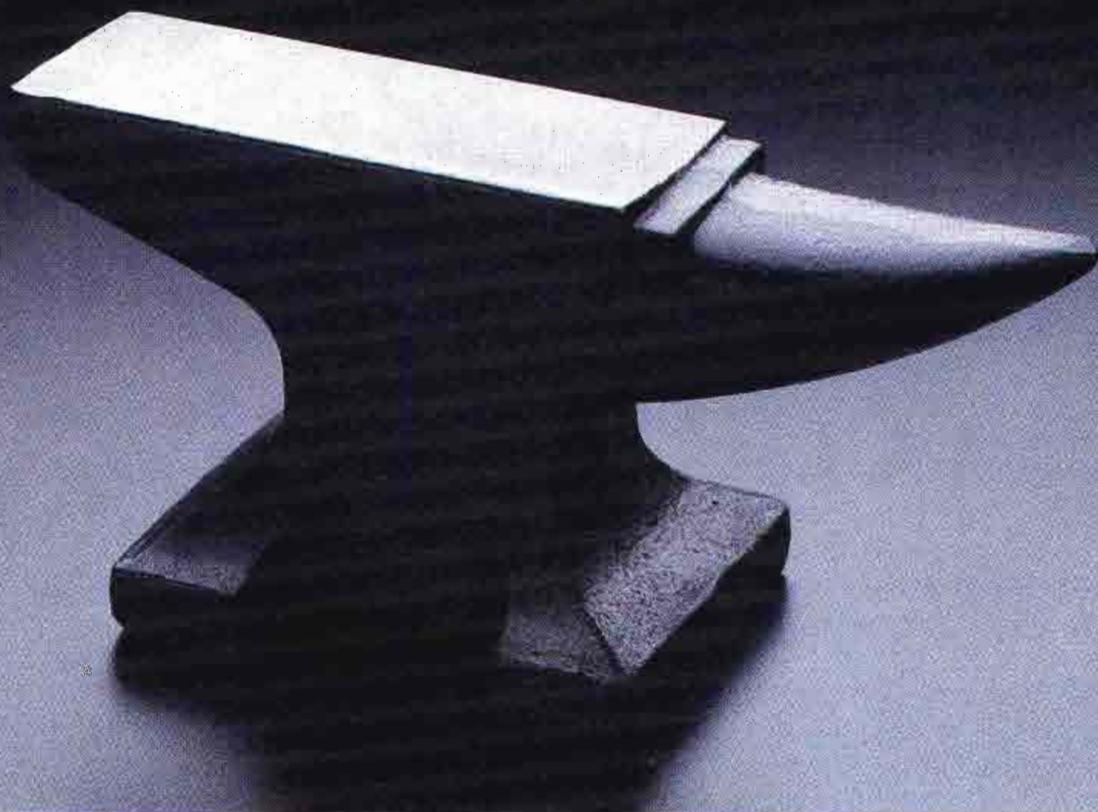

Introducing the tougher U-matic tapes from the inventors of tough tape.

Now U-matic® users have an even tougher new class of videocassette: Sony BRS and the extraordinary Sony XBR.

Both are produced in the U.S. with a dramatically improved Vivax™ formulation. And both have the new Sony anti-static shell and Carbonmirror™ back coating for a new level



of durability, runability and especially, fewer dropouts.

Thanks to Sony's latest advances in manufacturing and quality control, the new Sony XBR U-matic videotape promises the finest performance achievable.

You can count on "strong as steel" performance with both new Sony XBR & BRS... edit after edit after edit.

And that's why they're the only U-matic videotapes you can treat like a Sony.

SONY
THE ONE AND ONLY.®

© 1987 Sony Corporation of America. Sony, Vivax, U-matic, Carbonmirror and The One and Only are trademarks of Sony.

Circle (161) on Reply Card



Troubleshooting transmission equipment

By Jerry Whitaker,
editorial director

Prepare for transmitter failures by carefully examining what can go wrong.

"We're off the air!"

No other single statement chills a broadcast engineer more. Pandemonium follows. The air staff, program director and station manager demand answers. "What's wrong with the transmitter, and how long until we're back on the air?"

The next stop in the mad race is the transmitter site. Probably one of the most nerve-racking experiences an engineer faces is the moment just before opening the door to the transmitter room, fearing what might be found inside.

Problems will occur from time to time

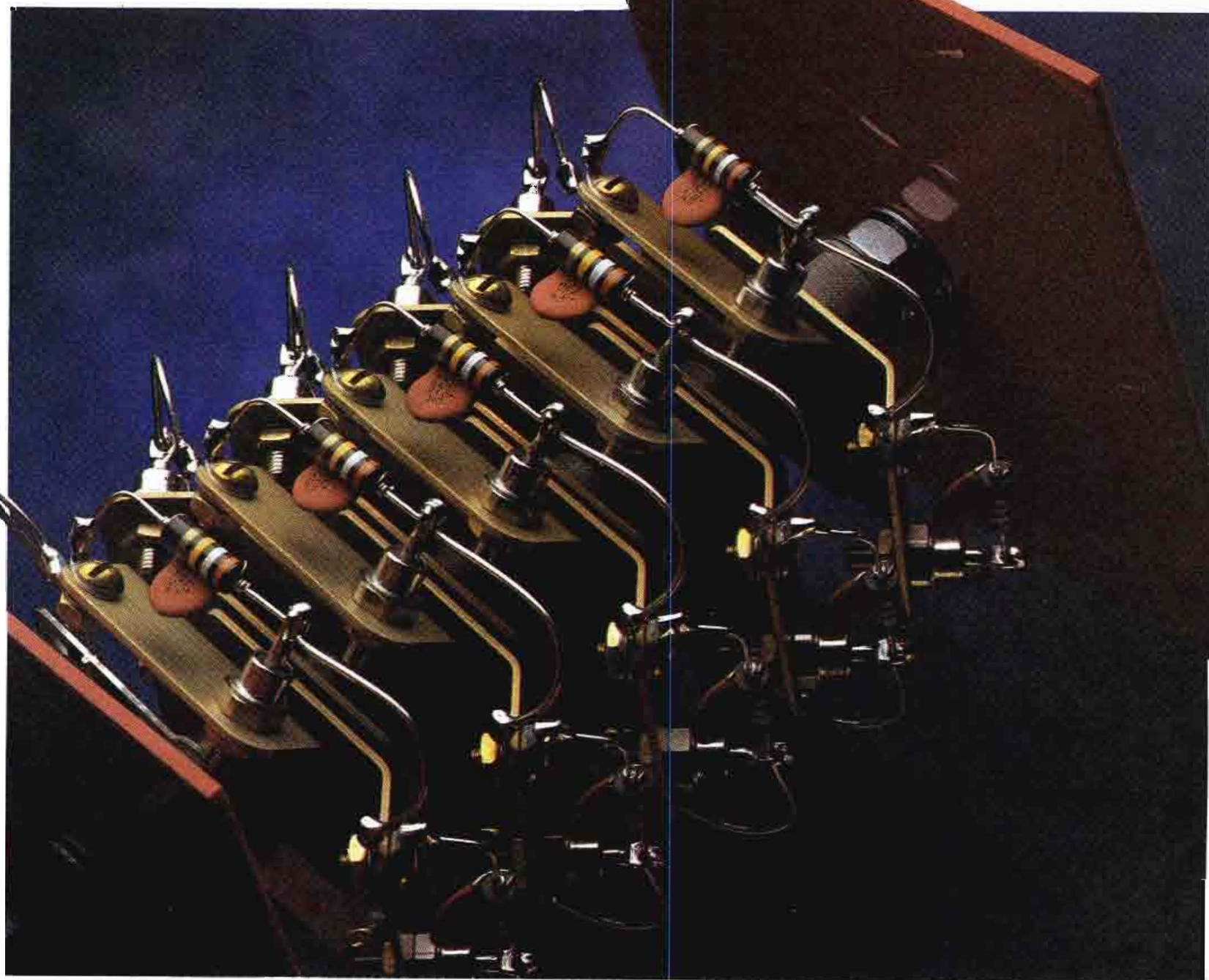



Editor's note: Transmitter reliability is best improved by understanding proper troubleshooting techniques and by implementing a thorough preventive maintenance program. This article describes in detail troubleshooting procedures. A companion article that appeared in the November 1986 *Maintenance Special Issue*—"Preventing Transmitter Failures"—discusses preventive maintenance. Taken together, these articles provide a full examination of how to keep RF systems operating properly.



with any piece of equipment, so be ready to handle whatever may come up. The best way to prepare for a transmitter problem is to know the equipment well. Study the transmitter design and layout. Know the schematic diagram and what each component does. Examine the history of the transmitter by reviewing old maintenance logs to see what components have failed in the past.

Troubleshooting procedures

When a problem occurs, your first task is to keep the transmitter on the air. If a standby transmitter is available, the solution is obvious. If the station does not have a standby, quick thinking will be needed to minimize downtime and keep the unit running until midnight or sign-off, when repairs can be made.

Most transmitters have sufficient protective devices so that it is impossible to operate them if there are serious problems. If the transmitter will not stay on the air on normal power, try lowering the power output and see if the trip-offs are eliminated. If this doesn't work, most TV transmitters have driver outputs that can be connected to the antenna on a temporary basis, thereby by-passing the final amplifiers—provided, of course, the failure is in one of the PA stages. Do not allow the transmitter to operate at any power level if the meter readings are out of tolerance. Serious system damage can result.

FM stations can use the output of the exciter to drive the antenna, by-passing the entire transmitter if needed. Operating the station on an FM exciter or TV visual and aural drivers can give better coverage than you might think. Most FM exciters will deliver a minimum of 20W output and TV visual and aural driver power outputs usually are rated in the hundreds of watts. Either of these signals fed into a high-gain antenna at a good location will provide a usable signal over a fairly wide area.

When presented with a problem, proceed in a calm, orderly manner to trace it down. Many failures are simple to repair if you stop and think about what's happening. Often the best troubleshooting work can be done by pulling the schematic diagram and pouring a cup of coffee. (Take the phone off the hook too!)

Examine the last set of transmitter readings and make a complete list of meter readings in the failure mode. Note which overload lamps are lit, and what other indicators are in an alarm state. With this information assembled, you often can identify the cause of the failure. Looking over the available data and the schematic diagram for 10 to 15 minutes can save hours of trial-and-error troubleshooting.

When checking inside the unit, look for changes in the physical appearance of components in the problem area. An overheated resistor or leaky capacitor may be the cause of the problem, or point to the cause.

Devices never fail without a reason. Try to piece together the sequence of events that led to the problem. Then, the cause of the failure—not just the more obvious symptoms—will be corrected. When working with direct-coupled transistors, a failure in one device will often cause a failure in another, so check all semiconductors associated with one found to be defective.

In higher-power transmitters, look for signs of arcing in the RF compartments. Loose connections and clamps can cause failures that are hard to locate. Never rush through a troubleshooting procedure. A thorough knowledge of the theory of operation and history of the transmitter is a great aid in locating problems in the RF sections.

Do not overlook the possibility of tube failure when troubleshooting a transmitter. Tubes can fail in peculiar ways, and substitution is the only real practical test for most power tubes used in modern transmitters.

Study the transmitter's control ladder so you can identify interlock or fail-safe problems. Most newer transmitters have excellent troubleshooting aids built-in to help locate problems in the control ladder. Older transmitters, however, often require a moderate amount of investigation before repairs can be accomplished.

Help!

Factory service engineers are available to aid in troubleshooting transmission equipment, but they have their limits. No factory engineer can fix a transmitter over the phone. The factory can suggest

areas of the system to investigate and relate the solutions to similar failure modes, but the station engineer is the person who does the repair work. If you know the equipment, and have done a good job of analyzing the problem, the factory can help.

When calling the factory service department, have the following basic items: first, the type of transmitter and the exact failure mode. The service department will need to know the meter readings before and after the problem, and whether any unusual circumstances preceded the failure. For example, it would be important for the factory to know that the failure occurred after a power outage or during an ice storm.

Second, explain what you have already done in an effort to correct the problem. All too often the factory is called *before* any repair efforts are made. The service engineer will need to know what happens when the high voltage is applied, and what overloads may occur.

Third, have the transmitter diagram and layout sheets. A thorough knowledge of the transmitter design and construction allows you to converse intelligently with the service representative.

The quick fix

There is no such thing as a *quick fix* with transmission equipment. Think out any problem and allow ample time for repair. It makes little sense to rush through a repair job in order to get the system back on the air if another failure occurs right after you walk out the door. Careful analysis of the cause and effects of the failure will ensure that the original problem is solved, not just its obvious symptoms.

If temporary repairs must be made in order to return the transmitter to a serviceable condition, make them and then finish the job as soon as the needed replacement parts are available. There is nothing more irritating than to start working on a transmitter only to find that someone had done a quick-fix job on it in the past and had never bothered to go back and do the maintenance the right way. A quick fix isn't that fast, and it seldom fixes the problem for any length of time.

Continued on page 90

"I'VE TESTED EVERY PRO

"No matter how diverse, clients such as National Geographic, Disney Corporation, CBS News, the Los Angeles Dodgers and Osh Kosh Overshoes have one thing in common. They demand perfection. In every project. I've field-tested every professional tape. I shoot **RAKS**. I get results—**RAKS** delivers the highest recording density and lowest chroma noise in the industry. Plus super toughness for flawless performance in editing, pass after pass.

"The goal is perfection. I'm not about to risk my time, or a client's project, on a lesser tape. That's why I shoot **RAKS**."

Jan Paul Anderson
President, Broadcast International
Costa Mesa, California

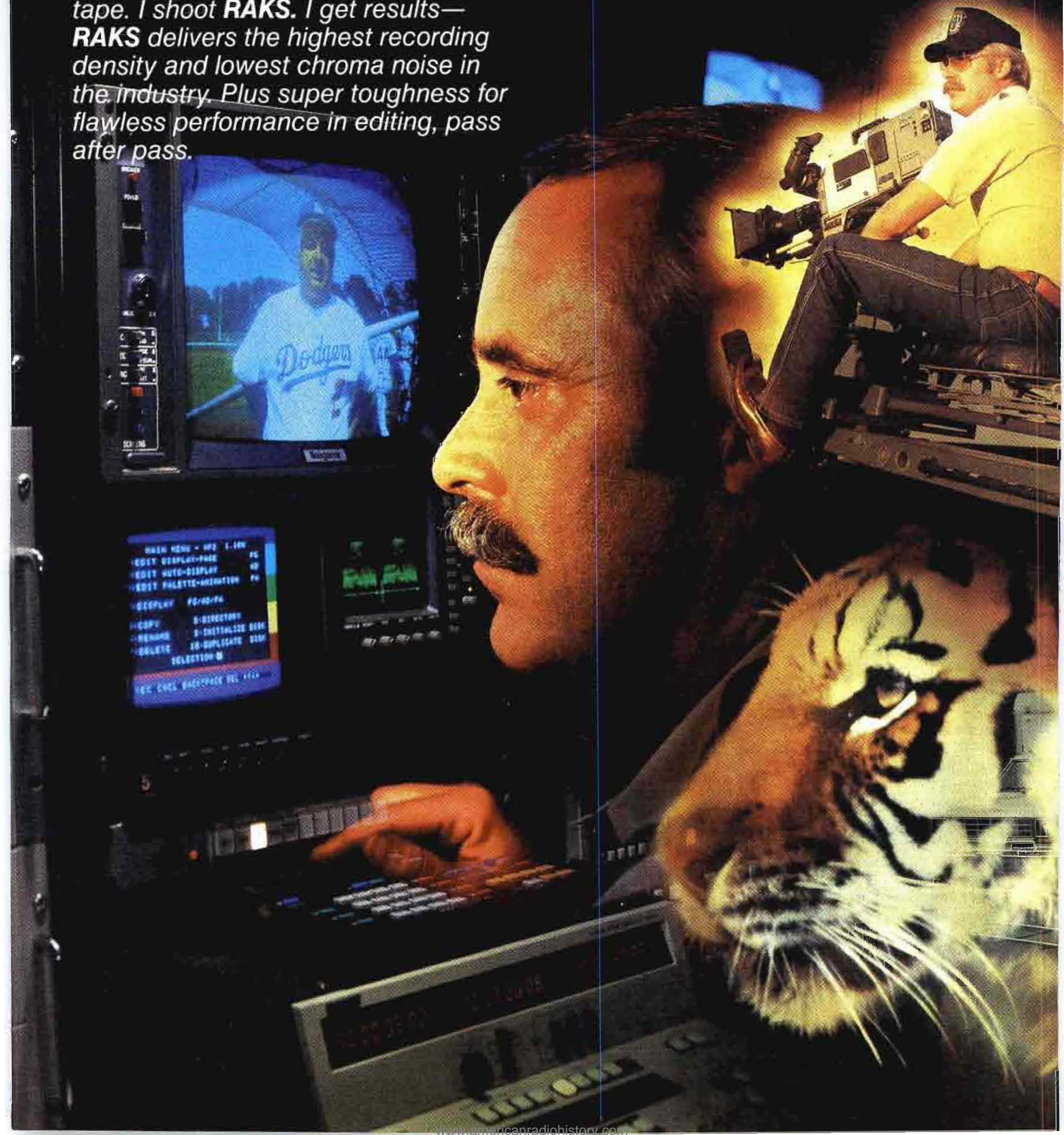

TAPE. I SHOOT RAKS!"

Four-time EMMY award winner Jan Paul Anderson knows how to shoot for success—with **RAKS** professional BetaCam® tape. For superb brilliance. Near zero dropout rate. Super durability. And absolute mechanical reliability.

Prove perfection for yourself. Request a test tape.

The first perfect tape

 **RAKS**®



CORPORATE OFFICE
201 Route 17, Suite 300
Rutherford, N.J. 07070
(201) 438-0119

MIDWESTERN
1660 North Lasalle St.
Suite 3310
Chicago, IL 60614
(312) 988-4075

WESTERN
8311 Westminster Blvd.
Suite 340 N
Westminster, CA 92683
(714) 891-6360

SOUTHWESTERN
6030 Spanish Oak Way
Spring, TX 77379
(713) 376-4546

Circle (162) on Reply Card

®BetaCam is a registered trademark of Sony Corp.

1. Plate overload faults

What to do after the smoke clears.

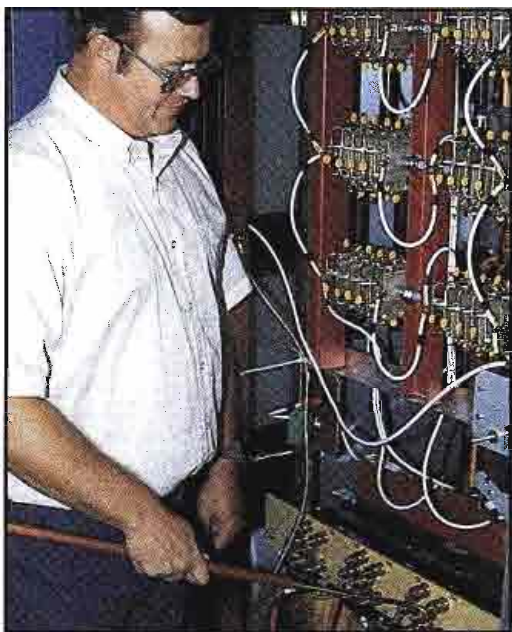

The first step in any troubleshooting procedure is to discharge all high-voltage capacitors using the grounding stick provided with the transmitter. Check also to confirm that primary ac power has been removed by touching the grounding stick across the ac input lines in the transmitter high-voltage cabinet.



Don't overlook the obvious. Check the tightness of high-voltage and/or high-current cable connections.

Of all the problems that can occur in a transmitter, probably the one that's best known—and most feared—is the plate supply overload. Occasional plate trip-offs (one or two a month) generally are not cause for concern. Most of these occurrences can be attributed to power line transients.

More frequent trip-offs require a closer inspection of the transmission system. For the purposes of this discussion, we will assume that the plate supply overload occurs frequently enough to make continued operation of the transmitter difficult.

The first step in any transmitter troubleshooting procedure is to switch the system to *local control* so that you, not the studio operator, have control over the unit. This is important for safety reasons.

The second step is to switch the transmitter's automatic recycle circuit off. While troubleshooting, you do not want the transmitter to cycle through an overload any more times than are necessary. Such action only increases the possibility of additional component damage.

Use a logical, methodical approach to finding the problem. The following procedure is recommended:

- Determine the fault condition. When you get to the transmitter building, the unit will probably be down. The carrier will be off, but the filaments will still be on. Check all of the multimeter readings on the transmitter and exciter. If they indicate a problem in a low-voltage stage, troubleshoot that failure before bringing the high voltage up.

- Assuming that all low-voltage systems are operating normally, switch the filaments off and make a quick visual check inside the transmitter cabinet. Determine whether there is any obvious problem. Pay particular attention to the condition

of power transformers and high-voltage capacitors. Check for signs of arcing in the PA compartment. Look on the floor of the transmitter and in the RF compartments to see if there are any pieces of components lying around. Sniff inside the cabinet for hints of smoke. Check the circuit breakers and fuses to see what failures might be indicated.

- After running through these preliminary steps, restart the filaments. Then, take a deep breath and bring up the high voltage. Watch the front panel meters to see how they react. Observe what happens and listen for any sound of arcing. If the transmitter will come up, quickly run through all the PA and IPA meter readings. Check the VSWR meter for excessive reflected power.

- Assuming that problems persist, determine whether the plate supply overload is RF- or dc-based. With the plate off, switch the exciter off. Bring up the high voltage (plate supply). If the overload problem remains, the failure is based in the dc high-voltage power supply. If the problem disappears, the failure is centered in the transmitter's RF chain.

It is important that proper bias is present on all vacuum tube stages of the RF system when this test is performed. The PA tube bias supply is usually switched on with the filaments, and can generally be read from the front panel of the transmitter. Proper bias should be confirmed before applying high voltage with no excitation.

It is also important that the exciter is switched off while the high voltage is off. Removing excitation from a transmitter while it is on the air can result in the generation of large transient overvoltages that can cause arcing or component damage.

- If the overload is based in the high-voltage dc power supply, shut down the transmitter and check the schematic for the location in the circuit of the plate overload sensor relay (or comparator circuit). This will show you within what limits component checking will need to be done.

The plate overload sensor is found usually in one of two locations: the PA cathode dc return or high-voltage power supply negative connection to ground. Transmitters using a cathode overload sensor generally have a separate high-voltage dc overload sensor in the plate power supply.

A sensor in the cathode circuit will substantially reduce the area of component checking required. A plate overload with no excitation in such an arrangement would almost certainly indicate a PA tube failure, because of either an interelectrode short inside the tube or a loss of vacuum in the tube.

Continued on page 94

Thomson LGT 5 kW transmitter :

COMPACT KNOW-HOW

BAZAINE.

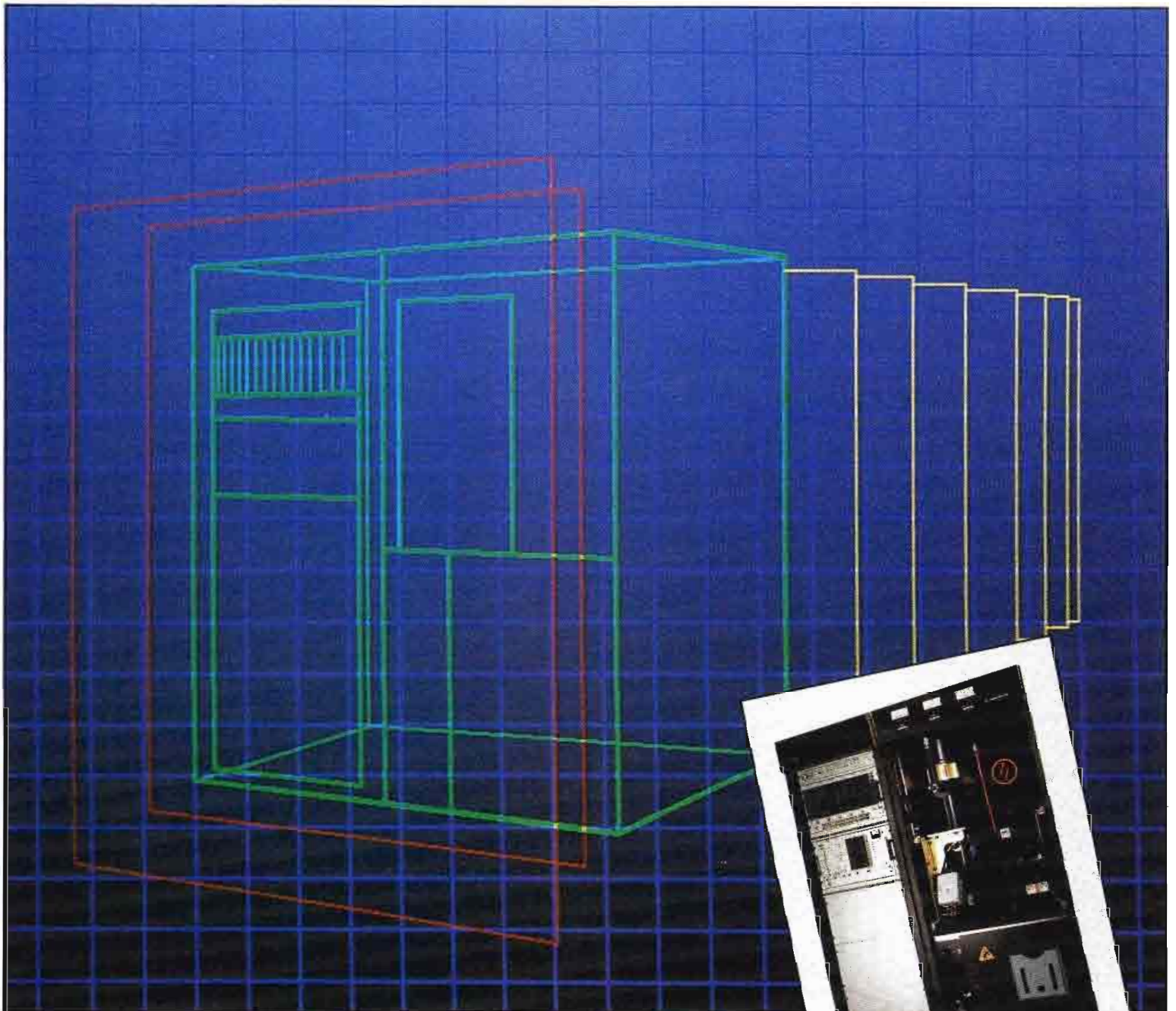

LGT, with the latest of its 5 kW UHF transmitters, the TRE 8510, offers you the following features :

High Profitability due to its competitive price, low floor area, low maintenance costs, and considerable energy saving through the use of a single very high efficiency TETRODE.

Enhanced Performance - this new transmitter, designed to meet the requirement of all new systems (MAC D, dual sound and videotext), uses a surface wave filter (SAW), a fixed group delay time corrector, precision off-set and a wide band configuration with optimised redundancy.

Improved Maintenance thanks to the use of a single air cooled tube, all the sub-assemblies being accessible from the front and a configuration specially designed to operate in Passive or Active Reserve Mode.

THE BEST POSSIBLE SIZE / EFFICIENCY

Please visit us
at Booth 3190
at the NAB.

 **THOMSON-LGT**

LABORATOIRE GÉNÉRAL DES TÉLÉCOMMUNICATIONS

1 Rue de L'Hautill-Z.I. Des Boutries, 78700 Conflans-Ste-Honorine/France, Tel: (33.1)34.90.31.00 - Fax: (33.1)34.90.30.00, Telex 696833 F

Circle (194) on Reply Card

www.americanradiohistory.com

5316

THE LEADER IN POST PR

The EMME®

A nine-VTR controller with cluster events functions, multiple workstation configuration, integrated time code modules and inter-format editing including multitrack ATR control. Priced under \$35,000.



The ECS-1000

A six VTR, serial format controller with assignable record, time code reading from the VTRs or internally, built-in time code generator, 1000 lines of edit memory, full list management, 409, CleanIt, two modes of auto-assembly. Comes with four VTR interfaces. Under \$23,000.



The IVES II®

A two- or three-VTR controller with an internal routing switcher, programmable general purpose interface, video and audio fade control, dual time code and color black generators, and two time code readers.



The Super 90

A single source edit-controller with two time code readers and one generator — all built-in. RS-232 out. 1/2" and 3/4" interfaces, multi-edit replay, high-speed hands-off VTR scan, optional black generator and fader.

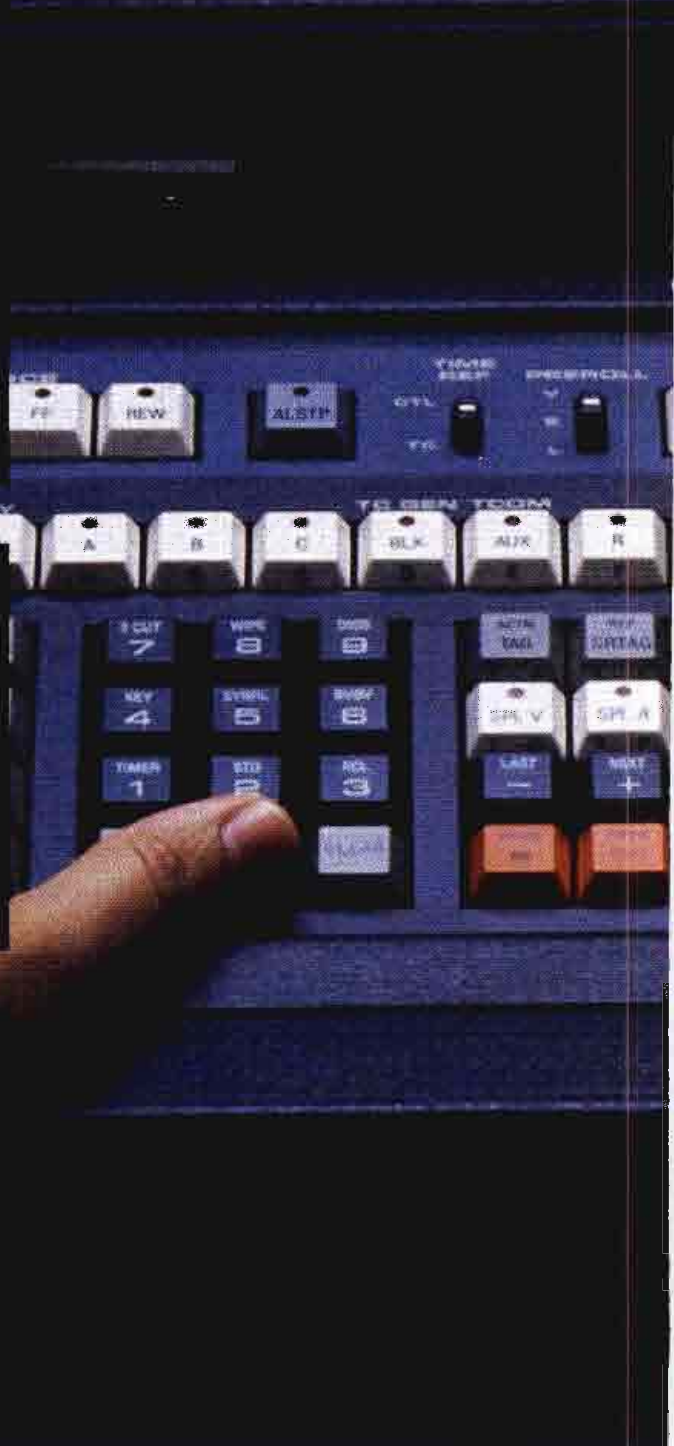

Convergence products are available through a worldwide distributor network.

*Any Convergence edit-controller in the ECS-200 Series may be upgraded to the ECS-205, an eight VTR controller with assignable record plus all features of the ECS-1000 Series.

CONVERGENCE CORPORATION ELECTRONICS

CONVERGENCE CORPORATION

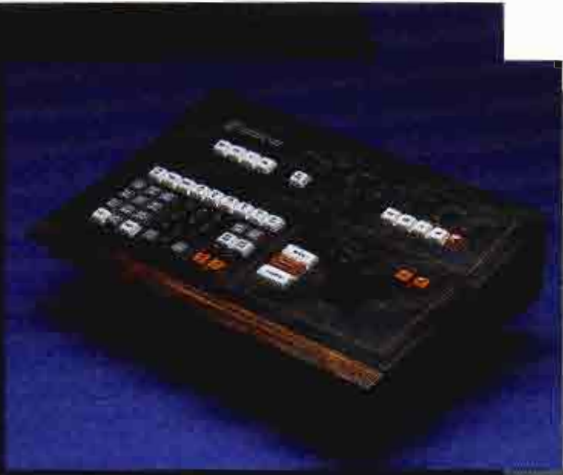

The ECS-204X

A four VTR edit-controller with assignable record, full list management, 409, sequential and checkerboard auto-assembly, built-in time code readers. Includes three VTR interfaces. Priced under \$20,000.*



NEW PRODUCT
AVAILABLE
APRIL 15, 1987

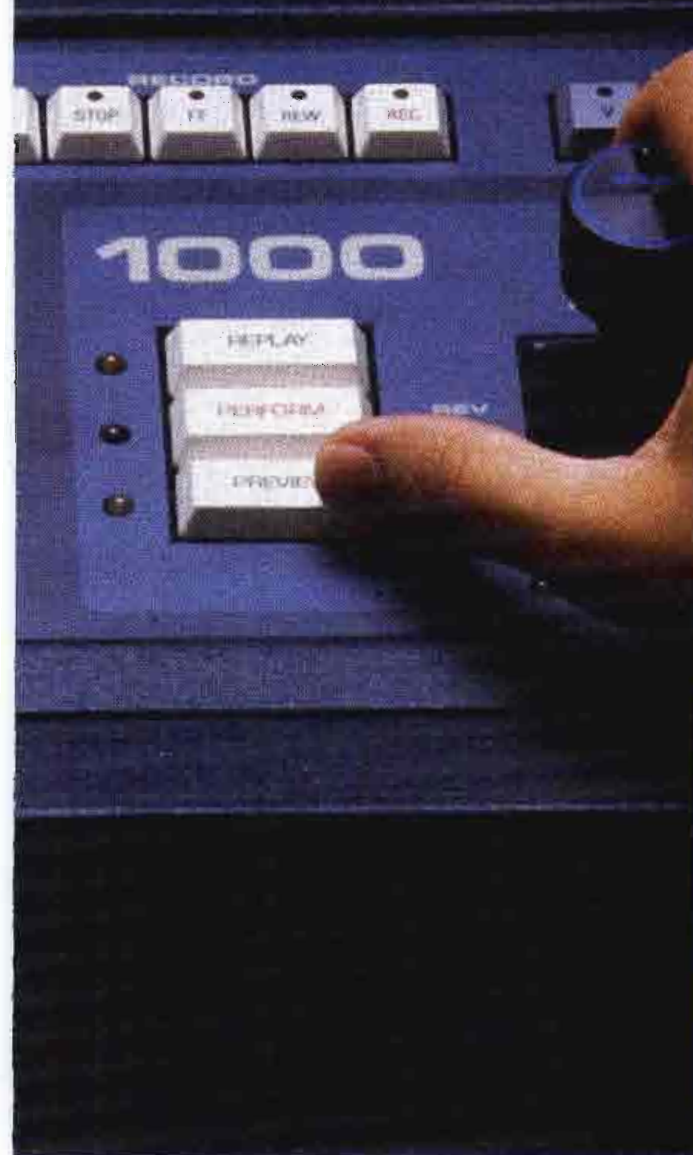

The CDS-2000

The new Convergence Digital Effects Switcher — programmable from the keyboards of all our A/B roll controllers — includes wipe patterns, dissolves, digital moves, two 16-line window TBCs, a sync and block generator and a five-stereo input audio mixer.



The ECS-195

A low-cost A/B roll controller. Includes three built-in time code readers, one generator, three VTR interfaces, 200-event memory list management, cleaning and auto-assembly. Priced under \$15,000.



EECONLINE[®] Time Code Systems

From EECO — the company that pioneered longitudinal and vertical interval time code reader/generator systems — come the most dependable, full featured products, available.

**Please see us at
NAB Booth #3252**

Circle (41) on Reply Card

Convergence Corporation is a subsidiary of EECO Incorporated.

U.S.A. OFFICE: 1601 East Chestnut Avenue,
Santa Ana, CA 92702-0659, U.S.A.
Telephone (714) 835-6000, TWX 910-595-1550,
Telex 67-8420, Facsimile (714) 953-3747

U.K. OFFICE: 7 Airlinks, Spitfire Way, Heston,
Middlesex TW5 9NR, U.K.
Telephone 01-759 3891 Telex 929344 ACQUIS G,
Facsimile 01-561 1122

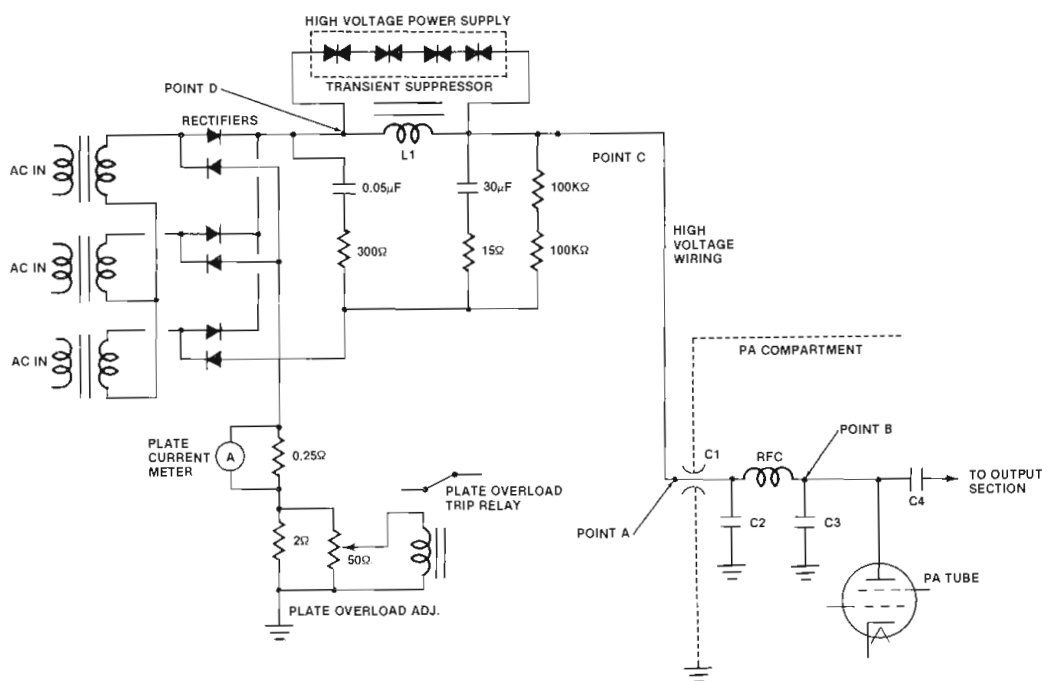
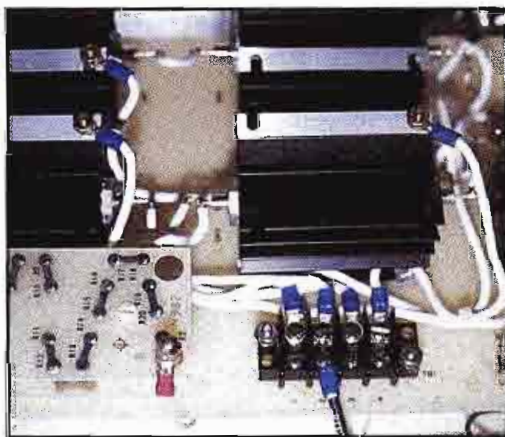

Figure 1. A common broadcast transmitter high-voltage 3-phase power supply circuit.



An overheated power resistor often will point to the cause of a power supply fault.



When replacing power semiconductors, use the proper heat sink hardware and heat-conducting compounds.

Continued from page 90

Do not operate the transmitter when the PA tube is out of its socket. This is not an acceptable method of determining whether a problem exists with the PA tube. Substitute a spare tube instead.

Operating a transmitter with the PA tube removed can result in damage in other tubes in the transmitter when the filaments are on, and damage to the driver tubes and driver output/PA input circuit components when the high voltage is on.

- Use an ohmmeter to check for short circuits in the power supply. Remove all power from the transmitter and discharge all filter capacitors before beginning any troubleshooting work inside the unit. When checking for short circuits with an ohmmeter, take into account the effects that bleeder resistors and high-voltage meter multiplier assemblies can have on resistance readings.

Most access panels on broadcast transmitters use an interlock system that will remove the high voltage and ground the high-voltage supplies when a panel is

removed. For the purposes of ohmmeter tests, these interlocks may have to be temporarily defeated. Never defeat the interlocks unless all ac power has been removed from the transmitter and all filter capacitors have been discharged using the grounding stick supplied with the transmitter.

- Following the preliminary ohmmeter tests, check the following components in the dc plate supply: all oil-filled capacitors for signs of overheating or leakage; all feed-through capacitors for signs of arcing or other damage; the dc plate-blocking capacitor for indications of insulation breakdown or arcing; all transformers and chokes for signs of overheating or winding failure; transient suppression devices for indications of overheating or failure; all bleeder resistors for signs of overheating; and any surge-limiting resistors placed in series with filter capacitors in the power supply for indications of overheating or failure. A series resistor that shows signs of overheating can be an indication that the associated filter capacitor has failed.

- If the plate overload trip-off occurs only at elevated voltage levels, ohmmeter checks will not reveal the cause of the problem. It may be necessary, therefore, to troubleshoot the problem using the process of elimination.

Process of elimination

This troubleshooting method involves isolating various portions of the circuit—one section at a time—until the defective component is found. However, special precautions are required:

- Never touch anything inside the transmitter without first removing all ac power and then discharging all filter capacitors with the grounding stick.
- Whenever you disconnect a wire, temporarily wrap it with electrical tape and secure it so that it will not arc-over to ground or another component when power is applied.
- Never perform this type of troubleshooting unless another person is in the room with you.
- Analyze each planned test before it is conducted. Every test in the troubleshooting process requires time, so steps should be arranged to provide you with the greatest amount of information about the problem.
- Check with the transmitter manufacturer to find out what testing procedures the company recommends. Ask what precautions should be taken.
- Troubleshooting the high-voltage plate supply is usually done under the following conditions: exciter off, plate and screen voltages for the IPA off, PA screen voltage off. Individual transmitters may require different procedures. Check with the manufacturer first.

Figure 1 shows a typical transmitter high-voltage power supply. Begin the troubleshooting process by breaking the circuit at point A. If the overload condition persists, the failure is caused by a problem in the power supply, not in the PA compartment.

If, on the other hand, the overload condition disappears, a failure in the feed-through capacitor (C1), decoupling capacitors (C2, C3) or blocking capacitor (C4) is indicated.

If a problem is indicated in the PA compartment, reconnect the high-voltage supply line at point A and break the circuit at point B. A return of the overload problem would indicate a failure in one of the decoupling capacitors or feed-through capacitor.

In order to avoid unnecessary effort and time in troubleshooting, use the process of elimination to identify sections of the circuit to be examined. If, for example, the test at point A had indicated the problem was not in the load, but in the power supply, a logical spot to perform the next test would be at point C

The Abekas A53-D Digital Special Effects System

The innovative tradition of Abekas continues with the A53-D—the most cost-effective, high-quality three-dimensional effects system available today.

In single or dual channel configuration, the A53-D gives you a full array of three-dimensional features. This includes: perspective and 3D rotation, variable rotation axes and 3D locate, field/frame freeze and full manipulation of frozen pictures, variable border and background, crop and aspect change, A/B switch-

ing and GPI control, and smooth linear motion and trajectory with variable tension.

The A53-D makes good sense for both live broadcast and post-production applications. For broadcasting, the A53-D offers a simple-to-use control panel with fast access to 24 on-line effects. For post-production, the system's extensive programming features and precise control let you create intricate effects limited only by your imagination.

You can digitally interface the A53-D to the highly acclaimed Abekas A62 digital disk recorder.

This unique duo gives you the ability to composite unlimited layers of manipulated video without generation loss.

Let the A53-D add a whole new dimension to your bottom line, with unmatched price and performance. For details, contact: Abekas Video Systems, Inc., 101 Galveston Drive, Redwood City, CA 94063. (415) 369-5111.

Abekas

Video Systems, Inc.

Now Anything is Possible

ADD NEW DIMENSION TO YOUR BOTTOM LINE



See us at NAB,
Booth #3527

Circle (195) on Reply Card

CURRENT VALUES THROUGH BODY TRUNK		EFFECT
SAFE CURRENT VALUES	1mA or less	Causes no sensation — not felt. Is at threshold of perception.
	1mA to 8mA	Sensation of shock. Not painful. Individual can let go at will, because muscular control is not lost. (5mA is accepted as maximum harmless current intensity.)
UNSAFE CURRENT VALUES	8mA to 15mA	Painful shock. Individual can let go at will, because muscular control is not lost.
	15mA to 20mA	Painful shock. Muscular control of adjacent muscles lost. Cannot let go.
	20mA to 50mA	Painful. Severe muscular contractions. Breathing is difficult.
	100mA to 200mA	Ventricular fibrillation (a heart condition that results in death). Disrupts or changes rhythm of the heart. No known remedy.
	200mA or more	Severe burns. Severe muscular contractions, so severe that chest muscles clamp heart and stop it during duration of shock. (This prevents ventricular fibrillation.)

Table 1. The effects of 60Hz current on humans.

(for long high-voltage cable runs). This test would identify or eliminate the interconnecting cable as a cause of the fault condition.

If the cable run from the high-voltage supply to the PA compartment is short, point *D* might be the next logical point to check. Breaking the connection at the input to the power supply filter assembly allows the rectifiers and interconnecting cables to be checked.

Components protected by transient suppression devices (as shown above L1) should be considered a part of the component they are designed to protect. If a choke is removed from the circuit for testing, its protective device should also be removed. Failure to remove both connections will usually damage the protective device.

To avoid creating a new problem while trying to correct the original failure, break the circuit in only one point at a time. Also, study the possible adverse effects of each planned step in the process. Disconnecting certain components from the circuit may cause overvoltages or power supply ripple that may damage other components in the transmitter. Consult the manufacturer to be sure.

Safety considerations

Perform any troubleshooting work on a transmitter with extreme care. Trans-

mitter high voltages can be lethal. Perform such work only when a second engineer is with you.

Work inside the transmitter only after all ac power has been removed and after all capacitors have been discharged using the grounding stick provided with the transmitter. Remove primary power from the unit by tripping the appropriate power distribution circuit breakers in the transmitter building. Do not rely on internal contactors or SCRs to remove all dangerous ac.

Be familiar with first aid treatment for electrical shock and burns. Always keep a first aid kit on hand at the transmitter site.

Do not defeat protective interlock circuits. Although defeating an access panel interlock switch may save work time, the consequences can be tragic.

Maintain a healthy respect for the high voltages that exist in your transmitter. Potentials that are present in many compartments and cabinets of the system are high enough to kill through electrocution. This warning applies equally to inexperienced and veteran transmitter engineers. A careless, casual attitude regarding safety can be fatal. Table 1 lists the effects of 60Hz current on humans. As you can see, electrocution can occur at just 100mA. Pay attention to safety. Do not take chances.

BROADCASTING Aug. 18, 1986

"Both COMARK and Thomson-LGT made news at the NAB..."
"COMARK introduced a 60 kw UHF transmitter with a KLYSTRODE..."
"...Thomson-LGT introduced a 30 kw SOLID-STATE VHF Transmitter..."

"Comark...first domestic source for BCD/ABC beam current pulsing systems."



**LEADING THE INDUSTRY
IN TECHNICAL
INNOVATIONS**

BM/E June 1986 NAB Show-In-Print

"...the principal advance reported at this NAB was the long-awaited commercial realization of the KLYSTRODE TUBE design in a production transmitter from COMARK."

"COMARK is first US manufacturer to build production transmitters specifically designed for and featuring wide band external cavity KLYSTRON amplifiers."

BROADCAST ENGINEERING— May 1986 Transmission Systems Special Issue

"High-performance Klystrons, Klystrodes and solid-state RF amplifiers are reducing operating costs and improving broadcast transmitter quality."

"COMARK was the 1st domestic manufacturer to design and produce no-tuning solid-state exciter/driver for use with Klystron transmitting systems."



**WHEN LOOKING FOR THE LATEST TECHNOLOGY
IN UHF AND VHF TRANSMITTERS...**

Comark's recent track record of technological innovations is unmatched by any other US manufacturer. This impressive history of recognized advancements demonstrates our commitment to the future. A commitment backed by continuing substantial investments in research and product development activities.

Incorporating new technology into today's products is your assurance that the Comark transmitter purchased now will still be current in the year 2000.

**COMARK
IS HERE**

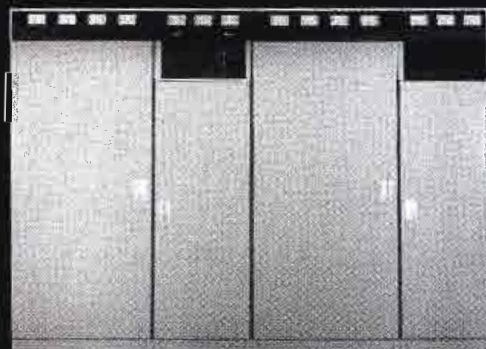

COMARK COMMUNICATIONS, INC.
A Thomson-CSF Company

Route 309 & Advance Lane • Colmar, PA 18915
(215) 822-0777 • Telex: 846075

Circle (43) on Reply Card

2. RF system faults

Troubleshooting RF power amplifier circuits requires patience and an understanding of how the system works.

Although RF troubleshooting may seem intimidating, there is no secret to it. Patience in examining the circuit and careful study of the schematic diagram will go a long way toward locating a problem. Consider the following troubleshooting steps after first confirming that the fault is RF-based, not dc-based.

Check the load by examining the transmitter overload indicators. Most transmitters monitor reflected power from the antenna and will trip off if excessive VSWR is detected. If the VSWR fault indicator is not lit, the load is not likely the cause of the problem. A definitive check of the load can be made by switching the transmitter output to a dummy load and bringing up the high voltage.

The PA tube may be checked by substituting one of known quality. When the tube is changed, carefully inspect the fingerstock for signs of overheating or arcing. Be extremely careful not to damage the socket fingerstock when removing and inserting the PA tube. Do

not change the tube unless there is good reason to believe it may be defective.

If problems with the PA stage persist, examine the grid circuit of the tube. Figure 2 shows the input stage of a grounded screen FM transmitter. A short in any of the capacitors in the grid circuit (C1-C5) will effectively ground the PA grid. This will cause a dramatic increase in plate current, because the PA bias supply will be shorted to ground along with the RF signal from the IPA stage.

Grid circuit troubleshooting

The process of finding a defective capacitor in the grid circuit begins with a visual inspection of the suspected components. Look for signs of discoloration because of overheating, loose connections and evidence of package rupture. The voltage and current levels found in a transmitter PA stage are often sufficient to rupture a capacitor package if an internal short occurs.

Check for component overheating right after shutting the transmitter down.

(As mentioned previously, remove all ac power and discharge all capacitors first.) A defective capacitor will often overheat. Such heating can also occur, however, because of improper tuning of the PA or IPA stage or a defective component elsewhere in the circuit.

Before replacing any components, study the transmitter schematic diagram to determine which parts in the circuit could cause the failure condition that exists. By knowing how the transmitter works, many hours can be saved in checking components that an examination of the fault condition and the transmitter design would show to be unlikely causes of the problem.

Check blocking capacitors C6 and C7. A breakdown in either component would have serious consequences. The PA tube would be driven into full conduction, and could arc internally. The working voltages of capacitors C1-C5 could also be exceeded, damaging one or more of the components.

Because most of the wiring in the grid circuit of a PA stage consists of wide metal straps (required because of the *skin effect*), it is not possible to view stress points in the circuit to narrow the scope of the troubleshooting work. Areas of the system that are interconnected using components that have low power dissipation capabilities, however, should be closely examined.

For example, the grid bias decoupling components shown in Figure 2 (R1, L3 and C5) include a low wattage (2W) resistor and a small RF choke. Because of the limited power dissipation capability of these two devices, a failure in decoupling capacitor C5 would likely cause R1 and possibly L3 to burn out.

The failure of C5 in a short circuit would pull the PA grid to near ground potential, causing the plate current to increase and trip off the transmitter high voltage. Depending on the sensitivity and speed of the plate overload sensor, L3 could be damaged or destroyed by the increased current it would carry to C5, and therefore, to ground.

If L3 were able to survive the surge currents that resulted in PA plate overload, the choke would continue to keep the plate supply off until C5 was replaced.

Bias supply resistor R1, however, would likely burn out because the bias power supply is generally switched on with the transmitter filament supply. Therefore, unless the PA bias power supply line fuse opened, R1 would overheat and probably fail.

Because of the close spacing of components in the input circuit of a PA stage, carefully check for signs of arcing between components or sections of the tube socket. Keep all components and

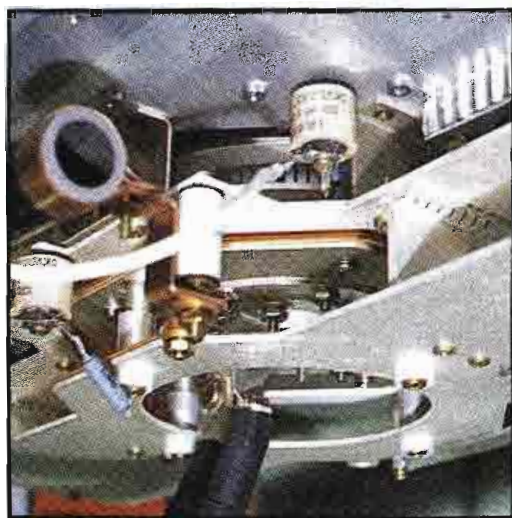

The only way to spot problems in the RF section of a transmitter is through careful observation with a trouble light and—in some cases—a magnifying glass.



Inspect AM system antenna tuning units for loose connections or contaminants that could cause arcing.



IN THE PAST WE HAD A BIG ADVANTAGE OVER THE COMPETITION. NOW WE'VE GOT A SMALL ONE.

Until UREI's 813 Time Align® Monitor entered the studio, speaker systems had become a "smear" on the industry. A "time smear," in which high and low frequencies subtly assaulted the ear because they arrived out of sync. The results were general listener fatigue and unrealistic sound, particularly on lead instruments and vocals.

The UREI 813 solved the "time smear" problem with Time Alignment™, unifying sound into a single point source. This dramatic breakthrough, along with other major technical advances, soon established the 813 as the industry standard.

Now UREI introduces less of a good thing: the 809 Time Align® Studio Monitor. The 809 delivers all the engineering depth of its big brother, but at a compact size and price that's ideal for small control rooms and near-field applications.

UREI's 809 features a remarkable, all-new 300mm (12") coaxial driver that achieves a true one-point sound source, superior stereo imaging, and tight bass. It incorporates a unique titanium diaphragm compression driver that unleashes unequalled high frequency response.

The 809 has exceptional power handling capabilities, high sound sensitivity, and low distortion. It accomplishes precise acoustic impedance matching and smooth out-of-band response with UREI's patented high-frequency horn with diffraction buffer. And its ferrite magnet structures assure the system's high sensitivity drivers will not degrade with time and use.

UREI's Model 809 Time Align® Studio Monitor. Smaller package. Smaller price. Same impeccable "813" sound quality. See how it fits into your studio today.

JB L Professional
8500 Balboa Boulevard
Northridge, CA 91329

UREI

Circle (42) on Reply Card

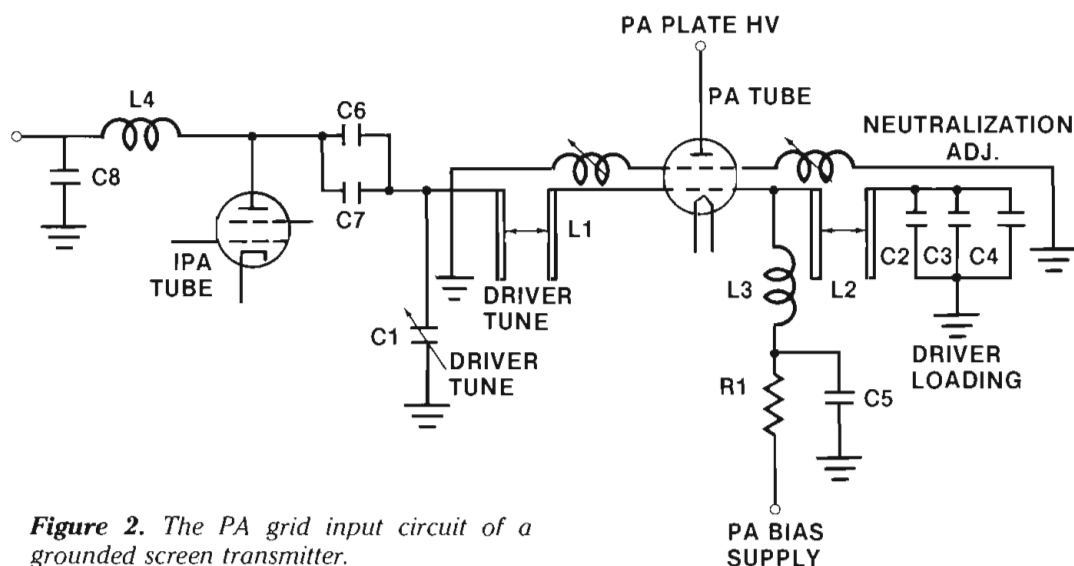

Figure 2. The PA grid input circuit of a grounded screen transmitter.

the socket itself clean at all times.

Inspect all interconnecting wiring for signs of damage, arcing to ground or loose connections.

Substitution

Substituting a new component for a suspected part can save valuable time when troubleshooting. With some components, it is cost-effective to replace a group of parts that may include one defective component because of the time involved in gaining access to the damaged device.

For example, the grid circuit of the PA stage shown in Figure 2 includes three doorknob capacitors (C2-C4) formed into a single assembly. If one device was found to be defective, it might be advantageous to simply replace all three capacitors.

These types of components are often integrated into a single unit that may be difficult to reach. Because doorknob capacitors are fairly inexpensive, it would probably be best to replace the three as a group. This way, the entire assembly is eliminated as a potential

cause of the fault condition.

A good supply of spare parts is a valuable troubleshooting tool. In high-power transmitting equipment, substitution is sometimes the only practical means of finding the cause of a problem.

Many parts—particularly in the high-voltage power supply and the RF chain—are difficult to test under static conditions. The only sure way to check the component is to substitute one of known quality. If the system returns to normal operation, the substitute component is defective.

Substitution is also a valuable tool in troubleshooting intermittent failures caused by component breakdown under peak power (or modulation) conditions.

The manufacturer's factory service department can advise you on the recommended spare parts to stock. Obvious candidates for the spare parts inventory include components that are not available locally. These would include high-voltage fixed-value capacitors, vacuum-variable capacitors and specialized semiconductors.

The past history of the transmitter is often useful in determining spare parts requirements of a particular piece of equipment. Compile a list of every component that failed from the station's

Make your most valuable communication tool even more valuable.

Our extensive line of telephone interface products can be used for:

- Talk shows
- IFB
- Sports remotes
- News remotes
- On-air calls
- Teleconferencing
- Transmitter Remote Control



NAB Booth
#2669

The telephone
interface specialists.

GENTNER[™]
ENGINEERING COMPANY, INC.

540 West 3560 South
Salt Lake City, Utah 84115
(801) 268-1117

Circle (44) on Reply Card

Microdyne presents the first automatic satellite program shifter.



See us at the NAB,
Booth #3520.

MAT: Microdyne Automated Terminal

Now you can take full advantage of the wealth of programming available via C- and Ku-band satellites with the only TVRO system that's as easy to use as a home VCR.

Rely on M.A.T.'s memory instead of your own.

M.A.T.'s microprocessor stores hundreds of program pre-sets—satellite position, signal polarization, transponder format and frequency. Once M.A.T. is programmed, subsequent reception is push-button easy. You enter a simple program code and M.A.T. does the rest, right down to peaking its motorized, high-resolution fiberglass antenna.



Turns on, tunes up, automatically.

M.A.T.'s system clock automatically turns the system on and tunes in the programming you want for any particular day and time. You can set it for one program, or a succession of programs, for as long as you want. It even controls descramblers, video recorders or other external equipment. And you can operate M.A.T. through its own front panel keypad or by remote terminal.

Economical base price, broadcast quality options.

No other satellite TVRO system is available anywhere, at any price, with the capabilities of

M.A.T. And you can have the flexibility and unlimited program access of M.A.T. for under \$20,000, installed. Options include a 5 or 7 meter antenna to meet the stringent requirements of broadcasters and cablecasters.

Installed and backed by Microdyne.

M.A.T. is built, installed, and backed by Microdyne, a company committed to exceptional reception and service since the beginning of satellite communications. Call (904) 687-4633 or write for more information today.



Microdyne Corporation

491 Oak Road • P.O. Box 7213
Ocala, FL 32672 • TWX: 810-858-0307

Circle (45) on Reply Card

ACOUSTIC SYSTEMS
 MODULAR STUDIOS
 for broadcast control,
 production,
 recording,
 on-air

Circle (46) on Reply Card

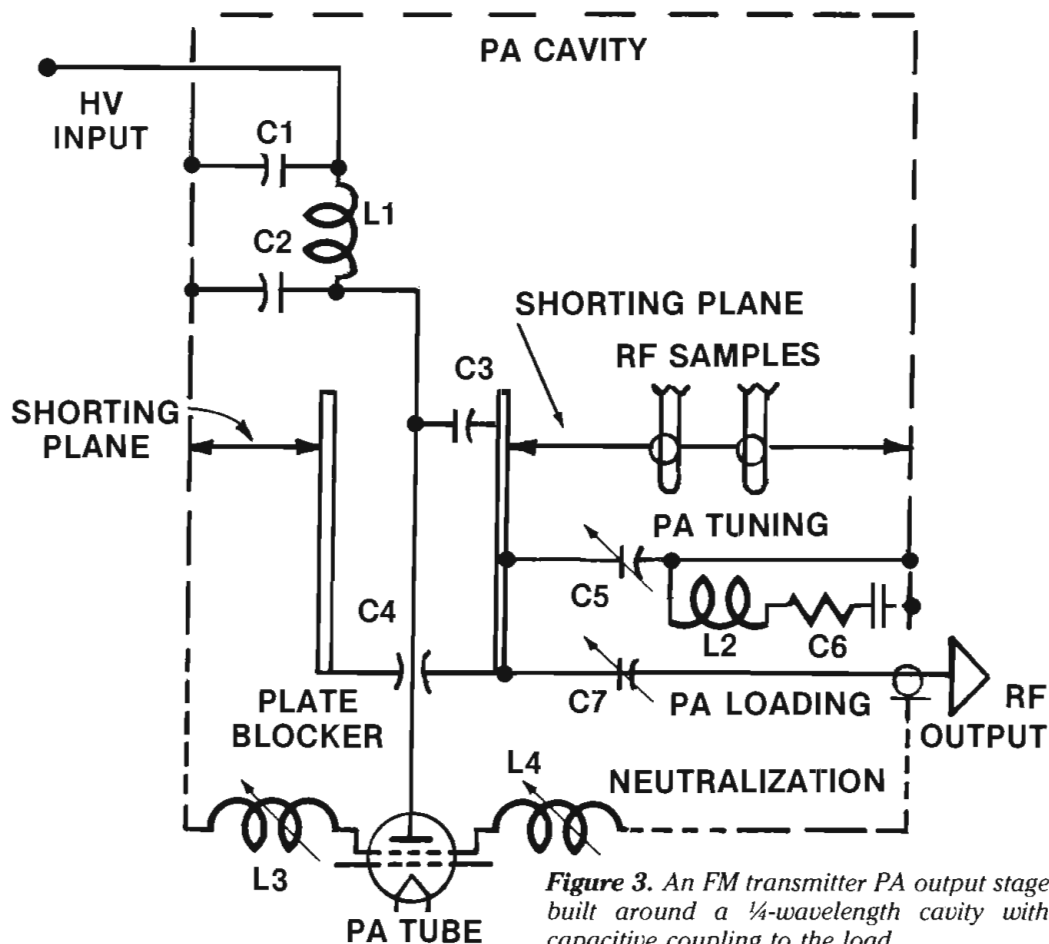

Figure 3. An FM transmitter PA output stage built around a $\frac{1}{4}$ -wavelength cavity with capacitive coupling to the load.

maintenance log when considering spare parts requirements.

Inside the PA cavity

One of the things that makes troubleshooting a cavity-type power amplifier stage difficult is the nature of the major component elements. The capacitors don't necessarily look like capacitors, and the inductors don't necessarily look like inductors. It is often difficult to relate the electrical schematic diagram to the mechanical assembly that exists within the transmitter output stage. At FM and TV frequencies—the domain of cavity PA designs—inductors and capacitors can be formed out of some strange-looking mechanical devices and hardware.

Consider the PA cavity schematic diagram shown in Figure 3. The grounded-screen stage is of conventional design. Decoupling of the high-voltage power supply is accomplished by C1, C2, C3 and L1. Capacitor C3 is located inside the PA chimney (cavity inner conductor). The RF sample lines provide two low-power RF outputs for a modulation monitor or other test instruments. Neutralization inductors L3 and L4 consist of adjustable grounding bars on the screen grid ring assembly.

Figure 4 shows the electrical equivalent of the PA cavity schematic diagram. The $\frac{1}{4}$ -wavelength cavity acts as the resonant tank for the PA. Coarse tuning of the cavity is accomplished by adjustment of the shorting plane. Fine tuning is performed by the PA tuning

control, which acts as a variable capacitor to bring the cavity into resonance.

The PA loading control consists of a variable capacitor that matches the cavity to the load. There is one value of plate loading that will yield optimum output power, efficiency and PA tube dissipation. This value is dictated by the cavity design and values of the various dc and RF voltages and currents supplied to the stage. The assembly made up of L2 and C6 of Figure 3 prevents spurious oscillations within the cavity.

The logic of a PA stage often disappears when you are confronted with the actual physical design of the system. As shown in Figure 5, many of the components take on an unfamiliar form. Blocking capacitor C4 is constructed of a roll of kapton insulating material sandwiched between two circular sections of aluminum. PA plate tuning control C5 consists of an aluminum plate of large surface area that can be moved in or out of the cavity to reach resonance. PA loading control C7 is constructed much the same as the PA tuning assembly, with a large-area paddle feeding the harmonic filter, located external to the cavity. The loading paddle may be moved toward the PA tube or away from it to achieve the required loading.

The L2-C6 damper assembly actually consists of a 50 Ω non-inductive resistor mounted on the side of the cavity wall. Component L2 is formed by the inductance of the connecting strap between the plate tuning paddle and the resistor.

DYNASTY

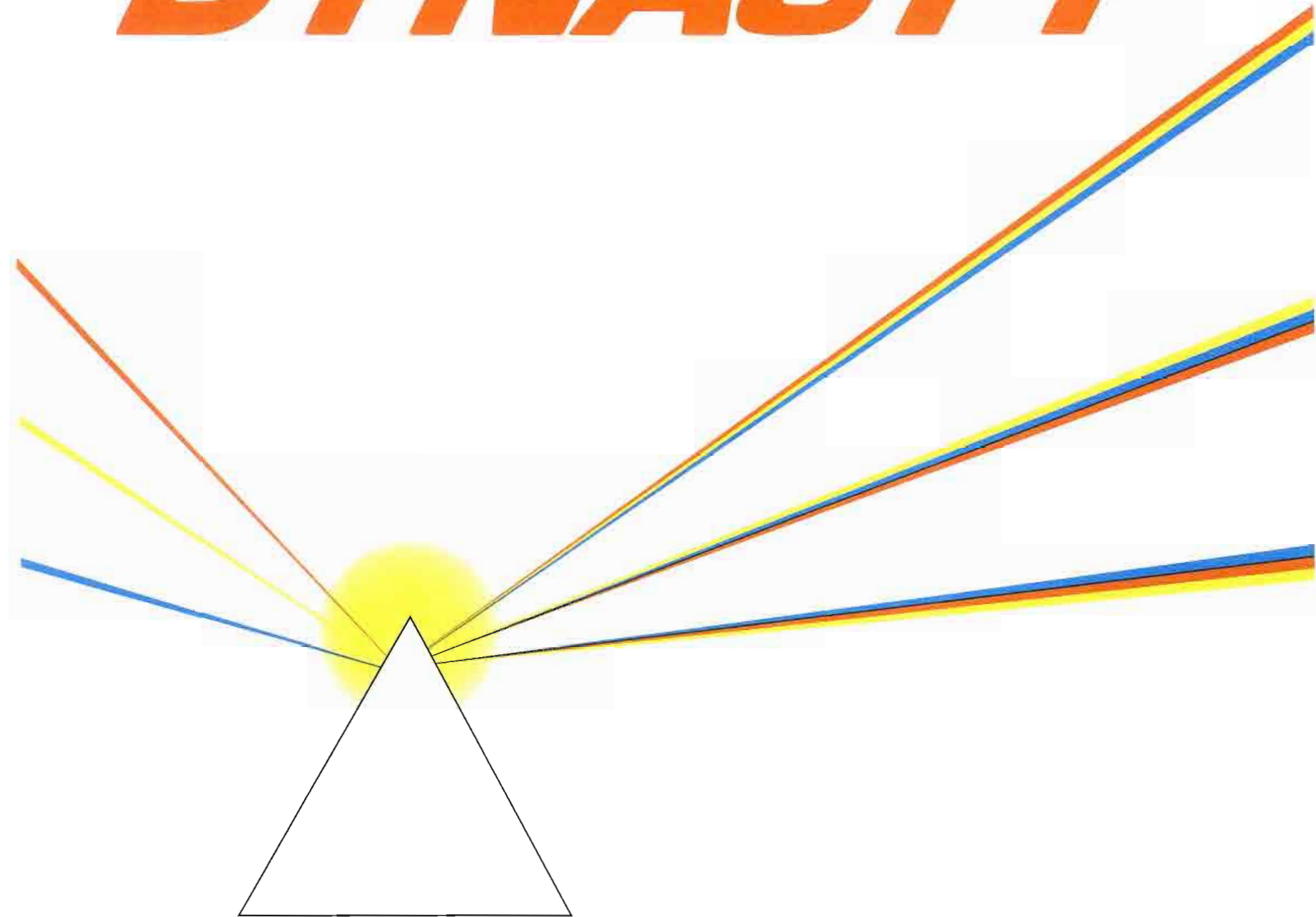

Signals The Start of an Era

Booth Number 3409 Level III West Hall
NATIONAL ASSOCIATION OF BROADCASTERS—DALLAS
March 28-31

Circle (47) on Reply Card

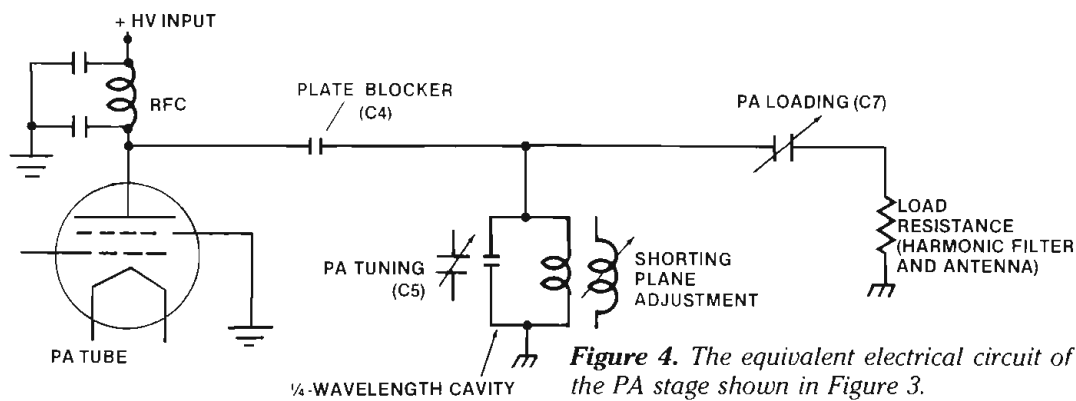

Figure 4. The equivalent electrical circuit of the PA stage shown in Figure 3.

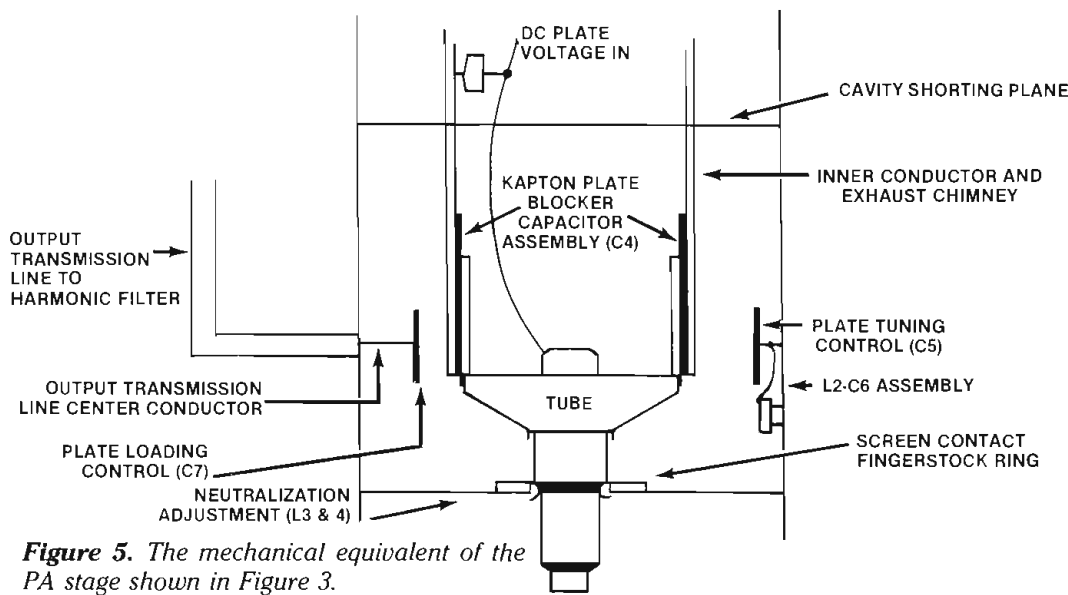

Figure 5. The mechanical equivalent of the PA stage shown in Figure 3.

Component C6 is the equivalent stray capacitance between the resistor and the surrounding cavity box.

From this example, you can see that many of the troubleshooting techniques that work well with low-frequency RF and dc do not necessarily apply in cavity stages. Therefore, it is critically important that you study how your particular transmitter operates, and what each component does. Because many of the cavity components—inductors and capacitors—are mechanical elements more than electrical ones, troubleshooting a cavity stage centers on checking the mechanical integrity of the box.

Most failures resulting from problems within a cavity are the result of poor mechanical connections. All screws and connections must be kept tight at all times. Every nut and bolt in a PA cavity was included for a reason. There are no insignificant screws that don't need to be tightened. But don't overtighten. Stripped threads and broken component connection lugs will only cause you additional grief.

When a problem occurs in a PA cavity, it is usually difficult to determine which individual element (such as a neutralization inductor, plate tuning capacitor or loading capacitor) is defective from the symptoms the failure will display. A fault within the cavity is usually a catastrophic event that will take you off the air and leave you there until the problem is cor-

rected. It is often impossible to bring the transmitter up for even a few seconds to assess the fault situation. The only way to get at the problem is to shut the transmitter down and take a look inside.

Closely inspect every connection, using a trouble light and magnifying glass. Look for signs of arcing or discoloration of components or metal connections. Check the mechanical integrity of each element in the circuit. Be certain the tuning and loading adjustments are solid, without excessive mechanical play. Look for signs of change in the cavity. Do any parts look different now than the last time you cleaned the transmitter?

Check areas of the cavity that may not seem like vital parts of the output stage, such as the maintenance access door fingerstock and screws. Any failure in the integrity of the cavity, whether at the base of the PA tube or on part of the access door, will cause high circulating currents to develop and may prevent proper operation of the stage.

If a problem is found that involves damaged fingerstock, replace the affected sections. Failure to do so will likely result in future problems because of the circulating currents that can develop at any discontinuity in the cavity inner or outer conductor.

VSWR overload

VSWR overloads in transmission equipment can be caused by a number of dif-

ferent problems. Some common problems and solutions:

Step 1: VSWR overloads are usually caused by an improper impedance match external to the transmitter. The first step in the troubleshooting procedure is to substitute a dummy load for the entire antenna and transmission line system. Connect the dummy load at the transmitter output port, thereby eliminating all coax, external filters and other RF hardware that might be present in the system.

Step 2: If the VSWR trip fault is eliminated in step 1, the problem is somewhere in the transmission line or antenna. The dummy load can next be moved to the point at which the transmission line leaves the building and heads for the tower (if different than the point checked in step 1). This test will allow you to check any RF plumbing, switches or filter assemblies. If the VSWR overload condition is still absent, the problem is in the transmission line or the antenna.

Step 3: If a standby antenna is not available, you may be able to run the system at reduced power on a temporary basis. For example, if arcing occurs in the antenna or line at full power, emergency operation may be possible at half power. Inspect the antenna and line for signs of trouble. Repair work beyond this point normally requires specialized equipment and a tower crew. This discussion assumes that the problem is not caused by ice build-up on the antenna, which can be alleviated by reducing the transmitter power output until VSWR trips do not occur.

Step 4: If you find the VSWR overload of step 1 to be internal to the transmitter, determine whether the problem is caused by an actual VSWR overload or by a failure in the VSWR control circuitry. Check this by disabling the transmitter exciter and bringing up the high voltage. Under these conditions, RF energy will not be generated. (We assume the transmitter has proper bias on all stages and is properly neutralized.) If a VSWR overload is indicated, the problem is centered in the VSWR control circuitry and not in the RF chain.

Possible explanations for control circuitry failure include loose connections; dirty switch contacts; dirty calibration potentiometers; poor PC board edge connector contacts; defective IC amplifiers or logic gates; and intermittent electrolytic capacitors.

Step 5: If step 4 shows the VSWR overload is real, and not the result of faulty control circuitry, check all connections in the output and coupling sections of the final stage. Look for signs of arcing or loose hardware particularly on any movable tuning components. Inspect

CLASSIC SIMPLICITY

To make something that works – and works well – is craftsmanship. To create a product which redefines its purpose and yet retains an essential simplicity is a work of art.

There are many intercoms on the market... and then there is the McCurdy Digital Intercom.

To say it works well is a classic understatement. To say it's ahead of its time is faint praise indeed. The truth is, the McCurdy CS9400 Digital Intercom simply puts broadcast intercommunication on a whole new level.

Consider these features: • Totally balanced solid state switching • Single pair control wiring • Redundant single station architecture for ultimate reliability • Alpha-numeric displays • Assignment of keys locally or at central location • Disc based interface for storage • Unique caller identification and reply system • Ease of future expansion and reconfiguration • Wide range of control panels and software options • Advanced microprocessor design for optimum performance and user flexibility to accommodate complex production reconfiguration with ease.

All in addition to McCurdy's wealth of experience and expertise in creating a full range of competitively-priced and critically-acclaimed broadcast quality electronic equipment.

When you're talking intercoms, if you're not talking McCurdy, you're making a simple choice much harder than it really needs to be.

The McCurdy CS9400 Digital Intercommunication System. What could be simpler?



Visit us at the
NAB, Booth 3028

McCurdy

Circle (48) on Reply Card

McCurdy Radio Industries

108 Camforth Road, Toronto, Ontario, Canada M4A 2L4 Tel: (416)751-6262 Telex: 06-963533 1051 Clinton Street, Buffalo, New York 14206 Tel: (212)772-0719
In Europe: Seltch International, Rose Industrial Estate, Bourne End, Bucks. SL8 5AT England Tel: (06285)29131 Telex: 848960

DIGITAL BELTPACK

featuring R.M.K.*



- ▶ Smaller
- ▶ Lighter
- ▶ Higher Output
- ▶ Electronic Switching
- ▶ Compatible with existing Clear-Com

* Kills all open mics from any remote location.

For more information on new features and models, contact your local dealer or:



1111 17th Street
San Francisco, CA 94107 • 415-861-6666
Export Division: P.O. Box 302
Walnut Creek, CA 94596 • 415-932-8134
Telex: 176340 CLEAR-COM WNCK

Circle (49) on Reply Card

YOUR "ONE-STOP SOURCE" FOR **Frezza-max**TM SUPER-PERFORMANCE-SERIES

battery packs - belts - chargers ac adapters - camera lights & kits

<p>Model UPS-14</p> <p>'Power-UPS Interface' runs camera during battery changing.</p> <p>*patent applied for</p>	<p>Multi-function Dual-channel AC Adapter-Battery Charger</p> <p>Two independent ac adapters or chargers in one unit.</p>	<p>Full 4AH Premium Battery Packs for portable cameras.</p>
<p>High-capacity Battery Belts power lights, cameras, & recorders</p>	<p>12-oz. "Mini-Fill" Camera Lights Accessories & Kits</p> <p>12 volts, 20 to 100 Watts</p> <p>Used by all 3 major networks.</p>	<p>FBP-90FC Exclusive: extra output connector for portable lights</p> <p>power lights, cameras, recorders</p> <p>1-hour re-charge.</p>

For information and catalogs
CALL (201) 427-1160



Frezzaolini Electronics Inc.
5 Valley St. Hawthorne, N.J. 07506
• TWX: 710-988-4142

See "Frezza-Max" products at our N.A.B. Booth 2716

Circle (60) on Reply Card

high-voltage capacitors for signs of overheating, which might indicate failure, and check coils for signs of dust build-up, which might cause a flash-over. In some transmitters, VSWR overloads can be caused by improper final stage tuning or loading. Consult your equipment instruction book for this possibility. Also, certain transmitters include glass-enclosed spark-gap lightning-protection devices that can be disconnected for testing.

Check the following items if your AM radio station experiences VSWR overload conditions that are caused by a fault external to the transmitter:

1. If a normal (near zero) reflected power reading is indicated at the transmitter under carrier-only conditions but VSWR overloads occur during modulation, there are two possible causes. A voltage breakdown could be occurring within one of the capacitors at the antenna tuning unit (ATU) or phaser. If the overloads occur with any modulating frequency, the probable cause of the fault is capacitor dielectric breakdown. If, on the other hand, the overload seems particularly sensitive to high-frequency modulation, then narrow antenna bandwidth is indicated.

Note the action of the transmitter's forward-reflected power meter. An upward deflection of reflected power with modulation is a symptom of limited antenna bandwidth. The greater the upward deflection, the more limited the bandwidth. If you note these indications, conduct an antenna impedance sweep of the system.

2. Tower static build-up can also cause VSWR tripping. This problem is characterized by a gradual increase in reflected power, as shown on the transmitter front panel. The static build-up—which usually occurs during poor weather conditions—continues until the tower base ball gaps arc-over and neutralize the charge. The reflected power reading then falls to zero. A static drain choke at the tower base to ground will generally prevent this problem.

3. Static build-up on guy wires is another phenomenon that can cause VSWR tripping of an AM transmitter. The effect is similar to a nearby lightning strike in that no charge is registered during the build-up of potential on the reflected power meter. Instead, the static charge builds on the guys until it is of sufficient potential to arc across the insulators to the tower. The charge is then removed by the static drain choke and/or ball gaps at the base of the tower. Static build-up on guy wires can be prevented by placing RF chokes across the insulators, or by using non-metallic guys. Arcing across the insulators may also be reduced or eliminated by regular cleaning.

Continued on page 110



PESA

The "NEW SWAT PLUS"

Best Stations and Production Houses Assistant

automatic analysis of all sync parameters of the video signal * video monitor output * local liquid crystal display * two independent video inputs * manual/automatic testing modes * alarm indicators for parameters out of tolerance * self-test software * RS 232 output to feed printer or PC * PAL/NTSC version.

Standard Measurements

Watcher-Analyzer:

- * sync and burst amplitude
- * horizontal sync width
- * number of cycles in burst
- * breezeway
- * number of vertical sync pulses
- * equalizer width
- * vertical pulse width
- * SC/H phase up to two degrees
- * SC frequency error up to 0.2 Hz

PLUS

- New * Horizontal Blanking Width
- New * Vertical Blanking Width
- New * Front Porch Width
- New * Amplitude in mV (PAL) IRE Units (NTSC) measurements also
- New * VITS information detection

Timer:

- * H and V lock
- * PAL lock
- * H delay and SC phase delay between Inputs A and B
- * S ync
- * W atcher
- * A nalyzer
- * T imer



Pesa Electrónica, S.A.

Albalá, 12 - 28037 Madrid (Spain) - Telex 48449 PESAE E - Tel.: 754 00 78

Pesa America Inc. 6073 NW 167th St.-Unit C-4 Miami FL 33015 (USA) - Telex: 6712435 PESAM - Tel. (305) 556 - 9638 - Toll Free: 1-800-USA-PESA (USA, Canada, South America, Caribbean)

Pesa International Ltd. The Paddocks 347 Cherry Hinton Road, Cambridge CB1 4DJ (U.K.) - Telex: 81678 PESAI G - Tel.: (223) 24 26 42 (UK, Europe, Middle East, Africa, Far East, Australasia)

The affordable hi-tech.

Circle (61) on Reply Card



Freeze.

Introducing the fastest, easiest way to get quality prints and slides from video.

Now you can capture the moment, freeze it, and frame it. All with the touch of a button.

With the new FreezeFrame Video Image Recorder from Polaroid.

FreezeFrame produces sharp, instant color prints and color or black and white 35mm slides from virtually any video source. And it delivers a finished picture that is far superior in quality and resolu-

tion to direct screen photography or thermal video image recorders.

If you use video, you need FreezeFrame.

FreezeFrame has hundreds of uses for anyone who uses video in their profession. It can be used in broadcast, production and advertising to proof, edit, storyboard or reference. It can be used to pull a

print off a just-breaking news story, or for color correcting a proof. It can even help in film-to-video transferring. Medical professionals can use FreezeFrame for diagnostic recording, patient referral or teaching. And it's the easiest way to get slides or prints for presentations or training.

FreezeFrame can improve your image.
FreezeFrame



System includes Video Image Recorder, control console, and print film camera/adaptor. 35mm camera/adaptor optional.



Frame.

connects easily to video cameras, professional VCR's, laser disc players and computer graphics systems.

You can preview and even improve the video image because FreezeFrame has a full range of image enhancing controls including tint, contrast, color, sharpness, brightness and raster fill. And if you're shooting prints, FreezeFrame uses a new color print film specially developed for use with video imaging.

New FreezeFrame from

Polaroid. It's fast, easy, and at \$1,899*, very affordable.

To find out how FreezeFrame can help you, call toll-free 800-225-1618, 9 a.m. to 6 p.m. Eastern Time.

Or fill out and return the coupon. We'll give you the full picture and show you just how easy it can be to capture the moment on FreezeFrame.



Polaroid

For more information, mail this coupon to Polaroid Corp., Dept. 671, P.O. Box 5011, Clifton, NJ 07015.

- Please send more information.
 I'd like a demonstration. BE 3/1

Name _____

Title _____

Organization _____

Address _____

City _____

State _____ Zip _____

Telephone _____

Video Source _____

Application _____

Circle (62) on Reply Card

3. Power control faults

When the power control system of a transmitter malfunctions, strange things can happen.

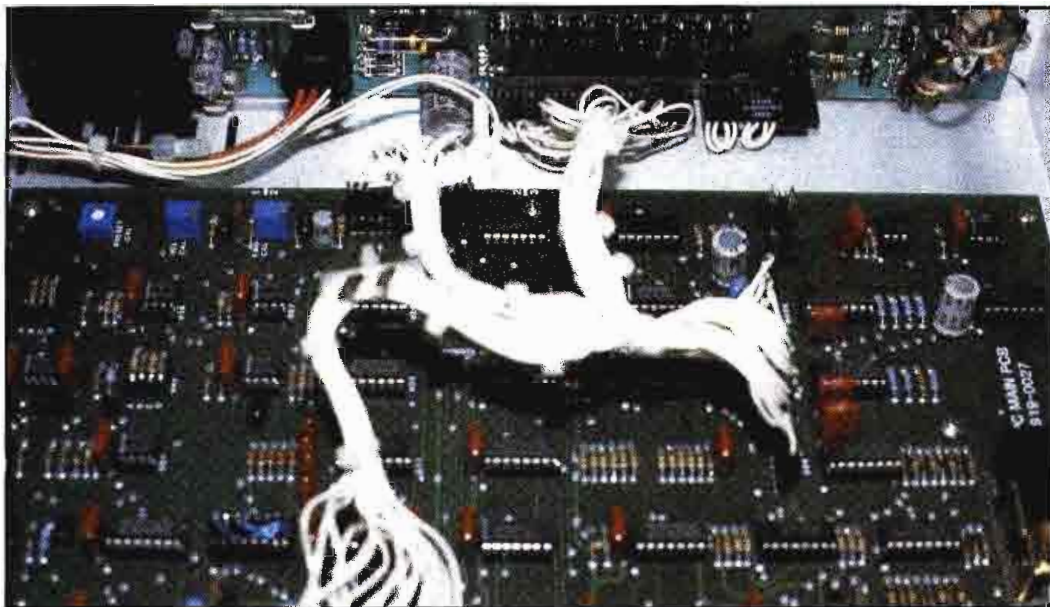

The rows of relays and shunt resistors common in the control/overload circuits of older transmitters are being replaced by integrated circuit logic gates and microprocessor chips. These high-tech designs have allowed additional features to be built into transmission equipment, greatly simplifying troubleshooting.



When troubleshooting a transmitter control ladder, don't forget to inspect the operation of the PA compartment air pressure switch and the associated blower assembly (shown here).

A failure in the transmitter ac power control circuitry can result in problems ranging from zero RF output to a fire inside the unit. Careful and logical troubleshooting of the control system is mandatory. Two basic types of primary ac control are used in transmitters today: relay logic and SCR (thyristor) systems.

A failure in the thyristor power control system of a broadcast transmitter isn't easy to overlook. In the worst case, no high voltage at all will be produced by the transmitter. In the best case, power control may be erratic or uneven when using the continuously variable power adjustment mode. The first step in correcting a problem in a transmitter using a thyristor power controller is to understand how the servo circuit works and how it is interconnected.

Figure 6 shows a block diagram of a typical thyristor control circuit. Three gating cards are used to drive back-to-back SCR pairs, which feed the high-voltage power transformer primary windings. Although the applied voltage is 3-phase, the thyristor power control configuration simulates a single-phase design for each phase-to-phase leg. This allows implementation of a control circuit that consists basically of a single-phase gating card duplicated three times (one for each load phase).

This approach has advantages from the standpoint of design simplicity, and also from the standpoint of field troubleshooting. In essence, each power control circuit is identical, allowing test voltages and waveforms from one gating card to be directly compared with a gating card experiencing problems.

If the high-voltage supply will not come up at all, your problem involves more than a failure in just one of the three gating cards. The failure of any one gating board would result in reduced power output (and other side effects), but not in zero output. Begin your search with the interlock system.

Interlock failures

Newer transmitters provide the engineer with built-in diagnostic readouts on the status of the transmitter's interlock circuit. These may involve discrete LEDs or a microcomputer-driven visual display of some type. If you are fortunate enough to have such a transmitter, the process of locating an interlock fault is relatively simple. If you have an older transmitter that is not so equipped, substantially more investigation will be needed.

Make a close observation of the status of all fuses, circuit breakers, transmitter cabinet doors and access panels. Confirm that all doors are fully closed and secured. Switch the transmitter from remote to local control (if operated

UPGRADE YOUR ENG SYSTEM WITH MII

remotely) to eliminate the remote-control system as a possible cause of the problem. Observe the status of all control-panel indicator lamps. Some transmitters include an *interlocks open* lamp; other units provide an indication of an open interlock through the *filament on or plate off* push-button lamps. These indicators can save valuable minutes or even hours of troubleshooting, so pay attention to them. And, by all means, make sure to replace any burned-out indicator lamps as soon as you notice them. Status lamps are of no use whatsoever if you can't trust what they are telling you.

If your front-panel indicators point to an interlock problem, pull out the schematic diagram of the transmitter, get out your DVM and shut down the transmitter. This is going to take awhile.

If your transmitter interlock circuit operates from a low-voltage power supply, such as 24Vdc, use a voltmeter to check for the loss of continuity. Remove ac power from all sections of the transmitter except the low-voltage supply by tripping the appropriate front-panel circuit breakers. Be extremely careful when working on the transmitter to avoid any line voltage ac. If the layout of the transmitter does not permit safe troubleshooting with just the low-voltage power supply active, remove all ac from the unit by tripping the wall-mounted main breaker. Then, use an ohmmeter to check for the loss of continuity.

If your transmitter interlock circuit operates from 120Vac or 220Vac, remove all power from the transmitter by tripping the wall-mounted main breaker. Use an ohmmeter to locate the problem. Many older transmitters use line voltages in the interlock system. Do not try to troubleshoot such transmitters with ac power applied. If you do, you are asking for serious trouble.

Finding a problem such as an open control circuit interlock is basically a simple procedure, in spite of the time involved. Do not rush through such work.

When searching for a break in the interlock system, use a methodical approach to solving the problem. Consider the circuit configuration shown in Figure 7. The most logical approach to finding a break in the control ladder is to begin at the source of the 24Vdc input and, step by step, work your way to the input of the power controller. Although this approach may be logical, it also can be time-consuming. Instead, eliminate *stages* of the interlock circuit.

For example, make your first test at terminal A. A correct voltage reading at this point in the circuit will confirm that all of the interlock door switches are operating properly. (Needless to say, you will have to manually close any interlocks for doors that must be opened to

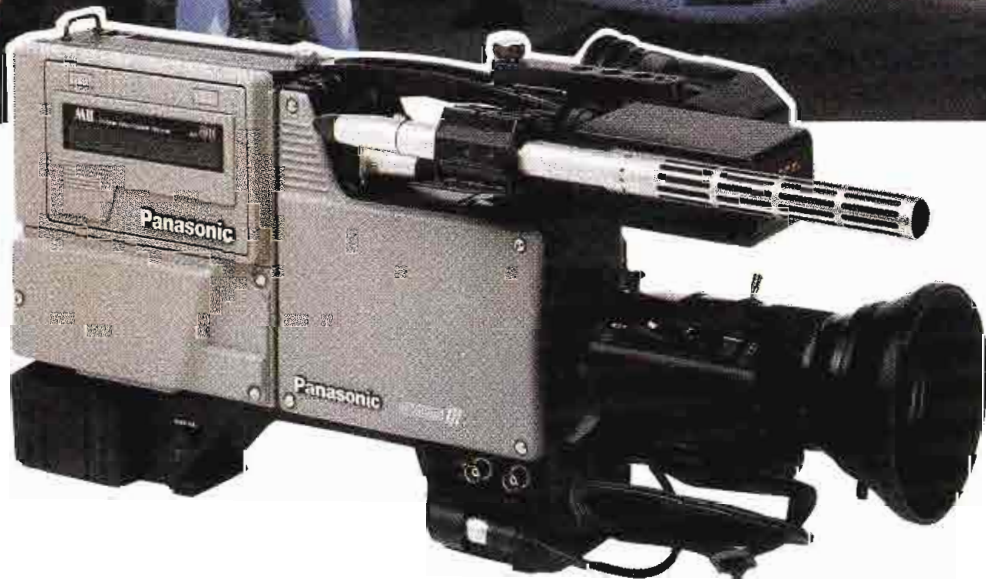

**If you use 1/2", 3/4" or any combination,
switch to MII and get high performance
and overall cost reductions.**

The MII Broadcast System is designed to enhance your ENG operations. With product like the AU-400 Camera Recorder that offers a combination of performance and capabilities never before available on 1/2".

Like multi-generation capability, playback through the view-finder, 4-channel audio, on-board time code generator/reader with selectable user bits and over 20 minutes of recording time on a compatible compact cassette. Even 90 minutes of operation with the MII Field Recorder, Field Editing and Studio VTR's. Plus performance of such high quality it can be used as an alternative to 1" C.

And with MII you have low maintenance and training costs. Tape consumption is dramatically reduced. Units are small and lightweight. Cassettes and parts inventory are interchangeable. And MII equipment is 100 percent compatible, so you can interface MII with your present system.

What's more, product is available now.

Find out how you can improve your production quality and cut your overall costs with the Panasonic MII Broadcast System.

*For more information call
(201) 348-7671.*



**Panasonic
Broadcast Systems**

Circle (63) on Reply Card

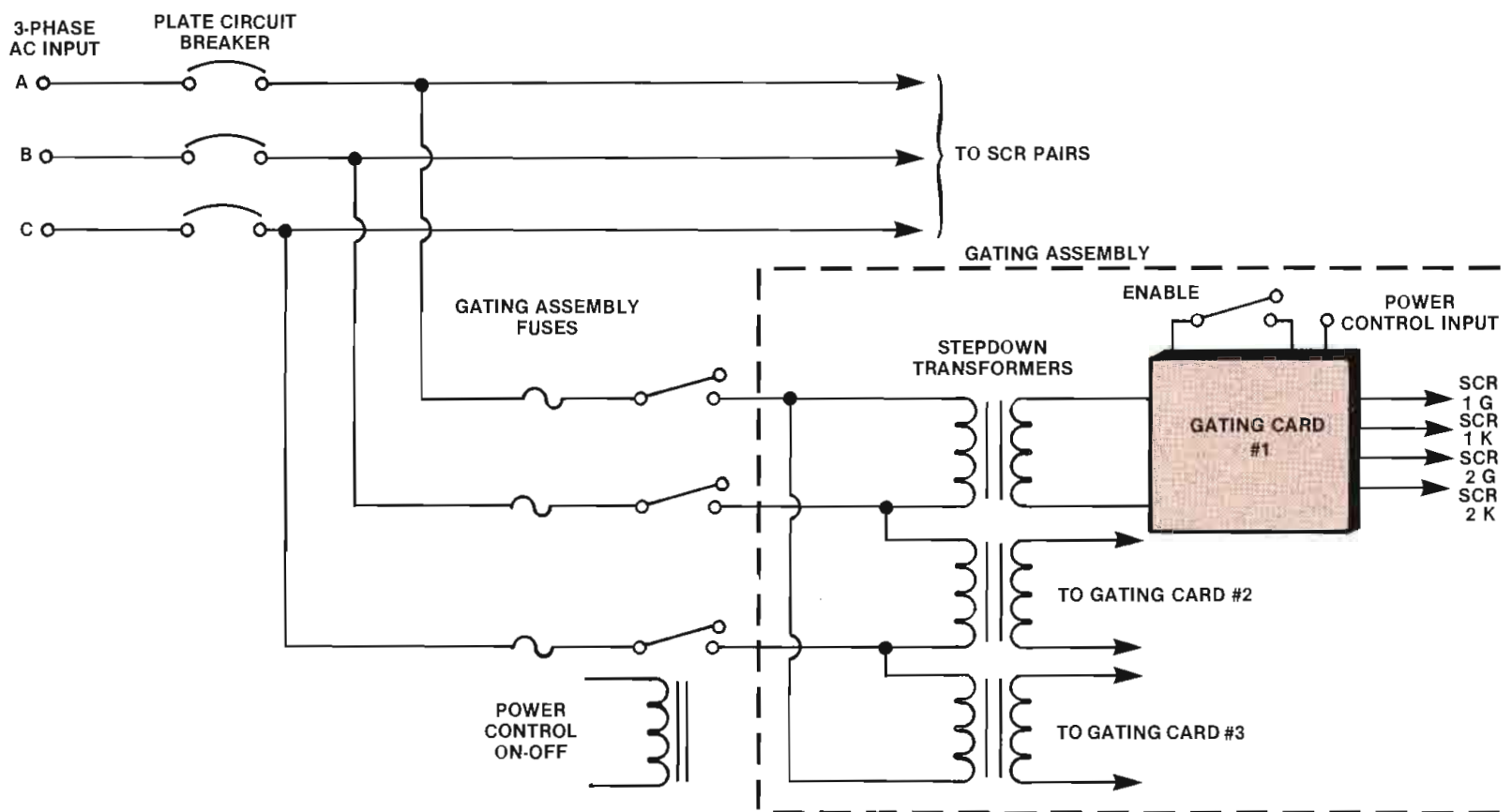

Figure 6. Block diagram of a 3-phase thyristor power control system.

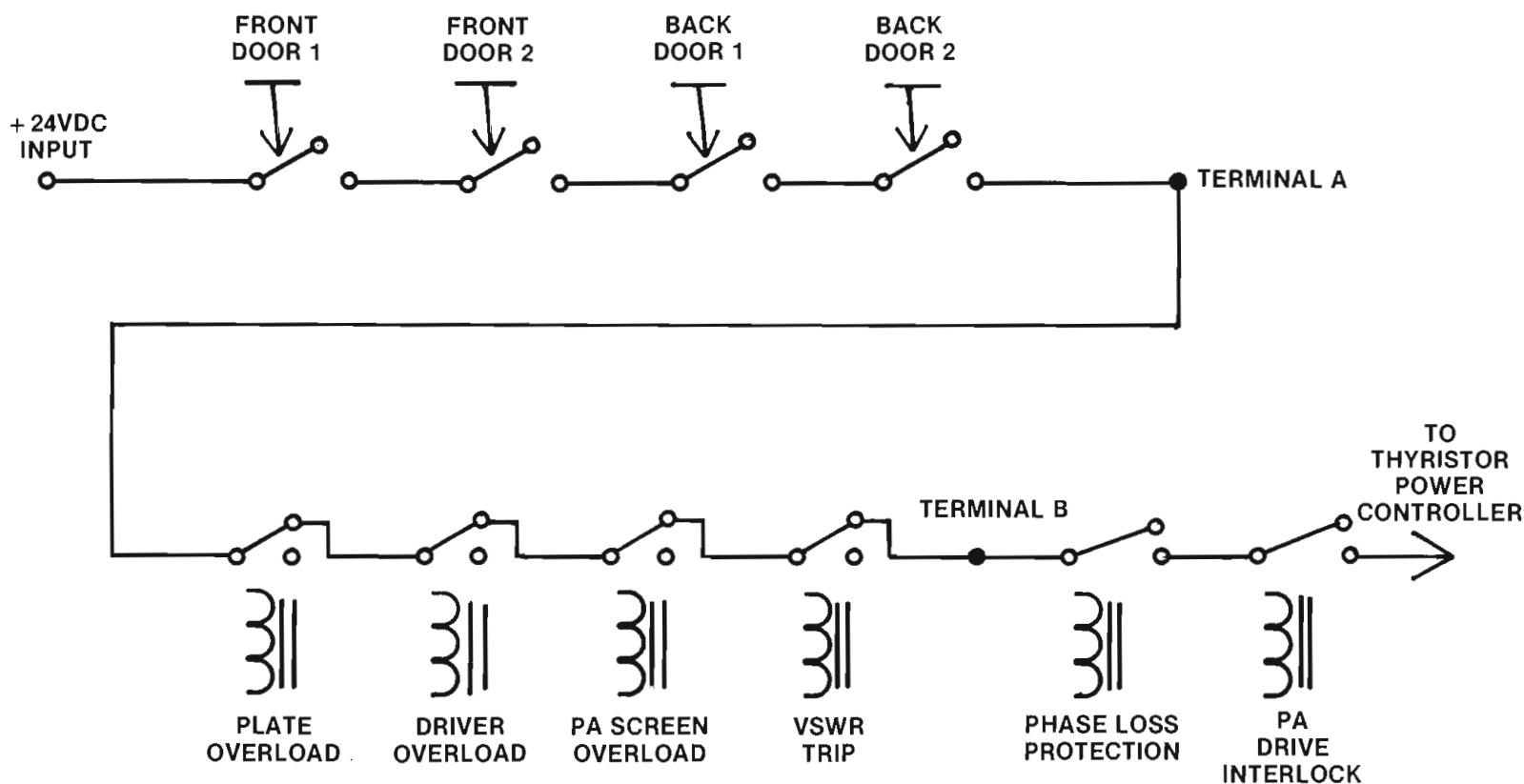

Figure 7. A typical transmitter interlock circuit. Terminals A and B are test points used for troubleshooting the system in the event of an interlock system failure.

gain access to the test terminals.)

With the knowledge that the problem is after terminal A, move on to terminal B. If your 24V supply voltage disappears, check the fault circuit overload relays to find where the control signal is lost. Often, such interlock problems can be attributed to dirty contacts in one of the

overload relays. If a problem is found with one set of relay contacts, clean all of the other contacts in the overload interlock string for good measure. Be sure to use the proper relay-contact cleaning tools. If sealed relays are used, do not attempt to clean them. Instead, replace the defective unit.

Step-start faults

The high-voltage power supply of any medium- or high-power transmitter must include provisions for in-rush current-limiting upon the application of a plate-on command. The filter capacitor(s) in the power supply will appear as a virtual short circuit during a sudden increase in

STANDARDIZE YOUR EFP SYSTEM WITH MII

voltage from the rectifier stacks. To avoid excessive current surges through the rectifiers, capacitor(s), choke and power transformer, nearly all transmitters use some form of *step-start* arrangement. Such circuits are designed to limit the in-rush current to a predictable level. Various methods can be used to accomplish this.

For transmitters using thyristor power control systems, the step-start function can be easily designed into the gate firing control circuits. An R-C network at the input point of the gating cards can be used to ramp the thyristor pairs from a zero conduction angle to full conduction (or a conduction angle preset by the user). This system provides an elegant solution to the step-start requirement, allowing plate voltage to be increased from zero to full value within about five seconds.

Transmitters employing a conventional ac power control system usually incorporate a step-start circuit using two sets of contactors: the *start contactor* and the *run contactor*, as illustrated in Figure 8. Surge-limiting resistors provide sufficient voltage drop upon application of a plate-on command to limit the surge current to a safe level. Auxiliary contacts on the start contactor cause the run contactor to close as soon as the start contacts have seated.

A fault in the step-start circuit of a transmitter is often evidenced—initially at least—by random tripping of the plate supply circuit breaker upon high-voltage turn-on. If left uncorrected, it can lead to problems such as failed power rectifiers or filter capacitors.

Troubleshooting a step-start fault in a system employing thyristor power control should begin at the R-C ramp network. Check the capacitor to see if it has opened. Monitor the control voltage to the thyristor gating cards to confirm that the output voltage of the controller slowly increases to full value. If it does and the turn-on problem persists, the failure involves one or more of the gating cards.

When troubleshooting a step-start fault in a transmitter employing the dual contactor arrangement, begin with a close inspection of all contact points on both contactors. Pay careful attention to the auxiliary relay contacts of the start contactor. If the contacts fail to properly close, the full load of the high-voltage power supply will be carried through the resistors and start contactor. These devices are normally sized only for intermittent duty. They are not intended to carry the full load current for any length of time.

Look for signs of arcing or overheating of the contact pairs and current-carrying connector bars. Check the current-limiting resistors for excessive dissipation and continuity.



If you use 1/2", 1" or any combination, switch to MII and get high performance and overall cost reductions.

The MII Broadcast System was designed to enhance your EFP operations. With product like the AU-500 Field Recorder that offers a combination of performance and capabilities never before available on 1/2".

Like over 90 minutes of recording time even in the field, multi-generation capability, field color playback, 4-channel audio, on-board time code generator/reader with selectable user bits and TBC connection. The Field Recorder also accepts compact cassettes from the MII Camera Recorder. Plus MII's performance is of such high quality it can be used as an alternative to 1" C.

And with MII you have low maintenance and training costs. Tape consumption is dramatically reduced. Units are small and lightweight. Cassettes and parts inventory are interchangeable. And MII equipment is 100 percent compatible, so you can interface MII with your present system.

What's more, product is available now.

Find out how you can improve your production quality and cut your overall costs with the Panasonic MII Broadcast System.

For more information call (201) 348-7671.



Panasonic
Broadcast Systems

Circle (64) on Reply Card

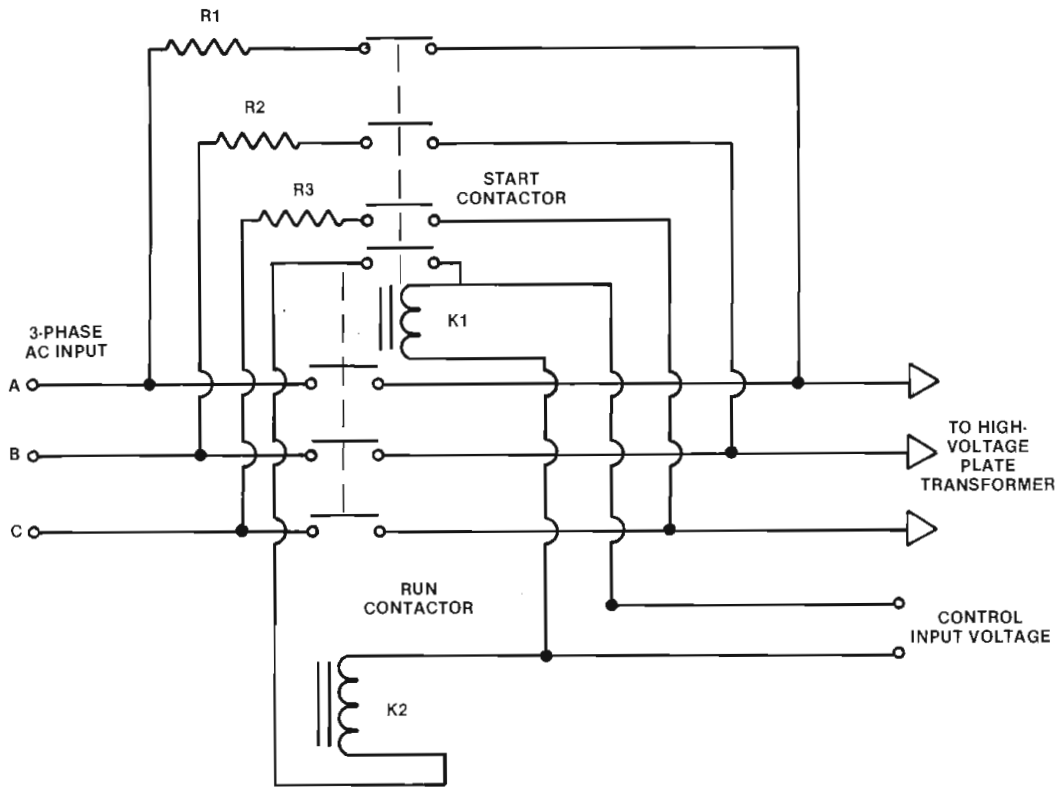

Figure 8. A typical 3-phase step-start power control system.

Protection circuits

Many engineers enjoy a false sense of security with transmission equipment because of the protection devices includ-

ed in most designs. Although conventional overload circuits provide protection against most common failure modes, they are not foolproof. The first line of

defense in the transmitter, the ac power system circuit breakers, can allow potentially disastrous currents to flow during certain fault conditions.

Consider the thyristor ac power servo system shown in Figure 9. This common type of voltage-regulator circuit adjusts the condition angle of the SCR pairs to achieve the desired dc output from the high-voltage power supply. An alternative configuration could have the output voltage sample derived from a transmission line RF pickup and amplifier/detector. In this way, the primary power control is adjusted to match the desired RF output from the transmitter.

If one of the high-voltage rectifier stacks of this system failed in a short-circuit condition, the output voltage (and RF output) would fall, causing the thyristor servo circuit to increase the conduction period of the SCR pairs. Depending on the series resistance of the failed rectifier stack and the rating of the primary side circuit breaker, the breaker may or may not trip.

Remember that the circuit breaker was chosen to allow operation at *full transmitter power* with the necessary headroom to prevent random tripping. The primary power system, therefore, can dissipate a significant amount of heat under reduced power conditions, such as

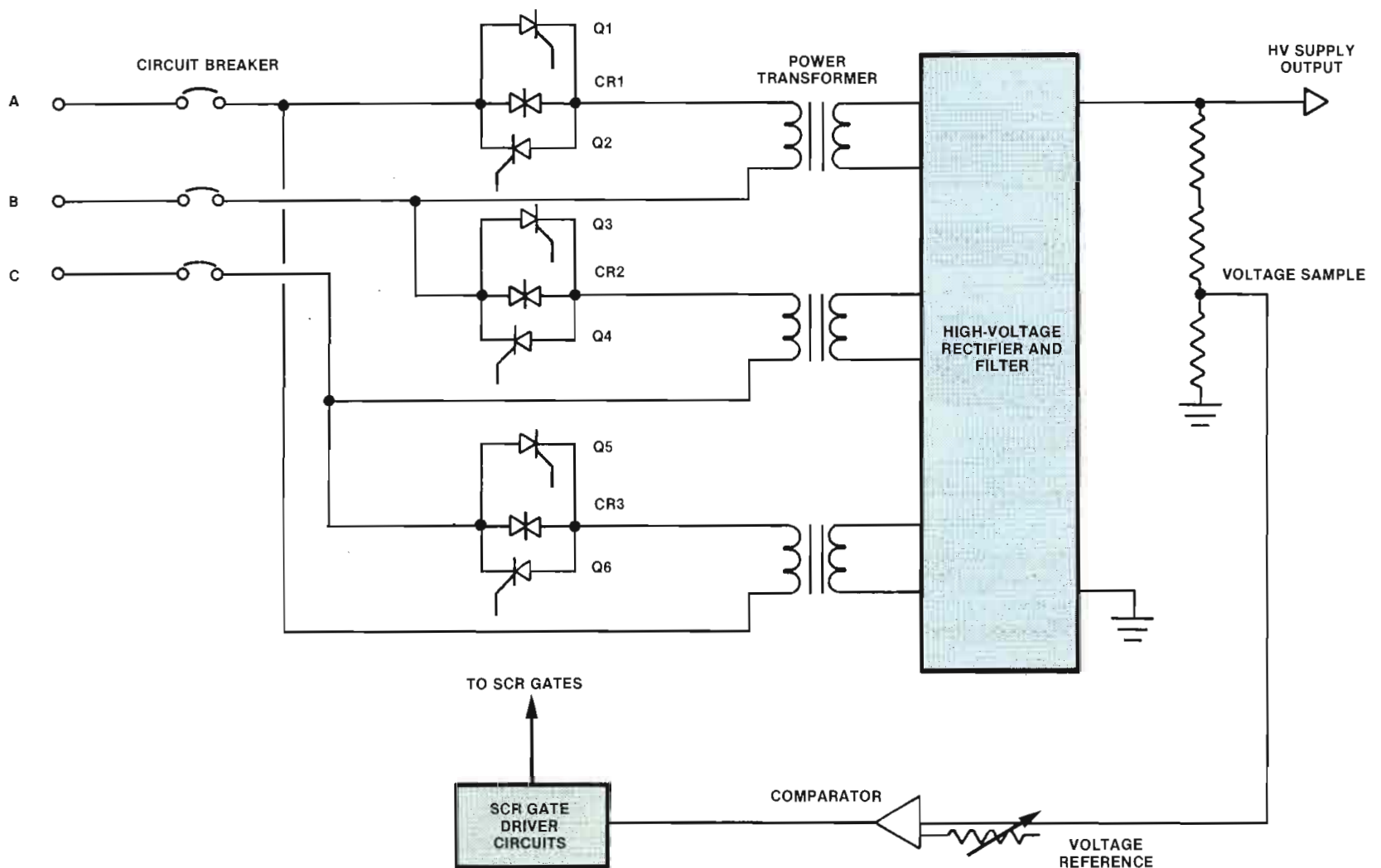

Figure 9. A common 3-phase thyristor servo ac power control system.

SUBSTITUTE YOUR STUDIO VTR'S WITH MII

those that would be experienced with a drop in the high-voltage supply output. The difference between the maximum designed power output of the supply (and, therefore, the transmitter) and the failure-induced power demand of the system can be dissipated as heat without tripping the main breaker.

Operation under such fault conditions, even for 20 seconds or less, can cause considerable damage to power supply components, such as the power transformer, rectifier stack, thyristors or system wiring. Damage can range from additional component failures to a fire in the affected section of the transmitter.

Case in point

Don't think that such a scenario is possible only in theory. I am aware of a case in which such a failure resulted in a fire inside a common radio transmitter. As far as we were able to determine, the following sequence of events led to the destruction of the unit:

- One or more transient overvoltages hit the transmitter site, causing an arc to occur within the driver stage plate transformer. The arcing continued until particles from the secondary winding broke free from the transformer.

- At this point, the driver output voltage dropped significantly, causing the RF output of the transmitter to decrease to about 25% of normal output. Because the failure occurred between windings of the secondary of the driver plate transformer (and before the driver stage over-current sensor), plate voltage remained on. Also, because of the point where the secondary winding short circuit occurred, the transformer primary did not draw sufficient current to initially trip the driver circuit breaker. As a result, ac power continued to flow to the damaged transformer.

- Small pieces of molten metal continued to drop from the driver transformer, landing on the PA plate transformer. These particles dropped into the windings, causing the plate transformer to short and starting a localized fire.

When the smoke finally cleared, the entire high-voltage power supply section of the transmitter had been damaged. Besides the two ruined transformers, logic relays were melted away, rectifier stacks were fried and most of the wiring harness was destroyed. The transmitter was determined to be damaged beyond repair.

Disasters such as this are rare, but they do occur. Be prepared to respond to any emergency by thoroughly understanding how the transmitter works and by identifying potential weak points in the system. Troubleshooting is far too important to be left to chance, or to the inexperienced. [:-:~))]]



If you use 1", switch to MII and get high performance and overall cost reductions.

The MII Broadcast System was designed to enhance your studio production. With product like the MII AU-650 Studio VTR that offers a combination of performance and capabilities never before available on 1/2".

Like over 90 minutes of recording time, multi-generation capability, on-board TBC and time code generator/reader with selectable user bits, editing functions, variable speed playback including slow and still, Dolby[®]-C noise reduction, and 4-channel audio. The Studio VTR also accepts compact cassettes from the MII Camera Recorder. Plus MII's performance is of such high quality it can be used as an alternative to 1" C.

And with MII you have low maintenance and training costs. Tape consumption is dramatically reduced. Units are small and lightweight. Cassettes and parts inventory are interchangeable. And MII equipment is 100 percent compatible, so you can interface MII with your present system.

What's more, product is available now.

Find out how you can improve your production quality and cut your overall costs with the Panasonic MII Broadcast System.

For more information call (201) 348-7671.



Panasonic
Broadcast Systems

*Dolby is a trademark of Dolby Laboratories, Inc.

Circle (65) on Reply Card

Repairing surface-mount PC boards

By Christopher Fenton

Don't attempt to remove that surface-mount device without having the proper tools and knowing the right procedures.

Today's sophisticated broadcast equipment often relies on surface-mount components. These devices provide extremely compact layout, allowing complex circuits to be entirely self-contained on a single printed circuit (PC) board. Although this is a great advantage to the user, repair of surface-mount components is complex and demands special skills and equipment. Attempting to remove these devices with the "ol' soldering iron and needle-nose pliers" can be an expensive proposition.

Unlike leaded components, surface-mount components have short, winged leads for solder attachment to the printed circuit board. This allows the components to be spaced closer together. Increased circuit density and the smaller size of surface-mount components may reduce the overall size of a PC board by as much as one-third.

Fenton is a consultant for the Western Reserve Tool and Machine Company.

Because the devices rely on closely spaced surface-mount multiple leads, rather than through-hole leads, removal can be difficult. Devices with through-hole leads can be removed by desoldering the leads one at a time. However, surface-mount leads cannot be desoldered in the same manner. Surface-mount devices can be removed only when all the solder connections between the component's connections and the printed circuit board have been reflowed—at once.

Conversely, in order to reattach a new device, all solder connections for the new component must be made at the same time. With some surface-mount package devices requiring as many as 75 solder connections, the problem becomes how to solder all of these connections simultaneously. It sounds impossible, but the process can be completed quickly and efficiently.

Currently there are two methods of removing and replacing a failed surface-

mount device: *conductive* heating and *convection* heating. Conductive heating uses a direct-contact approach to remove and to resolder a surface-mount component. Convection heating uses hot air to remove and resolder a component.

Conductive heating

Conductive heating is identical to using a soldering iron to remove and resolder components, except that all component connections are soldered at the same time. After a failed device has been located, a hand-held heated probe is used to remove and resolder it.

The heated probe has two L-shaped nickel tips that are designed to contact and reflow the solder joints on all four sides of the component simultaneously. The heating tips are mounted at the ends of two short metal tubes containing heating elements. The tubes are connected to a hinged handle similar to a pair of tongs. This tong action allows the

Continued on page 120

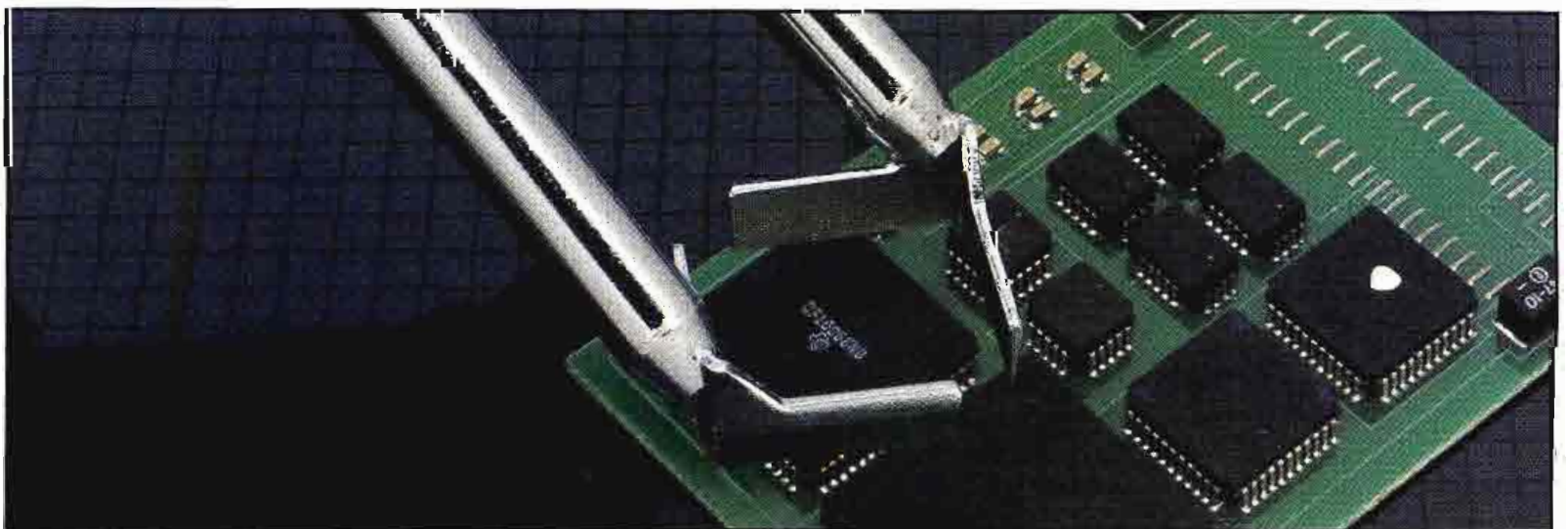

Heated probe tips come in various shapes and sizes. The probe's parallel tips allow all leads of the IC to be heated simultaneously.

Some of our Painter's exciting graphics.



Modified frames over embossed background

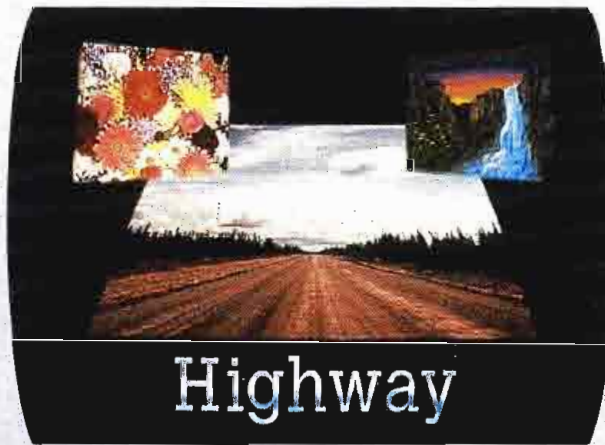

Highway

Perspective mapped video and painted frames

\$20,000

System base price



Dubner's DPS-1 Painter can store, paint and manipulate a frame of real video. All this and more for \$20,000.

Designed to meet the needs of broadcast, teleproduction, corporate and industrial users, the Painter also features: anti-aliased brushes, fonts and stencils; color and contrast correction; air,

solid, wash, fuzz, averaging, chalk, chrome, pattern and correcting brushes in 32 sizes with 100 transparency levels; millions of colors; X, Y, Z perspective mapping; 4-way color ramping; keying; posterizing; embossing; mosaic; magnify.

For more information on the DPS-1 Painter, call your authorized dealer.



DUBNER

See us at Booth 3110

Circle (67) on Reply Card

Relax! We didn't meddle with a great format. But now that Ampex is delivering Beta-cam,[™] you get a lot of things that make this great format even better, and your job a lot easier.

Our field service people will solve your problems *fast* wherever you are in the world. Reach us in the U.S.

via our technical support hotline.

Our spare parts operation makes sure you get the right parts for your needs, and will advise you of any upgrades available.

Besides parts and fast service, Ampex offers pre-packaged repair kits. These simplify maintenance, insure peak performance,

and reduce down-time. You can get kits and parts from 14 regional warehouses designed as a worldwide network, close to you wherever you are.

And if you need help in the training department, classes are taught by experienced Ampex instructors at reasonable rates.

It also is comforting to

Ampex gives you



know that when one of those real tough problems that crop up now and then comes along, you can reach right into the heart of Ampex and talk to our product specialists and product managers.

So look into *our* line of CCD and tube-type camcorders, portable recorders/players, and studio editing

VTRs. Because now you've got the best of both worlds—a reliable format that makes quality pictures, and a supplier who has a reputation for customer service and product support second-to-none. And while you're looking, you'll want to check on our complete line of NEWS-oriented products, like graphics systems, editors, ADO opti-

cal effects, "C" format recorders, and a full line of production switchers.

Atlanta (404) 491-7112 Chicago (312) 593-6000
Dallas (214) 960-1162 Los Angeles (818) 365-8627
New Jersey (201) 825-9600 (In New York (212) 947-8633)
San Francisco (415) 367-2296
Washington, D.C. (301) 530-8800
Canada (416) 821-8840

AMPEX



more Betacam.



© Ampex Corporation 1986
Betacam is a registered trademark of Sony Corporation

Circle (68) on Reply Card



For Excellence In Antennas

- A complete line of TV and FM Broadcast Antennas
- Modern 7,000 ft. test range facilities
- Innovative Engineering Careful construction
- Two Year Warranty on Product and Workmanship

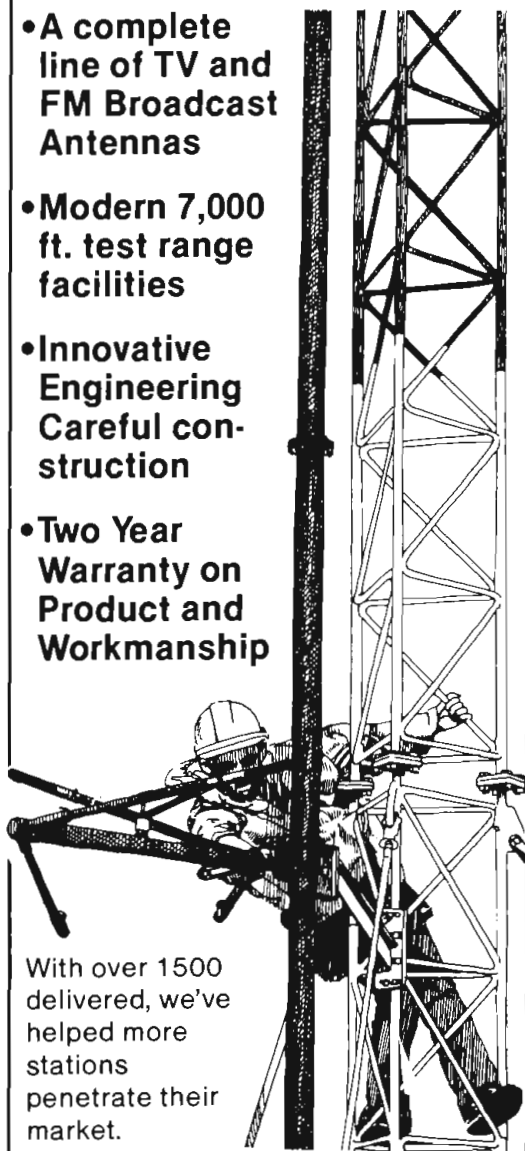

With over 1500 delivered, we've helped more stations penetrate their market.

FCC Directionals
Pattern Studies
Multi-Station Arrays
Full Scale Measurement

JAMPRO ANTENNAS, Inc.
6939 Power Inn Road
Sacramento, CA 95828

(916) 383-1177 TELEX 377321

Circle (196) on Reply Card



The control station, shown in the background, allows the probe tip temperature to be carefully controlled to prevent damage to the ICs.

Caution!

Before removing a surface-mount component (or any kind of IC) from a printed circuit board, you should ground the printed circuit board to avoid possible electrostatic discharge damage. This must be done because it is often difficult to recognize components that are susceptible to degradation or destruction without knowing the history of every component on the board. Therefore, it must be assumed that all components are vulnerable. And you must be grounded too. Use a wrist strap device, which drains electric build-up away before it can discharge through the circuit board.

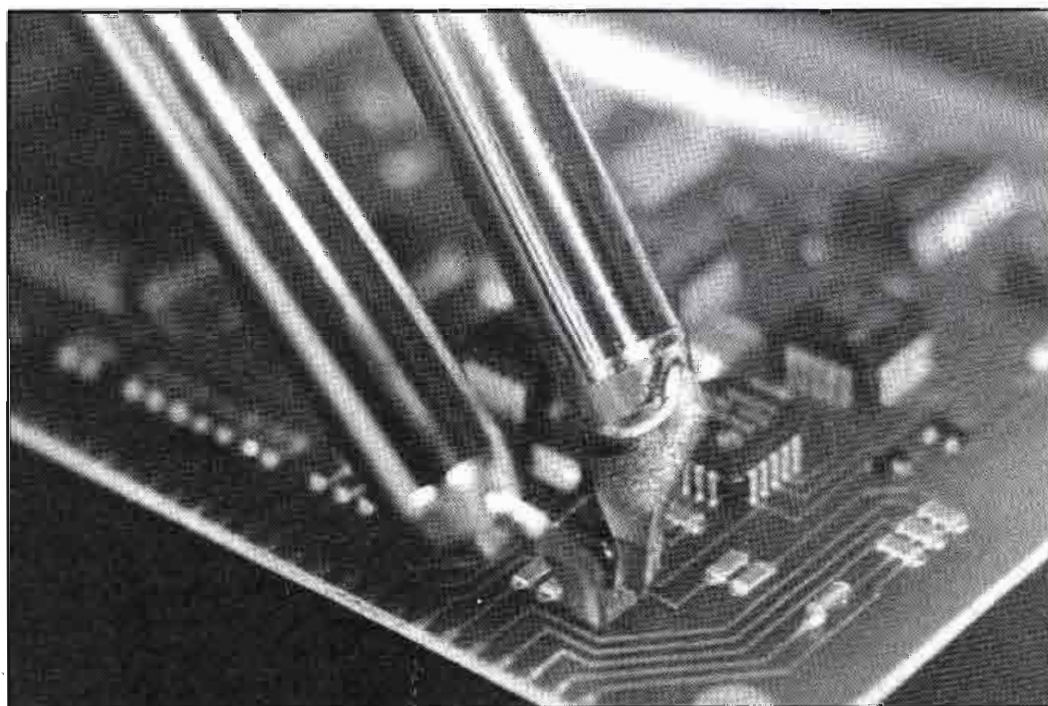

Small components, such as resistors and chip capacitors, can be removed with a parallel-tipped probe.

Continued from page 116

operator to align the tips of the heated probe to all four sides of the component package.

Heated probes are available in sizes ranging from 0.185 inches to 1.5 inches in square or rectangular shapes. Anyone who has occasion to replace surface-mount components should have several heated probes of various sizes and tip configurations.

Fast and effective component removal and replacement depends on the amount of heat transferred between the component's solder joints, substrate material and the heat source. The key is to transfer the greatest amount of heat from the heat source in the shortest amount of time to reflow solder connections quickly and efficiently.

Step by step

Inspect the *solder fillets* at the component's contact tabs and footprint junction on the board. A solder fillet is the concave junction formed by the solder between the footprint pads and the component contact tabs. If the solder fillets are small or are devoid of solder, you should add solder to the connection. Solder paste used sparingly is usually sufficient. Solder is then added to the solder fillet so that when it comes in contact with the heated probe, the solder joint will conduct as much heat as possible to the rest of the solder joint. This heat transfer immediately floods the portion of the solder fillet that is bonded to the footprint pad and results in a fast and efficient exchange of heat.

With some components, especially

TWO for the Road.

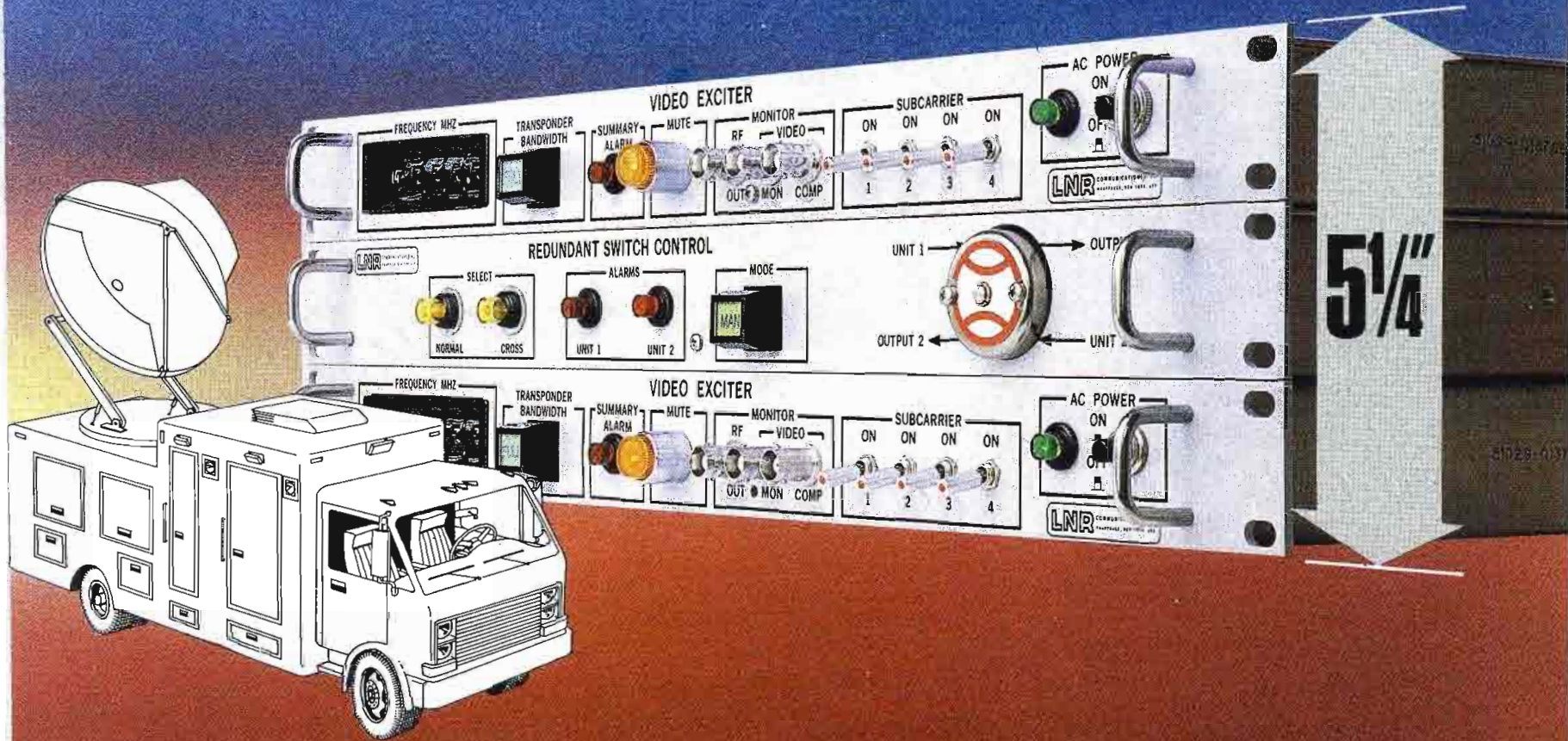

Now, LNR puts two Video Exciters and a Switch in the space of one Exciter for your SNV.

That's right! LNR's new Video Exciter is only 1 $\frac{3}{4}$ " high. Together with an automatic redundancy switch and a backup Video Exciter, the entire package fits into a 5 $\frac{1}{2}$ " slot. So you can eliminate worry about down time—even uplink two simultaneous video signals if you wish.

LNR hasn't sacrificed quality in bringing you a compact video exciter. The model LVE-14 uses a highly integrated Ku-Band RF section, together with proven, reliable video circuitry to provide RS250B performance. And, for the first time, you can go from full to half transponder operation at the press of a button.

Here are a few of the special features of the new LVE-14 Video Exciter: • Reduced size and weight • Up to 4 synthesized audio subcarriers • Full or half transponder operation • High power output: 0 dBm standard, +6 dBm optional • Compatibility with all video standards and scrambling techniques • Optional PTT and MCPC voice channels • 6 GHz version also available.

A new low package price is now available. For information on the LVE-14 or other new LNR slimline products for compact mobile applications, call LNR marketing today, or write for detailed literature.

LNR

AT THE FOREFRONT OF TELECOMMUNICATIONS TECHNOLOGY

COMMUNICATIONS INC. 180 Marcus Blvd., Hauppauge, N.Y. 11788 • Tel: (516) 273-7111 • Telex: 221620 • FAX: (516) 273-7119

Circle (69) on Reply Card

www.americanradiohistory.com

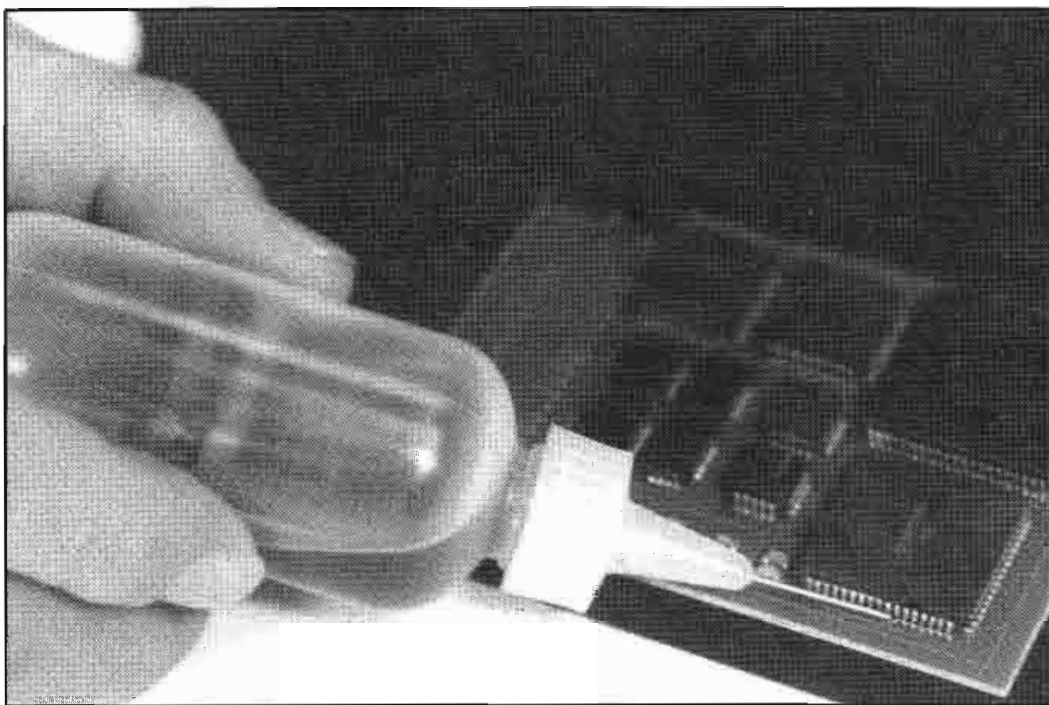

Liquid flux applied to the solder pads aids in heat transfer.

those with lead contacts narrower than the footprint pad, the solder fillet helps spread the heat to the outer edges of the solder joint. Efficient heat transfer is imperative. Otherwise, you run the risk of ruining an expensive component by lingering too long on the component

with the heated probe.

Circuit boards with ceramic substrates and boards with large heat sinks should be preheated before component removal. Preheating reduces the heat-draining effects of heat sinks and also reduces localized thermal expansion that

may crack a ceramic substrate.

Removing the surface-mount component

Before removing a surface-mount component, first secure the board in a grounded holder or place it on a grounded surface. The heated probe is plugged into a controller unit, which enables the technician to vary the probe's temperature for different types of component packages and applications.

Liquid flux should be applied to all solder points around the component. The flux not only improves the solder fillets' heat transfer characteristics, but also provides a clean surface on the board's footprint pads for soldering a new component.

Position the heated probe tips around the edges of the failed component and parallel with the board's substrate. Firmly grasp the component with the probe tips so that they contact all four sides of the failed device simultaneously. After the solder has reflowed on all joints, raise the heated probe with the failed component held between the probe tips. Because the inside tip dimensions are smaller than the outside component dimensions, the heated probe can be used to pick up the failed component.

ALAMAR Update NAB Booth #3561

ALAMAR ADDS REMOTE CONTROL TO AUTOMATION LINEUP

Alamar Leads in Net Delay/Program Playback

KSPR, Springfield, Mo., and WPWR-TV, Aurora, Ill., are the 25th and 26th North American installations of Alamar's MC-1050 Television Sequencer Systems. Broadcasters, cable systems and program originators are finding the MC-1050 the most cost-effective way to automate one-to-six independent program channels while using the general purpose record/play channel for network delay.

In the CATV field Montgomery County (Md.) Television has purchased the MC-1050, with Alamar's Schedule Manager, for its community access cable system.

As with all Alamar automation systems the SMPTE/EBU bus interface is one reason for the MC-1050's growing acceptance.

Auto-Cart Delivers Affordable Automated Programming

Auto-Cart, Alamar's newest moderately-priced VTR Sequencer, is now installed at WYZZ-TV, Bloomington, Ill., where the compact single channel system is used for commercial insertion and program playback. Auto-Cart prices begin at \$7995.

Holiday Inn Uplink Orders New RCMP Remote Panels

Hi-Net, Holiday Inn's commercial insert and movie playback joint venture in Memphis, Tenn., has purchased Alamar RCMP Remote Control Panels to handle remote access of all machines including VTRs and switchers.

Software Solutions for Media, Scheduling and Traffic

Alamar's Media Manager is a software program that offers TV news departments and production facilities a comprehensive, inexpensive way to catalog film and videotape programming. The Schedule Manager creates daily logs and down loads them to the MC-1050. And the Traffic Manager lets the MC-1050 down load files from

existing in-house traffic systems. All software is IBM XT/AT compatible. It adds up to real hardware and software automation and integration. And it's all from Alamar. The company is headquartered at 36 Railway Avenue, Campbell, Calif., 95008. Telephone is (408) 866-9373.

Circle (236) on Reply Card

Hi-Performance Communication



In A Compact, Maneuverable System

Midwest utilizes a heavy-duty structural system to combine a 1.8M dual offset-fed antenna with an extended body one-ton van. The result is a powerful satellite communications system that can maneuver easily in city traffic or on narrow country roads.

The Vertex 1.8M antenna has a transmit gain of 46.6 dbi and meets the 29-25 log θ FCC 2° spacing curves. The standard RF package includes a single thread 300 watt TWT amplifier, a Ku exciter with two agile audio subcarriers, a Ku receiver and a spectrum monitor. Modular dual 200 watt phase combined amplifiers, providing fail-safe



redundancy are optional, as are several baseband equipment packages. The S-18's spacious, acoustically treated interior provides an optimum work environment. The unit has ample storage space, and there is enough room for the addition of a VTR editing system.

The S-18 is a flexible satellite communications system, ideal for up-linking news or special events, and easily adaptable for voice and data applications.

Contact Midwest for complete information.

The Midwest S-18. Performance and Flexibility. In a compact, maneuverable package.



See Midwest at Indoor Booth #3210
and at Outside Booth #10.

Circle (71) on Reply Card



MIDWEST
Communications Corp.

One Sperti Drive
Edgewood, KY 41017
606-331-8990

A basic surface-mount glossary

With the ever-changing state of electronics technology, it helps to know exactly what you're talking about. The following is a basic primer on some of the terms associated with surface-mount technology.

•**Contacts:** The wing-shaped leads protruding from the component package body, which are electrically conductive and are used for solder attachment.

•**Dip** (dual in-package): An integrated circuit that has two rows of pins for through-hole mounting along the two longest parallel sides of the component.

•**Fillet:** A junction formed by solder between the board footprint pads and the component's contacts.

•**Footprint:** The group of board contacts corresponding to the leads of the component package to which it is soldered.

•**LCCC** (leadless ceramic chip carrier): A component package containing an IC, which is mounted to a printed circuit board as a surface-mount component. Made from a ceramic material, it is hermetically sealed and can withstand high temperatures. Instead of wire leads, it has contact tabs around the perimeter of the component package for solder attachment.

•**Pads** (lead contacts): The individual contacts of a printed circuit board's footprint.

•**Pre-tinning:** Applying solder to the component's contacts or tabs and to the board's footprint pads to improve solderability characteristics before soldering a new component in place.

•**SMC** (surface-mounted compo-

nent): A component that is mounted to the surface of a printed circuit board's substrate, instead of being soldered through plated holes, as in a standard printed circuit board.

•**SOIC** (small outline integrated circuit): A component package that houses an integrated circuit chip for surface-mounting; it is approximately one-third smaller than conventional integrated circuit packages.

•**Solderability:** The capability of solder to reflow and wet the circuit board footprint pads and the component leads during component removal and resoldering.

•**Solder reflow:** The point at which solder paste applied to both the component contacts and the board substrate footprint pads melts or reflows. The solder from both the component and substrate contacts reflows to form or to break the solder fillets depending on the repair operation.

•**Substrate:** The material that forms the base of the printed circuit board, usually made from a fiber-glass-epoxy composite or a ceramic material.

•**TCE** (thermal coefficient of expansion): The rate at which a component and substrate expand when exposed to heat, expressed in parts per million per Celsius degree (ppm/°C). The TCE of the component must be matched to the TCE of the substrate in order to minimize thermal stress from warping or cracking the printed circuit board.

•**Through-hole board:** A printed circuit board that has plated holes through its substrate in which wire leads are inserted and then soldered to the other side. This is currently the industry standard.

To remove or replace a chip capacitor, resistor or other passive component, a different type of heated probe, with parallel tips, is used. This type of heated probe is available with various length tips for removing and resoldering components that have parallel multiple-lead contacts. The basic procedure for removing and resoldering these components is the same as previously described.

Installing the replacement component

Before resoldering a new component, it's important to pre-tin the component's contacts. This ensures good solder flow between the component and substrate. Pre-tinning also replaces the solder lost when the defective device is removed from the printed circuit board.

Examine the board footprint pad for a clean solder surface and for consistently sized solder beads. Any solder bridges that may have formed during the removal procedure should be removed before resoldering a new component. If more solder is required on the footprint pads, solder paste should be applied sparingly. Too much solder paste may result in unwanted solder bridges. Too little may result in an open or weak connection.

Place the new component in position and align it by hand with the board's footprint pads. Position the heated probe tips against the component's lead contacts and push lightly against the substrate surface. When the solder has reflowed evenly on all connections, remove the tips of the heated probe and allow the surface tension of the molten solder to pull the component into final alignment with the solder fillet.

The heated probe is fast and effective. It is also the simplest way to remove a surface-mount component. Using the heated probe requires little training and removing a defective component takes an average of four seconds. Resoldering a new component takes about the same amount of time. The process does, however, require a little more dexterity than the removal procedure.

Heated probes have a limitation. Their use is limited to circuit boards with low component densities. It is impossible to operate the heated probe if you don't have room to open and close the probe's tips. For boards with high component densities, there is another method of removing and replacing surface-mount components: convection heating.

Convection heating

Convection heating uses hot air to remove and replace a failed component. Using a hot-air repair terminal (HART), the convection method preheats the printed circuit board before reflowing the solder connections for component

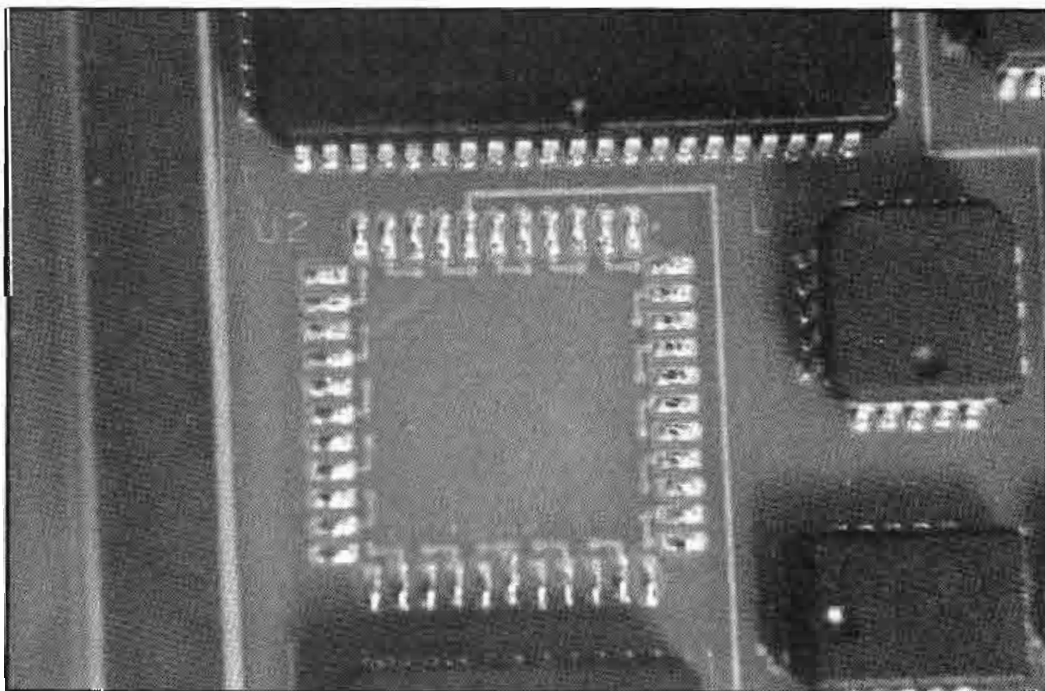

The solder pads shown here have been properly prepared for the replacement of the IC. Note the filled solder pads and lack of solder bridges.

Performance and Portability



The S-1 Flyaway — Another Midwest Innovation

It's the world's first hi-performance, truly portable Ku-band satellite uplink. Each of the 13 A.T.A. approved cases weighs less than 100 pounds, and the complete system conforms to international baggage regulations. Checked as excess baggage, the S-1 arrives when you arrive. Economically.

The system utilizes a Vertex 1.8M offset-fed antenna with a transmit gain of 46.6 dbi. This precision, aluminum surfaced reflector antenna meets the 29-25 log θ FCC 2° spacing curves.

Two STS phase combined power amplifiers provide fail-safe redundancy and plenty of reserve power. And an Intelsat-approved exciter

with half and full transponder transmit capabilities allows you to operate on any available satellite system. The S-1 can be set up fast, on-line in less than 30 minutes. And the S-1's modular electronics make system repair or replacement in the field easy.

Video and audio control and monitoring equipment are included in the standard S-1 package. Options include a 2-way communications channel, and an international receive configuration is available. The S-1 is also easily adaptable for data transmission. Contact Midwest for complete information.

The S-1 Flyaway from Midwest. Built to perform. Packaged to go... anywhere.

See Midwest at Indoor Booth #3210
and at Outside Booth #10.

Circle (72) on Reply Card



MIDWEST
Communications Corp.

One Sperti Drive
Edgewood, KY 41017
605-331-8990

The difference is what you don't hear

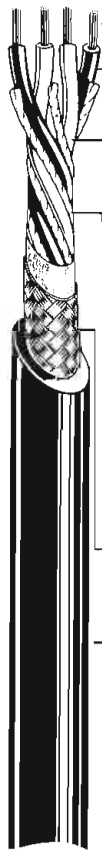

- Each inner conductor has 40 strands of small diameter (.00315") copper wire that provide maximum flexibility and avoid breakage.
- "Star-Quad" configuration with 4 inner conductors provides a substantial improvement in rejection of EMI.
- Polyethylene insulation is a better dielectric than rubber insulation, thereby reducing capacitive coupling for improved high frequency response.
- Cotton filler acts as strain relief and also reduces handling noise by preventing changes in stray capacitance.
- Very high density, braided shield blocks most static and other noise.
- Tough yet very flexible jacket can be unpacked from extreme cold and used immediately. The brittle point is -56°F (-49°C).

Available with a satin finish in 10 attractive colors to aid channel identification and / or to complement visual appearance. Fits standard XLR connectors.

You don't hear the fluorescent lights, motors, SCR dimmers, static, buzz, hum and handling noise with Canare L-4E6S. This shielded professional microphone cable is immune to electro magnetic noise due to its unique Star-Quad configuration. Compared to the leading 2-conductor microphone cable, Canare L-4E6S offers 10 times more rejection of the worst source of EMI...impulse noise from SCR dimmers. This cable blocks the noise, but not the program. Its low series resistance and low capacitance give L-4E6S extended frequency response, in mic runs of over 300 feet the 3 dB downpoint is at 50 KHZ.

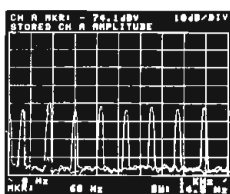

TYPICAL 2-CONDUCTOR
MIC CABLE

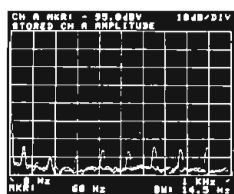

CANARE L-4E6S

CANARE T.M.

CANARE CABLE INC.

832 N Victory Blvd. / Burbank, CA 91502
(818) 840-0993

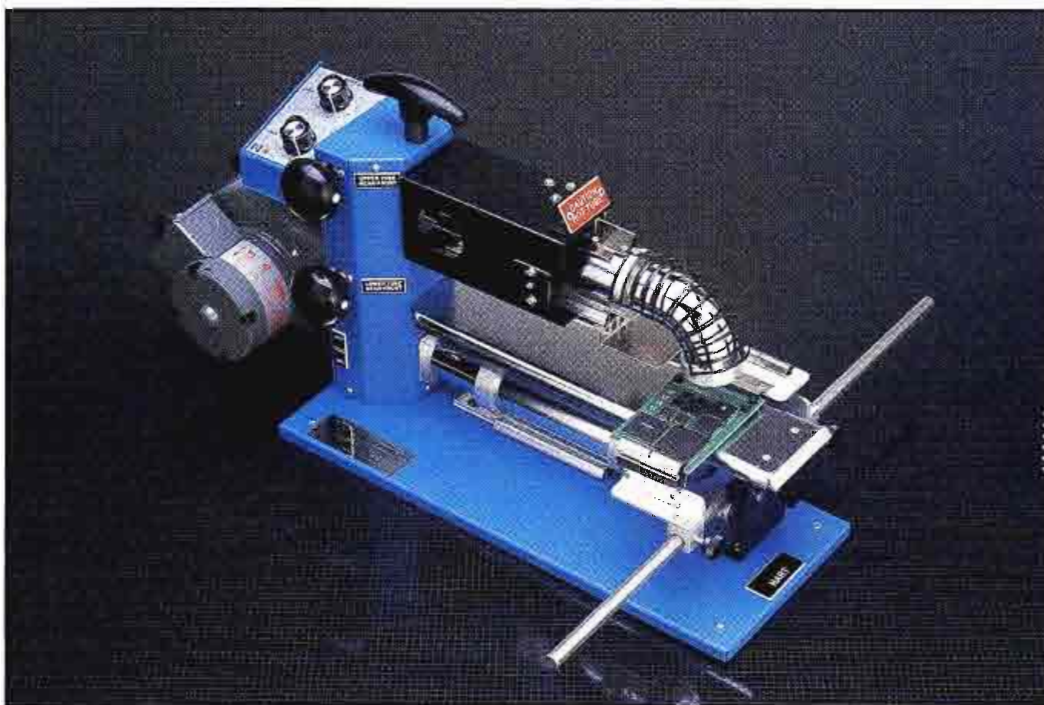

A hot-air repair terminal (HART) simplifies removal of surface-mounted ICs while protecting the board and components from heat-stress fractures.

removal or resoldering.

The convection system uses low-pressure hot air directed toward the failed component and the area surrounding the component to reflow all solder connections simultaneously. With this process, there is no direct contact between the heat source and component and board surface.

The printed circuit board is clamped into a platform between two air tubes that are connected to a blower. The top tube provides hot air to reflow the solder connections and the bottom tube directs a flow of cooler air onto the bottom surface of the printed circuit board. The cooler air prevents the circuit board from overheating, which could ruin components. The desired air temperature is set on the HART, or a temperature-indicating liquid is applied to the top of the failed component.

A temperature-indicating liquid is a milky colored fluid that becomes clear when it is heated to within 1% of its given temperature. This is the most reliable indicator of solder reflow.

After the circuit board has been secured in the machine's platform, the platform is adjusted so the component is directly in the flow of hot air from the upper tube. Components adjacent to the failed component are not susceptible to degradation or damage because the removal temperature used does not exceed the reflow temperature used during the manufacturing process.

After the machine has warmed up and after the temperature-indicating fluid has become clear, the solder fillets are molten and the failed component can be removed with a pair of tweezers. Circuit boards with large heat sinks may require more time in the airflow to compensate

for the thermal-draining effects of heat sinks. The average component removal time is approximately 25 seconds.

Before reattaching a new component, first examine the board's footprint for evenly sized solder beads and for solder bridges. If more solder is required, solder paste can be used as described previously. Solder bridges should be removed at this point.

As with conductive heating, pre-tin the component leads to ensure good solder flow between the leads and the board's footprint pads. Components can be pre-tinned by applying solder paste to the component's contacts and then placing them upside down on the platform directly in the hot airflow.

Liquid flux is then applied to the board's footprint pads. Next, the component is placed in the liquid flux by hand and generally aligned. When the component is soldered, the surface tension of the solder will float the component into final alignment with the footprint pad.

When the indicating liquid has become clear, the resoldering process is complete. If the component fails to line up correctly, it may be repositioned with a pair of tweezers while the solder joints are still molten.

With the increasing use of surface-mount components in computers and broadcast equipment, an engineer must know how to effectively remove and resolder surface-mount components in the most efficient way possible. The devices and procedures described here may allow you to repair equipment that you would have returned to the factory for service. If so, one or two repairs can more than cover the cost of the soldering equipment.

||-[:(-))]]]]

Circle (73) on Reply Card

THE GRAPHICS PACKAGE YOU HAVE BEEN WAITING FOR...

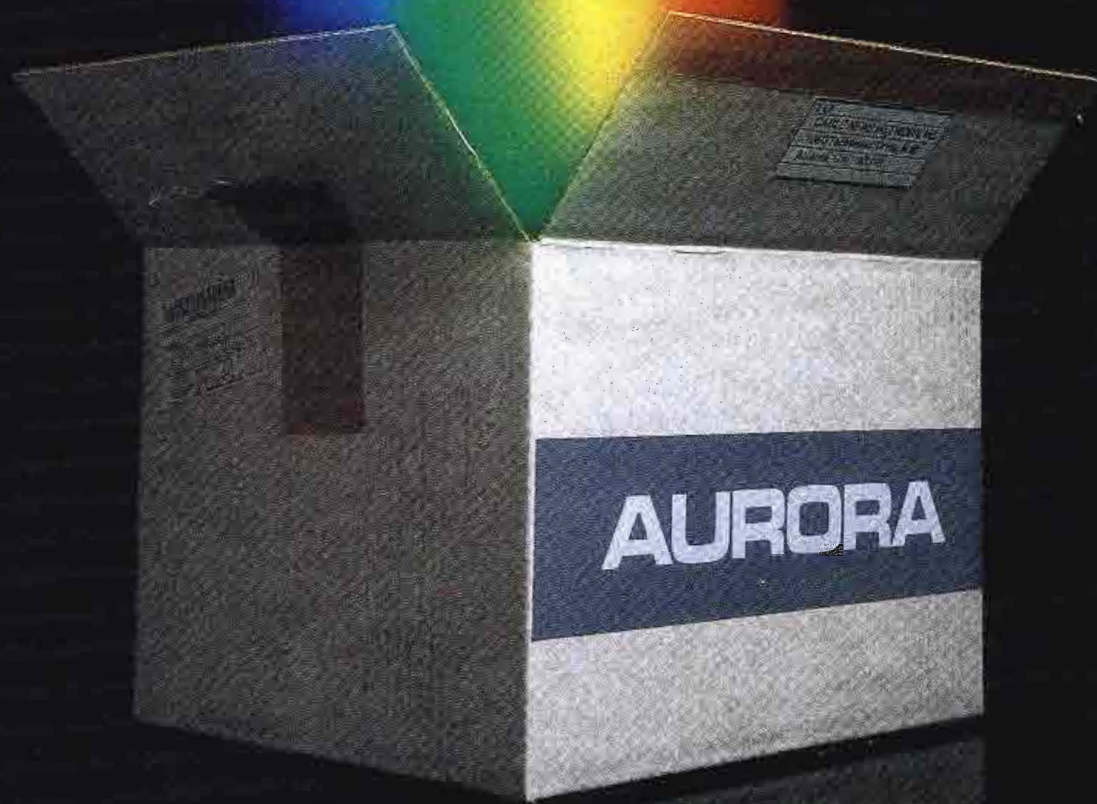

HAS ARRIVED!

Aurora Systems' new AU/200 series is the next generation in digital videographics. For the first time a system that combines all these features in one box!

- ▶ 32-bit full color
- ▶ complete paint system
- ▶ frame grab and still store
- ▶ multiple-station networking
- ▶ 3-D modeling
- ▶ compositing and matting
- ▶ vector-based font library
- ▶ real-time multiplane effects
- ▶ animation with VTR control
- ▶ automated weather graphics

Tomorrow's state-of-the-art graphics can be yours today.

Call for further information or see a full demonstration in Dallas
at NAB Booth #3592

AURORA 

185 Berry Street San Francisco, CA 94107 (415) 777-2288

Circle (74) on Reply Card

Studer A820, A812 and A810 recorders are at the leading edge of microprocessor control technology. The common design goal: unprecedented transport quickness, sonic accuracy, and production flexibility.

A New Concept – It began with the A810. Utilizing innovative microprocessor control networks, Studer engineers developed the first “computer age” recorder based on a total systems integration concept.

Extended further in the A812 and A820, this concept is now revolutionizing production and maintenance procedures in studios all around the world.

Programmable for Your Production – The old approach to recorder design had one button for one fixed operating feature. Then Studer opened a whole new realm of flexibility by making a variety of features user programmable. Greater operating flexibility was easily achieved without extra options or costly custom modifications.

Studer pioneered this concept, and today no other recorder line comes close. On the A820 and A812, for example, over forty different features can be programmed and assigned to any panel button. Even highly specialized production demands are easily accommodated. For example, three different sequences for start locate and rollback are available.

Essentially, every button on a Studer does something *you* want it to do.

Faster Set-Up – Studer was also the first to offer digital setting and storage of audio alignment parameters. Alignment parameters are keyed directly into the ma-

Studer: Leading Edge



chine or transferred via serial interface from an out-board computer. Non-volatile memory holds data for two tape formulations at all four speeds.

Interchangeable Cards – All three recorders share the same new generation of plug-in audio circuit boards. Noise and distortion specifications are significantly better than designs from just a few years back. Advanced phase compensation improves high frequency dynamics. And both transformer and transformerless inputs and outputs are available.

Systems Smart – For complex audio/video/film production systems, available options include center track time code, serial data bus, and special FM pilot and Neopilot versions.

A820: Ultimate Mastering – The fastest, smoothest, most “intelligent” tape transport ever made. Period. Available in 1/4" or 1/2" two-track versions.

A812: Mid-Sized and Sophisticated – An all-new transport with 12 1/2" reel capacity, the A812 offers the same operating system software as the A820.

A810: The Compact Pioneer – Though the smallest and lowest-priced of the three, the A810 offers the same uncompromising audio performance. Available in console, rack mount, or portable versions.

Bring Your Production to the Leading Edge – For more information on the new generation of Studer recorders, please call your nearest Studer office.

STUDER REVOX

STUDER REVOX AMERICA, INC.
1425 Elm Hill Pike, Nashville, TN 37210, (615) 254-5651

Offices: Los Angeles (818) 780-4234/New York (212) 244-4462/
Chicago (312) 526-1660/Dallas (214) 943-2239
San Francisco (415) 930-9866

Technology.



Circle (75) on Reply Card

Planning for audio post-production

By Richard Maddox

Adding A/V post-production capability to a recording studio provides the opportunity for additional revenue.

It was only a few years ago that stereo VCRs first whetted the American public's appetite for high-quality stereo audio for video. Many movie videotapes released today contain high-quality stereo audio. In addition, more broadcasters and cable programmers are supplying programming in stereo.

Network shows such as "Miami Vice," "The Tonight Show" and even sporting events are now transmitted in stereo. Cable programmers, including Showtime, The Nashville Network and HBO, now provide stereo audio to subscribers. Although seldom carried in BTSC format, stereo audio signals are often avail-

able through a cable's FM system. Today's viewer now expects even the local programming to come alive with coordinated visuals and stereo audio sound effects (FX).

The popularity of high-quality audio (and video) also has influenced corporate marketing and communications departments. Companies now look for the same flashy audio and video effects in their trade show and sales presentation tapes.

These new demands for additional audio services may mean that the typical recording studio is missing out on additional revenues. Lucrative business expansion may be possible by incorporating the tools necessary to perform video post-production work. This article will look at some of the tools required as well as other factors to consider before

entering the world of A/V post-production. Because the costs to provide these production services are high, it's not the field to enter on a snap decision.

Opportunities

If television follows the same historical path as FM, all but the smallest TV stations will eventually broadcast in stereo. The current trend indicates that many stations plan on upgrading to network stereo audio feeds. However, the cost to upgrade an entire TV facility from monaural to stereo production capability is extremely high. Some TV stations do not have the time, space or even the desire to upgrade their facilities to provide stereo production capability. Many stations may not be able to produce stereo local programming for many years.

This phenomenon has created a new market for audio recording studios. Recording studios often can become video post-production houses for these TV stations. Recording stereo audio for TV production is only one area in which the post-A/V studio can become involved. There are many other markets that can be approached:

- TV commercial post-production for advertising agencies;
- Film scoring, sound FX and post-production;
- Post-production for corporate and industrial videos;
- Music video sweetening;
- Slide show presentations; and
- Local videotape productions.

Requirements

Post-production work can be divided into two general categories. The first type of recording session uses little or no live music. The session may simply record a narrative or dialogue together with an FX loop. The second type of recording session is more complex. Often an in-house composer writes a complete score for the video. These sessions rely on standard multitrack recording techniques.

Turning a standard audio studio into

Maddox is a free-lance recording engineer, writer and technician in Lynnwood, WA.



Courtesy of Soundtrek recording studios

Video post-production requires much of the same equipment found in a recording studio.

What are the People at CRL Cooking up Now?

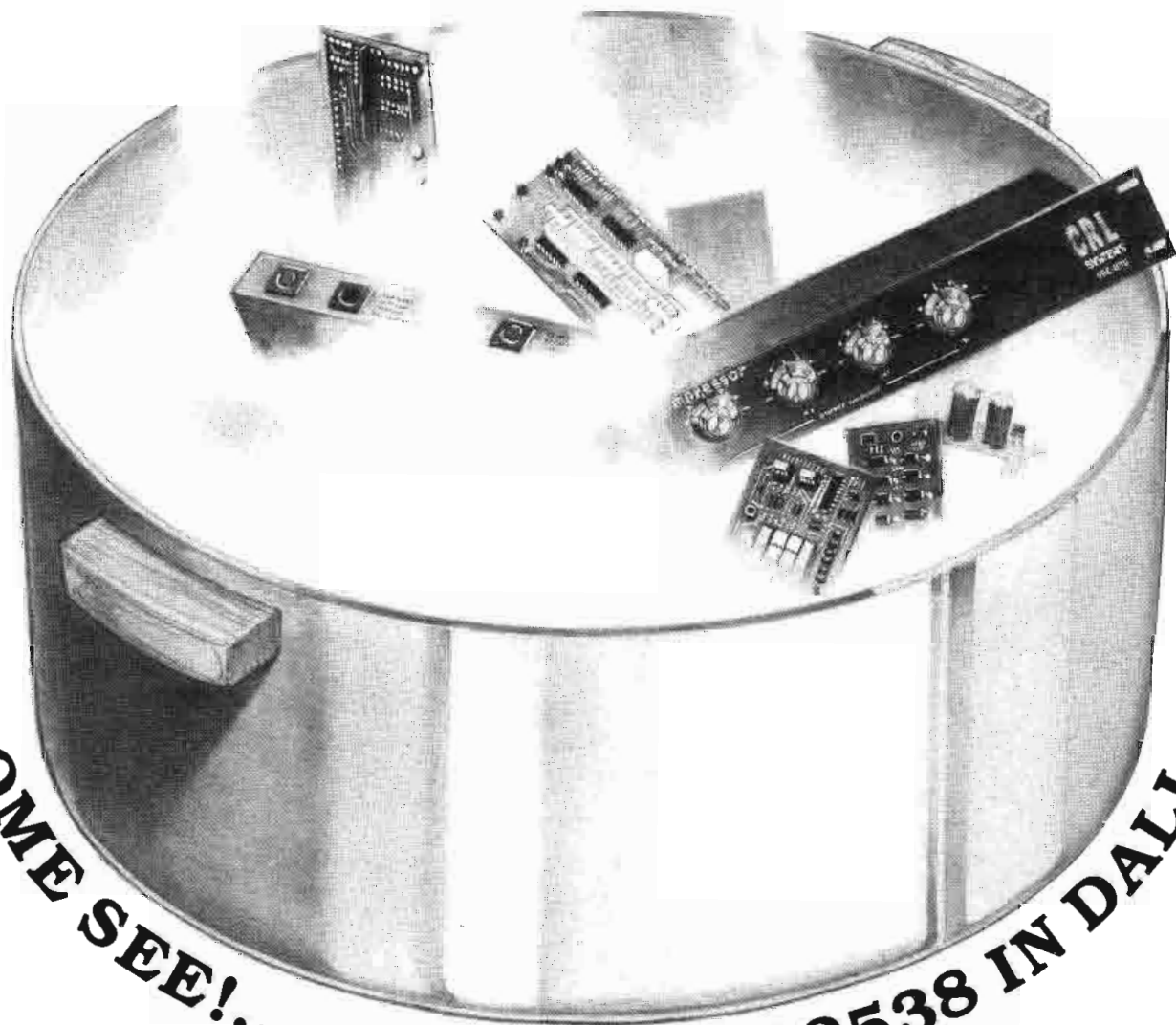

COME SEE!.....AT BOOTH 2538 IN DALLAS.

**THE
PROFESSIONAL'S
CHOICE**



CRL Systems

2522 West Geneva Drive
Tempe, Arizona 85282
(800) 535-7648 (602) 438-0888
TELEX: 350464 CRL TMPE. UD.



This control room is designed for mixdown work and does not connect to a recording studio. The SMPTE controller, located to the engineer's right, synchronizes the ATR to the edit-master or window-dub videotape.

an A/V post-production house can be expensive. At minimum, several pieces of video and synchronizing equipment are required. Some find that an entirely new studio and control room layout is needed before they can enter the field.

Beyond the equipment and studio requirements, there are marketing changes you will have to face. Successful post-A/V houses find that corporate accounts can be quite lucrative. Corporate clients, however, don't just "walk in the door." It takes a lot of sales calls, good luck and just the right timing to attract that first corporate client. Often, the corporate client is one step removed from the selection process. It may be the producer who actually selects the post-production studio.

Studio design

Studio design is constantly evolving as new information is gathered and new techniques are discovered. Throughout the 1950s and '60s the typical recording studio included a large room designed for orchestral and big band recording. The control room typically was almost an afterthought. The room was usually just large enough to hold the console, tape machines, effects racks and other ancillary equipment. If you were lucky, the room was large enough so that four or five people could cram inside to listen to a playback.

As more groups began to record in stereo and stereo imaging became important, producers realized that a good-sounding control room was as important as the studio. Thus, control rooms became larger and more accurately tuned for better sound reproduction and better stereo imaging.

At the same time, different types of instruments became popular. Electronic synthesizers, drum machines, electric pianos, electric guitars, basses and other non-acoustic devices became common to the recording studio. With an electronic (non-acoustic) instrument, it became possible to directly couple the instrument

to the mixing console. The musician no longer had to remain in the studio, but could actually work in the control room. The changes in instrumentation and the need for stereo capability helped reinforce the trend toward larger control rooms and smaller studios.

The combination of larger control rooms and smaller studios is exactly what is required for post-production work. In many instances, representatives from the advertising agency, the product manufacturer, the jingle writer, the producer and the engineer all want to be in the control room at the same time. Also, talent often is crammed into the control room during the sessions. A large, comfortable control room is paramount to a successful post-A/V studio.

Lighting is as important in video work as it is in audio work. The main thrust in video post-production room design is usually to keep reflections off the video monitor. New research indicates that the areas on either side of the monitor should be illuminated separately. Two small dimmer-controlled spotlights will help reduce the eye fatigue normally encountered in long recording sessions.

Control room lighting must not produce harsh reflections on the monitor. Any spotlights for the console, ancillary racks and the producer's area must be carefully located so glare is not produced. Ceiling-mounted spotlights are often used with good results. Track lighting mounted above the racks and producer's area or small Tensor lights also are effective.

Beyond the facilities themselves, the ambiance, professionalism and studio location often are more important factors than the equipment. This is especially true when you're wooing advertising agencies and TV stations. The people at a successful recording studio already know this.

Engineering talents

Being a good, or even great, audio recording engineer does not automatically make one a great post-A/V engineer. It seems to take a special combination of talents to successfully make the transition from audio-only to post-A/V work. Those engineers with a radio or theater sound background seem to have the best luck moving into video post-production work.

A good post-A/V engineer must be fast and, at times, willing to accept less-than-perfect audio. The engineer must be capable of patching and operating all types of ancillary gear—from limiters and equalizers to CD players—for sound FX. Although this may not seem complex, keep in mind these tasks sometimes must be accomplished in the midst of a 24-track mix, when everyone is on edge.

Finally, the engineer must be creative enough to produce FX that may exist only in the client's mind, with the facilities on hand.

Synchronization

After being involved in several film projects, the rock band the Police recorded two songs, "Synchronicity I" and "Synchronicity II." Although the songs refer to Jung's thesis about time and space, they also indicate the extraordinary importance of time when recording audio for film or video. In fact, the total emphasis of time, even down to fractions of a second, is the biggest difference between a standard music session and a post-A/V session.

Time is everything, and it is usually controlled through SMPTE time code. The time code provides hours, minutes, seconds and frame numbers for recording along with the audio tracks. Before a post-A/V session even begins, time code is recorded onto one track of the master audiotape. The time code also is recorded onto the videotape to be used in the session. The process allows both the audio and video recorders to later be synced together for a perfect time-match. (See the related story, "SMPTE/EBU Time Code," for more information.)

The time code also can be used for more than recorder synchronization. It can be used to trigger events, such as an automated mixdown sequence, and auxiliary sound sources such as cart machines, CD players, turntables and audio or video recorders.

The time code also provides time references for use in the post-production work. The producer can list edits by exact location, either by time or frame. Time code also allows the engineer to program automatic punch-ins, punch-outs and auto restarts. In a post-production setting, using time code makes life much easier for everyone.

Equipment

Post-A/V work requires several additional pieces of equipment not usually found in audio studios. The first equipment purchase should be a professional-grade ¾-inch VCR. The VCR is used to play the videotape and will be used as a guide to the location for the FX and audio cues to be recorded onto the multitrack tape.

A control room video monitor plus several portable monitors for the studio are needed. Many VCRs will drive three or more monitors, if the monitors provide loop-through circuitry. If the monitors don't have loop-through connections, then a video distribution amplifier may be needed.

To synchronize the multitrack audio-

ADD 4 NEW STUDIOS FOR DIGITAL AUDIO POST-PRODUCTION... WITHOUT BUILDING A SINGLE WALL

See
Us At NAB
Booth 228

Synclavier is a registered trademark of New England Digital Corp. © 1987 N.E.D.

A Foley Stage

Foley-style sound effect creation and editing in real time to picture, with thousands of effects on-line and instantly available.

An ADR Studio

Automatic Dialogue Replacement and editing with advanced mouse-controlled software.

A Multi-Track Recording Studio

Score to picture with a 200-track digital recorder and the most complete library of musical instruments available anywhere.

A Film-Style Mixing Studio

Up to 200 tracks of music, effects and dialogue can be independently locked to picture and controlled at a single terminal.



The Tapeless Studio™

Featuring the Synclavier® Digital Audio System and Direct-to-Disk™ Multi-Track Recorder.

The single workstation solution for today's demanding stereo post-production audio requirements.

Circle (78) on Reply Card

New England Digital White River Jct., VT, 802/295-5800 NY 212/977-4510 LA 213/651-4016

Authorized Distributors - Nashville 615/327-4343 London 202-4366 Tokyo 341-4660 Toronto 416/868-0528



To accommodate the many people who want to be a part of the recording process, today's control rooms are larger than ever before.

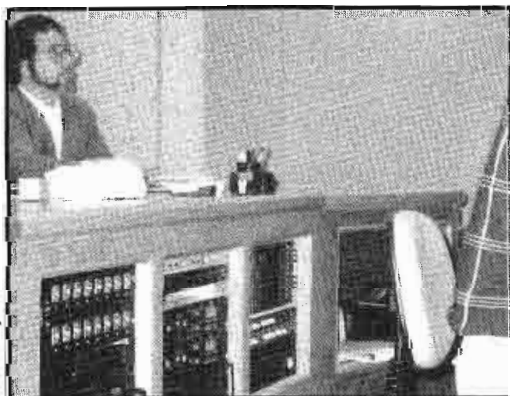

In this control room, the ancillary equipment, turntable, CD player and audio processors are located behind the engineers. The equipment rack's top surface provides working space for the producer.

tape to the VCR, a controller and the necessary interface cards for each machine are required. When purchasing the equipment, be sure each component is fully compatible with the time-code controller.

After the multitrack audiotape has been mastered, it must be mixed down to a different format. The mixed version can be recorded onto the master videotape or to a submaster audiotape. If a submaster audiotape is used, the audiotape is usually then taken to a video editing house where the audio is dubbed onto the edit master videotape.

One of two common practices is used to transfer the audio from the master audiotape to the master videotape. The most frequently used technique relies on a 1/2-inch 4-track deck with two channels allocated for audio and one channel for the time code. Some newer 1/4-inch stereo recorders can provide the same feature through the use of a center-channel time-code track.

If the recording studio wants to provide topnotch services, then a video layback deck or a 1-inch type C-format VTR can be used for the final mixdown. A video layback deck is similar to a standard 1-inch audio recorder, except the layback deck has no video provisions and only three audio tracks. Two tracks are used for recording and playing the stereo audio, and one track is used for the time code.

The video layback deck is designed to record only the audio channels. The time code synchronizes the multitrack audio recorder with the 1-inch master videotape. The original master video information is not affected during the process. Using a 1-inch VTR or a layback deck eliminates one audio generation and the inherent loss of quality. Without this equipment (layback deck or 1-inch VTR) the audio must undergo an additional recording process before it is finally transferred to the master videotape.

The process is not without its drawbacks, however. A video layback deck or a 1-inch VTR is quite expensive. Some engineers also think that because the video layback machine handles the videotape as if it were audiotape, the video signal may be affected. These engineers think that because the layback deck's tape path is so different from a VTR (with rotating video heads) the exact sound and visual sync will be affected when the tape is finally played on a 1-inch VTR. The debate rages on and probably will never be laid to rest.

To many studio owners and engineers, these objections are nothing new. However, at this point, there are few documented examples to prove either point of view.

Another objection to using a 1-inch

VTR in the post-A/V production house centers on cost. Not only is the machine itself quite expensive, but if outside maintenance help is needed, the per-hour operating cost may be prohibitive.

Ancillary audio sources are often as important to the final product as is the music. Cart machines seldom are used today for FX material. Most studios still provide at least one cart machine for clients who still rely on that format. However, many studios now rely on CD players for FX. This combination of CD player, music and FX library can provide superior music and FX for almost any production need. The new CD players provide virtually instant access to the desired cuts. When used with time-code controllers, even automatic inserts are possible.

Other important, although usually existing, equipment includes a turntable, cassette deck and a 1/4-inch deck with a complement of head stacks. The recording studio needs to be capable of accommodating 1/4-inch full-, half- and quarter-track tapes.

The process

Video productions usually are recorded either on 3/4-inch or 1-inch videotape. The individual shots are assembled and edited together onto what is called an *edit master*. The edit master often consists of one or more reels of 1-inch type C-format videotapes.

Ideally, the edit master is used only three times. It's used first to make a 3/4-inch *window dub*, second to record the mixdown audio and the third time to make multiple 3/4-inch or 1/2-inch copies for distribution.

The post-production working tape (window dub) has the time code recorded into the video (VITC) so that it can be seen on the video monitor. In addition, the tape retains the longitudinal time code from the edit-master tape. Prior to the recording session, the multitrack audiotape records one track of time code. This recorded time code allows the audio recorder to run in sync with the 3/4-inch window dub.

Once both the video and audio decks are loaded up and synchronized, the session is ready to begin. The sound bites, sound FX, dialogue and music are now recorded in sync with the video. This stage is much like a standard music recording session. The various sounds and music are each recorded on different tracks of the audio recorder.

After all the various sounds and music are completed, a mixdown session begins. The mixdown is recorded directly onto the 1-inch video edit-master tape. The time code provides the necessary signals to lock the audio and video machines together.

See us at NAB
booth #3586

"THE ODETICS CART MACHINE SET US FREE!"

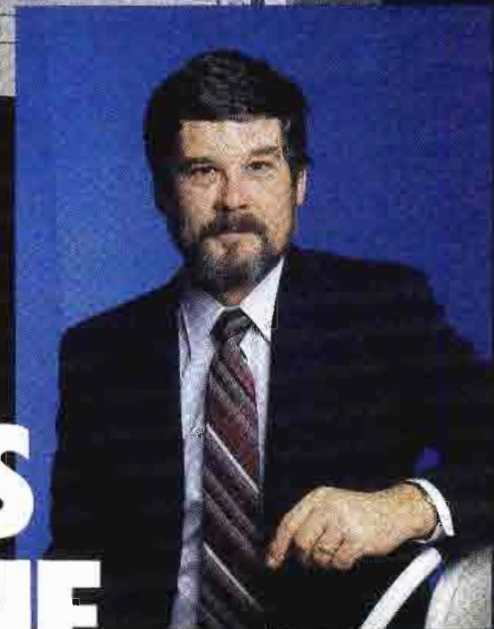

George Danner
Chief Engineer
WPEC
West Palm Beach
Florida

Now that the engineers at WPEC are free from the routine of continually handling carts, they have more time to be engineers.

As George explains:

"We air about 300 to 450 carts per 24 hour period. Before we installed the Odetics Cart Machine, our engineers had to devote a better part of their shift to filing carts and monitoring the programming system. With the Cart Machine working for us, we spend a lot less time handling carts. It means that for the first time we're free to keep a closer watch on station operations and attend to other responsibilities."

The Cart Machine can automatically manage, record and play-to-air all forms of spots and programs. Besides reducing cart handling time at WPEC, The Cart Machine's reliability allows the station to operate without dub reels. The Cart Machine even makes it simple to air the new 10 and 15 second spots.

Transfer of the daily program schedules from the traffic department is smoother because the Cart Machine interfaces with traffic computers and automatically downloads the schedules. Armed with a 65,000 cart database and 1,600 event look-ahead feature, The Cart Machine can automatically preplan spot play lists hours or even days in advance of airing.

The Cart Machine is available in your choice of small formats.

Call now and start streamlining your station operations with The Cart Machine.



The Cart Machine from Odetics

1515 S. Manchester Ave.
Anaheim, CA 92802-2907

Call toll free 800-243-2001
In California call 800-238-4422
or 714-774-2200

Circle (79) on Reply Card

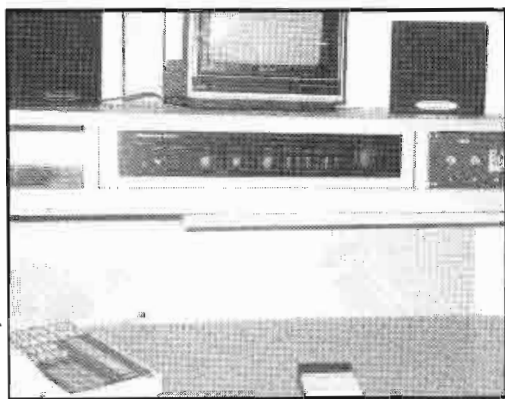

Located just outside the mixing control room, the producer's alcove provides a separate area so the producer and client can discuss the recording process without interfering with quiet needed by the engineers.

If the recording studio does not have a 1-inch machine, then the 3/4-inch window dub is used. In this case, the final mix-down is recorded to either the 1/4-inch 3-track format, which has the center time-code channel, or to a standard 4-track tape. If a 4-track recorder is used, then tracks one and two are allocated for audio, track three is left open as a buffer and track four is used for the time code. After the recording process is completed, the audiotape is returned to the video editor, who transfers the mixed audio

tracks back onto the 1-inch edit-master tape.

Potential payoff

A typical well-booked 24-track studio may find that the video post-production capabilities add from 10% to 20% to the company's overhead. Experience shows that gross revenues, even in a secondary market, typically increase by 15% to 30% within the first year. Because the first year's margin is so small, a studio must look closely at the market potential before purchasing the needed equipment.

There is a growing trend for musicians and musical groups to purchase their own portable studios. Record companies also are signing fewer new and unknown acts every year. This combination is making it difficult for all but the best-known and best-equipped studios to remain busy.

By increasing the market base, through expansion into post-A/V work, an audio studio can attract a whole new class of clients. Local advertising agencies, film and TV producers, TV and radio stations and corporate accounts are all potential new customers. Although the start-up price may be high, the potential rewards can be much greater.

SMPTE/EBU time code

Without recorded time code, many of the visuals and audio effects we take for granted today would not be possible. Early videotape editors found it quite difficult to make edits in the recorded tape. Because the recorded video images were not visible, splices often caused the image to jump or break up when later viewed. To provide error-free edits, some form of frame-identification process was needed.

In the late 1960s time-code editing systems first became available. VTR manufacturers, unfortunately, adopted different methods of coding tapes. The Society of Motion Picture and Television Engineers (SMPTE) helped develop a standard for coding tapes. The system was later adopted by the European Broadcasting Union (EBU), thereby creating a truly international standard.

Coding

Time code provides two important features for video and audio produc-



Stop by and see us
at NAB/Dallas—Booth #3345 and
our Demo Suite at Loews—Anatole Hotel!!

The Best Just Got Better...

We Have Invested In The Future.

audiopak[®] BY CAPITOL[®]

Broadcast Cartridges

FOR STATIONS WHO CARE HOW THEY SOUND!

Capitol Magnetic Products[®]

CORPORATE AND INTERNATIONAL SALES OFFICES:

6902 Sunset Boulevard Hollywood, CA 90028 (213) 461-2701 Telex: 4720854 Facsimile: 12134676550

EASTERN SALES OFFICE: 2980 Avenue B Lehigh Valley Industrial Park #1 Bethlehem, PA 18017 (215) 868-1401 Telex: 4761180 Facsimile: 12158610878

CENTRAL SALES OFFICE: 1400 Renaissance Drive, Suite 309 Park Ridge, IL 60068 (312) 298-1806

WESTERN SALES OFFICE: 3116 West Avenue 32 Los Angeles, CA 90065 (213) 254-9111 Facsimile: 2132553392

UNITED KINGDOM: 1-3 Uxbridge Road Hayes, Middlesex UB4 0TG United Kingdom 561-0922 Telex: 917029 Facsimile: 15739623

© 1987 Capitol Records, Inc.

Circle (108) on Reply Card



HHSmith. Your exclusive connection for Neutrik® precision connectors.

Today's sophisticated audio and industrial componentry is only as good as what links it all together. And it never gets as good as Neutrik brand precision engineered connectors, only from HHSmith. Advanced interconnects that receive a level of design attention usually reserved for the finest electronic circuitry.

Take our XLR straight and right angle connectors for example. Alloy gold and silver plated contacts for ease of signal flow. Hard polyester inserts, fiberglass reinforced for extra strength. A

chuck type clamp for secure strain relief without damage to insulation. And a high reliability die-cast zinc shell, finished in satin nickel or black chrome.

Or our XLR receptacles with gold or silver plated brass pins, beryllium copper contacts and easy 2-screw mounting.

There's even an X series 3 pin male/female connection system that saves you up to 50% in assembly time. Or our same-size male/female "D" series receptacles with PC board or solder spring selection, and receptacle inserts that lock in and

out for repair without shell removal.

All examples of truly precision engineering and craftsmanship. The kind that makes itself evident in every Neutrik product, including AC connectors and receptacles, phone jacks, plugs, goosenecks and transformers.

To find out more about the full line of Neutrik products, hook up with a free HHSmith catalog. Write HHSmith, 1913 Atlantic Ave., Manasquan, NJ 08736 or call (201) 223-9400 today.

DIALIGHT CORPORATION

DIALIGHT • KULKA • HHSMITH

A North American Phillips Company

Circle (81) on Reply Card

® Registered Trademark of Neutrik AG

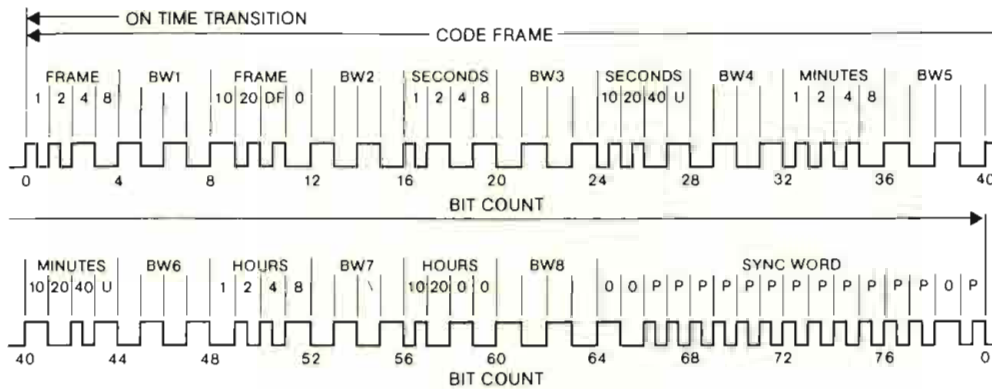

One frame of longitudinal time code contains 80 bits of information.

tion. First, time code provides a method whereby precise edit points on a tape can be located. Every point on the tape is identified by hours, minutes, seconds and frames. By specifying the in and out points, automated editing can be accomplished.

Second, time code allows multiple video and audio recorders to be perfectly synchronized. Through frame-to-frame matching, clean edits are easily made. Audio recorders synchronized to a video recorder can provide sophisticated audio recording capability. Time code makes it possible to generate 24 or even 48 tracks of audio, all perfectly synchronized to a video signal. When mixed into stereo, the result far exceeds what would be possible with only the one or two channels of audio on a video recorder.

Longitudinal time code

There are two basic types of time code: longitudinal and vertical interval timing (VITC). The longitudinal time code is an electronic signal similar to that shown above. Each second of time code is broken into 2,400 equal parts. The NTSC system of 30 frames per second (fps) results in 80 bits of information per frame. These 80 bits contain the exact time and frame number for each block of data. Because the 30fps would produce an error of 3.6s per hour, additional information is included in the data block.

This information, bit 10, is called the *drop frame*. The 3.6s equals 108 frames. Therefore, 108 frames per hour must be "dropped" if the tape is to remain time-accurate. To accomplish this feat, the time-code equipment drops two frames per minute, except for every 10th minute. If two frames per minute were dropped, then a total of 120 frames would be lost per hour. Eliminating the 10th-minute frame loss retains the required accuracy.

VITC

VITC is similar to longitudinal time code, except that additional data is

provided in each data block. As the name implies, VITC is recorded in the vertical blanking interval. Therefore, additional information is required to maintain synchronization and provide the necessary editing pulses.

VITC provides 90 bits of information per frame. In addition, each of the nine data-carrying bit groups is preceded by two sync bits. VITC also provides a field bit, bit 27. This bit allows VITC readers to index each video field, providing 1/2-frame accuracy.

Each frame of VITC also contains error-detection codes, cyclic redundancy check code (CRC). This code is common to many digital data recording systems. The CRC provides an indication if databits are lost (or added) to the bitstream, which would indicate a timing error.

Recording process

The two types of time code are recorded in different ways. Longitudinal time code is recorded on one of the VTR's longitudinal tracks, usually the audio or cue track. Separate audio tracks are used to place time code on audiotape. Because of the high recording level required, a buffer (empty) track is usually required when recording time code on audio recorders.

Longitudinal time code becomes difficult to read at high and low speeds (rewind/fast forward or slow search). At low tape speeds or stop-mode, the time-code amplitude drops below the ambient noise level or may even disappear completely. For this reason, equipment must be in top operating condition if the time code is to be accurate.

Many of the reading problems associated with longitudinal time code are solved by VITC. Because helical scan VTRs rely on rotating heads, it is possible to view pictures at almost any speed, including freeze-frame. Longitudinal time code disappears when the tape stops. However, by recording the time-code information in the vertical blanking interval, the time-code information is available whenever the VTR head is spinning.

VITC is normally recorded on two non-adjacent vertical blanking interval lines in both fields of frames for lines 10 through 20. Recording four times per frame provides a redundancy factor, lowering the possibility of reading errors.

Another advantage of VITC is that once it is recorded, it becomes an integral part of the video signal. No special treatment or routing is required.

Acknowledgment: Information obtained from "SMPTE/EBU Longitudinal & Vertical Interval Time Code," Convergence Corporation/EECO, Santa Ana, CA.

VITC

VITC BIT NO		BIT NO
0	"1"	0
1	"0"	1
2	1	2
3	2	3
4	4	4
5	8	5
6		6
7		7
8		8
9		9
10	"1"	10
11	"0"	11
12		12
13	10	13
14	20	14
15	DROP FRAME FLAG	15
16	COLOR FRAME FLAG	16
17		17
18		18
19		19
20		20
21	"1"	21
22	"0"	22
23	1	23
24	2	24
25	4	25
26	8	26
27		27
28		28
29		29
30	"1"	30
31	"0"	31
32	10	32
33	20	33
34	40	34
35		35
36		36
37		37
38		38
39		39
40	"1"	40
41	"0"	41
42	1	42
43	2	43
44	4	44
45	8	45
46		46
47		47
48		48
49		49
50	"1"	50
51	"0"	51
52	10	52
53	20	53
54	40	54
55		55
56		56
57		57
58		58
59		59
60	"1"	60
61	"0"	61
62	1	62
63	2	63
64	4	64
65	8	65
66		66
67		67
68		68
69		69
70	"1"	70
71	"0"	71
72	10	72
73	20	73
74		74
75		75
76		76
77		77
78		78
79		79
80	"1"	80
81	"0"	81
82		82
83		83
84		84
85		85
86		86
87		87
88		88
89		89

Vertical interval time code contains 90 bits of information. The additional data aids "housekeeping" chores and provides field, rather than frame, edit capability.



BROADCAST
ENGINEERING
CONFERENCE

Don't miss it:

***The second annual SBE
National Convention
and
Broadcast Engineering
Conference***

Plan now to attend the working engineer's convention. View the latest in broadcast equipment from leading manufacturers. Attend technical sessions designed to provide practical answers for the problems faced by broadcast engineers. Building on last year's outstanding success, the 1987 convention will provide more exclusive exhibit hours and an outstanding line-up of the industry's best technical experts.

The SBE National Convention and **Broadcast Engineering** Conference — the *must-attend* event for this fall.

***A.J. Cervantes
Convention Center
St. Louis
November 10,11,12***

FIELD PRODUCTION

A special job demanding specialized products.



For your audio needs: a growing line of compact, easy-to-use FP amps and mixers.

Shure FP products are built specifically for ENG, EFP, film, and video work. They're not general audio products that "might" work on remotes. And no one offers as wide a selection with this kind of built-in ruggedness and reliability.

FP32



FP42



For Stereo Remotes. The FP32 Stereo Mixer is comparable in size and features to our famous FP31. Its stereo capability, light weight, easy-to-use controls and convenient shoulder harness make it the first choice of field crews. Our FP42 Stereo Mixer simplifies mic cueing, so important in situations like sports remotes. Plus it enables

you to easily mix down stereo in your post production booth. It offers all the features of the popular M267 plus stereo capability and a stereo headphone amp.

FP31



FP16



The Industry Standards. The FP31 is Shure's original field production mixer. Thousands bet their audio on it worldwide. The FP16, a one-by-six distribution amp with transformer balancing and link jacks, outperforms all competition. It's also ideal as a portable press bridge.

FP11

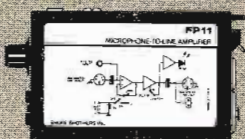

FP12

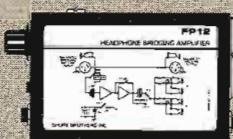

For Long Yardage Situations. The FP11 Mic-to-Line Amp provides freedom from noise in long line situations, with up to 84 dB of gain in 15 6-dB steps. It converts any mic to line level and includes an invaluable limiter circuit. The FP12 Headphone Bridging Amp is a must for shotgun and boom operators. It keeps them on target without need for a return line. It's ideal for multiple headphone feeds, troubleshooting, and as an intercom.

For more information on the entire FP line, call or write Shure Brothers Inc., 222 Hartrey Avenue, Evanston, IL 60202-3696. (312) 866-2553.

Come See Us
At Booth #3320
At The NAB Show

SHURE

Breaking Sound Barriers™

Circle (52) on Reply Card

3/87-BE-FP

To a tape as tough as Maxell 1/2" BQ,
it was just like any other...



DON'T MISS OUR **SNEAK PREVIEW** AT NAB BOOTH #3551. ALL THE
NEWEST STARS: DAT, PCM AUDIO TAPES, **MI** VIDEOTAPE, **8MM** VIDEOTAPE
AND EVEN **BETACAM** TAPES! THIS IS A **MAJOR EPIC PRODUCTION**,
SO BE THERE, OR BE SQUARE. **BOOTH #3551**, NAB, MARCH 28-31.

ANOTHER MAJOR STUDIO RELEASE FROM

maxell
PROFESSIONAL/INDUSTRIAL DIVISION

SEE YOU AT NAB
BOOTH #3551



Exhibitor listings

More than 35,000 people from the broadcast and production industry will make an annual pilgrimage to the annual NAB convention. As in 1986, the 1987 site is Dallas. If you already haven't made housing arrangements, you may have difficulties locating a room within a reasonable driving distance.

This greatest show on earth for the broadcast industry has its moments of circus atmosphere. True, the show is not all business, but it is not all ballyhoo, either. There is as much business conducted during the show as is written the rest of the year. The show is also a chance to see old faces and to chat with friends that you may not have seen since last year's show.

Above all, NAB is the chance to see many of the newest products the manufacturers have to offer. And even more important, the exhibition allows you to compare them side by side. But there is so much that is being introduced, there is no way for one person to see everything.

BE's lists of exhibitors and new products will make it easier to find what you want. You probably aren't interested in every product from a specific manufacturer, but you may want to survey all the available models of a particular product type. That is the concept behind this year's presentation.

This alphabetic exhibitors' list contains booth numbers and generic notes of products expected to be exhibited. Asterisks (*) by key words alert you that the company has a new product in that category, if the company has been able to share that information with us. A Reader Service number is provided with each listing. To get information from a manufacturer, circle the appropriate number on the Reader Service Card bound into the back of this issue.

Many companies that will be at the show are advertising in this issue. For these entries, a colored page reference, "See ad page XX," has been provided, so you can get information immediately.

If you want to find out about a specific product, you will find "New at NAB" helpful. This section contains listings of new products by category, arranged alphabetically by company.

"New at NAB" begins on page 214.

To find out where to go once you get to the show, refer to the annual NAB map, bound into this issue. Both convention floors are included, with an alphabetical listing of all the exhibiting companies.

A final word: Every effort has been made to make sure that all the information is as complete and accurate as possible. Because of early production dead-

lines, some information may have changed. Refer to your show program for the final list of companies, and be sure to look for **BE's** revised floor map when you get to the show.

Aarmor Cases (2781)
Equipment transportation, protective cases, containers.
Circle (501)

Abekas Video (3527)
Digital video effects systems; real-time digital disc recorder; still store systems.
Circle (502) [See ad page 95](#)

Accu-Weather (2529)
*Weather graphics equipment, data, maps.
Circle (503)

Acoustic Systems (2786)
Acoustic treatments; prefabricated broadcast booths, studios.
Circle (504) [See ad page 102](#)

Acrodyne Industries (3521)
High, medium, low power TV *transmitter, translator systems.
Circle (505)

Adams-Smith (2495)
Videotape, audio editing controllers; time code products; machine synchronizers.
Circle (506)

Canon Quality. Canon Value.

Now available in a full line of camera support products.

MC-200/MC-300 PEDESTALS



Featuring Canon's sophisticated Modular Cassette Counterbalance (MCC) system that makes them far lighter and more mobile, Canon pedestals also feature a very short mounting height, making them ideal for low-angle shooting.

MC-200
Maximum Mounting Weight: 286 lbs.
Elevation: 24-49 inches
MC-300
Maximum Mounting Weight: 242 lbs.
Elevation: 23-60 inches

TR-60/TR-90 TRIPODS



Featuring collapsible tubular leg construction, integral spreaders, flip-tip legs with spikes and rubber padding.

TR-60
Maximum Mounting Weight: 132 lbs.
Elevation: 20-45 inches

TR-90
Maximum Mounting Weight: 198 lbs.
Elevation: 26-48 inches

SC-15 CAM HEAD

Designed for use with all pedestals and tripods, it features a convenient "V" wedge mounting system and center-of-gravity adjustment control. The modular panning rod may be used on both sides.

Maximum Mounting Weight: 330 lbs.
Tilting: $\pm 50^\circ$; Panning: 360°

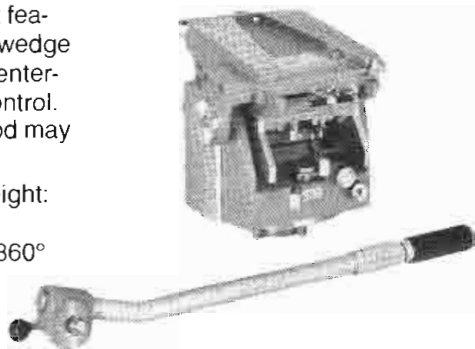

CD-10 DOLLY

Designed for use with both Canon tripods, features a tricycle caster undercarriage that enables both free and single-direction movement.

Maximum Mounting Weight: 198 lbs.

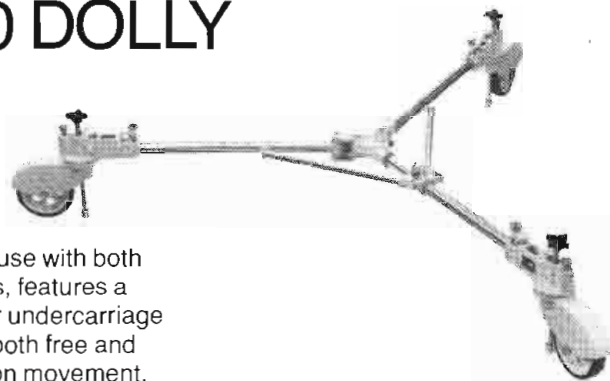

For years, broadcasters have made Canon lenses a top choice for studio, field and news production because they know and trust Canon's proven commitment to quality and value.

Now Canon is proud to introduce a complete, full-featured, high-quality camera support system, built to the same high standards and backed by the Canon service network.

Canon[®]

Please see us at
Booth #3300

Optics Division

Canon USA, Inc., Head Office: One Canon Plaza, Lake Success, NY 11042 (516) 488-6700
Dallas Office: 3200 Regent Blvd., Irving, TX 75063 (214) 830-9600. Chicago Office: 100 Park Blvd., Itasca, IL 60143 (312) 250-6200
West Coast Office: 123 Paularino Avenue East, Costa Mesa, CA 92626 (714) 979-6000
Canon Canada, Inc., 6390 Dixie Road, Mississauga, Ontario L5T1P7, Canada (416) 678-2730

© 1985 Canon U.S.A., Inc.

Circle (84) on Reply Card

www.americanradiohistory.com

Canon Broadcast

Designed to meet all your



PV40x13.5BIE para cámaras de 30 mm y 25 mm. La Olímpica — puesta a prueba en los Juegos Olímpicos de 1984. Su alcance de 40X es ideal para toda clase de transmisiones deportivas y al aire libre. Distancia focal: 13.5-540 mm (27-1080 mm con extensor incorporado)
Apertura relativa máxima*: 1:1.7 hasta 270 mm
1:2.8 en 540 mm

*formato de 25 mm



P18x15BIE para cámaras de 30 mm y 25 mm. Máxima amplitud. Un ángulo panorámico de 60° y una nitidez, fidelidad y sensibilidad extraordinarias, de borde a borde. Equipada con extensores incorporados de 1.5X y 2X y de un proyector de imagen. Distancia focal: 15-270 mm (390-540 mm con extensor de 2X)
Apertura relativa máxima*: 1:2.1 hasta 218 mm
1:2.7 en 270 mm

*formato de 25 mm



PV14x12.5BIE Lente de alta resolución para cámaras de 30 mm y 25 mm. Diseño singular en el cual se destaca el uso de elementos ópticos de fluorita. Esta lente de 14X, ligera y compacta, tiene alta sensibilidad y una nitidez absoluta en todas las distancias focales. Ideal para tomas en estudio. Distancia focal: 12.5-175 mm (con extensores incorporados de 1.5X y 2X)
Apertura relativa máxima*: 1:1.6 para todas las distancias focales

*formato de 25 mm



J15x8.5BIE para cámaras de 2/3". Economía con cámaras de 2/3". Para toda clase de tomas en estudio, esta lente combina un objetivo de distancia focal regulable de 15X con una M.O.D. de menos de dos pies, un ángulo panorámico de 54° y alta sensibilidad en todo su alcance. Distancia focal: 8.5-128 mm (17-256 mm con extensor incorporado)
Apertura relativa máxima: 1:1.6 en todas las distancias focales



J18x9BIE para cámaras de 2/3". Mayor alcance, menor peso. Nada se compara con la potencia de esta lente con enfoque ajustable de 18X. ¡Y pesa menos de 4 libras! Realza la flexibilidad de cualquier cámara portátil. Distancia focal: 9-162 mm (18-324 mm con extensor de 2X)
Apertura relativa máxima: 1:1.7 hasta 116 mm
1:2.4 en 162 mm



J14x8BIE Lente de alta resolución para cámaras de 2/3". Super angular (60°) y extra nitida en toda su extensión. Esta lente compacta tiene también un objetivo regulable de 14X y un extensor de 2X incorporado. Distancia focal: 8-112 mm (16-224 mm con extensor incorporado)
Apertura relativa máxima: 1:1.7 hasta 91 mm
1:2.2 en 112 mm

Television Lenses. needs. Now and in the future.



J45x9.5BIE para cámaras de 2/3"
¡Incredible alcance de 45X para sus cámaras de 2/3"!
Perfecta para toda clase de transmisiones deportivas
y al aire libre.
Distancia focal: 9.5-430 mm (19-860 mm con
extensor incorporado)
Apertura relativa máxima: 1:1.7 hasta 201 mm
1:3.0 en 430 mm



J25x11.5BIE para cámaras de 2/3"
Mayor alcance. Una lente con enfoque ajustable de
25X, especialmente diseñada para las cámaras de
2/3". La potencia y el alcance de los sistemas de 1"
combinados con la economía y eficiencia de las
cámaras de 2/3".
Distancia focal: 11.5-288 mm (23-576 mm con
extensor de 2X)
Apertura relativa máxima: 1:1.6 hasta 220 mm
1:2.1 en 288 mm



J20x8.5BIE para cámaras de 2/3"
Doble función — use una lente de 13X con enfoque
ajustable para la recolección electrónica de noticias
(ENG) y la J20x8.5BIE para transmisiones en
estudio o al aire libre... ¡con la misma cámara de 2/3"!
Distancia focal: 8.5-170 mm (17-340 mm con extensor
de 2X)
Apertura relativa máxima: 1:1.6 hasta 130 mm
1:2.1 en 170 mm



J13x9BIE para cámaras de 2/3"
La portátil estándar preferida por los camarógrafos
de todo el mundo en cualquier situación. La
J13x9BIE es de comprobada eficacia, gran nitidez y
alta sensibilidad.
Distancia focal: 9-118 mm (18-236 mm con extensor
de 2X)
Apertura relativa máxima: 1:1.6 hasta 99 mm
1:1.9 en 118 mm



J15x9.5 para cámaras de 2/3"
Calidad y economía. No se puede conseguir una lente
de esta calidad por menos dinero. Ligera y sensible,
responde por igual a las exigencias del camarógrafo o
del contador, manteniéndose siempre a la altura de la
marca Canon.
Distancia focal: 9.5-143 mm
Apertura relativa máxima: 1:1.8 hasta 112 mm
1:2.3 en 143 mm



J8x6B Lente ultrapanorámica para cámaras
de 2/3"
La más amplia de las cámaras de total amplitud
angular de lente telescópica de 72.5"; esta, increíble
lente de 8X posee también un mod de sólo 11" — ¡Es
ideal para entrevistas!
Distancia focal: de 6-48 mm
Apertura relativa máxima: 1:1.7 hasta 33 mm
1:1.9 en 48 mm

Canon

Optics Division

Canon USA, Inc., Head Office: One Canon Plaza, Lake Success, NY 11042 (516) 488-6700
Dallas Office: 3200 Regent Blvd., Irving, TX 75063 (214) 830-9600. Chicago Office: 100 Park Blvd., Itasca, IL 60143 (312) 250-6200
West Coast Office: 123 Paularino Avenue East, Costa Mesa, CA 92626 (714) 979-6000
Canon Canada, Inc., 6390 Dixie Road, Mississauga, Ontario L5T1P7, Canada (416) 678-2730

Please see us at
Booth #3300

Circle (85) on Reply Card

© 1985 Canon U.S.A., Inc.

www.americanradiohistory.com

ADC Telecommunications (2819)

*Patch panels, designation strips; patch cords, connectors; hum-stop coils.
Circle (507) [See ad pages 212-213](#)

Adelphon (234)

Circle (508)

ADM Technology (3266)

*Audio mixers for radio, TV on-air and production applications; audio *DAs.
Circle (509) [See inside front cover, 322](#)

Advanced Designs (2419)

Doppler *weather radar systems, display equipment.
Circle (510)

Advanced Micro Dynamics (2672)

*RF amplifiers; transmitter *remote control systems.
Circle (511)

AEG (2700)

*FM broadcast transmitters; SCA, stereo encoders; RF coaxial changeover switches; audio reel tape recorders.
Circle (512) [See ad page 351](#)

AF Associates (3170)

AVS *standards convertors; Audix intercoms, *audio mixing desks; Marconi FM, TV, uplink transmitters, telecines; Pegasus *automation products; Radamac remote *camera controllers; turnkey projects, mobile vehicles.
Circle (513) [See ads pages 236, 329](#)

Agfa-Gevaert (2815)

*Videotape, all formats.

Circle (514)

AKG Acoustics (2454)

*Mics, wireless mics; phono cartridges; *headphones; *digital audio delays.
Circle (515)

Alamar Electronics (3561)

Program and business station *automation controllers, software, accessories.
Circle (516) [See ad page 122](#)

Alden Electronics (2759)

*Weather radar systems, data services.
Circle (517) [See ad page 23](#)

Alexander Mfg (2924)

Batteries, chargers
Circle (518)

Alias Research (2751)

*Electronic graphic arts systems.
Circle (519) [See ad page 243](#)

Allen Avionics (2724)

*Electronic filters; *video/pulse delays; attenuators.
Circle (520)

Allied Broadcast Equipment (3414)

Distributors, audio, RF equipment; CD players; digital audio disc recorders; radio program automation systems; remote *equipment controllers; *phono equipment.
Circle (521)

Allied Tower (3432)

Communications, broadcast towers, services.
Circle (522)

Alpha Audio (100)

*Acoustic treatments; noise reduction equipment; audio editing systems.
Circle (523) [See ad page 261](#)

Alpha Electronics (2788)

Camera tubes; RF power output tubes.
Circle (524)

Alpha Video & Electronics (2524)

Sony VCR modifications.
Circle (525)

Alta Group (2502)

Digital video production systems; time base correctors, video switchers.
Circle (638) [See ad page 246](#)

Altronic Research (146)

RF dummy load *test equipment.
Circle (526)

Amber Electro Design (2426)

Audio distortion measurement systems; automated audio *test equipment.
Circle (527) [See ad page 208](#)

AMCO Engineering (3294)

Racks, standard/custom designs, EMI rated.
Circle (528)

AMEK Consoles (2558)

*Audio mixing desks for on-air, production, recording.
Circle (529) [See ad page 293](#)

SOLUTIONS

MODULA

MODULA® — software based routing switcher with video only, audio only, or video plus audio, in expandable matrix sizes from 8 inputs x 8 outputs to 256 x 256 for virtually any signal handling installation.

MINI MODULA

MINI MODULA — software based video/audio routing switcher in a smaller enclosure than MODULA (circuit cards interchangeable) in expandable matrix sizes from 8 x 8 to 24 inputs x 32 outputs.

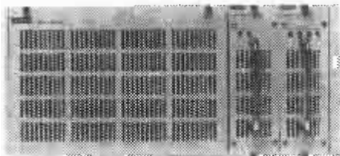

ARS 100 Series

ARS 100 Series — 10 inputs x 1 output audio routing switchers with front panel pushbutton controls and LED readouts. Mono version upgrades to stereo with a slide-in card.



VRS 200 Series

VRS 200 Series — 10 inputs x 1 output video routing switchers in video only, video plus mono, or video plus stereo, with no increase of enclosure size.



ADA 100 Series

ADA 100 Series — 1 input x 10 output audio distribution amplifier in a small, self-contained unit, with stereo optional.



VDA 200/400 Series

VDA 200/400 Series — dual and quad, 1 input x 6 output video distribution amplifiers in single rack unit enclosures featuring six isolated outputs for up to four independent video signals.



BROADCAST SYSTEMS, INC.

NAB Booth 2668

P.O. Box 19007 • Spokane, WA 99219 • (509) 838-0110

Circle (86) on Reply Card

Stations looking to automate, look to IGM.

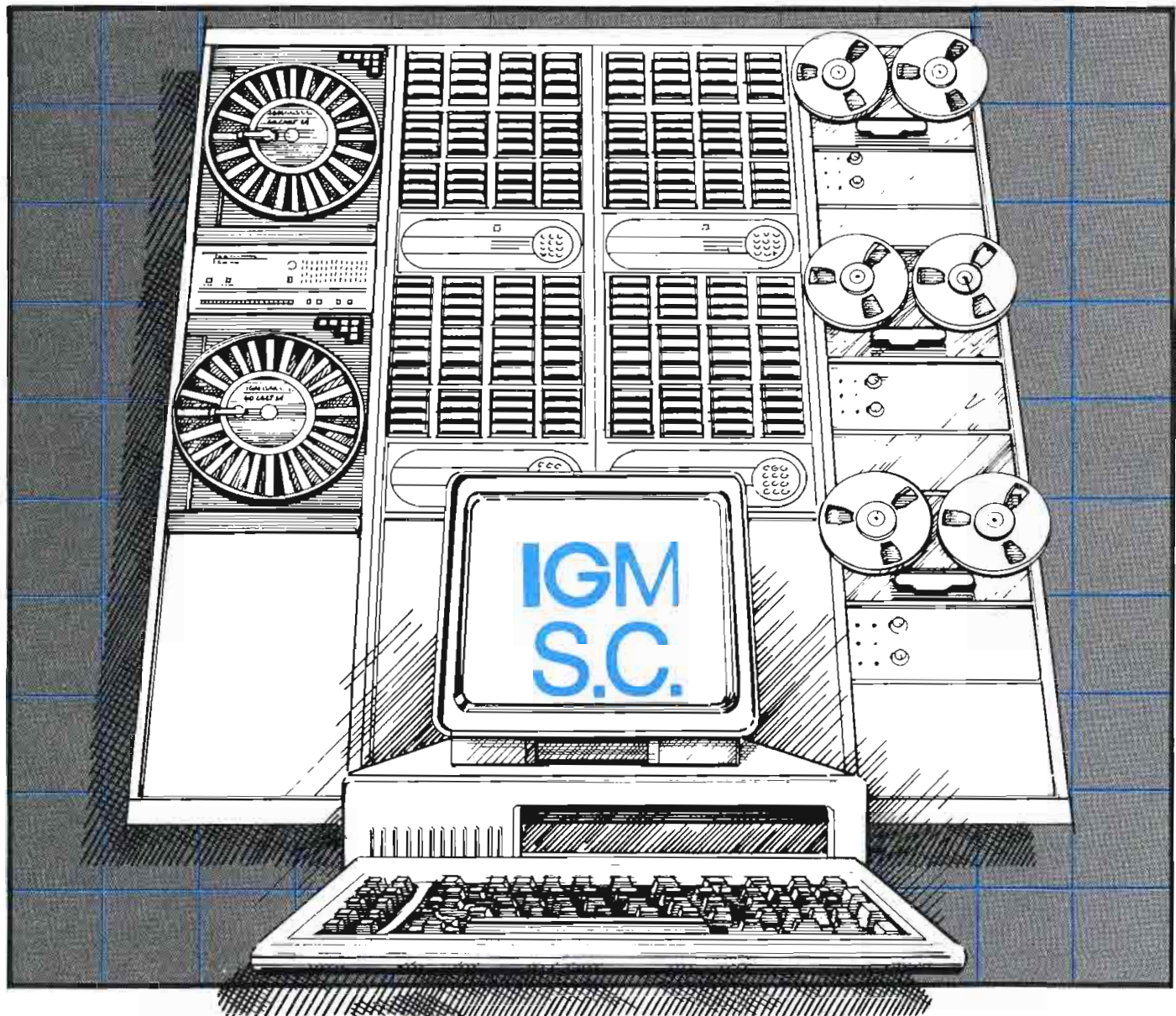

When you are thinking of using a program automation system, a number of questions come to mind. How do I handle network news? How many events of memory do I need to handle any format? How will this work with my billing system? With over 20 years of experience, IGM can help you determine how best to add automation to your operation. The broadcast industry has counted on IGM to build automation systems for all kinds of operations, from small radio stations to network operations.

We can build a program automation system for your station using an IBM-PC or compatible as the brain to

control the IGM-SC or IGM-EC automation controllers. Depending on your specific application, you can add the IGM GoCart and Instacart to handle your commercials and announcements or, if you need reel-to-reel machines or other cart machines, we can include the Studer-Revox PR-99 and Fidelipac cart machines in your system.

For information on how you can use automation successfully, call

800-628-2828 Ext. 578

IGM COMMUNICATIONS

282 West Kellogg Road

Bellingham, Washington 98226

(206) 733-4567

Circle (87) on Reply Card

www.americanradiohistory.com

DATUM 5300 ITP



Intelligent Time Processor

The 5300 ITP provides SMPTE/EBU time code support for any video application. The unit is expandable, with configurations ranging from a basic LTC reader/generator to a full-function processor with VITC and character insertion.

- Microprocessor Based
- NTSC and PAL Formats
- Dub or Jam Sync Modes
- Parallel BCD Time Outputs
- User Bit Outputs
- Character Inserter Option
- VITC Reader/Gen Option
- Expandable Design
- Low Power Requirements
- Compact, Modular Design

For more information on this and other DATUM video products, call or write.

datum inc Timing Division

1363 S. State College Blvd., Anaheim, CA 92806-5790
(714) 533-6333

Circle (88) on Reply Card

American Studio Equipment (2440)
Grip, electrical equipment; automotive camera mounts; camera wheel chair dollies.
Circle (530)

Amherst Electronic Instruments (2622)
Digital image processors; editing controllers; machine automation.
Circle (531)

Amperex Electronic (3238)
Plumbicon camera tubes; *CCDs; RF power amplifier tubes; klystrons.
Circle (532) [See ads pages 205, 269](#)

Ampex AVSD (3108)
*Video recorders; TBCs, synchronizers; *still stores; *video image processors; *graphic systems; *video effects units; ENG, studio *cameras; video production, master control *switchers; *program automation.
Circle (533) [See ad pages 118-119](#)

Ampex MTD (3108)
Audio, video magnetic recording tape in all formats.
Circle (534) [See ad pages 68-69](#)

AMS Advanced Music Systems (2825)
Audio processing, delay, effects systems; *Winchester disk audio recording systems.
Circle (535)

Amtel Systems (2820)
Time code equipment; *editing equipment; machine synchronizers; routing switchers; timers; video, audio DAs.
Circle (536)

AMX Corporation (2908)
Controls for audio, video equipment and teleconferencing systems.
Circle (537)

Andiamo (2609)
Transportation, protective equipment cases.
Circle (538)

Andrew Corporation (3098)
Transmission line, coaxial, waveguide; equipment shelters; earth station, TV broadcast, microwave antennas; antenna controllers; consulting; fiber optic products; STL equipment; satellite receivers.
Circle (539) [See ad page 341](#)

Angenieux (3020)
*Camera lens systems.
Circle (540) [See ad page 287](#)

Anritsu (2444)
RF test equipment.
Circle (541)

Anton-Bauer (2729)
Batteries, *chargers, evaluators; portable lighting products.
Circle (542) [See ad page 331](#)

Anvil Cases (2706)
Equipment transport *cases.
Circle (543) [See ad page 312](#)

Apert-Herzog (2931)
TBCs; video DAs; editing accessories.
Circle (544) [See ad page 349](#)

Aphex Systems (2816)
Audio spectral processors; FM stereo generators.
Circle (545)

You Can Always
Believe What
You Hear...

When it's Quality
Equipment

ROH

A DIVISION OF ANCHOR AUDIO, INC.

913 West 223rd St.
Torrance, CA 90502
(213) 533-5984

Telex: 91020400141
Outside Calif.
1-800-262-4671

Circle (89) on Reply Card

The first intelligent broadcast color monitors



BARCO INDUSTRIES' new CVS professional broadcast monitors are microprocessor-based to make them intelligent in operation and easy to use.

They have both a digital and an analog bus for maximum flexibility. Plus four "open" slots that let you plug in today's options and those yet to come.

As new features do come along, you'll be able to add them through software — no hardware changes!

All CVS functions are controlled from the front of the monitor or

from a remote keyboard. An optional master remote permits control of a series of monitors.

You can also store, and automatically call up, either calibrated presets or your own preferred presets.

Like your best master control monitors, the CVS has Automatic Kinescope Biasing (AKB) to maintain color and black level stability.

The CVS also generates more internal test patterns than any other monitor. Among others, the patterns include white field, cross hatch and color bars.

The CVS is available in both 14 inch and 20 inch versions, and provides outstanding quality in any TV standard.

For complete specifications, contact your local Barco Industries Dealer or Barco Industries, Inc., 170 Knowles Drive, Suite 212, Los Gatos, CA 95030. Phone: 408-370-3721.

BARCO INDUSTRIES, Inc. is a member of the ACEC group. © Barco Industries, Inc., 1986.

**We put the future
in the picture.**

See us at NAB
Booth 2577

**BARCO
INDUSTRIES** INC.

Circle (90) on Reply Card

Arben Design (2675)
*Studio fixtures; cyc mounting equipment; facilities design; consulting.
Circle (546)

Arbitron Ratings (3103)
Audience measurement services.
Circle (547)

Armstrong Display Concepts (2493)
Circle (548)

Arrakis Systems (2742)
Audio mixers for on-air, audio production; routing switchers; audio DAs.
Circle (549) [See ad page 21](#)

Arriflex (3553)
Cine cameras, lenses, accessories; lighting accessories.
Circle (550)

Artel Communication (2903)
Fiber-optic products.
Circle (551)

Artronics (104)
Electronic graphics systems.
Circle (552)

ASACA ShibaSoku (3278)
Videotape, videodisc *program automation systems; AF, video and RF *test equipment; stereo TV demodulators; VTR test systems; *video monitors; HDTV equipment.
Circle (553) [See ad page 207](#)

Associated Press/Broadcast (3395)

News *program services.
Circle (554)

Associated Production Music (2650)
Music *services.
Circle (555)

Aston Electronics (223)
Character titling, *logo generators; linear video keying *processors; hard disk memory.
Circle (556)

ATI Audio Technologies (2508)
On-air *mixers; audio DAs, monitoring amps; audio processors; interface, impedance converters; mic, phono preamps.
Circle (557) [See ad page 141](#)

AT&T Communications (3212)
PBX, computer, voice, data, LAN for broadcast affiliates; 800-/900- services.
Circle (558)

Auburn Instruments (2836)
Remote machine control systems.
Circle (559)

Audico (2720)
Recording *tape winders, cyclers, loaders.
Circle (560)

Audio Accessories (2754)
Connectors; patch cables, holders; cleaners.
Circle (561) [See ad page 294](#)

Audio Broadcast Group (2581)
Consultants; turnkey studio designs, including related equipment.

Circle (562)

Audio Developments (2933)
Portable ENG *audio mixers; editing mixers.
Circle (563)

Audio Kinetics (2506)
Time code systems; machine synchronizers.
Circle (565) [See ad page 225](#)

Audio Precision (2452)
PC-based *audio test systems; distortion analyzers.
Circle (566) [See ad page 196](#)

Audio Technica US (2407)
Microphones; portable mic *mixers; headphones; phono cartridges; audio accessories.
Circle (567)

Audio-Video Engineering (2703)
Video hum-stop *filters.
Circle (568) [See ad page 260](#)

Auditronics (3310)
On-air, radio, TV production audio consoles.
Circle (569) [See ad page 53](#)

Audix (3170)
*Assignable audio desks for production, on-air broadcast.
Circle (570)

Aurora Systems (3592)
*Electronic videographics systems.
Circle (571) [See ad page 127](#)

Autogram (2702)



The choice of the professionals...

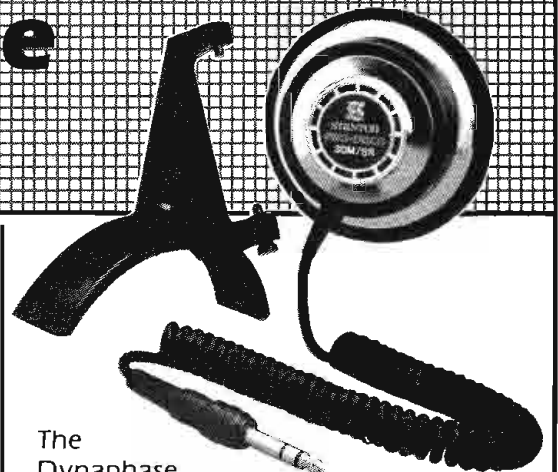

The Dynaphase 30M/SR is a shoulder rest single cup headphone that provides the ultimate in convenience, comfort and superb sound quality. Made to rest on either your left or right shoulder, or shoulder rest can be detached and used as a single cup hand-held monitor.



310B
PROFESSIONAL
PHONO PREAMP/EQUALIZER
... Interfaces magnetic phono cartridges for optimum calibration of audio systems. Available with balanced or unbalanced output.



PBR ANNOUNCER'S EARPHONE ...
Ideal for on camera studio work
and remote coverage.

Stanton is the company with a total commitment to quality and reliability—producing products for the Recording Industry, the Broadcast Industry and the Professionals in Audio.



200 Terminal Dr., Plainview, NY 11803



680EL ... Delivers sound excellence and stands up to backcueing, vibrations and mishandling.



500AL ... For heavy duty on-the-air use with wide tracking force range.

Circle (99) on Reply Card

MACHINES MULTIPLYING?

IT'S TIME TO DECIDE ON A SAFE, RELIABLE, and
COST EFFECTIVE METHOD OF MACHINE CONTROL

PROPOSAL

3M

Proposal Number 311002
February 15, 1992

STEVE,
ISN'T THERE SOME WAY WE
CAN GET MORE USE OUT OF
THE MACHINES WE ALREADY
HAVE?
DP.

CAPITAL BUDGET PLANNING 1987 - 1992

The days when your facility had a limited number of machines in a centralized control area are now a distant memory. Today the machines are where the people are: in newsrooms, editing suites, and various other locations.

You may be finding it difficult to control these machines now that they are scattered throughout your facility. Homegrown methods and the last generation of over-the-counter control systems can't cope with the complex interconnections that are required. Often, the unwanted result is the addition of more machines, rather than solving the problem with an effective method of machine control.

The ESBUS Machine Control System provides a cost effective solution that bridges the generation gaps in your facility; efficiently controlling older machines, the intelligent new ones, and the future arrivals that are lurking somewhere in that five-year plan.

You can use your 3M machine control system with complete confidence... the system is based on ESBUS, the serial communications standard now being developed by SMPTE and the European Broadcasting Union. We can communicate with ESBUS supported machines and any other device you ask us to control.

Make the decision to put your machines on an effective method of machine control. The 3M ESBUS Machine Control System.

Take a closer look... NAB Booth 3120.

On-air, production *audio mixing consoles; timers.
Circle (572)

AVCOM of VA (2425)
Spectrum analyzers.
Circle (573)

AVS (3170)
*Standards conversion systems.
Circle (574) [See ad page 229](#)

B & B Systems (2665)
Audio phase measurement *test systems.
Circle (575)

BAF Communication (2544)
Satellite relay vehicles, uplink trucks, fly-away systems.
Circle (576)

Barco Industries (2577)
Multi-standard, grade 1, 2 *video monitors; color decoders; TV demods, modulators.
Circle (578) [See ad page 161](#)

Barrett Associates (2768)
CD players; Studer recorders; *telephone hybrids; distributor of audio, RF products; remote test sensors; signal faders/*switchers.
Circle (579)

Basys (2913)
Automated newsroom systems; PC software.
Circle (580) [See ad page 193](#)

BCS (2785)
Used broadcast equipment brokers.
Circle (581)

Beaveronics (2703)
Video production switchers; downstream keyer system; Favag analog and digital, master, submaster, secondary clocks.
Circle (582)

Belar Electronics Lab (3347)
AM, FM, TV stereo modulation monitors.
Circle (583) [See ad page 204](#)

Belden Communications (2926)
Lee *lighting filters.
Circle (584)

Belden Wire & Cable (2651)
*Coaxial, video cables, audio wire; fiber optic materials.
Circle (585)

Bencher (2568)
Camera stands for animation, photo copying.
Circle (586)

Benchmark Media Systems (2470)
Audio distribution *amplifiers; mic preamps.
Circle (587) [See ad page 211](#)

Bend-A-Lite/Menu-Lite (2907)
Flexible tube lights, neon blackboards.
Circle (588)

Beyer Dynamic (2823)
*Microphones, wireless mics; *headphones; M-S ribbon mics.
Circle (589) [See ad page 190](#)

BHP (2795)
*Editing controllers.
Circle (590)

Bird Electronic (3472)
RF *test/power systems, dummy loads; RF attenuators; *wattmeters.
Circle (591)

Bogner Broadcast Equipment (3406)
TV, microwave, land-mobile *antennas.
Circle (592) [See ad page 187](#)

Boonton Electronics (124)
AM, FM, TV, communications modulation monitoring systems.
Circle (594) [See ad page 200](#)

Bowen Broadcast Service (2522)
VTR modification kits; equipment maintenance software.
Circle (595)

Bradley Broadcast Sales (2556)
Distributor of audio, RF products; telephone

hybrids; audio recorders.
Circle (596)

Brintec/Abbott Division (2478)
Wire, cable; power connectors.
Circle (597)

Broadcast Audio (2615)
On-air, production *audio mixers; audio monitor, preamps; console timers; audio dynamics *processors.
Circle (598)

Broadcast Automation (2697)
*IGM automation systems; Otari, SMC, audio recorders/players.
Circle (599)

Broadcast Dynamics Pty Ltd (2560)
Circle (601)

Broadcast Electronics (3226)
FM broadcast transmitters; radio on-air, production mixers; radio automation systems; remote control systems; stereo exciters; sub-carrier generators; phono turntables, preamps, accessories; audio cartridge recorders.
Circle (602)

Broadcast Management Plus (2646)
*Software for programming, sales, analysis.
Circle (603)

Broadcast Microwave Service (3578)
ENG microwave transmitters, receivers, antennas.
Circle (604)

Broadcast Music (2632)
Music licensing.
Circle (605)

Broadcast Supply West (2743)
*Phono products; audio *DAs; *timers; on-air, production audio mixers; studio furniture; audio cartridge racks; digital audio recorders.
Circle (606) [See ad page 250](#)

Broadcast Systems (3418)
Videocassette *automation systems.
Circle (607)

TENTEL® MAKES IT EASY TO DIAGNOSE VCR MECHANICS

Award winning Tentelometer tape tension gauge for proper interchange and tape handling. One gauge for Beta, VHS and U-Matic.
T2-H7-UM \$295

Head protrusion and eccentricity gauge to determine the amount of wear remaining on the VCR heads; safe, easy, measures in microns.
HPC-1 \$479

Torque gauge NEW from Tentel to save you money—Universal and accurate for Beta and VHS—0 to 600 gm/cm. Take-up, FF and Rew torques.
TO600 \$139

Spindle height and elevator latch and alignment gauge to diagnose cassette binding and edge damage problems. Finds problems not detected by any other method.
TSH-V4 \$395

Tentel manufactures a complete line of gauges for U-matic, 1" Type "C", Betacam and other recorders, too. If you've suffered the frustration of having a master tape ruined, or if you are responsible for maintaining and repairing VCRs—There's no faster, easier method to test the various mechanics that make VCRs work properly. Call our technical engineering dept. for details—ask about the combo discount for all 4 gauges. We've been helping customers for years and want to help you too—your satisfaction is guaranteed.

TENTEL® CORP. 1506 Dell Ave. (408) 379-1881
Campbell, CA 95008 800 538-6894 (Not in CA)

Circle (93) on Reply Card

Agile Omni, the industry's most advanced receiver designed by the most relied upon name in the business... Standard.

With the new Agile Omni, you need no other receiver.

Standard designed it for cable TV operators, broadcasters, CATV, SMATV, and business and special teleconferencing networks – now and in the future.

An onboard microprocessor permits selection of any band available from domestic satellites, including the 32-channel ANIK C2. Channel tuning provides direct reading of the transponder-assigned channel number and a format control permits selection of six frequency band formats – 24-channel C-band, SBS/USAT and Spacenet already installed. Select channel and format, and the microprocessor controls frequency, channel spacing, transponder bandwidth, audio

frequency and bandwidth, and antenna and video polarity – automatically.

Omni's flexible design can handle up to three separate subcarriers including stereo programming or data. Omni also will accept descrambling modules – eliminating the need for expensive add-on descramblers.

For CATV and SMATV applications, severe microwave terrestrial interference is minimized by optional internal SAW notch filters, automatically programmed to switch in. A 30 MHz low DG/DP LC bandwidth filter is standard, and a second internally installed optional filter of 18, 22, 26, or 36 MHz bandwidth can be controlled by the microprocessor, or manually switched.

Standard's proven RF

loop-thru circuitry and blockdown conversion technology combine, with better image rejection and lower differential gain and phase, to provide excellent video performance. C/N threshold is an impressive 6.5 dB at the wide 30 MHz bandwidth.

Agile Omni is an affordable, flexible receiver designed to keep you in business, a commitment Standard backs with its unique 5-year warranty program. Contact us for further information.

Standard Communications

P.O. Box 92151
Los Angeles, CA 90009-2151
Toll free 800/243-1357
(In Calif. 800/824-7766, ext. 275)

Engineered to a new Standard



Operating functions including MGC, AGC, AFC, level sets, normal/invert video, clamp/unclamp video, skew, subcarrier frequency selection, video and IF test points are conveniently located on the front panel. Meter reads C/N ratio, signal strength or center-tune.



Format control enables selections of desired satellite system. Direct-reading channel selector displays transponder-assigned channel. Second selectable, subcarrier and space for optional third subcarrier or descrambler modules.

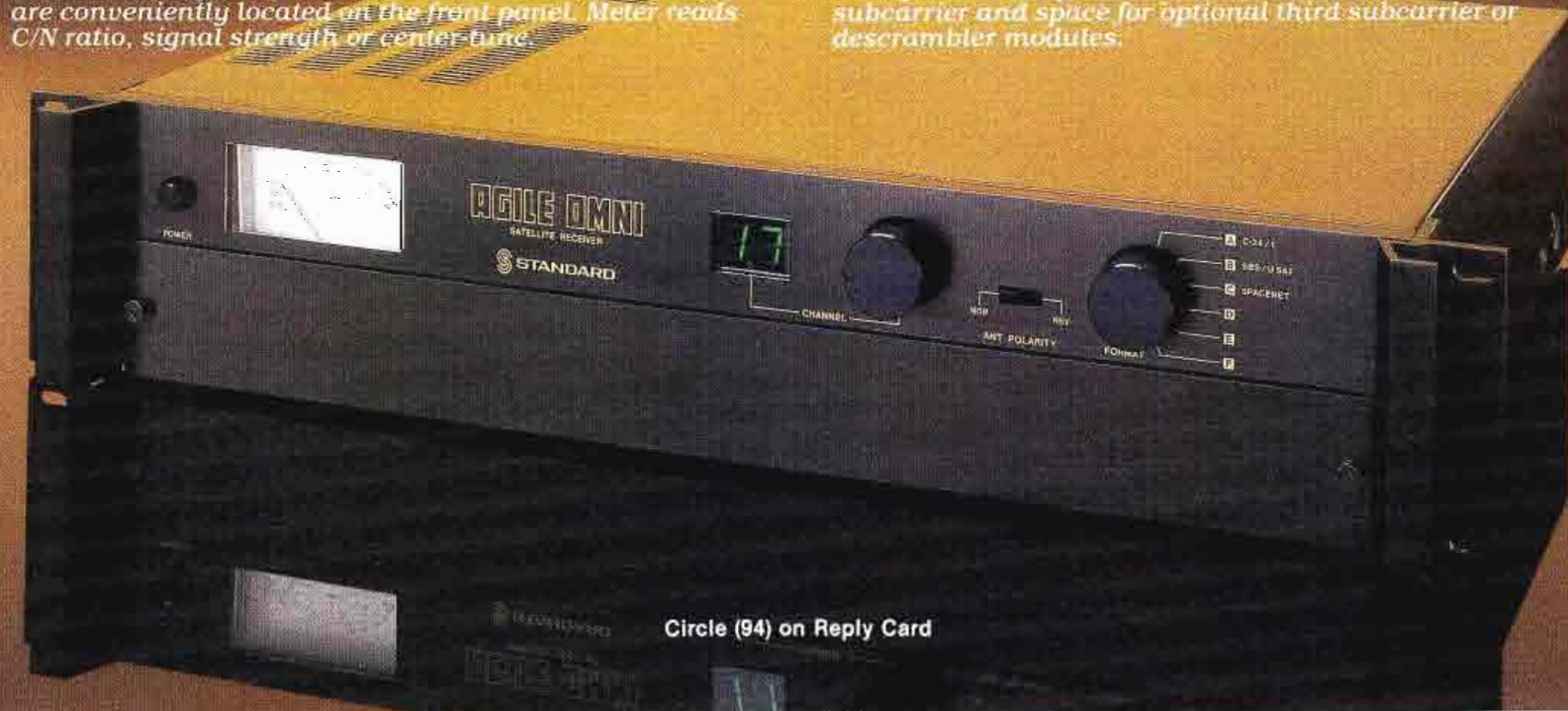

Circle (94) on Reply Card

Broadcast Video Systems/BVS (2730)
Cox video *switchers, video *encoders, *keyers; EV *waveform/vector monitors; safe area generators; video DAs, delay systems; color corrector processors; slate generators.
Circle (608) [See ad pages 266,194](#)

Bryston Limited (2406)
Audio monitor amplifiers.
Circle (609)

BSM Broadcast Systems (2668)
Audio, video distribution amplifiers, routing switchers.
Circle (610) [See ad pages 158,350](#)

BTS Broadcast TV Systems (3140)
Studio, ENG *cameras; cassette, reel *video

recorders; video production, *master control switchers; audio/video routing switchers, *DAs; video monitors; electronic *graphic equipment; *station automation.
Circle (611) [See ad page 233](#)

BW Lighting Systems (2418)
*Lighting instruments, control systems; studio fixtures, sets, draperies.
Circle (612)

Cablewave Systems Div/CELWAVE(3489)
Coaxial, waveguide *transmission line; tower, *antenna product, services; consulting.
Circle (613)

Calaway Engineering (Quanta) (3128)
Editing controller systems.
Circle (614) [See ad page 227](#)

Calrec by AMS (2825)
Assignable, portable audio *mixing desks; Soundfield microphones.
Circle (615)

Calzone Case (2502)
ATA equipment cases.
Circle (616)

Cam-Lok (213)
Power, multi-conductor control connectors; power interlock systems.
Circle (617)

Cambridge Products (2731)
Audio, video connectors; patch cord assemblies.
Circle (618)

Camera Mart (3040)
Audio, video products distributors; cameras; audio mixers; batteries, chargers; audio, video recorders; lighting products.
Circle (619) [See ad page 217](#)

Canare Cable (2523)
Audio/video wire, coax *cable in colors; *connectors.
Circle (620) [See ad page 126](#)

Canon USA (3300)
TV camera lenses; camera support products.
Circle (621) [See ads pages 155-157](#)

Capitol Magnetic Products (3345)
Magnetic tape, audio cartridges.
Circle (622) [See ad page 136](#)

CASCOM (2648)
Animation services.
Circle (623)

CAT Systems (3426)
*Remote control of multiple sites from multiple control sites; computer graphic status displays.
Circle (624)

Catel Telecommunications (2585)
*TV demods; TV, FM *stereo generators; *satellite receivers; microwave/IR *links.
Circle (625)

Dwight Cavendish (2662)
Audio, video duplication systems.
Circle (626)

CBSI Custom Business Systems (2517)
*Station business software.
Circle (627)

CCA Electronics (2584)
AM, FM *transmitters; *exciters.
Circle (628)

Central Dynamics (3080)
Routing switchers; video *production, master control switchers; keying systems.
Circle (629) [See ad page 356](#)

Central Tower (2799)
Towers for communications, broadcast, microwave; tower accessories; services.
Circle (630)

Centro (3181)
Facilities, studio, remote vehicle designs, construction; consulting; turnkey projects; equipment racks.
Circle (631) [See ad page 71](#)

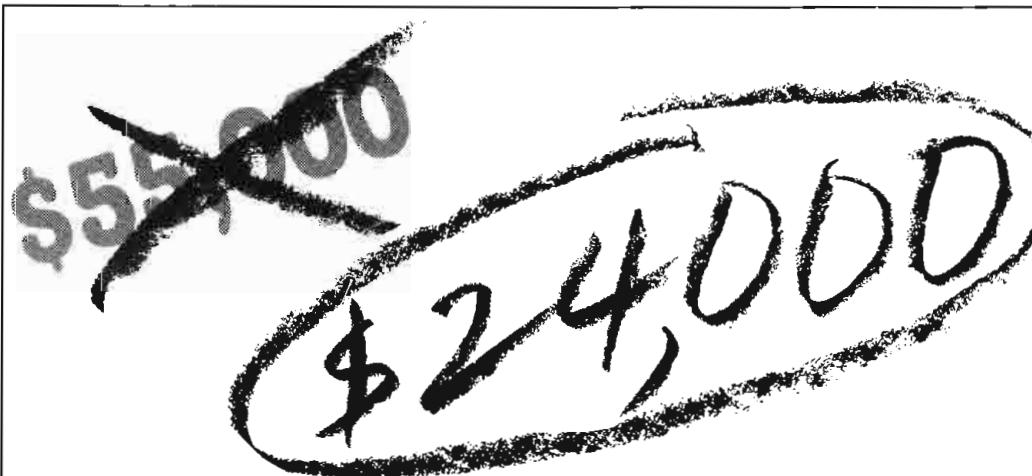

EDIT THE PRICE, NOT THE FEATURES.

Spend less for the CED+ video editing system from Calaway Engineering without compromising on features.

At \$24,000, the CED+ handles your editing requirements for a fraction of the cost of similar systems. Standard features include:

- Control of 6 VTR's
- Decision list compatible with CMX™ and GVG/ISC™
- List manipulation and sorted lists
- Motion controller
- E-MEM™ control
- Macros
- Serial CG control
- Fast operation

Call today for more information about the CED+ and other Calaway Engineering products. See us in booth 3128 at NAB.



CALAWAY ENGINEERING

A Division of Quanta Corporation
49 South Baldwin Avenue
Sierra Madre, CA 91024
(818) 355-2094

Circle (95) on Reply Card



Point Source Monitors for Point Blank Truth.



When it comes to sound, some people get a little funny about the point blank truth, in that they don't want to hear it.

They've come to expect that low end bump around 200 Hz because it makes the kick drum punchier, or they like the phase irregularities of the typical tweeter because the highs are all tst-tst.

At Fostex, we believe that truth is stronger than fiction. That's why we made the RM-Series. Point Source. Phase Coherent. Near Field.

They are reference monitors. They tell you exactly what you have and let you hear precisely what you're doing. Period. With neither apologies nor pamperings. Just the point blank truth.

What's more, when you mix with RM-765s or 780s, tape playback remains relatively the same from studio mains, to home stereo to car.

How many times have you heard just the right sound on a mix, only to find a completely different sound when you hear the tape on other monitors?

When you work with sound, you need a truthful reference. One that lets you hear the misses as well as the hits.

We encourage you to audition these Fostex reference monitors with a known source. Because we're confident that you'll know the truth when you hear it.

Point Blank.

Circle (96) on Reply Card



RM-765/780



Pro Sound Division
15431 Blackburn Ave.
Norwalk, CA 90650
(213) 921-1112

- Century 21 Programming** (3452)
Programming services for radio broadcasters.
Circle (632)
- Century Precision Optics** (2422)
Camera lens, prisms; wide-angle telephoto accessories.
Circle (633)
- Cetec Vega** (3394)
*Wireless mics, diversity receivers.
Circle (634) [See ad page 32](#)
- Channelmatic** (2548)
Videocassette automation systems.
Circle (635)
- Chester Cable** (2734)
Wire, cable products.
Circle (636)
- Chisan Unitec** (2494)
Video sync generators, encoders; video interfaces; computer products.
Circle (637)
- Christie Electric** (----)
Batteries, battery chargers, analyzers.
Circle (638) [See ad page 186](#)
- Chyron Telesystems** (3072)
*Electronic graphic art/titler systems.
Circle (639) [See ad page 321](#)
- Chyron Video Products** (3072)
*Electronic graphic art/titler systems.
Circle (640)
- Cine 60** (3428)
Batteries, battery accessories; lighting accessories.
Circle (641)
- Cinemills** (2777)
Lighting equipment, filters, gobos.
Circle (643)
- Cipher Digital** (2605)
Time code systems, coincidence detectors; machine synchronizers; audio edit systems.
Circle (644) [See ad page 247](#)
- Clear Com Intercoms** (3352)
*Digital intercom systems, wired, wireless.
Circle (645) [See ad page 106](#)
- CMC Technology** (3340)
Replacement type C videotape heads; AST, DT, parallel-tracking heads; tape degaussers.
Circle (646)
- CMX** (3232)
*Editing controller systems; EDL utilities.
Circle (647)
- Coaxial Dynamics** (108)
Analog, digital readout wattmeters; power terminators, loads; *RF test systems.
Circle (648)
- Coherent Communications** (2801)
*Time code units; video/audio transmitters; *wireless mics; audio mixers, mic supplies.
Circle (649)
- Colorado Video** (3447)
*Still-store, video noise reduction systems.
Circle (650) [See ad page 324](#)
- Colorgraphics Systems** (3128)
*Electronic graphics equipment; *weather graphics, data services.
Circle (651)
- Columbine Systems** (3405)
*Computer software for music rotation, newsroom management, traffic.
Circle (652)
- Comark Comm./Thomson-LGT** (3561)
FM, VHF/UHF TV *transmitters, translators; transmission lines.
Circle (653) [See ad pages 98-99](#)
- Communication Microwave** (139)
*Microwave transmitters, repeaters for ITFS, OFS, MDSS, audio, video, data.
Circle (654)
- Communications Graphics** (2423)
Promotional, presentation packages.
Circle (655)
- Comprehensive Video Supply** (3593)
Distributors for audio, video, *lighting equipment; production management software.
Circle (656)
- Comprompter** (2710)
IBM PC *newsroom, *prompting systems.
Circle (657)
- Compu-Prompt** (2408)
Computer *prompters; equipment cases.
Circle (658)
- Compusonics** (2533)
Digital audio disc *recording system.
Circle (659)
- Computer Prompting** (132)
Computer *prompting, captioning systems.
Circle (661)
- Comrex** (3460)
*Telephone bandwidth extenders, hybrids; ENG, RF cue systems, TV aural receivers, monitors.
Circle (662) [See ad page 270](#)
- Comsat General/Comsat Int'l** (3540)
Global TV Intelsat service.
Circle (663)
- Comsat Space Communications** (2792)
*CTVS on-line access to COMSAT scheduling system; satellite program distribution.
Circle (664)
- ComTek Communications** (2652)
TV signal monitoring receivers, wireless microphones.
Circle (665) [See ad page 184](#)
- Concept Productions** (3334)
Production, programmed music services.
Circle (666)
- Connectronics** (2403)
*Audio multi-pair cable, connectors; recording, portable *audio mixers.
Circle (667)
- Conrac** (3124)
Color, monochrome video monitors; automated setup monitors.
Circle (668)
- Continental Electronics/Varian** (3200)
AM, FM transmitters; RF antennas; coaxial switching systems; related RF equipment.
Circle (669) [See ad page 220](#)
- Control Concepts** (2687)
*Power line filters, conditioners.
Circle (670) [See ad page 73](#)
- Conus Communications** (3385)
Satellite program/news information delivery.
Circle (671)
- Convergence** (3252)
Videotape editing controllers.
Circle (672) [See ad pages 92-93](#)
- Michael Cox Electronics** (2730)
*Video production switchers; *video encoders.
Circle (675)
- CRL Systems** (2538)
Audio dynamics processors; AM stereo equipment; subcarrier, FM generators; MTS processors.
Circle (676) [See ad pages 13,131](#)
- Crosspoint Latch** (3533)
Production, master control switchers; TBCs; video keyers, sync generators; encoders.
Circle (677) [See ad page 332](#)
- Crown International** (2927)
Audio monitor amp; audio test equipment.
Circle (678)
- CSI Marketing** (3306)
AM, FM *transmitter systems.
Circle (679)
- Cubicomp** (3478)
Electronic graphic systems; 3D graphics.
Circle (680)
- Current Technology** (2723)
Power conditioners; surge protection.
Circle (681) [See ad page 328](#)
- Cycle-Sat** (2654)
Circle (682)
- Peter W. Dahl** (222)
Audio, power transformers, inductors.
Circle (683)
- Dalsat** (2424)
Satellite news gathering vehicles.
Circle (685)
- Data Center Management** (2760)
Newsroom systems, multi-user DEC computers.
Circle (687)
- Data Check** (NA)
*Video waveform monitors.
Circle (564) [See ads pages 259, 261, 263](#)
- Datacount** (2758)
DARTS station data management software.
Circle (688)
- Datatek** (3547)
Audio/video routing switchers, DAs; control panels; machine controls; interface modules.
Circle (689) [See ad page 55](#)

ARIZONA

AUDIO VIDEO RECORDERS
3830 North 7th Street
Phoenix, AZ 85014
(602) 277-4723

CALIFORNIA

IMAGE ELECTRONICS
18437-C Mt. Langley
Fountain Valley, CA 92708
(714) 964-0145
Serving Orange County.

WALT DAVIS ENTERPRISES
3439 Cahuenga Blvd.
Hollywood, CA 90068
(213) 876-6400
Serving Los Angeles
& Hollywood.

AUDIO VIDEO SUPPLY, INC.
5563 Kearny Villa Road
San Diego, CA 92123-1162
(619) 565-1101
Serving the San Diego area.

COLORADO

DAVIS AUDIO VISUAL
1801 Federal Blvd.
Denver, CO 80204
(303) 455-1122

FLORIDA

MIDWEST COMMUNICATIONS
CORP.
8875 N.W. 23rd Street
Miami, FL 33172
(305) 592-5355

**KA-3
COMPONENT
VCR
ADAPTOR**

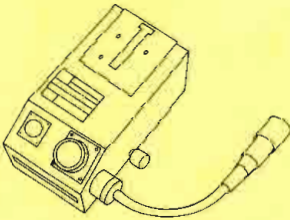

Equips PROCAMS for all component formats, including the increasingly popular M-II. Attaches to rear of camera head. Comes with mount shoe, 4-pin connector, and output selector switch.

GEORGIA

MIDWEST COMMUNICATIONS
CORP.
522 Armour Circle NE
Atlanta, GA 30324
(404) 875-3753
Serving GA & AL.

ILLINOIS

SWIDERSKI ELECTRONICS, INC.
1200 Greenleaf Ave.
Elk Grove, IL 60007
(312) 364-1900
Serving the Chicago area.

PROCAM® 950 B

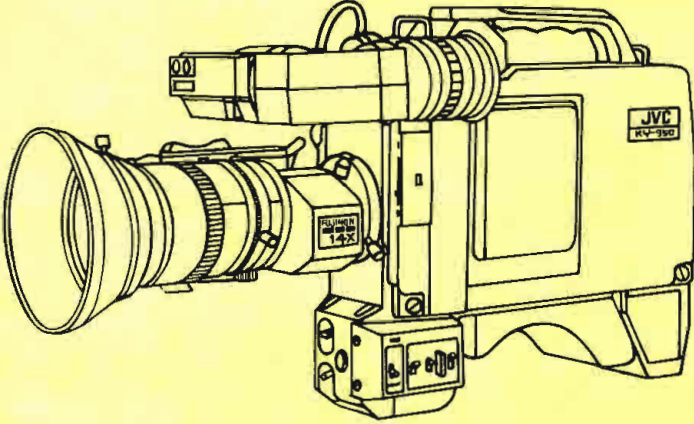

3 L.O.C. Diode Gun Plumbicon tubes • prism optics
59 dB S/N • 700 lines resolution at center
compact, rugged, lightweight • broadcast quality

KANSAS

MISSION ELECTRONICS, INC.
3897 W. 95th Street
Overland Park, KS 66206
(913) 341-8370
Serving KS & western MO.

KENTUCKY

MIDWEST COMMUNICATIONS
CORP.
One Sperti Drive
Edgewood, KY 41017
(606) 331-8990
Serving KY, PA, OH, IN & MI.

MASSACHUSETTS

CRIMSON TECH
325 Vassar Street
Cambridge, MA 02139
(617) 868-5150
Serving MA, NH, ME & VT.

MINNESOTA

BLUMBERG
COMMUNICATIONS, INC.
525 N. Washington Avenue
Minneapolis, MN 55401
(612) 333-1271

MISSOURI

LINES VIDEO SYSTEMS
219 South Jefferson
Springfield, MO 65805
(417) 862-5533
Serving southwestern MO,
OK & AR.

VMI COMPANY OF ST. LOUIS
2368 Schuetz Road
St. Louis, MO 63146
(314) 569-1334
Serving eastern MO
& southern IL.

NEW JERSEY

VIDEO CORPORATION OF
AMERICA
7 Veronica Ave.
Somerset, NJ 08873
(201) 545-8000

NEW MEXICO

G.C. VIDEO, INC.
Box 178, Erickson Road
Sandia Park, NM 37047
(505) 281-1303

PROCAM® 320 B

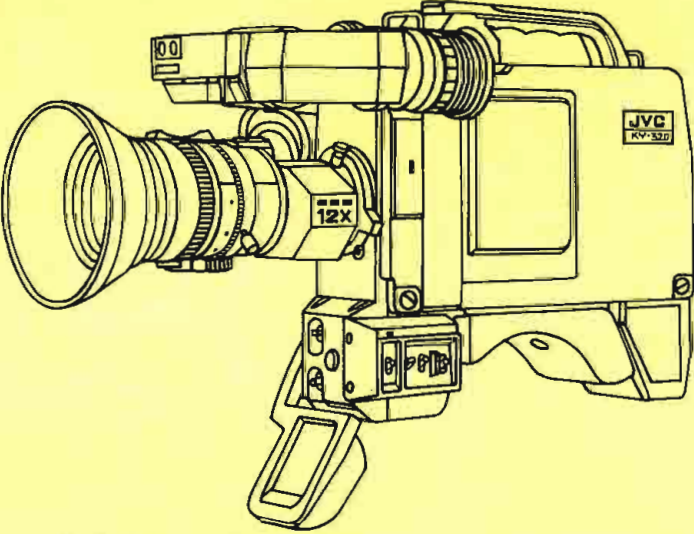

3 Plumbicon S-M tubes • prism optics • 58 dB
Signal-to-noise ratio • 650 lines resolution at center
compact, rugged, lightweight
superb studio and location camera

NEW YORK

L. MATTHEW MILLER
ASSOCIATES
48 W. 21st Street
New York, NY 10010
(212) 741-8011
Serving New York City.
UNIVISIONS
2011 Teall Avenue
Syracuse, NY 13206
(315) 437-0301
Serving New York State.

NORTH DAKOTA

AUDIOVISUAL, INC.
1818 Broadway
Bismarck, ND 58501
(701) 258-6360
Serving ND, SD, IA, NE,
MT & WY.

TEXAS

MAGNETIC MEDIA
3440 Sojourn Drive
Suite 200
Carrollton, TX 75006
(214) 931-0404

TRIAxIAL CAMERA CONTROL

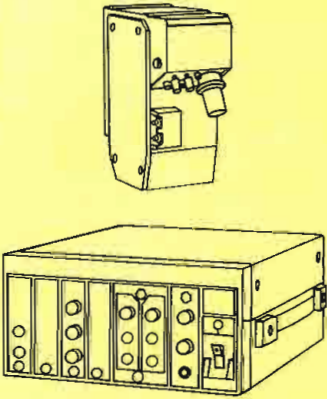

PROCAMS can be equipped for operation via triaxial cable for long-distance remote work. Cables can be as long as 4,920 feet. Only system with chroma key.

VIRGINIA

MIDWEST COMMUNICATIONS
CORP.
1395 Air Rail Ave.
Virginia Beach, VA 23455
(804) 464-6256
Serving VA, WV, NC, SC & DC.

WASHINGTON

LINES & ASSOCIATES
14801 119th Ave. NE
Kirkland, WA 98034
(206) 488-3653
Serving WA, OR, ID,
& northern CA.

WISCONSIN

AVONIX VIDEO SYSTEMS, INC.
3495 North 124th St.
Brookfield, WI 53005
(414) 783-6050



- 1. John Miller – Midwest Communications
- 2. Bob Romano – Central New York Univisions
- 3. Terry Moore – Audio Video Supply
- 4. Chuck Taylor – Mission Electronics
- 5. John Leveck – Image Electronics
- 6. Jay Adrick – Midwest Communications

- 7. Fred Wood – Midwest Communications
- 8. Ron Bradley – Midwest Communications
- 9. John Fode – Walt Davis Enterprises
- 10. Bruce Michael – Davis Audio Visual
- 11. Gene Tollini – Magnetic Media
- 12. Mark Swiderski – Swiderski Electronics

JVC® PROFESS

GO TO PROM PROM



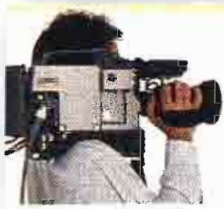

Baptist Medical System
Little Rock, AR



Boeing Aircraft Company
Wichita, KS



Dyna-Mark
Oklahoma City, OK



University of Arkansas
Fayetteville, AR



Monroe Community College
Rochester, NY



Syracuse Fire Department
Syracuse, NY



BF Goodrich
Cleveland, OH

PROCAM: The choice of hundreds



Mark III
Miami, FL



WNSC-TV
Rock Hill, SC



Miami Lakes Tech High School
Miami, FL



Harris Corporation
Palm Bay, FL



Prime Computer, Inc.
Framingham, MA



University of Texas (Health Service-Center)
Dallas, TX



University of New Mexico
Albuquerque, NM



First Baptist Church
Fort Smith, AR



E.R. Squibb & Sons
Princeton, NJ



KFBB-TV
Great Falls, MT



ARCO Oil & Gas Company
Dallas, TX



Dallas Power & Light
Dallas, TX



Harley Davidson Motor Company
Milwaukee, WI



General Electric
Binghamton, NY



Video Comm.
Montgomery, AL



WDSI-TV
Chattanooga, TN



WPGH Television
Pittsburgh, PA



McDonnell Douglas Aircraft
St. Louis, MO



University of Georgia
Athens, GA



George A. Hormel Company
Austin, MN



Videomaster of New England
Portsmouth, NH



University of Texas
Austin, TX



WMDT Television
Salisbury, MD



CNA Insurance Company
Chicago, IL



Beard Publishing Company
Arlington, TX



Tampa General Hospital
Tampa, FL



WIPR-TV
Hato Rey, PR



E.R. Squibb & Sons
Princeton, NJ



Video Consultants
Overland Park, KS



Puerto Rican Senate
San Juan, PR



Media Artists, Inc.
Manlius, NY



St. Joseph Hospital
Kansas City, MO



NASA
Palo Alto, CA



PSE&G
Newark, NJ



WDAZ-TV
Grand Forks, ND



Living Faith World Outreach
Myrtle Beach, SC



Paradise Video
Miami, FL



Group W Cable
Chicago, IL



Applied Media Group
Providence, RI



Houston Independent School District
Houston, TX



LSW Systems
El Paso, TX



Gator Productions
Hialeah, FL





WXEL-TV
Boynton Beach, FL



Rochester Institute
of Technology
Rochester, NY



Video Genesis, Inc.
Beachwood, OH



Reliance Electric
Visual Systems
Eastlake, OH



Searle's Video News
Service
Richmond, MA



Coastal Video
Productions
Norfolk, VA



Laird Telemedia
Salt Lake City, UT

eds in high-end teleproduction.



Valcas Video
Production, Inc.
River Edge, NJ



VideoAds
Kennebunkport, ME



Mitre
Bedford, MA



Sandia Laboratories
Albuquerque, NM



KAIT-TV
Jonesboro, AR



USAA Insurance
Company
San Antonio, TX



I Shoot Video
Tulsa, OK



Main Stream
Communications
Minneapolis, MN



Bloomington Assembly
of God Church
Bloomington, MN



Boston College
Chestnut Hill, MA



United Telecom Inc.
Shawnee Mission,
KS



Mountain Video
Productions
St. Thomas,
US Virgin Islands



Square Wheel
Productions
Hollywood, CA



Priority One
Plano, TX



North American Coal
Company
Bismarck, ND



S.C. Johnson & Son
Racine, WI



Jet Propulsion
Laboratory
Pasadena, CA



Sheridan Hills
Baptist Church
Hollywood, FL



WINK-TV
Ft. Myers, FL



Doerr
Electric Company
Cedar Berg, WI



MCNC Research
Triangle Park, NC



WBNG-TV
Binghamton, NY



WTVT-TV
Tampa, FL



WDAY-TV
Fargo, ND



Hartwick Przyborski
Pittsburgh, PA



Newman
Communications, Inc
Grand Rapids, MI



Bureau of
Jewish Education
Newton, MA



Southeastern Bank
Miami, FL



American
Video Cinemas
Lake City, FL



WKOW-TV
Madison, WI



Cleveland
State University
Cleveland, OH



On Q
Video Productions
West Allis, WI



D-L Images
Indianapolis, IN



Independent
News Service
Ambridge, PA



University of Florida
Gainesville, FL



TAVPRO
Omaha, NE



Comm. Energy
Cambridge, MA



David Hetlend LTD.
Fargo, ND



Carlson Video
Billings, MT



Tecumseh
Grafton, WI



JVC™

OTHE CAM SO





13. Al Berlin – Video Corporation of America
 14. Phil Dalen – Blumberg Communications
 15. Joe Stoebner – Audiovisual
 16. Bernie Palmer – L. Matthew Miller Associates
 17. Dave Rauth – VMI Company of St. Louis
 18. Helene Anderson – Crimson Tech

19. Lloyd Hicks – Midwest Communications
 20. Bud Lines – Lines Video Systems
 21. Ken Muehnbauer – Avonix Video Systems
 22. George Crowder – G.C. Video
 23. Paul Lines – Lines & Associates

SIONAL VIDEO

Join the hundreds of professionals who are closing ranks behind the JVC PROCAMS so solidly and so fast that the PROCAMS are assuming an almost generic identity as *the* high-end teleproduction cameras.

KY-950B. KY-320B. The PROCAMS. JVC's crowning achievements in packaging ultra-reliable performance in compact, affordable, professional, 3-tube color cameras.

PLUMBICON* TUBES, of course, whose built-in bias light practically eliminates lag differential; and whose high beam current stabilizes highlights. The "comet tailing" and loss of detail that can mar shiny or glittery subjects is virtually eliminated.

Other common video problems are dispatched, too, like image retention—even with brilliant reds. And your Plumbicon-equipped PROCAM does all these things automatically, while never compromising the highest possible resolution. Plumbicons prevent the build-up of microphonic vibrations, too, helping maintain a high S/N.

PROCAMS. Superlative professional cameras whose performance

meets the most sophisticated requirements of broadcast, ENG, EFP, and, indeed, any high-end teleproduction.

But what about special situations that arise from day to day? Is your PROCAM adaptable?

And how about emerging technologies? Is your PROCAM—or will it be—compatible with TRIAX CABLE, for example; or COMPONENT VIDEO.

TRIAX CABLE is a boon to video production in its ability to retain signal strength despite increasing distance from the source. Triax is indispensable to much EFP and ENG work, and in sporting and other public events where cameras are necessarily positioned some distance from the action.

Don't worry. JVC's Triaxial Adaptor mounts easily on your PROCAM. The cable permits extension to almost a full mile. And JVC's is the *only* Triaxial system in its price range offering chroma key capability.

COMPONENT VIDEO. By far the brightest technological star on the video horizon, component video handles signals individually instead of

combining them. Component color signals are measurably brighter, sharper, and truer than composite signals. With the handy JVC KA-3 Component Adaptor, any PROCAM can record video signals in component, and is fully compatible with the M-II tape format which is coming on strong, as well as all other 1/2" component formats. And you can keep your signals in component form right on through editing and other processing, retaining component clarity and color fidelity right up to delivery.

Component video starts with the recording—the camera—and you're ready for it. Because your PROCAM is ready for it.

And we haven't even mentioned PROCAM performance and convenience features, many of them automated to simplify portability, set-up, and operation. A partial list includes: Better than 650 Lines Resolution... Signal-to-Noise ratio of 58dB... Auto-Shift Registration... Automatic White and Black Balance... Automatic Level Depend... Automatic Highlight Compression... Auto Black Level Stabilization

... Corner Registration Correction... Matrix Masking... Flare Compensation... Focus Wobble... Zebra Stripe Video Level Indicators in Viewfinder... 2H Vertical Contour Correction... RS-189 Split Field Color Bar Generator... f/1.4 Prism Optics With Built-In Quartz Filter... Stable RS-170A Sync Output with Color Frame Pulse... Light Weight... Pickup Tube Protection Circuit... Compact, Solid Aluminum-Diecast Body... Long-term Memory Back-Up for automatic functions... Preheating Circuit... Video Recorder Power Save Circuit... LED Viewfinder Indicators... Digital H/V Variable Blanking... and more.

The PROCAMS. The KY-950B. The KY-320B. Penetrating dozens of new markets. Outperforming the competition in scores of imaginative applications in the hands of demanding professional users.

See for yourself.

For a demo, call us toll-free for the name of your PROCAM Representative.

1-800-JVC-5825

*Plumbicon is a registered trademark of N.V. Philips

JVC COMPANY OF AMERICA, PROFESSIONAL VIDEO COMMUNICATIONS DIVISION, 41 SLATER DRIVE, ELMWOOD PARK, NJ 07407 JVC CANADA, SCARBORDUGH, ONTARIO

JVC®

- Dataworld** (2779)
Broadcast industry databases; computational programs; allocation, interference, population studies.
Circle (690)
- Datum** (2446)
SMPTE time code systems; source ID readers, encoders.
Circle (691) [See ad page 160](#)
- Davis & Sanford** (2496)
Pan/tilt heads, tripods, accessories.
Circle (692)
- dbx** (2740)
Audio dynamics processors; MTS processors.
Circle (693)
- Dedo Weigert Film GmbH** (2748)
*Lighting systems; *lens attachments; *periscopes.
Circle (694)
- Del Compu-Cable Systems** (2551)
*Broadcast, CATV character generators.
Circle (695)
- Delcom** (2551)
Studio furnishings, lighting, draperies.
Circle (696)
- Delta Electronics** (3488)
RF ammeters, impedance bridges; remote control systems; coaxial transfer switches; power, modulation controllers; *AM stereo processors.
Circle (698) [See ad page 238](#)
- Desisti Lighting/Desmar** (2796)
*Lighting instruments, mounting devices; lamps; dimmers; rigging *fixtures.
Circle (699)
- DeWolfe Music Library** (2712)
Production music, effects libraries.
Circle (700)
- Dialight/Neutrik** (2691)
Audio *plugs, jacks; *patching accessories.
Circle (702) [See ad page 137](#)
- Dielectric Communications** (3436)
Transmission line, waveguide; CP, panel antennas; RF switchers, combiners, diplexers, filters; RF test loads; dehydrators; microwave absorption products.
Circle (703)
- Digital Arts** (2482)
*Electronic graphic/animation systems.
Circle (704)
- Digital Services/DSC** (3304)
Digital video effects systems; still store equipment; graphics animation systems.
Circle (705)
- Digital Video Systems/S-A** (3272)
TBCs, frame synchronizers.
Circle (706) [See ad page 286](#)
- Di-Tech** (3567)
Audio/video *routing switchers, control panels; audio, video, pulse DAs.
Circle (708)
- Dolby Laboratories** (2705)
*Audio noise reduction, spectral *processors.
Circle (709) [See ad page 237](#)
- Dorrough Electronics** (2602)
Audio processors, meters, *mixers.
Circle (710) [See ad page 204](#)
- The Droid Works** (128)
Videotape, audiotape editing systems.
Circle (711)
- Dubner Computer Systems** (3110)
Electronic *graphic/titling systems; slide, *still stores.
Circle (712) [See ad page 117](#)
- DX Communications** (2693)
Satellite receivers.
Circle (713)
- Dynair Electronics** (3409)
*Routing switchers; control panels.
Circle (714) [See ad page 103](#)
- Dynamic Sound & Vision Pty** (2578)
Circle (715)
- Dynamic Technology** (2588)
Routing, distribution systems.
Circle (1155)
- Dynatech NewStar** (3128)
Automated newsroom systems.
Circle (716)
- Eastman Kodak** (3208)
*Videotape; motion picture film.
Circle (717) [See ad page 11](#)
- Echolab** (2827)
*Video production switchers.
Circle (718)
- Editron Australia** (---)
Audio, video film *machine synchronizers.
Circle (720)
- EECO** (3540)
Time code generators, readers, accessories; videotape editing control systems.
Circle (721)
- EEG Enterprises** (2802)
*Teletext/captioning systems; vertical interval data insertion equipment.
Circle (722)
- EEV** (2626)
*Leddicon, vidicon camera tubes; *power tubes; klystrons.
Circle (723) [See ad page 81](#)
- Elcon Associates** (2621)
*Videotape conditioner, cleaner, evaluators.
Circle (724)
- Electro Impulse Laboratory** (3431)
Forced air dummy *RF test loads; calorimeters; RF attenuators; wattmeters.
Circle (725) [See ad page 202](#)
- Electro-Optics Div/EG&G** (2612)
*Tower lights, controls; beacons.
Circle (726)
- Electro Voice** (3430)
Control room speakers, monitors; mics, mixers; production, reinforcement, mixers, audio processing systems.
Circle (727)
- Electronic Research** (2576)
FM antennas; diplexers, notch filters.
Circle (728)
- Electronic Systems Lab** (2640)
Eela audio mixers; RTW meters; audio, video RF distributor.
Circle (729)
- Electronic Visuals** (2730)
*TV signal waveform/vector monitors.
Circle (730)
- Elicon** (3220)
*Motion control, camera support systems.
Circle (1157)
- EMCEE** (3032)
*UHF TV transmitters; *MDS/ITFS systems.
Circle (731)
- Emcor Products/Crenlo** (2402)
Standard, custom equipment racks, EMI enclosures.
Circle (732) [See ad page 215](#)
- Energy-Onyx** (2703)
FM transmitter systems.
Circle (733)
- E-N-G Corporation** (3308)
ENG, small mobile production vehicles.
Circle (734)
- Environmental Satellite Data/ESD** (2787)
*Weather graphics equipment, work stations; weather database, data processing systems for radio, TV.
Circle (735)
- Environmental Technology** (2696)
Antenna deicing systems.
Circle (736)
- ESE** (3470)
Timers, digital clocks; time code systems; telephone hybrids; distribution amps.
Circle (737) [See ad page 343](#)
- Ethereum Scientific** (2464)
Transportable satellite uplink systems.
Circle (738)
- Eventide** (2830)
Digital audio *delays, programmable *effects processors; time compression systems.
Circle (739)
- Evertz Microsystems** (201)
*Time code-based systems; VTR emulation modules for ATRs; *machine synchronizers.
Circle (740)
- Excalibur Industries** (2637)
*Equipment cases.
Circle (741)
- Factbook Research** (3383)
Industry data books, reference sources.
Circle (742)
- Fairlight Instruments** (215)
Videographic synthesizer computer.
Circle (743) [See ad page 203](#)
- Faroudja Laboratories** (2488)
Video encoder/decoders, noise reduction.
Circle (744) [See ad page 309](#)
- Ferno Washington** (2914)
Audio/video location *equipment cart.
Circle (745)
- Fidelipac** (3092)

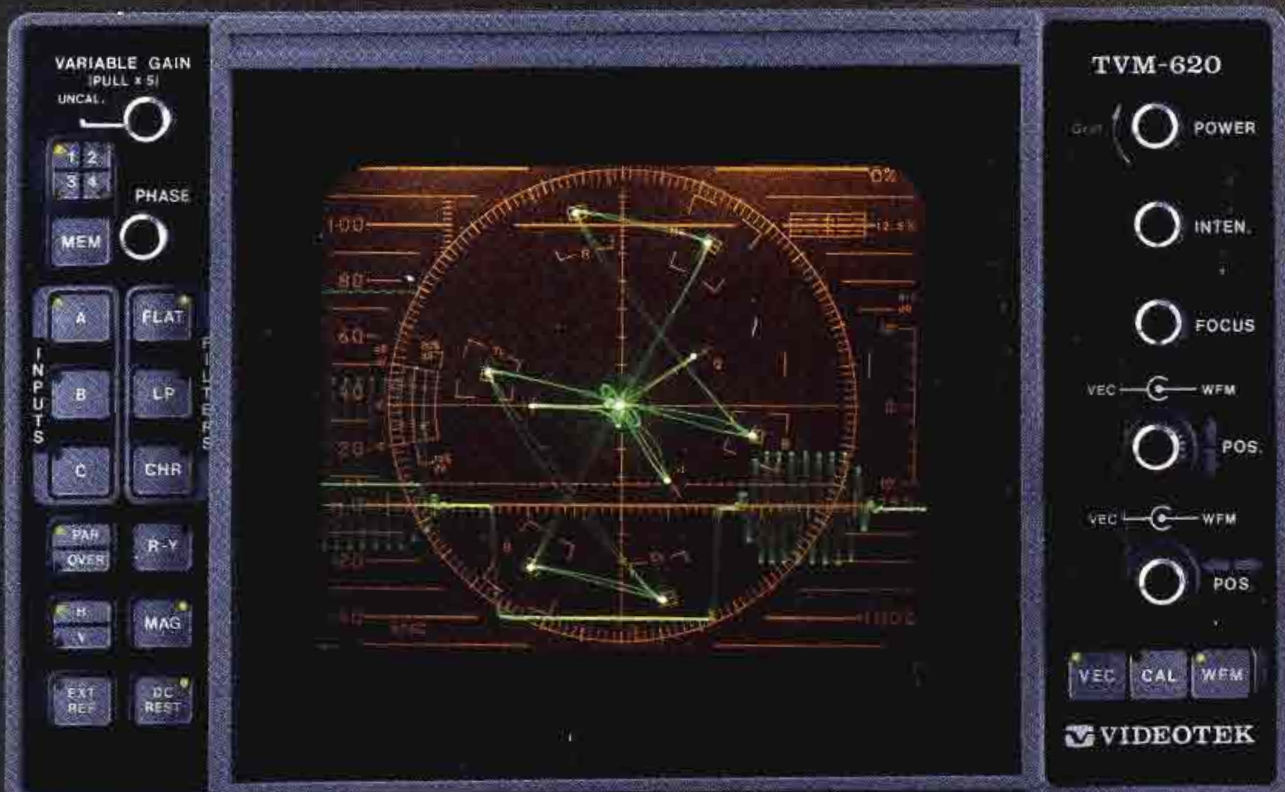

TVM-620

- 15 MHz Bandwidth
- AC or DC (optional) operation
- Flat, Low Pass, Chroma, R-Y display modes
- Multiple display combinations for signal comparisons
- Storage/recall of 4 user-programmed set-ups

VPH-360

- Generates SCH phase markers on any vectorscope
- Absolute SCH phase monitoring
- Normal/bypass modes
- Rack-mountable in optional DAT-1 or DAT-3 tray

DM-140S

- 140-channels (UHF/VHF/Cable)
- Frequency-synthesized varactor tuning
- MTS stereo or SAP audio outputs
- Stereo amplifier w/ext. speakers
- Unlimited favored channel programming
- Int: 3" speaker on front panel

TIMES SIX AND TIMES SIX PLUS

- Centralized control of system timing
- 6 adjustable black burst outputs
- 6 horiz./subcarrier timing adjustments
- Stand-alone or gen lock operation
- Automatically compensates for cable length/equip. drift (TIMES SIX PLUS)

Hot Stuff!

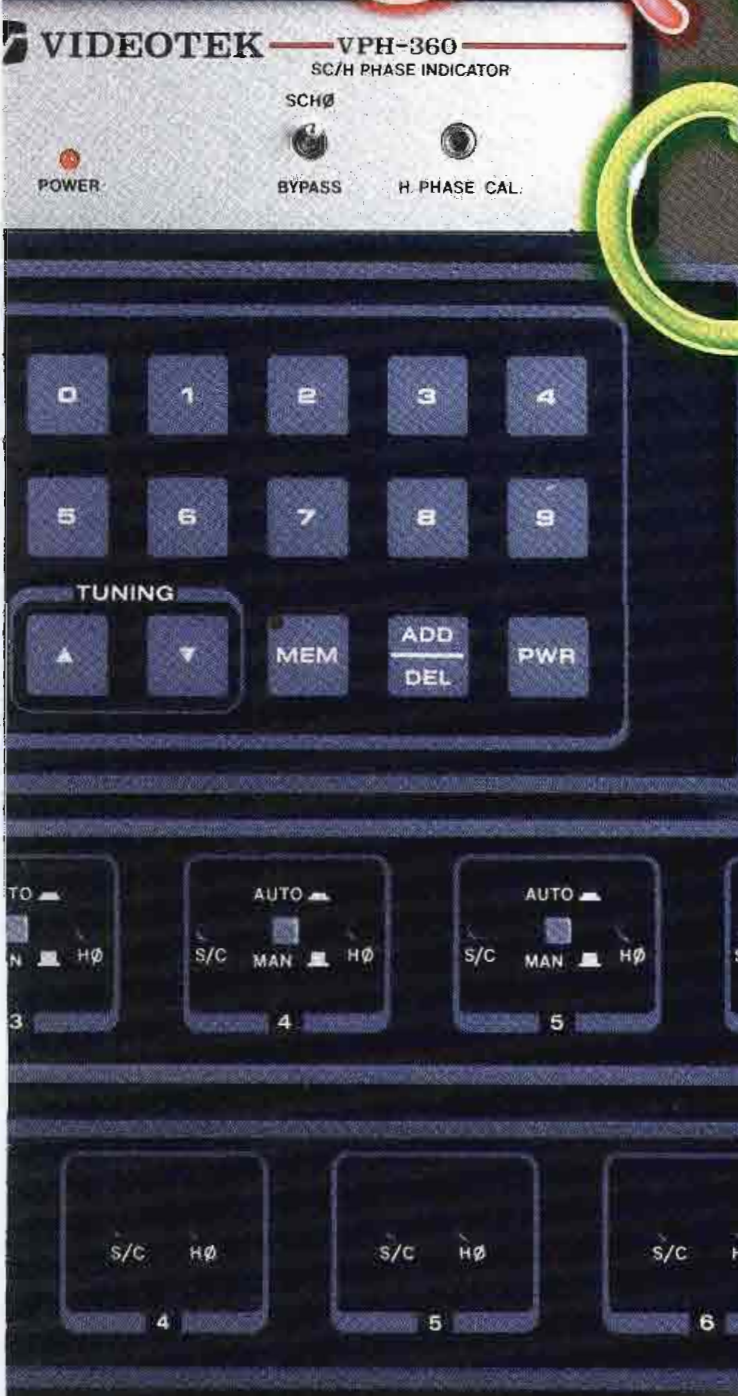

Videotek introduces a new breed of value-engineered products.

Extraordinary engineering and unusual economy... A rare combination—and Videotek's got it, with a unique line-up of feature-loaded new equipment for '87.

Take our new microprocessor-based TVM-620 waveform monitor/vectorscope, which boasts user-defined memory recall plus three selectable inputs. View any waveform combination simultaneously in parade mode. Or overlay waveform and/or vector displays at the gentle touch of a membrane push button.

Our new DM-140S demodulator provides 140-channel tuning capability, with balanced or unbalanced MT5 stereo or SAP audio outputs and a separate mono-aural output. Unit comes with volume-adjustable internal speaker, external stereo speakers and tactile membrane control panel.

Get in sync with our new TIMES SIX black burst generator with individual horizontal and sub-carrier timing correction for up to six video sources. Better yet, the TIMES SIX PLUS with digital horizontal lock lets you choose manual or fully automatic operation for quick set-up.

And there's more—like our VPH-360 sub-carrier phase indicator, which interfaces with any vectorscope for inexpensive absolute SCH phase monitoring. They're all designed for ease of operation and built for reliability. Discover a new breed of video products at your Videotek dealer today.

See our "Hot Stuff" at NAB and win prizes
 Visit booth #3316
 Circle (98) on Reply Card

 **VIDEOTEK INC.**
 Designed for real needs.
 Priced for real budgets.

243 Shoemaker Road, Pottstown, Pennsylvania 19464
 (215) 327-2292 TWX 710-653-0125 FAX (215) 327-9295

*Audio cartridge recorders; audio tape.
Circle (746)

Fife-Pearce Electronic (2686)
*Electro-Matic tape degaussers; erasers.
Circle (747)

Film House (2816)
TV commercials to promote radio stations.
Circle (748)

Firstcom (2829)
Financial services.
Circle (749)

Flash Technology (3454)
*Tower obstruction lighting, beacons.
Circle (750)

For-A of America (3599)
*Digital audio memory recorder; *production switchers; video processors, TBCs, *color correctors; *time code systems; component video equipment; graphic/titler systems.
Circle (751) See ad page 47

Fort Worth Tower (3360)
Broadcast towers; services consulting.
Circle (752)

Fortel (3044)
TBCs, frame synchronizers; color/noise correction equipment.
Circle (753)

Fostex of America (2579)

Audio tape recorders, mixers, equalizers.
Circle (754) See ad page 167

Frezzolini Electronics (2716)
*Batteries, chargers, analyzers; lights; Power interface device.
Circle (755) See ad page 106

Fuji Photo Film USA (3240)
Standard, metallic *videotape.
Circle (756)

Fujinon (3410)
TV camera lens systems.
Circle (757) See ad page 31

Future Productions (2790)
*Tape duplication services, systems.
Circle (758)

G&M Power Products (2930)
Batteries, chargers; battery belts; lights.
Circle (759)

Garner Industries (2601)
Audio/video tape erasers, degaussers.
Circle (760)

General Electric/Comband (2479)
*MDS/MMDS, ITFS down converter.
Circle (761)

General Electric Lighting (2717)
*Stage, studio lights.
Circle (762)

Generic Computer Systems (2818)
Billing, traffic, affidavits software.
Circle (763)

Gentner Engineering (2669)
Transmitter remote controllers; telephone bandwidth extenders, *hybrids, interfaces; audio routing switchers; radio intercoms.
Circle (764) See ads pages 100, 264

GML America (2745)
Frame synchronizers; TBCs; special effects production systems.
Circle (766) See ad page 195

Alan Gordon Enterprises (3435)
Animation systems; mics, audio accessories; camera support products; equipment rental.
Circle (768)

Gorman Redlich (2715)
EBS, NOAA weather encoders, decoders, receivers; digital AM antenna monitors.
Circle (769)

Gotham Audio (3354)
*Neumann condenser mic; audio *noise reduction filters; EMT transient limiters; CD players; audio recorders; K&H speakers.
Circle (770)

Graham Patten Systems (2528)
ESAM edit audio mixers, programmable EQ; video keying systems; utility, remote-control audio, video DAs; equipment control systems; audio/video multiplexing process for microwave.
Circle (771) See ad page 298

Grass Valley Group (3112)
*Routing, *production and master control switchers; switcher automation; *sync generator changeover switches; *stereo DAs; com-

Two Rules Every Broadcast Professional Ought to Know

RULE 1

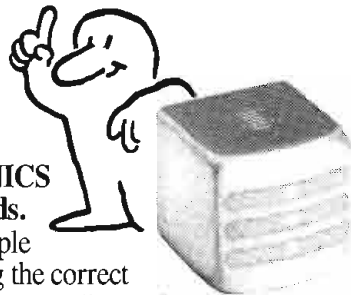

Always Use NORTRONICS Replacement Tape Heads. NORTRONICS salespeople will assist you in selecting the correct replacement head for your recording and duplicating equipment, even over the telephone. Just tell us the manufacturer and model number of your equipment—or the manufacturer's head part number—and we guarantee you'll get the right part every time.

NORTRONICS Replacement Tape Heads are available for most models, including:

- Ampex
- Broadcast Electronics
- ITC/3M
- Pentagon
- Recordex
- Scully
- Telex
- Most Others

RULE 2

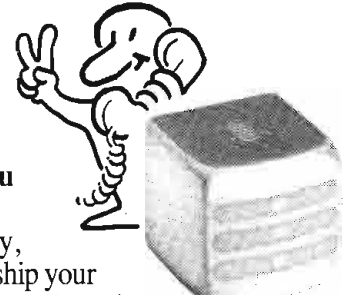

NORTRONICS Lets You Order Direct. Call NORTRONICS today, toll free, and we'll direct ship your quality replacement head usually within one day. If you are not completely satisfied, you can return the head within 30 days for a full refund. And all NORTRONICS parts come with a comprehensive warranty on materials and workmanship.

For more information or to place your order, call toll free:

1-800-328-5640, ext. 677 (USA) 612-545-0401, ext. 677
1-800-742-0687, ext. 677 (MN) TELEX 29-0304

NORTRONICS®

8101 10th Avenue North ■ Minneapolis, MN 55427 USA

Circle (91) on Reply Card

CTM-10 CARTRIDGE RECORDER

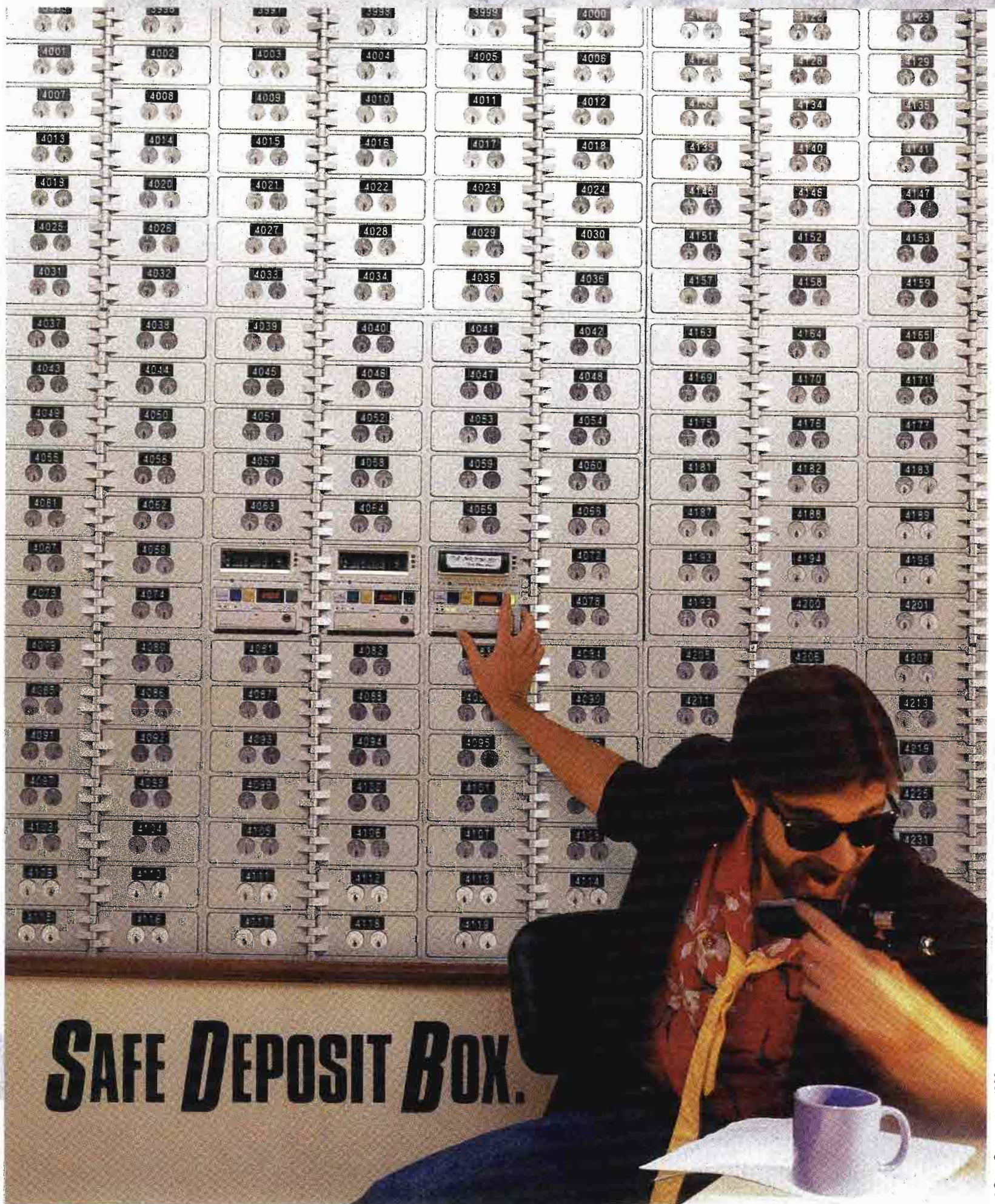

©Otari Corporation, 1986

Finally, a cart machine you can bank on. ■ No jams, no repeats and no make goods. ■ Our new CTM-10 cart machine has the same famous reliability that is built into our 5050 BII, ■ plus many new features like Hx-Pro,* ■ so 7.5 ips sounds like 15 ips and your listeners don't tune-out when you shift from CD to cart.

So call us for Technology You Can Trust. ■ Otari Corporation, 2 Davis Drive, Belmont, CA 94002 (415) 592-8311 TWX 9103764890.



*Trademark Dolby Laboratories Licensing Corporation

Circle (100) on Reply Card

Grass Valley, continued

ponent *video encoders, effects, editing systems; fiber-optic products.

Circle (772) [See ads pages 9, 291](#)

Gray Communications (3402)
Distributor of audio, video equipment.
Circle (773)

Gray Engineering Labs (2515)
Time code products.
Circle (774) [See ad page 230](#)

Great American Market (2714)
Lighting instruments, lamps; effects, pattern projectors, pattern templates; aluminum light block.
Circle (775)

Grumman (2481)
Commercial insertion systems, linked to traffic, billing.
Circle (776)

James L. Grunder Associates (2429)
CEL TBCs, synchronizers, *video effects systems; *editing controllers; video monitors; video test products; standards converters.
Circle (777)

GTE Spacenet (3324)
Satellite transmission, news gathering, voice, data services; *program distribution; signal turnaround, bandwidth conversion.
Circle (778)

Hallikainen & Friend (2925)
*Remote control systems; logging systems; *stereo TV on-air mixer; digital metering update kits.
Circle (779)

Hardigg Industries (2489)
Reusable equipment containers; protective packaging materials.
Circle (780)

Harris Broadcast Group (3136)
*AM/FM, *TV, *STL/ENG, uplink transmitters, antennas; video effects still stores; TBCs, frame synchronizers; audio mixers, processors, phase correctors; remote control, automation equipment; *video interfaces.
Circle (781) [See ad pages 234-235](#)

Harrison Systems (3412)
On-air, production audio mixing consoles.
Circle (782) [See ad page 354](#)

HEDCO (2751)
Audio, video DAs, companion rack-frames, power supplies; video, stereo audio routing switching systems.
Circle (783)

Karl Heitz (2900)
Camera support products; mic poles.
Circle (785)

Hipotronics (2645)
Power automatic voltage regulation systems.
Circle (786) [See ad page 255](#)

Hitachi Denshi America (3160)
Portable, studio cameras; videorecording systems; HDTV equipment.
Circle (787) [See ad page 3](#)

HM Electronics (2619)

Wireless *mic systems; wired, wireless intercoms, speaker, headset stations.

Circle (788) [See ad page 77](#)

Hoffend & Sons (2641)
Studio rigging systems; programmable rigging controllers.
Circle (789)

Holiday Industries (2737)
Instruments for magnetic, electric field, non-ionizing radiation measurements.
Circle (790)

Home Shopping Network (2753)
CATV shopping service.
Circle (791)

Hotronics (2531)
TBCs, frame synchronizers.
Circle (792) [See ad page 281](#)

Howe Audio Productions (2832)
*Audio signal phase analyzer; on-air, production mixers; *headphone amp; turnkey studio, furnishings design, construction.
Circle (793) [See ad page 249](#)

Hubbard Communications (3286)
Program distribution services; satellite time brokers.
Circle (794) [See ad page 241](#)

Hughes Communications (204)
Satellite program distribution services.
Circle (795)

ICM Video (2468)
Audio, video DAs, utility *routing switchers; video enhancers, processors; character generator, titlers, NTSC, PAL.
Circle (796) [See ad page 231](#)

IGM Communications (3378)
Radio automation Carousel equipment.
Circle (797) [See ad page 159](#)

Ikegami Electronics (3150)
Studio, ENG *cameras; color, b/w monitors; large screen projectors; HDTV equipment; ENG *microwave systems; telecine; security systems.
Circle (798) [See ads 300-301, 314-315, 352-353](#)

ILC Technology (212)
Daymax HMI lamps.
Circle (799)

Image Video (2636)
Master control, routing switchers.
Circle (800)

Imageering Laser Disk Systems (235)
Interactive video disc systems; electronic *graphic paint systems; *still stores.
Circle (801)

Information Display Systems (2485)
Turnkey studios, world-wide services; U.S. sales, service for Swiss-made Eidophor.
Circle (802)

Innovative TV Eqpt/ITE (3258)
Pan/tilt heads, tripods, pedestals.
Circle (803)

Inovonics (2434)
*FM, FMX stereo generators; *multi-band audio processors; *magnetic film recorders; CRT audio level displays.
Circle (805) [See ad page 290](#)

All of TFT's fine products are available from:

Continental Electronics —All Offices
Harris Corporation —All Offices
Midwest Corporation —All Offices
RF Specialties —All Offices

Arizona:
Spencer Broadcast, Inc.

California:
Barrett Associates Inc.
Broadcast Marketing Assoc.
Elcom/Bauer
Funke & Associates
Kidd Communications, Inc.
Marcom
Western Broadcast Systems

Colorado:
Didier Broadcast Assoc.
Television Tech. Corp.

Florida:
Broadcast Systems Corp.
Control Technology Inc.
Electrex Co.
Pro Audio General Store

Georgia:
Broadcast Sales Corp.
Pro Audio General Store
Radford Associates

Hawaii:
John J. Harding Co., Ltd.

Idaho:
Hall Electronics

Illinois:
Broadcast Electronics, Inc.
NEC America
Pro Audio General Store
RAM Broadcast Systems

Louisiana:
Audiomedia Associates

Massachusetts:
Landy Associates Inc.
M/A Com
Townsend Associates

Maryland:
Bradley Broadcast Sales
Larcan Comm. Equip. Inc.
NCI
Radio Resources

Michigan:
Dyer Electronics
Hy James, Inc.

Minnesota:
Emmons Associates
Todd Communications

North Carolina:
EME I, Inc.

New Jersey:
BTS/Broadcast TV Systems Inc.
Holzberg Associates
Landy Associates, Inc.

New Mexico:
Dyma Engineering

New York:
Henry Grossman Associates

Oregon:
Norcom

Pennsylvania:
Acrodyne Industries
Barker Electronics
Radio Systems, Inc.
Val-tronics, Inc.

Puerto Rico:
Turabo Radio

Texas:
Broadcast Systems, Inc.
Crouse-Kimzey Company
Giesler Bcstg Supply, Inc.
NTSC
Parcom
Savco

Utah:
Media-West, Inc.

Virginia:
Old Dominion Bdcst Eng. Svc.

Washington:

Broadcast Supply West

Wisconsin:
Electronic Industries Inc.

Canada:
MSC Electronics—All Offices

Canada (Western Provinces):
Nortec West

RACK OUR BRAINS,

● STL SYSTEMS

The New 8600—Monaural

The 8300—Composite

The 7700B—Composite

● BTSC STEREO

The 850 BTSC TV Stereo Monitor

The 855 SAP/Pro Modulation Monitor

The 8500 TV Subcarrier System

● REMOTE CONTROL

The New 8610

● MONITORS

The 844 FM Stereo Off-Air Monitor

The 845 SCA Monitor

The 753/755A AM Off-Air Monitor

● EBS—Emergency Broadcast System

NOT YOURS.

For nearly two decades, broadcasters have consistently chosen TFT for accurate, convenient and reliable monitoring and transmission control equipment. Today, a majority of the radio and television stations in the U.S. depend on one or more TFT precision instruments.

Contact us or a TFT dealer now for information on our complete product line. Rack our brains, not yours.

Today's **TFT** INC

3090 Oakmead Village Drive, Santa Clara, California 95051
(408) 727-7272 Telex: 910-338-0584 Fax: (408) 727-5942

Circle (101) on Reply Card

Integrated Technologies (2610)

*Electronic graphic systems with 3D modeling.
Circle (806)

Interactive Motion Control (2771)

*Computer controlled animation tables and accessories.
Circle (807)

Intergroup Video Systems (3312)

*Production, master control switchers; audio/video routing switcher; pattern generator.
Circle (808)

International Music Company/IMC (2920)

Akai multi-track audio recorders; digital sampling units; RSD Soundmaster audio desks; Fane speakers, cabinets; Ross Systems PA systems.
Circle (810)

International Tapetronics/3M (3052)

Audio reel, cartridge *recorders; recording tape, erasers; cart analyzer.
Circle (811)

Intelco USA (2765)

AM, FM, TV transmitters, transposers.
Circle (812)

ITS/Information Transmission (2415)

VHF, UHF TV exciters, *transmitters; ITFS, MMDS *equipment; *ICPM test measurement sets.
Circle (813)

J&R Film/Moviola (3493)

Film-to-tape transfer systems; machine synchronizers; editing accessories.
Circle (814)

Jampro Antennas (3587)

FM and TV transmitting antenna systems.
Circle (815) See ad page 120

JBL Professional (2727)

Auto mic mixers; studio monitor speakers, amplifiers; EQ systems.
Circle (816) See ad page 97

Jefferson Pilot Data Systems (3204)

Newsroom, business, music rotation *software.
Circle (817)

Jensen Tools (2721)

Broadcast, electronic technician's tool kits; tools; transport cases; *fiber-optic splicing kits; *precision VCR alignment tools.
Circle (818)

J-Lab (2521)

Video recording interfaces.
Circle (819)

Johnson Electronics (3451)

SCA, EBS receivers; receiving antennas; audio amplifiers; audio products.
Circle (820)

JVC of America (3180)

Audio mixers; studio, ENG *cameras, lenses; *electronic graphic, titling systems; video

monitors; video recorders; routing switcher; TBCs; recording tape; tape duplicators.
Circle (821) See ads pages 19, 169-176

K&H Products (2532)

Camera support products.
Circle (822) See ad page 266

Kahn Communications (2922)

Audio processing systems; telephone bandwidth extenders; AM stereo signal systems.
Circle (823)

Kaman Sciences (3078)

Station business systems, software.
Circle (824)

Kangaroo Video Products (2676)

Protective video equipment *cases.
Circle (825)

Kavouras (2657)

*Weather radar systems; maps.
Circle (826)

Kay Industries (2511)

Power line conditioners; electrical power phase converters.
Circle (827)

Keltec Florida (2435)

*Satellite uplink, HPA electronics.
Circle (828)

KEM Elektronik Mechanik GmbH (2467)

Film, sound tables; machine synchronizer, interlock systems.
Circle (829)

**TURN-ON TO COMTEK....
IT'S TIME YOU HEARD FROM US!**

We've been making sound believers out of critics of wireless microphone systems for nearly fourteen years. Contractors and engineers throughout the country have come to **depend on COMTEK** for:

- WIRELESS MICROPHONES, FULL DUPLEX COMMUNICATIONS, PERSONAL CUING SYSTEMS, RF ASSISTIVE LISTENING DEVICES FOR THE HEARING IMPAIRED.
- SYSTEMS OPERATING IN THE HIGH BAND FREQUENCIES UP TO 216 MHz.
- GUARANTEED PERFORMANCE AND HIGHEST BATTERY EFFICIENCY IN THE INDUSTRY FOR RELIABLE OPERATION.
- FACTORY TECHNICAL SUPPORT AND A FULL ONE-YEAR WARRANTY PLUS 24-HOUR TURN-AROUND SERVICING ON COMTEK EQUIPMENT.



First quality in wireless sound

FOR FULL PRODUCT INFORMATION
CALL COMTEK OR YOUR NEAREST
COMTEK DEALER TODAY.

Phone: (801) 466-3463

357 West 2700 South, Salt Lake City, Utah 84115

COMTEK®

Circle (102) on Reply Card



Precision Performance

That's what you get with Utah Scientific's routing switchers. Stable, precise performance is assured by circuitry employing very close tolerance components in high-gain feedback loops.

And, you get long-term stability. It's a well known fact that component life is an inverse function of operating temperature—that's why our routers have cooling fans in plug-in modules. We worry about long-term stability so you won't have to.

Plus, Utah Scientific routing switchers perform to the industry's best specifications, offer the widest choice of control panels, on-line reprogramming, and a five-year parts and labor warranty.

Call or write today for more information. Find out about the precision performance of Utah Scientific routing systems.

**See us at NAB
Dynatech Booth
3128**

Circle (103) on Reply Card

USJ UTAH SCIENTIFIC, INC.
DYNATECH Broadcast Group

1685 West 2200 South, Salt Lake City, Utah 84119
(801) 973-6840 · Toll Free 1-800-453-8782
TLX: 269-916 · FAX: 8019730255

CASP will
Charge & Analyze

ANY Battery and Faster

New software in Christie Electric Corp's CASP make it instantly compatible with ANY battery. CASP is now the only truly universal charger/analyzer/sequencer/power supply.

One software program will accommodate ANY battery. You will never need software updates or custom software to be able to service *any* manufacturers' product.

CASP will charge & analyze ANY battery in *Record Time*.

ANY MANUFACTURER *Faster*

- Anton/Bauer
- Alexander
- Christie
- Frezzolini
- Pag
- Panasonic
- PEP
- Perrott
- Sanyo
- Sony

and ALL others

See
demo at
Embassy Suites,
Love Field.

ANY Battery and Faster

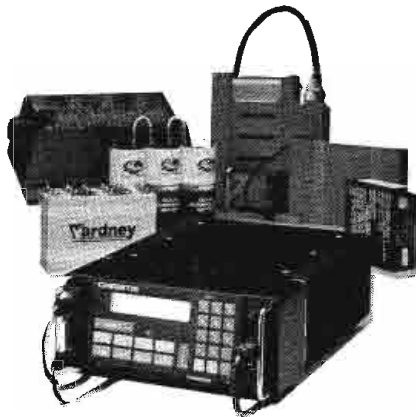

CHRISTIE

ELECTRIC CORP.

20665 Manhattan Pl.
Torrance, CA 90501 USA
213-320-0808 800-421-2955
TWX 910-349-6260

Circle (104) on Reply Card

Keylite PSI (2789)
Lighting instruments, dimmers, controllers,
*lighting cable protective accessories.
Circle (830)

Kinematics/Truetime (2513)
Precision timers, *synchronized clock
systems.
Circle (831)

Kings Electronics (3464)
RF, video, co-/triflex connectors.
Circle (832)

Kintek (2455)
Stereo converters, *processors; polarity cor-
rectors; phase meters; stereo identifiers.
Circle (833)

Kintronic Laboratories (2540)
AM DA phasors, tuners; *RF patch panels; HV
insulators; *RF switches; tower transformers,
lighting chokes; variable inductors.
Circle (834)

Kliegl Brothers Stage Lighting (3581)
Lighting instruments; studio lamps; dimmers,
dimmer controllers.
Circle (835)

Kline Iron & Steel (2797)
Broadcast, communication towers, services,
accessories.
Circle (836)

Knox Video Products (2611)
Electronic graphic titlers; video signal proc-
essors.
Circle (837)

Kobold Lighting (2834)
Studio, portable lighting, accessories.
Circle (837)

Laird Telemedia (3474)
TV film multiplexers; production titlers.
Circle (838)

Lake Systems (112)
*Automated VCR playback system, software.
Circle (839) [See ads pages 43, 45](#)

Landy Associates (3429)
Video equipment distributor; *cameras;
*editing control systems; *graphic systems;
*computer software.
Circle (840)

Larcan Comm Equipment (3314)
UHF/VHF TV, *FM radio transmitters; MTS
equipment.
Circle (842)

LEA/Dynatech (3332)
Lightning protection and deterrent products;
power surge protection devices.
Circle (843)

Leader Brac Industries (2542)
Audio *tape editing accessories.
Circle (844)

Leader Instruments (2763)
Sync, video *test signal generators;
*waveform, vector monitors, *oscilloscopes.
Circle (845) [See ad page 5](#)

Leasing Concepts (2822)
Equipment rental, leasing.
Circle (848)

LeBlanc & Dick Communications (2417)
Communications, broadcast towers, services,
accessories.
Circle (849)

Lectrosonics (2445)
Portable PA systems; VHF hi-band *wireless
mic systems.
Circle (850) [See ad page 253](#)

Lee Colortran (3598)
*Lighting equipment, lamps, controllers, dim-
mers, accessories.
Circle (851)

Leitch Video (3559)
*Digital still stores; *sync, VBI test
generators, inserters; SC/H *test monitors;
*tone generators; *audio DAs; timing
systems; frame synchronizers.
Circle (852) [See ad page 59](#)

LEMO USA (2805)
Audio, video *connectors; coax, triax,
multicore, mixed coax/multi-pin connectors.
Circle (853)

Lenco (3056)
Audio/video DAs; audio monitor amps; *sync
generators; SC/H monitors; TBCs; video en-
coders.
Circle (854)

Lexicon (136)
Audio delay/effects processor; digital audio
*mixing/editing system; time compressor.
Circle (855)

Lighting Methods (2673)
Portable and rack-mounted *dimmers; dim-
mer control consoles.
Circle (856)

Lightning Eliminators/Consultants (151)
Lightning dissipation arrays; ground rods;
warning systems; power conditioning con-
sultants.
Circle (857)

Listec Video (3468)
Computer video *prompters; script tables;
video enhancers.
Circle (858) [See ad page 230](#)

Logitek (2807)
Audio production, broadcast mixers; audio
monitor amps, speakers; impedance interface
devices.
Circle (859)

Lowel Light (2600)
*Lighting instruments, lamps, for film, video,
still photography.
Circle (860)

LPB (3338)
Audio mixers; low power AM transmitters.
Circle (861)

LTM of America (2537)
*Lighting instruments; carbon fiber *mic
poles; fiber-optic lighting system.
Circle (862)

Luxor (237)
Satellite receivers.
Circle (863)

Lyon Lamb VAS (3492)
Video animation systems.
Circle (864)

The World's Best UHF TV Transmitting Antenna Just Got A Lighter Brother Easier To Install And Less Expensive

Tower legs make great supports for side mounted system components; a luxury not enjoyed by our top-mounted systems.

By removing our support pole for leg-mounted operation, Bogner's UHF TV antennas are now not only the world's best antennas but our new side mount version is a lot lighter, easier to install and costs considerably less.

Bogner's slot broadcast antennas have long been known for their outstanding performance and ability to custom tailor vertical and horizontal radiation patterns to fit the specific needs of each location. A patented director system with radiating elements is largely responsible for this impressive performance. So impressive that over 1,000 Bogner TV Broadcast antennas employing this technique are now in use.

For top-of-the-tower mounting, Bogner antennas employ a simple single row of radiating slot cavities bolted to a supporting steel pipe which also encloses the feedlines.

Now, Bogner's DUI Series antennas can be side-mounted to a tower leg without using a

support pipe at all. Instead, the slot cavities and the power divider are bolted directly to a tower leg and are interconnected with 3 1/2" pressurized semi-flexible coaxial cables. Weight, wind load, and cost are markedly reduced. But performance is virtually unchanged with power gains to 16 dB and VSWRs of under 1.08:1 over an entire channel (better than 1.05:1 at visual). In fact, the side-mounted array has precisely the same gain, VSWR and horizontal and vertical radiation patterns as our top-mounted version.

Yet the best news is that Bogner side mount antennas still offer radiation patterns that are tailored to each application and are individually guaranteed to meet or exceed Bogner's specifications.

Bogner ... always the world's best antenna.

BOGNER * 603 Cantigue Rock Road
Westbury, N.Y. 11590
(516) 997-7800
Broadcast Equipment Corp.

- Tower Leg Mounted
- No Support Pole
- Reduced Weight
- Reduced Wind Load
- Reduced Cost
- Full Bogner Performance

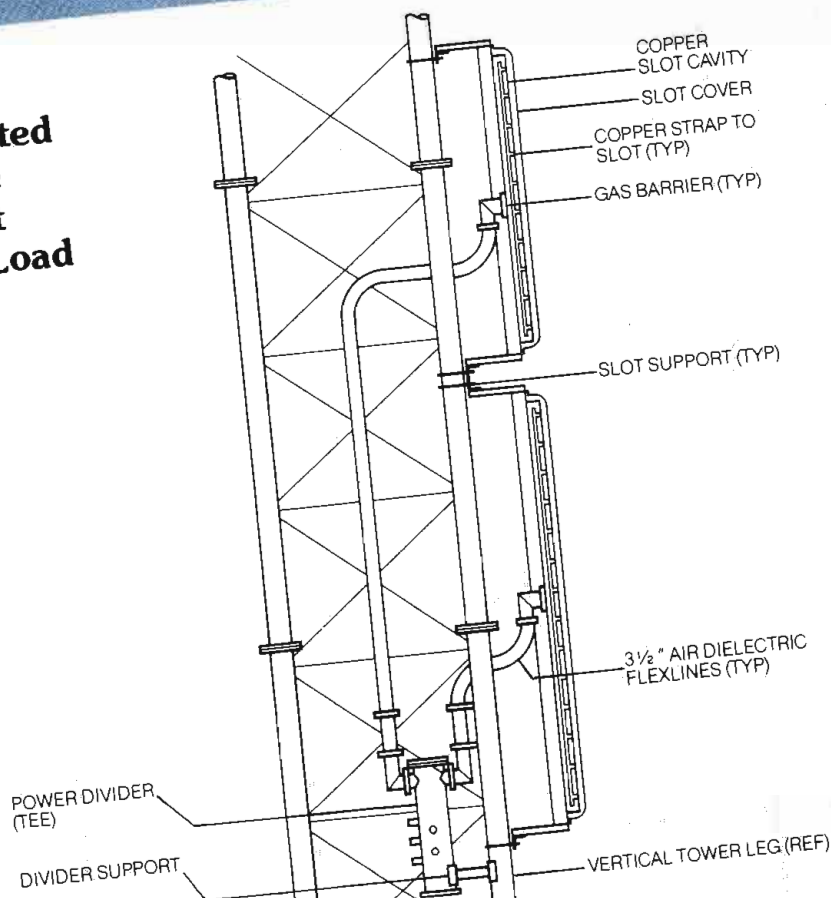

Circle (105) on Reply Card

M/A-COM MAC (3280)
 *STL/ENG at 18GHz, 23GHz; fixed, portable microwave radio, 2-40GHz.
 Circle (865) [See ad page 289](#)

Magni Systems (2827)
 Programmable *test signal generators, software; video waveform, vector monitors.
 Circle (866) [See ad page 75](#)

Magnum Tower (2901)
 Triangular, self-supporting, knock-down towers.
 Circle (867)

The Management (2512)
 Station business automation.
 Circle (868)

Manhattan Production Music (2550)
 Programmed music services.
 Circle (869)

MARCOM (2433)
 TV, Rood FM *stereo generators, metered receivers; TFT BTSC mod kits; Rood telephone frequency extenders.
 Circle (870)

Marconi Communications Systems (3572)
 TV excitors, *transmitters; klystron pulsars; AM, FM *radio transmitters; telecines.
 Circle (871)

Marconi Electronics (2794)
 TV test signal generators; automated test systems; VBI inserters, signal analyzers.
 Circle (872)

Marti Electronics (3496)
 RPU, STL antennas, electronics; wireless mics; *STL/TSL electronics; *remote pickup unit transmitters, receivers.
 Circle (873)

Matco (NA)
 Sequencers, routing switchers, distribution amps, dubbing controllers, commercial inserters.
 Circle (1154)

Matthews Studio Equipment (3220)
 Grip trucks, dollies; *camera tracks; lighting supports, booms.
 Circle (874)

Matthey Electronics (3342)
 Video, pulse *delays, filters; HDTV filters; video amplifiers.
 Circle (875)

Maxell of America (3551)
 *Videotape cassettes, reels; audio, video cables; audio tape.
 Circle (876) [See ads pages 152, 153](#)

Maze Broadcast (107)
 Used equipment brokers, audio, RF.
 Circle (877)

McCurdy Radio Industries (3028)
 Audio production, broadcast mixers; phono products; studio furniture; intercom products.
 Circle (878) [See ad page 105](#)

McDonnell Douglas Astronautics (2546)
 *Fiber optic transmission systems.
 Circle (879)

MCL (NA)
 *Ku-band TWT amplifiers for uplinks.
 Circle (880) [See ad page 296](#)

Media Computing (2803)
 Election/news graphics, newsroom software.
 Circle (881)

Media General Broadcast (3335)
 Production music, sales libraries; promos; station IDs, jingles, music formats.
 Circle (882)

Merlin Engineering (3408)
 Equipment reconditioning/rebuilding; VTR modification kits, electronics.
 Circle (883)

Micro Communications (3438)
 VHF-TV, FM antennas; circular, rectangular waveguide; RF transfer switches, components; TV diplexers; switchless signal combiners, multiplexers, *filters.
 Circle (884)

Microdyne (3520)
 *Satellite antennas, mounting; up/downlink electronics, receivers.
 Circle (885) [See ad page 101](#)

Micron Audio Products (2752)
 Wireless mics; multichannel receivers.
 Circle (886) [See ad page 242](#)

Microprobe Electronics/MEI (2620)
 *Digital audio storage recorders; satellite, tape format *program automation systems; tone generators.
 Circle (887)

What Tape Problems?

Before we started using the RTI TapeChek™ Evaluator/Cleaner to inspect our videotapes, we had tape problems throughout our station. Our news crews insisted on only new tapes. Now we recycle cleaned and evaluated tapes without worrying about losing the "burning building." We've saved thousands of dollars! And tapes we use for commercials and programming can be checked before **and** after recording, drastically reducing our makegood obligations. In fact, we even check brand new tapes to avoid unexpected problems. Now that we use TapeChek, we look smoother and better on the air. (Our programming department loves that!) I just wish that we had not waited so long to get one.

Thanks RTI!

RTI TapeChek Videotape Evaluator/Cleaners are available for 1" B & C, 3/4" U-Matic, 1/2" Beta/Betacam and VHS/M Formats.

See us at NAB Booth #3386

RTI RESEARCH TECHNOLOGY INTERNATIONAL

4700 Chase Avenue Lincolnwood, IL 60646-1689

Call Toll-Free 800/323-7520 or 312/677-3000 for more information...TODAY!

Circle (106) on Reply Card

Focus On Excellence



Introducing the MR-1 Discrete Head Professional Cassette Deck—
From Nakamichi—the company that created the cassette revolution!

The MR-1—a *professional* deck with front and rear
balanced inputs, unbalanced inputs, balanced and unbalanced outputs,
linear-scale peak-reading meters, independent
Tape and EQ selection, Dolby-B and -C NR, provision for external NR,
remote control, EIA rack mount and more!

The MR-1—with an Asymmetrical Dual-Capstan Direct-Drive Transport with
less than 0.027% flutter, an exclusive pressure-pad lifter that eliminates
scrape flutter and modulation noise, and a Motor-Driven-Cam operating
system that ensures gentle tape handling, automatic slack takeup,
and long-term reliability.

The MR-1—with the legendary Nakamichi Discrete 3-Head recording system
for 20—20,000 Hz ± 3 dB response, absolute azimuth accuracy,
and incredible headroom.

The MR-1 Discrete Head Professional Cassette Deck—
From Nakamichi—the company whose profession is recording!



Nakamichi U.S.A. Corporation 19701 South Vermont Ave., Torrance, CA 90502 (213) 538-8150

*Dolby NR manufactured under license from Dolby Laboratories Licensing Corporation.
The word "DOLBY" is a trademark of Dolby Laboratories Licensing Corporation.

Circle (107) on Reply Card

Microsonics (2543)
Video filters, delay lines.
Circle (888)

Microtime (3086)
*TBCs, frame synchronizers; *digital video effects systems; component format interfaces.
Circle (889)

Microwave Radio (3280)
ENG microwave electronics, antennas.
Circle (890)

Midwest Communication (3210)
Production vehicle designs, construction; turnkey facilities.
Circle (891) See ad pages 1, 123, 125

Miller Fluid Heads (USA) (3440)

Camera support products; pan/tilt heads.
Circle (892) See ad page 232

Minolta (2810)
Light meters; monitor colorimetry checking systems.
Circle (893)

Mitsubishi International (2476)
Digital audio storage systems.
Circle (894) See ad page 197

Mitsubishi Pro Audio (3530)
Analog, digital *audio recorders; audio mixer for post production, recording.
Circle (895)

Mobile-Cam Products (2725)
*Camera pan/tilt heads, cradles.

Circle (896)

Modulation Sciences (2811)
MTS/SAP/PRO generators, *test demods; FM SCA systems; composite RF processing equipment; stereo *audio processors.
Circle (897)

Modulite/Bardwell-McAlister (2746)
Lighting products, systems, accessories.
Circle (898)

Mole-Richardson (3368)
*Lighting instruments, lamps.
Circle (899)

Morton Hi-Tek Furnishing (210)
Studio consoles, equipment racks.
Circle (900)

Moseley Associates (3202)
*Remote control systems; *STLs.
Circle (901) See ad page 283

Motorola C & E (3442)
Mobile radio equipment; remote pickup systems.
Circle (902)

Motorola C-Quam/AM Stereo (3539)
AM stereo exciters, generators, modulation monitor systems.
Circle (903)

MPO Videotronics (2549)
Integrated video systems using 8mm, VHS tape, videodisc sources.
Circle (904)

Musco Mobile Lighting (---)
Lighting systems for outdoor events.
Circle (905)

The Musicworks (2443)
Syndicated radio music formats, country, casual, adult contemporary, personality shows.
Circle (906)

Mycomp Technologies/MTC (---)
Audio, video distribution amplifiers.
Circle (907)

MycroTek (2490)
Electronic production titling systems, video message systems.
Circle (908)

MZB & Associates (NA)
Audio, video distributors; antennas, batteries, wireless mics, cameras, support products; tape, intercoms, STL systems.
Circle (909)

NAC (2932)
Circle (910)

Nady Systems (2902)
Stage, location *wireless mic systems.
Circle (911)

Nagra Magnetic Recorders (3453)
Audio reel recorders.
Circle (912)

Nakamichi USA (2456)
Audio cassette recorders; headphones.
Circle (913) See ad page 189

SIX ADVANTAGES OF A STUDIO CONDENSER WITHOUT A SOUND OF ITS OWN



1 The MC 740 Studio Condenser is ideal for critical analog and digital recording situations because it is virtually inaudible — no self-noise, coloration or sonic footprint of any kind.

2 All five of the MC 740's pickup patterns have equally uniform and identically transparent frequency response curves — a unique achievement for a large diaphragm condenser design.

3 Like our ribbon mics, the MC 740 eliminates the icy, strident quality typical of condensers to reproduce voices and instruments with uncharacteristic warmth and intimacy.

4 Unlike other condensers, the MC 740 is free of exaggerated sibilance, graininess or distortion.

5 The MC 740 is exceptionally sensitive, yet also withstands extreme SPLs (up to 144 dB with the 10 dB attenuator in circuit).

6 Typifying Beyer's world-renowned accuracy, the MC 740 reveals the subtle differences between instruments and ambient environments.

If the advantages implicit in the unconventional design of the MC 740 are important to you, arrange for a hands-on audition of this remarkable instrument by contacting your Beyer dealer or writing us direct at:

Beyer Dynamic Inc.
5-05 Burns Avenue
Hicksville, NY 11801

ACCURACY IN AUDIO

beyerdynamic

Circle (80) on Reply Card

EIMAC Tubes Provide Superior Reliability at radio station KWAV — over 112,000 hours of service!

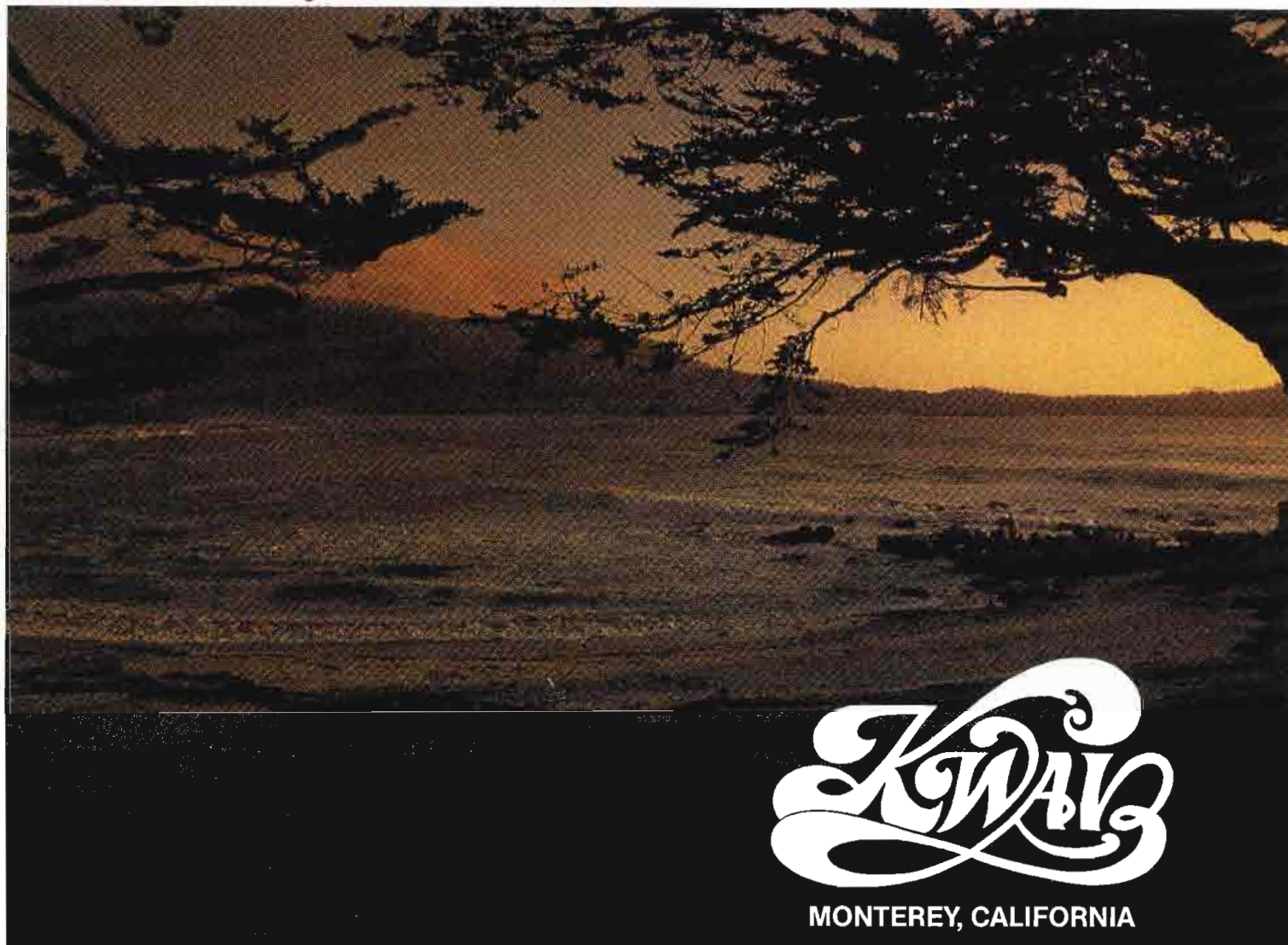

KWAV

MONTEREY, CALIFORNIA

Ken Warren, Chief Engineer at KWAV reports that their 10 kW FM transmitter went on the air in November, 1972, equipped with EIMAC power tubes. The original tubes are still in operation after over 13 years of continuous duty!

Ken says, "In spite of terrible power line regulation, we've had no problems with EIMAC tubes. In fact, in the last two years, our standby transmitter has operated less than two hours!"

Transmitter downtime means less revenue. EIMAC tube reliability gives you *more* of what you need and *less* of what you don't want. More operating time and less downtime!

EIMAC backs their proven tube

reliability with the longest and best warranty program in the business. Up to 10,000 hours for selected types.

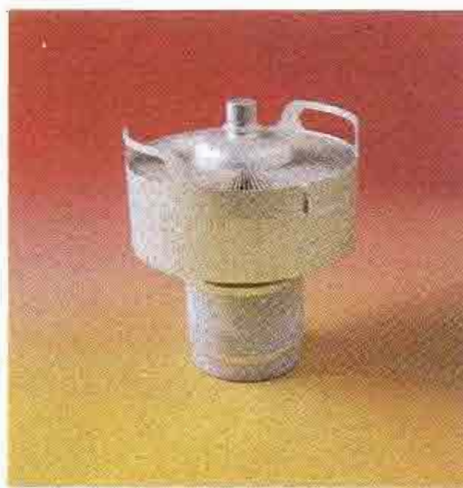

Quality is a top priority at EIMAC, where our 50-year charter is to produce long-life products.

Send for our free Extended Warranty Brochure which covers this program in detail.

Write to:

Varian EIMAC
301 Industrial Way
San Carlos, CA 94070
Telephone: (415) 592-1221



Nalpak Video Sales (2800)
Equipment *cases; production equipment
*carts; video *test charts.
Circle (914)

Narda Microwave (2545)
STL and ENG microwave electronics,
amplifiers.
Circle (915)

National Public Radio (203)
Radio program distribution services; paging
services.
Circle (916)

Nautel Maine (2658)
AM radio transmitters, solid-state models.
Circle (917) [See ad page 271](#)

NEC America/Broadcast (3161)
*Digital effects systems, TBCs, frame syn-
chronizers; CCD ENG *cameras; UHF/VHF
*TV transmitters; digital recorders; *routing
switchers.
Circle (918) [See ad page 34](#)

L.E. Nelson/Thorn EMI Lighting (2918)
*Lamps, lighting accessories.
Circle (919)

Neotek (2782)
Reinforcement; production audio consoles.
Circle (920)

Network Production Music (2627)
*Production music, sound effects, CDs.
Circle (921)

Rupert Neve (3318)
Digital tape transfer *consoles; audio produc-
tion consoles; audio console automation.
Circle (922)

New England Digital (228)
*Direct-to-disk audio recording, editing.
Circle (923) [See ad page 133](#)

A. C. Nielsen (2798)
Audience research, viewership measure-
ments.
Circle (924)

Norpak (2574)
*Teletext, NABTS data delivery systems to
graphic work stations.
Circle (925)

Nortronics (3384)
Recording heads for audio recorders.
Circle (926) [See ad page 180](#)

nova systems (2778)
Video TBCs.
Circle (927)

Nurad (3573)
STL, ENG microwave products, electronics,
antennas; remote control equipment.
Circle (928)

Nytone (2836)
TV slide projection equipment.
Circle (929)

O'Connor Engineering Lab (3364)
Fluid heads; *tripods; dollies, pedestals.
Circle (930) [See ads pages 256, 257](#)

Odetics (3586)
*TV program automation systems, traffic
interface software; programmable recorders.
Circle (931) [See ad page 135](#)

Olesen (3550)
Lighting instruments, related products.
Circle (932)

Omicron Video (2661)
Utility routing, *component video switcher;
preset-take video switcher; audio, video
*DAs.
Circle (933) [See ad page 263](#)

Omnimusic (2775)
Production, music libraries, tape, CD formats.
Circle (934)

Optical Disc (2527)
Optical disc recording equipment.
Circle (935)

Orban Associates (3444)
*Audio processors, multi-band limiters;
stereo generators for AM, FM, TV; program-
mable mic *processors; graphic, parametric
EQ; stereo synthesizers; de-essers.
Circle (936) [See ads pages 7, 17, 28-29](#)

Orion Research (2588)
Software-based *audio mixer systems;
computer-controlled *routing switchers.
Circle (937) [See ad page 224](#)

Osram/Siemens (2688)
Stage, theater, studio lamps.
Circle (938)

Otari (3246)
Multitrack audio reel *recorders, analog,

VISIT US AT NAB, BOOTH 2442

FM Antennas
FCC Directionals • Multistations
Rigid Transmission Line
Pattern Studies
Combiners

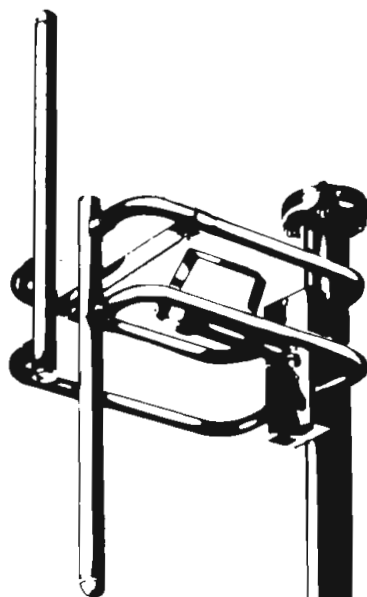

MULTISTATIONS

From two to nine or more stations, Shively offers multistation components which have the industry's best specs. Branched or balanced combiners, side mount or panel antennas; whatever the requirements, Shively can supply.

SPECIAL ENGINEERING

Such as helping you to conform to the new FCC/ANSI standards for non-ionizing radiation. We offer half-wave spaced FM antennas at all power levels designed to significantly and economically reduce downward radiation.

PATTERN WORK

In over a dozen years of providing formal directional patterns to both the FCC and DOC, Shively has never had a pattern rejected; ever. We've earned the trust of the industry in all aspects of pattern work. What are your requirements?

Shively Labs

a division of Howell Laboratories, Inc.

36 Harrison Rd
Bridgton, ME 04009
(207) 647-3327

TWX-710-223-8910 SHIVELY BRGT
FAX (207) 647-8273

call or write for more information

Circle (110) on Reply Card

W

hat size does a newsroom
have to be before a
Basys newsroom computer
will fit in perfectly?

small



medium

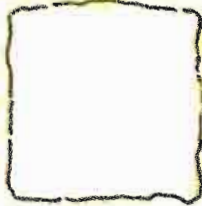

large

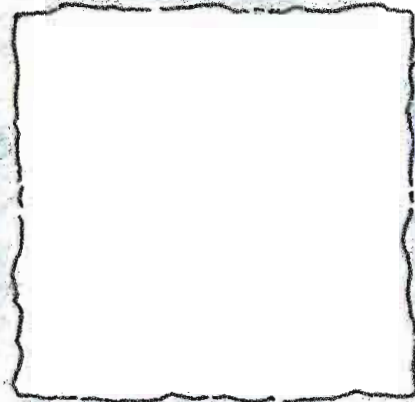

huge



any of the above

Basys systems are used in some of the largest newsrooms in the world.

Now Basys has a new system designed specifically for smaller radio and television stations—a system which can provide *your* station with the same advanced features currently used by ABC, CNN, NBC and the BBC.

All of our customers, regardless of size, get the same easy-to-use, flexible, expandable and *proven* software—plus our experience, service and support.

We'd like to show you what that means for *your* newsroom.

Just call for our free demonstration video. You'll see for yourself what makes Basys the world's leading newsroom computer system.

Call 1-800-847-0633, Dept. B10.
In CA, call 1-800-332-2245,
Dept. B10.

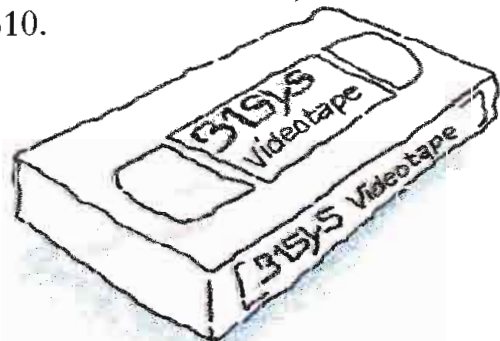

Basys, Inc., 900 Stierlin Road, Mountain View, CA 94043

This free video offer limited to qualified newsrooms.

Circle (111) on Reply Card

Otari, continued

digital; cart recorder; cassette duplicators.
Circle (939) [See ads pages 15, 181](#)

Pacific Recorders/Engineering (3151)
On-air, production *audio mixers; audio cartridge *recorders.
Circle (940) [See ad page 67](#)

Paco Electronics USA (2718)
*Batteries, chargers.
Circle (941) [See ad page 194](#)

PAG America (2708)
*Batteries, chargers, camera mounting systems; low-light ENG cameras.
Circle (942)

Paltex (3260)
Videotape *editing equipment.
Circle (943)

Panasonic Industrial/Broadcast (3216)
Studio, ENG *cameras; videocassette *recorders, specialized players; videotape.
Circle (944)

Panasonic/Ramsa (3216)
Post-production, recording audio mixers.
Circle (945) [See ad page 223](#)

Patch Bay Designation (2409)
Label products for *patch bays.
Circle (946)

Peerless Sales (2412)
Equipment carts for receivers, monitors.
Circle (947)

Pegasus Systems (3170)
*Automated spot reel assembly, program presentation systems.
Circle (948)

Penny & Giles (2774)
Audio faders; T-bar controls; audio, RF attenuators.
Circle (949)

PEP (3387)
Batteries, chargers.
Circle (950)

Perrott Engineering Labs (2733)
Batteries, chargers; equipment covers; color correction filters.
Circle (952) [See ad page 356](#)

PESA Electronics (3417)
Video monitors; *character generators, titlers; automated *test monitoring systems; FM, TV transmitters, translators; KU-band satellite receivers; *intercoms.
Circle (953) [See ad page 107](#)

Philips T&MI (3238)
TV sync, pattern generators; picture, waveform, vector, SC/H *test monitors; video, VBI test equipment; TV IF *modulators; color analyzers; demodulators.
Circle (954) [See ad page 357](#)

Pinnacle Systems (122)
*Electronic graphic arts, *digital effects and *still store systems, PC-compatible.
Circle (956)

Pinzone communications (2411)
VBI audio multiplexing system.
Circle (957)

Pioneer Electronics (3546)
Optical disc memories.
Circle (957)

PKE International (144)
Circle (958)

Polaroid (2837)
Instant print, slide films; video printer.
Circle (959) [See ad pages 108-109](#)

Polar Video (---)
*Linear keyers; production switchers; faders; safe area generator.
Circle (1150)

Porta-Pattern (3538)
Camera test charts, transparencies, illuminators, films.
Circle (960)

Potomac Instruments (3329)
DA antenna analyzers; audio test systems; automatic remote control products; field strength meters; modulation, power controllers; AM monitor receivers, detectors.
Circle (961) [See ad page 290](#)

Pro Battery (2761)
Batteries, replacement inserts; chargers.
Circle (963)

PYE-TV (3238)
Radio, TV broadcast transmitters.
Circle (600)

PACO Ni-Cad BATTERY PACK

POWER UP! NEW PACO DP-11 (13.2V 1.7Ah)



■ NEW HIGH POWER CELLS ENABLE 1.7AH(0.2C Discharge Rate)

■ THE MAINTENANCE FREE THERMAL PROTECTOR IS BUILT-IN, AS OTHER PACO BATTERY PACKS.

■ THIS IS THE DIRECT REPLACEMENT FOR SONY NP-1.

PACO ELECTRONICS U.S.A., INC.

714 WEST OLYMPIC BLVD., SUITE 706, LOS ANGELES, CA 90015
TEL-213-747-6540/TLX-756923/FAX-213-747-3731

Circle (112) on Reply Card

IF YOU THOUGHT YOU COULDN'T
AFFORD DIGITAL VIDEO EFFECTS...



... HAVE WE GOT NEWS FOR YOU!

Digital video effects have usually meant big money. Until now.

GML have changed all that ..dramatically. With a new TBC and frame store synchroniser system which puts effects within the reach of even the tightest budget.

But there's more good news. The system is expandable, covering one to four easily

upgradable stages, each with a progressively larger repertoire of effects. So you can come in at the level that suits you and move up as your performance needs change.

We're looking forward to giving you a demonstration. And proving that we can make a very considerable impression on you. Without making much impression on your wallet.

GML America Inc.,
8150 Leesburg Pike, Suite 910,
Vienna, Virginia 22180.
Tel: (703) 790-0101



GML, 143/145 Cardiff Road, Reading, Berks RG1 8JF, England □ GML France, 50 Bis, Rue Maurice Arnoux, 92120 Montrouge, Paris

Circle (113) on Reply Card

www.americanradiohistory.com

Q-TV (3469)
Studio and location prompter systems.
Circle (964)

QEI (3336)
FM *transmitters, modulation monitors, exciters; remote transmitter control systems.
Circle (965) [See ad page 65](#)

QSI Systems (2722)
Blackburst, vertical interval, SID generators, encoders, decoders.
Circle (966)

Quality Video Supply (2461)
Color/mono video signal combiners.
Circle (967)

Quanta (3128)

Electronic graphics and *titlers; editing control systems.
Circle (968) [See ads pages 166, 227](#)

Quantel (3171)
Electronic graphic art systems, caption generators; standards conversion systems; digital still libraries, optical disk memories; digital video production system.
Circle (969) [See ad page 299](#)

Quantum Audio Labs (3446)
Audio mixing systems for production, on-air applications.
Circle (970)

Quickset (3380)
Tripods, pan/tilt heads; camera support.
Circle (971)

R-Columbia Products (2671)
Wired, wireless *intercom systems; amplified camera operator headsets; headphones, headsets.
Circle (972) [See ad page 228](#)

Radiation Systems (2929)
*TVRO, satellite news gathering antennas.
Circle (973)

Radio Resources (2833)
Distributor of audio, radio products.
Circle (974)

Radio Systems (2680)
On-air audio mixers; SCA receivers; phono preamps; audio DAs, monitor amps; LED meters; cart machines; *cabinetry.
Circle (975)

RAM Broadcast (3028)
*Audio phase test monitors; cabinetry, furniture; consulting; video monitors; routing switchers; audio, video, RF distributor.
Circle (976)

Rank Cintel (3066)
Telecine systems; image still-stores; color correction products; electronic graphic art systems.
Circle (977) [See ad page 61](#)

RCA American Communications (3298)
Satellite program distribution services.
Circle (978)

RCA New Products (3292)
Camera tubes; power amplifier tubes.
Circle (979)

Reach Electronics (2437)
FM *SCA paging equipment; switches.
Circle (980)

Rees Associates (2500)
Studio, facilities design consultants.
Circle (981)

Register Data Systems (2505)
Automated station business systems.
Circle (982)

Research Technology Int'l (3386)
Videotape evaluators, cleaners; *film editing systems.
Circle (983) [See ad page 188](#)

RF Scientific (2701)
Ku-band fly-away earth station systems.
Circle (984)

RF Technology (2809)
*ENG/STL microwave equipment.
Circle (985)

Richardson Electronics (3343)
RF power, amplifier tubes; camera pickup tubes.
Circle (986) [See ad page 63](#)

Riviera Broadcast Leasing (2793)
Equipment leasing, financing & sales programs.
Circle (987)

The Robot Factory (2569)
Robotic promotional, educational products.
Circle (988)

Rockwell International (3484)
Weather Doppler radar equipment; weather

HIGH PERFORMANCE

System One is HIGH PERFORMANCE. Combined generator-analyzer thd + n guaranteed below 18 ppm (0.0018%) 20 Hz to 20 kHz; typical mid-band residuals below 5 ppm. Flatness 0.05 dB 20 Hz-20 kHz, noise typically below -118 dBu (1 microvolt) in a 22 kHz bandwidth. System One measures 16-bit digital audio systems to manufacturer's specs; in the mid-'80s, should you invest in equipment that can't?

Audio precision

P.O. Box 2209
Beaverton, Oregon 97075
503/297-4837, 1-800/231-7350
TELEX: 283957 AUDIO UR

Now, that's the way to test audio!

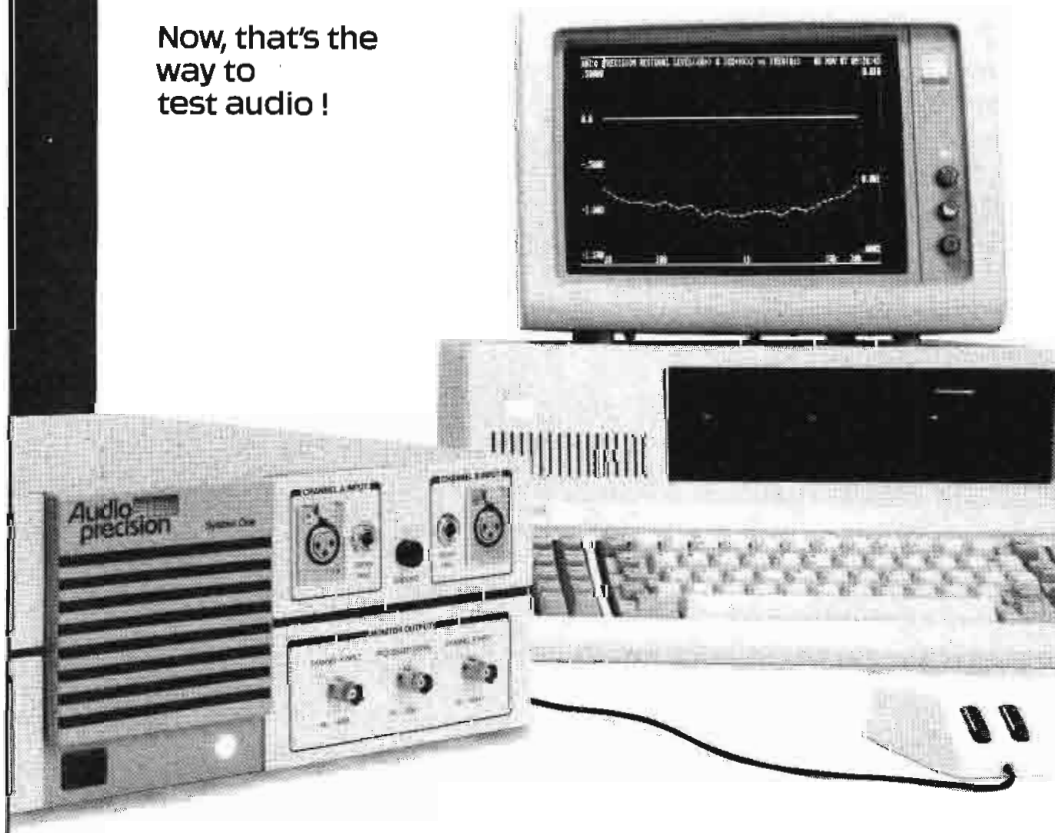

Circle (114) on Reply Card

Say goodbye to mechanical tape failures — with the DAS-2 digital audio system

No more jammed tapes, broken cartridges, wow and flutter, phase problems, loss of high frequency response, tape breakage, machine malfunctions, airplay of outdated spots, and errors caused by manual logging. . .

The DAS-2 DIGITAL AUDIO FILE SYSTEM solves these problems PLUS:

- You can store up to 28 hours of high quality digital programming — spot announcements, sales promotions, news actualities as well as full length programs — using the state-of-the-art DPCM-AQ-AS recording method.
- The DAS-2 can be interfaced with your station's EDP or traffic computer via a serial port or MS DOS floppy disk providing positive verification of airplay.
- Special 20 button, 4 page access feature offers you the choice of up to 80 events for instant playback.
- Choice of either automatic or manual mode.



- User friendly operation.
- Easy to expand for your station's future growth.

Proven track record.

The DAS-2 system has been operating flawlessly at major overseas stations for more than 5 years, and has been redesigned to meet the needs of the American broadcaster.

Three systems are offered:

AM @ 10 kHz, FM @ 15 kHz and FM @ 20 kHz response.

Are you ready to upgrade to the DAS-2 digital audio system?

For further information or to arrange for a hands-on demonstration,

contact:

Broadcast Engineering
Mitsubishi International Corp.
46305 Landing Parkway
Fremont, California 94538

(415) 651-9931. Call collect.



Designed and built by the innovators of digital storage for broadcasting:
Nippon Television Industry Corporation



Sold and supported in the U.S.A. by:
Mitsubishi International Corporation
Electronic Equipment Division: Fremont, CA

Circle (115) on Reply Card

Rockwell, continued

graphic display software.
Circle (989)

ROH/Anchor Audio (2432)
Audio monitors, DAs; self-powered speakers, sound systems; *amp input expansion panels; intercom, party-line, IFB systems.
Circle (990) See ad page 160

Rohde & Schwarz (3491)
Audio, *video, *RF test equipment; signal generators, monitors; FM, *TV demodulators.
Circle (991) See ad page 325

ROHN (2449)
Communications support structures, towers, accessories; equipment shelters; lightning protection products.
Circle (992)

Rosco Laboratories (3443)
Chroma-key, Ultimatte paints, backgrounds, fabrics; *smoke/fog machine, *lighting gels, projectors; light block foil; stage plugs.
Circle (993)

Roscor (3404)
*News production, gathering vehicles.
Circle (994) See ad page 152

Ross Video (2616)
*Video production switchers; linear keyers.
Circle (995)

RPG Diffusor Systems (2633)
Acoustical *studio treatments; diffusive, ab-

sorptive, reflective modules.
Circle (996) See ad page 222

RTNDA (2405)
Trade association.
Circle (997)

RTS Systems (3566)
Intercom systems; *modular speakers; *test tone generators.
Circle (998) See ads pages 216, 218

Sachtler of America (3419)
*Camera pan/tilt heads, tripods, pedestals.
Circle (999)

Samson Products (2784)
Wireless mics, receivers.
Circle (1000)

Schafer World Comm. (3353)
Automated CD player systems.
Circle (1001)

Schmid Telecommunication (2462)
Automated audio test systems.
Circle (1002)

Schneider Optics (3221)
*Camera lens systems, accessories.
Circle (1003) See ad page 313

Schwem Technology (3272)
Lens controls, stabilizers; wide angle units.
Circle (1004) See ad page 295

Scientific-Atlanta (3272)
Satellite up/downlink electronics, antennas.
Circle (1005)

Selco/Sifam (2450)
*Fuseholders (cable); VU, PPM meters; knobs.
Circle (1006) See ad page 252

Sennheiser Electric (2664)
Audio, mic mixers; wireless mics; reference headsets; dynamic, condenser mics.
Circle (1007) See ad page 327

SESCOM (3445)
Audio *test, TV pattern generators; *audio processors; audio *amplifiers; impedance interfacing; audio transformers.
Circle (1008) See ad page 266

SG Communications (2535)
Tower, antenna installation, maintenance services.
Circle (1009)

Sharp Electronics/Broadcast (3305)
Studio, ENG *cameras; color video monitors; industrial VCRs; audio systems, recorders.
Circle (1010) See ad pages 346-347

Shima Seiki USA (2573)
*Electronic graphic paint system.
Circle (1011)

Shintron (3036)
Video production switchers; video encoders, decoders; time code equipment; component video equipment.
Circle (1012)

Shively Labs (2442)
Single, multiple FM *antennas; power combiners, multi-station directional couplers.
Circle (1013) See ad page 192

The SSL Stereo Video System

The Practical Standard For MTS Production

Before and beyond the transmitter, Multichannel Television Sound is an art. In the studio and post-production suite, the creative use of stereo can do as much or more than lighting, lensing, colour and video effects to give depth, impact and immediacy to the television picture. It quite literally adds an entirely new dimension to the viewing experience.

In stereo, television is a whole new ball game — or newscast, or series, or advert, or sitcom, or special. Because stereo is both natural and compelling, the programming possibilities are as broad as the imagination and skills of today's sound designers. Technical limitations and the constraints of time are the only obstacles. And that's where SSL can help.

Our SL 6000 E Series Stereo Video System handles complex MTS production with unrivalled ease and efficiency. Designed to simultaneously speed and enhance all aspects of television audio production,



the SL 6000 E Series makes innovative stereo programming practical on a daily basis.

Only SSL has triple stereo mix buses for stereo music, dialogue and effects, plus rapid mix-minus matrixing for Second Audio Program creation. Only SSL provides compressor/limiters, parametric equalizers, expanders and noise gates on every channel — plus balance and image width controls for all stereo sources. And only SSL provides such time-saving operational features as patch-free audio subgrouping and pushbutton signal processor routing. For post-production efficiency, even the multitrack electronics remotes are built right in. And that's just the new line standard equipment!



Options include Total Recall™ — an SSL exclusive, completely independent of the audio path, which allows any operator to recreate the most intricate console setups for any programme with rapid accuracy, week after week. Programmable dynamic stereo equalisation and panning may also be added, along with

- Shook Electronic Enterprises (3222)**
*Mobile production vehicles.
Circle (1014)
- Shure Brothers (3320)**
Audio DAs, monitor amps; phono cartridges, preamps; field production *mixers; *mics; *wireless mics.
Circle (1015) [See ads pages 140,318](#)
- Sigma Electronics (2905)**
Blackburst, color bar generators; video processing, DA amplifiers.
Circle (1016)
- Singer Products (2584)**
Distributor, TV/radio, audio, video equipment.
Circle (1017)
- Skotel (2738)**
*Time code readers, generators, accessories.
Circle (1018) [See ad page 265](#)
- SMPTTE (2501)**
Standards coordination; trade information.
Circle (1019)
- Solid State Logic (3560)**
*Broadcast, production audio mixing desks; console automation.
Circle (1020) [See ad pages 198-199](#)
- H. A. Solutec (2530)**
*Stereo phase, VU/PPM test indicators; audio, video DAs; commercial insertion systems.
Circle (1021) [See ad page 288](#)
- Sono-Mag (3480)**
Radio program automation; bidirectional audio multicartridge carousel systems.
Circle (1022)
- Sony (3100)**
Studio, ENG *cameras, camcorders; analog, digital *VTRs/VCRs; cassette *automation systems; *editing controllers; *video monitors; *HDTV equipment; digital, analog audio recorders; CD players; *audio mixer, console automation; mics, wireless mics.
Circle (1023) [See ad pages 24-25](#)
- Sony Information Systems (3100)**
*Cameras, still video recorders.
Circle (1156)
- Sony Pro Audio (3100)**
*Audio mixers; audio recorders.
circle (1151)
- Sony Pro Video (3100)**
*Video recorders, *monitors, editor control.
Circle (1152)
- Sony Tape Products (3101)**
Audio, video recording *tape, all formats.
Circle (1024) [See ads pages 83-85](#)
- Sound Ideas Library (2561)**
Sound effects, music libraries.
Circle (1025)
- Sound Technology (3328)**
Programmable audio *test generator, transmission audio *analyzer; *MTS switcher; audio *test system software; precision filters.
Circle (1026) [See ad page 209](#)
- Soundcraft Electronics (2770)**
On-air, production *audio mixers; multitrack audio recorders.
Circle (1027)
- Soundmaster International (2780)**
Audio *edit controller; machine synchronizers.
Circle (1028)
- Soundtrack/Aircraft (2554)**
Syndicated music, tape, record, CD formats.
Circle (1029)
- Soundtracs PLC (2454)**
Audio production, on-air *mixing desks; console automation.
Circle (1030)
- Spectrum Planning/Compucon (2634)**
Telecommunications, broadcast consultants.
Circle (1031) [See ad page 254](#)
- Stainless (2735)**
Broadcast towers, lighting, guys; services.
Circle (1033) [See ad page 326](#)
- Standard Communication (2709)**
Earth station receivers.
Circle (1034) [See page 165](#)
- Stanton Magnetics (3331)**
*Phono cartridges, preamps, styli, mats; *headphones; audio accessories.
Circle (1035) [See ad page 162](#)
- Stantron Unit/Zero (2911)**
Equipment racks, spec/custom; enclosures.
Circle (1036) [See ad page 359](#)

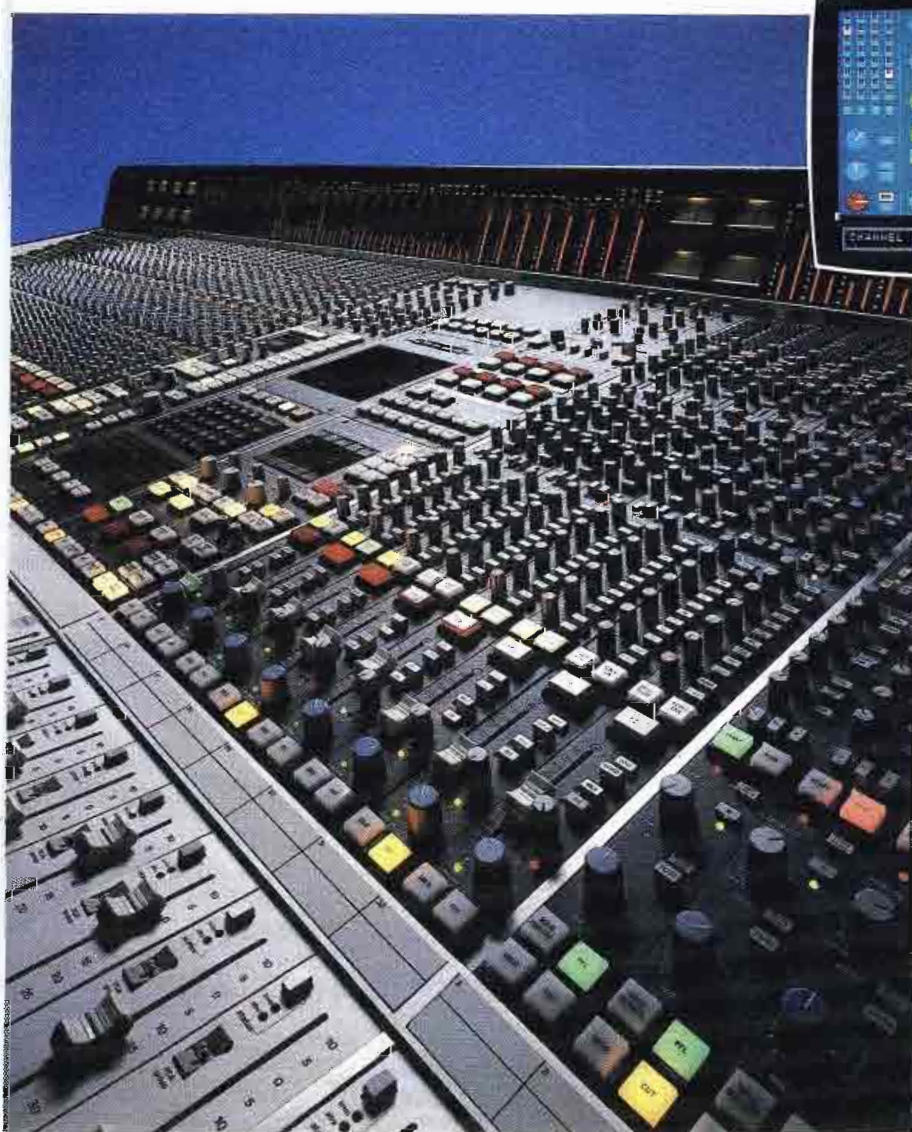

multi-repeatable Events Control, Automatic Dialogue Replacement, and centralised command of up to five synchronised audio and video machines. All of this is thoroughly integrated with the SSL Studio Computer – the world's number one choice for mixing automation.

Best of all, the SSL Stereo Video System is not a hasty revamp of an old mono design. Nor is it an experimental project in search of a guinea pig. It is a practical, reliable international standard for advanced television audio production – proven in well over half a million hours of network and independent studio and mobile operation – in Great Britain, Japan, Germany, Scandinavia, Australia, Canada and all across the United States.

Take advantage of our experience. Call or write today for a free 40 page colour brochure describing the operation and applications of the SL 6000 E Series Stereo Video System. If your station or facility is contemplating an upgrade to full MTS production capabilities, we'll be happy to arrange a complete demonstration. And be sure to ask about our training programmes.

Solid State Logic

Begbroke, Oxford, England OX5 1RU • (08675) 4353
200 West 57th Street • New York, New York 10019 • (212) 315-1111
6255 Sunset Boulevard • Los Angeles, California 90028 • (213) 463-4444
Circle (116) on Reply Card



WHO DO YOU THINK OF FIRST IN RF VOLTMETERS?

BOONTON

Every brand recognition study proves it. When you think of rf voltmeters, you think of Boonton. After all, we introduced the first sensitive rf voltmeter years ago. Now there's a new generation. Still a choice of high resolution digital and low cost analog models. Still featuring low noise, passive, rms detection with microvolt sensitivity in both unterminated and terminated modes. But now with extended frequency coverage from 10 Hz to 1.2 GHz—to 2.5 GHz with 50-ohm sensor.

A redesigned probe tip mates directly with BNC connectors and accepts all Boonton accessories, including a new convenient ground clip. Detachable and replaceable probe cables available in standard lengths to 100 feet. Special cables to virtually any length.

Choose the digital 9200B and you can store in memory complete calibration data for up to 8 interchangeable probes... low frequency (10 Hz-100 MHz), standard (10 kHz-1.2GHz), or 50-ohm (100 kHz-2.5 GHz). Or add an optional second input channel, GPIB, or MATE interface capability. The analog 92EA is available with a wide choice of meter scales to meet your particular requirements. And both models continue the Boonton tradition for highest accuracy and reliability.

Call your local representative or Boonton directly for full information on the latest generation of rf voltmeters.

Boonton Electronics Corp.

791 Route 10, Randolph, NJ 07869
Telephone (201) 584-1077

Signal Generators ■ Modulation Analyzers ■ RF Power Meters ■ RF Millivoltmeters ■ Capacitance Meters and Bridges ■ Audio Test Instruments

Circle (118) on Reply Card

- Star Case** (2503)
Equipment transport, flight *cases.
Circle (1037)
- Status Cabinetry** (2909)
Studio furnishings, furniture.
Circle (1038)
- Steady-Film** (2648)
Tape-to-transfer film gate stabilizer.
Circle (1039)
- Steenbeck** (2749)
Videotape, film editing systems.
Circle (1040)
- Storeel** (3322)
Compact videocassette storage *racks; high density CD storage; set-up trucks for tape; ABS high density storage.
Circle (1041)
- Straight Wire Audio** (2518)
*CD players; phono preamps; audio processor, stereo matrix *amps; cart machine preamps.
Circle (1042)
- Strand Lighting** (3024)
Lighting instruments; dimmers, controllers; lighting accessories.
Circle (1043)
- Strata Marketing** (2689)
Radio station business, accounting computer software.
Circle (1044)
- Studer Revox America** (3048)
*Audio mixers; cassette to multitrack *audio recorders; CD players; machine synchronizers; monitor amps, speakers; telephone hybrids.
Circle (1045) [See ad pages 128-129](#)
- Studio Technologies** (2514)
Stereo simulation systems.
Circle (1046)
- Sunspot** (2679)
Station business systems.
Circle (1047)
- Swintek Enterprises** (2413)
*Wireless mic systems; intercom systems; headphones; video accessories.
Circle (1048) [See ad page 349](#)
- Switchcraft** (2711)
Audio/video connectors; patch panel accessories.
Circle (1049)
- SWR** (3350)
FM, UHF TV antennas; transmission lines.
Circle (1050)
- Sylvania Lighting** (3327)
Studio, stage lamps.
Circle (1051)
- Symbolics/Graphics Div.** (2567)
Electronic graphics equipment.
Circle (1052)
- Symetrix** (2519)
Voice/mic *audio processors; telephone hybrids.
Circle (1053) [See ad page 240](#)
- System Associates** (3392)
Used, reconditioned equipment brokers.
Circle (1054)
- Systemation** (2458)
*Automated program control systems.
Circle (1055)
- Taber Mfg/AVSC** (3333)
Audio recording heads; tape erasers, conditioners, cleaners; recording tape.
Circle (1056)
- Tamron Industries** (120)
ENG camera lenses; video image processor.
Circle (1057)
- TASCAM** (3416)
Audio *mixers for production, recording, broadcast; audio reel and cassette *recorders; optical disc recorders.
Circle (1058) [See ad page 244](#)
- Teatronics** (2756)
*Lighting dimmers, control systems.
Circle (1059)
- Technov Industries** (148)
Editing controllers; video black, sync generators; audio/video DAs.
Circle (1060)
- TEKNO** (2472)
Lighting instruments, lamps; accessories.
Circle (1061)
- Tekskil Industries** (2570)
Computer *prompting systems.
Circle (1062)
- Tektronix** (3214)
Audio, video, RF test equipment; waveform, vector, video, monitors; oscilloscopes, spectrum analyzers; time base correctors, frame synchronizers; audio delay products; modulation monitors.
Circle (1063) [See ad page 49](#)
- Telemet Div/Geotel** (3396)
Audio DAs, monitor amps; video DAs, encoders, decoders; TV precision *demods; fiber-optic products; sync, test pattern generators; routing switcher systems.
Circle (1064)
- Telemetry** (2608)
*Remote controlled camera mount products.
Circle (1065) [See ad page 206](#)
- Telepak San Diego** (2566)
*Battery belts; *equipment cases.
Circle (1066)
- Telescript** (3351)
Computer-based teleprompting equipment.
Circle (1067)
- Teletech** (2762)
Studio, transmitter facilities designs, turnkey construction.
Circle (1068)
- Television Engineering** (3400)
*Mobile production vehicles.
Circle (1069)
- Television Equipment Assoc.** (3342)
Matthey video *delays, *filters; Racial headsets; Elcon *tape evaluators.
Circle (1070)

Total Radio Recall.



The Dictaphone 5600 Veritrac™ voice communication recording system is a complete broadcast recording-retrieval system that lets your radio station keep its entire broadcast day on the record. In one dependable unit you get around-the-clock verification that you're running your advertiser's spots on schedule and meeting all your FCC requirements. So if they ask for proof, you've got it all there on tape, ready for quick retrieval and replay.

Tune into the Dictaphone 5600 Veritrac logger. And never get your signals crossed again.

For more information, fill in the coupon or call toll-free:

1-800-342-8439 QBE-37

Or mail to: Dictaphone Corporation,
120 Old Post Road, Rye, NY 10580

Name _____
Title _____ Phone _____
Company _____
Address _____
City _____ State _____ Zip _____

DICTAPHONE® and Veritrac are trademarks of Dictaphone Corp., Rye, N.Y. ©1985 Dictaphone Corp.

 **Dictaphone**

A Pitney Bowes Company
Circle (117) on Reply Card

Television Information Office (3105)
TV industry information.
Circle (1071)

Television Technology/TTC (3580)
FM, *TV transmitters, translators, *exciters;
audio recorders; STLs.
Circle (1072)

Telex Communications (3370)
*Wireless mics; intercoms; mic accessories;
audio tape duplicators.
Circle (1073)

Tennaplex Systems (2812)
FM, TV *antennas; combiners.
Circle (1074)

Tentel (3326)
VCR, VTR alignment gauges, *tools.
Circle (1075) [See ad page 16](#)

Texar (2571)
Audio dynamics control systems.
Circle (1076) [See ad pages 40-41](#)

TFT (3420)
*Remote pickup systems; STL systems; *EBS
systems; modulation monitors with SAP,
PRO; distortion analyzers; remote control
systems.
Circle (1078) [See ad pages 182,183](#)

Theatre Service & Supply (2917)
Studio cys, tracks, fixtures; lighting grids,
hardware; scenic supplies.
Circle (1079)

Theatre Vision/TVI (2555)

*Studio fixtures; dimmers, power distribu-
tion; eyes, tracks; chromakey fabrics,
draperies.
Circle (1080)

Thermodyne International (2824)
Equipment transportation cases.
Circle (1081)

Thomson Electron Tube Div. (3422)
Camera tubes, CCDs; RF power tubes; solid-
state devices.
Circle (1082) [See ad page 319](#)

Thomson-CSF Broadcast (3190)
Studio, ENG *cameras; *still store; digital
*video production switchers; A/D, D/A con-
verters; *video recorders; electronic
graphics, titler systems; CCD slide scanners.
Circle (1083) [See ad pages 219,319](#)

Thomson-LGT (3561)
FM, UHF/VHF TV *transmitters, transposers.
Circle (1084) [See ad page 91](#)

3M Broadcast/Related Products (3120)
3M Magnetic A/V Products
Video/audio tape; *electronic graphic, titling
systems; routing switchers; *master control
switchers; *machine control systems.
Circle (1085) [See ads pages 56-57, 163](#)

3M Optical Recording (3120)
Laser videodiscs, CD ROM applications;
videodisc mastering, replication services.
Circle (1086)

Tiffen Mfg. (2736)
Photo optical filters.

Circle (1087)

Timeline (2684)
Time code systems; machine control systems,
software; chase synchronizers.
Circle (1088) [See ad page 273](#)

Titus Technological Labs (3414)
On-air lights; *stereo multi-channel audio
controllers.
Circle (1089) [See ad page 273](#)

TMD Div/Will-Burt (2587)
*Pneumatic control, portable support masts.
Circle (1090) [See ad page 226](#)

TOA America (2498)
Audio mixers, equalizers, effects systems;
digital signal *processors.
Circle (1091)

Torpey Controls & Engineering (2906)
Clocks, *timers.
Circle (1092)

Toshiba America/OEM Div. (3302)
Audio/video delay systems; TV cameras;
radio, TV transmitters; satellite electronics.
Circle (1093) [See ad page 285](#)

Total Spectrum Mfg. (3534)
Camera mounting systems with remote con-
trol; ENG accessories; titling stands.
Circle (1094) [See ad page 348](#)

Townsend Associates (3305)
VHF, UHF *transmitters, *exciters, RF
*amplifiers; pulser systems; TV transmission

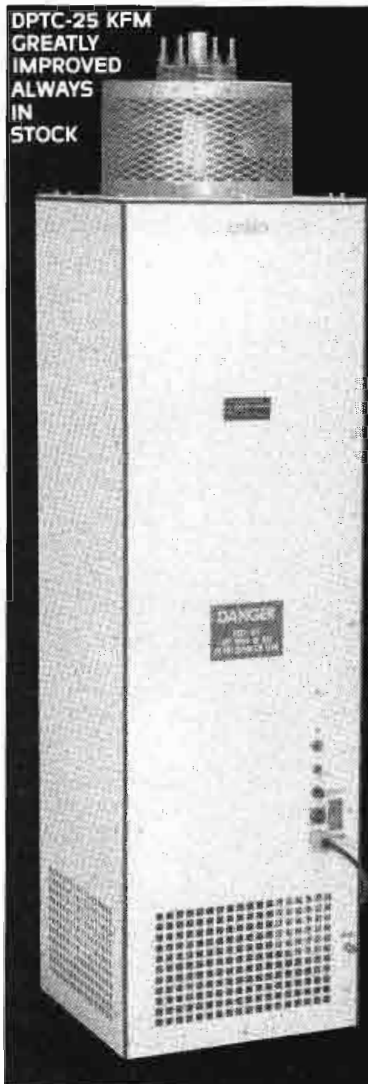

Electro Impulse New Dry FM Loads

Rugged & Reliable

- Greatly Improved 25 and 50KW Dry Loads; new 75KW load
- Reduced Load and RF Connector Temperatures
- More Efficient Air Flow Pattern
- Inexpensive Field Mod Kits Available for DPTC 25KFM and 50KFM Loads already in service



Electro Impulse Lab
116 Chestnut Street
Red Bank, NJ 07701
201-741-0404

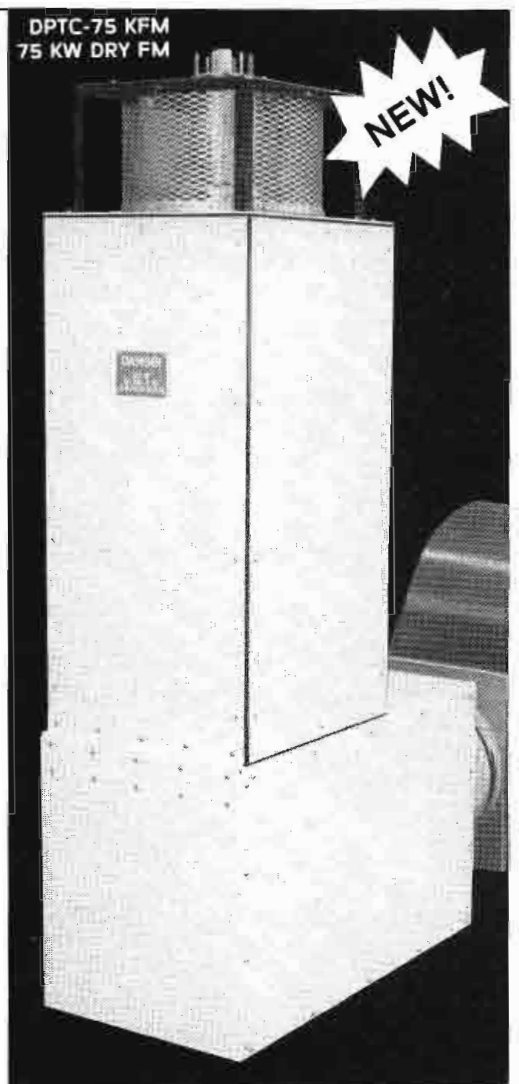

Circle (119) on Reply Card

THE AUDIO/POST SOLUTION

FILM/VIDEO SCORING
SOUND DESIGN
SMPTE, MIDI,
SCSI CONTROL
HARD DISK RECORDING
USER FRIENDLY

CMI

SERIES

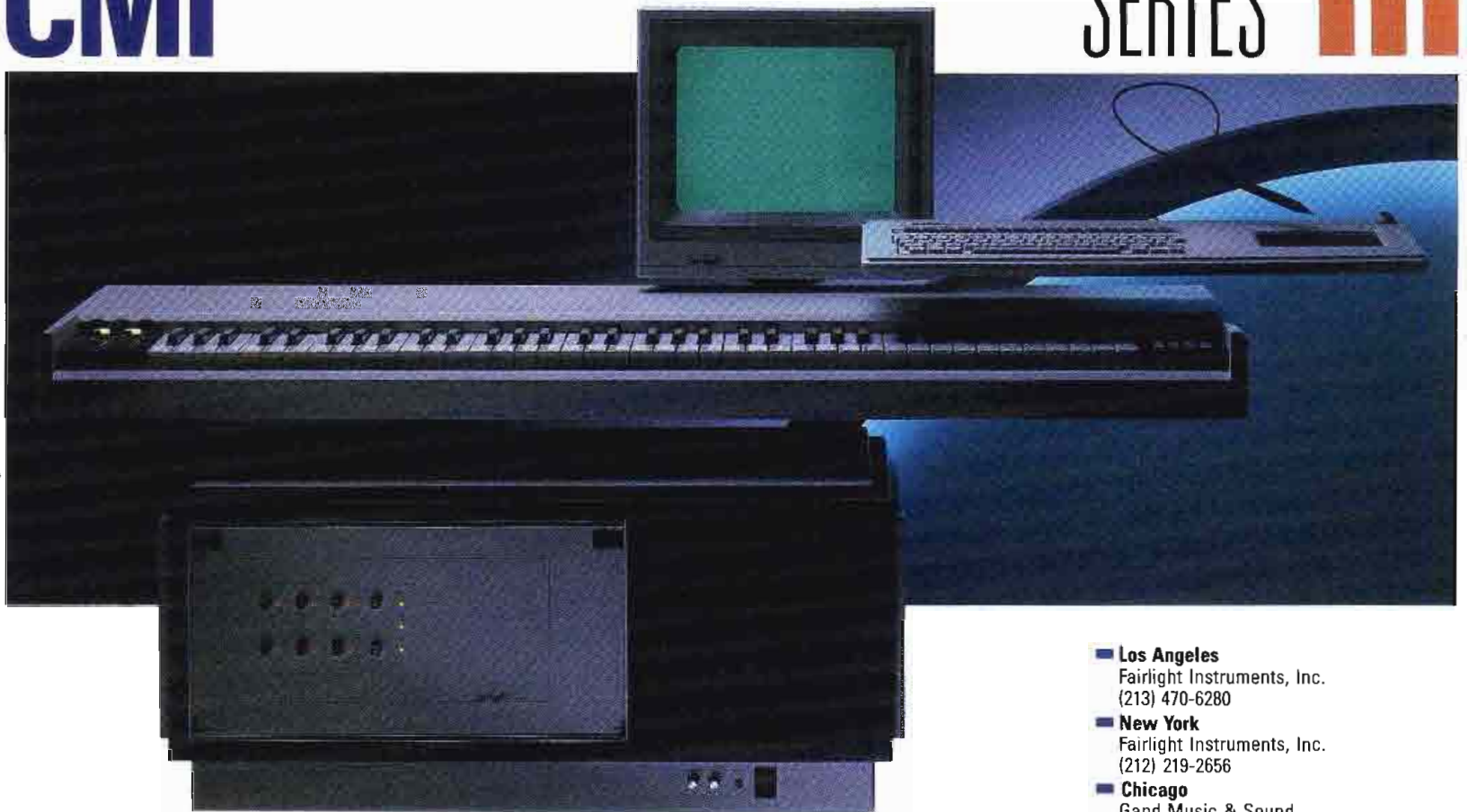

- **Los Angeles**
Fairlight Instruments, Inc.
(213) 470-6280
- **New York**
Fairlight Instruments, Inc.
(212) 219-2656
- **Chicago**
Gand Music & Sound
(312) 446-4263
- **Miami**
Limelite Video
(305) 593-6969
- **San Francisco**
AIC
(415) 686-6493
- **Australia**
Fairlight Instruments, Pty. Ltd.
(02) 331-6333
- **Canada**
Computer Music International
(416) 964-1885
- **U.K.**
Syco Systems, Ltd.
(01) 724-2451

Fairlight

THE COMPANY
BEHIND YOUR
SUCCESS

Please see us at NAB Booth 104

Circle (120) on Reply Card

March 1987 *Broadcast Engineering* 203

**You
can measure...**

with the best monitor and the most accurate test set.

The FMM-2/FMS-2 series monitors provide an even greater degree of precision measurement than ever before... **You can measure** S/N below **90 dB**, **You can measure** crosstalk below **85 dB**, **You can measure** separations of better than **70 dB**, **You can measure** frequency response to better than **0.25 dB**, **You can measure** distortions to lower than **0.01%**, and much more... Our uncluttered panels and autoranging voltmeters make these measurements a dream.

BELAR CALL ARNO MEYER (215) 687-5550
ELECTRONICS LABORATORY, INC.
 LANCASTER AVENUE AT DORSET, DEVON, PENNSYLVANIA 19333
 Call or write for more information on Belar AM, FM, Stereo, SCA and TV monitors.

Circle (121) on Reply Card

The Dorrrough Loudness Monitor



Model 40-A
 Dimensions: 8 1/4" X 2 7/8" X 6 1/2"

**Simultaneous display of Peak and Average
 on one simple-to-read scale.**

Equal perceived loudness from program to program can now be achieved.
 Dual bridging inputs allow for monitoring L+R or L-R.

More and more broadcasters and production houses
 are discovering the accuracy of this visual display.

See us in NAB booth 2602
DORROUGH ELECTRONICS

5221 Collier Place
 Woodland Hills, California 91364
 (818) 999-1132

Circle (142) on Reply Card

Townsend, continued

antennas.
 Circle (1095)

See ad page 275

Transformations (2631)
 3D *electronic graphics, animation systems.
 Circle (1096)

Transmission Structures (2623)
 Towers for broadcast, communications;
 tower accessories, services.
 Circle (1097)

Trimm (2649)
 *Patch panels; plugs, jacks; terminal blocks;
 connectors.
 Circle (1098)

See ad page 323

Trompeter Electronics (3346)
 Patch panels, connectors, patch cords; cable
 assemblies.
 Circle (1099)

See ad page 286

TWR Lighting (236)
 Tower obstruction lighting products, con-
 trollers.
 Circle (1100)

Ultimate (3552)
 Video compositing, linear keying products.
 Circle (1101)

See ad page 288

Unicol Products (2474)
 Support stands for audio, video equipment.
 Circle (1102)

Union Connector (2923)
 *Distribution systems for theatrical, studio
 lighting; lighting controllers, dimmers.
 Circle (1103)

UniSet (2806)
 Studio fixtures, sets, furniture.
 Circle (1104)

United Ad Label (2459)
 Circle (1105)

United Media (3036)
 Basic, expandable videotape editing systems;
 time code products; editing switchers, control
 products.
 Circle (1106)

United Press International (3374)
 News programming services.
 Circle (1107)

United Ropeworks (USA) (2420)
 Phillystran tower guys; tower accessories.
 Circle (1108)

See ad page 248

UREI (2727)
 Studio *monitor systems; on-air audio con-
 soles; EQ, audio processors.
 Circle (1109)

U.S. Tape & Label (2630)
 Self-adhesive label materials for window,
 bumper promotions.
 Circle (1110)

US West (2791)
 Cellular, land-mobile products.
 Circle (1111)

Utah Scientific (3128)
 Master control, routing switchers; assignable
 switcher control panels.
 Circle (1112)

See ad page 185

The image makers

Whatever your imaging application – medical or industrial diagnostics, machine vision, broadcasting or CCTV, surveillance or robotics – Amperex is eager to work with you.

The resources available to you at our Slatersville, Rhode Island facility include our Research and Development and Applications Engineering Departments. Both are integrated with a “super clean” Class 100 manufacturing plant. In addition to offering a broad range of imaging devices including the newest solid state image sensors, Amperex is continuously developing new technologies and adapting existing products to the specific needs of our customers.

The Amperex reputation as an image maker is based on supplying the right products for your imaging needs. For more information call or write Imaging Products Group, Amperex Electronic Corporation, Slatersville, Rhode Island 02876. (401) 762-3800. A North American Philips Company. Outside the U.S.A. contact: Philips Electronic Components and Materials Division, 5600 MD Eindhoven, The Netherlands.

High Resolution Diode Gun™
Plumbicon® TV Camera Tubes for
diagnostic imaging.

Pyroelectric DTGFB vidicon tube
with 8-14 micron sensitivity for
thermal imaging and 24-hour
surveillance.

Amperex®

*Amperex Imaging Products
... we see things your way.*

Electro-magnetic coil
assemblies.

Vidicon
tubes – low
cost general purpose
to fiber optic
special window
types.

Image intensifier tubes
including microchannel
plate and proximity
focused types.

Solid state
thermal imaging
devices for 3-5
micron and 8-13 micron
applications.

Newvicon®
high-sensitivity
camera tubes for
low light and 1
micron IR imaging.

High resolution frame
transfer CCD image
sensors for color and
black and white applications.

Diode Gun and Triode Gun Plumbicon camera
tubes for color or general purpose imaging.

Circle (122) on Reply Card

**SEE US AT THE
NAB SHOW, BOOTH 3238**

March 1987 *Broadcast Engineering* 205

- Utility Tower (3485)**
Towers for broadcast, communications; tower accessories, services.
Circle (1113)
- Valentino Production Music (3465)**
Production *music, effects libraries, on CD.
Circle (1114)
- Valley People (2747)**
Audio *noise gates, *processors.
Circle (1115)
- Valmont Industries (224)**
Guyed, self-supporting support structures for fixed, temporary, emergency *antenna use.
Circle (1116)
- Varian Associates/Eimac (3206)**
*Grid power tubes; klystrons; Klystrodes; *TWT devices.
Circle (1117) [See ads pages 39, 191](#)
- Veam Div./Litton Systems (123)**
Quick-disconnect power connectors; *fiber-optic products.
Circle (1118)
- Vector Technology (---)**
AM directional *antenna phasing, matching systems; *toroidal transformers.
Circle (1119)
- Vertex Communication (2447)**
*Flyaway, fixed earth station antennas.
Circle (1120)
- Vertigo Systems International (225)**
- Electronic graphic animation systems. Circle (1121)**
- Video Aids of Colorado (2910)**
Audio/video signal generators; subcarrier phase measurement systems.
Circle (1123)
- Video Associates Labs (3330)**
Videograph titling keyer systems.
Circle (1124)
- Video International (---)**
TBC, frame synchronizer, standards converters.
Circle (1125)
- Video Services Unlimited (2436)**
Circle (1126)
- Videolab (138)**
Shuttle, balanced audio, time code retrofit modules for Sony *VCRs.
Circle (1127)
- Videomedia (3558)**
Videotape editing controllers; machine synchronizers.
Circle (1128)
- Videotek (3316)**
Routing switchers; video *waveform, vector monitors; TV *demods; *video monitors; SC/H indicators; *blackburst signal generators.
Circle (1129) [See ad pages 178-179](#)
- VideoTeleCom (2683)**
- Camera pedestals, dollies, boom mounts; hand-held camera stabilizers. Circle (1130)**
- Viking Cases (2915)**
Containers, cases for production equipment.
Circle (1131)
- Vinten Equipment (3579)**
Camera *pedestals; *tripod/head combo packages; pan/tilt heads; remote camera control systems.
Circle (1132)
- Vital Industries (3191)**
Video production, master switcher systems; master switcher automation; digital video effects systems.
Circle (1133) [See ad page 345](#)
- Ward Beck Systems (3060)**
Audio consoles for radio, TV on-air, production; routing signal distribution switchers; studio furniture; intercom systems.
Circle (1134) [See ad on back cover](#)
- Wavefront Technologies (2590)**
Electronic graphics, 3D, animation systems.
Circle (1135)
- Wegener Communications (2491)**
Microwave, satellite communications audio, data encoders/decoders; network communication controllers.
Circle (1136)
- Wheatstone Broadcast Group (2400)**
*Audio mixing consoles for production, post-

remote control } PLUS {

- camera video from camera
- external video to viewfinder
- microphone audio from camera
- interphone (bi-directional)
- genlock to camera

} PLUS

coax cable; local power, or optional triax cable-remote power
(up to 2500 feet using standard coax cable, or up to 1 mile using triax cable)

Circle (123) on Reply Card
See Us At NAB Booth 2608

Telemetrics Inc.
7 Valley St. Hawthorne, N.J. 07506
* For Information Call (201) 423-0347

“Telemetrics — over 20 years the innovators in camera control signal multiplexing”
* Ask for details on Telemetrics Remote Pan/Tilt Systems.

EVERY SECOND COUNTS!!

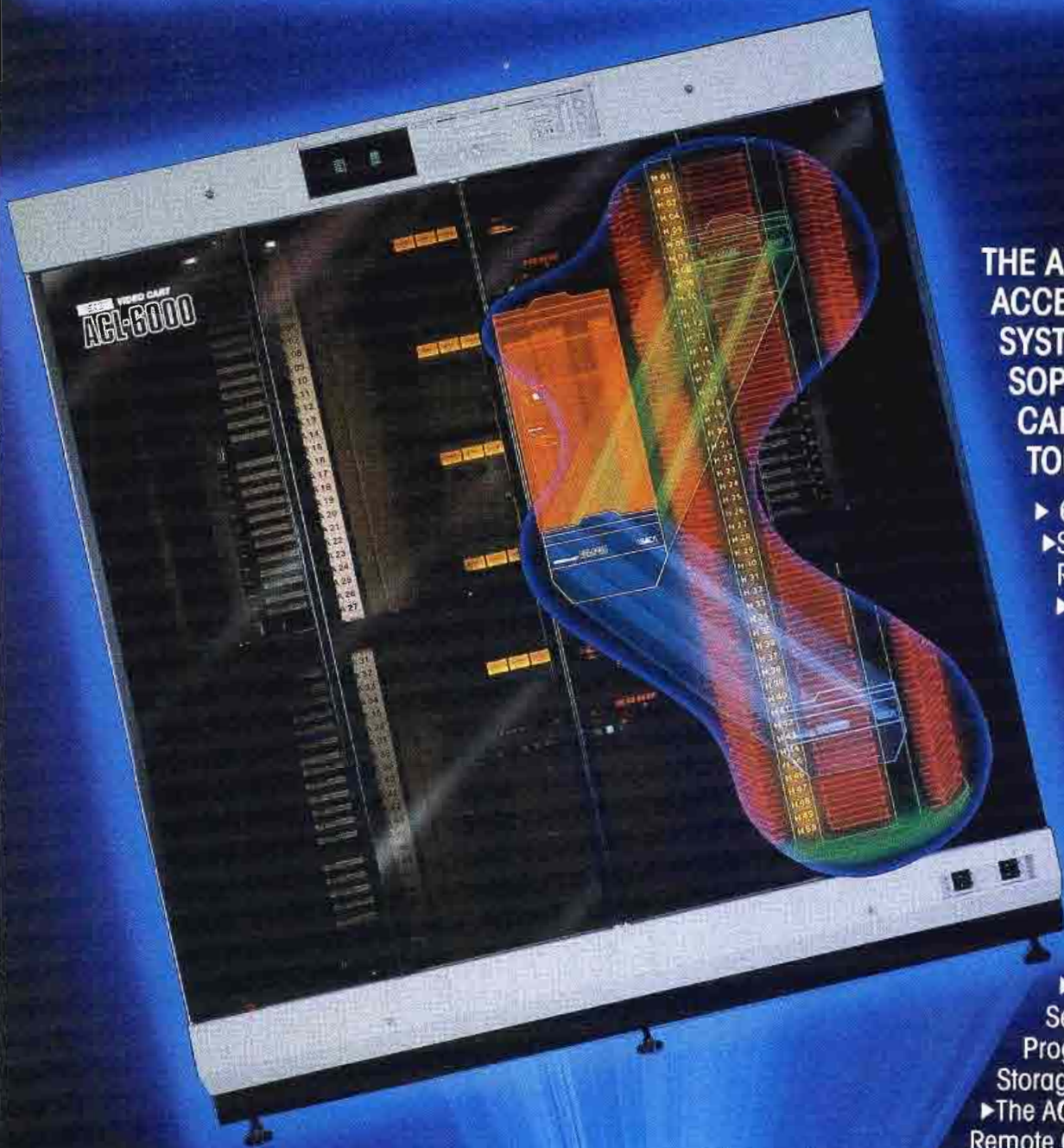

THE ASACA ACL-6000C RANDOM ACCESS AUTOMATIC VIDEO CART SYSTEM IS THE MOST SOPHISTICATED AND VERSATILE CART SYSTEM IN THE WORLD TODAY

- ▶ 600 1/2" Cassette Capacity
- ▶ Sophisticated Bar Code Reader/ Identification System
- ▶ Side Door Load/Eject System for Last Minute Changes and Complete User Safety
- ▶ State-of-the-Art Software Designed by Dubner Computer Systems
- ▶ Software Support and Modification by Dubner Computer Systems
- ▶ The ACL-6000C is Controlled by a Charles River Universe 6835 Computer
- ▶ SMPTE Time Code is Utilized for Precise Cueing
- ▶ The ACL-6000C is Capable of Multiple Segments on Cassettes for Total Programming Automation and Library Storage
- ▶ The ACL-6000C is Capable of Stand Alone Remote Control Operations or May Be Interfaced With a Station Automation System
- ▶ Complete Flexibility Using Either Sony Betacam or Panasonic M-II Formats

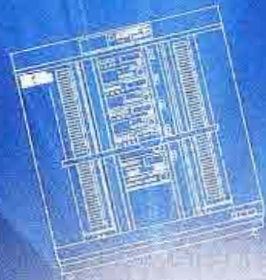

ASACA
ASACA/SHIBASOKU
CORP. OF AMERICA

12509 Beatrice Street, Los Angeles, California 90066
213-827-7144/800-423-6347/Telex-182089

Circle (124) on Reply Card

www.americanradiohistory.com

Comprehensive Audio Testing...

The Amber model 5500 Programmable Audio Measurement System is quite simply the most flexible and comprehensive audio analyzer you can own. Its broad range of features, high performance and expandable modular system architecture ensure that your 5500 will meet all of your audio measurement needs today - and tomorrow.

The 5500 measures absolute and relative signal level over a 160dB range in Volts, dBV, dBm or Watts. Harmonic and IM distortion measurements to IHF, DIN, SMPTE, CCIF and other standards to below 0.001% are fast and automatic. And noise measurements can be unweighted, weighted, band limited or narrow band using true rms, average or quasi-peak detectors.

Stereo balanced and unbalanced inputs and outputs allow interface to virtually any consumer, professional, broadcast or industrial device. And total computer control is possible using the IEEE-488 and RS-232 ports.

The friendly front panel and ten user-definable non-volatile setups make the 5500 at home in the R & D lab, the service bench or the production test environment.

Our detailed brochure gives the whole story - ask for one today.

Amber also makes one of the most popular portable high performance audio measurement systems - the 3501. Half the weight and size of comparable instruments, the 3501 has one of the best reliability records in the industry.

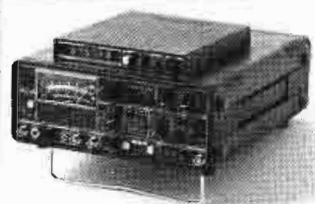

Amber Electro Design Inc.
4810 Jean Talon West
Montreal Canada H4P 2N5
Telephone (514) 735 4105
Telex 05-827598
US Toll free 800-361 3697

amber

Circle (125) on Reply Card

Wheatstone, continued

production, on-air.

Circle (1137)

See ad inside back cover

Wheelit

(2783)

Production equipment trucks, carts.

Circle (1138)

Whirlwind

(2643)

Audio cables, assemblies; direct boxes, connectors; cable testers.

Circle (1139)

H. Wilson Div./Ebsco

(2757)

Furniture, cabinetry for video, audio, computer equipment.

Circle (1140)

Winsted

(3424)

Modular equipment *racks for editing suites and other production applications.

Circle (1141)

See ads pages 254, 265

Wireworks

(2401)

Audio, video cable, wire; wiring harnesses.

Circle (1142)

Wold Communications

(2606)

Satellite time broker; program distribution.

Circle (1143)

Wolf Coach

(3541)

Remote/*mobile TV production vehicles.

Circle (1144)

World Tower

(2814)

Communications, broadcast towers, services.

Circle (1145)

WSI

(2642)

Weather graphic data, *satellite imagery; weather database; sports information.

Circle (1146)

Zellan Optics

(2477)

Cine cameras, lenses; time code systems.

Circle (1147)

Zephyr Weather Information

(2759)

Weather data services.

Circle (1148)

Zonal/Mag-Zon

(2586)

Magnetic recording tape.

Circle (1149)

||-[:(-))]]]]

"THESE KNOBS TURN HEADS"



When format, polarity, phase or routing errors threaten your stereo image, reach for the SCIP Stereo Signal Manager.™ Comprehensive signal monitoring and manipulation features let you *diagnose, reconfigure, correct* and *calibrate* stereo signals quickly and precisely. Even *azimuth errors* from fixed audio head VTR's. Give yourself the latitude to enhance your mono capability and stereo imaging.

See us at NAB Booth #2602

3302 Stereo Signal Manager ≡ The Control Solution



16169 Sunset Boulevard
Pacific Palisades, California
90272 ☎ 213-454-1889

Circle (126) on Reply Card

Want more information on advertised products? Use the Reader Service Card.

The best of both worlds:

THE SOUND TECH 1510A AUDIO TEST SYSTEM

Until recently, most Audio Test Systems have been either manual stand-alone systems or external-computer driven automated systems.

Engineers have long enjoyed the portability, ease of operation and cost effectiveness associated with manual stand-alone systems. Unfortunately, these systems have always lacked speed and documentation capabilities.

On the other hand, the ideally configured external-computer driven test system can provide speed, data analysis, documentation, graphics and integration with other GPIB test systems. Unfortunately external-computer driven systems are designed for production testing and are not suitable for troubleshooting or field work.

However, Sound Technology has combined the Best of Both Worlds into a portable, intelligent stand-alone system with complete PC compatibility: the Model 1510A! The Model 1510A can be used as an intelligent stand-alone system, and when connected to an external computer it becomes the ideal Automated Test System.

The ST1510A as a Stand-alone System

- Built-in Intelligence
- Portable
- Semi-automatic and Manual Test modes for fast troubleshooting
- Built-in CRT/Graphics

The ST1510A as an Automated Test System

- Graphics
- Test Chaining/limit testing
- Industry-standard Computer Interface (GPIB)
- User Choice of PC
- Bundled software for IBM, HP
- Compatible with Automated Switchers
- Production Testing

Contact us now for full technical and applications information. Learn firsthand why the ST1510A is the only test system that combines the best of both worlds!

SOUND TECHNOLOGY

1400 Dell Avenue
Campbell, California 95008
(408) 378-6540 Telex: 357445

At NAB, See us on the
Main Floor, Booth 3328.



**Put The Best
To Test!**

Circle (53) on Reply Card

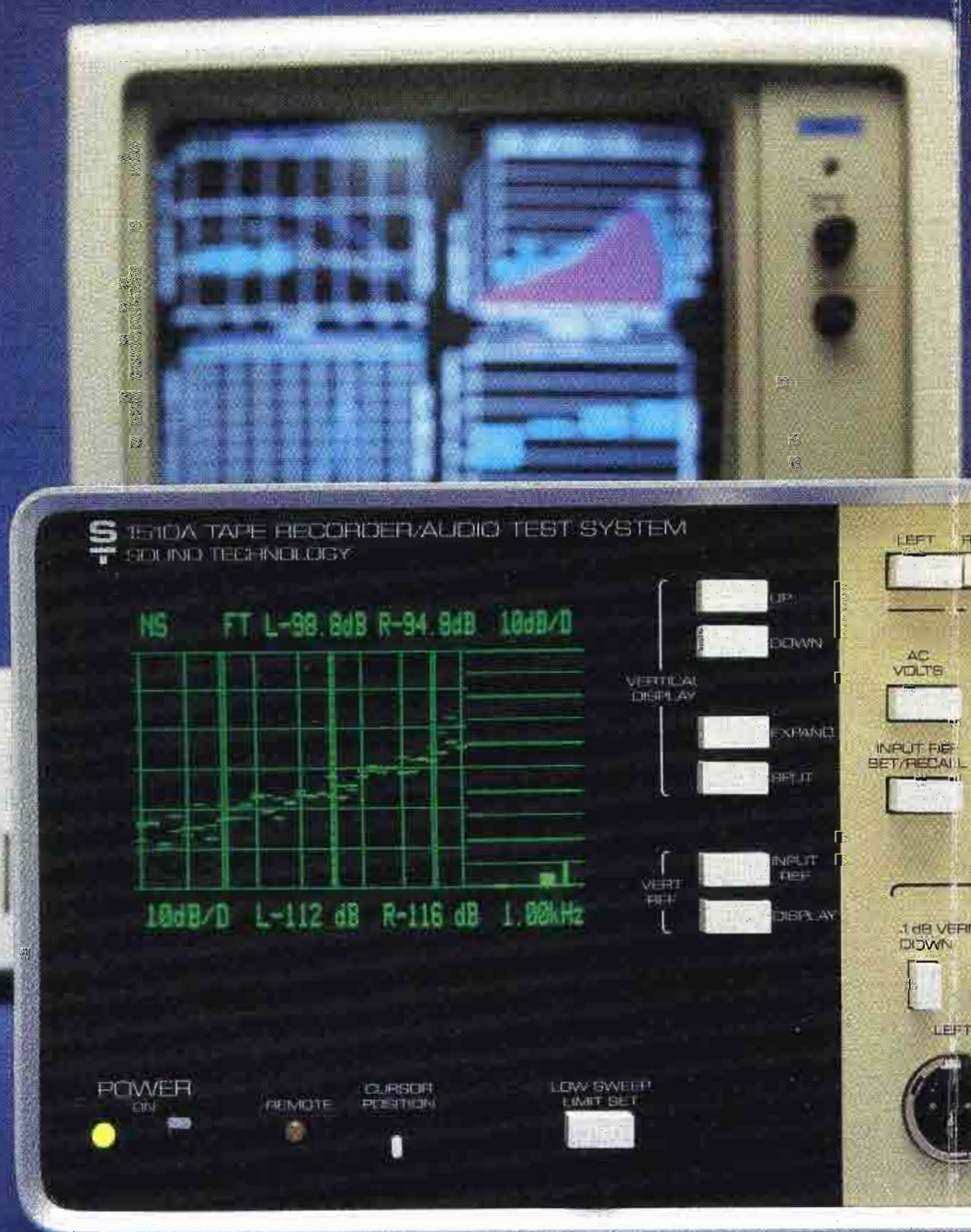

“Here’s why Blane Webster bought Auditronics for WLAK-FM”



Blane Webster,
Chief Engineer, WLAK-FM



“**W**hen I prepared the budget for our new facilities on Chicago’s Michigan Avenue, I could have included any console I wanted, be it Ward-Beck, Neve, you name it. So I looked at and listened to everything the industry had to offer, from the Harrison to the Harris Medalist, and I bought Auditronics.

I bought the Auditronics 200 primarily for its audio quality, by which I mean its waveform integrity, freedom from distortion and low noise floor. The quality of its sound is remarkably transparent. I think Auditronics’ VCA technology is really good too, maybe the best on the market.

I also looked for reliability. The console’s the most important link in the studio chain because it’s on the air all the time. We just can’t afford a failure, and I recalled that our old Auditronics console at Sears Tower never had an on-air failure.

Features were important too, like the modular concept that lets me pull a module out and pop another one in almost

as fast as making an Indianapolis pit stop. If I need another mike channel or cart machine channel, I’ve got it right here on the shelf for immediate use. The layout of the Auditronics 200 is almost self-explanatory so our on-air people can use it without making mistakes, and the 200 is rugged enough to withstand the jocks’ abuse and coffee spills.

One of the things that sets WLAK apart is that we’re the number 1 adult contemporary station in the Chicago market, and to us being number 1 means more than just winning in the ratings. It means being the best both on and off-the-air. This includes the kind of equipment we buy and the way we use it. We’re a winner and we’re proud of it.”

If you’d like to know more about why Viacom’s Blane Webster specifies Auditronics consoles for *both* on-air and production, call 800-638-0977 toll free, for complete information and a demonstration near you.

 **auditronics, inc.**

3750 Old Getwell Road,
Memphis, TN 38118 • 901-362-1350

Circle (26) on Reply Card

BENCHMARK RE-DEFINES AUDIO CONTROL

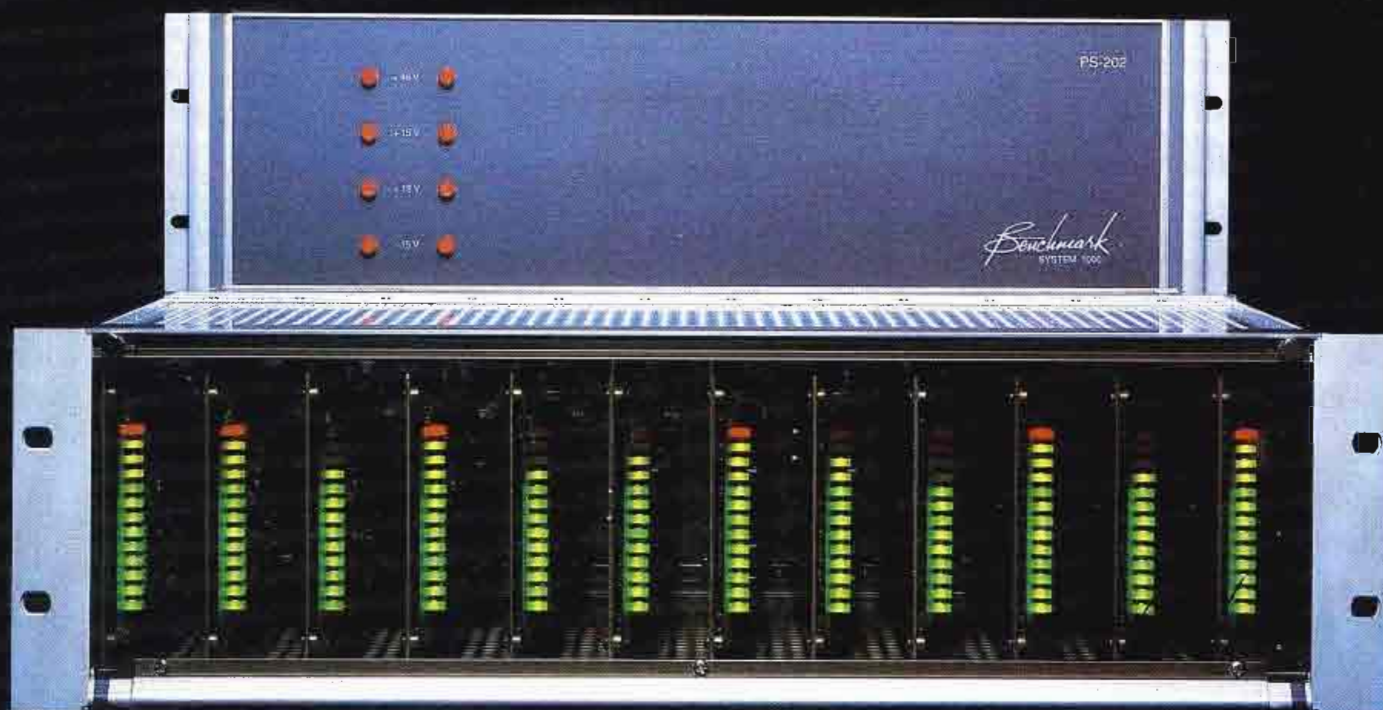

YOU'RE IN CONTROL WITH THE SYSTEM 1000

SYSTEM 1000 MODULES

DA-101

- MONO AUDIO INTERFACE WITH DUAL INPUTS
- L, R, L+R, L-R OR TIMECODE DISTRIBUTION
- VARIABLE GAIN, OFF TO +20dB, OR FIXED UNITY
- 1KHz THD = 0.0010 %, 20KHz THD = 0.0035 %
- OUTPUT NOISE = -96dBu, S/N = 100dB
- CMRR: 100dB TO 1KHz, 80dB @ 20KHz
- MAX IN/OUT = +27dBu, DYNAMIC RANGE = 123dB
- TEN 60 OHM BALANCED PLUS TWO DIRECT OUTS
- 40 WATTS @ 8 OHMS WILL DRIVE UP TO 100 DA OUTPUTS
- METERING: 12 SEGMENT LED PLUS PEAK O/L INDICATOR
- COMPATIBLE WITH ALL SYSTEM 1000 DAUGHTER BOARDS

DA-102

- UNIVERSAL AUDIO INTERFACE FOR STEREO DISTRIBUTION
- GAIN: VARIABLE, OFF TO +20dB, OR FIXED UNITY
- 150KHz BANDWIDTH
- 2KHz THD = 0.0008 %, 20KHz THD = 0.0025 %
- OUTPUT NOISE = -104dBu, S/N = 108dB
- CMRR: 100dB @ 2KHz, 80dB @ 20KHz
- CROSSTALK: -100dB @ 2KHz, -80dB @ 20KHz
- MAX IN/OUT = +27dBu, DYNAMIC RANGE = 131dB
- FIVE 60 OHM BALANCED PLUS DIRECT OUTS PER CHANNEL
- COMPATIBLE WITH ALL SYSTEM 1000 DAUGHTER BOARDS

DAUGHTER BOARDS

RGC-02

- 2 CHANNEL REMOTE GAIN CONTROL
- STEREO, MONO, LEFT / RIGHT DISTRIBUTION
- LOGIC LEVEL SWITCHING WILL COMPUTER INTERFACE

MTX-02

- STEREO, MONO, LEFT / RIGHT, MATRIX DISTRIBUTION
- ENCODE AND DECODE MATRIX FROM DISCRETE STEREO
- CHANNEL REVERSAL IN DISCRETE STEREO MODE
- REMOTE POLARITY REVERSAL IN ALL MODES
- LOGIC LEVEL SWITCHING WILL COMPUTER INTERFACE

OSC-01

- ULTRA LOW DISTORTION OSCILLATOR (0.001% THD)
- USE FOR LEVEL AND THD SPOT CHECKS
- REMOTE SELECT NORMAL DA INPUT OR OSCILLATOR
- EXTERNAL TEST SIGNAL INPUT
- LOGIC LEVEL SWITCHING WILL COMPUTER INTERFACE

EQ-02

- DUAL 3 BAND "SEMI-PARAMETRIC" EQ
- VARIABLE CUT/BOOST TO 15dB
- LOW BAND: VARIABLE FREQUENCY SHELving FILTER
- MID BAND: VARIABLE FREQUENCY "PRESENCE" EQ
- HIGH BAND: VARIABLE SLOPE 7KHz SHELving FILTER
- BALANCED INSERTION CAN BE USED AS THIRD INPUT

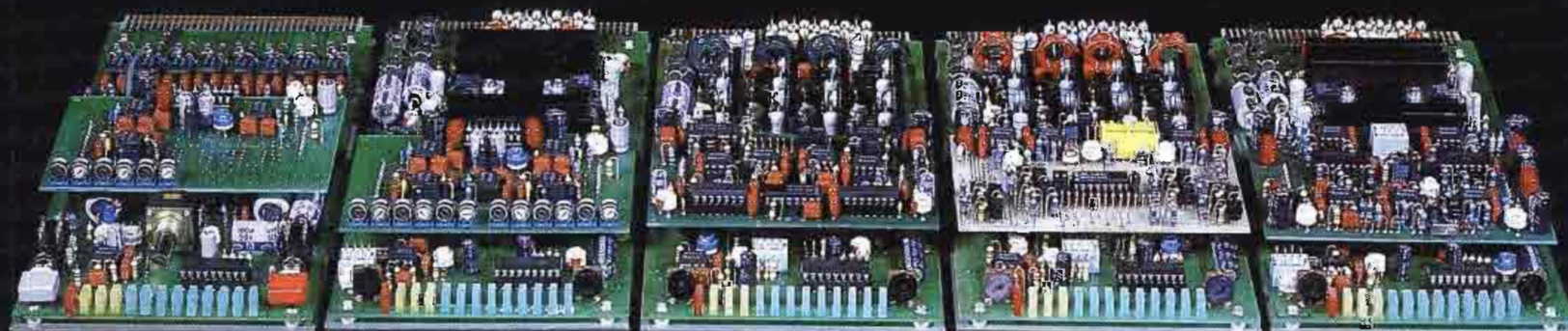

MDA-101 / EQ-01

DA-101 / EQ-02

DA-102 / RGC-02

DA-102 / MTX-02

DA-101 / OSC-01

Benchmark
MEDIA SYSTEMS INC.

Circle (127) on Reply Card

3817 BREWERTON ROAD, N SYRACUSE, NY 13212 1-800-BNCHMRK or 315-452-0400

SOME OF THE FORTUNATE....CHICAGO SYMPHONY, BBC, PBS, NBC RADIO, WGN-TV, WBZ-TV, SCENE III NASHVILLE

www.americanradiohistory.com

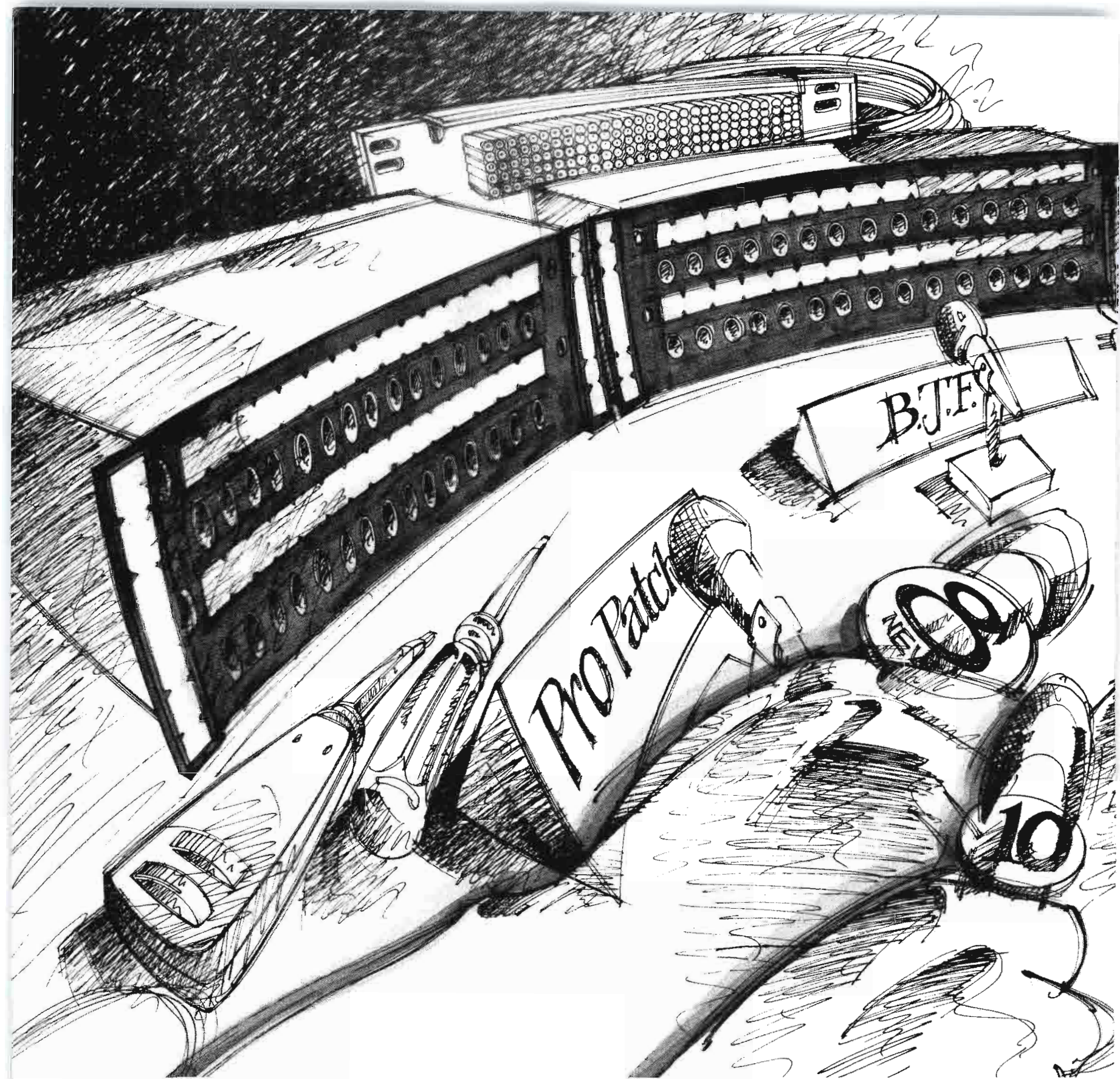

NO PATCHING QUESTION IS TOO TOUGH FOR ADC'S "PANEL OF EXPERTS."

MODERATOR: "Thank you, and welcome. First question, please — don't hesitate to give us your best shot."

QUESTION #1: "OK, Panel, I need patchbays that keep my racks neat and tidy, without a lot of cabling clutter. And I need to install them quickly and securely. Any suggestions?"

PROPATCH: "Sure — try ADC ProPatch Mark II patchbays. They're fully enclosed, and all the terminations are QCP punchdowns on the back of the box. Fast installation is one reason we're the panel of experts."

QUESTION #2: "This one's tougher, Panel. I need to terminate

my patchbays in the bottom of the rack, but I want my jacks protected."

BJF: "No problem. ADC's Broadcast Jackfield (BJF) Mark II series gives you the best of both worlds. They feature Ultra Patch termination panels with QCP punchdowns on the end of a harness. So you can terminate your cabling wherever it's most convenient. The patchbay chassis supports the cable harness and covers the jacks."

QUESTION #3: "What about when your budget's tight? I need quality patchbays, but I've got a small facility and I can't spend a lot of money."

PATCH KIT: "Our Patch Kit is

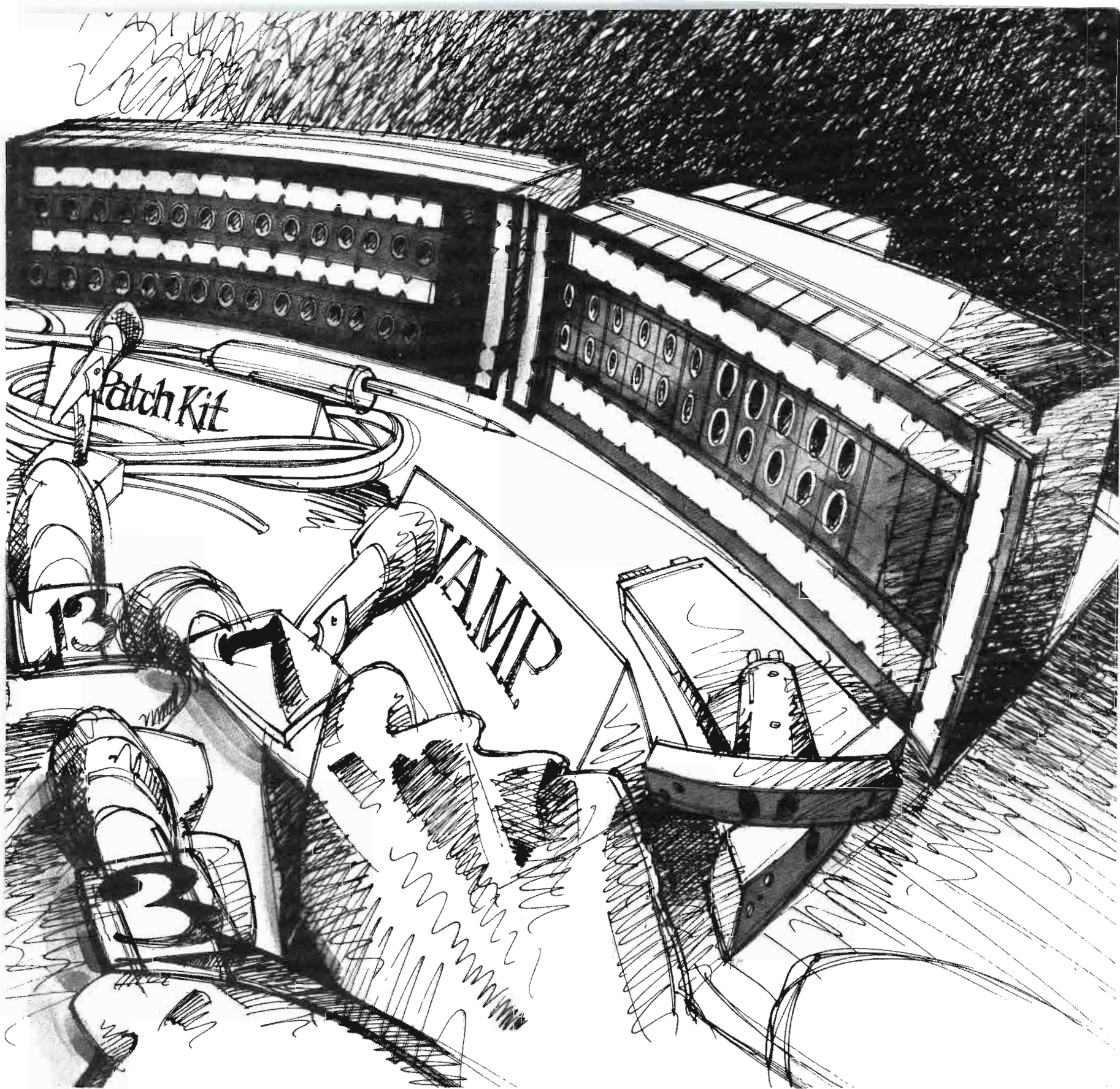

exactly what you're looking for. It's a Broadcast Jackfield Mark II chassis without the cabling. Just add your own cable and you'll have it made. And you'll save money by doing it yourself."

QUESTION #4: "Let's see you answer this one, Panel. I have a small off-line suite and I need to patch a few audio circuits AND a few video circuits. If you want me to buy two dozen circuits at a time, forget it."

VAMP: "Don't buy more patching than you need. Buy an ADC Video/Audio Modular Patchbay (VAMP)

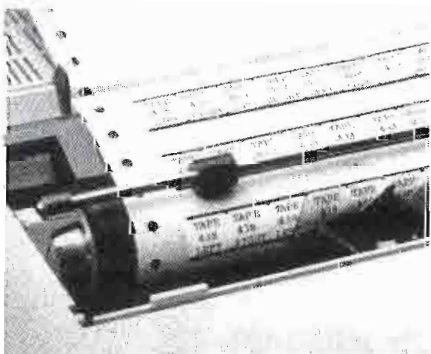

instead. Because it's modular, you can install the number of video and/or audio modules you need—no more, no less. And it's expandable."

"We've got the answer—our Self Adhesive Identification Labeling System (SAILS for short). It's a special computer-printable, adhesive-backed polyester label.

QUESTION #5: "I'm convinced, Panel. You're great patchbays. But doing designation strips drives me crazy."

MODERATOR:

SAILS won't discolor, smear or tear, and they're removable. You don't even need special software to print on them. You'll find SAILS on every ADC patchbay. Any more questions?"

QUESTION #6: "Just one. Where can I buy ADC patchbays in a hurry?"

MODERATOR: "Call us at (612) 893-3010, and we'll give you the name of your nearest ADC stocking distributor. Like everyone on our panel of experts, he really delivers."



ADC Telecommunications, Inc. 4900 West 78th Street
Minneapolis, Minnesota 55435 (612) 893-3010

Circle (128) on Reply Card



New at NAB

Product Directory

In mid-December 1986, BE sent a questionnaire to all companies that were expected to be NAB exhibitors. In it, we asked them to provide information on new products that were to be introduced at the show.

Many companies responded to our query, and the following list gives you an idea of what will be at the convention. However, our early production deadlines did not allow some companies to disclose their plans, as they did not know exactly what their plans were.

So although "New at NAB" will give you an idea of what will be at the show, expect a surprise or two once you hit the floor.

In the exhibitors' list, which starts on page 154, asterisks (*) were used by key words to indicate that a company was announcing a product in a certain category. By looking at this listing, you will be able to locate the product grouping for that type of equipment.

Within each major grouping, information is listed alphabetically by company, with a short product description. At the end of each entry is a Reader Service number, the same one used for each entry in the exhibitor listings. To get more information from a particular company, circle the appropriate number on the Reader Service Card, bound into the back of this issue.

Audio Products 216

- Audio amplifiers/processors: compressors, limiters, noise reduction, delays, effects, telephone hybrids.
- Audio mixer systems.
- Audio recorders: analog, digital, synchronizers, recording accessories.
- Audio sources, monitoring: microphones, wireless mics, audio remote pickup equipment, phono players, CD players, intercoms, headphones and headsets.

- Time code, timers, counters.
- Videotape recorders.
- Weather graphics, data systems.

RF/Tower Products . . . 249

AM, FM radio transmitters: ITFS, MDS/MMDS, STL, microwave equipment; power amplifier tubes, klystrons; RF amplifiers; RF generators (SCA, stereo, MTS); towers, tower lighting.

Video Products 230

- Batteries, chargers, lighting.
- Cameras.
- Camera support products.
- Digital effects equipment.
- Editing equipment: controllers, machine synchronizers.
- Monitors.
- Processing equipment.
- Production, master control switchers.
- Prompting systems.
- Telecine, film products.

Support Products 253

- Automation equipment: program, newsroom, business.
- Cable, wire.
- Cases, racks, carts.
- Recording tape, degaussers, reconditioners.
- Signal distribution: routing switchers, distribution amplifiers.
- Syndicated programming distribution: music, sound effects libraries.
- Test/monitoring equipment, tools: filers, delay lines.

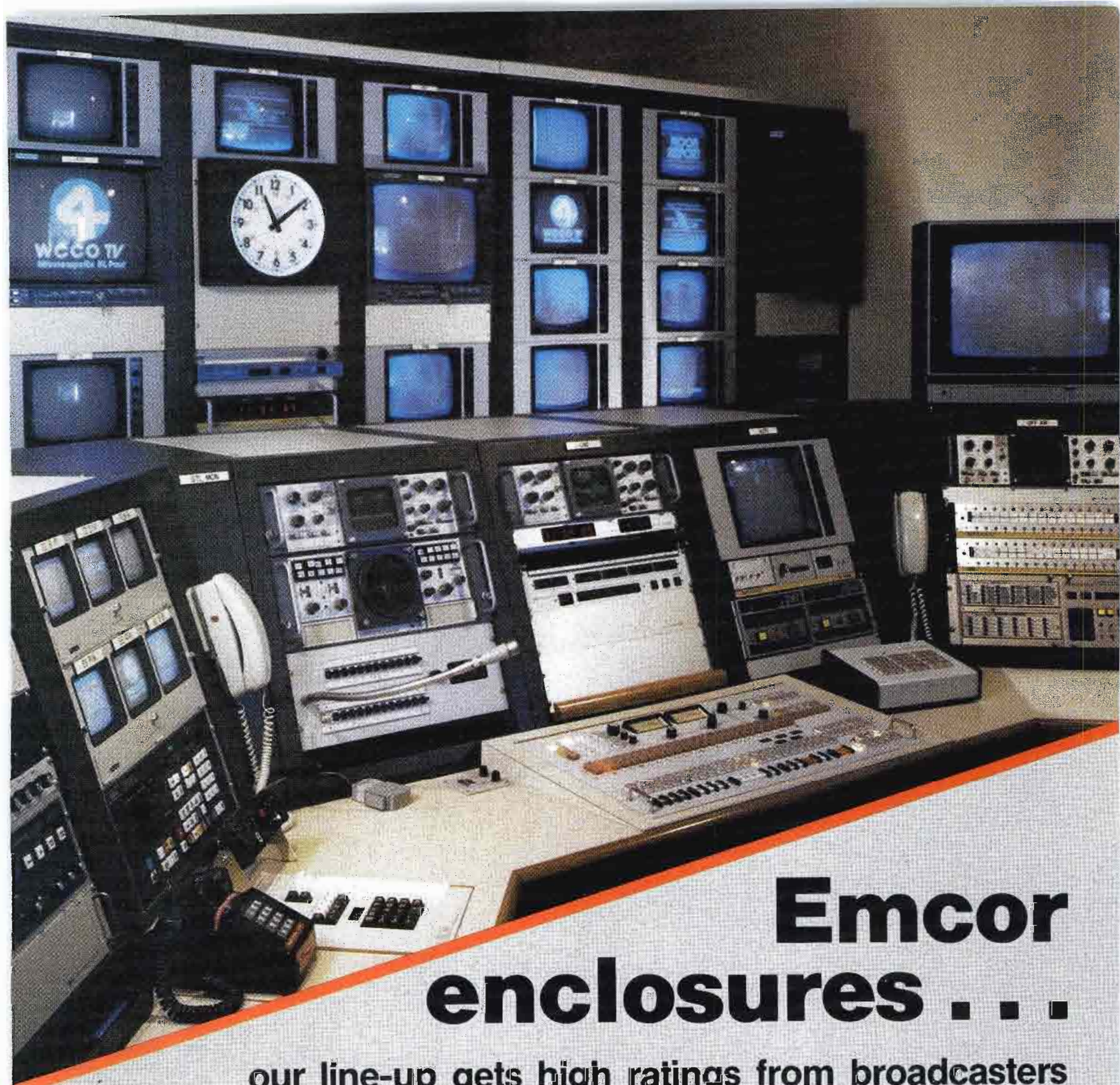

Emcor enclosures . . .

our line-up gets high ratings from broadcasters

Leading TV and radio broadcasters, such as WCCO-TV in Minneapolis/St. Paul, put their equipment in Emcor enclosures. And our line-up is impressive — six distinct product lines featuring more than 9,000 standard items.

Emcor gets high ratings because

we meet the needs of broadcasters. For those who need it fast, Instant Emcor is ready to ship in five working days. In addition to standard products, we can manufacture modified designs for your special needs.

Call us with your requirements.



Crenlo, Inc.

EMCOR

1600 Fourth Avenue N.W., Rochester, Minnesota 55901 507-289-3371

Circle (129) on Reply Card

www.americanradiohistory.com

Good Reasons To Call RTS When You Need High-Performance Intercom Systems.

Professional intercom systems from RTS—a great way to keep in touch, no matter what the application.

Our Series 800 features multi-channel intercom products ranging from sophisticated *microprocessor-assisted* to simple and direct. And our TW Intercom offers a wide array of two-channel system components.

RTS Systems intercom—for all the right reasons. Please call or write for descriptive literature.

PROFESSIONAL INTERCOMMUNICATIONS • PROFESSIONAL AUDIO PRODUCTS

Circle (130) on Reply Card

RTS SYSTEMS
INCORPORATED

1100 West Chestnut Street • Burbank, California 91506 • Telephone 818 840 7119 • Telex 194855 • Telefax 818 842 4921

Audio products

Audio amplifiers/ processors

- Compressors
- Limiters
- Noise reduction
- Delays
- Effects
- Telephone hybrids

AKG Acoustics (2454)

ADR68K: digital reverb/effects system; 8s delay can be divided into four segments of 2s; 16-bit, 15kHz sampling; plate, chamber, room, hall, plate/hall, and room/room programs.

Circle (515)

Barrett Associates (2763)

Satellink: allows fading from satellite to any or all of six local audio sources and return to satellite feed.

Circle (579)

Benchmark Media Systems (2470)

MIA-4x4: quad mic preamp system.

SPM 2/3: stereo metering systems.

RGC-02: remote gain control daughter board for System 1000.

MTX-02: remote matrix switch board for System 1000.

MMA-101: mix-minus amp card for System 1000.

OSC-01: precision oscillator daughter board for System 1000.

Circle (587)

Bradley Broadcast Sales (2556)

Telos 100: digital telephone hybrid system.

Circle (596)

Broadcast Audio (2615)

Headphone EQ: 3-band circuit option for series II and IV mixers.

Advanced audio processor.

Circle (598)

Broadcast Supply West (2743)

Interalia announcer: digital voice source for telephone use.

Circle (606)

Comrex (3460)

Telephone hybrid interface.

Circle (662)

Delta Electronics (3488)

Audio processor: matrix AM stereo system.

Circle (698)

Dolby Laboratories (2705)

Model XP24SR: 24-channel Dolby SR production package.

Model 365SR: 2-channel Spectral Recording production package.

Model 390: 2-channel type C noise reduction device, for STL and VCR.

Circle (709)

Eventide (2830)

BD980 delay: stereo broadcast unit; 10-sec, with auto catch-up, ramp-to-zero, wait-exit.

Camera Mart

Video Systems:

We don't love you and leave you.

At Camera Mart, we believe our responsibility for your video system doesn't end with its installation.

Not only do we design, engineer, build and install the video system you need, we also *service* what we sell.

And, at Camera Mart, size doesn't matter. Whether your video system is a simple off-line unit or a complex broadcast studio, you get Camera Mart's *total* support. We give you a complete "turn-key" system. Delivered on time, and on budget.

This policy—where old-fashioned service is a thing of the *present*—sets us apart from other designers of production, post-production and mobile video systems.

Whatever you spend, we have so many sources to choose from, we can customize a system to any specs. And then keep it working.

And that's kind of unusual these days.

Typical Systems From Camera Mart:

1. Longwood Video Post-Production Facility.
2. Sheridan-Elson Production House Editing System.
3. CMTV Transportable "Super System."
4. Camera Mart Broadcast Multi Source Editing Suite.

Video Systems designed,
engineered,
serviced
by



See Us At NAB
Booth #3040

Headquarters/New York
456 West 55th Street, New York 10019
(212) 757-6977
Telex: 275619/FAX (212) 582-2498

Upstate/Central N.Y.
305 Vine Street, Liverpool, N.Y. 13088
(315) 457-3703 FAX (315) 457-3795

California
1900 W. Burbank Blvd., Burbank,
CA 91506 (818) 843-6644

Indiana
825 Royal Avenue, Evansville,
Ind. 47715 (812) 476-6327

Circle (131) on Reply Card



The Camera Mart, Inc.

SALES • SERVICE • RENTAL

A Good Reason To Call RTS When You're In The Business Of Recording On Tape.



Our Model 927 Programmable Reference Tone Generator adds a new dimension to tape recording quality assurance.

Operating in a *stereo* mode, it is user programmable with discrete tones, pink noise, noise reduction tones, phase check, stereo I.D. and more.

We think the 927 can improve your audio business. Please call or write for descriptive literature.

PROFESSIONAL INTERCOMMUNICATIONS • PROFESSIONAL AUDIO PRODUCTS

Circle (132) on Reply Card

RTS SYSTEMS

INCORPORATED

1100 West Chestnut Street • Burbank, California 91506 • Telephone 818 840 7119 • Telex 194855 • Telefax 818 842 4921

*Audio amplifiers
Eventide, continued*

time compression capability.
Software: various upgrades for SP2016 digital effects processor.
Circle (739)

**Gentner Engineering/
Gentner RF Products** (2669)
Digital hybrid: auto-nulling telephone system; digital signal processing.
Circle (764)

Gotham Audio (3354)
EMT-258: EMT-Franz dynamic noise filter; cleans up audio recordings and sound tracks.
Circle (770)

Howe Audio Productions (2832)
Model HDP-1000: stereo headphone amp; two balanced inputs; two 200Ω headphone outputs; separate volume controls; switches provide 6-signal matrix.
Circle (793)

Inovonics (2434)
Model 255: tri-band/PWM audio processor system.
Model 390: mag film recording electronics.
Circle (805)

Kahn Communications (2922)
FLATTERER: aids in broadbanding AM antennas.
POWER-side: reduces interference, noise for AM; increases power in one sideband for pseudo SSB efficiency.
GOOD N LOUD: audio processor; increases loudness no spatter at +125% modulation.
Circle (823)

Modulation Sciences (2811)
StereoMaxx: spatial image enlarger, enhances and widens the stereo image, for AM, FM or TV use; mono-compatible.
Circle (897)

Orban Associates (3444)
XT2 accessory: 6-band limiter for use with the Orban 8100A Optimod-FM; increases loudness without audible side-effects.
Model 787A: programmable mic processor; 32-register memory retains setups of EQ; compression; noise gate.
464A Co-Operator: level control; adjustable slow AGC level, fast attack compression; prevents tape, STL overload.
9100B Optimod-AM: updated version to NRSC pre-emphasis curve; update kits for previous units available.
Circle (936)

RTS Systems (3566)
Model MSA325: modular loudspeaker; fits into standard 19-inch rack; 1-rack unit high, ½-rack unit wide; rated 10W.
Circle (998)

SESCOM (3445)
SAT-2: audio leveler for satellite programming; rack-mount.
MDL-6: dual mic-line driver; rack-mount.
TR-IL series: hi-Z to hi-Z interconnection equipment, includes transformer pads, mini-compressor.
PO-44/-52: additions to portable series.
Circle (1008)

Stanton Magnetics (3331)
Slip mat: designed for disco use.

TTV 1530, the middle-weight video camera which takes on all-comers. Now, Thomson presents a team of all-round champions.



NEW MIDDLE WEIGHT CHAMPION

TTV 1530 is a professional 2/3 inch studio and OB camera. For the least possible investment, it gives you the best of Thomson's technology and quality: the know-how of a world leader in advanced electronic equipment. Great image quality, automatic setup and all the operational facilities of bigger cameras. Compact, maneuverable and lightweight.

Circle (133) on Reply Card

 **THOMSON VIDEO EQUIPEMENT**

Because the best need the best

FRANCE (HEAD OFFICE)
THOMSON VIDÉO ÉQUIPEMENT
17, rue du Petit Albi - CERGY-SAINT-CHRISTOPHE
BP 8244 - 95801 CERGY-PONTOISE CEDEX
Phone (1) 34.20.70.00 - Telex 204.780 F
Fax (1) 34.20.70.47

U.S.A.
THOMSON-CSF BROADCAST Inc.
37 Brownhouse Road - STAMFORD
CT 06902 - U.S.A.
Phone (1203) 965.7000 - Telex 6819035 TCS FB.
Fax (1203) 327.6175.
NAB 87 Stand N° 3190

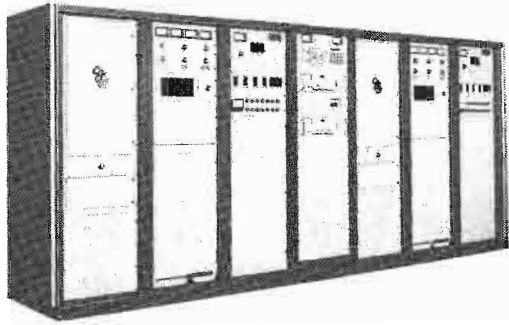

**A First
For The
Industry**

70,000 watts FM

Continental's new 817R-5 combines two proven 816R-5 35 kW transmitters to offer broadcasters many operating advantages. The 817R-5 uses husky components and is built to give many years of dependable service. The first 817R-5 has been shipped to KABL, San Francisco. For product data, call your local Continental Sales Manager.

- SCR power control
- Automatic RF power output control
- Automatic SWR circuit protection
- SWR output power foldback
- Remote control interface
- AC power failure recycle
- Grounded screen amplifier
- 802A exciter

Transmitters: 1 to 50 kW AM and to 70 kW FM, antennas, studio & RF equipment © 1986 Continental Electronics/6322



Circle (134) on Reply Card

Audio amplifiers
Stanton, continued

Model 30M/SR: disco headphones.
Circle (1035)

Straight Wire Audio/AD+R (2518)
EZ-Wider: stereo expander.
Scamp: A+DR modular audio processor; EQ, compressor, limiter.
Circle (1042)

Symetrix (2519)
Model 528: voice processor; mic preamp, compressor/limiter, expander, parametric EQ.
Circle (1053)

TFT (3420)
EBS system: multi-function equipment, dual receiver, reminder clocks, alarms.
Circle (1078)

Titus Technological Labs (3414)
MLW-1: microprocessor-controlled multi-channel audio controller.
Circle (1089)

UREI (2727)
Monitors: Time-Align coaxial studio audio systems.
Circle (1109)

Valley People (2747)
Autogate: 2-channel frequency selective noise gate and expander.
Model 816: 800 series leveller module; 1-channel level control device.
Model 817: 800 series 1-channel compressor/expander.
Circle (1115)

Audio mixer systems

ADM Technology (3266)
System RM1083: rack-mount, modular 8x3 audio mixer; 8 mic/line input; full EQ; stereo panning.
RM1168: audio mix-minus matrix for multiple satellite news feeds; 8-output from 16-/24-/32-/48-input system.
Circle (509)

A.F. Associates (3170)
Audix AAT-3000: assignable digital audio mixer.
Circle (513)

AMEK Systems & Consoles (2558)
Classic: broadcast console system.
G2520 system: multitrack mixdown console.
Circle (529)

AMS/Advanced Music System (2825)
Assignable console: audio mixing desk; computer control with Total Instant Reset; channel controls, routing, faders for 128 channels, 12 stereo groups; floppy disk memory backup.
Circle (535)

ATI Audio Technologies Inc. (2508)
BC12DSL: a Vanguard series model; 12-mixer, 24-input dual stereo audio console.
Circle (557)

Audio Developments (2933)
AD066: Port-a-Flex mixer, 10-input system.
Circle (563)

Aspen Music Festival

Four two-week sessions, June 29–August 23, 1987

Gordon Hardy, President

Jorge Mester, Music Director

The Aspen Audio Recording Institute • Aspen, Colorado

FACULTY

Dan Craik, Director, Ray Barker, John Eargle
Andrew Heller, Thomas Knab, Shawn Murphy

Full use of professional recording equipment provided by James B. Lansing Sound, Inc.; TEAC-Tascam; Beyer Dynamic; UREI; Lexicon; Yamaha; Mitsubishi; and Studer-Revox America.



Write or call for information: • Aspen Audio Recording Institute
Aspen Music School • 250 West 54th Street • 10th Floor East
New York, NY 10019 • (212) 581-2196

Circle (135) on Reply Card



Larry W. White
Chief Engineer
KOAM-TV, Pittsburg, KS

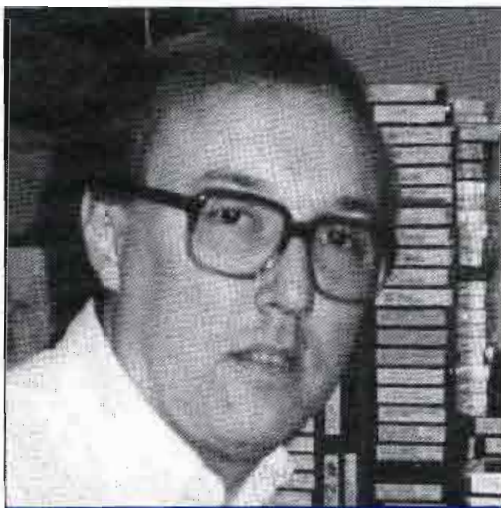

James L. Sorensen
Chief Engineer
WJQY-FM, Fort Lauderdale, FL



Daniel S. Bruck
Telecommunications Specialist
Channel 25, Beverly Hills, CA

How 3 Broadcasters Solved Their Power Problems

LARRY W. WHITE 3 KVA FERRUPS Uninterruptible Power Supply

EQUIPMENT SUPPORTED: IBM System 36 with two workstations, two IBM-PC XTs, 3 printers.

WHITE'S STORY: "Pittsburg, KS, has 'soft' power. We are at the end of a long leg from a rural electric company. If a farmer down the road turns on an arc welder, we see a drop in power. Just turning on a gang of lights in the studio drags the line below 108 volts. We lose power completely to thunderstorms in the summer and snowstorms in the winter.

"All these problems—outages, soft power, brownouts—played havoc with our computer, which runs day and night doing traffic, payables, receivables, administration.

"Since installation of the FERRUPS in May, 1986 to support the computer, we have not had a single glitch. I'm real happy with the FERRUPS."

JAMES L. SORENSEN 7.5 KVA FERRUPS

EQUIPMENT SUPPORTED: IBM System 36 with 3 terminals and 3 printers; microwave transmitter, 2 IBM-PCs with printers, telephone system, satellite down-link equipment.

SORENSEN'S STORY: "We were plagued by large voltage swings, outages and surges, which our utility considers 'acceptable' power. All crashed our computer and shut down the microwave transmitter. We installed a 350 KVA diesel generator. There was a 12-second gap between power failure and generator coming on line. Twelve seconds is a disaster in radio.

"In the first 2 months after installation of the Best FERRUPS, we experienced 43 power problems that would have crashed our systems. Protected by the FERRUPS, everything just hummed on. FERRUPS closed the generator gap."

DANIEL S. BRUCK 1 KVA MICRO-FERRUPS

EQUIPMENT SUPPORTED: Electronic billboard (specialized character generator), sync generator, frame store synchronizer.

BRUCK'S STORY: "The smallest power glitch would cause the unattended 24-hour-a-day character generator to go down, leaving us with a blank screen. When the character generator crashed, memory was lost. It took 3 hours to restore messages. These glitches also affected synchronization between other devices necessary for stable signals. These power problems occurred twice a month.

"Since installation of Best's unit in early 1986, we have not had a single power problem with any equipment. And the character generator works better because of the line conditioning provided by the MICRO-FERRUPS, in addition to uninterruptible power."

Among the many features of Best's Uninterruptible Power Systems are:

- Continuous computer grade power
- Traps spikes, surges, sags
- On-line in phase
- Microprocessor control
- Computer interactive
- User programmable
- RS232 port standard
- Extensive diagnostics
- Low component count
- Lowest noise level
- Least heat throwoff
- 250 VA to 15 KVA range
- Lowest price/most efficient
- UL approved

For your free catalog on all of Best's Uninterruptible Power Supplies, call or write today.



UL approved FERRUPS, in 250 VA to 15 KVA capacities, are as much as 33% smaller than any other unit on the market.



Best Power Technology, Inc.

P.O. Box 280 Necedah, WI 54646
(608) 565-7200

Toll Free (800) 356-5794 - Ext. 028

IBM System 36 and IBM-PC are registered trademarks of International Business Machines Corporation.

Circle (136) on Reply Card

Audio mixers

Audio Technica US (2407)
Model AT4462: stereo field portable audio mixer with MODU-COMM IFB system.
Circle (567)

Audix (3170)
AAT-3000: audio production mixing desk; digitally controlled, assignable; memory recall of all console settings; remotely located electronics.
Circle (570)

Autogram (2702)
RTV-12: 12-position audio console; electronic switching, VCA level control; P&G faders; shadow selector switches; remote control options; interface for print logger and live assist.
Circle (572)

Broadcast Audio (2615)
Rack-mount console: 6-mixer, front panel cue speaker, metered level preselect.
Series V: console with integral digital timer, control room monitor panel with headphone EQ.
Circle (598)

Calrec by AMS (2825)
Assignable console: audio mixing desk; computer control with Total Instant Reset; channel controls, routing, faders for 128 channels, 12 stereo groups; floppy disk memory backup.
Circle (615)

Connectronics (2403)
Seck-62B: broadcast version of Seck-62

recording and PA portable audio console.
Circle (667)

Dorrrough Electronics (2602)
Model 700: broadcast audio console.
Circle (710)

Hallikainen & Friends (2925)
TVA200: stereo version of TVA series TV audio mixers.
Circle (779)

Logitek (2807)
Crossfire: automated audio cross-fader; 4-channel; adjustable fade rate, style; for A/B edit or automated radio.
Stereorack: 6-channel stereo, rack-mountable console.
Circle (859)

Mitsubishi Pro Audio Group (3530)
Westar 8300: film re-recording console; 2-/3-channel pan pots; 8-/16-/24-mixing bus, 10-aux send bus; plug-in EQ, dynamics or mic preamp; fader options include audio, VCA with sub-groups, tape and computer automation.
Circle (895)

Rupert Neve (3318)
DTC-1 console: Digital tape transfer system mixing, EQ, dynamic range control processing in digital domain; one analog and two digital channels, all stereo, provide real-time crossfade; 4-band EQ, and dynamic processing with Instant Reset in digital domain.
Circle (922)

Orion Research (2588)
AMU console: production model of software-based audio mixer; 32 stereo inputs, full stereo processing and ReMem setup recall from memory.
Circle (937)

Pacific Recorders & Engineering (3151)
Compact mixer system.
Circle (940)

Shure Brothers (3320)
Model FP51: compressor, mixer unit.
Circle (1015)

Solid State Logic (3560)
Console/studio computer: increased high-speed, dynamic RAM for faster access to instructions; 20MByte compact disk cartridges hold equivalent of 80 floppies.
Circle (1020)

Sony Professional Audio (3100)
ADS-3000: automation system for MXP-3000 audio console series.
Circle (1023)

Soundcraft Electronics (2770)
SAC-2000: on-air broadcast, production audio mixing desk.
Model TS-12: multi-track production mixing desk.
Circle (1027)

Soundtracs (2454)
Model FME: fully modular 16 or 24-input audio production desk.

The RPG Diffusor Revolutionizes Acoustical Design



Blue Jay Studios, Carlisle

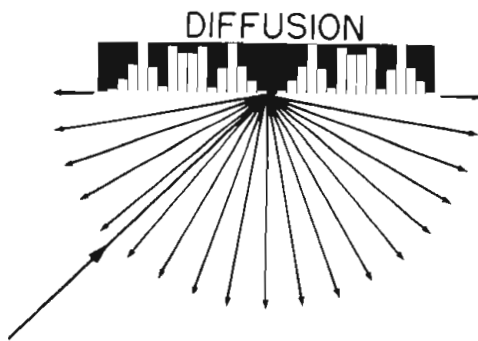

Tele-Image, Dallas

NEW ACOUSTICAL TREATMENT

The RPG is a new modular computer-designed reflection-phase grating, based on mathematical number-theory sequences. The RPG scatters sound from any direction, in all directions — for any desired frequency bandwidth. Now you can easily eliminate flutter and slap echos, while maintaining a natural ambiance; provide diffuse lateral reflections which increase the spatial impression; improve intelligibility and provide ensemble reflections. **Call or write for our free brochure.**

SELECTED BROADCAST USERS

- BBC Maida Vale 4**, London, UK
- KMJQ**, Houston, TX
- NBC-TV Stereo Training**, NY
- NBC-TV Studios**, Burbank & NY
- NPR**, Washington, DC
- Radio New Zealand**
- Rogers Radio**, Toronto, Canada
- Jimmy Swaggart**, Baton Rouge, LA
- WBGO**, Newark, NJ
- WFMT**, Chicago, IL & Phil., PA
- WJHU**, Baltimore, MD
- WLLT**, Cincinnati, OH
- Word-of-Faith**, Dallas, TX

APPLICATIONS

- Recording/Broadcast/Post Facilities
- Audio/Video & Teleconference Rooms
- Worship Spaces • Acoustical Shells
- Music Rehearsal Rooms • Auditoriums
- Audiophile Home Listening Rooms
- Performing Arts Facilities • Schools



RPG Diffusor Systems, Inc. 12003 Wimpleton St., Largo, MD 20772 Phone 301-249-5647 Telex 5106004126 RPG
RPG Europe — Phone 01-900-0355 Telex 935847 CETECA G **RPG Far East** — Phone 3-7446189 Telex 393097 POSOD HX
Canadian Rep — Gerr Electro-Acoustics, Ltd.

Patent Pending

Circle (137) on Reply Card



Truly great amplifiers are measured by two standards. Sonic quality and reliability. Our new RAMSA 9055, 9110 and 9220 power amplifiers achieve excellence on both counts. And their superb, well-balanced design, combined with Matsushita's manufacturing processes and rigid quality control, gives us the confidence to back them with a 5-year limited warranty.* This RAMSA warranty and UL listing assures you that we stand behind the 9000 series with everything we've got. And that's saying something. We challenge you to compare these new amps for yourself. But you better be prepared to re-evaluate your standards.

RAMSA
Panasonic
Industrial Company

*See terms of warranty for details. © 1986 Panasonic.

Circle (138) on Reply Card

www.americanradiohistory.com

Audio mixers
Soundtracks, continued

Model MRX: modular 24 or 32-input audio production desk.

Model FMX: stereo 8-4-2 mixer.

Circle (1030)

Studer Revox America (3048)

Model C279: 6-channel mixer; switchable mic/line; EQ, phantom power, PFL, phono-input option; compact design.

Circle (1045)

TASCAM (3416)

M600: modular audio mixer; 16-bus, 32-input mono or stereo positions; 16-/32-in monitor configuration; 66 inputs when in 32-in monitor and 32 inputs.

Circle (1058)

Wheatstone (2400)

Model SP-6: radio production console; stereo/mono input modules with machine control, remote on/off, control room/studio muting and tally.

Circle (1137)

Audio recorders

- Analog
- Digital
- Synchronizers
- Recording accessories

AMS/Advanced Music Systems (2825)

AudioFile: hard disk digital audio recorder;

software updates allow sync recording, punch in/out; remote machine control; digital interfaces to other PCM equipment.

Circle (535)

CompuSonics (2533)

DSP 1000: digital audio disk recorder; records, edits on laser optical disk media; 72 minutes stereo; 44.1kHz 16-bit.

DSP 1500: digital audio recorder; CSX format super-floppy disk media; 32kHz 16-bit sampling; 6.6MByte for 4 minutes stereo.

Circle (659)

Evertz Microsystems (201)

7100 emulator: audio tape transport interface for video editor.

Circle (740)

Fidelipac (3092)

CTR30: 3-deck audio cartridge recorder/reproducer.

Circle (746)

FOR-A (3599)

Sirius-100: digital audio memory.

Circle (751)

International Tapetronics/3M (3052)

Model DCM-1: Dynamic Cartridge Monitor; tracks cartridge performance; helps to find carts that might fail on-air.

Circle (811)

Leader-Brac (2542)

Leader-Brac: recording accessories, dispenser for leader, splicing materials.

Circle (844)

Lexicon (133-136)

Opus audio: complete digital audio production system; random access; recording, non-destructive editing, time alignment, mixing, panning, overdubbing, signal processing in digital domain.

Circle (855)

Microprobe Electronics/MEI (2620)

Digisound-E: economy series of digital audio mass storage system.

Circle (887)

Mitsubishi Pro Audio Group (3530)

XE-2 editor: complete digital-to-digital editing; selective cross-fade times; auto tape location through SMPTE time code; full screen edit-data display.

Circle (895)

New England Digital (228)

Direct-to-Disk: multi-track recording option for Synclavier; 16-track disk recorder; 100kHz, 16-bit sampling.

Circle (923)

Otari (3246)

Model MX-80: multi-channel open reel audio recorder; 24, 32 channel models; 2-inch tape.

DTR-900: 1-inch 32-channel professional digital recorder; PD format.

CTM-10: audio cartridge recorder deck; NAB type.

Circle (939)

Pacific Recorders & Engineering (3151)

MicroMax: cartridge recorder.

Circle (940)

Sony Professional Audio (3100)

PCM-3401: twin-speed DASH 2-track digital



AUDIO MIXING, TELEVISION STYLE

Designed specifically for television and video post, the split-concept serial architecture found in the Orion AMU series audio mixing system enables interface to virtually any SMPTE controllable device including production, routing, and master control switchers and video editors.

Standard software features include ReMem™ the disc based Recall Memory System that allows on-demand storage, recall, and reset of full panel set-ups (including EQ), providing an invaluable tool for any repetitive program or complex edit session.

With full input-to-output stereo processing — and up to 32 stereo inputs plus a traditional panel layout, the AMU has the capacity, audio features, and ease of operation necessary for efficient audio production in both broadcast and video post.

State-of-the-art audio mixing for television . . . from . . .

ORION

RESEARCH INC.

4650 W. 160th St. • Cleveland, OH 44135 • (216) 267-7700
Toll Free (except Ohio and outside USA): 1-800-82 AUDIO
Telex: 510 600-0034 • FAX: (216) 267-5894

Circle (141) on Reply Card

AUTOMATIC AUDIO POST-PRODUCTION

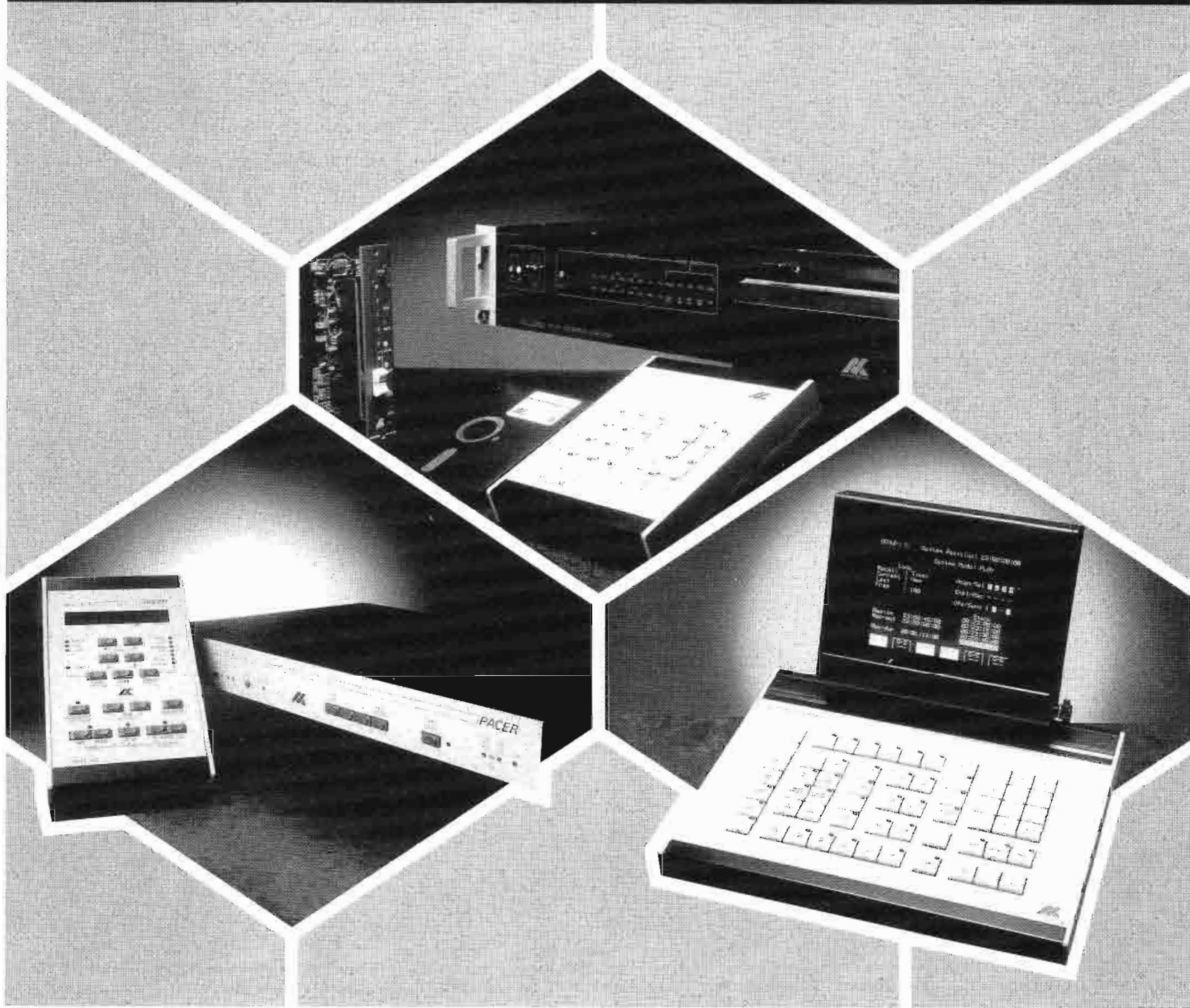

ATNAB

BOOTH 2506

Audio Kinetics has the highest reputation for post-production synchronizers and mix-down automation which are reliable, cost-effective and user-orientated.

MASTERMIX: Automatic Automation. Disc-Based, which can be fitted to almost any console. Easy to use, with the highest quality VCA faders available on the market.

ECLIPSE: Tomorrow's Audio Editor Today. Multi-machine, Dual Tasking, and user programmable keys. A really powerful machine-control editing system.

PACER: New. The low-cost solution to two-machine synchronizing, but with no sacrifice in performance. Built-in time code generator.

Come and talk to the experts.



AUDIO KINETICS LIMITED
Kinetic Centre, Theobald Street,
Borehamwood, Herts. WD6 4PJ, England.
Tel: 01-953 8118 Tlx: 299951 Fax: 01-953 1118

AUDIO KINETICS

Circle (140) on Reply Card

AUDIO KINETICS INC
1650 Highway 35, Suite 5, Middletown,
New Jersey 07748, U.S.A. 201-671 8668
Fax: 201 671 6902

Audio recorders
Sony, continued

audio recorder; advanced electronic recording capabilities.
Circle (1152)

Soundmaster International (2780)
SYNCRO: programmable machine synchronizer; component of editing system; IBM PC software-based system; machine-mounted interfaces for universal cabling; expandable to 16 plus transports, multi-tasking.
Circle (1028)

Studer Revox America (3048)
Model A820: 8/16/24-track multi-channel re-

corded; full microprocessor deck control; integral Dolby SR option.

A807 ATR: 2-track recorder; microprocessor for programmable function buttons; digital parameter setting; thumbwheel tape shuttle; rack, portable, console configurations.
Circle (1045)

TASCAM (3416)
CD501: professional CD player; rack-mount; +4dBm; hardwired remote control (controller capable of running two units); console fader remote start.
ATR80-24: 2", 24-track audio recorder; 14" reel capability; designed for post production with seamless insert editing.
122 Mark II: audio cassette deck; front panel bias, EQ controls; test tone oscillator; rack-

mount; +4dBm, Dolby B/C, HX Pro; tape run timer in min/sec; console fader remote start and full remote controls.

Model 112: rack-mount cassette deck with Dolby B/C, HX Pro; 2-head system; remote controllable.
Circle (1058)

Audio sources, monitoring

- Microphones
- Wireless mics
- Audio remote pickup equipment
- Phono players
- CD players
- Intercoms
- Headphones & headsets

AKG Acoustics (2454)
Model D-112: large diaphragm broadcast mic.
Model Q-15: light-weight communications headset with monitor.
Model C-410: light weight vocal headset without monitor.
Model C-522: stereo X-Y ENG microphone.
Circle (515)

Allied Broadcast Equipment (3414)
Laser phono: Finial Technology turntable; LP reproduction with laser beam.
Circle (521)

Beyer Dynamics (2823)
DT-770/-990: studio, EFP monitoring headphones.
MC 736-PV: short shotgun microphone, condenser design.
MC 737-PV: long shotgun condenser mic.
MCE-10: miniature cardioid condenser mic.
MCE-80: cardioid condenser mic.
M-700: cardioid dynamic mic.
Circle (589)

Broadcast Supply West (2743)
Model TP500: Radix phono preamp.
ProBase III: turntable isolation unit for Technics turntables.
Circle (606)

Cetec Vega (3394)
R-33 Pro Plus: miniature, portable wireless receiver.
T-86 Pro Plus: omnidirectional handheld wireless transmitter; designed for interview work.
Q Plus: wireless intercom system, with single-package wireless remotes.
XRS-15: miniature lavalier electret mic.
REPORTER: portable wireless mic system for low-budget needs.
M-117B: antenna multicoupler; improved IMD performance.
Circle (634)

Clear-Com (3352)
Models 500, 501, 522: belt-pack digital intercom units.
Circle (645)

Gotham Audio (3354)
RSM-190: Neumann Stereo condenser shot-

Telescoping Pneumatically Raised Support Masts for Remote Broadcasting.

OEM or accessory mounted on your truck, van, trailer or free-standing. Operational in minutes. Available in extended heights from 20 to 134 feet with a full range of support equipment including remote controlled positioners.

Performance proven in thousands of demanding installations and applications world-wide since 1954.

Inquiries handled promptly. Use the card number below or for "Right Now" action, phone (216) 682-7015 Ext. 286.

TMD

A DIVISION OF THE WILL-BURT COMPANY
AN EMPLOYEE OWNED COMPANY
P.O. Box 900 • Orrville, OH 44667

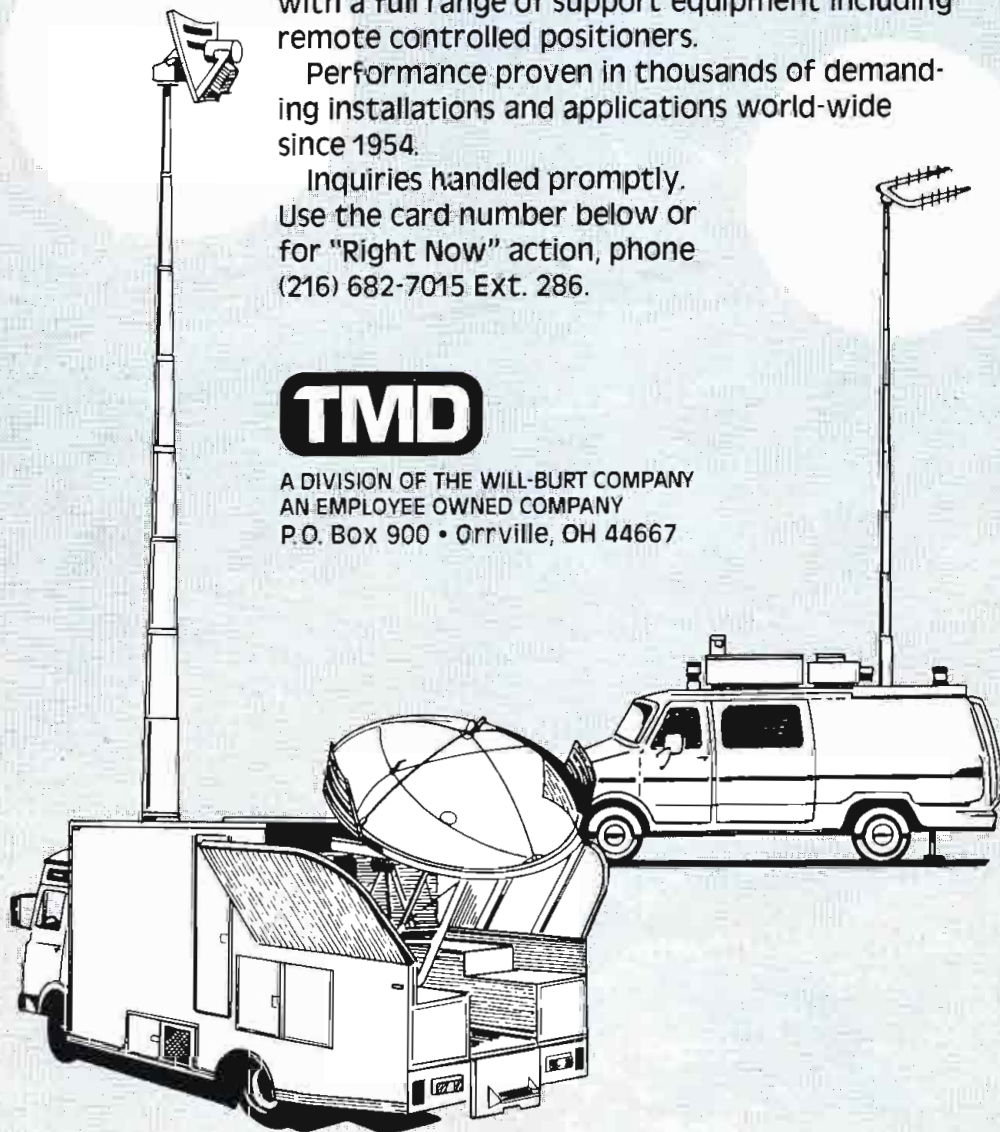

Circle (139) on Reply Card

The Art of Imagination from Quanta.

*Graphics systems that
put creativity at your
fingertips.*

We just want
to mention one simple fact:
Quanta equipment, from our
economical character generators
to our full-featured paint and 3D
systems, is *easy to use*.

We understand crunch time
and sudden deadlines. When
we design our products we
concentrate on making them
easy to operate. The end result
is more time creating and
less time operating. And that's
an art in itself.

To find out how easy it is
to use Quanta products, call
your nearest dealer. Then you
be the judge. Draw
your own
conclusions.

Quanta Corporation
2440 So. Progress Drive
Salt Lake City, Utah 84119
(801) 974-0992

We liberate the imagination.

QUANTA

DYNATECH Broadcast Group

Circle (143) on Reply Card

Professional SOUND recording & duplicating

SUPPLIES

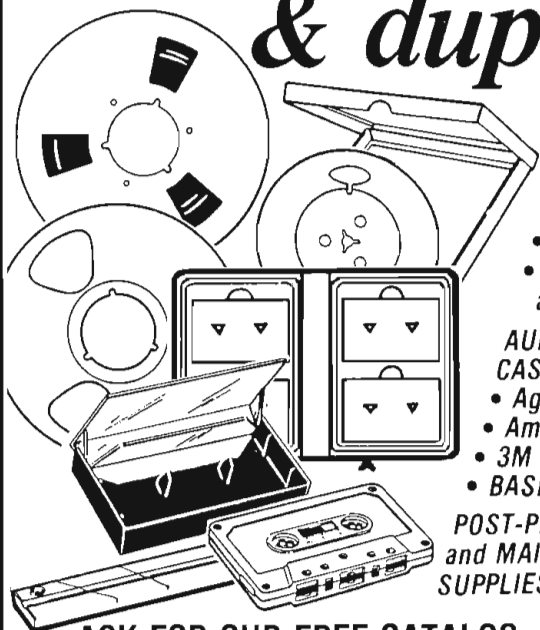

POLYLINE
 • Blank-loaded audio cassettes
 • Empty reels and boxes
 • Audio cassette boxes and albums

AUDIO TAPE and CASSETTES from
 • Agfa • FUJI
 • Ampex • Maxell
 • 3M • TDK
 • BASF

POST-PRODUCTION and MAINTENANCE SUPPLIES

SHIPPED FROM STOCK WITHIN 24 HOURS
 under normal circumstances

ASK FOR OUR FREE CATALOG

Call Polyline
312 / 298-5300
 8:30 am - 5 pm Central Time

Polyline Corp.
 1233 Rand Road
 Des Plaines, IL 60016

Circle (144) on Reply Card

HANDS-FREE ENG/IFB/TELEPHONE

- Operates From Any Modular Telephone Jack.
- Single or Double-Line Models.
- Tone or Pulse Dialing.
- 1 Ounce Headphone/Mic.

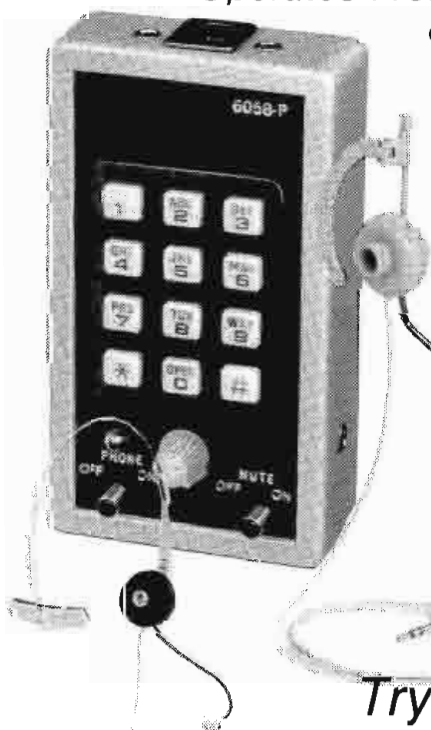

Exclusive features for ENG/IFB use include a mic mute switch, control for adjusting incoming volume, 3 mic inputs, 3 headphone outputs, ringer circuit for alerting user to incoming calls.

A 1 ounce headphone/mic (with or without headband) is available for "hands-free" telephone operation. Full size circumaural headphones with noise cancelling mics are also available for use in high ambients. Telephone is small, approx. 2" x 4" x 1" and has a clip for attaching to user's belt. Tone or pulse dialing. Single or switchable 2-line models available.

Try it At NAB Booth 2671

R-COLUMBIA PRODUCTS

2008 St., Johns Ave., Highland Park, IL. 60035-2499 • (312) 432-7915 TWX: 910-692-2160

Circle (145) on Reply Card

Audio sources
 Gotham, continued

gun mic; sports and ENG.
 Circle (770)

HM Electronics (2619)
HM58: dynamic hand-held cabled microphones.
HM77: reverb electret mic.
FR200A: field pac.
 Circle (788)

Lectrosonics (2445)
Pro 185 system: M-185 wireless mic transmitter; R-185 receiver with diversity reception possible.
 Circle (850)

Marti Electronics (3496)
Model RPT-30: remote pickup broadcast transmitter.
 Circle (873)

Nady Systems (2902)
Model 501VR: portable wireless mic receiver.
Model IR-300: infrared receiver.
 Circle (911)

PESA America (3417)
SIM-4000: intercom system; matrix core with computer smart terminals.
 Circle (953)

R-Columbia (2671)
TR-55/pro: 5-channel FM wireless intercom headphones; for 2-way intercommunication without wires to 150 yards; receiver, transmitter in each unit operates from standard 9V battery with rubber-duckie antenna.
Model 52/700: replaces carbon mic type headphones with integral phantom-powered amplifier; noise cancelling condenser mic.
TR-50/B: wireless base station for full duplex intercom between producer/director and lighting/camera/sound operators on hard-wired intercom.

Model 6058P/T: hands-free ENG/IFB tone/pulse telephone; compatible with modular telephone jack; clips to user's belt and uses UL-85/M headphone/mic.
900 series: headphone or headphone/mic sets to be worn under hats, helmets, hardhats; noise attenuating; available with throat mic or mic boom.
 Circle (972)

Shure Brothers (3320)
Model SM89: shotgun microphone.
BC series: broadcast phono cartridges.
 Wireless microphones.
 Circle (1015)

Straight Wire Audio/AD+R (2518)
Speed Demon: variable speed controller for CD players.
 Circle (1042)

Swintek Enterprises (2413)
MK200D/C-s: radio intercom, compatible to RTS, Clear-Com hard-wired systems.
MK21-Hi-Fi: switching diversity receiver.
 Circle (1048)

Telex Communications (3370)
Model HT-400: wireless mic transmitter; 2-channel.
Model FMR-4: 4-channel wireless mic receiver.

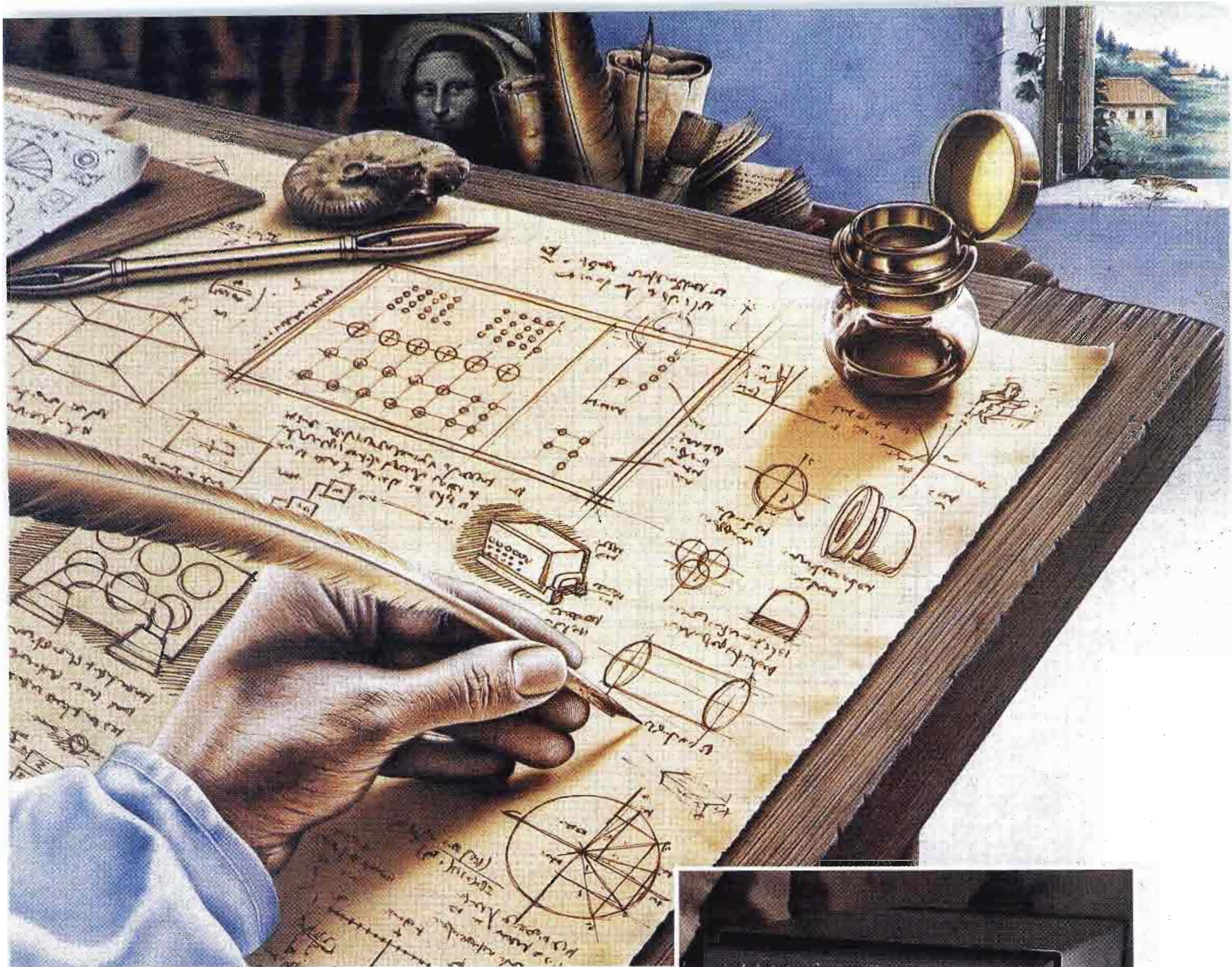

A NEW MASTERPIECE IN STANDARDS CONVERTERS IS OFF THE DRAWING BOARD AND READY FOR ACTION.

It's the revolutionary AVS ADAC—the new criteria against which all standard converters will now be measured.

It's a completely integrated design concept—a combination of advanced circuit design and the very latest component technology.

It's the only converter in existence with dynamic motion interpolation—constantly analyzing and adjusting every picture point to optimize quality of motion and provide transparent conversion.

The result is a true masterpiece of engineering innovation.

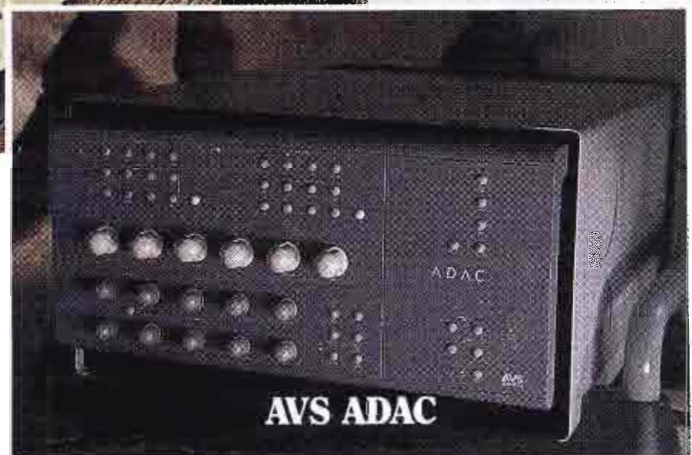

- Produces full broadcast quality
- Operates for all broadcast standards—including RGB, YUV (YIQ) and 4:2:2 digital—and all video formats
- The most sophisticated motion adaptive interpolation system ever devised
- Adaptive digital comb filter decoder
- Remarkably only 10½" high
- Exclusive sales and service in the U.S.A. by AFA



A.F. ASSOCIATES INC.

ADVANCED SYSTEMS AND PRODUCTS FOR THE VIDEO INDUSTRY
100 STONEHURST COURT NORTHVALE NJ 07647 (201) 767-1000
IN THE WEST: 10650 SCRIPPS RANCH BLVD. SUITE 200 SAN DIEGO, CA (619) 530-2970

Circle (146) on Reply Card



Audio sources
Telex, continued

Model LM-300: unidirectional lapel microphone system.
Circle (1073)

TFT (3420)
Model 8770: RPU system, frequency agile; 5-channel; includes companding.
Circle (1078)

Video products

Batteries, chargers, lighting

- Studio fixtures
- Sets

Anton/Bauer (2600)
MP-4, MP-8: Lifesaver microprocessor series; charging, diagnostic evaluators for Nicad batteries.
Snap-On Gold: battery mounting bracket.
Circle (542)

Belden Communications (2926)
Lee filter materials: Tough Spun FR, 5 grades;

white diffusion, 2 grades; Hampshire Frost; Lee Scrim; silver reflector, 2 grades; soft gold reflector.
Circle (584)

BW Lighting Systems (2418)
Model 20.110: focusing broad lighting instrument.
Circle (612)

Comprehensive Video Supply (3593)
Softouch: series of five soft lights for film/TV studio, location production.
V20/10: 2kW focusing spot light for film, TV.
Circle (656)

Dedo Weigert Film (2748)
DedoLight: high efficiency light; small, wide focus range; true optical system; 20W, 50W, 100W; 12Vdc adapter.
DedoMac: macro lens system, high transmission factor: 4-foot between camera and object.
Periscope optical system.
Circle (694)

Desisti Lighting/DESMAR (2796)
TWB series: studio rigging system.
MP series: motorized pantographs and self-climbing hoists.
PA-DE200: 200W HMI lamp (Venture Lighting).
400 series: cyclorama lighting.
311 series: pole-operated fixtures; 1kW, 2kW, 5kW.
VMH hanger: motorized video monitor support.
Circle (699)

Frezzolini Electronics (2716)
FBP-90P: Frezzi-Max premium, no-memory, fuseless protected battery pack.
UPS-10/14: uninterruptible 10/14V input AVX on-board power interface.
Mini-Fill: on-board camera light.
FMPC-87: automatic battery charger.
Circle (755)

General Electric/Lighting (2717)
F18BX/SPX30: compact biaxial fluorescent lamp, 18W.
F39BX/SPX30: compact biaxial fluorescent lamp, 39W.
Circle (762)

Keylight PSI (2789)
Crossovers: cable protector device for location and stage.
Circle (830)

Lee Colortran (3598)
MICROPRO: ENG/location lighting series; 6-/8-lamp units.
REPORTER LIGHT: hand-held or stand-mount light; interchangeable optical systems for beam angle, light output control.
Circle (851)

Lighting Methods (2673)
Series L-86: series of dimmer racks for fixed installation or portable applications.
Circle (856)

Lowel-Light (2610)
Lowel-Light Array: folding fluorescent light system.
VIP system: small, low-wattage lights.
Circle (860)

SMPTE/EBU Time Code Reader & Character Generator

Model DR-107B



- Unique font, plain or bordered
- Easy to read for off line editing window dubs & video monitor viewing
- Choose Time Code or User-Bit display
- Front panel controls for character modulation & vertical interval insertion
- Drop/non-drop frame indication

- Superior code reading using "The McFadin Window®"
- Reads 1/100 to 100 times play speed (machine dependent)
- Restored Time Code output for dubbing
- Parallel BCD output
- 1 3/4" Rack mounting
- 5-Year warranty including parts and labor

GRAY ENGINEERING LABORATORIES
504-P West Chapman Avenue
Orange, CA 92668
714-997-4151

See us at Booth 2515

Circle (147) on Reply Card

RESCUE!

TIRED OF COMPLAINTS?
Then consider a
PROMPTING SYSTEM
from
LISTEC VIDEO

Only LISTEC VIDEO offers a
19" DISPLAY
as well as a standard 15"

- FULLY 50% LARGER PICTURE
- BETTER BRIGHTNESS with our hot mirrors

Complement your script table with a
VIDEO ENHANCER
that really brightens up that aged
Vidicon camera!

SEE US AT BOOTH 3468

LISTEC VIDEO CORP.

30 Oser Ave., Hauppauge, New York 11788
Telephone: (516) 273-3020
Telex: 5106018234 Fax: (516) 435-4544

Circle (148) on Reply Card

Character generation should be as easy as

CLEAN
ANGLES

SMOOTH
CURVES

A B C

COLORIZING

and cost this much

CLARITY
WITH
SIMPLIFIED
CONTROL

\$2,195.

MULTIPLE
FONTS

The ICM CG-7000 character generator.

In character generators, quality doesn't have to mean complicated — or expensive.

The CG-7000 from ICM is simple to operate, regardless of your background. Its capabilities are as wide ranging as many models that cost far more, from genlock to colorizing, from special effects to the availability of multiple fonts. And its utility is rock-solid: the CG-7000 will do what you want, simply, swiftly, surely. There's even an unlimited modular memory capacity to let you store material forever.

What it won't do is burden you with an enormous investment cost. For full information on the CG-7000 and its base price of \$1,995, *call Toll Free or write for a free catalog today.*



ICM VIDEO

P.O. Box 26330 701 W. Sheridan Ave.
Oklahoma City, OK 73126 Toll Free (800) 426-9825

Circle (149) on Reply Card

March 1987 *Broadcast Engineering* 231

MILLER

EQUIPPED
TO WIN!



MILLER 20
with counterbalancing
Lightweight ENG

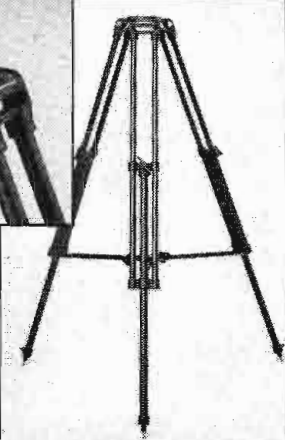

COMPACT TRIPOD
with spreader
ENG



MILLER 30
with counterbalancing
multi-step drag control
ENG

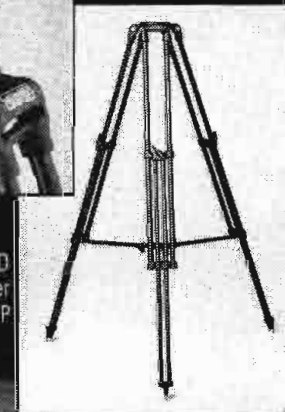

MIDI TRIPOD
with spreader
ENG/EFP



MILLER 50
with counterbalancing
multi-step drag control
ENG/EFP

see us at NAB
Booth 3440
Upper Level

MILLER FLUID HEADS (USA) INC.
2819 W. OLIVE AVE.
BURBANK, CA 91505
Tel: (818) 841-6262

Circle (150) on Reply Card

Video: batteries

LTM (2537)

Soft Lights: 575W and 1200W; HMI type.
Sun Gun: 270W HMI.
Mic pole: carbon fiber; light-weight.
Multipar light: eight 200W HMI.
Circle (862)

Mole-Richardson (3368)

Mole Solar-ARC: 12kW Fresnel HMI light.
Ballast: Molelectronic flicker-free; solid-state.
Junior: 2kW 8-inch mirrorless cool Redhea Solarspot.
Circle (899)

L E Nelson Sales (2918)

Type DSF: 1.5kW scoop lamp.
Types FGM, FGN, FGP: 1kW PAR64 dichroic-coated; 5200K, 800hr; spot, medium, wide flood.
Circle (919)

Paco Electronics USA (2718)

KD-11 system: fast charger for DP-11 replacement batteries.
Charger/dememorizer.
Sequential charger: fast, 4-channel charger.
Circle (941)

PAG America (2708)

PAG-LOK: series of batteries; improved mounting system.
Circle (942)

Rosco Labs (3443)

Model 1500: smoke generator; non-toxic smoke fluid.
Circle (993)

Teatronics (2756)

DPI 624: 6-channel, 2.4kW/channel SSR dimmer.
DPI 1212: 12-channel, 1.2kW/channel SSR dimmer.
Genesis 660: 6-channel, 6kW/channel SSR dimmer.
Genesis 1224: 12-channel, 2.4kW/channel SSR dimmer.
Producer II: 24/36/48-channel computer-assisted lighting consoles.
Circle (1059)

Theatre Vision/TVI (2555)

Studio fixtures: portable stages, platforms; removable control room flooring.
Circle (1080)

Union Connector (2923)

Power system: electrical distribution, rain-proof; 400A at 120/240V to serve 48kW of HMI or incandescent lighting.
Circle (1103)

Cameras

• Accessories

BTS Broadcast TV Systems (3140)

LDK90: ENG camera; frame-transfer CCDs/shutter eliminates smear.
KCM125: studio, OB camera.
Circle (611)

Ikegami Electronics (3150)

ICD-200: B&W CCD camera.
MKC-100: color CCD camera.

PP-70: portable mini microwave link.
Circle (798)

JVC of America (3180)

KY-9508: upgrade to Procam 3-tube camera.
TK-870: color CCD camera for computer graphics imaging.
Triaxial adapter: to extend range of broadcast cameras.
CCD camera for broadcast use.
Circle (821)

Landy Associates (3429)

Ikegami CCD cameras.
Circle (840)

NEC America (3161)

SP-3A: CCD ENG camera; variable speed electronic shutter; universal integration with on-board VTR formats.
Circle (918)

Panasonic Industrial/Broadcast (3216)

AK-400: ENG/EFP CCD camera; electronic shutter system.
Circle (944)

Sharp Electronics/Broadcast

XC-B20P: diode-gun Plumbicon broadcast camera; low capacitance, mixed field tubes.
XC-B10TX: triax control system for XC-B10, XC-B20P cameras.
Circle (1010)

Sony Broadcast (3100)

BVW-505: CCD camera with BVV-5 recorder.
BVW-503: Saticon camera with BVV-5 Betacam recorder.
BVP-360: studio/field production camera; three 2/3" mixed field Plumbicon or Saticon; triax or multi-core cables.
BVP-350: portable companion to BVP-360; uses same control unit.
HDTV system: complete production system.
Circle (1023)

Sony Professional Video (3100)

DXC-3000, DXC-M3: CCD and tube cameras.
Circle (1151)

Telemetrics (2608)

Control panels: custom designs for camera use.
Circle (1065)

Thomson-CSF Broadcast (3190)

CCD ENG camera.
TTV-1530: studio, OB camera.
Circle (1083)

Camera support, pickups, lenses

A.F. Associates (3170)

Camera controls: Radamac EPO remote computer and servo controlled camera mounting systems; teleconferencing to broadcast applications; memories retain sequences of camera movements.
Circle (513)

Amperex Electronic (3238)

NXA1011: 604x576-pixel, 3-color, or 1-chip B/W PAL cameras.
NXA1021: 604x576-pixel, 1-chip color PAL camera.
NXA1031: 604x576-pixel, 3-color or 1-chip

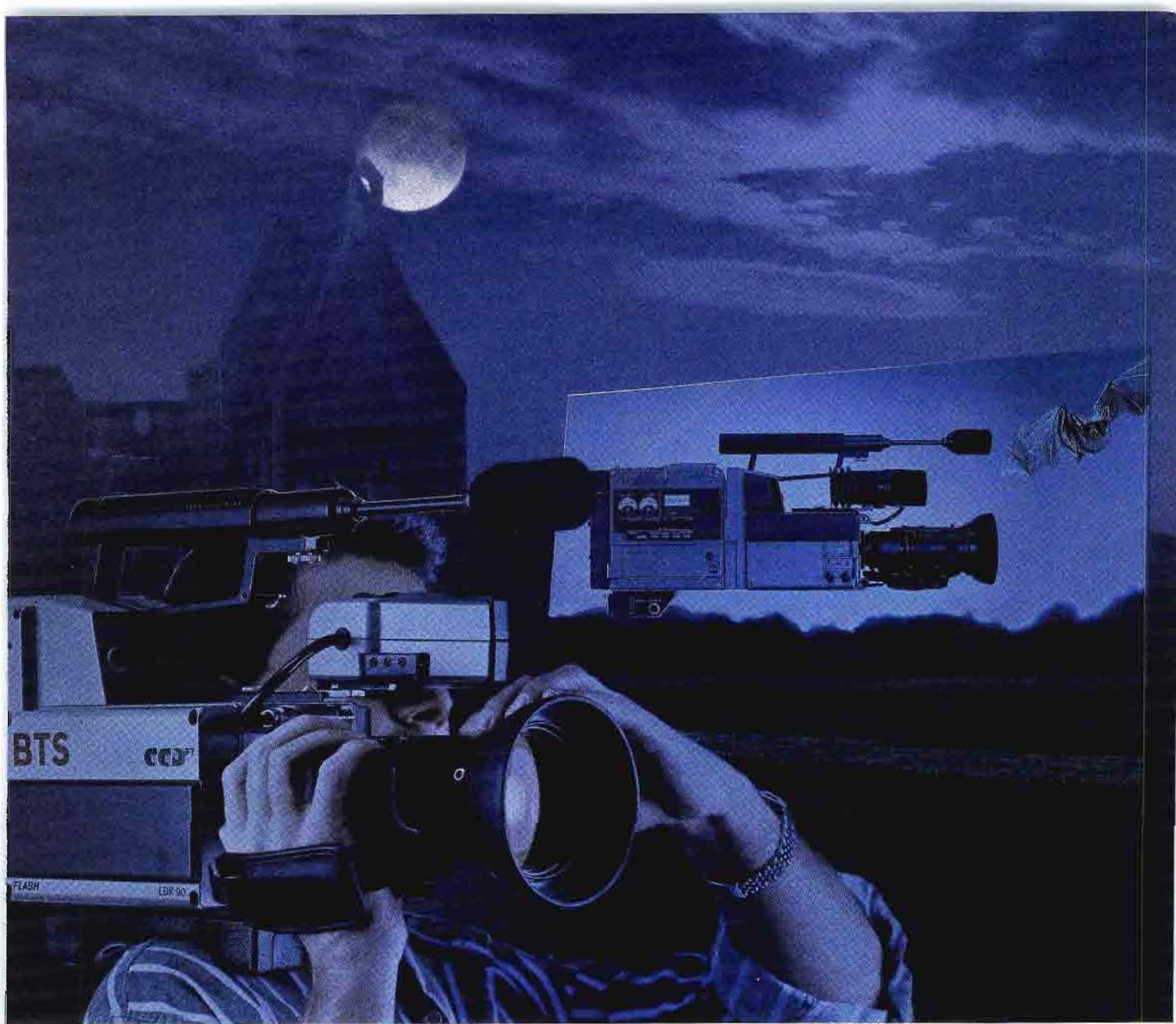

NAB, Dallas
Booth 3140
March 28 - 31, 1987

The new LDK 90 CCD camera takes the fear out of even the most difficult situations

Lags, burn-in, smears - everyday horrors a cameraman had to face. Until now. The new BTS LDK 90 camera with high resolution frame transfer CCD's sets new standards for ENG cameras. With not just superior picture quality, but the best obtainable. Negligible registration error, perfect geometry, corner-to-corner sharpness, no comet-tailing, no microphonics. Quick-fit adaptors allow the camera to be used for on-camera recording (Betacam and other professional

systems) and for EFP and studio use. There is microprocessor control, a new operational menu system and a very wide range of viewfinder indicators. For the cameraman an excellent view over the camera, low profile, low weight, a flat base, control protection, rugged construction, - all add to ease-of-use.

These facts combine to put an end to the everyday horrors of television production. Broadcast Television Systems Inc.,

900 Corporate Drive, P. O. Box 618, Mahwah, New Jersey 07430, USA, Tel. (201) 529-1550, TX: 37-62558.

Robert Bosch Inc., TV Division, 6811 Century Avenue, Mississauga, Ontario L5N 1R1, Canada, Tel. (416) 826-6060, TX: 06-97604.

BTS Broadcast Television Systems GmbH

A joint company of Bosch and Philips

Circle (151) on Reply Card

THE
HARRIS CONNECTION
WILL KEEP YOU ...



Here's What Broadcasters Say About THE HARRIS CONNECTION:

VHF-TV

Joseph A. Carriere, President
Caprock Telecasting, Roswell, NM/Lubbock, TX:

"When a studio fire wiped us out, our Harris sales manager was on the scene in six hours and we were back on the air in 10 days!

Our VHF equipment from Harris gives us the best quality money can buy. And Harris really stands behind its products.

Over the years, Harris has treated us very well. Other manufacturers may make good equipment, but not all can give the kind of support we get from Harris."

KNOB, FM-RADIO

John R. Banoczi, General Manager
Anaheim, CA:

"When it came time to buy a 35 kW transmitter, we found that Harris had the right product with the right features at the right price — so we went with the Harris FM-35K.

Besides — Harris has an excellent reputation for backing and servicing the products it sells."

KCOB, AM-RADIO

John Carl, General Manager
Newton, IA:

"Our SX-1A, 1 kW AM transmitter performs as advertised. It gives us a stand-out presence on the dial — especially in our fringe areas.

And Harris's SunWatch has completely solved our PSA/PSSA power scheduling problems. I don't know how a station could do it otherwise.

When we've needed service, Harris has always come through."

WEAT, AM-RADIO

Bert Brown, Chief Engineer
West Palm Beach, FL:

"Most AM broadcasters who have upgraded their facilities in this part of the state have gone with Harris SX transmitters. As you are well aware, this is a lightning prone area of the country, and our SX-5A has performed well above our expectations in the area of maintenance and downtime.

We chose Harris for its professional service and support. I have a good rapport with Harris people."

WSTQ, FM-RADIO

Al Moll, General Manager
Streator, IL:

"Before we switched to Harris, we were barely on the air with a poor signal. Our FM-3.5K, 3.5 kW transmitter makes us a stand-out on the dial."

KHBS, UHF-TV

Don Vest, Director of Engineering
Sigma Broadcasting, Fort Smith, AR:

"KHBS is our first Harris installation, and I'm very glad I did it.

What impresses me most about Harris is the service and parts support. In 19 years of broadcasting, it's the most cooperative and helpful in the industry.

Harris knows how to treat its customers. Harris is going to win!"

WOMA, FM-RADIO

Dale Eggert, General Manager
Algoma, WI:

"Our FM-3.5K, 3.5 kW transmitter has operated flawlessly since our sign-on last November.

*And our Harris representative not only helped us put our equipment package together, but stayed on duty **after** the sale to see that we met our critical air date!"*

WKNO, VHF-TV

Pat Lane, Chief Engineer
Memphis, TN:

"Before I ordered our two new transmitters, I tested three service departments. Harris was the only one with an engineer on duty at 10:30 p.m., the Fourth of July. With the others I got a recording and an answering service.

What impresses me most about Harris is the attitude and the people."

Find out today how The Harris Connection can keep your station ON THE AIR . . .

. . . and we'll send you your free, full-color ON THE AIR poster. An up-to-the-minute symbol of our industry's rich tradition.

Just call us TOLL FREE at 1-800-4-HARRIS, ext. 3002. Or write: Harris Corporation, Broadcast Division, Marketing Department, P.O. Box 4290, Quincy, IL 62305. Our poster supply is limited, so act today.



HARRIS

Circle (152) on Reply Card

Video: camera support
Amperex, continued

B/W NTSC cameras.
NXA1041: 604x576-pixel, 1-chip color NTSC camera.
Circle (532)

Angenieux (3020)
14x5.8: ½" CCD camera lens system.
14x7: ½" format CCD camera lens.
40x9.5: studio and OB camera lens.
Circle (540)

EEV (2626)
XQ1410/P8520: 30mm triode-gun Leddicon; direct replacement for XQ1410/1430 in new cameras where coaxial structure of P8400 is not required.
XQ3457/P8474: 2/3" mixed field Leddicon camera tube for ENG.
XQ3427/P8462: 2/3" Leddicon; diode-gun, low output capacitance.
XQ2170/P8496: 1" Leddicon; long-life barium aluminate cathode.
Circle (723)

Elicon (3220)
Model PCCS: portable field motion control system.
Videocassette handling system.
Circle (1157)

Interactive Motion Control (2771)
Motion control stage: modular system with 10 feet of track.
V-16 lens: periscope.

Slide Image System: mounts on animation table.
Circle (807)

Matthews Studio Equipment (3220)
Grip truck
Unit 85: delta & briefcase dollies.
Booms.
Equipment mounts.
Circle (874)

Mobile-Cam Products (2725)
Pan&Tilt: remotely controlled unit; 12Vdc stepper motors.
Cable reel: 12Vdc powered reel; delivered with cable installed with Mobile-Cam cable terminator.
Circle (896)

O'Connor Engineering (3364)
Model 105: ENG tripod.
Model 35: ENG tripod.
Model 127-A: Acroped pedestal.
Circle (930)

Sachtler (3419)
Combi-Pedestal: portable camera support unit; with Video 25/30 head supports to 88 lbs.
OB-System: for camera-lens combinations to 200 lbs; 2-stage tripod; dolly; elevation unit; fixed-foot option; height range - 1.6' to 4.4', optional 2' elevation unit available.
HotPod dolly: quick set-up ENG tripod.
Circle (999)

Schneider Optics (3221)
Speed Gizmo: zoom lens speed control device.
Circle (1003)

Telemetrics (2608)
Trolley assembly: remote controlled, for pan/tilt head.
Circle (1065)

VideoTeleCom (2683)
Barber Dolly: 3-wheel pedestal capable of all standard track or floor use.
Circle (1130)

Vinten Equipment (3579)
3286-3 Midiped: lightweight pedestal for ENG/EFP cameras; from 28.5" to 58" height; demountable.
3322-3/3312-3: Vision 20 system; continuously adjustable EFP head, 2-stage tripod; range from 18" to 61".
Circle (1132)

Digital effects equipment

Ampex AVSD (3108)
ADO digital interface: CCIR-601 component digital inputs, outputs to any ADO system; external device, easily interfaced.
Target Frame Store: for ADO 1000/2000; swirls, trails, sparkles, decay effects to ADO systems.
ADO combiner: 2-channel option for ADO

We've Just Made Satellite News Gathering As Simple As ENG.



The Marconi NEWSHAWK

It's Marconi's NEWSHAWK – a superior, lightweight satellite transmitting system that is rapidly becoming the standard for portable Satellite News Gathering operations.

The unique design of NEWSHAWK's one-piece, self-storing, elliptical antenna permits you to transport it, set it up, use it, store it and re-use it time and again without effecting its 2° spacing alignment. Unlike multi-sectioned antenna systems, the NEWSHAWK won't lose its accuracy in spite of frequent usage. And its two-piece, portable electronics package is the perfect complement to the NEWSHAWK'S outstanding antenna design.

What's more, the NEWSHAWK is so compact that it is easily transported in or on top of an ENG van, by small plane or commercial airliner.

NEWSHAWK. Manufactured by Marconi. Sold and serviced in North America by AFA.



A.F. ASSOCIATES INC.

ADVANCED SYSTEMS AND PRODUCTS FOR THE VIDEO INDUSTRY
100 STONEHURST COURT NORTHVALE NJ 07647 (201) 767-1000
IN THE WEST: 10650 SCRIPPS RANCH BLVD. SUITE 200 SAN DIEGO, CA (619) 530-2970

Circle (153) on Reply Card



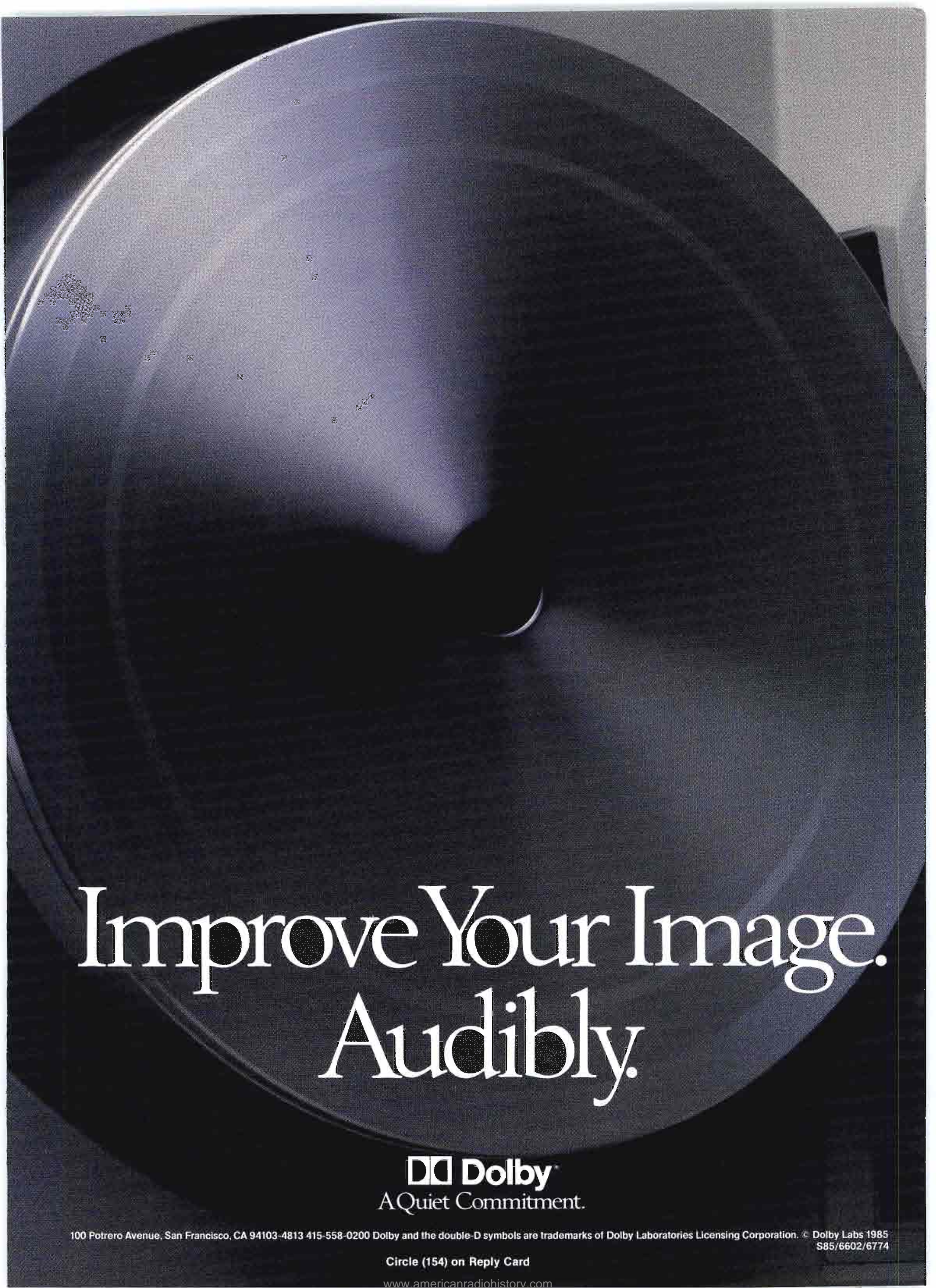

Improve Your Image. Audibly.

 **Dolby**
A Quiet Commitment.

100 Potrero Avenue, San Francisco, CA 94103-4813 415-558-0200 Dolby and the double-D symbols are trademarks of Dolby Laboratories Licensing Corporation. © Dolby Labs 1985 S85/6602/6774

Circle (154) on Reply Card

www.americanradiohistory.com

Video: digital effects
Ampex, continued

1000/2000 systems.

Operational Features: ADO software enhancements.

Circle (533)

James L. Grunder & Associate (2429)

Software: programming for CEL EFX II, EFX III and EFX IV digital effects systems incorporating editing control.

Digital effects: includes zoom capability and optional border color.

Circle (777)

Intergroup Video Systems

(3312)

Model 4001: digital video pattern generator.
Circle (808)

Microtime

(3086)

RP-1 effects system: digital effects with rotation, perspective, matt channel, diagnostics, full anti-aliasing, smooth motion.

Circle (889)

NEC America

(3161)

DVE System 10/10C: digital effects with curvilinear effects for 3-D curl within 2-D raster.

Circle (918)

Editing equipment

• Controllers

• Machine synchronizers

Ampex AVSD

(3108)

ACE addition: controls 16 devices including 12 VTRs; 6,000 line EDL; triggers up to 20 GPIs; internal 20MByte hard disk; keyboard or TouchScreen control; compatible with previous ACE models.

Frame accurate editing: for VRC-2; serial remote controller capable of handling a mix of VTR formats.

Serial Slow Motion: editing operational feature for VPR-80.

Circle (533)

Amtel Systems

(2820)

Transform-I: post-production management system; allows production originated on film to be edited on videotape; includes film conform system, list management, storyboard feature.

Circle (536)

BHP

(2795)

Model 8100: TouchVision non-linear videotape editing system; touch-screen control; film-style; supports up to 24 VCRs in 3/4" or 1/2" VHS format.

Circle (590)

BTS Broadcast TV Systems

(3140)

BBE-900: automatic editing control unit.

Circle (611)

Calaway Engineering

(3128)

CED editor: can be driven by IBM or Compaq PCs; options include machine/motion control, disc interchange, A/V switching.

Circle (614)

CMX

(3232)

Model 6000: videodisc based film, video editing system.

Model 100: video editor controller with integrated A/V switcher; designed for promos, news applications.

Circle (647)

Evertz Microsystems

(201)

7000RCT: audio/video multi-machine chase synchronizer.

Circle (740)

Editron Australia

(NA)

System 500V: film-to-tape transfer synchronizers.

Circle (720)

James L. Grunder & Associate

(2429)

Edit controller: by CEL Electronics, England.

Circle (777)

Landy Associates

(3429)

Paltex EDDi editing system.

Circle (840)

Paltex

(3260)

EDDi system: laser disc or VHS non-linear editor for filmstyle off-line editing; data in terms of projects, scenes, clips, labels, bins.

Circle (943)

Quanta

(3128)

Editing systems: Calaway Engineering systems.

Circle (968)

Sony Broadcast

(3100)

BVE-9000: expandable editing controller.

Circle (1150)

DELTA does it accurately

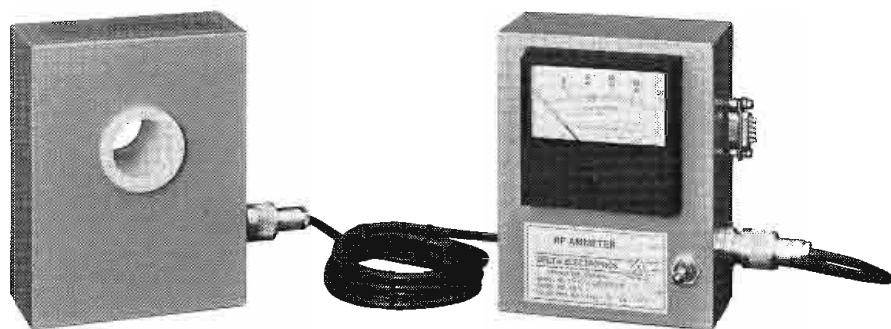

TCA-10/20-EXR Dual Scale Remote Output
On/Off and Hi/Lo Switching.

RF Ammeter Systems

- MEETS FCC REQUIREMENTS OF 2% ACCURACY •
- MINIMUM MODULATION EFFECT •
- ALL COMPONENTS CAN BE GROUNDED FOR SAFETY •
- ON/OFF SWITCH FOR GREATER LIGHTNING PROTECTION •
- PATENTED TEMPERATURE COMPENSATED RECTIFIER CIRCUIT •
- WIDE TEMPERATURE RANGE -40°F to $+150^{\circ}\text{F}$ •

The Delta series of TCA RF Ammeter systems utilize a toroidal current transformer (TCT) to obtain a sample voltage proportional to the RF current flowing in a conductor. This sample is then connected to a special temperature compensated rectifier circuit via a 50 ohm coaxial cable. The rectifier converts the RF sample voltage to a DC current to drive an indicating instrument.

Every TCA system is calibrated at our laboratory at an RF frequency in the broadcast band. Correction curves are supplied when greater than 2% accuracy is required—correlated to the National Bureau of Standards.

We have a wide range of models, scales and optional items which are illustrated and explained in our Broadcast Products catalog.

Just call or write us for more information.

DELTA ELECTRONICS



5730 GENERAL WASHINGTON DRIVE
P.O. Box 11268 • ALEXANDRIA, VIRGINIA 22312
TELEPHONE: 703/354-3350 TELEX: 90-1963

Circle (155) on Reply Card



Just Like the Real Thing

The Oki LT1210 Digital Television Standards Converter can improve TV images with dramatic results. With its image enhancement function, this machine offers the kind of sharp definition and crisp clarity required in professional TV standards conversion work. The LT1210 is exceptionally compact, portable, and fully compatible with NTSC, PAL and SECAM standards, and can handle PAL-M conversion as an option. It is also a totally integrated unit, requiring no adaptor or change of encoder/decoder modules for conversion from one standard to another. Use the LT1210 or the high-end LT1015Σ to meet your TV standards conversion requirements. Either model can make images look like the real thing.



LT1210 Digital Television Standards Converter

Head Office:
Overseas Marketing & Sales
10-3, Shibaura 4-chome,
Minato-ku, Tokyo 108, Japan
Tel: (03) 454-2111 Telex: J22627
Cable: OKIDENKI TOKYO

Oki Telecom Group
(An Oki America Company)
22-08 Route 208
Fair Lawn, New Jersey 07410, U.S.A.
Tel: (201) 654-1414
Fax: (201) 794-1179

London Office
Ground Floor North 3, Shortlands
Hammersmith International Centre,
London W6, U.K.
Tel: (01) 741-2324
Fax: (01) 741-4122
Telex: 927029 OKIDEN G

OKI

Oki Electric Industry Co., Ltd.
Tokyo, Japan

Circle (156) on Reply Card

Video: editing equipment

Sony Professional Video (3100)
BVE-900: 6-VTR controller; selectable VITC, LTC, CTL per VTR; auto color frame; menu-driven.
Circle (1151)

3M Broadcast/Related, Video Products (3120)
ESBUS: machine control system; serial SMPTE/EBU communications.
Circle (1085)

Electronic graphics systems

- Character generators/titlers
- Video logo, clock systems
- Animation equipment

Alias Research (2751)
Alias/I: new version of electronic animation system, full 3D modeling, choreography; multiple cameras.
Pixar: image computer, 3D rendering speed 50 times faster than previous system.
Video 40: frame grab capability from camera, tape, off-air.
Abekas A62: interface to Abekas digital video recorder.
Circle (519)

Ampex AVSD (3108)
Graphic storage/management: composition, storage system with 160Mbyte disk drive holds 200 NTSC (160 PAL) images; on-line catalog function retrieves stills by ID#, alpha title, category, date; optional graphics kit forms composition tool.
Rendering Engine: complements Cubicomp PictureMaker system for designing, while images are being rendered and recorded.
SpeedTrace: AVA-3 and PictureMaker option; scans, digitizes symbols, fonts; eliminates manual digitizing into the system.
PictureMaker upgrade: graphics system uses 80386 microprocessor by Intel; 100% increase in speed.
Circle (533)

Aston Electronics (223)
LogoMaster: create logos with A4 titler; input freeze picture; includes line draws, fills, shaded backgrounds.
A4 memory: hard disk memory system.
Acron 610N: linear keyer-encoder for anti-aliased titling systems.
Circle (556)

Aurora Systems (3592)
System AU/280: digital videographic system.
Circle (571)

BTS Broadcast TV Systems (3140)
High resolution output: 4,000TVL resolution from FGS-4000 through offline feature of SUN interfaced via Ethernet; output stored on 9-track digital magnetic tape for use with various slide, print devices.
Circle (611)

Chyron Telesystems (3072)
SCRIBE options: Logo Compose with digitizing tablet, for artisting effects, 3D rotation, texture mapping, character shading, banners, dynamic effects; Preview Channel; streaming tape backup for messages, font storage; Networking.
RGU-2 options: digital effects with motion; spins, tumbles, zooms, linear splits, wipes.
Chyron IV software: increases font library with 100 fonts; interfaces with various election reporting systems.
Circle (639)

Chyron Video Products (3072)
Chameleon Paint: produces composite or RGB signals, in NTSC or PAL.
VP-2 upgrade: new fonts, for high-resolution displays.
Chameleon/VP-2 combo: provides Text Grab to transfer images to VP-2 screen; mix graphics with titler.
Circle (640)

Colorado Video (3447)
Model 286: digital freeze frame video communication system.
Model 499: video frame store multiple memory.
Circle (650)

Color Graphics Systems (3145)
ArtStar workstation LAN: multiple on-line terminal capability for graphics generation system provided through Ethernet local area network system.
ArtStar II/3D enhancements: improved user interfaces; enhanced animation capabilities;



Get what you pay for.

Good talent's not cheap. But why pay that big salary if, somewhere in the signal chain, The Voice loses its distinction? With the 528 Voice Processor, you'll definitely get what you pay for, and then some. Five high performance signal processors in a single rack space, for about what you'd expect to pay for each unit. Mic Preamp, De-esser, Compressor/Limiter, Downward Expander, 3-band Parametric EQ/Notch Filter. Even 48v phantom powering and a balanced line input. No compromises, nothing left out. The 528 Voice Processor works with any mic. It cleans up your signal by reducing control room noises from paper rattling and cart solenoids. It controls sibilance and "lip smacking," and adds just the right EQ to any mic, any control room. Get what you pay for, and then some, with the 528 Voice Processor. Call Dane Butcher for a detailed spec sheet.

Symetrix

4211 24th Avenue West
Seattle, Washington 98199, USA
Telephone (206) 282-2555
Telex 703282

Signal processing at its best

Circle (157) on Reply Card

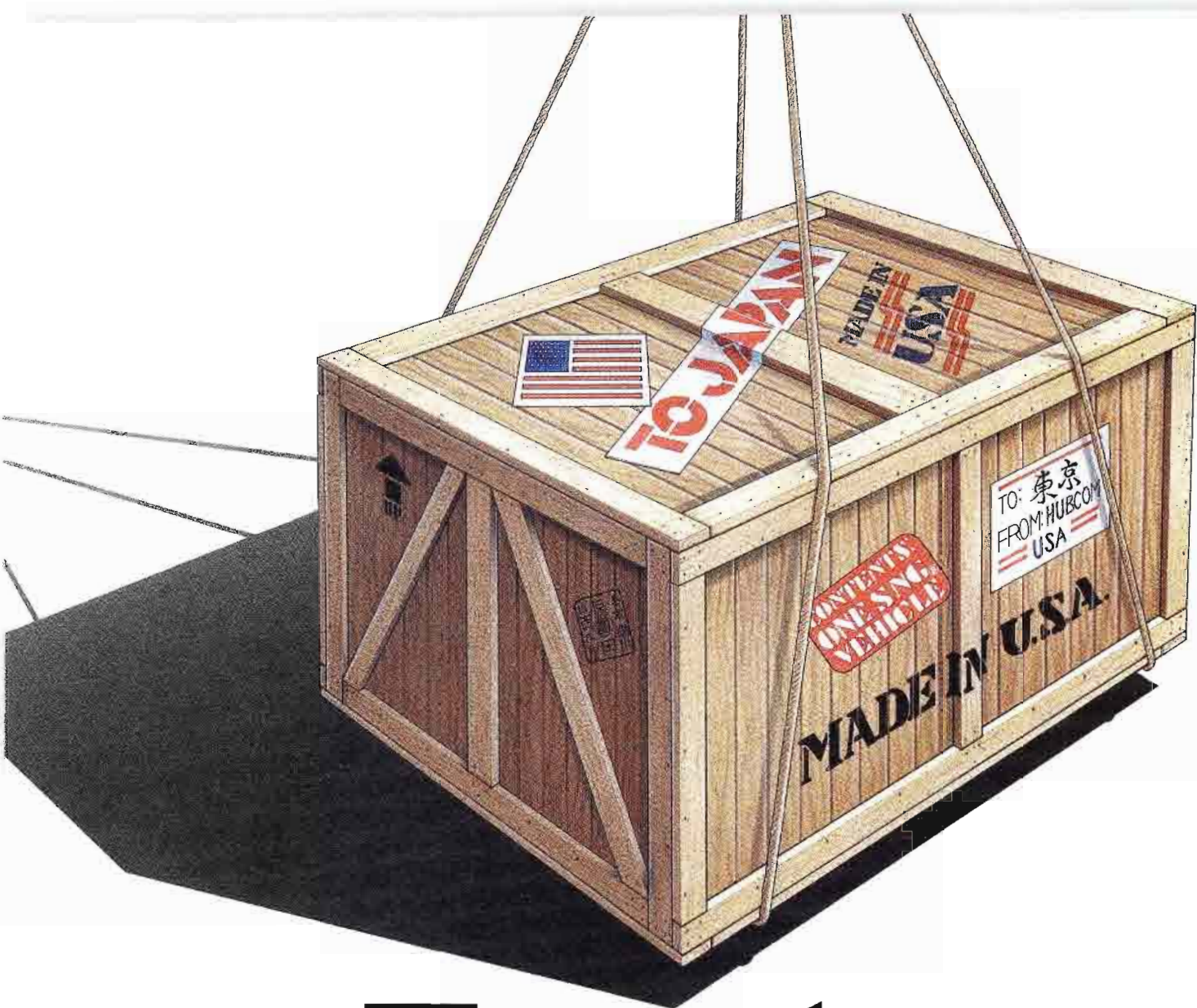

Turnabout Is Fair Play.

Year in year out, more and more Japanese electronic equipment arrives on our shores.

So it's especially gratifying that when one of the leaders in Japanese electronics needed a high tech SNG[®] truck — they asked HUBCOM to build it.

But it's not really surprising.



HUBCOM built the first SNG[®] truck in the United States. We've built more than everyone else combined. And now we've built an SNG[®] truck on a Hino chassis for shipment to Japan.

Call today and let us build one for you... whether you're in Yokohama or Youngstown.

HUBCOM
HUBBARD COMMUNICATIONS, INC.

The last word in technology from the first name in the industry

12495 34th Street North, St. Petersburg, FL 33702

(813) 577-7759

A subsidiary of Hubbard Broadcasting, Inc.

See us at the NAB booth 3286
Circle (158) on Reply Card

Video: electronic graphics
ColorGraphics, continued

16-light 3-D rendering; multi-colored fonts for chromes, reflections, rainbow effects.
Circle (651)

Data Center Management (2760)
Election system: multi-user computer system for election reporting; based on mini-DEC computer.
Circle (687)

Del CompuCable Systems (2551)
Production titler: character generator with gen-lock color features.
Circle (695)

Digital Arts (2482)
DGS 1.0: PC-based software for 3D computer animation to film or videotape, hierarchal motion; texture, bump, reflection mapping; shadows, transparency features; multiple objects and multiple light sources possible; AT&T TARGA frame buffer, DEFINICON processor.
Circle (704)

Dubner Computer Systems (3110)
Model 5-K: full feature character generator/titler at low cost.
Model 30-K: dual channel character generator/titler.
Model SST-4: still/slide storage system; 2-channel, composite digital 4-field tech-

nology.
Circle (712)

EEG Enterprises (2802)
Model VDR101: video data receiver; 5.72MHz VBI data.
Circle (722)

Imageering Laser Disk Systems (235)
Paint Store: optical disk-based still store; 600TVL images; 800 per disk; multi-disks possible; full paint capability.
Still store: basic still image storage, optical disk-based; extensive database software.
Circle (801)

Integrated Technologies (2610)
Image-Maker: 24-bit paint system; real time frame grab, 3-D animation, texture mapping, metamorphosis, transparency.
News-Maker: PC-based still store with frame grab and integrated 24-bit paint system.
Circle (806)

JVC of America (3180)
Model 4000: Mindset hardware and animation software.
Circle (821)

Landy Associates (3429)
Ampex/Cubicom PictureMaker.
Circle (840)

Leitch Video (3559)
DSS-3100N: digital slide store; IBM/AT with SCSI interface.
Circle (852)

PESA America (3417)
CG-4722: mid-range character generator/titler.
Circle (953)

Quanta (3128)
Graphic titlers: high-resolution characters.
Circle (968)

Shima Seiki USA (2573)
SDS480 Shimatronic: fully integrated computer-graphic paint system with 2D/3D software; optical or hard disk storage; full range of input capability; optional 3D software and UltraRay rendering system.
Circle (1011)

Thomson-CSF Broadcast (3190)
TTV-3100: digital still store.
Circle (1083)

Torpey Controls & Engineering (2906)
VCLK-20: video display of time, temperature; Celsius, Fahrenheit; optional station logo.
Circle (1092)

Transformations (2631)
EFX graphics: 3D animation system based on ADAGE frame buffer, DEC host computer.
Circle (1096)



Exhaustive testing. That's what every Micron wireless microphone goes through before it ever leaves our factory. Not the usual "assembly line" battery of tests. But hours of individualized, single unit testing. Should any one of our expertly crafted units fail to perform perfectly, we'll be the first to know. What you'll receive, is unparalleled performance.



Micron Wireless Microphone Systems
Performance That's Tested... To Perfection

MICRON
AUDIO PRODUCTS, LTD.

210 WESTLAKE DRIVE • VALHALLA, N.Y. 10595 • (914) 761-6520

Circle (159) on Reply Card

Reconfirm your involvement
in the
broadcast industry!
Renew your subscription
today.

ALIAS / 1. A NEW GENERATION



NOW THE POWER TO PRODUCE
3D COMPUTER ANIMATION IN A SINGLE DAY. PIXAR
RENDERING SPEED COMBINED WITH THE
ALIAS INTERFACE. THE MOST POWERFUL INTERFACE
BETWEEN THE ANIMATOR AND THE WORLD OF PRECISION
3D MODELING AND ANIMATION. DIGITAL LINKS
TO THE QUANTEL HARRY AND ABEKAS A-62.
ALIAS / 1. AN EASY TO USE 3D ANIMATION SYSTEM.
BECAUSE YOU HAVE TO DELIVER EVERY DAY.

Alias
RESEARCH INCORPORATED
Circle (54) on Reply Card

HEAD OFFICE, 110 RICHMOND STREET EAST, TORONTO, CANADA M5C 1P1 (416) 362-9181
SALES HEADQUARTERS, 210 CARNEGIE CENTRE, SUITE 101, PRINCETON, N.J. 08540 (609) 987-8686



ALIAS AND ALIAS / 1 IS A REGISTERED TRADEMARK OF ALIAS RESEARCH INC. ABEKAS IS A TRADEMARK OF ABEKAS VIDEO SYSTEMS INC. PIXAR IS A TRADEMARK OF PIXAR. QUANTEL HARRY IS A TRADEMARK OF QUANTEL LTD.

BUILT FOR THE DEMANDS OF PRODUCTION.



In the production business, quality plus speed equals success.

That's why the TASCAM ATR-60 Series is engineered for those who make their living with recorders. All five share a design philosophy stressing function over flash; an overriding concern for performance without complication; a thoughtful integration of features which respond to the needs of the professional.

—On every ATR-60, the deck plate won't flex. Ever. So you won't be compensating for flex-induced phase or wow and flutter in post production.

—The unique Omega Drive puts less stress on your tape, so the cumulative tension of a thousand start/stop passes won't reach your tape.

—Heads designed and man-

ufactured by TASCAM means Sync frequency response equals Repro, so you don't have to rewind and change modes to make critical audio decisions.

—Sync Lock and the most responsive servo control in the business will keep you working instead of waiting for a machine to lock up.

—Time Code Lock keeps code coming from the Sync head, regardless of the audio monitor mode, so your synchronizer won't get confusing double messages when modes are switched.

—Input Enable/Disable allows you to monitor any source without repatching or changing mixer settings, avoiding a common cause of aborts.

—Long cable runs don't bother a TASCAM ATR-60, since +4 dBm, +8 dBm and even +10 dBm levels are available.

There are five ATR-60 recorders: the ATR-60-2T (IEC Standard) Center Track Time Code; ATR-60-2N/2D Quarter-inch Mastering; ATR-60-2HS Half-inch High Speed Mastering; ATR-60-4HS Half-inch 4-Track High Speed Mastering or Multitrack; and the ATR-60-8 Half-inch Production Quality 8-track.

To see, hear and feel them, visit your nearby TASCAM dealer, or call TASCAM for the name of the dealer nearest you.

Production is a demanding business. And the ATR-60's are built to meet the demand.

Pure Performance
TASCAM
TEAC Professional Division

7733 Telegraph Rd. • Montebello, CA 90640
Telephone: (213) 726-0303

Circle (55) on Reply Card

Monitors

ASACA ShibaSoku (3278)

Color monitors: low cost, high resolution.
Circle (553)

Barco Industries (2577)

Controller: multi-monitor remote controller; control of 48 CVS monitors simultaneously. CVS options: programmable component input module; input extension module; audio module; full remote control; automatic color analyzer.
Circle (578)

Ikegami Electronics (3150)

Series 15: auto setup color monitors. TPP-500: large screen projector.
Circle (798)

Sony Broadcast (3100)

BVM-1310: 14" color monitor; 0.25-pitch CRT, more than 600 lines resolution. Cubic monitors: 20" and 25" models, stackable. BVM-1900C: 900TVL resolution; component interface switchable for RGB or Betacam Y/R-Y/B-Y.
Circle (1023)

Sony Professional Video (3100)

Multiscan video projectors. PVM-2530: cubic stackable monitors.
Circle (1151)

Videotek (3316)

AVM-19S: 19" color monitor.
Circle (1129)

Processing equipment

- Time base correction
- Signal correction
- A/D, D/A conversion
- Sync generators
- Film synchronizers
- Signal encoding/decoding
- Video keyers
- Color black generators

A.F. Associates (3170)

AVS ADAC: standards converter; digital and component inputs/outputs; motion interpolation; digital comb filtering.
Circle (513)

Ampex AVSD (3108)

Zeus features: heterodyne processing for 3/4" machines; sync capability locks input signals to in-house sync. Status-at-a-Glance: on-demand video monitor display of VTR set-up parameters. Multi-Gen: set-up mode enhancement with Zeus/Type C VTR.
Circle (533)

AVS (3170)

ADAC: digital standards converter; 4-field, 4:2:2 digital, component in/out; adaptive motion interpolation; digital comb filtering.
Circle (574)

Broadcast Systems/BSI (3418)

Automatic video signal processors.
Circle (607)

Broadcast Video Systems (2730)

Cox 204: NTSC encoder; switchable RGB/component inputs. UltraKey: video keyer; adjustable linearity, gain, slope, mix; for anti-aliased titling and digital effect keying. Vistec: varicomb NTSC decoder.
Circle (608)

Crosspoint Latch (3533)

Model 6051: rack-mount RGB encoder with genlocking integral sync generator. Model 6070: RS-170A sync generator; 6-output black burst source.
Circle (677)

FOR-A (3599)

CCS-4350: video color corrector.
Circle (751)

GML America (2745)

Upgradable TBC: standard system with optional 2nd channel; field stores, effects.
Circle (766)

Grass Valley Group (3112)

Model 9550: changeover switch for 9500 series sync generator. CV-25 encoder: completes CV-20 component video terminal set.
Circle (772)

Ikegami Electronics (3150)

DSC-1050: digital scan converter.
Circle (798)

NOISE REDUCTION FOR UNDER \$10.

MIXING CONSOLES

SWITCHES

MICROPHONE CONNECTORS

SNAKE CABLES

BATTERY CONTACTS



ALL PLUGS & JACKS
(XLR, PHONE, PHONO, DIN, MIDI, ETC.)

PATCHBAYS

FADERS, POTS

TERMINAL STRIPS

SPEAKER TERMINALS

CRAMOLIN®

Even the finest equipment in the world can't guarantee a noise-free recording. One "dirty" connection anywhere in the electrical path can cause unwanted noise or signal loss.

"MORE THAN A CONTACT CLEANER"

CRAMOLIN® is a fast-acting, anti-oxidizing lubricant that cleans and preserves all metal surfaces, including gold.

When applied to metal contacts and connectors, CRAMOLIN® removes resistive oxides as it forms a protective molecular layer that adheres to the metal surfaces and maintains maximum electrical conductivity.

CRAMOLIN® - USED BY THOSE WHO DEMAND THE BEST:

Bell & Howell	Hewlett Packard	MCI(Sony)	Nakamichi
Boeing	John Fluke Mfg.	Motorola	RCA
Capitol Records	McIntosh Labs	NASA	Switchcraft

SINCE 1956

CAIG LABORATORIES INC.

1175-O Industrial Ave., (P.O. Box J) - Escondido, CA 92025 0051 U.S.A. • (619) 743-7143

Circle (163) on Reply Card

Leitch Video (3559)
SPG-1510P: PAL sync generator.
Circle (852)

Polar Video (NA)
PCK-1: chromakey/linear downstream keyer.
Circle (1150)

Lenco/Electronics Division (3056)
PSG-313A: RS-170A sync generator system; multi-function genlock includes PC lock; optional TCVCXO broadcast spec.
Circle (854)

Thomson-CSF Broadcast (3190)
TTV-7650: A/D converter.
TTV-7660: D/A converter.
Circle (1083)

Microtime (3086)
Frame-TBC: includes freeze; component processing, dub input, noise reduction with Vari-

Videotek (3316)
TIMES SIX: black burst generator.
TIMES SIX PLUS: automatic black burst generator.
Circle (1129)

Production, master control switchers

Ampex AVSD (3108)
AVC series: compact, low-cost 10-/18-input switcher; full mix/effects capability; two linear keyers; luminance, ISO, composite chroma, RGB keying; DSK with two additional keyers, master fade to black; interface to ADO effects system.
AVC Century: 16-/32-input video switchers; two or three mix/effects versions; memory learns any manual operation up to 15 minute lengths; 48 on-line setups; 3.5" floppy storage; three complete keyers per M/E and DSK.
Circle (533)

Broadcast Video Systems (2730)
Cox T8C switcher: Component production switching system.
Circle (608)

BTS Broadcast TV Systems (3140)
MCS-2000: master control switcher; includes mix keys, key mixes, border video keys, color bordered matte keys.
Circle (611)

Central Dynamics (3080)
Strata-7: 7-level video processing system.
CD400LE: 16-input production switcher.
Circle (629)

Michael Cox Electronics (2730)
T8C switcher: component video switcher.
Circle (675)

Echolab (2827)
Model DV-5: 12-input broadcast video production switcher with computer calibration.
Circle (718)

FOR-A (3599)
PVM-600: video production switcher.
Circle (751)

Grass Valley Group (3112)
Model 200: production switcher; two mix effects amps; new keying capabilities.
Circle (772)

Intergroup Video Systems (3312)
Model 9600: video production switcher.
Circle (808)

Omicron Video (2661)
551-5/1-3V: 5x1 component video switcher.
Circle (933)

Ross Video (2616)
Model 210A: 10-input production switcher; multi-level effects; DSK, memory, 3 matte generators; 3 auto transition units.
Model 216A: 16-input video switcher; multi-level effects, DSK, encoded chroma key, analog border key; memory, serial interface.
Circle (995)

Thomson-CSF Broadcast (3190)
TTV-5650: digital production switcher.
Circle (1083)

3M Broadcast/Related, Video Products (3120)
Model 324: master control switcher.
Circle (1085)

THE ALTA THEORY OF VERSATILITY

"Infinite Window" TBC+Video
Effects+H&V Image Enhancement
+DOC+4x1 Video & Audio
Routing Switcher+Digital Picture
Freeze—The Usual High Cost =

CYGNUS

It's simple arithmetic. Cygnus is more than just a TBC.



picture strobe, posterization, colorization and mosaic.

Cygnus

It's a four input video and audio switcher; a video enhancer; and a digital effects device with digital picture freeze,

Cygnus boosts your production efficiency while maximizing your production options.

So find out about Cygnus from your ALTA Group Distributor.

At \$4990 Cygnus Adds Up — For You!

**ALTA
GROUP, INC**

535 RACE STREET, SUITE 230 SAN JOSE, CA 95126 (408) 297-2582

Circle (164) on Reply Card

Utah Scientific (3128)
MC-502B: master control switcher; control panel includes full metering, monitoring for stereo plus SAP; expanded main frame accommodates SAP, Dynabus and optoisolator card with 64 optos for machine status sensing; 16-bit microprocessor.
Circle (1112)

Prompting systems

Comprompter (2710)
ENR-PC: IBM compatible electronic newsroom system; available as software only, hardware only, or complete system.
TOTAPrompt-PC: portable ac/dc-powered production/prompting system; available as software, hardware or entire system.
Circle (657)

Compu-Prompt (2408)
System support: extended memories (to 80 minutes); up-loadable, user-defined character sets; file transfer utilities for most computers.
Circle (658)

Computer Prompting (132)
CPC-2000: teleprompter system; simultaneous real-time outputs for prompter and closed captions standard.
Circle (661)

Listec Video (3468)
A-2100B prompter: computer-driven teleprompter with dedicated software complete with international keyboard.
Model A-4071: portable ENG/EFP prompter, 9" screen; 12Vdc power; ultra bright screen.
Model A-2220: universal input, 12Vdc/110Vac, short script table with fold-away lighting fixture.
Circle (858)

Tekskil Industries (2570)
Model 909C: computer prompter; 20lb system; membrane seal on keyboard; internally switchable to NTSC or PAL; vacuum fluorescent display.
Circle (1062)

Telecine, film products

BTS Broadcast TV Systems (3140)
FDL-60 CCD telecine: new-generation CCD line sensors eliminate burn-in, lag.
Circle (611)

Rank Cintel (3066)
MkIIIc enhancement: digital add-on for flying spot telecine.
ADS-1 addition: preprogramming system for CCD telecine.
Slide File enhancement: dual picture display, transmission display capability.
Circle (977)

Research Technology Int'l (3386)
TV-2000: film editing system; PHASAR electronic defect detector; finds defects without touching film at any speed.
Circle (983)

Time code, timers, counters

Ampex AVSD (3108)
VITC: vertical time code products for VPR-3/VPR-6.
Circle (533)

Autogram (2702)
Autocount: count-up clock.
Circle (572)

Broadcast Supply West (2743)
Model ST500: Radix studio timer.
Circle (606)

Circle (606)

Broadcast Video Systems (2730)
Model VT-100: VTR leader clock and slate.
Circle (608)

Coherent Communications (2801)
TC-500A: Smart Slate; time code reader/generator; puts SMPTE time code on film during production.
Circle (649)

Evertz Microsystems (201)
Model 120: multi-format time code display.
Circle (740)

FOR-A (3599)
TGR-3300: time code reader/generator; pro-

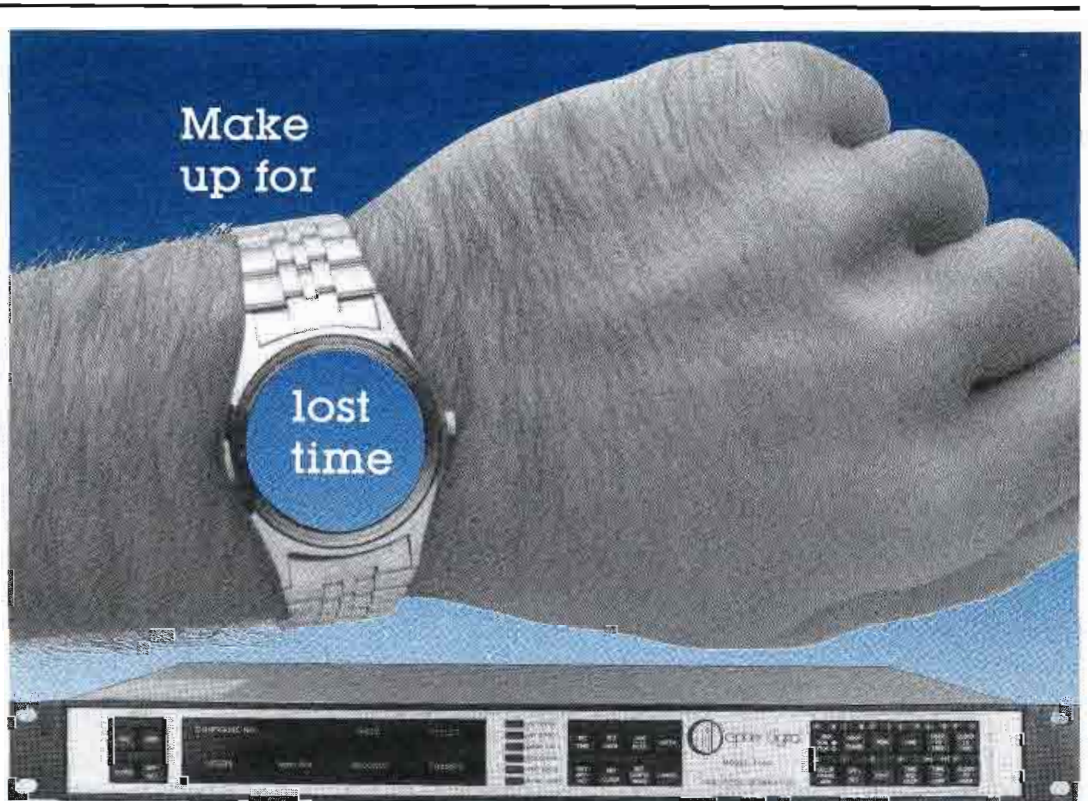

You can fill in missing time code gaps with the CDI-716A's unique multi-function jam sync, which permits correction of errors produced by head offset, mistracking, and tape dropouts.

The microprocessor-based Time Code Generator is a cost effective answer to

the needs of today's video, audio, production and post production studios. It handles both SMPTE and EBU longitudinal time code formats for data, user data, status and flag bits. And, like all Cipher Digital products, it carries a 3 year warranty.

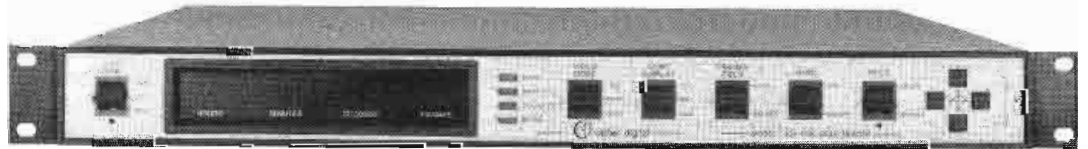

Sophisticated timing

The CDI-710A Time Code Reader offers all the latest features demanded by today's professionals.

It's completely regenerated time code output corrects incoming code for phase shift and short and long-term timing error. When used with the error bypass feature it actually eliminates

defective code. This feature is particularly important where code fed to a computer editor has been displaced in relation to the video signal, causing edit aborts.

The CDI-710A. The answer for today's sophisticated video production.

For more details on both of these fine products, contact Cipher Digital today. Call (800) 331-9066.



cipher digital, inc.
 P.O. BOX 170/FREDERICK, MD 21701
 (301) 695-0200 TELEX: 272065

Timely today, consistent with tomorrow.

Circle (165) on Reply Card

vides LTC and VITC output formats to cover VTR speeds from still through 110X.
Circle (751)

Skotel (2738)
TCR-132: VITC, LTC reader; video monitor display, reshaped LTC output; auto VITC/LTC select; desk or rack package.
Circle (1018)

Videolab (138)
TGR6: time code retrofit module for Sony VO-6800 VCR.
Circle (1127)

Videotape recorders

Ampex AVSD (3108)
Status-at-a-Glance: on-demand video monitor display of VTR set-up parameters.
ACR-225 demonstrations: digital cart spot player.
CVR-5 camcorder VCR: viewfinder playback, confidence playback, full transport control; works with CVC-5/-3A/-30 to form CVR-35, -503A or -530 complete camcorders; Beta-SP capable.
CVR-35: field portable VTR, serial remote control; audio/video confidence heads, full

metering and control of four audio channels; Beta-SP capable.
CVR-75: studio VTR, full record, play, editing capability; integral TBC with AST for still frame, slow motion; 30-/90-minute cassette capability; Beta-SP capable.
Circle (533)

BTS Broadcast TV Systems (3140)
BCB-10: Betacam studio playback unit.
BCB-15: Betacam format studio player; dynamic tracking; simple interface with BCB-10/40 and BBE-900 edit control system.
BCB-21: Betacam player; well suited to office or field use.
BCB-40: studio recorder/player; integral editing functions.
Circle (611)

JVC of America (3180)
BR-7700U: VCR.
BR-3100U: VCR.
M-II format equipment.
Circle (821)

Optical Disc (2527)
Model 615: pulldown processor.
Circle (935)

Panasonic Industrial/Broadcast (3216)
AU-550: field editing VTR, M-II format.
AU-650 panel: enhanced control panel for AU-650 studio VCR.
Other M-II products: two cart machines, studio player, office player.
Circle (944)

Sony Broadcast (3100)
BVW-35: Betacam SP field recorder/reproducer; color playback, 4-channel audio.
BVW-75: SP studio recorder/player; Dynamic Tracking, 90-minute record time; component/composite interface; NTSC decoder; 32x shuttle speed.
BVV-5: SP field recorder; viewfinder playback or 4-channel audio and color with VA-500 playback adapter.
Type C series: CPU/VLSI circuitry, improved picture processing.
DVR-1000: component digital VTR.
Circle (1023)

Sony Information Systems (3100)
MVR-5500 Pro Mavica: recorder player.
MVP-2500: Mavica playback unit only.
Still video recorder/player, battery operated.
Circle (1156)

Sony Professional Video (3100)
U-matic SP: series of 3/4" VCRs.
Circle (1151)

TASCAM (3416)
Teac LV-200: video DRAW disc recorder; 12" disc holds 30 minutes or 54,000 frames per side; full remote/computer controllable.
Circle (1058)

Thomson-CSF Broadcast (3190)
BVW-60: Betacam SP system.
BVW-75: Betacam SP.
Circle (1083)

Weather graphics, data systems

Accu-Weather (2529)
High res maps: satellite images; temperature

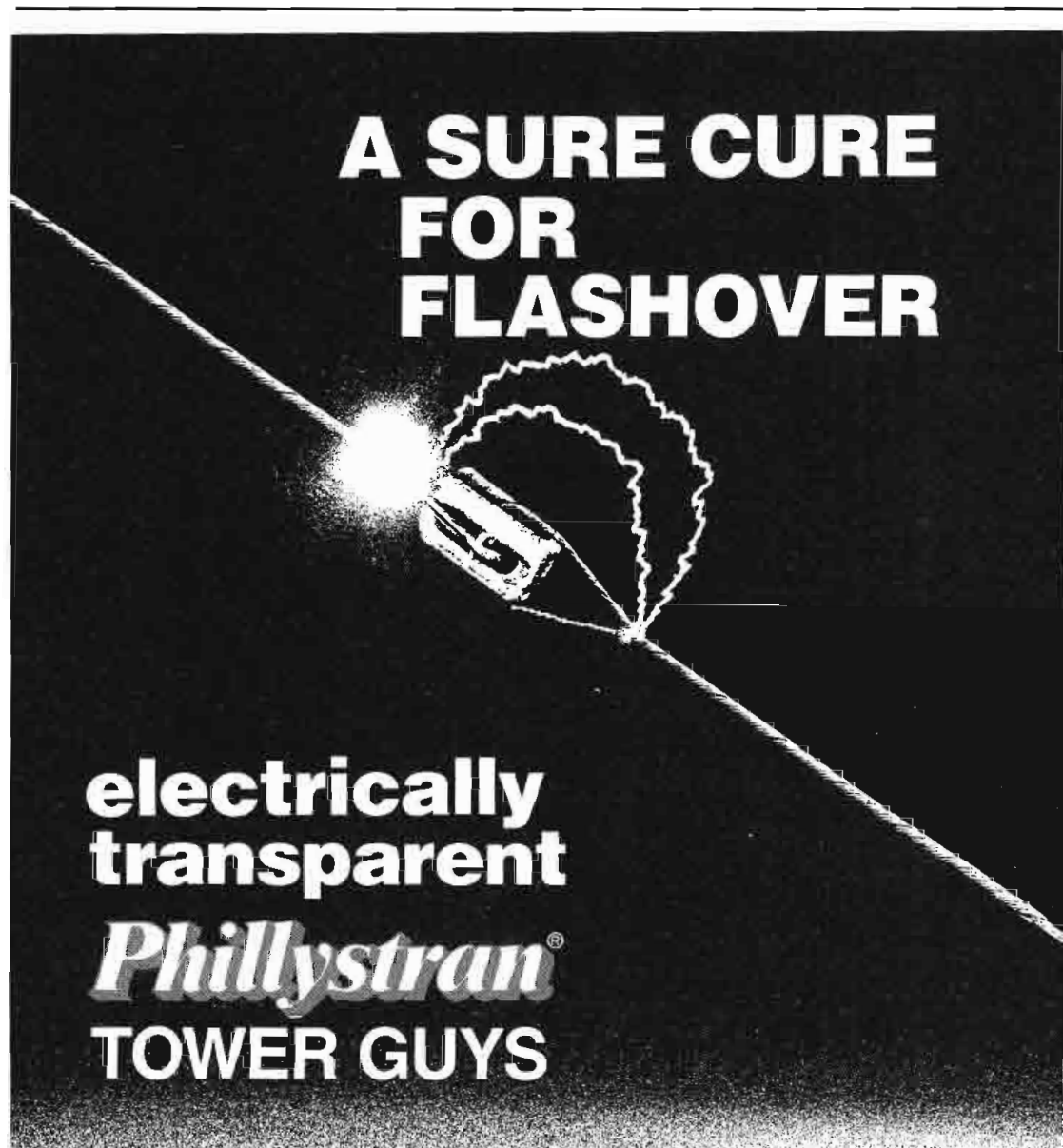

electrically transparent Phillystran[®] TOWER GUYS

Phillystran is now protecting more than a thousand broadcast towers preventing white-noise arcing across ceramic insulators (they aren't required) eliminating problems with on-off cycling due to static discharge on steel guys.

With Phillystran HPTG, tower-guy maintenance and costly re-guying are problems of the past.

For all the Facts—including "Electrical and Mechanical Analysis of Synthetic Tower Guys"—call/write

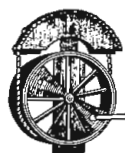

Phillystran[®]
UNITED ROPEWORKS (U.S.A.) INC.

20 COMMERCE DRIVE, P.O. BOX 306
MONTGOMERYVILLE, PA 18936 U.S.A.
(215) 368-6611 TELEEX: 846342

Circle (166) on Reply Card

band maps; weather map graphics.
Front Door 600: PC-based hardware, software; receive and archive satellite-delivered weather graphics.
Sisuriter 2000-D: plain-paper printer for DIFAX weather maps; high resolution; 4-hour maintenance plan.
Circle (503)

Advanced Designs (2419)
Doprad II updates: software for Doppler radar system; 768x484x8 resolution; pull-down menus, windows, icons; touch membrane radar control panel; map builder.
Circle (510)

Alden Electronics (2759)
C2000C: remote weather radar system; collects precip data from NWS radar sites, overlays intensities on map backgrounds; ground clutter suppressed; higher intensities take precedence; zoom, sweep lines, multi-memory standard.
Circle (517)

ColorGraphics Systems (3128)
LiveLine V: 32-bit/pixel weather graphics with cut/paste, stencil, pan/zoom, full-color paint; compatibility or weather services; animation; extensive maps; optional Doppler radar interface, RRWDS dial-up radar; Ethernet LAN option to ArtStar.
LiveLine PC: IBM PC/AT-based weather graphics unit; animation includes satellite loops, color cycling; auto map drawing; interface to weather services; wide paint range.
LiveLine IVA enhancements: additional cel, image looping and other animation modes; improved user control; text shading, vector fonts; Ethernet LAN option.
Circle (651)

Environmental Satellite Data (2787)
Slick 'n Quick: automatic Weathergraphix system.
EaSyData: alphanumeric text weather database.
Model 7000: super FRONT END weather data processing system.
Circle (735)

Kavouras (2657)
AP series: Triton graphics/animation system with art and paint; speed increased by 10x; improved scaling, rotating; in-betweening, zooms, pans, scrolls, synoptic weather animation; GOES satellite and radar animation of 64k colors at 30fps.
Surecasting: weather maps, charts, generated in Kavouras earth weather data base; MCI-DAS-type pinpoints weather conditions.
RADAC 2000: increased resolution base maps; multiple radar images displayed simultaneously, easier image manipulation; composite radar; GOES imagery, advanced overlays (lightning).
Circle (826)

WSI (2642)
SUPERseer: forecast cloud graphics for 12, 24, 36 and 48 hours into future.
Visible satellite imagery: high resolution, fully sectorable, visible satellite imagery.
Circle (1146)

RF/Tower products

- AM/FM radio transmitters
- TV transmitters
- ITFS, MDS/MMDS, STL equipment
- RF amplifiers
- Power amplifier tubes, klystrons
- RF generators (SCA, stereo, MTS)

Acrodyne Industries (3521)
TRH/30KA: single-tube, 30kW VHF TV transmitter.
TRU-25KVC: 25kW UHF TV transmitter; tet-

rode final.
LL/400: 400W solid-state VHF amplifier module.
TLU/200: 200W solid-state UHF TV transmitter.
Circle (505)

Advanced Micro-Dynamics (2672)
TC-X system: expandable transmitter remote control; flexible communication options include wire, STL, SCA and dial-up.
CDA-4: FM composite distribution amp; low noise, low distortion.
Circle (511)

AEG (2700)
Model S3217: 10kW single tube FM transmitter.
Circle (512)

Hearing out of focus?



Solved: stereo phase errors

How? By using the Howe Audio 2300 Phase Chaser you can correct phase errors in stereo signals which cause problems in mono compatibility and stereo imaging.

The 2300 Phase Chaser detects and corrects phase inversion, time delay and channel dropout. Additional features include a clip indicator, 180° phase inversion

indicator, phase error indicator scaled in millisecond, bypass switch, XLR input/output connections and 1 3/4" X 19" rack mount.

For more information contact Howe Audio, 2300 Central Avenue, Suite E, Boulder, Colorado, 80301, (800) 525-7520.

See us at NAB, booth #2832.

 **HOWE**

Circle (370) on Reply Card

Allied Broadcast Equipment (3414)
Model 2000: Media Touch equipment control system; touch-screen technology.
Circle (521)

Bogner Broadcast Equipment (3406)
DUI series: reduced weight, reduced wind load side mount antennas for UHF TV broadcast.
Circle (592)

Cablewave Systems Div/CELWAVE (3489)
Rigid transmission line.

Fiberglass microwave antennas.
Circle (613)

CAT Systems (3426)
HQ series: high speed option for all CAT systems; 50% faster.
Uplink controller: multi-site capability.
Video switch controller.
Circle (624)

Catel Telecommunications (2585)
Model D-850: tunable TV demodulator.
TVS-2000: TV stereo generator.
FMS-3000: FM stereo system.
Series 3000: remote satellite receiver transmission system.
Microwave video links; IR links.
Circle (625)

CCA Electronics (2584)
FM exciter.
FM transmitter: rated 600W.
AM transmitter: broadcast band, rated 25kW.
Circle (628)

Comark Comm./Thomson-LGT (3190)
CTT-U-60SK: 50kW UHF Klystron TV transmitter.
CTT-V-30L/H: 30kW VHF transmitter; all solid-state design.
CTT-V-50-L/H: 50kW VHF TV transmitter; single-tube design.
Circle (653)

Communication Microwave (139)
A100S amplifier: 100W solid-state unit for MMDS/ITFS/OFS service.
R10S repeater: for ITFS service, external-duplexed; solid-state.
SB050-MRC/SB100-MRC: 50W and 100W MMDS/ITFS/OFS transmitters; solid-state.
SB010-MRC/SB020-MRC: 15W and 30W MMDS/ITFS/OFS transmitters; solid-state.
Circle (654)

CSI Marketing (3418)
T-40-F2: 40kW single-ended FM transmitter; grounded grid tetrode stability and high gain.
CSX-20F: FM exciter; 2nd order phase lock loop for low noise, distortion; high reliability.
Circle (679)

EEV (2626)
K3672BCD: 60W high efficiency, wideband UHF klystron; continuously tunable cavities.
K3271BCD: 30kW wideband UHF klystron; high efficiency, continuously tuning cavities.
Circle (723)

Electro Optics Div./EG&G (2612)
Model LS-161: aviation obstruction beacon; FAA Spec L866 white medium intensity, omnidirectional.
Model LS-159: aviation obstruction beacon; like LS-161, for antenna mounting; reduces antenna painting.
Circle (726)

EMCEE (3032)
TTS10FA: synthesized frequency agile MMDS/ITFS transmitters.
Downconverter: broadband unit with antenna for MMDS/ITFS.
New line of UHF/VHF TV transmission equipment.
Leasing services.
Circle (731)

Flash Technology (3454)
FTB-301: medium intensity beacon for towers to 500 feet tall.
SC110: controller for high intensity beacons.
RSC-610: controller for red lighting systems.
Circle (750)

General Electric/Comband (2479)
3BDC900: ITFS/MDS/MMDS microwave block downconverter; low noise, high gain; to midband, superband CATV frequencies.
Circle (761)

Hallikainen & Friends (2925)
DRC190: digital remote control; new software, low-cost TRL equipment; IEEE-488 auto test equipment interface; status panel.
ITO177: adapter, lets Commodore 64 control transmitter and logging with TEL171 or Moseley TRC-15A.
Circle (779)

Harrison Air-7



If you are budgeting for Audiotronics, Pacific Recorders or similar consoles in this range, Harrison is a must consideration. Call toll free 1-800-426-8434.

Ask about a hands on demonstration.

The Ultimate Broadcast Console



BROADCAST • SUPPLY • WEST
 7012 - 27th Street West • Tacoma, Washington 98466 • 1-800-426-8434

Circle (168) on Reply Card

Harris/Broadcast Division (3136)
TV-RF: external cavity klystron UHF transmitter.
SiteLink: 950MHz aural STL for radio use.
Global 6: microwave system.
FM-25K1: 25kW FM radio transmitter.
Circle (781)

Inovonics (2434)
Model 705: FM/FMX stereo generator.
Circle (805)

ITS/Information Transmission (2415)
ITS-12: VHF exciter.
ITS-27: VHF aural IF modulator.
ITS-75: VHF solid-state video modulator.
ITS-1610C: 10W ITFS/MMDS transmitter.
ITS-1658C: 100W ITFS/MMDS amplifier.
Circle (813)

Keltec Florida Microwave (2435)
R60-300Ku: 300W CS HPA, 14-14.5GHz; rack-mount; 70lbs.
H60-300Ku: 300W CW HPA, 14-14.5GHz, environmentally sealed chassis; mounts on antenna hub with remote control panel.
Circle (828)

Kintronic Laboratories (2540)
PP-78-7U: 7-port patch panel for 7/8" unpressurized line.
AG-3: variable horn gap assembly.
Custom HV insulators.
RFC-20-10-2: double-pole, double-throw RF contactor.
Circle (834)

Larcac Communications Equipment (3314)
TTS-5LH: 5kW VHF hi-band transmitter; solid-state, external diplexed.
Circle (842)

M/A-COM MAC (3280)
18GHz microwave: terrestrial systems for broadcast; meets RS250B short haul, hot stand-by; synthesized Gunn oscillator; modular.
Circle (865)

MARCOM (2433)
Model 711: TV stereo generator; limited front-panel control, LED metering; for no-frills stereo requirements.
Circle (870)

Marconi Communications Systems (3572)
Model B7500: 30kW high-band TV transmitter.
Model B6128: 500kW HF transmitter; ground-grid final.
Circle (871)

Marti Electronics (3496)
Model ATS-15D: automatic transmitter switcher for STL and TSL.
Model TSL-30: transmitter-to-studio data link with 30W transmitter.
Circle (873)

McDonnell Douglas Astronautics/OptoElectronics (2546)
VF series: fiber-optic products for video, audio, data; meets RS-232; laser/led types, multi-mode, single mode.
Module rack: houses multiple fiber-optic units.
16x16 switch: fiber-optic switch; non-blocking; for video, audio, data.
Airlink system: atmospheric light-based com-

munications system.
Circle (879)

MCL (NA)
Model 10844: 300W Ku-band TWT satcom amplifier, for MSD use.
Model 10901: 300W Ku-band TWT satcom amplifier, hub-mount MSD.
Model 10880: 300W Ku-band TWT amp for ABC-Sat applications.
Circle (880)

Micro Communications (3438)
No. 55000: dual-channel combiners.
High-band pass filters.
Circle (884)

Microdyne (3520)

1100-BKR: broadcast C/Ku-band receiver; fully agile.
1100-CKR: fully agile C/Ku-band satellite video CATV receiver.
Circle (885)

Moseley Associates (3202)
PCL-600: STL system.
Model MDU: dial-access remote control system.
Circle (901)

NEC America (3161)
PCU-960: 60kW UHF transmitter.
PCN-1430: 30kW VHF transmitter; low-band; solid-state; dependable exciter.
Circle (918)

A Legend in Time

T5010. The SMPTE Time Code Generator/Reader

Legends are made to face the test of time. The T5010 is no exception. Our most versatile Time Code Generator/Reader/Character Generator, the T5010 leads the industry with its user oriented features. Discover a legend in time. Contact your local Telecom dealer, or call us for details. We'd like to share our time with you. The Telecom T5010.

telcom research

1163 King Road, Burlington, Ontario, L7R 3X5 (416)681-2450

Circle (169) on Reply Card

Pinzone Communications Products (2411)
 8250K: Ku-band satellite receiver, all format capable from front panel controls.
 8250S: S-band ENG receiver; 2GHz service.
 CPG-ASWA: anti-skywave AM antenna; physical low profile for approximate 30 ft. nominal height; 6-12dB gain in azimuth plane.
Circle (957)

Pye-TV (3238)
 Type LDM-179: 60kW UHF TV transmitter.
 FM radio transmitters: 5kW, 1kW, 500W, 300W models.
 LDM 1900: TV transmitter with dual channel

sound-in-sync.
Circle (964)

Radiation Systems (2929)
 Model 240KV: RSNG antennas.
 Laux/Kenwood TVRO system.
Circle (973)

REACH Electronics (2437)
 Model 2VR81: SCA TOP tone only pager.
 21DYE1: LIAISON dial access paging terminal.
 Model 2TE7: L'Page manual paging terminal.
Circle (980)

RF Technology (2809)
 UPL series: ultra portable transmitters for ENG, EJ, racecam and wireless camera operation.

RFL-200: frequency agile transmitters for medium range ENG.
 LONGRANGER: mast-mounted repeaters/translators for extended range, ENG, EJ coverage.
Circle (985)

Shively Labs (2442)
 FM antennas: 1/2-wave spaced for reduced downward radiation.
 Custom antennas: FM broadcast antennas, custom H/V ratios.
Circle (1013)

Standard Communications (2709)
 AGILE OMNI PRO: C/Ku-band broadcast grade video, audio satellite receiver; exceeds RS-250 parameters.
 AGILE OMNI INTERNATIONAL: Expanded frequency range satellite receiver; for TV and audio; applicable to all ITU regions and all TV standards.
Circle (1034)

Television Technology/ TTC Wilkinson (3580)
 Silverline: 60kW UHF TV transmitter.
Circle (1072)

Tennaplex Systems (2812)
 System MEG1: multi-station combiner; capable of 1MW input prime power (TPO).
 FMI: FM broadcast antenna with ideal vertical pattern (cosecant null fill).
 TVI: TV broadcast antenna with ideal vertical pattern (cosecant null fill).
Circle (1074)

TMD/Div. of Will-Burt (2587)
 TMD-7-42: heavy duty pneumatic telescoping mast; external wiper bumper reduces water and dirt contamination in mast; close tolerance azimuth locking.
 TMD-C-287/C-288: 1/6HP 115Vac and 1/8HP 12Vdc pneumatic systems for use with standard duty masts; no receiving tanks included.
Circle (1090)

Thomson-LGT (3190)
 EVHF 1000 AS.TR: 10kW VHF TV transmitter, all solid-state.
 EVHF 2000 AS.TR: 2kW VHF TV transmitter, all solid-state.
 EUHF 1000 AS.TR: 1kW UHF TV transmitter, total solid-state.
 EVHF 105+SR: 10W VHF TV transmitter with TVRO system.
 EFM 100: 100W FM transmitter.
 EFM 10000: 10kW FM radio transmitter.
Circle (1084)

Townsend Associates (3305)
 TA-30TL: 30kW 2-6 VHF TV transmitter.
 TA-60TG: 60kW UHF TV klystron amplifier; new cabinet and operating features.
 TA-10TM: 10kW UHF klystron amplifier; air-cooled; additional features.
 DC-60G: driver, controller for 60kW UHF TV transmitter; added features.
 TE-3: VHF/UHF exciter; newly designed circuitry, controls, chassis.
Circle (1095)

Varian/Eimac (3206)
 Y-683: retrofit replacing 8F76R for VHF-TV.
 YC-112: retrofit kit for Y-863.
 YC-130: VHF tetrode at 110MHz.
 VPW-6892: modular replacement TWT power supply.
 Ku-band: medium power amplifier.
 VZU-2701H GEN II: Ku-band klystron high-

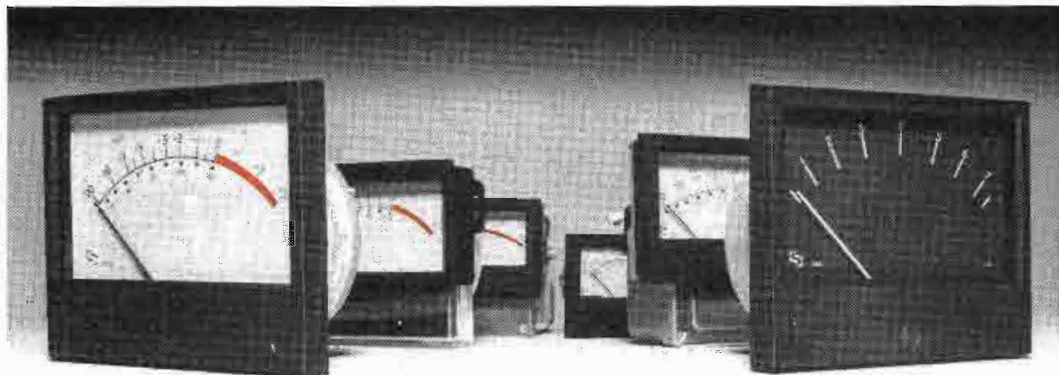

GOOD LISTENERS.

If you're fanatical about the quality of your audio recording or reproduction, let Selco's superb VU Meters, PPM Indicators, and Audio Level Meters listen in.

No mistake, Selco's VU's and PPM's are truly professional instruments. VU Meters meet the full requirements of American National Standard ANS C16.5-1954. PPM Indicators conform to specification BS 4297:1968, with models available meeting European and BBC specs.

Several different styles in each type of meter gives you a wide choice of sizes, mount-

ing arrangements, and scale lengths, too.

How pleasant that these outstanding instruments are priced as low as 36.88 each in OEM quantities.

And if you have slightly less demanding applications, Selco's reliable, well made Audio Level Meters may be your answer. Same quality taut band meter movement, similar handsome cases and scales. But prices as low as 15.50 each in quantity.

Request Selco's full color brochure on the entire line. Or give us a call. We're good listeners, too.



7580 Stage Rd. • Buena Park, CA 90621 • Phone (213) 921-0681, (800) 25-SELCO • Telex 655457.

Circle (167) on Reply Card

RELIABLE ROTARY ATTENUATORS

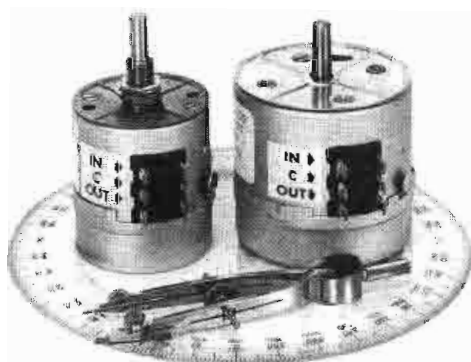

- PREMIUM MATERIALS
- QUALITY WORKMANSHIP
- PROVEN PERFORMANCE
- MANY STYLES
- ALL IMPEDANCES

SHALLCO, INC.
 P. O. BOX 1089
 SMITHFIELD, N. C. 27577
 919/934-3135

Circle (366) on Reply Card

power amplifier.
VTU-6693C1: 300W Ku-band travelling wave tube.
VTU-6393: 300W conduction cooled travelling wave tube.
VTU-6191C1: 80W travelling wave tube.
Circle (1117)

Valmont Industries (224)
Antennas support structures: free-standing poles (to 250 feet), free-standing towers (to 400 feet), guyed towers (to 1000 feet).
Circle (1116)

Vertex Communications (2447)
Flyaway system: 1.8m antenna, self-contained in 5 suitcases; flies on commercial air as luggage; 2-minute assembly.
Circle (1120)

Support products Automation equipment

- Program
- Newsroom
- Business

A.F. Associates (3170)
Pegasus automation: computer controlled on-air playback of commercials and programs; interface to traffic computer, master control switcher and various VTR/VCR systems.
Circle (513)

Alamar Electronics (3561)
Copy-Cart: net delay record/play automation system.
Auto-Cart: single channel system; 1-32 multi-format VCRs with one strip switcher.
MC-1050: multi-channel system with multiple spot tapes; handles all format VTRs, master/routing switchers, ancillary systems.
RCMP-5: remote control panel; for integrated SMPTE/EBU network control system.
SC-2000: remote controller for all types of broadcast equipment using SMPTE/EBU control network.
Traffic Manager: interfaces Columbine, Bias, Jefferson traffic systems to MC-1050.
Schedule Manager: integrated traffic package to generate daily logs; direct interface to MC-1050.
Circle (516)

Ampex AVSD (3108)
ACR-225 demonstrations: digital cart spot player.
Circle (533)

ASACA ShibaSoku (3278)
ADR5000: erasable optical disc system; 18,000 stills or 10 minutes live video per disc; 100ms access to any frame; sequenced play-backs of 10 discs to 160 minutes.
Circle (553)

Broadcast Automation (2697)
IGM-EC system: automation equipment with Otari ARS-1000 tape decks, single play cart decks and remanufactured SMC 250 Carousels.
BAI EC monitor: cue amp and speaker for EC system.

EC interface: for 250 Carousel.
Carousel replacement boards.
Circle (599)

Broadcast Management Plus (2646)
Software: workstation concept for programming and sales; revenue development package; pre/post buy analysis; account list list-management; traffic order.
Circle (603)

Broadcast Systems/BSI (3418)
DC-80 EP: economy automatic video cart machine.
Circle (607)

BTS Broadcast TV Systems (3140)
Station automation: provides machine con-

trol, distribution switcher and master control automation; H-P 9000 series, 300 hardware; Unix operating system, 68020 CPU.
Circle (611)

CBSI/Custom Business Systems (2517)
CO-OP: copywriter software.
Circle (627)

Columbine Systems (3405)
Unified system: completely rewritten traffic software package.
Circle (652)

Datacount (2758)
DARTS: integrated station business computer software package.
Circle (688)

Introducing
FREEDOMIKE®
 VHF Pro Series Wireless Microphone System

A New Dimension in Wireless Performance

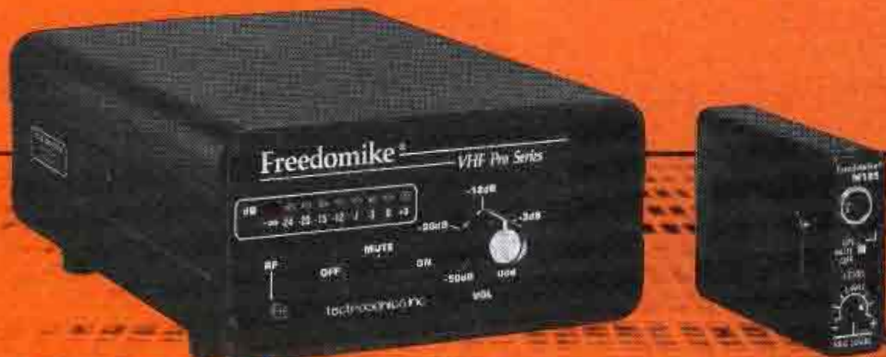

The all-new Freedomike VHF Pro Series Wireless Microphone System offers a new high in performance, with a quarter-mile operating range and outstanding selectivity — over 200 operating frequencies possible — from 169 to 216 MHz. It is the most versatile system available for audio, video and multi-media.

Freedomike VHF Pro Systems are complete packages including transmitter, receiver, case and high-quality microphone. Three different configurations are offered with standard, diversity or miniature receivers.

Freedomike Systems are designed and built in the U.S.A. by a tireless group of engineering fanatics — just the way they ought to be.

Call us now at 1-800-821-1121 for complete information and specifications.



LECTROSONICS, INC.
 See us at Booth 2445 — NAB
 P.O. Box 12617 • Albuquerque, New Mexico 87195 • Phone: 505-831-1010

Circle (360) on Reply Card

Dataworld (2779)
Updated databases: FCC records with comprehensive information on AM, FM, TV, LPTV and ITFS operations; allocation, interference studies; population base; terrain elevation retrieval program.
Circle (690)

Jefferson-Pilot Data Systems (3204)
JDS AutoSelect III: upgrade generation of AutoSelect music rotation system.
BUYLINE invoice: electronic transfer of station invoices to advertising agencies.
Circle (817)

Lake Systems (120)
LaKart LS: random access library system; 500, 1000, 1500 cassette capacity; Beta, Beta SP, M, M-II formats per customer choice; shortest segment of 10s.
Circle (839)

Odetics (3586)
TSC2000: video cart machine; traffic interface software; sequential continuous recording simultaneous with spot playback.
Circle (931)

Pegasus Systems (3170)
Station automation: computer-controlled on-air playback of commercial and program material; interfacing for traffic computers, master control switchers, VTRs, VCRs.
Circle (948)

Sony Broadcast (3100)

Library Management: prototype system to manage Betacart Multi-Cassette library.
Circle (1023)

Systemation (2458)
8mm random access: cassette automation system; play up to 300 songs on one cassette with DX-7 control computer and interfaced cassette decks.
SuperTrack: satellite automation; interfaces satellite audio source and three decks with SuperSwitch controller.
Circle (1055)

Utah Scientific (3128)
SAS-2: improved speed through faster processors and more efficient coding; menu-driven color displays; multi-line displays per event; word processing type editing features.
Circle (1112)

Vidcom International (NA)
Software: BAT-PC billing, accounting, traffic system; for IBM and compatibles; stand-alone or LAN environment.
Circle (1122)

Wire, cable

Belden Wire & Cable (2651)
8281 coax: video cable; available in colors.
9307/9308: conformable coaxial cable.
Circle (585)

Canare Cable (2523)

VAC-FB: videopatch cables; BNC-BNC with LV-61S (RG-59); colors.
MR202AT: multichannel mic cable; 2 to 24 channel; flexible, foil shield.
Type 4S: Quad speaker cable; multichannel; 11AWG to 18AWG.
Type 4Vs: multichannel coax 75Ω.
F-10 series: cable-mount plugs; RCA, phone, mini, BNC types.
Circle (620)

Connectronics (2403)
Studiflex-24: 24-pair cable for studio installations, harnesses.
UX connector: connectors for loudspeakers; heavy-duty, allowing more than 30A at more than over 100V.
Circle (667)

Dialight/Neutrik (2691)
NC3FX-HD: waterproof XLR connector.
NC3FX-S: 3-pin XLR connector with circular switch.
GNS-18: black gooseneck with antitheft locking ring.
X series: 3-pin screwless XLR connector.
NTE series: audio transformer.
Circle (702)

LEMO USA (2805)
Audio connectors: quick-connect/disconnect, self-latching audio connectors; to 500Vdc, 3A; less than 1" long, 1/4" diameter; 2-3 contacts.
Circle (853)

Selco/Sifam (2450)
Components: fuse holders in high- and low-profile types; knobs; more.
Circle (1006)

You'll meet your match with our EDITING CONSOLES

No matter what VTR equipment you use, Winsted offers Editing Consoles to match your requirements! Our designs are based on consultations with professional users like yourself.

You've chosen your VTR equipment carefully, to meet your specific needs. Now choose the Editing Consoles that fit your equipment - quality consoles from Winsted.

For our free full-color FULL-LINE CATALOG call us toll free:

800-447-2257
 TELEX: 510-601-0887

Winsted

9801 James Circle
 Minneapolis, MN 55431



Circle (170) on Reply Card

Nothing Comes Remotely Close SPECTRUM RPU LINKS



SCT500 RPU Transmitter

- TX FEATURES**
- VHF & UHF Units
 - 2-75 Watts
 - Direct FM
 - Front Panel Metering & Indicators
 - Built-in AC Supply
 - 12VDC Input or "Battery Backup"
 - 19" Rack Mt. - Cabinets Available
 - FCC Type Accepted. Parts 74, 90

The Spectrum SCR500 & SCT500 are a series of high performance broadcast quality RPU Receivers and Transmitters. They incorporate the latest advances in solid state technology—brought about by Spectrum's more than a decade of experience in the two way radio field. These rugged units use the highest quality components & construction for high reliability in either fixed or mobile applications.

RX FEATURES

- VHF & UHF Units
- High Sensitivity & Selectivity
- High Rejection of IMs & strong local signals
- 4 IF Bandwidths Available
- Very Low Distortion
- Full Panel Metering
- Built-in AC Supply
- Many Advanced Features

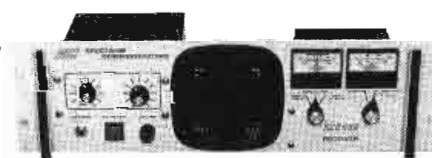

SCR500M RPU Receiver

Call or Write for Details



SPECTRUM COMMUNICATIONS CORP.

1055 W. Germantown Pk., Norristown, PA 19403
 (215) 631-1710 • Telex: 846-211

Circle (171) on Reply Card

Trimm (2649)
Jacks: mini coaxial connectors for DSX 3/4 application.
TPS series: mini coaxial plugs and jacks.
Circle (1098)

Cases

- Storage
- Racks
- Carts

Anvil Cases (2706)
Equipment cases: additions to EIA Rack-mount and Anvil Design transport case series, as well as standard ATA and MACC product lines.
Circle (543)

Ferno-Washington (2914)
Freelancer: audio/video location cart for carrying equipment.
Circle (745)

Kangaroo Video Products (2676)
KVP-6400: case for Panasonic AG-6400.
KRC-3BVF: raincover for Sony BVP-3, BVF-50 viewfinder.
KAC-500: case for Panasonic AG-500 monitor.
KAC-8020: case for Sony PVM-8020 monitor.
KRP-KK: Kangaroo Klips, detachable cable organizers.
Circle (825)

K&H Products/Porta-Brace (2532)
TC-50: cordura-padded nylon tripod cases with pockets.
BP-30: belt-pack with slip-on accessory cases.
SC-series: shoulder cases for professional camcorders.
Circle (822)

Nalpak Video Sales (2800)
TP1144: 11"x44" Tri-Pak case.
TP0936: 9"x36" Tri-Pak case.
Roto-Kase: rotationally molded cases.
TK-500: video-to-go production kart.
Vertex: expandable line of test charts.
Rack-n-Go: molded instrumentation shock-mount case.
Circle (914)

Star Case (2503)
Series F-5: new style of flight rack case; removable fronts, tops.
Circle (1037)

Storeel (3322)
System RS-II: compact storage for M-II format material.
System RS-VHS: storage for M-II or VHS.
System RS-CD: high density storage units for compact discs.
Circle (1041)

Telepak San Diego (2566)
T-Cam: broadcast camera case.
T-Gaf: mini grip gaffer pak.
T-25: BVW-25 case.
T-15: BVU-150 case.
T-PWR: 12B 10AH battery belt.
T-M 1395: monitor cover MGA CS 1395.
Circle (1066)

Wheelit (2783)
Model 6000: video transporter; handles up to 25" monitor with associated VCR.
Circle (1138)

Winsted (3424)
Model H8597: editing console for BVE-900.
Model G8753: mini editing cart.
Storage: 1/2-inch tape storage system; Betacam.
Circle (1141)

Wolf Coach (3541)
News Gathering Vehicles: smaller, lighter weight designs.
Circle (1144)

Recording tape, degaussers, reconditioners

Agfa-Gevaert (2815)
PEV192 tape: bulk videocassette tape in standard and high grade.
Circle (514)

Audico (2720)
Tape loader: cassette tape loader, reloader, rewriter for M-II or Betacam formats.
Model 609: videocassette rewriter, cycler, counter for U-matic, VHS and Beta formats.
Reloader: 8mm rewriter, reloader system.
Circle (560)

OVERVOLTAGE

OR

UNDERVOLTAGE

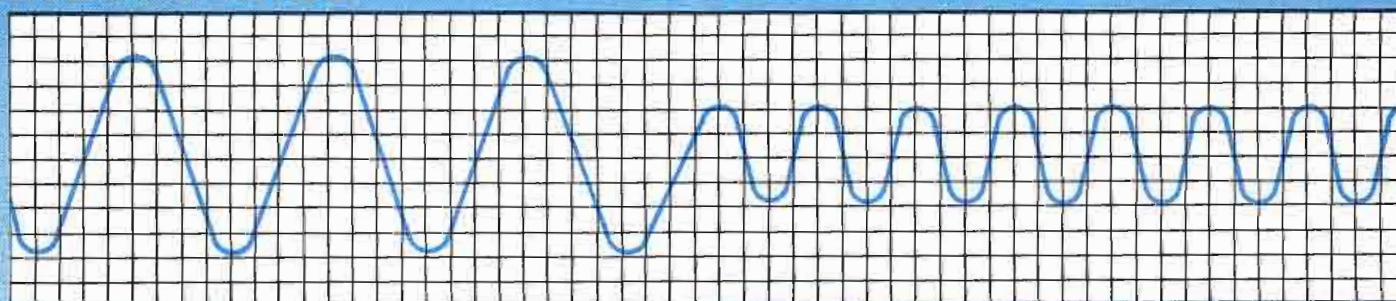

THE SOLUTION —
 THE PESCHEL
 AUTOMATIC
 VOLTAGE
 REGULATOR™
 (PAVR)



MEETS YOUR SERVICE LINE REQUIREMENTS
 FROM 50A TO 2000A, 240 V TO 118 kV
 KEEPS YOUR PLANT RUNNING WHILE:
 ■ INCREASING EFFICIENCY
 ■ INCREASING PRODUCTIVITY
 ■ REDUCING MAINTENANCE COSTS

The Peschel Automatic Voltage Regulator is designed for loads that do not require instantaneous voltage correction. The regulator that corrects for line voltage variations instantly sacrifices efficiency, size, weight, output accuracy, serviceability, produces wave form distortion and is expensive. Most applications, even most computer applications, do not require a line voltage correction to be made instantly to within $\pm 1\%$ of the nominal voltage. Why pay extra for a regulator that corrects instantly, like an electronic tap changer or a saturating core type, when your equipment does not need it?

A PAVR, often equipped with a transient suppressor, will provide the protection you need. If you're going to buy an electromechanical type, don't buy an antiquated, induction voltage regulator. There is an alternative.

The PAVR is an electromechanical regulator (easy to understand and service) that is designed specifically for medium to high power loads. It is efficient, reliable and economical.

From the World Leader in High Voltage Technology



P.O. Drawer A, Route 22, Brewster, New York 10509 Phone (914) 279-8091 Twx: 710-574-2420 HIPO BRWS NY Tlx: 425476 HIP U

Circle (172) on Reply Card

Recording tape

Eastman Kodak (3208)

PRO FORMAT II: professional videocassette, M-II.
Circle (717)

Elcon Associates (2621)

Model EA1200: tape cleaner/profiler series for B/C formats.
Circle (724)

Fife-Pearce Electric (2686)

Model 2PT5FP: automatic video bulk eraser; continuous duty; 40FPM belt speed; sound alert; by Electro-Matic Products.
Circle (747)

Fuji Photo Film USA (3240)

H521E-BR: 3/4" broadcast videocassettes.
H521E: 3/4" professional videocassettes.
Circle (756)

Future Productions (2790)

FP80 duplicator: small, full function system, to 80 VCRs.
Circle (758)

Maxell (3551)

Betacam: B5, B10, B20 length videocassettes.
M-II: videocassettes.
PCM audio tape: open reel 1/4", 1/2", 1".
R-DAT cassettes.
Cables: audio/video accessories.
Circle (876)

Sony Magnetic Products (3100)

Betacam SP: 30-/90-minute sizes.

U-matic SP: 10-/30-/60-minute lengths.
D-1 format: 10-/30-/60-minute lengths.
Circle (1024)

Television Equipment Associates (3342)

Elcon EA1200: tape cleaner/profiler series for B/C formats.
Circle (1070)

Zonal/Mag-Zon (2586)

839 series: audio recording tape; suitable for broadcast, portable recorders; duplication and logging; matte backcoat or unbacked; standard, long, double, triple play.
Circle (1149)

Signal distribution

- Routing switchers
- Distribution amplifiers

ADC Telecommunications (2819)

I.C.O.N.: integrated cable organization network audio, video cable termination, distribution devices.
Circle (507)

ADM Technology (3266)

Model DA26: stereo 1x6 or monaural 1x12 audio DA; optional VCA control.
Circle (509)

Broadcast Supply West (2743)

Model DA160: Radix audio DA.
Circle (606)

BTS Broadcast TV Systems (3140)

BVA-350 VDA: differential input distribution amplifier; 7-output, ac-coupled or backporch clamped.
BBA-350 ADA: 1-in/6 to 12 balanced or unbalanced outputs; VTR duplication connections provided.
Circle (611)

Comprehensive Video Supply (3593)

Distribution amplifier series.
Circle (656)

Di-Tech (3567)

Model 936: control panel; user assignable, alphanumeric 10-bus.
Models 931, 939: control panels; user assignable, alphanumeric; single-bus.
Circle (708)

Dynair Electronics (3409)

DYNASTY: family of routing switchers; mix, match components with bandwidths from 20MHz to 100MHz; for composite, component, HDTV and graphics.
Circle (714)

Future Productions (2790)

SR1, SR2-5: source routing for duplication; 4-in/5-out.
AVD-24: A/V DAs for duplication; 25 outputs.
Circle (758)

Grass Valley Group (3112)

Ten-20: 20-in/10-out routing switcher.
20-TEN: 10-in/20-out routing switcher.
Model 8560: stereo audio distribution amp.
Circle (772)

Harris/Broadcast Division (3136)

I-NET, I-MAC: video equipment interfacing systems.
Circle (781)

ICM Video (2468)

Model RS-400: routing switcher; 12-in/1-out; video, stereo audio; BNC video, RCA phono audio connectors.
Circle (796)

Ikegami Electronics (3150)

TSW-502: source selector.
Circle (798)

Leitch Video (3559)

ADA-881: low impedance audio DA.
Circle (852)

Omicron Video (2661)

Model 470: 12Vdc powered A/V DA and 5x1 A/V switcher.
Circle (933)

Orion Research (2588)

Model 3900: computer controlled A/V routing switcher.
Circle (937)

ROH/Anchor Audio (2432)

Model 191X-16: expansion panel for existing or new ROH line monitors; 16-input.
Circle (990)

H.A. Solutec (2430)

SOL ADA: stereo audio distribution amplifier.
SOL VDA: video distribution amplifier.
Circle (1021)

Utah Scientific (3128)

B spec DAs: series of audio/video DAs; 11-card rack modular motherboard elimi-

O'Connor
CAMERA SUPPORT SYSTEMS

- Rigid and durable
- Fully adjustable
- Quick set-up
- Lightweight

Universal Top Casting

E N G T R I P O D

State-of-the-art...the most carefully engineered professional tripod on the market today.

O'Connor Engineering Labs
100 Kalmus Drive • Costa Mesa, CA 92626 • (714) 979-3993
NAB Booth #3364

MADE IN THE USA

Circle (173) on Reply Card

nates wired connections.
Dual video DA: two 1-in/4-out on single card with 0-1,000ft cable EQ; driven clamp, 5ms delay trim; allows 22 DAs per rack card cage.
Circle (1112)

Syndicated programming distribution

- Music
- Sound effects libraries

AP Broadcast Services (3395)

TV Direct: video news service with AP Videograph computer-enhanced graphics and Laserphoto news graphics.

Washington Direct: live coverage of major Washington news events.

Beatcheck: packaged stand-ups, video of Washington news events.

Circle (554)

Associated Production Music (2650)

KPM 1351CD: Inspiration classic; sparkling melodic, on CD.

KPM 1361CD: Classic Fusion 3; classical, 80's industrial, on CD.

Circle (555)

GTE Spacenet (3324)

News Express: satellite news gathering services.

Call Express: for voice and remote data transmission.

Turnaround Service: bandwidth conversion service.

Circle (778)

Network Production Music (2627)

Production music: compact disc library.

Sound effects: CD library.

Circle (921)

Valentino (3465)

Digital sound effects: compact disc library.

Production music: compact disc library.

Circle (1114)

Test & measuring equipment, tools

Allen Avionics (2724)

Delay lines: zero loss.

Variable gain amplifier.

Fixed attenuators.

Tubular hi/lo-pass filters.

Circle (520)

Altronic Research (146)

5800 series: heat exchanger type dummy loads.

6700 series: air cooled dummy loads.

Circle (526)

Amber Electro Design (2426)

Model 8000: PC instrument controller.

5500 options: additional software and accessories for 5500 programmable distortion/

noise measuring set.

Circle (527)

Audio Precision (2452)

System One additions: dc voltage/resistance module, variable dc output voltages, digital input/output, for measurement of VCAs, speaker small signal parameters; tone generator, tone bursts, square waves, pink noise, narrow-band noise.

Circle (566)

Audio-Video Engineering (2703)

Model HSC-2: video hum-stop coil.

Circle (568)

B&B Systems (2665)

AM-3B: CRT real-time stereo audio phase monitor; visual, audible display of program phase, VU, peak threshold levels; L, R, L+R, Aux inputs; internal speaker, headphone amp.

Circle (575)

Barrett Associates (2763)

Tapesenz: Jasoni test unit for broadcast tape machines.

Tempsenz: Jasoni temperature sensing device for remote transmitter housings.

Circle (579)

Bird Electronic (3472)

4641/42 series: single/double-socket directional THRULINE wattmeters, 4 1/16" flanged; 50-750 MHz, 2.5-80kW.

4843/44 series: single/double-socket directional THRULINE wattmeters, 4 1/16" unflanged; 50-750 MHz, 2.5-80kW.

8575 series: 5kW forced-air cooling, dry load resistors' dc-500MHz.

8345-115: 6kW attenuator, 30dB \pm 0.5dB, dc-500MHz.

Circle (591)

Broadcast Video Systems (2730)

EV4050: Electronic Visuals component waveform monitor.

Delay system: automatic, for video.

Circle (608)

Coaxial Dynamics (2766)

Model 81070: Wattchman transmitter protection system.

Circle (648)

Peter W. Dahl (222)

Transient suppressors: prewired assemblies; fast acting selenium, high energy MOV devices.

Circle (683)

Electro Impulse Laboratory (3431)

DPTC-25KFM: improved FM dummy load; dry, forced-air cooling.

DPTC-50KFM: improved FM dummy load; dry, forced-air.

DPTC-75KFM: FM dummy load; replaces -65KFM.

Circle (725)

Electronic Systems Laboratories (2640)

PE1A: Lydkraft TUBE-TECH tube equalizer.

Circle (729)

Electronic Visuals (2730)

EV4050: component waveform monitor; ap-





- Free-floating column
- Adjustable counterbalance
- Position readout
- 120 lb. capacity

A E R O P E D



State-of-the-art... portable studio pedestal designed and manufactured by the people who created the first true fluid head over 35 years ago.



O'Connor Engineering Labs
 100 Kalmus Drive • Costa Mesa, CA 92626 • (714) 979-3993
 NAB Booth #3364

Circle (174) on Reply Card

plicable to RGB, Betacam, M-II and other formats; parade, overlay and vector displays.
Circle (730)

Holaday Industries (2737)
Radiation measurement: checks non-ionizing radiation from video display terminals.
Circle (790)

Howe Audio Technologies (2832)
Phase Analyzer: lab test instrument to detect relative phase between two audio input sources; user selected phase compensation may be applied to either channel.
Circle (793)

ITS/Information Transmission (2415)
ITS-300: ICPM measurement system.
Circle (813)

Jensen Tools (2721)
TELVAC: economy tool kits.
23B840: VCR precision alignment kit.
480B230: fiber optic splicing kit.
Circle (818)

Leader Instruments (2763)
LBO-5860B: low cost waveform monitor without line select.
LCG-410: video test signal generator.
LCG-420: additional plug-in modules for video test signal generator.
LCG-409: portable video test signal generator; integral modulator operates from battery

power.
LCD-100: portable DVM/digital storage oscilloscope; battery powered.
LBO-315: portable analog oscilloscope; battery powering.
Circle (845)

Leitch Video (3559)
ITG-3400N: vertical interval test generator, inserter.
SCH-7000: system displays SC/H data, H-phase, color frame and time code framing.
ATG-880: audio tone generator.
Circle (852)

Magni Systems (2827)
Model 2015PL: programmable test signal generator for multiple TV standards; supports PAL.
Circle (866)

Matthey Electronics (3342)
VSA series: low cost video filters.
4.22LC: low cost triple filter; for pre/post digital systems (video frequency, low pass).
Delay line series: 30MHz bandwidth, for HDTV use.
Circle (875)

Modulation Sciences (2811)
ModMinder: TV audio modulation status panel; with wideband TV demodulators for at-a-glance readings of total modulation (metered), peak indicator and subcarrier status.
Circle (897)

PESA America (3417)

ASC-4652B: SWAT Plus; sync watcher, analyzer, timer; H&V blanking, front porch read-outs.
Circle (953)

Philips Test & Measuring (3238)
PM 5661: waveform/vector monitor.
PM 5662: waveform/vector monitor with SC/H phase.
PM 5665: video waveform monitor.
PM 5667: vectorscope.
PM 5668: vectorscope with SC/H phase.
PM 5680: TV IF modulator.
Circle (954)

RAM Broadcast (3028)
Model PS-2000: 3-channel audio phase scope.
Circle (976)

Rohde & Schwarz (3410)
EMF family: synthesized TV demodulators.
VMS 100: video/RF signal quality monitoring system.
LDS-LFM2 ODF: sideband analyzer; selective demod; 60MHz IF.
LSM2: group delay measuring, sweep set.
ODF: digital TV oscilloscope.
Circle (991)

RTS Systems (3566)
Model 927: reference tone generator; for tones on master or duplication tapes; provides discrete tones, white/pink noise, noise reduction tones, stereo channel ID.
Circle (998)

Selco/Sifam (2450)
Components: fuse holders in high and low

Remote Control FREEDOM...

Gentner's VRC-1000™ Remote Control Unit uses inexpensive, readily available dial-up circuits for all types of remote control applications.

- Transmitter - Main/back-up
- ENG
- Satellite
- Machine Control
- STL/Microwave

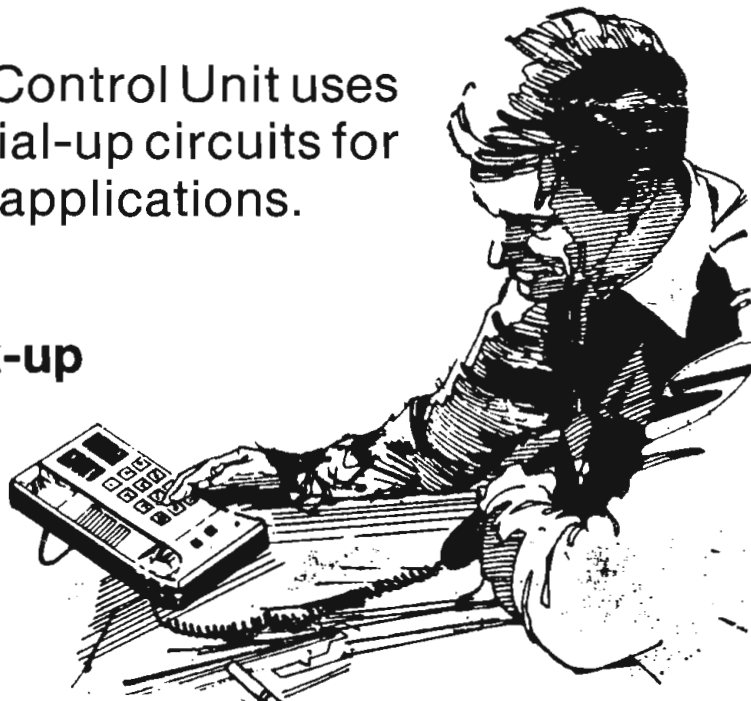

GENTNER
RF PRODUCTS DIVISION

P.O. Box 32550, San Jose, CA 95152 (408) 926-3400
TWX: 510-600-1445 (GENTNER RF PRDT)

NAB BOOTH
#2669

Circle (184) on Reply Card

profile types; knobs.

Circle (1006)

SESCOM (3445)

Model AG-1: rack-mount audio generator.

Model PG-1: rack-mount video pattern generator.

Circle (1008)

H.A. Solutec (2430)

SOL 2221: stereo VU/PPM meter, phase indicator.

Circle (1021)

Sound Technology (3328)

Model 3100A: programmable audio generator.

Model 3200A: programmable transmission/audio analyzer.

Model 1530A: MTS stereo analyzer/monitor.

Model MSAT: multi-channel switching system.

MP510: IBM-PC compatible software for 1500A/1510A test systems.

Circle (1026)

Tektronix (3214)

Model 1705: spectrum monitor.

Model 1735: dual standard spectrum monitor.

Model 1480F30: noise measurement kit.

Automated video measurement equipment.

Circle (1063)

Telemet/Div. of Geotel (3396)

Model 3713: precision demodulator for stereo TV; quad outputs.

Circle (1064)

Television Equipment Associates (3342)

Matthey delays: zero-loss video delay; 10-1830ns; PC board with video amp; fills GVG 3400 frames.

Matthey BRICKWALL: video filters for STL, ENG microwave; flat to 4.2MHz, -40dB at 4.48MHz.

Circle (1070)

Tentel (3326)

T2-H5-UMC: Tentelometer for Panasonic M-II.

T2-H7-UMC: Tentelometer for JVC 850 U-matic.

WS-108: calibration weight set for Tentelometer gauges.

Circle (1075)

Vector Technology (NA)

Model 100: portable phase, current measuring device.

Series 600: toroidal current transformers; -201 0.25V/a, -202 0.5V/a, -203 1V/a, -204 1.5V/a.

Circle (1119)

Videotek (3316)

TVM-620: combination waveform, vector monitor.

VPH-360: SC/H phase indicator.

DM-140S: stereo TV demodulator.

Circle (1129)

Late arrivals

Auditronics (3310)

Series 400 console: production mixer with 12, 18 or 24-input and 4 or 8-output configurations; standard items include 2 aux buses, VCA level control, 16-track monitor, patch-

point switching; EQ available on mono, stereo inputs; optional telephone interface handles two hybrids/lines.

Circle (659)

Concept Production (3334)

Radio formats: available on digital audio tape.

Program controller: computer based system.

Circle (666)

Datacheck (2696)

Series 1200 waveform monitor: puts up to seven NTSC waveform monitors in a single 3.5" rackframe; front panel controls.

Circle (564)

Dwight Cavendish (2662)

QC 10/50: Copymaster automated QC station; checks audio and video quality of recorded videocassettes; allows one operator to check up to 50 cassettes at a time; auto or manual sequencing.

CM500: for large quantity duplication; signal routing of six A/V inputs; remote control; video, stereo audio, waveform and VU monitoring.

Circle (626)

Thomson Electron Tubes/Devices (3422)

TH546 tetrode: Hypervapotron-cooled; 100kW rated for FM service.

TH346 tetrode: Air-cooled; rated 50kW for FM service.

TH3759 TWT: Ku-band, rated 300W; conduction-cooled.

Circle (1082)

Continued on page 359

VID VIDEO

announces ADDRESS TRACK MODIFICATION

- Update all VO-5850, VO-5800, VO-5600, VP-5000 with O-frame offset
- Allows third channel time code capability
- Head switching to 2 1/4 H/V sync
- BVU-800 compatible
- And now also for the VO-6800

SHUTTLE I

- A new remote controller
- Adds shuttle knob to VP-5000 or VO-5600
- Allows same control as VO-5800 or VO-5850
- Variable speed—0 to 5X in forward and reverse
- Great for logging time code numbers
- Control track readout/preroll

SHUTTLE II

- A new interface box
- Allows use of VP-5000 or VO-5600 with: RM-440, ECS-90, ECS-204
- Saves \$2,000 per playback VTR
- Variable speed—0 to 5X in forward and reverse, and bump commands from edit controller

Contact: Russell W. Glenn

Service Manager/Owner

Former Sony Broadcast Instructor

3919A W. Magnolia Blvd., Burbank, CA 91505
(800) 826-2035. In California (818) 845-1515

Circle (176) on Reply Card

WHILE YOU'RE LOOKING AT THIS CHANNEL ...

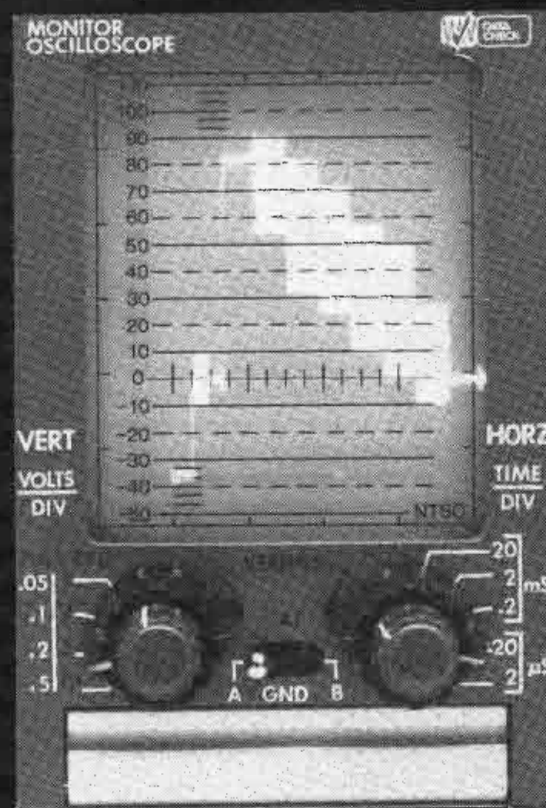



Engineering Conference schedule

From a technical standpoint, the cornerstone of the NAB convention is the annual Engineering Conference, which brings together the top technical experts in the industry. The following summary of technical sessions is presented to aid you in planning your convention activities. The schedule may change between presstime and March 27 (the beginning of the convention), so check your NAB schedule when you get to Dallas to be sure.

Radio sessions

Friday, March 27, 11 a.m.-4 p.m. AM Improvement Session East Ballroom D

- "Modulation, Overmodulation and Occupied Bandwidth," Harrison Klein, Hammett & Edison Consulting Engineers, San Francisco.
- "Broadcast AM Synchronous Transmission," Robert R. Weirather, Harris Corporation, Quincy, IL.
- "The NRSC Voluntary National Standard for AM Pre-emphasis," John Morino, NewCity Communications, Bridgeport, CT, and William Gilbert, Delco Electronics, Kokomo, IN.
- "Methods for Testing AM Overmodulation and Splatter," Leonard R. Kahn, Kahn Communications, Westbury, NY.
- "Broadbanding AM Antennas for

Higher Fidelity and Stereo," Alan W. Parnau, Capital Cities/ABC, New York.

- "Sharing AM Transmitter Sites by Duplicating Antenna Systems," Benjamin F. Dawson III, Hatfield & Dawson Consulting Engineers, Seattle.
- Panel on Implementing the NRSC Pre-emphasis and 10kHz Cutoff Standard.

Saturday, March 28, 9 a.m.-1:30 p.m. Radio Broadcast Engineering East Ballroom D

- "Quantized Amplitude Modulation for AM Transmitters," H. I. Swanson, Harris Corporation, Quincy, IL.
- "Using Helicopters to Evaluate Sources of Re-Radiation From AM Stations," Jeffrey M. Bixby, Moffett, Larson & Johnson Consulting Engineers, Arlington, VA.
- "Protecting a Broadcast Facility from Transient Power Line Disturbances," Jerry Whitaker, **Broadcast Engineering** magazine, Overland Park, KS.
- "An Economical Directional System for AM Stations," Grant W. Bingeman, Continental Electronics, Dallas.
- "Propagation of FM Broadcast Signals Over Water," Lloyd Berg, WDAE-FM, Tampa, FL.
- "Solution to the Network and Antenna Problem Using Microcomputers," Thomas G. Osenkowski, Radio Engineering Consultant, Brookfield, CT.

- "Selection of Optimum FM-SCA Frequencies for Minimum Reception Degradation," James H. Paffenberger, Minnesota Public Radio, St. Paul, MN.
- "An Update on the Status of the Development of the FMX Improved FM Transmission System," Emil Torick, Greenwich, CT.
- "Report on the Formation of the NAB FM Transmission Subcommittee," John Morino, chairman.
- "Highway Information Radio Systems—What They Do, How They Work," Richard H. Crompton, LPB, Frazer, PA.
- "Applying International Broadcast System Automation Techniques to Domestic Stations," Vladimir Nikanorov, Contel Federal Systems, Fairfax, VA.
- "Matching FM Antenna Patterns to the Desired Coverage," George M. Harris and Robert A. Surette, Shively Labs, Bridgton, ME.
- "Understanding the Fundamentals and Operating Characteristics of FM Broadcasting Antennas," Marvin B. Crouch, Tenneplex Systems, Nepean, Ontario, Canada.

Sunday, March 29, 9:30 a.m.-11:30 a.m. Radio Station Maintenance East Ballroom D

- Presentation by Dick Smith, FCC FOB.
- Panel on Radio Station Maintenance

(cart tape, transmitter, digital towers).

Monday, March 30, 9 a.m.-11 a.m.

AM-FM Allocations

East Ballroom D

- "Status of International Broadcast Agreements," William Hassinger, FCC, Washington, DC.
- "Report on FM/Aeronautical Interference Problems and other CCIR Reference Receivers," Ralph H. Justus, NAB, Washington, DC.
- "A Proposal for Increasing Power and Antenna Height of Class A FM Stations," John Furr, Clear Channel Communications, San Antonio, TX.

11 a.m.-12:30 p.m.

Radio Production

East Ballroom D

- "Solving Phase Problems in Stereo Audio Broadcast Facilities," William Laletin, Howe Audio, Boulder, CO.
- "Live-Via-Satellite Remotes for the 15th Anniversary Party at Walt Disney World," Ralph Beaver, WRBQ Radio, Tampa, FL.
- "Multitrack Production Enhances On-Air Image and Quality," Robert M. Smith, WRKO Radio, Boston.

Tuesday, March 31, 9 a.m.-11 a.m.

Radio New Technology

East Ballroom D

- "Automatic Phase Correction for Tape Cartridge Machines," James R. Carpenter, Broadcast Electronics, Quincy, IL.
- "New Generation Audio Routing Switchers Perform Multiple Functions," Dr. Gunther E. Urbanek, Siemens Sound & Studio Systems, Vienna, Austria.
- "Using the New Technologies for Radio News Gathering and Production," Alan W. Clarke, KNUZ/KQUE Radio, Houston.

11 a.m.-12:30 p.m.

The Digital Radio Studio

East Ballroom D

- "Using the R-DAT Digital Recording System in Broadcasting," R. Katsume and Peter Dare, Sony Corporation.
- "Error Correcting System for Digital Audio Recorders," Robert Youngquist, International Tapetronics Corporation/3M, Bloomington, IN.
- "New Concept Audio Console," Jack Connell, Media Touch Systems, Salem, NH.
- "Cost Effective Implementation of Digital Systems in Broadcast Facilities," Skip Pizzi, National Public Radio, Washington, DC.

TV sessions

Friday, March 27, 11 a.m.-2 p.m.

Television Cameras and Recorders

East Ballroom B

- "Adapting the M-II Tape Format for Station Automation Systems," Dr. Peter Smith and Eric Pohl, NBC Television, New York.
- "Solving Type-C VTR Interchange Problems," Larry S. Jefferson, Public Broadcasting Service, Alexandria, VA.
- "Magneto-Optical Disk Video Recorder/Reproducer," Asaka/Shibusuko Corporation, Los Angeles.
- "Solid State Image Sensors for Broadcast Cameras," M. J. H. van de Steeg, Philips Research Labs/Amperex Electronic Corporation, Eindhoven, The Netherlands.
- "User Developed Field Camera Uses Advanced CCD Image Sensor Technology," Hank Griffioen, BTS Broadcast Television Systems, Mahwah, NJ.
- "Integrating Modern Video Cart Machines Into Station Automation Systems," David Lewis, Odetics.
- "CBS Hard News Center Relies on New Video Cart Systems," Rupert L. Stowe, CBS Engineering & Operations, New York.

2 p.m.-5 p.m.

Trends in Television Audio

East Ballroom B

- "Trends in Television Audio—Now and in the Future," Randy Hoffner, NBC Television, New York.

Continued on page 358

The art of shaping sound.

SONEX is a high-performance acoustical foam that upgrades your studio inexpensively.

Ideal for a temporary isolation booth, it can also eliminate slap echo and harsh resonances in the main room or silence noisy tape equipment in the control booth. Write for our color brochure today.

SONEX is manufactured by Illbruck and distributed exclusively to the pro sound market by Alpha Audio.



Alpha Audio

2049 West Broad Street
Richmond, Virginia 23220 (804) 358-3852

Acoustic Products for the Audio Industry

DOES ANOTHER CHANNEL HAVE A PROBLEM?

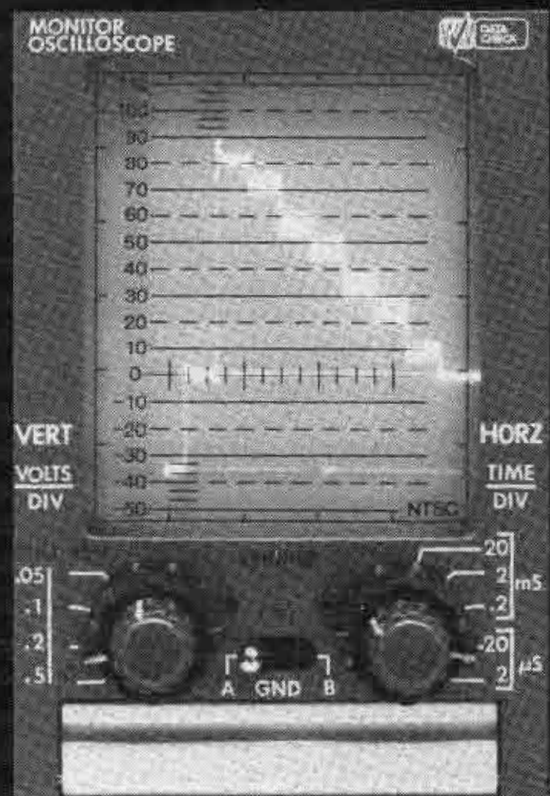

Circle (180) on Reply Card

A design approach to lighting

By Eric Neil Angevine, P.E.

To provide the proper lighting and environment, you'll need a carefully thought-out approach—and a written program.



Control room lighting must illuminate the work surfaces (console) as well as other controls. If a CRT is located within the work area, it must not reflect glare from the lighting source.

Lighting design traditionally has been considered the realm of electrical engineers. Apparently the idea was that because artificial light is produced by electricity, only electrical engineers could produce an acceptable layout. Most electrical engineers, unfortunately, have no formal training in lighting or aesthetic design.

Many architects are comfortable with this arrangement because they, too, lack adequate training in lighting and also have a limited understanding of electricity. In general, architects mistakenly believe that an understanding of electrical principles is essential to good lighting design.

In recent years, some of the best lighting designers have been people who are trained in interior design. These designers are regularly denigrated by architects and engineers alike as "non-professionals." Architects seem to believe that anything related to *design* must be controlled by architects. Many of them view interior designers as decorators, qualified only to select wallcoverings and fabrics.

Engineers usually argue that interior

Angevine, BE's consultant on acoustics, is an associate professor at Oklahoma State University's School of Architecture, Stillwater, OK.

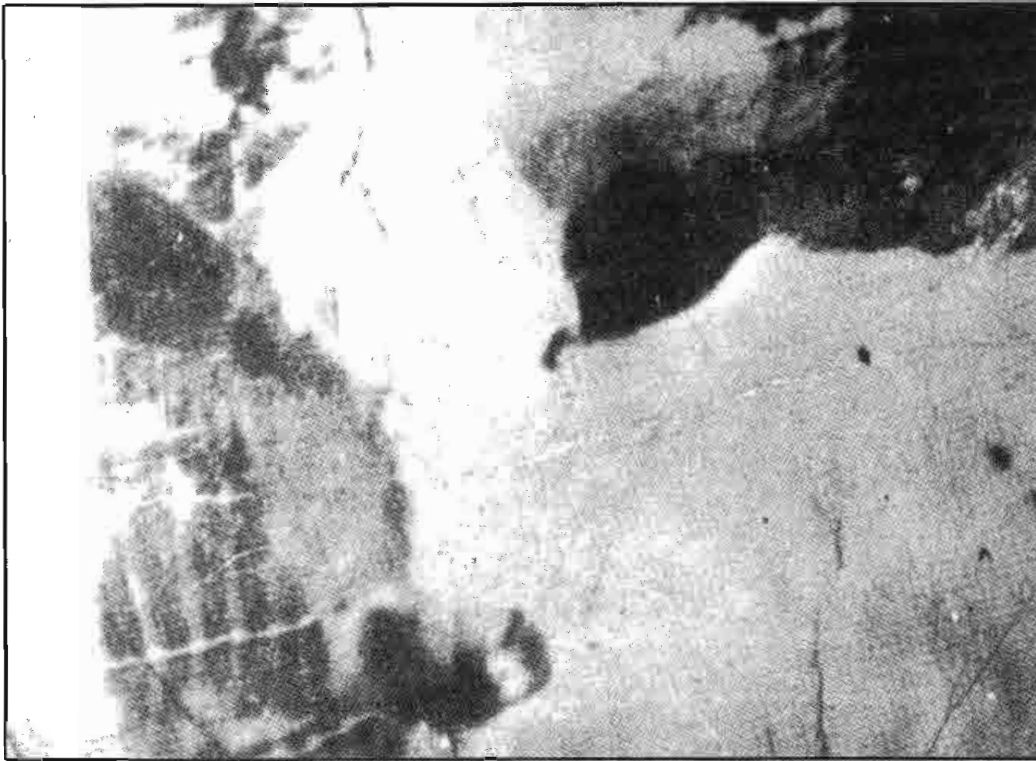

This photograph is confusing because of a lack of adequate contrast between the image and background. Need some help? The picture shows a cow looking directly at the camera.

The engineering approach

Over the years, the Illuminating Engineering Society of North America (IESNA) developed illuminance recommendations for a wide variety of visual tasks. Until 1981, these recommendations were specified by minimum foot-candle (fc) levels on the task at any time. While energy was inexpensive, the minimum levels kept increasing.

The IESNA issued revised recommendations in 1986 that specify three illuminance values for each *illuminance category* or task. The new recommendations allow for some variation in the minimum illuminance. The suggested levels depend upon the occupants' ages, demands for speed and accuracy and the reflectance of the task background. Illuminating engineers also have developed methods of selecting the number and spacing for light fixtures, which will assure that the minimum illuminance is achieved.

Inadequate recommendations

Recently, this system has come under fire. Many experts recognize that the IESNA recommendations can produce lighting environments that fail to provide acceptable or pleasing lighting conditions. Also, they may require the use of

designers are not technically qualified to design lighting systems. They often claim that interior designers produce systems

that fail to provide adequate light or that don't meet some arbitrary criteria that the engineers have developed.

SIERRA VIDEO SYSTEMS

COMPONENT VIDEO



NEW

CIK-1

COMPONENT
(RGB or Y/R-Y/B-Y)

KEYER/MIXER

- KEY SOURCE SELECTOR
- STABLE LINEAR CLOSED LOOP MULTIPLIERS
- WIDEBAND (HDTV OPT.)
- KEY SIGNAL OUTPUT
- RACK OR CONSOLE MOUNT PANELS
- REMOTE KEY GAIN
- GPI INTERFACE

• \$2490.00

ALSO

- ROUTERS
- CONVERTERS
- COLOR BAR GENERATORS
- DISTRIBUTION
- BETACAM™ & MII™ PRODUCTS

P.O. BOX 2462 GRASS VALLEY CA 95945 (916) 273-9331

NOW MONITOR EVERY CHANNEL AT ONCE.



While you're monitoring every channel, you can see costly problems instantly. And react quickly to correct them.

Data Check's Series 1200 NTSC Waveform Display Monitors are so compact, they fit up to seven channels across in a 3-1/2 inch RETMA rack. And all the basic controls are conveniently located on the front panel.

These precision oscilloscopes are government and military proven instruments now available for the television industry.

Yet the price is surprisingly low. Less than \$800.00 a channel. Certainly much less than a single "make good" for a commercial run with a signal problem.

Which of your channels has a problem? Don't be left wondering. For information or to order, contact us today ... and see all your channels at once.



DATA CHECK CORPORATION

9918 Via Pasar • San Diego, CA 92126
(619) 578-0101 • TWX: (910) 335-1596

Circle (179) on Reply Card

Be sure to see us at NAB Booth No. 2696

Circle (183) on Reply Card

far too much expensive energy. Let's examine the major fallacy in the engineering approach to design.

The illuminance recommendations are based upon the supposition that they provide the minimum illuminance level at which the given task can be performed. They further suppose that the task for which the illuminance is selected is both common and could occur anywhere within the space.

Consider the traffic office in a broadcast station. Occasionally, there is a need to quickly and accurately read hard pencil copy on poor quality paper. However, most tasks involve reading typed or printed materials or handwritten ink copy. The minimum illuminance requirement for pencil copy is 200fc. For typed, printed or ink copy, the recommended illuminance level is only 30fc.

Rather than providing the entire office area with 200fc (the engineering approach), it makes more sense to first provide 30fc everywhere. Then, add supplementary task lighting to increase the illuminance to 200fc for those people who might occasionally need it.

Another myth that needs to be dispelled is the belief that low illuminance levels are harmful to the eye. Continuous work with fine detail under any lighting

A sample lighting program

The following is a concise lighting program for the reception/waiting area of a broadcast studio facility.

- **Design objectives:** The reception area is the first point of contact between the public and the studio. As such, it must establish the appropriate mood and project the desired image of the broadcaster. The visitor should feel comfortable and lighting should aid in orientation, circulation and safety. If appropriate, the lighting can emphasize the form or structural design provided by the architect.

- **Orientation/circulation:** Patterns of light should aid in clarifying public circulation routes, while downplaying non-public routes. An accent light on the receptionist will draw the visitor to this desk. Similar accents can be used to identify restrooms, coat rooms and magazine racks.

- **Image:** The station call letters, corporate symbol or logo should be prominently located and illuminated. The careful selection of colors to provide good contrast between task and background is important. If direct illumination is to be used, specular (shiny) surfaces should be avoided.

- **Form and structure:** Where appropriate, lighting should enhance the

room proportions by illuminating the surfaces with the narrowest dimension. Similarly, lighting should emphasize desirable aesthetic features such as structure or texture. Unattractive elements should not be lighted.

- **Reception:** Task lighting may be necessary for the receptionist, depending upon the tasks required at this position. Accent lighting may be sufficient to light the receptionist and provide task lighting.

- **Waiting:** The task of waiting usually gives way to one of reading or relaxing. Both have definite lighting requirements. Good reading light provides light on the lap of the reader. Fixed lighting to accomplish this objective requires fixed seating. Adjustable reading lights seldom work well.

Relaxation requires a visual focus. This can be a work of art, a window, or other visual stimulus. Whatever the focus, it should be appropriately lighted.

- **Safety and security:** Ambient lighting for other purposes should provide adequate light for safety and security. Steps or other changes in grade should be lighted to create shadows on the protruding edges.

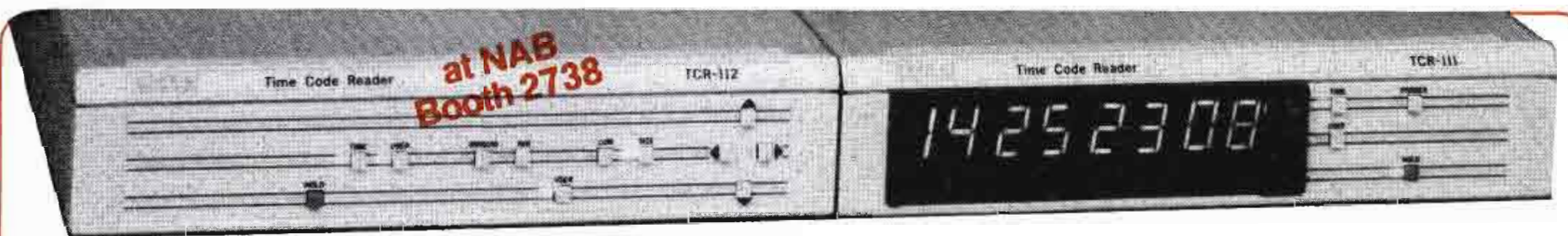

Two new Time Code Readers from skotel

AVAILABLE
...NOW.

All new... from front panels to advanced reader and error checking electronic circuits. Enhanced full reader features and performance... read from 1/40 up to 80X play speed... small, smart packaging designed for desk or rack mount (1/2 rack width).

For all those who told us... "All I want is an LTC reader with a video display for window dubs." **It's the TCR-112 at \$1350.** (F.O.B. Destination)

- Simultaneous display of Time and User bits.
- 4 character heights... highly legible font.
- Positionable over full raster.

For those who say... "I only need an LED display!"

It's the TCR-111 at \$1100. (F.O.B. Destination)

- Large green LEDs for visual comfort.
- Reshaped code output (also TCR-112).
- Dual standard SMPTE/EBU (also TCR-112).

Call or write for name of your nearest dealer and our latest Product Guide.

Skotel... for 10 years a pioneer of VITC, color field ID, User bit and video display applications.

Skotel Corporation, 1445 Boul. Provencher
Brossard, Que., Canada J4W1Z3
(514) 465-8990 In U.S. 1-800-361-4999

Circle (371) on Reply Card

- Audio Follow Video
- Balanced Stereo Audio
- Rack Mount 19" x 1-3/4"
- BNC Connectors - Video
- Multiple Edge-Board Audio Connector
- Centralab Switches - Interlocking
- Bifurcated Silver Contracts
- Legend Strip
- Unswitched Video Terminated - 75 OHMS
- Unswitched Audio Easily Terminated
- No Signal Loss
- No Signal Degradation
- Cross Talk Better Than -60db
- No Power Required
- Simple Construction - Long Life
- Light Weight - Under 5 lbs.



THE IDEAL WAY TO SWITCH MONITOR FEEDS
IN A PROBLEM-FREE, ECONOMICAL MANNER.

10 x 1 PASSIVE SWITCHER

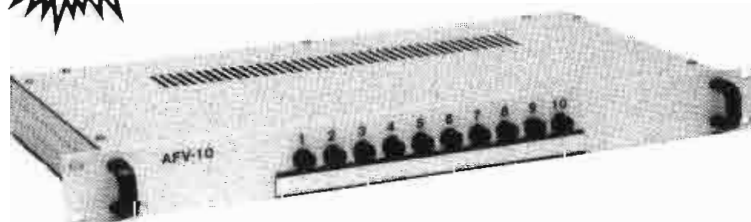

LOW COST
\$295.00

Model AFV - 10

H.M. DYER Electronics, Inc.

48647 Twelve Mile Road Novi, Michigan 48050 (313) 349-7910

Circle (175) on Reply Card

Lighting terminology

- **Diffuse light:** Lighting, on the work surface or on an object, that is not predominantly incident from any particular direction.
- **Direct light:** Luminaire lighting that arrives at a work surface without being reflected by room surfaces; usually refers to light in the downward direction.
- **Footcandle (fc):** The unit of illuminance when the foot is taken as the unit of length; equivalent to 1 lumen/square foot.
- **Footlambert (fL):** The unit of luminance when the foot is the unit of length. Like the footcandle, it is equivalent to 1 lumen/square foot.
- **Glare:** The sensation produced by brightness within the visual field that is sufficiently greater than the luminance to which the eyes are adapted. It causes annoyance, discomfort or loss in visual performance.
- **Grazing light:** Light that strikes a flat surface, making an angle of less than 5° with the surface.
- **Illuminance:** The amount of light incident on any surface (formerly called illumination).
- **Indirect light:** Lighting from a luminaire, which arrives at a work surface after being reflected by room surfaces. Usually refers to light directed upward, reflected from the ceiling.
- **Lumen (lm):** The unit of luminous flux (light). It is sometimes useful to think of light as a steady flow of lumens, as water flows from a hose.
- **Luminaire:** A complete light fixture including a lamp or lamps together with parts designed to distribute the light and to position and protect the lamps.
- **Luminance:** The brightness of an object. Technically, luminance is the amount of light emitted by or reflected from a surface. It may be computed as the product of illuminance and the reflectivity of the surface.
- **Specular surface:** A surface from which light will be reflected such that the angle of reflection equals the angle of incidence; typically a shiny surface.
- **Visual acuity:** Sharpness of vision; measured by the smallest detail that can be seen clearly at a given distance.
- **Visual field:** The locus of objects that can be seen with the head and eyes held fixed.
- **Visual task:** The details and objects that must be seen to perform a given activity.
- **Wall washer:** A luminaire that directly illuminates a vertical surface.

conditions can cause eye strain. However, medical evidence does not suggest that inadequate lighting causes any more damage to the eye than listening to low-level sound does to the ears.¹

The IESNA recommendations also assume that how well a person can see is a function solely of the *quantity* of light upon the task. Although illuminance is one of the factors to be considered when evaluating one's ability to discriminate detail, it is only one factor, and not the most important one. Other considerations are contrast, context and the person's experience and level of concentration.

Contrast and context

Contrast is the relationship between the luminance or brightness of an object and the luminance of its immediate background. Because the human eye can discriminate among objects of different colors with the same *value*, contrast involves not only light and dark, but also color. That is, some colors appear as identical shades of gray when viewed in monochrome.

It should come as no surprise that it is easier to identify objects when they are viewed against a contrasting background. The photo on page 263 shows a familiar subject viewed against a

NEW!

With 300+ Page
Supplement Included



Engineering Handbook

- **Latest edition** of this primary reference for radio and television engineers.
- **Relevant, practical information** on building and operating high quality production and transmission facilities.
- **Available** only from NAB.

Call our Services Department toll-free hotline:
800-368-5644

Winsted®

FREE CATALOG



Winsted Matchmaker Systems

Big, full color catalog includes complete descriptions, pricing and ordering information on:

- Editing Consoles • Video Consoles
- Production Consoles • Dubbing Racks
- Equipment Cabinets • Micro Computer Stations
- Computer Graphic & Newsroom Consoles
- Tape & Film Storage Systems

Winsted Matchmaker Systems... *the Perfect Match*
for all professional Video Equipment

THE WINSTED CORPORATION

9801 James Circle • Minneapolis, MN 55431

Call for your nearest dealer
Phone Toll Free **(800) 447-2257**

TELEX: 510-601-0887

Circle (186) on Reply Card

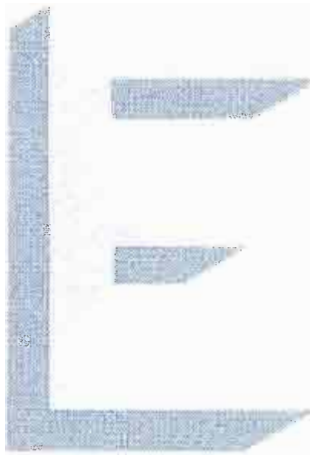

Figure 1. At top, raised letters on a light background illuminated with direct light are more easily identified if they are also light in color, contrasting with their shadow. At bottom, when illuminated with diffuse light, the absence of shadows requires the letters to contrast with the background to be more easily identified.

background that provides little contrast. Do you recognize it?

There are various aspects about the context in which an object is viewed that influence a person's ability to properly identify the object. When the entire context is unfamiliar, it may take the brain some time to identify the object. Even in a familiar context, the brain can be confused by extraneous detail or lack of detail. This is one of the ways in which *quality* lighting can improve visibility.

For example, direct light casts shadows that emphasize detail and texture. Diffuse light blinds and softens shadows. Using direct light to illuminate raised letters on a background of the same color produces shadows that make the letters more visible. The same light can render these letters almost unreadable when the letter and shadows become merged. In diffuse light, raised letters must contrast with

Check these out at NAB!



BOOTH 2730
LOWER LEVEL

- ✓ **ULTRAKEY** - super smooth linear keying
- ✓ **VARICOMB** NTSC decoder
- ✓ **AUTOMATIC** multiple video delay system
- ✓ **VTR** leader clock and slate
- ✓ **COX** 2nd generation encoder
- ✓ **COMPONENT** waveform monitor
- ✓ **CCIR** 601 video A/D - D/A system

- ✓ Plus our full range of component and composite video terminal equipment, delay lines and filters.

broadcast video systems Ltd.

40 West Wilmot Street, Richmond Hill, Ontario L4B 1H8
Telephone: (416) 764-1584 Telex:06-964652

Circle (187) on Reply Card

**THE
PORTA-
BRACE®
GRIP**



*A
remarkably
practical
heavy-duty
production
cart.*



K&H Products, Ltd.
Box 246
North Bennington
Vermont 05257
802-442-8171

Circle (188) on Reply Card

If outside windows exist, carefully consider the effect sunlight may have on the room. At night, that light will not be available.

the background, because shadows will not reinforce their shape. (See Figure 1.)

The shadows created by direct lighting can produce confusion when a complex object, such as a wire sculpture, is viewed. Direct lighting also can emphasize unwanted detail, such as flaws in a plaster wall.

Experience and attention

The observer's personal experience and concentration play equally important roles in determining visibility. An object that does not draw the observer's attention will make little, if any, impression on the conscious mind. In fact, if there are other objects in the visual field that create more of a focus, the desired task may go unnoticed. This aspect is particularly important when designing and locating directional signs.

It is not surprising that unfamiliar objects or tasks are not so easily identified. The more familiar an observer is with a particular object or task, the shorter the time required to identify it. In reality, the brain identifies most words on sight. Unfamiliar words must be broken into syllables or individual letters to be interpreted. For this reason, familiar tasks can be performed under poorer lighting conditions. Unfamiliar tasks require the highest illuminance and best-quality lighting.

Visibility

Visibility does not increase in direct proportion to the luminance level. Rather, it can be shown that visual acuity is 57% of maximum when the task luminance is only 1 footlambert (fL). When the task luminance is increased to 10fL, visual acuity increases to 78% of maximum. Where visibility is limited by contrast, rather than optical size of the task, acuity is 65% of maximum at 1fL and 87% of maximum at 10fL. Further increases in task brightness provide smaller and smaller increases in visual acuity.²

Increasing the optical size of an object can increase visibility. This crucial concept is regularly employed in television and film. When greater detail is needed, the object is enlarged by "zooming in." When you have trouble discerning a picture or other printed task, you move it closer to your eyes. (How many of you moved the magazine closer to your eyes



CUT TRANSMITTER CONTROL COSTS

MONROE
DTMF
Remote
Controls



Take advantage of recent rule changes. MONROE DTMF Remote Controls give you full-featured transmitter monitoring and control using inexpensive dial-up telephone lines, eliminating dedicated lines.

Now Available:

- MODEL 6005 controls 8 outputs, monitors 8 inputs — automatically detects faults, originates DTMF alarm reports via 2-wire port or dial-up phone line. Options include 12 event/wk real time control, analog alarm card.
- MODEL 5001 detects faults, originates alarm reports in DTMF tones or **synthesized speech** via 2-wire, 4-wire or dial-up phone line. Big 16 input, 16 output capacity.
- CENTRAL CONTROLLER communications interface/phone coupler links your PC with up to 100 control sites. Software supports plain-English status displays, readouts in engineering units, keyboard interrogation and control, file sorting, more.

RAM BROADCASTING SYSTEMS, INC.

249 North Eric Drive, Palatine IL 60067

[312] 358-3330

Distributors of MONROE ELECTRONICS, INC. Broadcast Products

See Us at NAB Booth #3028

Circle (189) on Reply Card

**Use our
bright,
based LEDs
and don't
change bulbs
again for
the next
12 years.**

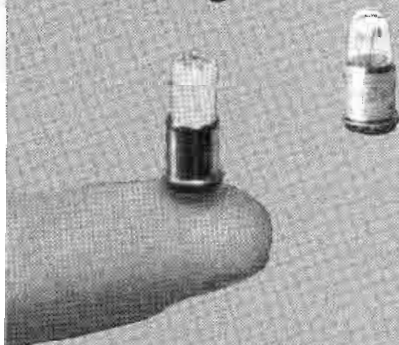

Relamp your incandescent sockets. Our based multi LED miniature lamps are exact replacements for T 1 $\frac{3}{4}$ and T 3 $\frac{1}{4}$ incandescent miniature lamps. Shock and vibration proof, they keep your lighted panel and switches going "on" for 100,000 hours.

- T 1 $\frac{3}{4}$ Bases: Midget Flange, Midget Groove, Wedge, Bi Pin, Telephone T5.5 & T5.5K.
- T 3 $\frac{1}{4}$ Bases: Miniature Screw, Miniature Bayonet, Candelabra Screw.
- 4, 5/6, 12/14, 24/28, 48 volts.
- Red, yellow & green colors.
- Bright and Super Bright 4 and 6 chip based LEDs.
- Low power & heat consumption.
- Shock & vibration proof.

Inquire for data sheet, pricing, samples, plus our new comprehensive lamp wall chart.

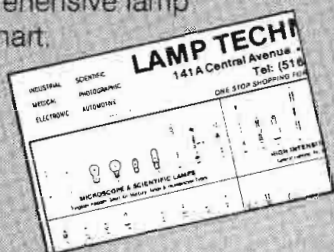

**LAMP
TECHNOLOGY INC.**
141A Central Avenue
Farmingdale, NY 11735
(516) 454-6464

Circle (190) on Reply Card



Using a wall washer fixture may prevent glare from large windows while providing even room illumination.

to examine the photograph of the cow?) Yet, this concept is commonly ignored by engineers, architects and building owners. They often try to solve this problem by increasing illuminance.

Put simply, it is easier to increase visibility by enlarging the task or moving it closer to the observer, than by increasing the lighting. Because an object's visual size is inversely proportional to the square of the viewing distance (inverse square law), a reduction in the viewing distance of only 25% can increase visibility by the same amount as a 100-fold increase in illuminance.³

The design approach

The design approach is a method of designing lighting environments to address the many needs of building users. The process also addresses the aspects of lighting quality. Although the design approach is commonly used in TV studios and sound stages, the procedure usually is completed by trial and error or past experience, not by design intent.

The favorable experiences in these environments led to the development of track lighting systems for other types of spaces. Some of the best lighting environments do use track lighting. However, this should not imply that track lighting is inherently good. In fact, unless the use of a space requires flexibility and frequent change in lighting, track lighting is both a waste of money and an aesthetic blunder. Although track lighting can be used to find the best lighting design by trial and error, the procedure discussed in this article can produce the same results.

The design approach is simple, but hinges on one important point that must be kept in mind at all times. People do not see *light*; they see only brightness (luminance). Recall that in a movie theater, the image is created on the screen by light. Yet, the light source is at the opposite end of the auditorium.

Unless the air is filled with dust or smoke, the beam of light is invisible. Thus, light does not become visible until it strikes something.

The key to good lighting is to identify the surfaces that must be illuminated to provide adequate light for all of the tasks and visual objectives within a space. Note that this goal does not necessarily require direct task illumination.

Develop a program

It is necessary to first establish the visual objectives before commencing any lighting design. However, the visual objectives for any space include far more than just identifying the primary task, as is done in the engineering approach.

First, all of the visual tasks within a space should be identified. In addition to the primary task, there are numerous others, such as circulation, orientation, safety and security. Other visual objectives might include establishing a mood or image. Lighting also can be used to reinforce or enhance form or structure.

Once the tasks and objectives have been determined, a written program statement should be created, outlining all of the goals for the lighting design. Although architects are familiar with the concept of programming for a project, they seldom incorporate lighting into their programs. A lighting scheme for a broadcast facility reception/waiting area is outlined in the related article, "A Sample Lighting Program," page 264.

From the program, it is possible to establish what surfaces should be lighted. It is usually not necessary to light all of the major task surfaces. Providing appropriate illumination of vertical surfaces and ceilings, plus the necessary spot illumination and accent lighting, is usually sufficient for major tasks.

Once the program is complete and the surfaces to be illuminated have been determined, it is a simple matter to select appropriate light fixtures and fixture



“Our Klystrons have tested tough in the field and proven to lower operating costs”

Rugged Amperex klystrons get you on the air, and keep you on longer, at a lower cost. Amperex UHF klystrons are built with more than three decades of design, production and proven field experience that broadcasters have come to rely on.

Performance data shows that our unique alumina ceramic-to-metal construction adds significantly to the life of our tubes. Actual station records show Amperex klystrons having average operating lifetimes exceeding 32,000 hours and peak lifetimes in excess of 80,000 hours.

Amperex klystrons reduce your operating costs. The advanced, low voltage, Annular Beam Control design allows you to operate with efficiencies in excess of 65%. Cooling costs are also reduced by giving you a choice of a highly effective vapor cooling, vapor condensation or water cooling system.

By using an innovative external cavity design there is at least a 40% savings in tube replacement cost, com-

pared to internal cavity klystrons, since only the tube is replaced.

With Amperex klystrons you select tubes with output power up to 64kW. Any one tube can cover the entire UHF range of 470MHz to 860MHz.

When you want the “tough tubes”, choose the Amperex klystrons with proven “on-the-air” performance.

Ask about our new YK1270 air cooled klystron with an output power of 16.5 kW vision or 11 kW combined.

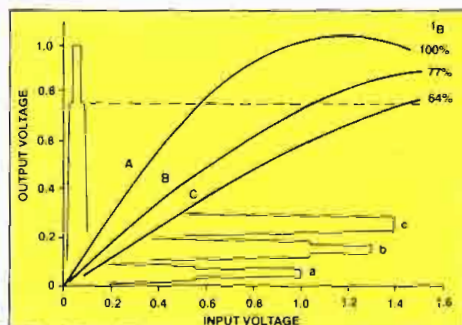

KLYSTRON OUTPUT VOLTAGE VERSUS INPUT VOLTAGE (RELATIVE VALUES)

800-227-1613

Thinking of new installations, retrofiting, improving on-the-air performance or reducing operating costs? Call Peter Fochi at the above toll free number for complete information.

Amperex® Electronic Corporation

A NORTH AMERICAN PHILIPS COMPANY

230 Duffy Avenue, Hicksville, NY 11802

Phone: 516/931-6200 TWX: 510/221-1839 WATTS: 1-800-227-1613

Circle (191) on Reply Card



Reflected light from light-colored walls provides even illumination in this work area.

locations. Then, if necessary, the project can be turned over to an electrical engineer to produce the wiring layout.

It is essential that the lighting program be created early in the design process. Decisions based on lighting needs can impact the project's architectural design. Far too often the lighting isn't even considered until the architectural design is nearly complete. At that point, it may not be possible to accommodate even minor changes that could significantly

improve the lighting design.

Form and structure

The lighting can and should enhance room proportions by illuminating the surfaces in the narrower dimensions. Thus, narrow corridors can be made to appear wider by lighting the walls. Low ceilings will appear higher if light is applied directly to them.

Lighting can emphasize structure, if desired. If unattractive structural or

mechanical elements are exposed, care must be taken not to illuminate them. In addition, any unattractive elements should be painted or finished to provide the least contrast with their visual background.

Grazing light will emphasize texture, whether desired or not. Lighting a brick wall or fireplace with grazing light can emphasize an irregular brick pattern. The same light on a flat wall also will emphasize any flaw or irregularity. Wall washers for textured surfaces should, therefore, be kept close to the wall, while those for flat surfaces should be spaced away from the wall.

Windows and daylighting

Daylighting means far more than including windows in a building. Although daylighting design is beyond the scope of this article, two points should be made regarding the impact of windows on other aspects of building design:

Windows transmit an image only when the object viewed through the window has a luminance (brightness) at least as great as the background luminance on the viewer's side of the window. This causes two problems at night. Windows without drapes or blinds often appear to be black holes that reflect interior im-

HERE'S ALL YOU NEED TO USE OUR COUPLERS

It's easy to put your audio on the phone with Comrex[®] broadcast couplers. Just plug in the standard connectors and you're ready to go.

Two models are available. The Comrex TCB-2A auto-answer coupler makes "listen lines" a snap. The TCB-1A manual coupler lets you send or receive program without interfering with normal phone use.

Built specifically for broadcast, both are FCC registered. And both provide clean audio and the dependability you expect from Comrex.

Comrex also makes frequency extenders to turn raw dial lines into broadcast quality. For more information on any Comrex product, call toll-free 1-800-237-1776. Or write Comrex Corporation, 65 Nonset Path, Acton, MA 01720. Tel. (617) 263-1800. TWX 710-347-1049.

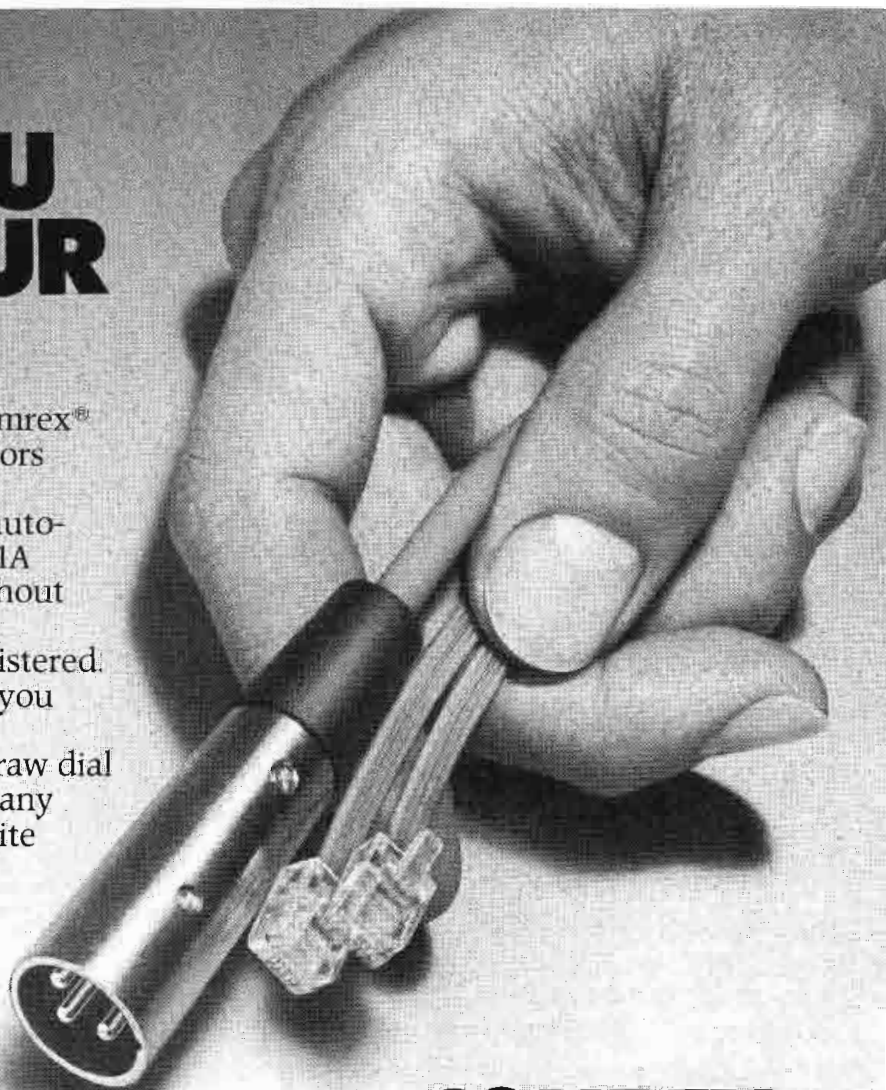

COMREX



Circle (17) on Reply Card

ages. To allow an exterior image to be seen from within, a few exterior objects must be lighted. General exterior illumination such as streetlighting is insufficient. A single lighted tree or sculpture usually will create the desired effect by providing viewers with a subject. Exterior illumination of objects or the building facade also can improve a building's appearance at night.

Some consideration also should be given to how the building will appear when interior lighting is on. Everyone has seen bad examples, particularly of office buildings, where nighttime lighting destroys the building's otherwise attractive appearance.

Safety and security

General illumination usually is sufficient for building security during the day. However, adequate security lighting is needed when the building is unoccupied. This needs to be accomplished without leaving on all of the building lights.

Lighting plays a major role in human safety concerns by identifying changes in elevation or corners and obstacles. Direct lighting produces shadows that make steps and corners obvious. Diffuse light can nearly eliminate these shadows and therefore obscure corners and grade changes.

To emphasize steps and corners, direct lighting should be applied to only one side of the corner. Stairs should be lighted from the top, to ensure that shadows are created to identify the edge. It also is helpful to paint the two sides of a corner in contrasting colors. The step treads and risers in a stairway can be finished in contrasting colors. Lighting step risers with small lamps located under the nosing of each tread also may help.

Results

Getting the light where it is needed is the most important goal. Far too many buildings use direct lighting from recessed or surface-mounted ceiling fixtures. Too often the result is a well-lighted floor and little else. This technique works in some offices, but fails miserably in other areas.

The importance of wall and ceiling illumination cannot be stressed enough. The brightness of these surfaces is what makes a room come alive. Concealed light sources also improve the environment. Because the eye is not confused by the brightness of the luminaire, the ceilings and walls appear brighter.

For many visual tasks, the ambient light reflected from walls and ceilings provides all the illuminance that is necessary. This usually is true for circulation, conversation and security lighting.

Other tasks may require directed-supplemental lighting. Seldom, if ever, should task-specific lighting be applied universally throughout a space.

When selecting lighting for any space or purpose, first decide what object or surface needs to be lighted. The cardinal rule is: Don't install lighting unless it is designed to light specific objects or surfaces. A second rule is: Put your lighting program in written form. This will help you and the architect meet your building's lighting needs.

Bibliography

1. Lam, W.M.C. "Perception and Lighting as Form-givers for Architecture." McGraw Hill, 1977, p. 76.
2. Ibid. p. 62.
3. Ibid. p. 63.

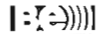

1987 NAB Convention BOOTH 2658



TOTALLY
SOLID STATE

AMPFET

SERIES

MODULAR

ALL POWERS

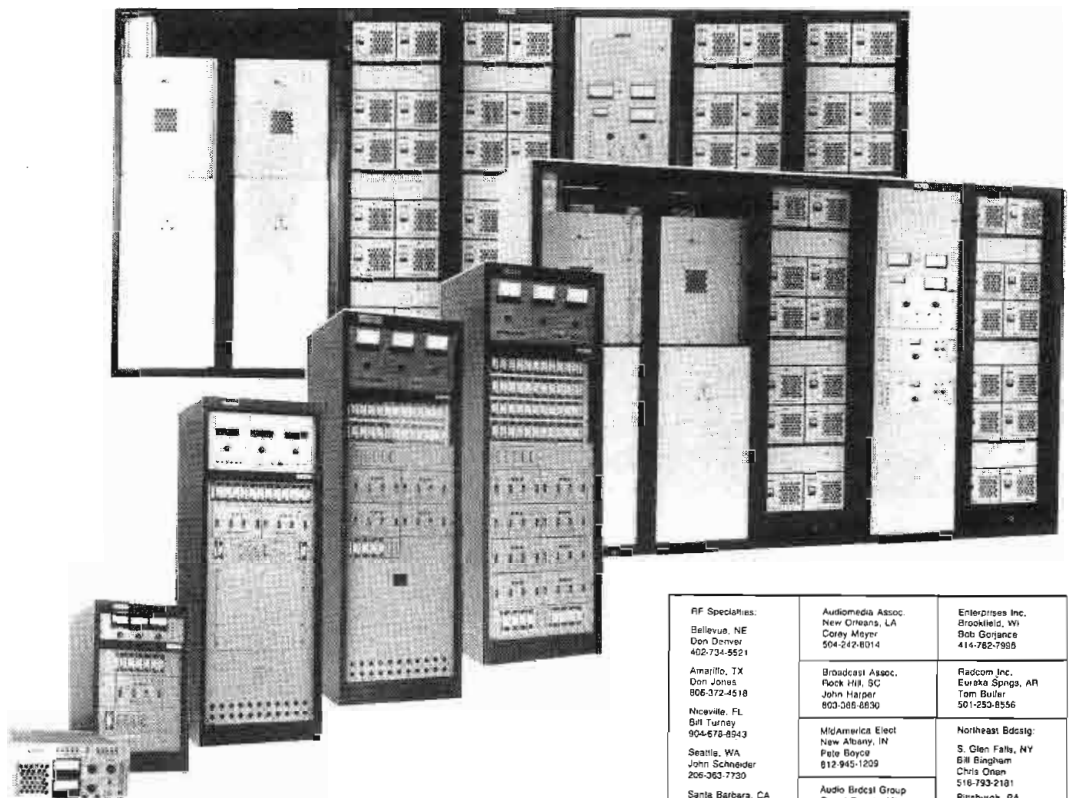

RF Specialists: Bellevue, NE Don Driver 402-734-5521	Audiomedia Assoc. New Orleans, LA Corey Meyer 504-242-8014	Enterprise Inc. Brookfield, WI Bob Gorzance 414-782-7989
Amarillo, TX Don Jones 806-372-4518	Broadcast Assoc. Rock Hill, SC John Harper 803-265-8530	Radcom Inc. Eureka Spings, AR Tom Butler 501-253-8556
Nowville, FL Bill Turvey 904-678-8543	MidAmerica Elect New Albany, IN Felix Boyce 812-945-1209	Northeast Bdstg: S. Glen Falls, NY Bill Bingham Chris Olson 516-793-2181
Seattle, WA John Schneider 206-263-7750	Audio Broadcast Group Grand Rapids, MI Dave Veldkamp 616-452-1596	Pittsburgh, PA Tom Monahan 412-733-1994
Santa Barbara, CA Sam Lane 805-682-9420		

totally solid state AM



NAUTEL
201 Target Industrial Circle
Bangor, Maine 04401
207-947-8200

Telex 944466

Jorgen Jensen
902-823-2233



Circle (192) on Reply Card

Audio equalization for cartridge recording

By Douglas W. Fearn

**Equalizing music before recording it onto cart
may improve your station's sound.**

On-air audio quality can often be improved through careful, customized equalization applied when the material is transferred to tape cartridge. Modifying the frequency content of the source

Fearn is chief engineer for WKSZ-FM, Media, PA.

material might be desirable for several reasons:

- To correct frequency-response deficiencies in the source material;
- To correct turntable and/or tape cartridge machine frequency-response deficiencies;

•To provide a consistent sound for the air product; and

- To reduce the amount of audio processing required.

At WKSZ-FM, equalization is used during the transfer of music from disc to cartridge for all four reasons. Equalization is sometimes used in commercial production as well, although this is generally for corrective reasons. Our station plays music from 30 years ago as well as current records. Although recording technology has changed considerably over this period, the biggest difference in sound is due more to changes in recording style, rather than technological improvements. Recording techniques in recent years tend to result in greater presence (through close microphone placement); brighter equalization (high-frequency boost); and use of more signal processing, such as limiting and digital effects (short delays and reverberation).

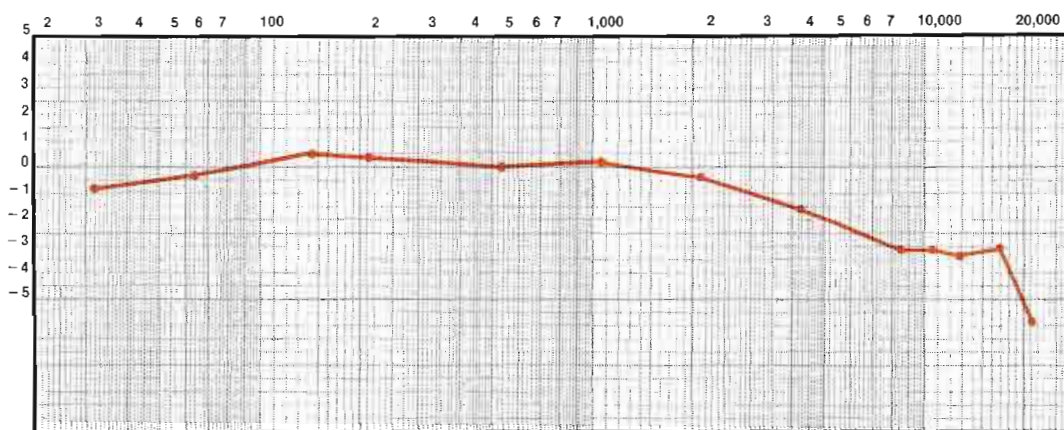

Figure 1. Typical phono cartridge/test record frequency response.

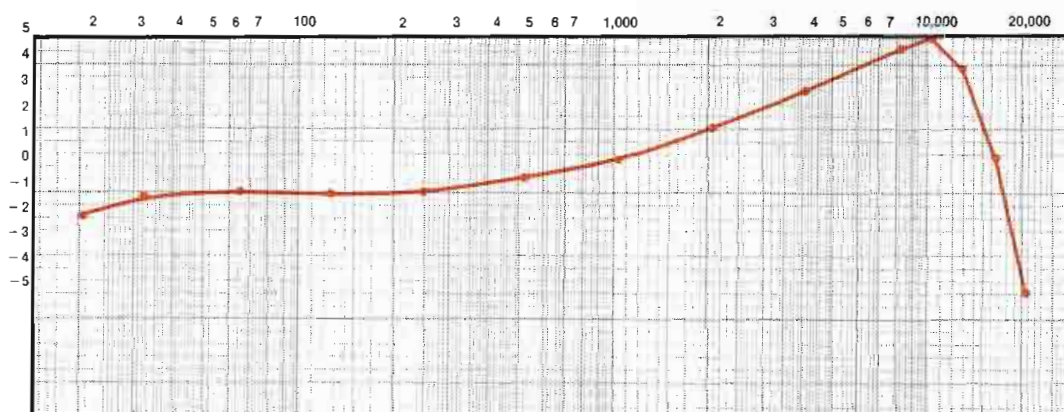

Figure 2. Equalization curve used in disc-to-cart music transfer.

Equalizing older recordings

Equalization can only partially make older recordings sound like modern records. However, special equipment that provides processing beyond simple EQ modification is usually not available in most broadcast production rooms. And, it is probably just as well to leave most of the original character of the recording intact. Too much modification could make an old classic unrecognizable, or at least make the listener uncomfortable. The goal in equalizing this material is to improve overall sound consistency while retaining the original flavor.

Older records often can be equalized to give them a more current sound. A broad shelving-type boost starting at about 4kHz often is effective. Most older recordings can be boosted 3dB to 4dB in this range with minimal side effects. Many records, especially if they are old, worn pressings, cannot tolerate much high-frequency boost before surface noise and tape hiss (from the master tape) become objectionable.

A low-pass filter is necessary in most cases to minimize high-frequency noise. The filter might be adjusted to -3dB at 5kHz in some cases. However, a similar reduction in the 7.5kHz to 10kHz range is more typical. My favorite equalizer has high- and low-pass filters with adjustable slope and frequency, providing a maximum cut of 24dB per octave. Experimentation is necessary to determine the best compromise setting, but I usually find the steeper slopes are best for maintaining brightness while minimizing noise. Even if the resulting frequency-response curves are similar, two equalizers of different design probably will sound different. I suspect this is due to phase shifts in the equalizer circuitry.

High-pass filtering is usually desirable. This filtering eliminates much of the

rumble (which may have been produced by the mastering disc lathe on records made in the pre-stereo days) and other low-frequency noise.

Rolling off the top and bottom octaves of most records, even modern ones, does little harm to the on-air sound. This practice may not be applicable to all station formats, however. Purists may shudder at such a thought, but the illusion of brightness and fullness can be maintained in other ways. A presence boost starting at about 3kHz or 4kHz, coupled with a sharp rolloff at 10kHz will still provide a bright and clean sound. A 24dB-per-octave rolloff at 80Hz or even 100Hz eliminates a lot of energy that is not necessary for many station formats. A broad 1dB or 2dB midrange cut restores the feeling of bass.

In addition to "cleaning up" the audio, such rolloffs also can increase transparency because the station's audio processing does not have to work as hard. The amplitude of frequencies below 80Hz can be significant, particularly on some modern records. The equalization used in the original recording may produce tremendous low-frequency content. This material causes the station limiters to work harder than necessary. The

same problem applies to high-frequency boost, which is particularly troublesome for FM stations, because of the pre-emphasis.

Turntable response deficiencies

The phono cartridges used in most broadcast stations do not have a perfectly flat frequency response. The response may have been compromised somewhat in favor of the mechanical ruggedness needed in the broadcast environment. Figure 1 shows the frequency response of a typical broadcast turntable while playing a standard test record. Although the low- and midrange response is good, the high end is down 3.5dB at 12.5kHz. Although this response is not the best that can be achieved, it is typical of radio station turntables in daily use.

The equalization curve, shown in Figure 2, is representative of what I frequently use in transferring modern disc recordings to tape cartridge. The curve exhibits some low-end rolloff, but the most significant feature is the broad, rising response, which peaks at 10kHz and then rapidly falls off.

The combined disc and equalizer frequency response is shown in Figure 3. This curve represents what you would

MURPHY'S LAW REPEALED

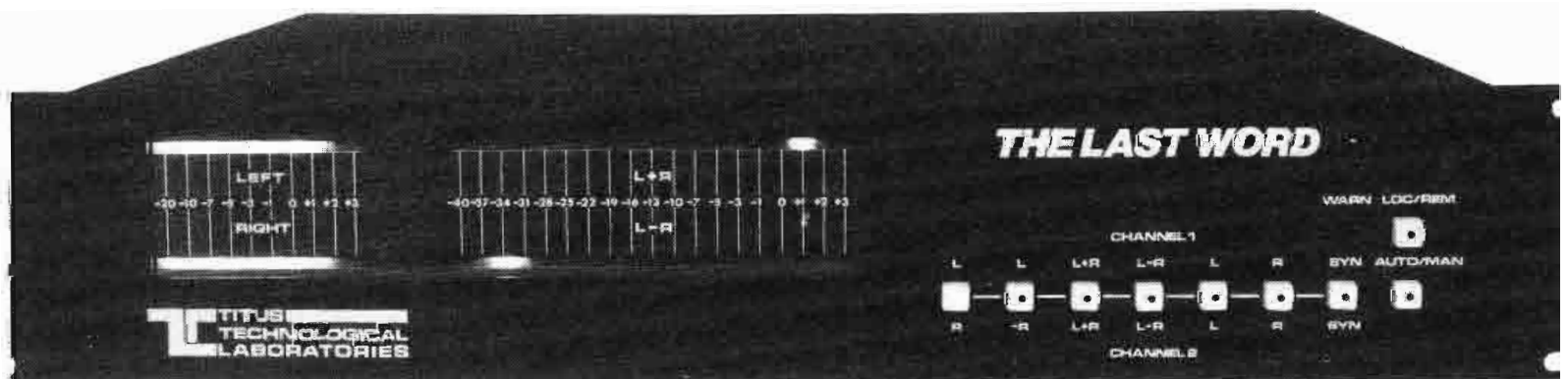

**DID THE STEREO NETWORK FEED DROP A CHANNEL ON YOU LAST NIGHT?
DID YOUR VTR OPERATOR FORGET TO SWITCH TO MONO FOR THAT ONE CHANNEL TAPE?
WAS THE AUDIO ON THAT STEREO SYNDICATED SHOW OUT OF PHASE?
WORRIED ABOUT CONVERTING TO TELEVISION STEREO?
WE'VE GOT YOU COVERED!**

Titus Technological Laboratories' **THE LAST WORD** handles these and a multitude of other problems with the speed and accuracy that can only be found in a microprocessor based automatic audio correction and routing device.

THE LAST WORD detects loss of a channel and automatically inserts the channel with audio into both outputs—with no loss of level.

THE LAST WORD detects polarity reversal and automatically corrects the problem.

THE LAST WORD will insert an alternate air chain, external stereo synthesizer, or internal stereo synthesizer into the air chain either automatically upon loss of channel, monaural source detection, or "FORCED" mode.

THE LAST WORD provides: FULL METERING of the Left, Right, Left plus Right, and Left minus Right channels; MANUAL CONTROL over the audio source (including reproducing stereo source, producing an out-of-phase stereo source, producing the sum of inputs, producing the difference between inputs on the outputs, producing the Left channel into both outputs, producing the Right channel into both outputs, and bringing

up the external/internal stereo synthesizer); ALARMS on loss of channel, polarity reversal, "SYN" on line; MONITOR OUTPUTS for Left, Right, L + R, L - R channels; CONTINUOUS AUDIO OUTPUT on "SYN" output for mono exciter feed, stereo synthesizer feed, or SAP "keep alive".

FEATURES:

- Three modes of operation: Automatic, Manual, Forced • True instrumentation amplifier inputs, balanced, high-Z or 600 ohm (switchable) • Full metering of Left, Right, L + R, L - R
- Microprocessor controlled audio routing and VCA control for precise and inaudible audio corrections • XLR type input and output connections • Power loss/audio bypass relay • External or internal stereo synthesizer • All outputs -active, X-balanced, D.C. isolated • Unity gain—can be inserted anywhere in audio chain • Optional Howe Audio PHASE CHASER™ for automatic audio TBC

DON'T JUST WATCH YOUR PROBLEMS ... LET THE LAST WORD FIX THEM

LIST PRICE \$2,975.00

Howe Phase Chaser™ option \$910.00

TITUS TECHNOLOGICAL LABORATORIES

1134 NEIPSIC RD., GLASTONBURY, CT 06033 (203) 633-5472

Circle (193) on Reply Card

hear in the monitor speakers while equalizing the record. For my taste, the slight depression of the lower middle frequencies (200Hz to 600Hz) improves the clarity, especially of vocals. Little equalization is required to achieve this, but the equalizer must be low-Q to be effective. It's been my experience that the lowest Q setting on many parametric equalizers is still too sharp to work properly in this application.

Here are three equalization rules that seem to generally hold true:

- Set the left and right channel

equalizer controls to the same positions.

- It is usually preferable to attenuate rather than boost, whenever possible. Attenuation is less obvious and doing so does not decrease the available headroom.

- Broad (low-Q) curves are preferable when equalizing music from records.

Cartridge machine deficiencies

Even the best tape cartridge machines do not provide a perfectly flat frequency-response curve. The record/play response of a typical cartridge machine is

shown in Figure 4. Many machines show a low-frequency bump in response at about 150Hz. The dip in response from 2kHz to 10kHz could be improved with additional boost from the machine's high-frequency equalization control. However, that would further increase the rise at 16kHz.

Resultant response

The resulting frequency-response curve, from disc through the equalizer to cartridge playback, is shown in Figure 5. The low end rolls off gradually below 100Hz. There is a slight dip in the 100Hz to 600Hz midrange with a rising response peaking at 10kHz. The frequency response rapidly rolls off thereafter.

Any equalization is highly subjective and not everyone will find this response curve ideal. I use the recording studio environment as my reference. To my ear, this type of equalization reproduces on the radio the sound I am accustomed to hearing in the recording studio control room. It's also been my observation that most recording studios turn out products that are amazingly consistent with the style of recording that is currently popular. So, with some exceptions, a curve such as this one is applicable to most contemporary records. It is mostly corrective equalization. The goal is to restore flat response for the listener, with lows and highs attenuated, to lessen audio processing.

Although the curve shown is typical, it is by no means ideal for all records. Significant departures from this curve are commonplace at WKSZ-FM. Some records need little modification, except for some rolloff at the low and high ends. Other records require cascaded equalizers to produce the sound needed.

Your goal may not be to reproduce the sound that was heard in the recording studio, however. Some stations may want to equalize for greater brightness, for more low-frequency content, or perhaps both. Equalization also might be used to give a station an identifiable *sound*, to differentiate it from others in the market.

The first step is to decide what the goal of the equalization is to be. Then, have only one person record all the cartridges with this sound in mind.

The production studio is just one link in the chain from disc to listener. Achieving the desired on-air sound may require additional manipulation in the cartridge recording process to compensate for other modifications that occur in the audio chain. The recordist will have to form an aural memory of how the material must sound in the production studio in order to produce the desired air sound. When used carefully, equalization can be a powerful tool for improving broadcast audio quality. **!:-:~)))))**

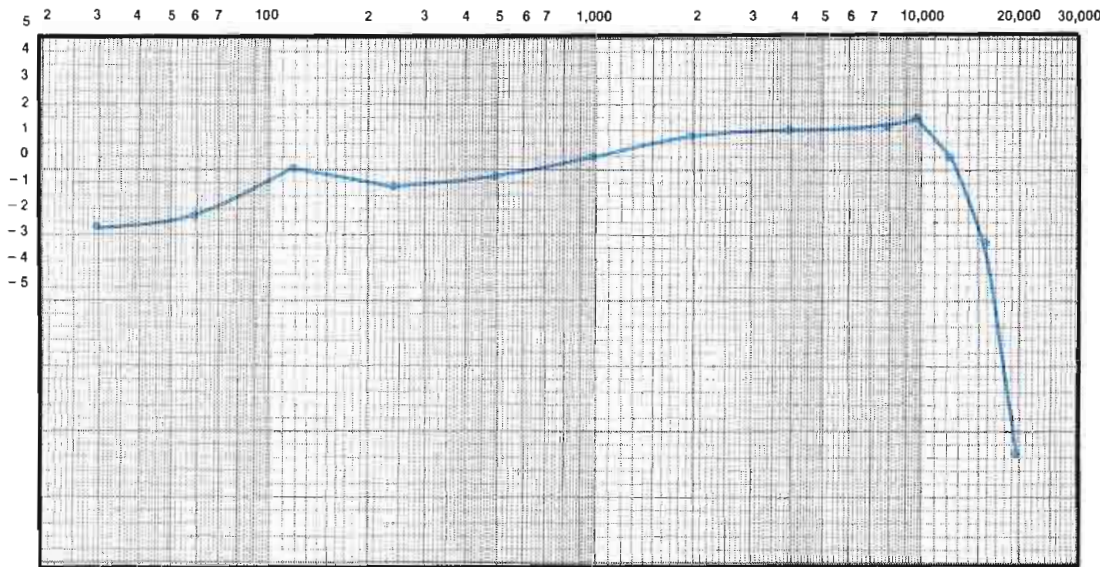

Figure 3. Resulting frequency response measured through the phono cartridge and music equalizer.

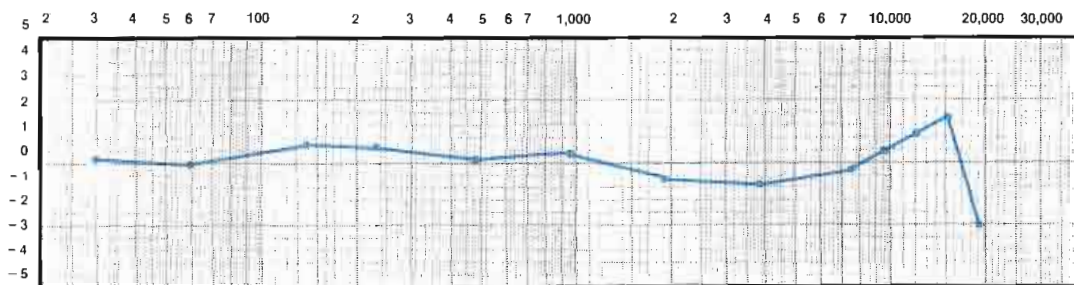

Figure 4. Typical cartridge machine record/play frequency response.

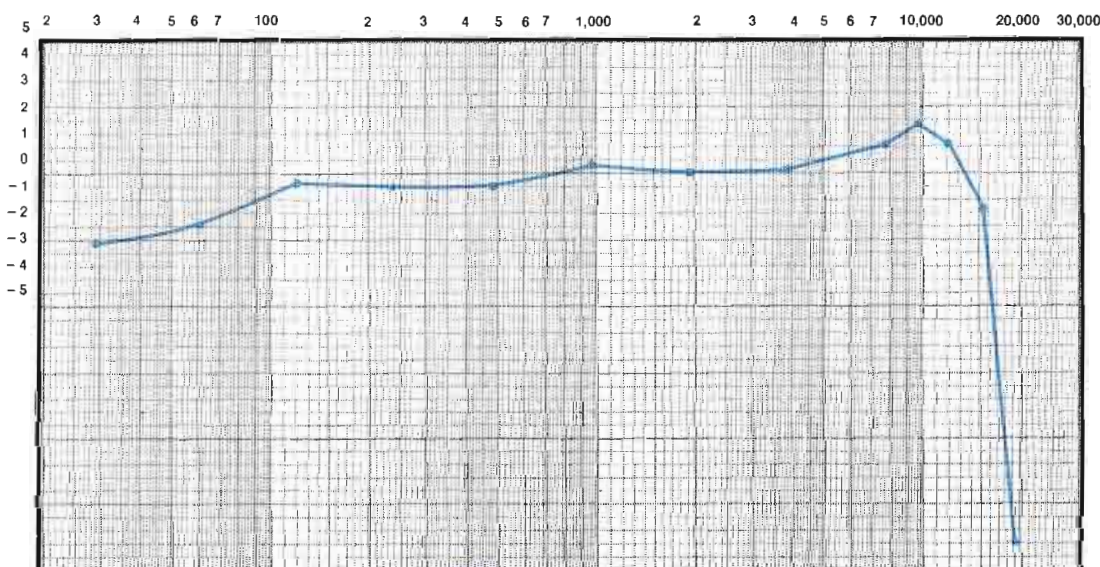

Figure 5. Resulting frequency response measured from phono cartridge through the equalizer and cartridge machine playback.

JANUARY 29th, 1987 . . . TOWNSEND ASSOCIATES, INC. OF WESTFIELD, MASSACHUSETTS ACQUIRED BROADCAST SYSTEMS, INC. OF AUSTIN, TEXAS.

TOWNSEND, A LEADING MANUFACTURER OF TELEVISION TRANSMITTERS, PURCHASED BROADCAST SYSTEMS, A MANUFACTURER OF TELEVISION STUDIO EQUIPMENT AND INTEGRATOR OF COMPLETE TELEVISION SYSTEMS, TO FORM TOWNSEND BROADCAST SYSTEMS.

TOWNSEND BROADCAST SYSTEMS' EXPANDED RESOURCES OF SALES, ENGINEERING, AND MANUFACTURING PROFESSIONALS CAN NOW SUPPLY THE ENTIRE EQUIPMENT NEEDS OF ANY TV STATION.

CALL THE PROFESSIONALS . . . TOWNSEND BROADCAST SYSTEMS . . . THE SINGLE SOURCE OF SUPPLY TO THE TELEVISION BROADCASTER, WHETHER HIGH OR LOW POWER, VIDEO OR RF, STUDIO OR TRANSMITTER, VHF OR UHF

TOWNSEND BROADCAST SYSTEMS

. . . AMERICAN QUALITY - SUPPORTED WITH PARTS AND SERVICE

TOWNSEND

BROADCAST SYSTEMS INC.

79 Mainline Dr., Westfield, MA 01085 • Tel. 413-568-9581 • 8222 Jamestown Dr., Austin, TX 78758 • Tel. 512-836-6011

NAB Booths 3305 and 3306

Circle (372) on Reply Card

Coping with solar outages

By John Loeffler

Accurate prediction of solar outages can save refeeds and avoid disasters on the air.

Unplanned solar outages constitute a serious threat to satellite programming at various times of the year. At best, an outage may mean the expense and hassle of a refeed for a program being recorded. At worst, it can be a bearer of disaster, roaring through the middle of a live program. In any event, it's no fun.

Although outages on satellite systems cannot at present be eliminated, they can be avoided and their destructive impact on programming minimized through careful planning.

Loeffler is president of Mannamedia Corporation, a Denver-based broadcast consulting firm.

Solar outage primer

A solar outage, also called a solar transit, is basically an astronomical event whereby the sun, as seen from the earth by a satellite receiver, passes behind a satellite in the course of its apparent daily journey across the sky. During this mini-eclipse, energy from the sun captured by the receiver's parabolic reflector raises its LNA background noise to a level that partially or totally obliterates RF incoming from the satellite, as shown in Figure 1.

C-band services are most greatly affected by outages; much less interference is noted in Ku-band transmissions. Some

Ku-band services may not notice interference.

This difference is due in part to the wider beamwidths of C-band receivers, which cause a greater part of the sun's energy to be captured for a longer period of time. Also, earth stations at high latitudes tend to have a few extra days of outage season and longer daily transit times than lower-latitude stations.

An outage on analog services, such as video, first appears as a series of black and white sparkles, increasing to overall picture noise; sometimes it culminates in a complete loss of video. Although it takes one or two minutes before a pic-

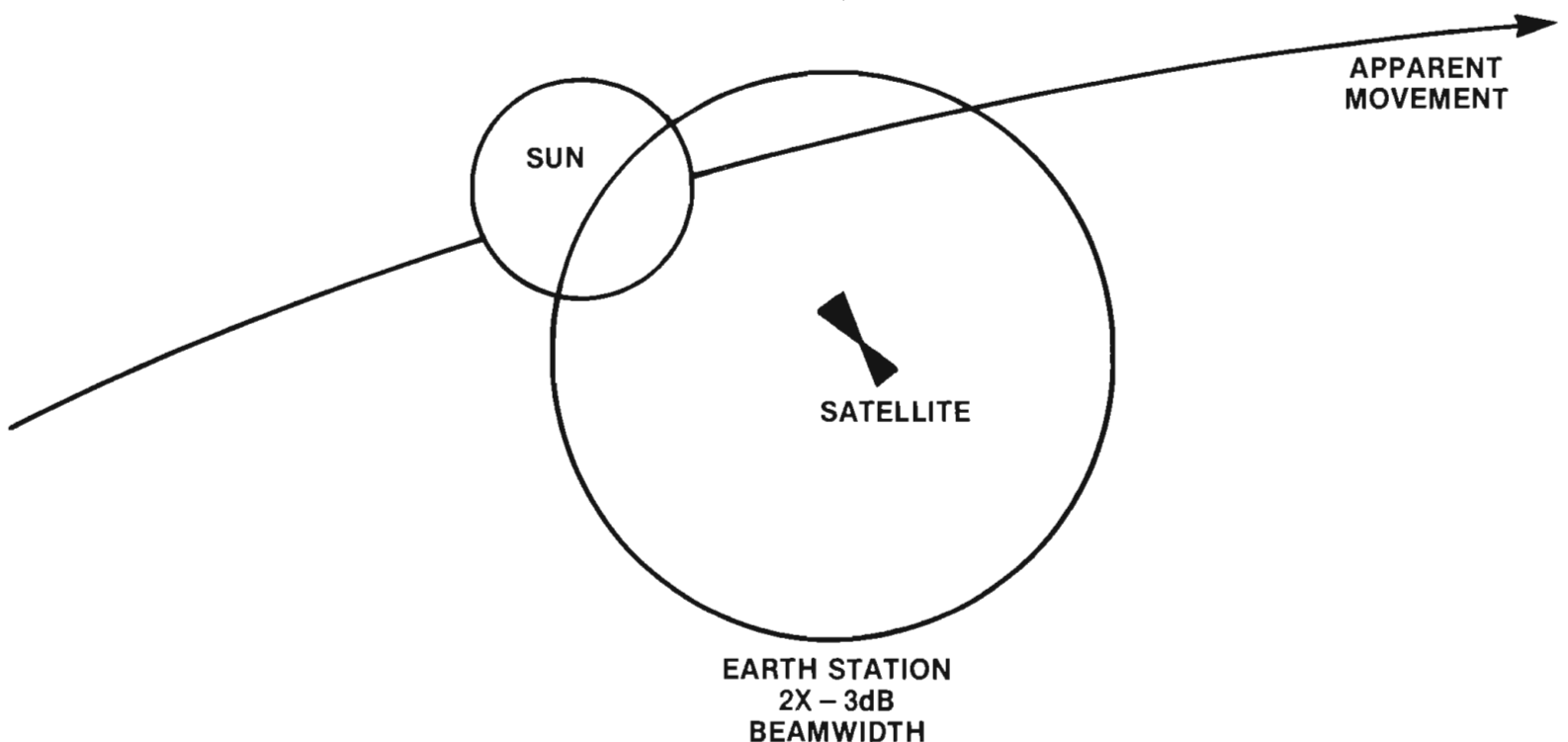

Figure 1. A solar outage is caused by a mini-eclipse of the sun by a satellite. LNA background noise from the sun may obliterate satellite RF.

BROADCAST 87



International Trade Fair for Film, Radio, Television.

"BROADCAST

hit the predicted market gap, spot on. We couldn't be more satisfied." "Frankfurt is the

EDDY DELCOURT, IKEGAMI

best place for a media fair.

It is ideal here." "For us, the

ADRIAN SCOTT, EUROPEAN OPERATIONS, BASYS

fair was a complete success.

We'll be back again next time."

HANS O. KÖFERL, VIDEO DIGITAL STUDIOTECHNIK

Please note the dates:

Frankfurt, 14th – 17th October, 87

Circle (200) on Reply Card

1987 will also be a good BROADCAST year. With the latest from film, radio and television, as well as an international congress, workshops, co-production exchange and "live" media technology. Highly qualified trade visitors. Top content. Ideal conditions: modern fair ground, easy road, rail and air connections, large hotel capacity, a wide range of cultural and leisure facilities. Welcome to BROADCAST 87.



ture vanishes during total outages, video deteriorates below broadcast quality long before the outage reaches peak. Analog audio will deteriorate only as an outage approaches peak. As the sun transits behind the satellite and the outage passes, this pattern is reversed.

Digital services, such as digital audio, usually notice little if anything at outage onset. Then there are sudden bursts of hash as circuits attempt to handle randomly missing data, culminating in an instantaneous and total shutdown of audio, when the bit-error rate attains an unmanageable level. At outage passage, as with analog services, this pattern reverses itself.

Outage mechanics

To comprehend outage mechanics, imagine that a satellite receiver sees a circular window in the sky having a diameter in degrees that corresponds to approximately twice the -3dB beamwidth of a station's parabolic reflector. The sun itself also occupies a 1.068° circle in the sky. Any time the circumferences of both circles overlap, an outage of some form occurs.

The actual intensity of an outage depends on how well the sun is aligned with a dish's central axis. The length of an outage is determined by the period of time the sun's disk or any portion of it remains within the receiver's window.

Outage season planning

Global solar outage season is that period of days when solar transits pose a threat to earth stations using geosynchronous satellites. During this time, some earth stations will be experiencing daily outages. Global outage season, as contrasted with local outage season, begins $3\frac{1}{2}$ weeks prior to each equinox (March

20 and Sept. 23) and ends $3\frac{1}{2}$ weeks after equinox, as shown in Figure 2.

This global outage season is fixed from year to year and all dates outside of the $3\frac{1}{2}$ weeks at each equinox are free from solar outage interference. This applies to geosynchronous satellites only. Line-of-sight collisions with the sun are common for satellites in non-equatorial orbits. Local outage season falls within global outage season, is much briefer and is station-specific, affecting only a limited number of stations at a time.

Each year, starting at about Dec. 22, due to the earth's 23.5° axis inclination and its orbit around the sun, the sun begins an apparent south-to-north movement. It starts at the Tropic of Capricorn (23.5° south latitude), and ends up at the Tropic of Cancer (23.5° north) on June 22. This trend then reverses itself and the sun moves southward, winding up at its starting latitude on Dec. 22.

Local outage season for a particular earth station begins when, during this journey, the sun reaches a latitude that will cause it to pass close enough to the geosynchronous satellite arc in the sky to cause partial or total outages.

In March, the sun has been in the Southern Hemisphere, moving northward. The first stations to be struck by outages $3\frac{1}{2}$ weeks prior to equinox on March 20 are those closest to the North Pole; the line-of-sight sun-satellite-station plane strikes that latitude band first in opposition to the sun's position.

From there, outage season begins moving southward as the sun moves northward. Both sun and season reach the equator simultaneously at equinox. Afterward, the sun passes into the Northern Hemisphere and outage season passes into the Southern Hemisphere, reaching the South Pole $3\frac{1}{2}$ weeks later.

In September, this pattern is reversed. Outages begin nearest the South Pole, move northward, arrive at the equator at about Sept. 23 and finally exit the North Pole $3\frac{1}{2}$ weeks later.

During its local solar outage season each earth station can expect one outage per day per satellite. If a satellite's longitude is east of an earth station's longitude, that earth station will experience an outage during local morning. If the reverse is true, outages will intrude during local afternoon.

Positive outage factors

Confusing as it may sound, daily outages do not move along the earth's surface starting with the easternmost stations and end with westernmost stations. All earth stations taking outages on the same satellite for a given day will do so within one hour real time, regardless of location on the earth's surface.

This is a real programming plus, because arrangements to avoid a daily network outage on a given satellite can be handled within the course of one scheduling hour. It also makes it unnecessary to study outage data from numerous earth stations. A programmer can create a network outage window by picking a few sample stations at different spots in the network's geographical region and confidently rely on that data as representing the entire system.

This is because earth stations to the east of a satellite's longitude have low dish elevations pointing westward and undergo outages in late local afternoon. Earth stations far west of the satellite have low dish elevations facing eastward and take outages in early local morning. Stations more directly beneath the satellite have outages toward local midday.

When all of these local outage times

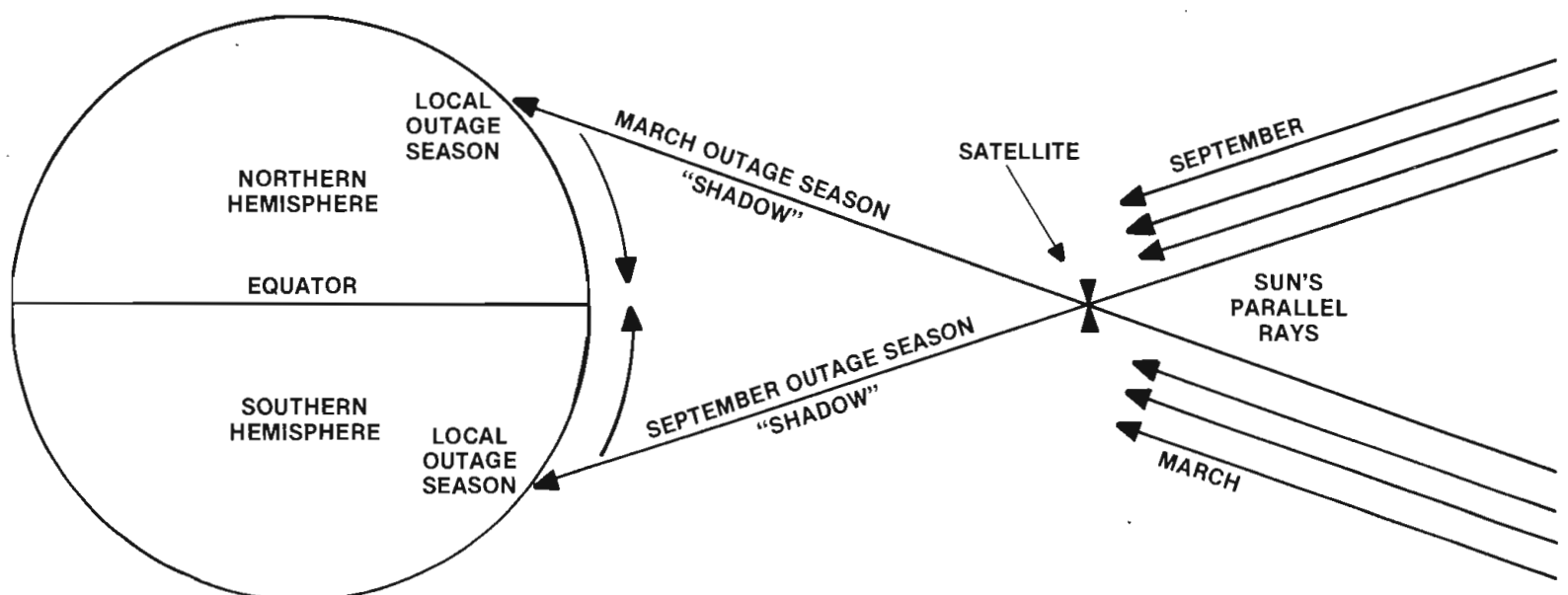

Figure 2. Global outages happen $3\frac{1}{2}$ weeks before and after the equinox each year. Local outages may occur almost any time, but are predictable.

Audio Transformers

Choose from a wide variety of types and packages

Computer optimized design

100% tested – consistent quality

Low distortion

Wide bandwidth

Minimum transient distortion (overshoot & ringing)

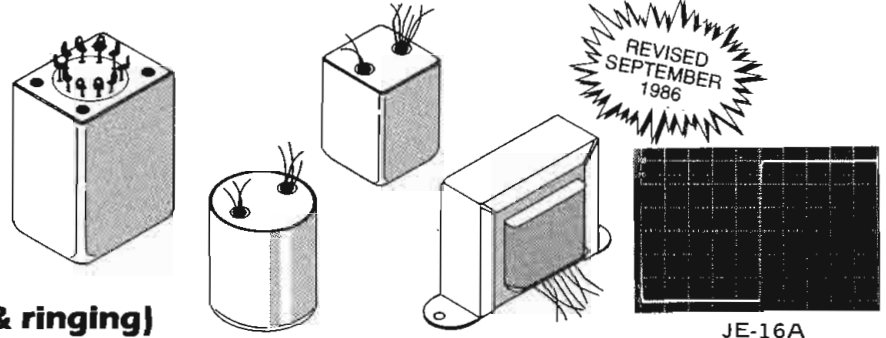

INPUT TRANSFORMERS AND SPECIAL TYPES

Model	Application	Impedance Ratio Pri:Sec	Turns Ratio Pri:Sec	20Hz Max Input Level ¹	Typical THD Below Saturation (%) 20 Hz / 1 kHz	Frequency Response (dB ref. 1 kHz) 20 Hz / 20 kHz	Band-Width ² -3 dB @ (kHz)	20 kHz Phase Response (degrees)	Over-Shoot (%)	Noise Figure (dB)	Magnetic Shield ⁴ (dB)	Number of Faraday ⁵ Shields	Package ⁵	PRICES		
														1-19	100-249	1000

MICROPHONE INPUT

JE-16-A	Mic in for 990 opamp	150-600	1:2	+8	0.036/0.003	-0.08/ -0.05	230	-8	<1	1.7	-30	1	A=1 B=2	75.42 82.89	49.87 54.81	34.40 37.81	
JE-13K7-A JE-13K7-B	Mic in for 990 or I.C.	150-3750	1:5	+8	0.036/0.003	-0.09/ -0.21	85	-19	<2	2.3	-30	1	A=1 B=2	75.42 82.89	49.87 54.81	34.40 37.81	
* JE-115K-E	Mic in for I.C. opamp	150-15 K	1:10	-6	0.170/0.010	-0.50/ +0.10	100	-16	<7	1.5	-30	1	3		54.81	36.24	28.39

LINE INPUT

JE-11P-9	Line in	15 K-15 K	1:1	+26	0.025/0.003	-0.03/ -0.30	52	-28	<3		-30	1	1	122.22	80.82	55.75
JE-11P-1	Line in	15 K-15 K	1:1	+17	0.045/0.003	-0.03/ -0.25	85	-23	<1		-30	1	3	52.32	34.59	27.10
JE-6110K-B JE-6110K-BB	Line in bridging	36 K-2200 (10 K-600)	4:1	+24	0.005/0.002	-0.02/ -0.09	125	-12	<1		-30	1	B=1 BB=2	73.95 85.59	48.90 56.59	35.88 39.04
JE-10KB-C	Line in bridging	30 K-1800 (10 K-600)	4:1	+19	0.033/0.003	-0.11/ -0.08	160	-9	<2		-30	1	3	53.17	35.16	24.53
JE-11SSP-8M	Line in/ repeat coil	600/150-600/150	1:1 split	+22	0.035/0.003	-0.03/ -0.00	120	-9	<3.5		-30	1	4	194.63	128.69	88.78
JE-11SSP-6M	Line in/ repeat coil	600/150-600/150	1:1 split	+17	0.035/0.003	-0.25/ -0.00	160	-5	<3		-30	1	5	98.39	65.06	44.88

SPECIAL TYPES

JE-MB-C	2-way ³ mic split	150-150	1:1	+1	0.050/0.003	-0.16/ -0.13	100	-12	<1		-30	2	3	44.85	29.65	23.24
JE-MB-D	3-way ³ mic split	150-150-150	1:1:1	+2	0.044/0.003	-0.14/ -0.16	100	-12	<1		-30	3	3	76.19	50.37	39.42
JE-MB-E	4-way ³ mic split	150-150-150-150	1:1:1:1	+10	0.050/0.002	-0.10/ -1.00	40	-18	<1		-30	4	1	114.40	75.64	52.18
JE-DB-E	Direct box for guitar	20 K-150	12:1	+19	0.096/0.005	-0.20/ -0.20	80	-18	<1		-30	2	6	54.56	36.07	28.23

- (dBu) Max input level = 1% THD; dBu = dBv ref. 0.775 V
- With recommended secondary termination
- Specifications shown are for max. number of secondaries terminated in 1000 ohm (typical mic preamp)
- Separate lead supplied for case and for each faraday shield
- Except as noted, above transformers are cased in 80% nickel mu-metal cans with wire leads.

PACKAGE DIMENSIONS:

	W	L	H
1	1 5/16" Diam.		1 9/16"
2	1 3/16" x 1 3/16"		1 5/8"
3	1 1/8" Diam.		1 1/16"
4	1 1/2" x 1 3/4"		2 1/2" w/ solder terminals
5	1 5/8" Diam.		1 3/4"
6	1 1/8" Diam.		1 5/16"

NICKEL CORE OUTPUT TRANSFORMERS⁶

Model	Construction	Nominal Impedance Ratio Pri:Sec	Turns Ratio Pri:Sec	20 Hz Max Output Level ⁷ (dBu)	600 Ω Load Loss across (n) windings (dB)	DC Resistance per Winding	Typical THD Below Saturation (%) 20 Hz / 1 kHz	Frequency Response (dB ref. 1 kHz) 20 Hz / 20 kHz	Band-Width -3 dB @ (kHz)	20 kHz Phase Response (degrees)	Over-Shoot (%)	Package	PRICES			
													1-19	100-249	1000	
JE-11-BMCF	Bifilar 80% nickel	600-600	1:1	+26	1	-1.1	40 Ω	0.002/0.002	>10MHz	-0.0	<1 ⁹	7	81.55	53.92	37.76	
JE-11-DMCF	Bifilar 80% nickel	600-600	1:1	+21	1	-1.0	38 Ω	0.004/0.002	>10MHz	-0.0	<1 ⁹	8	56.32	37.24	25.69	
JE-123-BLCF	Quadfilar	600-600 150-600	1:1 1:2	+32	2	-1.1	20 Ω	0.041/0.003	>450 170	-1.9 -4.0	<1 ⁸	7	73.85	43.14	29.76	
JE-11SS-DLCF	Bifilar split/split	600-600 150-600	1:1 1:2	+27	2	-1.0	19 Ω	0.065/0.003	>10MHz 245	-0.0 -2.5	<1 ⁸	8	53.62	35.45	24.46	
JE-11-ELCF	Bifilar	600-600	1:1	+23.5	1	-1.1	40 Ω	0.088/0.003	>10MHz	-0.0	<1 ⁹	9	36.36	24.04	16.59	
JE-11-FLCF	Bifilar	600-600	1:1	+20.4	1	-1.6	58 Ω	0.114/0.003	>10MHz	-0.0	<1 ⁹	10	27.36	18.09	12.48	
JE-112-LCF	Quadfilar	600-600 150-600	1:1 1:2	+20.4	2	-1.6	29 Ω	0.114/0.003	>450 205	-1.2 -3.2	<1 ⁸	10	32.80	21.69	14.96	
JE-123-ALCF	Quadfilar	66.7-600	1:3	+26.5	3	-1.3	8 Ω	0.125/0.003	-0.04/ +0.06	190	-4.6	<6 ⁸	8	50.96	33.69	23.24
JE-11S-LCF	Bifilar w/ split pri.	600-600 150-600	1:1 1:2	+30	1 (sec)	-1.7	63 Ω	0.058/0.002	-0.02/ +0.01 -0.02/ -0.05	>10MHz 155	+1.1 -4.1	<1 ⁸	8	50.96	33.69	23.24

- Multifilar construction has no faraday shield: cannot be used as input transformer. All specifications are for 0 Ω source, 600 Ω load.
- Max output level = 1% THD; dBu = dBv ref. 0.775 V
- Source amplifier -3 dB @ 100 kHz
- Source amplifier -3 dB @ 200 kHz
- Output transformers are horizontal channel frame type with wire leads, vertical channel frames available. PC types available.

PACKAGE DIMENSIONS:

	W	L	H	Mounting Centers
7	1 1/2" x 2 5/16"		1 15/16"	2 13/16"
8	1 5/16" x 1 15/16"		1 5/8"	2 3/8"
9	1 1/8" x 1 11/16"		1 3/8"	2"
10	1 1/16" x 1 7/16"		1 3/16"	1 3/4"

These charts include the most popular types which are usually available from stock. Many other types are available from stock or custom designs for OEM orders of 100 pieces or more can be made to order. Certified computer testing is available for OEM orders. Call or write for applications assistance and/or detailed data sheets on individual models.

Prices shown are effective 9/15/86 and are subject to change without notice. Packing, shipping, and applicable sales taxes additional.

jensen transformers
INCORPORATED

10735 Burbank Boulevard • North Hollywood, California 91601
(213) 876-0059 • TELEX via WUI 6502919207 MCI UW
Closed Fridays, visitors by appointment only.

Circle (201) on Reply Card

are computed and then converted to a single time zone for comparison, it turns out that all outages occur in a continuous time cluster. It's even possible for an earth station far to the west of a satellite to experience an outage prior to that of an eastern station on the same day.

Another important factor to remember, if you happen to work for an uplink, is that outages *do not affect transmissions*. They affect only receivers. Granted, this may not make you feel any better when a return picture off satellite looks awful, the transmitter gauges continue to read normal and no alarms have been triggered, save possibly for incom-

ing RF or sync alarms.

It should be pointed out that during outage season, a parabolic antenna has the potential to turn itself into a solar oven, given that the paint has a high enough reflectance. Although data on solar damage to professional equipment is unavailable, considerable damage to consumer receivers has been reported, including melted plastic LNA covers and one case in which an LNA was actually welded off its mount during an outage.

Daily outage computation

Predicting both seasons when outages pose a threat and outage peak times for a

given day is easy by using an almanac and reworking spherical trigonometry commonly used for navigation and astronomy.

Unfortunately, prediction of outage lengths and total days when outages will be in force involves somewhat more complicated math than can be covered here. To solve this, we've averaged readouts from representative latitudes for 5- and 10-meter stations to provide rule-of-thumb maximum threat windows (see Table 1). Generally, any time or date outside these windows may be considered outage-free, provided the season and time computations have been completed accurately. Armed with this information, you should be able to easily avoid unexpected outages on your satellite system.

Table 1 is a 20-year solar almanac in decimal values, which has been created by averaging values for the years 1987 through 2007 at zero hours Coordinated Universal Time (UTC, formerly Greenwich Mean Time, or GMT). Maximum instantaneous variation from the listed values in any year is only 10.6 minutes of arc for solar declination (DEC) and 9.7 seconds of time for the equation of time (EqT), which, for purposes of outage prediction, is extremely accurate.

Feb. 29 has been eliminated for leap years, because they tend to confuse things. Just remember to hedge an extra day if your station has outages at this time of year.

To compute outage for any satellite, you will need to know the following data:

- *Latitude (LAT)* of the earth station in decimal degrees, where north is (+) and south is (-).
- *Longitude (LON)* of the earth station in decimal degrees, where west is (+) and east is (-).
- *Azimuth (AZ)* of the earth station's dish in decimal degrees, measured clockwise in true degrees from geographic north.
- *Elevation (EL)* of the earth station's dish, measured in degrees above the true horizon.
- *Conversion Factor to UTC* in whole hours where Western Hemisphere hours are (+) and Eastern Hemisphere hours are (-).

For purposes of illustration, an earth station/satellite configuration will be used with the following data:

LAT: 45°30' 30"N
 LON: 107°20' 10"W
 AZ: 169.7696°
 EL: 37.11609°
 UTC: +7

Latitude and longitude information in degrees (D), minutes (M) and seconds (S) is readily available from station licenses. These values must be converted to deci-

DATE	DEC	EqT	DATE	DEC	EqT
Feb 21	-10.7579	-0.2288	Aug 26	10.5229	-0.0326
Feb 22	-10.3962	-0.2269	Aug 27	10.1747	-0.0280
Feb 23	-10.0319	-0.2248	Aug 28	9.8239	-0.0231
Feb 24	-9.6650	-0.2225	Aug 29	9.4703	-0.0182
Feb 25	-9.2956	-0.2200	Aug 30	9.1144	-0.0132
Feb 26	-8.9239	-0.2174	Aug 31	8.7560	-0.0081
Feb 27	-8.5501	-0.2146	Sep 01	8.3953	-0.0029
Feb 28	-8.1741	-0.2117	Sep 02	8.0322	0.0024
Mar 01	-7.7059	-0.2079	Sep 03	7.6671	0.0077
Mar 02	-7.3258	-0.2046	Sep 04	7.2999	0.0132
Mar 03	-6.9435	-0.2012	Sep 05	6.9307	0.0187
Mar 04	-6.5598	-0.1977	Sep 06	6.5597	0.0243
Mar 05	-6.1747	-0.1941	Sep 07	6.1868	0.0299
Mar 06	-5.7881	-0.1903	Sep 08	5.8123	0.0356
Mar 07	-5.4001	-0.1864	Sep 09	5.4362	0.0413
Mar 08	-5.0110	-0.1824	Sep 10	5.0586	0.0471
Mar 09	-4.6207	-0.1783	Sep 11	4.6793	0.0529
Mar 10	-4.2296	-0.1741	Sep 12	4.2991	0.0588
Mar 11	-3.8377	-0.1698	Sep 13	3.9169	0.0646
Mar 12	-3.4447	-0.1654	Sep 14	3.5345	0.0706
Mar 13	-3.0510	-0.1610	Sep 15	3.1505	0.0765
Mar 14	-2.6570	-0.1564	Sep 16	2.7652	0.0824
Mar 15	-2.2624	-0.1518	Sep 17	2.3794	0.0883
Mar 16	-1.8674	-0.1471	Sep 18	1.9929	0.0943
Mar 17	-1.4725	-0.1423	Sep 19	1.6059	0.1003
Mar 18	-1.0769	-0.1375	Sep 20	1.2179	0.1062
Mar 19	-0.6815	-0.1327	Sep 21	0.8296	0.1121
Mar 20	-0.2862	-0.1278	Sep 22	0.4406	0.1180
Mar 21	0.1090	-0.1228	Sep 23	0.0515	0.1239
Mar 22	0.5040	-0.1179	Sep 24	-0.3379	0.1297
Mar 23	0.8987	-0.1129	Sep 25	-0.7275	0.1355
Mar 24	1.2928	-0.1079	Sep 26	-1.1169	0.1412
Mar 25	1.6863	-0.1028	Sep 27	-1.5065	0.1469
Mar 26	2.0792	-0.0978	Sep 28	-1.8958	0.1526
Mar 27	2.4716	-0.0927	Sep 29	-2.2849	0.1582
Mar 28	2.8631	-0.0877	Sep 30	-2.6738	0.1637
Mar 29	3.2534	-0.0827	Oct 01	-3.0617	0.1692
Mar 30	3.6426	-0.0776	Oct 02	-3.4497	0.1745
Mar 31	4.0310	-0.0726	Oct 03	-3.8370	0.1798
Apr 01	4.4179	-0.0676	Oct 04	-4.2233	0.1850
Apr 02	4.8038	-0.0627	Oct 05	-4.6087	0.1901
Apr 03	5.1876	-0.0577	Oct 06	-4.9934	0.1951
Apr 04	5.5704	-0.0528	Oct 07	-5.3771	0.2000
Apr 05	5.9517	-0.0480	Oct 08	-5.7595	0.2047
Apr 06	6.3310	-0.0432	Oct 09	-6.1406	0.2094
Apr 07	6.7084	-0.0384	Oct 10	-6.5205	0.2140
Apr 08	7.0839	-0.0338	Oct 11	-6.8989	0.2184
Apr 09	7.4577	-0.0292	Oct 12	-7.2759	0.2226
Apr 10	7.8290	-0.0246	Oct 13	-7.6510	0.2268
Apr 11	8.1986	-0.0202	Oct 14	-8.0245	0.2308
Apr 12	8.5656	-0.0157	Oct 15	-8.3961	0.2346
Apr 13	8.9300	-0.0114	Oct 16	-8.7660	0.2383
Apr 14	9.2923	-0.0072	Oct 17	-9.1333	0.2419
Apr 15	9.6520	-0.0031	Oct 18	-9.4989	0.2452
Apr 16	10.0088	0.0010	Oct 19	-9.8620	0.2484
Apr 17	10.3630	0.0049	Oct 20	-10.2226	0.2515
Aug 25	10.8683	-0.0373	Oct 21	-10.5809	0.2543

Table 1. This 20-year almanac (good through 2007) provides data for computing local solar outages.

THE POWER OF PERFORMANCE

AE61

TIME BASE CORRECTOR

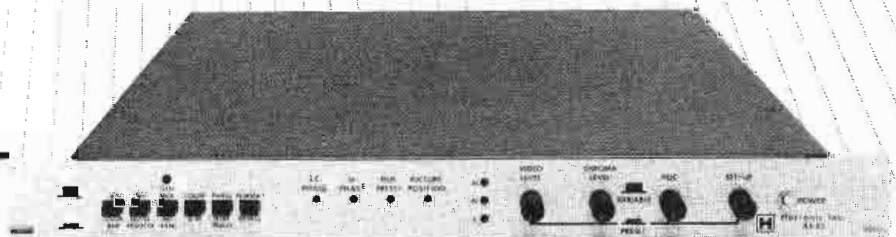

Time base correction for Heterodyne VTRs, standalone with 3.58 sub-carrier feedback

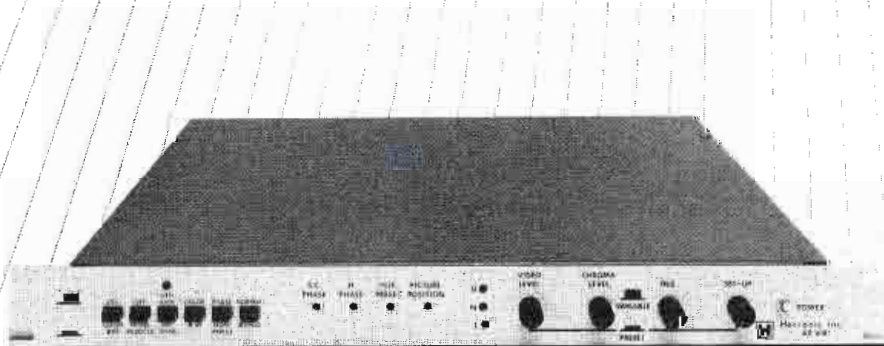

Time base correction for Heterodyne VTRs, standalone without 3.58 sub-carrier feedback

AE61B

TIME BASE CORRECTOR

AF71

TBC/FRAME SYNCHRONIZER

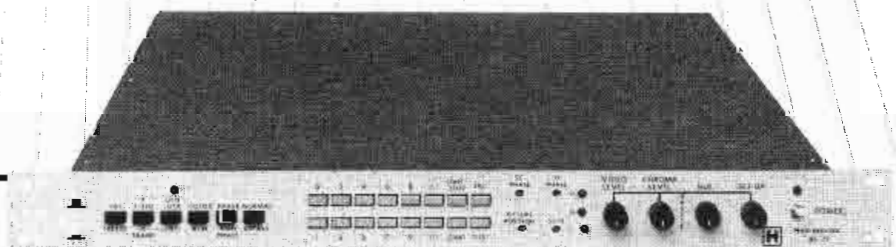

Time base correction & frame synchronization for Heterodyne VTRs with more than two frame memory; full bandwidth freeze field/freeze frame

Performance and Power — the epitomy of the Hotronic heritage — reflects the ceaseless innovative and refined techniques of Hotronic engineers. Compare our TBCs with any other competitive products. Only Hotronic stands up to the stringent standards demanded by our quality-conscious users.



HOTRONIC, INC.

1875 S. Winchester Blvd., Campbell, CA 95008
408/292-1176 or 408/378-3883

Circle (202) on Reply Card

Azimuth/ elevation computations

The following calculations will allow you to compute azimuth (AZ) and elevation (EL) from any earth station/geosynchronous satellite combination.

You must know the earth station latitude (LAT) and longitude (LON) plus the longitude of the satellite (SAT), all in decimal degrees. Observe the same sign values for north/south and east/west as those used for predicting solar outages.

Notes included for using these formulas are for a microcomputer, which thinks in radians. Remember to convert decimal degrees to radians prior to plugging them into the following formulas.

For calculation purposes:

$$f = 5.62168309325$$

- (1) Compute T1:
 $T1 = \cos(\text{SAT} - \text{LON}) \cdot \cos \text{LAT}$
- (2) If the arc cosine of T1 is greater than 81.3° (1.419 rad) then the satellite is below this earth station's horizon and no further computations are necessary.
- (3) Compute T2:
 $T2 = \arctan(\tan(\text{SAT} - \text{LON}) / \sin \text{LAT})$
- (4) Compute azimuth from T2 by a clearing process:
 - (a) For Northern Hemisphere stations (LAT is greater than 0):
 $\text{AZ} = T2 + 180$
[rad: $\text{AZ} = T2 + \pi$]
 - (b) For Southern Hemisphere stations (LAT is less than 0):
If T2 is less than 0 then
 $\text{AZ} = T2 + 360$
[rad: $\text{AZ} = T2 + \pi \cdot 2$]
If T2 is greater than 0 then
 $\text{AZ} = T2$
- (5) Compute T3:
 $T3 = \sqrt{1 + (1 + f)^2 - 2 \cdot T1 \cdot (1 + f)}$
- (6) Compute T4:
 $T4 = \arccos((T3^2 + 1 - (1 + f)^2) / (2 \cdot T3))$
- (7) Compute elevation (EL):
 $\text{EL} = T4 - 90$ [rad: $T4 - \pi / 2$]

If you performed these operations in radians, remember that the results will be in radians and may need to be converted to degrees before use in another application.

mal degrees (DD) for processing. The following formula will accomplish this:

Formula 1.

$$\text{DD} = D + (M + S/60)/60$$

Note that negative latitude and longitude values must be processed through the formula as positive values, with the result being converted to negative. The answers for the sample earth station are:

$$\text{LAT: } 45^\circ 30' 30'' \text{N} = +45.5083333^\circ$$

$$\text{LON: } 107^\circ 20' 10'' \text{W} = +107.336111^\circ$$

Obtaining azimuth and elevation data is a bit more difficult, because station licenses don't have this. However, given the information available on station licenses, along with known satellite locations and the math provided in the related article, "Azimuth/Elevation Computations," you will be able to figure out azimuth and elevation if you don't already have the means to do so.

Solar declination

There are two dates in any year when outages will be worse for any geosynchronous satellite/earth station combination. These may be found by computing the solar declination (DEC), essentially a measure of the sun's latitude north or south of the equator, and choosing dates from Table 1.

Formula 2.

$$\text{DEC} = \sin^{-1}(\sin \text{EL} \cdot \sin \text{LAT} + \cos \text{EL} \cdot \cos \text{LAT} \cdot \cos \text{AZ})$$

The result for the sample station is -6.8626° . Using the DEC column in Table 1, you'll find that the two dates when the sun's declination is closest to this value are March 3 and Oct. 11. These dates are the peaks of both local outage seasons for this earth station/satellite combination. The value of DEC never changes and, because the almanac data will not drift more than a few minutes of arc annually, the two dates will remain relatively constant.

Peak outage time

To find peak outage times on any given day, you must compute the sun's longitudinal distance from the earth station at maximum outage, the local hour angle (LHA). This involves a main step and an adjustment:

Formula 3.

$$\text{LHA} = \cos^{-1}((\sin \text{EL} - \sin \text{LAT} \cdot \sin \text{DEC}) / (\cos \text{LAT} \cdot \cos \text{DEC}))$$

The result is 8.2011° . If the satellite is east of the earth station (AZ is less than 180°), then make LHA a negative number. Otherwise, leave it alone. For our sample earth station, the satellite is east so the answer becomes -8.2011° . LHA values do not change from year to year.

To compute local mean time (LMT) of outage peaks, take the EqT values from the same dates previously determined (March 3 and Oct. 11) to be the days of maximum outage. Take care to conserve

the sign values of LON, EqT and UTC.

Formula 4.

$$\text{LMT} = (\text{LHA} + \text{LON}) / 15 - 12 - \text{EqT} - \text{UTC}$$

To clear what may appear to be a strange-looking time, if the answer is less than 0, add 24. If it is greater than 24, subtract 24. The answer will be in a 24-hour decimal format. You may need to run it through this clearing routine twice to arrive at a satisfactory result.

For March, the answer is 11.81019927 hours; for October, 11.39059928 hours. These values will drift slightly from year to year due to EqT changes, but because the maximum EqT error in the 20-year almanac is 9.7 seconds, it's still fairly constant.

The fractional portion of hours may be converted to minutes by multiplying the fraction by 60. For example, to convert 11.7878 hours: $0.7878 \times 60 = 00:47$, or 11:47.

Outage threat windows

The threat windows are for C-band analog stations, because they are most susceptible to outages. C-band digital and Ku-band stations will fall well inside these windows.

For 5-meter stations, local solar outage season lasts a maximum of nine days, with the two annual days of peak outage falling directly in the middle of this time period. The maximum outage length is 11 minutes, with the peak outage time computed falling in the middle of this period. Ten-meter stations have local outage seasons of five days and 7-minute daily windows.

Stations smaller than five meters have much larger seasons and windows. However, beginnings and ends of small-dish seasons are mild and, in some cases, pass with only a few perfectly acceptable sparkles or crackles with nothing observed in digital services. A lower-than-5-meter outage season can be considered serious in the same period as that of 5-meter stations.

Also, stations with extremely low dish elevations of 15° or less tend to have slightly extended seasons and daily windows. In these cases, it would be prudent to add one day at either end of a season and one minute at either end of a daily window to allow for this variation.

If you intend to use this math in a computer that uses radians instead of degrees, observe the following:

- Convert all decimal degrees (DD) to radians (rad): $\text{rad} = \text{DD} / (180 / \pi)$
- For the LHA adjustment, substitute π (3.141592654) for 180° in the decision-making process (i.e., if AZ is less than π , then make LHA negative).
- Change 15° in the LMT (Formula 4) to 0.261799387 rad.

!:-:~))]]



Beat the traffic.

M/A-COM opens up a new lane for broadcasters with our new 18GHz microwave system.

If you've been looking for an open frequency at 7 or 13GHz, you're not alone. In many areas, they simply aren't available: there's too much traffic and not enough spectrum.

M/A-COM's new 18GHz microwave system gives you another option: a wide-open band which the FCC has assigned to broadcast. It gives you 50% better link availability (or 40% longer range) than 23GHz, and none of the congestion of the lower frequencies.

The MA-18CC is a fully-featured microwave system, designed to meet or exceed all RS-250B short-haul performance

specifications. It is field tunable, and a single gunn oscillator covers a wide selection of frequencies so spare parts can be kept to a minimum.

For over 20 years M/A-COM MAC has specialized in providing microwave radio equipment to broadcasters. Every unit with our name on it is built in our own factory, so we not only control the quality, but we know how to service it.

For more information on how you can streamline your microwave needs, contact M/A-COM MAC, Inc., 5 Omni Way, Chelmsford, MA 01824, (617) 272-3100.

Product cannot be offered for sale pending FCC notification.



Circle (210) on Reply Card

LCD display technology

Prepared by
Conrad Persson

Advancements in LCD display technology are beginning to rival CRTs.

The cathode-ray tube has been the standard display for TV and test applications for almost 50 years. The CRT also has some well-known drawbacks such as

Persson is BE's electronics editorial consultant.

its large size, weight and fragility; filament and high-voltage requirements; high power consumption; limited light output and screen-size limitations. Today's flat-panel display technologies are challenging the supremacy of the time-

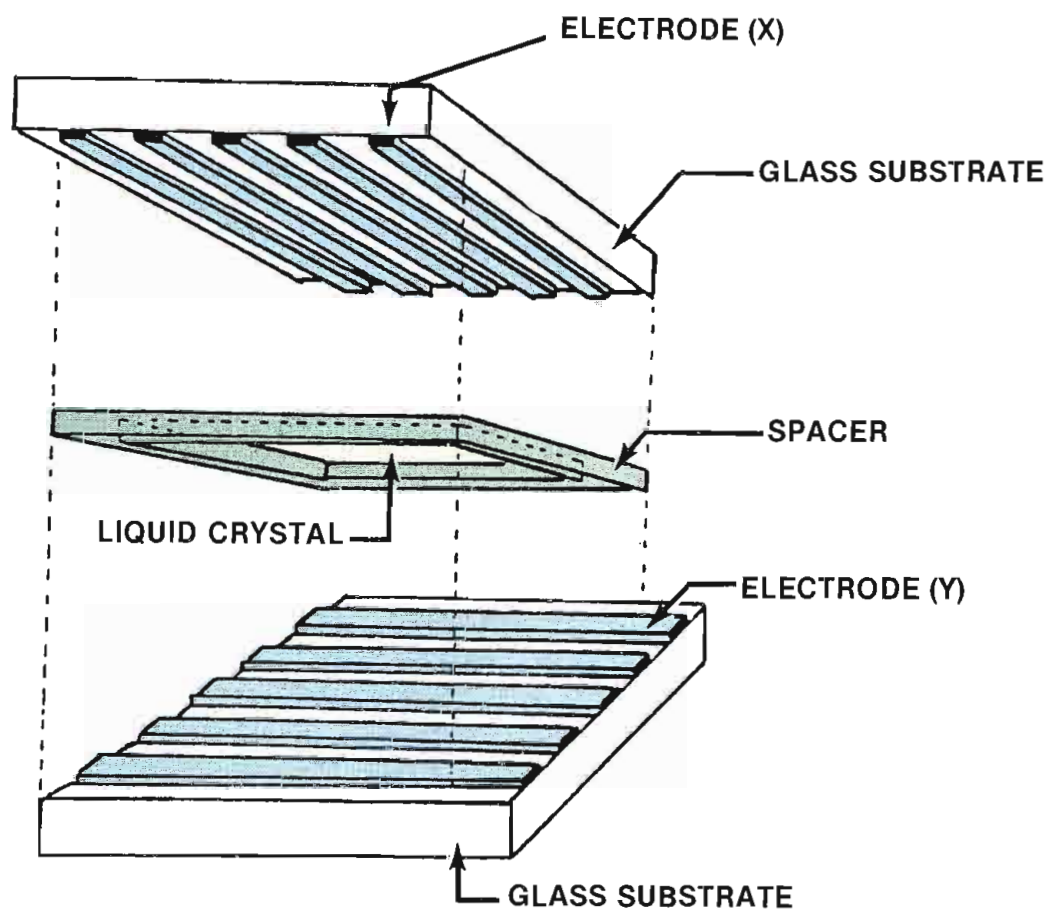

Figure 1. A simple matrix liquid crystal display consists of two glass substrates containing transparent electrodes with liquid crystal material sandwiched between.

tested CRT.

The major flat-panel technologies competing with the CRT include: thin-film electroluminescent (EL), plasma display panels (PDPs), vacuum fluorescent displays (VFDs) and liquid crystal displays (LCDs). Each technology offers unique strengths and weaknesses. None of them offers a perfect solution for every application, although many of them may already be in use at your station.

The popularity of the personal computer has created a strong demand for alternative (non-CRT) displays and has stimulated the research and development of improved technologies. Rapid advances in the performance and cost-effectiveness of flat-panel displays have made their way to the marketplace over the past few years, particularly in the area of LCDs.

A history of LCDs

Liquid crystals are simply rod-shaped molecules in a viscous liquid that feature many of the characteristics of a solid crystal. A number of existing liquid crystal displays are already being used in personal computers, DMMs, and personal small-screen "pocket" televisions. For any kind of display device, the fundamental question is, "How much information can be displayed in a given area?"

The first-generation LCDs appeared on the market from 1975 to 1979, on wristwatches and calculators. These displays are extremely low cost, and consume very little power, compared with earlier light-emitting diode (LED) displays. Their simple construction makes them ideal for high-volume production. Today the annual production of digital watches is about 200 million, nearly one-half of total watch volume. Another 120 million LCDs are used annually in calculators.

These first-generation displays are useful only for displaying simple numerals. They have limited applications for computers and virtually no applications for TV displays.

Second-generation LCDs, introduced in 1980, proved acceptable for displaying alphanumeric characters and some graphic symbols, and are found on some audio and test equipment.

The new wave of third-generation LCDs is just beginning to appear on the market. They feature a relatively large, high-resolution dot matrix display area. This advantage over previous generations suits this new wave of LCDs to television (both black-and-white and color) and computer image displays.

Simple matrix displays

The simple matrix LCD, as shown in Figure 1, demonstrates the basic operating principle of all LCDs. The display consists of two glass substrates



EXCITING NEW ANGLES.

Yours With Toshiba's New Microminiature Color Video Camera.

Our Microminiature Color Video Camera is smaller than small. It's tiny.

The 200,000-pixel CCD image sensor camera head fits in the palm of your hand and easily goes almost anywhere imaginable. A slim 4mm cable connects the head and paperback book-sized camera control unit for superb mobility.

Aside from exciting once-in-a-lifetime camera angles, the Toshiba Microminiature Color Video Camera

delivers sharp, natural image and color resolution. Focusing from 20mm to infinity and interchangeable C-mount lenses further enhance versatility.

For live telecast, portable VCR and monitoring system use, the Toshiba Microminiature Color Camera can't be beat.



Actual Size



Model 1K-M10B

TOSHIBA

TOSHIBA CORPORATION TOKYO JAPAN

ELECTRONIC SYSTEMS DEPARTMENT

1-1, SHIBAURA 1-CHOME, MINATO-KU, TOKYO, 105, JAPAN

TELEX: J22587 TOSHIBA CABLE: TOSHIBA TOKYO PHONE: 457-3246-8

Circle (204) on Reply Card

See us at NAB Booth # 3302

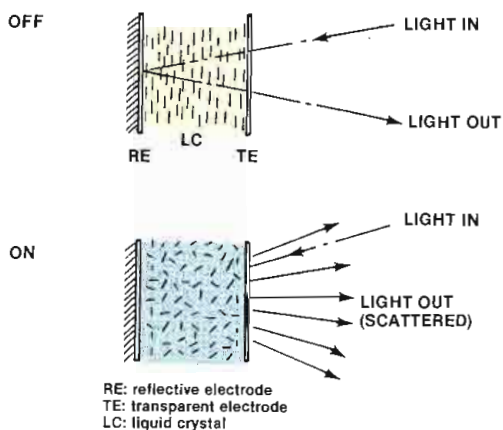
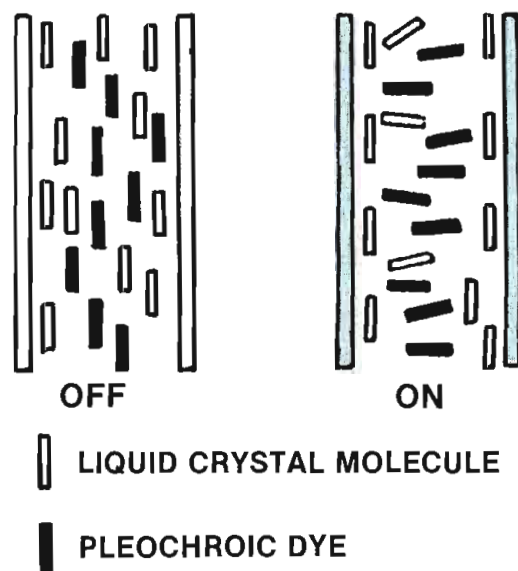

Figure 2. In a dynamic scattering mode display, application of a sufficiently strong electrical field generates a strong turbulence, producing a white opaque appearance similar to frosted glass.

Figure 3. A guest host display uses a dissolved dye to achieve a wide viewing angle and color brightness.



DPS-170 Time Base Corrector

New technology yields a price/performance breakthrough in a single, space-saving rack unit. The DPS-170 time-base corrects monochrome and heterodyne inputs for editing, assembly and match framing. Direct-color is achieved with 3.58 MHz feedback to tape player.

The DPS-170 gives you a wide dynamic tracking range of -1 to +3 with clear viewing at up to $\pm 30X$ normal tape speed. You get tape source flexibility, with a 16-line buffered

correction window and RF/TTL selectable drop out compensator input.

- High performance/low cost
- Heterodyne or Direct Colour
- Dynamic Tracking[®] capability
- Digital Dropout Compensator
- Matched Frame Editing

*Trade mark of Sony Corp.

Scientific Atlanta

Digital Video Systems Division

120 Middlefield Road, Scarborough, Ontario
Canada M1S 4M6 (416) 299-6888 Telex 065-25344

Circle (205) on Reply Card

FREE
CATALOG

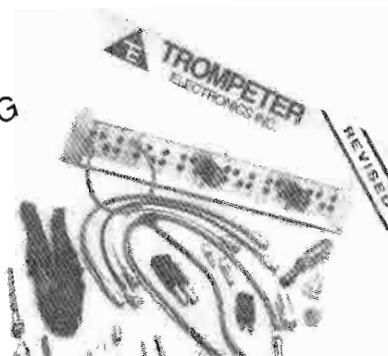

RF & Video Patching Connectors & Accessories

- Coax
- Twinax
- Triax
- Subminiature
- Miniature
- Standard

Wrench Crimp & Tool Crimp Assemblies

Visit us at booth 3346

TROMPETER
ELECTRONICS

31186 La Baya Dr., Westlake, Vlg., CA 91359
(818) 707-2020/TWX 910-494-1210

Circle (206) on Reply Card

containing transparent electrodes, with the liquid crystal material sandwiched between them. Electrodes control the arrangement of molecules in the liquid crystal material that, in turn, control the passage of light through the cell. This simple construction makes the LCD inexpensive to mass produce, which is a major reason for its phenomenal growth in the display market.

Basic principles of LCD operation

Liquid crystal material is an organic liquid that exhibits the optical properties of a crystal. Liquid crystals are made from three types of material. In *cholesteric* liquid crystals, the individual molecules of the material are aligned parallel to each other and are grouped in layers; each layer is rotated relative to the previous layer by a few degrees, producing a helical arrangement.

In *nematic* liquid crystal materials, the molecules are aligned with their long axes parallel to each other, and the molecules are free to move up and down. There are no distinct layers of molecules in nematic materials.

Smectic liquid crystal materials also incorporate parallel molecule alignment, but molecules are confined to distinct layers that are also parallel to each other. There is no rotation between layers. At least nine types of smectic materials are known.

These viscous materials are convenient for use in making displays because the molecular structure of the liquid makes it easier to control the orientation of molecules than it would be in a solid crystal.

Each orientation of molecules represents a particular liquid crystal phase, and each phase affects the passage of light through it differently. Controlling the phase of a given liquid crystal material by means of a voltage applied to electrodes, therefore, controls the flow of light through the cell.

- Fastest 14x lens made f1.6 (T1.8)
- Exclusive variable zoom potentiometer knob.
- Built-in 2x extender—easiest macro focus.
- Exclusive stronger zoom rod construction—to absorb shock and rough handling.
- Super-wide angles—7mm, 8mm, 9mm.
- Super sharp, crisp images—unique fluo-phosphate glass for optimum registration.
- Non-rotating front focusing element on 14x8.
- Weighs as little as 1.4 kg. (3.1 lbs)
- Weather resistant servo housing



HERE'S WHY THE NEW ANGENIEUX 14X ENG/EFP LENSES ARE THE BEST AVAILABLE TODAY:

The features go on and on. Simply put, no other lens can match the new Angenieux generation. Complete range of accessories available. Immediate national and international service.

Angenieux lenses available in 14x9, 14x8 and 14x7 for Ikegami, Sony, JVC, Ampex, Hitachi, Thomson, Philips, Panasonic and NEC cameras.

angenieux

See a demonstration at your Angenieux dealer or write:

Corp. of America 7700 No. Kendall Dr., Miami, FL 33156 • Tel: (305) 595-1144 • New York (516) 735-2454

Opticam SA, Case postale 91, 1211-Geneva-17, Switzerland • Tel: 22-36-22-66 • Telex: 27670 Optic CH • FAX: 22-86-12-49

Circle (207) on Reply Card

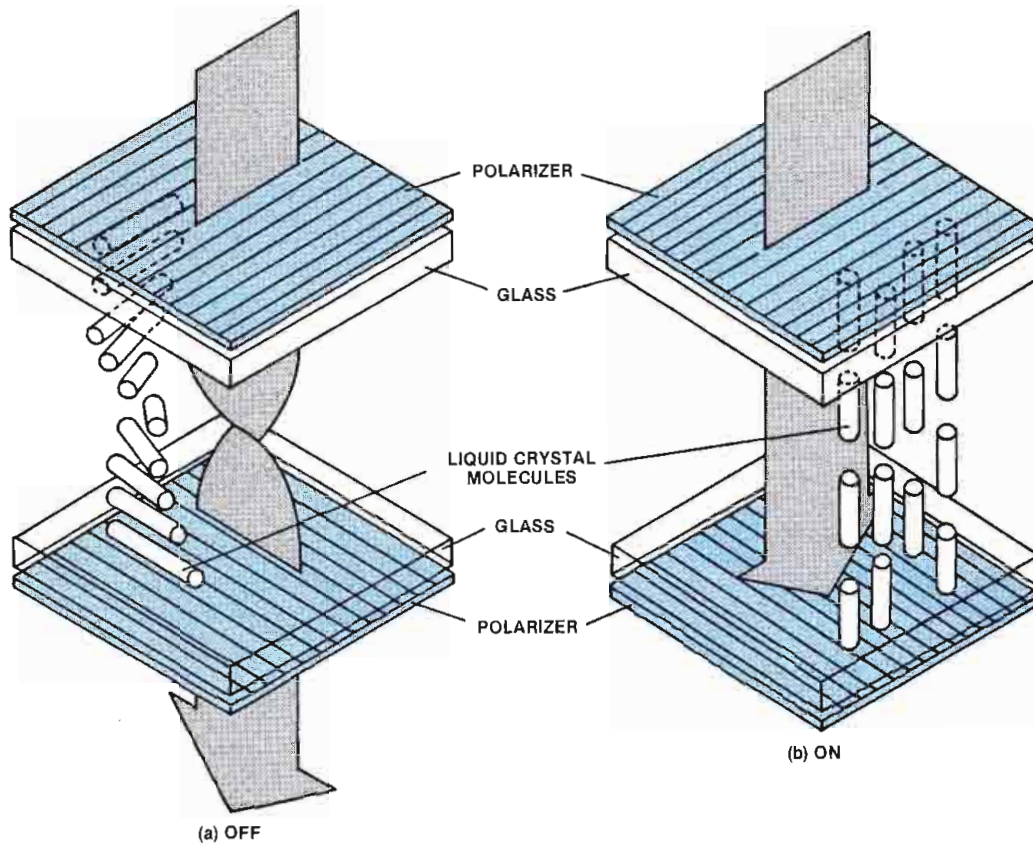

Figure 4. A standard twisted nematic display controls the liquid crystal molecule and makes it act like a valve, either allowing light to pass, or shutting it off.

Although there are more than 10 liquid crystal phases, many are not efficient for displays; some are still in development and some are too complex to be cost-effective for commercial products. Three types are typically used: *dynamic scattering mode* (DSM, or simply DS for

dynamic scattering), *guest host mode* (GHM) and *twisted nematic* (TN).

Liquid crystal phases

Dynamic scattering displays were the first practical LCDs. Based on nematic materials, these displays are well suited

for use in watches, calculators and other applications that don't require a fast response time.

When an electrical field is applied across the layer of nematic liquid crystal material, the molecules orient themselves to the field. If a sufficiently strong field is applied (1V/micron), the ion flow generates a strong turbulence, resulting in a white opaque appearance similar to frosted glass, as shown in Figure 2.

In GHM displays, a dye is dissolved in a positive liquid crystal matrix. The dye has different optical characteristics parallel and perpendicular to its axes and can be aligned by interaction with the liquid crystal molecules. The dye has its maximum absorption when the electric field vector is parallel to the axis of the molecules (see Figure 3).

Using polarizers to direct the light produces an effect called *switched light absorption*. This type of guest-host display has a wide viewing angle, high contrast and bright color.

"The ultimate"

ULTIMATE-5

Solves Production Problems— Saves Production Time!

- Post Production—Makes high quality composites from taped (analog component) originals.
- Soft or hard-edge windows.
- Reverse window. Allows shut-off of background scene within window area.
- Digitally based remote control over a single coax cable.
- Can be controlled from 4 remote locations.
- 32K random access memory.
- Accepts all inputs, RGB/YRGB/YR-Y B-Y/YIQ (YUV)/NTSC (BG only).
- Automatic BG matte setting.
- Dynamic BG matte tracking through color changes from back wall, through coving, to floor. (A breakthrough)
- Matting logic for Blue, Green, White, and Black backings.
- May be computer controlled through switchable interface.
- RGB Black balance/RGB white balance. Permits matching of color tones in FG/BG blacks and whites.
- Inserts Glow or title—solid or transparent.
- Accepts external Matte (key) signal.

ULTIMATE CORP.

18607 Topham Street, Reseda, CA 91335 U.S.A.
Telephone (818) 345-5525, Telex 662453

See us at NAB Booth 3552
Circle (208) on Reply Card

AUTOMATED BROADCASTING SYSTEMS

Four Models

SOL-6800/MICRO

For 1 VTR with 4-input AV switcher
From \$2,500

SOL-6800/MINI

(Fully programmable)
For 4 VTRs with 6-input AV switcher
From \$9,000

SOL-6800/U.I.S.

(Upgradable intelligent system)
For 8 VTRs with 12-input AV switcher
From \$12,000

SOL-6800

(Fully programmable/expandable)
For 8 VTRs with 12-input AV switcher
From \$17,000

A COMPANY DEDICATED TO AUTOMATION

SOLUTEC

H.A. Solutec Ltd.
4360 d'Iberville, Montreal
Quebec Canada H2H 2L8
Tel: (514) 522-8960 Telex: 055-62139

Circle (209) on Reply Card

Satisfy your Curiosity.

If you're curious about Moseley, come visit us at NAB Booth #3202. We'll demonstrate our new cost-effective STL system, and Dial-Access Remote Control with a voice-response system that's understandable.

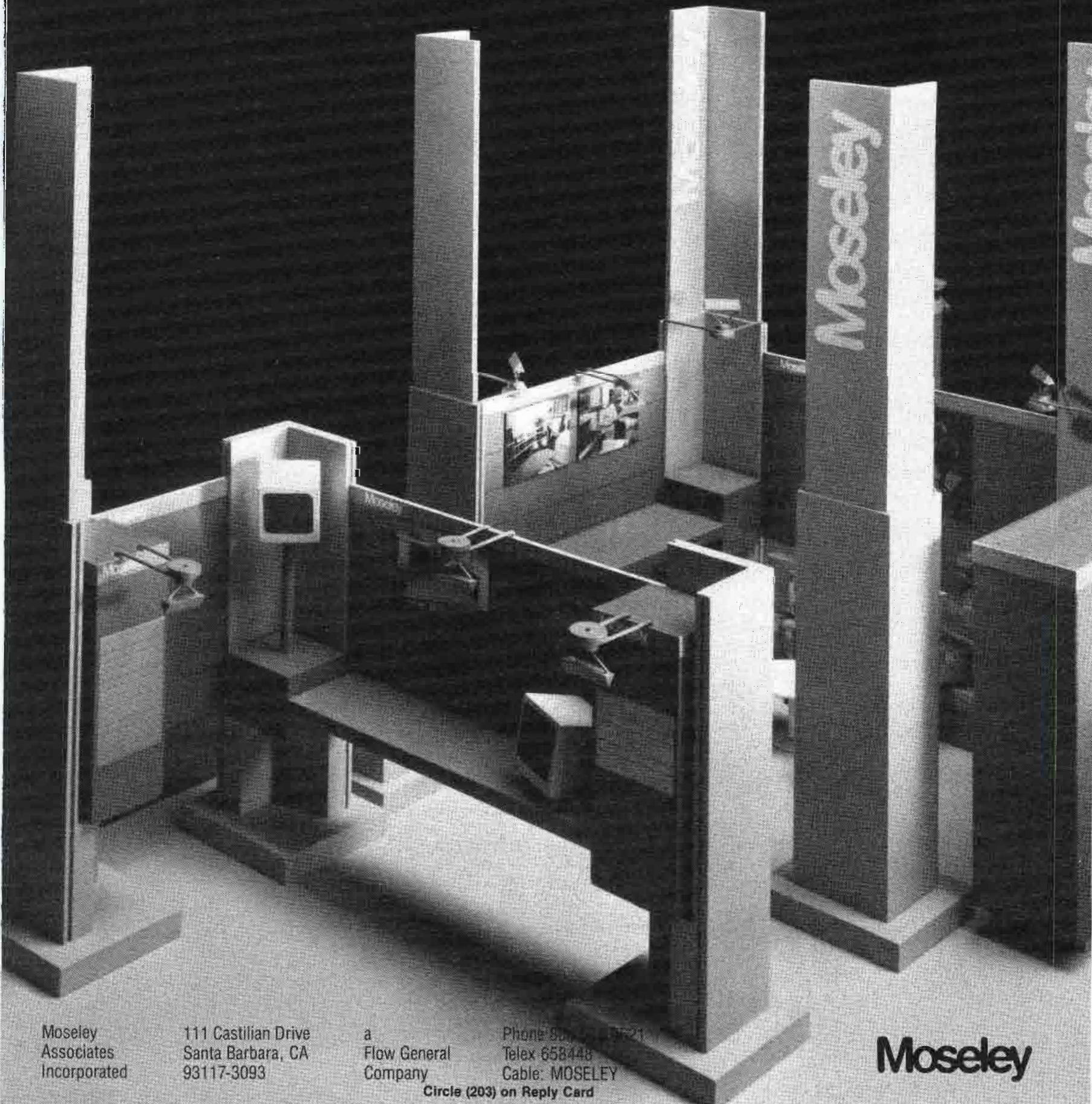

Moseley
Associates
Incorporated

111 Castilian Drive
Santa Barbara, CA
93117-3093

a
Flow General
Company

Phone 805-963-9521
Telex 658448
Cable: MOSELEY

Circle (203) on Reply Card

Moseley

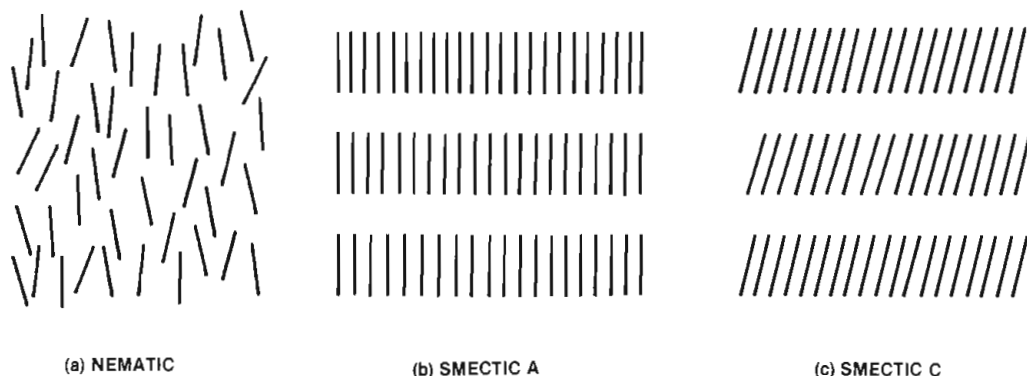

Figure 5. The molecular structure of the three most important classes of liquid crystals: nematic, smectic A and smectic C.

The twisted nematic (TN) display relies on positive nematic materials and is not the most widely used type of LCD. Because of its low operating voltage (typically 3V to 5V) and low power consumption, the TN LCD is increasing in popularity for large-volume applications.

A standard TN display is illustrated in Figure 4. The TN display acts like a valve, either allowing light to pass through it or shutting off the light.

Transparent electrodes control the alignment of the molecules in the positive nematic material. Two polarizers (one in the upper glass, the other in the lower glass) are aligned so

they are off by 90°. If a light is shone through the cell, it will be polarized by the first polarizer, then blocked by the second polarizer. The cell will always appear dark.

The positive nematic liquid crystal material in the cell is prepared so that its molecules line up along the plane of each electrode. Because the two planes are different, the orientation of the structure gradually rotates by 90° between the upper and lower electrodes. This rotates the polarized light coming through the top polarizer by 90° and allows it to pass through the bottom polarizer. This rotation of light provides the 90° "twist" that

gives these displays their name.

Translucency is the normal condition of the TN display cell when the pixel is off (when no voltage is applied to the electrodes). When voltage is applied, the molecules realign themselves to follow a perpendicular orientation. With this action, the twist is eliminated and the cell switches from light to dark. The light can't pass through the bottom polarizer. Removing the charge applied to the electrodes restores the twist.

The advantages of the TN display are:

- Low operating voltages (3V to 5V), which allows low-voltage ICs to drive the display;
- Low operating power (typically 0.1μW/pixel), which makes TN displays practical for portable applications;
- A well-defined threshold (approximately 2V) that simplifies multiplexing and matrix addressing; and
- Long life expectancy due to low voltages and currents.

Multiplexing and matrix addressing

A major technical problem of flat-panel graphic and video displays is addressing the hundreds of thousands of picture elements (pixels). The major success of CRTs, in contrast, is a result of the simplicity of raster addressing.

This new QuantAural™ QA-100 Audio Program Analyzer gives you the advantage in competitive broadcasting

Simply put, the QA-100 quantifies what you hear. Your station sound can now be electronically monitored the way you hear it. Exactly. And, you can monitor the competition too!

Real time analysis of any audio signal. From a receiver, tape recorder, or processing equipment. You see the measurements as you hear the sound. Changes in processing or variations in system performance are immediately shown on the QA-100 panel meter or bargraph display—using program material as the signal source.

The QA-100 hears like a program director and talks like an engineer. With it you can monitor maximum peak level (relative peak modulation), overall

processing effectiveness (average level), tightness of sound and processing control (peak density), tonal balance, consistency and preemphasis (four band real time analyzer), stereo image width (L + R to L - R ratio) and "punch" (special "aural intensity" measurement).

Interested? To learn more about how the QA-100 will help your station compete, call Potomac Instruments today.

QuantAural is a registered trademark.



POTOMAC INSTRUMENTS
932 PHILADELPHIA AVE. SILVER SPRING, MD 20910
(301) 589-2662

Circle (317) on Reply Card

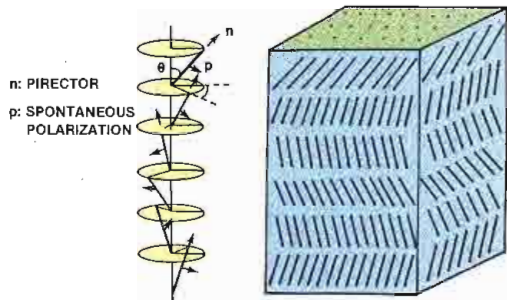

Figure 6. Smectic C liquid crystals have the potential of being ferroelectric and, therefore, suitable for LCDs.

In a typical CRT, such as the ones found in TV receivers and monitors, approximately 250,000 pixels are addressed 30 times each second with a gray scale and color information transmitted at frequencies up to 6MHz. No commercially available flat-panel display offers this level of performance.

Each pixel of a flat-panel display has a row-and-column address. A matrix of 480 rows \times 500 columns (comparable to the average TV picture tube) requires 250,000 individual addresses. To use an individual wire for each pixel is virtually impossible unless the matrix is the size of a billboard.

Usually, a pixel is a dual-terminal device. When a voltage is applied across the two terminals, the pixel produces a visible contrast. In order to accommodate all pixel addresses, all of the pixels in a row share one terminal, and all of the pixels in a column share one terminal. To turn on a particular pixel, voltage must be applied across the appropriate row and column terminals.

In this matrix scheme, however, a fraction of the applied voltage exists across the terminals of all pixels in the matrix. These pixels partially turn on, creating a background image that reduces the contrast of the programmed image.

The problem of selecting a specific pixel is compounded when a second pixel on another row or column is selected. Ideally, only the two pixels would be energized; but in reality two additional pixels will see full voltage across their terminals.

These two problems are inherent in the matrix-addressing technique. The solution to the fractional voltage problem is to use elements that exhibit a non-linear response to voltage. The solution to the multiple-addressing problem lies in sequenced line-at-a-time addressing.

Rather than tying the row terminals of pixels together, rows are addressed individually. The controller addresses a column terminal and then each pixel line in sequence. The controller addresses the next column and each individual line terminal.

If you don't have room for a 10 x 20 routing system, we have a little suggestion.

Introducing the latest low cost additions to our compact video and audio router family: the full-function TEN-20™ or our 20-TEN™. Each requires just one rack unit per matrix. When you need to save space — and money — there's always room for a little innovation.

Grass Valley Group

STRENGTH YOU CAN RELY ON



THE GRASS VALLEY GROUP, INC. — P.O. Box 1114 — Grass Valley, CA 95945 USA
Telephone (916) 478-3000 — TRT: 160432 —
OFFICES: New York (201) 845-7988; District of Columbia (301) 622-6313; Atlanta (404) 493-1255;
Chicago (219) 264-0931; Minneapolis (612) 483-2594; Dallas/Fort Worth (817) 483-7447;
Los Angeles (818) 999-2303; San Francisco (415) 968-6680. A TEKTRONIX COMPANY

Circle (214) on Reply Card

Our new 20 x 10 router is no big thing.

Announcing our new 20-TEN™ and our TEN-20™, the newest additions to the GVG compact video and audio router family. Both are full function systems that need just one rack unit per matrix, and fit your budget, too.

When it comes to saving space — and money — you always have room for a little innovation.

Grass Valley Group

STRENGTH YOU CAN RELY ON



THE GRASS VALLEY GROUP, INC. — P.O. Box 1114 — Grass Valley, CA 95945 USA
Telephone (916) 478-3000 — TRT: 160432 —
OFFICES: New York (201) 845-7988; District of Columbia (301) 622-6313; Atlanta (404) 493-1255;
Chicago (219) 264-0931; Minneapolis (612) 483-2594; Dallas/Fort Worth (817) 483-7447;
Los Angeles (818) 999-2303; San Francisco (415) 968-6680. A TEKTRONIX COMPANY

Circle (215) on Reply Card

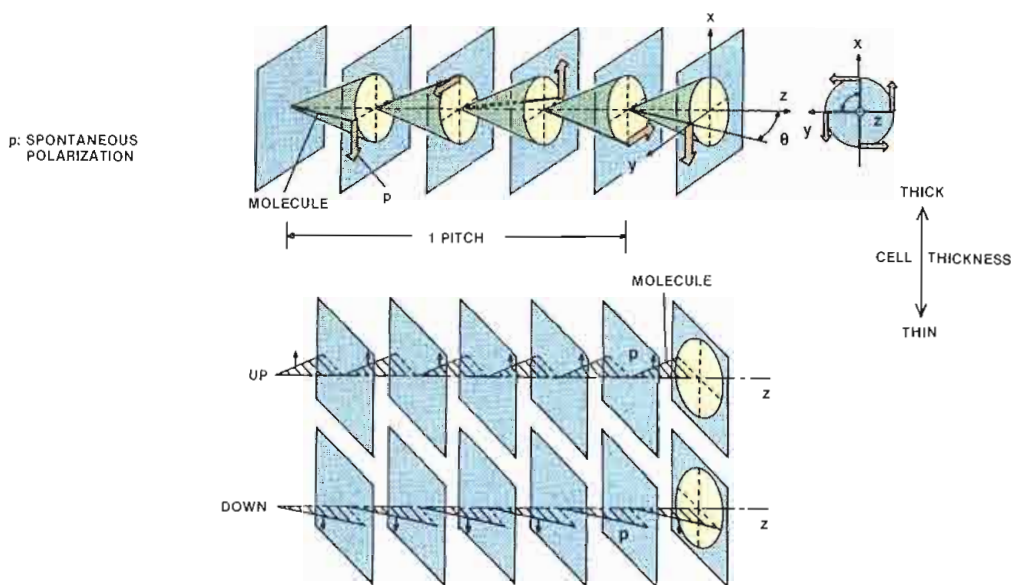

Figure 7. In smectic C liquid crystals, an unwinding action gives the material its ferroelectric properties.

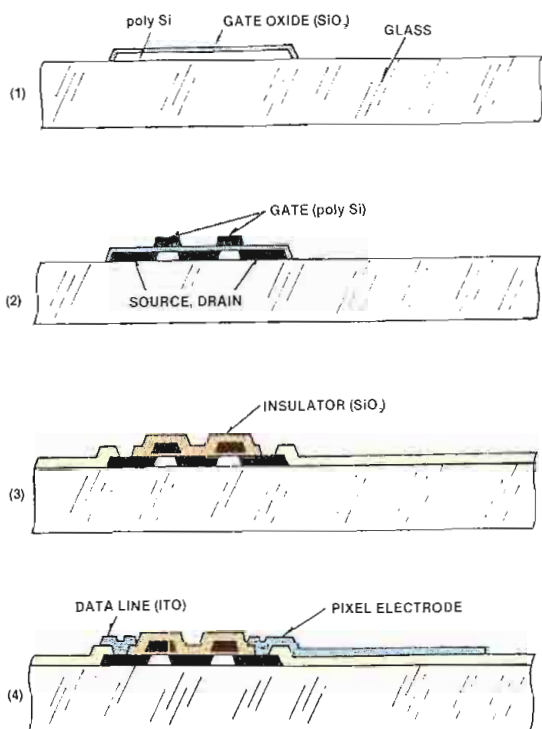

Figure 8. A polysilicon thin film transistor used in active matrix LCDs is made using only four photo masks.

Because of the large number of lines, line-by-line addressing must occur quickly. The controller must address every line terminal in a row in the same time period that it previously took to address the entire row. As a result, the display must be responsive to a short duty cycle. The individual lines are addressed in sequence; they time-share the address cycle. This time-sharing is called *multiplexing*.

The duty cycle is determined by the number of lines that must be addressed within one cycle. A 1/200-cycle, for example, means that during every addressing cycle, the controller must address 200 lines. This fraction is also known as the *duty cycle ratio*.

Improvements in simple matrix displays

Steady improvements in LCD technology are creating new applications for LCDs in the TV/video, computer and test equipment marketplace. New liquid crystal compounds with improved elastic constants, viscosity and dielectric anisotropy are being developed. Advancements in the mixing of liquid crystal compounds have improved performance over broader temperature ranges.

Advancements in the surface alignment techniques have increased the control of tilt angle and the domain of liquid crystal molecules. New panel designs are optimizing the geometric design of polarizers and bi-refringence of liquid crystal materials.

Two emerging LCD technologies hold particular promise. The first is a *supertwisted* nematic display, in which the light passing through it is twisted by 270°. The supertwisted display provides high multiplexibility greater than 200 lines with good contrast, because of a well-defined threshold. Unfortunately, the supertwisted display will have the same slow response time (typically, 100ms) as a conventional TN display, making it unsuitable for TV applications.

Ferroelectric smectic

The second emerging LCD technology is based on a smectic liquid crystal material that uses a new, but simple, geometric structure. A ferroelectric material is simply a crystalline material whose polarization can be controlled by an electrical field. It is often referred to as *smectic C*.

Smectic C materials promise to open the doors to video and TV displays with an extremely fast response time (10µs) and a memory. The rapid response time will increase the available resolution;

refreshing an entire 500-line smectic C display requires only 5ms.

Memory means that the display retains what is written until it is refreshed. The memory feature is especially important for reducing the power consumption of displays used in portable equipment. The memory also will eliminate flicker and enhance the quality of moving images against a stationary background.

Figure 5 contrasts the molecular structure of the three most important classes of liquid crystals: nematic (N), smectic A and smectic C. Neither nematic nor smectic A can ever be ferroelectric. Smectic C, however (see Figure 6), has the potential of being ferroelectric and is practical for LCD video displays.

In a smectic C display, as illustrated in Figure 7, the smectic layers are aligned parallel to the glass surface. If the liquid crystal material is thin enough, the surface interactions will unwind the helix. This unwinding action gives the material its ferroelectric properties. A pulsed electrical field switches the polarization of the cell. The closeness of the surfaces causes it to latch in that state, maintaining it indefinitely after the pulse is over. Polarizers produce a visible contrast between the two states of the cell as the light is shining through.

New developments in the ferroelectric area may be slow in coming because there are only a few ferroelectric materials available. Research is under way to synthesize new compounds that have ferroelectric properties.

Active matrix LCD displays

Simple matrix displays satisfy the demand for flat panels in many applications. In recent years, TN displays have become extremely sophisticated. Driven at high multiplexing rates, TN displays can be found in portable computers and pocket televisions. These products often use large numbers of scanning lines, sometimes more than 400, requiring a highly multiplexed driving method.

The operating principles of TN displays dictate that as the duty ratio becomes higher, the image quality (viewing angle and contrast ratio) becomes lower. Its static contrast ratio might be 20:1. However, when a display is multiplexed at a duty ratio of 1/200, the contrast ratio may drop as low as 3:1.

This limitation results from a characteristic of multiplexing: The difference between the voltage applied when a cell is off and when it is on lessens with higher duty cycles. This voltage differential determines the contrast ratio.

Active matrix techniques

The active matrix driving method is one attempt to solve this problem. An active matrix LCD is a display that has an active element such as a thin film tran-

AMEK

AMEK BCII - Compact Audio Engineering for Broadcast Production

Preferred for Film and Video Post · Audio Post for Radio · Stereo
Television · Foley · ADR · Transfer · ENG · On-Location Recording
Corporate Video Production.

AMEK's BCII System responds to the needs of the contemporary Broadcast Production environment for a higher standard of performance and flexibility in compact audio production consoles.

Our in-depth understanding of operational and creative requirements has led to the inclusion of many new and valid design ideas. Our innovative approach has created an audio-mixing system which is truly compatible with almost any operating environment; whilst its competitive pricing makes the BCII extremely budget-efficient.

A range of interchangeable modules in both Mono and Stereo formats utilising plug-in subassemblies, combined with comprehensive control facilities, allow many tasks to be accomplished in a number of ways. Customization of signal flow paths using internal links, optional Dynamics modules and several chassis variations, further serve to increase the capabilities of the system.

The robust, all-metal chassis design fully screens the electronics from stray electromagnetic fields; ultra-low-noise circuitry, balanced outputs, and the use of balanced bussing provide exceptional performance characteristics. The AMEK equalizer has a very wide operating range, suited to any application from delicate track sweetening to severe, corrective equalization.



AMEK BCII
IN 8/4/2 VERSION

The monitoring system allows comprehensive handling of gallery/control room requirements. Various metering arrangements are available.

Furthermore, the BCII has ports for AFV (Audio Follows Video) which can be configured for either Remote Muting in the standard version or for remote DC control of fader levels in the VCA version.

In essence, an outstanding product specified worldwide by a diverse range of clients, from owner-operators to major, multi-installation broadcasters such as the BBC and NBC.

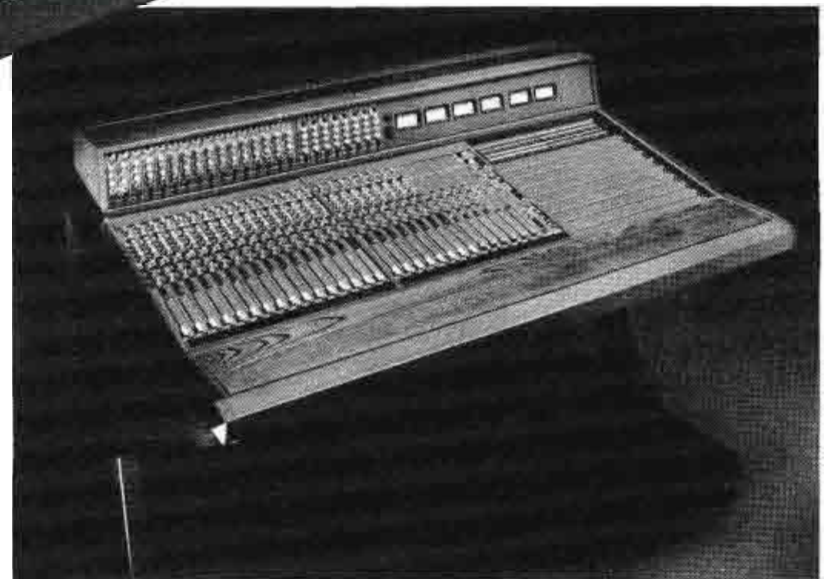

AMEK BCII
IN 24/4/2
STUDIO CHASSIS
VERSION

Head Office, Factory and Sales: AMEK Systems and Controls Ltd, Islington Mill,
James Street, Salford M3 5HW, England. Tel: 061-834 6747.
Telex: 668127 AMEK G E-MAIL: AMEK-UK. Fax: 061-834 0593.

In the USA: AMEK Controls Inc. 10815 Burbank Blvd, North Hollywood, CA 91601.
Tel: 818/508 9788. Telex: 662526 AMEK USA E-MAIL: AMEK US. Fax: 818/508 8619.



AMEK



Circle (216) on Reply Card

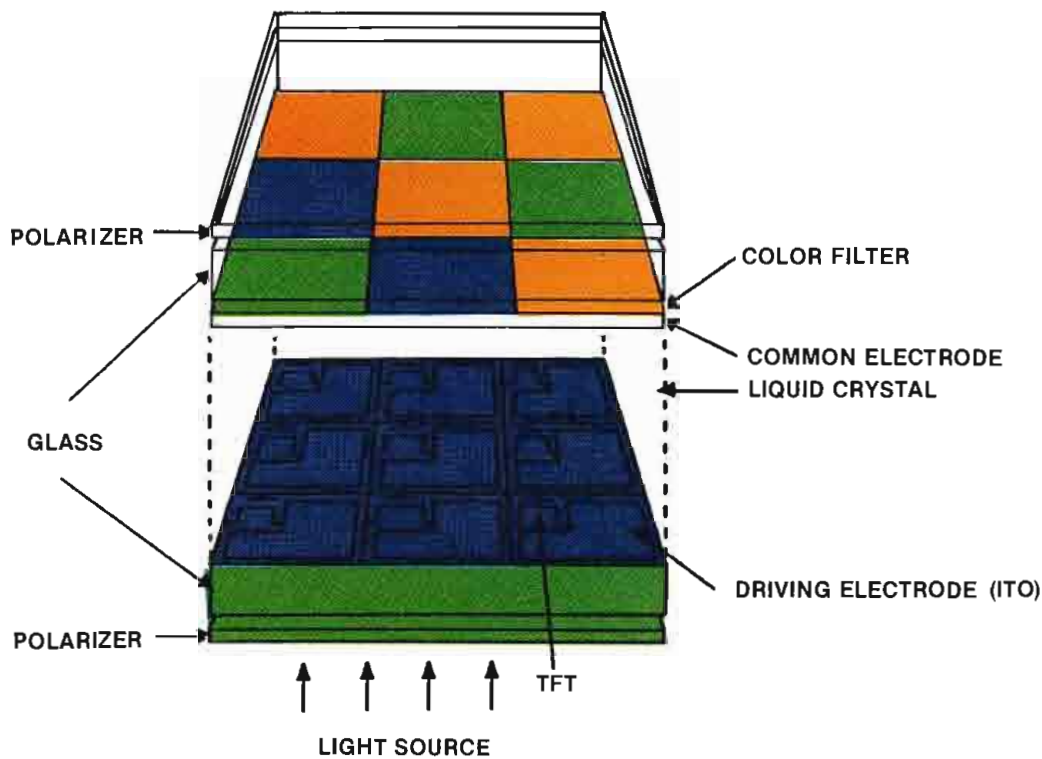

Figure 9. In a color TFT LCD, when the TFT turns on, the data is written into the pixel. After the TFT turns off, it holds the charge that was written into the pixel in the correct state. The charge written to the cell determines whether the pixel is on or off.

sistor (TFT) or diode that directly drives each pixel. Active matrix displays have been in development as long as TN displays, and were intended to provide

designers with a flat-panel display with resolution and performance matching that of CRTs. Currently available active matrix displays feature:

- High image quality. A high contrast ratio (23:1 even at high duty cycles) and a wide viewing angle;
- The use of a variety of liquid crystal modes (such as guest host and twisted nematic);
- In the case of TFT, capability to integrate drivers on the same substrate as the display, making the display package more compact and cost-effective; and
- A full-color image, comparable to that of a CRT.

Types of active elements

The active elements of a display directly control each pixel. In a practical display, therefore, the active elements must provide a low resistance when the controller writes to a particular cell, and a high resistance to maintain the cell's state. Two types of thin film devices, polysilicon (poly-si) TFTs, and lateral metal-insulator-metal (MIM) thin film diodes, meet these requirements and are typically used as active elements.

Although the fabrication process of TFTs is more complex than for MIMs, their switching characteristics provide better image quality for viewing moving pictures that require a gray scale. The simple fabrication of MIMs, on the other hand, makes it simple to create large-

LET'S TALK KEYERS



VK-900

MIX TO KEY IN EITHER INTERNAL OR EXTERNAL MODE PLUS A/B ADDITIVE MIX.



DK-400

SAME FEATURES AS VK-900 PLUS KEY PREVIEW AND MASTER FADE TO BLACK.

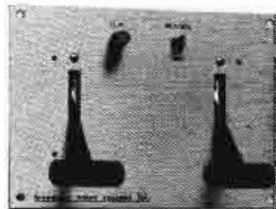

OPTIONAL FOUR SPEED AUTO MIX MAY BE ADDED TO EITHER KEYER.

THE ECONOMICAL SOLUTION TO ADDING EXTRA MIX/KEY LEVELS TO EXISTING SYSTEMS.

broadcast video systems ltd.

40 West Wilmot Street, Richmond Hill, Ontario L4B 1H8
Telephone: (416) 764-1584
See us at NAB, Booth 2730

Circle (217) on Reply Card

THE OPTIONS ARE YOURS! THE KNOW-HOW IS OURS!

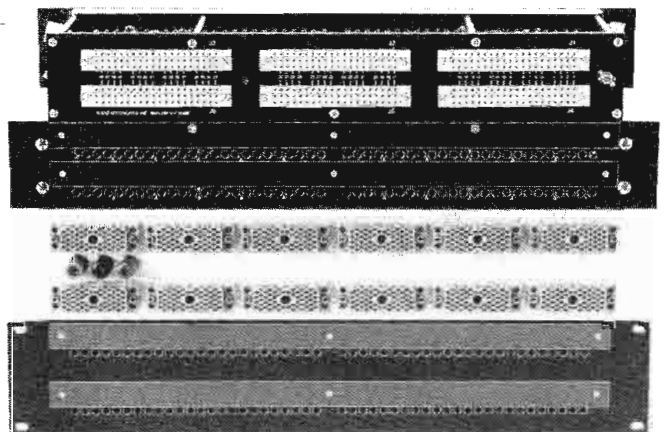

AUDIO-LINE panels can be custom-fabricated to suit your audio application. We give YOU the option of wiring configurations, connectors, and termination.

AUDIO ACCESSORIES, INC., a manufacturer of high quality audio jacks and jack panels, is one of the few companies providing custom-wired audio panels to the field. Write or phone for information.

See us in March at the NAB Show in Dallas, Booth No. 2754.

audio accessories
audio line

Circle (185) on Reply Card

AUDIO ACCESSORIES, INC., MILL ST., MARLOW, NH 03456
603-446-3335

Circle (185) on Reply Card

GYROZOOM® USER'S PROFILE

**Congratulations,
Stars & Stripes!**

**“Not even high seas
could shake, rattle or
roll our America’s
Cup coverage.”**

Allan Smith,
TVW Channel 7,
Perth, Australia

“Shooting the America’s Cup 12 meter races in the seas off Fremantle, Australia presents an interesting challenge,” writes TVW Channel 7’s Allan Smith. “Of course we have to keep our distance—400 to 500 yards—and often the shooting stand on our small boat is pitching so violently that we have difficulty keeping the 12 meter boats framed up, much less focused,” Smith continued. “The Gyrozoom 60-300 Image Stabilizing Lens has solved these problems for us, and lets us think about other matters...such as how to keep our lunches down.”

For more information on the Schwem Gyrozoom Image Stabilizing Lens, call or write Schwem Technology today.



SCHWEM
TECHNOLOGY

3305 Vincent Rd., Pleasant Hill,
CA 94523. Call (800) 228-1333-242
or (415) 935-1226.

Circle (218) on Reply Card

www.americanradiohistory.com



GLOBAL SUPPORT FOR GLOBAL COMMUNICATIONS

Microprocessor Controlled Klystron High Power Amplifiers

Field-proven and recognized for wide spectrum coverage and consistent, reliable output, MCL's Microprocessor Controlled (and Standard Logic) Klystron High Power Amplifiers (SATCOM C-Band and Ku-Band) are accepted and proven by communications experts worldwide. MCL Series 10000 Klystron Amplifiers are designed to withstand variable environmental and mechanical conditions and are engineered for minimum maintenance and repair.

MCL's SATCOM Series 10000 Amplifier Systems feature a host of standard equipment and options, including:

- full microprocessor (or CMOS Logic) system control panel
- modular assembly for rapid sub-assembly access
- Motorized Channel Selectors available
- RS232, RS422, IEEE488, or Contact Remote Interfaces
- electrical/mechanical "no-step" or SCR AC line regulator drawer
- Beam Supply on casters; all other assemblies on slides
- ruggedization for transportable applications
- and more!

MCL is the leader in the field of amplifiers and allied equipment for the field of satellite communications. MCL offers a complete line of products, at competitive prices, quality-tested and proven to provide *unexcelled performance*.

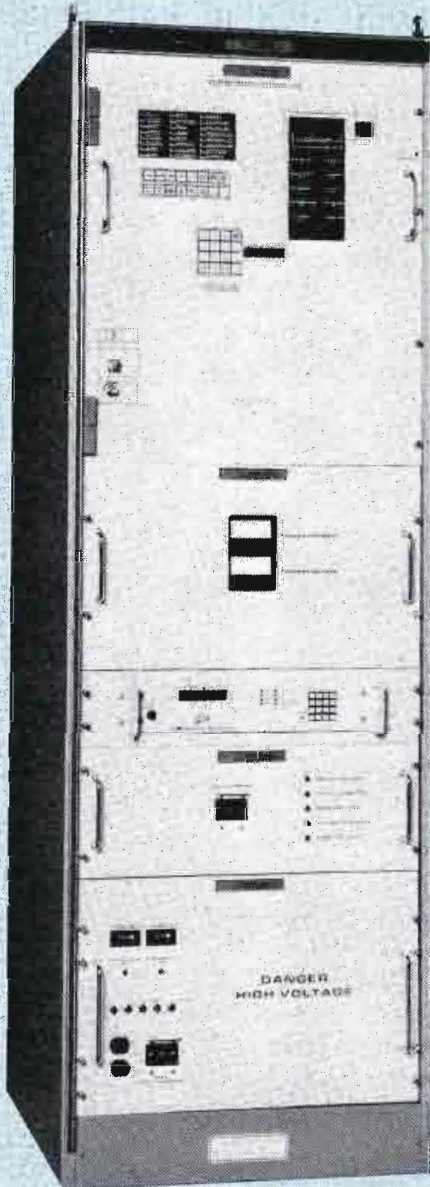

Microprocessor amplifier shown

Write or call MCL today and request your FREE copy of Brochure #1001 (Microprocessor Logic) or Brochure #9009 (Standard CMOS Logic) for details and technical specifications.



MCL

MCL, INC.
501 S. Woodcreek Road
Bolingbrook, IL 60439
312-759-9500 TWX 910-683-1899

Manufacturers of TWT and Klystron Amplifiers for Satellite Communications.
24-Hour Sales and Technical Support for Immediate Service Worldwide.

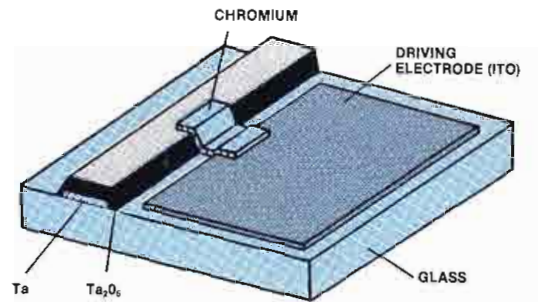

Figure 10. For larger display areas, MIMs are suitable. MIMs can be made using only two or three photo masks.

area, high-resolution LCDs for computers. Typically, computers with LCD displays don't require a gray scale.

Amorphous silicon was tried as a material for TFTs, but it has some reliability problems and doesn't provide enough *on* current (the current that acts as a write signal for the cell) to furnish an optimum picture display.

The newest displays use poly-si TFTs, which provide a high *on* current. They also are more reliable and have a lower light-induced leakage current. The poly-si transistor, as shown in Figure 8, is made using only four photo masks.

Color LCD displays

Figure 9 shows the basic construction of a full-color TFT LCD. When the TFT turns on, data is written into the pixel; after the TFT turns off, it holds the charge that was written in to keep the pixel in the correct state. The charge written to the cell determines whether the cell is on or off.

The upper glass substrate contains a multiple-color filter that determines whether a given cell will be red, green or blue. Each pixel of the display contains one cell of each color. A white light source, such as a fluorescent tube, shines through the cell from behind. Because the light source is placed behind the display, the LCD is called a backlit display.

The basic design lies behind the display used in the first full-color LCD televisions. The 2-inch diagonal displays used in these early color LCD televisions use poly-si TFT drivers to produce a matrix of 220x240 dots: 52,800 dots divided equally among red, green and blue. This technology is less than three years old.

More recently, newer LCD televisions have been introduced with higher resolution. A 5.13-inch diagonal television features a matrix of 440x480 dots with a pitch of 0.2mm along both the horizontal and vertical axes. Only the best high-resolution color video CRTs approach a pitch this fine.

Circle (219) on Reply Card

Mosses & Mitchell Jacks & Jackfields *used in Broadcast Systems Worldwide*

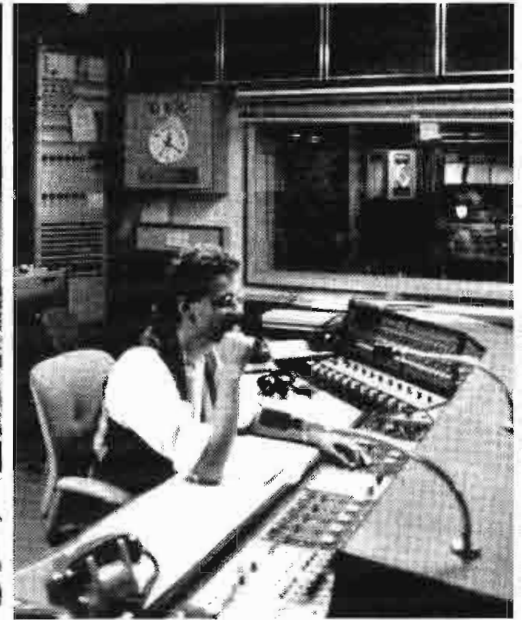

Plasmec Systems, a member of Plasmec plc are a leading manufacturer of Jack Sockets and Jackfields with a well earned reputation for excellent engineering standards.

Plasmec's range of Jacks and Jackfields are marketed to Broadcasting and Telecommunications industries throughout the world under the trade name of Mosses & Mitchell.

PLASMEC
Systems Limited

Weydon Lane, Farnham
Surrey GU9 8QL
Tel: (0252) 721236
Telex: 858820

Using the latest engineering techniques Mosses & Mitchell Jacks and Jackfields are manufactured from the highest quality materials, to meet the most exacting specifications for quality and reliability that our customers demand.

For more details of the Plasmec range of products send for our new brochure.

For enquiries in the U.S.A. contact:
Penny & Giles Inc.
2716 Ocean Park Boulevard
Suite 1005, Santa Monica 90405
California. Tel: 2133 930014

Circle (220) on Reply Card

March 1987 **Broadcast Engineering** 297

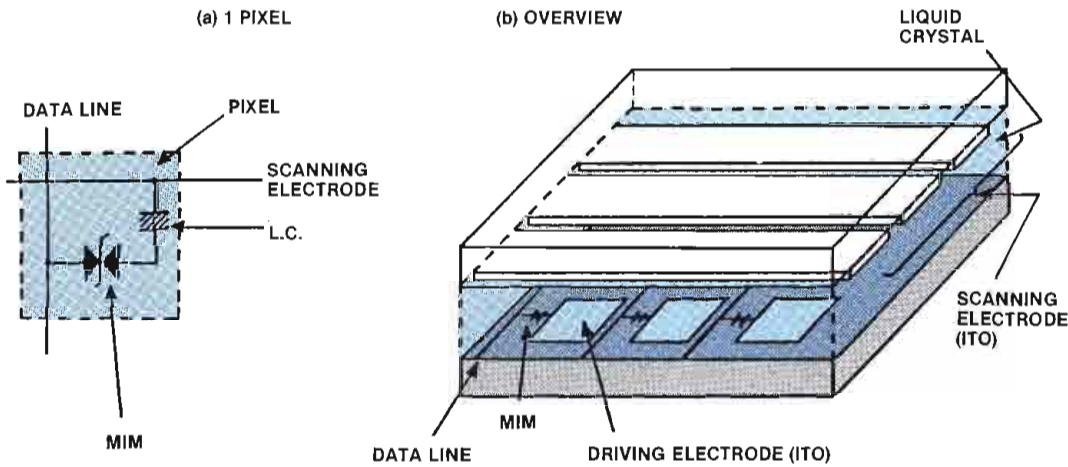

Figure 11. In an MIM LCD, the driver diodes have a stable threshold voltage; once the voltage applied exceeds the threshold, the on current flows. Dropping the voltage below the threshold turns the current off.

The nature of TFT displays makes them suitable for highly miniaturized applications. A new display with integrated poly-si TFT drivers has a matrix of 220x318 dots, yet measures only 1.27 inches diagonally. This application works extremely well in specialized applications, such as solid-state electronic viewfinders.

Large area displays

Computer applications may require larger display areas than can be fabricated using TFT driver elements. These applications yield to MIM diodes. MIMs require a simpler fabrication process than TFTs (see Figures 10 and 11). MIM displays can be made using only two or three photo masks, compared to the four photo masks required when making a TFT display. The metal film used to create the diode is deposited by a sputtering process that makes it fairly easy to fabricate displays that measure more than 10 inches diagonally. Because active matrix displays are transparent, they may be incorporated in projection TV applications in the near future.

Newer MIM LCD displays provide 400x640 dot resolution, with a pitch of 0.3mm in both the horizontal and vertical axes. This pitch is equivalent to that of typical high-resolution color CRT broadcast video monitors.

In a reflective display, in which the light source enters from the front, these newer displays can easily achieve a contrast ratio of 15:1 and a viewing angle of more than 50°. In this newer design, each dot to be displayed is divided into two pixels, so that even if a pixel fails, the dot will still be visible. This process increases the fabrication yield and ensures the display's reliability.

As costs go down with the learning curve, the use of flat-panel LCD video displays will increase. But don't throw away your picture tube rejuvenator yet. For broadcast and production applications, colorimetry and esoteric considerations will probably keep CRTs in vogue for many years to come.

Editor's note: This article was adapted from information presented by Epson America, Torrance, CA, at recent seminars in New York and San Jose, CA. All art is courtesy of Epson. Papers included in this article were presented by Toshiaki Saito, director of research and development; Yoshio Yamazaki, general manager, fundamental technology research; and Shinji Morozumi, manager of fundamental technology research.

**NEED TO EDIT AUDIO
FASTER?**

We have the Solution...

With Our
**Edit Suite
Audio Mixers**



Model 616

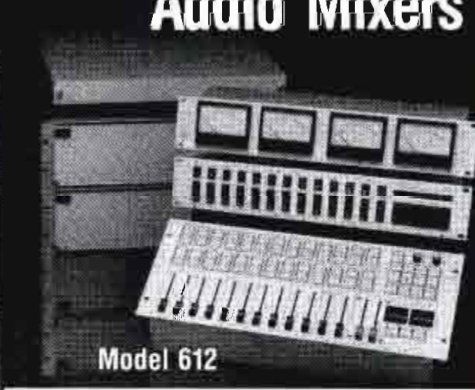

Model 612



Model 608 (New for '86)

Specially designed for television, the ESAM from Graham-Patten Systems lets you edit audio the same way you do video... operating from the edit keyboard. Only the ESAM has a proven track record in edit system integration: for Ampex ACE, CMX, Calaway, Convergence, Grass Valley Group, and other editing systems that operate a production switcher. Tailored to the needs of every facility, ESAMs are offered in 8-, 12-, and 16-input models. Additionally, an electronically controlled programmable equalizer is available for the 12- and 16-input models. Here are just a few other innovative ESAM features:

- Operates like a video switcher with preset, program & preview busses
- Manual & full edit system control of source selection, transitions, & previews
- Separate electronics & control panels for maximum flexibility & compact size
- Delivers high quality demanded by recording & post production professionals

Yet there's more! For a complete brochure, call us toll free:



GRAHAM-PATTEN SYSTEMS, INC.
P.O. Box 1960, Grass Valley, CA 95945

See us at NAB
Booth 2528

Inside Calif.: (800) 422-6662 • Outside Calif.: (800) 547-2489 • TWX 910-333-6065

Circle (221) on Reply Card

“We wanted the best standards converter on the market. In side-by-side tests, SATIN was clearly superior.”

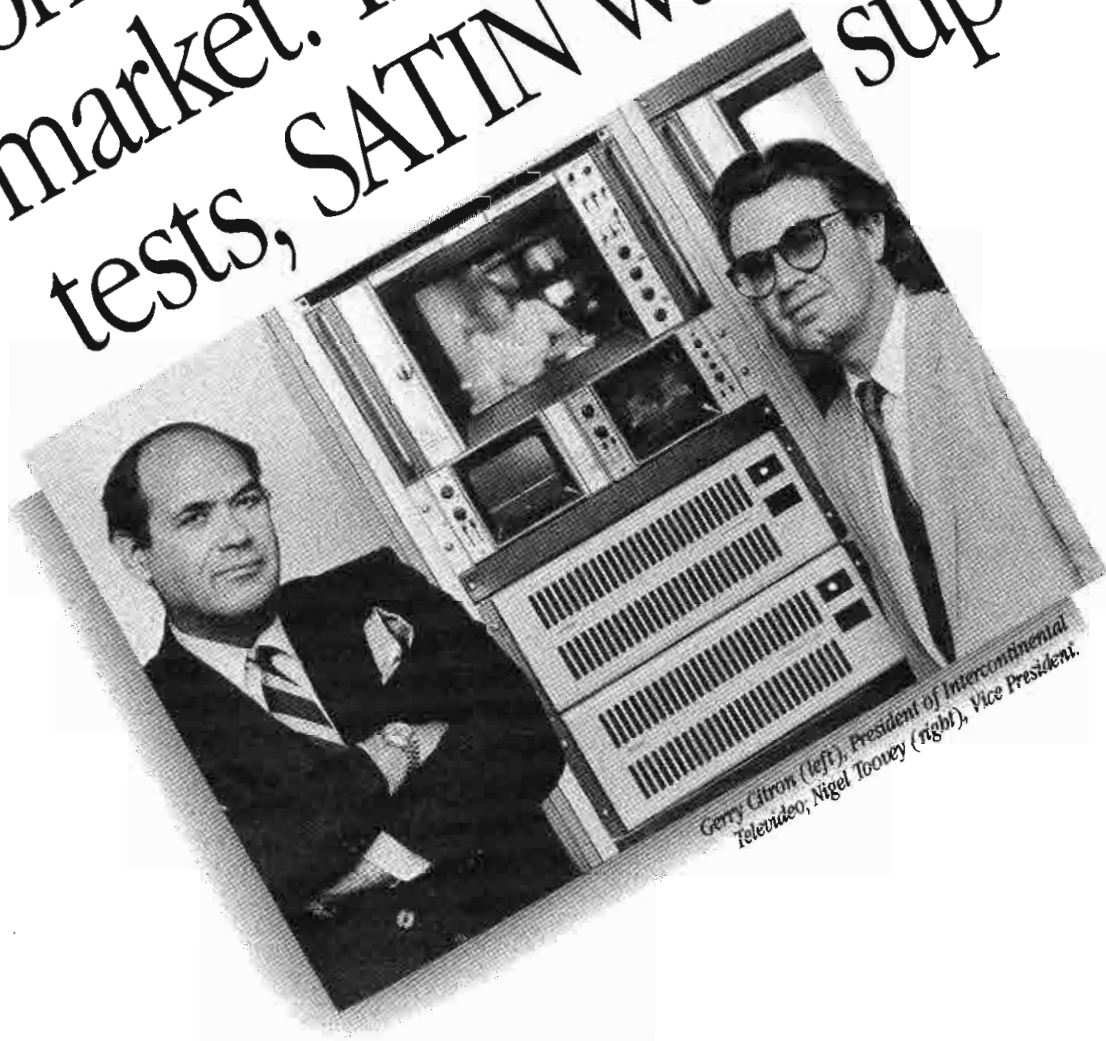

Gerry Citron (left), President of Intercontinental Televideo; Nigel Toovey (right), Vice President.

Gerry Citron, President of Intercontinental Televideo, the oldest and one of the largest conversion facilities in the country, knew exactly what he wanted: “The very best, the latest, the finest converter available.” Here’s why he bought the Quantel Satin:

“We made our own demo tape,” Gerry said. “A very difficult tape, with lots of graphics and movement. We converted that tape on Satin and on the leading competitor...”

Everybody picked Quantel Satin. “We asked knowledgeable people from the Broadcast Industry to view the tapes side-by-side in a split screen test. Everybody picked Satin.”

“In signal-to-noise ratio, color imagery, resolution and movement interpolation, Satin was significantly superior,” according to Intercontinental’s Vice President, Nigel Toovey.

“We were also attracted by Satin’s all digital design,” Toovey continued. “Digital VTR is the next thing, and Satin, with its direct 4:2:2 interface, will put us in the forefront of that movement.”

And price? “We didn’t buy on price,” stated President Citron. “We bought on performance, reputation, technology and support. But the price was competitive. Quantel’s Satin offers much more than early systems for almost the same cost.”

Satin’s superior picture quality and outstanding price/performance will convert you, too.

For information, contact Intercontinental Televideo at (212) 719-0202, or write to Quantel, 3290 West Bayshore Road, Palo Alto, CA 94303, (415) 856-6226.



Step into the digital studio

QUANTEL

Circle (222) on Reply Card



The Right Stuff!

Ikegami's HK-322 Studio and HK-323

Field/Studio Cameras:

Here to Stay.

Ikegami's HK-323 1" and $\frac{2}{3}$ " field/studio cameras, alongside the ever popular HK-322 full production camera, gives the broadcast marketplace a choice of two distinct, yet unique cameras, second to none.

The HK-322 with 1" or $1\frac{1}{4}$ " tubes remains the ultimate production camera in the industry, with specialized functions not found on any other camera. These include 6 vector color corrector, scan reversal with memory, negative video, out-of-bands horizontal aperture correction, scene files with extensive memories, dream effect and much more. For complete flexibility, the hand-held HL-79EP is available as the companion camera.

For field/studio operation, the HK-323 1" and $\frac{2}{3}$ " cameras, recently introduced by Ikegami, are quickly gaining acceptance with the networks as the market leaders in this segment of fully automatic micro-processor controlled, lighter weight broadcast cameras. The HK-323 is available with the optional hand-held companion, the HK-323P, which operates off the same base station.

Once again Ikegami is right where the marketplace expects us to be; with a commitment to excellence and our assurance of the best.

For a demonstration of the Ikegami HK-323 and HK-322, contact us or your local Ikegami dealer.

Ikegami

Ikegami Electronics (USA), Inc. 37 Brook Avenue Maywood, NJ 07607

East Coast: (201) 368-9171; West Coast: (213) 534-0050; Southeast: (813) 884-2046 Southwest: (214) 233-2844;
Midwest: (312) 834-9774; Hawaii: (808) 946-5955



HK-322 hand-held companion HL-79E

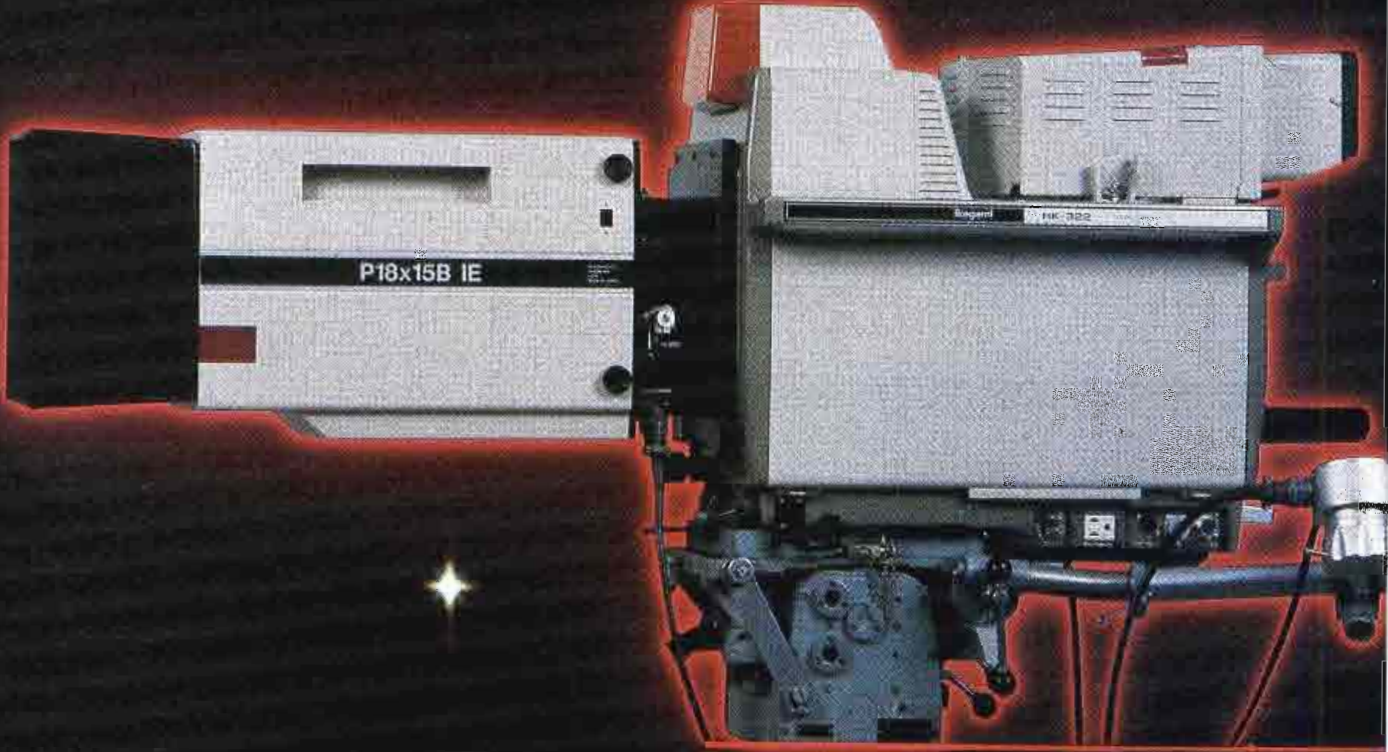

HK-323 hand-held companion HK-323P

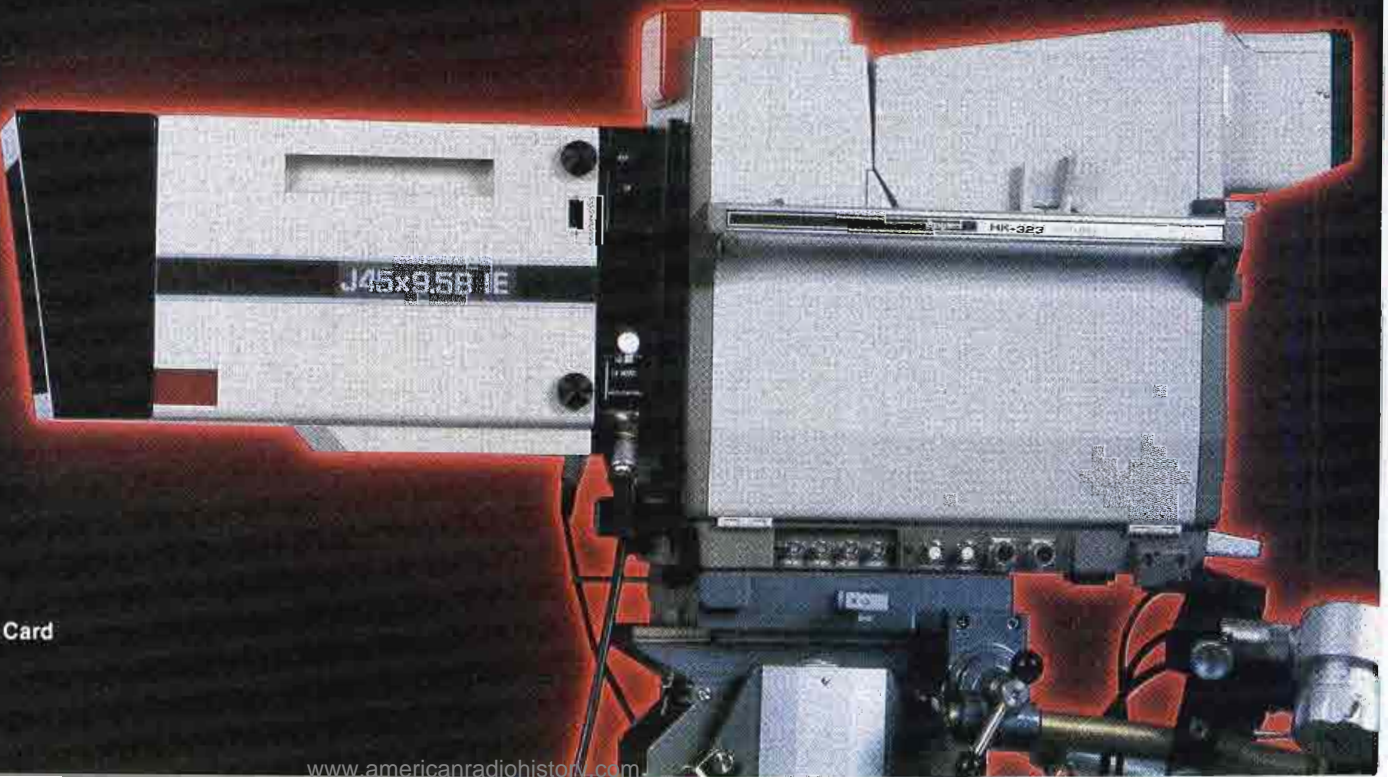

Circle (223) on Reply Card

DBS digital sound-coding format

By Carl Bentz, special projects editor

Before compact discs, much of the music heard on the radio has survived three massacres. First, and worst, a stylus scrapes along the grooves in the record turning physical vibration into electronic sound. Then, audio processing equipment and the transmitter add their own brand of degradation. And finally, no receiver, as good as its specifications may claim, is perfect.

CD laser reproduction eases the first onslaught, because a physical groove-stylus contact is no longer necessary. The result is obvious to listeners. In response radio stations, particularly FM, now program CD sources from 30% to more than 50% of the time.

A digital challenge

The next step in audio improvement is to bring a digital signal to your receiver. To be workable with current channel assignments, however, a different approach from normal digital systems must be taken. That is the concept of Dolby Laboratories Soundlink, a digital sound-coding format for DBS, cable and terrestrial broadcast.

Constraints on broadcasting digital audio result from existing broadcast systems and digital formats. In terrestrial broadcasting, for example, fitting more information into a bounded-frequency spectrum presents problems. In satellite broadcasting, channels are wider, but costs in building, launching and operating a satellite suggest each transponder must be used as efficiently as possible. Achieving that efficiency means a reduction in the bandwidth of the transmitted digital audio signal.

Established methods

Most digital audio recording and presentation equipment (including CDs) use pulse-code modulation (PCM). Audio is sampled into a 0-1 pulse train at a standardized 44.1kHz rate. Each sample consists of 16 bits, producing a serial audio data rate of 1.4112Mbit/s for a stereo channel pair, plus error protection.

Acknowledgment: This article is based on material provided from Dolby Laboratories by John Fisher and Graham Carter, London, and Ken Gundry and Craig Todd, San Francisco.



The quality of PCM audio, its 80dB or greater dynamic range and its apparent freedom from noise and distortion results from its precision design. Components, elaborate filters and a 0.01% precision requirement in the output signal result in excellent quality as long as digital data error rates remain less than 10^{-4} . The cost of PCM equipment in consumer quantities reflects the need for precision.

Based upon sampling frequency and the number of quantizing bits, PCM bandwidth requirements for RF broadcasting are impractically wide. However, if the digital bit rate can be held between 200kbit/s and 300kbit/s per channel, the scheme is workable. One way to get closer is to use a lower standardized sampling rate of 32kHz.

A characteristic of digital audio is its capability to withstand less than desirable environments and to allow correction or at least concealment of errors occurring in the transmission path. Without some type of cosmetic treatment, the data errors of PCM audio cause loud cracks and bangs in the signal. As significant bits of a sample are removed (or added), the amplitude of the reconstructed sample would be reduced (or increased) by a factor of two/bit. Technically, such errors are only one sample time in length and are algorithmically correctable by repetition of previous samples or interpolation from comparisons with previous and subsequent samples.

Signal processing to determine error presence and implement corrections is

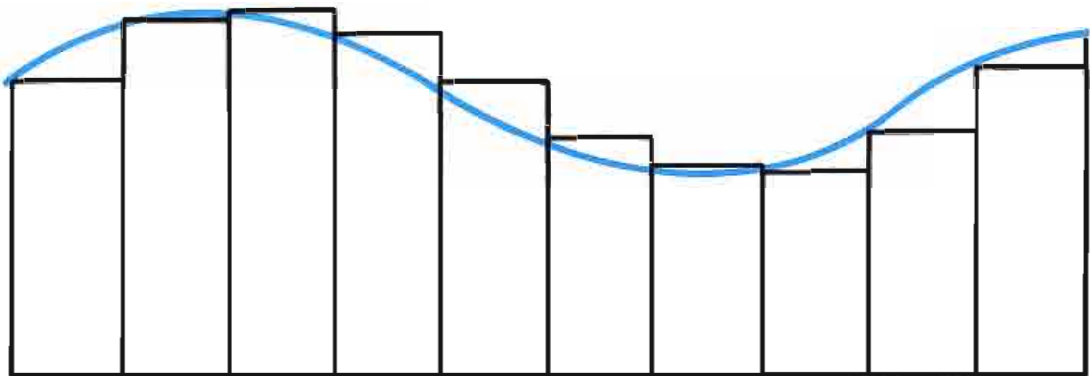

TYPICAL PCM CODING OF AN AUDIO WAVEFORM

Figure 1. In PCM coding the exact instantaneous signal level is represented by a multibit digital word.

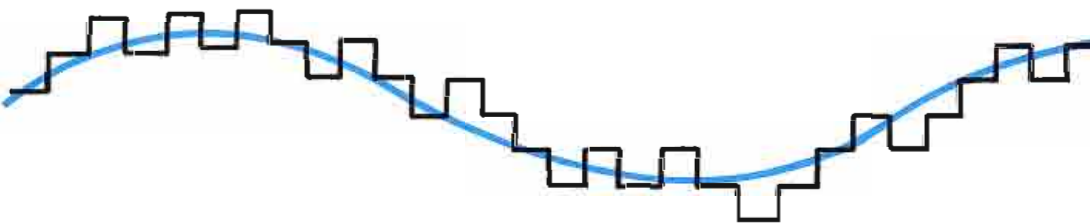

TYPICAL ADM CODING OF AN AUDIO WAVEFORM

Figure 2. ADM coding represents increases or decreases in the audio level as 1s or 0s.

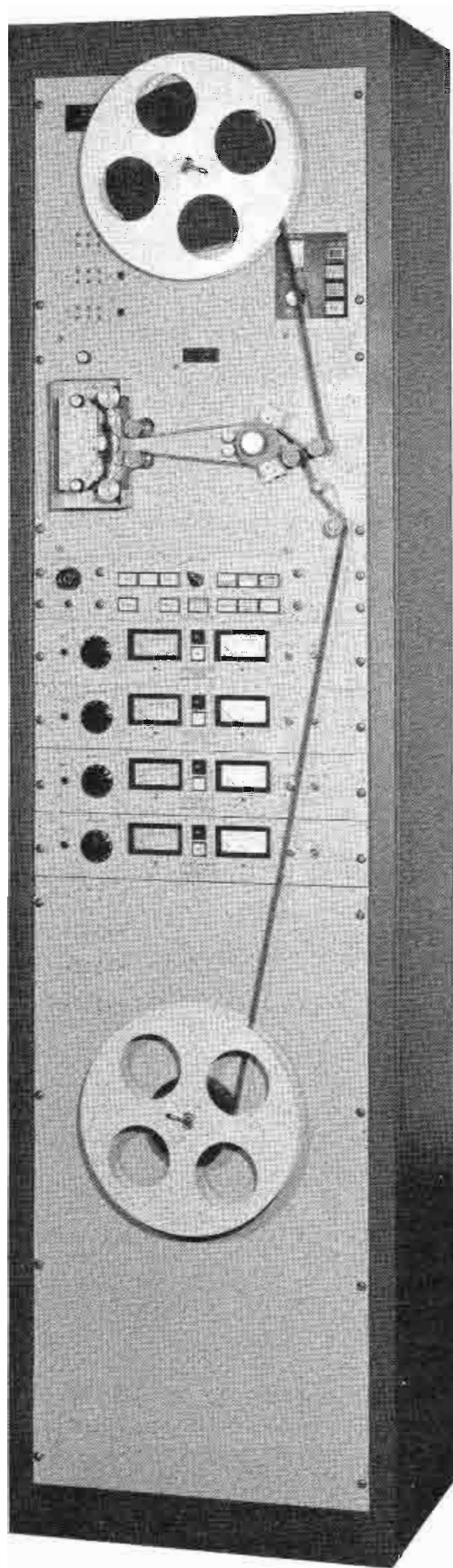

MAGNA-TECH

THE SOUND HEARD AROUND THE WORLD

**Magnetic Film
Recorders and Reproducers
for Television and Film
Sound Post-Production**

HIGH SPEED

Telecine Magnetic Followers
Video Tape-Film Interlock
Electronic Looping
Dubbing Systems
16 and 35mm Electronic Projectors
Total Facility Engineering

WORLDWIDE SALES OFFICES

Paris
Hi-Fidelity Services
4 Rue Semard
75009 Paris, France

Sydney
Magna-Techtronics (Aust.)
PO Box 150
Crows Nest NSW 2064
Australia – Telex 24655

Johannesburg
General Optical Co., Ltd.
15 Hulbert Road
Johannesburg 2001,
South Africa

Rome
Alberto Sciarretta
Via Siria 24
Rome 00179
Telephone 7943618

Brussels
A.R.C.
Rue de Boisdé Linthout 45
1200 Brussels Belgium

Hong Kong
Paul Yang and Associates
901 Star House
3 Salisbury Road
Kowloon, Hong Kong

Bombay
Capt. P.K. Vishwanath
234/4 Rama Baug,
Deodhar Road
Bombay 400 019, India

Kehl West Germany
Zenon GMBH
Postfach 1743
Hauptstrasse 128
Kehl am Rhein
Tel: 07851/2991
Telex: 753537

London
Branch & Appleby
42 High Street
Harrow-on-the-Hill
Middlesex HA1 3LL,
England

Kuala Lumpur
Kinematronika Sdn. Bhd.
2852, Jalan Selangor/
Persekutuan,
Federal Hill
Kuala Lumpur, Malaysia

Caracas
Cine Materiales srl
Apartado Postal 61.098
Caracas 106 Venezuela

MAGNA-TECH ELECTRONIC CO., INC.

630 Ninth Avenue, New York, N.Y. 10036

Telephone (212) 586-7240

Telex 126191

Cables "Magtech"

Circle (224) on Reply Card

March 1987 *Broadcast Engineering* 303

quite complicated. Due to the complexity, the cost of decoding at the receiver for error correction becomes a consideration in the receiver system cost. For marketing purposes, a less expensive product would be preferred.

DM explored

PCM samples the absolute value of the signal at a fixed rate at least 2X the highest expected frequency in the audio to be sampled (the Nyquist criterion). Unless some type of sample compression is applied, all 16 bits are necessary to ascribe the proper characteristics in reconstructing the signal at the decoder.

Another method of converting analog to digital is delta modulation (DM), sometimes referred to as *1-bit differential PCM*. DM, a less precise system, determines if the audio level has increased or decreased since the previous sample. In an adaptive system, as levels increase, the digitizing steps also increase, relatively. Because the result is not an absolute measurement of the level, just the relative change, DM sampling is restricted by its relative inability to respond to sudden changes in input signal. For large level changes, overload may result; for minute signals, quantization noise tends to be higher.

Noise modulation of simple DM audio increases as the signal frequency increases, not because of high-amplitude signals, but because of large slope signals. The high frequencies present in the signal will mask the noise, however, making this characteristic less objectionable. Errors in DM sampling from noise or other sources are less critical than with PCM because a DM sample is a single bit.

Adaptive delta modulation (ADM) was developed for the Dolby Soundlink system actually samples more frequently than PCM. Rather than dealing with a 16-bit representation of an absolute value, the ADM sample indicates if the input signal increased with a (1) or decreased with a (0) from the previous sample. An auxiliary 8kbit/s step-size control channel is provided.

A second auxiliary 8kbit/s emphasis control channel provides variable de-emphasis of the signal to the receiver. Conventional frequency emphasis is effective for input signals of predominantly mid or low frequencies. At high frequencies, the boost leads to increased step size and therefore increased broadband noise, which cannot be reduced by subsequent de-emphasis filtering.

For best noise performance in a 200-300kbit/s system, the ADM encoder

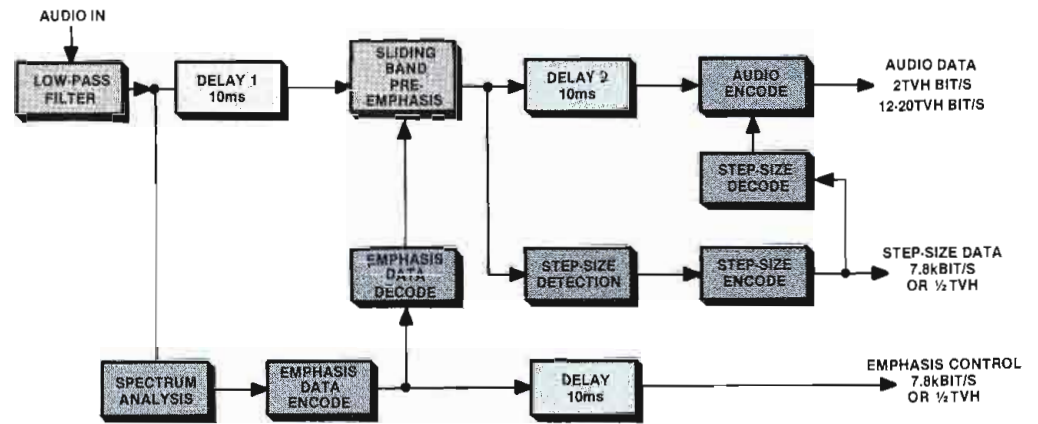

Figure 3. An ADM encoder includes delays to compensate for input signal spectral analysis and generation of step and emphasis controls.

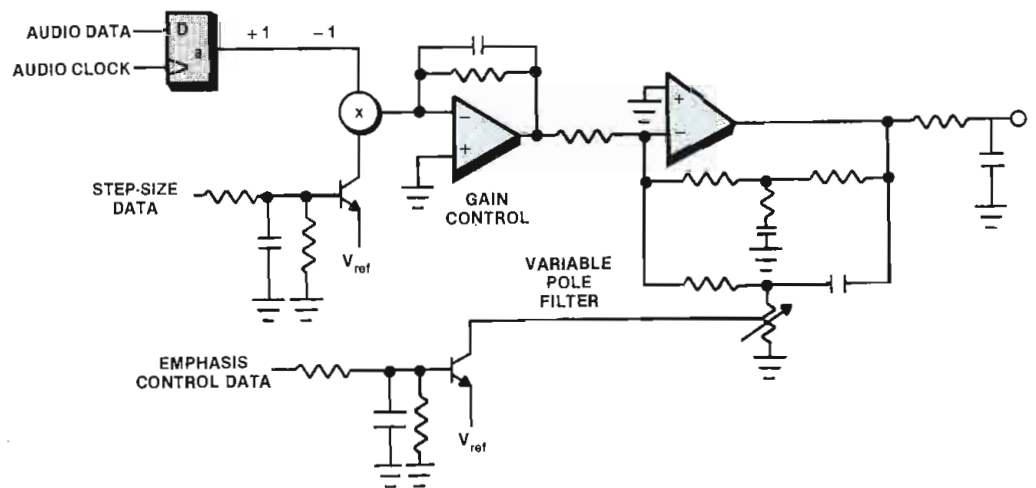

Figure 4. Control data, separated by low-pass filtering, provides logarithmic gain control and variable pole control in the de-emphasis network.

is optimized in terms of the step change and emphasis control. A 3-band division of the spectral content determines the variable emphasis control.

If predominant spectral components lie below 500Hz, a large high-frequency pre-/de-emphasis reduces noise sufficiently to hide noise modulation. From 500Hz to 2kHz or 3kHz, the emphasis curve must move upward to maintain noise reduction above the spectral component. Predominant spectral elements above 3kHz require noise reduction at low and very high frequencies. The emphasis curve places a dip at the predominant frequency, reducing step size and broadband noise in the system.

These control channels direct the decoder in the receiver to recover the audio with the original dynamics and de-emphasis. The step-control signal is separated from the serial datastream and low-

pass filtering, and the resulting signal voltage exponentiated for gain control. Recovery of the emphasis-control signal is similar, with the resulting voltage producing a variable-pole frequency in the de-emphasis network.

The low-control signal data rates suggest sluggish response and poor transient performance. To avoid this, the audio input to the encoder is first analyzed to develop the control signals, while the main audio path includes a delay. As a result, the control signals begin to respond in advance of the arrival of the audio to be encoded.

The total bandwidth of the audio information and the two 8kbit/s control signals remains manageable within the broadcast environment.

Cost control

A product that will ultimately serve the

Exclusive, triple patented dynamic cap and coil analyzing . . . guaranteed to pinpoint your problem every time or your money back

consumer must be realistically priced. For Soundlink, the design places the most expensive processing in the encoder system. The receiver decoder device, on the other hand, requires no precision parts and can be manufactured at low cost.

In the encoder, the emphasis control block must analyze the spectrum to determine the optimum emphasis characteristic to minimize audibility of codec noise in the presence of that signal spectrum. In converting this bitstream to a control signal for the decoder variable de-emphasis network, the bandwidth is limited to about 50Hz, corresponding to a rise time of 10ms. Audio is delayed by 10ms before entering the encoder variable emphasis circuit.

Emphasized audio is analyzed for step size by measuring the slope of the signal. The logarithm of the measured value is coded into the step-size control data. Upon decoding, bandwidth limiting again requires that a delay be placed in the main audio path.

Without a word

The flexibility of ADM digital sound is derived from its lack of the structured format of most digital signal schemes. The sampling frequency and bit-rate may be selected over a range to meet the bandwidth capability of a transmission system. The decoder is not frequency sensitive and merely follows the instructions given to it by the signal.

Error correction and concealment is a major concern of other digital formats. Without a complex circuit to detect possible errors and algorithmic treatments to smooth missing or extra bits that constitute an error, PCM audio produces undesirable noises. If errors are too extensive, the PCM channel mutes the output.

ADM audio and its 1 or 0 representation of increases and decreases requires no error-correction scheme. An extra bit causes a positive offset of two steps. Uncorrected, the error decays at a rate determined by a leaky integrator in the receiver decoder circuit. A bit in error causes a 2-step offset, which decays through the decoder.

Soundlink exists as a multiplexed signal, allowing right and left audio channels and their two control signals to be delivered to a decoder on a single serial bitstream. By changing the multiplex format, a large number of permutations of data are available for encrypted or scrambled audio signals.

Increased capacity

Feasible applications for Dolby Sound-



with the all new LC75 "Z METER 2"
Capacitor Inductor Analyzer
Patented \$995

The "Z METER" is the only LC tester that enables you to test all capacitors and coils dynamically — plus, it's now faster, more accurate, and checks Equivalent Series Resistance (ESR) plus small wire high resistance coils.

Eliminate expensive part substitution and time-consuming shotgunning with patented tests that give you results you can trust every time. Test capacitor value, leakage, dielectric absorption, and ESR dynamically; with up to 600 volts applied for guaranteed 100% reliable results — it's exclusive — it's triple patented.

Save time and money with the only 100% reliable, in- or out-of-circuit inductor tester available. Dynamically test inductors for value, shorts, and opens, automatically under "dynamic" circuit conditions.

Reduce costly parts inventory with patented tests you can trust. No more need to stock a large inventory of caps, coils, flybacks, and IHVTs. The "Z METER" eliminates time-consuming and expensive parts substituting with 100% reliable LC analyzing.

Turn chaos into cash by quickly locating transmission line distance to opens and shorts to within feet, in any transmission line.

Test troublesome SCRs & TRIACs easily and automatically without investing in an expensive second tester. The patented "Z METER 2" even tests SCRs, TRIACs, and High-Voltage Diodes dynamically with up to 600 volts applied by adding the new SCR250 SCR and TRIAC Test Accessory for only \$148 or FREE OF CHARGE on Kick Off promotion.

To try the world's only Dynamic LC Tester for yourself, CALL TODAY, WATS FREE, 1-800-843-3338, for a FREE 15 day Self Demo.

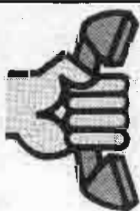

Call Today Wats Free 1-800-843-3338

SENCORE

3200 Sencore Drive

Sioux Falls, SD 57107

605-339-0100 In SD Only

*innovatively designed
with your time in mind.*

Circle (304) on Reply Card

March 1987 **Broadcast Engineering** 305

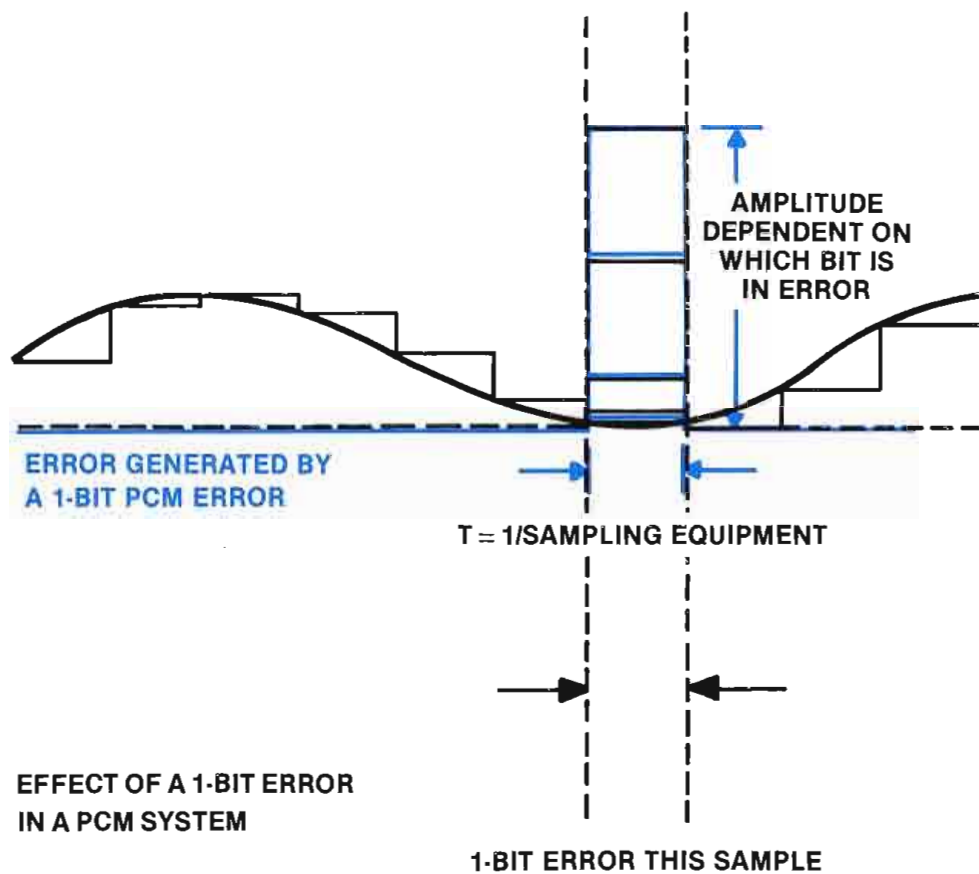

Figure 5. Errors in PCM audio create obvious unusual conditions, while a similar error in ADM coding produces a minimum, self-correcting level offset.

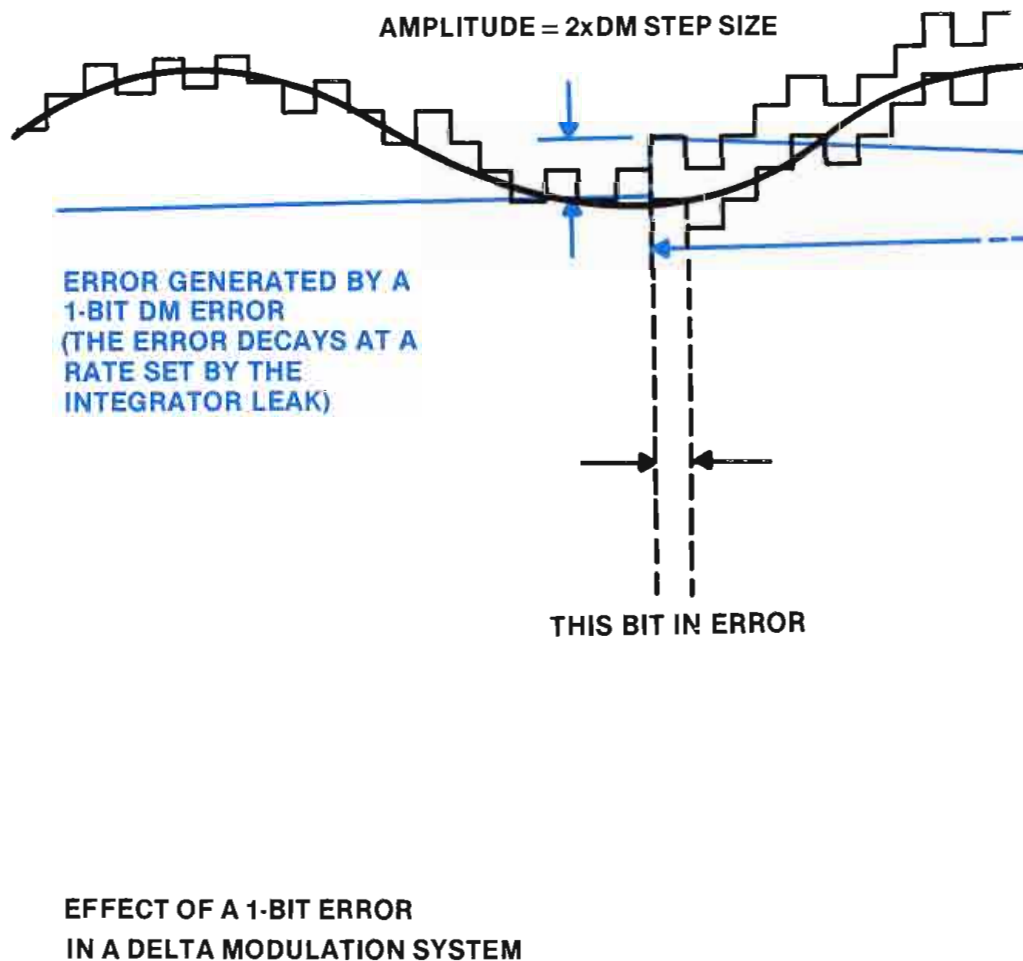

Figure 6. Error generated by a 1-bit DM error. (Error decays at a rate set by the integrator leak.)

link are not limited by the transmission medium as other digital formats might be. A number of projects, proposed and implemented, have used the Soundlink ADM system for varied functions. European research has used this method with both PAL-B and PAL-I formats (7MHz and 8MHz bandwidth TV channels, respectively).

In a transmission medium, such as television with sound-in-syncs, audio information occurs in bursts, encoded into the horizontal interval of a TV line. In such cases, the sampling rate is usually set between 12X and 20X the horizontal line rate for audio data, while control information is at half the line rate.

Dual-language broadcast applications are possible instead of stereo, or, if sufficient channel bandwidth is available, with stereo. Two audio channels use 13 bits per line per audio channel in NTSC video. The B-MAC format can support four audio channels with 21 bits per line per channel, although an extra subcarrier is added in European proposals for terrestrial TV transmissions. The Australian B-MAC DBS system includes an option for 6-channel audio for two stereo radio signals and TV audio (a total of three stereo pairs). In the United States, the system delivers music video audio to cable TV outlets.

A final analysis

Bringing digital audio into the home via the broadcast signal must do so at a relatively small increase in the cost of the receiver. With the current arrangement of radio and TV channels, the implementation of digital audio must not cause a major alteration of established frequency assignments.

Although ADM digital audio encoding and decoding present some compromises, when compared to PCM-based systems, the signal quality delivered to a receiver exceeds the limitations found in a normal home listening environment. An 80dB dynamic range, for example, can easily be lost in the home setting as a result of ambient noise sources. For that reason, a method to compress the dynamic limits can be provided to overcome the surrounding conditions.

PCM digital audio is well suited to the master recording environment and to those applications where bandwidth limitations are not constrictive. ADM encoded digital sound promises to be a valuable addition to entertainment electronics, particularly in those services transmitted directly to the home.

[:T=))]]

JVC[®]



***Professional video.
In stock and ready to ship.***

You know JVC. Loads of features backed by rock-solid reliability. Now you can have the best selection of JVC professional video equipment around. We're VideoTape Products, and we've got it all.

Pick up the phone and discover why we're one of the largest JVC dealers in the West.

Los Angeles, CA
213/664-1144
San Diego, CA
619/542-0425
San Francisco, CA
707/579-9292

**VIDEOTAPE
PRODUCTS INC**

320 North Madison Avenue • Los Angeles, CA 90004
800/422-2444

Seattle, WA
206/630-3917
Phoenix, AZ
602/483-0418
Portland, OR
503/650-0560

Circle (226) on Reply Card

Ampex AVA-3

By Mike Berry

Although video paint systems are, at present, luxuries to some stations, they are in every TV station's future. The Ampex AVA-3 video art system represents the current technology and was installed at WHAS-TV more than a year ago.

Hardware

The basic paint system consists of: the signal system, the keyboard, a tablet and stylus and the storage units. The storage devices may be fixed or removable. The amount of storage can be expanded as needed by the station.

One important user feature is the removable disk packs or cartridges. With the removable cartridges, called toolboxes, the artist can safely transport and store brushes, colors and unfinished work.

The processing system mounts in a

Berry is a broadcast designer for WHAS-TV, Louisville, KY.



Performance at a glance

- Graphics remain totally digital, suffering no quality loss on successive updates and save procedures
- Magnification of up to 1/64th of the picture to a full screen
- Artist-friendly, menu-driven (no icons)
- The stylus and tablet control all functions except text entry
- Computer-assisted design with the layout mode
- SpeedTrace automatically converts scanned-in images to vector-based databases, which eliminates the need to physically trace the outline
- Compatible with other Ampex equipment: ADO, ESS-3, VPR-3, PictureMaker

rack and is just over 22 inches high. The paint system provides for the usual inputs: composite, key, reference and an optional RGB. The outputs consist of the main RGB, menu RGB and key. An optional composite output is available.

The processing system relies on a 32-bit architecture design. Twenty-four bits are used for color and eight bits for stencil functions. The paint system offers more than 16 million colors with 708 x 484 pixel resolution for NTSC and 708 x 585 pixel resolution for PAL standards. All full-color images, which remain totally digital, can be stored as either an RGB or composite picture. (See Figure 1.)

The electrical performance, while ultimately important, tells little about the image quality the paint system is capable of producing. Differential gain and phase, linearity and K factor are all within 2%. The luminance frequency response extends out to 5MHz within ± 0.5 dB. The chrominance output extends to 1.4MHz within the same tolerance.

Software

By their nature, all computer paint/graphics systems require that artists interact with a machine. The initial response of artists new to this type of environment is usually, and understandably, negative. One way to see how well

the equipment's designers have done their jobs is to see how easy or difficult it is for new operators to overcome their reluctance and begin to operate the system proficiently. In our station, the AVA-3 scored well in that respect.

After only a few minutes of instruction, new artists were able to create and move images around the work area. Like any complex device, new users have to practice and try the various features and options before they begin to feel comfortable with them. To become truly proficient on the system, however, requires a certain amount of time.

One way to help novice users reach proficiency quickly is through the use of menus. After working with the paint system for even a short time, it becomes obvious that it was designed as an artist's and not an engineer's or technician's tool. The various operations and procedures are controlled through the stylus and tablet, the method most comfortable



The menus temporarily overlay the screen image. Shown is a mixing pallet for color selection.



To magnify an image, the artist first selects the area to be expanded.

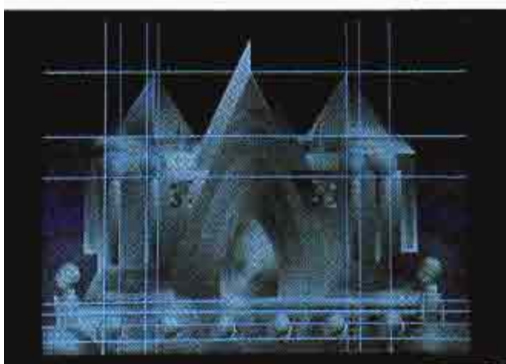

The overlay grids are user selectable and assist the development of various designs and shapes.



The expanded image, selected from the above photo, has been magnified to full-screen size. Note the anti-aliasing.

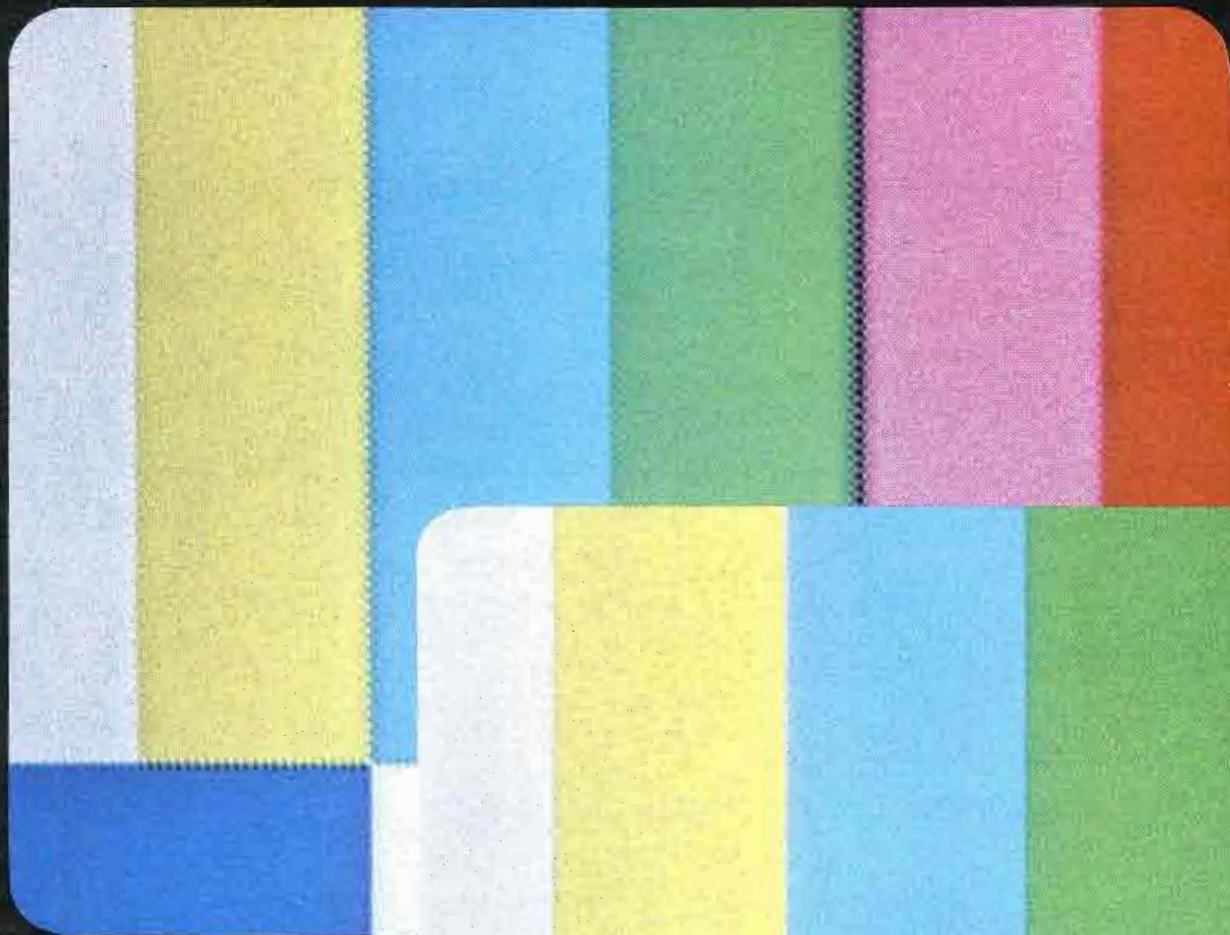

Conventional NTSC

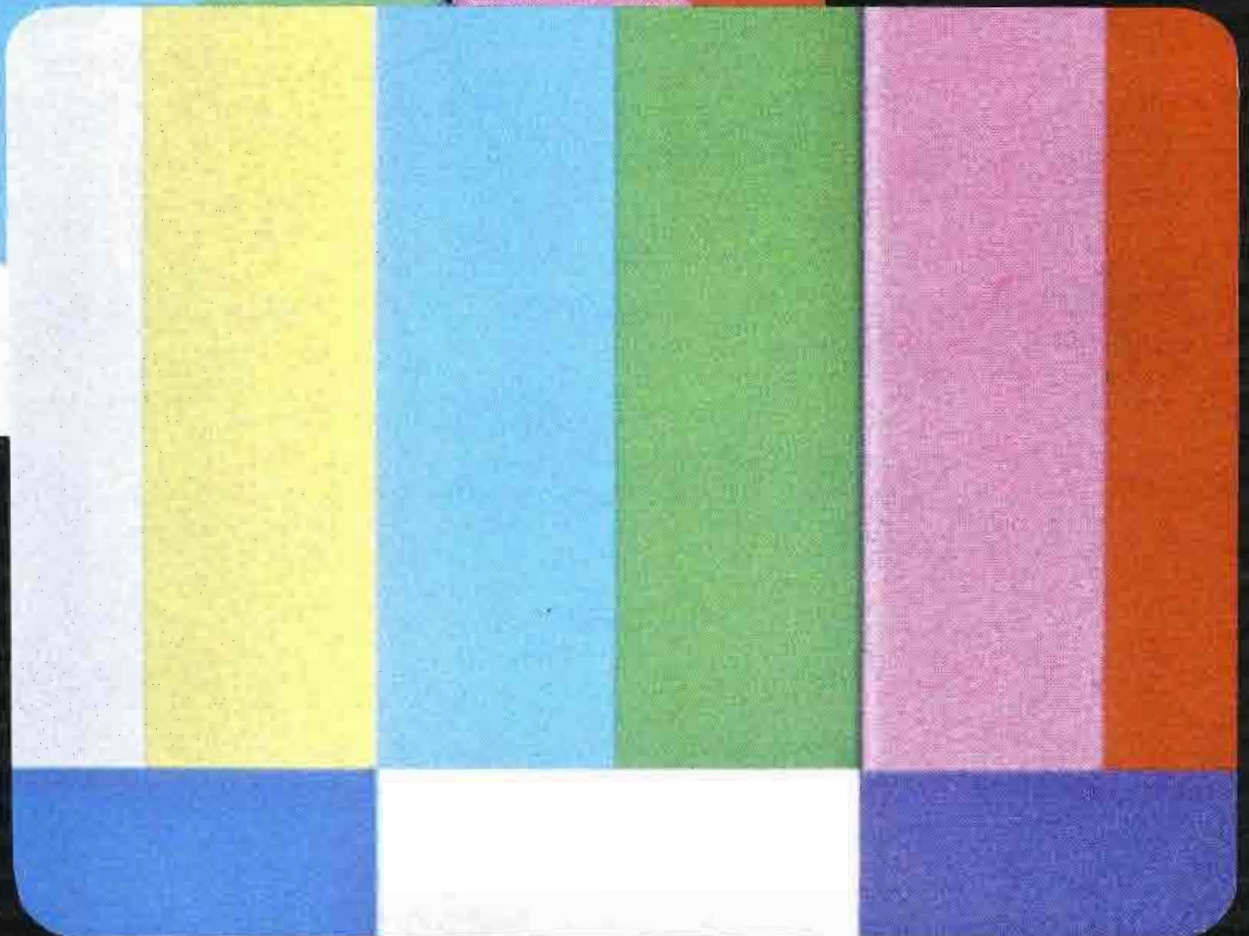

Unretouched reproductions
of actual monitor displays.

Faroudja NTSC Encoder and Decoder

IMPROVE YOUR NTSC

Faroudja Laboratories improved NTSC is fully compatible with the present system. Faroudja technology is licensed to Conrac, Fortel, Ikegami, JVC, Sony, etc...

If you want your NTSC to look like R.G.B., see us at NAB Booth 2488.

FAROUDJA Laboratories

Faroudja Laboratories Inc.
946 Benicia Avenue
Sunnyvale, California 94086
Telephone 408/245-1492
Telex 278559 MUHA UR
Fax 408/245-3363

Circle (227) on Reply Card

www.americanradiohistory.com

to artists. The keyboard is used only for text entry.

The menus are logical and consistent. No ambiguous icons or computerese are used. A certain amount of menu redundancy, which is preferred, exists. At first, this may seem like a waste of processing speed and storage space. However, the



The SpeedTrace function allows any image to be scanned-in to the system with a video camera.

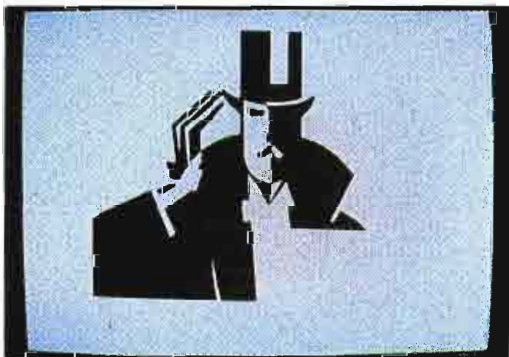

The scanned image has been digitized and stored in the system for further development.

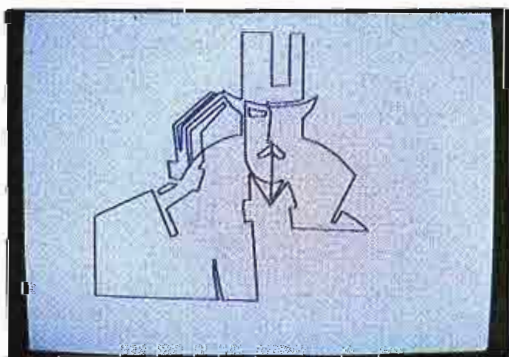

The image has now been automatically converted to a vector-based graphic element.



The completed image.

duplication in menus eliminates unnecessary and time-consuming backing up and searching submenus for the desired tasks.

The menus themselves are pop-up (not swipe on/off). They display at a glance the currently selected options. Although the menus temporarily obscure about one-fourth of the horizontal picture area, they generally afford quicker access to choices than a separate menu monitor. The pop-up menu also cut down on operator neck strain by keeping everything on one screen.

The menu may be placed in either the top or bottom portion of the picture. After the artist becomes familiar and feels competent with the system, options can be selected and the menu then removed completely from the screen.

Storage

The paint system is capable of storing full color pictures on up to five fixed hard disks. Each disk is capable of storing up to 500 stills. Removable disk packs provide storage for up to 50 stills. Stills also can be routed and stored on an Ampex ESS-3 composition graphics and storage system directly and digitally through a coaxial cable.

Disk packs for the system and the ESS-3 are interchangeable. This permits artwork generated on the paint system to be transferred to the ESS-3 for on-air use and then back to the paint system for updates.

A VPR-3 1-inch videotape recorder also can be controlled from the sketch tablet. The remote-control provisions include: play, record, jog, shuttle and slow motion. Many consecutive video frames can be transferred to and from the VPR-3 and the paint system automatically. This process permits rotoscoping or frame-by-frame animation.

Paint

Full color video can be retrieved from almost any storage media, scanned-in from any source (moving or still) or original art, or created within the system. Through the paint menu, the hue, saturation, luminance and opacity of any selected color can be altered independently. Colors can be chosen from any scanned-in source, a default color palette, or they can be mixed fresh.

The capability to save a customized color palette on a small, removable toolbox cartridge provides security, graphic and color continuity. It also allows more than one artist to use the system without jeopardizing another artist's work.

Brushes can be saved as well. The paint system provides standard brushes,

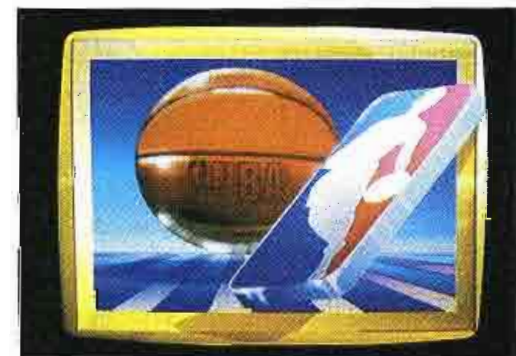
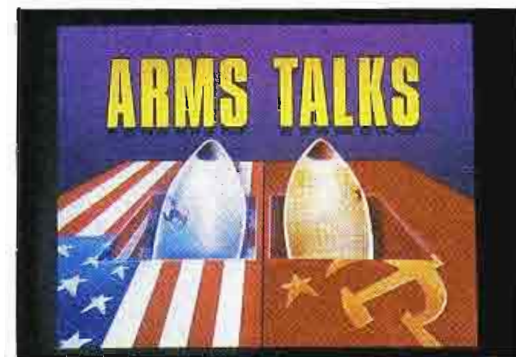
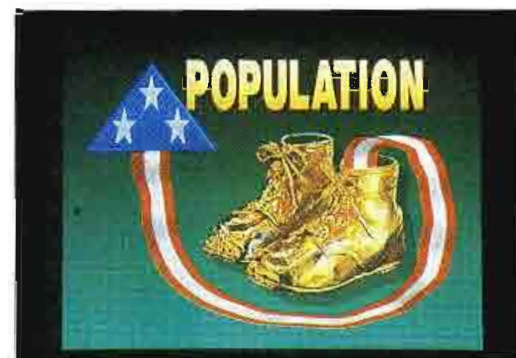

The photos show a combination of elements brought together to develop stills for on-air use.

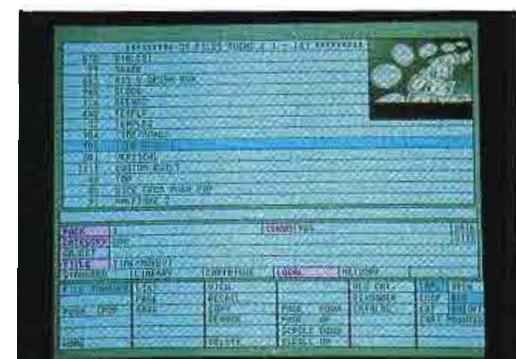

The file manager provides quick and easy access to stored brushes, colors, fonts, symbols, scrap and finished art.

including an airbrush, in various sizes and shapes. Artists also can develop custom brushes, such as pencil, chalk, multicolor, neon and calligraphy. Brushes can be made from picture elements and then rubber stamped. Any brush, from completely transparent to 100% opaque, can be applied smoothly or at predetermined, regularly spaced intervals or grid points.

Painting can be done freehand or with the aid of geometric shapes. These aids include: horizontal, vertical or diagonal lines, grids, rectangles, squares, circles, ellipses, curves or custom-made polygons. Once an area is defined, it can be outlined with any brush or filled with one color or a blended gradient of up to four different colors.

Another useful feature allows small picture areas to be expanded. Any screen area, as small as 1/64th of the picture, can be magnified up to full-screen size.

This feature allows artists to perform fine, detail work on the expanded image. After the inspection or work is completed, the image can then be restored to the original size. Because the magnification process is performed in the video output stage, the process can be completed again and again with no loss of picture quality.

The paint features also can be used in conjunction with stencil. This function dramatically enhances the ability of artists to create images without the fear of

changing or losing previously created images. Like a traditional stencil, the feature allows an area of the screen to be protected with a transparent mask while other areas are being painted. Unlike the traditional stencil, however, the AVA-3 stencil can be of varying opacities, different colors, invisible, reversed, retouched, stored and retrieved.

Stencil also affords maximum use of cut and paste by designating the area to be cut. Once cut, the image can be expanded, compressed, inverted, skewed, moved or drop-shadowed on either or both X and Y axes. The image also can be manipulated in three axes (X, Y, Z) with true ADO-like perspective and rotation. The capability to match ADO moves enables our station to prepare electronic storyboards that more accurately depict how a proposed idea will actually be produced with the ADO, thus improving communications.

Another feature unique to the paint system is its capability to automatically make a white-on-black matte. The matte can be of varying opacity if desired. This matte can then be used as a linear key signal to key an image through a switcher or ADO Digi-Matte.

Layout

The "artist's touch" gained through paint is aided greatly through the use of the layout mode. Layout, which is unique to the AVA-3, is essentially a computer-

assisted design (CAD) function. The feature simplifies and hastens traditional paste-up chores. In the vector-based computer graphics mode, the artist can define and store a specific shape or logo as a distinct, individual graphic element.

The layout function also can be used in combination with other elements, such as the internal character generator or geometric symbols. It is then possible to selectively alter an element's color, position, size, opacity, degree of rotation and italics. The border size color, opacity, its drop-shadow position, color and opacity are all adjustable. These variables can even be determined for two extremes. The system will automatically and evenly match or distribute the desired values over any number of selected elements. Their background-to-foreground priority also can be changed.

Collective or individual options can be revised and the entire picture redrawn, automatically and immediately. The process can be repeated as many times as necessary to settle on a design.

Each function also can be used with the system's internal character generator. A number of fonts are resident within the system. A larger library of optional fonts also are available.

Formats and layouts for any print project (such as a newspaper advertisement) can be designed and revised much quicker through the paint system's layout mode than on paper. Although it is cur-

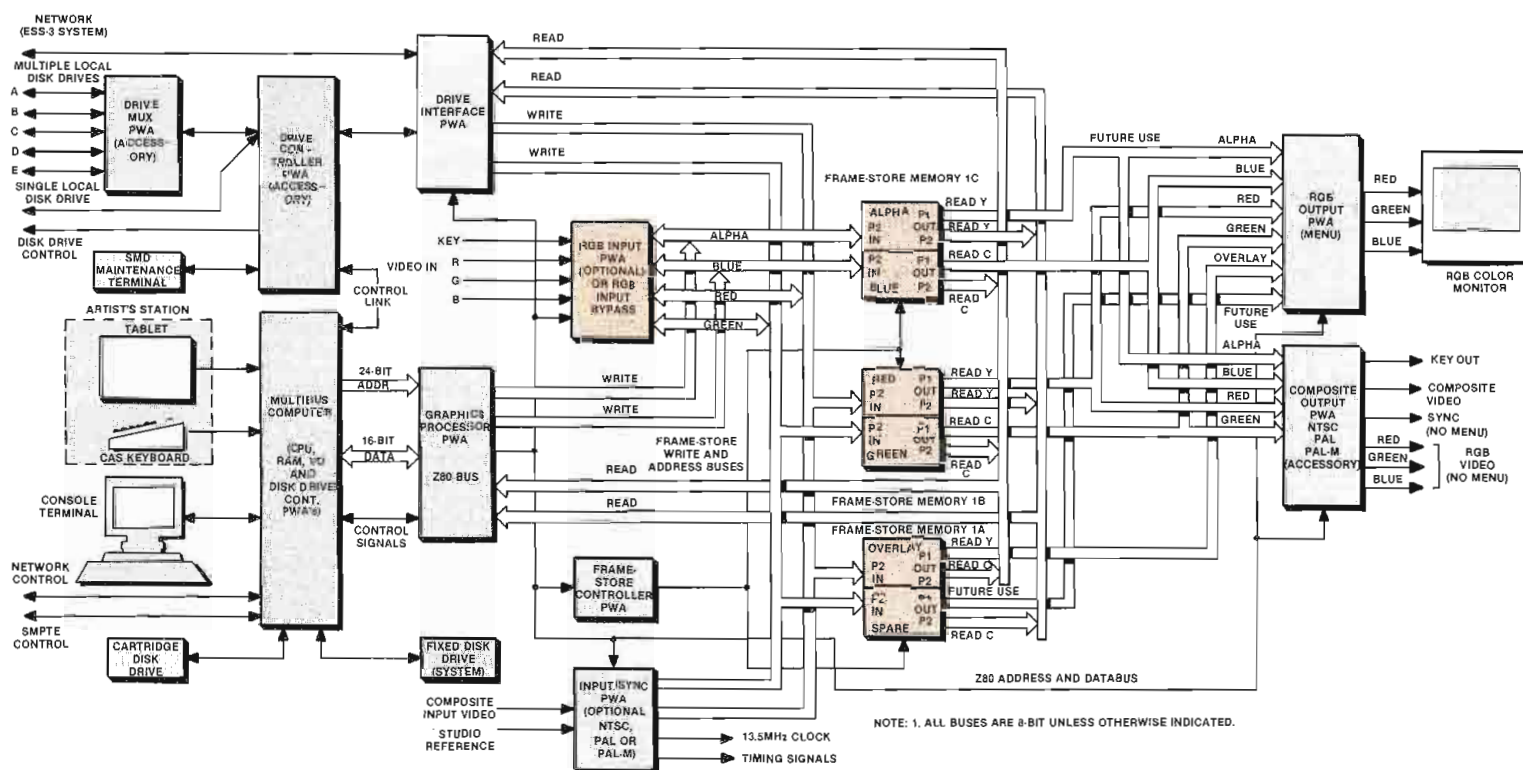

Figure 1. Simplified block diagram of the Ampex AVA-3 video art system.

rently lacking in the industry, there is a need to be able to turn this type of image into camera-ready art for printing. If this were possible, maximum continuity between the on-air look and the print medium would be maintained.

SpeedTrace

In addition, any font, logo or symbol can be scanned-in through any video camera. Using the system's SpeedTrace

option, these elements are scanned and automatically converted to vector-based databases and then stored. Once stored, they can be altered, like any graphic element's database, using the layout function.

File manager

Most menus, including paint and layout, offer the option to save and retrieve graphics temporarily, without entering

the more time-consuming file manager. This capability is extremely useful because it allows artists the freedom to experiment with a brush, color or technique. If they are unhappy with the result, they can retrieve the original. When the time does come to permanently save and catalogue the graphic, the file manager works much like a still store. Pictures can be saved with a name, number, category and pack destination number. They can later be recalled alphanumerically or by a key word. A small version of the still also can be viewed for verification without exiting the file manager.

It is through this menu that artists determine the destination of a still. The destination can be a non-removable hard disk, removable disk pack, the small removable cartridge (toolbox) or the ESS-3. A number of file housekeeping chores also can be accomplished in the file manager routine. These housekeeping chores include renumbering, renaming, copying and deleting stills. One desired feature would be the capability to perform these tasks on any selected group of stills. Such a global command would greatly simplify and reduce the amount of time required to copy, delete or renumber stills.

Our station is somewhat unique in that we have four full-time designers on staff. Because of the workload between 8 a.m. and midnight, the paint system is seldom idle. The combined, and diverse, demands of three daily newscasts, programming, promotion and our own production company place heavy demands on the Ampex AVA-3. Even under this load, the system has proven itself to be an excellent and reliable tool.



SHOCK ABSORBERS

Transit Cases from ANVIL®

SHOCK ABSORBERS! That's a pretty bold statement. ANVIL® believes that the case, not the contents, should absorb the shock, take the bumps, grinds, falls, and foul weather. Never the equipment. ANVIL® ATA Cases are built with longevity in mind and total customer satisfaction a goal adhered to by each and every employee. Not only has ANVIL® achieved generic respect throughout the industries it serves, it boasts the highest degree of experience & design art within the transit case industry. The following words are not taken lightly at ANVIL® . . . if it doesn't have an ANVIL® you don't have a case!



ANVIL® CASES, INC., 4128 Temple City Blvd., Rosemead, CA 91770
(818) 575-8614 or (800) 242-4466 in CA & (800) 423-4279 out of CA

Please visit the ANVIL exhibit at the NAB Convention,
Dallas, TX – March 28-31, 1987, Booth #2706

Circle (228) on Reply Card

Editor's note: The field report is an exclusive BE feature for broadcasters. Each report is prepared by the staff of a broadcast station, production facility or consulting firm.

In essence, these reports are prepared by the industry and for the industry. Manufacturer's support is limited to providing loan equipment and to aiding the author if support is requested in some area.

It is the responsibility of **Broadcast Engineering** to publish the results of any piece tested, whether positive or negative. No report should be considered an endorsement or disapproval by **Broadcast Engineering** magazine.

!-?-)!!!

WE PUT SOMETHING VERY SPECIAL INTO OUR NEW TV-80 ZOOM....



A LOT OF THOUGHT.

We got inside the heads of professionals like you before we designed a single component inside the new Schneider TV-80.

The result is a 17X studio zoom that's picture perfect. One that's easy to use. Easy to service. And one that delivers uncompromising image quality. Truly, the ideal mate for the new generation of 2/3-inch studio/OB cameras.

Our advanced servo module with digital feedback and built-in microprocessor typifies the innovative thinking that's gone into this lens. The servos align themselves automatically whenever you power up, and the easily removable module is interchangeable with flexible cable drives for control flexibility.

The built-in pattern projector employs a unique color mixing system that insures correct color temperature and illumination. Full servo zoom is under one second, and when

used with its built-in 2X range extender, the servo iris automatically compensates for light loss, producing constant video level at all times.

The TV-80 is rugged and compact. All adjustment points are grouped together for easy access. An optional diagnostic digital test unit is available for quick analysis of all electronic functions via one simple connector. And plug-in electronic components make service a snap.

The new Schneider TV-80 Zoom. We put a lot of thought into it, so you'll never think twice before buying it. For more information or a demo, contact: Schneider Corporation of America, 400 Crossways Park Drive, Woodbury, NY 11797, (516) 496-8500.

Western U.S.A. Service: 861 Production Place, Newport Beach, CA 92663, (714) 631-7430.



 **Schneider**
KREUZNACH
SHOOT FOR THE BEST.

Circle (229) on Reply Card

www.americanradiohistory.com

See us at
Booth 3221

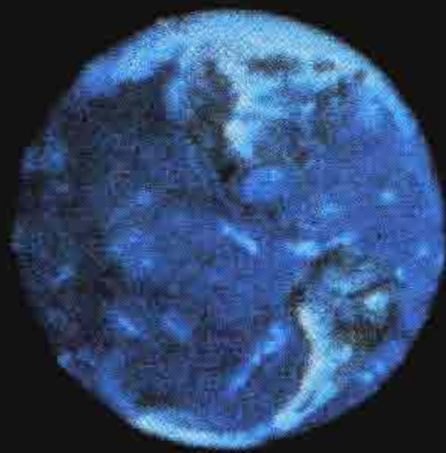

ENGenius!

IKEGAMI HL-95 IS
THE CROWNING ACHIEVEMENT OF THE 80's.

The engineers at Ikegami have just enhanced the finest ENG component camera in the industry, by making it the most versatile.

Now the Ikegami HL-95 camera head can be the crown jewel of your 1/2" Beta ENG system, as well as three other configurations including 3/4", 1/4" and MII formats.

Considered by many as the most impressive and important hand-held camera breakthrough of the 80's, the HL-95 achieves total operational flexibility without compromising strict performance, sensitivity, resolution and registration.

Featuring registration stability without adjustment (proven over many weeks); better shoulder balance; better low light level sensitivity (1.5 ft. candles); better S/N for given low light levels (proven in exhaustive comparison tests); plus minimum maintenance, weight and power consumption. The Ikegami HL-95 far outdistances any camera in its class. It's pure ENGenius.

For a demonstration of the HL-95 and other Ikegami cameras and monitors, contact us or visit your local Ikegami dealer.

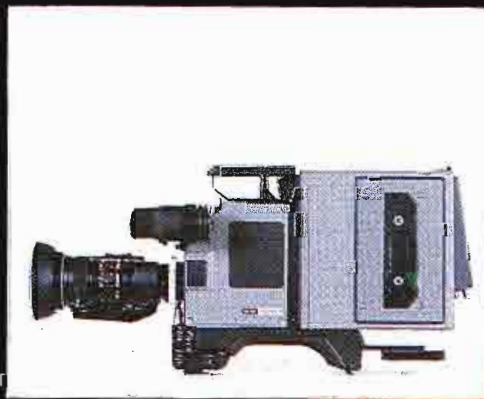

Ask About Our Special
NAB Promotion at Booth 3150



Ikegami[®]

Circle (230) on Reply Card

East Coast: (201) 368-9171 West Coast: (213) 534-0050 Southeast: (813) 884-2046
Southwest: (214) 233-2844 Midwest: (312) 834-9774 Hawaii: (808) 946-5955



Pan pots add versatility

By Bill Harris

When a station begins stereo production, the capability to *pan* a signal between the two output channels becomes important. Often the panning is needed on a microphone channel. During mix-down, a voice track can be placed effectively with a pan control.

Monaural input modules on many consoles provide a pan pot. However, panning also is useful for line-level sources. Unfortunately, pan pots for stereo line-level inputs are less common. This was the problem we faced with our production consoles.

Modification

Two Audiotronics 200 series consoles were installed in the KMJI-FM studios in 1985. Later, a 4-channel tape machine was added. At this point, it became apparent that we needed some way to pan the four channels of audio into the stereo field. Unfortunately, the 200 series console is available only with stereo input modules. Line-level pan facilities are not available. Audiotronics agreed to provide custom modules to meet our needs, but the cost was prohibitive. We decided, instead, to perform the modification in-house.

Close inspection of the 200 MIS microphone input module and the 200 SLI stereo line-input module schematics revealed they were quite similar. The output sections used the same basic design, so installing a stereo pan pot on the stereo line-input module looked feasible.

The standard monaural module output wiring is shown in the upper half of Figure 1. The normal stereo output module schematic is shown in the lower portion of Figure 1. A comparison showed enough similarity to make the modification relatively straightforward.

The basic schematic of the completed modification is shown in Figure 2. The DPDT switch provides either pan or normal stereo operation. In the pan position, the input module's left channel can be panned from hard left to hard right. In the stereo position, the module operates normally with one additional feature.

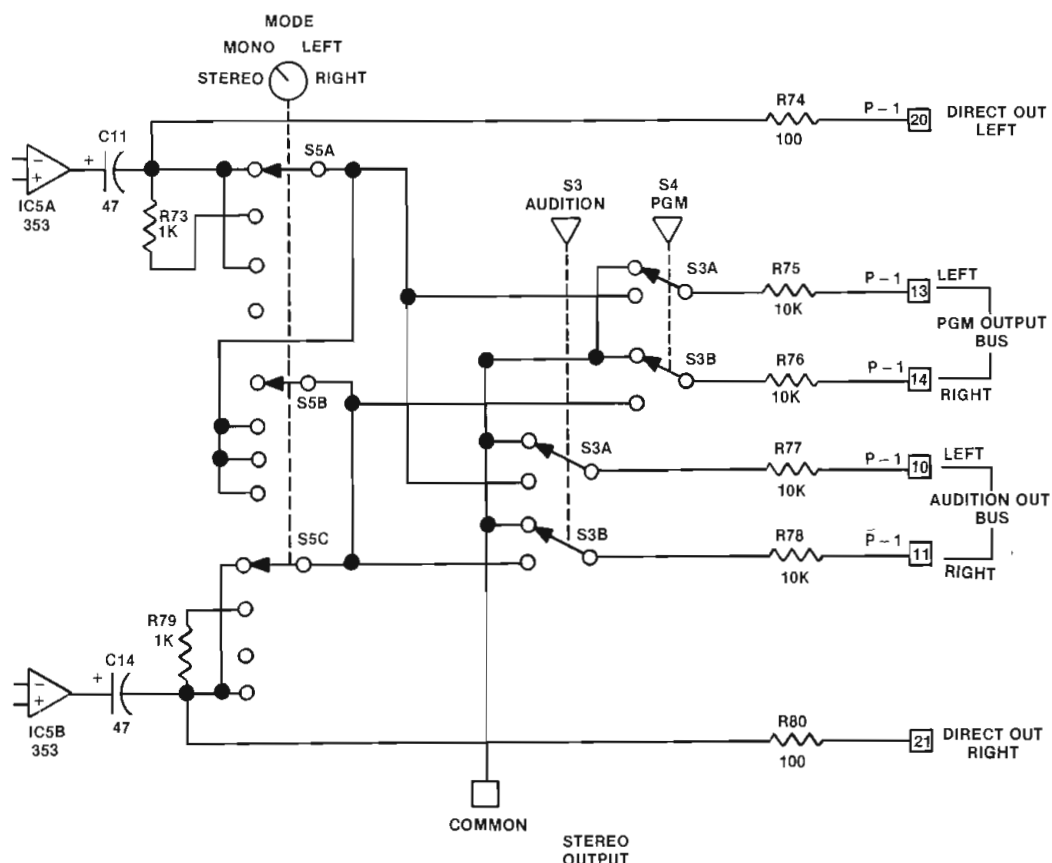
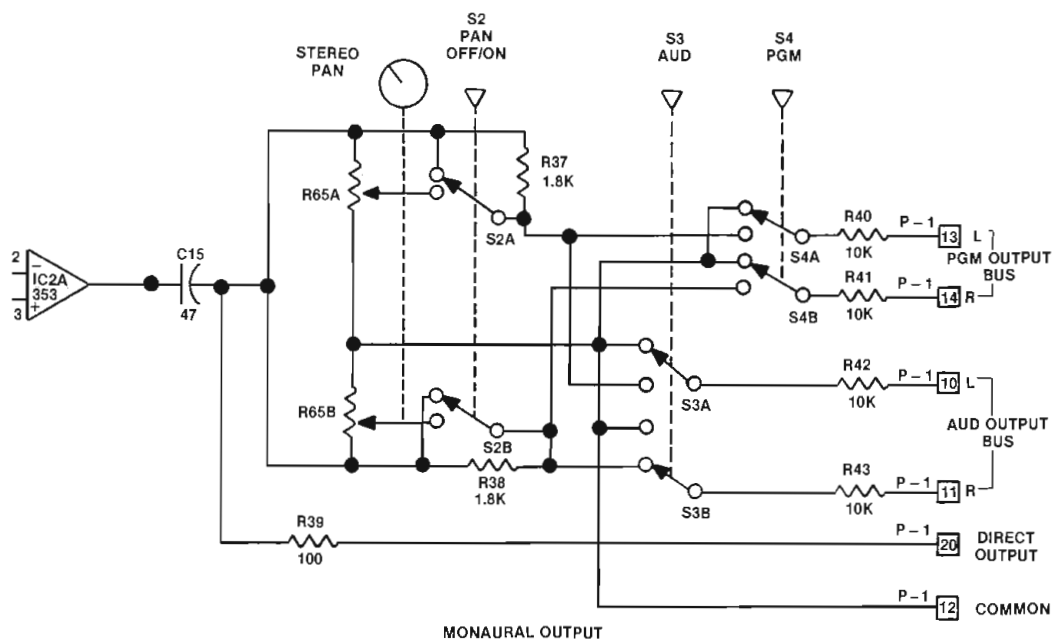

Figure 1. Output wiring for standard Audiotronics monaural (upper) and stereo line-level (lower) modules.

Harris is technical director for KRZN-AM, and KMJI-FM, Englewood, CA.

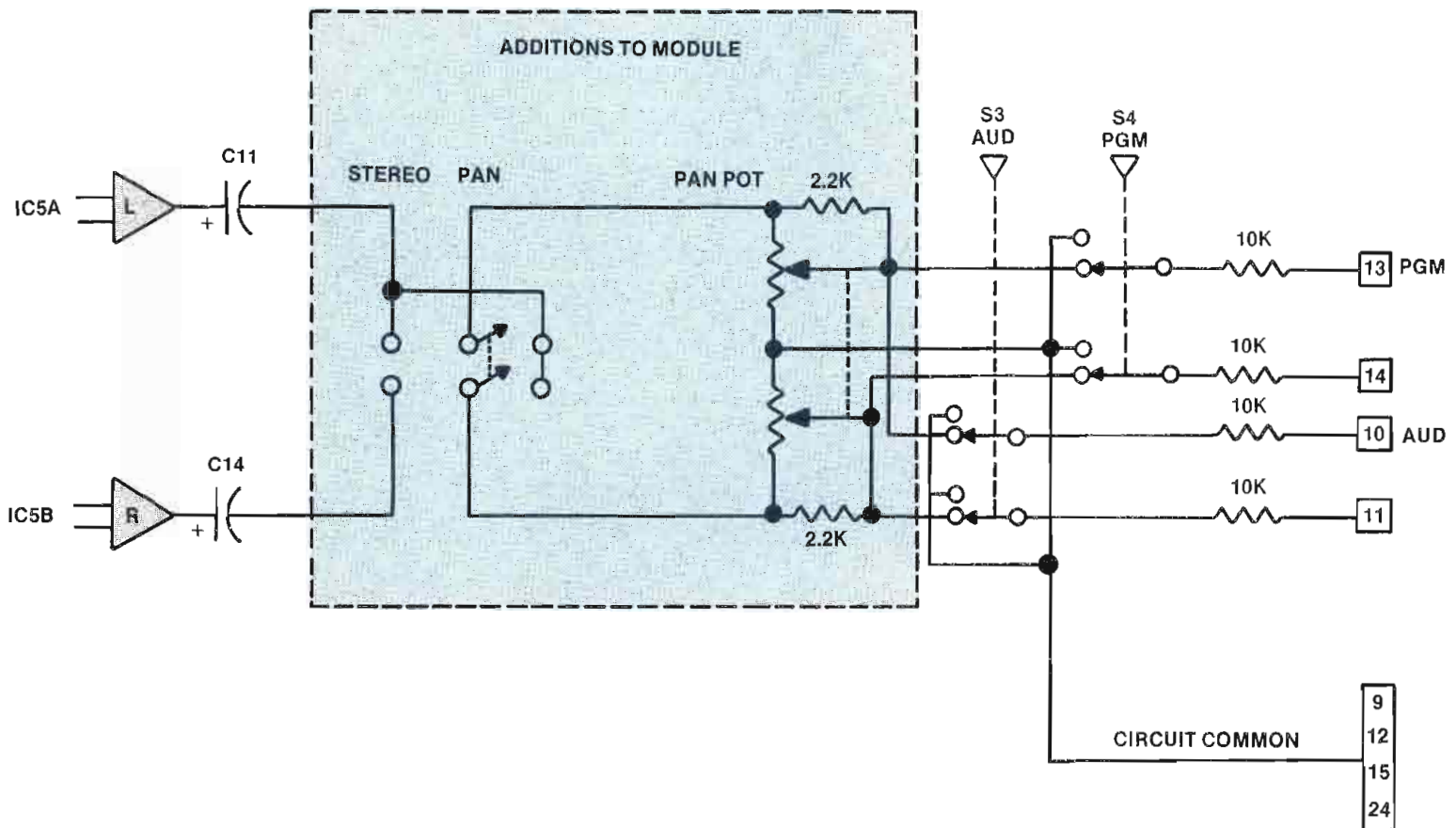

Figure 2. Basic schematic for console modification.

50% OFF
Manufacturer's List Price

Ask for current specials and save even more!
Call Toll-Free: 1-800-426-5938
(In Iowa, 1-800-272-6459)

- More than 400 stage, studio and projector lamps from G.E., Sylvania and Wiko in stock.
- 12-hour turnaround guaranteed.

For free price list write: Box 10,
702 E. Washington, Washington, IA 52353
Since 1964

Sittler's Suppliers Inc.

Circle (232) on Reply Card

PRECISION MAGNETIC TEST TAPES

STL

Standard Tape Laboratory, Inc.
26120 Eden Landing Road #5, Hayward, CA 94545
(415) 786-3546

Circle (233) on Reply Card

SESCOM, INC.
"the audio source"

FOR ALL OF YOUR AUDIO NEEDS

2100 Ward Drive Henderson, NV 89015 U.S.A.

CALL TO RECEIVE A COPY OF
OUR POCKET-SIZED CATALOG

CATALOGS & ORDERS: (800)634-3457

OTHER BUSINESS: (702)565-3400
TWX(910)397-6996

Circle (234) on Reply Card

We've taken apart half a million videocassettes and saved our customers 2 million dollars



Before we'll reload a 3/4" u-matic videocassette we take it completely apart and rebuild it inside and out. We replace wiper flaps, friction pads, tape guides and leader — everything that's needed to make the cassette test as good as new. Only then will we reload it with new 3 M videotapes or other major brands. If we can't rebuild it we won't reload it.

Coarc also loads new cassettes with broadcast quality videotape for Betacart and 3/4" cart systems.

CoarcVideo™

Custom Loaded Videocassettes (518) 672-7202
P.O. Box 2, Route 217, Mellenville, New York 12544

3/4" RELOADING □ PROFESSIONAL VHS & BETA □ 1/2" AND 3/4" CART CASSETTES

Circle (235) on Reply Card

Want more information
on advertised products?
Use the
Reader Service Card.

FREE 32pg Catalog & 50 Audio/Video Applic.

PWR SUPP. EQ.
PHONO, MIC,
TRANS. ACN,
TAPE, VIDEO,
LINE, OSC

Stereo/Mono Pwr Ampl.

8-in/2-out, 12-in/4-out, 16-in/4-out
Video & Audio Dist Ampl. TV Audio & Recd Prod Consoles

OPAMP LABS INC (213) 934-3566
1033 N Sycamore Av LOS ANGELES CA, 90038

When the module is switched to stereo, the pan control acts as a left-right balance control. Preserving the capability for normal stereo input configuration is important if more than one source appears on that console module.

Remove the module from the console. The mode select switch, S5, is replaced by a pan pot like that used on the microphone input modules. Remove S5 by first

unsoldering all of the attached wires from the PC board. The switch can then be taken out. Next, remove the 1kΩ resistors, R73 and R79. They are located just below where the mode select switch was mounted.

Drill a small hole for the DPDT switch near the top of the module. Make sure it will not interfere with the top support rail when the module is reinstalled in the

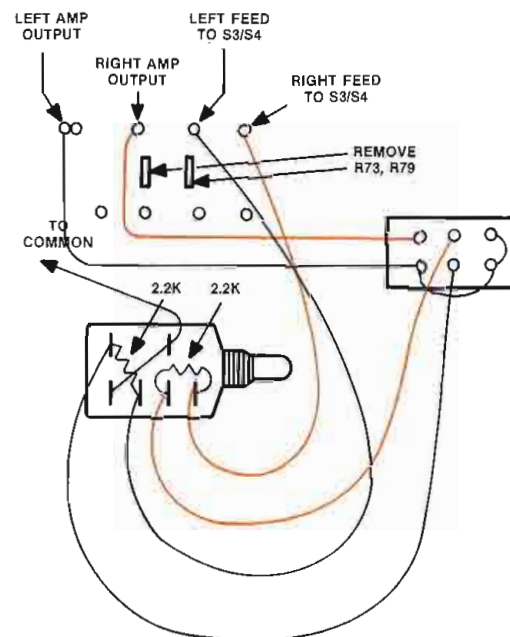

Figure 3. Wiring guide for connecting the pan pot to the PC board and switch.

console. Before you mount the switch, label the module with dry transfer letters. Spray the letters with several coats of clear lacquer for protection. After the lacquer dries, mount the switch.

Install two 2.2kΩ resistors on the pan pot as shown in Figure 3. Now, replace S5 with the dual 10kΩ pan pot. Using Figures 2 and 3 as guides, connect the pot to the PC board and switch. Notice that the pot's two channels are wired in opposite fashion. One output goes up while the other goes down. If you follow the wiring color code shown, the modification wiring will match that used throughout the console.

Using the two blue/white wires left over from switch S5, connect the pan pot common to the first two contacts on S3, the audition switch. Reinstall the module and the modification is completed.

Level adjustment

The input-module trim pots may need adjustment after the modification. Feed a standard level to each input and readjust the trim level controls as required for both A and B inputs. The adjustment is necessary because with the pan/balance pot in the center of rotation, neither of the mix buses receives the same level as they did before the pot was added.

The operators really appreciate being able to pan the four tape recorder channels. Even though the pan pots are expensive, the added versatility makes the modification worthwhile. If your console is not identical to ours, a similar procedure may still be possible. It's worthwhile checking with the manufacturer before making changes in the console wiring.

||=|(-)))))



The alternative to our "double isolation" headsets.

The Shure SM1 and SM2 Headsets isolate you from sound in two exclusive ways.

First, these headsets use extra-large, pillow-soft ear pads for superior noise isolation and comfort. Second, they feature a noise-reducing mic, with a precision cardioid polar pattern, to leave background noises where they belong...in the background. The mic's tailored frequency response insures outstanding voice reproduction.

Other features include: an all-metal boom and double-braced, all-metal headband for greater durability and comfort; a patented boom mount for total mic position flexibility; detachable cable; and a stylish matte chrome and black finish that looks great "on camera".

The SM2 is a dual-ear headset, the SM1 — single. For complete information, write or call Shure Brothers Inc., 222 Hartrey Avenue, Evanston, IL 60202-3696. (312) 866-2553.



SHURE
Breaking Sound Barriers™

Circle (70) on Reply Card

THOMSON-CSF

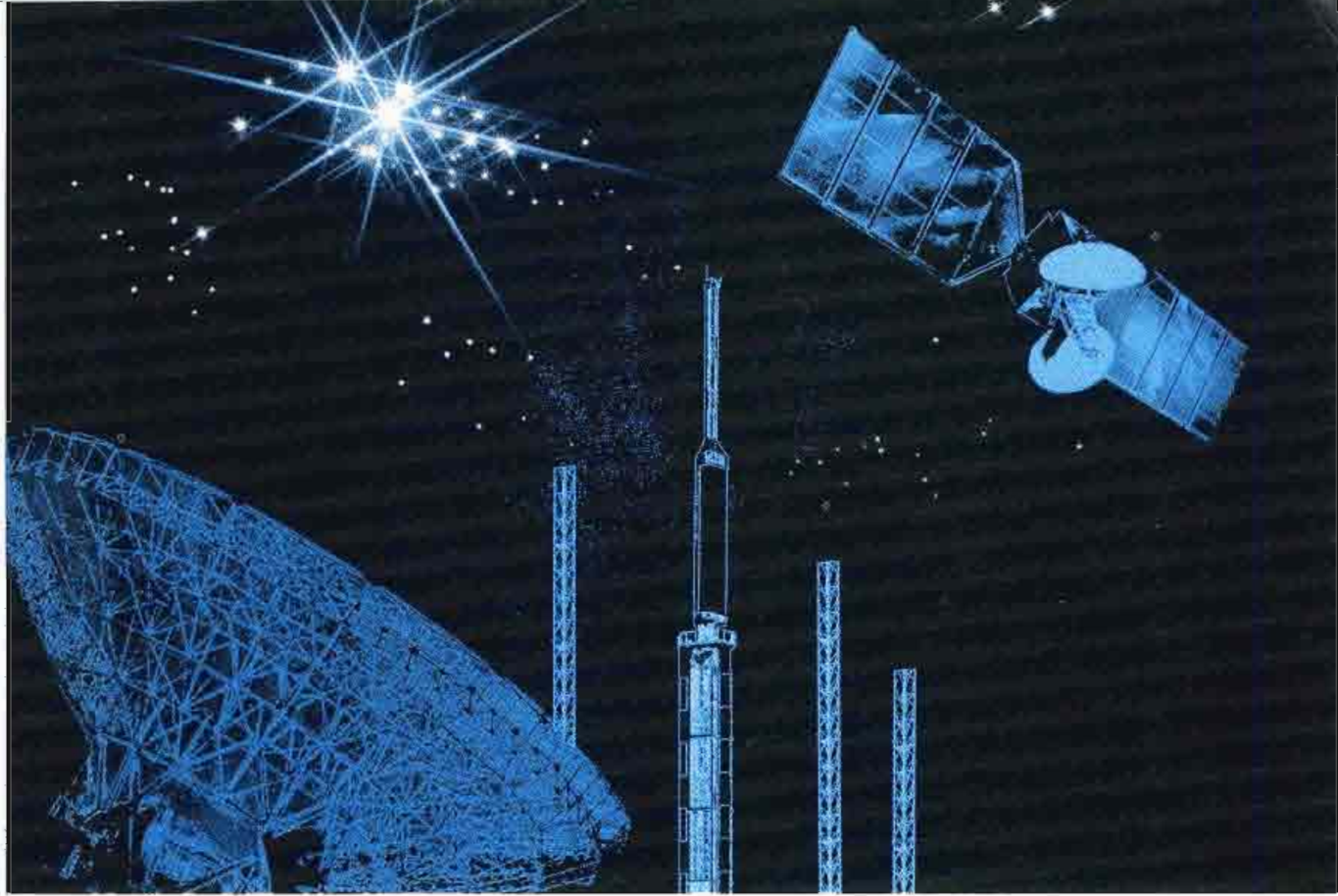

THE FURTHER WE GO, THE FURTHER YOU GO.

At Thomson-CSF we've been pioneers in developing the use of high-power tetrodes in transmitters for more than 70 years.

Over the years we've stayed ahead with such developments as Pyroblock® grids and the Hypervapotron® cooling system.

We offer: A complete line of tubes for radio broadcasting applications from FM to the most powerful SW and LW transmitters - the quality of our 500-600 kW tubes has been amply demonstrated in 15 years of service in over forty transmitters worldwide.

A complete line of power grid tubes and their associated cavities for UHF/VHF TV transmitters. Thanks to their efficiency, reliability and tight tolerances, systems makers can offer their customers substantially more cost-effective products.



High power radio broadcasting tetrodes up to 1.2 MW.

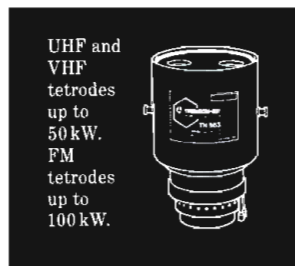

UHF and VHF tetrodes up to 50 kW. FM tetrodes up to 100 kW.



Matched cavities for best results.

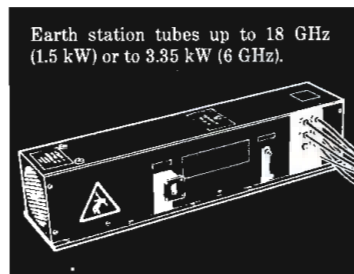

Earth station tubes up to 18 GHz (1.5 kW) or to 3.35 kW (6 GHz).

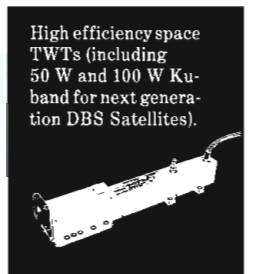

High efficiency space TWTs (including 50 W and 100 W Ku-band for next generation DBS Satellites).

A complete line of klystrons and TWTs for ground stations and space TWTs for direct broadcasting satellites (DBS) designed to last for at least a decade.

And we also produce high-resolution image pick-up tubes and devices (CCDs), and high-luminosity CRTs for top range professional applications.

In radio and television, telecommunications, military and civil aviation, as well as in a wide range of scientific and medical applications, Thomson-CSF know-how gets your systems moving. Fast.

The world's most powerful tubes for radio and TV broadcasting.



Circle (237) on Reply Card

THOMSON ELECTRON TUBES AND DEVICES CORPORATION
550 Mount Pleasant Avenue
P.O. Box 6500
DOVER, NEW JERSEY 07801.
Tel.: (201) 328-1400. TWX: 710987 7901.

Belgique: BRUXELLES
Tel. (32-2) 648 64 85
Tx 23113 THXL B

Brazil: SAO PAULO
Tel. (55-11) 542 47 22
Tx (011) 24 226 TCSF BR

Canada: MONTREAL QUEBEC
Tel. (1-514) 288 41 48
Tx 5 560 248 TESAFI MTL

Deutschland: MÜNCHEN
Tel. (49-89) 78 79-0
Tx 522 916 CSF D

España: MADRID
Tel. (34-3) 405 16 15
Tx 46 033 TCCE E

France: BOULOGNE-BILLANCOURT
Tel. (33-1) 46 04 81 75
Tx THOMTUB 200 772 F

Italia: ROMA
Tel. (39-6) 639 02 48
Tx 620 683 THQMT E I

Japan: TOKYO
Tel. (81-3) 264 63 46
Tx 2 324 241 THCSF J

Sverige: TYRESÖ
Tel. (46-8) 742 02 10

United Kingdom: BASINGSTOKE
Tel. (44-256) 29 155
Tx 858 665 TESAFI G

U.S.A.: DOVER
Tel. (1-201) 328 1400
TWX 710987 7901

Sony forms satellite group; provides equipment to HBO

Sony Information Systems Company, Park Ridge, NJ, has established a satellite communications group. The group will market products that reflect Sony's experience in Ku-band products and technology. The group's two initial products—a Ku-band satellite receiver and a low-noise block downconverter—have been selected by Home Box Office, for its program to distribute Ku-band reception equipment to cable operators. HBO is promoting the advanced transmission capabilities of Ku-band technology with its associated cost, reliability and installation benefits.

The Sony Broadcast Products Division, *Sony Communications Products Company*, Teaneck, NJ, has announced the formation of a northwestern sales region based in northern California. This region was part of the Western regional office.

Rational Broadcast Systems moves

Rational Broadcast Systems has moved its national headquarters. The address is 2306 Church Rd., Cherry Hills, NJ 08002; telephone 609-667-7300.

LeBlanc & Dick and Larcan form organization

LeBlanc & Dick Communications and the marketing division of Larcan Communications Equipment have merged into a single operating company under the banner of *LDL Communications*. The company is located at 14440 Cherry Lane Court, Laurel, MD 20707; telephone 301-498-7952. The formation of LDL Communications will result in a larger enterprise able to custom design, manufacture and install all the major components of a broadcast transmission system.

Microwave Radio buys ENG line

Microwave Radio, Lowell, MA, has purchased the electronic news gathering product line from M/A-COM MAC, including the professional and production team. The company will manufacture, sell and perform service and warranty work on all M/A-COM products.

NEC posts TV transmitter sales

Global Communications has ordered three transmitters for its broadcast facilities from *NEC*, Wood Dale, IL. Two PCU-930HC UHF TV transmitters will be used by Channel 41 to broadcast from the CN

Tower in Toronto. Global Communications also acquired a PCN-1425BH 25kW VHF TV transmitter for Channel 7 in Midland, Ontario.

KTIV-TV Channel 4, Sioux City, IA, placed an order for a low-band model PCN-1430AL/1 VHF transmitter.

Optimus, Szabo-Tohtz place CMX 6000 orders

Optimus and Szabo-Tohtz film and video production houses in Chicago, have ordered CMX 6000 disc-based editing systems from *CMX*, Santa Clara, CA. Optimus has ordered three laser disc-based editing systems. They will join the CMX 3400A and 340X videotape on-line editing systems. Szabo-Tohtz has ordered two CMX 6000 systems.

Artel and Dynair enter joint agreement

Dynair Electronics, San Diego, CA, and *Artel Communications*, Worcester, MA, have signed a reciprocal marketing agreement. Under this agreement, the sales organizations of both companies will have available the full broadcast product line of Artel and Dynair.

Increase in Orban stereo TV systems

Orban Associates, San Francisco, has announced that more than 200 stereo TV stations are on-the-air using the Orban stereo TV system. The system consists of the model 8182A OPTIMOD-TV audio processing system and the model 8182A/SG TV stereo generator. Most of the stereo TV stations are using the 275A automatic stereo synthesizer to create pseudo-stereo from mono source material.

The Power Station buys Otari recorders

The Power Station, New York City, has purchased two DTR-900 32-track PD format digital tape recorders from *Otari*, Belmont, CA.

Hearst selects Ampex Betacam

The Hearst Corporation has purchased an equipment package from *Ampex*, Redwood City, CA, that includes Betacam cameras and videotape recorders, type C VTRs and ADO digital effects systems. The equipment was distributed among the six Hearst affiliates: WTAE, Pittsburgh; WCVB, Boston; WDTN, Dayton, OH; WBAL, Baltimore; KMBC, Kansas City, MO; and WISN, Milwaukee. The package in-

cludes: three CVR-3A portable ENG camcorders, three CVR-10 studio players, one CVC-30 Plumbicon ENG camera, one CVR-40 studio recorder/player, two VPR-80/TBC-6 low-cost C format VTRs, one VPR-6/TBC-6 midrange C format VTR, and two ADO 1000 digital effects systems.

Graham-Patten supplies multiplex hardware

Graham-Patten Systems, Grass Valley, CA, has been selected to supply channels 7, 9 and 10, the three principal commercial broadcast networks in Australia, with multiplexing hardware to be used for distributing programming to their affiliated stations over AUSSAT, Australia's national satellite system.

Collaboration between Graham-Patten and Dolby began early last year, when the two systems were being evaluated by the Public Broadcast Service and ABC. The agreement between Graham-Patten and Dolby involves the purchase, from Dolby, of standard DP-85s, along with specially designed multiplexer cards, demultiplexer cards, and 4-channel ADM decoder cards. The equipment will be packaged and the system tested at Graham-Patten's headquarters and then shipped to the Australian customers.

The initial network order will equip 20 uplink and 37 downlink facilities. Delivery will begin in April and the system will be operational by August.

Wheatstone relocates

Wheatstone Corporation has relocated to 6720 VIP Parkway, Syracuse, NY, 13211; telephone 315-455-7740. The move is intended to provide access to major shipping and transportation hubs and accommodate sales growth.

RAM opens regional office

RAM Broadcast Systems, Chicago, has opened a West Coast regional office in San Bernardino, CA. The address is 1525 East Eureka St., San Bernardino, CA 92404.

CPC negotiates subcarrier authorizations

CPC, Garden Grove, CA, a newly formed subcarrier negotiations and consultant company, is currently negotiating subcarrier authorizations for customers of SCA data systems, American Diversified Capital Corporation, Adams Communications, Chinese Radio Network Corporation, SCA/USA, First Continental

CHYRON IV and CHYRON's SCRIBE

Today's Graphics and Text Generators for the Next Generation!

In our fast-paced technology, helping professionals project the ultimate video image is CHYRON's constant goal...and CHYRON's repeated achievement. This requires the advanced expertise to innovate in systems and products—plus the resources to innovate continuously, to deliver the best in equipment today, and to enhance it with the breakthroughs of tomorrow, next year, and the next generation. That's why, in a world of studios, the name CHYRON is a "household" word.



The photographs shown are unretouched.

CHYRON IV. The First Graphics Generator with Motion. Electronic magic enhances CHYRON IV again! Now, with this industry pacesetter, you can create and screen sparkling animation, multi-color characters, independent background graphics, special effects and more—all with ultra-high resolution. First from CHYRON of course.

SCRIBE. The Ultimate Text Generator. Another "first!" CHYRON's SCRIBE unites the operating/chromatic capabilities of the character generator with the high resolution of a virtually unlimited range of typographic images and styles formerly confined to print media. SCRIBE text generates new potentials in creativity and performance.

For all the facts on CHYRON IV, CHYRON's SCRIBE, or both—call CHYRON today.

The Breakthroughs of Tomorrow...Today.

See us at NAB
Booth #3072

CHYRON TELESYSTEMS
A MEMBER OF THE CHYRON GROUP

Circle (238) on Reply Card

265 Spagnoli Road, Melville, NY 11747 • 516-249-3296 • Telex: 144522 CHYRON MELV

West Coast: 20469 E. Valley Blvd., City of Walnut, CA 91789 • 714-598-4111

St. Louis: 13009 Twin Meadows, St. Louis, MO 63146 • 314-469-3455

Chyron (U.K.) Limited, Dancon House North Circular Road, Stonebridge Park, London NW10 7SS • Tel: (44-1) 965-6599

www.americanradiohistory.com

Communications, and Extended Search Paging International. CPC also acts as broker and consultant in all phases of leasing and subcarrier consultancy matters using consulting engineers geographically located in the United States in various levels of radio station

management. CPC also represents a number of equipment manufacturers involved in subcarrier activities.

Shook delivers mobile TV systems to NASA

Shook Electronics USA, San Antonio,

TX, has delivered two mobile TV production systems to NASA. The systems are built on an industry standard chassis, and custom finished to house the specified electronics for microwave transmission of remote shoots. One is a Chevrolet Suburban chassis. The other system is a cube van built on a 1 ton, dual-wheeled GMC chassis. Ed Shook created the mobile cube van concept to meet remote TV shoot requirements.

Drake and RTS Systems enter agreement

Philip Drake Electronics, Herts, England, and RTS Systems, Burbank, CA, have announced plans to enter into a marketing agreement that appoints RTS Systems as the exclusive Drake distributor for the United States. This arrangement will provide Philip Drake Electronics a U.S.-based company to represent its 6000 series matrix intercom systems.

Drake has received an order from NDR W. Germany via BFE, Mainz, for an 80x80 central matrix intercom system. The system will be custom engineered to requirements and is based upon the reconfigurable 6000 series.

Drake has been awarded a contract for a 6000 series intercom/talkback system for Guangdong Television. This is the first European-manufactured system of its type to be sold to China.

Viewplan Facilities in Stockport has placed an order for a Drake Compact 6 talkback system.

ODC installs recording system in Tokyo

Optical Disc Corporation, Cerritos, CA, has installed its videodisc recording system in Laser Disc Corporation's facility in Tokyo, Japan.

The ODC model 610A videodisc recorder has been installed at the Beijing Film and Video Laboratory. The discs recorded at the Beijing Film and Video Labs will be used in the study of films as well as for interactive uses. They are also investigating the use of hybrid Laser-Vision videodiscs for storing documents.

Dynatech announces Canadian sales

Dynatech NEWSTAR, Madison, WI, has announced Canadian sales of its NEWSTAR and NEWSTAR DISCOVERY automated newsroom systems. Since September 1986, orders have been received from: CKWX Radio, Vancouver, BC; CFPL-AM, London, Ontario; CKNX-TV, Wingham, Ontario; CFRB-AM/FM, To-

NEW!

THE STEREO TV PROBLEM SOLVER by ADM...

The NEW ADM RM1010 switching matrix offers solutions to many of the problems associated with stereo audio. The RM1010 accepts a stereo input and redistributes it in the proper stereo format.

Stereo and Monaural are front panel selectable. And, the phase of the left channel can be reversed, which solves the "monaural sum" problem associated with "out-

of-phase" stereo program material. A stereo monitor circuit, stereo analog metering, a line level output with level control and a front panel stereo headphone jack permit precise level control and output balancing.

The RM1010 . . . another example of the quality, reliability and performance that makes it possible for ADM to offer the exclusive 5 year warranty on parts and labor.



Visit us at Booth 3266

Contact ADM, your regional manager or audio distributor.



ADM Technology, Inc.
1626 E. Big Beaver Road, Troy, Michigan 48084
Phone: (313) 524-2100 TLX 23-1114

Circle (309) on Reply Card

ronto, Ontario; CJAD-AM/FM, Montreal, Quebec; CJCA Radio, Edmonton, Alberta; CKCO-TV, Kitchener, Ontario. These orders represent multiple systems within several major Canadian broadcast groups, including Selkirk Broadcasting, Standard Broadcasting Corporation and CFPL Broadcasting.

Jampro installs TV antenna

Jampro Antennas, Sacramento, CA, has installed its low-band spiral circular polarized TV antenna at KTVK-TV, Channel 3, Phoenix, AZ.

Kaleidoscope goes on-line at National Video

National Video Center/Recording Studios, New York City, has put the Kaleidoscope digital effects device into operation. The Kaleidoscope, manufactured by the Grass Valley Group, is a device that provides high-quality digital effects.

AFA opens West Coast sales/engineering operation

A.F. Associates, Northvale, NJ, has opened a West Coast sales and engineering operation. The address is 10650 Scripps Ranch Blvd., Suite 200, San Diego, CA 92131; telephone 619-530-2970.

MCI helps air HDTV

Micro Communications, Manchester, NH, has announced the manufacture and installation of an HDTV horn antenna for a terrestrial TV broadcast demonstration, organized by the NAB and the Association of Maximum Service Telecasters. The electromagnetic horn antenna for HDTV UHF TV transmission minimizes wind loading. It is a high-gain antenna mounted with a rotary polarized ring assembly that permits multiplicity of polarization and is currently mounted on the WUSA tower in Washington, DC. The antenna is being used to help demonstrate to the FCC and to Congress the capability of HDTV transmission on terrestrial channels.

Montevallo University buys Comprompter newsroom

Comprompter, La Crosse, WI, has installed an electronic newsroom at the University of Montevallo, Montevallo, AL. The mass communications division of the Department of Communications will use the system in its media training program and for campus cable newscasts. The ENR provides scriptwriting,

organization and presentation of newscasts for classroom and on-air use. The floppy disk Apple IIe computer system features scriptwriting/editing, archiving, newscast producing and a built-in electronic prompting of the talent during live broadcasts.

Neve delivers consoles

Rupert Neve, Bethel, CT, has delivered an 8232 series console to Reflections Studio.

Magno Sound and Video also took delivery of the V series 48-track with a Necam 96 console.

WE HAVE SOME OF THE BEST CONNECTIONS IN THE COMMUNICATIONS BUSINESS

If you're in the telecommunications, audio or video broadcast industry, you should get to know Trimm. We have a complete line of audio telephone jacks, plugs, jack panels, patch cords, terminal blocks, as well as a broad line of coaxial jacks, plugs, fuse panels and related components. Connect up with Trimm. Call or write for our catalog.

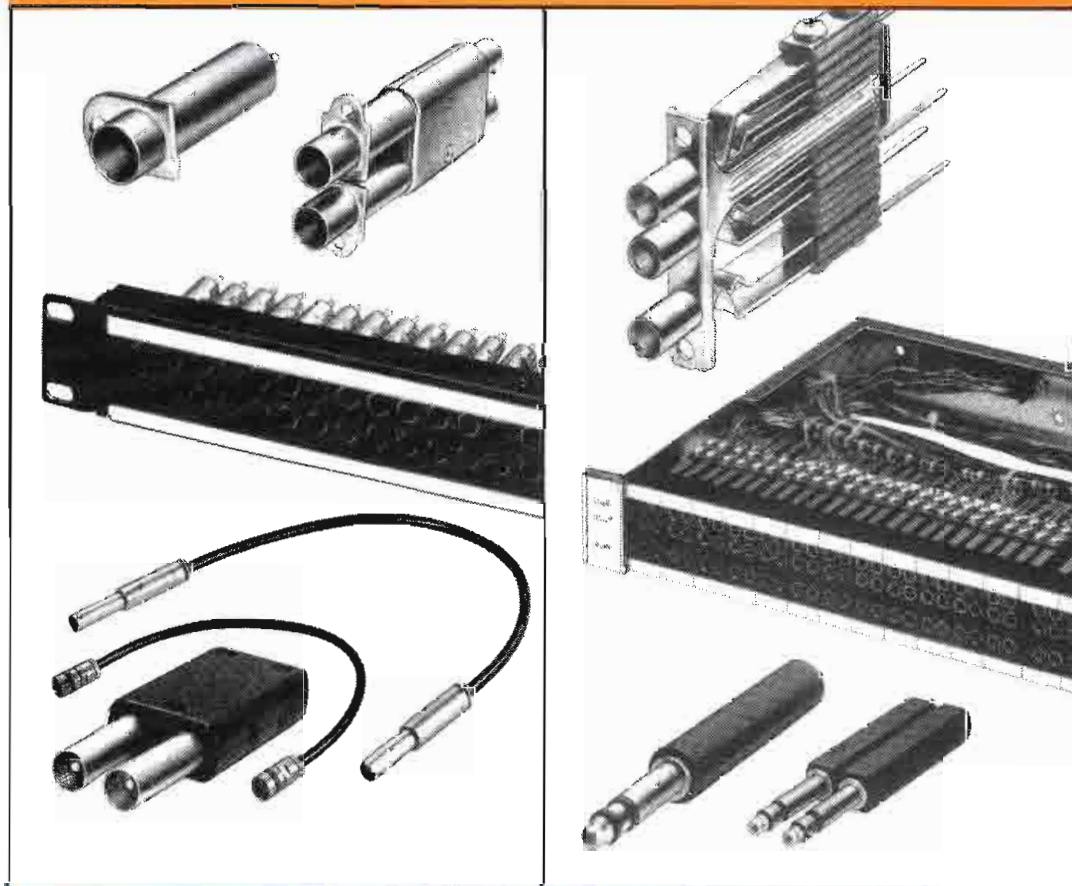

TRIMM INC.

A DIVISION OF NEWTON INSTRUMENT COMPANY

400 West Lake St., P.O. Box 489, Libertyville, Illinois 60048
Phone 312-362-3700, Telex 728452, Fax 312-680-3888

NAB Show Booth #2649

Circle (239) on Reply Card

Townsend acquires Broadcast Systems

Townsend Associates, Westfield, MA, has announced the acquisition of Broadcast Systems, Austin, TX. The company name has been changed to Townsend Broadcast Systems. Townsend was

founded in 1963 as a TV transmitter manufacturer. Products include transmitters for VHF and UHF in both low- and high-power versions. RF system packages are provided including transmitter, transmission line, antenna and accessories.

Broadcast Systems, in business since 1978, is a manufacturer of TV studio equipment specializing in automated video cart systems. In addition, as a distributor of numerous video products, they have the capability to design and build studio packages customized to a particular TV station's requirements.



FREEZE FRAME BROADCASTING

Colorado Video offers three unique solutions to the effective, low cost delivery of visual information:

- **Subcarrier transmission** of "still-frame" color images in 8 seconds over a 10 kHz channel. Use FM radio, television or satellite.
- **Vertical interval multiplexing** in a conventional television signal.
- **Time division multiplexing** of single frames into a normal TV program (or mix four separate programs onto a single channel with slightly reduced motion reproduction).

Selective addressing may be used to allow special routing to individual locations. Computer image storage and retrieval provides exceptional programming convenience.

Call us for more information.

See us at NAB, Booth 3447

Colorado Video Inc.

Box 928 Boulder, Colorado 80306 USA

(303) 444-3972 TWX 910-940-3248 COLO VIDEO BDR

AV-SYNC Electronic bulletin board service

Surveys on computer-usage trends in the sound and video industry indicate that many people are starting to learn about personal computers and communications via modem or are interested in the medium to interact with others through electronic mail.

In response to computer users in sound, video and related areas, a non-profit bulletin board service (A-V SYNC) is scheduled to go on-line in late April. The service is dedicated to a free exchange of ideas, special interests and discussions among professionals in audio, video and production-oriented areas.

The system will feature multiple lines which may be accessed through either standard dialing or various networks available to users of personal computers. Conferences or forums to cover most special interests in the industry are divided into: audio for video; TV sound; production Q&As; new technology; manufacturers' forum; trends; and system files conference. Where applicable, new or modified files will be available for users of software-based mixing and editing systems with updates and related text files as supplied by various manufacturers and programmers. Call 404-438-5858.

ITFS system combines latest technology

The Long Beach Unified School District replaced its entire instructional TV fixed service system with new solid-state repeater transmitters produced by *EMCEE Broadcast Products*, White Haven, PA.

A new 6GHz microwave link and two new ITFS transmitters have been installed on Fairview Mountain outside Hagerstown, MD.

Alden acquires Zephyr

Zephyr Weather Information Service has been acquired by *Alden Electronics*, Westborough, MA. As a wholly owned subsidiary of Alden Electronics, Zephyr will continue to broadcast its data services on transponder 3 of Galaxy 1.

||:~:~)))))

Circle (321) on Reply Card

Switch to the brightest displays for every TV signal!

No matter what TV signal you have to analyze, the new Philips Waveform Monitors and Vectorscopes give you a new standard for bright, crisp displays. And now they can even be combined into one efficient, high performance unit to lead the industry.

■ **PM 5665 Waveform Monitor and PM 5667/68 Vectorscopes** The ultimate in measuring and monitoring. Even VITS appear sharp and easy to see. And the PM 5668 also features Sc-H phase.

■ **PM 5661 Waveform Monitor/Vector scope.** Two instruments combined into one lower-priced unit. Compact size is ideal when space and power are limited, without sacrificing performance.

■ **PM 5662 Waveform Monitor/Vector scope.** Also a combined configuration for greater efficiency, with Sc-H display for even higher performance.

A whole new range of Philips Waveform Monitors & Vectorscopes are now ready to fill all your TV-signal monitoring and measuring needs, no matter where you have to work. With, of course, worldwide Philips service guaranteed for a unit's entire product lifetime.

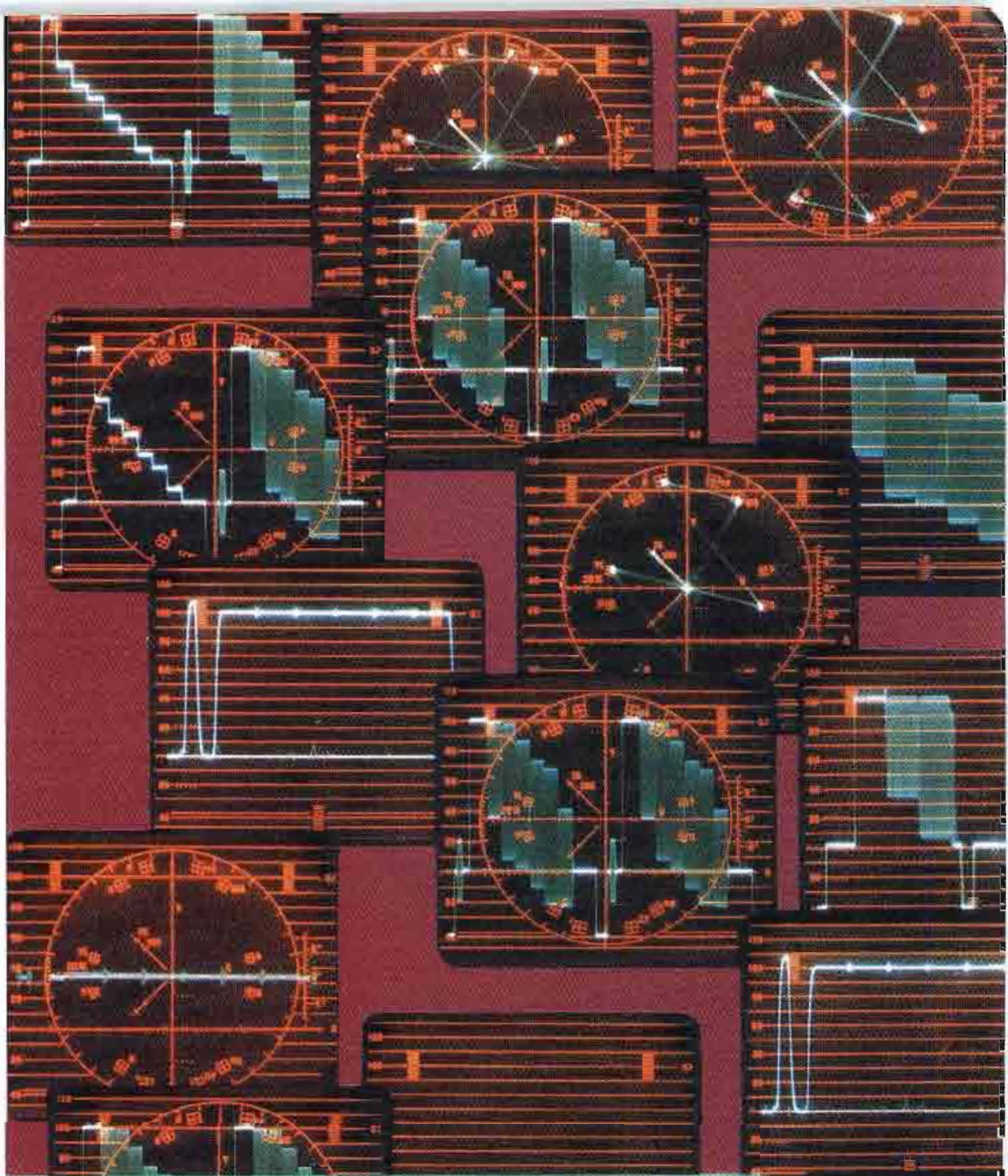

Test the difference

All over the world, in broadcasting, program production and set manufacturing, Philips Professional Television instruments are used when state-of-the-art technology is needed to ensure the highest test and measuring standards. That's why we say with pride...

*Every day,
over a billion people
watch us work.*



Test the difference and you'll also agree that Philips wins on price and performance every time.

Call or write:

Philips Test & Measuring Instruments, INC. 85 McKee Drive, Mahwah, New Jersey 07430.

Phone: 800-631-7172
201-529-3800



Test & Measurement

PHILIPS

Circle (240) on Reply Card

R. Bland McCartha has been appointed director of marketing for the Audio-Video Systems Division of Ampex, Redwood City, CA. He will oversee all aspects of product and applications marketing as well as technology planning. Managerial posts reporting to him are ap-

plications marketing, product and program management, turnkey systems, technology planning and marketing communications. McCartha is a former division manager of applications marketing for the company. **Robert Wilson**, vice president and general

manager of Ampex Magnetic Tape Division, has been elected to the board of directors of the International Tape/Disc Association.

Robert S. Pariseau, Douglas Harrison and **Isaac Agam** have been appointed positions with Cubicomp, Hayward, CA. Pariseau is vice president of engineering. He will direct the development of new products, enhancements to existing systems, and will provide technological planning for future products in a variety of markets. He also will work with Ampex, which is partnered with Cubicomp, in co-developing products. Harrison is broadcast and video production product marketing manager. Agam is creative design product marketing manager.

Peter Kehoe has been appointed Mid-Atlantic regional manager for Studer Revox America, Nashville, TN. Based out of the company's New York City field office, he will be responsible for sales and technical support of the company's products from New Jersey to Washington, DC, along with some accounts in Manhattan.

Chuck Martin has been named Western regional manager, broadcast sales, for Odetics, Anaheim, CA. He will be responsible for the marketing of the TCS2000 cart machine.

Nigel Branwell has been appointed to a position with Calrec by AMS, Seattle, WA. He is sales and marketing coordinator for the North American market for the UA8000 music console, computer-controlled assignable mixers for TV and teleproduction, the M Series mixers, the Soundfield microphones and the condenser microphones.

James A. Smith has been elected president of the 48-year-old Society of Television Engineers. Smith is engineering manager of KCOP-TV, channel 13, Los Angeles. In 1952, Smith was instrumental in establishing the first privately owned TV station in Canada. He later served as director of operations and engineering for the CTV Television Network.

Ken Marcoux, Jeffrey Michael, Terry Sweeney, Joe Davis and **Kristi Urquidi** have been appointed positions with Howe Audio Productions, Boulder, CO. Marcoux is president and chief executive officer. Michael is vice president

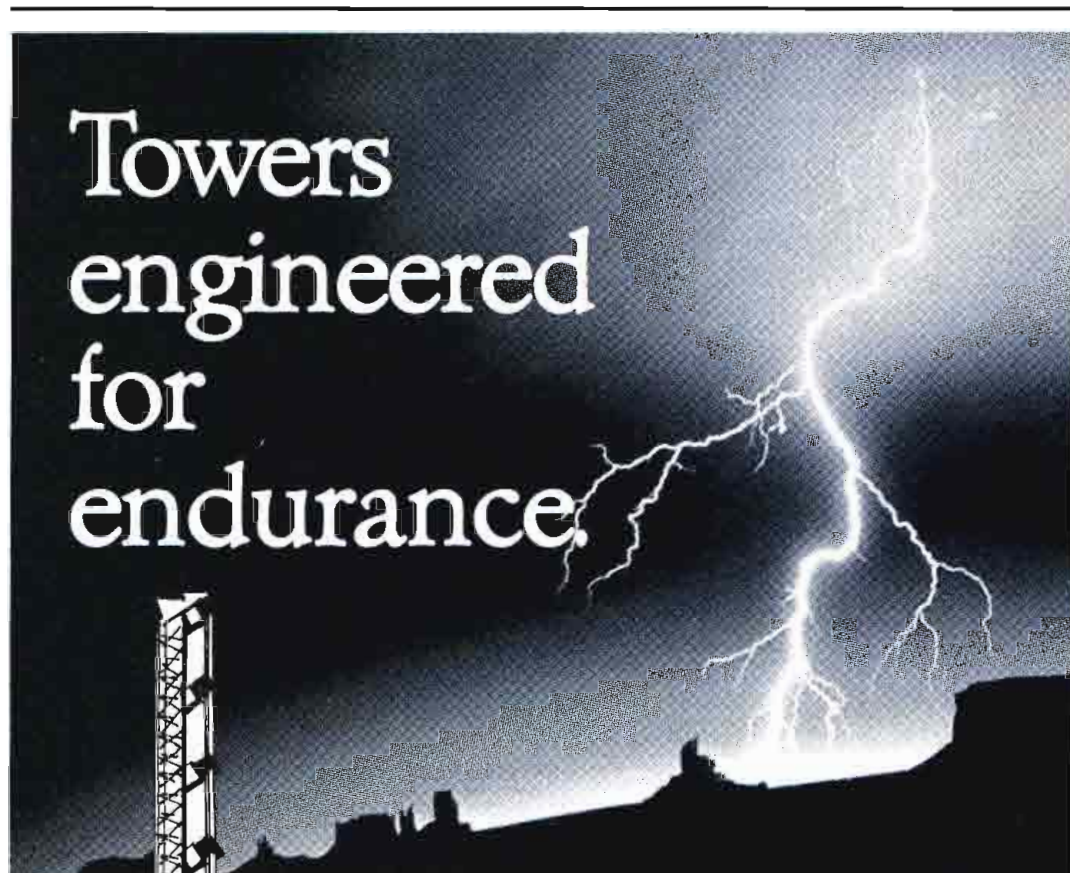

Towers engineered for endurance.

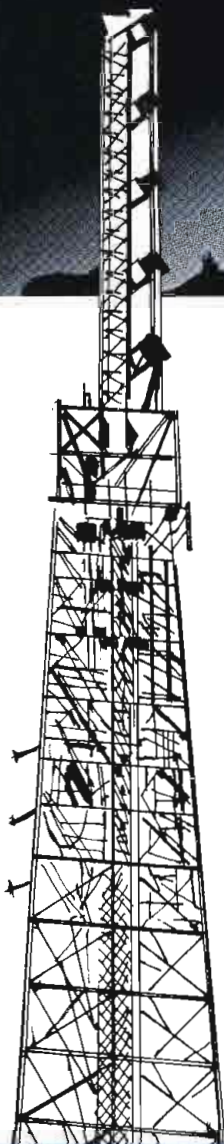

At Stainless, Inc., before we begin designing a tower, we take into consideration equipment loading specifications, unique terrain conditions and any other requirements that would dictate special design criteria. Only after we've thoroughly analyzed your specifications do we begin engineering and constructing a top quality Stainless tower.

As a result of our high standards, we've been commissioned to design and build more than 6,500 towers of all heights and sizes worldwide. We've conquered all types of building challenges. And we've been doing it for 40 years.



Stainless, inc.

North Wales, PA • USA 19454
Phone: (215) 699-4871 Telex: 510-661-8097

Now celebrating our 40th Anniversary.

See us at NAB, booth #2735.

Circle (241) on Reply Card

We have many competitors. But no competition.



© 1987 Sennheiser Electronic Corporation (N.Y.)

Sennheiser Electronic Corporation (N.Y.), 48 West 38th Street, New York, N.Y. 10018 (212) 944-9440 Manufacturing Plant: D-3002 Wedemark, West Germany
PROFESSIONAL MICROPHONES • HEADPHONES • WIRELESS MICROPHONES • INFRA-RED SYSTEMS

Circle (242) on Reply Card

www.americanradiohistory.com

of operations. Sweeney is vice president of marketing and sales. Davis is vice president of production and Urquidi is senior engineer for research and development.

Ron Phenicie has been promoted to

vice president of marketing for Anvil Cases, Los Angeles. He will work with other personnel in developing and targeting major marketing decisions for the veteran transit case manufacturer. Phenicie is a former Eastern regional sales manager for the company.

Vince Jakimzak has been appointed a position with A.F. Associates, Northvale, NJ. He is Western regional sales manager for the West Coast sales and engineering operation in San Diego, CA.

Joe De Angelo has been appointed to the new position of broadcast product marketing manager for Harris Broadcast Division, Quincy, IL. He will be responsible for the identification and development of marketing for new products and services in the radio and TV RF lines and remote control, marketing support for existing products, and the coordination and development of future products.

Morris Washington, Steve Beck, Kenny Katayama and **June Dean** have been appointed to positions at Panasonic Broadcast Systems Company, Secaucus, NJ. Washington is manager of marketing information systems. He is responsible for gathering and analyzing information on the company's operation and the broadcast industry. Beck was promoted to administration manager. He is responsible for general/order/contract administration. Katayama was promoted to manager of manufacturing resource planning. He is in charge of inventory control and liaison with the video systems division factory in Japan. Dean was promoted to staff order administrator. She is responsible for processing orders for M-II equipment. She also is in charge of loan equipment and show samples.

Thomas R. Meyer and **James S. Meek** have been appointed to positions with Dynair Electronics, San Diego. Meyer has been promoted to director of engineering. He has been with the company for 10 years, and was previously product manager. Meek has been promoted to product manager. He has been with the company for the past two years and was promoted from product specialist.

David Aufdenberg has been promoted to national technical service manager for Lenco, Jackson, MO. He will be responsible for supervising the technical customer service with Lenco's national network of TV/radio broadcast dealers and computer graphics products dealers, representing Lenco at national trade shows and providing technical support within the sales staff.



**K104
TAMED
VOLTAGE
TRANSIENTS
WITH
POWER SIFTOR®**

"You may not know it, but right now your new whiz bang piece of equipment could be destroyed, not by an overzealous, hyperactive disc jockey, but by an even more insidious menace: voltage transients, or spikes, on the electrical lines in your studios or transmitters.

"At K104, we can't afford to go off the air because of power surges and lightning strikes. Our Current Technology Power Siftors have saved us from these perils on a number of occasions. That's why I recommend them for studio and transmitter site protection.

"If you CAN'T AFFORD to be off the air...you CAN AFFORD Current Technology Power Siftors."

-Gerry Dalton
*Director of Engineering
KKDA FM/AM Dallas*

CURRENT Technology
1400 South Sherman Drive, Suite 202
Richardson, TX 75081 Phone 214/238-5300

Power Siftor is a registered trademark of Current Technology Incorporated

Circle (243) on Reply Card

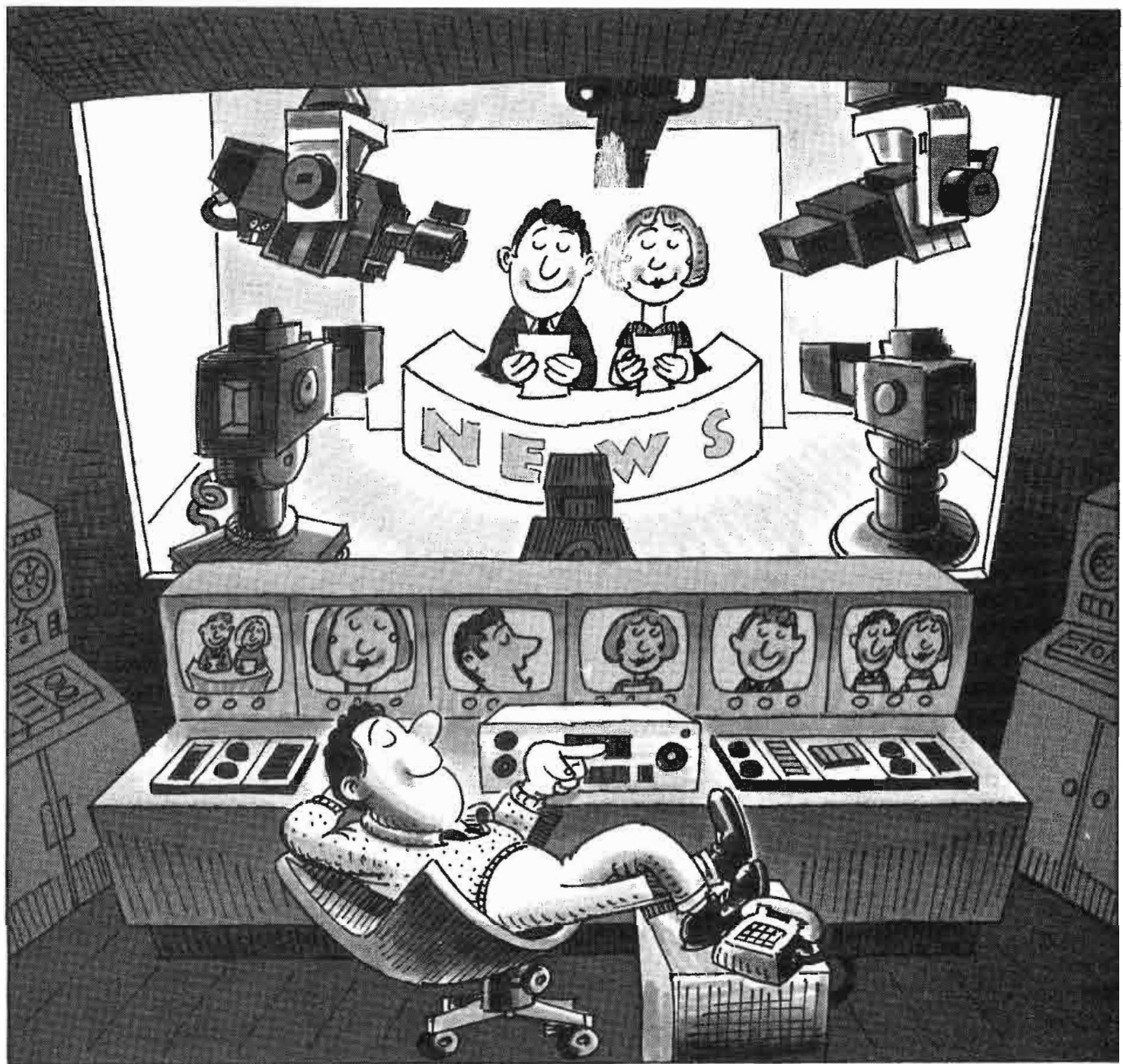

MULTIPLE CAMERAS. ONE OPERATOR.

Impossible? Not if your cameras are mounted on EPO Servo-Controlled pan and tilt heads. These extraordinary, labor-saving devices, which first found favor in legislatures where remote-controlled, unobtrusive coverage was a key factor, are now the basis for complete remote-controlled news studios.

Just look at these outstanding features:

- Up to 500 preprogrammed positions per camera, including control of iris and black levels
- Programmable fade modes that provide smooth transition from preprogrammed shots
- Ability to zoom and focus
- Unobtrusive
- Can be operated via telephone lines or microwave in a remote studio away from the main studio location
- Wide range of pan and tilt heads, for full studio cameras with teleprompters to ENG type cameras
- Wide range of control options, from panels with multiple-shot memories to simple joy stick remote controls.

It's flexible, affordable—and it's sold and serviced exclusively in the U.S.A. by A.F. Associates.

THE RADAMEC EPO REMOTE CAMERA CONTROL SYSTEMS

Your news show's bottom line will never look so good.



A.F. ASSOCIATES INC.

ADVANCED SYSTEMS AND PRODUCTS FOR THE VIDEO INDUSTRY
100 STONEHURST COURT NORTHVALE NJ 07647 (201) 767-1000
10650 SCRIPPS RANCH BLVD SUITE 200 SAN DIEGO CA (609) 530-2970

Circle (245) on Reply Card

New products

Audiotape recorders

AEG has introduced the M-20 and M-21 series 2-tracks and a new version of the M-15A 2-inch, 32-track professional audiotape recorders. The M-20 series, available in ¼-inch, 2-track and center-track time-code versions, is totally microprocessor controlled and incorporates complete 4-speed operation with digitally stored audio alignment parameters for 3-tape formulations at each speed stored in non-volatile memory. It includes a 6-position locator with automatic logging of the last execution of play or record, a looping function, $\pm 25\%$ varispeed, TBI readout, and is equipped with wide profile amorphous metal asymmetric butterfly core heads and dual stage high-frequency equalization circuitry. The M-21 series, available in ¼-inch and ½-inch 2-track versions, includes microprocessor transport control, 2-speed operation, a 2-position locator, and $\pm 10\%$ varispeed functions. The M-15A multitrack recorder has a 2-inch, 32-track format, including the new MTC 104 locator/remote.

Circle (1400) on Reply Card

Stereo processor

AKG Acoustics has introduced a multi-identity digital audio processor. The processor produces a 20kHz bandwidth, has a 360ms delay line with 12 separate taps, has eight programs, including mono to stereo conversion via time delays, stereo room reflection patterns and Haas Effect stereo imaging.

Circle (1401) on Reply Card

Studio mastering tape

Agfa-Gevaert, Magnetic Tape Division, has introduced an improved formulation of the PEM 469 studio mastering tape. An improved backcoating binder and refined manufacturing process make the tape cleaner and more durable. Print-through alleviates pre- and post-echo. It also features slitting for consistent phase stability and winding performance even at top transport speeds. Currently available in 1-inch and 2-inch width reels and ½-inch and ¼-inch width reels and hubs, the tape conforms to the IEC reference blank tape standard for compatibility with a wide variety of tapes and machines.

Circle (1402) on Reply Card

Fresnel lights



ARRI has introduced the ARRI fresnel line of lights. The ARRI 2000 features a fresnel lens one inch wider than traditional lights. The fresnels are built of extruded aluminum with a durable housing that is integral to the fixture's convection cooling system. The door latch and internal lampholder feature 1-handed operation. The 1k, 2k and 5k fresnels have both front and back focus knobs, and all are available with either European or American style barndoor holders, and in manual- or pole-operated versions.

Circle (1403) on Reply Card

Multitrack console

Amek has introduced the G2520, the replacement for the M2500 multitrack console. The unit is available in two frame sizes accommodating 40 or 56 inputs. Features include: gas-filled bar graph plasma metering; separate fader block; the Audio Kinetics VCA MasterMix and the digital creations disc mix; digital grouping; master status switching of all principal functions; and dual input capability allowing each module to have two inputs during mix down.

Circle (1404) on Reply Card

Tape eraser

AVSC has announced the 1500H tape eraser, an all-automatic bulk eraser for high coercivity videotape in all formats. Features include: The capability to degauss all tape formats without mechanical or electrical adjustments; long duty cycle that permits greater throughput; and electronically controlled decline of erase field for smoother erasure.

Circle (1405) on Reply Card

Precision audiotape reel

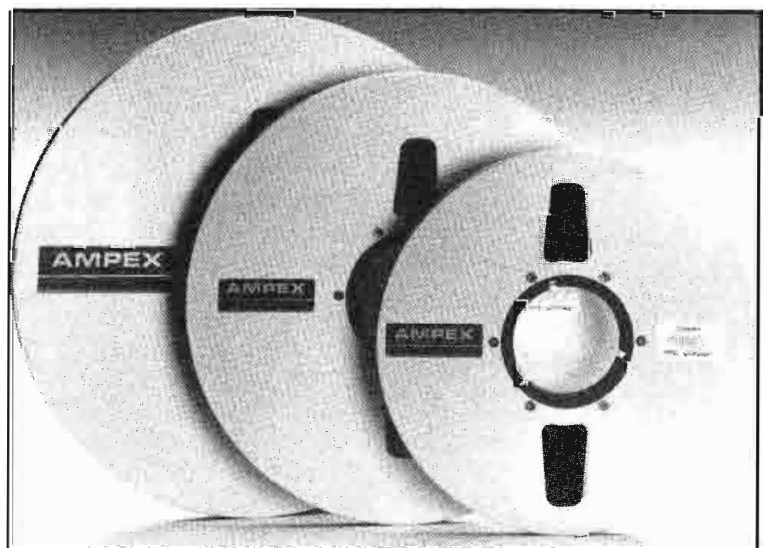

Ampex Magnetic Tape Division has announced a ¼-inch precision reel for its Ampex 467 digital audiotape. Three ¼-inch configurations and three equivalent size empty ¼-inch precision accessory reels in boxes are being added. The reels will include 4,600-foot, 7,200-foot and 9,700-foot configurations. The accessory reels will be available in 10½-inch, 12½-inch and 14-inch sizes.

Circle (1406) on Reply Card

The logo is printed on a dark, textured surface, likely a control panel, and is oriented vertically.The logo is printed on a dark, textured surface, likely a control panel, and is oriented vertically.

MICROPROCESSOR

O.K.

FAULT

#6 Charging (Fast) 3.3
NICAD 14.4a 20.0V

New.

The First and Only.

Anton/Bauer introduces the next generation battery/charging system.

The new Anton/Bauer microprocessor series features:

- Three times the control systems of any other microprocessor charger... a quantum leap in reliability.
- Diagnostics that identify battery problems and specific cell deficiencies.
- Programmable for virtually all new battery technologies under development.

See the new Anton/Bauer microprocessor based battery/charger/mounting system at NAB... Booth 2600... or write for details.

The logo features the words 'anton' and 'bauer' in a bold, italicized, sans-serif font, enclosed within a rectangular border.

*The quality standard
of the video industry.*

Anton/Bauer, Inc.® □ One Controls Drive, Shelton, CT06484 □ 203-929-1100

Circle (246) on Reply Card
www.americanradiohistory.com

THE RIGHT STUFF



Lenco's New 600 System Audio Distribution Components Put All the Right Stuff Together...

Lenco's new 600 System audio components bring a new standard of performance to the field of audio/video distribution equipment. But that's not the only reason why you'll want to specify the Lenco 600 System for your next purchase.

UNMATCHED VERSATILITY

Mix Lenco Audio and Video Distribution Equipment to suit your needs. Virtually all Lenco distribution components fit the 600 System Main Frame. And you can mix audio/video in almost any combination in the unique 9 cell frame. You're not limited to a 50/50 maximum video-to-audio mix. Engineers will also appreciate our innovative frame and module design which ensures ease of installation and maintenance.

ENGINEERED FOR PERFORMANCE

Lenco 600 System components are built to the toughest standards in the industry, and engineered to assure unmatched performance with specifications such as:

**ANY
WAY
YOU
WANT
IT!**

- S/N 105 dBv
- Common Mode Rejection 70 dB
- Intermodulation Distortion < .004%
- Total Harmonic Distortion < .006% up to 24 dBm

Finally, our design engineers have taken extreme caution using grounding and shielding to minimize crosstalk.

SUSTAINED SUPPORT SERVICE

If you should experience a problem with any Lenco component, we can supply a loan replacement from our factory ... Fast, usually within 24 hours. It's just one more reason why, when you need "the right stuff" for your audio or video operation, your first choice should be *The Professional's Choice ... Lenco.*

For complete technical information on Lenco's New 600 System Components and the full line of quality Lenco distribution equipment.

Call Toll-free: 1-800-325-8494.



Circle (375) on Reply Card

300 N. Maryland St.
P.O. Box 348
Jackson, MO 63755
1-314-243-3147



**HS-100P with
MultiController**

**New.
SportsFocuser
for needle sharp
auto-focusing.**

**New.
HS-110P Studio Camera
Automation System
for News Rooms
and sporting events.**

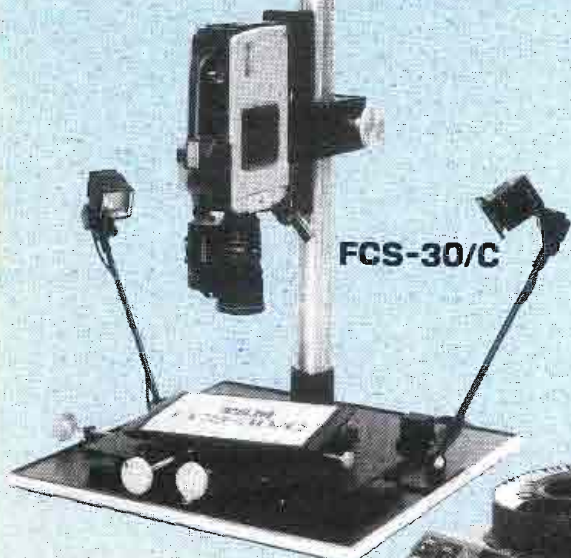

FCS-30/C

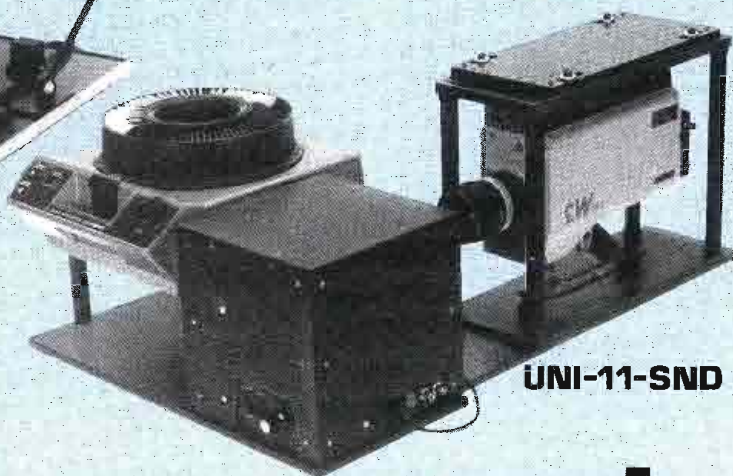

UNI-11-SND

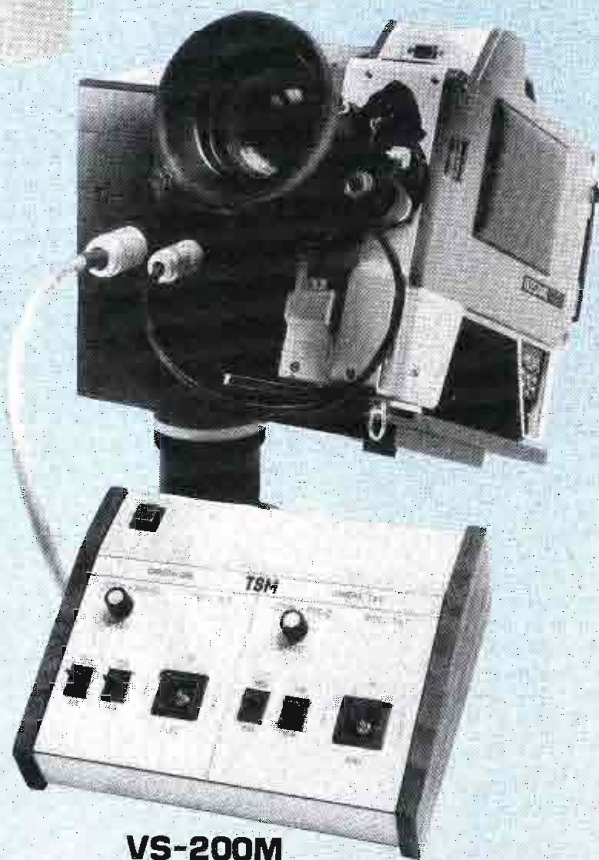

VS-200M

The camera control specialists.

- **HS-100P** High Speed Programmable Servo Pan/Tilt System with MultiController.
- **FCS-30/C** Color Font Compose/Title Stand.
- **UNI-11-SND** Uniplexer.
- **VS-200M** Variable Speed Motorized Pan/Tilt System.

**See our full product line
at NAB... Booth 3534**



**TOTAL SPECTRUM
MANUFACTURING INC.**
20 Virginia Avenue, West Nyack, NY 10994
(914) 358-8820

Circle (303) on Reply Card

Amplifiers, mixer

Biamp Systems has introduced the following products:

- The XA and T series stereo MOSFET power amplifiers are equipped with auto-limit, eliminating clipping distortion. The XA series are available in four power ratings: 50W/side in a single rack space, 150W and 300W each in two rack spaces, and 500W in three rack spaces. The amplifiers are cooled by continuously variable speed fans pumping air through enclosed heat sink tunnels, eliminating the need for air filters. The T series are passively cooled MOSFET units designed for 2 Ω operation. The series includes complete LED metering and are available in 240W and 510W per side.
- The RackMax is a 16-input stereo mixer that includes 48V phantom power switchable on each channel, 100mm faders, a complete solo system, three jumperable auxiliary sends per channel and complete LED metering in a standard rack width, 3-inch deep unit.

Circle (1409) on Reply Card

Modulation monitor

Broadcast Electronics has announced the model AS-10 AM stereo modulation monitor, the companion to the AX-10 C-QUAM AM stereo exciter. The monitor's second generation

digital circuitry includes an RF AGC that eliminates AGC tracking errors. Precision-filtering networks in the monitor reduce overshoot errors to typically less than 1%. The monitor also features digital pilot detection. The unit is primarily designed for broadcasters who use the C-QUAM AM stereo format, but it can also be used to monitor and measure monaural signals.

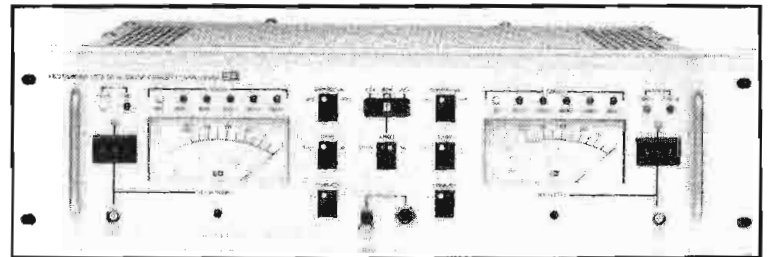

Circle (1410) on Reply Card

RF power meter

Bird Electronics has announced the model 4421 RF power meter, a programmable, microprocessor-based instrument that measures forward and reflected RF power, VSWR and return loss in watts or dBm to 1GHz and 1kW. The meter's accuracy is $\pm 3\%$ of reading. The package includes a 4020-series remote sensor head based on THRULINE prin-

ERASE IT!

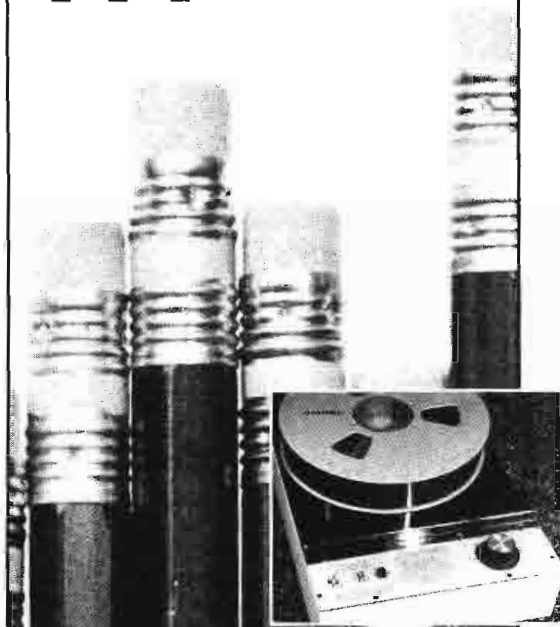

Nothing erases audio, video or computer tape better than Audiolab degaussers.

For information call: 916/485-0500

AUDIOLAB ELECTRONICS

3725 Esperanza Drive, Sacramento, CA 95864

Circle (212) on Reply Card



YOU CAN'T MISS IT!

Inovonics' "TVU" puts your audio level metering where it commands attention: *on the video monitor.*

A stereo level bar graph is keyed over the picture and may be positioned anywhere on the screen. Switchable between VU (with Peak Flasher) and PPM display characteristics, "TVU" provides high resolution and complete scale annotation.

Circuitry is transparent to picture video and accepts both balanced program lines and semi-pro inputs. "TVU" is self-contained in a small, mount-anywhere box chassis with rack-mount option.

"TVU" only \$500.00

Inovonics Inc.

1305 Fair Ave., Santa Cruz, CA 95060
(408) 458-0552 TLX: 325670



Circle (211) on Reply Card

CDE CORNELL-DUBILIER

Mica Capacitors

LARGE

STOCK



VACUUM CAPACITORS

JENNINGS

SURCOM ASSOCIATES, INC.

305 Wisconsin Avenue
Oceanside, California 92054
(619) 722-6162

Circle (213) on Reply Card

principles for in-line, unterminated measurements to 1kW without the need for directional couplers or attenuators. The frequency range of 1.8MHz to 1GHz is covered by two sensors. Each sensor carries its own calibration profile in a reprogrammable memory. The unit features a backlit 3½ digit LCD display with annunciators for function and input trends; arrow indicators; and an audible alarm to warn of overloads in excess of 120% of the selected range.

Circle (1411) on Reply Card

Video production system

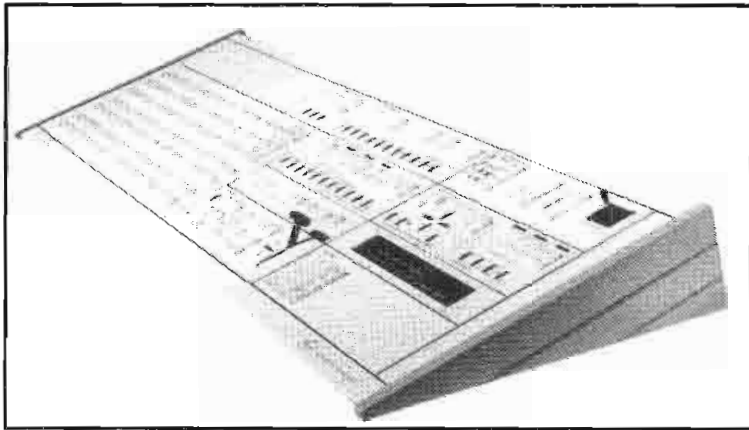

Central Dynamics has introduced the STRATA-7 new generation, 7-layer video production system. The system makes use of extensive microprocessor control to simultaneously process up to seven different video signals through its Super SFX overlay processing system. Other features include: a range of level modifiers; layer priority transitions; five transition linearity modes; three full-facility pattern generators; 10 matte generators; four mask generators; two independent full facility 1- to 4-lines analog key border generators addressable to four levels; a preview selector allowing single level PV of a multilevel composite; and RS-422 communication, designed for expansion and up to 36 inputs.

Circle (1412) on Reply Card

Omnidirectional lavalier and condenser mics

Crown International has introduced the following microphones:

- The GLM-100/D is a dual lavalier omnidirectional condenser microphone. The 50Hz to 18kHz frequency response is emphasized at high frequencies to compensate for high-frequency losses when the microphone is worn on the chest. Low frequency response is rolled off to reduce pickup of background mechanical rumble. Specifications include: impedance of 240Ω balanced; sensitivity of -73.5dBV per microbar; self-noise of 28dBA; and maximum SPL of 150dB.
- The GLM-100/ENG miniature condenser microphone is an omnidirectional electret-condenser microphone that can be battery or phantom-powered. The mic features a wide, smooth frequency response. Extreme low frequencies are filtered out to reduce pickup of low-frequency ambient noises for lavalier use and to reduce boominess. Other features include minimal off-axis coloration and low vibration pickup. The interface is balanced, low impedance, which allows long cable runs without hum pickup or high-frequency loss. The mic can be powered by a 12V to 48V phantom power supply or by an internal 1.5V AA cell. Included with the mic is a tie

Perfect Timing

PROGRAMMABLE CLOCKS



750 E SERIES

One or Two Events,
Thumbwheel Programming
\$341-430



720 SERIES

10 Events,
Micro-Processor Based
\$845-1150



780 SERIES

Up to 96 Events Stored
in Random Access Memory
\$1313-1654



ES 790

1000 Events, Microprocessor-
Based, 32 Output Channels
\$2300



(213) 322-2136

142 Sierra St., El Segundo, CA 90245

Circle (310) on Reply Card

Get It Up —

Get your sensors, antennas or illumination systems up to where they can work best with

an Allen Osborne Associates

telescopic hilomasts

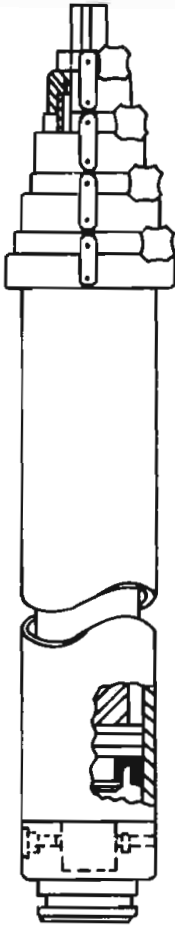

If you need to elevate your communications, jamming, or surveillance antenna or other type of sensor, the convenient, compact and portable family of Allen Osborne Associates telescopic masts is the answer. Osborne masts come in a variety of configurations with pneumatic, electric or manual drives. Adaptable for easy installation on vehicles or in fixed facilities, Osborne masts are also available as a self contained trailer system that can be towed behind your vehicles.

MIL STD 810D QUALIFIED.

With retracted sizes from three to fifteen feet, Osborne masts can extend to over 90 feet above intervening terrain.

For details on how Allen Osborne Associates can help you get it up, contact

ALLEN OSBORNE ASSOCIATES
756 Lakefield Road,
Building J
Westlake Village,
California 91361
(805) 495-8420
TWX: 910-494-1710



Circle (311) on Reply Card

mount and two styles of windscreens. Specifications include: frequency response of 80Hz to 20kHz; impedance of 240Ω balanced; sensitivity of -73.5dBV per microbar; and self-noise of 28dBA.

Circle (1413) on Reply Card

Degausser

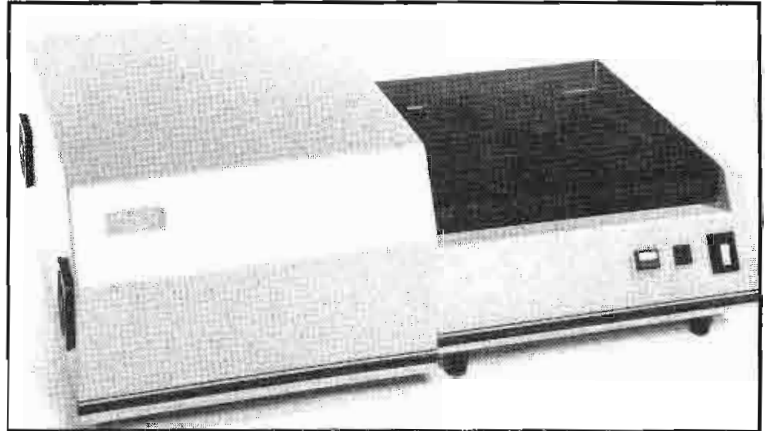

The Tape Care Division of *Data Security* has introduced the Type II degausser, which will erase the 1500 Oersted metal particle videotape used with Panasonic's M-II and Sony's

Continued on page 348

THE COMPLETE CLIP-ON

For your camera



PE "214 c" (14.4V Ni-cad)
(13.2V or 12.0 available)

- Reliable
- Compact
- All-in-one system

See us at NAB, Booth 2733

It's our clip-on with the *built-in* charger*

*115/230 AC switchable

PERROTT ENGINEERING LABS, INC.
7201 Lee Highway, Falls Church, Va. 22046 (703) 532-0700

Circle (316) on Reply Card

KEYING POWER. SIMPLE OPERATION. STATE-OF-THE-ART TECHNOLOGY.

SEE
AT NAB
BOOTH
3191

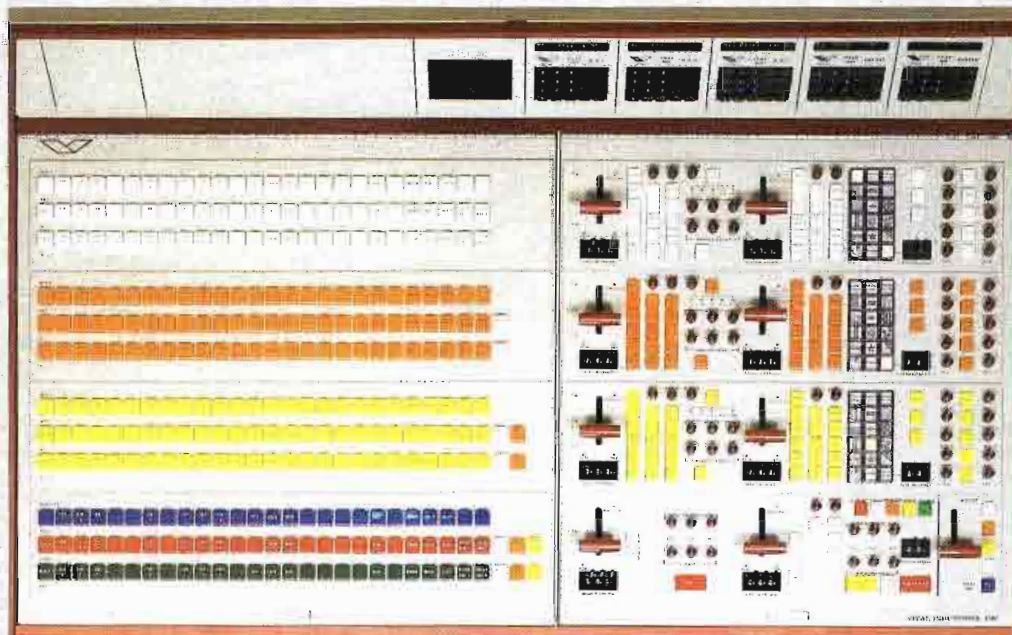

That's Vital's **NEW** 3000 & 3000 + Series Production Switchers.

Need more keying power? Try 4 Video Keys, or a Chroma Key plus 4 Video Keys, in each M/E Plus, all M/E's have separate key inputs with discrete filling signals, permitting 16 self-filled keys in our largest 3000 model. That's our new 3000 Series Production Switcher.

Want simple operation? How about Dual Handlebars, two Auto Transition Units, Simul-Key System for multiple key entries and exits, plus automatic key set-ups in memory for instant access. That's Vital's new 3000 Series Production Switcher.

And state-of-the-art technology? Compare our 3000 Series with any other production switcher in the market. If you can find a better one for less, buy it! This is VITAL's top of the line production switcher—one so fully-loaded that the only option is the stereo audio-follow-video package.

And don't forget SAM... the most advanced station automation system in the world!

For edit suites, remote or ENG vans... 3000 + the most powerful little switcher in the world!



Here's a fantastic switcher with 2, 3 or even 4 Double-Level Mix/Effects systems and occupies only 27" x 18" of console space. This simple ergonomically-designed operations panel can control multiple M/E's at the touch of a button. Yet each M/E of the 3000+ is the same switching powerhouse as the Vital 3000 Series: 2 levels of switching each; an Upstream section that mixes, wipes, title keys and chroma keys, and much more.

So if you've been dreaming of the ultimate switching package—the Vital 3000 Plus Video Production Switching system is here, now, ready to make your wildest production dreams come true.



*Creating Modern Tools
For Creative Minds.*

VITAL INDUSTRIES, INC.

For more information call toll free 800-84-VITAL (U.S. only)

MAIN OFFICE: 3700 N.E. 53rd Ave., Gainesville, FL 32601 (USA) • Tel.: (904) 378-1581 • TWX 810-825-2370 • FLX 80-8572 Vital-A-Gain
Circle (301) on Reply Card

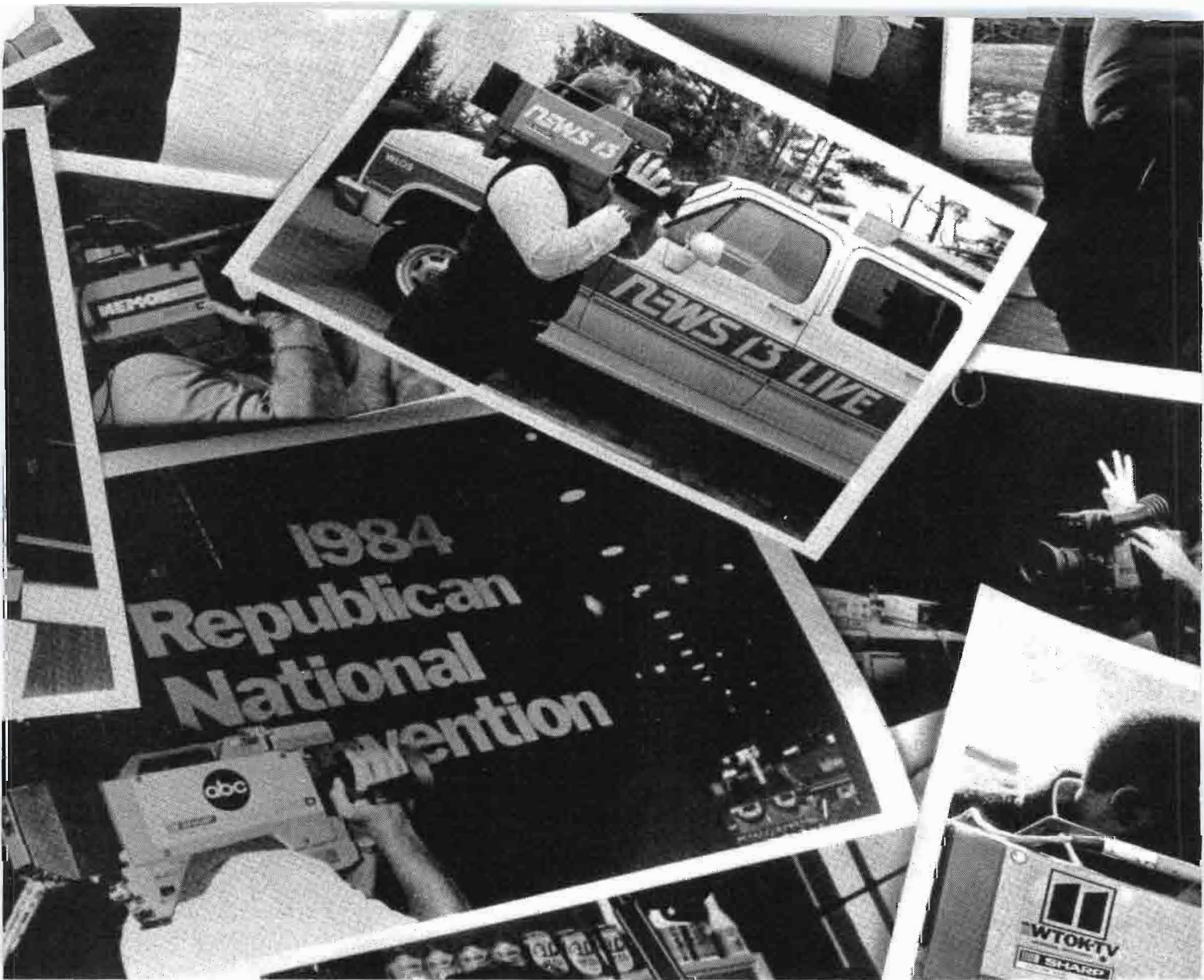

IT ONLY TOOK TEN YEARS TO GET TO

After ten years of research, design, and field experience, Sharp has developed two new video cameras to meet the demands of the broadcast and professional users: the XC-B10 with Saticon® tubes and the XC-B20P with Plumbicons.®

What make both of these cameras so remarkable are their features.

Like Beta and MII component output. So you can connect directly into component recorders without adapters.

And a unique auto contrast circuit to change washed out video into crisp, clean information. Plus auto knee that prevents losing your video in ultra-bright scenes.

We've even put in a unique computer-controlled clock/calendar that gives you the option of burning the date and time into your recordings for editing and archival use.

THE NEW XC-B10 SATICON®

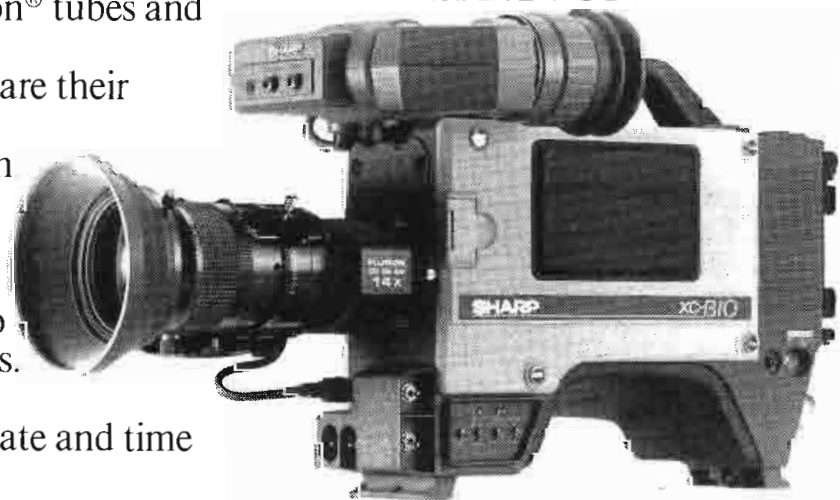

For more information or the name of your local Sharp broadcast dealer, call (201) 529-8731 or write Sharp Electronics Corp.,



AND THOUSANDS OF CAMERAS THESE TWO.

THE NEW XC-B20P PLUMBICON®

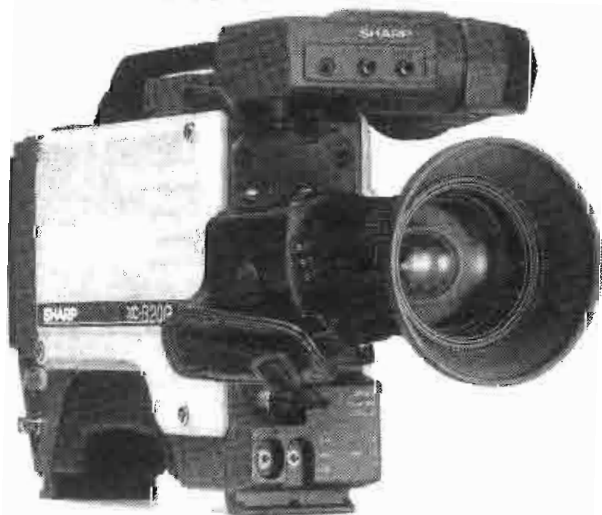

The tubes themselves deliver exceptional pictures, thanks to their state-of-the-art low capacitance mixed-field diode gun technology.

And both cameras have information-packed viewfinders, multicore and triax remote units with full system capability, and prism temperature sensing. Not to mention selectable 6-12 or 9-18dB gain and rugged diecast construction with extensive EMI protection.

All in all, the XC-B10 and XC-B20P are truly remarkable cameras. But don't just take our word for it. Contact your local Sharp broadcast dealer and ask for a demonstration.

Then you can see for yourself the kind of technology that's made Sharp one of the fastest growing camera companies in America.

SHARP®
FROM SHARP MINDS
COME SHARP PRODUCTS™

Betacam SP. The degausser was designed to meet National Security Agency specifications regarding declassification of high-energy tape. The degausser erases the saturated square wave signal of 25kHz at 30ips (1.2 mil wavelength) more than -80dB.

Circle (1414) on Reply Card

Wide-angle lens attachments

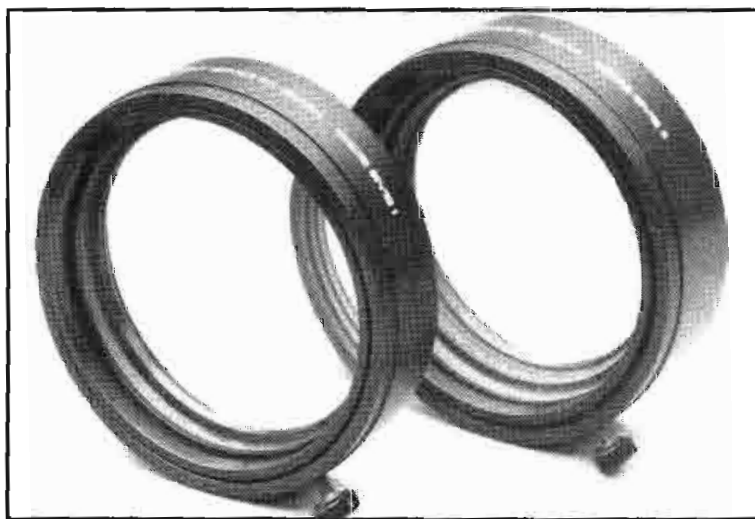

Film/Video Equipment Service Company has introduced the WIDE EYE I and WIDE EYE II wide-angle lens attachments, which can be attached to most video zoom lenses that have macro and/or adjustable back-focusing capabilities. The attachments are made of high-quality optical glass with multiple high-efficiency antireflective coatings, and are available in two versions: slip-on or threaded screw-in models. The front-mounted attachments convert the widest angle of video zoom lenses into ultra wide-angle fixed-focal-length lenses with no loss in light transmittance.

Circle (1415) on Reply Card

Line driver

FM Acoustics has introduced the FM 214 precision-balanced line driver. The unit is a complete stereo system that resolves level and impedance problems that might exist between consumer and professional equipment working at nominal +4dBV and similar levels. Features include: delayed turn-on circuitry; front-panel inputs/outputs and controls; -10dBV inputs via short-circuiting RCA-cinch connectors, guaranteeing thump-free operation; input impedance of 50kΩ; recessed gain controls on the front panel, allowing level adjustment from -70dBV to +14dBV; and short circuit-proof balanced audio outputs. On special request infra- and ultrasonic

STOP GROUND-LOOP HUM!

VIDEO HUM STOP COIL - HSC1

Will ELIMINATE HUM and other INTERFERENCE in Video Lines caused by differences in Ground Potential

- FLAT DC to 6.5 MHz
- No Low-Freq. or Hi-Freq. Roll-off
- No Differential Phase Distortion
- No Differential Gain Distortion
- No Envelope Delay
- Passive Device - Failure Free - Low Price
- Small Compact Package 4" x 4" x 2 1/4"

ELIMINATES HUM AND INTERFERENCE

IN STUDIO

- Between Buildings
- On long runs in Buildings
- Between Studio and Transmitter
- On Incoming circuits
- On Outgoing circuits

IN FIELD

- Betw. Remote Truck and Telco
- Betw. Remote Truck and Microwave
- For Intetruck Hookup
- For VTR Units
- For Monitoring Lines

Available on 10 day free trial

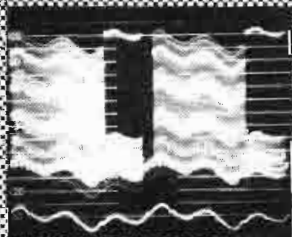

NEW!



\$190

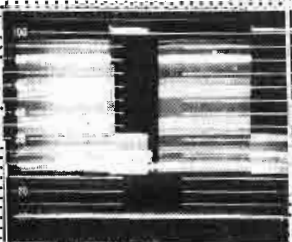

AV AUDIO-VIDEO ENGINEERING COMPANY
65 NANCY BLVD · MERRICK, NY 11566 · 516 546 4239

Circle (178) on Reply Card

Looking for... DA?

Come to Us!

We make plain vanilla as well as special audio/video DA's such as component video and DC 12V powered.

- 200-1 Plain vanilla video DA, 8 outputs.
- 200-2 Cable equalizing video DA, up to 3000 ft.
- 200-3 Chroma equalizing video DA, up to +/-3dB.
- 200-4 Delayed video DA, up to 750 nS.
- 200-5* VCA video DA, remote control system DA.
- 215-1 Line driver V DA, bal/unbal in-out 75/125 ohms.
- 220* DC 12 V powered video DA, 8 outputs.
- 230* 10 outputs video/2 ch audio, dubing system DA.
- 232* 20 outputs video/2 ch audio, dubing system DA.
- 233* 50 outputs video/2 ch audio, dubing system DA.
- 240-1 Plain vanilla audio DA, 12 outputs.
- 240-2 VCA audio DA, remote control system DA.
- 273* Component video DA one gain control for 3 CH.
- 280* DC 12V powered audio DA, 8 outputs.
- 470* DC 12 V powered - V DA, A DA, 5x1 V xp A xp in one 1 RU package.

*New products -

- Other quality products from OMICRON VIDEO.
- Model 310 4 frequency tone generator.
- Model 410 series sync generators.
- Model 500 series audio/video routing switchers.
- Model 700 series data distribution equipment.

5 YEAR WARRANTY

See us at NAB, Booth 2661

OMICRON VIDEO TEL: (818) 700-0742
FAX: (818) 700-0313
9700-F Owensmouth Ave., Chatsworth, CA. 91311

Circle (182) on Reply Card

filters settable to any frequency between 1Hz and 100Hz and between 10kHz and 1MHz can be installed at the factory.

Circle (1416) on Reply Card

Metal videotape

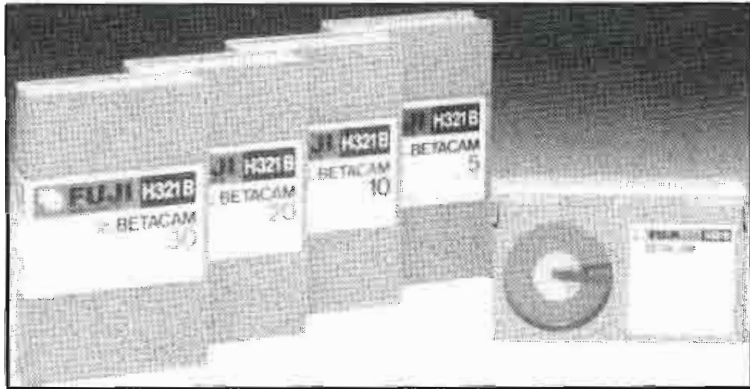

H321B Betacam format videocassettes

Fuji Photo Film U.S.A. has introduced the following products:

- The M401 videocassette is the world's first 1/2-inch metal videotape. It features a formulation of microscopic metal magnetic particles that are dispersed with uniformity and

high density and produces coercivity of 1,500 Oe. The 4-layer structure consists of a magnetic layer, undercoating layer, smooth base and special backcoating on a thin tape measuring 13.5 microns.

- The H321B 1/2-inch Betacam format videocassettes now come in a 30-minute version. A hard resin shell also has been developed for the H321B line. It is manufactured with a special antistatic treatment.

Circle (1417) on Reply Card

Infrared transmission system

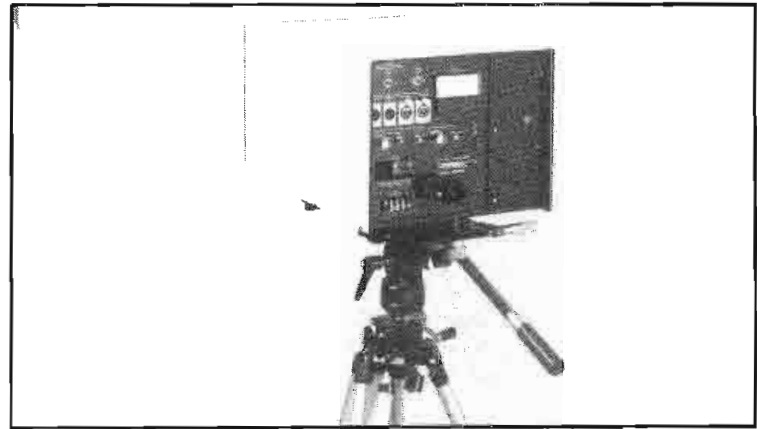

VIDEO DISTRIBUTION AMP FEATURING:

VBB-1 Amplifier in a chip

Power 115/220 VAC

Size 4" x 4" x 2"

Apert
Herzog

408-225-1425

99.⁹⁵*

*Quantity Price

Circle (315) on Reply Card

SAVE TIME

For fast, accurate service, please remove the Peel-Off Label (which is used to address your magazine) and affix it to the Reader Service Card, the Address Change Card, or to any correspondence you send us regarding your subscription.

FREE CATALOG
on interfacing your
RTS or Clear-Com hardware
with a full duplex
Swintek WIRELESS HEADSET

When you're
really serious...



Directly interfaces with three pin XLR hardwire patch for power and dual channel operation.

User net for a complete VHF MARK 200D/C-S including two transceivers and Beyer headset... **\$1995.00**

Manufactured in the United States in all metal cases. Demo units available on request.

Swintek

TELECOMMUNICATIONS DIVISION
587 DIVISION STREET / CAMPBELL, CA 95008
(408) 378-8091 / TELEX 4970334 SWINTEK SUVL

Circle (318) on Reply Card

The Grass Valley Group has introduced the model 3290/91 ATS. It allows infrared transmission of video, data and audio up to 1,500 feet. Video specifications meet broadcast, short-haul RS-250B. Features include fiber-optic ports and a frame designed around the existing fiber cards, so the cards are completely interchangeable with the fiber transmission systems. Each unit can be mounted temporarily on a tripod for ENG purposes, or can be permanently mounted to a building for teleconferencing in a bypass situation. Signals are transmitted using frequency modulation.

Circle (1418) on Reply Card

Stereo generator

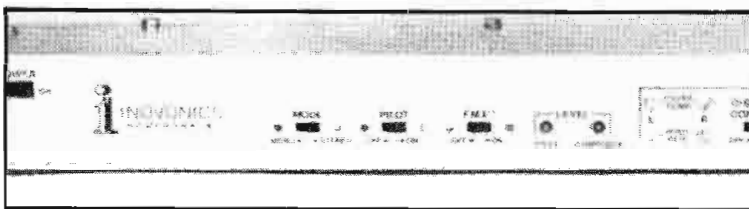

Inovonics has announced the model 705 FM stereo generator with provision for FMX. The generator features digital synthesis of subcarriers and pilots, internal peak over-modulation protection, selectable pre-emphasis and 7-pole ac-

tive/elliptic input filtering with proprietary overshoot control circuitry. The unit yields full program modulation without the need for internal or add-on composite signal processing. Audio response is flat between 25Hz and 16kHz, and stereo separation exceeds 55dB over the entire range.

Circle (1419) on Reply Card

Loudspeaker system, mixer



PMC 402 portable film/ENG mixer

Klark-Teknik Electronics has introduced the following products:

- The JADE 1 active monitor loudspeaker system is designed as a near-field reference point monitor for assessment of

SOLUTIONS

MODULA, MINI MODULA, AND SUPPORT EQUIPMENT from BSM Broadcast Systems

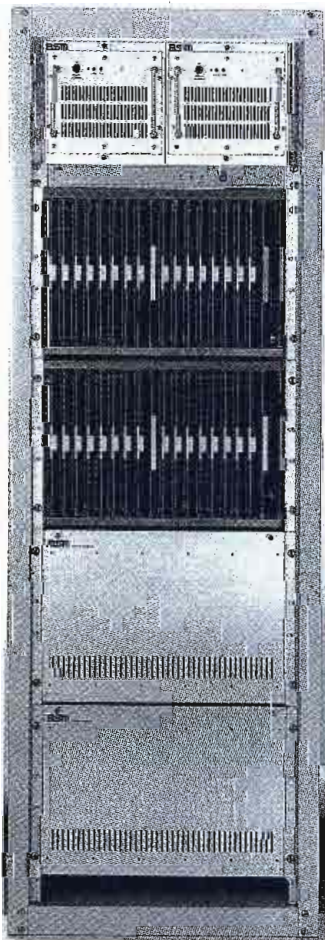

MODULA

PROBLEMS:

1. Expandability
2. Programming
3. Cost

1. BSM Broadcast Systems solves your expansion planning problems for video and audio signal routing with **MINI MODULA**, in matrix sizes from 8 x 8 to 24 x 32, and **MODULA**, for matrices as large as 256 x 256. Both products use the same circuit cards to preserve your initial investment in an expandable system.

2. Both **MODULA** and **MINI MODULA** solve your custom programming needs because the systems are software driven. You re-program to the matrix without sending equipment back to the manufacturer.

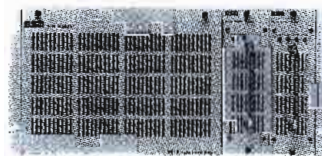

MINI MODULA

3. You can see that BSM system costs are highly competitive—user programming, no hybrids, virtually maintenance free. **MODULA** and **MINI MODULA** expandability enhances your initial investment through growth phases of your development.

BSM also offers a complete line of distribution amplifiers and smaller video or audio switchers to complete your system.

Phone BSM today and discuss the SOLUTIONS for your signal handling requirements. Our engineers and managers want to work with you from the start.



BROADCAST SYSTEMS, INC.

SOLUTIONS:
(509) 838-0110
P.O. Box 19007
Spokane, WA 99219

Circle (312) on Reply Card

digital material. All support electronics, including amplifier and crossover, are incorporated, allowing critical matching of electrical and mechanical properties. The system requires line-level audio and ac powering, and is based on a 2-way bass reflex design with an extra-large port to reduce distortion. On-board controls include driver protection, HF and LF compensation, and input level controls.

- The PMC402 portable film/ENG mixer is powered by 12 AA cells, providing about eight hours of operation. Each of the four inputs, as well as outputs A and B, are balanced using audio transformers. Each input channel incorporates a signal limiter, -20dB pad, HP filter and a pan pot. Microphone powering is accomplished with 12V or 48V phantom and DIN A-B. Direct connection to a NAGRA is made possible via the external interface connection.

Circle (1420) on Reply Card

Generators

Kohler Company's generator division has expanded its Fast Response II line of generators to include two 20kW models. The model 20R0Z features a Cummins 4B3.9 diesel engine. Continuous standby operation is rated 25kW and 18kW. Prime power ratings are 22kW and 16kW. The model 20RZ is powered by a Ford LSG-432 engine and features optional gasoline, LP gas or natural gas fuel systems. Continuous standby ratings are 20kW and 17kW. For prime power applications, the ratings are 18kW and 15kW.

Circle (1421) on Reply Card

Color camera

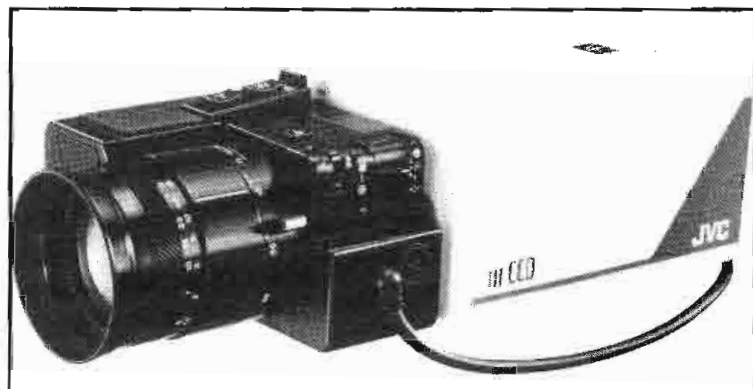

JVC Company of America has introduced the TK-870 color camera. Without the need to encode or decode, the camera provides the component RGB signals required for use with digitizer systems. Features include: resolution of more than 176,000 pixels; gen-lock circuitry, with H phase and SC phase adjustment; an RGB filter; selectable color balance; and a single 9-pin D computer connector for RGB and sync signals. Composite video is available through a standard BNC connector. The camera has a single 2/3-inch CCD image sensor and uses 5W of power. A 2-position switch adjusts for indoor and outdoor lighting conditions.

Circle (1422) on Reply Card

Audio mixing console

Soundtracs has announced the Midi PC series. It is an in-line configuration with either 16- or 24-input/output module mainframe with 16-track monitoring and 16 subgroups. The series has 32 or 48 Midi-controlled inputs with additional

Continued on page 354

AEG SINCE 1885

NOW KNOWN THROUGHOUT THE WORLD AS THE BEST IN FM



10 to 100 Watt
Transmitter
Exciter
S3161



Stereo/SCA
Generator
S3158

Solid State to
5kW Convection
Cooled

500 Watt
Transmitter
S3169



The
unbeatable, modular
FM system.

AEG

Bayly

A member of
the AEG group

AEG Corp.
P.O. Box 3800
Route 22, Orr Dr.
Somerville, N.J. 08876-1269
Telephone (201) 722-9800
TLX 833 409

AEG Bayly Inc.
167 Hunt St.
Canada L1S 1P6
Telephone (416) 683-8200
TLX 0698 1293
FAX 416 683 0186

SEE IT ALL AT NAB: BOOTH NUMBER 2700

Circle (306) on Reply Card

WHY IT PAYS TO WAIT
FOR IKEGAMI'S NEW CHIP CAMERA.



To see Ikegami's new chip camera you'll have to wait until the NAB. Of course there are other chips available, but if the rumblings are true, you owe it to yourself to see what the premier name in cameras has to offer.

For Ikegami, the chip camera is much more than an engineering achievement. It's the result of our commitment to manufacture the very finest hand-held cameras in the world.

Still, all things considered, if you need a camera now,

SAVE BIG ON OUR HL-95B, WHILE YOU WAIT.

1. From now until the last day of the 1987 NAB, get immediate delivery on a brand new, fully warranted HL-95B with tubes, not for the list price of \$30,000, but around \$19,000 (not much more than the competition charges for its chip camera). The core of our Unicam® System, the HL-95B, is operational in all formats and performs at a level no chip can match. After seven months, keep it and get a \$500 rebate on the purchase of our chip camera, and receive \$100 in free accessories.

2. Take immediate delivery on the HL-95B. Use it for the next *seven* months. With trade in you will pay around \$1,500 for a new Ikegami chip camera.

The choice is yours. Order an HL-95B today. Keep it or trade it. Either way you'll own the best camera value.

The HL-95B offer is only available through NAB. Quantities are limited. So act now.

Patience does have its rewards. To get yours, call your nearest Regional Office for the name of a participating dealer nearest you.

Ikegami

Ikegami Electronics (USA), Inc. 37 Brook Avenue, Maywood, NJ 07607
East Coast: (201) 368-9171 West Coast: (213) 534-0050 Southeast: (813) 884-2046
Southwest: (214) 233-2844 Midwest: (312) 834-9774 Hawaii: (808) 946-5955

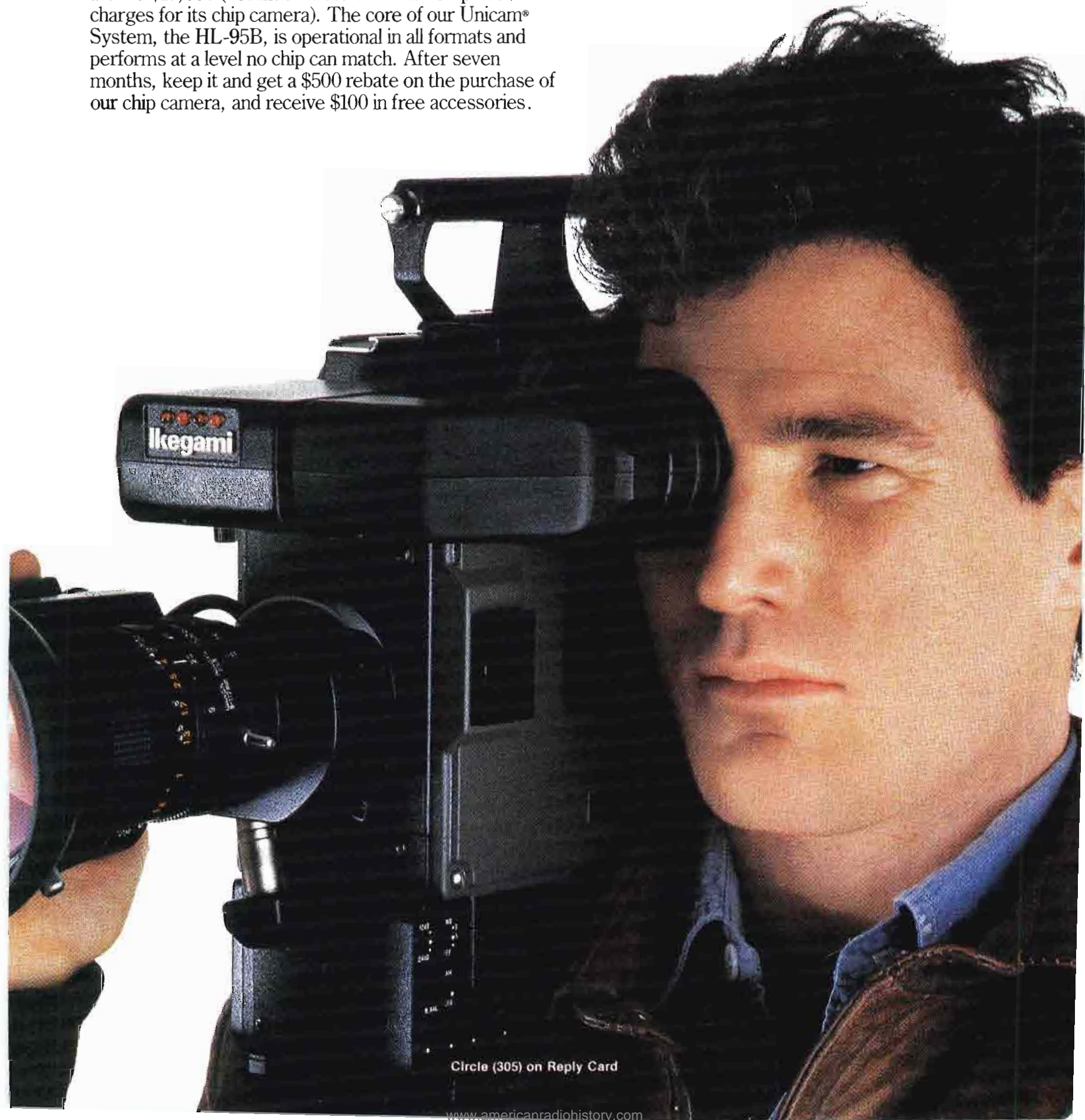

Circle (305) on Reply Card

Continued from page 351

Midi control on four auxiliaries. The series does not require an external computer to function and is designed to be user friendly. The built in microprocessor enables programming of the console which may be designated to any of the 16 Midi channels.

Circle (1423) on Reply Card

Triangle bags

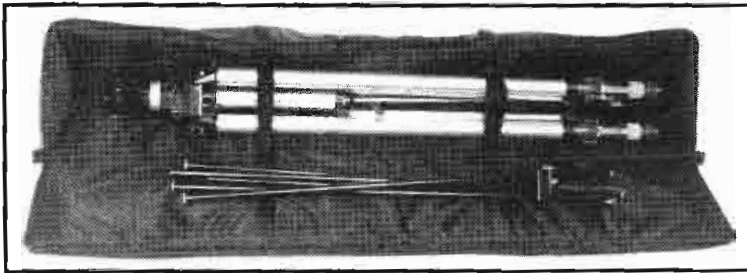

Kiwi has introduced three triangle bags for tripods, lightstands and telescopes. The elongated, pyramid-shaped bags are lined with two layers of high-impact foam between Cordura nylon and nylon pack cloth. Four of the five walls have Cellular Armor, a honeycomber and shock-resistant thermoplastic. The interior has double tie-down fittings for carrying a tripod and light stands, plus a wall of nylon to separate the gear. The exterior has an outer zippered pocket and double straps that lengthen from handle to shoulder straps. Three sizes are available.

Circle (1424) on Reply Card

Distribution amplifier

HEDCO has announced the model BPE-301, a battery-powered, 8-output equalizing distribution amplifier. The amplifier provides cable equalization and distribution for applications where ac power is not available. The DA is self-contained with a rechargeable 1.9Ah gel cell battery. With a fully charged battery the DA will drive all eight outputs for at least 24 hours, and will equalize 1,000 feet of 8281 type cable to 30MHz. A 4-pole cable equalizer allows four individual peaking circuits to compensate for various types of cable. Equalization controls, each covering a separate frequency band, are located on the front panel along with gain and response controls.

Circle (1425) on Reply Card

Digital audio U-matic cassette line

3M has introduced a digital audio U-matic cassette line. It offers an antistat system and high-durability backing. Both shell halves and internal components are treated with a compound that dissipates static electricity. The system also includes an antistat leader and trailer and a conductive, controlled-wind backside treatment.

Circle (1426) on Reply Card

Matrix intercom station

RTS Systems has announced the model 848, the main component of a 24-bus matrix intercom system. Each station in the system can talk to any one or a combination of other stations. All communications are dedicated-line. Each station has an all-talk bus and two TW intercom conference line circuits for connection to standard RTS Systems intercoms. Systems

vary in size from 2x2 to 24x24 and allow addition or deletion of stations. Operating in a 4-wire, full-duplex mode, all communication paths are distributed to each station and all station-select switching is done at each station.

Circle (1427) on Reply Card

Attenuators



RF Industries has introduced a 1W, BNC in-line, tubular, fully shielded and color-coded attenuator line. The line includes 1dB, 2dB, 3dB, 6dB, 10dB, 20dB and 40dB models. The BNC fittings have gold pins for high conductivity, zero tarnish and low-loss characteristics. The attenuators are for operation to 1GHz and have an accuracy of $\pm 0.2\text{dB}$ to 0.6dB.

Circle (1428) on Reply Card

Betacam cassette

The Raks Corporation has introduced a professional-quality 1/2-inch, 30-minute Betacam cassette tape. The tape features a precision-engineered ABS antistatic plastic shell, polished stainless steel pins with double-action clasper and stainless steel spool springs, and an ultrafine cobalt oxide tape formulation.

Circle (1429) on Reply Card

Amplifiers

Scientific-Atlanta has announced the series 303 C-band low-noise amplifier, designed for use in satellite earth stations operating in the 3.625GHz to 4.200GHz frequency band. The amplifier uses GaAsFET technology, comes with an integral isolator to protect against antenna mismatch, provides uniform source impedance for the first FET, and has a gain of 60dB. The cooled amplifiers are available in two configurations: model 303-1, with a noise temperature of 55°K; and model 303-2, with a noise temperature of 45°K.

Circle (1430) on Reply Card

Video camera

Sharp has announced the professional broadcast XC-B10 Saticon and XC-B20P Plumbicon tube video cameras. The cameras have an interformat capability, eliminating adapters for Betacam, M-II and SMPTE interfaces. Both cameras generate viewfinder graphics for monitoring of critical camera status and recording levels. Other features are: automatic white knee highlight compression, white/black balancing, centering, iris beam optimization, auto contrast that continuously adjusts master black (pedestal), and a log-

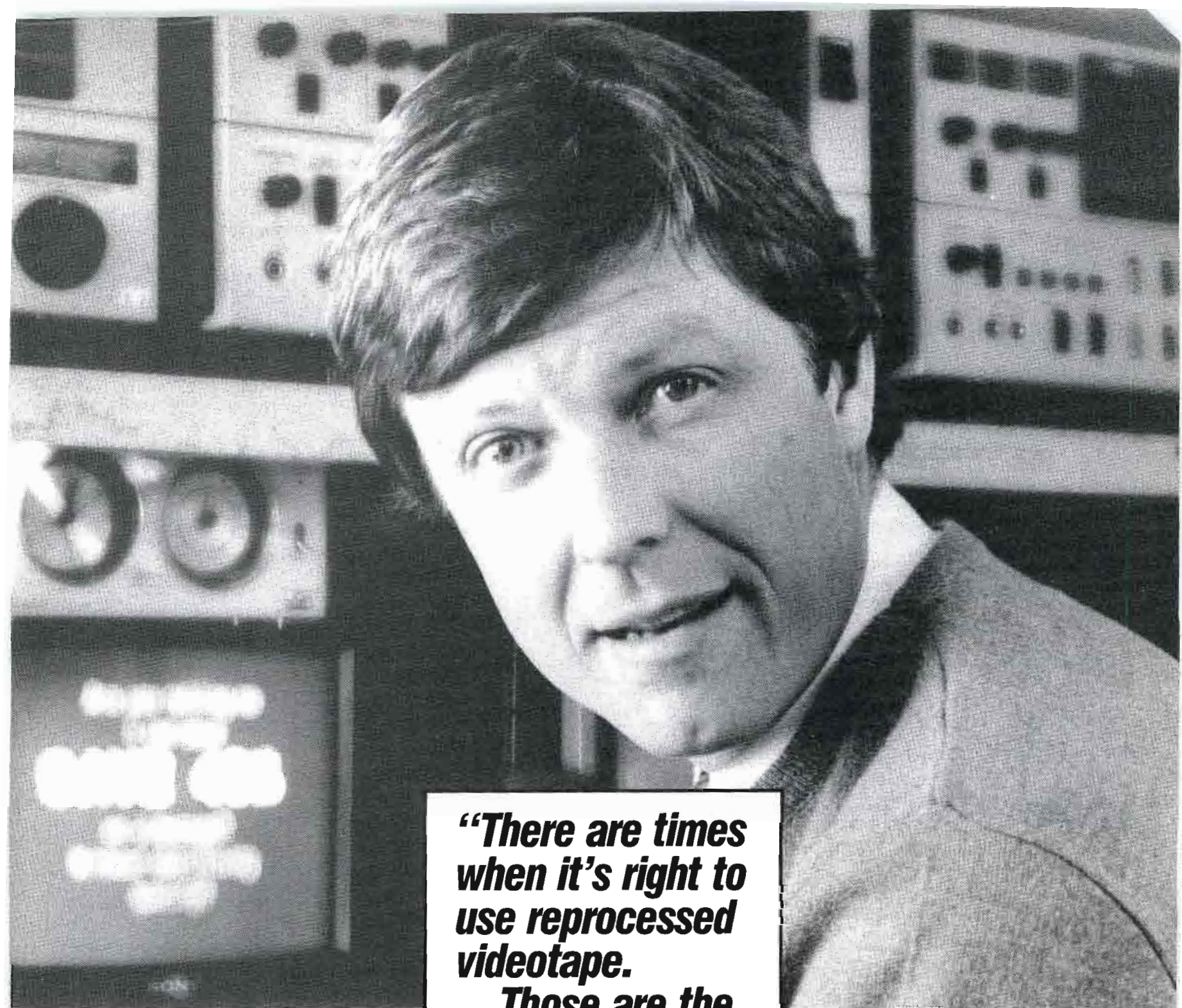

“There are times when it’s right to use reprocessed videotape.

Those are the times I’m glad MAXIMA is our supplier.”

“Of all the video equipment and supplies we buy, probably the least costly is blank videotape.

“Why then would we even want to consider using anything but new tape?”

“The fact is at times it’s a downright waste of money to use new tape. For dubs, archiving, syndication and distribution, we always use MAXIMA reprocessed tape and at about 60% the cost of new.

“Quality? MAXIMA’s reprocessed videotape is not only covered by the same guarantee as new tape, it’s also subject to more rigorous quality control. It’s been cleaned of surface dirt and rubble, and evaluated by test recording from end to end. That step polishes the oxide layer, providing for more consistent tape-to-head contact for a better video image. With abrasion reduced, there’s less head

wear—so I get less drop-outs and longer intervals between costly head replacements.

“Sure, we can easily afford new tape—and probably wouldn’t use anything but new for mastering. But for most other purposes, MAXIMA’s reprocessed tape is not only the least expensive way to go—it’s the best way.”

Send for our free brochure... and introductory offer of 50% off on a one hour videotape or cassette.

Use coupon or call toll-free 1-800-3MAXIMA (In PA Call (215) 443-0700).

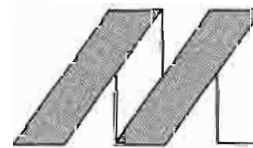

MAXIMA
magnetics, inc.
300 Bonair Ave.,
Hatboro, PA 19040

- New tape—distributor for AMPEX, EASTMAN, AGFA, Custom Loading of VHS and BETA cassettes • 3/4" reloads
- Tape cleaning and evaluation service • Audio tape, packaged or custom loaded • VHS and BETA duplication

Maxima Magnetics, Inc.,
300 Bonair Ave., Hatboro, PA 19040

Yes! Send me your brochure and the coupon for an introductory hour of MAXIMA reprocessed tape at HALF-PRICE.

Name _____

Title _____

Company _____

Address _____

Phone # _____

Circle (313) on Reply Card

ging system that burns the time and date onto the first two seconds of a recording.

Circle (1431) on Reply Card

Wireless systems; microphone and shock mount



SM89 condenser shotgun microphone

Shure has introduced the following products:

- The W1020 non-diversity wireless system and the W1025 diversity wireless system are VHF systems that include a bodypack transmitter, a receiver and a lavalier microphone. The non-diversity system includes the model W20R receiver, a single-channel, crystal-controlled, companded receiver that uses an external ac to dc power converter, furnished with the system. The diversity system includes the model W25DR Diversiphase receiver, similar to the W20R but with the addition of diversity performance, which has a phase-correcting circuit to keep the signals for its two antennas in phase.
- The SM89 condenser shotgun microphone has an on-axis frequency response of 60Hz to 20,000Hz, a low-frequency rolloff below 60Hz, a 160Hz rolloff for adverse conditions, and clear dialogue reproduction at 30° off-axis. Other features include a wide phantom voltage range (11V to 52V), a built-in windscreen and a 2-piece design.
- The A89SM shock mount, primarily intended for the SM89 microphone, fits all 3/4-inch diameter microphones and reduces mechanical and vibration noises by more than 20dB. Other features are an asymmetrical design, three different head sizes and a positive locking knob.

Circle (1432) on Reply Card

1-7-88

News

Continued from page 4

report No. 7. These efforts have developed an understanding between technical representatives of the TV and the telecommunications industries.

NTC is an industry committee devoted to promoting uniform technical practices in TV transmission. NTC helps ensure that TV transmissions are of the highest possible quality consistent with the state-of-the-art and various national and international recommendations.

The transmission of television requires the cooperative efforts of satellite communications carriers, terrestrial communication carriers, and broadcasters.

According to the NTC, it is desirable that technical operations and engineering performance be coordinated. These requirements have a high degree of urgency due to rapid technical evolution. NTC, in recognition of the need to develop unified operating practices and technical quality criteria, was recently reorganized with three purposes:

- Resolving within North America difficulties that exist because of a lack of unified practices and criteria.
- Identifying areas of mutual concern on the subject of the transmission of television and developing reports and other documents as contributions to standards organizations.
- Studying the development of digital transmission systems, TV audio, vertical

interval signals, identifying problems or potential problem areas and making recommendations.

AES opens awards program

The Audio Engineering Society Educational Foundation has announced the opening of its 1987 educational grant program for university studies with emphasis on audio topics. Awards, for graduate students only, are made annually, and successful applicants may request a 1-time renewal of their grants. Previous awardees have been enrolled at Georgia Institute of Technology, Iowa State University, Memphis State University, Rensselaer Polytechnic University and the Swiss Federal Institute of Technology.

Additional information and application forms are available from the AES Educational Foundation, 60 E. 42nd St., New York, NY 10165. Completed applications must be submitted by May 1 to be considered for the 1987-88 academic year.

NAB forms available

NAB is offering metric AM ground-wave and field-strength curves and graph paper to help stations meet the commission's requirements for all AM

signal measurement studies. The curves must be used for studies filed with the commission after Jan. 1, 1987. NAB is offering 19 sets of frequency-dependent propagation curves encompassing frequencies from 540Hz to 1,610kHz, drawn on both regular and expanded graphs. The set, including instruction sheet and graph paper, is available to NAB members for \$45 and to non-members for \$60. Twenty-five supplemental sheets of the regular and expanded versions of graph paper are available for \$25 (non-members \$40).

1-7-88

Correction

An error was made in the February Chyron Corporation advertising supplement. Timeline information for the year 1986 (page 72 of the February issue) stated that 5,000 Chameleon units (a product of the Chyron Video Products Division) had been shipped. This was in error. The listing should have read that more than 5,000 units from the Video Products Division had been shipped. Chameleon is a new introduction (November 1986) of the Chyron Video Products Division. We apologize for the error.

Q. What's the radio industry's best kept secret?

Harrison Systems, Inc., P.O. Box 22964, Nashville, TN, 37202, Phone (615) 834-1184, Telex 555133



Interested? Give us a call.

HARRISON is the only audio console manufacturer who makes its On-Air boards with the same program origination quality signal electronics used in recording and mixing today's music. If you are critical enough to be playing DIGITAL Compact Disks for your audience, then the HARRISON difference should be critically important to you. Beyond that, HARRISON puts critical care into every AIR-7 system. You already know HARRISON boards are built to last, and the HARRISON Support Hotline, 1-800-821-1560, gets you professional help when you need it—immediately.



The HARRISON AIR-7. Why? Because your competition and our competition won't tell you about it. And, we haven't done a good enough job telling you either.

A.

AIR-7

Circle (308) on Reply Card

NAB Engineering Conference

Continued from page 261

- "Transmission of Television Stereo Program Audio on Terrestrial and Satellite Links," Ned L. Mountain, Wegener Communications, Norcross, GA.
- "Surround-Sound Enhances Use of TV Multichannel Sound Channels," Robert Schulein, Shure Brothers, Evanston, IL.
- "A State of the Art Stereo Audio Production Facility for Television," R. Kisor, CBS Television, New York.
- "Digital Sound & Data for Broadcast Television—A Compatible System," Craig Todd, Dolby Laboratories, San Francisco.

Saturday, March 28, 9 a.m.-12 noon Television Graphics East Ballroom B

- "Sorting Out TV Graphics Systems for Broadcasters," Steve Davis, WPRI-TV, Providence, RI.
- "Managing Still Store Picture Material," NBC.
- "Developments in Weather Graphics, Data Bases and Delivery Systems," Joel N. Myers, Accu-Weather.
- "A State of the Art Graphics Animation Facility," Mark A. Harris, CBS Engineering and Operations, New York.

Sunday, March 29, 10 a.m.-12 noon Television System Maintenance East Ballroom C

- "The Care and Feeding of an Elderly ACR-25," Thomas J. Beauchamp, WTVJ-TV, Miami.
- "Using Custom VITS for Automatic Transmission System Video Performance Analysis," William R. Ramsay, Nebraska Educational Telecommunications Commission, Lincoln, NE.
- Managing video cart systems.
- Panel with Tektronix, Harris, Ampex, others.

Monday, March 30, 9 a.m.-12 noon Advanced Television Systems East Ballroom B

- "Report from the Advanced Television Systems Committee," Dr. Robert Hopkins, executive director, ATSC, Washington, DC.
- "New Developments in a Compatible High-Definition Television Transmission System," Dr. William R. Glenn, New York Institute of Technology.
- "The NHK Plan for HDTV Via DBS Satellite," NHK.
- The MUSE system, NHK.
- "Terrestrial High-Definition Television Project Report," E. B. Crutchfield, NAB, Washington, DC.
- Panel on HDTV systems.

2:30 p.m.-5:30 p.m. UHF-TV Transmission Systems East Ballroom B

- "Using 60kW Klystrodes as Building Blocks for Future UHF Super Power Sta-

tions," Nathaniel S. Ostroff, Andrew Whiteside & David D. Smith, Comark, Colmar, PA.

- "Adapting Wideband External Cavity Klystron Technology to Integral Cavity Equipped Transmitters," Matthew A. Sanderford, Media Central, Chattanooga, TN.
- "The UHF Transmitter for the 21st Century," Howard McClure, Townsend Associates.
- "New Circular Waveguide Techniques Lowers Windloading and Cross-Polarized Mode Propagation," Cole N. Plummer, Dielectric Communications, Raymond, ME.
- MDC klystron report.

Tuesday, March 31, 9 a.m.-12:30 p.m. Television Engineering and New Technology East Ballroom B

- "Switchless Combiner Isolation Requirements for Television Transmitters," Gregory L. Best, Harris Corporation, Quincy, IL.
- "New Developments in Computer Controlled Operatorless Remote Control Television Cameras," Radamec EPO, Chertsey, Surrey, England.
- "Electrical Performance Standards for Television Broadcast Transmitters," Tony Uytendaele, member, EIA TR-4.1 Committee on Transmitters.
- "Computer-Aided Design (CAD) Simplifies Audio-Video System Design and Documentation," Walter Black, Video Design Pro, Las Cruces, NM.
- "Integrating Digital Video Systems into the Analog and Hybrid Broadcast Plant," Curtis Chan & Ian Collis, Sony Broadcast Company, San Jose, CA.
- "New Fiber-Optic Developments Provide High-Quality Video Transmission," Steve Jackson, Artel Communications, Worcester, MA.
- "Multichannel Broadcast Television Antenna System," J. Stenberg, Micro Communication, Manchester, NH and E. Mayberry, LeBlanc & Dick, Laurel, MD.
- "Digital Techniques for Television Antenna Impedance Measurements," Donald L. Markley, D. L. Markley & Associates Consulting Engineers, Peoria, IL.
- "High-Quality Digital Video at 45Mbit/sec Data Rate for Network Transmission," Robert J. Blackburn, Bell Communications Research, Morristown, NJ.

Special sessions

Sunday, March 29, 9 a.m.-12 noon HDTV Production I East Ballroom B

- Overview of the U.S. HDTV test.
- Production center reports from Canada, France, Italy, New York, Australia.
- Equipment (VTR, telecine, cameras, effects).

3 p.m.-6 p.m. HDTV Production II

East Ballroom B

- Production and equipment reports.

2:30 p.m.-6:30 p.m. Satellite Systems East Ballroom C

- "Technical Trade-offs in Designing Systems for Gathering News via Satellite," Raymond A. Conover, Conus Communications, Minneapolis.
- "Computer Techniques Help Solve Satellite Earth Station Site Design Problems," Michael V. Chiarille, Capital Cities/ABC, New York.
- "Fixed Earth Station Design and Operation for Broadcast Video," Alton C. Stalker, Group W Satellite Communications, Stamford, CT.
- "Evaluating Mobile Ku-band Satellite Antennas for FCC Compliance," Loring Fisher, Andrew Corporation, Ridgewood, NJ.
- Skycom by NBC.
- "CBS Mini-RADET Operational Experience," Stavros Hilaris, CBS Engineering and Operations, New York.
- "Voice Transmission Considerations for Satellite News Gathering Operations," Kurt van Arsdall, GTE Spacenet, McLean, VA.
- Panel various on satellite operations.

3 p.m.-5:30 p.m. Studio Construction and Acoustics East Ballroom D

- "Prefabricated Studios for Radio Stations: How and when to use them effectively," J. Andrew Butler, WHN/WQHT Radio, Astoria, NY.
- "Designing New York's Largest AM/FM Studio Facility," Alfred W. D'Allesio, Northeastern Communications Concepts, New York.
- "The New PBS Television Technical Facilities," Alfred A. Norcott, Public Broadcasting Service, Alexandria, VA.
- "Facility and Equipment Purchase Decision-Making Process," Marvin C. Born, KRIS-TV, Corpus Christi, TX.
- Acoustics paper by Peter D'Antonio.
- Panel discussion.

Monday, March 30, 3 p.m.-5:30 p.m. Environmental Concerns of Broadcasters East Ballroom C

- "Design & Testing of High-Power RF Amplifiers to Prevent Lightning-Induced Damage," Claud Clinault, Thomson-LGT, Conflans, France.
- "Measuring and Managing Occupational RF Radiation Exposure On Broadcast Towers," Thomas Vaughn, Micro Communications, Manchester, NH.
- "Identifying and Managing PCBs in Broadcast Facilities," Jack G. Pfrimmer, General Electric Company.
- Tower deicing.
- Panel discussion.

3 p.m.-6 p.m. Broadcast Auxiliary

East Ballroom D

- "An Overview of the Alternatives to Conventional 950MHz Wide Deviation STL Channels," Michael D. Callaghan, KIIS AM/FM, Los Angeles, and Barry Victor, The Victor Group, Los Angeles.
- "Installing and Operating a 23GHz Radio STL System," Mathew J. Valleau, WMJX-FM/WMEX-AM, Boston.
- "Novel Use of Microwave Alternatives for Radio STL Systems," Ray Klotz, KZLA/KLAC Radio, Burbank, CA.
- "Frequency Division Multiplex Techniques Increase Aural STL Capacity," Timothy C. Cutforth, VIR James Consulting Engineers, and Jan Chadwell, KOA Radio, Denver.
- "Improving STL Aural Channel Quality by Use of Noise Reduction Techniques," Steve Smith, Dolby Laboratories, San Francisco.
- Panel on Radio-TV frequency coordination.
- ENG van safety.

Tuesday, March 31, 4 p.m.-5:30 p.m. FCC Engineers Q & A Forum East Ballroom B

- Panel discussion featuring James C. McKinney, chief of the mass media branch of the FCC, and other commission engineers.

I:~(=)))))

New at NAB

Continued from page 259

Itelco (2675)
TV transmitters: band I, 20kW, output power externally diplexed; band III, 20kW, output power.
Radio relay link.
Circle (804)

Microsonics (2543)
Video data filters.
Circle (888)

Schneider Optics (3221)
TV80: x17 studio zoom lens; 2x extender and diascope.
TV56 APO-Varon: x14 zoom lens (9mm-126mm) for 2/3", 1/2" format; macrofocus feature; reduced lateral and longitudinal chromatic aberration.
TV85: x35 tele lens; 2x extender and diascope available; zoom and focus interrelated through microprocessor in lens avoids mechanical cam drive; separate control of lens groups reduces chromatic aberration.
Circle (1003)

Steenbeck (2749)
ST 7223: studio magnetic film recorder, reproducer system.
Circle (1040)

I:~(=)))))

STANTRON

CENTER

for • VIDEO PRODUCTION
• POST-PRODUCTION
• EDITING • ENG • EFP

- CABINET CONSOLES
- DESK CONSOLES
- VTR/VCR RACKS
- DUBBING RACKS

STANTRON VIDEO CENTER

Designed for YOUR VIDEO EQUIPMENT has modular "add-on" features that allow maximum flexibility and versatility in designing console arrangements for professional, industrial, communication and educational VIDEO CENTERS.

Write or call for FREE VIDEO CENTER CATALOG # 200

mailing address: P.O. Box 9158VC
No. Hollywood, CA 91609 U.S.A.
or call Toll Free: 1-800-821-0019
No. Calif. Toll Free: 1-800-821-0020
So. Calif. please call 1-213-875-0800
TWX- 910-499-2177

STANTRON
Unit of Zero Corporation

factory:
6900-6918 Beck Ave.
No. Hollywood, CA 91605

Circle (322) for IMMEDIATE REQUIREMENT.
Circle (323) for LITERATURE ONLY.

Classified

Advertising rates in Classified Section are \$1.50 per word, each insertion, and must be accompanied by payment to insure publication.

Each initial or abbreviation counts a full word. Minimum classified charge, \$35.00.

For ads on which replies are sent to us for forwarding (blind ads), there is an additional charge of \$35.00 per insertion, to cover department number, processing of replies, and mailing costs.

Classified columns are not open to advertising of any products regularly produced by manufacturers unless used and no longer owned by the manufacturer or distributor.

TRAINING

ELECTRONICS DEGREE by correspondence. Earn Associate, then Bachelor's. NHSC accredited. Free catalog. Write Grantham College of Engineering, Dept. EE-5, 10570 Humbolt St., Los Alamitos, CA 90720. 8-82-tfn

FCC GENERAL RADIOTELEPHONE operators license through cassette recorded lessons at home plus one week seminar in Boston, Washington, Detroit or Philadelphia. Our twentieth year teaching FCC license courses. Bob Johnson Radio License Preparation, 1201 Ninth, Manhattan Beach, Calif. 90266, Telephone (213) 379-4461. 8-81-tfn

SERVICES

ONE STOP FOR ALL YOUR PROFESSIONAL AUDIO REQUIREMENTS. Bottom line oriented. F.T.C. Brewer Company, P.O. Box 8057, Pensacola, Florida 32506. 7-71-tf

3-D TELEVISION,—true stereographic NEW! LeaVision tm over/under (not red/blue). Viewers, consulting, lens rental. Info-SASE. DEMO (VHS/BETA)®photo® viewers-\$29.95 * \$2 S&H. TVLI-BE, CS3030 Lindenhurst, NY 11757 (516) 957-4393 (212) 245-6119. 9-86-tfn

TRANSMITTER TUBE REBUILDING SINCE 1941: 3CX2500, 4CX5000, 4CX15000 and many others. Write for details. FREELAND PRODUCTS CO., Rt. 7, Box 628, Covington, LA 70433. (504) 893-1243 or (800) 624-7626. 6-79-tfn

SQUEEZOOM FIELD SERVICE. Rebuild/Refurbish, Upgrade, or Repair your machine by Factory Trained Engineer. Retsyl Engineering, 515 Randwick Road, Dothan, Alabama 36301, (205) 794-7767. 3-87-1t

VITAL SWITCHERS: Buying one used? Need one refurbished? Adjusted? Call an expert, call Charles Kunz, (305) 556-9638 (work) or (305) 362-3308 (evenings). 3-87-3t

FOR SALE

RCA COLOR TELECINE SYSTEM, New/unused. To include: TK-66, color camera, TP-66, 16mm telecine projector, TP-7, 35mm slide projector, TP-55B, camera multiplexer. Write to: P.O. Box 23555-273, San Diego, CA 92123. 1-86-tfn

DEMO EQUIPMENT. BRAND NEW CONDITION. Lang Two Shot. Ikegami cameras, monitors. Videotek routing switchers. ADC audio/video patch panels. Vectorscopes, waveform monitors. Save up to half. DYMA Engineering (800) 222-3962. 1-87-3t

SONY BETACAM BVV-1A RECORDER & BVW20 FIELDPLAYER. Recorder has custom carrybag and audio and timecode mods. Both units in excellent cond. \$4750 ea. Call: 415-383-5994. 2-87-3t

COPPER! For all your broadcast needs. #10 ground radials; 2, 4, 5, 8" strap, flyscreen, counter poise mesh. 317-962-8596. Ask for copper sales. 2-87-6t

32' MOBILE VAN, 4 cameras. 2-1" VTRs, digital effects, CG, currently doing regional network basketball & football. Call 317/849-3202. 2-87-3t

FOR SALE (CONT.)

ADM 2400 stereo/multichannel television audio production board. Twelve of 24 inputs populated, some Eq'd. New modules available current production. Talkback/foldback/echo send, control/studio/studio/director monitoring modules. Redundant PS, internal patch bay, new 1978. Used price less than half new today. Dave Solinske, WSyr, Syracuse. 315-472-9797. 3-87-2t

FOR SALE, 2-VR2000/1200 Capstan Assemblies, rebuilt to Ampex specs. Also 1-AVR2 Capstan, rebuilt to specs. Call 7A-9A PST 213-397-4127 Bob Springer. 3-87-1t

¾" U-MATIC videocassette recorders: Panasonic NV-9200A. Many excellent features. Ideal for recording, playback or source recorder in a basic editing system. Excellent condition. \$1,200.00. Call 213-299-1411. 3-87-1t

FOR SALE: CMX Edge editing system with interfaces for two Sony 5850 & one Sony 5800. Used less than 8 hours. Paid \$10,000 new, asking \$8,000 or best offer. Contact David Heberlein at the University of Wisconsin-River Falls, Television Services, River Falls, WI 54022, or call (715) 425-3175. 3-87-1t

Reconfirm your involvement
in the
broadcast industry!
Renew your subscription
today.

WANTED TO BUY

HIGHEST PRICES for 112 Phase Monitors, vacuum capacitors and clean, one kw or greater powered AM and FM Transmitters. All duty and transportation paid. Surplus Equipment Sales, 2 Throncliffe Park Dr., Unit 28, Toronto, Canada M4H 1H2, 416-421-5631. 3-86-tfn

WANTED: WW-II German and Japanese radio equipment. Unused US Navy and Signal Corps radio equipment before 1943. Pre-1923 radio equipment and tubes. August J. Link, Surcom Associates Inc., 305 Wisconsin Ave., Oceanside, CA 92054, (619) 722-6162. 7-86-tf

HELP WANTED

MAINTENANCE SUPERVISOR: Top 20 market on the Florida Suncoast, UHF Independent. Good maintenance background of 3-5 years, with supervisory experience desirable. Will be in charge of staff of 5 maintenance engineers. Send resumé to Mark Greenleaf, A.C.E., WTOG-TV, P.O. Box 20144, St. Petersburg, Fl. 33742, 813-576-4444. 3-87-1t

MAINTENANCE ENGINEER: Top 20 market on the Florida Suncoast, UHF Independent, three-five years maintenance experience desirable. Good knowledge of 2", 1" and ¾" VTRs with digital background a must. Send resumé to: Mark Greenleaf, A.C.E., WTOG-TV, P.O. Box 20144, St. Petersburg, Fl. 33742, 813-576-4444. 3-87-1t

TRANSMITTER/MAINTENANCE SUPERVISOR. Must have hands-on UHF abilities and be able to take complete responsibility for transmitter. Townsend experience desirable. On the southeastern Connecticut coast. Contact Chief Engineer, Steve Ellis, WTWS-TV-26, (203) 444-2626, 216 Broad St., New London, Ct. 06320. 3-87-1t

TV ENGINEER: Responsible for maintenance of new, broadcast quality equipment in university Telecommunications Center. Minimum requirements: 2 year degree in electronics or related area plus 2 years commercial/public TV maintenance experience. For job description and application send resume by April 15, 1987 to: Marshall E. Allen, Director, Telecommunications Center, Oklahoma State University, Stillwater, OK 74078-0585. OSU IS AN AFFIRMATIVE ACTION/EQUAL OPPORTUNITY EMPLOYER. 3-87-1t

HELP WANTED (CONT.)

CHIEF ENGINEER: for UHF Indy in Southeast. Hands-on maintenance experience and operational knowledge of UHF transmitter required. General Class License preferred. Send resume and salary requirements to Personnel Manager, WGGT-TV, P.O. Box 1618, Greensboro, NC 27401. EOE. 3-87-1t

TELEVISION ENGINEER III for public TV station reposted. Requires two years of technical training or ASET degree, plus five years of progressively responsible experience in broadcast TV equipment installation, operation, maintenance, or any equivalent combination of education and experience; FCC Restricted Radio-Telephone Permit. Will perform planning and supervisory duties in installation and maintenance of all types of TV studio and transmission equipment; will operate, maintain and repair equipment; train and direct subordinates in operation and maintenance; make recommendations for purchase and procedures. Salary \$22,366 minimum plus benefits. Send resume, names of three professional references to Jim Dryden, KRWG-TV, Box TV22, Las Cruces, NM 88003. Deadline is March 25, 1987 or until filled. New Mexico State University is an EO/AA Employer. 3-87-1t

HELP WANTED-TECHNICAL. VACATION RELIEF ENGINEER—KRIV-TV, Fox Television, Houston, is seeking a qualified vacation relief engineer. Must have minimum of 1 year MCR experience. FCC license preferred but not necessary. Send resume to: KRIV-TV, P.O. Box 22810, Houston, Tx. 77227, Attn: Mike Chase, E.O.E. 3-87-2t

SALES POSITIONS

The Utah Scientific sales force is expanding. We need qualified sales engineers for the following positions:

- **Midwest territory**—located in either the Chicago or Cleveland areas
- **Northeast territory**—located preferably in the metro New York area
- **Government specialist**—located in the Washington, D.C. area
- **Inside sales**—located in Salt Lake City.

Please send resumes to, or call:
Gary LaMunyan
National Sales Manager
1-800 453-8782 or 1-801 973-6840

UTAH SCIENTIFIC
DYNATECH Broadcast Group

1685 West 2200 South
Salt Lake City, Utah 84119
an equal opportunity employer

Classified

HELP WANTED (CONT.)

TRANSMITTER SUPERVISOR. 3 years high power UHF experience required. Studio maintenance experience preferred. Connecticut's leading independent. Pay commensurate with experience. EOE. Call Charles Allen (203) 575-2020. 3-87-2t

VARITEL VIDEO is looking for a video engineer with strong post-production experience. Equipment includes: VPR-3, BVH 2000, 3/4", 1/2", ADO, GVG Switchers, Paintbox, ISC, Convergence, & A-62. Send resume to: Varitel Video, Engineering Dept., 3575 Cahuenga Blvd. West, Suite 675, Los Angeles, CA 90068. 3-87-1t

TELEVISION HELP WANTED: TECHNICAL. Chief engineer. CBS, Greenville, Mississippi. Good company and benefits. If you are number 2 but feel you should be number 1, this is your opportunity. Reply to Joe Macione, WXVT, 3015 E. Reed, Greenville, MS or call (601) 334-1500. EOE. 3-87-1t

IMMEDIATE OPENING: Maintenance Engineer for a 24-hour news operation in Washington, DC. Must have 3-5 years experience. Send resume to Steve Hocker, PVS, 111 Massachusetts Ave., N.W., Washington, DC 20001, (202) 898-7919. 3-87-1t

HELP WANTED - TECHNICAL: MASTER CONTROL OPERATOR - KRIV-TV, Fox Television, Houston, Tx. is seeking a qualified Master Control Operator. Must have minimum 2 years prior MCR experience. FCC license or SBE certification required. Send resume to KRIV-TV, P.O. Box 22810, Houston, Tx. 77227, Attn: Wendell Wyborny, VP/Chief Engineer, E.O.E. 3-87-2t

VIDEO ENGINEER/TECHNICIAN: Immediate opening for a person to service, maintain, & troubleshoot a broadcast quality television production/post production facility. Must have experience in 3/4", 1" VTR's, digital effects, switchers, editing systems, color camera and paint systems. Knowledge of interactive discs helpful but not necessary. Contact Nancy Miller, Media Operations, ByVideo Inc., (408) 747-1101. 3-87-1t

TELEVISION CHIEF ENGINEER. UHF Network Affiliate in Fayetteville, Arkansas is seeking a hands-on chief. Good pay and benefits. Send resume to Don Vest, Sigma Broadcasting, P.O. Box 4150, Fort Smith, AR 72914. 3-87-1t

MAINTENANCE ENGINEER for new South Florida Post Production Facility. 1" with film to tape, Sony, Ikegami, ADO, CMX, Grass Valley. Should have extensive background. Salary commensurate w/experience. Send resume to Broadcast Engineering, P.O. Box 12901, Dept. #676, Overland Park, KS 66212. 3-87-1t

Want more information on advertised products? Use the Reader Service Card.

SENIOR VIDEO/AUDIO SYSTEMS ENGINEERS

If you have at least 5 years experience in video / audio systems engineering and are a creative person, **WE WANT YOU!** We are expanding our operations into new modern facilities in scenic Salt Lake City. These immediate openings come with a compensation package that includes excellent benefits.

Centro

Setting new standards in the design and integration of teleproduction facilities and remote production vehicles.

WRITE TO:

Gene DeSantis
Centro Corporation
369 Billy Mitchell Road
Salt Lake City, Utah 84116
No phone inquiries accepted.

Reconfirm your involvement in the broadcast industry
Renew your subscription today.

REPRINTS

Interested in ordering article reprints out of this or another issue? * Reprints can be excellent learning tools for your technical staff and great marketing tools for your sales staff. Call or write Cynthia Sedler at Intertec Publishing Corp., P.O. Box 12901, Overland Park, KS 66212; (913) 888-4664.

* Minimum order 1,000 copies

Advertising sales offices

CHICAGO, ILLINOIS

Tom Nilsen
Phone: (312) 887-0677
(312) 887-0684
15 Spinning Wheel Rd.
Ste. 430
Hinsdale, IL 60521

NEW YORK, NEW YORK

Diane Gottlieb-Klusner
Phone: (212) 702-3404
Josh Gordon
Phone: (212) 702-3405
866 Third Ave.
New York, NY 10022

SANTA MONICA, CALIFORNIA

Herbert A. Schiff
Phone (213) 393-9285
Jason Perlman
Phone (213) 458-9987
Chris Woodbury
Phone (213) 451-8695
Schiff & Associates
501 Santa Monica Blvd., Ste. 504
Santa Monica, CA 90401

NORWOOD, AUSTRALIA
Hastwell, Williamson, R
P.O. Box 419
Norwood 5067, Aust
Phone: 332-3322
Telex: AA87113

LONDON, ENG
Nicholas McGr
Suite 460, Se
Black Princ
London SF
Telex: 29
Telephr

TO:
H:
F

Ad index

Advertiser	Page Number	Reader Service Number	Advertiser Hotline
ADM Technology, Inc.	IFC	1	313/524-2100
ADM Technology, Inc.	322	309	313/524-2100
AVS	229	146	201/767-1000
A.F. Associates Inc.	236	153	213/466-5066
A.F. Associates	329	245	213/466-5066
Abekas Video Systems	95	195	415/571-1711
Acoustic Systems	102	46	512/444-1961
ADC Telecommunications, Inc.	212-213	128	612/893-3010
AEG Bayly Inc.	351	306	416/683-8200
Alamar Electronics USA, Inc.	122	236	408/866-9373
Alden Electronics	23	15	617/366-8851
Alias Research Group	243	54	609/987-8686
Alpha Audio	261	180	804/358-3852
Alta Group Inc.	246	164	408/297-2582
Amber Electro Design Inc.	208	125	514/735-4105
Ameek Systems and Controls Ltd.	208	216	818/508-9788
Amperex Corp. (Klystron Div.)	293	122	401/762-3800
Amperex Electronic Corp.	205	191	800/227-1613
Ampex Corp. (AVSD)	269	68	415/367-2911
Ampex Corp. (MTD)	118-119	34	415/367-2911
Angenieux Corp. of America	68-69	207	305/595-1144
Anton/Bauer Inc.	287	246	203/929-1100
Anvil Cases, Inc.	331	315	818/575-8614
Apert Herzog	312	14	408/225-1425
Arrakis Systems, Inc.	349	303/224-2248	
Asaca/Shibasoku Corp. America	21	124	800/423-6347
Aspen Music Festival	207	135	212/581-2196
Audio Accessories	220	185	603/446-3335
Audio Kinetics Ltd.	224	140	800/231-7350
Audio Precision	295	114	215/443-0330
Audio Technologies Inc.	196	82	516/546-4239
Audio-Video Engineering Co.	141	178	916/485-0500
Audiolab Electronics	348	212	901/362-1350
Audiotronics, Inc.	342	26	415/777-2288
Aurora Systems	53	74	408/370-3721
Barco	127	111	800/847-0653
Basys	161	121	215/687-5550
Belar Electronics Laboratory Inc.	193	127	315/452-0400
Benchmark Media Systems	204	136	800/356-5794
Best Power Technology, Inc.	211	80	516/935-8000
Boyer Dynamic Inc.	221	105	516/997-7800
Bugner Broadcast Equipment Corp.	190	118	201/584-1077
Boston Electronics Corp.	187	151	801/972-8000
Broadcast Television Systems	200	25	801/972-8000
Broadcast Television Systems	233	168	800/426-8434
Broadcast Supply West	51	217	416/764-1584
Broadcast Video Systems	250	187	416/764-1584
Broadcast Video Systems	294	200	
Broadcast Systems	266	86	509/448-0697
Broadcast Systems, Inc.	277	312	509/448-0697
Broadcast Systems, Inc.	158	235	518/672-7202
Broadcast Systems, Inc.	350	163	619/743-7143
Broadcast Systems, Inc.	317	131	212/757-6977
Broadcast Systems, Inc.	245	73	818/840-0993
Broadcast Systems, Inc.	217	85	516/488-6700
Broadcast Systems, Inc.	126	84	516/488-6700
Broadcast Systems, Inc.	156-157	108	213/461-2701
Broadcast Systems, Inc.	155	35	619/560-1578
Broadcast Systems, Inc.	136	19	818/442-0782
Broadcast Systems, Inc.	71	104	800/421-2955
Broadcast Systems, Inc.	32	238	516/249-3018
Broadcast Systems, Inc.	186	165	301/695-0200
Broadcast Systems, Inc.	321	76	800/535-7648
Broadcast Systems, Inc.	147		
Broadcast Systems, Inc.	131		
Circuit Research Labs, Inc.	13	10	800/535-7648
Clear-Com Intercom Systems	106	49	415/861-6666
Colorado Video Inc.	324	321	303/444-3972
Comark	96,97	43	215/822-0777
Comrex Corp.	270	17	617/443-8811
Comtek	184	102	801/466-3463
Continental Electronics, Div. of Varian	220	134	214/381-7161
Control Concepts Corp.	79	36	607/722-4248
Convergence Corp.	92-93	41	714/250-1641
Current Technology Inc.	328	243	214/238-5300
Data Check Corp.	261	183	619/578-0101
Data Check Corp.	259	27	619/578-0101
Data Check Corp.	263	88	201/654-8100
Datatek, Inc.	55	155	714/533-6333
Datum Inc.	160	81	703/354-3350
Delta Electronics	238	117	201/223-9400
Dialight Corporation	137	205	800/431-1708
Dictaphone Corp.	201	154	416/299-6888
Digital Video Systems Div.	286	142	415/558-0200
Dolby Labs Inc.	237	67	818/999-1132
Dorough Electronics	204	47	201/592-6500
Dubner Computer Systems	117	9	914/592-6050
Dynair Electronics Inc.	103	119	212/930-7500
E E V, Inc.	81	129	201/741-0404
Eastman Kodak Co.	202	310	507/289-3371
Electro Impulse Lab.	215	120	914/592-6050
Emcro Products	343	227	213/470-6280
Emcor Products	203	23	408/245-1492
ESE	309	96	213/402-5391
Fairlight Instruments	677	60	213/921-1112
Faroudja Labs.	167	320	201/427-1160
For-A Corp. of America	106	18	914/472-9800
Fostex Corp. of America	53	44	801/268-1117
Frezzolini Electronics Inc.	31	184	408/926-3400
Fujinon Inc.	100	113	703/790-0101
Gentner Engineering Co., Inc.	258	221	916/273-8412
Gentner RF Products Div.	195	8	916/273-8421
GML America Inc.	298	214,215	916/273-8421
Graham-Patten Systems Inc.	9		
Grass Valley Group, Inc.	291		
Grass Valley Group, Inc. Laboratories	230		
H.W. Dyer Electronics, Inc.	258		
Harris Corp.	234-235		
Harrison Systems	357		
Hipotronics, Inc.	255		
Hitachi Denshi America Ltd.	3		
HM Electronics	77		
Hotronic, Inc.	281		
Howe Audio	249		
Hubbard Communications, Inc.	241		
ICM Video	231		
IGM Communications Inc.	159		
Ikegami Electronics Inc.	300-301		
Ikegami Electronics Inc.	352-353		
Ikegami Electronics Inc.	314-315		
Inovonics, Inc.	342		
Jampro Antennas Inc.	120		
JBL Professional	99		
Jensen Transformers, Inc.	279		
JVC Company of America	169-176		
JVC Company of America	19		
K & H Products, Ltd.	266		
The Lake Systems Company	43,45		
Lamp Technology Inc.	268		
Leader Instruments Corp.	5		

Ad index

Page Number	Reader Service Number	Advertiser Hotline	Page Number	Reader Service Number	Advertiser Hotline	
Lectrosonics	253	360	505/831-1010	ROH	160	
Leitch Video of America, Inc.	59	29	804/424-7290	Roscor Corp.	150	
Lenco Electronics	322	375	314/243-3147	RPG Diffuser Systems	222	
Listec Corp.	230	148	516/694-8963	RTS Systems, Inc.	216	
LNR Communications, Inc.	121	69	516/273-7111	RTS Systems, Inc.	218	
3M	56-57	28	800/328-1684	Rupert Neve, Inc.	33	
3M Broadcast & Related Products	163	92	800/328-1684	Schneider Lens Corp.	313	
MA/COMM MAC, Inc.	283	210	617/272-3100	Schwem Technology	295	
Magna-Tech Electronics Co., Inc.	303	224	212/586-7240	SCIP Electronic Systems	208	
Magni Systems, Inc.	75	37	503/626-8400	Selco Products Co.	252	
Maxell Corp. of America	153	37	201/641-8600	Sencore	305	
Maxima Magnetics	355	313	800/362-9462	Sennheiser Electronic Corp.	327	
McCurdy Radio Industries	105	48	416/751-6262	Sescom, Inc.	317	
MCL, Inc.	296	219	312/354-4350	Shallco, Inc.	252	
Microdyne Corp.	101	45	904/687-4633	Sharp Electronics Corp.	346-347	
Micron Audio Products Ltd.	242	159	914/761-6520	Shively Labs	192	
Midwest Communications Corp.	125	72	800/543-1584	Shure Brothers Inc.	140	
Midwest Communications Corp.	123	71	800/543-1584	Shure Brothers Inc.	318	
Midwest Communications Corp.	1	3	800/543-1584	Siemens - Neve	33	
Miller, R.E. Pty. Ltd.	232	150	818/841-6262	Sierra Video Systems	263	
Mitsubishi International Corp.	197	115	415/651-9931	Sitler's Inc.	317	
Monroe Electronics, Inc.	267	189	312/358-3330	Skotel	264	
Moseley Associates Inc.	289	203	806/968-9621	Solid State Logic	198-199	
Mosses and Mitchell Ltd.	297	220		Solutec Ltd.	288	
Nakamichi USA Corp.	189	107	213/538-8150	Sony Corp. of America (Broadcast)	24-25	
Nautel	271	192	902/823-2233	Sony Mag Tape	83	
NEC America Inc.	34	51	800/323-6656	Sony Mag Tape	85	
New England Digital	133	79	212/977-4510	Sound Technology	209	
Nortronics Co., Inc.	180	91	800/328-5640	Spectrum Communications	254	
O'Connor Engineering	256-257	173,174	714/979-3993	Stainless, Inc.	326	
Odetics, Inc.	135	79	800/243-2001	Standard Communications	165	
OKI Electric Industry Co. Ltd.	239	156		Standard Tape Laboratory, Inc.	317	
Omicron Video	348	182	818/700-0742	Stanton Magnetics	162	
Opamp Labs Inc.	317	236	213/934-3566	Stantron/Unit of Zero Corp.	359	
Orban Associates Inc.	17	12	800/227-4498	Studer Revox America Inc.	128-129	
Orban Associates Inc.	7	7	800/227-4498	Surcom Associates Inc.	342	
Orban Associates Inc.	28-29	16	800/227-4498	Swintek Telecommunications Div.	349	
Orion Research Inc.	224	141	800/227-4498	Symetrix, Inc.	240	
Osborne, Alan	344	311	805/495-8420	Tascam Div. TEAC Corp. of America	244	
Otari Corp.	15	11	415/592-8311	Tektronix Inc.	49	
Otari Corp.	181	100	415/592-8311	Telcom Research	251	
Pacific Recorders and Engineering Corp.	67	33	619/438-3911	Telemetry Inc.	206	
Paco Electronics	194	112	213/747-6540	Tentel	16	
Panasonic Broadcast Systems Co.	113	64	201/348-7336	Tex AR	40-41	
Panasonic Broadcast Systems Co.	111	63	201/348-7336	TFT, Inc.	182-183	
Panasonic Broadcast Systems Co.	115	65	201/348-7336	Thomson Video Equipment	219	
Perrott Engineering	344	316	702/532-0700	Thomson-CSF/DTE	319	
PESA	107	61	800/872-7372	Thomson-CSF/LGT	91	
Philips Test and Measuring Instruments	325	240	201/529-3800	Titus Technological Labs	273	
Polaroid Corp.	108-109	62	800/225-1618	TMD, A Will-Burt Co.	226	
Polyline Corp.	228	144	312/297-0955	Toshiba Corp.	285	
Potomac Instruments	290	317	301/589-2662	Total Spectrum Manufacturing, Inc.	341	
QEI	65	32	800/334-9154	Townsend Broadcast Systems	275	
Quanta Corp.	166	95	801/974-0992	Trimm Inc.	323	
Quanta Corp.	227	143	801/974-0992	Trompeter Electronics, Inc.	286	
Quantel Ltd.	299	222	415/856-6226	Ultimatte Corp.	288	
R-Columbia Products, Inc.	228	145	312/432-7915	United Rope Works	248	
RAKS	88-89	162	201/438-0119	Utah Scientific Inc.	185	
Ramsa/Panasonic	223	138		Varian	39	
Rank Cintel	61	30		Varian	191	
Research Technology Inc.	188	106	800/323-7520	Vid Video	259	
Richardson Electronics Inc.	63	31	800/323-1770	Videotape Products Inc.	307	
				Videotek, Inc.	178-179	
				Vital Industries, Inc.	345	
				Ward-Beck Systems Ltd.	BC	
				Wheatstone Broadcast Group	IBC	
				Winsted Corp.	254	
				Winsted Corp.	265	
				Yamaha International Corp.	73	
					89	800/262-4671
					225	312/539-7700
					137	301/249-5647
					130	818/843-7022
					132	818/843-7022
					50	203/744-6230
					229	714/631-7430
					218	415/935-1226
					126	213/454-1889
					167	800/257-3526
					304	800/843-3338
					242	212/944-9440
					234	800/634-3457
					366	919/934-3135
					302	201/529/8731
					110	207/747-3327
					52	312/866-2553
					70	312/866-2553
					50	203/744-6230
					179	916/273-9331
					232	800/426-3938
					371	514/465-8990
					116	212/315-1111
					209	514/521-5464

Professional services

VIR JAMES P.C.
CONSULTING ENGINEERS
Applications and Field Engineering
Computerized Frequency Surveys
3137 W. Kentucky Ave. — 80219
(303) 937-1900
DENVER, COLORADO
Member AFCCE & NAB

**STEIGER, HURRAY &
ASSOCIATES INC.**
CONSULTING ENGINEER SERVICES
6816 Westview Drive
Cleveland, OH 44141
(216) 526-7187

EVANS ASSOCIATES
CONSULTING TELECOMMUNICATIONS ENGINEER
AM-FM-TV-CATV-ITFS-LPTV SATELLITE
216 N. Green Bay Road
Thiensville, Wisconsin 53092
Phone: (414) 242-6000 Member AFCCE

FCC ON-LINE DATABASE
dataworld[®]
Allocation/Terrain Studies
AM • FM • TV • LPTV • ITFS
P.O. Box 30730
Bethesda, MD 20814
(301) 652-8822 1-800-368-5754

D. L. MARKLEY
& Associates, Inc.
CONSULTING ENGINEERS
206 North Bergan
Peoria, Illinois 61604
(309) 673-7511
Member AFCCE

**CHIPS DAVIS
LEDE DESIGNS, INC.**
Acoustics for Stereo
Facility Design
Consultation
(415) 459-2888

TEKNIMAX
TELECOMMUNICATIONS

DENNIS R. CIAPURA
PRESIDENT

11385 FORESTVIEW LN.
SAN DIEGO, CA 92131 (619) 695-2429

SMITH and POWSTENKO
Broadcasting and Telecommunications
Consultants
2033 M Street N.W., Suite 600
Washington, D. C. 20036
(202) 293-7742

BLAIR BENSON
Engineering Consultant
TV Systems Design and Operation
23 Park Lane
Norwalk, CT 06854
203-838-9049



LAWRENCE L. MORTON
ASSOCIATES
21671 SUPERIOR LANE
LAKE FOREST, CALIFORNIA 92630

LAWRENCE L. MORTON, E.E.
AM • FM • TV
APPLICATIONS • FIELD ENGINEERING
ANTENNA BROADBANDING FOR AM STEREO
(714) 859-6015

JOHN H. BATTISON PE.
CONSULTING BROADCAST ENGINEER,
FCC APPLICATIONS AM, FM, TV, LPTV
Antenna Design, Proofs, Fieldwork
890 Clubview Blvd. North
Columbus, Ohio 43085
614/888-3364

Robert J. Nissen
THE NISSEN GROUP, INC.
Communications Technology Consultants
32 Ridge Drive • Port Washington, New York 11050
(516) 944-5477

**BROADCASTING CONSULTANTS
AND ENGINEERS**
• FCC Applications and Field Engineering
• Frequency Searches and Coordination
• Tower Erection and Maintenance
• Facility Design and Construction
Contact:
KENNETH W. HOEHN
23400 Michigan Avenue
Dearborn, MI 48124

Teletech, Inc.
Communications Engineering Services
(313) 562-6873

SELLMEYER & KRAMER, INC.
CONSULTING ENGINEERS
Steve Kramer, P.E. (214) 548-8244
Jack Sellmeyer, P.E. (214) 542-2056
AM FM TV MDS ITFS LPTV CATV
APPLICATIONS • FIELD ENGINEERING
P.O. Box 841 McKinney, TX 75069

ERIC NEIL ANGEVINE, P.E.
consultant in acoustics
specializing in broadcast studio acoustics
910 Lakeridge Drive Stillwater, OK 74075
405-624-6043 405-372-3949

ATT: CHIEF ENGINEERS
broadcast video maintenance
LUNAR VIDEO LTD.
FAST TURNAROUND ON ENG, EFP, EDIT
SYSTEMS, MONITORS, TEST EQUIP. SONY, JVC,
PANASONIC, TEKTRONIX — UPS & AIR FREIGHT.
PUDEL DAILY.
CALL COLLECT
138 E. 26th St, NYC (212) 686-4802

Consultation Services
Lightning • Power Conditioning • Grounding
Over 40 years experience, work guaranteed
Roy Carpenter
President

Lightning Eliminators and Consultants
13007 Lakeland Rd., Santa Fe Springs, CA 90670
(213) 946-6886 TWX 910-586-1381

PATCHPRINTS Video Tie Lines
In 1 2 Aux 1 2 Mon A B
Custom Patch Bay Labeling for the Audio/Video Industries
By
PATCH BAY DESIGNATION COMPANY
Div. of Glendale Rubber Stamp & Printing Co., Inc.
CHARLIE SCHUFER
P.O. Box 6278, Glendale, CA 91205
4742 San Fernando Road Telephone
Glendale, CA 91204 (818) 241-5585

ENG SERVICE Bill Nelson
Chief Engineer
V T R Associates, Inc.
Prompt TURNAROUND on
¾" editors, color ENG cameras.
3023 Holiday Drive, S.W. Phone
Huntsville, AL 35805 (205) 533-0571

**UNUSED
CALL LETTERS
CALL
dataworld**[®]
1-800-368-5754

HOW SAFE IS YOUR TOWER?
 **Alpha Tower Design, Inc.**
901 Waterfall Way, Richardson, Texas 75080
214-783-2578
STRUCTURAL ENGINEERS SPECIALIZING IN TOWER DESIGN
REGISTERED TO PRACTICE IN 48 STATES...THREE DIMEN-
SIONAL COMPUTER ANALYSIS WITH LATEST DESIGN TECH-
NOLOGY...INSPECTION & REVIEW TOWER MODIFICATIONS

R.J. GRANDMAISON, P.E.
CONSULTING ENGINEER
Applications and Rulemakings
11213 Split Rail Lane
Fairfax Station, VA 22039
(703) 764-0513
Member AFCCE

Why not run your business
card here?
Only \$65 per insertion.
Frequency discounts available.
Call 913/888-4664

EMJ
803-736-0540
Eureka Media Service
PAUL J. MASTORAKIS, CONSULTANT
TV—Systems Design—Installation—Repairs
Freelance Engineer
104 Charmont Drive, Columbia, SC 29223



A SUCCESS STORY

THE OBJECTIVE was no small task: design a radio console that would become the new standard.

THE METHOD involved listening to veteran broadcast engineers and installers. After all, they're the people who have seen and experienced all the ideas that came before. From this research we learned of the problems that had to be solved and the features that broadcasters required. We then added ten years of console building experience and innovation, and created the A-500a console.

THE RESULT: An unsurpassed console that exceeds prior broadcast standards. Its module/mainframe interface borrows from the computer industry, utilizing all-gold contact insulation displacement technology. The logic system is based on programming the module slot, allowing full module interchangeability. It also provides for separate programming of the module's "B" input selection, thus avoiding embarrassing false starts and mutes. Full console-to-machine control is supported without extensive use of interface boxes and cables. Three audio busses are provided to enhance talkshows and remote functions. There are separate processing loops for the speech and music paths, as well as individual channel insert points. A complete line of microphone and line inputs, remote selectors, and machine control modules is offered in virtually any combination, configuration or mainframe size you desire. The A-500a also features a full family of studio turret and turret components to ease facility design.

THE PERFORMANCE: Needless to say, it's a new age for audio, and the A-500a is a step ahead. While specifications don't say it all, ruler flat frequency response, .003% distortion, crisp square wave response and a noise spec that's unheard of deserve merit. Couple such performance, reliability and innovation together, and a new broadcast standard is set.

THE SUCCESS: WHEATSTONE broadcast consoles are installed in major markets all over the country, from frontline independents to national networks. They are in use right now at some of the world's largest institutions.

THE POSSIBILITIES: The possibilities are up to you.

 Wheatstone Corporation
6720 V.I.P. Parkway, Syracuse, N.Y. 13211 (315-455-7740)

Circle (2) on Reply Card

Ward-Beck's Ubiquitous ST!

No matter what size the market - Chicago to Shreveport, New York to Seoul, Vancouver to Greenville - the versatility of Ward-Beck's ST Stereo Console is unsurpassed.

Flexible 24, 36 or 48 channel configurations can meet every need and fit every budget.

Available features... • 4-BAND EQ • INTEGRAL ROUTING SWITCHER • CENTRAL MICROPROCESSOR CONTROLLER • PROGRAMMING KEYBOARD • ALPHA-NUMERIC DISPLAYS • PEAK MONITOR/ANNUNCIATOR • AUDIO-FOLLOW-VIDEO INTERFACE.

Talk to us! Discover how affordable Super-Quality can be!

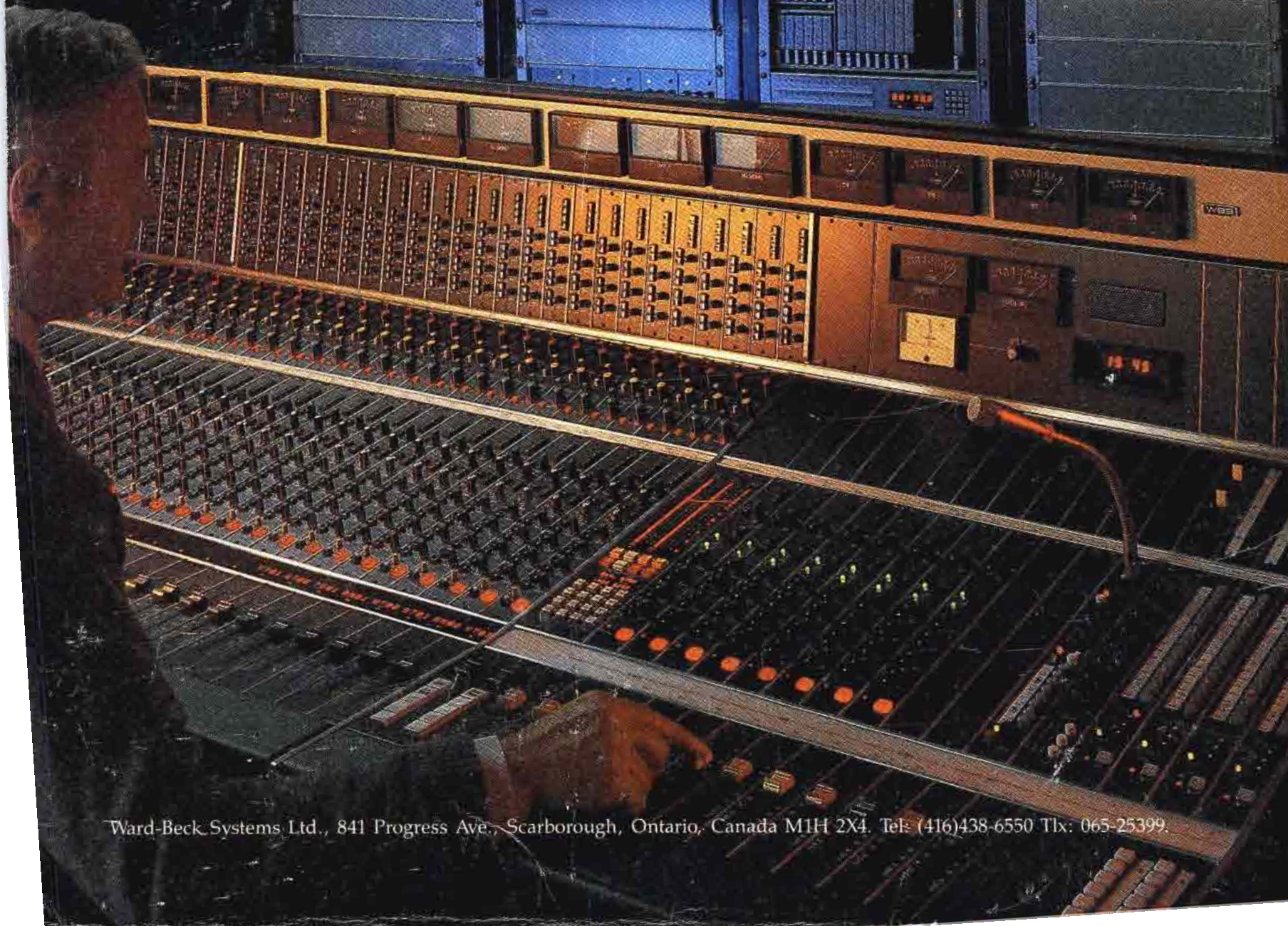
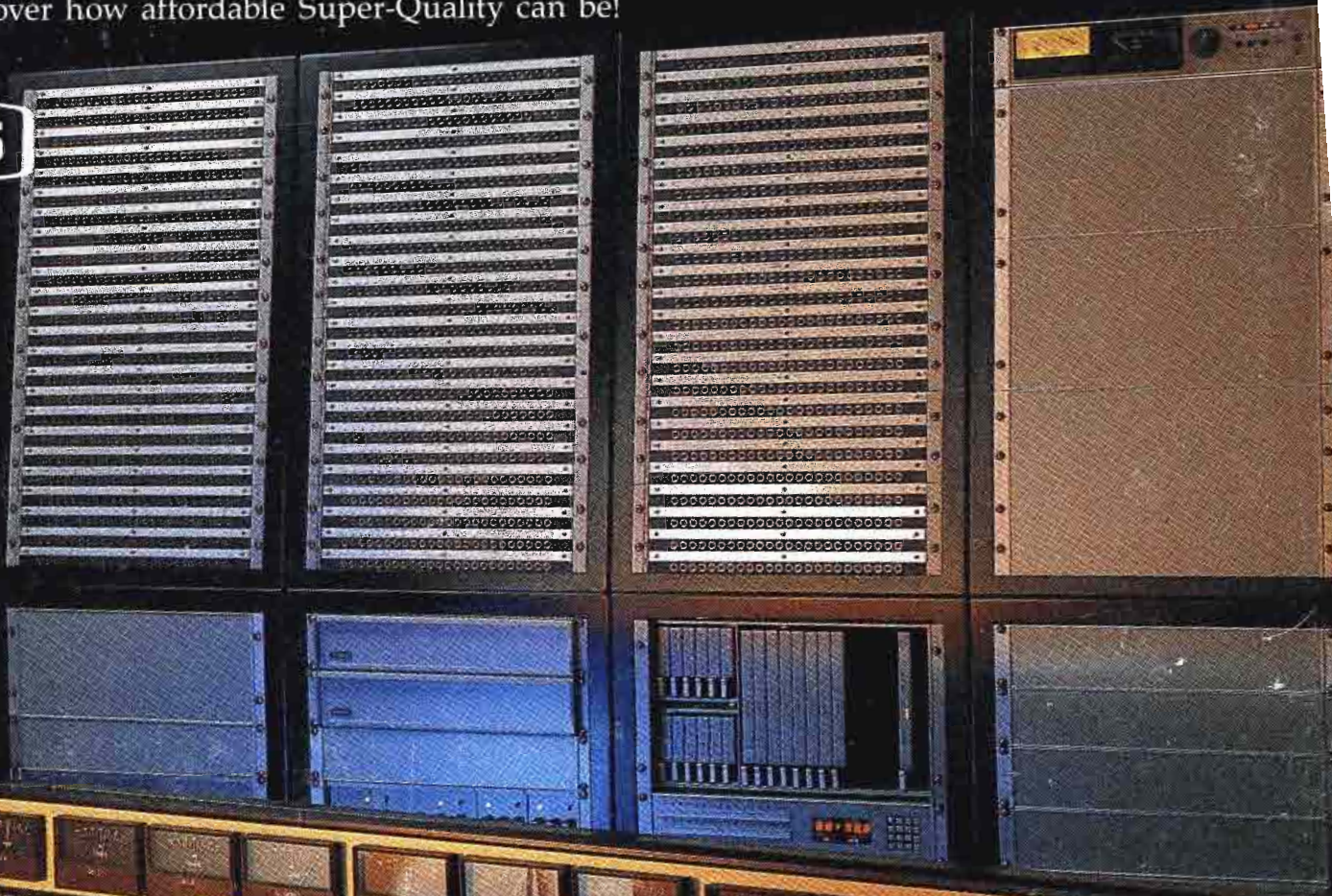

Ward-Beck Systems Ltd., 841 Progress Ave., Scarborough, Ontario, Canada M1H 2X4. Tel: (416)438-6550 Tlx: 065-25399.