

# BROADCAST ENGINEERING

June 1985/\$3

## Radio's high tech talk

A98100-----DNEUNI V C 1 XXXX BEQ  
F111028400CC0C0 22B  
TERRY DENBROOK  
KUOW FM WASH D5 50 DIR  
UNIV OF WASH D5 50 WA 98195  
SEATTLE

Show review

**NAB**  
1985

# Embarrassing questions to ask audio console salespeople

Sometimes it pays to ask questions. If the subject is audio consoles, asking difficult questions can be very revealing in comparing one console to another. Here are some of the questions that make most console salespeople squirm.

**Is the console "human engineered"?** Does the console have an esthetically "professional" appearance? Is the layout well defined and uncluttered? Are controls large? Do they fit the hand? Are they well labelled and lighted? Do they provide adequate visual feedback to affirm the position of the control? Is console nomenclature permanently engraved?

**Easy to service?** Are all components readily accessible and isolated for individual servicing? Are op-amps in plug-in sockets? Are there service loops in the wiring harness? Are extender boards provided? Are all wires uniquely numbered and referenced to your system documentation?

**How responsive is the service department?** Can they provide a history of fast, efficient customer service? Are they confident enough to furnish a complete list of customers for you to call?

**How easy is installation?** Is the console completely assembled and ready to install? Are installation points readily accessible? Are all program inputs and outputs uniquely transformer isolated?

**How about specifications?** Are the manufacturers' published specifications consistent and easily understandable or mired in the game called "specsmanship"?

**How good is reliability?** Do all modules receive three levels of testing? Does the total system receive 4 levels of performance verification? Do both the modules and system receive extensive burn-in?

**Is the console backed by a 5-year, all-inclusive warranty?** (Only ADM answers "yes" to that one.)

ADM and only ADM answers all of these questions with a full, no weaseling, resounding "YES"! The only question remaining is, when would you like to talk to us about a new audio console?

For facts about our complete product line, contact ADM Technology, Inc., 1626 East Big Beaver Road, Troy, Michigan 48084.  
Phone (313) 524-2100.  
TLX 23-1114.



ADM VP 1603  
Post Production  
Console.

**ADM**<sup>®</sup>  
The  
Audio  
Company

Circle (1) on Reply Card



STUDIOS • POST PRODUCTION • MOBILE UNITS  
MASTER CONTROL • MICROWAVE • FIBER OPTICS

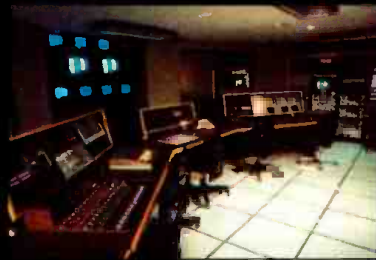

If your future plans include an individual component, a turnkey system, or something in between, we can develop your ideas into a complete television facility.

THE  
**LERRO**  
CORPORATION

3125 N. Broad St., Philadelphia, Pa. 19132  
215 - 223-8200

# Contents

June 1985 • Volume 27 • Number 6



Page 22

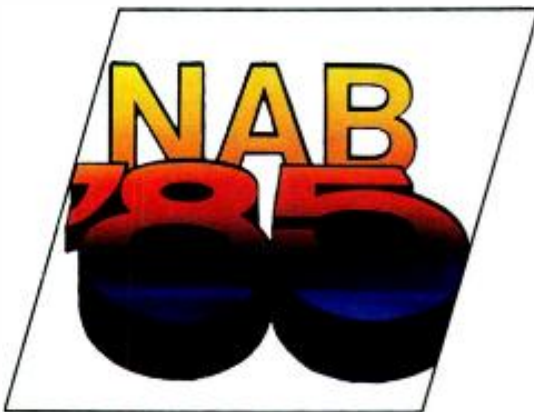

Page 42

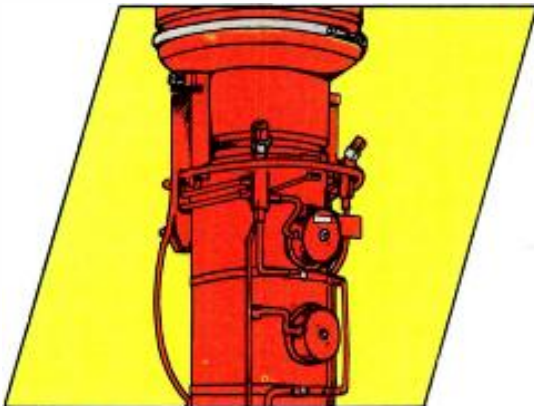

Page 76

## ON THE COVER

Network radio is a changing industry, driven primarily by new technology. Our cover this month shows the new technical operations center of ABC Radio in New York City. The computer-driven facility controls all program feeds for six full-service networks and ABC Talkradio. (Courtesy of ABC Radio.)

## BROADCAST ENGINEERING

### 22 Radio's High Tech Talk

By Jerry Whitaker, editor

New technology is reshaping the face of radio networks, removing the chains of telephone company technical limitations. We profile in this article the newly opened operations center for ABC Radio in New York City.

### SPECIAL REPORT: NAB '85 REVIEW

The 1985 NAB convention in Las Vegas set new exhibitor and attendance records. In our coverage of the broadcast industry's primary trade show, we examine what happened and who made it happen.

### 44 Pick Hits of NAB '85

By Jerry Whitaker, editor, and Carl Bentz, technical editor  
A snapshot look at some of the exciting new products displayed at the convention. We commissioned a panel of independent industry experts to give us their list of the show's 10 hot TV products and 10 hot radio products.

### 71 Opening Doors to the Future

By Brad Dick, KANU Radio, and Don Markley, consultant  
A review of the major radio and TV engineering papers presented at the convention. Significant technological trends are outlined and their impact on the industry is discussed.

### 76 New Frontiers for Efficiency

By Don Markley, consultant

A report on new developments discussed at the NAB concerning improvements in UHF TV transmitter efficiency. Progress was reported in both tube and transmitter design efforts.

### 82 Show of Shows

By the BE staff

A complete rundown of all the new products displayed at the convention. If you didn't make it to all of the booths at the show, check out this section.

## DEPARTMENTS

4 News	12 re: Radio
6 Editorial	14 Satellite Technology
8 FCC Update	16 Troubleshooting
10 Strictly TV	156 Business
	157 New Products



# Comark's "S" Series UHF Television Transmitters

*Simply Superior*

Stereo-Ready



10kW/30kW/60kW model shown

Integrating low initial and operating costs, high efficiency and reliability, each "S" Series model incorporates state-of-the-art technologies to achieve a unique combination of unparalleled features:

- External cavity, full-band, field proven, klystron power amplifiers, combining highest beam efficiencies, compact size and lower operating and replacement costs than comparable internal cavity tubes.
- Broadband, Stereo-Ready exciter system, featuring parallel channel RF operation as well as the new Comark/Marconi B7500 Modulator with advanced IF linearity, E.D. and ICPM pre-correction.
- Space efficient, mechanical and electrical layouts, fully engineered for maximum EMI/RFI isolation and overall operator convenience.
- Fiber optic telemetry for all floating high voltage metering functions, incorporated into a complete, remote control-compatible, latched fault and status display system.
- Clean, fully isolated, high voltage compartments, with double-filtered air cooling and front access. (No exposed high voltage in klystron areas.)

Comark's "S" Series transmitters are available in power ranges from 10kW through 240kW with advanced system features, including effective klystron beam current pulsers, motorized and Magic Tee RF switching systems and the services of Comark's 24-hour field operations group.

*Simply Superior*

**COMARK**

Circle (3) on Reply Card

Administrative and  
Marketing Offices:  
Rt. 309 and Advance Lane  
P.O. Box 275  
Colmar, PA 18915  
(215) 822-0777  
Telex: 84-6075

Engineering and  
Manufacturing Headquarters:  
Rt. 57, Feeding Hills Road  
P.O. Box 229  
Southwick, MA 01077  
(413) 569-5939  
Telex: 95-1159

## Kodak calls for imaging technologies standard

In a speech to the American National Standards Institute (ANSI), Raymond H. DeMoulin, vice president and general manager for Kodak's professional photography division, urged members to "build bridges" among the various standards boards governing the imaging field, including image capture, storage and display. He said industry professionals should turn their attention to three factors that are shaping the future of the industry.

The first factor is the interdependence of emerging technologies of hybrid imaging technologies, such as machine vision, which combines robotics with electronic imaging.

ANSI, as an example, has three distinct technology boards, which will be affected by emerging imaging systems. The Image Technology Standards Board, which governs photographic standards; the Electrical and Electronic Standards Board, which is involved in transmission and componentry of imaging systems;

and the Information Systems Standards Board, which is concerned with collection, processing, storage and display of information.

One upcoming technology requiring cooperative standardization will be the marriage of motion picture film to electronic technology. Industry scientists anticipate that it will be possible to electronically scan film images and place them on electronic storage media such as ultra-high density magnetic or optical disks, for editing or special effects. The images could then be transferred back to film for distribution or display on theater screens.

The second factor is the need for standards groups to anticipate rather than react to rapid technological change, and introduce standards that will ease that change.

"If we are to realize a future in which the full information content of a film image can be shipped over a wire," DeMoulin said, "then new standards in bandwidth—or the amount of informa-

tion that can be transmitted in a unit of time—must be established."

The third factor is competition in the global marketplace. "A single product may contain components made in a half-dozen countries—and assembled in still others," he said. "That makes the coordination of domestic and international standards increasingly important to the success of American products both at home and abroad."

In another case, DeMoulin indicated that the European Computer Manufacturers Association is presently creating standards for optical disks while a U.S. counterpart is doing the same. "In the future, American industry—and domestic standards groups—will need to work more closely with their counterparts in Europe, Japan and around the world," he said.

"All of us will benefit from the potential of these technologies to improve the way we live, work and do business," DeMoulin said. "Standardization can help to achieve that potential." [:(-)]

## BROADCAST engineering

Editorial and advertising correspondence should be addressed to: P.O. Box 12901, Overland Park, KS 66212-9981 (a suburb of Kansas City, MO); (913) 888-4664. Telex: 42-4156 Intertec OLPK. Circulation correspondence should be sent to the above address, under P.O. Box 12937.

### EDITORIAL

Jerry Whitaker, *Editor*  
 Carl Bentz, *Technical Editor*  
 Nils Conrad Persson, *Electronics Editor*  
 David Hodes, *Video Editor*  
 Miguel Chivite, *International Editor*  
 Fred Ampel, *Audio Editor*  
 Rhonda L. Wickham, *Managing Editor*  
 Paula Janicke, *Associate Editor*  
 Dawn Hightower, *Editorial Assistant*  
 Pat Blanton, *Directory Editor*

### TECHNICAL CONSULTANTS

Eric Neil Angevine, *Broadcast Acoustics*  
 John H. Battison, *Antennas/Radiation*  
 Blair Benson, *TV Technology*  
 Dennis Ciapura, *Radio Technology*  
 Brad Dick, *Studio Facilities*  
 Dane E. Ericksen, *Systems Design*  
 Howard T. Head, *FCC Rules*  
 Wallace Johnson, *FCC/Bdct. Engineering*  
 John Kean, *Subcarrier Technology*  
 Donald L. Markley, *Transmission Facilities*  
 Harry C. Martin, *Legal*  
 Robert J. Nissen, *Studio/Communications*  
 Hugh R. Paul, *International Engineering*  
 Richard Rudman, *Spectrum Management*  
 Art Schneider, *A.C.E., Post-production*  
 Elmer Smalling, III, *Cable Systems*  
 Vincent Wasilewski, *Communications Law*

### ART

Kevin Callahan, *Art Director*  
 Doug Coonrod, *Graphic Designer*  
 Leigh Coffman, *Graphic Designer*  
 Carolyn Cory, *Graphic Designer*

### CORRESPONDING ASSOCIATIONS

American Society of TV Cameramen  
 Assn. for Bdct. Engr. Standards  
 National Association of Broadcasters  
 National Radio Broadcasters Assn.

### MEMBER ORGANIZATIONS

Acoustical Society of America  
 Society of Broadcast Engineers

### CIRCULATION

John C. Arnst, *Director*  
 Evelyn Rogers, *Manager*  
 Dee Manies, *Reader Correspondent*

### ADMINISTRATION

R. J. Hancock, *President*  
 Cameron Bishop, *Publisher*  
 Eric Jacobson, *Associate Publisher*

### ADVERTISING

Dee Unger, *Advertising Supervisor*  
 Mary Birnbaum, *Production Manager*

### MARKETING

Stephanie Fagan, *Promotions Manager*  
 Kelly Hawthorne, *Marketing Assistant*

Member,  
 American Business Press  
 Member,  
 Business Publications  
 Audit of Circulation



**BROADCAST ENGINEERING** is edited for corporate management, engineers/technicians and other station management personnel at commercial and educational radio and TV stations, teleproduction studios, recording studios, CATV and CCTV facilities and government agencies. Qualified persons include consulting engineers and dealer/distributors of broadcast equipment.

**SUBSCRIPTIONS: BROADCAST ENGINEERING** is mailed free to qualified persons within the United States and Canada in occupations described above. Non-qualified persons may subscribe at the following rates: United States and Canada: one year, \$25.00. Qualified and non-qualified persons in all other countries: one year, \$30.00 (surface mail); \$108.00 (air mail). Back issue rates, \$5, except for the September Buyers' Guide/Spec Book, which is \$20. Rates include postage. Adjustments necessitated by subscription termination at single copy rate. Allow 6-8 weeks for new subscriptions or for change of address. Second class postage paid at Shawnee Mission, KS.

**BROADCAST ENGINEERING** (USPS 338-130) is published monthly (except in December, when two issues are published) by Intertec Publishing Corporation, 3221 Quivira Road, P.O. Box 12901, Overland Park, KS 66212-9981. Postmaster, return form 3579 to P.O. Box 12938 at the above address.

Photocopy rights: Permission to photocopy for internal or personal use is granted by Intertec Publishing Corporation for libraries and others registered with Copyright Clearance Center (CCC), provided the base fee of \$2.00 per copy of article is paid directly to CCC, 21 Congress St., Salem, MA 01970. Special requests should be addressed to Cameron Bishop, publisher. ISSN 0007-1794 \$2.00 + \$0.00.

©1985. All rights reserved.





# LEADER

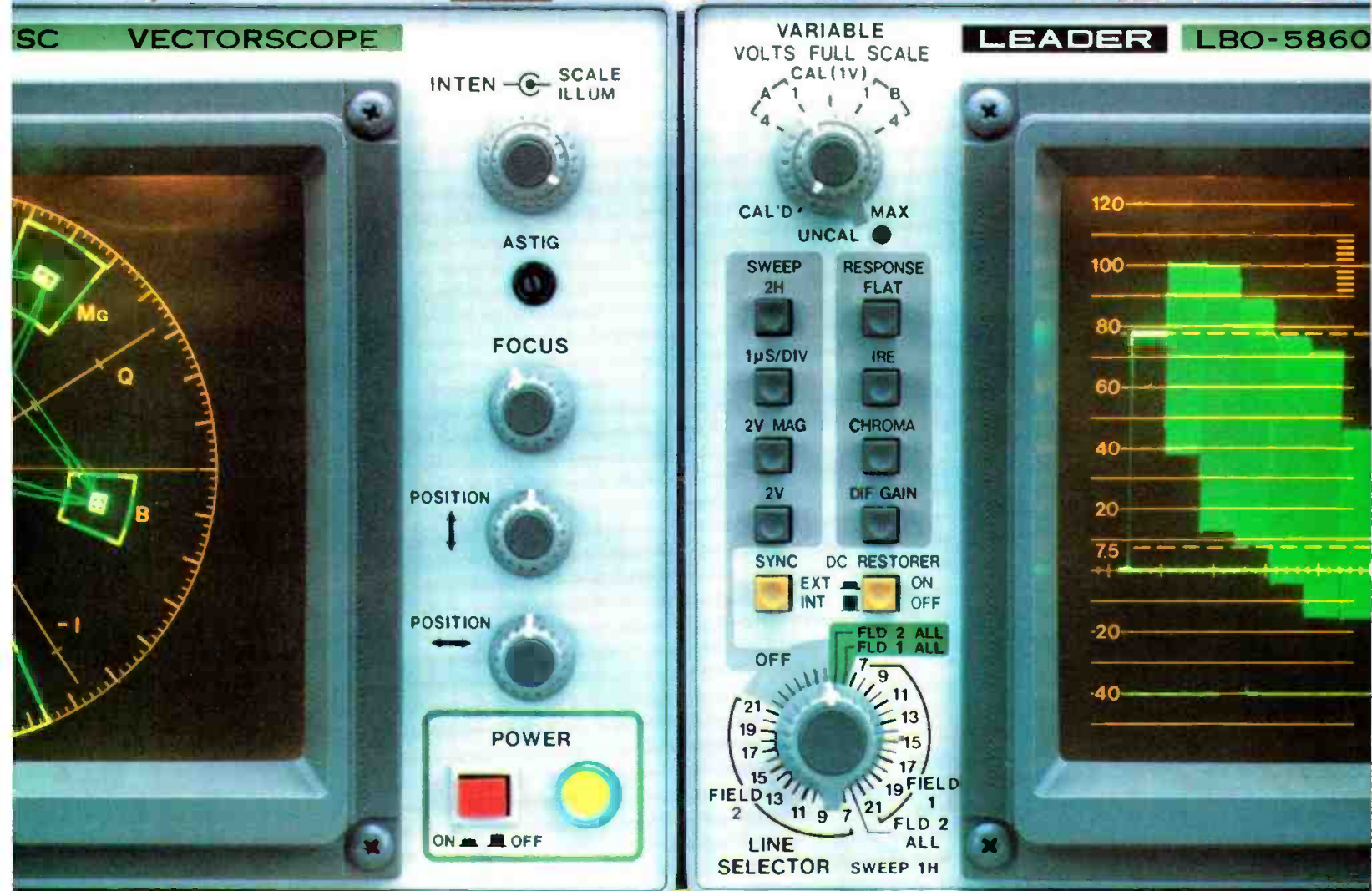

ACTUAL SIZE

## Two Leaders with an important following.

Check the racks of the industry's leaders, and you'll find Leader instruments. At ABC, Sony Broadcast, Reeves, Zenith, HBO, RCA, A.F. Associates, Group W, ATC, Midwest Corporation, and NBC, to name a few... where quality is paramount, Leader has been their choice.

**You could pay more for others. But you'll get more from Leader.**

For instance, our half-rack LBO-5860A Waveform Monitor is the only one that lets you select

lines 14-21 (fields 1 and 2) from the front panel. And there's an L model that shows you lines 7-21 for coding information, too. Our half-rack LVS-5850B Vectorscope is the perfect mate, with selectable, electronically-generated targets\* that can be read from across the room. Electronically-generated targets also provide the highest level of measurement accuracy, even if you misalign the CRT center dot. It also has an internal etched graticule, and gives a VITS display with strobe input.

### More than just competitively priced.

The convenience of viewing both vector and waveform displays simultaneously gives you uninterrupted monitoring capability.

Top broadcasters rely on Leader quality. It's backed by a two-year warranty (including CRT's) and factory service depots on both coasts.

Ask for a catalog of our waveform monitors, vectorscopes, signal generators and other instruments; an evaluation unit, and the name of your nearest "Select" Leader distributor.

Call toll-free  
**(800) 645-5104**

In New York State  
**(516) 231-6900**

For professionals

who know the difference.

**LEADER**  
Instruments Corporation

380 Oser Avenue  
Hauppauge, New York 11788  
Regional Offices:  
Chicago, Dallas, Atlanta,  
Los Angeles, Boston  
In Canada call Omnitrion Ltd.  
(514) 337-9500

## Organized confusion

The NAB convention is not *the most* disorganized and inflexible major trade show that we have seen in recent years, but it does rate at least an honorable mention. The exhibit portion of the show has been plagued with problems—some minor and some major—for years. This past convention, however, hit new lows in organization and timely communication with manufacturers and the press. It can best be described as *organized confusion*. Confusion for which broadcast equipment users—radio and TV stations—will ultimately pick up the tab.

Our complaint is with the exhibit portion of the show, which is orchestrated, for the most part, by the association's convention planning office in St. Louis. The St. Louis group has handled the show for more than 20 years. The arrangement began back when the convention was small and easily managed. The St. Louis office, however, continues to run the show the way it did in 1965.

For years, our staff members have heard about the recurring problems between the manufacturers and the group in St. Louis. Complaints are nothing new. The frequency and intensity of the grumblings this year, however, is worthy of special mention.

Manufacturers make the NAB convention. They pay the bills and are responsible for the ever-increasing attendance at the show. There's no doubt about it: the convention is a money-maker for the association. That money comes from exhibitors and attendees. Both are getting short-changed by the NAB.

Manufacturers, from the very large to the very small, report having trouble getting information out of St. Louis. Exhibitors say the office deals with them in an aloof and dictatorial manner. The show management doesn't act on requests for reasonable changes in booth size, configuration or location. Exhibitors have surprisingly little voice in critically important matters concerning their own exhibits. This may seem like a minor issue to the casual convention-goer, but to the exhibitor, such problems are far from trivial.

Preparing, transporting, assembling, operating and removing an exhibit is difficult under the best of conditions. The NAB convention, however, makes it a real challenge. The inflexibility of the St. Louis office is nearly equaled by its inability (or unwillingness) to communicate with individual exhibitors—large or small—and the trade press. Phone calls regularly go unanswered. Letters receive no response. The office in St. Louis is out of touch with the industry. It ignores the folks who pay the bills.

Some equipment manufacturers, frustrated by the continuing problems with St. Louis, have talked about pulling out of the annual NAB convention. They say it's just too much hassle and expense. We have spoken to manufacturers who have wasted huge amounts of time and money battling with the regime in St. Louis. Others have discussed the possibility of starting an "alternative NAB" convention to be held on a regular basis for exhibitors who are fed up with the same old problems. And we are not talking only about small exhibitors. Some major equipment manufacturers are among the ranks of the disgruntled.

Such action would impact not only on the NAB convention, but also on the 38,000-plus radio and TV station engineers, managers and operations personnel that attend the show each year. Because of poor show management, convention-goers may begin seeing fewer exhibitors each year, rather than more.

As a case in point, consider what happened to the manufacturers who exhibited this year in the Hilton Center. To say that traffic there was light is perhaps one of the great understatements of 1985. The experiment was generally described by exhibitors as a flop. The Hilton exhibit area was poorly marked (at least at the beginning of the show) and was difficult to reach from the main convention area. In fact, it was hard to reach from the Hilton itself. Some companies packed up and left the show early because of the poor booth traffic. Most complained loudly to show management, with little result. A petition protesting the Hilton arrangement, signed by 73 companies, attests to the dissatisfaction experienced by the exhibitors.

It is clear to us that the planning and management of this year's NAB convention fell far short of the professional standards that the broadcast industry has a right to expect from its primary trade show.

If the problem is a lack of adequate staff, money should be allocated to correct the situation. If management is the problem—and we fear it is—then a change is warranted. The NAB convention is too important to our industry to be handled in the unprofessional manner demonstrated this year and in previous years.

Next year the NAB convention moves to Dallas. Many manufacturers fear that the problems experienced in Las Vegas will seem trivial compared to the confusion that may reign in Dallas. If a disaster is to be avoided in '86, pressure must be brought to bear from within the broadcast industry to replace, or at least improve, the St. Louis show management. Our industry has had enough of the NAB's *organized confusion*.

! :? :-)))

We acknowledge that an effort is currently under way to form an advisory committee to the NAB, consisting of a cross section of exhibitors. We applaud this *first step* in the right direction.



# We designed-in features the competition couldn't.

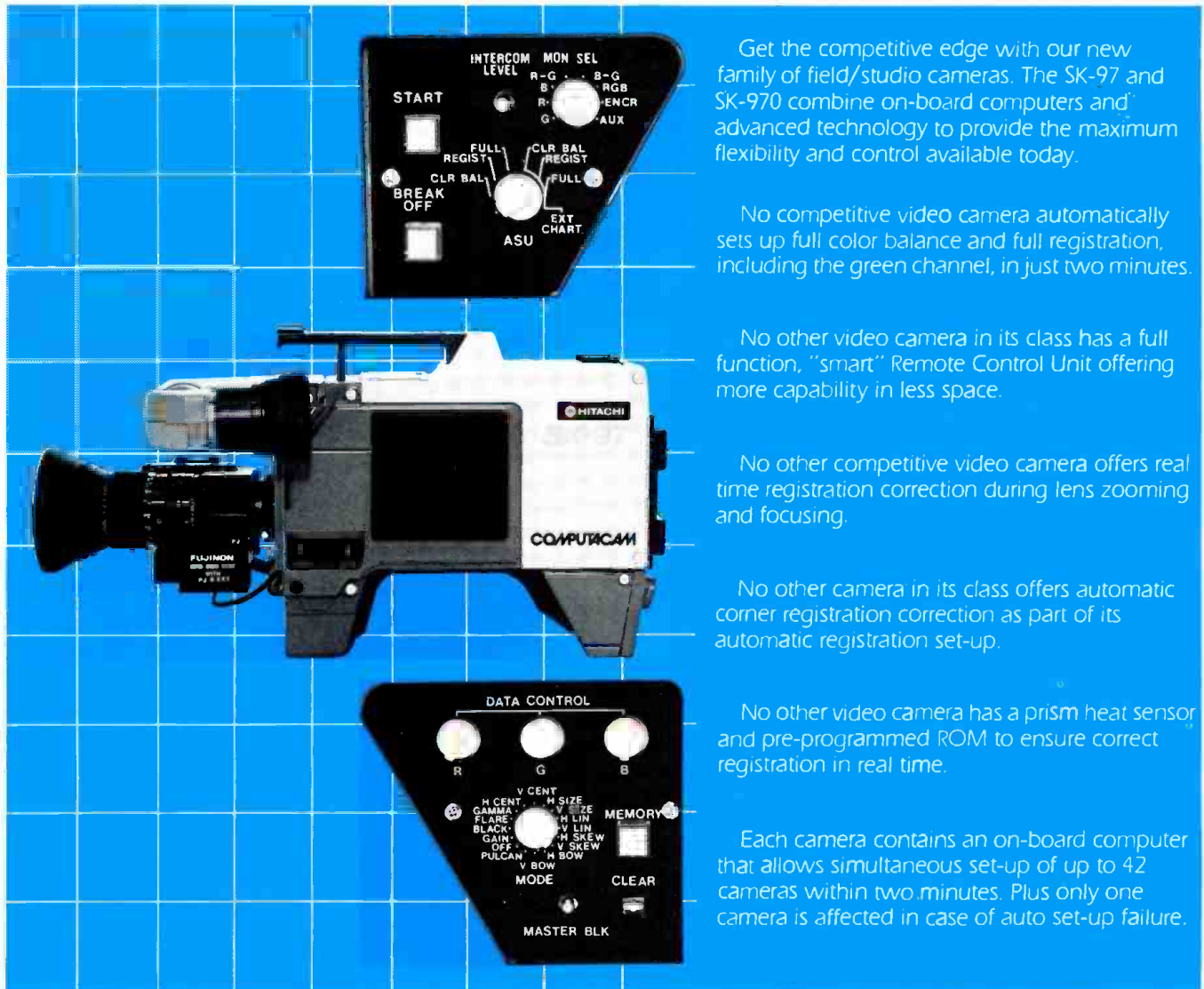

Get the competitive edge with our new family of field/studio cameras. The SK-97 and SK-970 combine on-board computers and advanced technology to provide the maximum flexibility and control available today.

No competitive video camera automatically sets up full color balance and full registration, including the green channel, in just two minutes.

No other video camera in its class has a full function, "smart" Remote Control Unit offering more capability in less space.

No other competitive video camera offers real time registration correction during lens zooming and focusing.

No other camera in its class offers automatic corner registration correction as part of its automatic registration set-up.

No other video camera has a prism heat sensor and pre-programmed ROM to ensure correct registration in real time.

Each camera contains an on-board computer that allows simultaneous set-up of up to 42 cameras within two minutes. Plus only one camera is affected in case of auto set-up failure.

## Hitachi's SK-970 and SK-97 Computacams.



Our SK-970 and SK-97 Computacams offer superior noise-free video (59 dB signal-to-noise-ratio!)

Combine all this with other advanced features such as 700 horizontal lines of resolution, high gain in 3 dB steps from 0-21 dB, completely interchangeable boards, and built-in auto diagnostics, and you can see why our SK-970 and SK-97 Computacams stand alone!

Get the features the competition couldn't design in. For descriptive literature, technical information, or a personal demonstration, contact Jack Breitenbucher, National Sales Manager, Hitachi Denshi America Ltd., Broadcast and Professional Division, 175 Crossways Park West, Woodbury, N.Y. 11797 (516) 921-7200 or (800) 645-7510.



Circle (140) on Reply Card

## Commission amends cable TV, AM rules

By Harry C. Martin

The FCC has amended its rules to implement the Cable Communications Policy Act of 1984, signed by President Reagan on Oct. 30. The important areas of change are:

- **Definitions.** The commission amended the definition of "cable operator" to include persons who provide cable service, own a significant interest in a cable system, or are responsible for the management and operation of a system. Telephone companies or others who only construct or lease facilities would not be considered cable operators subject to the new policy.

The commission also redefined the term "cable system" to exclude facilities that retransmit over-the-air TV broadcast signals. Existing facilities that perform only a retransmission function will remain subject to must-carry requirements. New facilities built after April 28 will not be subject to must-carry requirements.

- **Ownership restrictions.** The Cable Act codified the FCC's existing TV/cable TV cross-ownership restrictions. The commission proposed no rule changes in this area, but adopted changes that liberalize restrictions regarding ownership of cable TV systems by local telephone companies, at least in rural areas.

- **Franchise requirements and fees.** In response to the Cable Act, the commission amended its franchise fee limitation rule to specify a maximum rate of 5% of gross revenue. Previously, FCC rules limited franchise fees to 3% of gross revenue, with a 5% fee obtainable upon a showing of reasonableness.

- **Rate regulation.** According to the Cable Act, the commission must establish standards for rate regulation by local authorities and exempt from local rates those systems that are subject to *effective competition*. Cable systems will be considered subject to effective competition if the cable community receives three or more unduplicated broadcast signals. In such communities, local authorities may not prescribe rates for basic cable service, defined as the tier of service regularly provided to all subscribers that includes the retransmission of all must-carry broadcast TV signals or, in the absence of at least three must-carry signals, any unaltered broadcast TV signals.

### 14 frequencies opened for nighttime operation

The commission has amended its AM rules to allow nighttime operations on



the 14 frequencies previously designated as Canadian, Mexican and Bahamian Class I-A clear channels. These frequencies are 540kHz, 690kHz, 730kHz, 740kHz, 800kHz, 860kHz, 900kHz, 990kHz, 1010kHz, 1050kHz, 1220kHz, 1540kHz, 1570kHz and 1580kHz.

When the new rules are implemented, daytime stations on these channels will be permitted to operate at night at up to 500W, reduced as necessary to provide interference protection to domestic and foreign full-time stations. Applications will not be required. The commission's staff will calculate permissible nighttime powers and issue orders proposing to modify the licenses of all affected stations. An opportunity will be provided for the establishment of new stations on the foreign clears, with a maximum power of 500W.

Within five years after implementation of the new rules, former daytime stations and new full-time stations may increase nighttime power to 500W maximum, without regard to the impact of such increases on one another. At the end of this 5-year period, nighttime protection will be afforded to all stations operating with at least 250W at night, and stations may increase power to 1kW if the increase complies with interference protection requirements.

Because an AM agreement has been reached with Canada, the commission will implement the new rules for the Canadian clear channels. Implementation of the rules as they affect the Bahamian and Mexican clears will begin when negotiations with those countries are completed.

### AM power levels

The FCC has eliminated the requirement that nominal power for AM stations be specified in discrete steps. Under the amended rules, stations that are unable to increase power to the next specified level (500W, 1000W, 2.5kW, etc.) may seek a lesser increase in power consistent with applicable interference protection requirements.

For three years after adoption of the rule, the commission will accept only ap-

plications that specify a power increase of 50% or more. An exception will be made for applications in conflict with power increase applications on cut-off lists. Such applications will need to specify only a 20% increase. At the end of the 3-year period, other applications specifying a power increase of 20% or more will be accepted for filing.

### Broadcast/aeronautical radio interference

The FCC has instituted a rulemaking proceeding to investigate the extent and nature of interference problems between the broadcasting services and VHF aeronautical mobile radio. The increasing number of stations in both services has heightened the potential for interference.

The two services are immediately adjacent in frequency and the power levels differ greatly (100kW for FM broadcast vs. 10W for aviation transmitters). Resulting interference can affect communications equipment aboard an aircraft and, in severe cases, the indications of navigation instruments. In the past 10 years, several incidents have been reported to the FAA.

Under the proposed rules, broadcasters who cause interference to aviation facilities would be required to eliminate it promptly. The chief of the Field Operations Bureau would be authorized to temporarily suspend the operation of interfering stations.

The commission's proposed action would eliminate or substantially simplify electromagnetic coordinations with the FAA. Currently, the FAA reviews most broadcast applications and issues an air hazard determination if it predicts that interference with its facilities may occur. The proposed ruling would make these reviews unnecessary.

According to the commission, the major cause of the interference is the inability of aviation receivers to reject a strong broadcast signal. Modest improvements to airborne receivers may eliminate the problem. The commission intends to define the criteria that would sufficiently protect airborne receivers used for instrument flight, yet not restrict the growth of the broadcast industry.

Martin is a partner with the legal firm of Reddy, Begley and Martin, Washington, DC.

[:?::)]))]]



# Our New 8500 Series Takes The Chance Out Of Buying An Inexpensive DA.



**Y**ou could be playing a dangerous game. Taking a chance on an inexpensive DA that can keep your signal from passing "Go." Keep you from collecting considerable revenue. And force you to "roll" again to catch up to the competition.

But paying less has always made signal distribution risky business. Until now. Grass Valley Group's new 8500 Series DA line dramatically reduces DA cost and risk, while impressively enlarging the state of your art with unique hybrid circuit design. Design that delivers unparalleled stability, repeatability, and substantially improved eq accuracy, frequency response and slew rate.

Advanced new engineering and manufacturing techniques give you all the technical sophistica-

tion and reliability of our industry-standard 3400 Series, but with a compact price that lets you cut cost instead of quality.

Finally, there's an inexpensive DA line that doesn't leave signal distribution to chance. Find out how Grass Valley Group's remarkable new 8500 Series can put you ahead of the game. For complete details, contact a regional sales office listed below, or your nearest Grass Valley Group distributor.

**Grass Valley Group**<sup>®</sup>  
A TEKTRONIX COMPANY

P.O. Box 1114, Grass Valley, CA 95945 USA  
Telephone (916) 273-8421 TRT: 160432

OFFICES: Edison, NJ (201) 549-9600; Atlanta, GA (404) 321-4318; Elkhart, IN (219) 264-0931; Arden Hills, MN (612) 483-2594; Fort Worth, TX (817) 921-9411; Woodland Hills, CA (818) 999-2303; Palo Alto, CA (415) 968-6680.

Circle (6) on Reply Card

## The consensus: 1125/60

By Carl Bentz, technical editor

The world standard for HDTV should be 1125-line, 60-field with 2:1 interlace and an aspect ratio of 5.33:3, at least in the studio. This is the recommendation the U.S. contingent will offer to the other 156 member countries of the CCIR, when the organization meets in October.

The consensus comes from the SMPTE HDTV working group and the Advanced TV Systems Committee (ATSC). ATSC requests continued research on colorimetry, gamma, constant luminance and other parameters important to HDTV, as well as 60Hz 1:1 progressive scanning technology.

Thus, ATSC would follow NHK's lead in moving toward an HDTV system for the world. Although the progressive scan concept is actually preferred, the interlace approach would speed the adoption of a world standard.

The interlace process simply means that every other line is written to the screen during the first field. In the second field, the intermediate lines are traced to complete the image. The 2:1 interlace image is by far the most economical to generate at this time because the required circuitry already exists. Progressive scanning would necessitate circuit changes from current TV designs because the scanning requires wider bandwidths to accommodate the expanded frequency spectra involved. Scanning parameters will require altered RC time constants. Care will be needed to maintain strict linearity of both H and V signals.

Progressive scanning would also require radically different receiver designs. Specifically, digital concepts will be needed, including a frame buffer section.

Although digital TV receivers using interlace scanning have existed for several years, little has been shown outside of consumer electronics exhibitions. Most designs use complex ICs to process luminance and chroma with fewer tuned circuits. The result is more stable color, less component-caused multiple imaging and less noise.

An added benefit of digital processing is multiple picture in picture displays (MPIP). With MPIP formats, inset images would allow the sports fanatic to keep up with two or more events simultaneously. MPIP would also allow the viewer to scan quickly on each channel. Then, at

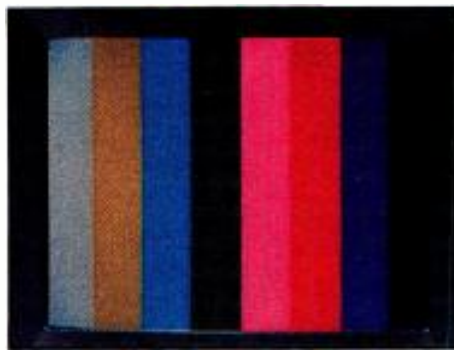

the touch of a remote-control button, the small inset picture fills the screen. The viewer may zoom in on a portion of the image for closer inspection.

### Beyond interlace

Put interlace aside for a moment. Consider a system in which every horizontal line is displayed in sequence. That is, each vertical scan of the tube is complete in itself. Progressive scanning allows such an image to be seen. Sixty complete pictures are displayed each second.

As the signal is received, it is demodulated to components and digitized at the 13.5MHz SMPTE-accepted sampling rate. In demonstrations, sampling is ac-

size and subsequent cost of the memory system. Some experimental designs use a digital CCD device to store one field, up to 308kbits of information. The technology to manufacture the necessary high-density devices is improving, but the yield is low and the cost is therefore high—too high, in fact, to allow a reasonably priced receiver.

A second point is motion display. Between field one and field two, an object may have moved. The amount of movement is made obvious if one compares sequential fields recorded on a videodisc system. In combining the two fields, movement could show the image displaced by several microseconds. The result is blur, a sure sign of motion, but unacceptable in an improved resolution system.

Point three involves a need to create

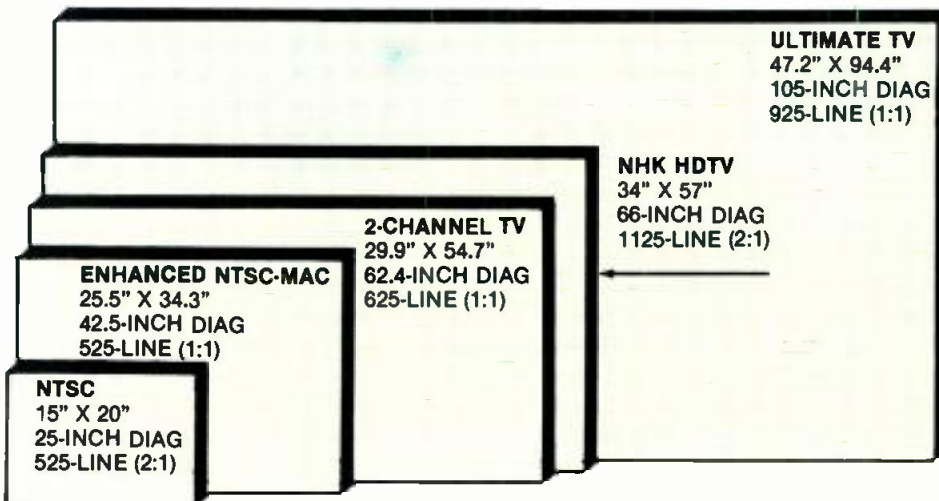

*If apparent vertical resolution is held constant, the size of the display can increase dramatically for HDTV and improved definition, as shown in this size comparison drawing. Figures in parentheses are interlace types.*

complished in a 4:1:1 Y/U/V format (PAL) and placed in very large-scale integrated circuit frame storage memory. Because the TV signal is serial in nature (random access is not absolutely essential), the memory architecture is simplified. Finally, stored data is clocked onto the screen at a rate of 60 images per second.

Several aspects of progressive scanning require further work. First is the

new lines in the image. When the complete picture is displayed each 1/60th of a second, we must either repeat frames or develop interim images. Repeating information could result in stepped motion. So the solution must be to interpolate *untransmitted* lines. Every time a field one is shown, field two must be the result of interpolation. Similarly, when field two lines are shown, field one must be generated.

In spite of the drawbacks, demonstrations of progressive scanning have been highly successful. The cost, however, is far beyond the resources of the general public, who could eventually make HDTV a success. [:(~:~)]



# Who's Pulsing the Editors?

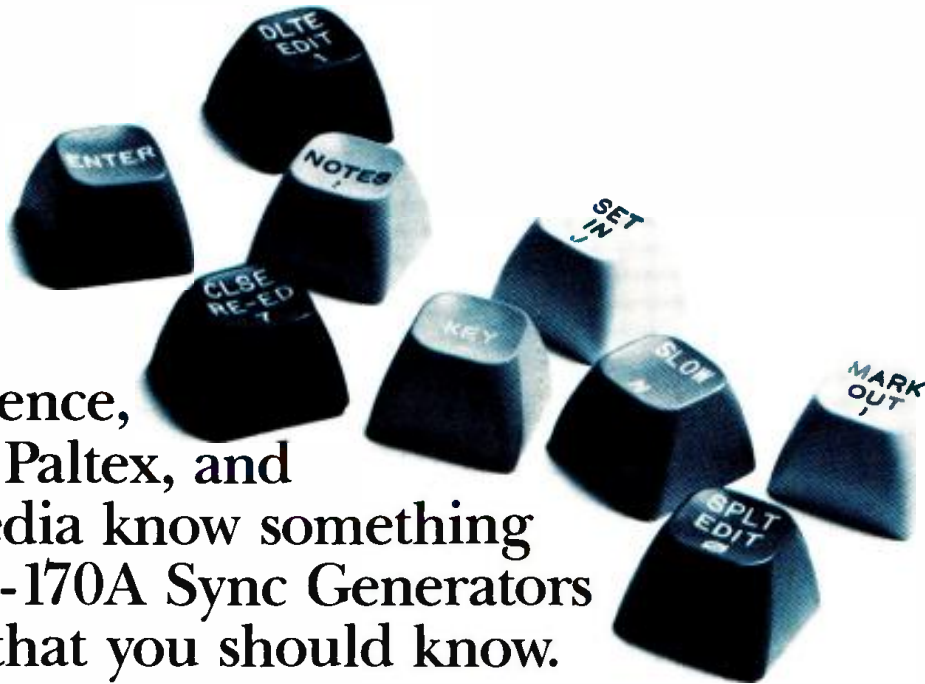

Convergence,  
CMX, Paltex, and  
Videomedia know something  
about RS-170A Sync Generators  
that you should know.

These and other leading manufacturers are committed to producing the ultimate in quality videotape editing equipment. How? By using the PMG-312 Master Sync Generator system to test and pulse their editing systems.

The complete dual sync system consists of a dual power supply frame, two RS-170A Generators, and an Automatic Changeover. The Automatic Changeover meters each generator pulse and DC voltage for fault indication. The PMG-312 offers chrominance subcarrier with an accuracy of .35Hz stability over a one year period. Subcarrier to horizontal phase relationship is maintained in reference to line 10, RS-170A. Black burst is optional. Professional broadcast quality at very attractive prices. Two year parts and labor warranty.

These manufacturers of editing systems know who's pulsing the system and now so do you. Is Lenco pulsing your editing equipment? Don't you think it is time we did?



300 N. Maryland St.  
Jackson, Missouri 63755  
Telephone: (314) 243-3147  
TWX 910-760-1382

Circle (7) on Reply Card

## Freedom reigns, but watch the details

By Bob Streeter, P.E.

Rule changes by the FCC have made possible the use of the AM transmission carrier for a wide variety of non-broadcast money-making services. Prior to the FCC action, the only permitted non-broadcast uses of the AM carrier were remote-control telemetry and utility-load management. This was rather restrictive in view of the subcarrier authority of FM and TV broadcasters.

The new AM rules allow almost anything, with only two restrictions: Non-broadcast uses of the carrier must not interfere with the station's main program channel and such uses must not interfere with the signals of other broadcast stations. Because there is no change in allowed station broadcast hours, the new service can be transmitted only in accordance with the station's licensed time and power restrictions. There are also specific rules governing common carrier services.

There are two basic methods of modulating an AM carrier: envelope and angular modulation. Either may be used for the new service. The FCC restriction on interference does, however, place certain limitations on how these modulation techniques are employed.

### Envelope modulation

In the case of envelope modulation, the subcarrier signal is added to the existing program audio and applied to the normal transmitter input. The modulating signals must be inaudible on the envelope program material and must not interfere with other stations. The restriction against interference to other stations prohibits the use of subcarriers above the audio-frequency band, because such signals would result in sidebands on adjacent channels. High-frequency subcarriers may not even pass through the AM transmitter and antenna system. FM and TV use subcarriers above the audio-frequency range; therefore, the equipment for those services cannot be used directly for AM.

Subcarriers in the audio-frequency band would cause direct interference to main channel programming unless they were held to a low modulating level, perhaps so low that the data signals could not be practically recovered. This

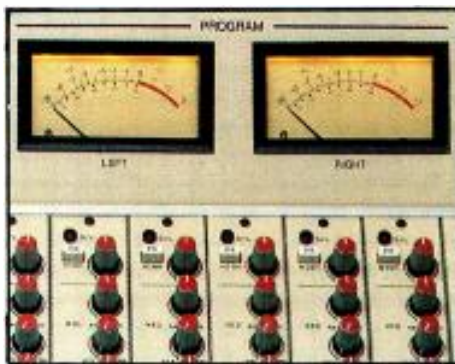

leaves only subaudible frequencies available for use and limits the data signal to slow-speed communications, because the energy to be transmitted must remain below the audio-frequency bandpass of the AM receiver. Such slow-speed subaudible tones are used for remote-control telemetry applications.

When using the envelope signal, remember that total envelope modulation is restricted to  $-100\%$  and  $+125\%$ . If you transmit a non-broadcast signal on the envelope, you must reduce the program audio modulation to stay within the peak modulation restrictions. The FCC, in authorizing the service, placed no modulation limits on non-broadcast subcarriers.

### Angular modulation

Angular modulation is a time variation of the RF-carrier frequency or phase. It is a general term referring both to FM and PM. This modulation method is used by all of the AM stereo systems to transmit the difference (L-R) signal.

If you are not now transmitting AM stereo, there is a treasure house of spectrum awaiting your use in this new service. To use this space, you must add equipment to the transmitter to angularly modulate the RF signal. It could be an AM stereo exciter, or a separate specialized unit.

Non-stereo stations have wide latitude in the types of information transmitted on the subcarrier channel. The signal need not be digital data as long as it does not cause interference to other services. Any AM stereo system can be used to angularly modulate the transmitter. The subcarrier information must be placed in the difference (L-R) channel. There are a few restrictions, however, that are aimed at preventing interference.

Super-audio subcarriers may not be used because of the interference they would cause to adjacent channels. As with envelope modulation, the additional information must not extend beyond the authorized AM bandwidth.

The subcarrier information could be placed in the audio portion of the difference channel. This would permit reasonably high data speeds or medium-bandwidth analog signals to be transmitted, conceivably at full equivalent modulation. Such applications, however, bring up a new set of problems that complicate the situation.

Although there will be no interference to the main program (envelope) channel when the transmitted signal is decoded using a wideband envelope detector, such as the station's modulation monitor, there may be interference when the envelope detector of an average AM receiver is used. Common narrowband

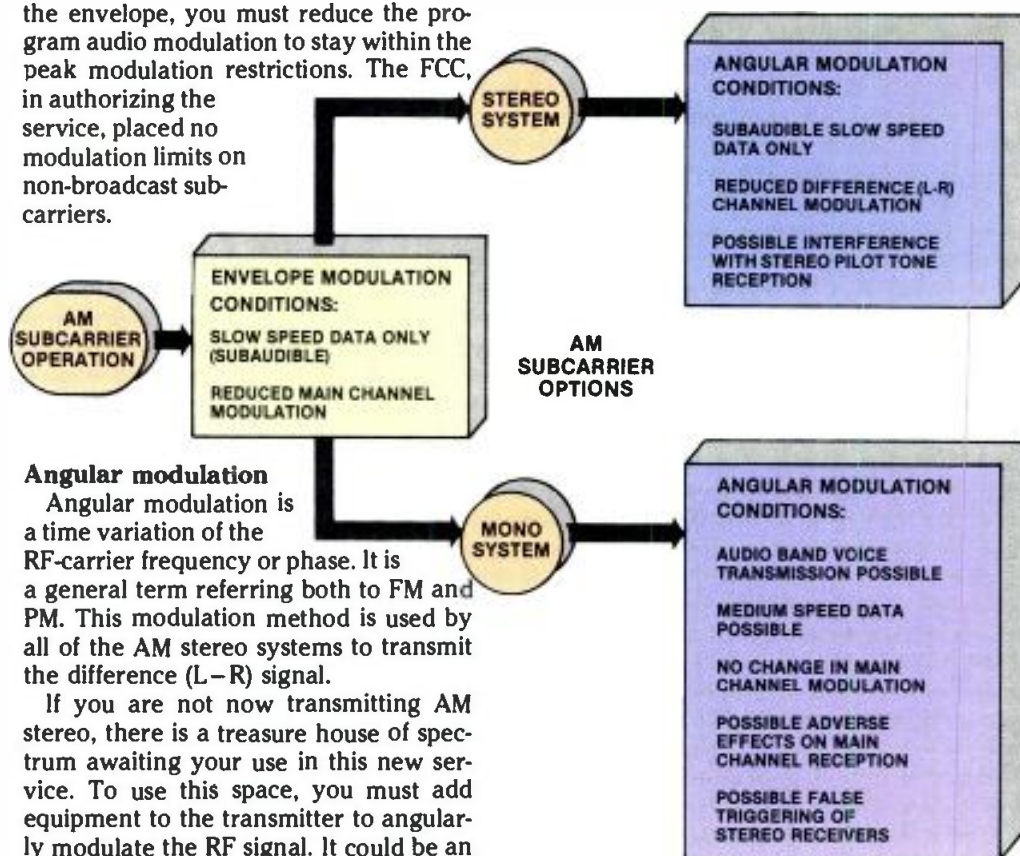

receivers will likely be plagued by crossmode conversion and mistuning effects, causing the non-broadcast signals (using angular modulation) to become a part of the main audio signal. Co-channel interference will have the same effect. The full extent of the interference process has yet to be determined, but we know it will depend on the non-broadcast signal characteristics, the design of the receiver and co-channel degradation. [:(~)]

Streeter is with the consulting firm of AM Stereo in Fort Wayne, IN. Information provided courtesy of Continental Electronics. Next month, we will examine the effect of an AM subcarrier signal on a station operating in stereo.





TOP OF THE LINE  
PROCESSING ...

## ... FOR BOTTOM LINE RESULTS.

Circuit Research Labs is proud to announce our latest system. It's the FM2 audio processor with the SG 800 Stereo Generator. This system will provide a substantial improvement in your on air signal. You will hear improved fidelity with better stereo separation. Best of all, you can improve the loudness of your signal as much as 6db compared to other processors.

With so many stations playing the same music it becomes very important that it sound the *best* on your station. It needs to be loud to maximize your stereo coverage. Put better sound and better coverage together and you have better ratings. And that can mean money in the bank.

Stations world-wide are discovering the advantages of CRL processing. But hearing is believing. Let us loan you the system of your choice for a free two week trial. Find out why broadcasters are upgrading to CRL. Radio stations all over America depend on CRL to give them their competitive advantage.

Why not give me a toll free call right now, and let me tell you all about it and send you complete information. It won't be long before another rating period starts, so don't wait.

**Call Bob Richards at  
800-535-7648.**

Circle (8) on Reply Card



**Circuit Research Labs, Inc.**

2522 W. Geneva Drive ■ Tempe, Arizona 85282

800-535-7648 ■ 602-438-0888

[www.americanradiohistory.com](http://www.americanradiohistory.com)

**SALE PRICED NOW  
FOR A LIMITED TIME ONLY**

## System keeps tabs on the right stuff

By John Kinik

The science and technology of satellite control has been so well perfected over the past 20 years that it is now possible, through highly accurate control of geostationary satellites, to maintain orbital station-keeping to a tight tolerance.

Typically, the satellites must stay within a box in the sky that measures less than  $0.1^\circ \times 0.1^\circ$ , as seen from the earth. To achieve this tolerance, satellite operators must conduct regular maneuvers, by means of controlled firing of small thrusters on the satellite, to correct for constant degradation of its orbit.

A nearly perfect geostationary orbit is attained after launch. Why does it degrade? Because the satellite is subjected to the combined gravitational forces of the earth, the sun and the moon. Also, force is exerted on the spacecraft by the *solar wind*, the stream of charged particles emitted by the sun.

In the early years of satellite communications (1965-1972), geostationary satellites serving the international community were allowed to drift in orbit about their assigned positions to an accuracy of within a few degrees. Because all earth stations operating with these satellites were equipped with sophisticated tracking systems, the loose station-keeping presented no problem.

Then, in the early 1970s, the first domestic satellite systems were established, and tight station-keeping became a fundamental system requirement because the majority of the earth stations had to be non-tracking in order to keep costs down. The methods developed at that time for satellite position determination and satellite position control are the basis for today's satellite control techniques. The following describes how satellites are controlled by an operating system.

### SBS satellite control system

Satellite Business Systems (SBS) maintains four Ku-band satellites (SBS-1, -2, -3 and -4) within very tight station-keeping boxes that measure  $0.06^\circ \times 0.06^\circ$ , as seen from the earth. SBS's system requirements for orbital position accuracy are more stringent than others because the traffic is predominantly digital, and a time-division-multiple-access (TDMA) technique is employed to share transponder capacity among various earth



stations in the network. The coordination of the timing of digital transmissions (*bursts*) from earth stations is critical; therefore, satellite position and motion must be maintained to tight tolerances.

SBS operates its satellites from a primary control center at Clarksburg, MD. It employs five tracking, telemetry and command (TT&C) antennas (one for each satellite, plus a backup antenna) at a facility with integrated electronics for telemetry reception, data processing and command transmissions to execute maneuvers. At the control center, R.J. Rugg, station manager, and 14 staff members perform an average of 14 maneuvers a week for the four satellites. The frequency of these maneuvers increases during the two annual solstices (late June and late December), when the satellites are subjected to the maximum gravitational forces from the sun and the moon.

### Orbit degradation

The two primary orbit degradations that occur are *orbit inclination*, deviation from true equatorial plane, and *orbit eccentricity*, deviation from true circular orbit at the geostationary distance of 22,238 miles. Another orbit degradation is *orbit drift*, a change in the distance from the earth to the spacecraft that results in an eastward or westward motion of the satellite.

### Maintenance maneuvers

The task of the satellite control facility is to maintain the satellite's position within the desired box by firing hydrazine thrusters on the satellite, according to instructions that result from computer-analyzed orbital position data. SBS obtains the data through constant logging of satellite range (exact distance from the earth) at the main control center in Clarksburg and a second facility in Castle Rock, CO. Computer analysis, employing station-keeping software and the consultation services of Judy Sauter, SBS mission analyst, provides the thruster firing instructions to the satellite control center.

In addition to the orbital position correction maneuvers, *attitude control* must be exerted over the satellite to maintain proper orientation with respect to the earth. The SBS satellites are spin-stabilized, spinning at a nominal rate of 55 rpm. The spin axis orientation is kept to within a  $0.13^\circ$  tolerance by regular firings of the thrusters, while the spin rate is maintained to within 3 rpm of the nominal spin rate. Because the satellite is spinning, the antenna must be *despun* in order to keep it pointed at the earth. The Hughes 376-B spacecraft used by SBS are designed with a despun platform, which includes the antenna and communications package. The spinning portion includes the attitude-control electronics, propulsion system, batteries and the solar cells that form the outer shell of the satellite.

In addition to being a backup to the primary control center, the Castle Rock facility performs another crucial function. The despinning of the antenna (and communications shelf) is controlled by means of a continuous beacon transmitted from Castle Rock, which is at the nominal geographic center of the uplink and downlink antenna beams. This system, employed on all Hughes satellites, maintains the critical pointing accuracy of the satellite antennas to within the limits necessary for communications links.

During the equinox periods, when the satellite goes through solar eclipse, the batteries must provide all of the power. This requires special reconditioning procedures several weeks before the onset of eclipse to prepare the batteries for their critical role. After the eclipse, the batteries must be recharged for nine to 10 hours.

### A slot in space

The satellite control center plays a major part during launches, by monitoring the satellite in transfer orbit and directing the firing of the *apogee kick motor* (AKM) that inserts the satellite into near geostationary orbit. The facility controls the satellite's drift through the orbital arc until it reaches its assigned orbital position, at which time normal satellite control procedures begin. Besides maneuvering its own satellites, SBS coordinates *fly-bys* of other satellites that have been launched and are being drifted to their proper orbital slots, to ensure that no collision occurs.

Kinik is a senior systems engineer for a satellite carrier service, and is BE's satellite correspondent.



# TAKE YOUR BEST SHOT

Otari's ARS-1000 Automated Radio Station Reproducer has taken just about everything that broadcast operation has thrown at it. From continuous day after day operation in hot, dusty corners — to cigarette smoke and coffee spills, an ARS performs automation tasks flawlessly and faithfully.



Born from Otari's line of heavy duty duplicating and loading equipment that moves tape at up to 480 ips, the ARS-1000 is engineered for continuous use, simple operation, and ease of maintenance.

Bulletproof? Of course not. But it is the kind of equipment that frees you to get involved in the real challenges of today's new, dynamic radio. Because you're not constantly fixing something that shouldn't have broken in the first place. From Otari: The Technology You Can Trust.

Contact your nearest Otari dealer for a demonstration, or call Otari Corporation, 2 Davis Drive, Belmont, CA 94002 (415) 592-8311 Telex: 910-376-4890

**OTARI**®



© Otari 1984

Circle (9) on Reply Card

## Basics count for coupling and loading

By Clarence Daugherty Jr.

Proper loading of a transmitter final stage to the output transmission line is critical to the dependable operation and optimum efficiency of the overall system. Before discussing how to troubleshoot the RF output section, a review of the principles that govern coupling and loading of 1/2- and 1/4-wavelength FM and TV cavity amplifiers is in order.

### Final stage coupling

Coupling refers to the methods used to transfer RF energy from the cavity that resonates the active power-amplifying device (the PA tube) to the output transmission line. Television RF power amplifiers use coupling to transfer energy from the primary cavity to the secondary cavity. Coupling in tube-type power amplifiers usually matches a high (plate or cavity) impedance to a lower output (transmission line) impedance.

Light coupling produces light loading and results in a high plate impedance; conversely, heavy coupling results in heavier loading and a lower plate impedance. Maximum output power, coinciding with efficient and acceptable dissipation, dictates a specific plate impedance for a cavity of given design. This plate impedance is also dependent upon the values of dc plate voltage ( $E_p$ ) and plate current ( $I_p$ ).

Plate impedance dictates the cavity parameters of loaded Q, RF circulating

Daugherty is a senior broadcast technology instructor for Harris, Quincy, IL.

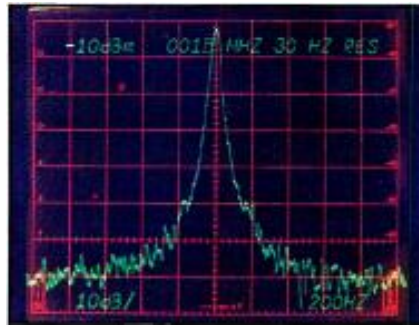

current and bandwidth. The relationships can be expressed as follows:

- Loaded Q is directly proportional to the plate impedance and controls the other two cavity parameters.

$$\text{Loaded } Q = \frac{Z_p}{X_L}$$

Where  $Z_p$  = cavity plate impedance  
 $X_L$  = cavity inductive reactance

- Circulating current in the cavity is much greater (by a factor of the loaded Q) than the RF current supplied by the tube.

$$\text{Circulating current} = Q (\times) I_p$$

Where  $I_p$  = the RF current supplied to the cavity by the tube

- The cavity bandwidth is dependent on the loaded Q and operating frequency.

$$\text{Bandwidth} = \frac{F_r}{Q}$$

Where  $F_r$  = the cavity resonant frequency

Both capacitive (electrostatic) and inductive (magnetic) coupling methods are used in cavity RF amplifiers.

### Magnetic coupling

Magnetic coupling employs the principles of transformer action. The efficiency of the coupling depends upon three conditions:

- The cross-sectional area under the coupling loop, compared to the cross-sectional area of the cavity. (See Figure 1.) This effect can be compared to the turns ratio principle of the transformer.
- The orientation of the coupling loop to the axis of the magnetic field. The coupling from the cavity is proportional to the cosine of the angle at which the coupling loop is rotated away from the axis of the magnetic field. (See Figures 2 and 3.)
- The amount of magnetic field that the coupling loop intercepts. The strongest magnetic field will be found at the point of maximum RF current in the cavity. This is the area where maximum inductive coupling is obtained. Greater magnetic field strength is also found closer to the center conductor of the cavity. Coupling, therefore, is inversely proportional to the distance of the coupling loop from the center conductor.

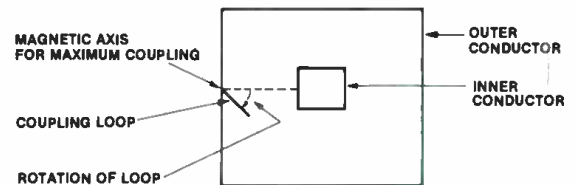

Figure 2. The top view of a cavity showing the inductive coupling loop rotated away from the axis of the magnetic field of the cavity.

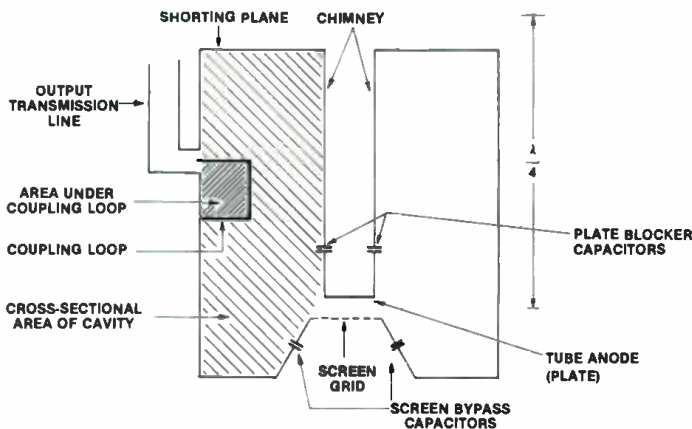

Figure 1. The use of inductive coupling in a 1/4-wavelength PA stage.

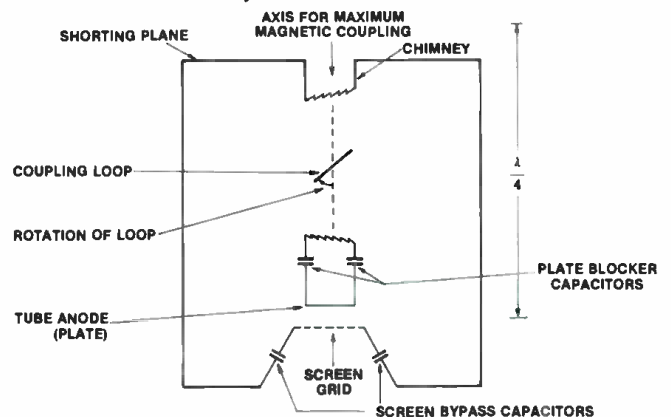
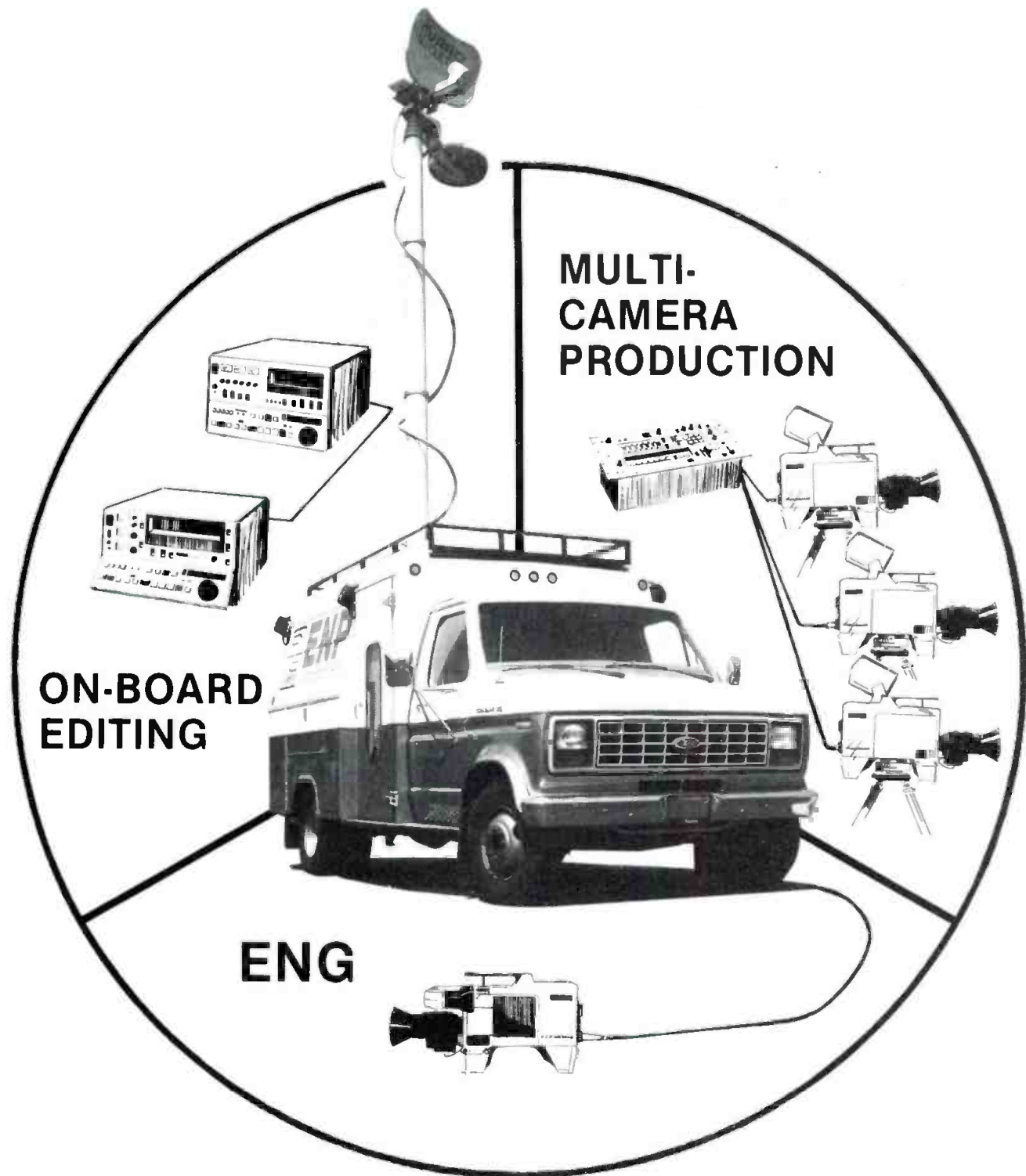

Figure 3. A cutaway view of the cavity showing the coupling loop rotated away from the axis of the magnetic field.





# ELECTRONIC NEWS PRODUCTION

**ENP** is Electronic News Production. This very versatile remote unit is equipped with on-board power generation, custom interior ventilation system, microwave transmitter, pneumatic mast and antenna. It is complete with many of Centro's custom suspension features and interior finishes.

The **ENP** remote unit is available fully equipped or ready for the installation of

your own existing electronics and equipment.

Centro's new **ENP** unit offers complete remote news capabilities including:

- Single Camera ENG Tasks
- Multi-Camera Production
- On-Board Editing
- Microwave Transmission

Circle (10) on Reply Card

(619) 560-1578

CENTRO CORPORATION  
9516 CHESAPEAKE DRIVE  
SAN DIEGO, CALIFORNIA 92123  
TWX: 910-335-1734 CENTRO SDG



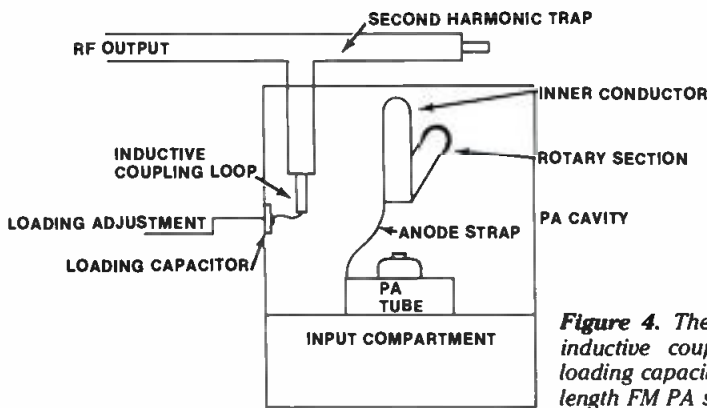
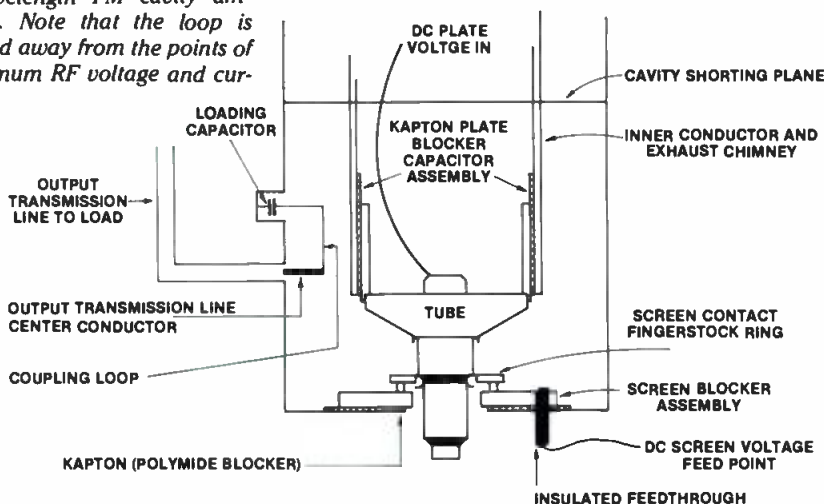

Figure 4. The location of the inductive coupling loop and loading capacitor in a 1/2-wavelength FM PA stage.

Figure 5. The position of the inductive coupling loop in a 1/4-wavelength FM cavity amplifier. Note that the loop is located away from the points of maximum RF voltage and current.



In both the 1/2- and 1/4-wavelength cavities, the coupling loop feeds a 50Ω transmission line (the load). The loop is in series with the load and has considerable inductance at VHF frequencies. The inductance will reduce the RF current that flows into the load, thus reducing the power output. This effect can be overcome by placing a variable capacitor in series with the output coupling loop, as shown in Figures 4 and 5. The load is connected to one end of the coupling loop and the variable capacitor ties the other end of the loop to ground. The variable capacitor cancels some or all of the loop inductance. It functions as the PA stage loading control.

Maximum load current and output power occurs when the loading capacitor cancels all of the inductance of the loading loop. This lowers the plate impedance and results in heavier loading.

Light loading results if the loading capacitance does not cancel all of the loop inductance. The loop inductance that is not canceled causes a decrease in load current and power output, and an increase in plate impedance.

### Capacitive coupling

Capacitive coupling, which physically appears to be straightforward, often baffles the technician due to its unique characteristics. Figure 6 shows a cavity

amplifier with a capacitive coupling plate positioned near its center conductor. This coupling plate is connected to the output load, which can be a transmission line or a secondary cavity (for TV service). The parameters that control the amount of capacitive coupling are: the area of the coupling capacitor plate (the larger the area, the greater the coupling) and the distance from the coupling plate to the center conductor (the greater the distance, the lighter the coupling). Maximum capacitive coupling occurs when the coupling plate is at the maximum voltage point on the cavity center conductor.

To understand the effects of capacitive coupling, the equivalent circuit of the cavity must be observed. Figure 7 shows the PA tube, cavity (functioning as a parallel resonant circuit) and output section. The plate blocking capacitor isolates the tube's dc voltage from the cavity. The coupling capacitor and output load are in series physically, but electrically they appear to be in parallel, as shown in Figure 8. The resistive component of the equivalent parallel circuit is increased by the coupling reactance. The equivalent parallel coupling reactance is absorbed into the parallel resonant circuit, thus, the necessity to retune after changing the PA stage coupling (loading). The coupling reactance can be a series capacitor or inductor.

The series-to-parallel transformations are explained by the following formula:

$$R_p = \frac{R_s^2 + X_s^2}{R_s} \quad \text{and} \quad X_p = \frac{R_s^2 + X_s^2}{X_s}$$

Where  $R_p$  = effective parallel resistance  
 $R_s$  = actual series resistance  
 $X_s$  = actual series reactance  
 $X_p$  = effective parallel reactance

### PA stage loading

Heavy loading lowers the PA plate impedance and cavity Q. A lower Q reduces the cavity RF circulating currents. In some cavities, high circulating currents can cause cavity heating and premature failure of the plate and screen blocking capacitors. The effects of lower plate impedance—a byproduct of heavy loading—are higher RF and dc plate cur-

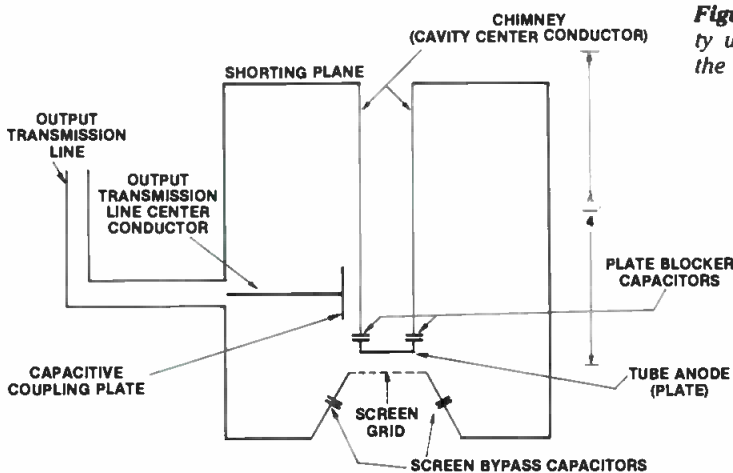

Figure 6. A 1/4-wavelength cavity with capacitive coupling to the output load.

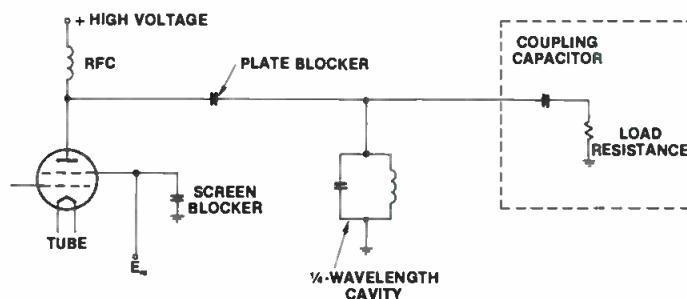

Figure 7. The equivalent circuit of a 1/4-wavelength cavity amplifier with capacitive coupling.



GEC McMICHAEL

# BROADCAST NEWS

## ADVANCED ANTENNA DESIGN/VIDEO COMPRESSION CREATES BREAKTHROUGH

### **New Portable Uplink Small Enough To Go Anywhere For Live Reports.**

Covering news events from "any" location in the world used to be an impossibility. Now it's a reality.

With GEC McMichael's unique Satellite News Gathering (SNG) FLY-AWAY, news events that previously could not be captured by existing television transmission systems can easily be covered "live," regardless of their location.

The entire FLY-AWAY system is compact and lightweight enough to be flown to remote locations in a private plane as well as by regularly scheduled airlines. Once on location, the SNG terminal can be quickly set up by as few as two men in 1/2 hour and powered by a hand-carried portable generator.

### **The entire FLY-AWAY system is compact and lightweight enough to be flown to remote locations in a private plane as well as by regularly scheduled airlines.**

The SNG terminal equipment is packaged in three shock-mounted aircraft enclosures. The majority of which weigh no more than 80 pounds. Since the weight and size of the system are so attractive, it can easily fit into an econoline-type van, allowing rapid deployment for live satellite coverage of local events.

Designed for portability and quick, efficient set-up, the FLY-AWAY is composed of GEC-McMichael's unique elliptical Ku band antenna, uplink Ku band electronics and McMichael's own video compression bandwidth electronics.

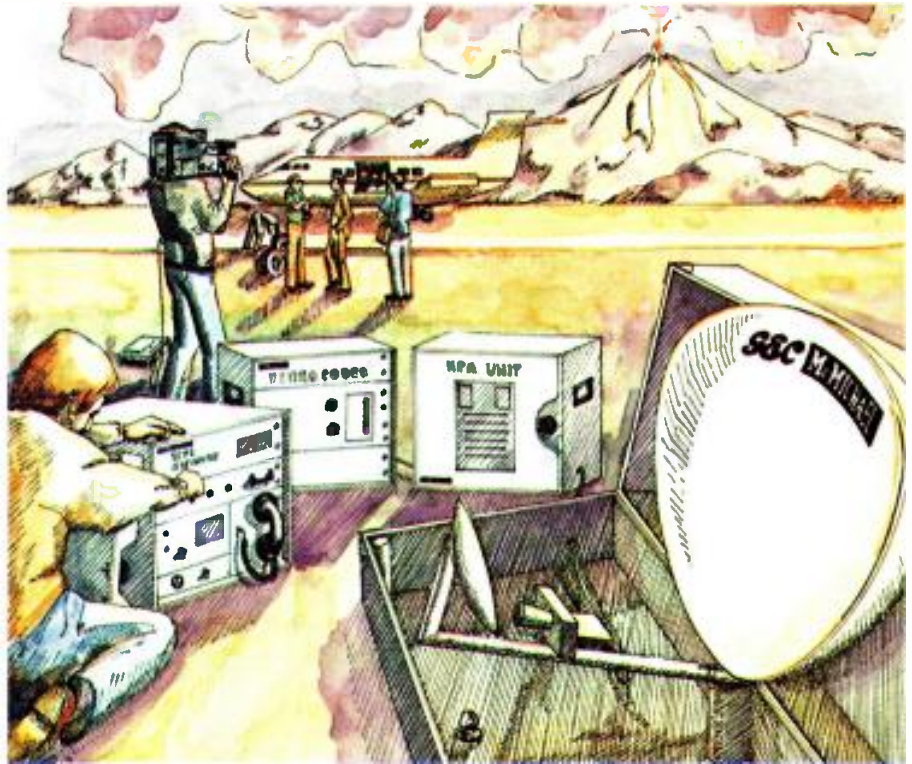

Each of the three shock-mounted containers which make up the SNG system measures 27" x 24" x 21". The total system including uplink/receive electronics, antenna and portable generator weigh no more than 500 pounds total. The one-piece offset gregorian-antenna measures 2 x 1 x .5 meters and weighs 90 lbs packaged. In order to ensure quick set-up time and retain critical surface tolerance enroute and during operation, the antenna reflector will remain in one piece.

The McMichael Ku band antenna is the heart of the FLY-AWAY system since it allows real-time transmission from anywhere in the world.

In the event of signal loss due to severe weather conditions or poor footprint locations, the GEC McMichael CODEC makes it possible for the operator to reduce the bandwidth. As a result, the system permits live video transmissions from any global location under practically any weather conditions.

GEC McMichael, a leader in Ku band satellite transportable technology in the United Kingdom and Europe for over 6 years, just recently introduced its line of broadcast products to the United States. The development of the portable SNG system resulted from the company's

expertise in Ku band transportable terminals, ACE standards conversion equipment and video bandwidth compression teleconferencing equipment.

**To date, there is absolutely no better way to beat the competition to the scene than with the new FLY-AWAY Satellite News/Data Gathering System. For more information about this exciting live/remote transmission breakthrough, please contact GEC McMichael 8260 East Raintree Drive, Scottsdale, Arizona 85260. Phone: 602/948-7255 TLX: 6502246202**

**GEC McMICHAEL**

**NOBODY DOES MORE WITH LESS SPACE**

Circle (11) on Reply Card to have a salesman call.  
Circle (12) on Reply Card to receive literature.

www.americanradiohistory.com

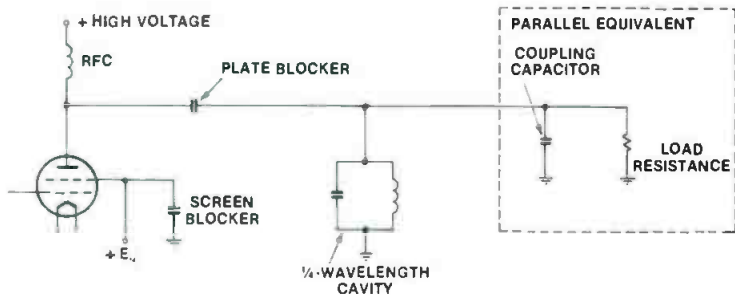

**Figure 8.** The equivalent circuit of a 1/4-wavelength cavity amplifier showing how the series capacitive coupling appears electrically as a parallel circuit to the PA tube.

rents and reduced RF plate voltage. The instantaneous plate voltage is the result of the RF plate voltage added to the dc plate voltage. The reduced swing of plate voltage causes less positive dc screen current to flow. Positive screen current flows only when the plate voltage swings close to or below the value of the positive screen grid.

There is one value of plate impedance that will yield optimum output power, efficiency, dissipation and dependable operation. It is dictated by cavity design and the values of the various dc and RF voltages and currents supplied to the stage.

#### Light loading

Light loading raises the plate impedance and cavity Q. A higher Q will increase the cavity circulating currents, raising the possibility of component overheating and failure. The effects of higher plate impedance are reduced RF

and dc plate current and increased RF and dc plate voltage excursions. The higher cavity RF or peak dc voltages may cause arcing in the cavity. The increased swing of the dc plate voltage will also cause greater dc screen current because the plate voltage swings will dip closer to or below the screen grid dc potential.

Depending on the cavity design, light loading may seem deceptively attractive. The dc plate voltage is constant (set by the power supply), and the lower dc plate current resulting from light loading reduces the tube's overall dc input power. The RF output power may change with light loading, depending on the plate impedance and cavity design, while efficiency will probably increase or, at worst, remain constant. Caution must be exercised with light loading however, because of the increased RF voltage and circulating currents that such operation creates. Possible adverse

effects include cavity arcing and overheating of cavity components, such as capacitors. The manufacturer's recommendations on PA tube loading should, therefore, be carefully observed.

#### Troubleshooting the cavity

It is much easier to prevent a failure in the output stage of a PA amplifier than it is to find the problem after it has occurred. Because the output section of a cavity amplifier is mostly a mechanical system, the tightness of all components must be checked on a regular basis.

Inspect all mechanical and electrical components in the cavity during each transmitter maintenance session. Look for signs of arcing or overheating of the various components of the cavity system. Check the tightness of all screws, clamps and connectors. Although all connections (mechanical and electrical) must be tight, do not over-tighten. Keep the output section free of dust. Use a clean brush and vacuum to remove any foreign matter from all parts of the cavity.

As we have pointed out in previous "Troubleshooting" columns, do not unnecessarily disturb the PA tube or other cavity components during the inspection or cleaning processes. If the stage is operating properly, simply clean what you can and make an overall visual inspection. As the saying goes, "If it's not broken, don't fix it." [:->)]

## "Flexibility and ease of operation; two reasons why KCPT automated with Alamar."

John Long  
Chief Engineer



KCPT Channel 19, Kansas City



- Station Automation
- Commercial Insertion
- Cart Machine Replacement
- Timed Remote Control
- Remote Monitoring
- Delayed Programming
- Movie Playback

**ALAMAR ELECTRONICS**  
Affordable Automation™

Alamar Electronics USA, Inc.  
36 Railway Avenue  
Campbell, CA 95008  
408/866-9373

Circle (133) on Reply Card



2100SC



## AUDIO CONSOLE PRODUCTS

Arrakis audio console products are designed by broadcast engineers for broadcasters at reasonable prices.

Our products sell themselves. Study our features, specs., and prices. Compare and you will find what thousands have found — The Arrakis Advantage —

### FEATURES

- VCA Faders
- P & G Sliders
- .01% Distortion
- Solid Oak Trim
- 10W/CH Monitor
- Remote Start
- Mix - Minus
- Modular Design
- Ultra-Reliable
- Mono Mixdowns
- Stereo Cue
- Full Muting
- Dimensions—  
30" W x 17" D x 7" H
- Weight—55 Lbs.

### MODELS

- 6 Channel Rotary
  - 150SC-6M \$1895
  - 150SC-6S \$1995
- 8 Channel Rotary
  - 500SC-8M \$3550
  - 500SC-8S \$3750
- 12 Channel Linear
  - 2000SC-12M \$4495
  - 2000SC-12S \$4695
- 12 Channel Linear
  - 2100SC-12M \$5495
  - 2100SC-12S \$5695

**arrakis**  
SYSTEMS, INC.



204 N LINK LANE, # 3  
FORT COLLINS, CO  
80524

(303) 224-2248

Circle (13) on Reply Card





# Radio's high tech talk

By Jerry Whitaker, editor

**Radio networks, once bound to earth by a maze of copper cable, have taken to the skies.**

Let's face it. When compared to the TV industry, radio has a hard time looking glamorous. Big-time television, armed with big-time money, is always coming up with new ways to dazzle its audience. Radio, however, is not without its triumphs. One of those triumphs certainly is the pioneering work in network distribution of audio via satellite.

Network radio was once only the domain of talk. The technical limitations imposed by thousands of miles of telephone cable were formidable. Frequency response of more than 5kHz was unlikely in the major metropolitan centers, let alone outlying rural areas. The limited response of the system, marginal noise floor level and distortion made network radio basically a medium for voice com-

munications. Music programs always left something to be desired, especially when carried on FM stations.

Satellite technology has, however, changed all that. Now, the link between the program source and the local radio station is essentially transparent. Not only has new technology allowed vastly improved system performance, but also has opened the door to new services for radio broadcasters.

## In the beginning

When television reached its golden age during the 1950s and '60s, some predicted the demise of radio, especially network radio. In point of fact, network radio has been pronounced dead several times by *experts* in the last three

decades, only to get up and keep going.

The formation of national networks and their growth is an exciting chapter in the history of broadcasting. The growth and prosperity of networks in the early days was linked tightly with the number of potential affiliates, as shown in Figure 1, page 26.

The giant RCA organization was the first company to recognize that the development of broadcast technology and management of broadcast services could best be performed by an independent organization. Accordingly, RCA set the trend in network formation by creating the National Broadcasting Company in 1926. The Columbia Broadcasting System (CBS) was formed one year later.



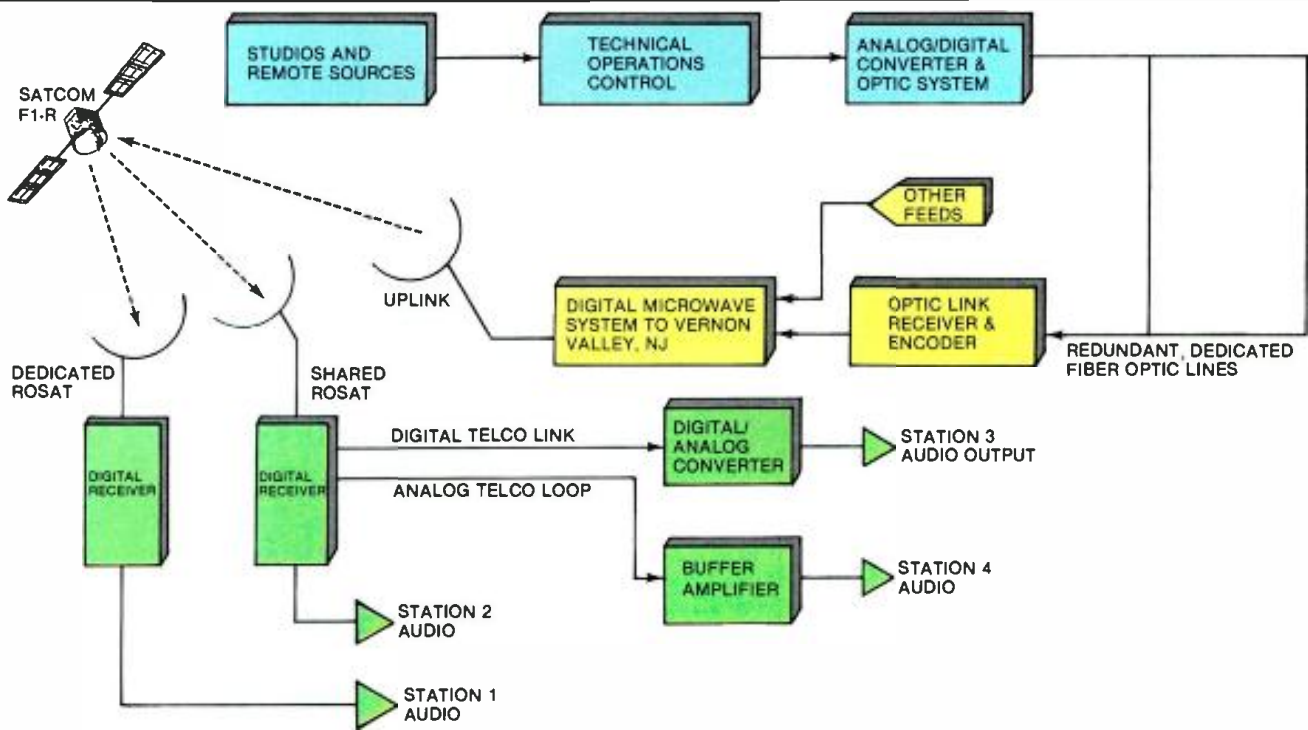

In 1934, the Mutual Broadcasting System was created to serve the increasing number of radio stations in existence at that time. During the 1940s, two additional radio networks were founded, the DuMont Network and the Liberty Broadcasting System. They played an important role in the broadcast industry of their time, but later bowed to the giant networks and their well-established affiliates.

In 1943, Edward J. Nobel bought the NBC Blue Network (one of two radio networks operated by NBC at the time). He renamed it the American Broadcasting Company two years later. In 1953, the company was merged with Paramount, and ABC—as we know it today—was born.

The development of satellite technology has made possible the creation of many new radio networks. Satellites also have reshaped the concept of a network from a complex wire-connected system to a simple point-to-point group of affiliates that draws from various satellite channels as needed.

This flexibility would be impossible using any other distribution method, with the exception of fiber-optic transmission (not practical at this time).

#### ABC makes the move

The transition from a Telco-based distribution system to the satellite link has brought dramatic changes for at least one major radio network, ABC. The network is currently putting the finishing touches on a new broadcast center that handles all of its own program feeds.

The center, located on the west side of Manhattan, is billed as the largest and most sophisticated commercial radio facility in the world. The 40,000-square-foot plant houses state-of-the-art studios and technical facilities designed for multiple transmissions to ABC's 1800 U.S. radio affiliates. In the planning and construction stage for more than three years, the new center employs a permanent staff of more than 200. The facility operates 24 hours a day, seven days a week.

The new network headquarters was planned from the ground up to serve the requirements of a major satellite-based program supplier. Equipment needs were carefully weighed with the requirements of the occupants for easy access to news feeds, air studios and production equipment. ABC gutted an existing building and began construction. The network was fortunate enough to be able to continue operation from existing facilities while the new plant was being built.

#### Technical facilities

There is a total of 13 studios at the plant. They are clustered around the work areas they serve, such as the newsroom or sports department. Two of the studios were designed for floating floors, walls and ceilings for an acoustically isolated environment. Creating this environment, however, was no easy task.

In order to achieve the required acoustical isolation, a concrete block exterior wall was built around the two

studios, extending from the floor slab to the ceiling slab. Within this concrete box, a 4-inch slab was poured and floated on springs. Acoustic double-width walls were then constructed using a floating arrangement so that the inside slab would not touch the outside concrete wall at any point.

The ceiling is a 3-tiered arrangement that completes the room-within-a-room structure. The first ceiling is attached to the slab above. The second ceiling is hung on springs a short distance below that. The perimeter of the second ceiling includes a soft liner that acoustically seals the ceiling, preventing the transfer of sound energy into the floating room. The third ceiling is a standard suspended acoustical drop grid system.

The floating studios are used for stereo concerts, and inside or outside commercial production. These areas are currently undergoing final equipment installation.

The newsroom is designed around the *work station* concept. The stations are semi-custom designs, having been used at the ABC News Washington bureau and other network operation centers. The layout of each work station was given careful consideration during the facility planning stage. The primary objective was to give workers the ability to perform all required functions without moving from their operating positions.

The newsroom is fed by a 52-channel cable feed from the TV network operations center across town. This cable system will be used in the future to distribute network audio around New

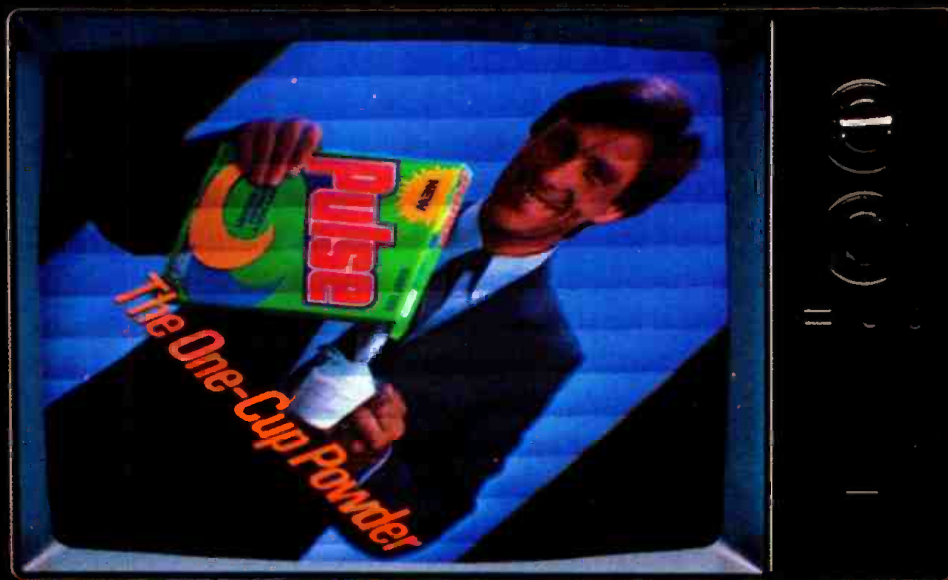

What you see above is yet another installment of TV's longest-running horror series: "The Lost Commercial."

The villain is the antiquated 2-inch cart machine—notorious for making valuable commercial air time vanish into thin air. And its appetite for destruction seems endless. Statistics show it's not unusual for a station to squander upwards of \$15 million yearly on makegoods alone.

But the nightmare is ending. Because Sony announces the first real advance in cart machine technology in over a decade. The new Betacart™ multicassette system.

#### THE CART MACHINE VS. THE SMART MACHINE.

What the old cart machine tried to do by mechanical means, the Sony Betacart achieves through superior intelligence.

Microprocessors keep constant track of 40 cassettes. They maintain the alignment of the system's four BVW-11 decks and its elevator. They run self-check diagnostic routines.

And, in the belief that an ounce of prevention is worth many times its weight in makegoods, they solve problems before they occur—such as warning a technician that he's about to remove a cassette that's due to air shortly.

The Betacart is communicative in other ways, too. It's smart enough to guide your technicians through its operation, and will even interface directly with your station's main computer.

#### MAINTAINING MACHINERY VS. MAINTAINING PROFITS.

The end result of all this electronic



# THE MACHINE INSPIRED BY BILLIONS OF DOLLARS WORTH OF COMMERCIAL FAILURES.

sophistication is the kind of mechanical simplicity that virtually eliminates breakdowns—not to mention the makegoods, excessive downtime and high maintenance costs that are generally part of the package.

And, as its name implies, the Sony Betacart uses Betacam cassettes—which cost less than a third of what 2-inch cartridges cost. Its format also makes the system ideal for ENG use during newscasts—thanks to its compatibility with the Betacam™ camera/recorder, along with its multiple video and audio outputs and freeze/instant-start capabilities.

All these advantages, plus its low initial cost make the Sony

Betacart multicassette an investment that will pay for itself quickly. And it will keep paying off in new ways. Its stereo capability, for example, will allow you to capitalize on the coming introduction of stereo TV broadcasting.

For more information, call in New York/New Jersey (201) 833-5350; in the Northeast/Mid-Atlantic (201) 833-5375; in the Midwest (312) 773-6045; in the Southeast (404) 451-7671; in the Southwest (214) 659-3600; in the West (213) 841-8711.

After all, to err may be human. But there's nothing divine about having to forgive a machine.

**SONY**  
Broadcast

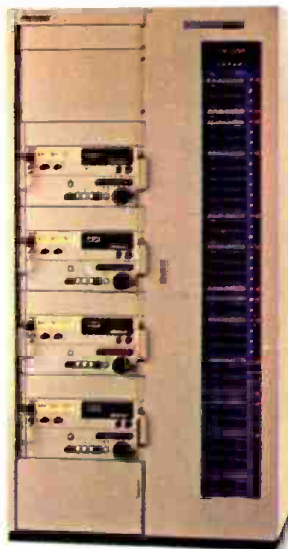

York City using FM modulators on a closed-circuit basis. The news center can monitor a variety of feeds, including satellite transmission return. News work stations include a video display terminal so that supervisory personnel can monitor the operation of each satellite channel. Every desk has audio monitoring facilities, auxiliary speakers and a routing switcher that can access any one of 200 feeds. Any news desk can be put on the air, if needed.

The ability to communicate easily within the plant and between the network headquarters and one or more remote locations is of critical importance to any news or sports operation. The New York facility intercom system allows access to 48 different locations and 24 IFB (interrupted program feed) lines from as many as 72 outside locations.

Getting a signal from here to there is often no easy task. ABC Radio uses a combination of land-line audio loops and satellite channels to tie its program origination centers together. Various common carriers (AT&T, U.S. Tel & Tel and others) link the New York headquarters to the Washington news bureau.

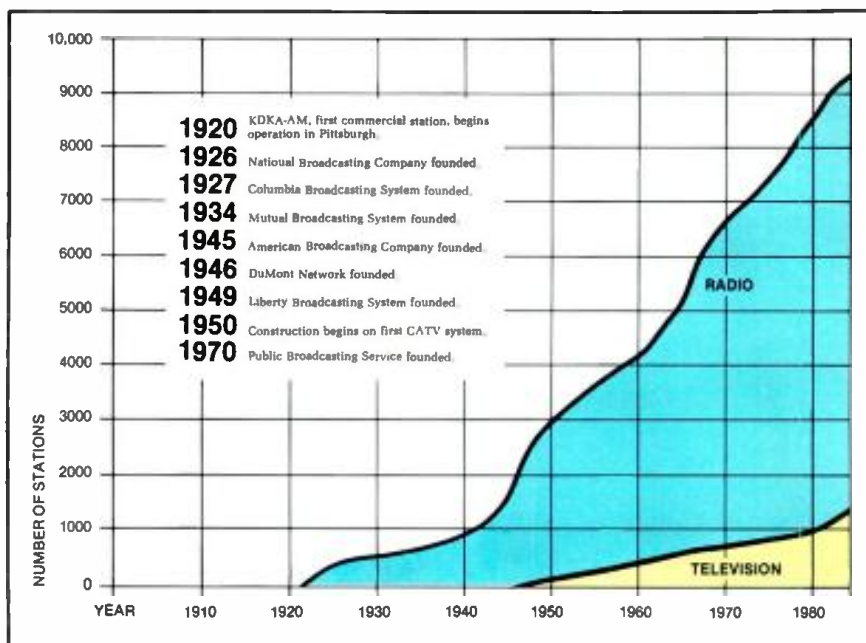

Figure 1. The growth of radio and TV networks in the United States.

A Western Union satellite channel is used between New York and Chicago, and a separate satellite link ties New York to Los Angeles.

The network is currently studying the feasibility of operating its own T-1 wide-band fiber-optic link between New York and Washington for program audio and

data transmission. A fiber-optic system will give the network flexibility in how channels are assigned. The channels can be divided into whatever configurations are required, such as high-quality 15kHz lines, medium-quality 8kHz lines, voice quality 3kHz lines or data-only lines. The network plans to buy and to operate the



Model 616 ESAM — 16 Input Mixer with Optional Equalizer

- 12, 16 or 20 inputs
- Editing system control integration
- Audio follow video capability
- Full manual control
- OUT OF PHASE warning system
- PPM or vu meters
- Optional programmable equalizer system

## 600 Series Edit Suite Audio Mixers

The 600 Series Edit Suite Audio Mixers from Graham-Patten Systems offer the most **Powerful** audio control system available for television post production in a **Compact** package that can be surface mounted in a variety of configurations.

**Powerful** — The video editing system can control any assigned input or combination of inputs as well as transitions and transition rates. An optional 5 Band programmable equalizer system with a serial port and up to 12 memory registers further expands the 600's capabilities.

**Compact** — The control panel, meters and electronics are in separate packages allowing flexibility in installation and operation. The Model 616 control panel with equalizer measures only 12 1/4" x 24" and requires only 6" of rear panel clearance.

For further information, call:



**GRAHAM-PATTEN SYSTEMS, INC.**  
P.O. Box 1960, Grass Valley, CA 95945  
916/273-8412

Circle (24) on Reply Card



# CLARITY

The purity of images  
attained from the  
absence of distortion  
or imperfections.  
Purity from using only  
premium magnetic  
materials and the most  
advanced production  
techniques. Purity  
resulting in a video  
tape of magnificent  
clarity. Ampex 196.

**AMPEX**

Ampex Corporation • One of The Signal Companies

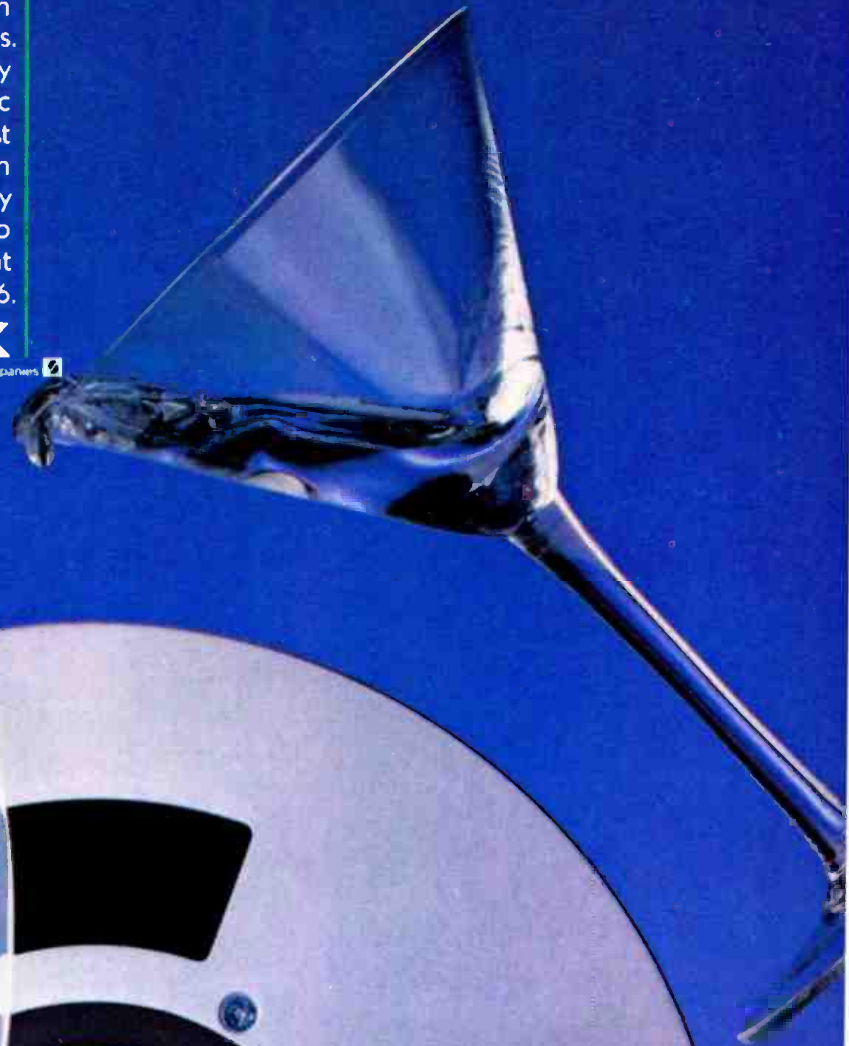

**AMPEX**

VHS

Ampex Corporation, Magnetic Tape Division, 401 Broadway, Redwood City, CA 94063, (415) 367-3809

Circle (56) on Reply Card

head-end equipment on its own, further cutting restrictive ties with the land-line telephone services.

Computer terminals are located throughout the plant. Each studio and office has (or soon will have) a terminal for system programming, status interrogation and/or word processing. The commercial schedules for the seven program channels (networks) operated by ABC are controlled by a central system that also handles all program audio switching, tone burst signaling and system machine control. Complex automation of the network operation is necessary because of the complexity of the job being performed. The network operates six full-service networks and ABC Talkradio. Each has its own schedule of programs and commercial announcements.

Facility automation has resulted in fewer on-air problems and errors. With centralization of control, however, comes the threat of a catastrophic failure due to computer downtime. For this reason, backup hardware has been in-



*Before*



*After*

*The outer masonry walls of studios 12 and 13, the floating production facilities.*

*The ABC Radio newsroom. Note the extensive use of video monitors.*

## VIDEO TAPE PROBLEMS ?

### RECORTEC THEM AWAY !

How good are the tapes in your library? Some of them may be bad enough to throw away. Is it safe to use them again? Are any of them reclaimable? Settle all these questions easily with a **RECORTEC VIDEO TAPE EVALUATOR** for any one-inch tape. Extend your tape life with regular cleaning and conditioning.



The VTE-102 is for 1" reels 90 minutes max.  
The VTE-103 is for 1" reels up to 3 hours.

**3/4-Inch Evaluators are also available.**

**RECORTEC, INC.** 275 Santa Ana Court, Sunnyvale, CA 94086 (408) 737-8441 TWX: 910-379-5022

Circle (14) on Reply Card



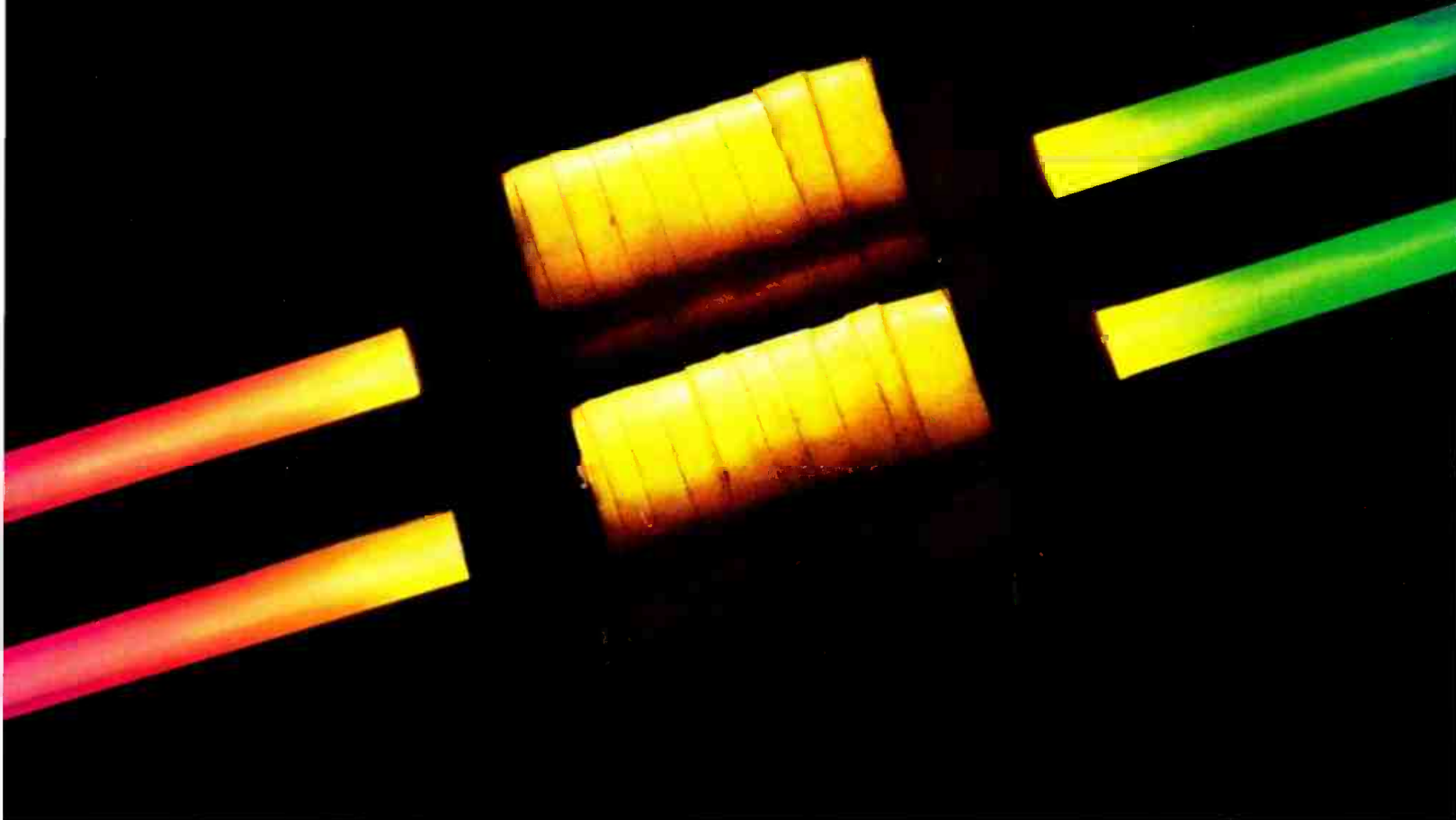

*Our painstaking vacuum and coil-winding technology increases efficiency and eliminates acoustical "buzz."*

## OUR SCIENTISTS HAD TO OPERATE IN A VACUUM TO GIVE YOU A NEW QUALITY OF SOUND.

The quality of any sound system begins at its source. Precision in the power supply is vital to capturing and maintaining the fullness and subtlety of amplified sound. The need for that exactness is why we insist on operating in a vacuum rather than depending on outside sources.

A vacuum tank, to be precise. An environment in which our transformer is created with an air expulsion process. Where air pockets are purged from multi-layers of the transformer's high grade core laminations, and the core made airtight with a special impregnating sealant.

This process gives us impeccable control of transformer function and quality. Which gives you the assurance of the most efficient transfer of power possible, and an end to the acoustical "buzz" that so often fights sound purity.

To a lot of manufacturers the lowly transformer is far down on the list of priorities. For us, every element in the sound system relies on the exacting performance of every other element, and must be painstakingly attended to.

Whether you're driving your studio monitors in a demanding final production mix with our 6000 Series amplifiers, or making critical adjustments to signal quality with our peak or RMS limiter/compressors, you'll find our audio science giving outstanding clarity to your work. To find out which system is designed to meet your needs, contact your authorized JBL/UREI professional products dealer today.

JBL Incorporated,  
8500 Balboa Boulevard  
P.O. Box 2200,  
Northridge, CA 91329  
U.S.A.



**UREI  
ELECTRONIC  
PRODUCTS**

JBL / harman international © JBL INCORPORATED 1984

Circle (15) on Reply Card

June 1985 *Broadcast Engineering* 29



stalled to prevent a system crash due to equipment failure.

The network uses a 20-channel digital audio distribution system to feed its 1800 affiliates. Nineteen channels are assigned to high-fidelity (15kHz) audio programming. The remaining satellite channel is reserved for voice commands and data distribution over the network. The data channel is subdivided into 12 narrow-band channels, seven of which are used for 1-way voice communications to affiliates and five for data transmission to stations.

Audio program material is digitized into a fiber-optic T-1 format before leaving the ABC plant. Dual (redundant) fiber-optic lines, routed underground via different paths through New York City, tie the facility with a central microwave transmission site several miles away. At the microwave link, the ABC signals are multiplexed with similarly formatted data from other radio networks and relayed to the satellite uplink facility in Vernon Valley, NJ.



*Before*



*After*

*A typical mono studio during construction at the ABC plant (left) and near completion (below).*

## A component for every camera. A tube for every transmitter.

Our purpose is clear: to provide the ultimate source for all broadcast related tubes and components. We've geared our entire distribution system to ship virtually every order the same day. Our highly personalized service and technical knowledge is legendary in the industry. Best of all, because of our large volume buying, Calvert has the lowest prices – and cannot be undersold.

**PRODUCTS:** Cathode Ray Tubes • Diodes • Klystrons • Monitor Tubes • Plumicons • Receiving Tubes  
RF Ceramic Capacitors • RF Transistors • Saticons • Solid State Replacements • Transmitter/Power  
Tubes • Tube Sockets, Accessories • TV Linear Devices • Vacuum Capacitors • Vidicons • Vistacons

**MANUFACTURERS:** Acrian • Amperex • Cetron • EEV • Eimac • GE • Hitachi • ITT • ITT Jennings  
Machlett • National • Philips • RCA • Raytheon • Thomson-CSF • Varian • Westinghouse

Call our Toll Free number now and start saving. **800-526-6362**

**CALVERT ELECTRONICS, INC.** 

One Branca Road, East Rutherford, NJ 07073 • 201-460-8600 • Telex 423205 CALV • TWX 710-989-0116  
Circle (131) on Reply Card





# KEY PERFORMANCE



**Performance and Design simplicity enhance Command Decisions.**

Horizon International introduces System Four, a computer assisted video editing system that combines creative engineering and user experience to produce a unique video editing system. System Four offers a five year warranty, is user compatible with CMX, ISC and Mach 1, has edit list for 850 events, includes a printer, and has provision for optional paper tape. It controls a combination of video and dual audio tracks from keyboard or track ball. The Horizon's System Four has bi-lingual capability in Spanish or English. This straight line approach to performance editing provides a key decision for a realistic investment.

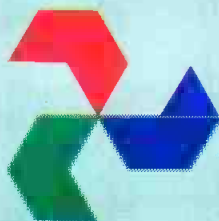

Select  
Representative Territories  
Available

HORIZON International • 3837 East Wier Avenue, Ste. 1 • Phoenix, Arizona 85040 • Phone 602/437-3800 • Telex 322043

Circle (16) on Reply Card

June 1985 *Broadcast Engineering* 31

**Cetec Antennas**  
EXCELLENCE  
IN ANTENNAS

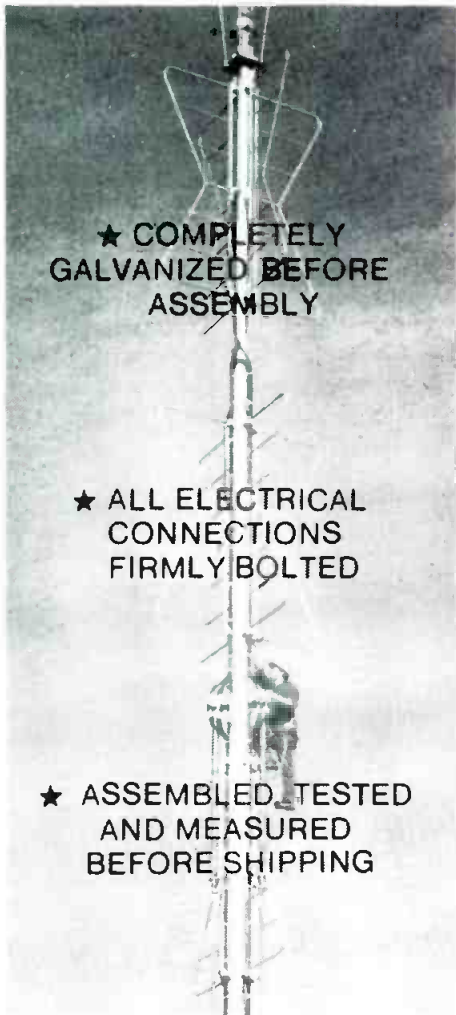

★ COMPLETELY GALVANIZED BEFORE ASSEMBLY

★ ALL ELECTRICAL CONNECTIONS FIRMLY BOLTED

★ ASSEMBLED, TESTED AND MEASURED BEFORE SHIPPING

★ TWO YEAR WARRANTY  
★ BEAM TILT & NULL FILL

FOR A STANDARD BATWING OR A CP SPIRAL ANTENNA, YOU SHOULD GET THE CETEC PICTURE. EXCELLENCE IS ALL WE DO!

CHECK WITH FACTORY SALES OR YOUR FAVORITE DEALER

**Cetec Antennas**

USE CETEC ANTENNAS  
THE EDGE  
IN EXCELLENCE  
6939 Power Inn Rd.  
Sacramento, CA 95828  
(916) 383-1177  
TELEX 377321

Circle (17) on Reply Card

The digital satellite transmission system used by ABC and other major radio networks provides for 15kHz bandwidth program audio, sampled at a rate of 32kHz. An electronic analysis of each 15-bit sample determines which bits may be considered insignificant. As a result, 15-bit words are shortened to 11 bits in a digital companding stage. A parity bit is then added, resulting in a 12-bit word length for each audio channel.

**The satellite link**

ABC and other networks use the advanced Satcom F1-R satellite for transmission of programming to affiliate earth station receivers. The F1-R spacecraft circles the earth in a 22,300-mile geosynchronous orbit. The Satcom satellite includes 28 individual 8.5W RF solid-state power amplifiers (SSPA) and four electronic power conditioners (EPC). Each EPC contains two power converters that feed six SSPA units on common buses. Redundancy provisions include three power conditioners for each two required and seven SSPAs for each six required.

Previous satellite designs used traveling wave tube amplifiers (TWTAs), rather than solid-state systems. Advantages of SSPA include greater reliability, simpler power supply requirements, improved phase linearity characteristics and improved carrier to third-order intermodulation performance.

*Continued on page 36*

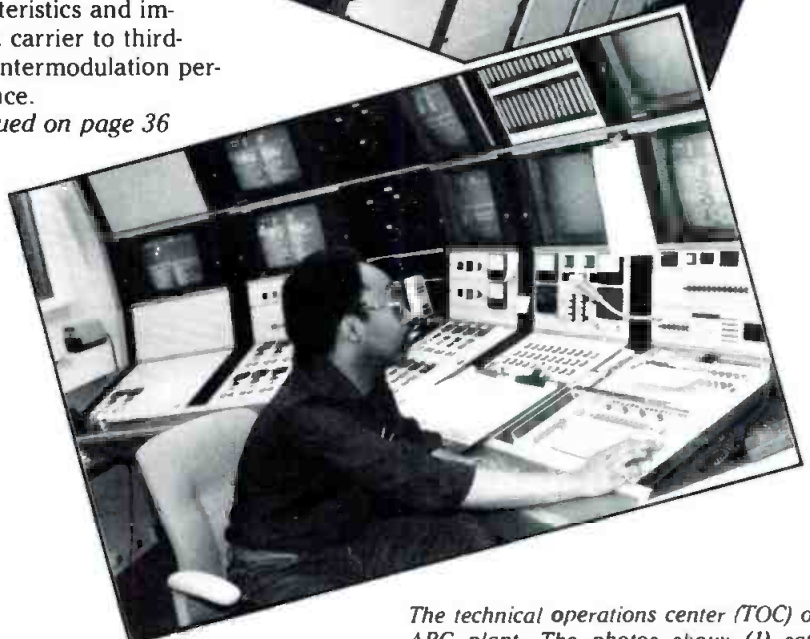
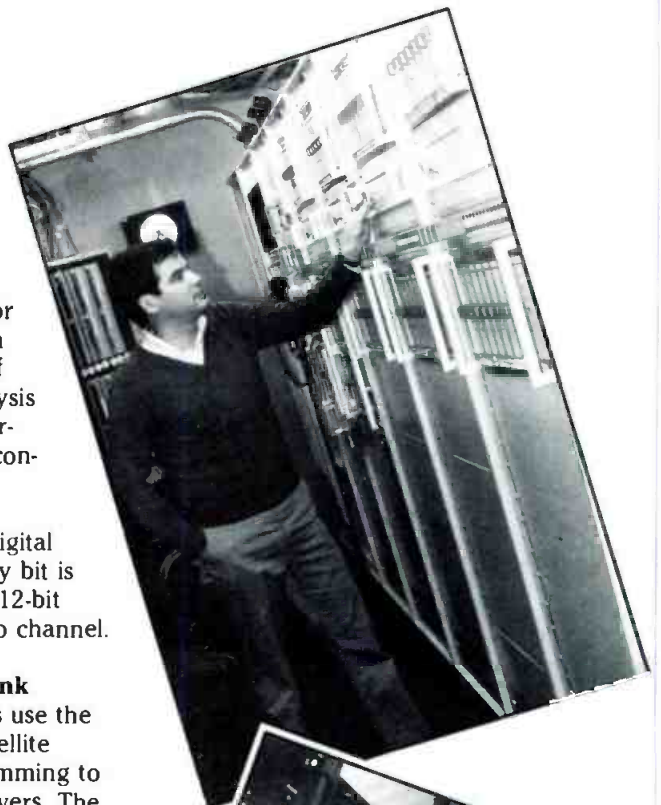

*The technical operations center (TOC) of the ABC plant. The photos show: (1) satellite transmission and monitoring equipment (2) commercial cartridge playback bays and (3) the TOC control console.*



Hugh Falls, VP Engineering, Radio Free Europe, Munich, stands beside CE 100 kW HF transmitter using EIMAC 4CV100,000C tube.



# EIMAC tubes provide long life for Radio Free Europe Service.

Radio Free Europe transmitters in Biblis and Lampertheim, West Germany, use EIMAC 4CV100,000C power tubes in 12 Continental Electronics 100 kW HF transmitters.

The station logbook shows most tubes have over 50,000 hours of service, and many tubes logged over 60,000 hours! And EIMAC tubes are still running strong—that's long life!

These figures are representative of the long life EIMAC tubes log in a variety of high power broadcast applications.

Take advantage of proven reliability, longest warranty in the industry and 50-year expertise. Choose EIMAC, the world's foremost manufacturer of high power broadcast tubes.

Call Varian EIMAC or contact any Electron Device Group sales organization worldwide.

Varian EIMAC  
301 Industrial Way  
San Carlos, CA 94070  
Telephone: 415 • 592-1221

Varian AG  
Steinhauserstrasse  
CH-6300 Zug, Switzerland  
Telephone: 042 • 23 25 75



SITE: Biblis MONTH: Up to December, 1984

TYPE	IN SERVICE		SPARES		REMARKS
	Serial	Hours	Serial	Hours	
4CV 100,000C	A6N-413	62660			
	A6N-415	68879			
	E6G-265	61829			
	E6G-270	59636			
	E6N-597	62456			
	G6R-896	59246			
	H6E-283	55892			
	H6J-368	64300			
	H6T-890	59472			
	P6Q-624	64066			
	GSD-155	62554			
	H6J-367	55907			
	H6J-371	59991			
	J6A-2	57805			
	D6V-817	42279			
	F3Q-730	59386			
	D6V-815	41416			
	E6G-273	47349			
	J6A-7	59067			
	E6G-266	57026			
	F6W-1297	57865			
	H6C-161	26683			
	J6A-6	31752			
		49355			



Circle (18) on Reply Card



**Multimedia Entertainment wanted us at Midwest to...**

deliver all the big hits – the game winning RBI's, plus stage shows, concerts and hit specials – from any location, at any time. We designed and constructed Eagle 1, 47 feet of production capacity with more versatility than any mobile unit on the road today. What makes it the biggest hit are fine components like:

- Ikegami HK-357AT Automatic Color Cameras that set the standards for picture resolution, signal to noise ratio and registration accuracy.
- Ikegami HL-79EAL, the hand held cameras that produce higher quality images than many other manufacturers' studio models.
- Ikegami 9-Series Color Monitors renowned for superb resolution and amazing life-like colors and high stability, unit changeability, and low power consumption.



# *Midwest and Ikegami*





This dedication to quality and versatility is evident throughout the unit. We used our 20 years of engineering experience to integrate these excellent components into complete systems that could handle any assignment.

The equipment package includes:

- Five Ikegami HK-357AT Cameras with Triax and Canon 40:1 Lenses.
- Two Ikegami HL-79EAL Cameras with Canon 13:1 Lenses.
- 24-Input Grass Valley 300/3A Production Switcher.

- Four Ampex VPR-2B One Inch Tape Machines with Slo-Mo.
- One Sony BVU-820 ¾" VTR with Slo-Mo.
- One Sony BVU-800 ¾" VTR.
- One Beta VTR.
- Harris HDE-200 Digital Effects System.
- Adda ESP II Still Store System.
- Auditronics 36-Input Stereo Audio Console.
- Chyron 4100 Graphics Generator.
- Two Adda VW2 Frame Synchronizers.

Eagle I is delivering the big hits for NBC and Sports Time Cable Network. In fact, because of its diverse capabilities, other networks and companies are leasing it as well.

For the large scale teleproduction unit or any other communications system, do what Multimedia did. Call on Midwest. We'll deliver a big hit for you. For further information about leasing the Eagle I, contact Bill Spiegel at Multimedia Entertainment 513-352-5065.



# *deliver another big hit!*

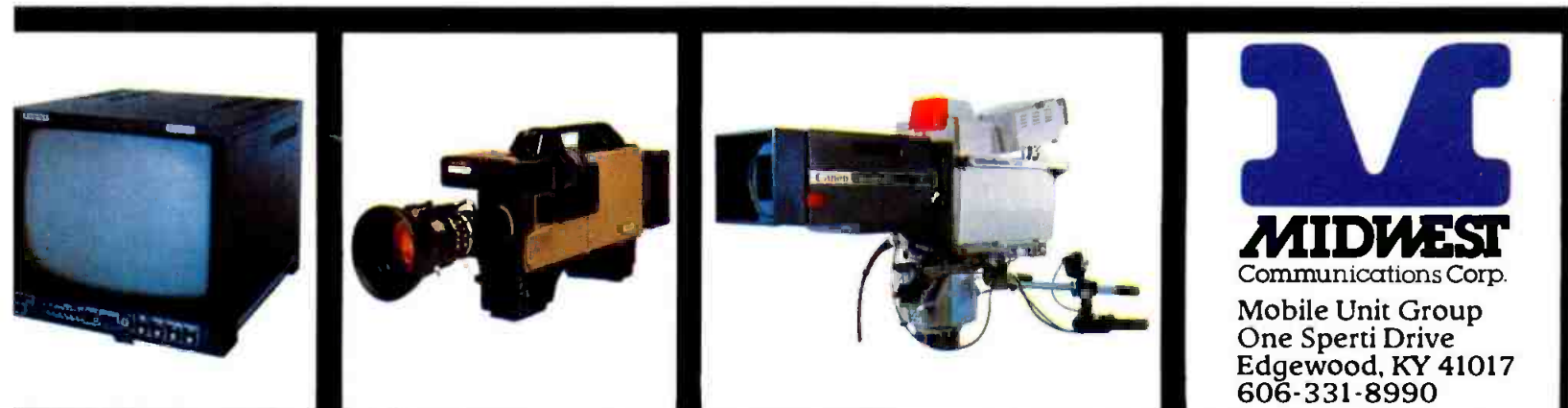

Circle (23) on Reply Card

[www.americanradiohistory.com](http://www.americanradiohistory.com)

The spacecraft power subsystem consists of two solar array panels and three nickel-cadium batteries. The system delivers a maximum power output of 1450W at 35V at the beginning of life, and an estimated 1100W after 10 years. During the two eclipse periods that are experienced each year, power is supplied to the on-board electronics by the battery bank.

The satellite's shaped-beam antenna incorporates a pair of orthogonally polarized, overlapped, offset parabolic reflectors. Each reflector can accommodate a linearly polarized, rectangular horn feed array to deliver shaped-beam antenna patterns of both horizontal and vertical polarizations.

**Back on earth**

Receiving terminal plans fall into two categories: a dedicated receive-only satellite (ROSAT) system and local telephone loops from a central ROSAT. The obvious benefit of the dedicated arrangement is that all of the system's equipment is under control of the station or the network. The familiar bottleneck to high-quality audio imposed by Telco loops is eliminated as well, creating a network system that is nearly transparent to program material.

The situation can change, however,

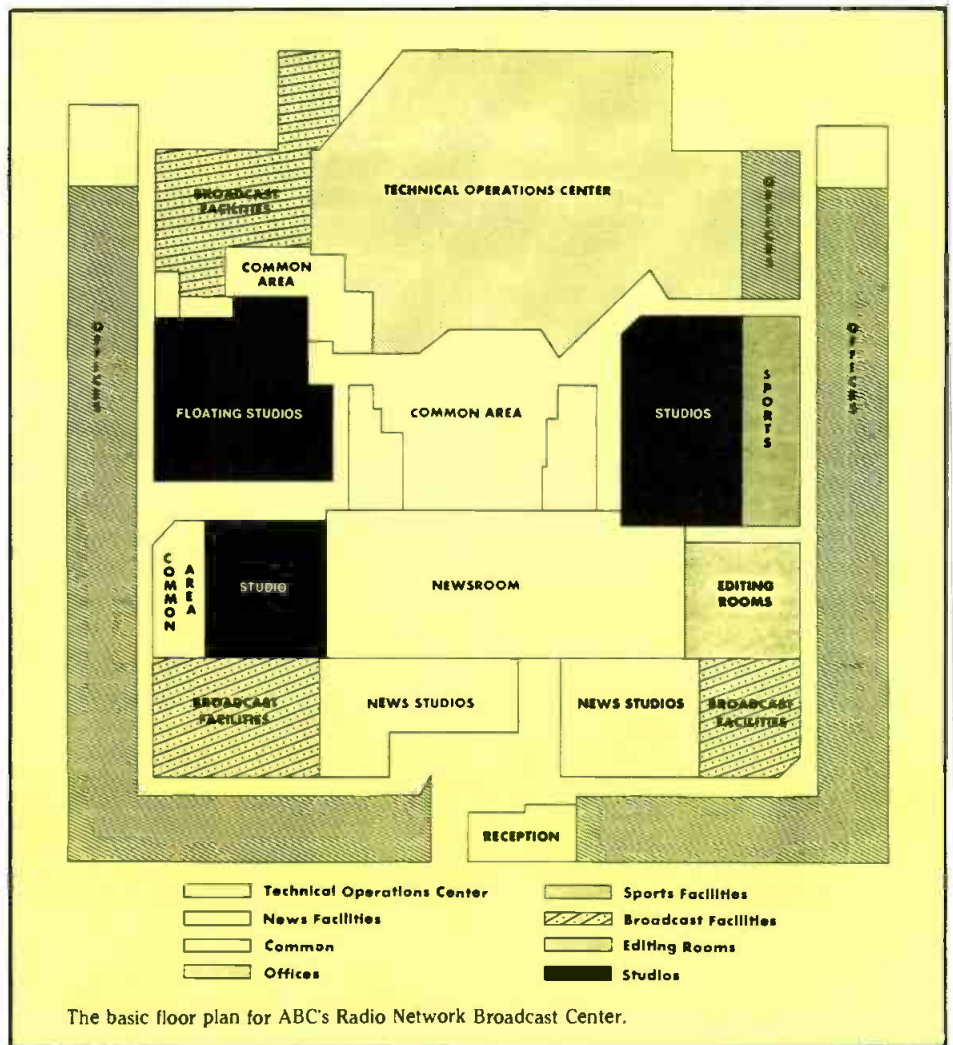

# Perfect reception in long yardage situations.

Shure's new FP11 and FP12 field production units help the signal come through loud and clear. The compact size and ultra-rugged design of these units make them perfect for ENG, EFP, film and even sound reinforcement situations. Lightweight, with belt clips, they'll go

anywhere to cover all the action. **FP12 Headphone Bridging Amp**  
The FP12 lets you check any audio line through headphones, without terminating the signal. The unit accepts standard 1/4" or 3.5 mm mini-plugs. Its 96 dB of gain drives headphones even with a weak signal.

**FP11 Mic-to-Line Amplifier**  
The FP11 boosts mic signals to line level by up to 84 dB, giving a clear, static-free signal over long distances. It features a precision stepped gain control, a switchable limiter, and easy access to batteries for checking or replacement.

For more information on Shure's complete field production family, call or write Shure Brothers, Inc., 222 Hartrey Ave., Evanston, IL 60204, (312) 866-2553.



**SHURE**  
THE SOUND OF THE PROFESSIONALS®...WORLDWIDE.





**Promise Born**

**Promise Delivered**

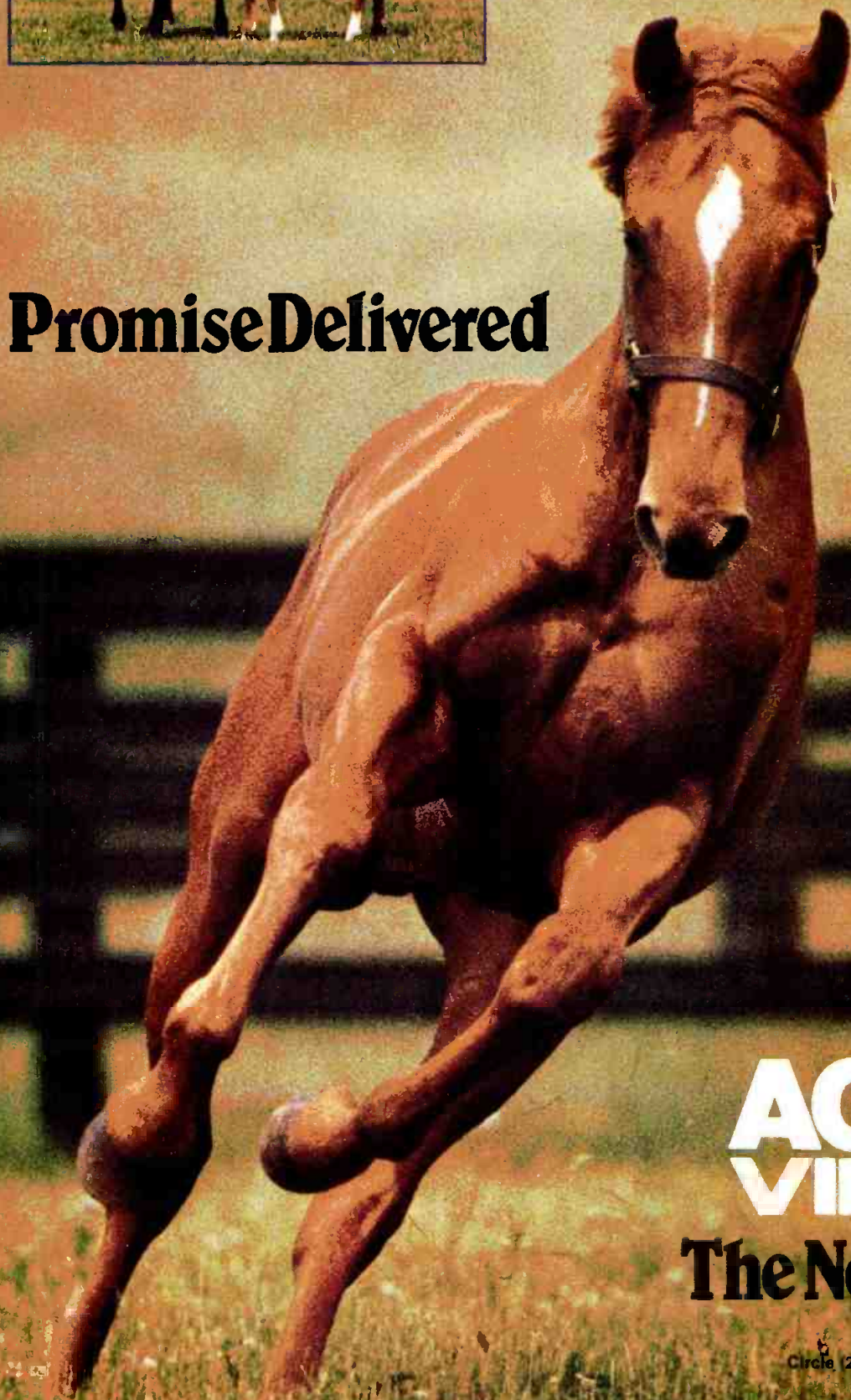

**AGFA  
VIDEO**

**The New Breed**

Circle (20) on Reply Card

AGFA-GEVAERT  MAGNETIC TAPE DIVISION, 275 NORTH STREET, TETERBORO, NJ 07608 (201) 288-4100



when the telephone company is used to provide the *last-mile* link between the ROSAT and the affiliate station. Although it is possible to get a good quality 15kHz, 2-channel loop with low noise, distortion and good phase coherence, such lines are expensive to install and can be difficult to maintain.

The high cost of multiple 15kHz equalized loops has caused many stations to purchase their own ROSAT systems, thereby eliminating the Telco link in the network chain. Other poten-

tial problems of a shared ROSAT, such as the lack of flexibility for the linked affiliates and responsibility questions that can arise in the event of equipment failure, are avoided.

An interesting (but at this point economically impractical) way around the analog Telco loop is to use a digital T-1 link between the shared ROSAT and the affiliate station. The baseband output of the downconverter chassis is transmitted from the receive site to the affiliate station, where individual program

channels are selected using the standard satellite demodulator chassis.

A totally digital network overcomes many of the problems inherent in an analog last-mile system. The satellite signal is converted into analog audio only at the affiliate station's studios.

Digital transmission is tolerant of many problems that might make an analog loop unusable. The digital link either works or it does not. If the Telco line is complete and operating reasonably well, transparent audio will be delivered to all affiliates.

Troubleshooting the Telco connection is simplified with a digital system, because disagreements over frequency response, noise floors or amounts of distortion are essentially eliminated. Engineers no longer need to hear the familiar, "It sounds fine to me," or "It's leaving here OK," from the toll test board.

A typical affiliate ROSAT consists of a 2.8m digital audio earth terminal, designed to receive high-speed time division multiplex (TDM) digital information at a rate of 9Mbits/s. A digital processing unit (DPU) decodes the baseband signal for reversion into analog audio.

The signal-to-idle-noise ratio of the reconverted audio is typically more than 80dB, while the sine-wave-to-quantization noise ratio is at least 56dB. Total harmonic distortion at peak level is 0.3%. Frequency response is flat ( $\pm 1.5$ dB) from 50Hz to 15kHz.

#### A question of quality

The quality of the audio delivered by the satellite system is of prime importance to a successful network operation. Even with the relatively low sampling rate of 32kHz, the perceived audio quality does not suffer. A higher sampling rate would be inefficient in terms of spectrum usage. Wider bandwidth translates into higher costs of operation for the network and fewer transponder spots available for the broadcast industry as a whole.

Network radio has made significant moves within the last few years toward using technology to solve old problems and to create new opportunities. As illustrated by the efforts of ABC and others, network radio is alive and well. It has permanently moved out of the confines of a *talk medium*.

#### Acknowledgement

The author wishes to thank Richard Martinez, director of technical operations for ABC Radio, for his assistance in preparing this article.

#### Bibliography

Bittner, John R., *Broadcasting: An Introduction*, Prentice-Hall, 1980. *Advanced RCA Satcom Communications Satellites*, RCA Commercial Communications Systems, Princeton, NJ, 1983.

# BATTERY PROBLEMS SOLVED

by CASP

Charger • Analyzer • Sequencer • Power Supply

CASP is a mystery solver to a myriad of battery problems, a virtual Sherlock Holmes. CASP, like Holmes, pursues the case until the last battery problem has disappeared.

#### THE CASE:

- Do you want to *murder* when your battery goes dead unexpectedly?
- Are you *entangled in a web* of different types of batteries and their associated chargers?
- Is time *escaping* you during lengthy charge, discharge, recharge and analyze sequences?
- Are your batteries *haunted* by memory?

CASP solves these mysteries and many more. CASP is a super sleuth in solving battery problems. With CASP, battery problems have been banished forever.

Christie Electric Corp.  
Communications Support Div.  
20665 Manhattan Pl.  
Torrance, California 90501  
213-320-0808 • 800-421-2955

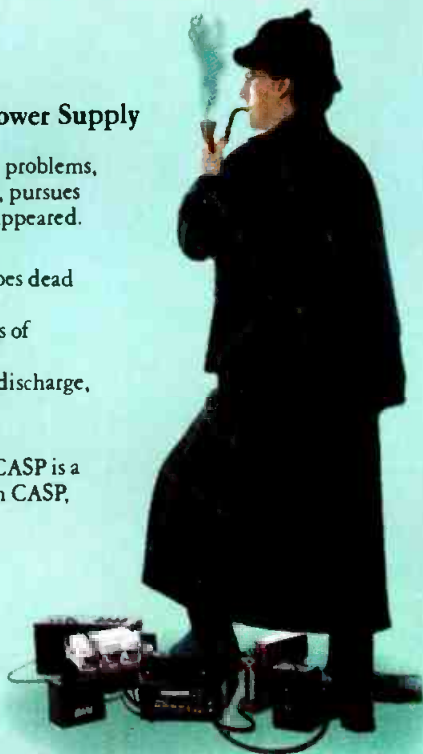

# CHRISTIE

ELECTRIC CORP.

Circle (21) on Reply Card

||:~:~))||



## Studer Audio: Advanced Recording Systems



# The hardware is typically Studer. The software is simply astounding.

The transport mechanics in our new A820 Analog Master Recorder are solid, stable, and precision-crafted in the Swiss tradition. That's all typically Studer. What's new is an ingenious network of software-controlled operating systems.

Future Perfect. The A820 is designed to meet the demands of tomorrow's computer-controlled audio production facilities. Multiple on-board microprocessors control all operating sub-systems, including capstan drive, spooling motors, and audio parameter settings. Most operating features are user programmable, allowing you to tailor an A820 to your exact needs in a matter of minutes. If your needs change, you simply re-program your features. Also, virtually every operating feature of the A820 may be accessed and controlled through an optional RS232/RS422 serial data port.

Gentle on the Wind. The A820 handles your valuable tapes with kid gloves. The DC capstan motor starts, following a defined ramp, only after the pinch roller is engaged. A closed

loop servo system monitors tape tension and reel inertia to provide optimum acceleration and braking. Both tape tension and tape winding speeds are user programmable.

The Wheel Thing. The A820's dual thumbwheel shuttle/edit control makes tape-cut editing a breeze. One wheel fast winds tape in either direction at increasing speeds while the other precisely positions tape for the edit.

Also Noteworthy. The A820 incorporates Studer's new generation of phase compensated audio electronics, available with either transformer or active balanced inputs and outputs. In sound quality, the A820 takes a quantum leap ahead of recorders made just a few years ago. Options for the A820 include a center-track SMPTE time code channel and test generator.

The Payback. The "hardware" in the Studer A820 is made to give you dependable service for years to come. That's the Studer tradition. Plus, with its advanced software, the A820 also does more different jobs,

gets more jobs done in less time, and produces sonically superior results. That's the bottom line in any upgrading program.

For more information on the new A820 Analog Master Recorder, please contact: Studer Revox America, 1425 Elm Hill Pike, Nashville, TN 37210; (615) 254-5651.

## STUDER REVOX



Circle (135) on Reply Card



# “Ikegami’s HL-95 Unicam can handle — and more!”

— John Hall, Director of Engineering  
WDAF-TV, Kansas City, Missouri





# gives you all the action you

The biggest eruption in the professional hand-held television camera market occurred with the introduction of Ikegami's UNICAM, a multipurpose Plumbicon® camera concept with a host of applications.

Utilizing a unique building block approach which incorporates the HL-95B basic camera head, various configurations are possible: Several ENG stand-alone cameras, combined camera-VTR units with a selection of 1/2 inch or 1/4 inch component recorders and remote controlled EFP cameras with multicore

cable or triax cable base stations can be assembled.

The versatility and flexibility of the HL-95 system is provided without sacrificing state-of-the-art performance in the areas of sensitivity, resolution and registration; these are achieved with minimum equipment size, weight and power consumption.

Pound for pound the HL-95 is the hottest little camera you'll ever hold in your hands.

For a demonstration of UNICAM and other Ikegami cameras and monitors, contact us or visit your local Ikegami dealer.

## Ikegami

Ikegami Electronics (U.S.A.), Inc., 37 Brook Avenue, Maywood, NJ 07607

• East Coast: (201) 368-9171 • West Coast: (213) 534-0050 • Southeast: (813) 884-2046

• Southwest: (214) 233-2844 • Midwest: (312) 834-9774



\*Plumbicon® is a registered trademark of N.V. Philips.

Circle (19) on Reply Card

[www.americanradiohistory.com](http://www.americanradiohistory.com)

# Looking inside



The National Association of Broadcasters' 63rd Annual Convention and Exhibition opened to a full-house crowd in the Convention Center in Las Vegas this year. More than 38,000 engineers and station management personnel wandered through the more than 700 exhibits at the show, examining the products and making purchasing decisions.

Covering more than 300,000 square feet, the exhibits showcased existing equipment lines introduced at previous NAB conventions as well as spotlighted the new products of each manufacturer. This year was no different than any other in terms of displaying breathtaking technological advancements, which ultimately translate into extra efficiency for the broadcaster.

#### BE's NAB coverage

Our "Show Review" coverage captures the essence of this year's event and shares some of the excitement that many of the attendees felt.

*BE's coverage of the 1985 NAB convention includes the following features:*

- **Pick Hits of NAB '85** . . . . . 44  
*A selection of the 10 hottest TV and 10 hottest radio products.*
- **Opening Doors to the Future** . . 71  
*A review of the engineering sessions.*
- **New Frontiers for Efficiency** . . . . . 76  
*A look at new developments in UHF transmitter design.*
- **Show of Shows** . . . . . 82  
*A complete listing of new products.*

An exciting first for **Broadcast Engineering** is publishing "Pick Hits of NAB '85" for both radio and TV products. We commissioned a panel of independent industry experts to give us its appraisal of the show and its list of the show's 10 hottest TV products and 10 hottest radio products.

In another article, "Opening Doors to the Future," Brad Dick and Don Markley, two **BE** consultants, review the NAB

engineering sessions. Summarizing the discussions on both the radio and TV sides, Dick and Markley outline the significant engineering trends and their possible impact on the industry.

"New Frontiers for Efficiency" takes a look at the progress in both tube and transmitter design efforts as discussed at the show.

And finally, "Show of Shows" presents our regular NAB coverage of each exhibitor at the show.

This presentation highlights the new products of each manufacturer. If the company had no new products at the show, we detailed its existing line of products that were on display. Each exhibitor's coverage is accompanied by a Reader Service Number. If you missed a particular booth or were not able to attend the show, circle this number on the card that is bound into the back of this issue to obtain more information on the product directly from the manufacturer.



## NTSC DIGITAL TEST GENERATOR DTG-1010N

# the multitasking machine...

Dual feeds of 40 test signals to FIVE different locations with complete remote control.

Two new test signals for chroma noise measurements and transmitter power calibration.

Three VITS packages.

Full range of trigger signals.

Variable H and V blanking.

Genlock.

RS170A ... of course.



STUDIO 1



STUDIO 2



VTR



MCR



MAINTENANCE

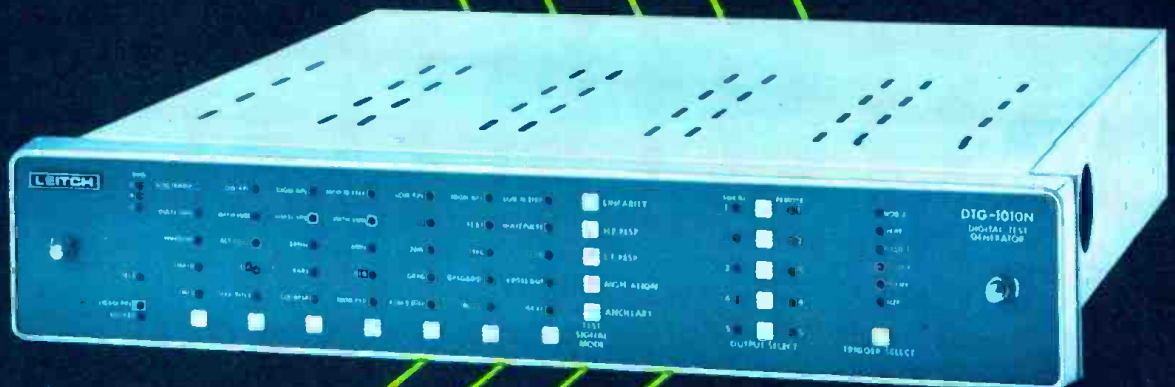

Plus  
outputs of

SYNC

BLANKING

SUBCARRIER

TRIGGERS

# LEITCH

*Progressive Concepts in Television Technology*

Leitch Video of America, Inc.  
825K Greenbrier Circle  
Chesapeake, VA 23320  
Tel.: (804) 424-7920  
Telex II: 710 882 4342

Leitch Video Limited  
10 Dyas Road  
Don Mills, Ontario M3B 1V5  
Tel.: (416) 445-9640  
Telex: 06 986 241

Circle (25) on Reply Card

# Pick hits of NAB '85

By Jerry Whitaker, editor and  
Carl Bentz, technical editor

Here's a look at some of the hot new items displayed  
at the NAB convention in Las Vegas.

The sheer number of exhibits at the annual NAB convention was overwhelming. With more than 700 exhibitors, many displaying new products and improved established products, it was impossible for most attendees to see all of the new equipment within the 3½-day span of the show. Likewise, it would be impossible for us to discuss in detail all of the new and improved products displayed at the NAB, because it would fill several issues.

This year, in order to bring the flavor of the convention to the reader, we formed a panel of 10 judges—five for radio products and five for TV products—to tour the convention hall and decide on a list of *Pick Hits* for the show. The panel of independent industry experts selected 10 radio products and 10 TV products. The judges looked for items that were exciting, useful and designed to offer unique solutions to common needs or problems. We are not saying



these are the "top products" of the convention, but rather a sampling of what the judges found to be of particular interest.

We established five basic guidelines for our panel:

1. **The items must be new products** (not shown at a previous NAB convention). In some cases, distinguishing a "new product" from a modified old product was difficult. For our purposes, we defined a new product as one with a new model number or new designation.

2. **The products must have some**

**positive impact on the everyday work of the user.** We were looking for equipment that would be used on a regular basis at radio and TV stations.

3. **The products must offer an improvement in current technology.** The equipment did not have to include unique circuit architecture, but it was expected to include some new ideas on applying current technology.

4. **The prices of products must be within reach of their intended users.** We were looking for products manufactured for a wide spectrum of broadcasters.

5. **The products must be available for purchase.** The equipment must have been on display on the convention floor and in production (or soon to be in production). Products demonstrated in private showings off the floor were not considered.

The products selected by our panel of judges follow in alphabetical order.

## Pick Hits-Radio

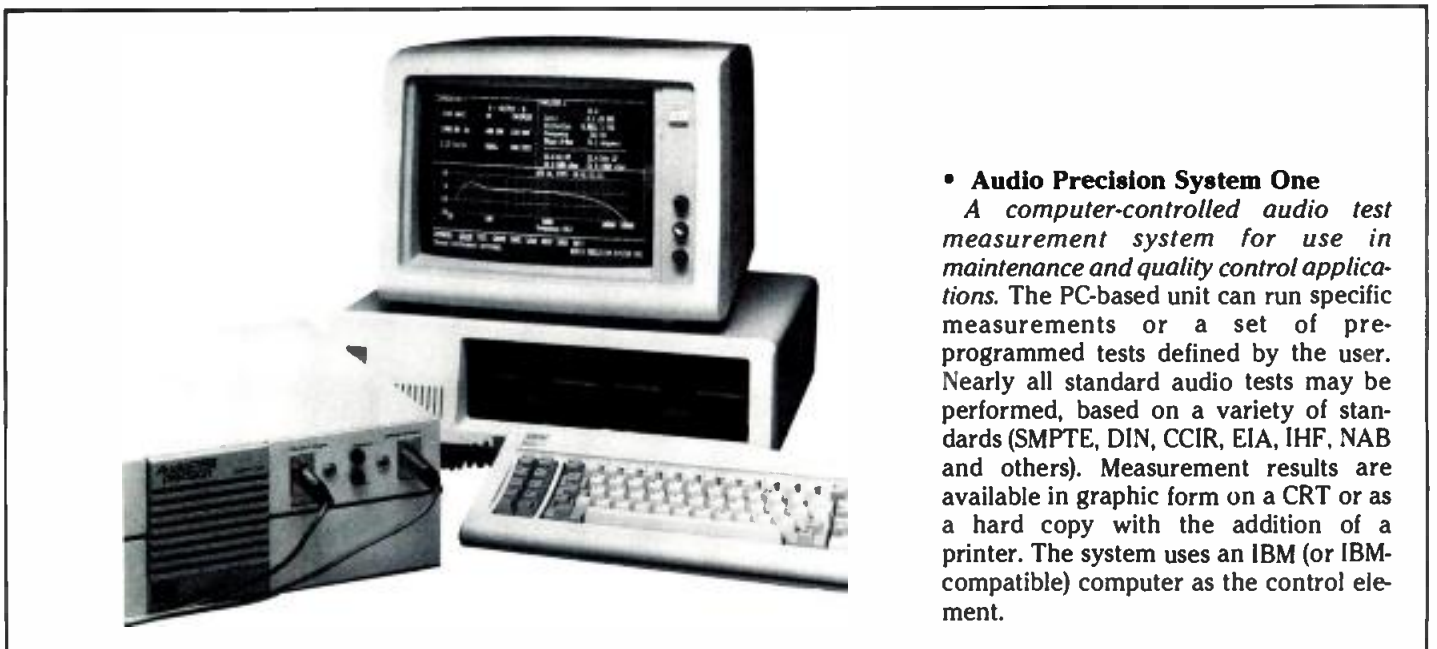

### • Audio Precision System One

A computer-controlled audio test measurement system for use in maintenance and quality control applications. The PC-based unit can run specific measurements or a set of pre-programmed tests defined by the user. Nearly all standard audio tests may be performed, based on a variety of standards (SMPTE, DIN, CCIR, EIA, IHF, NAB and others). Measurement results are available in graphic form on a CRT or as a hard copy with the addition of a printer. The system uses an IBM (or IBM-compatible) computer as the control element.



# TEK'S NEW 1710B: THE BRIGHTEST IDEA IN WAVEFORM MONITORING.

## One-of-a-kind capability in a new waveform monitor that's easy to use and afford!

The Tek 1710B has all the essentials for reliable, consistent monitoring of your video signal. For example, it includes the first-ever burst phase indicator found in a waveform monitor. This special new color display indicates if burst is properly set: a green light means it's right!

**Operating simplicity anyone will appreciate.** The

front panel controls of the 1710B are logically grouped and labeled for fast, easy handling. And the high quality Tektronix CRT offers a sharp, bright trace so it's easy to see.

You get outstanding versatility and Tek quality in a convenient, compact package that fits in half a rack. DC power operation can be installed and used with a battery pack for fully portable operation in the field.

If you see a place for a cost-effective waveform monitor in your operation, you owe it to yourself to see the 1710B. Available in both NTSC and PAL versions, the 1710B is our most economical answer yet to improving picture quality through video waveform monitoring.

For a look, contact a Tektronix Professional Video Dealer, or your local Tektronix Sales Engineer, listed in major-city directories.



BEHIND THE SCENES  
IN QUALITY TELEVISION

**Tektronix**  
COMMITTED TO EXCELLENCE

Circle (27) on Reply Card

• **Benchmark Media Systems DIA-1 and DOA-1A amplifiers**

A product line of differential input and output amplifiers for interface between semi-pro/consumer gear and broadcast equipment. The amplifiers feature input/output level adjustments and internal power supply regulation. The units are available mounted on either male or female chassis XLR connectors or 1/4-inch female phone plugs, simplifying modification of semi-pro gear to provide balanced input/output connections. The amplifiers are powered from a low voltage dc supply tap on the semi-pro unit.

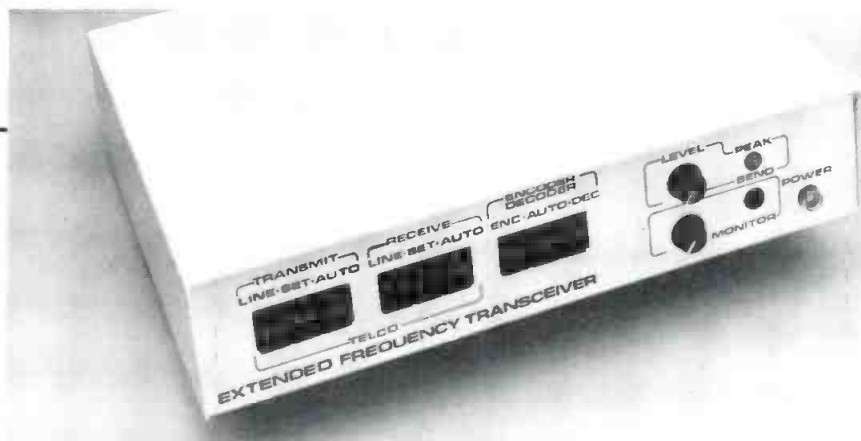
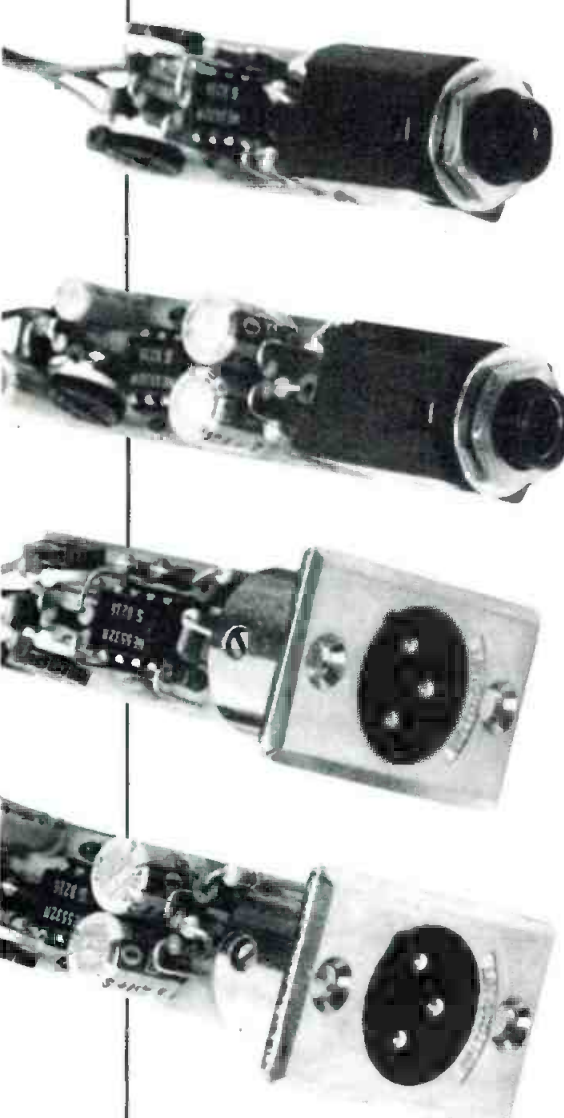

• **Gentner Engineering EFT-1000**

A telephone interface system that improves the quality of remote broadcasts through single-line bandwidth expansion of both the high and low frequency spectrum. The unit also operates as a full duplex transceiver on a single telephone line for remote cueing. The bandwidth extension circuits add low-frequency re-

sponse and extend the apparent high-frequency response through even-order harmonic generation. Automatic encode/decode switching is handled by a handshaking control tone. Standard connections, internal couplers and internal backup batteries reduce the amount of equipment needed at the remote site.

• **Harris Phase Fixer**

An audio time base corrector system designed to eliminate audible phasing errors on stereo cartridges and reel-to-reel tapes. The system ensures monophonic compatibility for stereo audio sources. A 19kHz pilot tone is recorded onto each stereo track during production at 27dB

below normal operating level. Upon playback, the pilot tone is detected and used to drive a dual 16-bit delay line to reduce phase errors and flutter. The presence of encoded information is automatically sensed by the unit, permitting a mixture of encoded and non-encoded tapes to be used on the air.



• **Harris SX-5A AM transmitter**

An improved version of the company's solid-state SX-5 5kW transmitter featuring the "Sunwatch" power control system. This circuit adjusts transmitter power output automatically to the pre-sunrise and post-sunset limits specified in the station's license. The microprocessor-controlled switching system provides a simple solution to the complex pre-sunrise and post-sunset power-switching requirements now facing some AM stations. The 100% solid-state transmitter uses MOSFET devices in an RF series configuration. Polyphase pulse-duration modulation drives four RF modules to produce a maximum rated output of 5.6kW through a ferrite combiner. Overall transmitter efficiency from ac to RF is greater than 65%.







## FINISH UP ON TIME WITHOUT SACRIFICING QUALITY.

You want it quick and you want it good. In today's competitive post-production audio/visual scene, the rewards go to those who can produce results that are quick *and* good. That's why TASCAM designed the MS-16 1" 16-track recorder—to bring together top-notch audio quality plus premium features that streamline production and move you ahead of schedule.

Quality reproduction starts with the heads, and TASCAM has three decades of design experience the MS-16's new micro-radii heads. They bring "head bumps" under control and ensure flat frequency response. And unlike most tape machines, the MS-16 record/stop and playback heads are identical in performance. Because sync response equals repro response on the MS-16, you can make critical EQ and processing decisions on overdubs or punch-ins without having to go back and listen a second time. You get what you want sooner and with fewer headaches.

The MS-16 cuts down on the time you spend locking up with other audio and video machines as well. A 38-pin standard SMPTE/EBU interface affords speedy, single-cable connection with most popular synchronizers and editing systems. It's the easy, efficient way to get the most out of today's sophisticated synchronization equipment. The MS-16's new Omega Drive transport is tough enough to stand up to long days of constant shuttling... while handling tapes with the kid-glove kindness they deserve.

Record/Function switches for each track allow effortless, one-button punch-ins. Input Enable allows instant talkback during rewinds, fast forwards and cue searches. These features speed you through sessions and let you concentrate on the project at hand... not on your tape machine.

Take a closer look at the MS-16. See your TASCAM dealer for a demo or write us for more information at 7733 Telegraph Road, Montebello, CA 90640.

### THE TASCAM MS-16 SIXTEEN TRACK



**TASCAM** THE SCIENCE OF BRINGING ART TO LIFE.

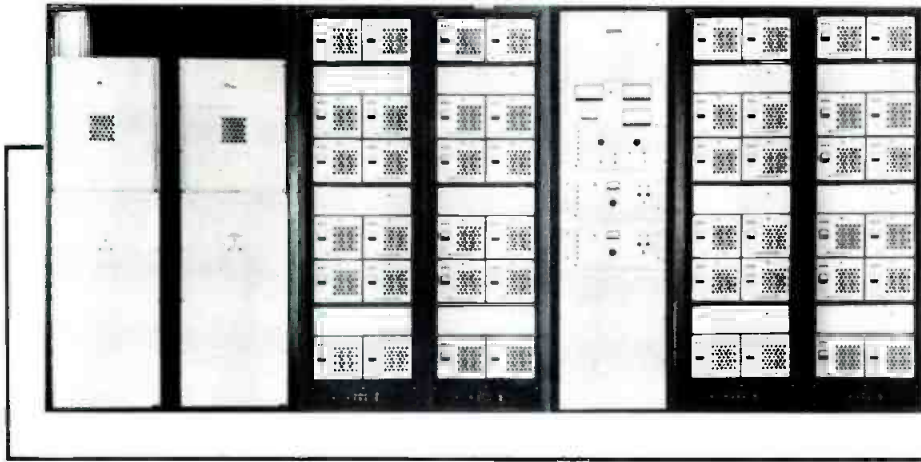

• **Nautel Ampfet 50 transmitter**  
*The first totally solid-state 50kW AM broadcast transmitter to be produced for commercial radio.* The system offers the user an overall efficiency of more than 75% at all modulation levels. The transmitter is based on 48 modular RF power subsystems, rated for 1.25kW power output each. The class D system is stereo-ready and includes dual power supplies and a standby exciter for backup protection. On-air servicing is accomplished through the use of isolation switches for each of the power blocks.



## THE BEST KEPT SECRET IN EUROPE IS FINALLY OUT.

Since 1971 Aston has been quietly building a dominant position in character generators throughout Europe. The third generation Aston 3 has the resolution, versatility, flexibility, dependability and ease of use to match any CG, from any country, at any price.

And now you Yanks can have it too. Call or write us for details. The British have finally started a revolution.



LONDON  
 KANSAS

ASTON ELECTRONICS INC.: 531 N. Murlen Rd. E. • Olathe, KS 66062  
 Telephone: (913) 782-4007

ASTON ELECTRONIC DESIGN LTD: 125 Deepcut Bridge Road • Deepcut,  
 Camberley, Surrey, GU16 6SD, England • Telephone: (0) 252 836221 Telex: 858813

Circle (26) on Reply Card

### The Judges

*We selected a group of 10 well-known and respected independent industry experts for our NAB '85 Pick Hits panel of judges. Five persons participated in the selection of radio products and five participated in the selection of TV products. The panel consisted of the following persons:*

#### For television

**John Battison**  
 Director of engineering, WOSU stations and BE's consultant on RF radiation.

**John Long**  
 Chief engineer, KCPT-TV, Kansas City.

**Don Markley**  
 Consulting engineer and BE's consultant on transmission facilities.

**Karl Renwanz**  
 Vice president of engineering and operations, WNEV-TV, Boston.

**Doyle Thompson**  
 Director of engineering, The Weather Channel.

#### For radio

**Brad Dick**  
 Director of engineering, KANU/KFKU, Lawrence, KS, and BE's consultant on studio facilities.

**Wally Johnson**  
 President, Moffett, Larson & Johnson consulting engineers and BE's consultant on FCC/Broadcast engineering.

**Andy Laird**  
 Chief engineer, KDAY, Los Angeles.

**Dave Obergonner**  
 Chief engineer, KUSA/KSD, St. Louis.

**Richard Rudman**  
 Engineering manager, KFVB, Los Angeles, and BE's consultant on spectrum management.

Continued on page 52



# THE IMPORTANCE OF MICROPHONE ACCURACY IN BROADCAST AUDIO

*A distinctive voice remains as important to a successful broadcast announcer as a recognizable visual presence. Microphones are the critical first step in the broadcast audio chain. Acting as a highly accurate sound "lens," they must be sensitive enough to faithfully transmit all of the subtle personal nuances and inflections that distinguish one announcer's voice from another.*

*Today's sophisticated broadcast productions demand more from microphones. Differences in relative mic performance are more readily apparent, and an inferior microphone stands out like the proverbial sore thumb.*

*In the most basic sense, any microphone need only capture the sound source exactly and convert it to electrical energy — no more, no less. Obviously, microphones necessarily have different characteristics based on differing transduction technologies and designs. But at Beyer, we believe that the superiority of a microphone is in large part based on how accurately it transduces the source material — with no excuses based on*

*size or applications.*

*In broadcast, Beyer's concept of "accuracy" means the difference between a microphone that can focus in on a specific voice and produce a totally realistic, professionally acceptable performance, and a mic that simulates a performance by only capturing the bare outline or "silhouette" of an announcer's voice. We've dedicated the most complex and sophisticated technology in existence to reinforce the truth of this basic premise.*

*Sensitive and natural-sounding, the MCE5 picks up the "whole truth" of audio broadcast sound because of an unusually wide frequency range (20Hz to 20kHz) and exceptionally fast transient response for any mic, let alone one that is virtually invisible on camera. Because the MCE5 has a uniform omnidirectional pickup pattern, mic placement is not critical and the announcer's head can move without going "off mic." Handling noise is kept to an absolute minimum so the MCE5 picks up the voice, not the rustling sounds of the announcer's expensive silk tie.*

*The MCE5 is available in various terminations for the widest range of broadcast applications including wireless. Underscoring our longterm commitment to the broadcast industry, the MCE5 is one of a family of reliable Beyer broadcast products designed for ENG, EFP and Film/Radio/Video studio production. It has been widely adopted by discerning broadcast engineers in the U.S. and Europe.*

*For those engineers who feel that announcers' voices should be as recognizable as their faces, the Beyer MCE5 proves that this level of accuracy exists in a lavalier design.*

*Beyer Dynamic Inc., 5-05 Burns Avenue, Hicksville, NY 11801.*

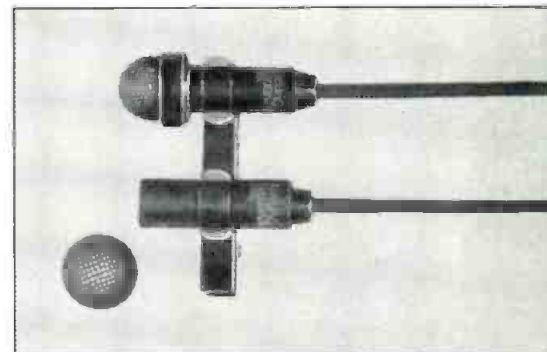

Circle (30) on Reply Card

**ACCURACY IN AUDIO**

**beyerbroadcast** 

**ONE STOP SHOPPING  
FOR ALL YOUR  
CONTROL ROOM NEEDS**

**UTAH SCIENTIFIC IS THE ONE COMPANY THAT CAN PROVIDE:**

**ROUTING SWITCHERS**

**MASTER CONTROL SWITCHERS**

**STATION AUTOMATION**

**MACHINE CONTROL SYSTEMS**

**VIDEO AND AUDIO DA'S**

**ALL IN ONE INTEGRATED PACKAGE, WITH SINGLE-SOURCE  
RESPONSIBILITY FOR YOUR NEXT FACILITY UPGRADE.**

EACH PRODUCT IS DESIGNED TO PERFORM TO THE SAME DEGREE OF PRECISION AND RELIABILITY THAT HAS MADE OUR ROUTING SWITCHERS THE INDUSTRY'S STANDARD OF COMPARISON, AND EACH IS BACKED BY OUR FIVE YEAR WARRANTY ON BOTH PARTS AND LABOR.

CALL OUR TOLL FREE NUMBER FOR A SALES QUOTATION OR A VISIT FROM YOUR UTAH SCIENTIFIC SALES ENGINEER.

**USUTAH SCIENTIFIC**  
DYNATECH BROADCAST GROUP

1685 West 2200 South, Salt Lake City, Utah 84119  
TOLL FREE (800) 453-8782 PHONE (801) 973-6840  
TWX: 910-925-4037



# THE LEADER ANNOUNCES AN ALL-NEW ROUTER

# AVS

**V I D E O**

- Differential Gain
- Differential Phase
- ± dB flatness
- ± dB gain uniformity

**A U D I O**

- THD @ +24 dBm/20 KHz
- IMD @ +24 dBm/20 KHz
- ± dB flatness
- ± dB gain uniformity

Utah Scientific reasserts its leadership in routing switcher performance with the all-new model AVS-1B. The above specs are representative of this new product's quality. Other features such as reprogrammable panels, and matrix sizes to 320 X 320 at 8 levels give assurance that this leadership position will continue over the years to come.

**STILL THE LEADER**

**USJ UTAH SCIENTIFIC**  
DY-NATECH BROADCAST GROUP

1685 West 2200 South, Salt Lake City, Utah 84119  
TOLL FREE (800) 453-8782 PHONE (801) 973-6840  
TWX: 910-925-4037  
Circle (31) on Reply Card

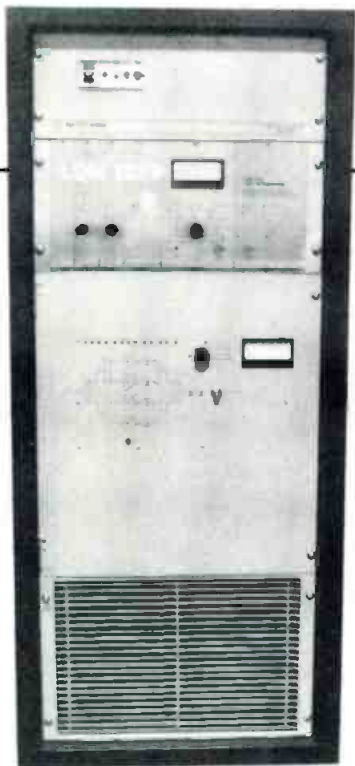

• **Philips LDM 1239 transmitter**  
*A completely solid-state FM transmitter featuring multiple amplifier modules and duplicate power supplies for protection against system failure. A frequency-synthesized exciter allows changes in operating frequency in the field, if required. Four modules are operated in parallel to develop the required output power. Front-panel fault-tally lights aid in troubleshooting.*

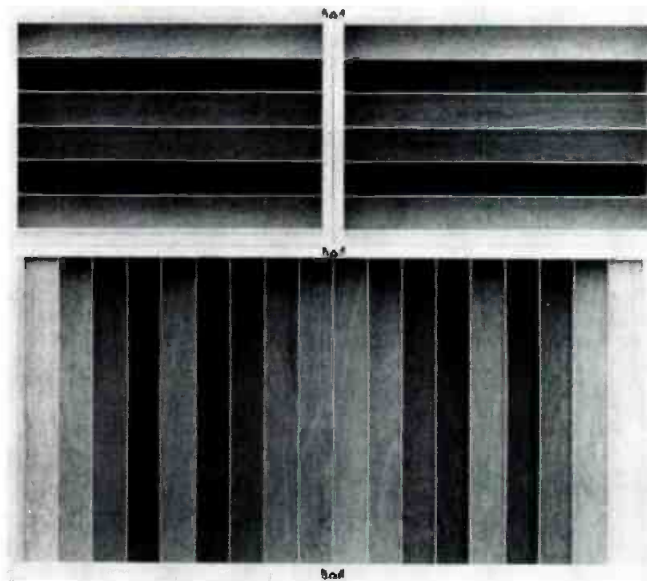

• **RPG Diffuser Systems acoustical diffuser**  
*A reflection phase-grating acoustical diffuser for on-air and recording studios that back-scatters sound over a broad range of frequencies with wide-angle coverage. The diffusers are designed to provide acoustical properties that cannot be obtained with conventional surface*

*treatments. A periodic grouping of wells of equal width, but varying depths, assures that equal amounts of energy are scattered in all directions over an audio spectrum spanning five octaves. Horizontal or vertical orientation of the wells allows tight control of sound characteristics (absorption, reflection and diffusion).*

• **Russco Electronics Telemote T-321**  
*A portable 2-channel remote audio mixer for use with a dial-up telephone line. The unit features a front-panel touch-tone keypad and three headphone outputs. Powered by the Telco dc line supply, the Telemote includes a built-in limiter and air-check switch for the remote operator. It makes possible "one-box" broadcasts.*

• **Sony APR-5000 series recorder**  
*A 1/4-inch analog tape recorder with microprocessor-managed alignment and reference adjustments. A non-volatile alignment memory can recall preset tape formats with the push of a single button. The microprocessor-based system allows format setup and routine maintenance measurements. Features include center-track time code, serial and parallel control ports and forward/reverse tape-shuttle control. The APR-5002 can accommodate a wide range of tape-head formats through replacement of alignment-stable head stacks. A tape counter is included on the transport with resolution to one time-code frame.*

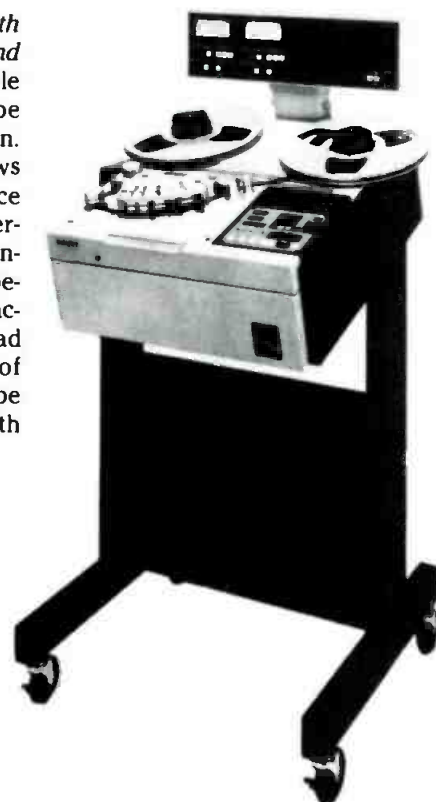



# The purr-fect match...CATS and Vega.

Cetec Vega wireless equipment plays a prominent role in the sound production of the famous musical, CATS.\* Jess Heimlich, sound engineer for the touring company, says, "Cetec Vega wireless systems are work-horses. They make my job a lot easier, and, more importantly, give me a feeling of security. They are subjected to the most unimaginable workout I have ever seen!"

Cetec Vega wireless microphones have helped CATS in the winning of seven Tony Awards (including Best Musical, 1983) and the Outer Critics' Circle Award—Best Musical (1983).

The road company of CATS uses 14 Cetec Vega Model R-42 dual-diversity wireless receivers with Model 77/DII bodypack transmitters. The system features DYNEX®II, Cetec Vega's new standard in audio processing. Jess also has two backup Vega systems on standby. "These 16 sys-

tems have been on the road for over a year now, providing about 95% reliability. When you put your reputation on the line eight times a week, you want equipment that'll back you up. Vega's do. And, more importantly, when there is a problem, you want a company and its representatives to provide you with immediate service. Vega has given me both. Typically, repair turnaround time has been 36 hours!"

The road company's stage managers also use the Cetec Vega "Q" System full-duplex wireless intercom system, which interfaces to their Clear-Com wired intercom system.

In all, between 15 and 17 wireless microphone and intercom systems are used simultaneously on stage, without a trace of interference between systems.

Cetec Vega wireless systems are also in use at the newly opened

CATS productions in Los Angeles, Toronto, and Chicago, and on Broadway. Jess says, "In the last three years, I have used more than 30 Vega systems on four different Broadway Productions. The plain and simple truth is: they work...MORE RELIABLY, MORE CONSISTENTLY, AND MORE OFTEN than any other wireless I've ever used."

If you must equip your performers with the most dependable, highest quality wireless microphones, remember the words of CATS' Jess Heimlich: "Cetec Vega wireless are the best I have ever used!"

 **Cetec Vega**

...the professional's wireless

Division of Cetec Corporation  
9900 Baldwin Place  
El Monte, California 91731  
(818) 442-0782

Circle (34) on Reply Card \*CATS is a registered trademark of THE REALLY USEFUL COMPANY, Ltd.



"Vega's top-of-the-line wireless systems are great!" says Jess Heimlich, CATS' sound engineer, standing next to their rack full of Cetec Vega R-42 dual-diversity wireless receivers.

# Pick Hits-Television

- **Ampex ACE $\mu$  Editor**

An editing system designed for the requirements of small post-production and large off-line editing applications. Fully compatible with other ACE systems, the product provides full-feature editing. Four-machine operation is standard for

ABC rolls, but AB roll edits with a non-VTR source or device are possible. Four general purpose interfaces and RS-232 printer port are standard components. The heart of ACE $\mu$  is the software, written for flexibility and intra-system compatibility.



- **Andrew TRASAR antenna**

A circularly polarized traveling-wave slotted-array antenna, designed for high-band TV transmission. Azimuth pattern control allows omnidirectional circularity to an accuracy of  $\pm 1.5$ dB. Twelve- or 16-bay models for channels 7 to 13 have a peak power input rating of 75kW + 20% aural. Near-in coverage is maintained while maximum energy is radiated to the radio horizon for beyond-horizon coverage. (A beamtilt of 0.75° is standard.) The antenna's cylindrical construction—without extended elements—reduces windloading effects.



Continued on page 58

## CART 'EM UP ON AA-4!

From AOR to CHR, Country to Jazz—Whatever the format, this cart's for you. For outstanding high frequency sensitivity and headroom, compatibility with all cart machines, the multi-format AA-4 delivers the sound that audiences turn on.

**THE AUDIOPAK AA-4**  
For stations who care how they sound.



Capitol Magnetic Products  
6902 Sunset Boulevard  
Los Angeles, CA 90028

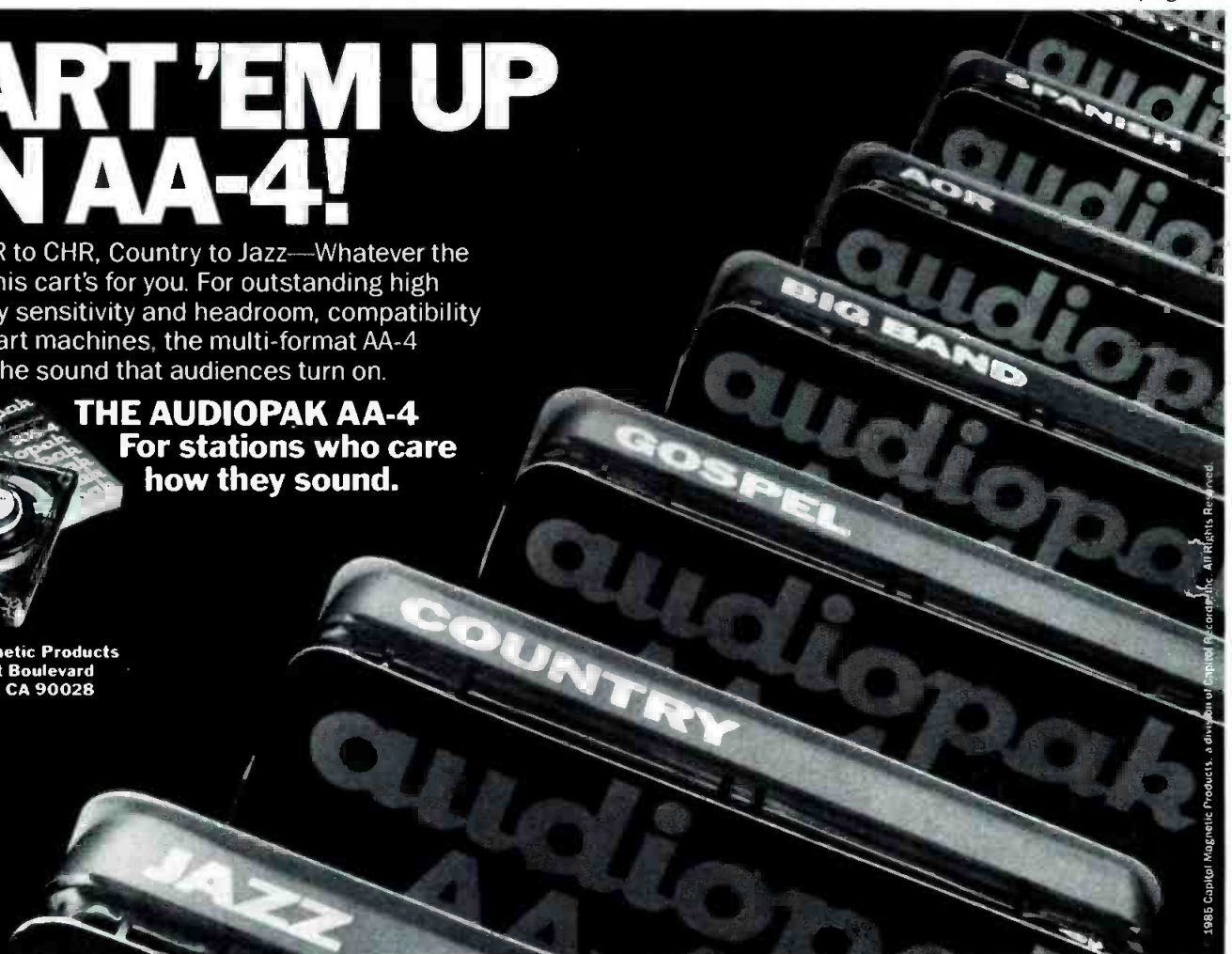

© 1985 Capitol Magnetic Products, a division of Capitol Records, Inc. All Rights Reserved.

Circle (28) on Reply Card



# TO CHECK A MONITOR'S COLOR ACCURACY, JUST PUT IT NEXT TO A SHARP.



The only colors you'll see on these Sharp monitors are true colors.

Because they both have a shadow mask CRT with U.S. controlled phosphors. Plus a comb filter that cuts cross-color interference.

They also have 600 lines of resolution, so the picture is as sharp as the color is accurate.

Plus multiple inputs, including RGB, that let you change sources at the flick of a switch.

And two time constants, so you can analyze VTR reproduction.

All for under \$3,000 for our 13-inch model and \$3,500 for our 19-inch.

Or for \$700, there's our 9-inch utility color monitor for remotes and editing. With many of the features our larger models have.

So contact your local Sharp dealer, call Sharp at (201) 265-5548, or write Sharp Electronics Corporation, Professional Products Division, 10 Sharp Plaza, Paramus, N.J. 07652.

And the next time you're checking out monitors, remember:

**Next to Sharp, any other monitor is the next best thing.**



*Our 9" color monitor for remotes and editing.*



**FROM SHARP MINDS  
COME SHARP PRODUCTS™**

A/V Equipment, Audio, Banking Systems, Broadcast Cameras, Calculators, Cash Registers, Computers, Copiers, Electronic Components, Electronic Typewriters, Facsimile, Medical Products, Microwave Ovens, Televisions, Vacuum Cleaners, Video Recorders.

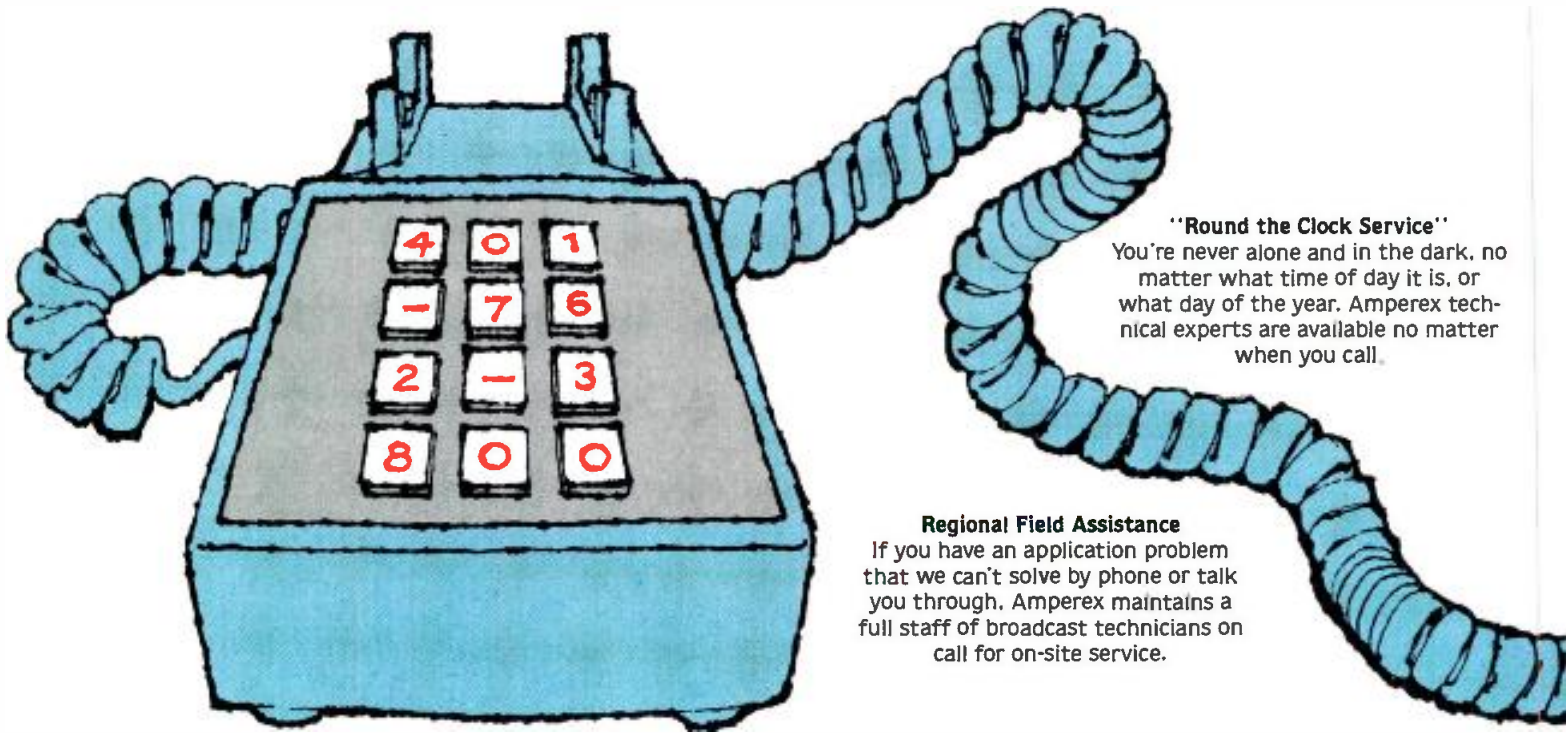

**“Round the Clock Service”**  
You’re never alone and in the dark, no matter what time of day it is, or what day of the year. AmpereX technical experts are available no matter when you call.

**Regional Field Assistance**  
If you have an application problem that we can’t solve by phone or talk you through, AmpereX maintains a full staff of broadcast technicians on call for on-site service.

**One telephone number gives you all this information.**



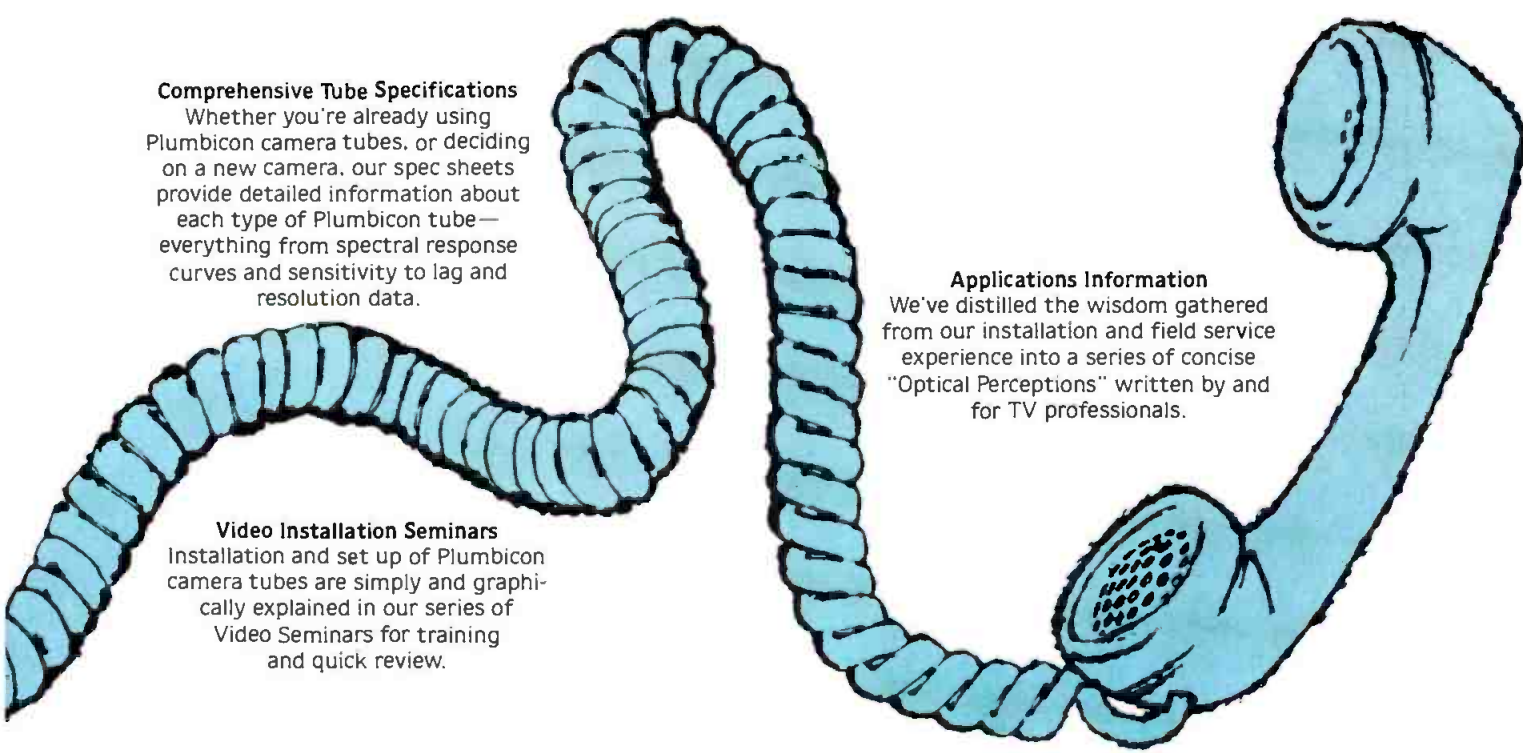

**Comprehensive Tube Specifications**  
Whether you're already using Plumbicon camera tubes, or deciding on a new camera, our spec sheets provide detailed information about each type of Plumbicon tube—everything from spectral response curves and sensitivity to lag and resolution data.

**Video Installation Seminars**  
Installation and set up of Plumbicon camera tubes are simply and graphically explained in our series of Video Seminars for training and quick review.

**Applications Information**  
We've distilled the wisdom gathered from our installation and field service experience into a series of concise "Optical Perceptions" written by and for TV professionals.

## about Amperex Plumbicon® TV Camera Tubes.



When you specify Amperex Plumbicon TV Camera Tubes: you're never more than a phone call away from competent technical assistance, 24 hours a day, 365 days a year. So you never have to worry about winding up "in the dark"—faced with a technical riddle you can't solve.

Of course, we have a generous warranty, (company policy and our own engineers insist we interpret it in the customer's favor!) But more important, we're here when you need us. On the phone to talk you through minor technical problems. On a plane if your problem is more than just routine. At your desk with a print and video library of technical applications, specifications, training and troubleshooting seminars.

Amperex Plumbicon TV Camera Tubes are made in Rhode Island, U.S.A. Delivered to you in twenty-four hours or less.

One telephone number is all you have to remember.

For more information call or write Imaging Products Group, Amperex Electronic Corporation, Slatersville, Rhode Island 02876. (401) 762-3800. A North American Philips Company. Outside the U.S.A. contact: Philips Electronic Components and Materials Division, 5600 MD Eindhoven, The Netherlands.

**Amperex®**

*Amperex Imaging Products  
...we see things your way.*

Circle (36) on Reply Card

**S&C McMICHAEL**



• **ESD Color Connection weather graphics**

A graphics system that runs on an IBM-PC with an HR videographics board. The system features 760x480 pixel resolution, custom font generation, digitizer pad, mapmaking and image pan/zoom capabilities. Special color enhancement (from a 16.7 million-choice palette) com-

bines with animation, looping sequences, retrievable maps and an on-line library of more than 200 images. Standard graphic features, as well as 3D displays, are controlled through menu instructions.

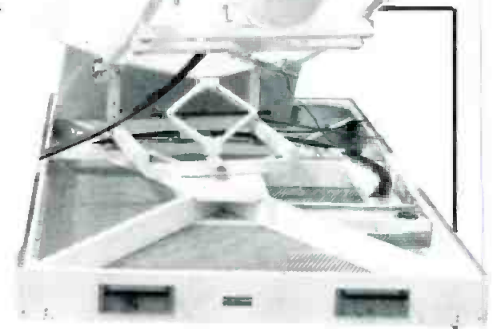

• **GEC McMichael NEWSHAWK**

A satellite news gathering (SNG) transmission package that includes all necessary electronics gear and a Ku-band dish antenna. The system is packaged for 2-person handling and transport by Lear jet, helicopter, van or commercial airliner. The system is a complete, compact, transportable satellite-uplink terminal. An elliptical dish antenna, a high-power amplifier and associated electronic equipment are contained in three separate packages. The system, although designed for transmit-only operation to Ku-band satellites, also includes a voice-grade engineering receive channel.

# SCULLY - The Originator of the DELTA Revolution.

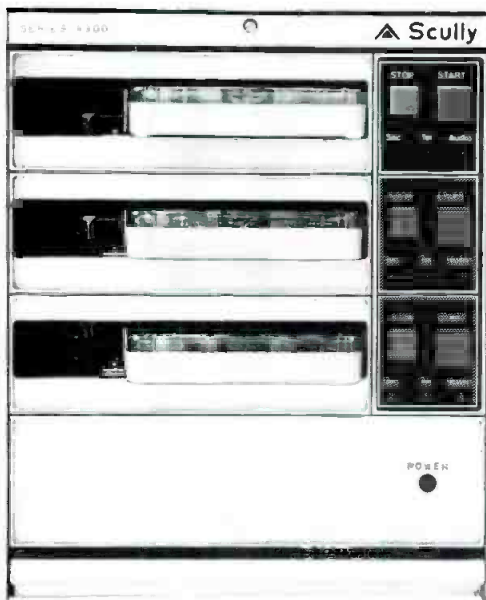

ITC would like you to believe they first conceived the modular tri-deck cart machine, but really it was part of the Scully 8300 way back in 1981.

Now that AMPRO/Scully is a Television Technology Company you can have the ORIGINAL revolutionary design. What else would you expect of Scully.

**The Scully 8300 offers:**

- Three independently removable decks
- Crystal referenced DC Servo Motor
- Non-magnetic stainless steel capstan shaft
- Even MORE affordable

**TTC**

AMPRO/Scully Division

Circle (37) on Reply Card

2360 Industrial Lane  
Broomfield, Colorado 80020  
(303) 465-4141  
TWX: 910-938-0396



## IF TRANSMITTER FAILURE HAS CAUSED YOU TO LOSE REVENUE, LET US INTRODUCE OUR INEXPENSIVE EMERGENCY TRANSMITTER.

What happens at your station when your FM transmitter goes down? Or your studio transmission link is disrupted? Or a power loss at the transmitter site occurs?

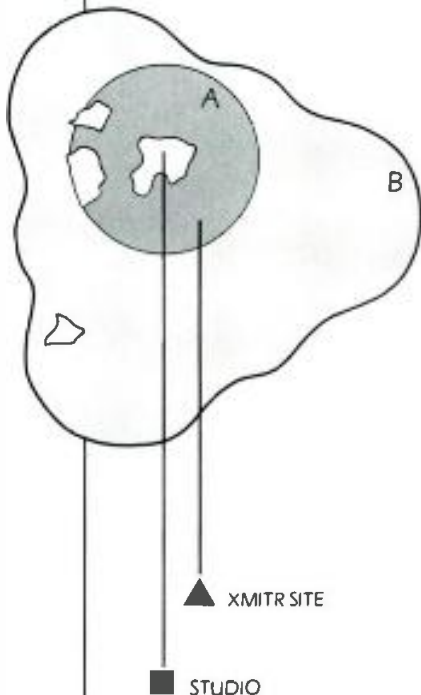

A — Coverage using QEI studio location transmitter  
 B — Coverage using station's primary transmitter

QEI has an inexpensive solution. Our low-power FM transmitter designed for studio operation can handle all these emergencies and keep you on the air. In many cases you'll retain the majority of your audience simply because your studio is usually located more central to your market than your transmitter site.

For a small investment your station will gain protection against lost revenues and the embarrassment of discontinued service.

QEI's low-power transmitters are all solid-state and are available in 150w, 300w or 500-watt power output levels. No warm-up is required. They are on the air in less than 10 seconds . . . and have hundreds of thousands of trouble-free hours. Virtually silent in operation, all our transmitters use QEI's famous 675 synthesized exciter.

So cover yourself with a QEI low-power FM transmitter located at your studio site . . .

Solve the problems caused by an STL or main transmitter failure . . . and do it on a modest budget.

For more information contact John Tiedeck at 609 728-2020. He will put a package together to meet your station's needs.

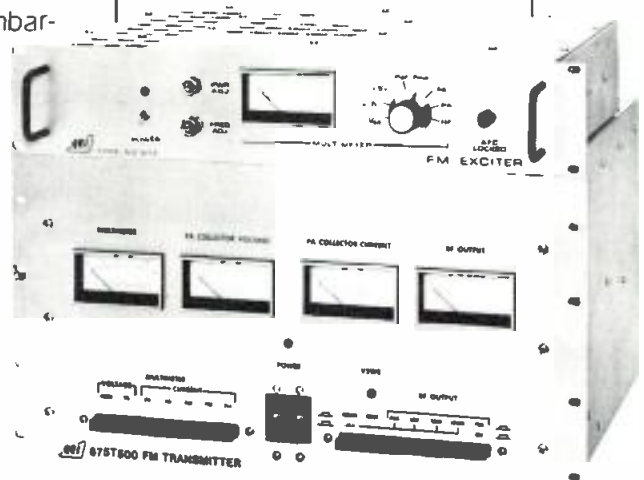

**QEI Corporation**  
 One Airport Drive  
 P.O. Box D  
 Williamstown, NJ 08094  
 Phone: 609-728-2020

# QEI Corporation

Circle (38) on Reply Card

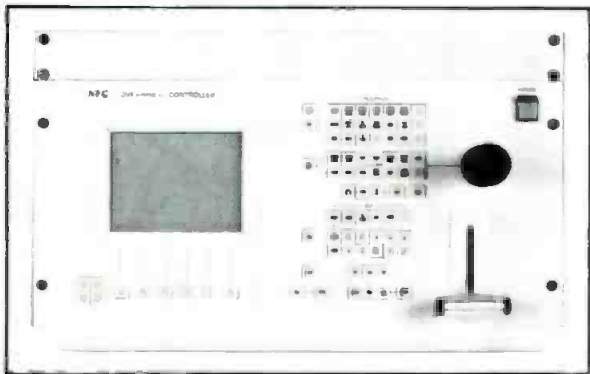

• **NEC DVE System 10 video effects**

A system that incorporates a number of E-Flex features in a 16-bit architecture package. Many functions of the E-Flex/Optiflex system are combined with new control and programming capabilities. Retained are 3D rotation and perspective, key tracking, cropping, mosaic tile and posterizing, with a programmable memory added using a 3.5-inch microfloppy disk for off-line storage. Real-time effects can be called by defined push-button controls. Soft-key programming is aided with a display-screen presentation of effects parameters.

• **Orban 8182A/SG Optimod-TV generator**

A BTSC generator for stereo TV applications. An internal dbx decoder card allows closed-circuit verification of proper operation. Computer-optimized left and right and sum and difference filters, designed for minimum overshoot and ringing, protect the BTSC channels from

crosstalk and out-of-band disturbances. A user-adjustable baseband clipper is used to control overshoots introduced by the 11-pole sum and difference filters, preventing intermodulation distortion between the pilot, stereo, SAP and PRO channels. An auxiliary input is provided for external SAP and PRO generators.



# THE DA-5000P DISTRIBUTION AMPLIFIER

The DA-5000P Distribution Amplifier combines video and audio into one convenient cabinet.

Its single video input and single audio input both provide ten matched, isolated outputs.

Rack mountable, the DA-5000P is 1 1/4 inches high. Additional units can be stacked to provide more outputs.

Front panel screwdriver adjustments and test points provide level and high frequency compensation.

The video section features a 10 MHz bandwidth, 1/2° differential phase with tilt and linearity figure of better than 1%.

The DA-5000P retails for \$595.00 and is ready for delivery.

Dealer inquiries invited.

ICM VIDEO  
10 NORTH LEE • P.O. BOX 26330  
OKLAHOMA CITY, OK 73126  
(405) 232-5808

**PRICE AND PERFORMANCE  
MAKE IT AN UNBEATABLE  
CHOICE.**



**ICM VIDEO**

Circle (39) on Reply Card



# IMAGINE OUR EFFECTS ON YOUR EFFECTS!

Whether you're using digital video effects on-line or off-line — for news, videos, TV spots, intros, sports or ads, NEC's DVE<sup>™</sup> System 10 gives you so much versatility, you'll have plenty to think about. Just sit back and imagine what you could do with:

- Electro-luminescent display of image information for easier duplication or modification of effects

- Function keys to quickly produce effects
- A 16-bit microprocessor for the most transparent effects processing in the business
- Unlimited key frames for the smoothest transitions yet
- A tearing effect you'll have to see to believe
- A 3-dimensional cube maker for 3-or 6-sided cubes

- Forced monochrome
- An on-board combiner to control two systems simultaneously
- Off-line storage featuring a 3.5" micro floppy disk drive

And more new features. All inside a system so easy to operate, you'll spend a lot less time using your hands . . . and a lot more time using your imagination.

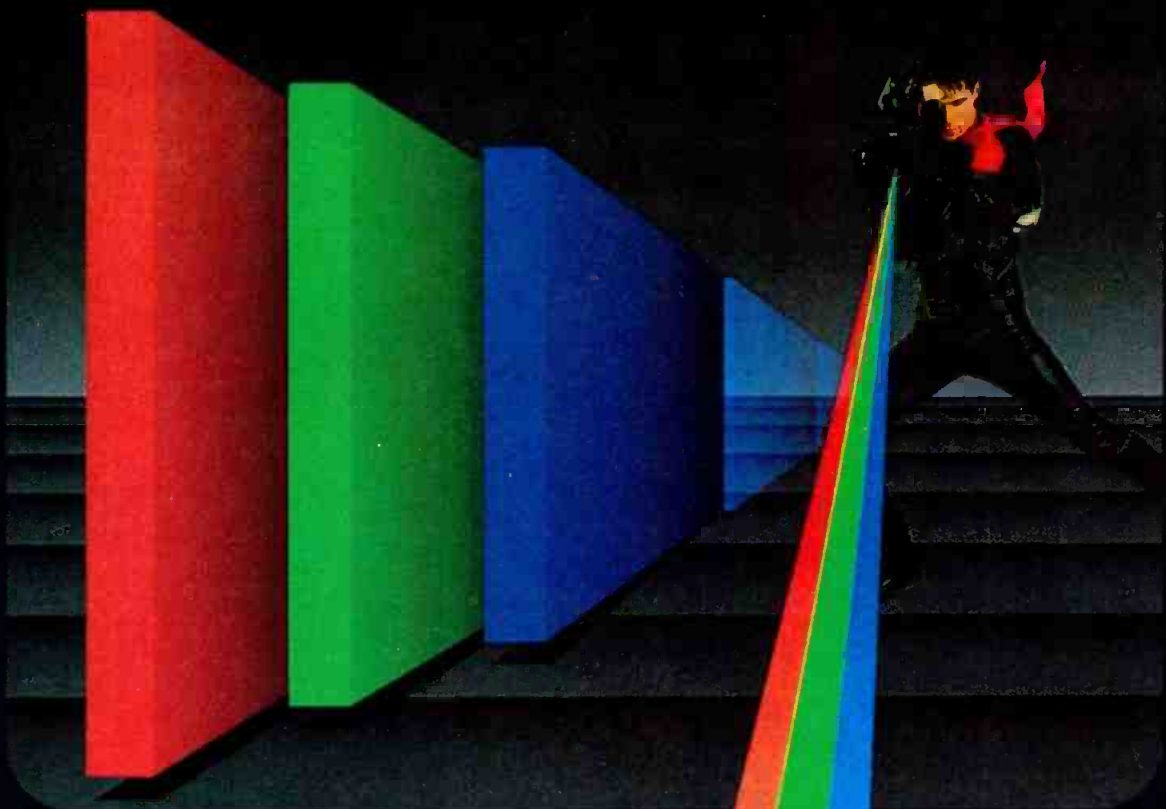

## NEC

**IMAGINE WHAT WE'LL DO FOR YOU**

NEC AMERICA, INC., Broadcast Equipment Division  
130 Martin Lane, Elk Grove Village, IL 60007  
In Illinois 312-640-3792

DVE<sup>™</sup> is a registered trademark of NEC Corporation.

Circle (40) on Reply Card



• **Panasonic M-II VCR**

A videocassette recorder that brings Type C quality to 1/2-inch tape for post-production or on-air operation. For studio or remote van use, the unit provides 4.5MHz bandwidth recording in an analog component system with Y and time-compressed R-Y and B-Y on separate tracks. RS-422 serial interfacing allows system transport and editing control. Although not tape-for-tape compatible with other 1/2-inch equipment, M-II has signal compatibility through an array of inputs and outputs for composite NTSC, Y/I/Q, Y/R-Y/B-Y, Y/C and RGB video. With T-120 length metal-particle tapes, a recording time of 65 minutes is realized.

• **Philips LDM 1791 transmitter**

A 60kW UHF transmitter system that uses the Amperex/Valvo YK1265 klystron for a 25% reduction in beam power requirements. IF modulation with SAW filtering is used in the design. The system occupies 60% of the volume of its predecessor, while the heat exchanger, located over the heat-generating amplifiers, reduces required floor space and coolant-pumping power. The visual PA uses an integral pulser system to take advantage of the high-efficiency capability of the external cavity, vapor and air-cooled klystrons. Broadband circuits prepare the LDM 1791 for MTS transmissions.

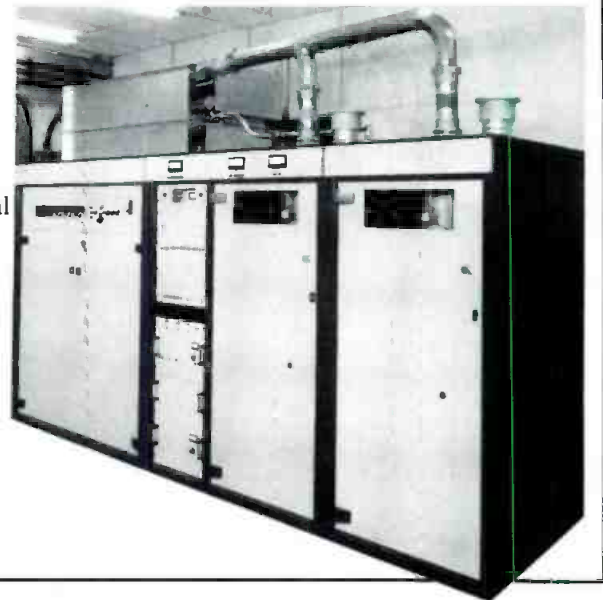

# Introducing the RVS-210

... never before have so many features been offered in a switcher that's this affordable.



Canada: Ross Video Limited, 500 John St., P.O. Box 220, Iroquois, Ont., K0E 1K0, 613-652-4886, Telex 05-811579  
 U.S.A.: Ross Video Inc., P.O. Box 880, Ogdensburg, N.Y., 13669-0880

Circle (41) on Reply Card



# If you demand absolutely the best audio transformer, insist on a Jensen!

## Choose From a Wide Variety of Types and Packages

- Microphone Input
- Microphone Bridging
- Line Input
- Direct Box
- Low Freq. Crossover
- M.C. Cart. Step-up
- Electret Mic Output
- Bridging
- Repeat Coil
- Line Output
- Special Types

Superb specifications, consistent performance, and unsurpassed reliability have earned Jensen a solid reputation as the world's preeminent manufacturer of audio transformers.

We control every facet of design and construction, from core alloy up, using sophisticated computer modeling techniques. With 5 years software development background, including an AC circuit analysis for Hewlett-Packard's desk top computers, we now market our own advanced circuit optimization programs. Because Jensen transformers are designed to function

as an integral part of the circuit, not as an afterthought, all parameters can be optimized. The result is a *clearly audible improvement in transformer technology*. For example, our Model JE-115K-E mic input transformer has under 1% overshoot with no RC damping network (bridged output), and exceptional magnitude and phase response.

Our highly qualified technical staff is eager to assist you with expert applications engineering. Discerning engineers have field proven our transformers, by the tens of thousands, in the most demanding environments – professional recording studios, fixed and mobile broadcast facilities, and touring sound systems. That returns and failures are rare is no accident; we place strong emphasis on quality control.

We carefully inspect every transformer before and after encapsulation. Then, in our computerized automated test lab, we verify that each and every transformer meets or exceeds its specs.

We take this extra care because we are dedicated to excellence. So next time you need a transformer, *insist on the best – insist on a Jensen.*

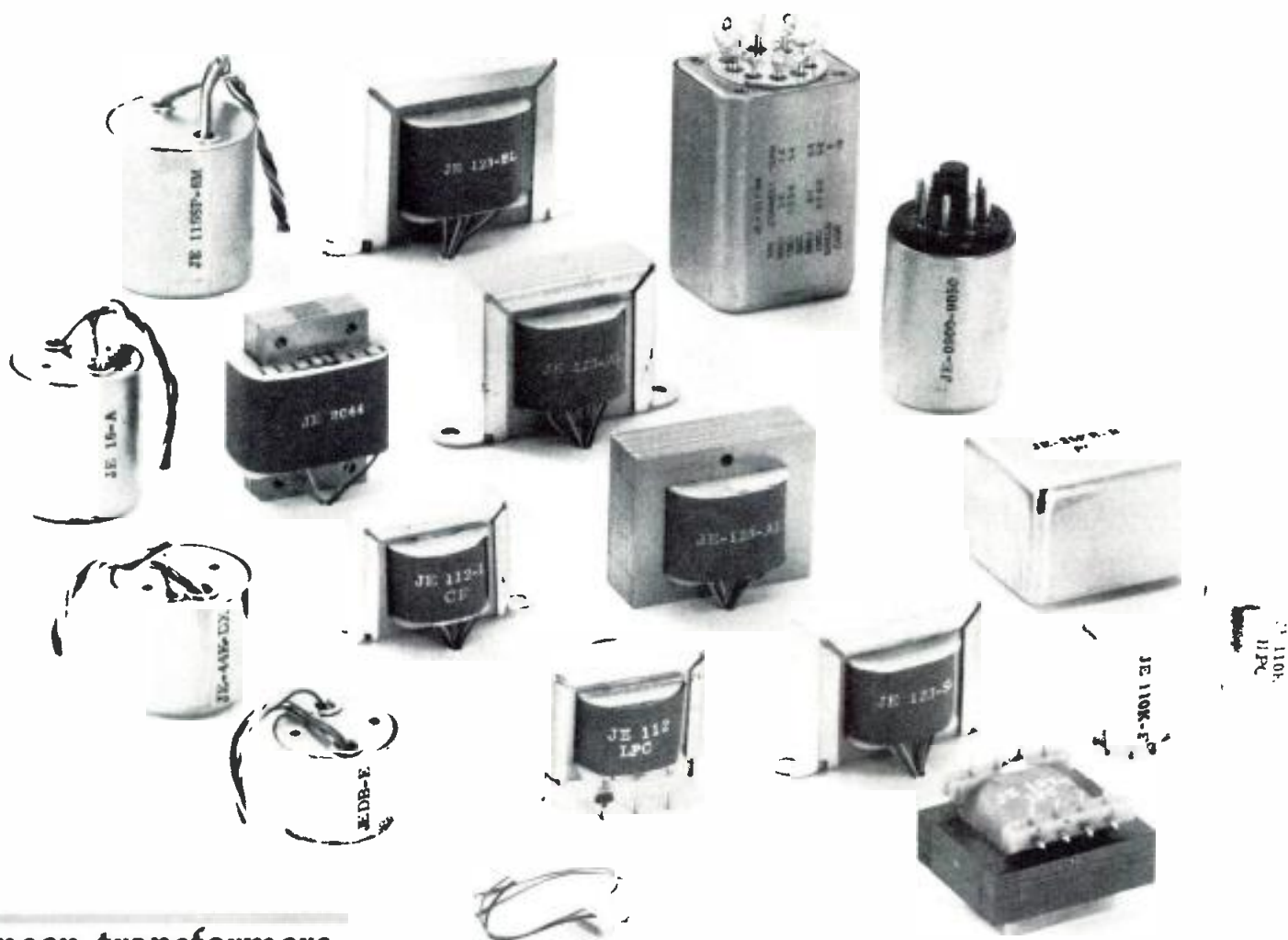

**jensen transformers**  
INCORPORATED

10735 Burbank Boulevard/N. Hollywood, CA 91601/(213) 876-0059

Write or call for information.  
Visitors by appointment only (closed Fridays).

UK Distribution by: Scenic Sounds Equipment Ltd. • Unit 2, 10 William Rd., London NW1 • Phone: (01) 387-1262 • Telex: 27 939 SCENIC G

Far East Distribution by: Towa Engineering Co. Ltd. • No. 7th Azuma Bldg. • 1-9, Sakuma-cho, Kanda • Chiyoda-ku, Tokyo 101 • Phone: (03) 253-3537

Australia Distribution by: Syntec International Pty. Ltd. • 53 Victoria Avenue • Chatswood, N.S.W. 2067 • Phone: (02) 406-4700 • Telex: SYNTEC AA 70570

Circle (42) on Reply Card

June 1985 **Broadcast Engineering** 63

• **RCA CCD-1S camera**

A sports camera that combines the advantages of solid-state image sensing with a 1/500-second shutter to avoid motion smear. The shutter system allows slow-motion or stop-action images when used with appropriate VTRs. CCD imaging offers reduction in lag, image reten-

tion, target burn and comet-tailing. A rotating shutter system controls the exposure time of 1/500 of a second to eliminate the interim image motion-smear of normal camera systems. The highlight performance and dynamic range enhance a low-sensitivity rating for fast-action sports pickups.



• **Schwem Technology Gyrozoom 60/300 lens**

An image-stabilizer zoom lens system that provides focal lengths from 60 to 300mm, starting from an MOD of 3.048m. Designed for 2/3-inch cameras, the automatic iris includes manual control and covers a range from f/6.2 to f/32. Gyros, incorporated into the lens assembly, provide immunity to high-frequency vibration for operation from a moving vehicle or hand-held use with maximum focal length. Powered from 12Vdc, the drain on the camera battery decreases running time by about one minute per hour. No external braces or brackets are required to support the 6-pound lens assembly. |:-?-)!!!

## Affordable Random Access Video Cart Systems

Cost effective, modular, and expandable



**Component Switching and Processing**

Modified 3/4" U-Matic Players with Y-C/DOC outputs or 1/2" Type M with YIQ outputs are switched through our vertical interval Matrix Switcher into a component TBC.

**Automatic Directory Reading**

Cassettes are loaded randomly into an empty deck. They rewind automatically to the head and the directory, containing a 4-digit reel ID number with precise start and finish times of each segment according to their location with reference to SMPTE time code is read into memory. The status indicating ID found and VTR location is displayed on the terminal.

**Send for Brochure**

Lake Systems Corporation, 55 Chapel Street, Newton, MA 02160 617/244-6881

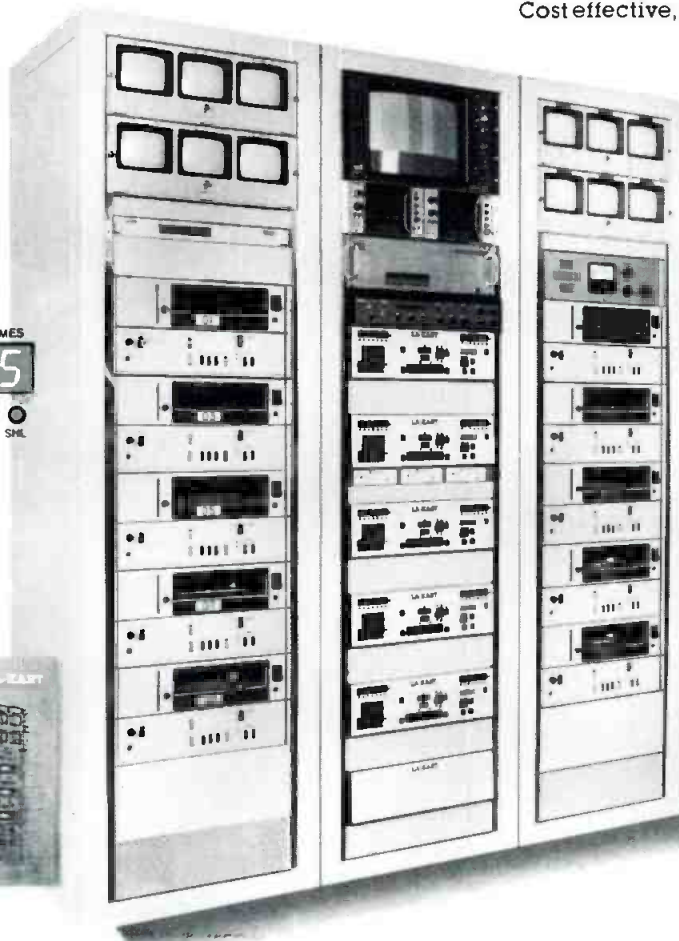

**Any Tape Format**

Choose from 1" Type C, 3/4" U-Matic, 1/2" Type M, or any combination.

**1000 EVENTS** Or more with 68K Multi-Event Programmer and Disc Drive.

The computer identifies, searches out, and activates tape segments to be cued and aired in the order scheduled.

Lease Plans Available

**LA-KART**<sup>TM</sup>  
LAKE SYSTEMS CORPORATION

Prices Start at \$89,900

© Lake Systems Corp. 1983

Circle (43) on Reply Card



# In 1982, ADC Introduced Pro Patch And Revolutionized Audio Patchbay Technology.



## Here's What We've Done For You Lately.



IN  
CKT  
8      IN  
CKT  
9      IN  
CKT  
10

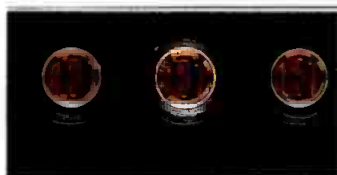

OUT  
CKT  
8      OUT  
CKT  
9      OUT  
CKT  
10

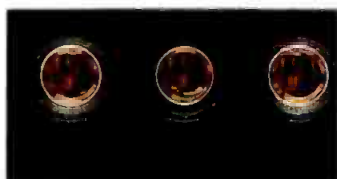

## SAILS Means The End Of Cumbersome Circuit Designations.

ADC makes circuit designations simple with new pressure sensitive labels. The labels for our exclusive Self Adhesive Identification Labeling System (SAILS) were developed by 3M for efficient and effective labeling.

- Each Pro Patch comes with a sheet of tractor feed, computer printable labels. Each sheet includes pre-numbered designations, blank labels and practice templates.
- Easy to write on, non-yellowing, non-smear surface.
- Labels adhere securely, but can be cleanly removed when necessary.

- Large labels afford more room for designations than with conventional systems. (Labels accept 3 lines of 12 point type, 6 characters per line).
- Recesses molded into the Dupont Lexan™ front panel protect labels.
- **Attention E F & I's and Contractors:** This is the system to use to make cost-effective, accurate designations for your customers' patchbays.

## When You're Ready For Stereo TV, ADC Is Ready With Stereo Pro Patch.

With our Stereo Pro Patch, you'll be ready for the coming change to Stereo TV. Jack pairings give you virtually mistake proof patching.

- Jacks grouped in pairs to accept dual patch cords.
- QCP terminations are labeled with stereo nomenclature.





## Dense Patch From ADC Adds A New Twist To Convenient Cable Terminations.

Our innovative Dense Patch is configured like a "Christmas tree," but it's like no "Christmas tree" you've ever seen. It's designed to make short work of cable terminations, with easy access to both sides of the panel. And our exclusive QCP system means no more wire wrap or solder connections.

- "Christmas Tree" configuration.
- Each Dense Patch panel pivots 90 degrees and locks into position automatically.
- Fast QCP Connections (see below).
- Easy rack or wall mounting.
- QCP layout allows quick normalizing and half normalizing (monitor without break) for jackfield terminations.

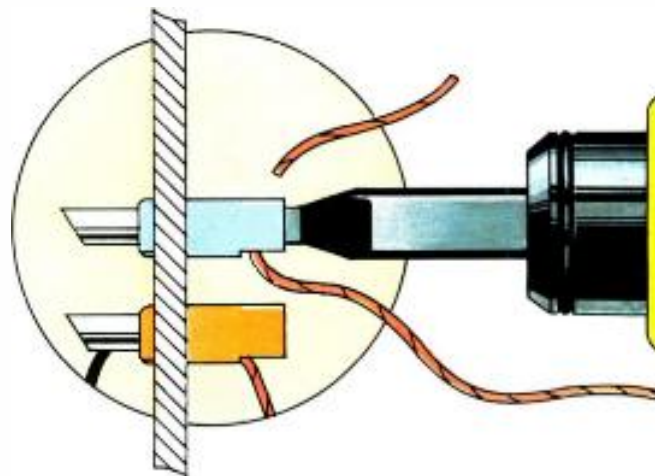
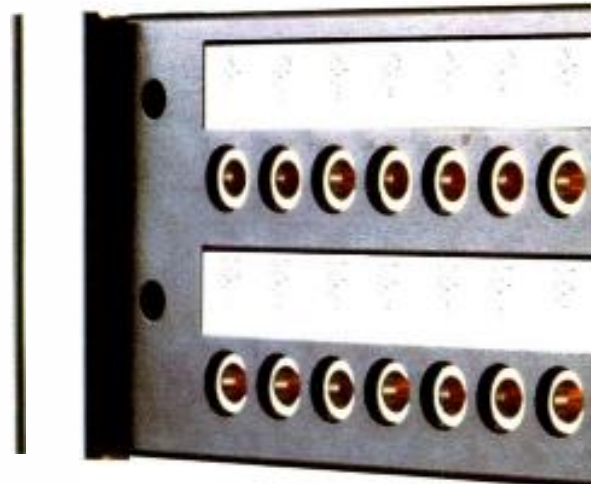

## Get ADC's QCP System ...The Innovation That Rocked the Broadcast Industry.

You'll save time with ADC's unique QCP split cylinder cable termination system. One simple operation connects and trims excess wire. Accepts two 22, 24, or 26 AWG solid or stranded wire on both sides of the contacts. Color coded plastic insulating modules and recessed QCP cylinders virtually eliminate shorting. Contacts are rated for a minimum of 100 insertions and withdrawals, allowing numerous reconfigurations.

- Wire is cleanly cut off with insertion tool.
- Split Cylinder both front and rear.
- Full strain relief.

---

**At ADC, Our  
Commitment To  
Quality And Innovation  
Gives You Peace Of  
Mind And A Piece Of  
The Future.**

ADC is consistently developing new and better products for the Broadcast industry. We've shown what we've done for you lately in this brochure. With innovative designs like DENSE PATCH, STEREO PRO PATCH, THE VIDEO AUDIO MODULAR PATCHBAY and SAILS, we've made your job easier and more efficient. But that's not all, we have a complete line of Broadcast patching products and accessories. Give us a call for more information or the name of the ADC distributor nearest you.



ADC Telecommunications  
4900 West 78th Street  
Minneapolis, Minnesota 55435  
(612) 893-3010

Items shown in this brochure will be available summer, 1985.



## ADC Lets You Design Your Own Custom Audio/Video Patchbay.

If you have limited or changing patching requirements, or need audio and video patching in the same bay, ADC has the answer. Our Video Audio Modular Patchbay (VAMP) gives you all the flexibility you need in a single bay. That means you no longer have to buy a fully loaded bay, just contact ADC or your nearest distributor to get the modules you need, as you need them.

- Chassis accepts 20 video and audio modules.
- Audio Module features unique QCP terminations.
- Video Module comes with the ADC SJ2000 self normalizing coax jack.
- ADC will supply blanks for unused positions to give the appearance of a fully loaded patchbay.

## Redesigned QCP Back Panel Makes Pro Patch The One For All, And All For One System.

ADC brings more flexibility to the Audio Pro Patch. Its new configuration allows a wider range of normalizing combinations. Top-to-bottom normalizing and half normal (monitor without break) configurations can now be done more quickly and easily, widening the spectrum of possible applications.

- Quick Connect QCP terminals.
- TRS and Normals grouped 1-24, 2-25 etc.
- *New for '85 — Pro Patch now available with normals at the panel.*

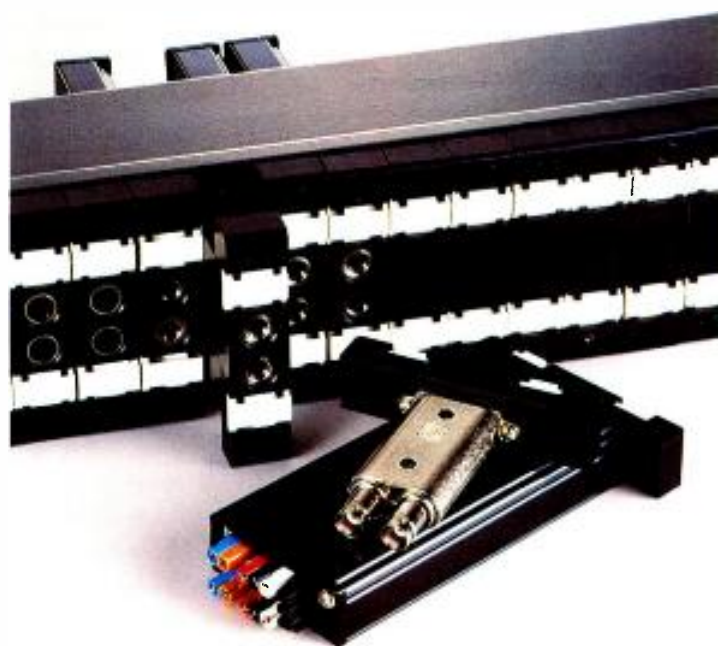



## **Pro Patch Design Enhancements Make A Good Thing Even Better.**

ADC has enhanced the design of Pro Patch front and back to deliver more time and work savings. In front, circuit designations are neat and convenient; and in back, the terminal layout affords faster installation and more flexibility of configuration.

For More Information  
Circle (33) on Reply Card



# Opening doors to the future

By Brad Dick and Don Markley

**The broadcast engineering sessions at NAB were a forum for questions and answers, cold facts and hot issues, some success stories and even a few dreams.**



The 1985 NAB convention was, as in previous years, a golden opportunity for broadcast engineers to bring themselves up to date on the latest equipment. The engineering sessions opened doors to understanding the new technology and modern engineering practices. Through these sessions, broadcast engineers were enlightened on timely topics—in radio and television—that affect the choices they will make as the door to the future opens ever wider.

## Radio's first steps

The general tone of the radio engineering sessions was set by Michael Rau, staff engineer for the NAB, when he said broadcasters must take immediate steps to improve AM broadcasting. He outlined eight steps that the NAB's AM Improvement Committee proposes to take in assisting AM broadcasters with improving their marketplace operations.

The first, and perhaps the most difficult, step is to implement an industry-wide AM promotional campaign to educate the consumer about the advantages of quality AM reception. Because the effectiveness of this campaign depends primarily on the availability of quality receivers for the consumer, Rau admitted that it will be a challenge.

Second, the NAB plans to establish a technical information base that will be of interest and value to engineers and managers. This base would provide an opportunity for engineers to learn more about how to improve the sound of their stations.

In addition to these general proposals, the committee has also set forth several technical proposals. The committee recommends that stations limit the amount of high-frequency boost applied to frequencies above 12kHz. Although the committee declined to approve or to recommend any specific pre-emphasis curve, it did not rule out a standardized receiver de-emphasis curve.

Other technical improvements sug-

gested by the committee include a study of directional antennas and broad-banding techniques. Current studies indicate that an improvement of 15dB in ground-wave coverage is possible with new antenna designs. Other possible antenna designs and their advantages will also be examined.

Transmitter Transient Distortion (TTD) seems to be an area not yet sufficiently addressed. According to Rau, the NAB hopes to undertake a study of TTD to define its cause and to find a cure.

Perhaps the most important step to the success of AM broadcasting is that of assisting receiver manufacturers in developing a high quality integrated circuit for use in AM radios. Although there are proponents who would argue that quality chips are already available, the committee suggests that lower unit costs would make the chips more attractive to receiver manufacturers and thereby increase the availability of quality receivers to the consumer.

Finally, Rau said the committee recommends that work be undertaken to mitigate existing and potential new interference from RF electrical devices. As most of us know, interference is already a serious problem, and the use of RF lamps could make things even worse. The committee suggests that an investigation of the potential interference from RF lighting be undertaken, and, if necessary, take steps to limit that interference.

## Improving AM radios

With the stage set for discussions on improving AM quality, the floor was turned over to a number of well-qualified engineers to voice their own insights.

The first of those proposing methods to improve AM quality was John P. GrosJean, consulting engineer. He provided a paper on the design of AM receivers, and outlined the need to use modern ICs in addition to proper filters in any modern receiver.

GrosJean stressed the need to be realistic about receiver frequency response. He reminded broadcasters that transmitting audio out to 15kHz was unrealistic, especially when that frequency exceeds the available channel spacing. He pointed out that any receiver will require a sharp 10kHz notch filter. The use of this filter, according to GrosJean, will limit received audio to about 8kHz.

For daytime reception, he suggested that an IF bandwidth of 20kHz coupled with the 10kHz notch filter would provide a dramatic improvement in the apparent quality of the AM receiver. GrosJean said nighttime reception audio would be limited to no more than 5kHz and that probably 4kHz is more practical. He warned that any station using heavy processing just to make old radios sound better, might actually be forcing the listeners to switch back to the nighttime mode or to turn down the treble to make the sound acceptable. GrosJean also suggested that a standardized pre-emphasis curve could be adopted and that transmitted frequencies should be limited to less than 10kHz.

Assuming the industry can finally build quality receivers, what do we need to do about the transmitter? Echoing GrosJean, Bob Orban, Orban Associates, and Greg Ogonowski, Gregg Laboratories, said the industry needed a set of standardized pre-emphasis curves for both receivers and transmitters. Their paper fully outlined their proposal.

Another area of concern to the panel members was AM stereo processing. This issue was addressed by Ron Jones, Circuit Research Labs. His paper outlined the reasoning behind matrix audio processing as opposed to separate left- and right-signal processing. This particular method of processing audio has been suggested before, but Jones' specific technique and recommendations offer some advantages over earlier designs.

Dick, BE's studio facilities consultant, is engineering director at KANU/KFKU, Lawrence, KS. Markley, BE's transmission facilities consultant, is with the consulting firm of D.L. Markley & Associates, Peoria, IL.

**OVER 233,000  
BASKETS SHOT AND  
WE'VE NEVER  
MISSED A POINT.**

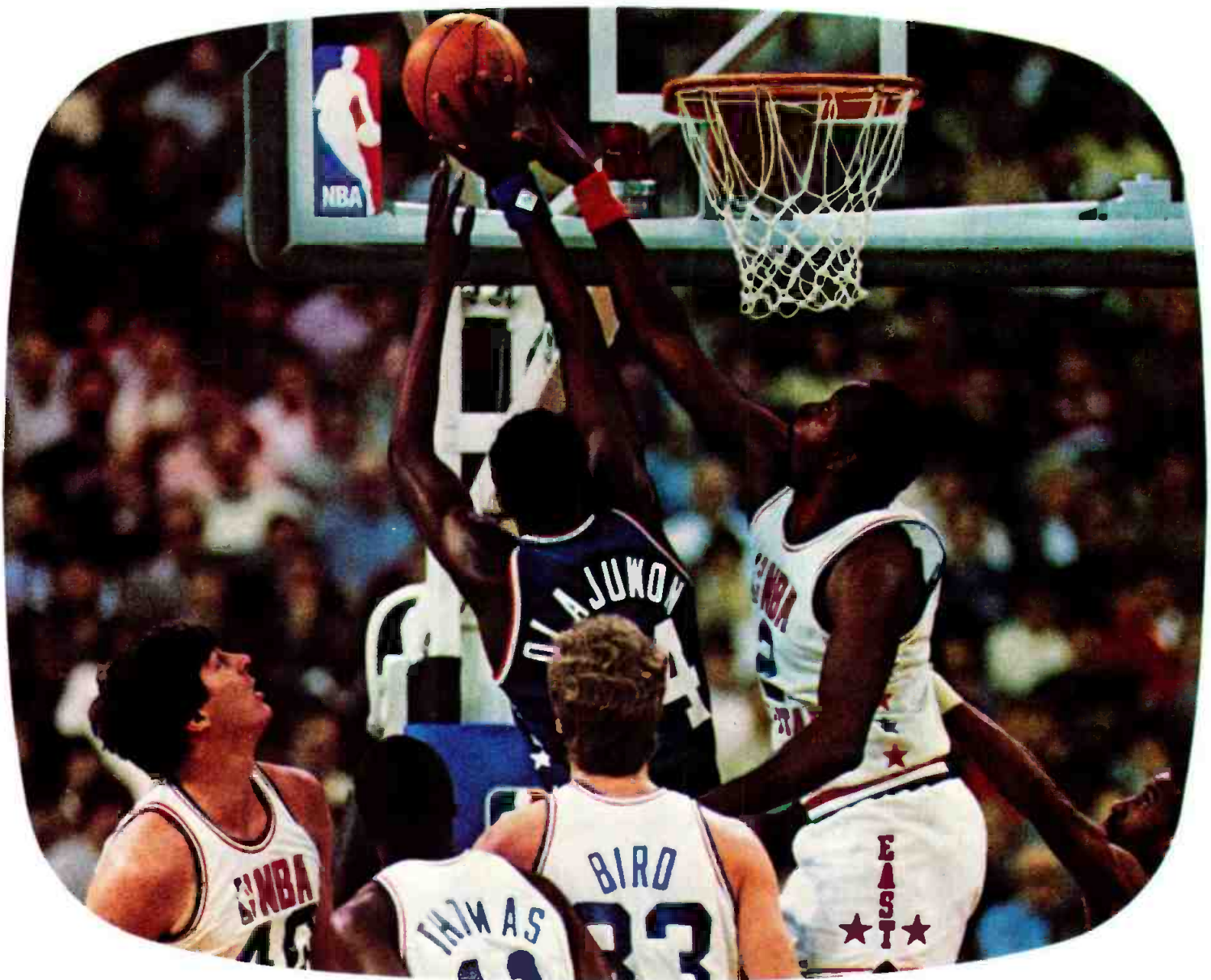



Pretty impressive record.

It's Sony's.

Because as the official videotape of the NBA, Sony has captured every slam, every jump, every dribble, every drive. And after 1022 games, Sony has a record of 1022 wins, no losses.

How have we done it? By formulating a videotape that's the most consistent in the industry line-up.

The K-Series is a tape that's been developed with an eye towards perfect coordination. Available in 3/4" cassette and 1" Type C format, its top players are uniformly dispersed, highly packed and well-oriented magnetic particles.

Complementing their strengths is the binder that distributes them evenly. And a unique surface treatment completes the team.

Then, to ensure that there be no technical fouls, Sony subjects the K-Series to pre-game check-ups lasting over 1000 hours.

By the time the K-Series makes it to the court, it's ready to turn in record-breaking audio and video performances. Play after play after play.

And that, after all, is the point.

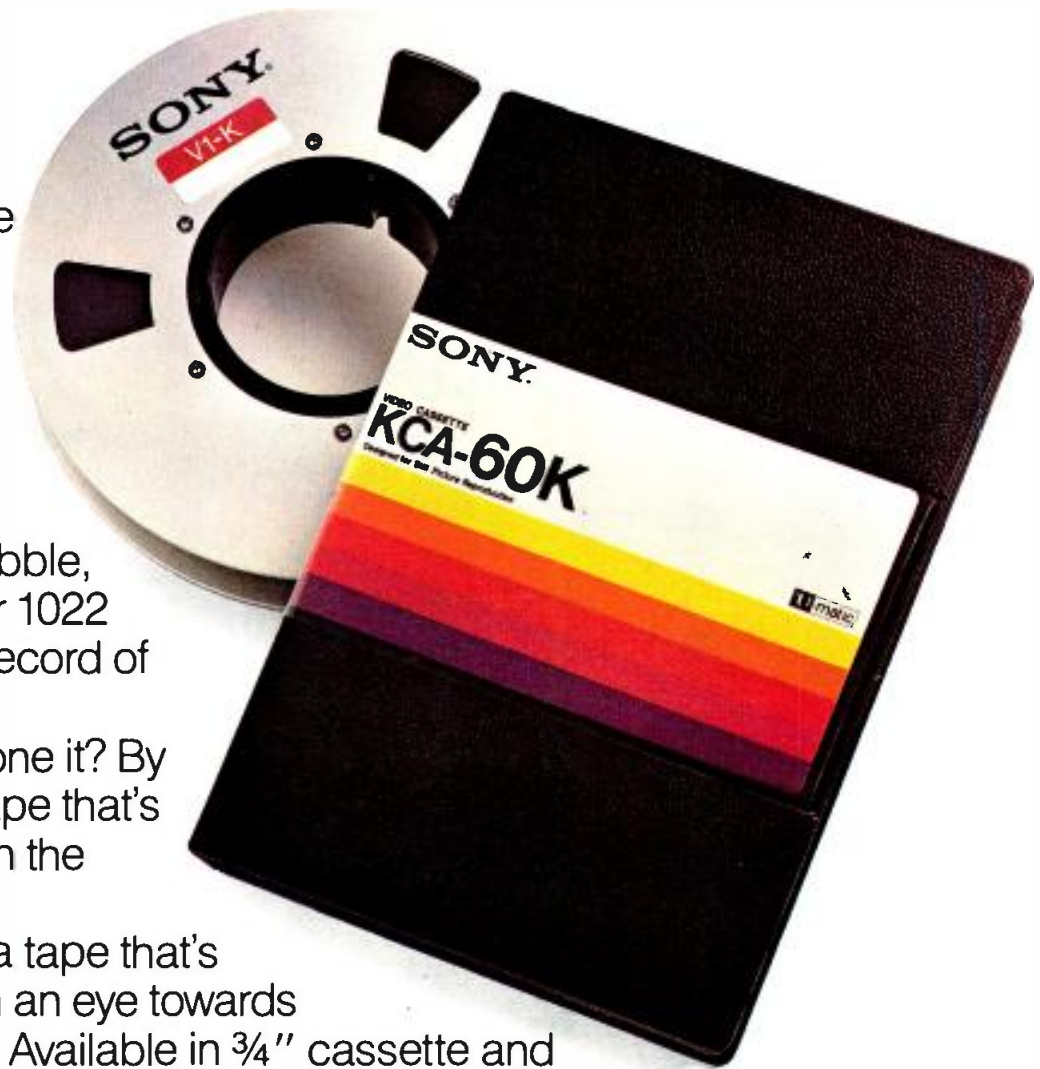

**SONY**  
Professional Tape Division

Following the discussion of specific needs for industry improvement, it was time to move on to the controversial issues. Though no one debates the need for improvement in frequency response or better noise rejection in receivers, many people still argue the merits of the two basic methods of generating AM stereo.

#### Motorola vs. Kahn

There are currently only two serious contenders for the AM stereo standard—the Motorola system and the Kahn system. Six months ago, Harris announced that it would manufacture its own design of AM stereo exciter, based on the Motorola C-Quam technology. That move reduced the number of players vying for the AM stereo broadcast standard from three to two, and Leonard Kahn's system was pitted directly against the Motorola C-Quam system, which is being used by a reported 70% of AM stereo broadcasters.

Motorola has been successful in getting 16 receiver manufacturers to adopt the single standard of C-Quam design. Two manufacturers currently make a multimode receiver capable of detecting both the Kahn system and the Motorola system.

Delco's decision to adopt the single standard of Motorola was a major blow to Kahn because he had been lobbying hard for the multimode design. One report shows that Delco has been successful in its attempt to promote the AM stereo receiver with 20% of some General Motors car models being purchased with C-Quam AM stereo radios.

Kahn made a presentation in which he briefly outlined his newest exciter design, the STR-84. He then addressed what he sees as the major drawback to the Motorola design: platform motion.

Platform motion relates to poor quality sound moving back and forth, from side to side, when a receiver is tuned to a distant station. Although Motorola suggests that the subject of platform motion has been overemphasized, it continues to be an issue with its critics.

Kahn said he sees the Harris/Motorola

agreement as nothing short of an anti-trust issue. He said that because he thinks the two companies are breaking the law, he has petitioned the U.S. Department of Justice to investigate.

#### This is it

This year's radio engineering sessions created a definite feeling that AM radio is at a fork in the road and will either make it soon or simply fade away as a competitive force in the marketplace. No surveys were conducted, but there was a

sense of optimism as attendees left the sessions. If a campaign to educate the consumer is effective, together with a sufficient supply of quality AM stereo receivers and a single marketplace AM stereo standard, then AM broadcasting may spring back to life. 1985 could very well be the year that AM broadcasters get back into step with the industry.

#### TV's new year

Just as the Chinese identify the years by associating them with an animal (1985 being the year of the rat), most years at the NAB TV technical sessions could be associated with a particular type of equipment. 1984 was the year of the stereo TV components. This year could be easily characterized as the year of the transmitter. The sessions resounded with discussions of the transmission system itself, related hardware (stereo) and problems associated with RF.

#### Stereo TV

The most interest was expressed in stereo audio for television or Multichannel TV Sound. The engineering papers uniformly agreed that the wealth of predicted problems, such as diplexer replacement, excessive noise and crosstalk levels, simply had not been found to be as serious as expected. To the contrary, it has been proved that most TV systems can be converted to Multichannel TV Sound (MTS) with relative ease.

The real problems—the ones that require solution or elimination—were outlined by Verne Mattison, RCA; Ronald Zborowski, ITS; James Swick, WTTW-TV; Randy Hoffner, NBC; and Ralph Haller, FCC. The speakers indicated that some correction must be made for incidental carrier phase modulation (ICPM), which appears as FM and causes signals to interfere in various forms with higher order aural sideband signals. This interference results in crosstalk between subcarriers and degrades stereo performance. The EIA/BTS Multichannel Sound Subcommittee has made recommendations for system bandpass and performance characteristics that identify the required system operation. Thus, the ICPM problem essentially has been eliminated by corrective circuits that can be incorporated into the visual exciters.

In addition to the problem of ICPM, another area of concern regarding MTS has been that existing diplexers might have to be replaced. This has been found not to be the case. Presentations by Byron St. Clair, TTC; Alan Parnau, ABC; Mark Aitken, Comark; Jerome Pozgay, Micro Communications; and Geoffrey N. Mendenhall, Broadcast Electronics, showed that with a hybrid that has not been tuned for years, some adjustment may be necessary. In a similar fashion, it

*Continued on page 163*

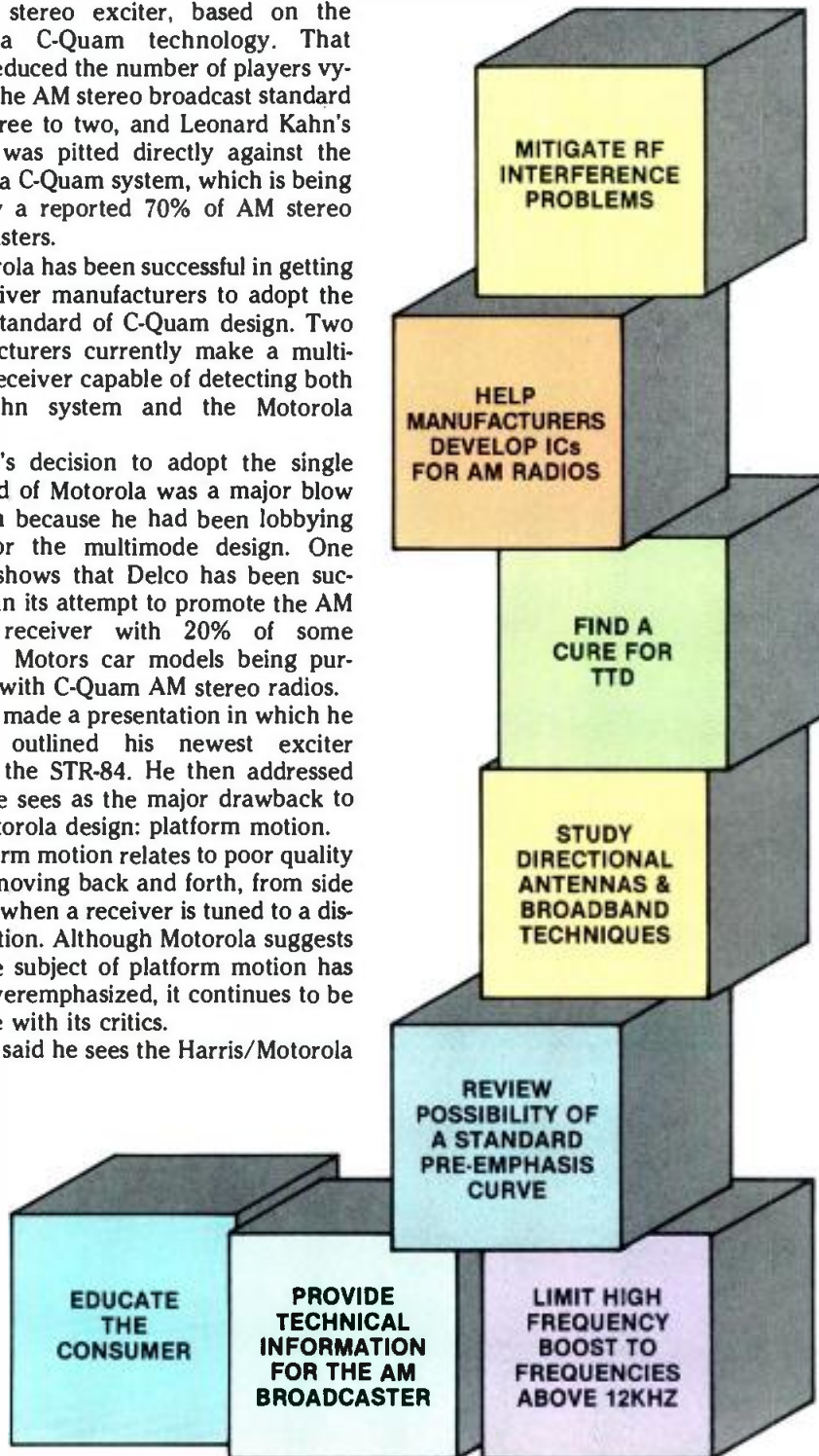

## NAB proposes to build broadcasting



# Can the Panasonic® AK-30 stand head to head with the bestselling broadcast camera in the world?



You bet it can. In fact, when you compare picture quality, automatic features and price, you'll discover the Panasonic AK-30 is far and away your best bet.

Compare pictures. You'll notice the AK-30 produces a superrefined video image. The kind of image broadcasters love to see. But that's not surprising with these kinds of specifications: Horizontal resolution is 650 lines center. S/N is a very quiet 62dB (-6dB gain), the highest ratio in the industry. Digital registration is 0.05%, 0.1% and 0.25%. And illumination is a mere 24 lux at f1.4 (+18dB gain).

This high level of performance is achieved with a unique combination of image-enhancing circuitry and high-focus-field Plumbicon\* tubes.

You'll also appreciate the AK-30's automatic circuits. Like auto-white balance with memory for setting 2 color temperatures. Presettable black stretcher. Auto-black balance, and a knee circuit for variable dynamic range.

Together, they let you customize the image you're shooting for.

Still, the AK-30 has plenty more going for it. Consider its dual outputs. One works with standard NTSC. The other lets you set new standards because it's compatible with component recording. That means you can use it as part of our famous M-format Recam system.

The Panasonic AK-30. Compare it to the world's bestselling broadcast camera. And see why it stands out far ahead.

For more information call your nearest Panasonic regional office: Northeast: (201) 348-7336. Southeast: (404) 925-6772. Central: (317) 852-5973. West: (619) 941-3387. In Canada call: (416) 624-5010.

\*Plumbicon is a registered trademark of N.V. Philips for TV camera tubes.

**Panasonic**  
Broadcast Systems

ANOTHER BROADCAST INNOVATION FROM MATSUSHITA ELECTRIC

# New frontiers for efficiency

By Don Markley

**Sophisticated new tube designs and the promise of reduced power consumption point to new frontiers in efficient UHF broadcasting.**

The UHF transmitters exhibited at the 1985 NAB convention reflect the achievement, by all of the major manufacturers, of a new level of overall operating efficiency.

NEC, Philips and Townsend introduced new transmitters that use the Amperex YK1265 klystron. This device is an external cavity design using the annular ring grid, normally referred to as an *ABC klystron*.

Initially, the concept would have modulated the tube with low-frequency video through the ring grid. However, a considerable degree of correction was required to compensate for distortion introduced into the RF signal by such modulation. Annular beam control has now been introduced as a low-voltage pulser with the voltage applied to the annular grid, reducing the beam during periods of the waveform when full beam current is not necessary. In effect, this is the same result achieved with higher voltage beam pulsers, but uses lower voltage devices. Designs with this klystron realize an overall power consumption in the middle 130kW range.

EEV also offers an annular grid tube that approximates the Amperex/Valvo operation. This device is rated at 55kW, compared to 60kW ratings of other tubes.

Harris and RCA systems using the Varian S-series (VKP-7550S) device obtain similar results. S tubes require approximately 70W of visual drive, or about 2W drive when used in aural service. To provide the added drive power, the transmitter includes IPA stages capable of 75W to 80W power output.

The good news is that the S tube, when tuned as a high-efficiency device, provides an operating efficiency of approximately 70% for the visual amplifier stage. Without a pulser, the efficiency is approximately 61%. These numbers assume a variable output coupler properly loads the final cavity. In all cases, both S- and previous H-series klystrons benefit



considerably from the variable output coupler.

A different transmitter design type, at the 60kW power level, is found in Comark systems, which include Marconi excitors. These transmitters employ klystrons with five external cavities from EEV and Valvo. Beam efficiency is reported to be 77.6% in pulsed mode operation. However, the significant feature is the amount of power that is actually drawn off the line for 60kW output as measured at the output of the diplexer. In this configuration, the consumption is approximately 130kW, nearly equal to that of the other new transmitter designs.

The cost difference between the internal and external cavity devices draws some operators to external types. The internal cavity tube may run from \$10,000 to \$15,000 more than nearly equivalent external cavity devices. Also, there are reports that output loading adjustments for some internal cavity devices are not as effective as might be hoped, resulting in somewhat reduced efficiency.

When the internal cavity klystron arrives from the factory, it is pretuned to the required operating frequency, and theoretically, may be put on the air in a short time. Though the task of preparing an external cavity tube for use requires four hands and approximately eight hours, some engineers believe the labor is an equitable trade-off for the savings. Klystron preparation, however, is not for the beginning engineer, and an array of sophisticated test equipment is required.

In the past, the primary problem in determining transmitter efficiency has been defining how these measurements

are to be performed. Traditionally, the ratio of peak sync power to average power from the line has been identified as efficiency. Obviously, there are problems in such a broad definition.

A term proposed by George Badger, of Varian, in a presentation at NAB is *figure of merit in percent*, which is equal to the peak sync power output divided by the average picture power input to the transmitter. He uses the figure of merit to evaluate various amplifier configurations. Perhaps the figure of merit should be used to evaluate the overall performance of the transmitter.

In any case, the broadcaster is concerned about the actual power consumption from the line, which includes that drawn by heat exchangers, water pumps, cooling blowers and other peripheral equipment that is typically part of the transmitter plant. These values are reflected in the figures shown in Table 1.

A third type of klystron, to be discussed in any evaluation of modern transmitters, is found in the RCA single visual tube 100kW TTG-100U transmitter. According to its accompanying literature, this is the highest power output klystron currently available for use in TV service. Two configurations employ the device—one rated at 100kW peak visual power, and a 2-tube model at 200kW. The aural system may use an S-series or a second 100kW tube. The 2-tube configuration, using the 100kW devices, will permit 5MW ERP values with a medium gain antenna system.

The 100kW klystrons are liquid-cooled units and require a higher drive power than for 60kW devices, as would be expected. Both aural and variable visual couplers are employed, as well as a pulser for the video system. The time required to change the internal cavity klystrons is minimal and all tuning is accomplished from one face of the amplifier assembly.

The life expectancy of S-series klystrons is anticipated to be nearly equivalent to H-series and other previous designs. Similarly, ABC klystrons should

*Continued on page 80*

Markley is with the consulting firm of D.L. Markley & Associates, Peoria, IL, and is BE's transmission facilities consultant.



**Only Panasonic® delivers a 1/2" recorder with color playback in the field.**



Is it a "wrap" or isn't it? Now you can tell right on the spot. Because the Panasonic Recam™ AU-220 is the only 1/2" VCR that gives you the quality of 1" color playback in the field. So you can instantly see what you've shot. Either through the viewfinder or a monitor.

Consider the facts: The Panasonic AU-220 records, utilizing the M-Format, on standard 1/2" VHS cassettes. Yet it delivers the kind of picture quality that's long been the broadcast standard. Luminance is 4.0MHz (typical). Chrominance is 1.0MHz. While the video S/N is every bit as good as 1" with chrominance better than 50dB.

For total flexibility, the AU-220 includes a built-in

switchable SMPTE time code generator. And it's compatible, not only with component analog video equipment, but also with YC and NTSC.

The Panasonic AU-220. 1" color quality from 1/2" tape makes it one of a kind.

For more information, call your nearest Panasonic regional office. Northeast: (201) 348-7336. Southeast: (404) 925-6772. Central: (317) 852-5973. West: (619) 941-3387. Canada: (416) 624-5010.

**Panasonic**  
Broadcast Systems

Circle (45) on Reply Card

**ANOTHER BROADCAST INNOVATION FROM MATSUSHITA ELECTRIC**



# Panasonic® just made dead air a



"Please stand by." Three words that make any broadcaster fighting mad. But now you can fight back because the MVP-100 video tape cart machine from Panasonic Broadcast Systems has just eliminated dead air for good. And virtually eliminated your biggest problem. "Make Goods."

#### **Built-in Redundancy**

The MVP-100 maintains broadcast continuity with an incredible array of technical achievements. Starting with its automatically threaded tape transport systems. Available in 8, 12, 16, 20, or 24 transport configurations. Each transport can be

individually programmed and controlled. All with the accuracy of SMPTE time code identification through the MVP-100's built-in computer.

#### **Automatic Continuous Programming**

News spots, commercials, editorials, station IDs, promos, even program length material can be scheduled in advance and automatically aired. But what really sets the MVP-100 apart is how easily it eliminates dead air. With its built-in recorders and spot players, you can forget about the hassle and expense of "double rolling" a second machine. Because the MVP-100 plays protection copies

ANOTHER BROADCAST INNOVATION



*dead issue.*



*simultaneously. So in the unlikely event that your "on air" transport fails, the MVP-100 can be programmed to switch to the protection copy maintaining broadcast continuity.*

*What's more, the MVP-100 also eliminates "custom mechanics." Since each removable transport operates independently of each other, individual repairs or maintenance can be done without putting the entire system out of commission.*

**YIQ Format Delivers 1" Quality from 1/2" Tape**

*Total, reliable automation of your broadcast day is just one reason to make the MVP-100 an integral*

*part of your station. The picture quality of its YIQ, M-format is another. Especially when you consider how good it is. One-inch quality from 1/2" VHS tape just about says it all.*

*The Panasonic MVP-100. Let it make dead air a dead issue for you. Call your nearest Panasonic regional office. Northeast: (201) 348-7336. Southeast: (404) 925-6772. Central: (317) 852-5973. West: (619) 941-3387. Canada: (416) 624-5010.*

**Panasonic**  
**Broadcast Systems**

**FROM MATSUSHITA ELECTRIC**

Circle (46) on Reply Card

## cure the 10 most common nuisances in PA instantly



**fact:** These 10 problem solvers in your toolbox are like 10 new tricks up your sleeve. Or 10 hours of saved time. Or money in the bank. They make molehills out of troubleshooting mountains, without soldering, or splicing, or internal equipment modifications.

### Problem: Solution:

<b>Input Overload</b>	<b>A15AS</b> Microphone Attenuator—prevents overload.
<b>Phasing</b>	<b>A15PRS</b> Phase Reverser for balanced lines.
<b>Low-Frequency Noise</b>	<b>A15HP</b> High Pass Filter—reduces low-frequency noises and proximity effect.
<b>High-Frequency Noise</b>	<b>A15LP</b> Low Pass Filter—reduces objectionable high-frequency noises.
<b>Lack of Presence</b>	<b>A15PA</b> Presence Adapter—adds intelligibility and brilliance.
<b>Sibilance</b>	<b>A15RS</b> Response Shaper—sibilance filtering, plus flattened response.
<b>Line Level to Mic Input</b>	<b>A15LA</b> Line Input Adapter—converts balanced low-impedance mic input to line level input.
<b>Matching/Bridging/Isolating</b>	<b>A15BT</b> Bridging Transformer—matches balanced or unbalanced devices of different impedances.
<b>Trouble-shooting</b>	<b>A15TG</b> Tone Generator—700 Hz signal helps check levels, connections, mixer inputs, and cables.
<b>Microphone Impedance Matching</b>	<b>A95 and A97</b> Series Line Transformers—make it possible to connect low-impedance lines to mid- and high-impedance inputs (or vice-versa.)



The Sound of the Professionals®



Send for the brochure, AL280F  
Shure Brothers Inc., 222 Hartrey Ave.,  
Evanston, IL 60204.

In Canada: A. C. Simmonds & Sons Limited  
Manufacturers of high fidelity components,  
microphones, sound systems and  
related circuitry.

Circle (47) on Reply Card

Continued from page 76

have a life expectancy roughly equal to the same klystron bodies without the beam control grid. Detailed field data is unavailable for the 100kW units, but there is no reason to assume these would vary significantly from other Varian products.

The result of the new klystrons is a far cry from that of previous internal cavity klystron amplifier designs, which reached 55kW output powers and required input powers in excess of 220kW. Efficiencies have been improved from approximately 30% to more than 70%. It is unlikely that the efficiency can be improved much more. Rather, it would appear that the next major increase in amplifier efficiency will be the result of a significant change in the type of device used.

This prediction was echoed in a paper presented at NAB by Earl McCune of Varian, which discussed the UHF TV multistage depressed collector klystron. The objective of the depressed collector program has been to design a device that would reduce the prime power consump-

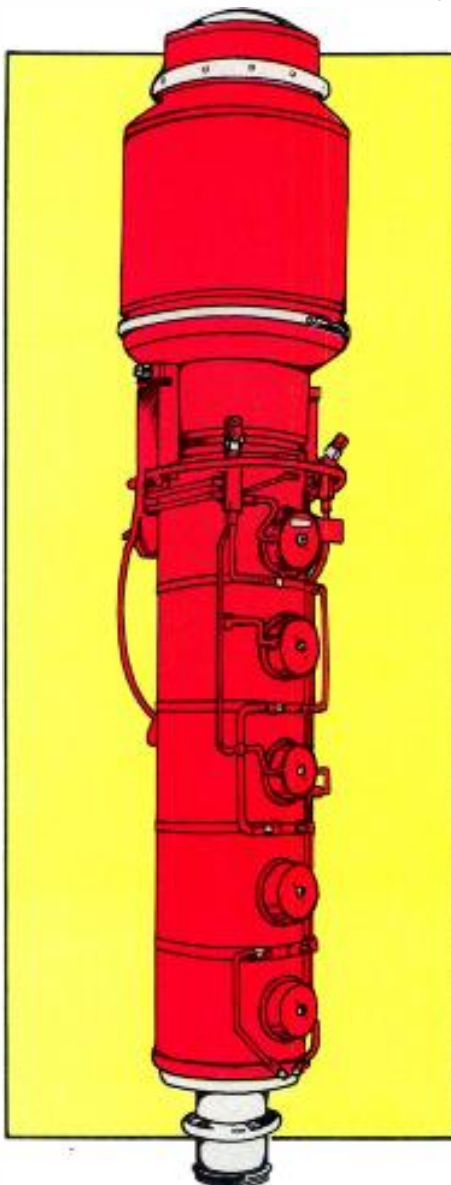

The efficiency of the klystron, once approximately 30%, is now more than 70%.

MANUFACTURER	POWER REQUIRED
COMARK	130KW
HARRIS	130KW <sup>1</sup>
NEC	138KW <sup>2,3</sup>
PHILIPS	135KW <sup>2</sup>
RCA	133KW <sup>1</sup>
TOWNSEND	133KW <sup>2</sup>

<sup>1</sup>Using Varian VKP-7550S  
<sup>2</sup>Using Amperex YK-1265  
<sup>3</sup>Two heat exchanger system

Table 1. 60kW transmitter power consumption.

All power consumption figures are from manufacturer's data and are subject to variation between channels. Because of different methods of measurement, direct comparisons may not be possible in all cases.

tion for the beam supply by at least 50%. Such a device would significantly reduce the overall operating power demand of the entire transmitter plant as well. Still, cooling fans, pumps, excitors and associated equipment must operate.

Another possibility, discussed by Badger in his paper "The Klystrode, a New High-Efficiency UHF TV Power Amplifier," is a hybrid between a klystron and a tetrode. The output cavity and collector of a klystron (for power-handling capability) would operate with the grid and cathode components of a tetrode (for control and modulation). This device could bring UHF transmitter efficiencies to a level approaching the operating economy of VHF transmitters.

Though not yet available in an existing UHF transmitter, the Klystrode holds promise for transmitter development of the future. Badger's figure of merit is approximately 75% for an S-series klystron operating anode pulsed. The Valvo gridded klystron with full-time modulation is at 94%, but the Klystrode reaches a figure of merit of 107%. (Figure of merit is not a true measure of efficiency as it relates a peak output to an average input; this is why 107% is possible.) For a system operating at 30kW at peak of sync, the operating cost could be reduced from \$13,899 annually for an S device to \$9,742 for the Klystrode, assuming 17-hour daily operation.

Power consumption of UHF transmitters has been reduced from approximately 220kW for 55kW outputs to 130kW for 60kW output powers. Naturally, some further development or sophistication of existing klystron amplifiers is probable, and additional efficiency improvements are almost certain. Quantum leaps in efficiency could be the result of significant changes in the amplifying devices, with depressed collector and Klystrode being two of the more promising designs of the future.

[:?=>)]]]



Thomson LGT 5 kW transmitter :

# COMPACT KNOW-HOW

BAZAINE

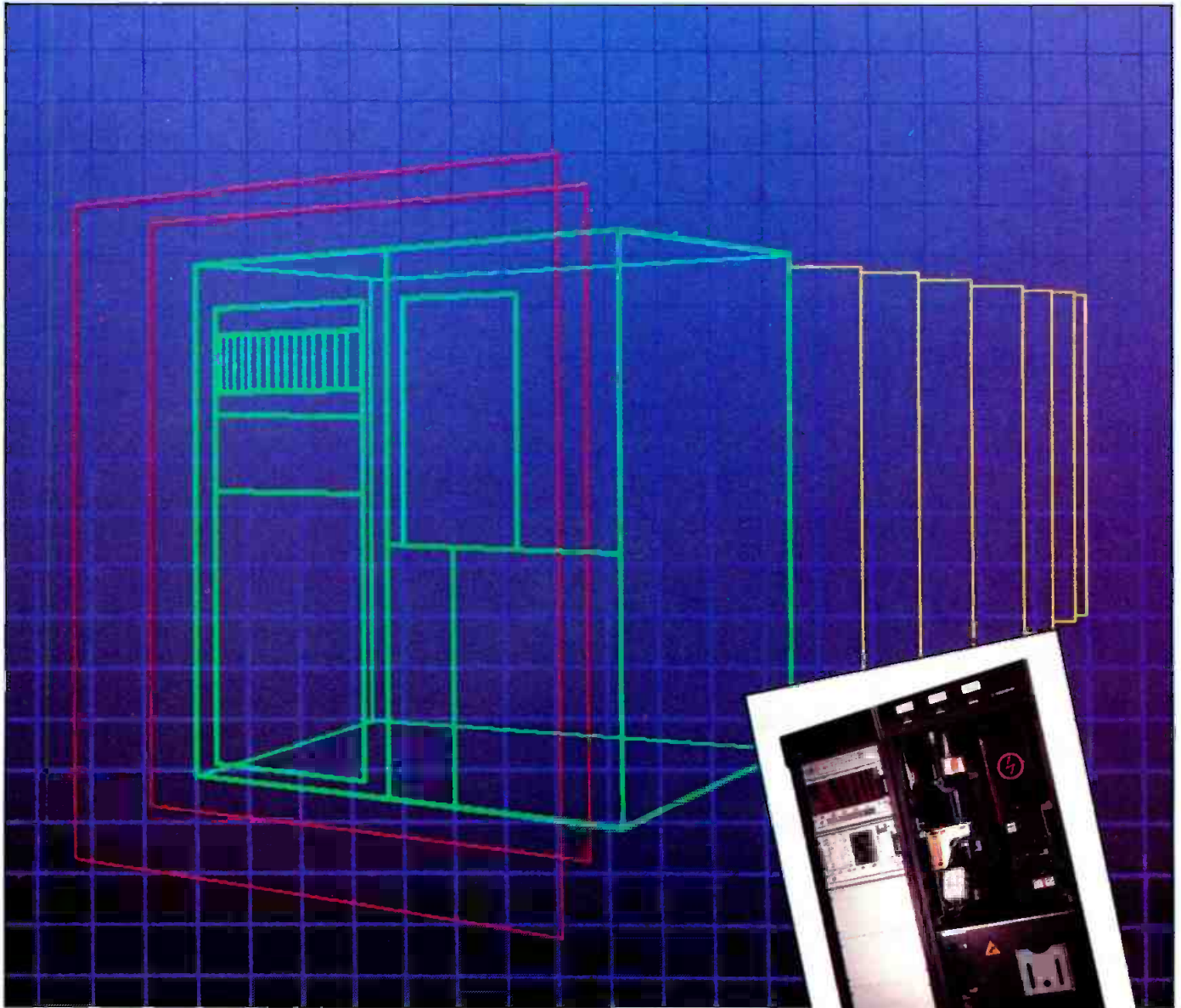

LGT, with the latest of its 5 kW UHF transmitters, the TRE 8510, offers you the following features :

High Profitability due to its competitive price, low floor area, low maintenance costs, and considerable energy saving through the use of a single very high efficiency TETRODE.

Enhanced Performance - this new transmitter, designed to meet the requirement of all new systems (MAC D, dual sound and videotext), uses a surface wave filter (SAW), a fixed group delay time corrector, precision off-set and a wide band configuration with optimised redundancy.

Improved Maintenance thanks to the use of a single air cooled tube, all the sub-assemblies being accessible from the front and a configuration specially designed to operate in Passive or Active Reserve Mode.

THE BEST POSSIBLE SIZE / EFFICIENCY

 **THOMSON-LGT**

LABORATOIRE GÉNÉRAL DES TÉLÉCOMMUNICATIONS  
51, boulevard de la République / BP 51 / 78401 Chatou Cedex / France. Tél : (3) 071 92 60.

5316

Circle (59) on Reply Card

# Show of shows

The NAB '85 convention played host to more than 700 exhibitors and their products. Every product displayed was designed with you, the engineer, in mind.



## ADC Telecommunications

- Dense Patch: insulation displacement punch-down terminal block.
- VAMP: video audio modular patchbay; 20-position modular audio and/or video patchbay.
- Sails: self-adhesive identification label system; strips for patchbays.

Circle (355)

See ad pages 65,70

## ADDA

- Vision: 8-bit TBC; heterodyne 1/2- and 3/4-inch.
- ESP-II: single-channel still store.
- VW-3-frame: synchronizer and freeze-frame 58dB S/N ratio.
- AC-21P: modular dual-channel TBC/synchronizer; PAL.
- VW-3: Freeze-frame synchronizer and TBC; 58dB S/N; for direct or heterodyne use.

Circle (356)

## ADM Technology

- Post-pro: compact audio console with 8-to-12 VCA inputs; interfaces to video editors via integral GPI or optional serial interface; in-line EQ, dual monitor buses.
- S/TV: 24-input TV console with VCA control, any mix of mic or stereo line inputs; in-line or auxiliary EQ or preselect; mono or stereo outputs; sub-mastering.

Circle (357)

See inside front cover

## AF Associates

- Commercial compilation system: computerizes assembly of daily spot, promo reels, uses existing VTRs.
- AVS6500: digital standards converter.
- Mycomp Technologies: control and distribution system for videocassette duplication.
- TV mobile production vehicles.

Circle (361)

## AKG Acoustics

- D-321: entertainer's mic; reduced handling noise possible through noise-canceling design and hum compensation.

Circle (363)

See ad page 130

## AMP Special Industries

- BNC Hex crimp plug: can be crimped by any existing hex type tool. Eliminates solder. Center contact and ferrule can be crimped in seconds.

- AMP taper techniques: small size; able to deliver electrical and mechanical performance under severe operating conditions.

Circle (1455)

## ANT Telecommunications/Solway

- Telcos-MC: routing switcher system.
- Newswire 2000: newsroom computer and automation system for press agencies, television and radio.

Circle (384)

## ATI-Audio Technologies Inc.

- MM100: Match-Maker bi-directional IHF to 600Ω level and impedance matching interface.
- DP100: Disc-Patcher IHF to 600Ω matching interface for CD digital players.

Circle (393)

## AT&T Communications

- Program distribution services; promotion management; teleconferencing, and information management via data services.

Circle (891)

## AT&T Information Systems

- Teleconferencing and communications products.
- PC 6300: personal computer.
- PC 7300: Unix-based personal computer.
- 3B2: microprocessor.
- FAX 3510D: computer.

Circle (394)

## AVSC

- Lumena: videographics equipment from Time Arts.

Circle (1302)

## Abekas Video Systems

- A62: digital video recorder, Winchester disk-based, with 50s or 100s capacity; random-access, variable-speed, single-frame or real-time simultaneous record and play; can interface to editing controllers.

Circle (350)

## Accu-Weather

- Database: real-time weather database; forecasts and data; access on as-needed basis.
- Satellite imaging: cloud coverage of entire hemisphere or U.S. sections; for on-air presentation.
- National Radar: precipitation patterns throughout continental United States.
- Graphics: news, sports, financial graphics package, for on-air use; available on 24-hour basis.
- NAFAX: weather charts, maps accessed through weather graphics system; usable in meteorological forecasting.

Circle (351)

## Acrodyne Industries

- TLU/1KAC: 1kW UHF LPTV transmitter.
- TRU/5KA: 5kW UHF TV transmitter.
- Frequency synthesizer: for 514-847MHz, band IV-V.
- MTS compatible transmitter systems.

Circle (352)

## Adams-Smith

- 2600BPI: bi-phase interface module to tape synchronizer; permits sprocketed film transport control by external bi-phase signals to be masters or slaves.
- 2600VRG: video reference generator; develops crystal-referenced NTSC, PAL composite sync signals for applications that do not require a sync generator.

Circle (353)

## Advanced Designs

- DOPRAD II: Doppler weather radar system with 768x480 pixel resolution; pan, zoom, fast-frame time lapse looping and animation; 16-display unit including six calibrated color rainfall rates; pan, zoom, auto time lapse; dial-up NWS display of 100nm and 200nm calibrated ranges.

Circle (358)

## Advanced Imaging Devices

- CT1500: videographic printer which converts images from any video source into 6" x 8" photographs.

Circle (359)

## Advanced Music Systems

- RMX16 updates: software improvements.



---

# The New TEN-XL, Suddenly Money Is No Objection.



**N**ow, when you buy a routing switcher you can feel like a big spender without having to spend like one. And without short-changing your system. The Grass Valley Group's remarkable new TEN-XL packs into one rack unit a program quality 10 x 1 routing switcher complete with video, breakaway stereo audio, and local control panel. All economically priced at about the cost of a ¾ inch video player. With optional remote control panel costing little more than a good cigar lighter.

You get Grass Valley Group quality in the plug in boards, removable from the front. Standard features include: DC restored differential video inputs, + 24dBu audio differential input/output levels, binary control,

power supply fault alarm, input expansion capability and one hour crosspoint memory.

The list of TEN-XL options includes a relay module, RS422/232 serial control, dual power supply, and even RGB capability.

If you're budgeting for new program quality 10 x 1 routing switchers, money should be no objection. For complete details, contact your regional Grass Valley Group office or local authorized distributor today.

---

**Grass Valley Group**<sup>®</sup>  
A TEKTRONIX COMPANY  
P.O. Box 1114, Grass Valley, CA 95945 USA  
Telephone (916) 273-8421 TRT: 160432

---

OFFICES: Edison, NJ (201) 549-9600; Atlanta, GA (404) 321-4318; Elkhart, IN (219) 264-0931; Arden Hills, MN (612) 483-2594; Fort Worth, TX (817) 921-9411; Woodland Hills, CA (818) 999-2303; Palo Alto, CA (415) 968-6680.

### Advanced Music (continued)

- DMX 15-80S: keyboard interface, allowing volt-per-octave control of digitally sampled material.
- Timeflex: digital audio time compression, expansion device.
- DMX15P: dedicated profanity digital delay with edit and catchup circuit.
- Audiofile: hard disk-based digital audio recording system.

Circle (360)

### Agfa-Gevaert

- Broadcast Plus 1: Type C videotape in 34-, 66-, 96- and 108-minute lengths in flame retardant shipping cases.

Circle (362)

See ad page 37

### Alamar Electronics

- MC-2000: TV automation system with intelligent machine controller; directory program cross-references tape directory; SMPTE time code controller and multiterminal software.

Circle (364)

See ad page 20

### Alden Electronics

- C2000M: color weather radar display system, designed for radio users; accesses National Weather Service by direct or dial-up lines.

Circle (365)

### Alexander Manufacturing

- Product line of ENG and VTR bat-

tery packs, battery chargers and analyzers.

Circle (366)

### Allen Avionics

- VAR 256: video delay line; adjusts from 0 to 256 ns.

Circle (367)

### Allied Broadcast Equipment

- DSP-2000: Compusonics audio computer generates, controls, processes, and reproduces digital audio.

Circle (368)

### Allied Tower

- RUFNEK: Pre-fab buildings.

Circle (369)

### Allsop

- 67,000: U-matic cleaner; update includes cleaning ribbon.
- 62,000: recorder cleaner.
- 63,000: Beta format cleaner for professional use with Betacam; Recam compatible.

Circle (370)

### Alpha Audio

- Product line of acoustic materials.

Circle (371)

See ad page 151

### Alpha Video & Electronics

- 5850 Alphasize: Sony machine with zero offset time code and time code restripping features.

Circle (1301)

### Amber Electro Design

- 5500: programmable noise and distortion analyzer.
- 054: Optional high speed plotting system.

Circle (372)

### Amco Engineering

- Product line of communications consoles, equipment racks, aluminum structural systems, blowers, fans and EMI-rated racks.

Circle (373)

### Amek Consoles

- Scorpion: 24x16x2 broadcast production console.
- BCO-1-II: portable ENG field mixer.
- M-1000 series II: stereo teleproduction digital assignment console including George Massenburg automated motorized faders.

Circle (374)

### Ameritext

- Product line of teletext equipment and services.

Circle (375)

### Amperex Electronics

- XQ4087: 1/2-inch high-stability camera tube.
- XQ4187: 2/3-inch high-stability camera tube.

# Simply Reliable

# We Have Your Console!

## the Sound Solution

# Expandable

... at any time





### 7000

Our premier consoles are designed for simplicity and reliability. The 7012 and 7012A consoles continue to be today's choice, allowing broadcasters excellent sound quality with efficient VCA control, all at a cost well below what others charge for less. 12 channels, 22 inputs, full stereo, with your choice of metering functions. Clearly an excellent console for today's broadcast needs



### 7512A

This console continues the **Howe** tradition of simple-to-operate, reliable products, but adds features to make the operator's job even easier. These include: remote control for machines, a clock and timer, 2 talkback circuits, and much more. Comprehensive operator control and superior sound quality make the **7512A** an exceptional choice.



### 9000

The latest in the legacy of quality consoles from **Howe**, the **9000** is available from 8 to 22 channels tailored to your needs. There is no costly mainframe, but full modular capability is built in. 3 inputs per channel, mix-minus on all channels, sealed membrane switches for channel and machine control, and unmatched audio performance. These features and more combine to give the broadcaster outstanding flexibility



## howe audio productions, inc.



# "TFT 8300 STL's Superior Design Made an Audible Difference on the Air"

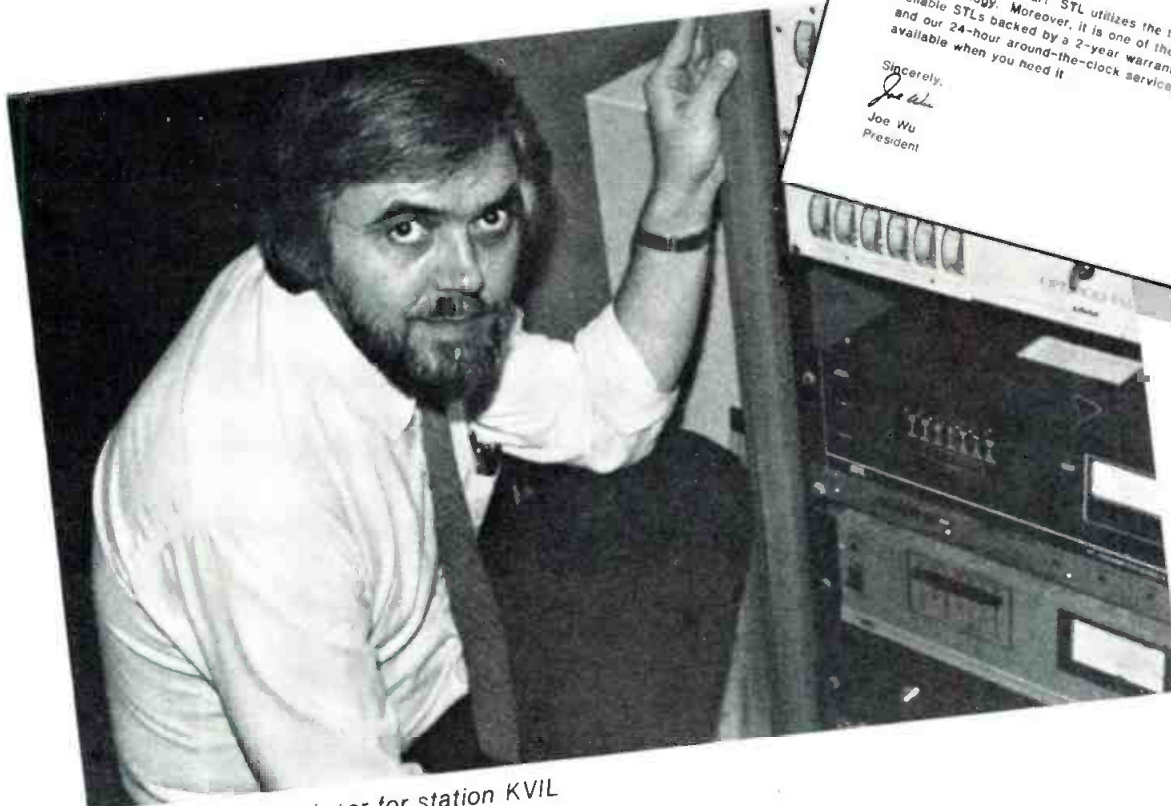

Bill Ryan-Chief Engineer for station KVIL  
Dallas/Ft. Worth Area

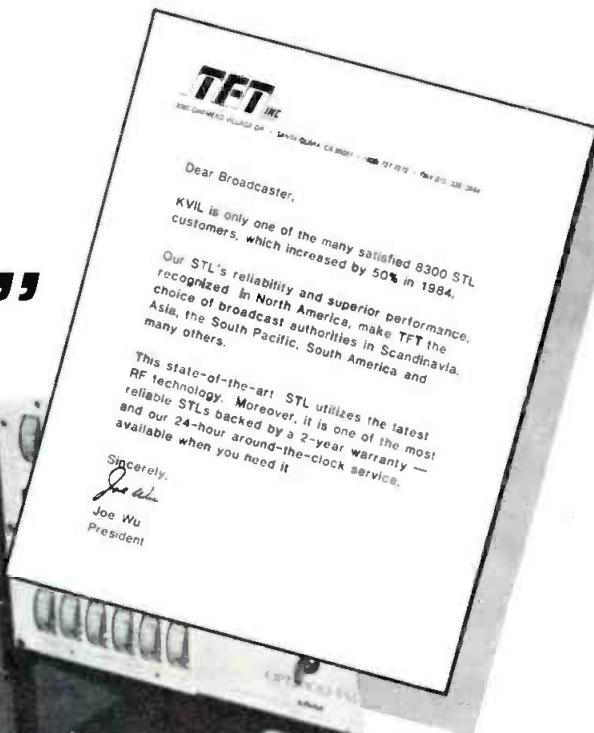

Dallas/Ft. Worth Station KVIL has enjoyed a Number One share of the market for the past several years, and Chief Engineer Bill Ryan aims to keep it that way. That's why he turned to the TFT 8300 STL when their antenna site on Cedar Hill became overcrowded.

"We needed a superior system with enough bandwidth and selectivity to overcome the RF congestion and white noise. TFT's new 8300 system provided a 100% audio improvement at both the high end and the low end."

"Hearing is all important. You can measure a lot of things, but you can't necessarily hear all the specs. The excellent audio quality of TFT 8300 was a very pleasant surprise."

"The 8300 System is helping to keep me young. Every problem you can eliminate adds a few years to your life. The installation and operation of TFT 8300 was literally problem free. You just plug it in and turn it on."

"With TFT, it wasn't just another sale. All the way from the local rep to the president of the company, they did a great deal of groundwork. They were genuinely trying to help us solve a problem. I never have any trouble contacting TFT for help."

"I'd have no problem recommending TFT 8300 to any of our other group stations throughout the country."

These comments are from another satisfied TFT 8300 user. Call us today for full facts on the STL system with a difference you can hear!



**Committed to keeping you, on the air!**

3090 Oakmead Village Dr., Santa Clara, CA 95051 • (408) 727-7272 • TWX 910-338-0584

*Amperex (continued)*

- XQ3457: 2/3-inch mixed-field camera tube.
- XQ3467: 2/3-inch electrostatic focus camera tube for low-cost, high-performance TV cameras.
- YK1233: high-efficiency klystron.
- YK1263: high-efficiency klystron.
- 9018/YL1631: tetrode and cavity for AM, FM or television.

Circle (376)

See ad pages 56,57

**Ampex**

- ACE Micro: software-oriented A/B or ABC roll editing controller; full transport control to four VTRs; preview in any mode or combination of audio/video inputs or switcher effects; EDL with all sequence parameters; interfaces to most serial-controlled VTRs.
- VPR-6: 1-inch Type C VTR with TBC-6 and advanced logic deck control system.
- ADO-2000: single-channel on-air effects system; expandable to multichannel.
- VCR-2: video recorder controller offers remote control; simple editing.
- TBC-40: for VPR-80 offers full record, play and edit capabilities with 8-bit processing; 16-line memory allows use with 1/2- and 3/4-inch VCRs.
- AVC options: controls ADO through

AVC-switcher interface and audio system for editing and post-production applications.

Circle (377)

See ad pages 27,90,91

**Amtel Systems/**

**Evertz Micro Systems**

- EV Bloc: modular time code system by including generators, readers, translators, character inserters and synchronizers for LTC and VITC modes.

Circle (378)

**Anchor Systems**

- AN-1000: audio monitor for video edit or on-line monitoring; 50W rms; 5 1/4" x 8" x 7 3/4".

Circle (379)

**Andrew**

- ESA45L-412: receive-only earth station; combined Ku- and C-band system; uses prime focus design, pedestal mount, 2-degree compliant, dual polarized, 4.5m, fully motorized; available with or without receiver equipment.
- ATW 12/16: VHF TV highband (channels 7-13) CP traveling wave antenna.
- G-series: traveling-wave slot-array UHF transmitting antennas.
- HMD series: MDS transmitting antennas.

Circle (380)

See ad page 119

**Angenieux**

- ENG lens: 14x9, 9-126mm, f/1.6.
- EFP lens: 25x10 HP.
- Studio lens: 15x17, 15x13.
- 14x8: zoom lens for 2/3-inch cameras f/1.6; high efficiency casting of glass elements.
- 24x10: EFP lens for 2/3-inch cameras; two integral extenders (1.5x, 2x).
- 18x12.5 HP: for 1-inch cameras with two integral extenders; f/1.5 maximum; mod 0.6m (18x16.5 for 1 1/4-inch).
- 25x8.5HP: 1/2-inch lens for CCD cameras; 2x extender; f/1.4 maximum.
- 15x13 HP: for 1-inch cameras (15x17HP for 1 1/4-inch) MOD of 0.8m; f/3.5; 1.7x extender.

Circle (381)

See ad page 114

**Antek Analysis Technologies**

- Communication services and consultants.

Circle (382)

**Anton/Bauer**

- Mobile fast charger: single-position universal charger.
- Microphaser: provides adjustable black burst signal and gen-lock to Micro-Control systems.
- LightLink: fiber-optic link for gen-lock, intercom, camera control and video on one fiber.

Continued on page 92

# YOU'VE SEEN THE REST, BUT, THIS IS THE BEST!

## Professional Wireless

The best wireless microphones should sound identical to the mic, hard-wired . . . HME systems do! Dynamic range, frequency response, and system gain are set for transparent performance.

The best wireless mic should provide years of reliable performance . . . HME systems do! Our unique Auto-Loc discriminator allows the receiver to actually track the transmitted RF signal to eliminate RF-related distortion.

The best wireless mic body-pac should be compact and ultralight, almost unnoticeable

## Systems — a Step Ahead

. . . HME systems are! Our Cyclolac housing and miniaturized circuitry allow a transmitter weight of only 2.5 ounces.

The best wireless microphones are available now . . . from HM Electronics, Inc.

Call or write for detailed information on our complete line of professional wireless microphones, wireless intercoms, and cabled intercoms.

**h m e**  
HM ELECTRONICS, INC.

9675  
Business Park  
Avenue  
San Diego,  
CA 92131  
(619) 578-8300  
Telex: 350-771



Circle (52) on Reply Card

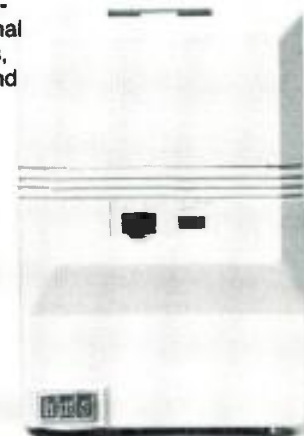



# Why discriminating customers specify Leddicons when buying their new cameras.

EEV Leddicons are respected by broadcasters the world over for superb color image performance. Many even insist on Leddicons when specifying their cameras - with good reason too!

No other company takes

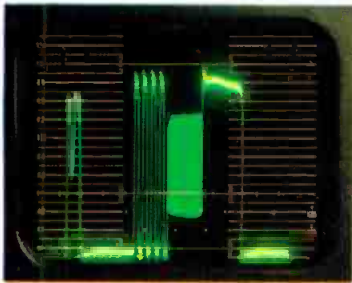

greater care to ensure camera tube quality and consistency. Meticulous control is taken at every stage of Leddicon production, from raw materials inspection right through to final assembly. Every Leddicon, without exception, undergoes at least 28 separate checks during manufacture.

And final testing is very thorough indeed, with a further eight stringent quality control stages to be passed. These include sensitivity, resolution, signal uniformity, geometry, lag, beam characteristics,

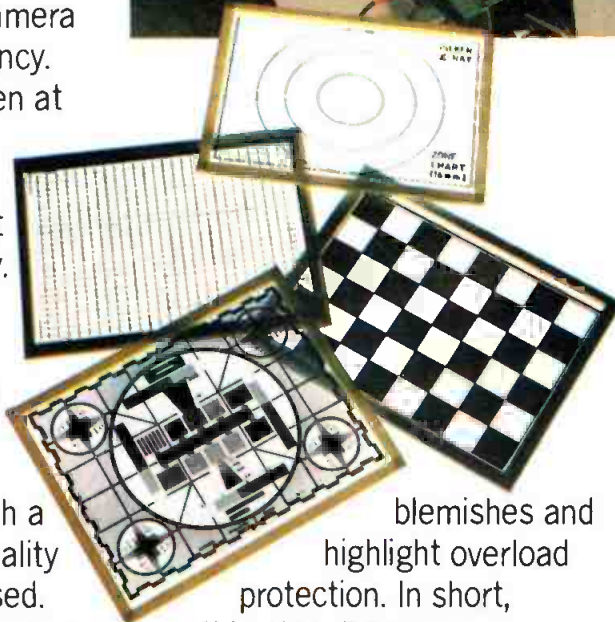

blemishes and highlight overload protection. In short, nothing is left to chance.

Even then, the job is not finished as far as EEV is con-

cerned. That's because we believe in offering our customers a delivery and after-sales service which is the finest in the industry.

Regardless of what your color camera tube requirements may be - for new equipment or fully-interchangeable replacement - talk to the one company that really knows how to meet all your needs.



## LEDDICONS<sup>®</sup>

The definition of the best color camera tubes in the world.

® Leddicon is the Registered Trademark of EEV Lead Oxide Camera Tubes

EEV Inc, 7 Westchester Plaza, Elmsford, NY 10523, USA. Tel: 914 592 6050. Telex 6818096.  
 EEV Canada Ltd, 67 Westmore Drive, Rexdale, Ontario M9V 3Y6, Canada. Tel: 416 745 9494. Telex: 06 989 363.  
 EEV, Waterhouse Lane, Chelmsford, Essex CM1 2QU, England. Tel: 0245 261777. Telex: 99103.

## EEV Camera Tubes

Circle (53) on Reply Card

***YOUR WORLD IS CHARGED  
WITH STATIC ELECTRICITY...***

***CAUSING A SHOCKING  
OF DROPOUTS.***



# GED WITH NUMBER

Your once-in-a-lifetime shots...destroyed by transient dropouts—caused by a fiber, a smoke particle, or even an eyelash that's been drawn into your videocassette by its inherent static charge. It's been an inevitable problem...until now.

We know you need a videocassette that can go anywhere and not pick up static-drawn souvenirs that will destroy your picture. So we developed the exclusive Scotch® Anti-Stat Treatment, a revolutionary cassette coating that minimizes static attraction, giving our new Broadcast Videocassettes the industry's lowest electrostatic charge levels. Automatically reducing your transient dropouts. Dramatically improving your picture. And we've applied this unique technology to the lengths and formats you need. All distinguished by our red doors and hubs for easy Anti-Stat identification. All backed by our engineers a call away. All the more reason we're number one in the world of the pro.

ELECTROSTATIC CHARGE (BETA)

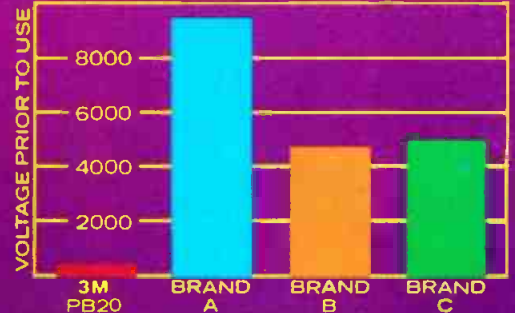

## OUR TAPE ANTI-STAT...ANTI-DROPOUT.

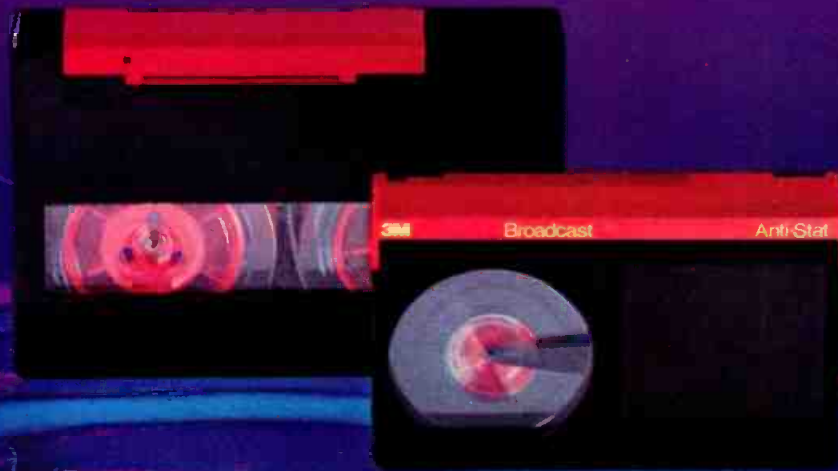

**Scotch**<sup>®</sup>  
AUDIO & VIDEO TAPES

NUMBER ONE IN THE WORLD OF THE PRO

**3M**

Circle (54) on Reply Card

# Ampex Listened When You Described Your Ideal VTR.

CONSOLE WITH OVERHEAD  
PICTURE MONITOR—ONE OF  
6 CONFIGURATIONS  
AVAILABLE

HI FI SPEAKERS LET YOU  
APPRECIATE SUPERIOR AUDIO  
QUALITY OF VPR-6 WITH  
EXCELLENT STEREO PHASE  
RESPONSE.

HANDLES SPOT TO 2 HOUR  
REELS WITH EQUAL PRECISION  
AND GENTLENESS

BRUSHLESS DC SCANNER  
MOTOR AND INDIVIDUALLY  
REPLACEABLE HEADS

LOGICAL, EFFICIENT CONTROL  
PANEL—ALL OPERATOR  
CONTROLS UP FRONT

TBC-6 WITH 32 LINE MEMORY  
AND 28 LINE CORRECTION  
WINDOW; PERFORMANCE  
MATCHED TO VPR-6.

DUAL NUMERIC READOUTS—  
ONE FOR TAPE TIME/TIME  
CODE; ONE FOR CUE POINTS,  
DIAGNOSTIC CODES, TAPE  
SPEED, SETUP CODES





# Now, Here It Is. The New VPR-6.

**W**hen hundreds of users worldwide told us what they wanted in a one-inch VTR, we listened closely and then designed and built it. It's our new VPR-6, the easiest VTR to operate, service and maintain of any in its class. And it's in the price/performance ratio that most users want.

## Smart, yes. Complicated, no.

Intelligent but not intimidating, the new VPR-6 offers features that allow you to get the job done more productively. For example, virtually all machine setup procedures can be done at the highly efficient control panel. Most board-edge controls typically found in VTR's have been eliminated.

You insisted on fast but gentle tape handling... the VPR-6 shuttles tape at speeds approaching 500 ips and handles all reel sizes from spot to 2 hours with equal precision and gentleness. The servo microprocessor senses when the end of the tape is near and slows down the reels and scanner and unthreads the tape gently.

You asked for power-down memory... so we built in a long-life battery to protect setups, edit and cue points and all editor configuration parameters.

"Make it easier to troubleshoot," you said, and we built in an extensive diagnostics system that constantly monitors many system conditions and warns you if a fault occurs. You can even run from the control panel a diagnostic routine using a logic probe to test every IC in direct communication with the two microprocessors.

## A tried and true transport

You demanded reliability. Not wanting to tamper with success, we borrowed the tape transport and mechanical

printed wiring boards and backplane connectors throughout. The modular package allows convenient access to any part of the VTR for easy maintenance.



## A TBC to Match

Because you wanted play speeds from -1 to 3X normal and picture in shuttle, we also developed the new TBC-6 digital time base corrector, performance-matched to the VPR-6. Its 32-line memory and 28-line correction window are the largest in any TBC appropriate for a VTR of this type.



## State of the art editing

So much for recording and playback, how about editing? The VPR-6 has all the capabilities you asked for, including

split audio-video auto edit and auto tag. RS-422 serial communications capability lets VPR-6 function efficiently in a state-of-the-art editing system with the Ampex ACE and other edit controllers.

## First-rate audio

"Make audio better," you said, and we did. The VPR-6 has audio (as well as video) confidence playback. The audio system also offers high quality stereo phase and an optional fourth audio channel for EBU systems.

## Selection of styles

Most users may agree on capabilities, but you prefer a variety of configurations to choose from. So, we offer the VPR-6/TBC-6 in four console styles as well as tabletop and rackmount versions. Many Ampex video accessories work with it, including some you may now own.

## In production now

The VPR-6 is too good to wait for, so it's already in factory production.

Ask your Ampex video sales engineer



design of our reliable and proven VPR-80. We also eliminated most wire harnesses in favor of more reliable

to quote price and delivery for any model in any world standard, and watch his face light up!

# AMPEX

Ampex Corporation • One of The Signal Companies

Atlanta 404/491-7112 • Chicago 312/593-6000 • Dallas 214/960-1162 • Dayton 513/254-6101 • Los Angeles 818/240-5000 • New York/New Jersey 201/825-9600 • Salt Lake City 801/487-8181 • San Francisco 415/367-2296 • Seattle 206/575-0156 • Washington, DC 301/530-8800  
Canada, Toronto 416/821-8840

June 1985 *Broadcast Engineering* 91

**Anton Bauer (continued)**

- UltraKit: portable 12V lighting kit.
- MFC: mobile fast charge for fast or selectable overnight charge capability.

Circle (383)

**Anvil Cases**

- Product line of equipment transportation cases.

Circle (385)

See ad page 110

**Apert-Herzog**

- Editing system enhancement facilities.
- Stepfast: speeds finding location of edit points.

Circle (386)

**Aphex Systems Ltd.**

- 9004: mic pre-amp; modular to fit dbx 900 series rack.
- 402: mic pre-amp; 2-channel; rack-mount; self-powered.
- 9002 aural exciter: modular version of the psycho-acoustic audio enhancer, to be housed in dbx rack.
- Dominator: intelligent multiband audio processor for broadcast use.

Circle (387)

**Applied Digital Technology**

- Relecon: remote level controller.
- ELT 100: alarm system.

Circle (388)

**Arrakis**

- 150 SC: redesigned audio mixing console.
- 2100 SC: audio console.
- Studio furniture.

Circle (389)

See ad page 21

**Arriflex**

- Arrilite 600: portable Tungsten light.
- Lightflex: matte box device with filters to aid in contrast ratio control; for film and video cameras.
- Hot dog dolly: base for CineJib crane or camera dolly.
- Arrisun 5: lighting fixture (575W)
- Arrisun 12: lighting fixture (1200W)
- Arri: 12K: HMI fresnel light.

Circle (390)

**Artel Communications**

- SL-3000: fiber-optic transmission system for video, audio or high-speed data; LED-based, laser FM system; single mode; distances to 32km.

Circle (391)

**Asaca/ShibaSoku**

- ACL-6000B: Betacam format automation system; holds 600 cassettes for random access; bar code ID.
- ASC 300: standards converter PAL/NTSC, SECAM optional.
- ADS 2000 still bank: digital still store system.

- CM90A6: 40-inch diagonal HDTV monitor (also 20- and 26-inch models)
- TG91A6 and 15A6: HDTV test pattern generators.
- TL 07A6: encoder/CD10A6 decoder.
- TS 30AS: sync generator for HDTV.
- TC12B6: vectorscope adapter.
- TA 35A: MTS generator, BTSC system design.
- AIP-1300 and 1320: image pickup and still transmission system for use with opaque graphics.

Circle (392)

See ad page 131

**Auburn Instruments**

- Product line of remote machine control systems.

Circle (395)

**Audico**

- System III-Q: cue-tone feature on video loader for U-matic, VHS, Beta cassettes and 1-inch reels.
- Label sheets: U-matic, VHS and Beta type; pressure-sensitive; for printing, typing or copying machines.
- 619 T: timer rewriter for U-matic, VHS and Beta.

Circle (396)

**Audi-Cord**

- E series: cartridge recorders, reproducers, electronic and mechanical updated version of previous A series.

Circle (397)

# MAKE YOUR MOBILE 1 NUMBER ONE IN MOBILITY.

## Hannay Reels Get You In And Out Fast.

Save precious seconds in set-up, tear-down time. Just pick up the durable, lightweight Hannay Portable Cable Reel, and go. When the story's in the can, direct rewind makes pick-up easy. And the Portable Cable Reel is compact to take up minimal storage space.

It's the newest addition to our complete line of cable reels, for an even bigger selection of unlimited sizes, shapes and capacities to choose from.

When it comes to getting in and out fast, no other reel is "remotely" as efficient as a Hannay Reel!



Send Today For Free Literature Packet. 



# HANNAY REELS

Circle (55) on Reply Card

CLIFFORD B. HANNAY & SON, INC., 600 EAST MAIN STREET WESTERLO, NEW YORK 12193 • TELEPHONE (518) 797-3791



# Designing A New Facility Or Updating An Existing One? Bosch Switchers Fit!

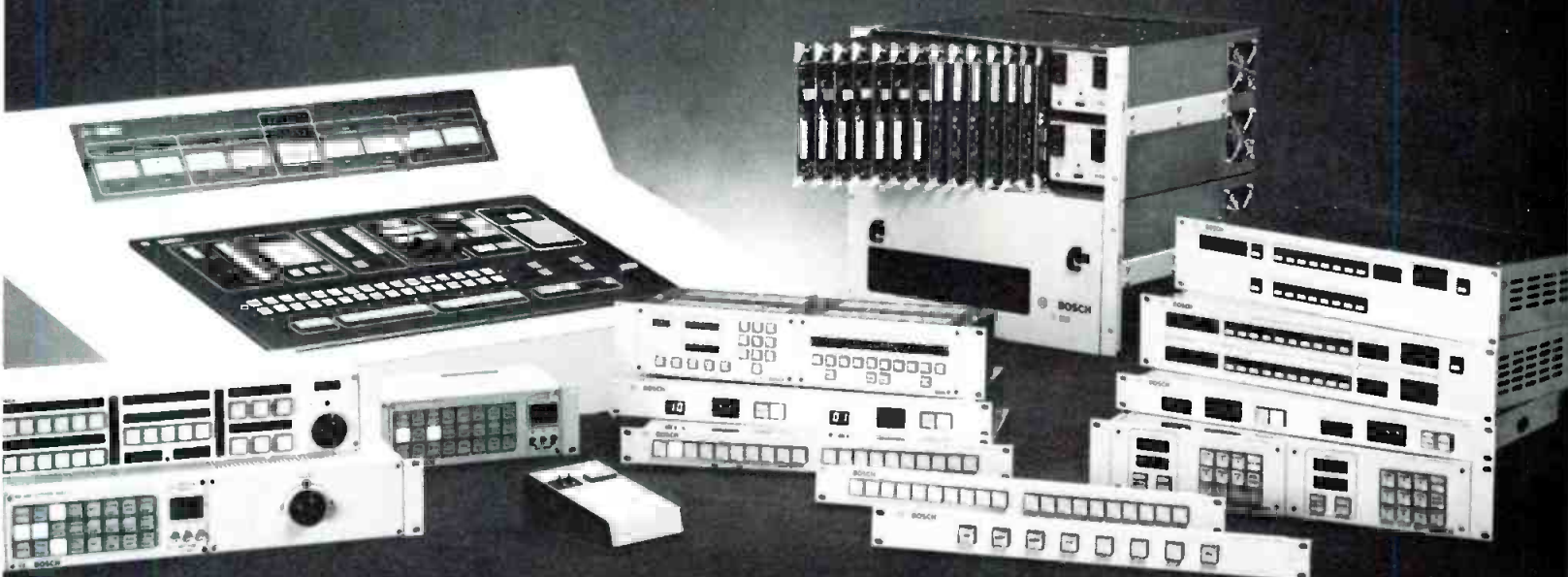

## The Bosch Switching Equipment System

ARE YOU PUZZLED with the type of switching system to install at your facility? Let Bosch fit all the pieces together for you! From Master Control to Machine Control, Bosch has all the switching equipment you will need to complete your equipment room requirements.

- **DISTRIBUTION SWITCHER — TVS/TAS-2000** will provide you with flawless service and unlimited expansion capabilities for video, audio and control signals.
- **MASTER CONTROL — MCS-2000** provides total studio control by combining the versatility of the distribution switcher and the creative capabilities of a production switcher to make the most versatile switcher with full stereo-audio capabilities.
- **MACHINE CONTROL — TCS-1** give you remote control of your video production equipment from single or multiple locations, resulting in substantial savings in equipment and manpower. The savings in wiring costs alone often offset the price of the system.
- **CONTROL SYSTEMS** that allow you exceptional flexibility in controlling the switchers.

Bosch distribution switching equipment offers years of reliable service and competitive pricing.

Don't be puzzled any longer . . . let Bosch supply your facility with the best switching equipment available!



# BOSCH

### Robert Bosch Corporation Video Equipment Division

2300 South, 2300 West, Salt Lake City, Utah 84119

Mailing Address:

P.O. Box 31816 / Salt Lake City, Utah 84131

(801) 972-8000 Telex: 38-8352 SLC

Specifications subject to change without notice.

©1985 Robert Bosch Corporation. All rights reserved. Printed in U.S.A.

Circle (57) on Reply Card

#### Audio Broadcast Group

- Product line of studio system design and construction.

Circle (398)

#### Audio + Design/Calrec

- Series M: Calrec portable mixer; to 16 inputs; full auxiliaries; optional dynamics.
- COMPEX 2: combines compressor, peak limiter, noise expander and noise gate.
- Calrec ITR: digitally assignable multitrack production console; instant total reset.
- Calrec UA8000: fully automated music recording and production console.
- UHJ Transcoder: creates wide stereo image while maintaining mono compatibility.
- Studio production consoles, custom console service.
- SCAMP compression system; multi-band noise reduction.

Circle (399)

#### Audio Developments

- 160-ENG: 4x1 audio mixer; 3 mic and 1 line inputs.

Circle (400)

#### Audio Kinetics

- Mastermix: console automation system.
- Q-Lock: machine synchronizer en-

hancements.

- Eclipse: machine editor controller.
- Time Link.

Circle (401)

#### Audio Precision

- System One: automated audio test system; includes high-level, balanced generator and measurement modules for level, frequency, noise and harmonic distortion; requires IBM-PC or compatible computer for operations.

Circle (402)

#### Audio Services

- Product line of sales rental and service of equipment for on-location production; audio mixers; mic power supplies; and audio accessories.

Circle (403)

#### Audio-Technica US

- AT-RMX64: 6-channel, 4-track mixer recorder.
- ATH series: 250Ω open and closed back headphones.
- AT 8512: passive direct box.
- nT8511: active direct box.

Circle (404)

See ad page 147

#### Audio Video Consultants

- AVC-CP601: remote control interface to operate an unlimited number of transports (VCRs).
- AVC-CP602: remote control interface

two groups of transports independently.

- AVC-CP607: remote control interface to operate up to seven groups of transports independently or simultaneously.

Circle (405)

#### Audio Video Engineering

- Hum and interference reduction coils.

Circle (1360)

See ad page 150

#### Auditronics

- Tapecaster: audio cart machines; economy models.
- Sam mixers: SATT audio mixers; 8 in x 2 out, 4 in x 2 out and 3 in x 1 out formats.

Circle (406)

#### Aurora Systems

- AU/100-QCR: Aurora/Matrix QCR D4-2 interface for 2048- or 4096-line resolution film output.
- Aurora/75: paint and graphics software for IBM PC/AT.

Circle (407)

#### Autocue

- Product line of video prompting systems based on camera or computer video.

Circle (408)

# TIME AND MOTION . . .

## Two Good Reasons for Time Code and DATUM's 5300 ITP



Timing and tape motion, two of the most important factors in video tape management, are what DATUM's 5300 Intelligent Time Processor (ITP) is all about.

- SMPTE/EBU time code reader/generator - LTC and VITC code formats
- Video character generator
- Jam sync code generation for dubbing
- Parallel BCD time and user bit outputs
- Microprocessor controlled
- Modular construction permits future expansion

The 5300 ITP can be a basic time code generator reader, or the most sophisticated time processor. It's ideally suited to the classical applications (editing, dubbing, master station timing, etc.).

Versatile, expandable and cost effective, DATUM's 5300 ITP makes good sense any way you look at it.

When it comes to time code technology, the people at DATUM are among the pioneers. Experience is reflected in everything we do.

For complete information, call or write.

**datum inc** Timing Division  
1363 S. State College Boulevard  
Anaheim, California 92806  
714/533-6333

TD112

Circle (58) on Reply Card



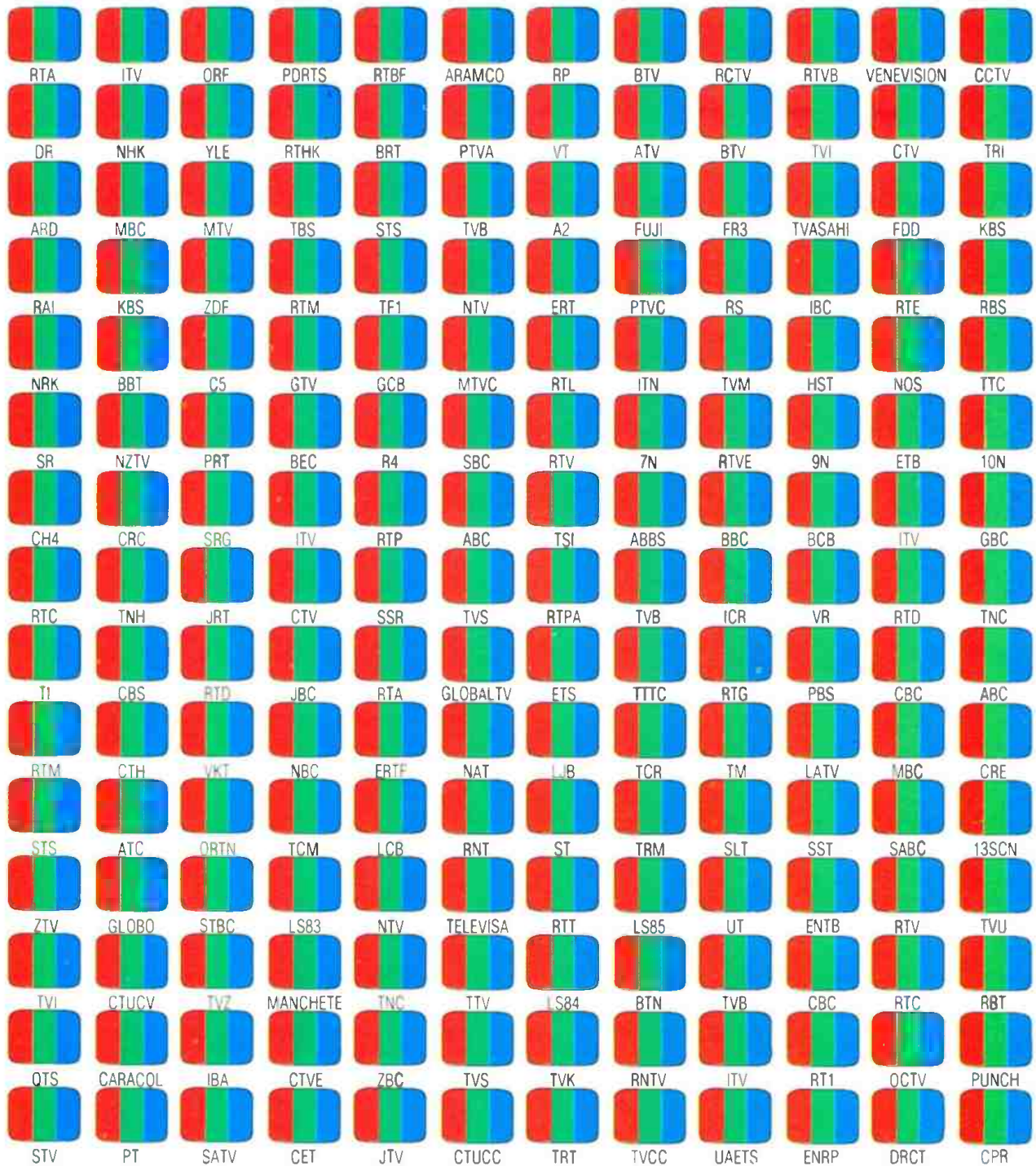

# MAXIMUM TRANSPARENCY, STABILITY, AND RELIABILITY ASSURED

Make sure that the monitors in your studio show the signals from your valuable video sources exactly as they are. The BARCO INDUSTRIES CTVM 4 series of master control monitors do just that, because they are stable, reliable and fully transparent.

The CTVM 4 series precision instruments have been developed and are manufactured by experts who:

- understand the monitor needs of your TV station;
- have been supplying you with state-of-the-art monitors for more than ten years;
- help you to cut costs for realignment and maintenance;
- allow your staff to concentrate on production, by making non-transparent and unreliable screens a thing of the past

Ask for the detailed brochure telling you all about how the CTVM 4 series meets your highest standards.

Or get in touch with the people who really care:

- your local BARCO INDUSTRIES distributor or directly from the world's vision electronics expert:



**BARCO  
INDUSTRIES**

BARCO INDUSTRIES, INC. 2211-B Executive Street  
Charlotte, North Carolina 28208 704/392-9371 Telex: 802-019

BARCO INDUSTRIES N.V. Sevenlaan 106, 8500 KORTRIJK Belgium  
Phone 32/56 23 32 11 or telex 85842 barind b or FAX 56/20 04 18  
BARCO INDUSTRIES is a member of the ACEC-group.

Circle (48) on Reply Card  
[www.americanradiohistory.com](http://www.americanradiohistory.com)

### Autogram

- Autoclock: in-console clock, timer and chronograph with day-date and temperature display.
- Autocoder II: encodes English to tape IDS and decodes the messages for as-run log printout.

Circle (409)

### B&B Systems

- AM-3: audio scope, phase display with headroom, VU metering for three channels, for TV stereo.
- AM-2: 2-channel audio scope; for radio and recording use.
- Image scope: stereo/graphic visual display of stereo sound as perceived by listener.

Circle (413)

### BGW Systems

- Model 85: stereo broadcast audio amp; 35W/channel 8Ω.

Circle (422)

### BIW Cable Systems

- Fiber-optics cable system connected with Hirakawa Electric System.

Circle (424)

### BSM Broadcast Systems

- 5000A: audio/video routing switcher; expandable from 8x8 to 256x256.

Circle (439)

### B-W Lighting Systems

- 70DTRS: cyclorama rotary switch.
- Railroad switch: eliminates two Y switches.

Circle (440)

### William Bal

- Silver Line: equipment cases.
- Survivors: heavy-duty shipping containers.

Circle (414)

### Barco Industries

- Component monitor: option for CTVM4 accepts RGBs or analog component inputs for critical analysis.
- Universal monitor: CTVM4 precision monitor with 26-inch CRT; switches between 525/60 and 625/50 standards automatically; accepts RGBs and Y/R-Y/B-Y or Y/I/Q.
- CM22 upgrade: Auto line biasing improves optical black and color temperature stability.
- HDTV displays: Custom precision monitors for 4:3 and 5:3 aspect ratios.

Circle (410)

See ad page 95

### Barrett Associates

- DMR: MacKenzie digital message repeater, EPROM memory; standard message time is up to 30s.

Circle (411)

### Basys

- BASYS: newsroom computer system; stand-alone; for radio and bureau application; with Parallel Computer

System hardware offering 100% back-up from 2 UPSs.

Circle (412)

See ad page 158

### Beaveronics

- FAVAG 2QMS-2: dual master clock system with auto changeover; pulse sensing.
- FAVAG 2QTMS: Remote satellite master clock system controlled by a dual central precision master.
- B-3.5F: color subcarrier countdown system; synchronizes FAVAG clock to rubidium frequency standard.

Circle (415)

### Belar Electronics

- TVM-100: aural modulation monitor, baseband, for multichannel sound.
- TVM-200: stereo modulation monitor, BTSC TV system.
- TVM-300: SAP/Pro channel modulation monitor.

Circle (416)

See ad page 163

### Belden Communications

- Lee lighting and filters.

Circle (417)

### Belden Electronic Wire & Cable

- Product line of audio, video and data cables; wire; and connectors.

Circle (418)

### Bencher

- M2-V: vertical camera stand.
- Copymate: vertical camera stand.

Circle (419)

### Benchmark Media Systems

- RPM-1: remote program meter.
- System 1000: audio distribution system, including DA-101 10x1 audio interface and MDA-101 mic pre-amp DAs.

Circle (420)

### Beyer Dynamics

- 185-VS: hand-held wireless mic.
- NE185-VS: 1-channel receiver; true diversity.
- TS85-VS: Procret transmitter.
- RR3000: three single-channel receivers with antenna splitter; in case.

Circle (421)

See ad page 49

### Bird Electronics

- 8572: 25kW dry load resistor; cooled by forced air.
- 4030 element: relative field-strength plug-in for Thruline meters.
- 3900: combination frequency meter and power meter; portable unit.

Circle (423)

### Black's Communications

- Upgraded product line of search and compare broadcast computer database.

Circle (1456)

### Bogen Photo

- Tripods: black anodized finish on

tripod and fluid head products.

- Mini-clamp system.

Circle (425)

### Bogner Broadcast Equipment

- Product line of TV transmitting antennas; SMR, cellular radio base station antennas.

Circle (426)

### Robert Bosch

- MCS-2000: master control switcher; assignable control system for stereo broadcasting.
- FGS-4000: computer graphics system; software improvements.
- TAS/TVS-2000: routing switcher system.
- QuarterCam: BCF-1/10 studio recorder/player.
- CP-series: TVS/TAS switcher control panels.

Circle (427)

See ad page 93

### Bowen Broadcast Service

- Isolator: optical isolation board for TCR-100 machines; reduces errors generated on remote control lines.

Circle (428)

### Bradley Broadcast

- Telos 10: digital telephone hybrid.
- Texar Audio Prism: audio processor.

Circle (429)

### British Aerospace

- Manufacturers of satellites.

Circle (430)

### Broadcast Audio

- Modular audio console with rear-mounted peak overload indicator; uses high intensity focused LEDs; optional active balanced mic input.

Circle (431)

### Broadcast Electronics

- FM-60: 60kW for transmitter, folded ½-wave cavity design.
- TP-30: Pro-channel generator.
- TS-30: SAP generator.
- TZ-30: TV stereo generator.
- AX-10: AM stereo generator.
- DV-1: digital audio *without* tape storage; 3-minute capacity.

Circle (432)

See ad page 142

### Broadcast Microwave Services

- GCA-4: helicopter microwave system with two independently LORAN-controlled 16dB antennas.
- BMA-1000: steerable antenna system; mounts on towers, trucks and tripods.
- BMA-2000: tower-mounted steerable antenna with radome.
- BMA-3000: antenna pedestal; available as steerable or auto-tracking for a variety of antenna sizes and frequencies; tower or pole mounted.
- BMA-4000: auto-tracking pedestal for antennas to 8-foot diameters; dual axis



# 'We selected the HK-357A for proven performance. It's a great addition to our team.'

— Bill Spiegel, General Manager Multimedia Sports Productions, Cincinnati, Ohio

The critical demands of live action sports coverage is one reason why more camera people choose the reliable, proven star over rookie hopefuls.

Bill Spiegel will tell you that. And so will the many other satisfied buyers who have recently purchased their HK-357A cameras.

And why not. Out of the truck and out of the box, the HK-357A features superb performance and a wide range of automatic operational conveniences.

Plus the HK-357A can be set-up using conventional manual techniques or with optional computer assist.

Currently available for immediate shipment, the HK-357A does more than look good on paper.

Doesn't it make sense to get behind a winner?

For a complete demonstration of the HK-357A and other Ikegami cameras and monitors, contact us or visit your local Ikegami dealer.

## Ikegami

**Ikegami Electronics (U.S.A.), Inc.,**  
37 Brook Avenue,  
Maywood, NJ 07607

- East Coast: (201) 368-9171
- West Coast: (213) 534-0050
- Southeast: (813) 884-2046
- Southwest: (214) 233-2844
- Midwest: (312) 834-9774

Circle (50) on Reply Card



*Broadcast Microwave (continued)*  
tracking available.  
Circle (433)

**Broadcast Supply West**

- CD20, CD40LS: compact disc wall, carousel racks.
  - Series C40: audio cartridge carousel racks.
  - W20, W300: audio cartridge wall racks.
- Circle (434)

**Broadcast Systems**

- DC-10: 1/2-inch Betacam automatic video cart machine.
- DC-20: auto network delay system; audio and video.
- DC-3: VHS automatic video cart

machine.

- News Cart: 2-channel cart playback system.
- Circle (435)

**Broadcast Video Systems**

- D-1000: decoder; NTSC in; YIQ, Y/R-Y/B-Y and RGB out.
  - Model 663: translator; component video in, RGB out.
  - Cox 203CV: video encoder; component video inputs.
  - VIC-900: transmission of ID, date, and time and control data in vertical blanking.
  - SA-102: portable safe area generator.
  - DL 605: video delay card.
- Circle (436) See ad page 140

**Bruel & Kjaer Instruments**

- Studio microphones: available in pairs with sensitivity, self-noise and response curves matched within 1dB; in carrying case.
- Circle (437)

**Bryston**

- 0.5B: phono pre-amp in 1 3/4-inch-high 19-inch rack-mount; XLR or RCA connectors.
- Circle (438)

**CAT Systems**

- CAT 3200/4200/7200: Facility and security monitoring systems; allows color CRT displays of monitor point status.
- Circle (892)

**CBX**

- Product line of facilities planning and design consultants for mobile units and radio/TV stations.
- Circle (451)

**CCA Electronics**

- FM-40G: E to G line converter.
- Circle (452)

**CCI/Commercial Cable**

- PAVC programmed access unit: interprogrammable VCR control system; handles locally originated program playback and commercial insertion.
- Circle (453) See ad page 123

**CMC Technology**

- Videomax TD-600: tape eraser for 1/2-inch to 2-inch videotape; automatic system for complete erasure.
  - DPT head: dynamic parallel tracking video head for 1-inch VTR C-format recorders.
- Circle (472)

**CMX Systems**

- CMX 33XL editing controllers.
  - Motion Memory: accessory for CMX series.
  - I<sup>2</sup> Interface: multiple unit control feature, shown with three VTR I<sup>2</sup> and one switcher I<sup>2</sup> in single chassis.
  - CMX 3400A: upgrade to CMX 3400; includes dynamic motion memory; 64 GPI channels.
- Circle (473)

**CRL Audio**

- TVS-3001: TV BTSC stereo audio processor for the studio.
  - TVS-3002: combination stereo limiter/generator for the TV transmitter site.
  - SEP-800: spectral energy processor; 4-band stereo system.
- Circle (503) See ad page 13

**CSI Electronics**

- Product line of AM, FM radio transmitters.
- Circle (506)

**CONCEPT TO COMPLETION**

From initial design to installation and service ...

**VICTOR DUNCAN, INC.**  
 CHICAGO • 661 N. LaSalle Street  
 Chicago, IL 60610-3770 • (312) 943-7360  
 DALLAS • Four Dallas Communications Complex  
 Irving, TX 75039-3510 • (214) 859-0200  
 DETROIT • 32360 Howard Street  
 Madison Heights, MI 48071-1429  
 (313) 589-1900

Circle (61) on Reply Card



# Stations that want to be #1 don't gamble with their sound,

The choice of an on-air console is the most critical equipment decision you can make. If your present console isn't in top condition or you find yourself forced into making more compromises with your operations than you'd like, then chances are you're seriously reading this ad to find out what to do about it.

We think we have the answer for you with our new BMX-III on-air console.

Here's some specifics:

- The BMX-III has three main stereo mix busses, each with distribution line amplifiers. For more flexibility, there's two telephone mix-minus feeds plus a headphone monitor mix. There's

monitor facilities for two studios, and independent outputs for the console, host, co-host and guest telephone feeds.

- The stereo cue systems has automatic headphone monitor switching.

- Each mic and line input has full, independent remote control logic.

- All BMX-III's have multi-function metering with automatic cue and solo level display and a built-in test oscillator.

- The mainframes are

available from 10 to 34 inputs.

- The audio and logic control systems are fully compatible with our new AMX and ABX consoles.

- A multi-way intercom system and a voice slating I.D. tone are just two examples of useful options that can be easily added to your BMX-III.

There's a lot more to impress you with, including the specs, and most of all — a reasonable price.

Call us now for a brochure with the details.

## They invest in a BMX console.



The Choice for More #1 Stations.

Pacific Recorders & Engineering Corp.  
2070 Las Palmas Drive  
Carlsbad, California 92008  
(619) 438-3911 Telex: 181777

© 1985 Pacific Recorders & Engineering Corp.

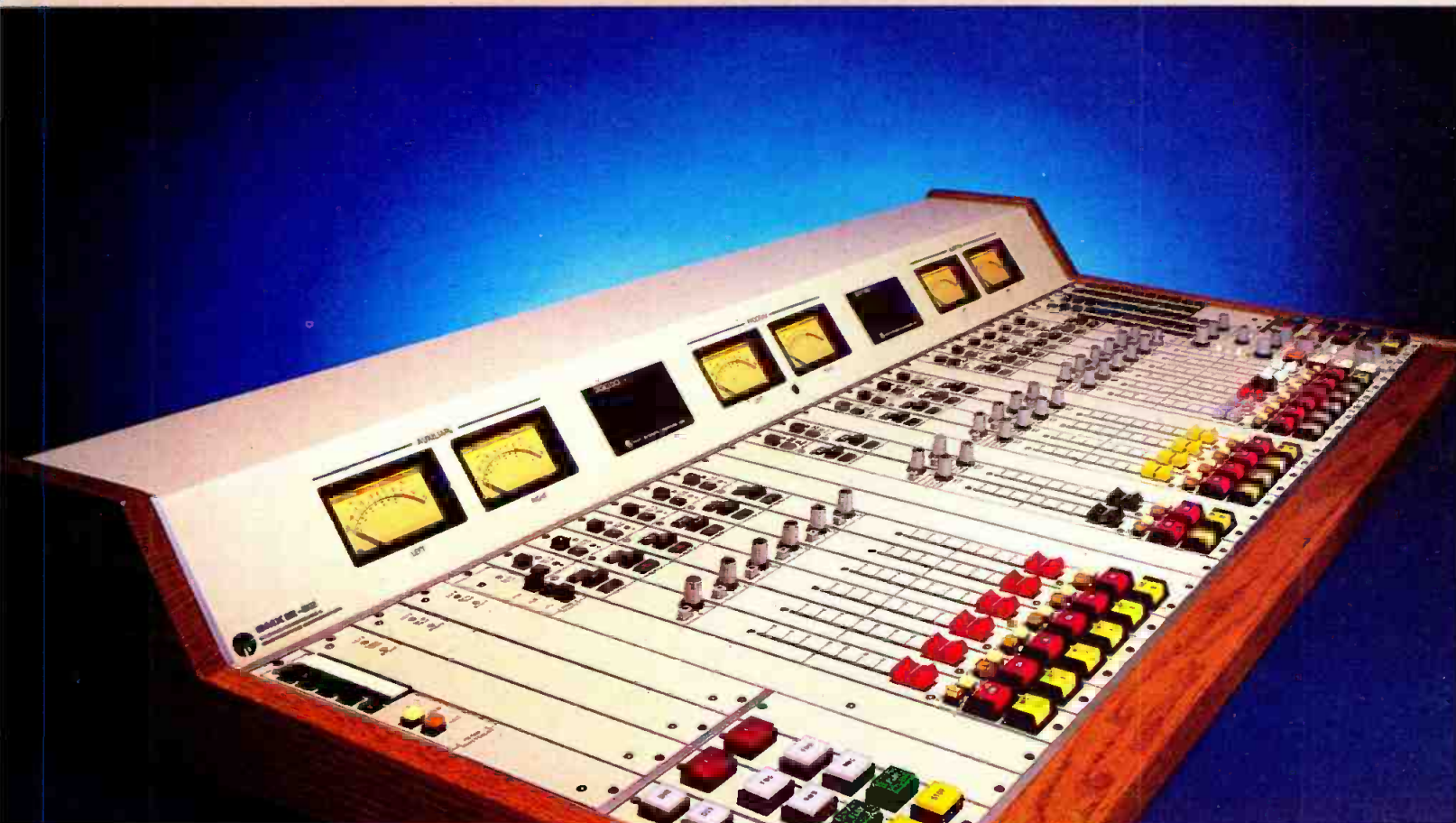

### Cablewave Systems

- 1 5/8-inch foam cable transmission line.

Circle (441)

### Calvert Electronics

- ITT vacuum capacitors and Siemens vacuum tubes.

Circle (442)

See ad page 30

### Calzone Case

- Additional models to Escort Proline II and Convoy case products.

Circle (443)

### Cambridge Products

- BNC and TNC connectors; flush-mounted on wall plates.

Circle (444)

### Camera Mart

- Distributor and rental for video, audio and film production.

Circle (445)

### Canare Cable

- L-V61: coaxial cable; 75Ω video; in 10 colors.
- L-V77: Dual-shielded RG59-type cable; 75Ω; in 10 colors.

Circle (446)

### Canon USA

- P12x18BIE, P14x16.5BIE, P18x15BIE, PV12x14BIE, PV14x12.5BIE, PV18x11BIE, PV40x13.5BIE, J15x9.5B, J20x8.5BIE, J15x8.5BIE: studio lens systems.
- J13x9BIE-II: ENG lens system.
- J25x11.5BIE, P40x18BIE: field lens systems.
- J45x9.5B: field production lens for 2/3-inch cameras.
- J8x6B: ultra wide ENG 2/3-inch lens.
- J14x8B: high resolution ENG lens, 2/3-inch format.
- MC200/300: pedestals.
- TR60/90: tripods for ENG.
- Lens accessories.

Circle (447)

### Capitol Magnetics

- Product line of audio cartridges and mastering recording tapes.

Circle (448)

See ad page 54

### Catel

- Product line of CAFM, CATV headend systems; FM, TV modulators; CV channel processors; bandpass filters and fiber optics.

Circle (449)

### Dwight Cavendish Company

- Copymaster 250: videocassette duplicators.
- Remote duplicator machine control systems.
- Modules: audio and video distribution amps.

Circle (450)

### CeCo Communications

- EIMAC tubes: 4CX15000A, 4CX35000C, 4CX10000D, 4CX5000A, 4CX1500A, B; 5CX15000A and EIMAC product warranty.

- RCA camera tubes; industrial, broadcast and solid-state devices.

Circle (454)

### Celwave RF

- Product line of transmission line and components; FM antennas; harmonic filters; signal couplers; custom rigid coaxial assemblies.

Circle (455)

### Central Dynamics

- Series 80 ICK: IO key system for series 80 switchers, with new design of RGB and encoded chroma-keyers.
- PGM PROC: program processors for series 680 and 1080 switchers; analog key borders; soft-color wipe borders.
- MC 4000: master control switcher.
- EIFS: serial editor interface.
- MC990: master control switcher with APC-990 computer control system.

Circle (456)

### Centro

- ENP trucks: electronic news production vehicle; includes 1 1/2-inch and U-matic formats, microwave transmitter with mast, dual power generators.
- Editainer: post-production edit station with Betacam decks; Graham Patten audio mixing; Grass Valley 1600-IXCU video switching; and ISC edit controller.

Circle (457)

See ad page 17

### Century Precision Optics

- V16: periscope design lens for 2/3-inch TV and 16mm film cameras; f/3.2, 1/1 relay optics; interchangeable camera mount.
- Wide angle set: 0.7x and 0.5x attachments for video zoom lens systems.

Circle (458)

### Cercone-Vincent Associates

- Turnkey lighting systems installations.

Circle (459)

### Cetec Antennas

- JSDP: "The Broadcaster" broadband community FM antenna.
- CP LPTV antenna for highband VHF and UHF

Circle (460)

See ad page 32

### Cetec Vega

- T-36: hand-held wireless mic with Electro-Voice BK-1 condenser element.
- 67A: portable diversity wireless mic receiver; operates from +10.5 to +18Vdc with DYNEX II processing.
- T-87: hand-held wireless mic with Shure SM-87 element.
- Beyer 500 ribbon element.
- T-84: hand-held wireless mic with Shure SM-87 element.

- R-31A: wireless mic receiver.
- T-37: Dynex transmitter mic.

Circle (461)

See ad page 53

### Channelmatic

- Product line of videocassette changer systems; random access CR automation system; audio and video routing switchers; satellite receiver controllers; audio and video DAs; time tone remote control systems.

Circle (462)

### Chemigraphic Products

- Product line of equipment transport carts.

Circle (463)

### Chester Cable

- Cabling services, installations and turnkey projects.

Circle (464)

### Christie Electric

- CASP: charger, analyzer, sequencer and programmable power supply for all ENG/EFP batteries.
- Max Erase-16B: bulk tape eraser/degausser.

Circle (464)

See ad page 38

### Chroma Digital Systems

- Chromafex 776: production effects system.

Circle (465)

### Chyron Telesystems

- Software enhancements for Chyron IV.
- EX: graphics generation system.
- Third input channel for Chyron IV system.
- Low-cost, stand-alone paint system.

Circle (466)

### Cine 60

- Modular replacement for OEM conventional on-board camera batteries; requires no cables, adapters or modifications for charging or camera operation.
- Betacam battery: offers three times the power available from Sony NP-1; special bracket clears mic and line connections on camera unit.

Circle (467)

### Cinema Products

- Cinevid Plus: image enhancer for film camera video assists.
- CP Co-Ax: digital remote control system for Ikegami HL-79E.
- Steadigate: film gate conversion for Rank Cintel film-to-tape transfer systems.
- CP/Tiltplate: balance/tiltplate for geared or fluid heads.
- WRC-3A wireless: remote control system using radio techniques.

Circle (1204)

### Cinemills

- 12kW Sunburst HMI lighting system.

Circle (468)



And  
now a message on  
Yamaha's M1500  
series  
mixing consoles.

# M1516A



## GENERAL SPECIFICATIONS

FREQUENCY RESPONSE +0, -3dB, 20Hz to 20kHz; +0, -0.5dB, 30Hz to 15kHz.

TOTAL HARMONIC DISTORTION (THD)\*

Less than 0.5% @ +10dB, 20Hz to 20kHz. Less than 0.1% @ +20dB, 50Hz to 20kHz.

HUM AND NOISE\* (20Hz to 20kHz, 150Ω source, Input Selector set at "-60")

- 128dBm Equivalent Input Noise (EIN);
- 95dB residual output noise with all Faders down.
- 73dB PROGRAM OUT (77dB S/N); Master Fader at nominal level & all Input Faders down.
- 64dB PROGRAM OUT (68dB S/N); Master Fader and one Input Fader at nominal level.
- 73dB MATRIX OUT; Matrix Mix and Master controls at maximum, one PGM Master Fader at nominal level, and all Input Faders down.
- 64dB MATRIX OUT (68dB S/N); Matrix Mix and Master controls at maximum, one PGM Master Fader and one Input Fader at nominal level.
- 70dB FB or ECHO OUT; Master level control at nominal level and all FB or ECHO mix controls at minimum level. (Pre/Post Sw. @ PRE.)
- 64dB FB or ECHO OUT (68dB S/N); Master level control and one FB or ECHO mix control at nominal level. (Pre/Post Sw. @ PRE.)

MAXIMUM VOLTAGE GAIN (Input Selectors set at "-60" where applicable)

PROGRAM & MATRIX 84dB; Channel In to the corresponding output. EFFECTS 20dB; Effects In to PGM Out.  
FB & ECHO 94dB; Channel In to FB/ECHO Out. SUB IN 10dB; Sub In to PGM Out.

EQUALIZATION ( $\pm 15$ dB maximum)

LOW: 50, 100, 200, 350, 500Hz, shelving. HIGH MID: 1.2, 2, 3.5, 5.7kHz, peaking.  
LOW MID: 250, 350, 500, 700, 1000Hz, peaking. HIGH: 10kHz, shelving.

HIGH PASS FILTER 18dB/octave rolloff below 80Hz.

PHANTOM POWER For remote powering of condenser microphones, +40V DC can be switched on via a rear panel Master phantom power switch. When an individual Input Phantom switch is also On, voltage is applied to pins 2 and 3 of that input's balanced XLR connector.

DIMENSIONS/WEIGHT M1516A 34" W x 36 1/2" D x 14 1/2" H 147 lbs. M1524 55 3/4" W x 36 3/4" D x 14 1/2" H 213 lbs.  
M1532 55 3/4" W x 36 3/4" D x 14 1/2" H 231 lbs.

\*Measured with a 6dB/octave filter @12.47kHz; equivalent to a 20kHz filter with infinite dB/octave attenuation.

The specs shown are for the 16-channel M1516A console. When you need the same outstanding performance but more channels, there's the 24-channel M1524 and the 32-channel M1532. All three mixers have remote rack-mounted power supplies and are ideal for just about any fixed or portable sound reinforcement or broadcast application.

Of course, all three M1500 consoles have legendary Yamaha quality, reliability and craftsmanship. Which explains why you see Yamaha mixers wherever you look. Studios. Concert halls. Clubs. Theatres. Churches. We could go on, but you get the message.

For more information, write: Yamaha International Corporation, Combo Products Division, P.O. Box 6600, Buena Park, CA 90622. In Canada, Yamaha Canada Music Ltd., 135 Milner Ave., Scarborough, Ont. M1S 3R1.



Circle (82) on Reply Card



### **Cin-Tech**

- Prototype: custom-designed lighting systems.
- Circle (469)

### **Cipher Digital**

- 716A: time code generator; continuous jam sync;  $\pm 30$ -frame offset.
  - 710A-100: time code reader for total regeneration of code.
  - 700A: time code reader with 4-keyer character inserter.
- Circle (470)

### **Clear-Com Intercom Systems**

- CC-25: lightweight Clear-Com comparable headset.
  - MA-4: stand-alone IFB system.
- Circle (471)

### **Coaxial Dynamics**

- 83500 RF AnaDigit Expiditer: computer-based RF power meter system.
  - RF terminating loads: equivalent to AN/PRM-33 mil specs.
  - 81000-A elements: cellular radio frequency plug-ins for portable directional RF wattmeter.
- Circle (479)

### **Coherent Communications**

- VT-2: miniature video transmitter for remote monitors.
  - TC-500 smart slate: time code reader/generator for film-to-video transfers.
  - FS-100: frame store for video-assisted film applications.
- Circle (474)

### **Colorado Video**

- Model 950: digital color image communications system with IBM-PC/XT; four full-frame memories (512x512x8); Winchester bulk storage to 500 images.
- Circle (475)

### **ColorGraphics Systems**

- ArtStar II: full-color graphics paint system with character generator and still-store.
  - NewStar: news system introduces automated tape rolls, character generator and still-store graphics with Utah Scientific advanced machine control.
  - ArtStar upgrades: multifunction painting with fonts and font generation, animation, background generator and wipes; 250,000 colors; hard copy output.
  - Weather Central upgrade: news graphics depicts top news stories received by Live-Line system.
  - Developmental system: real time 3D graphics animation.
- Circle (476)

### **Colortran**

- 192 Pack dimmer.
  - Pack Master: 12- and 24-channel dimmer controller.
- Circle (477)

### **Columbine**

- Product line of radio business automation with music playlist; based on IBM mini and personal computer systems.
- Circle (478)

### **Comark Communications**

- CTT-U-60RE: 60kW UHF TV transmitter; fully redundant; stereo-ready with Marconi B7500 modulator.
  - B7536: 25kW VHF TV transmitter (Marconi).
  - B6525: FM transmitter (Marconi).
  - B7500: TV modulator with ED and ICPM precorrection.
  - Retrofit packages for UHF TV transmitters to improve efficiency.
- Circle (480) [See ad page 3](#)

### **Comex**

- MCD/4: Conifer MMDS 4-channel downconverter and antenna system.
- Circle (481)

### **Comprehensive Video Supply**

- Edit Lister: PC software for list management.
- Circle (482)

### **Comprompter**

- ENR: Comprompter hard-disk electronic newsroom; full network/electronic mailbox.
  - 4353: Totaprompter—portable electronic ac/dc prompting—news or commercial productions.
- Circle (483)

### **Compucon**

- Product line of frequency coordination; consultant services.
- Circle (484)

### **Compulink**

- Sales Assistant: software for traffic, billing and station management.
- Circle (485)

### **Compu-Prompt**

- CP Junior: lightweight camera-mounted prompter system for ENG use.
  - CP2000: color computer prompter; provides infinite text length; editing during scrolling.
  - Uninterruptible power supply.
  - Deluxe podium prompter and monitor system.
- Circle (486)

### **Computer Concepts**

- Co-Operator: PC software accesses information from more than 3500 co-op plans.
  - Micro Broadcast System: Wang and IBM-XT software for station receivables, scheduling and sales.
- Circle (487)

### **Computer Graphics Labs**

- Single-frame animation package for Images II; includes remote control for the VTR.
  - Reel-Time Grab: gets a single frame from videotape with proper NTSC mapping components; full color.
  - CGL/Trillium Corporation real time simulation systems.
- Circle (488)

### **Computer Prompting**

- CPC-1000: computerized color

prompter; IBM and compatible.

Circle (489)

### **Comrex**

- Telephone couplers: meet FCC regulations specifically for broadcast; modular connectors.
  - LX-L: automatic level set for unattended operation of dual-line frequency extender.
- Circle (490)

### **Comsat World Systems**

- Various audio and video services available in addition to international broadcasting services. Also international telephone, telex, facsimile and data transmission services.
- Circle (491)

### **COM-TEK Communications**

- IR-312: inductive receiver for the RC-72 Receive-A-Cue system.
- Circle (492)

### **Comtronix Systems**

- CP-15-AB: pulser; UHF TV; ABC- or BCD-type klystrons.
  - KT-22: Klystron gas test system.
- Circle (493)

### **Comvid**

- RGB-30: RGB converter to NTSC video.
  - RGB-30A: same as RGB-30 but maintains sync subcarrier phase.
  - Image Master: video animation system with integral film-to-video conversion functions.
- Circle (494)

### **Connectronics**

- SECK 62, 122: portable mixing consoles.
  - VX1, VX2: video cable.
- Circle (495)

### **Conrac**

- 2600 series: monochrome monitor in 9-, 15- and 19-inch diagonal sizes.
- Circle (496)

### **Continental Electronics**

- C-QUAM: AM stereo generator.
  - Type 817A: 60kw FM transmitter.
  - C-Quam modulation monitor.
- Circle (497) [See ad page 142](#)

### **Control Concepts**

- ISAFIL: active tracking filters with magnetic isolation; reduces power line transients.
- Circle (498)

### **Convergence/Aquis**

- ECS-195: A/B roll editing control system; based on expanded ECS-90 with modified features from ECS-204; EDL; integral time code generator.
- ECS-205: upgraded; expanded ECS-204 for twice as many source VTRs.
- DD-300: dual disk drive.
- ECS-225: 8-machine edit controller.

### Convergence (continued)

- Edit-Pack: IBM-compatible editing software.

Circle (499)

### Cool Light

- L-13: battery belt.
- L-20: battery belt.
- Mini-cool: heat-free light; ac or ac/dc models.
- Accessories for Mini-Cool light.

Circle (500)

### Corporate Commission Consultants

- System BM: component video system; automatic operation reduces time required for color correction.

- System 60XLB-3: automatic system for color correction from CCD and flying spot scanners.
- XL 2000: color correction system; voice activated.
- IIIXL: "one light" color corrector for video components or composite signals.
- Simplex I-C: "one light" color corrector for analog components.

Circle (501)

### Corporate Excellence

- Surveyor 8: automatic calling system for sales leads and public opinion polls.

Circle (894)

### Countryman Associates

- Wireless microphones for broadcast.
- Isomax IV: flexible extension tube microphones.

Circle (502)

### Crosspoint Latch

- 6150BK: master control switcher.
- 6116: component and encoded video switcher.
- 6112AK: video switcher with microprocessor-assisted operation.
- 8000: time base corrector for A/B editing systems; locks two source VTRs to one another.

Circle (504)

See ad page 166

### Crown International

- Micro-Tech 1000: miniaturized stereo power amplifiers.
- FM-3: tuner.
- PCC 160: phase coherent cardioid microphone; surface-mount super-cardioid.

Circle (505)

### Cubicomp

- Picturemaker: 3D video animation system with typography for IBM PC.

Circle (507)

### Custom Business Systems

- The System PC: station business automation system using PC computers.
- Software changes: open item accounts receivable; available for IBM and Wang PCs.

Circle (508)

### dbx

- 166: three dynamic processors in one package; noise gate; compressor/limiter; peak clipper.
- 321: noise reduction circuitry for satellite products.
- 221: noise reduction circuitry; Type II.
- 211: noise reduction circuitry; Type I.

Circle (515)

### Dalsat

- SNG 25: Satellite news gathering Ku-band uplink and downlink system.

Circle (509)

### Bill Daniels

- Telephone directories for product manufacturers.

Circle (510)

### Data Communications

- BIAS Newsroom: IBM PC-based newsroom system.
- BIAS MCA: master control automation ties traffic to engineering by using 8086 processor.
- BIAS PC Cable: business software for CATV.

Circle (511)

# Performance Plus...

... from



No, this is not an advertisement for a computerized news room...

But if you are interested in what the talent sees, at a really affordable price,\* then read on!

Listec Prompting Systems include the new Memory ScriptWriter with a capacity of over 6,000 lines of formatted text — equivalent to over 1½ hours of reading time — in clear, clean, easy to read reversible black on white characters.

Entry is made easy with a "Querty" type keyboard, and there are no computer codes to unscramble. The Remote Control Module allows Variable Speed, Forward and Reverse, Pause, Next Story, Previous Story and Story Reset.

Listec offers the latest in Wide Angle Mirror Assemblies, for our new on-camera monitor display. This concept is in keeping with the News Room Sets popularly used, and completely eliminates shading... even when pulling back on the latest wide angle zoom lenses!

\* \$6,500. for system  
Less optional Monitors and  
Large Character Printer

CALL OR WRITE FOR OUR ALL NEW '85 BROCHURE!



**LISTEC TELEVISION EQUIPMENT CORPORATION**  
39 Cain Drive, Plainview, New York 11803 / (516) 694-8963  
Telex: 640470

**LISTEC (WEST) CORP.**  
1619 Cosmic Way, Glendale, California 91201 / (818) 247-9247  
Telex: 182686

Circle (63) on Reply Card



# Silk and Steel.

First the steel:

Crank up your CHR, AOR, Urban, or Modern Country format in home or car. What you'll hear is an audience-grabbing sound that jumps off the dial, out-punches the competition, and makes points with your listeners.

Then the silk:

Take the same signal and play it softly on a little bedroom clock or table radio with a tiny, tinny speaker. Many "competitive" processors can't pass this seemingly-simple test — they sound fine when you listen loud on big speakers, but collapse to reveal a pumpy, unnatural midrange when the boom and sizzle are taken away.

Not the new Six-Band Optimod-FM. Thanks to our patented multiband distortion-cancelling clipper, the sound is simultaneously spectacular and subtle — the peak limiter uses no gain reduction, so neither the bass nor the highs can ever cause midrange pumping.

If you own an 8100A or 8100A/1 Optimod-FM of any vintage, our new 8100A/XT Six-Band Limiter Accessory Chassis can readily upgrade it to aggressive, six-band operation at surprisingly low cost. That's because the 8100A/XT uses the host 8100's power supply and most of its circuitry to achieve an efficient, affordable *system* whose parts and sonics are perfectly harmonized.

Ratings leaders in every format have overwhelmingly chosen the 8100A system. Its preeminence comes from our basic audio processing patents, proprietary circuitry, and stable, professional design, plus our proven commitment to quality and service. With the availability of the new Six-Band Accessory Chassis, now more than ever, you can't go wrong with Optimod-FM — no matter what your processing objective.

See your favorite Orban dealer, or write or call us for more information.

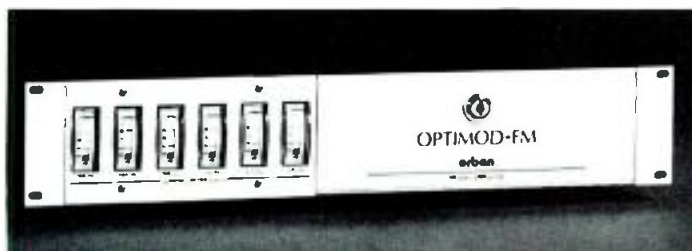

**Orban Associates Inc.**

645 Bryant St., San Francisco, CA 94107

Toll Free: (800) 227-4498, In California: (415) 957-1067

Telex: 17-1480

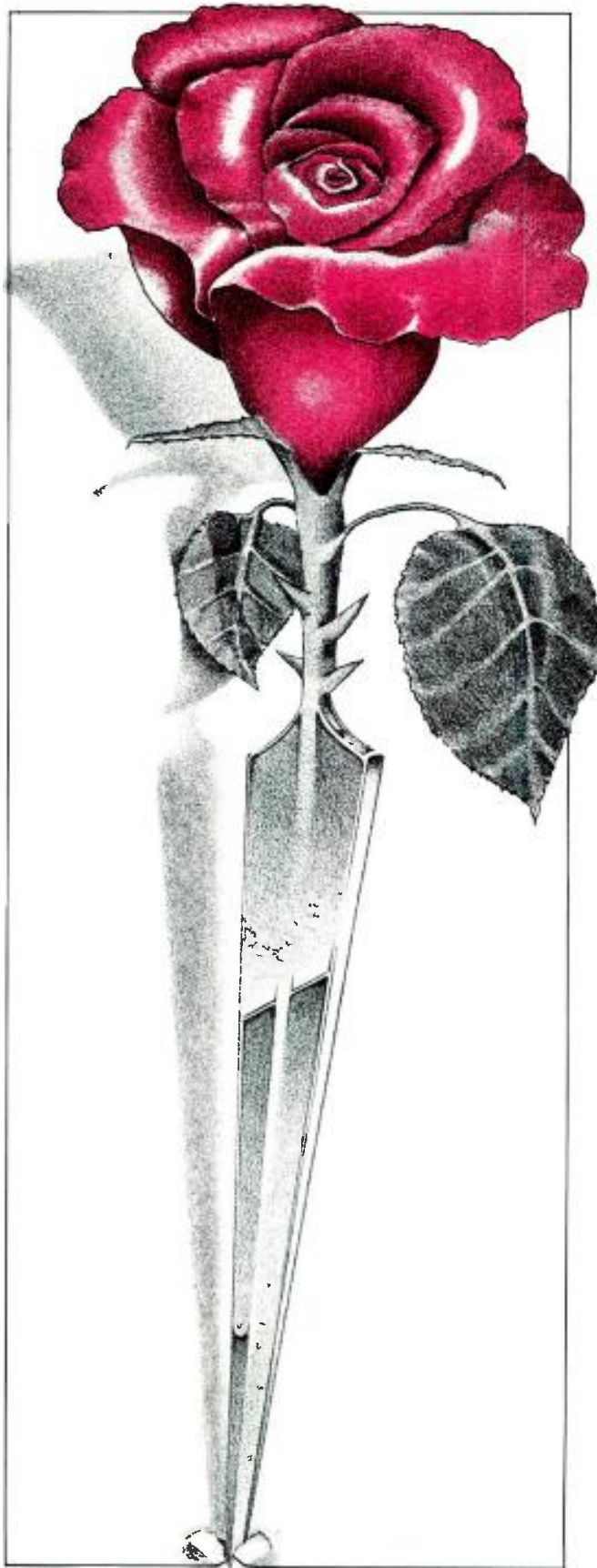

**orban**

**ORBAN PROCESSING KEEPS YOU COMPETITIVE**

Circle (64) on Reply Card

#### Datatek

- D-524: audio preliminary/line amp.
- D-525: dual channel/stereo audio DA.
- D-664: video DA.
- D-2300: video/audio routing system; standard frame 120 in x 4 out; expandable.

Circle (512)

#### Dataworld

- Product line of comprehensive database of AM, FM and television facts.

Circle (513)

#### Datum

- 9550-689: video data encoder; inserts data into video but remains transparent to viewer.
- 9200-401: video data reader recovers encoded information.

Circle (514)

See ad page 94

#### Deloitte, Haskins & Sell

- Financial consulting company for broadcasters.

Circle (516)

#### Delta-Benco-Cascade Ltd.

- TMU-2100: 100W UHF single-tube TV transmitter.
- TMU-2020: 20W UHF TV transmitter.
- TMVL-2010: 10W lowband VHF TV transmitter.
- TMVH-2010: 10W highband VHF TV transmitter.

Circle (517)

#### Delta Electronics

- AM stereo system: ASE-1 exciter and ASL-1 stereo modulation monitor.
- RG4: receiver generator.

Circle (1362)

See ad page 135

#### DeSisti Lighting/Desmar

- 310, 320, 350: 1kW, 2kW and 5kW fresnel lights.
- 2020: 2.5kW HMI softlight.
- 2120: 4kW tungsten softlight.
- 2230: 1.2kW HMI PAR 64 light.
- 2200: 200W CID sungun; daylight.
- 2205: electronic ballast for 2200.

Circle (518)

#### Dielectric Communications

- 600: automatic dehydrator for feed-line pressurization; dew point below -40°F.

Circle (519)

See ad page 136

#### Digital Entertainment

- DEC VCO: synchronizer interface for X-80 recorders.

Circle (1203)

#### Digital Services/DSC

- ISS100: still-store option to illusion effects system; various drive configurations to increase storage capacity; all stored frames available for effects system.
- ILN4000: illusion multichannel video effects system.

Circle (520)

#### Digital Techniques

- Touchcom: interactive graphics and videodisc system using touch screen control.
- Touchcom Workstation: graphics, character generator and video-disc programming system.

Circle (521)

#### Digital Video Systems

*Exhibited with Scientific Atlanta*

- Production models of B-MAC transmission equipment.

Circle (1375)

#### DigiVision

- FV-170: fluorovision video processor.
- VT-100: videotape encryption system.

Circle (522)

#### Dilor Industries

- DGM 48/400: computer memory and light grouping control console.

Circle (523)

#### Di-Tech

- 5850 routing switcher: expandable 40 x 20 AFV system for three

**A SURE CURE  
FOR  
FLASHOVER**

**electrically  
transparent  
Phillystran®  
TOWER GUYS**

Phillystran is now protecting more than a thousand broadcast towers  preventing white-noise arcing across ceramic insulators (they aren't required)  eliminating problems with on-off cycling due to static discharge on steel guys.

With Phillystran HPTG, tower-guy maintenance and costly re-guying are problems of the past.

For all the Facts—including "Electrical and Mechanical Analysis of Synthetic Tower Guys"—call/write



**Phillystran**

**UNITED ROPEWORKS (U.S.A.) INC.**

20 COMMERCE DRIVE, P.O. BOX 306  
MONTGOMERYVILLE, PA 18936 U.S.A.  
(215) 368-5611 TELEEX: 846342

Circle (142) on Reply Card



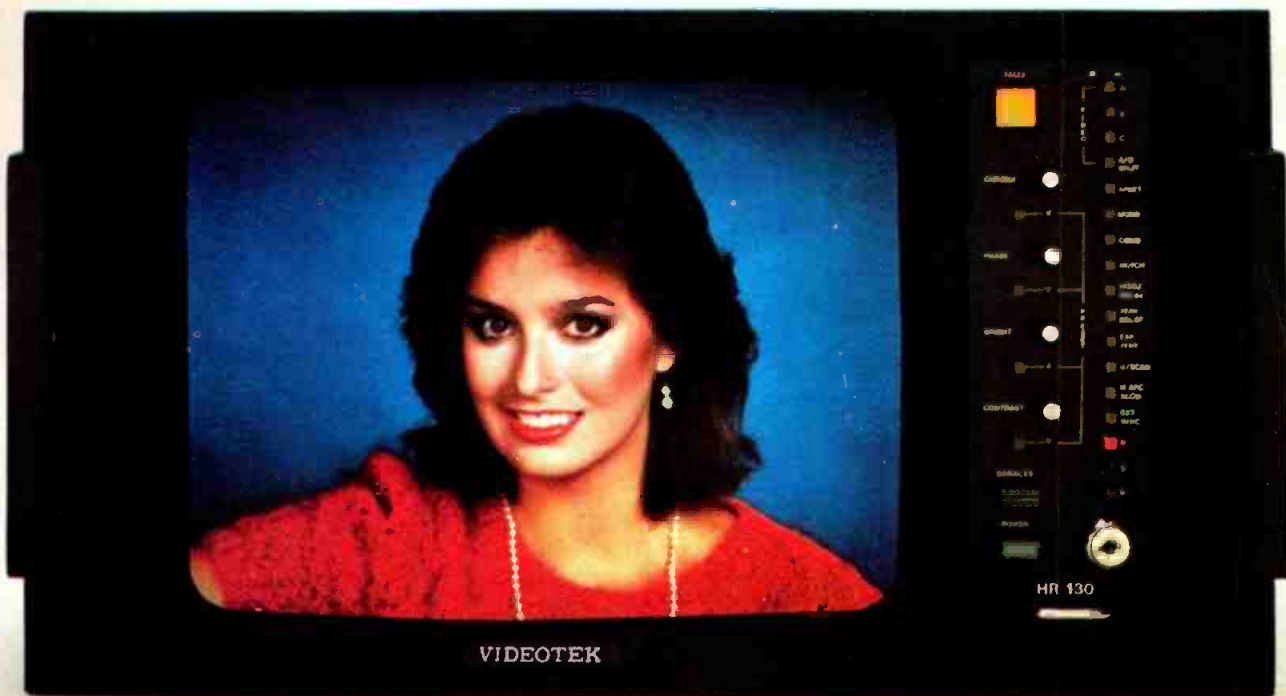

## PHASE II: HIGH-RESOLUTION

For over a decade, critical customers have been using Videotek color monitors for a wide variety of applications.

Join us now in Phase II: High Resolution.

The HR130 is perfect for use in studios, control rooms, engineering bays, and many other areas that require critical signal evaluation.

Precision circuitry is based around a PIL-Delta CRT, with .31mm dot pitch, producing in excess of 600 lines of resolution.

Standard features include: three Composite Inputs,

A-B Split Screen, Analog RGB Input, High Voltage Regulation,

Linear Phase Aperture Correction, Switchable Comb Filter and Notch Filter,

Horizontal and Vertical Delay with Switchable Expanded Vertical,

Underscan, Selectable Time Constant, Presets, and

Lockable Engineering Adjustment Drawer.

For a close-up look at the HR130, contact your local Videotek dealer.

A DECADE OF PROGRESS



A DESIGN FOR THE FUTURE

**VIDEOTEK** INC.

© copyright 1984—Videotek, Inc.

243 Shoemaker Road, Pottstown, PA 19464. (215) 327-2292. TWX 710-653-0125. 9625 North 21st Drive, Phoenix, AZ 85021. (602) 997-7523. TWX 910-951-0621.

Circle (65) on Reply Card

June 1985 **Broadcast Engineering** 107

www.americanradiohistory.com



Ask for our  
**44 PAGE CATALOG**  
 of  
**PROFESSIONAL  
 SOUND RECORDING  
 & DUPLICATING SUPPLIES**

Recording Supply Div. of Polyline Corp  
 1233 Rand Road, Des Plaines IL 60016  
 (312) 298 - 5300

35

Circle (119) on Reply Card

## NOW Coarc™ "Hub-Loads" 1/2" VHS Videocassettes

- Hub-Loading means winding videotape onto the cassette hubs before the hubs are put into the cassette. It's the best way to do it because hub loading machines wind the tape exactly in the center of the hub without edge damage and with perfect tensioning. All Coarc rebuilt videocassettes are hub loaded — because it is the only proper way to reload a 3/4" U-Matic.
- Our new 1/2" videocassettes are hub loaded also because it's the best way to load a new 1/2" VHS videocassette. National brands of new, first quality videotape are available under Coarc's brand name with Coarc's guarantee.

Hub Loading — exclusively from Coarc — the people who gave re-loading a good name.

**CoarcVideo™**  
 CUSTOM LOADED VIDEOCASSETTES

PO BOX 2, ROUTE 217  
 MELLENVILLE, NEW YORK 12544  
 518/672-7202

Circle (120) on Reply Card

*Di-Tech (continued)*  
 levels of audio per input.  
 Circle (524)

### Dolby Labs

- Digital Audio System: processor for audio signals for DBS, cable and broadcast.  
 Circle (525)

### Dorrough Electronics

- 80-B: stereo generator for FM broadcast.  
 Circle (526)

### The Droid Works

- EditDroid: fast-access editing system based on videotape/videodisc technology.
- SoundDroid: all-digital audio processing and editing system for mixing and other special processing for film and TV post-production and music recording.  
 Circle (844)

### Dubner Computer Systems

- Texta: character generator with 37ns resolution; hardware anti-aliasing, font compose and animation capability.
- 10-K: character generator with animation capability for professional video.
- Chromas: full-color video paint system.
- CBG-2 enhancements: automated election system; advanced weather graphics and third-plane capability.
- CCC-12 enhancements: video signal processor for color corrector computer.  
 Circle (527)

### Dynair Electronics

- PCA-900A: alphanumeric control unit for 1000x1000 routing switchers; uses standard mnemonics.
- PCA-901A: terminal interface allows data terminal control and display.
- MP-9290A: control panel CPU provides serial communications and RS-422 serial lines, keyboard interface and display controller.
- PCA-904A: key control panel for alphanumeric control of System 21 and 25 routing switcher.  
 Circle (528)

### Dynascan/B&K Precision

- 126S: waveform monitor.
- 1270: vectorscope.  
 Circle (529)

### ECD Industries

- E-Prom programmer.  
 Circle (531)

### EECO

- Cinemagraphic editing workstation: plug-in control center for EMME editing controller; offers mouse and on-screen menus for all edit and control functions.

- EECOKER: still-frame audio video-disk KIOSK presentations.
- IVESII: editing system for PAL video; A/B enhancement.
- EMME interfaces: for HR-230 VTR and Greco Systems minifile disk memory.  
 Circle (534)

### EEG Enterprises

- TE510: NABTS teletext video data bridge.
- TE521: line 21 to NABTS teletext transcoder.  
 Circle (535)

### EEV

- P8474: 2/3-inch mixed-field Leducon for Sony BVP-30 and BVP-360 cameras.
- P8164: 2/3-inch hybrid Leducon for Hitachi FP-22 and JVC KY-320E.
- 3672: 60kW klystron direct replacement for Amperex; air-cooled.
- 3372: 60kW klystron; water cooled.  
 Circle (536) See ad page 87

### EG&G

- SS-125: StrobeGuard flashhead; narrow vertical beam; self-activating monitoring system; exceeds 200,000 candela effective intensity for daylight operation.
- SS-125: "Owl" single enclosure obstruction warning light; StrobeGuard unit.  
 Circle (537)

### EMCEE Broadcast Products

- TTU-100SR: 100W UHF LPTV transmitter.
- TTU-1000: 1kW UHF LPTV transmitter.
- TTS10GA: 10W ITFS MMDS transmitter.
- TSA-100B: 100W ITFS MMDS amplifier.
- TTU-500: 5kW UHF TV transmitter.  
 Circle (546)

### E-N-G

- Product line of mobile production vehicles.  
 Circle (548)

### ESD (Environmental Satellite)

- Color Connection: weather display software; based on IBM PC; 8-plane graphic option gives 256 simultaneous colors; accesses ESD, Zephyr, RRWDS, LPATS and Doppler radar.
- ESD-1: weather data service via Galaxy 1 satellite.  
 Circle (549)

### ESE

- 207: 1x4 video DAs.
- 208: 1x12 video DAs.  
 Circle (550) See ad page 159

### Eastman Kodak

- EB-930/FP-930: 3/4-inch video tape; increased coercivity (680



# Go For The Gold!

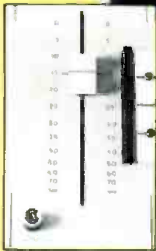

4-position  
stereo  
preselector

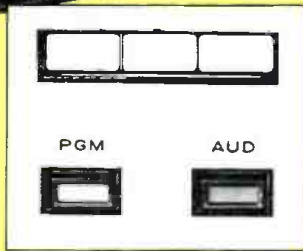

PGM-AUD routing switches



Input punch  
block

## the MEDALIST *Au*

The competition is tough, but you'll be tougher with the all new Harris GOLD (Au) MEDALIST Audio Console! It is the only one in its price range with all of these features:

- 36 inputs with logic controlled switching
- Up to 72 sources into 12 input channels
- End-of-message controlled channel-off switching
- Transformerless input/output for best sound quality
- DC control from P&G faders drives VCAs
- Conductive plastic phone, cue and monitor controls
- Stereo tracking within 0.1 dB on all controls
- 0.05% distortion, +0.0/-0.25 dB response, 20 Hz to 20 kHz

- 77 dB S/N on MIC, 95 dB S/N on M-L inputs, 20 Hz to 20 kHz
- Operates in high RF environment (5V/m)
- Superior punch blocks for quick installation
- Comfortable padded arm rest, ch-on/off switches, more . . .

More features, better sound, exceptional price... proven by over 300 consoles of the Medalist family in operation. From start to finish, you'll be more competitive with the GOLD MEDALIST on your team! For more information, contact Harris Corporation, Studio Division, P.O. Box 4290, Quincy, Illinois 62305. Phone 217/222-8200.

 HARRIS

## For your information, our name is Harris.

Circle (87) on Reply Card

June 1985 *Broadcast Engineering* 109

*Eastman (continued)*

oersteds) and retentivity (1300 Gauss); greater RF output; improved luminance; chroma S/N ratios.

Circle (530)

See ad page 125

**Echolab**

- SE-6: production switcher.
- ACG: prototype touch-screen for animation, graphics and paint box control.

Circle (532)

**Econco Broadcast Services**

- 4CV50000E: rebuilt vapor water-cooled power tetrode.
- 8990: rebuilt high power FM tube.

Circle (533)

**Elcom-Bauer**

- 6020: synthesized 20W FM exciter.
- 601C: 800W FM transmitter.
- 6015C: 1.5kW FM transmitter.
- 603C: 3kW FM transmitter.
- 605C: 5kW FM transmitter.
- 610C: 10kW FM transmitter.
- 630C: 30kW FM transmitter.
- SS250 AM: solid-state AM transmitter.
- 610A: 10kW FM amplifier.
- 650C: 50kW FM transmitter; single 4CX 30,000 G final; 72kW consumption.

Circle (538)

**Electro**

- Barco large screen projector system.

Circle (539)

**Electro Controls:**

- Premiere lighting control system: 500 control channels, fade profiles, unlimited cue insertion, two direct view CRTs. Uses IBM-PC-AT computer.
- Celebrity Plus lighting console: tape module, LCD display, stepback, patch readouts, A/B split faders, auto-load/auto-go, memory.

Circle (1457)

**Electrohome Ltd.**

- ECD-1904 and -2504: 19- and 25-inch medium resolution color display monitors.
- EVM series: high-resolution monochrome video monitors with Autoscan; available in 9-, 12-, 15-, 17- and 23-inch diagonals.

Circle (540)

See ad page 116

**Electro Impulse**

- Product line of dry, forced-air cooled FM loads, RF calorimeters, wattmeters and attenuators.

Circle (541)

**Electronic Research**

- Series 205-1AE: side-mount CP FM antenna.
- Series 940: constant impedance diplexer.

Circle (542)

**Electronic Systems Labs**

- EELA: audio mixers and special processing units.
- C-O/V-O: newly designed torque-tester.
- Haase—humkiller.
- Friese: sync system for film and video.
- V311: R. Barth KG-Dynaset audio processor.

Circle (543)

**Electro-Voice**

- Product line of audio mixers, microphones and accessories, speakers and equalizers.

Circle (544)

**Elicon**

- Product line of real time overhead gantry effects robot.

Circle (1458)

**El Mar Plastics**

- Plastic reels.

Circle (545)

**Emcor Products**

- Mission control cabinetry: EMI/RFI enclosure systems.
- EM-COR I: conventional cabinetry.

Circle (547)

**Eventide**

- H969: harmonizer pitch change, effects unit, with delays, musical intervals, flanging, reverse and repeat audio.

**ANVIL**®

#

Anvil protects the best.

The best video equipment. The finest musical instruments. The most sensitive computer systems. No matter what it is. If it's worth protecting, Anvil does it best.

That's because Anvil knows cases. From their custom-made, high-impact cases to their shock-absorbent, vibration-resistant, hand-sculptured interiors. Every hinge, handle and corner. Inside and out. No detail's too small when it comes to protecting your investment.

That's why, after more than 30 years, Anvil remains the standard for an industry in which "good enough" isn't. An industry where a small mistake can cost a small fortune.

So, if it's worth anything to you, protect it with Anvil. Don't trust anyone but number one.

**ANVIL CASES**

If it doesn't have an ANVIL... you don't have a case.

ANVIL CASES, INC., 4128 TEMPLE CITY BLVD., ROSEMEAD, CA 91770 (818) 575-8614

Circle (68) on Reply Card



# 320.

The ProCam™ Video Camera  
with Plumbicon\* tubes at Saticon\*\* price.

JVC's experience — and success — in designing the highest quality and reliability into compact video production cameras is unmatched. Now, continuing this tradition of high performance at an affordable price, JVC has brought a "high-end" teleproduction camera within the financial reach of production people often victimized by modest budgets. This time, it's ProCam 320.

What a package!

**SENSITIVITY.** ProCam 320 features three, 2/3" Plumbicon pick-up tubes for incomparable picture quality. A refined f/1.4 prism optics system provides horizontal resolution of better than 600 lines at center. A 2H vertical contour correction circuit further assures image clarity. And minimum illumination measures only 38 lux (3.6 fc) at f/1.7, permitting shooting even in limited or artificial light.

A video S/N ratio of 57 dB. Color framing output signal (RS-170A). A split field color bar generator for consistent color reference. A genlock circuit for maintaining a stable picture while switching or mixing with other signals locked on the same source.

**EASY OPERATION.**

Several 8-bit data memory chips offer operator conveniences for quick set-up and consistent performance. These include: Auto centering, auto-black balance and auto-white balance, auto black level stabilization and auto beam control circuits. Matrix masking for true color reproduction and automatic protection for the pick-up tubes are a few of the many features standard on this new camera.

**VERSATILITY.** Easy portability. Outstanding performance in low-level



lighting. High degree of automation. An extensive selection of options and accessories combine to make the ProCam 320 suitable for both studio production, EFP, or ENG; or, indeed, to any application, anywhere, that calls for top quality video production while staying within a tight budget.

**PROCAM TECHNICAL SUPPORT.** Your ProCam sales representative will be happy to explain the availability and calibre of the ProCam technical support program.

For a demonstration of the ProCam 320 Video Camera, a 320 Spec Sheet, or JVC's complete catalog, call, toll-free:

**1-800-JVC-5825**

JVC Company of America  
Professional Video Division  
41 Slater Drive,  
Elmwood Park, N.J. 07407  
JVC CANADA,  
Scarborough, Ont.

© 1984 JVC Company of America  
ProCam is a trademark of US JVC CORP.  
\* Plumbicon is a registered trademark of  
North American Philips Corp.  
\*\* Saticon is a registered trademark of  
Hitachi Denshi, Ltd.



# JVC

JVC COMPANY OF AMERICA  
Professional Video Division

Circle (69) on Reply Card

[www.americanradiohistory.com](http://www.americanradiohistory.com)

#### Eventide (continued)

- Generation II: SP2016 effects software; includes stereo room, loop edit, flanging and chorus.

Circle (551)

#### Evertz Microsystems/Amtel

- Chaser: synchronizer system; causes ATRs to emulate VTRs for synchronous operation with video equipment in editing system.
- SC/H phase meter: measures subcarrier to H-sync phase, H-timing of two sources; reads time code and checks placement of code with respect to 4-frame NTSC or 8-frame PAL signals.

Circle (552)

#### Excalibur Industries

- Custom cases: interlocking 19-inch rack-style cases.

Circle (553)

#### Farrtronics

- Product line of intercom systems and system packages, audio and video patch panels, audio DA packages and IFB systems.

Circle (554)

#### Feldmar Watch Company

- Product line of timers and stop-watches.

Circle (555)

#### Fenwal

- Product line of Halon 1301 fire protection products and systems.

Circle (556)

#### Ficon/Broadcast

- The Broadcasters: radio station traffic manager software.

Circle (557)

#### Fidelipac

- CTR100: NAB record/play cartridge machines; with SMPTE time code, auto stereo/mono switching and variable speed.

Circle (558)

#### Film/Video Equipment

- Modified CP J6 zoom control for video lens systems.

Circle (559)

#### Flash Technology

- SC110: tower-mounted obstruction light system controller.
- FTB-205-3: obstruction lighting beacon.

Circle (560)

#### John L. Fluke Company

- CRC option: asynchronous signature analysis hardware package for 9010 automated test system; operates independently of equipment microprocessor; includes transitions count-

- ing and waveform capture; to 25MHz.
- 80186/80188: interfaces automated test system to Intel 80186 and 80188 microprocessor-based equipment.
- IBM-PC troubleshooting software: aids repair of system; monochrome and disc controller boards.
- 70 series multimeter.
- 8060 multimeter.
- 25/27 multimeter.

Circle (561)

See ad page 133

#### FOR-A

- Autocor FA-800: frame synchronizer with auto level and setup.
- FA-450 TBC: with input/output cross matrix between NTSC, UIQ, RGB, Y/R-Y/B-Y and Y/C dub.
- CE-10: character processor; effects unit enhances black-and-white characters or camera graphics.
- CVM-500: component video switcher; six input uses Y/R-Y/B-Y processing internally.
- PVM-500: composite NTSC switcher; six input; three colorizers, DSK, component color key and edit of interface.
- FA-440: TBC with effects, keying and 9-page memory of 127 special effect events per page.
- VTW-400: character generator/titles
- ENC-110 upgrade: adjustable video level; 360° system phase and front panel line selector.

Circle (562)

See ad page 134



## A NEW DAT REMOTE CONTROL FROM MONROE ELECTRONICS

The Monroe Model 5002 Remote Control will handle channel selection for two dual audio or voice cue modules for the Scientific Atlanta DAT-32\* and the Comtech DART-384\*. It will also provide remote transponder selection for the DART-384\*.

**THE NEW 5002 WILL SAVE YOU TIME AND MONEY AS YOU REDUCE THE NUMBER OF DEDICATED LINES AND CHANNEL CARDS.**

- Control by phone
- Access Code
- Memory
- Automatic Disconnect
- Low Priced

Write or phone today for literature. See us at the NAB.

**M** MONROE ELECTRONICS, INC.  
**E** 100 Housel Avenue, Lyndonville,  
NY 14098 Phone: (716) 765-2254  
Telex: 756662 Easylink: 625-47850

\* Registered Trade Names

Circle (89) on Reply Card





# On a Rank Telecine you can play it again

Making the successful transition from the film medium has been our business since Sam played it for Bogie the first time around. Today, we've covered all the creative, operational and engineering angles by bringing film to video with our totally unique product range. Our revolutionary ADS 1 offers the broadcaster the optimum equipment for handling material originated for the tv screen: multiplexed configuration; slim, space-saving modules; system expandable up to three dual-gauge transports per electronics control unit; low

capital and running costs; solid-state scanning with innovative electronic dirt and scratch concealment.

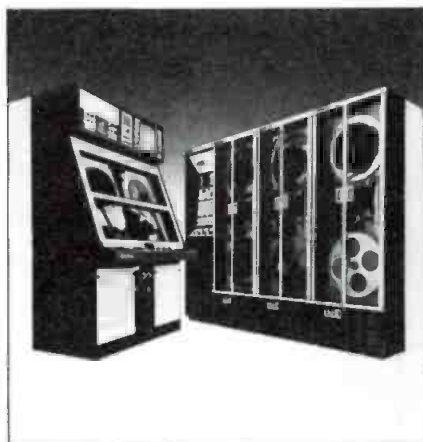

The flying-spot Mk IIIC brings the ultimate post-production power to all types and conditions of film for all tv standards: x-y zoom and position at full tv resolution; variable speed between 16 and 30 frames per second; true still-frame and slide capability — fully pre-programmable on Amigo, the simple yet powerful telecine computer. At the viewing end of the post-production line, or television-broadcasting system, it's the "film feel" that matters, so, whatever the film, play it with feeling on a Rank Cintel — again and again.

 **Rank Cintel**

The World leader in telecine

Sales and Service: Rank Precision Industries Inc.,

13340 Satcoy Street, North Hollywood, CA 91605  
Telephone: (818) 765 7265 Contact: Neil Kempt

Circle (70) on Reply Card

For sales literature only.  
411 East Jarvis Avenue, Des Plaines, Illinois 60018  
Telephone (312) 297 7720 Contact Claire Brogni

North Route 303, West Nyack, New York 10094  
Phone: (914) 353 1914 Contact: David Fenton

**Fortel**

- DP/G corrector: corrects differential phasing gain errors.
- TBC<sup>32</sup> option: 9-bit processing.

Circle (563)

**Fort Worth Tower**

- Product line of guyed, self-supported towers; aluminum and fiber-glass equipment buildings.

Circle (564)

**Fostex**

- B16M: 16-track recorder with dedicated monitor package.
- TT-15: audio test-tone oscillator.
- RN865: 3-way near field monitor.
- M-22: M-S stereo mic.

Circle (565)

See ad page 143

**Frezzolini**

- Mini-Fill enhancement: dual configured 12V and 30V lighting systems.
- Compact NiCad fast chargers/power supplies.
- Bracket: allows battery or power supply to be mounted on Betacam system.

Circle (566)

**Fujinon**

- P20x14: studio lens; widest angle system available for length. Hand controls for lens systems.
- Controllers for teleconferencing systems.
- A44x9.5ESM lens: f/1.4 aperture for 2/3-inch EFP cameras.
- A44x9.5RM: lightweight weatherized

- with macro for ENG 2/3-inch cameras.
- MD series: motor-driven lens systems; f/1.8-2 for teleconferencing systems; 2/3 and 1/2-inch formats.
- A44x9.5ESM lens: f/1.2 aperture optics for 2/3-inch cameras; weighs 56 pounds.

Circle (567)

**Fuji Photo Film USA**

- Product line of videotape, reel and cassette and photographic films.

Circle (568)

**G & M Power Products**

- GMNP-4: Betacam battery holder for BP90-type batteries.

Circle (578)

**GEC McMichael/Marconi**

- News Hawk: satellite news gathering system using RADET rapid deployment terminals; folding dish and electronics; transportable in station wagon.
- GM 9050 series: transportable T/R satellite terminals; trailer-mounted; for Ku-band frequencies; towed by domestic vehicle; air transportable in 747.
- B3410: line array telecine with Vari-speed.
- GM 2020: NTSC comb filter decoder using digital circuitry; PAL model available.

Circle (570)

See ad page 19

**GML**

- 8300: microphone pre-amplifier.

Circle (577)

**GTE Spacenet**

- Product line of satellite communications services for program distribution.

Circle (590)

**GTE/Sylvania Lighting**

- Incandescent and quartz-halide lamps.

Circle (895)

**Garner Industries**

- Product line of audio, video and computer tape erasers.

Circle (569)

**General Electric**

- Product line of quartz-halide and incandescent lamps.

Circle (571)

**Generic Computer Systems**

- Product line of Apple and IBM-XT traffic and billing software for radio, TV and CATV with help screens.

Circle (572)

**Gentner Engineering**

- Switchers: passive audio or control signal routing systems; 10x2 10-in, 2-out (stereo), 20x1 20-in, 1-out (mono); remountable.
- EFT 1000: frequency extender transceiver.

**To create the world's best 14x9 Video Lens, we had to innovate, design new and better optics, build a better housing. And we did!**

*This lens clearly outperforms everything in its category. With an aperture of 1.6, it's the fastest 14X lens made. Superior optics, superior design, superior mechanical construction. The center of gravity has been positioned closer to the cameraman to substantially reduce torque and the weight factor. It feels significantly lighter. We know the abuse ENG/EFP lenses take, so we did away with the internal pins which often become damaged causing zooming bumps and jumps. We replaced the pins with super strong rods and grooves so this won't happen, even under constant rugged use.*

Test the spectacular new Angenieux 14X now and see the remarkable difference. There's never been anything like it!

# angenieux

SALES • 7700 N. Kendall Dr., Miami, FL 33156 (305) 595-1144  
 SERVICE • 120 Derry Rd., Hudson, NH 03051 (800) 258-1382  
 • 13381 Beach Ave., Venice, CA 90291 (213) 821-5080  
 • 190 Don Park Rd., Markham, Ontario, Canada L3R-2V8

Opticom SA Case postale 91, 1211 Geneva 17, Switzerland Tel (22) 362266 Telex 276700OPTIC CH

Circle (71) on Reply Card



# THE MAGIC TOUCH

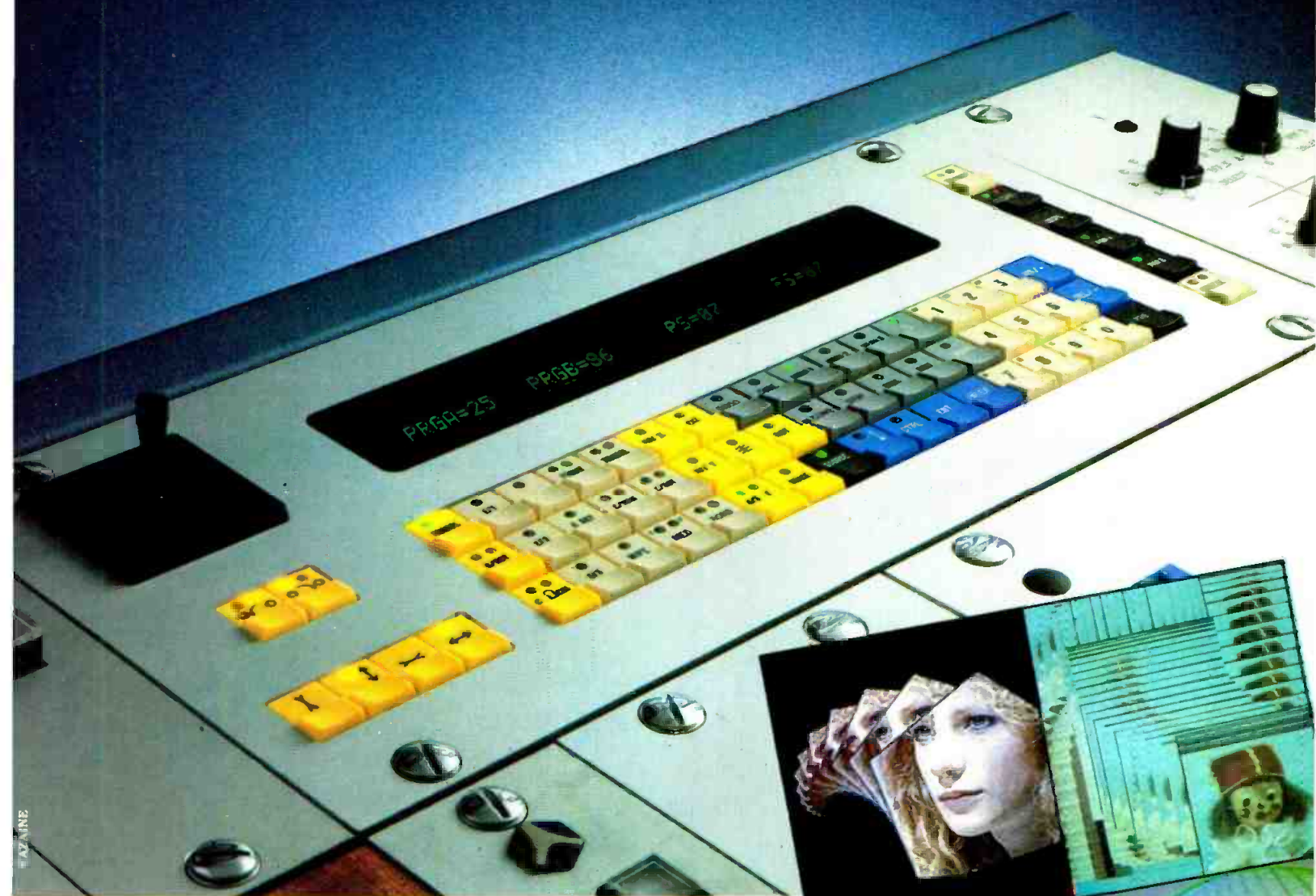

## Genese : Digital Video effects generator.

- Superb image quality and silk smooth moves.
- Easy recording and playback of special effects programs.
- Zoom in, Zoom out, image shift, flips, tumbles, Z rotations, freezes, trails, mixer key tracking...
- Digital component (4.2.2.) international standard.

The last touch ..... its price !

Circle (72) on Reply Card



## THOMSON VIDEO EQUIPEMENT

94, rue du Fossé Blanc 92231 Gennevilliers/France  
Tél. : (1) 790.65.49. - Télex : 620 573 F

June 1985 *Broadcast Engineering* 115

**Gentner (continued)**

- IC-20: intercom system for radio stations.  
Circle (573) See ad page 150

**Gerstenslager**

- ENG-EFP van: Chevy-van styled by Gerstenslager and electronically equipped by A.F. Associates.  
Circle (574)

**Giese Electronics**

- Product line of editing controller systems, time code synchronizers, time code readers and generators in LTC, VITC formats.  
Circle (575)

**Global Systems**

- RTTB-24: ITFS response transmitter.
- GaAs FET-A1: low noise microwave pre-amp.
- GaAs 01.7M: GaAs FET downconverter.  
Circle (576)

**Alan Gordon Enterprises**

- Cinemeter: still exposure meter.
- Imerect 500: low-angle prism.
- Imerect 925: low-angle prism.  
Circle (1450)

**Gorman Redlich**

- Product line of EBS encoders, decoders, NOAA weather receivers and digital AM directional array monitors.  
Circle (579)

**Gotham Audio**

- EMT 448: digital audio spot recorder; Winchester removable disk memory.
- SYSTEX: digital audio storage for commercials, news actualities, music libraries; uses host computer control.
- Neumann sound mixing systems.  
Circle (580)

**Graham Patten**

- 600 series: E SAM edit suite audio mixers; 16- to 20-input; AFC capable; editor controlled.
- 700 series: programmable equalizers; 5-band with 16 individually selectable channels.
- 500 series: peak program meter system with four lighted meters with single rack-mount.  
Circle (581) See ad page 26

**Grass Valley Group**

- 8500 series: video, audio and pulse DAs.
- Key-Mem effects memory for \*100/100CV switches.
- OmniKey enhancement for 300 switchers.
- Series 300: HDTV switcher; 1125-L/60-F standard system.
- 100CV: component switches, 8-input for RGB, Y/R-Y/B-Y video.
- Ten-XL, -XT: 10x1 routing switchers.  
Circle (582) See ad page 9,83

**Gray Communications**

- Remote production van.  
Circle (583)

**Gray Engineering**

- DT-213: SMPTE LTC and control transmitter for master generator use; advanced slave decoding; NTSC 30-frame, PAL 25-frame and film 24-frame.
- FC-142: film counter character generator determines film feet and frames for 3:2 transfers, with data output.  
Circle (584) See ad page 145

**David Green**

- Product line of radio business automation systems; recording accessories; audio product distributor.  
Circle (585)

**Great American Market**

- ShowPlot: computer-aided drafting and scheduling system for lighting designer; includes voice-command vocal control.
- SMS: linear non-dim controller with 12-outputs.  
Circle (586)

**Grosh Scenic Studios**

- Product line of studio fixtures for lighting and draperies.  
Circle (587)

# AFFORDABLE RELIABILITY

## ELECTROHOME EVM SERIES MONITORS HAVE BEEN PROVEN RELIABLE WITH 60,000 HOUR MTBF TESTING.

Other Electrohome strengths for the broadcast industry include—

- High resolution, precise linearity and geometry
- Switchable dual differential inputs
- D.C. restoration
- Convenient front controls
- Switchable underscan
- Wall, ceiling and rack mount accessories
- 9", 12", 15", 17" and 23" screen sizes
- Switchable power supply 110/220/240 volt 50/60 Hz operation
- Custom design service available to meet your specifications or requirements



EVM/BE/06

Please send me more information on the Electrohome Video Monitor.

Electrohome Limited  
Advertising Department  
P.O. Box 1663  
Buffalo, New York 14203

Name \_\_\_\_\_

Company \_\_\_\_\_

Street \_\_\_\_\_ City \_\_\_\_\_

State \_\_\_\_\_ Zip Code \_\_\_\_\_ Phone \_\_\_\_\_

\*Support documentation available upon request.

# ELECTROHOME ELECTRONICS

Electrohome Limited, 809 Wellington Street North, Kitchener, Ontario, Canada N2G 4J6. Telephone (519) 744-7111. Telex 069-55449.

Circle (73) on Reply Card



# Feature Rich

Our new Model 440 Limiter/Compressor/Dynamic Sibilance Processor is packed with features sure to meet the most exacting standards. The Model 440 consists of a fast peak limiter section, a compressor/expander section, and a Dynamic Sibilance Processor section, each controlling a common VCA. Sophisticated intercoupling of the control circuitry used for each function allows the device to simultaneously limit, compress, expand, and eliminate undesirable high frequency components in sibilance.

Since you know the limitations of your present equipment, or that which you have been evaluating, better than anyone else, we won't attempt to sell you on the 440 with a lot of flowery prose. Just look over the list of features and their benefits found below. Then, use a 440 and listen to the results. The 440's performance speaks for itself.

**Linear Integration Detection** – Emulates the response of the human ear to maintain correct musical relationships in processed material.

**Peak Reversion Correction** – Compensates for discrimination against low frequencies to eliminate "pumping" and "breathing".

**Anticipatory Release Computation** – Automatically alters release time to eliminate dynamic distortion.

**Gain Recovery Computation** – Maintains a preset nominal output level under varying conditions of input signal level, ratio, and threshold settings in order to simplify set-up.

**Interactive Expander circuitry in the Compressor section** – To reduce residual noise which would otherwise be "pumped-up" or accentuated by the compression process.

**Auto mode** – Places the compressor/expander attack time, ratio, and release time under the control of sophisticated circuitry, thus allowing the operator to obtain more or less compression by simply adjusting the threshold control.

**FM pre-emphasis compensated compression and limiting** – Replaces outmoded pre-emphasis/de-emphasis processing for FM broadcast feeds.

**Switch-selectable AGC operation** – Configures the limiter as a fast attack, slow release AGC eliminating the need for an AGC device to feed the compressor.

**Safety Clipper** – The clipper threshold automatically tracks that of the limiter control section in order to control extremely fast transients.

**Dynamic Sibilance Processor** – The only sibilance processor that can be used on mixed program material without subjectively affecting the tonal balance of the material.

**Complete, Easy-to-Read Metering** – Allows operator to simultaneously monitor limiter operation, compressor/expander operation, and input or output line level at a glance.

**Stereo Couple or Master/Slave operation** – At the user's option, two Model 440's may be linked in a Master/Slave configuration allowing one device's controls to operate both units, or may be stereo coupled to maintain a musically correct stereo image.

**Hardwire Bypass** – Provides a passive, hardwired connection between the 440 input and output allowing the signal to bypass the processing circuitry in the event of equipment failure. In this mode, only the vu meter remains active.

**Electronically balanced inputs and outputs** – Offer excellent noise rejection and RF immunity.

**Logical front panel lay-out with freedom from control interaction** – Allows the operator to quickly comprehend control functions.

**Compact and easy to interface** – The Model 440 is packaged in a custom aluminum and steel, rack-mountable housing which provides an attractive appearance, while affording excellent RFI rejection and the ability to withstand the punishment of on-road use. Barrier strip inputs and outputs are standard.

**The Model 440... Feature rich, yet affordably priced!**

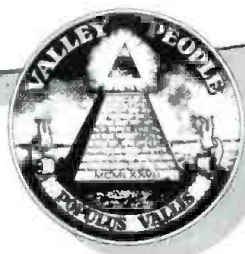

**VALLEY PEOPLE, INC.**

P.O. Box 40306 2817 Erica Place Nashville, Tenn. 37204  
(615) 383-4737 • TELEX 3785899 • NASH AUDIO

Circle (74) on Reply Card

# do you know!

INFORMATION ABOUT SAVING YOUR ELECTRONIC EQUIPMENT

## Your Broadcast Operations are in Danger!



The danger is serious and ever-present. In a split second you could be off the air...or operating with a scrambled program-control system...or totally shut down with equipment catastrophically damaged. It's a threat you live with day after day and one that merits your closest attention.

**The Threat** Abnormal voltage surges that occur on AC power lines, communications lines and data lines are a major cause of misinformation and equipment failure for the broadcaster. Broadcasting equipment is especially vulnerable, with tall antennas

reaching up into the skies and with electronic units of unusual sensitivity.

Difficulties manifest themselves in two ways: (1) as physical *damage*...this is obvious damage that occurs directly as the result of an electrical storm, or less obvious failures that seem to occur almost at random; (2) as *misinformation*... where the power surge is coupled into the equipment causing improper events to occur or incorrect data to be presented.

These problems are familiar ones to broadcasters. And now, with the ever-expanding dependence on computer control and the corresponding increase in the susceptibility of these sensitive devices to damage from voltage surges, overvoltages must be controlled and eliminated.

\*Allen & Segall/IBM. 1974

# MCG

ELECTRONICS INC.

12 Burt Drive, Deer Park, NY 11729 • 516-586-5125

Specialists in Circuit Protectors, Transients, Lightning & Surges.

Circle (75) on Reply Card

**The Causes** Transient power problems originate outside buildings from lightning, ground faults, and public utility switching, and inside buildings from inductive loads, transmitters, air conditioners, fluorescent lights, etc. A study at IBM\* identified transients as the cause of 88.5% of all line disturbances. Transients, sudden and extreme "spikes" in voltage, can be as short as a few nanoseconds or as long as several milliseconds. Their effect can range from total failure to the gradual degradation and breakdown of electronic components or systems.

**The Solution** MCG Electronics provides total protection against these transients for your broadcasting operation. AC power lines and data lines that serve your internal communications network are guarded day and night.

### AC Power Line Protection

MCG's Surge-Master™ provides high speed (5ns), heavy-duty protection that limits AC overvoltage spikes to safe levels. Surge-Master protectors are your first line of defense, and are available in configurations designed to meet your needs, from complete building protection to individual equipment protection.

**Data Line Protection** Interfaced between network equipment and data lines, MCG's Data Line Protectors provide a sophisticated blend of high speed (less than 5ns) and brute force protection against induced transient voltage surges. Available in multiple configurations, they are designed to meet your every need, and will keep your data network out of danger.

**MCG Protectors** Your most cost effective insurance against downtime and data loss caused by voltage surges and transients.

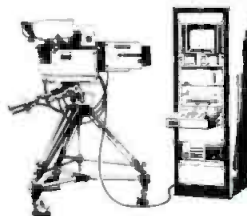

Call or write for our  
FREE CATALOG



### Grumman Aerospace

- AIS-5000: automatic commercial insertion system for LDTV, CATV or automated systems.

Circle (588)

### James L. Grunder/CEL

- P-148: video effects controller.
- P-147-20: digital effects TBC, synchronizer and frame store.
- P-147-12 SXT: PAL-NTSC translator.
- P-169: 8x4 routing switcher, digitally controlled.

Circle (589)

### HEDCO

- SVS-340, SAS-341: HEDLINE video/audio routing switcher; 4x1.
- SAA-320: audio DA; 1x6.
- SAA-330: remote gain audio DA; 1x6.
- SVA-300: video DA; 1x8.
- SVA-302: video equalizing amp; 1x8.

Circle (594)

### HM Electronics

- System 87: wireless mic incorporates Shure SM 87 mic element.

Circle (599)

See ad page 86

### Hallikainen & Friends

- DRC190 updates: software; disk drive; status panel; SCA boards and TRL equipment; multiple site control, for AM, FM and TV combos; multihop microwave.
- DRG 190: digital remote control.

Circle (591)

### Clifford B. Hannay & Son

- Portable and stationary cable reels for signal, power and camera cables.

Circle (1363)

See ad page 92

### Harris

- Phase Fixer: audio time base device; corrects stereo phase error, wow and flutter from any tape source.
- Gold Medalist: 12-channel audio console.
- Ulti-Mate 91: tri-band AGC system.
- IRIS C: compact still-store.
- HDE series: digital special effects units.
- SXA series: medium-wave transmitters; 1kW, 2.5kW, 5kW.
- SunWatch option: programmable power switching feature.
- STM-1B: AM stereo modulation monitor.
- STX-1B: AM stereo exciter.
- FM-3.5kW: FM transmitter; 3.5kW.
- SignalStar: FM antenna.
- TV-30H: highband VHF transmitter; 30kW.
- TVE-60S: 60kW UHF TV transmitter.
- Challenger: microwave receiver.
- TV stereo demonstrations.

Circle (592)

See ad page 109

### Harrison Systems

- HM4: front-of-house live sound mixer: to 32 inputs; mono/stereo.

Continued on page 120





# High Tech

## FCC Grade B Contour 64 dBu 1000' HAAT

— HPOL 2500 kW  
— VPOL 500 kW

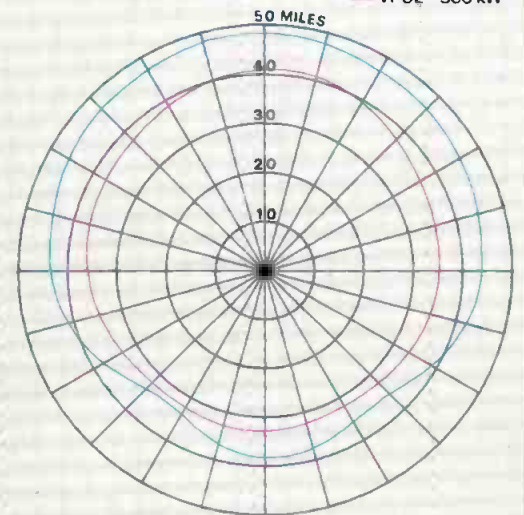

Eleven hundred feet above Memphis, Tennessee this Andrew TRASAR™ transmitting antenna employs the latest concept in UHF-TV broadcasting... elliptical polarization. This feature significantly increases the quality of coverage in markets where the higher start up and operating costs associated with full circular polarization can't be justified.

The antenna pictured radiates 20% of its energy in the vertical plane. This component reaches 4/5 the distance of the horizontally polarized mileage contours. In addition to providing improved signal strength and reduced reflections it shares the features of all TRASAR antennas. Exclusive traveling wave slotted array design. Heavy null fill.

Low VSWR. Up to 2.5° beamtilt without gain loss. High power rating and reserve capability. Totally protected in a pressurized fiberglass radome.

Broadcasters worldwide look up to Andrew UHF-TV antennas. For the TRASAR antenna best suited to your application write for Bulletin 1083 or call your Andrew Sales Engineer. Andrew Corporation, 10500 West 153rd Street, Orland Park, IL 60462. Telephone (312) 349-3300. Telex: 25-3897.



# ANDREW

Our concern is communications.

Circle (76) on Reply Card

[www.americanradiohistory.com](http://www.americanradiohistory.com)

*Harrison (continued)*

- SM4: stage monitor mixer; to 32 inputs; mono mics; eight main mono outputs; four aux send groups; EQ and filtering.
  - RM-8: rack-mounted stand-alone mixer or pre-mix input expander; DIN Eurocard design.
  - Audio routing switcher: intelligent control logic; 256x256 matrix.
- Circle (593)

**Heie Engineering/Gaminc**

- Commander: on-air mixing board for radio stations.
- Circle (595)

**Karl Heitz**

- 564LM: GITZO compact mic; 5-section fishpole; fits in briefcase; extends from 1.5 feet to 7 feet.
  - 122,222,322: GITZO 4-section monopod.
  - Mini-collimator: Kinoptik portable unit; tests video, cine and photo lens system.
- Circle (596)

**Hipotronics**

- Peschel auto voltage regulator, stabilizes ac power into broadcast transmitters and studios.
- Circle (597)

**Hitachi Denshi**

- SK-110D: full auto set-up computer-

controlled studio camera.

- HR-230 editing systems: includes interfacing of ISC, EECO, Paltex, CMX and Ampex controllers to HR-230 1-inch VTRs.
  - HDTV system.
  - HDTV: digital recorder; 20MHz bandwidth for luminance; 5.5 MHz line sequential chroma.
  - SK-1200: HDTV camera for 1125-L/60-F scan; 5:3 aspect ratio.
- Circle (598) See ad page 7

**Holiday Industries**

- HI-3113: fiber-optic link for remote readout of isotropic field strength meter line.
- Circle (600)

**Horizon Systems**

- System Four Edit controller: in both English and Spanish; with 10-year non-volatile memory; 5-year warranty; 800-event list and a printer.
  - DCS-100 diagnostic system: testing and full remote control of TV transmitter; system calls pertinent staff member to indicate when failures occur.
  - MAS-100: master automation system for TV stations or CATV.
- Circle (601) See ad page 31

**Hotronic**

- AE61: TBC 16-line window correction with optional drop-out com-

pensator and color bar generator.  
Circle (602)

**Howe Audio**

- 9000 series: modular audio consoles; 8- to 22-channel; 3-input/channel; three outputs include mix-minus on all channels; optional 3-band EQ.
- Circle (603) See ad page 84

**Hubbard Broadcasting**

- HCF-ONE: telecine camera replaces TK-27 and GE 240 series.
  - HCC-55: cart machine.
  - Satellite newsgathering truck for mobile Ku-band uplink.
- Circle (604)

**Hungerford & Company**

- Product line of services for broadcast accounting.
- Circle (605)

**IBM**

- System/38: broadcast management system.
- Circle (606)

**ICM Video**

- VC-2500P: automatic video processor.
- Circle (607) See ad page 60

**IGM Communications**

- IGM-SC: system controller for full- or part-time unattended operation with live assist with audio switcher; uses IBM-PC.
- Custom services: design and manu-

# You'll meet your match with our EDITING CONSOLES

No matter what VTR equipment you use, Winsted offers Editing Consoles to match your requirements! Our designs are based on consultations with professional users like yourself.

You've chosen your VTR equipment carefully, to meet your specific needs. Now choose the Editing Consoles that fit your equipment - quality consoles from Winsted.

For our free full-color FULL-LINE CATALOG and the name of nearest dealer, call toll-free: **800-328-2962**  
TELEX: 910-576-2740



9801 James Circle  
Minneapolis, MN 55431



Circle (125) on Reply Card

## IMMEDIATE DELIVERY FROM STOCK ON OVER 900 CABLE, CONNECTOR & SMATV PRODUCTS!



**WIRE & CABLE**

- Coaxial/RG
- Cable Assemblies
- Multiconductor
- Plenum/Teflon (NEC 725, 760, 800)
- Alarm
- Computer/Low-Cap
- Telephone
- Hardline
- Satellite Control

**CONNECTORS**

- Type N
- Type C, LC
- BNC
- TNC
- SMA
- Type F
- UHF
- Twinaxial
- D subminiature
- Crimp/Solder

**SMATV**

- Modulators
- Distribution Amps
- Taps
- Splitters
- Switches
- Transformers
- Trunkline
- Traps
- Jumper Cables

**ACCESSORIES**

- Crimping Tools • Test Equipment • Coax Seal
- Power Filters • Cable Ties • Shrink Tubing

**COMPLETE LINES**

Amphenol, Kings, Columbia, Cablewave  
B&K, Tyton, Blonder-Tongue, Coleflex

**ORDER TOLL-FREE**

Nationwide: **1-800-327-5999**  
Florida: **1-800-52-CABLE / Telex: 532362**



**ELECTRONICS INTERNATIONAL**  
12240 N.E. 14th Avenue  
N. Miami, FL 33161 (305) 893-3924

Circle (126) on Reply Card



# 'The HK-322 gives us great studio performance—first time and every time!'

Jeanine Fox, Technical Manager ABC-TV, Hollywood, California

Rarely does a product stand the test of time, consistently outperforming those that would take its place.

Such a product is the HK-322 broadcast color television camera, ideal for studio or field use. And it is no small tribute to Ikegami's engineering foresight and technological superiority that today, their HK-322 is still playing to standing ovations.

The HK-322, equipped with 30 mm or 25 mm Plumbicon® tubes, features: standard diode gun or ACT pick-up tubes, advanced operational automatics including auto pedestal control and auto highlight compression, complete set-up automatics, diagnostics and a wide range of special features.

The HK-322 can be furnished with mini camera cable (up to 600 meters) or optional triax for lengths up to 1500 meters. Two types of camera control systems are available with an optional control panel configuration to suit user preference.

Forget the imitators. For rave reviews, it's the HK-322.

For a complete demonstration of the HK-322 and other Ikegami cameras and monitors, contact us or visit your local Ikegami dealer.

## Ikegami

Ikegami Electronics (U.S.A.), Inc.,  
37 Brook Avenue,  
Maywood, NJ 07607

- East Coast: (201) 368-9171
- West Coast: (213) 534-0050
- Southeast: (813) 884-2046
- Southwest: (214) 233-2844
- Midwest: (312) 834-9774

\*Plumbicon® is a registered trademark of N.V. Philips.

Circle (77) on Reply Card



### IGM (continued)

facturing service; includes hardware and software per request.

Circle (608)

### Ikegami Electronics

- ITC-730AP: upgrades ITC-730A camera to Plumbicon tubes.
- SC-500: low-cost 2/3-inch camera with extensive auto-setup features.
- HL-95: upgrade package includes additional accessories to UniCam system.
- Series 10: production models in 13V and 19V delta-gun monitors.
- Film island: includes TKC-990 telecine camera, projectors and multiplexers.
- HK323: studio or EFP camera, 2/3-inch format with fiber-optic cable options.

Circle (609) See ad pages 40, 41, 97, 121

### Image Video Ltd.

- Stereo master control switchers: three configurations.
- Master control switcher automation system.
- Conventional and wide bandwidth routing switchers with computer control.

Circle (610)

### Industrial Acoustics

- Acoustic structures and complete studio for radio and television.

Circle (611)

### Information Transmission

- ITS-231: 1kW UHF standby exciter transmitter.
- ITS-235: 5kW UHF standby exciter transmitter.
- ITS-10: lowband VHF exciter.
- ITS-11: lowband aural VHF exciter, multichannel sound retrofit.
- ITS-15: highband VHF exciter.
- ITS-16: highband aural VHF exciter, multichannel sound retrofit.

Circle (612)

### Innovative TV Equipment

- H30/T30: fluid head and tripod system for cameras to 15 pounds; quick-release adapter; one handle; tripod elevator column.
- H40: fluid head for loads to 25 pounds; quick-release system, one handle; ENG-type tripod, weighs 12 pounds.
- P1 pedestal: pneumatic compressed air or N<sub>2</sub> design with H100 camera head; loads to 260 pounds; head with two handles, wedge plate; shipping case; smooth fluid drag in pan/tilt.
- EFPZ: cart.
- H 17: fluid head.
- P2: pedestal.

Circle (613)

### Inovion

- Inovision: PC graphics system.

Circle (614)

### Inovonics

- Model 260: multifunction FM, TV stereo audio processor.
- TVU: export version of on-screen audio level display; PAL/SECAM compatible.
- 710: stereo TV generator.

Circle (615)

### Integrated Media Systems

- 200: intelligent audio access system with 256 summing crosspoints.
- 400: intelligent audio access system with up to 1024 summing audio crosspoints.
- Gemini I: ultra-high precision D/A and A/D audio conversion modules.

Circle (616)

### Interactive Motion Control

- Product line of computer-controlled animation products.

Circle (617)

### Interactive Systems/GVG

- System 51: edit controller with expanded RS-422 capabilities and edit decision list interchange features; for simplified editing.
- Upgrade packages: retrofit brings previous systems to System 51 level.
- RS-422 control interfaces for Betacam, VPR-6 and other VTRs and switchers.
- Super-Edit software enhancements.

Circle (618)

# The TSM advantage.

- A price and performance breakthrough ... the HS-100P is the latest micro-processor controlled high speed preset Pan/Tilt System.

- TSM's exclusive Zoom/Focus preset servo drive for ENG bayonet mount lenses.

This combination of cost and unique features is creating new applications for the HS-100P every day ... including teleconferencing, automated news sets, Music TV, remote sports pickups, training, medical documentation, and ideal for any pickup where a camera cannot or should not be locally controlled.

Operating features: High speed ... 1° up to 40°/Sec.; Return accuracy ... less than 0.2°; 100 Preset Pan/Tilt/Zoom/Focus positions; rugged, servo driven anti-backlash gear drives with MIL spec "follow" pots; adjustable for center of gravity control; is easily converted to ceiling mount.

Call or write for complete details on the HS-100P and TSM's complete line of Pan/Tilt heads and accessories.

Dealer inquiries are welcomed.



**TOTAL SPECTRUM  
MANUFACTURING INC.**  
20 Virginia Avenue, West Nyack, NY 10994  
(914) 358-8820

THE NEW, INNOVATIVE EQUIPMENT SOURCE.



Circle (78) on Reply Card



# AUTOMATION

## Your Way!

Your requirements are unique to your organization, and that's how your operating system should be.

CCI offers a complete line of video automation equipment that is software based. You tell us how you want your system to run. You even select the format from 1/2" to 1" and how many machines you want.

CCI custom-builds the system to your specifications in our own plant. If you later change your mind about the way your system should operate, no problem. Our CMOS circuitry is driven by EPROMs, so just tell us what you want done differently, and we'll blast a new EPROM. Presto, the change is made.

There is nothing CCI loves more than a challenge, so challenge us with your requirements. We've met a lot of challenges already and have over 500 channels currently in operation.

Call us toll-free and let CCI demonstrate how to have automation your way.

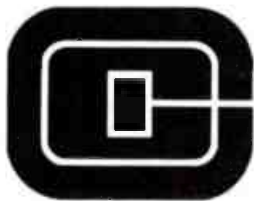

**7353 Lee Highway  
Chattanooga, TN 37421  
Phone: (615) 894-2580**

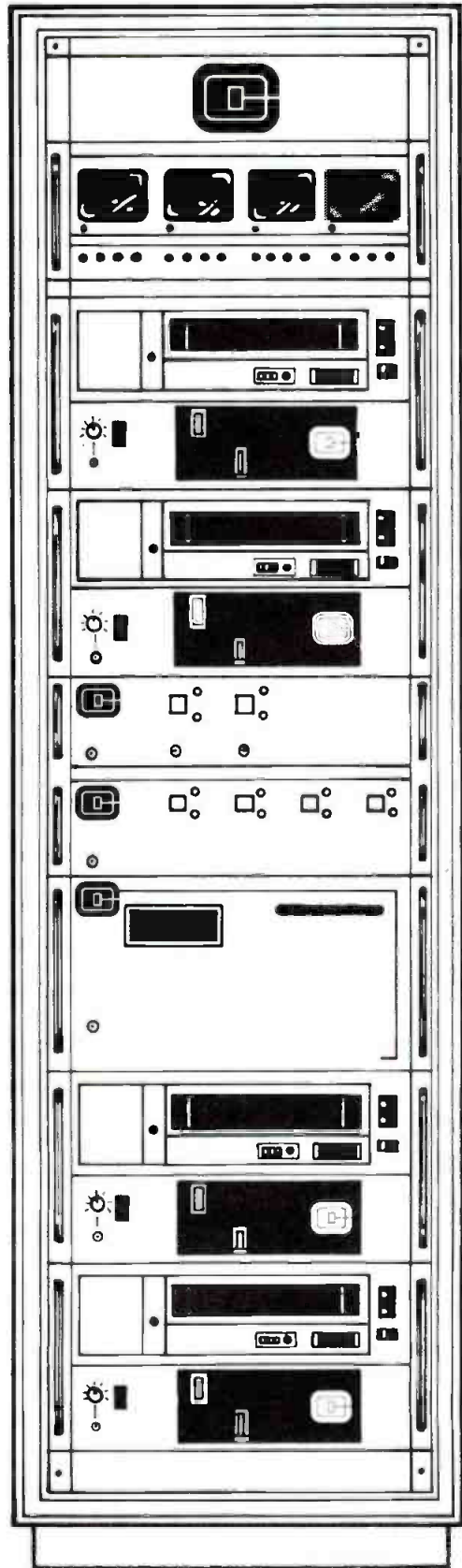

**(800) 367-5742**

### Interand

- Discon 725: compact, modular teleconferencing system; combines full color, high resolution transceiver of FastScan with 7-color annotation capability of Discon 500; allows camera, computer or drawing pad images to be sent via Telco lines.

Circle (619)

### Intergroup Video Systems (ISI)

- 8001 Mini-Master Control: 8-input audio-follow switcher with interface for automation of playback VTRs.
- 904 series: production switchers to 20 inputs with dual mix effects, and DSK.
- Master control switchers: 899 upgradable to stereo.

Circle (620)

### International Tapetronics/3M

- OMEGA series: audio cartridge record/playback machines; mono and stereo; with 150Hz tone standard.

Circle (621)

### Itelco SPA

- FM transmitters: 5W to 55kW.
- TV transmitters: UHF and VHF; 10W to 40kW.
- TV transposer/translators: any VHF/UHF combination with precision offset.
- Microwave radio links: audio, video and data capable.

Circle (623)

### JBL/UREI

- 4425 speaker: 12-inch biradial horn.
- 1693: broadcast console; expansion of 1680 series to 12 mixing channels.

Circle (625)

See ad page 29

### J-Lab

- Viewfinders for cameras.

Circle (628)

### JVC

- KY-210U accessories: C-mount, Nikon lens adapters; KA-500U quick-release tripod plate.
- BY-100U accessories: C-mount, Nikon lens adapters; quick-release plate; HZ-110MD remote control unit.
- SS-M208U: portable or desktop mixer with eight inputs; balanced XLR connectors; peak LED input indicators with fluorescent output meters.
- KM-1200W: special effects generator with auto-take function; 4-inputs; background colors.
- MI-2000: rack-mounted audio mixer.
- CR-850: U-matic recorder with editing functions; SMPTE time code; 47dB S/N ratio.
- BR1500W: front-load VHS VCR.
- BR-1600A: portable VCR uses standard VHS cassettes.
- TM series monitors: 14-inch studio and 9-inch and 13-inch

color utility monitors.

Circle (630)

See ad page 111

### James Thomas Engineering

- Pre-rigged truss.
- Follow-spot chair.
- Par 16: spotlight.

Circle (624)

### Jefferson Data

- JDS-2000: In-station broadcast sales management system.
- Financial management system: general ledger, payables, POs, balance sheets, multistation corporate reports and expense analysis.
- Program management system: tracking system for syndicated programs, film amortization for full financial analysis of titles.
- Auto-Select System: music rotation for radio stations.
- BreakOut System: demographic and proposal system for ARB and Birch rating analysis.
- Electronic news processing: interfaces with wire services and script archives.
- DARTS: IBM-PC software for sales, traffic and general accounting.

Circle (626)

### Jensen Tools

- JTK-47: zipper tool kit for carrying instruments.
- AMP coaxial stripper and connector kit.

Circle (627)

### Johnson Electronics

- STS-II: portable test set, for FM band signal analysis; in field (SCA); two subcarriers available; shows signal in  $\mu$ V; subcarrier injection; 8-hour operation without recharge.
- DTR: desktop SCA receiver; listening device for visually impaired or school announce systems.
- AT-IVA: addressable SCA tuner.

Circle (629)

### K & H Products

- Nylon cases and covers for Betacam system.
- Nylon recorder case for Sony VO6800 recorder.

Circle (637)

### Kahn Communications

- STR-84: AM stereo exciter for improved loudness and lower distortion for mono reception; dc coupled square wave L+R, L-R signals.
- LP-2B: low and high audio frequency extender.
- DAT-IR: AM radio data transmission system.
- Sony XR-33A: AM stereo car radio compatible to all stereo systems.
- RF-01: Kahn system modulation monitor.
- STR-84: second generation AM stereo exciter.
- "The Secret": modular adapter for

Delco radios to add Kahn decoding.

Circle (631)

### Kaman Sciences/KBS

- Software: demographics, search and sales proposals.
- Software: films program encompasses entry of all programming with control of amortization and payables.

Circle (632)

### Kangaroo Video Products

- Super-Tough: top-loading, aluminum-reinforced camera case; for various video cameras or camera recorder units.
- KVP-18s: case for Sony BVV-1 recorder with VA-1 or VA-1V unit; access to cable ports; external battery attachment; wireless mic connections.
- KVP raincover: for Sony BVW-3, BVP-3.

Circle (633)

### Kavouras

- DIFAX: weather maps and WMO alphanumeric data circuit transmitted to various printers.

Circle (634)

### Kay Industries

- Power phase conversions systems.

Circle (696)

### Keylight Production Services

- Handilight: folding 2kW modulight soft light.

Circle (635)

### Key Video

- Custom audio and/or video routing switchers.

Circle (636)

### Kinometrics/Truetime

- Universal clock upgrade: driver option.

Circle (638)

### Kings Electronics

- KC-59-657 M06: toolless connector.
- Low cost 75 $\Omega$  terminators.
- KC-79-302M06: BNC isolated-ground receptacle with metal threads.

Circle (639)

### Kintronic Labs

- Product line of broadcast antenna systems and components.

Circle (640)

### Kliegl Brothers

- Product line of lighting instruments, dimmers and dimmer controllers.

Circle (641)

### Knox Video

- K-100 upgrade and option C: additional font package and accessories to K-100 character generator.

Circle (642)





# Eastman Professional Video Cassette

U-matic

KCS  
20min. **20**  
Broadcast Quality  
EB-930

## THE NEW NAME IN VIDEO WON'T DISTORT THE NEWS.

The new three-quarter-inch EASTMAN Professional Video Tape gives your news crews the reliability needed to deliver the story accurately every time. With high signal-to-noise ratio and the lowest of dropouts. With consistency, cassette after cassette.

This broadcast-quality video tape is designed

to work with today's state-of-the-art recording and editing equipment. It's available in all popular sizes of standard and mini cassettes.

Ask your dealer or Kodak sales and engineering representative about the complete line of EASTMAN Professional Video Tape.

Eastman Kodak Company, Motion Picture and Audiovisual Markets Division

Atlanta: 404/351-6510 • Chicago: 312/654-5300 • Dallas: 214/351-3221 • Honolulu: 808/833-1661  
Hollywood: 213/464-6131 • New York: 212/930-7500 • Rochester: 716/254-1300 • San Francisco: 415/989-8434  
Washington, D.C.: 703/558-9220 • Montreal: 514/761-3481 • Toronto: 416/766-8233 • Vancouver: 604/926-7411



Circle (80) on Reply Card

### Kobold Lighting

- Lighting fixtures and batteries.
- Circle (897)

### LB Telesystems

- ENG production vehicles.
- Circle (649)

### LEA/Dynatech

- Surge eliminators: high current, high power unit; handles 1kA, 1.5kA, 2kA and 4kA continuous 60Hz current.
- KleanLine: additional models for power line filtering to 1kA, 1.5kA and 2kA.

Circle (650)

See ad page 146

### LPB

- Alpha series: on-air audio consoles; VCA control; electronic switching; integral monitor amp; 6-, 8-, 10-channel; stereo.

Circle (661)

See ad page 151

### LTM of America

- Microphone pole.
- Line of studio quartz lighting.
- Luxarc: 12,000 HMI light.

Circle (662)

### L-W International

- Product line of telecine projectors and systems.

Circle (663)

### Laird Telemedia

- 1500: character generator featuring 35ns resolution; 64k resident colors;

70-font library; dual-disk drives; centering, italics and proportional spacing.

Circle (643)

### Lake Systems

- L-Kart Beta: ½-inch L-Kart system based on Betacart, stereo or bilingual capabilities; SMPTE time code; 1000 events with 68000 processor.
- Combined Betacart and Type M video cart system.

Circle (644)

See ad page 64

### Landy Associates

- M-40: interphase machine control system for small format tape duplicator; serial bus connection for up to 100 VTRs and CRT status display.
- M-41: interphase machine control system for small to medium size broadcast or post-production operation; single 75Ω serial bus connection.
- N79E: shuttered HL-79E camera for slow motion.
- Paltex Espirit edit controller.

Circle (645)

### Lang Video Systems

- Super-Vax: automatic 2x1 video switcher with audio follow.
- Two-Shot: rack mount switcher.
- Supervax VAX-700: designed for

MDS use.

Circle (646)

See ad page 153

### Larcam Communications Equipment

- FMT-25L: 25kW FM transmitter with FME-30L 30W exciter.
- TTC-250LH: 250W highband VHF TV transmitter; total solid-state design.
- TTC-30LH: highband VHF TV transmitter, rated 30kW, with TEC1V multichannel sound exciter.

Circle (647)

### Laumic

- CMX Edge: for use with ½-inch and 1-inch; with interformat and computer-assisted editing program.
- Broadcast PC software for broadcast station management.
- Benchmark Video Services Edit System Evaluator: edit lister (for EDL management).

Circle (648)

### Leader Instruments

- LCG-420: NTSC plug-in modular sync/test pattern generator.
- LBO-5825: digital storage oscilloscope.
- LAG-125S: low distortion audio generator with balanced output.
- LBO-552BH1: stereo oscilloscope.

Circle (651)

See ad pages 5, 118A, 118B

### LeBlanc & Dick Communications

*Between you and everyone else,*

# **THIS IS THE ONE.**

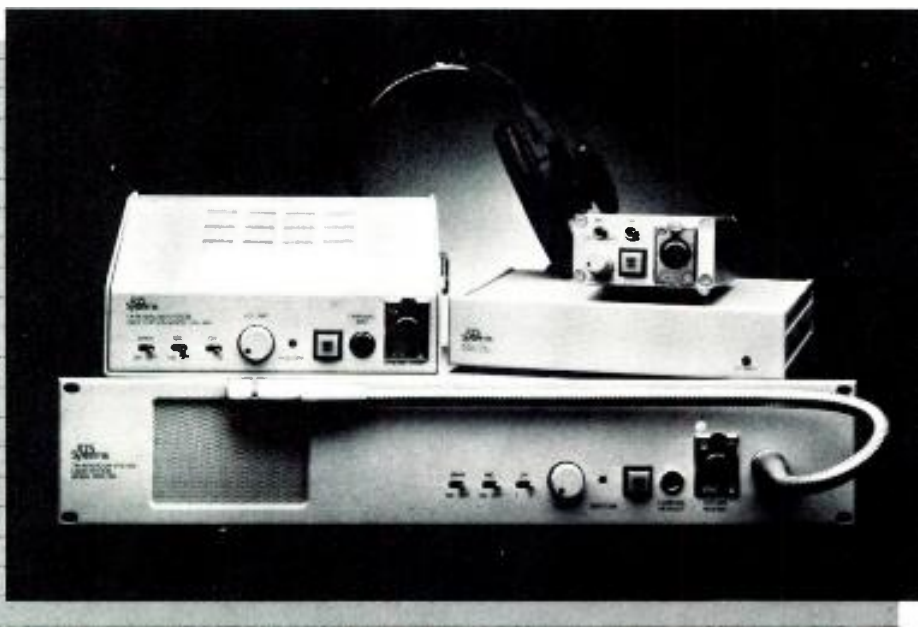

**T**his is the TW Intercom System: A high performance conference-line communications system that accommodates an almost infinite variety of system configurations. Its universal design meets the most demanding needs of teleproduction, broadcast, industrial, and commercial applications.

In a few short years, it's become the virtual standard in the field. Up to 75 user stations on line, two-channel operation on standard microphone cable, 12-volt operation, and many other features make it the one system you can take for granted. Call or write for detailed information.

RTS SYSTEMS, INC. • PROFESSIONAL INTERCOMMUNICATIONS • PROFESSIONAL AUDIO PRODUCTS  
1100 WEST CHESTNUT STREET • BURBANK, CA 91506 • 818/843-7022 • TWX 910-498-4987 • TELEX 194855

**RTS SYSTEMS**  
INCORPORATED  
A Compact Video Company

Circle (181) on Reply Card



- AM and FM transmitting antennas.  
Circle (652)

#### Leitch Video

- DFP-3000N: digital frame processor.
- DTG-1010N: digital test signal generator.
- CTG-240N: calibrated test signal generator.
- VPA-331N: video processor amplifier.
- ADA-860: audio DA with 1x6 balanced outputs; 100dB S/N.
- CSD-5300N: clock system driver; central time source with SMPTE time code output.
- DAC-5012N: digital analog clock.
- AVS-481: audio/video switcher in 8x1 matrix units.

Circle (653)

See ad page 43

#### LEMO

- Product line of audio and video connectors; including miniatures, subminiatures, coaxial, triaxial, multipin and mixed forms.

Circle (654)

#### Lenco

- PVS-435P: videoscope for PAL SC/H measurements.
- PAA-100: 100W/channel stereo amplifier.
- PSG-313: sync generator for 300 series; RS-170A.
- PSG-410: RS-170A sync generator; 1-rack height unit.

- PCE-4662: encoder gen-lock option.  
Circle (655) See ad page 11

#### Lexicon

- Model 1200C: digital audio time compressor and expander; stereo system possible using two units and matrix interface.
- 200 and 224L: reverb and room simulators; improved software; acoustic space simulations.

Circle (656)

#### Lighting Methods

- PD-1200: dimmer pack; 24 10A circuits.
- PD-2400: dimmer pack; 12 20A circuits.
- PD-6000: dimmer pack; five 50A circuits.

Circle (657)

#### Listec TV Equipment

- A-2100: electronic scriptwriter for digital prompting system.
- A-4000: portable prompter; acetate; typewritten scripts.
- 2019W: 19-inch on-camera prompter with wide-angle hood.
- Microswift 200: digital remote control system for cameras and pedestals.

Circle (658)

See ad page 104

#### Logitek

- BPA-2000: balanced-input phono pre-amp; low noise circuit with

high RFI immunity.

- Monitor-10: monitor/meter system for any of 10 switch-selected stereo inputs.
- Perfectionist 12: 12 slider or rotary potentiometer audio console.

Circle (659)

See ad page 148

#### Lowel-Light

- Frame-up sets.
- Molded cases.
- GS: Air-cushioned grand stand.

Circle (660)

#### Lyon Lamb Video

- ENC VI: color encoder/sync generator converts RGB to NTSC signal.

Circle (664)

#### M/A-COM MAC

- Microscan: dual-band ENG antenna.
- PAC-10, PAC-12: program audio channel system.

Circle (667)

#### MATCO

- Station Automation Sequencer: multimachine controller with time or tone signaling; includes VCR and switcher control functions.

Circle (898)

#### MCG Electronics

- Product line of transient suppressors

*We call it the intelligent choice. You'll call it*

# **SIMPLY REMARKABLE.**

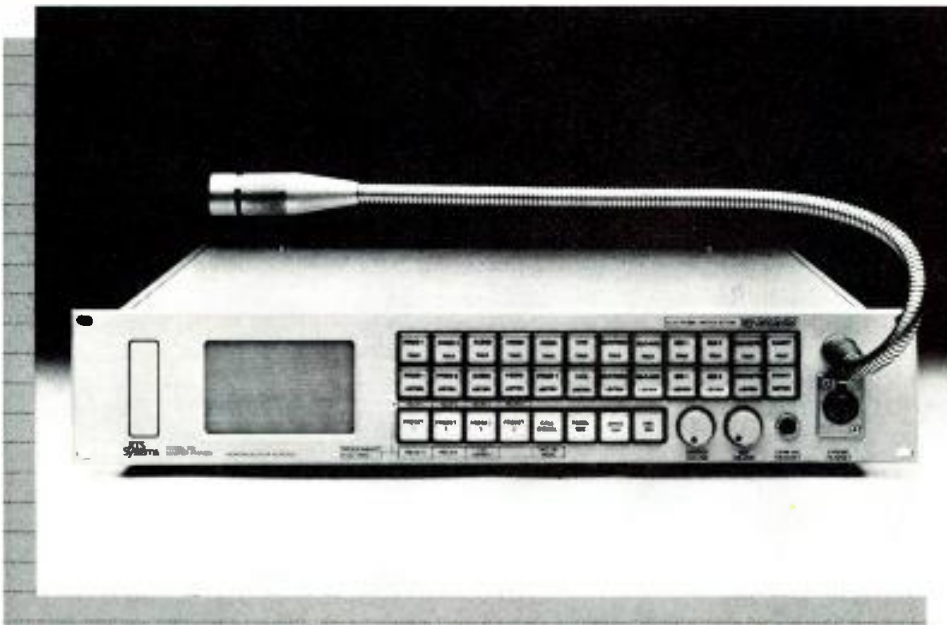

**O**ur new Model 802 Master Station represents a major advance in inter-communications systems. This unique, microprocessor-assisted control station provides 22 independent signal paths operating in up to six separate modes. And that's just the beginning. It features conference-line, dedicated-line, squawk, IFB/SA, station-iso, control functions and signaling capabilities. And user programming can adapt the operating format to individual needs in a variety of applications... The 802: Consider the possibilities. Call or write for detailed information.

RTS SYSTEMS, INC. • PROFESSIONAL INTERCOMMUNICATIONS • PROFESSIONAL AUDIO PRODUCTS  
1100 WEST CHESTNUT STREET • BURBANK, CA 91506 • 818/843-7022 • TWX 910-498-4987 • TELEX 194855

**RTS SYSTEMS**  
INCORPORATED  
A Compact Video Company

Circle (81) on Reply Card

**MCG (continued)**

and power line protection equipment.  
Circle (678) See ad page 118

**MCL**

- Model 10779: 500W Ku-band high-power amplifier; used for uplink and satellite communication.
- Model 10765: 160W Ku-band high-power amplifier.
- Model 10755: 75W Ku-band high-power amplifier.

Circle (899)

**MCI/Quantel**

- Harry: digital cel animation recorder and editor.
- Morph: shape-generating software for the Mirage system.
- Cypher: caption generator and manipulator with Paintbox quality typefaces.

Circle (680)

**MPCS**

- Complete self-contained and portable editing system plus production capability.

Circle (698)

**MPO Videotronics**

- SZ 340: sound program analyzer; measures audio transmission parameters for telephone and stereo circuits.
- SZ 331 and SZ 311: signal transmitter and measuring receiver for

Telco Sound program line maintenance.

- ATME: automatic transmission measuring equipment for telephone lines.

Circle (699)

**MZB & Associates**

- 4x4 ENG: Jimmy TV mobile vehicle.
- IVECO-12: 12-foot mobile production vehicle in Iveco chassis.

Circle (702)

**Magnasync/Moviola**

- Plus Video module: replaces picture box of film bed to allow film-to-tape transfers.

Circle (668)

**Magnum Towers**

- Product line of AM, FM, TV and microwave towers; installation and service.

Circle (669)

**The Management**

- Co-Operator: co-op management system; aids managing co-op clients and account information.
- Sales Manager: tracks performance and projections of sales people and customers.

Circle (845)

**Marcom**

- 710: BTSC TV stereo generator.
- 720: FM stereo generator

- 730: metered TV stereo monitor.  
Circle (670)

**Marconi Instruments**

- Model 2022: signal generator covering 10kHz to 1GHz spectrum; AM, FM, PM modulation; GPIB programmable option; RF levels from -127dBm to +6dBm.
- 2923: TV signal generator/inserter.
- 2955: radio communication test set.  
Circle (671)

**Mark Electronics**

- Model 1002: audio console.
- 202: audio monitoring system.  
Circle (672)

**Marshall Electronics**

- BNC312-TBR: Tajimi Hi-Tek BNC receptacle; integral 75Ω termination switch.
- BNC301BR: Tajimi male BNC isolated panel-mount; solder type.
- BNC307BA: Tajimi BNC-to-BNC isolated panel-mount connector.
- 2799: Mogami mini-quad; high-definition; low noise cable.  
Circle (673)

**Marti Electronics**

- AR-10: mobile repeater receiver.
- CR-10: rack-mount base RPU receiver with monitor speaker.
- Computer-controlled remote control system.
- MA-2525: dual audio amp.



# TC-4 DIGITAL DELAY

A great value at

## \$1,645

MONO

"... clean sound ... excellent response ... well built ..."  
Thanks NAB attendees, your comments confirm what we've known all along!



- 6.8 SECOND DELAY
  - 15 KHz BANDWIDTH
  - 85 db DYNAMIC RANGE
    - ACTIVE, BALANCED INPUTS & OUTPUTS
    - ADJUSTABLE REBUILD RATE AFTER MEMORY DUMP
    - FULLY REMOTEABLE
    - MONO OR STEREO

For more information or name of distributor near you, call:

**800-423-1082**

1000 S. Bertelsen Road, Suite 4  
Eugene, OR 97402

Another quality broadcast product exclusively represented by:

### Z-Comm

PO 1301 Solana Beach, CA 92075 619-481-5999

Circle (82) on Reply Card



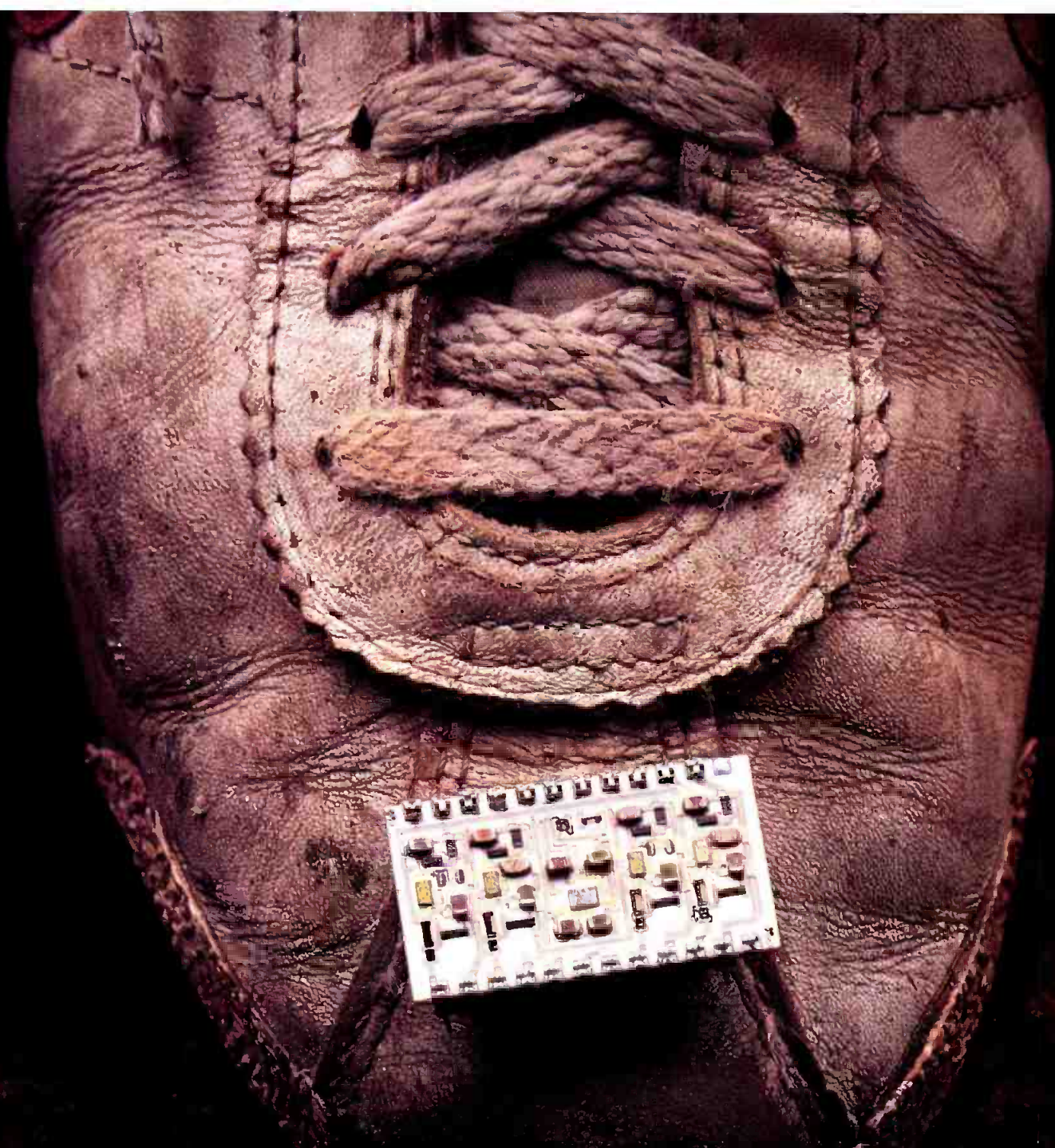

## HOW WE BECAME THE FRONTRUNNER IN THE ROUTING SWITCHER BUSINESS.

While everyone else was making minor refinements, we went back to the drawing boards. We took the best that modern hybrid technology had to offer and designed it into our Series H Switching Systems.

The result is a new state-of-the-art in every respect. We offer the best performance specs available. Reliability is unquestioned. Maintenance is reduced.

And expansion is easier than ever.

There's a 300% increase in crosspoints-per-rack-unit. So what used to fill an entire room can now fit inside a closet.

And The Series H is available in the configuration you need to make the system practical.

Best of all, we can offer these advantages at a price that's actually

less than the price of conventional switching systems.

If you'd like us to prove how far out in front we are, call us toll-free at 1-800-328-1684. In Minnesota, call toll-free 1-800-792-1072. Outside the continental U.S., call International Operations collect at 1-612-736-2549.

We'll give you the best run for your money.

Professional Audio/Video Equipment

3M hears you...

Circle (83) on Reply Card

[www.americanradiohistory.com](http://www.americanradiohistory.com)

**3M**



*Marti (continued)*

- RFA-100: RF booster amp.  
Circle (674)

**Matthews**

- Product line of camera support systems, cranes, dollies, remote camera control systems, specialized camera mount products and grip equipment.

Circle (675)

**Maxell Professional**

- Videotape: 1-inch tape material offers consistent RF output level; high chroma-to-noise ratio; low dropout; resists heat and humidity for reduced stiction; scratch-resistant surfaces.

Circle (676)

**McCurdy Radio**

- 9000 series: digitally controlled intercom.
- Century series: audio-routing switchers.
- Video and audio-follow-video switchers.
- ADU 10: digital audio delay unit.
- 8800 series: console with all electronic switching.
- Clocks and timers.

Circle (677)

**McGraw-Edison Power Systems**

- System 37/5: AM SCA utility load management equipment.

Circle (679)

**Media Computing**

- Software for news and music playlist; IBM/PC and compatibles.
- Wire service interface: ties station to wire news services.

Circle (681)

**Merlin Engineering**

- VTR, VCR, video equipment modifications.
- Refurbishing services.

Circle (1202)

**Micro Communications**

- MMDS: multichannel stereo TV diplexer system.
- MTS: UHF-TV diplexers.
- MDS/ITFS: diplexers.

Circle (682)

**Micro Controls**

- MCI 2001 (T/R): TSL system; 450MHz, 2W to 10W transmitter.
- MCI 2002: remote pickup equipment; 450MHz, 2W to 45W.
- MCI Galaxy: subcarrier paging equipment for American Diversified DiversiCom paging system.

Circle (683)

**Microdyne**

- 1100HDR: C-/Ku-band LNC-type video receiver.
- 1100PCDR(5): SCPC demodulator; frequency agile with selectable trans-

mission setup switches.

- PR23K: 7-meter Ku-band antenna; for receive or transmit.
- MAPSIII: motorized polar mount for 5- and 7-meter antennas.
- QuickLink: Ku-band, trailer-mounted uplink; cooperative venture with Wold Communications.
- 1100TVL/K: video/audio scrambler and descrambler system.

Circle (684)

**Micron Audio Products**

- CTR-501: wireless mic system with CNS noise suppression.
- TX-503: hand-held CNS transmitter.
- MDS-2: modular multichannel space diversity receiver with CNS.
- MDR-540: modular space diversity plug-in with CNS.
- CM-1: camera-mount wireless mic.

Circle (685)

**Microprobe**

- Controller and tone generator for mastering tape.
- Digisound: digital audio storage system; random-access playback; 44-minute capacity on 3Mb hard disk.

Circle (686)

**Microsonics**

- Video delay lines for switchers and cameras; for both digital and analog products.

# SOUND REPUTATION.

AKG has been providing television and radio broadcast engineers with the right microphones to meet their demanding requirements.

Now AKG has developed three new professional microphones all built with AKG reliability and studio quality sound.

These three low-noise condenser microphones meet very specific needs: the C-535 cardioid for hand-held vocals or speech pick-up, the C-567 miniature lavalier for uncanny "live intelligibility" and the C-568 short shot-gun for that extended reach with switchable roll-off to eliminate rumble and wind noise.

For a sound reputation, choose AKG.



77 Selleck Street  
Stamford, CT 06902  
203/348-2121



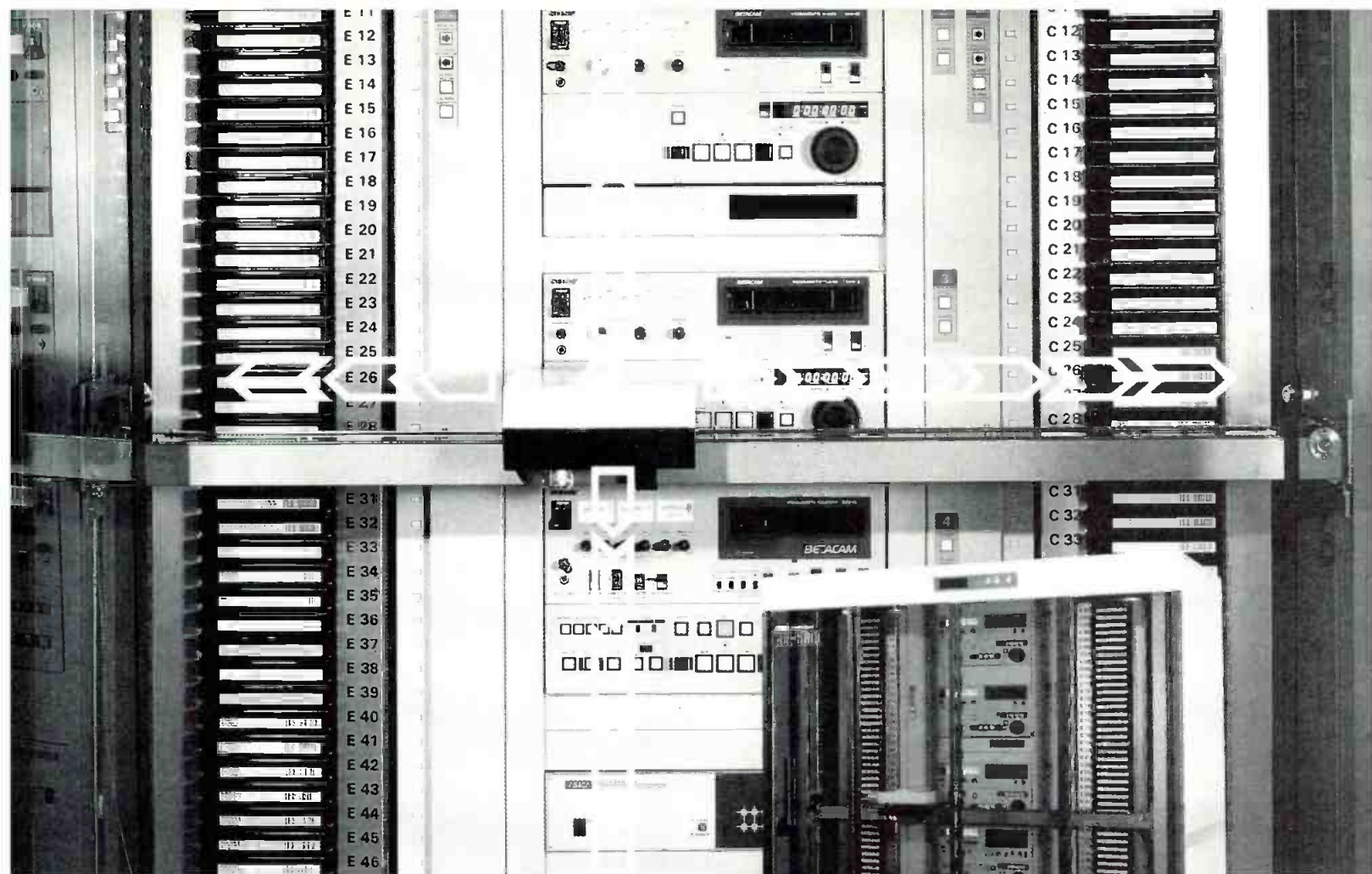

## VIDEO CART

**ASACA ACL-6000B**

Automatic Random Access Cart System

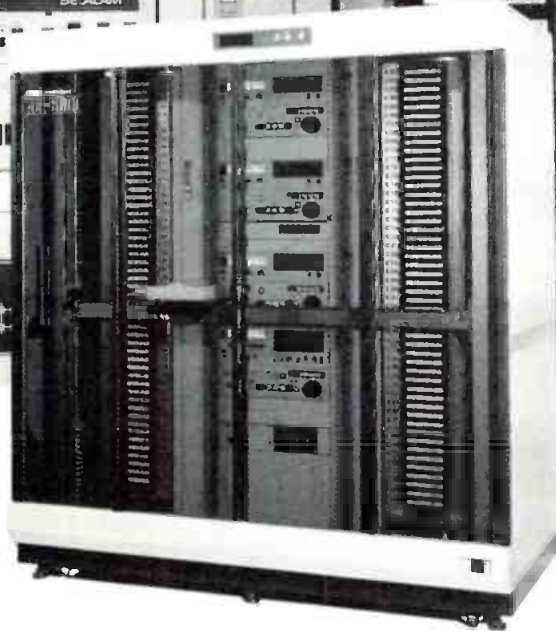

## 600 Video Cassette Capacity is the ideal system for Commercial Broadcast Programming

With the one cassette/one program system, ASACA's Video Cart enables concentrated management and automatic/continuous transmission of 600 cassettes. It shows its power especially in sending CMs, news and station breaks.

- ◆ Completely automatic/continuous random access operation.
- ◆ ACL-6000B utilizes a sophisticated bar code reader/identification system to eliminate any possibility of error.

- ◆ One cassette/one program format facilitates program scheduling.
- ◆ The high speed cassette delivery system enables the ACL-6000B to complete the program unload/load access time in 15 seconds.
- ◆ Programs that have completed their daily schedule are automatically ejected to provide space for additional cassettes.
- ◆ A highly accurate queing system utilizing SMPTE Time Code has been designed for precise start and stop points of the commercial program.
- ◆ The ACL-6000B utilizes either Betacom or M-format 1/2 inch cassettes.

**ASACA**<sup>®</sup>

**ASACA CORPORATION**

12509 Beatrice Street  
Los Angeles, CA 90066  
(213) 827-7144 (800) 423-6347  
ATTN: Alan Davis

Circle (84) on Reply Card

#### Microsonics (continued)

- Active video delay rack.
  - Bal cases.
- Circle (687)

#### Microtime

- Genesis 1: video special effects system.
  - T220 FIT: format interchange TBC, time base correction from any 1/2- or 3/4-inch format.
  - ALT1: artistic control terminal for Gemini effects system with DataKey effects instruction storage.
- Circle (688)

#### Midwest

- Product line of mobile production vehicles. Distributor of audio, video and RF equipment.
- Circle (689) **See ad pages 34, 35**

#### Milab Professional Microphones

- VIP 50: condenser microphone.
- Circle (690)

#### Minolta

- Product line of TV color analyzers and light meters.
- Circle (691)

#### Miralite

- Earth station antenna systems.
- Circle (900)

#### Mitomo

- Computerized laserdisc random-access changer.

- MTM-3: UHF TV transmitter.
- Circle (692)

#### Modulation Associates

- SCPC solid-state uplink: 10W with 50dB gain at -10dB input; compact and fully redundant; comes with carrying case.
  - T-SAT: tunable SCPC receiver; two-channel receivable, frequency agile, contains multiplex port, LED display, can be channel switched remotely.
  - N-SAT: switchable SCPC receiver; two-channel switchable, frequency agile, contains multiplex port, LED display.
  - SR-13: frequency agile subcarrier demodulator with fully synthesized low noise PLL converter and linear PLL demodulator; remotely programmable; active audio low pass filter; front panel audio monitor jack.
- Circle (901)

#### Modulation Sciences

- TSG(STV-784): TV stereo generator with audio processing and loudness controller.
  - TV Sidekick (TSCA-189A): SAP generator; integral dbx processing.
  - Pro Sidekick (SCA-186): Pro channel generator with dbx processing.
  - Data-Pro: data distribution for Pro channel on TV.
  - TV stereo REF decoder.
- Circle (693)

#### Mole-Richardson

- Type 4271: motorized Molepar.

- Type 2981: mini Softlight.
  - Type 5321: 2.4kW dc Moletronic dimmer.
  - Type 5361: 12kW ac to dc Moletronic dimmer.
  - Type 2901: 2-inch Tiny-Mole Solarspot.
  - Type 6281A: 6kW HMI Mole Solar-Arc light.
  - 6295: 12,000 HMI ballast.
- Circle (694)

#### Montage Computer

- Picture Cutter: for finishing on film; does 3:2 tape-to-film pulldown; syncs audio/picture to clap board; prints negative cutting list by edge numbers on film.
  - Picture Processor: editing control system; assigns labels to audio and video for editing.
- Circle (695)

#### Moseley Associates

- Product line of aural STL systems, multiplexed data links, remote control equipment, stereo and subcarrier generators, demods, telemetry equipment and audio processors.
- Circle (696)

#### Motorola

- Potomac SMR-11 AM: M stereo receiver with 14kHz audio bandwidth.
- Automotive AM stereo radios: by Ford, Kraco, Volkswagen, Sparkomatic, Nissan, Audiovox, Toyota,

## This new QuantAural™ QA-100 Audio Program Analyzer gives you the advantage in competitive broadcasting

Simply put, the QA-100 quantifies what you hear. Your station sound can now be electronically monitored the way you hear it. Exactly. And, you can monitor the competition too!

Real time analysis of any audio signal. From a receiver, tape recorder, or processing equipment. You see the measurements as you hear the sound. Changes in processing or variations in system performance are immediately shown on the QA-100 panel meter or bargraph display—using program material as the signal source.

The QA-100 hears like a program director and talks like an engineer. With it you can monitor maximum peak level (relative peak modulation), overall

processing effectiveness (average level), tightness of sound and processing control (peak density), tonal balance, consistency and preemphasis (four band real time analyzer), stereo image width (L + R to L - R ratio) and "punch" (special "aural intensity" measurement).

Interested? To learn more about how the QA-100 will help your station compete, call Potomac Instruments today.

QuantAural is a registered trademark.



**POTOMAC INSTRUMENTS**  
932 PHILADELPHIA AVE. SILVER SPRING, MD 20910  
(301) 589-2662

Circle (85) on Reply Card



# Fluke takes the trouble out of broadcast troubleshooting.

**The Fluke 9010A.** Now, a fast troubleshooter that cuts critical microprocessor-based equipment downtime to an absolute minimum.

The Fluke 9010A offers a refreshing solution to the broadcast engineer's problem of repairing microprocessor equipment by converting costly downtime to productive uptime.

The 9010A plugs into the microprocessor socket of your camera, VTR, video router, video switcher or graphics generator. It has a complete array of built-in preprogrammed tests to make fault isolation fast and foolproof. And operation characteristics so clear and straight-forward that no lengthy training is needed for effective troubleshooting.

The result is fast, easy, low-cost repairs without complicated hardware hookups, or excessive board inventories. All at a price that can pay for itself with time savings alone.

So, if your position involves the testing and repair of broadcast equipment, contact your local Fluke representative or call our toll-free hotline **1-800-426-0361** for more information on the Fluke 9010A. And take the trouble out of broadcast troubleshooting.

IN THE U.S. AND NON-EUROPEAN COUNTRIES:

**John Fluke Mfg. Co., Inc.**  
P.O. Box C9090, M/S 250C  
Everett, WA 98206  
(206) 356-5400, Tlx: 152662

IN EUROPE:

**Fluke (Holland) B.V.**  
P.O. Box 5053, 5004 EB  
Tilburg, The Netherlands  
(013) 673973, Tlx: 52237

**FLUKE**®

Motorola (continued)

- Delco and Chrysler.
  - OPTRX: display radio pagers.
- Circle (697)

Multi-track Magnetics

- MTM-8500: dc servo drive for tape decks.
- Circle (700)

Mycro-Tek

- ERNIE: character generator and titler; newswire receive terminal.
  - Video switcher: selects signal source from VCRs and titlers on prerecorded cue tones.
- Circle (701)

NEC America

- SP-3A: CCD camera; uses improved imaging devices.
  - System-10: combines many features of E-Flex effects with 16-bit processing and unlimited key frames for smooth effects transitions.
  - PCN-1400 series: broadband VHF TV transmitters, 10kW to 35kW; solid-state aural; RCA 8984 grounded grid PA.
  - PCU-900 series: 1F-modulated UHF TV transmitters; 10kW to 60kW; klystrons from NEC, Amperex or EEV.
- Circle (710)

See ad pages 61,157

NETCOM

- Product line of satellite program transmission and distribution service.
- Circle (711)

Nady Systems

- 501 VHF, 601 VHF: highband VHF wireless microphone systems.
  - 701 VHF: highband VHF wireless microphone system with diversity reception.
  - IRT-200: infrared cordless studio monitor system.
- Circle (703)

See ad page 149

Nagra Magnetic Recorders

- T-Audio: production models with time-code synchronizer.
  - IV-STC: portable stereo audio recorder with time code generator and reader.
- Circle (704)

Nakamichi UA

- MR-1: discrete head audio cassette deck.
- Circle (705)

Nalpak Video Sales

- TP1S, TP2B, TP2R: tripack tubular cases, designed for tripods and lighting equipment.
  - RT19 Rack-TOTE: rack case for transportation of 19-inch rack-mounted equipment.
- Circle (706)

Narda Microwave

- Radiation monitoring systems.
- Circle (707)

National Video Service

- NVS TCR-100 cartridges.
- Circle (708)

See ad page 145

Nautel Maine

- AMPFET 50: 50kW solid-state AM broadcast transmitter; based on high-power MOSFET devices in 48 1.25kW power blocks; on-air block replacement possible.
- Circle (709)

See ad page 138

Rupert Neve

- Necam 96 moving fader: automation fitted to 5116/36.
  - 51 series stereo console: from 16 to 60 inputs; two to 48 outputs.
  - Video editor interfacing: for the 5432 and 5452 (542 series stereo consoles) with eight, 12 or 16 inputs and two or four outputs.
  - 8128 V 81 series audio console: with 32 to 56 inputs/24- to 48-track outputs; four stereo buses for music, effects and dialogue.
- Circle (712)

Nisus Video

- N-79E: stop-action camera based on the Ikegami HL-79E ENG camera.
- Circle (713)

# Broadcast-Color: Correct

Available Now



Advanced color correction and video processing techniques are used in the new FOR-A CCS-4300 Color Corrector to solve a variety of color balance and level problems in on-line broadcast production, post production editing and duplication systems.

No compromise because FOR-A's design:

- Uses an exclusive technique to maintain the highest signal quality — check the specs!

- Makes the system user friendly by incorporating RGB controls which broadcast and post production people already know how to use.
- Considers *your* system design first and provides: a by-pass delay equal to the processing delay, burst phase and chroma controls, plus the capability for remote cables up to 1,000 feet — all insuring easy system integration.

The CCS-4300 is easy to use:

- Simple and independent adjustment of RGB Black and White balance and gamma correction.
- Full proc amp signal control
- Three operating modes: Correction-On, Correction-Off and By-Pass.

- Balanced and Differential correction modes.
  - Presets for all controls
- Plus the FOR-A performance edge with:
- 0.25 Differential Phase and 0.5% Differential Gain
  - Full bandwidth well beyond 4.2 MHz
  - Less than 1% K-Factor
- Off color? Make it proper . . . professionally with the CCS-4300.



FOR-A CORPORATION OF AMERICA 49 Lexington St., Newton, MA 02165  
 East Coast: (617) 244-3223 West Coast: (213) 402-5391

Circle (90) on Reply Card



# AM Stereo Without Compromise

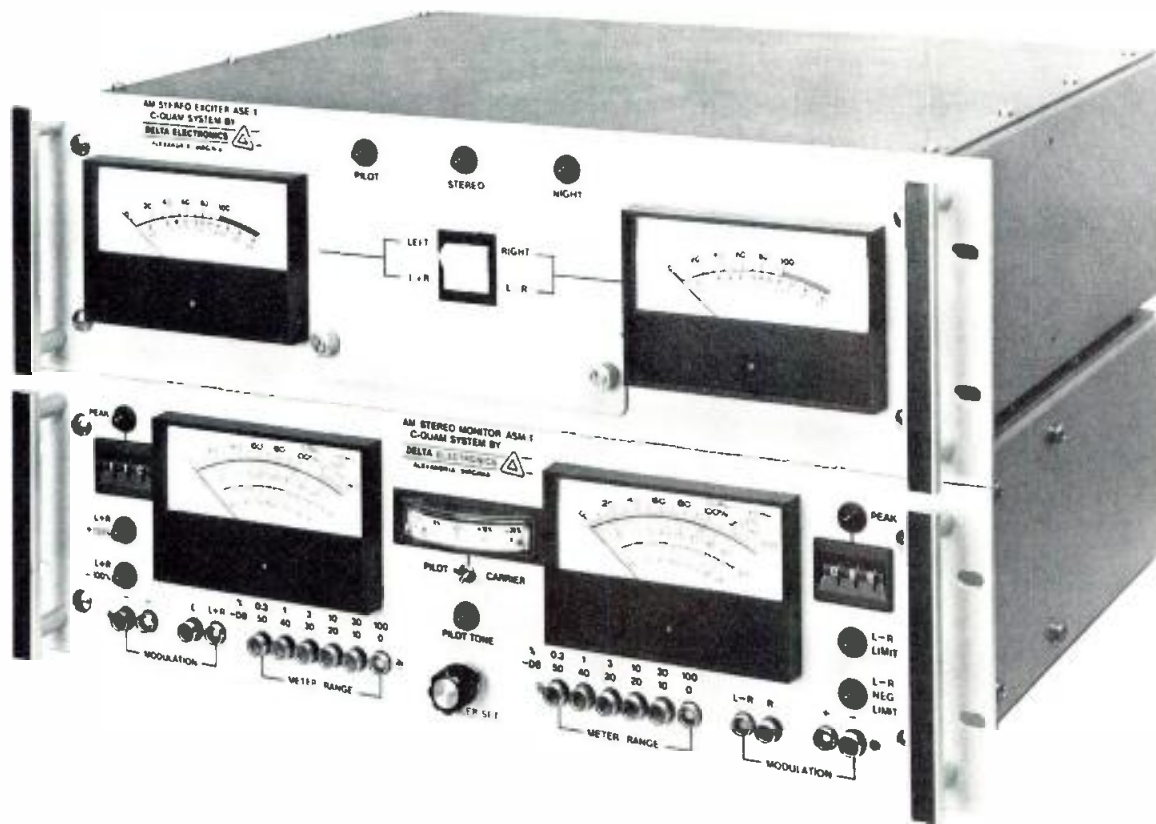

## C-QUAM<sup>®</sup> AM Stereo System by Delta Electronics, Inc. FCC Type Accepted

Delta Electronics, Inc. introduces the ASE-1 AM Stereo Exciter and ASM-1 AM Stereo Modulation Monitor: FCC type-accepted C-Quam System transmission equipment for the AM Stereo broadcast market. C-Quam is the *Compatible Quadrature Amplitude Modulation* system developed by Motorola, Inc. C-Quam is the system of choice for more than 200 U.S. stations plus additional Canadian stations. Users range from kilowatt day-timers to full-time network flagships. These stations report enthusiastic response from listeners using multimode and full C-Quam stereo receivers as well as typical monophonic receivers. The key is compatibility without compromise. All listeners, stereo and mono, receive a clear signal with low distortion. Delta's twenty-year leadership in the

field of broadcast instrumentation solidly backs this technological advance.

The proliferation of receivers from GM's Delco Electronics, Inc., MacIntosh Labs, Sherwood Electronics, Chrysler Corporation, Concord Electronics, Samsung Electronics and others not yet announced, is creating a sizeable C-Quam audience. With the outstanding performance of this equipment, you can be sure that the audience will *stay* tuned to your Delta C-Quam AM Stereo transmission system.

For additional information, contact Bob Bousman at (703) 354-3350.

C-QUAM is a registered trademark of Motorola, Inc. Manufactured under license from Motorola, Inc.

---

## DELTA ELECTRONICS

---

5730 General Washington Drive, Alexandria, Virginia 22312  
Telephone: 703-354-3350 • TWX: 710-832-0273 • Telex: 90-1963

Circle (22) on Reply Card

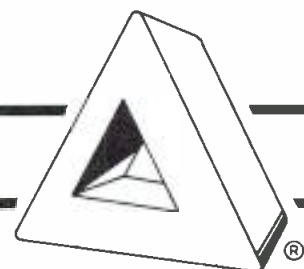

#### Nordic Software

- Open invoice billing system: enhancement runs on Apple disk drive.
- Circle (714)

#### Norpak

- TDS 3: NABTS teletext delivery system.
  - TMS 3: NABTS teletext management system.
  - TTX 6: teletext decoder module.
  - IPS 3: NAPLPS information provider system.
  - TTX 5: NABTS teletext terminal.
- Circle (715)

#### Nortronics

- Head manufacturing service for audio recorders.
- Circle (716) See ad page 156

#### Nova Systems

- Nova 490: digital TBC for 1- and 3/4-inch VCRs: 32-line storage; heterodyne operation: 8-bit 4xfsc sampling, 1-rack-unit high.
  - Nova 510: digital TBC: heterodyne or subcarrier feedback: 1-rack-unit high.
- Circle (717)

#### Nurad

- SQ6-series: receive antenna; 6-foot SuperQuad II with quad polarization, high gain and low sidelobes.

- 130CT1: compact 22-channel transmitter for 13GHz for window links.
  - 130OR1: compact 14.5-inch parabolic antenna for 130CT1; detachable offset feed/waveguide.
  - 20CT1: compact transmitter and 20PA15(A) mast-mount amplifier; supplements Silhouette remote transmitters.
  - Logic-Track: helicopter auto-tracking receive systems; Loran heading determination.
  - 20CA1: compact antenna with same gain as comparable-sized disc, rod or helical antenna; improved axial ratio and sidelobe characteristics.
  - SuperTrack System: auto-tracking option for SQ6, SuperQuad II and Silhouette antennas.
  - AT-series: rack-mounted agile transmitters; in 2GHz, 2.5GHz, 6GHz, 7GHz and 13GHz spectra.
  - 130AR2: 13GHz 22-channel agile rack-mounted receiver.
  - 20 AR2 series: central ENG/EJ receivers; improved signal-to-noise and adjacent-channel rejection performance.
- Circle (718)

#### Nytone Electronics

- VSS-1: video-slide scanner systems.
- VSS-2: slide transparency or transfer system; RGB or NTSC composite video signals; random access ca-

pability.  
Circle (719)

#### Oak Communications

- Satellite transmission security system.
- Circle (725)

#### O'Connor Engineering Labs

- System 105HD: camera support system for large video cameras: 100HD heavy-duty fluid head; side-loading; adjustable platform; dual extendable handles; claw-ball leveling tripod with internal spreader.
  - 100C-HD: fluid camera head.
  - 150-B: fluid camera head.
  - 53: tripod dolly.
- Circle (720)

#### Oleson

- Apollo lighting control console.
  - Micron lighting memory control console.
  - Trouping box truss.
  - Mini Striplight.
- Circle (721)

#### Omicron Video

- 506: video production switcher.
  - ElePac-90: replaces Sony BP-90 battery.
  - Elicon/Eiden 465: stereo TV modulator.
- Circle (722)

## Broaden Your Horizons

### QUALITY MANUFACTURING & PERFORMANCE

Dielectric Communications expands your broadcasting horizons with a complete line of broadcast components—known worldwide for their reliability.

- Coaxial and Waveguide Diplexers for combining aural and visual TV transmitters to a common coaxial transmission line—all with high isolation between transmitters
- Motorized Waveguide and Coaxial Switches are designed for the broadcast industry's high-power requirements, with low VSWR, high isolation and low insertion loss

- Rigid Coax, Waveguide Transmission Line and Filter Products manufactured of high conductivity copper or aluminum
- Custom RF Systems to fit your specific design requirements and qualified field personnel to assist you during installation and final testing

Dielectric broadcast equipment is manufactured to meet your specific mechanical and electrical criteria. For all your equipment needs, there's only one number to call: (800) 341-9678.

**DIELECTRIC**



Raymond, Maine 04071  
(207) 655-4555 • (800) 341-9678  
TWX: 710-229-6890



Circle (32) on Reply Card



# WE'VE GOT YOUR NUMBER!

**Wilkinson 8090**

Not just a tired design with a new exciter or a revised paint scheme, the 8090 Series is a new approach to meeting the challenge of competitive FM broadcasting today and tomorrow.

Superb craftsmanship, unsurpassed performance, and tough reliability on the job make the Wilkinson 8090 Series your only real choice.

## STANDARD FEATURES:

- Full FIVE year warranty the industry's best\*.
- Five subcarrier inputs.
- Single tube design up to 30 kilowatts.
- Internal RF routing for flexibility and redundancy.
- Designed from the ground up for impressive main channel audio performance with multiple SCA operation.
- Exclusive POWER-GARD™ control and protection package.
- Spare parts kit with each transmitter.
- Extra metering for ease of adjustment.
- Backed by 24-hour service.

\*Limited warranty, some exclusions apply.

Call our Marketing Department for more information on your winning number — 8090.



Wilkinson Radio Division

2360 Industrial Lane  
Broomfield, Colorado 80020  
(303) 465-4141  
TWX: 910-938-0396

Circle (92) on Reply Card

**Omnimount Systems**

- Series 101UDM: mounting devices for horn and driver combinations.
- Series 50QCM: quick-release equipment for film and video cameras.
- Series 200WB: sidewall mounting systems with 19-inch distance from mounting surface.
- Cablemount: ball, socket and cable adds stability to heavier mounted equipment.

Circle (902)

**Orban**

- 8182A/SG: stereo TV generator.
- 700: absolute loudness meter.
- 414A: stereo compressor/limiter.
- ACC-11: security covers for all products.
- 8182A: SAP generator.

Circle (723)

See ad page 105

**Otari**

- EC-101: edit code synchronizer for MTR-90 multichannel recorder.
- CB-121: remote controller for EC-101.

Circle (724)

See ad page 15

**PAG America, Ltd.**

- 9420 Mastercharger: microprocessor-controlled, 4-channel charger; auto 110/220 switching; sequential fast charge or simultaneous slow charge of assortment of NiCad batteries in the range of 2 to 12Ah and 10V to 15V.

- 9407 Speedcharge 6000: microprocessor-controlled NiCad battery charging system in range of 2 to 12Ah and 10V to 12V; fast and slow charge; revitalizes poor batteries.
- 9418 Sequencer 6000: add-on for Speedcharge 6000 to fast charge sequentially an assortment of eight batteries; eight status indicators.
- 9303: custom-designed Betacam NiCad 13.2V, 4Ah battery; runs Betacam recorder for 75 minutes.

Circle (730)

**PEP**

- AS64/800: alternate VHS edit source with interface to BVU800; push-button changeover from professional VHS deck on 3/4-inch machine to 3/4-inch recorder.

Circle (737)

**Pacific Bell**

- 3291-10L: laser fiber-optic system for broadcast video services; dual audio carriers.
- 3210: balanced cable transmission system for video, with dual audio carriers at 5.8MHz and 6.4MHz.

Circle (726)

**Pacific Radio**

- Ventigo patchbay burnisher, patchbay jack, contact cleaner.
- Chemical inspection for cleaning

normalizing contacts.

Circle (727)

**Pacific Recorders & Engineering**

- BMX-III: modular on-air radio console.
- Newsmixer: compact, modular dual-bus mixer; routing and monitoring system for radio newsrooms.
- AMX: modular on-air/production console.
- Micromax: NAB cartridge reproducer.

Circle (728)

See ad page 99

**Paco Electronics USA**

- KD-120: battery refresher.

Circle (729)

**Paltex/California Paltex**

- ESPRIT: 5-VTR edit controller, with edit list memory, back-track EDL trace, editing, animation, user-defined keys and HELP.
- GEMINI: component digital video processor with 8-bit 4-2-2 sampling; handles stable and unstable VTR outputs and non-synchronous video.
- Time Sync Monitor: machine synchronizer with NTSC and SMPTE code track.

Circle (731)

**Panasonic Industrial Video Systems**

- AK30: 3-tube ENG/EFP camera; M-format outputs.
- AU-350: M-Format recorder, player and editor with 422-bus control.



# AMPFET 50

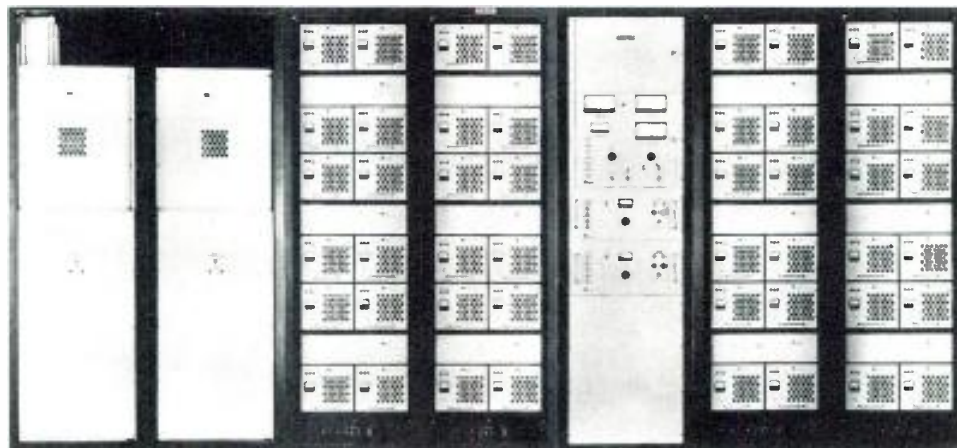

400 WATTS

1kW

2.5kW

5kW

10kW

25kW

## 50 KW totally solid state AM

NAUTEL MAINE INC. 201 Target Industrial Circle Bangor, Maine 04401 207-947-8200  Telex 944466  Jorgen Jensen 902-823-2233	Audiomedia Assoc. New Orleans, LA Corey Meyer 504-242-8014	Enterprises Inc. Brookfield, WI Bob Gorjance 414-782-7996	MidAmerica Elect. New Albany, IN Pete Boyce 812-945-1209	Northeast Bdcstg. S. Glens Falls, NY Bill Bingham Criss Onan 518-793-2181	R.F. Specialties	
	Broadcast Assoc. Rock Hill, SC John Harper 803-366-8830	Hill Radio Equip. Claremore, OK Claude Hill 918-341-5240	Spencer Broadcast Phoenix, AZ Chuck Spencer 602-242-2211	Pittsburgh, PA Tom Monahan 412-733-1994	Niceville, FL 8111 Turney 904-678-8943	Seattle, WA John Schneider 206-525-6974

Circle (93) on Reply Card



**Panasonic (continued)**

- AU-600 M-II: 1/2-inch recorder which offers 65 minutes from metal particle tape, 4.5MHz luminance bandwidth.
- Nite Hawk WV555BN: color camera that uses Newvicons, for ENG and EFP.
- WV6000 camera: single-tube camera with title, time/date and video generator.
- VW890 camera: 3-Plumbicon unit for portable or studio; 59dB S/N.
- Dubbing system: AG-SW100 10-input switcher, AG-DA100 video/two audio DA; and AG-A100 dubbing controller for 10-slaves and two-master VTRs.

Circle (732) See ad pages 75, 77, 78, 79

**Parsons Manufacturing Company**

- ATA-CASES: Heavy-duty shipping cases for air freight of broadcast and A-V equipment.

Circle (733)

**Patchbay Designations**

- Patch prints.
- Film inserts for rear-illuminated button switches.

Circle (734)

**Peerless Sales**

- 4004-050/4004: false ceiling camera-mount arms.

- 1330-500: button-head security screw kit.

Circle (735)

**Penny & Giles**

- Servo-controlled, motor-driven audio fader.

Circle (736)

**Perrott Engineering**

- Product line of clip-on and belt battery systems. Also battery chargers and lighting systems.

Circle (738)

**Philips Test & Measuring**

- PM5633: sync-pattern generator with component output.
- PM5652: NTC-7 VITS generator/ inserter, which includes external signal input.

Circle (739)

**Philips TV Systems**

- LDK-54: new generation of portable cameras with configurations for ENG, EFP multicore and EFP triax; includes Lineplex tape format products.
- LDH-7020: 20-inch high resolution color monitor.
- CVE: component video effects system with dual-channel, integral digital switcher and realtime capability.
- LDM-3003: digital comb filter decoder.
- LDM-1791: high efficiency Klystron

UHF TV transmitter.

Circle (740)

See ad pages 154, 155

**Phoebus**

- Mighty Arc: mini version of Ultra Arc followspot; rated at 70% light output of Ultra Arc short-throw unit.
- Ultra Arc series II: high intensity, long-life lamp for long-throw use.

Circle (741)

**Piher Electronics/PESA**

- Video monitors: monochrome and color monitors; 14- and 20-inch models, broadcast grade.
- Sync analyzer.
- Cable tester.
- Upgrades to character-generator products.

Circle (742)

**Pinzone**

- TCR-10: total system refurbishment service.
- Microtek Time Slot personnel scheduling software.
- Vertical interval multichannel audio encoder/decoder for stereo conversion of any existing video system.
- 5-meter motor-driven polar-mounted turnkey satellite system.

Circle (743)

**Pioneer Video**

- Prototype 13-inch monitor.
- LD-V6010: videodisc player: level 1, 2 and 3 capability.

# Switch to Videotek Value

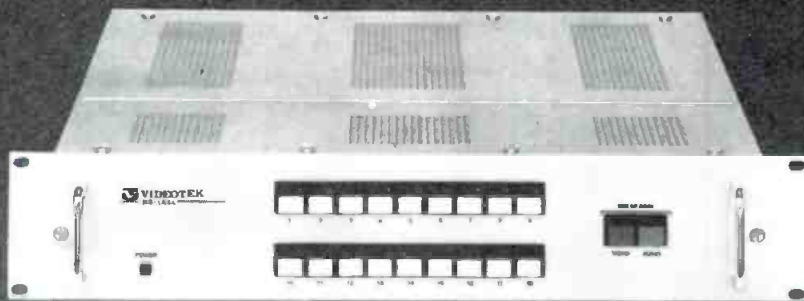

◀ **RS-183A**

**18x1 Audio Follow Video Routing Switcher\***

- 18 Looping Video Inputs
- 18 Stereo & Data Inputs
- Video/Audio Breakaway
- RS422 Computer Interface



▲ **RS-10A**

**10x1 Audio Follow Video Routing Switcher\***

- 10 Looping Video Inputs
- 2 Audio Inputs per Video Channel
- Video/Audio Breakaway



▲ **RS-12 12x1 Video Only Routing Switcher\***

- 12 Looping Video Inputs
- 24-Hour Channel Memory

A DECADE OF PROGRESS



A DESIGN FOR THE FUTURE

**VIDEOTEK** INC.

\*Optional Remote Control available.

243 Shoemaker Road, Pottstown, PA 19464. (215) 327-2292. TWX 710-653-0125. 9625 North 21st Drive, Phoenix, AZ 85021. (602) 997-7523. TWX 910-951-0621.

© Videotek-1985

Circle (94) on Reply Card

## TELEVISION TRANSMITTERS ECONOMY!



**Custom Engineering**—for field modernizing and up-powering all makes of VHF and UHF transmitters. **Spares** for most makes of VHF and UHF transmitters.

Townsend's continuous increase in market share, we think, is importantly a reflection of a policy to offer quality transmitters at prices that do not carry conglomerate cost burdens.

### Townsend Product Lines:

- High power **UHF** to 240 Kw
- High power **VHF** to 50 Kw
- **VHF** and **UHF LPTV** transmitters
- All solid state **MDS** and **ITFS** transmitters

# TOWNSEND

**The Television Transmission Specialists**

Townsend Associates, Inc.

79 Mainline Drive, Westfield, MA 01085 • 413-568-9581

Circle (141) on Reply Card

## COX THE ENCODER COMPANY



### New Options: black stretch, component video inputs.

There's a lot more to encoding than taking a three wire signal and combining it into one. COX, the world's foremost encoder manufacturer has elevated the encoding of color primaries to a fine art. With a time tested, no-compromise design, COX has gained the enviable reputation of building encoders by which others are judged. COX encoders are the choice of manufacturers who lead the industry in telecine systems, computer graphics and matting equipment.

Available in NTSC, PAL, PAL M, SECAM and switchable, multistandard versions. For detailed data and our encoder evaluation check list, call:

EXCLUSIVE NORTH AMERICAN DISTRIBUTOR

**broadcast video systems**

1050 McNicoll Avenue, Agincourt, Ontario M1W 2L8

Telephone (416) 497-1020 Telex 065-25329

Circle (95) on Reply Card

Want more information on  
advertised products? Use the  
Reader Service Card.

### Pioneer (continued)

- Prototype: videodisc controller.
- Prototype: portable 8-inch video-disc player.
- Prototype: laserdisc autochanger for 60 discs.

Circle (744)

### Porta-Pattern

- 001-30, 001-31: BBC zone plate chart.
- 006-30, 006-31: BBC zone plate transparencies.
- 001-44, 006-44: 11-step log gray scale chart and matching transparency.
- 001-45, 006-45: depth of modulation chart and matching transparency.
- Series 050: bantam test chart systems.
- Series 030: 18"x24" test charts and systems.

Circle (745)

### Potomac Instruments

- QuantAural QA-100: realtime program audio analyzer, evaluates character and amount of audio processing; meter and bargraph display shows spectrum, peak-to-average ratio and peak density.
- AMS-11: C-QUAM stereo demodulator used with SMR-11 receiver for off-air monitoring of AM stereo.

Circle (746)

See ad page 132

### Procart

- Product line of broadcast recording cartridges.

Circle (747)

### Protolite

- Mirror Image: video projection screens, available in portable, tripod and wall screens.

Circle (748)

### QEI

- 695T2kW: 2kW FM transmitter; solid-state; similar to 1kW (695T1kW) but with 2PAs.

Circle (749)

See ad page 59

### QSC Audio Products

- 1080: 35W/channel 8Ω power amp.
- 3200: 110W/channel 8Ω power amp.

Circle (750)

### QSI Systems

- PSF-777: battery-powered split field color bar generator with programmable 8-character source ID; 1kHz tone.
- SW-402: mini-EFP vertical interval switcher, 4-input/2-output, with lap dissolve and tally closures.
- CB-1680: source ID generator; SMPTE bars; 1kHz tone; 16-character ID; stores 80 messages.

Circle (751)

### Q-TV

- VPS-500: ComputerPrompter system.



**QTV (continued)**

- VPS-1000: Super Computer Prompter system.
- Mini Video Prompter.

Circle (752)

**Quanta**

- Microgen MG200: titling character generator with multiple fonts, colorization, automation and disc memory.
- EVP-500/800 electronic video paint systems: versatile art systems to create TV graphics on the screen with interfacing to titling and effects generators.
- QCG-series: true character generator systems; 300, with two resident faces; 400, with seven resident faces; 500, with two faces and logo on line for multiple fonts.

Circle (753)

**Quantum Audio/Gotham**

- Series 22: audio console to 28-input mainframe: two stereo out pairs.

Circle (754)

**Quickscan Systems**

- VCR or disc-based for electronic publishing with data encoded in video.

Circle (755)

**Quickset**

- Product line of tripods, pedestals, cam.

fluid heads and CCTV camera mounting systems.

Circle (756)

**RCA**

- TTG-60U: 60kW solid-state UHF transmitter.
- CCD-1S: sports model camera with CCD image sensing, shutter and slow motion capability.
- TH-700: Type C video recorder.
- TCR 500: Silverlake M-format cassette automation.
- Multichannel TV sound generation equipment.

Circle (761)

**R-Columbia**

- 6058: ENG/IFB hands-free telephone with tone or pulse dialing, mic mute, volume control, three mic in, three headphone out and clips to belt.
- CC-700: EC headphone.
- SB 700: Broadcast headset/mic.
- TR-50/PRO: Wireless headset/intercom.

Circle (762)

**RF Technology/CML**

- TX-100: 950MHz wireless microphone transmitter with any of three diversity receivers.
- RF-710/715: high gain, weather-proofed RF power amplifiers at 7GHz. 50dB gain. 10W.

- RF-704/705A: rack-mount, fixed-link systems with programmable frequencies and built-in diagnostics.
- RF-272: 2.7GHz agile; 2W to 10W switchable transmitter for international market; remote control; weatherproof.
- RF-700/701: 7GHz portable microwave system for ENG.

Circle (768)

**ROH**

- 100 series: extended range of line monitors in rack-mounted and portable packages.
- ADA-211/212: audio DAs with 150Ω and 600Ω impedance capability.
- System 2000: prewired mainframe racks for modular audio DAs.

Circle (772)

**ROHN**

- Equipment shelters: fiber-glass construction and environmental control.

Circle (773)

**RPG Diffuser Systems**

- Acoustical materials to control the studio or control room sound.

Circle (777)

**R/Scan**

- Product line of lighting detection equipment.

Circle (778)

# Tune into Videotek Value



**DM-4RA** 82 Channel Television Tuner/Demodulator

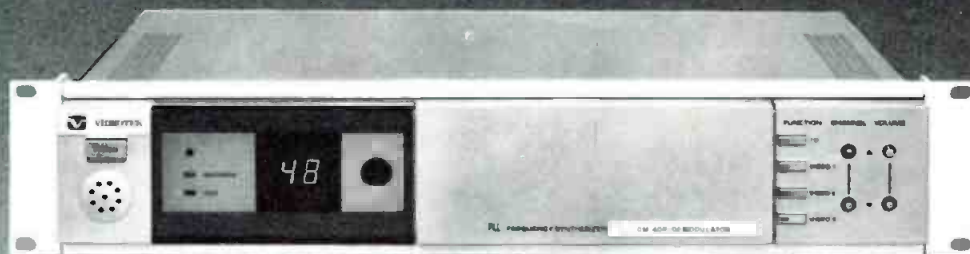

**DM-40RA** 125 Channel Cable Ready Television Tuner/Demodulator

A DECADE OF PROGRESS



A DESIGN FOR THE FUTURE

VIDEOTEK Inc.

243 Shoemaker Road, Pottstown, PA 19464, (215) 327-2292, TWX 710-653-0125, 9625 North 21st Drive, Phoenix, AZ 85021, (602) 997-7523, TWX 910-951-0621.

Videotek-1985

Circle (97) on Reply Card



## Continental's 1 kW AM Power Rock: a sound winner that's ready for AM stereo.

Tough market or not, the Power Rock is designed to give you the best signal around. Listen to the loud, clear signal, and you know you have a winner. The Power Rock is ready for AM Stereo and accepts sophisticated audio. Conservatively-rated components give you an extra margin of safety for steady and reliable on-air performance.

For information, call 214/381-7161  
Continental Electronics Division of  
Varian Associates, Inc.  
Box 270879 Dallas, TX 75227



**Continental  
Electronics**

Send me 1 kW AM Power Rock brochure

Name \_\_\_\_\_

Station \_\_\_\_\_

Address \_\_\_\_\_

City \_\_\_\_\_

State Zip \_\_\_\_\_

Phone (\_\_\_\_) \_\_\_\_\_

© 1985 Continental Electronics/4966A

Circle (99) on Reply Card

### RTS Systems

- Series 17: low-cost intercom system.
- Series 2500: card-cage amplifier system.
- Model 810: dedicated line and intercom system.
- Plantronics lightweight headsets.

Circle (779)

See ad pages 126, 127

### Radio Systems

- DM-2: LED-type stereo VU meter.
- MA-5: 5-channel mic pre-amp.

Circle (757)

### Ramko Research

- PRIMUS RS-1616 controller: switching, amplifying, routing and mixing with paging/call override.

Circle (758)

### RAM Broadcast Systems

- Distributors of audio products for broadcasters.

Circle (759)

### Rank Cintel

- Shot change detector: facilitates film color grading on Mk III/Amigo, identifies scene changes and refers all corrections to the beginning of the scene.
- Steadyguide: anti-weave feature; guides film at point of scan to reduce picture weave.
- MkIII HD: high definition telecine for 1125-L/60-F system.

Circle (760)

See ad page 113

### Real World Technologies

- RG-341: safe area/safe title, pulse cross generator with MicroMark locator.
- uniVUer: VU model; PPM stereo with phase error indicator.
- MonSter: option for the uniVUer gives a go/no-go decision on the uniVUer display; for program material and setup tones.

Circle (763)

### Recortec

- VTE-102: 90-minute 1-inch reel tape evaluator.
- VTE-103: 3-hour 1-inch reel tape evaluator.

Circle (764)

See ad page 28

### Rees Associates

- Facilities design, architectural planning, engineering services and project management services.

Circle (765)

### Register Data

- Computer software for radio business systems.
- Data Scan: ratings breakout software for ARB, Birch.
- Register Data Systems: Music Master music library program.

Circle (766)

### Research Technology

- Evaluator: 1-inch videotape prod-



# 60,000 Reliable FM Watts.

The Model FM-60 - the world's most powerful FM Broadcast Transmitter. Combine the outputs of a pair of the reliable, highly regarded Broadcast Electronics FM-30 one tube 30 kW FM Transmitters and enjoy the ultimate in high power FM broadcasting.

- Patented folded halfwave cavity eliminates sliding contacts and plate blocking capacitor.
- Proportional automatic power control maintains constant output power with VSWR protection.
- Field proven and FCC type accepted.



**BROADCAST  
ELECTRONICS INC.**

4100 N. 24th ST., P.O. BOX 3606, QUINCY, IL 62305-3606. (217) 224-9600. TELEX: 250142

Circle (98) on Reply Card



uct inspects tape for physical damage and dropout, high speed and color CRT defect display.

- 6120 tape check: 1-inch evaluator cleaner and color CRT display.
- Tape check 320: inspector cleaner for VHS.

Circle (767)

#### Riviera Broadcast

- Equipment leasing services.

Circle (769)

#### Rockwell Int'l.

- MSR-6: microwave relay radio; enables four signals on one RF carrier-signal.

Circle (770)

#### Rohde & Schwarz

- UVF: portable video analyzer with quasi-analog measured parameter.
- RS002: satellite receiving system.
- SPF2C: component video signal generator.

Circle (771)

#### Rosco Laboratories

- Cinegel: expanded, improved color selection and light control system.
- Roscolux: heat-resistant color effects filters and diffusion materials.
- Designer patterns: projector effects used in spotlights.
- S720-21: Ultimatte paints for the Ultimatte system.
- S710-11: Chroma-key paints; special formulations provide high luminance values and color saturation for keying effects.

Circle (774)

#### Roscor

- TV-45: remote truck.
- Mini-Ram: ENG van.

Circle (775)

#### Ross Video

- RVS 210: 10-input video production switcher, includes multilevel effects, 12 patterns per M/E amp, three auto transition units, color generators, extensive keying, optional RGB keyer and serial RS-422 interface to editing controller.

Circle (776)

See ad page 62

#### Rusco Electronics

- Dial-up remote: portable unit with speech compressor, inputs from two microphones and one line level source; powered from Telco line to avoid batteries or power supply weight.
- IM24: line level interface matches consumer to BC equipment.

Circle (780)

#### SECOA

- CCT series: studio lighting for TV and video.



## HERE'S $\pi$ IN YOUR EYE

In any monitor, especially a near-field type, response will vary from a  $2\pi$  (wall/soffit) to a  $4\pi$  (free field/console) environment.

The better the performance, the more noticeable the phenomenon. In our case, with more than 20 international patents so far, this field select switch was absolutely necessary.

So that you could have the same flat response in either field or both fields.

These are Point Source reference monitors. Coaxial, and time compensation adjusted in a true concentric design. Stereo imaging the way it happens in nature.

They also take lots of power without distortion or complaint. They are stunning.

Audition the Near-Field Point Source Reference Monitors. From Fostex. RM-765 (6½" woofer) and RM-780 (8" woofer). Both with patented RP Technology. For flat response in both  $2\pi$  and  $4\pi$  environments.



RM765



RM780

# Fostex®

Pro Sound Division

FOSTEX CORPORATION OF AMERICA

15431 Blackburn Avenue, Norwalk, CA 90650 (213) 921-1112

Circle (121) on Reply Card

# Total Radio Recall.



The Dictaphone 5600 Veritrac™ voice communication recording system is a complete broadcast recording-retrieval system that lets your radio station keep its entire broadcast day on the record. In one dependable unit you get around-the-clock verification that you're running your advertiser's spots on schedule and meeting all your FCC requirements. So if they ask for proof, you've got it all there on tape, ready for quick retrieval and replay.

Tune into the Dictaphone 5600 Veritrac logger. And never get your signals crossed again.

For more information, fill in the coupon or call toll-free:  
**1-800-431-1708** (Except in Hawaii and Alaska) In New York call **1-914-967-2249**  
**Or mail to: Dictaphone Corporation,**  
**120 Old Post Road, Rye, NY 10580**

Name \_\_\_\_\_  
 Title \_\_\_\_\_ Phone \_\_\_\_\_  
 Company \_\_\_\_\_  
 Address \_\_\_\_\_  
 City \_\_\_\_\_ State \_\_\_\_\_ Zip \_\_\_\_\_

Dictaphone® and Veritrac are trademarks of Dictaphone Corp., Rye, N.Y. ©1985 Dictaphone Corp. QBE-65



**Dictaphone**

A Pitney Bowes Company  
 Circle (122) on Reply Card

## SECOA (continued)

- Minuet: cyc lighting system. Circle (788)

## SG Communications

- Antenna and tower service. Circle (792)

## SWR

- Coaxial switch: adaptation converts existing RF patch panel to coaxial switch without modifications to current equipment.
- K-line flange: enhancement to 4 1/16-inch coaxial feed line.
- Clarion: waveguide VHF transmitting antenna. Circle (827)

## Sachtler

- Video 20: studio and OB pedestal; lightweight, stable tripod with pneumatic center column; can be used with Semi Dolly.
- Hot pod: tripod for ENG.
- Semi Dolly: lightweight triangular dolly, independent brakes and cable guards; folds to minimum volume with hand grip for carrying. Circle (781)

## Saki Magnetics

- Base plate: for ATR100 2-track and 1/4-inch and 1/2-inch machines; duplicates all functions of original. Circle (782)

## Samson Music Products

- TH-1: body pack VHF highband wireless transmitter for instrument or lavalier mic.
- RH-1: single-channel highband VHF receiver. Circle (783)

## Schafer World Communications

- Automation products for radio. Circle (784)

## Schneider

- TV64/65/66: 14.5x wide-angle lens in 2/3-inch, 1-inch and 1 1/4-inch formats; optional integral diascope.
- Type TV80: 17x zoom lens with 2x extender for 2/3-inch format camera. Circle (785)

## Schwem Technology

- 60/300 image stabilizer: gyroscopic device in lens system eliminates or significantly reduces jitter and unwanted movement during hand-held or vehicular camera operation. Circle (786) [See inside back cover](#)

## Scientific-Atlanta

- Portable earth terminal for Ku-band.
- RFT-1200: integrated RF terminal for Ku-band.
- B-MAC transmission system products.
- DPS-185: digital test generator, 32 switch-selected signals, two inde-

pendent outputs.

- 6380: BTSC stereo encoder. Circle (787)

## Selco/Sifam

- AL19, AL29: audio level indicators.
- R22F, R32F: full spec VU meters.
- 22A, 32A, 34A: peak program meters. Circle (789)

## Sennheiser Electronic

- SK-2012 system: wireless body-pac transmitter and UHF or VHF EM-202 modular, wireless body-pac receiver VHF.
- SKM 4031: hand-held wireless transmitter; UHF or VHF.
- EM-2003: single-channel diversity VHF receiver.
- EM-1001: single-channel receiver.
- EM-1036: multichannel diversity modular receiver; rack-mount UHF or VHF.
- MKE-212: boundary microphone.
- MD 441V3: dynamic mic. Circle (790) [See ad page 146](#)

## Sescom

- Series PO: miniature modular system with power supply mini-amplifiers, DAs, 3-channel mini-mixers, phono pre-amp, source and output selector. Circle (791) [See ad page 153](#)

## Sharp Electronics

- XC-A1: low-cost 3-tube Saticon II camera for corporate and CATV production.
- XM-1900: high resolution color monitor with comb filtering.
- XM-900: utility TV color monitor, 1/2-rack ac/dc power.
- XC-89CAB/CAB: VTR format adapters interface XC cameras to Beta and M VTRS. Circle (793) [See ad page 55](#)

## Shintron

- Product line of character generators, composite, component video switching equipment, routing switchers and time code equipment. Circle (794)

## Shively Labs

- 2530: balanced bandpass filter combiner for 10FM 40kW inputs; bandwidths to ±150kHz; ±25ns group delay; channel-to-channel isolation 50dB or greater at carrier frequency. Circle (795)

## Shook Electronics

- 1020 Omega Van: new design on chassis where box can be removed.
- 45-foot network production trailer. Circle (796)

## Shure Brothers

- FP11: mic-to-line amplifier.
- FP12: headphone bridging amplifier.



- FP31: ENG/EFP portable mic mixer.
- SM83-CN: omnidirectional and lavalier condenser mic.
- SM90, SM91: surface-mount microphones with mono- and unidirectional characteristics.
- FP-16: 1x6 audio DA.

Circle (797) **See ad page 36, 80**

#### **Sigma Electronics**

- SCH-385: subcarrier, horizontal phase meter.
- VSS-120: video switcher with stereo audio control, 12x1 configuration.
- VSD-200: video and stereo audio DA system; 1x6 configuration.

Circle (798)

#### **Si-Tex Marine Electronics**

- CR-1011: color weather radar system.

Circle (799)

#### **Skotel**

- TCG-80N/006: LTC/VITC jam sync time code generator.

Circle (800)

#### **Warren R. Smith**

- Graphics and animation equipment.

Circle (1304)

#### **Softpedal**

- Business software for IBM and compatible PCs.

Circle (801)

#### **Softube Company**

- Softube lights: fluorescent type lighting in 3200°K, 5600°K, cool white and warm white; 2.5 times the output of conventional fluorescent tubes.

Circle (802)

#### **Solid State Logic**

- Series SL 5000 M: computer-controlled TV audio consoles, for mono, stereo and multichannel production; modular; accommodates from 12 to 42 mono/stereo inputs; signal processing for each input.
- SSL synchronizer: 5-machine control system; distributed microprocessor design; for ATR, VTR or film.
- SSL programmable equalizer: console-mounted control panel, remote electronics, two channels of 3-band parametric EQ and stereo pan.

Circle (803)

#### **H.A. Solutec**

- SOL-6800 ADID/Q: generator for ID code on commercial spots.
- SOL-6800: automated broadcasting system for commercial insertion; controls one VTR; integrated 4-input stereo audio, video switcher; satellite cue-tone triggered.
- SOL: two or three levels component video switcher for SOL-6800 system.

Circle (804)

#### **Sono-Mag**

- ESP-2: automation programmer system for radio.

Circle (805)

## “UNEQUIVOCALLY THE BEST TCR-100 CARTRIDGE AVAILABLE”

— Expressed by engineers at over 100 TV stations across the U.S.



National Video Service is confident you, too, will be sold on our TCR-100 cartridge. That's why we're offering you a **free sample**, one test and you'll be hooked. To receive your free TCR-100 cartridge call (415) 846-1500.

### THE BEST PRODUCT

Reliability is one of the most important features to look for in a TCR-100 cartridge. You can always trust National Video Service's TCR-100 cartridges. It is manufactured to RCA's TCR-100 specifications, and has Lexan<sup>®</sup> door latches to provide a *lifetime guarantee* against the number one breakage problem of the competition! To provide the best quality, NVS uses only 3M Scotch 400 video tape.

### THE BEST PRICE

National Video Service will not knowingly be undersold on any of our services. New, one minute message cartridges are as low as \$2495.

**Emergency?** National Video Service offers same day shipping via pre-paid Federal Express.



#### **National Video Service**

2150 Rheem Drive  
Building G  
Pleasanton, CA 94566  
(415) 846-1500

TCR-100 New Cartridge Sales • Reloading • Trade-In-Exchange

Circle (102) on Reply Card

## DON'T GET CAUGHT WITHOUT ONE



### CODE PHASE CORRECTOR CPC 700 SERIES

Have you ever experienced the trauma of having your editing computer refuse to edit due to the SMPTE Cue Code being out of phase with the video? Fear no longer, as the CPC-700 equipment automatically re-phases and transmits a corrected code for computer acceptance and happiness.



504 W. CHAPMAN AVE.  
SUITE P  
ORANGE, CA 92668  
714-997-4151

Circle (103) on Reply Card

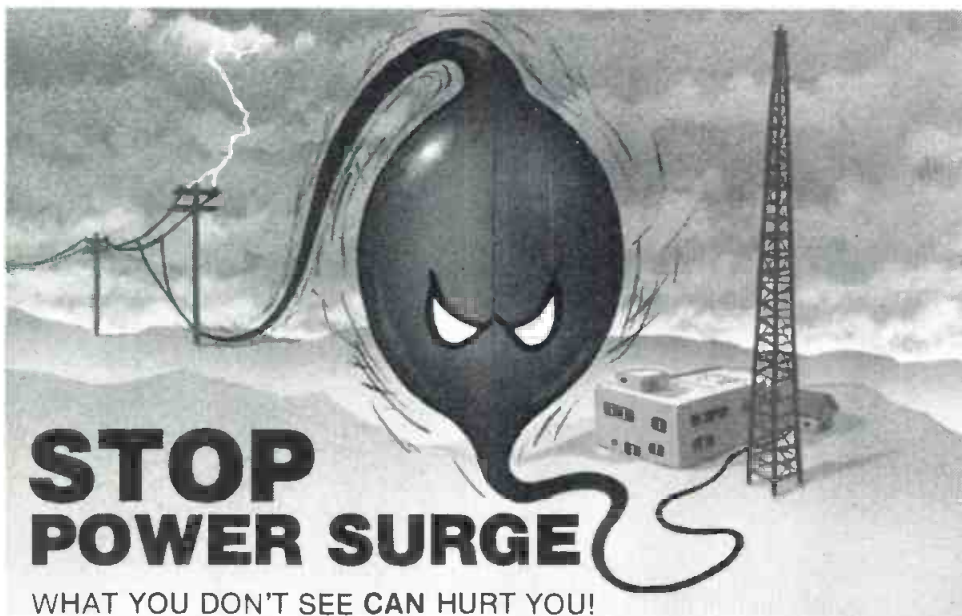

# STOP POWER SURGE

WHAT YOU DON'T SEE CAN HURT YOU!

Installed between the power source and equipment to be protected, the LEA line of Surge Eliminators will prevent equipment loss and downtime due to High Current Surges, Overvoltage Transients and EMP.

They're available in powerline current ratings from 10 to 4,000 amperes for computer, Radio/TV Broadcast, industrial and other loads.



LEA Dynatech Inc.

TWX: 910-586-1381

#### LEA Surge Eliminators:

- Handle up to 50,000 joules of energy
- Dissipate 99% of lightning surges
- Handle surge currents up to 200,000 amperes
- Respond in 5 nanoseconds
- Are available in 1 through 3300 KVA ratings
- Automatically reset
- Use a Multistage SERIES hybrid design

12516 Lakeland Road  
Santa Fe Springs, CA 90670  
(213) 944-0916

Circle (104) on Reply Card

# NO OVERLOAD. NO MATTER WHERE YOU USE IT.

In-studio or on-location from a whisper to the roar of a full-blown rock concert, nothing can overload our MD 421. *Nothing.*

**NOW WITH  
2-YEAR  
LIMITED  
WARRANTY**



**SENNHEISER®**  
Sennheiser Electronic Corporation (N.Y.)  
48 West 38th Street • New York, NY 10018 • (212) 944-9440  
Manufacturing Plant: D-3002 Wedermark, West Germany  
©1985 Sennheiser Electronic Corporation (N.Y.)

Circle (105) on Reply Card

## Sony

### (Broadcast Products)

- BVM-8021 field monitor: 8-inch high resolution.
- Auto monitor setup device: in prototype, for BVM-1900.
- BVP-3A: Betacam camera.
- BVP-360 camera: production models.
- BVW-11 VCR player: complements BVW-10 systems.
- BVW-15: studio player.
- BVW-25: field recorder/player.
- HDTV system includes TV projector.
- BVP-3000/BVH-2700 Super Motion: camera/recorder system.
- BVT-810 TBC: for BVU 800 VCRs.
- BK-2150 TBC: for BVH-2000 series: plug-in module.
- CA-31: triax adapter converts BVP-3A/-30 to -360.

### (Pro Audio)

- APR-5000 analog ATR: uses 16-bit digital deck control.
- ECM-series: 55, 66, 77 lavalier mics, in black or nickel-plate.
- PCM-3102: 2-channel digital ATR; production model; DASH system.
- MX-P61VU/PK: portable 12-channel audio mixer.
- K-1105 digital mixer: prototype 8-channel system including signal processor, control unit and A/D, D/A units.
- APR-2003: portable 2-channel recorder for ENG/EFP and film sound.

### (Tape Sales)

- HG Betacam tape: 5- and 30-minute cassettes.
- VI-K: 1-inch tape with Vivax magnetic material.

### (Video Communications)

- Vidimagic FP-60: video projector with tuner and Betamax VCR.
- VO-6800: portable U-matic VCR: 12 pounds; video confidence head.
- DXC-M3A: 3-tube camera.

Circle (806)

See ad pages 24, 25, 72, 73

### Soundcraft Electronics

- SAC2000: stereo on-air console for radio.
- Series 20: microprocessor-controlled 2-track audio recorder.
- Series 600: 8-bus recording console.

Circle (807)

### Sound Technology

- Series 2000 and 3000: programmable, bus-controllable signal generators and distortion analyzers; single and dual channels; integral computer controller; applicable to radio and TV proofs.

Circle (808)

### Southlake Technologies

(formerly Datatronix)

- TLC-224: intelligent telephone interface; auto-nulling; 4-wire to 2-wire conversion; handles two lines.
- Intelligent Intercom: software programmable intercom, party line



and point-to-point IFB in one system.

- 318: compact, high quality audio distribution amp and powered trays.
- API equalizers and other audio components.

Circle (809)

#### Spectratek/ESS

- Spectrastar and Novastar: in-camera visual effects.

Circle (810)

#### Spectrum Planning

- Engineering and consulting services.

Circle (811)

#### Spencer Broadcast

- ATK-1: Audio-path stereo phone pre-amp with axial tilt correction.
- SO-2: Audio-path stereo separation optimizer.
- EPA 250: Technics tone arm for SP-015, SP-10 turntables, QSC audio amplifiers.
- Sansui Line with AM stereo.

Circle (812)

#### Sphere Electronics

- MAX-EQ equalizer: portable system provides space and power for light and sphere equalizers.

Circle (813)

#### Sprague Magnetics

- Film heads for Magnasync, MTM, Quad-Eight/Westrex and Steenbeck.
- Replacement heads for Sony BVH-1000 and BVH-2000.
- Duplicator heads for Cetec Gauss and Electro Sound.
- Replacement cartridge heads.

Circle (814)

#### Stage Lighting

- 1280: Opti-Mist fog and smoke machine.
- 1580: Mini-Mist fog and smoke machine.
- 8080: Maxi-Mist fog and smoke machine.
- SLD100: automatic color changer.
- Q6A1: auto iris control for ellipsoids.

Circle (815)

#### Stainless

- Product line of guyed, self-supporting towers for TV, FM, AM, microwave; multi-use to 2000 feet.

Circle (816)

#### Stanton Magnetics

- Dynaphase 30M: single-sided headphone; 100 $\Omega$  or 600 $\Omega$ .
- UD-100G, UD-100B: pro disco unidirectional dynamic mic; 500 $\Omega$ ; 60Hz-15kHz.
- Narrator: headphone/mic combination with 20Hz-20kHz response; gooseneck boom; 32 $\Omega$  headphones.
- 681 EEE MK II-s phono cartridge.

Circle (817)

#### Stanton/Unit of Zero

- Product line of equipment racks and enclosures.

Circle (818)

#### Star Case Manufacturing

- Equipment transport cases: air-line approved.

Circle (819)

#### Steenbeck

- ST201V: video recorder and video-cassette machine with electronic control and synchronizing system; tabletop controls.
- ST1B: 35mm film-to-tape transfer unit with electronic counter; loop programming and interlock capabilities.

Circle (820)

#### Storeel

- Room Stretchers: high-density storage system for Beta and VHS cartridges.

Circle (821)

#### Straight Wire Audio

- Stereo Sentinel: automatic stereo synthesizer.
- 3D/RP: playback amp for ITC machines.
- MTS L+R/L-R matrix processor.

Circle (822)

#### Strand Century

- Product line of lighting instruments, dimmers and dimmer controllers.

Circle (823)

#### Studer Revox

- A820: audio recorder, microprocessor-controlled functions and internal settings.
- A725: broadcast compact disc player.
- A80 Mkiv: multitrack audio recorder.
- A80VU-3LB: 1-inch B and C video playback recorder.
- B215: cassette deck with automatic alignment and level setting.

Circle (824)

See ad page 39

#### Swintek Enterprises

- MARK 200/AC: mini full-duplex radio intercom system, for use with hard-wired intercom links from TRS and Clear-Com; powered from the hard-wire; accepts external tone-encoded feeds.
- MARK QDC: Wireless mic system for use with TV cameras.
- 2L/RFS: ac switching diversity receiver featuring DBS compounding; crystal discriminators.
- SM 87: hand-held wireless equipment with Shure SM 87 mic element.
- NB-D: rechargeable NiCad belt power pack; contains H6900 transceiver batteries.

Circle (825)

#### Switchcraft

- Series TPC: PC board jackfields.

Take  
a long  
look...  
And  
listen!

Model  
AT859

You've seen long skinny mikes before. But not like this one. The AT859 is both long and skinny and an excellent cardioid microphone. In fact, its small diameter makes it a better cardioid than the fat ones!

With its extendable wand, it makes the perfect mike for interviews, talk shows... wherever you need to get the mike close while you stand back. Phantom or battery powered to go anywhere.

It's just one of a series of Audio-Technica advanced-design UniPoint™ condenser microphones designed to solve sound problems without getting in the way. See them now at your nearby Audio-Technica sound specialist, or write for literature today.



audio-technica.

1221 Commerce Dr., Stow, OH 44224  
(216) 686-2600

Circle (106) on Reply Card

*Switchcraft (continued)*

- Series RAPC: right-angle PC mount audio connectors, receptacles.
  - Series E: audio connectors and receptacles.
- Circle (826)

**Symetrix**

- 108 & 104: multiline broadcast telephone interface system.
  - DCS-16: transmitter remote control system.
- Circle (828)

**Symtec**

- Supercolor 1024: graphics system

- and titler; operates on 68000 microprocessor and IBM PC-XT; with 1024 displayable colors available; NTSC or RGB outputs.
  - PGS III 2+2: memory expansion upgrade of PGS graphic system.
  - FontCreat: IBM PGXIII software for pixel-mapped characters and art.
  - Overlay System: graphics generator allows computer art overlay onto NTSC video.
- Circle (829)

**System Associates**

- Broker of used broadcast equipment.
- Circle (830)

**Systemation**

- Systemation: Computer automation for radio stations using cassette format.
- Circle (831)

**3M Magnetic Audio/Video Products**

- Premium grade U-matic cassette.
  - Super High Grade Beta and VHS cassettes for 1/2-inch camera systems.
  - 6600: control system, five multi-faceted control panels.
  - Artronics/3M: graphic art system; 24-bit architecture; anti-aliasing; camera input.
  - Graphics packages: AniMagic animation; PC graphics software; service bureau slide production; Quick-Proof printout software; Ink/et printer interface.
- Circle (665) See ad page 129

**3M Stormscope**

- Stormscope: thunderstorm mapping system.
  - Model WX-120: radio applications.
  - Model WX-140: TV applications.
- Circle (666)

**TFT**

- 831: TV/SAP generator.
  - 832: TV/Pro channel generator.
  - 850: TV stereo modulation monitor.
  - 8500: TV/microwave composite sub-carrier generator.
  - 8501: TV/microwave composite sub-carrier demodulator.
  - 840: AM stereo exciter.
  - 841: AM stereo monitor.
- Circle (843) See ad page 85

**TSM**

- HS-100P: servo-controlled pan/tilt system.
  - Micro-controller: for HS-100P; provides 100 presets for zoom, focus, pan and tilt for single camera.
  - Micro-controller IV: controls HS-100P systems for four cameras; includes 20 motion memories.
- Circle (849) See ad page 122

**TTC-Television Technology**

- 8090 series: FM transmitters with single PA tube and advanced control circuitry.
  - LA2C limiter.
  - S/A series: line surge protectors.
  - XL20: 20W UHF translator.
  - XLFM: FM translator.
- Circle (1365)

**Taber**

- 2200: single-line full duplex telecommunications interface.
  - 2202: 2-line telecommunications interface.
  - 2204: 4-line telecommunications interface.
- Circle (832)

**Taft TV and Radio**

**NEW**

# Better than BMX! Ahead of Auditronics! Astounding Price!

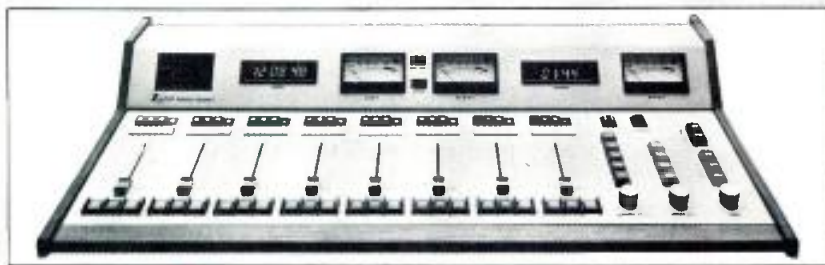

## The Logitek **PERFECTIONIST** 8 and 12-Channel Broadcast Consoles

	<b>PERFECTIONIST</b>	<b>Audi. 200</b>	<b>BMX</b>
Max THD	<.1%	<.15%	<.3%
Inputs/ mix channel	4	2	2
Fader Type	rotary or slide	slide only	slide only
Connectors	remote punch blocks	internal plugs	rear panel Molex
Switches	hall-effect	hall-effect	mechanical
Warranty	5 years	1 year	not listed
Price (8 ch/12 ch)	\$8,500/10,500	much more	even higher

**CALL 800-231-5870**

(Texas, Alaska, Hawaii call 713-782-4592 collect)  
for full information and the name of your  
Logitek *Instant Action Dealer*.

**Logitek** Electronic Systems, Inc.

Circle (107) on Reply Card



- Up/downlink services.

Circle (833)

#### Tamron

- H12x9.5BEII: ENG lens for 2/3-inch cameras; f/1.6 to f/2.0; 2x extender; 48mm back focus.
- H12x9.5CEII: ENG lens for 2/3-inch cameras with 58mm back focus.
- H14x9BI: for 2/3-inch ENG cameras; f/1.6-1.9; 48mm back focus.
- Lens accessories: remote focus systems with servo and zoom gear modules.

Circle (834)

#### Tandberg of America

- TCD 900 series: professional cassette decks.
- ID 20A-L: logging recorder.

Circle (835)

#### TASCAM, TEAC Professional Division

- MS-16: 1-inch 16-track ATR; includes compatibility with SMPTE interlock, +4dBm XLR connectors, 10-point autolocator and dbx.
- T-2640 duplicators: MS and 2S versions for master-slave and 2-slave connections.
- M-300 mixers: recording and PA systems in 8-, 12- and 20-input configurations.
- Porta-One Ministudio: 4-input mixer combined with standard speed cassette recorder.
- 225 cassette deck: 4-track, 2-channel recorder; allows independent recording on left and right channels.
- 48X recorders: logging recorder systems using an 8-track design.

Circle (903)

See ad page 47

#### Tekskill Industries

- System 909: Teleprompter specifically designed for ENG/EFP cameras.
- 909T: text table for material up to 10 inches wide; with remote control.
- 909V: Teleprompter video head with folded optics.

Circle (836)

#### Tekskill

- Distributors of amplifiers, cartridges, cart machines, cassette decks, consoles, digital delays, headsets, intercount logging systems, microphones, processing equipment, speakers, tape machines, tuners and turntables.

Circle (837)

#### Tektronix

- 1710B series: NTSC or PAL waveform monitor; helps monitor burst phasing for system timing adjustments.
- 1750 waveform/vector monitor: simultaneous display of waveform and vectors with display of SC/H phasing; for NTSC and PAL.

# SPECIFY EXCELLENCE!

from the company who pioneered equalization

## • ACTIVE AND PASSIVE EQUALIZERS

18 different Models to choose from

## • REAL TIME ANALYZERS

Octave Band, one-third and one-sixth octave

## • BI-AMP AND TRI-AMP CROSSOVERS

Low-level at any frequency and slope

## • NARROW BANDWIDTH NOTCH FILTERS

Control of room feedback and ring modes

## • CUSTOM FILTERS FOR AUDIO APPLICATIONS

High-pass low-pass band-pass notch

SEND FOR OUR COMPLETE PRODUCT CATALOG



INSTRUMENTS, INCORPORATED  
P.O. BOX 698  
AUSTIN, TX 78767  
(512) 892-0752  
TELEX 776409 WHITE INST AUS

Circle (108) on Reply Card

## Nady VHF. The best sounding wireless is now also the most user friendly.

NADY 601 VHF RECEIVER

NADY 701 TRUE DIVERSITY RECEIVER

501 LT TRANSMITTER WITH LAVALIER MICROPHONE

601/701 LT TRANSMITTER BODYPACK IS THE SMALLEST IN THE BUSINESS. INCLUDES PHANTOM POWERING FOR ANY LAVALIER MIC.

NADY 501 VHF RECEIVER — OUR NEW AFFORDABLE VHF SYSTEM

601/701 HT AUDIO TECHNICA PR-60 ELEMENT. DIMENSIONS: 8.75" x 1.44", TAPERED. WEIGHT: 0.5 OZ.

601/701 HT WIDE CHOICE OF POPULAR ELEMENTS AVAILABLE.

HANDHELD MICROPHONE/TRANSMITTERS

Virtually all of today's major touring entertainers choose Nady VHF wireless microphone systems. Why? Because Nady consistently delivers the highest quality audio and the most reliable radio transmission in the high SPL environment of the performing stage. We pioneered the use of compansion for increased dynamic range years ahead of everyone else. And Nady technology continues to set the standard in wireless system performance.

From our affordable new 501 VHF to the 701 True Diversity system, the best sounding wireless is now also in the best format for production — as well as stage — applications. Features include a versatile audio output arrangement, full LED status indicators, and the smallest, toughest transmitter bodypack in the business. Everything you need in a wireless microphone system — plus the legendary Nady sound.

Contact your sound equipment supplier and arrange for a Nady VHF demonstration. You'll see — and hear — what we mean.

NADY SYSTEMS, INC., 1145 65TH STREET, OAKLAND, CA 94608 • 415/652-2411  
CANADA: HEINL ELECTRONICS, INC., 14 MARY STREET, UNIT 1 • AURORA, ONTARIO L4G 3W8 • 416/727-1951



Circle (109) on Reply Card

### Tektronix (continued)

- TSG-170A: signal generator: sync and test signals from front-panel selector include SMPTE bars, audio tone and video source IDs.
- TSG-300 video generator: 10-bit digital techniques produce all analog component format signals for 525/60 and 625/50 TV systems.
- 1434 video noise generator: a controlled noise source to evaluate how equipment handles noise on a video signal.
- 1450 demod upgrades: one for multi-channel wideband sound compatibility; for PAL-D (China).
- 118-F02: video interface allows use of 118-AS audio synchronizer with any video synchronizer; PAL or NTSC.
- Lightning: a proposed method to monitor and to measure component video parameter interrelationships and delays.

Circle (838)

See ad page 45

### Telemet

- 4501B: precision broadcast stereo audio demodulator.
- 3710B: precision broadcast stereo audio demodulator.
- Product line of fiber-optic links and routing switchers.

Circle (1200)

### Telemetrics

- TM-832: remote control pan/tilt system that can be operated with twisted pair audio link and local power; smooth, slow and fast modes; 360° continuous rotation in triax mode.
- TM-8505: coax connected control system with compact, lightweight battery-operated camera adapter; coax cable up to 500 feet, video, audio, interphone, controls, genlock, 3½-inch-high base station rack.

Circle (1201)

### Telepak San Diego

- T-scope: TEK 1740/50 waveform/vector pak.
- T-GRA: Nagra recorder pak.
- T-Gaf, T-MiniGaf: grip and gaffer paks.
- T-20, T-68, T-50TCG: paks for Sony BVW-20, VO-6800 and BVW-50 with TC generator pocket.

Circle (839)

### Telescript

- C-64 prompter: prompting program for Commodore C-64 personal computer.

Circle (840)

### Television Engineering

- Latest design in mobile vehicles.

Circle (841)

### Television Equipment

- Freedom-1: Racal ultra-light headsets with cushioned, flat-surface receiver; fully adjustable headband; miniature microphone; 2 oz. approximate weight.
- MCL 420B: satellite receiver sub-carrier filter; reduces herringbone pattern interference.
- MDP525B: filter maintains 75Ω impedance across video band per NTSC comparator; for control of 16 devices.
- List management software.

Circle (842)

### Telex Communications

- FMR-50 wireless mic: four models offer condenser or dynamic mic in hand-held configuration or electret lavalier or head-worn mic with belt pack transmitter.

Circle (904)

### Tennaplex

- Transmission and receiving antennas for radio and TV.

Circle (905)

### Tentel

- HPG-C: Video head tip protrusion, drum eccentricity gauge for type C VTRs.
- T-H18-CBD: tape tension gauge for type C VTRs.

Circle (906)

## STOP GROUND-LOOP HUM!

### VIDEO HUM STOP COIL...HSC 1

Will ELIMINATE HUM and other INTERFERENCE in Video Lines caused by differences in Ground Potential.

- For Color and Black and White.
- FLAT-DC to 6.5 MHZ.
- No Low-Freq. or Hi-Freq. Roll-off.
- No Differential Phase Distortion.
- No Differential Gain Distortion.
- No Envelope Delay.
- Passive Device - Failure Free-Low Price.
- Small Compact Package 4" x 4" x 2-1/4".

### ELIMINATES HUM AND INTERFERENCE:

#### IN STUDIO

- Between Buildings
- On long runs in Buildings
- Between Studio and Transmitter
- On Incoming Telco circuits
- On Outgoing Telco circuits

#### IN FIELD

- Betw. Remote Truck and Telco
- Betw. Remote Truck and Microwave
- For Intertruck Hookup
- For VTR Units
- For Monitoring Lines

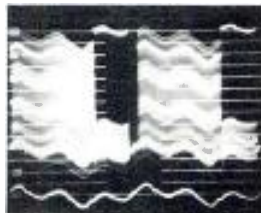

NEW!

\$190  
F.O.B.  
N.Y.

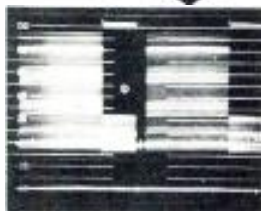

Available on  
10 day free trial

AUDIO-VIDEO ENGINEERING COMPANY  
65 Nancy Blvd., Merrick, N.Y. 11566  
Tel. (516) 546-4239

Circle (110) on Reply Card

## Versatility. Flexibility.



### Versapatch.

Gentner Engineering's Versapatch is the only chassis-enclosed patch panel with the unique Flexiblock termination. With Versapatch, you get the ease of punch-down connections combined with high density (up to 8 connections per circuit) and the flex strength of stranded wire.



Whether you're rewiring your facility or upgrading a room, Versapatch will make your job easier.

The  
Clear  
Choice.

**GENTNER**  
ENGINEERING COMPANY, INC.

540 West 3560 South  
Salt Lake City, Utah 84115  
(801) 268-1117

Circle (111) on Reply Card



### Thermodyne

- Transportation cases.
- Circle (907)

### Thomson-CSF Broadcast

- TTV-1624 camera: Betacam system using camera outfitted with Plumbicon tubes.
- 5700 NTSC: chroma processor with black stretch feature.
- Vidifont updates: back-to-basics system for quality basic titling requirements; GraphicStore disc storage library system.

Circle (908)

### Thomson-CSF/Tube Division

- TH-3639A: 160W Ku-band TWT for portable uplinks.
- TH-3689: 85W Ku-band TWT for portable uplinks.
- TH-563 tetrode: 50kW rated tube for TV broadcast.
- TH-558 tetrode: 500kW PA tube for shortwave applications.

Circle (909)

See ad page 161

### Thorn EMI/E Nelson

- CID lamp sealed beam; 1200W.
- CID lamp sealed beam; 575W.

Circle (846)

### Tiffin

- MCS: filter holder system;

attaches to camera magnetically.

Circle (910)

### Toshiba Tokyo

- Product line of TV transmitters, radio transmitters, TV cameras, satellite uplink electronics and teletext system.

Circle (847)

### Transimage House Int'l.

- TS-102: TBC time sharer.

Circle (848)

### Trident

- Series 75: audio console includes 24-monitor system in 24-bus board; standard configuration of 28-inputs.

Circle (911)

### Trompeter Electronics

- RF, video connectors, audio patching systems, cables and plugs.

Circle (912)

### Ultimate Support Systems

- Mounting and support products for lighting and mics.

Circle (913)

### Ultimatte

- Ultimatte-5: improved version of

video compositing (keying) system.

Circle (914)

### Unicol Products

- Stands, trolleys and interchangeable components for supporting audio-visual, electronic and video equipment.

Circle (850)

### Union Connector

- SU-1 dimmer: rated at 2.4kW load; remote control from computer.

Circle (915)

### Uni-Set

- Table systems for quick set construction; scenery.

Circle (916)

### United Media

- Image Artist: image processing system combines effects with graphics input system.
- 500 sequencer: control of 16 devices possible with real-time or time-code comparison system.
- Mini-Comm editor: A/B-roll edit controller; upgradable; for three VTRs includes switcher interface; EDL.

Circle (917)

### United Press International

- UPI-I: updated version of broadcast

# SONEX CONTROLS SOUND.



With its patented anechoic foam wedge, SONEX absorbs and diffuses unwanted sound in your studio. And it can effectively replace traditional acoustic materials at a fraction of the cost. SONEX blends with almost any pro audio decor and looks

clean, sharp, professional. Check into this attractive alternative for sound control. Call or write us for all the facts and prices.

SONEX is manufactured by Illbruck and distributed exclusively to the pro sound industry by Alpha Audio.

**Alpha Audio**<sup>®</sup>

2049 West Broad Street  
Richmond, Virginia 23220 (804) 358-3852

Acoustic Products for the Audio Industry

Circle (112) on Reply Card

## The only professional tone arm reliable as an LPB<sup>®</sup> console.



- Lightweight alloy head shell and arm
- Removable head shell accepts all standard 1/2" mount cartridges
- Adjustable arm height
- Plug-in 60" output cable assembly with molded plugs and separate ground wire
- Extremely low friction horizontal and vertical pivots utilize miniature high precision ball bearings
- Adjustable lateral balance weight
- User Net-\$85

Call your LPB Dealer or LPB

**LPB**<sup>®</sup>

LPB Inc.  
28 Bacton Hill Road  
Frazer, PA 19355  
(215) 644-1123  
Telex: 70300

© 1985, LPB Inc.  
is a registered trademark of LPB Inc.

Circle (113) on Reply Card

**CDE CORNELL-DUBILIER**

## Mica Capacitors

LARGE

STOCK



## VACUUM CAPACITORS

**ITT JENNINGS**

**SURCOM ASSOCIATES, INC.**

305 Wisconsin Avenue  
Oceanside, California 92054  
(619) 722-6162

Circle (114) on Reply Card

## ALUMA TOWERS

FIXED BASE, MOBILE TRUCK,  
TRAILER OR VAN TYPE

### EXCELLENT FOR REMOTE SIGNAL TRANSMISSION

- TELESOPING—TO 100 FEET
- EASY TO ERECT AND USE
- MOBILE OPERATIONS
- INEXPENSIVE
- RELIABLE

FOR ALL TYPES OF  
COMMUNICATIONS



▲ MOBILE TRUCK TYPE ▼



FIXED BASE TYPE

MOBILE VAN TYPE

**ALUMA TOWER COMPANY**

BOX 2806BE  
VERO BEACH, FL 32960-2806  
(305) 567-3423 TELEX 80-3405

Circle (115) on Reply Card

### UPI (continued)

computer.  
Circle (851)

### United Research

• AS6002M: 3-speed reel-to-reel recorder.  
Circle (852)

### United Ropeworks Phillystran Division

• Product line of electrically transparent tower-guy materials.  
Circle (853) [See ad page 106](#)

### URSA Major

• MSP-126: multtape stereo processor; 20kHz bandwidth; eight processing modes; switchable input for mono operation.  
• 8x32-Mk II: digital reverb system to 20s decay time; 64 memories, eight reverb programs; optional remote control.  
Circle (854)

### Utah Scientific

• AVS-1B: routing switcher with eight levels of switching; standard matrix 260x320; expandable; reprogrammable control panels; redundant control; memory systems.  
• Control systems: dumb terminal series controller for AVS-1B; six different 4-level reprogrammable panels.  
• Machine control system: per proposed SMPTE control bus standards.  
• Station automation hardware: features speed, flexibility and failure protection.  
• Party line machine control system.  
Circle (855) [See ad pages 50, 51](#)

### Valley People

• 440: Limiter, compressor and de-esser; single-channel multi-function audio processor.  
Circle (856) [See ad page 117](#)

### Varian EIMAC/Utah

• 3CX1200A7: linear triode tube.  
• 4CX1500BC: linear tetrode tube.

### Varian Associates

(Microwave Equipment Division)  
(Microwave Tube Division)

• VPW-6890: 800W TWT power supply, integral with Ku-band TWT amplifier.

### Varian EIMAC/California

• 4CM400,000A: multiphase cooled tetrode; 500kW for MW; short-wave broadcast service.  
• CV2225: 5kW FM cavity.  
• CV2228: 10kW FM cavity.  
• CV2202: 30kW FM cavity.  
• CV2230: 60kW FM cavity.  
• CV2242: 14kW lowband VHF TV cavity.  
• CV2252: 15kW highband VHF TV

cavity.

• Klystrode: UHF TV high efficiency tube.  
• 3CX500A7: focus triode.  
• 4CX20,000D: tetrode power tube.  
• BCX5000U7: tetrode power tube, UHF.  
• 4CX25,000A: triode power tube, HF.  
• 3CX10,000B7: triode power tube, HF.  
• AM-2215: solid-state amplifier, 86MHz to 108MHz.  
• 3CX800A7: triode power tube; VHF.  
• 3CX500A7: triode power tube; HF.  
• 4CV100,000E: tetrode power tube; HF.  
Circle (857) [See ad page 33](#)

### Vector Technology/CSP

• 600-175-2: isocoupler.  
Circle (858)

### Video Associates Labs

• Microkey system RGB for the PAL overlay.  
• Overlay for AT&T computer.  
• Interactive training program.  
• Post-production editing software using IBM-PC.  
Circle (859)

### Video International

• STC 2003/4: digital standards converter system handles all standards; incorporates time base corrector, frame synchronizer, effects generator and 12dB of noise reduction (EBU standard).  
Circle (860)

### Videomagnetics

• Product line of VTR head refurbishing services.  
Circle (861)

### Videomedia

• EAGLE XR: 150-event A/B roll upgradable editing controller.  
• MAGNUM: 250-event, disc-operating system with list management.  
• VNC-202: station management and traffic control system.  
• EAGLE I, II, III: 250-event, upgradable editing controllers.  
Circle (862)

### Videoplex

• Video multiplexers: in color and b/w offering four, nine, 13 or 16 video feeds to be displayed simultaneously on one screen.  
Circle (863)

### VideoStar Connections

• Satellite transmission services: for broadcast and corporate users.  
• Demonstration: satellite uplink.  
Circle (864)

### Videotek

• HR-130: 13-inch resolution color monitor.



## G.E., Sylvania and Wiko long life lamps

Special Prices on many  
numbers. Phone Toll Free.

**Sitler's** Supplies.  
Inc.

Box 10 Washington, Iowa 52353  
Ph: 800-426-3938 • In Iowa 800-272-6459

Circle (118) on Reply Card

FREE 32pg Catalog & 50 Audio/Video Applic.



OPAMP LABS INC (213) 934-3566  
1033 N Sycamore Av LOS ANGELES CA, 90038

Circle (116) on Reply Card



**SESCOM, INC.**  
1111 Las Vegas Blvd. North  
Las Vegas, NV 89101 U.S.A.

"the audio source" FOR ALL OF YOUR AUDIO NEEDS  
CALL OR SEND FOR A COPY OF OUR CATALOG  
CATALOG REQUESTS & ORDERS: (800)634-3457

OTHER BUSINESS: (702)384-0993 TWX (910)397-6998

Circle (86) on Reply Card

## PRECISION MAGNETIC TEST TAPES

**STL**



Standard Tape Laboratory, Inc.  
26120 Eden Landing Road #5, Hayward, CA 94545  
(415) 786-3546

Circle (87) on Reply Card

## Have "TWO-SHOT" Will Travel

- Switcher
- Mixer
- Identifier
- Color Monitors



**LANG VIDEO SYSTEMS** (800) 222-LANG  
700 Warrington Avenue  
Redwood City, California 94063 • (415) 364-1287

Circle (117) on Reply Card

Reconfirm your  
involvement in the  
broadcast industry!

Renew  
your subscription  
today.

### Videotek (continued)

- RS-183A: 18x1 computer controlled routing switcher with three audio channels.
- VIS-1200: 12x1 routing switcher.
- System 8: 8-inch professional color monitor, waveform monitor and 6x1 switcher package.
- VM-17 Pro: 17-inch rack-mount color monitor for teleproduction.
- 800 series: modular DAs; VDA-816S video; VDA-816 clamp; EQ-800 equalizer.

Circle (865) See ad pages 107, 139, 141

### Viking Cases

- Super Vikilite: equipment containers.

Circle (866)

### Vital Industries

- SAM: station automation manager.

Circle (867)

### WSI

- WSISAT: 31-level high-resolution clouds-only satellite imagery.
- FAXbrief: National Weather Service difax maps on standard, portable dot-matrix computer terminal/printer.

Circle (883)

### Ward-Beck Systems

- ST-series: TV production console with stereo submaster, master and auxiliary mix buses; standard 24-input and 36-input frame sizes.

Circle (868)

### Weather Bank

- WeatherCheck: satellite-delivered weather information system.
- WeatherBrief: Telco-delivered weather information system.

Circle (869) See back cover

### Wegener Communications

- 1739: demodulator for digital audio signals via satellite relays.

Circle (870)

### Westlake Audio

- BBSM-4: reference monitor.
- BBSM-5: reference monitor.
- MRX-2: 2-way crossover.

Circle (871)

### Wheatstone Broadcast Group

- TV-80: production console for eight to 48 inputs; discrete and VCA subgroups; remote editor control; four sends; routing and control for SAP formats.

Circle (872)

### Wheelit

- GR-3: folding video cart includes column with pan and tilt head.

Circle (873)

### Whirlwind

- FP-1: custom fabricated rack panels and audio wiring boxes.
- PB: series of passive press feed boxes line and mic level.

Circle (874)

## PNEUMATICALLY OPERATED

# TELESCOPIC MASTS

Convenient  
Compact  
Portable

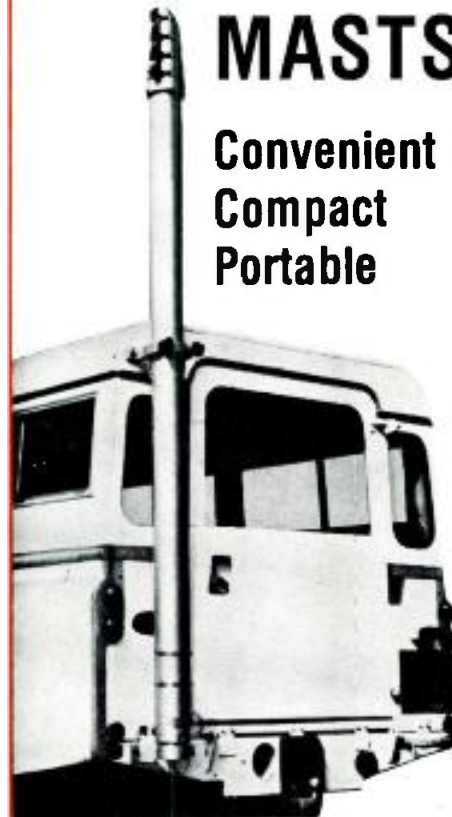

- ENG
- Fixed or Mobile Radio Communications
- Field Strength Measurements
- Camera or Microphone Support
- Noise Level Measurements
- Temporary Flood-lighting
- Environmental Sensors
- Sizes Available:  
Retracted 5.5 to 15 ft.  
Extended 20 to 92 ft.

For details contact:

**Allen Osborne Associates**  
756 Lakefield Rd.  
Westlake Village, CA 91361  
(805) 495-8420  
TWX: 910-494-1710  
U.S. Distributor for  
Hilomast Ltd., Essex, England

Circle (86) on Reply Card

New Generation  
New Generation  
New Generation  
New Generation  
New Generation

# UHF Television Transmitters

The LDM 1790 Series is a new range of high power (60–120 kW) UHF television transmitters. The first of the third generation from Pye TVT. Incorporating the latest Amperex compact klystrons, which give more power from smaller tubes. Allowing Pye TVT to build smaller and more cost-effective transmitters.

Designed specifically to suit United States requirements, these transmitters comply with FCC (CCIR 'M') transmission standards with NTSC color. They are suitable for stereo/multi-channel sound.

Pye TVT is the transmitter manufacturing center for Philips, with 40 years product development and manufacturing experience. Success has been proven in the field of UHF television and FM radio transmitters with over 2000 installed in 74 countries worldwide.



New Generation  
New Generation  
New Generation



# PHILIPS

Reliability through Quality



# Quality

# Quality



The first thing a discerning engineer wants from FM radio transmitters is outstanding technical quality – closely followed by reliability. Both virtues are inherent in the Pye TVT family of FM radio transmitters – along with superb value for money.

Their excellence is the culmination of 30 years' experience in transmitter production. Their low cost of ownership is the result of simplicity of design, ensuring minimum maintenance requirement and the high level of parts standardisation which reduces spares holdings.

Six basic transmitters provide from 15 W to 20 kW output power, extendible to 40 kW. The 15 – 100 W drive is also ideally suited to OEM applications. They all meet or exceed the world's most exacting broadcast standards.

For further information use the circle nos or send the coupon to:

## PHILIPS TELEVISION SYSTEMS, INC.

900 Corporate Drive, PO Box 618 Mahwah, New Jersey 07430. USA  
Tel: 201-529-1550 Telex: 37-62558

Canada: Electro & Optical Systems Ltd, 31 Progress Court,  
Scarborough, Ontario, Canada M1G 3V5 Tel: (416) 439-9333 Telex: 065-25431

### Please send me further information on

- UHF Television transmitters **100**
- FM Radio transmitters **101**

Name \_\_\_\_\_

Position \_\_\_\_\_

Organisation \_\_\_\_\_

Address \_\_\_\_\_

\_\_\_\_\_

### White Instruments

- 4500: active 1/3-octave graphic equalizer.

Circle (875)

See ad page 149

### Will-Burt/TMD

- TMD-5-20-157/167: telescoping mast for ENG and remote operation.

Circle (876)

### Winsted

- Mobile rollup cart: A-V equipment cart for small audio mixers, turntables, tape decks and extra VTRs.
- Betacam/Betacart: tape truck for programming setup, tape transport and portable storage.
- Sloping consoles: 19 1/4-inch rack-based for 1/2-inch editing setup.
- Consoles: paint box, electronic newsroom and editing styles.

Circle (877)

See ad page 120

### Wireworks

- MMB series: microphone multicable miniboxes; smaller-than-usual stage boxes for on-camera use.
- TE-3: microphone cable tester.
- MYJ/MYC: prism components; units that allow different channel sizes to be integrated into one system.
- MSJ/MSC: multipin input microphone splitter.

Circle (878)

### Wold Communications

#### (Satellite Division)

- Product line of satellite communications up/downlinking services.

Circle (879)

### Wolf Coach

- Satellite news gathering services.

Circle (880)

### Frank Woolley & Company

- Product line of video animation using polarized light.

Circle (881)

### World Towers

- Product line of tower and tower services.

Circle (882)

### Yamaha

- RM 602: recording mixer, 6-input, 4-track output.
- MC1204/1604/2404: recording studio consoles in 12-, 16- and 24-channel configuration, with four program, two effects and two foldback buses.
- MC1608M/2408M: monitor consoles, 16- and 24-input systems with eight output channels.
- GC2020: compressor, limiter and noise gate; 2-channel.
- D1500: digital audio delay, 16-program memory.
- Q2031: dual-channel 1/3-octave equalizer.
- S10X/S10X: compact speaker systems, for small area monitoring; 75W program rating.
- C200: stereo cassette recorder; 4-head system; two direct drive motors.
- MT44D: 4-track cassette recorder; includes Dolby B and C noise reduction.
- P series amps: stereo and mono monitor amps rated 105W to 250W per channel.

Circle (884)

See ad pages 101, 102

### Zellan Optics

- CamRail: portable flexible track system.
- Portamount: helicopter shock mount.
- Video Matte Box: for HL79/SK-91/BEM.
- Aaton: Film data track SMPTE time code on film.
- CamCulp: quick-release filter system.

Circle (885)

### Zonal Ltd.

- 675: pro recording tape for low print studio mastering high output, low noise.
- 800, 900 and 950 series: magnetic sound recording film.

Circle (886)

!:-:)))

Now there  
are 3  
ways to  
purchase  
**Nortronics'**  
broadcast  
replacement  
tape heads:

1. OEM
2. Distributor
3. Direct

TO ORDER  
**CALL TOLL FREE**  
1-800-328-5640 ext. 677 (USA)  
1-800-742-0687 ext. 677 (MN)  
545-0401 ext. 677 (Mpls., St. Paul)  
TELEX 29-0304

Detach here

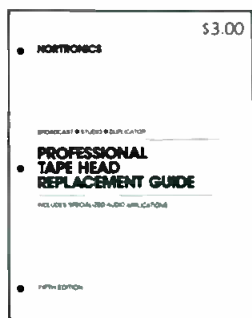

BE06-85

**FREE!**

Please send me a complimentary copy of the revised 5th edition, PROFESSIONAL TAPE HEAD REPLACEMENT GUIDE.

Name \_\_\_\_\_

Title \_\_\_\_\_

Company \_\_\_\_\_

Address \_\_\_\_\_

City \_\_\_\_\_ State \_\_\_\_\_ Zip \_\_\_\_\_

Telephone (\_\_\_\_\_) \_\_\_\_\_

Complete and mail to: Nortronics Company, Inc.,  
P.O. Box 3064, Cedar Rapids, Iowa 52406.

Circle (123) on Reply Card

**JBL forms a new company**

A new company has been formed from *JBL's* professional products division, Santa Ana, CA, according to Ron Means, newly elected president.

JBL Professional is one of four units recently created due to the overall growth of JBL. The consumer division is now Harman-America. JBL's exporting group is JBL International, and the manufacturing arm is Harman-Manufacturing.

JBL Professional will operate its own finance and credit departments, purchase products from the manufacturing groups and maintain its own inventory.

Mark Gander, former product manager, has been promoted to vice president of marketing of JBL Professional. Ken Lopez, former national sales manager, has been named vice president of sales. Two new positions have been created within the marketing department at JBL Professional; one to concentrate on the sound contracting, broadcasting and theater markets; the other to focus on the MI, pro audio and studio/recording markets.

**Varian realigns solid-state microwave operations**

*Varian Associates*, Palo Alto, CA, announced a realignment of its solid-state microwave activities. Known as Solid-State Operations, the new unit was formed by combining two existing entities—the Solid-State Microwave Division in Santa Clara, CA, and the Solid-State Department at Varian's Eastern microwave complex in Beverly, MA, with a newly formed III-V device center, to be located in Santa Clara.

**Colorgraphics signs contracts**

*ColorGraphics Systems*, Madison, WI, has announced the signing of several major contracts for both its production graphics and computer newsroom equipment divisions as a result of the 1985 NAB Convention.

Among those companies, which signed contracts at the NAB, are KTTV, Los Angeles, Wodlinger Broadcasting, Houston and Miller Design Productions, Tucson, AZ. ColorGraphics is working with three production houses in New York, Chicago and San Francisco on installations planned for later this year. The three networks have each asked to have in-house demos within the next three to six months.

L. Sanders Smith, vice president and general manager of ColorGraphics NewStar Division, announced receipt of a contract at NAB from Dow Jones Company for installation of ColorGraphics' NewStar newsroom computer. The contract calls for installation of a fully redundant NewStar System at Dow Jones' Princeton, NJ, office.

**Five stations purchase Fujinon equipment**

Five TV stations throughout the United States have ordered *Fujinon* lenses for their cameras. KMGH, Denver, ordered three 17x16.5 lenses for their HK322 cameras; WFLD-TV, Chicago, purchased five A14x8ESM lenses for their Philips LDK-26 cameras; WWBT-TV, Richmond, VA, bought three P17x16.5ESM lenses for their RCA TK-47B cameras; KTSP, Phoenix, AZ, placed orders for three 17x16.5 lenses for their HK322 cameras; and WVIZ-TV, Cleveland, placed an order for three R17x12.5ESM lenses for their Philips LDK-6 cameras.

**Auditronics acquires Tapecaster TCM**

*Auditronics*, Memphis, TN, has acquired Tapecaster TCM, Rockville, MD, a manufacturer of audiotape cartridge recorders, reproducers and loaders.

Paul Shore, former owner and president of Tapecaster TCM, will remain general manager of Tapecaster Division of Auditronics. Operations will continue at the Rockville plant.

||:~::~)))



# New products

## Narrowband VHF receiver

*Sennheiser* introduces the EM 2003-9 narrowband VHF receiver. Available for use with carrier frequencies ranging from 150MHz to 216MHz, the unit may be rack-mounted or stacked, and has an integral antenna splitter. LED instrumentation displays audio modulation and RF strength. Adjustable squelch and two outputs, balanced and unbalanced, are also available.

Circle (1009) on Reply Card

## Satellite receivers and positioners

The Star Odyssey, a series of satellite receivers and antenna positioners, has been introduced by *Geotech Communications Inc.*, (GCI). The series offers quartz-synthesized channels, signal strength meter plus LED channel display and microprocessor-controlled digital tuning. The series also includes digital audio tuning and individually addressable left and right channels, with narrow/wideband selection and matrix/discrete capability.

The 2001C control console is compatible with any 36Vdc, 10-turn potentiometer actuator and can be readily interfaced with many other receivers.

Circle (1010) on Reply Card

## Portable video light

A Hahnel portable video light, providing a high-power light source in a flexible, compact and lightweight package, is being imported by *Argraph*, U.S. distributor of Hahnel products. The light can be used in the studio, on location on video or movie cameras, on light stands, tripods or wall/table mounts.

The light provides 1000W (model CHN710) or 2000W (model CHN715) of quartz-halogen light, operating on 110Vac current. Four rectangular barndoors are built in, as is a cooling fan. Safety features include heat-resistant lamp shields and a 3-wire grounded plug.

Circle (1011) on Reply Card

## Video communications system

Tele-Imager is the first of a new generation of low-cost, high-speed freeze-frame video communications systems available from *LCA*. It can send and receive images over regular telephone lines.

Circle (1012) on Reply Card

## OEM CCD package

*EEV* announces the availability of an electronics package for manufacturers wishing to build their own high-resolution CCD cameras. The P4310E package contains a frame-transfer CCD image sensor with a 385 x 576 scanned pixel matrix, with associated drive and control electronics.

The electronics package, consisting of three PCBs and an associated EPROM, is optimized to produce the best TV image from the sensor. Connection to the package consists of a 6Vdc supply and a composite video output. Synchronization signals can be derived for computer links and network format purposes.

Circle (1013) on Reply Card

## Thyristor driver card

*Skantronics* is manufacturing a universal thyristor driver card intended for lighting intensity control. The SKT-TTD card contains electronics to control Triacs or SCR pairs for lamp loads from 10A to 600A rms. Features include square law B transfer characteristics and a feedback network, which holds lamp intensity constant regardless of line and load variations. This card may be used in new lamp dimmer design

# IMAGINE A ONE TUBE VHF TRANSMITTER

Imagine a powerful 35kw system, the PCN-1435. It's one of 7 brand new PCN-1400 Series VHF transmitters: 100% solid-state to 10 kw, only one tube to 35kw.

Imagine exciters with 30% fewer parts, giving you 50% improvement in MTBF (now 30,000 hours). And capable of stereo sound without modification.

Now . . . imagine what the new VHF transmitters from NEC can do for you. For more information call Joe Engle at 1-800-323-6656.

## PCN 1400 SERIES TRANSMITTERS

# NEC

IMAGINE WHAT WE'LL DO FOR YOU  
NEC America, Inc., Broadcast Equipment Division  
130 Martin Lane, Elk Grove Village, IL 60007  
In Illinois 312/640-3792.

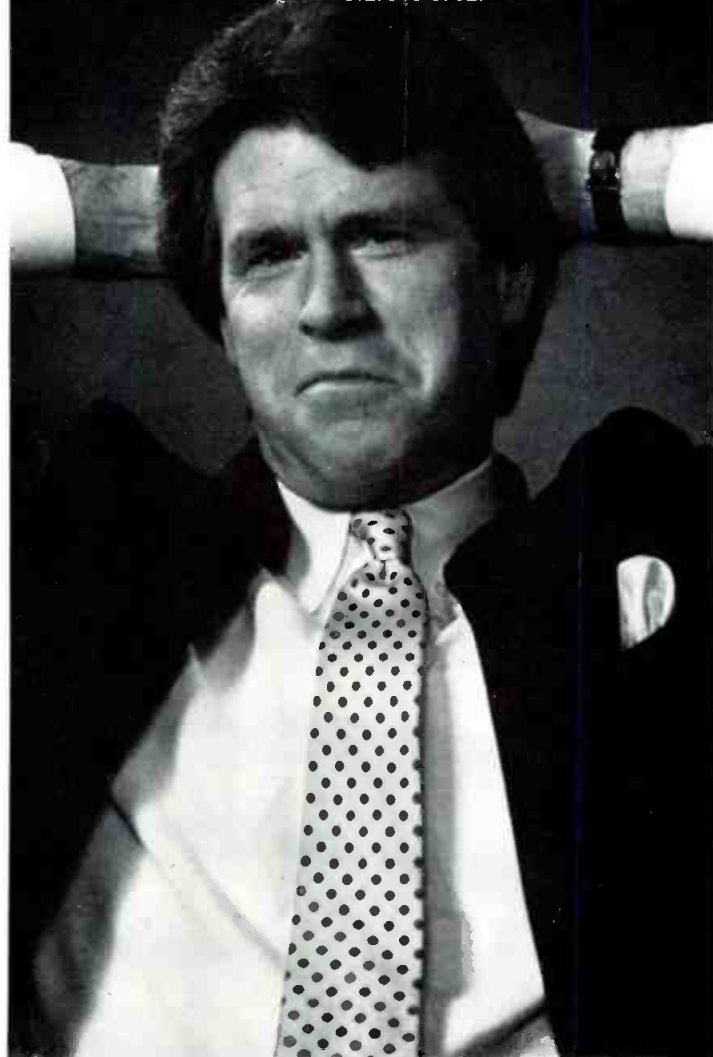

Circle (124) on Reply Card

# HOW DO YOU JUDGE A COMPUTER NEWS SYSTEM?

**NEW**  
BY THE COMPANIES IT KEEPS.

NBC NEWS • BBC RADIO • CNN • 2V  
RVN2-TV • BUSINESS TIMES • KRLD-  
TV-AM • 4BH • ITN • KRON-TV • BTQ-T  
CHANNEL FOUR NEWS • 2GB • 3AV  
MV4-TV • ANGLIA TELEVISION • 4A  
MACNEIL/LEHRER NEWSHOUR • 2C  
DN • WOR-AM RADIO • RAI • WFAA-

From the largest to the smallest, more and more broadcasters are winning with Basys, the one computer news system designed by newsmen for newsmen. **NBC News** (USA) is computerizing its worldwide radio and television news network with Basys. **MacQuarie Broadcasting Network** selected Basys to link its seven radio stations into Australia's first computer news network. **Anglia Television** (Britain) became the first regional ITV company to computerize its newsroom. **RVN2-TV** and **AMV4-TV** (Australia) chose Basys to bring big city news coverage to Riverina. **BTQ-TV** stays on top in Brisbane with Basys. They join: **CNN** (USA) produces 24 hours of news every 24 hours with Basys. **ITN, Independent Television News** (Britain) stays the independent alternative and ahead of the competition with Basys. **RAI, Radiotelevisione Italiana** (Italy) operates the world's largest computer news facility with Basys. **WOR-AM Radio** (New York) looks to Basys to help compete in the land of the network flagships. **BBC-Radio** (Britain) chose Basys for all its nationwide radio news. **KTUL- KATV- WDBJ-TV; WKQX- KIMN- WBT- WBCY- WKNE- WNBX- KYGO- KSAN-Radio** and **CBS Extravision** chose Basys software for their Basys and Jefferson Pilot Data System IBM-PC computers. They and **The MacNeil/Lehrer Newshour, Business Times, KRON-TV, WFAA-TV, KRLD-TV** all in the United States; and **Channel Four News** and **TV-AM**, Britain's breakfast show, make Basys the world's leading computer news system.

**Basys, the hard news software.**

The logo for Basys, featuring the word "BASYS" in a stylized, blue, lowercase font with a unique, rounded, and interconnected letter design.

Basys Inc.,  
2685 Marine Way,  
Mountain View, California, 94043,  
Tel: 415 969 9810, Telex 171604

Circle (130) on Reply Card



or as a service or update component for any thyristor dimmer. It is a direct plug-in driver replacement for most Skirpan dimmers.

Circle (1002) on Reply Card

### Color weather radar display

Alden Electronics introduces a color weather radar display monitor, the model C2000M.

The monitor is designed to receive and to store a single real-time precipitation picture from any weather radar site equipped with government-owned radar remote weather display system transmitters. Access is available via leased or dial-up phone lines using an Alden auto-dialer phone provided with the system.

Circle (1001) on Reply Card

### Open-reel tape recorder

Uher of America has introduced the Uher 6000 report universal open-reel tape recorder. The recorder features 3 3/4, 1 7/8, 15/16 and 15/32 ips tape speeds plus logic control, electronic tape tension control and four motors for constant tape speed and low wow and flutter.

Other features include built-in DNR noise reduction, mark and find cueing on both rewind and fast-forward, switchable automatic level control and solenoid-operated function controls.

The unit has a built-in switchable loudspeaker, mechanical tape counter and an A-V input jack for use with sync sound and film work.

Circle (1004) on Reply Card

### Time code reconditioning system

Image Technology announces the model TCR-600 time code reconditioning system. The built-in 6-output DA eliminates the need for a separate audio DA for time code distribution. It has a variable bandwidth circuit to track the rise time of the outputs to the input frequency.

Circle (1005) on Reply Card

### Colorgraphic display system

Chromatics introduces the CX 1280 colorgraphic display system, which features a high-speed colorgraphic engine combined with a 1280 x 1024, 60Hz non-interlaced color monitor.

The base system includes four single-buffered image planes; 512K display list memory; CX 1280 resident/firmware; 1280 x 1024 resolution monitor; and colorgraphic engine in an office-environment enclosure.

Circle (1006) on Reply Card

### Film-to-tape editing

Laser Edit's Spectra/Ace editing system allows film productions to be edited on laser disc, maintains picture and sound in sync and saves up to 50% of the cost of conventional film-style editing.

Circle (1007) on Reply Card

### Portable oscilloscope

Hitachi Denshi has introduced the V-1100A, an intelligent 100MHz portable oscilloscope. This full-function scope features a CRT readout that displays frequency counter and DVM functions as well as constant ground level display.

Additional features include quad channel with independent position controls, 8-trace with alternate sweep, 18kV, 6-inch rectangular CRT, minimum deflection factor 1mv/div, maximum sweep time 2ns/div, TV-sync, X-Y operation up to 1MHz (3° or less), variable hold-off, gate output for A and B sweep and channel 1 signal output to 100MHz.

Circle (1014) on Reply Card

1:~(-))]]

# Perfect Timing

## MASTER CLOCK SYSTEMS



If seeing the same time on all your clocks is important, select **ES 192E-Line Frequency** timebase, for only \$358.

If a guaranteed accuracy of three seconds per month is what you want, choose **ES 160** — \$1.158.

How about one second per month? **ES 160/1** — \$1,350.

Or National Bureau of Standards accuracy! **ES 199** is synchronized to Radio Station WWV to provide a Master with unquestioned accuracy. \$1,575 with receiver and antenna.

**ESE Master Clock Systems are simple to install. All Masters have a Serial Time Code output, able to drive twenty slave displays without buffering. Slaves range in size from .4" LED to 2" gas discharge displays, priced from \$166 to \$471.**

**IF YOU ALREADY HAVE A SYSTEM AND WANT TO EXPAND IT**, get the **ES 167B** Serial Time Code Generator (\$161), then add any number of our low cost slaves.

Many, many options and accessories are available. Ask us about them. Our brochure tells the whole story, but not for long. We keep adding new products.



Write, Wire or Call: (213) 322-2136  
142 SIERRA STREET • EL SEGUNDO, CALIFORNIA 90245

Circle (127) on Reply Card

# Ad index

Advertiser	Page Number	Reader Service Number	Advertiser Hotline	Advertiser	Page Number	Reader Service Number	Advertiser Hotline
ADC Telecommunications, Inc.	65-70	33	612/893-3000	Leader Instruments Corp.	5	4,5	800/645-5104
ADM Technology	IFC	1	313/524-2100	Leader Instruments Corp.	118A		800/645-5104
Agfa-Gevaert Inc.	37	20	201/288-4100	Leader Instruments Corp.	118B		800/645-5104
AKG Acoustics, Inc.	130		203/348-2121	Leitch Video Ltd.	43	25	804/424-7290
Alamar Electronics USA, Inc.	20	133	408/866-9373	Lenco Electronics	11	7	314/243-3147
Alpha Audio	151	112	804/358-3852	Lerro Electrical Corp.	1		215/223-8200
Aluma Tower Company	152	115	305/567-3423	Listec Corp.	104	63	516/654-8963
Amperex Electronic Corp.	56-57	36	401/762-3800	Logitek Electronic Systems	148	107	800/231-5870
Ampex Corp. (AVSD)	90-91		818/240-5000	LPB Inc.	151	113	215/644-1123
Ampex Corp. (MTD)	27	56	415/367-3809	M C G Electronics, Inc.	118	75	516/586-5125
Andrew Corp.	119	76	312/349-3300	3M Broadcast & Related Products	129	83	800/792-1072
Angenieux Corp. of America	114	71	800/256-1382	3M Corp.	88-89	54	800/792-1072
Anvil Cases, Inc.	110	68	818/575-8614	Midwest Communications Corp.	34-35	23	606/331-8990
Arrakis Systems	21	13	303/224-2248	Monroe Electronics, Inc.	112	89	716/765-2254
Asaca/Shibasoku Corp.				Nady Systems Inc.	149	109	415/652-2411
America	131	84	800/423-6347	National Video Service	145	102	415/846-1500
Aston Electronics Inc.	48	26	913/782-4007	Nautel	138	93	207/947-8200
Audio-Technica U.S., Inc.	147	106	216/686-2600	NEC America Inc.	157	124	800/323-6656
Audio-Video Engineering Co.	150	110	516/546-4239	NEC America Inc.	61	40	800/323-6656
Barco Industries, Inc.	95	48	704/392-9371	Nema Electronics International	120	126	415/969-9810
BASYS	158	130	415/969-9810	Nortronics Co., Inc.	156	123	800/328-5640
Belar Electronic Labs	163	146	215/687-5550	Opamp Labs Inc.	153	116	213/934-3566
Beyer Dynamic Inc.	49	30	516/935-8000	Orban Associates Inc.	105	64	800/227-4498
Bi-Tronics	169,170		800/522-7377	Osborne, Alan	153	66	805/495-8420
Bosch Corp.	93	57	801/972-8000	Otari Corp.	15	9	415/592-8311
Broadcast Electronics Inc.	142	98	217/224-9600	P.T.S.I.	154-155	100-101	201/529-1550
Broadcast Video Systems Ltd.	140	95	416/497-1020	Pacific Recorders and Engineering	99		619/438-3911
C.O.A.R.C.	108	120	518/672-7202	Panasonic	75	44	201/348-7336
Calvert Electronics Inc.	30	131	800/526-6362	Panasonic	77	45	201/348-7336
Capitol Magnetics	54	28	213/462-6252	Panasonic	78-79	46	201/348-7336
Centro Corp.	17	10	619/560-1578	Polyline Corp.	108	119	312/298-5300
Cetec Antennas	32	17	916/383-1177	Potomac Instruments	132	85	301/589-2662
Cetec Vega	53	34	818/442-0782	QEI	59	38	609/728-2020
Christie Electric Corp.	38	21	800/421-2955	Rank Cintel	113	70	312/297-7720
Circuit Research Labs, Inc.	13	8	800/535-7648	Recortec, Inc.	28	14	408/737-8441
Comark	3	3	215/822-0777	Ross Video Ltd.	62	41	613/652-4886
Commercial Communications, Inc.	123	79	800/367-5742	RTS Systems, Inc.	126-127	81,181	818/843-7022
Continental Electronics Mfg. Co.	142	99	214/381-7161	Schwem Technologies	IBC	2	415/935-1226
Crosspoint Latch Corp.	166	127	201/688-1510	Sennheiser Electronic Corp.	146	105	212/944-9440
Datum Inc.	94	58	714/533-6333	Sescom, Inc.	153	86	800/634-3457
Delta Electronics	135	22	704/454-3350	Sharp Electronics Corp.	55	35	201/265-5548
Dictaphone Corp.	144	122	800/431-1708	Shure Brothers Inc.	80	47	312/866-2553
Dielectric	136	32	800/341-9678	Shure Brothers Inc.	36	91	312/866-2553
Duncan, Victor Inc.	98	61	313/589-1900	Sitler's Inc.	153	118	800/272-6459
EEV, Inc.	87	53	914/592-6050	Sony Corp. of America (Broadcast)	24-25		
Eastman Kodak Co.	125	80	212/930-7500	Sony Tapes Product Sales Co.	72-73	145	
Electrohome Ltd.	116	73	519/744-7111	Standard Tape Laboratory, Inc.	153	87	415/786-3546
ESE	159	127	213/322-2136	Studer Revox America Inc.	39	135	615/254-5651
Fluke Mfg. Co., Inc.	133	88	206/356-5400	Surcom Associates Inc.	152	114	619/722-6163
For A Corp.	134	90	213/402-5391	Tascam div. TEAC Corp. of America	47	29	213/726-0303
Fostex Corp. of America	143	121	(213) 921-1112	Tektronix Inc.	45	27	800/452-1877
GEC McMichael Ltd.	19	11,12	602/948-7255	TFT, Inc.	85	51	408/727-7272
Gentner Engineering Co., Inc.	150	111	801/268-1177	Thomson Video Equipment	115	72	
Graham-Patten Systems Inc.	26	24	916/273-8412	Thomson-CSF/DTE	161	136	
Grass Valley Group, Inc.	9	6	916/273-8421	Thomson-CSF/LGT	81	59	
Grass Valley Group, Inc.	83	60	916/273-8421	Total Spectrum Manufacturing, Inc.	122	78	914/358-8820
Gray Engineering Laboratories	145	103	714/997-4151	Townsend Associates, Inc.	140	141	413/568-9581
Hannay Reels	92	55	518/797-3791	TTC/Ampro Scully	58	37	303/465-4141
Harris Corp.	109	67	217/222-8200	TTC/Wilkinson	137	92	303/465-4141
Hitachi Denshi America Ltd.	7	140	800/645-7510	United Rope Works	106	142	215/855-8450
HM Electronics	86	52	619/578-8300	Utah Scientific Inc.	50-51	34	800/453-8782
Horizon International	31	16	602/437-3800	Valley People, Inc.	117	71	615/383-4737
ICM Video	60	39	405/232-5808	Varlan	33	18	415/592-1221
Ikegami Electronics Inc.	97	50	201/368-9171	Videotek, Inc.	139	94	602/997-7523
Ikegami Electronics Inc.	40-41	19	201/368-9171	Videotek, Inc.	141	97	602/997-7523
Ikegami Electronics Inc.	121	77	201/368-9171	Videotek, Inc.	107	65	602/997-7523
JBL Inc.	29	15	818/893-8411	Ward-Beck Systems Ltd.	BC		416/438-6550
Jensen Transformers	63	42	213/876-0059	White Instruments Inc.	149	108	512/892-0752
JVC Company of America	111	69	800/582-5825	Winsted Corp.	120	125	800/328-2962
Lake Systems Corp.	64	43	617/244-6881	Yamaha International Corp.	101		
Lang Video Systems Corp.	153	117	800/222-5264	Yamaha International Corp.	102	62	800/328-2962
LEA Dynatech Inc.	146	104	213/944-0916	Z-Comm/Audio Digital Inc.	128	82	619/481-5999



# 70 YEARS OF EXPERIENCE IN POWER GRID TUBES...

And still looking ahead!  
That's your assurance of  
world-class UHF/VHF-TV  
tetrodes and coaxial-cavity  
circuits:

- up to 50 kW UHF output  
power and 40 kW VHF output  
power
- up to 18 dB typical gain.

Incorporating decades of  
innovation and experience with  
Hypervapotron<sup>®</sup> anode cooling  
and Pyrobloc<sup>®</sup> pyrolytic-graphite  
grids.

THOMSON-CSF  
COMPONENTS CORPORATION  
Electron Tube Division  
301 Route Seventeen North  
RUTHERFORD, NEW JERSEY 07070  
Tel.: (201) 438.23.00  
TWX: 710989 7286

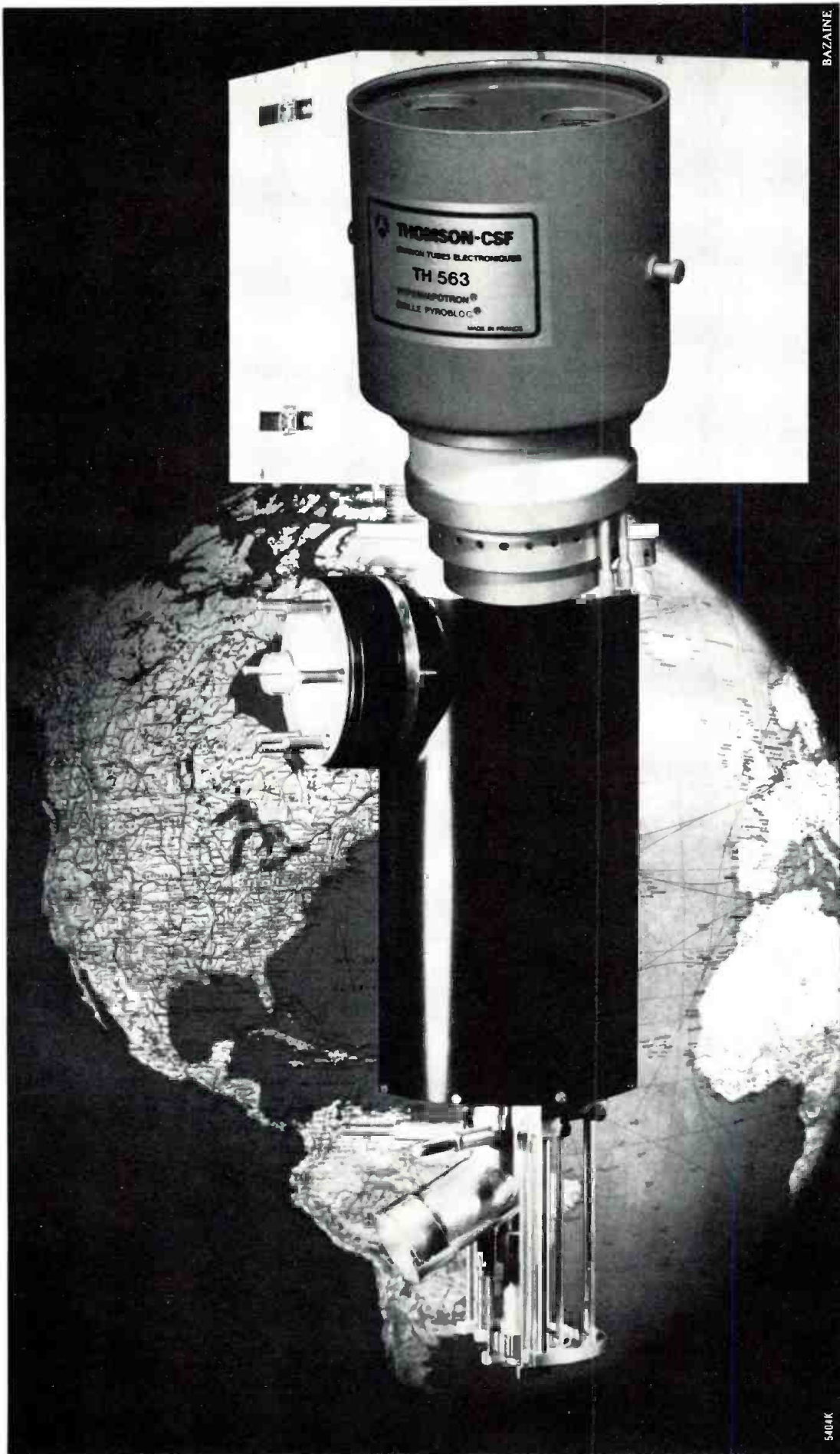
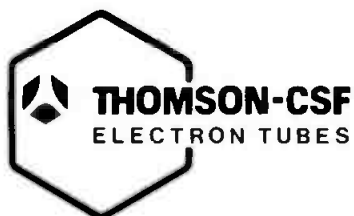

<b>Belgique</b> BRUXELLES Tel (32-2) 648 64 85 Tx: 23113 THBXL B	<b>Brasil</b> SÃO PAULO Tel (55-11) 542 47 22 Tx: (011) 24226 TCSF BR	<b>Deutschland</b> MÜNCHEN Tel (49-89) 78 79 0 Tx: 522 916 CSF D	<b>España</b> MADRID Tel (34-1) 405 16 15 Tx: 46033 TCCE E	<b>France</b> BOULOGNE-BILLANCOURT Tel (33-1) 604 81 75 Tx: THOMTUB 200 772 F	<b>Italia</b> ROMA Tel (39-6) 639 02 48 Tx: 620 683 THOMTE I	<b>Japan</b> TOKYO Tel (81-3) 264 63 46 Tx: 2324241 THCSF J	<b>Sverige</b> STOCKHOLM Tel (46-8) 63 50 60 Tx: 12078 THCSF S	<b>United-Kingdom</b> BASINGSTOKE Tel (44-256) 29*55 Tx: 858865 TESAFI G	<b>U.S.A.</b> RUTHERFORD, NJ Tel (1-201) 438 23 00 Tx: 710989 7286
---	--	---	---	--	---	--	---	---	---

Circle (138) on Reply Card

# Professional services

**VIR JAMES P.C.**  
CONSULTING ENGINEERS  
Applications and Field Engineering  
Computerized Frequency Surveys  
3137 W. Kentucky Ave. - 80219  
(303) 937-1900  
**DENVER, COLORADO**  
Member AFCCE & NAB

**STEIGER, HURRAY &  
ASSOCIATES INC.**  
CONSULTING ENGINEER SERVICES  
6816 Westview Drive  
Cleveland, OH 44141  
(216) 526-7187

**EVANS ASSOCIATES**  
CONSULTING TELECOMMUNICATIONS ENGINEERS  
AM-FM-TV-CATV-ITFS-LPTV SATELLITE  
216 N. Green Bay Road  
Thiensville, Wisconsin 53092  
Phone: (414) 242-6000 Member AFCCE

**R. L. HOOVER**  
Consulting Telecommunications  
Engineer  
11704 Seven Locks Road  
Potomac, Maryland 20854  
301-983-0054  
Member AFCCE

**D. L. MARKLEY**  
& Associates, Inc.  
CONSULTING ENGINEERS  
206 North Bergan  
Peoria, Illinois 61604  
(309) 673-7511  
Member AFCCE

## Radiotechniques

RADIO CONSULTING ENGINEERS  
STATION DESIGN AND SERVICE  
ELECTRONIC PRODUCT DESIGN  
Edward A. Schober, P.E.  
402 Tenth Avenue, Haddon Heights, NJ 08035  
(609) 546-1841

**ENTERPRISE ENGINEERING P.C.**  
Consulting Engineers  
F.W. Hannel P.E.  
P.O. Box 9001  
Peoria, Illinois 61614  
(309) 691-4155 Member AFCCE

**ALL JAPAN RADIO & TV  
ENGINEERING SERVICES CO.,**  
RADIO & TELEVISION CONSULTANTS,  
BROADCASTING SYSTEM, CATV SYSTEM,  
ARCHITECTURAL ENGINEERING & DESIGN,  
EARTH STATION WORKS FOR B S  
Address: Kyodo-bldg, 41-1 Udagawa-cho,  
Shibuyaku, Tokyo, 150, JAPAN. Phone:  
Tokyo 03-454-4874 TLX: J29518 NHKINT

CALL THE SPECIALISTS

**AUTERI**  
Associates Inc.  
Professional Magnetic  
Audio Head Reconditioning

9 HENARELY DRIVE  
MILLER PLACE NY 11784

ROBERT W. AUTERI  
(516) 331-5022

**HORIZON INTERNATIONAL**  
Broadcast Implementation Engineering  
Bcat. & Video Facility Design & Installation  
Systems Evaluations & Critiques  
Emergency Service & Support  
3837 E. Wier Ave., Suite 1, Phx., AZ 85040  
602-437-3800

**SMITH and POWSTENKO**  
Broadcasting and Telecommunications  
Consultants  
2033 M Street N.W., Suite 600  
Washington, D. C. 20036  
(202) 293-7742

**BLAIR BENSON**  
Engineering Consultant  
TV Systems Design and Operation  
23 Park Lane  
Norwalk, CT 06854  
203-838-9049

**BROADCAST ENGINEERING  
SERVICE COMPANY**  
TV-FM-AM Field Engineering -  
Emergency Maintenance - Turnkey Installation -  
System Design - Survey and Critique -  
Interim Maintenance or Chief Engineer  
**B E S COMPANY**  
100 Star Trail, New Port Richey, Fla. 33553. 813-868-2989

**T & G OPTICS, INC.**  
71-01 INGRAM STREET  
FOREST HILLS, NY 11375  
COMPLETE REPAIR SERVICE FOR COLOR TELEVISION  
CAMERA BEAMSPLITTER OPTICS, LENSES, COATINGS,  
MULTIPLEXER MIRRORS, FILTERS AND PROJECTORS.  
WRITE OR CALL GERALD PINCUS (718) 544-8156 twenty  
four hour service with pleasure.

**TLWI**  
The Light Works, Inc.

Consultants  
Television  
Motion Picture  
Theatrical  
Lighting • Rigging  
Facility Design • Programming

72 County Road • Tanafly, New Jersey 07670  
201-567-6664

**John Aalto, P.E.**  
Consulting Engineer  
TELEVISION PRODUCTION AND POST PRODUCTION SYSTEMS  
DESIGN AND PROJECT MANAGEMENT  
4534 Van Noord Avenue  
Studio City, CA 91604  
(818) 784-2208

**SELLMEYER & KRAMER, INC.**  
CONSULTING ENGINEERS  
J.S. Sellmeyer, P.E., S.M. Kramer, P.E.  
AM FM TV MDS ITFS LPTV CATV  
APPLICATIONS • FIELD ENGINEERING  
P.O. Box 841 Mckinney, TX 75069  
(214) 542-2056

O. L. Angevine, P.E. Eric Neil Angevine, P.E.  
**ANGEVINE ACOUSTICAL  
CONSULTANTS, Inc.**  
7349 DAVIS ROAD  
WEST FALLS, N.Y. 14170  
(716) 652-0282  
MEMBER: National Council of Acoustical Consultants

**Why not run your business  
card here?  
Only \$60 per insertion.  
Frequency discounts available.  
Call 913/888-4664**

**STARLIGHT COMMUNICATIONS, INC.**  
Satellite Down-Linking  
Satellite Systems  
Satellite System Maintenance & Repair

BRUCE BLUMENTHAL P.O. Box 523  
(312) 459-4122 Northbrook, IL 60065

## TERRY REAVES ENGINEERING

FCC Filings - Turnkey Systems - Coverage Predictions  
FM - AM - STL - RPU - 2 Way FM - Satellite  
Computerized AM Broadbanding

**MAINTENANCE - EMERGENCY DR CONTRACT  
(904) 351-0469**

5004 N.E. 18th Court, Ocala, FL 32670

**KANSAS CITY, MISSOURI**  
Keith A. Willis,  
National Sales Mgr.  
P.O. Box 12901, Overland Park, KS 66212  
Phone: (913) 888-4664

**NEW YORK, NEW YORK**  
Joe Concert,  
Phone: (212) 682-6630  
Josh Gordon  
Phone: (212) 697-7050  
630 Third Ave., Eighth Floor  
New York, NY 10017

**SANTA MONICA, CALIFORNIA**  
Herbert A. Schiff,  
Phone (213) 393-9285  
Jason Perlman,  
Phone (213) 458-9987  
Schiff & Associates  
1408 Santa Monica Mall, Suite 200  
Santa Monica, CA 90401

**NORWOOD, AUSTRALIA**  
Hastwell, Williamson, Rouse Pty. Ltd.  
P.O. Box 419  
Norwood 5067, Australia  
Phone: 332-3322  
Telex: AA87113

**LONDON, ENGLAND**  
Nicholas McGeachin,  
Suite 460, Southbank House,  
Black Prince Rd.  
London SE1 7SJ  
Telex: 295555LSPG  
Telephones: 01-582-7522  
01-587-1578

**TOKYO, JAPAN**  
Haruki Hirayama  
EMS, Inc.,  
Sagami Bldg., 4-2-21, Shinjuku,  
Shinjuku-ku, Tokyo 160, Japan  
(03) 350-5666  
Cable: EMSINCPERIOD  
Telex: 2322520 EMSINCJ

©1985. All rights reserved.

**INTERTEC**  
PUBLISHING CORPORATION

## Advertising sales offices



## Opening Doors

Continued from page 74

may be necessary to adjust your notch diplexer slightly to optimize its operation for stereo. Only in a limited number of cases, unless you have old hardware, will you have to replace some or all of the diplexer equipment.

### UHF efficiency

A panel of industry representatives, including E.W. McCune, Varian, discussed the efficiency of UHF systems. McCune reported on the status of multistage depressed collector klystrons such as those in an ongoing Varian project. Following McCune's presentation, the panel discussed various topics, including the 100kW klystron development, a report on an integrated exciter/pulsar and a report on the Klystrode (a klystron-tetrode hybrid) and its development. The panel generally agreed that a 60kW klystron is capable of efficiency greater than the 70% level suggested by today's klystron devices. This results in a total transmitter power demand of less than 140kW from the power line for peak visual output of 60kW (including aural and cooling). These numbers may improve even more with further development of the multistage depressed collector klystron and the Klystrode. (For more information, see "New Frontiers For Efficiency," page 76.)

### RF radiation

The FCC's recent announcement concerning the permissible levels of non-ionizing radiation renewed interest in the subject at the engineering sessions. FCC and EPA representatives formed a panel to discuss actual measurement techniques that can be used. In concluding, the panel left the impression that all of the ballots are not in at this time concerning the commission's measurement techniques or the exact limits that may finally be used for future rulemaking. In the future, however, broadcasters will be required to show they comply with the new standards. The exact financial impact of this requirement is unknown at this time, but it has been estimated by the EPA for various levels of protection. In any case, broadcasters will have to be aware of radiation hazards that may create a public health risk, and they will have to demonstrate clearly that their facilities do not cause hazards.

### Until next year

Another April has come and gone, closing the doors on yet another NAB. However, the doors that have been opened and the channels of communication that have been developed for the broadcast engineer to explore the new technology, and take practical, useful information back to the facility, make the future seem all that much the closer.

[ :-(-: )]]]]



For AM, FM, SCA  
and TV modulation monitors

**WHEN ACCURACY COUNTS...COUNT ON...**

Call (215) 687-5550 or write for more information on Belar AM, FM, Stereo, SCA and TV monitors.

**BELAR**  
ELECTRONICS LABORATORY, INC.  
LANCASTER AVE AT DORSET DEVON PA 19333

Circle (146) on Reply Card

## Classified

Advertising rates in Classified Section are \$1.25 per word, each insertion, and must be accompanied by cash to insure publication.

Each initial or abbreviation counts a full word. Minimum classified charge, \$30.00.

For ads on which replies are sent to us for forwarding (blind ads), there is an additional charge of \$35.00 per insertion, to cover department number, processing of replies, and mailing costs.

Classified columns are not open to advertising of any products regularly produced by manufacturers unless used and no longer owned by the manufacturer or distributor.

### TRAINING

**ELECTRONICS DEGREE** by correspondence. Earn A.S.E.T., then B.S.E.T. Free catalog. Grantham College of Engineering, 10570 Humbolt St., Los Alamitos, CA 90720. 7-82-tfn

**CASSETTE RECORDED PREPARATION** for FCC General Class license plus one week seminar in Washington, Boston, Philadelphia or Detroit. Bob Johnson Telecommunications, 1201 Ninth, Manhattan Beach, Calif. 90266, Phone (213) 379-4461. 6-85-tfn.

### SERVICES

**ONE STOP FOR ALL YOUR PROFESSIONAL AUDIO REQUIREMENTS.** Bottom line oriented. F.T.C. Brewer Company, P.O. Box 8057, Pensacola, Florida 32506. 7-71-tf

**HELIX-STYROFLEX.** Large stock - bargain prices - tested and certified. Write for price and stock lists. Sierra Western Electric, Box 23872, Oakland, Calif. 94623. Telephone (415) 832-3527. 1-73-tf

**TRANSMITTER TUBES REPROCESSED** - Save 40 to 50%. 3CX2500, 4CX5000, 4CX15000 and many others. Write for details. FREELAND PRODUCTS CO., Rt. 7, Box 628, Covington, LA 70433. (504) 893-1243 or (800) 624-7626. 6-79-tfn

### EMPLOYMENT SERVICES

**10,000 RADIO AND TV JOBS** a year for men and women are listed in the American Radio job market weekly paper. Up to 300 every week. Engineers, DJs, Newspeople, Program Directors, Production, Sales. All markets, all formats. One week computer list, \$6.00. Special bonus 6 weeks, \$14.95. You save \$21.00. American Radio Job Market, Dept. 3, 1553 North Eastern. Las Vegas, Nevada 89101. 7-84-tfn

### EMPLOYMENT SERVICES

WE PLACE

**TV and Video Engineers**  
COAST TO COAST

[All Levels, But Not Operators]  
ALL FEES PAID BY EMPLOYERS  
Phone/Resume

**KEY SYSTEMS**

Westminster Road  
Wilkes-Barre, PA 18702

Phone Alan Kornish at  
**(717) 655-1458**

### HELP WANTED

**CHIEF ENGINEER, KMET-FM, LOS ANGELES,** a top rated AOR station, is seeking experienced Chief Engineer to head its Engineering Department. Applicants must be experienced at studio construction and maintenance, remote broadcasts, transmitter and antenna construction and maintenance. Please send resumes to Philip Harris, Director of Engineering, Metromedia Radio, 19th and Walnut Streets, Philadelphia, PA 19103-9467. EOE. 5-85-2f

**MAINTENANCE ENGINEER** for N.Y.C. post-production company. Must have 3-5 years experience in maintaining Sony 1", GVG switcher, Quantel, CMX, Sony 3/4", RCA 2" quads and other related equipment. Experience in systems design helpful. Salary commensurate with experience. Video 44, 219 East 44th St., New York, N.Y. 10017 212/661-2727. 2-85-tfn

**LOCATE IN SUNNY FLORIDA! LOOKING FOR EXPERIENCED BROADCAST ENGINEER FOR TAMPA BAY AREA POWER HOUSE AM/FM FACILITIES.** SEND RESUME: MARK WILLIAMES, 9720 EXECUTIVE CENTER DR., SUITE 200, ST. PETE, FL 33702. 6-85-1f

**MARKETING/SALES MANAGER:** TV broadcast equipment manufacturer with a new and unique product line seeks parttime National Marketing and Sales Manager based in the Boston area. Tasks include customer correspondence, sales development, ad and brochure design and trade show planning. If you are interested in helping us grow, send reply to Dept. 645, Broadcast Engineering, P.O. Box 12900, Overland Park, KS 66212. 6-85-1f

## ADVERTISING MANAGER

### Broadcasting Equipment

Broadcast Electronics is seeking a creative individual to direct the company's total advertising/promotion program. This key position reports to the Vice President-Marketing.

Minimum requirements are 2 years industrial product/ad merchandising experience and a BS or MS degree, preferably in journalism. Applicant must possess good writing skills in addition to creativity and management ability.

Salary commensurate with experience, education and abilities. Exceptional benefit package includes profit sharing plan. Excellent working environment in air conditioned 70,000 sq. ft. modern plant.

Established in 1959, Broadcast Electronics is a major manufacturer of broadcasting equipment with headquarters in Quincy, IL.

Please send resume to Director of Personnel.



4100 NORTH 24TH STREET, P.O. BOX 3606  
QUINCY, IL 62305. PHONE (217) 224-9600  
An Equal Opportunity Employer

## SYSTEMS ENGINEERING MANAGER

Moseley Associates, Inc., a company specializing in the manufacture and supply of broadcast remote control and studio transmitter link equipment has an immediate opening for a Systems Engineering Manager.

Successful applicant will be degree qualified, have considerable broadcast equipment and/or systems experience. Must be able to engineer large, turn key projects. Must be marketing oriented with good interpersonal skills and free to travel extensively, both internationally and domestically. Supervisory skills.

Moseley offers an excellent salary and benefits package, relocation assistance, payroll stock purchase plan, and a congenial working environment located near the beach in beautiful Southern California, and proximity to University (UCSB).

You may send resume and salary history to:

Personnel Director

**MOSELEY**

**ASSOCIATES, INC.**  
A Flow General Company

111 Castilian Drive  
Goleta, CA 93117

Equal Opportunity Employer M/F

**THE STEUBEN-ALLEGANY COUNTIES BOARD** of Cooperative Educational Services will be accepting, on or before June 30, 1985, proposals for the leasing of the fifteen-television towers that make up the STEUBEN COUNTY INSTRUCTIONAL TELEVISION NETWORK. This network reaches a population of slightly over 100,000. Path clearances between towers have been verified for the 407-806-Mhz UHF television band and for the 2 Ghz microwave bands, making them acceptable for Digital Communication links as well as FM and LPTV broadcasting. Interested persons may request a sketch of the tower site locations, as well as data giving the tower height, coordinate location, type of tower, ground elevation above mean sea level, and the UHF TV frequency currently being transmitted from the tower from Dr. Robert J. Holmes, Steuben Co. BOCES, RO #1, Bath, NY 14810. 6-85-11

**MAINTENANCE ENGINEER FOR A FLORIDA** production company. Must have 3-5 years experience with state-of-the-art teleproduction equipment and an intimate knowledge of digital theory. Send Resume to: Chief Engineer, 150 Riverside Avenue, Jacksonville, Florida 32202. 6-85-21

**ENGINEERING TECHNICIAN, TELEVISION:** Post production computer editor needed, with experience in all facets of computer editing and post-production techniques. Must have operational knowledge, hands-on new state-of-the-art equipment, consisting of Ampex ACE computer editor, fully interfaced to AVC Switcher, VPR 3's, AOO, ETC. Union position. Send resume to Engineering Technician Position, c/o Oeborah Palmer, Director of Personnel, WHYI, Inc., 150 North Sixth Street, Philadelphia, PA 19106. EOE M/F. 6-85-11

**MAINTENANCE TECHNICIANS** - Immediate need for two people with BVU 800 and Sony 1 inch maintenance experience. Large plant system maintenance background helpful. Apply by sending resume promptly to: Manager, Operations, Engineering Group, Group W Satellite Communications, Stamford, CT 06904. An Equal Opportunity Employer-M/F. 6-85-11

**WCHL-AM, CHAPEL HILL, NC,** one of the Village Companies, seeks full time Chief Engineer. Qualified applicants should possess FCC General Class License and/or SBE Certification, knowledge of AM directionals and AM stereo systems. Duties would also include some work with state-of-the-art class C, FM and North Carolina's #1 sports network. Competitive salary and benefits. Send resumes to: Dianne Smith, The Village Companies, P.O. Box 3300, Chapel Hill, NC 27514. EOE. 6-85-11

**TRANSMITTER SUPERVISOR:** Northern New England. Experienced in high power UHF, translators, microwave. Knowledge of 4 wheel drive, snow machines, diesels. Salaried, growth potential, group owner. First or General License. Resume to Dept. 646, Broadcast Engineering, P.O. Box 12901, Overland Park, KS 66212. 6-85-11

**DIRECTOR OF ENGINEERING AND OPERATIONS.** Are you an assistant looking for more responsibility? Are your management skills waiting to be implemented? Would you like to lead our transition into state-of-the-art technology. Would you accept a challenge to become part of the management team? We are looking for the person to be responsible for a public television V in northern Minnesota. Our need is immediate. Send resume to Paul Stankovich, General Manager, KAWV TV, Box 9 BSU, Bemidji, MN 56601. This position will remain open until the right person is found. EOE. 6-85-11

**TELEVISION/HELP WANTED: CHIEF ENGINEER** - 7 years experience in technical and operations area of broadcast TV stations including a minimum 3 years supervisory experience. Must be capable of "hands on" repair and instruction of engineering staff. Salary range depending on expertise and qualifications. Excellent benefits. Resume/salary history to Vince O'Connell, WHSV-TV, Box TV3, Harrisonburg, VA 22801 (703) 433-9191. 6-85-21

**FLORIDA PRODUCTION/POST-PRODUCTION** company has opening for maintenance engineer. Computerized editing experience necessary. CMX, Chyron, RCA and Sony VTR's, GVG switcher, ADDA EFX. Salary commensurate with experience. Image Communications, Inc., Tampa, Florida, 33614. (813) 885-7793. 6-85-11

**FACTORY REP.** Factory reps needed to represent a solid, stable company. The company manufactures a line of terminal and accessory products for the pro or industrial video markets and CATV. Company is growing rapidly, has a hot product line, pays 10%, furnishes samples at no charge. Excellent national advertising & promotional backup. Areas Reps most needed are in: D.C./Virginia/Maryland, Florida, Texas, Illinois & Michigan. Submit background & list of other lines to: Dept. 647, Broadcast Engineering, P.O. Box 12901, Overland Park, KS 66212. 6-85-11

**RF MAINTENANCE ENGINEER:** Minimum 5 yrs. experience in maintenance of VHF and microwave equipment. Familiarity with Harris transmitter and terrestrial microwave a plus. Should be highly motivated and require little direction. Send resume to: Ira Goldstone, Director of Engineering, KTLA-TV, 5800 Sunset Blvd., Los Angeles, CA 90028. 6-85-11

**BROADCAST TELEVISION EQUIPMENT MAINTENANCE ENGINEER.** If you're looking for the challenge of hands-on problem solving in an environment where the capable engineer is recognized as an integral part of each and every project, VIDEOCOM has an opportunity to interest you. VIDEOCOM, a major teleproduction facility, located in the Boston area, has need for a self-motivated equipment maintenance professional with varied experience in television systems operations, maintenance and repair. FCC General Class License, supervisory experience and proven ability in Ampex 2" Quad maintenance/repair are necessary ingredients for success in this position. Please send resume to: Box BE, VIDEOCOM, 502 Sprague Street, Oedham, MA 02026. 6-85-11

**BROADCAST ENGINEERS!** Looking for Something Creative & Challenging? Broadcast Technician II - \$1654-\$2117 per month. Broadcast Technician III - \$1826-\$2337 per month. Washington State University's department of Radio-TV Services is growing and needs broadcast engineers. We are building a statewide microwave system, operate three radio stations and a TV station and need good people. Broadcast Technician II requires: two years full-time experience/training in radio or television technician work, ability to perform maintenance on broadcast equipment. Broadcast Technician III requires: four years of full-time experience/training in radio or television broadcast technician work. Strong experience in RF transmission, microwave systems and two-way radio preferred. Experience with Harris, GE and Macom a plus. Apply by July 18, 1985. Send resumes to Staff Personnel, 134 French Administration Bldg., Pullman, WA 99164-1014. (509) 335-4521. WSU is an EOE. 6-85-11

**MID-ATLANTIC INDEPENDENT IN HUNTING,** fishing, winter-sports area looking for TOP maintenance engineer. Must have experience on Ampex 1200s, 3/4", TK-28s. First phone or equivalent necessary with emphasis on maintenance. Growing Chain offers opportunity for advancement to right individual. Replies to Dept. 648, Broadcast Engineering, P.O. Box 12901, Overland Park, KS 66212. EOE. 6-85-11

**TV TRANSMITTER ENGINEER.** Harris BT25H2 and studio experience. Good benefits. Send resume to KLAS-TV, P.O. Box 15047, Las Vegas, NV 89114. EOE/M/F. 6-85-11

**RADIO MAINTENANCE TECHNICIAN:** Group W is looking for a rare individual qualified for audio and RF technical tasks for its All News station in Los Angeles, KFWB. This individual will be an expert in audio, RF, digital design/repair and station operations, plus have a working knowledge of trades and skills from telephony to electronic construction techniques. This individual will be an effective communicator, both verbally and in writing; a proven troubleshooter, proficient at thorough schematic documentation; and sensitive to the human engineering and service organization requirements of a technical department at a major market station. Applicants should have a minimum of an Associated Degree in broadcast electronics along with three years station experience in maintenance and construction, or six years of solid station technical background with a proven performance record. Certification as a Senior Broadcast Engineer by the SBE will be regarded favorably, as will a background in hobbies such as Amateur Radio, electronics, or personal computers. The successful applicant will receive competitive pay, a superb benefit package, and a chance to help shape the future of All News Radio. Resumes or questions regarding this position should be directed to Richard A. Rudman, Engineering Manager, KFWB, 6230 Yucca Street, Los Angeles, California 90028. Telephone inquiries will be refused. Group W Broadcasting and Cable, Inc./KFWB is an Equal Opportunity Employer. 6-86-11



**TV BROADCAST TRANSMITTER ENGINEER**—Must have extensive experience with broadcast transmitters and hold valid F.C.C. operators license. RCA "F" line experience a plus. Must have ability to troubleshoot and maintain terminal gear, STL, ENG/EFP microwave, digital systems and earth station hardware. Experienced only please. Also interviewing experienced studio maintenance engineers. Contact William Seaman, Manager of Engineering, WTVN-TV, 1261 Dublin Road, Col., OH 43216, (614) 481-6663. EOE. 6-85-1t

**TV ENGINEER—RESPONSIBLE FOR THE IMPLEMENTATION**, operation and maintenance of a state-wide TVRO satellite based network and the University's state-of-the-art broadcast quality equipment. Minimum requirements are: A 2 year degree in electronics and 2 years' experience in satellite TVRO operation, maintenance and installation. To receive full consideration, submit resume by June 28, 1985 to: Marshall E. Allen, Director, Educational Television Services, 104 Telecommunications Center, Oklahoma State University, Stillwater, OK 74078. OSU IS AN AFFIRMATIVE ACTION/EQUAL OPPORTUNITY EMPLOYER. 6-85-1t

**CHIEF ENGINEER—NEEDED FOR NEW 5,000 KW, UHF, Northeast Market.** (Serving Hudson Valley.) Construction from ground up. Semi-Turnkey at studio and transmitter. All new equipment. First class station with remote production van—120 KW Comark transmitter—ST&L, IC&R, Remote Pickup Microwave—Complete production studio plus Master Control—TVRO satellite installation. Prefer 3 to 5 years hands-on experience, state-of-the-art equipment for installation and supervision. General Class FCC License. Knowledge of FCC Rules and Regulations. Resume/Salary requirements to: P.O. Box 1609, Kingston, New York, 12401. EOE. M-F. 6-85-1t

**ENGINEER IN CHARGE—State-of-the-Art 48' Mobile Unit** with experience on TK 47's, BVH-2000's, Abekas Digital Systems, Chyron 4100 necessary. Competitive salary/benefits. Mobile unit supported by large established production facilities. Contact Hal Lipman, E.J. Stewart, Inc., (212) 626-6500. EOE/MF. 6-85-2t

## POSITION WANTED

**TRANSMITTER ENGINEER** experienced in installation and maintenance. Desire position with progressive station. Can assume full maintenance duties. Strong television background. Dept. 644, Broadcast Engineering, P.O. Box 12901, Overland Park, KS 66212. 6-85-1t

## FOR SALE

**COPPER!** For all your broadcast needs. #10 Ground radials, 2, 4, 6, 8" strap, counterpoise mesh. 317-962-8596. Ask for Copper sales. 3-85-7t

**BROADCAST EQUIPMENT—VHF low, NTSC, 20 KW OR MORE TRANSMITTER, TOWER, ANTENNA, STUDIO EQUIPMENT, TEST EQUIPMENT,** (203) 625-0393 DAVE. 5-85-3t

**VIDEO PRODUCTION & POST-PRODUCTION EQUIPMENT**, new and used, all types and makes, write or call for latest inventory list. Pioneer Technology Corporation, 1021 N. Lake St., Burbank, CA 91502, (818) 842-7165. 6-85-eom

**1" EDITING SUITE—RCA TH100's, GV1600 with E-Mem, CMX edge, Yamaha console, GV sync and Proc. Conrac monitors, Tektronix test equipment consoles, etc. Cube vans—Video and Tape. Five triaxed cameras, GV1600, GV400 routing, Chyron 4000, VPR2's with Slo-Mo. Yamaha console, RTS Intercom, generators. Excellent condition. Gerstenlager 38' van. Three axle, recently re-built, new interior, excellent condition. Tek 465 and 475 scopes, 25X and 22X lenses, TK760 and TK-76 cameras. 1" C used video tape, video monitors, etc. Call Jack Taylor, WVSCO, (215) 367-2800. 6-85-1t**

**FIVE PE G.E. BROADCAST CAMERAS, 850' cable, 5 encoders, enhancers, monitors, reel to reel machines, much more. \$12,500, firm. Send for list. Rex Nichols, Cross Broadcasting Corporation, Box 429, Tafton, PA 18464, (717) 226-9481. 6-85-1t**

**VPR-80's WITH TBC-80's—deluxe color monitor bridge, low hours, mint condition. Three available. WTC-TV, (203) 527-6161. 6-85-2t**

**1-AMPEX AVR-2 in excellent condition!** Includes: Spin Physics Mark XV headwheel, waveform, vectorscope, and color monitor, auto chroma, auto tracking, digital TBC, Gen. locking sync gen., and Editor. Call Bay Area Interconnect, ask for Jack Goldie. (408) 998-7344. 6-85-2t

# Oldies but goodies.

Special sealed bid auction by the City of New York:

- Two inch video tape machine, AMPEX, type 1200B s/n 0346520. Purchased in June 1973.
- Two inch video tape machine, AMPEX, type 1200B s/n 1416242 with Mark II edition. Purchased in April 1971.
- Two inch video tape machine, AMPEX, type 1200B s/n 1595897 with Mark II edition. Purchased in June 1969.
- Two inch video tape machine, AMPEX, type 1200B s/n 0346519. Purchased in June 1973.
- All of the above with options: Amtec, Colortech, VHO, dropout compensator, velocity compensator. No video or wave for monitor; is side car configuration.
- Two inch video tape machine, AMPEX, type 1200B s/n 8135313 with options: Amtec, Colortec, VHO, dropout compensator, velocity compensator. Overhead configuration. Purchased in July 1967.

Each bid must be accompanied by a deposit of 10% of total amount of bid in cashier's check, certified check or money order (no cash) payable to "Director of Finance, City of New York." No personal checks. Deposit of successful bidders applied as partial payment; others returned.

For Bid Proposal Packets Contact: Gordon Shaw  
(212) 669-8548

Sealed bid opening June 27, 1985.

For inspection of equipment, contact Stuart M. Lefkowitz, Department of General Services, WNYC-TV, Municipal Bldg., 25th Floor, 1 Centre St., New York, N.Y. 10007. Telephone (212) 669-7709.

The City of New York

Department of General Services, Division of Municipal Supplies  
Robert M. Litke, Commissioner

**Ampex ACR-25 cartloader, headwheel test jig WTC-TV** (203) 527-6161. 6-85-2t

**TELEVISION TRANSLATORS! ACRODYNE T-230V/U VHF in, UHF out. Solid state except final amplifier. Removed from service, tested. One available now, Channel 3, 6, or 12 in Channel 57 out. Another available soon, a third good for rebuilding or parts. Cost \$24,000 new. Make offer. Jerry Lewine, (408) 422-1299. 6-85-1t**

**TWO AMPEX AVR-1 2" VIDEO recorders, excellent condition. \$12,000 each or best offer; you remove and ship. Massachusetts Institute of Technology. Tom Donnelly, MIT, Cambridge, MA (617) 253-2776. 6-85-1t**

**OFF-LEASE/REPO CAMERA SYSTEMS, including RCA TK-760, Hitachi SK-80A & SK-96, and Sony DXC-Mk3. Contact Bob Jagemann at SCIENTIFIC CLEARING HOUSE, 471 Atlas, Brea, CA 92621, 714/529-9666. 1-85-6t**

## EQUIPMENT LEASE

**SATCOM 3-R AUDIO SUBCARRIERS FOR LEASE.** SATCOM 3-R audio subcarriers for lease, Los Angeles area uplink. Can provide up to eight 15 KHz subcarriers on Transponder 4, 24-hour service. Call: John Roberts, United Video, 918/665-8890. 6-85-2t

## WANTED TO BUY

**WANTED: Pre-1923 radio equipment and tubes.** August J. Link, Surcom Associates, 305 Wisconsin Ave., Oceanside, CA 92054, (619) 722-6162. 3-76-1t

**WISH TO PURCHASE broadcast camera tubes, transmitting tubes & equipment in good operable condition. State condition and age. Will make best offer. S&M Associates, 105 Cedar Ave., Hewlett, N.Y. 11557. (516) 599-6434. 6-85-1t**







## GET THE PICTURE

### With the Schwem Gyrozoom 60/300™ Image Stabilizer Lens



**Now, truly stabilized optics.** The new Schwem Gyrozoom 60/300 Image Stabilizer Lens fits most  $\frac{2}{3}$ " ENG cameras and eliminates virtually all image vibration. Smooth footage is obtained when shooting from any moving vehicle—helicopter, truck, boat, motorcycle—even on foot—whether

the camera is hand-held or on a tripod. The image is stabilized optically—not with braces or brackets.



**Zoom from 60mm to 300mm.** This lens enables you to shoot close-up from 1000 feet with a perfectly steady image. It is ideal for newsgathering and sports coverage.

**Compact and lightweight.** The Gyrozoom weighs in at approximately 6 lbs. Power drain is only 1 additional minute/hour.

**Easy to operate.** There's no special training required. It is as easy as 1. Attach 2. Aim 3. Shoot.

**American quality backed by a full warranty.** Fully warranted for 6 months with an optional service contract after warranty period.

To get the picture, you have to see the picture. Call Schwem Technology today to arrange a free demonstration.

3305 Vincent Road, Pleasant Hill, CA 94523, Call Collect (415) 935-1226.



**SCHWEM**  
TECHNOLOGY

Circle (2) on Reply Card



# For the engineer who has everything...

We present the Ward-Beck family of DAs that offers even more!

Engineered to provide flawless performance with complete operational flexibility, the units may be arranged in numerous combinations within the MF-6B 3 1/2" standard rack mounting frame. Each module is individually self-powered, with a choice of either actively balanced transformerless circuitry or a fully balanced transformer design, and features front panel LED level and status indicators. Fully enclosed metal construction, utilizing a unique combination of custom extrusions, provides maximum RF immunity. Remote sensitivity is also available.

The M600 Series... created for systems focussing on the future!

## WBS

First by Design.

Ward-Beck Systems Ltd.,  
841 Progress Avenue, Scarborough,  
Ontario, Canada M1H 2X4.  
Tel: (416) 438-6550.  
Tlx: 065-25399.

