

OCTOBER, 1971/75 cents

# Broadcast Engineering®

*the technical journal of the broadcast-communications industry*



A HOWARD W. SAMS PUBLICATION

**Those New System  
Specs** page 31

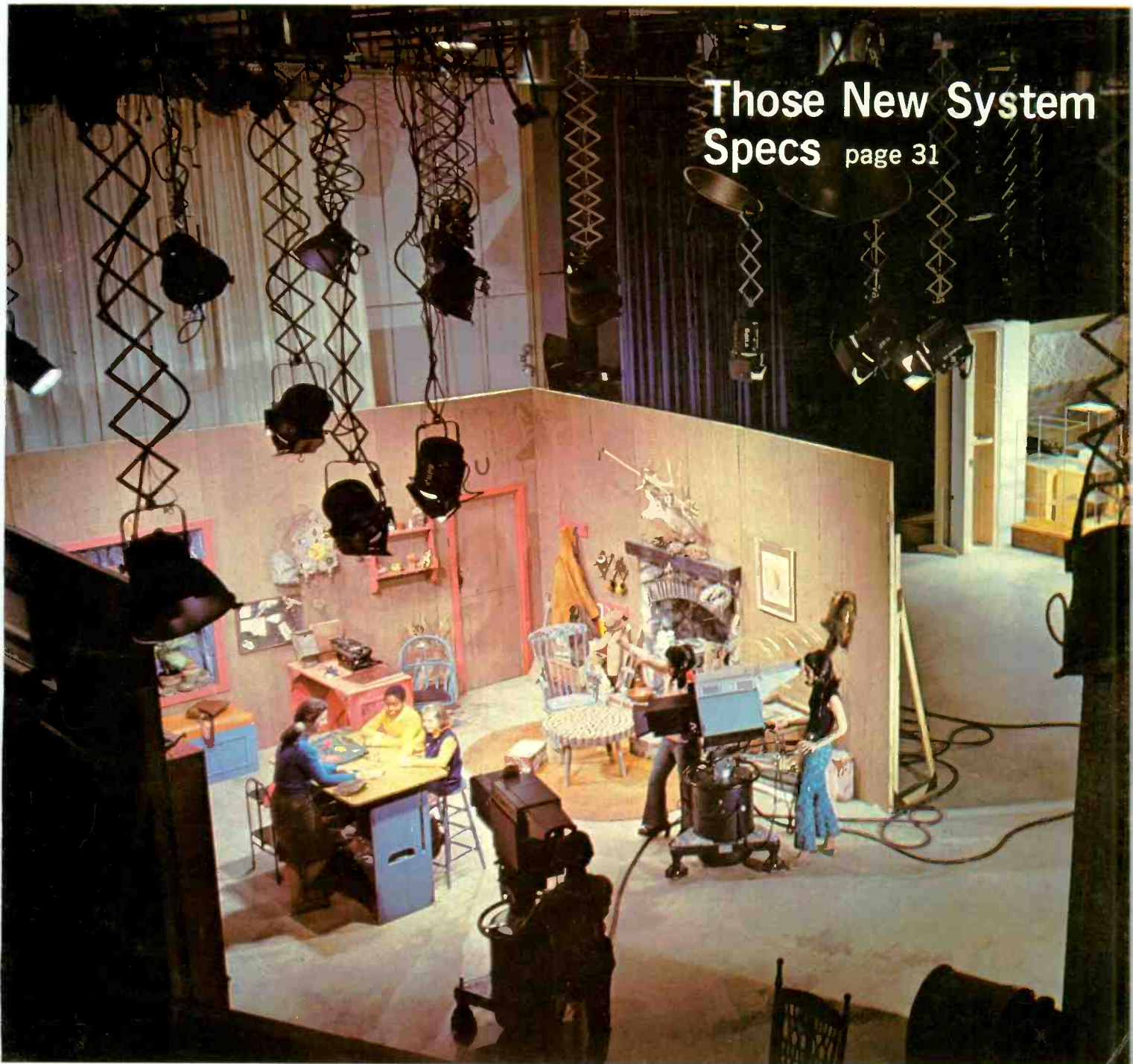

**Educational Roundup  
Tape Recorder Repair  
Local Power Systems**

# Teledyne announces the introduction of their new Color Telefilm Recorder that transfers color tape to color film with remarkable quality.



Teledyne Camera Systems' CTR-2 Color Telefilm Recorder.

## Extraordinary quality and practical economy from the outset.

Teledyne has developed the first broadcast quality Color Telefilm Recorder. They knew that excellence was mandatory. A piece of equipment that wouldn't deliver sharp, clear, color-balanced 16mm film transfers would not stand up to your criteria. So, the system was perfected and then it was introduced.

### Engineering bottom line.

Primary heart of the system is the camera (DBM-64B) which uses compressed air to pull down and stabilize the film in less time than the television vertical blanking period. Result is full

frame recording without mid-field splice or shutter bar.

### System works for operator not the other way around.

Human engineering, ease of operation, and maintenance maximizes productivity. All components are immediately accessible. Test points on the printed circuit cards used with the built-in waveform monitor allow operation, adjustment, and trouble shooting without a separate oscilloscope. Slanted camera optical path is very convenient for magazine loading.

### It almost had to be Teledyne.

You expect innovation from pioneers. Because the camera came first, from Teledyne, the system's development was only an extension. That camera revolutionized tape to film transfer and is clearly the industry's standard.

### Partial list of nomenclature that makes the point.

DBM-64B Camera. Conrac RHM-19 Display. Tektronic 528 Waveform Monitor. Modified Tektronic 602 "X-Y" Display. CBS Labs Mark II Image Enhancer. Rank Decoder. Maurer "F" Prime or Auricon "Modulite" Variable Area Recording Galvanometers. Teledyne CK-120 Magnetic Recording System. And so on.

### Giant step for the state of the art.

Video tape production and 16mm broadcast and dupe transmission are now a quality reality. To learn more about this capability and making it available to your operation, contact Teledyne Camera Systems at 131 North Fifth Avenue in Arcadia, California 91006. Telephone (213) 359-6691. They'll send you a reel sample.

 **TELEDYNE CAMERA SYSTEMS**

Circle Number 1 on Reader Reply Card

Cohu's Broadcast Color Film Camera offers superlative performance with complete convenience at a moderate price.

Rapidly adjust for poor film colorimetry with "Instant Paint Control" and return to normal colorimetry with the touch of a button. Enjoy ease of operation with precision triple action automatic circuitry. Reduce annual retubing costs to an industry low with three long-life separate mesh vidicons.

A new optical system design virtually eliminates flare and ghosting to give you unsurpassed colorimetry. All circuit boards

are silkscreened with each circuit function clearly designated by name. The price includes image enhancer, color encoder, remote setup and control panels, remote setup and waveform monitors and a cable connector kit.

For complete information on the Model 1500 contact Cohu Electronics, Inc., Box 623, San Diego, California 92112 Telephone 714-277-6700 TWX 910-335-1244

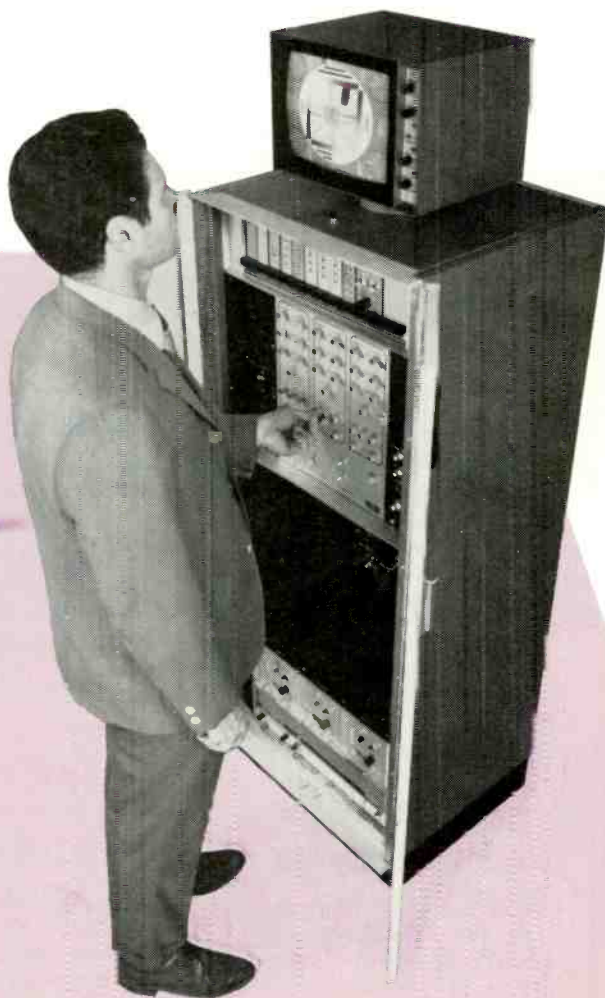

## THE PERFORMER

REGISTER THE  
CAMERA IN ONLY  
2 TO 3 MINUTES

COLOR  
BALANCE  
IN LESS THAN  
3 MINUTES

CHANGE A VIDICON  
IN 30 SECONDS

WITHOUT DISTURBING  
THE YOKE OR  
OPTICAL ALIGNMENT

Circle Number 4 on Reader Reply Card

# Broadcast Engineering

The technical journal of the broadcast-communications industry

*in this issue...*

**22 Film In Local Origination.** Part three of a 4-part series on the use of film in CATV and educational systems. Includes discussion of equipment selection and staffing. **R. J. Wulf.**

**26 NAEB Convention Roundup.** Preview of major educational broadcasting trends and a look at the business of the October 17-19 national convention in Miami Beach.

**31 That New System . . . What Am I Bid?** Includes considerations engineering must make in writing up the specifications for bids on a new system. **Kenneth B. Knecht.**

**36 Care Package For Tape Recorders.** A review of inspection and maintenance procedures for professional tape recorders. **Gene Titterington.**

**42 Power Systems And Their Effects On Station Audio.** A professional engineer describes typical AC power sources for broadcast stations and shows how these can affect audio quality. **Leon B. Davis.**

**47 Air Force ITV Goes Mobile.** An Air Force training unit improves efficiency and flexibility by putting together a truly mobile ITV studio. **Capt. A.M. Garfield.**

## ABOUT THE COVER

The cover this month depicts the sophistication of educational/public broadcasting in the 1970's. See articles on NAEB, page 26, System Bidding, page 31; and Air Force ITV, page 47. Photo courtesy of Maryland ETV system and RCA.

## DEPARTMENTS

Direct Current . . . . .	4
Letters To The Editor . . .	8
Industry News . . . . .	11
Industry Calendar . . . . .	15
CATV Scope . . . . .	16
Engineer's Exchange . . .	51
New Products . . . . .	55
Tech Data . . . . .	62
Ad Index . . . . .	65
Classified Ads . . . . .	66

Copyright, 1971, Howard W. Sams & Co., Inc. All Rights Reserved: Material may not be reproduced or photocopied in any form without written permission of publisher.

## EDITORIAL

GEO. H. SEFEROVICH, Director  
RONALD N. MERRELL, Editor  
CARL BABCOKE, Technical  
MORRIS COURTRIGHT, Automation  
PAT FINNEGAN, Maintenance  
HOWARD T. HEAD, FCC Rules  
ROBERT A. JONES, Facilities  
WALTER JUNG, Solid State  
ANDRA BOYLE, Editorial Assistant  
H. G. ROESLER, Cartoonist  
DUDLEY ROSE, Art Director  
LEO G. SANDS, CATV

## EDITORIAL ADVISORY BOARD

LES NELSON, Chairman  
Howard W. Sams & Co., Indianapolis

## CIRCULATION

EVELYN ROGERS, Manager

## ADVERTISING

E. P. LANGAN, Director  
R. JACK HANCOCK, Manager  
JOAN HIRES, Production  
JAKE STOCKWELL, Sales

## REGIONAL ADVERTISING SALES OFFICES

MICHAEL KREITER  
1014 Wyandotte St.  
Kansas City, Mo. 64105

Indianapolis, Indiana 46206  
ROY HENRY  
HOWARD W. SAMS & CO., INC.  
2469 E. 98th St.  
Tele: 317/846-7026

New York, New York 10019  
CHARLES C. HORNER  
3 W 57th St.  
Tele: 212/688-6350

Los Angeles, California  
JOHN D. GILLIES  
3600 Wilshire Blvd., Suite 1510  
Los Angeles, California 90005  
Tele: 213/383-1552

London W. C. 2, England  
JOHN ASHCRAFT & CO.  
12 Bear Street  
Leicester Square  
Tele: 930-0525

Amsterdam C, Holland  
JOHN ASHCRAFT & CO.  
W.J.M. Sanders, Mgr.  
for Benelux & Germany  
Herengracht 365  
Tele: 020-240908

Tokyo, Japan  
INTERNATIONAL MEDIA  
REPRESENTATIVES, LTD.  
1, Shiba-Kotohiracho, Minato-ku  
Tele: 502-0656



BROADCAST ENGINEERING is published monthly by Intertec Publishing Corp., 1014 Wyandotte Street, Kansas City, Missouri 64105. Telephone: 913/888-4664.

BROADCAST ENGINEERING is mailed free to qualified persons engaged in commercial and educational radio and television broadcasting. Non-qualified subscriptions in the U.S. are \$6.00 one year, \$10.00 two years, \$13.00 three years. Outside the USA add \$1.00 per year to cover postage. Single copy rate 75 cents. Back issue rate \$1.00. Adjustments necessitated by subscription termination at single copy rate.

Controlled Circulation postage paid at Indianapolis, Indiana.



Robert E. Hertel, Publisher

Intertec Publishing Corp.  
Subsidiary of Howard W. Sams & Co., Inc.

# HELICAL SCAN VTR PROCESSOR SYSTEM

940H PROCESSING SYSTEMS RELIABLY REPLACE ALL SYNC AND BLANKING PULSES MISSING DURING THE PERIOD OF THE HELICAL SCAN (SLANT TRACK) VTR DROPOUT. BY INSERTING STANDARD PULSES INTO THE VIDEO SIGNAL, DUBS TO OTHER HELICAL SCAN OR QUADRUPLIX MACHINES CAN BE MADE. IN ADDITION, SYNCHRONIZING PULSES AVAILABLE FROM THE 950H SYNC GENERATOR CAN BE USED TO DRIVE CAMERAS AND SPECIAL EFFECTS SYSTEMS FOR TITLE INSERTION, ETC.

FOUR SYSTEMS ARE AVAILABLE, ONE FOR MONOCHROME AND THREE FOR COLOR. MODEL 940H-4 COLOR SYSTEM EMPLOYS A MODEL 955 COLOR LOCK AND COUNTER TO PROVIDE THE USER WITH A COMPLETE COLOR SYNC GENERATOR SYSTEM WHEN PROCESSING IS NOT REQUIRED.

ALL MODELS EMPLOY THE SAME TYPE MOUNTING FRAME. THE MONOCHROME VERSION (940H-1) CAN BE CONVERTED TO COLOR AT ANY TIME BY INSERTION OF A 955, 962, OR 966 MODULE.

MODEL 940H-1 . . . . .	\$1,550 *
(Monochrome)	
MODEL 940H-2 . . . . .	\$1,775 *
(Color w/Burst Amplifier)	
MODEL 940H-3 . . . . .	\$2,035
(Color w/Color Lock)	
MODEL 940H-4 . . . . .	\$2,300
(Color w/Complete Color Sync Gen)	
AGC OPTION (MODEL 906)	
FOR ANY SYSTEM	\$500

GVG PROCESSORS CARRY A TWO YEAR WARRANTY AND ARE AVAILABLE ON A 30-DAY TRIAL.

\*NOW AVAILABLE IN PAL AND SECAM VERSIONS.

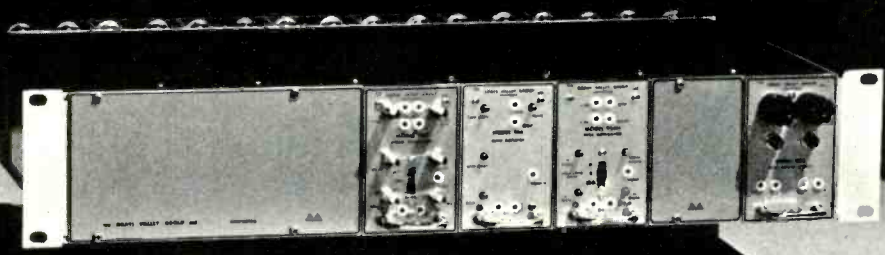

THE GRASS VALLEY GROUP, INC. 

FOR ADDITIONAL INFORMATION, CONTACT GRAVCO SALES, INC.

6515 Sunset Blvd.  
LOS ANGELES, CALIF.  
(213) 462-6618

Station Plaza East  
GREAT NECK, N.Y.  
(516) 487-1311

125 South Wilke Road  
ARLINGTON HEIGHTS, ILL.  
(312) 394-1344

2626 Mockingbird Lane  
DALLAS, TEXAS  
(214) 352-2475

1644 Tullie Circle, N.E.  
ATLANTA, GEORGIA  
(404) 634-0521

Circle Number 5 on Reader Reply Card

# DIRECT CURRENT FROM D. C.

October, 1971

Howard T. Head

## VIT Insertion Required for Television Remote Control

The Commission has adopted final technical regulations governing locally-generated vertical interval test (VIT) signals to be employed for monitoring purposes when television broadcast transmitters are being operated by remote control (see May, 1971 D.C.). The new rules are to become effective April 1, 1972, providing remote control applicants with sufficient time to obtain the necessary equipment for generation of the VIT signals.

As reported in this column last month, the new remote control application form (FCC Form 301-A) has been adopted. With the standardization of the VIT and monitoring requirements, the Commission is ready to act on the first group of VHF remote control applications. The Commission is expected to act cautiously in making its first grants, to assure that high standards are set in the processing of future remote-control applications.

The VIT signal is to be inserted on Line 18 of both fields 1 and 2 and Line 19 of field 1. Various options are permitted with respect to the use of Line 19 of field 2. The various test signals consist of a white window followed by multiburst, color bars, and a composite signal consisting of 3.58 MHz modulated stairstrip followed by 2T and 12.5T sin<sup>2</sup>pluses with an 18 microsecond white reference bar.

Specific observations to be performed on the test signals are not set forth in the Commission's new regulations. The purpose of the new test signal, however, is to permit all transmissions to be maintained within the limits required by the Technical Standards. A special article by a member of the Commission's staff in next month's BROADCAST ENGINEERING will explain the Commission's requirements in more detail.

Although the requirement for the test signals was associated primarily with the authorization of remote control for VHF television transmitters, UHF licensees should bear in mind that the test requirements are applicable to all TV stations operated by remote control.

## OTP Studying CATV Broadband Feasibility

The White House Office of Telecommunications Policy (OTP) has awarded a study contract to a Washington consulting firm to pinpoint the areas in which two-way broadband transmission by CATV systems is most likely to prove of public benefit. Many such ideas have been suggested, such as burglar alarms, utility meter readings, home shopping, and the like, but there has been little development in any of these areas beyond the exploratory stage.

*(Continued on page 6)*

# The History Savers at work.



David Hall and Sam Sanders discuss a fine point.

Deep inside a building at New York's Lincoln Center for the Performing Arts, recorded history is being recorded again. At the Rodgers and Hammerstein Archives of Recorded Sound, technician Sam Sanders is busy continually transcribing all sorts of old recordings, transcriptions and acetates. Not only will there then be a more permanent record of this valuable material, but access to it is made easy through a sophisticated catalogue system, by which interested persons can hear material that was otherwise unavailable.

The Rodgers and Hammerstein Archives of Recorded Sound are part of the New York Public Library, Research Library of the Performing Arts, and encompass virtually the entire history of recorded sound. But to get these early (and often irreplaceable) discs onto tape wasn't easy. Because until the recording industry established its own standards, playing speeds, groove widths and depths were widely varied.



Stanton engineers worked closely with Archive Head David Hall and engineer Sam Sanders

when the Archive Preservation Laboratory was being set up. Standard Stanton 681 cartridge bodies were chosen for their superior reproduction characteristics. However, some 30 different stylus types had to be prepared to give the tape transfer operation the variety needed to match the various old groove specifications. Each was hand-made by Stanton engineers to fit a particular disc's requirements. So when Sam Sanders begins the careful disc-to-tape transfer, he must first match the stylus to the record. Both microscope and trial-and-error techniques must be often used together. But one of the special styli will enable every last bit of material to be extracted from these recorded rarities.

It goes without saying that a company willing to take such care in helping to preserve recorded history must also be interested in superior reproduction of today's high fidelity pressings. Which is one reason why Stanton cartridges remain the choice of professionals the world over.

For an informative brochure about our professional-quality cartridges, write to Stanton Magnetics, Inc., Terminal Drive, Plainview, N.Y. 11803.



STANTON

Circle Number 6 on Reader Reply Card

(Continued from page 4)

The new studies are expected to be completed within the next few months, and are intended to make recommendations concerning the commercial viability of these and other schemes for which two-way broadband transmissions by CATV is most likely to be fruitful. These studies are expected to produce a list of experiments considered to be technically feasible, together with recommendations as to locations where testing might be fruitful. Criteria for evaluating the results of the work are to be included.

The initial contract does not include actual experimentation. If OTP agrees with the initial recommendations, actual work along these lines might begin in the summer of 1972.

#### Government Agencies Study Television for Time and Frequency Standardization

The National Bureau of Standards (NBS), working with the U.S. Air Force and the U.S. Naval Observatory, has successfully demonstrated the use of television network transmissions originating in New York as a basis for highly accurate relative time measurements. Accuracies on the order of 1 microsecond have been achieved in the tests.

The high degree of accuracy provided by the New York City network transmissions arises from the fact that the three major networks employ rubidium frequency standards for their New York originations. The NBS system requires no modification of the video waveform as presently transmitted, measuring the time interval between successive frames by measuring the time between the trailing edges of the line 10 vertical synchronizing pulses. Line 10 was chosen because its relation to the equalizing pulse train makes the horizontal sync pulse and its field particularly easy to identify. The NBS method is quite simple, with test units having been constructed for less than \$200 each.

Experiments have also been conducted involving the insertion of special test signals on Line 16 which would provide the station with various waveforms now required to be generated locally. Initial work in this area held considerable promise, especially in the area of providing color reference signal sufficiently stable to permit precise transmitter frequency control. The Commission, however, discouraged further experimentation, one reason being the large number of conflicting demands for special signals in the non-picture portion of the waveform (see above).

#### Short Circuits

The Commission has proposed rules to govern the incidental RF radiation of electronic video recorders (EVR) and other similar devices, and has provided for temporary waivers while the new rules are under study . . . Look for the AM "freeze" to continue to drag on; there is lack of agreement in the Commission as to the shape of new AM rules . . . The Commission has approved the technical details of a second system for off-the-air Pay-TV.



# You can do more

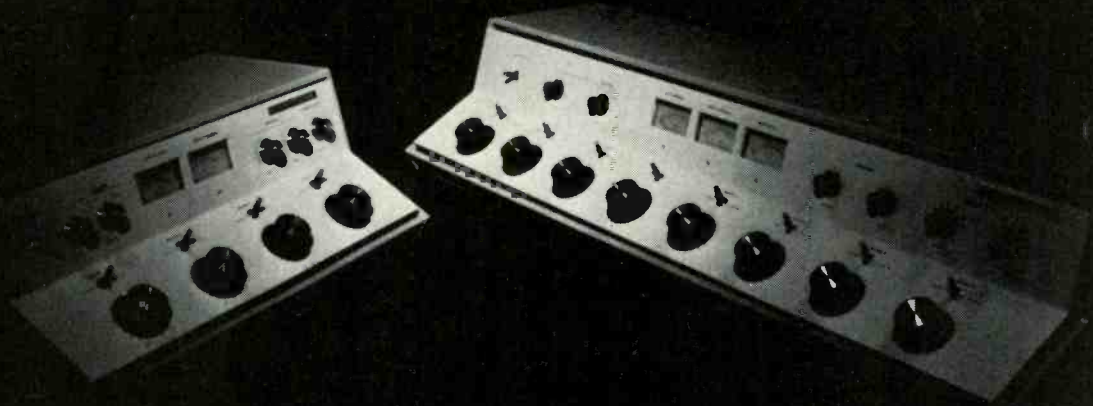

## with Collins new stereo consoles

Increase your station's capability and programming flexibility by selecting Collins 4-channel 212K-1 or 8-channel 212L-1. Both are all new, all solid-state. And packed with features such as reverse cue and stereo headphone output jacks.

The 212L-1 has dual stereo monitor outputs and a monaural program output.

Both consoles have fresh new styling—easy to look at, comfortable to use.

And under this new look . . . Collins design and manufacturing quality.

For more information, see your Collins representative or contact  
Collins Radio Company, Dept. 400, Dallas, Texas 75207.

Phone: (214) 235-7863 (direct line).



COMMUNICATION/COMPUTATION/CONTROL

Circle Number 7 on Reader Reply Card

Spotmaster

## The Top Turntable



... is Spotmaster's new Studio Pro B, offering instant start and the tightest cue potential in the industry. Heavy duty hysteresis motor drives a 6½ lb. machined aluminum platter in a solid-cast aluminum chassis for inaudible rumble, lowest wow and flutter. Indicator lights tell speed (33 or 45) at a glance, and speeds can be changed with platter in motion. Detachable mounting plate (accepts any tonearm), integral 45 spindle and neutral cue position are other features ... all for just \$198.00.

## And an Outstanding New Tonearm

... is the Spotmaster stereo BE-402 (mounted on Studio Pro B above), which combines reasonable cost, rugged design and professional specs. Features include high compliance for modern stereo cartridges, minimum tracking error, anti-skating, low mass, quick-change head, easy single-hole mounting ... for only \$54.95.

Complete line of Gray professional arms and all broadcast quality phono cartridges also available at competitive prices.

## And the Best Turntable Preamp

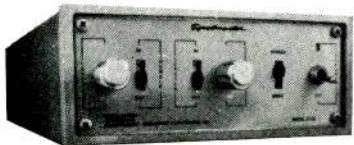

... is our new Model TT-22, all solid state, modular, stereo equalized and completely self-contained. Features separate balance/level controls, high output (+8dbm), phone jack ... plus switchable and removable rumble and scratch filters. Both stereo and mono models are available, starting at \$121.50. Our time-tested TT-20B mono preamp and PR-4C power supply (will power up to 4 preamps) are also available, providing top performance at economy prices.

## ...all from Spotmaster

PLUS a complete range of accessories for both turntable and cartridge tape operation. Write for details.

**BROADCAST ELECTRONICS, INC.**

A Filmways Company

8810 Brookville Rd., Silver Spring, Md. 20910  
(301) 588-4983

# LETTERS TO THE EDITOR

## Titles, Titles Everywhere ...

**Dear Editor:**

In response to Mr. Alexander's question in the July issue of **BE**, there should not be any special licenses to separate (what he terms) the "sheep" from the "goats" in the engineering field.

All novice engineers, and I include myself, are only educated with the basic knowledge of engineering that the FCC requires for a license. The lack of experience and training in the technical aspects of radio should be expected from a beginner. Separating the "qualified" licensees from the "unqualified", on the basis that the latter acquired their Tickets through the "quickie" schools, is like keeping a promising radio announcer from advancing, professionally, because he developed his skills by means other than the standard college radio route.

I agree with Mr. Alexander that a new licensee be trained under the guidance of an experienced Chief Engineer. Not only would this be advantageous for both involved, but as Mr. Ridgeway suggested, the qualification of a licensee would be measured by the experience he has acquired through the benefit of his First Class License.

**John Cali, Eng.**  
**KAZA-Radio**  
**Gilroy, Calif.**

## Engineers Design

**Dear Editor:**

Fred Chapman mentions in his letter, in the June issue of **BE**, a "general plot" to downgrade engineers. I personally think it is the contrary; there is a definite trend to upgrade the engineer to where he really should be, distinguishing from those which traditionally have called themselves so unrightfully.

An engineer is a person who designs and develops. A person who

builds, installs, operates, and fixes, as Mr. Chapman mentions, is not an engineer but a technician. Generally, a good technician is a college graduate, but with studies different from and not as extensive as those of an engineer. A station cannot operate without an engineer, technicians, or announcers because all three are important. If one person in a small station does announcing and technical tasks plus a bit of engineering intermittently, I don't think he should be given the title of Broadcast Engineer.

**Jorge M. Moran**  
**Elmhurst, N.Y.**

## Look To Organizations For Qualifications

**Dear Editor:**

In regard to the letter in **BE** from L. H. Garner of Torrance, Calif. (August 1971 issue), I would in general agree with his analysis of the "Engineer/Technician Controversy". However, I do not agree with his conclusions.

I feel that no amount of rhetoric will solve the problem, logical or otherwise. The only solution will be when responsible engineering organizations set up qualifications for those using the title of engineer in its many classifications for those employed in private industry and grant certificates to those who so qualify just as the state governments now do for those who desire to offer their services to the public and advertise themselves as engineers.

**L. W. Mallach, EE**  
**Los Altos, Calif.**

**Editor's Note:** If working under a given set of responsibilities gives you a title, we have one set of titles that might work. But if we talk only of qualifications, we are on another subject. Only the state tests

(Continued on page 10)

# How does WDCa-TV deliver a super power UHF signal to Washington, D.C. viewers?

To bombard a 70-mile radius with total strength, Milton Grant, Vice President and General Manager, and Don Doughty, Director of Engineering, had to be innovators. And now WDCa-TV has the world's most powerful transmitter. A 220 kW Gates UHF television transmitter . . . super power with IF modulation.

Today, WDCa-TV delivers a greater intensity of signal strength than any other TV station in the world, let alone in Washington, D.C.



Quincy, Illinois 62301



*Don Doughty, Director of Engineering*



*Milton Grant, Vice President and General Manager*

**With the most powerful TV transmitter in the world, that's how. The Gates 220 kW.**

# READY TO TRADE IT IN?

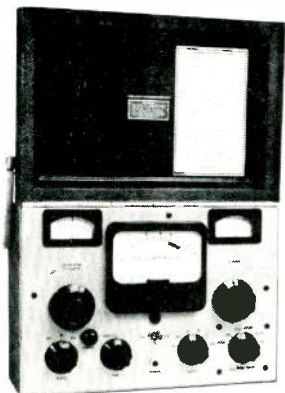

We're offering these two solid-state replacements in trade:

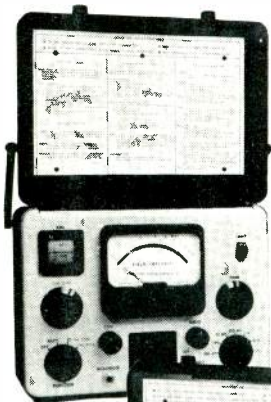

**FIM-21**  
535 KHz to  
1605 KHz

or

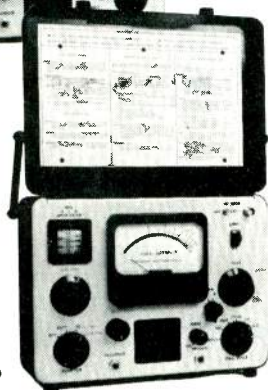

**FIM-41**  
540 KHz to  
4.8 MHz  
(Measures AM Broadcast  
Harmonics to -80db)

#### Typical Features:

- Front Panel Speaker
- Illuminated Meter and Dial
- Ganged Osc/Receiver Tuning
- High Adjacent Channel Rejection
- Stable over Wide Temperature Range
- Long Battery Life (standard D cells)
- External RF Input Jack

If you're ready to trade up to the next generation of Field Strength Meters from the manufacturer of the 120(WX-2), please write or call:



**POTOMAC INSTRUMENTS, inc.**

932 Philadelphia Ave.  
Silver Spring, Md. 20910  
Phone: (301) 589-3125

Circle Number 10 on Reader Reply Card

## Letters

(Continued from page 8)

qualify one for the title of Professional Engineer. And after passing that test, he is a registered PE whether he uses it or not.

The FCC exam qualifies you under the title of Operator, although you may not "operate" anything, but rather, you may maintain, build, or redesign station equipment. It would be more accurate to say that the Third Class license is an operator license; the Second Class license is a technician license; and the First Class license is a technician/engineer license.

But the DJ increases his job opportunities when he takes a license course for the First Class license (technician/engineer) yet continues to work as a DJ (operator).

For that matter, the PE may find himself working as a consultant at a station where he often finds he is working as a technician.

## How To Lose Your Job

**Dear Editor:**

Regarding Mr. Walker Bennett's letter in the August 1971 issue of **BE**, I must agree his suggestion of making a report to the FCC of improper operation after trying unsuccessfully to get the owner to finance necessary repairs will definitely get results.

Not only will the station quickly meet specs, but in addition, there will probably be a quick change of personnel in the engineering department.

**Stu Rasmussen**  
Beaverton, Ore.

## Closing The 'Gap'

**Dear Editor:**

"Kudos for Cottingham!!" I can't say how much I enjoyed Mr. Cottingham's articles (series Jan., Feb. and March, 1971) in **BE**. Tremendous! The insight he displays into the many and varied problems of engineer/management communication is nothing short of amazing! Evidently he came "up through the ranks", too. In my opinion, this article will prove to be the most significant in your magazine's career. Thank you for printing it and

most gracious appreciation to Mr. Cottingham for his insight and for putting it into print and sharing it.

While I'm about it, may I say that your magazine is **MUST** reading for any and all technical people in broadcasting.

**Henly McElveen, CE**  
WJOT Radio  
Lake City, S.C.

## Station Break Solution

**Dear Editor:**

The usual procedure for making station breaks during a long night of maintenance at a remotely controlled transmitter, it seems, is to use a single-channel remote amplifier and a microphone. Too often the amplifier is needed regularly at the studio, and remembering to bring it along is just one more minor inconvenience the engineer has to deal with.

However, I've developed a quick-and-dirty solution that gets around the problem quite nicely. The only equipment necessary is a pair of clip leads, and the transmitter telephone.

The procedure is quite simple. First, pick up the phone and dial any number, except 0 or 1. This gets rid of the dial tone. Then place the clip leads from the phone terminals to the program line terminals on the telephone line input board. This, as you can see, feeds the output of the phone to the limiter amplifier input. Speaking into the phone will then put you on the air.

Don't forget to disconnect the leads between breaks, however, because some of the things said while working shouldn't be aired!

Although this solution is quite simple, the results are quite satisfactory. There was a small amount of personal satisfaction involved in this discovery, because I rarely think of anything that my engineering "guru", Tom Hill of KLCN, Blytheville, Arkansas, hasn't discovered already.

**Hollis W. Duncan**  
Chief Engineer  
Herber Springs, Ark.

**Send Your Letters  
or Comments  
To Broadcast Engineering**

## FCC Adopts VIT Rules For Remote Control

Rules governing the transmission and observation of vertical interval test signals by television stations authorized to operate by remote control have been adopted by the Commission (Docket 18425). The action amends Part 73 of the rules, and becomes effective on October 5, 1971.

The rules require use of a "package" of test signals developed by the Electronic Industries Association (EIA). They standardize the requirements for the test signals, and specify that transmission will not be required until April 1, 1972, pending the general availability of suitable equipment for this purpose.

Earlier this year the Commission adopted amendments to rules governing operation of remotely controlled TV stations, requiring in part that each remotely operated station generate special test signals, which would be inserted in the vertical interval at the remote control point and observed at the remote control point after off-the-air reception of the transmitted signal. The Commission suspended the effectiveness of the amended rules, however, until standards were developed for their use and invited comments and information from interested parties.

In adopting the EIA test signal package, the Commission said the EIA proposal was tailored specifically for transmitter surveillance and, "with the problems of off-the-air reception in mind," is the most appropriate plan for use with remotely controlled broadcast transmissions.

The rules also require continuous test signal transmission during all periods of station operation when actually operating by remote control and the logging of the results of test signal observations at least once each half-hour.

The Commission reassured li-

censees that it does not intend to use the results of off-the-air monitoring of these test signals in enforcing its rules, and said it will not hold the licensee responsible for transmissions, which off-the-air monitoring of test signals might indicate to be faulty, in the absence of substantiating on-the-site observations and measurements.

## Torbert Will Handle Freeze Policy Questions

Executive Director John M. Torbet has been designated by FCC Chairman Dean Burch to handle all inquiries directed to the FCC concerning the impact of the economic stabilization policies and programs announced by President Nixon on August 15, 1971.

Noting that the Commission had been "deluged" with inquiries from all areas of the communications industry, the Chairman stated that the FCC was working to coordinate presentation of communications oriented problems with the Cost of Living Council and the Office of Emergency Preparedness. He said that key decisions would be transmitted to the industries involved as they are formulated.

Chairman Burch said that the Commission was aware of the unique problems faced by the communications industries. He cited seasonal broadcast rate cards and the fact that common carrier rates for various interstate services are established in tariffs filed and reviewed by the Commission.

Pointing out that Secretary of the Treasury John Connally and the Cost of Living Council were working to develop authoritative guidelines with all possible speed, Chairman Burch stated that inquiries on communications could be handled most effectively if they were directed to a single point at the FCC, the Executive Director's Office.

your  
**NORTRONICS**  
distributor is  
the best source  
for professional  
tape heads!

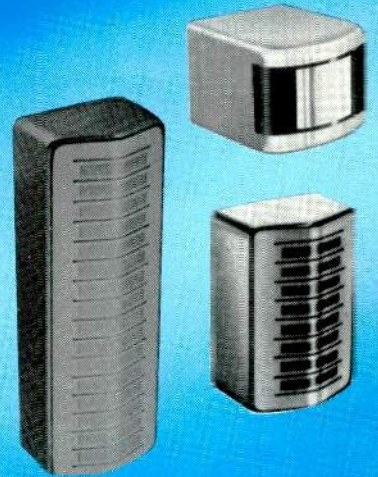

Nortronics . . . world's leading designer and manufacturer of magnetic heads . . . offers the precise replacement head for virtually every professional recorder . . . heads that provide outstanding performance, longest life and easy replacement with minimum downtime.

Nortronics' distributors stock the 'right' replacement head for your professional recorder—be it Ampex, Magnecord, Scully, Concertone, Gates, Crown, RCA, ATC, Collins, KRS, Macarta, MCI, Tape-A-Thon, Sparta, Tapecaster—or any other!

See your Nortronics distributor today for professional reel-to-reel or cartridge head requirements. He also carries a complete line of Nortronics accessories and offers head relapping services.



world's leader in magnetic heads

**NORTRONICS**

COMPANY, INC.

6143 Wayzata Blvd.  
Minneapolis, Minn. 55416  
(612) 544-0381

In Canada  
Len Finkler, Ltd.  
25 Toro Road, Downsview, Ontario  
(416) 630-9103

Circle Number 11 on Reader Reply Card

# Put an AKG on the job.



**D-160E**  
**\$60.00**  
**Net**

AKG-12

## It will sound better!

For complete information  
on AKG performance at  
prices ranging from  
\$40. to \$75. net write to:



**MICROPHONES • HEADPHONES**

DISTRIBUTED BY  
**NORTH AMERICAN PHILIPS CORPORATION**  
100 EAST 42ND STREET, NEW YORK, NEW YORK 10017

AKG CANADA • DIVISION OF DOUBLE DIAMOND ELECTRONICS • SCARBOROUGH, ONTARIO

Circle Number 12 on Reader Reply Card

## NBS Experimental System Ready For Network Tests

A new experimental system using a single video line to disseminate accurate frequency and time information over the nation's commercial TV networks was previewed in the NBS Booth at WESCON.

The system, designed to fill a broad spectrum of needs of national frequency and time, is capable of time resolution to nanoseconds and frequency accuracies to  $10^{-11}$ . It will be tested nationally in October. When operational, the system benefits will avail themselves to engineers, scientists, TV viewers, broadcasters and the general public.

The new system puts a 3-part time code on line one of the TV vertical interval consisting of an hours, minutes and seconds (HMS) code alternated with a more precise time code and a 1 MHz signal. The time code is not seen by the viewer and does not affect TV broadcast operation. The television synchronizing pulses on this line are not disturbed.

When broadcast by commercial TV stations, the digital information can be recovered using a low-cost decoder. Part of the code contains

a unique digital prefix, enabling the decoder to recognize it and display the information in proper sequence. The code and its complement are both sent to avoid transmission errors.

The experimental system has important ramifications for engineers and scientists, broadcasters and the general public. Currently, precise time information requires purchasing expensive portable atomic clocks which must be transported to a standard on a regular basis. Even a low-accuracy timing signal is costly in terms of manpower and equipment. If implemented, the TV system will provide both frequency and time signals inexpensively.

Although the new system is designed to provide time and frequency information for engineers, scientists, and the public, there are "fall-out" benefits to TV broadcasters.

Since the time and frequency information is transmitted on only four frames each second, there are additional lines each second available for internal teletype communication between networks and their affiliated stations. By using a stan-

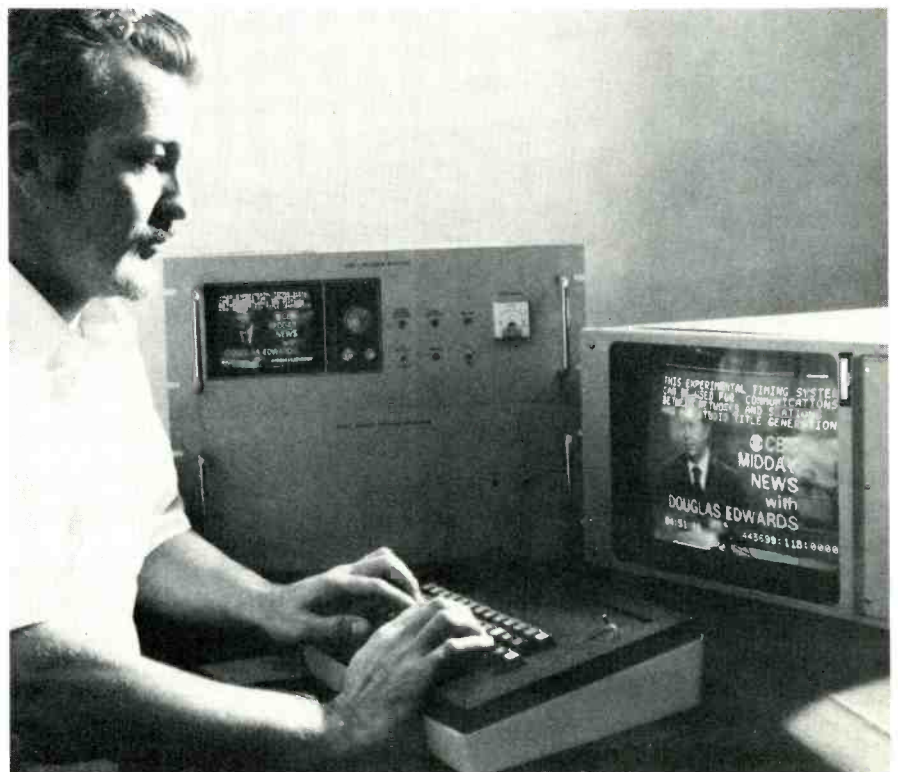

dard keyboard and a message processor, alphameric messages can be transmitted and displayed on remote monitors. The affiliated station can use the same keyboard to generate video titles for home viewers.

Home viewers, in the future, may have an automatic clock TV. A small circuit modification incorporated in future sets by the TV manufacturers will allow the viewer to see a digital clock display on the TV screen. More extensive circuits could be developed to provide "wake-up" signals, timing of an event or used to reset electric clocks in the home.

The TV time system has been thoroughly and carefully tested in local and regional experiments. The national test in October is designed to test the system nationwide via the major networks.

For further information, contact James Kluge, Information Office National Bureau of Standards, Boulder, Colo. 80302 or 303-447-1000.

## FCC Grants Approval For Subscription System

The Blonder-Tongue Laboratories "Number 4745" subscription television system has been granted advance approval by the FCC. This is the second pay-TV technical system to be approved by the Commission. On August 24, 1970, Zenith Radio Corporation's "Phonevision" became the first to receive Commission approval.

"Number 4745" transmits a television signal which is altered by a device which "scrambles" the picture and sound as received by a standard TV receiver. Subscribers to "Number 4745" rent a device which unscrambles the picture and sound.

FCC requirements call for delivery, to the antenna terminals of a subscriber's receiver, of a signal complying with all Commission technical standards for color or monochrome transmission and accompanying aural signal; no internal modifications to the subscriber's receiver; and reception equal to that received with conventional TV programs.

All subscription TV technical systems must be granted approval in advance by the Commission.

## WHAD Silenced

The mystery guests at station WHAD-FM slipped in and signed out . . . out with an entry in the station log "Very early in the morning. Removed exciter and driver amplifier . . . Thank You."

Thoughtful of the thieves, but

deadly for the Delafield, Wisconsin 250 watt station that was silenced.

Meanwhile, Gates' salesman Bob Gorjance was listening to WTMJ, Milwaukee enroute to Chicago when he heard a news announcement of the WHAD-FM predicament. Gorjance contacted John Stiehl, chief engineer at WHA-FM (parent station of WHAD-FM), and negotiations were made for the replacement of the stolen Gates equipment.

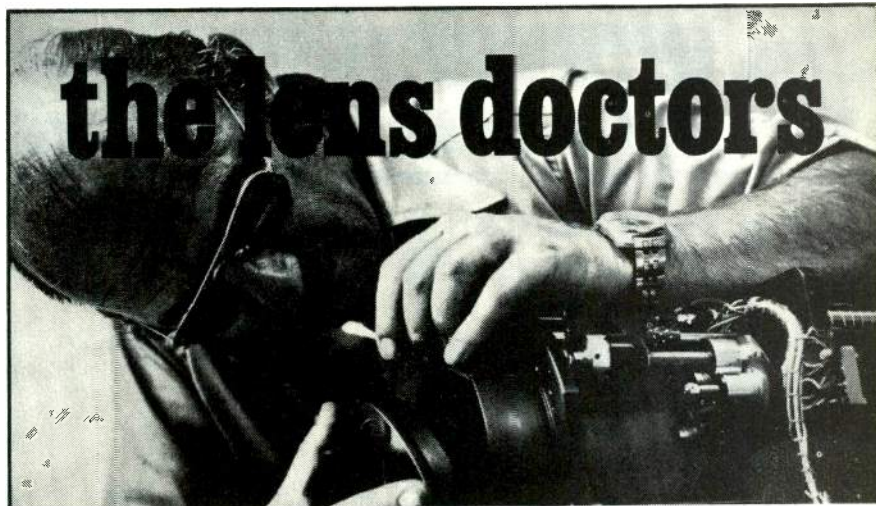

They're good men to know. Because today's tighter schedules have less margin for breakdowns. Because today's higher standards demand more exacting performance. And because today's lenses are increasingly more expensive and complex.

When something happens, you need someone who knows what to do and does it. Fast.

**If it fits on the business end of a camera, they can fix it—television or film—manual or servo.**

The lens doctors aren't just lens mechanics...the foundation of their sizeable organization is lens repair. So service isn't just the name of a department to them... it's a way of life. They guarantee completion of most repairs in under 24 hours. And right—the first time!

But all the commitment in the world won't fix a stripped gear or damaged element. That takes skill.

And equipment. The calibre to repair virtually any lens on the market, including Angenieux, Canon, Taylor-Hobson and dozens more. And the kind of knowledge that convinced the selective Schneider people to bestow their coveted factory-service authorization. Backed by extensive optical and electronic testing facilities, including equipment to test color tracking.

Not that repair is all the lens doctors do. People around the world have created a demand for their innovations, including custom work such as special remoted and automated focus, zoom and aperture controls.

If you have a problem (or want to prevent one), call the lens doctors: Max Blaim and Walter Reiche. You don't need an appointment. And the staff makes house calls in emergencies.

# EASTCOAST CAMERA CENTER, INC.

248 LAFAYETTE STREET, NEW YORK, N.Y. 10012 • (212) 966-5433

Circle Number 13 on Reader Reply Card

## Whitehead Will Address November NAB Conference

Clay T. Whitehead, director of President Nixon's Office of Telecommunications Policy, will be the luncheon speaker at the National Association of Broadcasters' final fall conference in Dallas, November 17.

The six conferences, in as many cities during October and November, serve as an information ex-

change between NAB and radio-tv executives on the major issues facing broadcasters. License renewals, news freedoms, political spending, cable television and other subjects of primary concern will be high on the agenda.

The series of conferences opens in Atlanta on October 15. Other meetings follow in Chicago, Oct. 18;

Boston, Oct. 22; Las Vegas, Nov. 12; Denver, Nov. 15, and Dallas, Nov. 17.

Luncheon speakers for the first five meetings will be announced later.

Dr. Whitehead, President Nixon's advisor on communications affairs, was named to the cabinet-level OTP post in September, 1970, following two years of service as special assistant to the president. Previously, Dr. Whitehead was a consultant to the Rand Corporation and the Bureau of the Budget.

## NAB Hits NCTA Receiver Request

One of the current keys to successful cablecasting is a compatible home TV receiver. And although at least one major manufacturer is now offering such a receiver, the NCTA is taking aim at the assurance of variety. The NCTA has urged the FCC to require that all TV sets be specially designed to receive CATV programs.

Meanwhile, the NAB has been doing its homework. It has asked the FCC to deny the NCTA request. The NAB said that because CATV is not broadcasting, the Commission cannot, without new legislation from Congress, proceed in the proposed rulemaking.

Noting that NCTA wants CATV to be "termed 'broadcasting' under Sections 303(s) and 330 of the Communications Act," NAB pointed out that a 1962 Federal District Court decision, **Cable Vision, et al. v. KUTV, Inc., et al**, held that cable television is **not** engaged in "broadcasting" within the meaning of Section 325 of the Act.

"NCTA and CATV have been content thus far," it said, "to abide by the Cable Vision ruling in that cable interests have not hesitated in the least to retransmit television signals without rebroadcast consent, and certainly have never been heard to insist that the Commission bring them within the language of Section 325."

"But now," the broadcast association added, "CATV wants to be termed 'broadcasting' under sections

*(Continued on page 65)*



# Spotmaster

The incomparable  
new **Ten700**



**World's finest  
cartridge tape  
equipment**

Here is the bold new standard in cartridge tape performance, versatility and ruggedness—the equipment that has *everything!* Five models of the magnificent Ten/70 are offered to meet every recording and playback application. All have identical dimensions. Any combination of two will fit in our sleek 19-inch roll-out rack panel, just 7 inches high.

Control features and options include manual high-speed advance, exclusive Auto-Cue with automatic fast-forward, automatic self-cancelling record pre-set, front panel test of cue and bias levels, built in mike and line level mixer, color-coded design for easiest possible operation.

Inside is a massive U.S.-made hysteresis synchronous "Direct Drive" motor, solid state logic switching, modular construction and premium components throughout, separate heads for A-B monitoring, full bias cue recording, transformer input and output, flip-top access to heads and capstan.

**THE CLASSIC 500 C SERIES.** Long the industry standard, SPOTMASTER'S 500 C series is still offered. Performance and specifications are second only to the Ten/70.

For complete details about SPOTMASTER cartridge units (stereo, delayed programming and multiple cartridge models, too), write or call today. Remember, Broadcast Electronics is the No. 1 designer/producer of broadcast quality cartridge tape equipment . . . worldwide!

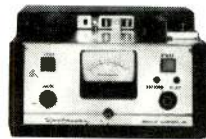

## BROADCAST ELECTRONICS, INC.

A Filmways Company

8810 Brookville Road, Silver Spring, Maryland 20910 • (301) 588-4983



# INDUSTRY CALENDAR

## October

- 17-19 The North Carolina Association of Broadcasters meeting will be held at Grove Park in Asheville.
- 17-19 The annual convention of the Nevada Broadcaster Association will be held at the Sahara-Tahoe hotel at Lake Tahoe.
- 17-20 The National Association of Educational Broadcasters will hold their annual convention at the Fontainebleau hotel in Miami Beach.
- 18-19 The National Association of Broadcasters regional meeting will be held at the Pick Congress hotel in Chicago.
- 20-22 The Indiana Broadcasters Association will hold their annual election of officers at the Ramada Inn in Nashville, Ind.
- 20-22 The annual fall meeting of the Pennsylvania Community Antenna Television Association will be held at the Host Farm in Lancaster.
- 21-22 The regional meeting of the National Association of Broadcasters will be at the Statler Hilton hotel in Boston.

## November

- 11-14 The Sixth annual Radio Program Conference will be held at the Roosevelt hotel in New Orleans.
- 14-17 Broadcasters Promotion Association will sponsor a seminar held at the Washington Plaza hotel, Seattle.
- 16-17 The NAB fall conference will be held at Fairmont hotel, Dallas.

**ERASE  
RECORD  
REPRODUCE**

**MONO - STEREO**

Professional Direct Replacement Heads with complete written and pictorial instructions

Our factory will clean, rebuild, adjust and test your head ASSEMBLY...install new MMI heads...replace minor hardware and modify your gate to accept our "NON-POPPING" springs







36 HOUR SERVICE - LOANERS AVAILABLE  
(612) 884-7393

**MINNEAPOLIS MAGNETICS, INC.**

8125 PLEASANT AVE. SO., MINNEAPOLIS, MINN. 55420

Circle Number 14 on Reader Reply Card

**D. J.'s... Combo-Men...  
Station Managers...  
Technical Assistants...**

## Want to move up faster in Broadcasting?

### Get yourself a First Class FCC License the CIE way!

No matter what your goals are in broadcasting—no matter which side of the microphone you want to work on—you'll earn more money, and get to do "your own thing" a lot faster, if you've got a First Class FCC License.

If you're a D.J. or Combo-Man looking for a better job and a chance to make a name for yourself—you'll find it's easier to get the spot you want at the station of your choice if you can say that you also have a First Class Ticket. Ask around and see.

If you're a station manager—having a First Class Ticket means you're better equipped both to supervise and to substitute for technical personnel—and to choose and evaluate new equipment. So you're worth more to any station owner.

If you're an announcer, technical assistant—or just an ambitious beginner waiting for a lucky break—you'll find that the "lucky breaks" come sooner if you have something more to offer your employer besides your interest and ambition. And that "something more" that separates the men from the boys in this business—is a First Class FCC License.

You've probably heard that it's very difficult to pass the FCC License exam. For un-trained men, it *is* hard. In fact, an average of two out of every three men who take the FCC exam fail.

There is one way, however, of being pretty certain that you will breeze through the FCC exam with flying colors. That's to take one of the FCC home study courses offered by the Cleveland Institute of Electronics. CIE courses explain things so clearly that better than 9 out of every 10 CIE graduates who take the FCC exam pass it. That's why CIE can afford to offer this ironclad, money-back Warranty: "A Cleveland Institute of Electronics FCC License course will quickly prepare you for a Government FCC License. If you don't pass the FCC exam after completing your course, CIE will refund all your tuition. You get an FCC License... or your money back!"

With that kind of Warranty you have nothing to lose on CIE training. And everything to gain.

So send today for our FREE booklet, "How To Get A Commercial FCC License." CIE, 1776 E. 17th St., Cleveland, Ohio 44114.

**CIE** Cleveland Institute of Electronics  
1776 East 17th Street, Cleveland, Ohio 44114

Please send me your FREE book, "How To Get A Commercial FCC License."

Print Name \_\_\_\_\_

Address \_\_\_\_\_

City \_\_\_\_\_

State \_\_\_\_\_ Zip \_\_\_\_\_ Age \_\_\_\_\_

Veterans & Servicemen: Check here for G.I. Bill Information

Accredited Member National Home Study Council

BE-72

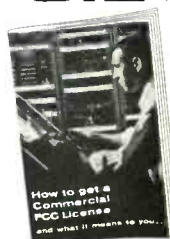

Circle Number 15 on Reader Reply Card

# SCANNING THE CATV SCOPE

By Leo G. Sands

## From Potential To Practice

Implementation of the anticipated FCC requirement that some CATV systems be capable of two-way non-voice transmission requires fairly sophisticated engineering. This requirement also can enhance the income of a CATV system. Included in non-voice communications capabilities are the following:

1. Closed circuit television channels.
2. Data transmission channels.
3. Facsimile transmission channels.
4. Slow-scan television channels.
5. Fire/intrusion alarm circuits.
6. Remote control and telemetry circuits.

The band occupancy of each of the above channels is 10 kHz or less except CCTV which for both picture and sound requires a 6-MHz wide channel. Theoretically, a coaxial cable multiplexed to transmit signals within the 5-270 MHz range could handle up to 63,750 voice grade channels, each of which could be further multiplexed to handle up to 26 tone channels for telegraph, data and remote control transmission. Obviously, the potential capacity of CATV system is impressive. However, in actual practice, all of the available spectrum can seldom be utilized because of intermodulation and cross-modulation problems. And, every CCTV and television program channel takes up as much spectrum space as 1500 voice channels or 39,000 slow-speed data and control channels.

When a single cable is used for two-way transmission, it can be multiplexed to provide 162 MHz of spectrum space between 108 MHz and 270 MHz for forward-direction transmission (away from the head end) and 103 MHz of spectrum space between 5 MHz and 108 MHz for reverse-direction transmission (toward the head end). If the split is at 48 MHz, there will be 43 MHz of spectrum for reverse-direction transmission and 222 MHz of spectrum for forward-direction transmission. In practice, however, some guard band space must be allowed above and below the split.

When two cables are used, each can be multiplexed to convey signals within the 5-270 MHz range in each direction.

When using leased telephone circuits, digital data signals are transmitted and received by a data "modem" at speeds ranging from 45 to 2400 baud (bits per second). A slow-speed data modem can consist of an FSK (frequency shift keyed) modulator and an FSK demodulator operating at a telegraph speed of 100 words per minute, approximately 45 baud. To transmit more data in parallel streams, the voice grade circuit can be multiplexed to transmit up to 16 FSK channels spaced 170 Hz apart.

An FSK modulator may consist of two oscillators, each operating at a different frequency. The output of one is transmitted to send a "space" or "o" signal, and the output of the other is transmitted

to send a "mark" or "1" signal. Or, it may consist of a single oscillator whose frequency is abruptly shifted to denote a mark or space signal. The channel or center frequency is midway between the upper and lower frequencies. A three-state FSK modulator actually transmits the center frequency which is shifted up and down to denote mark and space signals.

A two-state FSK demodulator senses the shift in frequency and responds by energizing a relay or delivering a DC voltage. A three-state FSK demodulator energizes one relay in response to a mark signal and another in response to a space signal, or a bipolar relay, or two different DC voltages. Some also monitor the center frequency and energize or de-energize a relay, or cut off the DC output signal when the center frequency is not received due to a malfunction.

There are various types of data modems. One, for example, contains two FSK transmitters within the modulator section, one operating at a center frequency of 1100 Hz and the other at 2500 Hz, each keyed  $\pm 400$  Hz at a rate of 1200 baud. To transmit data at the rate of 2400 baud, the pulses of the two transmitters are interlaced.

Most data modems are designed to interface with a 600-ohm voice grade or higher grade circuit. When the subscriber furnishes his own data modems, the CATV system operator must provide the equivalent of a voice grade circuit from

(Continued on page 18)

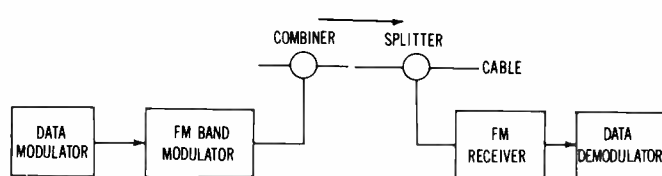

Fig. 1 Modified CATV-type FM modulator can transmit data to an FM receiver.

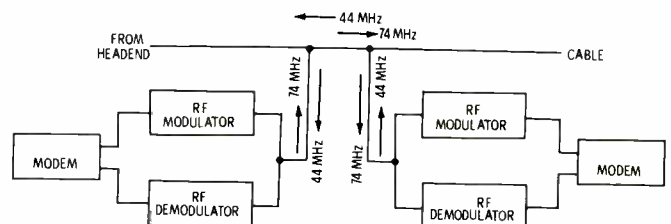

Fig. 2 Example of a two-way data link using bidirectional cable as the medium.

# LECTROTECH Oscilloscope/Vectorscope

**TO-50** . . . High performance, wide band, triggered-sweep oscilloscope at a price you can afford . . . offering features normally found only in laboratory quality instruments

MADE IN USA ■ 1 YEAR WARRANTY

## Model TO-50 Oscilloscope

- All solid state (tube protected input).
- Wide bandwidth (10 mhz minimum).
- DC coupled vertical amplifiers.
- Calibrated vertical attenuator.
- Triggered horizontal sweep.
- Calibrated horizontal time base.
- Automatic sync mode.

- TV sync selector.
- Vectorscope input for color TV
- External horizontal amplifier.
- 60 cycle horizontal sweep (sine wave) with phasing control. Compatible with all sweep generators.
- Edge lit calibrated scale.

These features make the TO-50 a highly essential test instrument for the TV service field, industrial applications such as production testing, communications, engineering and other areas requiring a stable, calibrated oscilloscope display.

### Vertical Amplifier

**Bandwidth:** DC to 10 mhz min.  
**Risetime:** 35 nano seconds  
**Sensitivity:** .02 volts/div. to 50 volts/div. in 2-5 step sequence plus continuously variable control.  
**Input impedance:** 1 meg  $\pm$  1% shunted by 30 pf. BNC connector

### Horizontal Sweep

**Type:** Miller Integrator  
**Sweep speeds:** .02 seconds/per div. to 1 micro seconds/per div. in 1-2 step sequence plus continuously variable control. With 5x magnifier sweep speed increases to .2 micro seconds/per div.

**Magnifier:** 5x magnifier provides magnifications at all sweep speeds

### Triggering

**Source:** Internal, external and line  
**Type:** Automatic or amplitude selection with preset stability  
**Slope:** + or -  
**TV sync:** Normal vertical or horizontal provides positive sync on composite video signals

### External Horizontal Amplifier

**Bandwidth:** DC to .5 mhz  
**Sensitivity:** .5 volt/per div.  
**Input impedance:** 100K shunted by 30 pf.  
**Line sweep:** Continuously variable in phase over 150°. Compatible with all generators for sweep alignment display

### Test Signals

**Calibrate:** 1 volt P-P line frequency square wave  
**Probe test:** Fast rise square wave for probe adjustment

### Cathode Ray Tube

**Display area:** 8 x 10 CM  
**Blanking:** DC coupled  
**Size:** 5 inch

### Power Requirements

**Voltage:** 105-125 volts, 60 cycles  
**Power:** 65 watts

### Mechanical

**Size:** 14 $\frac{1}{8}$ " H x 10 $\frac{1}{4}$ " W x 16 $\frac{1}{2}$ " D  
**Weight:** 23 lbs.



Model TO-50 ..... Net **339<sup>50</sup>**

**TROY ELECTRONIC SALES CO.** 4529 N. Kedzie Avenue, Chicago, Illinois 60625

Circle Number 17 on Reader Reply Card

One of a series of brief discussions  
by Electro-Voice engineers

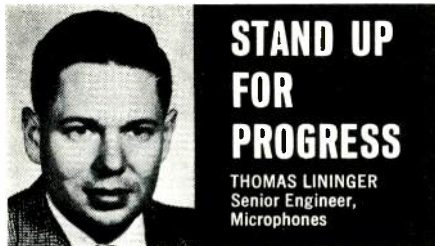

For years microphone stands have received little attention from designers. Once basic functions were satisfied (i.e., floor or desk mounting, switching, etc.) only minor variations were seen, based more on aesthetic considerations than on functional superiority.

Recently Electro-Voice took a close look at the design of their desk stands for broadcast and professional sound applications. The need was underscored by the major change in microphone size and shape in the past decade. With lighter, smaller microphones came a need for matching microphone stands.

Our goal, however, was not to simply make a "pretty" stand, but to provide a design that eliminated several problems noted by studios using current stand designs. The stand had to be low and inconspicuous. It had to be simple, rugged, and easy to use. Assembly had to be quick, and ideally it should provide a degree of noise isolation in addition to simply supporting the microphone.

All of these goals were met in the new Model 421/422 desk stands. Designed to accommodate microphones held in either the Model 300 (1") or Model 310/311 (¾") microphone clamps, the stands are less than 1" high and are available in two sizes: 3½" x 3¾" or 4¼" x 4½". The entire stand is composed of just three parts: a heavy metal casting, a rubber base, and a neoprene mounting insert.

The mounting insert is similar to a large grommet, and is easily pressed into the base casting. A microphone is attached by simply inserting the microphone clamp firmly into the neoprene insert where it is held by pressure of the neoprene. The design eliminates any threading or metal uprights.

By eliminating the upright, minimum height is achieved, varied by sliding the microphone in its clamp, or by tilting the microphone to the appropriate angle. In addition, the grommet provides part of the isolation from shock noise achieved by the stand.

Additional damping of noise is achieved by use of a relatively soft rubber pad that covers the entire bottom of the stand, rather than small, hard rubber feet. Use of a large pad also offers maximum resistance to sliding, even on very smooth surfaces. The low height and resistance to sliding creates a stable platform with minimum weight and complexity.

While a stand is perhaps incidental to the success of a microphone, attention to details such as this can contribute to the overall worth of a product. That's why Electro-Voice engineers continue to work closely with studio engineers to help solve their sound problems.

For reprints of other discussions in this series,  
or technical data on any E-V products, write:  
ELECTRO-VOICE, INC., Dept. 1013V  
638 Cecil St., Buchanan, Michigan 49107

**Electro-Voice**  
a GULTON subsidiary

Circle Number 18 on Reader Reply Card

(Continued from page 16)

point A to point B along the cable route.

Over a telephone company circuit, the data signals are transmitted via a physical (metallic) wire pair or on a carrier-derived voice channel. A carrier-derived channel employs a voice modem at each end of the circuit, each consisting of an SSB modulator and an SSB demodulator. These SSB modulators and demodulators operate at frequencies above audibility. Those that are designed to meet CCITT recommendations operate at frequencies above 60 kHz. For example, a 12-channel carrier terminal operates at frequencies between 60 kHz and 108 kHz with the channels spaced 4 kHz apart.

It is possible to translate this band of frequencies to a higher band of frequencies for transmission over a CATV system. However, the translator must have extremely tight frequency stability. An alternative is to apply this block of frequencies to a wideband FM modulator for transmission and receive them with an FM demodulator.

There are also carrier telephone modems that are individually "stackable" which operate at lower frequencies. However, neither type is easily adapted for CATV system applications.

For single-cable CATV applications, the voice channel modem should consist of a modulator and demodulator which operate in different frequency bands. In dual-cable systems, they could operate in the same frequency band. Also, their band occupancy can be much greater than that of standard telephone carrier modems.

One practical but Rube Goldberg type approach would be to employ an FM band modulator as the carrier transmitter and a fixed-tuned FM receiver as the demodulator, as shown in Fig. 1. Such a carrier circuit should accommodate up to 15 kHz of non-voice signals. Of course, the modulator and demodulator would have to be modified for operation at frequencies other than within the 88-108 MHz band or fed through frequency translators. If the carriers are spaced 200 kHz apart, there would be room for five channels within

each 1 MHz of reverse-direction and forward-direction frequency space assigned to this service. Each such channel can accommodate a single data channel or be multiplexed to provide up to 70 or more slow speed FSK data channels, or a smaller number of higher speed data channels.

A more straight-forward approach would be to feed the output of a data modem to an AM, FM or SSB modulator operating at a frequency within the range of frequencies that can be accommodated by the CATV system, and the input of a data modem from an AM, FM or SSB demodulator.

An even more straight-forward approach would be to have the data signals key an RF FSK modulator directly. Incoming data signals would be translated into DC pulses by an RF FSK demodulator.

At present, off-the-shelf hardware for implementing the above two techniques is not known to be available. But, it undoubtedly will be in the near future.

### The PCM System

Still another approach is to use PCM (pulse code modulation). Several companies produce PCM voice channeling equipment for use over video pair cable. Canadian Marconi Company has developed a PCM system that will handle either data or voice signals and which undoubtedly could be adapted for CATV applications. The Canadian Marconi equipment differs from other PCM equipment in that a single voice or data channel can be dropped and inserted without requiring expensive common equipment.

In a PCM system, the data signals can be applied without first converting them into audio tones. However, in a CATV application, the PCM signal would have to be applied to an RF modulator and extracted from an RF demodulator.

Except in very large cities where some subscribers may require extremely high data transmission capability, the typical CATV system can be expected to serve subscribers whose requirements can be met with a single data transmission circuit. Each data channel would be transmitted at a different RF carrier frequency.

**Transmission  
Of Analog Data**

Different techniques are required for transmission of analog data. The data modem transmits and receives a signal that varies in frequency in step-less fashion.

In addition to transmission of data signals to and from computers, CATV systems can transmit fire and intrusion alarm signals as well as remote control signals.

In such applications, transmission speed is usually of no significance and only the mere presence or absence of a signal is required. When more than a "yes" or "no" signal is required, the modulator and demodulator can employ any of several types of audio frequency resonators which are highly selective. This includes vibrating reed relays, electro-magnetic reed resonators, piezo-electric resonators and the Twintron. These resonators typically require more than 100 milliseconds to respond. Since their cost is relatively low and because they are reliable, they lend themselves to remote control and status alarm applications. When tone combinations are used, thousands of codes are possible.

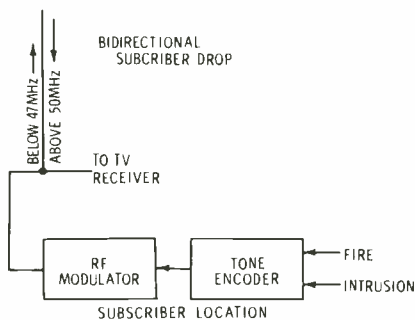

**Fig. 3** Fire-intrusion alarm

It might appear to a CATV system operator that providing data transmission and security alarm services adds greatly to engineering problems. It does, in fact. But the financial returns can be of significance. Once the CATV system has been initially designed or converted for two-way operation, implementation for data and alarm services will not be really difficult when suitable hardware becomes available. This hardware can be expected to become available as soon as manufacturers see market activity.

# Get "Down-In-Earth" Results with the NEW DITCH WITCH EARTH SAW

**Cut  
frozen  
earth...  
coral...  
rock**



Now you can trench where you couldn't before with the Ditch Witch Earth Saw attachment. Turn your basic 65-HP R60 or new R65 trencher into a year-round production tool. Remove the regular digging assembly and install the Earth Saw with four bolts. It's one of the most powerful attachments on the market, but don't overlook the features of the basic trencher! In cold climates, trench with the regular digging chain in warm months; cut frozen earth in winter with the Earth Saw. Use standard assembly in normal conditions; switch to Earth Saw in rocky areas. Two Earth Saw models are available to cut 24" and 30" trench — both at 4" widths. Get proven performance in frozen earth, coral and rock and many types of concrete. Mechanically powered for minimum power loss and maximum performance. Ask your Ditch Witch Professional for a demonstration!



**CUT FROZEN EARTH** — The Earth Saw cuts trench in completely frozen ground for an electric and telephone service line in Michigan.



**CUT CORAL** — In a field demonstration in Florida, the Earth Saw slashes through coral formations.

**The Professionals**



A Division of the  
**CHARLES MACHINE WORKS, INC.**  
100 Ash Street  
Perry, Oklahoma 73077

A full line of trenching equipment — from 7-HP to 65-HP

Circle Number 19 on Reader Reply Card

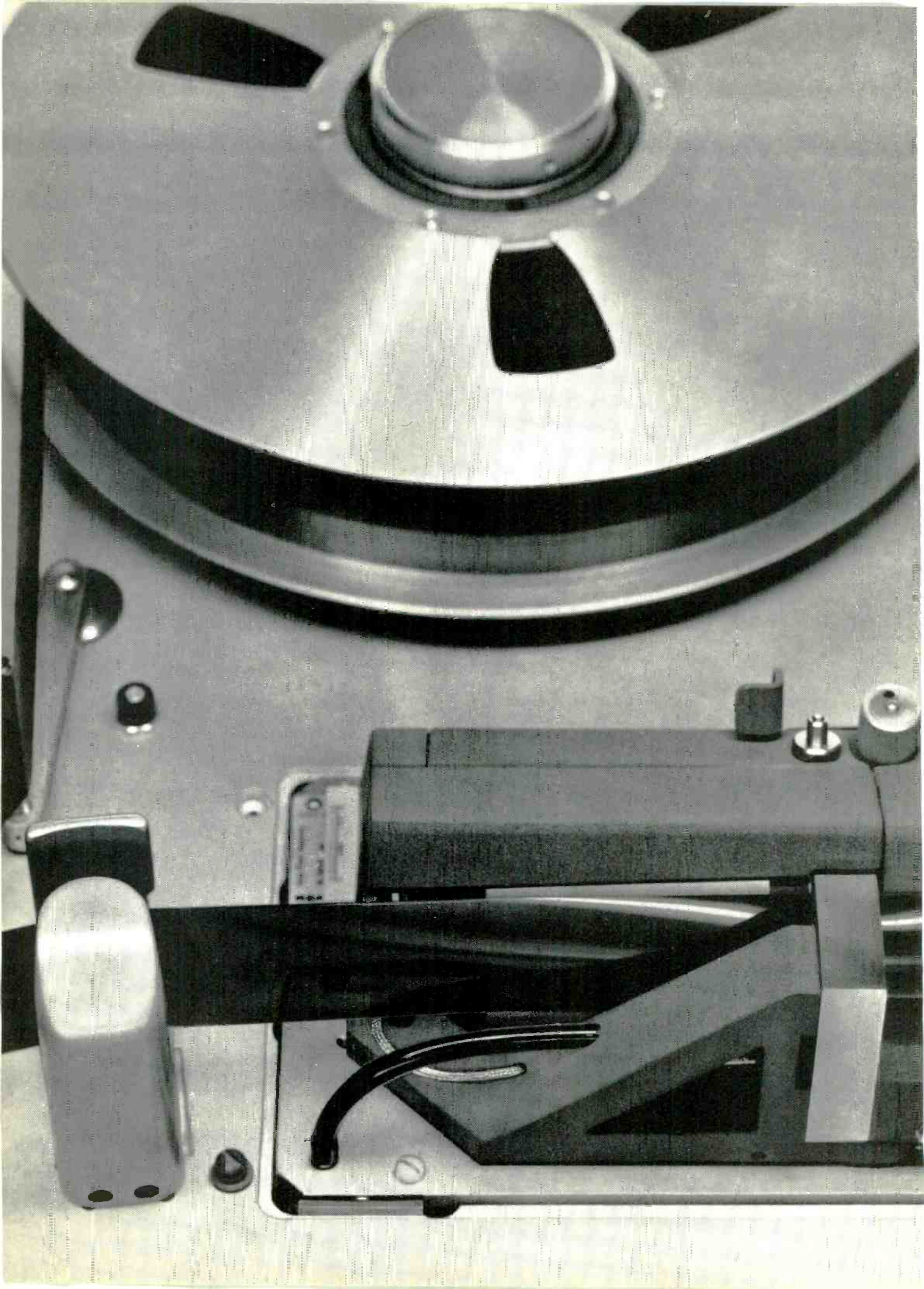

# RCA proudly announces the failure of its new headwheel at KENI-TV, Alaska.

At 3001 hours. We almost can't believe it ourselves.

When we introduced our new, long-life headwheel, we guaranteed it for 200 hours.

Reports back from the field indicate a general life average of more than 500 hours.

Some 35 users are already members of our 1000-hour club—and that used to be an incredible life for any headwheel.

And then there's that little beauty at KENI in Anchorage, Alaska that recorded beautifully right up to 3001 hours. We reworked it more than a year ago using Alfecon II—our new headwheel material.

What's it all mean? Well, our customers are pleased because they don't have to pay for new headwheels so often.

And there are fewer 11th hour decisions about whether to go into a taping session with a wheel that's nearing the end of its average life.

The new headwheel comes with all RCA VTR's, and, of course, the world's first Cartridge Video Machine, our TCR-100.

RCA is in business to help you get your job done more easily, and with more profit.

Our new headwheel is doing it.

The RCA logo is displayed in a bold, black, sans-serif font. The letters are thick and closely spaced, with a distinctive shape for the 'A' that has a pointed top and a wide base.

# Film In Local Origination

By R. J. Wulf, Eastman Kodak

You can't talk very much about local origination on film without looking at the film medium itself. And when we at Kodak talk about the "universal high-speed color film for TV news", we mean Kodak Ektachrome EF film 7242 (tungsten).

Ektachrome EF film 7242 is balanced for tungsten illumination at 3200 K, so a camera crew can use it indoors without a filter. Outdoors, in daylight, the filmmaker can achieve lifelike balance and color with the addition of an 85B filter over the camera lens.

The exposure index (E.I.) is fast (125) so that Ektachrome EF film can be used under tough, available-light conditions. If a cameraman finds that he needs more light, he can rate the film at 250 and still get a quality image. Even in "impossible-but-must-have" situations, he can choose an E.I. of 500 or even 1000 and still have a chance for a usable picture. Naturally, the best results are designed for the normal index, and compensation in

processing must be made when the film is exposed at other settings.

In addition, Ektachrome EF film is a color reversal film, which means that directly upon development, it provides a color positive image that is ready for transmission over the cable. And it's a color image that can be evaluated easily by the naked eye. No need for elaborate machinery for electronic scanning and editing.

## System Approach

While we recommend that a cable manager consider the advantages of an initial investment in **color** local origination, there are 16mm black-and-white Kodak films that lend themselves to available-light news photography. For example, there's Kodak Tri-X reversal film 7278 — a high-speed, reversal-type panchromatic film with an E.I. of 200 for daylight; 160 in tungsten.

It might be helpful, at this point, to review the range of approaches open to a cable system in planning

and shooting film stories in 16mm:

1. Silent coverage
2. Silent coverage with pre-stripped film for 'voice over' post-recording
3. Single-system sound

Silent coverage includes motion-picture film with sound provided, for example, via live narration by a studio announcer. In the post-recording approach, the cameraman shoots the picture without sound but using magnetically prestripped film. After processing, the footage is edited, then run through a 16mm projector that has a built-in recording head. The narration can be a recorded 'voice-over' to match the visual coverage of the event, with the added option of erasing and rerecording the audio with no possibility of harming the film image.

In addition, sound can be recorded onto a standard audiotape cassette recorder at the shooting site and post-recorded onto the magnetically prestripped film. Such a technique can be used effectively in documentaries in two ways: 'Wild sound' can be recorded and later added to the film, where desired, to provide authentic background noise behind the narrator's voice. Sound can also be post-recorded in 'lip-sync' with people on the film where desired. Double-system sound — combining simple 'voice-over' narration, 'wild sound,' and 'lip sync'—offers the film editor a great deal of variety when editing documentary footage.

The most economic and efficient means of recording sound on film is single system sound, widely used in television throughout the world. Picture and sound are recorded simultaneously on prestripped film in the camera. This approach entails more elaborate cameras and editing equipment than silent or post-recording sound, as well as a more experienced film editor.

Whatever the shooting and sound system, however, the exposed film must be processed. And, with to-



Fig. 1 Combining directing and cinematography skills, a film crew from a Florida cable system prepare to film a 60-second commercial for a skin care product.



# End Fuzzy Arguments

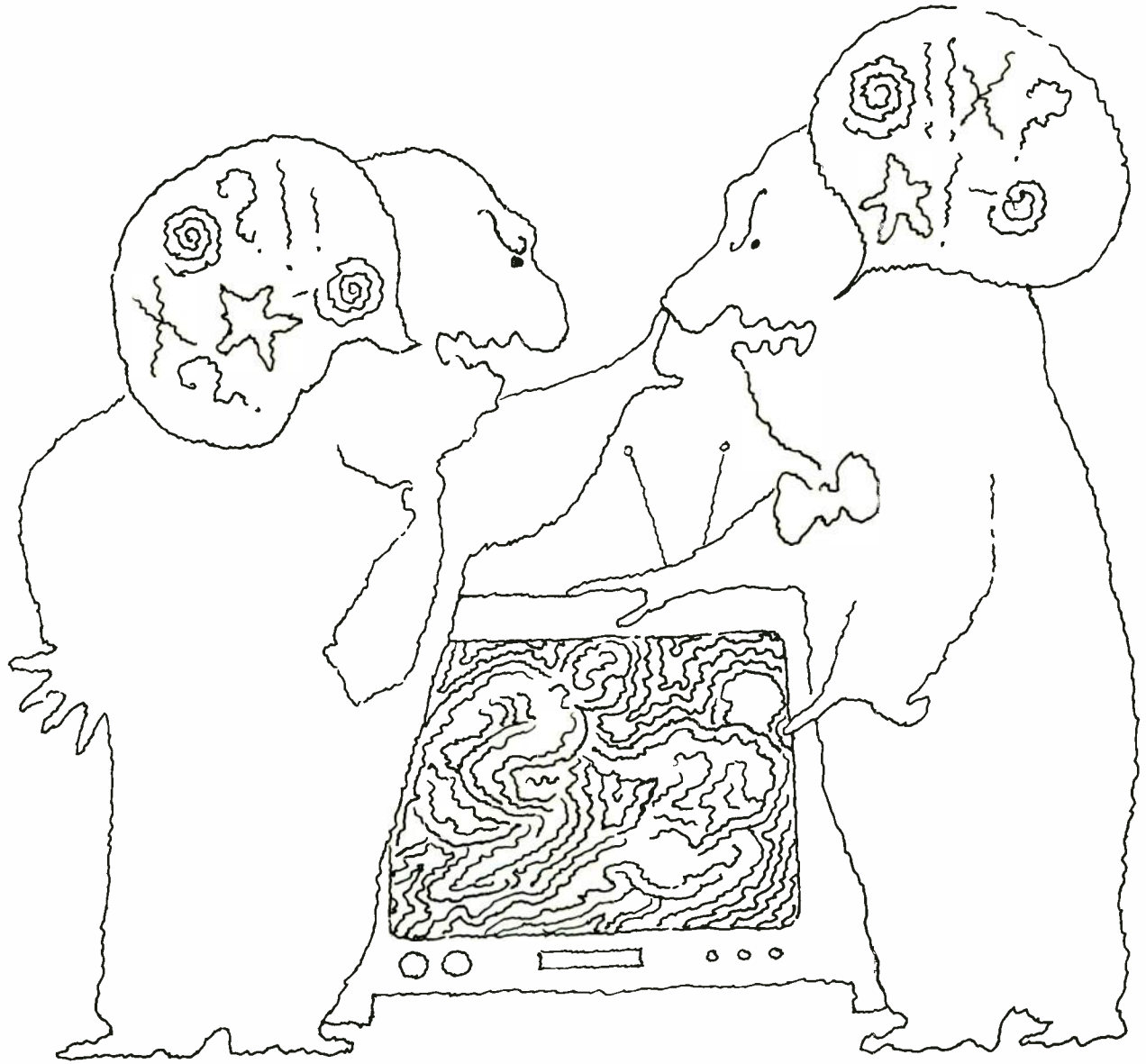

with CBS Laboratories Mark III Image Enhancer — it sharpens the picture automatically!



The Mark III Image Enhancer is a solid state device that for the first time helps to produce a perfect picture automatically. It adjusts vertical and horizontal elements to eliminate color softness. It produces highest stability and lowest drift. It rearranges all the ingredients of the picture so that contrasts are sharper and details more clearly defined. Even numerals on football jerseys can be easily identified. All things being equal, the CBS

Laboratories Mark III Image Enhancer will focus all eyes on your station and make you the undisputed leader in viewer ratings.

## CBS LABORATORIES

A Division of Columbia Broadcasting System, Inc.  
227 High Ridge Road, Stamford, Connecticut 06905

Circle Number 21 on Reader Reply Card

day's automated techniques, processing can be fast and virtually fool-proof, whether the CATV manager elects to handle it via an outside lab or 'in-house.'

### **In House Processing**

At the outset, the cable operator may wonder why he might ever want to process his own film, since service is so readily available from many labs around the country. The answer is fourfold:

**Time.** You can process on your own premises, under your own control. No waiting your turn; the schedule is up to you.

**Independence.** You don't have to depend on an outside source to get your film in time for your all-important newscasts, especially if you're on a tight deadline.

**Quality.** The processing standards are up to you to set and maintain.

**Money.** You save money by handling your own film; and, just as important, you may be able to make money by selling your processing services to other filmmakers in your area and by expanding your own ability to make film commercials for local advertisers.

Before making a decision about in-house processing facilities, a

cable manager should ask a variety of questions, such as: Will I be doing enough local production to justify a processing machine? Do I have the needed space for processing equipment? Who will operate the equipment? Are there other filmmakers in the area to whom I might sell my in-house processing services? For example, high schools and colleges may need a local supplier to process athletic movies.

To determine whether or not processing equipment would be a worthwhile investment, the cable owner should estimate how much film his system will be using. A quick rule of thumb is that you'll shoot at least twice as much film as you eventually put on the air, a 2 to 1 ratio. Some kinds of local documentaries, controversial city council hearings, for example, may approach a 1 to 1 ratio, but most other coverage requires keener editing.

Using a 2 to 1 ratio, the cable system is likely to be shooting about 360 feet of film for every five minutes of edited footage that appears on the home screen.

A good approach for a cable manager is to assume, for the moment, that you're going to install a processing machine. With a tenta-

tive decision, two more questions are essential: What kind of equipment do I need, and how much will it cost?

There are some established guidelines: You will probably want a 10 to 30 feet-per-minute processing machine, based on the decisions reached by others with local TV and CATV film operations. And that machine, plus installation, will probably cost between \$10,000 and \$20,000.

Two pitfalls to avoid in selecting a processor are going too small or too large. It is possible to process Ektachrome EF film in small batches in some of the very small continuous-processing machines. While this represents a minimum initial investment, and while it would provide satisfactory quality, you're liable to find yourself using more film than the machine can adequately process for you in a given period of time. On the other hand, a processor too large for your operation would ingest its daily supply of film in minutes and then sit idle the rest of the time.

Besides processing speed, incidentally, you'll want to know the machine's 'dry-to-dry' time, the time it takes the dry, exposed film to travel through the machine and come out the other end dry, developed, and ready to use. Thus, if a machine has a 30-minute dry-to-dry time and runs at 20 feet per minute, this means that it will take 35 minutes to process a 100-foot roll of Ektachrome EF film.

There are a few other considerations when buying a processor: Is the machine flexible enough to add super 8 processing capability in the future? Does it have an automatic chemical replenishment system? What are the specific steps involved in cleaning and maintaining the machine? How readily available are parts and service from the manufacturer?

The experience of a news director for a small commercial station in Montana holds relevance for cable managers:

"We were the first station in the state to go full color with the addition of a processor and Kodak process ME-4 chemicals," relates

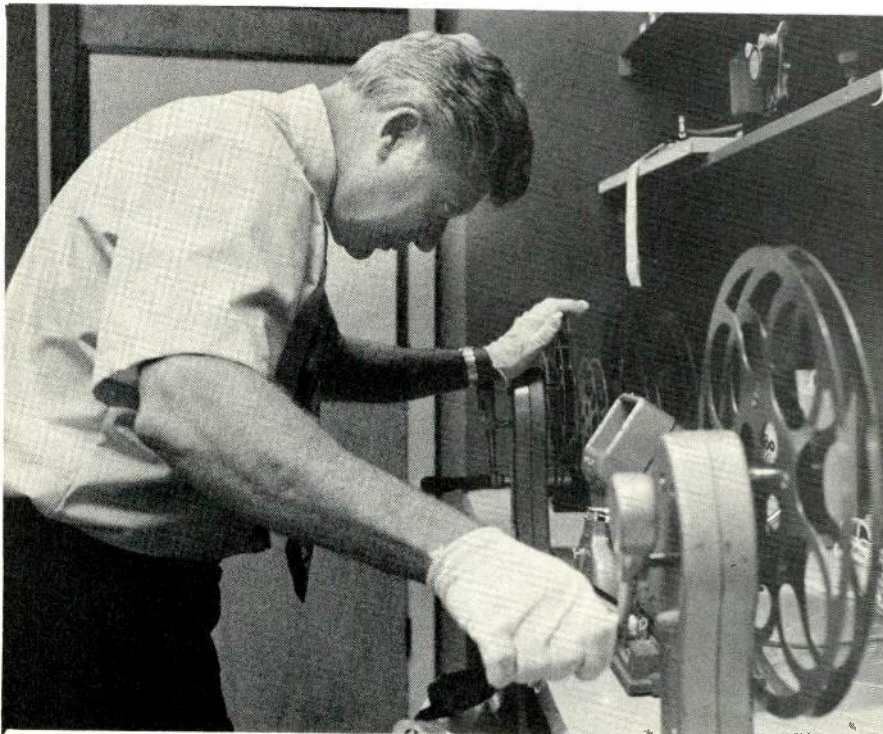

**Fig. 2** Film editor is editing 16mm film. Note he is using white gloves to avoid leaving fingerprints on the film.

the news director. "We're using our color capability mostly for news, shooting about 7,000 feet a month. We've got a great installation. The processor, replenisher tank, mixer, venting, and everything fit into a 15 x 12-foot room, with working space left over. Now that we're into it, we like what we're producing and we've got the lead in our market by a mile."

### The Film Staff

When it comes to staffing for CATV local origination, you'll discover a big advantage in using film: A film crew on location can consist of one man, even one using the finest 16mm film equipment available, unhampered by cables that connect him to an electronic "life-support-system." He is completely independent and completely mobile. In a tight news situation, he can shoot from the roof of a building to get an overhead shot of the entire scene.

Once acquiring the basics, and deciding to move up to single-sys-

tem sound, the cable manager may want to expand his one-man film to two: one shooting footage and one recording the audio.

Ideally, a cable system shooting a fair amount of single-system sound should have a film department of two people. If, after having used film for a while, the shooting schedule gets larger, the manager may want to think about two film teams of two people each. It's important not to have too many staffers, they may tend to get in each other's way. The same goes for the editing department, where a skilled operator will probably do a better job on his own than several not-so-skilled staff people. In short, multiple film teams of two seem to work best in the majority of situations.

When shooting local documentaries and feature stories, advance planning can pay off in a big way by reducing shooting time, and thus, the cost of the program. When planning to go out for a story, have an idea of what the story will tell and

how it will be told. Anticipate such things as poor weather, indoor and outdoor scenes that can involve a variety of lighting conditions, etc. In nearly all cases, the cinematographer will be a lot safer carrying extra accessories, such as portable lights, additional lenses, and—most important—a couple of extra rolls of film.

It's good business to estimate what the probable costs will be in the production of any locally originated program and to keep a running check on expenses so that a program will be a profitable one.

Planning is feasible and desirable on locally produced feature stories, commercials, and documentaries. But when a fast-breaking news event occurs, a film crew can't do much more than try to formulate a visual approach as they rush to the scene. With a loaded camera in the front seat of his car, the cameraman has a head start in capturing a first-rate report of events on film that are of paramount importance to your subscribers. ▲

**If you are contemplating  
a switching system,  
you should take a look at  
DYNAIR's  
Series-5100 equipment.**

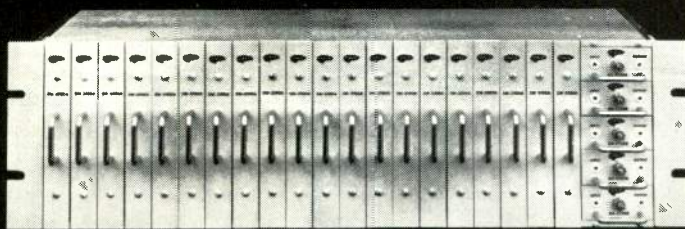

BASIC 20X5 MATRIX

That's right. Take a look at the Series-5100 . . . take a look at the leader. Take a look at the equipment used in many of the world's largest video switching systems, including numerous critical aerospace, military and broadcast applications.

You'll find a very flexible package which is designed to simplify assembly of systems of virtually any size or configuration, and with most methods of switch control. And a complete machine-control capability too. A total system concept, designed to fill your needs, regardless of the complexity of your requirement. And, if you desire, we will design your system, rack it, wire it and test it as a system. Custom control panels are no problem either.

We manufacture a variety of other switching equipment too, including a full line of inexpen-

sive production switchers, 70-MHz computer-controlled IF switching systems, and solid-state video switching systems for bandwidths of greater than 50 MHz, with full equalization of all video paths.

Whether you need a focal-pushbutton-controlled 12X12 matrix, or a 500X500 computer-controlled audio-follow system, your best bet is DYNAIR.

So leave your problem with the experts . . . send us your requirements today. We'll fire back a design and quotation with a realistic approach to the solution.

**DYNAIR ELECTRONICS, INC.**

6360 Federal Blvd., San Diego, Calif. 92114  
Telephone: (714) 582-9211

**DYNAIR**

# STUDIO RECORDERS

by

*Crown*



SX711

CX822

## MINIMUM DOWNTIME

Each unit undergoes more than 100 hours cumulative testing ■ Typical parts shipment from factory service department - under 48 hours ■ Easy access plug-in modules for instant servicing ■ Patented electromagnetic brakes never need adjusting ■ Simple transports - only 9 or 10 moving parts, all solenoid operation ■ Superior tape head contact plus light tape tension for low head wear

## MAXIMUM LIFETIME

Design lifetime is 10 years continuous use or 65,000 hours, with three service check-ups ■ Construction "rugged enough to withstand parachute drops" (AUDIO magazine) ■ Top-grade components such as silicon transistors and tantalum capacitors ■ One of the two remaining original American tape recorder manufacturers; still supplying parts and service for broadcast units 15 years and older

## MAXIMUM PERFORMANCE

Computer logic controls provide rapid fool-proof tape handling, safe popless remote control, prevent broken tapes ■ Best frequency response among all recorders, pro or semi-pro, and the only one that's guaranteed ■ Every unit shipped with its hand-entered proof-of-performance report

Speed	Response-Hz	S/N	Wow
15 ips	+2db 40-30K	-60db	0.06%
7½ ips	+2db 20-20K	-60db	0.09%
3¾ ips	+2db 20-10K	-55db	0.18%

## MAXIMUM FLEXIBILITY

Bias metering and adjustment; record and play equalization switching ■ 2 line level inputs per channel and a 600-ohm line output for each channel ■ Third head monitor with A/B switch ■ At-the-head editing plus cue lever ■ Full line of 1, 2 and 4-channel recorders and players ■ From the mono SX711 at \$895 to the stereo CX822 with typical options at \$2300, you can pay less for a semi-pro recorder, and replace it every couple years . . . or pay more for a wide-tape mastering machine, and get no better performance. It's your choice. To help you make it, we'll be glad to send you full technical data with performance graphs.



® *Crown*  
BOX 1000, ELKHART, INDIANA 46514, U.S.A.



## NAEB Convention Preview

On the 17th of this month about 6,000 people will gather in Miami Beach for the 47th running of the National Association of Educational Broadcasters annual convention. With so many sky blue predictions for cable TV, it will be interesting to see what part the educational broadcasters see themselves playing in the years ahead.

This general theme is the platform upon which most conventions are put together these days. And the NAEB will work into the question marks with sessions on audience research, broadcast education, cable systems, cassettes and cartridges, computer systems, engineering practice, management problems, political programming, and telecommunications.

The record does show that the public, educational, and instructional media will make their mark on the communications scene. Vincennes University has so successfully designed and operated CATV systems that their profit supports the university's instructional and public television services. Georgia Tech student station WREK is one of the first such stations to combine with a commercial station to deliver quadrasonic music.

Meanwhile, the educational FM total two years ago was 387. Today it has reached 460 stations. During the same period, educational TV has jumped to just over 200 stations. And we have no way of totalling the number of new closed circuit systems. What's more, a number of educational FM stations have been climbing above the 10 Watt class of operation.

Aside from the technical advancements in the industry, it's interesting to see how educational broadcasters are meeting today's challenges. The Central Educational Networks WTTW (Chicago)

aired a two-hour special "Wage-Price Freeze: Questions and Answers" that was carried by 22 stations in nine Midwest states. National Public Radio and their new national network have made great strides in public information and have added new perspectives to broadcasting.

"Images and Things," a new 30-lesson art series, was introduced to Kentucky teachers last month through a closed circuit state-wide workshop conducted by the Kentucky Educational Television 13-transmitter network.

Kentucky's network is the only ETV operation in the country with technical facilities to conduct such a workshop. Funded by National Instructional Television and a 26-member consortium, the new series will be seen by about 750,000 grade school students in the U.S. and Canada. Other programs are being produced by the Northern Virginia Educational Television Association and KETC of St. Louis.

Of course, SECA is growing stronger, and a host of other networks such as the New Jersey Public Broadcasting Network have gained acceptance.

### Engineering Challenge

Because educational and instructional broadcasting has been flexing its unique programming muscle, engineering has been thoroughly challenged. Fact is, more attention will need to be given to NAEB engineering groups, committees, and convention engineering sessions. So the challenge is passed to the Association. Then too, the growth of educational and instructional TV in Canada, as evidenced by the growth of York University, will place an extra load on that country's responsible associations.

BROADCAST ENGINEERING

now...

a company  
that has AM, FM  
and TV frequency  
and modulation  
monitoring  
systems.

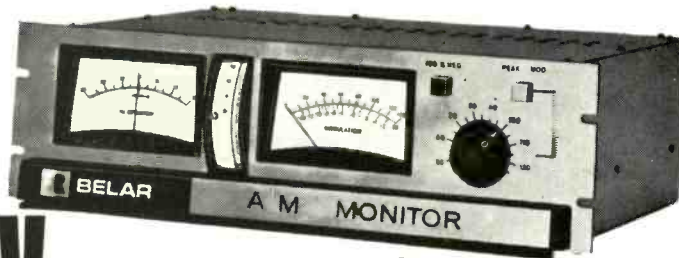

Type Approval #3-176

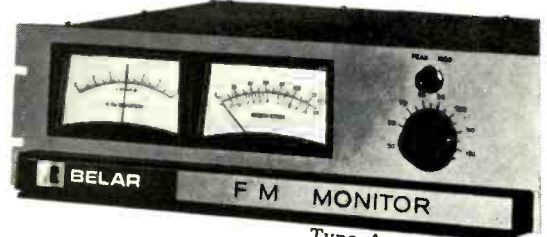

Type Approval #3-129

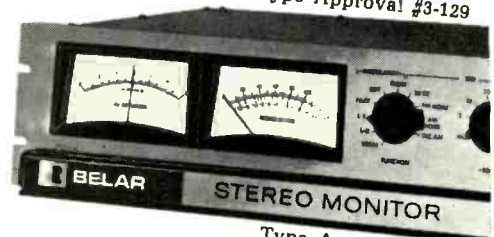

Type Approval #3-146



Type Approval #3-162



Type Approval #3-181



Type Approval Not Required

Now . . . Belar. Belar is the only company that has the necessary type approvals on all three monitoring systems. Belar accuracy permits use of the maximum power allowable and maximum power means maximum profit. Add to this that all Belar equipment is immediately available.

Isn't it time you stopped running around and finally settled for a company that can handle *all* your frequency and modulation monitoring needs? Contact Arno Meyer . . . he'll show you the way.



BELAR ELECTRONICS LABORATORY, INC., DEPT. BE-101  
BOX 83, UPPER DARBY, PA. 19084 • (215) 789-0550

Circle Number 35 on Reader Reply Card

### Monday Morning

Morning sessions will open up with a general session in which the keynote address will be given and the distinguished service award will be presented. Meeting will be followed by concurrent sessions on Job Information Exchange, Graphics/Staging/Lighting Professional Emphasis Group, and a report from the chairman of the NAEB Instructional and Professional Services Board.

### Monday Afternoon

Starts with a two-part ETV Stations management and business meeting. Richard Estell will chair the NAEB/NER annual business meeting. Afternoon engineering papers include: new developments in videotape, helical VTR maintenance, national TV time signals, interconnections, satellites, cable TV, and vertical interval test signals.

Additional sessions will cover public programming, public relations in broadcasting led by Dr. Thomas Skinner, broadcast education chaired by Charles Woodliff, as well as sessions on graphics and lighting and case studies in television teaching.

### Tuesday Morning

Early Bird sessions begin at 8 am, and the emphasis will be on ITV. Concurrent sessions on the remainder of the morning include engineering papers on "A Case For A Better TV Set", and slow scan TV via narrow band FM.

Other sessions of interest will include computers in instructional services, ETV national organizations group discussions. Also, Gerald Yokom will head a session on public radio and politics.

The general session speaker will be Dr. Sidney Marland, US Commissioner of Education.

NAEB evening sessions will touch on the FCC and legal matters, an open forum on "New Audio Technology", and contact may be made at this time with NAEB, CPB, PBS, HEW/BLET/EBFP, FCC, NTCA, and producers of nationally distributed programs.

### Wednesday Morning

Wednesday early bird sessions will touch on instructional radio task force hearings, an EBI preview, and television teachers professional emphasis group.

The remainder of the morning sessions will be NAEB business

oriented, with the exception of a session on minority affairs in public broadcasting.

### Wednesday Afternoon

Concurrent afternoon sessions will run from 2:30 until 6 pm. Engineering papers will cover TV transmitter remote control, station construction considerations, quality audio, 16 track audio techniques, and audio production.

There will be a NPR membership meeting, followed by sessions on a PBS business meeting, and sessions on graphics and lighting, how to use a station's total staff to increase impact, and classroom case studies.

Throughout the convention sessions, special attention will be given to engineering, management, and production. The lineup of sessions looks as if this should be one of the best NAEB conventions in recent years.

Look for three topics of crucial importance to ETV stations—national programming, system financing, and cable and local community service—will be discussed by rotating groups of station personnel.

Discussion starters will be

#### National programming:

Robert A. Mott, director of station relations, PBS (chairman)  
Samuel C. O. Holt, coordinator of programming, PBS  
Billy B. Oxley, associate coordinator of programming, PBS  
Robert M. Reed, director, Public Television Library, and  
Edward L. Morris, director of public information, PBS.

Representatives from producers of national programs will also accompany this team from group to group.

#### System financing:

Chalmers B. Marquis, executive vice president, NAEB (chairman)  
William E. Duke, director of public affairs, CPB

John P. Witherspoon, director of television activities, CPB

#### Cable and local community service:

H. Holt Riddleberger, deputy director, ETS/NAEB (chairman)  
Robert A. Woods, Schwartz and Woods

Philip Rubin, director of engineering, research and development, CPB

Walter Briscoe, managing director, National Cable Television Association.

## the new mcmartin consoles

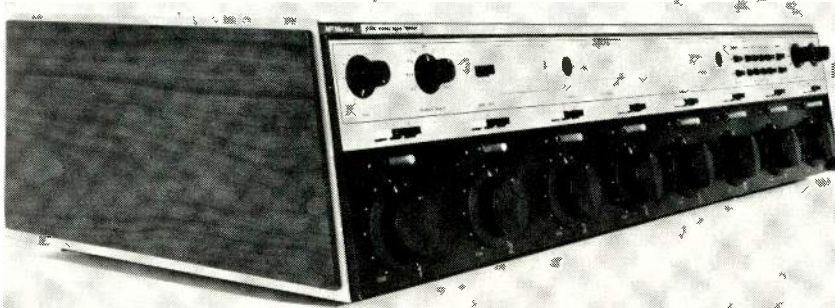

The new 8-mixer McMartin consoles feature outstanding flexibility, ease of operation and clean-cut styling. All modules are plug-in. Up to 27 inputs may be accommodated. Highest quality components, including maintainable step-type attenuators, are used.

Typical program circuit program specifications are:  $\pm 0.5$  dB frequency response; distortion of 0.5%; 20 to 20,000 Hz; and signal-to-noise ratio of 74 dB for all models. Full cue, intercom and monitor facilities are standard.

Mono, stereo or dual channel models are available. The new McMartin B-800 series consoles deliver performance, operating flexibility and are priced right.

MONAURAL	
B-801.....	\$2,350.
STEREO	
B-802.....	\$3,200.
DUAL CHANNEL	
B-803.....	\$2,650.

For details, contact:  
Broadcast Product Manager

**McMartin**  
mcmartin industries, inc.  
605 north thirteenth street  
omaha, nebraska 68102

Circle Number 23 on Reader Reply Card

# HELIAX COAXIAL CABLE...

the ultimate  
in high power  
performance



3-70

The one cable that has all the advantages for transmission of high power RF. One piece connects transmitter to antenna. Eliminates the numerous flanges and bullets of rigid systems. HELIAX is easiest to plan. Easiest to install. Most reliable. Corrugated conductors eliminate the differential expansion problems. Cable can be clamped directly to tower, buried directly in earth. Standard types and sizes up to 8". Communicate with Andrew

 **ANDREW**

ANDREW CORPORATION, 10500 W. 153RD STREET, ORLAND PARK, ILLINOIS 60462, PHONE (312) 349-3300

Circle Number 25 on Reader Reply Card

# Sony makes a case for its professional microphones.

Sony has six professionals ready to go to work for you. And each one is unqualifiedly the best microphone money can buy. Contact your nearest Sony/Superscope Special Applications Dealer or write: Sony/Superscope, 8132 Sunland Blvd., Sun Valley, Calif. 91352.



A. ECM-53 CARDIOID CONDENSER: 40-16k Hz  $\pm 3$ dB; MAX. SPL:  $\sim 26$ dB @ 1% THD;  $-53.2$ dB SENS. @ 250 $\Omega$  IMP. \$149.50.

B. \*ECM-377 CARDIOID CONDENSER: 20-20k Hz  $\pm 3$ dB; MAX. SPL: 140dB @ 1% THD;  $-49$ dB SENS. @ 250 $\Omega$  IMP. \$195.

C. \*C-37P OMNI/CARDIOID CONDENSER: 30-16k Hz  $\pm 2.5$ dB; MAX. SPL: 154dB @ 1% THD;  $-49$ dB SENS @ 250 $\Omega$  IMP. \$325.

D. \*C-500 CARDIOID CONDENSER: 20-20k Hz  $\pm 3$ dB MAX. SPL 154dB @ 1% THD;  $-50$ dB SENS. @ 250 $\Omega$  IMP. \$395.

E. ECM-50 OMNI LAPEL CONDENSER: 50-16k Hz; MAX. SPL: 126dB @ 1% THD;  $-53.2$ dB SENS. @ 250 $\Omega$  IMP. \$129.95.

F. ECM-51 TELESCOPIC OMNI CONDENSER: 50-16k Hz; MAX. SPL 126dB @ 1% THD;  $-53.2$ dB SENS. @ 250 $\Omega$  IMP. \$129.95.

\*AC-148A PHANTOM POWER SUPPLY: 49 V.D.C.  $\pm 1$  VOLT; BUILT-IN CONNECTORS FOR 2 MICROPHONES. UP TO 10 ADAPT DUAL MICS WITH EXTERNAL ADAPTORS. \$99.95.

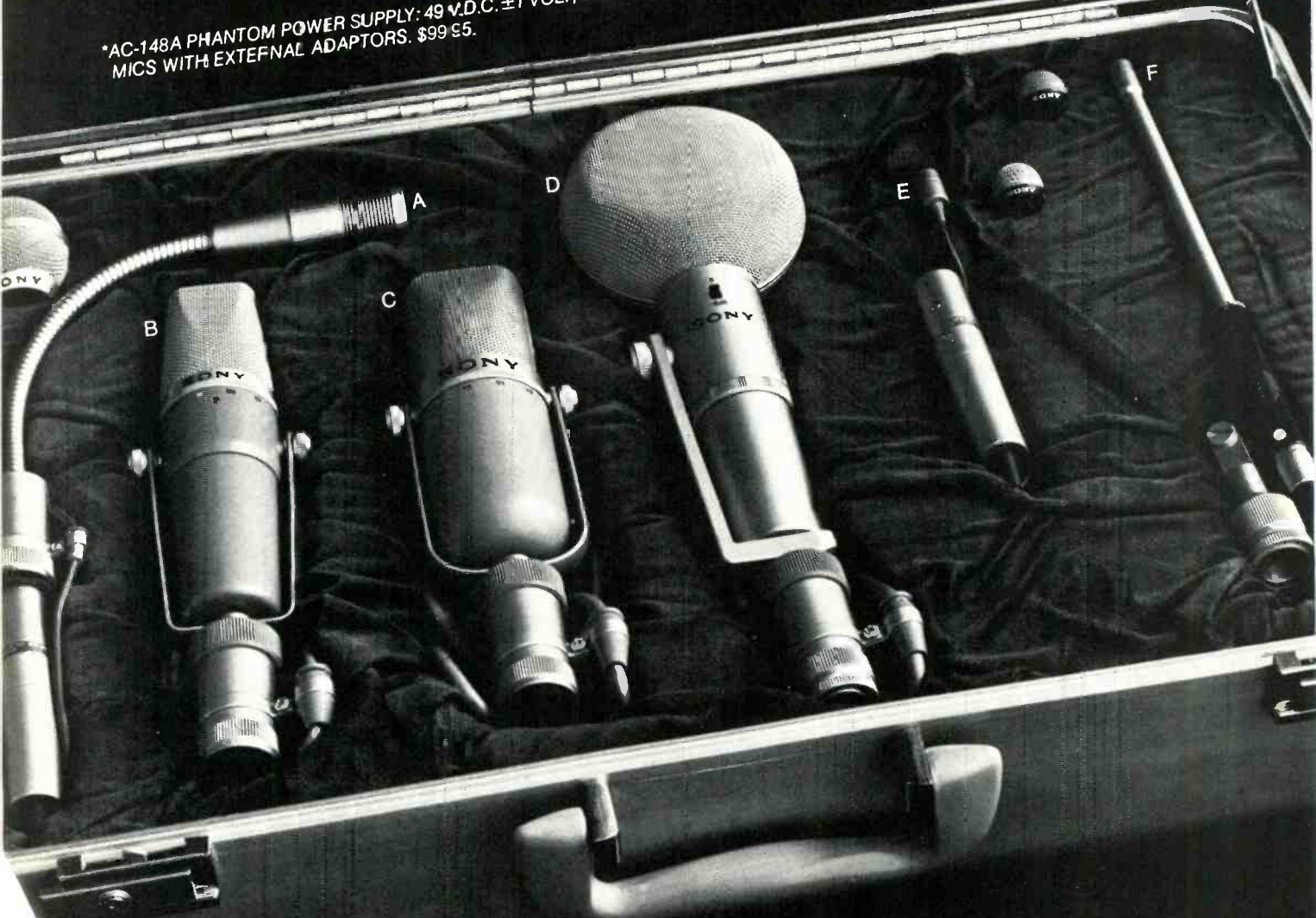



# What am I Bid?

By Kenneth B. Knecht\*

When you have finally gathered up all the money you need for that new system or equipment you want, you might want to put part, or all of it out to bid. This may be required by your school system or company, but also is one way to get the lowest price for the system you desire. This is especially true for television, audio reproduction or mastering, and radio systems.

Obviously, the information I am about to impart will not hold true for every situation. But parts of it will be important to any operation anticipating a CP.

Briefly, a bid specification should set the minimum quality of the equipment required and help you get a good, workman-like installation. It should also guarantee an acceptable level of expertise of the installers. Educational institutions are among those who might rely on this method. In some cases it is required.

A specification is usually divided into several portions. We will use a television studio system as an example. We will assume that it is to be a turnkey system, one that is completely finished, tested and turned over to you ready for operation.

We can start with the "boiler-plate", a term sometimes used to describe the part of the specification that can set forth some or all of the following requirements.

The **qualifications of the bidder** can be outlined. This includes length of time in the systems installing business, number of other comparable systems installed along with their locations and time in use, spare parts facilities and experienced technicians available for warranty and later service as required.

The warranty time you require should also be stated. You can outline the time the areas under construction will be accessible to

\*Engineer, State University College, New Paltz, N.Y.

the installers. Availability of space for storage of equipment and tools during the installation period can be described including their security.

## Test Guarantee

You can outline a detailed description of the testing of the system and who will accept it, or make the submission of the test procedure part of the bid. It would be preferable to make up your own test procedure, being sure to properly test all parameters. In either case, lay down the technical specifications of all the equipment, as connected together and operating as a system. The manuals, drawings, cable run sheets, etc. required can also be outlined. Don't forget requiring any damage caused by the installers to be repaired.

## Operator Training

You could also ask for on-site training in the operation and maintenance of the system. You should also ask for a guaranteed installation date. It would be well to add a paragraph requiring communication with the local chief engineer concerning technical co-ordination, i.e., equipment location details and other such subjective information.

You should include what might be termed your design philosophy—a description of what you expect the system to do for you—how it should work together. This will help the bidder to visualize your system, rather than a list of equipment and some block diagrams.

But block diagrams are important. You should supply the following diagrams in block form: video, audio, pulse, control, tally and intercom.

The video diagram should show all the equipment hard wired into the system, including major equipment, patches, terminations, unused inputs and outputs, sync generator remote inputs and cross-hatch outputs, and peripheral equipment.

You should show whether a piece of equipment utilizes the looping input or should be terminated.

Don't forget to indicate whether a picture monitor is to be looped or fed by the video output jack of a waveform monitor to utilize the single line monitoring feature. Any balanced video should be clearly differentiated from the normal 75 ohm unbalanced circuitry.

## The Audio Plan

The audio diagram will be similar to the video, showing all terminations, patches, etc. We prefer to source terminate the audio, using all bridging inputs at 0 dBm. This allows freedom in patching without regard to impedances and bridging other inputs across the line by using multiples or parallel patches. (We have not had any problems with noise or hum using this system if the grounds are all wired properly.)

A system using separate lines and distribution amplifiers for each pulse type or a system using encoders and decoders can be used. For those not familiar with the second type, an encoder combines all the pulse outputs of the sync generator into a single signal, which can be patched into any decoder desired, which converts the signal back to the original pulses. The advantage here is that the signals can be routed and delayed, if necessary, using a single cable. This results in a much smaller patch panel and few, if any, distribution amplifiers. In a medium sized system the price is about the same for either system. If you use the single cable system, it is a good idea to carefully analyze your system for maximum flexibility.

If two sync generators and a changeover switch are used, you can wire the backup generator to be patch available. In the single cable system it can feed your backup encoder. Then you can patch the backup generator into any

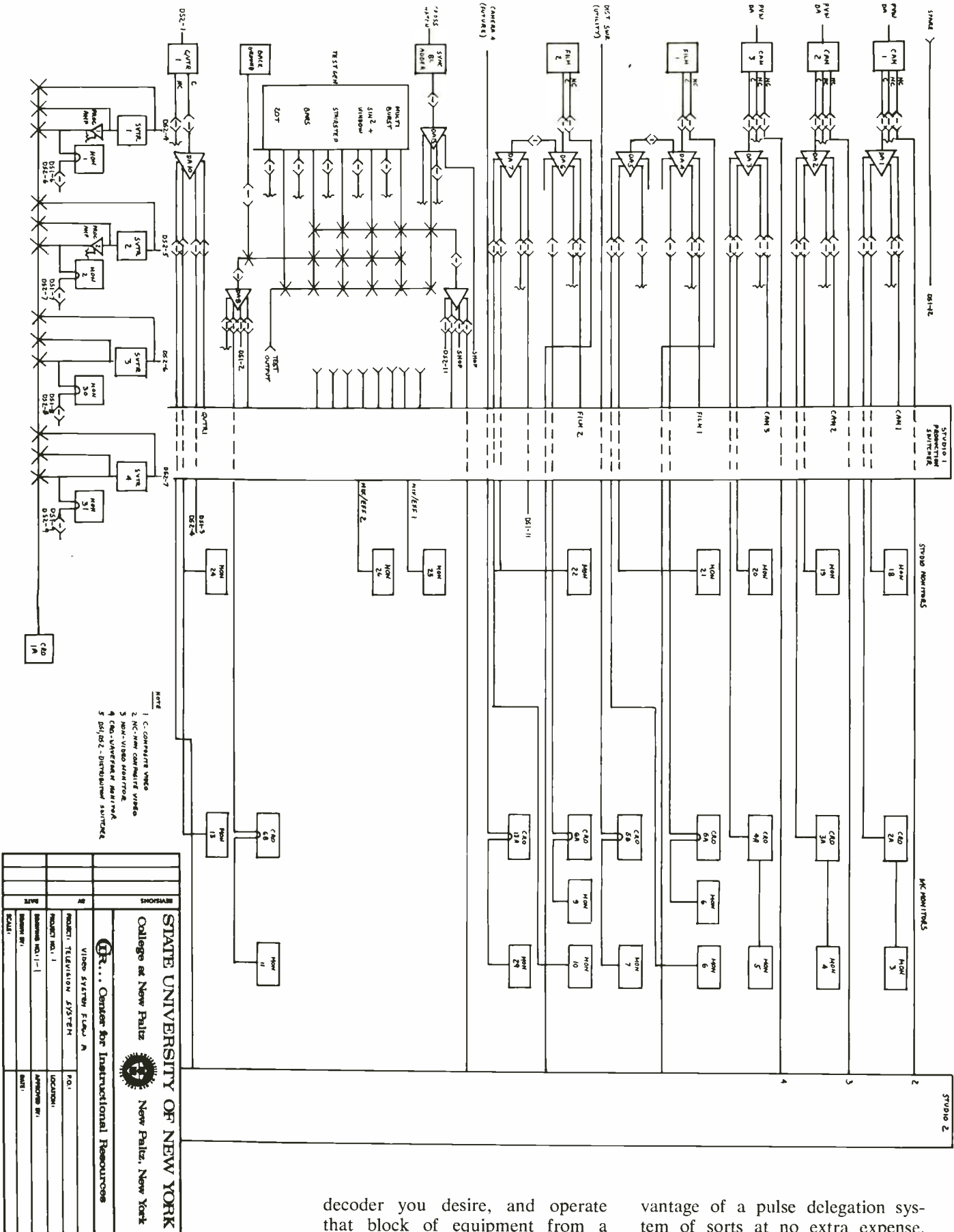
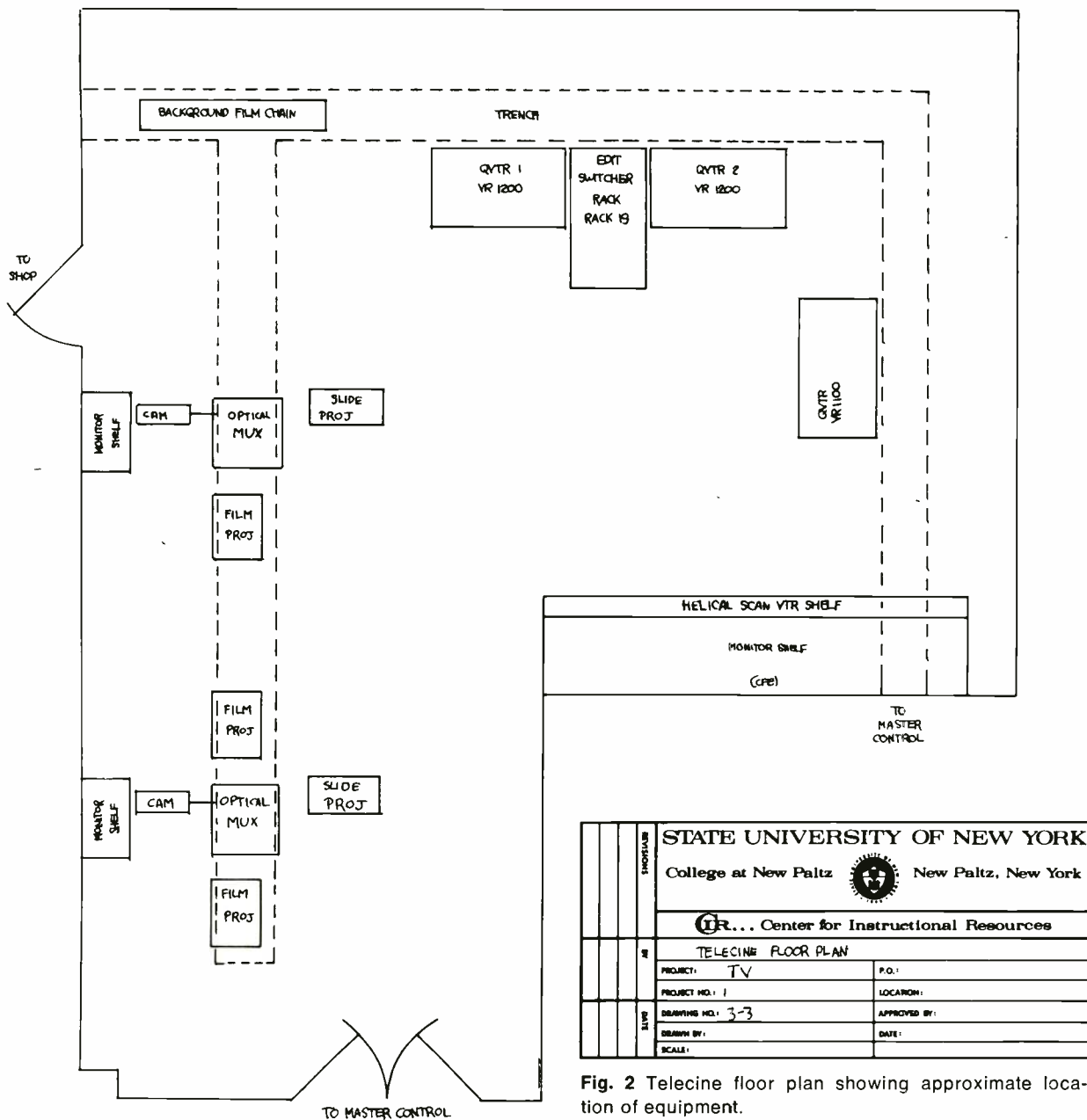

Fig. 1 Video System Flow Chart.

decoder you desire, and operate that block of equipment from a separate sync standard, locked to any source you desire via the remote input on the sync generator. This effectively gives you the ad-

vantage of a pulse delegation system of sorts at no extra expense, assuming you had planned on using the above mentioned backup equipment.

The control diagram is not abso-



STATE UNIVERSITY OF NEW YORK	
College at New Paltz  New Paltz, New York	
CIR... Center for Instructional Resources	
TELECINE FLOOR PLAN	
PROJECT:	TV
PROJECT NO.:	1
LOCATION:	
DRAWING NO.:	3-3
APPROVED BY:	
DRAWN BY:	
DATE:	
SCALE:	

Fig. 2 Telecine floor plan showing approximate location of equipment.

lutely necessary. You could just specify the remote control required by each piece of equipment to be so controlled—video tape recorders, audio tape equipment, film islands, video and audio levels, etc. Specify each function to be controlled and each point they are to be controlled from. Distribution switcher remote switching can be specified in the switcher specifications. Don't forget to specify parallel or delegated control. Some equipment may require rewiring to use parallel control.

A power supply with good voltage regulation over a wide range of current should be specified for the tally light system. If you use a

distribution switcher you might want only the tally lights to work if certain output busses are used. This can usually be incorporated into the switcher specifications. Don't forget to specify the placement of the tally lights on equipment that does not include them, such as monitors.

#### Specification Details

A simple intercom/interphone system that uses only one bus can include a public address amplifier bridged across the intercom line with relay controlled speakers in important areas. Then a switch panel selecting appropriate speakers can be placed at areas requiring

paging control. This will allow people to use their speaker as an intercom without wearing a headset. It also allows using a headset microphone at positions with speaker switches to page other areas. If this system does not meet your requirements they should be outlined in detail.

In any case, be sure to detail all interphone jack locations and the number of speakers and headsets required. Don't forget to mute the studio intercom speakers when a mike is turned on.

Check the unit heat specs to be sure that the system won't "take off" from the smokestack effect or from rising room temperatures. (See

"Air, Give Me Air", page 28, April, 1971 Broadcast Engineering.)

You should try to lay the equipment out in the number of racks you require to insure yourself of enough rack space. If you have enough racks, you should allow as much room as possible for future expansion. You would be surprised at how far you can spread out in a year or two.

### **System Drawing**

To help the bidder estimate the cable required, a floor plan of each of the rooms to be wired along with a plan of the relationship of the rooms to each other should be supplied. Be sure to show the scale of each drawing.

It would be wise to submit drawings of the audio, video and pulse patch panels to show where each patch in the system is located in the jackfield, allowing the most convenient placement for your needs. Again, be sure to allow sufficient room for system expansion.

Power wiring can be considered next. We like to use two power strips in each rack, one for equipment that runs 24 hours a day, and the other for equipment turned on only during working hours. The breakers in the power panel can be color coded so you will know which to turn off and which to leave on. We run our power wiring in flexible conduit, but any method using good shielding practices should be adequate. Check your local electrical regulations.

As you lay your system out you will find that some racks lend themselves to being grouped together and supplied by one breaker, while others will require their own breaker. It would be nice to put every power strip on its own breaker, but this method requires a very large power panel in a medium sized system and a large amount of power conduit, which takes up a lot of valuable room in the trench.

Speaking of trenches, if you have the choice and the money, I suggest using computer floor. It's the most convenient. However, you usually have that choice made for you by the building architect. In

fact, sometimes you don't even get a trench and have to get by with wall moulding or some other substitute.

In a turnkey installation you can save money by specifying that you will supply the power from the power panel to the contractor supplied and installed power strips. Specify auxiliary outlets on the bottom of the rack fronts for test equipment. Another point to keep in mind is to try to balance the load evenly between the three phases of power in your panel.

When specifying equipment, you can copy the specification sheet of the specific model you want, or you can just name it. If you have no particular piece of equipment in mind or want to be custom, list the physical and electronic specifications you require and let the contractor supply whatever will meet your specifications. Be sure your specifications are not so loose as to cause the system to fail to meet the required system specification or so tight as to put the price out of sight.

### **Nothing To Chance**

It is important to consider outlining construction practices. Leave as little as possible to chance and you will be much less likely to be disappointed. For example, you might consider some of the following items: wire markers on the cables, cable run sheets, cable lacing, separation of cables carrying different signal levels or types of signals, methods of labeling patch panels, finish of contractor supplied control panels, mounting film chains, wall mounting of speakers and picture monitors, grounding, cable and connector types, and other details not spelled out elsewhere in the specification.

In general, wherever there might be any doubt as to what you want, don't be afraid to go into some detail. Don't just specify a film island to be installed in a certain room. Show where you want it and its picture monitor on a scaled floor plan, and specify how you want the mounting area leveled and how the units are to be fastened to the floor.

You could now make up an equipment list, by model numbers

or specification paragraph number. Be sure to number every paragraph or sub-section for reference purposes. Designate quantity or "as required" for items like blank panels, cable, terminations, connectors, etc.

List everything you need, including: rack side panels and work-writing shelves, extra rack hardware, matching paint, headsets, tables or consoles for audio console and video production switcher, shelves for mounting monitors, cable tray, test equipment, spare boards, extender boards, black generator, patch panels, interphone system power supply, camera cable patch cords, camera cable patch panel and studio panels, mike and interphone jacks in the studio and at the lighting panel, floor monitor outlets in the studios, camera cable, terminal blocks, monitor and intercom speakers, projector and camera lenses, mikes, test pattern illuminator, video test generator, and any other items you might have overlooked.

If you can afford it and don't have the maintenance time and/or personnel available, order spare boards, monitors, power supplies, distribution amplifiers, and anything else you may need. This can save a lot of down-time later.

Just to be on the safe side, it is a good idea to put a paragraph in the specifications somewhere that says certain items such as miscellaneous hardware, surface conduit, connectors, cable tray sections, etc., though not specifically mentioned, shall be furnished and installed by the contractor, thus insuring a complete operational system. This covers you if you leave out some relatively minor items.

You will probably find specifications writing interesting but tedious. And it undoubtedly will take a lot longer than you had anticipated. The biggest problem is finishing. Everytime you reread it you will find something to add or change.

Don't hesitate to ask other engineers about specific system bid problem areas. But above all, make certain your new system specs will match your system philosophy and its possible future expansion. ▲

# GET THE WORLD'S BEST FM STEREO WITH THE WORLD'S BEST EQUIPMENT THE WORLD'S BEST SOLID STATE STEREO GENERATOR

## POSITIVE PROOF

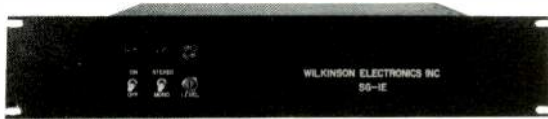

WILKINSON ELECTRONICS SG1E

- \* 60 db separation ..... 50 Hz-7500 Hz
- \* 55 db separation ..... 7500 Hz-10000 Hz
- \* 50 db separation ..... 10 KHz 15 KHz
- \* FM Noise - 75 db ..... Cross Talk - 60 db

COMES COMPLETE WITH POWER SUPPLY - REQUIRES ONLY 3½ RACK SPACE.  
ONLY ONE FRONT PANEL ADJUSTMENT. REMOTE STEREO ON/OFF FUNCTION.  
PRECISION BUILT BY INSTRUMENT MAKERS - TRULY BUILT TO LAST FOREVER.

# THE WORLD'S BEST SOLID STATE FM EXCITER

## POSITIVE PROOF



WILKINSON ELECTRONICS FME10

- \* Frequency response  $\pm 1/4$  DB 15Hz-350KHz.
- \* FM Noise Level - 75 DB below 100% Mod.
- \* Harmonic Distortion - 0.3%.
- \* Type Modulation - Direct FM.
- \* Power Output - Adjustable to 18 watts.
- \* Modulation capability - 200%.
- \* Stability 1 part in 100000
- \* Requires no oven and is not susceptible to rumble and microphonics.

FCC TYPE ACCEPTED - POWER SUPPLY INCLUDED - REQUIRES 7" VERT. SPACE  
IMMEDIATELY USABLE IN ANY TRANSMITTER - DRAWER CONSTRUCTION FOR ACCESS:  
SHIELDED BY BOTH STEEL AND ALUMINUM. COMPLETELY METERED. ADJUSTMENT FREE.

## NO ONE IN THE WORLD CAN MATCH THIS COMBINATION

**WILKINSON**  
ELECTRONICS, INC.

1937 W. MacDADE BLVD.

WOODLYN, PA. 19094

TELEPHONE (215) 874-5236/874-5237

# Care package for tape recorders

By Gene Titterington\*

Broadcast engineers are intimately familiar with the instructions for the care of magnetic tape recorders, yet we cannot escape the belief that periodically there is value in repeating these instructions. For

\*Field Service Engineer, Ampex Corporation, Audio Division.

those who have recently joined us, of course. If we occasionally encounter a new way to forecast trouble, is there any feeling more rewarding than applying service **before** the recorder goes haywire?

Subscribing to an incredibly simple rule of thumb, we feel that

"What goes in should come out!" And the fact that what comes out is remarkably similar to what goes in, is what makes the magnetic tape recorder the useful tool that it is.

In calling it a "professional" recorder we are simply defining the category of recorder used by the broadcast engineer in the normal course of his day-to-day activities.

Of course, there may be some surprising twists to the process. Occasionally, more comes out than expected. Noise, for example. And a surplus of low frequencies. At the same time **less** comes out. High frequencies get lost in the shuffle of loading signals on tape and getting them off again.

Some of this gaining and losing is cancelled out by some pretty nifty adjustments made by the manufacturer and recording engineers operating as a team. But there are some residual effects which are undesirable and these are the ones we'll attempt to thwart.

## Three Easy Steps To Preventive Maintenance

First, let's assume immediately that all broadcast-type professional audio recorders perform as specified and that performance as specified is satisfactory. Our job: to unseat those malevolent forces which suddenly appear to upset our assumptions.

Most readers will recognize three basic principles right off:

1. A recorder with clean heads, guides, capstan and surfaces is less susceptible to problems caused by dirt and oxide than a dirty recorder.

2. Proper and regular demagnetization of all elements in the tape path is quite likely to eliminate problems caused by magnetized heads, guides, etc.

3. A properly lubricated transport will not be over-lubricated or under-lubricated.

When analyzed, these three basic

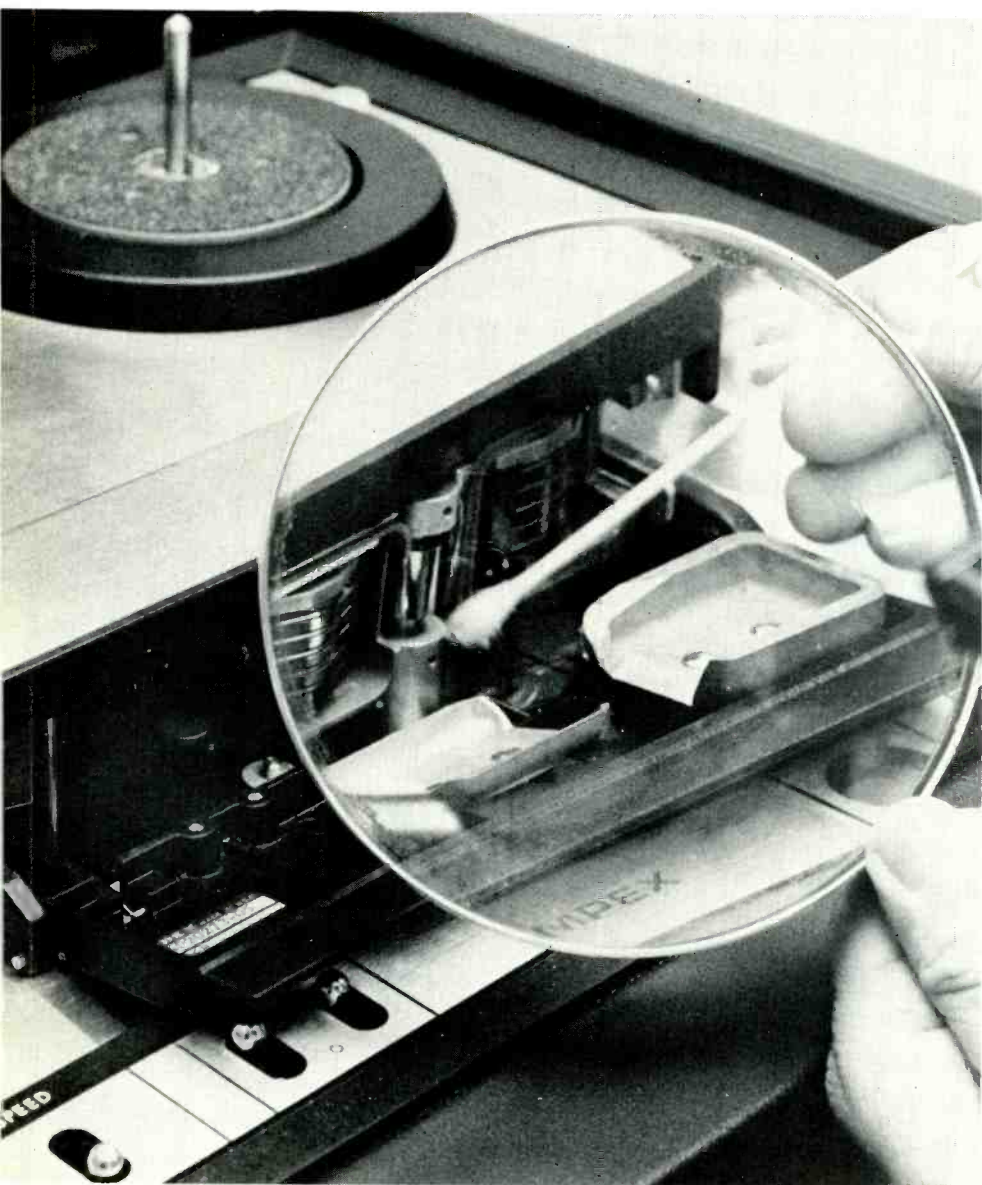

Fig. 1 The magnifying glass will reveal "hidden" problems. Here, a considerable amount of oxide could be seen on the scap-flutter idler even after a quick, initial cleaning.



**Fig. 2** Even the professional can improve his cleaning habits. This photo taken in a broadcast station shows bits of tape exactly where they were found. The swab stick points to a scrap uncomfortably close to the heads.

statements will reveal one startling fact: together they constitute the entire preventive maintenance routine. Anything above or beyond this constitutes inspection, checking or trouble-shooting.

This in no way implies that inspection, checking and trouble-shooting are not to be indulged in. It just pays dividends to know where one leaves off and the others begin. And while the preventive maintenance routine can be delegated to an assistant, the really careful engineer will do the next step himself: the inspection.

### **The Long, Hard Look**

You'll get no quarrel from anyone by claiming that a good visual inspection can reveal many little pieces of information that together tell a significant story about the condition of the recorder.

While there is no way to describe it adequately, a properly adjusted tape transport literally sings a song of well-being. You can feel it. By the same token, an ailing recorder can cause the hair on the back of your neck to stand out straight. You're uncomfortable being in the same room with it.

The well-behaved transport on

close inspection will be passing tape in an absolutely flat path—flat in that motion is nearly imperceptible. It is this comfortable sensation of the rightness of things plus the smooth flow of tape that encourages the engineer to proceed knowing that **today** things will go well.

At this point, the engineer can check the braking system. Note that the engineer in checking "stops" is also checking "starts" in approximately a 1:1 ratio. In both cases, the stop/start times can be checked against the manufacturer's spec.

Satisfied that the transport functions are just short of perfection, the engineer can now continue his inspection by removing the tape from the machine and preparing for a thorough examination of the entire transport.

Two tools are helpful. Good light and a man sized magnifying glass. There need be no shame connected with the use of the glass. After all, the idea is to see what's going on.

From the engineer's vantage point all manner of wonderful things show up in the glass. (And you thought you cleaned the system, didn't you?)

Dirt and oxide particles stare balefully back from hidden corners. Here's a piece of torn tape tucked away. Safe enough where it is, but what if it should move and lodge itself against a head at a critical instant?

And while you are getting rid of the scrap of tape, you've a perfect right to ask where it came from. One scrap could be a piece knocked off the end of a tape during a fast rewind—several pieces of similar size and shape **could** indicate a burr on a contact surface somewhere—missed at the last inspection.

And that oxide, where did it come from? Poor cleaning? Or is it a new sign of trouble?

Now the value of the glass really shows. A careful check of stationary guides and the heads will reveal any signs of wear. If slot-wear is present yet recorder performance is satisfactory, there may be no cause for alarm. Leaving well-enough alone applies. It may be sufficient simply to make a note that the wear is taking place and watch for further developments. But if the engineer is contemplating a change in head alignment, those wear slots will present some real problems.

Tapes will not track smoothly through the misaligned slots. Buckling, bowing or warping of the tape could result with an attendant loss of intimate tape-to-head contact. High frequency response drops off quickly and physical tape damage is a good possibility.

Under the assumption made in the beginning, the recorder under survey is in decent condition. We have observed no signs of wear. But we're not through yet. Some additional checks should be performed.

Head alignment and electronics are still unknown quantities. While these items appear to be in proper working trim, the "let's make sure" checks are not difficult to perform, nor need they require much time.

### **Test Tapes**

Select the proper test tapes needed (reproducer alignment tapes

Fig. 3 The HD-16 head degausser at work. Extreme care is necessary when turning strong degaussers on and off.

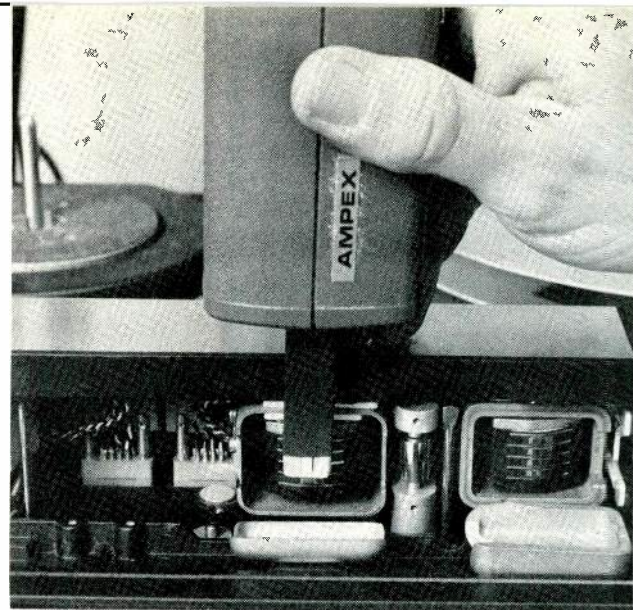

recorded at the proper speeds). Ideally, you should use test tapes with track configurations matching that of the recorder. You're already aware of the fringe-effect that occurs when using full-track tapes to check multitrack recorders. Low frequency response is magnified and it is next to impossible to equalize for a flat response. (Remember, the "bumps" will still be there.)

Thread the alignment tape carefully and follow the voice instructions on the tape. In most test tapes, signals are provided for checking head azimuth, frequency response and the operating level. Make the essential adjustments for both speeds, using the tape made for each speed. (Although the NAB equalization curves are identical for 15 ips and 1½ ips, the frequency response adjustments must be made with separate tapes to assure accuracy.)

In using test tapes, the confident voice on tape may sound more authoritative than the condition of the tape warrants. **Know your test tape.**

#### Care For Test Tapes

While test tapes are masters so far as the recorded signals are concerned, they are fragile things. Once they leave the environment in which they were made, they are susceptible to the same damage as any other tape. They not only wear out in use, but even deteriorate magnetically on the shelf. Shelf deterioration can be minimized by proper storage, but only care in use can successfully combat physical damage to test tapes.

Manufacturers are cautious in

expressing life-expectancy figures. Fifty to a hundred plays seems to be a safe figure. Losses as high as 5 dB have been noticed at the hundred play mark. Offsetting this are tests where tape life has been extended well beyond one-hundred plays when normal cleaning and degaussing routines are followed. Professional quality heads generally will extend the life of test tapes. This would indicate the need for caution in using tapes on heads of doubtful quality—at least those test tapes you depend on for use with your professional gear.

Under no circumstances should a test tape be used on a machine prior to cleaning and degaussing. Remember that short wavelength flux literally rides on the oxide surface. Wear it thin and you've lost the high frequencies. Even if no wear occurs, dirt causes loss of intimate contact and again, there go the highs.

Running test tapes on magnetized surfaces offers more trouble. You can erase the highs and replace them with noise rather easily.

A word about the efficiency of head degaussers should be dropped in here. With the wide availability of low-noise tapes, noise reduction systems, and multichannel recording systems, noise or signal damage caused by magnetized elements in the tape path is more than ever noticeable. Tests have shown that the old familiar head degausser is not doing the job adequately. Special, more effective degaussers will undoubtedly reach the market in the near future. Until they are available, the professional must use what he has. Multichannel head

systems that can be removed from the transport should be degaussed with the more powerful bulk degaussers. Even the hand-held bulk degaussers will do a better job of degaussing parts such as capstans and guides.

In storing your test tapes, rewind them carefully and store them in a magnetically secure environment away from speakers, microphones and other magnetic devices (including magnetic latches on cabinet doors)!

Once you have checked the recorder by means of the reproducer alignment tape, you will have established several points: the azimuth of the reproducing heads is correct, the frequency response has been equalized at each operating speed and you have adjusted the output to the standard operating level.

See how conveniently our assumption has served us? Since your recorder was assumed to be in good working order, all you've had to do is to perform three simple preventive maintenance steps, a visual inspection (**thorough** visual inspection), and a check of the system using properly configured alignment tapes.

Together, these routines comprise the basic care package for your recorder. Because they are simple routines, they can be repeated often. Others must be performed too, and these routines will generally be spelled out by the manufacturer in the instruction manual.

Since most of these more specialized checks and adjustments are peculiar to the machine involved, we won't detail them here.

Instead, we'll make a list of the routines, suggesting the frequency of application, and give the reasons why they should be done. Table 1 is a more complete "care package for the magnetic audio recorder."

Obviously there isn't much glory in doing these things. But keeping accurate records is one way to get some satisfaction out of doing them. The neat columns of figures should give you some pride of accomplish-



# SCALA ANTENNAS... WITH ENGINEERED-IN HIGH PERFORMANCE

The Paraslot is a typical example of Scala's design and fabrication philosophy. There are no elements outside to offer wind resistance, or to collect ice or snow; all exposed parts are made of anodized aluminum or stainless steel; precision-machined slots are covered watertight with laminated plastic sheet held in position with adhesive—and additionally secured with an aluminum extrusion fastened to the antenna body with stainless steel machine screws; it features an exclusive patented parallel feed system which tracks temperature variances so precisely that energy phase to the slots remains within 1° under extreme temperature changes . . . these are some of the many features which make the Paraslot stand out among omni-directional TV broadcast antennas.

Scala's VHF Color Log series is another instance of high-performance, functionally designed, well-built antennas. Their center mounts permit use of larger active regions, so that only two Color Logs cover VHF channels 2-13. Also, not restricted by the weight limitation of end-mounting, Color Logs use laminated construction, which our 20 years' experience has proven essential to overcome the fatigue problems of aluminum and to take full advantage of its light weight. Look into the complete line of performance-engineered precision antennas, accessories, and mounting hardware in the 40-1000 MHz range available from Scala Radio.

**YAGIS**—medium priced, highest gain per size antennas for a wide range of applications.

**VHF YAGI**—Model CA5-150: 40-225 MHz, for general communications. Models HDCA-5 & HDCA-10: channels 2-13, high gain VHF TV applications.

**FM YAGI**—Models HDCA-5 & HDCA-10: 88-108 MHz, high gain 5 and 10 element yagis for the FM band, 6 MHz bandwidth.

**UHF YAGI**—Model CA5-450: 225-1000 MHz, for general communications. Model RA5-450: 400-1000 MHz, completely protected in a Fibreglas radome housing, for all weather communications.

**COLOR LOGS**—Broadband, directional antennas with high front-to-back ratio and low side lobes. Ideal for co-channel and multi-path rejection.

**VHF COLOR LOG**—Model CL-26: channels 2-6; Model CL-713: channels 7-13, VHF TV applications.

**FM COLOR LOG**—Model CLFM, one model covers the 88-108 MHz FM band.

**UHF COLOR LOG**—Model CL-1483: channels 14-83, UHF TV applications; precision silver-plated elements enclosed within a Fibreglas radome housing.

**PARAFLECTOR**—A parabolic section in one plane with exclusive dipole feed; it is lightweight, has low wind resistance and is extremely durable. Model PR-450U: 350-1000 MHz, general communications and TV applications.

**MINIFLECTOR**—A parabolic cylindrical reflector with a unique dielectric phaser dipole feed. Model MF-960: 940-960 MHz, communications, STL and telemetry applications.

**PARASLOT**—A high gain, rugged slotted cylinder antenna. Model SL-8: channels 14-83, UHF TV broadcast applications.

**FM OMNI-DIRECTIONAL**—Balun fed, quadrature phased, crossed dipole array. Model FMO, one model covers the 88-108 MHz FM band.

**GROUND PLANE**—Model GP-150: 40-170 MHz, ideal for non-directional all-weather communications.

**COLLINEAR ARRAY**—Omni-directional, rugged parallel fed collinear array. Model OG-4: 150-170 MHz; Model OG-6: 450-470 MHz. A useful optional feature available: vertical downtilt.

**POWER DIVIDERS**—Allow division of transmitter power to two or more antennas in the proportion needed.

Phasing and stacking harnesses, inter-connecting cables, and fastening hardware are made to your specifications.

Special arrays are custom designed to achieve maximum gain or to provide optimum solution to co-channel, multi-path and other radiation problems.

Miniflector

Color Log VHF Antenna

Paraslot

Color Log UHF Antenna

Paraflector

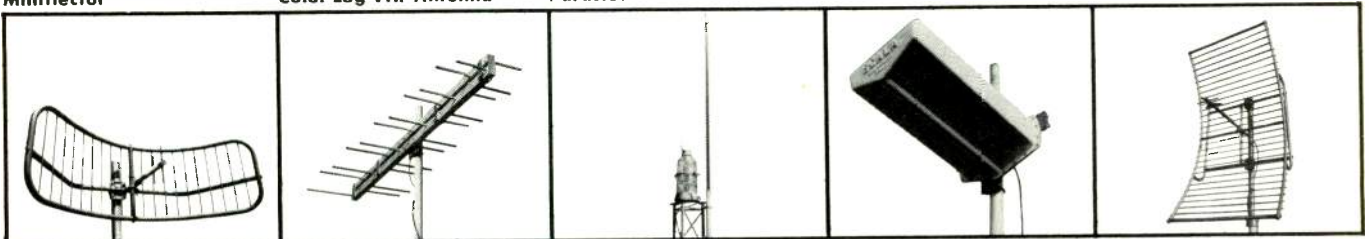

LONG EXPERIENCE IN PAINSTAKING RESEARCH, INNOVATIVE DESIGN, AND SOUND CONSTRUCTION MAKE FOR SCALA'S CONTINUING LEADERSHIP IN THE MANUFACTURE OF PRECISION ANTENNAS FOR PROFESSIONAL APPLICATIONS. EXPERIENCE THAT IS YOURS FOR THE ASKING. CALL OR WRITE TODAY.

## Scala Radio Corporation

1970 REPUBLIC AVENUE, SAN LEANDRO, CA 94577 (415) 351-3792

Circle Number 28 on Reader Reply Card

**Table 1—Recorder Care Package Schedule**

<b>Routine</b>	<b>How Often</b>	<b>Why</b>
1. Cleaning	As often as desired but certainly no less than once every eight operating hours.	Clean recorders eliminate a lot of possible problems. Dirt and oxide accelerate wear and degrade performance.
2. Demagnetizing	Should be considered as part of the cleaning routine.	Magnetic cleanliness is as desirable as physical cleanliness. Stray field can rob you of the quality you put in so carefully.
3. Lubrication	As recommended by the manufacturer. No more, no less. This is no place to exercise creativity. Follow	No one likes a squeaky wheel. Too much lubrication attracts dirt, destroys components.
4. Visual Inspection	Follow your own time-table. In practice, the careful engineer is always inspecting.	Observation of normal behavior can tune the eye to abnormal conditions. Also, some problems can be observed in development and corrected before catastrophe.
5. System Check Out (using alignment tapes)	After cleaning and demagnetizing, generally prior to an important program. As the commercial says, "once in the morning does it."	Test tapes are a primary reference and remove any doubts you might have.
6. System Check Out (using manufacturer's check list and flutter test tape)	Follow the manufacturer's instructions. Use flutter test tape after all adjustments to the tape handling system.	These checks determine whether or not adjustments should be made in brake or hold-back tensions, capstan idler pressures, etc. Flutter test checks adjustments in reproduce mode and is a comfortable reassurance that tape is being handled properly.

ment and, when the records grow in number, consistent readings will give you the comforting knowledge that you're getting the most out of your recorder—regardless of make or age.

Please note that we have resisted the urge to discuss the routines in detail. No two makes or models of recorders are alike in all respects. Our purpose here is to remind you that following the basic procedures is the best way to avoid serious problems.

The pleasure of tracking down problems and successfully correcting them we leave in your capable hands. You may, however, want more information on some of the points we've made, particularly those dealing with test tapes and degaussing. Four worthwhile papers are available.

1. "Reproducer Test Tapes: Evolution and Manufacturer," Robert K. Morrison. Presented October 12, 1966, to the 21st Convention of the Audio Engineering Society, New York.

2. "Tape Reproducer Response Measurements with a Reproducer Test Tape," John G. McKnight. Presented October 12, 1966, to the 31st Convention of the Audio Engineering Society, New York.

3. "Flux and Flux-Frequency Measurements and Standardization in Magnetic Recording," John G. McKnight. Published June 1969 in the *Journal of the SMPTE*, Vol. 78.

4. "Remanence and Demagnetization Problems in Magnetic Recorder Heads," by Avner Levi (originally presented at the 1970 International Telemetry Conference).

Papers No. 1, No. 2 and No. 4 are available from Ampex Corporation, M.S. 7-13, 401 Broadway, Redwood City, California, 94063. Ask for A-223, "Test Tape Applications," and TIP No. 11 (Demagnetization). Paper No. 3 may be obtained from the Society of Motion Picture and Television Engineers, Inc., 9 E. 41st Street, New York, N.Y., 10017. ▲

# Shopping for lenses? Compare Canon!

Draw up a checklist that includes price, specifications and image brilliance, then start comparing catalogues. You'll probably come up with the Canon answer, like so many major camera producers—for broadcast 1" or 1 1/4" PLUMBICON® or CCTV 1", 2/3" vidicon.

Stack these two Canon popularity favorites against anything else on the market and see what we mean.

The Canon TV Zoom Lens P17X30B2 has an impressive 1:2.5 relative aperture at focal length range (440-500mm), in spite of its 17X zoom ratio. At 30—440mm it's a remarkable 1:2.2, offering the same performance as our P10X20B, specially designed for maximum versatility with three different range extenders.

Both are ideal for a variety of situation, including dim lighting and open areas like field events.

Here are some other examples of the wide Canon line:

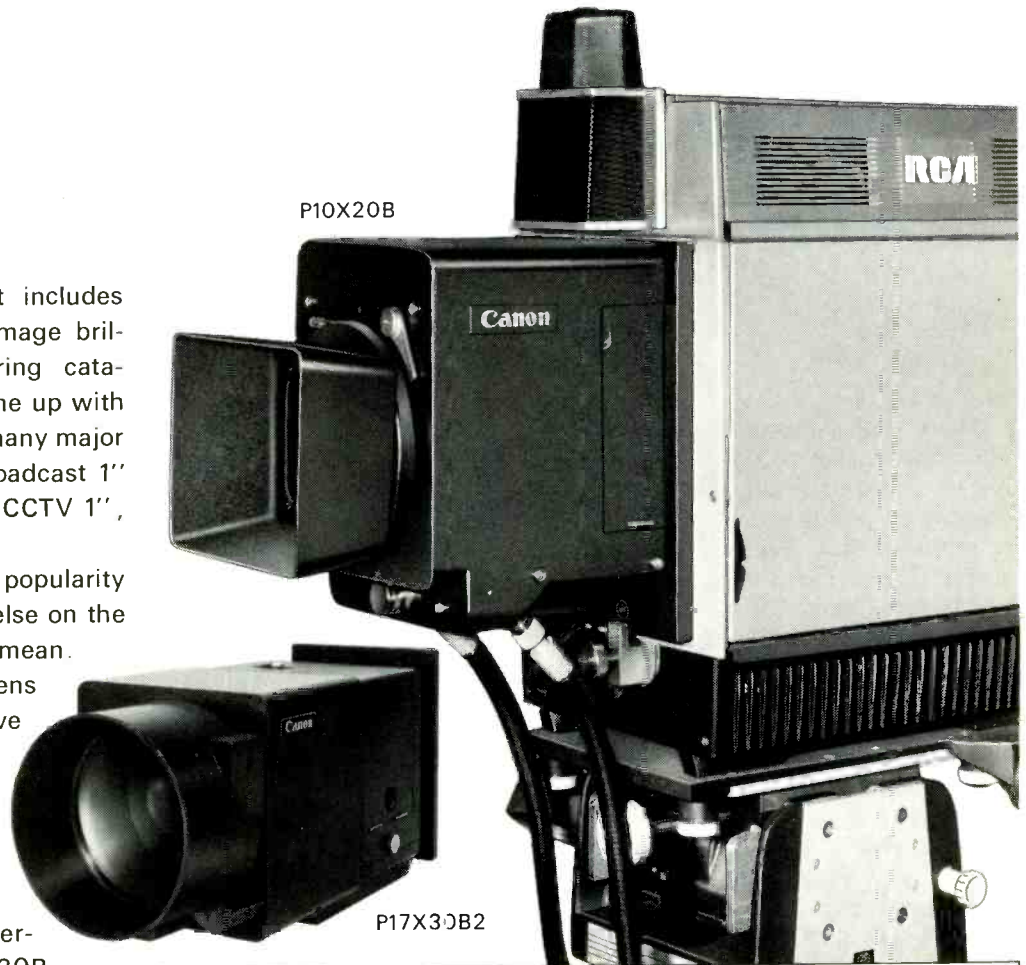

Manual				
	Name	Range of Focal Length	Zoom Ratio	Maximum Relative Aperture
1 1/4" PLUMBICON	P17 x 30B2	30—500mm	1 : 17	F 2.2
	P10 x 20	20—200mm	1 : 10	F 2.2
1" PLUMBICON	PV17 x 24B	24—400mm	1 : 17	F 1.8
	PV10 x 16	16—160mm	1 : 10	F 1.6
	PV10 x 15B	15—150mm	1 : 10	F 2.0
1" Vidicon	V10 x 15	15—150mm	1 : 10	F 2.8
	V6 x 16	16.9—95mm	1 : 6	F 2.0
	V5 x 20	20—100mm	1 : 5	F 2.5
	V4 x 25	25—100mm	1 : 4	F 1.8
2/3" Vidicon	J10 x 13	13—130mm	1 : 10	F 2.8
	J 6 x 13	13—76mm	1 : 6	F 1.9
	J 5 x 15	15—75mm	1 : 5	F 2.1
	J 4 x 12	12.5—50mm	1 : 4	F 1.8
Servorized/Motorized				
	Name	Range of Focal Length	Zoom Ratio	Maximum Relative Aperture
1 1/4" PLUMBICON	P10 x 20B4	20—200mm	1 : 10	F 2.2
1" Vidicon	V10 x 15R (DC)	15—150mm	1 : 10	F 2.8
	V6 x 16R (AC/DC)	16.9—95mm	1 : 6	F 2.0
	V4 x 25R (AC/DC,EE)	25—100mm	1 : 4	F 2.5

© N.V. Philips of Holland

CANON U.S.A., INC.: 64-10 Queens Blvd., Woodside, New York 11377, U.S.A. (Phone) 212-478-5600  
 CANON U.S.A., INC.: 457 Fullerton Ave., Elmhurst, Illinois 60126, U.S.A. (Phone) 312-833-3070  
 CANON OPTICS & BUSINESS MACHINES CO., INC.: 3113 Wilshire Blvd., Los Angeles, California 90005, U.S.A. (Phone) 213-384-3113  
 CANON AMSTERDAM N.V.: Gebouw 70, Schiphol Oost, Holland  
 CANON LATIN AMERICA, INC.: Apartado 7022, Panama 5, Panama  
 CANON INC.: 9-9, Ginza 5-chome, Chuo-ku, Tokyo 104, Japan

# Canon

Circle Number 29 on Reader Reply Card

# Power Systems and Their Effects on Station Audio Lines

By Leon B. Davis\*

Many audio channels are provided to broadcasters by the telephone companies. Sometimes noise induced by power systems becomes a problem. The purpose of this article is to explore the conditions which cause noise or the appearance of disruptive voltages as well as measures which can be taken to minimize the difficulties.

## Power Systems

The output of an alternator with single winding has only two terminals available to a load. By means of a transformer as shown in Figure 1a, more terminals can be made available. If the secondary wind-

\*Professional Engineer, Gaithersburg, Md.

ings are connected in series aiding, the voltages across the combination are in phase and add algebraically. This can also be represented vectorially as shown in Figure 1b. The length of the resultant vector is equal to the sum of the two.

Most power is generated by machines with more than one winding, the usual case being three. The windings are displaced with respect to each other by  $120^\circ$  as shown in Figure 2a. The sinusoidal outputs of windings B and C will lag behind winding A by  $120^\circ$  and  $240^\circ$  respectively. Figure 2b is a plot of voltage vs. time for the three windings. Assume, now, that the inner winding ends are connected to-

gether and brought out as a neutral conductor. The voltages from the neutral to A, B and C can be represented vectorially. Vectorially this is represented in Figure 2c. The vector sum of these voltages in a balanced three phase alternator is zero. Later it will be shown how unbalances can affect broadcasters.

In the usual case in residential or some light industrial and business areas, the power companies deliver single phase secondary power at nominal 120-240 volts, so-called because both voltages are available. Large users, on the other hand, are usually served by a three phase system. Voltages available on a three phase power service are selected to fit the requirements of the user.

A typical business building will require 120 volts to operate small motors, incandescent lamps and portable equipment. In such a case the power can be supplied at 120 volts between the neutral and any phase of a Y connected system. It is called a Y system because the three phase windings schematically resemble the letter Y. Power to operate three phase equipment is available at 208 volts, phase-to-phase. If you plot the voltage vectors to scale, you will note that the phase-to-phase voltage bears the relationship 3: 1 to the phase to neutral voltage, not 2:1 as in a single phase three wire system.

Transformer connections in single phase systems are self-evident to anyone familiar with audio circuitry. Input and output voltages are related directly to the number

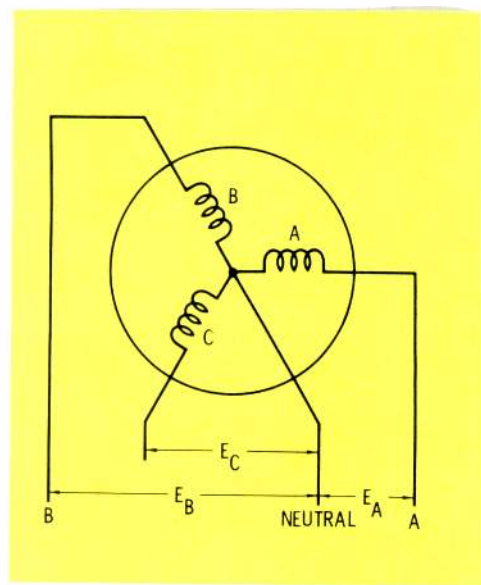

Fig. 2a Three phase alternator.

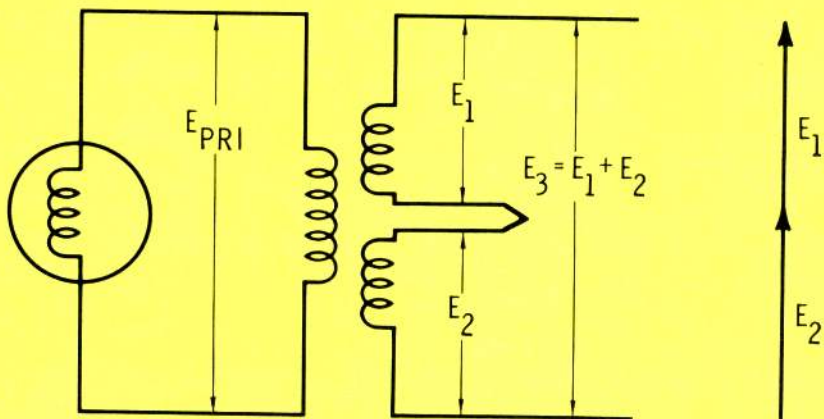

Fig. 1a Single phase alternator and transformer with two secondary windings.

Fig. 1b Vertical addition of transformer secondary voltages.

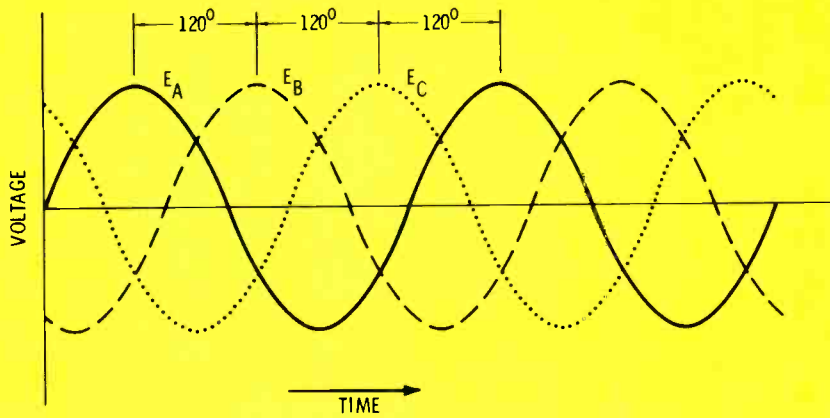

Fig. 2b Plot of output voltages of a three phase generator

of turns on the input and output windings. So it is with transformers in polyphase systems. Several single phase transformers can be used together to form a polyphase bank or a polyphase transformer can be built. In the interest of keeping this article simple, only the use of single phase transformers will be discussed.

Generators, transformers and loads in three phase systems can be connected either Y or delta. As the term suggests, the former has one end of each winding or load connected to a common point. The other ends are then the points of a three point star or Y. In a delta system the ends of the windings or loads connected in the form of a triangle or delta. Figure 3 shows how this is done.

By examining a voltage vector diagram of a delta connected transformer, it can be seen, as in Figure 3c that if one of the windings is omitted, the voltage relationships of the remaining windings remain unchanged. This form of connection is known as "open delta." This configuration is sometimes used for economic reasons.

Various combinations of wye and delta transformers are used in power transmission and distribution. Usually the junction of a wye connection will be grounded and may be extended as a neutral conductor. If the three phase system is balanced no current will flow in the ground connection. If a ground fault occurs on the line, current will flow in the ground connection and can be

used to operate circuit breakers.

---

**Distribution systems usually start as three phase systems, either wye or delta. If there is no three phase load requirement, the power company may elect to run branches of only one phase, rather than all three, to save construction costs. This results in an unbalanced system which may have a disastrous effect on broadcasting.**

---

The generation of a pure sinusoid is not practicable; some harmonic content is always present, although well designed generators produce them in very low quantities. The main sources of harmonics are transformers, motors, rectifiers, SCR devices and other utilization equipment. Rectifiers, SCR devices and other non-linear equipment can generate both odd and even harmonics. Motors and transformers usually produce only odd harmonics. Sometimes spurious products not harmonically related to the power system fundamental are produced by the winding slots in motors and by commutators.

Harmonics and other extraneous energy have little effect on the power system but may have a undesirable effect on audio lines served by telephone facilities. Most telephone lines are either on the same poles with the power system or separated by the width of the road. In either case, coupling exists between the two systems. The

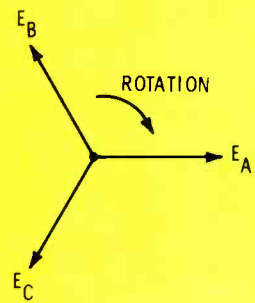

Fig. 2c Vectorial representation of three phase alternator output with respect to neutral.

power systems fundamental and harmonic currents induce voltages on the telephone system. If the telephone system is well balanced, no residual noise will result.

Factors contributing to unbalance may be high resistance splices, leakages to ground, faulty transpositions and unbalanced terminal equipment. Most telephone lines are in metallic sheathed cable. The sheath, if continuous, acts as a shield and reduces the induced emf on the cable conductors. In addition, cable pairs are twisted every few inches to maintain equal exposure and coupling to both sides of the pair. Open wire, on the other hand, may be twisted, or transposed, every several hundred feet or more.

Whenever a conductor carries alternating current, an alternating magnetic field is produced. Other conductors within the influence of the magnetic field will have an AC potential induced in them. This is the condition existing between power systems and communication conductors which follow the same routes.

The alternating magnetic field is called INFLUENCE. Conditions such as length of exposure, distance between the power and communications systems, earth resistivity and the presence of other conductors affecting COUPLING. When influence and coupling exist, an emf will exist on the communication conductors. Whether or not this emf will be harmful to the communications systems depends upon the magnitude of the emf

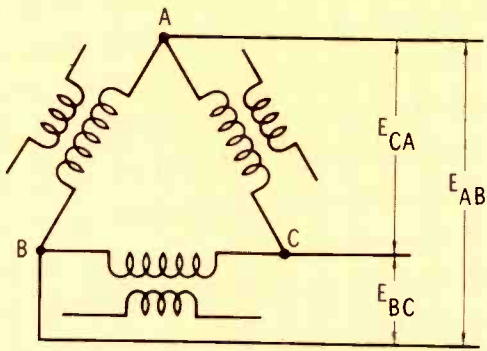

Fig. 3a Three transformers with Delta connected secondaries.

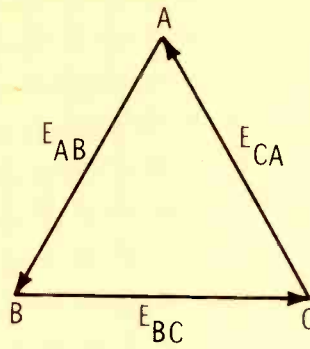

Fig. 3b Vector diagram of Figure 3a.

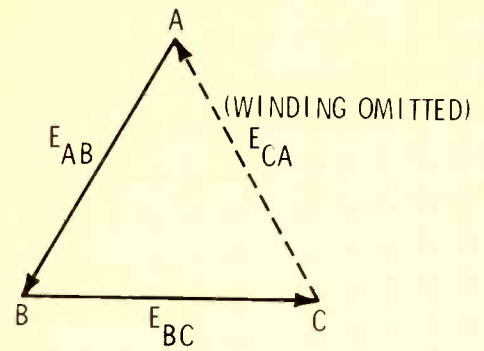

Fig. 3c Vector diagram of Figure 3a with transformer C-A omitted.

and the SUSCEPTIVENESS of the communications system. Harmful effects may be noise or may be voltages hazardous to persons or equipment. For these effects to occur, however, INFLUENCE, COUPLING and SUSCEPTIVENESS must all three be present.

### Influence

Now let us examine these conditions one at a time. Magnetic influence is caused by the power system currents, either at the fundamental frequency or its harmonics. It is also a function of the configuration of the power system. A well balanced three phase system (one with the load well balanced among the three phases) will produce little influence at the fundamental frequency because the residual current in a balanced system is zero. On the other hand, a single phase or an unbalanced polyphase system may produce a high influence. But, even in a well balanced three phase system certain harmonics will add directly. These effects are illustrated in Figure 4.

The fundamental and its third harmonic are indicated for all three phases. At any instant the sum of the fundamentals is zero. The third harmonics are in phase with each other and add directly. This is true of the odd triple harmonics, i.e. the 3rd, 9th, 15th, 21st, etc. No amount of system balance can reduce the effect of these. Only by suppressing these at their source or by employing three phase transformers with tertiary windings can the odd triples be dealt with. This is covered widely in engineering

texts and will not be discussed further here.

Modern power distribution systems have the primary neutral and secondary neutral tied together. Frequently it is the same wire. The neutral is grounded at frequent intervals either via the customer service entrance ground, transformer ground rods, or through guy wires which have not been insulated. There are a number of advantages to an interconnected or multi-grounded neutral (MGN) including better lightning protection for distribution transformers and provision of a low impedance ground for prompt de-energization of circuit breakers in the event of a phase-to-neutral fault.

When under normal operating conditions, residual neutral current exists because of load unbalances, and most of the fundamental current returns via the neutral. Because of inductance of the neutral conductor, it presents a higher impedance to harmonic currents and more will tend to return via the earth, this being a function of frequency. The result is that there will be an unbalance between the harmonic currents in the phase conductors and those in the neutral. This produces a residual magnetic field at harmonic frequencies which may be more disturbing to communication conductors than at the fundamental.

### Coupling

Coupling is affected by the relationship of the disturbing and disturbed conductors. Many communication conductors are on the same

poles with power conductors. If not, they may be separated by the width of a road, on separate pole lines, or the communication conductors may be buried in the ground. In any case, they may be within the influence of the power system. The coupling can be decreased by the presence of other grounded con-

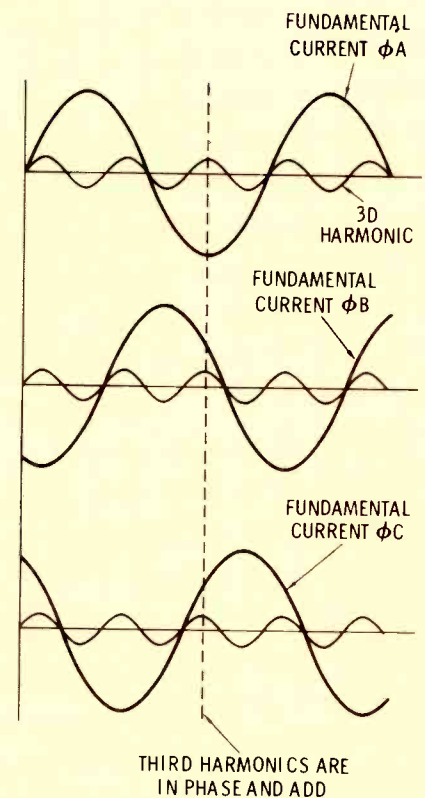

Fig. 4 Relationship of fundamentals and third harmonics in a balanced three phase system.

ductors such as cable shields, supporting strand or other communication conductors.

### Susceptiveness

Susceptiveness, the third ingredient necessary to produce disturbing effects, is a function of the configuration of the communication conductors and the balance of the terminal equipment. The worst case is the open wire telephone line. Its conductors are spaced about one foot apart and one conductor may be significantly closer to the disturbing power wires than the other. To reduce this effect the communication conductors are transposed or twisted at intervals. If one could maintain exactly the same spacing between the power and telephone conductors or both systems and transpositions, or twists, at uniform intervals, it is theoretically possible to reduce the susceptiveness of an open wire circuit to zero. This never happens in real life.

Power and telephone conductors are different materials and react differently to temperature, wind and ice loading conditions. Cable circuits, on the other hand, have none of these disadvantages. The communication conductors in each pair are, for all practical purposes, spaced equally from the power conductors and are transposed every few inches instead of at intervals of hundreds of feet. In addition, cables have metallic shields, either in the form of a lead sheath or an aluminum, steel or other metal under a plastic jacket.

While the balance of a pair of wires may be optimized, if longitudinal unbalances exist in terminal equipment noise may be a problem. Well designed input and output transformers exhibit excellent common mode rejection. This is accomplished by controlling the R, L and C of each side of the line winding with respect to ground.

Under normal power system operating conditions, fundamental and harmonic frequency voltages may appear on the communication conductors. Unwanted energy will not appear at the terminals of a well balanced communication system and, therefore, no harm results. Under power line fault conditions,

high currents may induce excessive voltages on telephone lines. In order to keep these voltages to safe levels, various protective devices are used on communication conductors. The most common is the carbon gap protector which has a breakdown voltage of nominally 350 volts RMS. Momentary high voltages from power surges or lightning may not damage the carbon gap protectors. Sustained high current will cause the protectors to ground the line permanently. The carbon gap blocks must then be replaced.

### Station Grounding

Broadcasting transmitter stations should be well grounded. Very important from the standpoint of safety to personnel and equipment is common bonding between all grounds in the installation. This is to prevent arcing between metallic structures in the event of lightning, power system surges or direct contact between power and communication conductors. Bonding between metal structures is more important, from the safety standpoint than a good ground, as such. The systems to be bonded include the station ground system, power neutral, communication company protectors, building structural steel and metal pipe systems.

In conclusion, the suppression of unwanted energy appearing on communication conductors as a result of induction from power systems is a joint responsibility of the communication and power companies. Mitigative measures applied by the communication company include shielding, conductor balance and terminal equipment balance. In addition, protective devices are applied to prevent hazards from high induced or direct contact voltages or lightning. Measures which can be applied by the power company include load balancing, suppression of harmonics generated in customer equipment, and the use of substation transformers with tertiary windings to suppress triple harmonics. Power and communication company engineers have been jointly solving these problems for years. If you have a power/noise problem, don't fight it alone. ▲

**Call Gates** for the most complete line of radio broadcast equipment . . . available from three separate centers.

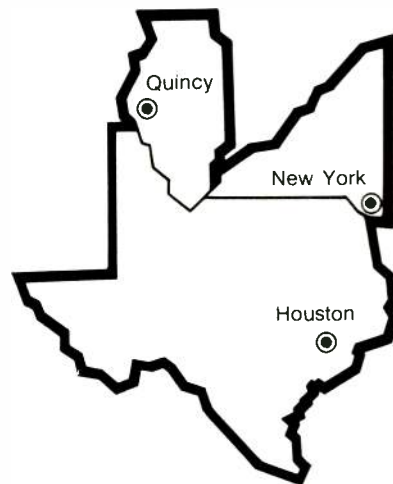

Home Office  
and Mfg. facilities  
123 Hampshire St.  
Quincy, Ill. 62301  
**(217) 222-8200**

Southwest  
service center  
4019 Richmond Ave.  
Houston, Tex. 77027  
**(713) 623-6655**

Eastern  
service center  
130 East 34th St.  
N.Y., N.Y. 10016  
**(212) 889-0790**



Circle Number 30 on Reader Reply Card

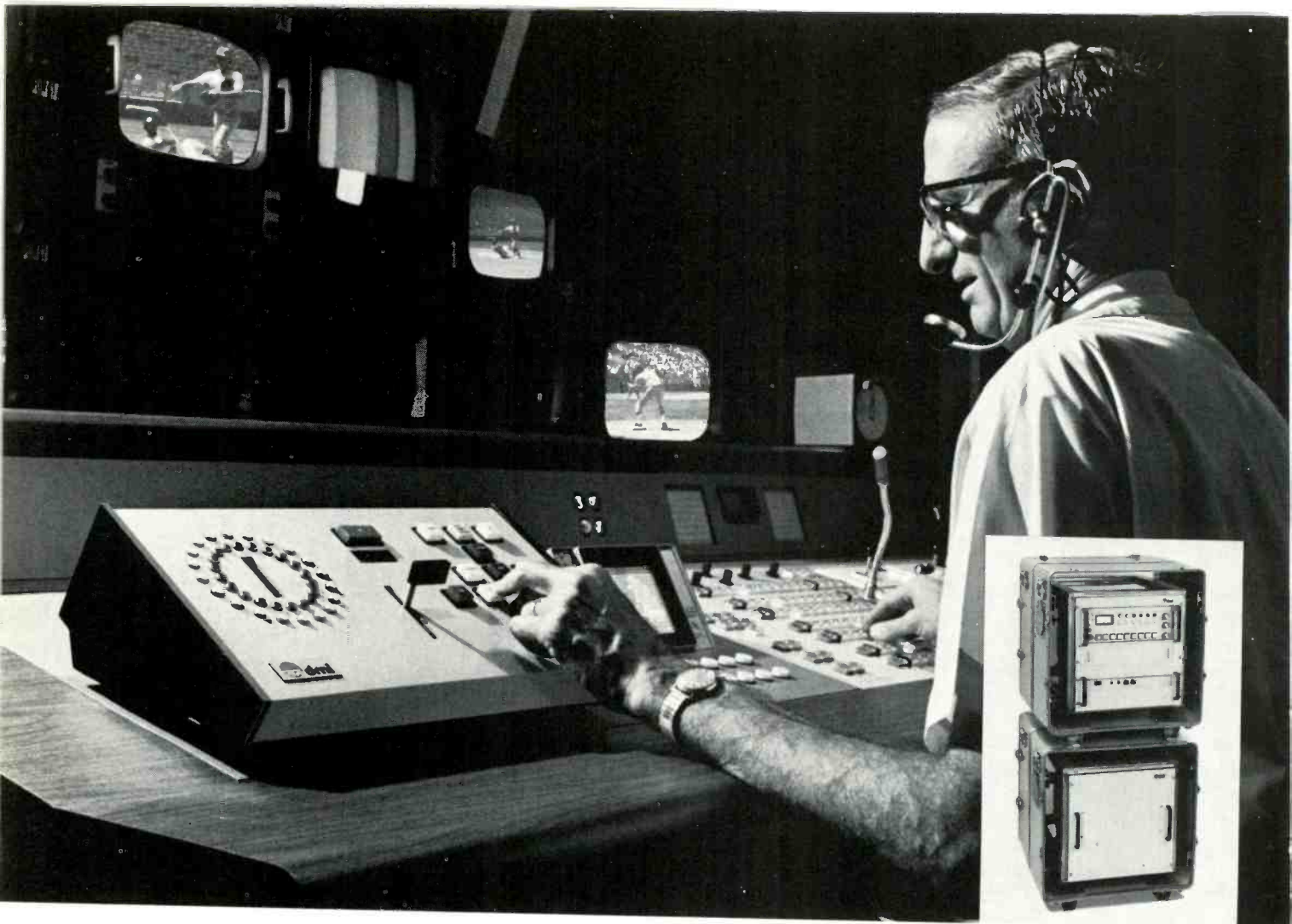

Location photograph courtesy KTTV Metromedia Television/Channel 11, Los Angeles.

# New low price for instant replay: \$5/hour

## TeleMation's\* VIDEODISC® VDR-1000 Instant Replay NTSC Recorder

The \$19,000 you save when you buy it (initial cost of chief competitive unit, about \$75K; of VIDEODISC, about \$56K) is just the beginning. Our single-disc, two-head design (much simpler than our chief competitor's two-disc, four-head unit) means fewer dropouts, higher reliability, and lower operating cost.

When you average out initial equipment purchase and disc/head replacement costs for the leading competitive unit—we'll call it Brand A—you come up with \$18.00 to \$20.00 an hour. The VIDEODISC VDR-1000, on the other hand, costs about \$5.00 an hour. That's a saving of up to \$15.00 for every hour that you use it.

So much for the *economy* story—there's more.

For example, the clearest, sharpest stop-action, slow-motion and time-lapse images you've ever seen. The *only* disc recorder that provides full 4.2 MHz bandwidth, with retention of luminance level in stop action and slow motion. Five speeds instead of two or three. Visual fast-forward and fast-reverse at any speed, including time lapse. Joystick speed control. Twenty indicator lamps to show you

exact head position second-by-second. Chromecote® proprietary protection to extend disc and head life. Disc design proven in long-term computerized data processing applications. Rugged construction and packaging for outstanding mobile operation. Modular design and built-in test circuits for easy maintenance anywhere. Test-panel access to all critical signal test points. Plus the fact that you don't have to replace heads just to change a disc.

If you can't see the point in working harder, worrying more, and paying four times the price for performance that falls short of ours, call or write us for a VIDEODISC demonstration. Instantly.

\*The "Instant Replay" product line developed over the years by DMI has been assumed by TeleMation. This product will henceforth have the financial, engineering and marketing background and support of TeleMation.



**TELEMATION**

P.O. Box 15068, Salt Lake City, Utah 84115  
Phone: 801-487-5399

TeleMation systems/sales offices in Albuquerque, Atlanta, Burlingame (Cal.), Chicago, Dallas, Denver, Houston, Indianapolis, Las Vegas, Little Rock, Los Angeles, Milwaukee, Needham Heights (Boston area), New York City, Norwalk (Conn.), Phoenix, St. Louis, Salt Lake City, San Diego, Tulsa, Washington, D.C.

Circle Number 31 on Reader Reply Card



# Air Force ITV Goes Mobile

1st Lt. A. M. Garfield\*

Lowry Air Force Base, Denver, paved the way for the use of educational television by the Air Force on August 6, 1958. The initial operation, including \$245,000 of new equipment and excess items procured from other Air Force bases, consisted of a studio installed in the spare rooms of the base's photographic school. Thirty hours of live programming a week were distributed to six monitors in the classroom building by dual channel coaxial cable.

Today, the Lowry Television Branch is the center for a vast network of Air Force instructional television which includes four major production facilities and numerous customers of playback material.

Beginning as a local production and playback studio, Lowry's television operation has achieved the status of an Air Training Command audio-visual center, providing support to any program necessary for the improvement of Air Force technical training.

The Lowry facility differs from most educational television installations in that it is administered by two major organizations. The equipment is installed and maintained by the engineers from the 1910th Communications Squadron of the Air Force Communications Service (AFCS). The facility is operated and used as a training aid by the Lowry Television and Training Film Production Branch of the Air Training Command (ATC), the "campus" for Air Force technical

\*1910th Comm. Squadron, Lowry Air Force Base.

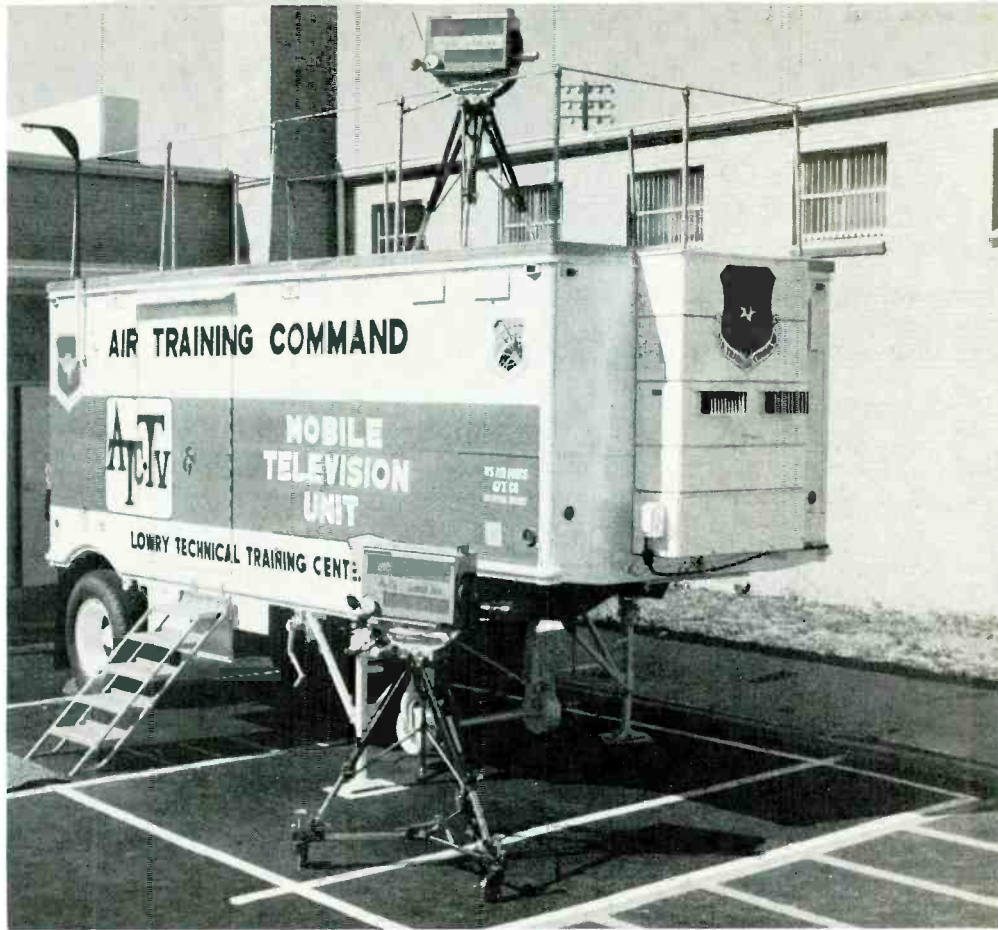

**Fig. 1** The mobile van maintained and operated by the Lowry Air Force Base educational TV system. Below, the mobile TV crew record a lesson on maintenance of the F-4 fighter at Eglin AFB in Florida.

training. The two agencies have pooled extensive engineering and production capabilities to solve the problems of continually expanding requirements—personnel training, equipment procurement and facility improvement.

The Lowry educational television building, completed in 1962, now houses a complete production facility including two studios, management offices and maintenance shops, film production and printing laboratories, graphics and script development offices. A video tape

and film library is maintained for use at Lowry and shipment of material to other installations. The building's master control room monitors studio production, electronic editing, kinescope recording, classroom playback and audio control.

The basic task of classroom instruction at Lowry has been considerably modified by twelve years of educational television use. In 1959 video tape and kinescope capabilities were established. Video tapes of lessons are converted to 16mm film and transmitted to distant

**Fig. 2** Maintenance Superintendent Senior Master Sergeant Martin Levandoski checks the levels on the videotape recorder in the mobile van.

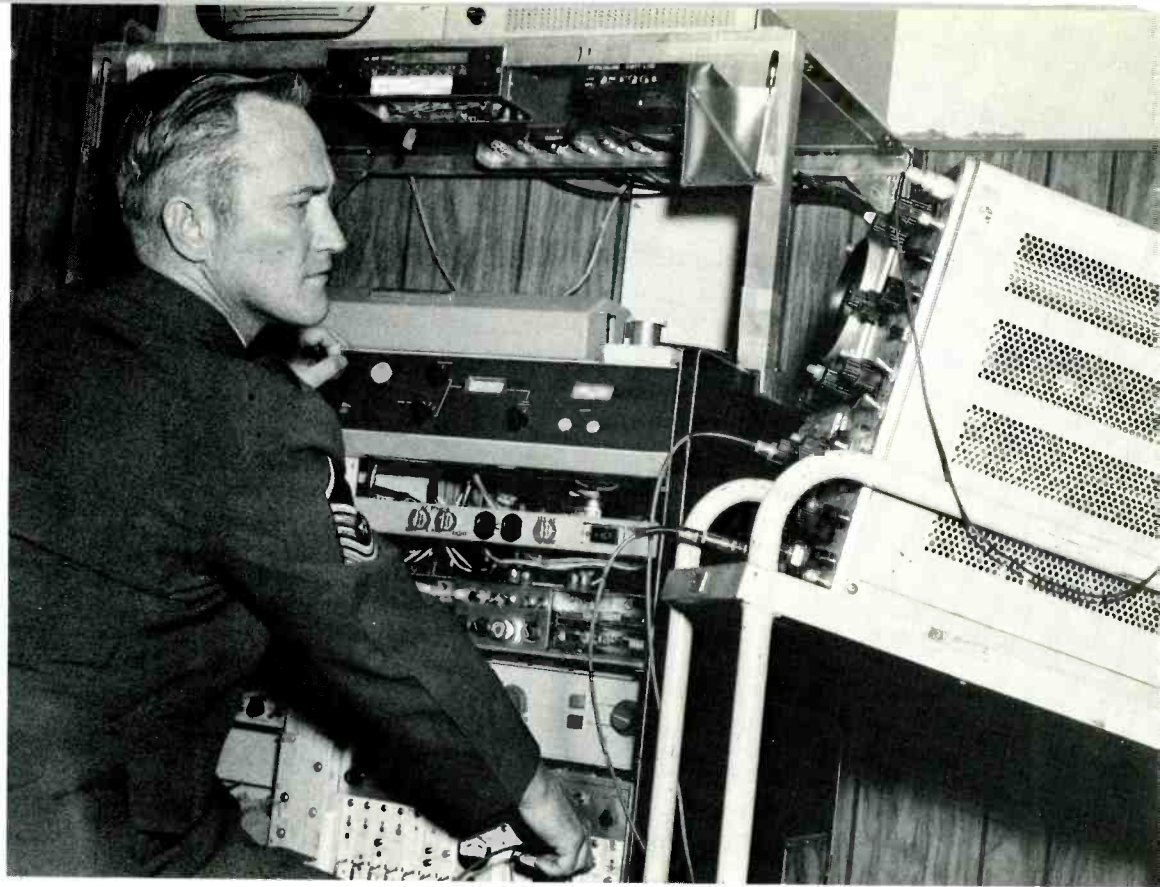

classrooms by a six channel video distribution system. As many as 30 films on basic electronics are shown from 6:00 A.M. to 6:00 P.M. daily. Other instructional programs use the 16mm film production for playback by projector in the classroom.

The two production studios are supported by RCA TK-31 studio cameras and Ampex 1000C video tape recorders equipped with Editec electronic editors. The adjoining studio control rooms feature video switchers capable of controlling four cameras and three auxiliary inputs including a 24 pattern special effects generator. One studio has special mixing capability including a separate special effects preview. The audio boards in each studio have capability for four mix inputs, two tape inputs, three auxiliary and one net turntable input. The completed and edited video tape productions are recorded on film by an RCA TFR-1 television recorder and a PM 80 audio recorder; audio and video are combined in the final film processing for the highest quality product.

Lowry handles video tape kine-scoping for other production facilities in the Air Training Command; Keesler, Sheppard, and Lackland Air Force Bases send video tapes to Lowry to be transcribed to

16mm film. Lowry transcribes and prints as much as 150,000 feet of film per month. Strict quality control is maintained throughout all stages of production. The television engineering section holds frequent customer conferences on improving the quality of video tape production to insure the best film result.

The Lowry Studio also assumes responsibility for production support to other military installations in the area. Lowry has an inter-service agreement for assistance to the Army's Fitzsimons General Hospital in Aurora, Colorado. Kinescoping and audio-visual support has also been extended to the Air Force Academy and the Air Force Accounting and Finance Center.

#### **Mobile Television**

Unique to Air Force educational television is the Lowry mobile television van, a portable production center capable of operation anywhere in the world. When the Air Training Command requires training film productions on subject matter which cannot be brought into the Lowry studios, the mobile van is dispatched to the location. The unit, originally a surplus radar van, was converted to a fully operational mobile television unit.

Its first mission in November, 1967 took it no further than six miles away to Fitzsimons General Hospital for a program on surgical scrub procedures. The van has since visited Texas, the Carolinas, Florida and Illinois, taping anything from aircraft maintenance to fire control systems. The mobile studio carries GE PE-23 Vidicon cameras and an Ampex VR 1100 physically modified for the van's limited space.

The specialized electronic features of the system make on-location video taping more flexible and convenient than cinematography. Electronic editing allows "on-the-spot" corrections and the use of special effects, as well as allowing the director an immediate viewing of the finished product.

The video taped lessons are sent to the Lowry television studios for conversion to film. Extending the capability of the mobile facility is cinemagraphic equipment capable of black and white or color film production. The camera, a 16mm Arriflex, is used to shoot the original footage. The film is then reduced to a Super-8 format.

Film produced by the Lowry television studios have been given world-wide distribution. Lessons have even been used for refresher training in Viet Nam.

The operation of the television

branch itself involves a monumental training program for Air Force television personnel. Television engineers come to the Air Force from three sources; directly from civilian life as "by-passed specialists" experienced in broadcast television, from the Army sponsored television engineering school at Ft. Monmouth, New Jersey, or from other military electronics fields with no prior experience in television engineering.

Personnel rotation is a particular problem. Many television specialists assigned to the facility have maintained only surveillance and monitoring systems with none of the complexities of television production. Frequently as soon as a man is qualified to maintain Lowry equipment he is reassigned to another location. The section also loses men temporarily to other installations. Other facilities draw from Lowry's pool of qualified

engineers for temporary maintenance duty and technical assistance visits, forcing the engineering staff to work around absences of qualified personnel.

The engineering section is stabilized by a core of ten civilians, many having received their experience at Lowry during military duty and returned to fill a permanent position. Two specially assigned civilian electronic engineers conduct training for newly assigned personnel, including Air Force specialty courses in television backed by daily classroom instruction and on-the-job training. Orientation in color equipment maintenance is included in preparation for future facility improvements.

Future plans include the acquisition of cameras capable of conversion to color. Transition to color will involve extensive modification to the existing facility, from acquisition of back-up electronic equip-

ment to studio rebuilding.

Bids covering Lowry specifications are submitted by various companies in competition; the contract usually goes to the lowest bidder satisfying the given requirements.

Television has earned its place as a prominent part of the Air Force educational system, proving to be an extremely efficient means of rapidly training future Air Force technicians. Zoom lenses magnify intricate equipment for easy viewing by an entire class at one time. The mobile television van brings the hardware of the entire Air Force into the classroom.

The engineers and production crew work together to insure proper functioning and operation of the television equipment so the finished product, a videotaped lesson, will meet the rigid technical and educational standards of the Air Force Communications Service and Air Training Command. ▲

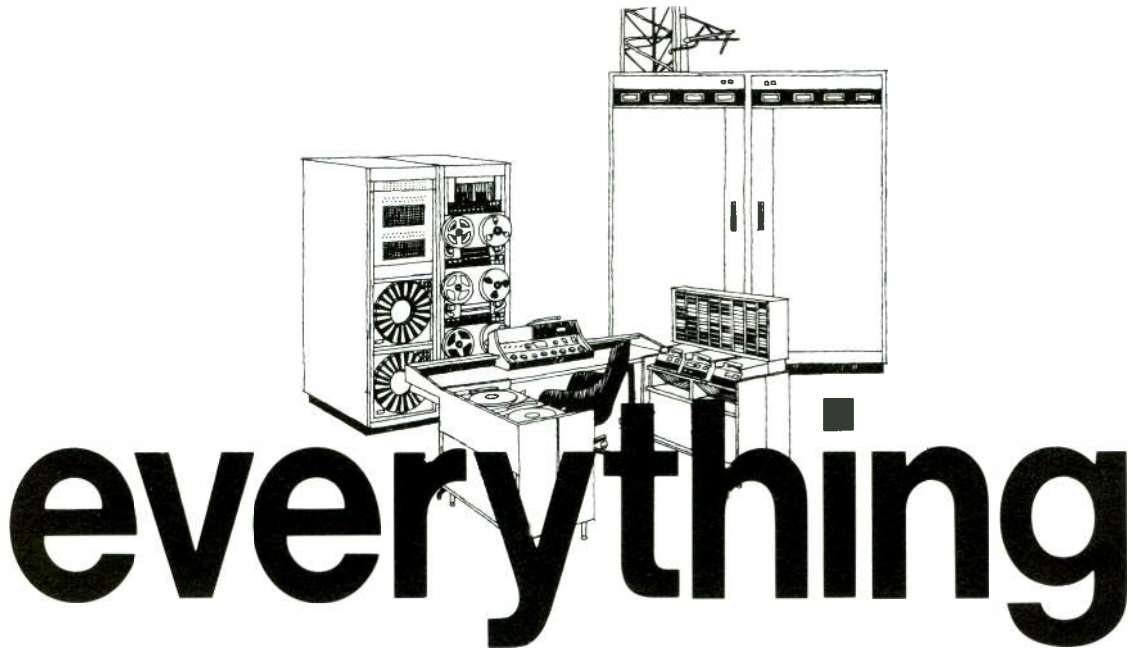

... for your every broadcasting need, and with 100% financing!! It's faster, easier, and less costly for you to let SPARTA service your needs.

A smooth and profitable operation is yours with SPARTA equipment because value is built in, in such a way that dollar for dollar you can't find a better buy in quality broadcast products.

Call or write us today and we'll send you colorful brochures detailing our complete product line.

SPARTA HAS EVERYTHING!!!



**SPARTA ELECTRONIC CORPORATION**

5851 FLORIN-PERKINS ROAD SACRAMENTO, CALIFORNIA 95828 (916) 383-5353

14616 SOUTHLAWN LANE, ROCKVILLE, MARYLAND 20850 (301) 424-2920

A DIVISION OF COMPUTER EQUIPMENT CORPORATION

Circle Number 32 on Reader Reply Card

# Switchers / Effects

buy

# TELEMET

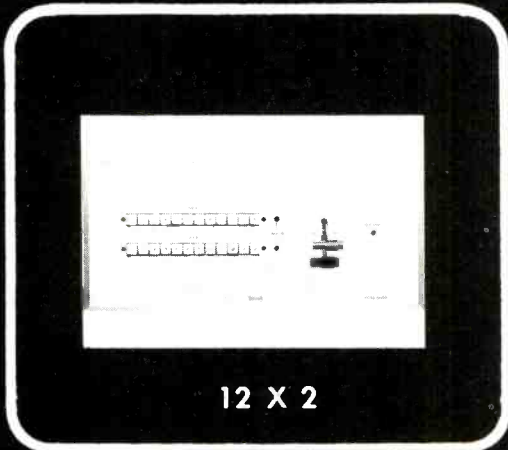

12 X 2

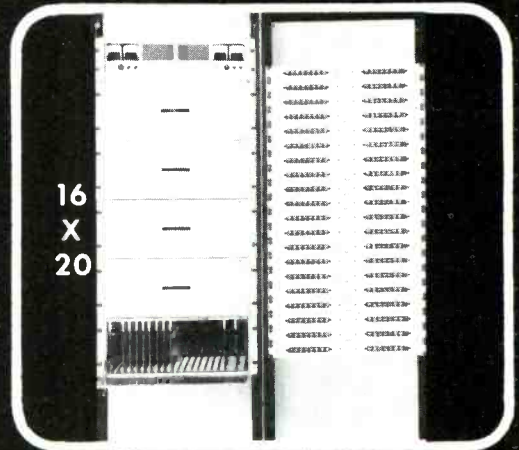

16  
X  
20

V.I.  
Production

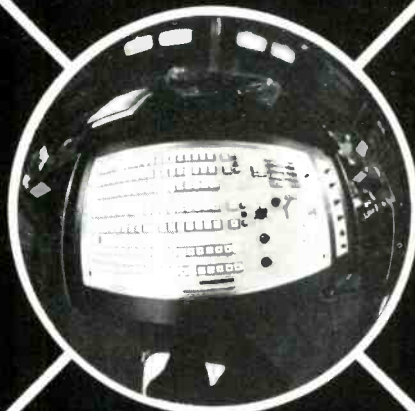

20 X 7

A/V  
Routing

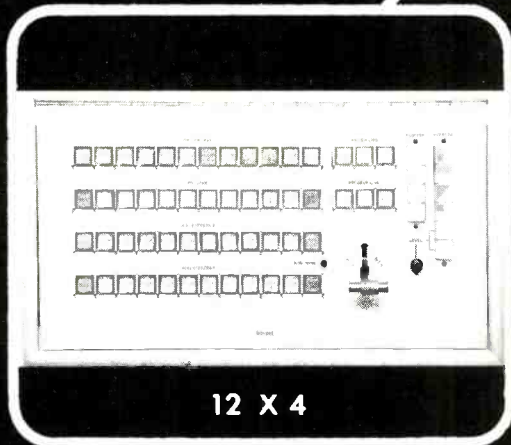

12 X 4

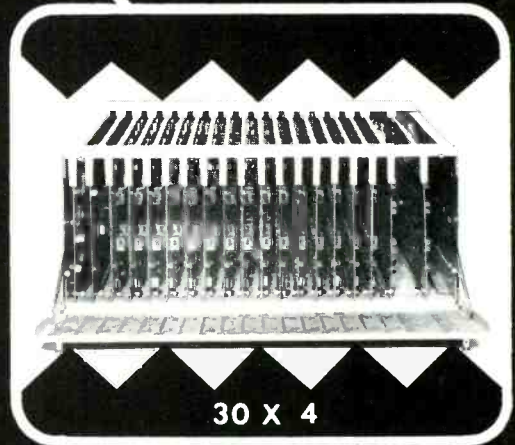

30 X 4

The answers to all your switching requirements are at TELEMET

Contact us at:



**Telemet**

A GEOTEL COMPANY  
AMITYVILLE, NEW YORK 11701  
516-541-3600

CHICAGO, ILL. 312-627-6026  
CHATTANOOGA, TENN. 615-886-3032

REGIONAL OFFICES

HOUSTON, TEX. 713-946-5796  
SAN FRANCISCO, CALIF. 415-797-0626

Circle Number 33 on Reader Reply Card

# ENGINEER'S EXCHANGE

## Built-in Telco Remote

It is possible to build a remote unit right in the telephone by removing the ringer assembly from a Bell System 500 Series telephone.

The PK-544 amplifier is an excellent choice for this use. It provides a high (85 dB) gain, low distortion, is temperature compensated and has a frequency response of 150-10 kHz. We find this response ideal, especially for sports remotes where an extended low range is not desirable. Furthermore, in this configuration the peak battery drain is about 30 ma., idle is 6 ma., and the unit will easily deliver +10 VU to the line. We have used remote units similar to this for over five years without any failures.

Briefly, here is how the unit works. Sw 1 is turned on, Sw 2 is thrown to phone position, number is called, switch 2 is thrown to remote position and remote broadcast proceeds. In either position of Sw 2, remote operator will be connected to the radio station. In fact, if the station cuts away for local commercials, the remote operator may switch back to phone and talk directly to, or receive

instructions from radio station. In "phone" position, the line is "held" by the output winding of the 425B network (200 ohms). In "remote" position, the line is "held" by the parallel resistances of the 6 dB pad and the resistance of the A67J secondary (400 ohms). Isolation capacitors are not strictly necessary, but 5 mf 150 VNP capacitors may be added between the A67J and pad. In either case, the pad resistors should be 1 watt units because they will have to dissipate about a 40 ma. current.

The NE-51H and 47K resistor may be tied across line to give visual indication of an incoming call.

C1 is added for RF pickup suppression because the unit is unshielded when mounted in a telephone body.

500 Series phones are available from Barry's Electronics, 512 Broadway, New York, N.Y., 10012 for \$23.95, Catalog No. 19-372.

With the ringer assembly removed, parts placement will be easy. I placed the XLR-3-31 mic input connector on top of the phone under the hand set, so that it is

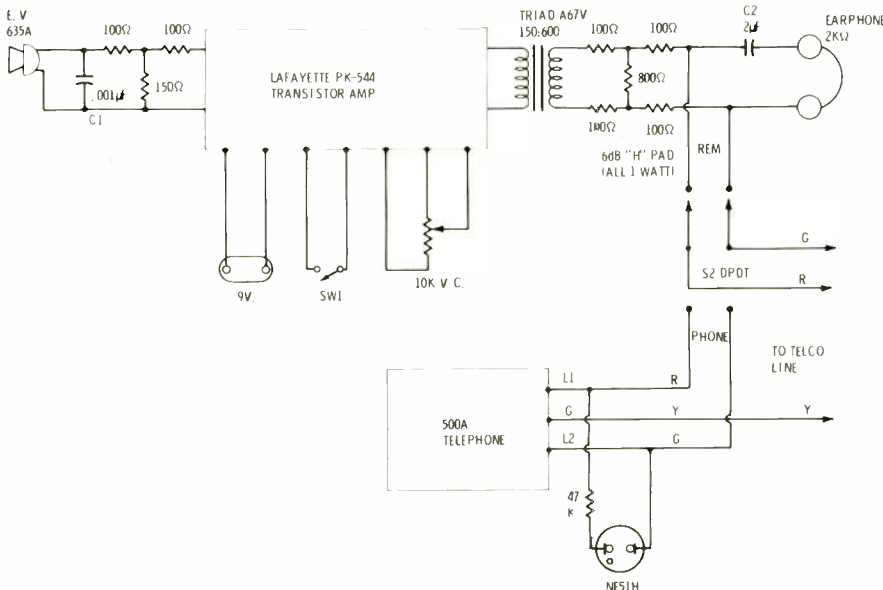

**WE HAVE  
ALL THE RIGHT  
CONNECTIONS.**

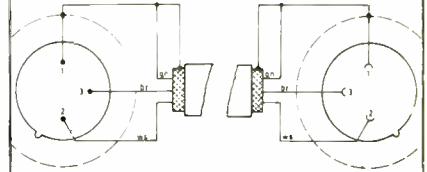

A "simple" microphone extension cable isn't so simple. Not if it's going to match today's phase accuracy and continuity requirements!

At Gotham, we start with double RF shielded, 3-conductor cables made to Neumann's tight specifications. And we attach Switchcraft "Q-G" (XLR compatible) connectors with a special technique, so the connector shell is grounded.

Our price? Practically what you'd pay for cable and plugs alone. Ten feet, \$7.50. Twenty-five feet, \$10.50. Fifty feet, \$16. One hundred feet, \$27.

Order through your Neumann Microphone Dealer. Or from Gotham directly.

**GOTHAM**  
AUDIO CORPORATION

2 West 46th Street, New York, N Y 10036  
(212) 265-4111  
1710 N. LaBrea Ave., Hollywood, CA 90046  
(213) 874-4444

**SPARTA**  
everything  
in  
AM transmitters

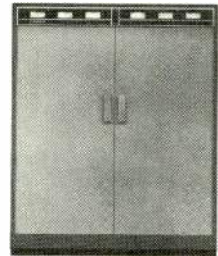

Throughout SPARTA's Fritz Bauer designed AM Transmitters you'll find quality components such as oil-filled modulation transformers, vacuum capacitor final tank tuning, and a tally-light fault finding system. AM Transmitter reliability is yours with SPARTA equipment. Call or write your SPARTAMAN today!

**SPARTA ELECTRONIC CORPORATION**  
5851 FLORENCE AVENUE ROAD SACRAMENTO CALIFORNIA 95829 (916) 382-5353  
14616 SOUTHLAWN LANE ROCKVILLE MARYLAND 20850 (301) 424-2900  
A DIVISION OF COMPUTER EQUIPMENT CORPORATION

Circle Number 34 on Reader Reply Card

impossible to hang up when external mic is connected. I placed the Sw 1 head phone jack and volume control to the rear of that and placed Sw 1 between the two rear posts of the phone cradle, so that it is protected from accidental activation. I placed S 2 in an existing hole on the right side dial support and cut a hole through the cyclac body of the phone for access. This protects the switch from accidental activation and if the hole is plugged with chassis plug, it adds to the appearance of the unit.

The switches were miniature models similar to JBT, JMT 123 and JMT 223.

The unit is compact, neat and easy to use.

**John Gaboury, CE**  
**KVOY Radio, Inc.**  
**Yuma, Ariz.**

Send Your  
 Exchange Ideas To  
 Broadcast Engineering

## On Solving VTR Switching Transients

Some time ago I had a problem with an Ampex 1200 VTR, which I have since seen on the air on other TV stations. I have no way of knowing what make or model the problem originated from the other times I have seen it.

Lined across the picture diagonally are switching transients which occur once per drum pass. That is a transient, the remainder of that heads' information and the information of the other three heads and then a transient displaced horizontally from the original transient when the original head is on again. The result, with interlace, is the production of two parallel rows of transients diagonally through the picture. The effect is most pronounced when in black with setup or when viewed against a solid background.

The transients occur at tach rate and drift back and forth very much like stability markers. In high band during program they can be tolerated by viewers, but in low band they enlarge to blotches almost twice the size of stability markers and are unacceptable.

To make matters worse, as I tracked the problem down I found that it would not occur all the time but only after the machine had been in operation for 20 to 40 minutes. On a cold day you could load the offending VTR with spots all day and never have the transients show up.

Now as we all feel, it is better to replace a part with a whisp of smoke rising from it than to try and do running battle with an intermittent. Sometimes we went for weeks with a clean signal. Then one day on the channel amp display, slowly growing out of the grass like corn, would appear a positive going spike and the transients would be back in the picture.

Our only clue, other than the transient and its rate, was that heat was involved. To make a long story short, here are some of the things it was not! The head blower, sparking in the rotary transformer spring loaded bearing, the head leads to

# COMPACT HIGH PERFORMANCE FOR MOBILE OR STUDIO

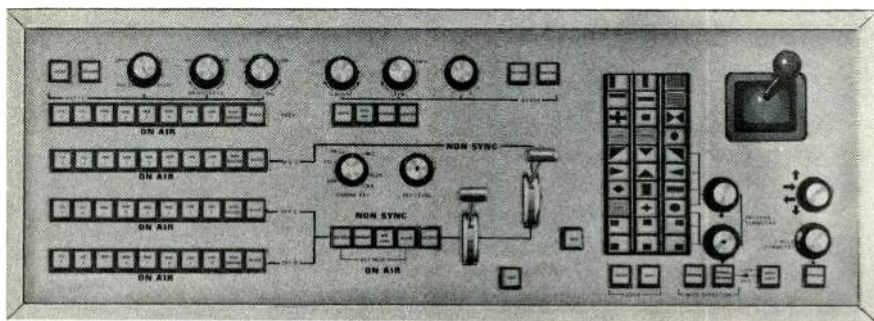

VPM 1004 VIDEO PRODUCTION SWITCHER.

for information on  
 production or master  
 control switching . . .  
 call RHL

**RICHMOND HILL LABORATORIES, INC.**

142 Central Ave., Clark, N.J. 07066

(201) 381-5955 Telex 01-38245

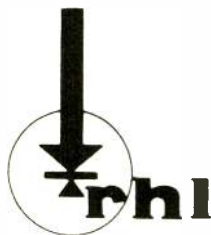

Western Regional Manager,  
 Eugene Sudduth,  
 3745 Blue Trace Lane,  
 Dallas, Texas. 75234  
 Phone: (214) 638-7090

Mid-Western Regional Manager,  
 Vince Lyons,  
 370 Nottingham Lane,  
 Hoffman Estates, Illinois. 60172  
 Phone: (312)882-4622

Eastern Regional Manager,  
 Joe Ewansky  
 142 Central Ave.,  
 Clark, N.J. 07066  
 Telex: 01-38245  
 Phone: (201) 381-5955

Circle Number 42 on Reader Reply Card

the channel amp card, adjustment of the switching transient suppression pulses in the signal system, the power supply, the tach circuitry or an open ground.

All cards in both the signal system and servo were examined one by one under the light of a magnifying lamp and portions of the wiring harness were rung out wire by wire.

After considerable testing, I was no where nearer an answer than when I had started, so I played a hunch. About the only place the transient rate was being produced with any power was in the motor drive amplifiers or "chopper outputs" that drive the capstan and drum motors.

These drive outputs are produced by a group of stud mounted power transistors that are located in the rear of the servo chassis and

show up only on the servo harness diagram. Stalking my personal gremlin, armed with an aerosol container of coolant, I waited for the transients to appear and then turned each transistor into a snowman. Sure enough the transients could be stopped by cooling one of the drum chopper transistors.

The old transistor showed no unusual characteristics when tested with a conventional transistor tester. But in some way it gave rise to the transients, whereas its replacement did not.

I should also note that there was nothing present in the motor drive waveforms to indicate any problem nor was there any waveform change there after the transistor was replaced.

**Roy Trumbull**  
**Metromedia**  
**El Cerrito, Calif.**

## Using The Cross Step Gray Scale

After reading with interest, a **Broadcast Engineering** article on aligning Color Film Cameras (Nov.,

### Easy Off Tape 'Scape

In response to D. Khali Jones of KID-TV. His suggestion of disposing of used video tape seems to be quite a tedious task. The method I have been using takes less than one minute to dispose of 30 minutes of tape.

Remove the take up reel from the machine, and load the tape to be disposed of but do not go through the transport itself. Wrap about three or four wraps of tape around the hub, and place a pencil eraser down vertical to the hub. Wrap about three more wraps of tape around both the hub and the pencil and place the machine in fast forward.

After all the tape is transferred to the takeup hub, remove the pencil. This creates a slack near the hub, and the tape is easily lifted off to be disposed of. Remember to hold the tension arm on so the transport will operate.

**Franklin Forgette**  
**Western Ky. Television**  
**Bowling Green, Ky.**

1970 issue page 43), and after more than three years of using slide gray scales, that are not really gray, (the base color of the film is not neutral); we arrived at a solution to our headaches.

The Kodak representatives gave us a demonstration on their new Cross Step Gray Scale 3 1/4 X 4 inches Slide for TV Camera film adjustments. We ordered two of them. As soon as the Kodak Slides arrived, we began thinking on an easy way to use them.

The slide is to be used in front of and as close as possible to the field lens of the film camera. We constructed a mounting with magnets that permitted us to install and quickly remove the slide at alignment time.

To do this the cover of the multiplexer had to be removed. In doing this a mirror of the multiplexer can be damaged. After a lot of planning and of prototype making, we finally arrived at the present model of what we call an "Instant Chip-Chart". Of course the gadget is made for the TK-27 RCA Color Film Camera and is basically an aluminum shutter that is held between two rails of plexiglass. In the aluminum shutter is mounted the slide and two small magnets

## IMITATED BUT- UNMATCHED!



**SP SERIES REPRODUCERS**  
**SP-0001 \$625**

- 8 1/2 Inches Wide
- 450 RPM Direct Capstan Drive Motor, Electrolyzed Shaft
- Quiet, Air Damped Solenoid
- Hi-Speed Cue Option
- Monophonic or Stereophonic



**INTERNATIONAL  
TAPETRONICS  
CORPORATION**

2425 South Main Street  
Bloomington, Illinois 61701  
Telephone: 309-828-1381

Circle Number 36 on Reader Reply Card

# SPARTA

everything  
in  
audio consoles



Five channels with 14 inputs or 8 mixing channels with 22 inputs, take your choice! SPARTA has the monaural console for your broadcast needs. SPARTA consoles are in a class by themselves in versatility and mixing. Add a SPARTA Extender Panel and the capability of your console is expanded! Quality equipment at a realistic price is yours with SPARTA. Contact your SPARTAman today.



**SPARTA ELECTRONIC CORPORATION**  
5851 FLORIN-PERKINS ROAD SACRAMENTO CALIFORNIA 95828 (916) 383-5353  
14616 SOUTH-LAWN LANE, ROCKVILLE, MARYLAND 20850 (301) 424-2990  
A DIVISION OF COMPUTER EQUIPMENT CORPORATION

Circle Number 37 on Reader Reply Card

# remote VHF-TV aural modulation monitoring

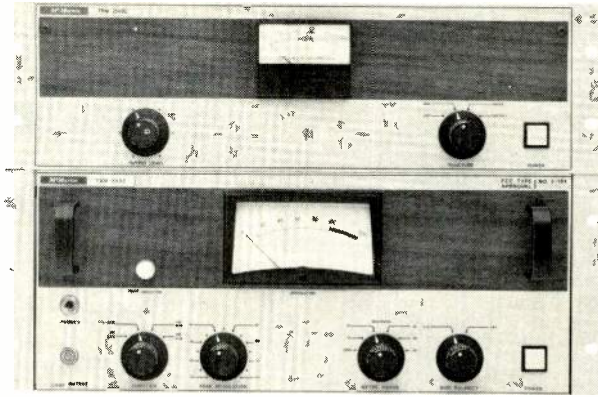

TBM-2500-CL .....\$510.00 | TBM-5500 .....\$1,300.00  
 TBM-2500-CH .....\$535.00

At a very practical price, McMartin's TBM-5500 satisfies new FCC rules for "a type approved aural modulation monitor, equipped where necessary, with a properly designed signal frequency amplifier..." Sec. 73.676(a)(5). ■ Driven by the TBM-2500-CL (Channels 2-6) or TBM-2500-CH (Channels 7-13) RF Amplifier, the TBM-5500 has a composite output signal termination to permit measurement of 39 kHz subcarrier injection level. Equipped with the TBM-2100 SCA Demodulator (optional at \$125.00), it also provides recovery of subcarrier telemetry tone information. ■ Long the leader in FM monitoring and professional receiving equipment, McMartin now provides the realistic answer to remote control VHF-TV aural monitoring. Coming soon—the TBM-5000 VHF-TV Digital Frequency Monitor—for visual, aural and intercarrier deviations.

For details, contact: Broadcast Product Manager (402) 342-2753

**McMartin**

605 north thirteenth street • omaha, nebraska • 68102

Circle Number 38 on Reader Reply Card

that hold the shutter in the up position.

The slide holder is mounted on the cover of the field lens mask. All the work is done on a circular cover that can be removed without disturbing operation of the TK-27. Observe that the plexiglass slides are shaped on top and in the middle to permit the insertion of the assembled holder, slide and handle between the camera wall and the field lens. The only modification to the camera itself consisted of removing the lower spacer and screw in the field lens mask.

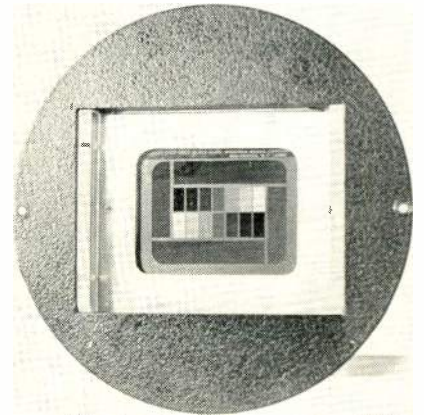

Slide in position in the round cover of the field lens.

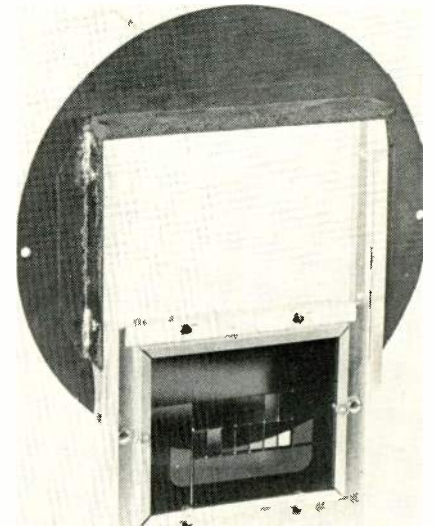

Identification in the rails permits insertion in film camera.

To balance the camera it is necessary to raise the slide into position, run the projector on an open gate and balance the film chain.

The mounting and the slide it-

2 NEW  
Low Cost

## AM FREQUENCY MONITORS



MODEL 520  
DIGITAL

MODEL 510  
ANALOG



- Solid state design.
- Proportional oven control for excellent stability.
- Fits standard relay rack.
- Remote metering available — Model 510

FCC TYPE APPROVED



**METRON INSTRUMENTS, INC.**

1051 South Platte River Drive Denver, Colo. 80223  
 (303) 744-1791 • TELEX 04-5729

Circle Number 39 on Reader Reply Card



self are physically mounted inside the TK-27 cabinet, free of dust, fingerprints and possible damage.

Photographs of the mounting gives a better idea of the construction of the gadget. Dull black paint was sprayed over metal and plexi-glass parts to prevent reflections.

**Miguel Triay**  
**WKAQ-TV**  
**San Juan, P.R.**

## Latest FCC Radio Equipment List Ready

The latest listing of Radio Equipment Acceptable for Licensing, dated May 11, 1971, has been issued by the Commission.

The list includes equipment for the Domestic Public Radio Services other than Maritime Mobile; Radio Broadcast Services; Experimental Auxiliary and Special Broadcast Services; Stations on Land in Maritime Services; Stations on Shipboard in Maritime Services; Public Fixed Stations and Stations in the Maritime Services in Alaska; Aviation Services; Public Safety Radio Services; Industrial Radio Services; Land Transportation Radio Services; and Citizens Radio Service.

The transmitters listed are considered acceptable for licensing in the various services provided that their operation is in accordance with Commission rules and the specifications for this equipment are not exceeded. The list also includes frequency and modulation monitors that are type approved for use in the radio broadcast service. Equipment is listed alphabetically by manufacturer and numerically by type number.

Copies of the list are not available from the Commission for purchase or public distribution. They are available for reference at the Commission offices at 1919 M Street N.W. in Washington, D.C. and at FCC field offices, and may be purchased from Keuffel & Esser Company (formerly Cooper-Trent), 1521 North Danville Street, Arlington, Va. 22201 (telephone 524-9000, area code 703). Inquiries, other than requests for purchase of the list, may be addressed to Technical Division, Technical Standards Branch, Federal Communications Commission, Washington, D.C.

## NEW PRODUCTS

### Compact L Band Amplifier/Modulator

Acrodyne Industries announces availability of its new 12 dB gain amplifier/modulator, Model A-2027.

A 20-ounce, totally solid-state unit measuring 4½" x 4½" x 1" less connectors, the A-2027 delivers up to 16 watts peak with 1-watt CW input. Peak output pulse power results when the amplifier/modulator is triggered by TTL level pulses at the trigger-pulse input connector.

Components include a 50 ohm RF attenuator providing good input VSWR characteristics; PIN diode RF switch; RF switch driver, and a pair of cascaded common base transistor amplifiers. The unit has a ±30 MHz bandwidth of "L" band, and can provide a maximum 33.0 micro-second pulse-width at a maximum duty cycle of 0.1%.

As a final amplifier itself or an intermediate amplifier in a chain the unit can be used in TACAN, DME, and other communications applications. Typical Acrodyne amplifier chains with specifications like those of Model A-2027 are available to the 10 KW peak pulse level and higher.

Circle Number 60 on Reader Reply Card

### Video Delay Modules

A series of equalized delay line modules for color video signals with delays of 5 ns. to 4 ms. are to be marketed by **Television Equipment Associates**, Bayville, N.Y.

According to Matthey Printed Products and British Broadcasting Corporation, these compact, high-precision 75-ohm modules overcome the need to employ bulky coaxial cable, attendant equalizers and high-gain amplifier circuits in

(Continued on page 56)

## THE STANDARD OF EXCELLENCE



### RP SERIES RECORDER/REPRODUCERS RP-0001 \$1150

- Six-Function Meter Switch
- 1 KHz Cue Tone Add and Defeat Switches
- Quiet, Air Damped Solenoid
- 450 RPM Direct Capstan Drive Motor, Electrolyzed Shaft
- Hi-Speed Cue Option
- Monophonic or Stereophonic



**INTERNATIONAL  
TAPETRONICS  
CORPORATION**

2425 South Main Street  
Bloomington, Illinois 61701  
Telephone: 309-828-1381

Circle Number 40 on Reader Reply Card

## SPARTA everything in automation systems



SPARTA-MATION systems offer the ultimate in flexibility. They accommodate different programming formats, automatic network joining, program logging, and remote control. SPARTA-MATION offers more realistic value than any other system. Contact your SPARTAMAN today!



**SPARTA ELECTRONIC CORPORATION**  
5851 FLORENCE-BERKINS ROAD SACRAMENTO CALIFORNIA 95828 (916) 283-5253  
14816 SOUTH-LAWN LANE ROCKVILLE MARYLAND 20850 (301) 494-4590  
A DIVISION OF COMPUTER EQUIPMENT CORPORATION

Circle Number 41 on Reader Reply Card

# new production techniques

## ROTEC

Rotating  
quad split

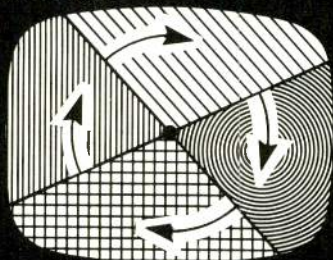

Rotating  
split

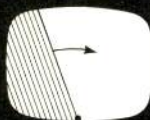
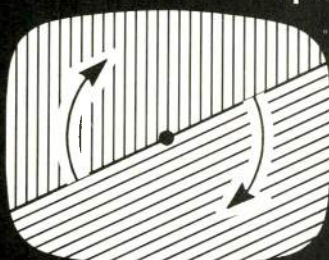

A family of windshield wipes (8)

Enjoy the competitive edge in your market with these exclusive production techniques.

Write or call: 812/332-7251



**SARKES TARZIAN, INC.**  
Broadcast Equipment Division  
Bloomington, Indiana 47401

Circle Number 52 on Reader Reply Card

**WHY  
BUY  
STL  
TEST  
TAPES**



Call or  
Write:

**TABER MANUFACTURING & ENGINEERING CO.**

2081 EDISON AVE. • SAN LEANDRO, CALIF. 94577 • PHONE: (415) 635-3832

Contact us for distributor in your area.

Circle Number 53 on Reader Reply Card

- *Highest quality*
- *Independent producer*
- *Available immediately*

Accepted as basic reference tools by major equipment manufacturers, broadcasters, and recording studios throughout the world, STL test tapes are unexcelled for quality.

Available in all audio tape widths—150 mil to 2 inch. Catalog-listed tapes of 1/4" are priced at \$24.00 each.

Supplied to the user promptly on order.

(Continued from page 55)

the delaying of color video signals. Each video module incorporates its own equalization circuit to preserve high-signal quality, and the units can be cascaded with others in the series to provide a wide range of accurate delays with minimum distortion and insertion loss. The final cost is equal to or less expensive than cable. Pulse delay modules are also available.



The variable delay unit shown here provides a rapid selection several delay times.

Intended primarily for color TV switchers to facilitate precise timing on a temporary basis for remotes, American engineers may use it to determine actual delay requirements needed for permanent installations. The delay unit can be cascaded with Matthey fixed delay modules of 200 ns., 500 ns., and 1,000 ns. The fixed delay modules can also be cascaded with each other to provide delays of up to 4 ns.

Circle Number 61 on Reader Reply Card

### Music Library For Automated FM & AM Stations

The BRIGHT NOW sound, a taped music service designed to operate on broadcast automation systems, is now available to stations on an exclusive market basis from **Schafer Electronics**.

BRIGHT NOW, which features the big, bold sound of today, lightly spiced with many of yesterday's gold award winners, is an announced service aimed at the 18-49 age group.

Based upon Billboard's "Easy Listening" charts, with added selections from the "Hot 100s" and best selling LP lists, the library is available in either of two forms.

Form I places major emphasis on the big beat instrumentals which

have particular appeal to the 25-49 age group. This up-tempo library is divided into four musical categories (1) Big band instrumentals, (2) Strings with a beat, (3) Combos and (4) Vocals (Male, female and groups). Form I subscribers start with all categories of music in a basic 66 hour library, with six hours of current music added monthly. The cost to Schafer system owners is \$750 for the initial library and \$225 per month for new reels. The cost to other stations is \$825 down and \$275 monthly.

Form II is more vocal-oriented with music selected for the 18-49 age group. This library contains five musical categories, three instrumental and two vocal. Categories are (1) Big Band Instrumentals, (2) Strings with a beat (3) Combos, (4) Male vocal, (5) Female and group vocal. The Form II initial library

contains 77 hours of music with 7 hours of new tapes added monthly. Initial library cost is \$940 for Schafer system owners and \$1025 for others. Monthly charge for new reels is \$275 and \$325, respectively.

The BRIGHT NOW sound is mastered on low noise tape in Schafer's modern recording studios. Each selection is recorded in two track stereo. 25 Hz tones for automatic switching are placed in the left channel only at exactly the right location for a smooth transition from selection to selection.

The music service is available on either 10½ inch or 14 inch reels. A play list accompanies each reel of music, identifying the title, artist, album & number, the publisher information and time required for each selection.

Circle Number 62 on Reader Reply Card

### Pulse Distribution System

A new pulse distribution system offering the advantages of a complete sync lock color generator system at a 20-40% price reduction has been introduced by **American Data Corporation**.

The Syncro-Pulse System offers programmable pulse delays, internal solid-state assignment system and the ability to generate H-Drive, V-Drive, Sync, Blanking, Subcarrier and Burst Flag pulse from each

Model 425 Slave Unit.

The Model 425 Slave Unit will continue sending pulses even when the synchronous signal from the master unit with clock times controlled by a quartz crystal VCO in a proportional oven. Assignment of the slave generators to the master generators is by means of a DC voltage. A single cable looped through all the slave units from the master unit is all that is necessary to provide synchronization to the system.

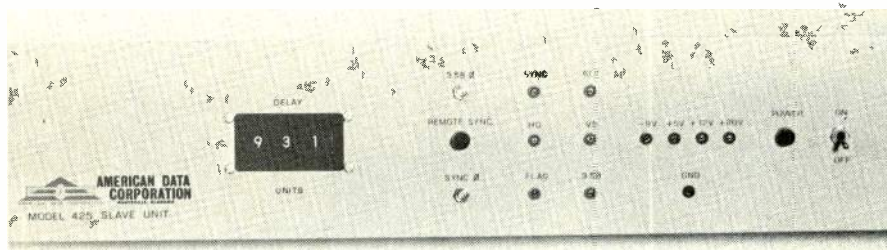

Circle Number 63 on Reader Reply Card

### Video Tape Timing System

**Holland Electronics Inc.** has announced the development of an Electronic Video Tape Timing System that reads down to an individual frame for accurate tape timing and editing on VTRs running at 15 ips. The series 800 Video Tape Timing System consists of a bidirectional electronic master counter, a transducer and a remote display unit which displays

the hours, minutes, seconds and FRAMES on Nixie tubes. It also contains a memory section and an elapsed time counter.

The control functions on the front panel are: 1. "Zero Reset" (resets counter to zero at anytime); 2. "Hold" (switches the count from the basic counter to the memory unit); 3. "Elapsed Time" (this indicates the exact time interval between pushing the hold button and

(Continued on page 58)

## THREE FOR THE PRICE OF TWO



### 3D SERIES REPRODUCERS 3D-0001 \$1395

- Three Rugged Cartridge Machines in One Small Package
- 450 RPM Common-Capstan, Direct-Drive Motor
- Independent control and Audio for Each Deck



INTERNATIONAL  
TAPETRONICS  
CORPORATION

2425 South Main Street  
Bloomington, Illinois 61701  
Telephone: 309-828-1381

Circle Number 43 on Reader Reply Card

# SPARTA

everything  
in  
FM antennas

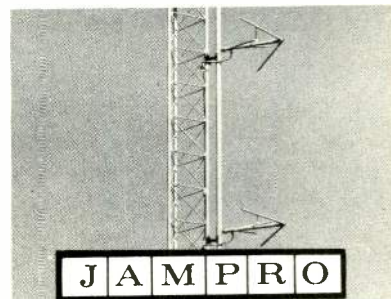

JAMPRO FM Antennas, available through SPARTA offer true circular polarization, adjustable polarization power ratios, and low wind loading and dead weight. A logical match for SPARTA's FM Transmitters. Complete station packages are available upon request, by contacting your SPARTAMAN today!



**SPARTA ELECTRONIC CORPORATION**  
881 FLORENCE DRIVE SACRAMENTO, CALIFORNIA 95828 (916) 383-7371  
14516 SOUTH LAWN LANE, ROCKVILLE, MARYLAND 20850 (301) 484-2900  
A DIVISION OF COMPUTER EQUIPMENT CORPORATION

Circle Number 44 on Reader Reply Card

(Continued from page 57)

the elapsed time control); and 4. "Count" (starts counter and switches the display back to the basic counter).

Up to five remote displays can be driven by a basic counter. The Hold and Elapsed Time features are optional, other options include True Time Function and Printer Output.

Tolerances: plus or minus one frame per hour in play mode; plus or minus three frames in fast forward, or rewind mode. The basic counter is a 5¼ X 11 rack mounted chassis and the remote display is a 1¾ X 11 rack mounted chassis.

Circle Number 64 on Reader Reply Card

### Monochrome Monitor

SC Electronics, Inc. recently announced the availability of its new Setchell Carlson 10-inch monochrome monitor. Model 10M915 is the only professional quality 10-inch monitor currently available and provides 13% more viewing area than standard 9-inch monitors. At \$189 Model 19M915 is the lowest priced American-made monitor of comparable size.

Designed for single or dual rack-mount applications, Model 10M915 offers a horizontal resolution of 640 lines or better, and is equipped with front-located operating controls for convenience and ease of operation; front panel screwdriver adjustments for Vertical Linearity, Height, and

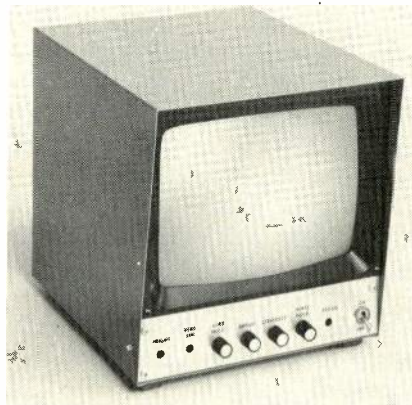

Focus to prevent accidental misadjustment; UNIT-IZED® plug-in circuit modules for rapid, on-the-spot maintenance and servicing; a fast AFC circuit which ensures excellent display for helical scan video recorders; and a regulated power supply for stable operation that prevents raster size or brightness deviations

due to line voltage fluctuations.

Designed for broadcast, educational, industrial, studio, and surveillance applications, Model 10M915 has an input power of 25 watts at 120VAC, a video input of 0.75 to 1.5 volts peak-to-peak, with looping provisions; an amplifier bandwidth greater than 8 MHz; and a horizontal resolution of 640 lines or better.

Circle Number 65 on Reader Reply Card

**Hickok Electrical Instrument Company** is now offering its 5000A oscilloscope. This high performance 25 MHz oscilloscope has stable triggering beyond 50 MHz.

Within its rugged design, the 5000A features 10 mV sensitivity with a built-in delay line. Also, it has 4-screen horizontal width and 5-screen height vertical deflection. The lightweight feature and compact design makes it a likely candidate for use in communications systems.

Circle Number 66 on Reader Reply Card

**Send Your New Products  
News to  
Broadcast Engineering**

# DEPENDABLE POWER

for REMOTE and NOT SO REMOTE' areas

can save you money and customers

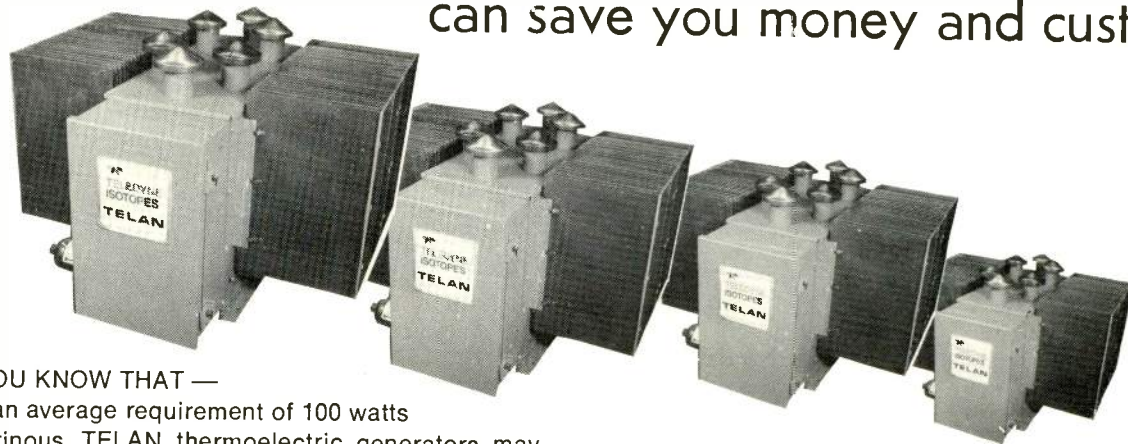

DID YOU KNOW THAT —

- for an average requirement of 100 watts continuous, TELAN thermoelectric generators may be cheaper than extending a power line even one mile?
- TELAN reject heat can be used for temperature control of your equipment?

AND IT'S DEPENDABLE!

- Stable catalytic burning; no flame to blow out
- Burner temperature regulator to prevent over-temperature
- Completely solid state system — no moving parts
- Use readily available propane, butane or natural gas fuel
- Years of field experience — and now even better

**TELEDYNE ISOTOPES**

110 W. TIMONIUM RD. — TIMONIUM, MD. 21093  
PHONE: 301-252-8220 — TELEX: 87-780

Circle Number 46 on Reader Reply Card

### CATV Conversion Kit For Bi-directional System

The new RK-1 and RK-2 Bi-Directional Retrofit Kits introduced by **AEL Communications Corporation** (AELCC), enables an existing single cable CATV trunk system to become a single cable trunk bi-directional system with additional channels carried in the reverse direction.

The RK-1 Bi-Directional Retro-

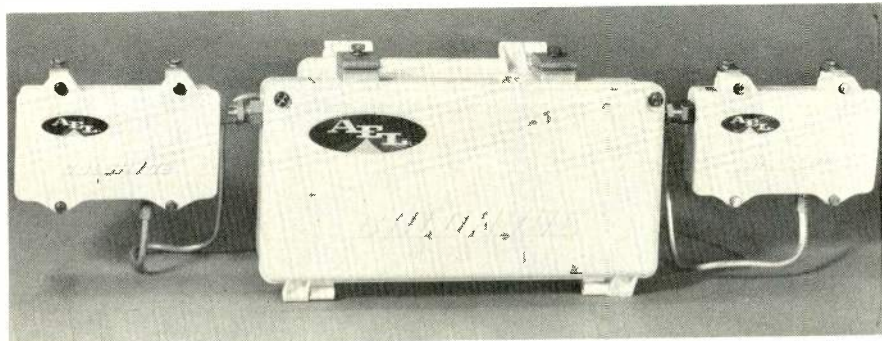

Circle Number 67 on Reader Reply Card

### Background Music Amplifier

The MS-75 Background Music amplifier introduced by **McMartin Industries** features a continuous 75-watt RMS rating at less than 2% harmonic distortion.

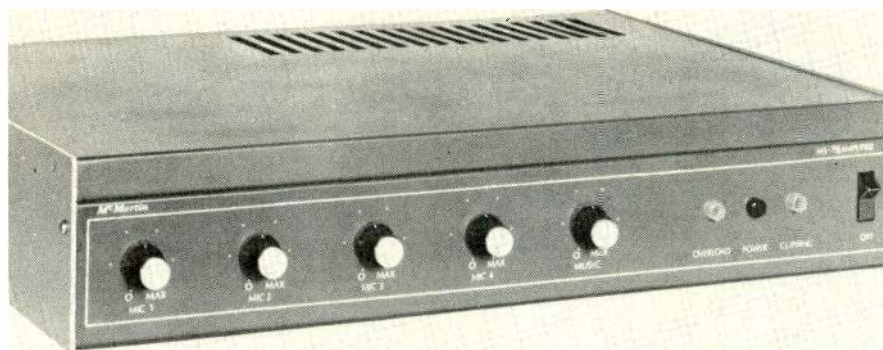

Input flexibility is assured by incorporating microphone pre-amplifiers, telephone page inputs, tone controls, chime tone and electronic muting on plug-in modules. The MS-75 will accept from one (1) to four (4) microphone modules in any combination of telephone, chime or

microphone inputs with a music input for Background Music and a separate additional auxiliary input that is adjustable on the rear panel. A Baxendall bass and treble control for the music circuit provides

full plus or minus 15 dB control.

Electronic muting with adjustable level control eliminates clicks or pops during paging. Also available is an electronic chime module for use with code call systems or for pre-announcement alerting.

Circle Number 68 on Reader Reply Card

### Film Processor

A new series of film processors for color and black & white film in Super 8, 16mm, or 35mm format is now available from the **Professional Equipment Division of Bell & Howell**.

Designated the FILMOpetite, its

features include compact size (48" L x 54" H x 24" D), daylight loading, and silent operation from speeds of 5 to 60 feet per minute.

The FILMOpetite meets the rigid specifications required by motion picture laboratories, microfilm users,

(Continued on page 60)

## FITS YOUR BUDGET

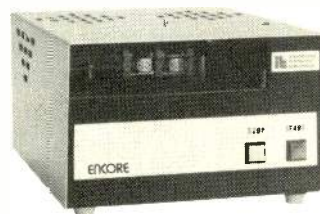

### ENCORE REPRODUCER \$385

- Quiet, Air-Damped Solenoid
- Precision, Micro-Adjust Head Assembly
- Three Independent Tape Guides
- 450 RPM, Direct-Drive Motor
- Monophonic, 1 KHz Cue
- Economy with Quality



INTERNATIONAL  
TAPETRONICS  
CORPORATION

2425 South Main Street  
Bloomington, Illinois 61701  
Telephone: 309-828-1381

Circle Number 47 on Reader Reply Card

## D-1500 TV CHARACTER GENERATOR



\$4000

The D-1500 portable character generator is completely contained within its keyboard package. Meets highest broadcast standards for studio use. Also ideal for remotes, tape editing, transmitter standbys, and for preparation and display of election returns.

- Store and readback page after page of display on your standard audio cartridge tape recorder with Audiotape Interface Option D-1500-3.
- Standard computer system compatibility and flexibility.
- Rapid access of subtitles from internal memory for news, sports, and interview programs.
- Automatic crawl without external reader.
- Full keyboard control features: line insert, line delete, and flash, among others.

For demonstration or further information, call or write:

**DATAVISION, INC.**  
2351 Shady Grove Road  
Rockville, Maryland 20850  
(301) 948-0460

Circle Number 48 on Reader Reply Card

(Continued from page 59)

television stations (broadcast and cable), schools, government and industry. Modular design concepts provide models for processing of color reversal, color reversal intermediate, black & white reversal and microfilm and negative and positive film.

The FILMOpetite ranges in price from \$6,000 to \$18,000 and can be delivered within 60 days after receipt of an order.

Circle Number 69 on Reader Reply Card

### Power Supplies

Eight 10 kW power supplies now have better reliability, and improved performance, according to **Hewlett-Packard**. These supplies cover the range from 0 to 8 volts at 2000 amperes to 0 to 600 volts at 15 amperes.

Typical of improved specifications are those for the 0.64 volt, 0-150 ampere Model 6472C. Line and load regulation was 0.2% + 100 mV and is now 0.05% + 100 mV. Stability is improved from 0.25% + 10 mV to 0.15% + 16 mV. Temperature specifications have similarly been improved.

The SCR's are protected against excessive voltage and current, peak line current is limited during start-up, and a separate overcurrent protection circuit is used. An independent overtemperature cutout with a front-panel indicator light is also included. Foolproof auto-series and auto-parallel operation is now provided.

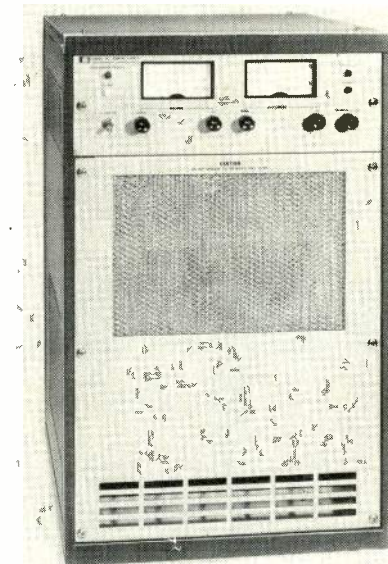

All supplies now meet the International Electrotechnical Commis-

sion specifications. They are of modular design for easy servicing—the front panel drops down so that all adjustments are accessible from the front of the installed unit.

Circle Number 70 on Reader Reply Card

### SCA Receiver

A new SCA receiver designed to provide the background music industry with the latest advances in technology was announced by **Perma/dyne Electronics Corporation**, Chicago, Illinois.

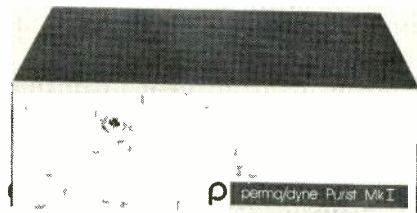

The compact Purist Mk I receiver is a completely solid state design utilizing integrated circuitry for stability and MTF reliability. An exclusive Phase-Lok method of detection permits the receiver to track the sub-carrier when slight phase shifts occur due to variable multipathing conditions.

# Neve

*the sound of Neve  
is world wide*



**NOW  
in the  
US**

... Neve expertise in the Broadcast Industry

exemplified by the Granada Television, Ltd. installation shown above, designed to meet Granada's specific requirements. This installation features a 24 channel, 6 buss fixed console with an additional 12 channel auxiliary mobile unit for extended flexibility.

## RUPERT NEVE INCORPORATED

Berkshire Industrial Park, Bethel, Connecticut 06801  
Tel. (203) 744-6230 • Telex 969638

Rupert Neve & Co., Ltd., Cambridge House, Melbourn, Royston, Herts, England  
Rupert Neve of Canada, Limited, P.O. Box 182, Etobicoke, Ontario

Circle Number 50 on Reader Reply Card

According to Perma/dyne, the unit has improved sensitivity rated by the most stringent testing methodology to assure expanded market coverage for the SCA operator. Stylized appearance, simplified installation and practically maintenance-free operation are additional features of the Purist Mk I.

Circle Number 71 on Reader Reply Card

### Two-Way Cable System

Kaiser CATV has developed the first operational two-way, one-cable system. The system is called the XR-2 and designed to adapt to ex-

isting cable systems as well as new plant applications. The heart of the system is the line amplifier with its specially-designed hybrid microcircuitry. The amplifier housing is engineered to contain both forward and reverse automatic gain control amplifier modules, downstream and upstream filters and either an intermediate, two- or four-output bridging module.

The system is capable of delivering 30 channels, 50-300 MHz, downstream and four channels, 5-35 MHz upstream.

Circle Number 72 on Reader Reply Card

### TV Film Chemical Pollution Control

Profit Recovery Systems, a division of CPAC, Leicester, N.Y. has introduced their new SILV-PAC STARTER KIT. The SILV-PAC System incorporates high current density electrolytic silver recovery and fixer purification and recirculation.

A discount allowance schedule allows a credit of the SILV-PAC purchase price toward the future purchase of a complete TV-PAC pollution Abatement System. The TV-PAC System is a completely automatic closed-loop pollution abatement system incorporating silver recovery, fixer purification for re-use, ozone bleach regeneration

and chemical destruction.

The manufacturer claims the TV-PAC System will render photochemical wastes either non-toxic or biodegradable so they will be accepted by the municipal sewage treatment plant. TV-PAC is the only system in use with Ektachrome processing, that uses ozone. It is the only system approved by a state water pollution control authority for fix and bleach treatment.

The SILV-PAC STARTER KIT (the same silver cell as used in TV-PAC) allows optimum recovery of silver ions normally lost to the municipal sewage plant. Fixer purification for re-use will eliminate chlorine-demand pollution.

Circle Number 73 on Reader Reply Card

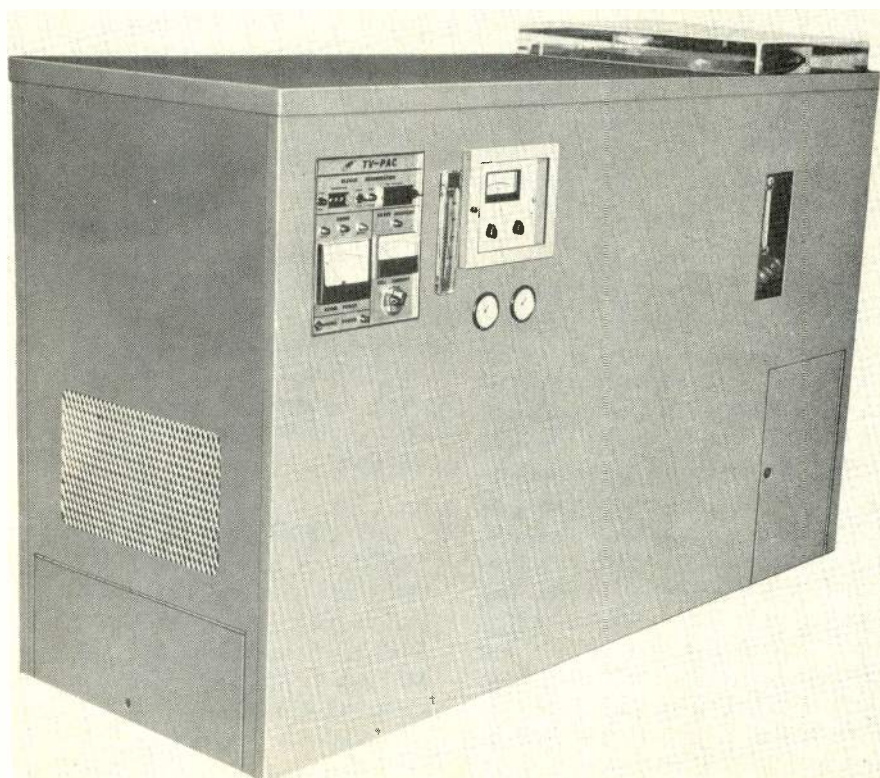

## PREMIUM FEATURES - ECONOMY PRICE



**ENCORE**  
RECORDER/REPRODUCER  
\$495

- Precision Head Assembly
- Fully Automatic Pressure Roller, Air-Damped
- 450 RPM Direct-Drive Motor
- Full Remote Control
- Monophonic, 1 KHz Cue



**INTERNATIONAL  
TAPETRONICS  
CORPORATION**

2425 South Main Street  
Bloomington, Illinois 61701  
Telephone: 309-828-1381

Circle Number 51 on Reader Reply Card



## AD1B Audio Distribution Amplifier

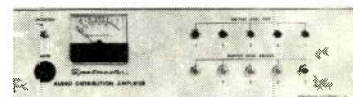

The solid state AD1B distributes audio signals to five separate points within a studio system or to telephone lines. Output level controls are individually adjustable. Adding our AD1B-X channel extenders allows up to 25 channels to be accommodated, with input metering and audio monitoring for all 25 provided by the AD1B. Both units meet traditional SPOTMASTER standards of performance and reliability. Response is essentially flat from 40 to 20,000 Hz with low distortion and noise and 60 db channel isolation. Input transformers are standard; the user may specify either balanced output transformers or unbalanced emitter follower outputs. Write for details.

**BROADCAST ELECTRONICS, INC.**

A Filmways Company

8810 Brookville Rd., Silver Spring, Md. 20910

# TECHNICAL DATA

For further information, circle data identification number on reader service card

## 100. AMPEX CORPORATION

—A two-color, six-page brochure describes the Ampex ACR-25 automatic broadcast video cassette recorder/reproducer, and explains its features and their use and providing performance specifications.



**TOOL KITS**  
FOR ELECTRONIC TECHNICIANS

Industrial kit JTK-2 above (44 pieces) only \$44.50 (delivered). Write for new tool catalog.

**JENSEN TOOLS and ALLOYS**  
4117 N. 44th Street, Phoenix, Arizona 85018

Circle Number 45 on Reader Reply Card

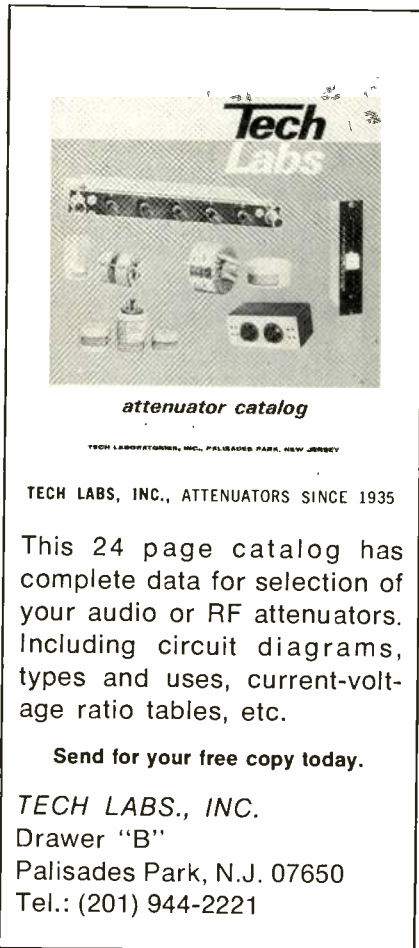

**Tech Labs**

attenuator catalog

TECH LABS, INC., ATTENUATORS SINCE 1935

This 24 page catalog has complete data for selection of your audio or RF attenuators. Including circuit diagrams, types and uses, current-voltage ratio tables, etc.

Send for your free copy today.

**TECH LABS., INC.**  
Drawer "B"  
Palisades Park, N.J. 07650  
Tel.: (201) 944-2221

Circle Number 49 on Reader Reply Card

## 101. AMPHENOL CONNECTOR DIVISION

—The Bunker-Ramo Corp. An extensive offering of standard circular connectors for both military and commercial applications is detailed in a new, 56-page catalog. The catalog contains a new glossary of terms section as well as photographs, line drawings, electrical characteristics and mechanical specifications for all interconnection products in Amphenol's standard circular line. A selection guide completes information necessary for finding the right Amphenol connector for any given commercial or military application.

## 102. COHU ELECTRONICS, INC.

—Features of Cohu's new 2810 Series Self-contained TV Camera are covered in a four-page, two-color technical data sheet (6-560). Specifications and photographs are included.

## 103. COLORADO VIDEO, INC.

—A four-page brochure entitled "Sampled Video Techniques for Processing and Narrow Band Transmission" is now available. The brochure describes numerous unique applications of video technology in industrial and scientific fields.

## 104. DATAPAC INCORPORATED

—A new, three-color brochure on the Datapac line of U-Core Read-Only Memories (ROM) is now available. The brochure outlines the theory, operation and use of ROMs which have come into widespread use. Because each customer usually presents a different set of requirements, the new brochure explains how a ROM can easily be adapted to his particular need. General specifications are listed for a family of ROMs from which a designer can configure his own memory. Graphics are used to illustrate the operational theory of

the U-Core ROM as well as to show some variations of packaging design. Timing and functional block diagrams are used to further describe basic operation principles.

## 105. DIGITAL PRODUCTS DIV.

—Cambridge Thermionic Corp. Ten new products recently introduced by the Digital Products Div. of Cambridge Thermionic Corp. are presented in a supplement to Catalog 92-A just released. Some of the latest Cambion devices illustrated are: a strip connector and cable assembly for interfacing a row of .025" square Wire-Wrap terminals aligned .100" apart; an innovative Integrated Socket strip; a new high quality receptacle for all standard 18-lead semiconductor memory dual in-line packages; and eight styles of component socket adapters for mating discrete components with dual in-line sockets.

## 106. GENERAL ELECTRIC

—A four-page, full-color brochure devoted to General Electric's 1500-Watt Multi-Vapor sportslamp and its advantages in the lighting of stadiums is now available. The brochure shows and describes installations of the sportslamp at municipal and college stadiums, and at high school and junior college football fields. Popularity of the new light source is attributed to the benefits it offers in the forms of low owning and operating costs, and its ability to provide the high levels of precisely controlled light of excellent color quality needed for color telecasting.

## 107. GENERAL MICROWAVE CORP.

—A complete technical data sheet describing General Microwave's new series of Pin Diode Switches is now available. The new M862-3-4 SPST switches feature ultra-broad frequency range, high isolation-to-insertion loss ratio, and fast switching time. Miniature size



and weight make these novel components ideal for tight space applications in instrument or systems designs.

**108. HEWLETT-PACKARD COMPANY**—A new 16-page brochure concisely summarizes pertinent specification of Hewlett-Packard's broad line of semiconductor diodes, transistors, and microwave modules. The brochure gives descriptions of microwave and RF mixers, detectors, switches, attenuators, limiters, multipliers, oscillators, and amplifiers. Included are components in chip form for hybrid circuits, beam-lead and strip-line components, discrete components, and packaged modules. The brochure is organized according to applications, within product categories, to assist the circuit designer in choosing the right components for his circuits.

**109. INDUSTRIAL ACOUSTICS CO., INC.**—The first "instant" commodity to gain favor was coffee, but so widespread now is the demand for the convenience and ease of ready-to-use products that even recording studios requiring top-flight acoustical integrity can be put together in jig time through use of modular, pre-engineered acoustical panels and components. The engineering and construction success of this system for building studios is spelled out in an authoritative technical report, Bulletin 6.008.0. The four-page bulletin gives detailed information on: Construction of the prefab panels, Design of the recording-studio complex, and construction of the facility. Seven diagrams illustrate panel design, studio layout, and construction procedures, while tables list typical transmission loss of the acoustical panels, their sound-absorption characteristics, and the acoustical performance of the assembled studio.

**110. ITHACO INC.** — Lock-in amplifier versatility is the subject of a new 12-page Specification/Application Guide. Starting with the Model 353SC, a basic single channel lock-in amplifier, this brochure describes many different lock-in systems which can be created at minimum cost by the addition of special

purpose plug-in modules. Included in the discussion are such special purpose systems as dual channel systems, in-phase and quadrature systems, single and dual channel logarithmic systems, ratiometric systems, and portable systems. The guide also provides complete specifications for each of the available plug-in modules as well as for compatible low noise preamplifiers, and light beam chopping accessories.

**111. ITT**—A short-form catalog outlining the company's complete line of electronic/electrical components is now available. ITT Jennings' new catalog is a guide for designers of high-power RF and power systems. The catalog lists vacuum fixed and variable capacitors, with working voltages up to 40 kV and capacitances to 5000 pF for such applications as tunable or fixed elements in transmitter tank circuits and in impedance-matching networks for antenna couplers. Also included are vacuum relays with current ratings to 75 amps; peak voltages to 30 kV; vacuum coaxial relays for line sizes to 6 1/8 inches; highpower RF contactors; AC/DC

contactors; high-current 3-pole contactors, as well as high-voltage measuring equipment, power systems, and testers.

**112. BRAMCO CONTROLS DIVISION**—Ledex Inc. Fundamental design concepts for building remote tone control and monitoring systems are discussed in the new 12-page "Bramco AM Tone Telemetry Systems Catalog" number 606. Comparative advantages of two types of systems are given in terms which are easily understood by individuals with little previous telemetry experience. The catalog contains specifications for the AM tone transmitters, receivers, power supplies, and card cages needed to build a modular tone control system. A combination price sheet and order check list is included with each catalog.

**113. PHELPS DODGE COMM. CO.**—The subject of phase stability of an RF transmission line feed system is dealt with in new data sheets. The series of seven sheets explains the importance of the ef-

*(Continued on page 64)*

# the Tracor 6500 Carrier Generator System

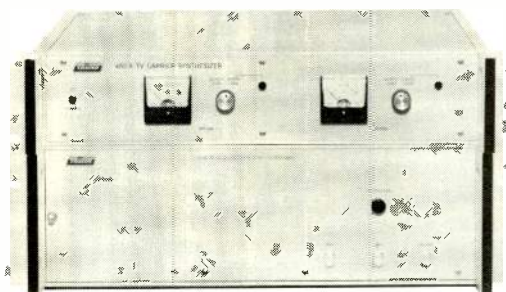

## stops "grade B" coverage loss

Co-channel interference is essentially eliminated adding solid audience to your coverage.

With a TRACOR 6500 Carrier Generator System driving each transmitter, co-channel carriers are held so constant (within 0.05 Hz) that visibility of the beat pattern is reduced 16 db. The **inherent stability of atomic frequency standards** also eliminates the need

for constant adjustment . . . making the 6500 ideal for remote-site operations.

For more information, contact TRACOR, manufacturers of the 6500, Carrier stabilization systems, sub carrier sync systems, and video failure alarms.



**Industrial Instruments Division**  
6500 Tracor Lane, Austin, Texas 78721, AC 512/926-2800

Circle Number 57 on Reader Reply Card

(Continued from page 63)

fect of temperature variation on coaxial cable and describes, in detail, the five Phelps Dodge Comm. coaxial cables on which phase-temperature coefficient tests were conducted. Tabular data is included which shows cable type, velocity, temperature range, measuring frequency, electrical length, change in electrical length per degree and movement in PP per degree.

**114. DOUGLAS RANDELL, INC.**—Div. of Walter Kidde & Co. This 12-page booklet entitled "Reed Relays" gives designers complete mechanical, electrical and environmental data on all standard relays to assist in the layout and development of printed circuit boards. Coil, contact, environmental and operational data are given for Douglas Randall's new Series SI snap in relays and Series XMG low profile miniature relays. Also included is full information on their standard or miniature molded and open relays, tubular and vertical, compact and high voltage reed relays. The catalog also illustrates Douglas Randall's engineering capabilities in the development of custom relay

designs to meet special high temperature, high voltage, and high insulation resistance requirements and to manufacture complete PCB as well as enclosed assemblies and sub-assemblies.

**115. RCA/ELECTRONIC COMPONENTS**—A new six-page "Helium-Neon Selection Guide" (PWR-554) covering the RCA modular Helium-Neon (He-Ne) Laser Product concept is now available. The new selection guide was devised to meet the many diverse needs of the laser applications designer's requirements from separate laser tube, exciter, head, or entire operating system for incorporation into a particular application. An initial selection chart provides a quick summary of RCA He-Ne laser product available. One initial selection is made, the designer is referenced to the characteristics chart where he can compare parameters of RCA product to those of his design needs. If his selection is a tube or head rather than a complete laser, he is referenced to the operating considerations section for information on supply, starting, mounting and cooling requirements.

**116. RHG ELECTRONICS LAB., INC.**—A new data sheet describing RHG's line of double balanced MIC mixers with IC preamps is now available. The new DM product sheet contains detailed specifications and prices on forty octave and multi-octave models. Actual size photos and an outline drawing show size and construction details. Typical performance charts for intermodulations, noise figures and isolation are also included.

**117. SPINDLER & SAUPPE INC.**—A new catalog entitled "Spindler & Sauppe Product Summary" briefly describes and illustrates the company's line of A/V equipment. Included in the eight-page publication are Spindler & Sauppe's programmers, the 27-channel Media Mix control model and the 4-channel Quadra Que programmer; dissolves, the Dynamic Dissolve with three speeds and the new low-cost Dynamic Que Dissolve that programs a tape recorder to automate 5 functions on playback; and projectors, 48-slide Selectroslide Unit and a dual 96-slide Selectroslide, and two random access models. Also, two systems are sug-

**FM** ... **ICE**

**FM** ... **ICE**

**FM** ... **ICE**

\* ... **ICE**

**GRAY'S 2570 ANTENNA HEATER CONTROL SYSTEM WON'T LET THIS HAPPEN TO YOU. WRITE FOR DETAILS**

**\* OFF THE AIR !!!**

**GRAY RESEARCH**  
ONE FIFTY PARK AVENUE  
EAST HARTFORD, CONN. 06108

Circle Number 55 on Reader Reply Card

**Handle Cable on Power Reels**

**HANNAY**  
Hose & Cable  
REELS

Specify Hannay electric rewind reels to handle long lengths of live power cable or for coaxial cable storage. Positive chain and sprocket rewind mechanism assures smooth, dependable re-winding at the touch of a button.

Send for complete catalog of power and manual rewind reels to handle cable.

**HANNAY REELS**

**CLIFFORD B. HANNAY & SON, INC., WESTERLO, NEW YORK 12193**  
Circle Number 56 on Reader Reply Card

Circle Number 56 on Reader Reply Card

gested, incorporating the necessary equipment to automate a three-screen slide and motion picture program.

**118. SWITCHCRAFT, INC.**—A catalog on the new Series PL-9000 "PL" Indicator, companion "look-a-like" for the Switchcraft "Push-Lite" switch is now available. The "PL" Indicator perfectly matches the "Push-Lite" switch in outward appearance while functioning only as a pilot light. With the new Indicator, designers can now create low profile, uncluttered rows and arrays of illuminated switches and indicators for computers and peripheral equipment, communications systems, industrial control systems and instrumentation equipment. Features include 1- and 2-lamps, full or horizontal split display screens, front-of-the-panel relamping and mounting, a variety of hot stamped legends, a selection of display screen and filters in seven colors.

**119. TECH LABORATORIES, INC.** — An informative, 28-page Switch Catalog provides a useful guide to the basic criteria on which switch selection should be based. Topics covered include types of switches available, carrying and rated current capacity, rated current and voltage capacities, contact resistance, dry circuits, switch life, quality control, government specification requirements, and pricing policy. Since the art of switching electric currents is not an exact science like so many other phases of electrical engineering, there are no mathematical formulas for determining or predicting the characteristics of any given switch under all conditions. As a result, empirical values and trial and error methods based on life tests are often depended on for the actual specification of switches. This catalog, recognizing that the selection of the correct switch to meet certain anticipated conditions is, therefore, not a matter to be taken lightly, presents a potentially time- and money-saving method of choosing switches that will do the best job in any particular situation.

**For Late Breaking  
News  
Read "Direct Current"  
Page 4**

(Continued from page 14)

303(s) and 330 of the Communications Act . . ."

"Cable television cannot have it both ways. If CATV is not 'broadcasting' under Section 325, it cannot be termed 'broadcasting' under Sections 303(s) or 330 in order to vest the Commission with authority it plainly does not possess."

Sections 303(s) and 330 constitute the All Channel Receiver Law. Passed by Congress in 1962, it authorized the FCC to require that all TV sets be capable of receiving VHF and UHF channels.

"But," NAB pointed out, "nowhere in the Law or in the legislative history of the Law is there any mention or concern with CATV. This is not surprising since Congress was dealing with 'broadcasting,' not CATV, and was attempting to make the reception of UHF broadcasting as readily available on television sets as VHF."

"NCTA cannot assert that a law enacted solely in response to the special dilemma of UHF broadcasting has any application to the present situation of CATV," NAB concluded.

## ADVERTISERS' INDEX

Andrew Corporation	29
Belar Electronic Laboratory, Inc.	27
Broadcast Electronics, Inc.	8, 14, 61
CBS Laboratories	23
Canon, Inc.	41
Cleveland Institute of Electronics	15
Cohu Electronics, Inc.	7
Collins Radio Co.	1
Crown International	26
Datavision	59
Ditch Witch Trenchers Div. Charles Machine Works, Inc.	19
Dynair Electronics, Inc.	25
Eastcoast Camera Center, Inc.	13
Electro-Voice, Inc.	18
Gates Radio Co., Inc.	9, 45
Gotham Audio Corporation	51
The Grass Valley Group, Inc.	3
Gray Research Division	64
Clifford B. Hannay & Son, Inc.	64
International Tapetronics Corp.	53, 55, 57, 59, 61
Jensen Tools & Alloys	62
McMartin Industries, Inc.	28, 54
Metron Instruments, Inc.	54
Minneapolis Magnetics, Inc.	15
Rupert Neve & Co., Ltd.	60
North American Philips Co., Inc.	12
Nortronics Co., Inc.	11
Potomac Instruments, Inc.	10
RCA Corp.	20-21
Richmond Hills Laboratories	52
Sarkes Tarzian, Inc.	56
Scala Radio Corp.	39
Shure Brothers, Inc.	Cover 4
Sparta Electronic Corp.	49, 51, 53, 55, 57
Spotmaster	14, 61, 63
Superscope, Inc.	30
Taber Manufacturing & Engineering Co.	56, 65
Tech Laboratories, Inc.	62
Teledyn Camera Systems	Cover 2
Teledyne Isotopes	58
Telemet Co.	50
Telemation, Inc.	46
Telex Communications Div.	Cover 3
Tracor Industrial Instruments Div.	63
Troy Electronic Sales	17
Wilkinson Electronics	35

## PROTECT YOUR SOUND REPUTATION

### VTR Audio Heads Manufactured and Reconditioned by TABER

*Nationally-recognized recorder head manufacturing and reconditioning experts.*

- Heads manufactured or reconditioned under controlled laboratory conditions.
- New or reconditioned heads are guaranteed to meet, or exceed, equipment manufacturer's specifications.
- Modern precision machine shop, and sophisticated laboratory installations insure highest quality newly-manufactured or reconditioned heads.
- Free loaner assemblies available on request.
- Cost: \$310.00 for four (4) new heads installed, or \$100.00 for four (4) reconditioned heads.



Taber's sophisticated quality control test insures total frequency response and uninterrupted sound playback. Maintain the high quality audio that your equipment was engineered to produce.

Call or write: **TABER** MANUFACTURING AND ENGINEERING COMPANY

OAKLAND INTERNATIONAL AIRPORT  
P. O. BOX 2365 • OAKLAND, CALIFORNIA 94614  
PHONE: (415) 635-3832 • SHIPPING ADDRESS: 2081 EDISON AVE. • SAN LEANDRO, CA. 94577

TABER IS THE NATIONAL  
DISTRIBUTOR OF  
STL TEST TAPES

Circle Number 54 on Reader Reply Card

# PROFESSIONAL SERVICES

## VIR JAMES

CONSULTING RADIO ENGINEERS  
Applications and Field Engineering  
345 Colorado Blvd.  
Phone: (Area Code 303) 333-5562

**DENVER, COLORADO 80206**

Member AFCCE  
TWX 910-931-0514

## WALTER F. KEAN CONSULTING RADIO ENGINEERS

P.O. Box 4201  
Santa Fe, New Mexico 87501

Phone: 505-983-5175

Member AFCCE

## CAMBRIDGE CRYSTALS PRECISION FREQUENCY MEASURING SERVICE

SPECIALISTS FOR AM-FM-TV

445 Concord Ave. Phone 876-2810  
Cambridge, Mass. 02138

## COURTRIGHT ENGINEERING

MORRIS COURTRIGHT, Jr., P.E.  
Automation - Applications Field Engineering  
ELECTRICAL AND BROADCASTING  
Route No. 1, Box 854A, Flagstaff, Ariz. 86001  
Phone (602) 774-8205

## RALPH E. EVANS ASSOCIATES

Consulting Radio Engineers  
AM - FM - TV - CATV - ITFS  
3500 North Sherman Blvd.

**MILWAUKEE, WISCONSIN 53216**

Phone: 414-442-4210

# CLASSIFIED

Advertising rates in Classified Section are 15¢ per word, each insertion, and must be accompanied by cash to insure publication.

Each initial or abbreviation counts a full word. Upper case words, 30¢ each.

Minimum classified charge, \$2.00.

For ads on which replies are sent to us for forwarding, there is an additional charge of \$2.00 to cover department number, etc., which is printed in advertising copy, and processing of replies.

Classified columns are not open to advertising of any products regularly produced by manufacturers unless used and no longer owned by the manufacturer or a distributor.

## Help Wanted

Job Headquarters for all Radio and Television Engineers. Immediate openings exist in 9 western states and elsewhere for qualified engineer and technical personnel. All categories from trainees to experienced transmitter maintenance, chief, assistant chief, live color video maintenance and technical operations. Send us your complete resume now. The AMPS Agency, 11661 San Vicente Blvd., Suite 300, Los Angeles, Calif. 90049. Telephone: 213-820-2678. By Broadcasters — For Broadcasters. 11-68-tf

## Equipment for Sale

**HELIAX—STYROFLEX.** Large stocks — bargain price — tested and certified. Write/call for price and stock list. Sierra-Western Electric, Box 23872, Oakland, Calif. 94623. Tele: (415) 832-3527. 1-71-tf

"New & Used Towers, Buy, Sell or Trade. Erect. Ground wire 85¢ lb. Bill Angle, 919-752-3040, Box 55, Greenville, N.C. 27834." 2-71-tf

**ONE STOP** for all your professional audio requirements. Bottom line oriented. F. T. C. Brewer Company, P. O. Box 8057, Pensacola, Florida 32505. 7-71-tf

**Grass Valley Routing Switcher.** Audio Follow Video. 12 x 10. 10 Control Panels with cable. Presently used Network Operations. New 15. 5K sell for 9K. Call KCET (213) 466-4212 Ext. 307. 9-71-2t

**Electronic Research type 425 25KW** isocoupler for feeding FM antenna on your AM tower. Frank Carman, KLUB, Salt Lake City. 801 359-7794. 9-71-3t

300 reels 2" broadcast Video Tape, good for color. B/W, mostly 3M type 379, used: \$25/hr., \$30/1½ hr. 200 empty aluminum NAB reels for 2" video tape: \$5/hr., \$6/1½ hr. Comquip. Box 12, Ridgewood, N.J. 07451 (201) 444-0196. 9-71-2t

Several Tektronix 526 Vectorscopes New original cartons \$1200.00. Also new Varian Klystrons. 609-541-4200. 10-71-1t

**GATES M-6543 SOLID STATESMAN LIMITER.** Two years old. Excellent condition. Manual included. Greg Zaker, 412-566-1360, WIXZ, 4 Gateway Center, Pittsburgh, Pa. 15222. 10-71-4t

**ADVERTISEMENT FOR BIDS.** Sealed bids for: The Sale of Used Television Transmitting Equipment consisting of: One (1) Used VHF Television Transmitter Amplifier, 20KW, GE type TF-4-A, serial number 2114C complete with external switchgear, blowers, transformers, but NOT including a Vestigial Side Band Filter. One (1) Used RCA water-cooled 25 KW Dummy load type MI-19193-LH, serial number 1080.—will be received by the undersigned at the office of the Purchasing agent, University of Missouri—Columbia, Room 102C, General Services Building, Columbia, Missouri, until 3:00 P.M., C.D.S.T. Friday, October 15, 1971, at which time they will be publicly opened and read aloud. For further information and the obtaining of bid forms on which bids must be made contact Mr. Bill Reagan, Director Broadcasting Engineer KOMU-TV, University of Missouri—Columbia, Columbia, Missouri, telephone 314-442-1122. The University reserves the right to waive any informalities in bids and to reject any or all bids. THE CURATORS OF THE UNIVERSITY OF MISSOURI, By: Harry J. Fields, Director of Purchasing. 10-71-1t

## Equipment Wanted

**URGENTLY WANTED:** Super universal zoomar lens with extenders. Contact Tri-Tronics Inc., N. Hollywood, Calif. 213/877-2207. 10-71-1t

## Radio Station For Sale

5,000 WATT AM RADIO DAYTIMER. \$150,000—29% down—\$45,000 real estate optional. Box 880, Willcox, Arizona. 7-71-5t

## Training

To advance in electronics, knowledge and ability are required. Grantham offers correspondence and resident instruction, in depth, leading to the degree of Associate in Science in Electronics Engineering. G. I. Bill approved. Credit for previous training and experience allowed. Free Catalog. Write: Dept. E-2, Grantham School of Electronics, 1505 N. Western Ave., Hollywood, California 90027. 6-67-tf

First phone through tape recorded lessons at home plus one week personal instruction in Washington, DC. Atlanta, Boston, Detroit, New Orleans, Minneapolis, Seattle, Denver, Portland, Los Angeles. Proven results. Our 17th year teaching FCC license courses, Bob Johnson Radio License Preparation, 1060D Duncan, Manhattan Beach, Calif. 80266. Phone 213-379-4461. 1-69-tf

**IMMEDIATE OPENINGS:** Qualify for any of the following positions: RCA CCTV Equipment, monochrome or color. Salesmen — TV Systems Engineers — Project Engineers — Supervisors — Managers — Maintenance Technicians — Video Engineers — to work either New York, Pennsylvania, New Jersey or California area. Write: RCA Rep., P. O. Box 268, New Hyde Park, New York 11040. 4-70-tf

## Miscellaneous

**ATTN: BROADCAST STATION HISTORY BUFFS:** Learn the history of your station. Airdate, ownership, location, power, etc. Send for free catalogue listing profiled stations. Price: Only \$5.00 each AM, \$2.50 each FM, accurately researched by pro. \$10.00 for custom profile. BROADCAST PRO-FILE, P. O. Box 982, Hollywood, Cal. 90028. 10-71-1t

**BROADCAST SERVICE & MAINTENANCE—J & J Electronics.** 20 years broadcast experience offers prompt expert service on amplifiers, monitors & equipment. Licensed engineer using lab equipment plus experience. J & J Electronics, Canterbury, Conn. 06331. Tel: 203-546-9126. 10-71-1t

"Do you have "Leftover" TR-22D modules after hi-banding? Would you donate them for use in Medical Education (TRT-1B update)? Please contact: University of Michigan, S 6432 University Hospital, Ann Arbor, Michigan 48104 or phone: 313-764-2275. 10-71-2t

## Keep in Touch Through Broadcast Engineering

- Drop a line to "Letters to the Editor"
- Keep CE's up to date with "Engineer's Exchange"

BE is for the engineer, to the engineer, and about the engineer. Write to BE, 1014 Wyandotte, Kansas City, Missouri 64105.

TELEX MAKES  
CHOICE  
TAPE EQUIPMENT  
SO YOU CAN BE  
CHOOOSY.

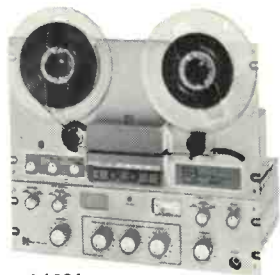

Magnecord 1021 —  
Single Channel Recorder

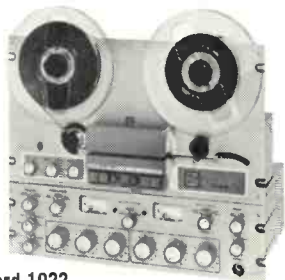

Magnecord 1022 —  
Two Channel Recorder

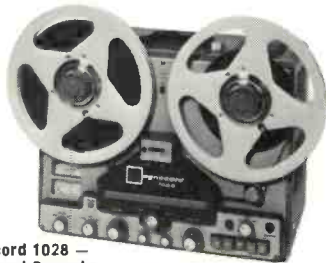

Magnecord 1028 —  
Two Channel Recorder



Viking Manual and  
Automatic Tape  
Cartridge Transports



Viking 87 —  
Tape Transport

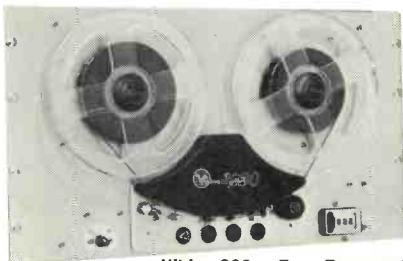

Viking 230 — Tape Transport



**KTIS AM/FM Stereo  
Had an opening in  
Their studio.  
They chose a  
Magnecord  
To fill it.**

PRODUCTS OF SOUND RESEARCH

**TELEX**®

COMMUNICATIONS DIVISION

9600 Aldrich Avenue South  
Minneapolis, Minnesota 55420

Circle Number 2 on Reader Reply Card

KTIS AM/FM STEREO, MINNEAPOLIS

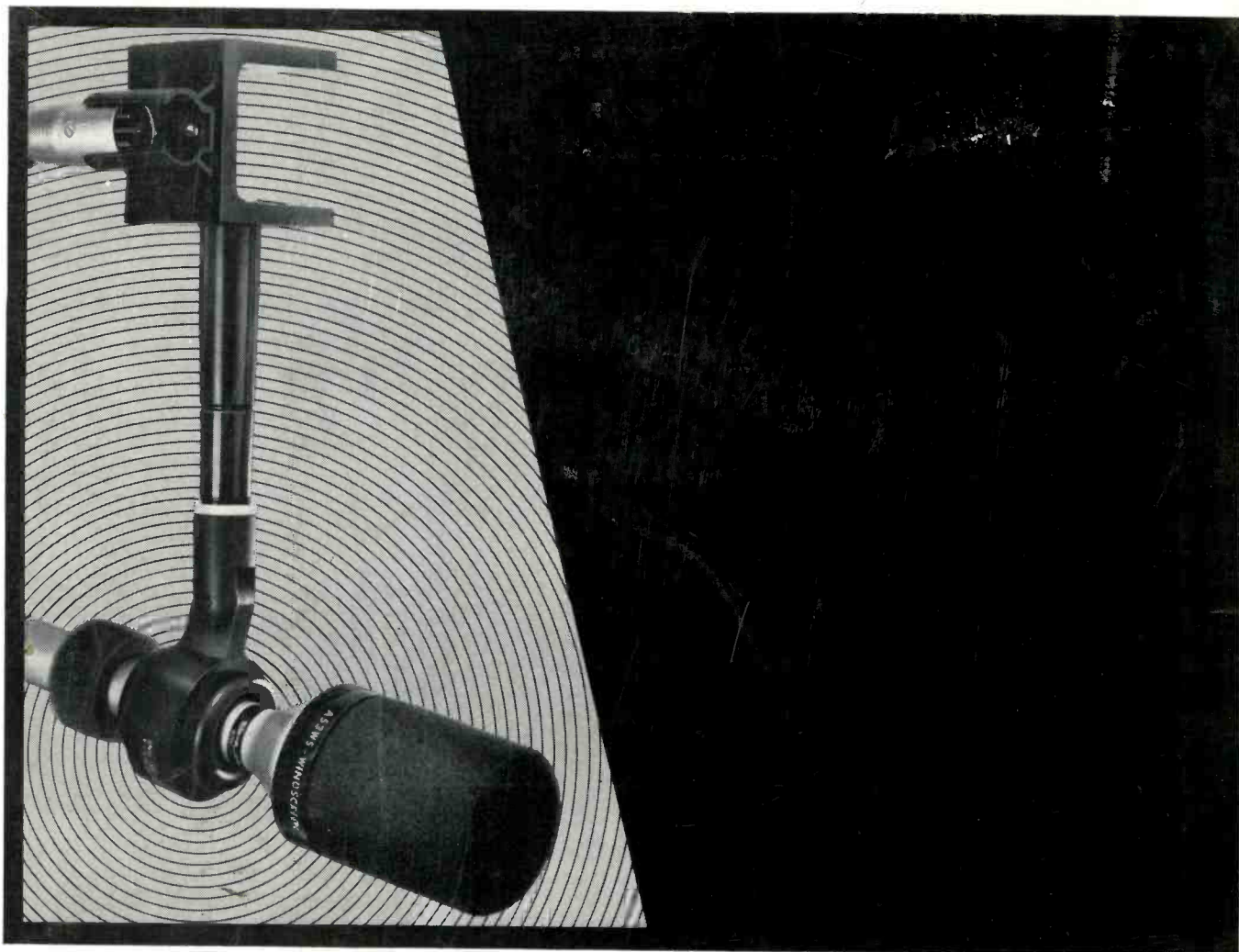

## Boom Boon.

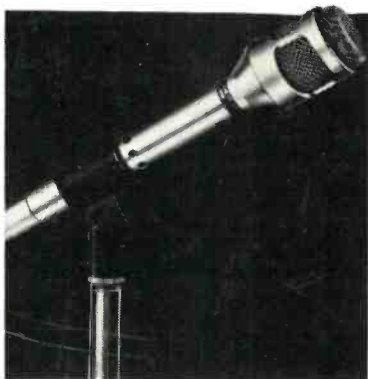

We've taken our most versatile, best-performing unidirectional studio microphone, the *Shure SM53*, and made it even more versatile by developing a complete boom accessory system that equips the SM53 for every conceivable boom and "fish-pole" application! Shure design engineers started with a major breakthrough in design: a small, lightweight, extremely effective isolation mount. They developed a super-flexible isolation cable, a pair of highly-efficient front-and-rear windscreens, and a 20" boom extension pipe. Finally, they developed a complete boom assembly that combines unusually small size with superb control and noise isolation. Result: an accessory lineup that makes every Shure SM53 studio microphone a complete microphone system! Write:

Shure Brothers Inc.,  
222 Hartrey Ave., Evanston, Ill. 60204.



Circle Number 3 on Reader Reply Card