

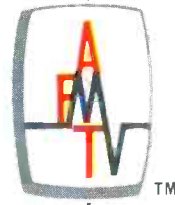

A HOWARD W. SAMS PUBLICATION



MARCH 1968/75 cents

Broadcast Engineering

*the technical journal
of the broadcast-
communications industry*

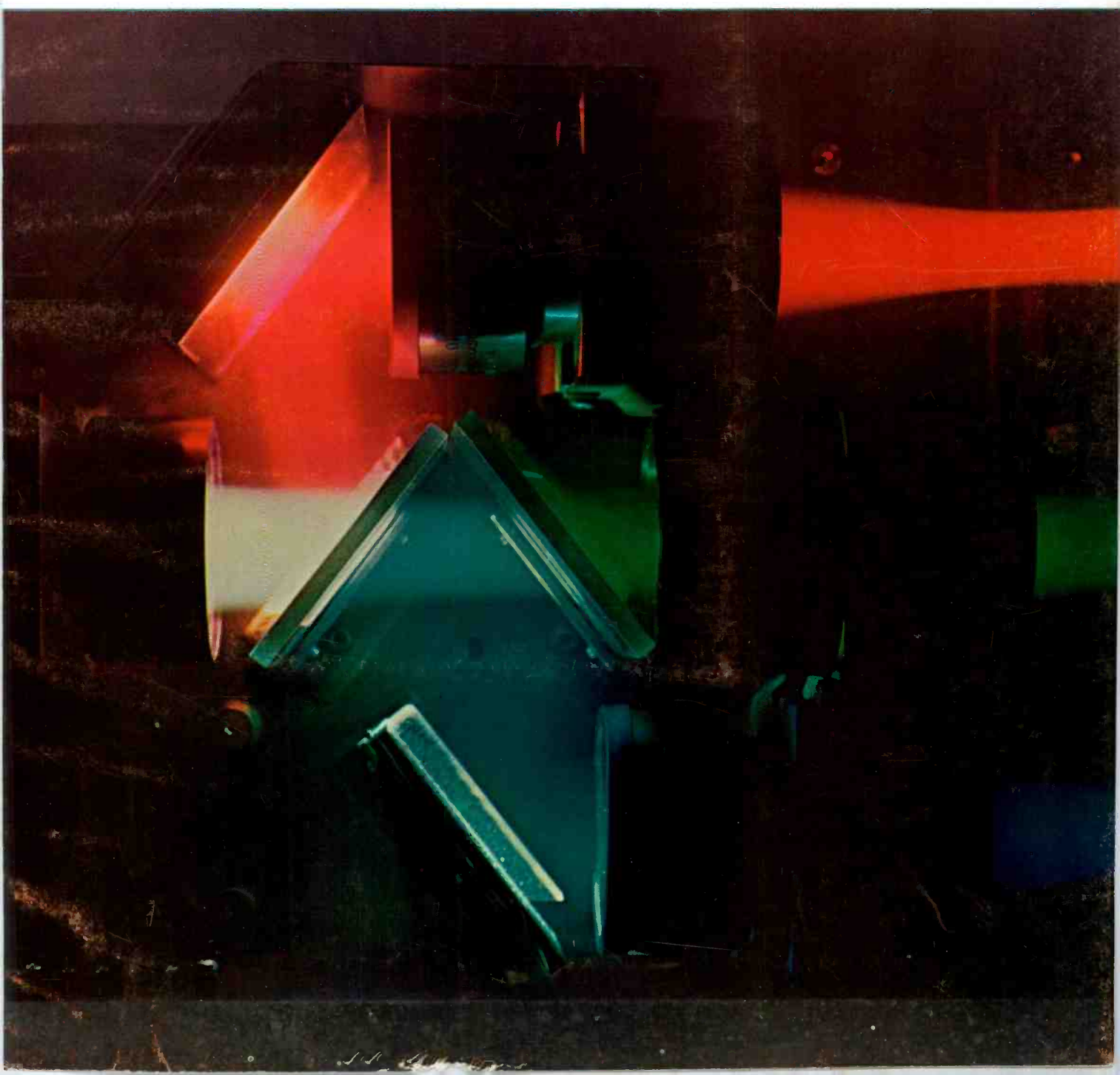

model 1551 video test set

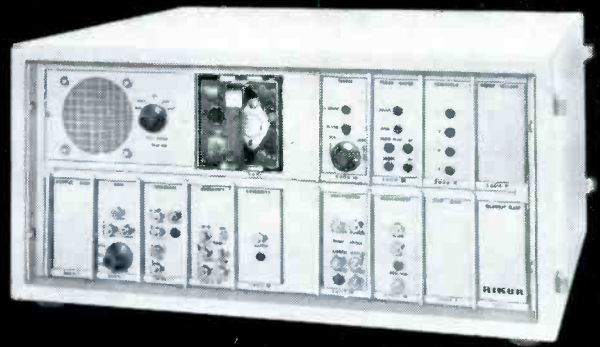

**here's a new, lightweight
portable video test set
that's as reliable
in death valley as it is
on pike's peak**



Removable front cover and accessories are self-storing.

available test signals

10 Step Linearity
Window
S_n² Window
Multiburst
Bar & Dot

features

Temperature stable
Reliable solid state design
Modular test signal generators
Dual isolated outputs
Self-storing accessories
Easily serviced in the field

Riker's new 1551 Video Test Set has been developed specifically for the telephone industry to insure accurate analysis of video transmission quality and is presently in use in a number of Bell System installations. The 1551 is lightweight, shock resistant and especially suited to field use, providing continuous and reliable operation over the widest possible range of climatic conditions.

All test signals generated by the 1551 are composite with standard EIA Sync. Dual outputs are provided at 124 ohms balanced and 75 ohms unbalanced allowing measurements to be made into balanced terminal equipment and unbalanced lines or facilities.

The plug-in design of the individual test signal modules makes it easy to service and maintain the test set in field locations. Failure or removal of any single module will not affect the performance of the remaining test signal generators. All accessories, including a removable cover, are self-storing to prevent loss during long term use.

RIKER

PRODUCTS FOR VIDEO ANALYSIS, SIMULATION & CONTROL.

RIKER VIDEO INDUSTRIES • 100 PARKWAY DRIVE SOUTH • HAUPPAUGE, L.I., NEW YORK 11787 • (516) 543-5200

Circle Item 1 on Tech Data Card

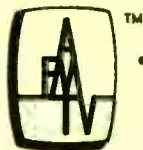

Broadcast Engineering



*1968 NAB Convention
Preview Supplement*

CONTENTS

Previews of the Equipment Exhibits	63
Exhibit-Hall Floor Plans	
West Hall (Booths 200-252)	74
East Hall (Booths 100-124)	75
Continental Room (Booths 301-327)	76
North Hall (Booths 401-423)	77
Second Floor (Booths A-AA)	78
List of Exhibitors	79
News About the NAB	86
Guide to Downtown Chicago	90

1968 NAB Annual Convention and Broadcast Engineering Conference

Conrad Hilton Hotel, Chicago

March 31-April 3

Highlights of the EQUIPMENT EXHIBITS

Conrad Hilton Hotel

March 31-April 3, 1968

The descriptions in this section are based on information received from the manufacturers up to press time.

A record number of broadcast-equipment manufacturers are scheduled to exhibit their products at the NAB 46th Annual Convention. Prior to the show, 126 manufacturers signed up to display the newest in radio-television equipment in six exhibit halls at the Conrad Hilton Hotel. The display will require approximately 54,000 square feet of exhibit space, 4000 square feet more than was used at last year's convention. The 54,000 square feet of space is the maximum footage available.

Exhibit space at the Convention will be located in the Continental Room, the East, North, and West exhibit halls, and two new areas—the Normandie Lounge and the Writing Room.

Addressograph Multigraph Corp. (Booth No. 231)

The Models 85 and 2550 Multilith offset duplicators, the Model 2000 copier, and the Model 2100 book copier will be featured.

Advance Industries (Booth No. 319)

A line of preassembled equipment buildings with from 64 to 160 square feet of floor space will be introduced. Available in either steel or aluminum, they are wired and forced-air ventilated; air-conditioning equipment is available. Also to be featured in this display are towers and reflectors.

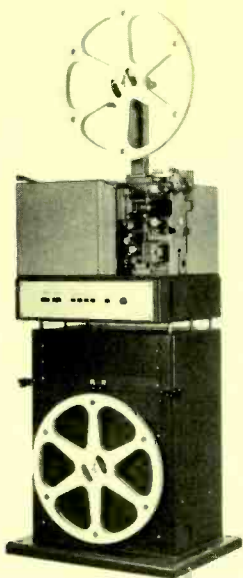

Allied Impex Corp.

(Booth No. 421)

To be presented for the first time is the Model "Bauer 16/TV" 16-mm automatic telecine projector (pictured). Also to be featured are the Bauer 16-mm heavy-duty double-band projector and the Model "Bauer 16/16" with a xenon light source.

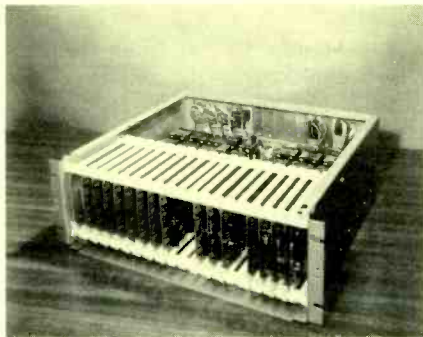

AMP Inc.

(Booth No. 308)

Demonstrations of a new automatic broadcast programmer will be the highlight of this display. Consisting

of a digital computer (Digital Equipment Corp. PDP-8) and an equipment package developed for broadcast programming, the system is capable of programming the following: (1) type and rate of audio and video transition into the scene, (2) scene duration in clock or elapsed time, (3) audio and video source, and (4) disposition of devices after termination of scene.

Also to be introduced, a new vertical-interval switcher uses plug-in relays and PC cards throughout (photo above). All electronics are rack-mounted and may be separated from the console by as much as 500 feet. By combining modules, the following functions are available: preset operation of a 24 x 2 video matrix, 24 x 2 audio matrix, a 6 x 2 video output unit, a "black" unit for inserting black between transitions, and a 24 x 1 mix row.

Equipment which has been introduced before, but is also to be featured, includes an audio output unit, AMP machine controls, and a transition-rate control unit.

Andrew Corp.

(Booth No. 220)

Making its debut is a new 8-inch flexible, air-dielectric coaxial cable. Usable at frequencies up to 600 MHz, its ratings for channel 35 include a loss of .15 dB per hundred feet and a power-handling capability of 70 kw (TV transmitter rating). On channel 4, the corresponding ratings are .042 dB and 223 kw, respectively. This cable is available in continuous lengths up to 1000 feet, and its corrugated conductors are designed to minimize thermal-expansion problems.

High-power coaxial switches, ETV microwave antenna systems, and flexible elliptical waveguides also will be featured.

Belar Electronics Laboratory, Inc.

(Booth No. 204)

The new SCM-1, SCA subcarrier frequency and modulation monitor, when used with the FMM-1 FM frequency and modulation monitor, provides monitoring and test functions for SCA and telemetering applications. Up to three crystal-controlled subcarrier frequencies may be selected by a switch. Two bandwidths (5kHz and 17 kHz) are provided, and a 50-kHz bandwidth is available. The deviation-meter range is ± 2 kHz, and modulation-meter accuracy is better than 5%.

Also to be introduced are the AMF-1 AM frequency monitor, AMM-1 companion modulation monitor, RFA-1 and -2 FM and AM RF amplifiers, remote-meter panels for the complete line of monitoring equipment, and a new SCA receiver.

Other models on display will be the FMM-1 frequency and modulation monitor for FM, FMS-1 stereo monitor, FMD-1 broadband FM detector, and the FMD-1TV broad-band FM detector for TV channels.

Monitoring-equipment demonstrations will be conducted in the booth.

Berkey-ColorTran, Inc.

(Booth No. 121)

A complete new line of quartz lighting equipment designed specifically for television-studio use will be featured. Also, the following equipment will be incorporated in a complete overhead-grid lighting display: LQF10-50 Super-Beam 1000, LQV-10 Vari-Beam 1000, LQTB-10 Tru-Broad, LQCS-15 (15-inch) and LQCS-18 (18-inch) fixed-focus scoops, LQCS-15F (15-inch) and LQCS-18F (18-inch) variable focus scoops, LQC10-1/A one-light high-intensity Cyc-Strip, CD12-120B

12-kw dimmer, and the ColorTran portable dimming system with control console.

Broadcast Electronics, Inc.

(Visual Electronics Booth)

The new 4-channel remote amplifier, Model RA-4CB, will be given a premiere showing by Broadcast Electronics. Operating from 115-volt AC or a self-contained battery, it has automatic switchover in case of power-line failure. The transformer-coupled inputs are 50/150/250 ohms, balanced or unbalanced; output is +4 dBm, switchable to 0 dBm across 600/150 ohms, balanced. Two equalized turntable inputs, a high-level input, and a tone generator for line testing are included. Specifications include gain of 83 dB, and noise 60 dB below +4 dBm.

Other items to be featured include the *Spotmaster* series of tape-cartridge recording and playback equipment, the Model 500B-DL delay unit, TP-1B tape winder, TT-20B turntable pre-amplifier, the BE-101 and -102 remote-control units, the ADIA audio distribution amplifier, the RA-4CA remote amplifier, and the PortaPak I portable cartridge playback machine.

CBS Laboratories, Div. of CBS, Inc.

(Booth No. 307)

New products to be displayed at the NAB Convention had not been selected at press time; however, a number of previously introduced items of equipment will be shown. Among them are: digital display and control units, Audimax automatic level control, Volumax and FM Volumax automatic peak controllers, loudness controller, Model 600 wide-range program monitor, loudness indicator, image enhancer, and masking amplifier. A mobile col-

or-TV system display will be presented in the exhibit.

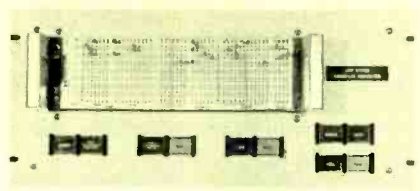

Chrono-Log Corp.

(Booth No. 246)

A new solid-state Step system, using a pin-board memory (see photo), for automated TV station-break switching will be introduced.

Continental Electronics Mfg. Co.

(Booth No. 200)

This display will feature the Type 317C 50-kw AM transmitter. A film-strip presentation of the proof of performance of this transmitter, showing its overall efficiency, will be a part of the exhibit.

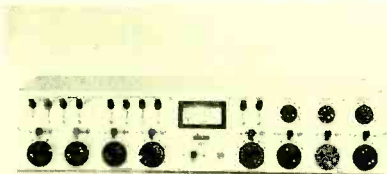

Disan Engineering Corp.

(Booth No. 423)

Making its initial appearance at the Convention, the Disan line includes a cartridge playback and a record/playback machine, Models 600 and 600A (available for rack or table mounting), and a delay programmer cartridge machine, Model 610. The 400 series has eight models of automated programming equipment ranging from the Model 400, with capability for 8 hours of programmed music and 31 spots, to the top-of-the-line Model 440 with

two music decks, a 40- to 60-cartridge handler, automatic fader, talking clock, and facilities for demand time and spots.

Also to be introduced are the RFA-8, an RF amplifier (88 to 108 MHz), REM-2 remote amplifier, SSR-12 solid-state regulated power supply, PA2B equalized turntable preamplifier, Model 650 background-music tape-cartridge machine, and the RCM-10-11, a 23-position transmitter remote-control system with twenty metering positions.

Rounding out the display are three models of solid-state audio consoles (two, four, and [in photo] eight channels) which are available for mono or stereo: a monitor amplifier; and a portable, professional studio consisting of a four-channel console, two turntables, and the equipment table.



Fairchild Recording Equipment Co.

(Booth No. 314)

New items to be featured by Fairchild are the FICM integrated control module, SWL fader, multichannel pan

pot, Model 1001 gain-shift intercom system, and the Integra II remote-control console. The FICM (illustrated) is a completely packaged, plug-in microphone channel for single-unit or "building-block" applications. Operating from 24 volts at 120 ma, it has input and output amplifiers, input fader, echo feed control, compression control, full-spectrum equalizers, output channel selector, and metering. The integra II console uses plug-in circuit cards to achieve design flexibility, and all audio components are located in the equipment rack. Thus, no audio signals are present in the control console.

Other equipment to be featured, although introduced previously, includes Reverbertron reverberation systems, monitor amplifiers, the 692 series of plug-in remote-control audio cards, and the 600/602 Conax. Live demonstrations of various consoles and reverberation systems are planned.

Gates Radio Co.

(Booth No. 221)

New equipment to be introduced at the show includes the TV-15 audio control console and the TVS-6 add-on submixer. The TV-15 is capable of mixing 15 signals from as many as 60 sources and provides completely independent audition-line and program outputs. Each TVS-6 adds six mixing channels to the TV-15. Another new item, the M-6543 solid-state limiter, also will be introduced.

A highlight of this display will be a completely automated 1-kw AM radio station demonstrating four program formats in addition to automatic programming and transmitter logging. Transmitting equipment to be featured will be the VP-50, 50-kw vapor-cooled AM transmitter; BC-5H, 5-kw AM transmitter; BC-1G and Vanguard II 1-kw AM transmitters; TE-1, FM ex-

citer; and the FM-1H, -5H, -10H, and -20H FM transmitters. Audio consoles to be displayed are the Dualux II, Gatesway II, Stereo Statesman, Executive, Diplomat, President, Ambassador, and Producer. In addition, three automation systems will be shown.



Gotham Audio Corp.

(Booth No. 226)

A new line of transistorized (FET) condenser microphones by Neumann is to be introduced. Labeled the "FET 80" Series, the line includes the KM-83 omnidirectional, KM-84 and -85 cardioids, KM-86 with three switchable patterns, and the U-87 (pictured here) which is the FET-80 Series counterpart of the U-67.

The Studer A-62 solid-state tape recorder, featuring modular construction with plug-in equalizer and heads, is another new product to be displayed. Using 1/4" tape, this machine is available in mono and two-track models.

Among the previously introduced products to be featured are a stereo microphone system, a studio turntable system, monitor speakers, an FM tuner, an FM-multiplex stereo fault

alarm, a polarity tester, a tape splicer, a tape timer, a pitch and tempo regulator, stereo headphones, input transformers, and linear-motion attenuators.

Gray Research and Development Div.

(Booth No. 414A)

The new Models 303 and 306 Micro-Trak stereo tone arms will make their debut at the show. In connection with demonstrations of the Model 303, Gray Research will distribute game calls with the theme "Micro-Trak can fool even the original." The Models 206 and 208 tone arms and the 602C equalizer also will be featured.

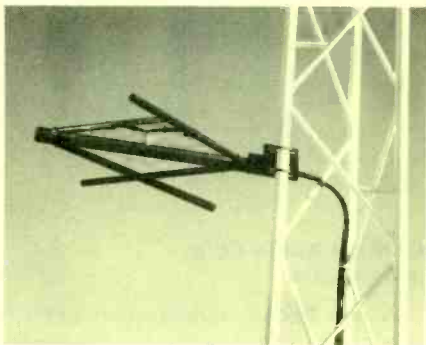

Jampro Antenna Co.

(Booth No. 305)

Featured as a new concept in circularly polarized FM antennas, a new Jampro antenna (above) features digital tuning caps for trimming VSWR to 1.08:1. The antenna is available for shunt feeding from a single 3/8-inch line, or it may be fed through a divider and individual element cables. The ratio of horizontally polarized energy to vertically polarized energy may be factory adjusted from 100% horizontal polarization to a 50/50 ratio.

Other items to be featured are batting TV antennas, UHF and high-channel VHF zig-zag antennas, and

the complete Jampro FM-antenna line. The availability of complete outdoor packages (antenna, tower, transmission line, and installation service) is to be announced.

Lenkurt Electric Co., Inc.

(Booth No. 402)

Two microwave-radio systems designed for long-haul video networks are to be shown. The Type 75A heterodyne-repeater system operates in the 5925- to 6425-MHz range, is of all-solid-state construction except for the traveling-wave amplifier tube, and accommodates 960 voice channels or color TV. Using solid-state circuitry and klystrons, the Type 76 is designed for service on the broadcast, common carrier, industrial, and government bands. This equipment also is designed for color transmission capability.

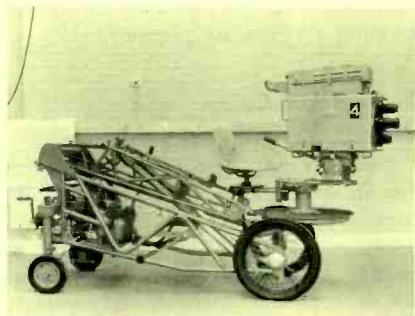

Listec Television Equipment Corp.

(Booth 427)

A new camera crane, manufactured by W. Vinten, Ltd. and designated the Falcon Type 526 (above), features hydraulic elevation control and counterbalancing without the use of added weights. It is demountable into four components, is self-powered, and has compensated steering for close maneuvering. Camera-platform height is 2'11" to 8'4" with the standard platform. An alternate platform is available to reduce the height to 1'3". The

Type 556 gas pedestal and the Mark III camera head will also be featured products from Vinten.

Also to be premiered is the Hoku-shin Type TC-510D 16-mm TV projector. Designed for automatic operation, it has the following features and specifications: reverse run at full speed, predetermined stop, automatic restoration of film loop, automatic replacement of exciter lamps, remote control, level matching for optical and magnetic sound reproduction, quiet operation, built-in tone test for sound system, application time of approximately 50%, film pull-down time of less than .01 second, and a starting time of less than 1 second for picture and sound.

BICC TV-camera cable will be included in the exhibit.

Marconi Instruments

(Booth No. 228)

Three new test instruments which have been added to the line will be introduced at the NAB show. Model T2905/1 generates a sine² pulse, a bar waveform with adjustable duration from 12 to 43 usec, and a staircase waveform. From 5 to 10 stairsteps having adjustable durations of 2.3 to 5 usec are available, or the instrument may be modified to generate a sawtooth waveform. The unit generates an internal trigger, or it may be triggered from an external source through the use of the TR2908 blanking and sync mixer, which also is being premiered.

The Model TF2904/1 is used to measure inequalities in gain and delay between the chrominance and luminance channels. Gain measurements within the range of +3 dB to -3 dB and delay measurements up to 110 nsec leading or lagging are possible. 525-line NTSC or PAL systems may be tested with this unit.

The TF2360 TV sideband analyzer, TF1099 video sweep generator, and TM6936 UHF adapter, also to be featured, have been introduced previously.

Marti Electronics

(Booth No. 237)

New additions to the line which will be introduced at the show are the RMC-2AX remote-control and telemetry system for AM and FM transmitters; solid-state RPU and STL receivers; the Model MR-50/150-450 solid-state, mobile communications receiver; and a solid-state RPU transmitter for 150- or 450-MHz operation. Also to be featured at the show are RPU and STL transmitters, an SCA-subcarrier generator, and audio amplifiers and preamplifiers.

McCurdy Radio Industries, Inc.

(Booth No. 309)

McCurdy will present the new Model SS4724A television audio-production console, the new Model SS4475 television audio console, and a new TV intercom system using modular construction. Also to be featured are their monitor amplifiers, preamplifiers, equalizers, and power supplies.

Memorex Corp.

(Booth No. 312)

Available in standard configurations for all helical-scan recorders, the 79 Series of video tape is to be introduced at the Memorex booth. Three different demonstrations of Memorex products are slated for the show: (1). A "live" feed from a video recorder in a second booth is designed to show the quality of Series 78V tape. (2). At announced times each day, the heads of the video recorder being used will be measured for wear. (3). A short technical pres-

entation on tape-testing procedures will be presented by a Memorex engineer.



Microwave Associates, Inc.

(Booth No. 115)

A live demonstration of microwave STL and TV pickup of color and monochrome TV and sound channels will be a highlight of the display. Three new models of microwave equipment for auxiliary broadcast, STL, intercity, and TV pickup are the Models MA2B, MA7B, and MA13B, operating at 2, 7, and 13 GHz, respectively (typical unit illustrated above). Hot-standby switchers for dual, solid-state STL equipment complete this category of equipment.

Two other new items to be shown are an 18-pound TV relay transmitter for use in helicopters, and a color-TV back-pack link to be used at the forthcoming political conventions.

D. B. Milliken Co., A Teledyne Co.

(Booth No. 405)

Incorporating the Model DBM-6A video film-recording camera which has been introduced previously, the new Model DBM-R1 video film-recording system will be displayed. It uses an optically flat-faced, high-resolution CRT to minimize edge-resolution problems and pincushion distortion. The film transport is air driven, and the

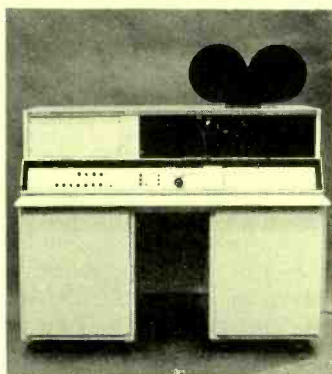

film is positioned during the vertical-blanking interval.

3M Co., Magnetic Products and Mincom Divisions

(Booth Nos. 247, 248)

Featured SCOTCH Brand products from the Magnetic Products Div. are No. 399 video tape and professional audio-range tapes, plus an improved shipping case for video tape.

In the same booth, the Mincom Div. will show several products. Three new items to be displayed carry the 3M Brand name. These are the EBR-100 electron-beam television film recorder, a color encoder, and a dropout counter. Two other 3M Brand products to be featured are a dropout compensator and a professional audio recorder.

Moseley Associates, Inc.

(Booth No. 223)

The fully solid-state PCL-303B/C composite aural STL (photo), capable of transmitting stereo over a single link, will make its debut. Using direct FM, the system also accepts subcarrier remote-control systems.

The new all-solid-state PCL-202 aural STL for foreign use (300 to 470 MHz) also will be introduced.

Also being featured are the ADP-101 digital automatic transmitter log-

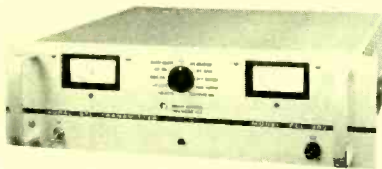
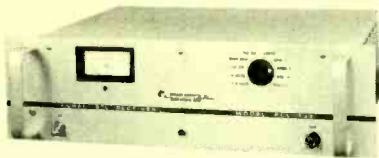

ger, the PCL-303 aural STL, and the PBR-21 and WRC-10T solid-state remote control systems.

Q-Tv Sales and Distributing Corp.
(Booth No. 118)

To be displayed are the "Q" prompter systems (standard and cartridge models), "Q" dispatcher system for horizontal or vertical operation, and 5/8" and 3/4" "Q" Videotypers.

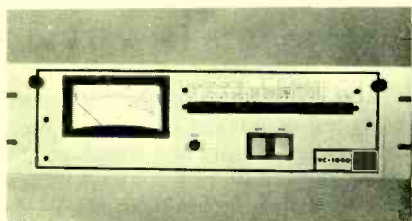

Rust Corp. of America
(Booth No. 251)

The Model RC-1000 remote-control system (in photo), a new, 10-position, push-button system using a single DC pair, will be demonstrated. Features include solid-state circuitry, "automatic synchronization," push-button position selection, isolation of metering

samplers from telephone lines, and a frequency-shift-carrier control system.

Another new product, the AL-400 Autolog, is a solid-state continuous-line charting system designed to log transmitter parameters automatically for over two months without adjustment.

Also being shown will be the Model RC-2400 remote-control system, the AL-100 and AL-100R automatic transmitter logging systems, a new 14C-3 AM RF preamplifier, and new versions of the 15C-3 FM RF preamplifier and the "RMS" video/audio random switcher. The latter item of equipment is scheduled to be in operation in both the Rust and Visual Electronics booths.

Seeburg Music Library, Inc.
(Booth No. 215)

Featured equipment will be the Model SABMC-1 automatic background-music center and the BMC-1 and BMS-2 on-premises record players.

Tape-Athon Corp.
(Booth No. 239)

The Model 900 logger is to be introduced. Also, the Model 5000 dual automated-broadcast system, the Model 900 professional recorder/reproducer, and the Programmer III background-music studio system will be shown.

Tektronix, Inc.
(Booth No. 111)

The Type 520 NTSC vectorscope (in illustration) will be shown for the first time at the NAB show. Designed to measure luminance, hue, and saturation of the NTSC color signal, it

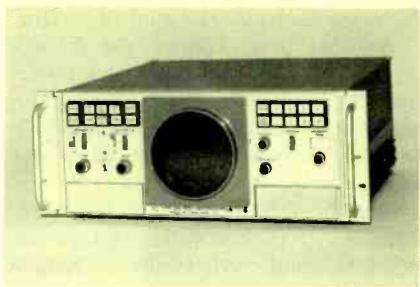

has push-button controls for operating convenience and rapid selection of displays. 0 to 360° phase shifters provide independent phase control of channels A and B, allowing phase shifts caused by unequal signal paths to be cancelled. The phase shifter has a dial resolution of 1° per inch with a range of 30°, and the instrument is designed to permit differential gain and phase measurements accurate within 1% and 0.2°, respectively. A Type 520 PAL vectorscope will be shown as well.

Also to be featured is the Type 529 television monitor designed for observation of sine pulses, bars, stair-step, and other waveforms. The Type 453 MOD 127C 50-MHz, dual-trace portable oscilloscope will be included in the display.

Telequip Corp.

(Booth No. 244)

New studio lighting equipment and color test-pattern equipment are to be unveiled at the NAB show. Television mounting equipment, video switchers, and special-effects equipment also will be featured.

Telesync Corp.

(Booth No. 218)

Two models of front-projection systems will be shown. The Basic Studio I (mirrors shown below) has a fully adjustable, lightweight aluminum tri-

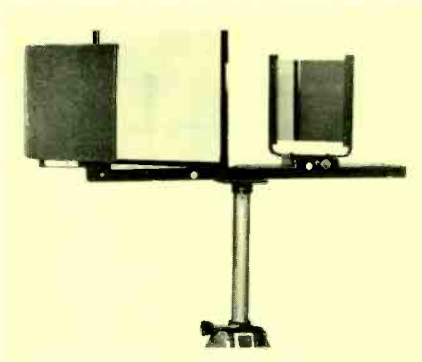

pod, 18-inch beam-splitter mirror, light-absorbing box, and 16-mm conversion mirrors.

The Studio 90 uses a pneumatically supported, adjustable pedestal, and the projector has capacity for 15 slides. With the front-projection assembly attached, pan and tilt capabilities of 40° and 15°, respectively, are available. With the assembly removed, these angles are increased to 180° and 40°. Total power consumption is 1200 watts (2 projectors).

Prompting equipment and the horizontal-vertical color-effects crawl also will be shown.

Television Zoomar Co.

(Booth No. 105)

Several new items will be introduced. In the test-equipment category, a modulation-transfer-function machine for testing resolution and contrast of lenses, and a manufacturer's model of the *TV Colorgard* Mark II for monitor color-temperature adjustments are to be announced. Studio equipment includes a pan and tilt head with velocity control and joy-stick operation. TVP pneumatic pedestals, H.T.S. HOB pedestal, H.T.S. caption scanner, and the H.T.S. mark II cam head for RCA Model TK-40, -41, -42, and 43 color cameras.

The caption scanner consists of four stages, or frames, each providing a 10" x 12" display area. These are mounted on a ball-bearing pivot and have supporting rollers running on a circular track. A flip-card attachment and a crawl-title unit are available as optional equipment.

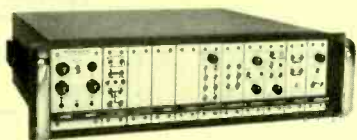
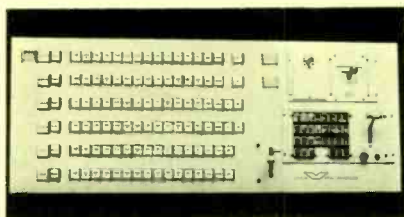

Videometrics, Inc.

(Booth No. 415)

A new line of video test-signal generating equipment is available in two packaging configurations: a modular package accommodates all of the generators, or each generator is available in a separate package. The complete package (in photo) with space for expansion, requires 5¼" of rack space. The individually packaged units are 1¾" by 19".

Generators in the line include the Polyburst, which generates a total of 12 bursts from .5 to 10 MHz over two horizontal lines. A modulated 20T pulse is used for measurement of luminance/chrominance gain ratios and delay in color circuits. The linearity generator produces stair-step and ramp signals, and there is a sine²-pulse- and window generator.

Vital Industries

(Booth No. 202)

Silicon solid-state devices and IC's are used extensively in the Model VIX-108 vertical-interval video switcher (illustrated here) which is being introduced. The unit has capacity for 18 inputs and 6 outputs in 5¼" of rack space. Switching is accomplished in

0.1 usec during the vertical interval (adjustable from line 6 to line 20), although random switching (also in 0.1 usec) is possible. Some specifications are: crosstalk, -60 dB; differential gain, less than 0.1 dB; differential phase, below 0.2°; signal-to-noise ratio, 65 dB; gain adjustment range ±3 dB; and gain stability, better than 1% per month.

The Model VI-1000 video processing amplifier, also to be premiered, uses IC's extensively. Requiring 3½" of rack space, it has the following listed functions and features: complete blanking and sync regeneration, including all vertical-interval pulses, or gated sync; internally generated sync is provided; accepts original color burst, reinserted color burst, or burst from internal phase-locked oscillator; automatic color/mono switching; VIT signals are allowed to be passed or deleted. Auto/manual chroma-level correction and video-level control is provided; regenerated pulses have adjustable width; white and black clip and sync level are adjustable; and white and black stretch are independently adjustable. Composite sync, composite blanking, vertical drive, horizontal drive, and front-porch switching pulses are available as outputs.

Switching equipment and the color-processing amplifier will be the subject of special demonstrations. The VI-500 video-stabilizing amplifier and VI-10 and -20 video and pulse-distribution amplifiers also will be on display. ▲

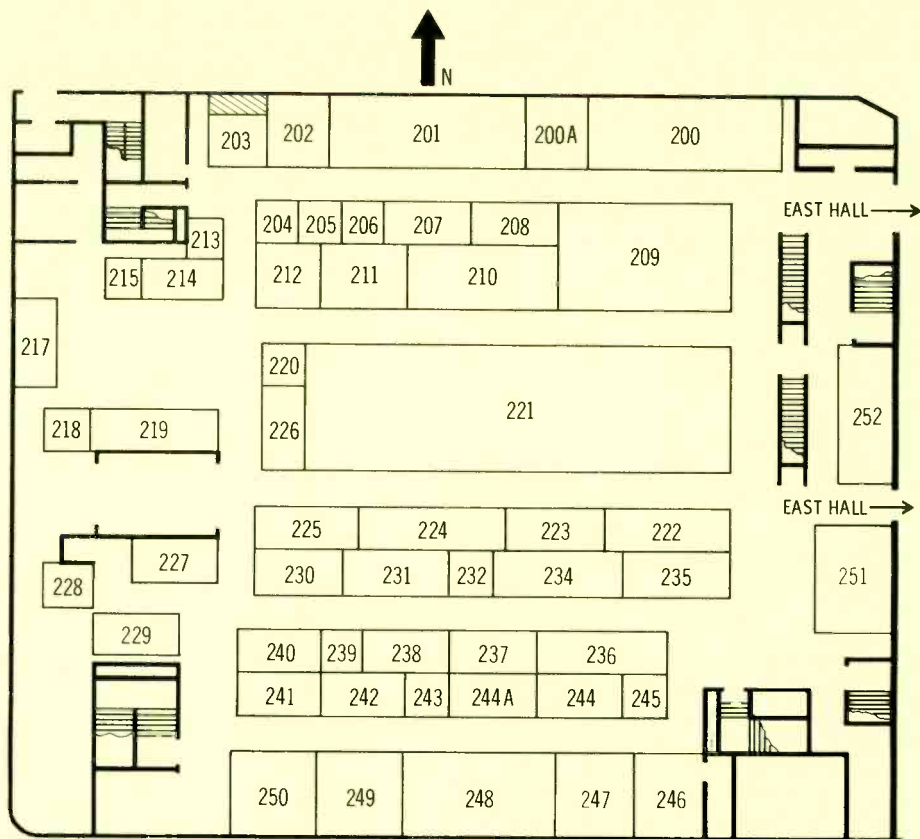

WEST HALL
 Conrad Hilton
 (Booths 200 through 252)

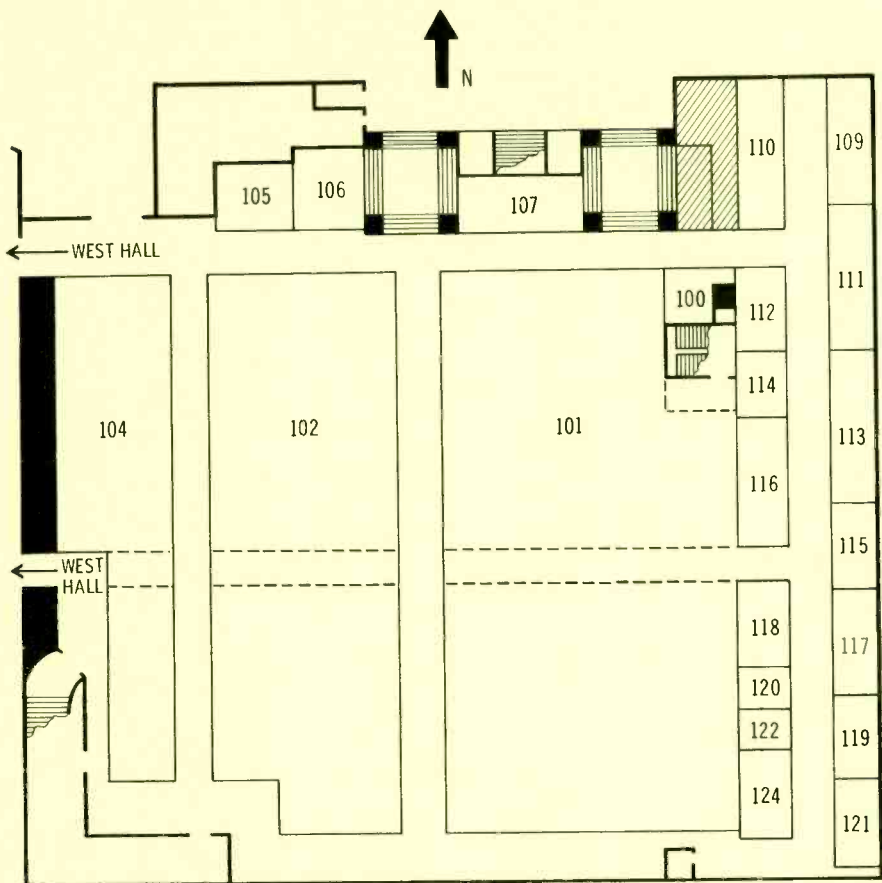

EAST HALL
 Conrad Hilton
 (Booths 100 through 124)

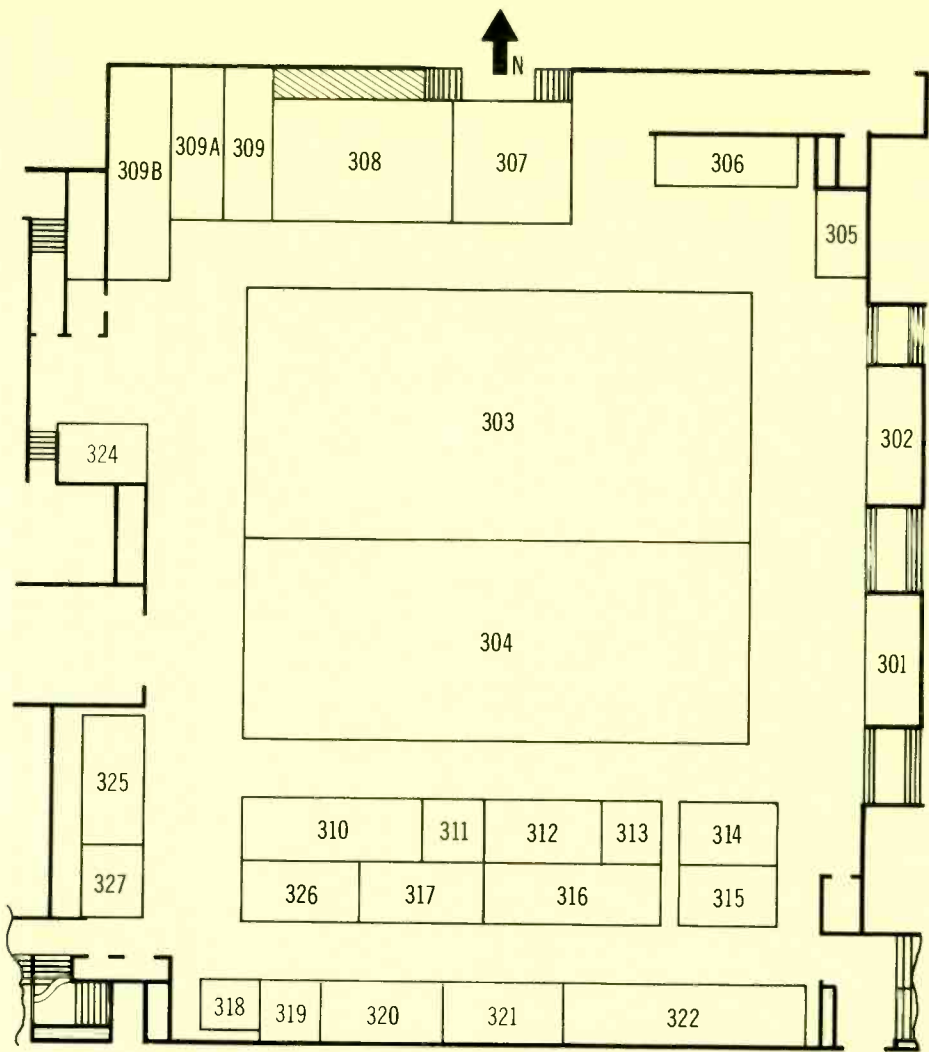

CONTINENTAL ROOM

Conrad Hilton

(Booths 301 through 327)

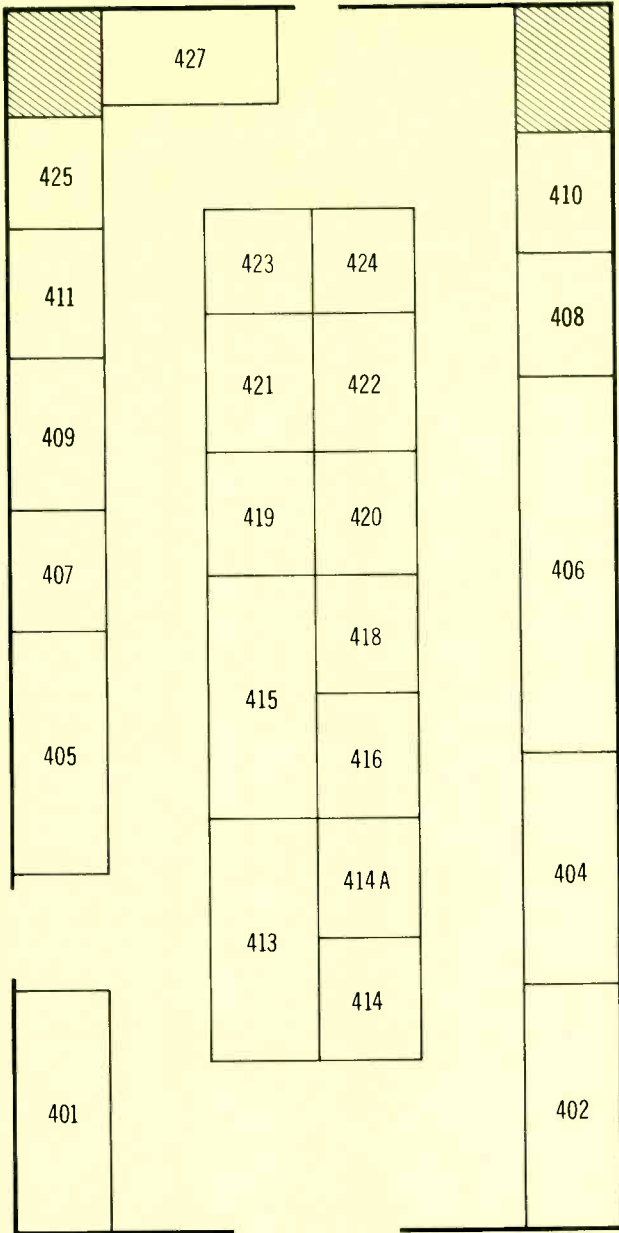

NORTH HALL
 Conrad Hilton
 (Booths 401 through 423)

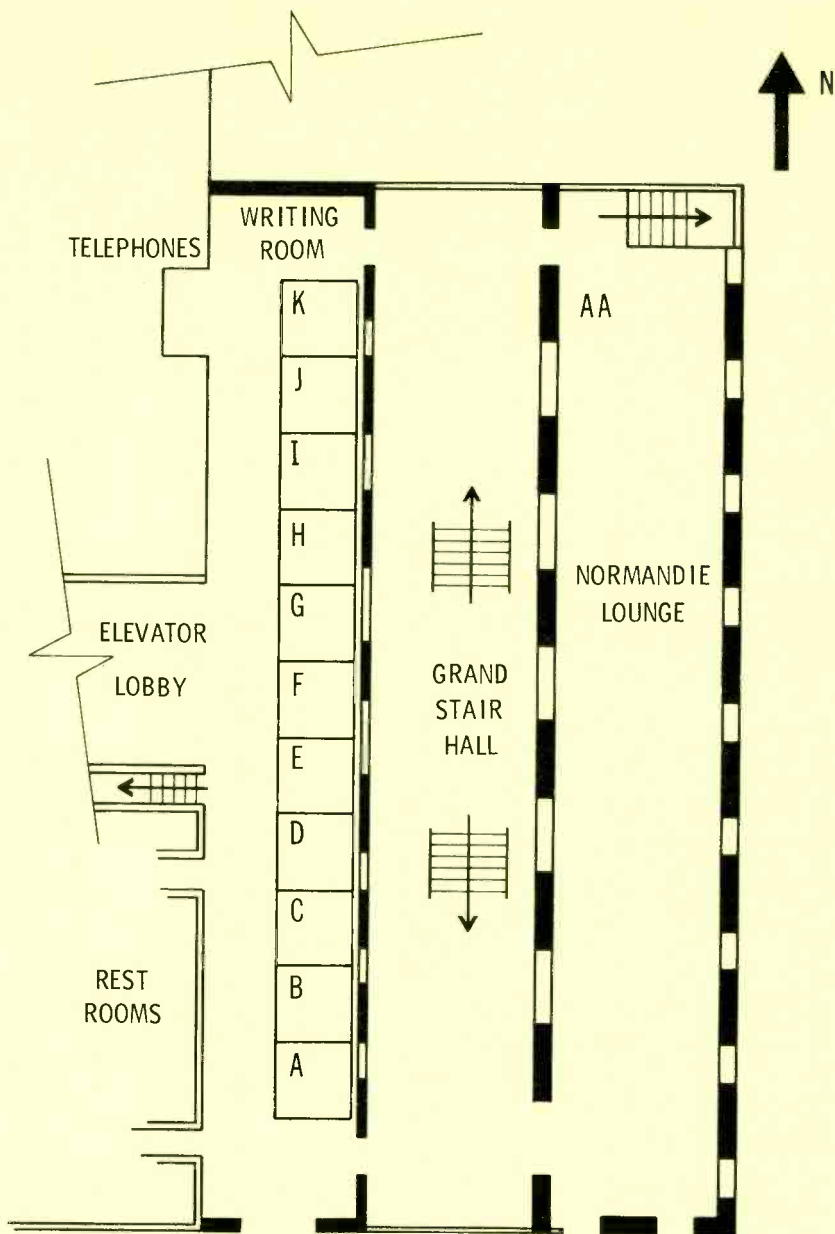

SECOND FLOOR
 Conrad Hilton
 (Booths A through AA)

NAB Associate-Member Exhibitors

NAB Convention

Conrad Hilton Hotel, Chicago

March 31-April 3, 1968

Addressograph Multigraph Corp.

1200 Babbitt Road
Cleveland, Ohio 44117
(Booth No. 231)

Advance Industries

705 Douglas Street
Sioux City, Iowa 51101
(Booth No. 319)

Albion Optical Co., Inc.

P. O. Box 463—260 North Route 303
West Nyack, New York 10994
(Booth No. 252)

Alford Manufacturing Co.

120 Cross Street
Winchester, Massachusetts 01890
(Booth No. 208)

Allied Impex Corp.

300 Park Avenue South
New York, New York 10010
(Booth No. 421)

Alma Engineering

8090 Engineer Road
San Diego, California 92111
(Booth No. 408)

Altec Lansing, Div. of

LTV Ling Altec, Inc.

1515 South Manchester Avenue
Anaheim, California 92803
(Booth No. 207)

Ameco, Inc.

P. O. Box 13741—2949 West
Osborn Road
Phoenix, Arizona 85002
(Booth No. 310)

American Electronic Laboratories, Inc.

P. O. Box 552
Lansdale, Pennsylvania 19446
(Booth No. 313)

American Enka Corp.

Brand-Rex Div.

West Main Street
Willimantic, Connecticut 06226
(Booth No. 409)

AMP, Inc.

Eisenhower Boulevard
Harrisburg, Pennsylvania 17105
(Booth No. 308)

Ampex Corp.

401 Broadway
Redwood City, California 94063
(Booth AA)

Andrew Corp.

10500 West 153rd Street
Orland Park, Illinois 60462
(Booth No. 220)

Arriflex Corp. of America

25-20 Brooklyn-Queens Expressway West
Woodside, New York 11377
(Booth No. 311)

Audio Devices, Inc.

235 East 42nd Street
New York, New York 10017
(Booth No. 232)

Ball Brothers Research Corp.

P. O. Box 1062—Industrial Park
Boulder, Colorado 80302
(Booth Nos. 214, 219)

Bauer Broadcast Products Div.

Granger Associates

1601 California Avenue
Palo Alto, California 94304
(Booth No. 222)

Belar Electronics Laboratory, Inc.

P.O. Box 83—Delaware and
Montrose Aves.
Upper Darby, Pennsylvania 19084
(Booth No. 204)

Berkey-ColorTran, Inc.

1015 Chestnut Street
Burbank, California 91502
(Booth No. 121)

Boston Insulated Wire & Cable Co.

65 Bay Street
Dorchester, Mass. 02125
(Booth No. 245)

Broadcast Electronics, Inc.

8810 Brookville Road
Silver Spring, Maryland 20910
(Visual Electronics Booth)

Broadcast Skills Bank

(Booth F)

CBS Laboratories,

Div. of CBS, Inc.

227 High Ridge Road
Stamford, Connecticut 06905
(Booth No. 307)

CCA Electronics Corp.

716 Jersey Avenue
Gloucester City, New Jersey 08030
(Booth No. 236)

Central Dynamics Corp.

903 Main Street
Cambridge, Massachusetts 02139
(Booth No. 413)

Century Lighting, Inc.

3 Entin Road
Clifton, New Jersey 07014
(Booth No. 122)

Chrono-Log Corp.

2583 West Chester Pike
Broomall, Pennsylvania 19008
(Booth No. 246)

Cleveland Electronics, Inc.

2000 Highland Road
Twinsburg, Ohio 44087
(Booth No. 119)

Cohu Electronics, Inc.

P. O. Box 623—5725 Kearny Villa Road
San Diego, California 92112
(Booth No. 326)

Collins Radio Co.

Dallas, Texas 75207
(Booth No. 209)

Conrac Div., Conrac Corp.

600 North Rimsdale Avenue
Covina, California 91722
(Booth No. 107)

**Continental Electronics
Manufacturing Co.**

P. O. Box 17040—4212 S. Buckner Blvd.
Dallas, Texas 75217
(Booth No. 200)

Cooke Engineering Co.

735 North Saint Asaph Street
Alexandria, Virginia 22314
(Booth No. 420)

Craftsman Electronic Products, Inc.

133 West Seneca Street
Manlius, New York 13104
(Booth No. 318)

Davis & Sanford Co., Inc.

24 Pleasant Street
New Rochelle, New York 10802
(Booth No. 120)

Delta Electronics, Inc.

4206 Wheeler Avenue
Alexandria, Virginia 22304
(Booth No. 205)

Disan Engineering Corp.
516 East Cherokee
Nowata, Oklahoma 74048
(Booth No. 423)

Dresser Crane, Hoist & Tower Div.
875 Michigan Avenue
Columbus, Ohio 43215
(Booth No. 206)

Dynair Electronics, Inc.
6360 Federal Boulevard
San Diego, California 92114
(Booth No. 211)

Effective Communication Systems, Inc.
P. O. Box 98
White Haven, Pennsylvania 18661
(Booth No. 324)

Electronic Engineering Co. of California
1601 East Chestnut Avenue
Santa Ana, California 92702
(Booth C)

Electronics, Missiles & Communications
160 East Third Street
Mount Vernon, New York 10550
(Booth No. 309B)

Entron, Inc.
2141 Industrial Parkway
Silver Spring, Maryland 20904
(Booth No. 320)

**F & M Systems Co., Div. of
Fischbach & Moore, Inc.**
2525 Walnut Hill Lane
Dallas, Texas 75220
(Booth No. 419)

Fairchild Recording Equipment Corp.
10-40 45th Avenue
Long Island City, New York 11101
(Booth No. 314)

Filmline Corp.
43 Erna Street
Milford, Connecticut 06460
(Booth No. 124)

Fort Worth Tower Co., Inc.
P. O. Box 8597—5201 Bridge Street
Fort Worth, Texas 76112
(Booth No. 315)

Gates Radio Co.
123 Hampshire Street
Quincy, Illinois 62301
(Booth No. 221)

Gauss Electrophysics, Inc.
1653 Twelfth Street
Santa Monica, California 90404
(Booth No. 418)

General Electric Co.
1900 Brewerton Road
Mattydale, New York 13211
(Booth No. 102)

Gotham Audio Corp.
2 West 46th Street
New York, New York 10036
(Booth No. 226)

Grass Valley Group, Inc.
Bitney Springs Road
Grass Valley, California 95945
(Booth No. 113)

Gray Research & Development Co. Div.
150 Park Avenue
East Hartford, Connecticut 06108
(Booth No. 414A)

Harwald Co.
1245 Chicago Avenue
Evanston, Illinois 60202
(Booth No. 225)

Hewlett-Packard Co.
100 Locust Avenue
Berkeley Heights, New Jersey 07922
(Booth No. 227)

Houston Fearless Corp.
11801 West Olympic Boulevard
Los Angeles, California 90064
(Booth No. 116)

**Ingersoll Products Div.
Borg-Warner Corp.**
1000 West 120th Street
Chicago, Illinois 60643
(Booth No. 217)

International Good Music, Inc.
P. O. Box 943
Bellingham, Washington 98225
(Booth No. 224)

I.T.T. Corp., Tube Div.

P. O. Box 100
Easton, Pennsylvania 18043
(Booth No. 425)

Jampro Antenna Co.

6939 Power Inn Road
Sacramento, California 95828.
(Booth No. 305)

Jerrold Corp.

401 Walnut Street
Philadelphia, Pennsylvania 19105
(Booth No. 322)

Johnson Electronics, Inc.

P. O. Box 7
Casselberry, Florida 32707
(Booth No. 243)

Kaiser CATV Corp.

P. O. Box 9728—2216 West Peoria Ave.
Phoenix, Arizona 85020
(Booth No. 321)

Kalart Co., Tele-Beam Div.

Hultenius Street
Plainville, Connecticut 06062
(Booth No. 416)

**Kliegl Bros. Universal Electric
Stage Lighting Co., Inc.**

32-32 48th Avenue
Long Island City, New York 11101
(Booth No. 100)

Lenkurt Electric Co., Inc.

1105 County Road
San Carlos, California 94070
(Booth No. 402)

Listec Television Equipment Corp.

35 Cain Drive
Plainview, New York 11803
(Booth No. 427)

MaCarTa, Inc.

709 Railroad Avenue
West Des Moines, Iowa 50265
(Booth No. 212)

Marconi Instruments

111 Cedar Lane
Englewood, New Jersey 07631
(Booth No. 228)

Marti Electronics

P. O. Box 661—105 Poindexter
Cleburne, Texas 76031
(Booth No. 237)

McCurdy Radio Industries, Inc.

57 North Putnam Street
Danvers, Massachusetts 01923
(Booth No. 309)

McMartin Industries, Inc.

3104 Farnam Street
Omaha, Nebraska 68131
(Booth No. 235)

Memorex Corp.

1180 Shulman Avenue
Santa Clara, California 95052
(Booth No. 312)

Microwave Associates, Inc.

Burlington, Massachusetts 01803
(Booth No. 115)

D. B. Milliken Co.,**A Teledyne Co.**

131 North Fifth Avenue
Arcadia, California 91006
(Booth No. 405)

3M Co.

3M Center
St. Paul, Minnesota 55101
(Booth Nos. 247, 248)

Mole-Richardson Co.

937 North Sycamore Avenue
Hollywood, California 90038
(Booth No. 401)

Moseley Associates, Inc.

P. O. Box 3192—135 Nogal Drive
Santa Barbara, California 93105
(Booth No. 223)

National Guard

(Booth I)

Nippon Columbia Corp. of America

501 Fifth Avenue
New York, New York 10017
(Booth No. 410)

North American Philips Co., Inc.

100 East 42nd Street
New York, New York 10017
(Booth No. 325)

Nortronics Co., Inc.

8101 Tenth Avenue North
Minneapolis, Minnesota 55427
(Booth No. 238)

Optical Imports, Inc.

440 Merrick Road
Oceanside, New York 11572
(Booth No. 203)

Packard Bell, Space & Systems Div.

649 Lawrence Drive
Newbury Park, California 91320
(Booth No. 240)

Philips Broadcast Equipment Corp.

299 Route 17
Paramus, New Jersey 07652
(Booth No. 304)

Power Optics, Inc.

Township Line and Jolly Roads
Plymouth Meeting, Pennsylvania 19462
(Booth No. 114)

Q-Tv Sales & Distributing Corp.

342 West 40th Street
New York, New York 10018
(Booth No. 118)

Quick-Set, Inc.

8121 Central Park Avenue
Skokie, Illinois 60078
(Booth No. 242)

Radio Corp. of America, Broadcast & Communications Products Div.

Building 15-5
Camden, New Jersey 08102
(Booth No. 101)

**Radio Corp. of America,
Electronic Components & Devices**

Harrison, New Jersey 07029
(Booth No. 117)

Raytheon Co.

1415 Boston-Prov. Turnpike
Norwood, Massachusetts 02062
(Booth No. 106)

Riker Video Industries, Inc.

100 Parkway Drive South
Hauppauge, L. I., New York 11787
(Booth No. 246)

Rohde and Schwarz Sales Co. (USA), Inc.

111 Lexington Avenue
Passaic, New Jersey 07055
(Booth No. 241)

Rohn Systems, Inc

P. O. Box 2000
Peoria, Illinois 61601
(Booth No. 229)

Rust Corp. of America

168 Tremont Street
Everett, Massachusetts 02149
(Booth No. 251)

Sarkes Tarzian, Inc.

Broadcast Equipment Div.
East Hillside Drive
Bloomington, Indiana 47401
(Booth No. 104)

Scantlin Electronics, Inc.

2231 Barrington Avenue
Los Angeles, California 90064
(Booth No. 422)

Schafer Electronics

9119 De Soto Avenue
Chatsworth, California 91311
(Booth No. 210)

Seeburg Music Library, Inc

1500 North Dayton Street
Chicago, Illinois 60622
(Booth No. 215)

Shibaden Corp. of America

58-25 Brooklyn-Queens Expressway
Woodside, New York 11377
(Booth No. 244A)

Shure Brothers, Inc.

222 Hartrey Avenue
Evanston, Illinois 60204
(Booth No. 213)

Sony Corp. of America
Industrial Products Div.
516 West Florence Avenue
Inglewood, California 90301
(Booth No. 109)

Sparta Electronic Corp.
5851 Florin-Perkins Road
Sacramento, California 95828
(Booth No. 306)

Spindler & Sauppe, Inc.
1329 Grand Central Avenue
Glendale, California 91201
(Booth No. 327)

Standard Electronics Corp.
P. O. Box 677—Route 33
Manalapan Twn.
Freehold, New Jersey 07728
(Booth No. 112)

Sylvania Electric Products, Inc.
Commercial Electronics Div.
P. O. Box 268—Burlington Road
Bedford, Massachusetts 01730
(Booth No. 250)

Tape-Athon Corp.
523 South Hindry
Inglewood, California 90301
(Booth No. 239)

Tapecaster Electronics
P. O. Box 662
Rockville, Maryland 20851
(Booth No. 230)

Technical Materiel Corp.
700 Fenimore Road
Mamaroneck, New York 10543
(Booth No. 424)

Tektronix, Inc.
P. O. Box 500
Beaverton, Oregon 97005
(Booth No. 111)

TeleMation, Inc.
2275 South West Temple
Salt Lake City, Utah 84115
(Booths D, E)

Telemet Co.
185 Dixon Avenue
Amityville, L. I., New York 11701
(Booth No. 249)

TelePro Industries, Inc.
Cherry Hill Industrial Center
Cherry Hill, New Jersey 08034
(Booth No. 414)

Telequip Corp.
224 Glen Cove Avenue
Glen Cove, L.I., New York 11542
(Booth No. 244)

Telesync Corp.
20 Insley Street
Demarest, New Jersey 07627
(Booth No. 218)

Television Zoomar Co.
870 High Ridge Road
Stamford, Connecticut 06905
(Booth No. 105)

Telex Corp.
9600 Aldrich Avenue South
Minneapolis, Minnesota 55420
(Booth No. 317)

Texas Electronics, Inc.
5529 Redfield Street
Dallas, Texas 75235
(Booth No. 407)

Townsend Associates, Inc.
P. O. Box 215
Feeding Hills, Massachusetts 01030
(Booth No. 110)

Transface Process Co.
480 Canal Street
New York, New York 10013
(Booth No. 411)

Trompeter Electronics, Inc.
8936 Comanche Avenue
Chatsworth, California 91311
(Booth No. 404)

U. S. Air Force

(Booth H)

U. S. Army

(Booth G)

U. S. Navy

(Booth K)

U. S. Treasury

(Booth J)

Utility Tower Co.

3200 N. W. 38th St.—P. O. Box 12027

Oklahoma City, Oklahoma 73112

(Booth No. 234)

Varian Associates

611 Hansen Way

Palo Alto, California 94303

(Booth No. 406)

Videometrics, Inc.

33 Cain Drive

Plainview, New York 11803

(Booth No. 415)

Vikoa, Inc

400 9th Street

Hoboken, New Jersey 07030

(Booth No. 316)

Visual Electronics Corp.

356 West 40th Street

New York, New York 10018

(Booth Nos. 301, 302, 303)

Vital Industries, Inc.

3614 S. W. Archer Road

Gainesville, Florida 32601

(Booth No. 202)

Ward Electronic Industries

142 Central Avenue

Clark, New Jersey 07066

(Booth No. 201)

Westbury CATV Corp.

212 South Fulton Avenue

Mount Vernon, New York 10550

(Booth No. 309A)

Wilkinson Electronics, Inc.

1937 West MacDade Boulevard

Woodlyn, Pennsylvania 19094

(Booth No. 200A)

News About the NAB

FCC Chairman To Address Convention

Chairman Rosel H. Hyde of the Federal Communications Commission will address the NAB Convention at the management luncheon on Tuesday, April 2. Mr. Hyde's acceptance of the invitation to address the meeting was announced by NAB President Vincent T. Wasilewski. Mr. Wasilewski will make his traditional Convention keynote address at the opening management luncheon on Monday, April 1.

Recipient of Distinguished Service Award Named

Lowell Thomas, internationally known news commentator, has been chosen to receive the 1968 NAB Distinguished Service Award. The Award, in recognition of Mr. Thomas' contributions to the broadcasting industry, will be presented at the opening General Assembly of the NAB 46th Annual Convention on Monday, April 1. Past recipients include the late President Herbert Hoover, comedian Bob Hope, and top station, network, and industry leaders.

Mr. Thomas has reached many millions through radio, television, motion pictures, newspapers, and lectures. He broadcast his first radio news commentary in 1930. For more than seventeen years, his was

the voice of Movietone News and of thousands of single-reel films. In addition to his early success in radio, Mr. Thomas also was a pioneer television news commentator. When television films came into use, he produced his "High Adventure" series, which has been seen in several countries.

He began his journalism career in a Colorado mining camp, where he was editor of two daily papers. Later, while studying and lecturing at three colleges, he continued as a full-time reporter. Mr. Thomas has traveled extensively during his years as a correspondent in both World Wars and while gathering material for his many adventure films.

A native of Woodington, Ohio, he has received degrees from the University of Northern Indiana, the University of Denver, and Princeton, where he also was a faculty member.

Established in 1953, the NAB Distinguished Service Award is presented to individuals who make "a significant and lasting contribution to the American system of broadcasting by virtue of singular achievement or continuing service for or in behalf of the industry in any or all phases."

Previous recipients are: Chet Huntley and David Brinkley (1967); Sol Taishoff (1966); Leonard H. Goldenson (1965); Donald

H. McGannon (1964); Bob Hope (1963); Edward R. Murrow (1962); Justin Miller (1961); Clair R. McCollough (1960); Robert W. Sarnoff (1959); Frank Stanton (1958); Herbert Hoover (1957); Robert E. Kintner (1956); Mark Ethridge (1955); William S. Paley (1954); and David Sarnoff (1953).

To Receive Engineering Achievement Award

Howard A. Chinn, director of general engineering for the CBS Television Network Engineering and Development Department, has been chosen to receive the annual NAB Engineering Achievement Award.

Mr. Chinn, a 36-year broadcast veteran, was selected for his leadership in helping to develop the new NAB Standard Loudness Reference Recording. An expert on audio volume levels, Mr. Chinn is a co-inventor of the standard volume indicator and has co-pioneered psychoacoustic studies to determine broadcast listeners' frequency-range and volume-level preference.

Mr. Chinn joined CBS in 1932, and, except for his World War II association with the Radio Research Laboratory and the U.S. Office of Scientific Research and Development, he has been employed by the network in an engineering capacity. When CBS decided to enter commercial television, its studios were designed and installed under Mr. Chinn's direction.

He received BS and MS degrees from the Massachusetts Institute of Technology and has lectured in electrical engineering at the New York University graduate school.

For his wartime activities, Mr. Chinn received the Presidential Certificate of Merit, the second highest award available to civilians.

The NAB award will be presented by George W. Bartlett, NAB vice-president for engineering, on Wednesday, April 3, at the final luncheon of the 1968 Broadcast Engineering Conference in Chicago.

Association Secretary-Treasurer Re-Elected

The NAB Board of Directors has unanimously re-elected Everett E. Revercomb to his 13th consecutive one-year term as the Association's secretary-treasurer. The election is required annually by the NAB by-laws.

Advanced Seminar Slated

The NAB Board of Directors has approved the holding of an Advanced Engineering/Management Development Seminar at Purdue University, West Lafayette, Ind., next fall. NAB previously has held three Engineering/Management Development Seminars designed to encourage and aid individual broadcast engineers in developing further their working philosophy of management. The advanced seminar next fall will be limited to those who participated in one of the last three seminars, and would continue the basic program at an advanced level.

Future Convention Dates and Sites

The NAB Board of Directors has approved the holding of the 1972 Annual Convention April 9-12 in

Chicago, and the 1973 Convention March 25-28 in Washington, D.C. Dates and sites of earlier Conventions previously approved by the Board are: 1968, March 31-April 3, Chicago; 1969, March 23-26, Washington; 1970, April 5-8, Chicago; and 1971, March 28-31, Chicago.

"New FM Horizons" Theme for FM Day

The FM Radio Committee of the NAB has set "New FM Horizons" as the theme for the special FM session at the NAB Annual Convention. The sessions will be part of the Convention FM Day on Sunday, March 31, with NAB programming the afternoon meeting and the National Association of FM Broadcasters in charge of the morning session.

Among the new horizons to be discussed will be the growing use of FM car radios, operations in both small and large markets by newer stations, and new technical developments including translators, on-channel boosters, and dual polarization.

Reports will be delivered by FM Radio Committee Chairman Harold I. Tanner, WLDM, Detroit, and by Charles M. Stone, NAB vice-president for radio.

Research Budget Approved

The Board of Directors of the NAB has approved an expenditure of \$124,000 for financing industry research during the next year. Projects will include studies of public attitudes, methodological research of audience measurements, and the

gathering of information needed to counter attempts to reallocate some of the present broadcast spectrum to business uses.

Headquarters Building Progresses

Clair R. McCollough, Chairman of the NAB Building Committee, has reported that construction on the Association's \$2,320,000 headquarters building in Washington is a week to ten days ahead of schedule. Construction is scheduled for completion on Feb. 1, 1969, with the structure ready for display to members attending the Washington Convention March 23-26 of that year.

Warns of Dangers to Broadcasting

Vincent T. Wasilewski, president of the National Association of Broadcasters, warned recently that the basic structure of communications in this country is in danger of being "torn apart" and reshaped "in an entirely different form."

Speaking before the International Radio and Television Society, Mr. Wasilewski told his fellow broadcasters that they must: "actively remind our fellow Americans of the values and contributions of the present system," "concentrate on preserving the basic structure of broadcasting," and, "accept constructive change."

An increasing pressure on spectrum space, the NAB president said, has resulted in "an alliance of interests whose power is formidable." One common issue ties this

group together, Mr. Wasilewski said. "They all are strong forces for change." Many of them, as advertisers, are "our friends," he noted. "But they are powerful, they are influential, and they cannot be underrated nor ignored," he stated.

Another pressure point, the industry spokesman noted, is the Office of Telecommunications Management—the agency in charge of the Government's use of its portion of the spectrum. This agency is sympathetic toward Government, he said, and its members have no commercial broadcasting background.

Mr. Wasilewski also called attention to efforts in Washington to establish a Department of Communications with cabinet status. Those backing this move, he said, seem to want to place the power to allocate spectrum space in the hands of the Executive Department.

Another development, which Mr. Wasilewski said in the long run would be "the most important," is the appointment by President Johnson of his Task Force on Communications. The Task Force must examine and make recommendations on: satellites, including the question of satellite-to-home broadcasting; the feasibility of a wired system of communications; the use of the spectrum and what changes might be made in that area; and the Communications Act, to determine whether that law needs basic revision and reorientation.

Mr. Wasilewski said the broadcasting industry hopes to assist the Task Force, whose report is due by next August. In turn, he said, broad-

casters want the Task Force to examine the reasons why in less than 20 years "Americans have spent \$20 billion for 120 million sets to receive free over-the-air service."

"Before broadcasting is deprived of any frequencies," the industry spokesman said, "it should be established by valid research that space presently allocated to land mobile is efficiently used" and "that the diversion will be for essential and superior purposes."

"It should also be borne in mind," he continued, "that broadcasting's future depends on spectrum space. If commercial television is to provide the specialized programming for minority tastes, if educational television is to flourish, they must have time and space in which to exist and grow."

And if the nation is wired, "... and that wire is controlled by an enormous common carrier ... what will become of local-interest programming and local public service?" he asked.

"While it is obvious that we do not intend idly to be a witness to the destruction of the present free broadcasting system," he said, "we should not always be defenders of the status quo."

"We should recognize that this industry is going to change," he said. "We should participate constructively in that change."

"The free broadcaster's effort is ... to make certain that policies are soundly based before they are adopted," Mr. Wasilewski emphasized. "Change must mold, improve, but not destroy ... free broadcasting." ▲

Guide to Downtown Chicago

Hotels and Motels

- 37. Ascot Inn
- 38. Avenue Motel
- 11. Bismarck
- 35. Conrad Hilton
- 36. Essex Inn
- 5. Executive House
- 13. LaSalle
- 18. Palmer House
- 30. Pick-Congress
- 33. Sheraton-Blackstone
- 7. Sherman House

Theaters

- 32. Blackstone
- 20. Goodman Memorial
- 22. Orchestra Hall
- 17. Schubert
- 26. Studebaker

Transportation

- Bus Stations:
 - 9. Continental Trailways
 - 8. Greyhound
- Railroad Stations:
 - 34. Dearborn Station
 - 31. Grand Central Station
 - 39. Illinois Central Station
 - 25. LaSalle Street Station
- City Parking Garages:
 - 2, 3, 6, 12, 14, 15, 29

Other Points of Interest

- 42. Adler Planetarium and Astronomical Museum
- 19. Art Institute
- 23. Board of Trade (Observation Tower)
- 28. Buckingham Fountain
- 41. Chicago Natural History Museum
- 24. DePaul University
- 4. Marina City
- 1. Navy Pier
- 10. Prudential Building (Observation Tower)
- 27. Roosevelt University
- 40. Shedd Aquarium
- 16. Visitors Bureau
- 21. United States Courthouse

The Museum of Science & Industry is at 57th Street and South Shore Drive (not shown on the map).

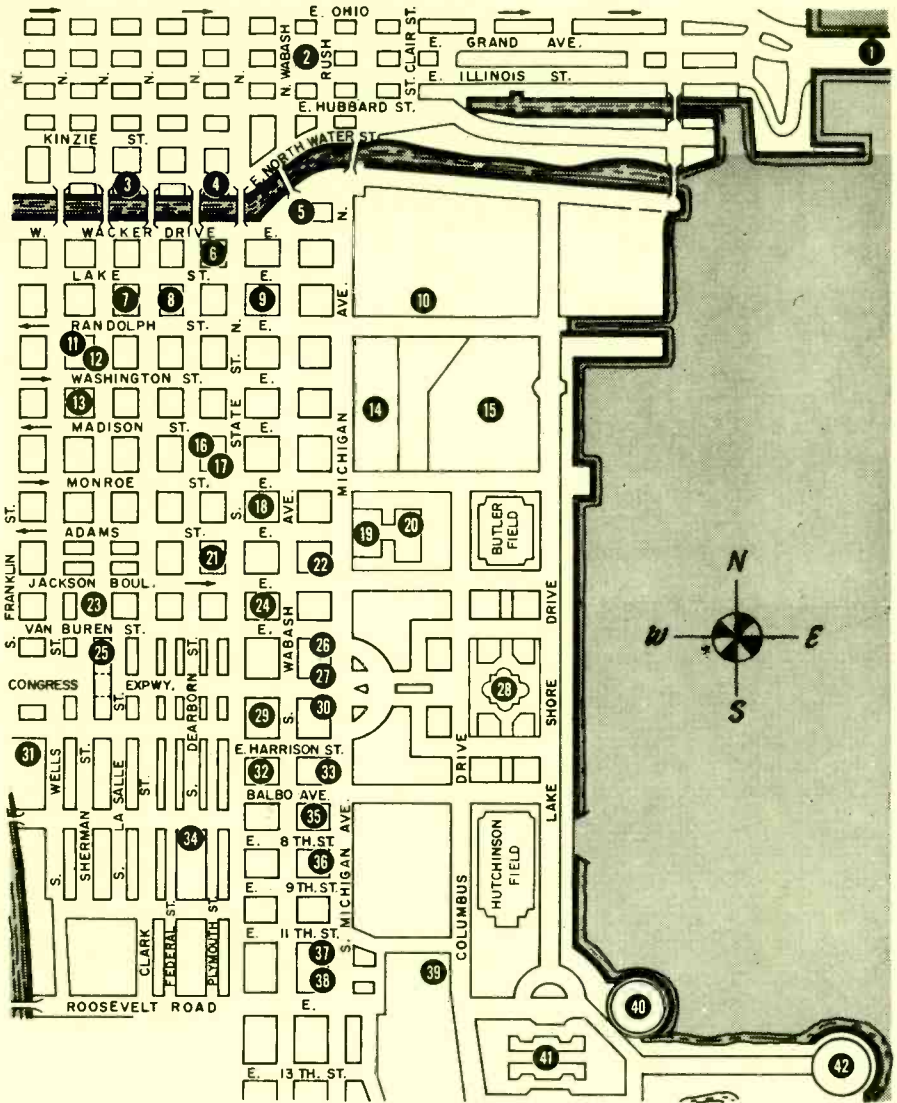

**1968 NAB
Convention
Report**



For a comprehensive
report on
what was new
at the Convention,
don't miss the May issue of

Broadcast Engineering

GROOVY!

Cohu's new TV accessory modules fit in anywhere.

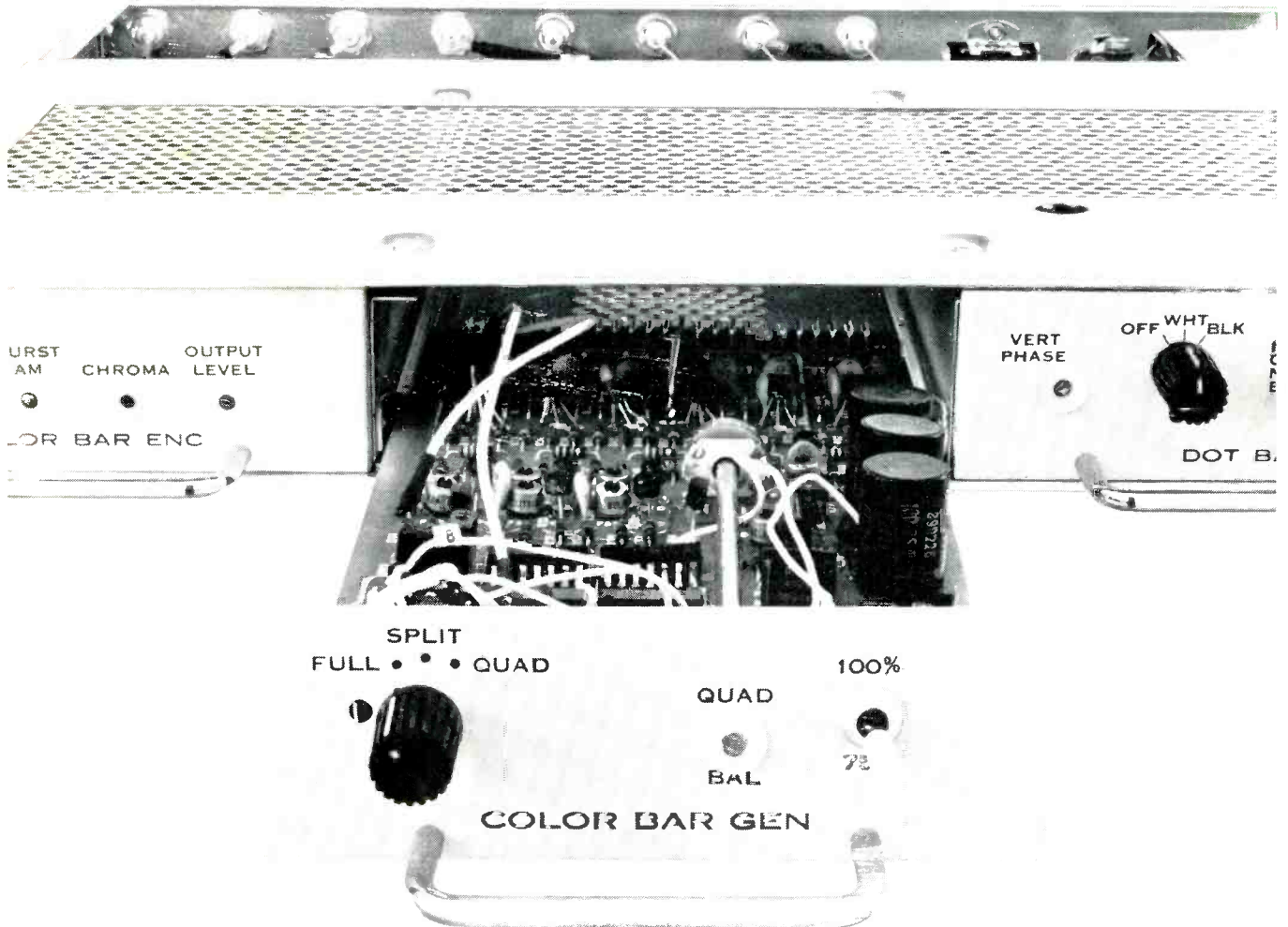

Modular construction and solid-state design provide excellent compatibility between Cohu's new 2610/2620 Accessory Series and existing broadcast equipment. Each frame occupies only 1 $\frac{3}{4}$ " of rack space, has a plug-in power supply, and is prewired for a combination of three modules. Accessories include a drive generator, colorlock, black burst generator, dot • bar • crosshatch generator, color bar generator and color bar encoder.

Also available in the 2610/2620 Series is the chroma detector, which improves the quality of monochrome transmission by automatically removing all chrominance from the encoder output during transition.

See our newest products demonstrated Continental Room—Booth 326

For specific data on each accessory, contact your local Cohu engineering representative, or call Bob Boulio direct at 714-277-6700. Box 623 • San Diego, California 92112 • TWX 910-335-1244.

ELECTRONICS, INC.
SAN DIEGO DIVISION

Circle Item 2 on Tech Data Card



the technical journal of the broadcast-communications industry

Broadcast Engineering

Volume 10, No. 3

March, 1968

CONTENTS

Features

Video Recorder Head-Tip Wear	<i>Dan Esterly and Peter Skalon</i>	10
Full-color illustrations are used to show the results of head-tip wear; causes and methods for reducing it are discussed in the text.		
Broadcast Towers and the FAA	<i>Robert A. Jones and Donald L. Markley</i>	15
Safety to life and property is one aspect of tower design that cannot be neglected		
Harmonic-Distortion Meters and Their Use	<i>Thomas R. Haskett</i>	26
To use this instrument effectively, you should understand how it is used and why it is needed.		
Digital Circuits for Broadcasters	<i>J. L. Smith</i>	29
Basic logic-circuit elements are the subject of the second article in a four-part series.		
Addendum to the 1968 Buyers' Guide		36
2500-MHz Reception and Distribution	<i>Allen Pawlowski</i>	37
Considerations in designing distribution systems for the ITFS are presented.		
Making Meter Repairs		50
Simple repairs for meters in noncritical applications are illustrated by this picture story.		
Portable Continuity and Phasing Tester	<i>A. Molchanovsky</i>	54
Construction notes are given for a compact audio testing unit for use in the field.		
Servicing Mobile Radio With a Scope	<i>Leo G. Sands</i>	59
A good oscilloscope is a useful tool in servicing mobile-radio equipment.		
1968 NAB Convention Preview Supplement		61
Introduction to FETs	<i>Thomas H. Lynch</i>	100
This useful device combines characteristics of solid-state devices and vacuum tubes.		

Departments

Engineers' Exchange	6	New Products	127
Washington Bulletin	45	Engineers' Tech Data	138
Book Review	97	Advertisers' Index	140
News of the Industry	105	Classified Ads	141

The colorful pattern on our cover shows the optics of a color TV camera in action. Color cameras will play a prominent role in the NAB Convention this month, but there will be hundreds of other things to see and hear as well. For a sample, see the preview starting on page 61. (Cover photo courtesy of General Electric Co.)



publisher
Howard W. Sams

publications director
J. J. Lieland

editor
William E. Burke

managing editor
James M. Moore

associate editor
Carl F. Moeller

regional editors
George M. Frese, Northwest
Howard T. Head, Wash., D.C.
Robert A. Jones, Midwest

research librarian
Bonny Howland

production manager
Susan M. Hayes

photography
Paul A. Cornelius, Jr.

circulation manager
Pat Osborne

advertising sales manager

Roy Henry
Howard W. Sams & Co., Inc.
4300 West 62nd St.
Indianapolis, Ind. 46206
(317) 291-3100

regional sales managers

eastern
Alfred A. Menegus
Howard W. Sams & Co., Inc.
3 West 57th St.
New York, N.Y. 10019
(212) 688-6350

southwestern
Martin Taylor
P.O. Box 22025
Houston, Tex. 77027
(713) 621-0000

advertising sales representatives

western
LOS ANGELES OFFICE
G. R. Holtz
The Maurice A. Kimball Co., Inc.
2008 West Carson St., Suites 203-204
Torrance, California 90501
(213) 320-2204

SAN FRANCISCO OFFICE
The Maurice A. Kimball Co., Inc.
580 Market St., Room 400
San Francisco, California 94104
(415) 392-3365

foreign
LONDON W.C. 2, ENGLAND
John Ashcraft, Leicester Square
Whitehall 0525

AMSTERDAM
John Ashcraft, Herengracht 365
Telefoon 24 09 08

PARIS 5, FRANCE
John Ashcraft, 9 Rue Lagrange
ODEon 20-87

TOKYO, JAPAN
International Media Representatives,
Ltd., 2-4, 6—Chrome,
Akasaka, Minatoku,
Tokyo, Japan



Copyright © 1968

by Howard W. Sams & Co., Inc.

BROADCAST ENGINEERING is published monthly by Howard W. Sams & Co., Inc., 4300 West 62nd Street, Indianapolis, Indiana 46206. SUBSCRIPTION PRICES: U.S.A. \$6.00, one year; \$10.00, two years; \$13.00, three years. Outside the U.S.A., add \$1.00 per year for postage. Single copies are 75 cents, back issues are \$1.00.

Look what your cameras can do with display units like this

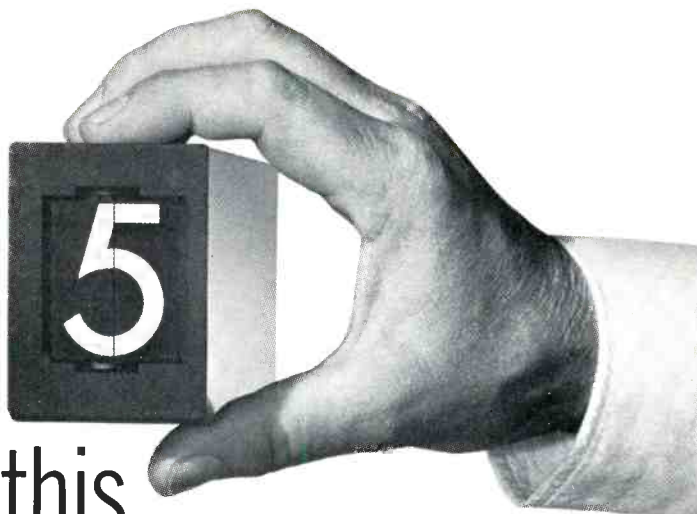

CBS Laboratories' Digital Display Units are part of a low cost, compact system that works daily wonders in any size TV studio!

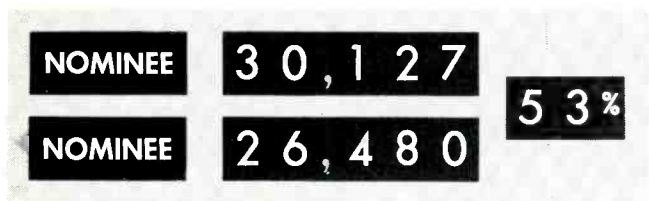

ELECTIONS - No contest.

These modular units were designed specifically for TV use to give optimum clarity up to 70 feet — from any camera angle up to 145 degrees.



WEATHER - Cool operation.

Only 2.7 watts required per unit, with no power between postings. Glare-free even under the strongest lighting conditions.

And all operated by one Controller that can handle 192 units — as many as 12 groups of 16 units each. This means up to 12 two-candidate election races; or runs, hits and errors for all major league teams; or 40 local stock issues plus volume and Dow Jones closing. A one-time investment for the professional way to take care of all your daily display needs.

Our engineers will even design your system for you. Don't take our word for it. Write or call us collect (203) 327-2000, and let us show you.

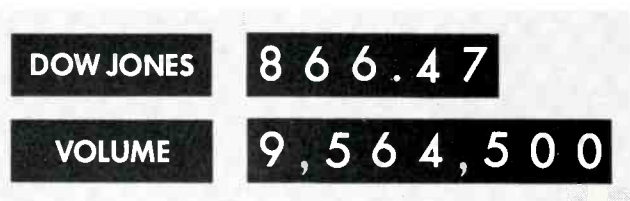

STOCK REPORTS - Excellent for the long pull.

Rugged electro-mechanical operation is fool-proof and built to last. No bulb burn-out or the other problems of rear-illuminated displays.



SPORTS - An easy set-up.

Just stack these units in a flat to suit any requirement. Custom designed matrix wiring also available for complete flexibility.

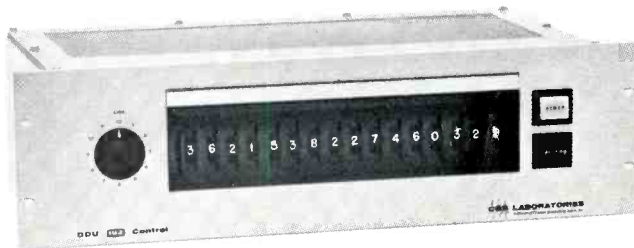

PROFESSIONAL
PRODUCTS
CBS LABORATORIES
Stamford, Connecticut. A Division of
Columbia Broadcasting System, Inc.

start with SUPER SOUNDS FAIRCHILD



New FAIRCHILD 42 input TV Network Mixer.

FAIRCHILD REVERBERATION SYSTEMS...

Now FAIRCHILD has created two electro-mechanical reverberation systems that produce a sound termed by recording studio mixers—the experts who know what they hear—as “extremely natural sound possessing the quality of good acoustical reverb chambers.” The two models differ more in their flexibility and cost rather than in reverberation effect.

MODEL 658A

The 658A is a complete solid state reverberation system with electronically controlled reverb time adjustments up to 5 seconds; mixing control for adjustment of reverberated to non-reverberated signal ratios; reverb equalization at 2, 3 and 5 KHZ. Size: 24½ x 19”



MODEL 658B

Compact, reverberation system for the ‘big’ sound in a small space. Contains reverb equalization in mid and low frequency range; level control; solid state design. Size: Only 5¼ x 3 x 10” deep.



The “sound” of the Model 658A and 658B REVERBERTRONS will satisfy the most demanding audio engineer. Their pricing and size makes them even more appealing.



FAIRCHILD CONAX

The world-accepted standard to control high frequency spillovers due to pre-emphasis. Maintain high levels even with brass and crashing cymbals in FM and recording.

Write to FAIRCHILD — the pacemaker in professional audio products — for complete details.

FAIRCHILD COMPACT COMPRESSOR MODEL 663

Allows creation of those up tight levels that contribute materially to presence and loudness combined with overload protection. The FAIRCHILD Model 663 Compact Compressor produces no distortion despite the amount of compression used... no thumps, no noise. The 663 provides adjustable release time and up to 20 db of compression. Model 663 NL comes with unity gain and additional gain if needed with +18 dbm output.



FAIRCHILD PROGRAM EQUALIZER MODEL 664NL

An ideal no loss equalizer for broadcast and recording. The FAIRCHILD Model 664NL allows the production of the “hot, solid commercial” sound standard with major recording studios; transforms any conventional console into ‘Big Board sound’. 1½” x 5¼” high unit provides equalization up to 10 db at 4, 6, 8, 10, or 15 KHZ and low end equalization up to 10 db. Rolloffs also provided. The Model 664NLB has equalization at 2, 3, 4, 5, and 7.5 KHZ for motion picture demands. The FAIRCHILD Program Equalizer contains equalization plus 18 dbm amplifier output. Put life into your sound with the FAIRCHILD Equalizer.



FAIRCHILD LIMITER MODEL 670

Fast attack Stereo Limiter (50 microseconds) with low distortion and absence of thumps. Sum and difference limiting position eliminates floating stereo image. Includes regular channel A and B limiting. Dual controls, dual meters provided. Used throughout the world. Flexible release times make it indispensable in stereo recording and broadcasting.



ENGINEERS' EXCHANGE

Gauge for Spark-Gap Settings

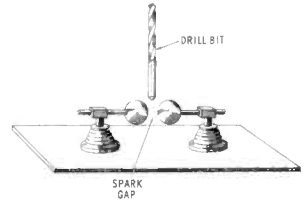

To meet the manufacturer's recommendation for initially setting spark gaps, use the shank of a drill bit of appropriate size. When the proper setting has been established for certain transformers, chokes, or lightning gaps, it is a good idea to make a record of the spacing so that it can be reset quickly after repairs or replacements have been made.

Terminals for Tight Places

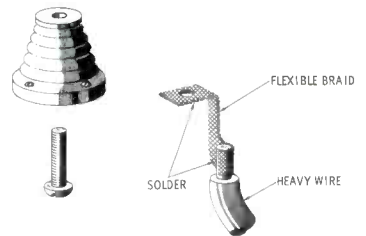

In cramped spots where ordinary terminals for heavy wires won't fit, shape a hole of the proper size in a strap of flexible braid. Tin the surfaces so they will hold the desired shape.

Mounting Heavy Chassis in Racks

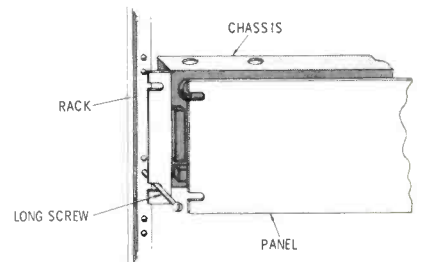

In some installations, a heavy chassis and its panel may be held in a rack by the same screws—and it's an exasperating job to get all the holes lined up. The work may be simplified by first inserting one long screw to keep the parts aligned until the regular screws are put in place.

—Items contributed by Hugh Lineback

FAIRCHILD

RECORDING EQUIPMENT CORPORATION
10-40 45th Ave., Long Island City 1, N. Y.

Circle Item 4 on Tech Data Card

audio DA

a unique, high-quality,
high-density
Audio Distribution System
— more compact, versatile
and reliable

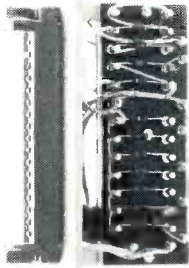

Plug-in rear assembly contains all connections and pads for matching or bridging input and (6) outputs.

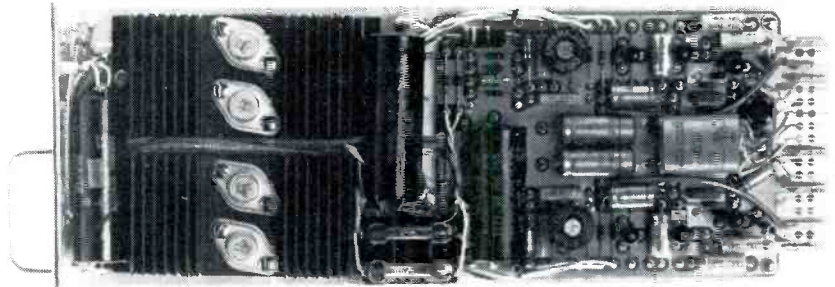

Solid-state AA-601 Audio Distribution Module provides 6 outputs at +24 dbm — 600 ohms balanced, or other combinations, as required. Modules can be added to system as requirements grow.

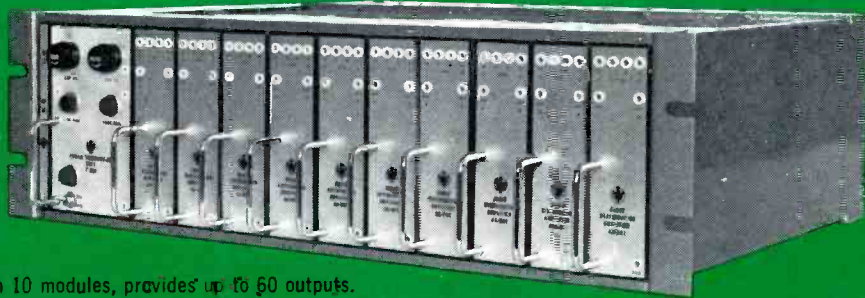

5 1/4" x 19" Frame, with 10 modules, provides up to 60 outputs.

- Most compact audio distribution system—no external pads—no output transformers.
- Easily customized for individual requirements—easily installed by merely wiring input and output lines.
- High isolation between outputs minimizes crosstalk, 60 db or better across entire audio band width.
- Response ± 0.25 db 30-15,000 cycles — less than 0.5% harmonic distortion
- Proven by continuous performance in a wide range of application in U.S. and overseas.



WARD ELECTRONIC INDUSTRIES

142 CENTRAL AVE., CLARK, NEW JERSEY 07066 • (201) 382-3700

See this, and many other new exciting Ward products at the NAB Convention

Circle Item 5 on Tech Data Card

BALL BROTHERS RESEARCH GREW UP ON SOLID STATE

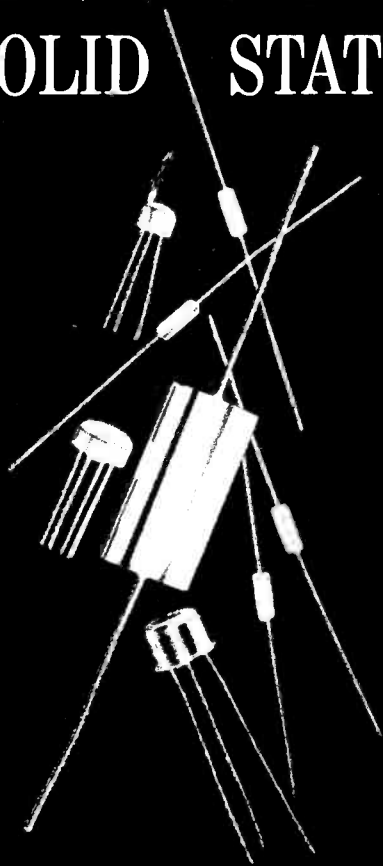

Ball Brothers Research Corporation's video technology is almost tubeless. Our Miratel Division has more solid-state picture monitor experience than any other monitor maker. Miratel has developed, manufactured and sold more solid-state monitors than anyone.

BBRC's other video products are solid-state, too.

Next time you're in the market for any of the products we make, consider buying some solid-state experience. Ours.



BALL BROTHERS RESEARCH CORPORATION • BOULDER, COLO. 80302
MIRATEL DIVISION • 3600 RICHARDSON STREET • NEW BRIGHTON • ST. PAUL, MINN. 55112

Circle Item 6 on Tech Data Card

Package deal lovers



VI 1000

In one 3½" package, "Vital" Model VI-1000 video processing amplifier performs all these functions: VTR proc. amp.; stab. amp.; AGC, APC amplifiers; clamp amplifier; sync generator; color lock; video and burst distribution amplifiers; and all the automatic safeguards against FCC violations.

FEATURES

- Extensive use of IC's.
- Complete blanking and sync regeneration including all vertical interval pulses or gated sync.
- In the absence of the input signal, internally generated sync and setup is provided.
- Auto/manual setup fully adjustable in either synchronous or non-synchronous modes.
- Original color burst or reinserted burst from local subcarrier or from highly stable phase-locked oscillator. Amplitude and phase adjustable, local or remote.
- Automatic switching between color/mono modes.
- VIT signals allowed to pass or be deleted.
- Auto/manual chroma level correction without distortion.
- Auto/manual video level control.
- Very high noise immune clamping.
- Adjustable regenerated pulse widths.
- Adjustable sync level.
- Adjustable white and black clip WITHOUT CLIPPING COLOR.
- White stretch, black stretch independently adjustable.
- Two input selector switch on front panel with 3-second fade in or out with automatic/manual bypass switch.
- Four isolated outputs: Composite or noncomposite.
- Pulse outputs: Composite sync, composite blanking, vertical drive, horizontal drive, front porch switching.
- All important functions remote controlled.

GOOD ENGINEERING IS VITAL



VITAL INDUSTRIES, INC.

3614 SOUTHWEST ARCHER ROAD
GAINESVILLE, FLORIDA 32601 - PHONE (904) 378-1581

Call or write for more information

Circle Item 7 on Tech Data Card

Video Recorder Head-Tip Wear

by Dan Esterly and Peter Skalon*

The causes of head-tip wear, how to detect it, and how to minimize it are discussed.

All magnetic recording tapes present an abrasive (oxide-coated) surface to the video head tips in the recorder or playback machine. Thus head wear begins the moment the first tape is recorded or reproduced. The rate of wear produced by undamaged tape of good quality is relatively low, but it has a finite value. Tape that has been mechanically damaged in a way that distorts its oxide-coated surface is quite another matter.

In the case of video head tips which traverse the tape at high writing speeds (e.g., 1500 inches per second), undamaged tape allows a useful head life of 100 hours or more. On the other hand, damaged tape may cause rates of wear ranging up to 400 microinches per hour, thereby reducing useful head life to only a few hours.

Evaluation of Tape Abrasion by Head Tip Coloration

Normal wear of polished head tips results in the appearance of tip coloration, which is characteristic of the brand of tape in use. The

density of the color and the area of the tip surface covered with color varies with the abrasive properties of the tape and with the time in operation. In general, when a tape produces a color on the head tips, it is safe to use. It is to be expected that one brand of tape may wipe off the color produced by another brand, before producing its own characteristic coloration on the tips.

The normal rate of head-tip wear ranges from less than six microinches per hour to 15 microinches per hour. When the wear rate is less than six microinches per hour, the color produced is most dense and covers the largest area on the tip surfaces. When the rate is between six and 15 microinches per hour, the color density will decrease or the colored area will become smaller. When the wear rate exceeds 15 microinches per hour, any color initially present on the head tips will disappear. Thus, if no coloration appears on the head tips, it may be assumed that the wear rate exceeds 15 microinches per hour.

Figs. 1 through 4 illustrate the variations in the color produced by

different brands of tape at wear rates of less than six microinches per hour. Fig. 5 illustrates the absence of head-tip coloration when the wear rate exceeds 15 microinches per hour.

Damaged Tape

Tape that has been physically damaged by creasing, crumpling, or scratching is the prime cause of the high wear rates approaching 400 microinches per hour mentioned earlier. Any sharp deformation or scratching of the oxide coating interrupts its continuity and uniformity, resulting in a cutting action somewhat akin to that of a file. (It also loosens individual particles of oxide, which may be picked up and retained by the head tips or the head drum; but more on this in a moment.) When physically damaged tape passes the head tips, the tips are scratched by this cutting action (see Fig. 6). Then, as more tape passes the scratched tips, it is damaged in turn by the milling action of the tips. For this reason, severely scratched head tips must be polished before further use.

*Engineers, Research and Advanced Technology Div., Ampex Corp.

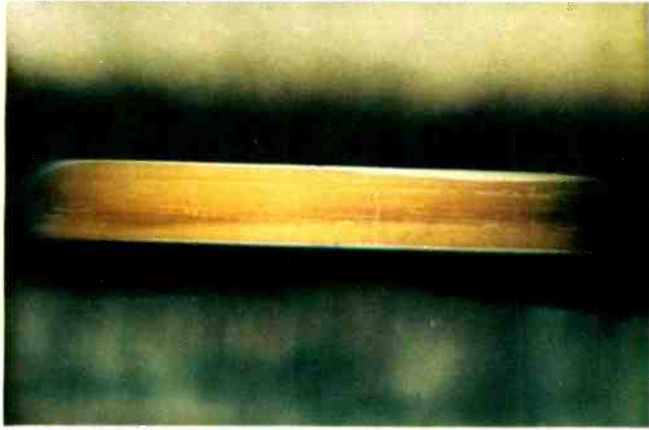

Fig. 1. Head tips exhibit a dense light-brown coloration which appears rapidly, reaches maximum density in less than 30 minutes, and covers 80 to 95% of tip surfaces.

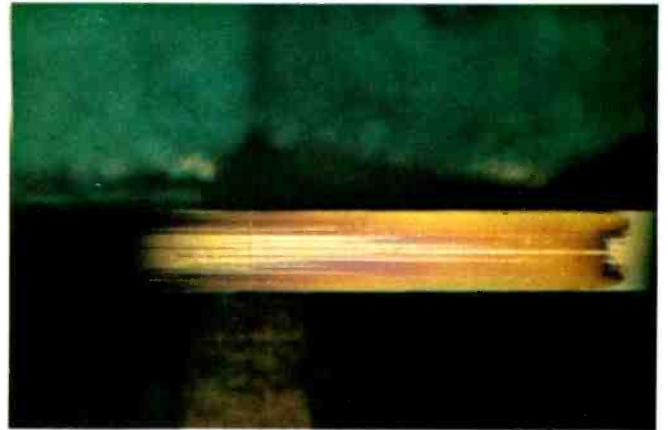

Fig. 2. Brown fringed with violet appears slowly, reaches maximum density and coverage in about 30 minutes, covers 60-90% of tip surfaces. Base-metal streaks are common.

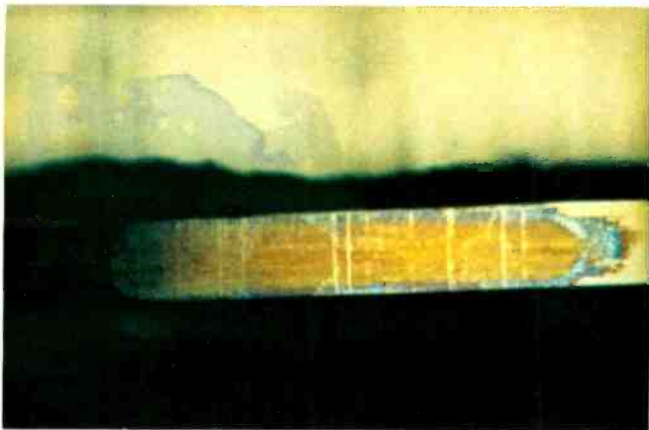

Fig. 3. Head tips exhibit golden-brown area fringed with blue. This coloration appears at the same rate and over the same percentage of the area as that shown in Fig. 2.



Fig. 4. Head tips exhibit blue-green and brown color. Coloration increases in density over 80 to 95% of the tip area. (Note appearance of Alfesil grain structure.)



Fig. 5. Wear rate high, head tips devoid of coloration.

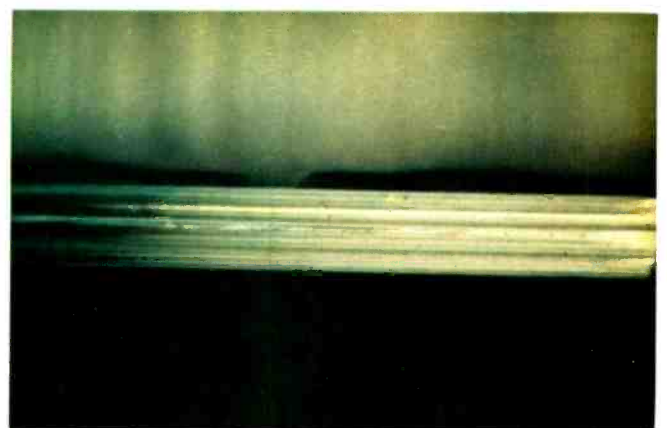

Fig. 6. Scratched head tips must be polished before use.



Fig. 7. Creases cause oxide buildup, high tip-wear rates.

Fig. 7 illustrates typical damage to tape caused by creasing or folding. When creased sections of tape pass the head tips, the rate of wear increases drastically, and loosened particles of oxide are picked up and retained by the head tips and the drum.

Fig. 8 shows the random redeposit of oxide particles near the edge of the tape. The appearance of these streaks signals the end of useful tape life, because it indicates a general breakdown of the oxide binder.

Fig. 9 illustrates a typical random crumpling of the tape from edge to edge. Crumpled tape represents the greatest danger that the head tips may encounter. There is a virtual certainty of tip damage in the form of long, deep scratches, and the subsequent damage of good tape by the damaged tips. Also, a rapid buildup of loose oxide may accumulate on the drum surfaces to aid in the destruction of the tape.

Fig. 10 shows the repeated transverse burns or scratches across the width of the tape caused by damaged head tips or by an oxide-loaded



Fig. 8. Oxide redeposits signal end of useful tape life.

head drum. The deformation of the *Mylar* backing over the same tape section is illustrated in Fig. 11.

Measurement of Wear Rates

The wear rate per hour equals the difference between the initial tip projection and the remaining tip projection, divided by the operating time in hours. If .000050 inch is worn from each tip over an operating time of two hours and 30 minutes, the wear rate is 20 microinches per hour.

Rules for Operation and Preventive Maintenance

1. Before each day of use, closely inspect all metal surfaces (including tape guides, idlers, compliance arms, head tips, and drum) that touch the oxide-coated surface of the tape for an accumulation of oxide. If any is present, remove it immediately, using a cotton-tipped swab moistened with head cleaner.

2. Be alert for sections of tape that are crumpled, creased, or scratched. These sections appear most often near the beginning of the tape, but

wherever they appear, they must be removed before the tape is used, to avoid needless head-tip damage.

3. Examine the head tips regularly by means of a tool-post-mounted microscope equipped with a diffused light source. The condition of the tapes being used may be determined by the appearance of the head tips. If severe scratches are detected, polish the tips by running the head for a short period with tape that produces a polished condition like that in Fig. 5. If any head tips are found to be broken, do not use the video-head assembly until it has been repaired or exchanged.

4. While tape is being manipulated by hand, use care to avoid situations that may lead to creasing or crumpling.

5. Remember that degradation of the reproduced picture, caused by a buildup of oxide on the head tips, is usually accompanied by a buildup of oxide on the drum surfaces as well. Make it a practice to clean the head tips and the head drum as soon as possible after such degradation first appears. ▲

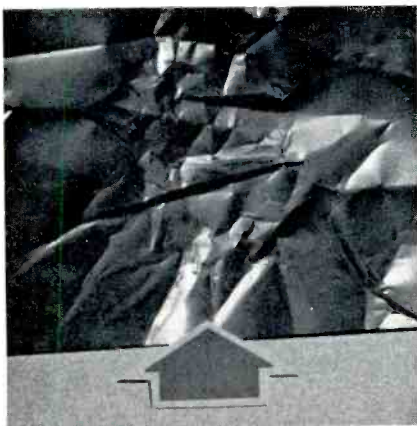

Fig. 9. Crumpled tape scratches tips, causes oxide buildup and rapid wear.

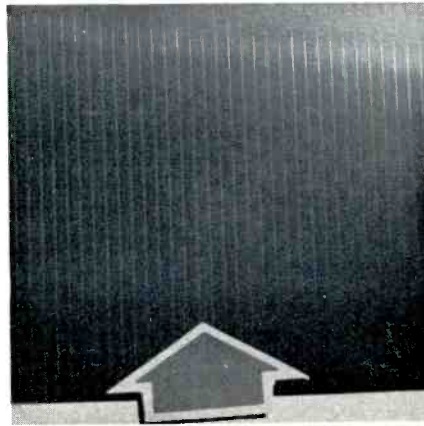

Fig. 10. Transverse burns from passing over a damaged tape cause wear.



Fig. 11. Opposite side of tape in Fig. 10; backing is permanently deformed.

You can earn more money if you get a Government FCC License

...and here's our famous **CIE Warranty** that you **will get your License** if you study with us **at home**

NOT SATISFIED with your present income? The most practical thing you can do about it is add to your Electronics know-how, pass the FCC exam and get your Government License.

The demand for licensed men is enormous. Today there are over a million licensed broadcast installations and mobile transmitters on the air, and the number is growing constantly. And according to Federal Law, no one is permitted to operate or service such equipment without a Government FCC License or without being under the direct supervision of a licensed operator.

This has resulted in a gold mine of new business for licensed service technicians. A typical mobile radio service contract pays an average of about \$100 a month. It's possible for one trained technician to maintain eight to ten such mobile systems. Some men cover as many as fifteen systems, each with perhaps a dozen units.

Opportunities in Plants

And there are other exciting opportunities in the aerospace industry, electronics manufacturing, telephone companies, and plants operated by electronic automation. Inside indus-



Matt Stuczynski, Senior Transmitter Operator, Radio Station WBOE: "I give CIE credit for my First Class Commercial FCC License. Even though I had only six weeks of high school algebra, CIE's lessons made Electronics easy. I now have a good job in studio operation, transmitting, proof of performance, equipment servicing... and am on my way up."

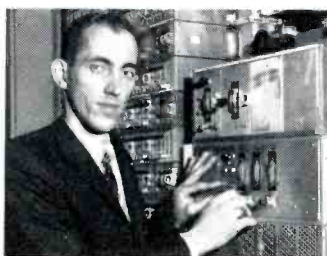

Thomas E. Miller, Jr., Engineer, Indiana Bell Telephone Company: "I completed my CIE course and passed my FCC exam while in the Navy. On my discharge, I was swamped with job offers from all over the country. My only problem was to pick the best one, and I did—engineer with Indiana Bell Telephone. CIE made the difference between just a job and a management position."

Cleveland Institute of Electronics

WARRANTY

OF SUCCESS IN OBTAINING A GOVERNMENT FCC LICENSE

A Cleveland Institute of Electronics FCC License course will quickly prepare you for a Government FCC License. If you don't pass the FCC exam after completing your course, CIE will refund all your tuition. You get an FCC License... or your money back!

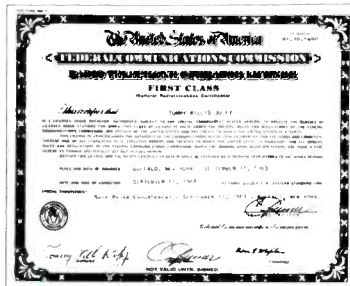

Ed Miller

trial plants like these, it's the licensed technician who is always considered first for promotion and in-plant training programs. The reason is simple. Passing the Federal Government's FCC exam and getting your License is widely accepted proof that you know the fundamentals of Electronics.

So why doesn't everybody who "tinkers" with electronic components get an FCC License and start cleaning up?

The answer: it's not that simple. The Government's licensing exam is tough. In fact, an average of two out of every three men who take the FCC exam fail.

There is one way, however, of being pretty certain that you will pass the FCC exam. That's to take one of the FCC home study courses offered by the Cleveland Institute of Electronics.

CIE courses are so effective that better than 9 out of every 10 CIE gradu-

ates who take the exam pass it. That's why we can afford to back our courses with the iron-clad Warranty shown above: you get your FCC License or your money back.

Mail Coupon for Two Free Books

Want to know more? Send the coupon below for free copies of our school catalog, "How To Succeed In Electronics," describing opportunities in Electronics, together with our special booklet, "How To Get A Commercial FCC License." If coupon has been removed, just send your name and address to us.

ENROLL UNDER NEW G.I. BILL

All CIE courses are available under the new G.I. Bill. If you served on active duty since January 31, 1955, or are in service now, check box in coupon for G.I. Bill information.

CIE Cleveland Institute of Electronics
1776 East 17th Street, Cleveland, Ohio 44114

Cleveland Institute of Electronics
1776 E. 17th St., Cleveland, Ohio 44114

Please send me without cost or obligation:

1. Your 40-page book "How To Succeed In Electronics" describing the job opportunities in Electronics today and how your courses can prepare me for them.
2. Your book "How To Get A Commercial FCC License."

Name _____ Age _____
(Please Print)

Address _____

City _____

State _____ Zip _____

Check here for G.I. Bill information
Accredited Member National Home Study Council
A Leader in Electronics Training... Since 1934
BE-45

Circle Item 8 on Tech Data Card

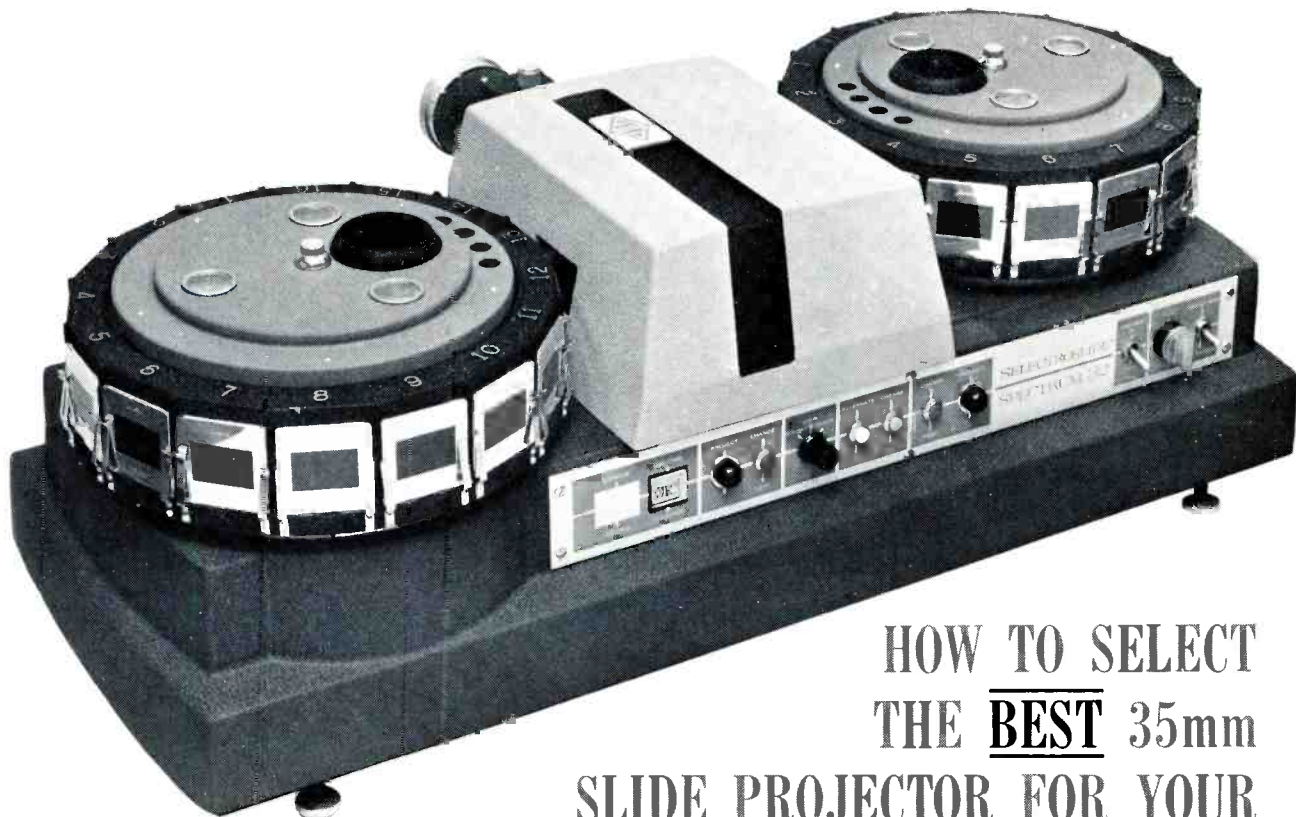

HOW TO SELECT THE BEST 35mm SLIDE PROJECTOR FOR YOUR COLOR TELEVISION BROADCAST CHAIN

Do you need 32-slide capacity, with quickly interchangeable magazines, fast cueing, and slide previewing to integrate with your film chain? YES NO

Should it be specifically designed and balanced for color television broadcasting, yet compatible with all black & white systems? YES NO

Would you favor a sliding mirror system (permanently adjusted) that eliminates motion during slide change? YES NO

Do you consider precision machined magazines and positive detent (to assure accurate registration) a plus feature? YES NO

Would fail-safe circuitry designed to prevent double cycling be of interest to your sales department? YES NO

If you could keep track of lamp-use time (lamps that last 8 times longer), and change lamps in less than 10 seconds would your management feel more at ease? YES NO

Does all solid state logic circuitry, the elimination of relays, and a built-in regulated power supply make sense? YES NO

Will modularly designed mechanical, optical, and electronic subassemblies (removable without disturbing projector alignment) simplify your maintenance program? YES NO

Would you feel guilty paying \$1000 less than the competition for all this? YES NO

Isn't it reassuring to know that the SPECTRUM 32, designed to specifications set forth by television engineers, is built by Spindler & Sauppe, the originator of slide projectors especially designed for television? YES NO

If you answer all the questions "yes," you have specified the new SPECTRUM 32 slide projector, illustrated above. If you answer all the questions "no" — GOOD LUCK! If you want to see the SPECTRUM 32 in action, stop by booth No. 327 at the NAB show.



spindler & sauppé inc.
1329 grand central
avenue / glendale
california / 91201

Broadcast Towers and the FAA

by Robert A. Jones*
and Donald L. Markley**

What do airplanes have to do with broadcast stations? Plenty, as this article shows.

When a broadcast tower of any type is planned, a study must be made to determine if navigable air space will be affected. Of course, this study must be made prior to the preparation of any necessary FCC applications, since it may reveal that the proposed tower site is unusable. While we all are aware of the necessity of such studies for the "monster" towers of 1000 feet and higher, it must be realized that under certain conditions even a 50-foot tower may be considered a hazard to air navigation. The following article is intended to explain some of these considerations and, hopefully, to show the need for cooperation between broadcasters and those engaged in aviation.

Airway Requirements

The Federal Aviation Agency (FAA) has the responsibility, among other things, of preserving as much as possible of the usable air space. This agency is justly concerned when a tower is proposed that will result in increasing the minimum en-route altitude (MEA) along any of the standard federal airways. When this minimum altitude has to be increased, more than a few feet of airspace at the tower location is lost; the airspace for the entire length of the airway is affected. For example, a typical airway extends between Chicago and Indianapolis. Assume the minimum obstruction clearance altitude (MOCA) for this airway is shown on the charts as 2100 feet above mean sea level (AMSL). The MEA would be 2500 feet, and, under the present rules, the lowest allowable altitude for instrument flight is at the next thousand-foot level, or 3000 feet. Assume also that the present MOCA is the result of a 400-foot tower. Then a new 1600-foot tower along this airway is proposed. This means the MOCA will have to be increased by 1200 feet to 3300 feet (AMSL). The MEA would increase to at least 3700 feet, and the lowest altitude then available for instrument flight on this section of the airway would be 4000 feet. While this may not appear to be a significant loss, in areas of high traffic density, such as surrounds Chicago and Indianapolis, the loss of this much usable flying room could be cause for concern. In areas having low traffic density, the FAA probably would make the change requested.

To conduct a feasibility study for a new tower structure, it is first necessary to acquaint yourself fully with Part 17 of the FCC Rules and Regulations. This part contains information regarding the various zones and requirements that must be considered, and it points out which tower proposals require an aeronautical-hazard study by the FAA. The next step should be to refer to a *current* aeronautical Sectional Chart of the area concerned. (See Fig. 1.) These charts can be obtained at most local airports, or they may be ordered from the U.S. Coast and Geodetic Survey, Department of Commerce, Washington, D. C. The Sectional Chart shows the location of all airports and airways in the area which might be affected by the proposed tower. Airways are shown as shaded lines and are identified by number in much the same way that highways are numbered on a road map. For most airways, a letter "V" precedes the number, as for example V-161. The letter signifies that this is a VHF airway; that is, its

*Consulting Engineer, LaGrange, Ill. and BE Midwest Regional Editor.
**Consulting Engineer, Mapleton, Ill.

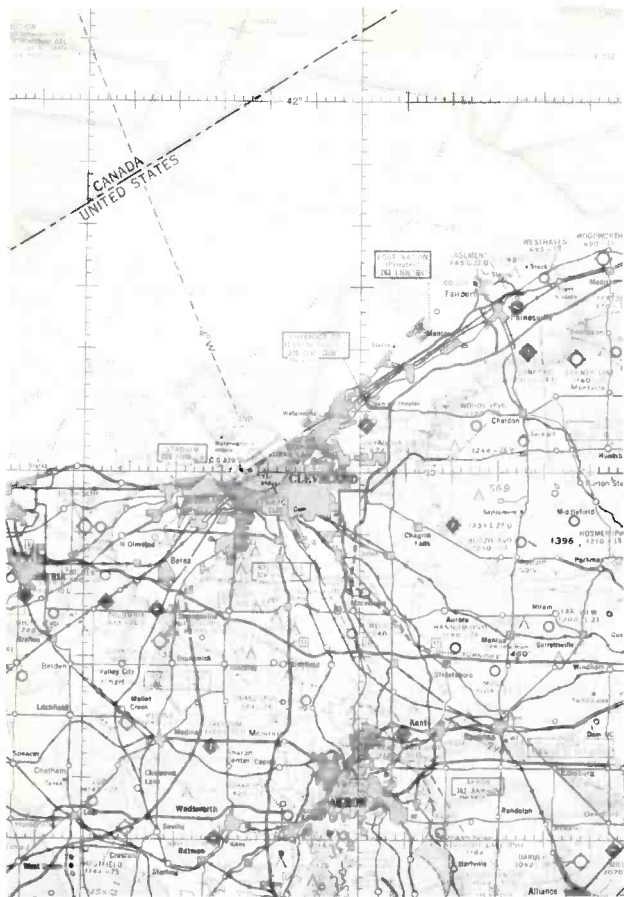

Fig. 1. Part of an aeronautical Sectional Chart is shown.

location is based on a VHF navigation facility. Some airways based on the old LF/MF radio ranges still exist, but these are becoming rare. On the charts, such airways are shaded a different color than are Victor (V) airways; standard practice at present is for the Victor airways to be shown in blue and the older LF/MF radio-range type to be shown in red.

Additional information about local airways can be found on the Low Altitude en Route Charts. The chart for a given area usually can be examined at the local airport, or it can be purchased from the U. S. Coast and Geodetic Survey. An example of this type of chart is shown in Fig. 2. These charts contain information about the MOCA and MEA for each airway. One point to keep in mind is that airways are not narrow highways through the sky. VHF airways extend four nautical miles each side of the center line, which is shown on the chart as a blue line. Thus the airway is the equivalent of about ten statute miles wide.

Airport Requirements

Broadcast towers normally are located outside, but near, the principal city to be served by the station. Unfortunately, airports for the same city are similarly located. This fact sometimes leads to conflict between airport planners and broadcasters, because the loss of usable air space in the region surrounding an airport, where aircraft are landing or departing, is a matter of great concern.

If it is proposed to construct a broadcast tower in the vicinity of an airport, more factors have to be considered. Again, the reader is urged to read FCC Part 17 and, in addition, to study Part 77 of the FAA Regulations. In these publications, several zones extending outward and upward from the end of the runway are identified. The width, slope rate, etc., of the zones depend largely on the type of airport and its radio and instrument approach facilities. These zones can be plotted on a topographic map of the area to help determine their relationship to the proposed tower site. In addition, if your local airport has instrument approach facilities (and most metropolitan airports do), you can obtain the following charts there:

1. Low Altitude Area Chart
2. Standard Instrument Departure Chart
3. Approach and Landing Chart

You can purchase these charts from the U.S. Coast and Geodetic Survey, but experience shows that it is much quicker to borrow a copy from a local source. For example, each of the pilots at a charter service will usually have a complete current set of these charts.

The local charts show the locations of the approach and departure routes and areas. They also contain information relative to the altitudes involved. You should locate the proposed broadcast tower on one of these charts and determine if any violations of navigable air space exist. If violations do exist, it may be necessary to relocate the tower or reduce its height.

VFR Requirements

In addition to the numbered federal flyways mentioned above, there are what may be called local or area VFR flyways. Most private pilots follow Visual Flight Rules (VFR), flying without the requirement of

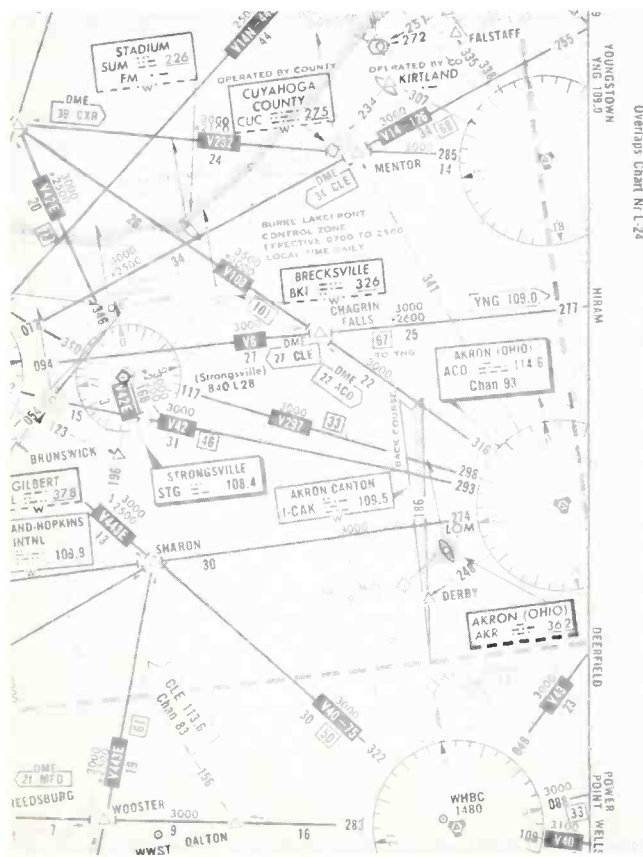
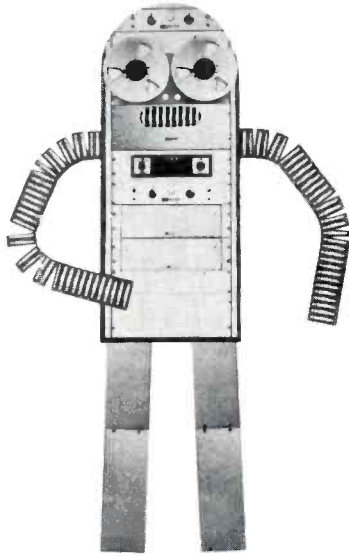

Fig. 2. Sample portion of a Low Altitude en Route Chart.

We didn't sell Perry Ury on automation.



A thing on the late, late movie did.

"We call our system 'R-KO, the shy but friendly robot,'" says Perry. "You simply tell the system what to do and when. It does it. It even logs what it has done and when."

Perry Ury has a Gates Automatic Tape Control System designed for the program requirements of WRKO-FM, a 100%-automated contemporary music station.

Yours are undoubtedly different. So Gates has a wide choice of basic automation systems, one of which can be adapted to your programming for more profitable broadcasting.

As a matter of fact, we may be able to get you fully automated for around \$65 a week. We're all experienced broadcasters so we understand budgets as well as program requirements.

The idea is worth a phone call, isn't it? Why not dial (309) 829-7006 right now? Or jot down your name, station and address on this ad and mail it to us.

*Perry S. Ury, V. P. & Gen. Mgr.,
WRKO-FM, Boston, Massachusetts*



GATES

AUTOMATIC TAPE CONTROL DIVISION
1107 East Croxton Avenue
Bloomington, Illinois 61702, U.S.A.



Circle Item 10 on Tech Data Card

Disney's Magic World of Sound... from Altec.

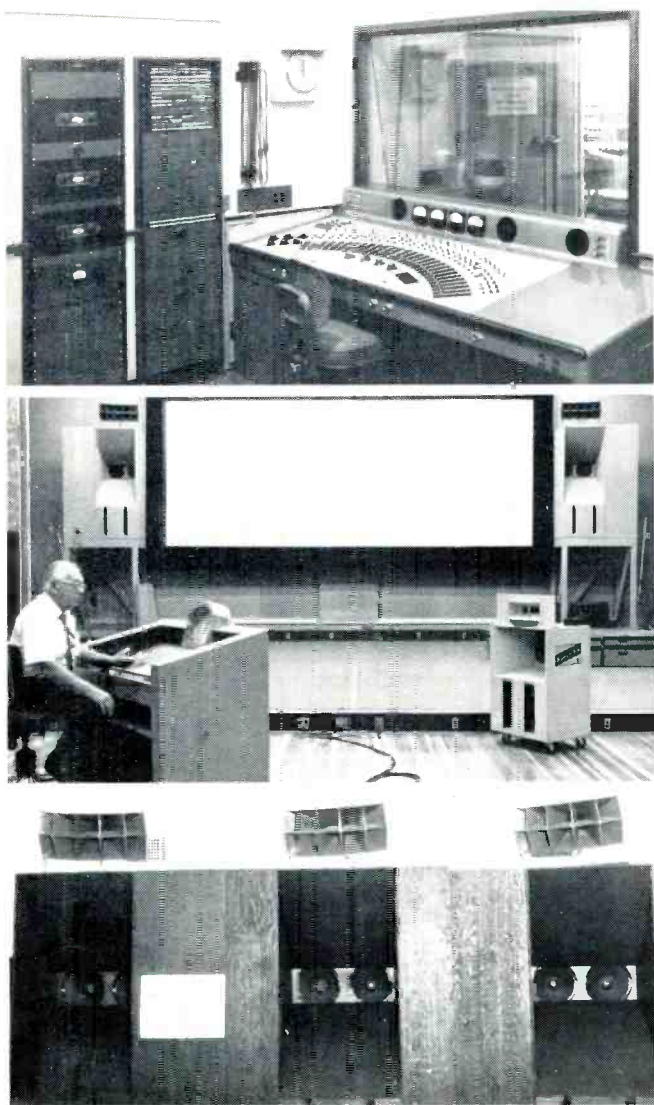

The magic that is Disney is not just a pat formula. It is a form of perfectionism that pervades everything which carries the Disney name. Certainly, there's a Disney look. But just as certainly there's a Disney sound. And that's where we come in.

For example, the new control console at the Disney Studio's orchestra stage is made up of 29 Altec slide-wire attenuators, 7 rotaries, and one 4-gang master. The works are powered by rack-mounted banks of Altec amplifiers. Monitoring in the control room is done in a big way—with three giant Altec A4 "Voice of the Theatre"® systems butted together in a single plane of the most powerful, pure sound you can get.

The stage itself uses three more A4's for monitoring, re-recording, and playback. (That's one good way to keep the musicians happy.) Eight caster-mounted A7 "Voice of the Theatre"® systems are mobile, may be moved where and as needed.

And that's not all. On the back lot Altec PA equipment provides the paging. Dialog stages at the Studios also use A4's, with Altec's space-saving 844A Monitor Speaker Systems in the compact transfer room. The list could go on, but the point is made.

So who listens when Altec Lansing sounds off at Disney? Everybody, that's who. And if you understand the remarkable expertise of Disney sound engineers, perhaps you should listen too. Let's hear from you. ALTEC LANSING, A Division of LSPV Ling Altec, Inc., Anaheim, California 92803



adhering to strict instrument or radio-range procedures. In VFR flying, pilots normally follow obvious landmarks, such as rivers, major highways, shorelines, and railroads. Because of this, the FAA and some state aeronautics commissions (for instance, the Wisconsin Aeronautics Commission) often object to any tall structures in or near these natural VFR flyways. This situation is especially true with respect to the new Interstate highways; experience indicates that one should stay at least four nautical miles either side of such routes, although other factors are involved as well.

Making Application

After the entire study has been completed and it appears that the tower will not be a serious hazard to air navigation, it is necessary to file FAA Form 117 with the regional FAA office. (The addresses of these offices are shown in Table 1.) The FAA then conducts a study of the structure and, if it deems it necessary, issues and circularizes a public notice of the investigation. All interested parties are requested to file comments and/or objections, setting forth all the reasons why approval of the application is opposed.

As the applicant, you should of course file comments, too. Do not go into the area of the wonderful public service you feel the station will furnish. The FAA ignores public service if there is a possibility that a multijet behemoth might wrap itself around a tower. Instead, explain why you feel the tower will cause no appreciable hazard to air navigation. Also, be quick to point out any existing buildings, other towers, or natural formations, such as hills or mountains, that may tend to shield the proposed tower.

If it appears that a proposed tower may cause some hazard to air navigation, a visit to the local FAA office may answer many questions before you go to the trouble of filing any applications. Remember that the FAA is simply trying to do its job and will cooperate with you to the highest degree possible.

Example Cases

In the foregoing sections, some of the FAA Regulations and their normal interpretations, as applied to broadcast-station towers, have been outlined. Now two recent cases, one an AM tower and the other a television tower, will be described to show the kind of studies normally made. It is hoped that these examples will help guide the reader in making his own tower-hazard studies. Again, the reader's attention is called to the need to become familiar with Part 17 of the FCC Regulations and Part 77 of the FAA Rules.

Radio Tower

The first case is that of an AM station, WGLC at Mendota, Illinois. Like many radio stations, WGLC operates with a nondirectional antenna. For the operating frequency of this station (1090 kHz), the desired tower height would be 199 feet. This height yields a good radiation efficiency, yet it is less than the height for which tower lights are required.

We first made a study of flyways, both IFR and VFR, from the most recent aeronautical charts of the general area around Mendota. No problems from this source were indicated in the ideal area for the transmitter site.

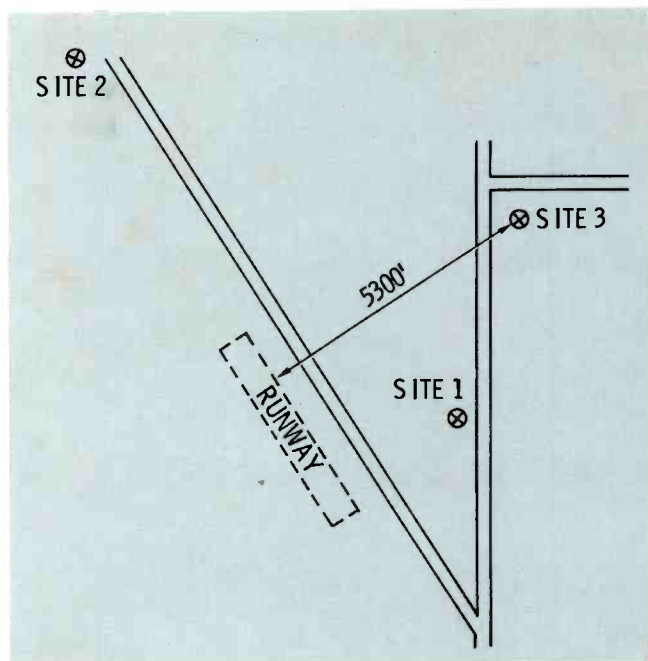

Fig. 3. Three possible sites considered for WGLC tower.

We did discover, however, that a local airport, Fitzgerald Airport, was close by. A United States Geological Survey map of Mendota and vicinity was then used for a more detailed study of the proposed site. Experience shows this kind of map is the most accurate to use for locating towers, boundaries of local airports, geographical coordinates, elevations, and other heights in the vicinity. On this work map, we marked three available sites (Fig. 3). These were based on conversations with local realtors and farmers concerning what land could be purchased. We were highly restricted in potential

Table 1. Federal Aviation Agency Regional Offices

Eastern Region	Address
Maine, N.H., Vt., Mass., R.I., Conn., N. Y., Del., N.J., Penn., Ohio, Md., Va., W.Va., Ky., D.C.	New York International Airport, Jamaica, Long Island, New York 11400
Southern Region	
Tenn., N.C., S.C., Ga., Fla., Ala., Miss., Puerto Rico, Canal Zone, Swan Island, Virgin Islands	P.O. Box 20636, Atlanta, Georgia 30320
Southwest Region	
Ark., La., Tex., Okla., N. M.	P.O. Box 1689, Fort Worth, Texas 76101
Central Region	
Mich., Ind., Wis., Ill., Minn., Mont., Iowa, Mo., N.D., S.D., Nebr., Kans.	4825 Troost Avenue, Kansas City, Missouri 64110
Western Region	
Wyo., Colo., Ariz., Utah, Idaho, Wash., Ore., Nev., Calif.	P.O. Box 90007, Airport Station, Los Angeles, California 90009
Pacific Region	
Areas contained within the Honolulu, Wake and Guam Flight Information Regions established by the International Civil Aviation Organization, and American Samoa.	P.O. Box 4009, Honolulu, Hawaii 96812
Alaskan Region	
Alaska	P.O. Box 440, Anchorage, Alaska 99501



When the record's being broken,



Permission to use the word "Olympic" granted by the U.S. Olympic Committee

the tape must not fail.

Some things don't happen twice. And if you don't record it the first time, you don't record it at all.

Take, for example, the Olympic games at Grenoble.

When a champion comes charging to the finish, he creates a dazzling moment that can never be recreated.

Except on something like tape.

Wouldn't it be a shame to miss it with tape that couldn't handle the video or the sound?

That's why we designed 78V as carefully as we did. It captures once-in-a-lifetime events the second they happen. Faithfully.

And that's why ABC chose 78V to tape the Winter Olympics at Grenoble.

78V, the high-chroma tape for critical applications. The non-fail tape.

(For information, write us: Memorex Park, Santa Clara, Calif. 95050.)

MEMOREX

sites in this general area of very productive farm land; most farmers were just not interested in parting with any acreage.

Prospective site No. 1 had to be dismissed because it was within a half mile of the airport, and definitely too close. Site No. 2, while over a mile from the closest point on the airport, would be in line with the single runway. This site obviously would be in the approach path and had to be ruled out. This left only site No. 3, also located about a mile from the airport, but in a direction at right angles to the single runway. A quick study of the topographic map indicated there was a ten-foot difference in elevation between the airport and this prospective site. This minor difference would have to be taken into consideration in making a final tower-height determination.

From the Mendota Topographic Map, the exact distance (5300 feet) and direction (25°) between the airport and the site were scaled. (These quantities were measured from the closest point on the airport boundary.) In accordance with Part 77 of the FAA Rules, the slope ratio for this distance was calculated to be 20:1. This is the ratio beyond the first 5000 feet from the airport reference point (Fig. 4). By simple mathematics it was easy to calculate that for a slope of 20:1 and a distance of 5300 feet, one could extend a tower upward to a height of 165 feet above the ground elevation of the airport. As noted above, this figure was corrected for the ten-foot difference in elevation between the site and the airport.

Thus the greatest height we could use was 155 feet, which is considerably less than the desired height. For a 199-foot tower at a right-angle direction from the runway, the site would have had to be at least 6180 feet from the airport. No land could be obtained at that distance. One or two sites farther out were available, but they were too far from the business district of Mendota. Section 73.30 must be kept in mind; after all, it would do no good to find a site acceptable to the FAA for tower heights, if it would be impossible to serve the principal city with the minimum signal required by the FCC.

After finding the maximum tower height at the No. 3 location to be 155 feet, we then checked this height for compliance with the FCC requirement for minimum radiation efficiency. For a class-II station, the required minimum effective field strength at one mile is 175 mv/m for one kilowatt (or 87.5 mv/m for 250 watts in the case of WGLC). This efficiency can be expected for an electrical height of 0.15 wavelength, or

134.6 feet at 1090 kHz. Thus our allowable height gives enough leeway for the tower pier and base insulator. Because of this height restriction, however, some top loading was added to increase the efficiency enough to be certain of compliance with the minimum FCC requirements.

As this example points out, one often has to compromise between heights desired for coverage and those that meet FAA limits for air safety.

Television Tower

The second example deals with a 917-foot television tower. Obviously, the FAA is greatly concerned with towers of such height, or greater, and their placement is very important. The best solution when locating a tower this high is to try to place it in an existing "antenna farm." Antenna farms are recognized as groups of tall towers in the same vicinity which, in effect, present just one hazard due to their proximity to each other. The addition of one new tower to an already existing group will not significantly add to the hazard, and probably would be approved. In this example, a new television tower near Evansville, Indiana was proposed. It was not possible to locate this structure near any existing towers because the FCC minimum-mileage Rules for cochannel and adjacent-channel separation prevented it.

First, it is easily recognized that no tower of this magnitude can be constructed anywhere near an airport. In general, it is best to try to maintain a distance of at least ten miles. Second, and usually more important, is the location of the tower with respect to flyways, both VFR and IFR. The proposed site is shown on the aeronautical map of Evansville and vicinity in Fig. 5. At the closest, this location is over 14 miles from the Evansville airport and over 16 miles from the Owensboro (Kentucky) airport. Also, the selected site is sufficiently far from the Ohio River, a natural VFR flyway, and as far south of Federal IFR flyway V-4 as possible. (This flyway is shown as a shaded line north of the proposed site.)

Because the tower exceeds 500 feet above ground level (AGL), the proposal is in conflict with Section 77.23(a)(1) of the FAA Standards of Part 77, Subpart C. Our initial study also indicated that it might be in conflict with Section 77.23(a)(5), which does not permit a tower to protrude within 1451 feet of an established minimum flight altitude. This requirement was not met with respect to V-4. But, there is another factor involved in this particular situation: Our study revealed

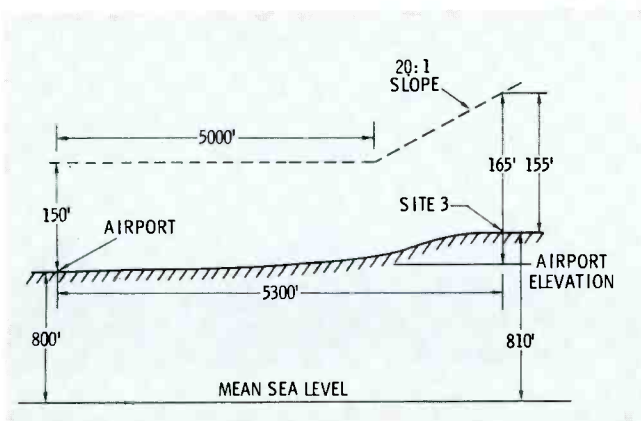

Fig. 4. Maximum height of the WGLC antenna structure was determined as shown.

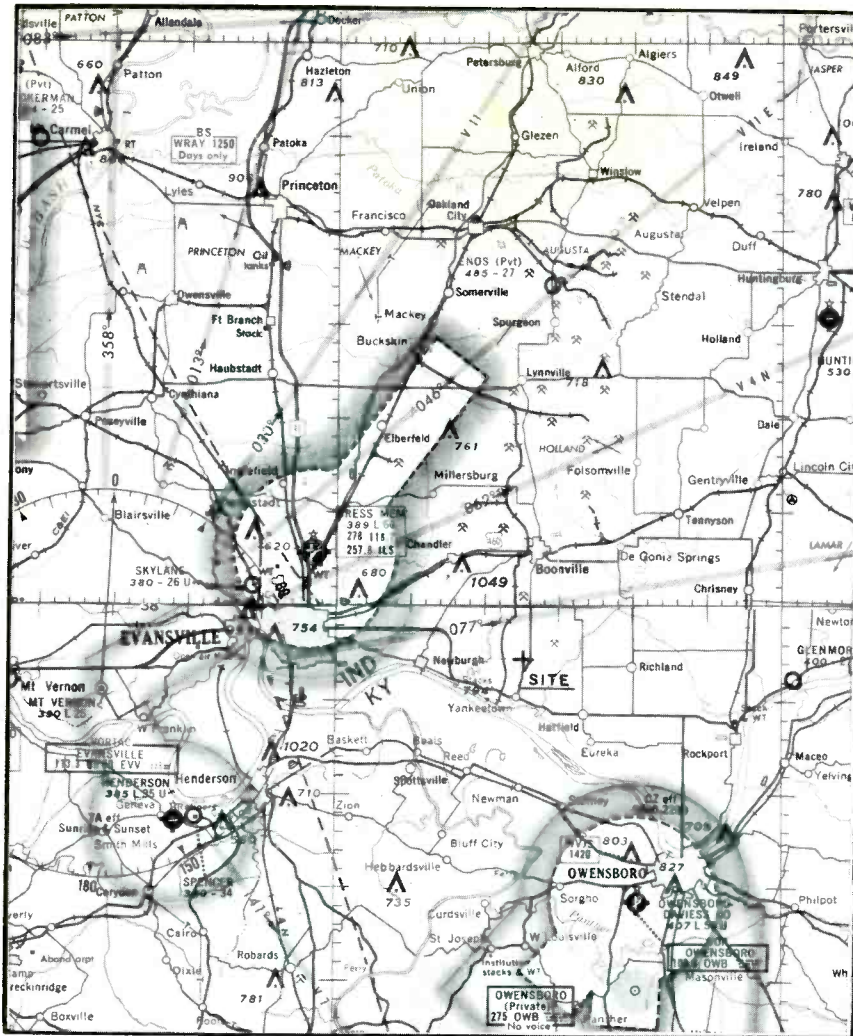

Fig. 5. Aeronautical map of Evansville area shows factors in choice of site for television tower in text example.

that another tall tower already existed a few miles to the northwest, near Chandler, also within the normal five-mile boundary of V-4. The map shows this tower to have a height of 1049 feet AMSL. This height is 380 feet less than our proposal of 1429 feet AMSL. Further study brought forth the fact that the existing tower had recently been approved for a height of 1449 feet AMSL. This height establishes the minimum flight altitude on V-4 as 2900 feet. It can be seen that our proposed tower height of just 1429 feet would not exceed the FAA requirements of Section 77.23(a)(5); in fact, we could have proposed an additional twenty feet of tower. Or, in other words, our tower height would not raise the MEA for flyway V-4.

In the example case, the FAA did circularize the proposed application, because of the above two FAA Rules. Two objections were received, and a hearing was held at the FAA office at Des Plaines, Illinois. (This is the Regional office that handles all Indiana matters.) Such proceedings are semiformal and provide the applicant and objectors with an opportunity to participate in discussing the proposal. In our case, most of the objections were directed toward the assumption that the new tower would raise the altitude of V-4 east of the Evansville VORTAC. Also, it was thought that the proposal would cause the loss of the "capital" altitude of 2000 feet AMSL. (A capital altitude is any altitude

which is a multiple of one thousand feet, e.g., 2000 feet, 3000 feet, etc.) After it was brought out that the MEA on flyway V-4 was already established at 2900 feet, all objections were withdrawn. The result of the hearing was the approval of the proposed tower.

Conclusion

While all this may sound easy, it is not necessarily so. It is very important to study the heights of all existing towers and/or other obstructions along the nearest flyway. It is also important to determine, if possible, the MEA for these nearby flyways. This will not relieve the applicant of the responsibility of filing FAA Form 117, nor the FAA from making the required study. But, it will provide a good idea of whether the proposal will be approved. It should be pointed out that MEA's are not completely rigid limits or sacred boundaries and can be changed if good cause can be shown. In and near airports, where the proposed tower would cause instrument-approach minimum altitudes to be affected, the FAA seldom yields. In general, any tower that will affect instrument approaches or other airport criteria can seldom be approved.

It is hoped that the foregoing article has served to show some of the more important criteria, and how to deal with them, in seeking FAA approval for your next tower.



see the newest

Circle Item 12 on Tech Data Card



at NAB

Harmonic-Distortion Meters and Their Use

by **Thomas R. Haskett**—Every technician who does audio maintenance must understand this instrument.

A radio broadcast transmitter is part of a chain of equipment which reproduces sound; the accuracy of reproduction depends on how well designed, constructed, and adjusted the links in this chain are. When the output differs from the input in any respect other than amplitude, distortion or noise (or both) has been introduced.

Distortion is more apparent with music than with speech, and more noticeable with a wide bandwidth than with a narrow bandwidth. In a 50-15,000 Hz system, for example, a critical listener may notice as little as 1% distortion, whereas many people only become aware of distortion at 2% or more. If the upper frequency limit is reduced to 7500 Hz, more distortion can be tolerated. When music distortion in a 50-15,000 Hz system exceeds about 3 or 4%, listener fatigue eventually sets in.

Setting up broadcast equipment for least distortion by ear is out of the question today. FCC Rules require annual proof-of-performance

measurements of audio transmitting equipment. When distortion or noise exceeds certain specified values, the station engineer must troubleshoot the equipment until the required performance is restored.

Harmonic Distortion

When FCC Rules were originally formulated, little was known about audio distortion. Today, two types of distortion are recognized—harmonic and intermodulation. When a single-frequency signal is put through an amplifier, any spurious output is harmonic distortion (or noise). But single frequencies seldom occur in normal program material, and with two or more frequencies in a signal, other effects can be observed. Like the mixer tube in a radio or TV receiver, which produces a beat, the usual audio stage produces a certain amount of beating between different frequencies. This beating is known as intermodulation distortion, or IM. Since only harmonic distortion is covered in the FCC proof-of-performance rules, the remaining discussion will

be confined to such distortion only.

There are two ways of measuring harmonic distortion. One method—used in laboratories and certain other specialized applications—is to measure the level of each harmonic by means of a wave analyzer. By far the most common method is the measurement of THD (total harmonic distortion), and this is the method usually used for broadcast purposes. The subject has been covered extensively elsewhere (1, 2).

Pertinent FCC Regulations

The Commission has established limits for harmonic distortion in studio and transmitting equipment (3). Sec. 73.40 applies to AM stations and limits distortion to 5% from 0 to 84% modulation, and to 7.5% from 85 to 95% modulation. Sections 73.317 and 73.554 apply to commercial and noncommercial FM stations, respectively, and limit distortion to 3.5% from 50 to 100 Hz, to 2.5% from 100 to 7500 Hz, and to 3.0% from

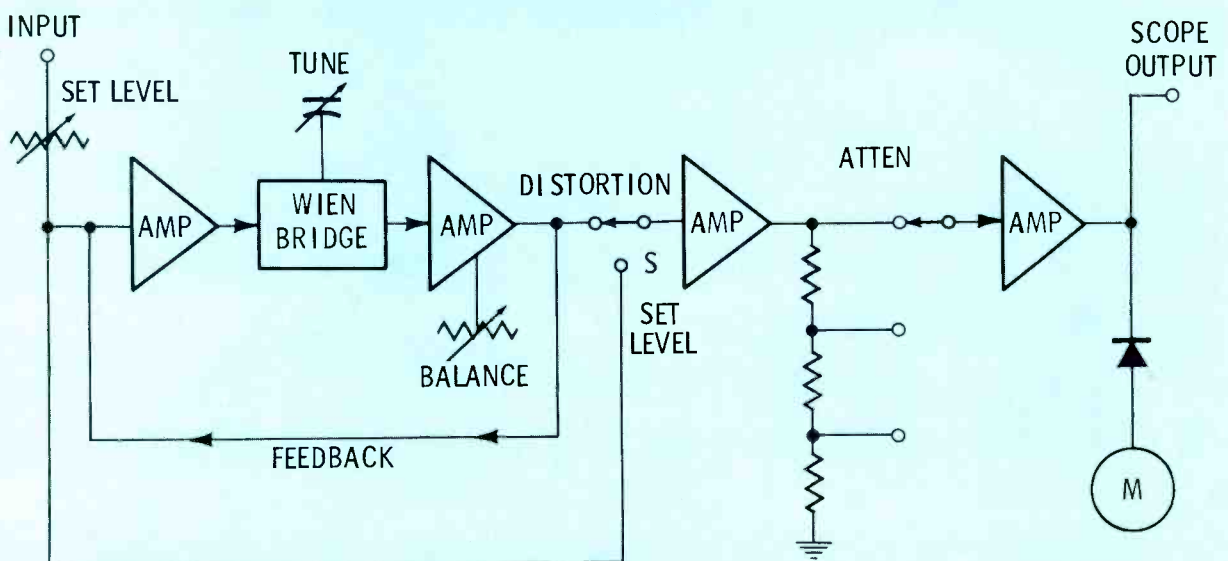

Fig. 1. Block diagram shows arrangement typically used in instruments for measurement of total harmonic distortion.

7500 to 15,000 Hz. Sec. 73.687 applies to TV stations, with the same requirements as for FM.

Sec. 73.47 (for AM stations) requires measurements to be made annually at 50, 100, 400, 1000, 5000, and 7500 Hz at 25, 50, 85, and 100% modulation. Harmonic measurements must be made up to the tenth harmonic or 16,000 Hz. Sec. 73.254 (for FM stations) requires annual measurements, including harmonics up to 30,000 Hz, at 50, 100, 400, 1000 and 5000 Hz at 25, 50, and 100% modulation, and at 10,000 and 15,000 Hz at 100% modulation.

There is no comparable requirement for annual proofing of the TV aural transmitter, but most engineers perform the measurements anyway to make sure the equipment is operating properly.

The Rules also provide for measurements of hum and noise. Limits are as follows: At AM stations, residual noise must be at least 45 dB below 100% modulation in the band 30-20,000 Hz. At FM stations, FM noise must be 60 dB below 100% modulation in the band 50-15,000 Hz. At TV stations, FM noise in the aural chain must be 55 dB below 100% modulation in the band 50-15,000 Hz. These hum and noise measurements are usually read on the HD meter. (Limits also are set for AM noise in FM and TV aural transmitters; for measurement techniques, see Reference 5, 6, 7, or 8.)

How the HD Meter Works

Total harmonic distortion is measured today by a system that has become standardized through practice. Fig. 1 is a block diagram of a hypothetical average HD meter. It is a typical circuit; some specific instruments may contain additional elements. In practice, the signal under test is fed to the input with switch S in the SET LEVEL position. The ATTEN switch is set to 100%, and the SET LEVEL control (at the input) is adjusted until the meter reads 100%. At this point, the total input to the instrument (fundamental plus any harmonics which may be present) is indicated on the meter as a reference level.

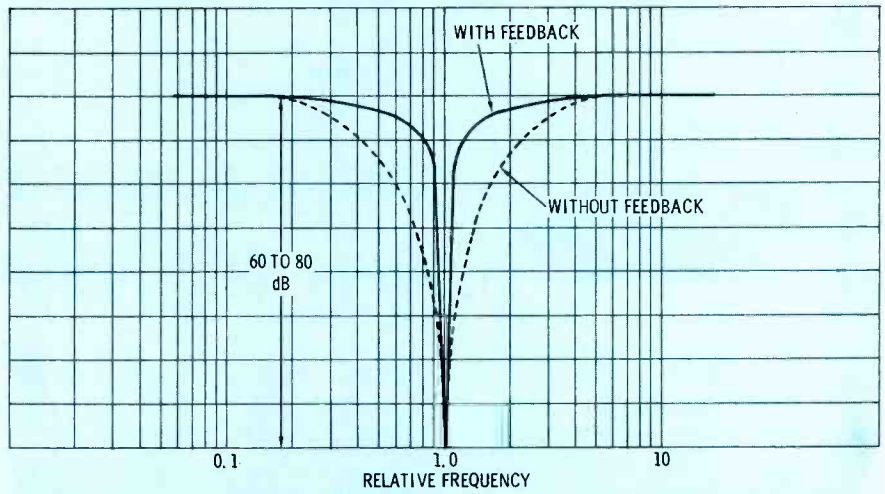

Fig. 2. Null-producing portion of HD meter produces rejection such as this.

Next S is thrown to the HD position, switching in the Wien bridge. The operator manipulates the TUNE control (a part of the bridge) and the BALANCE control (usually a part of a following amplifier) to null out the fundamental signal. With feedback, this null is quite sharp (Fig. 2). Once the fundamental has been removed, what is left is harmonic distortion and noise. The ATTEN switch is moved downrange until a meter deflection is obtained. This reading is the total harmonic distortion and noise in percentage.

To measure residual hum and noise in station equipment, the HD meter is used in the SET LEVEL position. First a reference 1000-Hz tone is fed through the system, and the meter is adjusted to this signal so that it reads 0 dB. (The meter scale is marked in % distortion, dB noise or dBm, and possibly volts and millivolts.) Then the generator feeding the 1000-Hz tone is disconnected from its power source. The HD meter is switched downrange until a reading is obtained. This reading is total hum and residual noise.

The oscilloscope output on the HD meter is usually a take-off point just before the meter rectifier. It is useful because it permits observation of the waveform being measured. The oscilloscope must have a high-impedance input (above 10K) to avoid loading the HD-meter circuit.

Some HD meters are furnished

with a three-wire AC cord and a grounding plug. When this AC ground is used, the instrument must not be grounded at the case. Alternatively, the AC ground may be eliminated and a ground at the meter input used instead. The rule is: only one ground per instrument, to avoid ground loops and spurious pickup.

Meters in Use Today

Several models of HD meters are available for broadcast-station use today. Typical specifications might include: frequency range, 20-20,000 Hz; HD accuracy, $\pm 5\%$ of full scale; lowest full-scale range, 1% (HD) and -50 dB (noise); residual HD and noise, 0.1%. Prices vary considerably, and generally the more expensive models have greater accuracy (usually far exceeding that needed for an audio proof) and permit measurements to be made more conveniently. Provided the operator knows what he is doing and knows the limitations of his equipment, most commercially available units can be used to perform satisfactory broadcast distortion measurements.

Operating Tips

Before accurate distortion measurements can be made, it is necessary to have an audio generator with low residual distortion. Generators are available—in the same price range as the HD meters—with

• Please turn to page 137.

FROM 10 W to 50 KW...



OFFERS THE COMPLETE AM-FM TRANSMITTER LINE

Complete? That's right! With sixteen different transmitters . . . from 250 W to 50 KW in AM and from 10 W to 40 KW in FM . . . AEL has the line that meets *your* broadcast requirements.

And right down the line, AEL transmitters meet your specs for down-to-earth prices and the up-to-date design features that guarantee better sound; easy, one-button operation; reliable, long-term performance; long tube life; low power consumption; and a minimum of service and maintenance.

Silicon power supplies are protected by automatic recycling, fast-operating overload relays, with added backup protection by carefully selected circuit breakers. Inexpensive tube complements. Designed for remote control operation. Running-time meters are standard.

For complete specifications on AEL's complete line of AM and FM broadcast transmitters, write today. Or call 215/822-2929.

SEE THE AEL TRANSMITTER LINE AT THE NAB SHOW—BOOTH 313 CONTINENTAL ROOM



FM TRANSMITTERS FROM 10 TO 40,000 WATTS / AM TRANSMITTERS FROM 250 TO 50,000 WATTS



American Electronic Laboratories, Inc. / BROADCAST EQUIPMENT DIVISION
RICHARDSON ROAD, COLMAR, PA. • Phone: 215/822-2929 • TWX: 510/661-4976 • Correspondence: P.O. Box 552CM, LANSDALE, PA. 19446

DIGITAL CIRCUITS FOR BROADCASTERS

by J. L. Smith*

Logic circuits are comprised of basic elements; these building blocks are described in this article.

Part 2 of four parts.

This is the second of a series of four articles being presented to provide a cursory look into the principles of digital circuits and how they may be applied to broadcast equipment. The first article provided an introduction to the subject by discussing binary states, binary numbers, and the general concept of logic circuits. This article will examine briefly the basic logic elements, *i.e.*, AND, OR, NOT, and Exclusive OR.

AND Circuit

The AND circuit, or AND gate as it is sometimes called, is in effect a special form of switch which has multiple inputs and a single out-

put. The output is at logic 1 when, and only when, *all* the inputs are at logic 1. Several ordinary switches connected in series constitute an AND gate if a closed switch is defined as logic 1. The string of switches is a closed circuit when, and only when, all the switches are closed.

A truth table is a tabular representation of the output of a logic circuit for all possible combinations of the inputs. The truth table for a three-input AND gate is shown in Fig. 1, along with schematic representations of the same circuit. Fig. 1A shows that there are eight separate combinations of the three

variables, A, B, and C, possible with a three-input gate. The number of combinations is 2^n , where n is the number of inputs. Also notice that the table starts with the binary number zero (000) and increases by adding one each time until the number seven (111) is reached. This method of generating the table insures that no combination is omitted. The output, D, is logic 1 only when all inputs are at logic 1.

Since digital equipment might employ a large number of identical AND gates, schematic diagrams are simplified by use of the symbol shown in Fig. 1B. The number of inputs may vary within limits, but there is always only one output.

*Manager, Broadcast Systems Engineering, Collins Radio Co.

AND			
A	B	C	D
0	0	0	0
0	0	1	0
0	1	0	0
0	1	1	0
1	0	0	0
1	0	1	0
1	1	0	0
1	1	1	1

(A) Truth table

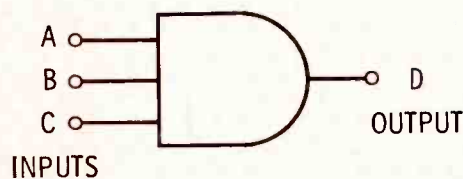

(B) AND symbol

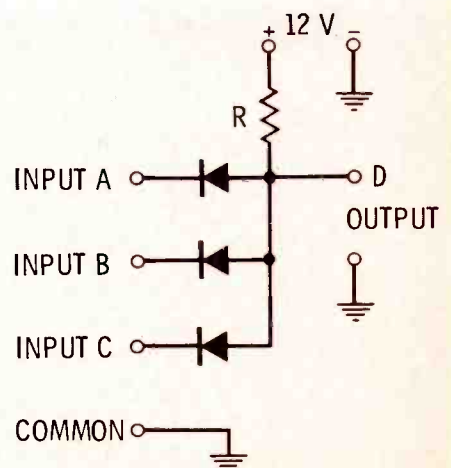

(C) Schematic

Fig. 1. Elements of AND gate are shown; circuit action is analogous to the action of switches connected in series.

OR			
A	B	C	D
0	0	0	0
0	0	1	1
0	1	0	1
0	1	1	1
1	0	0	1
1	0	1	1
1	1	0	1
1	1	1	1

(A) Truth table

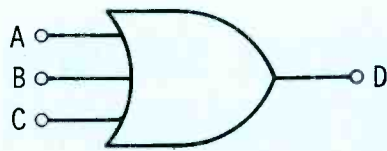

(B) OR symbol

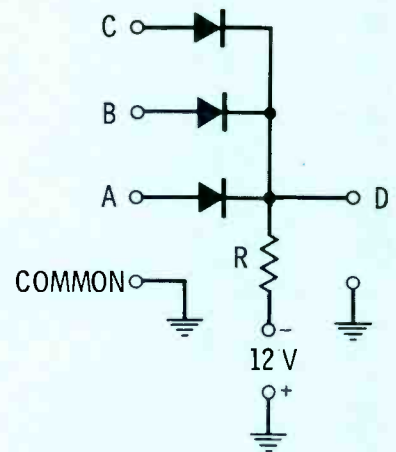

(C) Circuit

Fig. 2. Diagrams and table show elements of the OR gate; circuit behavior is similar to that of switches in parallel.

Electrically, the AND gate may be implemented by the circuit in Fig. 1C. When inputs A, B, and C are at a logic 0, they are at ground potential. Current is from the +12-volt terminal, through resistor R and the diodes, to ground. (*Editor's note: Observe the distinction here between current, which is from positive to negative, and electron flow, which is from negative to positive.*) The output is at ground potential except for the forward voltage drop across the diodes, which is perhaps on the order of 1/2 volt. If only one or two inputs are raised to logic 1 (6 volts, for example), the output cannot rise to logic 1 because the third diode is still conducting and shunts the output, thus holding it at logic 0. When all three inputs are at logic 1, the output rises to logic 1

because there is no shunting path.

Logic circuits are simplified by use of a mathematical analysis called Boolean algebra, the algebra of the two-state variable. Boolean algebra will be discussed only briefly in this series. Algebraically, the three-input AND gate is represented by

$$ABC = D$$

This representation should not be confused with algebraic multiplication, for it is not. The expression should be read as "A and B and C equals D."

The AND gate is used to perform the logic needed when it is desired to have an indication that two or more occurrences are present simultaneously. For example, the three-

input AND gate shown may be put to work by using D as the controlling signal to apply high voltage to a transmitter when: (A) the filaments are on, and (B) the blowers are running, and (C) the door interlocks are closed. If any one of these three input conditions is missing, the high voltage will not be activated.

Also, when A and B are inputs of serial binary data, then a level applied to C will serve to switch on and off the data A and B at the output. In this application, the AND circuit is used as a gate to control the function A and B, thus the name, AND gate.

OR Circuit

The OR circuit, sometimes called an OR gate, is another form of special switch which has multiple

NOT	
INPUT	OUTPUT
1	0
0	1

(A) Truth table

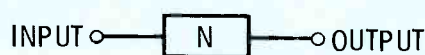

(B) NOT symbol

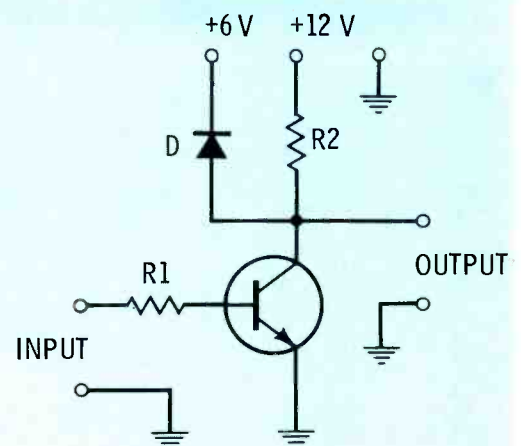

(C) Schematic

Fig. 3. Elements of the NOT circuit; circuit action produces output that is the complement of the input logic level.

inputs and a single output. The output of the OR gate is logic 1 when *any* of the multiple inputs is at logic 1. The OR gate can be visualized by considering a number of ordinary switches in parallel and defining logic 1 as a switch closure. It matters little if one or many switches are closed, the result is still a closed circuit.

The truth table describing a three-input OR gate is shown in Fig. 2A. The schematic representation is shown in Fig. 2B, and the diode logic implementing the OR is shown in Fig. 2C.

By comparing the truth tables of the AND gate and the OR gate, it is noticed that one truth table can be made identical to the other if the 1's and 0's are interchanged. (When this substitution is made in, say, the truth table in Fig. 2A, the resulting table is inverted with respect to the truth table in Fig. 1A, but otherwise identical to it.) Consequently, it is said that the OR gate is the complement of the AND gate, and a logic 1 is the complement of logic 0.

Electrically, implementation of the OR gate is similar to that of the AND gate, but it is important to note some of the complementary features in the electrical circuit. The supply voltage is negative in the OR gate, whereas it was positive in the AND gate. Also, the diode polarity is reversed. When all inputs are at logic 0 (ground potential), current is through the diodes and resistor R to the -12-volt terminal. Under this condition, output D is at logic 0. (The output is below ground potential by the forward drop across the diodes. This is part of the logic noise and is negative in this particular configuration, whereas it is positive in the AND gate.)

When any *one* of the inputs is raised above ground by applying a logic 1 (+6 volts, for example), all the other diodes are back-biased by this amount, and the output is allowed to go to logic 1.

The Boolean-algebra expression for the OR gate is written as

$$A + B + C = D$$

An additional word of caution is worthwhile here. The above expression *does not* represent the algebraic sum of the terms, but is read as "A or B or C equals D."

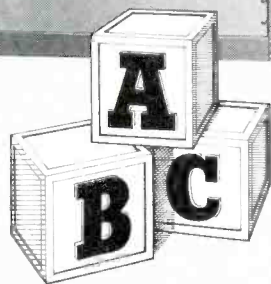
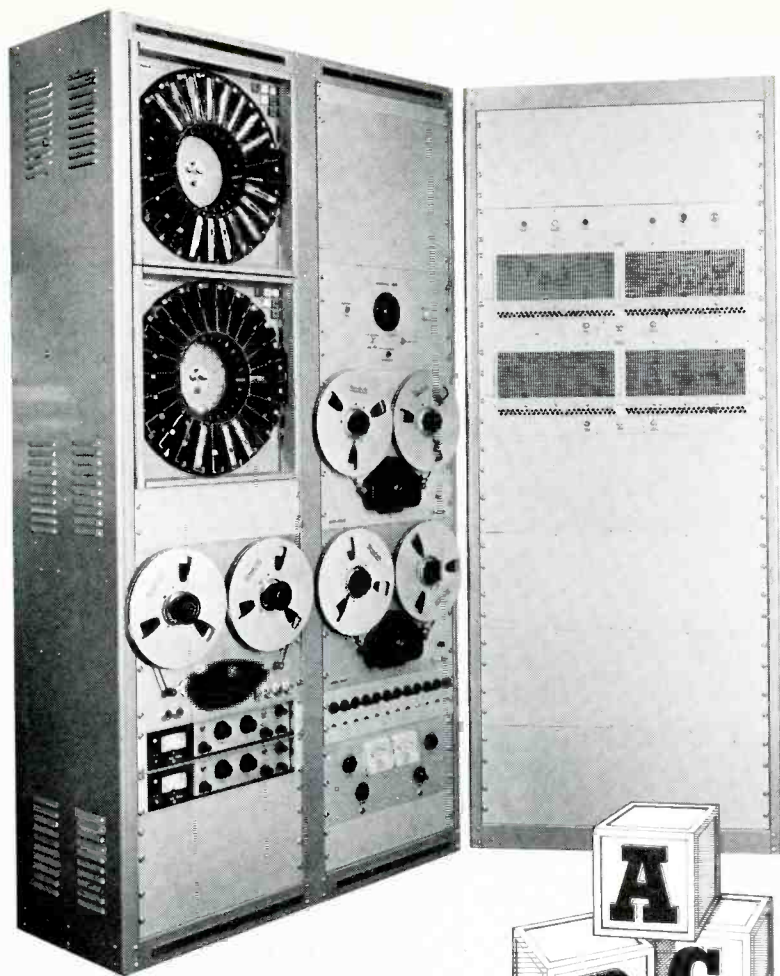

Tape-Athon reduces station automation to its simplest terms

A Simple to Adapt—“Building Block” construction of the Tape-Athon Model 5000 Automatic Broadcasting System permits initial installation of basic system to fit budget and/or station requirements. Then, system may be easily expanded to increase capacity as needs arise.

B Simple to Buy—The 5000 System is priced a comfortable margin lower than other systems, and may be purchased in “starter” and “add-on” modules to spread the investment. Prices start at \$5000.00. All specifications conform to NAB standards.

C Simple to Control—The Tape-Athon Model 5000 Automatic Broadcasting System incorporates a unique but easily operated system of switchboard and timers to pre-set programming of music, announcements, and commercials for the day, week, or even an entire month.

A NEW BROCHURE PROVIDING DETAILS AND SPECIFICATIONS ON THE 5000 IS AVAILABLE ON REQUEST.

See **TAPE-ATHON** at **NAB**

Booth 239, West Hall.

Tape-Athon

523 S. Hindry, Inglewood, Calif. 90307 • 213-678-5445

Circle Item 14 on Tech Data Card

The OR gate is used when it is desired to have an indication when any one of several occurrences takes place. The three-input OR gate may be used to let D remove high voltage from the transmitter when: (A) the cabinet temperature exceeds a high limit, or (B) the VSWR exceeds a high limit, or (C) the plate current exceeds a high limit.

NOT Circuit

A NOT circuit is a device with one input and one output. The output is always the complement (op-

posite state) of the input; that is, if the input is logic 1, the output is logic 0, and vice versa. The NOT circuit is best visualized as a phase-inverting transistor stage operating in the saturated mode. Fig. 3 presents the elements of the NOT circuit.

When a logic signal is passed through a NOT circuit, the complement of the signal appears at the output. Fig. 3C shows how this is accomplished. If logic 1 (+6 volts, for example) is applied to the input, the transistor is turned on to saturation. The collector-to-emitter resis-

tance becomes very low, and the output is at zero potential except for the saturation voltage across the transistor. Resistor R1 serves to limit the base current of the transistor, and R2 serves to limit the collector current. When the input is logic 0 (0 volts), the transistor does not conduct, the collector-to-emitter resistance is high, and the output rises. Clamp diode D prevents the output from rising above +6 volts; when the transistor is off, current flows through R2 and D to the +6-volt terminal and, in effect, the output is connected to the +6-volt supply. When the transistor is conducting, the diode is back-biased and is effectively out of the circuit. Therefore, the logic levels at the output of the NOT are the same as the levels at the input.

The Boolean-algebra expression for the output of the NOT circuit with a signal applied to the input is \bar{A} . This is read as "A complement," or simply "A bar."

The NOT is used when it is desired to perform a function with the absence of an occurrence. For example, generally speaking, a voltage level (logic 1) is required to operate a relay, turn on a light, etc. If it is desired to perform one of these operations when the control function is at ground potential (logic 0), then the control function is run through a NOT to obtain the complement level. \bar{A} is logic 1 when A is not logic 1.

The output of the NOT may be used to operate a shorting switch across the high-voltage filter capacitor when the high voltage is not turned on. If one side of an SPDT switch is designated A, then the other side is automatically \bar{A} because when one side is open, the other is closed and vice versa.

Exclusive OR Circuit

The Exclusive OR circuit is a special form of the OR gate and is made up of a combination of OR gates and NOT circuits. The Exclusive OR has two inputs and one output. The output is logic 1 when either (but not both) of the inputs is logic 1; it is logic 0 when both of the inputs are logic 1 or logic 0. Fig. 4A demonstrates the usefulness of the truth table by clearly showing the logic of the Exclusive OR.

The implementation of the Ex-

• Please turn to page 115.

NOW TELE-PAT IV

is the ONLY TEST PATTERN ILLUMINATOR for
100% TV COLOR or MONO-CHROME CAMERA
SET-UP/PERFORMANCE CONTROL

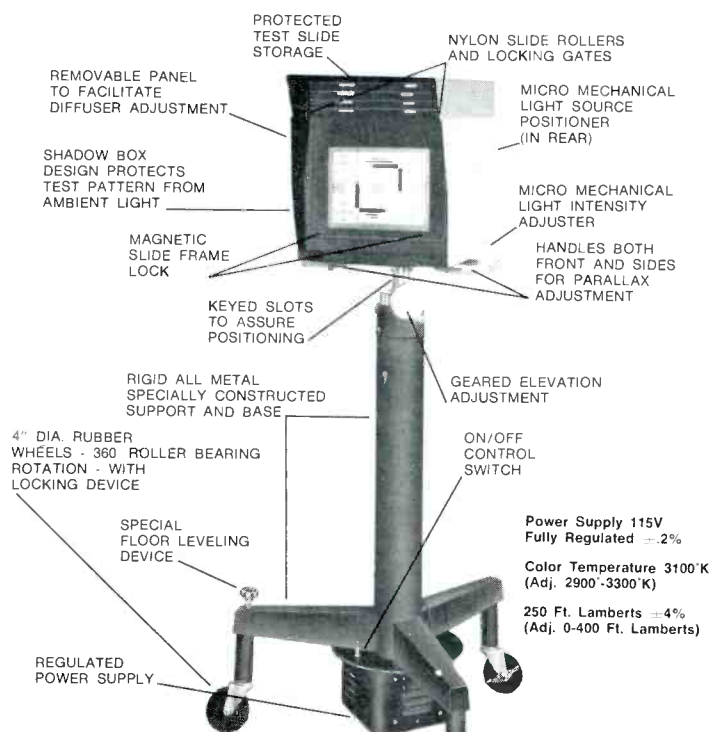

NETWORK APPROVED

TELE-MEASUREMENTS, INC.

145 MAIN AVENUE, CLIFTON, NEW JERSEY 07014

PHONE: (201) 473-8822; (212) 581-9020

Providing the only complete line of precision test slides and illuminators for color and mono-chrome cameras. Send for catalog listing 8" x 10" and 2" x 2" test pattern slides available.



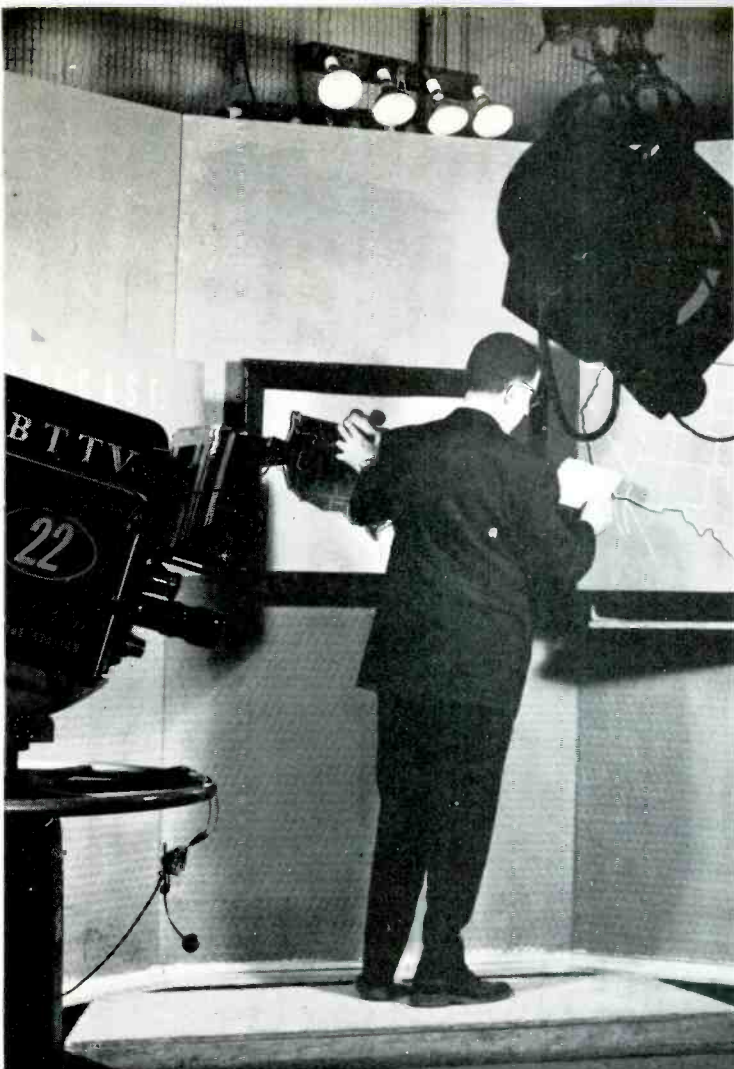

The Year-'Round Lavalier

E-V Around most TV stations, E-V lavaliers are taken pretty much for granted. Just hang one around your neck, or clip it onto lapel or pocket—and start talking.

Nothing could make us happier. Because we take great pains to insure the absolute reliability of these tiny microphones. And frankly, no other type of microphone poses a bigger design problem. The lavalier gets dropped, stepped on, swung by its cord, smashed and banged—not once, but often during its life. Most of the abuse is accidental—but inevitable.

So we developed a "nesting" principle of construction that is based on tolerances so tight that the internal element acts as a solid mass, reducing damage due to shock. And we use nothing but Acoustalloy® diaphragms... almost indestructible despite heat, humidity, dirt, or high intensity noise or shock.

We've also spent years developing cable specifications—and methods for attaching it. We've taken into account all the tugs and twists that are the fate of any lavalier cable. That's why our strain relief is so effective. And knowing that no cable can last forever, we've made replacement easy and fast.

Of course reliability by itself is not enough. So our field testing of E-V lavaliers is also devoted to sound quality. We must satisfy major network and independent stations on every score. As a result, E-V lavaliers can be mixed in the same program with stand microphones with no change in voice quality.

In the process of developing the lavalier, we've also made it smaller. Our original model was 7" long and 1" in diameter. Today's Model 649B is just 2-1/4" long, 3/4" in diameter, and weighs a mere 31 grams!

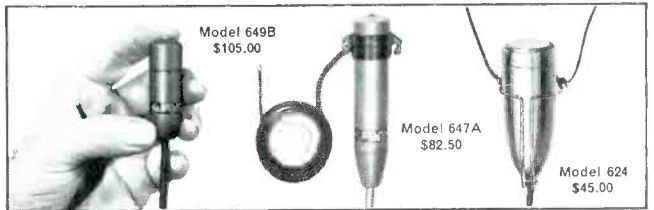

Normal trade discounts apply to list prices shown.

Of course TV studios aren't the only places you'll find E-V lavaliers. They're used in classrooms, lecture halls, conferences, stages and business meetings. And they offer the same year-round reliability with no compromise of sound quality.

Every E-V professional lavalier is protected by our unique 2-year unconditional warranty against failure of any kind, plus the lifetime guarantee of workmanship and materials that is an integral part of every E-V microphone. Full details are waiting at your nearby Electro-Voice microphone headquarters. Or write us about your special needs. We're ready to solve the toughest sound problems—off the shelf—all year 'round!

high fidelity systems and speakers • tuners, amplifiers, receivers
 • public address loudspeakers • microphones • phono needles
 and cartridges • organs • space and defense electronics



ELECTRO-VOICE, INC., Dept. 381V
 638 Cecil Street, Buchanan, Michigan 49107

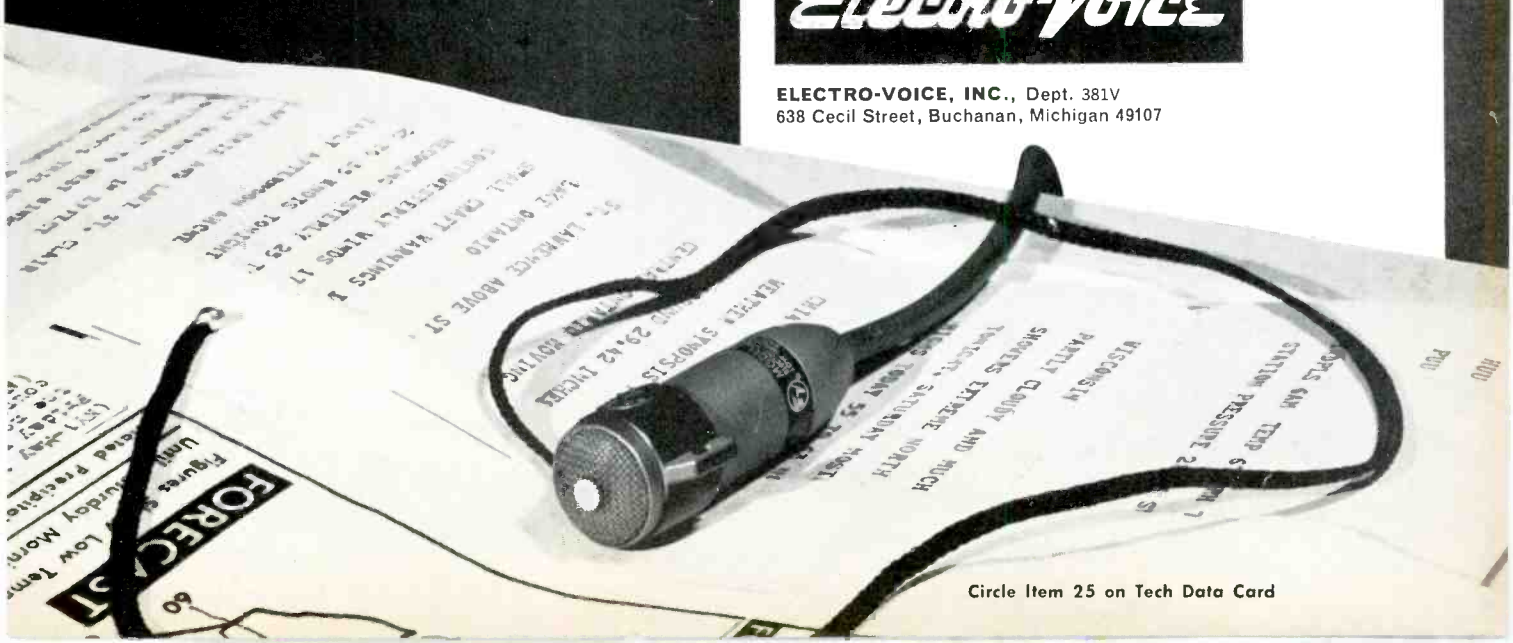

Circle Item 25 on Tech Data Card

VISUAL

Your Major
Source for
Advanced
Equipment

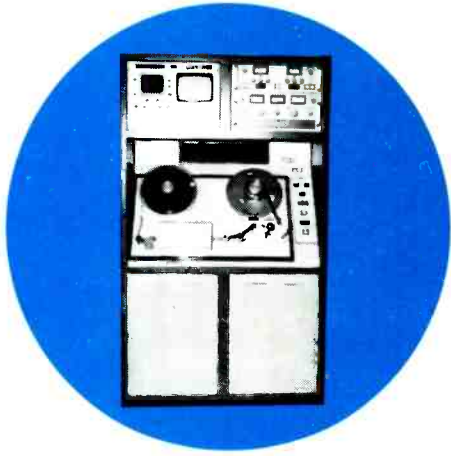

VA/50 HIGH BAND COLOR VTR

... brings new meaning to the blue ribbon line

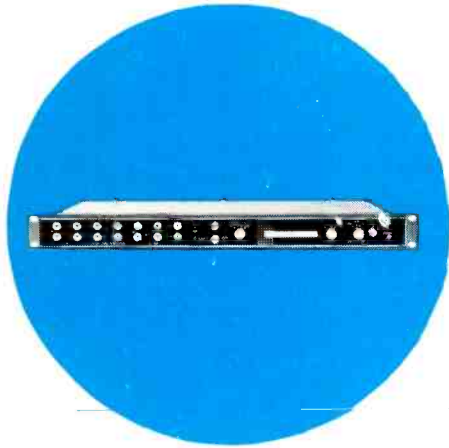

DIGITAL SYNC GENERATOR



VISUAL INFORMATION SYSTEMS



COLOR VIDEO DISC RECORDER

Advanced equipment and new techniques provide greater customer benefits. That's the key to these superior products from Visual Electronics Corporation. State-of-the-art electronics help assure absolute top performance with greater simplicity. Incorporation of integrated circuitry, new components and new techniques not previously available give Visual's advanced equipment that extra edge in reliability and economy.

Bringing advanced engineering concepts to practical reality are these latest additions to the Blue Ribbon Line, shown above. These include Visual's: *Color Video Disc Recorder*, for full-color slow motion and stop-action playback; *Digital Sync Generator*, the first to bring digital techniques to color sync; *Model 990 Display Control Unit*, affording instantaneous digital-to-video character conversion; and *High Band Color VTR's*, the complete line of precision video tape recording equipment . . . plus many more products to follow.



VISUAL ELECTRONICS CORPORATION

356 west 40th street • new york, n.y. 10018 • (212) 736-5840

THE MAJOR SOURCE FOR ADVANCED EQUIPMENT

Addendum to the 1968 BUYERS' GUIDE

The following listings constitute additions and corrections to the Buyers' Guide in the January issue.

BELDEN MANUFACTURING COMPANY

(312) 389-1000
TWX 910 221-5620
LEADS, TEST
WIRE & CABLING SERVICES

EMI ELECTRONICS LIMITED

SALES MANAGER
S. V. TUFF
COMPANY ADDRESS
HAYES, MIDDLESEX, ENGLAND
01-573-3888
TWX LONDON 22417
AMPLIFIER, CATV
AMPLIFIER, CLAMPING
AMPLIFIER, DISTRIBUTION
AMPLIFIER, PULSE
AMPLIFIER, STABILIZING
AMPLIFIER, VIDEO, SWEEP
ANTENNAS, TV
BROADCAST PROGRAMMING
SERVICE, CATV
BROADCAST PROGRAMMING
SERVICE, RADIO
BROADCAST PROGRAMMING
SERVICE, VIDEO
CAMERA, REMOTE CONTROL
EQUIPMENT
CAMERAS, TV, COLOR
CAMERAS, TV, MONOCHROME
CATV, CHANNEL AMPLIFIERS
CATV, HEAD END EQUIPMENT
COILS, ANTENNA LOADING
COMMUNICATIONS SYSTEMS,
INTERCOM, WIRED
CONSOLE, AUDIO, AM
CONSOLE, AUDIO, RECORDING
CONSOLE, AUDIO, TV
CONSOLE, VIDEO, STUDIO
DEMODULATORS
DIALS, TELEPHONE
DUMMY LOAD
GENERATORS, SIGNAL, DOT BAR
GENERATORS, SIGNAL, SQUARE WAVE

HARDWARE, ELECTRIC MOTORS,
FRACTIONAL HP
INDUSTRIAL TV
MOBILE EQUIPMENT, TV
MONITORS, VIDEO
POTENTIOMETERS, CARBON
POTENTIOMETERS, WIREWOUND
RECORDERS, MAGNETIC TAPE, AUDIO
SWITCHES, MULTICONTACT
SWITCHES, PUSHBUTTON
SWITCHES, ROTARY
SWITCHES, SLIDE
TAPE, MAGNETIC RECORDING, TEST
TELEPHONE EQUIPMENT
TRANSFORMERS, GENERAL
TV SYSTEMS, CLOSED CIRCUIT
VACUUM TUBES, CAMERA,
IMAGE-ORTHICON
VACUUM TUBES, CAMERA,
VIDICON
VACUUM TUBES, CATHODE RAY,
OSCILLOSCOPE
VACUUM TUBES, CATHODE RAY,
TV, MONOCHROME

ERCONA CORPORATION

SALES MANAGER
MELVIN KANDELL
COMPANY ADDRESS
432 PARK AVE.
NEW YORK, N. Y. 10016
(212) LE2-6560
CONNECTORS, ANTENNA
CONNECTORS, COAXIAL CABLE
DEMAGNETIZERS, HEAD
EARPHONES, HEADPHONES
ENCLOSURES, SPEAKER
FUSES
HEADS, ERASE, MAGNETIC
HEADS, RECORDING MAGNETIC
HOLDERS, FUSE
LENSES, OPTICAL FIXED
MICROPHONES, CONDENSER
MICROPHONES, DYNAMIC
MICROPHONE STANDS & BOOMS

MICROPHONES, WIRELESS
PLUGS, COAXIAL
PLUGS, PHONE
SPEAKERS
SPLICERS, MAGNETIC TAPE & FILM
STYLII, PLAYBACK
TERMINAL BLOCKS
TERMINALS, SOLDER
TERMINALS, SOLDERLESS
TV SYSTEMS, CLOSED CIRCUIT
VACUUM TUBES, RECEIVING

MICRO COMMUNICATIONS, INC.

COMPANY ADDRESS
GRENIER FIELD
MANCHESTER, N. H. 03103
(603) 624-4351
ANTENNAS, HF
ANTENNAS, 2500 MHZ
BALUNS
CABLE, COAXIAL, RIGID
DIVIDERS, POWER
FILTERS, ANTENNA
FILTERS, RF
MICROWAVE COMPONENTS
SWITCHES, COAXIAL

PHILIPS BROADCAST EQUIPMENT CORP.

DIRECTOR OF MARKETING
ANTHONY R. PIGNONI
GENERAL SALES MANAGER
A. JACOBOWITZ
COMPANY ADDRESS
299 ROUTE 17
PARAMUS, NEW JERSEY 07652
(201) 262-7300
TWX 710-990-4955
AMPLIFIER, AF, COMPRESSING
AMPLIFIER, AF, GENERAL PURPOSE
AMPLIFIER, AF, MONAURAL
AMPLIFIER, AF, PEAK LIMITING, AM
AMPLIFIER, AF, PEAK LIMITING, FM
AMPLIFIER, AF, REVERBERATION
AMPLIFIER, TV, VIDEO

CAMERAS, FILM, CINE
CAMERAS, TV, COLOR
CAMERAS, TV, MONOCHROME
COMMUNICATIONS SYSTEMS,
INTERCOM, WIRED
CONSOLE, AUDIO, AM
CONSOLE, AUDIO, FM
CONSOLE, AUDIO, PORTABLE
CONSOLE, AUDIO, RECORDING
CONSOLE, AUDIO, TV
INDUSTRIAL TV—ALSO SEE TV,
CLOSED CIRCUIT
MICROPHONE HARDWARE
MICROPHONES, CONDENSER
MICROPHONES, DYNAMIC
MICROPHONE STANDS & BOOMS
MIXERS—SEE CONSOLES
MOBILE EQUIPMENT, TV
MONITORS, VIDEO
MONITORS, WAVEFORM
PREAMPLIFIERS, AUDIO
PREAMPLIFIERS, VIDEO
PROJECTORS, FILM
PROJECTORS, TV, LARGE SCREEN
RECORDERS, MAGNETIC TAPE, AUDIO
RECORDERS, MAGNETIC TAPE,
AUDIO, CARTRIDGE
RECORDERS, MAGNETIC TAPE, LOGGING
RECORDERS, MAGNETIC TAPE, VIDEO
SERVICES, INSTALLATION
SOUND SYSTEMS, OUTDOOR
SOUND SYSTEMS, PORTABLE
SOUND SYSTEMS, THEATER
SPEAKER COMPONENTS
SPEAKERS
SWITCHING SYSTEMS
TAPE ACCESSORIES
TAPE DECKS, MAGNETIC
TAPE, MAGNETIC RECORDING, AUDIO
TAPE, MAGNETIC RECORDING,
AUDIO, CARTRIDGE
TRANSMITTERS, TV, 12 KW
TRANSMITTERS, TV, 25 KW
TRANSMITTERS, TV, 35 KW
TRANSMITTERS, TV, 55 KW
TV SYSTEMS, CLOSED CIRCUIT

WOULD YOU BELIEVE

A PERFECT MONITORING SYSTEM? ... BELAR HAS IT!

- | | |
|--|--------------|
| Totally integrated, solid state design | BELAR HAS IT |
| Functional design for ease in
proof-of-performance measurements | BELAR HAS IT |
| Accurate modulation metering of
complex program material | BELAR HAS IT |
| Automatic Pilot Frequency Meter | BELAR HAS IT |
| SCA Frequency Meter | BELAR HAS IT |
| Pilot Phase Discriminator | BELAR HAS IT |
| Built-in Incidental AM Meter | BELAR HAS IT |
| Front Panel Modulation Calibrator | BELAR HAS IT |

ONLY BELAR OFFERS ALL THIS AND MORE

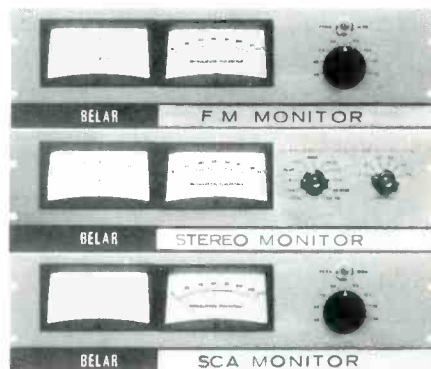

IT'S TIME TO BUY BELAR . . . OUR PROMISE IS PERFORMANCE
Seeing is believing. See us at the NAB Show in Chicago—booth 204.



BELAR ELECTRONICS LABORATORY, INC.
DELAWARE AND MONTROSE AVENUES, UPPER DARBY, PA. 19084 • BOX 83

2500-MHz Reception and Distribution

by Allen Pawlowski*—

Consideration is given to the requirements for getting the signal from the receiving antenna to the set.

Assignments in the 2500-MHz ITFS band are made according to a frequency plan which specifies channel groupings (Table 1). Each group consists of four 6-MHz channels spaced 6-MHz apart. This is the typical semi-adjacent channel spacing used in TV broadcasting, so a single unit can be used to receive ITFS channels and convert them to semi-adjacent VHF channels, typically 7, 9, 11, and 13. The converted channels are then amplified and distributed through cable to standard classroom receivers. The converter and distribution system must handle these signals together.

Computations of signal level and fade margin for the 2500-MHz converter must include distribution-system considerations. The first involves signal-to-noise ratio. This is a measure of how much snow is in the picture. The second comes about because the converter and distribution system must handle more than one channel at the same time. The basic system parameter in question here is multichannel intermodulation. This is a measure of how much the signal of one channel interferes with another.

The job of the systems designer is to understand the principles of noise and intermodulation and to apply this understanding carefully to each system. On the one hand, he must maintain signal levels sufficiently high to prevent snowy pictures. On the other hand, he must carefully maintain operating levels below the intermodulation point of the equipment used. This means that any system performs best if it operates at levels between these two areas of degradation. How these degrading

parameters are defined and behave in a system is the basis of this article. Also discussed is the interaction between the 2500-MHz receiver and the school distribution system.

Signal-to-Noise Ratio

Table 2 lists picture-quality definitions for different values of signal-to-noise ratio. These definitions are based on reports by the Television Allocations Study Organization (TASO). The levels given have been adjusted to represent RF measurements as opposed to video measurements.

The list of picture definitions in Table 2 gives the system designer some basis upon which to make recommendations. It must be his objective to provide high-quality viewing in the classroom while not over-engineering the system.

Intermodulation

Multichannel intermodulation is, as stated earlier, a measure of how much a signal on one channel is interfering with that on any other channel. Just as there is a list of

definitions for signal-to-noise ratio, there is one for intermodulation also. This list, Table 3, has grown out of the CATV industry and has become that industry's standard. Intermodulation is more commonly stated in percent or dB below the desired signal, as shown in the table, rather than as a ratio.

Here again are some basic considerations which will assist the systems design engineer in providing high-quality viewing in the classroom.

Application

Application of the factors just discussed involves the operating parameters of the equipment used in a system. Since the amount of equipment used depends on the size of the system, it is better for purposes of discussion to consider one that is moderately large. Assume that four amplifiers in cascade are required to distribute signals to all classroom outlets. Also assume that it is desired to distribute local TV and ETV broadcast signals in addition to the ITFS signals. This can easily require a distribution system designed for 7 to 12 channels, so assume that 12

Table 1. ITFS Channels

Group A		Group B		Group C		Group D	
Channel No.	Band limits MHz	Channel No.	Band limits MHz	Channel No.	Band limits MHz	Channel No.	Band limits MHz
A-1	2500-2506	B-1	2506-2512	C-1	2548-2554	D-1	2554-2560
A-2	2512-2518	B-2	2518-2524	C-2	2560-2566	D-2	2566-2572
A-3	2524-2530	B-3	2530-2536	C-3	2572-2578	D-3	2578-2584
A-4	2536-2542	B-4	2542-2548	C-4	2584-2590	D-4	2590-2596
Group E		Group F		Group G		Group H	
Channel No.	Band limits MHz	Channel No.	Band limits MHz	Channel No.	Band limits MHz	Channel No.	Band limits MHz
E-1	2596-2602	F-1	2602-2608	G-1	2644-2650	H-1	2650-2656
E-2	2608-2614	F-2	2614-2620	G-2	2656-2662	H-2	2662-2668
E-3	2620-2626	F-3	2626-2632	G-3	2668-2674	H-3	2674-2680
E-4	2632-2638	F-4	2638-2644	G-4	2680-2686		

*Senior Systems Engineer, Educational and Communications Systems Div., Jerrold Electronics Corp.

Table 2. Picture Quality vs S/N Ratio

S/N Ratio (dB)	Picture Quality	Picture Quality Definition
49	Excellent	Snow-free pictures as judged by all viewers
39	Fine	Just perceptible background snow
33	Good	Snow in picture but not yet objectionable
29	Marginal	Somewhat objectionable snow

channels are required. It is now possible to look at the distribution system to see what considerations will reflect back to the 2500-MHz system design.

Amplifier Levels

One typical amplifier for multi-channel cascaded systems is of the split-band type, with separate low- and high-band sections. Only the high-band section will be considered here, since that is the portion which will handle the converted ITFS signals. The pertinent specifications for this amplifier are as follows:

Gain: 40 dB maximum, can be reduced with the gain control to 30 dB

Noise Figure: 9 dB maximum

Output Capacity: +46 dBmv per channel for 12 channels at 0.5% cross modulation

With this information given, it is possible to determine the best operating conditions for the distribution system. This will result in the important operating parameters of signal-to-noise ratio and overload limits.

First, it is necessary to determine the noise level at the output of the

last amplifier. This is expressed as:

$$\text{Noise dBmv} = -59 + F + G + 10 \log_{10} N$$

where,

F is the individual amplifier noise figure in dB,

G is the operating gain of the amplifier, and

N is the number of amplifiers in cascade.

In the example:

$$\begin{aligned} \text{Noise dBmv} &= -59 + 9 + 37 + 10 \log_{10} 4 \\ &= -7 \text{ dBmv} \end{aligned}$$

(Operating gain of 37 dB selected to provide 3-dB maintenance margin).

With the level of noise at the last amplifier found, it is now necessary to determine the maximum permissible signal level to assure operation below visible cross modulation. This can be done by calculating the derating figure for the number of amplifiers in cascade and subtracting this result from the maximum permissible output for one amplifier. The derating calculation is the same

Table 3. Intermodulation Criteria

Level	Definition
-46 dB or 0.5%	Level at which the interference is not visible when viewing an average picture
-52 dB or 0.25%	Level at which the interference is not visible when viewing a blank (white) screen

as used for the noise computation above, $10 \log_{10} N$. For four amplifiers in cascade, this is 6 dB.

At this point, it becomes necessary to look into the meaning of the term "maximum output." The specification for the amplifier says that the output will contain not more than 0.5% cross modulation when operation is with 12 channels at a level of +46 dBmv. Considering the system as a whole, the cross modulation cannot be allowed to exceed the 0.5% level. The engineer must, therefore, derate the amplifier so that the entire cross-modulation latitude is not consumed by this portion of the system. A minimum of 3-dB derating is desirable. This means that half the permissible cross modulation is generated by the distribution amplifiers and the remainder is reserved for other system equipment. The total derating is, therefore, 9 dB from catalog rated output, or +46 dBmv -9 dB derating = +37 dBmv maximum output per channel.

S/N Ratio

By comparing the maximum output of the system amplifiers, +37 dBmv, with the noise output computed earlier, -7 dBmv, it can be seen that the quality of signal delivered to the last outlet on the system is limited by the system to a 44-dB signal-to-noise ratio. Table 2 shows that the system qualifies as "extra fine," in that performance is located between the "fine" and "excellent" ratings. This rating, however, holds true only if the input signal is noise free. Thus, two important points are indicated: (1.) The picture quality at the last outlet can be no better than 44 dB S/N as controlled by the system. (2.) If the input signal contains noise, this noise will add to that generated by the system and result in an overall degradation of pictures.

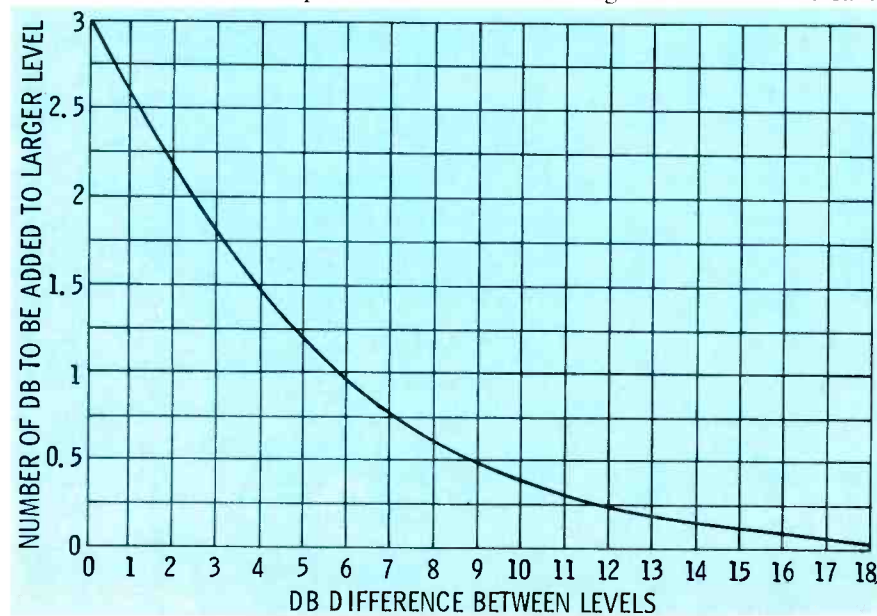

Fig. 1. Graph shows the result when two different noise levels are combined.

At first glance, it would seem that nothing but the best-quality input signal can be tolerated. At second glance, it can be seen that this is not really true. Fig. 1 shows how two noise levels add. For example, this graph shows that when two noise levels are equal (0-dB difference) the combined level is 3-dB higher than the individual levels. When the difference between two noise levels is 6 dB, the combined level is only 1-dB higher than the highest level.

To illustrate: If the signals delivered by the converter have a 50-dB signal-to-noise ratio, they will combine with the 44-dB signal-to-noise ratio of the system to deliver signals of 43-dB signal-to-noise ratio at the system extremities. These are the desirable operating conditions for the system, and performance still qualifies as "extra fine" in picture rating.

Fading

One last consideration must now be brought into play; this is the fading of the 2500-MHz air signals. The calculations must include a fade margin to some minimum permissible received level. Fade-margin allowances (Fig. 2) are based on 99.99% reliability for this range of frequencies. The minimum signal quality at the maximum fade condition can be selected from Table 2. Here it is desirable to use the 33-dB point. This is known to be a snowy picture and not objectionable, especially since the duration of fading this deep will be very short, usually in the range of a few seconds.

By now, there are enough things under consideration to require a graphic representation to keep them all in order. Fig. 3 is a plot of these items. Note first the consideration of the school distribution system. Regardless of where the school is, the system will be designed for a minimum operating signal-to-noise ratio of 44 dB (line 1 on the graph). So as not to degrade this operation by more than 1 dB, the unfaded signal quality from the ITFS converter is designed to have a minimum signal-to-noise ratio of 50 dB (line 2 on the graph). Under a maximum faded condition, the quality of converted signal would follow the dash line (line 3) on the graph. Note that maximum expected fading does not cause degradation to the

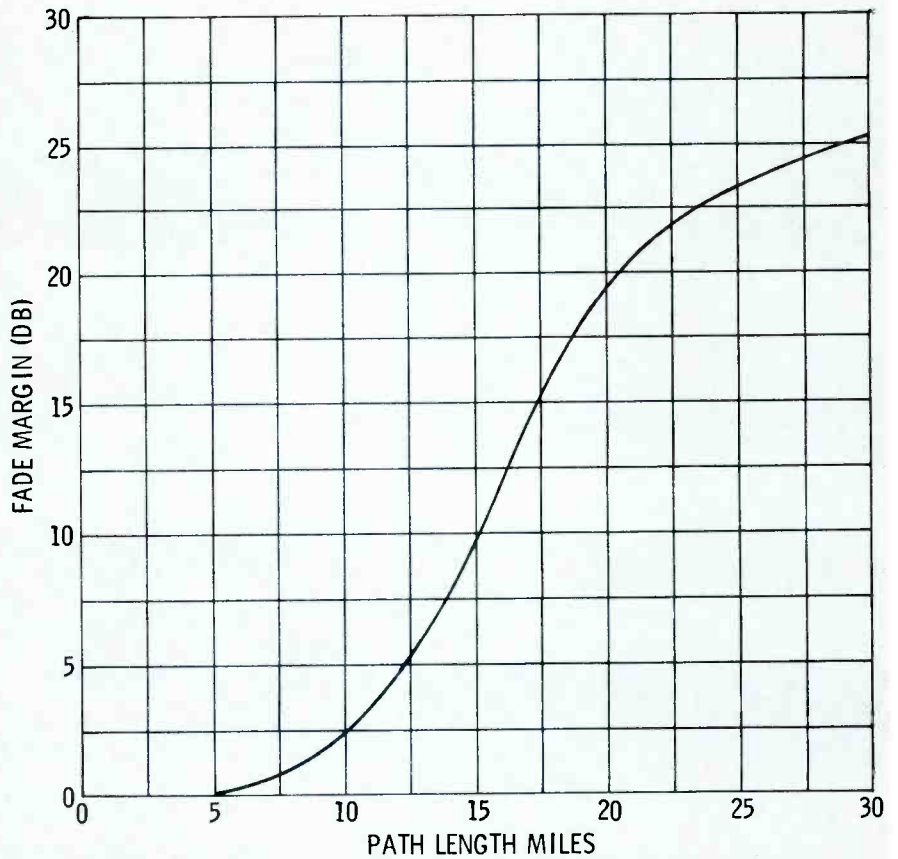

Fig. 2. Fade margin for 2500-MHz band is shown as a function of path length.

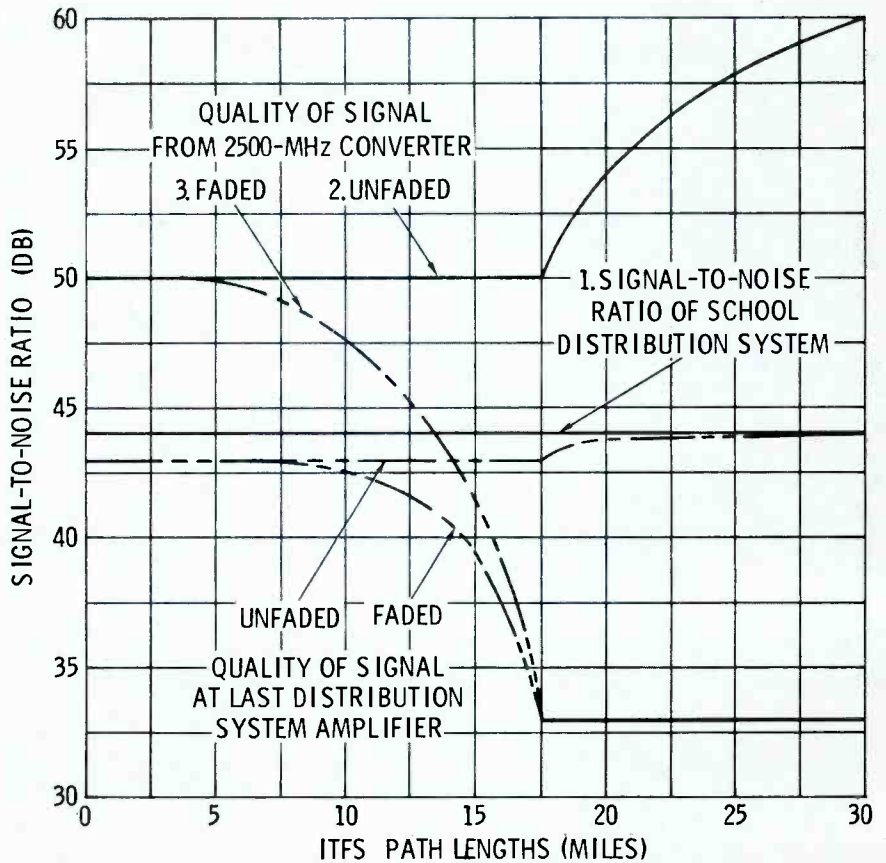
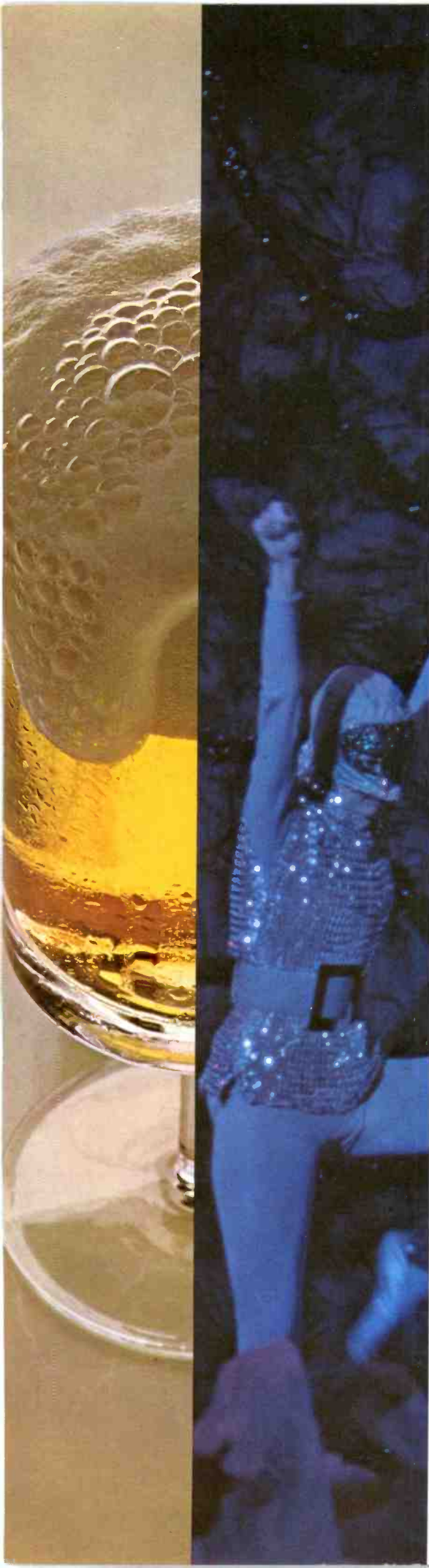

Fig. 3. Graphical plot shows factors being considered in design of the system.





ELECTOGRAPHY



**Videotaping
has gotten
so good,
it has
a new
name!**

Tape is more versatile than ever!

Everybody knows the key advantages of video tape. You work fast. You see your work as you go. You can be more daring and experimental.

But perhaps you didn't realize how sophisticated the art of videotaping has really become: You can edit instantly... electronically... frame by frame. You can use slow motion, fast motion, stop motion and reverse action. You can go out on location. And you can combine all types of existing footage (stills, film) with new footage.

**Now, the most life-like color yet:
"Scotch" Brand Color Tape Plus.**

"Scotch" Brand Video Tape No. 399 gives you the ultimate in color fidelity. The brightest, clearest, most life-like color ever. Color Tape Plus is so ultra-sensitive, you can use the most subtle lighting techniques. Copies are perfect. Blacks and whites are stronger. And No. 399 is almost impossible to wear out.

So please don't call it videotaping any more. There's now a new name for this complete creative medium... electography!

Want more facts? Write: 3M Company, Magnetic Products Division, 3M Center, St. Paul, Minn. 55101.



***SCOTCH** IS A REGISTERED TRADEMARK OF 3M CO.

selected 33-dB minimum S/N until the path length has reached 17.5 miles. For paths that exceed 17.5 miles, it is necessary to design for higher receiver signal input to prevent fading below the selected minimum.

Received Signal

Until now, signal quality has been discussed in terms of signal-to-noise ratio. It is now necessary to relate this to actual operating levels for a typical 2500-MHz converter. This involves application of the formula for determining the noise threshold of a given unit:

$$\text{Noise dBw} = -204 + F + 10 \log_{10} B$$

where,

F is the converter noise figure in dB, and

B is the bandwidth consideration in Hz.

One typical ITFS converter has a specified noise figure of 13 dB. The formula also requires a bandwidth consideration. Since a standard video signal is involved, a

bandwidth of only 4 MHz need be considered. Substituting these values in the formula:

$$\begin{aligned} \text{Noise dBw} &= -204 + 13 \\ &\quad + 10 \log_{10} (4 \times 10^6) \\ &= -204 + 13 + 60 \\ &\quad + 10 \log_{10} 4 \\ &= -125 \text{ dBw} \end{aligned}$$

The calculated noise threshold is -125 dBw for this particular converter. For a 50-dB signal-to-noise ratio, 50 dB is added to the -125 dBw level, resulting in a desired level of -75 dBw. This is the minimum design signal level for paths up to 17.5 miles long. Beyond that distance, the input signal level required increases as indicated by Fig. 3. The input requirement shown in Fig. 4 represents a compromise between high cost and substandard performance. This graph is provided on a universal basis in that it can be used with any receiver/converter having a noise figure between 5 and 15 dB.

Application of Fig. 4 is illustrated by the following example. A receiver/converter is quoted as having

a noise figure of 9 dB maximum. Assume that a school is located 20 miles from the transmitter. The intersection of 20 miles with the design curve is extended to an intersection with the 9-dB receiver noise-figure line. The required input signal is determined by extending this intersection diagonally downward to the scale and reading -74.5 dBw, for this example.

Conclusion

A rather long series of conditions has been taken into account here. The example used is not unreal, yet it carries all considerations to their extremes which, in practice, will be the exception rather than the rule. The objective was to set some standards of operation that would allow for future expansion that could easily reach the conditions of the example. In either smaller systems or ones carrying fewer channels, utilizing the graphs and other parameters recommended will provide the margin for expansion which, in education, is the rule rather than the exception. ▲

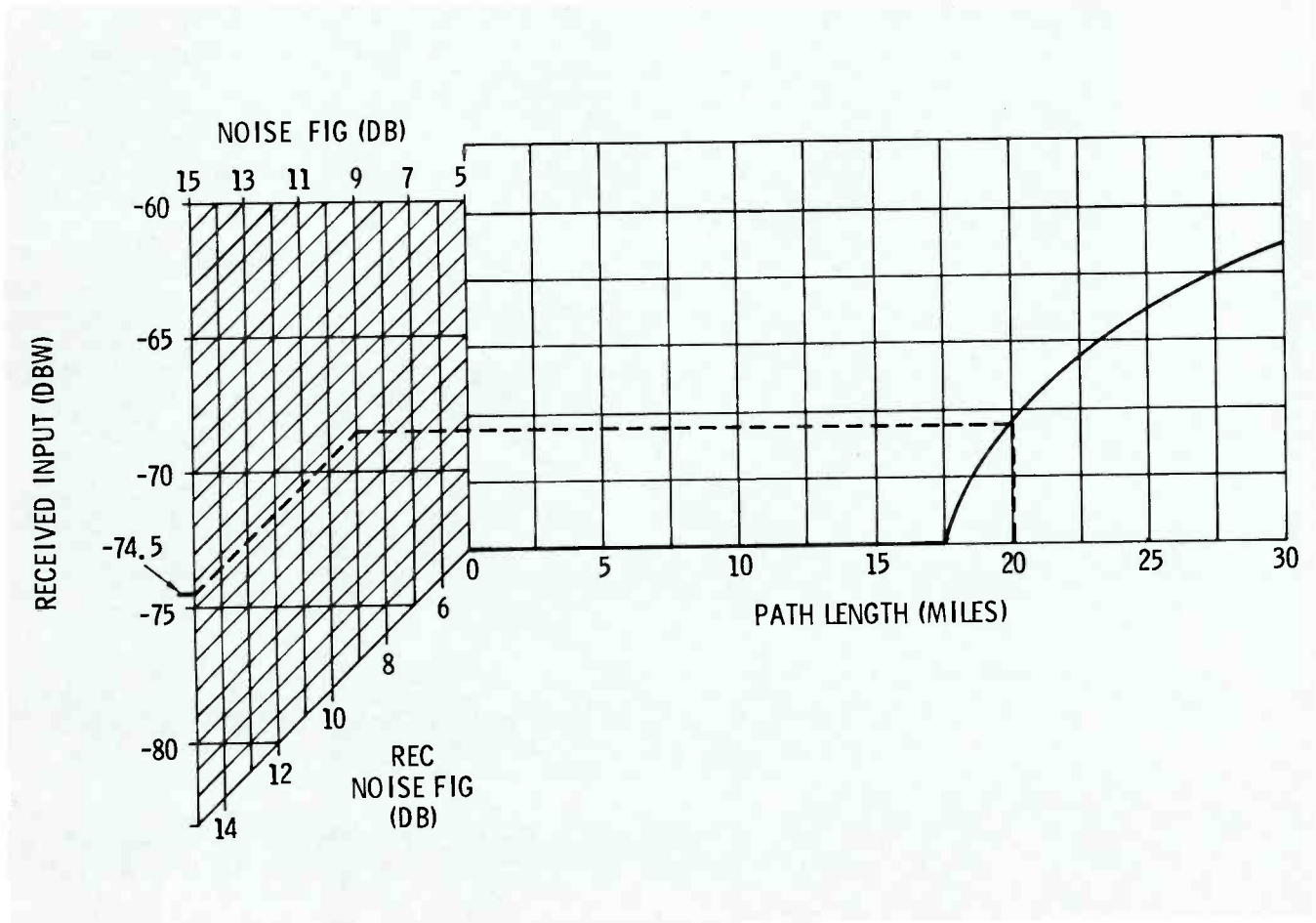
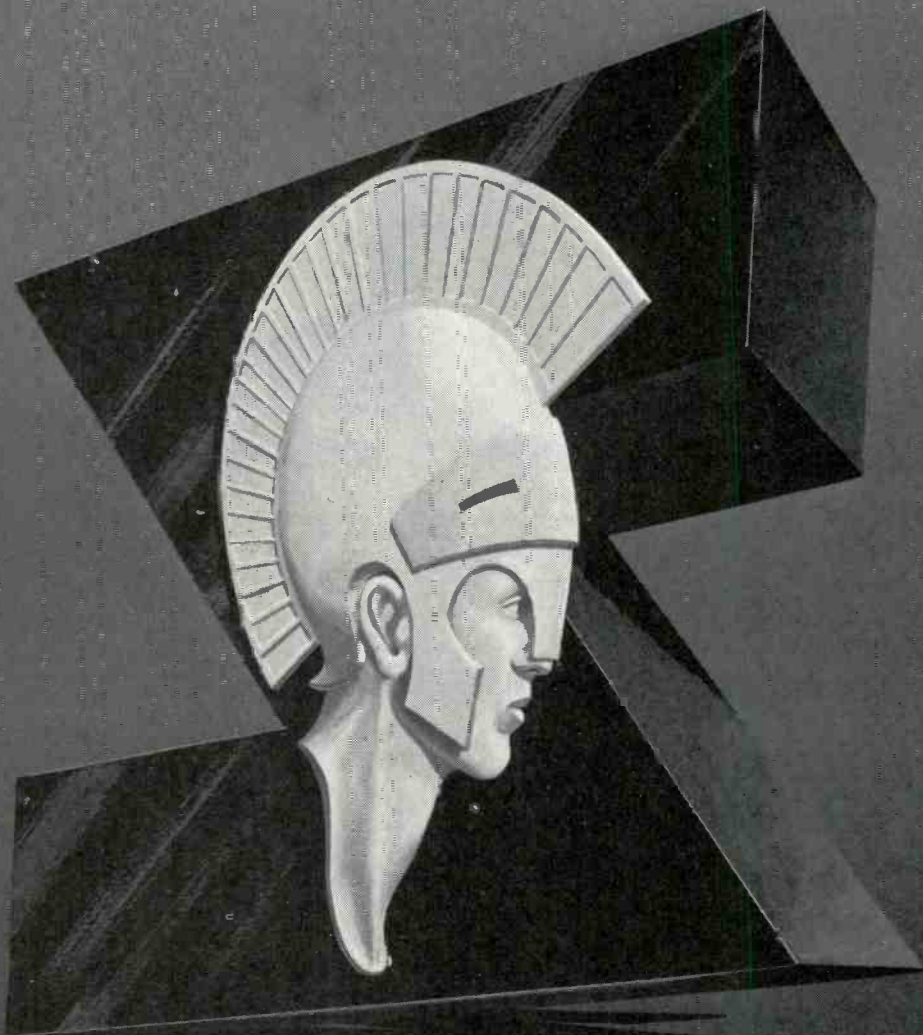

Fig. 4. 2500-MHz received-signal design curve relates the required signal to the path length and receiver noise figure.

the look of things to come



A fresh new appearance with the same high quality in service and products. Join us at NAB when we unveil "The New Look" in professional audio products. (If you can't be there, write for our new Products brochure.)



SPARTA

ELECTRONIC CORPORATION

5851 FLORIN-PERKINS ROAD SACRAMENTO, CALIFORNIA 95828

A DIVISION OF COMPUTER EQUIPMENT CORPORATION

For **Whatever** Is Worth Watching...

BROADCASTING



TYPES	COLOR FILM CAMERAS
7038V } 8572V } 8134V }	PE 24, PE 240 TK 27
	LIVE COLOR CAMERAS
Z-7929R } Z-7929G } Z-7929B }	TK 42, TK 43

INDUSTRIAL AND ETV

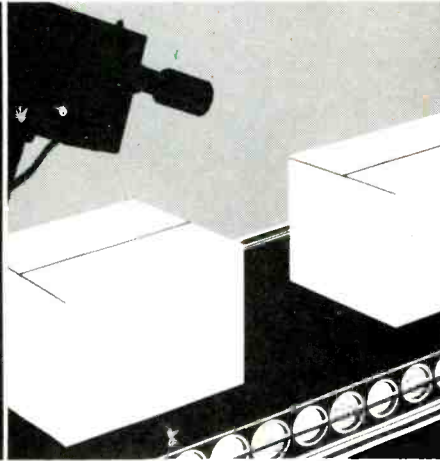

TYPES	FEATURES
7735B	EXTREMELY LOW LAG <i>excels in live pickup</i>
8484	HIGH SENSITIVITY <i>industrial remote use</i>
7262A	LOW HEATER POWER <i>for remote surveillance</i>
8507A	HIGH RESOLUTION <i>separate mesh 7735B</i>
8572	HIGH RESOLUTION <i>separate mesh 8484</i>

OR WHATEVER



APPLICATION REQUIRING EMPHASIS ON:
Sensitivity
Very High Resolution
Spectral Response
Ruggedness
Reticule Face Plate
Radiation Resistance
Minimum Lag
Extended Persistence

Do It Better with General Electric Vidicons!

Whatever TV camera you use or whatever your application... General Electric vidicons provide better pictures, performance and reliability. Significant advances in vidicon chemistry give the *lowest lag* of any vidicon available for demanding television applications. Similar advances now allow a selection of vidicons with a notable combination of long life and high sensitivity.

For Top-Notch Broadcasting — GE vidicons give the best picture your live and color film cameras were designed to produce, to an audience where only the best is good enough!

For Demanding Industrial Use — GE vidicons provide rugged and reliable performance with clarity and detail... from monitoring a blast furnace to process control.

For Flexible Education and Audio Visual Aids — Where closed circuit TV is an integral part of new teaching concepts, GE vidicons offer high resolution and excellent sensitivity for better pictures under normal classroom lighting.

For Unusual Applications — *Whatever* demands something special... from underwater research to day-night automotive rearview TV... GE vidicons may

already exist to provide the unique performance you require.

BUY GE VIDICON TUBES FOR A BETTER PICTURE!

For any replacement or new application write:

Pickup Tube Operation
General Electric Company
Building 6, Electronics Park
Syracuse, New York 13201

"Come see us at Booth #102
at the NAB Show!"

GENERAL  ELECTRIC

288-15

March 1968

We interrupt this magazine to bring you. . .

Late Bulletin from Washington

by Howard T. Head

New Nighttime Interference Calculations Studied

Comments are due soon on a Commission proposal for the adoption of new rules governing the calculation of AM directional-antenna patterns and mutual interference among stations employing such antennas. The purpose of the proposal is to establish uniform tolerances on directional-antenna patterns. This would have the dual advantages of ruling out the filing of impractical proposals, and of permitting the calculation of patterns and skywave interference using high-speed digital computers. Extensive studies of the Commission proposal have been made on an informal basis by the Association of Federal Communications Consulting Engineers (AFCCE).

The new proposal would replace all existing directional-antenna patterns with those calculated using the new standardized method. The method presently under study would establish calculated patterns based on the assumptions of sinusoidal thin-wire current distribution, an infinite ground plane, and an assumed 1-ohm loss resistance in series with each element of the antenna system. Tolerances would be established by augmenting the calculated pattern with a 5% tolerance, to which would be added a quadrature term consisting of 3.5% of the rms value of the horizontal-plane pattern. In no event would an inverse field less than 6 mv/m be permitted.

The patterns for licensed directional antennas now in operation have been computed by a variety of methods, and few, if any, correspond to the patterns determined under the new proposal. If this proposal is adopted, the Commission would consider requiring all existing licensees to file new patterns and interference studies in accordance with the new procedure. Readjustment of existing directional antennas might be required of stations whose patterns exceed those computed by the new methods.

Presunrise Activity for AM Stations

The United States has held informal discussions in Ottawa with engineers of the Canadian Department of Transport (DOT), looking toward further extension of hours under Presunrise Service Authority (PSA). The present agreement with Canada provides relaxed requirements for determining presunrise interference requirements where Canadian stations are affected; however, presunrise operation may not begin until 6:00 a.m. local standard time. Canadian consent is being sought to permit presunrise operation to begin at 6:00 a.m. daylight time. Both daytime-only and unlimited-time stations would be affected.

A number of unlimited-time stations have taken advantage of the provisions for operation with daytime facilities between 6:00 a.m. and local sunrise with power in excess of 500 watts (see January 1968 Bulletin). In some instances, presunrise power must be reduced below the regularly licensed daytime power, and three modes of operation -- daytime, nighttime, and presunrise with reduced power -- result. One particularly burdensome effect involves stations operating directional antennas by remote control; inspections at the transmitter are required within two hours after commencing any directional mode of operation, and as many as three modes may be involved for some stations. In some cases, the Commission has relaxed this requirement to the extent of permitting omission of inspections where operation in a given mode lasts for less than one hour. Specific permission must be sought for such relaxation in each individual case.

Noncommercial Educational FM Agreement With Canada Sought

The Commission delegation discussing AM presunrise operation with the Canadian officials also discussed international agreement on a table of FM channel assignments covering the noncommercial band (Channels 201-220, inclusive). Agreement with Canada is essential before the Commission can implement its proposals to adopt a Table of Assignments and new Technical Standards for noncommercial educational FM stations (see January 1967 Bulletin).

Meanwhile, television stations on Channel 6 are apprehensive about possible interference caused to channel-6 (82-88 MHz) reception by operations in the noncommercial FM band (88-92 MHz). The Commission is proposing to limit this interference by confining the higher-power FM stations to channels near the upper end of the noncommercial band. However, available reports, including one published by the Commission Chief Engineer's office, indicate that it may not be possible to eliminate completely all interference caused by noncommercial educational FM stations to channel-6 television reception.

Land Mobile/Television Frequency Struggle Intensifies

A special all-industry Committee has been formed jointly by several leading television trade associations to combat the threat to television channel assignments imposed by the increasing demands of the land mobile radio services (see February 1968 Bulletin). The Advisory Committee for the Land Mobile Radio Services, composed solely of land-mobile radio manufacturers and users, has submitted a detailed report to the Commission. The report concludes that existing frequency space cannot accommodate expected land-mobile expansion, and it proposes that television channels be reallocated to land mobile services. Included in the proposals is a suggestion that the Commission look toward the ultimate shift of all home television reception from broadcasting to wire distribution, such as that provided by CATV.

Short Circuits

Effective March 15, the Commission will issue provisional third-class radiotelephone permits, good for a twelve-month period, by mail (see November 1967 Bulletin). . . The U.S. and Mexico have extended the existing AM treaty through 1968, pending the negotiation of a new treaty. . . Proposed rules to require the display of call signs of television auxiliary stations on the antenna supporting structure have been made final. . . An ETV station has been granted a waiver of the rule requiring a first- or second-class operator on duty in control of the television STL station. . . NAB has asked the Commission to simplify the AM and FM program logging rules.

Howard T. Head. . . in Washington



**lower
attenuation**

**higher
power**

8" diameter flexible HELIAX® coaxial cable

8" Air dielectric HELIAX coax extends the advantages of flexible cable to very low attenuation or very high power applications that formerly required rigid transmission line.

Corrugated inner and outer copper conductors accommodate thermal expansion without the need for sliding contacts. End connectors mate with 6 1/8" EIA flanges and lock inner and outer conductors together to eliminate differential expansion.

The continuous, connector free cable assures freedom from the VSWR "spikes" associated with the periodic inner connectors of rigid line in a long feeder. Cable assemblies can easily be electrically tested on the reel to assure your exact system performance. For complete details write Andrew Corporation, 10500 West 153rd Street, Orland Park, Illinois 60432.

HJ 10-50 HELIAX COAXIAL CABLE

	At 30 MHz	At 600 MHz
Attenuation	.027 dB/100 ft	.15 dB/100 ft
Average Power	300 kW	58 kW
Other Power Ratings	For SSB, 200 kW PEP with antenna VSWR of 3:1 2 Megawatts Peak	TV transmitter power ratings, 223 kW at Channel 4 and 70 kW at Channel 35

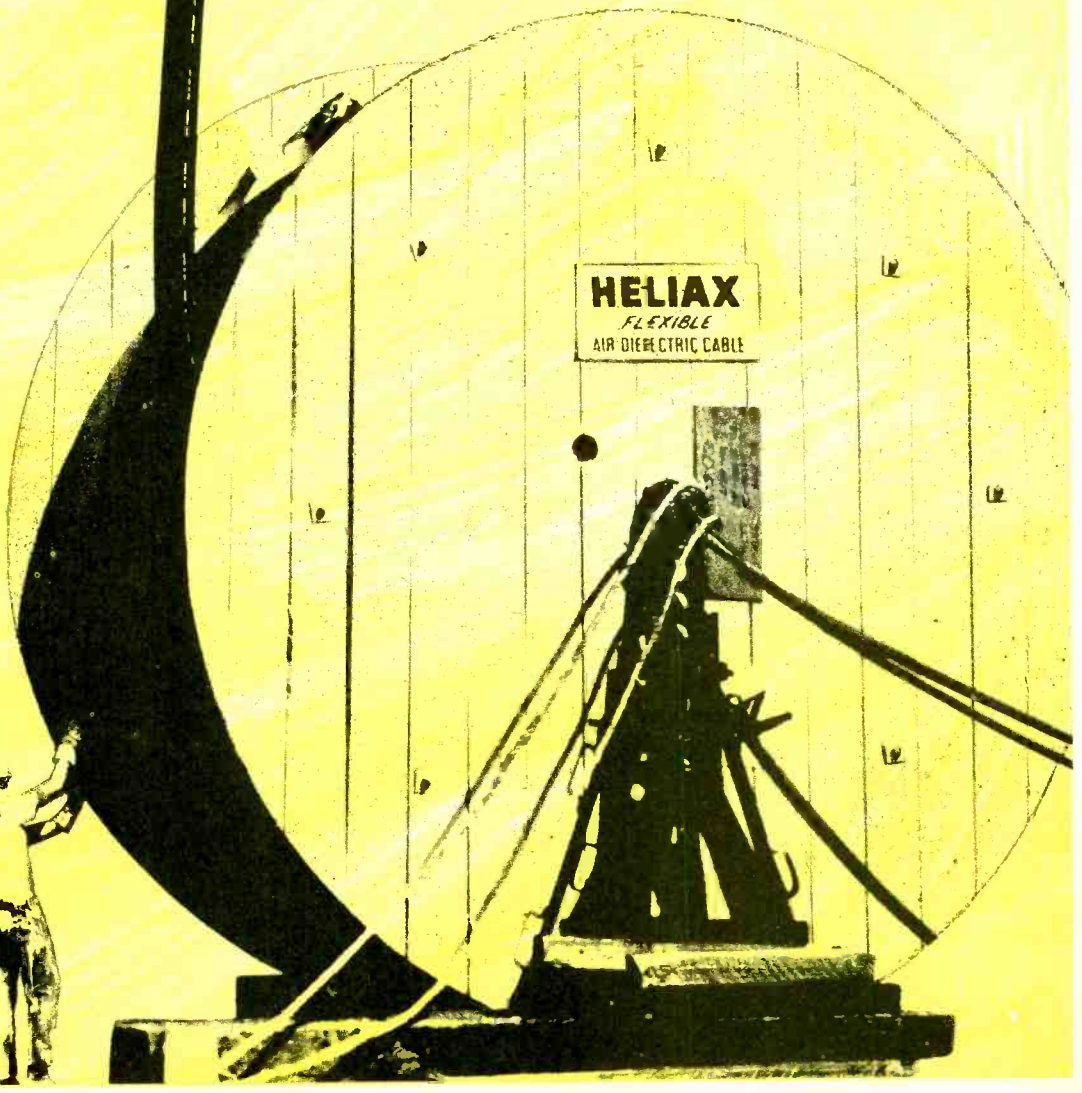

2-68

Circle Item 20 on Tech Data Card

FOR ANY FM POWER



The CCA FMA-6601 is a medium power, (1KW per bay) horizontally polarized element, constructed of stainless steel with basic broad band characteristics. Minimum windloading weight per bay is only five pounds. Available up to 16 bays. Cost approximately \$350.00/bay. Basic cost includes matching transformer with guaranteed VSWR of 1.1:1. Can be used in following suggested popular combinations:—

1KW Trans. + 4 Bay Ant. = 3KW ERP
 5KW Trans. + 6 Bay Ant. = 25KW ERP
 5KW Trans. + 12 Bay Ant. = 50KW ERP
 10KW Trans. + 12 Bay Ant. = 100KW ERP

The popular CCA FM-3000D, 3KW FM Broadcast Transmitter uses the famous CCA grounded grid circuitry and an Eimac, zero bias tetrode—3CX3000A7. This tube only costs \$265.00 and tube life of 15,000—to 20,000 hours are not unusual when used in the super cooled, conservatively rated CCA FM-3000D. Other features including 20KW RF tuning components, complete accessibility, calibrated controls, sealed control relays, 3 cycle automatic recycling, no requirement for neutralization. These are but a few of the many features that have made the CCA FM-3000D, the broadcasters most popular choice in their Class "A" 3KW circularly polarized stations.

FOR CLASS "A" FM CHANNELS

*3KW ERP HORIZONTAL + *3KW ERP VERTICAL

CCA FM-3000D (3KW Trans.) + CCA FMA-6811-3 (3 Bay Circular Antenna) = 3KW-H
 3KW-V
 \$8,995.00 + \$1,350.00 = \$10,345.00

*3KW ERP HORIZONTAL

CCA FM-1000D (1KW Trans.) + CCA FMA-6601-4 (4 Bay Horizontal) = 3KW-H
 \$5,795.00 + \$1,400.00 = \$7,195.00

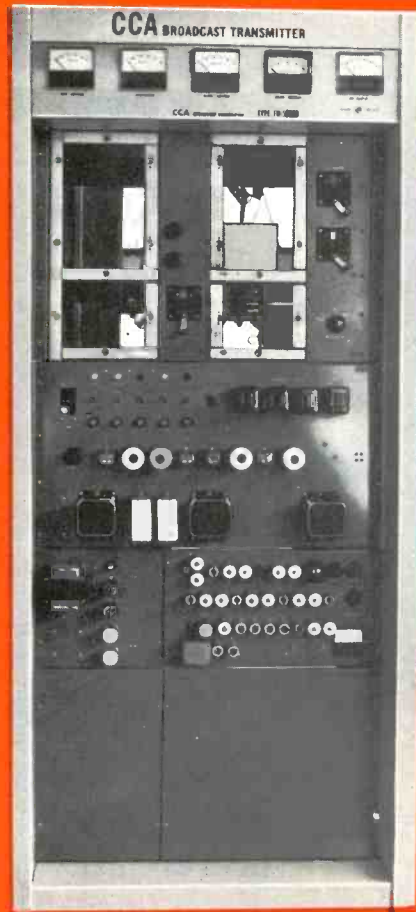

FRONT VIEW CCA FM-3000D



The CCA FMA-6811 is a medium powered (1KW per bay) circularly polarized antenna. Rugged stainless steel construction, but with minimum windloading. Weight per bay is only seven pounds. Available to 16 bays. Cost approximately \$450.00/bay. Basic patterns are comparable to higher power units. Excellent for medium and low power applications. Suggested popular combinations:—

1KW Trans. + 7 Bay Horiz. = 3KWH + 3KWV
 3KW Trans. + 3 Bay Ant. = 3KWH + 3KWV
 5KW Trans. + 12 Bay Ant. = 25KWH + 25KWV
 10KW Trans. + 12 Bay Ant. = 50KWH + 50KWV

CCA · CCA · CCA · CCA · CCA · CCA · CCA · CCA · CCA · CCA · CCA · CCA · CCA · CCA · CCA · CCA · CCA · CCA · CCA

RECENT CCA BROADCAST CUSTOMERS

1KW-AM—WAYS, Charlotte, No. Car.; WRBN, Warner Robins, Ga.; WVMG, Cochran, Ga.; WJTS, Jupiter, Fla.; WIXI, Lancaster, Ky.; WKAL, Rome, N. Y.; WSEB, Sebring, Fla.; WBOM, Jacksonville, Fla.; WNES, Central City, Ky.; WEEW, Washington, No. Car.; WAZS, Summerville, So. Car.; KAGT, Anacortes, Wash.; KENT, Prescott, Ariz.; KTCH, Wayne, Nebr. * 5KW-AM—WFI, Devon, Conn.; WCOA, Pensacola, Fla.; KPUG, Bellingham, Wash.; KVOR, Colorado Springs, Colo.; WQIZ, St. George, So. Car.; KOSG, Pawhuska, Okla.; WKOP, Binghamton, N. Y.; WVAM, Altoona, Penna.; KATN, Boise, Idaho; KDOT, Scottsdale, Ariz. * 10KW-AM—CHOO, Canada; KTAC, Tacoma, Wash. * 250W-FM—Lane Community College, Eugene, Ore.; B & B Broadcasting, Greenville, Penna. * 1KW-FM—WYGO, Corbin, Ky.; KOTO, Alamogordo, N. Mex.; WOZK, Ozark, Ala.; WMAS, Springfield, Mass.; WSIP, Paintsville, Ky.; WVMG, Cochran, Ga.; WNGO, Mayfield, Ky. *

3KW-FM—WNWC, Agington Hts., Ill.; WRIO, Rio Grande, N. J.; WLCK, Scottsville, Ky.; KLCO, Pouteau, Okla.; KWHP, Edmond, Okla.; WLBC, Muncie, Ind.; WSEN, Baldwinville, N. Y.; KSWM, Aurora, Mo.; WRLS, Hayward, Wisc.; WOCO, Oconto, Wisc. * 5KW-FM—WAKW, Cincinnati, Ohio; KUAC, College, Alaska; WGUS, North Augusta, So. Car.; WGVM, Greenville, Miss.; KCSC, Edmond, Okla. * 10KW-FM—WDAS, Philadelphia, Penna.; WAEF, Cincinnati, Ohio; WWQT, Gainesville, Ga.; WHOS, Decatur, Ala.; KMYR, Denver, Colo.; KCMS, Manitou Springs, Colo.; WIFL, Philadelphia, Penna.; WMAS, Springfield, Mass.; WFMG, Gallatin, Tenn.; WFMF, Chicago, Ill.; WRVM, Madison, Wisc.; WNES, Central City, Ky.; WGNU, Granite City, Ill.; WAMO, Pittsburgh, Penna.; KXLS, Oklahoma City, Okla.; WCOA, Pensacola, Fla. * 20KW-FM—WOPA, Oak Park, Ill.; KNDX, Yakima, Wash.; WAGY, Forest City, No. Car.; KALF, Mesa, Ariz.; KGAF, Gainesville, Tex.

CCA IS OUTSTANDING

FOR CLASS "B" & "C" FM CHANNELS

CIRCULAR

CCA 10KW Transmitter + 12 Bay Antenna = $\begin{matrix} 50KW-H \\ 50KW-V \end{matrix}$
\$15,900.00 + \$5,400.00 = \$21,300.00

CCA 20KW Transmitter + 12 Bay Antenna = $\begin{matrix} 100KW-H \\ 100KW-V \end{matrix}$
\$22,500.00 + \$9,000.00 = \$31,500.00

HORIZONTAL

CCA 10KW Transmitter + 6 Bay Antenna = 50KW
\$15,900.00 + \$3,000.00 = \$18,900.00

CCA 10KW Transmitter + 12 Bay Antenna = 100KW
\$15,900.00 + \$4,200.00 = \$20,100.00



MODEL 6710 HI POWER— ADJUSTABLE—CIRCULARLY POLARIZED ANTENNA

The super deluxe CCA model 6710 is a high power (5KW per bay) circularly polarized antenna with unique facilities to adjust the ratio between vertical and horizontal fields. Thus, for those stations that desire vertical polarization with their maximum allowed horizontal radiation and do not have adequate transmitter power to achieve equal radiation in both fields, the CCA 6710 is a perfect solution. Thus, it is possible with an 8 bay antenna and a 10KW FM transmitter, for stations to achieve 50KW ERP—Horizontal and 30KW vertical. A 20KW transmitter and 8 bay antenna can obtain 100KW ERP Horizontal and 60KW ERP Vertical. CCA also offers a fixed version which provides equal horizontal and vertical components at a slightly reduced selling price. Antenna sells for approximately \$850.00 per bay and includes matching transformer and tower mounting brackets.

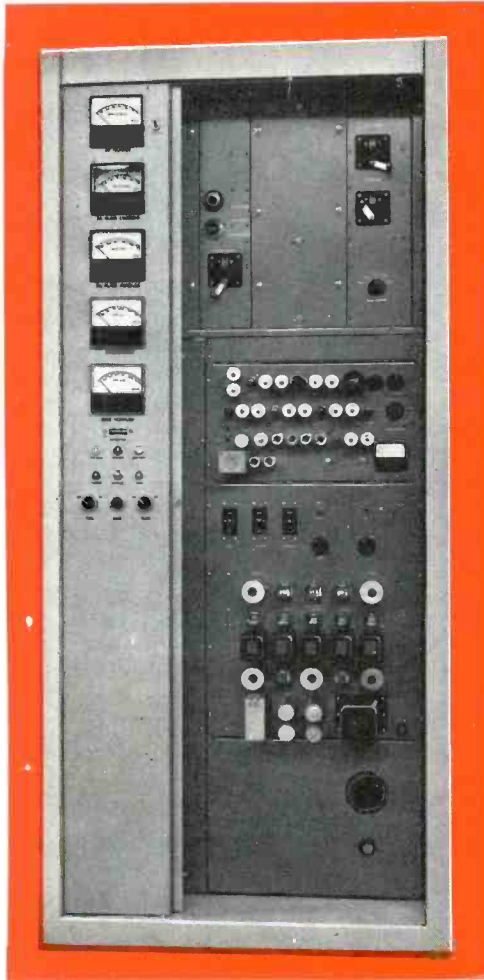

FRONT VIEW CCA FM-20000

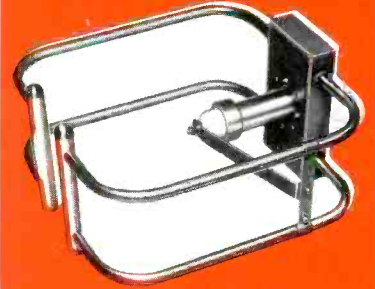

MODEL FMA—() D HI POWER—HORIZONTAL POLARIZED ANTENNA

Pictured above is the conservative, high power CCA type FMA—() D horizontally polarized antenna. The folded back square loop construction assures broad band, low Q, characteristics. The elements are tested at 20KW to assure conservative 5KW per bay rating. Constructed of stainless steel, it can be used with high power transmitters to produce high power horizontal polarized patterns with excellent circularization. Basic cost of approximately \$550.00 per bay includes matching transformer and tower mounting brackets.

The rugged CCA FM-20,000, 20KW FM Broadcast Transmitter is the broadcaster's answer for a reliable FM broadcast "power house". This transmitter produces 20KW output with only 26.1KW input to the final PA. The zero bias triode—3CX10, 000A7 which is used in the PA costs only \$590.00, operates at only 60% of maximum dissipation and has exhibited perfect stability and exceptionally long life when used with CCA circuitry and cooling techniques in the production of 20KW output. Some of the many features of this transmitter are—super rated silicones (we've never lost any), indicator lights for overload circuitry; patented tuning assemblies which after 9 years of service show no evidence of pitting or overheating; rugged RF circuitry using $\frac{1}{8}$ " thick, silver plated copper components; elimination of RF by pass capacitors in output circuitry; no requirement for neutralization, hinged meter panel. Truly, the broadcaster's choice for 100KW ERP stations!!



CCA • CCA • CCA • CCA • CCA • CCA • CCA • CCA • CCA • CCA • CCA • CCA • CCA • CCA • CCA • CCA • CCA



ELECTRONICS CORPORATION

716 Jersey Ave., Gloucester City, N. J. 08030 • 609-456-1716

AM AND FM BROADCAST EQUIPMENT

WHY PAY MORE AND GET LESS?

WE'RE ONLY #3

WE'RE NOT PARTICULARLY PROUD THAT WE'RE ONLY #3, BUT CONSIDERING THAT #4 HAS BEEN IN BUSINESS FOR 30 YEARS, WE FEEL IT'S QUITE AN ACCOMPLISHMENT!! BROADCASTERS UNDERSTAND THAT CCA PROVIDES MORE THAN JUST A RELIABLE, ECONOMICAL TRANSMITTER — WE PROVIDE PERSONALIZED SERVICE — WE HAVE TO — WE'RE ONLY #3!!

Making Meter Repairs

If there are useless meters lying around your station, there needn't be. Minor repairs can be made by anyone with steady hands. This article can't help you in those instances where the FCC Rules and Regulations state specific repair requirements (*e.g.*, Sections 73.39, 73.320, and 73.688); but in the case of meters used in noncritical applications, a broken glass or a sticking pointer usually can be repaired with a minimum of effort.

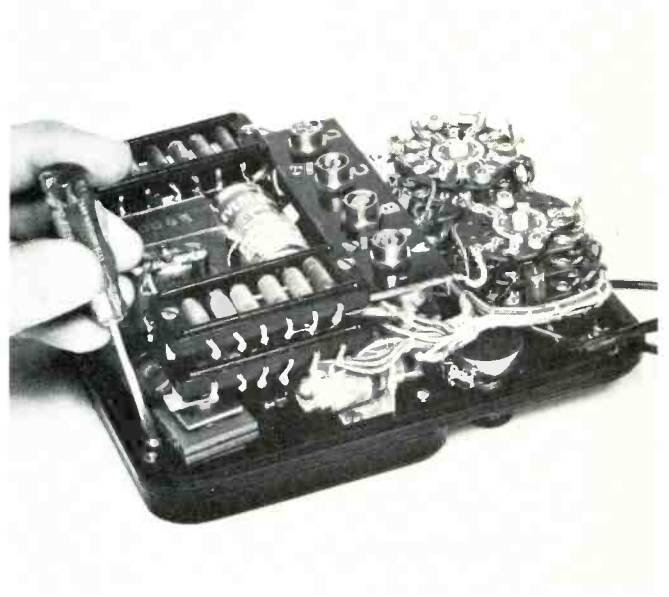
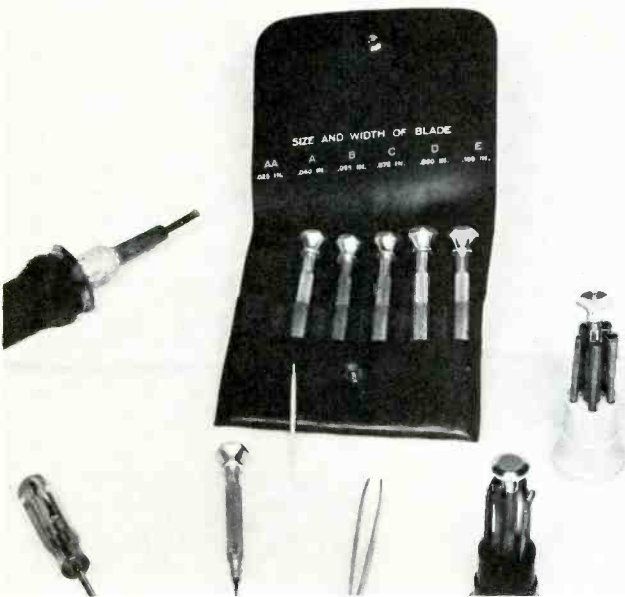

Recommended tools include pencil iron, jeweler's screwdrivers, small socket wrenches, small end wrenches, nonmagnetic tweezers, small pocket-type screwdriver, and clean rubber mat.

Access to the meter mounting screws is usually gained after the instrument back is removed. The meter is secured by two to four screws entering from the rear. Captive screws with mounting nuts also are used. Removal of the screws shown releases the meter cover in this instrument. In others, entire meter is released, then cover can be removed.



A broken glass can be changed by removing mounting screws or clips. A hardware store usually can provide a replacement cut to size. Order single-weight glass.

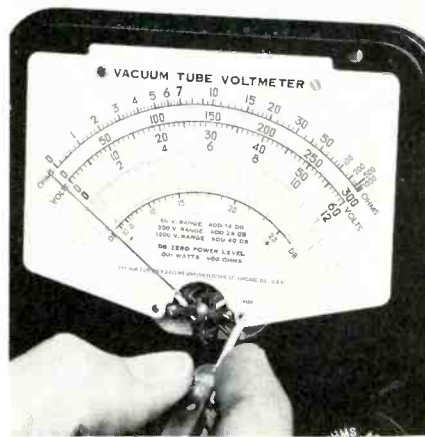

With meter cover removed, scale is exposed. Mounting screws usually number two or four. Use small screwdriver and remove screws carefully. Don't drop screws or lockwashers into meter movement.



A high-intensity lamp can be used to detect visible dirt or magnetic particles in magnet gap. Often, a slightly moistened toothpick will remove the dirt. Magnetic particles must be removed with tweezers.

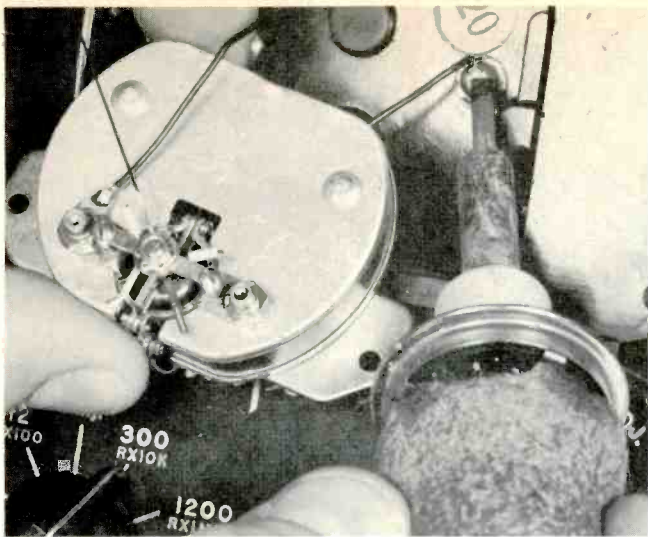

Unsolder meter leads. Avoid use of soldering gun unless mounting studs are large. The magnetic field of a gun can damage the meter. Pencil iron will usually do the job. Meter and pointer are vulnerable—handle carefully.

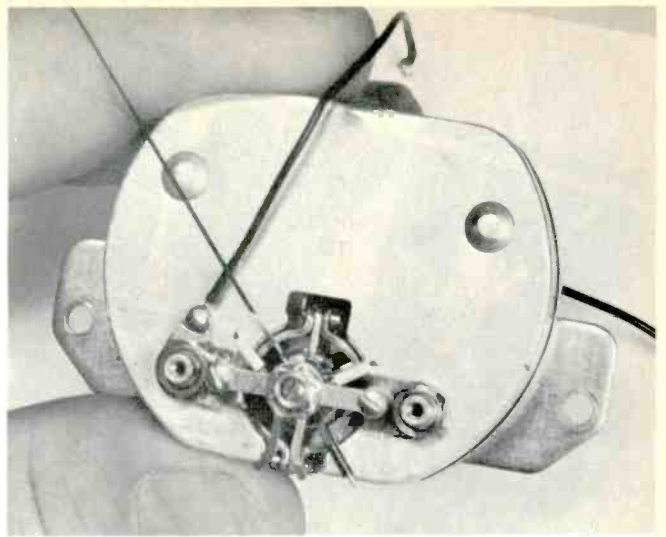

Hold sheet of white paper behind meter and look through magnet gap. Dirt and magnetic particles can be seen easily. Check armature bobbin for burned or frayed wires. If these are visible, meter is beyond your repair.

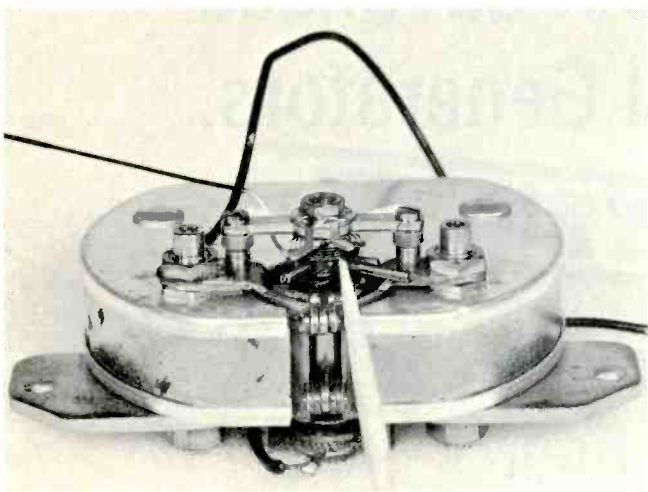

Check hairsprings at top and bottom. Each spring should make a perfect, flat spiral and be soldered at both ends. Overlapped or tangled springs can be released with toothpick. Kinked springs can be straightened gently with tweezers.

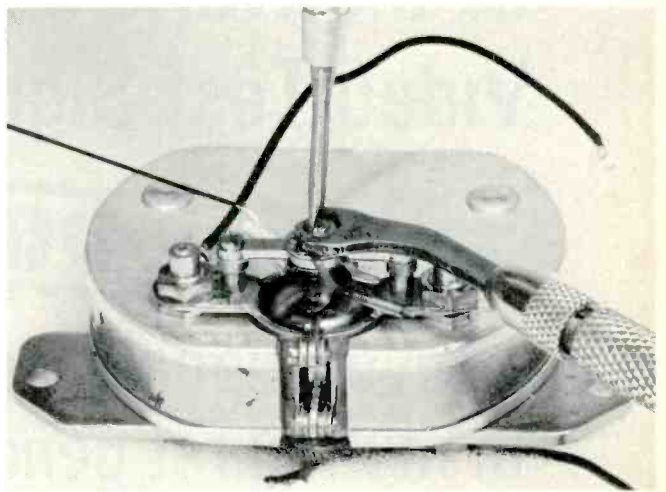

Loosen bearing shaft locknut with wrench. Turn screw clockwise very gently until resistance is felt, then back screw off $\frac{1}{2}$ turn. Hold screw stationary and tighten locknut. Grasp pointer and the rear extension gently, and check vertical movement, which should be very slight.

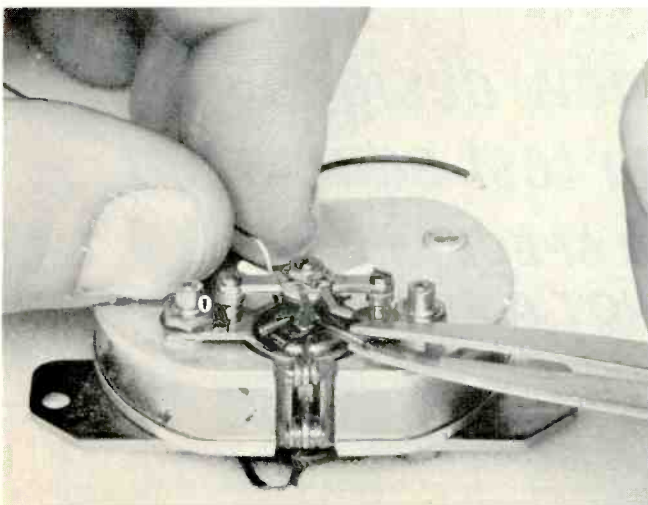

If meter readings change when physical position is changed, counterweights need to be adjusted. Grasp pointer gently whenever weight is moved to prevent bending of meter pivots. Use a trial-and-error method until movement is minimized.

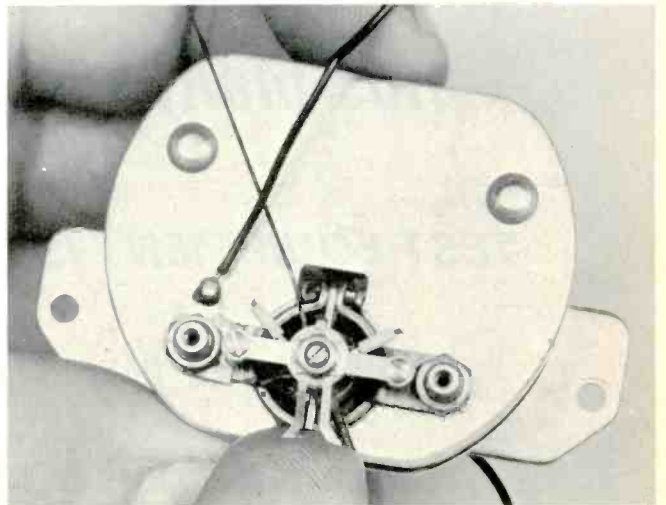

Set zeroing arms at top and bottom to their center positions. Set zero screw on meter front to its zero position so that the pin will engage slot in top arm when cover is replaced. Back arm may have to be moved later to insure correct range of zero screw.

STOP!

at our booth at the
NAB Show for a preview
of the world's most advanced
Video Test Signal Generators.

SEE THE POLYBURST—

a revolutionary new concept
in multiburst generation.
See the 20T-Pulse, a stairstep
generator loaded with new features
—*plus many other new designs
in test equipment.*

**TEST EQUIPMENT IS OUR SPECIALTY
—NOT A SIDELINE**

SEE US AT THE NAB SHOW — BOOTHS 413, 415, 417

For more information write



VIDEOMETRICS, INC.

subsidiary of **CENTRAL DYNAMICS CORP**

33 Cain Dr., Plainview, N.Y. 11803

Tel. (516) 249-5662

**THIS BOOM MICROPHONE
IGNORES EVERYTHING
...EXCEPT THE DIALOGUE**

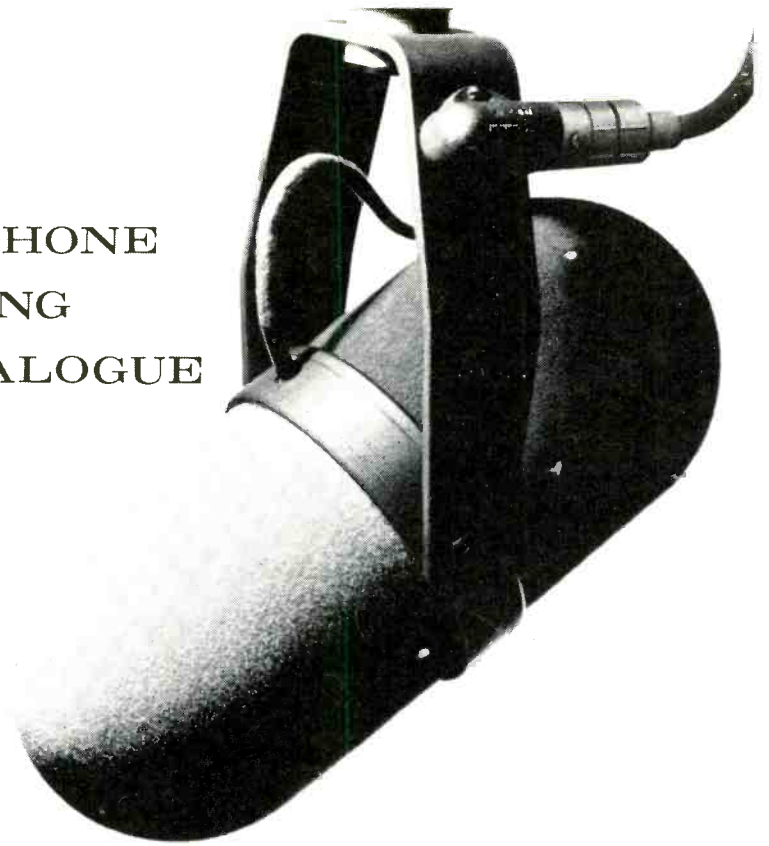

Consistency of sound track quality on an endless variety of locations and sets can be dramatically improved with the remarkable Shure SM5 Boom Microphone. It "hears" the dialogue rather than the ever-changing character of the surroundings.

Because its cardioid directional pattern is uniquely uniform with frequency and symmetrical about its axis, the SM5 is singularly independent of the effects of environment. Even in extreme shooting situations (such as with tight sets, low ceilings, hard walls, low microphone angles, traffic or air conditioner noise and rumble, and changing distance) the SM5 minimizes sound coloration and ambient noise pickup. Equalization

changes—on the set or in transfer—are seldom, if ever, necessary.

The highly effective attached windscreen completely encloses the two-stage mechanical filter, so that there are no external "rubber bands" for the wind to "strum." The absence of response-correcting inductors or impedance transformers assures freedom from hum.

Call on the Shure SM5 to solve your most annoying boom problems!

For additional information, write directly to Mr. Robert Carr, Manager of Professional Products Division, Shure Brothers, Inc., 222 Hartrey Ave., Evanston, Illinois.

SHURE SM5

UNIDIRECTIONAL DYNAMIC BOOM MICROPHONE

SHURE PROFESSIONAL MICROPHONES . . . FOR BETTER AUDIO



**MODEL SM56
CARDIOID
DYNAMIC**

Extremely versatile in studio, control room, and remote use. Also widely acclaimed for rhythm recording. Bright, clean sound. Exceptionally uniform cardioid pattern gives optimum control of environment.



**MODEL SM33
UNIDIRECTIONAL
RIBBON**

Warm, smooth sound for studio, control room, and scoring stage. Super-cardioid directional pattern. Compact, yet rugged.

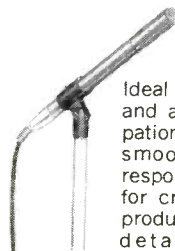

**MODEL SM76
3/4" OMIDIRECTIONAL
DYNAMIC**

Ideal for interviews and audience participation, yet unusually smooth wide range response (40-20 KC) for critical music reproduction. Instantly detachable from stand. Steel case with Cannon connector.



**MODEL SM50
OMNIDIRECTIONAL
DYNAMIC**

Self-windscreened and pop-free for news, sports, remotes, and interviews. Also ideal for many studio and control room applications. Comfortably balanced for hand or stand use. Natural response.

PORTABLE CONTINUITY AND PHASING TESTER

by A. Molchanovsky*

—A simple solid-state test set speeds audio check-out in the field.

Tests for continuity and phasing should be performed after an installation for an outside broadcast is completed. The need for a continuity test is obvious, but an audio signal source rather than an ohmmeter should be used. An ohmmeter check is not only tedious and time consuming, but also incomplete. It checks the cables, but it does not include any mixing amplifiers and transformers, which most certainly are incorporated in the installation.

The phasing test is very important also. Consider two microphones connected to a mixing amplifier and placed before a group of singers. Both microphones receive more or less the same signal, and if the microphone outputs arrive at the mixing amplifier in opposite phase, they tend to cancel each other. This results in the curious effect that the output of the mixer rises as one of the faders is closed. Another effect of improper phasing of two microphones is the loss of low frequencies. This comes about in the following manner: Sound travels at a speed of about 1100 feet per second, so the wavelength at 1 kHz is about one foot. This means that the phase of a 1-kHz signal changes about every six inches. This distance of phase reversal becomes progressively smaller at higher frequencies, and therefore the phase relationship between different high-frequency signals arriving at the faces of the two

microphones changes all the time. Thus the actual phasing of the two microphones becomes unimportant when high frequencies are considered. This is not the case, however, for the lower frequencies, where the wavelength is much longer and the phase changes but slightly with distance. In this case, the signals arrive either in phase or out of phase at the two microphones. This is the reason that a whole "slice" of the low-frequency spectrum can be lost by improper phasing of microphones, making the performers sound unnatural.

Phasing can be checked by sending an asymmetrical signal from the microphone ends of the cables and observing the signal at the output of the mixing amplifier on an oscilloscope (Fig. 1). The signal on the oscilloscope should be of the same phase for all the microphone inputs.

Since the continuity and phasing tests are so important, it was decided to develop a small, simple test unit which checks both continuity and phasing of any audio installation. At the same time, this test unit should afford a possibility to check the sensitivity (gain) of each channel. Phasing should be indicated by pilot lamps rather than by means of an oscilloscope.

The testing unit built with these considerations in mind consists of

two parts, a generator and a receiver. The generator develops either a sine-wave signal at microphone level and 50-ohms impedance (to check channel gain), or a special phasing signal. The receiving unit has a green and a red pilot lamp to indicate the phase of the arriving signal. Both units are small, as can be seen in Fig. 2, and are operated by internal batteries.

Generator Unit

Externally, the sending unit consists of a metal tube which has a slide switch at one end and a microphone connector at the other end. The generator consumes only 2 ma and is powered by a small 15-volt battery. A small hole was drilled in the base of the microphone plug, and a pin was inserted through it. A miniature switch was placed behind the base so that the switch is actuated by the pin whenever the plug is inserted into a socket. The switch connects the battery to the generator circuit and thus turns the unit on; consequently the battery cannot be used up inadvertently between tests. This arrangement also obviates a need for an "on" pilot lamp which would shorten drastically the life of the battery.

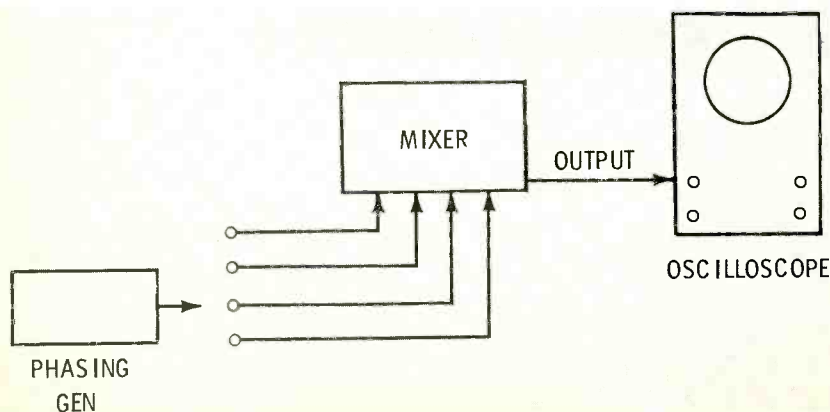
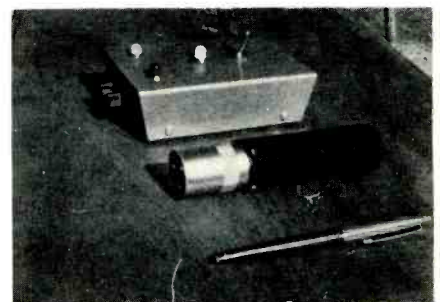

Fig. 1. Phasing is checked by observing output signal for known input phase.



(A) Sender and receiver



(B) Receiver outside case

Fig. 2. Solid-state audio testing set.

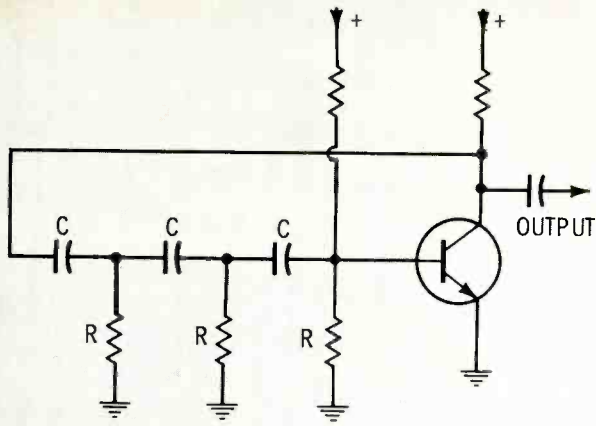

Fig. 3. Diagram of conventional phase-shift oscillator.

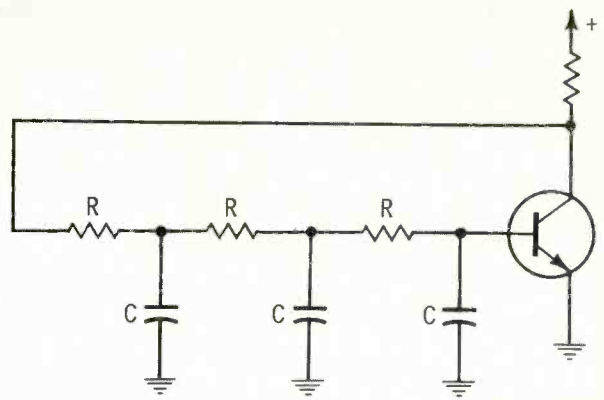

Fig. 4. Phase-shift network also acts as low-pass filter.

Phase-Retard Oscillator

The generator circuit presented a problem, since all standard oscillator circuits contain a level-stabilizing element such as a thermistor or pilot-lamp filament. This was out of the question since battery drain has to be kept very small. It was therefore decided to use a "phase-retard" oscillator, which consumes very little current. In addition, this circuit is inherently self-limiting and thus provides a sine wave of about 2% harmonic distortion and a constant and stable amplitude.

Since the "phase-retard" oscillator is not well known, a short review of the circuit will be given here. Consider first the circuit in Fig. 3. This is the well-known "phase shift" oscillator. The amount of phase shift introduced by the R-C network

depends on frequency, so at some frequency it is 180° , making the feedback from collector to base positive. At that frequency, the loss of the network is 29 (gain of $1/29$), so if the gain of the transistor is more than 29, the circuit will oscillate. The amplitude of the oscillations is limited only by the transistor gain curve, and the output signal is severely distorted and of badly defined amplitude.

Now consider the circuit of Fig. 4. This is actually the same circuit as in Fig. 3, but with the C and R positions interchanged. The phase-shifting ability of the network remains unchanged, and the circuit oscillates as before. However, the R-C network doubles as a low-pass filter, and, because of attenuation of the

harmonic frequencies by the network, a rather distorted sine wave at its input emerges quite pure at its output. It can be shown mathematically that a square wave at the input of such a network (at the frequency of oscillation) emerges as a sine wave having only 2.4% distortion.

The idea of using this circuit is as follows: If the operating point of the oscillator transistor is chosen correctly, the wave shape at the collector will become a square wave (because of overload) of a definite amplitude. After passing through the R-C network, the signal will arrive at the base as a sine wave and thus maintain oscillation. This sine wave will be of an amplitude as constant as that of its parent square wave.

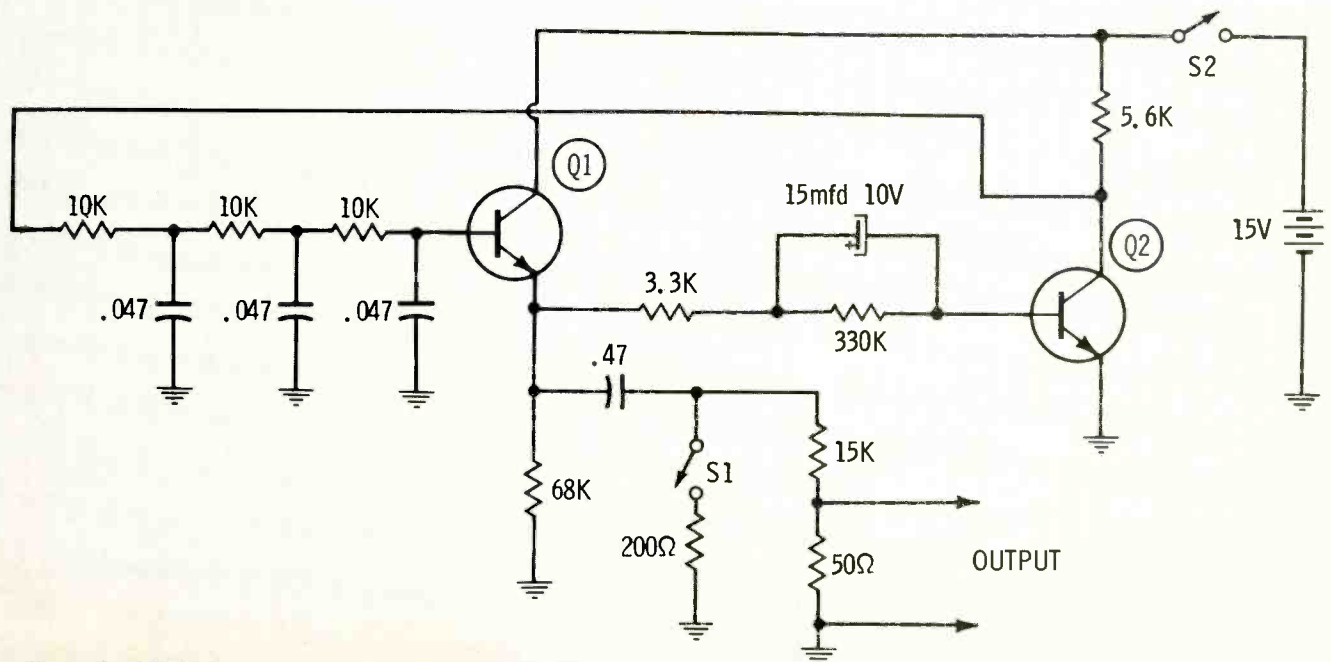
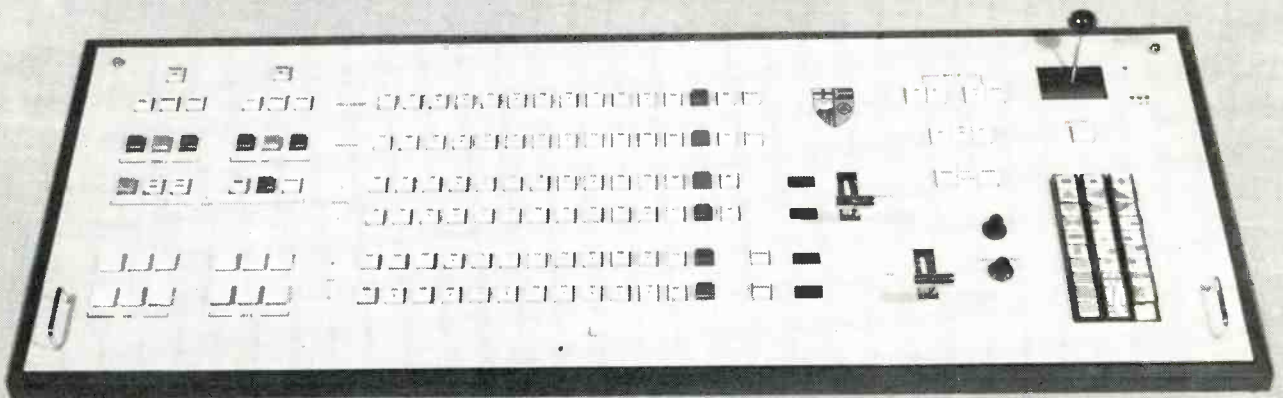

Fig. 5. Complete circuit of the sending unit. Power is applied only when unit is plugged into microphone receptacle.

Meet the video switcher a perfectionist gets excited about.



Custom switcher panel for Southern Alberta Institute of Technology

It isn't really surprising that the first piece of equipment a station engineer shows to "visiting firemen" is usually his custom-designed R.H.L. VSB-3 Series Video Switcher.

There are so many things about it that turn him on.

The personalized control panel where room for future facility expansion can be provided.

The remarkable system design flexibility that makes it possible for him to start with what he needs then expand to suit his future requirements by the easy addition of plug-in modules. (Think of the economy.)

The precise system timing and equalization. Every path through the switcher is timed with electronic delay switching and equalized to give him the only thing he'll buy. **Perfection.**

Vertical Interval Switching. Superior. Complete. Nothing to add. Period.

The bridging input drivers with looped inputs, providing monitor access to actual input signals and very low impedance feeds to crosspoints.

The unique R.H.L. Duty Cycle Integrator which samples the energy content of the signals and derives a D.C. component to minimize bounce.

The electronic tally control. Electronic logic gates control signal-source cueing, delay switching and provide a contact closure available for other purposes.

And more. For instance: the tally lights on the rack electronics and control panel are in exactly the same relative position for instant identification. (Local operation of crosspoints is available by replacing tally lights with miniature lighted push-buttons.)

Every unit is backed by a five-year guarantee and carries this extra bit of assurance — every component operates well below normal rating and must meet our rigid quality control requirements.

We invite the perfectionist to see us at the N.A.B. Convention. Or, we'll be happy to send you complete details and specifications.

NAB BOOTH NUMBER 412, NORTH EXHIBIT HALL



RICHMOND HILL LABORATORIES LIMITED

1610 MIDLAND AVENUE, SCARBOROUGH, ONT., CANADA, PHONE (416) 757-3631 / cable RICHILL / TELEX 02 29803

FOR BEST ALL AROUND FM SOUND...

...GO TRUE CIRCULARIZED!

JAMPRO CP-IX FM ANTENNAS

VARIABLE HORIZONTAL TO VERTICAL RATIOS are available only in JAMPRO circularized antennas. These ratios may be adjusted from 50:50 or varied to other percentages up to 90% horizontal and 10% vertical.

EXCLUSIVE DIGITAL TUNING END STUBS allow extremely low VSWR. JAMPRO guarantees a VSWR of under 1.1 to 1 when mounted on your tower, then field trimmed to 1.08 to 1, carrier, \pm 200 KC.

The only true circularly polarized FM antenna with variable power ratio AVAILABLE IN TWO DIFFERENT FEED SYSTEMS PARALLEL SYSTEM using individual interbay cables from one power divider, resulting in the best possible FM antenna performance.

SHUNT SYSTEM with elements across a single 3/8" rigid coaxial line.

TAKE A CIRCULAR STEP!

Write for full specifications, or make a circular motion on your phone dial (916) 383-1177.

JAMPRO

A Division of Computer Equipment Corp

ANTENNA COMPANY

6939 POWER INN ROAD

SACRAMENTO CALIFORNIA 95828

The Receiving Unit

The receiving unit is used to check the phasing of different channels in the installation. This unit is connected to the output of the mixing amplifier, and the signal at its input should be about 0 dBm. Phasing is indicated by the lighting of either a green or a red lamp.

The receiving unit consists of two identical channels (Fig. 6). Each channel starts with a rectifier which operates on positive pulses only. Each rectifier is followed by a Schmitt Trigger, which in turn controls the lamp-driver transistor.

The input is connected through a miniature push-pull driver transformer so that the two channels always receive oppositely phased signals. In this way, only one channel (which receives the positively phased pulse) is operated, depending on the polarity of the incoming signal. The complete schematic of the receiving unit is shown in Fig. 7.

The two units are very small and easy to handle, as can be seen from Fig. 1, and once put into use, they become indispensable on outside broadcasts.

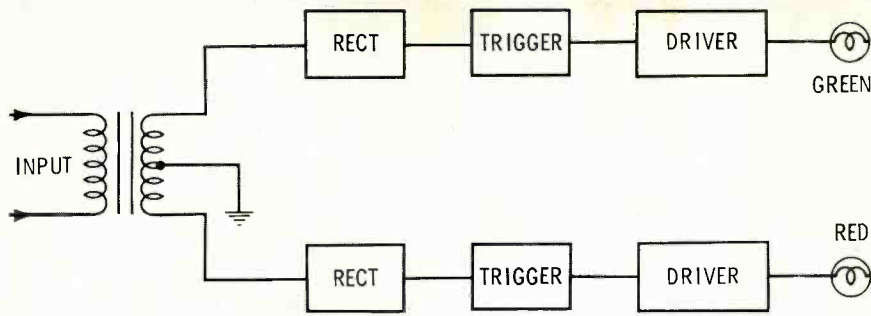

Fig. 6. The receiving unit differentiates between signals of opposite phase.

Complete Circuit

The complete schematic of the sending unit is shown in Fig. 5. The R-C network is connected between the collector and base (through emitter follower Q1) of oscillating transistor Q2. The operating point of Q2 is chosen so that the transistor is symmetrically overloaded and thus supplies a square wave of constant amplitude to the phase-shift network, which changes the signal into a sine wave at the base of Q1. The emitter of Q1 follows its base and is the source of the output signal, thus isolating the phase-shift network from the external load. The amplitude of the output signals depends

on that of the square wave at the collector of Q2, which in turn depends only on the DC supply voltage. Thus the output amplitude is stabilized.

There are two more points to note: (1.) The resistor network at the output serves to reduce the oscillator output (which is about 0.2 volt) to microphone level at 50-ohms output resistance, and to change it from a sine wave to sharp positive pulses (by loading the oscillator) when switch S1 is closed. This signal is used to check phasing. (2.) Switch S2 is the power switch mentioned earlier. It connects the battery only when the unit is plugged into a microphone receptacle.

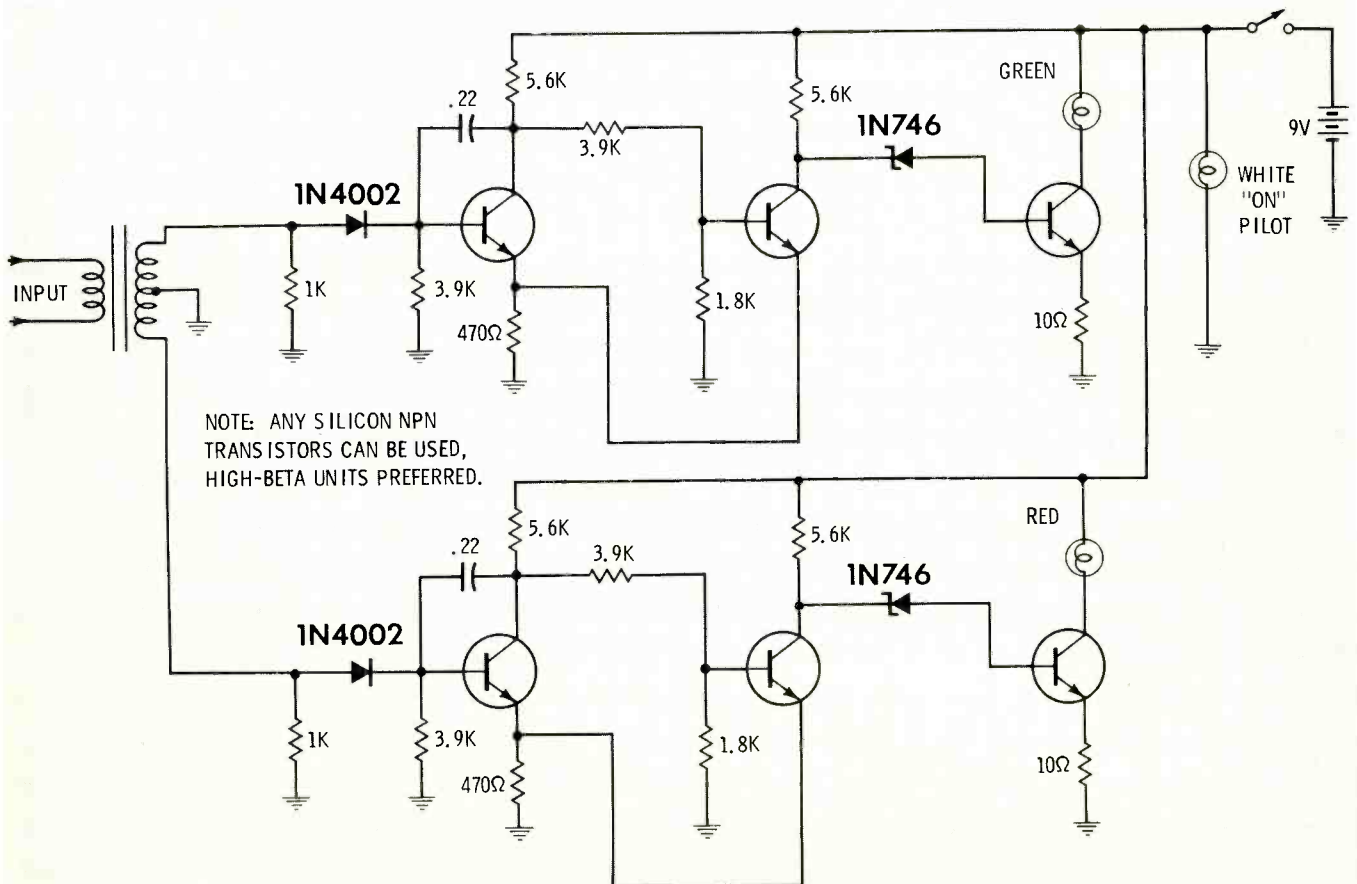

Fig. 7. Receiving unit has push-pull input transformer driving identical channels which control two indicator lamps.

Servicing Mobile Radio With a Scope

If your maintenance responsibility includes mobile equipment, the versatile oscilloscope can help you.

by **Leo G. Sands**

The oscilloscope is probably the least-used instrument in mobile-radio maintenance, although it is one of the most valuable servicing tools. It can be used wherever AC power is available, or even in the field when a DC-to-AC inverter is used to operate it from a battery. Units operated from self-contained batteries are available, although they are relatively expensive. Modern AC-operated scopes are much smaller and lighter than those available in the past, and many are useful at frequencies up to 12 MHz. Several recently available models are rated for flat response from DC to 4.5 MHz, but are often useful well above 10 MHz.

For mobile-radio servicing, a scope should be capable of being used for measurements at frequencies from DC to 4.5 MHz or higher. When set for DC, such a scope can be used instead of a VOM or VTVM for making DC-voltage measurements, and for monitoring limiter, AVC, and discriminator circuits.

DC Measurements

When the horizontal sweep is set to zero and the scope vertical input

is set for DC, a dot appears at the center of the screen when the DC-input voltage is zero. The dot moves an amount and in a direction depending on the polarity and magnitude of the DC-input voltage.

For setting an FM discriminator, the usual procedure is to use a VTVM with center-scale zero, so the discriminator can be tuned for zero output when an unmodulated input test signal is applied. A DC scope can be used for the same purpose; it is probably easier to read at the zero-voltage point, and it is not necessary to keep resetting the zero point. A scope also can be used for monitoring limiter voltage when an FM receiver is being aligned, or AVC voltage when an AM receiver is being aligned.

For FM-discriminator alignment in a tube-type receiver, the vertical input of the scope is connected to Point A as shown in Fig. 1A, and the scope ground lead is connected to the receiver chassis. The same is true in the case of a solid-state receiver, except when Point B (Fig. 1B) is not at DC ground potential. In that case, the scope ground is connected to Point B, but care must be exercised to prevent the scope chassis from making contact with the receiver chassis.

For aligning a tube-type FM receiver, the scope vertical input may be connected across R1 to monitor limiter voltage when the circuit shown in Fig. 2 is used, and when the input is an AM or unmodulated test signal. If the grid resistor is located directly from grid to ground, the scope can be connected to the limiter through an RF probe. For aligning AM receivers, the scope input is usually connected across the AVC bus.

Some scopes are equipped with an internal reference voltage for calibration. This arrangement makes it

possible to read DC voltages from the scope screen with approximately the same accuracy as with a VTVM.

Sweep Alignment

Although most technicians peak receiver IF and RF circuits with an AM or unmodulated test signal while monitoring limiter or AVC voltage, the correct bandpass characteristics can be preserved more easily by using a sweep generator. In the latter case, a scope is required.

For alignment of an FM receiver, the scope vertical input is connected across the grid resistor (Point A in Fig. 2) or to the limiter grid through a probe. For alignment of an AM receiver, the vertical input of the scope may be connected, through a probe, to the detector side of the last IF transformer. The sweep-signal output of the generator is connected to the scope horizontal input to apply a 60-Hz sine wave for horizontal deflection. The RF output of the generator is fed through a small capacitor to the grid of the stage ahead of the one being aligned; the feed point is moved stage by stage toward the receiver front end as the alignment proceeds.

The sweep generator is set to the applicable IF or RF frequency, and the sweep may be set at 100 kHz initially and then reduced until the

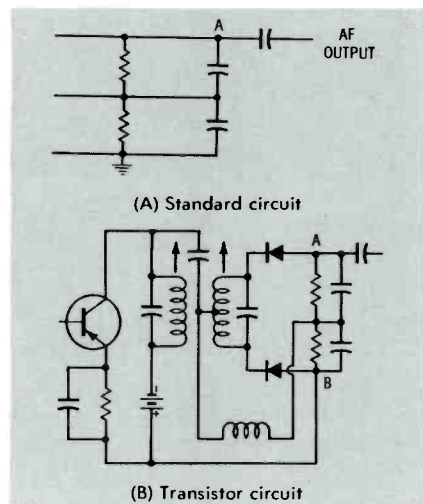

Fig. 1. Discriminator test points for scope during FM alignment procedure.

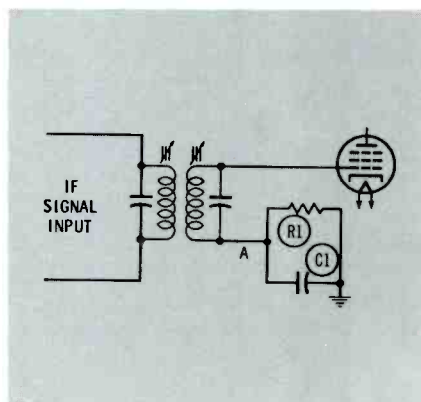

Fig. 2. Monitor limiter voltage at point A when an AM input signal is used.

Look at the Difference



Unretouched photographs of 21" studio monitor. Photographic data: Rolleiflex C-3, CPS color negative film — ASA 100, 1/15 second at f/5.6

...after 3M Color Dropout Compensation

Here's what 3M's Color Dropout Compensator does for your VTR reproduction:

Look at this unretouched composite photograph of a studio monitor. It shows, at the left, a videotape playback with 13 electronically recorded-in dropouts. These dropouts were created by a special test generator which attenuates the RF level to the record driver. On the right, these dropouts have been completely restored by the DOC.

The black dropouts shown on the left are followed by a complete loss of color-lock in the direct color recovery equipment. Since these dropouts include horizontal sync and color burst, they cause transient color flashing not ordinarily attributed to the dropouts themselves. Even shallow dropouts can create a similar problem due to loss of side-band information.

Only the 3M Color DOC corrects all these effects.

After compensation, note the precise color match and complete freedom from switching transients. Also, the dropout disturbance to the time correction unit has been eliminated. Proc amp and

servo stability are improved to such a degree that it is possible to play this tape in full intersync or pixloc mode.

In the compensated half of the photo, compare the replacement material with the original signal two scan lines above the dropout due to a *complete* frame being photographed. Try to find the 13 switching transients.



The 3M Color Dropout Compensator is the only system available that can provide proper color and luminance replacement. For details write for the booklet, "Compensating for Dropouts in Color Television Recording."

Mincom Division **3M**
COMPANY
300 SOUTH LEWIS ROAD • CAMARILLO, CALIFORNIA 93010

See it at NAB

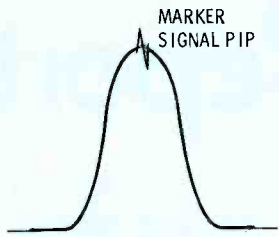

Fig. 3. Bandpass curve showing a marker pip to indicate center of passband.

trace on the scope screen is of suitable width. The bandpass of a receiver, as seen on the CRT, should look approximately as shown in Fig. 3. It is important that the center of the waveform be at exactly the right IF or RF frequency. This can be determined by applying a frequency-marker signal in addition to the sweep. Sweep generators are often equipped with a built-in marker generator, but for best accuracy an external crystal-controlled marker generator, or a frequency meter, should be used.

FM-Detector Adjustment

As discussed earlier, the usual way of adjusting an FM discriminator is to set it for zero output as indicated by a VTVM, with an unmodulated test signal applied. This technique is by no means ideal, since the response can be nonlinear even if the adjustment appears to be correct. A better job can be done with a scope and a sweep generator. The vertical input of the scope is connected to the output of the discriminator as shown in Fig. 4. The RF

output of the sweep generator is fed to the grid of the limiter stage immediately preceding the discriminator. Both the primary and secondary of the discriminator IF transformer are tuned until the waveform is balanced, as shown in Fig. 5A. This waveform is obtained with the scope horizontal deflection provided by the sine-wave signal from the sweep generator. By setting the scope sweep to twice the sweep-rate frequency (usually 60 Hz) and using the scope internal sawtooth generator, a double pattern is obtained which looks something like the one shown in Fig. 5C. For some technicians, this pattern may be a better one for checking out discriminator balance, but the choice is a purely personal one.

Many FM receivers now employ a gated-beam FM discriminator, which is much easier to adjust than the conventional discriminator. As shown in Fig. 6A, there is a parallel resonant circuit connected to the quadrature grid of the tube. The slug of coil L is adjusted for maximum audio recovery, as determined by listening to an FM signal. No meters are required. However, a more accurate job can be done by looking at the IF signal at grid 3 with a scope. Use a low-capacitance probe, and adjust L for maximum signal amplitude with an unmodulated signal applied. Also the receiver audio output may be monitored with the scope while a tone-modulated FM signal is fed into the receiver and L is adjusted for maximum amplitude and minimum distortion of the recovered tone signal.

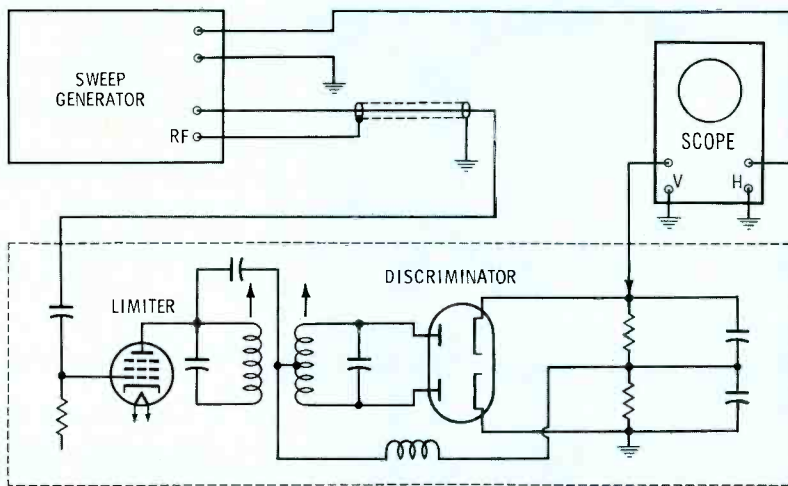
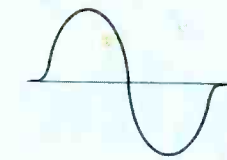
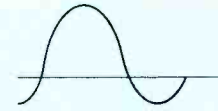

Fig. 4. Equipment properly set up for tube-type FM discriminator alignment.



(A) Correct single



(B) Incorrect single

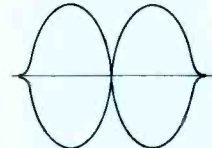

(C) Correct double

Fig. 5. Output waveforms from FM discriminator using sweep-signal input.

The test point (TP) shown in Fig. 6A is used when the preceding stages are aligned. A VTVM can be connected there, or a scope can be used to monitor the signal at this point when the sweep-generator alignment technique is being used.

Another type of FM detector, which is similar to the gated-beam discriminator, is shown in Fig. 6B. The tube is a 6DT6 or other sharp-cutoff pentode. The quadrature coil (L) is tuned for maximum DC voltage across R1, as monitored by a scope (set for DC); the test signal is unmodulated.

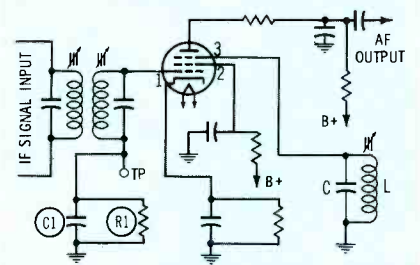

(A) Gated beam

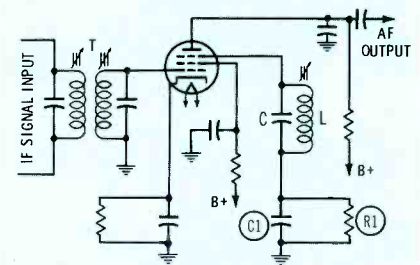

(B) Pentode

Fig. 6. Three-grid FM discriminators.

Now you have 101 reasons to buy the Uher® 4000 Report-L

After June 15th you'll have only 1.

The first 100 reasons are all one doll bills you won't have to part with, during our "Own the Best" sale. The UHER 4000-L will cost you \$340 instead of \$440 now through June 15th.

The 101st reason... and the most important one... is quality. The UHER 4000 Report-L is the world's finest portable tape recorder. A lightweight 7 pounds that goes anywhere comfortably, the UHER 4000 is solid state and operates on rechargeable or ordinary batteries.

It does everything the professional wants it to do, up at the Arctic or down at the Equator. That's why it's first choice with explorers, naturalists, reporters, radio and TV commentators, as well as doctors, scientists and lawyers. It records or plays back at four speeds and gives you great frequency response with each. It has a highly visible, three digit indicator counter with a push-button reset.

Audio Magazine calls it "Magic in a Matchbox." Professionals call it the greatest. Now that we've made it \$100 easier to "Own the Best," clip the coupon, take it to your UHER dealer and walk out with 7 pounds of greatness—the UHER 4000 Report-L.

Save \$100.

Upon presentation of this coupon to any UHER dealer, the bearer may purchase the world famous UHER 4000 Report-L Tape Recorder at the special price of \$340. (Regular price \$440). This unique "Own the Best" offer includes the following high quality accessories for the UHER 4000:

Dynamic Microphone with built in wind screen, music/speech switch (#M514)
• Long Life Accumulator Dryfit battery pack (#433) • AC power supply and battery charger (#880) • Genuine Leather Carrying Case (#861).

This offer expires June 15, 1968 and is applicable only on the UHER 4000 Report-L Tape Recorder.

NAME _____

ADDRESS _____

CITY _____ STATE _____ ZIP CODE _____

Copyright 1968

Uher by Martel

Martel Electronics Inc. Sole U. S. Importers
2339 South Cotner Avenue, Los Angeles,
California 90064; New York: 1199 Broadway
Chicago: 5445 No. Lincoln

Circle Item 23 on Tech Data Card

The stages preceding the detector may be aligned by connecting a scope to the first grid through an RF probe when an AM test signal is used, or through a low-capacitance probe when an unmodulated signal is used. Adjust the stages for maximum signal indication on the scope. If there is a limiter stage ahead of the detector, however, it is better to monitor the signal at the limiter input.

After the receiver has been aligned, the detector-input transformer (T, Fig. 6B) should be tuned for best signal-to-noise ratio with a very weak FM signal applied. If the FM signal is tone modulated, the audio output of the receiver can be monitored with a scope, and the best signal-to-noise ratio can be noted visually. The final tuning consists of trimming coil L for best audio recovery and signal-to-noise ratio, and minimum audio distortion.

Transmitter Servicing

A wideband scope can be used for direct observation of RF signals in transmitters at stages operating at frequencies below approximately 12 MHz. To observe signals at higher frequencies, a "down converter" can be used (Fig. 7). This is simply a mixer stage into which the signal under test is injected along with a reference signal from a local oscillator. The oscillator may be built into the down converter, or an external signal generator may be used. In a pinch, an RF probe can be used as a mixer by feeding the reference signal into it through a small capacitor, along with the transmitter signal. However, a down converter with an output circuit tuned to the desired difference frequency is better.

By observing the RF signal, it is possible to detect hum and unwanted AM on an FM signal. The scope

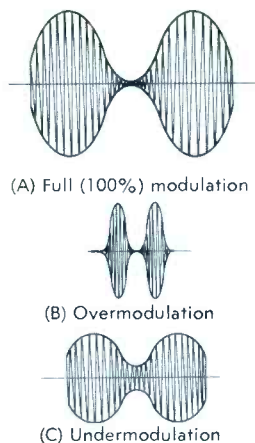

Fig. 8. AM RF waveforms showing 100%, high, low modulation levels.

also provides a convenient way to check the modulation percentage of AM transmitters.¹ The carrier envelopes for various percentages of modulation are shown in Fig. 8.

A scope can be used for checking the performance of transmitter audio circuits. An AF test signal is fed into the microphone-input circuit, and the waveform of the audio signal being fed to the phase modulator of an FM transmitter is observed on a scope. In an AM transmitter, the signal at the output of the modulator can be observed. The distortion and frequency response of the modulator system can be checked by tuning the audio signal generator and by varying its output level. The action of modulation limiters, if used, can be checked by watching the output variations as the input level is changed.

Tone Checks

A scope is very handy for checking tone encoders. You can observe the waveform, and, by using an audio signal generator as a reference, you can measure the tone frequency by means of Lissajous patterns. You can also observe the tone waveform at the input of a tone decoder after the signal has passed through a transmitter and receiver.

Summary

A wideband oscilloscope is an invaluable tool for servicing mobile-

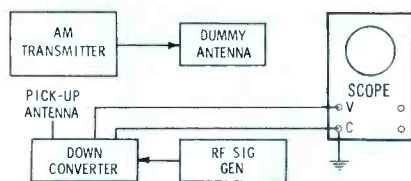

Fig. 7. Method for observing a VHF signal with a scope and converter.

radio equipment. However, to do a thorough job, it should be capable of measuring DC as well as AC, AF, and RF. It can be used for many purposes, including checking vibrators, transistor switching, and silicon controlled rectifier operation in power supplies, as well as for measuring dynamotor ripple. When its versatility and capabilities are thoroughly understood, the technician will find the scope a very valuable instrument on his maintenance bench. ▲

FLICKERLESS! STOP MOTION! SLOW MOTION!

MODEL 16N/TV



NOW!
TELECAST ANY 16mm
FILM WITHOUT FLICKER—
even in slow or stop motion!

This remarkable new 16mm projector is designed especially for telecasting! It lets you telecast any film exposed at normal speed at from 1 to 12 frames per second **WITHOUT FLICKER**. It also lets you "freeze" any action on one frame without loss of light, or damage to film. Also instant stop — start — forward — and reverse controls.

It's especially useful for telecasting sports events, closed circuit classroom teaching, and all applications where you want to slow down or stop the action. Synchronous motor maintains 24 frames per second with AC line synchronization. Special shutter provides exact synchronization in television chains, eliminating all "shutter-bar" effect.

WRITE OR PHONE FOR COMPLETE INFORMATION OR DEMONSTRATION

TRAIID CORPORATION

777 Flower St., Glendale, Calif. 91201
Phone (213) 247-3000

Circle Item 88 on Tech Data Card

Harvey's is selling stuff you may not know exists.

There's an information gap in the broadcast and recording fields today. Sometimes we find ourselves distributing an exciting new product that many professionals don't even know exists.

For example, did you know that there's a new boom headset with built-in microphone that's so light you can actually forget you're wearing it? It can pick up two different signals at once. It's interchangeable with any standard boom headset. And if you want one now, Harvey's is the only place you can get it.

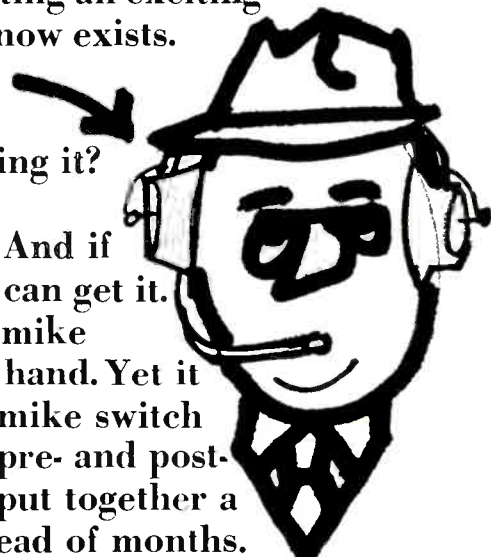

Also, there's now a complete console mike channel so small, you can hold it in your hand. Yet it includes a fader, program equalizer, line-mike switch with input pad, reverb-send channel and pre- and post-echo switch. With a few of them you can put together a complete console in a couple of days instead of months. It's revolutionary—yet, just about the only people who know of it are Harvey customers. Because just about the only place you can get it is Harvey's.



There's much more that's new. We have several new low-cost microphones that sound just as good as the most expensive mikes of a few years ago.

And so on. And so on.

Harvey's is in the habit of finding new equipment and distributing it before anyone else does. Often before anyone else knows about it, in fact. That's why almost every major sound studio and radio station already deals with Harvey's.

Help us close the information gap in the broadcast and recording fields. Call or write Harvey's regularly.

Open an account, if you want, and we'll start sending you our newsletter.

You don't necessarily have to buy anything. We'll just feel a lot better if you, at least, know what exists.

Harvey Radio Co., Inc.

Professional A/V Division, 2 West 45th St., New York, N.Y. 10036 (212) JU 2-1500

Circle Item 24 on Tech Data Card

BOOK REVIEW

FET Circuits: Rufus P. Turner; Howard W. Sams & Co., Inc., Indianapolis, 1967; 160 pages, 5½" x 8½", soft cover; \$3.25.

The author devotes the first chapter to the fundamentals of the FET. This section contains 10 pages of field-effect theory, geometry, history, and ratings.

With the necessary theory covered, the discussion moves to amplifier circuits. In the 22-page second chapter, 18 circuits are shown; complete parts data are included for each circuit. Included in the chapter are: a simple small-signal AF preamplifier, AF source follower, two-stage RC-coupled amplifiers, phase inverters, audio mixers, audio bandpass and band-reject amplifiers, video amplifiers, IF amplifiers, etc.

Chapter 3 deals with oscillator circuits. Twelve circuits are shown, ranging from AF oscillators to HF crystal oscillators. Analyzing these circuits, the reader immediately perceives that FETs can be substituted for tubes in nearly all triode applications.

Chapter 4 is titled "Receiver and Receiver-Accessory Circuits." The first

circuit shown is a basic broadcast-band superheterodyne receiver. There are several interesting innovations, including the use of ceramic filters instead of IF transformers. Other circuits in this chapter include crystal converters, BFOs, a Q-multiplier, and a squelch circuit.

Chapter 5 deals with transmitters and accessories. Several low-power transmitters are shown, as well as frequency multipliers, a balanced modulator, and two monitors.

Control circuits are explained in Chapter 6. Among the projects are controlled relay units ranging from VOX to light-operated. Also shown is a modulated-light detector/amplifier.

The last chapter covers instruments. Circuits are shown for nineteen different test instruments, from voltmeters to light meters. Included is a circuit for a direct-reading audio-frequency meter. This instrument employs two FETs and eighteen resistors and capacitors; it covers 0-100 kHz in four ranges.

Included in the appendixes are biasing diagrams and source guides for all the FETs mentioned in the text. ▲

Replace Your Present AM Monitor with a

all
solid
state

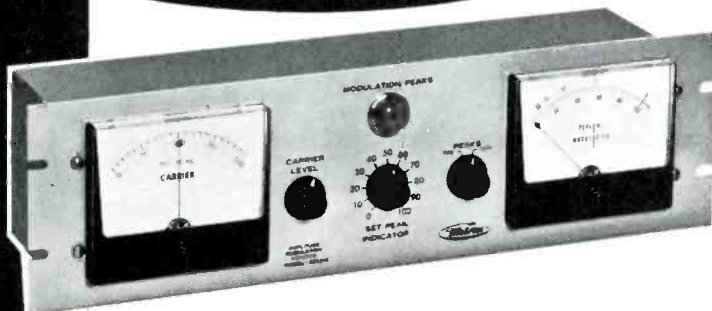

* AM MODULATION MONITOR

The Metron Model 506B-1 Amplitude Modulation Monitor is a high quality instrument, field-proven for several years.

- FCC Type Approval 3-127
- Compact — Only 5¼" high on a standard 19" rack
- All solid state circuits — silicon transistors for greater reliability.
- Low Cost — only \$550.00.



METRON INSTRUMENTS, INC.
1051 South Platte River Drive Denver, Colo. 80223
(303) 744-1791 • TELEX 04-5729

Circle Item 70 on Tech Data Card

To Meet All
Federal Regulations*

SPECIFY & INSIST

on
Hughey & Phillips

The leader in tower
obstruction lighting
and control systems.

* FCC — FAA and Nat'l. Elec.
Code Regulations



**300MM BEACONS
SINGLE AND DOUBLE
OBSTRUCTION LIGHTS**



APPROVED
by the FAA

TOWER LIGHTING ISOLATION TRANSFORMERS
750, 1750, 3500, 5000, 7500 Watts

FEATURING...

- HIGHER EFFICIENCY
- IMPROVED REGULATION
- FIBERGLAS INSULATION
- EPOXY ENCASED
- VERSATILE MOUNTING



CONTROL UNITS to meet
Standard or Special Requirements.

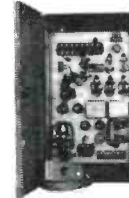

**LAMP FAILURE
ALARM SYSTEMS
FOR UNATTENDED
INSTALLATIONS**

**TUBELESS PHOTOELECTRIC
CONTROL UNITS**

Indoor or Outdoor
Many Sizes and Voltages



BEACON FLASHERS
Single and Multi-circuit
Indoor or Outdoor

FOR TALL TV TOWERS



**LAMP FAILURE
INDICATOR PANELS**

Request our exclusive TALL TOWER
Specification Guide.

HUGHEY & PHILLIPS, INC.

Specialized Mfrs. of
300MM Beacons, Obstruction Lights,
Tubeless Photoelectric Control Units,
Beacon Flashers, Lamp Failure Alarms,
Tower Lighting Isolation Transformers,
Complete Tower Lighting & Deicer Kits.

3050 N. California St., Burbank, California 91503

Circle Item 79 on Tech Data Card



The Norelco "Little Shaver" does everything its big brother, the PC-70, can do ...and gets around a lot more.

This is the new Norelco PCP-70 Portable Color Television Camera. We call it the "Little Shaver" for short.

Like its big brother, the PC-70, which is used on the majority of top network live



and taped shows, it employs the exclusive Norelco 3-Plumbicon* tube system that provides the truest color, highest resolution and maximum sensitivity available today.

The "Little Shaver" goes where the action is.

Sports. News and documentaries. Political events . . . just about anywhere a man can go.

The "Little Shaver" is fully compatible with the camera control unit of the PC-70 studio camera. Thus, present PC-70 owners have an even greater advantage in that they can have the versatility of the PCP-70 with



no further expense for control equipment.

Instantly accepted by all the major networks, the Norelco PCP-70 is the portable that gives you the

world's best color television picture.

If you want faithful color reproduction in a port-



able camera, you want the "Little Shaver." For a live demonstration and technical data, call or write.

*Registered trade mark for television camera tubes.



Norelco

**PHILIPS BROADCAST
EQUIPMENT CORP.**

299 Route 17, Paramus, N. J. 07652 • 201/262-7300

Introduction to FETs

Through a concerted industrial effort, the field-effect transistor (FET) is beginning to find favor with commercial equipment manufacturers. It is actually an old device, but semiconductor manufacturers only recently have been able to produce it consistently and at an economical price.

The FET has a number of features that make it superior to the transistor, diode, and tube for many applications. Some of these are:

1. Square-Law Operation. The FET drain current is proportional to the square of the gate voltage. This feature makes the device ideal for use in mixer stages, since it produces just the second harmonics necessary for mixer operation. Other devices such as tubes, transistors, and diodes also produce third-order and other harmonics; this causes cross-modulation distortion, a defect that takes considerable effort to reduce.

2. Low Noise. Because the FET is a majority-carrier device, it is not as noisy as transistors, which depend on both majority and minority carriers for operation. This feature makes the FET the logical choice for use in preamplifiers and other

applications where low noise is important.

3. High Input Impedance. This feature, similar to that of vacuum tubes, considerably simplifies the design of amplifiers since the input of one stage does not load down the output of a preceding stage. The large coupling capacitors and tapped interstage transformers associated with conventional transistor circuitry are not needed with FETs.

Basic Theory

For anyone familiar with tubes, FETs should present no problem. The nomenclature for the two devices is compared as follows:

Tube	FET
Plate	Drain
Grid	Gate
Cathode	Source

The FET nomenclature was chosen for obvious reasons. The source generates the electrons or holes, the gate modulates (or controls) the current, and the drain receives the current.

In a vacuum triode, electrons leave the cathode and travel through a grid to the plate. A voltage can be put on the grid to either increase or decrease the flow of electrons. FETs

operate in almost the same manner, and have characteristics similar to those of tubes.

To gain a good understanding of the FET, first consider a semiconductor diode rectifier. It is composed of two types of semiconductor material as shown in Fig. 1A. The N-type material has a surplus of electrons (represented by $-$ signs in the diagram), and the P-type material has an excess of holes (or places where electrons could fit), represented by $+$ signs.

In Fig. 1B, a bias voltage has been placed across the diode. The electrons from the negative terminal of the battery repel the negative charge (electrons) of the N-type material. The positive charge in the P-type material is likewise repelled by the positive connection of the battery. The negative and positive charges meet at the junction. Now assume one electron from the N-type material combines with a hole in the P-type material. In order to maintain balance, an electron from the negative terminal of the battery enters the N-type material. Likewise, a hole moves from the positive terminal of the battery into the P-type material (or an electron goes from

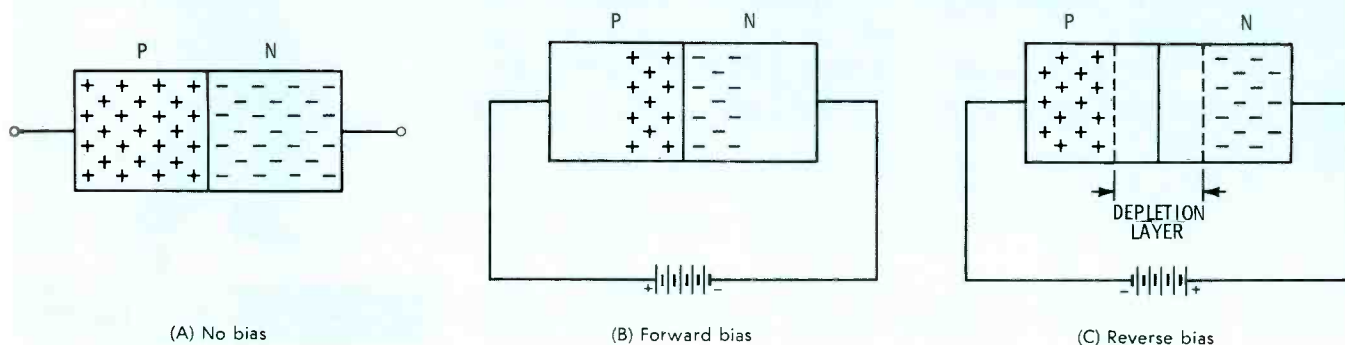

Fig. 1. The unidirectional conduction characteristic of a PN junction is explained by reference to simplified diagrams.

This semiconductor device resembles a vacuum tube in its behavior.

by Thomas H. Lynch

the P-type material to the positive terminal of the battery). This completes the circuit, and one electron has passed through the forward-biased diode. A very large current through the diode can exist, depending on the number of electrons the battery can supply.

Fig. 1C depicts the condition known as reverse bias. In this case, the electrons and holes are forced away from the PN junction by the attraction of the battery. There is no current because there are no electrons or holes at the junction to combine. The area devoid of electrons is called the depletion layer. Its width increases with an increase in applied voltage; here lies the key to understanding the FET.

A cross-sectional view of an N-channel junction FET is shown in Fig. 2. This type is most nearly like a tube in that it requires a positive voltage on the drain (plate) and a negative control voltage on the gate (grid). When the gate voltage is zero, current is allowed to be established from the source to the drain, as shown in Fig. 3A. When a negative voltage is connected to the gate, as shown in Fig. 3B, and the flow of electrons is reduced. This is because

the depletion layer becomes larger, and as it does so it restricts the passage of electrons. The action is analogous to that of a water control valve. This phenomenon allows the FET to amplify and perform the same functions as those of a tube. It should be noted that since the gate junction is reversed biased, there is no gate current. This is the same condition as for a tube grid.

The P-channel junction FET operates in the same manner, except that all the voltages are reversed. Holes then flow from the source to the drain (or, equivalently, electrons flow from the drain to the source).

In both of the preceding cases, conduction takes place with zero gate voltage. For this reason, such a device sometimes is referred to as a "depletion" type, since the correct gate voltage depletes the electron (or hole) flow.

The above discussion has been based on the junction-gate FET. Another type is illustrated in Fig. 4. This device has one more connection to an additional layer called the substrate, which in most cases is connected to the source. The key to the operation of this type of FET is the capacitor formed by the metal gate, the silicon-dioxide insulator, and the silicon semiconductor. From the words Metal-Oxide-Semiconductor is derived the abbreviation MOS, and the device in Fig. 4 is referred to as a MOSFET. Since an ideal capacitor does not conduct current, the gate electrode of an MOSFET has no leakage current with either positive or negative signals (the grid of a tube draws current with a positive voltage).

The MOSFET can be made so that at zero gate voltage there is

• Please turn to page 122

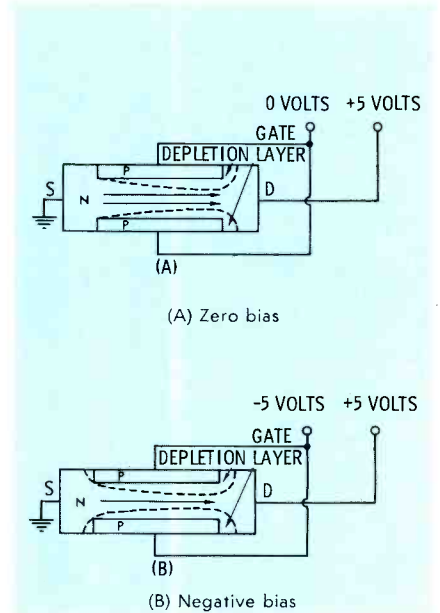

Fig. 3. Gate voltage controls source-drain current of the junction-gate FET.

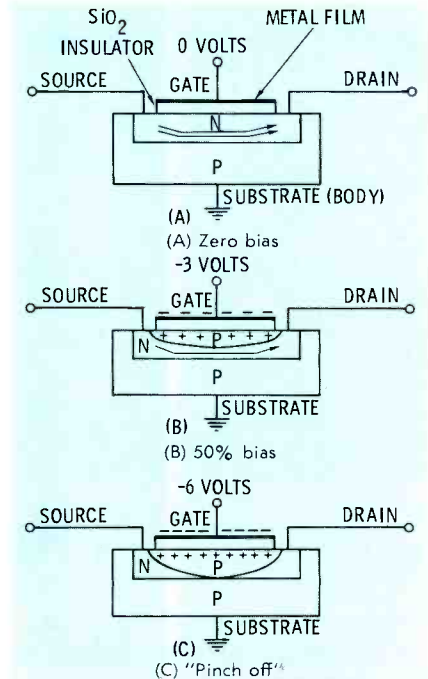

Fig. 4. Operating principle of an N-channel depletion MOSFET is shown.

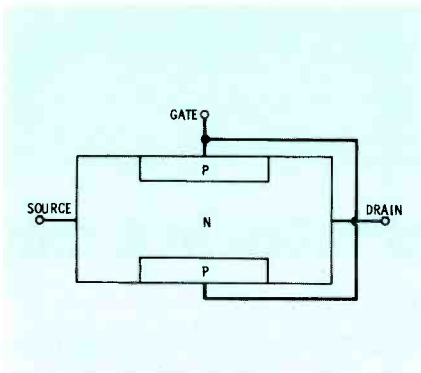
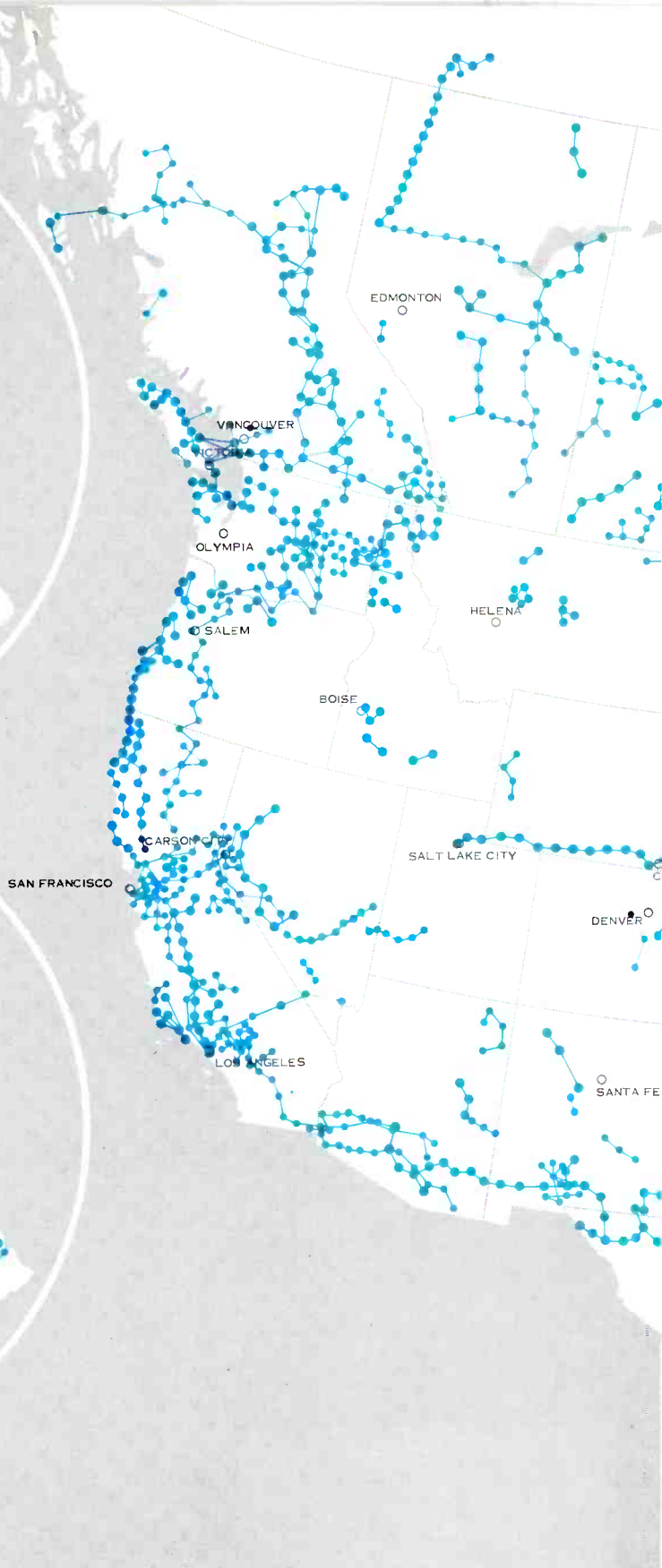
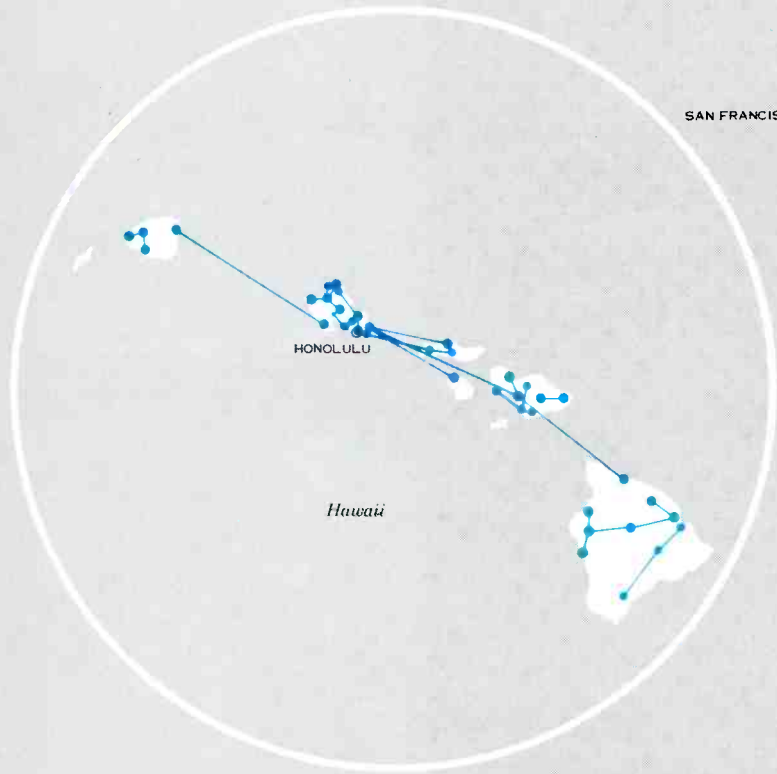
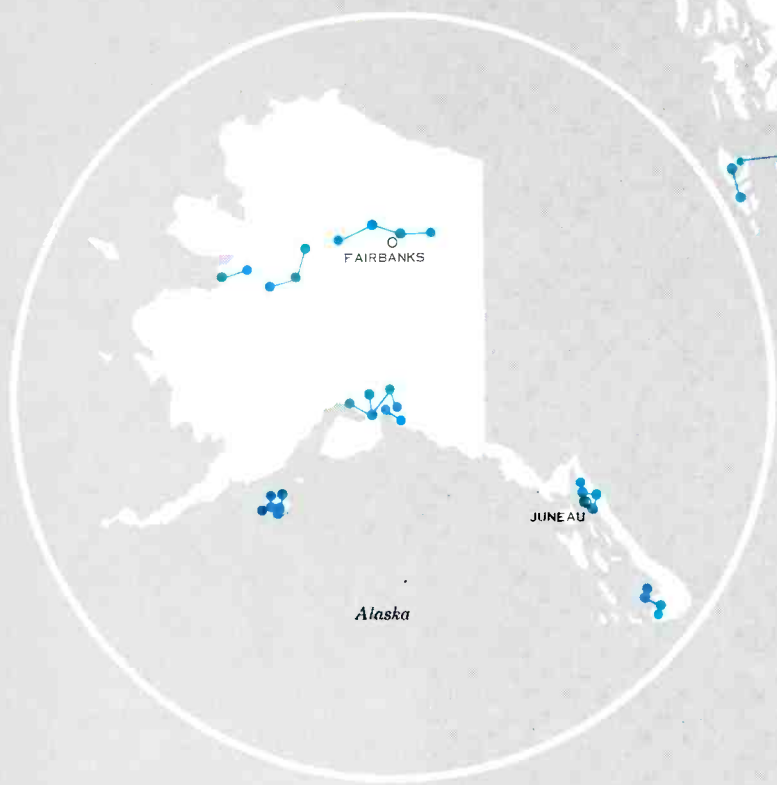

Fig. 2. N-channel junction-gate FET shown in diagrammatic presentation.



Why should you be interested in a map

Because it could mean a lot to you.

You see, each system on this map represents someone like you, who had a need for more effective and economical point-to-point voice, video, and data communications.

Your needs can be satisfied, as theirs were, by Lenkurt's complete line: microwave radio, multiplex, signaling, supervision and control, auxiliary equipment, and Lenkurt's engi-

neering and installation service.

Today there are over 500 separate Lenkurt microwave systems, covering more than a quarter million microwave radio path miles throughout the United States, Canada, and 36 foreign countries.

Reasons?

We pioneered microwave radio and are continually working

LENKURT MICROWAVE SYSTEMS - U.S. and CANADA

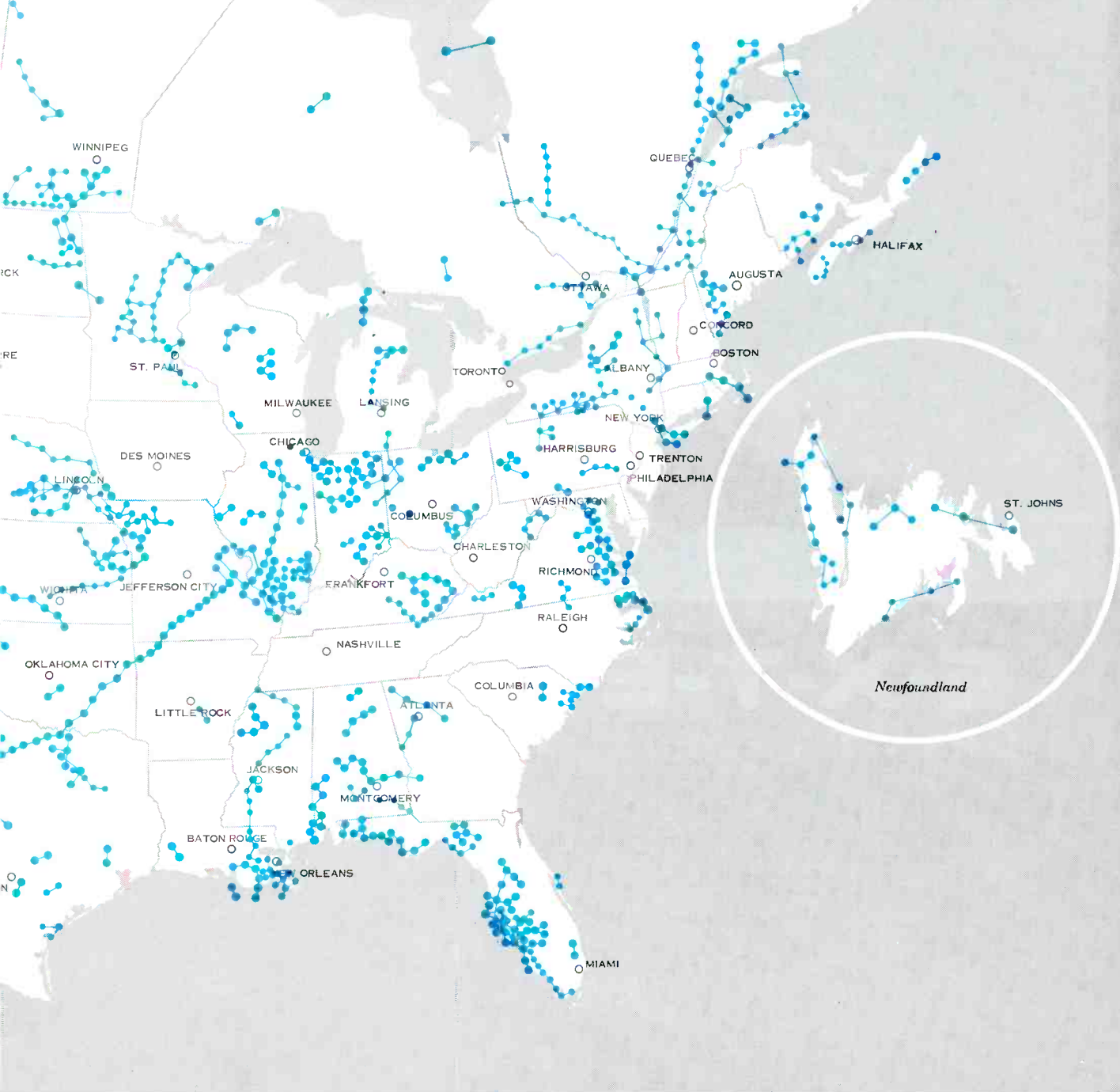

of Lenkurt's microwave installations?

on new developments and improvements. Figures show we're the leading supplier of microwave equipment to independent telephone companies, industrial companies, government agencies, and military services. Almost half the microwave purchased by these users is Lenkurt. We offer 20 varieties of microwave radio operating from the 150 MHz band to the 13250 MHz band. Shouldn't you be on our map?

Contact your local Lenkurt representative or call Lenkurt Electric Co., Inc., San Carlos, California. Offices in Atlanta, Chicago, Dallas, and Stamford, Connecticut.

LENKURT ELECTRIC
SUBSIDIARY OF
GENERAL TELEPHONE & ELECTRONICS GTE

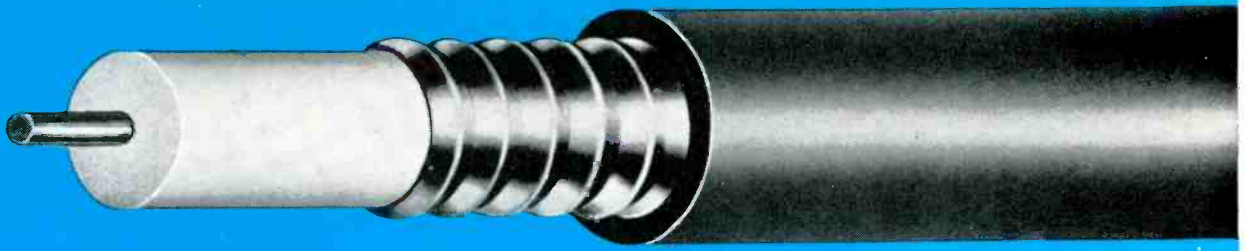

to 300 MHz



and beyond



SUPERIOR CONTINENTAL'S
E-X-T-E-N-D-E-D
SPECTRUM COAXIAL CABLES
for MORE services and MORE revenue.

Controlled impedance uniformity over the extended range provides bandwidth for 14 additional 6 MHz TV channels — with no discontinuity at any point. Now, with this new 84 MHz segment available you can expand your operation to include

- ETV and ITV programming
- CCTV for business and industry
- Data transmission
- Remote control telemetering
- Alert and alarm systems
- Traffic and highway control system

Superior Continental Extended or Full Spectrum Coaxials can also be ordered in IM construction and direct burial types.

Full spectrum coaxials, with no discontinuities to 220 MHz also available.

Write or call for information and prices to:

Superior Sales and Service Division P. O. Box 2327 Hickory, North Carolina 28601 Phone 704/328-2171



**SUPERIOR
CONTINENTAL
CORPORATION**

Circle Item 29 on Tech Data Card

NEWS OF THE INDUSTRY

NATIONAL

Anniversary Marked

Ameco, Inc. recently celebrated its fifteenth anniversary. The cable-television firm filed articles of incorporation with the Arizona Corporation Commission on December 23, 1952. Among the incorporators were Bruce Merrill, now Ameco president, and Edward E. Furman, physical properties director. J. Earl Hickman, president of **Ameco Engineering Corp.**, a subsidiary, was among the original subscribers to stock. Articles of incorporation were issued on January 13, 1953, and that year Antennavision, Inc. constructed a cable TV system at Globe-Miami, Ariz.

In March, 1956, the company moved its headquarters from Safford to Phoenix and adopted its present name, Ameco, Inc. (Antennavision Manufacturing & Engineering Co.)

Industry Relations Operation Moved

In a move designed to strengthen liaison with FCC consulting engineers and attorneys, government agencies, and trade and professional groups, the **General Electric Visual Communication Products Department** has transferred its Industry Relations Operation from Syracuse, N.Y. to Washington, D.C. John Wall, who has been closely associated with GE's broadcast equipment business, will continue as manager of the operation, reporting directly to William B. Gaither, manager-marketing of the department.

Warehouse Opened

A new warehouse has been opened in Atlanta, Ga. to serve the southeastern region of the CATV Systems Division of **Jerrold Electronics Corp.** The new 6500-square-foot facility will stock all of Jerrold's standard CATV systems equipment and a line of aluminum-sheathed coaxial cable. The region includes Georgia, Florida, Alabama, Mississippi, Tennessee, North Carolina, South Carolina, and Kentucky.

Operating Divisions Formed

Three discrete operating divisions to be directed from the Cohasset, Mass. plant have been formed by **RF Systems, Inc.** The Astro Structures Div. manufactures military and commercial antennas, towers, and scaffolding. The RF Components Div. manufactures and markets large and small wave-guide components plus standard and special feed horns and related equipment. The newly formed Industrial Antenna Div. is responsible for the company's industrial products, including those used in the CATV, ETV, MATV, and broadcast industries.

Douglas R. Vining has been named marketing manager, responsible for all marketing and sales activities of the Corporation. James E. Hayes will be manager of the Astro Structures Div.

West-Coast Office

Jack A. Rickel Associates, Inc., Washington, D. C. communications consulting firm, has opened a new office in San Diego, Calif. Donald N. Bowdish will head the new facility.



CUSTOM 12"
also available in
STANDARD 12" or 16"

Someone near you has a QRK spinning away

Before you install any turntable, you owe it to yourself to see a QRK in use. Find one and see it work. Listen to the shape of every note coming off the disk. Try the smooth action of the speed selector. Note that the QRK spins any platter with no need for pop-up gadgets. Try a cue. QRK starts fast, doesn't it? Ask about long-time, little-service operation of the QRK. Sold already? Then . . .

See your dealer today or call or write us
for complete information.



QRK ELECTRONIC PRODUCTS

2125 N. Barton, Fresno, Calif. 93703

QRK's new direct line - (209) 251-0001

Circle Item 72 on Tech Data Card



LARGE OR SMALL...



ALMA SWITCHERS offer VALUE!

PRODUCTION—VAN—ROUTING—DIAL ACCESS

**ALMA
ENGINEERING**

8090 ENGINEER RD.
SAN DIEGO, CALIF.
(714) 278-9330

QUALITY VIDEO
AND AUDIO
TERMINAL EQUIPMENT

**FAST LAP OR
VERTICAL INTERVAL**

Simply add a module at any time
—No other modifications required
All Solid State

Single or Double Reentry
Timed for Color

LOW, LOW COST

To find out how low write or phone
for a quote to your requirements.

NAB SHOW BOOTH 408 / NORTH EXHIBIT HALL

Circle Item 30 on Tech Data Card

New Jersey Regional Office

ITV, Inc., a division of Riker Video Industries, has opened a regional office in Clifton, New Jersey. The new facility houses equipment and personnel for designing, fabricating, and servicing audio-video communications systems. It also contains an equipment display area, a television studio and a videotape duplication center.

ORGANIZATIONS

NAB

In a meeting of 18 representatives of six major broadcasting industry or-

ganizations, it was decided to recommend to their governing bodies that extensive research and other activities be conducted to refute arguments of "... those who seem to favor a new, all-wire system, reallocating the television broadcast band to nonbroadcast use." Organizations participating were: the All-Channel Television Society; Maximum Service Telecasters, Inc.; the National Association of Broadcasters; the National Association of Educational Broadcasters; the Television Bureau of Advertising; and the Television Information Office.

A spokesman for the groups noted that proposals for nonbroadcast use

of the spectrum include allocation of these TV frequencies to land mobile or business services for such uses as vehicle dispatching. The spokesman said that advocates of the reallocation may be "well meaning," but added, "We know that the American commercial and educational system of broadcasting evolved as a free distributive method of communications, and we are convinced that this system must be maintained and protected. Otherwise, the inner-city dwellers and those who live in the rural areas will, at worst, be completely denied the service they now receive without charge or, at best, be required to pay for getting only a part of what they now receive. Either way, the public will suffer."

The group hopes to provide findings in support of its position to President Johnson's recently appointed Task Force on Telecommunications.

The NAB has asked the Federal Communications Commission to simplify its program-logging rules for AM and FM radio stations. The petition stated that an easing of logging rules for radio to make them compatible with those for television would be of "immense benefit to radio broadcasters" and would relieve them of "burdensome and unnecessary logging requirements."

The Spotlight Is on

Spotmaster

Superior Tape Cartridge Recording and Playback Equipment

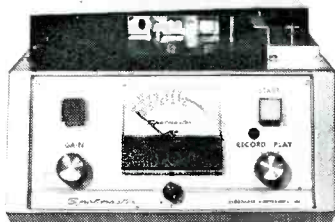

Model 500 Super B



Model 400-A

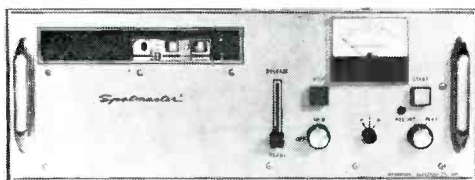

Model 500-BR

COMPACT 500 SUPER B SERIES—Completely solid state, handsome Super B equipment features functional styling and ease of operation, modular design, choice of 1, 2, or 3 automatic electronic cueing tones, separate record and play heads, A-B monitoring, biased cue recording, triple zener controlled power supply, transformer output . . . adding up to pushbutton broadcasting at its finest. Super B specs and performance equal or exceed NAB standards. Record-play and playback-only models are available.

RACK-MOUNTED SUPER B MODELS—The 500-BR rack models offer the same Super B design and performance features and are equipped with chassis slides ready to mount in your rack. Each unit slides out for easy head and capstan cleaning and other routine maintenance.

All Super B models carry iron-clad full-year guarantees.

ECONOMICAL 400-A SERIES—Now even the smallest stations can enjoy Spotmaster dependability with the low-cost, all solid state 400-A series, available in compact record-play and playback-only models. Performance and specifications are second only to the Super B series.

For complete details about these and other Spotmaster cartridge units (stereo, delayed-programming and multiple-cartridge models, too), write, wire or call today. Remember, Broadcast Electronics is the No. 1 designer/producer of broadcast quality cartridge tape equipment . . . worldwide!

BROADCAST ELECTRONICS, INC.

8810 Brookville Road, Silver Spring, Maryland 20910; Area Code 301, 588-4983



ROHN®

Mighty big in towers

CATV • MICROWAVE • COMMUNICATIONS • BROADCAST • HOME TV
• AMATEUR • SPECIALTY TOWERS

Rohn dominance in the tower field is based on the concept of giving the customer more than he expects to get.

Every step — engineering and design, manufacturing, finishing, warehousing, turnkey tower erection service, accessories and equipment, world-wide representatives and service — all are dedicated to **extra quality — extra satisfaction.**

For further information contact

ROHN® Home Office
P.O. Box 2000, Peoria, Illinois 61601
Ph. 309/637-8416 TWX 309/697-1488



Circle Item 31 on Tech Data Card

BROADCAST ENGINEERING

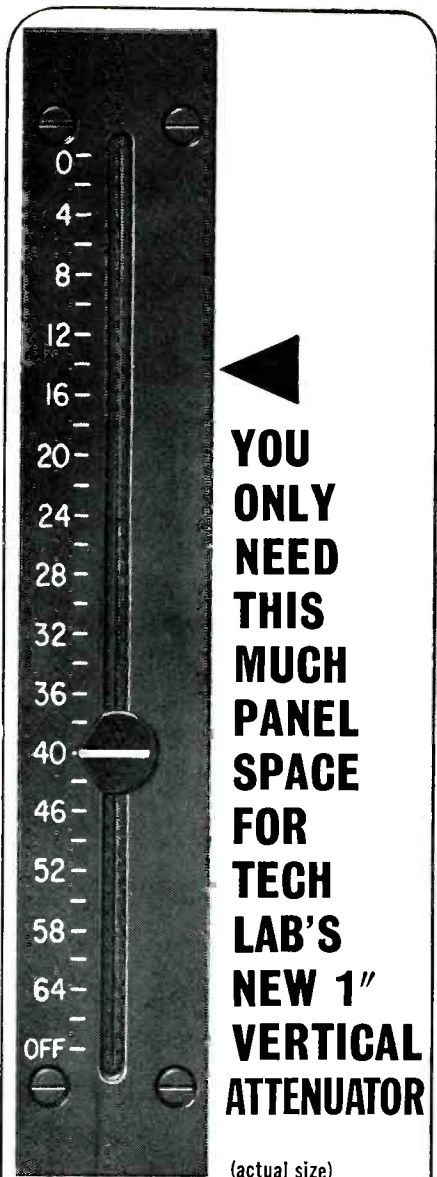

YOU ONLY NEED THIS MUCH PANEL SPACE FOR TECH LAB'S NEW 1" VERTICAL ATTENUATOR

(actual size)

Here's the smallest vertical attenuator made in the U.S.A. . . . another first from Tech Labs, pioneers in vertical attenuators since 1937.

It uses little panel space . . . only 1" wide x 6" long. It provides quick change of levels on multiple mixers and assures long, noise-free life. Units are available in 20 or 30 steps with balanced or unbalanced ladder or "T", or potentiometer circuits. Standard Db per step is 1.5, others on order. Impedance ranges are 30 to 600 ohms on ladders or "T's" and up to 1 megohm on pots.

Don't wait, send for complete data today! **Need Video or Audio Rotary Attenuators?**

All Tech rotary attenuators are precision made for extended noise-free service. Many standard designs available and specials made to your specs. Send for literature today.

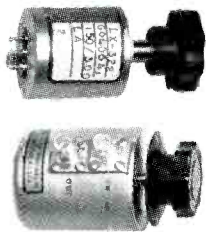

TECH LABORATORIES, INC.

Bergen & Edsall Blvds., Palisades Park, N.J. 07650
Tel: 201-944-2221 • TWX: 510-230-9780

Circle Item 32 on Tech Data Card

The petition said a simplification of the AM-FM rules to make them as uniform as practicable with those applying to television would be "of immense benefit to radio broadcasters." The proposed modification, it said, "would not adversely affect" AM and FM reports on station operations but, rather, would "facilitate the compilation" of the required information. Furthermore, it said, the proposed revision would "remove from the rules the apparent inequities" existing between AM-FM and TV stations and would "relieve AM and FM broadcasters of burdensome and unnecessary logging requirements."

SMPTTE

Arrangements chairmen for the 103rd SMPTTE Technical Conference have been appointed by SMPTTE Conference vice-president E. B. (Mike) McGreal. The Conference is set for the Century Plaza Hotel in Los Angeles, May 5-10, 1968.

Topics for the Conference technical program were recently announced by program chairman Alan M. Gundelfinger. Papers are to be presented on the following topics: Instrumentation and High-Speed Photography, Laboratory Practices and Color Quality control. Television, Systems Approach to Television Color Quality Control, Photographic and Allied Science, Photosensitive materials for Motion Pictures and Television, Theater Presentation and Projection, Small Format Films, Studio Practices, Sound, Education, and Medicine.

In addition to the papers program, the Conference will feature an equipment exhibit where equipment will be on display in some 90 booths.

PERSONALITIES

Bill Gleaves, midwestern marketing manager for **Berkey-ColorTran** (a division of **Berkey Photo Inc.**), will be in charge of the company's new sales office at 600 South Michigan Avenue, Chicago.

Elliot Bell has been appointed senior sales engineer for the Commercial Marketing Department at the newly opened **AEL** office at 8939 South Sepulveda Boulevard, Los Angeles.

Benjamin B. Bauer, vice-president of the Acoustics and Magnetics Department for **CBS Laboratories**, has been elected executive vice-president of the **U.S. Audio Engineering Society**. Mr. Bauer has been responsible for many innovations in audio and acoustics, including advanced microphones for radio and television broadcasting, phonograph sound pick-up devices, and tape-recording heads. He is responsible for heading the development

**SERVICE MASTER
HANDIEST
HANDFUL
of service tools**

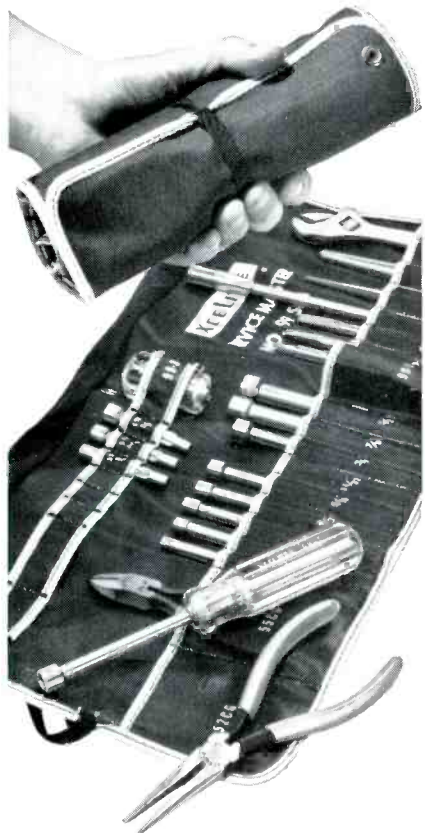

23 essential tools at your fingertips in this lightweight (only 2 3/4 lbs.), compact, easy-to-carry, roll-up kit. Contains long nose plier, diagonal plier, adjustable wrench, regular and stubby plastic handles with these interchangeable blades: 9 regular and 3 stubby nutdriver, 2 slotted and 1 Phillips screwdriver, 2 reamer, 1 extension. Eyelets in plastic-coated canvas case permit wall hanging. New elastic loop secures roll, eliminates need for tying.

many optional accessories:

Junior and Tee handles . . . Additional nutdriver, Phillips & slotted screwdriver, and extension blade sizes . . . Allen hex type, Bristol multiple spline, Frearson, Scrulox, and clutch head blades . . . Awl/Scraper . . . Chuck adaptors to use blades in spiral ratchet drivers.

WRITE FOR CATALOG 166



XCELITE, INC., 118 Bank St., Orchard Park, N. Y. 14127
In Canada contact Charles W. Pointon, Ltd.
Circle Item 33 on Tech Data Card

Formal Announcement

ARROW  **ELECTRONICS, INC.**

is proud to
announce a new
arrival.....

AMPEX PROFESSIONAL 4 TRACK RECORDING SYSTEM

FLEXIBILITY allows you to add three channel capability to a monophonic machine by installing two additional panels of electronics, changing heads and head cabling. For the first time, you can build a single channel full track Ampex up to a four channel, four track recorder.

OBSELETE PROOF allows you to expand without replacement. You can keep pace with the changing requirements of the industry, by using the building block increments of Ampex's new generation of professional audio recorders.

JEWEL BEARING SCRAPE FLUTTER IDLERS minimizes scrape flutter (especially important to production of master tapes).

AUTOMATIC TAPE LIFTERS with electrical and mechanical override ease the tape away from the heads during rewind and fast forward modes.

FAST HEAD CHANGES You can remove a 1/4 inch head assembly and replace with a 1/2 inch head assembly or change from four track to three track operation in a few minutes.

AMPEX ONE YEAR WARRANTY
ON ALL PARTS

AMPEX ONE YEAR WARRANTY ON
ALL PARTS

Now Ampex introduces a new generation of professional audio recorders. Now with transport rigidity previously limited to higher costing machines.

WE HAVE A COMPLETE LINE OF AMPEX PROFESSIONAL RECORDING EQUIPMENT TAPE DECKS, CONSOLES ETC. IMMEDIATE DELIVERY ASSURED! CALL OR WRITE MR. HOWARD WINCH, BROADCAST DEPARTMENT, 516-694-6800 212 - JA 6-0300

ARROW  **ELECTRONICS, INC.**
900 ROUTE 110 • FARMINGDALE, L.I., N.Y. 11735

of new acoustical devices introduced by CBS Laboratories for the broadcasting industry, including the recently announced loudness-level monitor.

Lawrence J. Cervone has been promoted to the new position of vice-president and general manager of the **Gates Radio Co.**, a subsidiary of **Harris-Intertype Corp.** Mr. Cervone has been with Gates for twenty years. He was named sales manager in 1953, vice-president-sales in 1960, and vice-president-operations in 1965. He was associated with Westinghouse Electric International and RCA International before joining Gates.

Stanley L. Pearl has been elected president of **Kappa Networks, Inc.** Mr. Pearl, previously vice-president-engineering, joined the company in 1965.

John P. Del Favero has been appointed to the newly created position of executive vice-president, Supplies Division, **Memorex Corp.** Mr. Del Favero, who held general management and engineering management positions at International Business Machines before joining Memorex, will head up the technical staff, manufacturing, and marketing operations for all tape and disc-pack products in North America.

John D. Mitchell has been named vice-president, industrial relations, and **David H. Foster** has been appointed vice-president, legal and secretary of **Collins Radio Co.** Both offices are newly created. Mr. Mitchell has been director of corporate industrial relations since 1966; he formerly served in a similar office for the Collins Dallas region. Mr. Foster joined Collins in 1959 as general attorney; in 1963, he was named secretary of the corporation.

William C. Simonite has been named to the newly created post of director of consumer and distributor sales for **Electro-Voice, Inc.** Formerly he was national sales manager at University Sound. In another announcement, **Harold "Bud" Mosier** has been promoted to chief engineer at Electro-Voice. In this new position, he will be responsible for educational activities relating to the engineering department, in addition to continuing as chief engineer of phonograph cartridges and serving as assistant to the director of the engineering division.

Howard M. Ham, Jr. is the new vice-president-engineering for **Moseley Associates, Inc.** Mr. Ham, who has been with Moseley since 1962, was previously with Raytheon and G.M. Giannini, Inc.

Gene Francis, national distributor sales manager for **Rohn Manufactur-**

• Please turn to page 114.

a new concept & performance in coaxial switching

TYPICAL PERFORMANCE CHARACTERISTICS

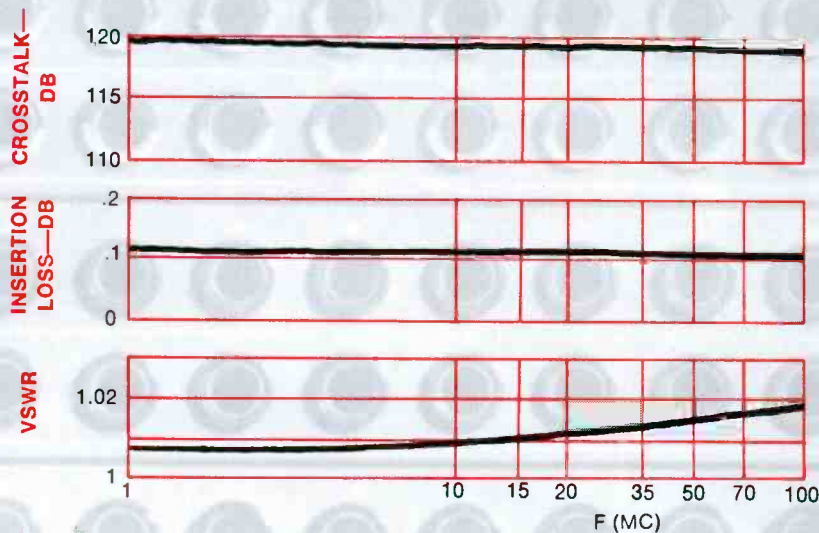

ONLY FROM COOKE Coterm 22T a normal-through coaxial* switching and terminating jack. * Patented

Complete compatibility and Cooke quality combine to make this coaxial switching equipment first choice for TV, radar, communication patching, data handling, etc. Advanced in concept, engineered for the utmost in reliability, it will provide years of dependable, economical service.

COOKE
ENGINEERING COMPANY
735 N. SAINT ASAPH STREET
ALEXANDRIA, VIRGINIA 22314

Test probe permits sampling or testing of normal-through circuit without interruption of signal

The Coterm 22T accepts either standard BNC connectors or Cooke-built quick-disconnect connectors.

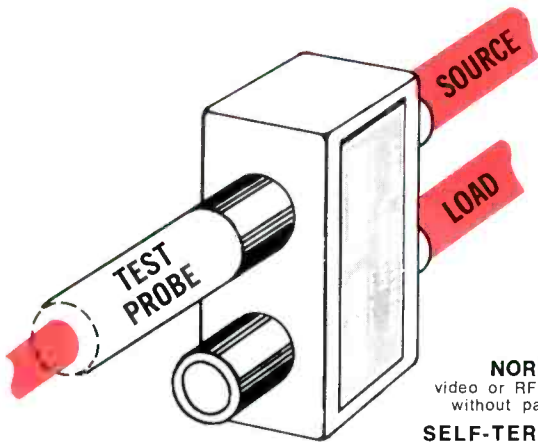

NORMAL-THROUGH
video or RF circuit is provided
without patch cords or plugs.

**SELF-TERMINATION OF
SOURCE** without extra terminating plug
when load side is patched. Patched in circuit feeds load.

TOTALLY FLEXIBLE PATCH FACILITY of extremely
high density possible when patch cords are inserted on both
sides.

COJAX® Model 22B. This normal-through coaxial switching jack is built to the same dimensions and standards as the Coterm Model 22T. It performs all functions except self-termination. It accepts the same equipment as the Coterm so can provide a mixed patch field.

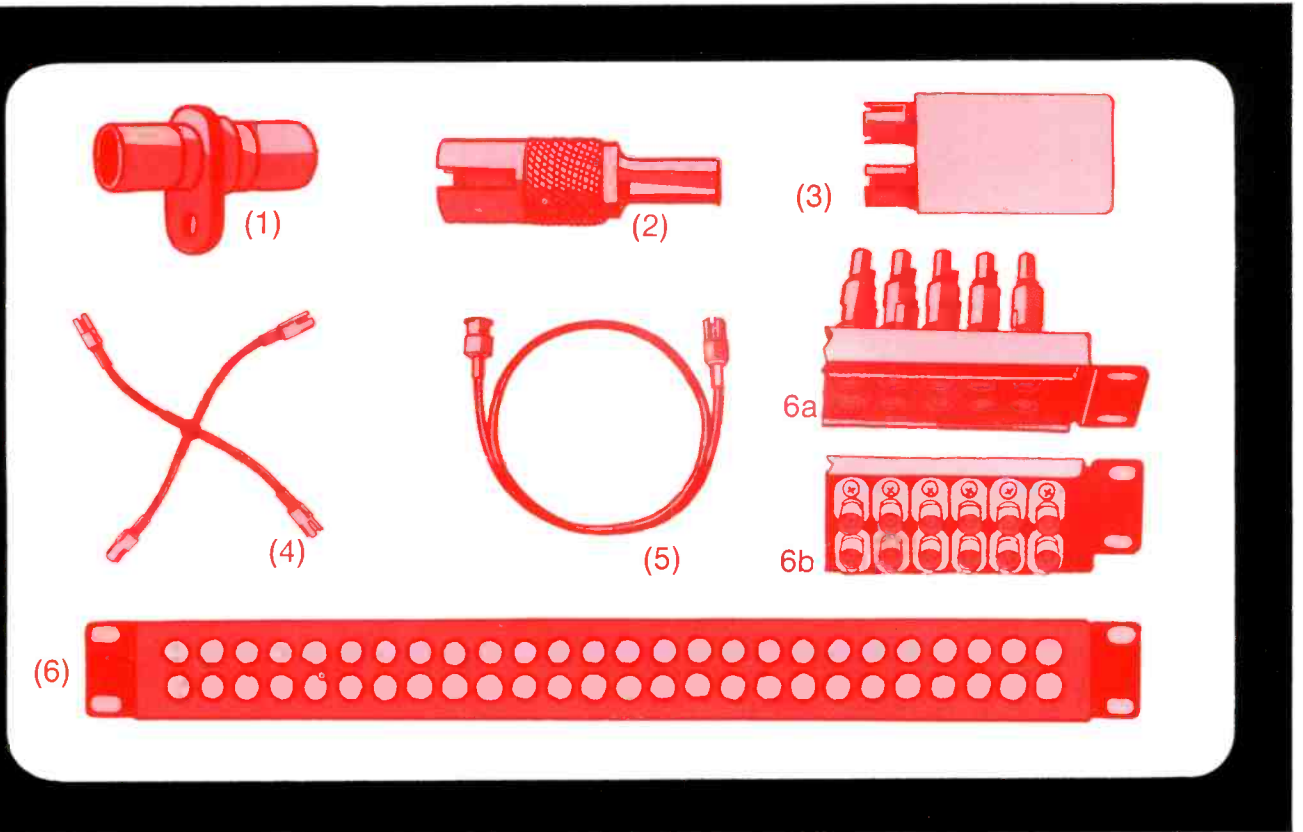
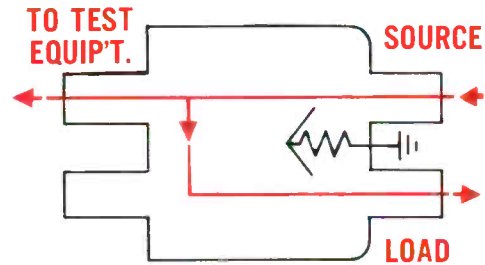

Other Cooke Coaxial Switching Equipment Available (1) Coaxial Patching Jacks. (2) Quick-Disconnect Snap-Lock Connectors*. (3) Quick-Disconnect Normalizing Plugs. (4) Bridging Networks, four and five way (four way shown). (5) Test and Patch Cords. (6) Panels . . . 6a showing permanent cabling, 6b showing Coaxial Patching Jacks, (1) above installed.

For further information write . . .

* Patented

COOKE
ENGINEERING COMPANY
735 N. SAINT ASAPH STREET
ALEXANDRIA, VIRGINIA 22314

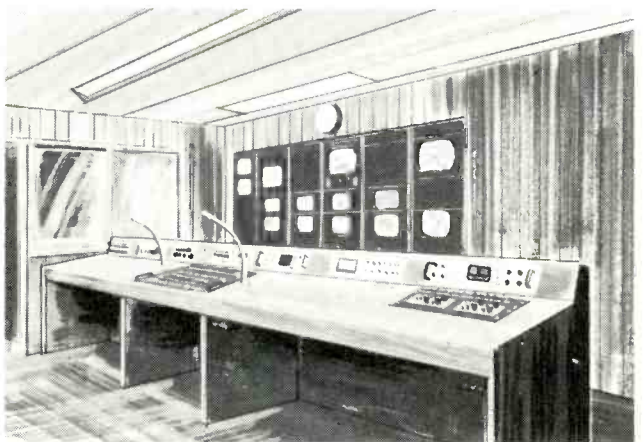
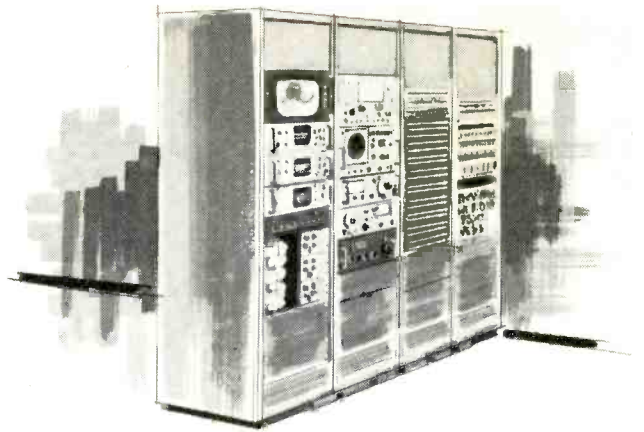
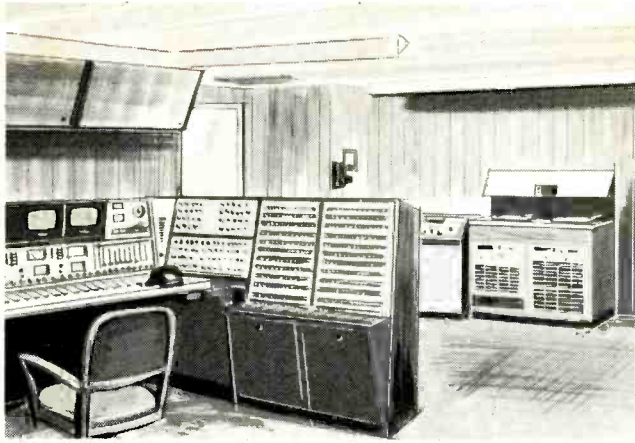

Now, from a single source, a full range of TV studio engineering services.

Studio engineers seeking the best in TV broadcasting technology rely on Federal Electric Corporation's full range of studio services, backed by the experience, skill and resources of ITT, world leader in communications research and engineering.

Federal Electric offers studio design, installation, and backup maintenance, custom-tailored to improve your studio's effi-

ciency and flexibility. Result: your station equipment is current, competitive and profit-making.

We design systems, select, install, tuneup and checkout equipment, and deliver as-installed records and technical manuals. Whether you are building a station from the ground up ... adding remote pickup ... converting from monochrome to color ... or

merely adding updated or expanded recording facilities, you'll find that service from Federal Electric brings you top professional people, fully matured in TV studio engineering.

ITT's Service Associate,
Federal Electric Corporation,
621 Industrial Avenue,
Paramus, N. J. 07652.
(201) 967-2554

ITT

You can't beat the system.

Not the Gauss System: two technically superior components that can be used separately or combined into the most revolutionary ultra-high-speed tape duplication system on the market.

The Ultra-High-Speed Duplicator

This Ultra-High-Speed Duplicator reproduces music, drama, educational programs, etc., in crisp, clean, clear fidelity. And fast, too. A 40-minute program in just 18 seconds! It's quality duplication that owes much to the design of the Focused Gap heads. Heads offering wider band width, greater fidelity, better signal-to-noise. It all adds up to quality duplication that can't be beat. Hard to believe? Send us your master, and we'll send back the most exact duplicate you've ever heard.

The Loop Bin

The loop bin problem has finally been solved! Now, thanks to the Gauss Loop Bin, an 1800-foot master can be run continuously, over and over again, without stopping to recue. Snarls and tangles just don't happen. And as for speed, it's close to four times as fast as any competitor. (240 inches-per-second) And there's rapid, easy conversion from cassette to eight-track. Gauss has effectively redesigned the horizontal system. This is one loop bin that can't be beat.

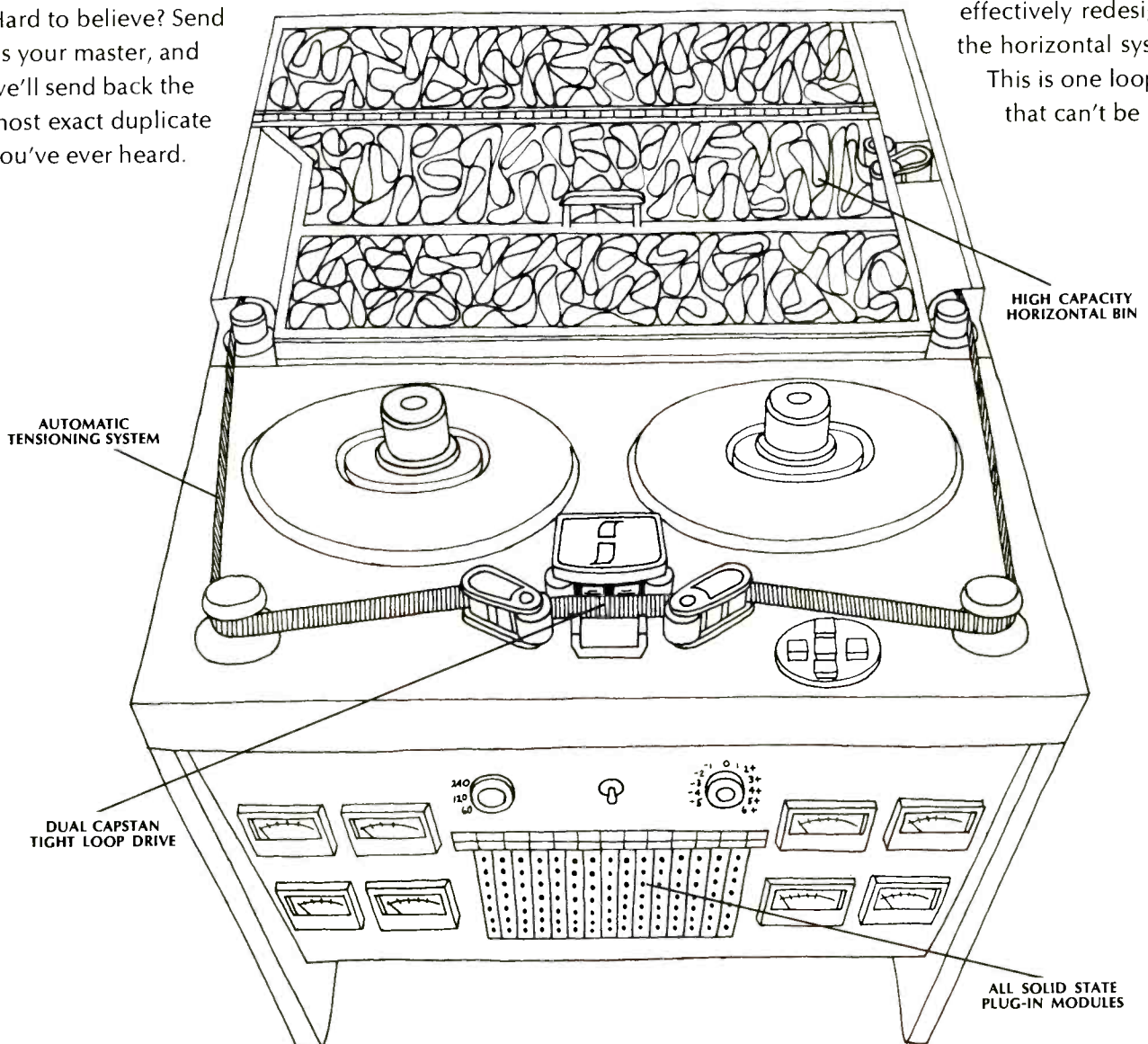

GAUSS ELECTROPHYSICS, INC. A SUBSIDIARY OF MCA, INC. 1653-12th Street, Santa Monica, California 90404

See it for yourself. Visit the Gauss booth at the N A B Convention in Chicago. (#418 in the north exhibit hall)

Circle Item 36 on Tech Data Card

When engineers get together,
the conversation turns to pickups.



It's an irresistible topic.
Especially since Stanton came out with the Model 500 stereo cartridge.
That's an engineer's pickup, if there ever was one.
Beautiful curve—within 1 db from 20 to 10,000 Hz, 2 db from 10,000 to 20,000 Hz.
Fantastically small moving system to trace the wildest twists in the groove.
Light weight (only 5 grams!) to take advantage of low-mass tone arms.
And, of course, Stanton's legendary quality control.
No wonder engineers use the Stanton 500 for critical broadcasting
and auditioning applications.
And to impress other engineers with their pickupmanship.
(Available with 0.7 or 0.5-mil diamond, \$30; with elliptical diamond, \$35.
For free literature, write to Stanton Magnetics, Inc., Plainview, L.I., N.Y.)



STANTON

Video Sweep Generator

One Unit Covers 500 Hz to 25 MHz

The VS-20 solid state sweep signal generator can be centered at any frequency between 500 HZ and 25 MHz and can sweep anywhere within this range. The sweep width is continuously adjustable from 500 HZ to 25 MHz. It is also provided with a CW output mode. RF output is at least 1.0v rms into a 50 ohm load. Flatness is ± 0.25 db at maximum sweep width. Four sweep rate modes are provided: variable from 5 HZ to 60 HZ, 50/60 HZ line rate, manual sweep and external. Options available are a calibrated variable marker which covers the complete frequency range of the unit and the option of changing sweep rate range to 0.1 HZ to 10 HZ. Price: \$1095.00

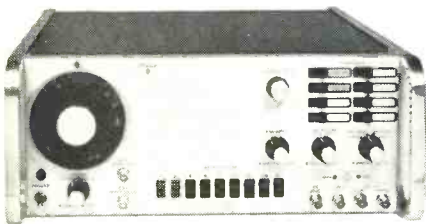

Specialists In Electronic Instrumentation

Texscan
CORPORATION
tc
2446 N. Shadeland Ave.
Indianapolis, Indiana 46219
Ph. (317) 357-8781
TWX. 810-341-3184

Circle Item 39 on Tech Data Card

News

(Continued from page 108)

ing Co., has been appointed western division sales manager for the West Coast, including Alaska and Hawaii. The main office and warehouse servicing this area are located in Reno, Nevada.

Raymond L. Kelley has been appointed vice-president—finance and treasurer of **Shure Brothers, Inc.** He returns to Shure, with whom he was previously associated as vice-president and controller, from a position as an officer of the Continental Bank.

Eugene A. Tymon has been appointed television sales engineer by **Tele-Measurements Inc.** Mr. Tymon, an electrical engineering graduate of Manhattan College, was formerly with Prudential Insurance Co. of Newark, in the sales promotion department.

Appointment of **Robert M. Williams** to the new post of manager, TV transmitter merchandising, has been announced by the **RCA Broadcast and Communications Products Div.** Mr. Williams has been a salesman of RCA broadcast equipment since 1960. He began his television career as a cameraman and program production manager for KGBT-TV, Harlingen Texas, and later worked as a TV director at KPAC-TV (now KJAC-TV), Port Arthur, Texas.

H. J. Orchard, a senior staff engineer at **Lenkurt Electric Co., Inc.**, a subsidiary of **General Telephone & Electronics Corp.**, has been awarded the grade of Fellow in the IEEE, for his contribution to the theory and engineering design of passive and active circuits.

At Lenkurt, Mr. Orchard is supervisor of the Networks and Mathematics Group in the Advanced Development Department. He is a consultant on network design, and his work includes general investigations into new circuit techniques and mathematical problems. Previously, he held a number of responsible positions with the British Post Office Engineering Department over a 22-year period, including that of principal scientific officer at the Research Department in London.

Named to head the sales organization of **Jampro Antenna Co.** is **Bud Blaksley**, who for the past five years has been western sales manager for Rohn Manufacturing Co. Prior to that, he was vice-president of Tri-Ex Tower Co., and for 10 years he was a power-company distribution engineer.

Robert W. Bell is now chief engineer of **WSBT AM-FM-TV**, South Bend, Indiana. He has been with the stations 15 years, previously serving as transmitter supervisor and assistant chief engineer. ▲



micro trak
303
STEREOPHONIC
BROADCAST
TRANSCRIPTION
ARM

Have you solved that stereo disc problem? Well, don't worry about it any longer, Gray's engineer's have solved it for you with Micro-Trak. This new series of 12" and 16" tone arms offer the higher compliance, lower mass and the absolute reliability demanded by the broadcaster . . . and less expensively than you might imagine. If you are still using those "obsolete" tone arms, why don't you get the answers from Gray. Write for complete information or better still a chat with Gray's sales engineer can bring fruitful results. . . . Give 'em a call.



GRAY RESEARCH AND DEVELOPMENT COMPANY DIV.

ONE FIFTY PARK AVENUE, EAST HARTFORD, CONNECTICUT 06108

PROFESSIONAL BROADCAST PRODUCTS

Circle Item 38 on Tech Data Card

BROADCAST ENGINEERING

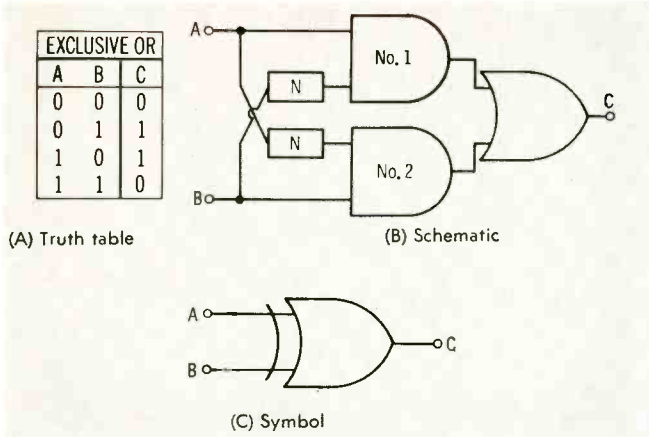

Fig. 4. Exclusive OR is combination of OR, ANDs, and NOTs.

clusive OR is arrived at by applying the principles of Boolean algebra to the information given by the truth table. It is seen that logic 1 is obtained for two conditions only: when A is not logic 1 AND when B is logic 1 OR when A is logic 1 AND B is not logic 1. Algebraically this is written as:

$$C = \bar{A}B + A\bar{B}$$

This is read as "C equals B and not A, or A and not B." The logic circuit (Fig. 4B) is made up of AND gate No. 1, with input A but NOT B, plus AND gate No. 2, with input B but NOT A. A logic 1 at C is desired when the No. 1 gate OR No. 2 gate is logic 1, so the two are combined with an OR gate.

Because the Exclusive OR is used so frequently, the schematic is simplified to the symbol of Fig. 4C,

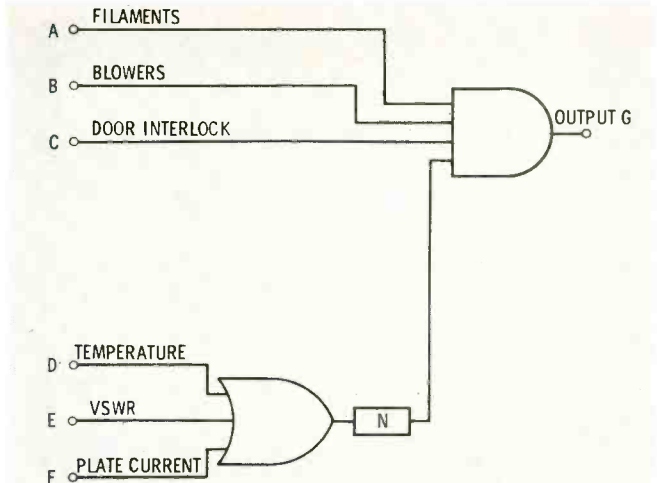

Fig. 5. Basic elements are combined for complex functions.

which represents the same function as that shown in Fig. 4B.

The Exclusive OR is used when it is desired to have an output if the two inputs are not identical. Consider the case in which a broadcast transmitter is switched from high power to low power by changing taps on the primary of the power transformer. The output, C, of an Exclusive OR is used as a control level for applying the high voltage.

MOUNTING PROBLEMS?

LET DAVIS & SANFORD HELP YOU SOLVE THEM

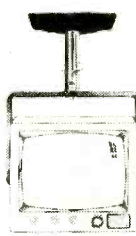

1. CEILING MOUNT FOR TV RECEIVERS AND MONITORS
Keep floor area clear and uncluttered. Adjustable horizontal and vertical tilts let you position set in direction of viewers.



2. PEDESTAL MOUNT FOR TV RECEIVERS AND MONITORS
Used where portability is desired. Rolls easily on 5" rubber wheel casters with brake. Set can be tilted 30° up or down.



3. WALL MOUNT FOR TV RECEIVERS AND MONITORS
Use when it is impractical to mount installations on high ceilings. May be turned to any angle and tilted 30° up or down.

Mounts are all steel construction. For more information and literature write:

DAVIS & SANFORD
24 Pleasant St., New Rochelle, N. Y.

24 HOURS CONTINUOUS RECORDINGS

Up to 4 separate channels recorded simultaneously, without interruption, on one 7" reel of standard 1/4" tape!

UNDER \$800.*



First heavy duty professional communications logger priced under \$800.00! The R-70 utilizes most advanced solid state circuitry, all silicon transistor plug-in amplifiers, achieving remarkable fidelity at very low tape speeds. Full line of accessories: AGC on each channel, recall facilities, full remote or automatic control, stereo, fail-safe, synchronous time injection, cabinet or carrying case.

FOR LOGGING ALL COMMUNICATIONS, INCLUDING 2-WAY RADIO, BROADCASTING, TELEPHONE AND SECURITY SURVEILLANCE

Now used by police, fire, airlines, armed forces, network radio and TV, security, telephone industry.

*prices from \$775.00 (32 lbs., 8 3/4" x 19" x 11 1/2" deep)
WRITE FOR SPECIFICATIONS AND PRICE LIST

STANCIL-HOFFMAN CORP.
921 NORTH HIGHLAND, HOLLYWOOD, CALIFORNIA 90038

Now... the first lavalier microphone without 'lavalier sound': the MD 214 by SENNHEISER



Among the many reasons for using lavalier microphones are their constant distance from the performer (less need to 'ride gain') and unobtrusiveness. However, ordinary lavalier microphones have 'lavalier sound,' a muffled, noisy quality that makes them unsuitable for commercial use.

What causes 'lavalier sound'?

1. Directional sound radiation: The mouth radiates sound, especially higher frequencies, in a beam-like pattern, resulting in lower off-axis sound pressures at lower frequencies. Since lavalier microphones are always significantly off-axis, a loss of 'presence' results.

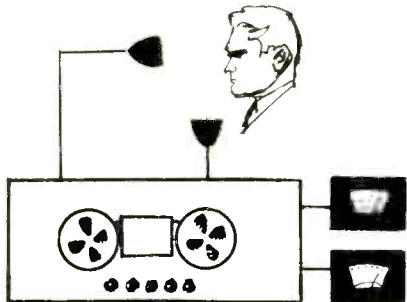

2. The vibrating chest: Extensive research has shown that the chest acts as a radiator in the region of 600-800 Hz, with peak energy radiated around 700 Hz (surprisingly, this figure varies little between the sexes). When ordinary lavalier microphones are placed in position they pick up this energy, imparting a boomy quality to speech and singing alike.

3. Noise problems: Three kinds of noise plague the ordinary lavalier microphone: mechanical noise conducted along the microphone cable, noise from friction generated when the microphone rubs against clothing, and airborne noise, such as cloth rubbing against itself.

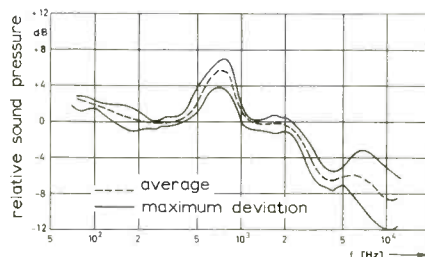

How the MD 214 eliminates these problems:

Contoured response restores lost 'presence': Sennheiser engineers conducted extensive tests, comparing the response of a microphone placed in the lavalier position with an identical one placed on-axis. Using a number of subjects, they were able to plot an average curve of difference. By judicious construction of the transducer assembly, the MD 214's response was tailored to a 'mirror-image' of the difference curve. The result: unusually flat response in the audio range.

Filtering prevents boominess: A specially-engineered filter, unique with Sennheiser, attenuates frequencies in a narrow region around 700 Hz, eliminating the hollow, muffled quality produced by pickup of chest vibrations.

Shock-isolation cuts noise: The MD 214 is built to eliminate noise from the inside out. The transducing assembly is housed in a 'case-within-a-case,' a separate assembly which is pneumatically damped and slides in a permanently-lubricated plastic gasket. This unit, which serves as a noise baffle, is in turn surrounded by a thick cast housing, which has rounded corners to reduce friction, while preventing the microphone from rolling side-to-side. The microphone cable has a flexible internal strain relief, which prevents mechanical noise from reaching the transducer via the cable.

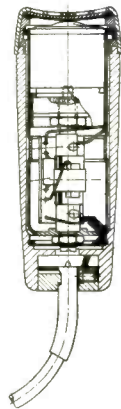

The result of these engineering innovations is a microphone specially-created to meet the stringent pickup requirements of the film and broadcast industries. For technical data on the MD 214 or any other dynamic or condenser microphones in the Sennheiser line, please call or write:

SENNHEISER
electronic
CORPORATION (N. Y.)



500 Fifth Avenue, New York, N.Y. 10036
Telephone (212) 564-0433

(manufacturing plant, Bissendorf, Hannover, West Germany)

Circle Item 42 on Tech Data Card

BROADCAST ENGINEERING

EECO ON TIME[®] equipment...



cuts video tape editing costs 75%



EECO's new ON-TIME Video Tape Editing and Control System can now be used with *either* quad-head or helical scan recorders. This means drastic cost reductions — 75%, in many cases — by permitting pre-editing on the helical scan unit, reserving the more costly quad-head machine time for final edit. EECO's ON-TIME pre-editing feature provides a work print and an editing log which allows you to make more than 30 edits per hour on your quad-head recorder. *Edit directly on video tape . . . no tape-to-film and film-to-tape transfers . . . no messy 24 frame-to-30 frame conversion table.* "EECO Time" recorded on the cue track of your video tape lets you find scenes quickly, controls electronic splicing to the precision of one frame, and accurately controls tape transport "stop" and "start" times. Get more information on EECO's money-saving ON-TIME system, and arrange for an early demonstration on your own recorder.



INSTRUMENTS DIVISION

ELECTRONIC ENGINEERING COMPANY OF CALIFORNIA

1601 EAST CHESTNUT AVENUE • SANTA ANA, CALIFORNIA 92701 • (714) 547-5501

See the ON-TIME System in action at the NAB Show, Booth C, Writing Room

Circle Item 43 on Tech Data Card

Circle Item 46 on Tech Data Card

PROFESSIONAL PRODUCTS FOR PROFITABLE BROADCASTING

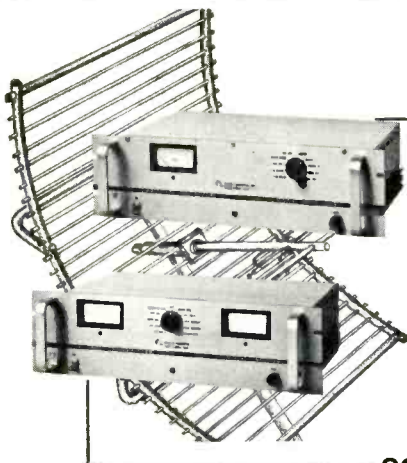
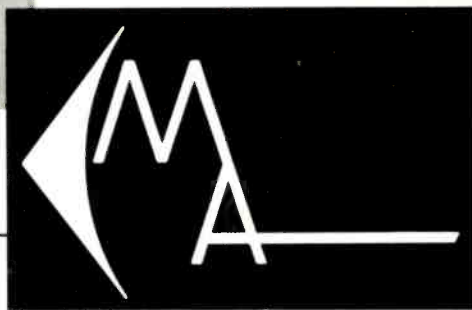

SOLID-STATE

AURAL STUDIO-TRANSMITTER LINKS FOR FM - AM - TV - INTERCITY RELAY

Fully silicon solid-state and utilizing true direct FM, this powerful STL offers uncompromised, dependable performance in the Moseley tradition . . .

Model PCL-303	890 - 960 MHz	8 Watts
Model PCL-202	300 - 470 MHz	10 Watts

Model PCL-303 COMPOSITE — for FM stereo. Another Moseley first! This single STL transmits a composite stereo waveform.

SOLID-STATE

REMOTE CONTROL SYSTEMS WIRE AND WIRELESS*

Model PBR-21A This 21 channel deluxe control system can be operated over a single wire line or STL. DC line continuity not required. A complete line of control subcarrier generators and detectors is available to adapt the PBR-21A to Dual or Composite STL systems for all-wireless control. All FM radio remote control systems compatible with stereophonic and SCA program operation.

Model WRC-10T Designed to operate over a single DC wire pair, this 10 channel all solid-state control system is dependable, accurate, and economical. 4" rectangular meter provided for easy readout.

Model SCS-1 Status/Control System This modular 8 channel system can be used as a status indicator, fault reporting or one-way control system. Uses single telco line.

*Patented

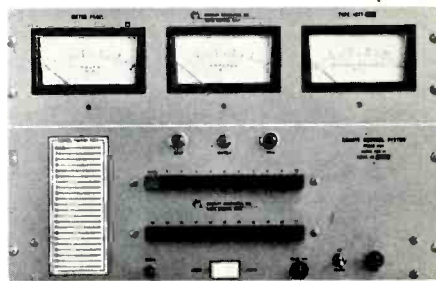

SOLID-STATE DIGITAL AUTOMATIC TRANSMITTER LOGGER THE EASIEST WAY TO LOG



FCC Rules now permit a digital presentation for automatic transmitter logging. The Model ADP-101 uses an IBM Output Writer to print the transmitter log as you are used to seeing it—in columnar format—on standard size 8½" x 11" sheets. The easy-to-read type-written log departs from the inherent shortcomings of the strip-chart recorder. Easy to file for quick retrieval, even a non-technical person can read it. System calibration requires only one man. It will log up to 10 parameters. Uses only one communications channel (600 Hz bandwidth).

SOLID-STATE MULTIPLEX EQUIPMENT

Model SCG-4T SCA Subcarrier Generator offers extreme stability, excellent sound quality and simplicity of operation. It incorporates a peak reading deviation meter calibrated directly in kHz, and all electronic muting circuitry (no relays). A companion demodulator is available when SCG-4T is used on an STL for an auxiliary program circuit.



Model SCG-3T Stereo Generator is all silicon solid-state using integrated circuits. Attention to design details has produced minimal quadrature error and phase difference between channels. Excellent channel separation (> 40 db). Designed to operate with the PCL-303 Composite STL.

See These
And Our Other Products
At The 1968
NAB SHOW
Booth 223
West Hall

MOSELEY ASSOCIATES, INC.

SANTA BARBARA RESEARCH PARK
111 CASTILIAN DRIVE, GOLETA, CALIFORNIA 93017 TELEPHONE 805-968-9621

AT NAB VISIT BOOTH 200A AND SEE WHAT'S

NEW FROM WILKINSON

- A SOLID STATE AM FREQUENCY MONITOR
- A SOLID STATE AM MODULATION MONITOR
- AN ARENA SATELLITE RF AMPLIFIER FOR REBROADCASTING IN SHIELDED AREAS
- A SOLID STATE AM RF AMPLIFIER
- THE SUPERIOR 4-N-1 FIELD METER
- DIRECT REPLACEMENT SILICON RECTIFIERS
- THE TUBE SAVER AIR PRESSURE MONITOR

COME SEE US AND PLAY THE TUBE SAVER GAME—
YOU MAY WIN ONE FREE!

WILKINSON ELECTRONICS,

1937 W. Mac Dade Boulevard, Woodlyn, Pa. 19094

NEW AS TOMORROW—RELIABLE AS FOREVER



All Digital Color Sync Generator



Pat. Pending

Exclusive Features —

- All pulses and transitions clock derived
- No monostables — no delay lines
- Integrated circuit reliability
- Dual outputs — permit pulse assignment with full standby
- Subcarrier vs. horizontal jitter better than 0.25 nsec.
- Pulse jitter better than 4 nsec throughout frame
- 1 3/4" rack space — including all "Add-In" modules

Prices and specifications subject to change without notice.

Add-In Modules —

- Monochrome Genlock
- Bar Dot Generator
- Color Genlock
- Sync Changeover Switch

Monochrome

Model TSG-2000M **\$1,000**

Color

Model TSG-2000C **\$1,500**

NEW PORTA-SYNC™

Identical Performance at a Great Savings!



Pat. Pending

Ideal for . . . REMOTE FIELD APPLICATIONS . . . PORTABLE TEST GENERATOR . . . SYSTEM SPARE . . . FULL TIME DUTY. Economical, yet absolutely no sacrifice of waveform performance. Specifications are the same as Models TSG-2000M/C, but Add-In modules are not available because of ultra-compact dimensions of 3 1/4" h x 5 1/4" w x 10" d.

For complete details, request Form TPB-30

Prices and specifications subject to change without notice.

. . . from Telemation — where experience powers pacesetting products!

Monochrome

Model TSG-1000M **\$695**

Color

Model TSG-1000C **\$1000**



TELEMATION, INC.

2275 So. West Temple / Salt Lake City, Utah 84115
Telephone (801) 486-7564

Circle Item 49 on Tech Data Card

FETs (Continued from page 101)

either drain current (depletion type) or no drain current (enhancement type). Fig. 4A shows a cross-sectional view of a depletion-mode MOSFET. When the device is conducting current, a channel of N-type material exists between the drain and source. (Only the N-Channel version is shown and discussed; the P-channel type is the exact opposite). When the gate voltage is zero as shown in Fig. 4A, the existing N channel can conduct electrons from the source to the drain. If a negative gate voltage is applied, the MOS capacitor will charge. This action causes positive carriers (holes for electrons) to be drawn toward the negative electrons on the gate and thus force electrons out of the N channel as shown in Fig. 4B. The channel is now smaller, and there is less current between the source and the drain. If a large negative voltage is applied to the gate, enough electrons will be forced out of the channel to "pinch it off" (Fig. 4C). The pinch-off voltage is considered to be that gate voltage which reduces the drain current to a small percentage (usually 1%) of its value with zero gate voltage and the specified drain-source voltage.

The enhancement-type MOSFET operates in the opposite manner, as shown in Fig. 5. With zero gate voltage, there is no channel to conduct significant current. If a positive volt-

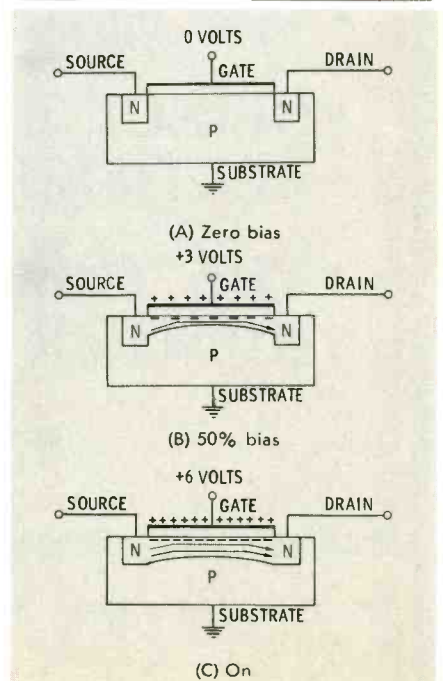

Fig. 5. Simplified diagram shows an N-channel enhancement-type MOSFET.

age is put on the gate, electrons are drawn toward the gate, creating an N channel. A drain-source current can then be established.

Test Procedures

Like virtually any device, the FET can fail. However, it does not, as a rule, degrade in performance over a long period of time as does a tube. The FET is similar to the transistor in that it can be somewhat sensitive to external circuit failures. Therefore, two types of failure problems—catastrophic circuit failure and device failure—can be considered.

Catastrophic Circuit Failure

The FET has certain specified voltage limits, and if these limits are exceeded permanent device failure can result. Therefore, when a device fails or is suspected of failure, the first check should be of the operating voltages to determine if they are in excess of the normal values. The usual result of an overvoltage stress is a short circuit in the device (because of excessive current).

Device Failure

FETs can malfunction in the same way as other transistors by becoming leaky. Usually the gate conducts current when it shouldn't. As with tubes, this problem can be detected in high-impedance circuits by measuring the voltage drop across the gate (grid) bias resistor with a VTVM.

Less common are device failures caused by vibration or shock. Damage results when the internal connections of the device break open.

Simple ohmmeter tests usually can be performed to check an FET for failure. Advantage is taken of the fact that a PN junction allows current to pass in one direction only. If the ohmmeter shows first a low resistance and then a high resistance (or vice versa) when the probes are reversed, this result gives a good indication of a diode. When a PN junction of an FET fails because of over voltage or current stress, the usual result is a short. Because of this fact, the device can usually be checked first in-circuit. When checked out-of-circuit with an ohmmeter, the various types of FETs show the characteristics indicated in Fig. 6. Compensation should be made for the shunting resistors when the FET is checked in-circuit.



SEE OUR EXHIBIT AT THE NAEB SHOW /
BOOTH 125 / DENVER / NOV. 5-8

Optical Multiplexer

For broadcast and ETV studios

The Model TMM-203A is designed for selective projection of two 16mm film projectors and one 2" x 2" slide projector into a single television camera. A rugged pedestal base with the precisely machined, cast aluminum optical transfer assembly assures permanent optical alignment.

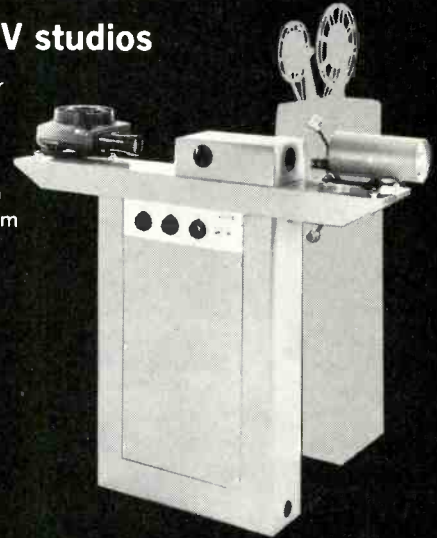

OPTICAL TRANSFER ASSEMBLY

First surface mirrors are operated by electric motors for fast, yet gentle "wipe" switching. Mirror action eliminates the need for separate projector doublers.

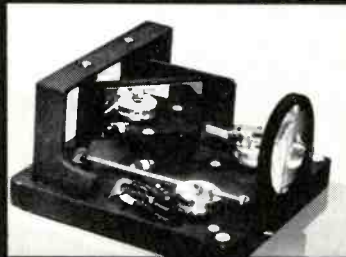

Plus Features —

- LAMP VOLTAGE CONTROLS provided for projectors
- LOCAL and REMOTE CONTROL provisions
- CUSTOM MOUNTING available for all brands and types of cameras and slide projectors

For complete details, request Form TPB-50
Model TMM-203A ONLY \$1,295.00

Television Equipment for Education, Industry and Military . . .



MULTICASTER™



PORTA-SYNC™



TELECTER™

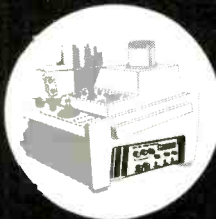

V2 660 Video Processor

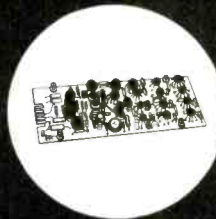

2:1 Interlace Sync Generator

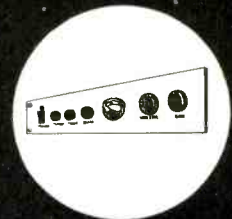

EIA Camera Control

. . . from TeleMation — where experience powers pacesetting products!



TELEMATION, INC.

2275 So. West Temple / Salt Lake City, Utah 84115
Telephone (801) 486-7564

In Performance • Design • Durability...

NEW VINTEN TELEVISION EQUIPMENT IS IMITATED BUT NEVER DUPLICATED!

For over a quarter of a century, Vinten Television Equipment has set the standards for performance, design and durability throughout the television world. These high standards, although often imitated but rarely duplicated, are attested to by the fact that W. Vinten, Ltd. is the proud recipient of the highly coveted Queen's Award for excellence in their field... an honor reserved only for the very finest of British industrial achievements.

The Mark III Pan and Tilt Cam Head, and Mark II and II Hydro-pneumatic TV Pedestal depicted here, are remarkable examples of unique Vinten design and craftsmanship. Their relatively low cost, dependable performance, and rugged durability are unmatched by any other at any price.

If your studio is ready to step up to quality production, in keeping with the new and more critical standards of the television industry, look into Vinten Television Equipment today!

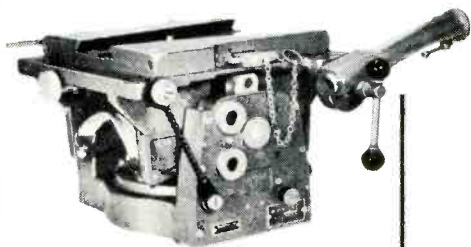

MARK III PAN AND TILT CAM HEAD

- Provides effortless control and smooth operation in both pan and tilt modes.
- Produces perfect free balance at all angles of tilt.
- Unique design provides and insures a constant center of gravity on one plane with any television camera.
- Allows an angle of tilt to 50 degrees from the horizontal in both directions.

MARK I AND II HYDRO-PNEUMATIC TV PEDESTALS

- Flexible, precise and sensitive operation.
- Powered assistance not required.
- Utilizes advanced design sealed compressed air system.
- Removable weights for compensation of variable weight changes.

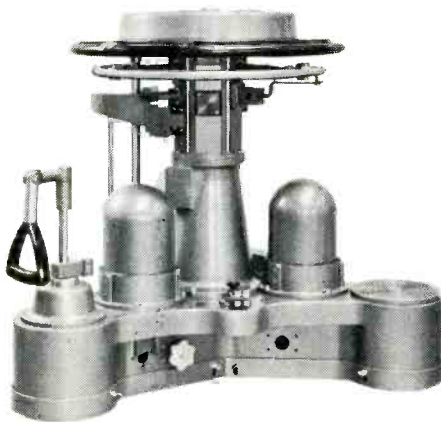

For complete details contact:



TELEVISION EQUIPMENT CORPORATION
35 Cain Drive Plainview, New York 11803
Phone: 516 694-8963

Circle Item 51 on Tech Data Card

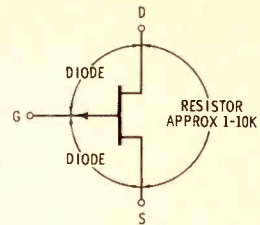

(A) Junction-gate FET

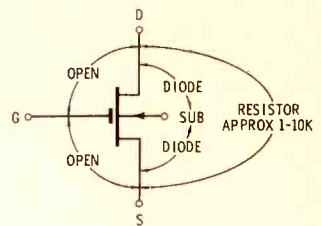

(B) Depletion MOSFET

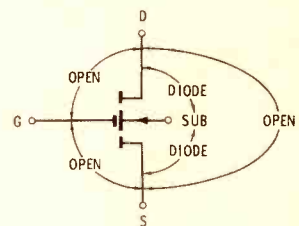

(C) Enhancement MOSFET

Fig. 6. Resistance checks may be used in testing of a field-effect transistor.

Special Precautions

Some special techniques are necessary in handling the MOSFET because of the delicate nature of the gate-to-channel capacitor. The dielectric is approximately four micro-inches thick and has a very high resistance. As a result, the capacitor can hold a charge for a long period of time. A charge sufficient to exceed the breakdown voltage of the capacitor can be developed merely by stroking the device leads through the hair. If the following handling precautions are observed, however, there should be no difficulties:

1. Out of Circuit: Keep MOSFET leads shorted together.
2. Installation: (a.) Short MOSFET leads, (b.) Ground soldering iron tip.

Additional Information

Semiconductor manufacturers have available many good application notes on FETs. Also, additional information on this subject may be found in the book *Field Effect Transistor Applications*, by William Gosling (John Wiley and Sons, Inc., 1965).

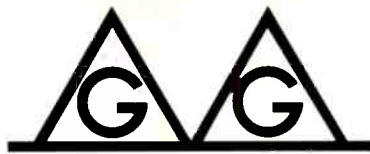

THE GRASS VALLEY GROUP, INC.

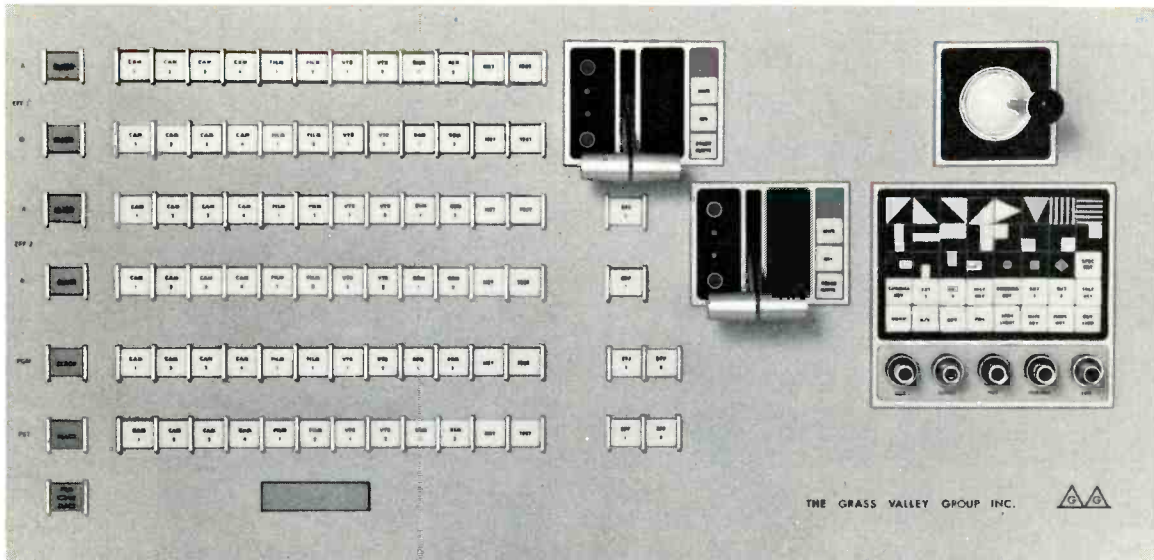

VERTICAL INTERVAL SWITCHING . . . complete systems, all solid state in off the shelf or custom designs, are available including Black Burst Logic, Auto. Sync. Detection, Auto. Sync. Add, Single or Double Re-entry and Limited or Full Effects.

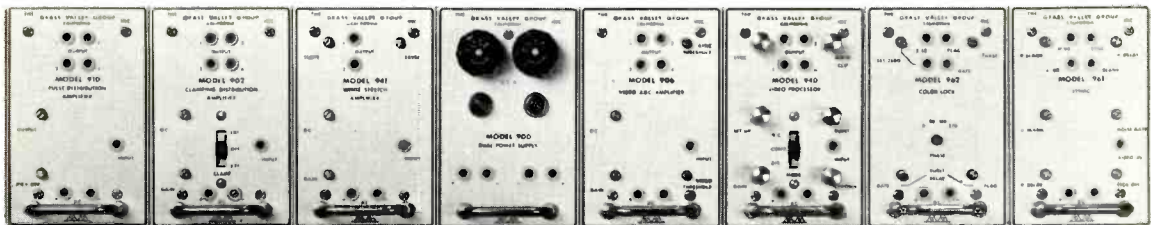

AND THE FINEST IN . . . Sync. Generators, Processing Amplifiers, Video DA's, Pulse DA's, Delay Amps, and Mix Amps.

SEE THESE UNITS AT THE NAB SHOW MAR. 31-APR. 3/BOOTH 113

SOLD EXCLUSIVELY BY: GRAVCO SALES, INC. / 6311 YUCCA ST. / HOLLYWOOD, CALIF. 90028 / (213) 462-1133

Circle Item 52 on Tech Data Card

Tape-Athon presents the new dimensions for a recorder/ reproducer **900x900x900**

No matter how you measure Tape-Athon's Model 900 — by performance, dependability, or price — you win all three ways.

1. The 900 features unique engineering concepts to provide a new level of performance — dual capstans for split-second timing and positive tape movement, special drive and braking systems for instant start-stop motion, a quick-threading tape guide, and a convenient editing mode.
2. For dependability, the 900 incorporates all solid state electronics, with a rugged transport panel to assure continuous tape alignment, and top quality electromechanical components for long service life.
3. Available in 1/4" and 1/2" versions for 2-, 4- or 8-track recording, with any head configuration desired, the 900 is priced well below units offering much less, performance-wise.

See a complete description of the 900 Recorder/Reproducer in catalog TA250. Send for your copy. Tape-Athon Corp., 523 S. Hindry, Inglewood, Calif. 90307

Tape - Athon

Tape-Athon Corp. 523 S. Hindry, Inglewood, Calif. 90307

Yes, send me catalog TA250 today.

Name _____

Firm _____

Address _____

City _____ State _____ Zip _____

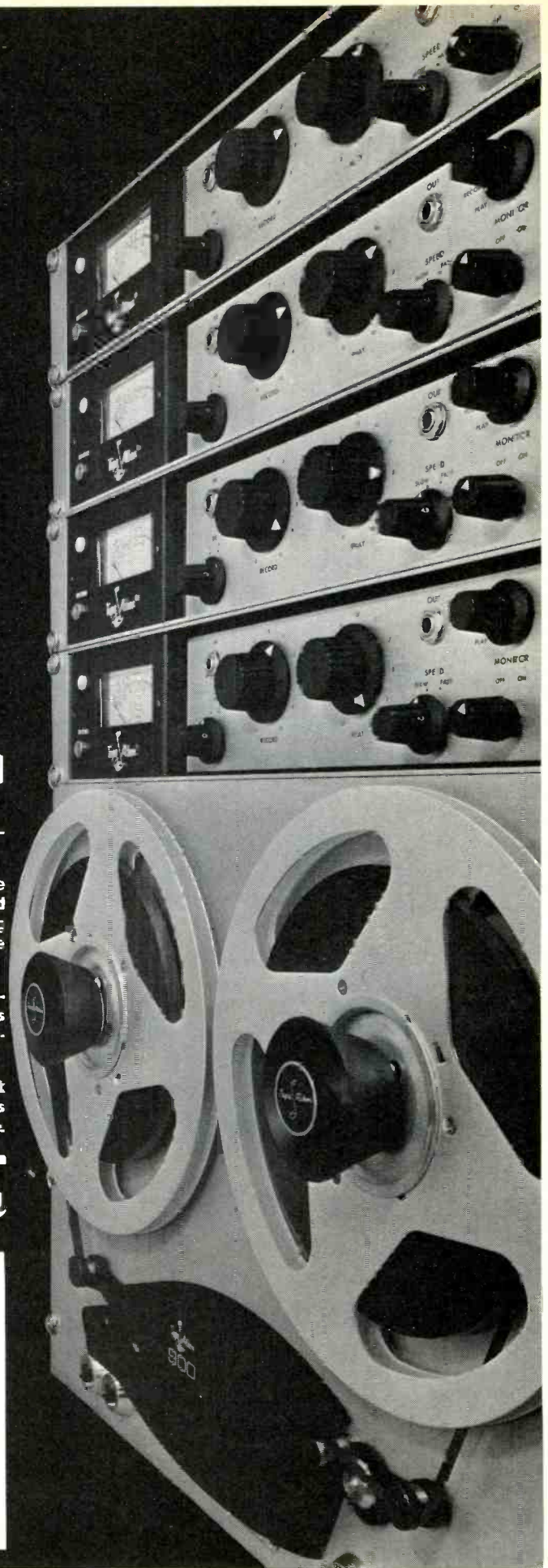

NEW PRODUCTS

For further information about any item, circle the associated number on the Tech Data Card.



Professional Audio Recorder
(100)

A line of magnetic recorders featuring console mounting, straight-line

tape threading, and front-panel controls has been introduced by **Metrotech Inc.** The Model 500A professional recorder offers two-directional record and reproduce capabilities; this feature doubles unattended reel times at any speed. Edit and cue controls provide tape positioning for addition, deletion, or playback of specific program segments.

The 500A is equipped with separate front-panel high/low torque switches for each reel-drive motor. A two-speed capstan motor is also front-panel controlled for high and low tape speeds, with automatic equalization switching. Any adjacent pair of standard speeds from 1 $\frac{7}{8}$ to 15 ips is available. All operating controls of the 500A can be removed. Capstan closure is adaptable for playback control by an automation system.

The 500A Series recorders and compatible reproducers are available in mono and stereo options for full-track, half-track, two-track, and four-track operation. Single-speed logger

models are available with 5/16, 15/32, or 15/16 ips tape speed. ▲

Bulk-Tape Eraser
(101)

The Model TM-88 hand-held bulk-tape eraser, from **Robins Industries Corp.**, is intended to handle any size reel of magnetic recording tape or magnetic stripped movie film. The eraser has a handle with a built-in momentary switch and is designed for crasing entire reels, with recorded material and background noise reduced to below the normal erase-head level, by moving the unit over each side of the reel. The TM-88 weighs two pounds, and operates on 4 amperes, 110-120 volts, 50-60 Hz. It lists at \$17.50.

Color Camera With Zoom Lens
(102)

A new compact compatible color TV camera contains a beam-splitting prism assembly feeding four lead-oxide vidicon tubes. The camera measures 29" x 15" x 15", including the integral zoom lens. Designed by **E.M.I. Electronics, Ltd.** to produce broadcast-

AMCI BROADCASTING ANTENNAS

For ITV, UHF-TV
VHF-TV and FM

- Directional and Omnidirectional TV Antennas
- Directional and Omnidirectional ITV Antennas
- Dual Polarized Directional and Omnidirectional FM Antennas
- May be top or side mounted

AMCI Antennas are ruggedly designed and constructed of noncorrosive materials such as 6061-T6 aluminum, copper, and stainless steel. This type of construction, combined with an electrical design that requires few transmission line seals (from $\frac{1}{8}$ to $\frac{1}{4}$ as many as other comparable antennas), yields an extremely dependable antenna that requires essentially no maintenance.

AMCI also custom designs antenna arrays to meet particular requirements. For a description of one of AMCI's custom designs (An FM Antenna on the Chrysler Building), write for Bulletin 10.

 **ALFORD**
Manufacturing Company
120 Cross Street, Winchester
(Greater Boston), Mass. 01890
Telephone: 617-729-8050 TWX: 710-348-1063
Cable Address: AMCIBOS

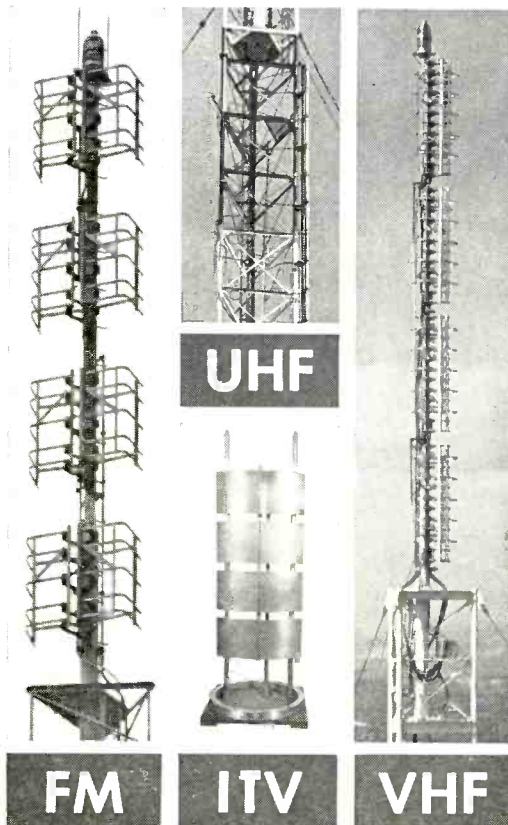

The soundest sound in audio
is the new sound of Gates



Need a really
portable
remote amplifier?

One . . . two . . . three . . . four! You have that choice of channels and models in Gates Solid Statesman remote amplifiers. All rugged, compact. Modern flightline styling. Choose a model ideal for your needs. Write or phone (217) 222-8202 for off-the-shelf delivery.

HARRIS
INTERTYPE
CORPORATION

GATES

GATES RADIO COMPANY
QUINCY, ILLINOIS 62301, U.S.A.
A subsidiary of Harris-Intertype Corporation

Circle Item 53 on Tech Data Card

Circle Item 54 on Tech Data Card



INSTANT REPLAY

Ideal instant playbacks at low cost with the cae Model 221 Mechanical Instant Playback Adapter

SATISFIES THE MOST DEMANDING VIDEO ENGINEER

Easily installed

Integrates with normal VTR operation. Levelling feet for precise tracking.

Fast, simple loading

Takes only 5 minutes, including splicing.

Efficient tape storage

Accommodates 18 to 39-second playbacks.

Adjustable

Sliding pulley adjusts tension for odd lengths of tape.

Strong and lightweight

Heavy gauge aluminum construction for easy portability.

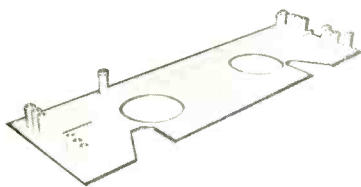

Let us solve your instant playback problems. Contact **ONEIDA ELECTRONICS INC.**
805 Court Street,
UTICA, New York.

cae INDUSTRIES LTD.
Electronics Division (Western),
387 Sutherland Avenue,
WINNIPEG 4, Manitoba.



Circle Item 56 on Tech Data Card

quality 525-line output, the 2001 camera processes the signals from its four tubes to produce three outputs, R, G and B, for direct application to standard NTSC encoders and to standard RGB color monitors. Weight of the camera (without lens package) is 160 pounds.

Alternative 10:1 zoom lens packages can be supplied. The relevant servo amplifiers are contained within the camera and are used with all zoom-lens packages. Zoom rate is controlled from a twist grip on the camera panning handle, and preset zoom positions can be selected by push buttons.

Cueing and communications facilities are included, and provision is made for mounting a visual prompter. The tilting electronic viewfinder is powered from the camera but can be used up to 33 feet away, if required. Solid-state circuits are built onto plug-in printed circuit boards, and extensive use is made of stage-by-stage and overall negative feedback, together with close component tolerances, for long-term stability.

Solid-State Video Monitor (103)

The Model VM-218 video monitor, from Maryland Telecommunications, Inc., employs all-solid-state circuitry, including the high-voltage rectifier.

Operating Remote Control? Be safe and sure!



with the **ALL SOLID-STATE AM RF AMPLIFIER FROM WILKINSON!**

Features of the Model TRF 1A:

- VERY LOW DISTORTION AND CARRIER SHIFT
- BROAD GAIN CHARACTERISTICS
- EXTREME STABILITY
- EXCELLENT SELECTIVITY
- ULTRA LINEARITY

PRICE: \$395

For complete details write:

WILKINSON ELECTRONICS, INC.

1937 MacDADE BLVD. • WOODLYN, PA. 19094
• TELEPHONE (215) 874-5236 874-5237 •

Circle Item 57 on Tech Data Card



Photo Research introduces an easier, faster, more accurate way to test TV cameras . . .

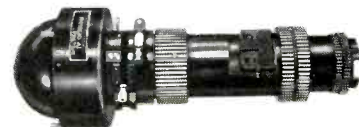

The SPECTRA TV OPTOLINER*

is a high resolution, precision TV camera tester that saves space by eliminating the elaborate test equipment formerly used for this operation. Now being used by RCA in their Burbank production facilities, the Optoliner attaches directly into the camera lens mount and provides microscopic alignment (within 0.002") of the slide mounted test patterns to the center of the camera lens. Ideal for use in production facilities, quality control operations or in standards labs, the Optoliner contains a constant, adjustable light source, and a special meter to indicate the exact illuminance and color temperature falling on the face of the camera tube. For more information on this simplified approach to TV camera testing, write, wire or phone today!

*Trademark of Photo Research Corp.



Karl Freund,
President

PHOTO RESEARCH corp.
"Photometric Equipment for Science and Industry"

837 N. Cahuenga Blvd., Hollywood, Calif. 90038
Telephone: (213) 462-6673 Cable: SPECTRA

Circle Item 58 on Tech Data Card

BROADCAST ENGINEERING



The design includes regulation of both the low-voltage and high-voltage supplies, a 9-inch bonded-face rectangular kinescope, switch-selectable DC restoration (0 to 100%), switchable raster size, loop-through operation, and input of 2.2 megohms in parallel with 15 pf or terminated into 75 ohms (switch selectable).

Some specifications are 525-line, 30-frame or 625-line, 25-frame scanning; 10-MHz bandwidth, differential gain less than 5% with 75-volt kinescope drive; 800-line resolution; and external sync, 1 to 100 volts negative, composite or separate sync (switch selectable).

Available models are: Model VM-218-NC (chassis only), \$415; Model VM-218-WC (portable cabinet), \$455; Model VM-218-RT (twin rack), \$865; and Model VM-218-RS (single rack), \$450.

TAPECASTER



Model 700-P

Solid state playback unit

Broadcaster net price \$300.

For information write
Box 662 • Rockville, Maryland 20851
or call 301-942-6666

TAPECASTER

* TCM

Circle Item 59 on Tech Data Card

March, 1968

get the turntable a studio needs ...and rek-o-kut durability, too!



There's hardly an engineer in the broadcast field that hasn't used a Rek-O-Kut turntable in his career. Rek-O-Kut has been building studio turntables for over a quarter century. So you are assured of buying top quality sound reproduction along with the ruggedness and durability that broadcast and commercial installations demand. The rim drive Rek-O-Kut B-12H by Koss Electronics permits slip cueing without sacrificing fidelity. And your Koss/Rek-O-Kut will last and last with a minimum of maintenance and repair. Write for complete details on the popular Model B-12H or the 16" studio B-16H today.

specifications:

SPEEDS: 33 $\frac{1}{3}$, 45, 78 rpm. NOISE LEVEL: — 59db below 5 cm/sec average recorded level. MOTOR: custom-built computer type heavy-duty hysteresis synchronous motor. 45 RPM HUB: instantaneously removable by hand. PILOT LIGHT: neon light acts as an "on/off" indicator. FINISH: grey and aluminum. DECK DIMENSIONS: 14 x 15 $\frac{1}{16}$ ". Minimum Dimensions: (for cabinet installation) 17 $\frac{1}{4}$ " w. x 16" d. x 3" above deck x 6 $\frac{1}{4}$ " below. PRICE: B-12H Turntable \$165. S-320 Tonearm \$34.95. Optional BH Base for audition room \$18.95.



Rek-O-Kut Turntables by

KOSS

Koss Electronics Inc., 2227 N. 31st St., Milwaukee, Wis. 53208
Export Cable: STEREOFONE • Koss-Impetus/2 Via Berna/Lugano, Switzerland

Circle Item 60 on Tech Data Card



1 Delta Model OIB-1 Operating Impedance Bridge measures "in circuit" impedance of networks, transmission lines and antennas while operating at full or reduced power. Accuracy: $\pm 5\% \pm 1$ Ohm. Power Rating: 5kw with VSWR of 3:1.



2 Delta Model CPB-1 Common Point Bridge measures common point resistance to $\pm 2\% \pm 1$ Ohm, and reactance to $\pm 5\% \pm 1$ Ohm operating at full power.



3 Delta Model RG-1 Receiver/Generator, a combination signal generator with high output power, and receiver with excellent shielding and metering for use with Model OIB-1 or any other impedance bridge.

THE DELTA TRIO

for optimum
monitoring
of your
antenna
system

△ With this "Delta Trio", you can either "spot check", or continuously monitor actual "on-the-air" operating impedance of transmission lines, networks and antenna systems accurately to maintain a "clean signal" at peak operating efficiency.

△ If you're operating with a directional antenna, there's real value in being able to keep the radiating system in close adjustment at all times . . . continuously verify common point impedance to insure full power output . . . plus locating and correcting any antenna problems—fast!

△ Complete details and application data are available without obligation—just write or call Robert Foley—(703) 751-3133.

DELTA ELECTRONICS



4206 Wheeler Avenue
Alexandria, Virginia 22304 U.S.A.
(703) 751-3133

Exclusive Export Distributor
ROCKE INTERNATIONAL CORPORATION
13 East 40th St., New York, N.Y. 10016 U.S.A.
Cable: "ARLAB"

Circle Item 61 on Tech Data Card



Translators (104)

A line of solid-state VHF and UHF television translators with power output levels to 20 watts is offered by Rodelco. Shown is the Model VHFT translator for converting any VHF TV channel to any other VHF TV channel at a power output level of 1 watt. The unit has a typical specified noise figure of 2 dB and 6-MHz bandwidth.

Cable Identification (105)

Transparent, reusable protectors for message identification of harnesses, harness breakouts, cabling, tubes, and pipes have been introduced by Thomas & Betts Co., Inc. Identification is achieved on the spot by writing the message with pencil, or other marking instruments, on paperboard cards that are torn from perforated sheets and inserted into the preformed pocket of the protector. The protectors are hole-punched and secured to the bundle

SPOTMASTER

RS-25



Tape
Cartridge
Racks

RM-100



... from
industry's
most comprehensive
line of cartridge tape equipment.

Enjoy finger-tip convenience with RM-100 wall-mount wood racks. Store 100 cartridges in minimum space (modular construction permits table-top mounting as well); \$40.00 per rack. SPOTMASTER Lazy Susan revolving cartridge wire rack holds 200 cartridges. Price \$145.50. Extra rack sections available at \$12.90.

Write or wire for complete details.

Spotmaster

BROADCAST ELECTRONICS, INC.
8800 Brookville Road
Silver Spring, Maryland

**Symbol of
outstanding
performance**



**Studio
Condenser Microphones
Transistorized
Condenser Microphones
Cardioid
Dynamic Microphones
Omni-directional
Dynamic Microphones
Special Purpose
Dynamic Microphones
Dynamic
Stereo Headphones
Headphone/Microphone
Combination Boom Sets
Accessories**

Over twenty years of intensive research, a complete knowledge of acoustics, measurement techniques and meticulous manufacturing standards have made **AKG** microphones the choice of professional recording and broadcast engineers.

AKG continues to pioneer in microphone development with the unique two-way dynamic microphone series and a breakthrough in transistorized condenser microphone design.

Write to us for literature or call your **AKG** dealer.



MICROPHONES • HEADPHONES

DISTRIBUTED BY
NORTH AMERICAN PHILIPS COMPANY, INC.
100 EAST 42ND STREET, NEW YORK, NEW YORK 10017

See us at NAB Booth No. 325

Circle Item 62 on Tech Data Card

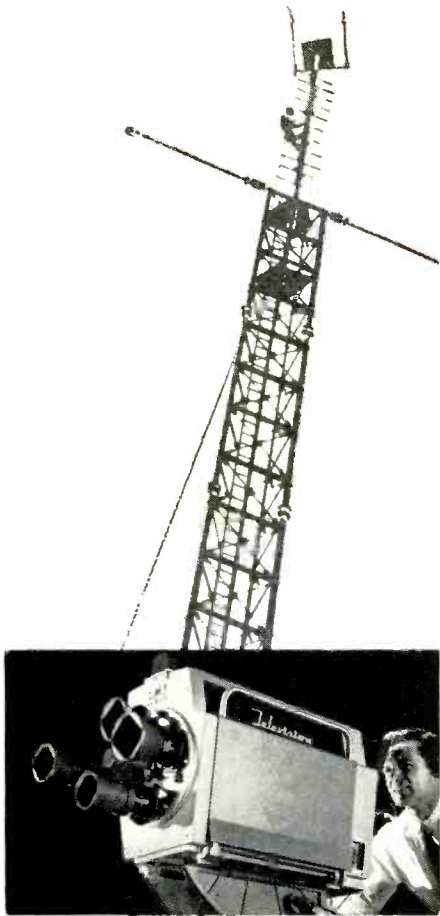

Command Performance? RCA SERVICE DELIVERS Expert, Repair and Overhaul Service

FOR:

- Video tape recorders
- TV Cameras
- Antennas
- Microphones
- Transmitters
- Installation
- Console
- TV Projectors
- Microwave

Dial either of these offices for full information about fast, dependable broadcast equipment maintenance service from RCA:

Chicago (312) WE 9-6117
Philadelphia (215) HO 7-3300

Or write:

RCA Service Company
A Division of RCA
Technical Products Service,
Bldg. CHIC-225,
Camden, N. J. 08101

RCA

with Thomas & Betts "Ty-Rap" ties. Ends of the protector may be sealed to provide moisture protection for the identifying message.

The protectors come in two sizes, 1 $\frac{1}{8}$ " x 1 $\frac{5}{8}$ " and 1 $\frac{1}{2}$ " x 2 $\frac{1}{4}$ ". Each size has a minimum bundle diameter of $\frac{1}{2}$ inch and a maximum of $\frac{3}{4}$ inch.



16-mm Projector
(106)

A projector designed for television use is available from **Traid Corp.** Some features listed for the Selecta-Frame Model 16N/TV are instantaneous stop-action, frame-by-frame slow motion, flickerless operation, and damage-free safety to film. A synchronous motor maintains the speed of 24 frames per second with AC line synchronization. A special shutter is intended to provide exact synchronization in television chains, eliminating "shutter-bar" effect.



Audio Connector Adapters
(107)

These audio connectors are designed by **Switchcraft, Inc.** to solve common interconnecting problems on components that do not have mating connectors. One adapter accommo-

dates a standard two-conductor phone plug to equipment that uses a three-pin audio receptacle. The other adapts a standard two-conductor phone plug to equipment using a three-contact audio receptacle.

The adapters feature a separate "ground terminal" which is electrically integral with the connector shell. "ground contactors" which provide ground continuity between mating plugs, and left-hand-threaded "captive design" insert screw, which eliminates loss of the screw during assembly. To reduce hum and noise problems normally encountered in high-impedance circuits, pins and contacts are insulated by a high-impact thermosetting plastic.

**IT'S A FACT . . . YOU PROFIT
WE DO THE WORK**



Let JOA Cartridge Specialists recondition and rebuild your worn cartridges to give you **EXTRA CARTRIDGE LIFE . . . EXTRA ENGINEERING TIME.**

—**JOA will inspect, service and reload your cartridges with ANY LENGTH tape**

NO EXTRA CHARGE FOR—

- (a) **FOAM TEFLON FACED PRESSURE PADS**
- (b) **replacement of minor parts**
- (c) **VISIBLE SPLICE**
- (d) **EVERY cartridge COMPLETELY PRETESTED** under actual broadcast conditions

NO MINIMUM
48-hour Processing
20 or more cartridges **SHIPPED PRE-PAID**

Need NEW CARTRIDGES fast? JOA will ship immediately . . . from stock . . . any size Fidelipac, precision manufactured NAB cartridge.

JOA—the cartridge service of authority—serving the broadcast industry.
Authorized distributor for **NORTRONIC HEADS**
phone or write



Cartridge Service
P. O. Box 3087
Philadelphia, Pa. 19150
Area Code 215, TUrner 6-7993

Circle Item 64 on Tech Data Card

VALUE • Integrity • Performance

LET'S GET OUR HEADS TOGETHER . . .

**STEREO RECORD & REPRODUCE HEADS
AMPEX 300, 350, 3200 SERIES**

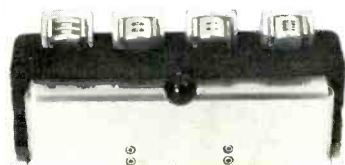

Take your pick!

- 2-Track Stereo
- 4-Track Stereo
- 8-Track Stereo
- 4-Track—4-Channel
- 8-Track—4-Channel

Write for details!



MINNEAPOLIS MAGNETICS, INC

2915 Huntington Avenue Minneapolis, Minnesota 55416

Circle Item 63 on Tech Data Card

BROADCAST ENGINEERING



Stereo Headphone

(108)

The Model ST-PRO-B stereo headphone is designed by **Suprex Electronics Corp.** for professional use. A dynamic woofer is used for the low-frequency response, and a ceramic tweeter is interconnected by a full crossover network. This woofer-tweeter combination is coaxially mounted in the ear cups. An ear seal is provided by removable vinyl cushions filled with urethane foam. An adjustable spring-steel headband is provided. An impedance of 8-16 ohms is standard; 600- 2000- or 15,000-ohms impedance is available. Net price is \$50. ▲

4-TUBE PERFORMANCE 3-TUBE SIMPLICITY

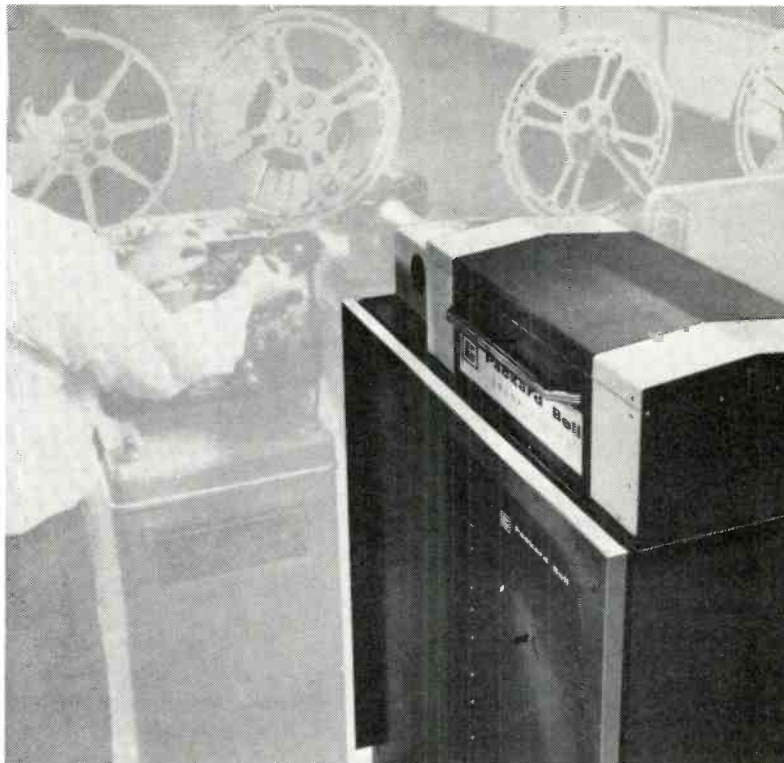

**Only new Packard Bell
Color Camera for film chains combines all
these high-performance features
in one economical package**

Complete matched system—camera plus optical multiplexer permits wide projector flexibility.

Full EIA/NTSC compatibility obtained with optional plug-in EIA sync modules and encoder.

Unmatrixed monochromatic signal for maximum definition and contrast.

Combination of precision fixed optics and 3-vidicon simplicity provides 4-channel standards of resolution, contrast and ease of registration.

Superior sensitivity—150 foot-lamberts high light-reflectance.

Write today for full information and prices.

CB6

TAPECASTER



Model 700-RPD

**Solid state combination
record-playback unit
for delayed programming**

Broadcaster net price \$500.

For information write
Box 662 • Rockville, Maryland 20851
or call 301-942-6666

TAPECASTER



Packard Bell



Lawrence & Arnold Drive, Newbury Park, Calif. 91320 • Tel: (805) 498-6601

Circle Item 65 on Tech Data Card

March, 1968

Circle Item 66 on Tech Data Card

The International Set.

Conrac watches television in about a hundred languages. Japanese, Thai, Swedish, Norwegian, Hebrew, French, German, you name it. In fact, just about every major TV broadcaster in the world uses Conrac monitors. Except the Russians. (But, you know how that is.)

conrac

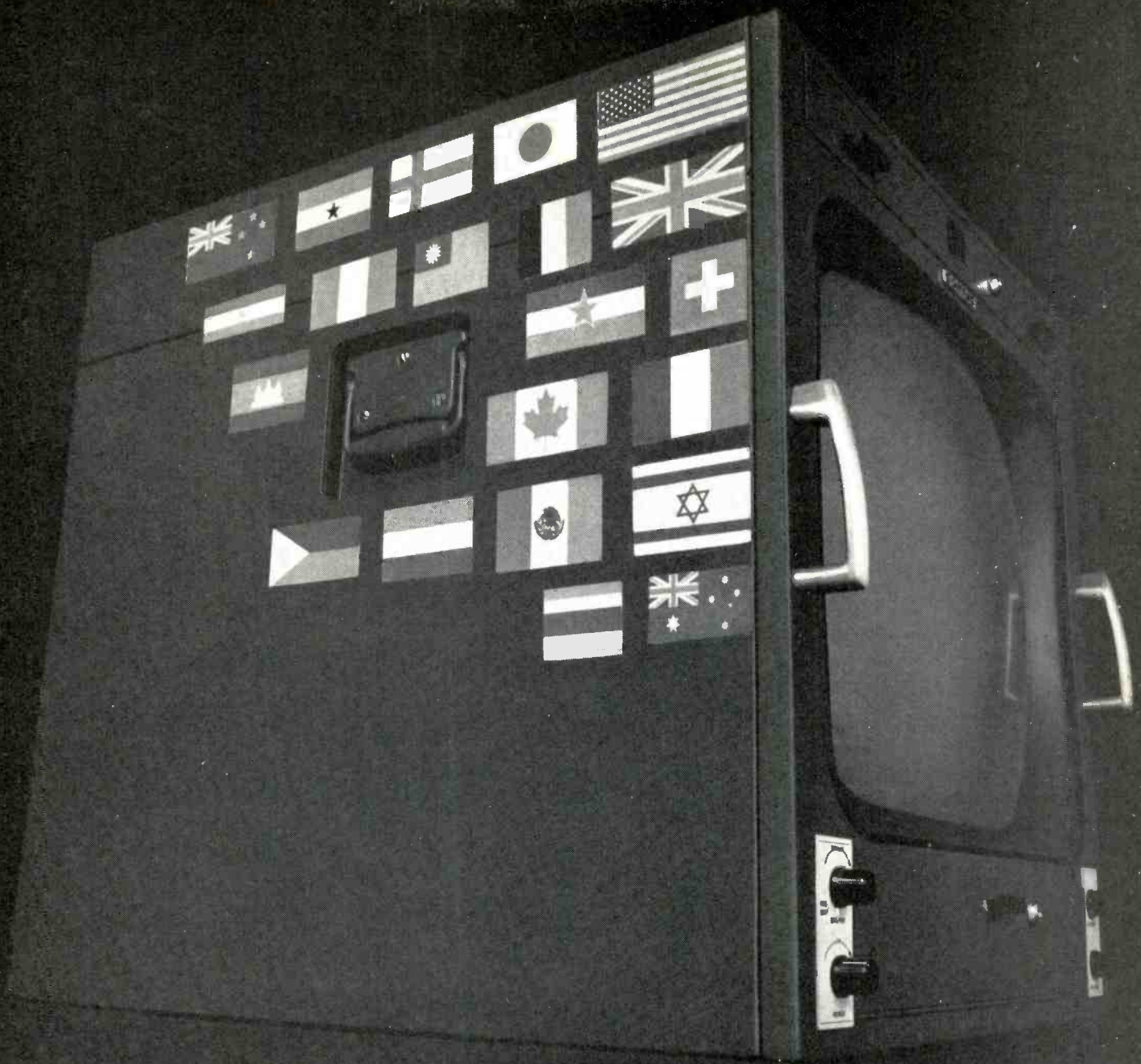

For the Best Color from Your RCA TK-42 and TK-43 Cameras

USE THE RCA-4536 IMAGE ORTHICON



The RCA-4536 Image Orthicon in the luminance channel of your TK-42 and TK-43 color cameras is the perfect companion tube for the RCA-4493, -4494 and -4495 Vidicons...designed specifically for RCA cameras and carefully quality-tested in the actual camera components.

The RCA-4536 gives a signal-to-noise-ratio 25% greater than the previous standard, 4492 Image Orthicon. The electronically-conducting glass target assures non-stick and anti-burn operation over a long operating life.

The RCA-4536 Image Orthicon assures the best color...the best in-studio service. Ask your RCA Broadcast Tube Representative about the RCA 4½" I.O. for TK-42 and TK-43 cameras.

Available from your RCA Broadcast Tube Distributor.
RCA Electronic Components & Devices, Harrison, N.J. 07029.

RCA

HD Meters

(Continued from page 27)

from 0.1 to 0.25% residual harmonic distortion in the range from 50 Hz to 15,000 Hz.

The techniques of running a complete audio proof have been well covered elsewhere (4, 5, 6, 7, 8, 9, 10). Distortion measurements, however, require special considerations. First, it is a good idea to make a distortion run using only the generator, a dummy load, and the HD meter. This control run will indicate the performance of the measuring instruments themselves. Usually, if the equipment is in good shape and there are no ground loops, residual distortion below 0.5% should be indicated between 50 and 15,000 Hz. Since the Commission does not require measurements for fundamental frequencies outside this range, there is no need to insist on very low distortion, for instance, below 50 Hz.

It is generally considered to be a good idea to make separate distortion measurements on the console, the amplifiers, and the transmitters (11, 12). If one equipment item contributes several times the distortion of any other unit, it is the piece to troubleshoot. "Creeping distortion" usually starts in a single amplifier, and eventually the entire audio chain exceeds FCC limits. Preventive maintenance at the proper time helps prevent this from happening.

Most technicians ignore residual distortion contained in the measuring instruments, as long as it is below about 0.5%. Of course, a copy of the control run with the instruments alone should be kept on file. It should be pointed out that subtracting the residual figure from the equipment measurement may yield an erroneous result, since distortion does not always add directly. The lowest FCC limit is 2.5% distortion from 100 to 7500 Hz for FM stations. Most stations can show only 1.5 to 2.0%, which gives room to spare for residual distortion. If the instruments check out over 0.5% residual, they probably need troubleshooting.

It has been said that an instrument with six-digit resolution is useless when manipulated by a two-digit operator. The technician must

know the limitations of his measuring equipment; only then can he make truly accurate measurements. ▲

References

1. Langford-Smith, F. "Fidelity and Distortion," *Radiotron Designer's Handbook*, Fourth Edition. Harrison, N.J.: Radio Corporation of America, 1953, p 603.
2. LeBel, C. J. "An Experimental Study of Distortion," *BROADCAST ENGINEERING*, 1 (December 1959), 22.
3. FCC. *Rules and Regulations*, Vol. III, Pt. 73, Radio Broadcast Services. Washington, D.C.: Supt. of Doc., U.S. Government Printing Office, 1964.
4. Haskey, Richard R. "Proof of Performance Made Easy," *BROADCAST ENGINEERING*, 1 (May 1959), 22.
5. Adair, George P. "Audio-Frequency Proof-of-Performance Measurements," in A. Prose Walker, ed. *NAB Engineering Handbook*, Fifth Edition. New York: McGraw-Hill Book Co., Inc., 1960, pp 8-198 to 8-214.
6. Stern, Joseph L. "Proof of Performance for a Television Station," in A. Prose Walker, ed. *NAB Engineering Handbook*, Fifth Edition. New York: McGraw-Hill Book Co., Inc., 1960, pp 8-215 to 8-249.
7. Alexander, Jack. "Practical FM Engineering, Part III," *BROADCAST ENGINEERING*, 4 (April 1962), 18.
8. Ennes, Harold E. *Broadcast Engineering Notebooks, Vol. 3, AM-FM Broadcast Maintenance*. Indianapolis: Howard W. Sams & Co., Inc., 1963, p 176 ff.
9. Etkin, Harry A. "FM Stereo Proof-of-Performance Measurements," *BROADCAST ENGINEERING*, 5 (August 1963), 10.
10. Haskett, Thomas R. "Small-Budget Audio-Proof Package," *BROADCAST ENGINEERING*, 8 (June 1966), 16.
11. Haskett, Thomas R. "Audio Studio Maintenance," *BROADCAST ENGINEERING*, 4 (June 1962), 14, and (July 1962), 12.
12. Murdoch, Ed. "When the Proof of Performance Fails," *BROADCAST ENGINEERING*, 5 (May 1963), 20; (June 1963), 20; (October 1963), 16; (December 1963), 12; and, 6 (February 1964), 28.

TAPECASTER

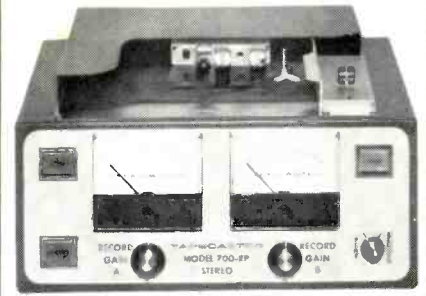

Model 700-RPS

Solid state stereo
combination
record-playback unit

Broadcaster net price \$700.

For information write
Box 662 • Rockville, Maryland 20851
or call 301-942-6666

TAPECASTER



Circle Item 69 on Tech Data Card

SUPERIOR!

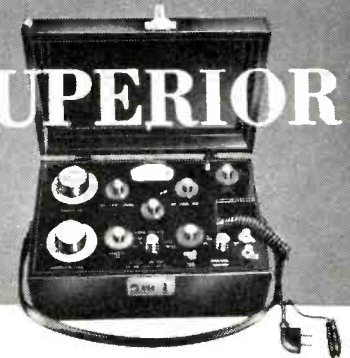

WILKINSON 4N1 Portable Solid-State

1. FIELD INTENSITY METER
2. NULL DETECTOR
3. STANDARD SIGNAL GENERATOR
4. AM MONITOR RECEIVER

SUPERIOR BECAUSE THE 4N1:

Measures field intensity with superior accuracy and reduces measurement time. • Requires only a bridge for easy RF impedance measurements. • Powered by rechargeable batteries and self-lighted for nighttime measurements. • Easier to carry and operate.

FOR COMPLETE DETAILS WRITE:

WILKINSON ELECTRONICS, INC.

1937 MacDADE BLVD. • WOODLYN, PA. 19094
• TELEPHONE (215) 874-5236 874-5237 •

Circle Item 68 on Tech Data Card

ANTENNAS, TOWERS, & TRANSMISSION LINES

- 116. ANDREW—Information is available about **Heliax** Type HF10, a new 8-inch flexible coaxial cable.
- 117. DELHI—Twelve-page catalog concerns towers and masts for citizens-band and similar applications.
- 118. FINNEY—Information about **Finco** 75-ohm master-system antennas is contained in brochure.
- 119. HUGHEY & PHILLIPS—Bulletin HPS-184 describes new combination photoelectric control and beacon flasher for tower obstruction lighting; Specification Guide SG-2 for tall-tower obstruction lighting also is offered.

AUDIO EQUIPMENT

- 120. ATLAS SOUND—Form PP-1840 describes microphone stands, microphone booms, and studio accessories.
- 121. BELL P/A PRODUCTS—Specification sheet giving details of the BE-M4 "A" transistorized mixer is offered.
- 122. FAIRCHILD RECORDING—FICM integrated control module is subject of technical bulletin.
- 123. NORTH AMERICAN PHILIPS—Booklet describing AKG transistorized (FET) condenser-microphone system is subject of literature offer.
- 124. RYDER MAGNETIC SALES—Information about Sela 2880 audio mixer for use with Nagra recorders is offered.
- 125. SUPERSCOPE—31-page catalog, "All the Best From Sony," features Sony/Superscope tape recorders, magnetic tape, microphones, and accessories. Additional catalog has technical specifications of consumer and professional microphones.
- 126. UNIVERSITY—28-page Commercial Sound Product Catalog lists speakers, horns, drivers, microphones, and sound columns; includes sound-system design chart, formulas, and technical data.

COMPONENTS & MATERIALS

- 127. MOTOROLA SEMICONDUCTOR—HEP Cross-Reference Guide lists 12,000 transistors, rectifiers, diodes, and SCRs.
- 128. PITTSBURGH CORNING—A 12-page bulletin, GC-7, describes use and installation procedure for **GEOCOUSTIC** acoustical units using "patch technique."

- 129. TECHNICAL WIRE PRODUCTS—Eight-page short-form catalog has information on shielded enclosures, EMI/RFI air filters, shielding gaskets and strips, conductive epoxy, and glass shielding panels.
- 130. TROMPETER—Catalogs T-6 and M-4, listing coax, twinax, and triax products for patching, switching, and matrixing, are offered.

LIGHTING EQUIPMENT

- 131. BERKEY-COLORTRAN—Vari-Beam "1000" variable light sources and accessories for use with them are described in Catalog No. Q-1024.

MICROWAVE & STL EQUIPMENT

- 132. LENKURT ELECTRIC—32-page catalog listing microwave-radio, multiplex, data-transmission, and related equipment in product line is offered.
- 133. MICRO-LINK/VARIAN—Specifications and prices for TVL Series TV-relay equipment are given in 2-page specification sheet.
- 134. MICROWAVE ASSOC.—Data sheets are about MA2B, MA7B, and MA13B equipment for TV intercity, STL, TSL, and remote-pickup uses.
- 135. MOSELEY ASSOC.—All-solid-state Model PCL-303B/C stereo STL is described in Bulletin No. 219A.

MISCELLANEOUS

- 136. WALLACH & ASSOC.—Cabinets for records, tapes, slides, film, and film strips are shown in 8-page catalog.

MOBILE RADIO & COMMUNICATIONS

- 137. CUSH CRAFT—New catalog CB-68 describes CB and business-band antennas and lightning arrestors.

POWER DEVICES

- 138. ONAN—Publications are "Standby Electric Power Systems" (No. 30d/On), catalog sheet "Automatic Line Transfers for Microwave Stations" (Form A364-B), and 8-page catalog F-205-D of Onan electric plants.

RECORDING & PLAYBACK EQUIPMENT

- 139. JOA—Prices and data are given for new tape cartridges and for cartridge-reconditioning service.

SATISFYING THE HIGHEST QUALITY DEMANDS OF BROADCASTERS

NEUMANN KM-84 CONDENSER MICROPHONE



World renowned standard of broadcast and recording industries • Now silicon FET equipped • Economical ultimate announce quality • Full accessories • Battery and AC power. **Price: \$237.00 up**

EMT-930stu STEREO/MONO TURNTABLE SYSTEM



Used worldwide • Precision construction • Exceptionally low flutter and rumble figures • Remote start/stop • Wow-less starts, cuing to syllable • Solid state eq/amp, line level out • U.S. cartridge. **Price: \$1350.00**

EMT-140st STEREO/MONO REVERBERATION UNITS



World famous steel plate device preferred by radio and TV networks and stations • Standard in recording industry • Variable decay 0.5 to 4.5 sec. • Line level in and out • Remote control available. **Price: \$2960.00**

EMT-159 FM-MX FAULT INDICATOR

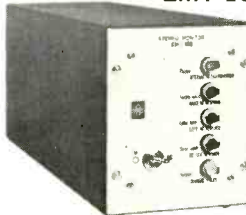

Invaluable to warn against difficult-to-detect failures such as loss of either, both, or difference channels, and phase reversal • Panel-lamps removable and/or to trigger aural alarm. **Price: \$595.00**



Client satisfaction is our best reference! Names will be furnished on request. Write on company letterhead for details on these or other equally fine products available from Gotham Audio.

GOTHAM AUDIO CORPORATION

2 WEST 46 STREET, NEW YORK, N. Y. 10036—(212) COLUMBUS 5-4111

SEE US IN BOOTH 226 AT THE NAB SHOW



140. RUSSCO—Data sheet describes turntable, mono and stereo phono preamplifiers, and companion power supply.
141. TELEX—Descriptions of Viking Studio 96 and Magnecord Models 1021 and 1022 tape recording and reproducing equipment are given in literature.
142. TEXWIPE—Information and prices for tape-head cleaning kit and its individual components are offered.

REFERENCE MATERIAL & SCHOOLS

143. CLEVELAND INSTITUTE OF ELECTRONICS—Pocket-size plastic "Electronics Data Guide" includes formulas and tables for: frequency vs. wavelength, dB, length of antennas, and color code.

TELEVISION EQUIPMENT

144. ALMA ENG'G—Brochure has to do with video switching systems, and specification sheet concerns audio console.
145. CANOGA ELECTRONICS—Data sheets for VT-5000 video transmission and terminal equipment, 1270 miniature camera control, and CH-1400 miniature vidicon camera are available.
146. CLEVELAND ELECTRONICS—A 52-page quick-reference catalog gives information on vidicon, **Plumbicon**, and image-orthicon deflection components.
147. COHU—Data sheets 6-488, 6-470, and 6-464 give specifications for the 2610/2620 series black-burst generator, drive generator and colorlock, and chroma detector, respectively.
148. COLORADO VIDEO—Preprint No. 102-25, "A Magnetic Disc Video-Scan Converter," presented at the 102nd SMPTE Technical Conference, is offered.
149. CONCORD ELECTRONICS—TV cameras, monitors, control panels and related accessories for CCTV and VTR systems are covered by descriptive literature.
150. KAPPA—Specification sheets describe the Model KR-250-4 video-cable simulator, and Series D, K, and L delay lines.
151. METRO TEL—Bulletin No. 21 describes TV line equalizer No. 323E and TV delay line No. 7292.
152. TELEMATION—Brochure describes and gives prices for Model TMV-707 universal camera control and accessories.
153. TV ZOOMAR—Literature covers H.T.S. studio equipment, Newsbreaker 400 color-film processor, and TV Colorgard meter to balance color TV monitors.
154. VITAL—Model VIX-108, new integrated-circuit vertical-interval switching system, is subject of literature.
155. ZOOMAR—Literature describes the 500 Sport Reflector, a 20-inch, F/5.6 lens; and the Variospeed-Hightorque-Control for ITV lenses.

TEST & MEASURING EQUIPMENT

156. ALFORD MFG.—Bulletin 701 gives descriptions and prices of the complete new line of **Hybridge** reflectometers.
157. BALLANTINE—Price list and twelve-page 1968 catalog are offered.
158. BARKER & WILLIAMSON—Sales Bulletin No. 111 illustrates and describes Model 210 audio oscillator and Model 410 distortion meter.
159. B&K—Bulletins are available for the following instruments: Model 2409 AC voltmeter/amplifier; Model 4240 simulated voice mechanism, for testing telephone transmitters and handsets; Model 2410 AF voltmeter/amplifier; Model 2417 rms voltmeter; Model 2006 heterodyne voltmeter; and Model 3350/51 electroacoustic transmission measuring system, for tests on telephone handsets.
160. DELTA—Information sheet has as its subject the Model RG-1 receiver/generator for use with antenna-impedance bridges.
161. EICO—1968 full-line catalog is offered.
162. TEKTRONIX—Specification brochures for Type 529 waveform monitor, Type 520 NTSC vectorscope, and Type 453 oscilloscope are available.
163. WEINSCHEL ENG'G—Line of barretters and thermistors is subject of 4-page publication.

TRANSMITTERS & ASSOCIATED EQUIPMENT

164. BARNSTEAD—Coolant repurification equipment is presented in Bulletin No. 201.
165. BAUER—Specifications of Model FB-10J, 10-kw AM transmitter are contained in catalog sheet.
166. GATES—Brochure describes Model FM-40H 40-kw FM transmitter; FM isolation transformers are subject of product information bulletin.
167. MARCONI—Technical description gives details of Type B.0502 10-kw UHF transmitter using vapor-cooled klystrons.

New...

BUDR-1 BALUN AMPLIFIER

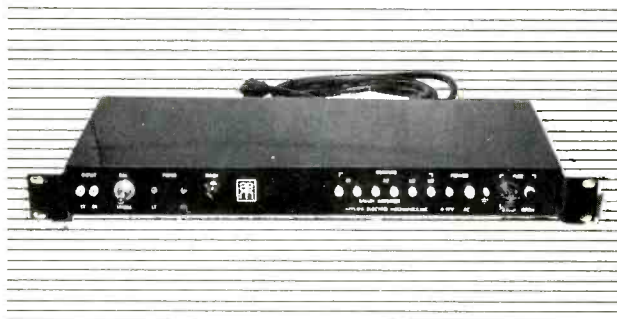

ACCEPTS BALANCED OR UNBALANCED INPUTS AND ELIMINATES FREQUENCY INTERFERENCE

The new Model BUDR-1 Balun Amplifier is ideally suited for distribution of video signals within the studio or from remote locations. The BUDR-1 automatically cancels out generated unbalanced voltages, and eliminates power hum or other spurious interference frequencies which could be induced into the cable. Completely transistorized, it accepts either balanced or unbalanced signal inputs while providing four outputs, two balanced at 124 ohms and two unbalanced at 75 ohms. Choice of inputs is selectable by a front panel switch.

Designed for operation on 105-120 volt, 60 Hz power, the BUDR-1 provides high common mode rejection of up to 50 db for power frequencies. Its signal handling capability is 2 volts p-p. Differential gain is typically less than 1% under normal use, and the gain is adjustable from -1.0 to +6.0 db. Frequency response is $\pm 1/2$ db from 10 Hz to 10 MHz. The amplifier exhibits very low noise, typically 70 db below 1 volt. Hum and noise together are less than 0.1 millivolt on any terminated output, and all output lines are connected to front panel test jacks for in-rack monitoring. Measuring 19" x 1 3/4" x 8", total weight is 5 pounds. Price: \$415.00. Please write for further information.

APPLIED ELECTRO MECHANICS, INC.

2350 Duke Street, Alexandria, Virginia 22314
PHONE: (703) 548-2166



NORTRONICS HAS THE REPLACEMENT TAPE HEAD YOU NEED FOR ANY TRACK STYLE OR FUNCTION!



To keep getting optimum performance from your tape recording equipment you must regularly replace worn tape heads. With Nortronics heads, adapters, and brackets, it can be done quickly and easily... and you can also *convert* track styles in minutes.



Replacements for
**AMPEX • MAGNECORD
CONCERTONE • RCA •
CROWN**



as well as 1500 popular
priced recorders



REEL-TO-REEL OR
CARTRIDGE TYPES



MONO/STEREO

FULL TRACK



HALF TRACK



QUARTER TRACK

EIGHTH TRACK

RECORD • PLAYBACK • ERASE



RECORD
RECORD • PLAYBACK
ERASE

NORTRONICS Bulletin 7230A describes the complete line of Nortronics replacement heads, conversion and mounting kits, and accessories. Write for free copy.



Nortronics
COMPANY, INC.

8101 Tenth Avenue North
Minneapolis, Minnesota 55427

Circle Item 76 on Tech Data Card

Advertisers' Index

Alford Manufacturing Co.	127
Alma Engineering	105
Altec Lansing, Div. of LTV Ling Altec, Inc.	18
American Electronics Laboratories, Inc.	28
Andrew Corp.	47
Applied Electro Mechanics, Inc.	139
Arrow Electronics, Inc.	108
Ball Brothers Research Corp.	8
Belar Electronics Laboratory, Inc.	36
CAE Industries, Ltd.	128
CBS Laboratories, Div. of CBS, Inc.	5
CCA Electronics Corp.	48, 49
Cleveland Institute of Electronics	13
Cohu Electronics, Inc.	3
Collins Radio Co.	24, 25
Conrac Div., Conrac Corp.	134, 135
Cooke Engineering Co.	109, 110
Davis & Sanford	115, 140
Delta Electronics, Inc.	130
Dresser Crane, Hoist & Tower Div.	118
Electronic Engineering Co. of California	117
Electro-Voice, Inc.	33
Fairchild Recording Equipment Corp.	6
Gates Radio Co.	17, 127
Gauss Electrophysics, Inc.	112
General Electric Co.	44
Gotham Audio Corp.	138
Gravoce Sales, Inc.	125
Gray Research and Development Co.	114
Harvey Radio Co., Inc.	96
Hughey & Phillips, Inc.	97
International Nuclear Corp.	Cover 3
ITT Federal Electric Corp.	111
Jampro Antenna Co.	57
JOA Cartridge Service	132
Koss Electronics, Inc.	129
Lenkurt Electric Co., Inc.	102, 103
Listec Television Equipment Corp.	124
Martel Electronics, Inc.	94
Memorex Corp.	20, 21
Metron Instruments, Inc.	97
Minneapolis Magnetics, Inc.	132
3M Co., Magnetic Tape Div.	40, 41
3M Co., Mincom Div.	60
Morhan National Sales	118
Moseley Associates, Inc.	120
North American Philips Co., Inc.	131
Nortronics Co., Inc.	140
Packard Bell, Space & Systems Div.	133
Philips Broadcast Equipment Corp.	98, 99
Photo Research Corp.	128
QRK Electronic Products	105
RCA Electronic Components & Devices	136
RCA Service Co.	132
Richmond Hill Laboratories, Ltd.	56
Riker Video Industries, Inc.	Cover 2
Rohn Manufacturing	106
Sennheiser Electronic Corp.	116
Shure Brothers, Inc.	53
Sparta Electronic Corp.	43
Spindler & Sauppe	14
Spotmaster (Broadcast Electronics, Inc.)	106, 130, 140
Stancil-Hoffman Corp.	115
Stanton Magnetics, Inc.	113
Superior Continental Corp.	104
Tape-Athon Corp.	31, 126
Tapecaster TCM	119, 129, 133, 137
Tech Laboratories, Inc.	107
Telemet Co.	Cover 4
TeleMation, Inc.	122, 123
Tele-Measurements, Inc.	32
Texscan Corp.	114
Traid Corp.	95
Videometrics, Inc. (Central Dynamics Corp.)	52
Visual Electronics Corp.	34, 35
Vital Industries	9
Ward Electronic Industries, Inc.	7
Wilkinson Electronics, Inc.	121, 128, 137
Xcelite, Inc.	107

Mounting and positioning equipment for cameras and space-age instruments



GENERAL PRECISION LABS Closed Circuit TV Camera on PS-34 Pedestal Stand with Model HD head. Model HD head features internal torsion spring to prevent camera dumping during extreme forward and backward tilts.

The PS-34 makes possible an infinite number of applications for mounting and positioning. It has "floating action," which means the actual weight of the camera is perfectly counterbalanced by a sturdy spring—just a touch and the camera automatically "floats" to the level you desire—stays there.

D & S offers the most complete line of stands and tripods. When standard models will not meet the requirement, we design and manufacture special tripods to order. Send us your specs.

For Further Information Write:

DAVIS & SANFORD

24 Pleasant St., New Rochelle, N. Y.

Circle Item 74 on Tech Data Card

SPOTMASTER Tape Cartridge Winder



The new Model TP-1A is a rugged, dependable and field tested unit. It is easy to operate and fills a need in every station using cartridge equipment. Will handle *all* reel sizes. High speed winding at 22 1/2" per second. Worn tape in old cartridges is easy to replace. New or old cartridges may be wound to any length. Tape Timer with minute and second calibration optional and extra. Installed on winder or available as accessory. TP-1A is \$94.50, with Tape Timer \$119.50.

Write or wire for complete details.

Spotmaster

BROADCAST ELECTRONICS, INC.

8800 Brookville Road
Silver Spring, Maryland

Professional Services

VIR JAMES

CONSULTING RADIO ENGINEERS
Applications and Field Engineering
345 Colorado Blvd.
Phone: (Area Code 303) 333-5562
DENVER, COLORADO 80206
Member AFCCE
TWX 910-931-0514

JAMES C. McNARY

Consulting Engineer
National Press Bldg.

Washington 4, D. C.
Telephone District 7-1285
Member AFCCE

CAMBRIDGE CRYSTALS PRECISION FREQUENCY MEASURING SERVICE

SPECIALISTS FOR AM-FM-TV
445 Concord Ave. Phone 876-2810
Cambridge, Mass. 02138

AMPEX HEAD ASSEMBLY RECONDITIONING SERVICE for all Ampex professional model recorders. This professional service features precision relapping of all heads for maximum head life. Your assembly is thoroughly cleaned and guides are replaced as required. Price includes optical and electrical inspection and complete testing on Ampex equipment in our plant. Full track or half track assemblies . . . \$35.00. One to two day service. "Loaner" assemblies available if necessary. LIPPS, INC., 1630 Euclid Street, Santa Monica, California 90404. (213) EX 3-0449. tf

CRYSTAL AND MONITOR SERVICE — Frequency change and repair service for AM monitors including G.R., RCA, Gates, W.E., and Doolittle; also H-P 335B FM. AM monitors bought and sold. What have you, what do you need? New or regrinding of AM crystals for RCA, Gates, Bliley, W.E., and J-K oven holders, repairs, etc. Fastest service, reasonable prices. Over 25 years in this business. Eidson Electronic Co., Box 96, Temple, Texas 76501, Phone 817 773-3901. 2-67-tf

ROSNER TELEVISION SYSTEMS

ENGINEERS
120 E. 56 St.
New York
N. Y. 10022

CONTRACTORS
29 South Mall
Plainview
N. Y. 11803

VIDEO TAPE RECORDER AUDIO HEAD ASSEMBLY SERVICE

Precision relapping of all heads and supporting posts, including cleaning and testing. Ampex head assembly with "cue" tracks, \$75.00 complete. RCA units also relapped. One to two day service. LIPPS, INC., 1630 Euclid St., Santa Monica, Calif. 90404. (213) EX 3-0449. tf

TAPE CARTRIDGE SERVICE Completely recondition your old tape cartridges, new tape cartridges available in all sizes for immediate shipment. Will supply complete price list on request. **M.S.I. CARTRIDGE SERVICE**, 279 West Main Street, Amsterdam, New York 12010. 3-68-3t

JOHN H. MULLANEY and ASSOCIATES

Suite 71,
1150 Connecticut Ave., N.W.
Washington, D. C. 20036
Phone 202-223-1180
Member AFCCE

FRANK A. ZOELLER

Television Systems Consultant
20 yrs. experience in TV and ETV
— All phases. Box 366, San Carlos,
Calif. 94070. Ph. (415) 593-1751

Professional tape cartridge rebuilding —
40-sec., 85c. Price list. Nulcart, 16 Columbus
Ave., Delaware, Ohio 43015. 3-68-1t

Announcer records inexpensively. send copy.
Free demonstration. Radio Recording Pro-
ductions, Box 13, Edgemont, Pa. 19028. 3-68-1t

Classified

Advertising rates in the Classified
Section are fifteen cents per word.
Minimum charge is \$2.00. Blind box
number is 50 cents extra.

Equipment for Sale

EQUIPMENT FOR SALE
Scully tape recorders as low as \$13.55
weekly. Three Spotmasters, one record/
playback, and two playbacks, all three,
\$38.25 monthly. Multiple units, Spot Five,
\$47.25 monthly. Two QRK or Rusco deluxe
turntables, \$10.80 monthly. Lower payments
with trade. Write for list. Purchase your
cartridges from us, we ship freight prepaid.
Audiobox, Box 7067-55, Miami—Florida.
33155. 4-68-tf

CO-AXIAL CABLE Heliax, Styroflex, Spiro-
line, etc. Also rigid and RG types in stock.
New material. Write for list. Sierra-Western
Electric Co., Willow and 24th Streets, Oak-
land, Calif. Phone 415 832-3527 5-66-tf

McMartin TBM-3500 modulation monitor like
new, tuned to 96.1 MHz. First offer over
\$550 takes it. WJLL Niagara Falls, N.Y.
3-68-2t

SALE! General Radio 1800A Vacuum-Tube
Voltsmeters, \$125.00. Mirror scale, 2% accy.,
.01-150V DC, .1-150V AC and RF. RF input
is good to 500 MHz and meter can be used
to measure RF voltages in AM & FM trans-
mitters and receivers. Supplied complete
with adapter to connect RF probe to G.R.
874 coaxial systems, 50-ohm RF terminating
resistor, and new AC cord. Units are used,
government surplus, in good operating
condition, checked and calibrated before ship-
ping. **OTHER SPECIALS:** General Radio
1606A RF Bridge, late model with the new
grey finish, calibration excellent, complete
with carrying case, \$795.00. ALSO Hewlett-
Packard 650A test oscillator, (audio-video),
10Hz to 10MHz, \$325.00. ALSO Ampex 351-2
stereo recorder, just overhauled, brand new
Nortronics heads, 30960 series electronics,
\$1495.00. All equipment F.O.B. San Fran-
cisco. **HUNTER ENGINEERING**, 2175 44th
Ave., San Francisco. 94116, 415-731-9197.
3-68-2t

Precision frequency and time instruments:
HP 5215L counter, HP 117A comparator, and
HP 5253B and HP 5262A plug-ins \$4000 total
or \$500 per year lease. Contact: A.M. Rut-
kowski, 610 Jefferson, Cape Canaveral, Fla.
32920. 3-68-1t

Condenser Mikes, used. 2-Altec M-11 Systems
1-Altec M20 System. All in operating
condition. No reasonable offer refused. Harry
McCune Sound Service, 960 Folsom St., San
Francisco, Cal. 94107. 415-982-1863 3-68-1t

**Television / Radio / communications gear of
any type available. From a tower to a
tube, Microwave, transmitters, cameras,
studio equipment, mikes, etc. Advise your
needs—offers. Electrofind Co., 440 Columbus
Ave., NYC. 212-EN-25680. 8-64 tf**

"AUDIO EQUIPMENT — Whatever your
needs, check us first. New and used. Am-
pex, Altec, AKG, EV, Fairchild, Neumann,
Langevin, Rek-O-Kut, Uher, Viking. Send
for equipment list." Audio Distributors,
Inc., 2342 S. Division Ave., Grand Rapids,
Michigan 49507. 6-66-tf

CARTRIDGE TAPE EQUIPMENT

Completely reconditioned and guaranteed.
Spotmaster Model 500 Record/Playbacks,
\$350.00. Model 505 Playbacks \$250.00. 30-
day money-back guarantee on all equip-
ment.

BROADCAST PRODUCTS COMPANY

18804 Woodway Drive, Derwood, Maryland,
20855
(301) 926-4600 3-67-tf

Everything in used broadcast equipment.
Write for complete listings. Broadcast
Equipment and Supply Co., Box 3141, Bris-
tol, Tennessee. 11-64-tf

Audio Equipment bought, sold, traded.
Ampex, Fairchild, Crown, McIntosh, Viking
F. T. C. Brewer Company, Town & Country
Plaza, Pensacola, Florida. 3-64-tf

BROADCAST EQUIPMENT REBUILDERS . . .
your headquarters for tape cartridge recon-
ditioning, all work fully guaranteed! Write
Quin Morrison about your used equipment
needs. New Address: Box 276, Hickory, N.C.
28601. 11-67-tf

Coils, Contactors, Switches, Complete ATU
systems. Top Quality, Lowest Prices, Fast
Delivery, No Duty. Write for catalogue:
Geleco Electronics Ltd., 2 Thorncliffe Pk.
Dr., Toronto 17, Ont. 416-421-5631. 11-67-12t

FM GE—3 kw Transmitter. Exceptionally
clean. RTFC, Rt. No. 2, Sioux City, Ia. 1-68-2t

TOWERS, lights and accessories AM FM communication, CATV, sales, erection and complete service, world wide. Write Dixie Steeplejack Company, 2832 Riverview Blvd. West, Bradenton, Florida. tf

Audio consoles complete with re-recording equalizers, compressor, three outputs including combining networks. Complete control facilities, patch board included. Other assorted audio equipment all in good condition. Phone 212-757-8855. Box No. 198 Broadcast Engineering. 3-68-1t

Equipment Wanted

We need used 250, 500, 5K & 10K Watts AM Transmitters. No Junk. Guarantee Radio Supply Corp., 1314 Iturbide St., Laredo, Texas 78040. 3-66-3t

SPOTMASTERS WANTED—Model 500 Record/Playbacks and Model 505 Playbacks. Send full details to: BROADCAST PRODUCTS COMPANY, 18804 Woodway Drive, Derwood, Maryland 20855 (301) 926-1600. 10-67-6t

Employment

IMMEDIATE OPENINGS—Qualify for any of the following positions: Technicians for RCA Closed Circuit Television equipment, Cameramen. Maintenance men. Video Tape men, Video Engineers, Sales Engineers. RCA Rep. 143-08 94th Ave., Jamaica, New York, or (212) 297-7344. 7-67-tf

Electrical Engineers needed immediately for TV/Radio stations, manufacturers, and CATV for all positions. Send well prepared resume to Nationwide Broadcast Personnel Consultants, 645 North Michigan Avenue, Chicago, Illinois, 60611. We have openings for all qualified applicants and the employer pays our fee. 10-67-tf

Immediate opening for Broadcast Engineer. All color station, second class license or better required. Send resume to WNYS-TV Channel 9, Syracuse, Inc. P.O. Box 9, Syracuse, N.Y. 13214. 10-67-3t

Job Headquarters for all Radio and Television Engineers. Immediate openings exist in 9 western states and elsewhere for qualified engineer and technical personnel. All categories from trainees to experienced transmitter maintenance, chief, assistant chief, live color video maintenance and technical operations. Send us your complete resume now. The AMPS Agency, 3924 Wilshire Blvd., Los Angeles, California 90005. Telephone DU 8-3116.

By Broadcasters—For Broadcasters 11-66-1f

Immediate opening for broadcast engineer with Second Class or First Class license to work in instructional television operation. Send resume to Barton R. Derby, Chief Engineer, ITV, Kent State University, Kent, Ohio 44240. 3-68-1t

TECHNICAL DIRECTOR

Required by large MSO headquartered in New York City. Experience required in all phases of CATV engineering and operations. This is a fine advancement opportunity for a seasoned field engineer or system chief technician. Offer open to anyone qualified. Send resume to Box 199. All information held in strict confidence. 3-68-1t

Leading Northeast educational TV station needs experienced maintenance engineer. Send resume. Box 200, BROADCAST ENGINEERING. 3-68-2t

IMMEDIATE openings for qualified technicians in all-color station. Experience desirable, first class license required. Contact R. L. Renaud, Chief Engineer, WWJ-TV, 622 Lafayette Boulevard, Detroit 48231. 313-222-2812. 3-68-1t

Wanted: Chief Engineer for medium market AM FM station. Northeast U.S. No announcing. Market leader. \$130/wk. Send resume to Box 190. 12-67-4t

WANTED—First Phone licensed engineer to work in South. Must have four to five years experience in TV broadcasting as studio maintenance engineer. Send resume with salary requirements to Box 191. 1-68-3t

WANTED—Experienced CATV technician to work in South. Send resume with salary requirements to Box 192. 1-68-3t

Established western manufacturer & distributor needs SERVICE MANAGER. Must be experienced in:
Broadcast Studio Equipment,
Including VTR
Color TV Equipment
Supervision of Technical Personnel
Limited travel. Excellent benefits.
Salary dependent on qualifications. Send resume to Box 197. 2-68-2t

BROADCAST SALES ENGINEER

Exclusive territory for sale of rapidly expanding line of broadcast equipment requires highly motivated, sales-minded individual with strong technical knowledge of equipment primarily to AM, FM, and TV stations. Leading company with history of high profit and rapid growth. Salary plus commission—with full fringe benefits and travel expenses paid. An equal opportunity employer. Send resume to Box 196. 2-68-2t

THE GRASS VALLEY GROUP

is forming a SALES organization.

BROADCAST TELEVISION ENGINEERS

are needed for all areas.

Sales experience helpful but not essential.



GRAVCO SALES, INC.
6311 Yucca St.,
Los Angeles, California
Call or Write:
(213) 462-6618

Position Wanted

Leaving USAF after 20 years. Desire permanent engineer/management employment in New Hampshire or Maine. First Phone since 1957, 2nd since 1951. Experienced in TV/-AM/FM. Trained and experienced in technical management. Excellent references. Will relocate at my expense after mid June. Salary open depending on location. Resume on request. Mr. E. Y. McKay, 4813 Lawrence Street, Alexandria, Virginia 22309. 3-68-1t

Training

To advance in electronics, knowledge and ability are required. Grantham offers correspondence and resident instruction, in depth, leading to the degree of Associate in Science in Electronics Engineering. G.I. Bill approved. Credit for previous training and experience allowed. Free Catalog. Write: Dept. E-2, Grantham School of Electronics, 1505 N. Western Ave., Hollywood, California 90027. 6-67-tf

**YOU'RE
WHISTLING
IN THE
DARK . . .**

. . . if you think that heart disease and stroke hit only the other fellow's family. No one is immune. Protect the hearts you love. For authoritative information, ask your Heart Association. For medical advice see your doctor. To safeguard your family . . .

**GIVE...
so more will live
HEART
FUND**



Contributed by the Publisher



TAA1 Preamplifier

The TAA1 Preamplifier is a completely transformerless audio line amplifier with highly desirable characteristics. Input: 150 or 600 ohms balanced, or bridging. Output: 150 or 600 ohms balanced. Gain: 40 db. Response: flat through 20 kHz. Distortion: less than 1/2%. Power: 18 DBM. It is shown above in the module rack which occupies only 5 3/4 inches of rack space. The TAA1 sells for \$130.00 and the mounting frame sells for \$100.00 F.O.B. Nashville, Tennessee. For complete information, write to:

INTERNATIONAL NUCLEAR CORPORATION
608 NORRIS AVE. • NASHVILLE, TENN. 37204 • PH.: (615) 254-3365

Circle Item 80 on Tech Data Card



TDA7 Video/Pulse Distribution Amplifier

The TDA7 is a completely transistorized distribution amplifier constructed as a plug-in module. The rack will hold 10 TDA7's and occupies only 5 1/4 inches of panel space. Each plug-in unit handles both the Video and Pulse functions with the flip of a switch. Provision is made to add a sync-adding circuit directly to the TDA7. This should be specified as TDA9. The individual TDA7 plug-in units are \$295.00 each F. O. B. Nashville and the mounting frame, which accommodates up to 10 units, sells for \$270.00. For complete specifications and information on other accessories, write:

INTERNATIONAL NUCLEAR CORPORATION
608 NORRIS AVE. • NASHVILLE, TENN. 37204 • PH.: (615) 254-3365

Circle Item 81 on Tech Data Card



TC1 Clamping Amplifier

The TC1 Clamping Amplifier employs tip clamping to remove low frequency signal deficiencies without disturbing burst and other chrominance information in or about back porch levels. The clamped stage utilizes a field effect transistor driven by a balanced bridge circuit. This advanced design technique produces highly effective and stable clamping. The TC1 Clamping Amplifier sells for \$325.00 F. O. B. Nashville. For complete information, write to:

INTERNATIONAL NUCLEAR CORPORATION
608 NORRIS AVE. • NASHVILLE, TENN. 37204 • PH.: (615) 254-3365

Circle Item 82 on Tech Data Card

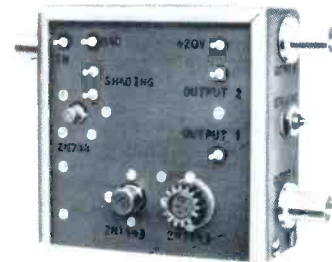

TCA3 Transistorized Camera Amplifier

The dependable TCA3 has almost become standard equipment in all image orthicon cameras. It replaces the vacuum tube pre-amplifier and is designed so it may be quickly mounted within available space in the camera without permanently disabling the vacuum tube amplifier. This cool little amplifier,

about the size of a package of cigarettes (101 mm), can add years to the life of cameras. The TCA3 sells for \$295.00 F. O. B. Nashville, Tennessee. For complete specifications and information write:

INTERNATIONAL NUCLEAR CORPORATION
608 NORRIS AVE. • NASHVILLE, TENN. 37204 • PH.: (615) 254-3365

Circle Item 83 on Tech Data Card



TBG2 Black Burst Generator

The brand new TBG2 Black Burst Generator allows you to go to black and back with perfection. The TBG2 has two outputs available for added versatility, and each has burst phase and burst amplitude adjustments so the two feeds can be matched under any condition. The TBG2 has the industry's only continuously rotatable phase control, and it's accurate to within one degree. All the controls are on the front panel and can be locked. The unit is small, compact and lightweight. So is the price . . . \$475.00 F. O. B. Nashville, Tennessee. For complete information, write to:

INTERNATIONAL NUCLEAR CORPORATION
608 NORRIS AVE. • NASHVILLE, TENN. 37204 • PH.: (615) 254-3365

Circle Item 84 on Tech Data Card



TVA1 Transistorized Video Stabilizing Amplifier

The TVA1 Stabilizing Amplifier with its associated plug-in units offers the highest level of performance and versatility for studio and transmitter use. The TVA1 removes all low frequency disturbances such as hum, bounce and tilt by sync-tip and back-porch clamping. The compact TVA1 chassis accepts 4 plug-in units. Five plug-in units are available covering the entire range of needs from input amplifiers to stripped video units. The TVA1 Stabilizing Amplifier (less plug-ins) sells for \$1380.00 F. O. B. Nashville, Tennessee. Plug-in units range from \$240.00 to \$450.00 each. Write for complete information to:

INTERNATIONAL NUCLEAR CORPORATION
608 NORRIS AVE. • NASHVILLE, TENN. 37204 • PH.: (615) 254-3365

Circle Item 85 on Tech Data Card



TDA2D Video/Pulse Distribution Amplifier

The now-famous TDA2 Distribution Amplifier, in use at most television stations and networks, has a recently added feature. The "D" stands for Differential Input, which we added to the TDA2. And not only did we add a differential input, we subtracted \$30.00 from the price. Instead of \$325.00, we're selling the new improved TDA2D for \$295.00 F. O. B. Nashville, Tennessee. The compact TDA2D fits neatly into 1 3/4 inches of panel space and produces virtually no heat. Write for complete information to:

INTERNATIONAL NUCLEAR CORPORATION
608 NORRIS AVE. • NASHVILLE, TENN. 37204 • PH.: (615) 254-3365

Circle Item 86 on Tech Data Card



TSA1 Clamping/Equalizing Video Amplifier

The TSA1 Clamping/Equalizing Video Amplifier is completely transistorized and designed with the most modern circuitry. It is designed to process signals from microwave, mobile gear, master control or feed-corrected signals to the input terminals of a television transmitter. It has a self-contained regulated power supply. Tip clamping is employed which does not disturb burst and other chrominance information in or about blanking or back porch levels. The TSA1 sells for \$850.00 F. O. B. Nashville, Tennessee. Write for complete specifications and information to:

INTERNATIONAL NUCLEAR CORPORATION
608 NORRIS AVE. • NASHVILLE, TENN. 37204 • PH.: (615) 254-3365

Circle Item 87 on Tech Data Card



“When you buy
Telemet’s Color
Processor you get
a sync generator

FREE OF CHARGE!”



*That’s because our color processing amplifier
includes an EIA sync generator
complete with outputs – ready to use.*

FEATURES:

RESHAPED SYNC MODE for processing signals containing jitter

REGENERATED SYNC MODE for complete replacement of sync

SET-UP ADJUSTMENTS on both reshaped and regenerated modes

FRONT PANEL ADJUSTMENTS include sync level; burst level; burst position; burst width; burst phase; white clip.

OUTPUTS:

composite video (2); non-composite video (2); sync; blanking; H drive; V drive; burst flag; sub-carrier.



TELEMET COMPANY

185 DIXON AVENUE / AMITYVILLE, NEW YORK 11701 / PHONE: (516) 541-3600

Circle Item 77 on Tech Data Card