



A HOWARD W. SAMS PUBLICATION



DECEMBER 1964/75 cents

Broadcast Engineering

*the technical journal
of the broadcast-
communications industry*



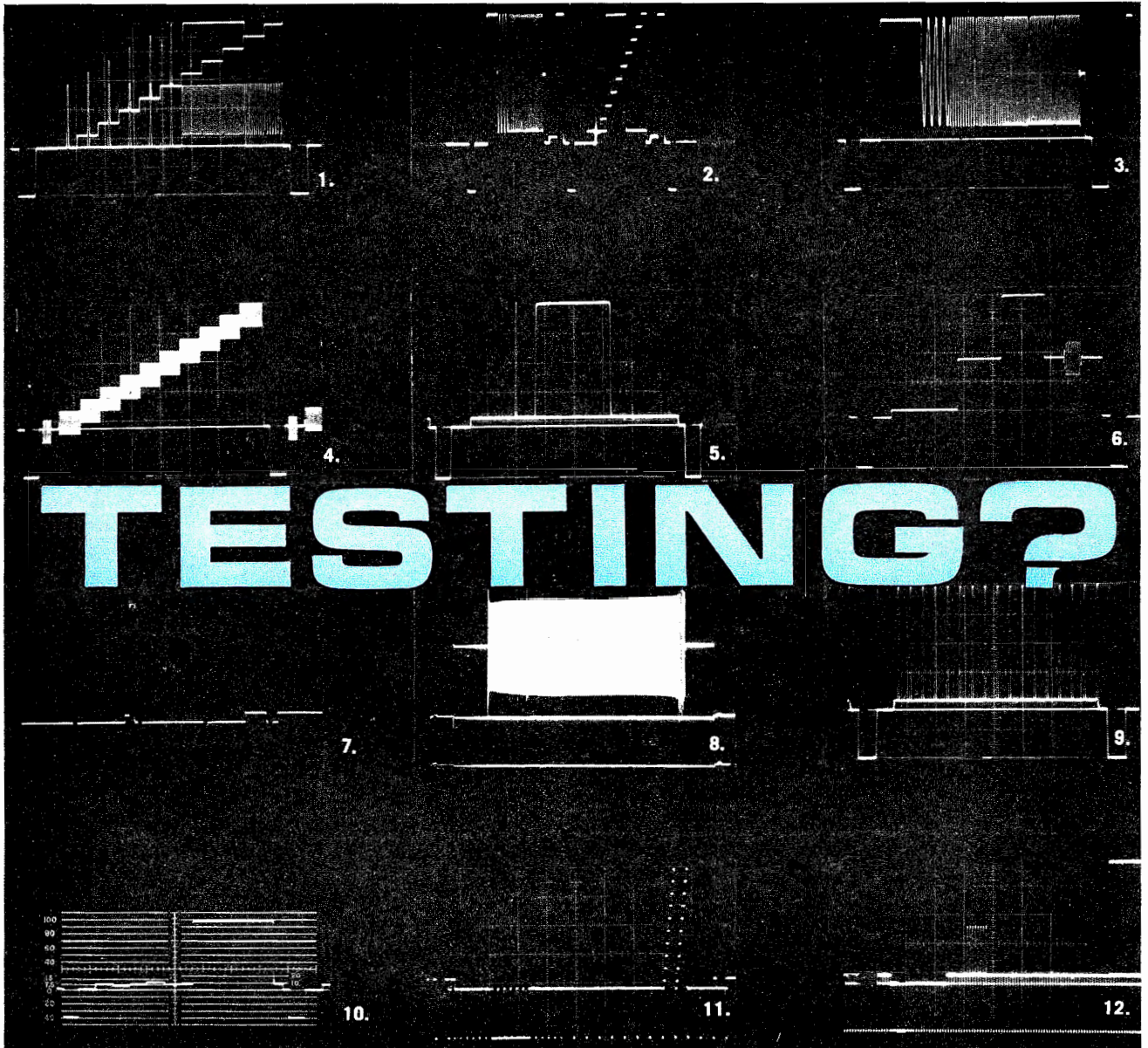

TESTING?

ONLY RIKER MAKES THEM ALL

1 SMPTE Tape Test Signal. 2 New VITEAC Test Signal. 3 Multi-burst. 4 Stairstep. 5 Sin²Window. 6 Tape Reference. 7 Black & White Reference. 8 Sync & Blanking Inserter. 9 Bar & Dot. 10 PLUGE Monitor Set Up Signal. 11 Vertical Interval Test Sets. 12 Cut Dot. 13 Diagonal Crosshatch. 14 Color Bars and others.

First to manufacture all-transistor Test Signal Generators, RIKER equipment has been proven by years of use in all major networks, leading TV stations, long lines carriers, government agencies and the White House, showing the way to ultimate accuracy and reliability. All RIKER equipment is packaged in identical modules allowing unequaled flexibility.

The great variety of possible combinations guarantees a Test Set to meet your exact needs. Let us help in selecting proper modules. Try our equipment in your facilities—no obligation, of course. Phone or write today for description and waveforms.

30 Day Delivery Guaranteed

VIDEO TEST SIGNALS

All Signal Generator modules provide Dual Isolated Outputs. Test Sets offer 6 simultaneous isolated outputs. You may include only the waveforms required—expandable later.

SMPTTE VTR TEST SIGNAL

SMPTTE Recommended Practice RP10 Tape Test Signal Generator. Select combined waveform patterns or individual Multi-burst—Stairstep—Sin²—Window.

VERTICAL INTERVAL TEST SIGNALS

VITEAC (Video Transmission Engineering Advisory Committee) recommended Vertical Interval Test Signals—4 simultaneous signals. Two in Field 1, lines 18 and 19; changing to two others in Field 2, lines 18 and 19; or automatic 2½ minute signal sequencing.

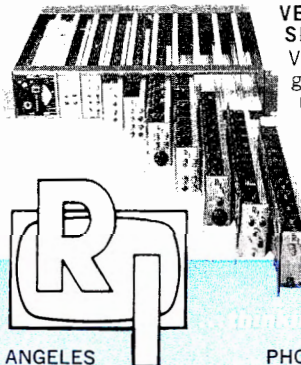

RIKER INDUSTRIES, INC. *Thinking always of tomorrow*
 NORDEN LANE, HUNTINGTON STATION, NEW YORK • MIAMI • LOS ANGELES PHONE 516 HA 1-3444

Circle Item 1 on Tech Data Card

LET'S LOOK UNDER THE HOOD AT RUST'S NEW 1 KW FM STEREO BROADCAST TRANSMITTER

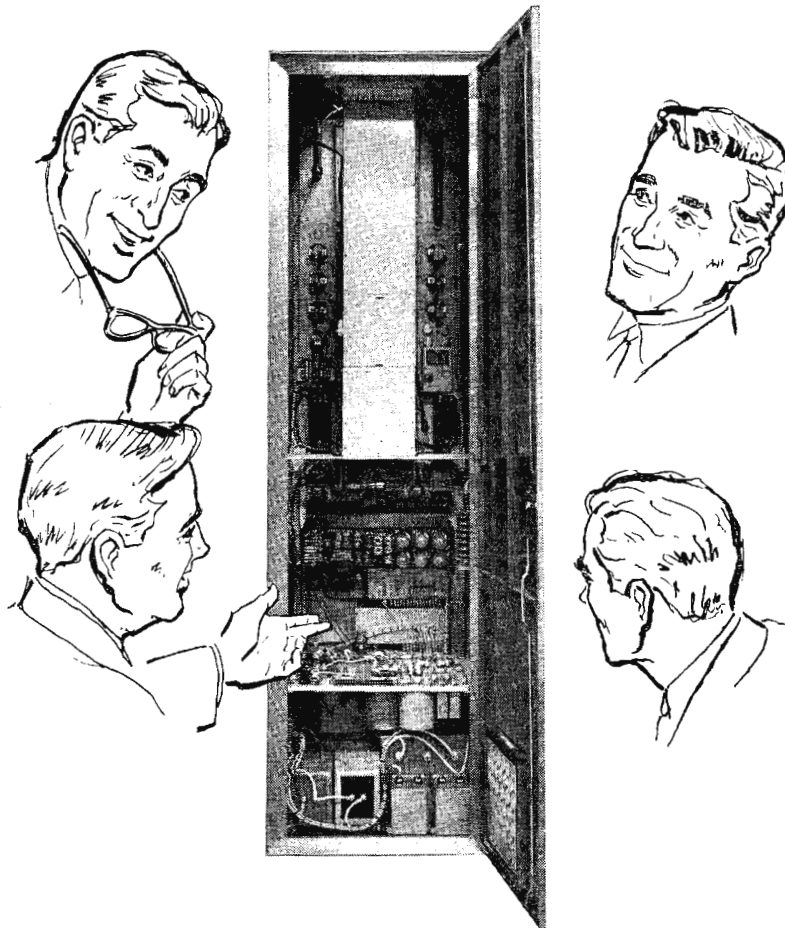

Here's the new 1 KW FM stereo transmitter from Rust. Notice the elbow room? Space galore! (Once, we even found an employee cat-napping there.)

The main channel SWING OUT FME Exciter, plus both subchannel generators are crystal controlled for reliability. As for a stable signal — it locks on like a tiger — never drifts — never lets go. And no more burned knuckles checking tubes. The New Rust power supply is completely solid state and unshirkingly reliable. Incidentally, check the space-saver cabinet — only 24" wide x 28" deep — not to mention the new low price.

The Rust 1 KW, with built-in components, comes ready for remote control.

A very desirable optional feature is our Autolog automatic transmitter logging system. Simply turn it on — and forget it! It frees station personnel for other duties.

For further information, prices, specifications and/or a brochure of the complete Rust line, address your inquiry to:

RUST  
corporation of america

Eastern Division
195 Mass. Avenue
Cambridge, Mass.

Washington, D. C.
13205 May Court
Silver Spring, Md.

Western Division
2921 South 104th St.
Omaha, Nebraska

RUST FM STEREO TRANSMITTERS • AUTOLOG • RUST REMOTE CONTROL

Circle Item 2 on Tech Data Card

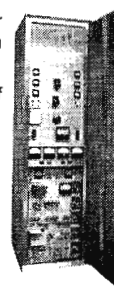



the technical journal of the broadcast-communications industry

Broadcast Engineering

Volume 6, No. 12

December, 1964

CONTENTS

FEATURES

- Locating Television Translator Antennas 12**
by George M. Frese — Points to consider in selecting the location and design of translator antennas.
- An Improved Fault Alarm for Automated Stations 14**
by James L. Tonne — Station-built equipment that detects interruptions to the station's audio signal.
- Push-Button Audio Switching System 16**
by Harold Schaaf — A simplified switching unit for program routing in an AM-FM station.
- The Lighting Man's Guide 18**
by Elmer Friman — How to do more with TV lighting than merely stimulate the camera tube.
- The 20th Annual National Electronics Conference 24**
A review of Conference activities from the viewpoint of the broadcast engineer.
- Audio Tape Equipment 30**
by Thomas R. Haskett — Part I. The first of three parts which analyze present-day tape recorders used in broadcasting.
- Norsk Rikskringkasting 38**
from Hans Richter — A look at the broadcasting system in Norway.
- Modulation and Frequency Monitor Operating Procedures 40**
by Lawrence L. Prado, Jr.—Some useful suggestions to help the operator make more effective use of station monitors.
- 1964 Subject Reference Index 55**
A complete listing giving the issue and page number for all subjects contained in 1964 issues.

DEPARTMENTS

- | | |
|-----------------------------------|---------------------------------|
| Letters to the Editor 6 | New Products 50 |
| Bulletin from Washington . . 27 | Engineers' Tech Data 54 |
| Engineers' Exchange 44 | Advertisers' Index 58 |
| Book Review 46 | Classified Ads 58 |
| News of the Industry 48 | |

PUBLISHER: Howard W. Sams.

EDITORIAL: Editor, Forest H. Belt; Associate Editors, Allen B. Smith, George F. Corne, Jr., and James M. Moore; Washington Correspondent, Howard T. Head.

CIRCULATION: Manager, Pat Tidd; Assistants, Katherine Krise and Cora LaVon Willard.

PRODUCTION: Manager, Robert N. Rippey; Art, Robert W. Pool; Photography, Paul A. Cornelius, Jr.

ADVERTISING: Sales Manager, David L. Milling; EAST—Gregory C. Masefield, Howard W. Sams & Company, Incorporated, 3 West 57th Street, New York, N. Y., Phone MU 8-6350; MIDWEST—Hugh Wallace, Howard W. Sams & Co., Inc., 4300 West 62nd Street, Indianapolis 6, Ind., Phone AX 1-3100; SOUTHWEST—C. H. Stockwell Co., 4916 West 64th Street, Mission, Kansas, Phone RA 2-4417; LOS ANGELES 57, CALIF., Maurice A. Kimball Co., Inc., 2550 Beverly Blvd., Phone DU 8-6178; SAN FRANCISCO, Maurice A. Kimball Co., 580 Market Street, Phone EX 2-3365; PARIS 5, FRANCE, John Ashcraft, 9 Rue Lagrange, Phone ODeon 20-87; LONDON W.C. 2, ENGLAND, John Ashcraft, 12 Bear Street, Leicester Square, Phone WHitehall 0525; TOKYO, JAPAN, International Media Representatives, Ltd., Kisha Kurabu 14, 2-chome Marunouchi, Phone (502) 0656.

SUBSCRIPTION PRICE: U.S. \$6.00, one year; \$10.00, two years; \$13.00, three years. Outside U.S.A. add \$1.00 per year for postage. Single copies, 75 cents, Back issues, \$1.00.

BROADCAST ENGINEERING is published monthly by Technical Publications, Inc., an affiliate of Howard W. Sams & Company, Inc. Editorial, Circulation, and Advertising headquarters: 4300 West 62nd Street, Indianapolis 6, Ind. Copyright © 1964 by Howard W. Sams & Co., Inc.

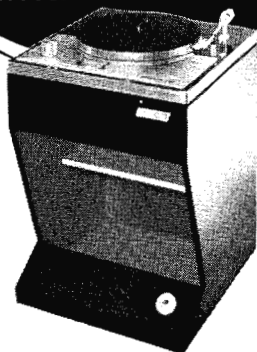

FAIRCHILD Model 750 — the only quality 3-speed, 16" turntable with —65 db rumble, .03% wow and flutter, 3 speeds easily selected, whisper soft operation, cue pad provided, and minimal moving parts for long trouble-free performance.

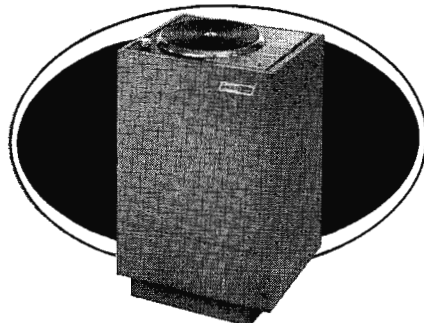

FAIRCHILD Model 755 — a quality 2-speed belt drive turntable which incorporates extremely low rumble and imperceptible wow and flutter, fast cueing, attractive packaging and easy installation. Far superior to any other turntable at this or even higher price.

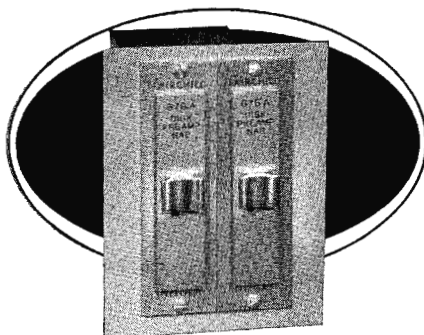

FAIRCHILD EQUALIZED NAB PLAYBACK PRE-AMP, Model 676A — a low noise silicon transistor preamp for proper NAB playback of records. Minimum controls assure consistency of station quality. Available mono — 676A; stereo — 676A-2 (pictured).

Write to FAIRCHILD — the pacemaker in professional audio products — for complete details.

FAIRCHILD
RECORDING EQUIPMENT CORPORATION
10-40 45th Ave., Long Island City 1, N. Y.

Circle Item 3 on Tech Data Card

 A HOWARD W. SAMS PUBLICATION



BROADCAST ENGINEERING

now read this



A well informed individual usually makes the wiser decision

INFORMATION:

Shown below is the rear of the rack mounting frame used with our video and pulse distribution amplifiers and other plug-in units. You will appreciate the easy accessibility afforded by the connector configuration. Note that no connector is closely surrounded by several other connectors, as is the case with many other frames. As a result, cables may be plugged or unplugged with greater ease and speed.



The pulse distribution amplifier, model VI-20, pictured above, offers superior performance with many desirable features. A few of these features are:

- **Self-contained, regulated power supply in each amplifier.**
- **Four plug-in amplifiers mount in a 1 3/4" rack frame providing a total of 16 outputs.**
- **High isolation between outputs during and between pulses.**
- **Maintains constant output levels.**
- **Indicator lamp shows presence or absence of output pulses.**

Clean and precisely controlled pulses assure stability of camera sweeps and improved tapes. Pulse defects such as ringing, overshoots, rounding, poor rise time, tilt and line reflections are overcome by the pulse reforming action of this unit. The VI-20 pulse D.A. is wired to operate in the same standard rack frame as the VI-10A video D.A.

Price: One complete frame with 4 pulse amplifiers.....\$1100.00

Write for complete information and specifications



VITAL INDUSTRIES

3614 SOUTHWEST ARCHER ROAD
GAINESVILLE, FLORIDA—PHONE 372-7254

Circle Item 4 on Tech Data Card

MORE ON-THE-AIR HOURS WITH THESE PENTA TUBES



PL-6775 unilaterally interchangeable with the 4-400A, reduces the problem of interelectrode shorts and weak plate seals. Because of an exclusive Penta filament-supporting insulator, the PL-6775 can be mounted in any position and will withstand extremes in shock and vibration. The rugged one-piece plate cap and seal won't easily break off, can't fall off. Ratings of this rugged tetrode, now widely used by broadcasters, are the same as for the 4-400A.

PL-4D21A is directly interchangeable with the 4D21 (4-125A) and offers a plate dissipation of 175 watts — 50 watts more than the 4D21 (4-125A). Broadcasters have reported up to three times the life of the conventional 4D21, thanks to the exclusive Penta ribbed anode and the one-piece plate cap and seal.



Write today for full details on both of these rugged, reliable Penta tubes.

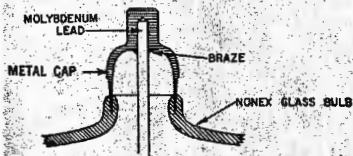

Rugged plate cap and seal used on PL-6775 and PL-4D21A. One-piece, low-loss seal has no screws or pieces to come loose. Won't break off.



THE PENTA LABORATORIES, INC.

A SUBSIDIARY OF RAYTHEON COMPANY

312 N. NOPAL ST. — SANTA BARBARA, CALIF. 93102

Circle Item 5 on Tech Data Card

LETTERS to the editor

DEAR EDITOR:

I would like to offer two suggestions in addition to those mentioned in the article, "Maintenance of Cartridge Tape Units," in your November issue.

First, before replacing heads with any other than original-equipment heads, the user should consult the manufacturer of the equipment. I will not attempt to speak for other manufacturers, but as far as SPOTMASTER is concerned, there is no such thing as a universal replacement head—that is, unless you change a few parts in the recording and playback amplifiers. A material adjustment in recording bias as well as a change in the VU-meter multiplier is also required unless an exact replacement is used.

Second, the new NAB magnetic-tape cartridge system standards have been approved and are now in print. All users of cartridge equipment should read these standards and be governed accordingly. Special attention should be given to the specifications for the NAB standard cartridge. I know of no cartridge, as of this moment, that meets these specifications 100%, but a couple are pretty close (and they are being redesigned to conform). There are cartridges that deviate considerably from the standards, and some broadcasters using these cartridges are running into trouble.

Cartridges conforming to the NAB specifications are even more necessary on the new NAB-type machines using separate record and reproduce heads.

ROSS BEVILLE

Broadcast Electronics, Inc.,
Silver Spring, Maryland

The NAB Magnetic Tape Cartridge Recording and Reproducing Standards, which Mr. Beville refers to, are available from the Engineering Department, National Association of Broadcasters, 1771 N Street, N.W., Washington, D.C. —Ed.

DEAR EDITOR:

We at KDPS-TV have completed construction and installation of the solid-state video chopper described in the June 1964 issue of BROADCAST ENGINEERING. We changed the mechanical configuration from that shown in the article and made slight changes in the power supply to utilize locally available components. We used 2N404's for Q1, Q2, and Q8, and 2N414's were used for Q4, Q5, and Q6.

We are well satisfied with the performance of this chopper and are most happy to bid adieu to the mechanical unit used up to this time.

WALTER G. ALLISS, JR.

Chief Engineer, KDPS-TV,
Des Moines, Iowa

Other readers who may be interested in building this chopper will want to note the alternate transistor types—and the fact that the unit turned out so well for KDPS-TV.—Ed. ▲

BROADCAST ENGINEERING

VME



Leads the way!

FOR TELSTAR/COMSAT PROGRAMS...

Type NV 15 Vidicon Standards Converter translates all recorded standards (405 lines, 25 frames; 525 lines, 30 frames; 625 lines, 25 frames; and 819 lines, 25 frames) to any other standard desired. Unique advantages: Large signal-to-noise ratio due to use of Vidicon camera; Very short warm-up time—requires no continual readjustment; Interference bars eliminated by means of spot-wobbling; and automatic control of signal level variations. Built-in temperature stabilization, unusual design and quality components produce minimal maintenance and virtually no loss of air time. Now in use by major network. Price \$75,000 F.O.B. New York.

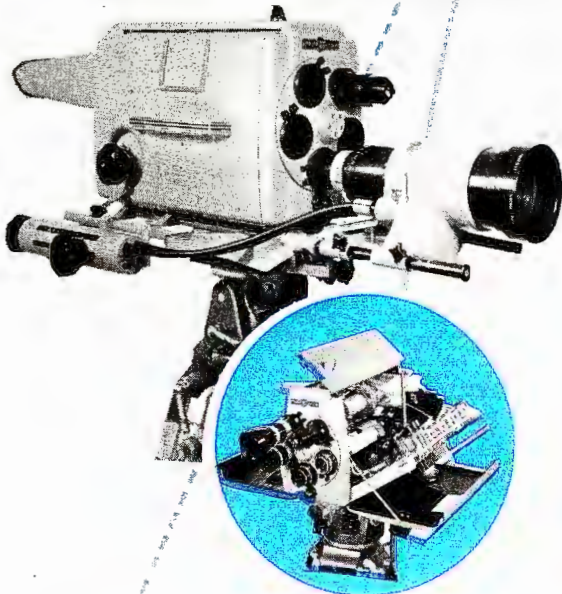
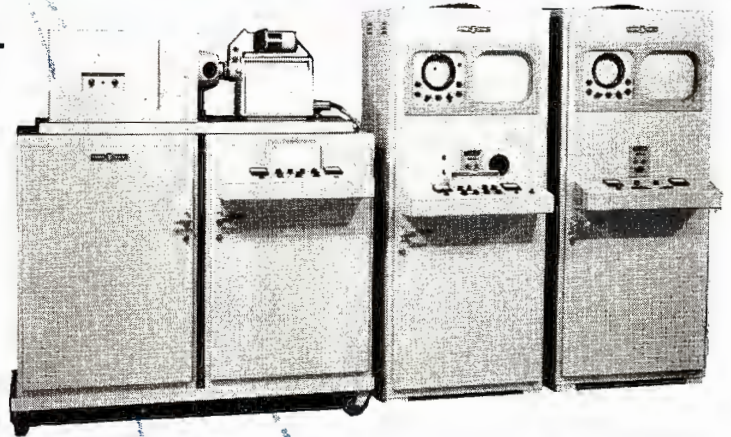

FOR STUDIO/FIELD BLACK AND WHITE PROGRAMS...

The New FERNSEH 3" ORTHICON CAMERA K075D

First temperature stabilized camera with total maintenance accessibility. Opens from sides, top, rear... inside decks slant out, too! Superior performance and maximum stability maintained regardless of temperature change. Features: Novel automatic temperature control for the camera tube • Noiseless fan virtually eliminates pickup by studio microphones • Heater equipment for rapid camera warmup • Iris control driven by noiseless servo motor—remote control and remote indicator at control position • Five-way lens turret with rapid change lens mounts and an illuminated test pattern projector • Lens indicator and camera signal lamp directly below viewfinder screen • Dynamic focus correction gives optimum focus and clean picture background • Automatically operating stabilizer keeps temperature of camera tube constant within a few degrees independent of the ambient temperature—corrects for ambients from 0° to 95° F. • The temperature of target of the image orthicon is read on the meter at the camera control position and is fully adjustable. Request quotation.

FOR STUDIO OR REMOTE PICKUP PROGRAMS...

FERNSEH CENTRAL SYNC. SYSTEM

Synchronizes any number of remote picture sources from central control point by telephone line so that horizontal and vertical pulses at all locations are in exact phase and can be cross faded or placed on common effects bus. Sync. information transmitted via 7.75 or 1.85 KC for use on 15 KC or 8-KC phone lines. Departure from vertical lock can only occur due to phone line break—never by TV feed interruption. Lack of vertical lock with any remote position flashed by indicator and reset by push button. High quality of sync. system results from extremely good noise suppression in sync. receiver. Solid state. Rack mounting. Sync. Transmitter YG 03A \$1,500. Sync. Receiver YE 02A \$1,250 (117 Volt, 60 cycle operation). Request quotation on 1.85 KC converter.



Write today on your company letterhead for complete details.



VIDEO-MEDICAL ELECTRONICS CORP.

TIME & LIFE BUILDING
ROCKEFELLER CENTER

NEW YORK, N.Y. 10020, Telephone: 245-2411 Cable: VIDMEDCOR NEW YORK, N.Y. Telex: 224573

Exclusive distributors for:

Fernseh Wireless (26 lbs.) Monochrome Camera with Remote Sync. Used by networks at political conventions.

Circle Item # on Tech Data Card

TV SPECIAL #106000 Boomman's Headset
List Price \$54.00

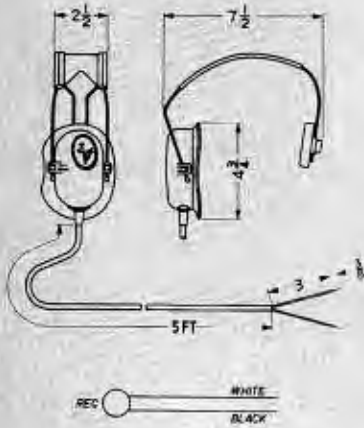

TV SPECIAL #106010 Boomman's Headset
List Price \$68.00

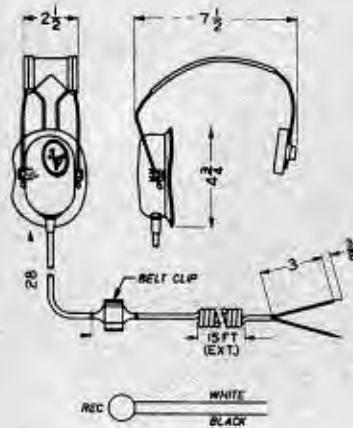

TV SPECIAL #106100 Boomman's Headset
List Price \$92.00

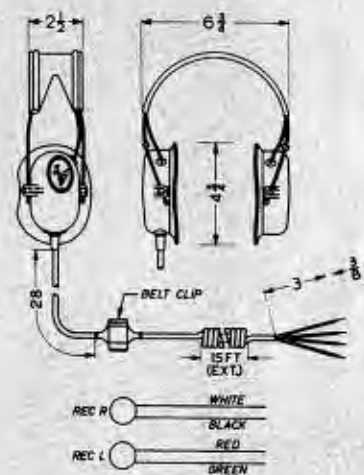

THE HEADSETS YOU SAW ON THE TV CONVENTION COVERAGE PROGRAMS

TV SPECIAL #106110 Boomman's Headset
List Price \$75.00

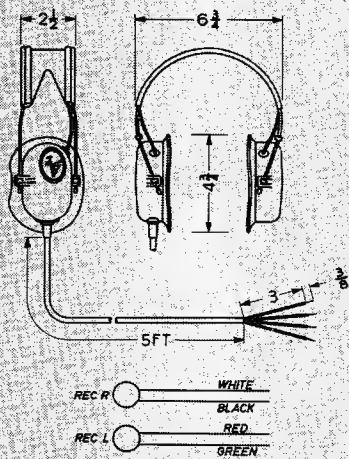

TV SPECIAL #106020 Cameraman's Headset
List Price \$105.00

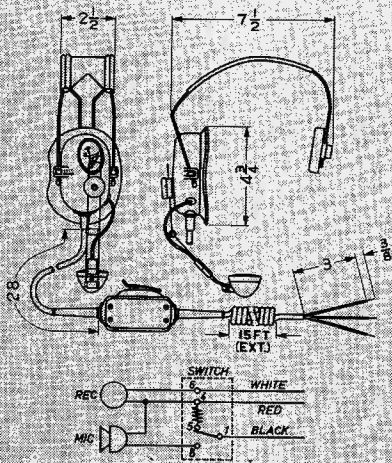

TV SPECIAL #106030 Cameraman's Headset
List Price \$75.00

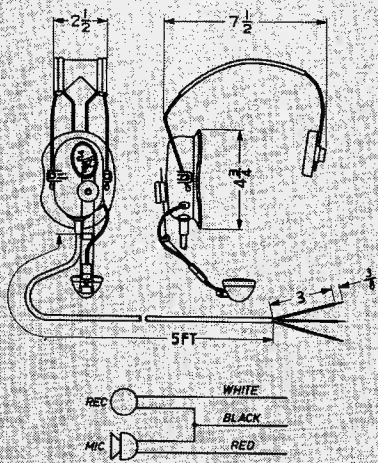

TV SPECIAL #106060 Cameraman's Headset
List Price \$128.00

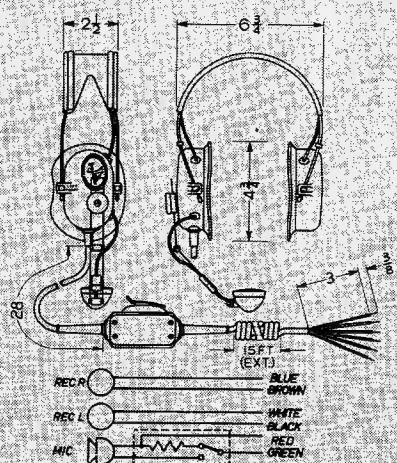

TV SPECIAL #106080 Cameraman's Headset
List Price \$103.00

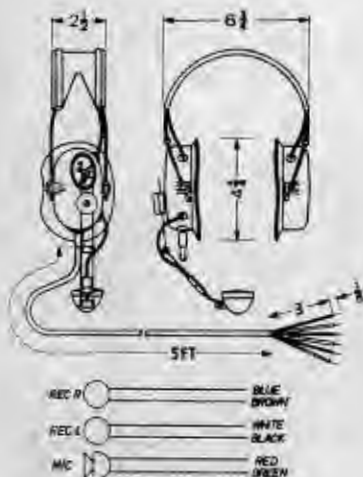

TV SPECIAL #106120 RF Cameraman's Headset
with Noise-Canceling Dynamic Microphone
(150 ohms) List Price \$143.00

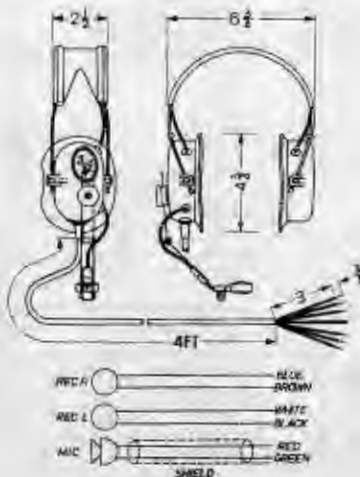

TV SPECIAL #106040 Commentator's Headset
with Noise-Canceling Dynamic Microphone
(150 ohms) List Price \$120.00

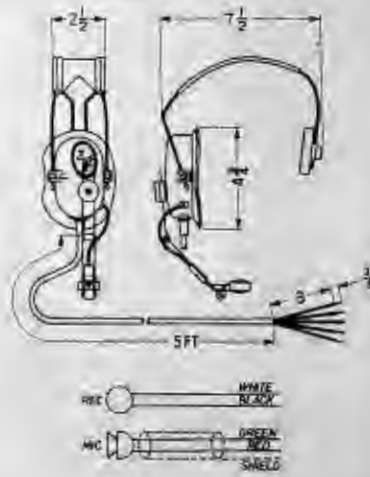

HERE THEY ARE . . . ONLY FROM ROANWELL:

11 different TV SPECIALS - A model for every TV/Radio, studio/field use

Choose the headset that fits your specific studio needs. Previously obtainable only by custom order, these TV Specials are now readily available.

These headsets include advanced design characteristics found in the latest type military communication terminal equipment. PLUS these additional custom features:

- Comfortable increased headband tension. Greater mobility without slippage.
- Sliding friction adjustments fit all sizes and head shapes.
- Adjustable boom-mounted microphone. Cone bearing joints provide positive fitted positioning.
- Heavy-duty, neoprene cordage, shielded when necessary.
- Belt clip to support cordage.

- Integral hand operated switch, 68 ohm dummy load resistor included.
- Momentary or lock-in two way conversation modes, leave both hands free.

Important Component Specs

- Monaural or binaural earphones (magnetic), Part #102040, 275 ohms impedance.
- Supplied with standard RN-1H carbon microphone, Part #10258, 25 ohms impedance, except for headsets #106120, #106040, and #106070, which use Dynamic Noise-Canceling Microphone, Part #101760, 150 ohms impedance.
- To change standard carbon microphone to noise-canceling carbon type, use Modification Kit #53760, 80 ohms impedance.

TV SPECIAL #106070 Commentator's Headset
with Noise-Canceling Dynamic Microphone
(150 ohms) List Price \$144.00

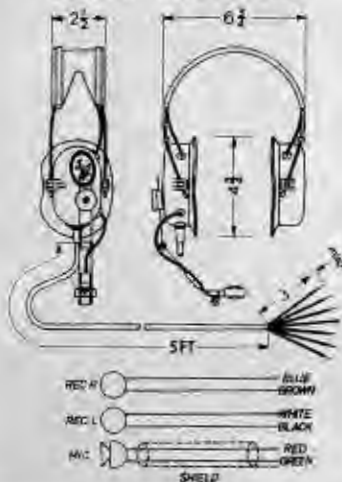

TV SPECIAL #53760 Noise-Canceling
Microphone Modification Kit
List Price \$19.00

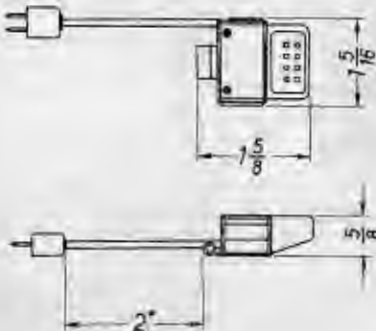

NO FATIGUE

An outstanding feature—standard in every TV Special—is the circumaural ear cushion. A cavity designed rigid plastic ear cup attenuates ambient noise. Foam-padded cushions act as an acoustic seal gently distributing pressure around the ear. This combination of wearing comfort and noise exclusion reduces fatigue. Permits longer wearing.

Order yours today. Call or write:



ROANWELL CORPORATION
Roanwell Building

180 Varick Street, New York, N. Y. 10014
(212) YUkon 9-1090 • TWX: (212) 640-4791

Circle Item 7 on Tech Data Card

Some plain talk from Kodak about tape:

physical testing and tape performance

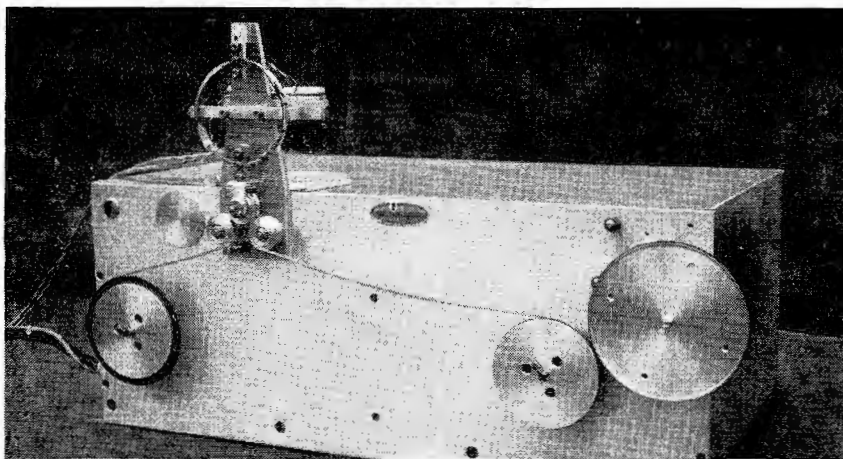

The High Speed Tensile Tester is designed to break tape under load . . . and gather a lot of useful data besides.

Magnetic tape is subject—day-in, day-out—to a wide variety of stresses and strains. That's why we are more than casually interested in its tensile properties. Tape is much like a rubber band. Put under tension, it will stretch. When the tension is released, it will snap back to its original shape. It will, that is, unless you've stretched it beyond its yield point. For if over a certain amount of longitudinal stress has been placed on a tape, the tape will lose its ability to recover and will, in fact, remain permanently elongated. Stretch it even further and, naturally, the tape will break.

Deformed tape will not reproduce sound faithfully. And tape that breaks too easily is just a plain nuisance. So we set our sights high and developed a special triacetate—called Durol base—that's exceptionally tough, yet breaks clean without "necking

down." In order to prove its worth *and keep it that way*, we developed a tight set of specs for our quality-control boys—specs which were a direct outgrowth of the conditions under which a tape is to be used. For example, the shock of going from fast wind to fast rewind. Or the shock generated on a running recorder when the supply spool jams.

We think that tape should be able to take this sort of punishment routinely. So, of course, we double, triple, even quadruple the requirements! And just to make sure that the tape performs we build torture tests that would have delighted Attila the Hun.

Here is one tester that is outstanding in its fiendishness. It's called the High Speed Tensile Tester and is designed to break tape under load.

But like any good one-man band, it does a lot more than just

one job. It not only breaks tape but gathers scads of very useful data as well—data which completely describes a tape's tensile properties. Here's how it works. It's built like a tape deck with the tape attached to one half of a split-ring electrical strain gauge. We run the deck and then jam on the brakes on the supply reel but keep the take-up reel going. The strain gauge takes the full load and the split ring spreads and deforms. This deformation causes the gauge to change resistance and causes the DC voltage on it to pulse. We monitor the pulse on a scope and measure the duration. This gives us a figure of merit in terms of tensile strength.

Just how good is Durol base? Well, consider this data. Yield strength for Durol base is 47% greater than regular triacetate and 70% greater than diacetate (the two most common plastic support materials). Break strength is 43% greater than triacetate and 80% greater than diacetate. And this is the kind of test that almost duplicates actual use conditions on your tape equipment.

But any torture test one engineer can devise, another engineer can improve upon. Take the Toughness Tester, for example. This is an instrument designed to determine a tape's strength (toughness) by measuring the force required to break a sample. A measured length of tape is held securely between two clamps. Then it is struck and broken by a falling pendulum. Because it has been raised to a fixed height, the

Kodak
TRADEMARK

pendulum always delivers a precise and repeatable amount of impact. The energy absorbed by the tape at impact controls the height of the pendulum's backswing. Thus, a measurement of backswing height is a direct measurement of toughness. The strain rate that this device imposes is on the order of magnitude of 200,000% per minute—enough to break any acetate-based tape. How does Durol base compare to conventional acetates? Well, it comes through this test, too, like an Olympic star. In test after test, Durol base proves to be about 40% stronger. This toughness test also provides a valuable measure of permanent elongation. Durol base's unique "shear-pin" action lets it break clean with minimum

elongation (less than 1% compared to 10% for other acetates). These are only two of the more interesting physical tests routinely performed on random samples of Kodak tape. There are dozens more, of course. And we haven't even gotten into electronic testing yet. But we'll save those for another day.

Choose KODAK Sound Recording Tape, Type 31A, for all general-purpose and low-print applications. Or Type 34A whenever you need high-output or low-noise characteristics. For extended play-

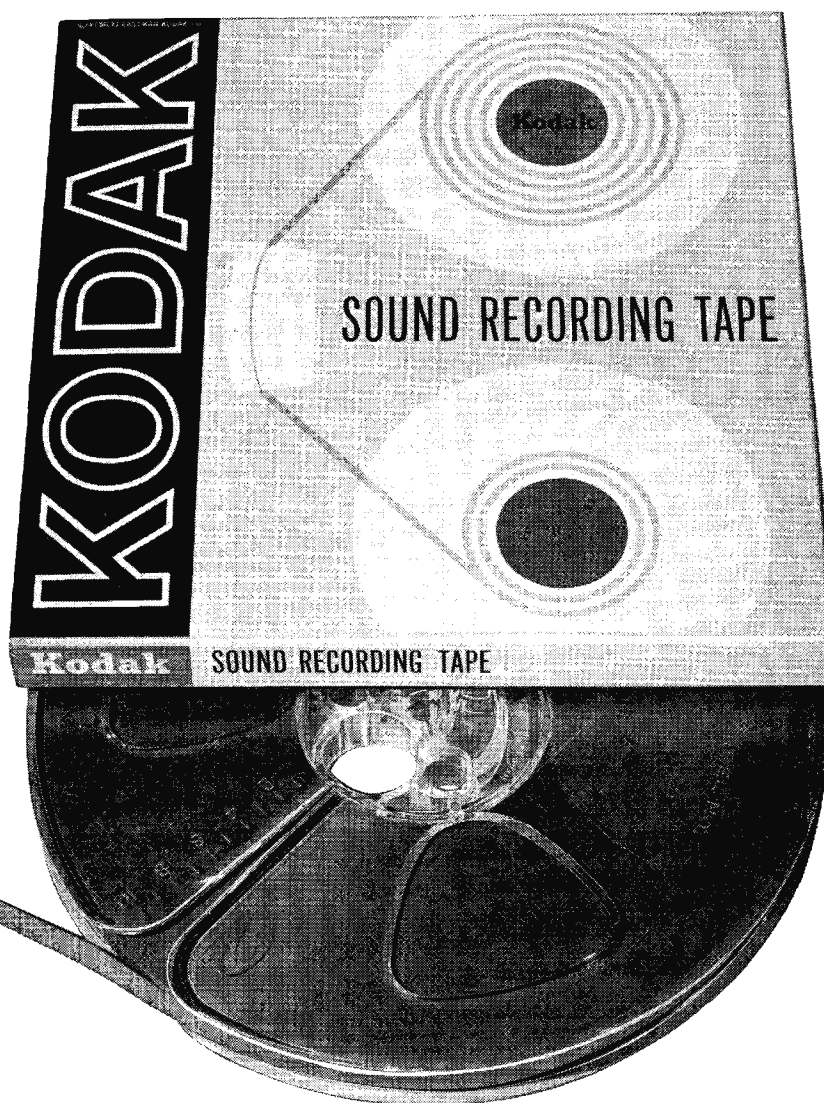

ing times try our extra or double-play tapes . . . or try the new triple-play tape, so thin you get 3600 feet on a 7-inch reel. KODAK

Sound Recording Tapes are available at electronic supply stores, camera shops, specialty shops, department stores . . . everywhere.

EASTMAN KODAK COMPANY
Rochester, N.Y.

Circle Item 8 on Tech Data Card

LOCATING TELEVISION TRANSLATOR ANTENNAS

by George M. Frese, Consulting
Author, Professional Engineer,
East Wenatchee, Wash.—How to
select the best spot for constructing
antennas for TV-translator service.

Each television translator installation is unique and requires special treatment, but there are some general techniques which should be applied in the selection of a site to avoid costly trial and error. The primary objective is to select a site that will result in the best possible received picture, although there are, of course, other considerations, such as roads, site accessibility, availability of land and rights of way, availability of commercial power, weather conditions, etc.

The factors which determine the best location for a television-translator receiving antenna are almost unrelated to the factors which determine where the transmitting antenna should be located, yet the two antenna systems must be reasonably close physically so that electrical interconnections can be made. If the two antennas cannot be economically tied together when they are at their optimum locations, a compromise installation must be made at one site or the other.

The Receiving Antenna

Field-intensity measurements are necessary to find the best receiving-antenna location. Before any measuring can be done, it is necessary to select some sites or areas in which to measure. Several methods can be used. A topographic map or maps will help to find the locations in the local area where the path to the TV-station antenna has a minimum of obstructions. Driving around the local area looking over the general terrain features is usually a necessary part of the planning. In general, a receiving site to the side of the population area is the most desirable, because the receiving antenna is better able to reject noise arriving at right angles to the direction of the desired signals. Receiving areas in front of the population area are next in desirability, and areas where the receiving antenna faces the population area are least desirable. At any given site, the strongest signal is usually found near the highest part of terrain that initially

slopes gently toward the broadcast station and then drops away more steeply. Any potential site should be thoroughly tested before the receiving array is constructed; general rules should only be used as guides to where to start testing.

Testing a TV Receiving Site

Over the distances and terrain where translators are usually involved, signals from TV broadcast stations are subject to fading from minute to minute, hour to hour, day to day, and season to season. This condition complicates the procedure for finding the best site. For example, at any given time the field intensity in a poorer location may actually be greater than the intensity in a better location; thus, if care is not taken in probing for the best location to erect a TV-translator receiving antenna, inferior results may be obtained.

All potential sites should be probed for three reasons: (1) to determine whether or not the site is in fact the best, (2) to determine the best location for the antennas, and (3) to determine the space characteristics of the field in order to design the most efficient receiving antenna configuration for the space conditions. The following equipment is helpful in conducting site tests:

1. Two field-strength meters (Preferably at least one should be battery-operated for portability, but long cordage back to a power source can be used if necessary.)
2. Several coaxial cables with connecting fittings
3. A TV receiver (A small transistorized set is ideal.)
4. A dipole antenna for each channel to be tested

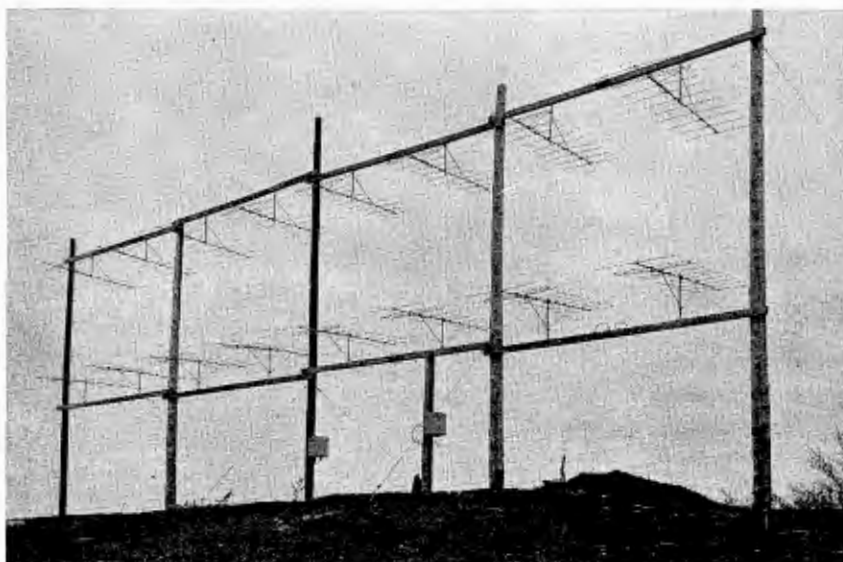

An example of a wide-spaced, low-band translator receiving antenna installation.

5. A high-gain yagi antenna for each channel to be tested

Since the field strength is constantly varying, it is desirable to use two field-strength meters simultaneously. One meter is used as a reference; the other is used in probing. The reference unit is fixed in location and may use any type of receiving antenna that provides adequate test signals. This antenna should be located in the space where an "educated guess" indicates maximum field strength can be expected. Then with the other unit, the entire area of interest is probed in a search for maximum signal strength. For each reading recorded for a particular point in space, recordings are made at the same time of the reference reading (usually in microvolts) and the amount (in db) the probe reading differs from the reference reading. The reference reading is used to compare the site to other tested sites, and the probe readings are used to determine exact requirements for antenna placement and design. Experience has shown that there is not enough diversity reception over a local receiving area to invalidate this technique.

Probing should be done from a few feet above the ground to practical heights of 25 to 50'. (Up to 100' may be desirable in some cases.) It should cover areas within the confines of the site both toward and away from the signal source and any place where high field strengths may exist. The purpose is to find the space in which the antenna will produce the highest possible terminal voltage.

Although maximum terminal voltage is usually of prime importance, there are other important characteristics to be observed. When a maximum-signal area is found, a simple but high-gain antenna (such as a yagi with 10 db of gain) should be erected at that spot. The picture on the test receiver should then be viewed and carefully examined for noise, interference, and ghosting. Using the two field-intensity meters, one tuned to the picture carrier frequency and the other to the sound carrier frequency, a reasonable observation of the differential fading between sound and picture should be made. It may be necessary to observe all of the above characteristics many times to gain

the information that will be needed for the design of the receiving antenna system.

Designing the Antenna System

Much can be done in the design of the antenna system to reduce interference by appropriate placement of the pattern nulls. However, this discussion will be confined to obtaining an antenna system which develops the highest terminal voltage possible. If the strength is consistently over 1000 microvolts with a simple yagi, a more elaborate design is not needed. Assume, however, that the highest possible terminal voltage is needed to overcome preamplifier noise.

The first step in designing the antenna is to analyze the probing data to determine how the field intensity varies throughout the available space. In general, the antenna should be confined to a space in no part of which the intensity is more than about 3 db below maximum (Fig. 1). An antenna element placed in a location where the field is 7 db or more below maximum becomes a liability to the array; it subtracts from the terminal voltage.

Many types of antennas might be used by an experienced receiving-

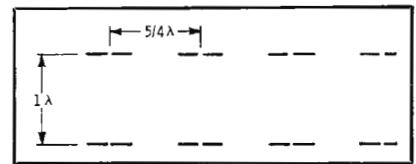

Fig. 2. Wide spacing gives maximum output voltage for number of elements used.

antenna engineer, but it is usually best to stick to the high-gain yagi as the basic unit from which more elaborate arrays can be built. Each antenna unit in the array is treated as a separate generator.

A cluster of yagis put in a small space will not develop as great a terminal voltage as it would if the units were spread out. In order for each yagi to develop the full voltage of which it is capable, the spacings shown in Fig. 2 must be equalled or exceeded. Closer spacings result in reduced output; a 1½ db reduction with the mere presence of a second yagi is not uncommon. With full spacing, two yagis can be connected together to provide an output 3 db greater than the output of either alone, provided they are in positions having the same field intensity. With close spacing, the output of the combination is, of course, reduced. There is still a net

• Please turn to page 51

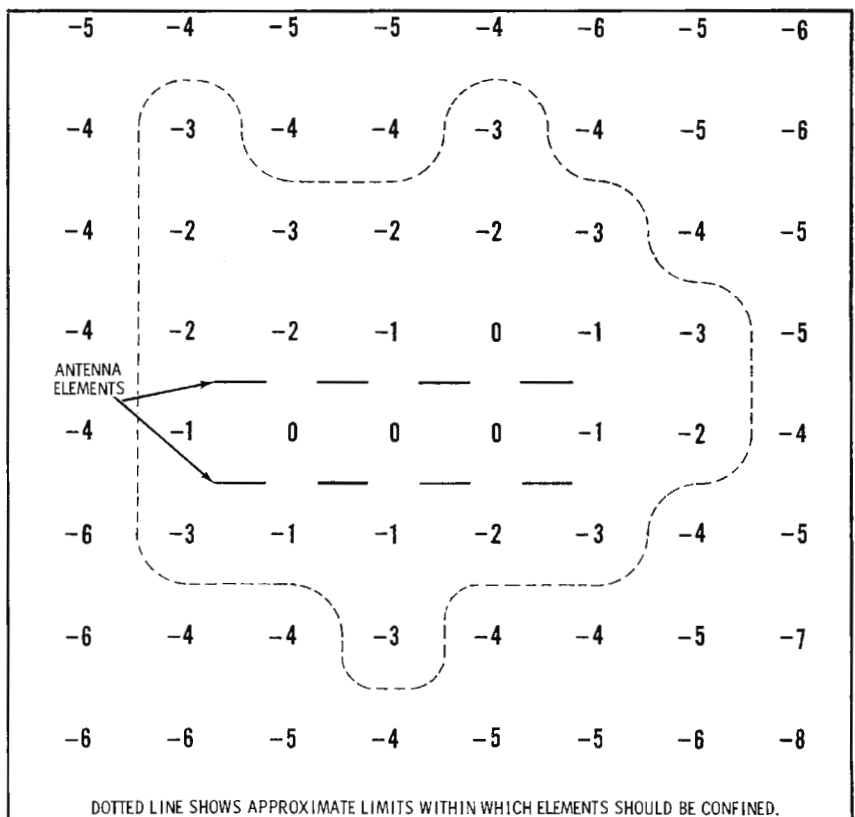

Fig. 1. Example of field-intensity distribution in plane perpendicular to path.

AN IMPROVED FAULT ALARM FOR AUTOMATED STATIONS

by James L. Tonne, Engineer,
KBIM AM-FM, Roswell, New Mexico—
A device for indicating any interruption
to the program signal fed to
the transmitter.

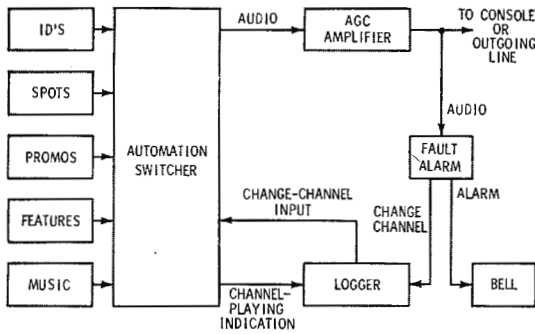

Fig. 1. Block diagram showing how alarm fits into KBIM system.

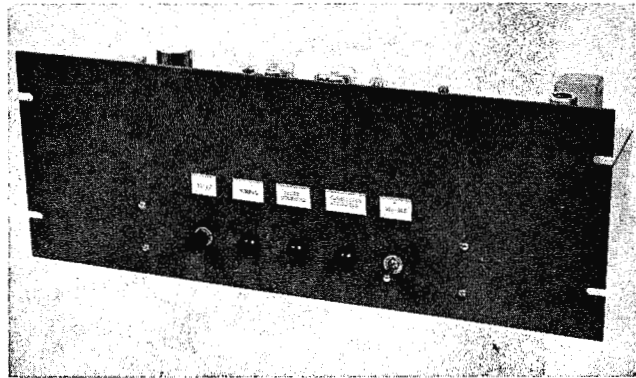

Fig. 2. A front-panel view of the automatic fault alarm unit.

A number of stations using automated programming have tied into their system some sort of alarm device to indicate program or equipment failure. This is usually a silence-sensing device, by its very nature level-sensitive; a prolonged low-level passage will sometimes trip the unit. If the equipment or signal source has some degree of noise, the unit may be a bit tricky to adjust to prevent such tripping. If a tape has a level-setting tone

at the start, the accidental appearance of such a tone on the program channel will certainly keep a silence-sensing alarm from acting.

The alarm to be described here works on a different principle, in that either silence or a steady signal will trip it. In effect, the device watches the outgoing-line volume level (Fig. 1). As long as the level is varying somewhat, the alarm remains turned off. If the level should cease varying — which is the case

for either no signal or a sustained level-setting tone — the alarm will be given.

The unit has three lights to show the status of the program material (Fig. 2). One light (next to the reset button) can be on only if all is normal. A second light (center) comes on and stays on if a fault has been detected. A third light (next to the toggle switch) comes on and locks on if a channel change has been attempted. The reset but-

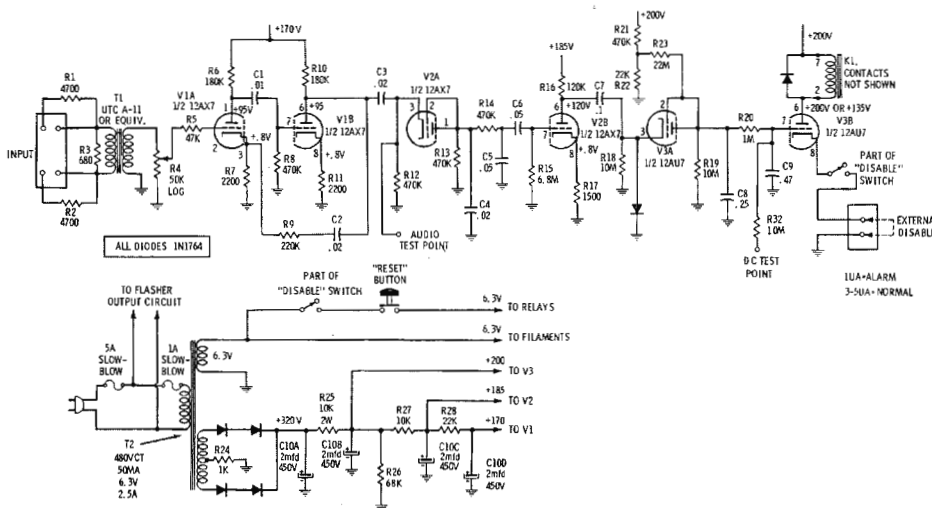

Fig. 3. This schematic diagram shows the circuits of the amplifier, detector, and power-supply sections of the fault-alarm unit.

ton and disabling switch complete the front-panel arrangement.

The Electronics

The alarm consists of a set of three tubes, several relays, and their associated components. The electronics will be described first, since a good understanding of this portion of the unit will enable the individual engineer to design the remainder to fit a particular situation.

The circuit is shown in Fig. 3. The input transformer and level control (R4) feed audio to the first two stages, which are provided with a large amount of negative feedback. These stages serve to increase the audio level a sufficient amount to operate the following stages.

The signal appearing at the cathode of V2A is detected, and the envelope of the audio appears across C4 and R13. This envelope signal is passed through a low-pass filter consisting of R14 and C5. Then the DC component is removed by C6 and R15. Appearing at the grid of V2B is a voltage having variations similar to the movement of a VU-meter needle about an average position on the dial. This signal is amplified by V2B and coupled to V3A by C7 and R18. This tube rectifies the signal and causes C8 to charge. The DC voltage across C8 is approximately proportional to the amount of swing of the needle of a VU meter placed across the audio line. The rise of the signal appearing at the grid of the relay tube, V3B, is slowed by R20 and C9 to prevent short bursts of signal from paralyzing the alarm.

Note that a signal charges C4, which can discharge only through R13. Hence, brief tape dropouts have little effect on the circuit. Signal increases cause an increase in the voltage across C4, but if they are of short enough duration they will not get through low-pass filter C5-R14. On large signal inputs, the audio may be clipped in the input stage, but this has not been found to degrade alarm operation in the least. A legitimate signal—and as far as this alarm is concerned, that means one that is varying in level to some extent—will develop a negative signal at the grid of V3B. This keeps the plate relay (K1) deenergized.

The “disable” switch opens the

cathode lead of V3B and also removes all relay power. When the automation is cueing itself (for example, during a newscast), the alarm must be externally disabled. This is accomplished by means of an external connector which ties into the remote-control panel. If the unit is externally disabled, the situation is considered under control. But if the local (front-panel) “disable” switch is thrown, the “normal” light (P1, Fig. 4) on the front panel is extinguished by a third set of contacts on the “disable” switch.

Up to this point the unit provides a plate relay (K1) which is pulled in on occurrence of an improper signal. The time delay involved is of the order of 10 to 15 seconds. Now one must decide what action the relay is going to initiate.

The Logic Section

The power for the other relays is routed from the 6-volt source through the reset button and one set of contacts on the plate relay (Fig. 4). Thermal time-delay relay K2 closes its contacts 20 seconds after K1 is energized. After both the

electronics and this thermal relay are in an alarm condition, the device is considered to have detected a fault. This generally takes about 30 or 35 seconds. If during this period of time the audio is restored to normal, the unit will “forgive and forget” and return to its original state—K1 is deenergized, and K2 does not close. If the fault condition persists, K2 closes, and the next relay in the chain locks in; this is the fault-occurred holding relay (K3). Across its coil is the red front-panel “fault” light (P2). At the same time, K7 is activated and applies power to K9 and K10; these drive the external flasher and alarm bell. Voltage is also applied to a second thermal-delay relay, the change-channel delay (K4). If the fault-occurred situation continues until the channel-change delay pulls in, the charged capacitor (C11) associated with the plate relay will discharge through the coil of the change-channel relay (K5). This relay pulls in briefly and then falls out as soon as the capacitor is discharged. One set of contacts on the

• Please turn to page 50

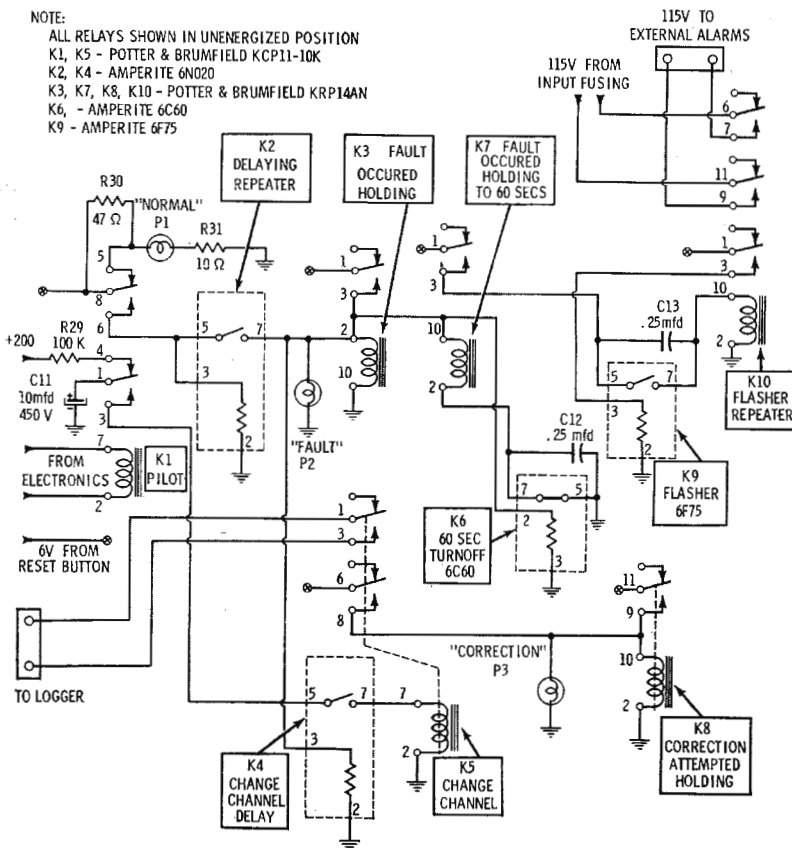

Fig. 4. Schematic diagram showing the logic section of the automatic fault-alarm unit.

PUSH-BUTTON AUDIO SWITCHING SYSTEM

by **Harold Schaaf**, Chief Engineer,
 WRFD AM-FM, Worthington, Ohio—
 A system for providing simplified
 console-transmitter switching
 in an AM-FM station.



Fig. 1. Control panel placed in console.

While planning for the addition of an FM facility to the existing AM facility at WRFD, it soon became apparent that a switching system between the consoles and the transmitters would be needed. The proposed operation called for both separate and simultaneous programming of the stations. Program sources consisted of consoles in the AM and FM control rooms and a third console which could be used as a spare. In addition, the consoles were to be useable for making program tapes when not feeding the transmitters. Since the announcers were expected to perform the switching operations, any system devised had to be easy to operate and capable of changing circuits with a minimum of time loss and chance for error.

With these requirements in mind, we designed and built an audio switching system which consists of a rack-mounted relay panel and push-button controls with tally lights

mounted in the AM and FM consoles. An announcer at either of the two consoles can perform any needed switching by merely pushing the proper button. Fig. 1 shows one of the control panels; it was made an integral part of the console by mounting the push buttons and tally lights in place of some of the original switches.

Fig. 2 shows the front and back of the relay panel. The panel consists of two groups of three relays which are used to connect the program sources to the proper busses to feed the transmitters. One group of relays is on what is termed the FM side of the system; the other group is on what is termed the AM side. One additional relay operates in conjunction with the FM group to provide dual or separate program feed to the transmitters. Electrical interlocking, source loading, and program-level balancing are also provided within the system. Any one of the three program sources may feed both transmitters, or any one of the sources may feed one transmitter while either of the remaining two sources feeds the other transmitter. Any program source that is not feeding one of the program busses is loaded with a 600-ohm resistor.

The Circuit

Fig. 3 shows a simplified diagram

of the connections of the program circuits. Each input is fed to the contacts of a relay in the FM group. The relay contacts can connect to the FM buss to feed the signal through the loss pad and K7 to the FM transmitter line, or they can connect to the contacts of a relay on the AM side of the system. This relay either feeds the signal to the AM buss and the splitting pad, or it connects a 600-ohm load resistor across the input. The splitter pad is used to feed the program signal from the AM buss to both transmitters. It has an insertion loss of about 4 db toward each line. The loss pad in the FM buss also has a 4 db loss to match that of the splitting pad. A 600-ohm resistor load is connected on the FM side of the splitter pad by K7 during separate programming. The splitter pad, the loss pad, and the 600-ohm resistor provide constant level regardless of what mode of operation may be set up. Relay K7 also switches the FM transmitter line onto the FM buss for separate programming, and it supplies voltage to the "dual" and "separate" tally lights. The contacts which operate K7 are on the relays in the FM group.

The basic control-circuit diagram, Fig. 4, shows how the relays are controlled by the push buttons and electrically interlocked. One side of each relay coil is connected to the positive side of the 12-volt DC supply. The negative side of the supply is connected through S6, a momentary push-to-open switch that is used to return all relays to the unenergized position. Relay K1 is shown in the energized position. From S6, the negative end of the supply connects to contact 5 of K1, through contact 6 of K1 to contact 2 of K2, through contact 1 of K2

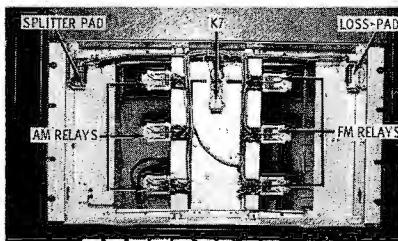

(A) Front (cover removed).

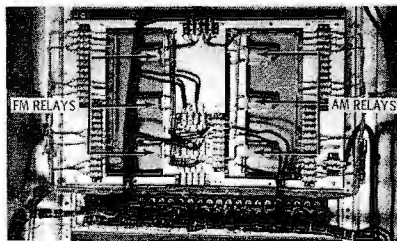

(B) Rear view of unit.

Fig. 2. Two views show the assembled switcher unit installed in an equipment rack.

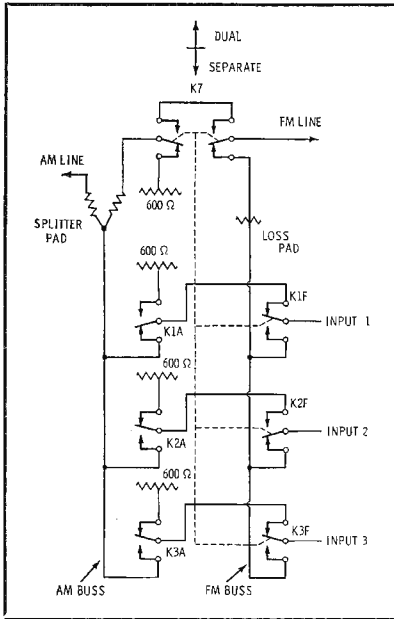

Fig. 3. Simplified diagram of switcher.

to contact 2 of K1, and then through contact 3 of K1 to the negative side of the K1 coil. Relay K1 is thus held in the energized position because its coil circuit is complete.

If it is desired to energize K2, S2 is depressed momentarily. This applies DC voltage to the coil of K2, and its movable contacts break the circuit that held K1 energized. The negative end of the DC supply now connects to contact 5 of K1 and through contact 4 of K1, contacts 5 and 6 of K2, contacts 2 and 1 of K1, and contacts 2 and 3 of K2 to the negative side of the coil of K2. Relay K2 thus remains energized after S2 is released. In each group, similar connections are made to each of the three relays. Depressing any one of the push buttons momentarily energizes the relay with which it is associated and returns the other relays in the group to the unenergized position.

The electrical interlock contacts shown in series with each push-button in Fig. 4 are contacts on the associated relay in the opposite group. The AM interlock contacts are on the FM-group relays, and the FM interlock contacts are on the AM-group relays. If a relay in

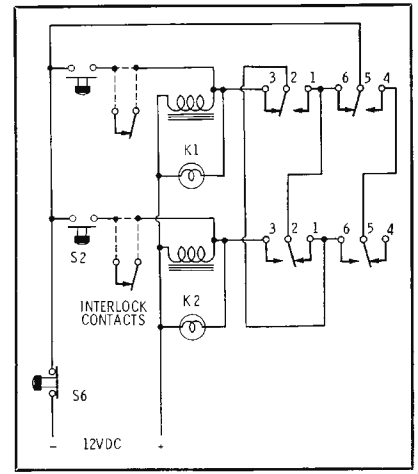

Fig. 4. Diagram showing relay interlock.

one group is energized, the push-button circuit of the associated relay in the opposite group is open, and that relay cannot be accidentally energized to transfer the program from one buss to the other. Some simplification of the system can be achieved by omitting the interlock feature. The complete circuit of the system is shown in Fig. 5.

• Please turn to page 49

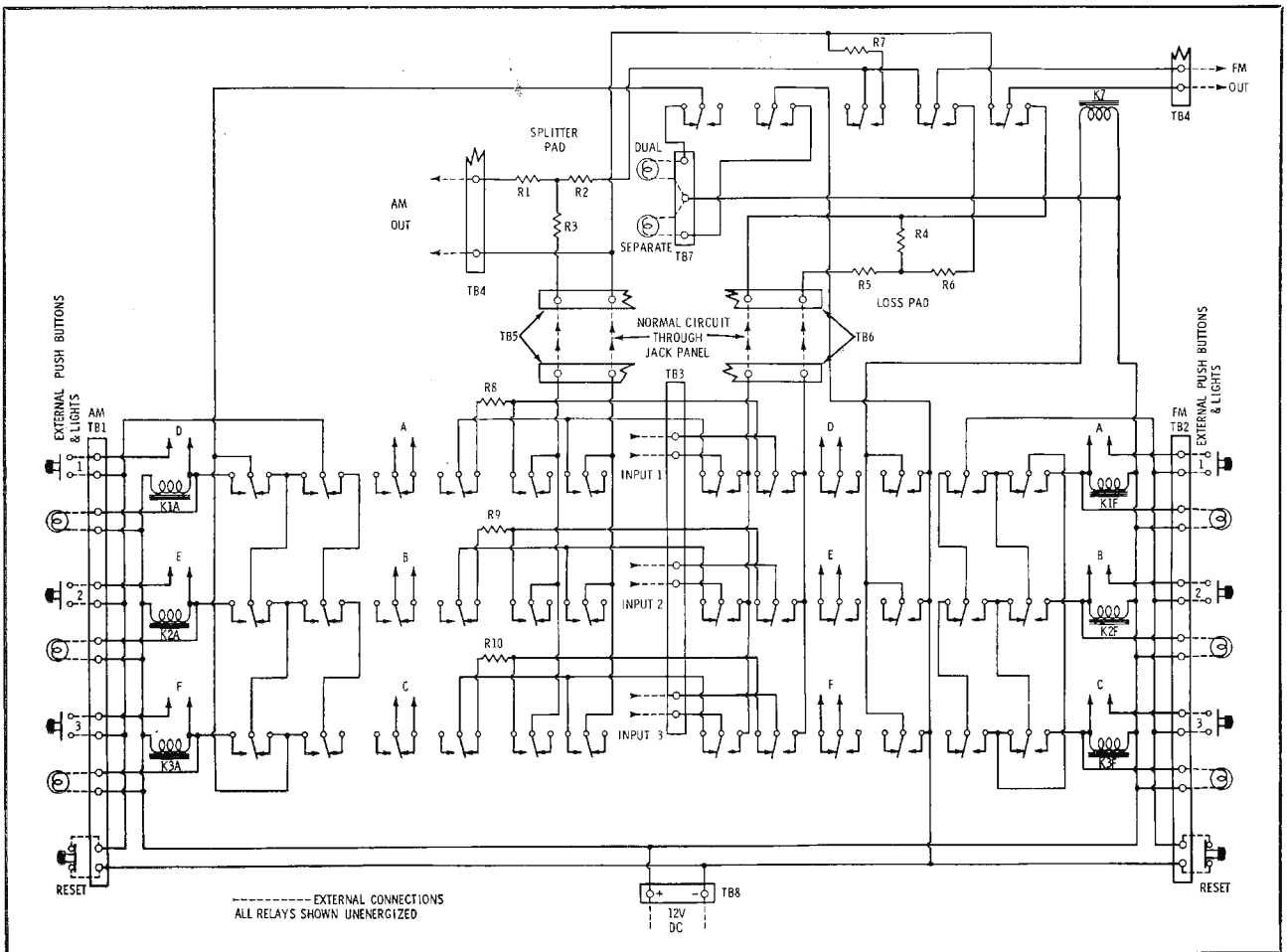

Fig. 5. A complete schematic diagram of the AM-FM console-transmitter switching unit designed for use in the WRFD stations.

THE LIGHTING MAN'S GUIDE

by **Elmer Friman**, Staff Engineer,
WFBM-TV, Indianapolis, Ind.—An
explanation of the equipment and
procedures employed in TV lighting.

“Sufficient foot-candles to create a level of reflected light that will adequately stimulate the image orthon” is not truly a definition of television lighting. Lighting for television is the artistic direction of light upon a scene in a way that creates an appropriate mood for the subject matter. If this be the case, the studio engineer must go beyond mere camera requirements, and strive for more than just “enough” light to dispel shadows and show the eyeballs.

Equipment

We will begin with an introduction to the different lights available and discuss their characteristics and usage in lighting assignments. Then

we will show correct placement of lights for various scenes and discuss proper balance among lights.

The **Fresnel-lens** spotlight is the most versatile lighting tool in the television studio. It can provide perfect control of the light beam without any spill light or side glare. It is extremely portable and is adjustable from wide-spread to minimum-spot position easily and quickly. Mounting this unit with an adjustable C-clamp and yoke makes possible a maximum of directional alignment. The use of “barndoors” increases control of the light beam to areas measuring in inches.

The **scoop** (flood) light in its various sizes and shapes is an excellent aid to the spotlight, since it

produces a smooth, even illumination of high intensity. A wide range of lamp wattages can be used with scoops, which makes this light helpful in bringing up the overall light level of a scene. The C-clamp and yoke mount used with a scoop are the same as with the spotlight fixture.

There are many variations of the two units available for the television studios — long-range scoops, high-intensity spots, baby spots, etc. However, utilizing the two basic lighting tools — Fresnel spots and scoops — the studio technician can produce set lighting that is both efficient and artistic.

Having decided which lighting units to use, let's next make sure of proper mounting, so the units can be handled with ease. General practice is to mount them on iron pipes — usually referred to as “grids” — spaced about 4' apart all the way across the studio and hung from the ceiling by chains that make their height adjustable. Individual grids can be raised or lowered for specific lighting problems.

Additional flexibility is obtained with pantograph mounting devices — extendable arms joined together in roughly parallelogram form. Pantograph mountings (called lazy-boys) allow raising and lowering individual lights, with the aid of a pole, while standing on the studio floor. In some instances, floor mounts have an advantage over ceiling mounts, but care must be taken so they don't impede studio traffic.

Terminology

Base or fill light is the overall lighting, produced mostly with the scoop light, for illumination of the entire scene.

Key or accent light is a controlled directional light, usually the Fresnel spotlight, which is used to highlight the subject in key areas and pro-



(A) Spot high and to one side.



(B) Spot added at 45°.



(C) Spot added low on other side.



(D) Final resultant illumination.

Fig. 1. Illustrations of the results obtained by addition of each lighting component.

duce shadows that add form and substance.

Back or rim light is a directional spot coming from behind the subject in a way that provides separation from the background, highlighting hair and shoulders or outlining objects.

Backdrop or splash light is the controlled placement of shafts or streaks of light upon backdrops or flats to produce contrast variations that control the eye's interest.

Eye or twinkle light is a small spotlight used to give the eyes sparkle or highlight in the iris.

High-key lighting means filling a scene with maximum illumination so it contains many bright areas and very little shadow area; care must be used to avoid washing out detail.

Low-key lighting means filling a scene with many shadow areas by using carefully selected illumination. Care must be taken not to produce a murky picture; a low-key scene must have **sharp blacks** to create proper effect.

Modeling describes the effect of showing form and texture in the subject; this term is almost synonymous with sculpturing, except that modeling is done with light.

The above terms are used mainly to describe the applications of light. Qualities of light also have their own language we should be familiar with, such as the following:

Hot light is a light concentration that is too intense and will cause the subject matter to lose detail (wash out). This type of light can be controlled to produce strong shadows, but should be used cautiously.

Soft light is the moderate application to obtain maximum detail while still retaining modeling. This is best accomplished by spun-glass diffusers over the lamp lens.

Reflected light is used when light cannot be aimed directly on a subject. Reflectors made of aluminum foil are used to redirect light into needed areas. This type of light is used outdoors with sunlight and limited field equipment, as well as in the studio.

Principles

The techniques we'll discuss are for equipment normally found in local studios, and don't require elaborate lighting boards or fancy lighting equipment. The tools of the

trade are a good light meter, a crescent wrench, and a pole with a hook for adjusting lights from the floor. Also, we must not forget the light-weight ladder that we'll drag around and climb up and down mounting lights on the studio grids.

The light meter should read incident light on a scale marked in foot-candles, or lumens per square foot. With it, the lighting can be checked for balance in relation to its source, not as it is absorbed in the screen. All lights on the set provide a certain number of lumens, and how many fall on a surface is a measure of the light intensity at that point. The total foot-candles required for the set depends upon the image orthicons being used in the television cameras. The newer 4½" tubes require less light than the older 5820A.

Although the **amount** of light in foot-candles is important to the video engineer in setting up his cameras, the **balancing** of the light is equally critical. Properly balanced lighting on a set will eliminate many shading problems that beset the cameraman and control-board operators. Once the lights are placed and the balancing completed with the aid of the light meter, the overall light in foot-candles can be adjusted to satisfy the camera's demands.

Setting Up

With the camera lens set between f8 and f16, the overall light-meter reading of incident light (as you walk across the front of the set) should be around 100 foot-candles. This will be from the fill lights and modeling lights combined. The next reading should be taken facing downstage, picking up readings from the back light. The ratio between back light and front light, for a normal set where no outstanding effect is desired, should be 2:1. This ratio will change when the subjects are to be more dramatically presented.

When performing this meter test, you'll find that some highlighted area will produce higher readings than the overall scene; a degree of this will be no problem to the camera tube. Areas that create too much unbalance can be controlled by inserting spun-glass diffusers in front of the spotlight lenses. Sometimes more than one sheet of spun-glass will be needed to reduce the

meter reading for a particular light. If too much diffusion affects the modeling, a smaller-wattage lamp should be substituted and the diffusion reduced. Adjustment of the flood-spot setting on the fixture can also regulate intensity to some degree while still keeping the accent desired.

Lighting the Face

The human face is a constant challenge to any lighting director. There are two basic approaches to the task of facial lighting. One is directional light; the other is nicknamed "the butterfly."

Directional light is recognizable as the type of lighting created by the sun shining through a window or by a table lamp placed near a chair. It can be reproduced on the set by balancing the lighting so it is stronger from one source than from all others. Fill lights are then used to soften hard shadows, while keeping the desired effect.

This type of lighting is produced by first setting a spot high and off to one side of the subject. The light should be directed to the bridge of the nose until a small triangle appears on the opposite cheek (Fig. 1A). Next, a light of equal intensity is created by another spot at about a 45° angle on the same side and behind the subject, also serving as a rim light. You've now created a pleasing directional source (Fig. 1B). To balance the source light, set a spot low and to the opposite side of the source. The angle is more to the front of the subject and fills the face planes just enough to soften the triangle shadow and light the eyes (Fig. 1C). A scoop is set to shine in from the latter side, softly rounding out the features of the head and offsetting the sharp outline on the source side. The result (Fig. 1D) is sometimes referred to as "Rembrandt" lighting.

The second basic facial-light technique—the "butterfly"—is an elaboration of the first. The directional source light is repeated on both cheeks. The patterns in fact appear as butterfly wings on the face. This method eliminates all shadows from the eyes and gives a twinkle to the iris (Fig. 2A). The patterns on the cheeks can be used to set the angles from each side so they match. Then the patterns can be removed or softened by filling in with a scoop or



(A) Lighting from spots.



(B) Diffused light added.

Fig. 2. Example of the results obtained when the "butterfly" lighting technique is used

diffused spot from directly in front and close to head height (Fig. 2B). This type lighting serves well where the head will turn from side to side, and therefore is excellent for panel or group assignments.

Eyeglasses! This word puts terror in the hearts of lighting directors. There are large lenses, round, square, and bifocal lenses. The frames can be in reflective black or sparkling gold with metallic decoration. In any case, they are a headache and interfere with good face lighting.

The best solution is to attempt to phase out eyeglass reflection, first by camera height or angle, or by

tilting the glasses on the subject's nose. If you're lucky, that will do it, but chances are it won't. The next step is to reset lights along the grids until changing the throw distance finally phases out the reflections, while the same lighting is retained. Moving the lights to another grid may sometimes help in reducing hot-spots on eyeglasses. More often, all these methods are necessary.

News or Weather Set

Equipment required is: five Fresnel adjustable spotlights — three 1000-watt, two 750-watt; two scoops—500 watts each; spun-glass

diffusers; barndoors for the spotlights.

This set requires care to keep the rear-projection screen in a minimum of light. The subject may be standing next to the screen and spots must be set to illuminate this confined area without spillover onto the screen.

Use the two 1000-watt spots as front-modeling lights about 5' off the floor to light the face and eyes. Put them slightly off to each side, where they will throw a cross-light into the troublesome area of the face where the eye sockets meet the top of the nose. Directly in front is the other 1000-watt lamp, on full flood to act as a fill light. Use the barn-doors only to block out the screen area, allowing spill from the scoops to mix with the semi-spot setting of the model lights. This brings up the overall intensity reading on the front lights.

The back lights are on full spot and produce a rim light for the subject's head and shoulders. Care must be taken not to overaccent this area as it could become distracting to viewers. Spun-glass diffusers may be used over the spots to create a softer appearance in the facial planes. This is especially a must when televising female talent.

Panel Show

Equipment needed is: six Fresnel spots — 1000-watt; four scoops — 500-watt; two background spots — 750-watt; barndoors for those spots used on the background.

The main problem of lighting a table group is the shadow caused by one subject's head getting in the path of light directed toward his neighbor. This is overcome by using the cross-light method and a strong front fill light.

With a group of four, as shown in Fig. 3, the front grid will have a lineup as follows, from left to right: One 1000-watt spot, full flood, directed in on the first two heads, producing an accent light from the front left. Next is a scoop (500-watt) in front and as low as possible. Then, two 1000-watt spots, full flood, crossed so the first is picking up the next two heads and the second is aimed left to complete the cross-light of the first two heads. Next is another 500-watt scoop, in front, low, followed by a 1000-watt spot on full flood, completing the

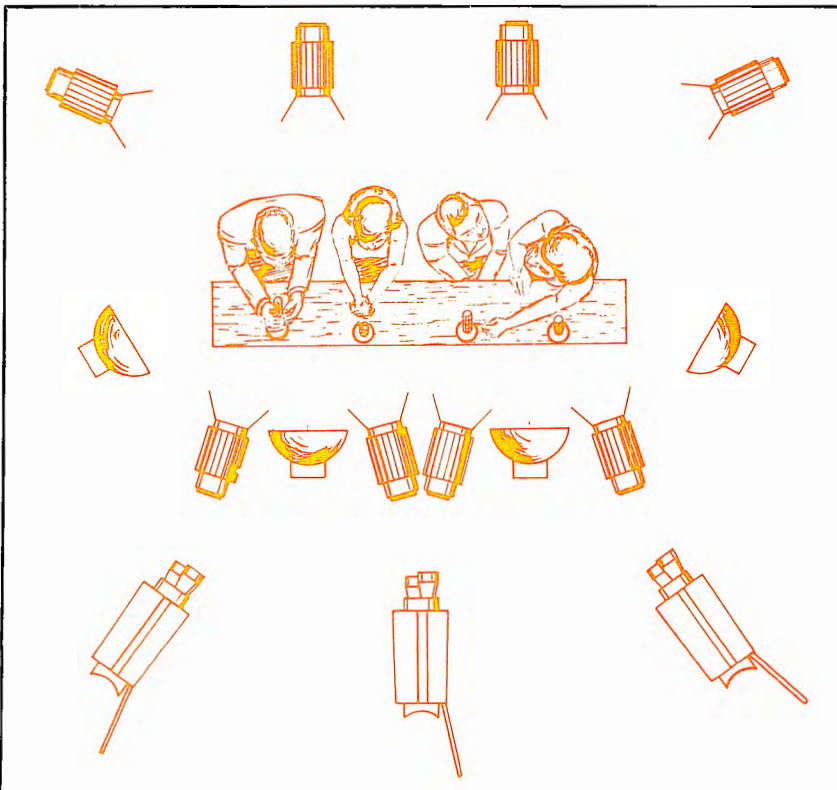

Fig. 3. Proper lighting for panel group of four requires variety of spots and scoops.

YOU said it!



SUPERIOR **Cell-O-Air[®] Coaxial Cable** with "COPPERGARD" is the star performer in CATV

Through superior design and highest possible quality of manufacture, Superior's Cell-O-Air Coaxial Cable with Coppergard offers you these advantages:

- Up to 20% lower attenuation.
- Solid tubular Coppergard corrugated 5-mil copper shield for positive protection against radiation leak.
- Far better long-term transmission stability.
- Corrugations permit hand bending to an acceptable limit of 20 times the cable diameter, for maximum flexibility without fracturing shield.

"We . . . like the Superior Cable we have used so far which was 4920 feeder and 4930 trunk."

"Superior Cable #4920 has been in the air five months . . . there's a great amount of salt in the air and high annual rainfall. Loss measurements showed .906 DB/100' on Ch. 6 and 1.54 DB/100' on Ch. 13. Additional attenuation due to aging, both channels, is approximately 3/10 of 1% over published specs . . . and, over the five month period, the additional attenuation is linear. Superior 4920 cable is far superior."

"During the past 12 months we have installed more than 1,600,000 feet of Superior 4920 Coppergard Coaxial. Of the total footage you supplied, no reels were rejected because of electrical integrity or cable quality or workmanship. You will be interested to learn that 4920 delivers far more in performance than you ever claimed for it."



Manufactured by
SUPERIOR CABLE

ELECTRONIC WIRES
AND CABLES

Superior Cable Corporation • Hickory, North Carolina

Circle Item 9 on Tech Data Card

8512

December, 1964

21



.....and Bauer has the packages to help you increase your effective power economically and quickly. The Bauer 1 KW FM Transmitter, for instance, with a four bay antenna will give you maximum power with watts to spare.

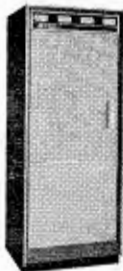

AMPLIFIER ONLY
AVAILABLE IF YOU
WANT TO USE YOUR
EXISTING EXCITER.

Features include:

Automatic Power Control—Lowest Tube Investment in the Industry—Automatic Voltage Control—Solid State Rectifiers—Stable Grounded Grid Operation—Remote Control Provisions. Both packages available in "Kit" form or factory assembled. High Power Amplifiers available for special Vertical Power Combinations.

Increase your power and coverage by calling Bauer today for all the facts.

Bauer

ELECTRONICS CORPORATION

1663 Industrial Road, San Carlos, California
Area Code 415 591-9466

Circle Item 10 on Tech Data Card

right-side cross-light for the second pair of heads. A grid just a little above the front of the table will have a scoop on either end as a side light and as an aid to any fall-off of the front lights at the corners of the set.

Back lights will be semi-spot to serve as a head highlight for each pair. On that same back grid will hang two spots of 750 watts each with barndoors creating a light slash on the backdrop. This will make a more pleasing pattern on the backdrop by keeping other areas subdued and by confining the eye on wide camera shots.

The Elaborate Set

There are times when you'll have to produce dramatic lighting for shows of an elaborate nature. Of course, each show has its own problems, and it would be difficult to set ground rules. Utilizing the basic lighting techniques we've just discussed will help achieve success in whatever assignment is undertaken. However, certain generalities can be mentioned as a further guide.

A conference with the producer and director will inform you of action areas. As camera blocking is worked out, the lighting requirements become apparent. You cannot begin to light until you know the direction the scene will be viewed from (camera angles). Then you need to know movements of the talent so you can put correct and adequate light in all areas of the set they may move to.

With these two important facts in mind, you can plan how to create the most pleasing light direction. While it would help to see the shows in dress rehearsal before attempting any lighting, this is not always possible. The limited time allowed for preshow work in the technical divisions is always a handicap to artistic endeavors. But you can overcome this with some early information and some imagination. Keep in mind that the setting and the props deserve good lighting as well as the talent. Accent-light the props that are significant to the theme or mood of the show. Treat each action area as a separate lighting assignment, then weave them all together with well placed fill lights. This technique will cut down resetting time after dress rehearsals.

Patterns for Effect

Patterns projected on wall areas or on limbo curtains can produce unusual effects in lighting. By the use of a projector with interchangeable patterns, flats can be painted with light and shadow.

The patterns can be used for artistic effect to break up a plain flat behind the performers. Directing the beam in from the side will not interfere with set action or lighting. Since it is an abstract pattern in most cases, there are no keystone effects to be concerned with. This system can also simulate light coming through windows, bars, gates, etc. Projecting these patterns on walls of a set will give the viewer a visual reference to the source of the light.

The fixture comes equipped with framing shutters so the pattern can be limited to desired areas without spillover. The beam-spread per foot of throw is approximately 6" for a 6" lens or 4" for an 8" lens. There are special snoots and lenses that can produce a 3" beam spread per foot of throw.

Conclusion

The artistic approach to television lighting is not beyond the means and ability of the small television station. With the learning of basic lighting skills usually comes the desire to create more artistic productions. Mastering the technical requirements of the television camera leads to concentration on the aesthetic aspects of studio lighting. A well lighted set will entice and hold the eye of the viewer, and after all, isn't that what television is for? ▲

About the Cover

The fact that television lighting is both an art and a science is illustrated in this month's cover. The view shows one of the color sets in the studios of WFBM-TV, Indianapolis, Indiana. Many of the types of lights and supports discussed in the above article are in evidence, along with the "shepherd stick" author Friman will use to make further adjustments.

For those who demand the finest in...

VIDEO EQUIPMENT

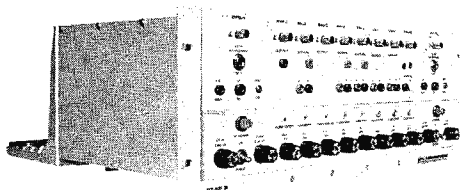

Solid State Amplifiers

- Video Distribution Amplifiers
- Self-Clamping Amplifiers
- Sync Separating Amplifiers
- Sync Mixing Amplifiers
- Pulse Regenerative Amplifiers

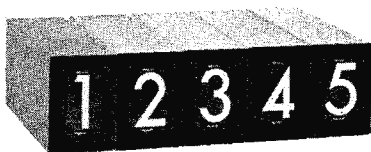

Digital Display Systems

Used for instant, legible display of such up-to-the-second numerical information as athletic scores, election returns, weather information. Sold as individual digits or as complete systems.

AUDIO EQUIPMENT

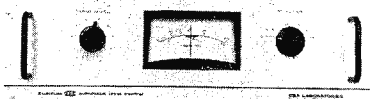

AUDIMAX®, the automatic level control that "rides" gain to quadruple average modulation and market coverage.

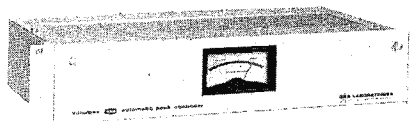

VOLUMAX™, the automatic peak controller that can double radiated program power by providing maximum control of peaks without any side effects. When used in combination with the AUDIMAX, an 8-to-1 increase in effective program power may be achieved.



TEST RECORDS to provide accurate input signals for audio system tests, in most cases eliminating the need for expensive test equipment. Available for test and adjustment of every necessary parameter of professional audio systems. Material specially selected by CBS Laboratories' scientists and recorded to precision laboratory standards.

For complete information on these

... Quality Products for Professional Broadcasters

write to:

CBS LABORATORIES
Stamford, Connecticut

A Division of Columbia Broadcasting System, Inc.

Outside the U.S.A. and Canada:
CBS International Division
46 East 52nd Street
New York 2, New York
Cable: COLUMBINE, New York

In Canada:
Caldwell A/V Equipment Co., Ltd.
443 Jarvis Street
Toronto 5, Ontario

Circle Item 11 on Tech Data Card

THE 20TH ANNUAL NATIONAL ELECTRONICS CONFERENCE

A review, from the broadcast engineer's viewpoint, of what took place at the conference.

The 20th anniversary National Electronics Conference was held October 19, 20, and 21; activities were centered at McCormick Place, Chicago's lakefront exhibit hall.

The list of sponsoring organizations is most impressive. Industry sponsors were the Electronic Representatives Association and the Scientific Apparatus Makers Association. The sponsoring engineering societies were the Institute of Electrical and Electronics Engineers and the Society of Motion Picture & Television Engineers. Educational institutions were well represented; sponsors in this category were: Illinois Institute of Technology, Iowa State University, Marquette University, Michigan State University, Northwestern University, Purdue University, University of Illinois, University of Michigan, University of Notre Dame, University of Wisconsin, and Wayne State University.

More than 450 exhibitors were present, and 57 technical sessions on a number of topics were held; over 300 papers were presented collectively in these "industry seminars."

Three all-day intensive refresher seminars were held. The first of these was concerned with "Topics in Modern Antenna Theory." The

topics included frequency-independent antennas, recent advances in the theory of unequally spaced arrays, application of some numerical-analysis techniques to the theory of nonuniform arrays, and discussions concerning data-processing antennas. Some idea of the level of presentation can be obtained from the nature of the subjects covered. The other intensive seminars were titled "Engineering Applications of Linear and Nonlinear Programming" and "Electronic Thin-Film Technology."

In addition to the refresher and industry sessions, new - products seminars were held. New products covered included precision laboratory instrumentation, components and interconnections, computers and data-logging, and electronic and infrared instruments.

Highlights of the Conference included luncheon speeches by James E. Webb, Administrator, National Aeronautics and Space Administration; Dr. Henry K. Puharich, President and Director, Medical Research Intellectron Corporation; and Dr. Albert V. Crewe, Director, Argonne National Laboratory.

Guided tours were conducted through the 755th Radar Squadron facilities, the Communication Cen-

ter and Crime Detection Laboratory of the Chicago Police Department, and selected areas of the Argonne National Laboratory.

As can be seen from the foregoing summary, almost the full spectrum of the science of electronics was covered at the Conference. In this sense, practically everything at the show could be related, at least indirectly, to broadcasting. There was, however, little of direct, immediate importance to the working broadcast engineer. Even so, a few topics of peripheral or possible future importance were included. One of these was a paper on "FM Broadcasting from Satellites: Preliminary Consideration of Standards and Sharing." Several papers dealt with theory and development in broadcast receiving equipment. One industry seminar dealt with modern microwave techniques. A paper was presented on "AM Transmitter Audio Performance Without Power Supply Filter Reactors."

All in all, the NEC was an interesting and useful meeting for the engineer or scientist in industry—at whom it was primarily directed. It was not basically a show for the broadcast engineer, nor was it intended as such. ▲



NASA Administrator James E. Webb, the Convention Monday luncheon speaker.



Dr. Henry K. Puharich was luncheon speaker at the Tuesday session of the NEC.



Dr. Albert V. Crewe, director of Argonne National Laboratory, spoke on Wednesday.

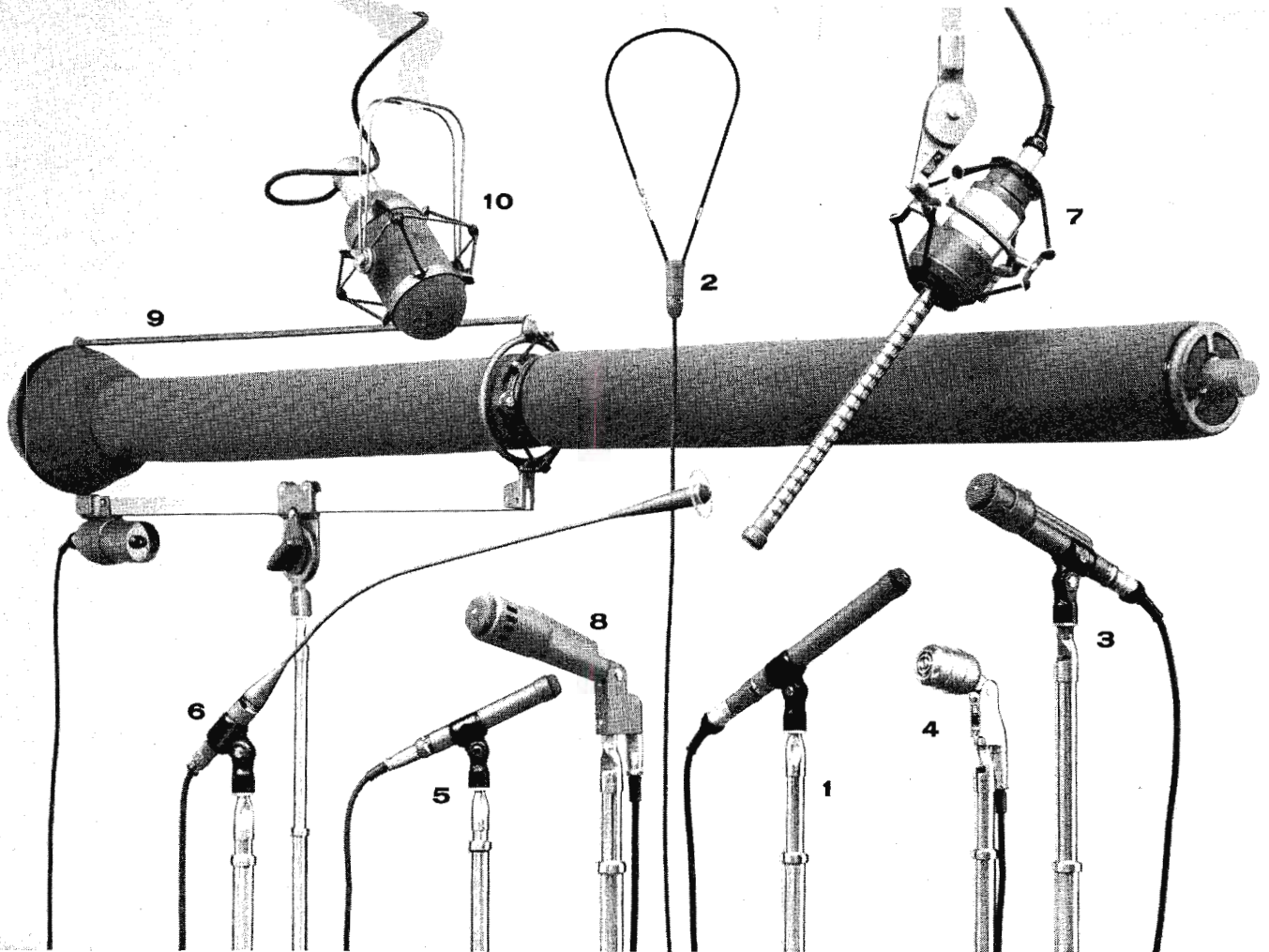

Ten Good Reasons Why Leading Audio Engineers (Who'll Stop at Nothing to Improve Quality) Choose E-V Professional Microphones!

1. High FIDELITY is your stock in trade. And the peak-free 40-20,000 cps response of the E-V 655C provides it simply and directly, with no complex added equipment to burden you.

2. It's quite easy to maintain complete COMPATIBILITY between the sound of lavalier microphones and stand units. Simply use the tiny E-V 649B with your larger E-V microphone. Voice quality mixes perfectly.

3. The reputation for RELIABILITY enjoyed by the E-V 666 comes from its ability to deliver superb cardioid response even after accidental abuse that would destroy many a lesser microphone.

4. The ready AVAILABILITY of E-V professional microphones at leading radio parts distributors everywhere is an E-V pioneered policy begun back when the "workhorse of the industry", the E-V 635, was introduced.

5. Outstanding in its FLEXIBILITY is the new E-V 654A. This versatile micro-

phone slips easily into floor or desk stands, or can be hand held or used as a lavalier.

6. Ten E-V professional models give you unusual VARIETY. For instance, if you require close-up sound pickup, yet mustn't hide the performer, the ultra-thin E-V 652 solves both problems handsomely.

7. The CREATIVITY of E-V engineers comes from intimate knowledge of field problems. It earned them an Academy Award for their unique solution to film and TV sound problems with the E-V 642 microphone.

8. ECONOMY is vital in every studio operation, yet quality must be upheld. And the E-V 665 is ideal where superb cardioid performance is needed, but the utmost in mounting flexibility is not required.

9. Even the 7-foot long E-V 643 ultra-directional microphone is protected by this unique E-V GUARANTEE: except for refinishing, all repairs are free no

matter what happens to the unit during the first two years!

10. The VITALITY of E-V design comes from constant improvement of existing models, plus fresh new ideas that solve your problems. Newest is the E-V 668, specifically created for boom microphone applications.

Put all ten good reasons to work for you in your studio or in the field by choosing the E-V Professional microphone that's right for your sound pickup requirements. Your E-V distributor can offer up to 15 years of experience in assisting studios to better sound. See him today, or write for a complete distributor list and free microphone catalog.

ELECTRO-VOICE, INC.

Dept. 124IV, Buchanan, Michigan

Electro-Voice®
SETTING NEW STANDARDS IN SOUND

Circle Item 12 on Tech Data Card

NEW FROM JAMPRO DIRECTIONAL FM ANTENNAS

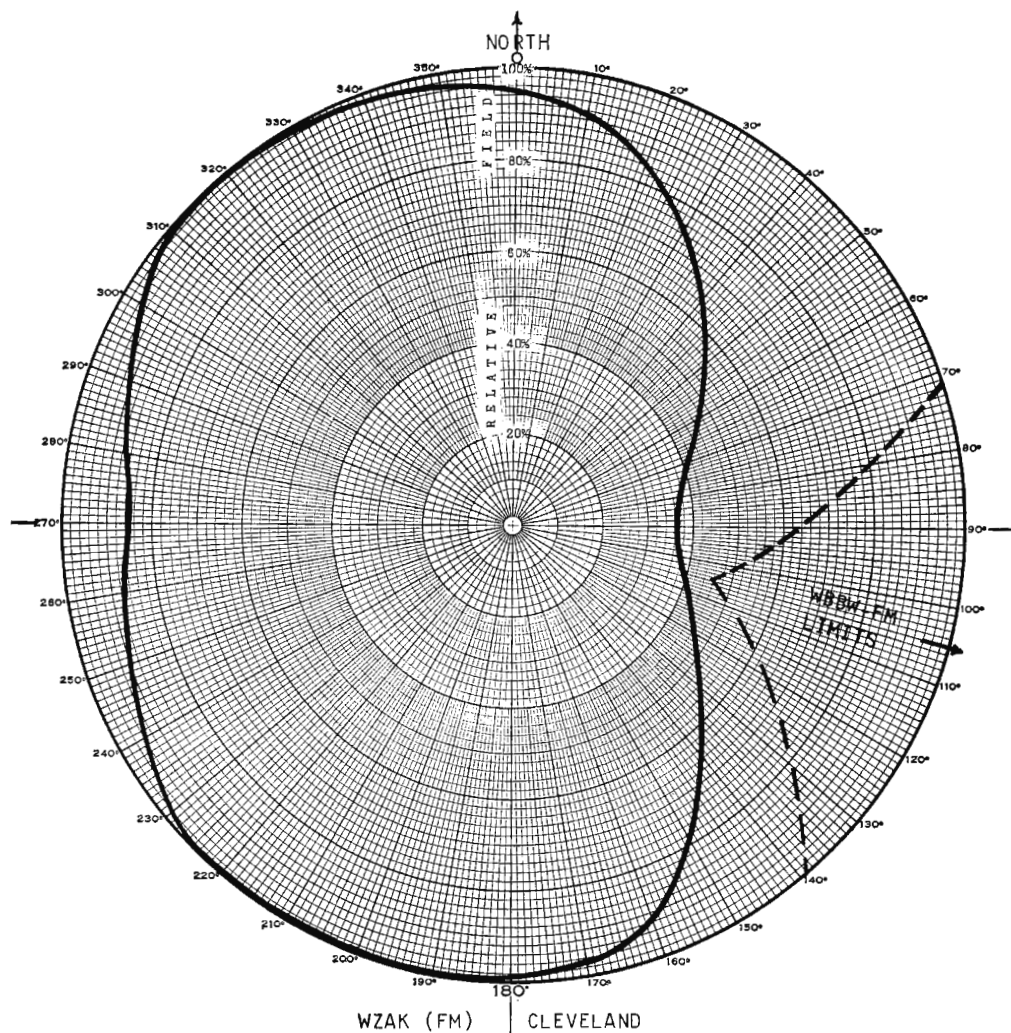

The FCC's 4th Order and Report now permits the use of directional FM transmitting antennas, to provide protection of short spaced stations. If you are now short spaced, you can, in most cases, increase your ERP in all directions except towards the short spaced station. Contact your consulting engineer for full details on how the new FCC Rules may help you increase your station's coverage.

JAMPRO directionalized FM antennas are excellent for FM stereo. VSWR bandwidth is not affected. JAMPRO dual polarized antennas may also be directionalized. The antenna peak gain is nearly always increased.

The JAMPRO FM antenna may be easily directionalized. By means of parasitic reflectors behind each bay, most patterns may be achieved. Tight or multiple null patterns may require phasing and spacing of dual bays stacked side by side. JAMPRO design engineers will be pleased to work up antenna designs meeting specific pattern requirements. Antennas are pattern tested prior to shipping.

JAMPRO's complete antenna test range is used to insure pattern conformity. The supporting tower or pole affects the radiated pattern, and therefore must be included in pattern measurements.

J A M P R O

ANTENNA COMPANY

6939 POWER INN ROAD
SACRAMENTO 28, CALIFORNIA

Circle Item 13 on Tech Data Card

December 1964

We interrupt this magazine to bring you...

Late Bulletin from Washington

by Howard T. Head

Power Increases For FM

The Commission has adopted new Rules governing power increases for existing FM broadcast stations operating at mileage separations less than the minimum values established by the new FM Technical Standards (see April Bulletin). Under these new Rules, which apply only to short-spaced stations authorized prior to the adoption of the new separations, the maximum permitted power is governed by the closest separation between short-spaced stations on the same channel and the first adjacent channels.

In most instances, the new Rules will permit worthwhile power increases for existing short-spaced stations, which had been frozen at their present power levels while the new proposals were under consideration. In many instances, where the spacings are not critical, existing stations will be permitted to increase power to the maximum levels permitted for their class.

In cases where spacings are too close to permit maximum-power operation, the new Rules provide for lesser power or the use of directional transmitting antennas to protect other stations. However, directional antennas will not be allowed for the purpose of permitting new short-spaced operations.

At the same time, the Commission also adopted new technical standards governing FM stations in Puerto Rico, and adopted a Table of FM Channel Assignments for Alaska, Hawaii, Puerto Rico, the Virgin Islands, and Guam.

Microwave Authorizations For CATV

Recent studies submitted to the Commission have revealed that, of the more than 1300 CATV systems in operation in the United States, over 250 employ microwave systems, both single- and multiple-hop.

The Commission has unquestioned authority to regulate microwave services, and has employed this authority to regulate the use of microwave systems by CATV operators. Several proposals are outstanding under which new or renewal microwave authorizations would be granted only if the CATV system agrees to protect television stations serving the same area. This protection might extend to carrying local stations on CATV systems, as well as to technical regulations governing the quality of CATV signals. Also being considered are prohibitions against carrying programs of out-of-town stations which duplicate those provided locally.

While these proposals are being considered, microwave authorizations continue to be granted, but many are on condition that CATV operators accept technical conditions included in any final Rules established by the Commission.

Sharing TV Microwave Relay Band

The Commission has proposed to make frequencies in the band 1990-2110 mc available for the use of government space-research stations in support of the National Aeronautics and Space Administration's Project Apollo. This is the project in which U.S. astronauts will be landed on the moon and returned to earth. This frequency band is within that (2093-2110 mc) presently assigned for exclusive use by television auxiliary broadcast stations, including remote pickup, studio-transmitter link, and intercity relay service.

Although use of this frequency band for space research is expected to be infrequent, the research program may continue up to 10 years. Present plans contemplate establishing high-power transmitters, operating principally on 2106.4 and 2101.8 mc, for space service near Goldstone, Calif.; Cape Kennedy, Fla.; Kauai, Hawaii; and Corpus Christi, Tex. Potential interference to earth stations is expected to extend little more than 175 miles from these locations, although individual technical factors in each case will influence the actual potential range of interference.

Loudness of Commercials

The Commission and the Commission's staff continue to grapple with the problem of formulating technical regulations intended to eliminate what many persons believe are excessively loud commercial announcements broadcast by radio and television stations (see April Bulletin). Recent demonstrations in New York City to the Commissioners and key staff members emphasized the highly subjective nature of the loudness phenomenon, and made clear the difficulty of defining loudness in terms of simple meter indications.

In the meantime, the Commission is considering referring the problem to the International Radio Consultative Committee (C.C.I.R.). Recommendations are needed for techniques suitable to measure the subjective loudness of program material, together with estimates as to their accuracy and as to correlation with present methods of measuring modulation levels.

New AM Allocation Standards

As reported in the October Bulletin, the Commission is now processing applications for new or improved AM facilities on the basis of revised Technical Standards. Key feature of the new Standards is a requirement prohibiting the overlap of specified field-strength contours between stations on the same and on adjacent channels.

Under a strict interpretation of the new Rules, new AM grants may not be made in the presence of any overlap of the forbidden contours. This, however, would lead to absurd situations where contour overlap in uninhabited areas, or even over bodies of water, would be a basis for denying applications. Several cases of this nature are now under study, and an interpretation by the Commission is expected in the near future.

Howard T. Head...in Washington

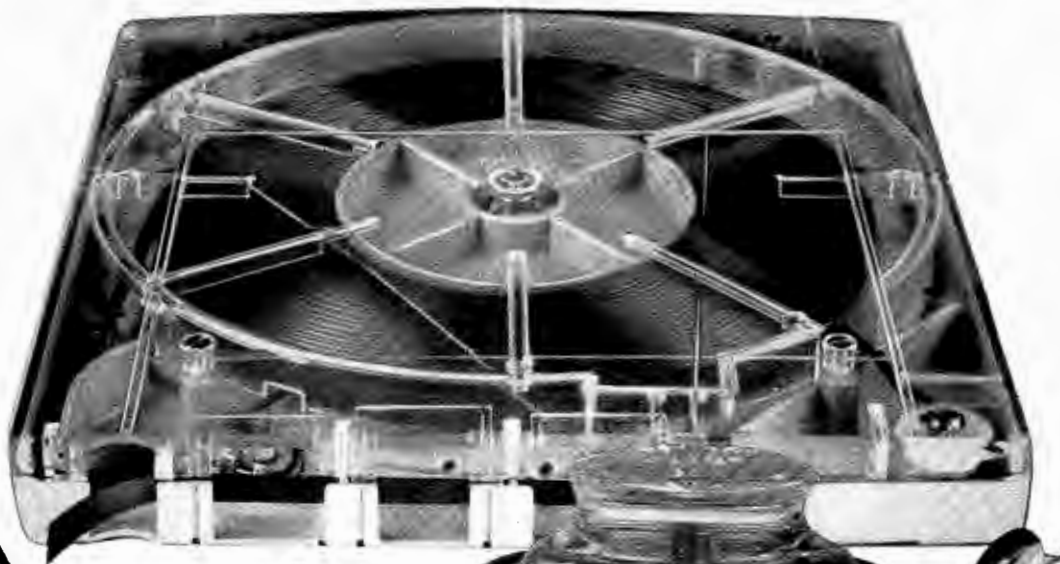

FIDELIPAC® WILL EVEN CUE YOUR COFFEE POT



Fidelipac is already used by over 2,860 stations as the standard tape cartridge for the continuous and repeated playback of recorded messages. But Fidelipac does more than repeat messages. It stores recorded information on **one** compact reel that never requires rewinding and is always ready to play the correct message at the correct time.

Now, about the coffee pot. Fidelipac accepts two kinds of cues: the first stops and starts the tape at the proper spot, so that it is never necessary to cue-up a commercial by hand; the second type of cue will activate turntables, slide and film projectors, other tape machines — and your coffee pot. With Fidelipac's automated assistance a whole day's programming can be set up and controlled with a minimum of supervision.

Your benefits? All material that has to be programmed can be contained in compact Fidelipac cartridges, **saving** the time usually spent cueing up discs and other tape machines. All of the material can be recorded at one speed selected by the engineer and played back at that speed without any chance of error. As a result of this efficiency fewer engineering hours are needed to control a day's programming, and this means savings to your personnel in valuable time. To sum up: Fidelipac saves engineering man hours, and **you** save money! What's more, you get better sound in the bargain.

TELEPRO INDUSTRIES, INC. A subsidiary of Defiance Industries
Cherry Hill Industrial Center • Cherry Hill, N.J. 08034

Write to TelePro Industries for free literature and the name of your nearest Fidelipac distributor. Then polish up the coffee pot!

TelePro Industries, Inc. A subsidiary of Defiance Industries
Cherry Hill Industrial Center • Cherry Hill, N.J. 08034

I need a coffee break! Please send me your free literature and the name of the nearest Fidelipac distributor.

Name _____ Title _____

Street _____

City _____ State _____ Zip _____

BE-12

New! LANG Monitor Amplifier... Speaks for Itself!

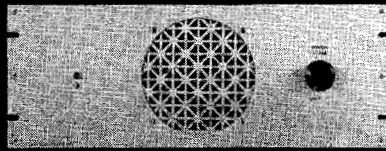

A completely self-contained monitor with its own amplifier and power supply, the new LANG MONITOR AMPLIFIER provides ample gain for any monitoring function. Consists of a Semi-conductor amplifier and power supply, a quality six-inch high fidelity loudspeaker, transformer isolated power supply, encapsulated amplifier module, and front panel gain control. New LANG MONITOR AMPLIFIER has a satin-anodized panel and mounts in a 7"x19" rack space. Ideal for the studio which wants a low-cost, rack-mounted quality monitor amplifier.

Write for Details

New Lang Catalog

Price: \$85.00

LANG ELECTRONICS INC.
507 FIFTH AVE., N.Y. 17
For all your audio needs - Look to Lang!

Circle Item 48 on Tech Data Card

Assure 100% COMPLETE ERASURE of Recorded Tape ON THE REEL



Use the

Magneraser®

- the Original and still the best!

Quickly erases a reel of magnetic tape or sound film of any size or type. Erasure is 100% complete even on severely overloaded tape. Lowers background noise level of unused tape 3 to 6 db. Also demagnetizes record-playback and erase heads. Only \$24.00. Two-Year Guarantee. Available at your dealer's or write us.

New ULTRA-SENSITIVE FLUTTER METER



With built-in Three-Range Filter, 3 kc Test Oscillator, High Gain Pre-amplifier and Limiter. Filter Ranges: 0.5 to 6 cps; 0.5 to 250 cps; 5 to 250 cps.

Designed for rapid visual indication of flutter and wow. Meets standards set by the IEEE... Condensed Specs.: Input Voltage, 0.001 to 300 Volts; Ranges, 0.01 to 3%; Limiter Range, 20 db.; Oscillator (built-in), 3000 cycles; Net Price, \$495.00... Write for complete specifications and free 12-page booklet on Flutter

AMPLIFIER CORP. of AMERICA
398 Broadway, New York 13, N. Y. - WO 6-2929

Circle Item 49 on Tech Data Card

ENGINEERS' EXCHANGE

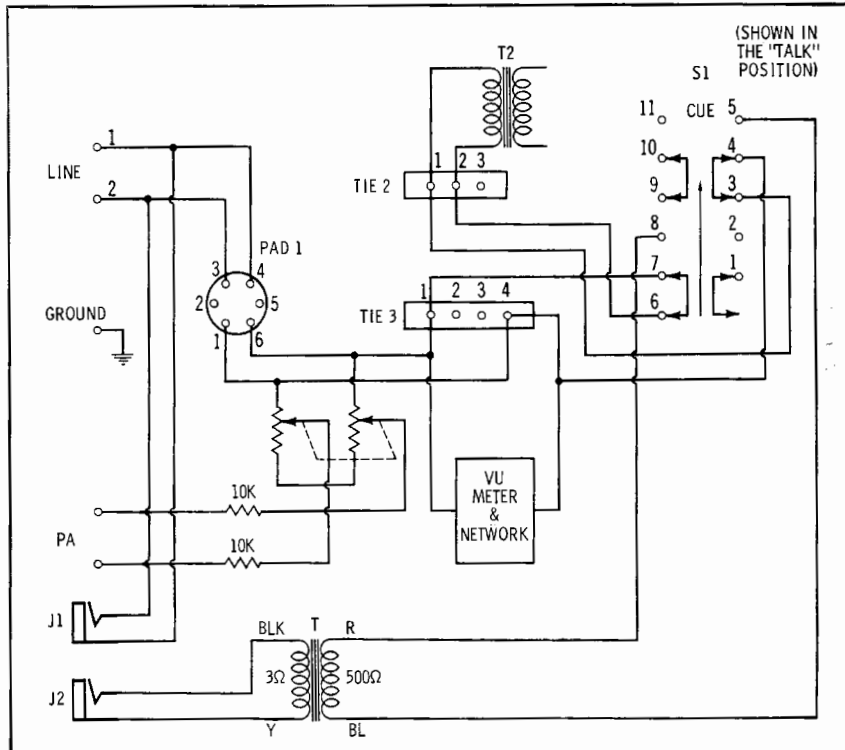

Remote Unit Operates with Portable Recorder

by John P. Hart, Chief Engineer, WHIL, Medford, Mass.

We recently made some modifications to one of our remote amplifiers to permit its use with a portable tape recorder. After installing a matching transformer and making some circuit changes, the speaker output of the recorder can be connected to the line terminals of the remote unit; the outgoing level can then be monitored on the remote-unit VU meter. Although similar modifications can be made to many remote amplifiers, the following procedure is that which we used with our Gates CB 66 "Dynamote."

First the connections for the talk position of the cue switch (S1) were made permanent. A four-lug terminal strip was mounted adjacent to the switch. The leads from the cathode of the output tube and the high end of the line transformer were removed from terminals 4 and 8, respectively, of the switch and tied together on one lug of the terminal strip. The leads from line terminal 2 and the outer contact of jack J1 (originally connected to switch ter-

minals 6 and 7, respectively) were treated similarly. The same procedure was also followed for the leads from line terminal 1 and the inner contact of J1 (originally connected to terminals 9 and 10, respectively, of S1). The jumper between switch terminals 3 and 8 (which formerly served to join the tube cathode to the transformer) was removed. The remaining leads from the switch to other points in the amplifier served to establish the listen mode; they were removed completely. The switch was then available to serve a new function when the appropriate connections were made.

The two leads coming from the line and meter circuit (by way of tie strip 3) were disconnected from terminals 1 and 2 of tie strip 2 and reconnected to terminals 4 and 7, respectively, of S1. New leads were run from terminal 1 of tie strip 2 to terminal 3 of S1 and from terminal 2 of tie strip 2 to terminal 6 of S1. The leads which connected J1 and J2 in parallel were removed.

A 500-ohm to 4-ohm transformer (we used a Triad S-65X) was installed on the panel close to the jacks. The 500-ohm winding was connected to terminals 5 and 8 of S1, and the 4-ohm portion of the

EIMAC

TUBES POWER 4 OUT OF 5 TRANSMITTERS AT NAB SHOW

Of 27 transmitters exhibited at the 1964 National Association of Broadcasters Show in Chicago, 22 (81.5%) use one or more Eimac tube types. Both high power klystrons and power grid tubes were represented in this comprehensive display of broadcasting equipment. The transmitter manufacturers who exhibited and employ Eimac tubes in various equipments are illustrated below by their logotypes. The chart identifies the Eimac tube types in the corresponding transmitters. The predominance of Eitel-McCullough products in broadcasting equipment manufactured by these industrial leaders proves Eimac's wide acceptance in this important area of communications. For details on a tube to meet your needs, write for Eimac's new catalog describing power tubes for the broadcasting industry.

MANUFACTURERS	TRANSMITTER	EIMAC TUBE TYPE
Bauer Electronics Corporation	1 kW FM	3-400Z (2)
	1 kW AM	4-400A (4)
Collins Radio Company	1 kW AM	4-400A (4)
	10 kW FM	4CX5000A
CCA Electronics Corporation	1 kW AM	4-400A (4)
	5 kW FM	3X3000A7
Continental Electronics Mfg. Co.	50 kW AM	4CX35,000C (2)
Dynair Electronics, Inc.	500 W VHF-TV	4CX350A (4)
Gates Radio Company	20 kW FM	4CX10,000D (2)
	10 kW FM	4CX10,000D
General Electric Company	5 kW AM	3X2500F3 (4)
	5 kW FM	4CX5000A
	1 kW AM	4CX3000A
	50 kW UHF-TV	4KM150klystron
	5 kW VHF-TV	4CX5000A
	1 kW VHF-Aural	4CX1000A
ITA Electronics	100 W UHF-TV	3CX100A5
	10 kW FM	4CX10,000D
Radio Corporation of America	10 kW FM	4CX10,000D
	30 kW UHF-TV	3CX100A5
Standard Electronics Corp.	2 kW VHF-TV	4-125A
		4CX250B
	250 W FM	4CX250B

EITEL-McCULLOUGH, INC., San Carlos, Calif.

In Europe, contact Eitel-McCullough, S.A.,
15 rue du Jeu-de-l'Arc, Geneva, Switzerland

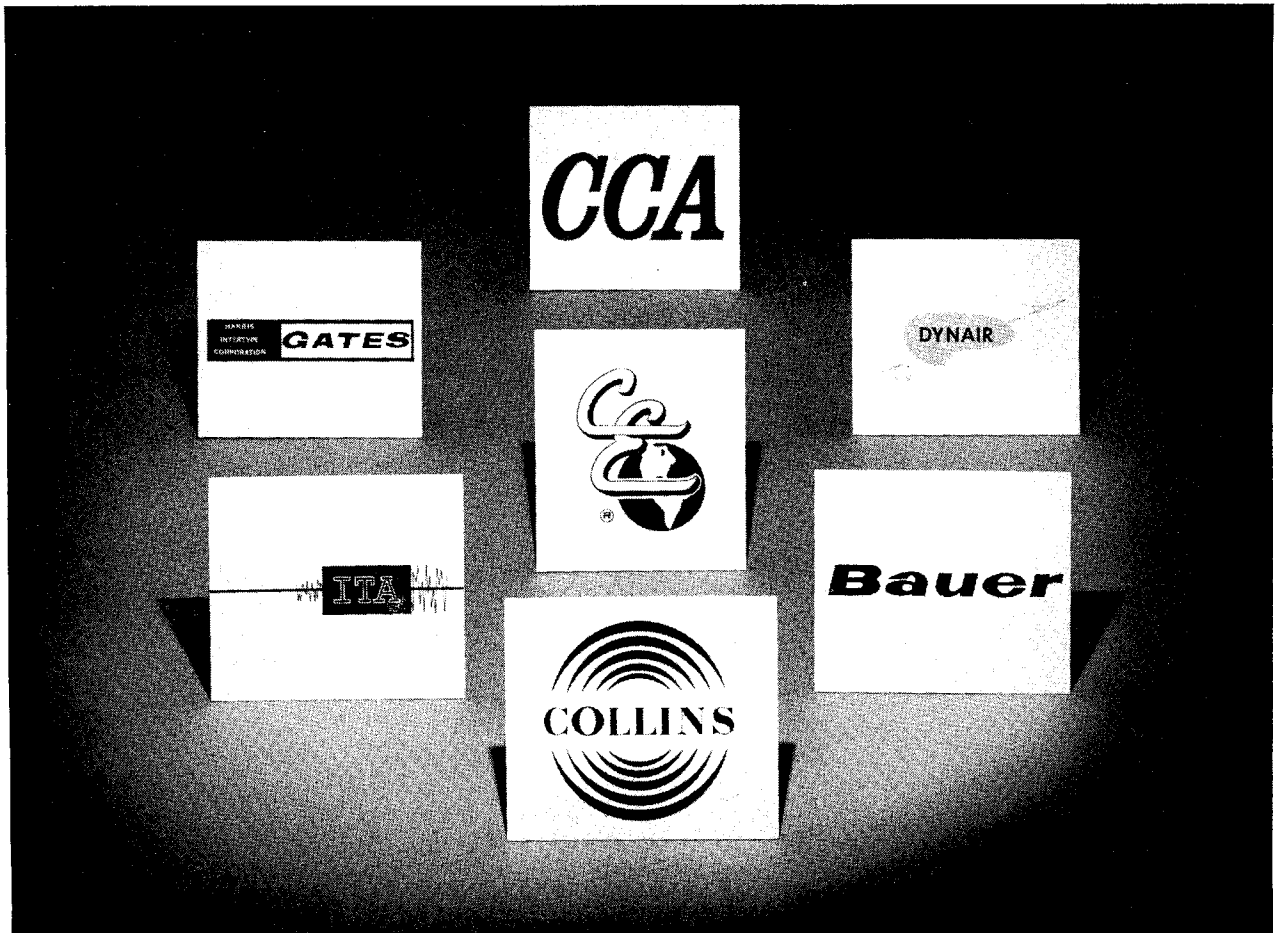

A SURVEY OF RECORDING AND BROADCAST ENGINEERS IS THE SECRET BEHIND THE NEW ALTEC 470A AMPLIFIER & 550A POWER SUPPLY

Before we did anything else, we surveyed hundreds of recording and broadcast engineers. Guided by the results, we built the 470A Amplifier and the 550A Power Supply. They provide both the size and capabilities you asked for. And the versatile 470A can serve as a preamp or line, booster, and program amp with no internal changes needed!

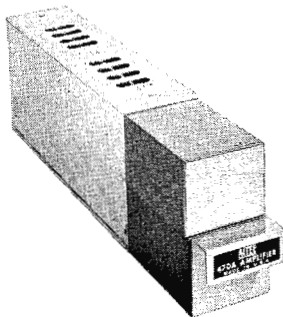

NO SACRIFICES FOR THE SAKE OF MINIATURIZATION

Most of you felt that miniaturization had gone too far. So the Altec 470A Amplifier is slightly larger than some "subminiature" models. But you'll still get eight in a 19" rack and occupy only 3½" height. That size difference you requested will help with the age-old heat problem with all the attendant damage. Another thing, the modern, all-silicon solid state design is rugged, compact and fully enclosed. Inputs and outputs are completely isolated. And larger "plug-in" connectors simplify wiring and circuit tracing; easier to connect and solder. Its sensible size makes it easier to maintain and service, too. On top of that, the Altec 470A Amplifier has a lower noise level than any tube amplifier designed for this function. And, it excels in patching applications because it is unaffected by length of transmission lines (over 100 feet fore and aft)!

CHECK THESE SPECS— YOU'LL LIKE THEM:

GAIN: 45 db (input terminated); FREQUENCY RESPONSE: ±0.5 db, 20-20,000 cps; POWER OUTPUT: +27 dbm max., 20-20,000 cps; DISTORTION: Less than 1% THD, 20-20,000 cps, with +27 dbm output; NOISE LEVEL (unweighted, 10 cycles to 25 kc band-pass): Equivalent input noise, -127 dbm (input un-terminated); OVERLOAD RECOVERY TIME: 5 micro-seconds for 100% overload.

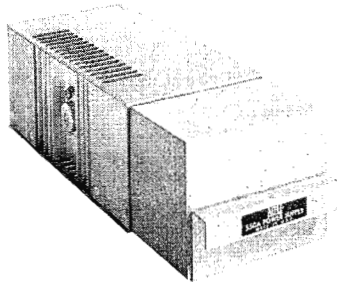

ALTEC 550A POWER SUPPLY ASSURES TROUBLE-FREE OPERATION

An all solid state device, the Altec 550A can power up to fifteen 470A amplifiers at full output. The design includes an external sensing circuit to insure that the output voltage will remain constant regardless of line voltage fluctuations. Output ripple and noise is only 200 microvolts under the full 2 amp load.

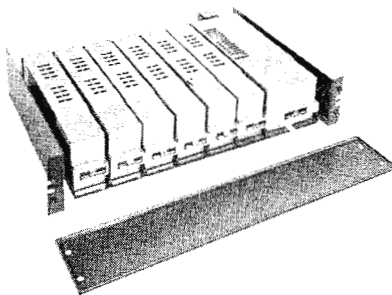

ACCESSORIES:

ALTEC 850A AND 852A TRAYS— Needed for mounting 470A and 550A whether in rack, console or bench use. Gold-plated receptacle permits instant plug-in of amp or power supply.

ALTEC 800A MOUNTING FRAME— Accommodates up to eight 470A Amplifiers in 850A Mounting Trays or a combination of amplifiers and power supplies.

Now in production! Altec new 61A and 63A Program Equalizers and three variable filters: 67A high and low pass, 68A low pass, 69A high pass will be ready for delivery soon. Write for complete specifications.

low-impedance winding was connected to J2.

Inspection of the diagram shows that S1 now serves to connect either T or T1 to the VU meter and the line and PA output circuits. With the switch in what formerly was the talk position, the remote unit operates normally. With the switch in the former listen position, a high-level, low-impedance output (for example, the speaker output of a portable tape recorder) can be fed to the line and the level monitored with the VU meter; the speaker output is simply fed into J2. (This modification also works for the Gates Model CB65.)

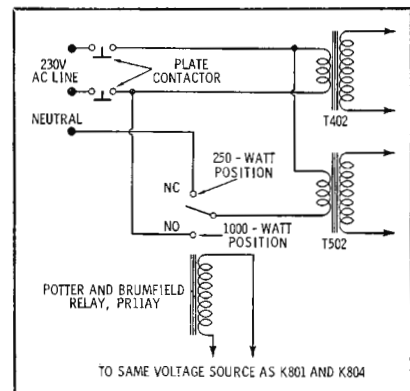

POWER CUT-BACK MODIFICATION

by Charles M. Sparks, Chief Engineer, WCRS, Greenwood, S. C.

By making this simple modification to the power cut-back arrangement in our RCA BTA-1R transmitter, we have eliminated the eight large, heat-producing dropping resistors and two high-voltage relays. The transmitter now runs much cooler, efficiency is increased, and power-change failures have all but been eliminated, since only one relay does the job that formerly required ten component parts.

As shown in the diagram, the modification causes power to be reduced by changing the AC voltage applied to the primary of the high-voltage supply transformer (T502) from 230 volts for 1000 watts output to 115 volts for 250 watts output. This is done by installing an SPDT relay at any convenient location in the space formerly occupied by the large power-change unit. The relay we used at WCRS is a Potter & Brumfield type PR11AY.

• Please turn to page 48

For Technical Literature or Ordering Information, Write to: AUDIO CONTROLS DIV.



ALTEC LANSING CORPORATION

LTV A Subsidiary of Ling-Temco-Vought, Inc.
©1964 ALTEC LANSING CORPORATION ANAHEIM, CALIFORNIA

Circle Item 103 on Tech Data Card

MICROWAVE ASSOCIATES, INC.

BURLINGTON, MASS. • WESTERN UNION FAX
TWX: 617-272-1492 • TEL: 617-272-3000

Overseas Sales: Microwave Associates International, Inc.
Burlington, Massachusetts

United Kingdom Sales: Microwave Associates, Ltd.
Cradock Road, Luton, Beds, England

A new breed of solid state, mobile, relay equipment is now fully operational at major TV networks. This unique equipment brings live TV field coverage within range of every broadcaster. ■ A rugged, weatherproof transmitter the size of a lunchbox transmits audio and video 12 miles without boosters. The receiver is smaller than a home portable TV set. ■ Instant reception without warmup on any of 7 channels, total relay power consumption less than 50 watts, lightweight TWT boosters for extended range — all facilitate news wagon, helicopter — yes, even foot coverage. Full accessories, including highly portable camera, available. ■ 2 Gc and 7 Gc now. 13 Gc soon.



WE INTERRUPT THIS PROGRAM TO BRING YOU...LIVE.....



December, 1964



Circle Item 104 on Tech Data Card

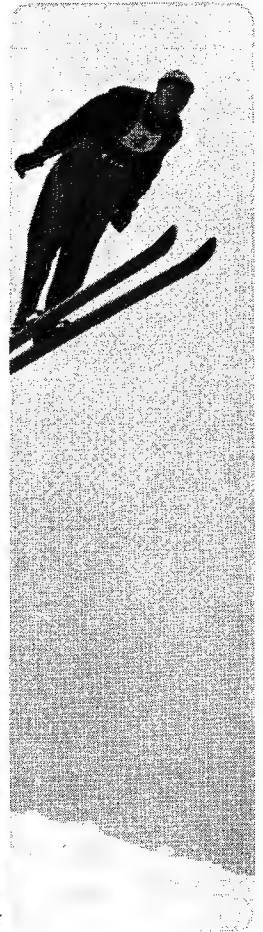

AUDIO TAPE EQUIPMENT

by **Thomas R. Haskett**, Consulting
Author, Haskett & Volkman,
Cincinnati, Ohio—Part I. The beginning
of a thorough three-part analysis
of modern sound recorders for the
broadcast industry.

The world's first magnetic recorder was called the **Telegraphone**. It used wire, and was built in 1898 by Valdemar Poulsen in Copenhagen.

The first **tape** recorder seems to have been the British Blattnerphone, developed in the 1920's. However, it used steel tape, as did the first U.S. tape machine—the Brush **Soundmirror** of the 1930's. Both had poor frequency response and were chiefly novelties.

In the 30's the Germans developed the **Magnetophone**, but the most significant development came later. By the close of World War II, the Germans had developed a relatively sophisticated version of the Magnetophone, utilizing oxide-coated, plastic-backed tape; they obtained response to 10 kc using a speed of 30 ips. This speed became the first standard, and all speeds since then have been multiples or submultiples of it. Shortly thereafter, Ampex, Magnecord, and Rangertone produced limited quantities of the first professional recorders in this country. Today, nearly a hundred firms manufacture commercial audio machines of great versatility and technical quality. These modern machines fall into several groups by use and function.

Standard Studio Recorders

Historically the first machines developed, studio recorders remain today the best available for audio work. Also called **reel-to-reel** recorders (by contrast with cartridge recorders), they are employed for original recording and dubbing where quality of finished product must be high and the work load is great.

They are more likely to be found in recording studios, but broadcasters use them, too. Although some stations use the same control room

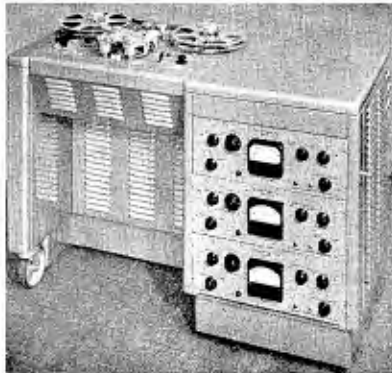

Machine with wheels for easy moving.

for both air and recording, because of studio recorders' high cost and continuous use, they are usually installed in a separate recording control room. Remote controls permit their takeover by master control.

While designed for permanent installation and for operation from AC lines, studio recorders are usually rugged enough to be made portable and taken to locations where excellent fidelity is important. Also, they are often mounted in consoles with wheels, so they can be moved easily from one control room to another.

Characteristics

Generally, conventional transport mechanisms and electronic layouts are used. In addition to high reliability and stringent electronic and mechanical standards, certain features are common to all—they meet NAB standards and provide: 10½" reel capacity; both 15 and

7½ ips speeds (some also have 30, 3¾, or 1⅞ ips); 3 motors, including a hysteresis-synchronous type driving the capstan; VU meter(s); ¼" tape width (a few also accept ½", ¾", or 1" tapes); tape motion controlled by push buttons, relays, and solenoids; separate control of tape tension for 10½" and 7" reels; separate heads for erase, record, and playback; separate amplifiers for recording and playback, allowing source or tape monitoring; recording-function indicator lamp; automatic motor shutoff when tape breaks or runs out.

In addition, most models include: record-function interlock; tape lifters, which remove tape from heads during high-speed shuttling (fast forward or rewind); forced-air cooling of the transport; headphone monitor jack; at least two inputs—low-impedance mike and high-impedance bridging; 600-ohm balanced output in range of 0 to +20 VU. Most provide adjustments and metering for bias current and equalization. While all employ the NAB characteristic, which furnishes treble boost in recording and bass boost in playback, NAB standards are for full-track mono, and make no provision for stereo. Hence, most recorders permit the user to optimize equalization according to use.

These machines are generally available in mono and stereo with half track, full track, two quarter tracks, two half tracks, and three and four tracks. One model is available with eight tracks. Frequency response at 15 ips is generally ± 2 db from about 30 to 18,000 cps. Typically, harmonic distortion is approximately 1%, stereo separation (crosstalk) from 40 to 50 db, full-track signal-to-noise ratio is 50 to 60 db, flutter and wow less than 1%, timing accuracy $\pm .2\%$, and almost all have remote control avail-

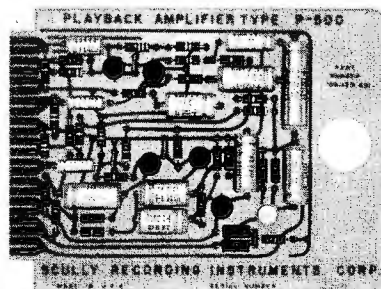

Example of a recorder electronic module.

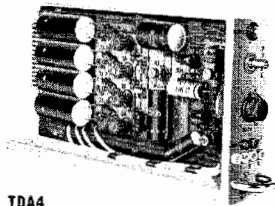

TDA4
Plug-in Video/Pulse
Distribution Amplifier



TDA2 Video/Pulse Distribution Amplifier

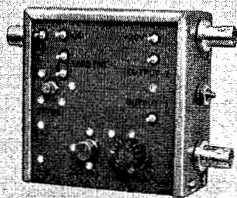

TCA3
Camera Amplifier



TCA7 Color Camera Amplifier



TDA26
High Gain Video Amplifier

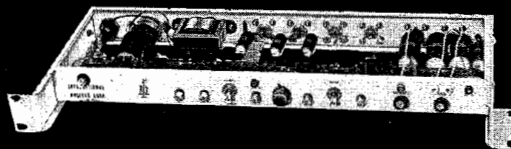

TDA5 Balanced/Unbalanced, Video/Pulse Distribution Amplifier

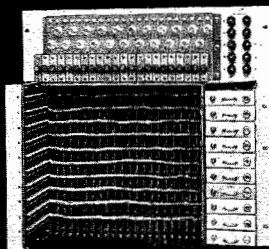

VS22-10 Video
Crossbar Switcher

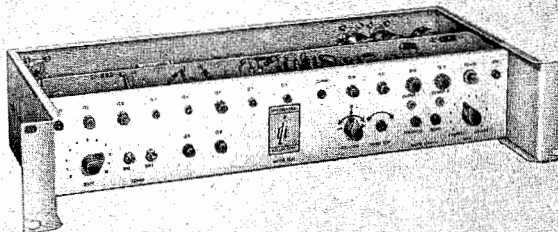

TSA1 Clamping/Equalizing Video Amplifier

Leading the Industry in Transistorization

Our goal is to make available reliable, modern instruments built to last virtually forever.

Our design criteria are precision, versatility, flexibility, simplicity, compactness and ease of maintenance in every piece of television equipment bearing the International Nuclear trademark.



Write for complete specifications and details to Department C.

INTERNATIONAL NUCLEAR CORPORATION

608 NORRIS AVENUE

NASHVILLE 4, TENN.

UP- DATE

YOUR OLD 3"

R.C.A. / IMAGE
G.E. / ORTHICON
DUMONT / T.V. CAMERA
MARCONI & OTHERS



with a



3" IMAGE ORTHICON DEFLECTION YOKE

(Part No. OY-64)

- Flatter Field
- Sharper Corners
- Improved Resolution
- Quieter Image Section
- Better Cooling for Longer Tube Life

and 3" IMAGE ORTHICON ALIGNMENT COIL

(Part No. OA-3)



Write today to:

CLEVELAND ELECTRONICS, INC.
1975 East 61st St. • Cleveland, Ohio 44103

Another quality product by
Cletron... Manufacturers of Deflection
Components, Custom Transformers
and Sound Reproducing Devices
Circle Item 16 on Tech Data Card

able. Prices vary from \$730 through \$10,000.

Note: By NAB standards, signal-to-noise ratio is measured from the 2% distortion point of a 400-cps tone. Some machines, however, are rated from the 3% point; this is roughly equivalent to a 3-db increase in S/N over that measured from the 2% point.

Special Features

One new machine uses military-grade nuvistors to achieve a high S/N—70 db. Another has provision for switching any record head to temporary playback during recording, thus allowing sound-on-sound and other special effects. At least four manufacturers offer transistors in the electronic sections. Manual cueing and editing are offered on several models. One unit comes with tape-marking and cutting accessories, and a running-time meter. Another uses an instrumentation-type head-wind to obtain minimum flutter. Still another uses plug-in module boards.

A recently-developed accessory permits changing the playback speed of a tape without altering pitch of the recorded signals. Speed range is from 50% to 180% of normal. It uses a multiple-head assembly which rotates in the direction of tape travel; thus reel-to-reel tape speed may be varied while the rotating assembly holds head-to-tape speed constant.

Considerations

Some confusion exists among users as to head mounting and contour in tape recorders. Figs. 1 and 2 will help clarify the various forms. The **straight-line** mount is illustrated in Fig. 1A. Pressure pads are required to maintain intimate tape-to-head contact. But this system causes rapid head wear, oxide build-up on heads and pads (which affects frequency response), and vertical walking or riding of the tape. At Fig. 1B, the more common method — **radial** mounting — is shown; the tape's own tension is used to maintain contact, no pads are required, and there is less likelihood of tape misalignment. However, the tension required for proper contact can be critical.

Fig. 2 illustrates the two general types of head contour. It's obvious that the hyperbolic shape permits less head-to-tape contact than the

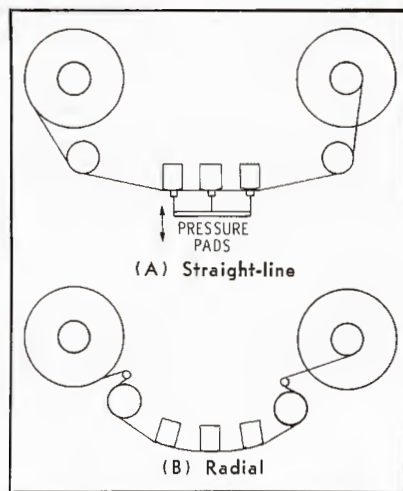

Fig. 1. Head-mounting arrangements.

cylindrical one. For this reason, the hyperbolic is preferable, as less tension is required to maintain the necessary contact without pads. This also minimizes wear, of course. There is one problem with the hyperbolic-contour, radial-mount head system—tape lifters must be used to remove the tape from the heads during high-speed shuttling, or extreme wear will result.

One problem often associated with a studio recorder is mechanical: Obviously, speed variations (wow and flutter) must be held to a minimum if the output signal is to be an accurate copy of the input. But a machine with a low flutter figure often applies high stress to tape during shuttling. For precise applications, you might best use such a recorder only for recording or playback, rewinding on a separate device.

Furthermore, low flutter, though desirable, isn't the only criterion in a high-quality tape system. Overall performance is limited as much by electronic circuitry as by any mechanical requirements. Pushing practical limits too far can result in a fussy machine that requires constant attention and adjustment.

Standard AC Portables

Just as some TV stations, for flexibility in operation, begin operations with remote gear, many a radio (and TV) station purchases

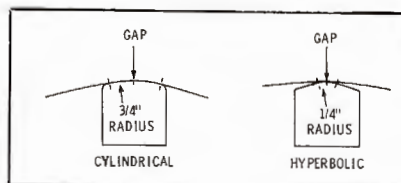

Fig. 2. Contours of tape-recording heads.



FIRST LOW COST AUTOMATED SOLID-STATE

MASTER CONTROL SWITCHING PACKAGE

...eliminates switching chaos and possibility of error during station breaks

The VSA-102 Switching Package is a highly sophisticated yet simplified system that switches from event to event by merely pressing the "Take Bar".

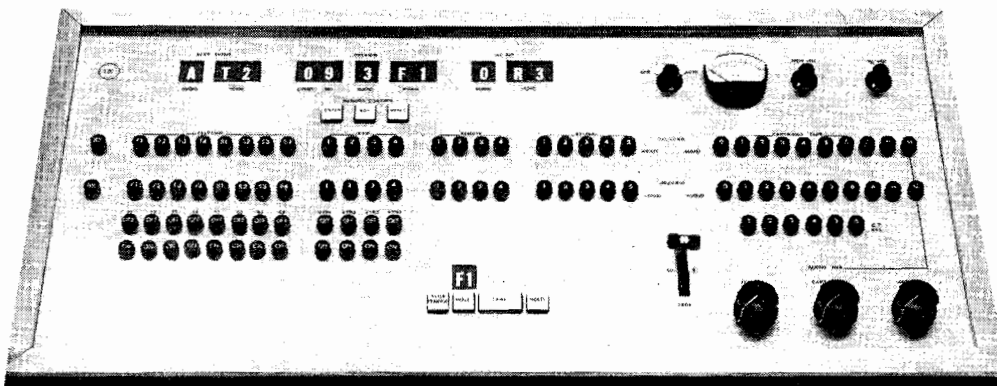

NEW ALL SOLID-STATE MASTER CONTROL SWITCHING PACKAGE FEATURES:

- 18 AUDIO/VIDEO COMPOSITE OR NON-COMPOSITE INPUTS, PLUS 8 AUDIO ONLY INPUTS
- AUDIO MIXING AND AUDIO FADES
- STEPPING SWITCH MEMORY PERMITS STORAGE OF UP TO 12 EVENTS
- SIMPLE LOADING FROM PREVIEW BUS
- 2 ADJUSTABLE PREROLL TIMERS
- READ OUT PANELS FOR NEXT PREVIEW AND ON-AIR AUDIO-VIDEO EVENTS
- EASILY ADAPTED TO VIDEO PROGRAMMER
- SYSTEM COMPLETELY WIRED AND FACTORY TESTED, READY FOR OPERATION

PACKAGE INCLUDES FOLLOWING EQUIPMENT:

- | | |
|---|--|
| <ul style="list-style-type: none"> — 18 x 2 VIDEO SWITCHER — 27 x 2 AUDIO SWITCHER — SIGNAL PROCESSING AMPLIFIER — 2 AUDIO LINE AMPLIFIERS — 2 AUDIO MONITOR AMPLIFIERS — 1 CBS AUDIMAX | <ul style="list-style-type: none"> — 12 EVENT 18 SOURCE VIDEO MEMORY UNIT — 12 EVENT 8 SOURCE AUDIO MEMORY UNIT — CONTROL PANEL COMPLETE WITH TWO MULTIPLEXER CONTROL CABLES & TWO VIDEO TAPE CONTROL CABLES — 84" MOUNTING RACK |
|---|--|

Write for complete information and specifications

WARD ELECTRONIC INDUSTRIES, Inc.

P. O. BOX 1045, MOUNTAINSIDE, N. J. • (201)-232-1167

Circle Item 17 on Tech Data Card

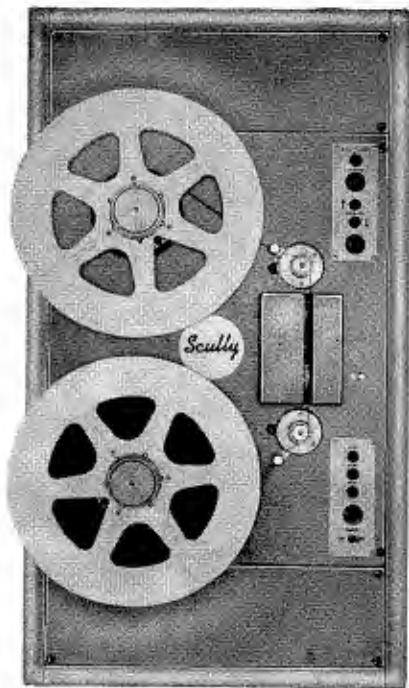

SCULLY 270 ... the Professional Tape Player for Broadcast Pros!

The extra-heavy duty transistorized tape playback unit that was designed for broadcasters . . . and is setting new endurance and performance records. The 270 is crafted in the traditional Scully manner for long life and truly professional operation.

Write for the name of the nearest distributor . . . and you will also receive data on the Scully 280 solid state recorder/reproducer.

SCULLY
Recording Instruments Corp.
480 BUNNELL STREET
BRIDGEPORT, CONNECTICUT

EXPORT DIVISION . . .
13 E. 40TH STREET
NEW YORK, NEW YORK
Circle Item 18 on Tech Data Card

an AC-operated portable as its first (or only) audio tape recorder. Portables cost less than studio console models, have many of the same operating conveniences, and frequently come close to the same specifications; some can be rack mounted. The chief disadvantage of a portable is that it generally isn't built to withstand continuous use.

AC portables are often used for on-location taping of church services, band concerts, and variety shows. Frequency and distortion requirements are important in such service, and this class of recorders must be as nearly like studio machines as possible, yet transportable.

Another common service for portables is telephone beeper work in the studio or newsroom. Many stations rack-mount portables for this job, saving their console machines for spots and music and using battery portables for on-the-scene news.

The typical beeper-phone furnishes voice signals ranging around -40 to -20 VU. Although most recorder inputs can easily handle such signals, it's often helpful to go through a compressor or AGC amplifier and then into the recorder. Levels vary in a beeped conversation, depending on phone-line quality, LD or toll-circuit amplifiers, and weather effects. The studio voice is generally louder; if the beeper is fed first to an AGC amplifier, unpleasant level variations can be practically eliminated.

Characteristics

Since these machines are professional portables, they meet NAB standards, some of which are: S/N no less than 55 db; flutter and wow not to exceed .2%. The most critical factor seems to be equalization; obviously, this must be the same on all machines in the studio if tapes are to be compatible. Most professional recorders use NAB equalization; but, as we said earlier, this standard applies only to mono.

Common features: stereo and monaural full, half, or quarter track; 15 and $7\frac{1}{2}$ or $7\frac{1}{2}$ and $3\frac{3}{4}$ ips speeds; $\frac{1}{4}$ " tape; VU meter(s); hysteresis-synchronous motor driving capstan (and some with three motors); recording-function indicator lamp; two inputs—mike and line. Output is approximately $+4$ VU at 600 ohms balanced, unless a cathode follower is used. In addition,



A portable, AC-operated tape recorder.

tion, most have a front-panel headphone monitoring jack. Frequency response averages ± 2 db 40-12,000 cps, timing accuracy is .2%, and reel capacity is usually 7", although a few will handle $10\frac{1}{2}$ ". Three heads are generally used (sometimes four), and remote-control facilities are often available. Prices range from \$525 to \$1255.

Some AC-portable recorders have balanced inputs and outputs; others don't. For those in which a low-impedance cathode follower is used, it's best to add a small 600-to-600 ohm isolating output transformer, as 95% of the time the unit will feed a 600-ohm line. The line input should also be balanced—and preferably padded for bridging, to avoid loading lines. Sometimes it's necessary to use the mike input to make up for loss in the bridging pad. Fig. 3 shows details of input and output pads.

Special Features

Most machines in the AC portable class permit simultaneous monitoring of what's on the tape a split second after it's recorded. This is the simplest, fastest, and surest operational proof of any recording session, and is the major advantage of having the third head. However,

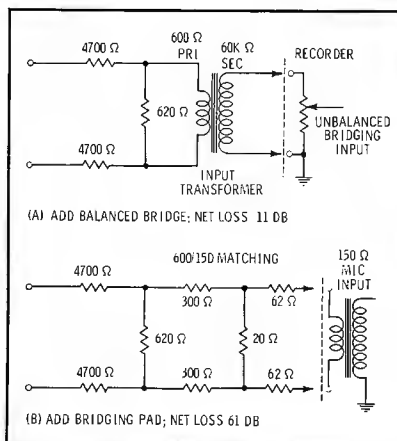
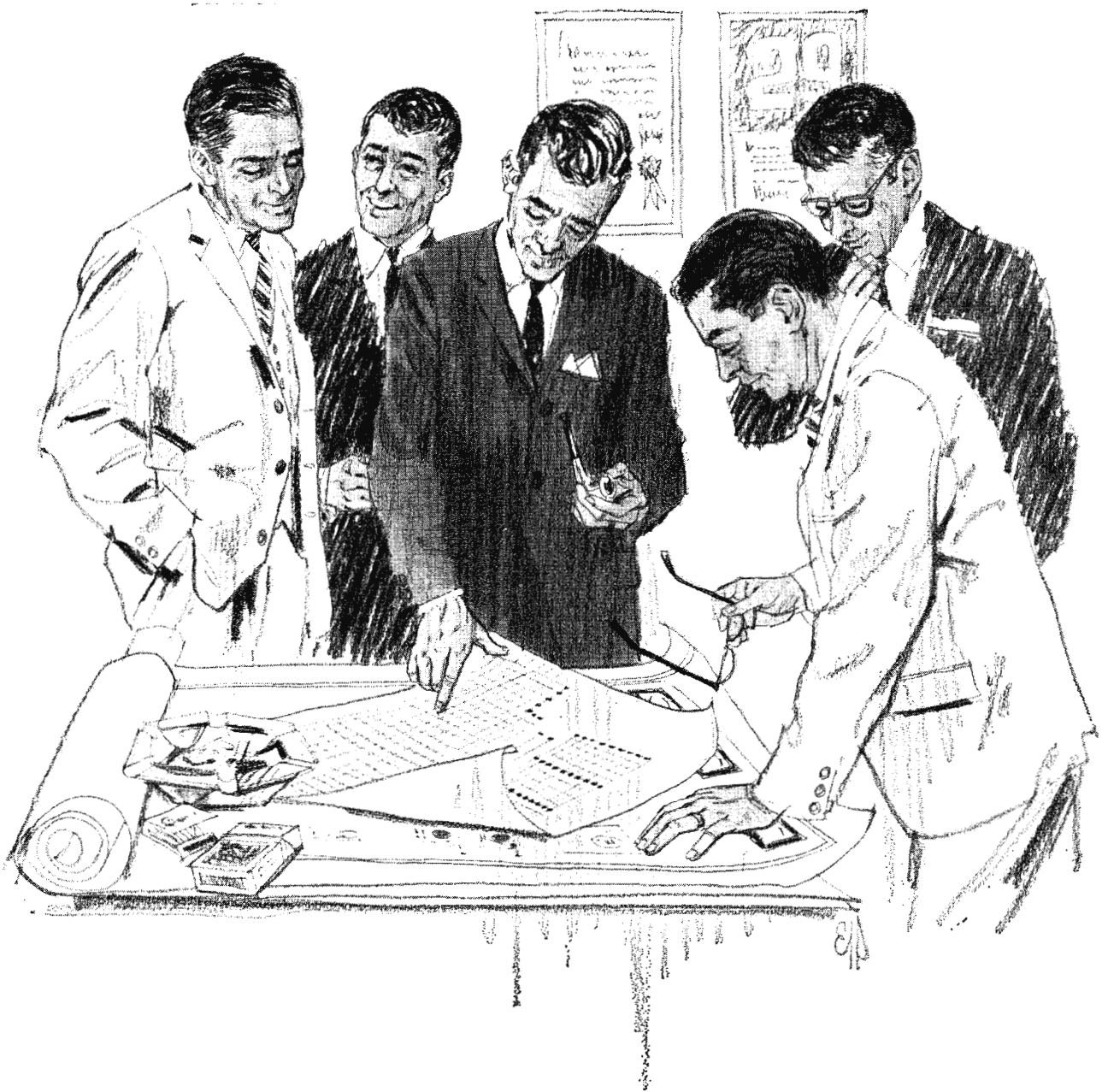

Fig. 3. Pads for adding a balanced input.



Odds Are—The Choice Will Be Tarzian for Elaborate New Switching Facilities

Why? Start with a proven system capability. In recent years, Sarkes Tarzian, Inc. has developed some of the most sophisticated switching complexes in the exciting world of television. Complicated master switching control systems, multiple studio controls, remote controls, automated control systems, delegation systems—each custom designed to fulfill an individual station's specific requirements. Each proving an impressive technical

competence. Tarzian's modular concept permits notable flexibility in planning. Solid state design delivers total reliability—dependable, maintenance-free performance.

Why not translate this technical competence into increased programming capability and smoother broadcast operation for your station? Complete system engineering is available if desired.

S A R K E S  **T A R Z I A N**
BROADCAST EQUIPMENT DIVISION BLOOMINGTON, INDIANA

Circle Item 19 on Tech Data Card

there's another desirable feature of a three-head machine—better performance. Instead of a single head having to function for both recording and playback, each head can be designed to do its different job most efficiently. Thus, the playback head has many turns of wire, giving maximum output—it's a voltage-operated device. The record head, on the other hand, has fewer turns—it's a current-operated device. Also, there is a difference in head gaps. The playback head, in order to reproduce high frequencies accurately, should have a very small gap. In a recording head, however, the gap can be larger for the same frequency response.

Early binaural and stereo recorders used two half-tracks and staggered heads. This system is largely obsolete, having been superseded by inline heads. However, both half- and quarter-track tapes are still used in practice. Though professional requirements would seem to demand half-track, the wide marketing of prerecorded quarter-track stereo tapes causes many stations to equip for both systems. Half-

track stereo uses all the tape width in one direction, while quarter-track uses only half the width (but split) each way. Other differences are minor. In many cases, recorders in this class can play back quarter-track stereo, though they cannot record the same. All stereo machines can record and play back mono.

Hyperbolic heads and tape lifters are found on many portables, as is an auto-shutoff arm. This latter is a device like the old railroad deadman switch in the locomotive cab—it has to be held on for the mechanism to operate. Tape threaded past the arm applies tension; if the tape breaks or runs out, motor power is killed.

For professional applications, pushbutton-solenoid transport operation is preferable to lever devices, because reliability is greater under continuous and possibly hurried use. Solid-state electronics, often on plug-in boards, plug-in heads, and instant-stop pause or edit buttons, are additional features of some recorders in this class.

While any three-head machine can be patched through a console

to provide echo/reverb effect, some recorders have integral switching or mixing of the playback signal for this purpose. This feature also permits what is called **sound-on-sound**—dubbing from one track to another with mike over, a la Les Paul & Mary Ford—that has some application where studio facilities are limited. **Sound-with-sound** means playback of one track while recording with the other, but with no connection between the two.

Another new feature on some machines is automatic playback reversing at end of reel. Sometimes this is done by a PE cell, sometimes by a metal-foil contact. Direction of tape motion is reversed, and heads are switched (to play opposite tracks).

Yet to Come

The second portion of this series will tell of battery portables and cartridge machines. The former are especially useful to the engineer working outside the studio on radio and TV-film coverages. The latter leads naturally into the third part—tape-machine automation.

... to be continued ▲

Spotmaster

NEW 500 SERIES ... World's Most Advanced Cartridge Tape Equipment

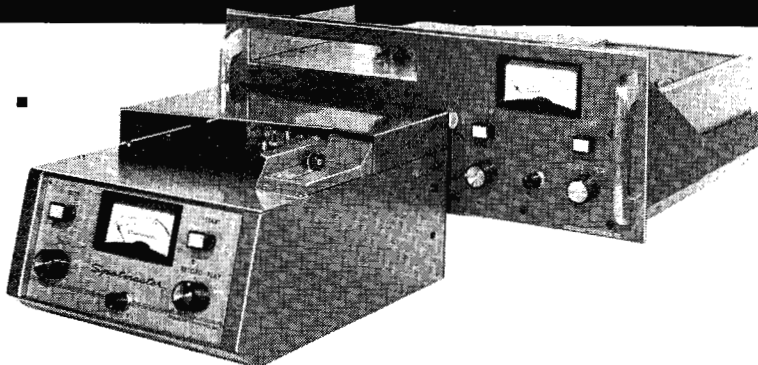

From the established leader in tape cartridge systems—SPOTMASTER—comes today's most advanced units, the 500B series. Featuring all-modular, all-solid-state design and your choice of 1, 2 or 3 automatic electronic cuing tones, the 500B continues the SPOTMASTER tradition of superior quality at sensible prices.

Check these other SPOTMASTER features:

- Meets or exceeds all existing and proposed NAB standards.
- Separate record and reproduce heads. A-B monitoring. Biased cue recording. Zener controlled power supply.
- Popular 500A series, today serving over 1,000 sta-

tions world-wide, now available at new low prices.

- 14 models match every programming need: recorder-playback and playback-only... compact and rack-mount... monophonic and stereo.
- Delayed Programming option permits instant deletion of objectionable material from live originations.
- Heavy duty construction throughout, with rugged hysteresis synchronous motors, top specs and performance.
- Lease/purchase option. Ironclad guarantee for one full year.

Write for complete information:

BROADCAST ELECTRONICS, INC.

3800 Brookville Rd., Silver Spring, Md. JU 8-4983 (301)



Circle Item 20 on Tech Data Card



Upper trace displays a composite LEFT only signal, including the 19 kc/s pilot carrier. Lower trace presents the 38 kc/s L-R subcarrier.

peak stereo performance
for FM STATIONS
with the aid of a Tektronix Oscilloscope



At Moseley Associates, Inc., an engineer uses a Tektronix Type 561A Oscilloscope to check performance characteristics of their FM Stereo Generator and Ten Watt FM Transmitter.

Making adjustments and observing the waveform displays, the engineer tests generator/transmitter operation quickly and conveniently, monitors equipment performance simply and reliably, and thus effectively evaluates operational features of the stereo instrumentation. High in performance, moderate in cost, the Type 561A ideally suits test applications of the FM Stereo Broadcaster.

Whatever your broadcast equipment test needs, the Type 561A can very likely meet them.

You can use any of 17 amplifier and time-base plug-in units for many different types of application.

You can display single or multi-trace presentations.

You can observe no-parallax displays and sharp trace photography over the full 8-cm by 10-cm viewing area. For the crt has an internal graticule with controllable edge lighting.

Type 561A Oscilloscope \$500
 Plug-Ins illustrated

Type 3A1 Dual-Trace Unit \$450

Type 2B67 Time-Base Unit \$210
 15 other plug-ins available.

For rack mounting, in 7 inches of standard rack height, order Type RM561A \$550

U. S. Sales Prices f.o.b. Beaverton, Oregon
 oscilloscope prices without plug-in units

For your test needs, there is a Tektronix Oscilloscope to fit every quality-assurance program—and comprehensive field services to back up every instrument. For information, call your Tektronix Field Engineer or representative now.

Tektronix, Inc.

P. O. BOX 500 • BEAVERTON, OREGON 97005
 Phone: JA 119 • Code 6031 Mitchell 4-0161
 Telex: 036 691 • TWX 503-291-6805
 Cable: TEKTRONIX

OVERSEAS DISTRIBUTORS IN 25 COUNTRIES
 TEKTRONIX FIELD OFFICES in principal cities
 in United States. Consult Telephone Directory.

Tektronix Australia Pty. Ltd., Melbourne, Sydney,
 Tektronix Canada Ltd., Montreal, Toronto,
 Tektronix International A.G., Zug, Switzerland,
 Tektronix Ltd., Ipswich, C-1,
 Tektronix U. K. Ltd., Harpenden, Hert-

Circle Item 21 on Tech Data Card

Norsk Rikskringkasting

by Hans Richter, Consulting Author,
Stockholm, Sweden—A report on radio
and television broadcasting in Norway.

Norwegian Broadcasting Corp. is an independent institution, formed by the Broadcasting Act of June 24, 1933. The institution has the exclusive right to erect and operate broadcasting stations within Norwegian territory for spreading words, music, pictures, and the like. The institution is governed by a board of five members, appointed by H.M. the King. A Broadcasting Council of 23 members, of whom 12 are chosen by the Parliament and the others appointed by the King, acts as an advisory group. This group represents various parts of the country, enlisting people who are well acquainted with the cultural and economic life of the country. The Broadcasting Council meets twice a year. The transmitters and the national distribution network are in the hands of the Administration of Telegraphs, which reports to the Ministry of Public Communication. The technical department of NRK is responsible for technical production facilities in the studios or elsewhere, for recordings and the like. This department is administered by NRK itself.

Soundbroadcasting

It is the duty of NRK to furnish programs of educational, cultural, and entertaining character, as well as news bulletins. For this purpose, the program department is subdivided into a number of sections:

1. News bulletins, short talks, or interviews on events of the day.
2. News and commentaries on foreign political and economic affairs—short-wave service intended particularly for Norwegians at sea or abroad.
3. Educational section, lectures, talks, etc., comprising school broadcasting and children's hours.
4. Dramas, plays, etc.
5. Music.
6. Entertainment (light programs).

A program secretariat collects the various programs prepared by the regular staff of the department. Furthermore, there are regional centers to take care of the program work in various parts of the country, such as Kristiansand, Stavanger, Bergen, Alesund, Trondheim, Bodo, Tromso, and Vadso, each covering the surrounding districts. These regional centers provide items of local character for the national program and take care of separate local transmissions. Local program councils, each consisting of four members appointed by the Minister of Education, assist the program secretaries

in their work to build up programs of local character.

The number of persons engaged daily in soundbroadcasting and television is about 1100. At present, there are in operation 32 sound broadcasting stations in the long- and medium-wave bands, 7 shortwave transmitters, 58 VHF transmitters, and 10 stations transmitting via power lines. Norway offers very unfavorable propagation conditions for a broadcasting service, and the task of providing good reception for all listeners requires considerable expense. The chief revenue of the Norsk Rikskringkasting comes from receiver license fees; the fee is now 40 kroner a year for sound only. License fees are collected and controlled by the broadcasting corporation itself, payments being made by mail, and a license card is issued as proof of payment. A license is valid for one household only, but this household may possess as many receiving sets as it desires for its own use, including car radios. The current number of radio licenses is 1.04 million. Further revenues are collected through a stamp duty on receiving sets and parts at the rate of approximately 10% of the retail price, purchase tax not included.

Television

The first experimental television transmissions in Norway started in 1954 from a small transmitter at Tryvasshogda, a hill near Oslo. The first steps towards Norwegian television were taken in 1950, when the Board of the Norwegian Broadcasting Corporation appointed a Television Committee to examine the technical and economic possibilities for television in Norway. In the autumn of 1951, the Television Committee submitted its recommendation, the conclusion of which contained a proposal to the effect that experimental transmissions ought to be continued for some years to obtain experience. The Board adopted the proposal, and in January 1953 the Storting (Norwegian Parliament) decided that experimental transmissions be performed for two years till the question of permanent Norwegian television be brought up. In February 1953, the Board appointed a Working Party to deal with test transmissions and gather experience. Besides, this Working Party should analyze technical and economic conditions for Norwegian TV and, if the possibilities should prove favorable, submit a national plan for a TV network, TV studios, radiolinks, and transmitters. The Working Party worked out a recommendation in

August of 1956, and the plan was adopted by both the Board and the Telecommunication Administration. In June 1957, the Storting decided to start a regular television service in Norway and that the development should follow the Working Party's recommendation. At present, radio-links for program distribution are being operated over the distance from Oslo to Bergen, with branches to Stavanger, Trondheim, and Kristiansand. Oslo, Kongsberg, Kristiansand, Nordhuc, Bergen, Stavanger, and Trondheim have permanent transmitters. Small transmitters (satellites) will fill the "holes" that occur in the coverage areas of the larger transmitters.

Two studios, a storeroom for scenery and properties, room for technical equipment, workshop, make-up room, etc., were put into use in the autumn of 1959. Apart from the outside (mobile) TV broadcasts, most program production has taken place in these studios. The first mobile broadcasting unit (with three cameras) was procured in the spring of 1959. As the radiolink network is finished, it will be possible to transmit live reports on current events from various parts of the country. To take advantage of these facilities, another outside broadcasting unit for TV was purchased in the spring of 1962. This unit, like the first one, consists of two vans, but they are larger and are equipped with four cameras.

The weekly programs now amount to some 22 hours, including Nordvision, Eurovision, and Intervision, which amount to about 4½ hours per week. Five TV recording machines are in constant use. Also, quite a lot of film is incorporated in the programs or shown as feature films. Norwegian TV was connected to the Eurovision network in 1959 via a radiolink between Oslo and Karlstad, Sweden. October 1959 has also been marked as the inauguration date for Nordvision, the special Scandinavian TV cooperation.

The population in the areas now covered by television is some 2.4 millions, and the number of TV receiver licenses has now passed 300,000. The TV license fee costs 125 kroner a year, in addition to the radio license.

A link between Oslo and Kristiansand was put into operation in 1963, making two different program routes between the eastern and western parts of the country—the inland link which is now in use and the link along the coast. Between Bergen and Trondheim (along the coast), construction work on another is practically finished. A provisional radio link along parts of this route feeds transmitters at Kristiansand and Alesund, and the permanent link will soon be ready. In northern Norway, work is almost done on the Trondheim-Bodo link. The first transmitters to the north of Trondelag will be fed with programs from this link.

A continuation further from Bodo will be effectuated in the course of the three-year period 1966-69. Plans for a new TV house are now ready, and the foundation work of the TV Center was started this past summer. ▲

Telechrome* SOLID STATE TV SPECIAL EFFECTS

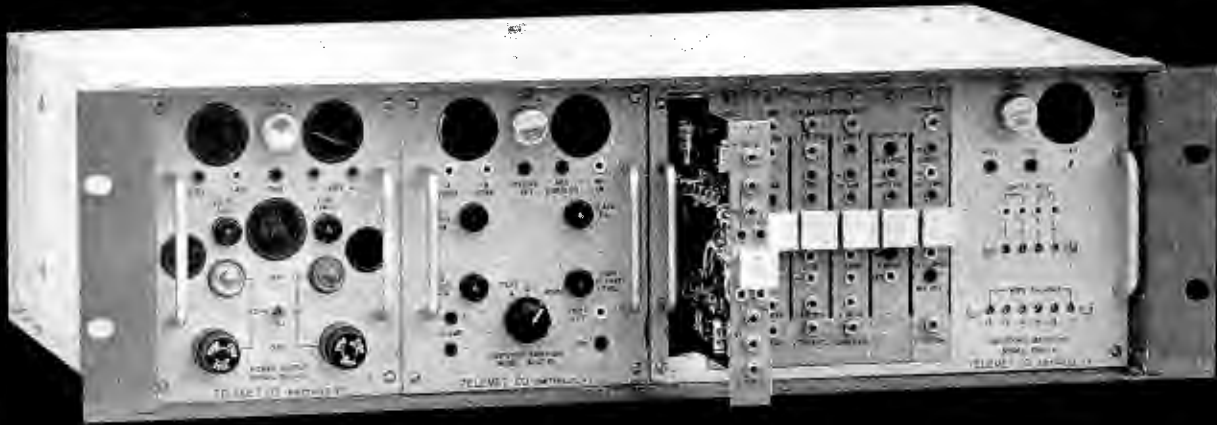

MODEL 3801A1 TV SPECIAL EFFECTS PICTURED WITH MODEL 13802A1 POSITIONER



*Brand Name

Designed for studio or mobile applications, the new TELECHROME Solid State Special Effects Generator, Model 3801A1, produces a multitude of visual effects to enhance scene changes, insert keying for commercials and bulletins, etc. The system comprises a power supply, switching amplifier and waveform generator in a 5¼" high rack mounting frame and remote control units. The waveform generator contains 7 plug-in cards, 6 for the effects and one for the accessory joy stick positioner. A newly designed effects remote control unit provides an illuminated pictorial of the selected effects—plus Thumb-Wheel control for rapid and positive wipe selection.

NEW! FRONT PANEL SWITCH SELECTS EITHER COMPOSITE OR NON-COMPOSITE OPERATING MODE.

TELEMET
COMPANY

185 DIXON AVENUE • AMITYVILLE, NEW YORK
TELEPHONE: (516) 541-3600

A Giannini Scientific Company



Circle Item 22 on Tech Data Card

FEATURES

- Occupies only 5¼" of rack space.
- Fully transistorized for reliable service free operation.
- Color or monochrome operation.
- Plug-in waveform generating cards.
- Inserts camera control and chroma keying.
- Up to 72 effects; including both horizontal and vertical wipes, diagonals, rectangle, diamond, circle, etc.
- Individual plug-in switching amplifier, waveform generator, and power supply.
- New compact remote control units occupy less console space.
- Thumb-wheel wipe selector eliminates parallax.
- Plug-in oscillators in positioner remote control unit for modulation of effects.

MODULATION AND FREQUENCY MONITOR OPERATING PROCEDURES

by Lawrence L. Prado, Jr., Chief Engineer, WWNH, Rochester, New Hampshire — A discussion of useful procedures to follow in working with monitors.

While the modulation and frequency monitors found in most radio stations are designed for long, trouble-free service, they are never fully understood by some operators and rarely receive proper maintenance. Here are some suggestions that may help remedy the situation.

Modulation Monitors

A typical AM modulation monitor is shown just below the communications receiver in the left-hand rack in Fig. 1. Such a monitor is one of the most important indicating devices in any station, but its full value can be gained only if the operators in the station know how to use it. For instance, how many third-class operators know that by merely looking at the carrier-level meter and percentage-of-modulation meter they can promptly ascertain if the transmitter is on the air and if modulation is taking place? True, they might not know the quality of the audio signal without making an additional aural check, but one glance at the station modulation monitor when something goes wrong can often prevent a panic situation.

Properly operating, the carrier-level meter should read 100 with little or no deviation as long as the transmitter remains on the air. Excessive deviation (carrier shift)

could indicate neutralization problems. The percentage-of-modulation meter should give a constantly varying reading as long as program modulation is taking place.

The instant there is an interruption to the program, the operator on duty should observe the modulation monitor to determine the status of the transmitter. If the carrier-level meter reads 100 (assuming the monitor is operating in a proper manner), it is apparent that the station is not off the air. If the percentage-of-modulation meter does not indicate modulation is taking place, several things could be wrong. Usually someone has turned on the wrong microphone. Perhaps the microphone has been patched out in a jack field for other usage or even disconnected. Don't overlook the defective microphone cut-out switch, commonly called the "cough button"; all too often this button has a copy book resting on it. One must learn not to assume or overlook anything during an outage, no matter how basic or foolish it may seem.

How does the operator play it safe and yet determine what is wrong? Turn off all microphones, air a recording, and observe the modulation monitor. If modulation is taking place, the next step is to check out the suspected microphone (on an audition circuit). If the percentage-of-modulation meter gives no indication of modulation, observe the console VU meter. If it indicates the presence of audio, check the meters on the various limiting or compression amplifiers between the console and the transmitter. Be sure to check all front-panel toggle switches to be sure a power switch hasn't been accidentally turned off (by a heavy arm, replacing ear-phones or patch cords, horseplay, etc.). Don't forget the jack field.

The operator has to know his equipment and what the indications for normal operation are.

Some stations operate by remote control within the same building; that is, the transmitter is located in a part of the building away from the studios, and the necessary metering and control functions are extended to the control room. Usually the final-plate-voltage, final-plate-current, and antenna-current meters appear on a panel (lower row in Fig. 2) along with the frequency-deviation and percentage-of-modulation meters (upper row in Fig. 2). The carrier-level meter usually is not extended. (The indicators at the left in Fig. 2 are indoor and outdoor thermometers.)

In such installations any one of three meters can indicate if the transmitter is off the air. If the final-plate-voltage, the plate-current, and antenna-current meters all read zero, it is almost certain the station is off the air. Even the frequency meter can be checked; in most cases, it will read plus or minus 30 cps—against the pin—without a carrier, although this varies in some makes.

Remote-control stations having the transmitter located in another part of town usually set the dialing or selector system to read antenna current constantly (except

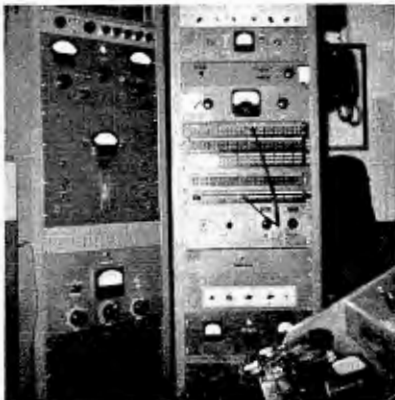

Fig. 1. AM monitors are in the left rack.

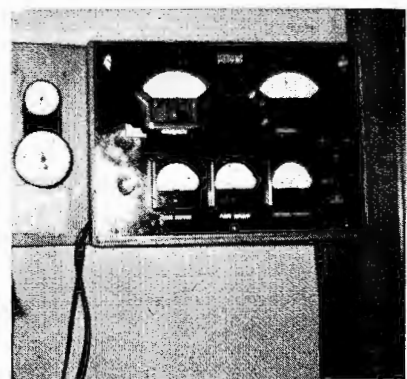

Fig. 2. A typical panel of remote meters.

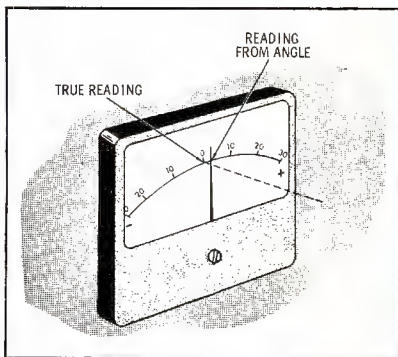

Fig. 3. Reading at angle causes errors.

when other readings are being made). They too, have provisions for some indication of modulation and frequency deviation.

Many announcer/operators—including some holding first-class licenses—sincerely believe that the percentage - of - modulation meter should never read below 85%. They are thinking of the FCC regulation that requires the modulation to be not less than 85% on peaks nor more than 100% on negative peaks of frequent recurrence. Some station engineers are guilty of leaving the modulation-monitor peaks switch set in the positive instead of the negative position for normal monitoring use. Obviously, the FCC requirements make it necessary that negative peaks be monitored.

Frequency Monitors

The purpose of the frequency monitor is to indicate the deviation from the assigned carrier frequency of the station. Construction and circuits vary from make to make; that is why such equipment is provided with instruction manuals.

Many operators have a habit of reading the deviation meter from an angle, thus obtaining a false reading (Fig. 3). One can seldom read a frequency monitor more accurately than within about .2 to .8 cps, yet operating logs sometimes show such readings as “.7 cps low,” or “1.3 cps high.” Read the deviation meter head-on, and don’t record readings that indicate greater accuracy than is really obtainable.

A good frequency-monitor adjustment is to have the transmitter set so that it starts on the low side of the assigned frequency (assuming the transmitter frequency drifts upward during the day). The frequency monitor would then give an indication varying from perhaps 1 or 2

Long-Life, High Performance 3" Television Camera Tube. An entirely new principle of operation, perfected by English Electric Valve, provides improved performance and increases tube life 3 to 4 times that of previous 3" image orthicons.

LONG-LIFE Achieved Without any Corresponding Disadvantages—

- No burn-in or "sticking" ■ Improved S/N ■ "Crisp" live pictures
- Sensitivity, resolution and gray scale remain constant over the life of tube ■ Reduced black compression.

This new ELCON tube can be used with existing image orthicon cameras, as well as in the newer transistorized zoom cameras built specifically to take maximum advantage of its performance.

For detailed information on this important technical breakthrough, write for Bulletin 410.

ELCON . . . stocked, tested and warranted only by VISUAL, the leader.



Keeps You in View!

For the best and most modern broadcast systems and supplies, look to VISUAL — your SOURCE for Superior Equipment from Specialists Manufacturers

Sold Nationally By

VISUAL ELECTRONICS CORPORATION
356 west 40th street • new york, n. y. 10018 • (212) 736-5840

In the January

BROADCAST ENGINEERING..

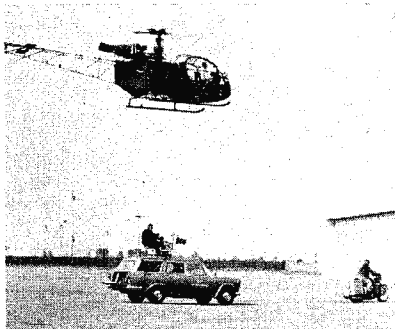

International Features—

- Helicopters in International Television
- Broadcasting in East Germany

Industry Features—

- Progress in Recording Standards
- CA and Pay TV

Other Feature Articles and—

Engineers' Exchange
Letters to the Editor
Book Review
New Products
News of the Industry
Bulletin from Washington

Reserve your copy now! Just fill out and send in the convenient subscription card bound in this issue—you'll receive the Broadcast Engineers' Maintenance Guide free of charge.

cps low at sign on to 1 or 2 cps high at sign off. This would vary from transmitter to transmitter of course, depending upon stability, length of operation, and amount of cooling provided.

When adjusting the transmitter, one should make sure that the deviation meter tracks properly. That means the monitor should indicate low if the transmitter frequency is adjusted downward, and vice versa. The approximate zero-deviation position should be marked on the transmitter frequency-adjusting control with plus and minus signs on either side to aid in making any minor corrections necessary when the frequency is measured by an external source. Most transmitters have a spare crystal that may be put into service merely by throwing a switch. This should be done, say weekly, so that the condition of both crystals may be observed, not just for a few minutes, but for a full week of actual operation. If your monitor employs a thermometer to measure the temperature of an internal oven, the temperature should be observed at least daily to be sure the internal thermostats are operating properly. In most cases, faulty thermostats produce erratic temperatures and excessive deviation readings. (Of course, defective stages in the monitor can produce the same effects.) Dust covers and bottom plates should be in place on the monitor; some frequency monitors show a difference of two or three cps deviation with the bottom plate removed.

Many engineers mount the frequency monitor in the top section of a rack and run a special AC line to an outlet provided for this unit alone. The special line is wired

ahead of the master switch that is usually located at the bottom of the rack. The ovens can thus operate even when the rest of the rack is turned off. Some monitors have an extra front-panel toggle switch that removes power from the amplifier sections only, leaving the oven in operation. Opinions vary, but monitors—modulation, frequency, phase, etc.—appear to give less trouble if the AC power is never turned off. In general, the current surge when a unit is first turned on causes greater damage than the constant application of power.

Maintenance

So far, this discussion has been concerned with the usage of the two monitors, and little has been said about maintenance. Two basic requirements apply to these units the same as they do to any other piece of broadcasting equipment—keep them clean and keep them cool. This means removing dust covers at least monthly, dusting with a paint brush, and/or complete vacuum cleaning. Removal of tubes for testing is of some value, but testers rarely duplicate the actual circuit and operating conditions of the unit. Measuring in-circuit currents (if the unit has jacks for this purpose) provides useful information to be compared with the instruction-manual charts. However, removal of the tubes is an excellent way to break down any possible contact resistance in the sockets. All nuts, screws, bolts, cable connectors, etc., that are supposed to be secured should be checked for tightness.

The electrical and mechanical zero settings of the various meters should be checked regularly. In modulation monitors, the flasher

Scala Precision Antennas

- ★ OFF-THE-AIR PICKUP—FM or TV
- ★ LOW POWER UHF, VHF TV TRANSMITTING
- ★ STL AND TELEMETERING ANTENNAS

Engineered to meet rigid FM and TV station specifications, and to endure the tests of weather and time.

Built to your specifications by

SCALA RADIO CORP.

2814 19th STREET
SAN FRANCISCO 10
VA 6-2898

Circle Item 24 on Tech Data Card

circuit must be properly calibrated and accuracy checks made periodically with an oscilloscope. (See "Calibration of AM & FM Modulation Monitors," by Robert A. Jones, in the November 1964 issue.)

Wiring and components should be inspected on a regular basis for signs of overheating or deterioration. Often a serious outage can be prevented merely by taking the time to look thoroughly. If the monitors are more than ten years old, it is prudent to return them to the factory for complete overhaul and general updating.

Other Pointers

Another important monitoring function must not be overlooked. The recent change from Conelrad to the Emergency Broadcast System caused no end of confusion and citations for many stations. Many broadcasters merely turned off their monitoring receivers and uttered a sigh of relief. Monitoring of a key station is still required, and so is the airing of a weekly EBS unscheduled test alert. All operators should know how to reset the monitoring receiver, what to do in case the regular key station goes off the air (regulations require that a station be monitored at all times), and how to air the actual test alert. (One of the most efficient methods of airing the weekly EBS test alert is to have the complete voice tracks, time blanks, and audio tone on tape; if you use cartridge tape units, the entire test becomes as simple as airing a regular commercial.)

All stations should have a current copy of Part 73 of the FCC Rules and Regulations (formerly Part 3), including all changes. Typical meter readings for the monitors and the final stage of the transmitter should be posted along with complete step-by-step procedures for turning the transmitter on or off.

Conclusion

Modulation and frequency monitors are among the most important pieces of equipment in a broadcast station; it is mandatory that these instruments be properly operated and maintained. All operators should be fully instructed on the proper use of them, and a regular preventive maintenance routine should be established. ▲

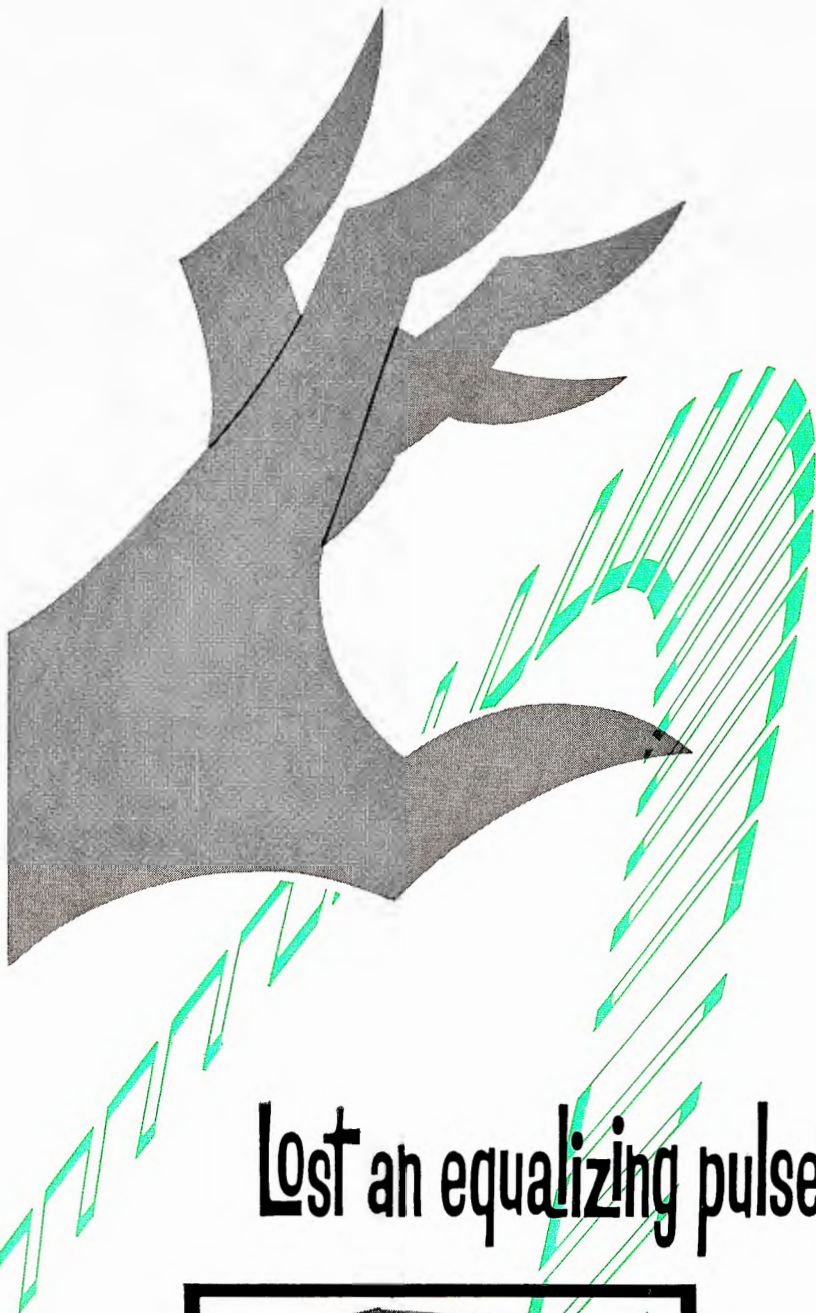

Lost an equalizing pulse?

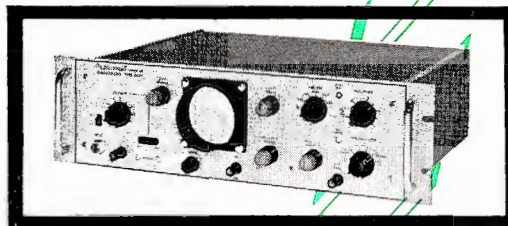

Why tie up your expensive line selecting monitors—looking to see if an equalizing pulse fell out between here and Washington? For \$425, the S32AR, the only wideband oscilloscope on a 5¼" panel, will monitor any incoming waveform. In the trigger circuits are a differentiator for the H pulses and an integrator for the frame group, ensuring a positive lock on composite video. Call or write today for full specifications.

data instruments

A DIVISION OF INDUSTRIAL ELECTRONIC HARDWARE CORP.



7300 CRESCENT BOULEVARD PENNSAUKEN, NEW JERSEY 609-662-3031

Circle Item 25 on Tech Data Card



**Let FAIRCHILD
put teeth
into your
sound!**

FAIRCHILD DYNALIZER

The newest approach for the creation of "apparent loudness" — the Dynalizer is an automatic audio spectrum equalizer which redistributes frequency response of the channel to compensate for listening response curves as developed by Fletcher-Munson. Adds fullness and body to program material. Completely automatic with flexible controls. Easily integrated into existing equipment. Two models available: Model 673 — Dynalizer only (17 db insertion loss.) Model 683 — Complete no loss Dynalizer system (as illustrated.)



FAIRCHILD CONAX



The world-acknowledged device that eliminates distortion problems caused by pre-emphasis curves. Allows higher average program levels through inaudible control of high frequencies. Invaluable in FM broadcast and disc recording. Eliminates stereo splatter problems in multiplex channels. Mono or stereo.

FAIRCHILD LIMITER

Fast attack stereo limiter with low distortion and absence of thumps. Sum and difference limiting position eliminates floating stereo image, despite amount of limiting used in one of the two channels. Also includes regular channel A and B limiting. Dual controls and dual meters provided. Now used throughout the world in recording and broadcast studios. (Mono model available.)

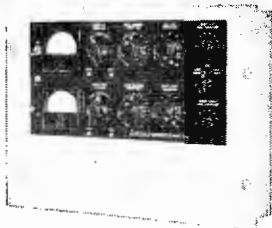

Introducing the New FAIRCHILD REVERBERTRON

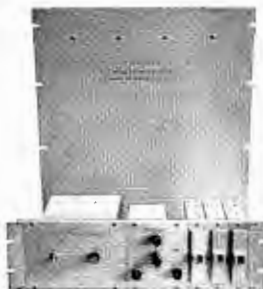

Reverberation now comes in a compact, portable, attractive and rack mountable package 24½" high by 19" wide with the FAIRCHILD REVERBERTRON. The REVERBERTRON, Model 658A, comes complete with mixing system for reverberated to regular signal mixing and contains a unique electronic control of reverberant time. Three time periods available at the flick of a switch — fast (staccato); a moderate time period; and a prolonged time decay for unusual effects.

The compact size of the FAIRCHILD REVERBERTRON and its relatively low cost now allows every studio and broadcaster to have the production-plus of controlled flexible reverberation with the FAIRCHILD REVERBERTRON.

Write to Fairchild — the pacemaker in professional audio products — for complete details.

FAIRCHILD

FAIRCHILD RECORDING EQUIPMENT CORP., 10-40 45TH AVE., LONG ISLAND CITY 1, N. Y.

Circle Item 105 on Tech Data Card

Engineer's Exchange

(Continued from page 32)

In the RCA BTA-1R transmitter, the primaries of transformers T502 and T402 are normally connected in parallel. In making the modification, do not disturb the connections to T402; it should be operated with 230 volts AC on its primary at both power levels. On T502, lift one primary lead and connect it to the center arm of the relay. The normally closed contact of the relay is connected to the neutral power-line wire to furnish 115 volts for 250-watt operation. The other relay contact is connected to one side of the line so that 230 volts is applied for normal 1000-watt operation. The relay coil is connected to the same points in the transmitter as were the coils of relays K801 and K804. (K801 and K804 are removed entirely.)

This modification was made in a couple of hours. After the conversion, our transmission efficiency had increased 3%, and the transmitter inside temperature ran about 7° cooler. The entire modification cost less than \$10.00.

Speed Variations In Ampex 350 Recorders

by Larry J. Gardner, Chief Engineer,
WCKY, Cincinnati, Ohio

When Ampex 350 recorders begin to show speed variations and it appears that a motor replacement is required, this tip may provide an economical answer. Frequently, motor trouble in these machines is caused by uneven wearing of the top motor bearing due to the pressure of the driver roller on one side of the capstan. When such wear appears, we remove the motor from the machine and reinstall it in a position rotated 90 or 180° from the original position. The pressure is then placed on an unworn portion of the top bearing, and normal operation is restored.

We have done this to two machines, and both are still operating satisfactorily, one of them after almost two years. Needless to say, management was delighted that the cash outlay for new motors was avoided. ▲

BROADCAST ENGINEERING

Switching System

(Continued from page 17)

Parts List

R1, R2, R3	200 ohms, 2 watts
R4	1000 ohms, 2 watts
R5, R6	150 ohms, 2 watts
R7, R8, R9, R10	600 ohms, 2 watts
All Relays	6PDT, Potter & Brumfield, LS 23 D (Note: Only 5 poles used on K7)
Lamps	12V, General Electric 1813
Push Buttons	6 normally open, 2 normally closed for each control panel

Using the Switches

Our broadcast day starts with separate programming. The announcer at the AM board sets up the mode of operation by pushing the No. 1 AM button, to connect the No. 1 console to the AM buss, and by pushing the No. 2 FM button, to connect the No. 2 console to the FM buss and place K7 in the "separate" mode. Thus, the No. 1 console feeds the AM transmitter, and the No. 2 console feeds the FM transmitter. When it is time to switch to dual operation, the announcer pushes the FM reset button. This takes the No. 2 console off the FM buss and de-energizes relay K7. The No. 1 console now feeds the AM buss and both transmitters. When it is time to return to separate programming, the announcer pushes the No. 2 FM button, and the transmitters are again fed from separate consoles. Any other combination can be easily set up.

The outputs of all three consoles appear on multiple jacks so that any console not being used to feed a transmitter may be used to feed the bridging input of a tape recorder. This does not upset the 600-ohm loading put on the consoles.

If more than one control panel is used, the corresponding reset buttons must be wired in series. All other corresponding buttons must be wired in parallel. Corresponding tally lights are also wired in parallel. Bringing the program sources and the busses out to jacks makes it possible to bypass defective sections until repairs are made. It must be remembered that this is not a fail-safe system. If power is lost, all relays are deenergized. The desired mode of operation must be set up again when power is restored. ▲

BROADCAST YOUR SOUND JUDGEMENT

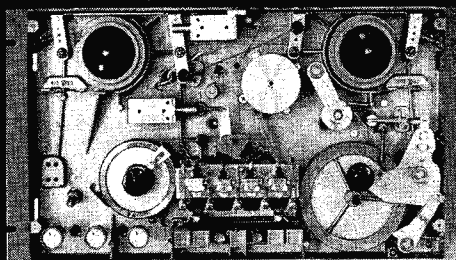

You'll tell the world how astute you are when you choose a New Magne-corder Model 1021. The Model 1021, designed for broadcasters, features smooth tape handling and braking with the thinnest tapes.

The Model 1021 incorporates standard connectors, impedances and levels. The cue-ing speaker has separate volume control, and the amplifier will drive an external speaker.

The Model 1021 has a cue button that lifts tape to the heads, releases the brakes and puts low, even torque on the reels. American-made components are compartmentalized for endurance and the front panel is removed for easy access. The Magne-corder 1021 is the best monaural recorder at any price and will broadcast your sound judgement to anyone who'll listen.

Only **\$659.00**

MAGNECORDER SALES DEPARTMENT
MIDWESTERN INSTRUMENTS, INC.
Subsidiary of the TELEX Corporation
P. O. Box 7509 / Tulsa, Oklahoma 74105

Circle Item 26 on Tech Data Card

Improved Fault Alarm

(Continued from page 15)

change-channel relay causes the correction-attempted holding relay to lock in; the red correction-attempted panel light (P3) is connected across its coil. The other set of contacts on K5 provides a channel-change impulse to the logger, which prints the letters "EF" on the log and passes the impulse along to the automation switcher.

Note that should the automation come to life after a fault has occurred but prior to an attempted channel change, capacitor C11, which provides the channel-change pulse, is immediately disconnected by the plate relay. This prevents a needless channel-changing attempt.

At KBIM, we allow our equipment to run during the night to re-wind at normal speed any program

tapes that are in use at signoff. This means that sometime during the night, when the tapes are finished playing, the alarm will operate. Naturally, no one is around at that time to turn it off, so another thermal time delay (K6) is used to shut off the external indicators after 60 seconds by removing power from K7.

Whenever the plate relay pulls in, R30 is no longer shorted, and the "normal" light on the front panel is dimmed to show that the first thermal relay is "thinking things over."

If the unit is externally disabled, the "normal" light will stay fully lit, but if the unit is locally disabled for any reason the "normal" light is extinguished. The end result of all this is that the "normal" light can be on only if the situation is entirely under control.

Miscellaneous Points

A 10-ohm voltage-dropping resistor (R31) is placed in series with the "normal" light to prolong bulb life. Capacitors C12 and C13 are used to reduce contact arcing of the flasher and 60-second turnoff relays.

A conservatively rated, silicon-rectifier power supply is used. No voltage distribution components were used across the diodes, and no deterioration of the diodes has been noted. Filtering follows the usual practice for a device of this type. The bleeder (R26) was added because a charged 20 mfd capacitor can give a painful shock to an unwary operator.

A 5-amp slow-blow fuse is used in the incoming line, and a 1-amp slow-blow fuse is used in series with the power transformer only. (One of these was added after Fig. 5 was taken.) Note that if either of these blows, the "normal" light cannot be on. No power switch is included because the unit is to be on continuously. With the sealed relays (important in dusty climates) and conservative design, long-time trouble-free performance is expected. Two views of the completed unit are shown in Fig. 5.

Adjustment of the input level control, R4, is not critical. Low-level passages should indicate about 2 ua when a 50 ua meter is connected to the DC test point. Rapidly

varying input levels will generate about 3 to 5 ua.

Experience has shown that this alarm does not sound even during quiet passages of classical music; this is due in part, of course, to the 30-second "thinking period." Yet a tone on a tape will cause the unit to sound. By changing the input plug connections, the device can be made either bridging or terminating. It may be tied onto the modulation monitor if the station is never run live. Line-level input is required unless the input-stage feedback is decreased. (Sensitivity could be increased more than 20 db this way.)

Conclusion

This unit has proved quite valuable as a fault alarm for automated programing, but there are other conceivable uses as well. For instance, a unit such as this (or a modification of it) could be used to free an announcer from monitoring duties. We at KBIM have been well pleased with this alarm. It is hoped that the information presented here will be found useful by engineers at other stations. ▲

BOOK REVIEW

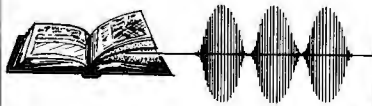

Mathematics for Electronics and Electricity; National Radio Institute Staff, John F. Rider Publisher, Inc., New York, New York; 250 pages, \$3.95. In its five chapters and 250 pages, this paperback volume covers the range of mathematics from counting in the decimal system to the fundamentals of Boolean algebra. The first chapter, "DC Circuit Calculations," is in reality a review of simple arithmetic—the basic operations of addition, subtraction, multiplication, and division as applied to whole numbers, fractions, and decimals. Simple electrical circuits are used as a basis for examples—a technique used throughout the book. The second chapter explains square roots, ratios, and positive and negative numbers. **Phasors** (vectors) are introduced in this chapter, also; solutions of problems by graphical means and by means of the theorem of Pythagoras are explained. Chapter three explains simple algebra and the operator j . The fourth chapter introduces elementary trigonometry, exponential numbers, significant figures, and the use of graphs. The last chapter is devoted to binary arithmetic and Boolean algebra. The explanations of the various topics are brief but adequate for the purpose. The experienced engineer or technician may have little need for such a text, but the beginner or the person whose knowledge of practical mathematics has grown "rusty" should find it useful.

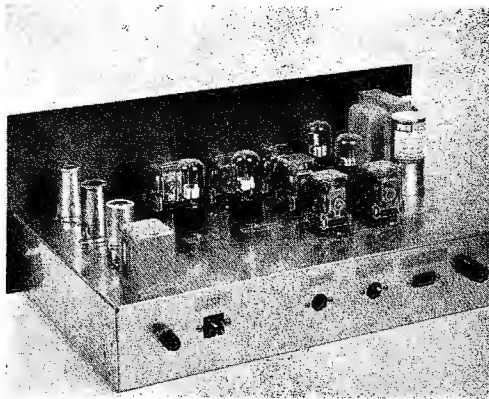

(A) Rear view.

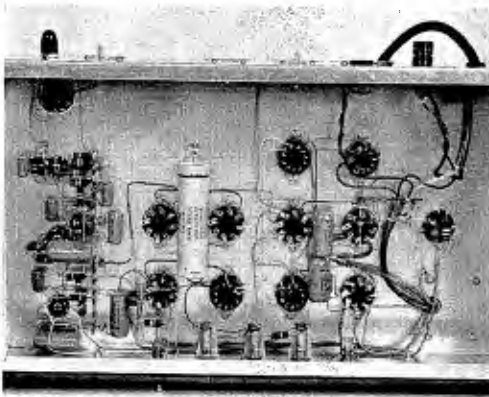

(B) Bottom of chassis.

Fig. 5. Views showing the completed unit.

Translator Antennas

(Continued from page 13)

gain when the units are properly tied together, however.

The two quantities, then, that determine the maximum developable terminal voltage are the field strength and the area (perpendicular to the direction of propagation) over which that field strength prevails. If the area is large enough, wide spacing of the units may be chosen in order to achieve maximum efficiency per element used. If the area of highest field is quite limited, close-spaced elements (Fig. 3) may be necessary in order to get maximum terminal voltage.

It is important to note that a harness for connecting the yagis can be designed to fit any stacking arrangement, and therefore the antenna configuration should not be influenced by any certain harness design. Rather, antenna design should be decided entirely by where the units should be placed for best signal pickup. It is desirable to use a number of antenna units that is some power of two—1, 2, 4, 8, 16, 32, 64, etc.—although in special cases other numbers can be used. In the latter case, the harness and transformers become more complex, however.

After the antenna is successfully installed to give the desired performance, deterioration inevitably sets in. With the antenna array installed, it is difficult to remeasure the field intensity to determine what the performance at any one time should be. Therefore provisions should be made for a monitor dipole or yagi. Although the monitor element should be removable from the weather, its mount should be such that the antenna can be easily placed in its exact location. This location should be in as good a signal area as possible, but outside the immediate influence of the large array. The monitor-antenna terminal voltage and the array terminal voltage should be read and recorded. This information will help the operator to know when defects have occurred in the master array.

Transmitting Antenna Location

The factors involved in locating a television-translator transmitting antenna are quite different from those involved in locating a receive-

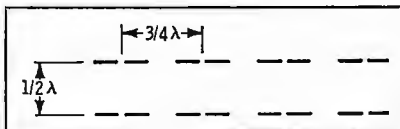

Fig. 3. Close spacing gives better output if strong field covers limited area.

ing antenna. In mountainous areas a site should be chosen only after weighing the following factors: (1) direct vision to the largest possible segment of the population to be covered (This usually requires considerable height.), (2) simplest possible connecting system between transmitter and receiver, (3) year-around accessibility of the site, and (4) availability of commercial power. The transmitting antenna system should be located on the edge of a reasonably sharp drop-off, so usually there is only need for a 10 to 25' supporting pole. If there are trees in front of the antenna system, they must be removed, or the antenna array must be elevated above them.

Translators in Flat Country

In flat country, as the distance from the TV broadcast station increases, the signal strength slowly decreases. Finally a point is reached where direct pickup of the signal with an antenna near the ground is no longer possible. In this case a site is usually chosen on the edge of town nearest the broadcast station. A tower as tall as practical (150 to perhaps 600') is erected. The receiving antenna is located at the height that gives the strongest signal. Usually it is made up of quads (close-spaced yagis), since it is necessary to obtain the maximum voltage possible within the limitations of available mounting space.

The transmitting antenna is generally located at the top of the tower. The radiation is directed toward the service area, and the beamwidth, tilt, and null fill-in characteristics are designed to give optimum coverage.

Conclusion

It can be seen that the choice of location for TV-translator antennas is not as simple as might first be supposed. While it has not been possible to give an all-inclusive coverage of the subject, a method has been described for making most efficient use of the available signal. ▲

sooner
or
later...



you will demand the extra quality and precision of Nortronics tape heads! All Nortronics heads feature:

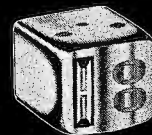

laminated core structures and deposited quartz gaps for superior high frequency response, and . . .



hyperbolic, all-metal faces for intimate tape-to-head contact—longer wear with minimum oxide loading.

Replace worn
tape heads with
Nortronics factory recommended replacement
heads—available from
your local Electronics
Distributor!

For complete information on Nortronics Replacement Heads for broadcast application, write today for Form No. A-12.

Nortronics 
8143 Tenth Ave. N., Minneapolis, Minn. 55427

Circle Item 27 on Tech Data Card

NEWS OF THE INDUSTRY

NATIONAL

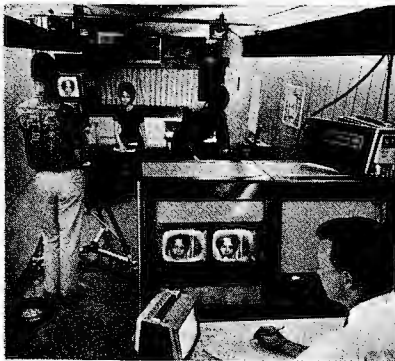

Mobile ETV Studio

A mobile television studio that can be "plugged in" to a coaxial cable to transmit educational programs was demonstrated by **Sylvania Electric Products, Inc.** and Darien, Conn., public school officials and students. This studio on wheels is believed to be the first used by a public school system. The studio measures 34' x 8', and was designed for operation by the faculty and students of the Darien schools. Programs may be taped, filmed, or presented live.

FCC At Fall Conferences

A member of the FCC will participate in each of the eight NAB Fall Conferences being held this October and November, addressing the delegates during a joint radio-television session on the second day of each day-and-a-half meeting. It is the first time in several years that FCC members have been invited to participate. Conferences will be held at Oklahoma City October 19-20, Salt Lake City October 12-13, Los Angeles October 15-16, Des Moines October 22-23, New Orleans October 26-27, Detroit November 9-10, Albany (N. Y.) November 12-13, and Richmond (Va.) November 16-17.

Broadcasters' Entry Into CATV

In comments filed with the Federal Communications Commission, the **National Association of Broadcasters** said that broadcasters should be encouraged rather than discouraged in owning and operating community antenna television systems. The NAB also felt that the Congress and the FCC should determine the role CATV is to play in the overall scheme of broadcasting before any limitations are placed upon ownership. This is necessary because "the problem is too big and too important for the piecemeal approach." Through the broadcaster's knowledge of public acceptance of programs, he can bring program balance to CATV offerings—and encourage a high standard of technical performance comparable to that of broadcast transmissions.

Division Shift

General Electric's Visual Communications Products Business, which manufactures and markets color and mono-

chrome television broadcast equipment and closed-circuit TV systems, has been transferred from the company's Military Communications Dept. to the Radio and Television Div. With the shift, all G-E business components focused on either end of the consumer electronics and home entertainment markets are now part of the same division.

Satellite Paper Wins Award

A technical paper on how glints of sunlight from the Telstar communications satellite were used to determine the spin axis and rate of spin won the 1964 Journal Award of the **Society of Motion Picture and Television Engineers**. Authors of the paper are Dr. J. S. Courtney-Pratt, Dr. John H. Hett, and J. W. McLaughlin, all of Bell Telephone Laboratories. The winning paper describes how glints of sunlight from the satellite were spotted with a computer-aimed telescope at distances up to 3700 nautical miles. By timing the flashes from a special arrangement of mirrors on the satellite, the scientists were able to determine the spin data. Honorable mention went to Dr. William C. Livingston for his paper, "Resolution Capability of the Image-Orthicon Camera Tube Under Non-standard Scan Conditions," which describes special modifications that increase the resolving power of image-orthicon TV camera tubes for use in astronomy and other scientific observation.

New Name

All **Eastman Kodak Co.** magnetic sound tapes marketed through electronic supply houses, audio departments, and similar outlets will hereafter be sold under the name **Kodak Sound Recording Tape**. The tapes will be identical to those previously sold under the Eastman brand name, except for new type designations and increased information printed on the back of the tape.

Continued Growth In Associations

Membership in the 47 state broadcasters' associations now stands at 3982—an increase of 393 since 1962 and 978 since 1959. The figures were revealed in a recently-completed NAB survey. Associations now represent 72% of radio and 76% of television stations in their respective states.

INTERNATIONAL

Communication TV Broadcasting Station for Erlau and Oberzell

Since October 1, TV stations at Erlau (channel 5, 10 watts) and Oberzell (channel 9, 6 watts) have broadcast Schedule 1 of the German TV Network and the regional broadcasts of the **Bayerischen Rundfunk** (Austrian TV Network). Both TV locations are east of Passau. The station at Erlau is in the vicinity of the German-Austrian border, and the station at Oberzell is beyond the border,

in the Austrian municipality of Esternberg. This is primarily an attempt at advancement; the convenience of the locations is yet to be justified.

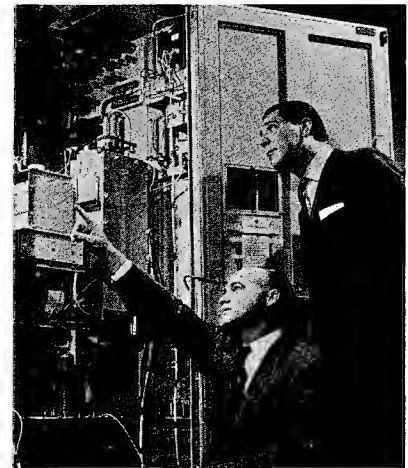

TV for Venezuela

A new 5-kw television transmitter receives a final check-out before shipment to Caracas, Venezuela. The **General Electric** high-channel VHF transmitter, together with G-E studio equipment and directionalized zig-zag antenna, will be used for Caracas' channel 11, the sixth TV station in the Venezuelan capital city. Inspecting equipment during factory test prior to its South American trip are James T. Tillman, Jr. (left) of G-E, and Amable Espina, owner and operator of Channel 11. Mr. Espina is the former general manager of Radio Caracas TV, a privately-owned broadcasting firm and one of the largest networks in Venezuela.

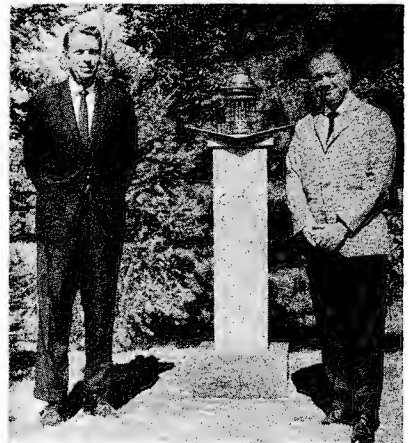

260-Year-Old Tube

The engineering personnel of **Radio Liberty's** transmitter site at Lampertheim, Germany, have erected a monument honoring B18, a transmitter tube that "lived" 39,459 hours instead of its life expectancy of 7000 hours. This corresponds to a human life span of 260 years. Radio Liberty handles around-the-clock broadcasts by privately sponsored networks to the Soviet Union from stations in Spain, Formosa, and at Lampertheim. Radio Liberty was the first American broadcaster to use this type of water-cooled, 50,000-watt tube.

PERSONALITIES



John L. Zimmer, former senior television-radio producer for Cunningham & Walsh and veteran of 14 years in commercial production and program supervision for leading New York agencies, has joined the Broadcast Department of the **Griswold-Eshleman Co.** His addition to the staff of the Cleveland-based agency is part of a program of major expansion of the company's 20-year-old commercial broadcasting department. Zimmer entered the broadcasting field in 1936 with Time, Inc., and was assistant producer of the March of Time in both radio and newsreel versions. As television opened up after World War II, he combined his wartime experience as an Army Air Corps advanced flight instructor with his background in motion pictures to produce televised flight training programs for the Office of Naval Research.



Robert C. Troup has been appointed Vice President-Sales for **Acme Film Laboratories'** new East Coast offices in New

STANCIL-HOFFMAN CORP.

- **MINITAPE PROFESSIONAL BATTERY** Operated Portable Recorder, Mono Stereo, Synchronous
 - **MAGNETIC FILM RECORDERS**, Single and Multi-Channel, 16, 17½, 35 MM.
 - **BROADCAST LOGGING** Recorders, Slow Speed Single Channel to 32 Channels.
 - **HIGH SPEED TAPE DUPLICATORS** for Full, Half and Two Track Stereo Duplication.
- 921 N. Highland Ave., Hollywood 38, Calif.

York City. Troup, a graduate of the University of Illinois and former Marine Corps captain, is well known in tennis circles and participates extensively in the activities of Big Brothers, Inc.

PROPERTY TRANSACTIONS

Gene Shumate, president of the **Snake River Radio and Television Co., Inc.**, of Jackson, Wyoming, announces the sale of assets of radio station **KSGT**, subject to FCC approval, to Max Lindberg and Jack Schroeder of Bettendorf, Iowa, and Mr. Lytton of Davenport, Iowa, for a total consideration of \$40,000.

The sale of radio station **WIKB**, Iron River, Mich., has been announced by Mr. Edwin Phelps, Sr., president of **Iron County Broadcasting Corp.**, sellers. Purchaser is Mr. **Eugene A. Halker**, who also owns and operates radio stations **WATW**, Ashland, Wis., and **WXMT**, Merrill, Wis. **WIKB** is a fulltime station with 1000 watts day and 250 watts night, on 1230 kc. Total consideration was \$70,000.

"**Buffalo**" **Bob Smith** of Howdy Doody fame enters radio-station ownership through his purchase of Radio Station **WQDY**, Calais, Maine, from **John H. Vondell, Jr.**, for \$110,000.00, subject to the approval of the FCC. ▲

Keep up
to date on
professional
audio recording
with this new
information kit
from Ampex.

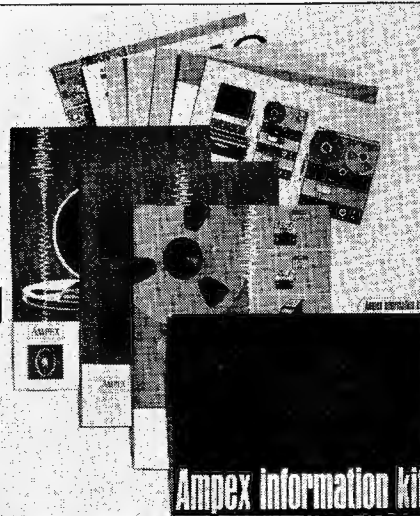

Kit contains latest brochures giving specifications, product data, and application news on the world's most complete line of professional recording equipment for **broadcast, education, industry**, including:

Portable Recorders. Professional quality in compact form. Find out why Ampex quality actually costs less in the long run than low-cost, run-of-the-mill portables. Full information on the new 4-track PR-10-4.

Studio Recorders. Get the full specifications on the console and rack recorders that are the recognized standard of the industry. Plus details on a new logging recorder and the new MR-70—world's most advanced master recorder.

Tape Duplicators. New developments for making fast, economical, high-quality copies of master tapes. Information about the new PD-10, a low-cost duplicator for schools, broadcast, and industry.

Recording Tape. Professional tapes, application-engineered for best results for any type of recording or duplicating.

AMPEX

Ampex Corporation
401-C Broadway, Redwood City, California

I want more information on: Portable Recorders Tape Duplicators
 Studio Recorders Recording Tape

NAME _____ TITLE _____
COMPANY _____
ADDRESS _____
CITY _____ STATE _____

New! LANG PROGRAM EQUALIZER

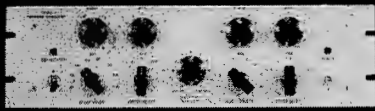

Surpasses All Others...

In design, performance and versatility! The new LANG PROGRAM EQUALIZER incorporates the finest features found in quality equalizers plus these

Exclusive Features —

Eight low boost shelf frequencies • Three low droop shelf frequencies • Eight high boost peak frequencies • Five high droop shelf frequencies • Frequency select switches and equalization controls for all boost and droop functions • All controls and switches may be used simultaneously • Low frequency peak boost by use of boost and droop controls • Equalization "on" lamp indicates when equalization is taking place and indicates plate power supply is functioning • Engraved stainless steel panel blends harmoniously with other equipment.

For complete details and new Lang Catalog write:

LANG ELECTRONICS INC.
507 FIFTH AVE., N.Y. 17
For all your audio needs — Look to Lang!

Circle Item 32 on Tech Data Card

SPOTMASTER



EQUALIZED TURNTABLE PREAMPLIFIER

The Model TT-20A is a compact, low distortion, transistorized turntable preamp for VR cartridges, with built-in NAB equalization. Design ingenuity reduces residual noise level to better than 65 db below rated output. Small current requirements permit 6 volt dry cell battery operation, eliminating AC hum worries. Response, 30-15,000 cps \pm 2 db... output -12 dbm, 600 ohm emitter follower... distortion under 1% at double rated output... size, 2½ x 2½ x 5½". Priced from \$46.50; transformer output and power supply available. Also available as a flat amplifier Model BA-20A. Write or wire for complete details.

Spotmaster

BROADCAST ELECTRONICS, INC.
8800 Brookville Road
Silver Spring, Maryland

Circle Item 33 on Tech Data Card

NEW PRODUCTS



Diode Tester

Before any diode or rectifier is finally soldered into a circuit, it should be checked for a short, open, or improperly marked polarity. The Model ID-1017 diode tester, built by Henry Francis Parks Laboratory, is strictly a "go-no go" testing unit. With very little practice, an operator can test a diode or rectifier every ten seconds. The load placed on the unit being tested is that of the #47 indicator lamp used (150 ma at 6.3 volts, or less than one watt), so any diode rated at one watt or more can be tested with it. Price is \$19.95.

Circle Item 38 on Tech Data Card

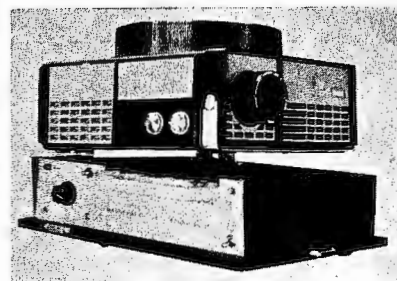

Automatic Sound-Slide Projector

A new and fully automatic synchronized sound-slide projector is being offered by the Amplifier Corp. of America. This unit combines a 500-300 watt Kodak "Carousel" projector with an automatic

tape-cartridge mechanism having fully transistorized electronics. Choice of three cartridge sizes provides playing time from a few minutes to four hours. During playback, a 20-cps control tone automatically changes the slides in precise synchronization. A time-differentiated pulse-length discriminator in the playback control circuit stops the playback unit at the end of the program so that synchronization between sound and slides is always maintained. The entire unit may be started automatically or by remote control. Program material or the slide-change signal may be altered independently without affecting the adjacent channel. The tape cartridge is available in three sizes for 300', 600', or 1200' of standard ¼" lubricated tape. The "Carousel" projector is equipped with local and remote (manual) slide-change and focus controls and built-in facilities for setting the change cycle for 5-, 10- or 20-second intervals, and handles up to 80 2" x 2" and 2¼" x 2¼" slides. A 500-300 watt blower-cooled lamp is used in conjunction with a 5" f3.5 lens. The projector has a 3-watt power amplifier and speaker.

Circle Item 39 on Tech Data Card

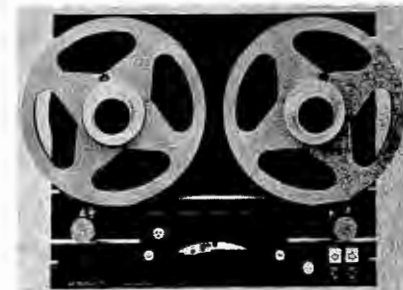

Tape Transport

A three-speed tape transport, designed by Metrotech, Inc., Mountain View, Calif., specifically for the broadcast industry, can be operated manually or from a remote location and is suited for use in program automation systems. The two-direction transport, known as the Model 1050, handles 10½" reels and has a solenoid-operated capstan with



STEP PREVENTS SWITCHING ERRORS AT

WTVR, KNTV,
KHOL, CBXT,
WAGA, XETV

STEP automates video and audio switching during station breaks.

The price? Only \$6900.

If you are interested in TV automation, get further details on STEP.



CHRONO-LOG CORP.
2583 WEST CHESTER PIKE, BROOMALL, PA.

AREA CODE 215
ELgin 6-6771

Circle Item 34 on Tech Data Card

BROADCAST ENGINEERING

automatic cycling and recycling. It is equipped with head mounting plates, which provide the customary azimuth and height adjustments and will accept any of the commonly used audio heads.

Circle Item 40 on Tech Data Card



Projector Speaks Thirteen Tongues

Audiences this past summer in the 500-seat auditorium at the World's Fair Sermons from Science pavilion watched sound movies showing the interrelationship of science and religion and heard a perfectly synchronized commentary in French, Japanese, Norwegian, Swedish, Spanish, Italian, Mandarin, German, Korean, Armenian, Danish, Finnish, and Greek, as well as English. All these languages are spoken by a **Stancil-Hoffman S-7 Reproducer** which plays back (five at a time) the commentaries pre-recorded on 16-mm magnetic film. It is mechanically linked to a "Graflex 16" sound motion picture projector which shows the picture and picks up the optical main English language, music, and sound-effects sound track, which is played at the screen. A gear box reduces the projector's 1440 rpm to the 900 rpm required by the reproducer. This mechanical link keeps pictures and languages in perfect sync, so the program does not turn into a modern-day Babel.

Circle Item 44 on Tech Data Card

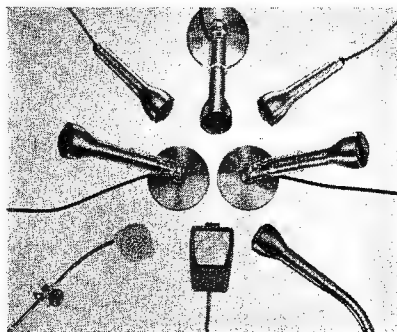

Low-Impedance Ceramic Microphones

This new line of ceramic microphones from **Sonotone Corporation** is especially designed to match low-impedance characteristics of communications units now on the market. Sonotone's new microphones cover a range of input impedances (low and high) from 10,000 ohms

**"The greatest contribution
we've made
towards upgrading WKFM"**

Frank Kovas

FRANK KOVAS, PRESIDENT
WKFM, CHICAGO

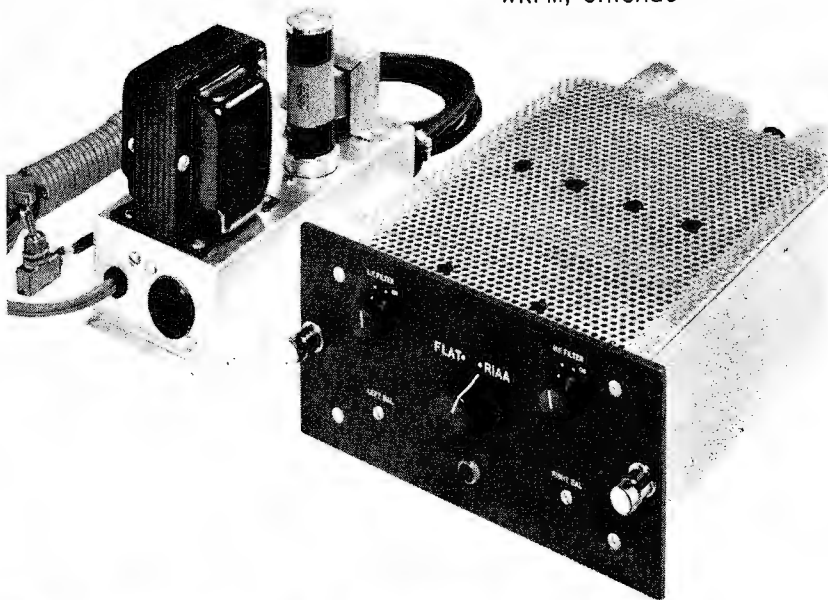

**SHURE
STUDIO
SE-1**

STEREO TRANSCRIPTION PREAMPLIFIER

Certified quality because every characteristic on every unit is checked to make sure it passes specifications. That's why Mr. Kovas says "It is unfortunate that we (WKFM) wasted so much time in experimenting with hi fi type stereo preamps which looked good on specifications . . .

I'll have to admit that nothing equals the performance of the Shure SE-1 for stereo multiplexing."

What are the certified specifications? The SE-1 has plenty of gain to feed a 600 ohm line at +4 or +8 dbm from a magnetic stereo phono cartridge and still provide for peak power. (1.2 mv input gives at least +4 dbm output.) Balance is provided with separate gain controls for each channel. *True* RIAA equalization with ± 1 db 30 to 15,000 c.p.s. of RIAA curve. Optional flat position for measurement and calibration in the studio. Separate high and low response trimmers for each channel with NO interaction between channels, or between high and low end. Hum and noise level at least 64 db below output level. Channel separation better than 37 db between 50 and 10,000 c.p.s. Distortion is under 1% at +15 dbm 150 or 600 ohms output impedance. Compact size (7" x 3 3/8" x 11" deep) . . . Convenient slip-in mounting for easy installation. Separate power supply reduces panel space requirements.

Priced at only \$295 net. Write for technical data sheet: Professional Products Division, Shure Brothers, Inc., 222 Hartrey Avenue, Evanston, Illinois.

Circle Item 28 on Tech Data Card

**PROGRAM DIRECTORS
CHIEF ENGINEERS
EXECUTIVES**

SAVE TIME

Identifying, Evaluating, Cataloging,
Inspecting 16mm Motion Picture Film
on the



moviola LIBRARY READER

- View at up to five times sound speed.
- View at governed sound speed.
- Twelve sided prism, high quality, projection system.
- Rapid rewind without switching reels.
- Performs all functions forward and reverse.
- Available with or without sound.

moviola
manufacturing co.
motion picture | tv equipment

5539 Riverton Ave., North Hollywood, Calif.
Telephone: 877-2173
Cable Address: Moviola, North Hollywood, Calif.

Circle Item 29 on Tech Data Card

through 5 megohms, with frequency responses of 200 cps to 9000 cps for speech and 50 cps to 12,000 cps for music now available; open-circuit sensitivity is up to -49 db.

Circle Item 45 on Tech Data Card

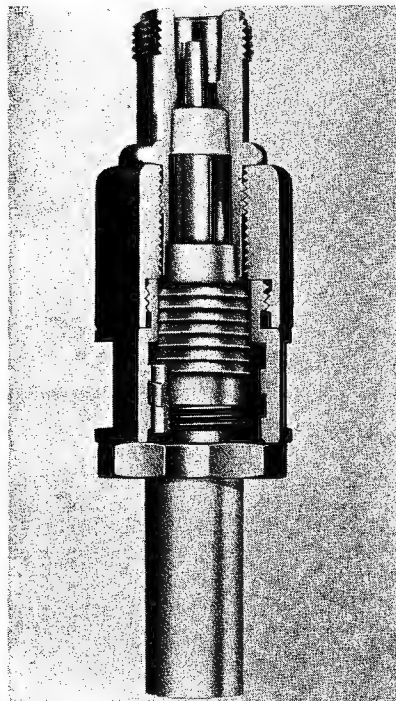

New Line of Connectors

This new line of one-piece TIMATCH connectors with its patented "Coil-Grip" cable clamp can be installed quickly and easily, and the connectors are reusable. Repeated assembly and disassembly operations do not impair either the RF or physical characteristics of the connector or the cable. Times Wire & Cable considers the new connectors a major advance in the connector field. TIMATCH connectors fit all metal-tube-sheathed coaxial cables.

Circle Item 41 on Tech Data Card

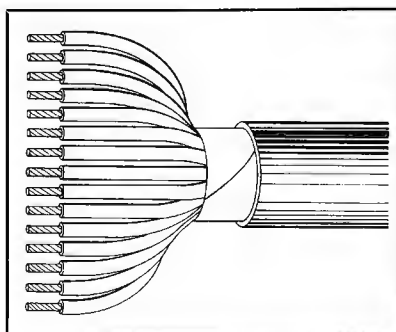

Control Cables

To their present line of control cables, Belden Mfg. Co. now adds 12 new types as stock items. Specifications range from 4- to 25-conductor, 22 to 14 gauge, and 200 to 600 WVDC. These cables were designed specifically for control and power supply of electrical and electronic equipment, and are IPECA color coded.

Circle Item 42 on Tech Data Card

BROADCAST ENGINEERING

ELIMINATE DOWN TIME

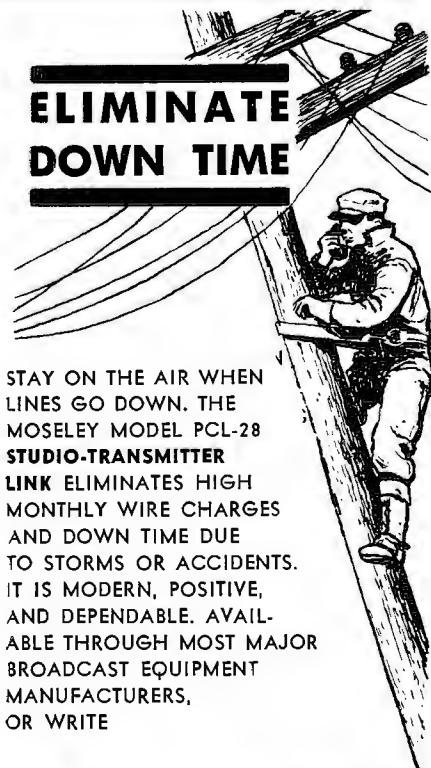

STAY ON THE AIR WHEN LINES GO DOWN. THE MOSELEY MODEL PCL-28 STUDIO-TRANSMITTER LINK ELIMINATES HIGH MONTHLY WIRE CHARGES AND DOWN TIME DUE TO STORMS OR ACCIDENTS. IT IS MODERN, POSITIVE, AND DEPENDABLE. AVAILABLE THROUGH MOST MAJOR BROADCAST EQUIPMENT MANUFACTURERS, OR WRITE



MOSELEY ASSOCIATES INC.

P. O. Box 3192, Santa Barbara, Calif.
Telephone — Area Code 805
967-0424

Circle Item 31 on Tech Data Card

SPOTMASTER

RS-25

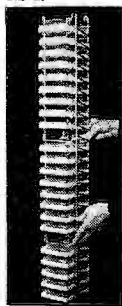

Tape Cartridge Racks

RM-100

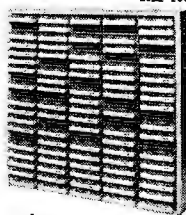

... from industry's most comprehensive line of cartridge tape equipment.

Enjoy finger-tip convenience with RM-100 wall-mount wood racks. Store 100 cartridges in minimum space (modular construction permits table-top mounting as well); \$40.00 per rack. SPOTMASTER Lazy Susan revolving cartridge wire rack holds 200 cartridges. Price \$145.50. Extra rack sections available at \$12.90.

Write or wire for complete details.

Spotmaster

BROADCAST ELECTRONICS, INC.
8800 Brookville Road
Silver Spring, Maryland

Circle Item 30 on Tech Data Card

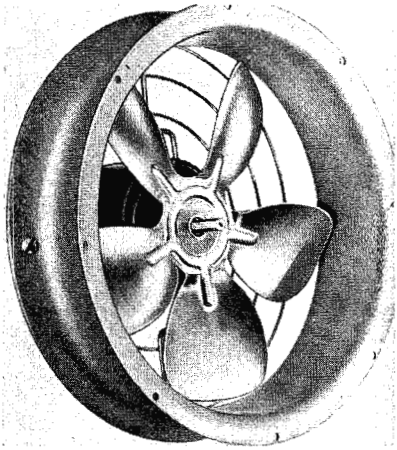

Fans

A new series of fourteen 8" power fans has been announced by the **Dynacool Mfg. Co., Inc.**, West Hurley, New York. The low-cost units, which deliver from 200 to 1000 cfm, are designed for commercial cooling applications requiring high air-moving efficiency coupled with compactness. They can be used for cabinet flushing of business machines, electronic equipment, air conditioners, communications equipment, and power supplies. All fans in the new line have UL listed motors and can be furnished with either shielded ball bearings or sleeve bearings. Ball-bearing versions are permanently lubricated for the life of the fan; sleeve-bearing models are factory-lubricated for the first year, but must be oiled every six months thereafter. Drive motors are available in single- or three-phase, for 50-60 cps, at 115 or 230 volts. The fans mount over a 9 1/8" diameter opening.

Circle Item 46 on Tech Data Card

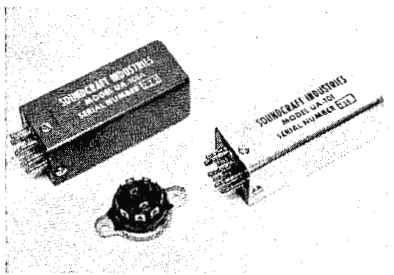

Sealed Amplifier Module

A transistorized plug-in amplifier measuring 1 5/16" square by 3 1/4" long, with an 11-pin base, has been placed on the market by **Soundcraft Industries**, and is called the UA101 unit amplifier. Electrical specifications are: gain—40 db (adjustable by external resistor); input impedance—10K ohms bridging impedance; operates from low-impedance source; operates into 150 ohms or more; output power—8 dbm, .5% distortion; input power—24 volts DC at 10 ma; noise better than 80 db below +8 dbm output; frequency response within .5 db, 20-15,000 cps; weight 6 ozs. Units may be cascaded for increased gain. Cost is \$21.95. ▲

Circle Item 47 on Tech Data Card



take me out to the ballpark...

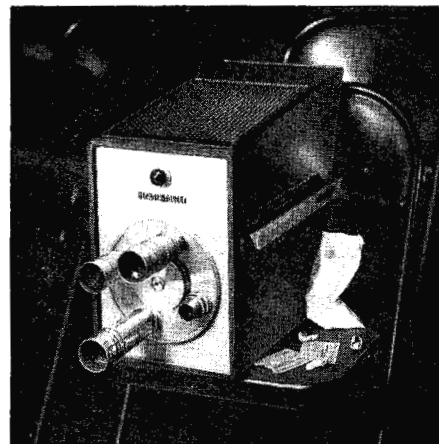

(and leave me there)

The Blonder-Tongue Observer 2 is a broadcast quality vidicon viewfinder camera. It's extremely light and portable, making it ideal for remotes. Also, picture quality is so close to that of an image orthicon, you can use it for up to 80% of your studio work.

You can buy the Observer 2 for a fraction of the cost of an image orthicon—\$4160. But, the biggest saving is in operating costs. For example, you can buy seven vidicon tubes for the price of a single image orthicon—and each vidicon lasts twice as long.

The B-T Observer 2 has an 8" viewfinder screen, a 4 lens turret, and reliable solid-state circuitry. To arrange for a demonstration by your local Blonder-Tongue representative, write:

BLONDER * TONGUE

9 Alling Street, Newark 2, N. J. • Canadian Division: Benco Television Assoc., Ltd., Toronto, Ontario

Circle Item 37 on Tech Data Card

AUDIO & RECORDING EQUIPMENT

50. AKG—Technical specifications, application notes, and other information on microphones and microphone accessories are provided in brochure.
51. ATLAS—Catalog No. 564 contains illustrations and specifications on PA speakers and microphone stands for commercial and industrial installations, and other products.
52. BROADCAST ELECTRONICS—Packet contains specifications and prices for "Spotmaster" tape cartridge systems.
53. CINE SONIC—Data sheet describes rental service which supplies background music prerecorded on 7", 10½", and 14" reels of tape or in cartridges.
54. CONCERTONE—Four-page brochure gives information on Series 800 "Reverse-O-Matic" stereo tape recorder.
55. EASTMAN KODAK—Folder SI-4 gives information on high-speed sound-film system. Brochures on recording film and magnetic tape are also available.
56. FAIRCHILD—Information on a compact console Model 803 for recording and broadcast production centers, including compression and equalization.
57. INTERNATIONAL RADIO AND ELECTRONICS—Literature tells about solid-state SS700 Series recorders.
58. MAGNASYNC—Catalog covers motion picture sound equipment, magnetic tape, film transports and degaussers, "Chronavoice," communications recorders, and electronic components.
59. MIDWESTERN—Operating and maintenance manual for Magnecorder Model 1021 magnetic tape recorder.
60. MOSELEY—Literature on Dual Model PCL-2B studio-transmitter link for FM stereo.
61. NORTRONICS—Engineering bulletin CEB No. 2 explains factors which should be considered when designing a 3.75-ips tape system; bulletin CEB No. 9 gives engineering data on silicon-transistor recording amplifier.
62. QUAM-NICHOLS—General catalog No. 64 listing over 30 speakers and transformers for sound system applications.
63. ROANWELL—Four-page brochure describing complete line of headset microphones for TV and radio broadcast-production communications.
64. SAXITONE—Sample mailing box for sending 3" tape reels through the mail.
65. SENNHEISER—Bulletin and technical information on Model MD 211 dynamic studio microphone.
66. SPARTA—Literature on broadcast turntables and accessories.
67. UNIVERSITY—"Technilog" gives information on selecting speaker systems.
68. VIKING—Specification bulletins describe Model 96 tape transport system, Model 38 cartridge handler, and Model 88 stereo compact.

COMPONENTS & MATERIALS

69. ALLIED—1965 Industrial Catalog No. 650.
70. AMPEREX—Condensed catalog lists receiving and transmitting tubes.
71. BOSTON WIRE—Two brochures list and provide detailed data on television cable assemblies and connectors.
72. IEH—Latest information on zener and stud-mount diodes.
73. PRECISION RESISTOR—Recently published catalog covering complete line of wirewound resistors.
74. SOLITRON—16-page catalog on silicon rectifiers and data sheet on solid-state tube replacements.
75. SWITCHCRAFT—Product bulletin No. 146 describing new QG audio connector; available with 3 or 4 contacts, brass or stainless-steel finished.

MICROWAVE DEVICES

76. SURFACE CONDUCTION—Bulletin on microwave-by-wire (G-line) for long-distance, broad-band transmission.

MOBILE RADIO & COMMUNICATIONS

77. MOSLEY—Literature describes Citizens-band antennas.
78. ROUND HILL—Booklet on "Page-Mate" RP-50 private paging system.

POWER DEVICES

79. HEVI-DUTY—Bulletin No. T-12 describes line-voltage regulator that uses saturable-core reactor.
80. LECTROTECH—Separate bulletins detail solid-state modular power supplies and meter-protective devices.

REFERENCE MATERIAL & SCHOOLS

81. CLEVELAND INSTITUTE—Booklet describes courses in electronics, including those for broadcast engineering and FCC license preparation.
82. RIKER—New brochure on how to assemble a custom video processing amplifier with all transistor video modules.

STUDIO & CAMERA EQUIPMENT

83. CBS LABS—Literature on Audiomax Automatic Level Controller, Volumax Peak Controller, and complete line of professional test records.
84. CLEVELAND ELECTRONICS—Data concerns deflection yoke and alignment coil for 3" image orthicons.
85. DYNAIR—Product bulletin No. 80A describes Series 3000 solid-state, modular video distribution amplifiers; bulletin No. 81A describes solid-state, modular video switcher-fader.
86. ZOOMAR—Bulletins contain descriptions of zoom lenses and remote-control systems for television cameras.

TELEVISION EQUIPMENT

87. INTERNATIONAL NUCLEAR—Illustrated price list on all-transistorized video equipment.
88. MIRATEL—Information on complete line of tube and transistorized monitors.
89. VITAL INDUSTRIES—Data sheets describing video distribution amplifier Model VI-10A and pulse distribution amplifier Model VI-20.

TEST EQUIPMENT & INSTRUMENTS

90. BALLANTINE—12-page catalog on AC/DC voltmeters, calibrators, and laboratory voltage standards.
91. SECO—Color folder includes data on color-bar generators, tube testers, and semiconductor testers.
92. SIMPSON—Bulletin on over 1325 stock sizes and types of panel meters; also information on other types of test equipment.

TRANSMITTER & ANTENNA DEVICES

93. AIR SPACE—Eight-page brochure describes and pictorially illustrates a new safety device to prevent falling when climbing any type of structure.
94. CORNELL-DUBILIER—Offers 20-page TV-FM reception booklet and brochure covering antenna rotors.
95. ELECTRONICS MISSILES & COMMUNICATIONS—Brochure on instructional TV transmitters Model 25-100 Series.
96. GATES—Latest information on dual-polarized FM antennas and new FM-10G 10-kw FM transmitter.
97. MARTI—Brochure and specification sheets on radio remote pickup equipment for operation in the 26-150 and 450 mc bands.
98. McMARTIN—Information on Model TBM-2500 RF amplifiers for remote operation of frequency and modulation monitors.
99. RUST—Descriptive literature gives details of transmitter automatic logging systems.
100. TELEMET—Latest catalog covering complete line of video products.
101. TELETRONIX—Specification sheets for 250, 1000, 3000, and 5000 watt FM broadcast transmitters.

SUBJECT REFERENCE INDEX-1964

ACOUSTICS

Recording studio, for.....Feb 12

AIRCRAFT APPLICATIONS

Helicopter news remotes.....Aug 34
Heliportable broadcast system...Jan 18

AM

Allocations and assignments...Feb 36
Application "freeze".....Jun 23
Blanket contour.....CE Aug 52
Class IV power increase...WB Nov 32
Clear channels.....WB Jul 21
Daytime hours.....WB Apr 28
Presunrise operation.....WB May 27
Rule, "10%".....CE Sep 48

ANTENNAS

Bandwidth correction.....Jan 32
De-ice control of.....Sep 34
Ice removal, manual.....Sep 37
Matching-network design...Jan 12
RF arcing.....CE Nov 55
Voltage and current relationships.....Jan 13

ANTENNAS, FM

SCA, for.....Mar 17
Vertical polarization.....Aug 14
WB Oct 36

ANTENNAS, RECEIVING

SCA, for.....Mar 17

ANTENNAS, TV

Vertical polarization.....WB Oct 36
UHF antennas
—characteristics.....Jan 14

ASSOCIATIONS AND CONFERENCES

AES 16th Fall Conference,
preview of.....Sep 28

BROADCAST ENGINEERING

tours the 1964 NAB
Convention Exhibits.....May 16

CA and Pay TV.....Oct 66

IEEE Broadcasting

Symposium.....WB Sep 22

ITU Conference, 1964.....Jan 22

NAB Broadcast Engineering

Conference, 18th
—agenda.....Mar 48
—exhibit hall floor plan...Mar 40

National Electronics

Conference, 20th.....Oct 20

SMPTE Technical

Conference, 95th.....Mar 55

SMPTE Technical

Conference, 96th.....Oct 20

AUDIO EQUIPMENT

Amplifier module, sealed.....Dec 53

Background-music system.....Sep 46

Console and switcher.....Sep 16

Crossbar-type switcher.....Aug 18

Fader, curved linear.....Apr 50

Mixer, dual-input.....Oct 40

SCA, for.....Mar 16

Signal fault alarm.....Dec 14

Switcher, push-button.....Dec 16

Turntable preamplifier.....Jan 39

AUTOMATION

Customized system for radio...Jun 10

Fault alarm.....Dec 14

Television, for.....Oct 45

CAMERA EQUIPMENT AND

OPERATION

Amplifier, transistorized.....Jun 20

Cam-operated head.....Oct 68

Cylindrical, miniature.....Oct 67

Focus-current meter.....EE Oct 56

Kinescope recorder.....Oct 70

Mobile platform.....Aug 13

Movement cues.....Oct 59

Positioning.....Oct 11

Selective vision.....Oct 11

TV cues.....Oct 58

TV techniques, introduction to...Oct 10

Vidicon lenses.....May 65

Zoom lens.....Sep 46

CARTRIDGE TAPE EQUIPMENT AND OPERATION

Adjustment of transport.....Nov 36
Cleaning of transport.....Nov 36
Clock for timing recordings...EE Sep 38
Cue tone for marking

spot end.....EE Sep 38

Equipment.....Apr 24

Head-alignment jig.....EE Nov 48

Installation.....Apr 26

Lubrication of transport.....Nov 36

Maintenance.....Nov 36

Motor binding in transport...EE Aug 42

Playback.....Apr 32

Recording procedure.....Apr 26

Standards.....WB Jul 22
Dec 6

Timing, automatic.....EE Jun 34

Transport hold-in problems...EE Oct 57

Winding of tape.....EE Jul 36

CATV

Distribution amplifier.....Jul 49

FCC control of.....WB May 28
WB Aug 21

General discussion

—basic system.....Feb 10

—distribution.....Feb 45

—head-end.....Feb 11

—importance to broadcasting...Feb 10

—state of art.....Feb 10

—transportation.....Feb 45

Microwave service.....WB Sep 21

Pay TV, and.....Oct 66

CCTV

Camera.....Jul 50

COAXIAL TRANSMISSION LINE

Flexible coax ratings.....Jan 36

COLOR TV

Subcarrier frequency measurements.....Apr 15

World's Fair studio.....Jul 44

COMPONENTS AND MATERIALS

Conductive gasket.....Feb 48

Connector, one-piece.....Dec 56

Control cable.....Dec 56

Dissipator-retainer, transistor...Feb 48

NAB product preview, 1964...Mar 43

Silicon rectifier to replace 816..Feb 48

CONSOLES

Emergency booth, for.....May 22

Music pickup on location, for...Feb 42

Semi-automatic, design for...Apr 20

Standby.....Jul 28

Tape inputs for.....EE Jun 34

U-shaped.....Jul 35

CONSTRUCTION AND MODIFICATION

Adjustable T-pad transmission set.....Sep 14

Audio switching system.....Dec 16

Automatic program logger.....Oct 12

Camera amplifier, transistorized...Jun 20

Carrier interruption system...EE Jan 29

Console, standby.....Jul 28

Cuing device for video recording.....Feb 16

Disc lathe modification for microgroove recording.....Sep 24

Fans, equipment-cooling.....Dec 57

Fixed T-pad transmission set...Sep 15

FM transmitter for remote pickup.....May 14

Mixer, transistorized dual-input...Oct 40

P60 & P75 recorders.....EE Apr 42

Power cut-back for BTA-1R.....EE Dec 32

Rear-view projection system...Oct 14

Signal fault alarm.....Dec 14

Switcher, reed-relay.....Sep 16

Tape speed change, 15/16 ips from 1 7/8.....Oct 12

Transmitter plate-primary failure alarm.....Aug 24

Video processor switch panel...May 42

CONTROL ROOM

Appearance considerations in design.....Jul 32

Design of.....Jul 32

Radio.....Oct 44

Television.....Oct 42

DESIGN

Antenna matching networks...Jan 12

Console, standby.....Jul 28

Directional antenna systems...May 10

Matching and isolating pads...May 12

Radio control room.....Jul 32

Semiautomatic control table...Apr 20

Translator antenna system...Dec 13

Video microwave systems.....Oct 30
Nov 20

VTR cuing device.....Feb 16

DIRECTIONAL ARRAYS

Adjustment.....Nov 16

Bandwidth correction.....Jan 12

Common-point.....Jan 10

—impedance.....Nov 17

Conductivity effects.....Jun 12

Correction (minimum power)...Jun 6

Current ratios.....Mar 22

Design.....May 10

Driving impedance.....May 11

Matching networks.....May 56

—design of.....Jan 12

Monitor points.....Mar 64

—field strength, high...CE Oct 71

Operation.....Jan 10

Phase monitor.....Jan 39
Mar 20

Phase readings.....Mar 21

Phase shifters.....May 57

Phasor and tuning unit.....Mar 20

Plant layout.....May 56

Power divider.....May 57

Sampling loops.....Mar 20

Tuning.....Mar 20

Voltage and current relationships.....Jan 13

DISC RECORDING AND PLAYBACK

Compared to cartridge tape...Apr 24

Lathe modification for microgroove.....Sep 24

Record cleaner.....Sep 38

Turntable combination.....Apr 51

EMERGENCY OPERATIONS AND EQUIPMENT

Generators.....May 20

Light blinker, warning.....Mar 58

Maintenance.....May 24

Plate-primary failure alarm system.....Aug 24

Power distribution.....May 24

Preparation for.....Nov 42

Requirements.....CE Nov 55

System for AM, FM, TV.....May 20

Tuning capacitor, antenna...EE Jul 36

ENGINEERING THEORY

Antenna Engineering Handbook

Antenna matching network design.....Jan 12

Basic Electronics for Engineers

BR Aug 51

Design of networks.....May 12

Directional antenna design...May 10

EQUIPMENT AND DEVICES (STATION-BUILT AIDS)

Audio oscillator, transistorized miniature.....Oct 63

Light blinker, warning.....Mar 58

Temperature gauge, electronic...May 59

Transmitter monitor lights...EE Feb 38

Tube socket adapters for input connections.....EE Feb 38

ETV

Educational television center...Jun 45

UHF installation.....Oct 64

Video recording in.....Oct 18

FACILITIES

Air cleaning, electronic.....Nov 26

Directional antenna, for.....May 56

Emergency booth.....May 22

FCC		Maintenance, of	Jan 6	TV camera antenna	Sep 47
See also SPECIFICATIONS		Program logger, automatic	Sep 12	TV system in Egypt	Jan 31
AND STANDARDS		STL, for	Oct 22	Video bounce	Nov 22
Aeronautical stations on		Translator operation, of	May 30	Video system specifications	Oct 30
108 mc.	WB Oct 35	LICENSES			Nov 20
Allocations and assignments	Feb 36	AM application "freeze"	Jun 23	Waveguide, open	May 52
CATV	WB May 28		WB Oct 35	MISCELLANEOUS	
—microwave channels	WB Sep 21	Display of	Oct 56	B-E consulting author staff	Jan 31
Fines and revocations	WB Aug 21	Filing fees	WB May 28	Copy-tape dispatcher	Nov 54
—notices	WB Sep 22	Third class endorsement		Electronics at the World's Fair	Jul 12
License, study-guide for		—element 1	Mar 30	National defense emergency	
3rd class	Jan 30	—element 2	Mar 32	authorization	May 20
Maintenance logs	Jan 6	—element 9	Mar 52	North American Radio-TV	
Mobile FM/TV enforcement		—objectives	Mar 30	Station Guide	BR Sep 30
unit	Apr 13	—radiotelephone operating		Service-dealer cooperation	Jun 6
Multiple ownership rules	WB Aug 22	practice	Mar 32	MIXERS	
Nonbroadcast television,		—study material	Jan 30	Dual-input, transistorized	Oct 40
control of	WB Aug 21		Mar 30	Tape inputs, for	EE Jun 34
Rule, "10%"	CE Sep 48	MAGNETIC RECORDING		MOBILE	
	Nov 6	See also audio, video, and tape		Custom-designed TV unit	Aug 12
Subscription television	WB Jul 21	Program logger, automatic	Oct 12	Monitoring unit	Apr 13
Vertically polarized FM		Television tape techniques	Apr 18	Noise-suppression kit	May 64
power	WB Aug 22	MAINTENANCE		MODULATION	
FM		Alert receivers	Nov 11	Cross	Jul 24
Allocations		Cartridge tape units	Nov 36	Maintenance of monitors	Dec 46
—assignments	Feb 36	Equalizers	Nov 10	Measurement of	Apr 14
—changes	WB Nov 31	Frequency monitors	EE Jan 29	Plate, methods of	Mar 18
Harmonic interference	Jun 23	—calibration of	Apr 6	Video, chopper for checking	Jun 26
Measurement of frequency	Apr 14	Logs	Jan 6	MONITORS	
Program service	Oct 50	Meters	EE Oct 52	Calibration	Nov 12
Simplex operation	WB Aug 21	Oscilloscope in TV, with	Mar 6	Frequency, operation of	Nov 11
Tower height and power	WB Apr 27	Shortwave transmitter	EE Jul 36		Dec 44
Vertical polarization,		Speed variation in Ampex		Maintenance	Dec 46
	WB Aug 22	350 recorder	EE Dec 48	Modulation, operation of	Nov 11
FCC rules on	WB Apr 27	Television translators	May 30		Dec 44
FREQUENCY MONITORS		MATCHING NETWORKS		Stereo FM	Jun 24
Calibration	Apr 6	Bridged-T	Jun 38		Sep 10
Maintenance	EE Jan 29	Directional antenna, for	May 56	Use of	Aug 6
	Dec 46	Disymmetrical	May 13	Video picture	Mar 72
Operation	Nov 11	—minimum-loss	Jun 39	Video, stabilized	Jul 47
	Dec 45	Isolating pads, and	May 12	MULTIPLEX	
INDUSTRY FEATURES		Symmetrical	May 13	Monitoring,	
Allocations and assignments	Feb 36		Jun 14	remote control	WB Nov 32
BROADCAST ENGINEERING		MEASUREMENTS		Review of principles	Sep 12
tours the 1964 NAB		Field strength, for		SCA subchannel	Sep 13
Convention Exhibits	May 16	remote control	CE Sep 48	Subchannel, 38-kc.	Sep 13
Early Evolution of		Frequency	Apr 14	Trouble sources in	Sep 42
Television, The	Jul 14	Impedance and inductance	EE Nov 48	NEWSFILM	
Network Coverage of a		Line impedance	Aug 26	Automatic sound-slide projector	Dec 50
Tragic Weekend	Feb 20	Modulation	Apr 15	Cleaning film ultrasonically	Nov 34
Shape of Broadcasting to		Vertically polarized radiation	Aug 15	Department at KCRA	Aug 38
Come—1984, The	Apr 34	Video signal to noise		Processor for magnetic-stripped	
INTERNATIONAL BROADCASTING		ratio, STL	May 46	film	Nov 52
Early Evolution of		METERS		Mixer for camera amplifier	Oct 40
Television, The	Jul 14	Elapsed-hour	Feb 46	Rear-view projection	Oct 14
Frequencies for space services	Jan 28	Focus-current	EE Oct 56	PADS	
ITU Conference, 1964	Jan 22	Maintenance of	EE Oct 52	Adjustable-T	Sep 14
Norwegian Broadcasting Corp.		Miniature, stackable	Oct 68	Bridged-T	Jun 38
operations	Dec 42	Stylus wear	Feb 47	Disymmetrical	May 13
LEVEL DEVICES, AUDIO		MICROPHONES		—minimum-loss	Jun 39
Accessories	May 40	Microphones	BR Jul 50	Fixed-T	Sep 15
Compressors, use of	May 40	Music pickup on location, for	Feb 15	Matching and isolating	May 12
Limiters, use of	May 40	Usage	Nov 10	Symmetrical	May 13
Use of	May 40	MICROWAVE			Jun 14
Zero-set control adjustment		Antenna alignment	May 44	PHASE	
(RCA)	Mar 60	Bandwidth, video	Oct 30	Cancellation of stereo signals	Jun 36
LIGHTING		Broadband noise	Oct 30	Check with scope	Feb 6
Elaborate sets	Dec 22	CATV service	WB Sep 21	Distortion in video microwave	Oct 30
Equipment	Dec 18	Cross-channel link	Sep 44	Monitor, antenna	Jan 39
Faces, techniques for	Dec 19	Differential gain	Oct 30	Shifters for directional	
Guide	Dec 18	Fade characteristics	Oct 30	antennas	May 57
News set	Dec 20	—margin	Jun 42	PORTABLE EQUIPMENT	
Panel show set	Dec 20	Ferrite isolators	Jun 18	Remote amplifier used with	
Principles of	Dec 19	Hum in	Oct 30	recorder	EE Dec 48
Setup	Dec 19	Interference	Nov 20, 22	Tape recorders	Dec 36
Terminology	Dec 18	Klystrons	Jun 16	Transistorized TV system	Mar 67
LINE VOLTAGE		Low-frequency response	Oct 30	Video recorder	Jan 37
High, corrections for	EE Apr 42	Low-pass filter	Nov 6		Oct 16
Regulation	Jul 10	Multihop noise	Nov 20	POWER SUPPLIES	
Regulators		Passive reflector	May 52	Emergency generators	May 20
—induction	Jul 11	Phase distortion	Oct 30	Fuses	Nov 46
—step	Jul 10	Plane-polarized antenna	Jan 36	Rectifier columns, high-power	Oct 67
—variable autotransformer	Jul 11	Pre-emphasis, video	Nov 24	Thermoelectric generators	Aug 10
Transformers for correcting	Jul 6	Solid-state switch	Mar 71	PROOF OF PERFORMANCE	
LOGS AND LOGGING		Test equipment	Jun 18	Frequency response	Feb 28
Automatic logging in AM		Transmitter and receiver		RADIATION AND PROPAGATION	
directional installations	CE Aug 52	locations	May 44	Antenna farms	WB Nov 31

Blanket contour	CE	Aug 52
Field-strength curves		
for TV	WB	Sep 21
Frequencies for space services	Jan	28
UHF curves	WB	Apr 27
Vertical polarization in FM	Aug	14
RECORDING, AUDIO		
Acoustics for studios	Feb	12
Automatic recorder	Jun	49
Cartridge head-mount kits	Jul	47
Conversion for 15/16 ips	Oct	12
Disc spot recorder	Aug	50
Editing system	May	64
Full-track head kit	Aug	50
Location recording of symphony orchestra	Feb	35
Logger, automatic program	Oct	12
Master recorder	Jul	48
Modifying the P60 & P75 (Magnecord)	EE	Apr 42
Recorder used with remote amplifier	Dec	30
Record-play-erase head	Feb	47
Speed variation in		
Ampex 350	EE	Dec 48
Tempo regulator	Nov	52
"Thread-easy" reel	Sep	47
RECORDING, VIDEO		
Compact machines	Apr	50
Cuing device	Feb	16
Editing	Apr	18
Educational applications	Oct	18
Helical-scan machines	Oct	16
Helical system	Apr	44
Kinescope recorder	Oct	70
Mobile recording applications	Oct	18
NTSC color		
—burst-lock system	Apr	19
—time-base correction, electronic	Apr	19
Photographic recorder	May	63
Portable equipment	Jan	37
	May	65
	Oct	16
Signal systems, advanced	Apr	44
Transverse machines	Oct	16
REMOTE CONTROL		
Automation system, in	Jun	11
Field-strength measurements	CE	Sep 48
Fuse protector, line	Aug	42
Heliportable broadcast system	Jan	18
Pulsing relay irregularity	Oct	71
Subaudible telemetering	WB	Jul 22
Television transmitters, of	WB	Jul 21
Transmitter monitor lights	EE	Feb 38
REMOTE PICKUP		
Alignment of transmitter	May	55
Amplifier, basic	EE	Jun 33
Antenna	Mar	75
CB Transceiver for	EE	Aug 43
Frequencies	May	14
Helicopter, via	Aug	34
Heliportable broadcast system	Jan	18
Live music, engineers' approach to		
—philosophy	Feb	14
—technical factors	Feb	15
Measuring lines	Aug	30
Power from thermoelectric generators	Aug	10
Safety during	Nov	15
SAFETY		
Climbing	Nov	15
Conductors, line cords, and leads	Nov	14
Electrical	Nov	14
Emergencies	Nov	42
Remotes, on	Nov	15
Tools, with	Nov	15
Training	Nov	42
SCA		
Minimizing problems in service of	Mar	16
Review of principles	Sep	12
Subcarrier frequency measurements	Apr	15
Tolerances in equipment	May	6

SEMICONDUCTOR APPLICATIONS		
Bias supply for camera preamp	Jun	22
Camera amplifier	Jun	20
Chopper for modulation checks	Jun	26
Microwave switches	Mar	71
Silicon rectifiers in high-voltage power supplies	Apr	16
Thermoelectric generators	Aug	10
SPECIFICATIONS AND STANDARDS		
Audio limiting	WB	Apr 28
Field-strength curves		
for TV	WB	Sep 21
Harmonic interference, FM	Jun	23
NARBA	CE	Oct 71
National defense emergency authorization	May	20
Presunrise operations of AM stations	WB	May 27
Remote pickup frequencies	May	14
SMPTE color standards	Aug	48
Tape cartridge	WB	Jul 22
TV and land-mobile sharing	Jun	24
Video microwave system	Oct	30
VTR cuing	Feb	16
White areas	CE	Oct 71
STEREO		
Monitors	Jun	24
	Aug	10
Phase cancellation of tape signals	Jun	36
STL		
Antennas	Oct	24
—alignment	May	44
Dual-channel	Oct	26
Equipment installation	Oct	22
Logging requirements	Oct	22
900-mc	Oct	22
Passive reflector	May	52
Receiver alignment	Oct	24
Single-channel	Oct	26
Video signal-to-noise ratio measurement	May	46
STUDIO		
Acoustics for recording	Feb	12
Elaborate sets, lighting	Dec	22
Lighting guide	Dec	18
Maintenance	Nov	10
News set, lighting a	Dec	20
Panel show set, lighting a	Dec	20
SWITCHING EQUIPMENT		
Audio crossbar-type	Aug	18
Emergency booth	May	22
Push-button audio system	Dec	16
Reed-relay system	Sep	16
Semiautomatic, for radio	Apr	21
Video processor panel	May	42
TAPE RECORDING		
See also audio, video, and magnetic		
Antimagnetic tape cases	Jul	49
Heads		
—alignment jig	EE	Nov 48
—cleaner	Mar	70
—demagnetization	Nov	36
—three-channel	Oct	68
Portables, AC operated	Dec	36
Stereo signal cancellation	Jun	36
Studio machines	Dec	34
Television techniques	Apr	18
TELEPHONE LINES		
Characteristic impedance formula	Oct	6
Impedance matching	Aug	26
TELEVISION		
Aural-visual ratios	WB	May 27
Evolution of	Jul	14
Frequencies, sharing with land mobile	Jun	24
Measurement of frequency	Apr	14
Moon-shot camera	Aug	48
Parallel operation of transmitters	Mar	24
Parametric amplifier	Jun	48
Remote control of transmitters	WB	Jul 21
Remote truck, WPIX	Aug	44
Subscription	WB	Jul 21
Waveform analysis	Apr	47

TEST EQUIPMENT AND INSTRUMENTS		
Audio source and attenuator	Feb	46
Dip oscillator, transistorized RF	Feb	46
Diode tester	Dec	54
Distortion analyzer, transistorized	Oct	67
Distortion monitoring, setup for	Sep	39
Field-strength meter	Nov	53
Impedance bridge, operating	Mar	69
Microwave, for	Jun	18
Noise meter, AM	Jul	47
Oscilloscope		
—monitor calibration with	Nov	12
—television, in	Mar	6
Television translators, for	May	32
The Oscilloscope	BR	Sep 30
Transmission set		
—adjustable T-pad	Sep	14
—fixed T-pad	Sep	15
Tube tester and cooker, mercury vapor	Oct	52
VOM/VTVM	Feb	46
Wattmeter, hall effect	Aug	51
TOOLS		
Desoldering iron	Apr	50
Label device	Jan	37
Wire-wrap plier	Mar	73
TOWERS		
Photoelectric control for lights	Jan	37
Microwave	Mar	73
Safety in climbing	Nov	15
TRANSISTOR APPLICATIONS		
Audio oscillator, miniature	Oct	63
Camera amplifier	Jun	20
Chopper	Jun	26
Light blinker, warning	Mar	58
Mixer, dual-input	Oct	40
Portable TV system	Mar	67
Remote amplifier, miniature	EE	Jun 33
TRANSLOCATORS		
Antenna system design	Dec	13
Locating antennas	Dec	12
Logging	May	30
Maintenance	May	30
Receiving antennas	Dec	12
TRANSMITTERS		
Air cleaning	Nov	26
Carrier, interruption during pattern switching	EE	Jan 29
Cross modulation	Jul	24
Failure alarm, plate primary	Aug	24
Final, unstable	EE	Nov 48
Linear amplifiers	Mar	19
Maintenance of shortwave	EE	Jul 36
Parallel operation	Mar	24
Power change	Nov	46
Power triode	Sep	46
Plate modulation	Mar	18
Remote monitor lights	EE	Feb 38
SCA, for	Mar	16
Television, remote control of	WB	Jul 21
UHF		
Allocation table	WB	Sep 21
Assignments	WB	May 28
ETV installation	Oct	64
KERO high-power installation	Apr	49
Klystron for television	Jun	48
Puerto Rico station	Sep	44
TV antennas (see also Antennas, TV)	Jan	14
VIDEO EQUIPMENT		
Bounce, in microwave	Nov	22
Chopper for checking modulation	Jun	26
	Dec	6
Console and switcher	Sep	16
Microwave systems specifications	Oct	30
	Nov	20
Monitor	Mar	72
Processor switch panel	May	42
Pre-emphasis in microwave systems	Nov	24

Professional Services

VIR JAMES

CONSULTING RADIO ENGINEERS
Applications and Field Engineering
345 Colorado Blvd.
Phone: (Area Code 303) 333-5562
DENVER, COLORADO 80206
Member AFCCE

JAMES C. McNARY

Consulting Engineer
National Press Bldg.
Washington 4, D. C.
Telephone District 7-1205
Member AFCCE

LAWRENCE BEHR ASSOCIATES, Inc.

RADIO ENGINEERING CONSULTANTS
FM Applications and Field Engineering
also
AM — Communications — CATV
LAWRENCE BEHR, PRESIDENT
2501 East Fourth Street
Greenville, North Carolina
919-PL 8-3966

OSCAR LEON CUELLAR

CONSULTING RADIO ENGINEER
AM-FM-TV
250 W. Santa Maria, P.O. Box 11276
Phone (Area Code 602) 294-7000
Directional Antennas Design
Applications and Field Engineering
Tucson, Arizona 85706
Member IEEE

CARL E. SMITH

CONSULTING RADIO ENGINEERS
AM, FM, TV and CATV
8200 Snowville Road
Cleveland, Ohio 44141
Phone: 216-526-4386
Member AFCCE

CAMBRIDGE CRYSTALS PRECISION FREQUENCY MEASURING SERVICE

SPECIALISTS FOR AM-FM-TV
445 Concord Ave. Phone 876-2810
Cambridge, Mass. 02138

Classified

Advertising rates in the Classified Section are ten cents per word. Minimum charge is \$2.00. Blind box number is 50 cents extra. Check or money order must be enclosed with ad.

The classified columns are not open to the advertising of any broadcast equipment or supplies regularly produced by manufacturers unless the equipment is used and no longer owned by the manufacturer. Display advertising must be purchased in such cases.

EQUIPMENT FOR SALE

Ampex Head Assemblies for 300 and 400 series recorders reconditioned. Service includes lapping and polishing all three head stacks, cleaning entire assembly, readjusting and replacement of guides, and realignment of stacks as to azimuth and zenith. Full track assemblies—\$60.00. Taber Manufacturing & Engineering Co., 2619 Lincoln Ave., Alameda, California, 5-64 tf

Will buy or trade used tape and disc recording equipment—Ampex, Concertone, Magnecord, Presto, etc. Audio equipment for sale. Boynton Studio, 295 Main St., Tuckahoe, N. Y. 1-64 tf

Audio Equipment bought, sold, traded. Ampex, Fairchild, Crown, McIntosh, Viking, F. T. C. Brewer Company, 2400 West Hayes Street, Pensacola, Florida. 3-64 tf

Television/Radio/communications gear of any type available. From a tower to a tube. Microwave, transmitters, cameras, studio equipment, mikes, etc. Advise your needs—offers. Electrofind Co., 440 Columbus Ave., NYC. 212-EN-25680. 8-64 tf

COMMERCIAL CRYSTALS and new or replacement crystals for RCA, Gates, W. E. Bliley, and J-K holders; regrounding, repair, etc. BC-604 crystals; also service on AM monitors and H-P 335B FM monitors. Nationwide unsolicited testimonials praise our products and fast service. Eidsen Electronic Company, Box 96, Temple, Texas. 5-64 tf

GOVERNMENT SURPLUS, NEW 10 CM WEATHER RADAR SYSTEM—Raytheon, 275 KW peak output S band, Rotating yoke P.P.I. Weather Band 4, 20, and 80 mi. range. Price \$975 complete. Has picked up clouds at 50 mi. Wt. 488 lbs. Radio Research Inst. Co., 550 5th Ave., New York, New York. 5-64 tf

TV antenna system—RCA 12 layer bating and filterplexer for channel 10. Can operate as bi-directional antenna with max. power gain of 25 and circularity better than 10 db. Cost over \$50,000. Make offer. Hammett & Edison, Box 68, International Airport, San Francisco 28, California 415-342-5208. 10-64 3t

Parabolic antennas, six foot dia., new, solid surface with hardware, dipole, etc. \$125.00 each. S-W Electric Cable Company, Willow & Twenty-Fourth Streets, Oakland, California. 832-3527. 10-64 tf

Everything in used broadcast equipment. Write for complete listings. Broadcast Equipment and Supply Co., Box 3141, Bristol, Tennessee. 11-64 6t

TRANSMITTING TUBE SALE: All items new with a 1000 hour pro rata warranty. 4CX250B—\$25. 4X150A—\$14. 5736—\$110. 891R—\$250. Call collect 201-354-2420. THOR ELECTRONICS CORP., 287 Morris Avenue, Elizabeth, N. J. 07207. 11-64 2t

A 469-B condenser manufactured by Western Electric Company for their 504 B2, 3 kw FM transmitter. Contact Bill Bratton, Chief engineer, WLAP, Lexington, Ky. 606-255-6300. 11-64-6t

Laboratory Test Equipment, microwave components, all frequency and makes at real low prices. Write or call for information. Jericho Electronic Supplies, Sid Gordon Electronics, 80 West Jericho Turnpike, Svosset, Long Island, N. Y. (516) WA 1-7580. 12-64 6t

2 639 Altec microphones. \$120.00 each. 2 RCA MI-11850C Disc Recording heads in original boxes, \$45.00 each. New Bozak B207A spcaker with warranty, \$50.00. Used motor for Gates CB500 turntable. Has pulley, \$10.00. Synchronous motor removed from late production Concertone 90 series tape recorder. Like new, \$75.00. Boyd Recording, 2924 Lemmon Ave. East, Dallas, Texas. 12-64 1t

2 ITA FM10B exciters, 2 ITA FM10BG sub-carrier generators. WAMO, 1811 Blvd. of Allies, Pittsburgh, Pa. 12-64 1t

Used Gates modulation monitor model 2639, and Raytheon limiter model RL-10. These are several years old but are now in regular use. KDUZ, Hutchinson, Minn. 12-64 1t

FOTO-VIDEO USERS—Denson Electronics Corp. has acquired extensive stock of equipment. Bargain prices. Free List. P.O. Box 85, Rockville, Conn. 12-64 3t

RCA Patch panel, 4 row, 96 pair \$75.00. RCA MI-11850C Disc Recording Head \$50.00. Gates 6C Disc-Recording Amp. \$65.00. RCA RT-11B Tape Record-Playback Amp. \$75.00. Old RCA Disc Recorder, Works, \$50.00. Input, Output and Power transformers. write for list. Don Warnock, 117 West 67th, Kansas City, Mo. 12-64 1t

RCA-TT-5A, 5KW TV transmitter (used) high band Channel 11, water cooled. Complete and in excellent condition, first cash offer over \$10,000. FOB N. Y. Telex, Quip Corp., 224 Glen Cove Ave., L. I., N. Y. 12-64 1t

Wanted To Buy

TV Equipment—Need Bridge Diplexer for 5KW television transmitter on Channel 10. Cornhusker Television Corp., 40th and W Sts., Lincoln, Nebraska. 12-64 1t

Personnel

Are you an above-average First Class man who really loves broadcast engineering? Are you competent in basic electronics theory and yet good with a soldering iron in your hand? Would you like to work for a station where everything works right or else we find out why fast? Can you follow a project through with little or no supervision? If so, contact Chief Engineer, WCOJ, Coatesville, Pa. 12-64 1t

TV STUDIO TECHNICIANS — Expanding staff and need men with 1st Phone, experienced in maintenance, video tape and studio operation. Send resume to WTTV, 3490 Bluff Road, Indianapolis, Indiana, c/o Don Morgan. 12-64 1t

SALES MANAGER ANTENNAS

Progressive and expanding antenna manufacturer is looking for ambitious and aggressive sales manager. Must have at least 2 years sales experience with broadcast equipment, and some knowledge of antennas, towers, transmission lines (we'll teach you the technical details). College graduate with at least 1 year of administrative experience desirable. Applicant must pass military security clearance and do light traveling. Send full resume with recent photo to: Jampro Antenna Company, 6939 Power Inn Road, Sacramento, California 95828. 12-64 1t

Advertisers' Index

Altec Lansing Corp.	32
Ampex Corp.	53
Amplifier Corp. of America	30
Bauer Electronics Corp.	22
Blonder-Tongue Labs	57
Broadcast Electronics.	40, 54, 56
CBS Labs, Inc.	23
Chrono-Log Corp.	54
Cleveland Electronics	36
Data Instruments, Div. of Industrial Electronic Hardware Corp.	47
Eastman Kodak Co.	10, 11
Eitel-McCullough, Inc.	31
Electro-Voice, Inc.	25
Fairchild Recording Co.	4, 48
International Nuclear Corp.	35
Jampro Antenna Co.	26
Lang Electronics, Inc.	30, 54
Magnecord Div., Midwestern Instruments	49
McMartin Industries	Cover 3
Microwave Associates	33
Moseley Associates	56
Moviola Mfg. Co.	56
Nortronics	51
Penta Laboratories	6
RCA Electronic Components & Devices	Cover 4
Riker Industries	Cover 2
Roanwell Corp.	8, 9
Rust Corp. of America	3
Sarkes Tarzian, Inc.	39
Scala Radio Co.	46
Scully Recording Instruments Corp.	38
Shure Brothers	55
Stancil-Hoffman Corp.	53
Superior Cable Corp.	21
Tektronix, Inc.	41
Telemet Co.	43
TelePro	29
Video Medical Electronics Corp.	7
Visual Electronics Corp.	45
Vital Industries	5
Ward Electronic Industries, Inc.	37

McMartin

No other FM MONITORS can do so much!



McMartin TBM-4000

FM/SCA MULTIPLEX MONITOR FCC TYPE APPROVED #3-116

This is the most versatile instrument available for monitoring all main channel modulation and SCA Multiplex operating characteristics. Compatible with FM stereo.

Direct meter readings of:

- Total Modulation
- SCA Modulation
- Crosstalk
- SCA Injection
- SCA Frequencies



McMartin
TBM-3000



McMartin
TBM-3500

FREQUENCY & MODULATION MONITORS FCC TYPE APPROVED #3-113, #3-119

- The TBM-3000 is a completely self-contained frequency monitor and the TBM-3500 is a self-contained modulation monitor.
- The 3000 used in conjunction with either the 3500 or 4000 fulfills the FCC requirement for a station monitor.
- The TBM-3500 is completely compatible with FM stereo.



McMartin TBM-2500

RF AMPLIFIER FOR REMOTE MONITOR OPERATION

The TBM-2500 will drive any combination of two monitors including other brands.

- Isolated high and low level outputs.
- Excellent stability and long tube life.
- 2 watt output with 1000 μ v input.
- Complete with yagi antenna and coaxial cable.

McMartin

Originality by

McMartin Industries, Inc.

605 North 13th Street

Omaha, Nebraska

Code 402 — 342-2753

In Canada Sold By: Canadian Marconi Company, Montreal 16, P. Q.

Circle Item 36 on Tech Data Card

Created by the hand of experience



RCA-7293A FIELD-MESH IMAGE ORTHICON

Clean...Precise...Ghost-Free Pictures

The RCA-7293A maintains the same flexibility and latitude of exposure and lighting that you experienced with the RCA 3" image orthicons while providing all of the benefits of field mesh construction. An additional feature of the RCA-7293A is the anti-ghost design which minimizes the highlight flare encountered in over-the-knee operation, providing a clean, precise picture.

Other design advantages of the 7293A include: *anti-port-hole feature*—the tube provides a uniform, distortion-free background to the edge and corners of the picture; *exceptional sensitivity*—equivalent to film rated ASA 8,000...produces broadcast quality pictures with only 5 footcandles of incident light on the faceplate; *high signal-to-noise ratio*—45:1; *high resolution and contrast*—field-mesh construction

assures sharp transition from black to white, minimizes distortion due to beam bending, and improves corner focus.

Get the most out of your camera tubes. Pick up a copy of this wall-chart (1G-1160A) on "Do's and Don'ts for Operating Image Orthicons and Vidicons". Operating characteristics of all RCA camera tubes are listed on the back. It's free at your local Authorized Distributor of RCA Broadcast Tubes.

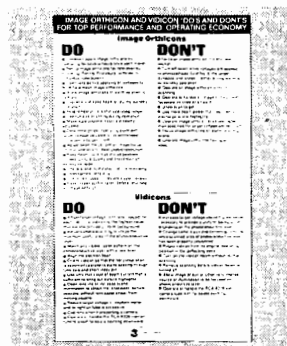

RCA ELECTRONIC COMPONENTS AND DEVICES, HARRISON, N.J.

AVAILABLE THROUGH YOUR LOCAL RCA BROADCAST TUBE DISTRIBUTOR

FOR NAME AND ADDRESS OF YOUR LOCAL DISTRIBUTOR WRITE OR CALL YOUR NEAREST RCA DISTRIBUTOR PRODUCTS SALES OFFICE—NEW YORK, NEW YORK: 36 W. 49th St., (212) MU 9-7200; NEEDHAM HEIGHTS 94, MASSACHUSETTS: 80 "A" St., (617) HI 4-8480; WASHINGTON 6, D. C.: 1725 "K" St., N.W., (202) FE 7-8500; ATLANTA, GA.: 134 Peachtree St., N.W., (404) JA 4-7703; CLEVELAND, OHIO: 1621 Euclid Ave., (216) CH 1-3450; CHICAGO, ILL.: Merchandise Mart, (312) 467-5900; DALLAS 7, TEXAS: 7901 Carpenter Freeway, (214) ME 1-3050; KANSAS CITY 14, MO.: 7711 State Line, (816) EM 1-6462; HOLLYWOOD, CALIFORNIA: 6363 Sunset Boulevard, (213) 461-9171; SAN FRANCISCO 2, CALIFORNIA: 420 Taylor St., (415) PR 5-5135-6-7.



The Most Trusted Name in Electronics