



SPECIAL TELEVISION FEATURES

Transmission Systems for ETV 18

A Proposed Television Center 20

A Copying System for News Slides 24

Directional Antenna Phasing 26

Broadcast Engineering

the technical journal of the broadcast-communications industry

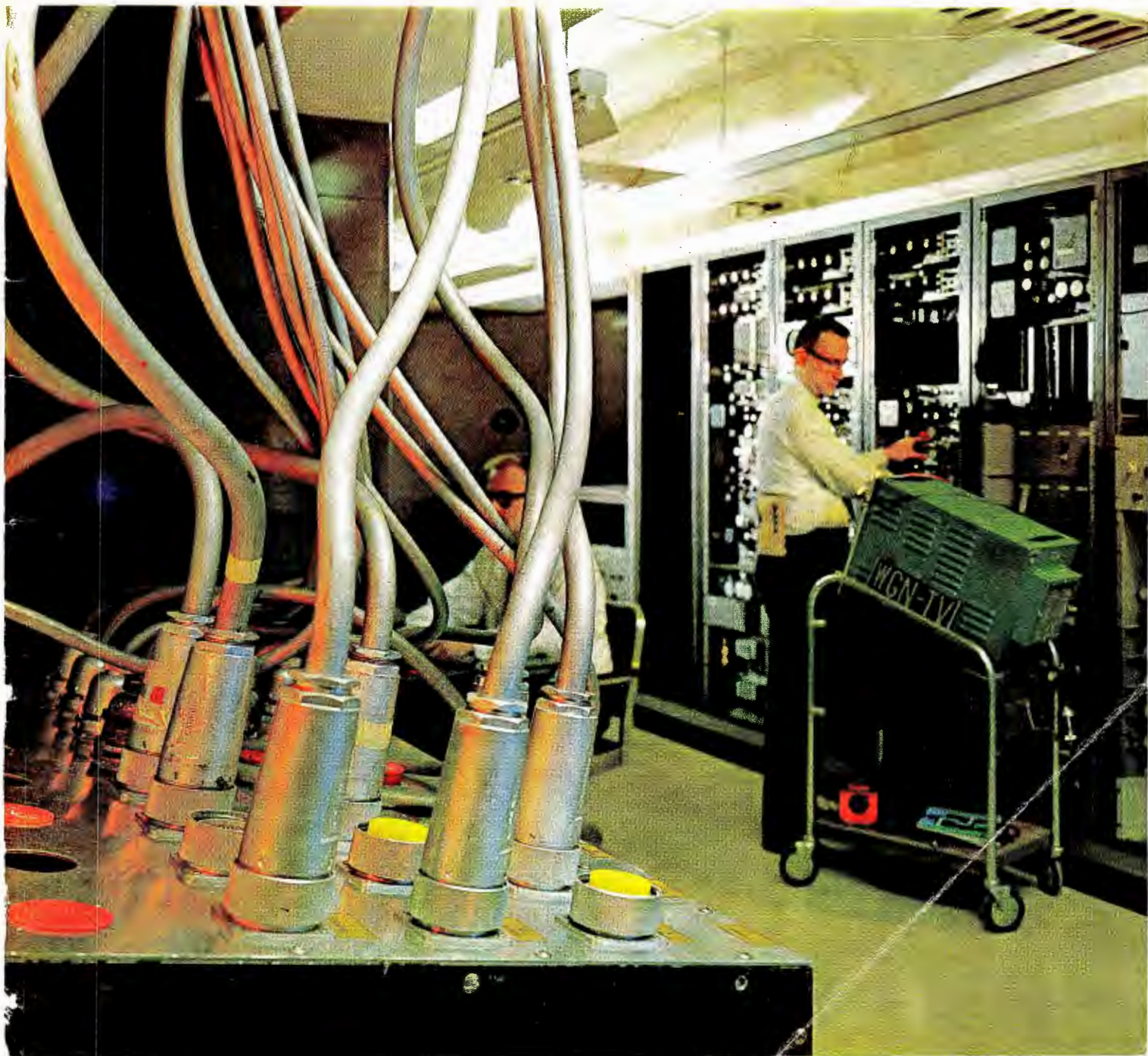

**Belden camera cable
in WGN-TV's unique
"Patch Panel" minimizes
switch over problems**



In their new Mid-America Broadcast Center, WGN-TV, Channel 9, Chicago, employs a unique centralized "patch panel" containing Belden TV Camera Cable. The panel allows a total of 15 black and white cameras, or seven color cameras, to be controlled from a single master control area by one engineer. The "patch panel" also greatly reduces the number of control units required and permits units to be changed rapidly in event of control failure. Defective cameras can also be replaced quickly using the same control unit.

90% Of all TV-Camera, Microphone, and Audio Cables at WGN-TV are made by Belden. And, according to Woody Crane, Chief Engineer for Television at WGN, Belden Camera Cable was specifically selected for the "patch panel" because of its extremely reliable performance, high-conductor insulation resistance, and ability to withstand the rigors of rapid switch overs.

Belden manufactures a complete line of wire and cable for TV and radio broadcasting, recording studios, remote control circuits, and similar applications. Call your Belden electronic distributor.



Better Built—Better Buy—Belden



power supply cords • cord sets and portable cordage •
electrical household cords • magnet wire • lead wire •
automotive wire and cable • aircraft wires • welding cable

8-5-3

Circle Item 1 on Tech Data Card



For distinguished service

If distinguished service in the field of video tape—for inventing it in the first place, for producing it in commercial quantities in 1957 to meet the scheduling demands of Daylight Savings Time, or for carrying the first taped pictures transmitted via Telstar—would deserve a medal, it might look something like the above.

But much more meaningful than any medal is the overwhelming preference engineers every day vote "SCOTCH" Brand Live-Action Video Tape.

This tape began its career nearly 7 years ago; and not a day has gone by since that 3M research in video recording and tape making hasn't been at work improving on this "seven-league-boots" head start. And in the audible range recording field as well, 3M is constantly developing refinements and improvements that set the standards in tape technology. "SCOTCH" Video Tape as well as "SCOTCH" Sound Recording Tapes put this experience and lead time at your service.

"SCOTCH" IS A REGISTERED TM OF 3M CO., ST. PAUL 19, MINN.

Magnetic Products Division **3M**
COMPANY

Circle Item 2 on Tech Data Card



Crown

— first choice
of those who
demand the best!

ESPECIALLY DESIGNED FOR

STEREO FM BROADCASTING

THE CROWN 822 is a precision 2-track recorder that answers the prime requisites for FM stereo broadcasting... (1) dependable, maintenance-free operation; (2) complete fidelity of reproduction.

In addition, the Crown 822 is ideal for program composition because of its extreme flexibility — 3 speeds, 4 mixing inputs (high or low level), separate bass/treble controls, adjustable echo, no cross-talk, Micro Touch electronic operator controls, remote facility, cue switch, magnetic brakes (no adjusting), photo-electric cell automatic stop, and many others... including individual performance guarantee.

Built by American craftsmen and engineers using American components. Write for further information and/or demonstration in your studios.

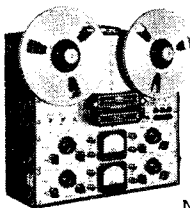

THE HALLMARK
OF CROWN —
SUPERLATIVE
CRAFTSMANSHIP
THROUGHOUT!

MODEL 822

**INDIVIDUAL PERFORMANCE
OF EACH CROWN IS
CERTIFIED AND GUARANTEED**

WRITE DEPT. BE-09



Crown
INTERNATIONAL
1718 Mishawaka Rd. • Elkhart, Ind.

Circle Item 3 on Tech Data Card



the technical journal of the broadcast-communications industry

Broadcast Engineering

Volume 5, No. 10

October, 1963

CONTENTS

FEATURES

- Analyzing Cascaded Amplifier Systems 14**
by Ken Simons — Noise, gain, and tolerance considerations in wide-band cascaded amplifier systems.
- When the Proof-of-Performance Fails 16**
by Ed Murdoch — Part Three. Continuing a discussion of troubleshooting techniques for checking out a faulty proof.
- Transmission Systems for ETV 18**
by Wm. P. Kruse — A look at the rules, specifications, and equipment used in educational TV systems.
- A Proposed Television Center 20**
by David Horowitz—Plans and description of a fully equipped TV/Radio facility.
- A Copying System for News Slides 24**
by Bert Goldrath—Transparencies can be quickly produced from news-film frames with the system described.
- Directional Antenna Phasing 26**
Technical Talks. Multi-color array phasing techniques; a guide for engineers.

DEPARTMENTS

- | | |
|-----------------------------------|------------------------------------|
| Letters to the Editor 6 | About the Cover 50 |
| Engineers' Exchange 30 | Engineers' Tech Data 52 |
| News of the Industry 34 | Advertisers' Index 54 |
| New Products 48 | Classified Ads 54 |
| | Professional Services 54 |

PUBLISHER: Howard W. Sams

GENERAL MANAGER: Mal Parks, Jr.

EDITORIAL: Exec. Editor, Verne M. Ray; Editor, Forest H. Belt; Managing Editor, Stuart N. Soll; Consulting Editor, John H. Battison.

CIRCULATION: Manager, J. A. Vitt; Fulfillment: Manager, Pat Tidd; Assistants, Katherine Krise and Cora LaVon Willard.

PRODUCTION: Manager, Robert N. Rippy.

ADVERTISING: Sales Manager, Dave L. Milling; EAST: Charles Horner, Howard W. Sams & Co., Inc., 3 West 57th Street, New York, N. Y., Phone—MU 8-6350; MIDWEST—Hugh Wallace, Howard W. Sams & Co., Inc., 4300 West 62nd Street, Indianapolis 6, Ind., Phone AX 1-3100; SOUTHWEST—C. H. Stockwell Co., 4916 West 64th Street, Mission, Kansas, Phone—RA 2-4417; LOS ANGELES 57 CALIF., Maurice A. Kimball Co., Inc., 2550 Beverly Blvd., Phone—DU-8-6178; SAN FRANCISCO Maurice A. Kimball Co., Inc., 580 Market Street, Phone—EX 2-3365; PARIS 5, FRANCE, John Ashcraft, 9 Rue Lagrange, Phone—ODeon 20-87; LONDON W.C. 2, ENGLAND, John Ashcraft, 12 Bear Street, Leicester Square, Phone—Whitehall 0525; TOKYO, JAPAN, International Media Representatives, Ltd., Kisha Kurabu 14, 2-chome Marunouchi, Phone—(502) 0656.

SUBSCRIPTION PRICE: U.S. \$6.00, one year; \$10.00, two years; \$13.00, three years. Outside U.S.A. add \$1.00 per year for postage. Single copies, 75 cents, Back issues, \$1.00.

BROADCAST ENGINEERING is published monthly by Technical Publications, Inc., an affiliate of Howard W. Sams & Company, Inc. Editorial, Circulation, and Advertising headquarters: 4300 West 62nd Street, Indianapolis 6, Ind. Copyright © 1963 by Howard W. Sams & Co., Inc.



A HOWARD W. SAMS PUBLICATION



BROADCAST ENGINEERING

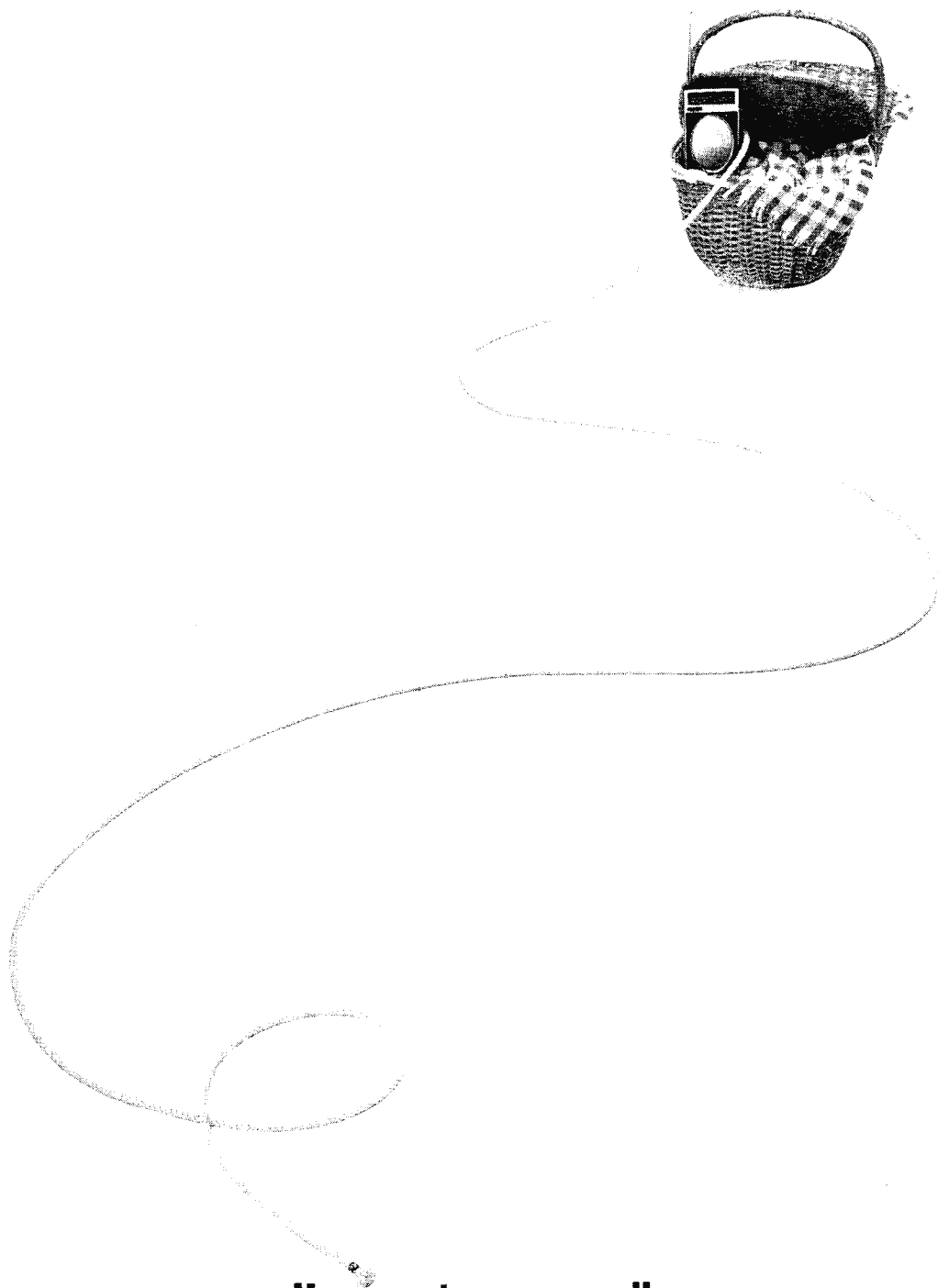

Hang onto your audience

—even when it's in fringe areas with those tiny transistor sets or in autos. Use the AUDIMAX[®] automatic level control! It's your route to as much as quadrupling your effective marketing area without increasing station power a single watt! Here's how: the exclusive gain platform principle of the AUDIMAX insists on maximum modulation... a clear, natural signal, even in fringe areas, with no distortion. The AUDIMAX logic and memory circuits discriminate between momentary and general changes in signal, to maintain gain at just the right level regardless of input. □ Yes, the AUDIMAX acts almost like another station engineer. The AUDIMAX thinks for itself! For details, call collect or write Professional Products, CBS Laboratories, a division of Columbia Broadcasting System, Inc., High Ridge Road, Stamford, Conn.

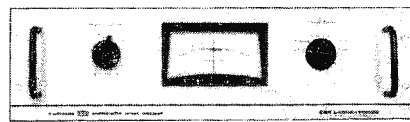

CBS LABORATORIES

Circle Item 4 on Tech Data Card

*Superb quality... moderately priced
... the preferred choice on five continents*

SPOTMASTER 500A

TAPE CARTRIDGE SYSTEMS

... NOW FEATURING DELAYED PROGRAMMING

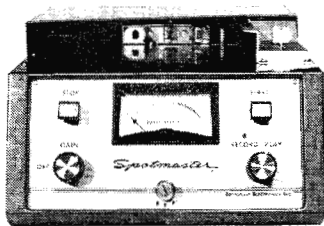

500A—complete record/playback unit

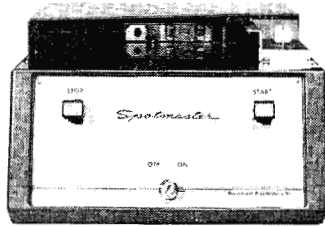

505A—playback unit

Spotmaster

The new SPOTMASTER 500A series of tape cartridge equipment is winning praise and acceptance throughout the world. These rugged, dependable machines provide snap-in cartridge loading, and split-second, one-hand operation . . . combined with high quality, wide range reproduction and all the time-tested, field-proven SPOTMASTER features.

And now something more has been added—the optional SPOTMASTER 500 A-DL Delayed Programmer. Designed to provide a 6-second to 16-minute delay in the broadcast of program material, the 500 A-DL makes possible “instant censoring” . . . lets you delete objectionable program material from

interviews and other live originations while the program is on the air. The 500 A-DL may also be used to meet many other delayed programming requirements. With the DL function switched off, the unit operates as a standard 500A recorder/playback.

On five continents, more stations use more SPOTMASTERS than any other cartridge tape system. Write or phone for full information; learn about the SPOTMASTER lease/purchase plans . . . mono and stereo models . . . rack-mount or compact models . . . complete line of equipment and accessories . . . 24-hour-a-day ruggedness and dependability . . . ironclad, full-year guarantee.



BROADCAST ELECTRONICS, INC.

8800 Brookville Road, Silver Spring, Maryland

Telephone: Area Code 301 • JUniper 8-4983

Sold nationally by:

VISUAL ELECTRONICS

356 W. 40th St., New York, N.Y.

Canada:

**Northern Electric
COMPANY LIMITED**

Branches from coast-to-coast in Canada

Circle Item 5 on Tech Data Card

LETTERS to the editor

DEAR EDITOR:

Our engineers in the Field Engineering Bureau are getting a big laugh over Ed Murdoch's article, "Twelve Rules for Dealing With the FCC Inspector," appearing in the May issue of BROADCAST ENGINEERING. As an old time field inspector, I have the feeling that Ed has probably not only survived many a broadcast inspection, but that he has gotten to know what makes us guys "tick."

I know that Ed's article is intended to be humorous, and in fact it is; however, between the lines it tells a story. Maybe I wouldn't be far wrong in categorizing it as "more truth than poetry."

In closing may I simply say more power to you and your magazine, Ed Murdoch, and all the radio operators with whom we have to do business. I am all in favor of anything that will make our respective jobs either easier, or more pleasant along the way.

GEO. S. TURNER
Chief, Field Engineering Bureau,
FCC, Washington, D. C.

There, readers, that proves it—FCC Inspectors are human. And thanks, Mr. Turner, for the encouraging words!—Ed.

DEAR EDITOR:

Enjoyed reading the article entitled "Tracing Television Interference," in the August issue. Noted that a shorted stub was called for to reduce the interference being caused by an FM station. Since a shorted quarter-wave stub would appear to be an open circuit across the antenna terminals at the interference frequency, it would not attenuate the FM signal; instead, it would attenuate the TV signals. On the other hand, if the stub was open ended it would provide an effective short across the antenna terminals for the interference and pass the TV signals.

An open-ended stub of this type is very effective in reducing TVI caused by amateur transmitters operating in the 2-meter band.

Doyle D. Thompson
Chief Engineer, WFMV-TV,
Greensboro, N. C.

Right you are, Doyle, we seem to have our stubs crossed. Thanks for pointing out the problem.—Ed.

DEAR EDITOR:

Congratulations to Thomas R. Haskett for an excellent series on audio level devices. With numerous units available to the broadcaster, these articles have proven to be an invaluable aid in choosing the device to fit a station's needs.

May I call your attention to page 17 of the August issue? The General Electric "Uni-Level" equipment pictured is the BA-9-A, the plug-in model. The BA-9-B is the self powered, rack-mounted unit.

Donald Lefebvre
WEDH-TV, Hartford, Conn.

The caption at the upper left corner

BROADCAST ENGINEERING



We wouldn't risk our artists to any other tape...why should you?

It's a ticklish business recording the world's greatest artists! You never know which take will capture that one magic performance! RCA Victor engineers must be able to depend on every inch of master recording tape to deliver the absolute ultimate in quality performance. That's why RCA Victor Recording Engineers use Red Seal Magnetic Recording Tape. In fact, Red Seal Tape was specially developed for their use.

In one of the newest, most modern plants in the country, Red Seal Tape is manufactured to the highest quality specifications in the industry — and it's now

available for your recording requirements!

Quality control-tested for frequency response, distortion, drop-out noise, print-through, Red Seal Tape is also mechanically tested for coating thickness, anchorage, layer-to-layer adhesion, aging, cupping, slitting tolerances. Every inch has the same magnetic properties, the same recording-bias characteristic, so you can use tapes interchangeably!

Get all the details, fill in the coupon now.



Circle Item 6 on Tech Data Card

Magnetic Tape Products Marketing
RCA Victor Record Division
155 East 24th Street
New York 10, N. Y.

Please rush me specifics on RCA Red Seal Magnetic Tape including all essential physical and magnetic characteristics.

NAME

TITLE

COMPANY

ADDRESS

CITY..... ZONE... STATE.....

Professional Performance ...at your fingertips

... with VIKING tape cartridges used in countless broadcast hours year after year.

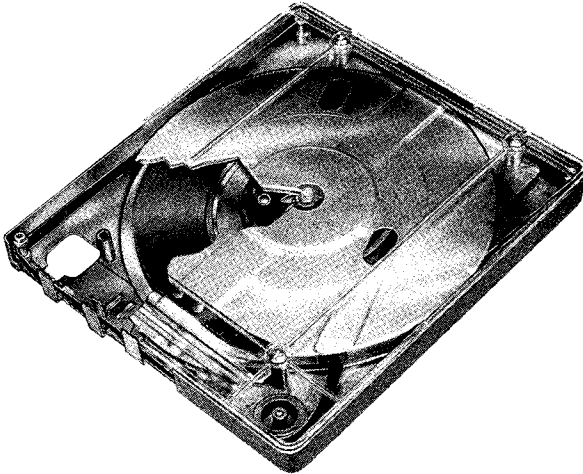

Lightweight, drawn aluminum cases give VIKING tape cartridges exceptional rigidity that lasts. Designed to perform with minimum tape friction when loaded with shortest tape length or when loaded to capacity.

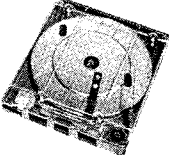
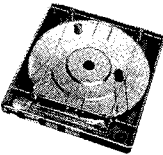
Cartridges With Clear Plastic Cover			
	M4 to 375'	M6 to 850'	M8A to 1700'
Single coated tape standard loop			
Double coated tape moebius loop			

For Information Write to Customer Service Dept.

IF IT'S USED WITH TAPE IT'S MADE BY VIKING



VIKING OF MINNEAPOLIS, INC.
9600 Aldrich Avenue South, Minneapolis, Minnesota, 55420

Your assurance of Quality in Tape Components

Circle Item 7 on Tech Data Card

of page 7 (August) should read: GE BA-9-A "Uni-Level." You've an observant eye, Don, thanks.—Ed.

DEAR EDITOR:

Sometime within the past year you ran a series of articles on preventive maintenance, with suggested checklists and guides for setting up a complete program.

If these back issues are still available, I would appreciate a copy of each.

Please forward same, and bill for the full amount.

Loring S. Fisher
General Manager, WRFY-FM,
Reading, Pa.

During the last 12 months the following articles concerning this subject have appeared:

Preventive Maintenance for the Studio—Dec. 62.

A Test Equipment Checklist—July, 63.
Maintenance of a Small TV Studio—July, 63.

Last year several maintenance series were published in BROADCAST ENGINEERING, and have since been collected in the Broadcast Engineers' Maintenance Guide. This book is not for sale, but is available free with a new or renewed subscription.—Ed.

NEXT MONTH

Recording and Reproduction:

TELEVISION TAPE TECHNIQUES TODAY

Systems and equipment currently employed in recording video tape.

AUDIO LEVEL DEVICES

Part Four—Specialized Equipment.

MODIFYING THE TR-11

Adding a variable-speed forward/rewind control.

TRANSISTORIZED AMPLIFIER SERVICING TECHNIQUES

Troubleshooting transistorized broadcast audio amplifiers.

Extra Recording Features

- Measuring Speed of Cartridge Units.
- Off-Air Logging with Existing Gear.

Plus—Engineers' Exchange, Technical Talks, and many other timely items.

Reserve your issues! Receive Broadcast Engineer's Maintenance Guide free, by filling out and sending in the convenient subscription card.

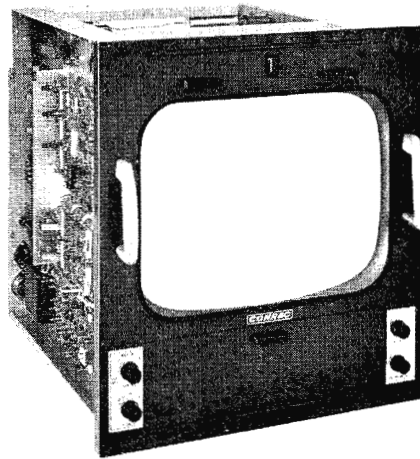

**Conrac's 17" color monitor:
\$2450, shipped next week**

The Conrac CYA 17 puts color where your black and white monitors used to be: right in 21 vertical inches of a standard 19" rack or console.

The CYA 17 weighs less than 100 pounds (101 transistors and 21 tubes).

Are there more features? We've just scratched the surface. Just ask anyone who attended the NAB show. Or request a CYA 17 data bulletin.

CONRAC **DIVISION** *Glendora, Calif.*
GIANNINI CONTROLS CORPORATION

Circle Item 8 on Tech Data Card

Telechrome* SOLID STATE TV SPECIAL EFFECTS

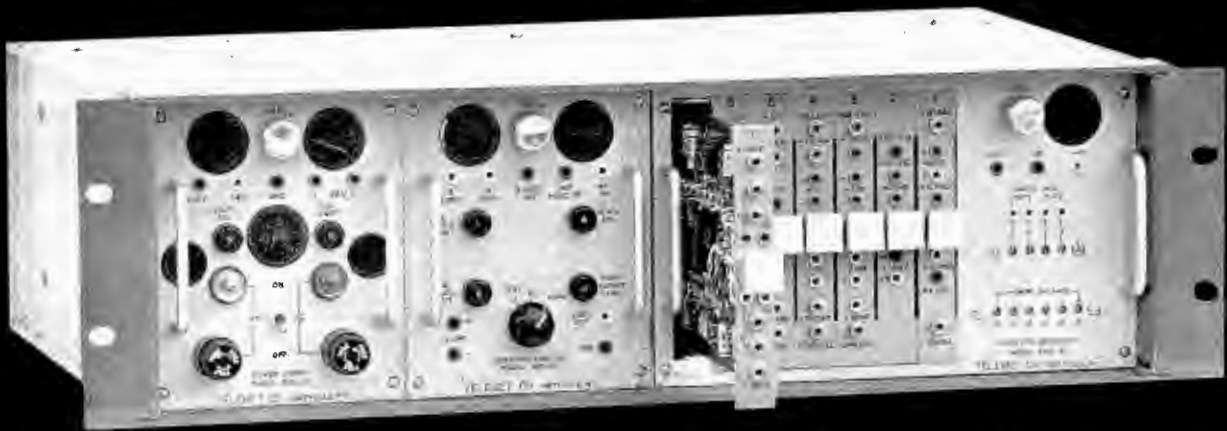

MODEL 3801A1 TV SPECIAL EFFECTS PICTURED WITH MODEL 13802A1 POSITIONER



©Brand Name

Designed for studio or mobile applications, the new TELECHROME Solid State Special Effects Generator, Model 3801A1, produces a multitude of visual effects to enhance scene changes, insert keying for commercials and bulletins, etc. The system comprises a power supply, switching amplifier and waveform generator in a 5¼" high rack mounting frame and remote control units. The waveform generator contains 7 plug-in cards, 6 for the effects and one for the accessory joy stick positioner. A newly designed effects remote control unit provides an illuminated pictorial of the selected effects—plus Thumb-Wheel control for rapid and positive wipe selection.

FEATURES

- Occupies only 5¼" of rack space.
- Fully transistorized for reliable service free operation.
- Color or monochrome operation.
- Plug-in waveform generating cards.
- Inserts camera control and chroma keying.
- Up to 72 effects; including both horizontal and vertical wipes, diagonals, rectangle, diamond, circle, etc.
- Individual plug-in switching amplifier, waveform generator, and power supply.
- New compact remote control units occupy less console space.
- Thumb-wheel wipe selector eliminates parallax.
- Plug-in oscillators in positioner remote control unit for modulation of effects.

TELEMET
COMPANY

185 DIXON AVENUE • AMITYVILLE, NEW YORK
TELEPHONE: (516) 541-3600

A Giannini Scientific Company



Circle Item 10 on Tech Data Card



Glutton for punishment

(Soundcraft's new Uni-Lube cartridge tape)

Soundcraft Uni-Lube is the new longer-wearing cartridge tape that plays and plays and play and plays. It meets the punishing conditions of endless loop cartridge applications head on—and comes back for more!

Uni-Lube is a Mylar* base tape, oxide-coated on one side, lubricated on the other. The base is coated with PERMA-GRAPH, a new permanent anti-static lubricant that keeps the tape free of friction during playback, eliminating the problems of heat and tape deterioration and assuring uniform tape motion.

The other side of Uni-Lube is coated with Soundcraft's new, durable, *ultra-thin oxide formulation* that produces maximum short wave length signal-to-noise characteristics

for low speed systems. Short wave sensitivity is 3 to 5 db higher than standard tapes. This remarkable oxide coating records the widest dynamic range ever achieved on a cartridge tape.

The combination of the physical properties of the "Mylar" base, the PERMA-GRAPH lubricant and the new oxide formulation result in the longest-wearing cartridge tape available today—a tape free from friction—free from shedding and head fouling—free from breakage and the effects of heat, cold and humidity. *This is the cartridge tape you've been waiting for.* Available in 1 mil "Mylar" and the new $\frac{3}{4}$ mil Tensitized "Mylar" for extra strength and longer play. Write for complete details. *DuPont T.M.

REEVES SOUNDRAFT

Division of Reeves Industries, Inc., Danbury, Conn. • New York • Chicago • Los Angeles • Foreign Division: 25 Warren St., N.Y.C. • Canadian Reps: Vancouver • Toronto

Circle Item 11 on Tech Data Card

ANALYZING CASCADED AMPLIFIER SYSTEMS

by Ken Simons* — Discussion of gain, noise, and tolerance in cascaded wide-band amplifier systems.

When a number of wide-band amplifiers are connected together with cable to form a TV distribution system, they either work well, or they don't. Either the system delivers a clean usable picture to all the customers, or it doesn't. There are a few fairly simple relationships that make it possible to determine ahead of time whether a given arrangement of amplifiers will operate properly.

An amplifier and a receiver can be connected to a source of TV signals as shown in Fig. 1. Suppose the amplifier input is varied by adjusting attenuator 1, keeping No. 2 adjusted so the receiver has a constant, comfortable input of 10 dbmv¹ (3.16 mv). When there is too much attenuation in No. 1, the picture becomes snowy, since the amplifier input is too weak (it's "in the snow"). When there isn't enough attenuation the amplifier becomes overloaded. With one TV channel the picture loses sync, or develops sound buzz; with several TV channels going through the amplifier "windshield wiper" effect

*Chief Engineer, Jerrold Electronics Corp.

Table I. Relation of S/N to Quality.

S/N (db)	Picture Quality
0 to 10 db	UGH!
10 to 20 db	Very Snowy
20 to 30 db	You can tell which blur is Perry Como
30 to 40 db	Good Usable Pictures
40 to 50 db	No Visible Noise

shows up—the input to the amplifier is too strong. What causes these troubles? Is it possible to make measurements and decide ahead of time when such problems will occur? It is. There are two main considerations — noise and overload. First consider noise, the factor that determines how weak a signal can become before it is "in the snow."

Noise

Any resistor can develop a noise signal all by itself. This signal is due to the random motion of electrons inside the resistance element. Anyway, it's a real noise which the resistor is happy to deliver to circuit connected to it. This same trick is performed not only by actual resistors, but by any resistive source such as an antenna or a transmission line. The amplitude of the noise depends on the bandwidth and on the size of the resistor; for TV bandwidth (4 m μ) the noise

level delivered by a 75-ohm resistive source to a matched load is —59 dbmv. Now it would seem obvious that when this noise source is connected to the input of an amplifier with, for example, a 40-db gain the output would be:

$$-59 \text{ dbmv} + 40 \text{ db} = -19 \text{ dbmv (noise)}$$

However, this isn't true. There is **always** more noise output than would be expected from the noise input and the gain of the amplifier. Why? Well, amplifiers are that way. They don't just amplify, but also produce a little noise on their own. They've got some electrons floating around too, in their tubes (or transistors—let's be modern!) and these electrons have "random motions." So, there is **more** noise. How much more? Well, that depends somewhat on the engineer who designed the amplifier. If he had all the factors under control, the noise output would be only 3 or 4 db higher than would be expected (such an amplifier is **real good**; it has a noise figure of 3 or 4 db). If not, the

¹In TV distribution systems, levels are conveniently measured in db above a reference level of 1 millivolt across 75 ohms, abbreviated **dbmv**.

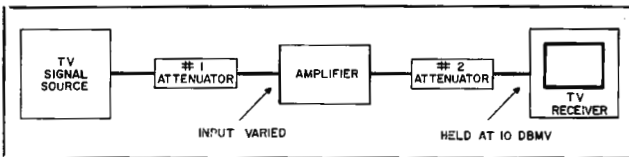

Fig. 1. Basic wide-band television distribution system.

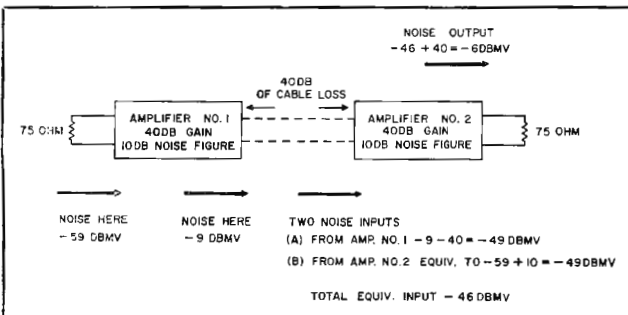

Fig. 2. System noise relationship with two amplifiers.

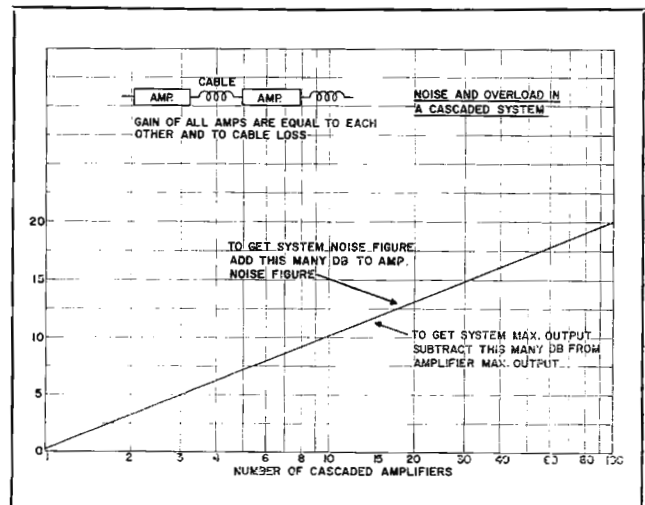

Fig. 3. Relation of number of amplifiers to noise figure.

Table 2. Number of Amplifiers Related to System Noise Figure.

Number of Amplifiers	System Noise Figure
1	0 db
2	3
4	6
8	9
16	12

noise may be 15 or even 20 db higher than -59 dbmv plus the amplifier gain. This amplifier has a noise figure of 15 or 20 db. The noise figure of any amplifier is simply the number of db by which its noise output exceeds the sum of the noise input (-59 dbmv), and the amplifier gain. In equation form:

$$\text{Output Noise Level (dbmv)} = -59 \text{ dbmv} + \text{Gain (db)} + \text{NF (db)}$$

Signal-to-Noise Ratio

Having decided how much noise is present at the output of an amplifier the next question is, "Does this much noise do any harm?" This depends on the TV signal strength. When the TV signal at the receiver is weaker than the noise, the picture can't even be seen. When the two are equal, the picture is terribly snowy. It isn't until the signal is decidedly stronger than the noise that the picture gets really usable. How much is decidedly? Table 1 shows how it stacks up.

Cascaded Systems

A distribution system usually involves more than one amplifier (except for real small systems, but they give little trouble anyway). The first amplifier feeds a length of cable with a loss equal to the amplifier's gain; the cable is connected to a second similar amplifier which feeds the next run of cable. The gain of each amplifier must approx-

imately make up for the loss of the following piece of cable, or the later amplifiers get into trouble as the system gets out of balance.

What happens to the noise in such a situation? Starting with -59 dbmv at the system input, the noise level at the output of the first amplifier (e.g., in Fig. 3 the noise output is -59 plus gain plus noise figure. By the time all this noise passes through the following cable, the following amplifier is presented with a noise signal higher in amplitude than -59 plus the noise figure of the first amplifier. Since the second amplifier has some noise of its own to contribute, its output contains noise from two sources, and thus has twice the noise power output (3 db more noise level) than the first amplifier (-49 dbmv in Fig. 3). Without getting elaborate, we can say each time the number of similar amplifiers in a cascaded system is doubled, the system noise figure increases by 3 db. The graph of Fig. 4 and Table 2 show this.

Overload

The overloading of an amplifier isn't as "mathematical" as its noise; we can't describe it as conveniently with nice numbers, but the condition is very definite! In most cases, when an amplifier starts to overload, things happen in a hurry. Increasing the level only a few db will generally change the picture from good to terrible. Take the commonest type of overload—cross-modulation or "windshield wiper"—that occurs in a multi-channel system. When an amplifier overloads in such a system, the interfering signal amplitude increases three times as

Table 3. Number of Amplifiers Related to Maximum Output.

Number of Amplifiers in Cascade	Max. Output of System (dbmv)
1	M
2	M-3
4	M-6
8	M-9
	and so on

Note: M is the maximum output of 1 amplifier (dbmv)

fast as that of the wanted signals. Consider a system in which cross-modulation is just visible at 40 dbmv. By the time the level reaches 45 dbmv, the cross-modulation will have increased about 15 db and is definitely visible.

Because of the drastic nature of overload, it needn't be defined as carefully. If the maximum output of a given amplifier is defined as the output level at which cross-modulation is first seen, there won't be much argument. As long as the number of channels is specified anyone can set up one amplifier, increase the input until the wiper starts wiping—and agree on the level within about three db. So without any calculations, an important amplifier property—its maximum output—can be described.

Maximum Output in a Cascade

Remembering the effect of noise in a cascade system, you may have figured out that doubling the number of cascade amplifiers causes the maximum output figure to go down 4 db, and this is just what happens.

This fact also can be tabulated as Table 3, or drawn as Fig. 4.

Tolerance

The quantity called "tolerance" is between snow and overload.

Consider an amplifier with:

• Please turn to page 38

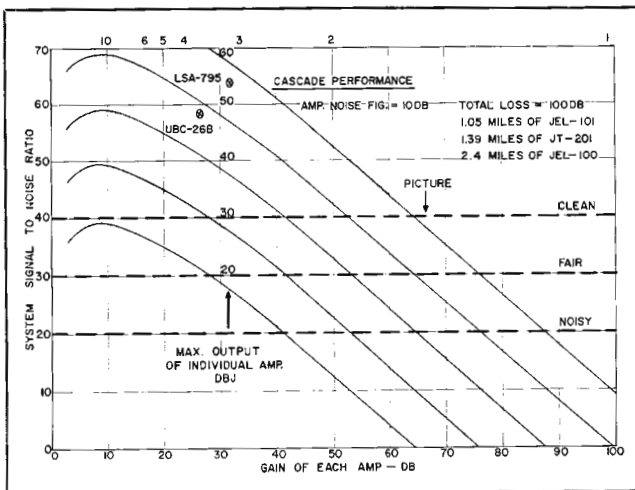

Fig. 4. Curves for 10 db noise figure and 100 db loss.

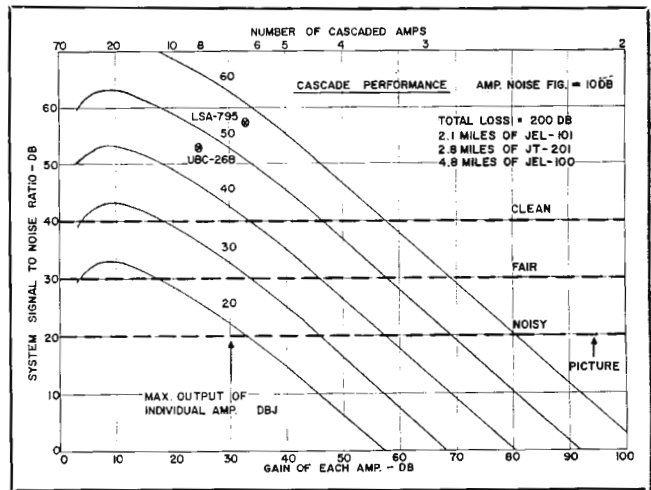

Fig. 5. Curves for 10 db noise figure and 200 db loss.

WHEN THE PROOF-OF-PERFORMANCE FAILS

by Ed Murdoch* — Part Three.

Continuing the discussion of troubleshooting a faulty proof, with tests for noise, distortion, and frequency response.

The discussion of noise and distortion was begun in Part Two of this series. The steps for tracing the noise source through the amplifiers were described therein. This month we will continue that discussion and proceed through the power supply, and the audio modulation portions of the transmitter.

Power Supply Tests

If you desire to "nail down" a noise problem to some portion of the power supply before replacing filters, the B+ lead to the amplifier can be disconnected, and a temporary load substituted (although this may not be necessary for an adequately designed supply). A wirewound resistor about one-third to one-fourth the value of the bleeder resistor, and two or three times its wattage rating, should suffice for a temporary load. The supply will have to operate in this manner only long enough to examine the output voltage for noise, using the scope. Separate supply sections, or a separate supply, can be treated in the same manner. Any series dropping resistors (low and intermediate B+ feeders) connected to the main B+ source can be disconnected at the power supply, and scope probe connections made at the terminals.

When the main supply is eliminated as a trouble spot, the next

step is to investigate lower-level decoupling networks which may be located within the amplifier. To assist in identification, the schematic should be consulted. Decoupling networks are the series isolating-dropping-resistors and accompanying bypass capacitors located between a main power source and the stage in question. A decoupling network for one stage might be an extension of the network for another stage.

As is the case with cathode capacitors, there must be a very noticeable amount of noise if a "disconnect" test is to be significant, since temporary removal of the capacitor may cause a change in stage gain. If oscillation should develop when a bypass capacitor is disconnected, the grid of the next succeeding stage which shares the same main supply can be bypassed temporarily with a large capacitor. (If that stage is self-biased, the grid can be jumpered directly to ground.) Noisy dropping resistors are best isolated by actual substitution. When examining decoupling networks, the scope should preferably be connected to the plate of the tube which the network feeds.

Transmitter

If necessary, similar techniques can be applied to the audio-driver section of the transmitter, but extreme caution should be exercised. The high-voltage power supply

should be made inoperative by pulling the rectifier caps, if there is no separate switch. Use a grounding stick to discharge all capacitors every time the power is turned off—and always before touching anything in the transmitter cabinet. (Use the grounding stick on the high-voltage capacitors even when the supply has been inoperative for a considerable time.) Make any necessary connections with the transmitter completely off, and stand well clear to make observations when it is on.

Fortunately, component noise is not nearly so serious in the relatively high-level stages of the transmitter audio system as in the earlier amplifiers of the chain; many transmitters will operate almost indefinitely without requiring special attention in this area. (Aside from noisy tubes, vibrating blower-motors are frequently guilty of causing microphonic noise by agitating components, but this can be detected by cabinet vibration. The remedies are tightening, lubrication, and/or replacement.) So, unless the excess noise has been definitely isolated to the transmitter, it is best not to tamper around. A couple db of improvement in the noise level of transmitter audio is hardly worth the effort.

In addition to intrinsic component noise, there are other causes of self-created amplifier noise, most of which relate to equipment age

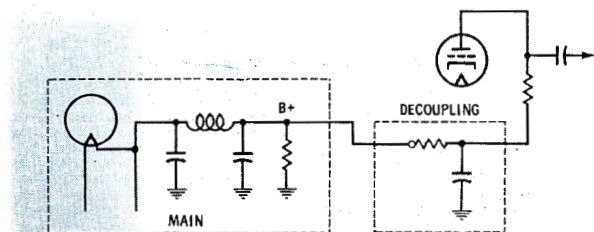

Fig. 1. Power supply—main B+ and decoupling networks.

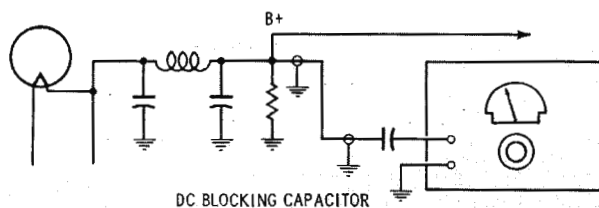

Fig. 2. Distortion analyzer connected to measure ripple.

and insufficient maintenance. Noise is created through contact resistance when tube pins do not make good low-resistance contact in their sockets. Gradual oxidation will cause the resistance to increase, simultaneously increasing the noise level of the system. Generally, this condition can be improved, or cured, by pushing the tube in and out of the socket several times. (In extreme cases it might be necessary to replace the socket.) Plug-in capacitors can cause serious hum and noise through contact resistance. One of the most severe cases of noise I have ever encountered was traced to a plug-in electrolytic capacitor, and required replacement of the socket.

Other noise sources are dirty or worn key-switch contacts and dirty or worn attenuator contacts and blades (also blade misalignment and poor blade pressure). It would be of value to investigate these possibilities in the event of noise which appears distributed, and not definitely traceable to a single defective component.

And don't forget poor solder joints! A poorly soldered connection may not give trouble when the equipment is brand new, but will cause increasing difficulty with age. Several years ago I ran across a case in which a rather high noise level was isolated to a microphone preamplifier, but the resistors and capacitors checked good. By resoldering every connection in the preamp—including power ties—the noise was considerably reduced. Although this was a relatively old amplifier, similar difficulties can occur with gear right out of the factory. Recently, I encountered a new limiting amplifier with a high, varying noise level. An oscilloscope wasn't required to find this one: Inspection revealed that one of the plate connections was so poorly soldered that the wire was "secured" to the contact with flux instead of solder.

Although considerable improvement seems to have been made in the manufacture of etched circuit boards, gear containing the early types was often more susceptible to solder difficulties than was hand-wired equipment. If no obvious soldering flukes are observable on a suspected circuit board, connect an oscilloscope to the amplifier

output, and tap the contact points while you observe the screen.

Hum

Much of the hum encountered in measurement work will, of course, be caused by tubes—routine substitution will solve this. Plug-in capacitors, especially electrolytics, can cause a good deal of hum and noise if contact resistance develops. Hum induced through magnetic coupling may sometimes be minimized by repositioning low-level audio input wiring at the console. This latter should be investigated especially in relation to nearby AC wiring to turntables or tape recorders. Replacement of "lamp-cord" wiring with heavy-duty shielded wire will frequently decrease the hum level appreciably. However, this, as well as magnetic ground-loops, has been discussed.

A natural source of hum, of course, is the power supply. While most modern supplies are designed for excellent filtering, the filtering efficiency decreases as capacitors begin to age, and the ripple component of the DC output begins to increase. While you have access to a distortion analyzer, you might as well use it to measure the ripple percentage of the supply for future reference, even though the present noise level may be okay.

First, measure the DC output of the main B+ supply with a VTVM or high-sensitivity VOM. Then use the distortion analyzer to measure the absolute rms value of the ripple component at this terminal. (Generally a shielded lead in series with a 1-mfd blocking capacitor is used to connect the B+ terminal to the analyzer input.) Compute the ripple percentage according to the formula:

$$\frac{E_{\text{ripple (rms)}}}{E_{\text{dc}}} \times 100 = \% \text{ ripple}$$

If this measured percentage exceeds the console manufacturer's speci-

fications, replacement of the filter capacitors is in order. If the published data does not specify a maximum ripple content for the supply, the manufacturer will generally send you the information upon request. As a guide, it is probably safe to estimate that the ripple of the main supply should be less than one-tenth of one per cent. If a supply shows a ripple of from 0.3 to 0.5% it definitely should be investigated.

Because of the added filtering offered by decoupling networks (or specially designed separate supplies) the ripple percentage for the intermediate stages should be somewhat lower than that measured at the main B+ terminal. For absolute measurement of ripple in the low-level preamp stages, adjust the analyzer to a full-scale sensitivity of .003 volt (corresponding to the 1% position of the range knob in some models); there should be almost no measureable ripple.

Here is a general guide for checking filtering efficiency: The 120 cps ripple through a properly operating decoupling network should be no more than approximately $1/520 \times CR$. Thus, a network consisting of a 10,000 ohm resistor bypassed by a 20-mfd capacitor should reduce ripple to only .04% of the ripple input to the filter (.00020 farad times 10,000 ohms equals .2; $1/520$ times .2 equals .0004, or .04%). When using this formula to predict ripple, remember it is only an approximation, and a deviation of perhaps 50% from the computed value should be evident before ripping out a decoupling capacitor, or network.

Distortion and Frequency Response

With modern studio equipment, there should be little difficulty in surpassing FCC limits with respect

- Please turn to page 44

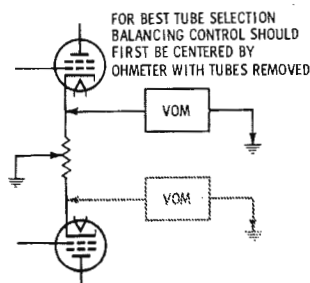

Fig. 3. Setup for matching tubes.

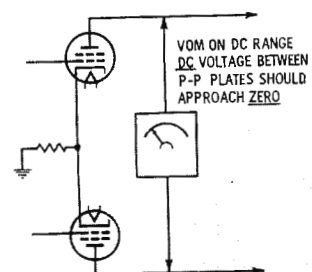

Fig. 4. Quick check for tube balance.

TRANSMISSION SYSTEMS FOR ETV

by Wm. P. Kruse* — A discussion of the rules, specs, and equipment for educational television transmitter installations.

With the current interest and rapid expansion of educational TV, the broadcast engineer may be called upon to offer recommendations regarding facilities for a specific installation. A brief review of the basic considerations of ETV transmission systems is in order.

First determine whether the system is to be "closed circuit" or "broadcast." Consideration of economics, availability of FCC assigned channels, geographical distances, and topography will usually render this decision automatic. It is also important to consider whether the programs will be produced exclusively for classroom viewing or for dissemination to the general public.

Closed-circuit distribution (via coaxial cable) is the economical method for use within one building or to serve classrooms in a group of buildings on a reasonably small campus. Broadcast techniques—employing transmitter, antenna, and off-the-air pickup—will prove more practical for program distribution to widely separated buildings. Of course, such a system is necessary if programs are to be transmitted to the general public. Available transmission channels for cable television signals are shown in Table 1.

*Gates Radio Co., Quincy, Ill.

Table 1. Closed Circuit Channels

Frequency Range	Losses	Correction
0-6 mc, direct video.....	very low	very large
10 thru 54 mc, carrier subchannels	low	large
54 thru 88 mc, carrier standard (channels 2-6)		useful
88 thru 174 mc, carrier non-standard channels..		medium
174 thru 216 mc, carrier standard channels 7-13	large	small
216 and up are uneconomical at present.....	excessive	small

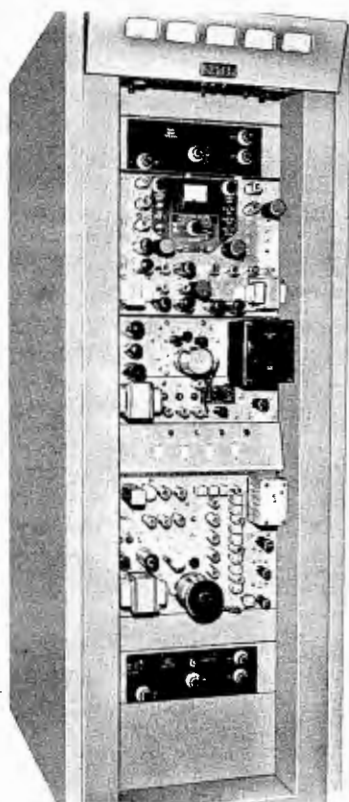

Fig. 1. Typical low-power TV transmitter.

Frequencies available for broadcast transmissions of ETV signals are:

- A. 54 to 72 and 76 to 88 mc for standard channels 2-6; use stock low-band VHF equipment.
- B. 174 through 216 mc for standard channels 7-13; use stock high-band VHF equipment.
- C. 470-890 mc for standard channels 14-83; use stock UHF equipment.
- D. 1990-2110 mc for ETV channels 101 through 120; equipment now on the drawing board or experimental.
- E. 2500-2686 mc. (Channel numbers not assigned).

The FCC has already made most of the channel allocations in bands

A, B, and C. The information is published in the FCC Rules and Regulations, and is kept current through an updating service. The Federal Register carries notifications that precede the updating service in order that interested parties may have time to petition and testify before an FCC committee.

The two newly allocated bands in D and E are as yet not specifically assigned. They will probably be put into use, chronologically, as requested.

Geographical Considerations

Coverage is determined by the terrain, antenna height, and pattern. Assuming matched-quality receiver and receiving antenna, the effective radiated power (erp) required for overcoming path-length losses is as shown in Table 2.

The figures in Table 2 merely indicate the proportions of effective radiated power required, not the actual power generated by the transmitter. For channels 2-13, antenna gains of up to 10 or more are available. Thus a maximum power of 100 kw erp would require either an antenna gain of 10 and a transmitter rated at 10 kw, or any other equivalent (such as antenna gain of 2 and a 50-kw transmitter). For most towns of under 10,000 population, 100- or 500-watt transmitter, with an antenna gain of 10 or 2, respectively, may suffice on channels 2-6 (1 kw erp). A 500-watt unit with an antenna gain of 6 would provide equivalent service

Table 2. Effective Radiated Power.

Channels	Frequency (mc)	Power
2-6	54-88	100kw max.
7-13	174-216	316kw max.
14-83	470-890	5,000kw max.
101-120	1990-2110	10,000kw estim'd.
	2500-2690	10,000kw estim'd.

on channels 7-13 (3 kw erp).

On VHF channels, only the antenna's vertical directivity may be altered to push greater effective signal into a desired area. On UHF channels, however, the antenna's horizontal directivity may also be used, provided the transmitter produces 1 kw or less. For UHF stations generating more than 1 kw, the horizontal radiation pattern may have a maximum to minimum ratio of 15 db.

The High Channels

The new channels in the 2000- and 2500-mc bands have few restrictions as yet. In ETV service, the licensee has a unique advantage—complete control of both transmitting and receiving installations. Such an arrangement permits considerable engineering planning to obtain maximum efficiency in the use of the band. Directional antennas with effective gains of several hundred are economically feasible, and are available for receivers and transmitters alike.

Effective September 9, 1963, the FCC authorized a new fixed instructional TV service "... for accredited public and private schools, colleges, and universities in the formal education of students." Special training material can also be transmitted to hospitals, rehabilitation centers, industrial establishments, and training centers. Thirty-one channels of 6 mc each are provided to operate in the 2.5-kmc band at a maximum power of 10 watts.

Adler Electronics has developed an experimental system for the Plainedge, N. Y. schools which has been operating for a year. They use 10 watts of visual and 1 watt of aural power at 209.25 and 2013.75 mc, respectively (channel limits are 2008-2014 mc). Two directional transmitting antennas are used to produce an erp of 136 watts each. Six schools have relatively simple antennas, while the seventh and most distant school uses a parabolic antenna. At each school building, a single converter picks up the 2,000 mc signal and feeds it into a master antenna distribution system as a channel 6 signal. Then it is cabled to standard TV receivers.

Applicants for new 2- and 2.5-kmc fixed ETV stations, or for an increase in transmitter power to

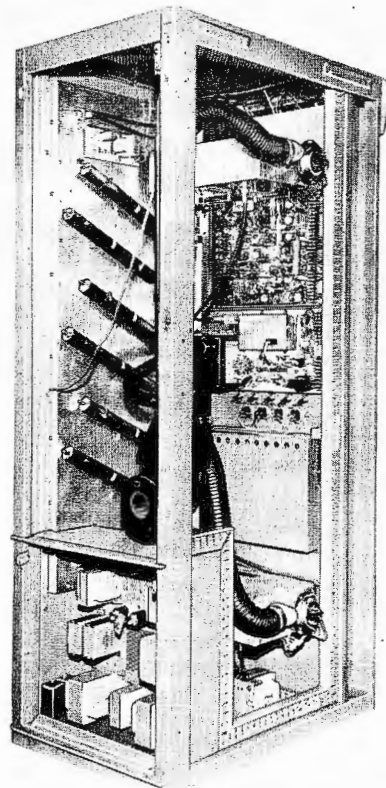

Fig. 2. Rear view of 120-watt transmitter.

greater than 10 watts, need only itemize the following items: distance, elevation, power gain, direction to each receiving point, verti-

cal and horizontal patterns, elevation of transmitting antenna, and significant terrain features in the transmission path. However, applicants are expected to take full advantage of directive antennas at both transmitting and receiving sites and use minimum power to perform the service. The horizontal directivity of the transmitting antenna depends entirely on the location of the transmitter and studio sites in relation to the receiving site.

Type Approved TV Transmitters.

Gates:	120 w, 500 w, 5,000 w VHF
General Electric:	5 kw, 10 kw, 11 kw, 35 kw, 50 kw, VHF; 50-100 w, 500-1000 w, 12 kw, 23.5 kw, 45 kw, UHF.
RCA:	120 w, 500 w, 2 kw, 5 kw, 6 kw, 10 kw, 11 kw, 20 kw, 25 kw, 35 kw, 50 kw, 100 kw VHF; 1 kw, 10-12 kw, 18 kw, 25 kw, 50 kw UHF.
Standard Electronics:	500 w, 10 kw, 25 kw, 50 kw VHF.

The engineer who is called upon to assist in planning an ETV installation can obtain any desired technical data on any of the TV transmitters listed here by writing directly to the manufacturers. Also, at the fall convention of the National Association of Educational Broadcasters in Milwaukee, Wisc., Nov. 17-20, much new and existing equipment will be displayed. ▲

Table 3. Technical Standards of New ETV Channels

channel width	6.0 mc
visual carrier frequency above lower band edge	±1.25 mc
visual carrier frequency tolerance, channels 2-83	±1.0 kc
visual carrier frequency tolerance, 2.0 and 2.5 kmc	±0.0005%
aural carrier frequency below upper band edge	0.25 mc
visual-aural frequency carrier spacing	4.5 mc
visual-aural carrier frequency tolerance	±1.0 kc
visual modulation	Amplitude
sync tip voltage	100%
blanking level voltage	75% ±2.5%
white level voltage	12.5% ±2.5%
visual power, sync tip rated	100%
aural power, channels 2-13	50-70%
aural power, channels 14-83	10.70%
aural power, 2 and 2.5 kmc	10.70%
visual frequency response below ideal demodulated curve	
±200 kc	Reference 0 db
±500 kc	not greater than -2 db
+1.25 mc	not greater than -2 db
+2.0 mc	not greater than -3 db
+3.0 mc	not greater than -6 db
+3.5 mc	not greater than -12 db
-750 kc	not greater than -4 db
*-1.25 mc through -4.75	more than -20 db
(Also see Docket 14744 and FCC Rules, Part 3.)	
*Not required for 1 kw or less on UHF channels 15 through 83, or 2.0 and 2.5 kmc.	
aural modulation	frequency
response	50-15,000 cps
from standard 75 microsecond pre-emphasis curve, see added	
tolerance in FCC Rules for 50 cps and 15 kc	+0, -3 db
distortion	
3.5%	
2.5%	
3.0%	
noise	
aural below 100% FM	-55 db 50-100 cps
aural below equivalent 100% AM	-50 db 100-7500 cps
visual below 100% AM	-26 db 7.5-15 kc

A PROPOSED TELEVISION CENTER

by David Horowitz* — Complete plans and description of a fully equipped television/radio facility.

This proposed design of a television center, although not revolutionary, does depart in some ways from the usual. It is a modified split level design providing the utmost in convenience and trafficability. The center includes radio facilities as an option and is intended as a large local originating station for use in "million plus" cities.

The building is 200' x 240' with about 70,000 square feet of floor space. The floor plan is, of course, the most important factor and the

*1st Lt., United States Army, Ft. Stewart, Ga.

outside design a matter of choice. One possibility, as shown, employs a canted roof and flare pillars on the front portion of the building.

There are three levels. The studio level (Fig. 1) is the largest, containing 3 studios, scenery storage, dressing rooms, shops, and a boiler room. The production level is five feet higher and contains all production control rooms, master control, film, TV tape, news, radio, music, and technical service facilities. The lobby leads directly to the audience studio. A ramp connects these levels. Directly above the produc-

tion level is the office level (Fig. 2). It is arranged to provide maximum accessibility between departments.

Production and Studio Levels

The most striking feature in the production and studio levels is the large master TV control room. The studios and production support areas appropriately revolve about it. The control room (Fig. 3) contains all camera control units, master switching, TV tape machines, and automatic programming equipment working in conjunction with

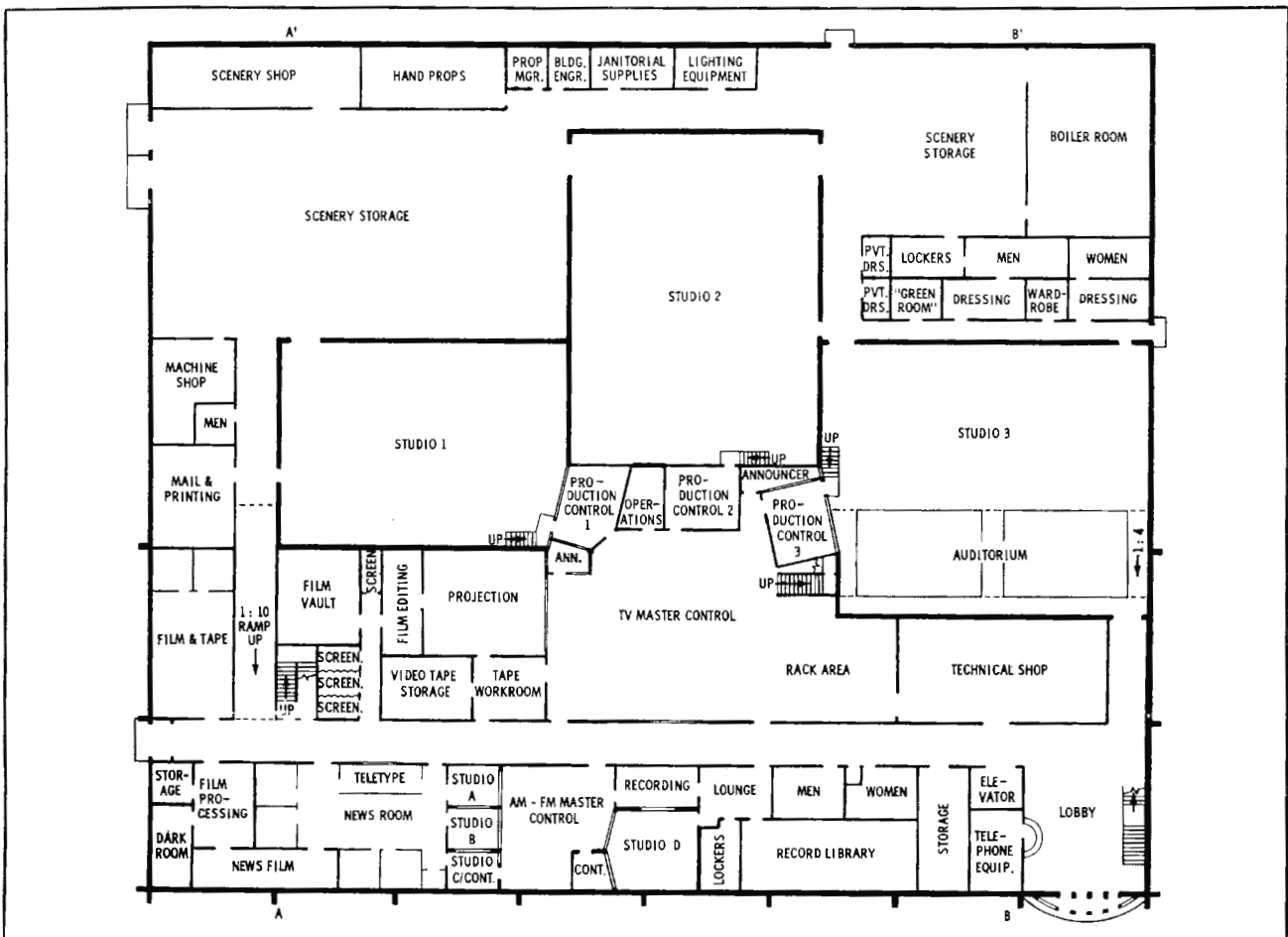

Fig. 1. Floor plans for the studio and production levels.

automatic data processing equipment located on the office level. The room is spacious, flexible, and will allow expansion. A small amount of traffic will pass through the room from the stairs (leading directly to programming and production offices) to the production control rooms. Layout of the equipment into islands will allow traffic to pass smoothly and not hinder operations. Sufficient room is provided for color operation.

Technical Facilities

All cables for live cameras (6 cables per studio and several others to various portions of the building) terminate in a patch panel near the live camera control island. The patch board contains the inputs to thirteen camera control units, twelve of which are in the island. The remaining unit is in the master switching island allowing a reduction of manpower during off hours when only one live camera may be needed. The output of that camera control unit must be patched into the switching system to be used. Four film camera con-

trol units and remote projector and video tape controls are adjacent to the output switching equipment. Other sections of the master switching island contain 2 audio cartridge-tape units, a standard tape deck, a turntable, and a telephone switchboard.

The output switcher feeds the studio-transmitter link, the network, and an auxiliary line. A preview line and monitor are provided. Inputs are: four film chain, four video tape, network, remote, monoscope, automatic program control, and the three studio "take" lines. Parallel audio facilities should be installed; however, the audio would

normally be locked to the video. The video lines may be locked to each other so that simultaneous preset (if selected) switching may be effected. Remote controls for six stabilizing amplifiers, sync generators, and monitors (master monitors and VU meters) allow supervision of the output lines. A panel containing additional audio controls for the announcer's mike, tape machines, projectors, and turntable is mounted next to the output switcher.

The automatic program control located next to the output switcher provides for unattended operation or limited attention operation. Any

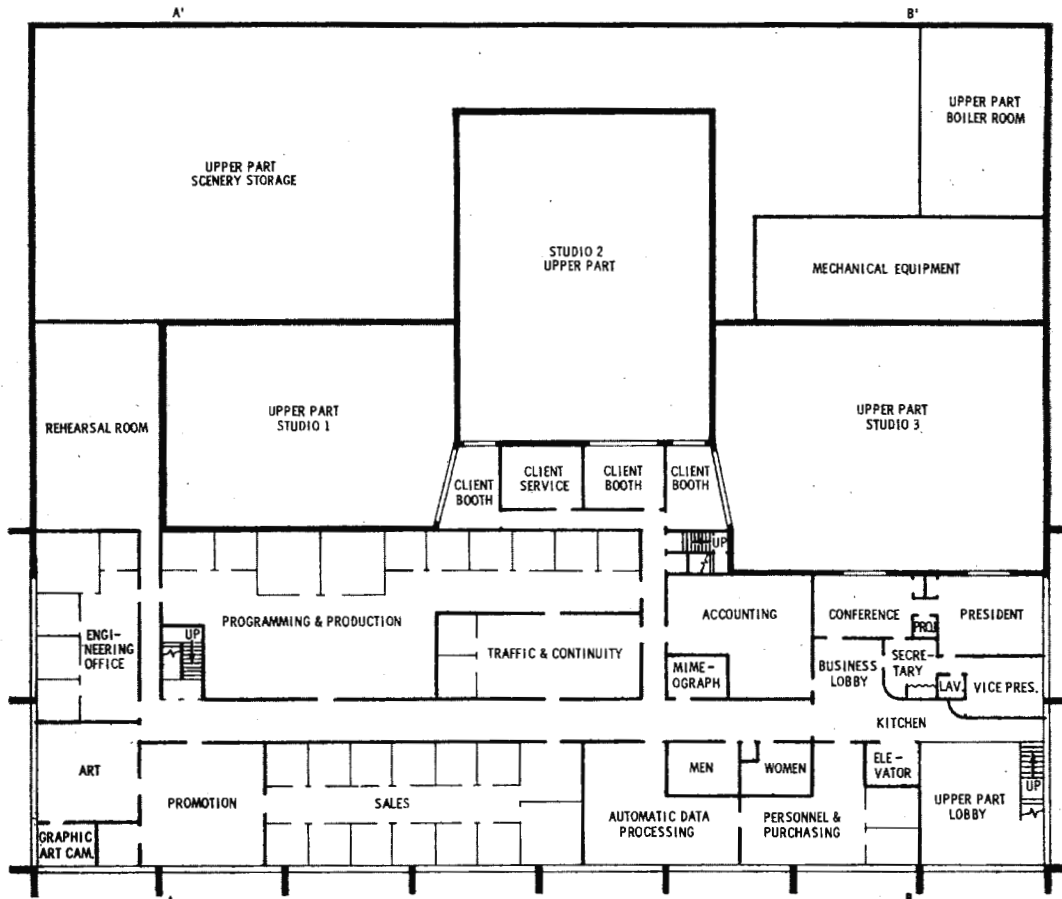
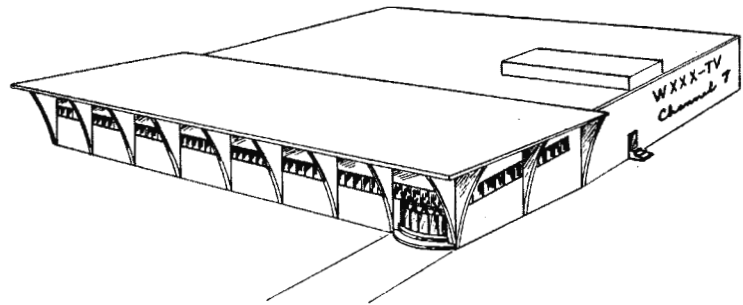

Fig. 2. Floor plans for the upper, or office, level.

further discussion of automatic devices would be too extensive to be covered here.

All video sources feed a dual 24 input, 10 output, transistorized, remote control switching system which serves almost the entire operation; this does not include certain monitors and the input switching to the video tape machines. Switcher A, serving studios two and three, has the following inputs: eight live cameras; four film; four video tape, network and remote (all noncomposite); monoscope; two mixing amplifiers' outputs; the effects amplifier output; and automatic program control output. Switcher A feeds two mixing amplifiers (four busses), the effects amp (two busses), two "take" lines, and two preview monitors. Switcher B, serving studio one and master control output switching has the following inputs: four other live cameras; the four film, the four video tape, the network, the remote, the monoscope, the effects amplifier, and the automatic program control in common with switcher A; a third mixing amplifier output; and the three "take" lines from the studios. Switcher B feeds one mixing amplifier (two busses); one "take" line; two lines to the automatic program control; two preview lines; and the local, network-feed, and auxiliary

output lines.

To compensate for delays through the various amplifiers associated with the switchers special delay lines must be used. Because of the already large number of inputs, five of the input busses on each switcher must be split to accommodate the extra returns. The present output switching in master control can be achieved by routing the switch trigger pulses (derived from the vertical sync) through an "operate" button, thus requiring an "and" condition (source select and operate) to effect the switch.

The effects amplifier has three inputs—picture A, B, and Key. Studios two and three share the use of the two busses on switcher A to provide picture A and B while studio one parallels its own mixing amplifiers inputs to the effects amp. Each studio has a remote control panel for the effects generator which feeds the Key input on the amplifier. The external camera input to the system must be patched in, thus saving a valuable bus.

The video tape machines are at the back of the room, along with an equipment rack containing input switching (completely separate manual system) and remote controls for the vtr's.

The three production control

rooms are identical and contain provisions for a director, technical director, assistant director and audio man although normal operations would involve only two, possibly three men.

An audio console, turntables, cartridge-type playback units, remote controls for video switching and special effects, monitors, and intercommunications equipment comprise the room's facilities. The monitors are mounted below the control room window to reduce the vertical angle the director must swing his eyes. There are seven monitors, any one may be connected to any of seven monitor lines by means of a small patch panel in the control room. This is done in order to tailor the monitors to the sources being used. Four of the lines are normally used for live cameras, a fifth for preview, a sixth chooses one of nine sources (four film, four video tape, and one automatic program control), and the seventh is the line monitor choosing between the studio outputs or any of the MCR outputs. Also, by being able to rearrange the order of the monitors the director may keep the line monitor directly in front of him whether or not he is his own technical director or where he chooses to sit. The monitors

● Please turn to page 41

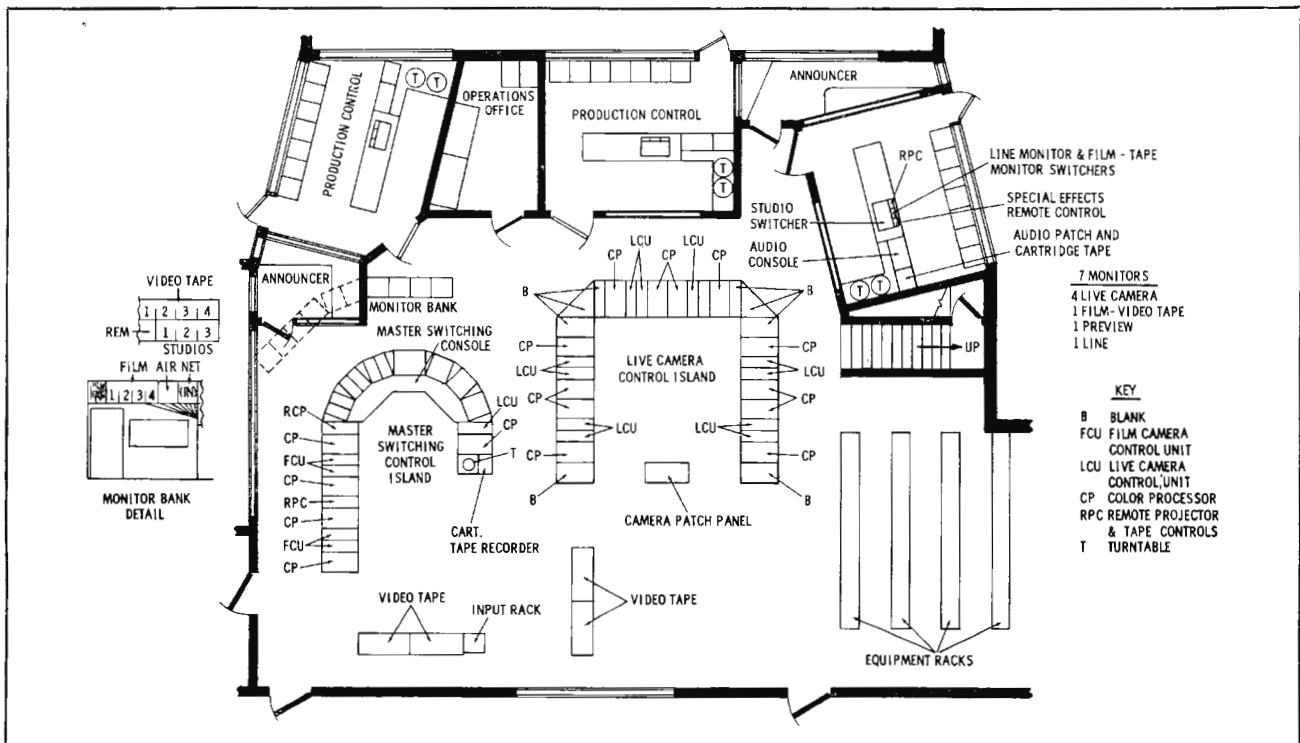
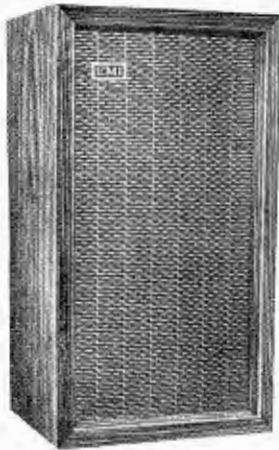

Fig. 3. Layout plan for the master TV control room.

Your money back
if this EMI speaker system
does not outperform
your present monitor!



EMI Model DLS-529: the ideal broadcast monitor

- ☞ Much higher efficiency than offered by other sophisticated systems of moderate size.
- ☞ Unique elliptical 13½" x 8⅛" woofer with patented aluminum center cone and molded polyvinyl chloride (PVC) suspension.
- ☞ Large undistorted woofer excursion, with outstanding transient recovery.
- ☞ Very low fundamental bass resonance.
- ☞ Exceptionally flat mid-frequency response plus one of the smoothest 1000-to-2000-cps response characteristics ever measured, resulting in extremely pure midrange quality.
- ☞ Two specially damped 3½" tweeters, with smooth response all the way to 20,000 cps.
- ☞ Wide high-frequency dispersion, with polar response characteristic far superior to that of conventional tweeters of similar size.
- ☞ 4,500-cps LC dividing network.
- ☞ Rigidly constructed cabinet with woven metal grille.
- ☞ Impedance: 4 ohms. Size: 24" x 13" x 12½" deep. Weight: 45 lbs.

Harvey Radio Company will cheerfully refund the net price of \$159.00 if you do not find the EMI Model DLS-529 superior to your present monitor.

H **arvey**
PROFESSIONAL AUDIO

Harvey Radio Company, Inc., 103 West 43rd Street, New York 36, N. Y.

Harvey Radio Company, Inc.
103 West 43rd Street, New York 36, N. Y. **BE**
Please enter my order for one a pair of EMI Model
DLS-529 loudspeaker system(s), with the understanding
that I may return the speaker(s) within 30 days for a
full refund of the purchase price if not satisfied.

Name _____
Title _____ Station _____
Address _____
City _____ Zone _____ State _____

Circle Item 12 on Tech Data Card

A COPYING SYSTEM FOR NEWS SLIDES

by Bert Goldrath* — A rapid system for producing transparencies from news film frames.

A clever copying system devised by staffers of KGO-TV, San Francisco, is bringing the station's viewers more local news pictures, providing coverage almost up to air time. The procedure, which depends basically on the relatively new Polaroid MP-3 industrial camera, is so simple that no special training other than a few instructions, are required.

The system solves the former problem of airing late news pictures in greater quantity and with a minimum of behind-the-scenes fuss. The station has a crew of news photographers on duty around the clock, seven days a week, who record the news on 16mm movie film.

Previously, a darkroom technician would prepare a transparency for rear-screen projection on the 7 PM and 11 PM news shows. To make a 3¼" x 4¼" transparency from a 16mm stop frame, the

darkroom man had first to make an intermediate negative by making a contact print on film from the 16 mm frame. Then he put the resultant negative in the enlarger and printed it on a sheet of film, cropping the shot to size.

This required two major darkroom processes and consumed anywhere from 90 minutes to three hours per evening, depending on the number of frames to be copied. It further required the presence of a darkroom technician for the early and late evening shows.

While the former procedure produced good-quality transparencies, the time required meant that many late news pictures couldn't be used. Since the last couple of hours before a TV news show are the most critical, there were usually two or three local stories which went without illustration. This was particularly frustrating since the pictures were often in the house, but couldn't be converted to the proper projection size in time for the next news show.

Production manager Cal Thomas and assistant art director Ed Smith gave the problem some serious thought and came up with a speedy system which has the additional advantage of retaining picture quality at least as good as the old method. In essence, the new procedure consists of a fixed Polaroid MP-3 setup. A direct copy is made of the stop frame and a black and white transparency is available on film in about two and a half minutes.

Here's how it works: An easel, with a foot-square hole cut in its center, is mounted on a specially-built table, three feet square and 30 inches high. A panel of translucent glass is positioned over the opening. The camera, mounted on

its stand, straddles the opening (Fig. 1).

The table has a shelf built into it just above floor level. On this shelf are secured a Mini 16 projector with a 25mm lens, and an 8" square mirror mounted at a 45° angle to both the projector lens and the translucent panel of the easel.

The 16mm film strip is cut to a clip of four frames, suitably masked, inserted in a glass holder (Fig. 2), and placed in the projector. The image is focused onto the translucent glass in the desired scale, with the camera adjusted to a height of 24¾" above the easel.

The slide projector is mounted on a carriage so it can be adjusted in two directions to center the desired frame exactly on the glass panel.

To complete the process, room lights and MP-3 lights are turned off and the exposure is made on Polaroid Type 46-L film (Fig. 3). Two minutes later the finished positive transparency is removed from

• Please turn to page 47

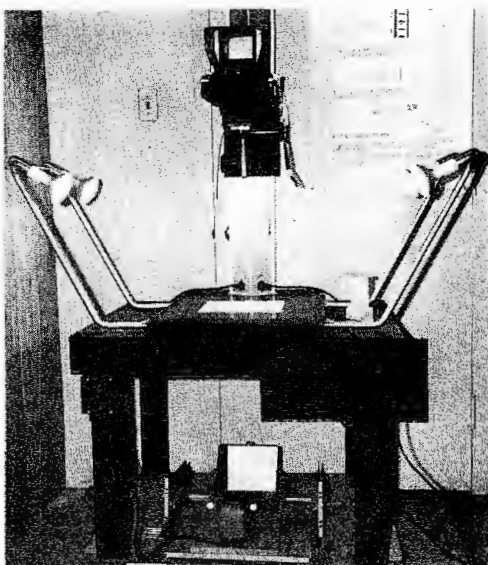

Fig. 1. Film-clip copying equipment setup.



Fig. 2. Film clip is inserted into holder.

WE ADMIT IT... OUR TOTAL EFFORT HAS GONE TO OUR HEADS!

Magnecord's MICRO-OPTIC Honing Process Revolutionizes Performance Standards

Magnecord's new half track and quarter track heads are the finest heads ever offered. Our revolutionary Micro-Optic honing process, together with other advances in design and production techniques, again demonstrates Magnecord's pre-eminence in the tape recorder field. Now, as always, you can depend upon Magnecord for the very best in professional sound.

NEW RECORD HEADS — By Magnecord's Micro-Optic honing process, both trailing and leading edges of recording head gap are polished to micro-inch flatness. The result: superior high frequency recording characteristics, because straightness or flatness of head's trailing edge is a critical measure of performance.

 *Magnecord Heads
are Finer than Ever*

NEW REPRODUCE HEADS—Hyperbolic wrap curve provides extended smoother low frequency response and better signal to noise ratio; prevents coupling of unwanted signals to pole faces. Sufficient tape wrap insures full coupling of high frequency signals with no loss, for superior performance at the extremes of the audio spectrum.

NEW ERASE HEADS
Erasure in excess of 70 db is assured by these recently developed double gap precision instrumentation type heads. Putting it another way, only 1 part in 10 million escapes erasure. The double gap increases erasing efficiency by a factor of two.

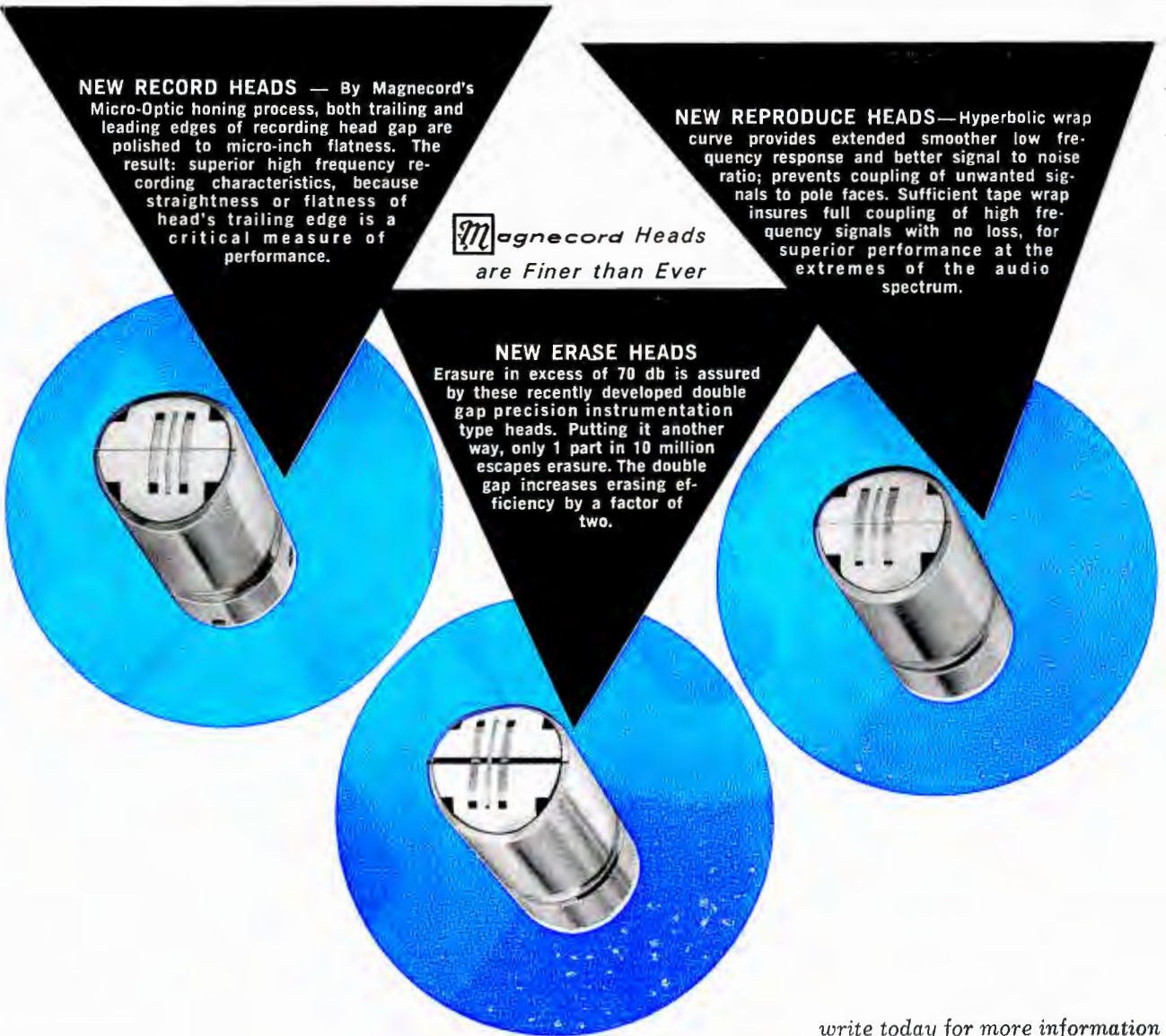

write today for more information

“MAGNECORD . . . CHOICE OF PROFESSIONALS”

 **Magnecord**

Circle Item 13 on Tech Data Card

MIDWESTERN INSTRUMENTS
P. O. BOX 7509 • TULSA 35, OKLA.

DIRECTIONAL ANTENNA PHASING

Technical Talks—The do's and don't's of directional antenna phasing techniques; an engineers' guide.

Many of our readers have the "good" fortune to be concerned only with nondirectional stations in the AM band. I say "good" rather hesitantly because in actual fact directional arrays are very interesting; and, until an engineer has had to deal with them, he has missed a lot of broadcast engineering experience. In fact, many of the ads for **chief** engineers specify experience with a DA. So this month we will talk about the guiding hand of the directional antenna—Phasing. The purpose of the directional antenna is to "fit in" a station where one could not be without the directional effect. The successful working of the whole AM system depends on carefully calculated and FCC approved directivity. For this reason, the FCC is very alert to the responsibilities of stations using directional antennas, and will clamp down on the unwary or sloppy operator.

If in doubt about a measurement, and especially if you're not familiar with DA's, call in the station's consulting engineer and GET IT RIGHT! When the pattern is cal-

culated the consulting engineer furnishes a set of operating parameters which, when properly implemented, will produce the FCC approved radiation pattern. If **not** properly used, they can produce chaos, a citation, and even a lost license!!!

In this Talk we shall assume that the original calculations were correct, and that the system has been operating properly and in tune. Now let's examine the various elements concerned with directional antenna phase.

The phasor is the device that distributes the power, in proper phase and proportions, to the various radiating elements of the directional antenna system. This device contains the distribution system, a phase shift network to produce the computed phase differences, impedance matching devices, and transmission lines.

Transmission lines are included because their lengths must be considered when computing how much phase shift must be introduced by the phasing network. Figs. 1 and 2 will show why this is so. In the case of a two-tower array, when it is possible to locate the transmitter equidistant between the two towers, the lines are sometimes made equal in length to facilitate design and measurement. The length is sometimes adjusted to provide all or part of the phase correction required by the DA design. Obviously, all the phase change cannot be made within the lines, and small adjustments are always required in such installations. The effect of propagation velocity must also be considered when computing electrical length of lines; a figure of 95% will fit most of the larger coaxial cables.

Phase Shift Networks

In general, phase delay networks are preferred to phase advance networks because the former attenuates harmonics far more effectively than the latter—the phase delay network is essentially a low-pass device. The effective range of a phase shift network is usually in the order of $+20^\circ$ to -20° from the design value; they are designed for a nominal shift of up to 90° without appreciably affecting the impedance.

The coupling networks shown in Fig. 2 are designed to match the line impedance to that of the towers. Because such a coupling device is bound to introduce some phase shift, the amount has to be taken into account when computing the total phase shift. To avoid large shunt currents, and to provide greater control, the coupling phase shifts are held within the 60° to 120° range.

The "T" network is generally used for the major phase network in a directional system. It is a very simple circuit, easy to design, and simple to construct in most systems. Since the T network uses two inductors in its series arms, it is possible to gang together the controls and vary the inductances simultaneously, this can provide a phase shift of $\pm 90^\circ$ without changing the transmission ratio of the circuit.

The 90° network is simple in concept and construction. For impedance ratios other than 1:1, the reactance of each branch is equal to geometric mean of the input and output resistances (the square root of the product). If the ratio is 1:1, the input, shunt, and output arms must have impedances equal to

● Please turn to page 48

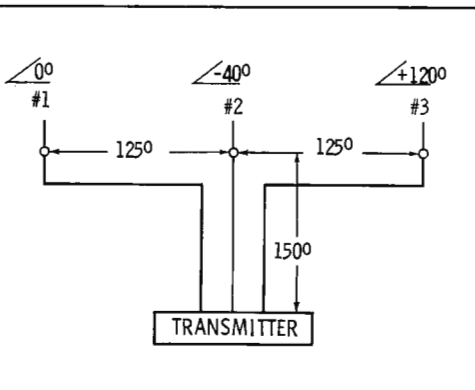
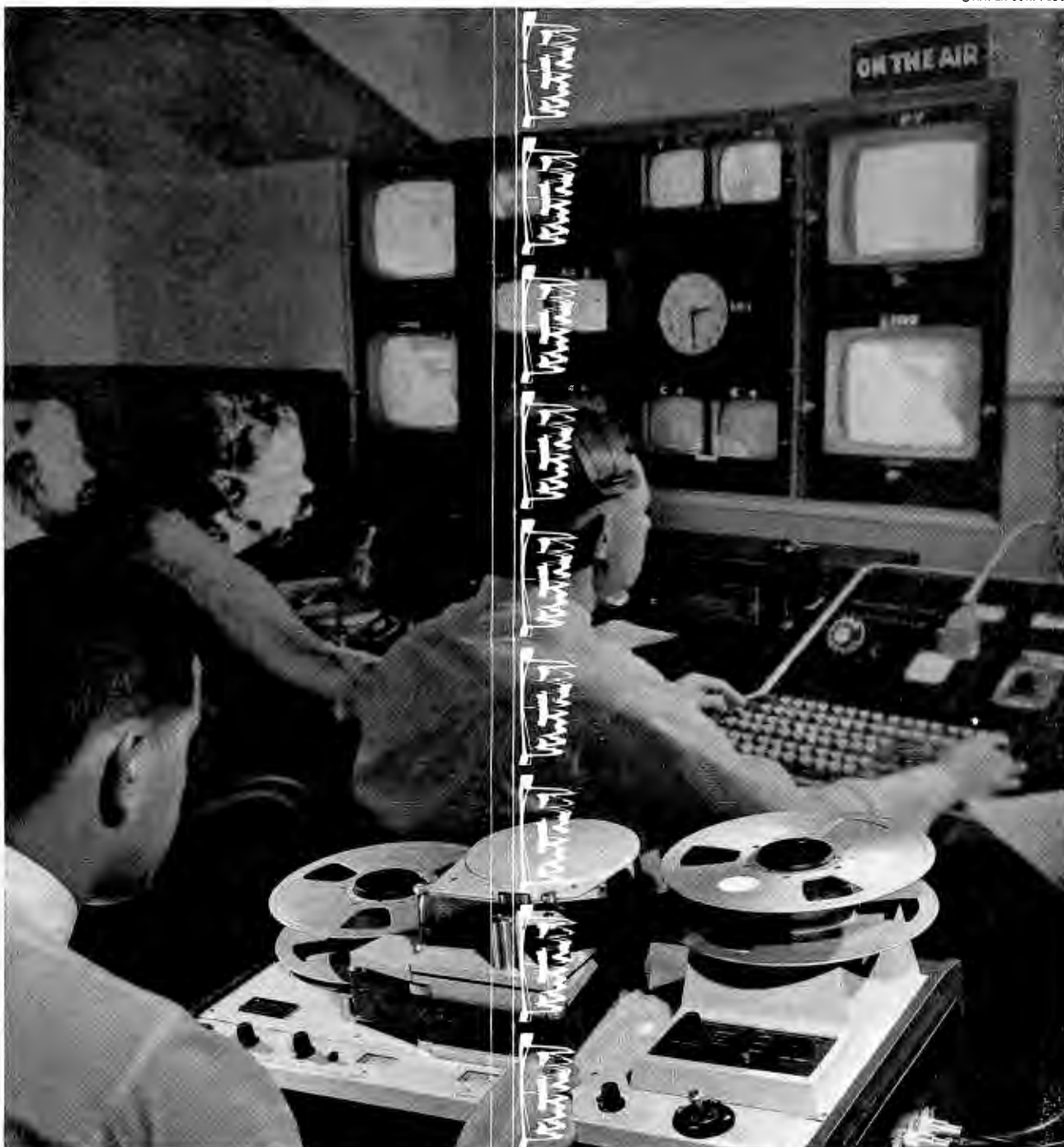

Fig. 1. Antenna phases and line lengths for a typical three-tower system.



What's new in broadcast VTRs?

AMPEX VR-660

Now: Ampex has a low-cost, portable VTR with full broadcast stability—the VR-660. It's ready and able to handle any broadcast job. And the complete price is just \$14,500. It weighs less than 100 pounds and is small enough to fit in a station wagon for a mobile unit. It's ideal for recording special events, local sports and news—even on-the-spot spots. It has signal compatibility with all other VTRs. And when played through your station's processing am-

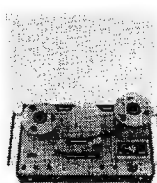

plifier, its signal meets all FCC broadcast specifications. The new Ampex VR-660 has two audio tracks. It records at 3.7 ips—or up to five hours on one reel of tape. And, too, it's extremely simple to operate. It's easy to maintain because it's fully transistorized. And, of course, it offers reliability—Ampex reliability. For more information please write to Ampex Corporation, Redwood City, California. Sales and service offices throughout the world.

Circle Item 17 on Tech Data Card

FM by GATES....

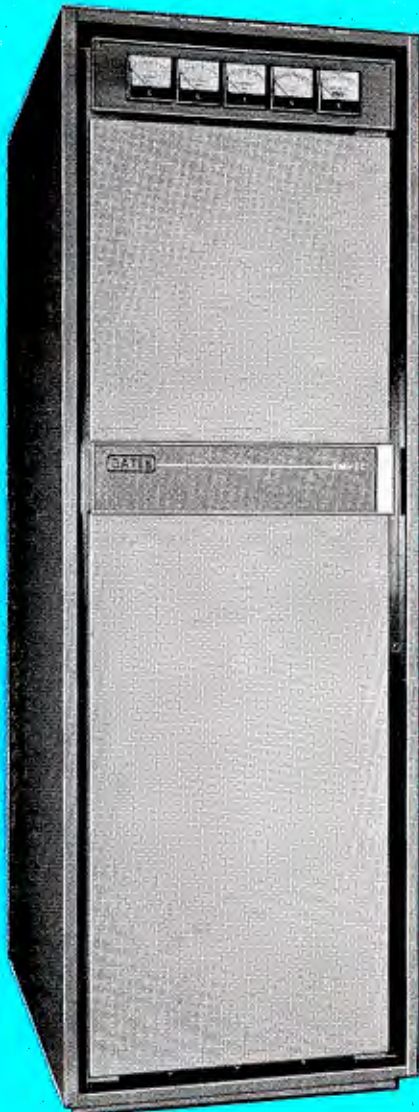

FM-1C 1kw FM Transmitter

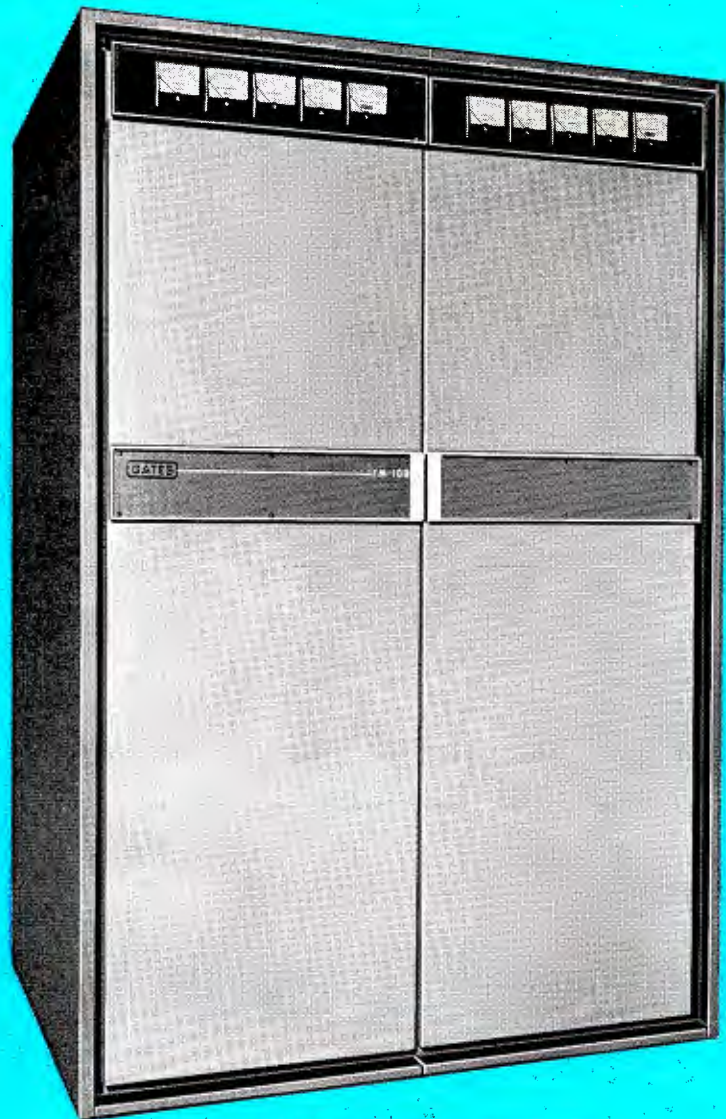

FM-10B 10kw FM Transmitter

The difference in broadcast equipment is reliability . . .

GATES MAKES THE

... Featuring simplified direct crystal controlled cascade modulation

FM by Gates means "Cascade" modulation that is entirely new, greatly simplified, and more dependable. Direct crystal control of the mean carrier frequency makes it inherently stable. Why be satisfied with complicated, older circuits when Gates can give you these important improvements plus many more exclusive features.



Gates FM Stereo Generating Equipment. Top unit is the new Cascade FM Exciter M-6095 and the lower unit is the M-6146 Stereo Generator. Note the blank space at the bottom of the M-6146 for the easy addition of 2 sub-carrier generators.

M-6160 Sub-carrier Generator with mute

FEATURES

- **DIRECT CRYSTAL CONTROL**—gives positive control of the mean carrier frequency. No complicated electronic or mechanical frequency stabilizers required. A single, precision crystal in a temperature controlled oven does the job.
- **SIMPLIFIED CIRCUIT DESIGN** — featuring fewer stages. Compare the Gates FM exciter with the others.
- **SIMULTANEOUS STEREO/SCA PROGRAMMING** —many prominent stations coast to coast are using the Gates "Cascade" exciter for stereo.
- **REMOTE CONTROL**—circuits provided for switching from monaural to stereo and one or two SCA channels.
- **WIDE BAND FREQUENCY RESPONSE**—the Gates FM exciter accepts modulation in the 30-75,000 cycle range.
- **NO EXPENSIVE SPECIAL COMPONENTS** — all components in the Gates FM exciter are standard and easily available. No special, hard to obtain tubes, transistors or diodes are used.
- **STABILITY** — "rock-bound" reliability assured with Gates direct crystal controlled "Cascade" modulator.

Circle Item 18 on Tech Data Card

DIFFERENCE

GATES

GATES RADIO COMPANY

A Subsidiary of Harris-Intertype Corporation
QUINCY, ILLINOIS



Offices in: Houston, New York, Los Angeles, Washington, D. C.

In Canada: Canadian Marconi Company, Montreal • Export Sales: Rocke International Corporation, New York City

ENGINEERS' EXCHANGE

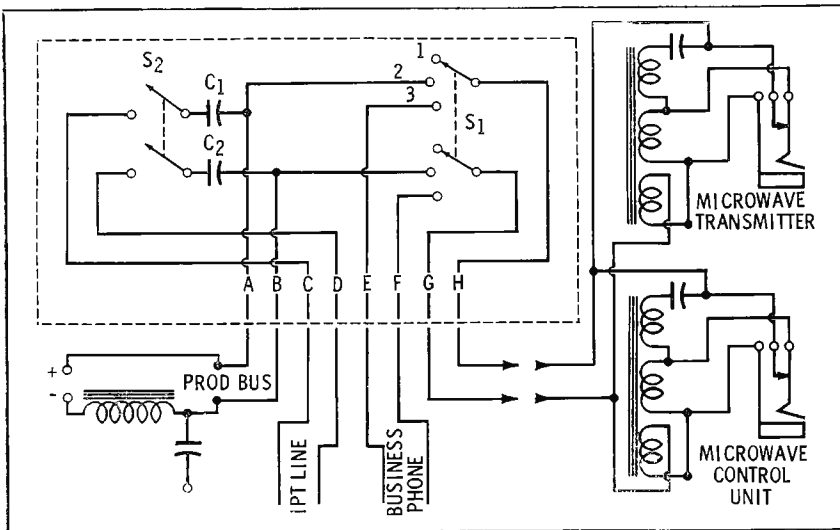

Microwave Intercom Facilities

by Robert Kastigar, WGN-TV, Chicago, Ill.

Any engineer who has spent a few cold mornings orienting a microwave link between a remote and studio can well appreciate any device that will make the job easier. A small versatile switchbox can be built to help provide communications directly with the receiving end of the link. This eliminates the "middle-man" at the control unit who does nothing more than act as liaison during orientation.

The circuit is simple and straightforward, the only caution being that all connections must be made above chassis ground. The switchbox can be built with spare parts from the junk-box and will operate with any type microwave gear—no modifications are required. It can be left in the remote truck when the microwave equipment is removed, since the unit operates through intercommunication equipment that is already a part of other gear in the remote truck.

Switch S1, a double-pole three-position nonshorting type, selects the mode of operation. Position 1 is "off," allowing the microwave control unit to be disconnected and removed without danger of shorting out the party-line bus.

In position 2 the PL facilities of the microwave are connected to the production-line bus of the truck. During program time this circuit is disconnected to avoid overloading the retard coil with the

additional load. Terminals A and B are connected to this bus.

When a program-type telephone line is used for talkback between remote and studio, terminals C and D are patched to this line. The production bus is also connected (temporarily) to this line, coupled through C1, C2, and S2. This is very useful to the engineer orienting the microwave transmitter, prior to program time, since he can hear precise instructions from the engineer operating the receiver. The program line could be used for this purpose, provided it is a two-way circuit. In either case, S2 is set to "off" during broadcast time so as not to interfere with program audio or cueing. Any nonelectro-

lytic capacitors (2 mfd or larger) may be used for coupling.

Terminals E and F are connected directly to a business-phone line, when one is available. To operate in this manner, S1 is left off until the call is completed. Then S1 is set to position 3. The microwave talkback facilities are then simply an "extension" of the regular business phone. Switch S1 must not be in position 3 initially or dialing will not be possible. Similarly, when orientation is finished, S1 must not be left in position 3 or the phone will be closed to incoming calls.

The wiper arms of the switch go directly to the intercommunication pair in the cable connecting the microwave control unit and transmitter. This connection can be made through a PL-55 plug, simple pig-tail, or whatever type connector is used on the microwave control unit. Terminals A through H may be brought out to a terminal strip or appropriate Jones plug. ▲

Automatic Record Tip Projection Control

by Bill Kessell, Chief Engineer, KTVT, Fort Worth, Texas.

How many times have you had to repeat an expensive video recording session because someone had inadvertently left the tip-projection control at a nonstandard setting? This is especially embarrassing in the case of tapes that are to be shipped out. After one such episode at our station, we decided to come up with an arrangement to circum-

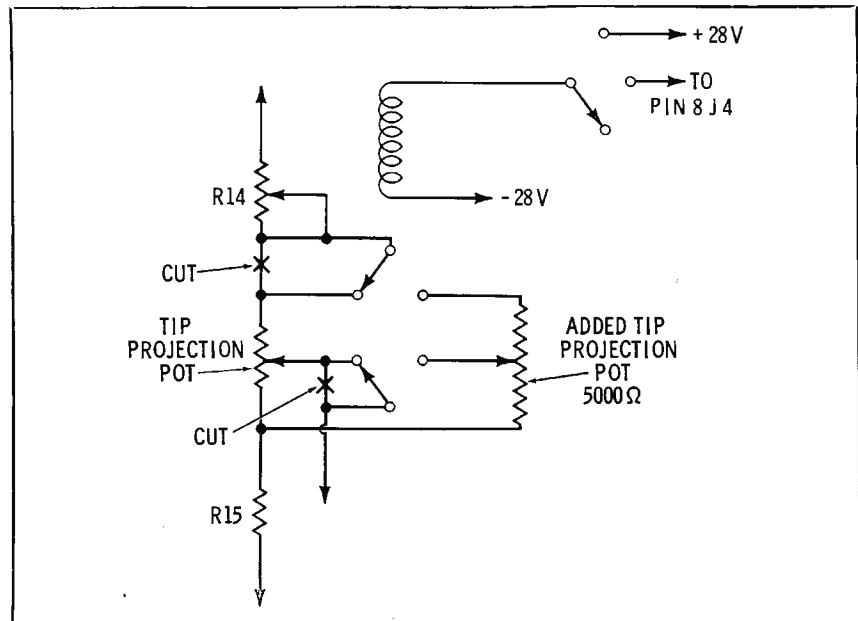



SARKES TARZIAN Tube Replacement Silicon Rectifiers

BIG

in broadcasting...

More and more broadcasting stations of all kinds are proving that the reliability and long, *long* life* of these units pay off in station on-time. Send for free replacement chart covering 95% of the vacuum tube rectifiers now in common use, price information, and case history data.

* *Not to mention instant warm-up, no appreciable heat radiation, no filament supply, compact size, ruggedness, and dc current ratings up to three times as high as the tubes they replace.*



SARKES TARZIAN Inc.

World's Leading Manufacturers of TV and FM Tuners • Closed Circuit TV Systems • Broadcast Equipment • Air Trimmers • FM Radios • Magnetic Recording Tape • Semiconductor Devices
SEMICONDUCTOR DIVISION • BLOOMINGTON, INDIANA
Canadian Licensee: Marsland Engineering Limited • 350 Weber Street North, Waterloo, Ontario

Circle Item 20 on Tech Data Card



(Model 539C illustrated above)

... experience-engineered for fast and accurate maintenance of industrial electronic equipment.

COMMUNICATIONS TECHNICIANS'
Model 752A Portable

Simplified, reliable, high-speed accuracy ... with versatility for testing all tubes normally encountered in industrial electronic maintenance.

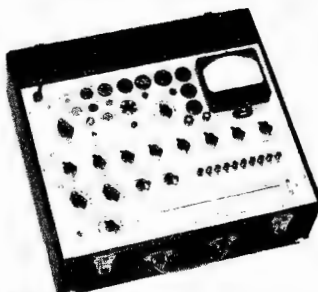

\$355

ELECTRONICS ENGINEERS'
Model 539C Portable

Provides for measuring plate milliamperes and heater current
 • Tube leakage indicated directly on the meter scale • 6 micromho ranges (to 60,000) • Metered line and grid voltages • New voltage-regulator tube test.

\$485

Ask your Electronic Distributor for a 'Hickok-demonstration'
 ...or write direct for additional technical information

THE HICKOK ELECTRICAL INSTRUMENT CO.

10544 Dupont Avenue
 Cleveland, Ohio 44108

Circle Item 21 on Tech Data Card



vent human error and assure that all of tapes would be recorded with standard tip projection.

The system we devised is very simple, actually consisting of a second tip-projection pot which is mounted inside the machine and switched into the circuit in **record** mode only. The parts required are a 5000-ohm pot, a DPDT 28-volt relay, and a single-pole triple-throw switch. These components were placed on a small chassis and mounted inside the left hand control panel of our B Ampex machine, as shown in Fig. 1.

The circuit was wired as shown in Fig. 2. The component numbers refer to B and C machines. Position #2 of the switch shows a connection to J4, pin 8. This could just as well be any other point which has a plus 28-volt potential in **record** mode and zero potential in **PLAY** mode.

It is obvious, then, that with the switch in position #2 the relay will pull in when the Record button is pushed, and the added pot will then control tip projection instead of the original pot. In **PLAY** mode the relay will be de-energized and the original pot will have control.

Since it is necessary to calibrate both pots with the standard alignment tape, there are two other switch positions. In position #1 the added pot has control in both **PLAY** and **RECORD**. In position #3 the original pot has control of both modes.

Mounting the additional pot inside the machine does away with the possibility of someone accidentally changing the setting.

We find that a routine check of both pots with the alignment tape is all that is required to assure standard tip projection on all recordings. ▲

BROADCAST ENGINEERING

Presenting...BETTER PRODUCTS FOR BETTER BROADCASTING!

SPARTA

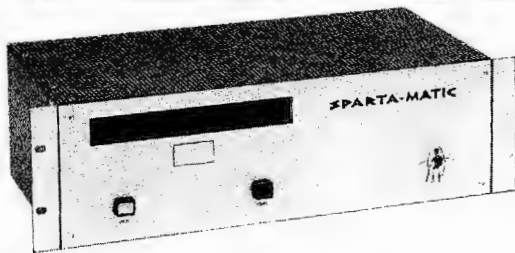

300 RECORD Just 3½ inches high the all-transistor record unit compliments the new compact, modern and functional design of the 300P. Both units allow table-top, custom, or, (illustrated) rack mounting.....**\$230.00**

300 PLAYBACK The absolute ultimate and most advanced design in a tape cartridge playback. All transistorized, plug-in modular construction. Continuous duty rated with proven reliability.....**\$495.00**

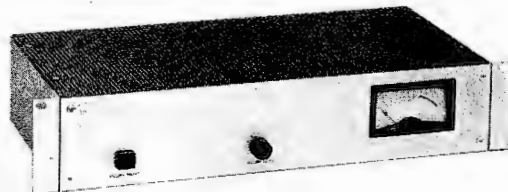

200 RECORD/PLAYBACK Economy with outstanding rugged reliability. Now every broadcaster can afford the up-to-date, modern benefits of cartridge equipment. Transistorized control circuitry for improved tone-burst cueing. Compare with others priced 20% to 40% higher.....**\$545.00**



200 STEREO RECORD/PLAYBACK Record and playback in stereo with full fidelity broadcast quality and positive performance. Enjoy the benefits of cartridge tape, producing all announcements, themes and production sound aids in wondrous stereo.....**\$750.00**
(Playback only**\$510.00**)



200 PLAYBACK The work horse of the industry! Offering simplicity with proven reliability. Compatible with all other cartridge equipment. Add another playback to your present system at only.....**\$385.00**

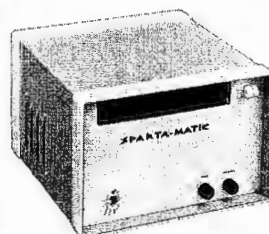

CP-5 PORTABLE PLAYBACK An invaluable new sales and production aid for all cartridge equipped stations. Light weight with convenient carrying handle to audition spot/presentations anywhere in the station or clients office.....**\$149.50**

OUR PRODUCTS ARE OUR BEST SALESMEN!



(Bench/Lid Optional)

SPARTA A-50 PORTABLE STUDIO Production studio, Remote Facility, Main Studio. A triple-threat, rugged and solidly built unit designed for many years of continuous duty. Legs unscrew and clip inside the bench which then becomes the lid for transporting. Complete with turntables, equalizers, pre-amps and A-10 Audio Console.....**\$845.00**

SPARTA A-10 AUDIO CONSOLE Provides a total of eight inputs selected through four mixing channels with completely transistorized circuitry and plug-in modular construction throughout.....**\$349.50**
(Carrying case with monitor speaker.....**\$49.50**)



Call, Write or Wire Today

SPARTA ELECTRONIC CORPORATION

6450 FREEPORT BOULEVARD • SACRAMENTO 22, CALIFORNIA • GA 1-2070

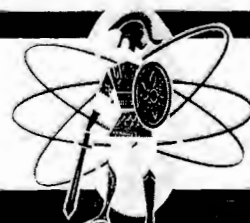

From
THE Translator Company

NOW AVAILABLE:

“
**All about
extra
TV
Coverage
and
fill in
via**”
Translators

• Write today for your Planning Package from EMCEE, the Translator manufacturer with more experience and more models . . . UHF VHF . . . 1 watt to 100 watts.

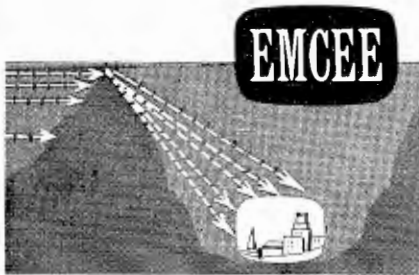

ELECTRONICS,
MISSILES AND
COMMUNICATIONS, INC.

160 East Third Street • Mount Vernon, New York 10550 • 914-668-3012

Gentlemen:

Please send your "TV Coverage Planning Package."

Name _____

Address _____ City _____ State _____

Circle Item 24 on Tech Data Card

NEWS OF THE INDUSTRY

Educational TV

Nearly \$1,000,000 worth of TV transmitters and studio equipment will be furnished by **International General Electric** for a planned six-station VHF educational television (ETV) system in American Samoa. IGE, overseas marketing division of General Electric, will furnish three 11-kw transmitters for the first three channels. In addition, it will also supply complete equipment for one main television studio.

Radio Station Sold

Colorado Springs' oldest radio station, **KVOR**, has been sold to radio veteran, **James A. Vinall**, and industrialist, **Gene Power**, for a consideration of \$240,000.

CCTV Representatives

Diamond Electronics, Diamond Power Specialty Corp. of Lancaster, Ohio, has appointed three firms as their exclusive industrial closed-circuit television representatives. **Gentry Associates**, headquartered in Orlando, Florida, will handle the Florida, Alabama, and Georgia territories, while **Philip Diamond Enterprises**, Los Angeles, will act as representatives in southern California. The area of Colorado, Wyoming, and Montana will be in the hands of **Ross Equipment Co.**, Denver, Colorado.

First ETV Grants Awarded

Award of the first five grants—totaling \$858,152—under a federal program designed to encourage establishment of new and improved educational television broadcast facilities was recently announced by Secretary of Health, Education, and Welfare, **Anthony J. Celebrezze**. The grants, for which recipients proved matching funds, were to: **Chicago Educational Television Assn.**, \$299,619, to establish a station on channel 20 at Chicago; est. cost—\$399,492. **Hampton Roads, Va. Educational Television Assn.**, \$129,143, to acquire studio equipment for channel 15 at Norfolk; est. cost—\$173,258. **Utah State Univ. of Agriculture and Applied Science**, \$99,865 to establish a station on channel 12 at Logan; est. cost—\$143,903. **South Carolina Educational Television Comm.**, \$270,303 to establish a station on channel 29 at Greenville; est. cost—\$457,358. Same group, \$59,222, to establish a station on channel 7 at Charleston; est. cost—\$118,444.

Satellite Stock Purchased

International Telephone and Telegraph Corp. announced that the FCC has approved the company's application to purchase stock in the newly formed **Communications Satellite Corp.** Although stock is not expected to be issued for several months, the FCC must determine before hand which carriers are qualified purchasers. **ITT** was the first major carrier to submit an application.

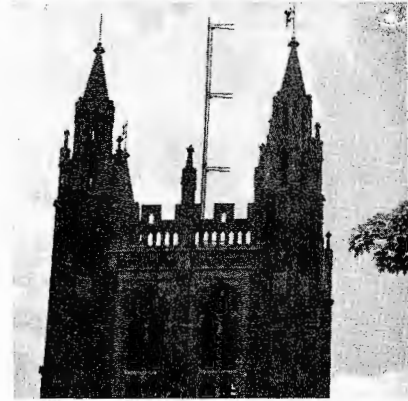

College Station to Broadcast Stereo

WPRB-FM, Princeton, New Jersey's, 17,000 watt FM outlet operated entirely by undergraduates of **Princeton University**, took final action recently to convert its facilities to stereo multiplex operation next fall. The station's Board of Trustees voted unanimously to accept a proposal submitted by the undergraduate Board of Directors concerning the switch, thus climaxing several months of investigation and discussion on the project. The decision will make **WPRB** the first student-owned and operated commercial station in the world to broadcast in stereo. In 1955, **WPRB** became the first completely student-operated station to broadcast with a commercial FM signal, and three years ago it became the first such station to be granted a license for high-power FM transmission. **WPRB's** FM antenna tower is shown in the accompanying photo.

ABC-TV Orders Television Tape Recorders

The **American Broadcasting Co.** has ordered 11 additional **RCA** transistorized television tape recorders, bringing its total purchases to 25 such units valued at more than \$2,000,000, the **RCA Broadcast and Communications Products Div.** announced. **C. H. Colledge**, division vice president and general manager, said the **TR-22** recorders would be delivered to the **ABC Television Center** in New York, for the network's use in recording and playback of TV programs on tape.

Satellite Network

A network of six satellites which brings TV viewing to an additional 15,000 Alaskans was completed early this year by **Northern Television, Inc.** Each satellite, located in a remote mountainous area, picks up the distant TV signals from Anchorage or Fairbanks, amplifies them, and retransmits to rural communities which otherwise would have no television. Fairbanks feeds three communities through **KTVF's** channel eleven. The first is **Clear**, which is one of the three

Famous RCA Broadcast Quality Microphones

Now available through Local Distributors



RCA Polydirectional
ribbon-type microphone
MA 2311 — chrome
MA 2312 — TV grey

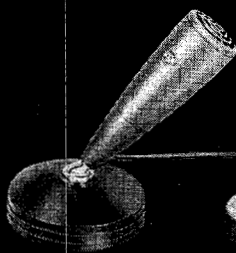

RCA MA 2313
Non-directional
dynamic mike

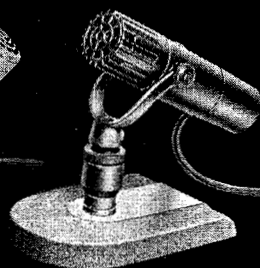

RCA MA 2314
Uniaxial ribbon mike



RCA MA 2315
Semi-directional
dynamic lavalier

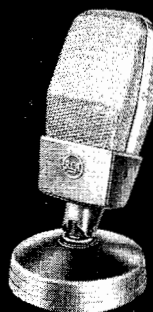

RCA MA 2316 Bi-directional
ribbon mike

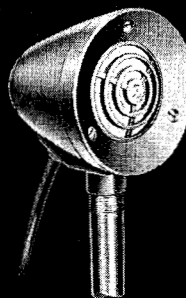

RCA MA 2317
Non-directional
dynamic mike



RCA MA 2318
Non-directional
dynamic mike



RCA MA 2319 Bi-directional
ribbon mike

Now—for the first time you can get world-famous RCA microphones RIGHT OFF THE SHELF—from local Authorized RCA Microphone Distributors.

This is good news for broadcasters. No longer need you accept substitutes for your favorite RCA microphones in emergency situations. RCA Microphone Distributors carry complete stocks available for immediate delivery. Call your nearest RCA distributor for fast microphone service.

RCA ELECTRONIC COMPONENTS AND DEVICES, HARRISON, N. J.

GET FULL TECHNICAL INFORMATION. CALL YOUR NEAREST RCA MICROPHONE DISTRIBUTOR OR ATTACH COUPON TO 4¢ POSTCARD AND MAIL



The Most Trusted Name in Sound

Circle Item 23 on Tech Data Card

Commercial Engineering, Section J-115-MC
RCA ELECTRONIC COMPONENTS AND DEVICES
415 South Fifth Street
Harrison, N. J.

Please send me the New RCA Microphones
Select-A-Guide 1S1014

Name _____ Title _____

Company _____

Address _____

City _____ Zone _____ State _____

SPOTMASTER

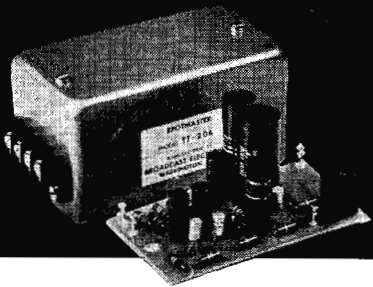

EQUALIZED TURNTABLE PREAMPLIFIER

The Model TT-20A is a compact, low distortion, transistorized turntable preamp for VR cartridges, with built-in NAB equalization. Design ingenuity reduces residual noise level to better than 65 db below rated output. Small current requirements permit 6 volt dry cell battery operation, eliminating AC hum worries. Response, 30-15,000 cps \pm 2 db... output —12 dbm, 600 ohm emitter follower... distortion under 1% at double rated output... size, 2½ x 2½ x 5½". Priced from \$46.50; transformer output and power supply available. Also available as a flat amplifier Model BA-20A. Write or wire for complete details.

Spotmaster

BROADCAST ELECTRONICS, INC.

8800 Brookville Road
Silver Spring, Maryland

Circle Item 14 on Tech Data Card

BEHIND THIS DOOR

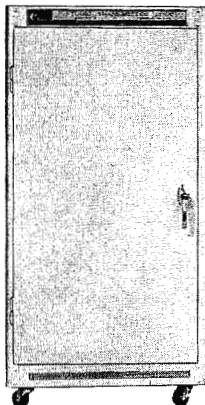

—IN THIS CABINET JUST 42" HIGH IS A DUAL STL THAT MEETS AND SURPASSES THE DEMANDS OF FM STEREO, TV AURAL, INTER-CITY STEREO AND OTHER AM OR FM STEREO OR MONAURAL REQUIREMENTS.

—FOR FURTHER INFORMATION ON WHAT'S BEHIND THE DOOR WRITE



MOSELEY ASSOCIATES INC.

P.O. BOX 3192, SANTA BARBARA, CALIF.
TELEPHONE-AREA CODE 805
967-1469 OR 967-8119

Circle Item 15 on Tech Data Card

Ballistic Missile Early Warning Sites in the world. This satellite, located on a 237-foot tower, services about 2200 people. The second translator fed by Fairbanks is at Delta, a military base as well as the central junction of the Alaska and Richardson highways. Nenana, at the convergence of the Alaska Railroad and Alaska's interior waterways, is served by a translator on a 1500-foot ridge, bringing TV to 500 persons. Anchorage, through ITVA, feeds the oil rich Kenai peninsula with channel 13. About 6000 persons on the Wildwood military reservation as well as in the towns of Kenai, Soldotna and Sterling are in the broadcasting area. At Eklutna, home of the Bureau of Reclamation Power Plant, a translator is behind an 1800-foot mountain ridge. The third Anchorage-fed translator, at Sutton, also transmits over the Chugach mountains to service approximately 500 persons in the Evans-Jones Alpine area.

PERSONALITIES

Appointment of **Eric C. Herud** as manager of the newly formed Medical Instrument Department of **Du Mont Laboratories, Div., Fairchild Camera & Instrument Corp.**, is announced by John S. Auld, general manager for Du Mont. The position will have responsibility for product evaluation, development, and engineering, as well as marketing of medical electronic product lines.

Robert W. Jennings, former manager of equipment assembly for **Ampex Corp.**, Redwood City, Calif., video and instrumentation division, has been named manufacturing manager of the division. The announcement was made by **C. Gus Grant**, vice president-general manager.

Dr. Jules S. Needle has been recently appointed chief engineer of the power grid tube division of **Eitel-McCullough, Inc.**, San Carlos, Calif. The appointment of the former University of Michigan professor was announced by **Thomas D. Sege**, power grid tube division manager.

Otto G. Lechlitter has been named assistant to the president at **International Electronic Research Corp.**, Burbank,

Calif., according to an announcement made by **Harvey Riggs**, president of the firm. Mr. Lechlitter's new responsibilities will include corporate planning and development of new products as a key part of the firm's immediate and long term "depth marketing" objectives.

Dr. G. Russell Tatum has been elected vice president of **Vitro Corporation of America**, according to **Frank B. Jewett, Jr.**, the firm's president. Dr. Tatum will be responsible for all technological activities of the corporation and will also continue in charge of the Vitro Laboratories Division in Silver Spring, Maryland.

The appointment of **Robert V. Jordan** as manager of market planning for the Electronic Tube and Microwave Device Divisions of **Sylvania Electric Products Inc.** has been announced by **Robert G. Lynch**, vice president in charge of marketing. Mr. Jordan is responsible for developing marketing programs for commercial, renewal, industrial, and military product lines for the two divisions.

H. Ronald Levine has been appointed vice president of the **Hammarlund Manufacturing Co.**, New York, N. Y., according to an announcement by **Stuart Meyer**, president. In his new post Mr. Levine will direct sales and marketing activities of the company, which is engaged in the manufacture of communications equipment for government and commercial users.

The appointment of **Edward S. Clammer** as government sales manager of **Visual Electronics Corp.**, Bethesda, Maryland, was recently announced by **James Tharpe**, president. Mr. Clammer is available for consultation with government agencies on Visual's line of solid-state equipment, including video switching equipment, etc.

Herbert L. Brown, former vice-president and general manager of **Ampex Corp.** audio division in Sunnyvale, Calif., has been appointed vice-president, **Ampex International**—manufacturing and engineering. In making the announcement, **William E. Roberts**, president and chief executive officer, said that Brown would work with the firm's increasing activities in the international market.

TELETRONIX LEVELING AMPLIFIER

NEW

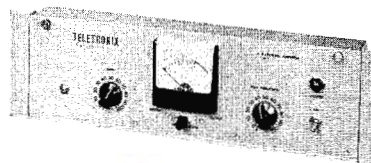

MODEL
LA-2

REVOLUTIONARY OPTICAL CONTROL FOR DISTORTIONLESS LEVEL REDUCTION.
40 DB OF LIMITING AT LESS THAN ½ % DISTORTION!

▲ BALANCED STEREO INTER-CONNECTION ▲

EXCLUSIVE ELECTRO-LUMINESCENT OPTICAL GAIN CONTROL SYSTEM OUTPERFORMS CONVENTIONAL COMPRESSORS AND LIMITERS FOR BROADCASTING AND RECORDING.

SEND FOR COMPLETE SPECIFICATIONS

TELETRONIX ENGINEERING COMPANY

4688 EAGLE ROCK BLVD.

LOS ANGELES 41, CALIFORNIA

Circle Item 16 on Tech Data Card

BROADCAST ENGINEERING

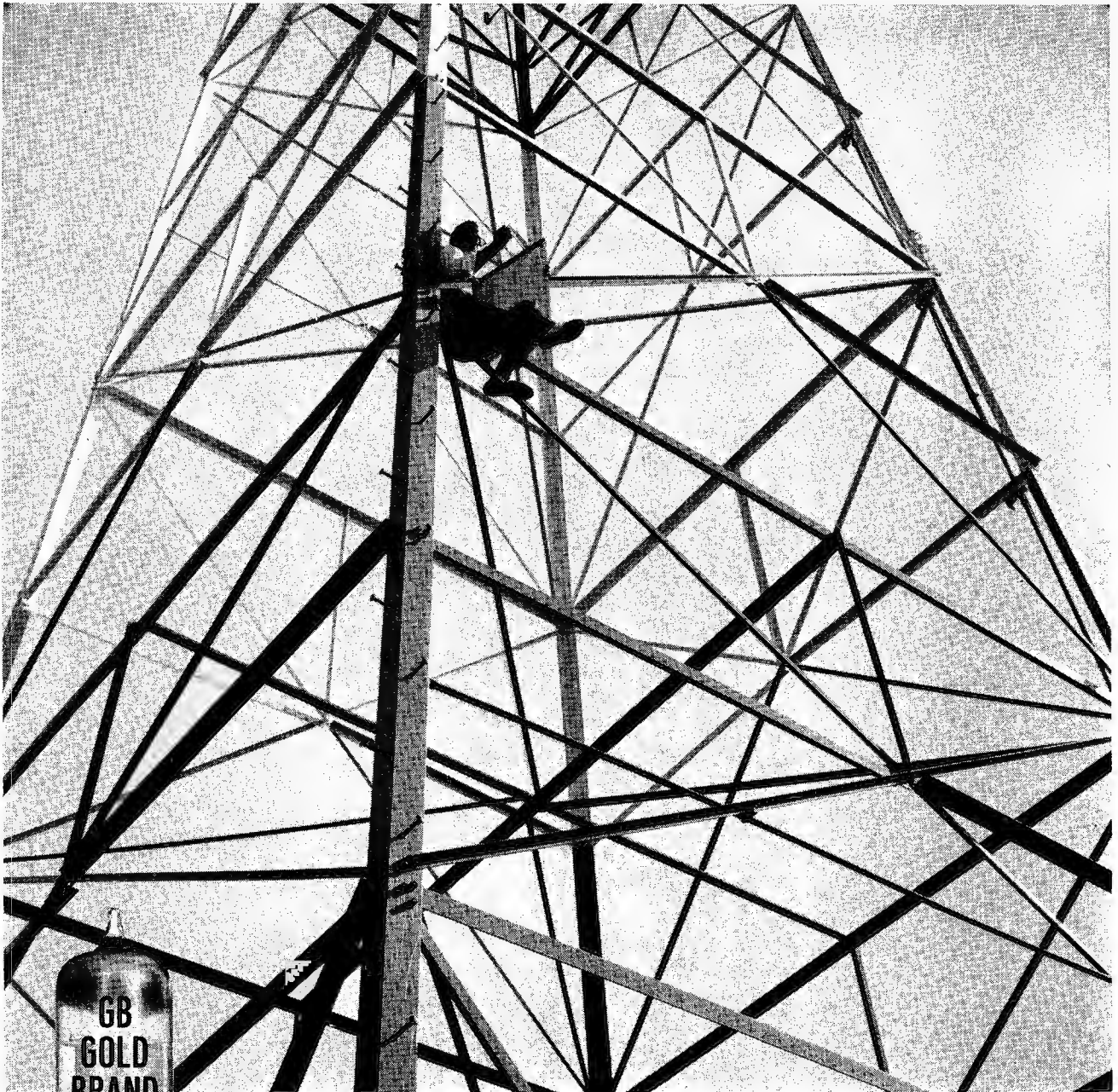

Tubes designed from the user's viewpoint

...use them wherever reliability is essential

When reliability really counts—as it does in broadcasting—be sure with tubes custom-designed and tested for the job.

Sylvania engineers traveled the country—met with engineers and maintenance groups in broadcasting, public service radio, industry, the airlines—listened to their problems and studied them. From this came GB Gold Brand, a superior line of new and upgraded tubes,

each tailor-made to a specific job. A given tube may have, for example, low noise, exceptional stability or vibration resistance. Or a critical parameter may be as much as three times the usual value. In each case, performance and reliability have been verified by actual user experience as well as laboratory testing.

This extra effort has paid off. "Excellent results," says an airline official, "No failures,"

reports a highway patrol department. "Hundreds of dollars saved in program interruptions," reports a TV station. "Less costly in the long run," discovered a county government. Similar results can be yours with a truly reliable, genuinely interchangeable GB Gold Brand Tube.

Electronic Tubes Division, Sylvania Electric Products Inc., 1100 Main St., Buffalo 9, N. Y.

AVAILABLE FROM YOUR SYLVANIA INDUSTRIAL TUBE DISTRIBUTOR

SYLVANIA

SUBSIDIARY OF

GENERAL TELEPHONE & ELECTRONICS

Circle Item 25 on Tech Data Card



SAMS TECHNICAL BOOKS

of special interest to Broadcast Engineers

BROADCAST ENGINEERING NOTEBOOKS

by Harold E. Ennes

Vol. 3: AM-FM Broadcast Maintenance

Just what you've been waiting for! A complete guide on the maintenance and repair of AM-FM broadcast equipment. Combines theory, principles, and practices to provide one of the most valuable reference handbooks for broadcast engineers. Essential data on both studio and transmitter equipment includes proof-of-performance procedures, maintenance and troubleshooting techniques.

Order **BEN-3**, only\$5.95

Vol. 2: AM-FM Broadcast Operations

Worried about your 3rd-class ticket holders being able to pass the FCC exam for Element 9? While the Commission hasn't yet released study data, it's obvious that your operators will be required to know more about studio and transmitter equipment. This new operator's handbook will help them learn all they need to know.

Order **BEN-2**, only\$5.95

Vol. 1: Television Tape Fundamentals

The only complete and up-to-date text on the subject. Covers rotating-head theory, system requirements, video-signal processing, servo systems, operations, maintenance.

Order **BEN-1**, only\$5.95

LICENSE AND REFERENCE HANDBOOKS

by Edward M. Noll

First-Class Radiotelephone License Handbook

Truly a Broadcast Engineer's handbook. In addition to nearly 300 Q & A's on Element 4, contains 12 comprehensive chapters on frequency assignments, duties and license requirements, microphones, record and tape machines, studio and control-room facilities, remote facilities, AM transmitters and antenna systems, FM transmitters, monitor and test equipment, proof-of-performance measurements, and television broadcasting. New Printing contains added Appendices on FM-Stereo Broadcasting.

Order **BON-1**, only\$4.95

Second-Class Radiotelephone License Handbook

New printing! Now includes supplementary Q & A's for Elements 2 and 3. Contains ALL the Q & A material needed to pass the 2nd-Class Exam, PLUS six comprehensive text sections covering fundamentals, transmission characteristics, 2-way radio services, station licensing and procedures, test equipment and measurements, transmitter tuning and adjustment.

Order **QAN-1**, only\$3.95

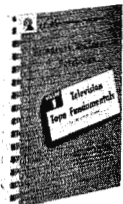

SEND NO MONEY • FULL RETURN PRIVILEGE

Howard W. Sams & Co., Inc., Dept. BE-1063
4300 W. 62nd Street, Indianapolis 6, Ind.

Send me the following books:

- BEN-1** **BON-1** **BILL ME (I pay postage)**
 BEN-2 **QAN-1**
 BEN-3 **FREE Booklist** \$..... enclosed. Send Postpaid.

Name

Address

City Zone State

Circle Item 48 on Tech Data Card

ORDER TODAY

Cascade Amplifiers

(Continued from page 15)

- a 10-db noise figure,
- 40 db gain,
- and 40 dbmv max. output.

The output noise will be —59 plus 10 plus 40, or —9 dbmv. If the input is gradually increased the output level at which noise becomes invisible will be about 40 db above this, or 31 dbmv. If the level is increased still further there will be good pictures over the next 9 db, but after 40 dbmv is passed overload will occur. This 9 db, the room between noise and overload, is the tolerance.

Application of Amplifier Performance Curves

How are these ideas put to work? Start with what is known about a single amplifier (either from measurement, or from manufacturer's specifications):

1. Noise figure,
2. Maximum output (before overload), and
3. Operating gain.

Then there are questions to be answered:

1. How many of these amplifiers can be cascaded before the noise rises so much and the output falls so much that there's no room left between (zero tolerance)?
2. What kind of amplifiers will be needed to go with 5 miles of a given cable?

There are others. All are practical problems which determine the importance of various amplifier characteristics in system operation. The curves are one way of showing these relationships.

The graph in Fig. 5 is based on two quantities: a 10 db noise figure for one amplifier, and a 100 db total loss for the entire system. Horizontally, along the bottom of the graph are shown possible values of individual amplifier gain from 0 to 100 db. The number of amplifiers required in cascade to give 100 db of total gain is shown at the top (e.g., 1—100 db amps, 2—50 db amps, 3—33 db amps).

Vertically, along the left side of the graph are shown possible signal-to-noise (S/N) ratios (in db's) from 0 to 70. These correspond to picture appearance at the end of the system, as indicated on the right.

Now look at the sloping curves.

They are labeled with the maximum output for a single amplifier. The top curve, for example, shows all the values of system S/N resulting from cascading amplifiers with 10 db noise figure and 60 dbmv maximum output for a total gain of 100 db. (The curves assume that the system is operated at the maximum output it will stand.) One amplifier with 100 db gain would give a S/N of only 9 db, corresponding to an extremely noisy picture. Two amplifiers, each having 50 db gain, and 60 dbmv maximum output would still have 100 db gain; but now the S/N ratio is 50 db—a nice, clean picture with lots of tolerance.

The other curves are plotted for other values of single-amplifier maximum output capability. Notice that a reduction in maximum output hurts system S/N directly. All other factors being the same, the use of an amplifier with 10 db less output capability gives 10 db poorer S/N ratio. Using two 30 dbmv, 50 db gain amplifiers gives only 22 db S/N ratio, instead of the 52 obtained with 60 dbmv output amplifiers.

Notice one other thing about these curves; they all show increased S/N ratios are obtained by using more and more amplifiers of less and less gain, until a gain of about 9 db per amplifier is reached. Then the ratios get worse again. This situation results from two effects that work in opposite directions. As more amplifiers of lower gain are used, there is less loss between amplifiers and the input signal to each is higher. This works in the direction of improving the S/N ratio. At the same time, each time the number of amplifiers is doubled, the system noise figure increases 3 db and the maximum system output level comes down 3 db. These effects work in the direction of giving poorer S/N as the number of amplifiers is increased. Nine db gain per amplifier is the point at which the second set of factors wins out; so below this the S/N worsens as the number of amplifiers is increased.

Longer Systems

Figs. 8, 9, and 10 show similar relations in longer systems. Each figure represents a system twice as long as the preceding one. Since doubling the length of a system increases the system noise figure by

A MUST FOR EVERY RECORDING & BROADCAST ENGINEER

ALTEC'S COMPLETE LINE OF
STUDIO PLAYBACK AND SPEECH-
INPUT EQUIPMENT IN ONE HANDY
REFERENCE CATALOG.

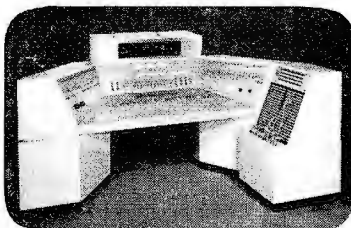

Custom-built Altec control console in ABC-TV's Studio One, New York. Note jack panel containing 720 connections that permit virtually any patching configuration.

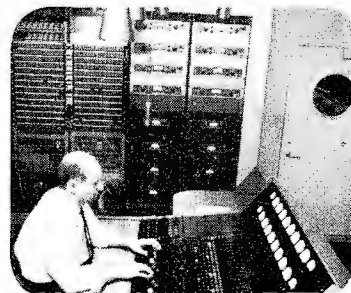

Banks of Altec 128B Amplifiers used for PLAYBACK monitoring by Universal Recording Corp., Chicago.



Control-room view of three A-7 Systems used for 3-channel PLAYBACK monitoring at United Recording Studios, Hollywood.

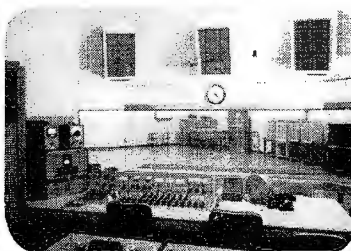

Monitoring with Altec "Duplex"® Speakers in Capitol's control room. More than 70 of these speakers are used throughout Capitol's recording studios in Hollywood.

ALTEC **PLAYBACK**
and speech input

for recording and broadcast studios



There's no longer any need to search through hundreds of Altec catalog sheets... everything is now together in one "book" especially prepared for the recording and broadcast engineer. In it, you will find complete information on...

- **SPEAKER SYSTEMS** to satisfy most stringent requirements of studio PLAYBACK. Indispensable for accurate A-B comparison of the taped recording with the live rendition for judging accuracy and realism.

- **MICROPHONES** including the only American-made condensers; 8 new models of studio dynamics featuring exclusive Altec Sintered Bronze Filters (some models come with individual, certified calibration curves); famous studio stand-bys, the W.E.-type 639 and 633; plus complete information on the revolutionary new 690A dynamic microphone / transistorized amplifier that directly replaces the carbon transmitter in ordinary handsets to provide broadcast quality in TV and radio programming.

- **AMPS AND PREAMPS** you've used or heard about, including a few that may be new to you. Covered are power, program, compressor, remote mixer amplifiers; preamplifiers; the all-purpose 250 SU Stereo Control Console.

- **TUNERS** guaranteed to meet the most critical FCC broadcast standards. The 314A FM MPX Tuner for the ultimate in multiplex network relay... and for off-the-air executive stereo monitoring, record and tape PLAYBACK, the 708A "Astro," the only AM/FM MPX Tuner-Amplifier with transistorized power output stages.

If you insist on the best in professional PLAYBACK and speech-input equipment, this new catalog is a MUST. Write to Dept. BE8 for your FREE copy now, while a sufficient supply is still available.

©1963 ALTEC LANSING CORPORATION



**ALTEC LANSING
CORPORATION**

LTV A Subsidiary of
Ling-Temco-Vought, Inc.
ANAHEIM, CALIFORNIA

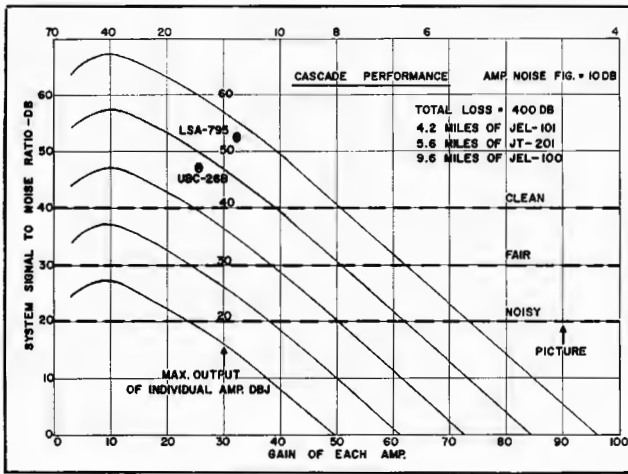

Fig. 6. Curves for 10 db noise figure and 400 db loss.

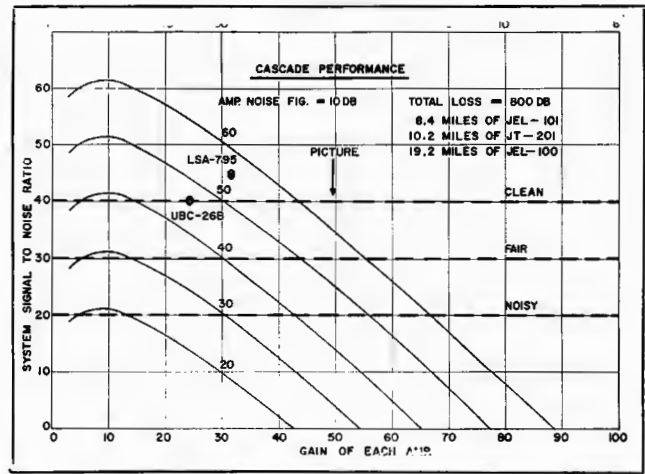

Fig. 7. Curves for 10 db noise figure and 800 db loss.

3 db, and decreases the system output by 3 db, the curves drop 6 db as compared with the preceding figure. This is just another way of saying that each figure (each doubling of system length) decreases the system output by 3 db, the curves drop 6 db as compared with the preceding figure. Also, this is another way of saying that each figure (each doubling of system length)

decreases the system tolerance by 6 db.

Taking Noise Figure Into Account

All of these curves are drawn for an individual amplifier noise figure of 10 db. This is a fairly good average figure, but characteristics of individual amplifiers may vary somewhat from it. Correct for a particular noise figure by moving up on

the chart when the amplifier's noise figure is better than 10 db, and down when it is worse. In each case, the number of db's to move is the difference between the actual noise figure and 10 db. Stating this another way, the system S/N ratio is affected directly by the individual amplifier's noise figure; the S/N ratio goes up as the noise figure goes down. ▲

Save TV alignment and test time!

Improve camera pick-ups!

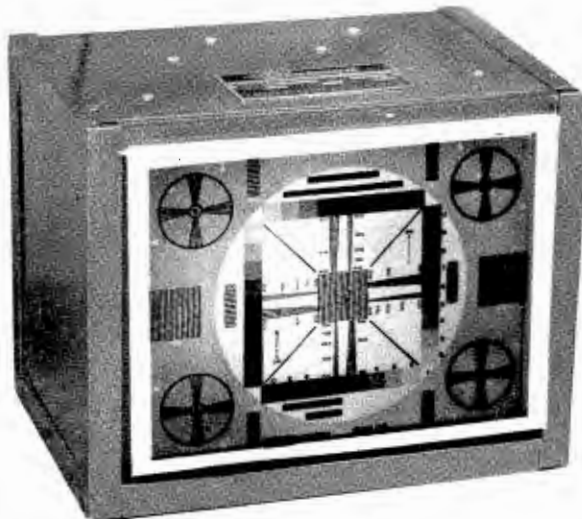

... with a Diamond TV Light Box. Plug in ... get proper color temperature plus immediate, uniform and correct illumination across entire test pattern—regardless of camera location. All three types (color, image orthicon, vidicon) use 8" x 10" transparencies, need no mounting rack, measure 12" x 9" x 8". Diamond TV Light Boxes are now used in over 200 stations and manufacturer's laboratories. Also available: complete selection of high quality test transparencies ... standard or custom-made and a line of video test and operating equipment.

For complete details and prices, contact:

Diamond Electronics

Diamond Power Specialty Corporation • Lancaster, Ohio
P. O. Box 415 • TWX 490 • Tel. 653-6540

Circle Item 27 on Tech Data Card

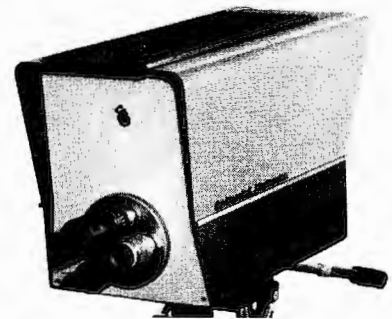

NEW

20A-1 VIDICON CAMERA CHAIN

- economical to operate and maintain
- can be used with any studio equipment utilizing EIA sync pulses
- easily and simply controlled
- recommended for educational tv, live programming, process monitoring

Continental Electronics

PRODUCTS COMPANY
BOX 5024 • DALLAS 22, TEXAS • TELEX CEPKO

LTV Subsidiary of Ling-Temco-Vought, Inc.

Circle Item 28 on Tech Data Card

BROADCAST ENGINEERING

Television Center

(Continued from page 22)

must be provided with a front panel sync selector.

The control rooms are only five feet above the level of the studios which may cause concern among those who prefer "2nd story control rooms." However, it is felt that more intimate contact can be obtained with the studio without sacrificing visibility. In addition, it puts the director's eyes below the lighting grid. Direct access to the studios is provided.

Two announcer's booths serve the operation. One serves Master Control and studio one, the "local" studio. The second booth is shared by studios two and three.

An operations office is included in the control area.

Studios

Studio One is 50' x 70' and with a 25' ceiling. It is intended for small productions such as news and weather. (The news room is directly down the corridor.) Studio Two is 60' x 80' x 25' and is used for larger productions. Studio Three is 65' x 80' x 25' and has a permanent 210 seat auditorium. The stage area is large enough to permit two small sets side by side, one set and an orchestra, or one large set.

Support Facilities

The talent dressing rooms are immediately adjacent to studios one and three. A wardrobe room and lounge ("Green Room") are available. A locker room for the stage and shop crews is provided in the same area.

A boiler room, stage lighting equipment storage, janitorial supply, offices for the building engineer and prop manager, hand property room, scenery shop, machine shop, mail and printing room, and a men's washroom are located around the periphery of 7,800 square feet of scenery storage areas.

On the production level, the TV master control room is flanked by an area set aside for equipment racks. Beyond this area is the electronics, or technical, shop. A storage room for this shop is provided directly across the hall. The opposite side of the control area contains a projection room with ample space for four complete color film



for the new CONCERTONE 607

The new Concertone 607 is dimensionally constructed to make it an exact replacement for the equipment you've been thinking of updating. But it's the same in size only. This surpassing tape recorder defies comparison, really. Its features are fabulous and only a demonstration will prove to you that its low price is not really a misprint. This is the high-impedance model of the famous Concertone 605 with provision for plug-in impedance matching transformers; precision plug-in head assembly, including four precision heads; separate mike and line controls; professional connectors; calibrated VU meters; delay memory control circuit; automatic glass tape lifters (including electric cue feature); sound-on-sound and add sound; solenoid operated brakes; three motors; automatic rewind. See your Concertone dealer, before you decide to replace or expand.

SERIES 90 PROFESSIONAL TAPE RECORDERS

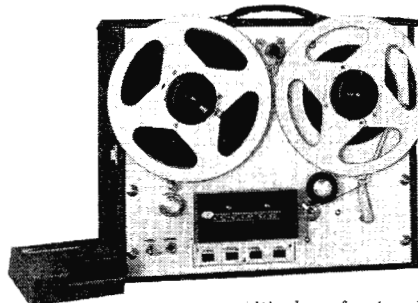

Distinguished performer for the most critical professional. Exclusive Concertone features such as "Edit-O-Matic" for high-speed tape cueing and editing. Four heads; 3-motor drive, including hysteresis synchronous capstan drive. Maximum in wide stereo-mono versatility and automatic-remote capabilities.

CONCERTONE 400 COSMOPOLITAN

For people on the go... it's the Cosmopolitan... combination tape recorder and AM radio. A versatile companion and co-worker for business and pleasure travels. Push-button operation.

Accommodates 5" reels, 2 speeds. This all-transistorized radio-tape recorder brings you big recorder features in precision-made miniature form.

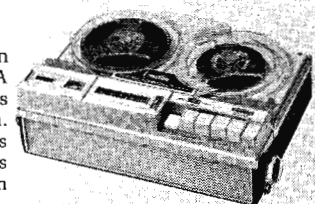

for further
information
write:



AMERICAN CONCERTONE, INC.
A DIVISION OF ASTRO-SCIENCE CORP.
9449 W. JEFFERSON BLVD. • CULVER CITY • CALIF.

Export: J. D. Marshall International, 170 W. Washington, Chicago, Illinois

Circle Item 29 on Tech Data Card

**talk about high-reliability?
HERE'S MORE PROOF!**

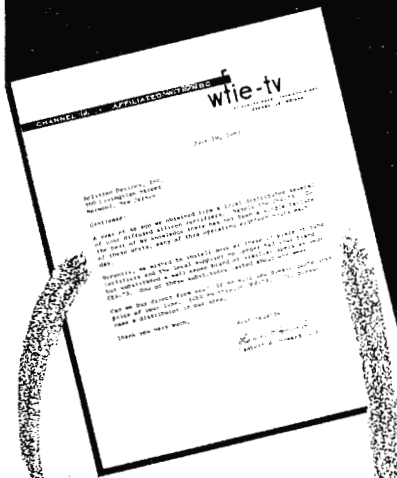

"A year or so ago we obtained from a local distributor several of your diffused silicon rectifiers. To the best of my knowledge there has not been a single failure of these units, many of them operating eighteen hours each day."

"Recently, we wished to install more of these in place of tube rectifiers and the local supplier substituted a well-known brand. One of these substitutes lasted about one week."

The above letter was recently sent to us by Mr. Lambert B. Howard, Chief Engineer of WFIE-TV, Evansville, Indiana. It is but one more in a continuous series of unsolicited testimonials from users of highly reliable, performance-proved Solitron products.

Solitron manufactures high reliability Solid-State Rectifier Tube Replacements for broadcast receivers and transmitters. Solitron also manufactures Solid-State Hi-Voltage Assemblies (Solidpaks®) and Noise Diodes (Sounvister®). Product specifications/applications data and price lists are available on request.



Circle Item 30 on Tech Data Card

chains (one camera, two film projectors, one slide projector per chain). There is an editing room, film vault, and four screening rooms within the immediate area. Three of the screening rooms are separated by movable partitions and can convert to one large room. A TV tape work room and storage room are also adjacent to the TV master control room.

A film and TV tape office is located near the above facilities serving also as receiving and shipping point. This area is oversized and may be used to provide additional film storage space. A dark room, supply room, and film processing room complete the film department.

The news room is located between the film department and radio studios. TV studio one, the news studio, is sixty feet away. The news film area is used to store, edit, and preview news film. It has access to the film processing room, so film may be quickly processed and edited. The projection room is just across the hall. A "hot" news film may then go from the news film camera to "air" with little time lost between departments. The news film room is situated so that films may be screened directly into two offices allowing the commentator to preview it with the least interruption to the preparation of his newscast. The news room has four offices and a teletype room to supplement the central writing area. Three radio studios adjoin the news room through double doors, enabling bulletins to be aired almost immediately.

Studios A and B are strictly "news and music" studios. They are about 10' x 12' and adequate for very small groups. Studio C contains control equipment so it may also be used as a control room for Studios A and B as well as the capability of being used as a "combo" room. Studio D is 20' x 22' and can be used for small productions; it has its own control room. The area between the two small control rooms is reserved for equipment racks. A recording room contains remotely controlled tape machines; disc cutters are also provided. Radio master control has the usual equipment and, if needed, can directly control all studio microphones.

A lounge is provided for the comfort of the announcers and technical crew, with a locker room adjacent.

The music, or record, library is within a short distance of the TV and radio control rooms. Audition booths here are supplemented by facilities in the above mentioned lounge so that "deejays" may audition records in relative comfort.

An elevator, telephone equipment room, rest rooms, and a lobby are provided. The receptionist is also the main switchboard operator. The corridors are wide and provide room to move large equipment. Waist-high show cases may be used to line the corridor walls displaying sponsors' products and laymen's explanations of "How TV . . ." Windows are used so the public may observe the innards of the operation.

The Office Level

On the office level one is greeted by a plush business lobby which leads to the executive suite consisting of the offices of the president and vice president, the executive secretary, a conference room, a lavatory, closets, and a projection booth; the latter may project into either the conference room or the president's office. These two rooms also have observation windows into Studio Three.

The basic concept of the office layout is one of a combined operation, i.e., the radio and TV sales departments are combined under one head. In this way, station policies throughout are uniform. Secondly, duplications are eliminated; thus making the building more adaptable to an all TV installation if desired.

The departments handling money are all closely grouped. The accounting office is convenient to the traffic department, automatic data processing, personnel, and purchasing offices.

Sales is adjacent to promotion and opposite traffic. Art is next to promotion and has a small studio for shooting of stills. This studio is directly above the dark room allowing a chute to be installed to expedite the production of slides. The engineering offices have ready access to the production department, so close cooperation may be achieved. Programming and p.o.

duction have a large area assigned to them, as this is the business of the television center. Traffic and continuity are within the same area. Direct access to the production control rooms is available.

A large room is marked rehearsal. In lieu of that function, it could be used as extra office space, a cafeteria, or a lounge and library.

Variations

If radio facilities are not desired, that space may be used as a fourth TV studio, probably a "news studio."

The fact that there is no front to rear corridor on the right side of the building may seem like a serious disadvantage. If the reader considers the small amount of traffic between these portions of the building he will find the corridor unnecessary. The corridor on the left side has a ramp connecting the levels (studio and production), allowing equipment such as cameras to be easily transported to the technical shop.

If requirements warrant it, the addition of a basement below the production level produces a true split level facility. The talent dressing area would be moved below the production control rooms with stairways leading directly into all three studios. The boiler room, machine shop, building crew dressing areas, and telephone equipment room should also be relocated in the basement. The cafeteria and rehearsal rooms which were alternate options can now easily be accommodated. There is sufficient room for additional film vaults, dead file areas and the like.

In the vacated areas above we may now add a mobile equipment garage and storage room (old boiler room), a public coat check room (old telephone equipment room), and additional office space (old rehearsal area). The stairwell in the production area has to be moved 5' away from the control room so that it can be extended down to the basement. The ramp in the hall would be replaced by a double split ramp.

In TV studio installations, as in everything else, there is no perfection or ultimate. The proposed design is the author's attempt at achieving, as closely as possible, the unattainable. ▲

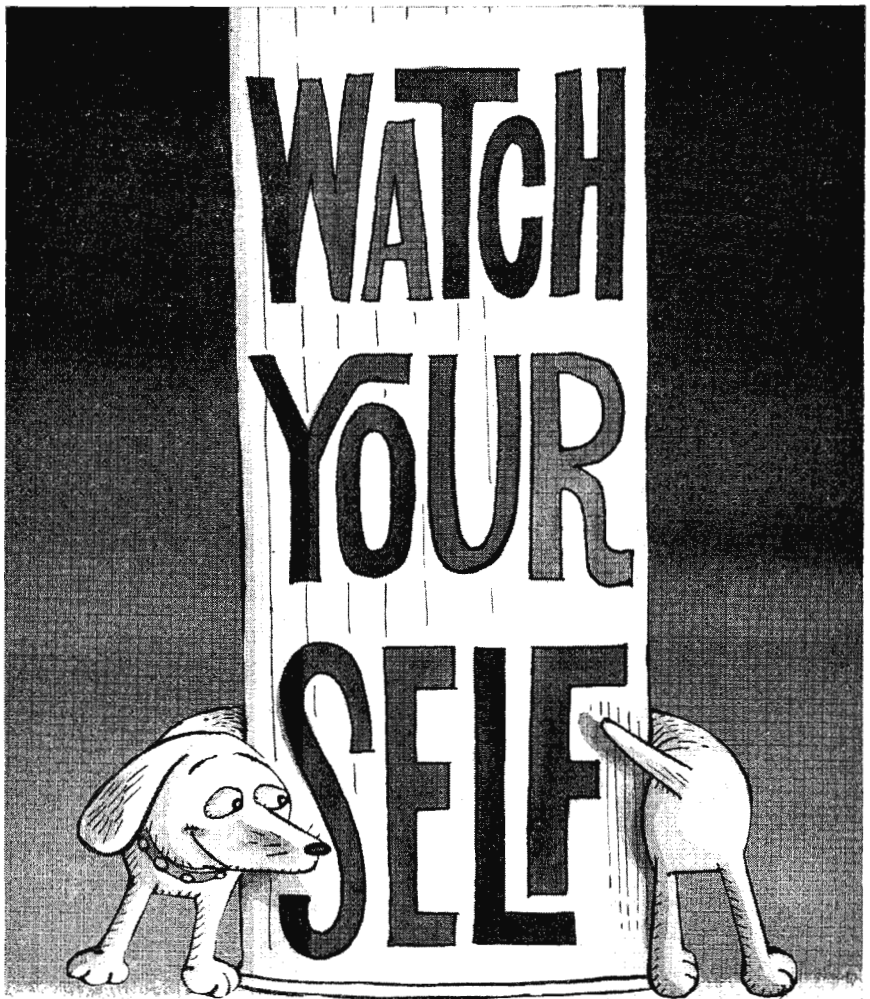

SEE the loud commercial...**AVOID CITATIONS!**

DETERMINE sideband and sub-carrier attenuation...**AVOID CITATIONS!**

MEASURE spurious radiation and other interference...**AVOID CITATIONS!**

Here, combined in one chassis, is a new Nems-Clarke high-resolution spectrum display and receiver unit that gives the broadcaster a complete picture of his operating frequency spectrum.

FM and VHF television channels are covered by a plug-in RF unit continuously tunable from 54-260 mc. The FM spectrum is displayed in segments of from 50 kc to 2 mc. Crystal controlled marker pips at ± 25 kc and ± 75 kc provide precise horizontal scale alignment. Resolution 3 kc. The SDM-520 also features an entire AM and FM audio channel and front panel speaker.

SDM-520 is available from off-shelf delivery. Send for specifications and new product data sheet.

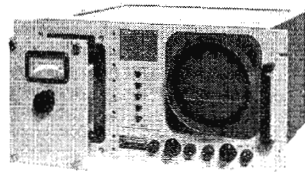

For information write: Vitro Electronics,
919 Jesup-Blair Dr., Silver Spring, Md.,
A Division of Vitro Corporation of America

VITRO ELECTRONICS

NEMS-CLARKE—RECOGNIZED STANDARD IN BROADCAST EQUIPMENT
Circle Item 31 on Tech Data Card

SPOTMASTER



Tape Cartridge Racks

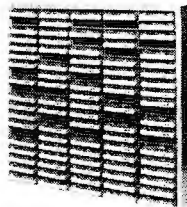

... from industry's most comprehensive line of cartridge tape equipment.

Enjoy finger-tip convenience with RM-100 wall-mount racks. Store 100 cartridges in minimum space (modular construction permits table-top mounting as well); \$40.00 per rack. Extra rack sections available at \$12.90. Spotmaster Lazy Susan revolving cartridge rack holds 200 cartridges. Price: \$145.50. Write or wire for complete details.

Spotmaster

BROADCAST ELECTRONICS, INC.
8800 Brookville Road
Silver Spring, Maryland

Circle Item 27 on Tech Data Card

IMMEDIATE DELIVERY from Stock!



Professional Transistorized Portable Field Recorders

Exceed NAB Broadcast Standards

Assure studio quality performance with complete independence from AC power.

Over 25 models available in two series:

TransFlyweight® Series 312: 8 lbs.; electric motor, battery-operated. Size: 5½ x 9 x 12 inches.

TransMagnemite® Series 612: 15 lbs.; spring motor. Operates 125 hours from rechargeable batteries.

Choice of single or multiple tape speeds, one or two tracks. All models equipped with multi-purpose VU meter. Full unconditional 2-year Guarantee.

Write for Literature

AMPLIFIER CORP. of AMERICA

An Affiliate of the Keystone Camera Co., Inc.
398 Broadway, New York 13, N. Y. • WO 6-2929

Circle Item 28 on Tech Data Card

Proof Fails

(Continued from page 17)

to harmonic distortion and frequency response—if everything is functioning properly. It is understood that poor response and distortion are related. Consequently, unless there is a serious sag in response, troubleshooting should proceed with minimizing distortion as its guiding light. (Special cases of poor response will be treated later.)

When it comes to amplifier fidelity, the consideration of tubes as a factor of poor performance goes beyond the "Good-Bad" indications of a tube tester. With the exception of the lower-level stages, the majority of the audio stages—from the console to the modulators—are operated in push-pull (or as back-to-back resistance-coupled stages, which are approximately equivalent to push-pull). Since the primary cause of distortion is nonlinearity, it is necessary to control as much as possible any unbalance introduced by tubes. Push-pull linearity caused by tube differences is much more likely to occur in the high-level stages because of the large excursions made by the plate current under signal conditions. In low-level stages, a gradually sloping plate current characteristic may seem like a straight line because of the relatively narrow portion used; but to a high-level stage a gradually sloping curve looks like a gradually sloping curve—and that's that! Thus, in a high-level stage, nonlinearity is automatically present even under the best conditions—although the effects may be partially neutralized by inverse feedback. Because of this built-in circuit limitation, it is important that individual tubes do not add unduly to the nonlinearity. Therefore, it is important that push-pull tubes be matched as closely as possible.

Within the full chain of station equipment, certain specific high-level stages will be more susceptible to nonlinearity than others. Relatively speaking, a class A output stage in a console will not be as touchy as a class AB₁ audio driver in the transmitter. A class AB₂ stage will be more prone to distortion than either of these. Most cantankerous of all will be the class B modulators, which may be operating in the extreme AB₂ region.

These latter stages cause more distortion than A or AB₁ because, to develop sufficient audio power to accomplish their purpose, they must be operated with their grids going positive for a portion of the operating cycle. This sudden burst of grid current creates havoc in several directions: The impedance presented to the preceding driver stages drops suddenly, causing a distorted wave-top to appear at the grid. Simultaneously, the current drawn by the grid decreases the amount available for the plate, further distorting the wave. With these limitations in mind, transmitter designers have done a marvelous job of minimizing distortion in modern gear. Nonetheless, all other things being relatively equal, severe distortion (and sagging response) is more likely to occur in the modulator stage than elsewhere.

As a matter of routine, the modulator tubes should be kept in a state of dynamic balance. However, this is not always easy to do without the aid of a distortion analyzer. If each modulator has its own plate-current meter, the static (no-signal) currents may be adjusted by the individual bias controls to the recommended value. In dynamic operation the meters are observed to see that they both swing in unison, and reach same values of peak current on loud passages of program modulation. But this procedure results only in an approximation; as far as the true minimum is concerned, adjustment is impossible without the aid of an analyzer.

Prevention of an extra one-half per cent of distortion in the modulators is more important than anywhere else in the equipment chain. Unbalanced modulator tubes can cause so much difficulty in making a proof that I have found it advisable to check the transmitter audio first. This is done by feeding in an unattenuated oscillator signal and spot-checking the distortion at 50, 1000, and 7500 cps, with both 25% and 100% modulation. This should be done before making any adjustments to the modulators, and the dynamic meter readings noted for reference.

Unless you were the last to set the modulator bias adjustments, the static current of each modulator tube should also be very carefully

noted before any adjustments are made. It is possible that these currents were previously adjusted to a state of DC unbalance because it was found by means of a distortion-analyzer that less overall distortion was obtainable. If the transmitter in question has only one meter which reads the combined modulator plate currents, and no method of switching the meter to each tube, then the actual bias voltages should be measured with a VOM. In any event, some reference should be established so the tubes may be returned quickly to the initial adjustments, if necessary.

As a starting point toward minimizing modulator distortion, the transmitter instruction manual should be consulted for the recommended tube current and the suggested procedure for balancing the stage. In adjusting the stage according to the specifications, it may be found that the distortion is worse than it was prior to the adjustment procedure. If this is the case, it is time to start "juggling" tubes. It is generally recognized that among any group of similar-type tubes a specific pair will balance somewhat better than others. The spare tubes should be brought into play for this comparison. If the RF power amplifiers are of an identical type they also should be rotated in the sequence until a pair with the lowest distortion characteristics is found. To keep from going off your rocker during this charade note the serial number of each tube, "pre-pair" them on paper, and record the test results for each pair.

After locating the tubes which cause least distortion when adjusted according to the manual, it is time to make slight readjustments in the bias controls to see if the level cannot be minimized even further (some manuals will include this as part of their adjustment procedure). A general method of doing this is to apply a 1000-cps signal and modulate the transmitter at 100%. The bias controls are varied slightly to see if a slight decrease in distortion is noted on the analyzer. (The first bias adjustments should be in the direction of lower plate current.) Sometimes one will have to be decreased slightly and the other increased slightly, to achieve minimum distortion.

The amount of improvement

Only **DYNAMIC DIMENSION** Control Equipment by **FAIRCHILD** Can Radically Improve Your Broadcast and Recording Sound!

FAIRCHILD DYNALIZER—Model 673

The newest approach for the creation of "apparent loudness"—the Dynalizer is an automatic dynamic audio spectrum equalizer which redistributes frequency response of the channel to compensate for listening response curves as developed by Fletcher-Munson. Adds fullness and body to program material. Completely automatic with flexible controls. Easily integrated into existing equipment.



FAIRCHILD CONAX Model 602

The world-acknowledged device that eliminates distortion problems caused by pre-emphasis curves. Allows higher average program levels through inaudible control of high frequencies. Invaluable in FM broadcast and disc recording. Eliminates stereo splatter problems in multiplex channels.



FAIRCHILD LIMITER—Model 670

Fast attack stereo limiter (50 micro-seconds) with low distortion and absence of thumps. Sum and difference limiting position eliminates floating stereo image, despite amount of limiting used in one of the two channels. Also includes regular channel A and B limiting. Dual controls and dual meters provided. Now used throughout the world in recording studios. (Mono model available).

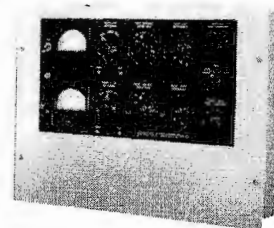

FAIRCHILD COMPRESSOR—Model 666

A flexible compressor capable of 40 db compression without distortion. Can also be used as line amplifier. Has 30 db of gain. Includes variable threshold and variable release up to 30 seconds, amplifier gain controls and compression meter. Special device—Fairchild Autoten eliminates compressor breathing during long pauses. Permits high average modulation levels.

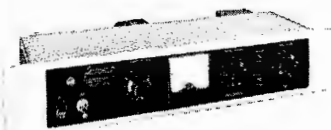

Write to Fairchild—the pacemaker in professional audio products—for complete details.

FAIRCHILD

FAIRCHILD RECORDING EQUIPMENT CORP., 10-40 45TH AVE., LONG ISLAND CITY 1, N. Y.

Circle Item 34 on Tech Data Card

ALL TAPE HEADS WEAR OUT! HERE'S HOW AND WHY!

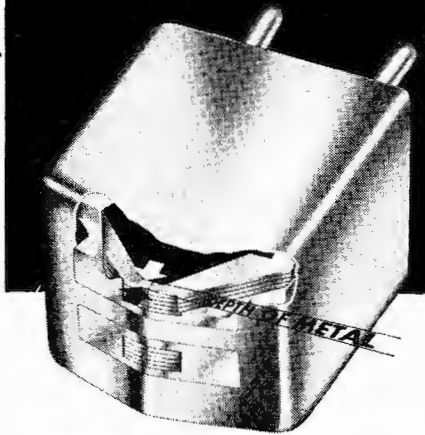

Magnetic tape itself is the real cause of head wear!

The abrasive action of tape as it passes over the head face gradually wears away the *depth of metal* left on a new head after final polishing (see above). Because wear is nearly always uneven, craters or ripples are also formed on the face as wear progresses, thus making it impossible to achieve good contact between the head gap and the all-important signal recorded on the tape. The severe high frequency losses and erratic output resulting from poor tape-to-gap contact are very annoying to the ear. Head wear should NOT be permitted to reach this point — much less go beyond it to the limit where the gap actually begins to open up.

By replacing the worn head with a new Nortronics professional type of laminated tape head you will obtain improved high frequency response over the original head, plus the added feature of longer life since laminated heads have 50% more depth of metal at the gap. Nortronics manufactures both laminated and solid-core heads, but recommends the use of the laminated types for station use.

Nortronics is the established source for replacement heads among broadcast engineers because of the excellent price structure and long wearing qualities of their professional type heads for erase, record and playback.

For complete information contact:
Thor Johnson, Distributor Sales Manager

*"Music sounds best on tape—
Tape sounds best with Nortronics heads"*

Nortronics 

8143 10th Ave., North • Minneapolis 27, Minn.

Write today for FREE copy of NORTRONICS
Tape Head Replacement Guide

Name _____
Address _____
City _____ State _____

Circle Item 35 on Tech Data Card

realized by such readjustment seems to depend on how well the two tubes match; the more nearly alike they are, the less improvement can be made by this fine adjustment. In any event, care must be exercised in attempting to reduce distortion by varying the bias; if the tubes are relatively well matched, the plate current might be increased to a dangerous value while attention is focused on the distortion meter.

Occasionally you will find a lower static current than that recommended by the manufacturer will result in slightly improved performance, due to several possible factors — one of which is aging high-voltage rectifier tubes. For instance, in a transmitter I recently adjusted, the recommended total static current for the modulators is 120 ma; however, extensive tests indicated that a static current of 90 ma produced less distortion throughout the spectrum. This condition, however, does not occur in that particular transmitter when the rectifiers are new. (Do not attempt this without the assurance of an analyzer.)

After the static currents are adjusted for minimum distortion at 1000 cps with 100% modulation, the distortion should be immediately checked at 50 cps. It may be found that a balance at 1000 cps will result in undue distortion in the low ranges. If this is the case, the tubes should be adjusted for minimum distortion at 50 cycles. Then check 1000 and 7500 cps to see if the readings remain in a reasonable range at the higher frequencies. In fact, if all available tubes are several years old, it might be wise to perform the bias readjustment at 50 cps to begin with, and then check the higher frequencies. It is probable that a compromise will have to be made. However, keep the figure as low as possible at the lower frequencies because as tubes age and the emission capability decreases; the low frequency range will be affected to a greater degree than the middle and high frequencies. If distortion measuring equipment is used only once a year (and the modulator bias is adjusted at 1000 cps) chances are that by next year's check the low frequency distortion will be considerably greater, while the 1000-cps reading may show only a relatively small increase. ▲



when acoustical conditions
vary widely . . .



. . . equalize with the Telefunken M 251 E Condenser Microphone

Pick your pattern with a flick of the switch . . . Cardioid, Omnidirectional or Bi-Directional. The Telefunken M 251 E gives you all three patterns, gives you other important advantages too: Flat frequency response with smooth roll off on both ends, high sensitivity, Telefunken design and construction throughout make the M 251 truly a "sound investment".

Whenever true recording excellence is essential, your finest choice is a professional microphone by Telefunken. There's one for every application — also a complete range of world-renowned studio equipment. Write today for further information and technical data to:



TELEFUNKEN



American Elite, Inc., Dept. 25, 48-50 34th St.
Long Island City, N. Y.
Telefunken Sales & Service
Headquarters for over a decade.

Circle Item 19 on Tech Data Card

BROADCAST ENGINEERING

Copy System

(Continued from page 24)



Fig. 3. Camera used to copy opaque.

the camera and placed in a small tank of emulsion-hardening solution for about 20 seconds. The slide is practically dry when removed from the tank and can be mounted and projected at once (Fig. 4).

The job is done under fixed conditions, listed on a large white instruction sheet posted on the wall next to the camera. Since the projector slides on drawer tracks it can be adjusted so that a section as

small as a quarter of the 16mm frame can be blown up and copied. There is an overall throw of 30" from projector to glass and this too can be regulated.

One of the system's chief advantages is that no longer is a dark-room technician needed to stand by in advance of the evening news shows. A floor man (production aide) can quickly learn the simple technique, freeing the technician for more complicated graphic work. Now there is no lapse in news picture projection—even through the weekends, when no technician is on duty.

KGO-TV now is projecting about 50% more news pictures than before. Pictures received as little as 15 minutes before air time can now be ready for use on the news shows. Thus, the emphasis at KGO has shifted substantially in favor of more local photos and fewer pictures off the wires. Having to go through few processing steps, the picture quality is clear and sharp. Transparencies are able to stand the ultimate blowup onto a 30" x 40" rear-projection screen.

There have been a few bugs,

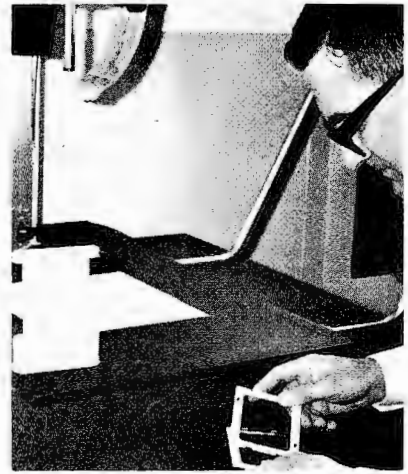

Fig. 4. Transparency is placed in mount.

but they were easily worked out. For example, a bright spot on the translucent glass was eliminated by adding a sheet of tracing paper for greater diffusion. The same diffuse effect could probably be achieved with clear glass and about two sheets of tracing paper.

Another obvious advantage of the equipment is that it can be—and is—used for copying opaque material, since it works in conjunction with four carefully positioned copy lights. ▲

50 WATT CARRIER CURRENT TRANSMITTER

The Bauer Broadcaster is ideal for Test Site, College & University, Military and other Low Power Applications because it utilizes AC Power Lines for the Antenna. VACUUM CRYSTAL CONTROLLED • WIDE OUTPUT TUNING RANGE • MEETS FCC SPECS • MIKE & TAPE LEVEL INPUTS • ONLY 10½" RACK SPACE. Write for complete story.

Bauer
ELECTRONICS CORPORATION
1663 Industrial Road, San Carlos, California
Area Code 415 591-9466

Technical Talks

(Continued from page 26)

plus j (line impedance), minus j (line impedance) and plus j (line impedance), respectively, in order to reflect the line impedance to the power dividing network.

The design of the power dividing network might appear simple—merely a matter of producing a volutage divider that can handle the power involved. Actually, it is quite involved; and because in general there is not too much that the station engineer can do about the divider we shall not treat the unit in very great detail.

The main point to bear in mind about power dividers is that Q has a decided effect on the operation of this circuit. Remember, coil taps have to be changed during tuning in order to get the desired currents into the different antennas. If Q is too low, there will be too much interaction when each tap is changed; changing one power tap will upset power distribution in the other lines. On the other hand, if Q is too high it may limit the bandwidth and

thus suppress sidebands and introduce distortion. In the case of a high fidelity transmitter this would be a serious matter, and could jeopardize the station's claim to high fidelity! As a general rule, designers try to achieve a Q of about 2.75 to 3.25 for this type of divider circuit.

Phase Monitor

Once the preliminary problem of phase angle and division is settled, and installation is completed, the phase monitor comes into play. This unit samples the current phase in each antenna, to see if it complies with the construction permit or license and thus produces the approved radiation pattern.

The usual method of sampling is to mount a small coil at each tower, and bring the induced currents back to the transmitter console for comparison in the phase monitor. The sampling loop is generally mounted about halfway up the tower, unless the tower is not a half wavelength tall; then the loop will be mounted at any height above 25' from the

ground. In half-wave towers, the current may be changing very rapidly below 25', and a small difference in placing the coil could result in a large phase error, or a problem in setting up the monitor system and consequent radiation pattern.

For simplifying phase considerations, it is best to make every sampling line the same length—the same as the longest one needed; any excess line can be coiled up out of the way.

The sampling loop will be provided by the manufacturer of the phase monitor so it is not often necessary to change it. Depending on the power of the station, the loop size may vary from 6" to 4'. The signal induced into the sampling line is normally 1 or 2 volts for each ampere of antenna tower current.

A point that is sometimes overlooked in maintaining towers is the need to isolate the sampling loop from ground. The normal method of doing this is to wind the coaxial sampling line into an RF choke at the base of the tower, using 40

NEW BRIDGE SIMPLIFIES RF IMPEDANCE MATCHING

FROM TRANSMITTER
COMMON POINT
OR
SIGNAL GENERATOR

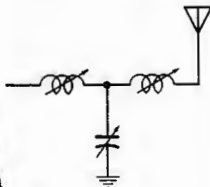

DELTA MODEL OIB-1 OPERATING IMPEDANCE BRIDGE

Connect in antenna lead, transmission line, common point, etc., turn on power (5 kw max.), adjust for null on meter and read R and X . Insertion does not upset directional parameters. Operating impedance is thus measured. In use by leading consultants and station engineers. (\$475.00)

DELTA ELECTRONICS



DELTA ELECTRONICS, INC.
4206 Wheeler Avenue, Alexandria, Virginia

Circle Item 37 on Tech Data Card

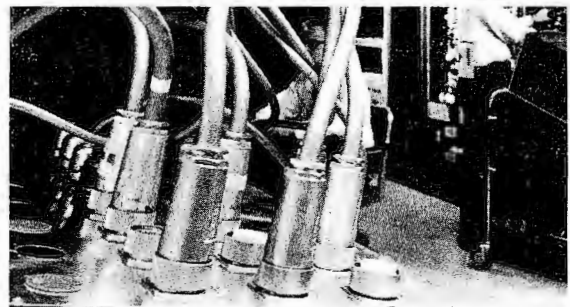

About the Cover

Featured on the cover this month is a scene in the master control area at WGN-TV, Chicago, Ill. In the foreground is seen a centralized patch panel which facilitates connecting a total of fifteen monochrome cameras and/or seven color cameras to camera control units in the master control area. Employing great quantities of Belden 8280 TV Camera Cable and Belden Color Camera Cable, the system minimizes the number of control units required. This results in cost savings and space economy.

Another advantage of the system is that any combination of cameras can be controlled by one engineer using control units directly in front of him. In the event of control unit failure, another unit can be patched in quickly. In addition, the arrangement provides for the quick replacement of a defective camera while retaining the same control unit.

The patching system was designed and constructed by staff personnel in the WGN-TV engineering department. Complete facilities for such work are provided at WGN's new center in north-central Chicago.

Such time saving devices are appearing on the television scene with great frequency. The science of television thus further advances, reaching higher plateaus of accuracy, efficiency, and technical capability.

turns of wire in a coil about 14 inches in diameter. If the base impedance is very high, it may become necessary to tune this coil with a capacitor to form a parallel circuit to present the desired impedance. This choke method is really similar to isolating the feed line for an FM, or similar auxiliary, antenna that is mounted on a broadcast tower although not electrically connected to it.

After isolation from the tower, the line — or lines — are led to the phase monitor at ground potential (sheath). Any excessive length of line is coiled neatly so that it will not be damaged nor work loose. If the lines are all the same length to maintain phase shift, it is advisable to store the excess in an area where the temperature is constant. This will ensure that all lines are exposed to the same changes in temperature, so any phase shift caused by temperature change will be common to all lines.

At the phase monitor, a resistance of the same value as the line impedance is bridged across each line to keep the standing wave ratio

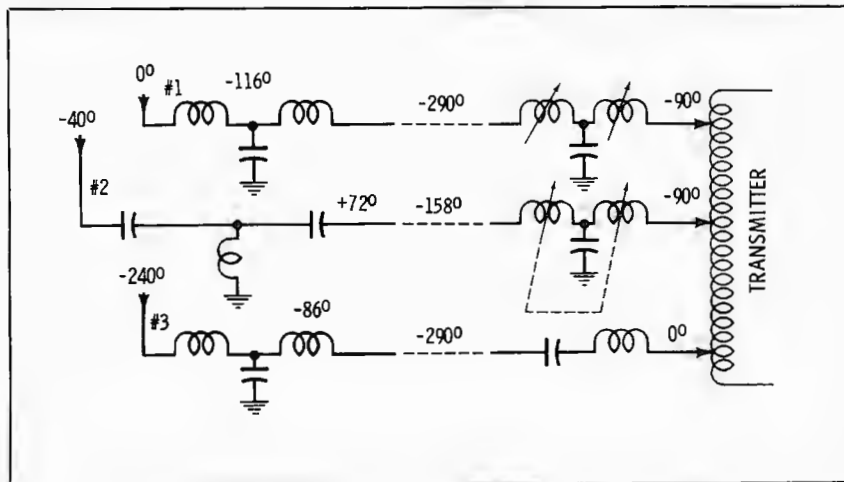

Fig. 2. Three-tower system with circuits for desired phase shifts and impedance.

very close to 1. To monitor antenna currents, RF meters are inserted in the lines at these points and give remote indications of antenna current.

In closing, it might be pointed out that if suddenly or consistently wrong phase readings and/or current readings are being obtained, it would be well to check the lines themselves with an RF bridge. These

should be made with lines open at each end, closed, and with the sampling coils connected—in other words, under all conditions. Each line should read the same; if one is different, the reason should be found and corrected. The actual line impedance is not extremely important, provided that it is not a great deal different from the pre-determined nominal. ▲

SMALLEST

649B shown actual size. List Price \$105.00.

This tiny handful is E-V's answer to studio requests for a truly miniaturized dynamic microphone. The Model 649B is just 2 1/4" long, weighs but 31 grams, yet has the remarkably high output of -61 db! Although just half the weight and bulk of competitive lavaliers, the 649B response is smooth, peak-free and full-bodied so that you can mix its output with that of any standard microphone!

No fragile "toy", the E-V 649B uses the famous Acoustalloy[®] diaphragm and a sturdy dynamic mechanism that is guaranteed unconditionally for two years except for finish, guaranteed for life against defects in materials or workmanship. It is omni-directional, with response tailored for the slightly "off-mike" location of a lavalier.

DYNAMIC LAVALIER!

A 649B in your studio will give your performers more freedom than they have ever had... while you get the fine sound and trouble-free operation that's traditional with all Electro-Voice microphones. Write for complete technical specifications today!

ELECTRO-VOICE, INC., Commercial Products Division, Dept. 1031V, Buchanan, Michigan

Subscribe today to "Microphone Facts", fact-filled, free series on modern microphone techniques. Request on studio letterhead.

Circle Item 39 on Tech Data Card

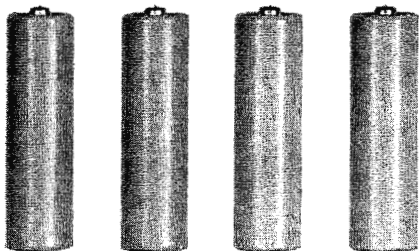

**"Have
Batteries,
Will
Travel"**

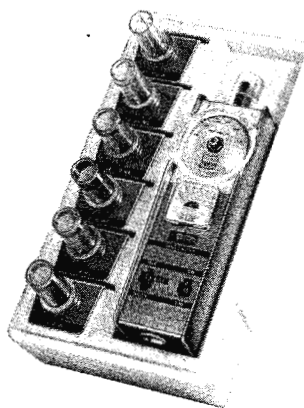

Waters "Little Dipper"

Transistorized Radio Frequency Dip Oscillator
Model 331

This fully transistorized, portable RF dip oscillator performs all the functions of a grid dip oscillator, an absorption wavemeter and, with its built-in audio modulation, a signal generator for field use.

The "LITTLE DIPPER" consists of: 1) a stabilized MADT transistor RF oscillator covering 2 to 230 mc in 7 overlapping, plug-in coil ranges (each coil carries its own linear calibrated frequency scale), 2) a transistorized 1,000 cycle audio oscillator for modulation, 3) a transistorized DC amplifier and meter for detecting the dip. Power is provided from four Size AA penlight batteries within the stainless steel case.

Available at leading distributors. Net \$129.75



WATERS MANUFACTURING, INC.
WAYLAND, MASSACHUSETTS

Q-Multiplier/Notch Filters • In-Line Coaxial
Switches • Grid Dip Meters • Dummy Load/Wattmeter

Circle Item 40 on Tech Data Card

NEW PRODUCTS

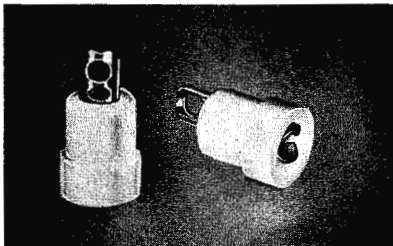

Test Point Jack

Sealectro Corp., Mamaroneck, New York, announces the development of a test-point jack designed for application where beneath-chassis space is extremely limited. Featuring a stamped beryllium-copper contact with a short extension below the bushing, the unit will mate with an .080" ($\pm .001$ ") diameter probe. The bushing, which is manufactured from Teflon, is available in any of the ten EIA colors for color-coded chassis test areas. Fast insertion into a prepared chassis hole is facilitated with the use of a new insertion tool also available from Sealectro.

Circle Item 50 on Tech Data Card

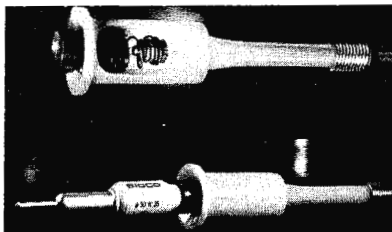

"Indicator" Soldering Iron

Electronic Ideas, Inc., Wyncote, Pa., manufacturer of the Sidco Kiss'n Cool pencil-type soldering iron (patented), announces what is believed to be the world's only soldering iron with a "built-in" light indicator. According to the manufacturer, a tiny lamp, built into the handles, gauges tip temperature and wattage. The lamp burns brightly on 50 watts and dimly on 40 watts. An added safety advantage is being able to tell when the iron is hot (when the lamp is

lit), thus preventing serious burns to workers and possible fire damage to property. The new soldering iron, called the Sidco "Sentry" (model KC 1200B), is made of special heat stabilized Nylon—it will not crack or break (if dropped)—is boilable, dust repellent. A self-adjusting spring socket holds tips in perfect contact. The iron handle comes in blue with a 6 ft. long grey cord and lists for \$2.50 each.

Circle Item 51 on Tech Data Card

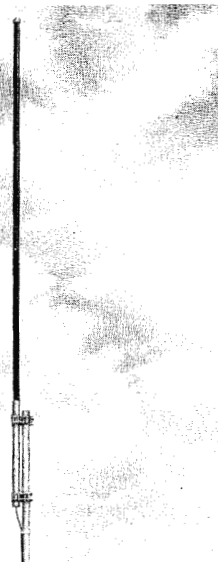

Omnidirectional Base Station Antennas

A line of low-priced omnidirectional base station antennas for two-way communications in the 150- and 450-mc ranges has been introduced by Mark Products Div., Dynascan Corp., Skokie, Ill. The line consists of half-wave dipole radiators fed in phase with RG-8A/U cabling harnesses. The colinear elements are encapsulated in cellular-core plastic to permanently isolate the antenna from the effects of weather. The number of fed elements and the spacing between stacked elements determines the gain. VSWR is

Scala Precision Antennas

- ★ OFF-THE-AIR PICKUP — FM or TV
- ★ LOW POWER UHF, VHF TV TRANSMITTING
- ★ STL AND TELEMETERING ANTENNAS

Engineered to meet rigid FM and TV station specifications, and to endure the tests of weather and time.

Built to your specifications by

SCALA RADIO CORP.

2814 19th STREET
SAN FRANCISCO 10
VA 6-2898

Circle Item 38 on Tech Data Card

1.5 or better for most ranges, referred to a 50-ohm coaxial line. Prices range from \$75 for the 8-foot model, to \$150 for the 21-foot antenna.

Check Item 52 on Tech Data Card

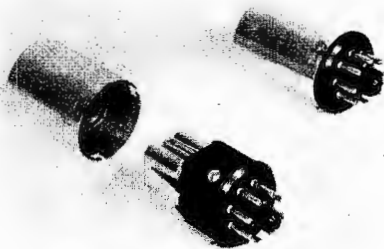

Plug-in Crystal Oven

A small crystal oven, particularly suitable for mobile communications equipment is available from **Cathodeon Crystals, Ltd.**, Cambridge, England. Designed to house two HC-6/U crystal units, the device employs a bi-metal thermostat as the temperature-control element. The mean chamber temperature is 75° C (other temperature settings can be supplied upon request). Operating on 6.3 or 12.6 volts AC/DC, the oven uses 7 watts maximum power input, weighs 1¼ oz., and has a standard octal base. The price is approximately \$5.00.

Check Item 53 on Tech Data Card

Heat-Shrinkable Wire Marker

A heat-shrinkable wire marker that identifies, protects, strengthens, and insulates wire and cable is available from **Alpha**

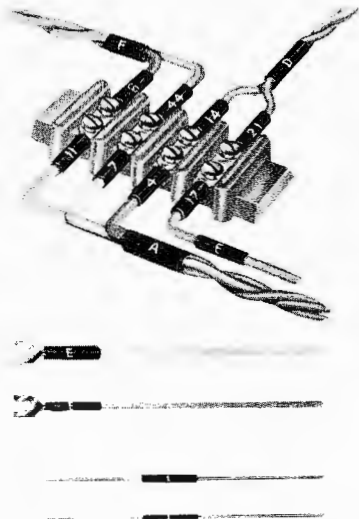

Wire Corp., New York, N. Y. Made of irradiated polyolefin, the Alphlex FIT marker comes in an expanded form that can be easily applied to wire, cable, or even over connectors of irregular shapes. When subjected to a temperature of approximately 275° F (135° C), the marker returns to its predetermined size, 50% smaller. This shrinkage process guarantees a slip-proof, tight bond which acts as a strain relief at stress points to insulate and protect the wire connector. Fabricated from black tubing and printed in white type for greatest legibility, standard markings are numbers from 1-50

and A-Z. They are supplied in a choice of three outer dimensions which cover the popular sizes of electronic wire and cable. The Alphlex FIT marker is resistant to fuel, oil, hydraulic fluid, solvents, and acids; they are noncorrosive and self-extinguishing.

Check Item 54 on Tech Data Card

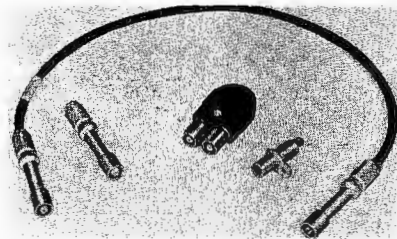

Video Patch Plugs

A wide variety of video patch plugs ranging from dual connectors with coaxial circuits on 5/8" centers, to patch cable assemblies four feet long is available from **Cannon Electric Co.**, Los Angeles, Calif. Included are single and dual plugs and panel jacks, as well as short and long patch cords. Designed originally for use with 75-ohm RG-59/U cable, the plugs can be readily adapted for use with 75-ohm RG-11/U cable through the use of an adapter kit. Cross talk and noise are held to a minimum by gold-plated metal parts and individual grounding of circuits. In addition, RF shielding is provided in both dual plugs and dual jacks.

Check Item 55 on Tech Data Card

SPOTMASTER Tape Cartridge Winder



The new Model TP-1A is a rugged, dependable and field tested unit. It is easy to operate and fills a need in every station using cartridge equipment. Will handle all reel sizes. High speed winding at 22½" per second. Worn tape in old cartridges is easy to replace. New or old cartridges may be wound to any length. Tape Timer with minute and second calibration optional and extra. Installed on winder or available as accessory. TP-1A is \$94.50, with Tape Timer \$119.50.

Write or wire for complete details.

Spotmaster
BROADCAST ELECTRONICS, INC.
8800 Brookville Road
Silver Spring, Maryland

Circle Item 41 on Tech Data Card

Surround yourself with silence
with **Hy-gain HY-LITES**



Dramatic backlit red on black Hy-Lite indicators clearly and authoritatively signal your desire to be surrounded by silence. Hy-Lites are housed in attractive, self-supporting, non-breakable gray cycolac cases that blend with any decor. They may be mounted or just set on top of gear, on wall brackets, on shelves...just about any place you want. They may be attached to transmitter control relay or recorder control relay. They are furnished complete with 6-foot cord and bulb. Indicator face is a 4"x8" oval. Cycolac case is 4" deep. Modestly priced at \$8.95 Net.

Available from your favorite Hy-Gain Distributor or write for the Hy-Gain Distributor nearest you.

HY-GAIN ANTENNA PRODUCTS CORPORATION
8498 N.E. Highway 6—Lincoln, Nebraska

Circle Item 42 on Tech Data Card

Get a top job in broadcasting . . .

A First Class FCC License

...or Your Money Back!



Your key to future success in electronics is a First-Class FCC License. It will permit you to operate and maintain transmitting equipment used in aviation, broadcasting, marine, microwave, mobile communications, or Citizens-Band. Cleveland Institute home study is the ideal way to get your FCC License. Here's why:

Our training programs will *quickly* prepare you for a First-Class Commercial Radio Telephone License with a Radar Endorsement. Should you fail to pass the FCC examination after completing your course, you will get a *full refund* of all tuition payments. You get an FCC License . . . or your money back!

You owe it to yourself, your family, your future to get the complete details on our "proven effective" Cleveland Institute home study. Just send the coupon below TODAY. There's no obligation.

MAIL COUPON TODAY FOR FREE CATALOG

Cleveland Institute of Electronics

1776 E. 17th St., Dept. BE-11
Cleveland 14, Ohio

Please send FREE Career Information prepared to help me get ahead in Electronics, without further obligation.

CHECK AREA OF MOST INTEREST -

- | | |
|---|--|
| <input type="checkbox"/> Electronics Technology | <input type="checkbox"/> First-Class FCC License |
| <input type="checkbox"/> Industrial Electronics | <input type="checkbox"/> Electronic Communications |
| <input type="checkbox"/> Broadcast Engineering | <input type="checkbox"/> _____ other _____ |

Your present occupation _____

Name _____ Age _____
(please print)

Address _____

City _____ Zone _____ State _____

Accredited Member National Home Study Council

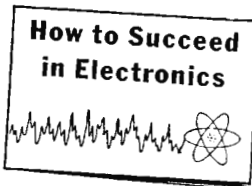

ENGINEERS' TECH DATA SECTION

AUDIO & RECORDING EQUIPMENT

65. AMERICAN CONCERTONE—Brochure has specs and photos of full line of tape recorders for professional applications.
66. AUTOMATIC TAPE CONTROL—Fact sheet on expandable broadcast automation system.
67. BROADCAST ELECTRONICS—Full line of cartridge equipment listed in set of spec sheets, includes recorders, players, racks, and accessories.
68. BURGESS BATTERY—Catalog sheet describes test-tape assortment for home recorder tests.
69. CROWN—Brochure covers seven distinct series of professional tape recorder/reproducers.
70. DYMO INDUSTRIES—Brochure describes Tapewriter tool and tape kit.
71. FAIRCHILD RECORDING—6-page catalog lists professional sound equipment.
72. 3M Co.—Specifications for physical and magnetic properties of Scotch professional tape line is listed in three brochures.
73. VIKING—Set of bulletins describe line of professional cartridge decks and heavy-duty reel-to-reel tape transport.

COMPONENTS & MATERIALS

74. AMPEREX—Condensed tube catalog lists line of special purpose tubes, and tubes for receiving equipment.
75. CORNELL-DUBILIER—Wall-mounted selector chart lists several different ceramic capacitors for commercial, industrial, and other applications.
76. CENTRAL TRANSFORMER—Eight-page brochure contains technical data of interest to engineers and technicians; includes design data.
77. ELECTRO-VOICE—Product catalog listing line of microphones and loudspeaker systems for commercial and high fidelity applications.
78. ERIE RESISTOR—Two-page bulletin contains data on line of miniature ceramic trimmers, designed for point-to-point wiring.
79. GREENLEE—Bulletin describes relay socket hole punch.
80. KURMAN INSTRUMENTS—Bulletin on line of magnetically shielded, dry reed relays describes various models.
81. LAFAYETTE RADIO—General product catalog lists all types of electronic gear.
82. LAMTEX/KOPPERS—Brochure on new reinforced plastic for material/design discusses applications.
83. MECTRON Co.—12-page catalog describes coaxial transmission lines and dehydrators; includes rough-in dimensions for fittings.
84. MILO—Bulletin lists several manufacturers' lines carried by distributing companies.
85. ROBINS—Catalog describes Cannon XL connectors for audio applications.
86. ROTRON—Four-page catalog contains information on compact fans for cooling, heat directing, and ventilating.
87. SYLVANIA—Booklet describes line of pencil tubes.
88. THOR ELECTRONICS—Electronic tube and semiconductor purchasing guide lists types and prices.
89. TOPFLIGHT CORPORATION—Six-page color brochure covers line of pressure-sensitive identification labels; includes planning guide.

POWER DEVICES

90. SECO—Four-page catalog describes Vari-Volt units for control of lighting, heating elements, and AC/DC motors up to 15 amps.

RADIO & CONTROL ROOM EQUIPMENT

91. ALTEC—Folder contains information on line of speech input equipment for recording and broadcast studios.
92. AUTOMATIC TAPE CONTROL—Brochure describes a simple automatic system for programming.
93. CONTINENTAL ELECTRONICS — Brochure describing high-level plate modulation, 50-kilowatt shortwave transmitter included photos and specs.
94. GATES—Brochure listing audio control consoles contains features of each.
95. McMARTIN—Brochure describes RF amplifier for use with remote operated FM frequency and modulation features.
96. TURNER—Specification sheet describing Model 220A broadcast lavalier microphone includes application data.

STUDIO & CAMERA EQUIPMENT

97. BLONDER-TONGUE — Brochure covers broadcast quality viewfinder vidicon camera.
98. BOSTON INSULATED WIRE—Catalogs on connectors for British cameras, and catalog listing cameras cables for U. S. and British built equipment.
99. KLIEGL BROS.—Descriptive sheets cover studio-type lighting equipment.
100. HOUSTON FEARLESS—Eight-page brochure describes microfilm processing and applications.
101. RCA — Catalog listing broadcast type microphones, and microphone selection guide.
102. SHURE—Product bulletin on studio lavalier microphone.
103. TELEVISION ZOOMAR—Illustrated catalog sheets cover line of lenses for image orthicon and vidicon broadcast television cameras.

TELEVISION EQUIPMENT

104. ELECTRONICS MISSILES AND COMMUNICATIONS—Translator brochure entitled "Does Your Community Suffer From Weak TV Reception?"
105. FAIRCHILD — Short form catalog of Dumont oscilloscopes, oscilloscope recording cameras, pulse generators, probes, and accessories lists wide line.
106. GENERAL ELECTRIC — Characteristics and operating data for five types of television broadcast image orthicons are given in brochure.

TEST EQUIPMENT & INSTRUMENTS

107. DELTA ELECTRONICS—Technical bulletin describing use of OIB-1 operating bridge for matching and measuring directional antenna system.
108. GENERAL MICROWAVE — Bulletin contains features and specifications of Model 350, National Bureau of Standard type A-T voltmeter.
109. HICKOK—Eight-page brochure describes professional oscilloscopes and plug-in preamplifiers.
110. INSTRUMENTS SYSTEMS—Catalog describes test equipment for magnetic measurements; portable and laboratory gaussmeters, ballistic fluxmeters, and magnet standards.
111. TELEMET — Brochures describing monoscope generator Model 1510BR, and solid state effects generator Model 3801 give features.

TRANSMITTER & ANTENNA DEVICES

112. BAUER—Specification sheet on Model 720 Broadcaster carrier current transmitter discusses application.
113. CO.EL.—Catalogs describe broadband dipole antennas, UHF slot antennas, filters, and duplexers.
114. JAMPRO—Reprints of article "Effects of FM Antenna System VSWR on Stereo Separation," include degradation chart.
115. TURNER—Two brochures describe 10 and 20 KW FM transmitters.

Now Available!

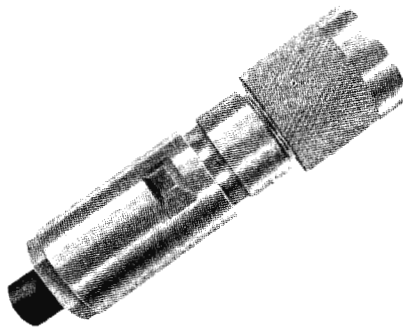

B.I.W. manufactures and supplies Television Camera Cables, Connectors, and Cable Assemblies for Marconi, E.M.I., Pye, R.C.A., General Electric, Grundig, Fernseh, and Dage Commercial Broadcast and special application television cameras and microwave relay equipment; Audio, and Coaxial Cables precision manufactured to Network color broadcast specifications.

In addition, B.I.W. makes camera cables and connectors with mating English pins and threads for use with British Broadcast Cameras incorporating stranded, color coded and Nylon jacketed conductors, option of Neoprene or Plastic outer jacket, and watertight repairable connector terminations.

Cables are supplied in 50, 100, and 200 foot lengths or cut to your requirements. Also offered are connectors as desired, right angle connectors and wall mounts.

B.I.W. manufactures the widest variety of television camera cables in the world. Since manufacturing the first cables for R.C.A.'s introduction of television at the 1937 New York World's Fair, B.I.W. has pioneered in the development of television cables for studio, color, outside broadcast, military and industrial applications, including reactor monitoring.

Superior Cable Construction — Signal leads are grouped to minimize cross-talk. Crush resistant, rope-lay configuration with resilient neoprene jacket makes B.I.W. cable superior in handling characteristics and resistant to sharp edges, studio rolling stock and weathering. Camera operators report that pliable B.I.W. cables permit smooth, easy camera motion without twisted or kinked cables.

B.I.W.'s service department will repair your damaged T.V. cables.

Send for complete information, or let us know your specifications and requirements for quotation.



"Designers and makers of

Specialty Cables since 1905"

BOSTON INSULATED WIRE & CABLE COMPANY

Main Office and Factory
71 Bay Street, Boston 25, Mass.
Telephone: COLUMBIA 5-2104

Canadian Factory
Boston Insulated Wire &
Cable Co., Ltd.
118 Shaw St., Hamilton,
Ontario, Canada
Telephone: JACKSON 9-7151

Circle Item 44 on Tech Data Card

Professional Services

- SYNCHRONOUS MAGNETIC FILM RECORDER/REPRODUCER
- MAGNETIC TAPE RECORDERS
- NEW—THE portable MINITAPE synchronous 13 lb., battery operated magnetic tape recorder for field recording.

THE STANCIL-HOFFMAN CORP.
845 N. Highland, Hollywood 38, Calif.
Dept. B HO 4-7461

JOHN H. BATTISON & ASSOCIATES CONSULTING RADIO ENGINEERS

TV-AM-FM & Microwave Applications and Installations
Specializing in all forms of communications engineering.
422 Washington Bldg. Washington 5, D. C.
Phone ST 3-3484
Established 1954

Classified

Advertising rates in the Classified Section are ten cents per word. Minimum charge is \$2.00. Blind box number is 50 cents extra. Check or money order must be enclosed with ad.

The classified columns are not open to the advertising of any broadcast equipment or supplies regularly produced by manufacturers unless the equipment is used and no longer owned by the manufacturer. Display advertising must be purchased in such cases.

EQUIPMENT FOR SALE

Commercial Crystals and new or replacement crystals for RCA, Gates, W. E., Bliley and J-K holders; regrounding, repair, etc. BC-604 crystals. Also A. M. monitor service. Nationwide unsolicited

**BACK ISSUES
AVAILABLE
ORDER NOW WHILE THEY
LAST... ONLY \$1.00
EACH**

January '61 thru December '61
(excluding April)

January '62 thru December '62
(excluding February)

January '63 thru May '63
(excluding June)

Broadcast Engineering
4300 W. 62nd St.
Indianapolis, Ind. 46206

Please send me back issues circled below:

1961
Jan. Feb. Mar. May June July
Aug. Sept. Oct. Nov. Dec.

1962
Jan. Mar. April May June July
Aug. Sept. Oct. Nov. Dec.

1963
Jan. Feb. Mar. April May July

- Please bill me
 Check or money order enclosed

Name.....

Firm.....

City..... State.....

1063

testimonials praise our products and fast service. Eidson Electronic Company, Box 96, Temple, Texas. 9-61 tf

Ampex Head Assemblies for 300 and 400 series recorders reconditioned. Service includes lapping and polishing all three head stacks, cleaning entire assembly, readjusting and replacement of guides, and realignment of stacks as to azimuth and zenith. Full track assemblies—\$60.00. Taber Manufacturing & Engineering Co., 2619 Lincoln Ave., Alameda, California. 8-63 5t

GOVERNMENT SURPLUS, NEW 10 CM. WEATHER RADAR SYSTEM—Raytheon, 275 KW peak output S band. Rotating yoke P.P.I. Weather Band 4, 20 and 80 mi. range. Price \$975 complete. Has picked up clouds at 50 mi. Wt. 488 lbs. Radio Research Inst. Co., 550 5th Ave., New York, New York. 8-63 6t

Single man, seeking association radio, recording studio, etc. wherein fine recording, sound and test equipment will be asset. Ampex, Neumann, Pultec, Fairchild, MacIntosh equipment, Hewlett-Packard test instruments. Studied music, acoustics, electronics on university graduate level. Years of practical experience remote, studio, high-quality P. A. Write for details. Prefer Tidewater section of Virginia; family home Mathews County. Self-employed Ohio fifteen years. Want to work WITH, not FOR! Willing to expand facilities if necessary. Write Broadcast Engineering, Dept. 101.

MICROWAVE ANTENNAS. Parabolic, 6 foot dia., Andrews, Spun Aluminum. 1700-2400 MCs Complete with mounting bracket, Di-pole, de-icers, etc. Unused-Crated - Cheap. One Hundred Available Sierra-Western Electric 1401 Middle Harbor Road, Oakland, Calif. Tele. 832-3427. 10-62 2t

CHIEF ENGINEER looking for permanent job in Florida area. Many years experience in installations, directionals high power am & fm. Write Broadcast Engineering, Box 103. 10-63 1t

Established California antenna manufacturer is looking for aggressive sales manager. Applicant must have demonstrated at least 5 years of broadcast equipment sales background; have knowledge of technical broadcast equipment; progressive upgraded sales ability; plus administrative ability in past positions. Our applicants personal life, must stand investigation. This new position will require permanent residence in California with some light traveling. This is a top management position requiring mature thinking, experience and qualifying background. We offer growth, salary plus commission to right man, besides fringe benefits. Send complete resumé with recent photo. Write Broadcast Engineering, Dept. 102. 10-63 1t

PROMPTING EQUIPMENT. Used one, two and three prompter packages. Full one year warranty. Limited quantity. TELESCRIPT CSP, Inc., 155 W. 72nd St., New York 23, New York. 10-63 2t

REAR SCREEN PROJECTORS. Used No. 7000 3 1/4 x 4" R.S.P., 70 slide capacity, 1/4 sec. fast slide changer, remote control. Taken in trade on new Dual Head R.S.P. Full one year warranty. Limited quantity. TELESCRIPT CSP, Inc., 155 W. 72nd St., New York 23, New York. 10-63 2t

Advertisers' Index

Altec Lansing Corp.	39
American Concertone, Inc.	41
American Elite, Inc.	46
Ampex Corp.	27
Amplifier Corp. of America.....	44
Bauer Electronics Corp.	47
Belden Mfg. Co.	Cover 2
Boston Insulated Wire & Cable Co.	53
Broadcast Electronics	6, 36, 44, 51
CBS Labs, Inc.	5
Cleveland Institute of Electronics...	52
Continental Electronics	40
Crown International	4
Delta Electronics, Inc.	48
Diamond Electronics	40
Electro-Voice, Inc.	49
Electronic, Missiles & Communications, Inc.	34
Fairchild Recording Co.	45
Gates Radio Co.	28-29
Conrac Div., Giannini Controls Corp.	8
Harvey Radio Co., Inc.	23
The Hickok Electrical Instrument Co.	32
Hunter Engineering	54
Hy-Gain Antenna Products Co.	51
Magnecord Div., Midwestern Instruments	25
McMartin Industries	Cover 3
Minnesota Mining & Mfg. Co.	3
Moseley Associates	36
Nortronics	46
RCA Electronic Components and Devices	35, Cover 4
RCA Victor Record Div.	7
Raytheon Distributor Products Div.	10-11
Reeves Industries	13
Sarkes Tarzian, Inc., Semiconductor Div.	31
Scala Radio Co.	50
Solitron Devices, Inc.	42
Sparta Electronics Corp.	33
Sylvania Electric Products, Inc.	37
Telemet Corp.	12
Teletrex Engineering Co.	36
Viking of Minneapolis, Inc.	8
Vitro Electronics	43
Waters Manufacturing, Inc.	50

EXCELLENT!

\$1995
BRAND NEW

For "Beeper" Leveling, Studio
Intercoms, Paging, P.A., Cue Amplifiers, etc.

AUTOMATIC GAIN CONTROL AMPLIFIERS

BRAND NEW government surplus. Highest quality. Components well overrated. No electrolytics. Full schematic clearly printed on bottom plate. Operating power 107-120 VAC, 50-60 cps. **TYPICAL SPECS**—INPUT LEVEL: -20 to +10 dbm for output constant within 2 db, or with a simple modification, -40 to -10 dbm. **POWER OUTPUT**—Full 4 watts. INPUT Z: 75, 150, 300 or 600 ohms balanced. OUTPUT Z: 200 or 600 ohms C.T. **FREQUENCY RESPONSE**—within 2 db 200-5000 cps. Gives excellent voice quality. **NOISE AND HUM**—down 50 db below full output. **TUBES**—1 ea., 5Y3, 6H6, 6SJ7, 6SK7, and 6V6. Amplifiers arranged for plug in mounting. If desired, they can be remounted on rack panels (2 per panel) and plugs replaced with barrier strips. (No rack shelves available at this time) Input and output also appear with insulated phone jacks on front panel. This type currently in use at stations including the top rated San Francisco radio station. **TERMS**—\$19.95 each...Cash, check or money order, shipped freight collect, F.O.B. Limited quantity. Price subject to change without notice.

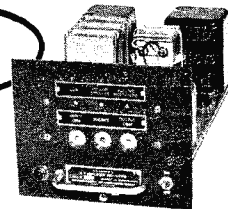

HUNTER ENGINEERING

2175 44th Avenue • San Francisco 16 • SE 1-9197

Circle Item 45 on Tech Data Card

BROADCAST ENGINEERING

McMartin

No other FM MONITORS can do so much!



McMartin TBM-4000

FM/SCA MULTIPLEX MONITOR FCC TYPE APPROVED #3-116

This is the most versatile instrument available for monitoring all main channel modulation and SCA Multiplex operating characteristics. Compatible with FM stereo.

Direct meter readings of:

- Total Modulation
- SCA Modulation
- Crosstalk
- SCA Injection
- SCA Frequencies



McMartin
TBM-3000



McMartin
TBM-3500

FREQUENCY & MODULATION MONITORS FCC TYPE APPROVED #3-113, #3-119

- The TBM-3000 is a completely self-contained frequency monitor and the TBM-3500 is a self-contained modulation monitor.
- The 3000 used in conjunction with either the 3500 or 4000 fulfills the FCC requirement for a station monitor.
- The TBM-3500 is completely compatible with FM stereo.



McMartin TBM-2500

RF AMPLIFIER FOR REMOTE MONITOR OPERATION

The TBM-2500 will drive any combination of two monitors including other brands.

- Isolated high and low level outputs.
- Excellent stability and long tube life.
- 2 watt output with 1000 μ v input.
- Complete with yagi antenna and coaxial cable.

McMartin

Originality by

McMartin Industries, Inc.

605 North 13th Street

Omaha, Nebraska

Code 402 — 342-2753

In Canada Sold By: Canadian Marconi Company, Montreal 16, P. Q.

Circle Item 46 on Tech Data Card

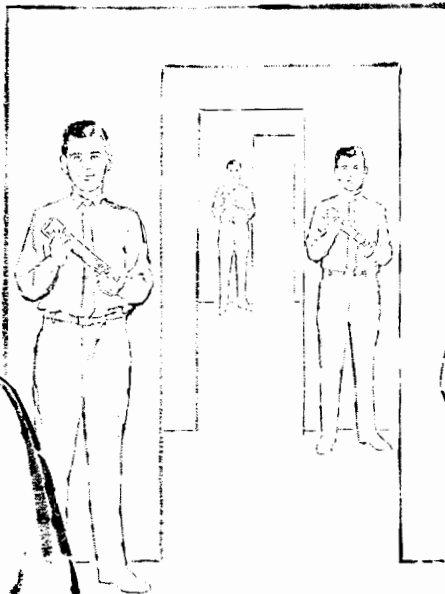

Improved RCA Image Orthicon RCA-5820A Has No Match for Tube-to-Tube Uniformity

The key to telecasting's highest performance uniformity from tube-to-tube is RCA-5820A, the Image Orthicon respected as "standard" of the industry.

On every major characteristic by which TV pictures are measured, RCA-5820A is quality assured. If you use RCA-5820A, you can get another like it with complete confidence. How can you be sure? Each and every RCA-5820A is tested and rated in three different cameras and given a final, thorough operational check prior to shipment!

The excellence you buy in today's RCA-5820A includes: High signal-to-noise ratio, uniformity of signal output and background, high sensitivity and improvements in resolution capability.

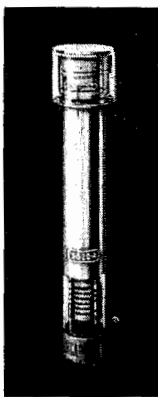

This RCA Image Orthicon is recognized as an exceptional all-purpose type for studio or remote use. It features microscopic gun alignment, gold-plated grids, and pre-tested mesh to assure reduced microphonics.

A leader in TV Camera Tube development since the early days of television, RCA today offers a complete line of Image Orthicons for black-and-white and color. SEE YOUR AUTHORIZED DISTRIBUTOR OF RCA BROADCAST TUBES.

RCA ELECTRONIC COMPONENTS AND DEVICES



The Most Trusted Name in Television

For name and address of your local distributor write or call your nearest RCA Distributor Products Sales Office—New York, N. Y.: 36 W. 49th St., MUrray Hill 9-7200; Needham Heights 94, Mass.: 80 "A" St., Hillcrest 4-8480; Washington 7, D. C.: 1725 "K" St., S.W., FEderal 7-8500; Atlanta, Ga.: 134 Peachtree St., N.W., JACKson 4-7703; Cleveland, Ohio: 1621 Euclid Ave., CHerry 1-3450; Chicago, Ill.: Merchandise Mart, 467-5900; Dallas 7, Texas: 7901 Carpenter Freeway, MELrose 1-3050; Kansas City 14, Mo.: 7711 State Line, EMerson 1-6462; Los Angeles 22, Cal.: 6801 E. Washington Blvd., RAYmond 3-8361.

Circle Item 47 on Tech Data Card