



**SPECIAL AUDIO and STUDIO FEATURES:**

Audio Level Devices	10
Planning A Modern Studio	14
Design of Resistance-Coupled Audio Amplifiers	16
"Roll Your Own" Automatic Tape	18
A Microphone Filter	24

# Broadcast Engineering<sup>®</sup>

*the technical journal of the broadcast-communications industry*



30 cycles

30 minutes

105% modulation

## WILL YOUR 1KW AM TRANSMITTER MEET THIS TEST ?

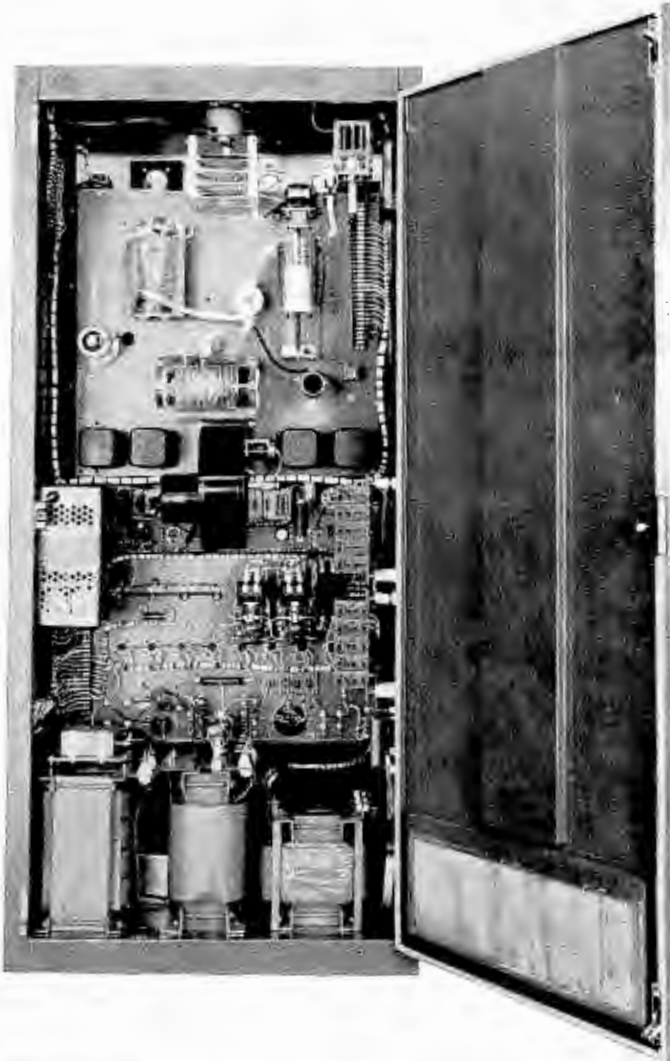

It will if it's the ITA AM-1000-A... the only 1 kw AM with all these features

- Sola Regulation
- Built-in Dummy Load
- Vacuum Capacitor Tuning
- Extra Heavy Duty Modulation Components
- Silicon Power Supplies
- Built-in Transfer Switch for Dummy Load
- Automatic Recycling
- Extra Large Blower
- Motor Driven RF Output Control

No other transmitter compares with this ITA unit for long-life and dependable operation at lowest cost. With regulated filament and low voltage power supplies the AM-1000-A features single control operation and requires only three tube types for easy maintenance. It's your best buy in 1 kw AM transmitters! For complete information contact ITA today.

**ITA ELECTRONICS CORPORATION**  
BROADCAST DIVISION • LANSDOWNE, PENNSYLVANIA

**ITA**

AFFILIATE OF TRIANGLE PUBLICATIONS, INC.

This is WBAL-TV's new building in Baltimore. The exclusive use of Belden Audio, Camera, and Control Cables in this \$2,000,000 studio building helps maintain their high level of broadcasting efficiency.

Looking over part of this 125,000-foot Belden wire and cable installation are John Wilner, Vice President, Engineering, Hearst Corporation, operators of WBAL-TV (left), Manny Kann, Belden Distributor (center), and Hank Hine, Belden Territory Salesman. All of the wire and cable for WBAL-TV was purchased from Kann-Ellert Electronics, Inc., Belden Warehouse distributor.

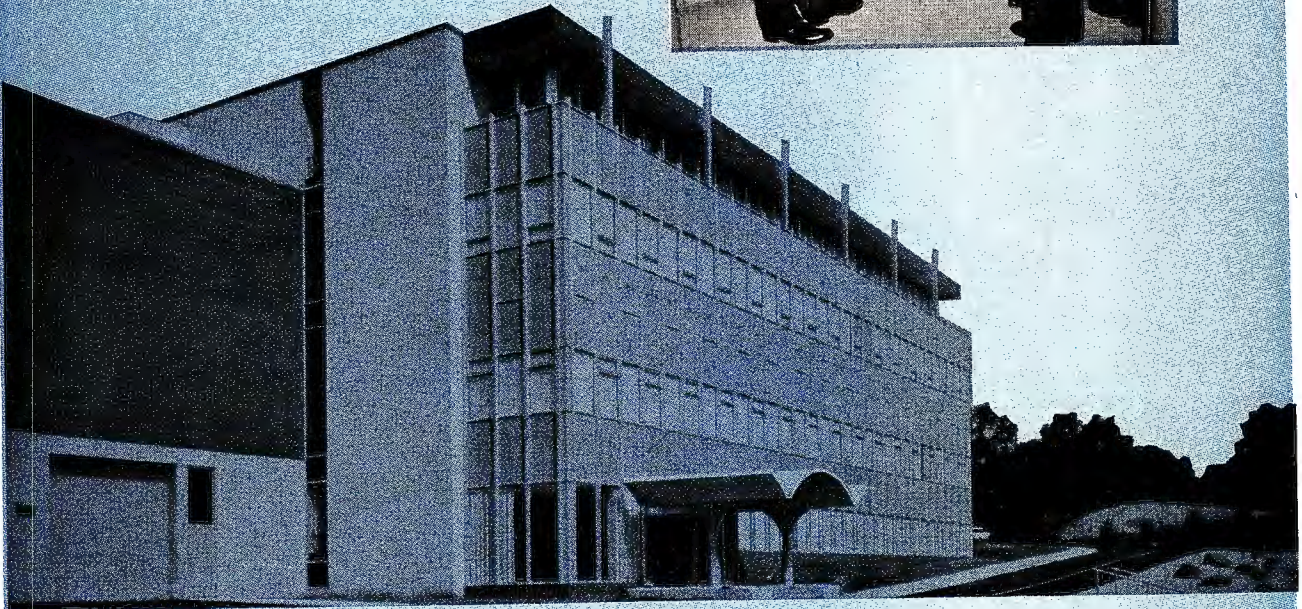

## WBAL-TV Turns to Belden Exclusively for Audio, Camera, and Control Cables

Belden manufactures a complete line of application-engineered wire and cable for TV and radio broadcasting, recording studios, remote control circuits, and similar applications. Call your Belden electronic distributor for complete specifications.

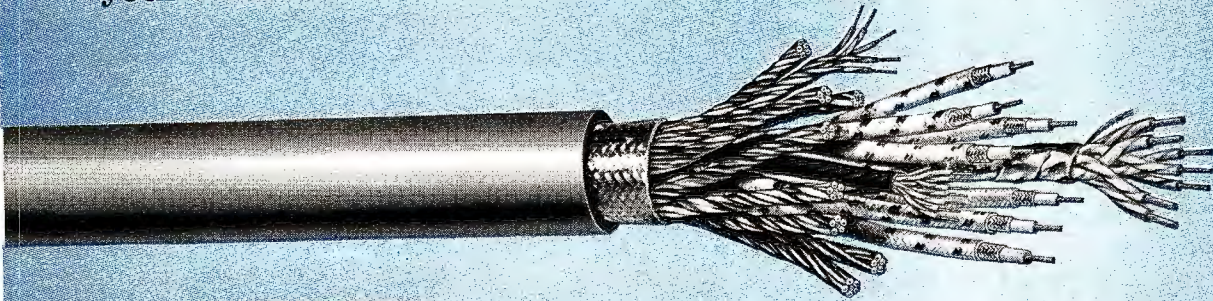

power supply cords • cord sets and portable cordage • electrical household cords • magnet wire • lead wire • automotive wire and cable • aircraft wires • welding cable

8-7-2

Circle Item 2 on Tech Data Card



# Broadcast Engineering®

Volume 5, No. 6

June, 1963

## CONTENTS

### FEATURES

<b>Audio Level Devices</b> . . . . .	<b>10</b>
by Thomas R. Haskett — Part One. A survey of peak limiters, their operating principles and features.	
<b>Planning A Modern Studio</b> . . . . .	<b>14</b>
by John J. Walsh — Description of a new studio installation, with points to consider in planning.	
<b>Design Of Resistance-Coupled Audio Amplifiers</b> . . . . .	<b>16</b>
by Bryce W. Tharp — Amplifier theory essential to design and maintenance.	
<b>"Roll Your Own" Automatic Tape</b> . . . . .	<b>18</b>
by Joe Nearns — Here's a simple automatic cartridge tape system employing conductive strip cuing.	
<b>When The Proof-Of-Performance Fails</b> . . . . .	<b>20</b>
by Ed Murdoch — Part Two. Measuring noise and distortion in troubleshooting a proof.	
<b>A Microphone Filter</b> . . . . .	<b>24</b>
by Elton B. Chick — A device you can build for producing special microphone effects.	
<b>Grid Modulation, Theory And Techniques</b> . . . . .	<b>28</b>
Technical Talks — Part one of a study covering the various methods for audio modulation.	

### DEPARTMENTS

Letters to the Editor . . . . .	6	Engineers' Tech	
Engineers' Exchange . . . . .	32	Data Section . . . . .	48
News of the Industry . . . . .	34	Advertisers' Index . . . . .	50
About the Cover . . . . .	41	Classified Ads . . . . .	50
New Products . . . . .	46	Professional Services . . . . .	50

More and more progressive broadcasting stations are enjoying the efficiencies and savings in operating costs inherent in ATC automatic programming systems. Because of ATC's modular concept of automation, no two ATC systems are identical—each is tailored to fit the exact programming requirements of the individual station, yet retains flexibility for future program changes. Every manager and chief engineer owes it to his station to get complete information on the ATC concept of automated broadcasting. Call Elmo Franklin or Bob Johnson (collect) for information on how ATC automation can meet the requirements of your operation.

Made by broadcasters for broadcasters

**AUTOMATIC ATC TAPE CONTROL**  
 209 E. Washington St. • Bloomington, Illinois  
 Circle Item 3 on Tech Data Card

**PUBLISHER:** Howard W. Sams

**GENERAL MANAGER:** Mal Parks, Jr.

**EDITORIAL:** Executive Editor, Verne M. Ray; Editor, Forest H. Belt; Managing Editor, Stuart N. Soll; Consulting Editor, John H. Battison.

**CIRCULATION:** Manager, Pat Tidd; Assistants, Katherine Krise, LaVon Willard.

**PRODUCTION:** Manager, Robert N. Rippy.

**ADVERTISING:** Sales Manager, John W. Groce; EAST: Charles Horner, Howard W. Sams & Co., Inc., 3 West 57th Street, New York, N. Y., Phone—MU 8-6350; MIDWEST—Hugh Wallace, Howard W. Sams & Co., Inc., 4300 West 62nd Street, Indianapolis 6, Ind., Phone AX 1-3100; SOUTHWEST—C. H. Stockwell Co., 4916 West 64th Street, Mission, Kansas, Phone—RA 2-4417; LOS ANGELES 57, CALIF., Maurice A. Kimball Co., Inc., 2550 Beverly Blvd., Phone—DU-8-6178; SAN FRANCISCO, Maurice A. Kimball Co., Inc., 580 Market Street, Phone—EX 2-3365; PARIS 5, FRANCE, John Ashcraft, 9 Rue Lagrange, Phone—ODEon 20-87; LONDON W.C. 2, ENGLAND, John Ashcraft, 12 Bear Street, Leicester Square, Phone—WHitehall 0525; TOKYO, JAPAN, International Media Representatives, Ltd., Kisha Kurabu 14, 2-chome Marunouchi, Phone—(502) 0656.

**SUBSCRIPTION PRICE:** U.S. \$6.00, one year; \$10.00, two years; \$13.00, three years. Outside U.S.A. add \$1.00 per year for postage. Single copies, 75 cents.

**BROADCAST ENGINEERING** is published monthly by Technical Publications, Inc., an affiliate of Howard W. Sams & Company, Inc. Editorial, Circulation, and Advertising headquarters: 4300 West 62nd Street, Indianapolis 6, Ind. Copyright (c) 1963 by Howard W. Sams & Co., Inc.

**A HOWARD W. SAMS PUBLICATION**



**BROADCAST ENGINEERING**

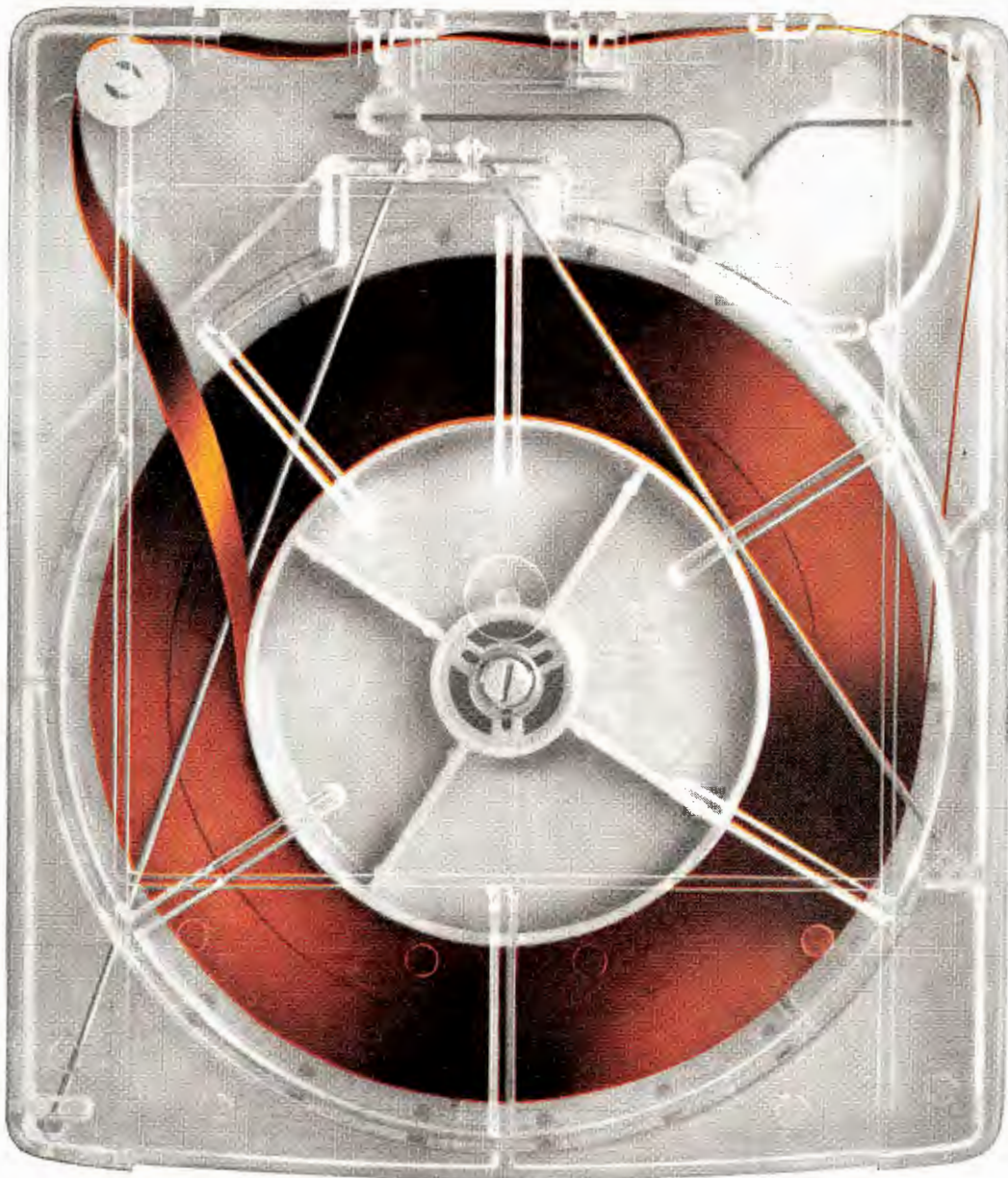

## Glutton for punishment

*(Soundcraft's new Uni-Lube cartridge tape)*

Soundcraft Uni-Lube is the new longer-wearing cartridge tape that plays and plays and play and plays. It meets the punishing conditions of endless loop cartridge applications head on—and comes back for more!

Uni-Lube is a Mylar\* base tape, oxide-coated on one side, lubricated on the other. The base is coated with PERMA-GRAPH, a new permanent anti-static lubricant that keeps the tape free of friction during playback, eliminating the problems of heat and tape deterioration and assuring uniform tape motion.

The other side of Uni-Lube is coated with Soundcraft's new, durable, *ultra-thin oxide formulation* that produces maximum short wave length signal-to-noise characteristics

for low speed systems. Short wave sensitivity is 3 to 5 db higher than standard tapes. This remarkable oxide coating records the widest dynamic range ever achieved on a cartridge tape.

The combination of the physical properties of the "Mylar" base, the PERMA-GRAPH lubricant and the new oxide formulation result in the longest-wearing cartridge tape available today—a tape free from friction—free from shedding and head fouling—free from breakage and the effects of heat, cold and humidity. *This is the cartridge tape you've been waiting for.* Available in 1 mil "Mylar" and the new  $\frac{3}{4}$  mil Tensitized "Mylar" for extra strength and longer play. Write for complete details. \*DuPont T.M.

### REEVES SOUNDRAFT

Division of Reeves Industries, Inc., Danbury, Conn. • New York • Chicago • Los Angeles • Foreign Division: 25 Warren St., N.Y.C. • Canadian Reps: Vancouver • Toronto  
Circle Item 4 on Tech Data Card

"King Mike I" Tells All! Or...

## HOW TO SUCCEED IN THE "KING" BUSINESS WHEN ALL THE CARDS ARE STACKED IN YOUR FAVOR



Altec Regional Sales Manager, Milt Thomas, after coronation as "King Mike the First" receives congrats of Altec President A. A. Ward (l.) and H. S. Morris, V.P. for Marketing. Thomas won crown and scepter when customers in the Southeast decided to up their purchases of Altec microphones by 235%.

"A funny thing happened to me on the way to the office the first day of the 'King Mike' Contest. I kept repeating the first principle of Salesmanship: Know Your Product—then tell the people the *facts* about it in terms of benefits. Well, I know my Altec mikes, and I knew the *facts* that made them preferred by many of those canny broadcast and recording engineers.

"On all my sales calls during the Contest, I laid it on the line to prospects about Altec's exclusive *Sintered Bronze Filter* and how it positively bars entry of iron dust, metal particles, or any foreign matter to make it the most perfect acoustical filter ever made... I waxed enthusiastic about Altec's *Microphone Exchange Plan* whereby customers return to Altec a microphone in need of repair and receive a brand new, factory-sealed mike in exchange for a nominal charge.

"I showed my prospects individual certified calibration curves that are supplied with each Altec 684, 685, 688 and 689 Dynamic, *free of charge*, as proof of their superior performance. I almost bought a couple myself as I showed them *documented comparisons* of Altec microphone curves vs. other famous-name competitive equipment (there was no comparison!).

"Next, I followed-up with *comparative A-B tests* that naturally proved Altec best in sensitivity, smoothest in response, best in overall performance.

"Finally, just to clinch the sale, I'd pull out all stops on Altec's 15 different models of professional mikes—from \$42.00 dynamics to \$275.00 condenser systems—for over fifty different applications in every area of broadcasting and recording. And, I bore down hard on the fact that *Altec competes on the basis of price and quality with any line of microphones offered by any manufacturer!*

"In conclusion, I'd like to offer a few words of advice to "King Mike II," whoever he may be: You gotta tell the customer about the many superiorities of Altec microphones that no other make of microphone can touch. So to get better results, *give 'em the facts* about Altec. The facts are enough..."

Here are two impressive examples:



**PROOF OF SUPERIOR PERFORMANCE!** In the entire broadcast and recording industry, only Altec provides concrete visual proof of superior performance by supplying individual, certified calibration curves with each of four models of professional dynamics.

For complete specifications, please call your nearest Altec Distributor (Yellow Pages) or write Dept. BE-6



# ALTEC LANSING CORPORATION

LTV A subsidiary of Ling-Temco-Vought, Inc.  
ANAHEIM, CALIFORNIA

©1963 ALTEC LANSING CORPORATION

Circle Item 5 on Tech Data Card

## LETTERS to the editor

DEAR EDITOR:

In Mr. Battison's article, "Practical Application of FCC Engineering Rules," (March, '63) maps obtained from Seabrooke Printing Co., Washington, D. C., are mentioned.

We recently ordered some maps using the above address. The letter was returned. Can you please give us a more complete address?

WM. H. HEBAL

Chief Engineer, AM Facilities,  
WTMJ-AM-FM-TV,  
Milwaukee 1, Wis.

Be happy to, Mr. Hebal. Try your order with this address:

Seabrooke Printing Co.  
514 10th Street, N.W.  
Washington, D. C.

—Ed.

DEAR EDITOR:

Several years ago someone wrote a rather humor filled article on noise and distortion measurements. He included a "finageling" factor which involved turning the distortion meter up on its left end to get a better reading after calibration.

I can't help but wonder if the owner of the field measuring set pictured on page 26 of the April issue has discovered a similar set of "operating aids."

CHARLES O. RICK

KXOX, St. Louis, Mo.

No, the owner of the set uses it right-side up. Our printer, however, has received a new "operating aid," a pair of glasses!—Ed.

DEAR EDITOR:

Just finished reading "A Plan For Making Antenna Proofs," by John Battison, in the April issue of BE.

I would like to commend Mr. Battison for cramming so much valuable information into this limited space.

Many engineers who have never worked with a DA will benefit greatly from the article. I only wish I could have had something like this before I hit my first (4-tower) one cold!

Whoever was responsible for getting the photo of the Nems-Clarke Field Intensity Meter upside down must have, by now, received a lot of good natured ribbing, so I won't add mine.

Sure do enjoy BE—haven't missed reading an issue since the first one was printed. Keep up the good work.

DEWEY A. TROSTEL

Chief Engineer, KARY, Prosser, Wash.

Thanks much for the kind thoughts, Dewey, we appreciate your interest and loyalty... and keep up the good reading.—Ed.

BROADCAST ENGINEERING

# OVER 400 TV, AM AND FM STATIONS ACCLAIM THE BENEFITS OF AUTOMATIC AUDIO LEVEL CONTROL

**Gates Level Devil Rides Gain Automatically and Delivers a Louder Constant Sound**

Now accepted as an industry standard, the *Level Devil* gated circuitry was pioneered by Gates over 10 years ago.

Today, the widely used Gates *Level Devil* is acknowledged as the industry standard automatic gain control amplifier. The *Level Devil* accepts varying input signals and holds the output constant. Depending on input signal level, the *Level Devil* operates as (1) a linear amplifier, (2) a volume expander, or (3) a limiting amplifier.

With average program content at normal input level, the *Level Devil* operates as a linear amplifier. With above normal

audio input level it operates as a limiting amplifier and maintains the desired output level. If the average input level should drop below normal by as much as 10 db, the *Level Devil* functions as a volume expander. But, when there is no signal for a period of 1 to 4 seconds the *Level Devil* returns to the linear amplifier mode of operation and does not emphasize or increase background noise.

The Gates *Level Devil* provides the means for any broadcaster to increase his audience and to expand his service area by this proven method of increasing average modulation. The result is a *louder* and more listenable signal.

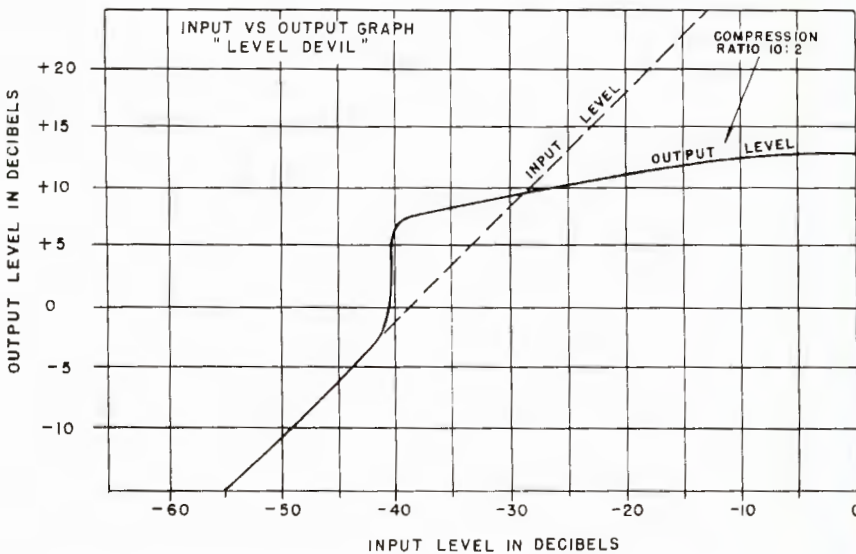
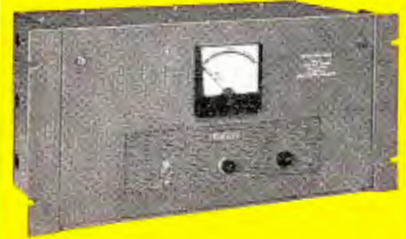

Fig. 1

(advertisement)

## GATES LEVEL DEVIL PROGRAM GATED AMPLIFIER



"Increased my coverage with a louder sound."

"Rides gain better and reacts faster than our most skilled operator."

"Our listeners like our constant output level all day."

"Keeps background noise low when there is no signal."

Radio and television station engineers make comments like these when asked about their *Level Devil* experience.

Order one today for your station. In stock for off-the-shelf delivery. Price — \$375.00.

**GATES**

**GATES RADIO COMPANY**

Subsidiary of Harris-Intertype Corporation

QUINCY, ILLINOIS

Offices in: HOUSTON, NEW YORK,

LOS ANGELES, WASHINGTON, D.C.

In Canada: CANADIAN MARCONI COMPANY

HARRIS  
INTERTYPE  
CORPORATION

# WHERE TO LOOK

## FOR THE MOST ADVANCED TV & FM ANTENNAS

Low Band Broadband ▷  
Dipole Antennas for  
Channels 2-6. Gains to  
10.3. VSWR of 1.04.

High Band Broadband  
Dipole Antennas for  
Channels 7-13. VSWR of  
1.04. Gains to 23.7.



Write for complete details on this outstanding  
line of antennas — Preferred by Broadcasters  
Around the World.



Specialists in  
Advanced Antenna Systems

24 CAROL ROAD, WESTFIELD, N. J.

◁ Multiguide UHF Slot  
Antenna for Chan-  
nels 14-83. Power to  
100 KW, Gains 11 to  
52. VSWR 1.07 or  
better. (Shown with  
fiberglass cylinder  
cover removed.)

Broadband FM An-  
tennas. 88-108 MC.  
Power to 45 KW.  
Gains to 28.2. VSWR  
1.1 over 10 MC band-  
width.

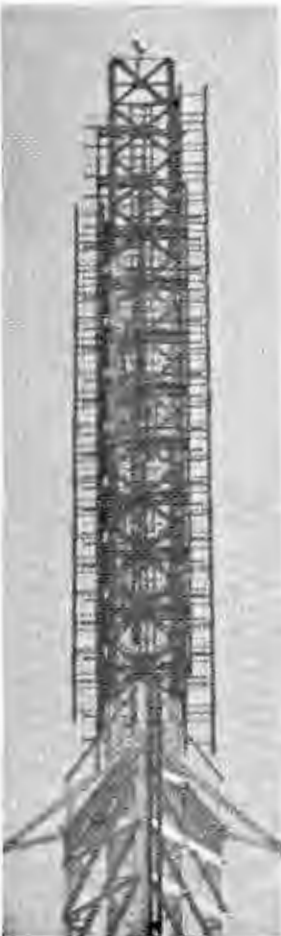
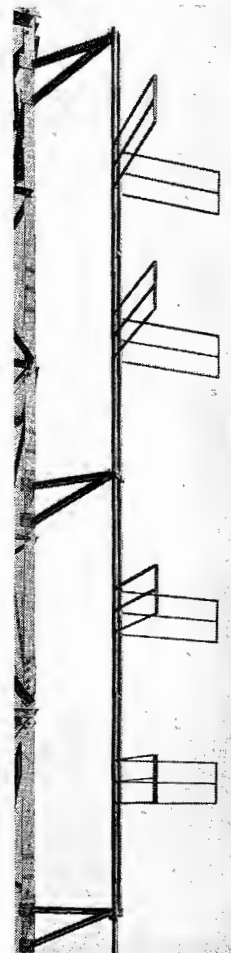

Circle Item 7 on Tech Data Card

BROADCAST ENGINEERING





## What's the lowest-cost fully transistorized broadcast VTR\*? **AMPEX VR-1100**

Now, any station can enjoy the advantages of Videotape\*—with all the quality of Ampex. Reason: the new Ampex VR-1100—a transistorized broadcast Videotape Television Recorder that costs less than \$35,000. And here's what you get for the price: two speeds—7½ ips and 15 ips; recording time up to 3 hours; compatibility with all 4-head recorders; half the floor space of previous VTRs; half the weight; single camera production capability; low power

\*TM Ampex Corp.



requirements; new convection cooling system; no need for blowers or special air conditioning in the station; minimal controls; low maintenance; superb reliability and performance. It's all in the Ampex tradition. For details on a complete production system, including Marconi 4½-inch image orthicon camera and accessories, call your Ampex representative or write: Ampex Corporation, Redwood City, California. Sales and service offices throughout the world.

Circle Item 8 on Tech Data Card

# AUDIO LEVEL DEVICES

by Thomas R. Haskett\* — Part One.

Peak Limiters: operating principles, theory, features, and a survey of currently available models.

The automatic control of audio level is a very specialized and sophisticated art today. The operating engineer is faced with a sometimes confusing array of devices: peak limiter, compressor, AGC amplifier, threshold, platform and gate amplifiers, etc. What is each used for? Should there be more than one per station? What are their advantages and disadvantages? We shall attempt to answer these questions in the following survey of devices on the market today.

Level-controlling devices can be grouped into three general categories, by function: (1) **Peak limiters**, or limiting amplifiers, tend to establish a ceiling or barrier, beyond which audio peaks cannot increase; (2) **Compressors**, or averaging devices, compress peaks and expand low passages, and such action is neither as fast nor as drastic as that of a limiter; (3) **Specialized devices** overcome disadvantages of limiters and compressors. We shall now examine each of the three groups in some detail.

\*Michigan City, Ind.

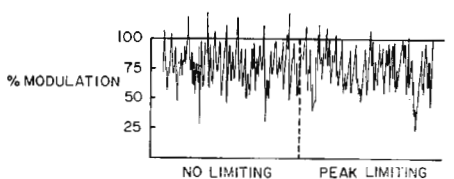

(A) Effect on audio peaks.

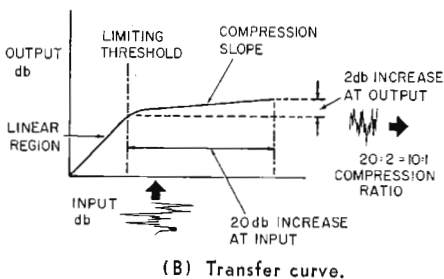

Fig. 1. Basic limiter-circuit action.

## Limiters

As most audio operators know, normal program material contains short, but high-amplitude peaks, which can overmodulate the transmitter. The FCC prohibits overmodulation, since it causes severe distortion at the receiver, adjacent-channel splatter or hash, and possibly even transmitter damage. In earlier days, the peak limiter was invented to avoid this trouble. It puts an approximate ceiling on audio peaks, as illustrated in Fig. 1a.

But the limiter not only prevents overmodulation; with the transmitter protected against instantaneous peaks, the average modulation can be raised somewhat. Since the result is to put more audio in the listener's receiver for the same carrier power, it means a louder signal. Note, however, that there are still low passages which the limiter doesn't affect.

### What a Limiter Does

When signal peaks are below a certain level, called the **limiting threshold**, a limiter acts like a linear amplifier; output is directly proportional to input, as shown in Fig. 1b. When a peak exceeds this threshold, amplifier gain is reduced. Ideally, no matter how high the input peak, the output would remain at the threshold level. Actually, no limiter is perfect; there is always a slight variation in output level caused by a change in input level. The relation between input and output variation is called the **compression ratio** (or slope). If the input increases by 20 db and the output by 2 db, as shown, this ratio is 10:1. The time it takes for limiting to begin is called the **attack time**, and since this is a few milliseconds or less, hardly any of the signal peak gets through to the transmitter. When the signal level drops below

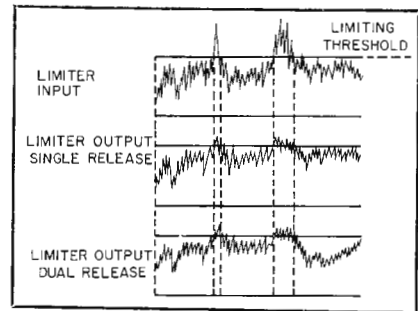

Fig. 2. Single and dual release times.

threshold again, there is a slight lag before amplifier gain returns to its former value. This period is known as the **release** or **recovery time**. In practice, half a second to several seconds of release is used, depending on the type of program material and the effect desired. Fig. 2 illustrates the two types of release commonly available on limiters. For most voice work, jazz and popular music, single release is preferred—gain returns to normal rapidly regardless of the peak duration. Dual recovery is used for other material, such as classical and religious music; following a short peak the gain returns to normal rapidly, but after a series of peaks, gain is held low for a longer period.

### How It Works

Fig. 3 is a block diagram of the conventional limiter. Each stage is push-pull; the first (V1-V2) is a variable-gain, controlled stage. The intermediate stage (V3-V4) and the output stage (V5-V6) employ fixed gain. A portion of the output is rectified by control diode V7, which is usually a full-wave rectifier, providing limiting action even on asymmetrical waveforms. The resulting DC is applied to a grid of the controlled stage; hence, input gain depends on output level. However, to establish the limiting threshold, diode V7 receives a fixed DC bias so it won't conduct until signal

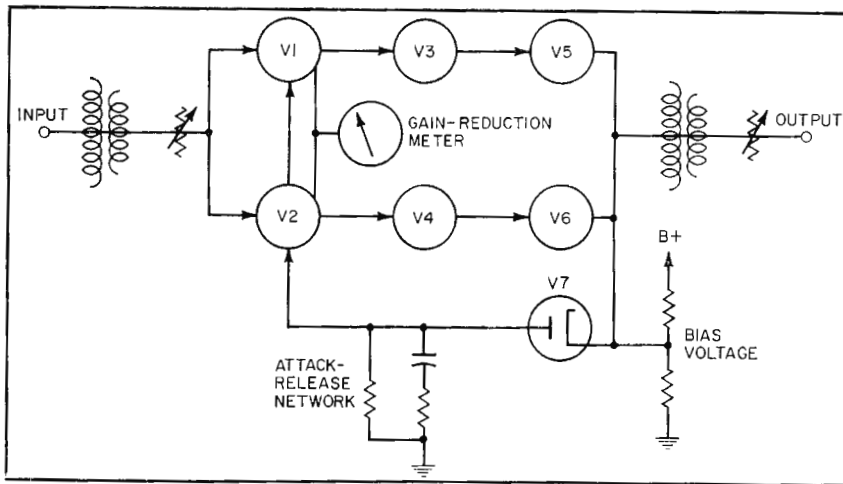

Fig. 3. Diagram of basic limiter circuit.

level exceeds this bias. This means that any signal which produces an output **lower** than the diode's bias will be amplified linearly. The attack and release time constants are set by RC networks in the line between the diode and the controlled stage.

#### Disadvantages

Limiter bugaboos are **thump** and **pumping**, or **breathing**. Thump is a low-frequency transient caused by a rapid change in grid voltage to the input stage, or by poor B+ regulation, or unbalance in any stage. The usual design employs a VR tube to establish a fixed supply voltage for controlled-stage plate and screen, and for grid bias. Arrangements are also normally made for balancing the push-pull stages where needed. Both of these measures reduce thump to a minimum. Pumping, on the other hand, isn't so easy to minimize. It's the effect noticed at a ball game, where the crowd noise rises and falls with the announcer's voice, at almost a syllabic rate. It's caused by a single, short release time constant, and the dual recovery circuit at least partially overcomes it.

#### Operating Practice

The usual place for the limiter is working into the audio input of the transmitter. Before the compressor was developed, many operators preferred to drive the limiter hard—10 db on average program material, and more on peaks. While this effectively increased the loudness at the receiver, it also increased distortion. For increasing the effective range of an AM trans-

mitter this practice is unnecessary today, if a compressor is used ahead of the limiter; the limiter is then only employed as peak protection. This is desirable, since most units today won't limit over 10 or 15 db without a considerable increase in distortion. (For an excellent treatment of this subject, see "Audio Limiting and AGC Action," in the June, 1962, issue.)

When a limiter drives an FM transmitter, the 75-microsecond pre-emphasis curve produces a problem. If the limiter is used solely to guard against overmodulation, it must be located **after** pre-emphasis; then, no matter what the frequency, no peaks can overmodulate the transmitter. But with such a hookup, there will be times when high-amplitude, high-frequency signals will cause limiting; and this limiting will decrease the gain for **all** frequencies, including the loudness-controlling middle frequencies. Hence, the limiter following pre-emphasis cannot be used in an effort to increase average modulation by heavy limiting. However, more about this in a later installment.

#### Features of Limiters in Current Use

Each of the limiters mentioned below is supplied with front-panel input and output attenuators, will match 600 ohms in and out, has a panel meter which reads limiting in db, and mounts in a 19-inch rack (although RCA needs an adaptor). Specifications are given in Table I; individual features follow here.

**Collins 26U-1** — The conventional circuit is used, with Daven step-type attenuators. Since the push-pull stages are self-balancing, they require no adjustment. Both attack and release times are continuously variable, so the operator can choose the exact time constants he wants. With a view to dependability, the power supply employs silicon rectifiers and extended-life capacitors. And there's a front-panel VU multiplier with a range of +4 to +24, as well as a five-function meter-selector switch.

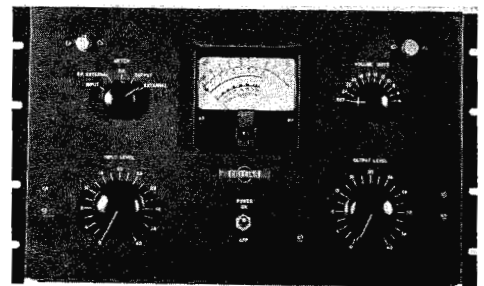

Collins 26U-1

**Fairchild 660 and 670**—The 660 (a single-channel unit), although nominally a limiter, can function either as a limiter or a compressor, depending on user preference. A six-position switch is used to vary the time constants of both attack and release, and a continuously-variable threshold control permits

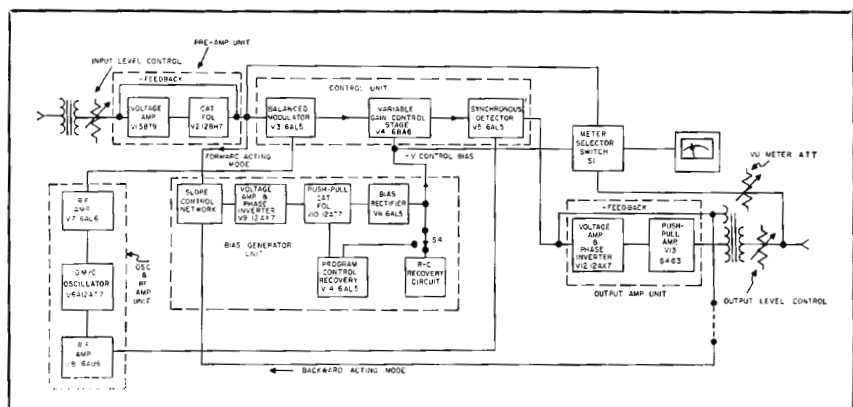

Fig. 4. Block diagram of General Electric BA-7-A.



Fairchild 670

varying the limiting point and compression ratio. Thus, gain control can be fast and extreme, like a peak limiter, or slow and moderate, like a compressor or averaging device. With both speed and degree of level control almost continuously variable, the action can be set up to match a wide variety of individual preferences.

The 670 (a dual-channel unit) consists of two 660's in parallel, fed by a single power supply. Except for a slight difference in gain and input level (see Table I) there are no variations between the two. The 670 can be operated in either of two modes: In the first, the left and right channels are handled separately; in the second, the two signals are matrixed to furnish sum and difference components, which then determine the amount of limiting. However, the outputs remain L and R. Hence, when used for stereo, limiting action occurs as a result of the combined effect of both channels. In the separate mode, channel separation is 70 db; in the combined mode, it's 40 db.

**Gates SA-39B and M-6144**—The SA-39B (a single-channel unit) uses the traditional circuit with one exception: A rather elaborate, electronically-regulated power supply furnishes a closely-regulated B+ for everything but the output tube plates. This reduces thump and instability to a very low value. The input attenuator is a grid-circuit potentiometer, permitting precise adjustment of input level and operating point. The input matches 500/600, 150/250, or 30/50 ohms, and there is a front-panel phone

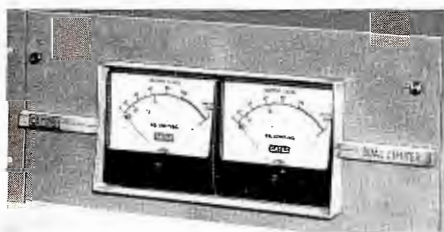

Gates M-6144

jack for output monitoring.

The M-6144 Dual Limiter has been designed specifically for stereo. The identical limiting channels share a common power supply, which uses solid-state components, and all low-level filaments



Gates SA-39B

are fed filtered DC. Each channel has its own continuously-adjustable input and output potentiometers, balancing and meter-zeroing controls, and meter-selector switches. Operation is possible either in separate (twin mono) or combined (single stereo) modes. In the separate configuration, the two separate limiters can be used on different pro-

grams with no interaction—channel separation is 70 db. In the combined or stereo arrangement, the limiting circuits of each channel are connected together so that the greatest peaks control both channels, thus preserving the stereo effect.

**ITA LA-1A**—ITA employs the conventional circuit, but adds a push-pull isolation amplifier between the output stage and the control-voltage rectifier diode. This isolation prevents clipping in the output stage, and by using a push-pull stage from both sides of the output, limiting still takes place on asymmetrical waveforms. The output attenuator is a Daven step type; the input control is a continuously-variable potentiometer. Standard,



ITA LA-1A

Model	Attack Time $\mu\text{sec}$	Release Time sec	Compr. Ratio	Input Level dbm	Output Level dbm	Gain db	Noise Level dbm	Frequency Response
Collins 26U-1	0.5 to 3.0	2.2 to 5.2	12:1	-20 to +20	-20 to +20	32	-50	$\pm 1.5$ db 50 to 15,000 cps
Fairchild 660	0.2 or 0.4	0.2 to 25	2:1 to 30:1	+4 or +16	+4 or +8	16	-66	$\pm 1.0$ db 20 to 15,000 cps
Fairchild 670 (Dual)				0 to +16		7		
Gates SA-39B	3.0	0.2 to 1.2	10:1	-20 to +20	0 to +19	50	-46	$\pm 1.5$ db 30 to 15,000 cps
Gates M-6144 (Dual)	Up to 0.6	2.0 to 4.0	10:1	-45 to +24	0 to +16	63	-54	$\pm 1.0$ db 30 to 15,000 cps
GE BA-7-A	0.07	0.5 to 1.5	20:1	-30 to +20	+12 to +27	57	-65	$\pm 1.0$ db 50 to 15,000 cps
ITA LA-1A	1.0	0.2 to 5.0	6.7:1	-25 to +10	0 to +20	65	-45	$\pm 1.0$ db 50 to 15,000 cps (limiting)
RCA BA-6A	0.6 or 900	0.33 or 2.0	10:1	-24 to +14	+9.5 to +38.5	54	-54	+1.0 to -2.0 db 30 to 15,000 cps (limiting)
Universal Audio 175-B	0.3 to 1.0	0.027 to 0.527	12:1	-24 to +13	-24 to +13	37	-67	$\pm 0.5$ db 20 to 20,000 cps (limiting)

Table 1.

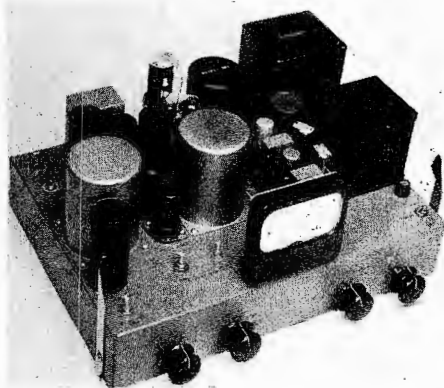

RCA BA-6A

easily-available parts are used throughout.

**RCA BA-6A**—RCA uses the traditional circuit, with ordinary, receiving-type tubes and balance controls for setting up the input stage. To facilitate such dynamic balancing, an internal constant-amplitude signal is provided. An extra feature is the use of the meter to read heater voltage on the variable-gain stage, and cathode current of all signal-channel tubes. The signal-to-thump ratio averages 26 db with non-selected tubes,

measured under 10 db of limiting. The input will match 150 as well as 600 ohms, the input tube has DC on its heater, and the power supply can furnish plate and filament power for an external pre-amplifier. The BA-6A is designed for plug-in mounting on an RCA type MI-11599 shelf, which mounts in a 19" rack.

**Universal Audio 175-B**—This is the smallest limiter available. By using miniature tubes, military type printed circuitry, and careful parts placement, it requires only 3½ inches of rack space. The conventional circuit has been followed, except that triodes are used instead of the usual pentodes. There are Daven 2-db-per-step attenuators at both input and output, and a vernier adjustment is provided alongside each, which covers the intervening 2-db range. Front-panel patch jacks for input and output are provided, in addition to a rear-panel terminal strip. Not only are tube-balance controls furnished, but an internal balance signal is available, making external test gear

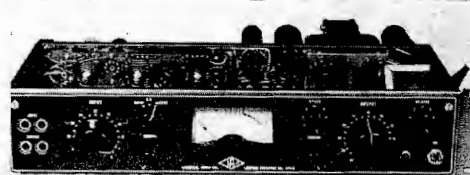

Universal Audio 175-B

unnecessary. Continuously-variable attack and release controls are mounted on the front panel.

**GE BA-7-A**—The design of GE's "Audiomatic" differs radically from the standard outlined earlier, and merits a close look. As Fig. 4 illustrates, there are five sections: oscillator-RF, bias generator,



General Electric BA-7-A

control, output, and preamp. The input signal is first amplified by the preamplifier, then split and fed to both the control and bias generator units. The oscillator-RF unit furnishes a constant-amplitude 10-mc RF carrier to the control unit's balanced modulator (V3). The incoming audio amplitude-modulates the RF; the carrier is then suppressed and only the modulated sidebands are passed to the variable-gain control stage (V4). Meanwhile, audio from the preamp is also fed to the bias generator unit. It goes through the slope control, which adjusts the compression ratio, and is further split and fed through a cathode-follower to the bias rectifier (V11), and the program-controlled recovery circuit (V14). (The low impedance of the bias generator permits fast attack time, 70 microseconds.) The bias diode furnishes operating bias for variable-gain control stage V4, and thus the modulated sideband amplitudes are controlled. Note that since control voltage is derived from input, rather than output, motor-boating cannot occur. Also, since no carrier is present at this point, any thump components

● Please turn to page 40

Harmonic Distortion	Meter Reads	19" Rack Space		Price	Model
		Height	Depth		
1.5%	Limit db Input vu Output vu Ext. Limit db Ext. vu	10 ½"	9"	\$ 425.00	Collins 26U-1
Below (10 db) 1.0% (limiting)	Limit db Tube bal.	14"	11"	970.00	Fairchild 660
				1495.00	Fairchild 670 (Dual)
1.5% (15 db) 30 to (limiting) 15,000 cps	Limit db	14"	9 ½"	445.00	Gates SA-39B
1.0% (25 db) 30 to (limiting) 15,000 cps	Limit db Output vu Tube bal.	7"	16"	867.50	Gates M-6144 (Dual)
2.5% (20 db) 50 to (limiting) 15,000 cps	Limit db Input vu Output vu Tube bal.	10 ½"	9 ½"	1000.00	GE BA-7-A
1.5% (20 db) 60 to (limiting) 20,000 cps	Limit db Tube bal.	8 ¾"	10 ¾"	425.00	ITA LA-1A
Below 1.0% 100 to (15 db) 15,000 cps (limit)	Limit db Tube bal.	8 ¾"	14" requires adapter	582.75	RCA BA-6A
Below 1.0% 50 to 15,000 cps	Limit db Input vu Output vu	3 ½"	9 ¼"	425.00	Universal Audio 175-B

Limiter Specifications.

# PLANNING THE MODERN STUDIO

by *John J. Walsh\** — Points to consider when planning a studio layout, which will pay off when the installation is put into use.

With changing times and changing programming it has become a necessity to modernize studio layouts. Music and news is more dominant in the broadcast field than it has ever been, in fact so much so that it has become necessary to alter our thinking in planning studios and control rooms. The days of the large studio for live broadcast have practically ended for today's radio. An improved, more efficient, design is required to produce an increase in profits by making maximum use of a comparatively small space. Therefore, a versatile arrangement, which allows each section of the production area to be used for more than one operation, is a necessity.

## The WMAK Plan

The entire operations area at WMAK is designed around music and news. Since ease of programming is so important, all controls are conveniently located within the reach of the operator to eliminate lost time and excess manipulations.

Talk-back systems and intercoms are too slow for cues, so visual contact is used. A simple wave of the hand, or the old fashioned point, serves as a much more rapid cue

\*Engineering Supervisor, Lin Broadcasting Corp., Nashville, Tenn.

for news or an upcoming live announcement.

At WMAK, a single straight raceway, passing beneath all racks and consoles, was built with removable covers for convenient inter-room wiring. The raceway extends between the outer walls to facilitate addition of any new equipment which may have to be located elsewhere. This system allows use to be made of all available space; also, installations are not limited to certain small areas, simply because it would be impractical to string wires across the floor.

Fig. 1 shows a floor plan of the layout which serves our needs quite well. Notice the operations areas are all in line, with visual contact provided between all rooms by means of double-panel windows. A word of advice—use as little glass as possible without hampering the visual contact; windows, even of twin sheets, are very difficult to soundproof.

## Production Control

Since most commercials are pre-recorded, a separate area was set aside for their preparation, so as not to interfere with the on-air operations. This recording area, or production control room, duplicates



Fig. 2. Production and recording room.

the master control room as closely as possible, so that it may be used in emergencies to originate programming (Fig. 2). The production room may be easily switched into the program line through a patch panel.

Just how elaborate an arrangement you should have in the recording room is governed entirely by the type of commercial production you intend to turn out. Some of the basic needs are a console large enough to handle all the equipment without doubling up on the inputs, at least two turntables to cross-fade from one record to another, and two good-quality tape recorders for dubbing.

Remember that your commercials will sound good only if they are well recorded. Therefore, choose a recorder that will stand up under constant use, and provide the sound quality required. WMAK is equipped with Ampex 351's which have consistently met with a great deal of success. Another consideration are the tapes which will be coming in from agencies, individuals, etc., for airing, that may have been recorded on almost any type of recorder. You may find half-track and quarter track, and recordings made at speeds other than the broadcast standards of 7½ or 15 ips. Between two recorders you should be able to handle any con-

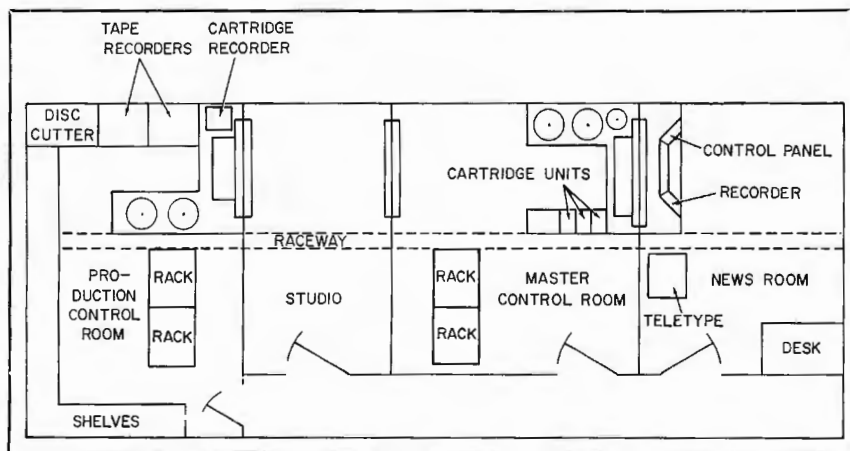

Fig. 1. Floor plan of studio and control rooms at radio station WMAK.

tingency, and dub to more suitable speeds. At WMAK, for example, we also use a Magnecorder model PT-63A with the 2-speed motor and capstan conversion kit. With half-track heads, we can play back any tape directly, with the exception of those recorded at  $1\frac{7}{8}$  ips. However, this problem is easily solved by playing the tape at  $3\frac{3}{4}$  ips and dubbing it at 15. When the tape is finally played at  $7\frac{1}{2}$ , it sounds normal.

Sufficient rack space should be planned for present and for future equipment. A good production operation adds new equipment often, to produce that "special effect" the client is looking for.

Keep an open mind and listen to the production staff. It may be that you could profit from the zaniest ideas they may come up with. Remember, new sounds and gimmicks in commercials and programming makes a station stand out from competition; and anything that makes you stand out sells!

### Studio

A large studio is virtually useless with the programming of today. Keep it as small as practical; don't tie up valuable floor space in an unused room. The WMAK studio is more than sufficient, yet measures only 6' x 13'. Notice the studio in the floor plan; it may be used

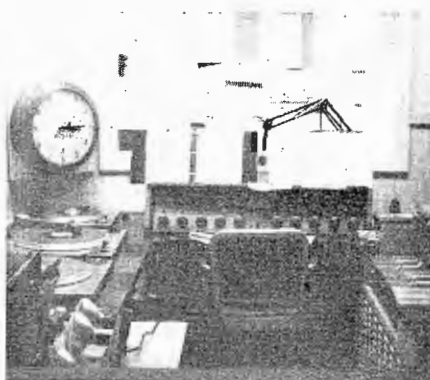

Fig. 3. Studio view of master control.

with both the master and the production control rooms. By installing separate microphone lines and "on-the-air" lights for each control room, and physically separating them, any possible confusion can be eliminated. Our on-the-air lights are located where people using the studio may easily see them while facing the appropriate control room.

In the studio, a single speaker, with a selector switch, is used to monitor either the master or the production control room, thus eliminating the cost of two speakers. An independent volume control was installed on the speaker so the occupants of the studio may adjust the level to their requirements.

### Master Control

A great deal of thought and consideration should go into the selec-

tion of master control room equipment (Fig. 3). Special care should be taken in choosing the console since it is the heart of the operation. Read, and carefully study, all available literature. Any manufacturer will be more than happy to supply you with brochures describing his equipment. Discuss it with the manufacturers representative. Will it meet all your needs? Are the components sturdy enough to stand up under constant use?

If possible, consult with someone who uses the type of equipment in which you are interested. This way, you can obtain information which might come to light only after several months, or years, in the field. There may be a fault which cropped up after use, but did not show up in the manufacturer's tests. If so, have they been remedied?

The preceding questions could be applied to any equipment you may wish to purchase. You will find, in many cases, even your biggest competitor will be willing to pass on information concerning faults in equipment.

A well constructed turntable with low rumble and noise is a must. The drive motor should be a hysteresis synchronous type, to maintain constant speed in spite of slight fluctuations in line current. It should have all three speeds,

● Please turn to page 42

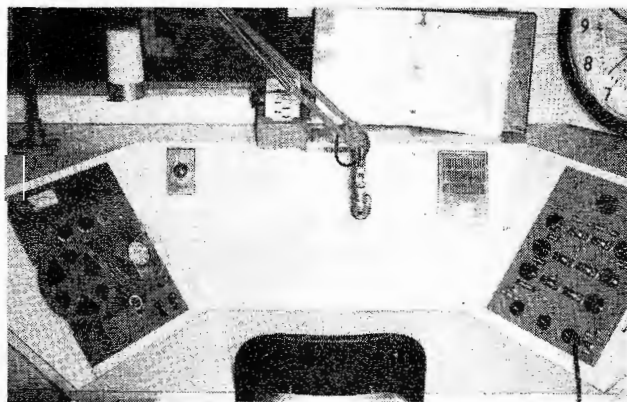

The News Room console is equipped with a high level mixer using double-pole, double-throw switches. In one switch position the audio is fed to the master control board, while in the other position it is fed directly to the tape recorder.

The high level mixer consists of six 600-ohm inputs, any of which may be fed on the air or into the recorder and two 600-ohm outputs. The six inputs are used for the following: (1) beeper phone, (2) tape recorder, (3) microphone, (4) input terminated at a phone plug (used for auxiliary equipment), (5) and (6) are spares.

Fig. 4. News room control console with high-level mixer.

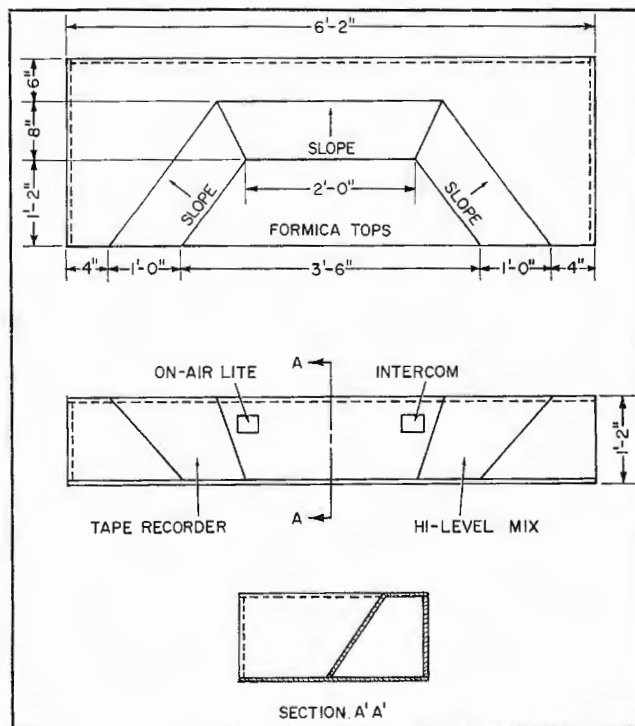

Fig. 5. Construction plan for news-room control board.

# DESIGN OF RESISTANCE- COUPLED AUDIO AMPLIFIERS

by *Bryce W. Tharp\** — Discussion of RC amplifier theory and practice essential to design and maintenance.

The purpose of this outline is to illustrate the general procedure followed in constructing and repairing resistance - capacitance - coupled audio amplifiers. These devices are important to broadcast stations, and their dependability and good performance are conjunctive. By proper design, a practically flat frequency response from 50 to 15,000 cps may be obtained. Transmitter manufacturers continue to design transmitters with these superb characteristics, even though (or in spite of the fact that) the average popular table radio has a frequency response of about 400 to 4,000 cps, plus or minus some db variation.

While the design of audio amplifiers frequently is taken for granted, with considerations such as "the bigger the coupling condenser and grid bias resistor, the better the amplifier"; this hypothesis is not necessarily true.

Considering the high cost of good interstage audio transformers, probably the best all around audio circuit is the resistance-coupled amplifier. The design is rather uncomplicated. The difference in gain per stage between RC and transformer-coupled amplifiers (the gain is greater in the latter type), can be compensated for by the addition of an extra stage. This is a simple procedure and is generally considered worth the expense. Resonance and peaking problems are not present in well-designed RC coupled amplifiers; phase shift is not serious.

\*Staff Engineer, Radio Station WXLW, Indianapolis, Ind.

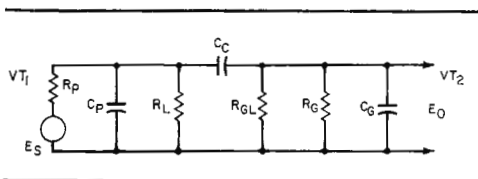

Fig. 1. Equivalent circuit of tube stage.

## Amplifier Distortion

The three types of distortion in amplifiers are frequency, amplitude, and phase.

Frequency distortion is the unequal amplification of various frequency components of the input voltage, and is primarily due to the changing of the tube load impedance with frequency. In RC coupled circuits the cause is variation of capacitive reactance with frequency, and in the case of transformer- or impedance-coupled amplifiers, the variation of inductive reactance.

The frequency response of an amplifier should extend to at least 9,000 cps since the important overtones of musical instruments occur in the range of about 4,000 to 9,000 cps. These overtones are what help distinguish one instrument from another. If the amplifier does not produce these higher frequencies, the input wave which is very complex with its harmonic and overtones content will appear at the output stripped of these frequencies, and only the bare fundamentals will remain.

Amplitude distortion is due to the nonlinear relations of voltage and current in the input and output of the amplifier stage. This is held to a minimum by operating the tube or transistor in the straight portion of the plate or collector curve. Amplitude distortion introduces harmonics of the signal frequency in the output of the stage. By measuring these harmonics, the amplifier distortion is found.

Phase distortion is caused by different frequencies passing through the amplifier at different speeds. This would cause an input signal to appear in the output with its harmonics shifted a few degrees from the fundamental frequency. The shape of the wave form is thus altered from that at the input.

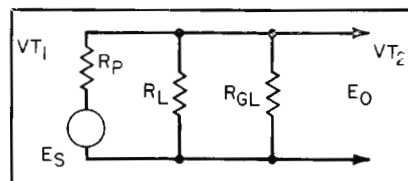

Fig. 2. Intermediate frequency circuit.

Ordinarily, phase distortion is relatively unimportant, since the human ear permits the phase to be altered over a wide range without noticeable effects. The most serious problems occur if the amplifier employs degenerative feedback over one or more stages.

## Amplifier Design

The exact equivalent circuit of an amplifier stage using tubes is shown in Fig. 1.

where,

- Rp is plate resistance of the tube,
- Cp is plate to cathode capacity,
- RL is resistance of the load,
- Cc is coupling capacitance,
- RGL is resistance of grid resistor,
- RG is resistance of grid to cathode,
- CG is capacity of grid to cathode.

Due to Cc having high reactance, there is a decrease in gain at low frequencies. At high frequencies the shunting effect of Cp and CG across the input of the second stage limits the gain.

At some intermediate frequency the gain will be maximum, due to the reactance of Cc being small and that of Cp and CG being large enough to have only a small shunting effect across RL. Under these conditions, the equivalent circuit is shown in Fig. 2. RG is neglected, since it usually is so large it will have little shunting effect.

The output voltage for a triode is found by Equation 1, and for a pentode by Equation 2:



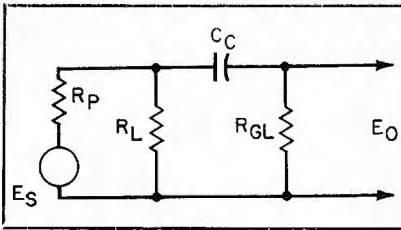

Fig 3. Low frequency equivalent circuit.

$$E_o = \mu E_s \frac{1}{1 + R_p \frac{R_L + R_{GL}}{R_L R_{GL}}} \quad (1)$$

$$\text{Maximum Gain} = GM R \quad (2)$$

where,

R is Rp, RL, and RGL in parallel,

GM is the mutual conductance.

From equation 1 we see that the gain increases as RL and RGL are made larger; however, the gain increases only minutely beyond the condition where this combination is equal to about two times the value of Rp. The gain can never exceed the mu of the tube, and usually does not exceed about 75% of mu. RGL cannot be increased too high either, or the tube may block on strong signals. The phase distortion is least at this intermediate frequency.

### Low-Frequency Gain

At low frequencies, with Cp and CG negligible, the equivalent circuit can be shown as in Fig. 3. Since the voltage across RGL is the input voltage to the following stage, it can be seen that Cc and RGL essentially form a voltage divider network from the output of the first stage. A compromise is required here.

If RGL is made too high, the grid can block on strong signals. If Cc is increased to a large value to lower the reactance, it is possible for Cc to become charged and shift the grid bias. The time constant of Cc and RGL could be too large at high frequencies. In practice, the value of RGL is made equal to the highest value recommended by the tube manufacturer; and the product RGL Cc is made not greater than .05.

The above considerations explain why such large coupling condensers are used in transistor amplifiers. With the input resistance of a transistor so very low, the coupling

capacitance has to be increased to heretofore unheard of values in order to keep the low-frequency response satisfactory.

At low frequencies, when the reactance of Cc equals the resistance of RGL, the gain of the stage will be .707 of the maximum intermediate-frequency gain. This is equal to a loss of 3 db, as shown in Fig. 4. The voltage across RL can be considered numerical 1. The voltage across RGL is found by the ratio of the reactance of Cc divided by RGL (in this case it is 1), as in formulas 3, 4, and 5.

$$\frac{XC_c}{R_{GL}} = 1 \quad (3)$$

$$\arctan -1 = 45^\circ \quad (4)$$

$$\cos 45^\circ = .707 \quad (5)$$

Therefore, the stage gain at low frequencies is determined by the ratio of X to R. Knowing this ratio, alpha can be found; and from this, the cosine can be determined. This will give the gain reduction from the maximum intermediate frequency gain. Knowing the reactance and value of capacity, the -3-db low-frequency point can be determined. The stage gain is also affected by the values of screen and cathode bypass capacitors. These should be made large for best low-frequency response.

### High-Frequency Gain

For high-frequency gain, the simplified equivalent circuit in Fig. 5 can be employed with great accuracy. The reactance of Cc can be neglected, since it will be very low. The factor determining gain will be the total shunting capacity across ZL. Equation 6 may be used to determine stage gain.

$$\frac{AHF}{AG} = \frac{1}{\sqrt{1 + (R/X_c)^2}} \quad (6)$$

where,

AHF is the gain at high frequencies,

AG is the maximum gain,

R is the parallel combination of Rp, RL, and RGL,

Xc is

$$\frac{1}{2 \pi F C_G}$$

CG is Cs + plate - to - cathode capacity of VT1 plus grid-to-

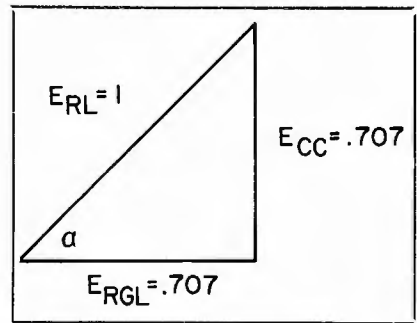

Fig. 4. Vector diagram of circuit voltages.

cathode capacity of VT2, plus grid-to-plate capacity of VT2 times (1 + M),

Cs is distributed capacity of wiring,

M is gain at intermediate frequency.

From Equation 6 it can be observed that when R/Xc equals one, the gain is down .707 or -3 db from the maximum intermediate frequency gain of transistor amplifier. An important factor in determining gain, it is now apparent why the high frequency gain of transistor amplifiers is usually so excellent. The input resistance of transistors is so low, that the shunting effect of CG is not nearly as great as in vacuum-tube circuits. Also with a rather low output resistance, the following stage CG has less shunting effect to reduce the high frequency response.

With the value of CG and its reactance known, the -3-db high-frequency point can be found.

### Phase Shift

As could be expected with a circuit containing reactive networks, RC amplifiers have a certain amount of phase shift. With the proper cathode and screen by-pass capacitors for all frequencies, the voltage gain and phase shift of triode or pentode stages is about equal.

The problem resolves into creating a linear phase shift throughout the audible range, since this characteristic is synonymous with constant time delay. Constant time delay through the amplifier frequency

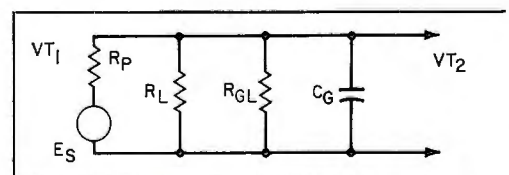

Fig. 5. High frequency equivalent circuit.

• Please turn to page 44

# "ROLL YOUR OWN" AUTOMATIC TAPE

by Joe Nearns\*—A simple automatic cartridge system which makes use of conductive-strip cueing and low-cost components.

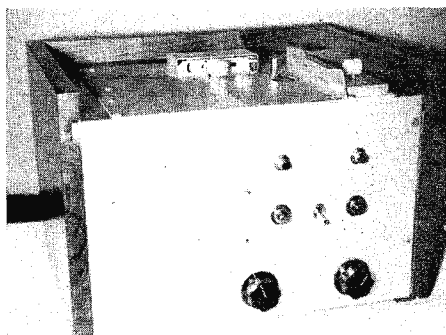

Fig. 1. Automatic cartridge-tape machine.

For many years broadcasters have realized the need for the automatic cartridge tape machine, which appeared on the market about three years ago.

The automatic cartridge tape machines need no cueing, threading, or rewinding of tapes. They fill the wide gap between expensive disc recorders and the conventional, often unwieldy, reel-to-reel tape machines, both of which have considerable drawbacks in the everyday operation of a busy station.

\*Chief Engineer, KLCN and KLCN-FM, Blytheville, Ark.

Larger and more prosperous stations were quick to purchase the new products, and thousands of these machines are in operation today.

KLCN was one of the first stations to utilize the cartridge tape, with the Viking Model 35 manual transport, before the advent of automatic machines. Having been stung several times in the past with new electronic gadgets (and rather than play the guinea pig again), we developed and perfected(?) our own automatic tape handler (Fig. 1) with an outlay of less than \$175 per machine — considerably less than the cost of the cheapest commercial machine we know of. The evolution of our system took about two years, and four units, now in use, are highly satisfactory.

We prefer the conductive strip method of automatic cueing, comments of some engineers notwithstanding. This technique affords a visual indication of cartridge readiness. It also insures that the best part of the recording tape will be

used every time, thus eliminating the possibility of muffled sounds caused by wrinkles and splices.

With the conductive strip method, more than one cue can be put on each cartridge for multiple-stop operations, such as program intros, themes, etc. The cue strip can also be readily removed and repositioned . . . and a dollar's worth of cue material will cue about a hundred tapes.

The automatic circuit is simplicity itself, using no complicated and critical vox circuits, oscillators, or tone-burst filters. It is a straightforward DC circuit, employing two relays and a mere handful of parts.

This system lends itself admirably to remote control operation, random placement of parts, and a variety of cabinet designs. Maintenance is practically nil, with no tubes to replace and nothing to heat up. Should trouble develop (and it hasn't yet) an emergency override switch bypasses the automatic circuit until repairs can be made.

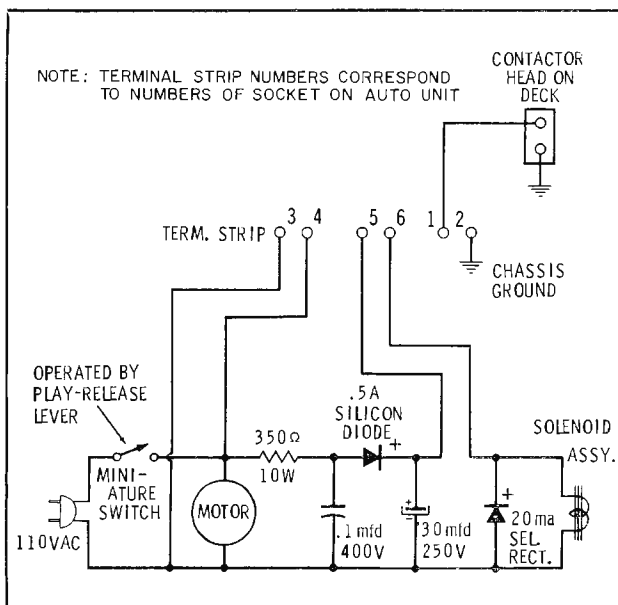

Fig. 2. Modified circuit of the cartridge-tape transport.

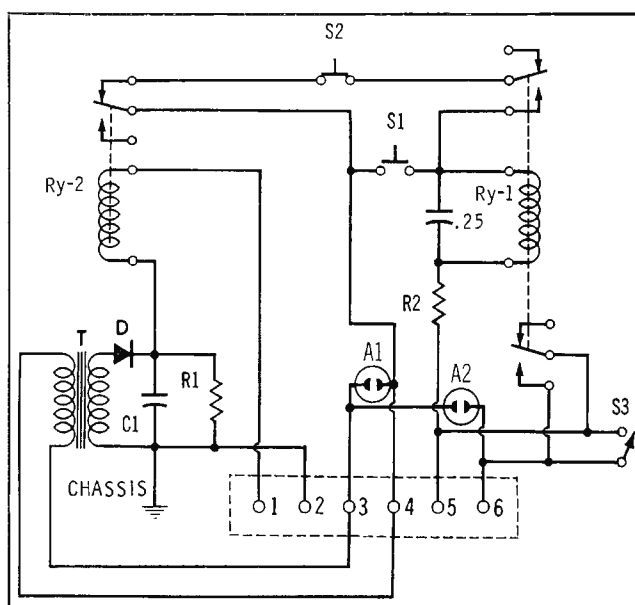

Fig. 3. Automatic-control circuit for cartridge-tape unit.



Fig. 4. Cabinet lined with sound-insulation material for reduction of noise.

### Theory of Operation

A close look at the circuit diagrams will reveal the simple operation. The following actions take place: When the "play" lever on the transport deck is pulled forward (Fig. 2), a micro-switch turns on the motor and switches in AC power for the relay power supplies.

Closing start button S1 (Fig. 3) energizes relay RY-1, which has two sets of contacts, a holding contact and a contact to complete the solenoid circuit. With the solenoid energized by the above operation, the machine will continue to run until RY-1 is de-energized either by stop button S2 or by the opening of the normally closed RY-2 contacts.

Automatic cueing is achieved through the use of a conductive strip, about ¼ inch long, fixed to the tape. When this conductive strip crosses the contactor head, RY-2 is energized, breaking the RY-1 coil circuit. RY-1, which has been held closed by its holding contacts, drops out and causes the machine to stop. Neon indicators show operating positions of "ready" when the play lever is pulled back, and "run" when RY-1 is energized.

Relay RY-2 has its own power supply; RY-1 "borrows" its power from the solenoid power supply in the tape transport. Both relays require only a fraction of the power available from the two supplies.

### Construction

Our four units are constructed identically with interchangeable auto circuits, transports, and record/play amplifiers. They are

mounted in solid walnut cabinets, built by a local cabinet maker to our specifications.

Any size or shape cabinet may be used, depending on your taste and needs. However, a couple of construction hints are in order. Wood cabinets, far quieter than metal ones, can be silenced even further by lining them with insulation (Fig. 4). And the entire unit should be mounted on foam rubber runners fixed to the bottom of the cabinet; our machines are whisper-quiet while operating. In fact, they are quieter than some commercial machines, which produce a loud mechanical "bang" upon starting.

Mechanical noise can be all but eliminated, in some machines, by placing a strip of plastic electrical tape on the solenoid armature face. This will prevent a metal-to-metal clash when the solenoid engages the pressure roller take-up paddle.

The entire circuit is constructed on a 3 × 4-inch aluminum chassis, which is then bolted to the back of the front panel (Fig. 5). All electrical connections from the front panel are made through a six-wire cable and plug assembly.

The front panels are ⅛-inch aluminum, cut to fit the cabinets. They are drilled to accommodate the start and stop switches, emergency switch, and the two pilot lights, in an orderly and symmetrical arrangement. The panels of our units have a satin finish; the result of a three-hour soaking in a solution of lye and water.

Several varieties of amplifiers are available, including the Viking RP61 and RP83-2, the latter of which contains a small VU meter. We have used both amplifiers and prefer the simpler RP61, mainly because the tone control and record level control can be pushed back into the amplifier.

When the amplifier is mounted behind the main panel, only the record/play switch and the play-back control are accessible to our non-engineer announcers. The headaches this will eliminate are obvious.

These amplifiers come from the factory with high-impedance inputs and outputs. They must be converted with good-quality transformers, if the common 600- or 250-ohm mixing system is used. The transport is normally equipped with

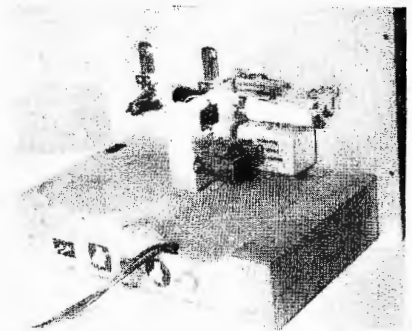

Fig. 5. Rear view of chassis and panel.

one half-track record/play head. A contactor head has to be ordered separately — its installation, however, is quite simple.

Bulk tape erasure, which has proven very satisfactory, is required with this system since there is no erase head on the deck. We recommend the use of the 7½ ips, two-belt eraser.

When operating properly, this cartridge tape device will produce incredible fidelity, and have cueing capabilities of splitting a word into syllables. Nevertheless, optimum results can be obtained only when the record/play head is clean, and the pressure roller is properly cared for. The pressure roller should be cleaned with denatured alcohol; this can be accomplished only by removing the roller entirely.

The cartridge machine is here to stay. Buy 'em tailor-made if you like, or "roll your own" and save a pot of money. ▲

### Parts List

Item	Description
C1	50-mfd, 50 VDC electrolytic capacitor
C2	0.25-mfd, 250 VDC capacitor
R1	1.5K, 1-watt resistor
R2	6.8K, 2-watt resistor
D	500-ma diode
RY-1	3K telephone-type relay
RY-2	10K sensitive relay (Sigma 5R-10000S, or equivalent)
T	filament transformer, 115-volt primary, 12-volt secondary
A1, A2	NE-51 neon lamps
S0	6-pin socket
S1	n/o push-button switch
S2	n/c push-button switch
S3	SPST toggle switch

# WHEN THE PROOF-OF-PERFORMANCE FAILS

by Ed Murdoch\* — Part two. How to measure noise and distortion in checking a proof-of-performance.

## Distortion

The technique for measuring distortion and noise is almost universal, and only a brief commentary will be given. The distortion measurements are not made with respect to a reference frequency. Each required frequency is treated as a separate entity for the various levels of modulation required in the proof—25, 50, 85, and 100%. Since it may be dangerous to the transmitter to maintain the 100% sine-wave modulation level for very long, especially at the higher audio frequencies, the distortion run for each frequency should be commenced with the console input level adjusted for 25% modulation for the first frequency under consideration; the distortion-analyzer null-bridge circuits are adjusted for minimum at this level. Then after taking the distortion-scale readings for 25% modulation at this frequency, the balancing circuits of the analyzer can be left as is, but the range control can be returned to the calibrate position to calibrate the scale for the next level of modulation at this same frequency. After taking each actual distortion reading, the console channel switch should be switched off immediately so that the tubes may cool while the range dial is being returned to calibrate.

At the higher percentages (85 and 100%), the setting of the transmitter modulation level and the switching of the analyzer range control to the proper distortion scale should be accomplished in two separate operations, to prevent the transmitter tubes from overheating. However, this is more important at the higher frequencies, 5 and 7.5 kc, than in the lower ranges. In other words, first the console input should be adjusted to produce 85%

modulation, and the analyzer calibrate control quickly adjusted for meter deflection to the calibration point. **Then** cut the console channel switch, reduce the range to the anticipated proper setting, and actuate the channel switch to quickly read the percentage of distortion, **in that order**. The signal should then be removed as soon as possible. (An assistant may be needed to perform the switching operation at the console.)

Thus, it is seen that each separate frequency of the required spectrum is treated fully before proceeding to the next, and the process for each frequency begins with nulling the analyzer at the 25% modulation level. (In a good analyzer the bridge balance will stay put long enough to proceed through all four levels of modulation without needing readjustment. If, however, the higher levels of modulation produce unexpected values of distortion after the original balance at 25%, the level should be returned to 25%, and the balance circuits manipulated to verify, or correct, the bridge tuning. Also, all oscillators generally recognized by the broadcast industry as suitable for proof measurements will be capable of retaining their frequency stability long enough to make the full run for any given frequency.)

## Carrier Shift

The technique for measuring carrier hum and noise generally causes less confusion than any other step in the proof, so it will be treated very briefly. The console input is adjusted to modulate the transmitter 100% at 400 cps; then the channel-switch is killed (removing the oscillator feed) and the oscillator and its attenuation units are disconnected from the console input. A load resistor, equal to the

channel input impedance, is connected to the input cable to the console—possibly by a pre-wired switch on a special unit for this purpose. Then the channel-switch is closed again, and the distortion-noise analyzer range switch is adjusted to produce a conveniently readable value on the meter db scale. The noise level of the system, then, is the sum of the actual meter reading in —db, **plus** the reading in —db indicated by the pointer on the range switch.

Next is the measurement of carrier shift for 25, 50, 85, and 100% modulation. With this is the program that asks the question, "Can this lil' ole carrier-shift meter on the modulation monitor be used to read the shift directly, rather than mess around with high-impedance voltmeters and mathematical computations?" Well, I've known several consulting engineers who habitually read the carrier shift from the carrier-level meter, not resorting to the use of an external voltmeter unless the other reading was suspiciously low, or pushing the limits. And the manuals for several makes of modulation monitors certainly imply that they can be used for this purpose. While the FCC doesn't specify **how** the carrier-shift is to be measured, to avoid all argument it would perhaps be best to take the long way around, since this will also offer a means of checking a

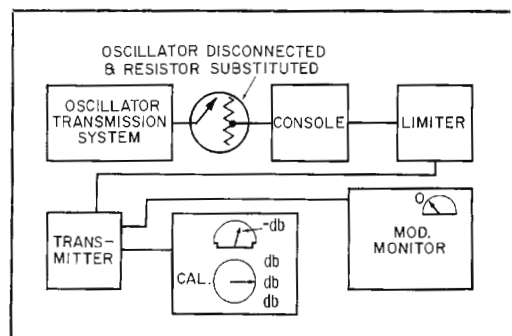

Fig. 1. Carrier hum and noise setup.

\*Melbourne, Florida

portion of the modulation monitor at the same time.

The method consists of connecting a high-sensitivity DC voltmeter (20,000 ohms/volt should do) across the output of the rectifier unit which is coupled to the transmitter (or across the special take-off on the modulator monitor, if used) and which up to now has been connected to the distortion analyzer. Note the DC voltage reading without modulation. Then apply a frequency of 400 cps and modulate the transmitter at 25, 50, 85, and 100% modulation levels, noting the DC voltage for each level. The carrier shift for each percentage is the difference between the unmodulated and modulated DC readings, expressed as a percentage of the higher.

Now let's get down to the business of trouble-shooting a faulty proof. For the purpose of this article it will be assumed that the station engineer has checked all tubes within a reasonable time prior to the performance measurements, and no duds are in use. If the measurements still indicate excessive noise and hum, with possibly an undue rise of distortion at the lower frequencies, the circuits should be checked for defective tubes in accordance with the routine outlined by Thomas Haskett in his excellent series of maintenance articles.<sup>1</sup>

However, it is not the purpose of this article to repeat previously outlined systems, but to offer suggestions as to "where to look" when routine has not solved the problem. And, let it be understood that as far as this discussion is concerned, merely squeezing by FCC specs is not considered satisfactory performance for modern equipment which

<sup>1</sup>Audio Studio Maintenance, Thomas R. Haskett, BROADCAST ENGINEERING, June, July, August, 1962.

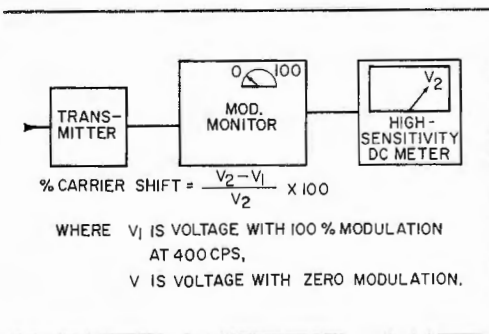

Fig. 2. Carrier shift measurement.

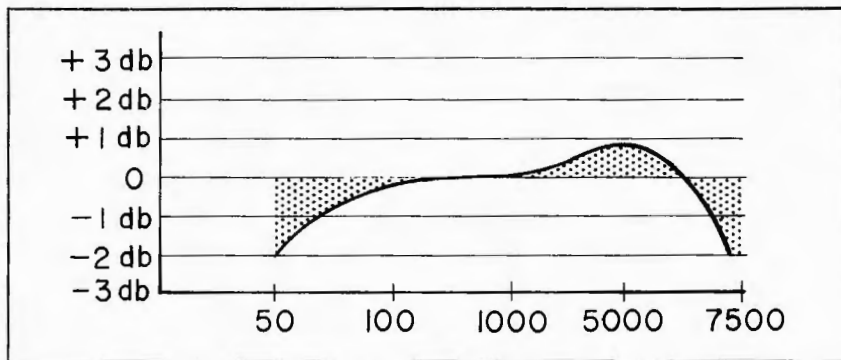

Fig. 3. Distortion and response relation.

should be capable of superior performance. For instance, if a manufacturer states that his console is flat within 2 db to 10 kc, and measurements indicate it barely squeezes by the 2-db legal limit at 5 kc, this will be considered unsatisfactory. The goal should always be maximum possible performance, not merely "legalizing" the gear.

It will be realized that due to the great diversity of equipment and circuits presently in use, it was impossible to relegate a separate discussion to each specific design, so to some degree the reader must apply the general treatment to his own particular needs.

Occasionally one will see in print a categorical statement such as "distortion and poor frequency response go hand in hand." This may be true as a relative generality, but it is confusing to the neophyte proofologist who has just discovered his rig squeezes by the FCC response requirements but doesn't make it from the viewpoint of distortion. Perhaps it should be emphasized here that excessive distortion does not necessarily result in great deviation in response, from the viewpoint of the regulations. I have occasionally measured systems which displayed a relatively flat response, but also exhibited excessive distortion throughout the entire spectrum. On the other hand, an amplifier which is relatively distortion-free in the mid-frequency ranges may exhibit a poor response. Again, a high noise level in the system will generally produce somewhat higher distortion readings, and the response may not be affected at all. (The distortion analyzer reading includes the noise of the system along with the actual distortion component.) Because of previous experiences with noise, I pre-

fer to make the system noise-measurement part of the Proof **first**, rather than after the response and distortion measurements, as is usually done. This way, if a high noise level is contributing appreciably to the distortion readings, you haven't wasted a lengthy set of measurements.

### Noise

In radio engineering, the word noise is a generic term which incorporates a multitude of sins. In addition to thermal and random noise created in the components of the system, the term includes hash added to the signal by rectification of rf signal in the system, as well as extraneous signals picked up from fluorescent lighting, etc. When used in general discussion, the word noise is also implied to include hum, unless specifically designated.

When making proof measurements, an oscilloscope should always be connected to the output terminals of the distortion analyzer; when the noise test is made, the scope screen will display the nature of the beast. The difficulty here is that the noise (and hum) level will be made up of several components, and it takes an experienced eye to discern their individual nature and relative contribution to the total noise level. In general, the total picture will be made up of actual component noise, 60 and 120-cycle hum, and pulses from detected rf and neon fluorescent wavefronts. Such pulses will perhaps be of sporadic wave form, but will be spaced at regular intervals across the noise picture. Hum components are evident by their continuous "waviness"; excessive component noise is indicated by closely packed non-periodic "pops" occurring throughout the trace. If this noise is the

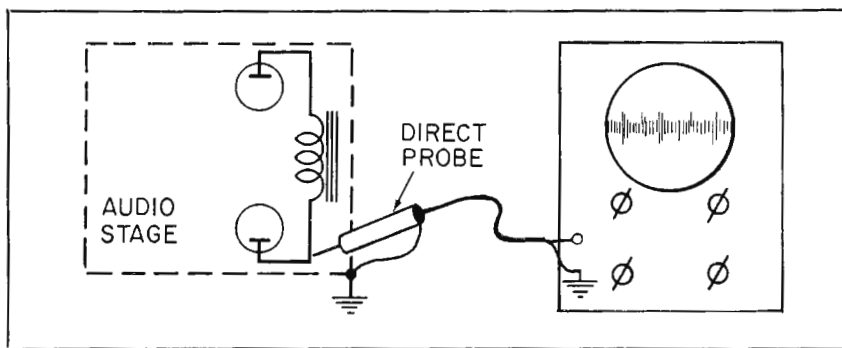

Fig. 4. Noise tracing with direct probe.

major contributor to the noise reading, it may not be possible to find the other components on the scope at all. The focus of this article will be toward troubleshooting for this component created noise.

Before making any mad lunges into a search for a noisy component an attempt should be made to verify that infiltrating hash is not the major problem. As a preliminary step, all possible fluorescent and neon lighting should be turned off—as well as any tape-recorders—the scope trace examined for any improvement, and an observation made of the distortion meter for a decrease in the reading. Then the oscillator should be fed to the transmitter input directly, and a noise measurement made separately (mercury vapor rectifier tubes can also cause considerable hash). If the noise level shows a considerable improvement when the transmitter is measured alone, i.e., in the vicinity of  $-60$  db or less, the transmitter may be regarded as satisfactory.

Next, determine whether the amplifiers preceding the transmitter are hashing the radiation. This may be checked by coupling the distortion analyzer to the output of the limiting amplifier and making the noise measurement at this point (the analyzer naturally being recalibrated for this level) and the oscillator again feeding the console input). The transmitter percentage of modulation should be reset to 100% at 400 cps, and the regular noise test conducted just as if the analyzer were still connected to the transmitter rectifier-unit output. If the original overall noise test indicated excessive noise, and the transmitter is clean, then the high noise should be evident at the limiter output. The transmitter should be cut off—if the meter reading

drops appreciably, the system prior to the transmitter is guilty of hash rather than excessive component noise, and should be investigated.

If the level remains excessive with the transmitter off, the next step is to determine: **whether external hum** is induced into the system, or if the high level is equally distributed among several amplifiers or localized to one unit. (At this point, the load resistor in the noise test is still connected across the console input, and the analyzer is still reading the noise level at the limiter output.)

First, determine if hum is getting in the console input wiring by shorting the input terminals of the channel in use at the terminal-board inside the cabinet (close the cabinet to prevent even further pickup of unwanted fields). Then check the noise meter for any significant decrease in reading. Repeat this at the input terminals of the limiter and observe the meter. If shorting the console input terminals produced a noticeable drop in the reading, the input wiring should be inspected. If shorting the limiter input terminals reduced the noise level appreciably, say, to about one-fourth (or less) of its previous reading, the trouble has been isolated to the console. If no significant change is observed with the limiter terminals shorted, the trouble obviously is in the limiter. The discussion which follows assumes that the major part of the noise has been isolated to one amplifier; however, the treatment may be expanded to include several amplifiers in the event of distributed excess noise.

Excessive noise is usually caused by defective tubes, generally in the low-level stages, and routine substitution will remedy this. But occasionally, other sources of noise develop. Plate and screen-grid re-

sistors can cause a high noise level, as may defective electrolytic bypass capacitors (or filter capacitors). Generally, when these items are at fault the noise is not of a smooth, consistent level, but shows some degree of popping or surging on the noise-meter; however, this is not always sharply defined, and such defects can cause a relatively smooth noise indication. Such noise can usually be isolated to a particular stage by the use of an oscilloscope and a shielded, "direct" probe. It is best to do this with no signal input to the amplifier—the input terminals shorted, preferably—and the scope vertical input attenuator adjusted to accommodate low input levels. By probing from the plates of the output tubes back down through the stages, plate by plate, the noise component can be isolated to a particular stage. When a point is found at which the noise either disappears or becomes very minimal, with a changed appearance on the scope, the noise is localized to the stage prior to this point in the testing sequence. (Due to the normal amplification of each stage, the amplitude of the noise trace will naturally decrease as the test proceeds. However, in the case of a **single** component creating excessive noise, the change should be obvious.) After determining the particular stage it may be necessary to pin down the faulty component by actual substitution, since the noise will generally appear on the scope to some degree no matter what point in the faulty stage is tested; and due to the amplification factor of the tube the noise will appear higher in the plate circuit than elsewhere.

Because of their high-voltage operating conditions, plate and screen resistors are probable as noise culprits; infrequently, grid resistors may become noisy also, and substitution should be made if all else fails.

A bypass capacitor can easily be checked for noise by unsoldering its lead to the tube and observing the plate waveform to see if the noise disappears (power removed from the unit during the soldering work, of course). Care in observation must be exercised here so as not to confuse degeneration of the stage-gain (due to loss of bypass action) with noise elimination. ▲



## We wouldn't risk our artists to any other tape... why should you?

It's a ticklish business recording the world's greatest artists! You never know which take will capture that one magic performance! RCA Victor engineers must be able to depend on every inch of master recording tape to deliver the absolute ultimate in quality performance. That's why RCA Victor Recording Engineers use Red Seal Magnetic Recording Tape. In fact, Red Seal Tape was specially developed for their use.

In one of the newest, most modern plants in the country, Red Seal Tape is manufactured to the highest quality specifications in the industry — and it's now

available for your recording requirements!

Quality control-tested for frequency response, distortion, drop-out noise, print-through, Red Seal Tape is also mechanically tested for coating thickness, anchorage, layer-to-layer adhesion, aging, cupping, slitting tolerances. Every inch has the same magnetic properties, the same recording-bias characteristic, so you can use tapes interchangeably!

Get all the details, fill in the coupon now.

**RCA VICTOR**   
THE MOST TRUSTED NAME IN SOUND

Magnetic Tape Products Marketing  
 RCA Victor Record Division  
 155 East 24th Street  
 New York 10, N. Y.

Please rush me specifics on RCA Red Seal Magnetic Tape including all essential physical and magnetic characteristics.

NAME .....

TITLE .....

COMPANY .....

ADDRESS .....

CITY..... ZONE... STATE.....

# A MICROPHONE FILTER

by *Elton B. Chick\** — A simple device for producing special microphone effects, with minimum distortion.

In broadcast news and program production, the need often arises to produce a filter effect for such things as simulating a telephone conversation or emphasizing news datelines. A number of gadgets have been employed for this purpose, many successfully, some not. For example, a carbon microphone can be used to produce the filter effect; however, some of these units have a surprisingly wide frequency range. The carbon microphone technique may be inconvenient, as it requires an instrument in addition to the regular microphone. Some methods use a bandpass filter which may cause a ringing or muffled sound. Still others cut off the high frequencies and result in a loss of intelligibility.

The unit described here overcomes many of these disadvantages. It is placed in the mixing circuit, after the microphone preamplifier, and can be inserted when needed by a push button. This arrangement permits the filter to be used

on the associated microphone circuit only, thereby allowing all other inputs to pass unfiltered. When the filter is not in use the microphone circuit is normal and may be operated normally. Another feature, and perhaps the most unique, is the property of the unit to attenuate only the lower frequencies, thus eliminating the bassy or muffled sounds that may be characteristic of other filter arrangements. This is advantageous since the lower speech and audio frequencies usually contain the major portion of the sound power, whereas the higher frequencies contain most of the intelligence. In this case the filtered sound is quite intelligible, using the filter.

## Operation

This device is built around the UTC HMI-500, a high pass filter for use in high impedance circuits, which has a cut-off frequency of 500 cps. Fig. 1 shows the circuit. In operation, the filter is placed in the output circuit of a microphone preamplifier by relay switching. When the relay is de-energized the preamplifier and microphone pro-

vide normal service. Resistor  $R_1$  provides the 10,000-ohm load required by the filter.  $R_2$  was selected to provide a loss in the normal circuit, of about 3 decibels more than the filter insertion loss. The latter is needed to avoid an apparent decrease in volume level while the filter is in operation; otherwise, it would be necessary to adjust the preamplifier gain each time the filter is used. The apparent level decrease is caused by loss of the lower frequencies. The curves in Fig. 2 show the response for normal and filter operation, and illustrate the purpose of resistor  $R_2$ .

Since the filter is operating in a relatively low level circuit, it is sensitive to interference from switching transients produced by relay operation<sup>1</sup>. To eliminate pops and clicks, the relay coil current is adjusted by  $R_3$  to the minimum required for satisfactory operation. In addition, a small silicon diode is connected across the relay coil

<sup>1</sup>The HMI-500 is very well shielded and is quite insensitive to hum pickup or transient fields. Noise pickup referred to here is that of the wiring.

\*Assistant Director of Engineering, Rounsaville Radio Stations.

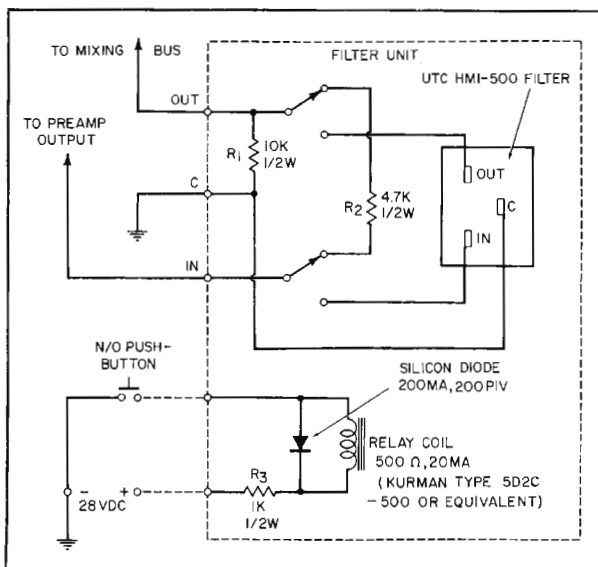

Fig. 1. Circuit diagram of the microphone filter.

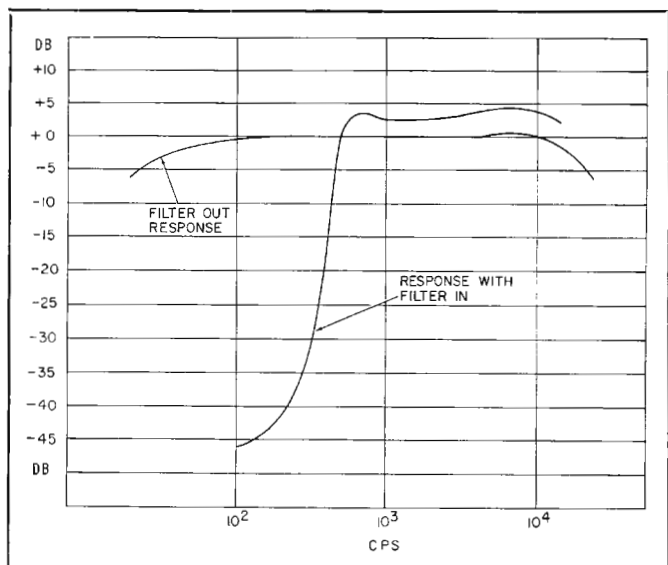
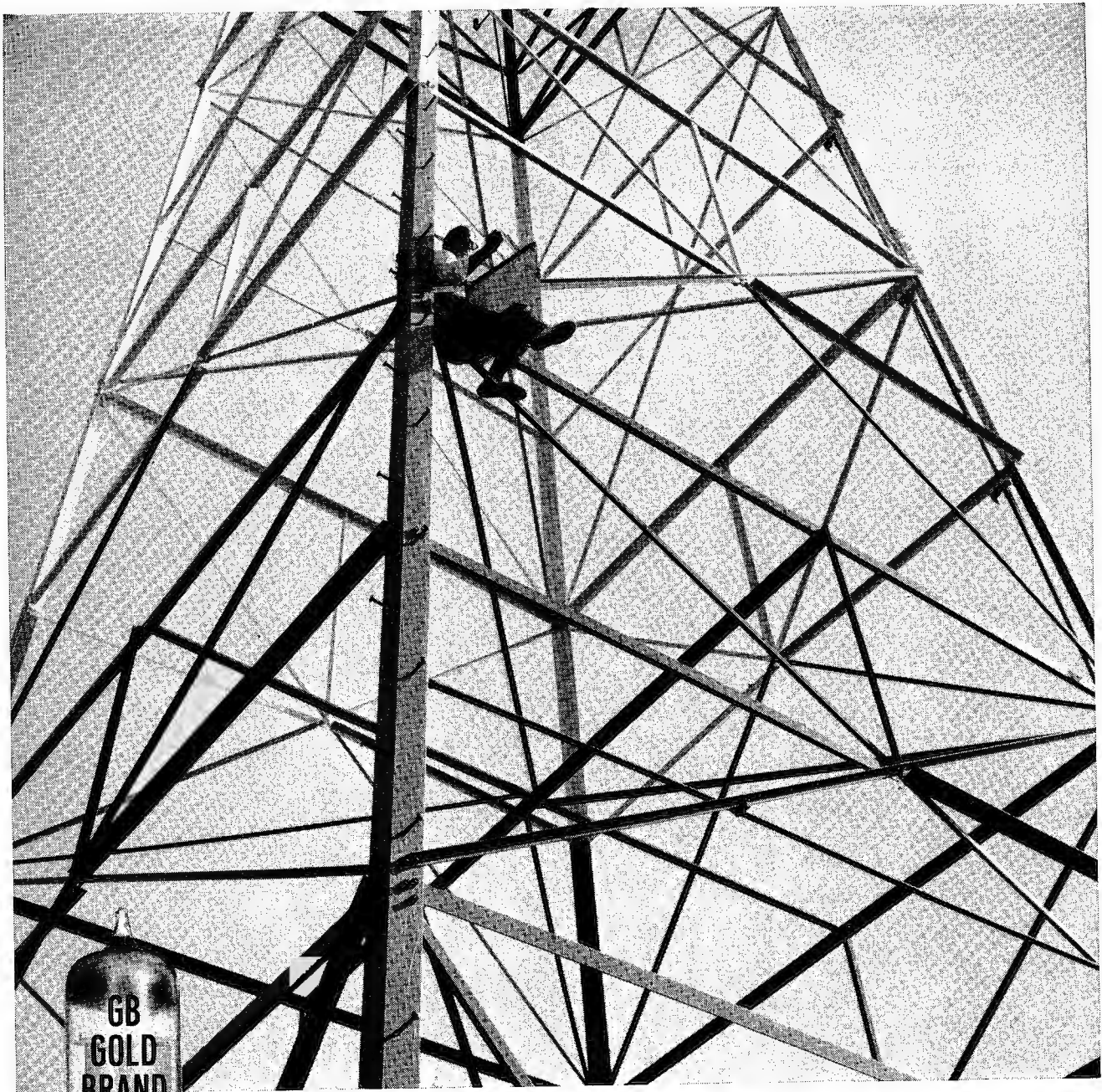

Fig. 2. Frequency response for filter and nonfilter operation.





## Tubes designed from the user's viewpoint

...use them wherever reliability is essential

When reliability really counts—as it does in broadcasting—be sure with tubes custom-designed and tested for the job.

Sylvania engineers traveled the country—met with engineers and maintenance groups in broadcasting, public service radio, industry, the airlines—listened to their problems and studied them. From this came GB Gold Brand, a superior line of new and upgraded tubes,

each tailor-made to a specific job. A given tube may have, for example, low noise, exceptional stability or vibration resistance. Or a critical parameter may be as much as three times the usual value. In each case, performance and reliability have been verified by actual user experience as well as laboratory testing.

This extra effort has paid off. "Excellent results," says an airline official. "No failures,"

reports a highway patrol department. "Hundreds of dollars saved in program interruptions," reports a TV station. "Less costly in the long run," discovered a county government. Similar results can be yours with a truly reliable, genuinely interchangeable GB Gold Brand Tube.

Electronic Tubes Division, Sylvania Electric Products Inc., 1100 Main St., Buffalo 9, N. Y.

AVAILABLE FROM YOUR SYLVANIA INDUSTRIAL TUBE DISTRIBUTOR

# SYLVANIA

SUBSIDIARY OF

**GENERAL TELEPHONE & ELECTRONICS**



Circle Item 9 on Tech Data Card

# New!

## from SPOTMASTER the 500A and 505A Cartridge Tape Systems



500A—complete recorder  
playback unit



505A—playback unit



**Now advanced design and modular construction assure split second operation, outstanding dependability**

With sleek new eye-appeal to match its ease of operation, the 500A series joins the SPOTMASTER family of equipment. On five continents, more stations use more SPOTMASTERS than any other cartridge tape systems.

- New Compact Design
- Quality Engineered
- Field Tested, Field Proven
- Modular Construction
- Easy Maintenance
- Most Complete Line
- Competitive Prices
- Lease or Purchase
- Iron-clad, Full Year Guarantee

For complete details and specifications, write or phone:



**BROADCAST ELECTRONICS, INC.**

8800 Brookville Road, Silver Spring, Maryland  
Area Code 301: JUniper 8-4983

Sold nationally by:

**VISUAL ELECTRONICS**

356 W. 40th St., New York, N.Y.

Canada:

**Northern Electric  
COMPANY LIMITED**

branches from coast-to-coast in Canada

as a suppressor. Further noise reduction can be accomplished by the use of a series resistor/capacitor combination across the push-button terminals.



Fig. 3. Filter mounted in console chassis.



Fig. 4. Underside of the circuit board.

### Construction

The unit described here was built to be mounted inside an RCA BC-3C audio console, in one of the spaces provided for accessory pre-amplifiers (Fig. 3). All components of the filter are assembled on a 3 x 5 x 3/32-inch paper base phenolic board. This board can easily be cut with a hacksaw and drilled. Holes for the filter and relay socket were punched with chassis punches. Fig. 4 shows the component layout and all wiring, which is kept on the under side of the board. To mount the unit, the holes provided in the preamplifier bar were tapped for 6-32 screws, and the board was mounted on 3/4-inch metal stand-offs. While this unit was assembled for the RCA console, variations of the mechanical arrangement will render the device suitable for other installations. ▲

Well behaved transmitters

# DON'T SHOUT

DON'T WHISPER!

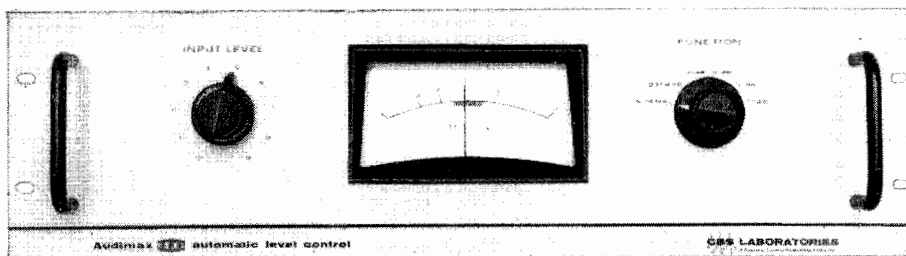

## Stay listenable with Audimax!

Undulating audio is not listenable! When it shouts—unpleasantness! When it whispers—strain! Every time your listener touches his volume control, you stand a chance of losing him! Audimax—the monitor with a memory—rides your output gain control with super-human speed. When levels are correct, gain remains constant—this

is the Audimax Gain Platform. Audio output remains on a natural listening keel at maximum modulation. There's no distortion, compression, thumping or pumping. No audio "holes." Audimax is not a Compressor, Limiter or AGC. Audimax is a control computer, complete with memory and judgement. You merely set the Gated Gain Stabi-

lizer to recognize noise and background effects, and electronics takes over. Proper levels are maintained; gain is held constant during pauses or returned to normal at standby—automatically. To get listener loyalty—and keep it—you need Audimax! It pays!

**CBS LABORATORIES**  
High Ridge Road, Stamford, Connecticut  
A Division of Columbia Broadcasting System, Inc.

Circle Item 11 on Tech Data Card

# GRID MODULATION, THEORY AND TECHNIQUES

*Technical Talks* — The first part  
of a discussion covering various  
methods of audio modulation.

For a change of pace, this month we are going to talk about audio and modulation. Modulation, in particular, is important to the broadcast engineer. Yet, many engineers do not fully understand the various types of modulation that are in use. Many of us are radio amateurs, and in that pursuit have a broader opportunity for experimentation than we have professionally. It is a comparatively simple thing for an amateur to tear out his modulation stage, and try a new idea. But even apart from the FCC's official frowning if the percentage is not correct, in broadcasting there is the possibility of lost revenue if the idea doesn't work! However, if the after-midnight hours can be used for testing out new ideas, there is still time to get the transmitter back into standard condition for the sign on.

My son Jimmy, age 13, has suddenly taken an interest in radio and is studying for his novice ticket. He asked me, "What does modulation mean?" And I found it necessary to think out an intelligent, accurate answer that still conveyed the right idea. Don't stop reading here—this is not going to be a beginners' article. I mentioned the incident to show how we do tend to take things for granted, and sometimes find ourselves at a loss when asked for a simple explanation. Of course, we all know what modulation is—a variation in frequency, amplitude, or phase of a constant-frequency carrier in direct relationship with the intelligence signal. This time, let's consider amplitude modulation, mainly, although we may digress a little as the subject develops.

## Amplitude Modulation

Amplitude modulation, as we are considering it here, involves the

changing in amplitude of a constant carrier by the application of an audio signal. Let us look, for a moment, at the application of a 1-kc tone to a 1-mc carrier. An upper sideband of  $1\text{ mc} + 1\text{ kc}$  and a lower sideband of  $1\text{ mc} - 1\text{ kc}$  will be produced. These upper and lower sidebands limit the bandwidth of transmission that a standard broadcast station operating in the U. S. radiates.

The standard allocation of radio stations in the U. S., which is also subject to the NARBA, is one every 10 kc from 540 kc through 1600 kc. Therefore, based solely on the allowable spread of upper and lower sidebands, 5 kc is theoretically the maximum allowable modulating frequency—but in too many cases this is not even approached! If we modulated with 7.5 kc the upper and lower sidebands would overlap, and in some service areas adjacent stations would receive sideband splatter. However, there is nothing to specifically limit the highest modulating frequency to 5 kc, provided there is no interference caused to other stations. Thus, if allocation conditions are such that sideband splatter will not occur with higher frequencies than 5 kc, they can be used—that is until a complaint is received.

Some idea of the power present in sidebands may be obtained from power relationships of carrier and sidebands. Fig. 1 shows a general representation of a modulated carrier (modulation a single tone). B is the base "zero" line and C the carrier amplitude without modulation. As shown, 80% modulation is being employed. This actually means that the negative peaks of modulation reduce the carrier to 20% of its normal value, and positive peaks increase it to 180% of normal.

When the signal is reduced to

zero on the negative peaks and 200% on the positive peaks, 100% modulation has been attained with the modulated peaks being twice the unmodulated carrier. If the modulation is increased the only result will be distortion, as the carrier is cut-off on negative peaks—of course, another result will be a pink ticket, if Big Brother is listening!

When the modulation is 100% the power in the sidebands will be half that of the unmodulated carrier; this is true whether the reference is in terms of voltage, current or field intensity. Therefore, each sideband contains 25% of the power of the unmodulated carrier. No matter what the depth of modulation is, the strength of the carrier will not be affected, and always remains constant. However, the power from the sidebands will vary, and produce a greater power requirement of the power supply. In the case discussed earlier the modulation consisted of a single tone, and thus resulted in the production of a carrier plus two sidebands; the total power radiated by this combination (with 100% modulation) is 1.5 times the carrier power. This is indicated by an increase in antenna current of 1.225 times, during 100% modulation (1.225 equals the square root of 1.5).

These modulation basics explain why the power supply of an AM transmitter is so important, and often is as costly as much of the rest of the transmitter—the availability of four times the nominal RF power for instantaneous peaks of 100% in the power supply, imposes some expensive design considerations on the engineers. Don't forget too that during periods of sustained 100% modulation the power supply has to provide 1.5 times the idling power.

• Please turn to page 30



## **Here's the First Broadcast Quality Transistorized\* Studio Camera Designed Specifically for Broadcasting**

We're confident you'll find the new Sarkes Tarzian 1500L Solid State Studio Camera System suitable for all but your most elaborate production requirements. Employing the newly released 1.5" image pickup tube, the 1500L camera delivers unmatched performance for 80-90% of your live programming. And it's thrifty, too. Operating cost is under twenty cents an hour—far less than that of an image orthicon camera system—and initial cost is 50% less. For more information, write or call:

\*All camera circuits are completely transistorized—without exception.



*Broadcast Equipment Division*  
**SARKES TARZIAN, INC.**  
East Hillside Drive, Bloomington, Ind.

Circle Item 12 on Tech Data Card

# BAFFLES

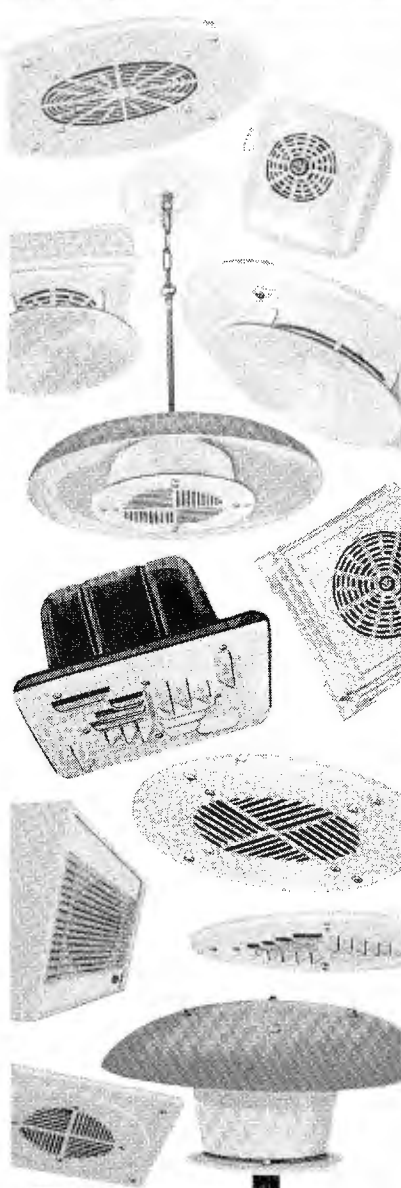

**FOURJAY  
INDUSTRIES**

2801 ONTARIO AVENUE  
DAYTON 14, OHIO

IN CANADA: Len Finkler, Ltd., Toronto.  
2 Tycos Drive • Toronto 19, Ontario

Circle Item 13 on Tech Data Card

## Grid Modulation

(Continued from page 28)

### Grid Modulation and Grounded Grids

The simplest form of modulation is grid modulation. In this system, a biasing voltage applied to the grid of the RF amplifier is varied in accordance with the modulation; the plate supply and excitation are kept constant. The method of operation is well known and there is no point in going into it here; however, some remarks on efficiency are appropriate. Efficiency is low! That is, in the final amplifier as far as conversion of DC to RF is concerned; but in the amount of audio drive required for 100% modulation, the grid technique scores well. For example, a 1-kw transmitter using grid modulation can be driven with only about 10 watts of audio.

Unfortunately, grid modulation has a few problems which can cause trouble, although many of the smaller broadcast transmitters do use it very successfully. Much of the success of modern grid modulation is due to the development of better tubes.

Probably the greatest problem faced by the designer in a grid modulated stage is grid current, and consequent carrier shift. The production of grid current is an inherent part of grid modulation and has to be accepted and corrected as well as can be. Whenever the grid is positive with respect to the cathode, grid current flows and power is taken. As the grid takes power the grid impedance decreases to a very low value, 1000 ohms or less, at the point of maximum current. This decrease in impedance results in an increased load being placed on the exciter. Because the exciter cannot usually produce the required extra power, there is a reduction in drive at the incidents of grid current; this results in less than the required four times power on positive modulation peaks, with a consequent flattening of the envelope. Unbalanced modulation is produced, with negative peaks going to zero currently, but positive peaks being limited to something less than 200% of the unmodulated carrier. This, in turn, reduces field intensity, produces audio distortion, and the resulting condition is known as

negative carrier shift.

Like many problems in our profession, a cure can be made by providing a swamping resistor between the grid and cathode of the amplifier. This resistor, in shunt with the exciter, acts to maintain a constant impedance across the input circuit so that the varying input impedance of the tube is masked by the lower impedance of the swamping resistor.

The grid modulated stage has other problems, among them the question of bias stability. This is quite similar to the grid current problem discussed above, and actually arises in connection with it. Again, modern design methods have practically eliminated this difficulty, but it is a basic part of grid modulation. At the moment of grid current the flow is into the grid, but the bias supply sees this as a flow in the reverse direction. In a bias supply with an effective internal impedance that is independent of current flow, such as a generator or battery, this reversal does not matter; but in the case of unidirectional devices (rectifiers), the flow of grid current is blocked by the immediate response of the bias supply in supplying more grid bias to prevent excursion into the grid current region. This again tends to flatten the RF envelope and produces audio distortion and carrier shift.

Again a swamping resistor can be used, it is connected across the bias supply so that at normal bias voltage it will draw the same current as the average grid current with 100% modulation.

The bias supply swamping current and the tube grid current both pass through this resistor in the same direction. While the rectifier is supplying current the drop across the resistor is constant, but as soon as the grid draws more current (through the resistor), less current will be taken from the bias supply, and there will not be the limitation of grid current envelope-flattening.

The grid modulated stage is very interesting but its full range has not been explored here. We shall continue this topic next time. ▲

**Editor's Note:** John H. Battison, author of *Technical Talks*, will help readers solve their technical problems. Address your questions to: *Technical Talks*, Broadcast Engineering, 4300 W. 62nd St., Indianapolis 6, Ind.

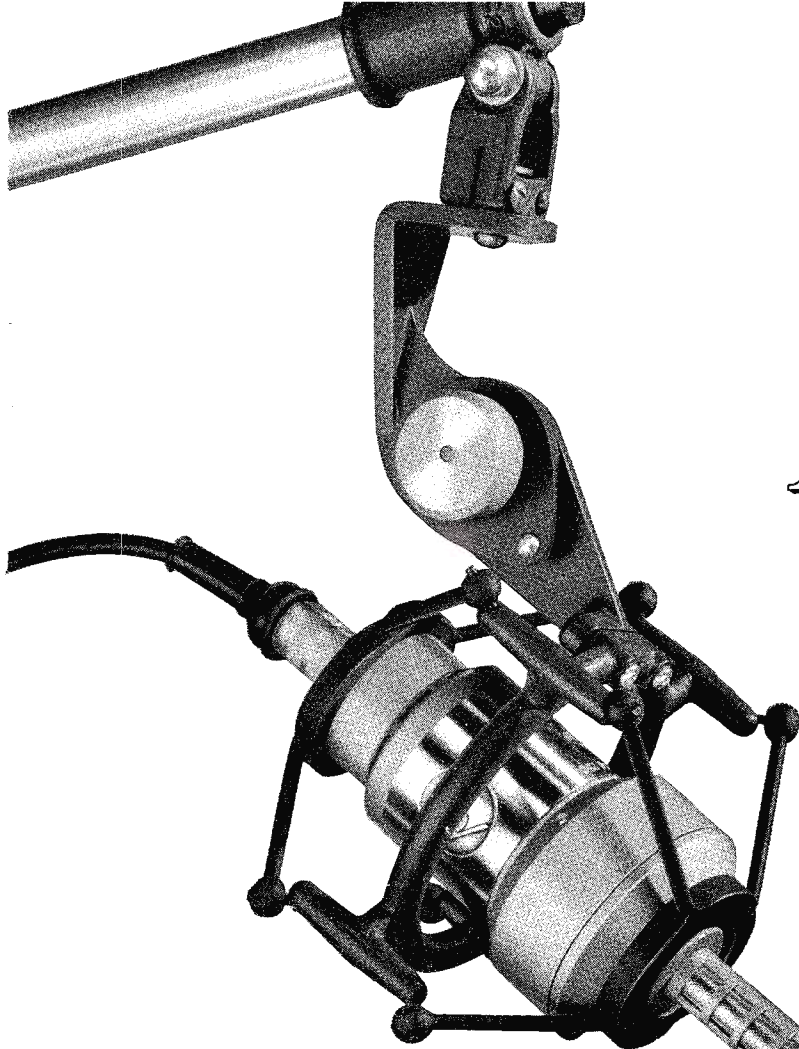

The Electro-Voice Model 642  
Cardiline Microphone Earns

**THE FIRST**  
**ACADEMY**  
**AWARD**  
**FOR**  
**MICROPHONE**  
**DESIGN**  
**IN 22 YEARS!**

Today's movies, radio, TV and recordings sound better, thanks to a microphone design that has revolutionized sound pickup techniques. It is the Electro-Voice Model 642 Cardiline® ultra-directional microphone.

The E-V 642 has contributed so much to motion picture sound that on April 8, 1963 it was presented the coveted Academy Award certificate by the Academy of Motion Picture Arts and Sciences—the first such award to a microphone in 22 years!

Film sound engineers found the unique 642 Cardiline design sharply reduced effects of noise and distance. They obtained clear, crisp sound under circumstances previously thought impossible.

The 642 is another major achievement by Electro-Voice in the art and science of electro-acoustics. This engineering leadership extends equally to professional and commercial sound, home high-fidelity recording and reproduction—even to phonograph needles and cartridges.

No matter what your interest in sound, look to Electro-Voice for the consistently superior engineering that means award-winning performance for you.

Model 642  
 \$390.00 list

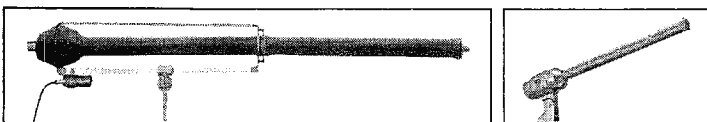

The E-V Cardiline\* principle is also found in the famed 7-foot long E-V Model 643 (\$1,560.00) and the popular Model 644 for critical commercial sound installations (\$110.00.) All prices list, less normal trade discounts.

\*T.M. Reg., Patents Applied For

Circle Item 14 on Tech Data Card



ELECTRO-VOICE, INC., Dept. 631V, Buchanan, Michigan

Enter my subscription to "Microphone Facts", the FREE E-V newsletter on professional microphone applications.

Name \_\_\_\_\_

Company \_\_\_\_\_

Address \_\_\_\_\_

City \_\_\_\_\_ State \_\_\_\_\_





It's a fact...  
G. E.'s 7629 and 8092  
image orthicons are  
highly sensitive,  
long-lived tubes...  
up to 9000 hours and more...



signal-to-noise ratios,  
however, were a bit low...

(36:1 and 34:1 average)

Now, in the "A"  
versions, we've quieted  
them down...

(to 48:1 and 37:1)

**HOW?** . . . with design improvements utilizing semiconductor target material. G. E.'s new I.O.'s are designated the GL-7629A and GL-8092A . . . why don't you try one in your camera? In fact, try the whole line of newly improved G-E image orthicons: G-E Type GL-5820A, S:N—48:1 GL-7293, S:N—45:1/GL-7629A, S:N—48:1/GL-8092A, S:N—37:1/GL-8093, S:N—55:1. **For your free facts folder**, containing data and application notes on the expanding line of G-E image orthicons and vidicons, write to General Electric Company, Room 8005, Owensboro, Kentucky, or call your nearest G-E Industrial Tube Distributor, today!

*Progress Is Our Most Important Product*

**GENERAL  ELECTRIC**

Circle Item 15 on Tech Data Card

# NEWS OF THE INDUSTRY

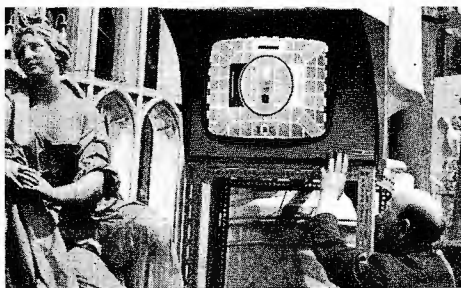

## Old and New

A modern TV viewing screen and loud-speaker take their places in Westminster Abbey beside statues predating the American revolution. The system, one of 30 installed by affiliate companies of **International Telephone and Telegraph Corp.** for the recent wedding of Princess Alexandra of Kent, enabled all 2,000 guests to see and hear the ceremony. Microphones were installed by **Standard Telephones and Cables Ltd.**, an ITT associate. Television receivers were installed by **Kolster-Brandes Ltd.**, an STC subsidiary.

## Recording On Mt. Everest

Tape recording, expected to play an important part in future space travel, achieved a new altitude record during the successful assault on Mt. Everest by the U. S. expedition led by Norman G. Dyhrenfurth of Santa Monica, Calif. Dr. Richard M. Emerson, Associate Professor of Sociology at the University of Cincinnati, actually carried a tape recorder in his back pack operated by a remote control hand switch. His minute by minute observations on group effectiveness under prolonged stress are expected to comprise a significant part of the expedition's scientific data. Dr. Emerson used 5" reels of new Agfa Triple-Play Tape; each reel contained 1,800 ft. yielding six hours of recording time at dictation speed, thus overcoming the problem of reel changing. Other members of the group also used tape for recording data for research studies in physiology, psychology, meteorology, radiation physics and glaciology. All of the tape used was made available to the expedition as part of a continuing program of support for manned space exploration by **Agfa Incorporated**, Rockleigh, N. J.

## Largest Console Order

A contract for "probably the largest single order for sound control equipment ever placed by a U. S. company" has been awarded to **Gates Radio Co.**, a subsidiary of **Harris-Intertype Corp.**, by **CBS Television Network Div.** The contract calls for design, construction, and delivery of over half a million dollars' worth of transistorized audio consoles and amplifiers for television facilities in the new CBS Broadcast Center under

construction on Manhattan's West Side. Seven studio consoles of advanced design, more than 1,000 transistor amplifiers, and supplementary components will be manufactured by Gates at its Quincy (Ill.) plant for delivery during 1963. Although designed to CBS specifications, the equipment will be available to other broadcasting stations as standard items in the Gates line.

## Engineering Societies Plan Merger

Three national engineering societies are proceeding with merger plans following preliminary approval by their governing bodies during the past month. The groups are the **Society of Motion Pictures and Television Engineers (SMPTE)**, the **Society of Photographic Scientists and Engineers (SPSE)**, and the **Society of Photographic Instrumentation Engineers (SPIE)**. Representatives of the three societies met recently to start work on a constitution for the proposed consolidated society and to make preliminary merger plans. If the constitution and plans are approved by the boards, they will be submitted to a referendum of the individual members.

## Tape Cabinet Offered

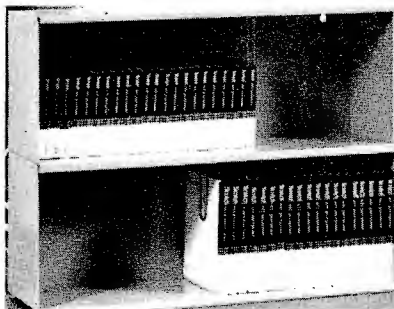

A small sound-tape storage unit has been made available to the users of "Scotch" brand magnetic tapes by the **3M Company**. The "storet" cabinet, the company says, is ideal for schools, churches, radio and TV stations, advertising agencies and businesses which store small quantities of tape. Each will hold a maximum of 36 rolls of 5 or 7-inch tapes, or 10 6½-inch video spot announcement reels. The cabinets stack or interlock so that space may be easily increased for storing larger quantities of tape. They are self-standing, with protective feet to prevent sliding or marking. The back is key slotted so the unit may be hung on a wall. Each has a gliding, positive-locking separator in the top to hold either a 5-inch or 7-inch tape box upright. The units, neutral medium gray in color, are 9¾ inches high, 25 inches wide, and 8 inches deep. They will be available for \$6.95 to the purchasers of 36 rolls of either 5-inch or 7-inch reels of "Scotch" brand professional recording tapes.

## WNAC-TV To Set Up Standby Transmitter Unit

WNAC-TV, Boston, will become the first U. S. television station to make use of a new transmitting procedure in which two 25-kw transmitters are operated in tandem to assure constant standby service, the **Radio Corporation of America** announced today. The "working standby" arrangement was developed by Harry B. Whittemore, director of corporate engineering for **RKO General Inc.**, owners of the station, in conjunction with engineers of the RCA Broadcast and Communications Products Div. It will make use of RCA's Type TT-50DH transmitter comprising two complete 25-kw units, each of which will contribute half power to the normal broadcast signal. The unit was designed for color transmission and has linearity correction circuit built into the modulator.

## Vidicon Camera Chain

Among the varied products which were on display at the **Continental Electronics Products Co.** NAB show booth was their 20A-1 vidicon camera chain. For educational, industrial, and broadcasting applications, the system meets all EIA and broadcasting standards. Resolution is 600 TV lines minimum at center with video response within 1 db to 8 mc. The sweep linearity is  $\pm 2\%$ . The basic units of the 20A-1 are the camera, CCU, and power supply. Some specs are: video output, noncomposite 1.0 volt p-p, or 1.4 volt p-p with EIA sync across 75 ohms; pulse inputs, EIA vertical and horiz. drive, 4.0 volt p-p; EIA blanking, 4.0 volts p-p; EIA sync 4.0 volts p-p. The power supply provides regulated 280, 150, and -2400 volts. The camera accepts 16 mm C-mount lenses in a 4-lens turret. Light requirements are 5 foot-lamberts min., 100-150 foot candles incident for noise-free pictures with 7735 vidicon and f1.5 lens. The camera chain requires 117 volts, 50-60 cps at 300 watts. Also shown at the Continental exhibit was a new 5/10 kw AM broadcast transmitter employing screen modulation and featuring centralized controls and overall feedback. The 315C/316C uses as final amplifier, the 4CX10,000D ceramic power tube. Rounding out the display were the new 1100 series tape transports and automated programming logging system for AM/FM broadcasting. The system operates with a 25 cps tone burst that follows each musical selection.

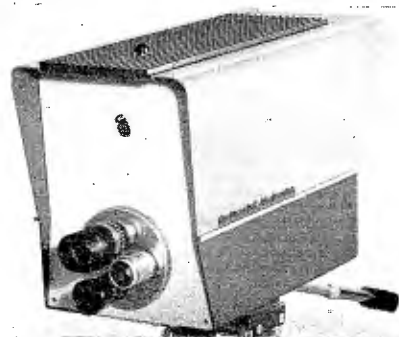

BROADCAST ENGINEERING

# Presenting...BETTER PRODUCTS FOR BETTER BROADCASTING!

SPARTA



**300 RECORD** Just 3½ inches high the all-transistor record unit compliments the new compact, modern and functional design of the 300P. Both units allow table-top, custom, or, (illustrated) rack mounting.....**\$230.00**

**300 PLAYBACK** The absolute ultimate and most advanced design in a tape cartridge playback. All transistorized, plug-in modular construction. Continuous duty rated with proven reliability.....**\$495.00**



**200 RECORD/PLAYBACK** Economy with outstanding rugged reliability. Now every broadcaster can afford the up-to-date, modern benefits of cartridge equipment. Transistorized control circuitry for improved tone-burst cueing. Compare with others priced 20% to 40% higher.....**\$545.00**

### 200 STEREO RECORD/PLAYBACK

Record and playback in stereo with full fidelity broadcast quality and positive performance. Enjoy the benefits of cartridge tape, producing all announcements, themes and production sound aids in wondrous stereo.....**\$750.00**  
(Playback only .....**\$510.00**)



**200 PLAYBACK** The work horse of the industry! Offering simplicity with proven reliability. Compatible with all other cartridge equipment. Add another playback to your present system at only.....**\$385.00**

### CP-5 PORTABLE PLAYBACK

An invaluable new sales and production aid for all cartridge equipped stations. Light weight with convenient carrying handle to audition spot/presentations anywhere in the station or clients office.....**\$149.50**



## OUR PRODUCTS ARE OUR BEST SALESMEN!



(Bench/Lid Optional)

**SPARTA A-50 PORTABLE STUDIO** Production studio, Remote Facility, Main Studio. A triple-threat, rugged and solidly built unit designed for many years of continuous duty. Legs unscrew and clip inside the bench which then becomes the lid for transporting. Complete with turntables, equalizers, pre-amps and A-10 Audio Console.....**\$845.00**

**SPARTA A-10 AUDIO CONSOLE** Provides a total of eight inputs selected through four mixing channels with completely transistorized circuitry and plug-in modular construction throughout.....**\$349.50**  
(Carrying case with monitor speaker.....**\$49.50**)



Call, Write or Wire Today

**SPARTA ELECTRONIC CORPORATION**

6450 FREEPORT BOULEVARD • SACRAMENTO 22, CALIFORNIA • GA 1-2070

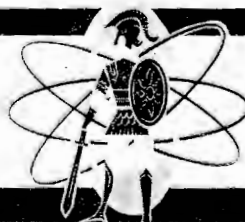



FROM **M**agnecord BY  
**PROFESSIONAL**  
**DEMAND** THE **728** PROFESSIONAL  
 SERIES

The professional audio engineer demands technical recording perfection with brilliant reproduction. Such tape recorder requirements — though simply stated — are rarely met. Magnecord, the choice of professionals for many years, exceeds the most exacting demands with the 728 Series (7½ and 15 ips) or with the 748 Series (3¾ and 7½ ips).

*Check these features:*

**Stereo Record / Stereo Playback • 4 Separate Heads —**  
**Plays 2 and 4 track tapes (¼ track optional). Handles**  
**10½", 7" and 5" reels. 2 Illuminated VU Meters • Matches**  
**Other Studio Equipment • Weight, 50 lbs. approximate.**

If you are a professional audio engineer in Television, Radio, Sound Studio, or Motion Pictures — your own demands for perfection will best be met by Magnecord.

*from \$900*

**WRITE TODAY FOR MORE INFORMATION**



**magnecord**  
SALES DEPARTMENT



**MIDWESTERN INSTRUMENTS**  
P. O. BOX 7509 • TULSA 35, OKLAHOMA

Circle Item 17 on Tech Data Card

### "Heaterless" Vacuum Tube

A radically new-type vacuum tube which has no heater to "light up"—and which could operate at room temperature—is under study at the **General Electric Receiving Tube Dept.** Involving what is called a "tunnel cathode," such a tube also would be likely to have higher tolerance to ionizing radiation than would thin film or other microminiature active devices based on semiconducting materials. Under a proposal entitled "Research and Development on a Tunnel Cathode for Long Life in an Earth Satellite," the work is being supported in part by the National Aeronautics and Space Administration by a contract granted to the company through the Harry Diamond Laboratories of the Department of Defense, Washington, D. C.

### CONTRACTS and REPS

#### USIA Awards Transmitter Contract

The **United States Information Agency** has awarded a contract to **ITA Electronics Corp.** for a 50-kw AM broadcast transmitter. According to Mr. Joseph Novik, director of ITA's Government and Industrial Div., the unit incorporates many new, advanced features that make it appealing to broadcasters. Extremely compact, the unit needs only 76 square feet of space including transformers. Featuring a new single tetrode power amplifier, that gives full output with minimum power consumption, the unit requires a total of only 11 tubes comprising 6 tube types, for easy maintenance.

#### Color TV Projector Delivered

**TNT Theatre Network Television, Inc.,** announced recently that it had delivered during May 1963 the first large-screen simultaneous color television projector in history—the **Eidophor**—for installation at the Rome Air Development Center, Air Force Systems Command at Rome, New York (RADC). The color projector, the first on National Television Standards Committee standards, was sold by TNT to **Hazeltine Electronics Div.** for delivery to RADC. Operating on high resolution standards for critical presentation of military visual displays in full color, the **Eidophor** represents an important advance in large-screen color television projection techniques.

#### Barnes to Rep Du Mont Instruments

The appointment of the **Arnold Barnes Co.** to represent **Fairchild's Du Mont Laboratories** as sales engineers for oscilloscopes, oscilloscope cameras, pulse generators and other instrument products on the Southwestern stages has been announced by Fred Katzmann, manager of the Scientific Instrument Department, Du Mont Laboratories, Divisions of Fairchild Camera and Instrument Cor-

# KEEP STATION PERFORMANCE UP MAINTENANCE COSTS DOWN...



Model 3508A1 Video Transmission Test Set pictured with optional Model 3507A1 EIA Sync Generator

## with Telechrome\* Transistorized Video Broadcast and Test Equipment

\*Brand name



Multiburst Signal-Line Rate-Internal Sync



10-Step Signal-Line Rate-Internal Sync



Sin<sup>2</sup> & Window Signal-Line Rate-Internal Sync

**NOW** — condensed into one small light-weight portable unit — fully transistorized

- Multiburst ■ Stairstep
- Sine Squared Pulse & Window
- Optional EIA Sync Generator

### FEATURES:

- Rack mount or portable
- Carrying case contains 1 1/4" utility drawer which can be removed for installation of an EIA Sync Generator (Model 3507A1). Case pre-wired for sync generator.
- All operating controls conveniently located on front panel.

- Operates from self contained non-interlaced sync, plug-in EIA Sync Generator, or external EIA Sync and Blanking.

- VIT Operation — when used with external VIT Keyer, provides vertical interval test signals through a high impedance (line bridging) output.

- Low distortion multiburst — plug-in oscillators permit selection of frequencies to 4.2 MC. 10 MC optional.

- Preset 3, 5 and 10-step stairsteps with variable APL and 3.58 MC sub-carrier on all modes.

- T and 2T (.125  $\mu$ sec and .250  $\mu$ sec) Sine squared pulses. Window signal also sine-square filtered.

# TELEMET

C O M P A N Y



A Giannini  
Scientific Co.

AMITYVILLE, NEW YORK: 185 DIXON AVENUE, (516) 541-3600 • SANTA ANA, CALIF.: 2509 SOUTH BROADWAY, (714) 546-2881

Circle Item 18 on Tech Data Card

## Are Your Station Turntables Ready for Stereo Broadcasting?



THE ANSWER IS YES if you're using the new Fairchild 750 16" belt-driven playback turntable. The only turntable designed for stereo broadcasting! Write today for complete technical specifications on this remarkable new turntable. Price: \$485.00

# FAIRCHILD

RECORDING EQUIPMENT CORPORATION  
10-40 45th Ave., Long Island City 1, N. Y.  
Circle Item 19 on Tech Data Card

## SPOTMASTER Tape Cartridge Winder



The new Model TP-1A is a rugged, dependable and field tested unit. It is easy to operate and fills a need in every station using cartridge equipment. Will handle all reel sizes. High speed winding at 22½" per second. Worn tape in old cartridges is easy to replace. New or old cartridges may be wound to any length. Tape Timer with minute and second calibration optional and extra. Installed on winder or available as accessory. TP-1A is \$94.50, with Tape Timer \$119.50.

Write or wire for complete details.

*Spotmaster*

**BROADCAST ELECTRONICS, INC.**  
8800 Brookville Road  
Silver Spring, Maryland

Circle Item 20 on Tech Data Card

poration. Barnes will represent Du Mont in Texas, Oklahoma, Arkansas, and Louisiana.

### Cannon Selects Distributor

Arrangements have been completed between **Robins Industries Corp.** (O-T-C), Flushing, N. Y., and **Cannon Plugs (Australia) Pty., Ltd.**, an affiliate of **Cannon Electric Co.**, Los Angeles, Calif., appointing Robins exclusive U. S. distributor of the Cannon XL series of audio connectors. Under the arrangement, Robins will maintain complete stocks of XL connectors consisting of 24 types for use with microphones, tape recorders, amplifiers, test instrumentation, computers, medical instruments, cameras, control devices, hi-fi, and many other equipments.

### Engineering Rep Named

**Tung-Sol Electric, Inc.**, announced the appointment of **Hitchens-DeCew Associates** as engineering representatives for their Chatham regulated power supply units. Located in Haddonfield, N. J., and Rosemont, Pa., the firm will handle sales of the power supplies in southern New Jersey, eastern Pennsylvania, Maryland and Delaware.

### EMT Appoints Rep

**EMT Wilhelm Franz GmbH** of Wettlingen, Switzerland, and its West German parent company located in Lahr in the Black Forest region, have appointed **Gotham Audio Corp.** their exclusive sales and service representatives for the United States and territories. EMT is already known in this country for its reverberation unit of which several hundred are in use in major recording and broadcasting installations from coast to coast. Additional equipment includes studio turntables, a professional tape recorder, and numerous pieces of test equipment and components specifically aimed at the recording and broadcasting industry.

### Names Contractor

**RETMA Electronics, Inc.**, has been named the exclusive **Jerrold** engineering contractor in the New York Metropolitan area for the Distributor Sales Div., Walter Goodman, division manager, announced recently. Mr. Goodman said, "The RETMA appointment is the latest addition to our national network of Jerrold engineering contractors designed to better serve local customers. A Jerrold contractor is now as near as the telephone, offering a complete design, installation, and maintenance program for master antenna and closed circuit television systems . . ."

## PERSONALITIES

**Dr. Keith E. McKee** was recently appointed director of mechanical design of **Andrew Corp.**, Chicago, Ill. In his new position, Dr. McKee will be responsible for the overall technical effort in the mechanical design and quality control of the company's product line of antennas and transmission lines.

**Robert Rausch**, formerly of Radio Station WREO in Ashtabula, Ohio, has been appointed the broadcast sales engineering representative for **General Electronic Laboratories, Inc.**, on the West Coast. His appointment will expand GEL's representation into the States of California, Oregon, Washington and Nevada.

**Donald C. Creswell** has been named direct manager of **Ampex Corp.** at Dayton, Ohio, succeeding **Thomas W. Harleman**, who becomes midwestern regional manager, it has been announced by **Thomas E. Davis**, national manager. Creswell is responsible for sales and service of Ampex instrumentation, computer and video products in the district, which includes Michigan, Kentucky and Ohio.

Appointment of **Karl E. Clough** as director of engineering for the **RADCOM-Westrex** div. of **Litton Industries** was announced by general manager **Joseph T. Colliflower**. The division develops and manufactures radio communication equipment and facsimile transmitters and recorders.

**Richard P. Gifford** has been appointed general manager of the **G-E Communication Products Dept.**, with full responsibility for all product lines. Gifford previously was manager of engineering for the department. Having joined General Electric's Transmitter Department after World War II, he was a member of the team of engineers which established the first microwave relay from New York to Schenectady for television transmission purposes. He served as a member of the Ad Hoc Committee on FCC Docket 11997, covering spectrum utilization from 25 mc. to 890 mc.

**Joel P. Smith** has been named manager, **Community Operations Div. Jerrold Electronics Corp.**, **Robert H. Beisswenger**, vice president and general manager, announced. Commenting on the appointment, Mr. Beisswenger said, "The Community Operations Division is concerned with the management of, or investment in, a number of CATV systems in which Jerrold has proprietary interests . . ."

The new **3M Company** magnetic products plant at Camarillo, Calif., will be managed by **James L. Bergstrom**, production superintendent at the company's Hutchison, Minn., magnetic products installation. Bergstrom's appointment was announced by **M. C. Hegdal**, manufacturing manager for the 3M magnetic products division.

**William E. Waldrup**, who has 15 years of experience in government and industrial electronic sales engineering and management, has been named eastern district manager of the **Continental Electronics Companies**, subsidiaries of **Ling-Temco-Vought, Inc.** He will be stationed at LTV's Washington office.

**Harold Mason** has been elected vice president, manufacturing and engineering, of **Alpha Wire Corp.**, it was announced by **Howard B. Saltzman**, president. In his new position, Mr. Mason will have complete responsibility for all manufacturing and engineering operations in all Alpha plants.

**BROADCAST ENGINEERING**



# SARKES TARZIAN Tube Replacement Silicon Rectifiers

# BIG

## in broadcasting...

More and more broadcasting stations of all kinds are proving that the reliability and long, *long* life\* of these units pay off in station on-time. Send for free replacement chart covering 95% of the vacuum tube rectifiers now in common use, price information, and case history data.

\* *Not to mention instant warm-up, no appreciable heat radiation, no filament supply, compact size, ruggedness, and dc current ratings up to three times as high as the tubes they replace.*



**SARKES TARZIAN, Inc.**

World's Leading Manufacturers of TV and FM Tuners • Closed Circuit TV Systems • Broadcast Equipment • Air Trimmers • FM Radios • Magnetic Recording Tape • Semiconductor Devices

**SEMICONDUCTOR DIVISION • BLOOMINGTON, INDIANA**

Canadian Licensee: Marsland Engineering Limited • 350 Weber Street North, Waterloo, Ontario

Circle Item 21 on Tech Data Card

# SAMS TECHNICAL BOOKS

of special interest to Broadcast Engineers

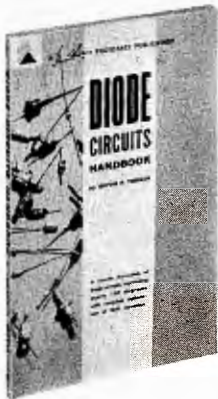

## THE COMPLETE GUIDE TO DIODE CIRCUIT DESIGN

### Diode Circuit Handbook

by Rufus P. Turner

This book is written to fill the need for a practical volume on diode functions and applications. The circuits included represent a general sampling of the uses for conventional diodes, either alone or in conjunction with transistors, varactors, and tunnel diodes. Containing 100 tested-and-proven small-signal diode circuits, the book will be of great value to engineers, technicians, and hams who design and construct electronic devices. Of special interest to broadcast engineers are the coil winding data for grid-dip and field-strength meters, as well as an adaptor for using a signal generator as a grid-dip oscillator; plus specific details on such circuits as: SWR bridges, DC power supplies, balanced modulators, regulators, varactor AFC, antenna impedance bridge, noise limiters, squelch, and time-marker generator. Because of the numerous applications covered, communications, instrumentation, and circuit design engineers and technicians will find the contents useful. Included are diagrams and operating descriptions for 23 receivers, 9 transmitters, 6 audio circuits, 15 power supplies, 6 relay and control circuits, 28 instruments, 9 computer circuits, and 4 miscellaneous circuits.

Order DIT-1, only .....\$2.50

### SPEEDS ELECTRONIC CALCULATIONS

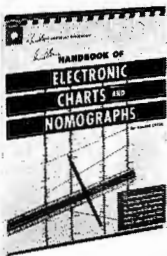

#### Handbook of Electronic Charts and Nomographs

by Allan Lytel

This unique timesaver contains 58 electronic charts and nomographs which will help broadcast engineers and technicians to rapidly derive answers to hundreds of formulas, with slide-rule accuracy. All charts and nomographs are positioned one on a page, and on one side only. The backup side of each preceding page tells, by examples, how to use each nomograph. A clear vinyl overlay sheet is hinged from the bottom of the back cover so it can be positioned over any nomograph, permitting the user to rule erasable pencil lines to connect the appropriate points on the graph scales. Comb-bound at the top, the book lies flat when open; its scales are large for maximum accuracy.

Order NOM-1, only .....\$4.95

### ENLARGED REFERENCE BOOK



#### Handbook of Electronic Tables and Formulas

Here's an invaluable reference tool for broadcast engineers, technicians, and others in electronics. Completely revised, and expanded, **Handbook of Electronic Tables and Formulas**

is a source for charts, tables, formulas, laws, symbols, and standards used in electronics. A unique feature is the 6-page, full-color foldout chart showing FCC frequency allocations. Now includes 7 major sections: Part One contains basic formulas and laws. Part Two has constants and standards. Part Three contains symbols, codes, and semiconductor information. Service items are found in Part Four. Circuit design data are included in Part Five. Six has mathematical formulae and tables.

Order HFT-2, only .....\$3.95

## Audio Level Devices

(Continued from page 13)

introduced by control-stage bias shifts can't be passed on. Hence, thump is very low—45 db below signal. The sidebands go to synchronous detector V5, which also receives the 10-mc carrier from the RF section; sidebands and carrier are recombined and the audio detected. Finally, the signal goes to the output amplifier.

Two recovery circuits are used. The first is the conventional dual

Collins Radio Co.  
Cedar Rapids, Iowa

Fairchild Recording Equip. Corp.  
10-40 45th Ave.  
Long Island City, N. Y.

Gates Radio Co.  
Quincy, Ill.

General Electric Co.  
Defense Electronics Div.  
Technical Products Operation  
Syracuse, N. Y.

ITA Electronics Corp.  
Broadcast Div.  
130 East Baltimore Ave.  
Lansdowne, Penn.

Radio Corporation of America  
Broadcast and Communications  
Products Div.  
Camden 2, N. J.

Universal Audio, Inc.  
6000 Sunset Blvd.  
Hollywood 28, Calif.

Table 2. Manufacturers' Addresses

RC network mentioned before. The other is called program-controlled recovery. It establishes a 6-db limiting platform, below which recovery time is long, thus minimizing pumping. Above the 6-db platform, recovery is much faster for short-duration, rapid-sequence peaks. However, if a high-amplitude, short-duration peak is followed by an absence of program material, the recovery rate is again long. Recovery is thus controlled by program material, making it possible to use a large compression ratio (20:1) with negligible pumping effect.

Normally the "Audiomatic" works forward—that is, input level controls output level. It's possible, however, to use it working back-

**ORDER  
TODAY**

See your parts distributor, or mail to:  
Howard W. Sams & Co., Inc., Dept. 463  
4300 W. 62nd St., Indianapolis 6, Ind.

Send me the following books:

- Diode Circuit Handbook (DIT-1)  
 Handbook of Electronic Charts and Nomographs (HTF-2)  
 Handbook of Electronic Tables and Formulas (HTF-2)

\$..... enclosed  Send Free Book List

Name.....

Station..... Position.....

Address.....

City..... Zone..... State.....

IN CANADA: A. C. Simmonds & Sons, Ltd., Toronto 7

Circle Item 22 on Tech Data Card



**ASK FOR YOUR FREE  
SAMS BOOKLIST**

New Spring-Summer Booklist describes over 250 books for engineers, technicians, and others in electronics.



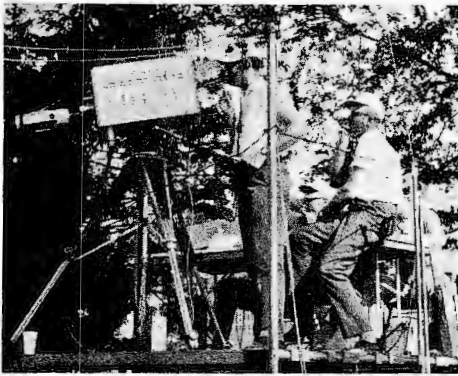

### About the Cover

The cover scene this month is the golf course at the Indianapolis Motor Speedway. Shown is some of the equipment employed by WFBM-TV in covering the 1963 500 Festival Golf Tournament. The van in the background houses a complete mobile television studio, including the equipment shown in the lower photo. A second mobile unit, at the other end of the course, was linked to the main remote truck via microwave relay (the "dish" antenna can be seen on the van roof). Zoom lens equipped cameras, built by the WFBM engineering department, were located at three positions around the course. The upper photo shows one of the camera equipment installations.

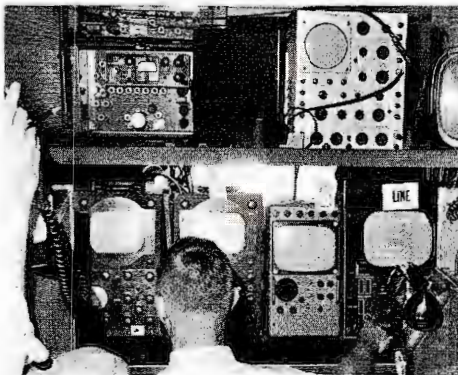

ward, with output controlling input (the conventional limiting arrangement). The backward compression ratio, however, is only 2:1, which makes it more of an averaging device than a limiter. Additional features: 600 or 150 ohms in and out, and a front-panel VU multiplier with a range of 40 db.

Part 2 of this series will discuss the operating principles, advantages, disadvantages, and features of compressors and averaging devices. Compressors currently in use will be described and illustrated. ▲

June, 1963

# LOW COST PROCESSOR DOES FAST, QUALITY WORK

Even though your processing needs may be relatively small, you will discover many advantages in owning a Labmaster. The low initial cost makes it practical to operate with a relatively small volume of work. As your volume grows you'll effect greater savings.

You'll save valuable time, too; have finished film days sooner. And you'll have complete control over film quality.

Labmaster is highly dependable; practically runs itself. It is a complete processing unit in every respect, ready to plug in and roll. Houston Fearless quality throughout. Get the facts today.

*\$4575 Complete, ready to operate  
16mm - B&W - Neg./Pos. FOB L.A.*

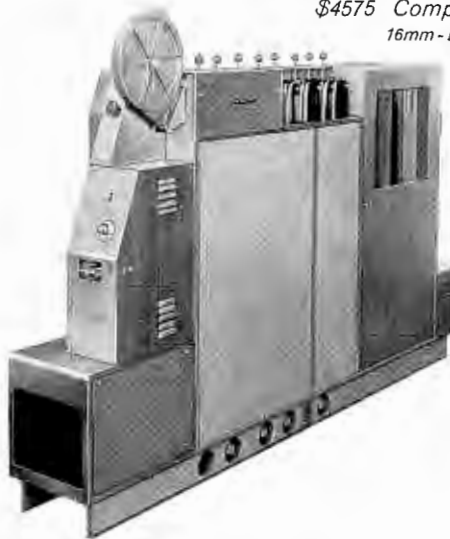

## **HF** Labmaster

FILM PROCESSORS BY HOUSTON FEARLESS

*16mm - 35mm - 16/35mm - Neg./Pos. - Rev. - B&W - Microfilm*

Westwood Division, Houston Fearless Corp. • 11801 West Olympic Boulevard, Los Angeles 64 • Phone 272-4331  
FILM PROCESSORS • CAMERA MOUNTS • ANTENNA ROTATORS • ELECTRONIC/OPTICAL INSTRUMENTS AND SYSTEMS  
Circle Item 23 on Tech Data Card

# Don't Read This Important News Unless You Are A

**RECORDING DIRECTOR  
STATION MANAGER  
RECORDING ENGINEER  
BROADCAST ENGINEER  
A & R PRODUCER  
ADVERTISING AGENCY**

Fairchild has now perfected the ultimate device to produce "true apparent loudness" without restricted, monotonous sound ■ This new and radically different Fairchild system accomplishes "apparent loudness" effectively and automatically by correcting the frequency response of an audio system to compensate for the hearing curves as developed by Fletcher and Munson ■ The Fairchild DYNALIZER (automatic dynamic equalizer) redistributes the low and high frequency response as program level drops so that a **balanced** program response is constantly maintained ■ The completely automatic FAIRCHILD DYNALIZER is indispensable for recording, broadcasting, background music and motion picture ■ The FAIRCHILD DYNALIZER provides full spectrum perception at all listening levels.

The Dynalizer is priced at \$199<sup>00</sup>

Write to FAIRCHILD—the pacemaker in professional audio products—for complete details.

**FAIRCHILD**  
RECORDING EQUIPMENT CORPORATION  
10-40 45th Ave., Long Island City 1, N. Y.

Circle Item 25 on Tech Data Card

## Modern Studio

(Continued from page 15)

33 $\frac{1}{3}$ , 45 and 78 rpm. Consider using a turn-around cartridge or plug-in heads to enable playing of both microgroove and standard discs on the same turntable.

Cartridge tape recorders are coming into wide application in more and more stations. Already cued and ready to be aired at the push of a button, they are a boon to recorded commercials and almost a necessity in modern tight radio operations. There are many cartridge playback units available, several of which are made in a variety of configurations, including stereo.

I would suggest equipping the control room with two turntables and four cartridge playback units. However, three of each works out quite well. Why so many, you may ask? At least two turntables are needed just to air music properly. If you do any on-the-air production, four cartridge playback units are needed to air commercials, and production material or promotions back-to-back, without the need of eight-armed disc-jockey.

Almost all brands of cartridge units are equipped with remote start facilities; make use of them. Locate the remote start buttons right in front of the operator where he won't have to grope for them. Use a button with a protective guard, such as the Ampex record button, so it will not be tripped accidentally. It is possible to mount this type right on the table, beneath the microphone, where it is easily seen and available when needed.

A liberal use of patch panels can improve the versatility of any console. Terminate all the inputs at the

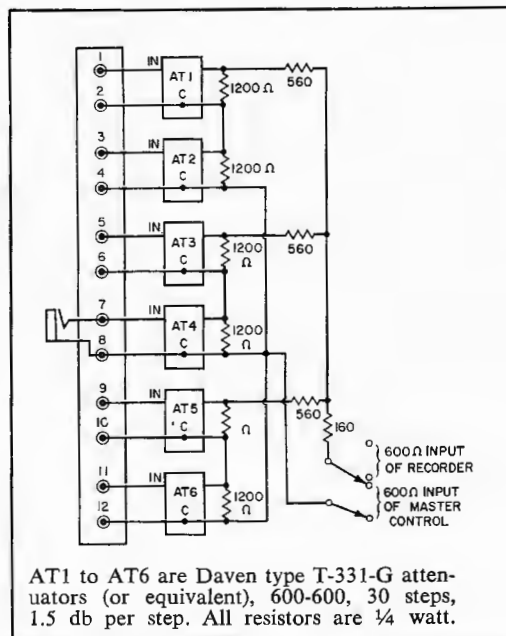

Fig. 6. High level mixer in news room.

panel. Those used most frequently such as microphones, tape recorders, turntables, and such should be normalled through. A patch cord inserted into the jack will open the circuit, enabling the use of that input for a special purpose. This technique can also be used to patch around a faulty amplifier. By using a jack panel, remote inputs may be normalled with a tape recorder, and still be available for remote broadcasts on insertion of a patch cord.

### News Room

The news room (Fig. 4) is an integral part of the modern radio station. It should be equipped so as to be completely independent from the rest of the operation. The news room should have its own recording system, and should be equipped with a beeper phone to enable the recording of phone interviews.

## SCA LEADS WITH THE

ACTUAL FULL SIZE: 4 1/8" x 5 5/16"

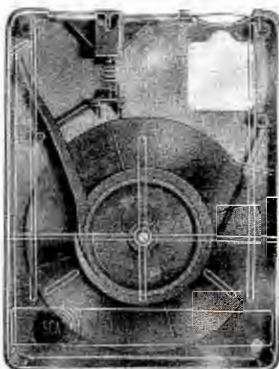

# BIG BREAK-THROUGH IN CARTRIDGE DESIGN AND PRICE!

They're lightweight, slim and trim in design . . . streamlined in price featuring:

- Constant tension pressure pad to reduce head wear
- Sturdy case of high heat-impact polystyrene
- Free floating hub design for the heavier loads of tape—low WOW and FLUTTER characteristics
- Conforms to NAB cartridge specs



Write for FREE sample and price list on your letterhead  
**SOUND CORPORATION OF AMERICA**  
WORCESTER 5, MASSACHUSETTS, U.S.A.

Circle Item 24 on Tech Data Card

**BROADCAST ENGINEERING**

The microphone in the news room, the only low level piece of equipment located there, is equipped with its own preamplifier. Thus, all signals are high level, fed into the mixer, and finally connected through a single line to the master console.

The control panel (Fig. 5) in the news room is also equipped with remote start buttons connected to the cartridge playback units in the master control room. This will enable the news man to start his own openings, closings, and story separators, eliminating the need for any cues between him and the man at the board. A small, inexpensive, vu meter was installed across the program output of the mixer (Fig. 6) so the news man may ride gain for himself, freeing the engineer or operator at the master board to prepare material for the following program.

Monitor receivers, if permitted in your locality, should be installed in the news room for monitoring local police, fire departments, and state police for news tips. These monitors should be connected to a common speaker to simplify muting when the news room microphone is live. Since the mixer is high level, the microphone switch may be used to mute the speaker without the problem of troublesome crosstalk.

### Conclusion

This may sound as if it is an elaborate arrangement, and it is, but many corners may be cut and equipment eliminated to fit your budget. For instance, a control board is the most expensive item in any studio. Instead of a large complex console, a small, used board could be used in the production control room, or by employing rack mounted preamps, a high level mixer could be used. In either case, there need not be too many inputs; a mixer with only three inputs terminated at a patch panel is sufficient.

WMAK has reduced by one-half the area used for broadcasting and has thereby provided more efficient and comfortable surroundings from which its air personalities operate. For a first-class modern radio station specializing in music and news, the arrangement described is a tried and proven system. ▲

June, 1963



## STACT BROADCASTER

### Reversible Continuous-Loop Cartridge Tape Unit

Professional reel-to-reel quality with tape cartridge convenience.

Now . . .

- **A BROADCAST CARTRIDGE** — provides reversible continuous-loop operation. Eliminates reel-to-reel production and transfer to cartridge.
- **QUALITY** — the first cartridge tape unit with the superior quality of professional reel-to-reel. Full-length program capability.
- **MULTI-DECK** — holds six tape cartridges in less space than normally required for one reel-to-reel unit. Five playback decks plus one combination record-playback deck.
- **AUTOMATIC CUEING** — provision for separate, automatic (1) stop cue, (2) end of message cue, and (3) random cue, can be used as automation building block.

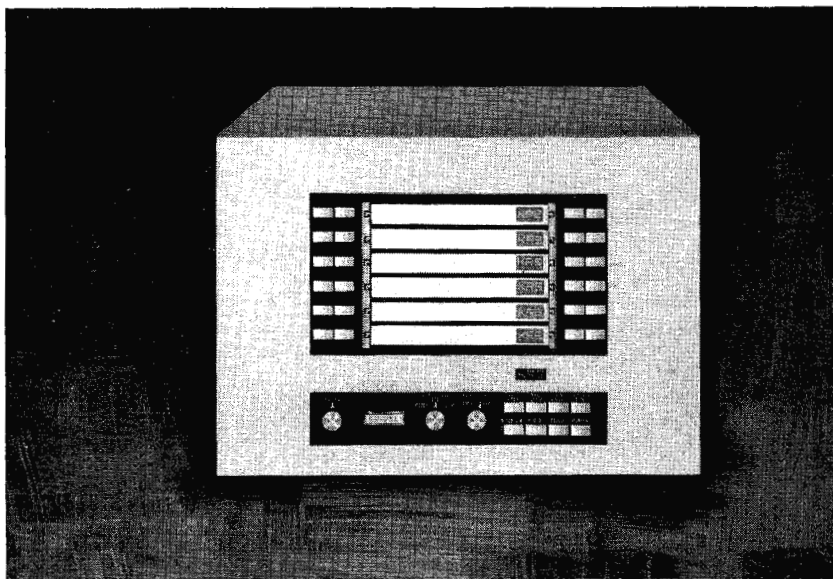

*Sold Nationally By*

**Visual . . .** the first to offer a complete solid-state broadcast facility.

**VISUAL ELECTRONICS CORPORATION**

356 west 40th street • new york 18, n. y. • pennsylvania 6-5840

Circle Item 26 on Tech Data Card

# ALL TAPE HEADS WEAR OUT! HERE'S HOW AND WHY!

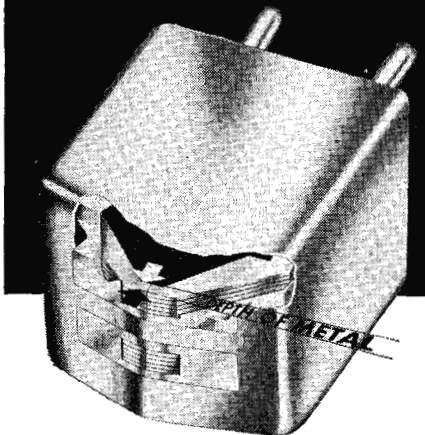

## Magnetic tape itself is the real cause of head wear!

The abrasive action of tape as it passes over the head face gradually wears away the *depth of metal* left on a new head after final polishing (see above). Because wear is nearly always uneven, craters or ripples are also formed on the face as wear progresses, thus making it impossible to achieve good contact between the head gap and the all-important signal recorded on the tape. The severe high frequency losses and erratic output resulting from poor tape-to-gap contact are very annoying to the ear. Head wear should NOT be permitted to reach this point — much less go beyond it to the limit where the gap actually begins to open up.

By replacing the worn head with a new Nortronics professional type of laminated tape head you will obtain improved high frequency response over the original head, plus the added feature of longer life since laminated heads have 50% more depth of metal at the gap. Nortronics manufactures both laminated and solid-core heads, but recommends the use of the laminated types for station use.

Nortronics is the established source for replacement heads among broadcast engineers because of the excellent price structure and long wearing qualities of their professional type heads for erase, record and playback.

For complete information contact:  
Thor Johnson, Distributor Sales Manager

"Music sounds best on tape—  
Tape sounds best with Nortronics heads"

**Nortronics** 

8143 10th Ave., North • Minneapolis 27, Minn.

Write today for FREE copy of NORTRONICS  
Tape Head Replacement Guide

Name \_\_\_\_\_  
Address \_\_\_\_\_  
City \_\_\_\_\_ State \_\_\_\_\_

Circle Item 27 on Tech Data Card

## Design of RC Amps

(Continued from page 17)

range means that all frequencies will be passed through at the same speed, thus producing no phase distortion. Usually non-linear phase shift occurs at the low and high ends. The total phase shift of an amplifier is equal to the **sum** of the individual stage shifts; and, of course, the gain is equal to the product of the stage gains.

At the middle frequency, where the gain is maximum, the phase shift is zero. This frequency can be

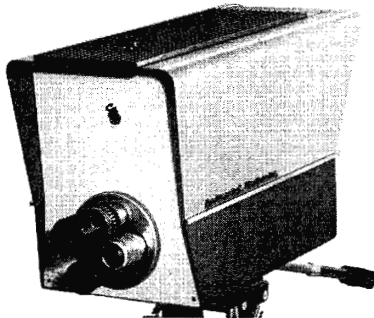

# NEW

## 20A-1 VIDICON CAMERA CHAIN

- economical to operate and maintain
- can be used with any studio equipment utilizing EIA sync pulses
- easily and simply controlled
- recommended for educational tv, live programming, process monitoring

*Continental  
Electronics*

PRODUCTS COMPANY  
BOX 5024 • DALLAS 22, TEXAS • TELEX CEPCO

↳ TV Subsidiary of Ling-Temco-Vought, Inc.

Circle Item 28 on Tech Data Card

determined by running a response curve on the amplifier after it is constructed.

At the low ranges, the phase shift at the —3-db frequency will be +45°. At other low frequencies, it will also be leading, and is determined by the equation:

$$\tan \delta = \frac{F}{FB}$$

where,

F is the frequency in question,  
FA is the —3-db frequency.

At high frequencies, the phase shift is lagging and is —45° at the —3-db reference frequency. At other high frequencies, it is:

$$\tan \delta = \frac{F}{FB}$$

where,

F is the frequency in question,  
FB is the —3-db reference frequency.

By keeping the plate and grid resistance as low as possible, serious high frequency phase shift can be avoided.

If inverse feedback is used, the phase shift at the two ends of the frequency spectrum must be considered. If the phase shift is too great, a reversal of phase is possible and regenerative instead of degenerative feedback occurs.

### General Considerations

Since the CG-RL combination determines the falling off of the high frequencies, it can be seen that the less shunting effect CG has across RL, the better the high response will be. The solution for this is to make Rp as low as gain requirements permit, since RL is made up partly of Rp. The tube capacity, however, should be low.

With the tube Rp partly de-

## QRK PROFESSIONAL TURNTABLES

offer you more...

- QUALITY
- CONTINUOUS PERFORMANCE
- SIMPLICITY

Quality all the way with QRK. Full speed range—33, 45, 78. Built rugged with jewel precision. Plays 45's without adapters. Rocket acceleration — EZ queuing. Single idler maintains constant speed regardless of normal wear.



Priced from  
\$110. to \$235.

Send for  
detailed folder!

Western Distributor

**RUSSCO Electronics Mfg.** 1406 Clovis Ave. — Clovis, Calif.

Phone CY 9-4692

Circle Item 29 on Tech Data Card

BROADCAST ENGINEERING

pendent upon the grid bias, the high-frequency response is greatly dependent upon the cathode bias resistance selected.

Television video amplifiers are good examples of using low  $R_p$  tubes for improving high-frequency response. These tubes have a plate resistance of about 1500 ohms and can be designed into circuits with a high-frequency response out to 100,000 cps, uncompensated. The gain, of course, is low.

The general procedure for selecting component parts for an amplifier is as follows:

1. Select the tubes considering the highest gain, consistent with the high frequency response desired.
2. Make  $RL$  about two or three times  $R_p$  or, for pentodes, as high as possible.
3. Estimate  $CG$ .
4. Make  $RGL$  from three to six times  $RL$ .

From the above quantities the other circuit may be calculated.

The low-frequency response should not be made lower than necessary, or decoupling devices in the power supply will be necessary to prevent motorboating.

For the design of a high fidelity amplifier, a compromise must frequently be made between high gain per stage, and wide response at low distortion.

In selecting the proper output transformer for the power amplifier, care should be taken to insure the proper impedance match. It is not generally known how an improper match affects frequency response. A match on either side of the optimum value results in loss of low frequencies and accentuation of the highs. The plate load is more nearly equal to the reactance of the transformer primary, instead of a reflected resistive value. The transformer should also have good frequency response.

#### Conclusion

The design procedures for determining the important —3-db high- and low-frequency points have been discussed. In addition, the three types of amplifier distortion have been analyzed, and ways to minimize these have been considered. By following such procedures, the design of resistance-coupled audio amplifiers should be simplified. ▲

# NOW TIME TICKS VIA 60KC VLF

## RECEIVER TO PICK UP NEW NBS STATION WWVB

Time ticks similar to those on WWV are now going on the air via the new NBS Station WWVB. This 60 kc signal is useful in calibrating timing systems, synchronizing events, and calibrating any clock. Interstate's new solid state Model LF-610 Receiver was specifically designed to receive WWVB. Complete VLF Time/Frequency Standard Systems are available. Write for details.



30 day delivery

WRITE TO:

 **Interstate** ELECTRONICS CORPORATION

707 East Vermont Avenue • Anaheim, California • Telephone 714-772-2222

(A subsidiary of Interstate Engineering Corporation)

NATIONWIDE REPRESENTATIVES

ANOTHER  **Interstate** SOLID-*state* INSTRUMENT

Circle Item 30 on Tech Data Card

# NEW PRODUCTS

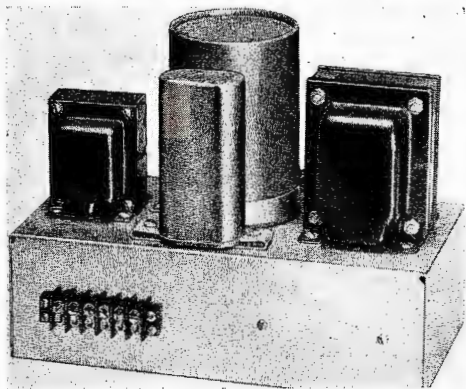

## Constant Voltage Supply

Supreme Electro-Magnetic Co., Dept. of Supreme Transformer, Chicago, Ill., has available a constant voltage DC power supply. This unit is designed for applications requiring a constant DC voltage source of low ripple content maintained over wide input line variations (up to  $\pm 25\%$ ). The AC is supplied by a SEMCO Constant Voltage Transformer, with the DC obtained through silicon full-wave bridge rectifier and high-capacity filters. Stable output is delivered to  $\pm 1\%$  with input variations from 90 to 150 volts. The ripple content is less than 0.2% at full-load; full-load to no-load output change is negligible.

Circle Item 40 on Tech Data Card

## Ampex 300-400 Replacement Heads

The Nortronics Company has announced the release of its Model RPE-75 full-track replacement kit for Ampex 300 and 400 series tape recorders. This is just one of a full line of replacement head kits available for professional tape recorders used in the broadcast field.

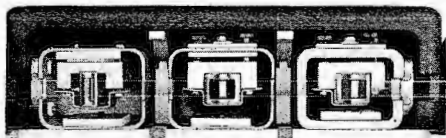

Erase, recording and playback heads are included, plus complete mounting adapters and connector plugs. The complete kit is priced at \$99.90.

Circle Item 41 on Tech Data Card

## Lavalier Microphone

A dual-impedance, dynamic microphone designed for lavalier use has been announced by Shure Brothers, Inc., Evanston, Ill. Called the model 560, the unit is built to match a special response curve developed for solving two basic problems: "bassy" sound characteristic produced by low-frequency energy transmitted through the speaker's chest cavity; and substantial loss of high frequencies due to voice projection across and away from, rather than into, the microphone. Investigation proved a response curve with smooth rolloff below 200 cps and smooth rise above 1500 cps corrected



these difficulties. The frequency response of the 560 is from 40 to 10,000 cps. The impedance is adjustable between high and 150 to 250 ohms with a pin-jack arrangement inside the case. List price of the model 560, including lavalier cord and clip assembly, is \$42.50.

Circle Item 42 on Tech Data Card

## Hybrid Color TV Monitor

Four new products, including the first professional color monitor which fits standard racks, were introduced at the National Association of Broadcasters Show by Conrac Div., Giannini Controls Corp. The four products included a transistorized 8" monitor, a kinescope recorder, a 23" audience and studio monitor, as well as the 17" color monitor. The color unit features a tri-gun shadow-mask picture tube. It uses both solid-state and vacuum-tube circuitry to meet

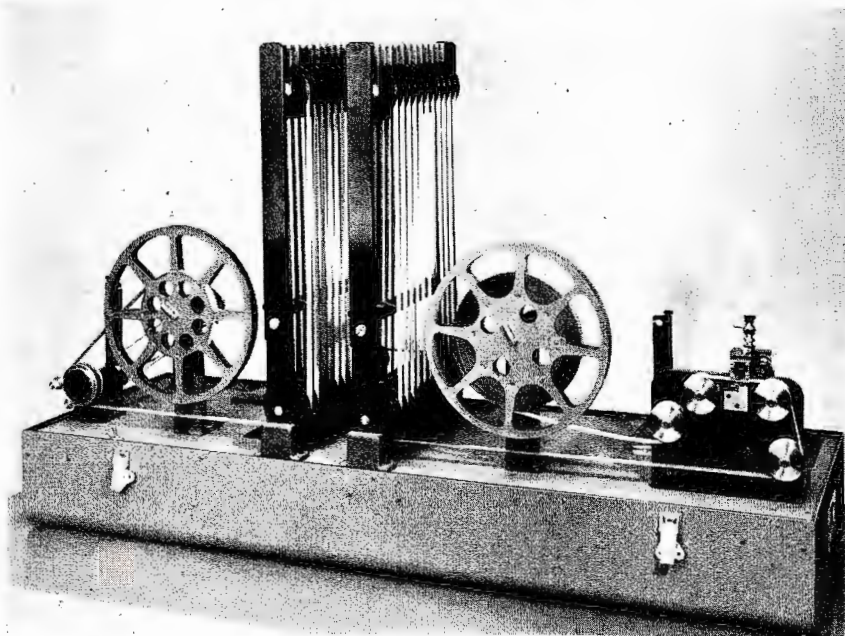

## Portable Striping Machine for On-Location Recording

Reeves Soundcraft Corp., Danbury, Conn., has introduced the P-16, a precision portable striping machine for 16-mm motion picture film. The machine enables film production teams in remote areas to stripe film with magnetic oxide suitable for sound recording rather than send it to commercial laboratories for processing. The operating principles of the P-16 meet all specifications of the Society of Motion Picture and Television Engineers and the American Standards Assn. Requiring less than 50 watts of power for operation, the unit has interchangeable striping applicators which can lay down oxide coatings on film in the following combinations: a 25-mil balance stripe and a 100-mil recording stripe; a 25-mil balance stripe and a nominal 50-mil half stripe for a combination of magnetic coating and photographic sound recording; and a 300-mil recording stripe with no balance stripe for the production of film to be used for original recordings. Price is \$2,000.

Circle Item 43 on Tech Data Card

maximum broadcast requirements for stability and performance. A total of 21 tubes and 95 transistors are employed. The CYA17 features a decoder which allows operating controls to be reduced to contrast and brightness; a calibrated chroma control which offers a pre-set position; solid-state sync-drop relay, automatic band-width change and color killer; complete control of individual guns; keyed back-porth clamp. Price of the color monitor is \$2,450.

Circle Item 44 on Tech Data Card

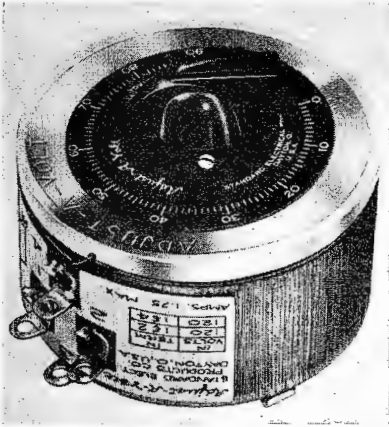

### Small Variable Transformer

Significant progress in obtaining increased power in a small variable transformer has been achieved by STACO®, Inc., Standard Electrical Products Div., Dayton, Ohio, in its 175 Series of Adjust-A-Volt® units. The 1.75-amp package is enclosed in the 2 $\frac{1}{8}$ " diameter and 2 $\frac{3}{8}$ " deep housing. Because of its unusual power in so small a package, the 175 Series is applicable in the control of voltage, heat, light, speed and power where space is scarce. This AC unit, with relatively low wattage requirements, can replace bulky rheostats or other resistive-type controls. Features of the open unit for panel mounting include a strong metal base, easily replaceable brush of new design, and soldered or push-on connections. The device has 1.75-amp output, with 120-volt input and 50/60 cps connection. The unit is available singly or as ganged assemblies, both manual and motorized. The unit is priced at \$8.50.

Circle Item 45 on Tech Data Card

### Microwave Relay Equipment

A 1-watt microwave relay equipment for point-to-point FM transmission of high-quality color TV signals and program audio, is available from Raytheon, Communications and Data Processing Operation, Norwood, Mass. The system can be employed in single or multiple installations for transmission of up to six RF channels. The full range from 5925 to 7425 mc can be used. Four compact units, comprising the transmitter control unit, transmitter RF head, receiver RF head, and receiver control unit are mounted in 19-inch rack mounting cases. Features include a variable frequency reference wavemeter in the transmitter RF head, wideband monitor circuit, saw-tooth test signal, regulated DC filament

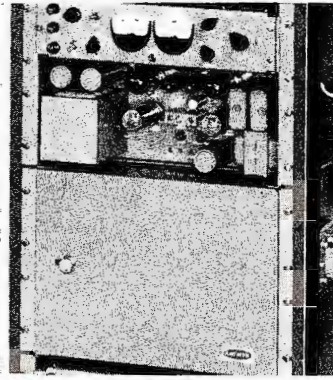

supply for transmitter head, individual regulated supplies, and frequency stability of  $\pm 0.02\%$  without AFC.

Circle Item 45 on Tech Data Card

### Portable Power Pack

A 60 cps AC portable power pack for 110-volt motion picture sound cameras is announced by Terado Corp., St. Paul, Minnesota. Housed in a pigskin leather case, it weighs only 12 pounds and can supply 25 watts. The power unit operates on self-contained 9-volt lantern bat-



teries to produce an output accurate to within  $\frac{1}{2}$  cycle. The Cinepower 25, according to the company, is ideal for operation of TV cameras in the field. Price of the unit is \$79.50 (list).

Circle Item 47 on Tech Data Card

### Loudspeaker Connectors

The availability of series 8-8145 Preh quick-action plugs and sockets has been announced by Telephone Dynamics Corp., Baldwin, L. I., N. Y. The connectors are designed to assure positive



contact and freedom from noise, leaks, and shorts. The devices offer quick-action current opening and closing, and quality at low cost. They are made with off-contact at 180°, without off-contact, and without changeable contact. The latter type may be used in place of a closed-circuit phone jack.

Circle Item 48 on Tech Data Card

## There's a FAIRCHILD CONAX



## on top of the Empire State Building!

WNEW-TV Channel 5 in New York uses the FAIRCHILD CONAX to maintain high average audio levels despite pre-emphasis problems. The CONAX is silently at work minimizing problems created by sibilants, finger snapping, the shrill sounds of children, the rattling of dishes, muted trumpets and cymbals, which are all part of WNEW-TV's program schedule. No more reduction of apparent loudness because of these high frequency problems.

Why not let the FAIRCHILD CONAX help you maintain high average audio levels.

FAIRCHILD RECORDING EQUIP. CORP.  
10-40 45th Avenue, Long Island City 1, N. Y.

Circle Item 31 on Tech Data Card

## NOW! FM STEREO and Aural Broadcast-Intercity Service Model PCL-2B STUDIO-TRANSMITTER LINK

Meets specifications for split channel operation.  
(FCC Docket effective 5/1/63)

WRITE FOR BULLETIN 209



MOSELEY ASSOCIATES INC.

P.O. BOX 3192 · 4416 HOLLISTER AVE SANTA BARBARA, CALIF

Circle Item 32 on Tech Data Card



— NEXT MONTH —

## SPECIAL TEST and MAINTENANCE ISSUE

Featuring:

### BASIC TEST INSTRUMENTS

A rundown of the standard equipment essential in broadcast station maintenance.

### MAINTENANCE OF A SMALL TV STUDIO

Standard studio maintenance practices modified to form an efficient working program for the small station.

### SPARE PARTS INVENTORY

What and how to stock for replacement, modification, and construction.

### SPECIALIZED TEST EQUIPMENT

A product report on test and measurement devices for radio and television broadcast stations.

**PLUS . . .** When the Proof-of-Performance Fails, Design of DA Systems, Audio Modulation, Engineers' Exchange, and a host of other timely items.

## NEW BRIDGE SIMPLIFIES RF IMPEDANCE MATCHING

FROM  
TRANSMITTER  
COMMON POINT  
OR  
SIGNAL  
GENERATOR

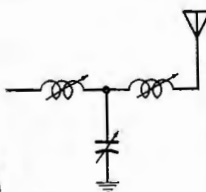

### DELTA MODEL OIB-1 OPERATING IMPEDANCE BRIDGE

Connect in antenna lead, transmission line, common point, etc., turn on power (5 kw max.), adjust for null on meter and read R and X. Insertion does not upset directional parameters. Operating impedance is thus measured. In use by leading consultants and station engineers. (\$475.00)

**DELTA ELECTRONICS**

DELTA ELECTRONICS, INC.  
4206 Wheeler Avenue, Alexandria, Virginia

Circle Item 33 on Tech Data Card

## ENGINEERS' TECH DATA SECTION

### AUDIO & RECORDING EQUIPMENT

60. BROADCAST ELECTRONICS—Complete information on line of cartridge tape equipment and accessories is given in data packet.
61. COUSINO ELECTRONICS CORP.—Information is available on line of cartridge tape devices and cartridges; specs and prices are included.
62. FAIRCHILD RECORDING EQUIPMENT CORP.—Technical bulletin details slide-type attenuator which boasts low noise and constant impedance characteristics; price list covers professional audio equipment.
63. FREEMAN ELECTRONICS CORP.—New literature details specs and features of the company's stereo tape recorders, dynamic microphone, walnut console, bulk tape eraser, head demagnetizer, and portable miniature tape recorders.
64. GOTHAM AUDIO CORP.—Brochures, catalogs, and other pieces cover reverberation units, turntables, tape machines, audio cables, and other audio products including linear motion deposited carbon pots, microphones, and disc recording equipment.
65. 3M CO.—"Playback" volume 2, number 1, including features on video dropout test tape, tape recorder roundup, SMPTE recommended practice RP10, and other information.
66. MICHIGAN MAGNETICS, INC.—Catalog sheet provides specifications for "B" line of record playback heads for use in two track stereo systems.
67. RCA VICTOR—Brochure lists properties of the company's magnetic recording tape.
68. SHURE BROTHERS, INC.—"Fact and Fiction" guide details specific unidirectional characteristics and performance features that should be expected from a true cardioid microphone.
69. SPARTA ELECTRONIC CORP.—Bulletin shows prices of Fidelipac tape cartridges, and cartridge reloading service fees.
70. TURNER CO.—Bulletin and spec sheet describe model 500 cardioid dynamic microphone.

### COMPONENTS & MATERIALS

71. BELDEN MANUFACTURING CO.—1963 wire and cable catalog covers complete line of wires and cable for electronics, and includes wide variety of types for broadcasting, audio, and recording applications.
72. CENTRALAB DIV., GLOBE-UNION, INC.—In a 16-page components catalog, just published, full price and product information on line of controls, switches, ceramic capacitors, and packaged circuits is given; included is replacement data on over 1,815 components, and descriptions of the company's control kits.
73. CLAROSTAT—1963 industrial products catalog includes complete information on precision pots, read-out multi-turn dial, trimmer pots, and other controls and resistors.
74. CORNELL-DUBILIER ELECTRONICS—A 17" x 22" wall chart has been compiled to help circuit designers select mica capacitors; it lists more than 40 types.
75. ELECTROVERT, INC.—Wire and cable harnessing and tying components are the subject of a four-page booklet which outlines the physical features of the devices.
76. EXIDE DIV., ELECTRIC STORAGE BATTERY CO.—Brochure describes technological advances in line of lead-acid storage batteries for stationary applications.
77. HI-Q DIV., AEROVOX CORP.—In 16 illustrated pages a new catalog of Cinema Instrument Switches presents electrical characteristics, selection information, deck and brush arrangements, dimensions, and order information.
78. KURMAN ELECTRIC CO.—New catalog presents specs and illustrations of sensitive, power, antenna, micro-miniature, telephone, hermetically sealed, and plastic housed plug-in relays.
79. SARKES TARZIAN, INC.—Tube replacement guide provides information for converting from tube rectifiers to silicon "Tube Replacement" rectifiers.
80. WILRITE PRODUCTS, INC.—Product data sheet presents Type "R" radial lead resistors, giving specs and special features.

### MISCELLANEOUS

81. JERROLD ELECTRONICS CORP.—Catalog sheets present Tele Trol Industrial Television Modulator and demodulator for TV camera broadcasts, off-air pickup, rebroadcasts, and originating system sound broadcasts.
82. LEL, INC.—Catalog '63 offers information on integrated mixer-preamplifiers, strip-type components, laboratory receivers, IF and RF amplifiers, and other special purpose receiving equipment.



83. PIC DESIGN CORP.—Spur gear design slide-chart gives tolerance and performance specs of fine pitch gears and gear tooth data for standard pitches 24 to 200.
84. SECO ELECTRONICS, INC.—Data sheet describes model 806 Vari Volt for the control of lighting and heating systems up to 1000 watts.
85. SUPREME ELECTRO-MAGNETIC CO.—Illustrated bulletin covers line of constant voltage transformers, constant voltage DC power supplies, and solid-state inverter, and provides operating principles thereof.

#### RADIO & CONTROL ROOM EQUIPMENT

86. AMPLIFIER CORP. OF AMERICA—In several catalog sheets, the following products are described: solid-state modules for various electronic applications; portable, transistorized, stereo, battery-operated tape recorders; continuous loop perforated tape cartridge, and plug-in instrument preamplifiers.
87. CBS LABORATORIES—Catalog sheets cover three broadcast items: video distribution amplifier, broadcast test record, and Microlap Ruby Styli.
88. COLLINS RADIO CO.—Illustrated brochure provides details on complete line of Marti Electronics remote pickup equipment designed specifically for broadcast applications.
89. GATES RADIO CO.—Bulletins provide technical information on the "Sta-Level" automatic program level amplifier, and the "Level Devil" program gated amplifier.
90. HAMMARLUND—Bulletin shows the "Weather Monitor" receiver for reception of U. S. weather bureau broadcasts. Covered in similar bulletins are VHF FM monitor receivers for remote broadcasts, and public safety frequencies.
91. McMARTIN IND., INC.—Spec sheet covers FM stereo re-broadcast receiver, providing technical details and illustrating the device.
92. MOSELEY ASSOCIATES, INC.—Bulletin 209 is devoted to the 950-mc FM stereo STL, designed to meet the FCC requirements for split channel operation.

#### TELEVISION EQUIPMENT

93. ITA ELECTRONICS—AM, FM, and TV transmitters; audio consoles, monitors, and logging equipment are covered in bulletins.
94. TELEMET CO.—Catalog covers complete line of television broadcast equipment.

#### TEST EQUIPMENT & INSTRUMENTS

95. EICO ELECTRONIC INSTRUMENT CO., INC.—Catalog sheet details im/harmonic distortion meter and AC vtm, giving specs and availability information.
96. HICKOCK ELECTRICAL INSTRUMENTS CO.—Bulletins describe FM stereo generator, tube testers, electronic voltmeter, and true vtm vom & capacitance meter.
97. TEKTRONIX, INC.—1963 abridged catalog covers scopes and other instruments used in broadcasting and electronics.
98. WESTON INSTRUMENTS & ELECTRONICS DIV., DAYSTROM, INC.—Twelve-page illustrated brochure describes line of light-beam portable wattmeters, and ammeter and voltmeter standards.

#### STUDIO & CAMERA EQUIPMENT

99. BOSTON INSULATED WIRE & CABLE CO.—Bulletins list complete line of broadcast wires and cables, including TV camera cables.
100. CENTURY LIGHTING, INC.—Databook aids in rapid selection of studio light, and provides performance and lamp data for various lighting devices; typical arrangements are shown for set lighting.
101. CONTINENTAL ELECTRONICS—4-page illustrated brochure describes 20A-1 Vidicon camera chain for educational, industrial, and broadcast applications.
102. TELEVISION ZOOMAR—Complete data and specs on Ever-shed Servo Remote Zoom Lens is presented in report and illustrated brochures.
103. WESTINGHOUSE ELECTRIC CORP.—Image orthicon selector gives sensitivity and spectral response for the most important tubes in company's line.

#### TRANSMITTER & ANTENNA DEVICES

104. ANDREW CORP.—8-page catalog shows pneumatically operated masts and accessories for transportable communication systems; detailed mechanical specs are given.
105. BARNSTEAD STILL AND STERILIZER CO.—Bulletin describes cooling-water purification system, claimed to add thousands of hours to UHF transmitting tube life.
106. BAUER ELECTRONICS CORP.—Brochure describes "Log-Alarm," a device that logs all required parameters and provides visual and audible alarms in the event out of tolerance readings occur.
107. CO.EL.—Catalogs describe broad-band dipole antennas, FM antennas, UHF slot antennas, filters, and duplexers.

# Now Available!

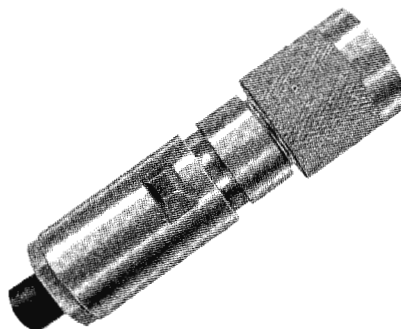

B.I.W. manufactures and supplies Television Camera Cables, Connectors, and Cable Assemblies for Marconi, E.M.I., Pye, R.C.A., General Electric, Grundig, Fernseh, and Dage Commercial Broadcast and special application television cameras and microwave relay equipment; Audio, and Coaxial Cables precision manufactured to Network color broadcast specifications.

In addition, B.I.W. makes camera cables and connectors with mating English pins and threads for use with British Broadcast Cameras incorporating stranded, color coded and Nylon jacketed conductors, option of Neoprene or Plastic outer jacket, and watertight repairable connector terminations.

Cables are supplied in 50, 100, and 200 foot lengths or cut to your requirements. Also offered are connectors as desired, right angle connectors and wall mounts.

B.I.W. manufactures the widest variety of television camera cables in the world. Since manufacturing the first cables for R.C.A.'s introduction of television at the 1937 New York World's Fair, B.I.W. has pioneered in the development of television cables for studio, color, outside broadcast, military and industrial applications, including reactor monitoring.

Superior Cable Construction — Signal leads are grouped to minimize cross-talk. Crush resistant, rope-lay configuration with resilient neoprene jacket makes B.I.W. cable superior in handling characteristics and resistant to sharp edges, studio rolling stock and weathering. Camera operators report that pliable B.I.W. cables permit smooth, easy camera motion without twisted or kinked cables.

B.I.W.'s service department will repair your damaged T.V. cables.

Send for complete information, or let us know your specifications and requirements for quotation.



"Designers and makers of  
Specialty Cables since 1905"  
**BOSTON INSULATED WIRE & CABLE COMPANY**

Main Office and Factory  
71 Bay Street, Boston 25, Mass.  
Telephone: Columbia 5-2104

Canadian Factory  
Boston Insulated Wire &  
Cable Co., Ltd.  
118 Shaw St., Hamilton,  
Ontario, Canada  
Telephone: Jackson 9-7151

Circle Item 34 on Tech Data Card

## Professional Services

**VIR N. JAMES**  
CONSULTING RADIO ENGINEERS  
Applications and Field Engineering  
232 S. Jasmine  
Phone: (Area Code 303) 333-5562  
**DENVER 22, COLORADO**  
Member AFCCE

- SYNCHRONOUS MAGNETIC FILM RECORDER/REPRODUCER
- MAGNETIC TAPE RECORDERS
- NEW—THE portable MINITAPE synchronous 13 lb., battery operated magnetic tape recorder for field recording.

**THE STANCIL-HOFFMAN CORP.**  
845 N. Highland, Hollywood 38, Calif.  
Dept. B HO 4-7461

**JOHN H. BATTISON & ASSOCIATES**  
CONSULTING RADIO ENGINEERS  
TV-AM-FM & Microwave Applications and Installations  
Specializing in all forms of communications engineering.  
422 Washington Bldg. Washington 5, D. C.  
Phone ST 3-3484  
Established 1954

## Classified

Advertising rates in the Classified Section are ten cents per word. Minimum charge is \$2.00. Blind box number is 50 cents extra. Check or money order must be enclosed with ad.

The classified columns are not open to the advertising of any broadcast equipment or supplies regularly produced by

manufacturers unless the equipment is used and no longer owned by the manufacturer. Display advertising must be purchased in such cases.

## EQUIPMENT FOR SALE

Commercial Crystals and new or replacement crystals for RCA Gates, W. E. Bliley and J-K holders; regrinding, repair, etc. BC-604 crystals. Also A. M. monitor service. Nationwide unsolicited testimonials praise our products and fast service. Eidson Electronic Company, Box 96, Temple, Texas. 9-61 tf

**USED TV EQUIPMENT FOR SALE**—Specialists in RCA Types. Many bargains in stock. TK-30's, TK-11's, Power Supplies, Monitors, etc. Our exclusive refurbishing process Guarantees Satisfaction. Write, Wire or call for prices.  
**TELEQUIP CORPORATION**, 319 East 48th St., New York 17, N. Y., PLaza 2-8885—PLaza 2-9037. 2-63-6t

**GOVERNMENT SURPLUS, NEW 10 CM. WEATHER RADAR SYSTEM**—Raytheon. 275 KW peak output S band. Rotating yoke P.P.I. Weather Band 4, 20 and 80 mi. range. Price \$975 complete. Has picked up clouds at 50 mi. Wt. 488 lbs. Radio Research Inst. Co., 550 5th Ave. New York, New York. 1-63 6t

Transmission line, styroflex, heliack, rigid with hardware and fittings. New at surplus prices. Write for stock list. Sierra Western Electric Cable Co., 1401 Middle Harbor Road, Oakland 20, California. 6-61 tf

Ampex Head Assemblies for 300 and 400 series recorders reconditioned. Service includes lapping and polishing all three head stacks, cleaning entire assembly, readjusting and replacement of guides, and realignment of stacks as to azimuth and zenith. Full track assemblies—\$60.00. Taber Manufacturing & Engineering Co., 2619 Lincoln Ave., Alameda, California. 5-63 2t

**TRANSMITTING TUBES FOR SALE** — 3X2500F3 — \$175. 4W20000A — \$1815. 450TL — \$25. 4-125A — \$22.50. 872A — \$5.25. 575A — \$15.50. Many Others. Brand New. 1,000 hour warranty. Write or call Calvert Electronics, Inc., Dept. BE-5, 220 E. 23rd St., New York 10, N. Y., (212) OR 9-1340.

**WE BUY USED TV AND RADIO EQUIPMENT. LET US KNOW WHAT YOU HAVE TO DISPOSE OF. WRITE TELEQUIP CORPORATION**, 319 East 48th St., New York 17, N. Y. 2-63-6t

Film cameras, slide projectors, monitors, power supplies, scopes, switchers, transmitter input equipment, color sinc generator, and many other items. Call or write, R. Truscott, WITI-TV, Milwaukee, Wisconsin. 5-63-2T

**3 KW CLEAN HF 2-14 MC AM TRANSMITTER COMPLETE: SPARES, MANUAL, ETC. F.O.B. ALBUQUERQUE, N.M., P.O. BOX 4092-A.**

**TRANSISTORIZED:** Pulse Distribution Amplifier, 8 in, 16 out. Sync Generator w/Regulated Power Supply. Sync Slave w/Regulated Power Supply. Aperture & Phase Correction Amplifier. Regulated Power Supply, 1.5 Amp., 285V. Video Equalizer Amplifier w/Regulated Power Supply. Waveform Monitor w/Regulated Power Supply. Keyed Video Signal Generator. TV-Radar Bar Dot Generator. **ALL UNITS ARE NEW AND GUARANTEED. PRICED AT A FRACTION OF ORIGINAL COST. LANG ELECTRONICS, INC.** 507 5th Ave., New York 17, N. Y., MU. 2-7147.

## Advertisers' Index

Altec Lansing Corp. ....	6
Ampex Corp. ....	9
Automatic Tape Control, Inc. ....	4
Bauer Electronics Corp. ....	50
Belden Mfg. Co. ....	3
Boston Insulated Wire and Cable Co. ....	49
Broadcast Electronics, Inc. ....	26, 38
CBS Laboratories ....	27
CO.EL. ....	8
Continental Electronic Products Co. ....	44
Delta Electronics, Inc. ....	48
Electro-Voice, Inc. ....	31
Fairchild Recording Equip. Co. ....	38
Fourjay Industries ....	30
Gates Radio Co. ....	7
General Electric/Tube Div. ....	33
Houston Fearless Corp. ....	41
Interstate Electronics Corp. ....	45
ITA Electronics Corp. ....	Cover 2
Jampro Antenna Co. ....	50
Magnecord Div. Midwestern Instr., Inc. ....	36
McMartin Industries, Inc. ....	Cover 3
Moseley Associates, Inc. ....	47
Nortronics ....	44
RCA/Electron Tube Div. ....	Cover 4
RCA Victor Records ....	23
Reeves Soundcraft Corp. ....	5
Russco Electronics Mfg. ....	44
Sarkes Tarzian, Inc./Broadcast Equipment Div. ....	29
Sarkes Tarzian, Inc./Semi-conductor Div. ....	39
Sound Corporation of America, Inc. ....	42
Sparta Electronics Corp. ....	35
Sylvania Electric Products, Inc. ....	25
Telemet Corp. ....	37
Visual Electronics Corp. ....	43



## NEW...PEAK LIMITING AMPLIFIER!

The Bauer "Peak Master" is the smallest, completely self-contained limiter available that can be used in critical broadcast, recording and motion picture audio applications • 3½" of Rack Space • Vernier Input—Output Controls • Switchable VU Meter • Fast Attack Time • Adjustable Release Time • \$440.00 • Send for Complete Details Today!

**Bauer** ELECTRONICS CORPORATION  
1663 Industrial Road, San Carlos, California  
Area Code 415 591-9466

Circle Item 35 on Tech Data Card

## NEW FM ANTENNAS WITH DIGITAL TUNING\*

JAMPRO now offers its wideband FM antennas with digital tuning.\* Vee element end caps may be field tuned for extremely low VSWR—so necessary for finest stereo. Check literature card for details.

## JAMPRO ANTENNA CO.

7500 - 14th Avenue  
Sacramento 20, California

Circle Item 36 on Tech Data Card





## RCA-7295B

### Now RCA Brings High Fidelity to Image Orthicons

Now! An RCA Image Orthicon with picture pickup fidelity so high, it's like bringing your audience right into the studio.

That's RCA-7295B...a new 4½" type unilaterally interchangeable with the 7295 and 7295A. Tighter performance limits and additional tests and inspections at RCA have refined processes and materials to such an extent that performance of this TV Camera Tube rivals that of any Image Orthicon on the market.

With this 4½" Image Orthicon, you get the ultimate in flexibility for high fidelity pickup in black-and-white TV. Because you get: improved background uniform-

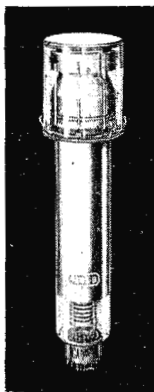

ity, higher signal output levels, better signal uniformity, higher signal-to-noise ratio, improved detail response, reduced microphonics, and stable sensitivity.

All these improvements had to come in a tube from RCA—a leader in TV Camera Tube development since the early days of television. Ask locally about a complete line of RCA Orthicons for color and black-and-white telecasting. SEE YOUR AUTHORIZED DISTRIBUTOR OF RCA BROADCAST TUBES.

RCA ELECTRON TUBE DIVISION, HARRISON, N. J.



The Most Trusted Name in Television

For name and address of your local distributor write or call your nearest RCA Distributor. Products Sales Office—New York, N. Y.: 36 W. 49th St., Murray Hill 9-7200; Needham Heights 94, Mass.: 80 "A" St., Hillcrest 4-8480; Washington 7, D. C.: 1725 "K" St., S.W., Federal 7-8500; Atlanta, Ga.: 134 Peachtree St., N.W., Jackson 4-7703; Cleveland, Ohio: 1621 Euclid Ave., Cherry 1-3450; Chicago, Ill.: Merchandise Mart, 467-5900; Dallas 7, Texas: 7901 Carpenter Freeway, Melrose 1-3050; Kansas City 14, Mo.: 7711 State Line, Emerson 1-6462; Los Angeles 22, Cal.: 6801 E. Washington Blvd., Raymond 3-8361.