

Broadcast Engineering

THE JOURNAL OF DIGITAL TELEVISION

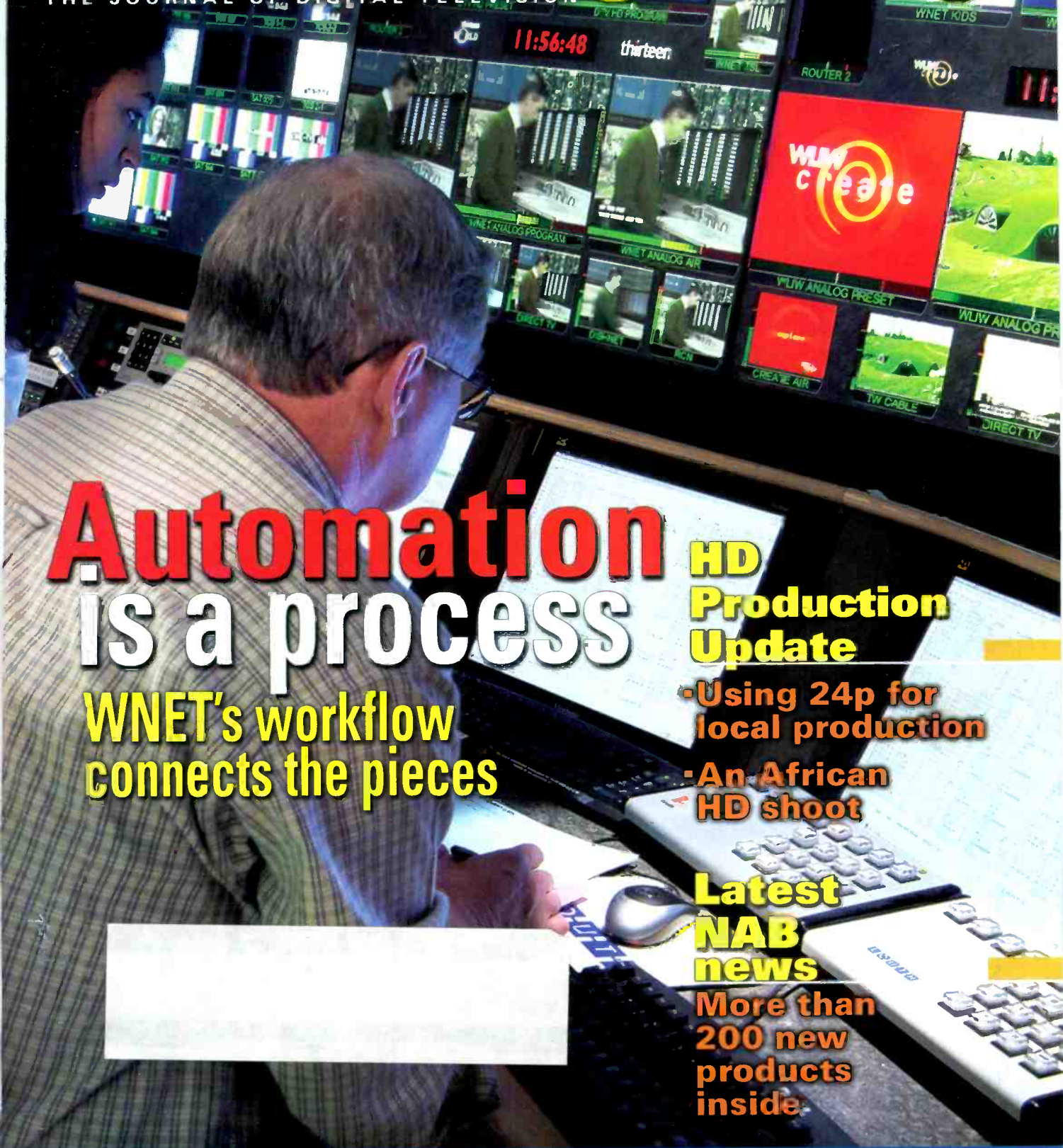

Automation is a process

WNET's workflow
connects the pieces

HD Production Update

- Using 24p for local production
- An African HD shoot

Latest NAB news

More than
200 new
products
inside

THIS IS NOT AN AUDIO CONSOLE

Audio Control

D-9



IT'S A DIGITAL CONTROL SURFACE

THE D-9 interfaces to WHEATSTONE's router-based BRIDGE MIXING SYSTEM—a digital network that lets multiple control surfaces share common audio resources, accessing signals and sending mixes throughout your facility.

Production



OTHER SURFACES can share common audio resources

Studio 2



I/O CONNECTIONS can be at point-of-use and accessed by any control surface

DEDICATED DSPs and controls, redundant automatic failover CPUs, mix engines and power supplies are all integral to the system. Components interconnect via CAT5 or fiberoptic cables for single-wire system integration.

A traditional intuitive surface layout gets your operators up and running FAST—even in full 5.1 surround mode.

TRUE RELIABLE mixing power; ease and clarity of operation—take ADVANTAGE of the WHEATSTONE BRIDGE Network System!

CENTRAL FRAME can control a 1024 x 1024 mixing based router



Engineering

Engineering



Talk to your **STATION ROUTER** bi-directionally for smooth integration

 **Wheatstone**

sales@wheatstone.com / tel 252-638-7000 / www.wheatstone.com

Copyright © 2005 by Wheatstone Corporation



The new Harris PowerCD® digital transmitter sets a new standard for power and intelligent manageability.

We're about to change your view of what a digital transmitter can be.

When you have a strong vision for the future, it's reflected in your products. At Harris, we created the new PowerCD® digital transmitter with the power, efficiency and built-in intelligent manageability to help broadcasters excel. A Linux-based Graphical User Interface is layered atop dedicated subsystem controllers. Extensive parameters and fault mapping quickly and intuitively guide the operator in daily operation. Through integral TCP/IP and SNMP technology, you can monitor and control the transmitter over your data network...and with local control reserves, we give the same user interface as the local transmitter control panel. PowerCD also integrates adaptive correction, automatically adjusting levels to ensure optimum performance, efficiency and extended operating life. Overall, the PowerCD

delivers maximum power-per-tube with industry-leading electrical savings. Finally, we made our new design more space efficient and environmentally friendly and we use a highly reliable and innovative water cooling system technology. So add more power and efficiency to your digital broadcasts. Choose Harris PowerCD, the industry's most intelligent transmitter.

POWERCD
INTELLIGENT TRANSMITTER

See the new PowerCD transmitter at NAB2005 in Las Vegas, booth C1907. For immediate information, call 888-711-7295, or visit www.intelligenttransmitter.com/harris.

HARRIS®

assuredcommunications™
Broadcast • Microwave • RF • Government

www.harris.com

A computer monitor with a silver bezel and a black stand is centered against a blue background with abstract white and black lines. The screen is black and displays the text "The newsroom is **changing**".

The newsroom is **changing**

Everything you've imagined. Nothing you'd expect.

Join Avid at NAB 2005 and see revolutionary software designed from a revolutionary point of view: yours. **Be the first** to see Avid unveil technology that will help news professionals take control of the story, the newscast, and the future.

Avid. do more.™

See it for yourself at NAB booth SL600 or register for the
online tour at www.avid.com/beimagine

© 2005 Avid Technology, Inc. All rights reserved. Product features, specifications, system requirements, and availability are subject to change without notice. Avid and do more are registered trademarks or trademarks of Avid Technology, Inc. in the United States and/or other countries. All other trademarks contained herein are the property of their respective owners.

Avid

Broadcast Engineering

THE JOURNAL OF DIGITAL TELEVISION

CONTENTS

FEATURES

62 Shooting in 24p for local TV

By Peter Fasciano

New technologies enable stations to shoot and edit 24p video for local production. What are the advantages?

68 On Safari with HD

By Lou Douros

One photographer's journey in Africa to capture native life in HD.

81 Special report: The tape archive solution — protecting your content

By Rich Harada

Tape is not dead. It's just being used in new ways.

88 NAB Update: New products

By Broadcast Engineering Staff

Latest hot new products for NAB2005.

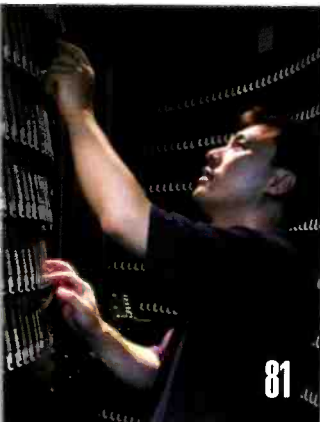

BEYOND THE HEADLINES

Download

16 HD anachronism

FCC Update

22 FCC rejects DTV multi-channel must-carry

DIGITAL HANDBOOK

Transition to Digital

24 Horizontal resolution: Pixels or lines

Computers and Networks

30 The accidental system administrator

Production Clips

41 The importance of studio acoustics

ON THE COVER:

Harris' NetVX is the heart of THIRTEEN/WNET's new centralized automation system.

(continued on page 10)

at NAB 2005, the most anticipated breakthrough
in video technology will be

unveiled



AG-HVX200

HD/SD multi-format: 1080/60i, 1080/24p, 1080/30p,
720/60p, 720/24p, 720/30p, 480/60i, 480/24p, 480/30p;
and multi-codec: DVCPRO HD, DVCPRO 50, DVCPRO, DV

DVCPRO HD *P2*

Panasonic
ideas for life



Surrounding broadcasters with



total content delivery solutions.

A world of possibilities is well within reach. From content creation to viewer consumption, surround yourself with Harris' full spectrum of enterprise-wide solutions. Now

deliver the right content to the right person on the right device at the right time. Our latest breakthroughs include the new H-Class™ content delivery platform, 5.1 surround

sound and transmission systems for mobile video. No matter where you turn, Harris' mission-critical solutions and unparalleled customer support have you covered from every angle

HARRIS®

assuredcommunications™

Broadcast • Microwave • RF • Government Systems

www.harris.com

Broadcast Engineering

THE JOURNAL OF DIGITAL TELEVISION

CONTENTS

SYSTEMS DESIGN & INTEGRATION

Systems Design Showcase

46 THIRTEEN/WNET builds integrated content management and distribution platform

Transmission & Distribution

54 Is 2005 the year of interactive TV?



NEW PRODUCTS & REVIEWS

Applied Technology

188 Bridging HDV with Miranda

190 Modulus' MPEG-4 AVC solution

192 The Optibase/ADI streaming platform

Field Report

194 KWTX speeds up with Quantel sQ

Technology in Transition

196 Fiber optic systems

DEPARTMENTS

12 Editorial

14 Reader Feedback

198 Classifieds

202 Advertisers Index

204 EOM

FreezeFrame

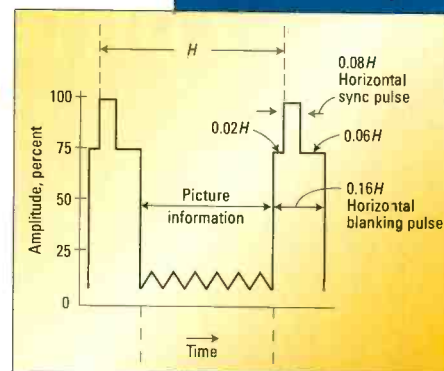

Complete the following sentence: The _____ is the portion of the video signal that lies between the trailing edge of the horizontal sync pulse and the start of active picture time.

Readers submitting winning entries will be entered into a drawing for *Broadcast Engineering* T-shirts. Enter by email. Title your entry "FreezeFrame-April" in the subject field and send it to: editor@primediabusiness.com. Answers must be received by June 1st.

Question courtesy Tektronix 2005 Desktop calendar.

► Nothing gets closer to reality than
Maxell High Definition Media.

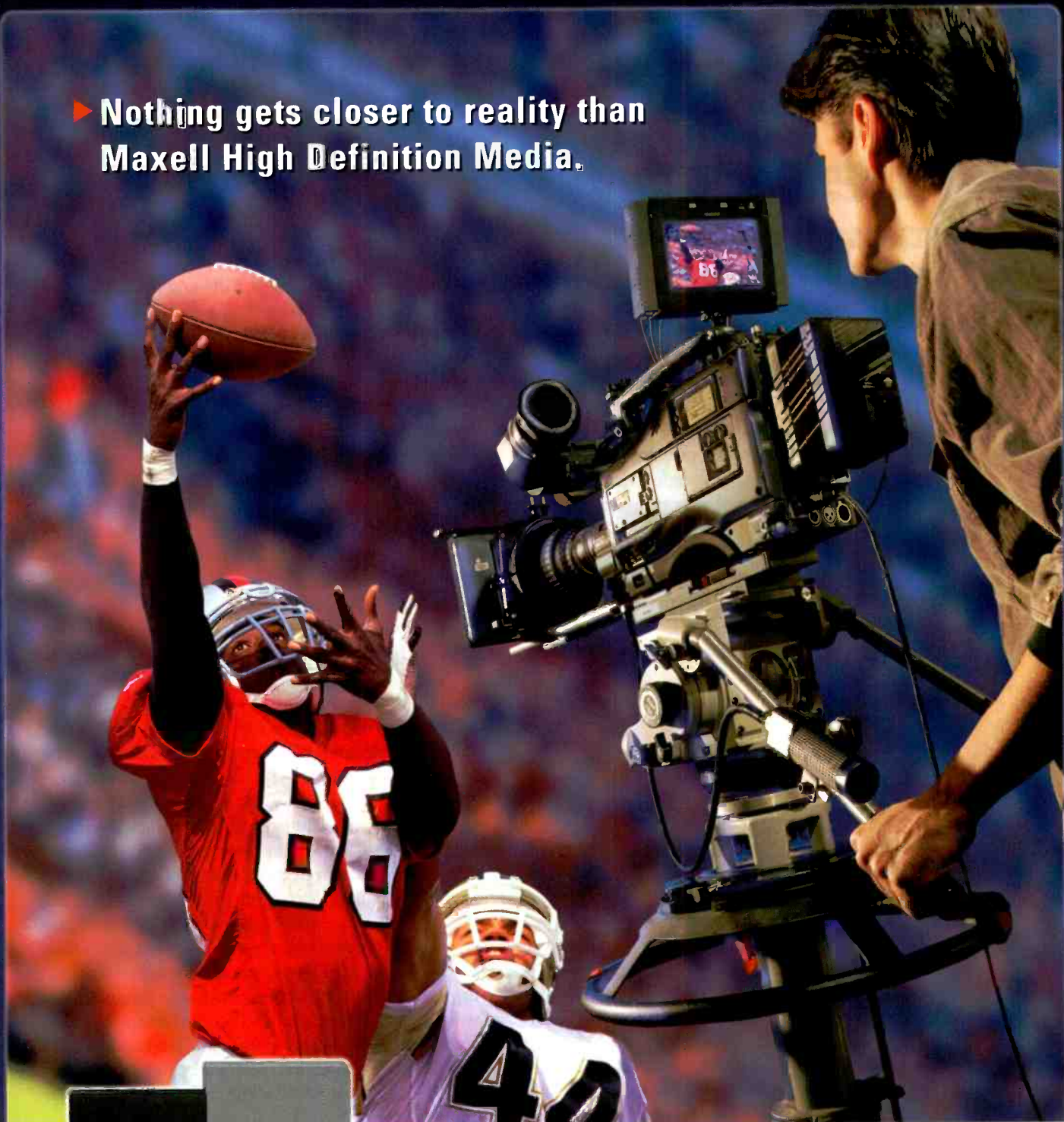

maxell
Expanding Memory & Mobility ►

Professional HD productions demand peak levels of reliability, versatility and durability. To that end, Maxell Professional HD Media utilizes Ceramic Armor Metal Particle technology to provide superior signal-to-noise, significantly reduced error rates and exceptional C/N. Maxell D-5, HDCAM, and DVCPRO HD - for high-definition video that rivals reality. To learn more, call 1.800.533.2836 or visit www.maxellpromedia.com



Learning can be fun

In a rapidly changing industry such as television, just keeping up with the technology front can be a full-time job. The problem is that no one can afford to spend that much time keeping current with events, regulations and technology.

Every industry's solution to this dilemma is to hold a trade show. The problem is that trade shows always focus on the exhibits, which overshadow the original intent — which was to help attendees learn something.



In the television industry, we enjoy a variety of conventions, conferences and seminars. Once we get past the NAB convention, the size of the events targeted at this industry fall off rapidly.

These second-tier events often are coordinated by member-based organizations (SBE, SMPTE, SCTE). The events have exhibits, which pay the bills, but these organizations live and breathe to promote educational value to their members.

SMPTE holds several events throughout the year. Most notable are the winter conference and fall convention. The SBE holds its yearly convention in combination with a chapter that runs a healthy local event. The combination works well for the chapter's visibility, while providing a base of support for the organization's national event.

Another organization, the Hollywood Post Alliance

(HPA), holds several events throughout the year that promote technology education.

The HPA is a trade association that represents Southern California-based businesses and individuals involved in the creation and finishing of television, commercials, movies, digital media and other dynamic media content.

One of the HPA's orchestrated events is the Winter Technology Retreat held in Palm Springs. The retreat focuses on more than just "post" issues. Cameras, storage, lenses, audio and a whole range of topics are discussed. While smaller in design than other conventions, this conference represents a jewel in the arena of attendee education.

Several things make this confab different from others you might have attended. First, it's held mid-winter in Palm Springs. Not a bad place to be in January. Second, the event's focus is on technology, complete with leading-edge papers and exhibits — no vendor sales pitches! Third, the event is definitely attended by Hollywood (and New York) content creators and production elite. And finally, the sessions always run on time, thanks to session coordinator Mark Schubin's edict of "be on time, or be gone."

The HPA winter retreat is focused on education and technology, rather than selling exhibit booth space. So, don't expect to see halls filled with glitzy Las Vegas-style flashing lights and a couple hundred exhibitors. Instead, there are several rooms of low-key technology exhibits showing current and future products. You will see traditional ready-to-buy products, but also some leading-edge demos. And, this is a hands-on exhibition. If you want to test drive the product or demo, you'll be able to do so, all while enjoying your favorite adult beverage.

Just think about spending several mid-winter days in Palm Springs, complete with more than 110 golf courses, great hotels, a temperate winter climate, top-notch sessions, good equipment demos and great hospitality. Now, what's not to like about this?

BE

Brod Dick
 editorial director

Send comments to: • editor@primediabusiness.com • www.broadcastengineering.com



MAKING IT HAPPEN

With complex HD playout, you need powerful monitoring and control.

You need smart systems that instantly report failures, and automatically present solutions to keep you on-air while you undertake emergency maintenance.

Miranda has pioneered the deployment of advanced multi-image display processing, integrated with monitoring and control over IP.

With our Kaleido and iControl monitoring systems plus our advanced HD/SD signal probing, you'll remain fully in control.

So if you're planning a new HD system, call Miranda. We'll help you make it happen.

Miranda Technologies
tel.: 514.333.1772 - ussales@miranda.com

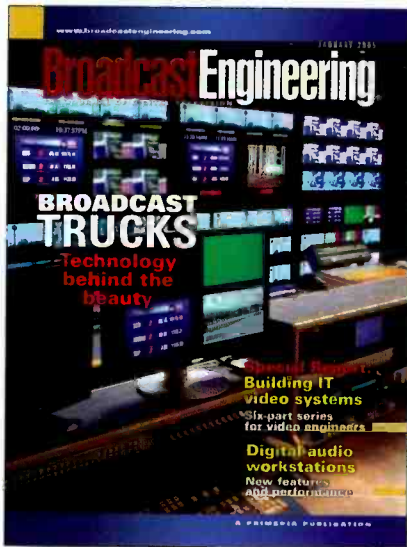

CRT gamma correction

Brad,

I enjoyed the article about CRT gamma in the January 2005 issue of *Broadcast Engineering*.

I can't tell you how many times over the past 20 years I have tried to explain the problem of CRT gamma correction to people. I was told repeatedly not to worry about something that didn't matter.

Well, I guess when the FCC is asked by Congress and the president to have its commission headed by broadcast engineers (not lawyers) to come up with a standard for digital broadcast, they will resolve all of these analog problems. Some, but not all, of the problems that the FCC will resolve might include making one digital standard for everyone to manufacture and use, one TV tuner or one set-top box, one recording format, and one compression scheme.

For frame rate, (29.94, 30, 24) interlace/progressive, drop frame/non-drop frame, set-up level (7.5 IRE 0 RE) and 100 percent white (235 or 256) and a few other items that don't make life simple.

DON SPITZMILLER

In sync

Mr. Luff,

In the analog domain, we have to do horizontal and subcarrier timing with the machines so they are in sync in a switcher. Is it the same in the digital domain? I think that there is timing to do, but the timing window is wider than in analog. There must be timing to do; otherwise, they would not put an out of sync light on our digital Saturn switcher (BTS). When the machines are not in sync, you cannot do a wipe, and you see the image with a vertical sync problem.

JEAN-FRANCOIS MATHIEU
MUSIQUE PLUS

John Luff responds:

The simple answer is that timing is just the same with digital as analog signals. The references used are the SAV/EAV signals. Digital video switchers are generally very forgiving, usually +/- 1/2 line or more. The vertical timing is just as critical as with analog. Hope that helps.

PVS problem

Hello Brad:

I am currently in Guadalajara, Mexico, and have just acquired one of Utah Scientific's switchers of the PVS series, but I don't have any training, and the service/operations manual is incorrect, so you can imagine how confused I am!

Utah Scientific stopped selling these devices more than 10 years ago. Do you know where I can get a copy of the original manuals?

CHEERS,
IVAN URRUTIA
CASA CULTURAL BERIA
RADIO AND TV PRODUCTION

Utah Scientific responds:

I have recently learned of your request for technical support on the Utah Scientific PVS-series switcher.

As you know, this product was discontinued more than 10 years ago. However, it is the long-standing policy of Utah Scientific to provide all possible technical support for our products — regardless of age.

In keeping with this policy, we have an arrangement with a technical support company to provide customer assistance on the PVS-series switchers. Your request has been forwarded to this company, and we are confident they will contact you shortly to determine what is required to bring your system up to full operating condition.

If you have any questions or need any further help with any of our products, please do not hesitate to contact me.

SCOTT BOSEN
DIRECTOR OF MARKETING
UTAH SCIENTIFIC

December FreezeFrame:

In December, we asked readers to name the winners of the 2003 *Broadcast Engineering* Excellence Awards.

Winners:

Rich Brockman
Rich Lohmueller
Karra Narsimhareddy
Karl Sargent
Peter J. Houghton

Test your knowledge!

See the FreezeFrame question of the month on page 10 and enter to win a *Broadcast Engineering* T-shirt.

Send answers to bdick@primediabusiness.com

AFFORDABILITY THROUGH INNOVATION

See us at
NAB 2005
Booth # SU-7823

Newton

Gecko

Control the signal, not just the module.

Kameleon

Maestro



Go ahead.
Demand more of your system.

Grass Valley™ signal management products pack more power in a module than anyone else.

Now, with our Newton™ modular control system, you get fast multi-module control of signal processing. Control all the audio, video, and conversion modules in a signal path at once with simultaneous four-function control of signal parameters. It's an elegant blend of software and hardware that lets you intuitively page through your signals for rapid control.

Demand more from your systems. We do.

To learn more contact your local Grass Valley™ sales representative, or visit:

www.thomsongrassvalley.com/newton

 grass valley

HD anachronism

BY CRAIG BIRKMAIER

Welcome to NAB2005 — your future starts here.

That's an interesting way to describe the world's biggest trade show and conference, an event that is focused on the rapidly evolving tools that we use to produce and distribute digital media content. Obviously, the National Association of Broadcasters (NAB) must be talking to a larger audience than its membership, which relies on the NAB to hold the future at bay.

Talk about a great deal. Everyone who wants to influence the future of digital media comes to NAB to push their vision of the future. Then the NAB takes their money and uses it to help its members delay that future another year. Then another, and another.

This year, according to a growing number of vendors, the HD highway will be running through NAB. In January, Steve Jobs proclaimed 2005 to be the year of HD for Apple, announc-

ing support for the HDV format that is being popularized by JVC and Sony. And Sony has invited us to travel the HD highway through its NAB booth; a pre-NAB press release tells us that planned exhibits and demonstrations will focus on current and future HD products and technologies, and on the

about HDV, you would conclude that it's time to jump aboard now or you'll be left behind. Somebody is putting the HD cart before the horse.

Will the mere existence of \$5000 HD camcorders create an overwhelming demand for low-cost HD production? I think not. Would it not be helpful to



The HD bandwagon appears to be moving now, but listening to all of the hype about HDV, you would conclude that it's time to jump aboard now or you'll be left behind.

roads customers can take to migrate from their SD infrastructures to HD-based operations. (See Web links on page 20.)

Somehow this all seems to be a bit anachronistic. To be certain, the HD bandwagon appears to be moving now, but listening to all of the hype

have a way of distributing HD content first? And how about an HD display to hook up to the HD-DVD players that will be here ... in the future?

Yes, the future starts here. Figuring out how to get from "here" to that HD future is the question that many will be asking as they travel the HD highway through the NAB exhibits. Many of those questions will involve intense debates about the technologies that will take us down that highway, and those that will wind up in the ditch.

Consider, for example, the debate about the future of HD-DVD. What color would you like: red or blue (laser)? What codec should you use: MPEG-2, AVC/H.264 or VC-1?

Will this be another Beta/VHS war, in which case, it may take a few more years for the winner to emerge? And what would happen if another optical storage technology blows them both off of the HD highway?

The clues will be at NAB2005, if you know where to look. This column will provide an analysis of what is likely to be important in the future, when the HD highway is ready to handle some serious traffic.

FRAME GRAB A look at the issues driving today's technology

Motivating factors to switch to telco TV

Respondants chose a lower monthly cost as the top reason

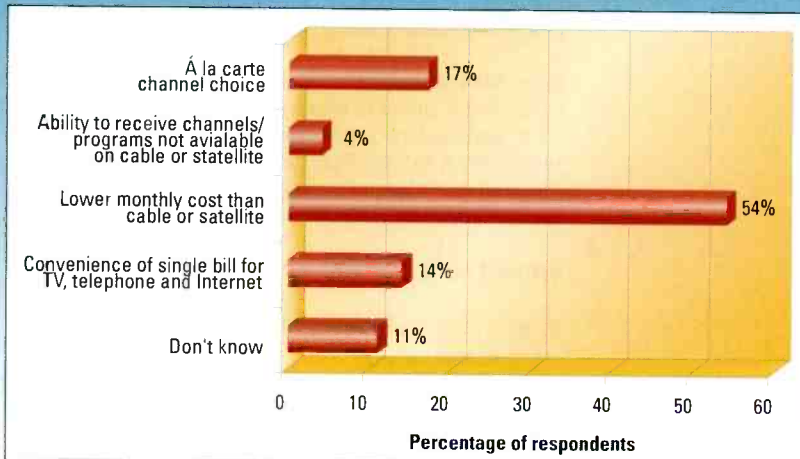

Source: Lyra Research

www.lyraresearch.com

Surround completes the HDTV experience.



Come see why Dolby® Digital 5.1 is the multichannel surround sound format for HDTV. From postproduction to set-top box, Dolby Digital technology delivers exceptional surround sound. Committed to ensuring the highest quality sound arrives in your customer's living room, Dolby offers commissioning services for postproduction and broadcast facilities. Visit us at NAB for a full demonstration on how to surround your audience in the best possible HDTV experience.

**NAB 2005, April 18–21, Las Vegas Convention Center.
Booth SU7870**

www.dolby.com/events/nab



Dolby and the double-D symbol are registered trademarks of Dolby Laboratories.
©2005 Dolby Laboratories, Inc. All rights reserved. S05/16005

The tapeless future

Remember way back, when the big hype at NAB was "the tapeless facility?" Today you can record bits on optical discs, magnetic hard disk drives, solid-state memory, and, you guessed it ... tape.

But tape does have limits, and it is linear, which implies a whole host of issues related to digital workflow. Optical discs are nonlinear, but they too are limited in terms of write speeds and are potentially more vulnerable to environmental issues when used to replace tape in a camcorder. Solid-state memory is fast and totally random; there are no moving parts, and power consumption is minimal. But they are expensive, and it is necessary to move the bits to another storage media for processing and archiving. Hard disks are cheap, totally random and competitive with tape in terms of price per stored gigabyte; but they have issues when integrated into a camcorder.

The emerging reality is that all of these storage media have a place (or multiple places) in the digital workflow of the future.

If you acquire to tape, you will more than likely digitize analog video and

store it on hard disks, or move digital video files to hard disk for processing. If you acquire to optical disc, you will probably move the bits to hard disks for processing, and to tape and disc for distribution and archiving. If you acquire to solid-state memory, you are likely to move the bits to hard disks, even as you are shooting, to free up the expensive memory modules. And if you acquire direct to hard disk, you will probably back up those disks to tape or optical disc for storage. Got the picture?

In the long term, tape probably will go away, because the storage densities



An HD version of Sony's XDCAM will be demonstrated this year at NAB. It is unknown if it will use the same compression as Sony's HDCAM (pictured here), but it is likely.

projected for optical and magnetic disks in the future and the I/O speeds,



Panasonic's challenger to HDV will support recording modes that use the original DVCPRO (25Mb/s) compression format, DVCPRO50 (pictured above) and DVCPROHD (100Mb/s).

will make tape slow and expensive. Solid-state memory has the right stuff for future acquisition products. It just needs a few more years ...

Blue-ray DVD looks attractive, given the large storage capacity relative to red laser DVD. But blue lasers can be used in innovative new ways to increase storage densities. This past January, InPhase Technologies, based in Longmont, CO, announced a working prototype of the world's first holographic drive, which stores bits as 3-D holograms within the writable media. (See Web links on page 20.) The company's first product will store 200GB in an optical disc that is comparable in size to the Blue-ray discs; future products are expected to reach



It's Not Like Any Other CG!

- Powerful multi-channel SD or HD.
- Blazing speed for real-time animations and 3D like you've never seen before.
- Fully integrated clipstore with video and key.

SD or HD -- don't compromise! It's the Duet HyperX and it's available now.

Xtraordinary Graphics



www.chyron.com

How to build a brand, instead of just graphics.



APR™ • ClipStore™ Video + key + audio = better branding for your station. The new, low-cost ClipStore DDR delivers live, full motion graphics that practically jump off the screen — truly unforgettable images that keep viewers glued to your channel. Capture, store and play pristine, uncompressed video + key + audio content, while seamlessly rendering projects directly to ClipStore via ultra-fast gigabit Ethernet. So fast and easy. Best of all, ClipStore is from Accom — the leader in reliable, innovative digital disk recorders. Visit www.accom.com to learn more about building a better station brand with ClipStore.

Accom®

Visit us at NAB Booth # SU7834.

1.6TB per disc. Current Blue-ray recordable drives, such as those that Sony uses in the XDCAM product line, can store 23.5GB on a disc that costs between \$25 to \$30. InPhase estimates that a 200GB disc will cost about \$60. That's nearly 10 times the storage for twice the price. In recent years, this technology has been previewed in off-the-floor hotel suites at NAB, but this year it will be on the show floor in the Maxell booth.

Sony has announced a technology demonstration of an HD version of XDCAM at this year's NAB. It is not known whether it will use the same compression as Sony's HDCAM products, but this would appear to be the likely choice to take full advantage of other HDCAM workflow products. To make this work, it will be necessary to increase the write speed of the Blue-ray recorder in the camera. The most likely scenario will be a dual head drive mechanism that Sony uses for its off-line transfer stations, which supports faster-than-real-time file transfers thanks to the higher I/O rate. But a new HD compression format could also be in the cards. And Sony will be adding products to support the HDV workflow, while promoting the availability of its FX-1 HDV camcorder.

Panasonic has a variety of industry forums abuzz with rumors of a challenger to HDV, based on the company's P2 solid-state acquisition systems. In pre-NAB press briefings, Panasonic has "leaked" the following information: The new camcorder will support recording modes that use the original DVCPRO (25Mb/s) compression format, DVCPRO50, and DVCPROHD (100Mb/s), storing the

bits on P2 memory modules; it will support 24p acquisition and cost less than \$10,000. The product will be shown as a mockup at NAB, where we'll learn details of its capabilities.

In private briefings at last year's NAB, company representatives were talking about several potential products. There was a mockup in the Panasonic booth of a P2 palmcorder and talk of an HD product with strong parallels

8GB modules this fall.

Ultimately, what is stored on P2 modules needs to be moved to hard disk for processing, and logically to optical disc or digital tape backup for archival storage. Early adopters have been using the portable P2 drive to move files from P2 modules to some kind of hard disk storage in the field. One of the more popular target drives for this application is an Apple iPod,

The HD hypeway will be filled with bumper-to-bumper traffic — lots of carts being pushed by horses.

to the high-end 720p Varicam. The latter could have tremendous appeal, and the P2 storage modules would provide a less complex, but more versatile, recording system than the DVCPRO tape drive used in the Varicam.

In order to make variable frame rate recording to tape possible, Varicam always uses the tape speed needed to record 720p at 60fps. For lower frame rates, the tape speed remains the same and each frame is recorded multiple times. Thus, the in-camera storage requirements are the same for any frame rate; when files are transferred to hard disk, the redundant frames are removed. Recording to solid-state memory has the advantage that each frame is only stored once. When shooting 60p, the storage rate would be the full 100Mb/s. At 24p, however, the storage required would be 24/60th of 100Mb/s, or 40 Mb/s. Thus, the recording capacity of a P2 storage module would more than double when shooting 24p.

When Panasonic introduced the P2 product line, it noted that the write speed for *all* P2 storage modules would be sufficient to support future HD products as well as faster-than-real-time file transfers. Current 2GB storage modules have a transfer rate of 320Mb/s, while the 4GB modules (and all future higher capacity modules) have a transfer rate of 640Mb/s. Panasonic expects to begin shipping

which has both IEEE-1394 (Firewire) and USB 2.0 I/O capabilities. The P2 drive uses USB 2.0 I/O.

In February, Panasonic announced the P2Store, a 60GB hard disk with an integrated P2 memory card reader. This P2Store is designed to attach to your belt. When you want to move the contents of a P2 module to the hard drive, you plug in the module and hit a single button to move the contents; the drive can be hooked up to a computer to process the files or to move them to another storage device.

Another year?

The stage is set for another NAB that will look a lot like those of years past. The HD hypeway will be filled with bumper-to-bumper traffic — lots of carts being pushed by horses. What ever happened to buggy whips? **BE**

Craig Birkmaier is a technology consultant at Pcube labs, and he hosts and moderates the OpenDTV Forum.

Web Links

Sony Pre-NAB release
<http://news.sel.sony.com/pressrelease/5591>

InPhase press release on Holographic optical storage
www.inphase-technologies.com/news/firstholoproto.html

 Send questions and comments to:
cbirkmaier@primediabusiness.com

ATTENTION READERS!
Sign up now for
BroadcastEngineering's
HD
Technology Update
e-newsletter
at www.broadcastengineering.com



The Cast (In Order of Appearance)

Aspect Ratios: Native 16:9 and 4:3	As Itself
Frame Rates: 60i, 30p, and 24p	As Itself
3 Progressive Scan CCDs	As Itself
Customizable Cine Settings	As Itself
Canon Interchangeable Lens System	As Itself
20x Professional Fluorite Lens	As Itself
Optical Image Stabilizer	As Itself
SMPTE Time Code	As Itself
Built-In XLR Audio Inputs	As Itself
Four Channel Independent Audio Control	As Itself
SMPTE Color Bars With Tone	As Itself
Program Auto Exposure Modes	As Itself
Zebra Pattern	As Itself
Skin Detail Adjustment	As Itself



Canon KNOW HOW®

Whether you're a videographer, documentarian, or filmmaker, you'll find the XL2 possesses all the range required to help you realize your creative vision. Its all-star cast of features gives you complete image control and lets you put to screen exactly what you see in your mind's eye. In fact, with so much creative power in your hands, you'll find the XL2 allows you to be the visionary you always thought you could be. To find out more, please log onto www.canondv.com. **digital REVOLUTIONIZED video ■ we REVOLUTIONIZED digital™**

©2005 Canon U.S.A., Inc. Canon and Canon Know How are registered trademarks and "digital revolutionized video, we revolutionized digital" is a trademark of Canon Inc. and may also be registered trademarks in other countries. Mac and the Mac logo are trademarks of Apple Computer, Inc., registered in the U.S. and other countries. Microsoft, Windows, and the Windows logo are trademarks or registered trademarks of Microsoft Corporation in the U.S. and/or other countries. The Designed for Windows XP logo refers to the digital camcorder and its driver only.

FCC rejects DTV multichannel must-carry



BY HARRY C. MARTIN

The FCC finally has addressed issues that had been pending for more than four years regarding the obligations of cable systems to carry DTV signals.

The results are not good for broadcasters. The FCC decided that cable operators are *not* required to carry multicasting or provide dual carriage.

Multicasting

In its January 2001 DTV Must-Carry Report and Order, the FCC found that the statutory requirement that cable providers carry only the "primary" video of a broadcast signal meant that stations were entitled to carriage of only one digital programming stream, rather than all or multiple streams. The commission reaffirmed this conclusion in its February 2005 order.

While it recognized that there is some ambiguity over what Congress might have meant by the term "primary video," the commission concluded that Congress' language implies that some programming is "secondary," and thus not entitled to must-

carry. Although the term "secondary" might have been intended to refer to digital services such as Internet access or data transmission, the FCC appears to have concluded that these non-video services are better described as "ancillary" services, which do not qualify for must-carry. That would leave multiple video programming streams as "secondary."

The commission also recognized that First Amendment considerations limited its ability to read the term "primary" expansively and, pursuant to that expansive reading, to enact requirements that the cable industry assert significantly burden cable operators' free speech rights to program their systems as they please.

The Supreme Court's 1997 Turner decision upheld the constitutionality of a single analog must-carry requirement by a narrow 5-4 vote, based on "substantial evidence" in the record that absence of an analog must-carry requirement would lead to such substantial financial hardship on stations that free over-the-air service to the public would suffer as stations died.

sioners, even if requiring dual carriage would promote the transition, the FCC did not have the authority to do so under the First Amendment.

Of course, even though broadcasters do not have mandatory rights to multicasting and dual carriage, that does not mean that they are barred from negotiating for some or all of those rights with cable operators on an individual basis. The commissioners pointed to such agreements.

It particularly noted the recent agreement between the cable TV industry and the Association of Public Television Stations and PBS, under which cable operators will voluntarily carry up to four streams of non-commercial digital programming streams from one public TV station in each market, along with that station's analog signal. Many cable operators have expressed an interest in obtaining locally oriented programming for their growing digital tiers, including local news and sports channels.

Broadcasters will have an opportunity to obtain voluntary digital carriage in the context of retransmission consent negotiations that will occur this year, leading up to the carriage election deadline of October 1. **BE**

Harry C. Martin is president of the Federal Communications Bar Association and a member of Fletcher, Heald and Hildreth PLC, Arlington, VA.

SEND Send questions and comments to:
harry_martin@primediabusiness.com

ATTENTION READERS!
Sign up now for
BroadcastEngineering's
e-newsletter
BEYOND
The Headlines
at www.broadcastengineering.com

Dateline

June 1 is the deadline for TV, TV translator and LPTV stations in Michigan and Ohio to file their renewal applications, biennial ownership reports and EEO program reports.

June 1 also is the deadline for TV stations in Illinois and Wisconsin to begin broadcasting their renewal prefiling announcements.

Network affiliates in top-100 markets must build out their full DTV facilities by July 1 or lose interference protection beyond the coverage areas of their actual facilities as of that date.

Dual carriage

The FCC concluded that a dual carriage requirement would violate the First Amendment rights of cable operators. Some broadcasters had hoped that the Communications Act's mandate that the FCC promote the DTV transition might overcome the FCC's other concerns. Addressing that argument, Chairman Powell noted that the FCC had taken many other actions designed to promote the DTV transition, including giving broadcasters a second channel during the transition and mandating the manufacture of digital TV tuners. According to the commis-

evolve.



think video. think Terayon.

Digital video changes everything - how we brand, communicate, entertain and inform. Terayon accelerates your ability to evolve and capitalize on new business opportunities brought on by this digital revolution. Terayon enables you to deliver picture perfect results where it matters most - on the screen and on your bottom line.

TERAYON

evolve faster.

www.terayon.com • info@terayon.com

See Terayon at NAB 2005, South Hall #11316



Horizontal resolution: Pixels or lines

BY MICHAEL ROBIN

Historically, resolution is understood to mean “limiting resolution,” or the point at which adjacent elements of an image cease to be distinguished. Various disciplines measure and specify resolution differently. Resolution can be specified as:

- The number of units (i.e., lines or line-pairs) per unit-distance along the vertical and horizontal axis such as lines/mm.
- The number of units (i.e., lines) for a full display such as lines per picture height (LPH).

In television, the resolution is specified in terms of LPH. The various conventional broadcast TV systems in use today were originally designed to achieve equal horizontal and vertical resolution, known as “square pixels.”

The analog heritage

The vertical resolution is indepen-

dent of the system bandwidth and defines the capability of the system to resolve horizontal lines. It is expressed as the number of distinct horizontal lines, alternately black and white, which can be satisfactorily resolved on a television screen. Vertical resolution depends primarily on the number of scanning lines per picture and the combined effects of the camera and display capabilities.

Ideally, the vertical resolution would be equal to the number of active lines per frame. This would happen if the scanning lines were centered on the picture details.

However, the scanning lines cannot be assumed to occupy a fixed position relative to vertical detail at all times. Complete loss of vertical resolution will occur when the scanning spot straddles picture details. From subjective data, obtained with progressive (non-interlaced) scanning, it

has been found that the vertical resolution is equal to 70 percent (the Kell factor) of the number of active lines. In the NTSC standard, there is a total of 525 lines per frame, of which about 40 are blanked, leaving, typically, about 485 active lines per frame. Given a Kell factor of 0.7, the effective vertical resolution is:

$$N_v = 0.7 \times 485 \approx 339 \text{ LPH}$$

The horizontal resolution defines the capability of the system to resolve vertical lines. It depends on the camera and display capabilities, as well as the bandwidth and the high-frequency amplitude and phase response of the transmission medium. In a 4:3 aspect ratio television system, it is expressed as the number of distinct vertical lines, alternately black and white, which can be satisfactorily resolved in three quarters of the width of a television screen. A system with a horizontal to vertical aspect ratio of 4:3, as in conventional television, needs to allow for $(4/3) N_v$ horizontal details to be resolved over the width of the display.

In the NTSC system, this results in $339 \times 4/3 \approx 452$ horizontal details to be resolved. Due to the limited system bandwidth, exploring a pair of contiguous white and black fine details (line-pair) results in a sinewave with a positive half-wave corresponding to the white detail and a negative half-wave corresponding to the black detail. Scanning 452 horizontal details results in an electrical signal with 226 complete cycles during the active horizontal scanning line.

In the NTSC standard, the total horizontal scanning line duration is 63.5 μsec , and the horizontal blanking duration is 10.7 μsec . This results in an

FRAME GRAB

A look at tomorrow's technology

Growth of IP-based entertainment content

Users paying for on-demand movies from the Internet

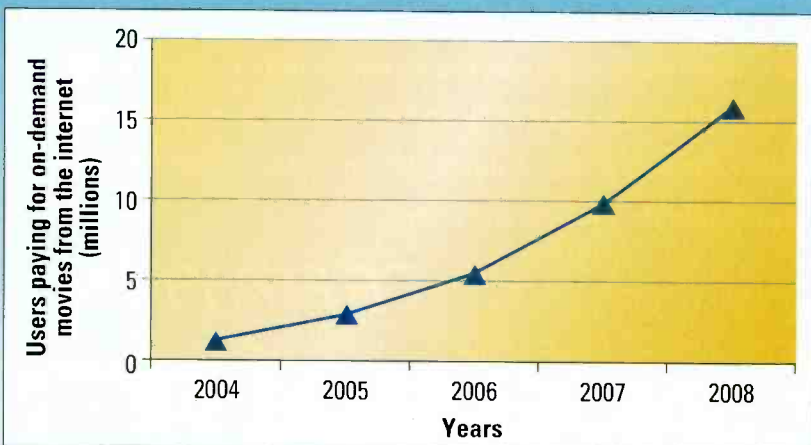

Source: Parks Associates

www.parksassociates.com

Raising the bar!

Endorsed by the Leading Broadcast Stations and Post Production Houses

Setting new standards in the post production industry.
Designed and Engineered for Intelligent Solutions.

The Time Tailor™

The Time Tailor™ micro editing process increases the producer's creative flexibility by enabling "time-fit" programming without data compression, picture impairment or pitch change in live or pre-recorded content.

The Time Tailor™ uses newly developed software to offer an integrated system designed and engineered to work with all equipment in a standard edit suite.

To learn more about the intelligent Time Tailor™, visit our web site at www.primeimageinc.com

Prime Image has more than 20 years of leading the industry with high performance broadcast and production solutions.



Standard Features:

- * Insert, delete, move black slugs all in one pass with frame accuracy
- * Micro editing technology
- * Maintains closed captioning
- * Windows based interface

Benefits:

- * Reduces content up to 8% with no loss of program integrity
- * No detectable change in video and audio quality
- * Operates in real time cutting work time by 70%
- * Proven technology

**Prime
Image**

Performance by definition.

Tel (408) 867-6519
Fax (408) 926-7294

www.primeimageinc.com

NAB 2005
THE WORLD'S LARGEST ELECTRONIC MEDIA SHOW

Next Show Event: Visit us at NAB 2005
Booth C5614 April 18-21

"We selected Omneon servers and shared storage for playout, and have since connected our production processes. Omneon is the one solution that fits our tight budget, meets all our requirements today and supports us as our needs change."

Helge Blucher

Vice President
Detroit Public Television

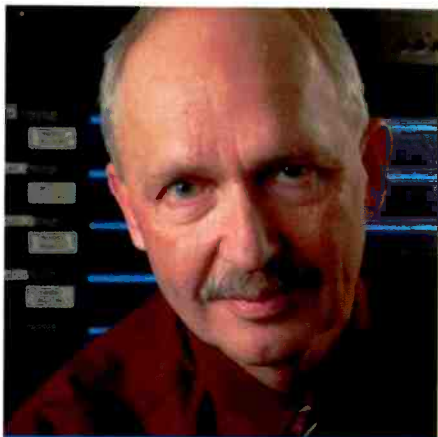

Detroit Public Television operates on a very tight budget with limited resources. When it came time to select a media server, they needed a cost-effective solution that gave them both operational efficiencies and the flexibility to satisfy multiple requirements.

With Omneon Spectrum™ media servers, Detroit Public TV implemented a solution that worked across their entire operation. Built around the concept of Smart Scalability™, Omneon Spectrum systems can be configured to meet precise format, channel count, bandwidth and storage specifications. What's more, Omneon Spectrum systems can then be expanded in smart, manageable increments—without replacing the original system and in many cases, without taking the system off-line.

To learn more about the unique advantages of an Omneon Spectrum media server system visit www.omneon.com.

It's not just
what you serve.

It's who.



Visit us at NAB, Booth #SU10724

PARAMETER	Value
Sampling frequency (MHz)	13.5
Nyquist frequency (MHz)	6.75
Cut-off frequency (MHz)	5.75
Number of samples per total line	858
Number of samples per active line	720
Resolution factor (Lines/MHz)	≈80
Horizontal resolution (LPH)*	≈460
Total number of lines per frame	525
Active number of lines per frame	485
Vertical resolution (LPH)**	≈339

*Horizontal resolution (LPH) = Resolution factor (lines/MHz) x cutoff frequency (MHz)

**Vertical resolution (LPH) = Active lines per frame x Kell factor (0.7)

Table 1. ITU-R BT 601 4:3 format Y channel characteristics

active line duration of 52.85 μsec. The duration of a single cycle is:

$$T = 52.85 \mu\text{sec} / 226 \approx 0.2338 \mu\text{sec}$$

The fundamental frequency resulting from scanning 452 horizontal details is:

$$F = 1/T = 1/0.2338 \mu\text{sec} \approx 4.28\text{MHz}$$

This is the bandwidth required for equal horizontal and vertical resolution. The horizontal resolution factor for a 4.28MHz bandwidth is: $339/4.28\text{MHz} = 79.2$ lines/MHz rounded to 80 lines/MHz. In countries using the NTSC standard (CCIR M), the maximum transmitted baseband video frequency is 4.2MHz, resulting in a transmitted horizontal resolution of:

$$N_H = 4.2\text{MHz} \times 80 \text{ lines/MHz} \approx 336 \text{ lines}$$

The resulting horizontal versus vertical resolution ratio is, therefore, $336/339 \approx 0.99$. From an analog point of view, this represents a quasi square pixel. It is important to note that the analog television concept is based on the vertical resolution and the Kell factor, and assumes a single format from the camera through the production-transmission-reception process to the CRT display.

Color television introduced the color CRT wherein there are separate Red, Green and Blue phosphor dots whose number and characteristics have an effect on the reproduced resolution.

The transmission of color information as a subcarrier modulated in amplitude and phase resulted in a frequency-division multiplexing of luminance-chrominance information which needed to be decoded to display the original Red, Green and Blue information. The final luminance resolution depended finally on the ability of the decoder to separate the two informations without mutual crosstalk and bandwidth reduction.

Digital concepts

The computer world introduced the concept of picture element shortened to "pixel" and sometimes "pel." Computers use progressive scanning to display digitally generated pixels and thus have no display related limitations other than the display resolution and the analog drive (Red, Green, Blue) circuits characteristics.

Rec 601, the first successful international digital video standard, specifies data acquisition in terms of samples per total line and per active line. No mention of pixels here! Resolution-related Y channel characteristics are shown in Table 1.

The luminance (Y) sampling frequency is 13.5MHz, resulting in 720 samples per active line. One would be tempted to assume that at every sampling instant, there would be a pixel ready to be sampled. This would be

The Fastest Alternative in the World!

NEW EDITION

Sachtleer, Fraenkel, HH



The new DV 15 Fluid Head is the perfect combination with any digital ENG camcorder. It is yet another example of Sachtleer's proven quality being used to support the new generation of cameras. And with its central locking for immediate leg release, the new Hot Pod CF is the fastest tripod in the world. Its maintenance-free pneumatic gas spring effortlessly lifts the camera over six feet high. So why wait? Optimize your equipment now. With Sachtleer!

Visit us at NAB Booth # C7319B
www.sachtler.com

sachtler
corporation of america

709 Executive Blvd.
Valley Cottage, NY 10989
Phone: (516) 867-4900
Fax: (516) 623-6844
email sachtlerUS@aol.com

3316, West Victory Blvd., Burbank, CA. 91505
Phone: (818) 845-4446



set your ideas in motion!



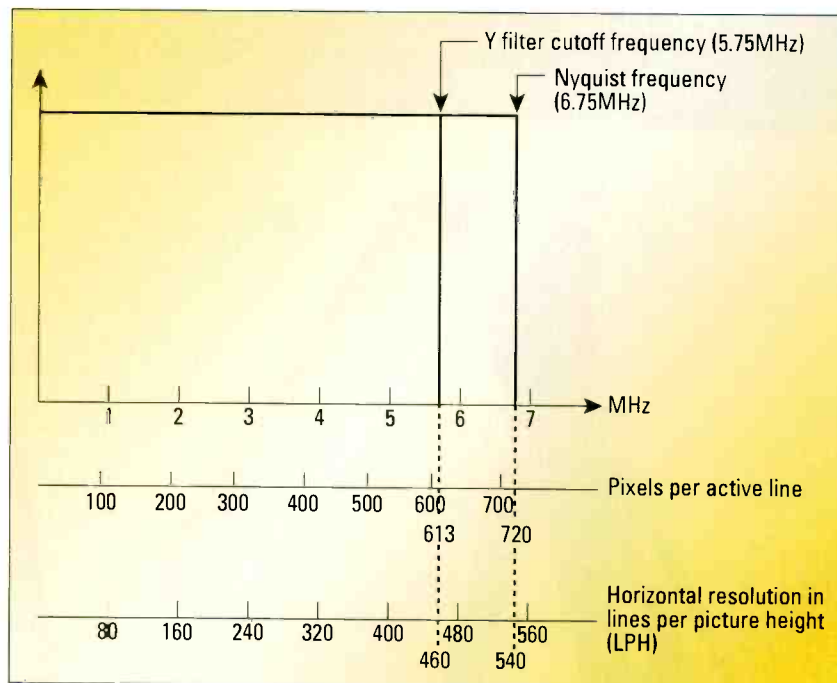

Figure 1. Relationship between the idealized luminance bandwidth, the resulting number of pixels per active line and the horizontal resolution

true in an ideal world where, given the Nyquist frequency of 6.75MHz, there would be $6.75 \times 80 \times 4/3 = 720$ active pixels on each line, yielding a horizon-

used a rounded figure of 80 lines/MHz. Expressing the horizontal resolution in a specific number of horizontal pixels is in conflict with the con-

reader to draw the proper conclusions.

Another contentious subject is the vertical resolution. Essentially, does the Kell factor apply to interlaced scanning, progressive scanning or both? As explained in my article "Revisiting Kell," published in the *Broadcast Engineering* March 2003 edition, the Kell factor was developed with progressive scanning in mind and applies to both interlaced and progressive scanning. Similar considerations apply to HDTV scanning systems.

The problem is further complicated by the use of various compression algorithms and format conversions in a production/transmission chain. The last element in the chain to leave its imprint is the ever more popular flat-panel display (LCD or plasma).

Conclusion

With digital television concepts and implementations, there is a trend towards expressing the picture resolution as the number of pixels per active line multiplied with the number of active lines per frame.

This trend tends to ignore the original definitions of horizontal and vertical resolution and is gradually replacing them in equipment and system specifications.

It is important to remember that television resolution is expressed in LPH. Ignoring this may result in quoting figures that are difficult, if not impossible, to compare. A return to basic concepts is essential in order to understand contemporary technologies. **BE**

PARAMETER	SMPTE 293M SDTV 720x483P	SMPTE 296M HDTV 1280x720P	SMPTE 274M HDTV 120x1080i
Sampling frequency (MHz)	27	74.25	74.25
Nyquist frequency (MHz)	13.5	37.125	37.125
Cutoff frequency (MHz)	12	30.00	30.00
Number of samples per total line	858	1650	2200
Number of samples per active line	720	1280	1920
Resolution factor (lines/MHz)	≈ 29	≈ 19.4	≈ 29
Horizontal resolution (LPH)*	≈ 348	≈ 582	≈ 870
Total number of lines per frame	525	750	1125
Active number of lines per frame	483	720	1080
Vertical resolution (LPH)**	338	504	756

*Horizontal resolution (LPH) = Resolution factor (lines/MHz) x cutoff frequency (MHz)
 **Vertical resolution (LPH) = Active lines per frame x Kell factor (0.7)

Table 2. 16:9 formats Y channel characteristics

tal resolution of $6.75 \times 80 = 540$ LPH.

In reality, the A/D converter is preceded by a low-pass (anti-aliasing) filter with a specified cut-off frequency of 5.75MHz. This results in $5.75 \times 80 \times 4/3 = 613$ sampled pixels per active line and a horizontal resolution of $5.75 \times 80 = 460$ LPH. (See Figure 1).

Note that in all these calculations, I

cept of the television resolution, which uses LPH.

Resolution-related Y channel characteristics of three ATSC 16:9 formats, shown in Table 2, allow you to compare conflicting resolution figures. Unfortunately, technical literature and equipment specifications often quote unrealistic figures, and it is up to the

Michael Robin, a fellow of the SMPTE and former engineer with the Canadian Broadcasting Corp.'s engineering headquarters, is an independent broadcast consultant located in Montreal, Canada. He is co-author of "Digital Television Fundamentals," published by McGraw-Hill and translated into Chinese and Japanese.



Send questions and comments to:
michael_robin@primediabusiness.com

HJ21ex7.5B
21x EFP

HJ22ex7.6B
22x TELE

HJ40x10B/HJ40x14B
PORTABLE LONG/TELE
(w/IMAGE STABILIZER)

HJ11ex4.7B
11x WIDE

HJ17ex7.7B
17x STANDARD

NEW

- PRIME TIME • REALITY TV • SPORTS EVENTS • ENTERTAINMENT
- COMMERCIALS • DOCUMENTARY • NEWS EVENTS • WORSHIP
- SURVEILLANCE • B2B

HD
SD

creativity

Canon has more ways to enhance production content.

J17ex7.7B
17X STANDARD

J11ex4.5B
11x WIDE

J22ex7.6B
22x TELE

J35ex11B
PORTABLE LONG

J35ex15B
PORTABLE TELE

Creative content is everything, which is why Canon has a portable lens selection that meets the needs of everyone. From SD to HD, tape to tapeless, studio to outdoor, Canon engineers a portable lens

family having extremely high optical performance, broad optical flexibilities, and powerful digital empowerment. To capture attention-getting, high-impact video, creativity begins with "C"anon portable lenses.

Canon's e-series portable lenses feature highly useful control tools to customize digital functions.



eIFXS
eHDXS

See US At NAB Booth #SU 7814.

Find out more at canonbroadcast.com

1-800-321-HDTV (Canada: 905-795-2012)

Maximize Your Camera's Performance.

Canon KNOW HOW®

©2005 Canon U.S.A., Inc. Canon and Canon Know How are registered trademarks of Canon Inc. in the United States and may also be registered trademarks or trademarks in other countries.

The accidental system administrator

BY BRAD GILMER



Last year, I wrote a column on how I became an accidental system administrator. An accidental system administrator is someone who finds himself in the position of administering computer systems and networks, even though it is not his “regular job.” Generally, the move into system administration is not planned. The interesting thing about this phenomenon is that there are people reading this column right now who are system administrators in their organizations but don’t realize it.

Training is key

It is difficult to be an effective system administrator without some education on the topic. Once you realize you are a system administrator, one of the first things you should do is seek opportunities for training, whether it is formal or informal. For me, the training that really sticks is the training that is directly related to my job. What does not work for me is to take some general computer classes covering techniques that I may never use. That said, if you find yourself becoming responsible for computer networks, switches, routers and so on, a general course on networking can be extremely useful. If you find that you are responsible for a specific operating system, Windows Server or FreeBSD, for example, a class on system administration of these operating systems can be useful. Community colleges in many areas offer these types of classes at reasonable cost.

If you cannot find appropriate classes in your area, you can learn a great deal through books. People al-

ways ask me for a list of books that they can read to learn more about computers and networks. Unfortunately, the most appropriate books for you will not be appropriate for someone else. I have found that people prefer different writing styles, and that while some people need basic information, others are asking detailed questions.

The best thing to do is go to a bookstore and take the time to find a book that contains the information you are seeking. If you have a specific question, you may have to buy an entire book just for one or two chapters. I have found this “cherry picking” approach to be quite effective in bolstering my own knowledge, although it can be expensive.

Private IP Address Range	Usage
10.200.20.0-10.200.20.255	On-air LAN
10.200.20.1-10.200.20.31	Servers & Routers
10.200.20.1	Switch used to connect to office LAN
10.200.20.11	Main file server
10.200.20.21	Main print server
10.200.20.32-10.200.20.159	General DHCP pool
10.200.20.160-10.200.20.255	Vendor equipment

Figure 1. Subsection from hypothetical IP address planning worksheet

Speaking of expense, it seems that computer books are among the most expensive books in the store. For this reason, I almost always buy used books unless I need information that I cannot get anywhere else. I strongly recommend Powell’s City of Books in Portland, OR (www.powells.com), as a great online source for training materials for system administrators. (If you ever find yourself in Portland, it is worth the trip to look over this technical bookstore.)

System integration

As an accidental system administra-

tor, you will find yourself involved in system integration projects. You should consider how you will handle integration of vendor-provided equipment with your networks. In some cases, the vendor may require that its network be completely stand-alone. In many cases, it is up to you to decide how and where vendor systems will integrate into your networks. As a broadcast engineer, you will probably be in a better position than a strictly IT-based person to decide these issues. It will help if you have taken some time in advance to plan for these systems.

Figure 1 shows a hypothetical worksheet for IP address configuration. Note that this is just a small section of the total worksheet. The complete worksheet would show the office network as well. It would also assign addresses in cases where vendors would like to have their own networks.

One of the hot topics with system administrators these days is security. Threats seem to be everywhere — from worms

and viruses to the loading of unauthorized software on critical systems; there are more than enough challenges to go around. If you are charged with maintaining networks and servers for both on-air and office environments, there are several things you can do to reduce security risks.

Isolate critical systems

Most people in the industry feel that it is best to run several physical networks within a facility and then interconnect these physical networks at specific, predetermined points. As Figure 2 on page 34 shows, one network

Who are you?

TELL US & WIN

GO TO THE WEBLINK BELOW and TELL US ABOUT YOU AND YOUR STUDIO FACILITY OR ENTER AT OUR NAB BOOTH C4915

STUDIO PRIZE PACKAGE valued over

\$40,000

Echolab Nova Identity⁴

HITACHI Z2500ST Professional video switcher & camera bundle!

It's about Personality, Creativity, Individuality.

Novaidentity⁴

A switcher as unique as you



CHECK IT OUT at NAB2005

Introducing the entire Echolab Nova Range at NAB'05
1ME • 1.5ME • 2.5 ME SDI Production Switchers
plus amazing AtoD, DtoA and ARC Converters!



Echolab.com / identity4 • **NAB2005 Booth C4915**

Enter the contest online NOW!

Contest includes Bonus iPod Prizes & FREE T-shirt Giveaway

Enter the contest by visiting our booth.

Take a hands-on demo of the remarkable Novaidentity⁴ at NAB!

may be reserved for critical on-air systems and another for general office applications. You may also want to establish a network for visitors. The visitor network is severely restricted, providing an Internet connection for http-based traffic and not much more.

Putting in several networks may seem like overkill, but the on-air en-

vironment needs to be strictly controlled to assure that risks are minimized. Unfortunately, this is in direct conflict with requirements of an office network, where people want to be able to share all sorts of information quickly and easily. The easiest way to deal with these conflicting technical goals is to create two (or more) physi-

cal networks in your facility.

As soon as you put in two networks, you will be faced with requests to connect the two together. You can take the easy way out and deny all bridging requests, but there is perhaps a more elegant and efficient solution. There are layer two switches that you can configure to pass traffic from one network to another based upon MAC addresses. MAC addresses are assigned to the network interface card installed in a computer. This will allow you to restrict access from one network to another. You should also configure the switch to block undesirable traffic that you would not want to appear on your on-air network, such as any electronic messages and email traffic.

Security of the on-air network traffic can be controlled in this way as well. You can strictly limit the traffic allowed on the network by type — no e-mail or electronic messages, for example. The network can also be locked down so that only computers with known Network Interface Card (NIC) addresses can talk. This will prevent someone from plugging a laptop or other unauthorized computer into the network. Computers in the on-air environment can be configured so that only authorized users can load new applications. The computers can also be configured so that removable media devices such as CD-ROMs and USB ports will not allow the introduction of unauthorized programs or viruses into the system.

Be pragmatic

There is a significant potential issue that I addressed in last year's column, which bears repeating. As a system administrator, perhaps the most important pitfall you should avoid is that of becoming a jerk. You probably have heard the saying, "Power tends to corrupt, and absolute power corrupts absolutely." I have observed several times that perfectly reasonable and pleasant people become very difficult to deal with when they become system administrators.

As a system administrator, you will

WE CAN TAKE YOU TO THE FUTURE - TODAY

MORPHEUS THE EVOLUTION OF AUTOMATION



- Multi-channel payout
- Scalable and flexible architecture
- Real-time, frame precise control
- Complex event support with MediaBall™ technology
- MXF compliant



www.pro-bel.com



UK +44 (0) 1189 866 123 USA +1 631 549 5159 France +33 (0) 1 45 18 39 80 Asia +852 2850 8383

Visit us at NAB, Booth# SU10730

your show matters

KCET Los Angeles

KLRU Austin

KQED San Francisco

MPTV Milwaukee

NETC Lincoln

WEDU Tampa

WIPR San Juan

WMHT Schenectady

“

We test drove multiple digital audio consoles but the Euphonix Max Air console outperformed them all in regard to intuitiveness and value. It is truly a great console - easy to use and very well priced for the quality.

Lee Young – Director of Engineering, KQED

”



Max Air at KQED

PBS is among the many TV stations and groups that have selected Euphonix to meet their broadcast audio needs. Euphonix is totally committed to providing the most effective and reliable audio mixing solutions for on-air and live-to-tape applications. We will do whatever it takes to get you on-air and keep you on-air with support, training, and technical expertise that is second to none.

The System 5 and Max Air models can be tailored to exactly meet your current and future production needs with a simple upgrade path and comprehensive features including surround, full integration with your facility router, automation connectivity to external GPIs, and a modular I/O system. Most importantly, the consoles are easy to learn and operate in a fast paced on-air environment.

Be Sure

euphonix.com

 **Euphonix**

digital emotion

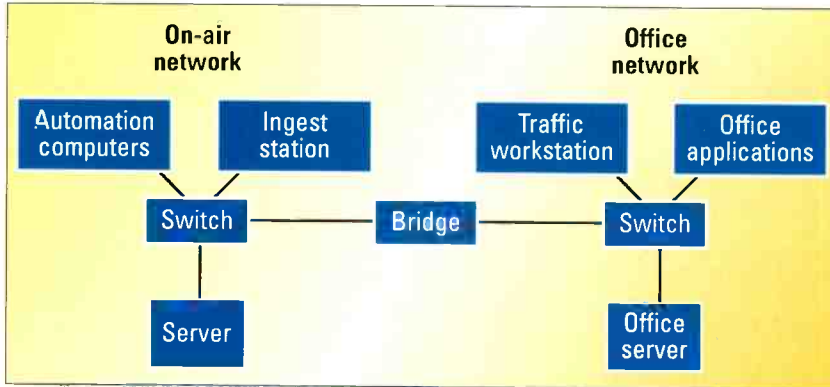

Figure 2. One network can be reserved for critical on-air systems and another for other general office applications.

systems, be cognizant of the fact that some of the measures you put into place will affect peoples' lives on a daily basis. You will need to balance the need for security with the impact of security on daily operations.

Brad Gilmer is president of Gilmer & Associates, executive director of the AAF Association and executive director of the Video Services Forum.



Send questions and comments to: brad_gilmer@primediabusiness.com

find yourself as a gatekeeper for many activities. People will need to get information from you. They will need you to do critical things for them. As you move into the system administrator role, you must realize that you are there to help others. Your main job is to make the technology serve the company and the people who work there.

If you hold back information — if you are unresponsive to requests from others — you may find yourself up to your elbows in mineral oil changing rectifier stacks at the transmitter rather than taking care of the core IT systems that will support your organization for the future. As you work to protect your organization's critical

To order Brad Gilmer's book, *File Interchange Handbook for Images, Audio and Metadata*, from Focal Press, visit www.focalpress.com or call 800-545-2522. The book is also available from most major booksellers.

Built to take the stress.

Our rugged XLR connectors withstand twice the stress than the ones you're using now:

- 100 pounds of pull
- 50,000 bends under stress
- Best in industry signal clarity
- Dependable connections

Put Pomona connectors to the test. To request a **FREE SAMPLE** connector, go to www.pomonaelectronics.com/sample or call 1-800-490-2361.

When everything is riding on your connections, choose Pomona.

Copyright ©2004 Pomona Electronics. Ad No. 01834

SNELL & WILCOX™

Engineering with Vision

KAHUNA - THE PRODUCTION SWITCHER THAT DEFIES DEFINITION

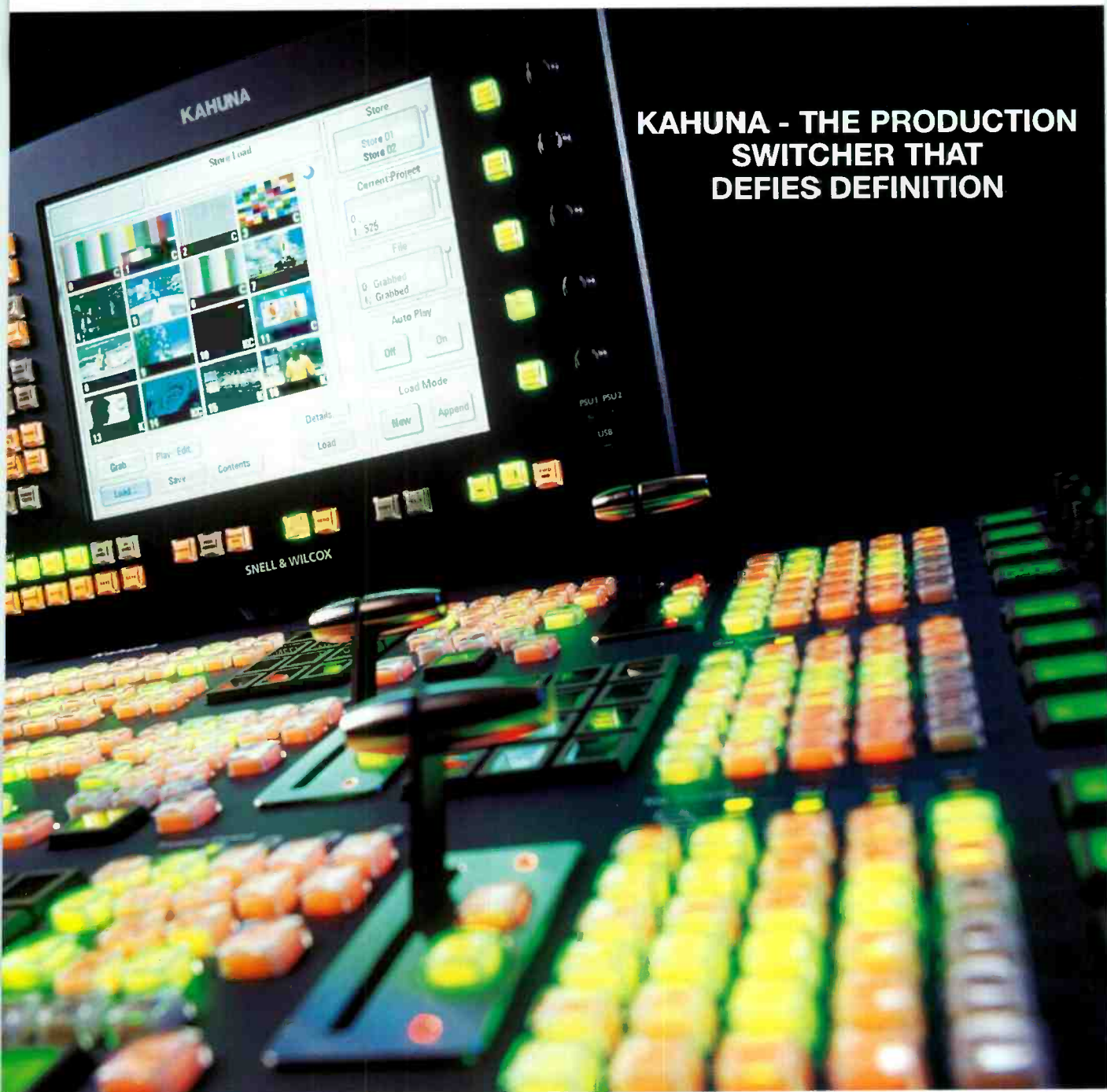

Standard definition? High definition? With Kahuna you don't have to worry. It can handle either of them - separately or at the same time. It can even incorporate SD sources into HD productions without upconversion.

Kahuna is the most versatile switcher on the market. And the most economical. Kahuna lets you take control of your transition to HD without having to re-equip with all-HD sources - and without having to put an upconverter on every SD input.

Even if you have no plans to go HD just yet, you can install Kahuna in SD only. Then when you are good and ready, upgrade to full multi-format SD/HD operation, with no operational disruption.



KAHUNA





KAHUNA - DESIGNED JUST THE WAY YOU WANT IT

4 M/E Control Panel

Each of the four comprehensive M/E banks has:

- Four keys able to perform luma, linear, and chroma keying
- Five transition wipe generators
- Still store and clipstore
- RGB color correction
- Four utility buses
- Timeline, DMEM and Macro capability

Each keyer in the system is equipped with:

- Its own FormatFusion engine to integrate SD and HD sources
- DVE send-and-return architecture that enable images to be manipulated



Every source has its own user-configurable mnemonic identification

**AT LAST.
COMPLETE FORMAT FREEDOM**

Kahuna is the first production switcher system in the world to offer simultaneous standard definition and high definition operation in the same mainframe with the same control panel.

Even more remarkably, thanks to a new technology called FormatFusion, it enables you to integrate any SD material, such as camera feeds, graphics or archives into live HD productions, seamlessly, without the need for upconversion.

Kahuna is a truly multi-format system that puts you in control of your transition to HD. It gives you the flexibility to use existing SD equipment, without the cost of completely re-equipping with HD.



KAHUNA - THE WORLD'S FIRST TRUE MULTI-FORMAT SD/HD PRODUCTION SWITCHER

Example of HD Output from a Single M/E Using Mixed SD/HD Inputs

HD background B

Wipe bar provided
by Utility Bus

HD background A

SD character
generator output
using FormatFusion
and resize engine

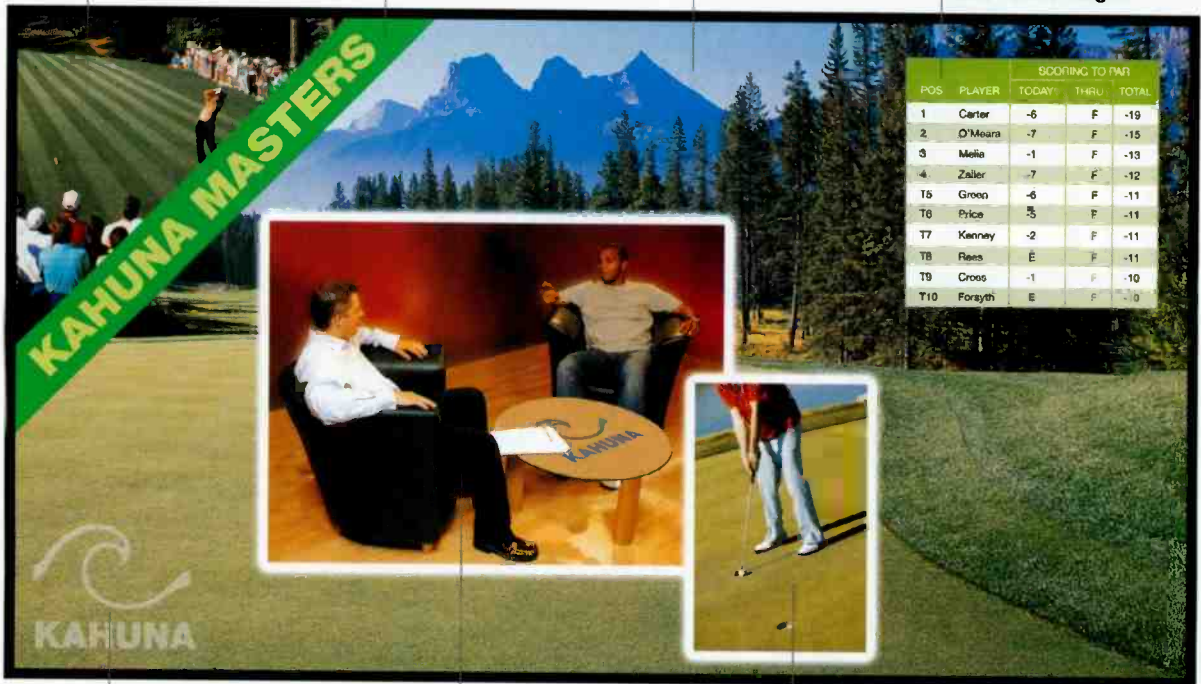

Animation via one of
the internal clip stores

HD camera studio shot
'squeezed back' using
picture resize engine

SD hand held camera
shot using FormatFusion
and resize engine

Benefits

- Legacy-compatible and future-proof
- Feature set and formats field-upgradable through software
- Puts you in control of your transition to HD
- Competitively priced throughout the range
- Integrates SD sources into HD productions
- No need to replace all SD equipment
- No need for expensive upconversion
- Can cut SD and HD simultaneously
- Resource-sharing maximizes M/E use
- Familiar, intuitive control panels
- Robust system design ensures reliability
- Compact size, less weight, lower power consumption

Features

- 1, 2, 3 and 4 M/E versions
- All functions, options and PSUs contained in a compact 11 RU chassis

- Accepts all SD and HD standards
- Up to 80 field-upgradeable inputs
- Up to 40 assignable outputs
- 4 keyers per M/E with flexible layering
- Each keyer able to perform luma and linear keying
- Each keyer with high quality chroma keying
- Each M/E with 4 FormatFusion and resize engines
- Independent keyer transition engine
- Every M/E has 4 stores for stills and clips
- Clipstores with 12 seconds of uncompressed HD
- Five transition wipe generators per M/E
- Input and color effects RGB color correction
- 4 utility buses per M/E for video in border and multi-program outputs
- DMEM and GMEM snapshot save and recall memories

- RGB & YUV color correction for all SD & HD outputs with full broadcast specification legalizers on each output (including auxiliary)
- Programmable clean feeds per M/E
- Integration with external equipment such as VTRs, DDRs, audio desks, external routers and edit controllers
- Powerful machine control
- Full source name displays
- Highly intuitive color touch-screen GUI
- Very powerful macro facility
- DMEM and GMEM snapshot save and recall memories
- Off-line PC applications supporting still/clip transfer to switcher system
- Multi-panel and multi-frame capability

Options

- Four twin channels / 8 channels of 3D DVE effects with warps, lighting and trail store



www.snellwilcox.com



The importance of studio acoustics

BY KEN C. POHLMANN

The frequency response of a power amplifier will be the same in your audio control room as it was on the test bench. Grounding and shielding issues aside, an amplifier's performance does not depend on its environment or location. On the other hand, the frequency response and many other performance criteria of microphones and loudspeakers are affected by the room they are in. Indeed, specifications of transducers have limited value because

think is recorded. For that reason, any serious studio needs serious acoustics.

Be quiet

First and foremost, any studio must be quiet. Ambient noise will ruin an acoustic recording, or potentially mask detail in a mixdown. Acousticians use a Noise Criterion (NC) rating to determine the noise floor in a room. The NC uses Sound Pressure Level measurements at nine frequencies and fits the resulting curve against standard curves. For example, an NC-15 rating allows an SPL level of 36dB at 125Hz and 17dB at 1kHz. Ratings above NC-20 will be problematic for most audio work. If your NC is too high, you need to take measures to reduce it.

Generally, source treatment is the most effective. Find out where the noise is coming from, and attack it there. For example, turbulence noise from air vents might be reduced by removing the vent's louvers. If footsteps in the room above yours are audible, generously offer to buy padded carpet for them. Low-frequency rumble from an air conditioner can be reduced by isolating the unit from the structural slab it sits on. If source treatment is impossible or not effective enough, you can try isolation techniques to block the noise. For example, use solid-core doors instead of hollow-core doors, replace single-pane glass with double-pane glass, and make door seals airtight to prevent sound from leaking around the edges.

In a worst-case (biggest budget) scenario, you may have to build new partitions to increase isolation. A partition's acoustical stopping power is measured by its Transmission Loss (TL). For example, if a partition has a TL of 50dB, then an incident sound of 80dB will be reduced to 30dB as it

passes through the partition. It is true that heavy, massive partitions (such as concrete) provide good sound isolation. But, lightweight partitions (such as staggered stud walls) can also be effective. Also, consider what frequencies you need to stop. Low frequencies are hard to isolate, and a music studio might require a concrete wall. But a voice-over studio might only need a stud wall and a microphone with a low-cut filter.

Room treatments

Isolation is critical, but room treatment is just as important. Even a quiet room will be unsuitable if its acoustics are wrong. For example, speech intelligibility is poor in a reverberant locker room. A room's reverberation time, measured as RT60, is the time it takes for an initial sound to decrease by 60dB. There is no "correct" reverberation time. A too-long reverberation time will mask detail, while a too-short reverberation time will sound unnatural. Very generally, a ballpark time of one-half to one second is about right for many music studios, while a shorter time of less than one-quarter second is better for voice-over studios.

Reverberation time is governed by absorption. The more absorption, the lower the reverberation time. The easiest way to add absorption is with porous absorbers. Sheets of acoustical foam placed on otherwise reflective surfaces can be added until reverberation time is suitably reduced. Conversely, removing absorbing materials lengthens reverberation time. This might be the ideal excuse to get rid of a ratty old sofa in your control room.

Sound quality is also affected by the way sound reflects from surfaces. A flat reflective wall will give a specular reflection, potentially yielding an echo,

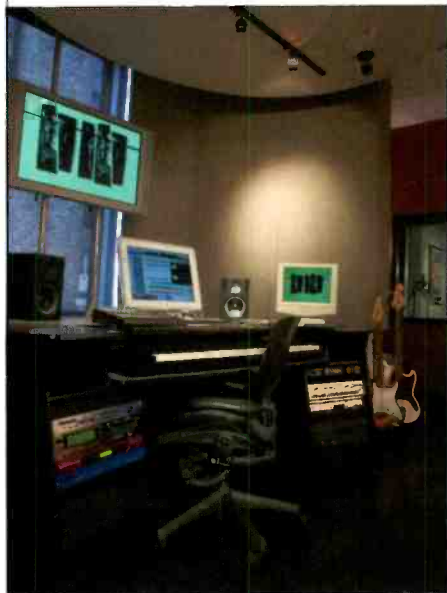

Any room can have the audio quality of a professional sound studio with the right acoustics. Photo courtesy JECO Music.

they cannot account for the real-world conditions of their use.

The acoustics of any room can profoundly affect the quality of any audio signal that is acoustically conveyed in that room. Whether you are recording voice or music into an open microphone, or monitoring or mixing over loudspeakers, the room can dictate what is recorded and what you

or perhaps a kind of "acoustic glare." Placing absorption on the surface would address the problem, but it would also decrease reverberation time.

In small rooms, low frequencies are hardest to tame. Room modes, areas of relatively high and low energy in the room due to reflections from the room surfaces, will yield an uneven frequency response that is inconsistent throughout the room. One solution is

ambient levels a bit, and thus lower the intrusion level into your room.

Outside expertise

If an existing workplace has minor acoustical problems, some common-sense solutions are worth trying. Simple noise source treatment and absorbers and diffusers can do wonders. For major problems, it is more cost-effective to hire an acoustician to advise you. When it comes to walls and

The quality of your acoustical audio work is only as good as the room's acoustics. Frankly, in today's digital era, anyone with a modest budget can set up a recording and mixing studio with electronics that are as good or better than your professional gear. The important difference between spare-bedroom audio and professional audio is the acoustical quality of a professional room.

You can do things a bedroom studio can't. You can make an acoustic recording or a mix and ensure that the recording is clean and accurate. If your studio is not up to acoustical code, then you might offer no technical advantage over the bedroom studio. Good studio acoustics is thus supremely important in keeping your work professional. **BE**

Many architects are geniuses, but many are not skilled in acoustics; you'll need both an architect and an acoustician.

the addition of bass traps, which are large hollow tubes filled with absorption, large blocks of acoustic foam or wall-mounted panel absorbers. These will help smooth bass response.

It's also worth noting that sound absorbers are generally poor isolators. If you are bothered by mechanical noise from an adjoining machine room, putting acoustical foam on your wall won't help. Alternatively, putting foam in the machine room might lower its

floors, wrong decisions can cost you dearly. Get it done right the first time. If you are lucky enough to be planning construction of a new facility, then an acoustician is an absolute must. Many architects are geniuses, but many are not skilled in acoustics; you'll need both an architect and an acoustician. For the latter, talk to the acoustician's past clients and even tour their facilities to make sure the sound quality of the design is solid.

Ken Pohlmann is director of the Music Engineering Technology program at the Frost School of Music at the University of Miami.

ATTENTION READERS!
 Sign up now for
 BroadcastEngineering's
Audio Technology Update
 e-newsletter
 at www.broadcastengineering.com

network
 the innovator



Contact Network Electronics
 Phone: 800 420-5909
 E-mail: ussales@network-electronics.com
 11075 South State Street, Suite 27
 Salt Lake City, Utah 84070

LATEST TECHNOLOGY

It's a competitive world. You need the latest and the best technology to stay at the top of your game. Our MTBF numbers are industry leading and will give you peace of mind.

QUICKEST DELIVERY

No more waiting! Our huge inventory guarantees speedy deliveries. 50-100 small routers usually ship in 5 working days; 10 routers or less can ship the same day.

FASTEST SERVICE

Through our Advanced Replacement Policy you will receive a new unit BEFORE you send the old one back - no questions asked!

HIGHEST INNOVATION

Need space? Need flexibility? Need expandability? Our compact routers, signal processing products and optical modules address every format in the most configurations available today.

3 YEAR WARRANTY

Worry free! Stress free! Our extensive warranty gives you peace of mind for 3 years. And if you want even more ask about our NET-CARE system that extends your coverage to 5 years or longer.

TOTAL PICTURE

A full range of products to accommodate every need, every format, every budget. Our TSS (Technical System Sales) Group is ready to design your system to suit your requirements at prices you can afford.

ROUTERS • FIBER OPTIC TRANSPORT • SIGNAL PROCESSING

www.network-electronics.com

Visit us at NAB, Booth #SU9311

When the broadcast industry needs rack systems... we deliver.

We understand the unique challenges faced by broadcast engineers and integrators, and offer engineered equipment mounting solutions to satisfy those requirements. For the past 25 years, when rack systems were needed in broadcast facilities, Middle Atlantic Products has been there with the most comprehensive line of racks and accessories available.

54 spaces for maximum equipment density

VMRK Series

optimized for effective cable management

MRK Series

VRK Series

The Middle Atlantic Products difference:

Custom configurations...
the way you want it.

On time shipping...
there when you need it.

Specify with confidence...
UL Listed, Seismic Certified standard.

NAB2005
THE WORLD'S LARGEST ELECTRONIC MEDIA SHOW

Visit us at the NAB show at booth# SL3606.

Learn how we solved the racking needs of CNN, the Home Shopping Network, the Discovery Channel and more at middleatlantic.com/broadcast2.htm



Middle Atlantic Products, Inc.

INTEGRATED



architectural



thermal



cable



power

SOLUTIONS

Engineered Mounting Solutions Since 1979

800-266-7225 | middleatlantic.com

“ We had three months to get HD content on-air. Sony's HD Select systems helped make it happen ”

— Jeff Friedman, Rainbow Studios

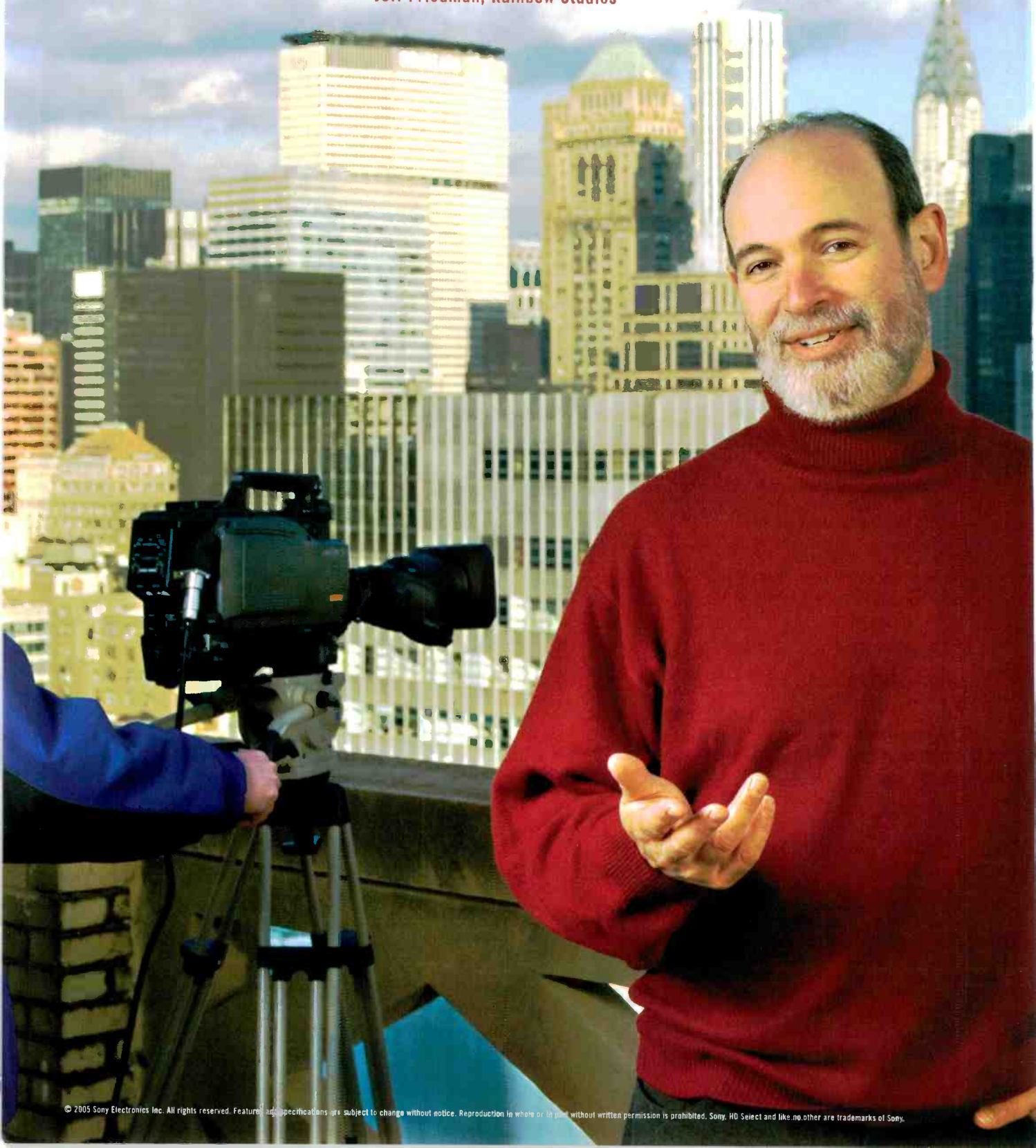



SONY®

HDelivered.

When Rainbow Studios, a part of Cablevision, needed high definition in a hurry, they turned to Sony HD Select™ systems. Jeff Friedman, VP of Technical Operations explains, "Not only did Sony work with us to meet our delivery schedule; but they insisted on sending their people in here to commission the studio cameras and the switcher. One of the great things was that our engineers worked hands-on with their guys, and our questions were answered right from the source."

"We send our ENG cameras all over the planet — for everything from fashion in Paris to extreme sports in Tibet and Madagascar," Friedman declares. "When you have cameras falling down mountains, you depend on service after the sale. Our maintenance contracts with Sony have been fabulous. We drop a camera off and two days later it's delivered back to my door. That really helps keep our customers satisfied."

If your own HD challenges extend beyond the box, go with a total HD solution from the company totally qualified to provide it. An HD Select system from Sony.

To learn about the HD Select Program and Sony's Music Download Promotion

VISIT WWW.SONY.COM/HDSELECT1
OR CALL YOUR SONY REPRESENTATIVE TODAY

like.no.other™



SYSTEMS
DESIGN
SHOWCASE

THIRTEEN/WNET

builds integrated content management and distribution platform

By James "Mac" Privette and Frank Graybill

Station automation is nothing new, nor is the concept of asset management. However, since the introduction of automation and management systems more than a decade ago, many things

have changed. These changes include widespread use of the Internet, high-speed networking and the availability of lower-cost data networks. Such new technologies allow systems and processes that were impossible just a few

years ago. Industry pioneers in both the vendor and customer arenas have sought new products, technologies and systems to take advantage of these opportunities. New technologies also bring with them the challenge of new

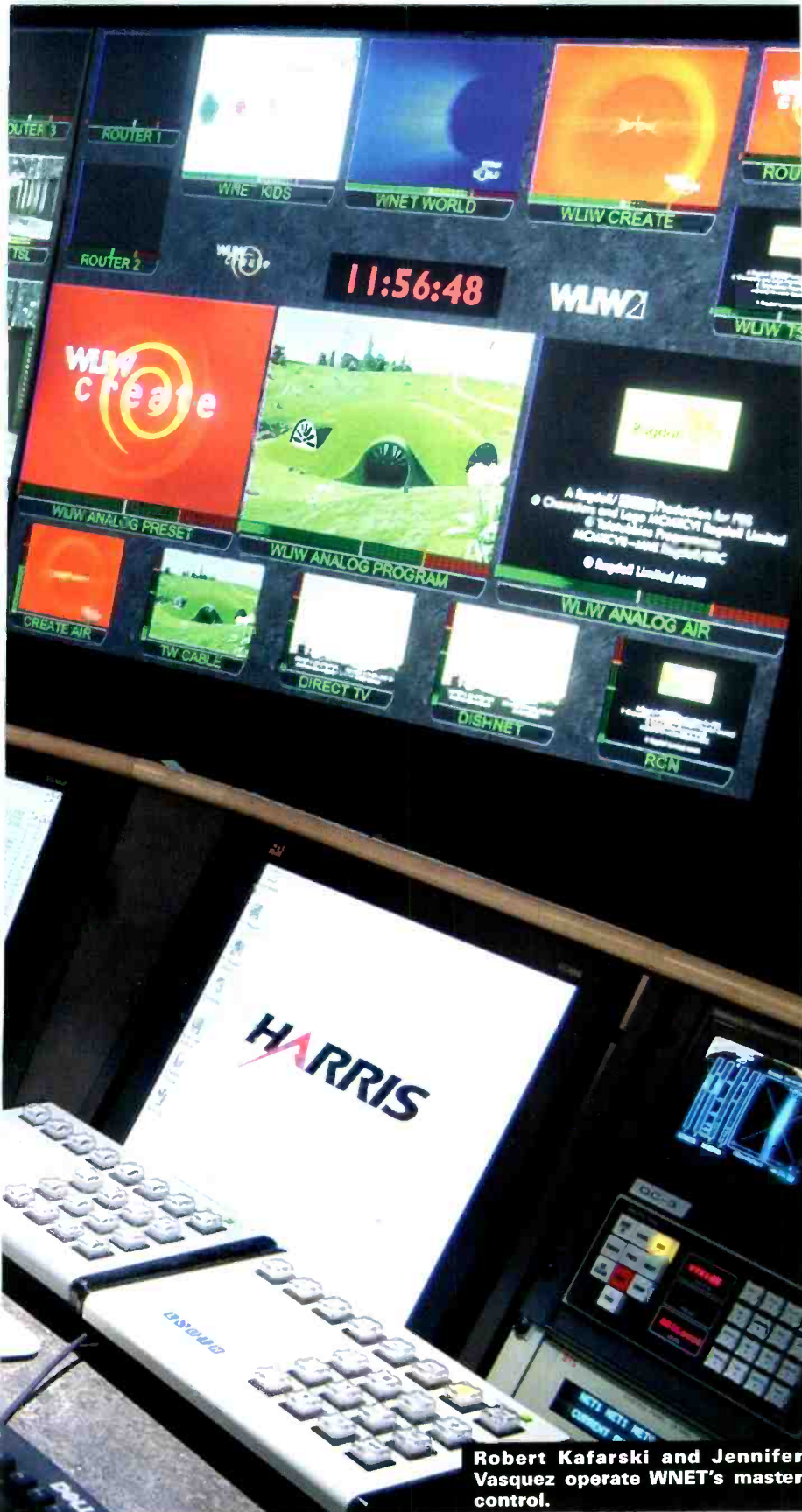

Robert Kafarski and Jennifer Vasquez operate WNET's master control.

system's ingest points are located many miles apart. The station is located in Manhattan, and its sister station, WLIW21, is located in Long Island. These stations supply viewers with several different program streams in both SD and HD through their digital and analog transmitters. The stations provide SD and HD feeds of their regular programming, a "World" channel, an educational "Kids" channel and a "Create" channel that encourages viewers to take a "hands-on approach to life." Automation is the key that makes these multiple streams possible.

A new perspective on content

Migrating from single to multiple streams requires not just new equipment, but new thinking and processes as well. The station's management, engineers and operations personnel started with a blank slate, rather than an equipment list. Programs, sponsor breaks and other interstitial material — once simply considered as linear entities — had to be reconsidered not only as file-based assets, but assets of variable length. One reason is that while segment lengths may remain unchanged, overall program lengths can vary depending on the lengths of segments plus breaks. End breaks can easily be different lengths depending on the time of day the program airs or the format of the channel it is running on. The more they looked at the challenge, the more it was also seen as an opportunity.

Beyond simply automating, management also desired capabilities that stretched the normal operations scenario. Automating WLIW's program streams from Manhattan was needed, but so too was the ability to provide local ingest and news from its facility into the automation system. Both real-time ingest and faster-than-real-time transfers were needed.

Ultimately, the solution came, not in a rack-full of equipment, but in a 5RU device — Harris' NetVX and a small number of additional components,

problems. Often, the solutions can be elusive. Typically, the larger the challenge, the more elusive the solution.

Such was the situation at THIRTEEN/WNET. Like most stations, it constantly faces the challenge of do-

ing more with less. In this case, it means running not one but multiple program streams from a single, centralized automation system — a challenging situation, and one that is made more difficult by the fact that the

**SYSTEMS
DESIGN
SHOWCASE**

including Harris' Flexicoder and ReCon software. NetVx is a modular network interface system that allows connectivity to variety of networks. Integral to the automation system is a LAN that includes a bi-directional DS3 link between the Manhattan and Long Island facilities. At either end of this link are NetVx's. Using telco circuits provided by Verizon, with limited backup through existing station microwave facilities, they allow IP traffic, network connectivity and faster-than-real-time file transfer of video and audio.

Using NetVx's Virtual Channel feature, the stations can do their own bandwidth management and set specific QoS levels on the DS3 channel. Today, the DS3 is used asymmetrically. Approximately 40Mb/s of the 45Mb/s bidirectional DS3 data channel is available for customer payload.

Currently, 38Mb/s is used in the Manhattan to Long Island direction, while 32Mb/s is used the other direction. The channel is split into three services: ATSC, NTSC and 10/100 IP traffic. Traffic going to Long Island includes 19.4Mb/s of ATSC traffic. The ATSC stream goes in as ASI, is output as SMPTE 310 and feeds the WLIW21 digital transmitter. For NTSC, 12Mb/s is used, and for 10/100 IP traffic, the allocation is 7Mb/s.

A variety of services are included in the 10/100 IP traffic, which is allocated at 20Mb/s from Long Island. Both WLIW21's digital and analog transmitters are remote-controlled using ReCon. ReCon is Windows-based software that is designed to communicate with broadcast, network and facility control equipment using IP and the serial interfaces found on most modern broadcast equipment. Both applications require some



Harris NetVx allows faster-than-real-time file transfer of full-motion video and audio.

bandwidth, but the major user of IP bandwidth is the ingest/payout system. It is essentially a remote node on the THIRTEEN/WNET system in

MegaPixel Resolution



1.2 TFT-MegaPixel™

Our new triple rackmount V-R653P-HDSDI has 1.2 TFT-Megapixel High Definition displays. Representing the leading edge of imaging technology, each screen will accept ALL Digital HD or SD formats, including 1080-24P, 1080-50/60i and 720-50/60P



Marshall Tel.: 800-800-6608
Fax: 310-333-0688

LCDRacks.com

NAB booth # SL913

visit us at NAB
18th - 25th April
C7319A



Revolutionary Wireless

CellCom digital wireless intercom. Truly new, truly revolutionary. The first stand-alone wireless to offer small group and person-to-person conversations among beltpacks.

- Complete programmability with up to six communications routes per beltpack
- The ability to remote and customize coverage areas, and connect with two wired party-line and four digital matrix channels
- Ten beltpacks per base - all license-free, above the UHF television bands and with no need for frequency coordination.

Cell Com. Join the revolution.

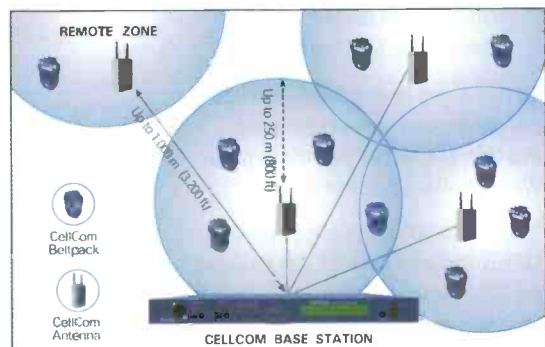

Clear-Com
COMMUNICATION SYSTEMS

SYSTEMS DESIGN SHOWCASE

Manhattan. Promos and other content can be ingested into the automation system in Long Island. As this is done, rather than inputting the necessary information into a database in Long Island, the information is input directly into the automation database in Manhattan over the network.

As needed, material stored in Long Island is transferred over the network and into the servers in Manhattan. In addition to the 10/100 IP channel, the Long Island to Manhattan direction has a 12Mb/s channel for NTSC, which is used for transporting live studio production back to Master Control for broadcast.



WNET uses Harris' main and backup servers for ingest and playout.

Scalable performance.



The portable DVM 400

High performance and flexibility for MPEG2 transport stream analysis.

The new DVM family of MPEG 2 instruments lets you know exactly what's going on, with powerful analysis capabilities. It gives you:

- Real-time monitoring
- In-depth analysis
- Networkability (SNMP)
- Scalability up to 20 signals

It's also a very flexible family that lets you get the configuration you need, and then add to it as your needs grow. We even offer a portable version.

So don't spend time puzzling over your MPEG2 transport streams. Ask us about the DVM family – with the performance you need, and the scalability you've been looking for.



Rohde & Schwarz, Inc. • Columbia, MD • 1-888-837-8772
www.rohde-schwarz.com/USA

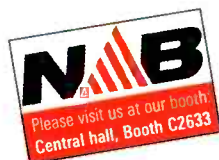

The DVM 100/120 monitoring system



The single/dual-stream DVM 50

The station's automation system consists of the LAN, ADIC archive and a SeaChange storage array, as well as four servers controlling the system, a main and backup for ingest and the same for playout. A remote client and remote (temporary) storage are in Long Island. The archive is used to store content that will air in the future, but not for at least two weeks.

The storage array consists of five RAID Arrays (nodes) configured in a RAID2 Array that allows not only for automatic rebuild from a failed drive, but also for automatic rebuild from a failed node. One useful feature of the RAID2 architecture is the ability to easily add nodes for additional storage. It is a simple matter to update each node's setup, and they do the rest. Once reconfigured, the nodes will determine the necessary info and begin the process of re-striping automatically. Depending on the storage, the number of nodes involved and the number of playout requests, the re-striping process can take from several hours to several days.

Between the automation system and the NetVX in Manhattan, a Flexicoder provides the necessary compression and encoding through a modular system that, like NetVX, can be user-configured and upgraded as necessary. Flexicoder can handle a variety of signal types and is capable of compressing multiple SD and HD streams simultaneously using statistical multiplexing and HD compression management (HDCM) software that dynamically allocates compression bandwidth for optimal picture quality.

CALREC BROADCAST SYSTEMS

ALPHA

S Y S T E M P L U S

THE EVOLUTION OF BROADCAST AUDIO PRODUCTION



The System Plus platform represents a new milestone in facilities which are now available across the Alpha, Sigma and Zeta range.

Alpha System Plus offers broadcasters a wealth of upgraded specifications. A new programmable monitoring system provides greatly expanded monitoring options and new colour TFT metering enables user defined metering schemes to be individually memorised. Alpha System Plus also enables the introduction of Calrec's powerful 5.1 source handling, creating an easy means of single source control with flexible control of individual discrete elements.

- Up to 96 channel/group faders
- Up to 226 equivalent mono channels
- Automatic redundancy on all PSUs, DSP and control processors
- All cards and panels are hot-swappable
- Comprehensive colour TFT metering with full configurability
- Fully configurable monitoring with user profiles can monitor up to 112 different sources at any one time
- 8x stereo or mono audio groups
- 20 auxes, 48 FB / multitrack outputs
- 4 main stereo or 5.1 surround outputs
- Simultaneous LCRS, stereo and mono outputs available from each 5.1 main output
- New SNMP reporting facilities



COMPATIBLE WITH HYDRA NETWORKING

South and Mid West States:
North East States and Canada:
Western States:

Tel: (615) 871 0094
Tel: (212) 586 7376
Tel: (818) 841 3000

Email: ericj@redwoodweb.com
Email: dsimon@studioconsultants.com
Email: jschaller@audiospec.com

Contact: Calrec Audio Ltd, Nutdough Mill, Hebden Bridge, West Yorkshire, HX7 8EZ, UK
Tel: 01144 1422 842159 Email: enquiries@calrec.com Web: www.calrec.com



Find out why the world's biggest
broadcasters trust Calrec with
their most crucial creative
decisions at www.calrec.com

SYSTEMS DESIGN SHOWCASE

Content management

Having the equipment in place is a requirement, but it is only the first step. Those who have worked with automation understand that it is also a process. This process involves a myriad of components all working together. Some components are software, others are hardware, and still others are human. To bring everything together harmoniously requires that all components function seamlessly.

Bringing everything together requires working a week in advance. Obviously, the traffic logs are prepared for all the program streams. Once the list of programming is complete, an inventory of required content is determined and compared with the content of the servers. Lists are generated that detail what is needed and where. Examples include satellite feeds, tapes

from out of house, archived content and content that is, or will be, produced in Long Island, as well as content that needs to be archived. Each day these lists are worked and the content is moved, either automatically or manually into and out of the storage and/or archive. Only a few things do air directly from tape, and these are typically items that arrive shortly before air and will only air once.

There are several "rules" that allow content to be managed in the system in a straightforward manner. In addition to the rule concerning late arrivals, all content is removed from the system in one of two ways. One way is to move it from the server to the

archive; the other way is to simply delete it. All content within the storage system fits into one or more of the following categories — either it has

Equipment List

Harris:

NetVX

Flexicoder MPEG-2

ReCon

Automation system for MC operations

ADIC Scalar 10K Robotic tape archive

SeaChange Video File Server Array

Avalon Archive Management Software

Design Team

Thirteen-WNET

James "Mac" Privette, dir. of engineering

Frank Graybill, chief engineer

Vince Lancellotti, assistant chief engineer

Harris Broadcast

Daryl Parry, systems engineer

Visit us at NAB, Booth # C10437

Fair and Balanced Color



It's true. Kino Flo's telegenic ParaBeam 400 studio fixture delivers 3,000 Watts worth of tungsten soft light on 2 Amps—without the heat and without compromising your picture's color quality! The ParaBeam's cool brilliance owes to

a special parabolic reflector that practically turns light waves into projectiles.

As for image quality, the fixture uses Kino Flo designed True Match® lamps that display professional tungsten and daylight balanced illumination (CRI 95). A center mount lets you rotate between a horizontal and vertical beam. Slide in your choice of focusing louvers to spot the beam down to a 90°, 60° or 45° pool of light. DMX, analog and manual controls can dim the light to black. Like all Kino Flos, the ParaBeam is flicker free and dead quiet.

If you think the ParaBeam looks good on paper, wait 'til you see how it looks on video.

ParaBeam

2840 North Hollywood Way Burbank CA 91505 818 767 6528 voice 818 767 7517 fax



www.kinoflo.com

ParaBeam

already aired, it will be aired within the next two weeks, or both. Content that has already aired and will not air again is deleted. If it will air again, but not within the next two weeks, it is moved to the archive. Later, that content will be moved back to the storage for broadcast.

This process will repeat until it's decided the content will not air again or the broadcast rights have been exhausted. At that point the content, along with its associated database entries and metadata, is purged from the archive and automation system.

Summary

THIRTEEN/WNET/WLIW21's content library churns nearly 100 hours of content each day. Accomplishing this with a small number of engineers and a single (large) server is possible through careful integration of equipment, people and processes.

Automated content transfers, a straightforward method of data entry, and automated updating of information all contribute to an efficient and streamlined operation. Integrated components such as NetVX, Flexicoder and ReCon minimize system complexity, and hence the learning curve, while maximizing onsite flexibility and customization.

Automating multiple channels requires not only new equipment, but also new processes. Integrated content management, especially across multiple facilities, requires equipment, processes and systems that can function seamlessly across the distance. With all the inter-related systems, tools such as NetVX, which integrates more than a dozen individual pieces of equipment into a single device, can

simplify long-distance network management and provide the tools needed for an integrated platform that will serve the needs of broadcasters today. With their software-based modular architecture, these tools are likely to remain in service for years to come. **BE**

James "Mac" Privette is the director of engineering, and Frank Graybill is the chief engineer at WNET.



The station's automation system includes the LAN, ADIC archive and a SeaChange storage array.



Photography: Tom Campbell

Takes you below the surface.

Discover a whole new world with ERG high-resolution HD monitors. With ultra-sharp images and vibrant color, they'll let you see things you've never seen before. ERG offers you an entire range of award-winning HD monitors to suit your needs, from rack-mounted monitors with four convenient inputs and easy-to-read data displays to portable monitors with rugged design and low power consumption, like the new ERG HDM-EV85. No matter which HD monitor you choose, you'll find yourself immersed in the image. NAB Booth #SU10134, erg-ventures.com, contact@erg-ventures.com
U.S.: +1-949-263-1630, Japan: +81-3-3760-8161

ERG HD Monitors

Is 2005 the year of interactive TV?

BY DAVID SHORT

The TV industry in the USA looks like it is planning big things for interactive TV

(iTV) over the next year. This follows several false starts during trials in the dot.com boom, which basically involved putting Internet content on TV with some modification — viewers were not impressed! In the USA and Europe, the industry is now maturing and finding ways to work with the audio-visual content rather than in spite of it.

In this article, we will discuss the following categories of interactive content:

- *“Always on” magazine services.* These are not associated with any particular TV program. These services typically

carry sports, weather and news. The EPG can be regarded as an always on application, albeit a rather special one.

- *Games.* We could include this in the “always on” category, but we have split it out to emphasize the importance of revenue from games. Viewers will pay \$1 per game, so this can be a significant revenue generator.

- *tCommerce or TV commerce.* Although it is an always-on service, this deserves a special mention, as it requires end-to-end encryption to ensure secure transactions. It has not proved a popular category of iTV, so far.

- *Enhanced TV.* This is where an application is available to viewers watching a certain channel at a certain time. These are usually produced to correspond with the program, e.g. multi-screen, multi-camera, voting and quizzes. Voting can be a significant revenue generator.

PVR/DVR and VOD should also be regarded as “interactive” as they give the viewer control over the content, but we will focus on the categories mentioned above. They all have a common requirement for a middleware in the STB.

In the USA, DVR and VOD have been the most successful interactive offerings to date. HD also has been a significant new feature for many consumers. This is in contrast to Europe, where games, always on and enhanced TV have been deployed first, while DVR, HD and VOD are still in trial or early-adopter phases.

New developments
Much of the new momentum for iTV is coming from the deployment of NDS MediaHighway middleware

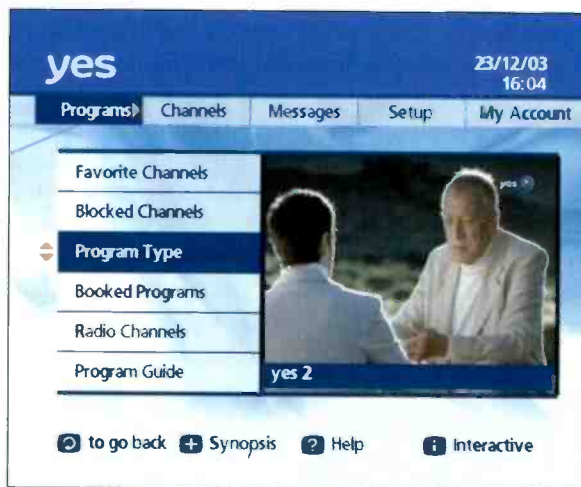

Commonly used applications, such as the EPG, sometimes are stored in the STB flash memory to improve reliability and response times. Image courtesy NDS.

FRAME GRAB A look at the consumer side of DTV

Attractiveness in switching to bundled services

Majority of respondents see saving money as top reason

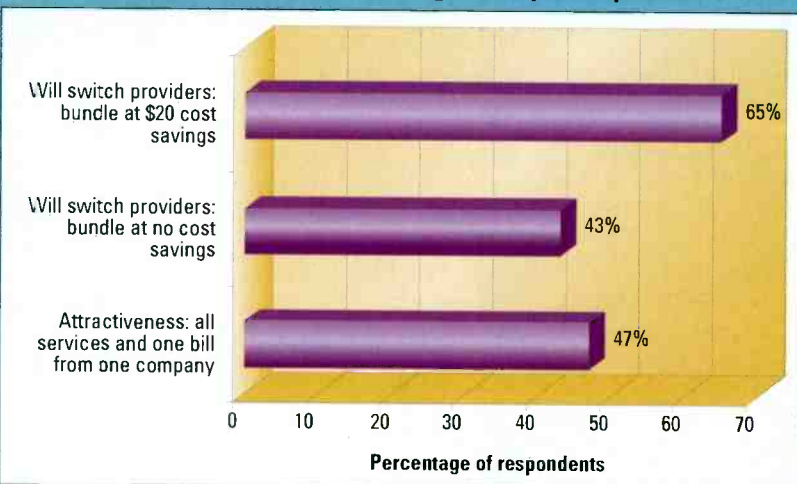

SOURCE: Parks Associates

www.parksassociates.com

our team +
worldwide experience =

PROVENTECHNOLOGY

DIGITAL TX UP TO 10kW DTV

Suitable for analog transmission (20 kW p.s.)

Configurable for Dual Cast transmission
(digital or analog by automatic switch)

LDMOS Technology

Broadband standardized design

Fully redundant, hot swappable PAs
(fault proof operation)

Remotely controllable



DMT USA

1224 Forest Parkway Unit 140,
West Deptford, NJ 08066
856.423.0010 tel - 856.423.7002 fax
sales@dmtonline.us - www.dmtonline.us

NAB2005
THE WORLD'S LARGEST ELECTRONIC MEDIA SHOW
BOOTH #C3016

Editorial Director: Brad Dick, bdick@primediabusiness.com
Editor/World Editor: David Austerberry, editor@broadcastengineeringworld.com
Managing Editor: Susan Anderson, sanderson@primediabusiness.com
Assoc. Editor/Webmaster: Chevonn Payton, cpayton@primediabusiness.com
Asst. Editor: Angela Daunis, adaunis@primediabusiness.com
Sr. Art Director: Michael J. Knust, mknust@primediabusiness.com
Art Director: Robin Morsbach, rmorsbach@primediabusiness.com
Technical Consultants: Computers & Networking - Brad Gilmer
 Antennas/Radiation - John H. Battison
 Digital Video - Michael Robin
 Transmission Facilities - Donald L. Markley
 Legal - Harry C. Martin
 New Technology - John Luff
 Industry Watcher - Paul McGoldrick
 New Media - Craig Birkaier

Sr. VP: Peter L. May, pmay@primediabusiness.com
Group Publisher: Dennis Triola, dtriola@primediabusiness.com
Marketing Dir.: Kirby Asplund, kasplund@primediabusiness.com
Online Sales & Marketing Dir.: Samantha Kahn, skahn@primediabusiness.com
Vice President of Production: Lisa Parks, lparks@primediabusiness.com
Sr. Ad Prod. Coord.: Kathy Daniels, kadaniels@primediabusiness.com
Classified Ad Coord.: Mary Corcoran, mcorcoran@primediabusiness.com
Dir., Audience Marketing: Barbara Kummer, bkummer@primediabusiness.com
Group Show Director/LDI: Sharon Morabito, smorabito@primediabusiness.com

PRIMEDIA

Business Magazines & Media

COO: Jack Condon, jcondon@primediabusiness.com
Executive Vice President: John French, jfrench@primediabusiness.com
Corp. Comm/Mktg.: Karen Garrison, kgarrison@primediabusiness.com

Primedia Inc.: 745 Fifth Ave., NY, New York 10151
Chairman: Dean Nelson, dean.nelson@primedia.com
President and CEO: Kelly Conlin, kelly.conlin@primedia.com
Vice Chairman & General Counsel: Beverly Cheil, beverly.cheil@primedia.com

MEMBER ORGANIZATIONS

Sustaining Member of:
 • Society of Broadcast Engineers
 Member, American Business Media; Member, BPA International



BROADCAST ENGINEERING, ISSN 0007-1994, is published monthly (except semi-monthly in June and December) by PRIMEDIA Business Magazines & Media Inc., 9800 Metcalf Ave., Overland Park, KS 66212 (primediabusiness.com). Current and back issues and additional resources, including subscription request forms and an editorial calendar, are available on the World Wide Web at broadcastengineering.com.

SUBSCRIPTION RATES: Free and controlled circulation to qualified subscribers. Non-qualified persons may subscribe at the following rates (Prices subject to change): USA and Canada, 1 year, \$70.00, 2 years, \$135.00, 3 years, \$200.00; Outside USA and Canada, 1 year, \$95.00, 2 years, \$165.00, 3 years, \$245.00 surface mail (1 year, \$155.00, 2 years, \$295.00, 3 years, \$440.00 airmail delivery). For subscriber services or to order single copies, write to Broadcast Engineering, 2104 Harvell Circle, Bellevue, NE 68005 USA; call 866-505-7173 (USA) or 402-505-7173 (outside USA); or visit www.broadcastengineering.com.

ARCHIVES AND MICROFORM: This magazine is available for research and retrieval of selected archived articles from leading electronic databases and online search services, including Factiva, Lexis/Nexis and Proquest. Formicroform availability, contact ProQuest at 800-521-0600 or 734-761-4700, or search the Serials in Microform listings at proquest.com.

REPRINTS: Contact FosteReprints to purchase quality custom reprints or e-reprints of articles appearing in this publication at 866-436-8366 (219-879-8366 outside the U.S. and Canada). Instant reprints and permissions may be purchased directly from our Web site; look for the RS/Copyright tag appended to the end of each article.

PHOTOCOPIES: Authorization to photocopy articles for internal corporate, personal, or instructional use may be obtained from the Copyright Clearance Center (CCC) at 978-750-8400. Obtain further information at copyright.com.

PRIVACY POLICY: Your privacy is a priority to us. For a detailed policy statement about privacy and information dissemination practices related to Primedia Business Magazines and Media products, please visit our Web site at www.primediabusiness.com.

CORPORATE OFFICE: Primedia Business Magazines & Media, 9800 Metcalf, Overland Park, Kansas 66212 • 913-341-1300 • primediabusiness.com

Copyright 2005, PRIMEDIA Business Magazines & Media Inc. All rights reserved.

Ad Index

Broadcast Engineering is not responsible for errors in the Advertisers Index.

	Page #	Advertiser Hotline	Web site Address
AES Europe	53		aes.org
AJA Video	51	530-274-2048	aja.com
Axon Digital Design	39	+31 13 511 6666	axon.tv
Broadcast Asia 2005	50	+65 6738 6776	broadcast-asia.com
Calrec Audio Ltd.	IFC	+44 1422-842159	calrec.com
Clear-Com Communication Systems	5	+44(0)1223 815000	clearcom.com
DMT	3		dmtonline.com
Elti	13		elti.com
Ensemble Designs	41-48	+1 530-478-1830	ensembledesigns.com
ESE	33	310-322-2136	ese-web.com
Evertz Microsystems Ltd.	IBC	905-335-3700	evertz.com
EVS Broadcast Equipment	12		evs.tv
Genelec Oy	37	+358 17 83 881	genelec.com
Harris Broadcast	6, 7		harris.com
ICF - Interactive Content Factory	33		icf.tv
Inter BEE 2005	27		bee.jesa.or.jp/
Just Edit	35	+34 93 734 9970	vsn-tv.com
Leitch Inc.	BC	+44(0)1344 446000	leitch.com
Marshall Electronics Inc.	18	310-333-0606	lcdracks.tv
Miranda Technologies Inc.	11	514-333-1772	miranda.com
Network Electronics AS	30		network-electronics.com
Nextamp	36	+33 (0) 2 99226162	nextamp.com
Octopus Newsroom	32		octopus-news.com
On-Air Systems Ltd.	40	+44 20 7663 3671	on-air-systems.com
Pro-Bel	31	+44(0)1189 866123	pro-bel.com
Promax Electronica SA	55	+34 93 260 20 02	promax.es
Screen Service Italia	9	+39 030 3582225	screen.it
Snell & Wilcox Ltd.	19-24		snellwilcox.com
Teko Telecom S.P.A.	55	+39 051 625 61 48	tekotelecom.it
Thales Angenieux	26		angenieux.com
Thales Broadcast & Multimedia	14		thales-bm.com
TMD Ltd.	49	+44(0)1296 745080	tmd.tv
360 Systems	29	+1 818-991-0360	360systems.com

Sales Offices

US/CANADA

WEST

George Watts III
 (360) 546-0379; Fax: (360) 546-0388
 georgeww3@aol.com

EAST

Josh Gordon
 (718) 802-0488; Fax: (718) 522-4751
 jgordon5@bellatlantic.net

EAST/MIDWEST

Joanne Melton
 (212) 462-3344; Fax: (913) 514-9249
 jmelton@primediabusiness.com

INTERNATIONAL

EUROPE

Richard Woolley
 +44-1295-278-407
 Fax: +44-1295-278-408
 richardwoolley@btclick.com

ISRAEL

Asa Talbar
Talbar Media
 +972-3-5629565; Fax: +972-3-5629567
 talbar@inter.net.il

JAPAN

Mashy Yoshikawa
Orient Echo, Inc.
 +81-3-3235-5961; Fax: +81-3-3235-5852
 mashy@fa2.so-net.ne.jp

CLASSIFIED ADVERTISING

Susan Schaefer
 484-478-0154
 Fax: 913-514-6417
 sschaefer@primediabusiness.com

REPRINTS

FosteReprints
 (866) 436-8366;
 International inquiries, (219) 879-8366

LIST RENTAL SERVICES

Marie Briganti, Statistics
 (203) 778-8700 x146
 (203) 778-4839
 primedia@statistics.com

Customer Service: 913-967-1707 or 800-441-0294

BROADCAST ENGINEERING & World Edition
 April 2005, Vol. 47, No. 4 (ISSN 0007-1994) is published monthly and mailed free to qualified persons by Primedia Business, 9800 Metcalf Ave., Overland Park, KS 66212-2216. Periodicals postage paid at Shawnee Mission, KS, and additional mailing offices. Canadian Post Publications Mail Agreement No. 40697023. Canada return address: DHL Global Mail, 7496 Bath Road, Unit 2, Mississauga, ON L4T 1L2. POSTMASTER: Send address changes to Broadcast Engineering, P.O. Box 2100, Skokie, IL 60076-7800 USA. CORRESPONDENCE: Editorial and Advertising: 9800 Metcalf, Overland Park, KS 66212-2216 Phone: 913-341-1300; Edit. fax: 913-967-1905. Advert. fax: 913-967-1904. © 2005 by Primedia Business. All rights reserved.

62x9.5AIF OB

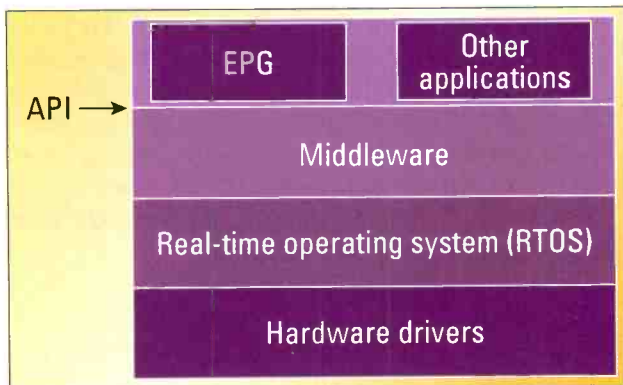

Figure 2. Middleware was introduced to abstract the application programming interface from the underlying hardware.

the native STB language and run alongside the middleware. This is usually done where a middleware-based EPG would give inadequate performance, usually on low-end STBs.

Middleware standards and products

The main middleware platforms deployed and planned in the USA are:

- OpenTV, which is deployed on EchoStar.
- MediaHighway, which is planned to launch on DirectTV mid-year.
- OnRamp and OCAP, which are planned for several cable companies.
- MSTV Foundation Edition, planned for Comcast.

The only "open" standard in this list is OnRamp/OCAP. OCAP is part of the CableLabs OpenCable standard for interoperable STBs. It is largely based on the Digital Video Broadcast (DVB) Multimedia Home Platform (MHP) specification, which is, in turn, based on Java. These standards provide a Java Virtual Machine (JVM) cut down to



Games are one example of interactive content. Viewers will pay \$1 per game, so this can be a significant revenue generator. Image courtesy Free-Thinking.



Token Creek
Mobile Television
Madison, WI

“Selecting Thales Angenieux’s 62X OB Lens was a no brainer. The lens has great glass and provides the perfect focal length we needed at a great price. After evaluating competitive lenses in this range, the Thales Angenieux 62X OB was the

clear choice,”
said John Salzwedel,
Owner of Token Creek
Mobile Television.



Digital 62 X 9.5AIF.HR OB
Digital 60 X 9.5AIF.HD OB
Digital 72 X 9.5AIF.HR OB
Digital 70 X 9.5AIF.HD OB

“We have been using Thales Angenieux’s 62X OB for over a year now with outstanding results...and most importantly, our clients are very pleased with the performance of the lenses,”
concluded Mr. Salzwedel.

angenieux THALES

For more information call 973-812-3858,
e-mail angenieux@tccus.com or visit www.angenieux.com

run on an STB, with classes added to support TV-specific functions, e.g. channel changing.

MHP and OCAP require relatively powerful STBs to run. To allow support for the current installed base, vendors and operators have been working together to define the "On-

Ramp to OCAP," a subset of the OCAP interface, which is small enough to implement on "legacy" STBs, e.g. Scientific-Atlanta and Motorola 2000 series. Liberate 5.0 (based on Liberate Compact) is an example of an OnRamp compliant middleware.

Microsoft's MSTV latest offering is

Foundation Edition, and this is designed to run the whole range of cable STBs for legacy boxes upwards. It supports applications written in Microsoft's C# language. It also has a version to support IPTV, which several telcos are using for their VOD over DSL deployments.

Critical mass

A large subscriber population is important to stimulate application development. The satellite operators are both using proprietary standards,

A large subscriber population is important to stimulate application development.

which have no other significant user bases in the USA. However, the size and relative homogeneity of their STB populations makes this tenable as developers and content providers will make the effort to port their applications onto these platforms. OpenTV and Media-Highway have been widely deployed for a long time and so have mature development communities with the tools to support them.

Cable operators are mainly standardizing OnRamp/OCAP to create a large target population of interactive boxes to attract high-quality development houses and content providers. **BE**

David Short is a technical architect working on the design of new DTV systems. He also is a member of BroadcastProjects.com, an alliance of independent consultants. For more information, visit www.broadcastprojects.com.

Look Smart.

Choosing Sundance Digital to be your automation provider isn't only good for operations. After all, making the smart decision always makes you look good. Not to mention that the smart call helps you avoid the other call — the one that gets you out of bed in the middle of the night.

Point being, the people at Sundance understand what you expect from an automation company, and they deliver on all counts. Reliability, professionalism, customer service, technical support, flexibility, integrity and rock-solid software. All these advantages make Sundance Digital the world's best automation value — and choosing that value makes you look smart.

Not to mention better rested.

www.sundancedigital.com 972.444.8442

SUNDANCE
DIGITAL
BROADCAST AUTOMATION SOLUTIONS

Visit us at NAB, Booth#SU10011

**Don't miss the
2005 Pick Hits**

Coming in
June

See the top 40 new products
from this year's NAB convention,
selected by readers like you!

PICK HIT
BroadcastEngineering

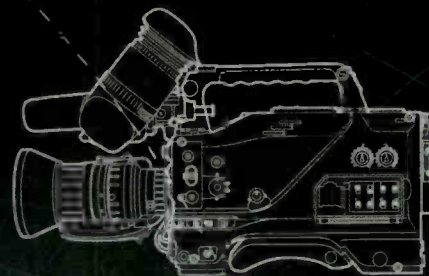
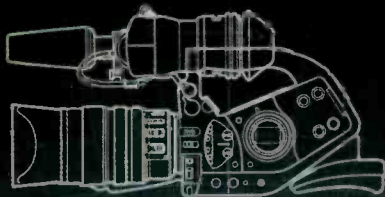
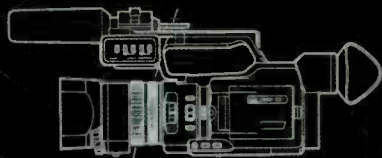

2.2 lbs - 22 lbs



Controlled balance fine-tuned

The 519 is the first professional fluid video head in the world with an interchangeable and adjustable counterbalance spring, allowing it to support camcorders from 2.2 to 22 lbs, and provide counterbalance that can be fine-tuned anywhere from 3.3 to 19.8 lbs - a range that makes the Manfrotto 519 ideal for all kinds of equipment from MiniDV to ENG.

Specifications:

Height - 5.9" | Half Ball - 75mm | Weight - 6.4 lbs | Max load - 22 lbs
Tilt - +91.5° -90° | Pan/Tilt drag - continuous variable

Also available as a kit with our leading video tripod models
525MVB, 351MVB, 532ART and 542ART



Manfrotto

ATM Broadcast Services

- not only for short-time transmission

Global communication and extensive rights of use (IPR) allow service providers today to market content (video, audio, data) across national borders and to other continents. In addition to marketing content, radio stations, production companies, program providers, studio operators, producers and the advertising industry, as well as other service providers, want to see existing infrastructures become effectively and productively integrated. Investments in transmission technology must be minimized accordingly. In general, it should be possible to effectively use existing terminal equipment. That can be supported through appropriate routing, use of standardized connectors, signal formats and data protocols.

Media&Broadcast, the media service provider at T-Systems, has implemented the "ATM Broadcast Services" (ATM = asynchronous transfer mode, ATM BS) platform and developed the 'Broadcast Service Multiplexer' (RfSMux) as a multifunctional network termination. The RfSMux allows service integration and shared use of the ATM subscriber line for various requirements and guarantees that real-time signals are given priority over file-transfer services (no cell losses during data traffic). In addition, IP-based services (IP-Link) which are based on permanent ATM connections and enable the implementation of point-to-point connections and IP networks have been offered since 2002. Switched virtual connections (SVCs) via ATM proxy enable fast file transfer with a data throughput of up to 130 Mbps – with little impact by signal phase delays: ideal for global applications.

Since 2003 T-Systems has offered the "ATM Broadcast Services" for the international arena including international support with identical technology, service and network capacity.

For this purpose, T-Systems maintains a globally accessible ATM network infrastructure. This G-ATM platform (Global ATM) can operate broadcast-based applications with the terminal equipment of the national ATM BS platform. The following interfaces are provided: video with digital SDI interface (270 Mbps), optionally with analog PAL interface (also NTSC), audio digital as embedded audio or via AES/EBU interface or analog 15 kHz (mono/stereo)). In addition, there are bi-directional narrowband channels (technical coordination circuits), DVB-ASI-/DVB-SPi interfaces, ATM user interface, CES (circuit emulation services: G.703 E1 at 2 Mbps, E2 at 8 Mbps, E3 at 34 Mbps, DS3 at 45 Mbps) and 10BaseT Ethernet interfaces. Local loops with up to 155 Mbps bandwidth are provided as access to the national ATM BS.

SVCs (switched virtual connection) and PVCs (permanent virtual connection) are offered over these lines as point-to-point (P2P) connections nationally, internationally and on the entire network: PVCs also as point-to-multipoint applications (P2MP).



The 'Broadcast Service Multiplexer' (RfSMux) as a multifunctional network termination.

Select your Quality of services

The quality of service (QoS) is ensured via CBR, nrt-VBR.1 with an SCR1/PCR2 rate of 1:2 to 1:3 for burst-like data traffic with specified MBS, nrt-VBR.3 or nrt-VBR plus with an SCR/PCR rate of 1:2 to 1:3 for burst-like traffic with specified MBS and UBR. VBR is offered only on a non-real-time basis with the nrt-VBR.1 and nrt-VBR.3 variants (or nrt-VBR+) in the ATM BS(i). T-Systems offers preconfigured and adaptable RfSMux equipment for use outside of Germany.

IP and MPLS-Services are possible via ATM Broadcast Services

More and more, ATM applications are being supplemented with IP applications, which could also lead to partial replacement and to other uses of services in the future. 'IP-Net' expands the ATM network by integrating IP technology so that IP services are possible via existing ATM BS connections. Router modules take over control and forwarding of IP traffic. 'Multi Protocol Label Switching' (MPLS) is used to handle the IP data efficiently.

The MPLS network standard offers freely configurable, maximum bandwidth for IP traffic (up to an ATM BS access capacity of 2, 34, 45 or 155 Mbps), high security for Virtual Private IP networks (comparable to leased lines) and transparent support of private IP addresses in the VPN. In addition, permanent connections (PVC) must be supported over ATM.

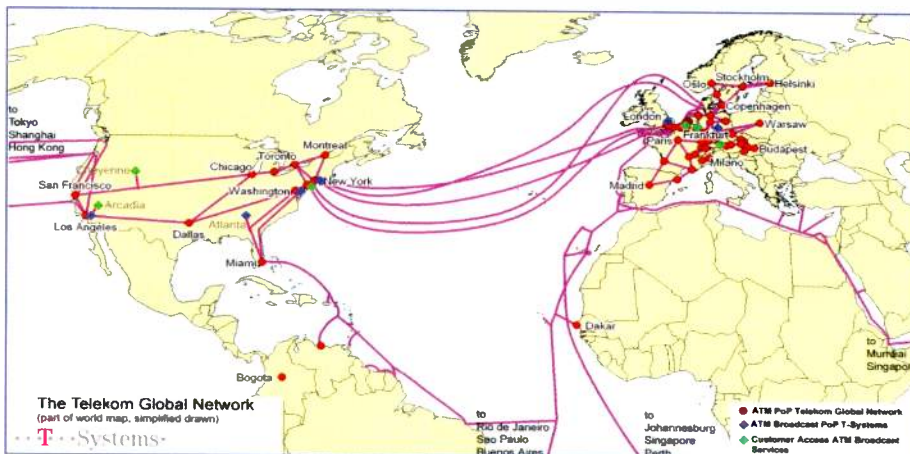

The Telekom Global ATM Platform is the basic platform for Broadcast Services International.

IP-Link BCN-Connect

With 'IP-Link BCN-Connect' (monthly flat rate), IP traffic is transmitted via a point-to-point ATM connection (P2P), and 'IP-Link TCP-Proxy' enables a customer to reach all sites connected to this platform via the local ATM BS site connection without occupying connection capacities (billed according to call minutes and bandwidth). In addition, 'IP-Net' offers the possibility of reaching every site connected to the IP-BS platform without having to reserve connection capacities explicitly for this purpose (billed according to transmitted IP traffic volume). It is impossible to interconnect customers who use IP-Net and IP-Link TCP proxy. The ATM proxy (10/100/1000BaseT) can be adapted directly on the network or optionally via the RfSMux or BCN-Connect.

ATM Broadcast Services have also been available internationally since June 30, 2003. This includes 17 countries in Europe with 71 German cities and in 32 other European urban centers. ATM BSI is currently offered in Canada and the U.S. (15 cities altogether) as well as in Tokyo, Hong Kong and Singapore. The services can be used for permanent/short-time broadcast transmissions, connection to satellite earth stations, as disaster solutions, for gateways to national carrier networks and to special broadcast networks of other carriers. The IMX and MXF formats are supported for connecting editing stations and studios. In addition, SLAs (service level agreements) can be signed to ensure 24/7 operation (local service partner) and an optional standards conversions (on request: NTSC/PAL/SECAM).

Examples

T-Systems used ATM to transmit the Ski World Cup in Italy for ARD, ZDF and the Swiss broadcasting corporation SRG SSR idee suisse (DRS, TSR, TSI). For this purpose T-Systems provided SRG SSR idee suisse with an ATM connection in Zurich over which ATM-BSi can be used. The broadband, scalable ATM BS connection featuring automatic dial-in is used for AV transmission and IP services. The terminal equipment can be configured individually to enable transmission of DVB-ASI, SDI, MXF and IMX signals. Currently customers can reach over 360 stations around the world via the ATM network to exchange programs.

In early 2004 T-Systems started up the first ATM Broadcast Service access in the U.S. A service provider for horse-race betting and totalizer systems assembles and edits horse racing programs in Arcadia for European customers and feeds them to Palo Alto to a POP (point of presence) using an RfSMux and special DVB interfaces. From Palo Alto the signals are transmitted to T-Systems' satellite earth station in



Reach the European Satellite Area via ATM Broadcast Services

Uisingen, Germany, using the global ATM broadcast network. The signals are then uplinked to a Hotbird 3 satellite, which digitally encrypts the program and transmits it throughout Europe.

T-Systems has reached an agreement on the provision of ATM BS technical services with DCI in Washington and Crawford Communications in Atlanta and set up corresponding POPs at these two companies. These POPs enable public dial-in access to the exclusive broadcast transmission network and the exchange of content between North America and Europe. At the same time, they set up permanent connections for contribution and distribution of programs. As part of the agreement, the companies assume responsibility for on-site service and technical operations at the respective feed accesses. Besides pure transmission services, there are gateways to the American distribution networks and the option of standards conversion.



T-Systems ATM Broadcast Installations while the Olympic Games 2004 in Athens

Other connections/POPs have been operating in Los Angeles, New York and London since early 2005. Past events such as the FIFA 2002 World Cup™ in Japan and Korea, the 2004 European Soccer Championship in Portugal and the 2004 Olympic Games in Greece were broadcast using ATM BSI. T-Systems configures and monitors the multiplex equipment of all sites and the associated transmission paths via an ATM network management system from Cologne/Germany.

2006 FIFA World Cup Germany™

In the future, connections via ATM Broadcast Services will form the basis for contribution and distribution of signals from large events around the world. In June 2005 T-Systems will deliver signals to TV and radio broadcasters during the FIFA Confederations Cup in Germany over these connections. During the 2006 FIFA World Cup Germany™, ATM BS will be used as an important medium in addition to satellite transmission for transmitting signals from the International Broadcasting Center IBC in Munich to international TV and radio broadcasters. Besides the variety of interfaces for international transmission, sufficient transmission capacity can be provided quickly within the scope of network resources.

IMX/MXF support

IMX and MXF were standardized in the studio/transmission area, driven by the increased networking of production centers and increasing volume of file transfers. T-Systems supports these file formats on the ATM BSI transmission paths. MXF file transfer is possible to all networks via TCP/IP. At its testing laboratories in Darmstadt, Germany, T-Systems tested the requirements of high-bit-rate file transfer, and the circumstances and limits with respect to MXF file transfer over networks and routers currently in operation. The results clearly showed that MXF can be used to transfer A/V materials effectively and simply via IP networks for asynchronous, networked file-based transmission.

The ATM Broadcast Services (national/international) are a cost-effective alternative to existing satellite links and permanent connections. A significant advantage of these services are the different levels of service and the flexibility of the customer terminal equipment – and, the automatic dial-in option for new connections should also be taken into account. T-Systems and its contractual partners are continually expanding the ATM platform, which means this new transmission technology can now be offered for global use.

Further Infos and contacts you will get on: www.t-systems-mediabroadcast.com

FOOTING



**in 24p
for local TV**

By Peter Fasciano

APRIL 2005



Once I heard the look of film described most succinctly by an ad agency client. I was writing and directing a series of film commercials for him. In the small talk that fills those time gaps between moments of progress, he opined, "Film offers this wonderful diaphanous veil of fantasy that you don't get from video."

My brain gnawed on that phrase. Diafph-a-what?

Well, it's been about 25 years and many rolls of both film and tape since I first absorbed some part of what that sweeping insight meant. In the last couple of years, digital 24p cameras and editing systems have substantially closed the visual gap between film and video. And, to fully cover this aspect of acquisition would require a sizable book. What I'd like to emphasize here is that new technologies are becoming available that will enable 24p video to be a new medium of visual expression for stations and other content producers.

The bottom line is that at the NAB2005 convention, attendees can see, try and even buy new 24p tools at price points previously not thought possible.

Several new and low-cost 24p cameras and technology are being shown for the first time at this year's convention. Readers will want to be sure they examine these new 24p technologies at exhibitors' booths. While all the solutions aren't yet completed, vendors assure me that we will see products on the street this year.

Another important aspect of the new generation of flexible 24p cameras is that they offer nonlinear gamma settings as adjustable contrast profiles that can emulate the response of film to light. The upper HD 24p image was obtained with a normal gamma response typical of a properly adjusted video camera. The lower image is typical of the film response curve that 24p cameras emulate through their nonlinear gamma settings. This response to light, coupled with progressive scanning at 24 frames, contributes to the final visual effect — a video camera that can behave like film.

The benefits of 24p

Today, many prime-time programs have moved from film to 24p high-definition video. Network sitcoms are regularly shot in 24p with three to four cameras. Dramas are shot on location, film-style, but using video cameras. Even national and regional commercials are now routinely created in 24p. Is the image film or video? It's no longer obvious.

Now, as smaller and less expensive 24p cameras come online, shooting content in 24p is something that I recommend broadcasters and content producers consider seriously.

Why? Put simply, this technology represents an opportunity to significantly expand a station's visual palette. Shooting in 24p enables the station's creatives to develop a sophisticated station look that is more visually consistent and competitive with national network programs and commercials that surround the local inserts. Lo-

cally-produced promos, show openings, bumpers and other interstitial visual elements that define a local station's identity can become visually richer when properly shot film style in 24p.

The new lower-cost cameras and editors mean 24p capabilities are no longer limited to high-dollar content. Even the local station can bring that high-end film look to its audience. Armed with this new technology, staff directors, videographers and editors can be encouraged to reach creatively beyond the limits of SD production.

Confirming viewpoints

To see if I am on track with others' viewpoints, I contacted two seasoned experts for some practical pointers on shooting and editing in 24p.

Sean Fairburn is an HD cinematog-

rapher/DP in Los Angeles and a regular contributor to HD magazines. Michael E. Phillips is the principal product designer for Avid Technology, a practicing editor/post-supervisor and Webmaster of *24P.com*. I asked both of them to comment on the advantages and challenges of using 24p technology.

Sean: While 24p can provide attractive moving images, there's more to achieving a rich film look than just having a camera that shoots 24-frame

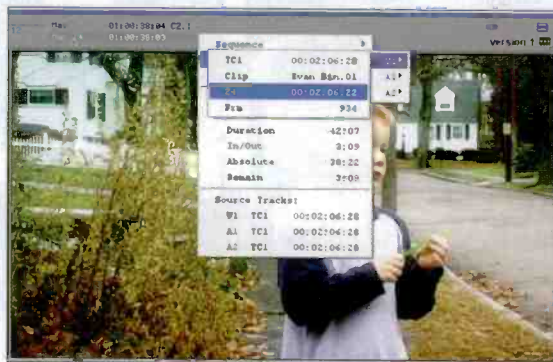

An Avid UI shot of the frame shows the metadata tracking that can be done in a 24-frame project — 30-frame master drop and non-drop, as well as 24fps source and record.

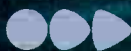
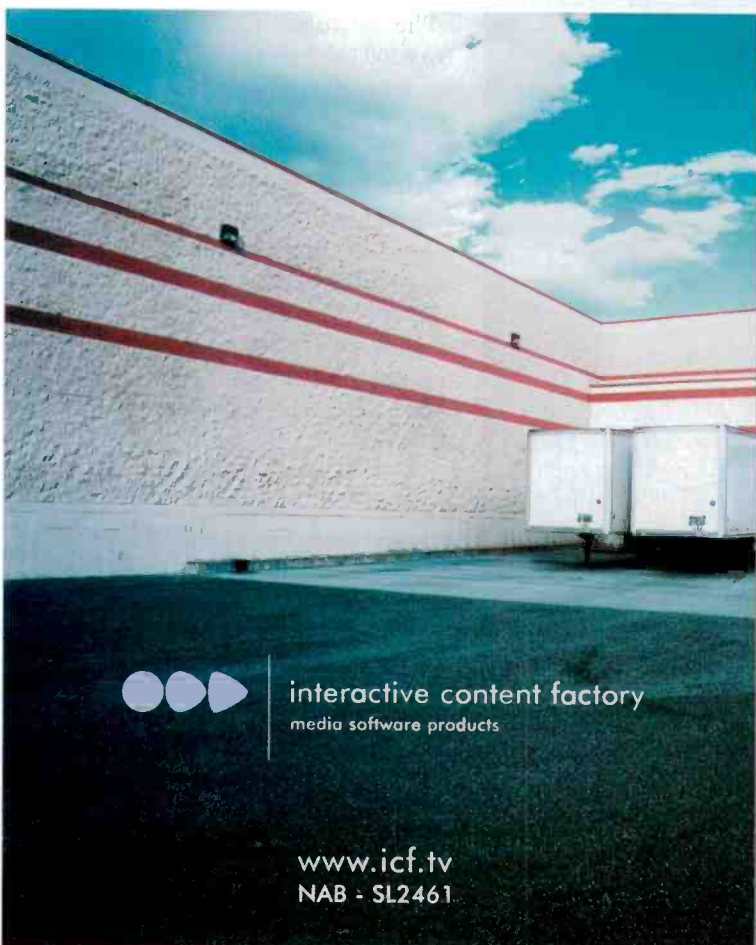

interactive content factory
media software products

www.icf.tv
NAB - SL2461



The only solution for Windows Media editing over IP

Browser-based

Microsoft Internet Explorer is all you need. Ideal for archive browsing and proxy editing solutions.

Edit anything, anywhere

Local or remote, all it takes is a 2mbps network or Internet connection. Edit while record capability for sport and news.

Brilliant quality

Frame-accurate editing using standard Microsoft Windows Media 9 Series files, PAL and NTSC.



Fully-featured but easy to use

Cuts, transitions, effects, graphics and voiceover in a simple package designed for producers and journalists.

Available as an SDK or as part of the



MEDIA PLATFORM

progressive images. Having the time and resources for proper lighting and camera support also are part of the visual equation. Video projects that are lit and framed beautifully will look all the better in 24p.

Michael: Because 24p is a video format, users have that valuable real-time visual feedback along with the usual benefits of efficiency and convenience of shooting with videotape. Videotapes can also run five times longer than film magazines.

Pete: True. The longer run time and lower cost of videotape do make it easier to maintain momentum with fewer reload breaks. As a director, I like to keep that shoot energy up on the set, and work with the talent to mix it up a bit with some extra takes when appropriate without worrying about running out of film.

Sean: I do see the lighting crew and others on set get into a shoot more when the images are available to ev-

eryone. As with any video shoot, seeing what the photo filters, lighting and so on can really do then and there can be a plus. You can't do that with film. Plus, the immediacy of video greatly reduces guesswork. However, like any good film project, the director and the DP should have a firmly established visual goal—an appropriate look that they've already discussed and defined in reproduction to complement the narrative objectives. Should the look of the project be hot, bright and colorful? Dark and mysterious? These questions of visual style should be answered in reproduction for all projects, film or 24p video.

Michael: Once you have the video, the editing process becomes the focus. Again, 24p has advantages. When properly shot 24p footage reaches the editor, it already looks and feels like film. This makes it easier for the editor to apply appropriate color correction and contrast management tech-

niques to further enhance the look of the 24p material. The workflow is the same for both video and film.

Sean: Ideally, the final look comes from a plan that the videographers and editor can execute as creative partners. Many DPs here in Los Angeles are learning much more about what's possible in post-production to enhance their work following the shoot.

One point to note about 24p is that, like film, the camera's normal exposure time should be set to 1/48th of a second for most work. That's the time equivalent of a film camera exposing 24 frames each second with a typical 180-degree shutter. The progressive scan video camera at 24 frames then generates the same resulting motion blur and integration as normally exposed film. The 24p frame rate and exposure timing provide the technical basis for the film look.

Pete: Keep in mind also that the same camera movement practices, pan

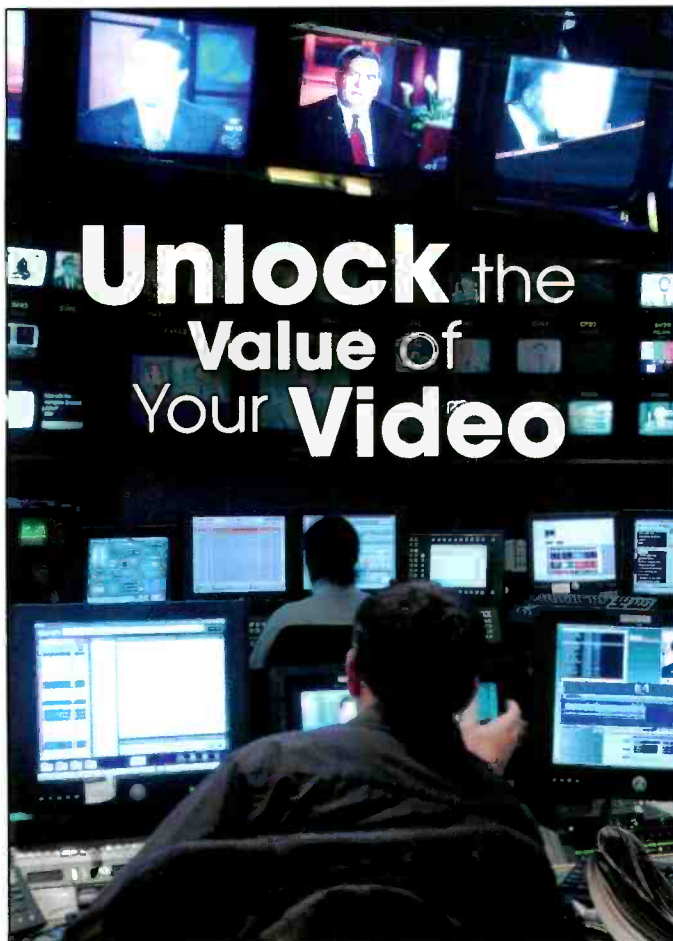

The keys to integrated content management and workflow:

- OmniBus Content Management and Workflow gives seamless access to content management throughout your operation. Track and control content acquisition, content transfers, and content archiving. Take control and streamline your entire workflow.
- Take advantage of sophisticated indexing and search functions through advanced metadata tagging capabilities. And easily interface to outside services such as program guides as well.
- From proxy browsing to schedule previewing to news editing to promo production, users throughout your facility can access the functions they need with OmniBus' complete desktop integration.

The right combination:

OmniBus provides the solutions to manage content and workflow in your facility. From ingest to playout—whether single channel or multichannel—OmniBus content management, workflow, transmission automation, and newsroom systems work together, and with third-party systems, for integration that opens up efficiencies. And, most importantly, maximizes the return on your broadcast content.



Innovate | Integrate | Deliver

www.omnibus.tv

Tel +1.303.237.4868 • USsales@omnibusystems.com
1536 Cole Blvd., Ste. 165, Lakewood CO 80401 USA

Visit us at NAB, Booth #SU7165

INERTIA™

Ultimate Interface Tool.

World's Most Advanced Media Transcoder.



Convert Anything to Anything Including DV & SDI.

Blows the doors off all other media converters & transcoders. Converts any format to any format including SDI & DV! ALL outputs active all the time! Dual analog outputs. 2RU.

MSRP \$2,995.00



Come See Us
At Booth # SL1243

LAIRD®
TELEMEDIA
www.lairdtelemedia.com
Life is Good.

rates, etc. used when shooting film also work well with the 24p video camera's motion characteristics. It's not like the shooter has to learn a whole new way of doing his job.

Production workflow

Michael: It's also important to understand that 24p as a video acquisition format easily dovetails into all the other video delivery formats, for example, 30i. The 24p material moves through post-production workflow just like standard video. Again, the staff doesn't need to learn a new set of skills. You shoot 24p video, and you edit using the same basic techniques as if the project were originally shot on film and transferred to videotape. The normal film-to-video 2:3 pull-down for playing back 24p images in the 30i video signal path is all managed by the editing system.

An editing system will also handle and track all of the timecode math for 24p and 30i video rates simultaneously and automatically. You always know exactly how long the project run time is to the frame and exactly where you are on the timeline.

Many people who are unfamiliar with 24p acquisition don't realize that it is just an acquisition format. What is delivered by the editing systems in the end is a normal video stream that matches whatever digital standard they've adopted for transmission, be it 30i or 60p.

Sean: Though we talk about working in 24p, we are actually shooting at 23.98 frames. However, there are no drop frame/non-drop frame settings to worry about. All of that is managed later on in the editing system. One important point about audio, however, is that when working with double system sound, I recommend that the separate digital sound recorders be run at the 29.97 frame rate, non-drop mode.

I prefer to operate my camera timecode in "Record Run" mode rather than time of day "Free Run." It's also smart in either timecode mode to maintain the good habit of running

several seconds of video "speed" before the director calls "Action."

HD versus SD

Michael: It's important to realize that the choice to work with the advantages of 24p can be made independently of the image resolution. What you shoot in and what you deliver in need not be the same.

Sean: Whether you are shooting an HD or SD project, if you think and work the project as though you were shooting film, and you apply the proper production values and principles in 24p videography, you will achieve a very pleasing film-like result. The technology will definitely support your creativity.

Michael: Editing in 24p doesn't have to be any more complicated than working at any other frame rate, and delivering the project in any of the other HD and SD frame rates is straightforward.

Sean: For me, working in 24p is a new art form. It's an opportunity to create something that can enjoy that desirable narrative fantasy of film while working with the convenience and immediacy of video. Production practices that create high-end images will always be important. What the new digital cameras do is help simplify and lower the cost of 24p acquisition.

Michael: In light of the new inexpensive 24p technologies, cameras and editors being shown at this NAB, readers should know that using 24p is no longer limited to high-end budgets.

Pete: So, as a TV station in a local market, if I wanted to embrace that diaphanously veiled film image for my station look, I could achieve it in-house using 24p equipment with a thinner, say, more diaphanous budget?

Michael: In a manner of speaking. You're the writer.

Sean: Diaphanous is good. 24p is good.

BE

Peter Fasciano is a fellow and advanced development and co-founder of Avid Technology. The views expressed in this article do not necessarily represent the views of Avid Technology.

STUDER

Vista 8 Digital Audio Console



You're live, totally in control...

The Studer Vista 8 with its unique, world-leading Vistonics® user interface ensures fast, intuitive console operation – the key to trouble free broadcasts.

The Vistonics concept of “where you look is where you control” marries the familiar feel of analog consoles with the powerful control features found on today’s digital consoles.

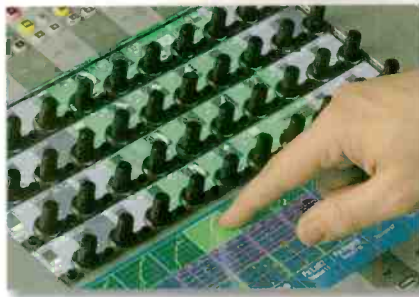

... and with the extra security of a fully redundant control system

With any live broadcast situation, redundancy is essential to ensure constant 24/7 operation. In addition to RAID drives, redundant power supplies throughout, and reserve DSP that engages automatically as needed, the Vista 8 also offers the security of a second complete control system. In the unlikely event of a control system problem, the operator can switch to this back-up system. Most importantly, operation resumes exactly as before, because all settings are constantly mirrored.

With all this, plus legendary Studer sound quality, Virtual Surround Panning, superb EQ and Dynamics, per channel Delay, internal Reverbs, flexible configuration and routing, and more, it's no wonder that broadcasters around the world are specifying Vista Digital Mixing Systems for their mission-critical applications.



VISTA
DIGITAL MIXING SYSTEM

www.studer.ch

STUDER
professional audio equipment

Harman Pro North America, 8500 Balboa Blvd., Northridge CA 91329
Tel: 1-866-406-2349 • Fax: 818-920-3208 • E-mail: studer-usa@harman.com

H A Harman International Company



On safari WITH HD

By Lou Douros

Artbeats Digital Film Library recently sent me Craig Walters to Africa to help produce a series of HD images for a new product covering indigenous peoples. This was not a typical tourist visit with all the trappings of safari lodges and eloquent, dashing, story-filled guides with British accents.

Rather, it was a luxury-free trek through some isolated villages of Africa. However, we came home with hours of to-die-for footage and some new ideas for successful shooting in the wilderness.

I've produced or shot in more than 25 countries over the past 12 years, all on SD formats. But, Africa has been on the top of my most wanted list for production since my first visit there in 1992. What made this assignment

Above: Shown here are Craig Walters and Lou Douros, on location in Tanzania. They used a Sony F900 CineAlta camera to help produce a series of HD images for new Artbeats stock footage titles covering indigenous peoples.

A.F. Associates, the global leader in **systems integration** and **engineering services** is changing its name – but *only* its name...

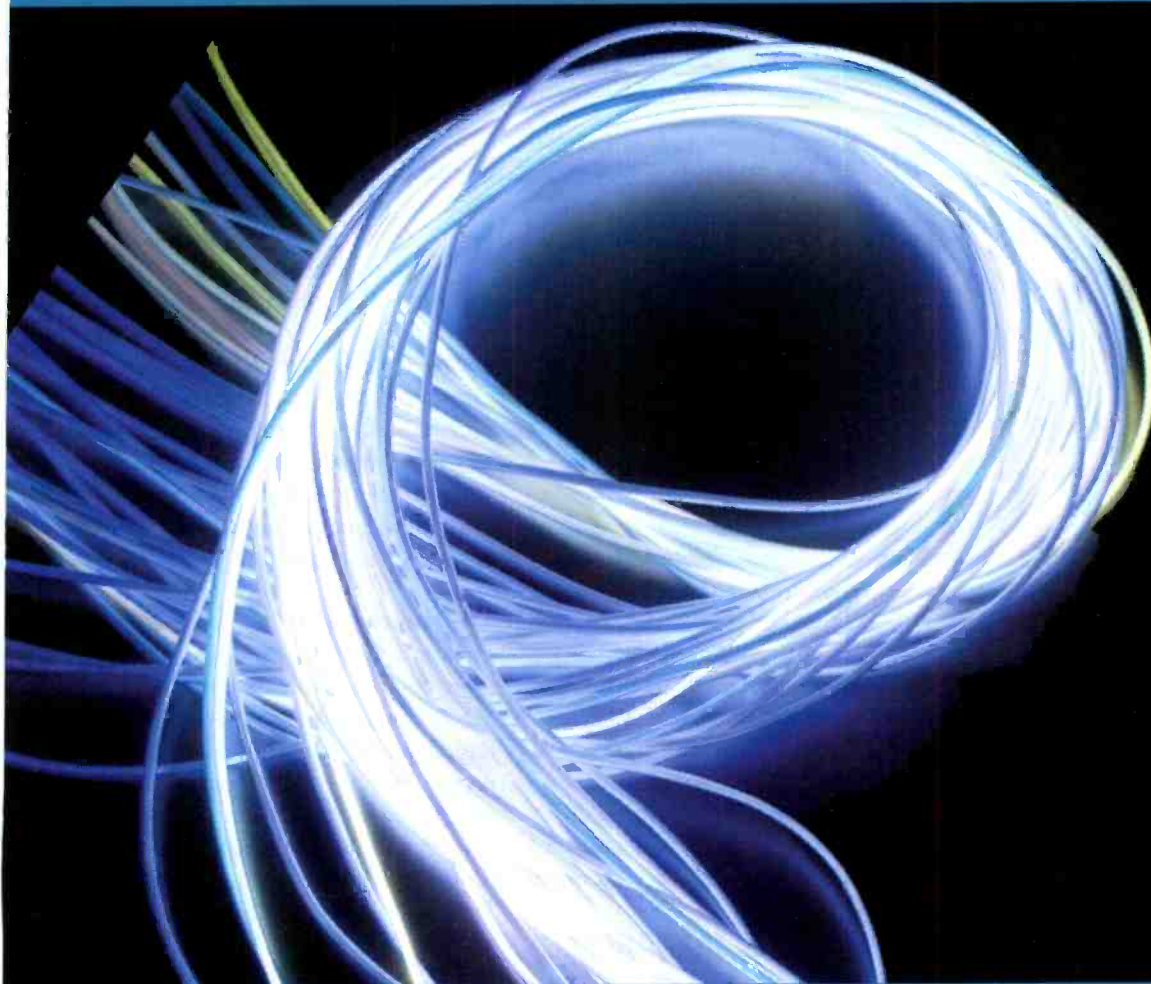

Introducing: Ascent Media *Systems & Technology Services*

In 2000, the 30-plus years of A.F. Associates' systems integration experience was added to the impressive roster of companies now known as Ascent Media Group.

At the end of 2003, Ascent Media enhanced A.F. Associates' depth of resources and global reach by acquiring the former Sony Systems Integration Center. In 2005, a systems integration operation was launched in London.

With full-service operations on both U.S. coasts, greater resources and expanded global capabilities, A.F. Associates is **proud to be known as Ascent Media Systems & Technology Services**: strategic growth providing ever greater value to our clients.

To learn more visit: MAB Booth #C5434,
www.ascentmedia.com/systems, call 201.767.1200 or send
an email to systemsales@ascentmedia.com

AAA
A.F. Associates, Inc.
An Ascent Media Company



**Ascent
Media**
Systems & Technology Services

Engineering the Future of Television™

San Jose, CA

Northvale, NJ

Palm Bay, FL

London, UK

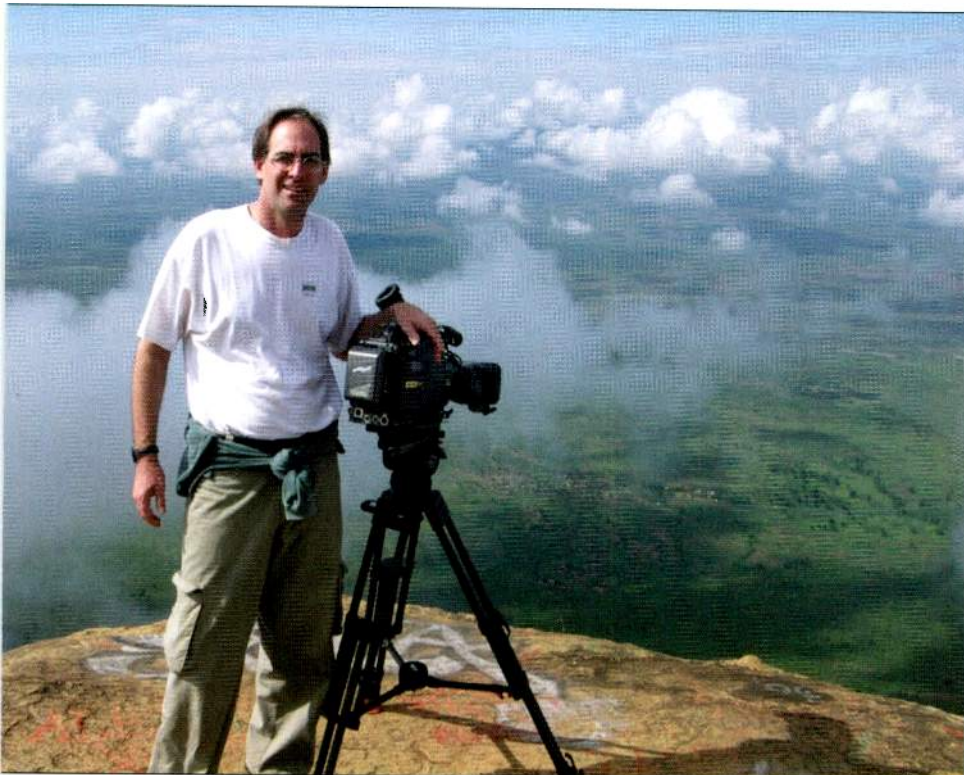

Fujinon's HA20x7.5 lens provides a wide range of zoom, making it easier to switch between upclose and faraway scenes. Shown here is Lou Douros, halfway between Kilimanjaro and Dar es Salaam.

different was that all images were to be captured in HD. My partner in this trip was Craig Walters, of Walters Productions.

Logistical issues

Shooting in the Third World is

six Anton Bauer Dionic 90 li-Ion batteries, plenty of tape, and a Sachtler 100mm and V20 tripod head. Even with the lighter-than-normal load, we were not exactly inconspicuous. Our pale presence in the sea of beautiful ebony skin was more of a curiosity

Shooting in the Third World is loaded with logistical challenges.

loaded with logistical challenges. Ideally, capturing stock footage of lifestyles would include a larger crew. Unfortunately, the reality was that showing up in a tiny Ugandan town with lighting, production assistants, a full camera crew and craft services would severely limit our take-homes — and bust the budget.

However, by rethinking our goals, we developed an equipment list more resembling a light documentary or ENG assignment. We opted for a basic equipment rental package from Bexel in Burbank. It included a Sony F900 CineAlta camera, two Fujinon lenses,

than was our equipment. "Mzungu" was the phrase used by the natives to refer to us, and not always with great charity. Loosely translated, the word means "runs around a lot."

Back roads

Our route took us from Tanzania to Zanzibar to the western region of Uganda. While in Tanzania, we traveled from the northern city of Arusha to the Masai lands and back each day. We made about as much progress on the roads as you would in LA traffic, but for different reasons.

The first two days were a guy's dream

come true — four-wheeling on rutted, pot-holed dirt roads. However, when traffic slowed our progress, it wasn't from fellow vehicles, but rather cattle with horns as tall as a man. Because we were bent on finding remote locations and villages, every day was spent pounding and tossing both us and the equipment about for five to seven hours. The novelty of off-road driving quickly dissipated, and I soon longed to escape the Land Rover and pour my jet-lagged body into a hotel bed.

We quickly learned some tricks to this kind of production, the first of which is to blur the roles between the partners. Craig's familiarity with the camera placed him as primary DP, and I functioned most often as a field producer, but we traded from time to time when it made sense. This permitted us to make quick setups and get talent release forms signed on-the-fly.

The equipment

I found the Sony F900 is only a bit more complicated to operate than the SD Betacams I am most used to (chiefly in the setup menus). We shot mostly from the tripod, though some setups led us to try some off-the-shoulder shots. The CineAlta is a bit on the heavy side, but not by much. The Fujinon HA20x7.5 lens gave us a nice long 150mm option for the wild-life shots, and the 7.5mm wide lens was adequate for most market scenes

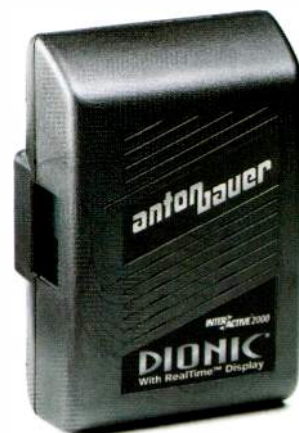

Anton Bauer's Dionic 90 is a good choice for videographers because of its light weight — just 1.7lbs.



Pelican equipment protection cases are unbreakable, watertight and dust-proof.

or tight village work.

While we tried using the lens doubler on a few occasions, we found the

Sachtler tripod head was just a tad light to hold most setups. The slightest puff of wind bounced our shots.

We elected to use a Sony DM-3000 LCD color viewfinder and an Astro DM-3000 LCD. The unit was adequate for framing shots when we were cramped for setup space or time. We calibrated it against a standard LCD monitor and rechecked for reference several times during the trip.

Were the equipment package configured the way many feature cinematographers prefer, we'd have required a caravan of support vehicles. Instead, we traveled with the camera in a soft case, often on our lap or seat-belted in beside us to minimize shock. When flying, we carried it onto the airplane rather than shipping with bulky flight cases. We used a Pelican case for most everything else, includ-

ing a Zeiss prime 5mm lens that we lovingly wrapped in shock-resilient materials. The prime only saw the African skies on a few special occasions, and when it did, it made for magnificent pictures. We were never sorry to find time to use it.

My fear was that we'd be out in the bush as the CineAlta drained the last drop of juice from the batteries just as the killer shot emerged before us. Didn't happen. The Anton Bauer Dionic 90 has a small footprint, excellent capacity and with some careful power management on our part, we never ran out of DC.

We also carried a 4:5 matte box with a small compliment of filters. The Tanzanian plains are all about the sky. No matter the foreground, we were often taming the clouds with filters. The package of filters included .3, .6 and .9 ND-to-clear grads and a polarizer. The contrast forgiveness inherent in

2GHz Relocation Solutions

Don't just replace – upgrade to the best!

Get the facts from BMS.

See Superior Adjacent Channel Performance

See Dual 6 MHz Channels in Operation

See How easy it is to use

Receive Site Solutions

Portable & Camera-Mount Systems

ENG Truck Systems

Visit
BMS & NEXTEL

NAB 2005
THE WORLD'S LARGEST ELECTRONIC MEDIA SHOW

Booth C1421

Ask a BMS representative how we outperform the competition.



BROADCAST MICROWAVE SERVICES, INC.
2367 Crosthwaite Circle www.bms-inc.com
Poway, CA 92064 U.S.A. E-mail: dept100@bms-inc.com

Tel: +1-858-391-3050
Toll Free (U.S.): 800-669-9667
Fax: +1-858-391-3049



Carl Zeiss DigiPrime lenses are designed for HDTV cameras with three 2/3in format CCD-Chips and a beam splitter HDTV prism.

our F900 setup was critical in getting a range of detail out of our subjects. A young Masai warrior or herdsman

wearing the traditional intense red blankets are a video camera's horror when he's surrounded by the light

other cameras I've used.

Part of my misconception was based on the promotional positioning

It's hard to imagine going back to SD video after experiencing the wide 16:9 field of view and beautiful detail of HD



browns and off-whites of drought-parched Tanzanian grasses. The surreal detail produced by the HD format, including skin tones and color saturation, was spectacular.

Stunning HD results

It's hard to imagine going back to SD video after experiencing the wide 16:9 field of view and beautiful detail of HD. My early perceptions about the F900 being a too-big camera for a low profile shoot like this were unfounded. It proved to be no more trouble than

these cameras for features-let alone works. Movie cinematographers will have to see accessories and large lenses hanging off the camera body. However, today's HD cameras are perfectly suited for a wide range of applications even without all those extras.

Lou Douros has produced, directed or photographed international documentary style projects since 1992. He's the president of Grass Roots Software in Grass Valley, CA. Craig Walters is a cinematographer for Artbeats, a royalty-free stock footage and video library company.

VERTIGO  MEDIA 
we know graphics

WE KNOW GRAPHICS

From simple data-driven tickers to centralized broadcasting to automated newsrooms - we know your graphics workflow better than anyone



Graphics Authoring



Asset Management



Graphics Systems



Real-Time Data Management



Playout/Playlist Controllers



Content Editing Tools

The Xmedia Suite, VertigoXmedia's 3rd generation graphics automation platform, is the only open system connecting your newsroom tools, station automation, asset management and databases to your CGs, Clip Players and Still Stores. And our VertigoXG family of graphics systems combines the ultimate rendering engine with the on-air robustness you require. For your next project, large or small, contact VertigoXmedia - We Know Graphics.

www.vertigoXmedia.com/know | 1-877-4-VERTIGO | info@vertigoXmedia.com



THE WORLD'S LARGEST ELECTRONIC MEDIA SHOW

Visit us at NAB 2005
Booth #SL2620



At the cornerstone of China Central TV's digitized operation is a StorageTek PowderHorn 9310 tape library with five T9840B and five T9940B tape drives.

The tape archive solution: **PROTECTING YOUR CONTENT**

By Rich Harada

Content digitization, HD programming and broadband distribution have brought unprecedented challenges and opportunities to broadcasters. The conversion from an analog to a digital workflow has required new system architectures along

with new investments in equipment. Meanwhile, the emergence of hundreds of new channels has increased viewer options and the opportunity for greater advertising revenue.

All of these changes mean that content producers and broadcasters need

to handle more data and store larger files. Fortunately, IT and computer technology have provided users with a new variety of solutions.

One of those solutions is the storage of these increasingly large files as data on tape. The implementation of digital

technologies has created new workflows with the result of dramatically improved productivity and efficiency. Archived video clips now can be located and loaded with just a few keystrokes, instead of manually searching through the shelves in a video archive library. Viewing and editing stations no longer need to manually handle cassettes, eliminating a major source

cesses, automation of broadcast servers, and the implementation of useful data protection policies are vast improvements on the previous ways content was handled. However, the most basic function, storage, remains key.

Storing content

Given the size of digital video files, data storage, as opposed to video stor-

and S-AIT, DLTtape, LTO, 3592 and 9940 tape formats. These formats provide a variety of storage capacities and performance (access and transfer rates), all with high reliability and compatibility, creating cost-effective content protection solutions.

Most of today's content processing takes place from hard disks. Servers provide the needed high-speed, multi-user access that news and promo production requires. Large disk systems also can handle the graphics files needed for effects and film projects. However, hard disks have their own limitations in terms of scalability, reliability and cost. Let's examine some of these issues.

Given the size of digital video files, data storage, as opposed to video storage, is one of the most critical components of today's new architectures.

of potential loss. And, with digital storage, multiple users now can access the same content simultaneously.

Simplified indexing and asset management, enhanced workflow pro-

cesses, is one of the most critical components of today's new architectures. Data storage has many benefits.

There are a variety of tape technologies to choose from, including AIT

Scalability

As a "fixed" storage medium, increasing system storage capacity usually requires adding new drives and controllers, or replacing the old drives



Intelligent Master Control

World leader in scalable multi-channel playout



QMC scales from a single channel to over 60, with the flexibility to meet your needs using a unique selection of HD and SD channels, control panels and upstream routers

NEW QMC-2

- HD or SD operation from a common hardware platform
- Handles dual stream Dolby E for 16 channel audio
- Dual logo stores and up to three external keyers

See it at NAB 2005 Booth SU9652

Toll Free: 888 638 8745

sales@quartzus.com

www.quartzus.com



On-Air

Automated VOD Production

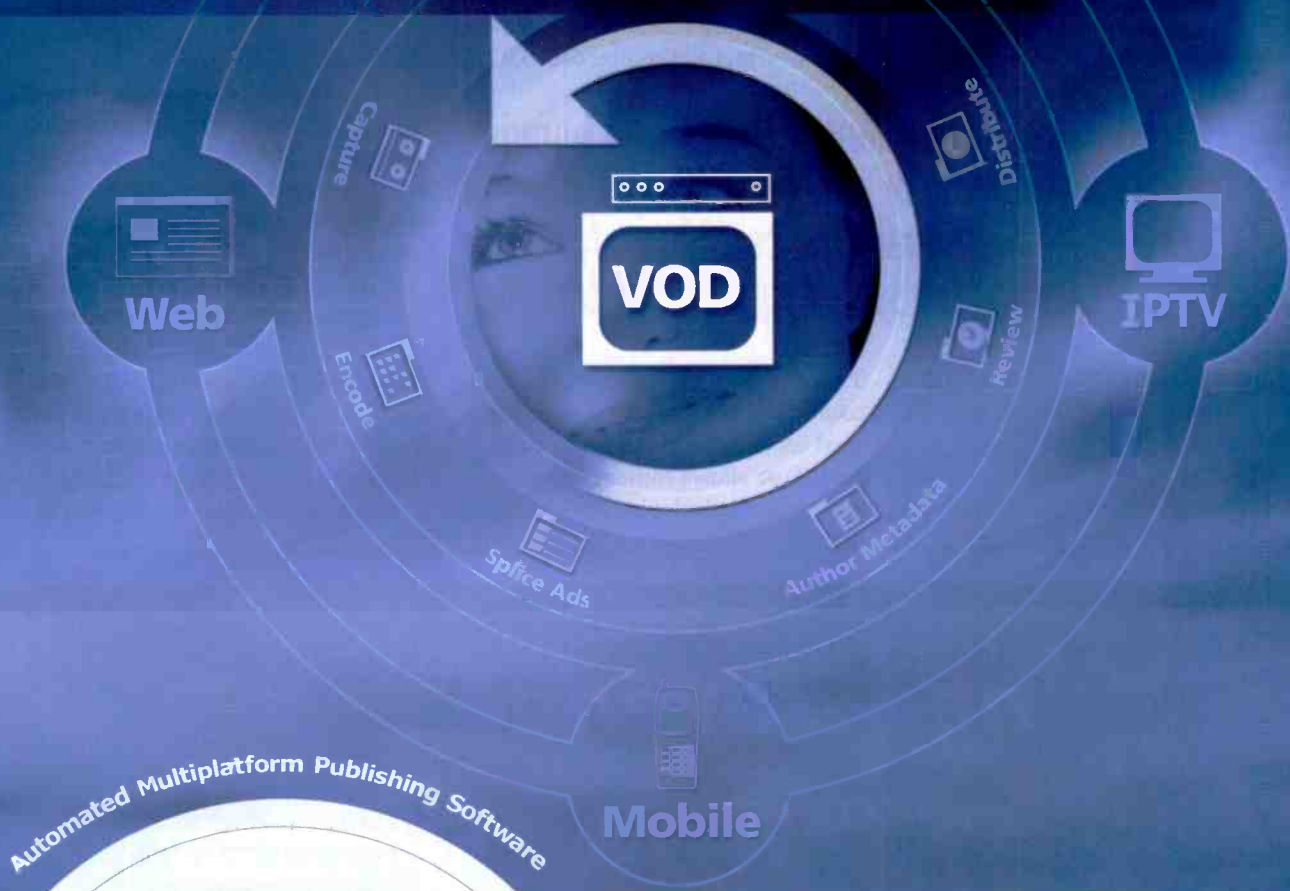

Anystream.
Agility[®]

See VOD
 at NAB
 Anystream
 Booth SL 3316



Good news: VOD is here!

Bad news: Your content production process isn't VOD-ready...

Anystream can solve your problem. Our Agility software automates routine media conversion and publishing tasks, giving you the efficiency, scalability and flexibility you need to serve emerging outlets.

Top media companies every day rely on Anystream Agility to transcode content for network exchange among multiple manufacturers' servers - whether HD or SD - and repurpose media for the Web, mobile, VOD and more.

Let Agility automation take your content to new places!

Call us today at 888-ANYSTREAM or visit www.Anystream.com

 **anystream.**
 software transforms content..

with more storage per disk. This is expensive and complex, no matter the vendor. And, many expansion paths require the storage to be "squared" in terms of size, bandwidth or both. Often the user can't simply add a few gigabytes of storage to a server without actually doubling the current amount of storage. This may also re-

quire additional bandwidth, which may require Fibre Channel switches and networks.

quire additional bandwidth, which may require Fibre Channel switches and networks.

With tape storage, users can scale up a storage system more ably. The ini-

Reliability

Computers, even professional systems, can suffer failure — perhaps even developing the dreaded BSOD.

This is where the reliability of tape comes in. Content that is lost or damaged isn't content that can be used or sold. Tape allows content to be safely stored in a reliable, long-term, stable

environment, thereby protecting it against failures such as destructive computer viruses and worms. Unlike hard disks, tape has a long history, more than 50 years, which certainly qualifies it as a reliable, long-term storage solution.

Cost

While the cost of hard disk storage has declined over the years, it is still more expensive compared to tape. Figure 1 compares storage costs for four common technologies. Let's compare the numbers.

Enterprise disk storage is 20 times more expensive than the cost of tape storage. Even a lower cost/performance disk technology, such as SATA, is still four times more expensive per gigabyte than is the cost of tape.

Typical storage costs for a high-performance disk storage system run in

The initial investment in drives and libraries can be incrementally expanded simply through additional tape cartridges. No more upgrades via forklifts!

get
new revenue

with your
**NBC
Weather Plus+**

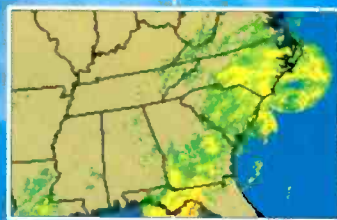
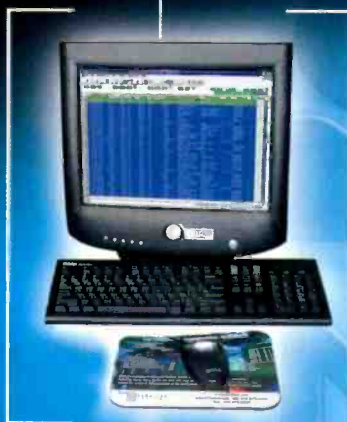

Available now...

 **AirBoss™ WP**

4581 NW 6th Street Gainesville FL 32609 Ph: 352.372.8326 Fax: 352.375.0859 Email: sales@floncal.com www.floncal.com

See us at
NAB
2005
April 16-21 - Las Vegas, NV
Booth SU#10000

 **FLONCAL
SYSTEMS**

The technical leader in tv automation.

the \$2000 to \$4000 per terabyte range. In contrast, storing that same content on data tape can be much less, as little as \$400 per terabyte — that's one-tenth the cost of disk storage. This means a data tape can store about nine hours of 50Mb/s video for less than \$10 per hour.

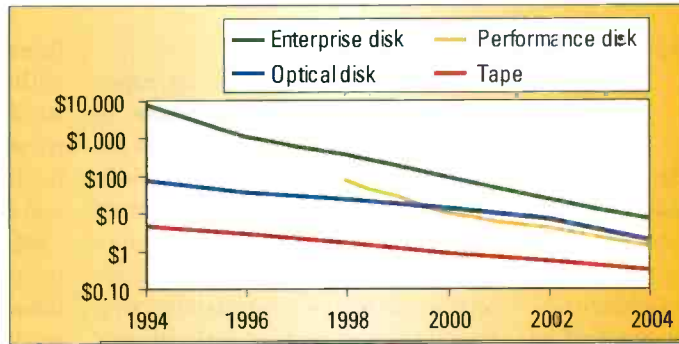

Figure 1. Enterprise disk, optical disk, performance disk and tape are the four common storage technologies. Of these, data tape continues to be the most cost-effective.

Capacity

Tape also excels in terms of storage density. Today's feature films demand significant storage capacity. For instance, a finished feature film of 2K resolution requires about 2TB.

The generated work product for a feature film with 2K resolution typically needs between 10TB and 100TB of storage. A finished feature film providing 4K resolution requires 8TB of storage. Any facility attempting to create workstations with this kind of storage capacity on disk will quickly see how expensive it can become.

As film makers move into 4K production, storage needs don't double; they quadruple! The generated work product for a typical feature film in 4K resolution requires between 40TB and 400TB of accessible storage.

Here are some other storage factors to consider. As film makers move into 4K production, storage needs don't double; they quadruple! The generated work product for a typical feature film in 4K resolution requires between 40TB and 400TB of accessible storage. A finished HD program

Over 1,000,000,000 seconds of precision timing



WHEN you require the best, most accurate in precision timing look only to ESE. Designed for "Precision Timing", ESE Master Clocks & Accessories have been the industry standard for over three decades. Whether using GPS, WWV, Modem, Crystal or line frequency accuracy – all ESE Master Clocks can drive digital or analog slave clocks, as well as interface with video and/or computer based systems. Call or visit our web site for more details.

• 3-Year Warranty •



142 Sierra Street • El Segundo, CA 90245 USA
Phone: (310) 322-2136 • Fax: 310.322.8127

www.e-se-web.com

Visit us at NAB, Booth #C2639

running at 50Mb/s uses 23GB per hour of storage.

Reliable solution

Analog and digital video tapes have long been a staple for broadcasters and content producers. Historically, no other medium could cost-effectively store the huge amounts of content created daily. Broadcasters are finding that truism still holds for digital images when they are stored on data tapes. Also, data storage tape formats are significantly less expensive than their video cousins, yet still provide high capacity, fast throughput and data reliability.

Tape's future

Today's tape technologies are experiencing solid market growth due to continuing improvements in capacity, performance and reliability while maintaining a cost-reduction curve that remains well ahead of other storage technologies. Mid-range and enterprise-class tape products support a wide range of storage applications, including long-term archival and preservation, data acquisition, disaster recovery protection, and mass storage for rich media.

Based on the roadmaps of the leading tape storage manufacturers, tape will continue to be more than three

times more storage-efficient (six times with compression) than hard disk storage. And data tape's high-speed transfer rates allow content to easily be stored in streams, providing quick and easy access.

Many disk storage solutions claim to protect your content, typically through RAID solutions. However, recall that most also offer to back up your data from disk to tape —just in case "something happens."

The bottom line is that without tape, your data could be at risk.

BE

Rich Harada is president of the Tape Technology Council, www.tapecouncil.org.

Don't miss the 2005 Pick Hits

See the top 40 new products from this year's NAB convention, selected by readers like you, in the June issue of *BroadcastEngineering*.



INTELLITRAC™

TBC Consoles' definitive technical furniture system sets new standards for modularity, ergonomics and high end aesthetics. Front and rear device tracks allow unlimited lateral positioning of critical monitors. Rack bay turrets

may be upgraded or relocated easily allowing quick, user friendly modifications. A full range of articulating arms for distance, height and tilt control may be utilized for mounting flat panel monitors, speakers, phones and task lighting.



console evolution.

NAB 2005
Booth #SU6831



tbconsoles.com
1.888.CONSOLE

[King of Processors]



X75™ HD
X75™ SD

Multiple Path Converter,
Synchronizer...and More



- Standard Definition
- Embedded Audio
- Fiber Interface
- Analog
- Web Server
- NTSC/PAL-M/PAL/SECAM
- Dolby®E/AC-3 de-compression

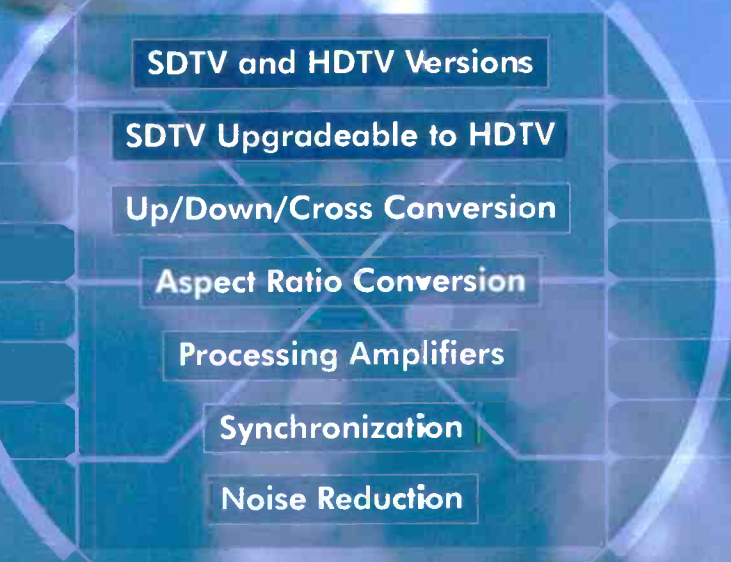

- High Definition
- Multi-Channel Audio
- AES/EBU
- Digital
- DVI-D and DV
- Streaming
- 1080i/720p

- Production/Editing
- News
- Broadcast
- Mobile
- Satellite

X75™ HD
X75™ SD



King of Processors

SHIPPING NOW!

Analog/Digital/Up/Down/Cross Conversion with Synchronization Starts With eXtra Processing Power

The X75 expands video processing to include "anything in" to "everything out" and simultaneous analog/digital and up/down conversions with field SD to HD upgradeability. Aspect ratio conversion, 3D adaptive decoding, TBC, SD/HD logos and noise reduction are all part of the vast array of X75 video capabilities.

For all audio applications, 8 or 16 channels of audio processing with embedded SD/HD, analog and digital interfaces are provided. Integrated Dolby® decompression and voice-over brings even more functionality.

- Less equipment required for your SDTV and HDTV video processing applications
- Multiple paths of processing for video and audio
- IP-enabled for control, monitoring and streaming including SNMP

Master Your Move to HD with the X75 HD/SD
www.leitch.com/X75

- Canada +1 (800) 387 0233
- USA +1 (800) 231 9673
- Europe +44 (0) 1344 446000
- France +33 (0) 1 42 87 09 09
- Italy +39 02 3655 3450
- Hong Kong +852 2776 0628
- China +86 10 6808 6301
- Japan +81 (3) 5423 3632



www.leitch.com

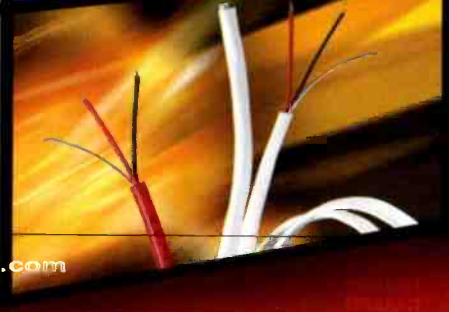

PRODUCT highlights

In hope of furthering your luck on the show floor at NAB2005, *Broadcast Engineering's* staff has compiled a second installment of new products for you to browse. These new products represent the latest developments just prior to showtime.

Inside are more than 200 new products, complete with photos, descriptions, contact information and booth numbers. We've made one-stop shopping for your facility easier than ever. Issue advertisers are indicated by colored listings.

BE



Stereo audio meter ▲

DK-Technologies MSD100C
Provides PPM/VU and phase meter displays, accepts analog or AES digital inputs; can display both analog and digital audio signals simultaneously..

+44 44 85 02 55; www.dk-technologies.com

Booth: C2757



High-resolution audio/DSD master recorder ▲

TASCAM DV-RA1000
Records high-resolution stereo audio to inexpensive DVD media; capable of audio recording at up to 192kHz/24-bit; features Sony's DSD format as an available recording format; records for over five hours of CD-quality audio to DVD+RW for capturing performances or meetings; can also operate as a professional CD recorder, recording standard audio CDs for studio or meeting room installations.

323-726-0303; www.tascam.com

Booth: SL310



Studio monitors ▲

TASCAM VL-X5
Powered speakers feature 5 1/4in woofers, silk-dome tweeters and a 60+30-watt bi-amplified active power amp; the monitors feature low- and high-frequency controls and an Acoustic Space Control to optimize their performance for room placement or listener preference; the monitors are shielded to prevent magnetic damage to CRTs; the deep cabinet and ported design produce a large amount of bass for the size of the monitors.

323-726-0303; www.tascam.com

Booth: SL310



Microphone ▲

Beyerdynamic M58
Designed for ENG as well as EFP in both indoor and outdoor situation; has a frequency response of 40Hz to 20,000Hz and has a non-reflective Nextel finish, which results in a low profile on camera.

631-293-3200

www.beyerdynamic-usa.com

Booth: C10421

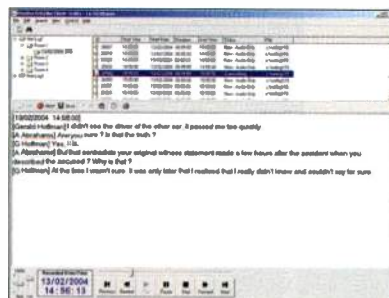

Transcription system ▲

Sonifex DDescribe
Recordings taken from any of the PC sound card inputs for mixing and recording; CD-ripper creates linear wave files from an audio CD and can also rip directly to MP3 files to reduce the file size; standalone version to be sold without foot pedal.

+44 1933 650700; www.sonifex.co.uk

Booth: C3526

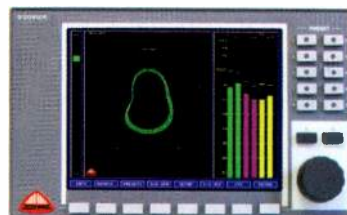

Multichannel/multiformat audio monitor ▲

DK-Technologies MSD660R
Incorporates a base unit and a remote panel with VGA display and control buttons; features point-to-point connection via Ethernet Cat. 5 cable/connectors, logging software for overs and mutes, and surround sound compatibility at 4.0, 5.1, 6.1 and 7.1 to monitor up to 32 channels of audio.

+44 44 85 02 55; www.dk-technologies.com

Booth: C2757

MCS

MULTI-CHANNEL SERVER

VIDEO SERVER



HD & SD

Automated Playback
Broadcast Time Delay
VTR Replacement
Sports Slow-Mo

Doremi Labs' MCS Video Server provides up to four independent record and play video channels in a compact 3RU chassis. A second MCS Server can be added to create a six channel system with shared RAID5 storage.

System Compatibility

- HD-SDI, SDI, YLV/RGB, SVideo, Comp. in-out
- P2, VDCP, Odetics and GPI control
- Compatible with leading automation systems
- Automated playback via our ListMaker GUI

Reliable and Upgradeable Design

- One to Six video channel configurations
- Dedicated video hardware platform
- External RAID5 or internal storage
- Redundant power supply



High Definition Video Server
MCS-HD Multi-channel record & playback server



Multi-Channel Server systems start at \$10,000

Video Servers - HD MPEG2 Encoders, Decoders & Players - HDSDI to DVI Converters - Test Generator

Doremi Labs, Inc. | tel. 818 562-1001 | info@doremilabs.com | www.doremilabs.com

doremi

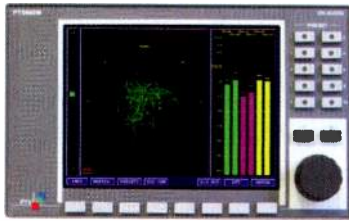

Rack mountable multichannel audio monitor ▲

DK-Technologies PT0660M

Offers from two to 32 channels of audio; modular structure with variety of modules available; features include HD and SDI de-embedding, AES signals, analog signals, surround sound monitoring; volume control for outputs.

+44 44 85 02 55; www.dk-technologies.com

Booth: C2757



Surround-field synthesizer ▲

Linear Acoustic UpMAX 2251

Produces a fully mono- and stereo-compatible 5.1 channel output from a convention left/right stereo signal input; creates downmix-compatible left, right, center, surround and LFE channels from the two-channel main input; "surround field" can then be adjusted via center-channel width and surround-channel depth controls, allowing programming from stereo to Lt-Rt to be appropriately reproduced from a 5.1 channel playback system.

717-735-3611; www.linearacoustic.com

Booth: C3612



Microphone ◀

Beyerdynamic M99

Uses TG-X technology; features a strong neodymium magnet system and a mass reduced special Mylar diaphragm to give the microphone powerful reproduction of excellent transient characteristics; has a frequency response of 30Hz to 18,000Hz.

631-293-3200

www.beyerdynamic-usa.com

Booth: C10421



Monitor system ◀

SLS Loudspeakers PS8R

Offers studios S8R ribbon equipped reference monitor as a standalone, bi-amplified nearfield critical listening monitor system; Evenstar Sigma-Delta digital amplifier in the unit is customized and matched to power the S8R drivers with exceptional headroom, damping and uniform response; unique amplifier topology lowers distortion, increases bandwidth and improves noise performance over traditional amplifier technologies.

417-883-4549; www.sisloudspeakers.com

Booth: N4002

Content management control system

WEGENER MediaPlan

Provides operators digital asset management in an end-to-end environment, supporting ingest of analog and digital assets, management of archived digital assets, remote tracking, updating or deleting of individual assets on the company's iPump media servers, targeting the company's receiver groups, regions or individual sites.

770-814-4000; www.wegener.com

Booth: C2624



Automation system ▲

Omnibus Systems Colossus V3

For the transmission arena; combines the automation architecture of the delivery system with the modular flexibility of G³ technology; is able to control large numbers of channels, items, or devices all through customizable desktop-based user interfaces; features an intuitive user interface with a timeline-based display; allows a single operator to monitor the status of all channels and to focus in on any single stream, confirm its data, and drive it in the traditional manner should the schedule require it.

704-319-2231; www.omnibus.tv

Booth: SU7165



Broadcast control ▲

Pharos Communications
Pilot Ria

Eliminates the clutter and expense of hard-wired panels and resource-hungry desktop applications; provides full reactive control of broadcast routing equipment from any Web browser via local or secure-coupled intranet; can be deployed quickly and easily throughout a single-site or multi-site facility; when necessary, allows engineering staff to reconfigure a system from home or while traveling.

+44 1189 502 323

www.pharos-comms.com

Booth: SU11835



Automation system ▲ Omnibus Systems TX>Play

Complements Colossus; is based fully on G³; is a highly scalable modular automation system for facilities operating from one to 12 channels; solution for broadcasters seeking a cost-effective path into the DTV market; features playlist editing and schedule importing; content metadata and schedule management tools facilitate simple or sophisticated levels of integration with business systems.

704-319-2231; www.omnibus.tv

Booth: SU7165

Automation software

Sundance Digital Seeker V3.0

Designed for broadcast operations with primary emphasis on enhanced workflow management; developed with customer assistance and feedback; provides tools that enable managers, producers and creative staff to collaborate and maximize efficiency.

972-444-8442; www.SundanceDigital.com

Booth: SU10011

The Unique Azden 1000 Integrated UHF Receiver



Gold Mount 1000URX/AB

IDX "V" Mount
1000UDX/VM

Whether you use the Anton-Bauer® Gold Mount® or a V-Mount battery, there's an Azden 1000 that's been designed to snap right onto your battery, and to give you maximum performance with no additional batteries needed in the receiver. Using the latest production techniques and the highest quality components, we've made a bullet-proof receiver which is ideal for broadcast cameras.

- 121 UHF channels (723-735MHz) user-selectable, with LCD readout
- True diversity system with 2 complete front-ends and high-gain antennas
- Proprietary DLC (Diversity Logic Control) circuitry for reduced dropouts
- State-of-the-art dielectric filters throughout, for improved image rejection and superior diversity isolation
- High 5th order filters for improved S/N ratio
- Multi-function LCD shows channel number and frequency, battery info, AF level, and diversity operation
- Ultra small, lightweight, switchable, Earphone-out w/level control

Note: Order cables specifically for your camera and battery configuration.



Bodypack transmitter (1000BT) with reduced current-drain for improved battery life, is available with Azden EX-503H, Sony ECM-44H.

Plug-in XLR transmitter (1000XT) works with dynamic mics.

AZDEN

P.O. Box 10, Franklin Square, NY 11010 • (516) 328-7500 • FAX: (516) 328-7506
E-Mail: azdenus@azdencorp.com Web site: www.azdencorp.com



Automation ◀ **Floral Systems AirLogger**

Off-air recording of 100 percent of transmitted video and audio in S-VHS resolution in AVC or MPEG-4 format can now be stored

permanently on inexpensive DVDs.

352-372-8326; www.floral.com

Booth: SU10000

Automation ▶ **Floral Systems Supervisory Monitor**

A single workstation provides horizontal timeline status of multiple channels, an overview of available resources in pie chart form, an SNMP message center to alert the supervisor of faulty equipment or operations, and an optional low resolution look at any material with point and click control.

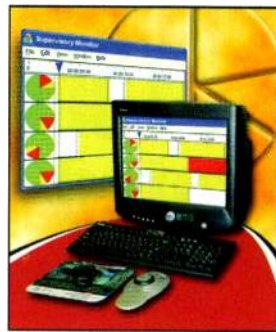

352-372-8326; www.floral.com

Booth: SU10000

Monitoring solution **Sundance Digital SNMP**

SNMP tracks the health of hardware sub-systems and digital signals.

972-444-8442; www.SundanceDigital.com

Booth: SU10011



Automation ◀ **Floral Systems Traffic Assist**

Forms a trio with traffic and automation systems to provide in advance the production detail for on-air operations that traffic systems are unable to supply, making unattended on-air operations possible.

352-372-8326; www.floral.com

Booth: SU10000



Automation interfaces ◀ ScheduALL Software .NET

New universal interface to network management systems (NMS) and monitoring and control systems (M&C); allows company's to easily interconnect and control external hardware and software sources creating an integrated and

automated broadcast workflow; communicates over a TCT/IP network using XML messaging.

800-334-5083; www.scheduall.com

Booth: SL767

Automation system

IBIS PAC

Allows broadcasters to implement a range of process, control and automation systems; adds to and integrates with the company's existing range of systems, including station automation, news/sports automation and channel/asset management.

877-541-IBIS, www.ibis.tv

Booth: SU10332

Automation software

Sundance Digital Fastbreak Automation V4.0

Fourth-generation reliable workhorse solution for broadcast automation shares some elements of the company's advanced Titan system architecture as well as an updated graphical user interface.

972-444-8442; www.SundanceDigital.com

Booth: SU10011



Automation system ◀

ON-AIR Systems playKast
Ideal for automated playback and live news production; designed for remote scheduling, media browsing, automated playout and events monitoring, integrated multi-layered graphics overlay generation, as-run logging

and management reporting.

800-379-0809; www.on-air-systems.com

Booth: SL5710

Managed monitoring for broadcast and distribution

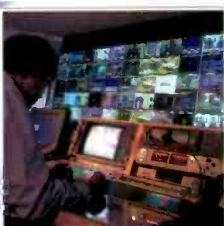

- Efficient solution to display analog, digital & High Definition video, audio, alarms, network load and computer generated data.
- Autonomous or multi-screen display to monitor up to 60 windows simultaneously.
- Perfect control room design offering the best possible combination of display technology, hardware and software for 24/7 operation.

Barco Control Rooms
Noordlaan 5, B8520 Kuurne - Belgium
Phone: +32 56 36 82 11 • Fax: +32 56 36 82 48
email: sales.bcd@barco.com

Barco Projection Systems
3240 Town Point Drive, Kennesaw, Georgia 30144 - United States
Phone: +1 770 2183200 • Fax: +1 770 2183250
email: bpsmarketing@barco.com

BARCO

Visibly yours

Automatic format conversion

ON-AIR Systems transKoder

Converts media files from nonlinear editing and graphics systems, such as Avid, Pinnacle and Apple, to formats supported by ON-AIR including the Windows media format.

800-379-0809; www.on-air-systems.com

Booth: SL5710

Ingest system

ON-AIR Systems Kapture

Integrates the ingest of tape-based content and satellite and line feeds into a single application; enables monitoring of tasks across multiple channels, providing reduced running costs in a traditionally labor-intensive process.

800-379-0809; www.on-air-systems.com

Booth: SL5710



Camera bag ▲

Cinebags The Cinematographer

Designed with numerous padded compartments; ensures that meters, digital cameras, and laptop are all in the same bag and well protected; all compartments feature heavy padding and a label holder that provides easy navigation through the bag to find the needed tool quickly; other features include heavy duty buckles, large padded shoulder strap, six padded meter compartments for tools such as lightmeter, sportmeter, digital camera, palm pilot, viewfinder, spare laptop battery or charger, and similar sized tools and a large padded compartment for laptop, script, or grayscale.

818-662-0605; www.cinebags.com

Booth: C11037

Pan/Tilt Head

Telemetrics PT-LP-S3

Has a weather proof option and new HD-HOU-S3 Weather Proof Housing; provides a high performance serial controlled pan/tilt system for demanding indoor and outdoor applications.

201-848-9818; www.telemetrysinc.com

Booth: C7337

Camera battery

IDX System Technology

Endure E-80

82Wh Lithium Ion V-mount battery pack with PowerLink, up to 164Wh; LED Accurate Power Status Display, supports Digi-View and new Digital Battery Management System.

310-891-2800; www.idx.tv

Booth: C3036

Televator II Elevating Pedestal Telemetrics EP-PT-S3

A two-stage version of the Televator series; provides greater range and speed; operation can be further enhanced with the addition of a new Flex Trak Interface that enables the product to be used in conjunction with Telemetrics' CTS Floor Track for motorized pedestal applications.

201-848-9818; www.telemetrysinc.com

Booth: C7337

NP boxes

IDX System Technology NH-100/201

Holders for using NP-style batteries with cameras and portable equipment; can be fitted directly to the back of cameras or via various adaptor plates to fit existing camera mounts where required; made in single and dual holders.

310-891-2800; www.idx.tv

Booth: C3036

LED light

Frezzi Energy Systems LED ENG light

Provides daylight balanced light for eye lighting and filling in unwanted shadows; consumes 12 watts of power; can operate on compact lightweight batteries as well as standard video power sources; color temperature of 5500°K; supplies daylight balanced light without the need for gels or filters, providing high quality full spectrum light over the full range of power source voltages.

800-345-1030; www.frezzi.com

Booth: SU10718

Camera Controller

Telemetrics CPO-D-2A-NU700

Designed specifically for Canon's new NU-700N Weather Proof PTZF Camera; delivers a comprehensive range of remote operations including pan, tilt, zoom and focus control, as well as a host of programmable camera presets and multiple camera operation.

201-848-9818; www.telemetrysinc.com

Booth: C7337



Camera support ▲

Frezzi Energy Systems Stable-Cam
A fully adjustable Mini-DV camera support and stabilizer; available with integrated broadcast battery brackets; supplies power to Mini-DV and Frezzi Micro-Fill lights providing total support; fully adjustable; features Stable-Grip and Hip-Grip balancing handles and waist support.

800-345-1030; www.frezzi.com

Booth: SU10718



Camera mount ◀

Glidecam Industries Smooth Shooter
Body-mounted camera stabilization system; designed for cameras weighing up to 6lbs when used with the Glidecam 2000 Pro, or for cameras weighing from 4lbs to 10lbs when used with the Glidecam 4000 Pro.

800-600-2011; www.glidecam.com

Booth: C8929

Point of View (POV) Pan/Tilt Head Telemetrics PT-BD

Features integral cable management, high speed and smooth operation.

201-848-9818; www.telemetricsinc.com

Booth: C7337



Get Connected with NVISION

NVISION®

Stop by our booth at NAB and check out our complete range of routers, master control switchers, and terminal equipment.

New products for 2005 include:

- > **NEW -- Synapse Modular Media System**
More than 100 modules provide an unprecedented level of multi-function signal processing.
- > **NEW -- NV7512 Expandable Digital Audio Router**
512x512 in only 14RU, linearly expandable to 2048x2048. Handles AES, MAD1, and analog I/O.
- > **NEW -- NV5256 Machine Control Router**
256 bi-directional ports in only 8RU, expandable to 512 ports in only 16RU
- > **NEW -- NV5128-MC Master Control Switcher Enhancements**
SD/HD capable processor with enhanced squeezeback effects, and more..



Visit our new web address: www.nvision.tv

Masters in Digital Audio, Pioneers in HDTV

BOOTH # SU9301
South Hall -- Upper Level

Camera battery

IDX System Technology Endura
Next-generation Lithium Ion technology; new ENDURA components provide the highest power-to-weight ratio in the industry, more power, longer run times, and longer life; new chargers provide faster charging, less weight, and incorporate advanced power technology; fully compatible with all existing ENDURA components and continue to meet all worldwide safety and air transportation regulations.

310-891-2800; www.idx.tv

Booth: C3036

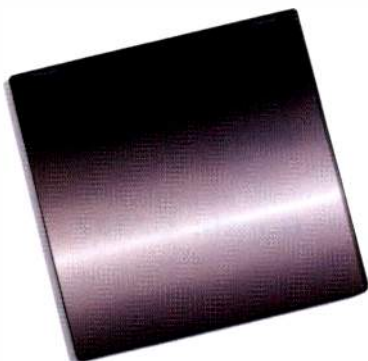

Optical filters ▲

Schneider Optics Century Division
ND Dual Grad

Designed to control exposure and/or depth of field for two different areas of frame; provides two graduated ND attenuator sections – one covering two-thirds of the glass graduates from four stops to the central clear and the other covering one-third of the glass graduates from two stops at the outer edge of the glass to the clear section (NDI.2 up / .6 down); available in 6.6in by 6.6in size.

818-766-3715; www.centuryoptics.com

Booth: SU10329

Closed captioning software

Baystor Teletext Search Software

Allows user to locate assets on a network; users can type in a keyword or phrase and instantly see the timecode In & Out locations and keyframe of the clip containing that phrase; will search assets that reside anywhere on the network of BK-2500's and within the BK-1500 player; once the original clip is located, it can be played back, copied to a DVD, scheduled for playback or transferred directly into an editing system, all without generation loss.

813-645-6666; www.baystor.com

Booth: SL4552

Character generator

Pixel Power Clarity300

Is a single-channel expandable CG; features a compact 3RU frame that is only 21" deep; features uncompressed clip playback, two channels of 2-D DVE and SDI preview, and program outputs; can be operated as a dual channel clip/still store.

954-943-2026; www.pixelpower.com

Booth: SU7132

Digital signage system

Keywest Technology MX5 PLUS Key

Offers multimedia messaging control functionality, character generator and seven independent element layers of the original MX5 with the addition of new capabilities; features a built-in keyer that will lay high-resolution graphics over background NTSC video.

913-492-4666; www.keywesttechnology.com

Booth: C9337



Character generator ▲

Dayang D3-CG HD

Provides the tools needed to create HD 16:9 graphics, titles and animation, including real-time letter-by-letter motion-path manipulation; runs on an open PC platform; delivers 1080i-native multiplayer graphics at 50/50.95/60 fields/s or 1080p at 23.967/24/25/29.97/30 frames/s.

+852 2730 2117; www.dayang.com

Booth: SU9352

Graphics system

GenArts Sapphire Plug-ins

Provides a collection of over 175 image processing and synthesis effects; fully and seamlessly integrate into a number of editing and compositing systems; offers a comprehensive suite of tools and effects that can transform any film or video clip; resolution-independent; includes multi-processor support for faster rendering; runs on Windows, Mac, Linux, and Irix.

617-492-2888; www.genarts.com

Booth: SL1213; Booth: SL760

[Videotek's New Look and Feel That's Impossible to Resist!]



US Patents 6,069,607, 6,532,024, and 6,828,981
 UK Patent 2,330,475 Other US and International Patents Pending

VTM-450E HD/SD

Coming Soon...

The New High Definition and Standard Definition TVM Series



See us at NAB in the Leitch Booth, #SU 7805.

The New VTM-300 and VTM-400 Series of High Definition and Standard Definition Test Instruments — Ergonomically Enriched and Environmentally Friendly

Now Featuring:

- Illuminated Labels and User Controls with Precision, Positive Tactile Feel
- State-of-the-Art "Whisper Quiet" Cooling System
- The Most Comprehensive and Advanced Feature Set for Audio and Video Measurement

Contact Videotek today to learn more about our advanced, precision instruments!

Videotek Toll Free USA (800) 800 5719
 Videotek USA (610) 327 2292
 Videotek Europe +49 8093 90 4082
 Videotek Asia +65 6356 5830
 www.videotek.com



www.leitch.com

VIDEOTEK[®]
 A ZERO DEFECTS COMPANY

www.videotek.com

Stock footage

Artbeats HD international lifestyles collections Royalty-free stock footage; international footage; new collections include Central American Culture, Andes Culture, East Africa Culture, Holy Land, etc.; Adolescent lifestyles collection includes College Life, School Days, Going Out, Teen Life, Teens on the Edge and Portraits; images are useful for broadcast, film features, commercial, desktop video, game development and multimedia.

541-863-4429; www.artbeats.com

Booth: SL1219



Weather graphics ▲

AccuWeather Galileo

Weather display system; tools inform viewers about the most damaging forms of severe weather; allows you to create an accurate local weather story; speed and ease-of-use ensure you are first to air with breaking weather news.

814-235-8636; www.accuweather.com

Booth: C5111

Graphics automation system **VertigoXmedia Product X**

A powerful and easy-to-use, PC-based graphics automation system; enables even non-programmers to build professional-quality graphics quickly, link on-air elements to live data sources, and create fully customized operator control screens.

514-397-0955; www.vertigoxmedia.com

Booth: SL2620

Visual effects

Boris FX Boris Continuum Complete AVX

Comprehensive suite of native plug-in filters and transitions designed to streamline workflow for users of Avid NLEs; is bundled with all Avid Media Composer Adrenaline systems; is available as an optional plug-in for other Avid systems; filter set includes more than 160 sophisticated filters such as Lens Flare, DeGrain and Match Grain.

617-451-9900; www.borisfx.com

Booth: SL4045

3-D compositing and motion graphics

Boris FX Boris Blue

Allows users to instantly preview on a client monitor without previewing to RAM, regardless of the complexity of the 3-D scene or materials; on-screen controls and parameter sliders can be adjusted in real time; custom curves can be defined to create highly detailed bevels with common spline drawing tools.

617-451-9900; www.borisfx.com

Booth: SL4045

Broadcast mapping software

Curious Software Map Presenter

Interactive playback system directly links to Traffic Producer; rundown of graphics or live video can be played directly to air with drag and drop ordering, automatic or presenter-cued playback and live or recorded telestration.

505-988-7243; www.curious-software.com

Booth: C9407

Graphics filter

Digital Anarchy Toon!

Filter for After Effects and Final Cut Pro gives video the look of a cartoon.

415-586-8434; www.digitalanarchy.com

Booth: SL1019

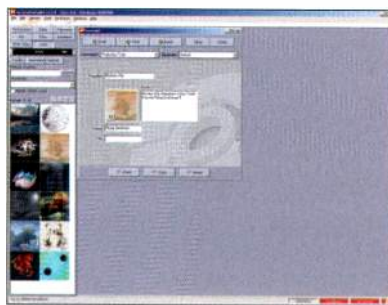

Content management and control software ▲

Vizrt Viz/Content Pilot Version 4.1

Improved newsroom and user interface for Viz/Object Store; full integration between Content Pilot and Proximity's Xenostore content management software; includes new multi-user playlist with real time updates that allow multiple producers to update the playlist simultaneously.

323-908-7004; www.vizrt.com

Booth: SL1137



Data service ▲

AccuWeather StormTeam Live

Allows local stations to complement their broadcast with live segments from the same severe weather experts seen nationally on *FOX NEWS*, *CNN*, *CNBC*, *MSNBC*, *PBS* and *ESPN*.

814-235-8636; www.accuweather.com

Booth: C5111



Talkback intercoms ▲

Sonifex TB-6D or TB-6R

Designed to interface with the S2 mixer, the TB-6D desktop or TB-6B rack-mount units can be used for general inter-studio talkback; versions available to with the Sonifex Station Master studio switcher (TB-SD and TB-SR).

+44 0 19 33 650700; www.sonifex.co.uk

Booth: C3526

TELEVISA CHOOSES FISSION SOFTWARE

To automate all of its local and most of its network repeating stations

In order to automate its operations, convert to a unified digital environment and cut costs, Televisa performed a massive update to all of its local and most of its network repeating stations within México, which used to rely on proprietary hardware and tapes.

Their experience with proprietary equipment was that its closed and incompatible technologies restricted the free flow of material once it was digitized. Even while using extremely expensive systems, audio and video distribution within the station was still performed by means of tapes, with the loss of quality, time and money that entails.

To achieve a unified and compatible digital environment that allowed for the free flow of material among areas, several options were compared, including costly proprietary equipment.

"We noticed that the solutions provided by proprietary broadcast manufacturers relied on the same hardware components such as video boards, hard drives and processors, as the manufacturers of standard computer equipment. The difference was the cost; several times higher, even though this excessive cost did not mean that we would obtain a greater capacity or effectiveness in that same proportion. We dedicated ourselves to the task of finding a solution that worked on standard hardware and open technology," comments Arturo Mignón González, Chief Technical and Engineering Director of Telesistema Mexicano.

The investigation process culminated with the selection of the Fission modular broadcast automation system, by Fission Software, Inc. which operates on standard hardware components in a unified, highly compatible digital environment in which material and resources are shared.

"The cost was surprisingly much lower than proprietary solutions. We realized that we implemented a complete automation solution for a fraction of the cost of a single proprietary server! Fission does allow us to operate on a lower budget. This reflects on our costs, and our costs are reflected on our revenue. Its impact has meant a gigantic result for us" concludes Mignón.

Fission Software, Inc.
Tel: (203) 730 2944
1(888) 644 8766
Fax: (203) 791 3844
info@fission-sw.com

Fission Software de México, S.A. de C.V.
A wholly owned subsidiary of Fission Software, Inc.
Latin America / Caribbean Sales Office
Tel: +52(55) 5559 4096
Sales: Ext. 112 and 115 Fax: Ext. 102
Email: salesla@fission-sw.com

Fission Software do Brasil
Opening September 2005

Fission Asia Limited
Opening May 2005

Techex, Inc.
Master Distributor
Latin America / Caribbean Sales
Tel: (305) 822-6773
Fax: (305) 822-6624
sales@techexport.com

www.fission-sw.com

NAB2005
THE WORLD'S LARGEST ELECTRONIC MEDIA SHOW

Visit us at
Booth # C 9807



Powered By:



Fission is a trademark of Fission Software, Inc. Fission Software, Inc. with the "X" design and the Fission logo are trademarks of Fission Software, Inc. © 2005 Fission Software, Inc., all rights reserved.

Image enhancement upgrades

da Vinci Systems 2K Elite Series

Available for new and existing 2K Plus users, options in the new 2K Elite series provide three upgrade packages, including creative panel designs that promote instant recognition; 2K Ruby, 2K Sapphire, and 2K Emerald systems combine functionality of company's PowerWindows with a combination of other popular features to provide post houses with tool for finishing feature films, TV shows and other video.

954-688-5600; www.davsys.com

Booth: C6207

Trunking software

Riedel Communications US Trunking Software

Developed for Artist intercom systems placed in diverse locations; provides networking of individual Artist Fiber Network installations; each system connects to a central trunk master via a WAN connection that allocates the audio trunks between the systems; audio trunks between the systems can be analog or digital (AES3) and routed through ATM, ISDN, VolP, digital leased lines or analog land lines.

818-563-4100; www.riedel.net

Booth: C11107

Beltpack software

Clear-Com V-Pack software

Software for RS-600 series beltpacks; complete with manual, and a special programming cable to be connected from the beltpack to the serial port of PC; users may program the beltpack using an array of options and save it to one of the four possible programming modes on the beltpack, which can be recalled at any time from the beltpack; Beltpack Cloning enables writing to a succession of beltpacks in quick order.

510-496-6666; www.clearcom.com

Booth: C7319A

Digital intercom system

Trilogy Broadcast Commander

Suitable for complex broadcast television studio, OBs, multi-networked conference and business applications; modular design from 6x6 up to 576x576 expandable in the field; options for analog telephone and ISDN interfacing; multi-system networking and control with other Trilogy or third-party intercom systems; intuitive PC software control package offers easy access to system.

+44 1264 384000; www.trilogy-broadcast.co.uk

Booth: C11722



3D character generator and graphics system

Vizrt Viz/Trio Version 2.2

Features new easy-to-use internal compositing tool and integration of several nonlinear editing systems; pre-defined graphic elements and animation are available; NLE plug-ins option supports Pinnacle's Liquid Edition and Liquid blue editing software as well as Avid's editing software using AVX.

323-908-7004; www.vizrt.com

Booth: SL1137

Client card for the Artist S matrix system

Riedel Communications US ADT-208 ADAT

Provides Toslink connectors for the optical input and output, enabling peripheral audio equipment such as mixing consoles, pre-amps, multi-track machines to be directly connected to the Artist system via fiber; provides electrical ADAT signal on RJ-45 for Cat. 5 cabling, extending the maximum distance for an ADAT connection to approximately 300 ft.

818-563-4100; www.riedel.net

Booth: C11107

Digital intercom system

Trilogy Broadcast Orator

Up to 36 ports retaining all functionality of the larger Commander system; 2U size with redundant power supply; full network capability for audio and control between Orator and/or Commander; PC software control with graphical configuration system; uses standard panels and interfaces from the Commander series.

+44 1264 384000; www.trilogy-broadcast.co.uk

Booth: C11722

VoIP interface

Riedel Communications US DHY-102

Provides all features of the DHY-101 plus voice over IP communication connectivity; establishes an integrated solution for connection Artist intercom matrix products over standard IP networks; H.323 Gateway functionality enables local IP-phones to call out to the PSTN if no active WAN connection is available.

818-563-4100; www.riedel.net

Booth: C11107

Wireless camera

Microwave Radio Communications REPORTER

For news or sports, handheld portable use and wireless studio applications; designed to broadcast live video to a central receiver site over distances not exceeding 1000m; features integrated MPEG-2 encoding with COFDM modulation.

978-671-5700; www.mrcbroadcast.com

Booth: C3007

Fiber-optic link

Telecast Fiber Systems CopperHead T-444

Allows for long-distance separation of the Sony HDC-F950 T-Cam optical block from the camera body's electronics; HD digital 14-bit RGB 4:4:4 link provides all camera signals, plus camera sync and controls, viewfinder video, bidirectional audio, intercom, and auxiliary data and closures.

508-754-4858; www.telecast-fiber.com

Booth: SU8375



Lighting

Dedolight SOFT200D

Designed for use within four types of soft boxes; soft boxes available in two sizes and surfaces; small size is 22in x 16in x 18in; medium size is 24in x 32in x 27in; the DSBS surface features a reflective inside surface; DSBW surface features translucent sides; louver with 40 degree grid is available for use with DSBS or DSBSM.

973-857-8118; www.dedolight.com

Booth: C10721

Wavelength-management CWDM multiplexer

Telecast Fiber Systems Teleport

Provides high-bandwidth optical signal multiplexing; using CWDM technology, each single-mode fiber can support up to 20Gb/s; supports as many as eight high-definition video signals or 64 analog video channels plus any associated audio; eliminates the need for wavelength-specific devices.

508-754-4858; www.telecast-fiber.com

Booth: SU8375



Rack-mounted control unit and mast-mounted transmitter

Broadcast Microwave Services Truck-Coder II (TCII)

Two unit systems features a Bright Selector panel display; front panel Ethernet port supports downloadable field upgrades and preset configurations; RF unit is configured to operate in the 2GHz frequency band; second optional RF unit can be added to allow selectable operation at either 2GHz or 7GHZ.

800-669-9667; www.bms-inc.com

Booth: C1421



Broadcast-quality decoder

Crystal Vision EMDEC-200

Product can be used in two ways: as a decoder or as a decoder with embedder; converts PAL/NTSC or Y/C composite video to SDI using 12-bit decoder; data is sampled at 54Mb/s; can be upgraded to embed AES or analog audio by adding an audio piggyback.

954-788-3334; www.crystalvision.tv

Booth: SU6361

Weather cell phone application

AccuWeather Wireless Weather

Brandable cell phone applications; by coupling your brand with AccuWeather.com's cell phone weather forecasts, radar images and severe weather watches and warnings, reach viewers around the clock.

814-235-8636; www.accuweather.com

Booth: C5111

DUAL MODE

not only analogue
not only digital

digital  analogue



Screen Service
ITALIA

SCREEN SERVICE ITALIA S.r.l.
Via G. Di Vittorio, 17 - 25125 Brescia - Italy
Tel. +39 030 3582225 Fax +39 030 3582226
www.screen.it e-mail: info@screen.it

A single equipment allows transmitting digital (DVB-T or ATSC) or analogue signals digitally generated and of extreme high quality. The commutation between analogue and digital mode can be local or by any remote control system or by a command inserted into the Transport Stream.



DBT 100U (DVB-T)
DTT 100U (ATSC)

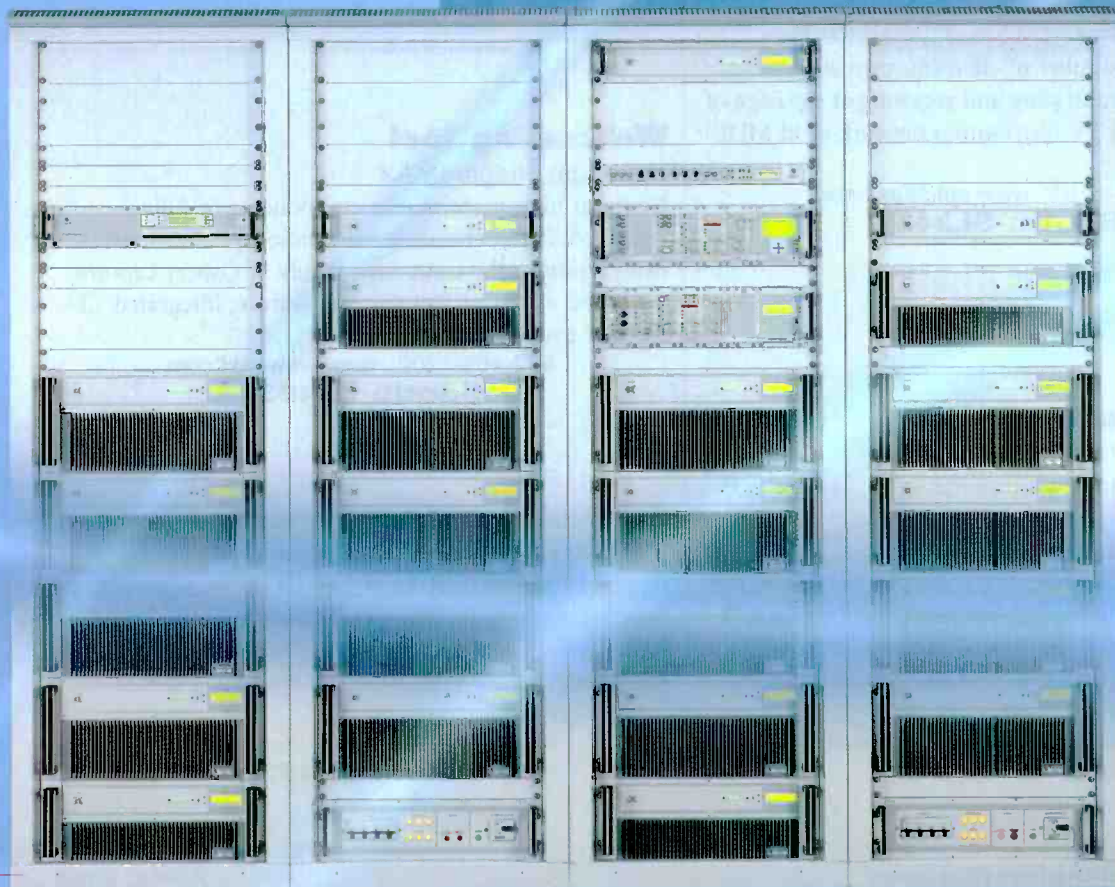

- Dual ASI input with statistical analysis and automatic switching
- PCR re-stamping
- Control of the crest factor
- Integrated SFN adaptor
- Management of the "null packets"
- Integrated test modes
- Integrated offset at steps of 1 Hz



Encoder ▲

TANDBERG Television EN5990

2 RU HD encoder for MPEG-4 AVC; includes range of advanced broadcast features with MPEG-4 part 10 (H.264/AVC) Main Profile Level 4.0 real-time video encoding; capable of delivering high quality HD images with bit-rate reductions of up to 60 percent on MPEG-2 performance.

+44 23 8048 4000; www.tandbergtv.com

Booth: SU7858



TV streaming platform ▲

Optibase MGW 1100

Enables TV over IP or ATM broadcast services for a small to medium number of channels; provides encoding, transcoding, transrating and recasting at the edge of a service provider's TV distribution network or at MDU access points.

800-451-5101; www.optibase.com

Booth: SL343

IP delivery software ►

Telestream MAPone for Mac

Mac version of company's personal IP delivery software; transmits news cuts, review-and-approvals, dailies and other edited material over any standard or wireless IP network; transcodes and delivers broadcast-quality media files directly from Apple's Power Mac G5 systems or PowerBook notebooks running Final Cut Pro HD or other QuickTime-based software.

877-257-6245; www.telestream.net

Booth: SU11404



Video encoder and professional decoder

Modulus Video ME1000/MD1000

Platforms deliver the AVC compressed stream over MPEG-2 transport stream using IP or optional ASI; offers a compression ratio improvement over MPEG-2 that provides two to three times more channels of video over the same carrier; enables video signals to be carried and multiplexed into existing MPEG-2 transport streams.

408-245-2150; www.modulusvideo.com

Booth: C11416



Media collaboration ▲

Telestream MAP Media Collaboration

Telestream and Microsoft will feature a joint media collaboration solution; targets video production companies and agencies, corporate communications, and marketing and training departments; built on the Microsoft.NET Web Services framework.

877-257-6245; www.telestream.net

Booth: SU11404

Webcasting tool

ViewCast NiagaraMAX

Contains high-performance components of fully equipped digital encoding workstation yet transports easily; features the company's family of Osprey capture cards and exclusive SimulStream feature; integrated CD-RW lets users archive live events.

972-488-7200; www.viewcast.com

Booth: LS4936

Streaming capture system

ViewCast Niagara PowerStream

Powered by dual Intel Xeon 2.4-GHz processors with hyper-threading technology; delivers high-quality video/audio capture from analog, DV, and professional digital sources for high-data-rate streaming media content creation.

972-488-7200; www.viewcast.com

Booth: LS4936



Perfect Connection

Easy to clean. Innovative. Reliable. Canare's Hybrid Fiber-Optic Camera Connectors feature a high-quality new fiber design that ensures optimal performance.



Tech Notes

Outer diameter of the clad is 0.125mm with a core of 0.010mm. Although the cables have superb transmission quality, even a minuscule speck on the core can have a disabling effect and cause a signal to be lost. Canare recommends proper maintenance and verifying the connector before use. Simply detach the alignment sleeve along with the insulator part for easy cleaning.



before cleaning



after cleaning

California

531 5th St., Unit A San Fernando, CA 91340
Tel: 818 365 2446 Fax: 816 365 0479

New York

60E, 42nd St., Suite 2306 NY, NY 10165
Tel: 212 682 9661 Fax: 212 682 9480

FC Series

SMPTE 304M and ARIB Compliant

Stainless Steel Body Shell

AdPC Polish

Insertion loss ≤ 0.5 dB; RL ≥ 45 dB

Visit us at NAB 2005 Booth # C5134

"Affordable, compact, simple and smart solutions"

Discover our all new Optic Products and more!

- Hybrid Fiber Optic camera connectors
- Palm size camera cable checker
- Converters and CWDM
- New Mid size video jacks

Encoder

TANDBERG Television EN5980
2 RU high definition encoder for Windows Media 9; packs a massive range of advanced broadcast features with Windows Media 9 real-time video encoding, Advanced Profile at Level 3; capable of delivering high quality HD images with bit-rate reductions of up to 60 percent on MPEG-2 performance.

+44 23 8048 4000; www.tandbergtv.com

Booth: SU7858

Video capture card

ViewCast Osprey-560

Offers high-quality video/audio capture from analog DV and professional digital sources; includes de-interlacing filter; offers a combination of digital and analog inputs for live or on-demand streaming and a 64-bit PCI-X compatible interface.

972-488-7200; www.viewcast.com

Booth: LS4936

Non-linear editor

Leitch Technology VelocityHD upgrade

New software for VelocityHD format-flexible HD/SD non-linear editing system; new version features a wide range of enhancements including HDV and Varicam support; brings real-time editing performance to the HD realm affordably; features full-quality HD playback of two video streams (compressed or uncompressed), two dynamic graphics streams, true real-time HD transitions and effects, optional 3-D effects, and extensive SD performance.

800-775-3314; www.leitch.com

Booth: SU7805, SU8199



SD and HD editing system ▲

Optibase Media 100 HD

Mixes SD and HD media, 4:3 and 16:9 aspect-ratio media, uncompressed and compressed media, M-JPEG, DV, animation, analog and digital video, and other QuickTime codecs in the same timeline — in real time without lengthy importing or rendering; views SD and HD output simultaneously regardless of source material.

800-451-5101; www.optibase.com

Booth: SL343

Color corrector

Digital Vision Valhall Color version 2.0

For 4:2:2 SDTV, 4:2:2 HDTV and 4:4:4 RGB/YUV formats; new features include waveform monitor and vectorscope, three layers of primary color correction, true layer handling, user-definable transfer functions and a dedicated vignette layer.

+46 8 546 182 00; www.digitalvision.se

Booth: C9732

Film grain and camera noise management system

Digital Vision AGR4ME

Incorporates a recursive filter combined with a new 3-D edge-preserving spatial/temporal filter, as well as Digital Vision's PHAME motion estimation algorithms; provides control of grain structure preservation; allows optimization of processing characteristics for negative or positive film.

+46 8 546 182 00; www.digitalvision.se

Booth: C9732

Video editing system

Pinnacle Systems Liquid 6

Features multi-stream HD/SD, format Independent FX, multi-cam, new audio engine, choice of I/O boxes including HD-SDI, HDV, improved Windows user interface, SmartEDIT native formats, Smart RT Real-Time FX, background render, advanced collaboration, networked editing, InstantSave, and XSend/XReceive.

650-526-1600; www.pinnaclesys.com

Booth: SU6341

Digital color grading solution

NUCODA Color Timer

Timer is resolution-independent, digital color grading solution that fully replicates the film lab process; crucial element of the grading process, which requires quick turn around for production and dailies.

+44 (0) 20 7734 8282; www.nucoda.com

Booth: SL3649

Storage

Ciprico 4Gb Fibre Channel RAID solution

Offers affordable, high performance, redundant storage for the video content creation market; demonstrates single and dual stream HD content (uncompressed 10 bit 1080i) playing live from this storage family.

800-727-4669; www.ciprico.com

Booth: SL3628

Technical Excellence, Advanced Features, An Affordable Price

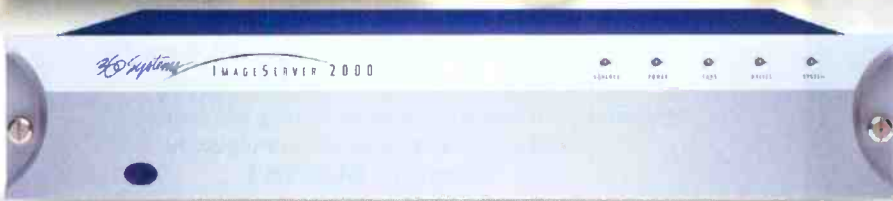

Sometimes it takes a new company to turn advanced technology into reality. In the server business, the new name is 360 Systems. In truth, we've spent the last 33 years designing advanced digital technology into broadcast products.

Now, the Image Server 2000 delivers a level of technical excellence unique to the broadcast industry. Its true next-generation design includes an exceptionally broad set of features, and a high standard for reliability. But most important, the Image Server 2000 establishes a new, reasonable price for broadcast video servers.

Join the hundreds of broadcast professionals who made the Image Server 2000 their first choice. Visit www.360Systems.com for the complete story on the next-generation Image Server 2000.

Sales line: (818) 735-8221
E-mail: Servers@360Systems.com

360 Systems
BROADCAST

What Can an Image Server 2000 Deliver at \$11,999?

- Three video channels
- 12 audio channels
- SDI and composite video
- AES digital and +4 analog audio
- 100 hours of RAID-5 storage
- MXF file transfers over Gigabit Ethernet
- Premium quality video to 50 Mb/sec
- VDCP, Odetics, P2 and GPI control
- On-screen GUI for full control, plus trimming, segmenting and playlisting
- Only 3 1/2" of rack space

NEW Multi-Format Server Option

- Import and play DV-format video
- Play TARGA graphics with Key-and-Fill
- Control by Ross Synergy™ switchers

Turnkey system

Pinnacle Systems Blue

Complements the new base software features of version 6 by adding unique features such as multi-speed SDTI capture, background capture and full DVCPRO50 support; offers end-to-end native digital production in all formats, supporting DV, DVCAM, DVCPRO 25/50, MPEG-2, MPEG IMX, and uncompressed with faster than real-time SDTI transfer (both 2x and 4x).

650-526-1600; www.pinnaclesys.com

Booth: SU6341



Post-production interface cards

Dayang MagicBox

Use SNMP for system control and monitoring; the first cards in the MagicBox series are designed for video and audio noise reduction, aspect ratio conversion, SD/HD and HD/SD conversion, frame synchronization, audio/metadata mux/demux, MPEG-4 browsing, SDI/ASI and ASI/SDI optical interfacing, and MPEG-2 transcoding.

+852 2730 2117; www.dayang.com

Booth: SU9352



Production switcher

Eyeheight irisHDi

Switcher with eight HD-SDI inputs, program and preset control and two auxiliary bus outputs; features video mix, wipe, cut as well as U and V fades/transitions under manual or automatic control; is structured as an 8x4 HSDI crosspoint router with referenced dual-input HD-SDI vision switcher; self-contained and field upgradable; based on Eyeheight's new geNETics Evolution hardware platform.

+44 1923 256 000; www.eyeheight.com

Booth: SU 8501



HD chroma keyer

Crystal Vision Safire HD

Works with all common HD formats; features additive and multiplicative keying; can be used with transparent and reflective objects; offers numerous fine adjustments for edge optimization and sophisticated shadow processing as well as key shrink; Force Foreground, Force FB and Luma Keying features are ideal for inserting graphics onto sporting surfaces during live events.

954-788-3334; www.crystalvision.tv

Booth: SU6361



News van

Wolf Coach COYOTE

Uses a new chassis and new generator, with a detailed fit-and-finish; can be delivered rack-ready in less than 60 days and as a full turn-key in less than 90 days; has a payload of more than 2000lbs in a rack-ready truck; reutilizes equipment and masts from existing news trucks

801-565-9533; www.wolfcoach.com

Booth: C4845

Restoration system

da Vinci revival

Upgrades include open file support, which lets revival directly access SMPTE DPX files for processing when connected to a LAN or SAN; a new color registration tool, which will automatically register or match the individual RGB channels in a previously combined image; and new digital intermediate tools.

954-688-5600; www.davsys.com

Booth: C6207

Yesterday, Today, & Tomorrow

MRC continues to build on its legacy of microwave products. We're not interested in quick fix solutions. We're always looking ahead to provide radios that meet both your current and future needs.

Our long history of innovative design has demonstrated our commitment to providing high quality radios that give years of reliable service, backed by our expert technical support.

In 1998, MRC introduced the TwinStream and CodeRunner series of radios. TwinStream was the first ever radio to carry both the standard and high definition signal in an existing channel space. CodeRunner broke ground using COFDM and MPEG Encoding, giving ENG crews the ability to broadcast from what used to be considered impossible locations.

Both TwinStream and CodeRunner answered unique challenges to help you make the digital transition for portable and STL solutions. Now we're ready to help you make the next major transition - the 2 GHz BAS Channel Reallocation.

At NAB 2005, we will introduce the MX4000 Demodulator & Decoder, allowing CodeRunner 4 owners to upgrade their central receive sites from analog to digital. This product builds on an already comprehensive array of digital radios: STRATA, CodeRunner, and REPORTER.

Have questions about the 2 GHz Reallocation? Then call us, or visit our booth at NAB 2005.

We're ready when you are ...



NAB 2005
THE WORLD'S LARGEST ELECTRONIC MEDIA SHOW

April 18-21 Las Vegas Convention Center Booth # C3007

MICROWAVE RADIO
COMMUNICATIONS

www.mrcbroadcast.com

Microwave Radio Communications • 101 Billerica Ave. Bldg 6 • North Billerica, MA USA 01862-1256 • +1-978-671-5700



Video media server ▲

WEGENER Video iPump

Combines feature of a professional satellite receiver and decoder with advantages of a video server and IP router; operators can reduce satellite space segment by storing programming in the unit and scheduling play times; enables users to utilize limited satellite time to refresh multiple program channels, data casts, and play-out schedules without need to maintain a constant signal on the satellite.

770-814-4000; www.wegener.com

Booth: C2624

DVR

Fast Forward Video

Outrider-IDE Board-Level DVR

Is equipped for use with a 2.5in hard drive; features a time/date stamp and character display, time-lapse recording, NTSC/PAL compatibility, composite and Y/C inputs and outputs, pre-event record, and loop record of PC-viewable or secure video files.

949-852-8404; www.ffv.com

Booth: C3253

Satellite receivers

WEGENER AVC

Fourth generation of satellite receivers for enterprise, broadcast and cable programming applications; support advanced video coding and high-definition video applications.

770-814-4000; www.wegener.com

Booth: C2624



Storage ◀

StorageTek SL500

A modular library system; provides scalable, rack mounted, tape automation; designed to handle growing data protection needs by providing flexibility through configurability; starts at 30 LTO cartridge slots and scales to over 500 LTO cartridge slots storing over 100TB of uncompressed data and can support up to 18 tape drives providing throughput rates of over 2TB/hour; supports midrange tape drive formats

including LTO Gen-2 and will support SDLT in future versions.

303-661-5079; www.storagetek.com

Booth: SL4632

Server and VTR/DDR controllers

Hi Tech Systems HT800

Comprises 4- and 8-channel VTR and DDR controllers; base models include the HT884 and HT888 4 or 8 channel controllers, the 4-channel HT884d for VDCP control, and the HT884s and HT888s, Slow Motion Sports Controllers with their dynamic slow-motion replays; all are complete and include on-panel displays; options add features such as more protocols, insert and assemble editing and GPI interface.

+44 1256 780 880; www.diskcontrol.com/
www.vtrcontrol.com

Booth: SU9711

Video disk recorder

Doremi Labs V1-HD

Features HD-SDI and SDI in/out and functions as a drop-in replacement for any HD VTR and an independent record and play option, and a dual-link HD-SDI option; random access and simple video clip and play list programming provides for efficient on-air and live event operation; dual-Link HD-SDI option offers 4:4:4 2k resolution for applications such as Digital Cinema, 3-D video and super-wide screen (stereoscopic) video.

818-562-1101; www.doremilabs.com

Booth: C2342



Transport storage system ▲

Pixelmetrix DVStor 2TB

Able to simultaneously record and play back MPEG-2 transport streams; offers online access to up to five days in a satellite environment or up to 10 days in a terrestrial environment; storage range from 100GB to 2TB.

866-749-3587; www.pixelmetrix.com

Booth: C7316

Ingest software

IBIS ServerLoad Sport

Allows the capture of highlights at ingest through up to six different feeds, providing the choice of viewing from multiple angles; dual screens and thumbnails are directly linked to video, providing fast turnaround for live sporting highlights production; allows an operator to process up to two sporting events at the same time.

877-541-IBIS, www.ibis.tv

Booth: SU10332



THE FUTURE OF HDTV IS FILM.

Film is by far the best capture medium for HDTV content. Film looks better, is easier to use, and offers more creative flexibility. Film is compatible with every format, and lasts longer.

These are just some of the reasons why the vast majority of narrative and commercial programming broadcast in HD format begins on film. The reasons are clear—film has a unique dreamlike quality that evokes emotional responses from audiences. Additionally, it is the only future-proof medium.

Film origination provides more creative flexibility and efficiency on the set.

Research by Kodak scientists* provides definitive evidence that there are measurable, significant differences between film and HD image capture, including resolution, dynamic range (the ability to record details in highlights and shadows in the same scenes), and color fidelity. Progress is ongoing with the introduction of a new generation of KODAK VISION2 Color Negative Films, which leverage dramatic advances in emulsion technology.

The convergence of dramatic advances in film imaging and hybrid postproduction technologies has created a new paradigm.

Breakthroughs in hybrid postproduction technologies, including film scanning and image manipulation, make it possible to efficiently and faithfully retain visual nuances recorded on the negative. In the past two years, Kodak has introduced five new camera films that utilize quantum improvements in grain, color rendition, light-gathering ability, and other attributes. The new generation of KODAK VISION2 Films is also optimized for digital postproduction.

The convergence of advances in film and hybrid postproduction technologies coupled with high-definition display creates a more immersive, cinematic experience on high-definition television screens.

"I think of videotape as FORMICA," says Steve Sabol, president of NFL Films. "It's smooth and has no depth. Film is like wood with subtle textures. We're romantics and we're storytellers. Film is the perfect medium for us. I love the fact that the other sports programs are on videotape because when they see NFL Films, it looks and feels different."

There have been amazing breakthroughs in both 35 mm and Super 16 mm camera and lens technologies. The new cameras are more compact and more mobile. The lenses are crystal clear. That combination results in creative

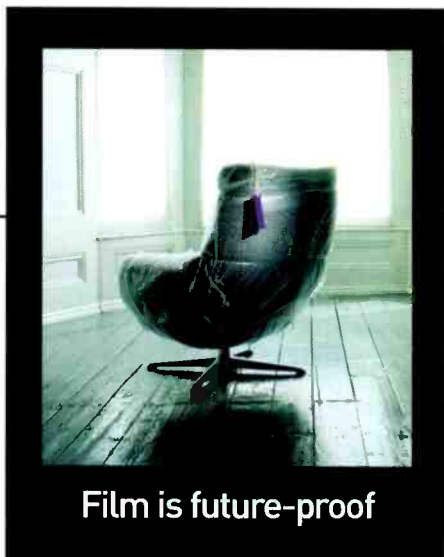

flexibility along with significant gains in efficiency during production. Unlike digital cameras, there are no cables tethering cameras to recording decks. That frees the creative team to move quickly and freely with the action. The new camera technology is also a future-proof investment.

"As a producer who invests in making my own films, if I'd chosen to go the video route 15 years ago

with my production company, I would have invested about \$100,000 every year or two, times 15 years. You think of it, that's over a million dollars in investment," says producer-director-cinematographer John Walker, CSC. "I bought this camera 15 years ago for \$40,000. I've spent no money on the camera and it's producing better image quality than it was 15 years ago. Why? Because Kodak is doing the R&D."

Super 16 mm film provides an affordable and higher quality alternative to HD capture.

It's a myth that the Super 16 mm format isn't robust enough for HDTV. It's time to file that notion under obsolete. Super 16 mm film is now a significantly more versatile and easy-to-use medium than it was just a couple of years ago. There is a long and growing list of television movies and episodic programs produced in Super 16 mm and broadcast in HD.

"Advances in camera, film, and HD postproduction technologies make the Super 16 mm format an attractive option," says James Chressanthis, ASC. "The cameras are mobile and the new generation of films renders sharp, clean, and grainless images with a wide tonal range, and subtleties in highlight and black areas. We shot '3: The Dale Earnhardt Story' in Super 16 mm for HD display. The new (KODAK VISION2) 7218 Color Negative Film is the sharpest, clearest, most grainless 500-speed film ever made. With the advances made in telecine technology, you can pull nuances in colors, contrast, and textures off the film and convert them to HD quality images."

"We were told upfront that the cable network (USA Cable Network) intended to air 'Frankenstein' in HD format,"

says cinematographer Daniel Pearl, ASC, who made the telefilm with director Marcus Nispel. "We discussed producing it in Super 16 mm to accommodate a relatively modest budget. I also felt that the more compact cameras could give us an edge in keeping pace with the ambitious shot list. After seeing tests of images transferred to HD format, the producer and director agreed that it was the right decision."

Film is the future.

Film is currently the only truly reliable archival medium that will ensure future dividends as the HD household population expands and evolves. Film is format-independent and will last for hundreds of years when properly archived. Conversely, the best digital storage media have a short life span even under optimum conditions, and digital formats are constantly changing. Digital video is an improvement over analog video signals, but the storage medium is still either a magnetic tape or a disk, which is comparatively volatile. According to the Library of Congress, the best magnetic storage media—the media usually used for digital video and HD images—can be depended on for a decade. Once a digital signal is gone, it's gone forever. More than 75 video formats have been introduced since 1956, and even if the media survived, in many or most cases, there is no equipment for playback.

"The bottom line is, what do you want your capture medium to be?" asks director-cinematographer Lance Acord, ASC ("Lost In Translation"). "Film is a very simple medium, in a way, to archive. Whether it be pictures you take of your kids or 35 mm motion picture film, it's incredibly archival. It's something you know that you will always be able to come back to. I wonder, all the videos that have been shot of people's kids and the digital pictures that are being taken of kids, where do they all end up? It's a question no one really knows the answer to."

Film is the superior capture medium for many fundamental reasons:

Resolution A recent study conducted by Kodak scientists* provides compelling evidence that when combined with digital scanning, a 35 mm frame of film can deliver at least 8K worth of meaningful digital data to postproduction processes. That's a number that today's electronic cameras just can't match. Even Super 16 mm has a higher limiting resolution than current HD cameras, where limiting resolution is defined as the highest spatial frequency with a minimum MTF (modulation transfer function) of five percent.

Summary of Scanned System Geometries**

	Television [16:9]		Feature [1.85:1]	
	Super 16 (KODAK VISION2 Film 5218)	24P	35 mm (KODAK VISION2 Film 5218)	24P
Scan Format	2K	HD	4K	HD
Scan Width [pixels]	2048	1920	3656	1920
Scan Height [pixels]	1152	1080	1976	1038

** Analysis by Kodak scientists David Long, Mike Ryan and Roger Morton (now retired) based on a 2K scan of S16 mm film in the 16:9 aspect ratio using the GENESIS scanner with no digital sharpening versus the native SONY FDW900 HDCAM format with sharpening controls set to the null position and image processing performed in the camera. Both systems were analyzed in a common data space extendable to similar downstream processing and postproduction paths.



Dynamic Range Color negative film has a dynamic range of 1,000:1, compared to 100:1 with digital video. Dynamic range describes the capacity for recording shades of tonality between black and white. The restricted dynamic range of digital video limits creative options in production and it may boost postproduction costs required to "fix" images.

Latitude and Exposure Control In challenging environments where filmmakers have less control, film can handle overexposure in a natural-looking way. Digital cameras do not handle overexposure nearly as well. Extreme brightness results in "clipping," where the image blows out. Once a video image has clipped highlights, no amount of post work or money can bring the highlight detail back.

"Day exteriors at the beach are probably not the strong point of 24P," says Jamie Barber, who photographs "The O.C." "With film, those day exteriors at the beach are brilliant. You can't hurt yourself by overexposing. I can bring anything back. When I need to protect beautiful girls, and prevent the raw sun from hitting them, I can brighten them but I still want to see the background. I don't have to worry about ever hitting the 100-percent clip."

Latitude and Lighting The wide exposure latitude of film enables cinematographers to record details simultaneously in both dim and bright light for greater creative control.

"The film stocks have become so fine-grained and so high speed that you don't need the light to get exposure anymore," says cinematographer Bill Bennett, ASC. "You light for effect. I lean upon that latitude to work faster because budgets are tight."

Tonality Like the human eye, the analog nature of film provides continuous tonal gradations between black and white. While a scanner reduces the number of available tones with digitization to 10 bits or more per color, this process can be done under creative control to achieve the best image quality. Digital cameras digitize the scene at the time of capture and are limited to the capabilities of their on-board electronics.

Color Fidelity Electronic cameras typically subsample the color information when they capture images. Cameras with single-chip sensors can only capture a single R, G, or B value at each pixel location, and data path limitations require 4:2:0, 4:1:1, or 4:2:2 chroma subsampling, even with three-chip cameras. Interpolation is required to get RGB values for each pixel. Film is much closer to a continuous sampling medium, with full RGB values at each location. This property provides greater color fidelity and minimizes color artifacts in postproduction.

Aliasing Artifacts Aliasing occurs when fine detail is not sampled at a high enough spatial resolution. A familiar example is the rainbow of false modulation that can occur on a tweed or pinstripe jacket during television broadcast. Because of the random nature of film grains, aliasing is never a problem in an original film negative, but aliasing can be introduced during conversion to a digital representation. Due to the high quality of today's telecines and film scanners, very little aliasing is introduced in the scanning process. In comparison, electronic cameras introduce significantly more aliasing because cost and weight constraints limit the optical components that control aliasing.

Artifacts Elimination A high-definition camera usually has about twice the number of pixel sensors as a standard definition camera. The number of pixels varies depending on the format. To pump this additional data through the narrow TV channels, images are digitized and then compressed before they are transmitted and then decompressed when they reach the TV. The video acquisition, recording, and delivery processes introduce a long list of artifacts and flaws¹. Technological advances are often aimed at reducing or minimizing these flaws. Conversely, film origination eliminates or minimizes most of these flaws, partly because the scanning process, where film images are converted to digital files, is slowed down from real time.

Kodak scientist Roger Morton (now retired) notes, "Our studies showed that commercial real-time compression hardware can preserve the desirable film grain characteristics even in the decompressed image, and that this film grain does effectively mask electronic, digital, and compression noise even at high compression levels in HDTV formats. While it has been mentioned that on earlier films (when contrast is set exceptionally high) that older compression hardware will produce blocking artifacts, the new KODAK VISION2 Films reduce grain to the extent that we have yet to see this phenomenon occur². In fact, we have not seen any problems on HDTV compression of any format or film including Super 8 mm."

Format Independence Film can be scanned and processed to meet almost any format requirements. Whether the need is for standard definition, high definition, or something else in the future, the same film original can be used to conform to different formats and with unsurpassed quality. Film's high resolution and large dynamic range provide additional future proofing. As scanners and signal processing technologies improve, the same film can be rescanned to take advantage of these improvements. Electronic origination just doesn't have this flexibility.

Slow Motion Film easily and accurately captures smooth, natural, and artful slow motion through the manipulation of higher frame rates in the camera. Electronic cameras are very limited in their frame rate capabilities and often give up resolution (using interlaced rather than progressive signals) to achieve higher frame rates. Costly postproduction techniques are used in an attempt to

replicate slow motion, but that can result in a distracting jerkiness and other artifacts such as blurring.

Durability Film cameras are proven performers in difficult situations. Digital cameras are more fragile, harder to fix, and subject to heat and humidity problems. Film cameras have proven to be dependable and robust whether they are used at the bottom of the ocean, in the Sahara Desert, or on top of Mount Everest.

Depth of Field Cinematographers use depth of field to draw the viewers' attention to elements in the frame, and a smaller depth of field is preferred to allow maximum creative flexibility. With many video cameras, controlling depth of field is difficult. Depth of field is determined by the camera's optical path and sensor geometry, and both 35 mm and Super 16 mm provide better depth of field control than 2/3-inch CCD HD cameras.

Compression Today's films are well suited for compressing with modern encoders for final distribution to the viewer. While 35 mm has always been a great starting point for HD distribution, concerns have been raised in the past about quality losses when compressing Super 16 mm because of its higher grain levels. With the significantly reduced grain of new KODAK VISION2 Films, these concerns about the compressibility of Super 16 mm are unfounded. Kodak scientists are currently conducting compression studies to demonstrate this conclusively.

The Conclusion is as Clear as HD

For all these reasons and more, film is the right choice for images intended for HD display. Programming originated on film and broadcast in high definition uses the strengths of both media. The superior image quality of HD delivery makes film's advantages even more obvious. It's clear that the future of HDTV is film.

* Excerpts of this insert have been taken from "A New Color Negative Film For the Digital Future," written by David Long, Mike Ryan and Roger Morton (now retired), and published in the October/November 2004 issue of the "SMPTE Motion Imaging Journal." To access the entire report, visit www.kodak.com/go/motion. This Web site also offers many feature articles describing the production of television films, episodic series and documentaries on Super 16 mm film. To access them, visit www.kodak.com/go/16mm.

To hear more about what filmmakers have to say about choosing film for HD broadcast, sign up to receive a free DVD from Kodak at www.kodak.com/go/filmthedifference.

¹The following is a list of electronic processes designed to compensate for the limitations of electronic technologies:

i. Compression and decompression, ii. Chroma sub-sampling, iii. Quantization contouring, iv. Digital saturation, v. Automatic white point, vi. Automatic exposure, vii. Knee adjustments, viii. Auto-gain controls, ix. Gamma clipping, x. Optical Beam splitting, xi. Electronic viewfinder, xii. Varispeed electronics

²If you have an example of this phenomenon on any film or hardware, Kodak would really like to see it. If it does ever occur, Kodak can also make a number of suggestions to prevent or correct the problem. Please send a copy of the tape to David Long, 2400 Mt Read Blvd - B205, Rochester, NY, 14650-3089, USA, with your phone number and details on the compression hardware used.





Storage ◀

StorageTek SL8500

High-performance robotics and hot-swappable, fully redundant components support maximum data accessibility and the ability to keep pace with unpredictable peak workloads, accommodating future demands for higher throughput and overall data growth; scalability and support for mixed media and diverse operating

environments; a modular library system for consolidating enterprise and midrange computing infrastructures.

303-661-5079; www.storagetek.com

Booth: SL4632

Workflow enhancements

Masstech Group Mass Media Box (MMB)

Tightly integrated, end-to-end workflow and production platform for digital content management; supports the entire media life cycle from ingest and delivery through preparation, quality control, format conversion and seamless synchronization with play to air automation systems.

905-886-1833; www.masstechgroup.com

Booth: SU10236



Video server ▲

Pathfire Server Connect for News

Enables newsrooms to transfer digital content from their DMG server to editing systems and play-to-air servers; streamlines content movement process; users can move content with drag-and-drop simplicity while the media remains in digital format throughout the entire delivery process, avoiding the conversion to video.

770-619-0801; www.pathfire.com

Booth: SL1353

Production edge server

Pinnacle Systems DekoCast HD

Handles video, audio, clips and graphics in one box; turnkey combination of real-time character generator, video and audio clip player, audio mixer and router, multichannel DVE and advanced keying engine.

650-526-1600; www.pinnaclesys.com

Booth: SU6341

Pocket-size DVR

Fast Forward Video Mini DVR Pro On-Body DVR Features scalable MJPEG compression and 720x486 pixel image resolution; can record up to two hours at 20:1 compression with readily available Compact Flash cards; is powered by four AA batteries or a low-voltage DC power input combined with low-power drain for full portability.

949-852-8404; www.ffv.com

Booth: C3253

Video storage and playback

Masstech Group MassDR

Incorporates replication and transfer tools from existing infrastructure video servers and transfers files and scheduling information to remote system; full resolution MPEG-2 video and transcoded WM9 low resolution full frame size can be intermixed and delivered at the remote site.

905-886-1833; www.masstechgroup.com

Booth: SU10236

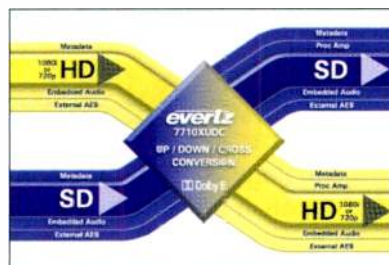

Cross Converter ▲

Evertz 7710XC Series

Designed to solve the problems of adapting to different HDTV formats, while offering high quality UP and DOWN conversion; available in four versions; the modules accept embedded audio on the input and re-embed them into the serial video outputs; the AES4 versions also accept four discrete unbalanced AES inputs and provide four AES outputs with the same audio that is being embedded.

905-335-3700; www.evertz.com

Booth: SU6433

Production server

Pinnacle Systems Thunder HD

Based on the Inflexion engine with the familiar Thunder application; available as a still store or with a clip option; serves video and key one each of its one to two channels and uses internal RAID 5 storage and dual power supplies; features one or two channels plus key, 1 TB storage+, 20 hours at 125 Mb/s and RAID 5.

650-526-1600; www.pinnaclesys.com

Booth: SU6341

Quad processor

Image Video VxV-4-SDI

A Quad processor; accepts SDI and analog video inputs to SDI and composite analog outputs, with embedded audio metering and UMD tally capability.

416-750-8872; www.imagevideo.com

Booth: SU7077

Rack/wall mount

Image Video LVX-4

A rack or wall mount 17in LCD panel with built in Quad split processor; accepts SDI and analog video inputs with embedded audio metering and UMD tally capability.

416-750-8872; www.imagevideo.com

Booth: SU7077

Audio monitoring device

TSL CAMEO

Complements existing TSL range of high-quality audio monitoring units by offering compact reference-quality sound monitoring.

+44 1628 687 200; www.televisionssystem.com

Booth: SU9656



Control system

Broadcast Technology Skyline DataMiner

A fully SNMP compatible system allowing control of equipment from many vendors via Ethernet; features include alarm correlation, automation, notification, scheduling, automated reporting, trend analysis and an MS Visio-based topological display.

+44 1264 332 633; www.btl.uk.com

Booth: SU 9317



Multi-display controller

Dayang Magic Wall

Is a 16-channel television channel monitor; designed for use in broadcast control rooms and transmission playout centers; has a wide range of preset and user-configurable image sizes and supporting information-display modes.

+852 2730 2117; www.dayang.com

Booth: SU9352



Synchronization equipment

Sigma Electronics Arbalest series

Digital audio-to-video synchronization equipment; uses Digital Automatic Time Compensation (DATC) technology; designed to provide flawless recovery from synchronization errors created by different video and audio transmission paths; for SD production applications; enables automatic detection and compensation for any delay incurred between a vision signal and a corresponding audio signal in a transmission environment.

425-315-1724; www.sigmaelectronics.com

Booth: SU10345

Time code inserter

Laird Telemedia TC100

External SMPTE LTC time code inserter interface onto the Firewire stream.

800-898-0759; www.lairdtelemedia.com

Booth: SL1243



Analysis software

Sencore H.264 Analysis Software

Provides in-depth analysis for Main Profiles at all levels including High and Low level; full bit stream analysis capabilities (SPS, PPSI), plus a video information overlay on top of the video frames (MB, MV, and Slice); provides picture level analysis capabilities that include current picture type, encoded picture size, and percentage of macro-block types per picture; allows you to be able to identify sub-partitions, or any quantized parameters or coded Block patterns, as well as, motion vector values.

800-736-2673; www.sencore.com

Booth: SU10006, C7331

EXTREME Definition

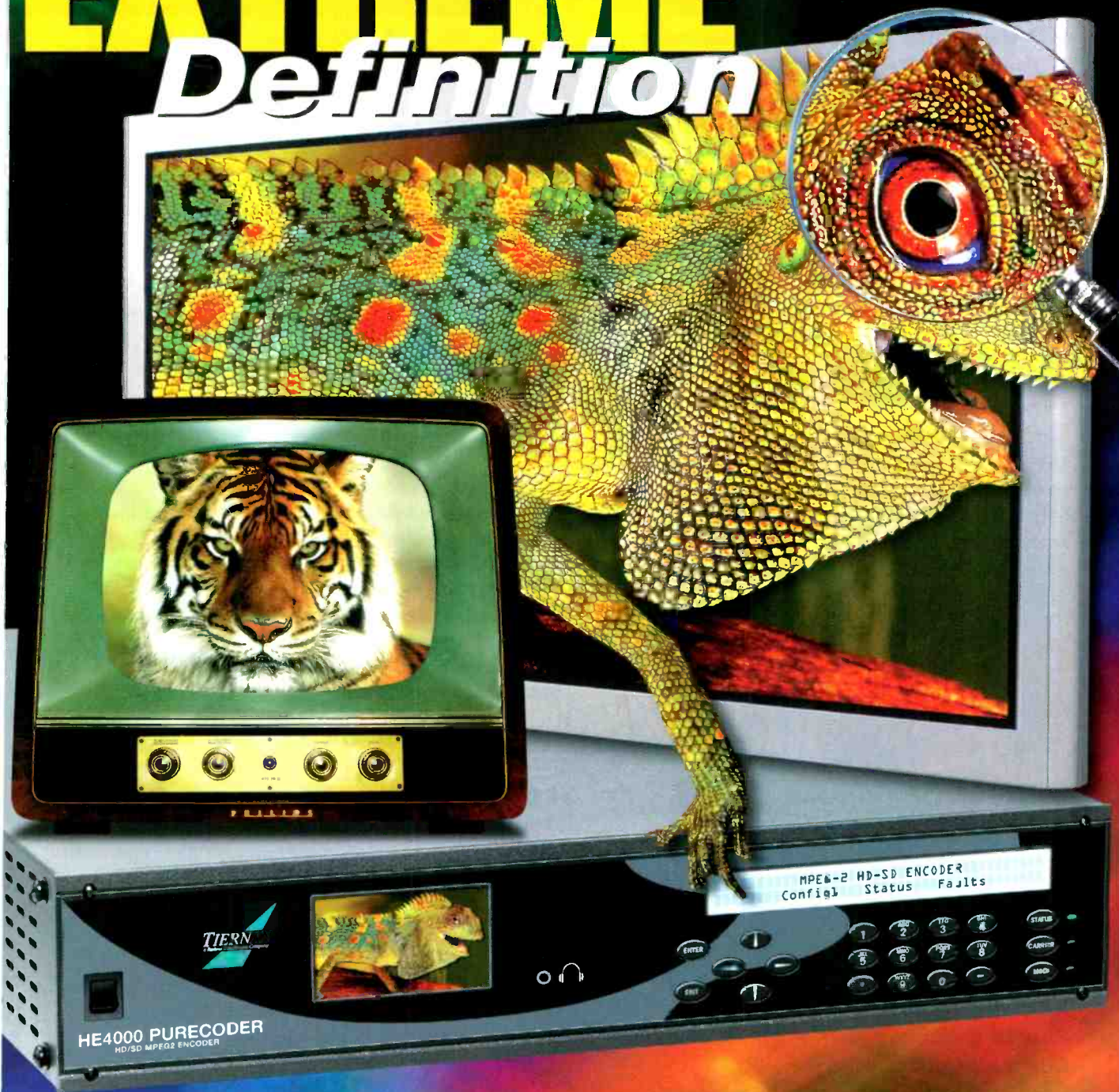

HE4000: HD AND SD Encoder

 HD and SD Encoding Simultaneously

 Front Panel Monitor

 Advanced "PUREPEG" Technology

- Enhanced Low Bit Rate Performance
- Absolute Finest Picture Quality

 Satellite and Terrestrial Interfaces

 1 MB/s to 160 MB/s

TIERNAN
A Raylne ComSirena Company

Phoenix: 602-437-9620
San Diego 858-458-1800
UK: 44-1420-54233
America: 358-458-1E00
Singapore 65-6225-4016
Beijing: 86-10-65831975
www.radr.com
www.tiernan.com

HD dual link graticule generator Evertz HD9690-444

A multi format digital video graticule generator that keys various alignment marks and mattes over a source video picture in a wide variety of applications; can be operated in a dual link mode for emerging 4:4:4 HD applications, or a 4:2:2 mode for SD (525 and 625 line) and HD (1125 and 750 line) digital video.

905-335-3700; www.evertz.com

Booth: SU6433

HD dual LCD screen Marshall Electronics V-R842P-AFHD

Occupies only three RU of a standard 19in EIA equipment rack; features 2.4 million pixel TFT screens; All SMPTE/ITU HD and SD video standards and signal types are accepted and displayed on each 4:3 aspect screen; standard inputs include HDS/SDI analog YPrPb, composite video and computer XGA (1024x768) for each screen.

310-333-0606; www.lcdracks.com

Booth: SL913



Audio meter ▲

DK-Technologies Leq software
Software for the MSD600M++ audio meter; aimed at engineers who are currently working with surround sound trailers and commercials for movie theatres; the new Graphical Leq software package allows users to mix to the highest score on the Leq loudness standard; SMPTE timecode input brings automated Start/Stop points and gives a direct readout of where the sound material can be optimized for louder trailers/commercials; new Windows-based software for internal matrix setting, a USB interface utility module and BNC versions of the input-/output modules.

800-421-0888; www.dk-technologies.com

Booth: C2757; C3612



Network monitoring and control ◀

Evertz VistaLINK PRO PLUS

Add user-configurable pictorial representations of a broadcast facility, local and remote; start with global perspectives and drill down to specific rack and frame layouts or consolidate important status information and direct configuration control on a single display; import facility block diagrams or generate an off-line simulation using virtual equipment and graphics.

905-335-3700; www.evertz.com

Booth: SU6433

Bitstream analyzer Dolby DM100

A portable, handheld diagnostic tool that can monitor and generate Dolby Digital, Dolby E and PCM bitstreams; has a built-in test-signal generator; accepts digital input signals via XLR, BNC, and Toslink optical connectors; a standard 1/8in stereo headphone jack can be switched to monitor any two decoded channels or a downmix of the whole program, while a small built-in speaker provides a mono output.

415-645-5293; www.dolby.com

Booth: SU7870

LCD monitor

Marshall Electronics V-ASL7000

Portable 7in monitor/receiver; features cable-ready NTSC tuner with booster interior rod antenna or CATV feed, two channels of video/audio input plus switched output of on-screen image and audio for routing to another display; audio can be transmitted to a close proximity FM receiver; five screen format zoom settings and the image can be inverted for ceiling mount applications.

310-333-0606; www.lcdracks.com

Booth: SL913

GPS master clock and time code generator

ESE ES-185U

Is an upgrade to the ES-185A/12 GPS master clock and time code generator; enhancements include IRIG AM or TTL time code, SMPTE time code selection through supplied software and USB connection for configuring set-up features; uses an on-board 12-channel GPS receiver for optimum performance.

310-322-2136; www.ese-web.com

Booth: C2639

Perfectly focused...every shot.



The background of the advertisement features a hand framing a landscape. The letters 'PF' are prominently displayed in the center, with a road leading towards them. The letters are stylized and appear to be made of a reflective material, possibly metal or glass, with a blue and white color scheme. The landscape behind them shows a road curving through a field under a blue sky with clouds.



XA101x8.9BESM-PF
HD Telephoto Lens



HA26x6.7BESM-PF
HD Studio Lens



HA22x7.3BRD-PF
HD EFP Lens



HA13x4.5BRD-PF
HD Wide-Angle Lens

Presenting Fujinon's Patented Precision Focus Assist System

Camera operators can finally have complete confidence knowing the HD images they capture will always be crisp, clean and perfectly in focus.

- Precise focusing even on wide shots
- Corrects focus imperfections that are undetectable in the viewfinder
- Focus indicator defines focus position in manual mode
- Extremely accurate in both manual and automatic modes
- Lightweight and low power consumption
- Mounts to standard 2/3" HD cameras

Take the guesswork out of focusing and optimize the quality of your HD images.

PF
Precision Focus

FUJINON
 **FUJIFILM**

Visit us at NAB
Booth SU6370.

Broadcast and Communications Products Division

FUJINON INC. 10 High Point Dr., Wayne, NJ 07470-7434 Phone: (973) 633-5600, FAX: (973) 633-5216

FUJINON CORPORATION 1-324 Uetake, Kita-Ku, Saitama City, Saitama 331-3624 Japan Phone: 81-48-668-2152

www.fujinon.com

Test and measurement

Acterna DTS MHP

Supported by both the DTS-330 and the DTS-200; allows operators to make interactive services available via multimedia applications on set-top boxes; designed to provide visibility into the object and data carousels going through the MPEG streams while operators — terrestrial, cable, telco, or satellite — host multiple services, such as sports programming and interactive trivia games, on one set; features accuracy of testing, ensuring the highest quality even when multiple applications are in use on one TV set.

240-404-1913; www.acterna.com

Booth: SU10043

HD test signal generator

Evertz 7751TG2-HD

Provides a cost-effective method of generating 1.5Gb/s HDTV 4:2:2 and 4:4:4 test signals; ideal for checking signal path integrity, or to determine system performance over varying cable lengths; generates test signals in a wide variety of SMPTE 292M video formats.

905-335-3700; www.evertz.com

Booth: SU6433



Portable analysis tool

Pixelmetrix DVStation-IP Portable

Suitable for users transmitting MPEG-2 data over the Internet or IP networks; portable package supports 10, 100, and 1000Mb/s Ethernet; can be set to detect video traffic on any set of IP address pairs, extract the MPEG transport stream, and perform extensive MPEG-2 verification.

866-749-3587; www.pixelmetrix.com

Booth: C7316

Transmitter

E2V Klystron

Are used as the final amplifier stage in UHF television transmitters of 5kW peak sync output power and above; will fit most transmitter types and extends from the older unpulsed tubes to modern wideband types and the latest Energy Saving Collector klystrons.

914-592-6050; www.e2v.com

Booth: C3146

Coding analysis tool

Pixelmetrix VISUALmpeg

Evaluates and tests MPEG-based advanced coding; models available for MPEG-1, MPEG-2 and H.264; MPEG parameters extracted and displayed in easy-to-understand format.

866-749-3587; www.pixelmetrix.com

Booth: C7316

Light

Kino Flo Kamio 6E

Ring-shaped light; weighs less than 1lb; for speed and performance when shooting digital video production or ENG assignments.

818-767-6528; www.kinoflo.com

Booth: C10437



Digital transcoder

LARCAN USA 8VSB REGEN Transcoder/Exciter Built for digital translator networks; uses 8VSB translator technology that extends digital coverage to rural areas.

303-665-8000; www.larcan.com

Booth: C5620

8.4-inch HD monitor

ERG Ventures HDM-EV80D

Offers enhanced color, gamma adjustment functions, additional framing markers and a memory preset functions; serves as a rack-mount monitor that can easily be adapted for location shoots; its HD/SD inputs can be intermingled; has four inputs; is able to flip the image right-side up.

949-263-1630; www.erg-ventures.com

Booth: SU10134



It's What's Inside That Counts!



MT4400
HPA



MT3400
HPA



MT3300
HPA



MCL's outdoor HPAs, offered in C-, X-, Ku- and DBS-Band, are now available with Integrated MITEQ L-Band Input Block Upconverter Modules, with optional 10 MHz internal or external frequency reference.

MITEQ offers a full line of separate BUC modules for C-, X-, Ku-, DBS-, Ka- and Multi-Band applications, in addition to our Outdoor Antenna Mountable Block Up- and Downconverter Solutions.

Visit us at www.miteq.com



&



For additional information, please contact the MCL Sales Department.

501 S. Woodcreek Road, Bolingbrook, IL 60440-4999
(630) 759-9500 • FAX: (630) 759-5018 • sales@mcl.com

www.mcl.com

Worldwide Communication Solutions!



Microwave power modules

L-3 Communications Electron Devices MPMs Combines solid-state driver with vacuum power booster and integrated power conditioner in small, light and efficient package; used in the USAF Predator and Global Hawk UAVs, as well as in various SATCOM applications.

570-326-3561; www.edd.l-3.com

Booth: C8507

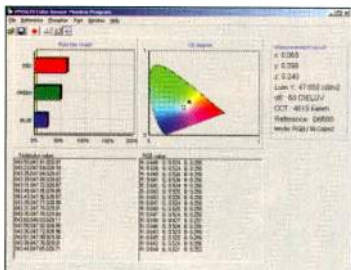

LCD color analyzer ▲

DK-Technologies USB interface LCD color probe With new Windows-based software now available for the probe, users can store measurements for use as a degrade reference at a later stage as well as see and adjust the current color temperature; existing users of the PM5639/94 probe will find a useful upgrade path.

800-421-0888; www.dk-technologies.com

Booth: C2757; C3612

Oil-cooled CEA tube

L-3 Communications Electron Devices CEA 130 High-efficiency tube covers the UHF-TV band; combines a multistage depressed collector with inductive output amplifier; DC power is made almost proportional to RF output over a wide power range; can be used in analog transmitters to improve efficiency over standard IOTs.

570-326-3561; www.edd.l-3.com

Booth: C8507

Inductive output amplifier

L-3 Communications Electron Devices IOT 80 high-efficiency tube operating in the UHF-TV frequency range of 470MHz to 810MHz; amplifier can be used in digital and analog transmitters requiring combined vision/aural service, vision-only service, and aural-only service.

570-326-3561; www.edd.l-3.com

Booth: C8507

Router control panels

Utah Scientific UCP Series

Full compatibility with the U-Con graphical system configuration utility; offers control panels for all applications.

801-575-3770; www.utahscientific.com

Booth: C5910

Routers

Sigma Electronics Dagger series routers

Designed for both high-definition and standard-definition uses; provides up to 16x16 compact routers; multiple levels of audio and video may be combined in the same frame; additional components available for the series include 16x2 HD/SDI router, 16x16 SDI router, 16x16 AES digital audio router, 16x16 analog audio router and compatible control panels.

425-315-1724; www.sigmaelectronics.com

Booth: SU10345

Triax camera cable

Gepco LVT61811

Extra-flexible triaxial camera cable for use in studio, remote, or other portable applications; features a precision-drawn, copper conductor and a low-loss, gas-injected polyethylene dielectric; the gas injection process achieves low attenuation, a precision 75ohm impedance, low structural return loss, and superior crush resistance; a tight-angle, heavy-gage braid shield provides RF/EMI shielding and low DCR; the master jacket is an all-weather TPE that is abrasion-resistant, durable, and remains flexible even in cold temperatures.

800-966-0069; www.gepco.com

Booth: C9341

Routing system

Quartz Electronics Topaz-HD

Offers a full 1.5Gb/s bandwidth to handle uncompressed HD signals; dual link operation is supported using ganged pairs of inputs and outputs to carry higher bandwidth signals or data; available in 16x16 or 32x32 sizes.

530-265-2815; www.quartzus.com

Booth: SU9652



Component video distribution amplifier ▲

Kramer Electronics VM-100C

Features 450MHz bandwidth at -3dB; level and EQ controls are available to provide compensation correction for signal loss in long-distance cable runs; separate level and EQ controls included for each of the Y, U and V output signals.

888-275-6311; www.kramerelectronics.com

Booth: SL854

fischer connectors



- ▶ Wide range of connectors for studio and outside broadcasting
- ▶ Sturdy watertight design with corrosion resistant finish for reliable outside broadcast application
- ▶ All approved triaxial cables accepted due to an extensive range of body styles and cables
- ▶ Interchangeable with the American Standard (Series 1052)

- ▶ Mixing different purpose contacts in one connector body provides unprecedented design flexibility
- ▶ "Mix-and-Match" contact elements as needed:

- Fiber-Optic (single - or multimode)
- Coaxial (50 or 75 Ω)
- Fluid or Gas
- High voltage
- High current

- ▶ Sealing to IP68
- ▶ Positive-locking, lightweight design
- ▶ Fully insulated plastic body provides maximum user safety and shock-protection
- ▶ Impervious to 1000's of sterilizations
- ▶ Interchangeable to Fischer metal connectors
- ▶ Sealing to IP68: ideal for wet applications
- ▶ EMI/RFI shielding available
- ▶ Hermetically sealed (10^{-6} mbar /s) and pressure tight for extreme environments and safety
- ▶ Meets and exceeds highest protection levels of IEC60529, BS5490, DIN40050
- ▶ High performance O-ring seals made of VITON as standard
- ▶ Insulator-contacts sealed by 3 component glass epoxy



Fischer Connectors, Inc.
1735 Founders Parkway Suite 100
Alpharetta, GA 30004
Tel. 800-551-0121
Fax 678-393-5401

www.fischerconnectors.com
mail@fischerconnectors.com

Subsidiaries

Asia
FISCHER CONNECTORS ASIA Ltd.
Hong Kong
Tel. +852 2238 6837
Fax +852 2268 6729
mail@fischerconnectors.com.hk
France
FISCHER CONNECTORS Sarl
Paris
Tel. +33 1 5578 2578
Fax +33 1 5578 2575
www.fischerconnectors.fr
mail@fischerconnectors.fr

Germany and Eastern Europe
FISCHER CONNECTORS GmbH
Kirchseeon-Eglharting
Tel. +49 8091 5583 0
Fax +49 8091 5583 23
www.fischerconnectors.de
mail@fischerconnectors.de
Italy
FISCHER CONNECTORS Srl
Monza
Tel. +39 039 321 275
Fax +39 039 325 766
www.fischerconnectors.it
mail@fischerconnectors.it

United Kingdom, Eire and India
FISCHER CONNECTORS Ltd.
Havant/Hampshire
Tel. +44 2392 459 600
Fax +44 2392 459 601
www.fischerconnectors.co.uk
sales@fischerconnectors.co.uk



Video router

The ISIS Group INNOVATION HD routers available in 16x16 and 32x32; an array of control panels and control interfaces available; feature internally-mounted main and optional redundant power supplies; PS and signal switching boards accessible from the front of the frames and are hot swappable.

888-622-4747; www.isis-group.com

Booth: C1836

Video jacks

Switchcraft

Single, mid-size jacks incorporate many video panel configurations; rated at 3GHZ; available in both short and long barrel lengths; in terminated and non-terminated versions.

773-792-2700; www.switchcraft.com

Booth: C2339



Cable connectors

Neutrik NP*X Series

Offers thin 1/4in plug with chuck type strain relief; offers higher cable retention force and the same reliability and features of current NP*C phone plug series; meets the most recent requirements for highest packing density, which is 15.88mm; all metal and available in mono and stereo versions with nickel or gold-plated contacts and nickel, black or velour chrome housings.

732-901-9488; www.neutrikusa.com

Booth: C5137

High definition coax cable

Gepeco VHD1100

Features a 3GHz bandwidth (for HDTV transmission), a gas-injected foam polyethylene dielectric, lower attenuation, more RG types, excellent crush resistance, easy termination, and a flexible, riser rated jacket; conductive elements consist of a precision-drawn solid copper center conductor and a 95 percent braid with 100 percent foil shield for complete broadband shielding; available in wide range of sizes to accommodate short distance rack wiring or extended distance point to point interconnect

800-966-0069; www.gepeco.com

Booth: C9341



Audio processor

Wheatstone Audio Processor

Two channel/stereo audio processor features single-rack design; provides an array of analog/digital inputs and outputs, four-band parametric EQ, three band compressor and tunable filters along with overall AGC, limiting and expansion; all settings can be stored and replayed as password-protected presets.

252-638-7000; www.wheatstone.com

Booth: N2802

Digital video router

Quartz Electronics Q256-SV

A compact large-scale serial digital video router; the unit can be scaled in steps of 32 through to 128x128 in a single 8U frame and up to 256x256 in a single 16U frame; expansion frames allow for up to 1024x1024.

530-265-2815; www.quartzus.com

Booth: SU9652



Plug connector

ADC Telecom BNC-3T

A custom straight BNC 75 Ohm plug connector; offers improved performance with true 75 ohm characteristic impedance through the connector, not just the interface; the BNC plug connector prevents damage during test or mating plug termination, has 100 percent guided mating, improved bandwidth performance to 3GHz, and sizes for multiple cable types.

800-366-3891; www.adc.com

Booth: C4515

SENCORE

*We've Got A Full House
Of Solutions For You!*



SENCORE Provides Products You Can Rely On Day-In, Day-Out.

- *Modular Receiver Decoders - That Change With Your Needs.*
- *Content Servers - With Editing Or Program Delay Capabilities.*
- *Signal Sources - To Show Your Product, Not The Competition's.*
- *Modulators - Used To Route Signals Throughout Your Facility.*

Look to
SENCORE
for the Solution,
not just a Solution!

NEW Products are coming to NAB 2005!
See how we can turn your laptop into
a MPEG-2 Analyzer, or a Portable
RF Analyzer, including 8-VSB and QAM.

Stop By Our Booths At NAB 2005
Booths: SU100006 Or C7331

Call Us at: 1-800-SENCORE (736-2673) or Visit us at: www.sencore.com



Camera Connector ▲ Canare Hybrid fiber optic camera connectors

New F.O. camera connector design; with a detachable alignment sleeve and insulator; easy maintenance; made with a stainless steel body shell; the connectors are SMPTE 304M compliant with an insertion loss =0.5dB; AdPC polish for a RL =45dB.

818-365-2446; www.canare.com

Booth: C5134

TBC control systems Ensemble Designs TC400D & CP10

Controls video, chroma, setup, hue and timing of digital and analog VTRs, TBCs and Frame Syncs; built-in networkability; any size system can be achieved with control of any VTR from any control panel; TC400D provides control of the proc-amp functions of four VTR Time Base Correctors; features hands-on control of levels and timing.

530-478-1830; www.ensembledesigns.com

Booth: SU10217

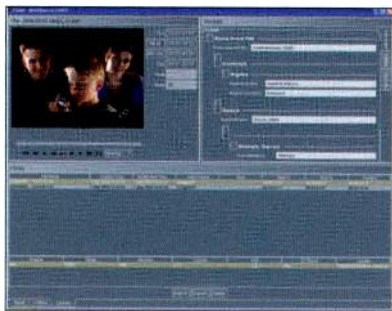

Open-standards ingest system ▲ Snell & Wilcox Comet

Powered by company's MediaX real-time MPEG-2 PCI encoder; enables broadcasters to create multi-vendor systems with complete interoperability and begin to move away from proprietary server storage and asset management systems.

212-481-2416; www.snellwilcox.com

Booth: SU6349

SD/HD audio/video air delay unit Accom Aircleaner

Is housed in a 1RU chassis with a front panel LCD screen; accepts either standard definition or high definition SDI video signals and up to eight channels of AES/EBU audio with 24bit resolution at 48kHz; allows a maximum delay of up to 10 seconds in HD formats and up to 30 seconds in SD formats.

650-328-3818; www.accom.com

Booth: SU7834



Audio console ▲ Wheatstone Gen 6 Console

Incorporates features from the series' larger surfaces into a studio-friendly footprint; integrates with the Bridge Digital Audio Router and allows system-wide access to a station's on-air and off-air audio resources via interlinked Cat. 5 or fiber-optic cable; features include Ethernet protocol, VDIP configuration, X-Y controllers, eight-character controller displays, AUX sends and increased PRESET options to boost save-recall capability.

252-638-7000; www.wheatstone.com

Booth: N2802

Camera support system Anton Bauer STASSIS

A lightweight shoulder mount; redirects the geometry of a mini-DV camera to make use of the body as a stable support platform; the body support system improves both the ergonomics and performance of a professional min-DV handheld; its adjustable front plate comfortably takes weight off the operator's hand; and the rear battery mount counters the forward weight of the camera; using any professional Gold Mount battery delivers extended runtimes up to 10 hours.

800-422-3473; www.antonbauer.com

Booth: C7319C

Monitoring solution Barco iStudio

Consists of a high-quality display with rear-screen projection, a graphic controller, and Web-based operating software; one projection module can display up to 60 video or audio windows simultaneously.

770-218-3200; www.barcocontrolrooms.com

Booth: SL1131



Patching system ▲

ADC Telecom UniPatch

Modular patching system with universal chassis; combines full AES compliance, a highly durable RS-422 patching interface, and a modular design; allows technicians to combine data, audio, and video patching modules in a single 2 RU modular panel.

800-366-3891; www.adc.com

Booth: C4515



SD/HD production switcher ▲

Snell & Wilcox Kahuna

Offers simultaneous HD and SD operations in the same mainframe with the same control panel; enables the seamless integration of SD sources into HD productions without outboard upconversion; users can work initially in SD-only or HD-only mode and then upgrade to multiformat SD/HD operation; allows users to mix existing SD camera feeds, graphics, handheld shots, and archive footage directly into an HD production.

212-481-2416; www.snellwilcox.com

Booth: SU6349

Signal integration system

Ensemble Designs Avenue

An expandable, modular tray-based signal integration system; housed in a 1RU or 3RU frame; allows any combination of HD video, SD video, DVB-ASI and audio modules in the same frame; modules include: embedders, synchronizers, converters, routers, sync gens, protection switches, and more.

530-478-1830; www.ensembledesigns.com

Booth: SU10217

Red highlight indicates advertiser

APRIL 2005

Broadcasters Trust Telecast Fiber for ALL their Fiber Optic Needs.



ADDER and ADDER II

Whether you need analog audio, AES, intercom or even A-D and D-A signal conversion, there is an Adder system ready to handle any audio challenge. Up to 256 channels per fiber, at 24-bit resolution, with optical redundancy for quiet, reliable sound.



SHED/HDX and COBRA

For Triax and hybrid cabled cameras, we have solutions to liberate you from your heavy copper. SHEDs eliminate your costly hybrid cables on HD cameras, while Cobras replace triax on HD or SD camera systems...with ten times the distance.



VIPER I / SIDEWINDER

For 14 years the Viper and Sidewinder have supported ENG/SNG applications around the globe. The reel-mounted Sidewinder and Viper Mussel Shell are immediately familiar as the workhorse systems that have proven themselves in the most extreme conditions...day in and day out.



VIPER II

With small "throw down" modules that can be converted to rack mount, the Viper II is an expandable system that grows with your facility. Modules range from video/audio to Ethernet to robotic HD/POV, for incredible flexibility using simple building blocks.



COPPERHEAD HD/SDI

Our camera-mounted CopperHead makes light work of a wide range of applications, from news coverage to digital cinematography. Turn your ENG camera into a remote production camera, and avoid the cumbersome, expensive triax backs and base stations.



DIAMONDBACK II

Picking up where its predecessor left off, the DBII now offers 8 channels of broadcast-quality NTSC/PAL video on each wavelength. With optional audio and CWDM technology a huge backbone can be implemented on a single optical core.



Save time on your event production schedule. On a single lightweight cable we support all your broadcast signals from the field and the booth to the truck. From Telecast, the leader in fiber for television broadcast production.



Telecast
Fiber Systems, Inc.

(508) 754-4858

All products mentioned herein are trademarks of Telecast Fiber Systems

www.telecast-fiber.com

Visit us at NAB, Booth #SU8375
broadcastengineering.com 129

SD/HD production server
Accom MultiflexMX

Delivers a high performance feature set, Media Management software, faster than real-time network media transfers, scaleable high capacity RAID storage and 24/7 reliability; allows mix and match of SD and HD channels using new high-quality JPEG-2000 compression technology; can record or play up to eight SD streams, or up to four HD streams, or any combination of SD/HD streams in the same chassis.

650-328-3818; www.accom.com

Booth: SU 7834

Creative and technical solutions services provider**Ascent Media Group**

Provides creative and technical solutions through its Creative Services, Creative Sound Services, Media Management Services and Networks Services groups for content creation, management and distribution; provides effective solutions for the creation, management and distribution of content to major motion picture studios, independent producers, broadcast networks, cable channels and advertising agencies.

310-434-7000; www.ascentmedia.com

Booth: C5434

**Serial digital to analog video converter****Ensemble Designs BrightEye 15**

A serial digital to analog video converter; allows user to time the analog output into a production switcher or routing switcher; offers video conversion and signal timing; useful for broadcasters that are integrating digital and analog signals into the same system; frame synchronization is accomplished by conventional drop/add of frames.

530-478-1830; www.ensembledesigns.com

Booth: SU 10217

Camera lens**Canon DIGI SUPER 100xs**

A triple digit zoom lens; incorporates Canon's Image Stabilizer technology; features a focal length of 9.3mm to 930mm (18.6mm to 1860mm using the 2X extender), a speed of F/1.7, and a weight of 23.5kg (50.18lbs); provides viewers with shake free images that offer incredible detail; the M.O.D. from lens front is 3.0m.

516-328-5000; www.canonbroadcast.com

Booth: SU7814

Control solution**Barco iPresent**

A complete backdrop solution that consists of specifically adapted rear-projection modules, combined with a customized controller and dedicated software; allows broadcasters to use the wall as a high-quality alternative for a traditional on-stage video wall; shows a multitude of video and graphical windows and produces smooth transitions from one display wall layout into another.

770-218-3200; www.barcocontrolrooms.com

Booth: SL1131

Multi-channel video server**Doremi Labs MCS-HD**

Features two record and two play independent high definition video channels with shared storage and selectable compression rates; features a front panel that mimics familiar VTR controls and is compatible with Odetics and VDCP automation protocols as well as Sony 9pin machine control; can record all popular HD and SD formats.

818-562-1101; www.doremilabs.com

Booth: C2342

**Digital console****Calrec Audio Sigma 100**

Up to 64 faders, with A & B layers of control, plus 2 main output faders with 2 sub-main outputs available; 120 equivalent channels: up to 48 stereo plus 24 mono channels or 60 stereo channels; comprehensive surround panning and monitoring with optional motorised joystick; optional I/O expansion via a wide area interface such as MADI or Hydra, Calrec's audio networking system.

+44 1422 842159; www.calrec.com

Booth: N802

Editing system**Canopus Workflow**

Combines the EDIUS realtime HD/HDV/DV editing solutions and ProCoder transcoding expertise with the MediaEdge enterprise video distribution solution; allows users to create, purpose and deliver video at a highest quality for broadcast, DVD, streaming and video-on-demand.

408-954-4500; www.canopus.com

Booth: SL325

Inter BEE 2005

International Broadcast Equipment Exhibition 2005

November 16-18, 2005 Makuhari Messe (Nippon Convention Center)



The Future Roads of Broadcasting

What lies ahead for broadcast communications? Professionals in broadcast, video, and audio technologies will encounter the latest currents of thought at this year's International Broadcast Equipment Exhibition (Inter BEE).

Promising more than 600 exhibitors and 31,000 industry members attending from around the world, we expect Inter BEE 2005 to generate the largest response in our 40-year history. Symposiums and seminars by prominent producers and systems hardware developers, as well as opportunities for marketing and networking, make this an essential forum for new concepts and technologies such as one-segment broadcasting.

See where you fit into the changing role of broadcasting. Bring your messages and image to the world. Join Inter BEE 2005 to assure your position on the road of opportunities ahead.

For more information on Inter BEE 2005, contact:

Japan Electronics Show Association

Sumitomo Shibadai-mon Bldg. 2 Gokan, 1-12-16, Shibadai-mon, Minato-ku, Tokyo 105-0012, Japan
Fax.: +81-3-5402-7605 E-mail: bee.info@jesa.or.jp URL: <http://bee.jesa.or.jp/>



Exhibition Categories

- Audio Equipment ● Cameras and Related Equipment
- Recording Equipment
- Editing and Production Equipment
- Electronic Displays ● System Conversion Equipment
- Output Systems ● Relay Systems
- Transmission Systems ● Lighting Equipment
- Measuring Equipment ● Transmission Cables
- Electric Power Units ● HDTV Systems
- Satellite Broadcasting Systems ● Virtual Systems
- CG Production Systems ● DVD Systems
- Multimedia Systems ● Software
- Multiplex Broadcasting Systems ● Others

Exhibition Application Deadline

Thursday, April 28, 2005



Test Generator ▲ Doremi Labs HD-G10

Portable test generator; features a dual-link HD-SDI 2k resolution video output; provides 15 still patterns and 7 moving test patterns in SD and HD formats; outputs audio tone, time code and close caption characters; has ability to combine any still pattern with a moving pattern to create hundreds of video pattern options.

818-562-1101; www.doremilabs.com

Booth: C2342

Digital console Calrec Audio ZETA 100

Combines simplistic operation and instant access with bullet-proof engineering features such as hot-swappable cards and panels and intelligent redundancy on all system-critical elements; provides broadcast-specific solutions for all types of production environments; three frame sizes — 24, 32 and 48 faders.

+44 1422 842159; www.calrec.com

Booth: N802



3-D on-air graphics ▲ FOR-A Corporation of America

Centered on Brainstorm Multimedia's eStudio virtual studio software program; features include VS Virtual Studio, used to construct simplified virtual studios, VS/RCG Virtual Studio for construction of both a simplified virtual studio and real-time computer graphics, Maya 3ds XSI, which enables 3D files and data to be imported

714-894-3311; www.for-a.com

Booth: C4519

Switcher

Echolab Nova identity4

Provides high-speed, next generation interconnectivity; have 100Mb Ethernet ports, supporting simultaneous connections to the outside world through Web, FTP and XML-RPC servers; the Web server enables an operator to remotely access the switcher from anywhere in the world via a web page to check on status and configuration; the XML-RPC Server provides a high-bandwidth remote control protocol for operation of any switcher function over a local or remote Internet connection; the FTP Server allows an operator to upload and download graphics to the frame buffer

978-262-0063; www.echolab.com

Booth: C4915



Fiber-optic connector for HDTV cameras ▲

Fischer Connectors 1053 Series

Co-developed with Corning; "No Epoxy – No Polish" fiber-optic contacts enable users to field-assemble and field-repair HDTV camera connectors anywhere; eliminates polishing fiber-optic elements as well as preparing special epoxies when using the new Series 1053T connector.

800-551-0121; www.fischerconnectors.com

Booth: SU11812

HD ENG-style lens

Fujinon HA25X11.5BERD

Ideally suited for gyro stabilized platforms in aircraft, wildlife photography in remote areas and HD surveillance applications, where light weight and unobtrusive appearance are critical; weighs 6.2lb; has a maximum focal length of 576mm (2x), reduced focus breathing, an F-stop range of 2.0 to 2.8 and DigiPower servo system for fast and accurate zooming.

847-945-8923; www.fujinon.com

Booth: SU6370



HD OVERVIEW GUIDE

THE INDUSTRY'S BROADEST LINE OF HD PRODUCTS

MASTER YOUR MOVE TO HD WITH LEITCH

THE INDUSTRY'S BROADEST
LINE OF HD PRODUCTS

[HD OVERVIEW GUIDE]

YOUR HD STRATEGY

ALL ABOUT HD...and MORE

It's your move. Leitch is thinking beyond the move to HD to help you master the implementation of new technologies with the broadest line of high-definition products and solutions. Whether you are producing content, monitoring it, or multi-casting, Leitch offers HD/SD compatibility, easy scalability for expansion and upgrades, and efficiency of a streamlined workflow as you integrate your environment. We are enabling customers to create new revenue streams today, providing stability during technology transitions and offering scalability to ensure a secure investment for expansions ahead. We include the service and support to back it up. Partnering with Leitch is a winning strategy.

OVERVIEW

We can help you leverage your infrastructure for HD production and all the multi-format content you're faced with in news and post production environments. From our NEXIO HD server platform for storage, to field production and post-production editing, character generation and graphic overlays, we out-perform under the most demanding conditions.

"We pride ourselves on bringing together exactly the right elements to ensure a seamless production. The VelocityHD fits our philosophy perfectly by making HD non-linear editing as efficient and easy as standard-definition editing."

-Peter Bates, director of production for Telogonic

WHAT'S NEW IN INGEST

INGEST CONTROL MANAGER™

ICM has now been enhanced to include devices that handle and process HD content, while continuing to support SD. Developed specifically for news and transmission environments, Ingest Control Manager uses EventBase for event scheduled record and device management, including program segmentation and extensive device control for HD/SD environments. ICM communicates directly with the NEXIO server system for up to 16 channel controls, and is fully integrated with Leitch's X75 multi-path converter/synchronizer, as well as up to eight routers and eight VTRs.

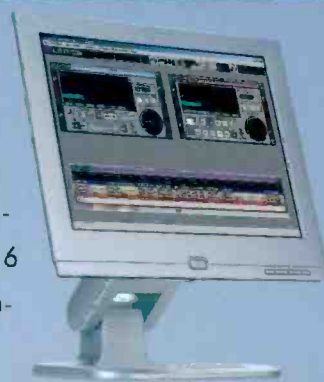

[MASTER YOUR MOVE TO HD WITH LEITCH]

INTRODUCING

HD CONTENT PRODUCTION

WHAT'S NEW IN EDITING

Designed for efficient workflow in newsrooms, the field and post production, Leitch editing solutions are integrated and scalable. For news, our NEXIO HD server provides a solid platform for newsroom and craft editing. The VelocityNX seamlessly integrates the award-winning Velocity interface into the NEXIO SAN. The NEXIO SAN is format-independent, allowing HD/SD content to be stored on common storage.

WHAT'S NEW IN POST

VelocityHD™

The award-winning VelocityHD non-linear editing system is the ultimate HD/SD editing solution for any post production environment. VelocityHD brings full-quality, real-time editing performance to high definition at a remarkable price point - the type of "real-time" performance that delivers true productivity gains in high-demand environments. VelocityHD features full quality HD playback of two video streams (compressed or uncompressed), two dynamic graphics streams and optional 3D effects. With flexible formats (1080i, 1080PsF, 720p, and our highest level of standard-definition editing performance yet), flexible I/O (including HD-SDI and new IEEE-1394 HDV I/O) and an intuitive and powerful user interface, VelocityHD is ideal for any HD editing task.



HD SELECTIONS

INGEST CONTROL MANAGER (ICM)™

Ingest Control Manager for NEXIO HD server

VelocityNX™

Craft Editor for NEXIO HD Server

VelocityHD™

Real-Time HD/SD Non-Linear Editing System

VelocityX™

Companion Laptop/Online Editor for VelocityHD

inca.autocg HD

Networked Graphics Solution

inca.studio HD

Character Generator and Graphics



NAB 2004 AWARDS

WHAT'S NEW IN GRAPHICS

inca.studio HD & inca.autocg HD

Inscriber Inca Studio HD is a real-time, multi-layer HD character generator that delivers unmatched graphic sophistication, composition and playback through a comprehensive suite of graphics tools. Inca Studio HD's versatility means it excels at post production, as well as the most demanding live sports event coverage. Inscriber's advanced solution enables multiple channel effects to be created on a single channel for breaking news or live events. For exceptional HD quality and creative CG versatility, Inca Studio is the choice for broadcast studio, post production and on-air operator-driven CG applications.

Inscriber Inca AutoCG HD is an innovative central graphics playout solution providing the combined functionality of a still store, character generator and clip player. The rich HD output of the AutoCG HD system operates under the remote command of industry-standard newsroom automation systems, MOS-enabled environments, or Inscriber's "Direct Control" user interface. Designed for broadcasters seeking to streamline their workflow, Inca AutoCG offers superior graphics capabilities, coordination and automated playout for template-intensive programming such as news or other live events. Inca AutoCG HD is an integral part of the HD/SD simulcast workflow innovation when used with an Inca AutoCG SD.

[MORE INFORMATION AT WWW.LEITCH.COM]

INTRODUCING

HD CONTENT PROCESSING & DISTRIBUTION

OVERVIEW

An aggressive HD strategy requires format flexibility in today's signal processing and distribution applications. Leitch's affordable, broadcast-quality routing switchers route all signal formats from analog to HD for any sized application. Together, 6800+ for all core processing requirements and NEO for advanced applications provide unparalleled functionality for analog, digital and high-definition content, while the X75 maximizes efficiency by combining conversion, processing and sync capabilities all in a space-saving 1RU package. And our award-winning Videotek DL-850HD's powerful features eliminate all the guesswork in legalizing HD SDI signals in any broadcast or post production facility.

"The X75 is a great tool and very handy to have around when you need that extra 'up/down/cross audio delay embedder/de-embedder' in your tool kit. I'd love to see one or two on all of our HD trucks."

• George Hoover, executive vice president of engineering, NEP Supershooters

WHAT'S NEW IN PROCESSING

X75™

The X75 combines SD to HD upgradeability with up/down/cross conversion, SD/HD frame sync and extensive processing capabilities all in a space-saving 1RU package, and is equally suited for analog, digital, or HD hybrid facilities. With capabilities that far exceed any digital processing synchronizer, the X75 allows broadcasters to do much more with less equipment. Video processing features include simultaneous upconversion and downconversion with aspect ratio conversion for hybrid standard- and high-definition facilities; level/color control; optional 3D adaptive color decoding with time base correction; and optional noise reduction. The X75's 8- or 16 channels of internal audio processing include timing with video for lip sync corrections: level control; A<>D conversion; embedded processing for both SDI and HD-SDI serial digital signals and integrated Dolby® decompression.



HD SELECTIONS

MODULAR PROCESSORS

6800+^{PLUS}

Core Processing Modules for multiple format up- and down-conversion, audio multiplexing and de-multiplexing, frame synchronization, optical conversion, and distribution amplification.

NEO™

Advanced Applications such as XHD-3902 series up/down/cross conversion, aspect ratio conversion, test signal generation, master timing generation, branding (LogoMotion I™ HD), and multi-source display processing (NEO SuiteView™).

CONVERTERS/SYNCHRONIZERS

X75™

Up/Down/Cross Conversion, HD/SD Frame Sync, Video and Audio Processing Capabilities

ROUTERS

PANACEA™

Affordable, Compact Routing Switcher

INTEGRATOR GOLD™

Wideband Digital Multi-rate Routing Switcher

LEGALIZERS

VIDEOTEK

— DL-850HD - High-Definition Serial Digital Legalizer

INTRODUCING

HD CONTENT TRANSMISSION

OVERVIEW

Leitch branding and master control products ensure quality and reliability are maintained at the crucial point of transmission as broadcasters transition to HD. High-impact graphics are easily integrated upstream or downstream of the master control switcher in any broadcast environment with Inca Station HD. Networked graphics and newsroom system connectivity are delivered with Inca AutoCG HD. High-quality motion graphics and logos are easily overlaid on pre-compressed SD and HD streams with our Digital Turnaround Processor (DTP). And an impressive on-air image is guaranteed with our feature-rich Opus HD master control system.

WHAT'S NEW IN MASTER CONTROL

inca station HD

Inca Station HD is redefining master control branding by combining unprecedented ease-of-use with animated and still logos, and multiple real-time data crawls to maximize viewer impact and retention. It is specifically designed for master control to insert graphics, promotional animations and clips, moving backgrounds, emergency programming, local news and advertising. Integrated upstream or downstream of the master control switcher to brand the final broadcast output, Inca Station HD features virtually unlimited layering and overlapping abilities and can display multiple dynamic data feeds, including multiple simultaneous crawls.

LOGOMOTION II HD

In conjunction with the Inca Station HD, LogoMotion II HD users can further enhance their graphics for multi-layered, real-time animations, clips and crawls. Using Ethernet control, the remote panel for LogoMotion II, users have full interface to connect full graphic layering capabilities within just one system, greatly increasing the on-air look. For customers using NEO LogoMotion II, our branding solution within the NEC frame of advanced applications, the LogoMotion II provides an easy-to-use, low-cost branding solution.

HD SELECTIONS

NEXIO MTS SERVER™

NEXIO HD SERVER™

DTP™

Digital Turnaround Processor for Localization of Graphic Content in Video

OPUS HD™

Master Control Switcher

inca autocg HD

Networked Graphics Solution

inca station HD

Enhanced Master Control Graphics and Branding

LOGOMOTION II HD

Content Branding Solution

VIDEOTEK

SQM-DDM 8VSB - Frequency Agile Demodulator Module



[MORE INFORMATION AT WWW.LEITCH.COM]

INTRODUCING

HD CONTENT STORAGE

OVERVIEW

Leitch's content storage solutions provide broadcasters with superb tools for maximizing efficiency, streamlining workflow and increasing the bottom line return as customers make the move to high definition. Leitch's NEXIO HD and MTS servers provide a shared storage infrastructure with open access to content and a cost-effective means by which facilities can scale their operations and transition to HD. Leitch's partner relationships further enhance our ability to serve our customers' diverse needs by providing solutions for content organization, automation, archiving and distribution. NEXIO server platforms offer integrated applications for editing, browsing and media management across multi-tiered storage hierarchy.

APPLICATION PARTNERS

Because broadcasters require products and services from multiple suppliers that match specific workflow, optimize efficiency and provide solid return on investment, Leitch has an extensive list of partners as part of our NEXIO Partner Program. We understand customers need a high degree of confidence in the compatibility and interoperability of our products, while delivering tightly integrated solutions. Our NEXIO system ensures management of SD and HD content as it is acquired, produced and distributed in multiple compression formats, then moved across both traditional and IT networks.

"The NEXIO™ HD platform clearly provides The Outdoor Channel a most robust architecture with which to grow our operations for years to come."

- Gene Brookhart, The Outdoor Channel's vice president of technical operations

HD SELECTIONS

NEXIO HD SERVER™
High-Performance, High-Definition Server System

NEXIO MTS SERVER™
MPEG Transport Stream Server

WHAT'S NEW IN SERVERS

NEXIO HD

The NEXIO™ HD server integrates the first software-based agile codec for high-definition video, allowing baseband high-definition record and playback from the same shared storage file system where SD content is stored. Based on a new high-performance, true 64-bit dual processor, the NEXIO HD platform provides two channels of HD output (decoding), or one channel of input (encoding) and one HD output in either 720p or 1080i format. Using the NEXIO MTS MPEG Transport Stream server, it is possible to ingest HD content pre-compressed by best-in-class transmission encoders, which can then be played back through the HD-SDI baseband output of the NEXIO HD platform. With agile codec technology making changing system compression formats effortless, the NEXIO HD server provides a highly flexible, cost-effective solution for broadcasters making the transition to high definition.



[MASTER YOUR MOVE TO HD WITH LEITCH]

INTRODUCING

HD CONTENT/SIGNAL MANAGEMENT

OVERVIEW

Broadcasters can realize the greatest high-definition productivity and performance gains when employing content and signal management operations under a common control system with a consistent, but flexible user-configurable interface, such as Leitch's CCS Navigator. Fully integrated with CCS and ideal for a wide range of monitoring applications, Leitch's SuiteView line of multi-viewer solutions renders video and computer signals in real time to high-resolution monitors or displays. And Videotek's VTM series of multi-format on-screen monitors and TVM/TSM/VSM series of waveform monitors and vectorscopes, including the new TVM-950HD, are well-suited for HD environments including broadcast, production, post production, quality assurance and cable.

"TBS needed a high-definition test and measurement solution suitable for monitoring the video quality of all HD transmissions, as well as Dolby® Digital and Dolby® E audio streams. We also required an instrument that was flexible and not intimidating to operators, while providing the utmost in current technology desired by our engineers. Videotek's HD test and measurement solution has been deployed in all of our QA positions as the de facto standard."

- Clyde Smith, senior vice president of broadcast engineering, research and development, quality assurance and metrics for TBS Inc.

WHAT'S NEW IN TEST & MEASUREMENT VIDEOTEK TVM-950HD

In keeping with a tradition of technical innovation, Videotek's precision TVM-950HD offers intelligent architecture that provides unparalleled performance and flexibility and sets a new benchmark for high-definition video and audio signal analysis. The feature-rich "950" provides waveform, vector, audio and picture all in one, convenient display. With back-lit controls and a compact half-rack configuration, the TVM-950HD is a perfect fit in any environment.

HD SELECTIONS

SUITEVIEW™ HD

Cost-Effective Multi-source Display Processor

CCS NAVIGATOR™

Advanced Graphical Navigation Software

MEDIANET™

Straightforward management of media assets across all your NEXIO server systems - in a single domain or multiple domains

VIDEOTEK

- VTM-450E HD/SD
Multi-format HD/SD-SDI On Screen Monitor with eye pattern
- VTM-440HD/SD
Multi-format HD/SD-SDI On Screen Monitor
- VTM-420HD/SD
Multi-format HD/SD-SDI On Screen Monitor
- TVM-950HD
Multi-format HD/SD-SDI Monitor with Integral XGA Display
- TVM-821D & TVM-321D/DC
Serial Digital Waveform Monitor, Vectorscope



[MORE INFORMATION AT WWW.LEITCH.COM]

[HD OVERVIEW GUIDE]

THE INDUSTRY'S BROADEST
LINE OF HD PRODUCTS

ABOUT LEITCH

Leitch Technology is a 34-year global leader in the design and distribution of high-performance video systems for the professional television industry. Leitch offers products and systems that enable operations of any size to streamline workflow, achieving a truly Integrated Content Environment for content production, processing, transmission, management and distribution and measurement. With a sole focus on and commitment to the television industry, Leitch provides premium customer support.

STANDARD WARRANTY

With every Leitch product, you'll receive a set of standard warranty services, backed by the manufacturer, which includes 24x7 technical phone support, After-Hour "Emergency" Support, 5-day Advance Exchange of Parts, Software Updates & Bug Fixes and Access to Technical Knowledge Bank. To maximize your product warranty, you can continue warranty services with the Basic Service package or upgrade your services to a Gold Service package, which includes 24x7 technical phone support and Next-day Advance Exchange of Parts for up to five additional years of coverage.

PROFESSIONAL SERVICES

At Leitch, we take our Professional Services business extremely seriously, offering integrated support solutions designed to help with every phase of your business. Our extensive service portfolio features Startup Services, including ReadyConfiguration Setup Services, QuickStart Commissioning and 90-day Elite Services; Operation Services, including Preventive Tracker, Educational/Training Program and RemoteLinX Monitoring Services; and Long-Term ServicePAKs, including Basic ServicePAK, Gold ServicePAK and Site ServicePAK.

At Leitch, we are committed to customer service excellence and strive to provide the highest level of support in the industry.

[MASTER YOUR MOVE TO HD WITH LEITCH]

EDITING

[VelocityHD™]
HD Non-Linear Editing

[VelocityNX™]
Craft Editor for NEXIO HD

[Inca Studio HD™]
Character Generator

[VelocityX™]
Laptop/Offline Editor for VelocityHD

SMALL AND LARGE ROUTING

[Panacea™ HD]
Small Routing

[Integrator® Gold]
Wideband Digital Multi-Rate Routing

SIGNAL PROCESSING (interface and conversion)

[6800+™ HD]
Modular Digital Processing

[NEO™ HD]
Advanced Processing

[X75™]
Up/Down/Cross Converter
and Frame Synchronizer

[Digital Legalizers]
Test and Measurement

MASTER CONTROL

[Opus™ HD]
HD Master Control

[DTP™]
Digital Turnaround Processor

[Inca Station™ HD / Inca Auto CG™ HD]
Master Control, Branding and Networked Graphics

BRANDING

[Inca Station™ HD / Inca Auto CG™ HD]
Master Control Branding and Character Generation

[DTP™]
Digital Turnaround Processor

[LogoMotion II HD]
Logo Generation and Branding

[6800+™ HD]
Modular Digital Processing

STORAGE AND TRANSMISSION

[NEXIO™ MTS Server]
MPEG Transport Stream Server

[NEXIO™ HD Server]
Scalable, Interoperable Server System

[DTP™]
Digital Turnaround Processor

[Digital Demodulator]
Professional ATSC Receiver

SIGNAL MANAGEMENT

[VTM™]
Video Testing and Monitoring

[TVM™]
Waveform Monitors and Vectorscopes

[SuiteView™ HD]
Multi-Source Display Processor

DIGITAL SIGNAGE

[InfoCaster™]
Digital Signage

See us at NAB
Booth# SU7805 & SU8100



VIDEOTEK®
A ZERO DEFECTS COMPANY



Camera lens

Canon HD Electronic Cinematography Lenses

Utilizes the Power Optical System featuring the X-Element, Hi-UD (High Index, Ultra Low Dispersion) glass and Flourite, which contribute to the lens' overall optical performance; the HJ21 has up to three times less focus breathing than any other comparable lens and with a maximum relative aperture (T Stop) of 2.1 .

516-328-5000; www.canonbroadcast.com

Booth: SU7814



Integrated high-speed networking platform

Harris NetVX

A key enhancement is a new MPEG-2 HD encoder that supports multiple HD video formats, including 1080i/29.97, 720p/59.94 and 1080i/25, as well as both standard 4:2:0 and 4:2:2 professional profiles; other upgrades include statistical multiplexing to enhance bandwidth efficiencies and support for constant bit rate to variable bit rate conversions of MPEG transport streams.

800-442-7747; www.broadcast.harris.com

Booth: C1907; SU10048

DVD media

Maxell Corp. of America DVD-R Plus 16X Series

Both new models feature 4.7GB capacity and support 16X write speeds for 200 percent more productivity; DVD-R Plus uses advanced proprietary organic dye recording layer; DVD-R BQ designed for post-production environment and is 40 times more scratch resistant and 20 times more dust resistant than standard discs.

800-533-2836; www.maxell.com

Booth: C8530

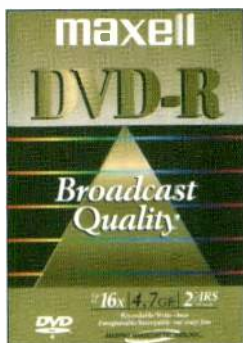

Graphics platform

FOR-A Corporation of America X-Presenter

For-A Corporation will be showcasing VertigoXmedia's X-Presenter PowerPoint CG solution; X-Presenter allows users to integrate broadcast-quality graphics and video into Microsoft PowerPoint presentations without using a scan converter; perfect for digital signage.

714-894-3311; www.for-a.com

Booth: C4519



Focus assist for lenses

Fujinon Precision Focus Assist system

A built-in feature that addresses precise focus issues in HDTV production stemming from the format's shallow depth of focus and the lack of size and resolution in camera viewfinders; will be available on the company's XA101x8.9BESM HD zoom, HA22X7.3BRD HD EFP lens and the HA13x4.5BRD-S28K HD wide-angle lens.

847-945-8923; www.fujinon.com

Booth: SU6370

Desk system

Middle Atlantic Products LCD Monitoring Desk

Designed to provide more usable space in a smaller footprint; optimized for use with LCD screens; modular design allows economical additions and limitless configuration choices; 64in and 48in widths available; optional lower light bridge allows better line of sight to video monitor walls.

973-839-1011; www.middleatlantic.com

Booth: SL3606

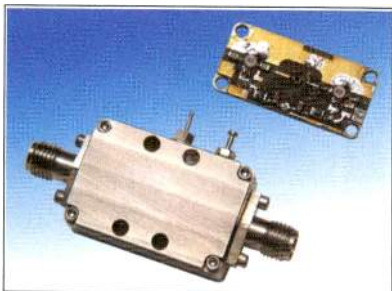

Multipliers ▲

MITEQ SYS2XA4509H and SYS3XA1957H

Available in either carrier form or standard SMA housing form; model SYS2XA4509H is a doubler with 10 dBm output from 6GHz to 12GHz, for a +5 dBm input; model SYS3XA1957H is a tripler with 12 dBm output from 4.2GHz to 7GHz, for a +4 dBm input; both units operate on +5 volts and have typical input harmonic suppression of 15 dBc; both measure .920in x .444in x .125in in carrier form.

630-759-9500; www.miteq.com

Booth: C6546

DV tape

Panasonic Advanced Master Quality (AMQ)

Includes a new surface treatment process that improves the thickness, quality, reliability and durability of the tape's diamond-like coating and improves interaction with its dry lubricant; the new Mini-DV and standard DV tapes offer better still photo performance and improvements against head clogging; provide an easy-to-write-on cassette label where the label is already affixed to the tape, and a two-way open soft case.

201-392-4127; www.panasonic.com/broadcast

Booth: C3617

High-power UHF ATSC transmitter ▶

Harris PowerCD

Features E2V's high-efficiency ESCIOT tubes, Harris' APEX exciter with its real-time adaptive correction for linear and nonlinear distortions, and other Harris filtering and correction techniques; liquid cooling minimizes expenses by reducing a transmitter facility's heat load and related cooling costs.

800-442-7747; www.broadcast.harris.com

Booth: C1907; SU10048



Camera lens

Canon IFpro lenses

Internal Focus enhances optical performance and provides user benefits, including improved chromatic aberrations, increasing resolution; no sensitivity to changes in object distances; a decrease in flare by use of a square hood; a higher level of creative filter work; no affect on the focusing operation when heavy optical accessories are attached at the front of the lens.

516-328-5000; www.canonbroadcast.com

Booth: SU7814



Nonlinear editing ▲

Prime Image Time Tailor

Designed to meet requirements of post production houses and their clients; reduces content up to 8 percent with no loss of program integrity; no detectable change in video and audio quality; maintains closed captioning; operates in real time, cutting work time by 70 percent; features insert, delete, move black slugs.

408-867-6519; www.primeimageinc.com

Booth: C5614



Amplifier ▲

MITEQ LNA Model AMF-2F-00500300-25-26P

A high dynamic range, low noise amplifier; operates over the 500/3000MHz communications band; has +26 dBm (1 dB) output power, an IP3 of +39 dBm and a 2.5 dB NF; makes an ideal Low Noise Front end with minimum distortion; gain is 29 dB Min., +/-2.5 dB flatness and operates from +15 VDC at 650 mA; size is 1.22in x .88in x .35in.

630-759-9500; www.miteq.com

Booth: C6546

Define the Future

HD/SD Switchable Product Lineup

Guarantees a reliable future with HD/SD Switchable Products. Join us at NAB2005 to see and experience why so many broadcasters are choosing FOR-A.



Video Switchers

Introducing the next generation of our popular HD/SD switchable HANABI series. Now, our 3D DVE and color correction functions are available for the 1 M/E HANABI. FOR-A, providing the ultimate switcher for your versatile production requirements.



Broadcast Graphics

Debuting our technically advanced and cost-effective VRF-7CHS chroma keyer. We're also exhibiting the newest version of digiStorm, a virtual studio solution born out of our technical collaborations with Brainstorm Multimedia. Don't miss a hands-on demo of VertigoXmedia's Xpresenter.



Frame Synchronizers

We'll be showing UFH-70FS with color correction, the newest addition to our industry proven frame synchronizer product lineup and FA-128, the world's first FS with a 14-bit internal processor. Come and see the difference.



Modular Products

Several HD/SD switchable products have been added to the UFH Series lineup, including frame synchronizers, still scores, title generators, distribution amplifiers, upconverters, downconverters, MUXs, DeMUXs, and more...

Visit **FOR-A @ NAB #C4519**

www.for-a.com



HD camera ▲ **Panasonic AK-HC900**

Weighs 3.9lb; provides astounding color reproduction accuracy and its compact size opens new avenues for HD sports coverage, television program production, business communications, and government and scientific imaging; offers a 720-line HD output at 60 progressive frames per second; employs three 2/3in 1 million-pixel (1280 x 720) IT CCDs with dramatically improved dark and highlight image quality.

201-392-4127; www.panasonic.com/broadcast

Booth: C3617



High-definition synchronizer ▲ **Prime Image HD/Sync**

Offers I/O flexibility, supporting standards from SD through HD in either analog or digital formats; incorporates 10-bit processing, digital FIR filtering, a 3-D adaptive COMB filter, full proc amp controls, color correction, and adaptive noise reduction; other features include a test signal generator, frame store with linear keyer, dual buffer still store with dissolve/clean cut, and an animated logo inserter.

408-867-6519; www.primeimageinc.com

Booth: C5614

HD and SD encoder **Radyne HE4000**

In its minimal configuration, the unit can simultaneously encode one HD and one SD video stream as well as up to four stereo audio pairs; can be equipped with an advanced satellite modulator, making it ideal for both contribution and distribution; includes front-panel video and audio confidence monitors that provide verification of input sources; offers 1Mb/s to 160Mb/s encoding.

602-437-9620; www.radn.com

Booth: SU9929

Fluid head **Sachtler DV II**

For use with MiniDV camcorders; easy to operate, lightweight, and automatically create clean pictures; weighs 4.7lb; payload is 0.8kg to 3.6 kg / 1.8lb to 7.9lb.

516-867-4900; www.sachtler.com

Booth: C7319B

Camera lens **Canon HDTV and SDTV Remote Control Lenses**

Based optically on the Canon HD ENG/EFP lenses of the same specifications, with the advanced capabilities of the HDxs system and the Power Optical System with the X-Element; the SD line includes the J22ex7.6B ITS, J17ex7.7B ITS, and wide angle J11ex4.5B ITS; all six lenses come with a manually controlled 2X extender, and can be paired with an optional motorized version.

516-328-5000; www.canonbroadcast.com

Booth: SU7814



Convertible camera ▲ **Panasonic AW-E860**

A native 16:9 2/3in 3-CCD convertible camera, and complementary accessories to bolster its line-up of remotely-controllable, multi-purpose cameras; new accessories include the AW-PH400 high-speed pan-tilt head, AW-PH360 pan-tilt head, the AW-RP400 pan-tilt controller, AW-RL400 rolling unit, AW-CB400 camera control unit and AW-RC400 cable compensation unit.

201-392-4127; www.panasonic.com/broadcast

Booth: C3617

Tripod system **Sachtler ENG 75/2D**

Tripod systems for DV cameras; compact dimensions — weight is 2.3kg / 5.1lb, payload is 20kg / 44.1lb, height minimum and maximum are 33.5cm to 146.5 cm and 13.2cm to 57.6cm; transport length is 65cm/25.6; the Touch & Go system enables fast changeover, so camera operators can go from using the tripod to shooting from the shoulder within a matter of seconds; in combination with fluid heads DV 4 II and DV 2 II, it is ideal for MiniDV camcorders starting from around 1kg / 2.2lb.

516-867-4900; www.sachtler.com

Booth: C7319B

Create with EDIUS



Edit HD, SD, HDV, and DV

EDIUS includes hundreds of features offering powerful, streamlined, mixed format editing, a flexible user interface, and full 1080i realtime output to a monitor or deck:

EDIUS	NX	SP	SD	HD
DV	✓	✓	✓	✓
HDV	✓	✓	✓	✓
SD (uncompressed)			✓	✓
HD				✓
IEEE 1394 (FireWire) w/deck control		✓	✓	✓
Composite Video Output	✓	✓	✓	✓
Composite Video Input	✓		✓	✓
Component Video Output		✓	✓	✓
Component Video Input		✓	✓	✓
RS-422 Deck Control		✓	✓	✓
AES / EBU Audio			✓	✓
SD SDI			✓	✓
HD SDI				✓



www.canopus.com
or call 1-888-899-EDIT

canopus[®]

Create. Purpose. Deliver

ESOE. All trademarks or registered trademarks are properties of their respective holders. VA080205-D

Transmitter

Screen Service Italia MDS/ MMDS Systems

Microwave Multipoint Distribution Systems; designed for the transmission of amplitude-modulated analog television signals, in the 2.0GHz to 2.7GHz band; available both in the separate amplification version for each individual channel and in the common amplification version for combined groups of channels; the separate amplification systems consist of a transmitter and, where necessary, an RF amplifier or a power combiner in the case of multichannel transmission.

+39 030 2582225; www.screen.it

Booth: N3922



Dockable solid-state recorder ▲ Grass Valley Venom FlashPak

Created for the Grass Valley Viper FilmStream Digital Cinematography camera; captures uncompressed output of the Viper camera in a lightweight solid-state system that is compact, dockable, and rugged.

503-526-8200; www.grassvalley.com

Booth: SU7823 and SU8434

Satellite data service

SES Americom IPlex solution

Features LAN-to-LAN connectivity between a central office and numerous remote sites for e-mail transfer, database applications and more; videoconferencing between any number of designated offices, via satellite or SES AMERICOM's terrestrial backbone network; multicast delivery of customer data, files and audio/video program streams from a central office to a customer's remote sites or between remote sites.

609-987-4000; www.ses-amicom.com

Booth: C5245

Digital mixing console

Studer OnAir 500 Modulo

Consists of one or two fader modules, one master module, the meter bridge and a 19in electronics rack, resulting in a six-fader or 12-fader mixing desk; is based on the same platform as the OnAir 500 in its fixed frame version but also offers the freedom to place the individual modules wherever it is most convenient for the users.

+41 1 870 75 11; www.studer.ch

Booth: N3626



Video server ▲

360 Systems Image Server

New features include Advanced Playlisting software, a 1.6Tb drive array with 170 hours of storage, embedded audio, remote-location of the server GUI, and built-in frame sync; new Advanced Playlisting software provides clear, on-screen presentation and an intuitive user interface that enables users to quickly build and edit commercial breaks, news rundowns and clip lists; Playlist features include drag-and-drop list building and editing, editing while running, on-the-fly use of Pause, Skip, Hold and Next functions.

818-991-0360; www.360systems.com

Booth: SU11011

Multiformat, HD SDI monitor

Videotek TVM-950HD

Offers high-resolution color LCD display; provides accurate, stable display of single or multiple waveform, vector, gamut, audio, picture, timing and data analyzer functions in quadrant or full-screen views; capabilities include advanced analysis tools, an extensive alarm set with peak level reporting, metadata, EIA-608, 708 closed caption, Teletext and XDS displays.

416-445-9640; www.videotek.com

Booth: SU7805; SU8705

System service and support

Grass Valley OnCall

Service level agreement limits broadcasters' exposure to potential equipment failures and helps them manage unplanned service costs; customized to user requirements.

503-526-8200; www.grassvalley.com

Booth: SU7823 and SU8434



Transmitter ◀ **DMT USA 1kW DTV UHF Transmitter**

Air cooling; LDMOS technology; broadband standardized design; "dual-cast" option; built-in output filter.

888-912-TEAM; www.dmtonline.us
Booth: C3016

Satellite data service **SES Americom Digital C**

An end-to-end video MCPC solution that offers programmers a choice of popular digital platforms, as well as customized bandwidth in a multiple-channel-per-carrier format (MCPC); designed to facilitate the economic distribution of compressed, digital cable programming services.

609-987-4000; www.ses-amicom.com

Booth: C5245



Media server ▲ **Avid Technology Airspeed**

A cost-effective, intelligent replacement for VTRs or any older server technology that no longer fits your budget or your plans; has two-channel DV25, DV50, and IMX50 playout capability; compact, its modular 3RU form factor reduces space requirements and its proven IT-standard design integrates easily with your existing equipment, applications, and processes – including third-party automation systems.

978-640-3594; www.avid.com

Booth: SL600

Wireless microphone **Azden 100LT**

Offers 63 user-selectable channels in the 794MHz to 806MHz band; includes the 100UPR receiver and 10BT body-pack transmitter, both of which are housed in small, 3 7/8in x 2 3/8in x 13/16in cases, ideal for smaller digital cameras.

516-328-7500; www.azdencorp.com

Booth: N4222

Zandar

TECHNOLOGIES

GET THE COMPLETE PICTURE...



...WITH ZANDAR TECHNOLOGIES

Zandar Technologies is a world leader in the provision of multi-window display solutions – with everything from simple screen splitters to advanced visual display systems. The virtual monitor wall concept is proven – don't be left with an outdated monitor stack, when you can have a display wall that is configurable, dynamic, and controllable. We have product to match your specific input sources, for display devices from CRT to rear projection, with extensive control options & interfaces. With Zandar you can be sure of excellent image quality, unsurpassed system flexibility and genuine value.

Fusion Series: Modular 3RU (26 inputs) and 1RU (8 inputs) racks; input cards for composite video/Y-C, SDI, HD-SDI and VGA sources; high resolution RGBHV output.

Predator Series: Fixed configuration solutions for 4, 12 or 16 video inputs; select from composite video, Y-C, SDI or HD-SDI inputs; RGBHV output.

DX Series: For 4, 8, 12 or 16 composite or SDI video inputs (auto-detecting); high quality composite, component, SDI and VGA outputs.

MX Series: For 4, 8, 12 or 16 NTSC or PAL inputs; composite, component or VGA outputs; preset layouts or custom layouts on request.

Think Zandar for:

- Master Control Rooms
- Command & Control
- Security & Surveillance
- Broadcast Multi-video
- Mosaic & Interactive Channels
- Audio Visual Presentations
- & Audio Monitoring
- Video-conferencing



FusionPro



DX



Predator

HEADQUARTERS:

Bracken Court, Bracken Road,
Sandyford, Dublin 18, Ireland.

Tel: +353 1 2938 966 Fax: +353 1 2936 955

E-mail: sales@zandar.com

US OFFICE:

1970 E. Osceola Parkway, No. 330,
Kissimmee, FL 34743, USA.

Tel: 321 9390 457 Fax: 321 9390 458

E-mail: advancedms@msn.com

WWW.ZANDAR.COM

Visit us at NAB, Booth #SU8367

broadcastengineering.com

Digital asset maximization initiative Grass Valley dMAX

Product expands company's Grass Valley C2MD program for centralized facility monitoring and management; new service level agreement gives users flexibility to implement multi-distribution workflows.

503-526-8200; www.grassvalley.com

Booth: SU7823 and SU8434

Monitoring and control over IP system

Miranda Technologies iControl

Adapted for key applications including incoming food management, multichannel HD/SD master control, and network operation centers for cable, satellite and IPTV operators; leverages industry standard SNMP protocols for monitoring and control of video as well as surrounding transmission, networking and building infrastructure.

561-477-6124; www.miranda.com

Booth: SU7841

Display processor

Zandar Technologies FusionPro

A multi-window display processor designed to accurately render multiple video and computer graphics sources to high resolution displays; currently supports resolutions up to SXGA (1280x1024) with pristine image quality achieved through a combination of 10 bit RGB outputs, an advanced video processing engine and dynamic phase adjustment for accurate pixel mapping; founded on a modular architecture consisting of a range of plug in processing cards and associated I/O.

+353 1 293 8966; www.zandar.com

Booth: SU9311

Software control platform

PRO-BEL PROCION

Contains major new features for the management of broadcast systems and media workflow; allows customers to design their own user interfaces; supports router control, modular product monitoring and control, media management, automation and master control.

631-549-5159; www.pro-bel.com

Booth: SU10730

Router

PRO-BEL SIRIUS GOLD

Features router sizes to 512x512; ability to mix and match different signals within the same frame; incorporates built-in analog and digital signal conversion for both video and audio signals; formats available are SDI/HD/analog video and AES audio.

631-549-5159; www.pro-bel.com

Booth: SU10730

MSDC-IOT transmitter

Thales Broadcast & Multimedia DCX Paragon

Supports DTV, NTSC and multiple manufacturers' tubes in both water- and oil-cooled versions; features the patented Soft Arc Technology, which eliminates the need for a crowbar and substantially increases the transmitter's overall reliability.

413-998-1100; www.thales-bm.com

Booth: C4508



Monitoring and control software Grass Valley NetCentral 4.1 and Grass Valley XMS

NetCentral 4.1 facility monitoring software enables technicians to easily evaluate system software, hardware, storage, and devices in their facilities and across their networks; XMS network management for digital content delivery systems enables users to control and monitor digital content delivery applications over satellite, terrestrial, DSL or cable.

503-526-8200; www.grassvalley.com

Booth: SU7823 and SU8434

Broadcast automation

Fission Software software

Integrated extensible software has the ability to digitally capture, insert, and manage and control the blocking of commercial spots and programming in all types of broadcasting facilities, including network local television stations, satellite ground stations, and remote repeater stations; created to replace tape playback systems and modernize station workflow.

203-791-3866; www.fission-sw.com

Booth: C9807



CALL ANY TIME.

We want to be your first call. That's why SES AMERICOM is building what we think you'll agree is the best 24x7 occasional broadcast service with our OCCASIONAL ALWAYS ON service.

With the acquisition of Verestar teleports, we're now providing you with expanded and improved occasional broadcast solutions. You get access to more satellites and ground facilities, improved online booking, dedicated account representatives, and great customer service.



OCCASIONAL
An SES AMERICOM Broadcast Service

Our experienced staff will work with you 24x7 to solve your occasional needs for special events, breaking news, entertainment, sports and teleconferences. Our tradition of excellence,

based on 30 years of industry leading service, assures we'll be here when you call.

OCCASIONAL ALWAYS ON delivers an expanded domestic and global network of distribution services –

full-time and ready to serve. We offer 120+ fixed and agile antennas spread among five major earth stations (two on

the West Coast, two on the East Coast, and one in Europe). We also have multiple access and connectivity to the AVOC in Washington, 60 Hudson in NYC, and BT Tower in London. SES AMERICOM is North America's leading trusted and reliable source for your satellite-delivered distribution needs.

Call any time for OCCASIONAL ALWAYS ON's complete teleport and satellite services: 800-732-3273 or +1-609-987-4144. For more information visit us at NAB 2005, Booth C5245, or online at: www.ses-americom.com

SES AMERICOM
An SES GLOBAL Company



Broadcast server ▲ **360 Systems Image Server 7000**

Full-featured, six-channel broadcast server; designed for satellite ingest, production and play-to-air; the 2-input, 6-output multi-format design supports MPEG-2, DV and TARGA graphics; up to 400 hours of internal RAID storage is available (accessible from the server front panel), plus redundant, hot-swappable power supplies; design supports MPEG-2 broadcast formats to 50Mb, in I-frame and long-GOP modes.

818-991-0360; www.360systems.com

Booth: SU11011

HD lenses **Thales Angenieux 70X HD OB/Sports Lens**

Designed for studio and sports applications; features unique advanced display system; new 26X HD Telephoto Zoom Lens also displayed, which provides extended focal range.

972-812-3858; www.angenieux.com

Booth: C5107



Portable HD monitor for Sony HDV camcorders ▲ **ERG Ventures HDM-EV85**

8.4in monitor is designed for the HDV camcorder, Sony HVR-Z1U and HDR-FX1; offers enhanced color, frame markers and a memory preset function; its HD analog input enables the HDV to connect to the HDM-EV85 directly; accepts most popular video image formats; with two 7.2V batteries, the monitor lasts for 2.5 to 3 hours.

949-263-1630; www.erg-ventures.com

Booth: SU10134



Editing system ▲ **Avid Technology Media Composer Adrenaline HD**

HD, SD and DV editing and finishing; features include 10-bit video capture and playback, real-time HD and SD multicamera editing and support for the most popular HD frame rates.

978-640-3594; www.avid.com

Booth: SL600



Cable connectors ▲ **Pomona Electronics XLR connectors**

Features a clamping mechanism that withstand 100lb of pull without disconnecting the cable; designed to deliver high-quality, low-noise audio transmission; feature gold contacts and black nickel coating to reduce reflection; are also available on 10ft to 25ft foot cable assemblies made with Belden 1172A four-conductor Star Quad, low-impedance cables.

800-490-2361; www.pomonaelectronics.com

Booth: C11814

Light **Kino Flo ParaBeam Zip 400 and 200**

Optics compress the focal range of the light wave to produce a broad soft source along the horizontal axis and a narrow beam on the vertical axis; measures 24inx 24in; can light a four-person news desk from approximately 15ft away; sweeps back the darkness in the foreground without washing out the foreground on the set.

818-767-6528; www.kinoflo.com

Booth: C10437

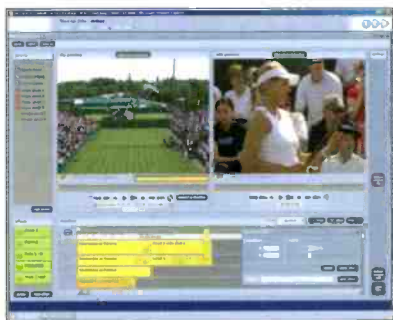

Broadcast software ▲
ICF – Interactive Content Factor

Product line designed for the ingest, management, production and delivery of digital content; HSM is an add-on module to ICF enabling near line archiving in partnership with ADIC; ICF inabox is a complete ICF in a mobile flight case; NetEdit SDK is a suite of components that enables broadcasters and integrators to build proxy video editing applications using the Windows Media 9 Series platform.

617-783-9032; www.twii.net

Booth: SL2461



Transport stream generator ▲
Rohde & Schwarz DVM400

Upgrade offers transport stream generator/analyzer/recorder functionality in one box; MPEG-2 analyzer and monitor with up to four stream inputs now includes MPEG-2 generator/recorder/player and data broadcast analysis option that includes DVB-H functionality.

888-837-8772; www.rohde-schwarz.com

Booth: C2633

Antennas

Dielectric 7C, 7P, and 7S Series
 700MHz antennas

A full line of antennas designed for the 700MHz spectrum; product line includes slotted coaxial antennas as well as panel antennas; all antennas in this new product line can be horizontally, vertically, or circularly polarized.

207-655-4555; www.dielectric.com

Booth: C7807

Why Pay Extra for Service and Support?

- ◆ **Ten-Year Warranty**
- ◆ **24 Hour Service / Support Line**
- ◆ **Full Support of All Legacy Products**

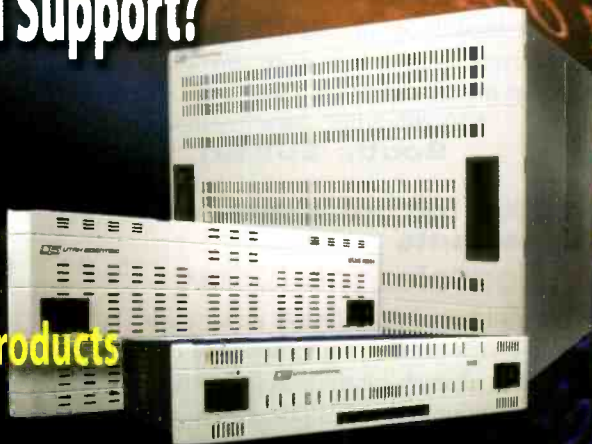

Utah Scientific gives you all three at no charge.

When you are choosing a routing or master control system, remember to consider the cost of support.

Only Utah offers these first-class support services to all customers at no additional charge.



New Directions in Digital Switching

www.utahscientific.com

Transmitters

Thales Broadcast & Multimedia Ultimate/Optimum

Analog, digital, air-cooled and liquid-cooled versions are available; the solid-state architecture is easily upgradeable from NTSC to DTV.

413-998-1100; www.thales-bm.com

Booth: C4508



Multi Channel MC switcher ▲ NVISION NV5128-MC

New master control switcher/router with enhanced squeezeback effects; field-upgradeable from SD to HD; new single-module SD processor with A/B mixer, 3 external keyers, built-in logo store, providing up to eight channels of master control in a single 8RU frame.

530-265-3055; www.nvision.tv

Booth: SU9301

Consoles for broadcast environments

TBC Consoles intelliTrac

Laterally sliding and positionable rack turrets easily upgraded or relocated as equipment and operational requirements change; continuous front and rear device tracks allow unlimited lateral positioning of critical equipment; articulating arms for distance, height and tilt control may be utilized for mounting flat panel monitors, speakers, phones and task lighting.

631-293-4068; www.tbconsoles.com

Booth: SU6831

Telestration tool

Chyron CodiStrator

An easy-to-use digital telestration tool; provides live presentation capabilities for highlighting over video, including sports, weather, news and security.

631-845-2000; www.chyron.com

Booth: SU7158

Video evaluator

K-WILL VP21S and VP21H

Performs detailed measurements and comparisons of reference and copies videos on a real-time and fully automated basis; offers pixel-by-pixel comparison and provides more than 150,000 real-time measurements on each field of video.

650-329-9988; www.kwillcorporation.com

C8941

Video display system

Chyron ChyTV

A low-cost informational display video system; users can display messages anywhere there's a television without disrupting the video source; displays a variety of graphic and text information overlaid or surrounding a live video region; the video region can be resized and repositioned from page to page with smooth, dynamic transitions.

631-845-2000; www.chyron.com

Booth: SU7158

HD SDI, SD SDI, analog and audio signal monitor

Hamlet LCD Scope 292

LCD display; produces a range of unique HD-SDI, SDI, NTSC and PAL composite, CAV, YC and DV signals, can be used in a variety of environments; ideal replacement for existing or failing CRT; is only 160mm deep.

+44 1494 729728; www.hamlet.co.uk

Booth: C7031

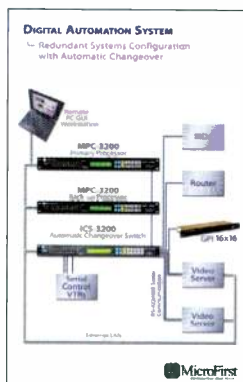

Digital automation system ◀

MicroFirst Engineering D.A.S.

Provides meta data management and device control through real-time automation and management system; offers sophisticated logging functionality, dynamic near real time integration, full-functioned

graphical device control, distributed or centralized IP control, monitoring and maintenance of WAN television system as well as interfaces to near line storage and archive management systems.

201-651-9300; www.MicroFirst.com

Booth: SU9643



CWDM fiber system ▲
Network Electronics 16-Channel CWDM system

Offers 16 independent SDI or HD-SDI channels multiplexed onto a single fiber strand; based on the company's new dual optical converters and widely deployed ultra-compact 8-Channel CWDM filter, the low power design consumes only 30W and operates without fans; features dual redundant AC/AC, AC/DC, or DC/DC power supplies with dual mains and front-loaded, hot-swappable optical transmitter and receiver cards.

800-420-5909; www.network-electronics.com

Booth: SU9311



Modular Broadcast System ▲
NVISION Synapse

Provides an unprecedented level of multi-function signal processing in a flexible, modular, remotely controllable platform; family is comprised of more than 100 modules, including 20 that support HD-SDI.

530-265-3055; www.nvision.tv

Booth: SU9301



Character generator ▲
Chyron Duet

New additions have been made to the line; use for HD, 3-D graphics; each product includes Lyric content creation and playout software; enables 3-D graphics, stunning real-time animations, and fast creation of advanced messages.

631-845-2000; www.chyron.com

Booth: SU7158

Crawl solution
Chyron DynaCrawl

A 2RU system featuring a simple-to-use GUI that enables quick creation of eye-catching tickers and crawls plus time and temperature display, complete with dynamic data fields and 3-D object animations; allows user to insert up to four news elements fast.

631-845-2000; www.chyron.com

Booth: SU7158

MicroFirst
Automation that Works

DIGITAL Automation SYSTEM

"It really works!"
- Bill Ziegler, CTO WLVZ

"Far more efficient!"
- Joe Glynn, VP Eng. WVIA

"Flexible, reliable, & stable!"
- Mike McGraw, Dir. Development Clear Channel Spectacolor

"Easy to use!"
- Paul Byers, Dir. Eng. & Ops. WOED

Modular Expandability:
Schedules, Devices, Workstations

Comprehensive Intuitive G.U.I.

Context Sensitive On-Line Help

Remote Control, Diagnostics, and Upgrades

Dynamic Logging, Error Checking, and Alarming

24/7/365 Technical Support

Interface to any Traffic System

NAB Booth #SU9643

www.microfirst.com

Automation that Works!



Router ▲ **NVISION NV5256**

Expandable 256 port machine control router; 8RU bi-directional port router for SMPTE 207M, RS-422 or RS-232 data, expandable to 512 ports using two frames.

530-265-3055; www.nvision.tv

Booth: SU9301

Waveform, vector and audio monitor

Hamlet Flexiscope

Uses a built-in 3.5in diagonal high-quality TFT display to show the picture in 4:3 or 16:9 formats; also shows conventional waveform, vector and audio displays together with data analysis; easy to plug-in input option modules allow operation in all current formats and enables future standards to be accommodated

+44 1494 729728; www.hamlet.co.uk

Booth: C7031



Mobile Transport Enclosure ▲ **Network Electronics MOT-BOX**

A compact 3RU, lightweight mobile transport enclosure; houses all flashlink optical transport, signal processing and distribution cards including WDM/CWDM; its rugged design and connector panel, including an expanded beam hermaphroditic fiber connector, make it the ideal choice for all mobile and outside broadcast applications; options include a fiber reel with MIL specified tactile fiber, AC and DC power supplies, and a monitoring/alarming function via Network's GYDA controller.

800-420-5909; www.network-electronics.com

Booth: SU9311

HD input interface

Omneon MediaPort 4010

Provides an input interface for HD material by ingesting an incoming ASI-based transport stream and demuxing the content into HD MPEG essence material; users can select the HD encoder of their choice to ingest HD MPEG material while using the integrated HD playback capability provided by the MultiPort 4000 series or MultiPort 4100 series for direct playback.

408-585-5000; www.omneon.com

Booth: SU10724



DTV data broadcasting system ▲ **Triveni Digital SkyScaper**

Allows broadcasters to offer new services by delivering various types of digitized content through their DTV signals; supports streaming media, web pages, interactive TV, and any other type of digitized data; features receiver targeting, encryption, and support for multi-station networks; can schedule content for distribution simultaneously through many DTV broadcast streams in a multi-station network.

714-378-5841; www.trivenidigital.com

Booth: SU11411



Television automation software ▲ **Digital Transaction Group Eclipse**

Surpasses traditional automation with a new technology framework and architecture; employs standard IT networking, non-proprietary hardware and high-performance SQL database.

800-243-2001; www.dtgtv.com

Booth: SU11533



Wireless intercom system

Eartec TD 900

Available as a stand alone system and can interface with wired intercoms such as ClearCom, RTS, and Telex; a simple interface allows wireless remotes to communicate as though plugged in with a cable; operates without base station repeaters, is powered by rechargeable ni-cad batteries, and has a 1/4mi range.

800-399-5994; www.eartec.com

Booth: C2643



Decoder

Omneon MultiPort 4000 Series

HD MPEG decoders for integrated playback of HD material ingested into an Omneon Spectrum media server; provides one or two independent channels of HD playback; capable of supporting material in either 4:2:0 or 4:2:2 profiles; includes outputs for HD-SDI video, audio, timecode and control.

408-585-5000; www.omneon.com

Booth: SU10724



Videotape recorder

Sony SRW-5500

Simultaneously provides HD, SD and Digital Betacam output; can record and playback HDCAM and HDCAM SR tapes at 24PsF, 25PsF and 30PsF, as well as at 1080/60i, 1080/50i and 720/60p; captures content to tape at 440Mb/s at 10-bit depth using the MPEG-4 Studio Profile compression scheme; records 12 channels of 24-bit uncompressed audio; features metadata handling, dynamic tracking playback, pre-read, and confidence playback and recording.

800-686-SONY

www.sony.com/professional

Booth: SU6406



PSIP generator/ Metadata management

Triveni Digital GuideBuilder

Metadata management systems; helps broadcasters comply with the ATSC PSIP standard, retain and enhance their market branding, and protect their channel identities with on-screen EPGs; supports the distribution of SCTE 35 digital cue tones and network program information, networks and affiliates can synchronize splicing between local and national programming while delivering up-to-date information.

714-378-5841;

www.trivenidigital.com

Booth: SU11411

Monitor Video Quality at the Pixel Level

Get reliable answers about the quality of your feed. You'll see differences in signal quality immediately – and be able to do something about it.

Eliminates concerns about human error, equipment malfunction and system failure. Our products can provide automated monitoring of video quality at the pixel level in real time.

K-WILL supplies a full line of high quality test and monitoring equipment that give broadcast engineers a forensic view of the signal they're putting out and the power to make immediate adjustments.



DigitalTV Magazine's "EDITOR'S PICK OF SHOW" AT NAB-2004 TSI-2000 provides centralized monitoring of video networks with automated, real-time assessment of the quality of MPEG-2 video transport streams.

QuMax-2000's flexible architecture can be customized for real-time on-air quality monitoring, dubbing and inspecting video quality written to servers.



Recommended by ITU Document J.144 The VP series includes the VP21S, which performs before and after quality evaluations in real-time of SD video. An HD product is also available.



K-WILL Corporation

100 Hamilton Ave., Suite 103

Palo Alto, CA 94301

PH: (949) 553-9701

salesus@kwillcorporation.com

www.kwillcorporation.com

See us at NAB, Booth C8941



Half-rack VTR ▲
Sony HDW-S280

New version includes the addition of 24p playback and recording capability; the upgrade is designed to create a lower cost of entry into HDCAM 24p production; is designed for ENG, OB van and field production applications; features 1080i/59.94/50, switchable operation; offers legacy support and upconversion for Sony's Betacam, Betacam SP and Betacam SX formats.

800-686-SONY; www.sony.com/professional
Booth: SU6406



Media server ▲
Omneon Spectrum media server

Delivers unparalleled scalability and modularity; capable of supporting both real-time (isochronous) broadcast connectivity and non-real-time (asynchronous) network connectivity; gives broadcasters the freedom to use multiple formats and applications simultaneously, with the compatibility required to support existing systems and add new services easily.

408-585-5000; www.omneon.com
Booth: SU10724

Handheld spectrum analyzer
Rohde & Schwarz FSH Family

Models go up to 6GHz; provides analog and digital TV measurements; performs true power measurement with external power sensors.

888-837-8772
www.rohde-schwarz.com
Booth: C2633

Dual
Net
OE-

Provi
packag
provid
receiv
DVB-t
wavele
clocke

rters
ics SDI-EO-2/
2/OE-2

d lower in a compact 2 RU
functionality and flexibility;
including high sensitivity
er for long distances, full
n crossover allowing
cy switching, and re-
formats.

-5909
electronics.com
U9311

HD f
Kod

A 16mm film system designed for cost-effective production of content in either SD or HD television format; it packages a new type of film with advanced hybrid motion imaging processing technology utilizing proprietary Kodak color science; it combines KODAK VISION2 HD Color Scan Film 7299 used in conjunction with a KODAK VISION2 HD Digital Processor.

HD System

855-781-7754; www.kodak.com/go/motion
Booth: C6226

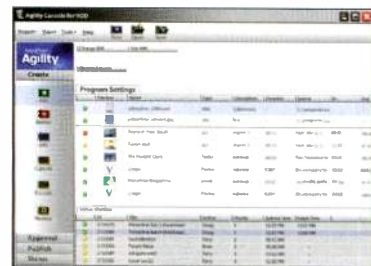

Video-on-demand
production software ▲
Anystream Agility VOD

Enterprise-level product; allows content producers to serve VOD outlets; designed in response to demand from broadcast customers for a way to create and deliver content to burgeoning video-on-demand outlets affordably as opposed to outsourcing.

703-450-7030; www.anystream.com
Booth: SL3316

Router integration
Euphonix

Integration of consoles with facility routers enabling audio and panel-controlled router operators to have independent control of every source on the system.

818-766-1666; www.euphonix.com
Booth: N3616

ADC Broadcast Products for Digital, High-Definition and IP-Based Audio and Video





Worldwide, HD is finally coming of age. Consumers are eager for HD TV and audio, and new entrants in production and distribution are working hard to fill the demand. With lower price points and more options, consumers are making the switch to HD TV.

Consumer expectation is driving a new standard for what's acceptable quality, and the benchmark is extremely high. And with HD DVD waiting in the wings, broadcasters have an even greater challenge to compete.

Many of the world's leading broadcasters turn to ADC to ensure the highest possible quality available. For over 50 years, ADC has led the industry in audio, video and data-patching products. Designing, engineering and manufacturing virtually all of its own components, ADC is established as a premier provider of these critical industry products.

All of ADC's products are designed for outstanding performance in real-world situations. ADC engineers understand typical industry applications and create products to solve the difficult problems other manufacturers prefer to overlook.

From our durable patchbays and jackfields to our precision jacks and connectors, consistent quality is the hallmark of everything ADC produces. And everything at ADC is built to last, from the corrosion-resistant nickel plating on our patch plugs to the tough steel chassis of our patch panels.

ADC broadcast products include:

- UniPatch® Modular Patching Systems
- ProPatch™ Professional Audio Patchbays and Broadcast Jackfields, Video Patch Systems and Optical Patch Systems
- Integrated Cable Organization Network (ICON®) Systems
- RF Worx® SignalOn™ RF Signal Management Solutions
- Ethernet and Data Connectivity Solutions
- Fiber Connectivity and Cable Management Systems
- Connectors and Accessories

The next few pages highlight a small portion of the diverse products that ADC has to offer. For the best possible quality for HD production and distribution, turn to ADC for patching and IP infrastructure solutions. For a complete catalog or to speak with an ADC representative, contact us by calling 1.800.336.3891 ext. 20000 or by visiting www.adc.com/broadcast.



Products You've Been Waiting For

ADC is the leader in innovative patching products because it listens to the needs of its customers. As a result, new and exciting products have been developed to enhance the performance and durability of your broadcast infrastructure.

Pro Patch™ Programmable Series

The ultimate audio patch panel is now a reality. The new Pro Patch Programmable patching system (patent-pending) combines the ruggedness and reliability of true WECO-compliant jacks with a precision DIP switch, enabling users to change normalling and grounds quickly and easily. Specifically designed for tough mobile environments, the ultra-lightweight Pro Patch Programmable panel weighs about six pounds and is only five-inches deep.



ProAx™ Triaxial Camera Connectors

For years, the industry has been locked into connector designs that are difficult to terminate, and even more difficult to field repair. ADC's line of ProAx Triaxial Camera Connectors will change the way you think about this component forever. Field repairable center conductors eliminate the need to restrip. O-rings protect the signal path against moisture. The connectors have fewer parts to assemble and are compatible with the tooling you already own.



Notched BNC

An idea whose time has come, the new notched BNC series (patent-pending) from ADC makes it easy to spot BNC connectors that are not properly latched to BNC jacks. This is especially helpful with high-density coax panels such as ADC's midsize video product offering where terminations are very tight, and in the back of dark racks.



PPE Video Panels

The all-new PPE series standard and midsize panels are designed to offer ADC performance on a modest budget. The PPE series is offered with the same jack options as the full-featured PPI/PPV series.



IEEE 1394a FireWire® Patch Panel

With the new IEEE 1394a FireWire patch panel, patching FireWire digital video signals is as easy as regular audio and video. The panels offer a 24-port passive interconnection for industry compatible six-pin IEEE 1394a connectors.



Broadcast Products



Pro Patch™ Programmable Series

High-Density Bantam Patching System

Features:

- Industry's only bantam audio panel fully qualified to meet demanding military standards (MIL-STD 202F) for ruggedness, and MIL-J-641E for jack compliance
- High-density 2x48 WECO-compliant bantam jacks on 0.312-inch centers
- DIP switch selectable circuit normals and grounds
- Ultra-shallow five-inch depth
- Fully AES/EBU 110 Ohm digital and analog compliant
- Lightweight panels weigh only 6.2 pounds
- Modular design allows individual jack access/configuration without affecting other circuits
- Grounds can be configured on an individual circuit basis for lift, chassis, sleeve, and common ground
- Modules snap into place, tabs lock into chassis
- Circuit status icons allow users to identify circuit status with colored snap-in icons in eight colors
- Designation strips cover tabs to prevent unauthorized access to circuit configuration switches
- Converts to a 1.5 rack unit panel with a patent-pending escutcheon kit
- Largest designations on the market, 0.410-inch top and bottom for 1 rack unit, 0.680-inch top and bottom for 1.5 rack unit
- New 1.4-inch straddle designation strip kit uses one strip for two panels, cutting designation strip labor in half

Broadcast Products



EDAC 90-pin Chassis (Front View)



EDAC 90-pin Chassis (Rear View)



EDAC 90-pin Chassis with 1.5 Designation Strips



EDAC 56-pin Chassis (Rear View)



EDAC 3-pin Chassis (Rear View)



Pro Patch™ Programmable Series

High-Density Bantam Patching System

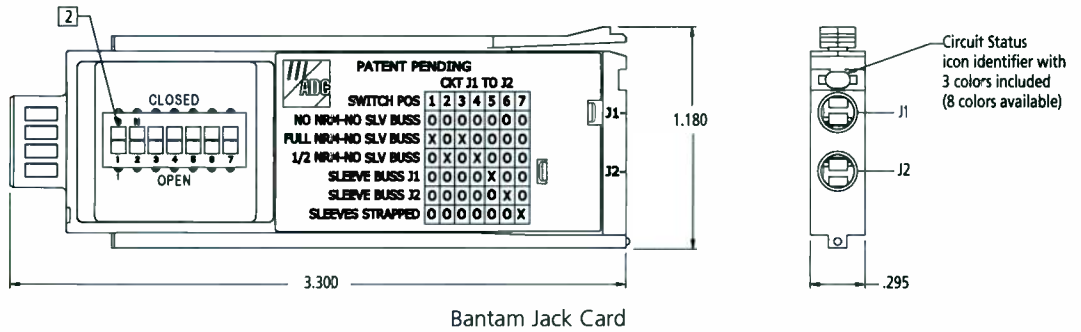

Individual Jack Access

Each Pro Patch® Programmable bantam panel features 48 individual bantam jack cards. Cards contain an individual circuit pair of jacks, front panel circuit status snap-in icon, and seven-position sealed DIP switch for normals and grounds configuration. The gold-plated header card plugs and sockets contained in the chassis ensure maximum reliability.

To remove a jack, first remove the top and bottom designation strips, push down the locking tab on the jack module and slide the module out from the front of the chassis. It is not necessary to remove the entire panel from the rack, or the cover from the chassis. Unauthorized circuit changes are eliminated because switches are hidden from front panel view.

The Pro Patch Programmable bantam system is the only product in its class that passes demanding MIL-202 environmental testing for thermal shock, resistance from moisture contamination, plating corrosion from salt fog, and vibration to simulate long-term over-the-road use.

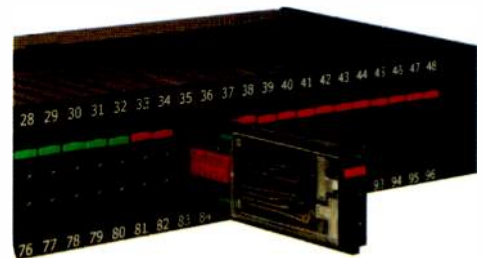

Pro Patch Programmable bantam panel allows individual front-panel jack access for normals and grounds without having to take the entire panel off-line. Special 7-position DIP switches allows configuration of the circuit normal and grounds without cumbersome jumpers or pins to lose. (See-through cover in photo is for demonstration purposes only.)

Broadcast Products

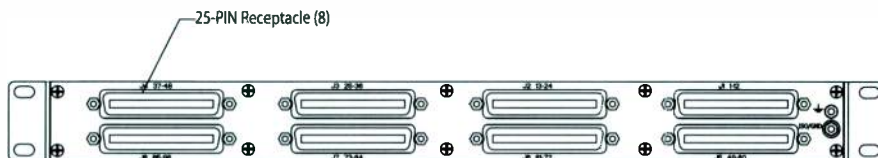

1 RU 48-Position Bantam/AMP 50-pin Audio Panel (Rear View)

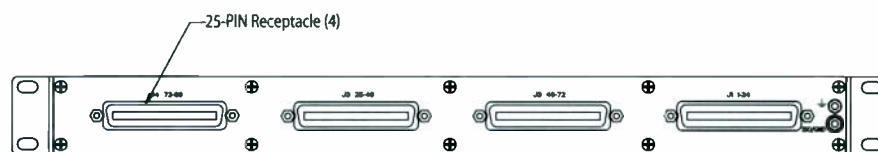

1 RU 48-Position Bantam/AMP 50-pin Intercom Panel, with bussed grounds (Rear View)



ProAx™ Triaxial Camera Connectors

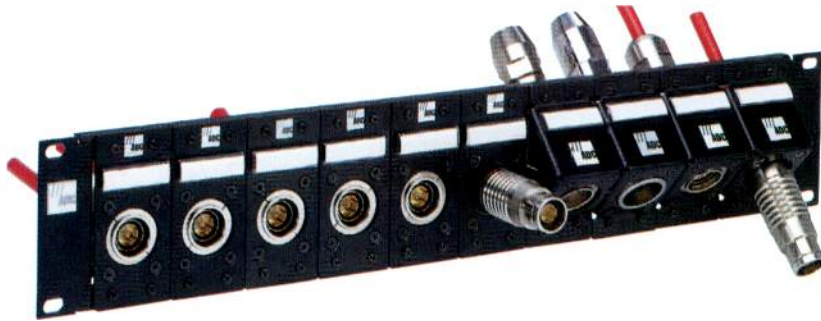

For years, the industry has been locked into connector designs that are difficult to terminate, and even more difficult to field repair. ADC's line of ProAx™ Triaxial Camera Connectors will change the way you think about this component forever. These connectors have innovative features such as field repairable center conductors that eliminate the need to restrip, O-rings that protect the signal path against moisture, fewer parts to assemble, and compatibility with the tooling you already own.

Broadcast Products

Field Repairable

Triax connectors can really take a beating — especially in field applications where dirt, sand and moisture are everywhere. When the female center conductor breaks, or the male latches are worn, the entire assembly must be cut off and reterminated.

Using a two-piece center conductor and housing assembly that can easily be replaced in the field without having to restrip and reterminate the entire connector, the patented ADC ProAx allows you to simply replace a damaged portion of the connector with common tools. When a repair is needed, the outer shell and insulator can be removed; next you simply unscrew the center conductor housing and replace the center conductor assembly, reversing the process to assemble. Absolutely no stripping or crimp tools are required.



Global Female Jack (Fischer™ compatible)



Global Male Plug (Fischer™ compatible)

Gender-Reversible

With ADC's ProAx connectors, gender parts can be swapped back and forth between males and females in only a few seconds. This process eliminates common problems such as when you've just run a thousand feet of triax only to discover the male is where the female should be. Simply trade the male for the female and continue with your project.

Format Reversible

With ADC's U.S. and six international standard (Fischer™; Lemo 4M, 4E and 3T; Damar and Hagen; Tajimi) versions, O.B. vans and internationally televised events no longer mean headaches for camera technicians. ADC's patented ProAx connectors can be format reversed between U.S. and global formats in only seconds. Plus, ADC's ProAx connectors are designed to fit standard U.S. triax cables as well as global metric 8mm, 11mm and 14mm cables.

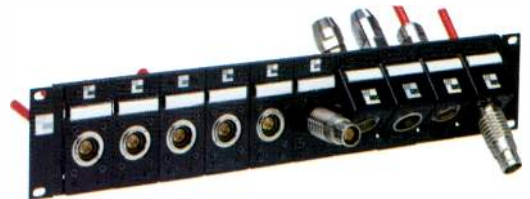



ProAx™ Triaxial Camera Connectors

Applications

High-Definition Digital Ready True 75 Ohm Impedance

The ADC ProAx™ connector line is designed for maximum bandwidth for serial digital and high-definition digital applications while maintaining a true 75 Ohm impedance. All critical path components are gold-plated for outstanding durability and connectivity.

US Standard Connectors (Kings® Compatible)

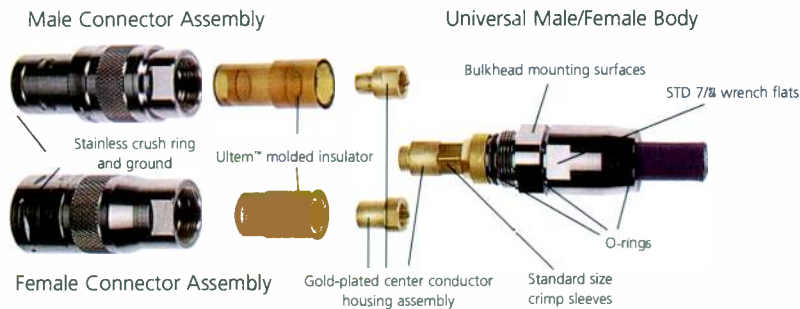

Global Connectors (Fischer™ Compatible Shown)

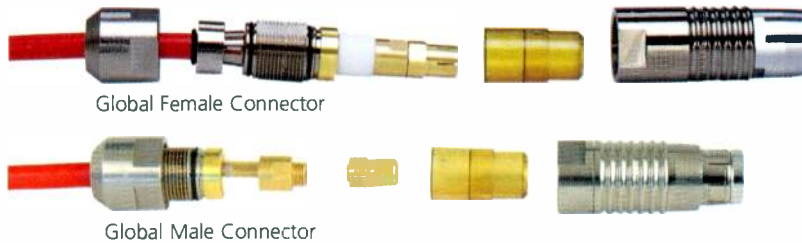

Solid Outer Shield Ground

The solid outer braid ground in the ProAx connectors maintains the ground no matter what the conditions. This eliminates camera shutdown from intermittent grounds, as well as the need for special conductive gaskets between the male and female connectors.

Sturdy Construction

Each female ProAx connector is made of machined brass with stainless steel crush rings to assure maximum crush strength. The assembly will not go out of round under typical mobile application wear and tear.

Patented Panel-Mount System

Each ProAx connector can be either cable-mounted or panel-mounted with our patented mounting kit. The mounting kit securely fastens the male or female connector to a steel plate that is attached to standard panels. Two different mounting options are available: a unique 45° and the standard 90° straight. ADC's angled 45° mounting option reduces the weight of the cables on the connectors, providing less strain on the connectors than the traditional 90° mounting. Mounting yokes are available separately for custom metalwork applications.

Compatibility

ProAx connectors are engineered to be compatible with other industry triaxial connectors from Kings Electronics Co., Inc., W.W. Fischer SA, LEMO SA, Tajimi, and Damer and Hagen, as well as standard industry tools and dies.

Broadcast Products



Pro Patch™

Optical Normal Through Panel



Module Front



Module Rear



Chassis Open

ADC's new Optical Normal Through Panel is the latest addition to its Pro Patch line of broadcast patching products. This new fiber panel is designed to provide patch by exception, normal through functionality, similar to copper-based patch panels. Traditional fiber patch panels require a fiber jumper to be in place at all times. With this newly designed panel, however, all fiber "Source" and "Destination" connections are on the rear of the panel, with a normal through connection between the "Source" and "Destination" ports. For greater convenience and reliability, patch and monitoring capabilities are accessed on the front of the panel.

Features:

Two density options:

- 3RU chassis houses 6 modules to provide 24 fiber terminations (12 pairs) using simplex connectors (SC, FC, ST)
- 4RU chassis houses 6 modules to provide 48 fiber terminations (24 pairs) using small-form-factor connectors (LC, LX.5)

Functionality:

- Each module contains pairs of "Source" and "Destination" fibers plus optional monitor ports and a switch for emergency patching.
- Accommodates 1310 and 1550 singlemode wavelengths (switch wavelength range is 1290-1330 and 1525-1610)
- Connector ports on front and rear may be SC, ST, FC, LC, or LX.5
- IL through module is approximately 0.5 dB (final specifications TBD)
- Module port is configurable to 90/10, 95/5 or 99/1 split ratios.

Module specifications:

- Modules may be added to the chassis as needed.
- "Source" and "Destination" terminations may be made by either splicing raw cable to pigtails attached to the modules or by routing connectorized patch cords to the back of the modules.
- Manual switch on front of module to change to "Patched" operation.
- LED indicators for "Normal" and "Patched" operations.
- Modules are available with or without monitor ports on the front.

Chassis specification:

- 19" EIA flush mounting
- Redundant, hot swappable power supply to power switches inside modules
- 110/220 IEC interface



Pro Patch™ Optical Normal Through Panel Module Schematics

The new Pro Patch Optical Normal Through Panel provides patch by exception, normal through functionality. With this newly designed panel, fiber "Source" and "Destination" connections are on the rear of the panel, with a normal through connection between the "Source" and "Destination" ports. To enable patching functionality, a fiber patch cord is plugged into the front of the panel and a switch is flipped.

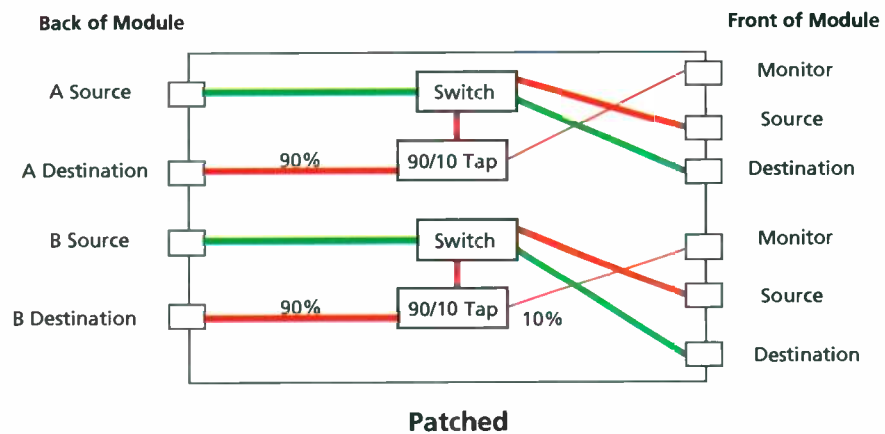
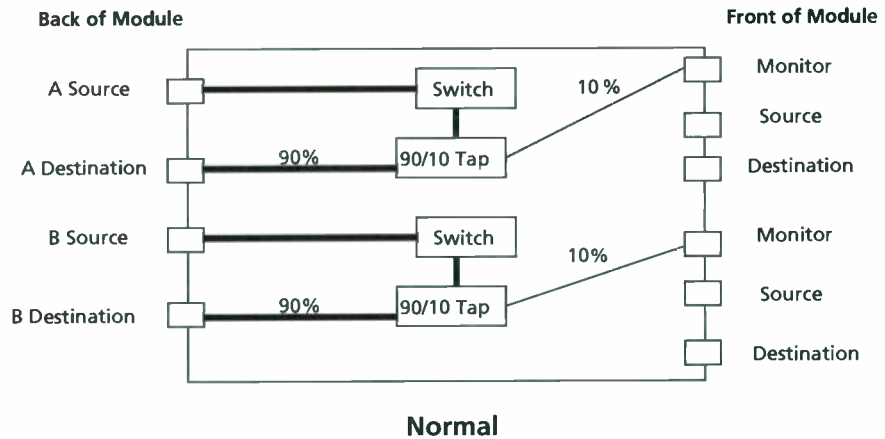

These are preliminary specifications.

Call an ADC distributor for more details. To find a distributor near you visit adc.com/partners.

Broadcast Products



FL2000 System



FL2000 Rack Mount Chassis

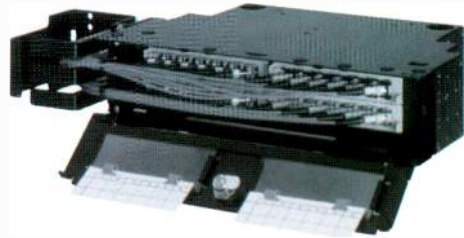

FL2000 Rack Mount Chassis (door open)

The economical and flexible FL2000 series of fiber optic products is ideal for small fiber counts and can be used in moderate fiber count applications as well by combining various panels. This leading fiber optic panel is now available in black.

Features

- A complete line of modular panels developed for cabinet, rack and wall mounting
- Fully adaptable for large or small main distribution frame (MDF), intermediate distribution frame (IDF) or telephone closet (TC) applications
- Designed for 19" (48.26 cm) EIA rack or cabinet environment found in many broadcast networks; optional brackets are available to accommodate 23" (58.42 cm) or ETSI rack or cabinet mounting
- Provides termination, splicing and storage capabilities for in-building cables, outside plant cables and fiber optic terminal (FOT) equipment patch cords
- Modular design offers maximum flexibility to satisfy both current needs and future growth requirements
- A full line of options and accessories ensures compatibility with existing optical equipment
- FL2000 systems accommodate the Value-Added plug-in modules, adding flexibility and functionality to the optical transport systems. Splitters, wavelength division multiplexers (WDMs) and other optical components can be easily incorporated
- All FL2000 panels accommodate the modular FL2000 6pak plug-ins. 6paks are available in all connector styles and can be ordered as needed
- ADC's patented removable angled retainers allow easy access for single fiber maintenance
- FL2000 panels and feature superior vertical cable protection and management
- Rack mount panels are hinged on one side, allowing full access to the rear of the front plate and the interior of the panel
- Rack mount panels are equipped with mounting brackets to provide 5" (12.7 cm) recess mounting; mounting brackets are available for virtually any mounting application
- Rack mount panels can be wall mounted
- The new FL2000 splice wheel allows easy roll-up of pigtail and buffer tube lengths and superior bend radius protection
- The FL2000 splice deck is available to complete existing installations



FPL Series

Fiber Panels For Termination, Splice and Storage

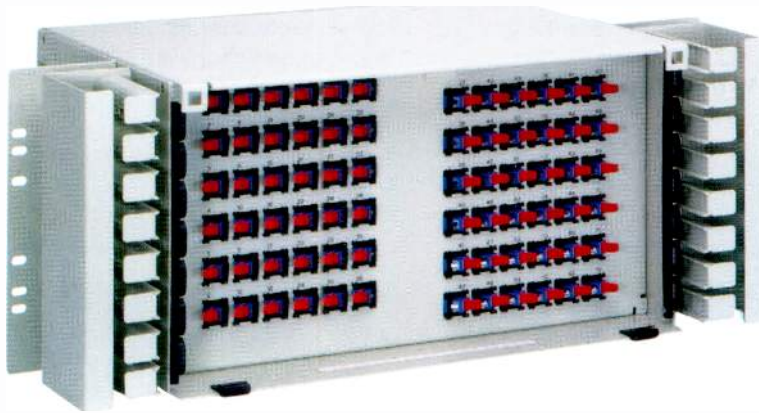

With a variety of fiber termination, splicing and storage solutions ADC's FPL Series fiber panels allow customers to optimize rack space and the dollars that go with it. The FPL panels combine the unique features of vertical cable guides and angle-left/angle-right adapters. This results in diverse cable routing options and a complete cable management solution. The panel's rear access splicing provides a high-density termination/splice solution maximizing rack space. And with a wide range of fiber capabilities and options, the panels are designed to meet growing network application needs.

ADC now introduces the 144-position High-Density Termination/Splice panel. The 144-position panel maintains all existing FPL panel capabilities – in the space of just five rack units (8.75").

Features

- Panels are equipped with adjustable mounting brackets to provide either 19" or 23" rack or cabinet mounting (EIA or WECO) as well as 4" or 5" recess mounting
- Available preterminated with pigtails to simplify ordering and reduce installation time
- ADC's patented removable angled retainers allow easy access for single fiber maintenance
- Vertical cable guides on either side of the panel provide bend radius protection and management of fibers exiting the panel
- Using an LC or ADC's LX.5* connector will double the capacity of each panel



Fiber Management Tray

ADC's Fiber Management Trays provide a flexible, economical approach to handling your network's most vital elements by offering four different designs. Termination, termination/splicing, termination/storage, and slack storage designs are offered with ADC's modular, all-front-access design.

Features:

All-Front-Access Design



Sliding radius limiters provide ultimate fiber management by addressing one of the most critical elements of fiber cable management: bend radius protection.

By controlling the movement of fibers into the tray, error-proof slack loop management is maintained, ensuring 30 mm bend radius protection. This is crucial to protecting fiber, eliminating service failures and decreasing costs.

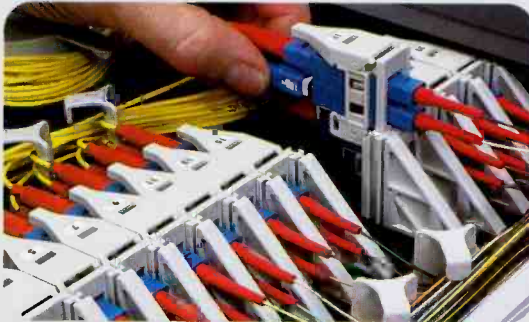

Sliding Adapter Packs

Sliding adapter packs allow easy access for connecting jumpers and cleaning connectors, ensuring that any fiber can be installed or removed without disturbing adjacent fibers. That can mean the difference between a network reconfiguration time of 20 minutes per fiber and one of over 90 minutes per fiber.



Modular Design

ADC's modular design offers the value of a single interface for performing multiple tasks in your network. By employing a one-rack-unit, modular tray, network technicians have familiar access to terminating, splicing, and storing fiber. This cable management approach translates to time and money saved, for moves, adds and changes.

Broadcast Products



RF Worx® SignalOn™ Series Passives

Introduction

The RF Worx® SignalOn™ Series, combined with the innovative cable management of the newly-designed chassis, provides engineers with a variety of products to simplify the headend signal management challenge.

Features

- Industry's highest density
- Industry's best performance and specifications
- Patented make-before-break attenuator pad design for hitless signal balancing
- Chassis supports both passive and active modules
- Clear chassis door provides protection and clear view of modules
- Clear attenuator pad covers and patented pad guides for simplified maintenance
- High quality, precision F or BNC connectors
- Designed to exceed NEBS requirements for grounding/bonding
- Independent EMI near and far-field testing
- Ten year warranty on all passive modules



Plain Module



Pad and Monitor Module with Make-Before-Break Attenuation



20-Position Chassis



2-Position Chassis

Broadcast Products



RF Worx® SignalOn™ Series Actives



Broadcast Products

Today's broadband services require high-quality headend infrastructure that offers excellent performance, reliability and design flexibility. Furthermore, your infrastructure solution should maximize the uptime of carrier-class services like VoIP, VOD and business-class HSD as applications evolve and your network changes.

Leveraging over a decade of RF amplifier design experience, ADC's new SignalOn Series amplifiers have been engineered to meet these demanding service requirements. Featuring operation from 50 MHz to 1 GHz, the amplifiers offer excellent performance and reliability. SignalOn Series amplifiers and associated power supplies can be housed in the same chassis as the SignalOn Series passive products for increased design flexibility. And with its electronically variable gain and slope controls, you can adjust signal levels in your network with no service downtime.



RF Worx® SignalOn™ Series Actives

Leveraging over a decade of RF Worx amplifier design experience, ADC's new SignalOn Series amplifiers feature 50 MHz to 1 GHz operation with excellent performance. The non-service-affecting gain and slope controls, along with the patented make-before-break attenuator pad design of the splitters and combiners, allow for "hitless" RF signal adjustment - critical for today's carrier-class broadband service applications.

Features

- Operation from 50 MHz to 1 GHz
- GaAs technology with near-100% surface mount design for high performance
- Meets MIL-202 specs for quality and reliability
- Mounts in same SignalOn chassis as passive modules for maximum design flexibility
- Digitally variable gain and slope control for non-service-affecting signal level adjustments
- 20 dB monitor points on both input and output signals for testing and troubleshooting
- "Blind-mate" power bus connector with gold-on-gold contacts; requires no cabling
- Chassis-mounted AC-DC and DC-DC power supply options
- Redundant powering with dual load shared power supplies for increased availability
- External +24VDC powering option



Amplifier, front view



Amplifier, rear view showing slide-on power connector



5RU Chassis with mixture of passive and active modules

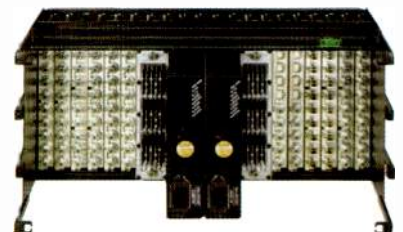

5RU Chassis, rear view



2RU Powered Chassis

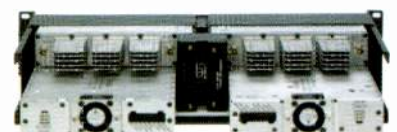

2RU Powered Chassis, rear view

Broadcast Products

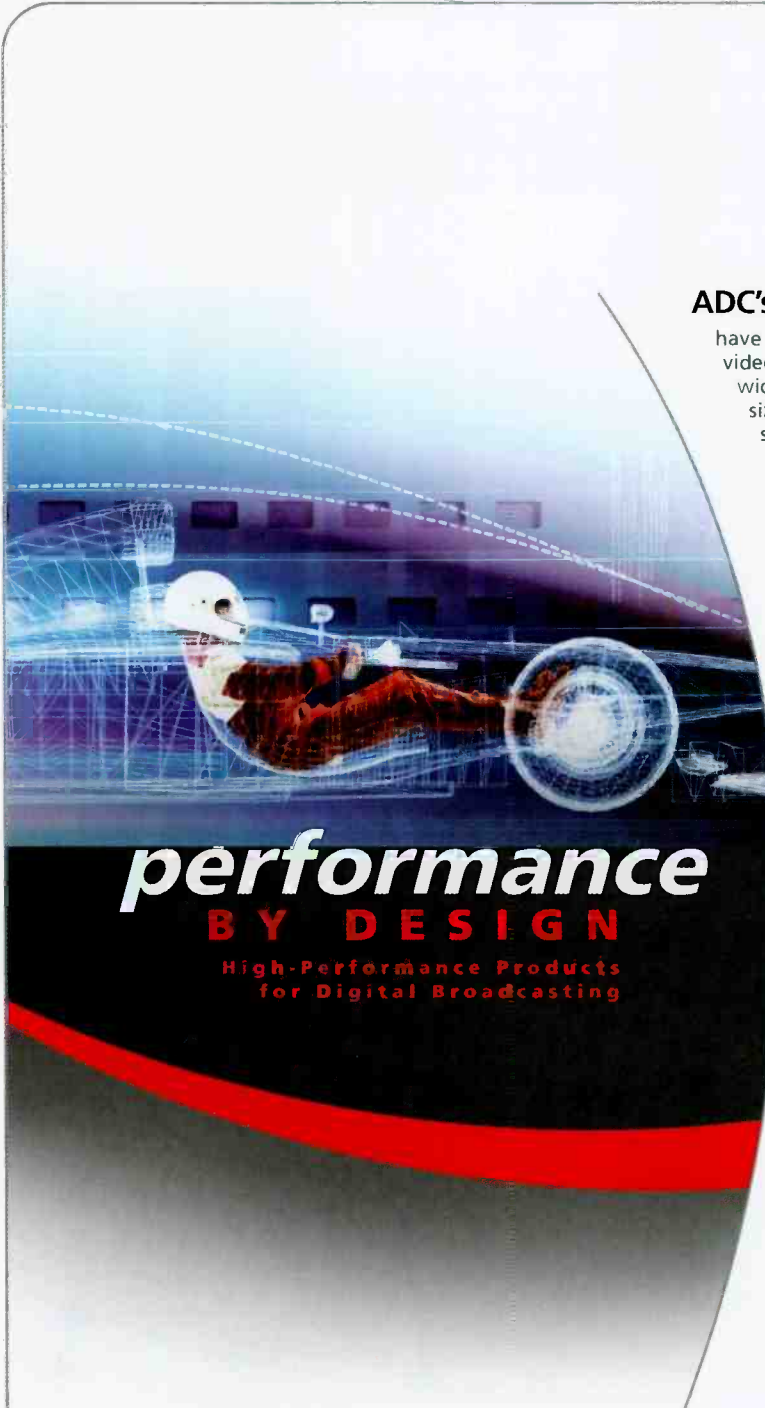

performance BY DESIGN

High-Performance Products
for Digital Broadcasting

ADC's Pro Patch™ video panels

have long been recognized as the leader in video patching. Panels are available in a wide variety of configurations for rack sizes, jack types, and color options. The PPI series panels are the ideal choice for demanding professional environments:

- Durable welded-steel frames prevent bent, cracked and broken ears
- Widest variety of jack types available including standard, midsize, and MUSA standard
- Exclusive snap-over designations keep cards and windows in place and make changes easier
- Durable molded ABS inserts prevent stripped screws and cracked inserts

Whether it's copper or fiber, ADC's audio, video and data products are built to provide unmatched performance and reliability, and all ADC products are backed by outstanding pre/post-sale engineering support as well as the industry's best warranty.

Contact us today and find out why ADC means "performance by design."



2x32 Midsize PPI Series Super Video Jack Panel

Call today for fast delivery!

For a free copy of ADC's 13th edition broadcast product catalog, call 1.800.366.3891 ext. 20000. Or visit adc.com/broadcast.



HD video, audio and DVD solution **Sony VEGAS+DVD**

A non-linear video and audio editing system, and DVD Architect authoring program; these two applications form the core of the new Vegas+DVD Production Suite, specifically upgraded for HDV, and also include a Dolby Digital AC-3 multi-channel encoder for 5.1 surround output.

800-686-SONY; www.sony.com/professional

Booth: SU6406



Audio mixing systems ▲ **Euphonix System 5-B and Max Air**

Showing both digital audio mixing systems for on-air broadcast applications.

818-766-1666; www.euphonix.com

Booth: N3616

Digital media software **Anystream Agility 5.0**

Broadcast transcoding solution for digital media production workflows; options for scaling Agility software to accommodate any of the four package applications; options add multi-system command, control, and failover management layers; includes workflow enhancements such as HD support to closed captioning.

703-450-7030; www.anystream.com

Booth: SL3316



HD and DV camera interfaces ◀

Miranda Technologies DVC-802/822

HD downconverter and DV encoder for Sony and Panasonic HD cameras as new, as well as the MDC-902-922 HD

downconverters; all feature 24p to 50i support; DV-Bridge-CAM interface for DV cameras provides high-quality DV-to-SDI conversion.

561-477-6124; www.miranda.com

Booth: SU7841



Broadcast platform ▲ **Terayon BP 5100**

Features enhancements to the system's digital graphic insertion capabilities; graphics can be inserted within the compressed MPEG video domain eliminating the need to decode and re-encode digital programming; can localize branding at distribution points closest to viewers.

408-235-5500; www.terayon.com

SU11316



Overhead paging system ▲ **Bogen 4-port VoIP Gateway**

Businesses can be set up for simultaneous company-wide overhead paging to multiple locations within a facility or across a campus without running new lines, or even to remote locations thousands of miles away; the PCM2000 Paging Control System, Telephone access modules (TAMB), and amplifiers integrate seamlessly with VOIP Gateways to provide overhead voice paging over IP networks; four analog ports for communication over an existing IP network or the Internet; for businesses requiring paging to one to four zones at remote locations.

201-818-9500; www.bogenimaging.us

Booth: C6726



Console ▲ **Euphonix 5-MC**

Designed for audio post applications; interfaces directly to Digital Audio Workstations, such as Steinberg's Nuendo and Merging Pyramix using the EuCon high-speed control protocol.

818-766-1666; www.euphonix.com

Booth: N3616

Come see our
latest baseband
creation...

**A fully
functional
HDTV
broadcast
facility!**

BURST Communications,
an authorized business
partner of Thomson, is
a full service design and
integration firm offering:

- Broadcast Television
RF and baseband
- Engineering Design
- AutoCAD
documentation
- Turnkey Installation
- Equipment
Procurement

Come see our latest
baseband creation...a
**fully functional HDTV
broadcast facility!**

Featuring...
the **Grass Valley HD
ProfileXP system**
for play to air.

Also visit us at the
Larcan booth #C5620
to see our **Larcan Plus
Complete LPTV
Transmission System**.
The complete LPTV
Transmission system!

NAB HD Booth #N-5000
Located in the North Hall



BURST

An Authorized Business Partner
of Thomson

www.burstvideo.com | 888.472.2820

grass valley

A THOMSON BRAND

www.thomsongrassvalley.com | 800.547-8949

PRODUCT highlights

Format converter/interface

Miranda Technologies DV-Bridge Cam

Lightweight and high quality DV-to-SDI converter for low-cost news gathering DV cameras; mounts securely under a handheld DV camera or between tripod and camera. Converts DV output to SDI-compatible signal with embedded audio and time code.

561-477-6124; www.miranda.com

Booth: SU7841



Amplifier

Bogen Power Vector amp

35W, 60W, 100W, 150W, & 250W models; each with a large power reserve; module input bays, accepts up to two signal-processing output modules or up to eight input modules; four priority levels; 4ohm, 8ohm, 25V, & 70V outputs; rack mountable w/ kit (sold separately).

201-818-9500; www.bogenimaging.us

Booth: C6726

Four input active video switcher

Burst Electronics Model VS4x1

A four input, one output vertical interval video switcher; features digital logic that inhibits selection of an unused input, i.e. one where no video is present; the output is dc clamped to zero Volts; this allows for jump free switching between genlocked sources; can be slaved with the AS4x1 audio switcher to allow audio follow video and breakaway switching; is 12 Vdc powered, wall module included.

505-898-1455; www.burstelectronics.com

Booth: C8915

Display system

WeatherBug Zoom

An all-digital, on-air display system; can report up to 27 different parameters from a single location or multiple locations around your market, region or country; creates email, phone and web alerts to monitor conditions in the WeatherBug network so your station can be the first to report sudden and severe weather; features time-lapse video and up-to-the-second weather coverage.

800-544-4429; www.weatherbugmedia.com

Booth: TBA

IT REALLY DOES ALL WORK TOGETHER!

NAB-HD will provide a hands-on look at everything that goes into putting together a digital television operation... by building a functional station right on the exhibit floor! From capture to editing to delivery, this is a unique opportunity to see how it all comes together.



After Experiencing NAB-HD In The LVCC North Hall, Follow Up At The Exhibits Of Our NAB-HD Partners!

YOUR FUTURE STARTS HERE

NAB 2005

THE WORLD'S LARGEST ELECTRONIC MEDIA SHOW
April 16-21, 2005 Las Vegas Convention Center Las Vegas, NV

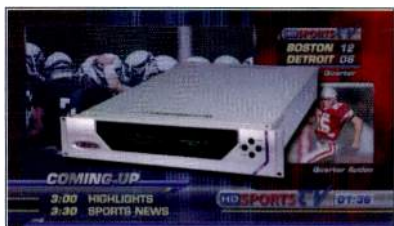

Master control and channel branding processor ▲

Miranda Technologies Imagestore HDTV

Enables creation of high-quality, dual picture-in-picture effects for compelling program junctions and promotional graphics, with full control via automation or by the PresStation manual control panel; the new audio mixer provides 16-channel audio mixing using embedded or AES audio.

561-477-6124; www.miranda.com

Booth: SU7841

Serial digital to analog converter Burst Electronics Model DV-1

Converts serial digital video into analog video; the output is selectable for composite or Y/C; features NTSC/PAL, NTSC Pedestal On or Off, 10 bit internal, 4:2:2 270 Mbit SMPTE 259M, Serial Digital input, Composite or Y/C output, Equalized for up to 1000ft of cable, and Internal Color Bars.

505-898-1455; www.burstelectronics.com

Booth: C8915



Transport stream analyzer ▲

Tektronix MTS 400 Compressed stream analyzer

Compressed video test system; automatically monitors, analyzes and debugs live and deferred time video transport streams; supports world transmission standards including; ATSC, DVB-T, -S, -H, -C, ISDB-S, IP and UMTS plus compressed video standards including; MPEG-2, -4, H.264, VC-1 and 3GPP; up to 400Mb/s analysis, modular design, hardware and software versions available.

800-833-9200; www.tektronix.com

Booth: C6231

Camera support ▶

16x9 Chrosziel Twister DV

A precisely balanced one-piece camera support system for popular lightweight cameras; offers stable and smooth support when shooting from any position; attaches to the system's central mounting plate; once installed, the camera pivots between two handgrips on the system's rotary axle, enabling the camera to establish its natural center of balance; regardless of how or where it is moved, the camera remains upright.

818-972-2839; www.16x9inc.com

Booth: SU6365



Modular audio DSP ▲

Symetrix Orion 8x8 Analog I/O processor

A new addition to the AirTools Studio Matrix series of modular audio products; equipped with eight line-level analog inputs and outputs; provides significant utility for such applications as gain control of satellite chains, equalization and filtering of telephone hybrids, news and production room applications, and management of multiple microphone signals in a talk-studio environment.

425-778-7728; www.symetrixaudio.com

Booth: 4006

HDV plug-in

Adobe Premiere Pro 1.5 HDV plug-in

Works with next generation HDV cameras such as Sony's HDR-FX1 so video professionals can quickly and easily capture, edit in real-time, and output broadcast-quality HDV; uses the same IEEE-1394 (Firewire) connector natively supported in Adobe Premiere Pro 1.5; provides direct HDV device control and video capture without the need for additional hardware.

408-536-6000; www.adobe.com

Booth: SL313

Video network server

Ai-Pixel VRX-8300

Provides cost-effective MPEG-2 industrial digital video solutions; 4-channel; allows for simultaneous recording, playback, streaming and export on all channels and has an exceptional internal storage capacity of up to 2Tb or four months of video content; features full SDI I/O, balanced audio (XLR) I/O, closed captioning/V-chip support, and enhanced broadcast GUI.

+31 6 21 884 675; www.ai-pixel.com

Booth: SL4353

Content delivery system

Pinnacle Systems MediaStream

A new version of MediaStream software supports up to 32 audio channels per video clip, closed caption remux, and seamless interoperability with Liquid version 6.1.

650-526-1600; www.pinnaclesys.com

Booth: SU6341



HDV shading solutions/ filtering effects ▲

16x9 Chrosziel Mattebox

Created especially for use with Sony's HVR-Z1U and HDR-FX1 camcorders; the true 16:9 housing design covers both 16:9 and 4:3; features include a filterstage for two filterholders (one 4x4 rotating and one 4x4/4x5.650 fixed), full-size French flag, 16:9 insert mask, and 110-72mm screw-in adapter ring. For a secure mount, the mattebox comes equipped with center bracket and lightweight support rods; is compatible with both wide and tele attachments.

818-972-2839; www.16x9inc.com

Booth: SU6365



Decoder ▲ Miranda Technologies HD- Bridge; HDV to HD-SDI decoder

Enables inexpensive, high quality HDV cameras to operate with HD-SDI editing systems and HD-SDI plant infrastructures.

561-477-6124; www.miranda.com

Booth: SU7841

Video server

Ai-Pixel Playout Server

Designed for small to medium sized TV stations; offers compliance with all standards (SDI, PAL, NTSC, analog, digital), compliance with automation servers (VDCP), easy operation, easy import/export, high functionality playlist, allowing the user to make "on the fly" changes in the playlist without interrupting any simultaneous operations, guaranteed high quality and reliability.

+31 6 21 884 675; www.ai-pixel.com

Booth: SL4353

World's First!



Flexiscope...

See us at
NAB 2005
Booth
C7031

HD/SD
SD/SD

Patent:
US 6,493,024B1
GB 2329294

HD and SD waveform, vectors and audio,
measurement and monitoring using proprietary
and Patented ALL digital processing
- ALL in the PALM of your hand!

IT'S ALL YOU EVER WANTED!

Covers ALL HD, SD standards, with
more plug in options to follow.

Made to measure. Irresistibly priced.

You can Exceed your Expectations

TEL: (949) 316-1070 TOLLFREE: 866-4-HAMLET E-Mail: sales@hamlet.us.com
Web site: www.hamlet.us.com

UK Tel: +44 (0) 1494 729 728 Freephone (UK): 0500 625 525 E-Mail: sales@hamlet.co.uk
Web site: www.hamlet.co.uk

HAMLET
EXCELLENCE IN VISION



Video card ▲

Blackmagic Design DeckLink for Windows v4.8 software

Dual stream RealTime effects in Premiere Pro 1.5; Premiere Pro 1.5 users have 8 and 10 bit uncompressed RealTime effects in standard definition; effects include cross, additive and dip-to-black dissolves; 3:2 Pulldown support for HD; all DeckLink HD series cards can now play out HD 1080/23.98p media at HD 1080/59.94i fps; HD monitoring and/or preview.

702-257-2371; www.blackmagic-design.com

Booth: SL4916

Content delivery system

Pinnacle Systems DekoCast Hybrid

A new native HD/SD switchable version of the category-defining automated edge graphics system, suitable for a wide range of channel branding, promotions and localization applications.

650-526-1600; www.pinnaclesys.com

Booth: SU6341

Audio codec

APT WorldNet Oslo

A modular, multiple channel audio codec; designed to transport exceptional quality audio and data over various digital networks such as T1, E1, TCP/IP and ISDN; highly customizable to the user's current requirements and enable future expansion of the unit as their needs evolve; offers savings on network infrastructure by allowing audio and data to be sent simultaneously via an E1/T1 circuit and provides power and transport back-up options for use in mission critical environments.

+44 0 28 9037 1110; www.aptx.com

Booth: N811, N811A

Pro-Tools plug-in

APT apt-X Pro

Software plug-in for the Pro Tools Digital Audio Workstation enabling the creation, editing, manipulation and sharing of Enhanced apt-X-encoded 16-to-24 bit audio; has an intuitive user interface and compatibility with both Mac and Windows version of Pro Tools; integrates seamlessly with the workstation and allows for lightning-fast encode and decode.

+44 0 28 9037 1110; www.aptx.com

Booth: N811, N811A

Multi-Image Video Display Processor

Avitech Video MCC8000

Is designed for a wide range of signal monitoring applications, whether it is HD, SD, analog video, analog audio, digital audio, embedded audio or computer generated graphics, and signals can be shown on the same display; information features and status indicators such as audiometers, UMD's, labels, borders, tallies and alarms complete the virtual information display system; provides reliability and redundancy.

877-284-8324; www.avitechvideo.com

Booth: SU9329

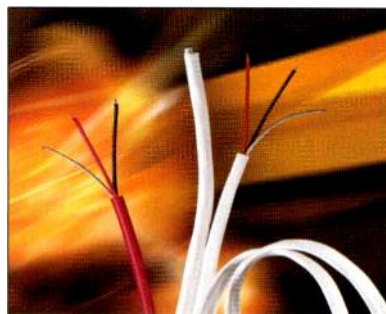

Analog audio cables ▲

Belden CDT Brilliance cable

Plenum versions of company's popular 9451 and 9451D analog audio cables; designed for line-level audio connections, audio distribution equipment, and studio wiring with room-to-room and plenum versions; applications include sports arenas, broadcast studios, post-production facilities, corporate boardrooms and houses of worship.

800-235-3364; www.belden.com

Booth: C2257

Wireless video transmitter

Broadcast Microwave Carry-Coder II

A portable module for video cameras; transmits video, audio, and user defined private data; can be used in a backpack configuration or plugged directly to the back of most professional video cameras; mechanical adapters are available on request for most professional video camera models; capable of driving a power amplifier in vehicle or helicopter applications; performs MPEG-2 encoding, COFDM digital modulation and RF amplification in a very compact package.

800-669-9667; www.bms-inc.com

Booth: C1421



Wide angle converter ▲

Schneider Optics Century Division Century .7X Wide Angle Converter

Designed to complement the Sony HDV camcorder's higher resolution, wider angle lens system; attaches to the front of the 12X lens to offer 30 percent more coverage at any setting from wide angle to telephoto; fully compatible with most professional matte boxes.

818-766-3715; www.centuryoptics.com

Booth: SU10329

Synapse

Axon TWINS

A range of Synapse modules with dual basic signal processing functionality which fit in the 4RU/1RU

Synapse housings; modules function alongside the existing Synapse SD and HD modules.

+31 13 511 6666; www.axon.tv

Booth: SU9301



Automation ▲

Crispin Supervisory View

Recently added to RapidPlayX; enables operators to see, from a single screen, multiple play-to-air channel status complete with visual notification of messages, warnings and operator intervention requests; notifies operators of an impending event through a set of color-specific flashing indicator boxes; operators can also see a scrolling index of cued and on-air events per channel; allows operators to configure multiple workstations on the network to monitor multiple channels.

919-845-7744;

www.crispincorp.com

Booth: SU9717



Studio microphone and line input intelligibility processors ▲

Crest Performance I-PRO-I and I-PRO-II

Both units are designed to optimise audio signals in recording, broadcasting and live applications by processing input signals via a parametric EQ section and a compand/limit (dynamics) section; the parametric EQ section has two frequency cut/boost controls: the I-PRO-I features a deep 24dB cut/12dB boost, while the I-PRO-II has a ± 15 dB cut boost; with bandwidth adjustment of 1/6 to 2 octaves, each parametric EQ has its own on/off switch to reroute the signal when not in use.

+ 49 2171 723364; www.crestaudio.com

Booth: TBA

Is your broadcast stream FCC compliant?



StreamScope™



To test drive the StreamScope Real-time ATSC transport stream monitor and analyzer, call 1-866-TRIVENI. Please visit us @ NAB Booth #SU11411

How do you know?

StreamScope MT30, the industry's most sophisticated MPEG monitoring and trouble shooting tool, from the leader in ATSC data and metadata systems. Offers advanced, time-saving trouble shooting features demanded by experts - yet provides intuitive, easy-to-use interface needed by novices. Available in rack mounted and portable configurations.

- On-site and remote real-time monitoring and analysis of multiple streams
- User-friendly graphical interfaces to simplify complex information interpretation
- Simultaneous input sources (VSB, QAM, ASI, SMPTE-310, GigE)
- QAM input enables monitoring of cable carriage of broadcast channels
- Multi-level analysis with drill down capability to any detail level
- Single view to one or multiple local and remote StreamScopes
- Auto-triggered recording of streams based on user-defined errors or conditions
- Time-saving diagnostics with PSIP and PSI cross table consistency checking
- Real-time PCR timing, video and audio buffer analysis and graphing



triveni
DIGITAL.

Asset management

DAX Solutions *Rough Cut Manager*

Allows instant viewing of rough-cuts, trailers, promos, screeners, commercials and more; integrated with EDL, ALE and Flex File users can create play lists; add comments linked to time code; freeze each frame; scrub frame by frame; go full screen or playback to a TV monitor at the click of a button; can work in WindowsMedia or Quicktime.

973-509-6523; www.daxsolutions.com

Booth: SL4259A



Video air check system ▲

Axon Digital Design BV TRACS (Transmission Recording And Compliance System)

Offers a highly reliable platform that fully automates the process of audio and video recordings for 30 or 90 consecutive days; consists of a range of networked digital video recorders connected to a request server that also acts as a web server and monitoring unit; records and plays out full Vertical Blanking Interval (VBI) content; the recorders, which use the MPEG-2 or MPEG-4 compression format with variable bit rate, are accessed through the request server by means of web pages.

+31 13 511 6666; www.axon.tv

Booth: SU9301

Audio automation console ▲

AMS NEVE Encore Plus

Delivers several major new features including Reconform, Automation in Stop, Mix Audition and Star Command remote control of digital audio workstations; through Automation Reconform now change lists can be taken into Encore Plus and the mix automation cut and spliced automatically to reflect picture changes, reducing the work load on the Mixer as pictures are re-cut as well as allowing greater freedom to the Director who can now continue to make creative changes right up to the dub without disrupting the mixing process.

818-753 8789; www.ams-neve.com

Booth: TBA

Direct to edit recorder

FOCUS Enhancements FireStore FS-4

Features a 40GB (3 hour) internal disk drive, a 6-pin FireWire connector for interface with camcorders, a 6-pin FireWire connector for interfacing with a computer for editing or file transfer, a backlit status LCD display and a comprehensive set of control buttons including a navigation pad; also supports DTE Technology file formats; adds support for the Avid OMF and Pinnacle AVI file formats, retro record modes so that a shot is never missed, user definable time lapse, loop playback, scene marking and multiple file folder capabilities; also available with an 80GB (6 hour) drive.

408-866-8300; www.focusinfo.com

Booth: SL4255E,SL505



Analog converter ▲

TV One SD-220A

SDI-to-analog converter; offers dependable 10-bit SDI to analog conversion with re-clocking and equalization of the input signal at distances of up to nearly 1000ft from the source; double-shielded coaxial cable is used; provides NTSC, NTSC-J, PAL, or PAL-N output; is capable of managing 525 or 625 line signals, and is controlled via buttons found on its front panel and an LCD display; component video output is menu-selectable as either RGB or YUV in SMPTE or Betacam formats, while an integral video processor facilitates adjustment of parameters including luminance, chrominance, setup, hue, and sharpness.

800-721-4044; www.tvone.com

Booth: C1846

Graphics content creation

VDS TWISTER HD V6.5

A complete paint, graphics content creation, and I/O solution; runs as a standalone application, or as a plug-in for industry-leading content creation, editing, management and display systems; artists have access to VDS' content creation tools and remote file transfer utilities from within a single user environment, including a full suite of comprehensive paint tools and brushes, unlimited layering capabilities, and sophisticated image processing and masking tools developed specifically for fast still graphic creation and distribution.

631-249-4399; www.videodesignsoftware.com

Booth: SL5300

Content delivery service

GlobeCast *WING*

Wireless Content Exchange Networks; a proprietary global IP-based contribution network using fiber and satellite to manage global content ingest, storage and live-to-air streaming direct from the laptop; IP-enabled file-based content exchange networks allow reporters to file stories – live or recorded – directly from any laptop or workstation over any wired or wireless internet connection to a central exchange hub, which controls and routes the story directly to the station newsroom.

202-383-2745; www.globecast.com

Booth: C2129

Content Creator

IMAKE OpenVision Content Creator

An open standards-based software tool that encodes content into Video On Demand (VOD) and Internet Protocol Television (IPTV) digital asset packages and associates CableLabs-compliant metadata; is a cost-effective and easy-to-use platform that enables the creation, management and editing of digital media; is designed for use by content providers who must prepare media prior to distributing it to a service provider, as well as service providers who deliver locally-focused content to regional markets.

301-896-9200; www.imake.com

Booth: TBA

Encoding solution

Inlet Technologies Fathom 2.0

A professional, real-time encoding solution for VC-1/WMV HD content creation; supports live HD SDI input, as well as uncompressed AVI and QuickTime source files; offers a redesigned user interface, integrated workflow management tools, advanced encoding options and a comprehensive analysis package to make high-definition content creation accessible, efficient and affordable for any post-production professional.

919-342-2860; www.inlethd.com

Booth: SL5829



Microphone ◀

Lectrosonics SM
(Super Mini)

A small professional audio wireless transmitter; when used in its native Digital Hybrid mode, it performs without the hindrance of an analog compandor or the headroom-limiting pre- and de-emphasis found in most analog systems; delivers 107dB signal-to-noise ratio and flat frequency response to 20kHz, uses both 24-

bit digital audio and analog FM signal transmission methods to encode a digital signal into a robust analog format for transmission over a UHF FM carrier.

800-821-1121; www.lectrosonics.com

Booth: N3611

Check it out: Booth C11107

NAB 2005
THE WORLD'S LARGEST ELECTRONIC MEDIA SHOW

RIEDEL

**WORLD'S
FIRST
DIGITAL
BELTPACK***

*2-channel operation on standard XLR cables, noise-free, digital audio quality, easy analog-style set-up incl. daisy-chaining. Successfully utilized at the 2004 Olympic Games and the 2005 Academy Awards.



Riedel Communications Inc. • 3605 W. Pacific Avenue • Burbank, CA 91505 • USA
Phone: +1 818 563 4100 • Fax: +1 818 563 4345 • www.riedel.net

Video encoding solution

Digital Rapids StreamZHD
Professional multi-format HD/SD video encoding solution featuring support for multiple formats including AVI, WM9, QuickTime, MPEG-2, AC-3, and many more, for archive, dailies, VOD or streaming media delivery from SD or HD source material.

905-946-9666, ext 121; www.digital-rapids.com

Booth: SL5331



Automation controller ▲

Leightronix NEXUS

A multi-task solution for local cable or television operations; it combines multi-channel digital video playback and recording, digital messaging/signage, DVD/VCR control, and video/audio signal routing; operates as a stand-alone device and is managed via network using provided WinNEXUS software; a built-in, high-speed Ethernet port and simplified front panel setup allow for quick and easy connection to a LAN, WAN or the Internet.

517-694-8000; www.leightronix.com

Booth: SU11223

Non-linear editing system

Leitch Technology VelocityQ NLE v.91

Features new tools for color correction, collaborative workflows, and audio processing, plus broadened media format support and a wide range of user interface enhancements; features new CPU-based color correction tools, including three-way color-wheel control, curves, color matching and automatic white and black re-balance; the new Interactive Editing paradigm enables edits including adding, deleting, moving and trimming clips - and real-time effects to be applied without stopping full-quality playback, providing immediate in-context feedback while editing and refining effects.

859-371-5533; www.leitch.com

Booth: SU7805, SU8199

Media asset management

Konan Digital DigitalArc

System provides solutions for the entire life cycle of digital assets management from ingesting, archiving, managing, searching, editing to the distribution of digital contents, enabling users in media and entertainment and enterprise sectors to utilize their valuable assets for maximum benefit.

www.konandigital.com

Booth: SL3919



Prompter ▲

Listec Video Z-Prompter Series

Mounts the prompter with camera over the pan head's balance point; eliminates need for a large balance plate and counterbalance weight, provides a range of adjustment; easy to transport; eliminates stress on tripod systems; can be supplied with either a Studio or Fold-down Hood; available with flat-panel displays through 15in; can be configured as a Presto system.

561-683-3002; www.listec.com

Booth: C6237

Media exchange platform

Marquis Broadcast Medway

Enables media files from multiple sources to be transferred seamlessly between a wide variety of vendor platforms; includes powerful EDL exchange functions and integration with asset management and other automation systems; is suitable for all digital applications, including newsrooms, playout centers, production and post production suites, and front and backroom processes; eliminates file compatibility issues that occur when media and its associated metadata move between target devices, providing speedy and invisible format conversion as required.

+44 0 118 984 4111; www.marquisbroadcast.com

Booth: TBA

Batteries ▶

Maha Energy PowerEx 2500mAh AA

Are specifically designed for high drain applications such as digital cameras and other portable electronics; have 2500mAh true capacity offering super long run times; can also be recharged hundreds of times with no memory effect; are available in four packs and will also be shipped in a battery carrying case - a unique device that allows users to conveniently hold up to four AA or AAA batteries.

800-376-9992; www.mahaenergy.com

Booth: TBA

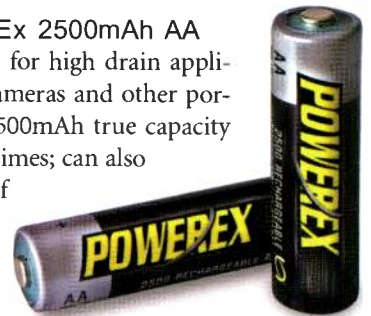



Video player/recorder ▲

Merging Technologies VCube HD-2K Capable of uncompressed 1920x1080 HD video resolution and more than 30 different SD/HD video formats; has ability to convert any video format to any other format, SD or HD and open multi-layer OMF Compositions from a drive or directly from an Avid Unity; can offer from 1.6TB to 6.4TB of media storage with the system, up to 12 audio channels and we are in the final stages of developing our own tactile remote controller for the system.

+44 0 1606 892788
www.merging.com
Booth: N4225

Content security solution

Irdeto Access PIsys for Mobile A content security solution that protects video broadcasts to wireless devices such as mobile phones, PDAs and specialized in-car devices; a conditional access system for mobile video, providing operators with the tools to secure the revenue for premium content delivered to consumers; applies to audio, video and data services and supports a variety of business models, ranging from subscriptions to pay per view, and works for Satellite and Terrestrial Digital Media Broadcasting (DMB) networks as well as DVB-H networks; uses patented Dual Key Hierarchy and Rapid Entitlement Refresh technologies to limit bandwidth use while maintaining high levels of security.

858-668-4878
www.irdetoaccess.com
Booth: SU8365

Acoustical brochure

illbruck acoustical product brochure Features its acoustical control products for recording and broadcast applications, including television and radio stations, film studios, recording studios, broadcast facilities, sound stages, control rooms, listening rooms and religious facilities at which recordings are made; these illbruck acoustical products treat challenges such as flutter echo, near field reflection, room resonances, standing waves and exterior sounds; the products - designed to absorb, block or contain sound - effectively and affordably solve these challenges in new construction and existing facilities.

800-662-0032

www.illbruck-sonex.com
Booth: N1600



Portable disc recorder ▲

Sennheiser Rosendahl bonsaiDRIVE A miniature, lightweight and extremely portable hard disc recorder that captures both high-quality video and multi-track audio; simultaneously handling 4:2:2 PAL or NTSC video signals alongside ten audio channels, it allows the user to specify their own choice of standard IDE drive which neatly slots into the unit itself; video is handled in either Composite, S-video or Component formats, and is processed using lossless 2:1 compression to yield extremely high-quality results, while the audio I/O is configured as an analogue stereo pair and a 24-bit, 48kHz ADAT eight-channel digital stream.

860-434-9190
www.sennheiserusa.com
Booth: N2822

Focal Press

9 years of

NAB

Partnership

Focal Press books will be available in the NAB Bookstores at the LVCC April 16th - 21st

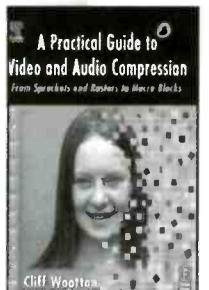
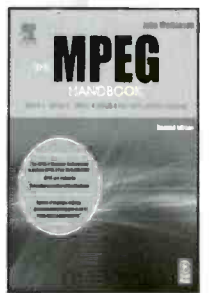
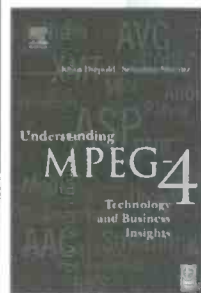
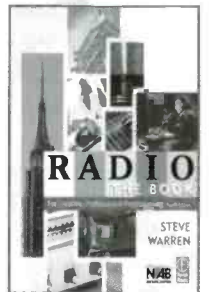
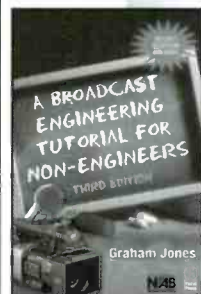
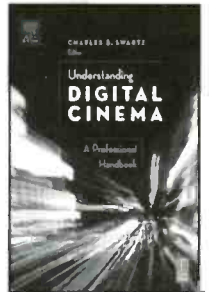
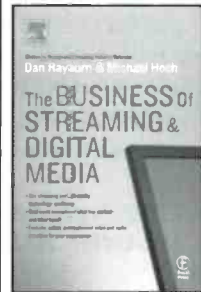

Focal Press has become the exclusive publisher of the NAB's elite technology titles. This new alliance will result in a greater number of broadcast related professional titles being published for the media professional.



Graphics/CG application

Orad Maestro

An HD and SD compatible system with all HD format supported; its extremely simple to operate, provides a very efficient workflow and allows creating state of the art 3-D and 2-D graphics and animations; includes a new scene-editing tool that allows easy re-composition of an exiting scene or a fast creation of a new one; is a Windows-based application with local preview capabilities and plug in to most of newsroom and automation systems.

972-9-7676862 ext. 520; www.orad.tv

Booth: SU7170



Wireless mic antenna combiner ▲

Sennheiser AC3000

Operates with all wireless systems, allows up to eight personal monitor transmitters to be connected to a single common transmitter antenna; occupying only a single rack space, it may be used across the entire UHF range from 470MHz to 870MHz; combining multiple RF monitoring systems through a single broadband device significantly reduces intermodulation between transmitters and additionally keeps cabling to an absolute minimum; the 19in housing includes front panel LEDs for RF level indication.

860-434-9190; www.sennheiserusa.com

Booth: N2822

Particle effects creation tool

wondertouch particleIllusion

A standalone version of the company's visual effects creation application; provides more than 750 preset effects to deliver a range of effects including smoke, fire, explosions, water effects, sparkles, colorful artistic effects, with the utmost speed and efficiency for Mac OS(R).

636-225-7861; www.wondertouch.com

Booth: SL453

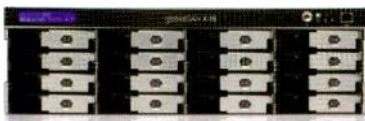

Shared storage system ▲

Studio Network Solutions globalSAN

A multi-user shared storage iSCSI SAN available for both Mac and PC; is offered in turnkey configurations of eight, 16 and 24 SATA drive arrays; enables iSCSI bridging to external Fibre Channel and SCSI storage devices.

877-537-2094; www.studionetworksolutions.com

Booth: SL3331



Connector ◀

Switchcraft FireWire

Is mounted within a universal style XLR panel receptacle housing; has feed-through connections and can be supplied in nickel or black XLR housings; other options within this range have BNC, RCA Phono and SVHS connectors and future additions will include USB and CAT6 versions.

773-792-2700; www.switchcraft.com

Booth: C2339

MPEG recorder/player

Tektronix MTX100 Version 5.1

Captures and plays out MPEG-2 data streams at the high data rates needed to verify and troubleshoot designs for high-performance consumer and professional video products and systems; is equipped with features to reduce development expenses; provides functional verification, conformance verification and stress testing in the design of MPEG video products.

800-833-9200; www.tektronix.com

Booth: C6231



Handle bracket ▲

VFGadgets.com Mini HDV Handle Bracket

Bracket for Sony HVR-Z1U-HDV Handycam and FX1-HDV Handycam; is perfect for adding extra mini LCD monitors, audio transmitters, or anything else, to Sony HDV cameras; the bracket's design is flat on top for direct mounting of mini SteadyCam's for low angle set shots.

416-686-1452; www.vfgadgets.com

Booth: C2163

Up converter

Vistek V6406

Converts all forms of SD-SDF into HD - and with a picture quality only seen before on high-end products; the key to this quality has been the adaptation of standards conversion technologies to a compact ultra high-speed processing platform; using proprietary Massive Parallel Memory Allocation (MPMA), it delivers truly clean de-interlacing - the core element of any quality Up Conversion.

+44 1628 531221; www.vistek.tv

Booth: SU7376

Converter

Astro Systems The Astro SC-2055 Multi-format converter, with integrated super scaling technology; can drive an array of up to 8 input/output interface options supporting a resolution up to 2048x1556 pixels or as desired; equipped with Astro's I/P conversion technology "SNAP (Super Natural motion Picture)," correction of the jaggy outlines that cause deterioration of image quality can be significantly improved without sacrificing the quality.

877-88-ASTRO; www.astro-systems.com

Booth: C9334



RF power monitor

Bird Electronic Broadcast Power Monitor - Enhanced (BPM-E) RF test port enables users to verify spectral compliance for applications such as IBOC or HDTV, at key test points; puts complete analog and digital broadcast monitoring at the user's fingertips through user-friendly, around-the-clock remote access from any web-enabled device; features include alarm detection and notification, instant email alerts, remote power/VSWR monitoring and administration, RF test port, access to historical data through data logging, and a small footprint requiring minimal rack space.

440-519-2062; www.bird-electronic.com/

Booth: N1116

Converter

Cobalt Digital HD8024 A dual-rate, format converter for up, down or cross format conversions of HD and SD signals; integrated front control panel and the included software application for set-up, configuration and control; features, dual-rate HD/SD digital inputs, digital outputs, analog high and standard definition outputs; all conversion modes include, full aspect ratio (XY scaling and panning) and reticule overlay controls

217-344-1243; www.cobaltdigital.com

Booth: SU8965

Transmitter

Harris Atlas

UHF solid-state transmitters; available in power levels ranging from 2.5kW to 30kW; available in PAL, NTSC and SECAM; common amplification design for simple and cost-effective upgrades to various digital standards; the compact footprint; features a fully broadband and frequency-agile solid-state architecture that minimizes maintenance procedures and allows the transmitters to work on any UHF channel.

800-442-7747; www.broadcast.harris.com

Booth: C1907; SU10048



Televator® Camera Elevator System

- Economical, remotely controlled, elevating motorized pedestal
- Mounts on floor plate, dolly or Telemetrics' Track System for motorized pedestal movement
- Servo controlled smooth and variable speed operation
- Fully programmable presets and motion control

Telemetrics Inc.
CAMERA CONTROL SYSTEMS
www.telemetricinc.com

Microphone

DPA Microphones WINDPAC

An ultra-lightweight weatherproof solution for location recording; fully wind and water resistant; weighs 9oz; comprised of a shock mount and a collapsible wind-shield; adjustable elastic straps with different settings to accommodate microphones of any brand; elastic straps can be adjusted according to the weight of the microphone being used; fabric blocks wind noise in gusts of up to 70mph while allowing accurate sound reproduction and audio transparency.

+45 4814 2828; www.dpamicrophones.com

Booth: N506



Smart audio consoles ▲

Smart AV Elite Series

Provides new standard of ergonomic efficiency for mixing and editing large numbers of channels with this new line of consoles; available in 48-, 72-, and 96-channel variants that can accommodate most professional sound applications; design features a physical arc that spans the console within reach of the operator; fitted with touch sensors, unit allows easy access to any channel.

+61 2 9648 6744; www.smartav.net

Booth: N3135

Television Sideband Adapter

Aerodynex TV Sideband Adapter (ATSA)

Replaces Tektronix 1405-03 Sideband Adapter, which is no longer available; used with a spectrum analyzer, measures the video output of a TV transmitter; generates a constant amplitude composite video signal that sweeps continuously between 0 and 15MHz and is used to modulate the TV transmitter; output is displayed on the spectrum analyzer representing transmitter's response curve.

212-737-3182; www.aerodynex.com

Booth: TBA

Video server

Leitch Technology NEXIO HD

Integrates baseband high-definition record and playback directly into NEXIO server system; provides two channels of HD output or one channel of input and one HD output in either 720p or 1080i format.

859-371-5533; www.leitch.com

Booth: SU7805, SU8199

Media interface adaptors

Omneon Multiport 4100 series

Line of media interface adapters available for Omneon Spectrum media server systems; can support simultaneous playback of both SD and HD MPEG2 material; features integrated capability for the simultaneous playback of HD and SD content on either the same channel or independent channels; in addition to outputs for SDI video, HD-SDI video, audio, timecode, and control, it also includes connectors to allow for the use of external up- and downconversion equipment.

408-585-5000; www.omneon.com

Booth: SU10724



Digital broadcast console ▲

Solid State Logic C100

New feature, TouchPan, provides full 5.1 panning access from the central touchscreen, with color coded displays and comprehensive control of all surround parameters, allows simple setup and control for sophisticated 5.1 productions; comes with new channel TFT Graphics, which enhance the operator's overview through per-channel display of processing, panning and source allocations; supports new I/O expansion for the Centuri core.

212-315-1111; www.solid-state-logic.com

Booth: N3211

Newsroom automation software

Dalet Digital Media Systems

DaletPlus News Suite

Source material, work in progress and finished packages are shared and instantly available on the desktop or remotely through secure web access; Metadata is captured automatically, and repetitive tasks can be automated; integrated asset management and archive capabilities provide access to tape and DVD libraries.

212-825-3322; www.dalet.com

Booth: SL1953

Switcher

SAV 2D DVE

A dual channel 2-D DVE; fits into the MX-AIR frame; works in several modes like Video + Video, Video + Key and Video + preview; the inputs feeding the DVE are selectable by the key bus and can be squeezed, teased, cropped, have color borders and 2-D xyz moves; the effects can be controlled via the T-bar, the automation and the autotransition button; they can be recalled from a library of 40 presets or can be created via the user friendly touch screen and joystick.

212-967-1774; www.sav.tv

Booth: SU11117

Digital production switchers

Ross Video Synergy SD

New, more powerful control panel CPU, keyboard support and USB removable storage; new Squeeze & Tease Warp effects include corner pinning, lens flare, obscure, and shards; automatic white flash effect added to generate this type of effect; robotic cameras, audio mixers, character generators and support for numerous additional manufacturers' products.

613-652-4886; www.rossvideo.com

Booth: SU7141



Encoder ▲

Scopus Network Technologies UE-9000

Universal MPEG Encoding Platform; now implements dual-channel MPEG-2 real-time encoding; provides broadcasters with a migration path from MPEG-2 to new compression algorithms such as the standard and high definition MPEG-4 Part 10 (H.264) and VCI formats.

609-987-8090; www.scopusamericas.com

Booth: SU8470

Routing switcher

Leitch Technology Panacea Clean/Quiet Switch

Clean video with embedded audio routing switcher; provides many features, functions and signal outputs; delivers master control features at a router price; provides simulcast of SD and HD, switch transitions and auxiliary outputs.

800-775-3314; www.leitch.com

Booth: SU7805, SU8199



Depressed collector IOT transmitter ▲

Acrodyne (Ai) Quantum

Designed to operate efficiently in either digital or analog service; is field-convertible; uses e2v ESCIOT water-cooled tubes; engineered to provide a high level of energy efficiency.

888-881-4447; www.acrodyne.com

Booth: C6212

UHF Digital and Analog Transmitter

Axcera Innovator HX

Based on the advanced design of the Innovator HX VHF transmitter; high-power solid-state UHF transmitter; features broadband amplifiers and combiners, high-gain power modules and hot swappable amplifiers; design offers the choice of linear or switching power supplies and uses identical amplifiers for internally diplexed, externally diplexed and DTV operation.

800-215-2614; www.axcera.com

Booth: C8014



Automatic dialog normalization system ▲

Linear Acoustic LA-5124

New version of the LA-5124 StreamStacker De-Multiplexer/AC-3 Splicer; long-term dialog loudness is measured in an ATSC standard manner, appropriate dialog level value is inserted into one of more precompressed Dolby Digital (AC-3) streams by the LA-5124; system provides automatic control of the long-term loudness of programming.

717-735-3611; www.linearacoustic.com

**Booth: Surround Pavilion/
C3612; C6221**

All booth numbers were provided by NAB and were current as of press time. Every effort has been made by Broadcast Engineering to ensure the accuracy of these listings.

Bridging H-DV with Miranda

BY GILBERT BESNARD

H-DV is now generating a lot of excitement. It offers amazingly good quality at a low price point. It should enable HD to move beyond networks and high-end content producers, as well as penetrate parts of the market that would have otherwise taken five years to move to HD.

However, until now, there has been an obvious area of concern: the connection of H-DV devices to higher-end editing systems and infrastructure. After all, without a solution for interfacing H-DV to existing plants, the format will never realize its full potential. This situation with H-DV has many parallels with earlier format introductions. For instance, in the 1980s, the Betacam camera and editing systems made quality video affordable for a wider range of stations.

In 1995, DV further "democratized" digital acquisition and editing for SD. DV offered much lower price points and was even nicknamed "Dispose-a-cam" by some. All this contributed to widespread adoption of DV for news and independent production.

With DV, the arrival of broadcast-quality DV interfacing, which allowed

control for effective operation with DV editing systems.

H-DV, which has a price point starting at \$3500 for cameras and an excellent quality/cost trade-off, seems set

support H-DV.

There are several key H-DV interfacing tasks to be addressed for successful adoption. Perhaps the most critical is broadcast distribution and



Miranda's HD-Bridge uncompresses the H-DV signal in such a way as to assure a first-generation, full-quality image. The image can be edited as HD-SDI without any need to recompress the material, thereby allowing lossless editing.

to follow the DV model. The new format is ideally positioned for rapid adoption as it uses the same cassettes as DV, the same 25Mb/s bit rate

and stored H-DV material to be transformed into an HD-SDI signal for direct on-air broadcasting. Post-production monitoring in the editing suite also will demand conversion of H-DV to various analog video, SD, HD and audio formats.

Another core requirement is converting H-DV captured on-set into HD-SDI so that it can be edited with HD-SDI systems for lossless content creation. Although it is anticipated that H-DV will be used mostly for local broadcast news and simpler documentaries, there are projects that will demand lossless, multi-generation editing. Here, converting H-DV to HD-

Without a solution for interfacing H-DV to existing plants, the format will never realize its full potential.

full interfacing with the station's SD infrastructures, was a key factor in driving the adoption of the format. For instance, the DV-Bridge from Miranda offered key features such as timecode conversion and machine

and the same IEEE-1394 transport (Firewire). H-DV also uses the same MPEG-2 long GOP format used for HDTV broadcast. In fact, major editing systems such as Avid, Apple, Sony and multiple smaller systems already

SDI ahead of editing can significantly improve the final quality. At this stage, a tool that allows all these interfacing tasks to be performed is Miranda's HD-Bridge.

This compact, desktop H-DV to HD-SDI decoder provides high-quality conversion and was developed in collaboration with Sony. Critically, the HD-Bridge uncompresses the H-DV signal in such a way as to assure a

The combination of the new H-DV cameras and H-DV decoders will further stimulate the adoption of HDTV payout around the world.

first-generation, full-quality image, which can be edited as HD-SDI without any need to recompress the material, thereby allowing lossless editing.

When paired with the new breed of H-DV cameras, this new type of interface effectively creates a new HD-SDI workflow paradigm, which just requires the H-DV camera and the H-DV to HD-SDI decoder to output full quality uncompressed HD format. This compact set-up comes at less than one-tenth of the cost of HD cameras or film cameras.

These H-DV to SD-HDI decoders represent the catalyst that will allow many budget-conscious operations to consider implementing high-quality, low-cost HD content creation. Key areas expected to migrate to H-DV are news, specialty and cable programming, and corporate video production. These are the content producers with exacting standards of image quality but typically without the budget for HD until now.

However, H-DV is not just of interest to smaller broadcasters and low-cost producers. At the other end of the production spectrum, there will be real interest from the big names in news, especially for generating HD content from places too unpredictable or dangerous to risk sending an expensive film or HD camera.

Looking ahead, it is obvious that the HD "chain reaction" is progressing fast. By making HD's bottom line more attractive, the combination of the new H-DV cameras and H-DV decoders will further stimulate the adoption of HDTV payout around the world. **BE**

Gilbert Besnard is director product development for Miranda Technologies.



View an online product demo whenever you see this logo.

www.broadcastengineering.com

Total Eclipse of Traditional Automation

Experience it!
NAB.2005
SU11231

DTG

DIGITAL TRANSACTION GROUP



Unique management of media assets allows you to dictate when, where and how content is distributed. Less human intervention all through the content lifecycle. Open data exchange, configurable rules based technology; business intelligence combined with extensible device and resource management.

Automation for the 21st century!

800.243.2001 www.dtgtv.com

Wireless Headsets for your Wired Intercom

**Simultaneous Talk
Hands Free
No base station**



Wireless user communicates in full duplex with all wired stations

TDx 901 Proline . . . \$655

Includes:

- 2 TD 900 Radios
- 1 TDx INT Wired Interface
- 1 Proline Headset

Indicate Clear Com®, Telex®, RTS®, etc.

Interface plugs into existing rack mounted power source or wall jack

E A R T E C®

**1-800-399-5994
www.eartec.com
free catalog!**

Modulus' MPEG-4 AVC solution

BY NEIL BRYDON

MPEG-2 video compression has been around for about 10 years, but a compelling new alternative known as MPEG-4 AVC is now available. The advantage of this standard over MPEG-2 is increased efficiency. It delivers video at half the bit rate of MPEG-2.

The standard was jointly developed by the ITU-T and ISO/MPEG standard committees and was ratified in May 1993. Based on MPEG-2 foun-

ds and describes the practical technology required to deliver both SD and HD AVC content.

Enhanced prediction modes

The superiority of the standard over MPEG-2 is largely due to substantial improvement of the motion compensated prediction. First, it doubles the accuracy of the motion prediction by implementing quarter pixel interpolation. The scenes that most challenge MPEG-2 are handled more effectively

Prediction options

AVC deserves the attention it has been getting, but it is not immune to the usual hype that surrounds a new technology. In the near term, it is realistic to expect the standard to match high-quality MPEG-2 at half the bit rate. However, AVC is poised at the start of its technology lifecycle. Its tools offer an array of permutations and development possibilities for improving video compression that are only beginning to be explored and exploited.

The AVC algorithms are flexible, with tremendous potential to be refined and enhanced. This favors a programmable approach to encoder design. Even though processing support for transform and rate control are well served by general purpose CPUs, the block-based processing and search

AVC doubles the accuracy of the motion prediction by implementing quarter pixel interpolation.

datations, it is designed to carry signals over the existing MPEG-2 transport and modulation infrastructure. The encoding and decoding elements of the standard are complex and technically challenging, ensuring that it will improve over a substantial period of time before the technology matures.

There are many profiles and levels associated with the standard. It is also known as MPEG-4 part 10 and is quite different from MPEG-4 part 2, a technology that failed to deliver adequate gains over MPEG-2. The standard also is sometimes referred to as H.264, which refers to the ITU-T H.264 video compression standard.

Both AVC and MPEG-2 rely on the principle that occasional pictures compressed spatially are interleaved with pictures that predict and describe the motion.

Products based on MPEG-4 AVC are now ready for deployment, enabling operators to deliver SD video at significantly lower bit rates. The following is an outline of how the standard evolved from familiar MPEG-2 meth-

ods with AVC. Fixed block sizing for motion-prediction processing is fundamentally a compromise. MPEG-2 relied on motion prediction based on fixed 16x16 blocks. The standard improves on MPEG-2 by supporting an adaptive hierarchical scheme with block size options down to 4x4.

The standard also extends the adaptive field or frame encoding mechanisms. MPEG-2 uses picture adaptive field or frame coding. AVC adds the tools to allow the field or frame coding to be adapted on a macro-block basis.

Improved intra-prediction modes

The standard also supports new intra-prediction modes that allow the spatially predicted frames and intra-coded macro blocks to be described with fewer bits, improving compression and providing more consistent processing, especially in flat areas.



The Modulus ME1000 SD MPEG-4 AVC encoder delivers video at half the bit rate of MPEG-2.

mechanisms are not. DSP chips can be used, but a more powerful and flexible approach is to employ programmable hardware such as an array of Field Programmable Gate Arrays (FPGAs). Implementations that combine FPGAs and general purpose CPUs offer the ideal combination of processing efficiency and power to fully support AVC encoding.

The standard accomplishes this with

enhanced versions of proven MPEG-2 mechanisms. The AVC standard does not define the process for managing quantization and optimizing the efficient use of available bits. General-purpose CPUs also can provide the processing cycles to support the de-blocking filter function.

Enhanced entropy encoding

Entropy coding is the final stage in the compression process. AVC Main Profile introduces powerful new technology options, known as Context Adaptive Variable Length Coding (CAVLC) or Context Adaptive Binary Arithmetic Coding (CABAC). The CABAC option is complex to implement but yields remarkable efficiency capability.

Windows Media

One alternative from the PC world that has survived and has received plenty of attention is Microsoft Windows Media technology. Microsoft has heavily promoted its Windows Media technology as the new compression format for video across all devices, not just PCs.

Microsoft is in the process of standardizing this format, now known as VC1 through SMPTE. As a result of the standards effort, Microsoft has revealed that the underlying technology is quite similar to AVC. VC1 differentiates itself by adopting a toolset that is optimized towards decoding on PCs at the cost of omitting some tools such as CABAC that would enable greater bandwidth efficiency.

Extending AVC's reach with new profiles

AVC is highly versatile with many profiles and levels to suit specific applications. Main Profile at Level three (MP@L3) is the appropriate one for the delivery of full resolution 4:2:0 interlaced video, while Level four (MP@L4) is designed for HD. At a meeting in Seattle last July, the MPEG committee approved a number of important High Profile amendments, known as Fidelity Rate Extensions

(FRExt). These extensions enhance efficiency and the scope of the standard by offering higher fidelity options, such as 4:2:2 coding, and greater sampling range to further extend the scope and value of AVC.

Deployment scenarios

MPEG-4 AVC has shown significant efficiency gains over MPEG-2, an advantage that is compelling for operations where bandwidth is limited or expensive. AVC effectively extends many MPEG-2 principles but is a big evolutionary step.

Australia, Korea and Japan, and strong European interest resurfaced again at the IBC2004 conference in Amsterdam. Interest in AVC is timely, as it dramatically enhances the practical ability of operators to deliver HD and other bandwidth-intensive services profitably.

AVC platform implementation

Practical AVC encoding and decoding solutions must overcome substantial technical challenges. SD AVC compression requires around 10 times

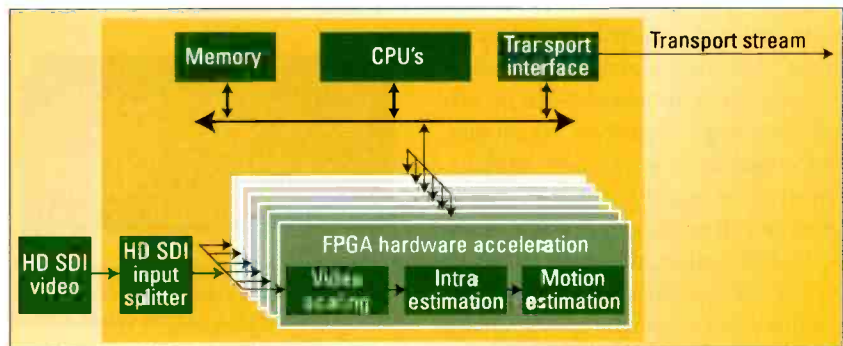

Shown here is the architecture of the Modulus ME6000 HD MPEG-4 AVC encoder. The unit supports advanced features such as CABAC entropy coding, macro block adaptive field frame coding and a de-blocking filter.

Early implementations may cost incrementally more than legacy MPEG-2 solutions, but open standards, market competition and the emergence of powerful integrated silicon will quickly take AVC beyond the technology limits constraining MPEG-2. Encoder and professional decoder products have been launched to deliver the standard over existing MPEG-2 transport infrastructures.

High definition

After many years of false starts, HDTV is now overcoming many of the obstacles that have hampered its introduction. HD content is now abundant, and HD-capable receivers are attaining mass market price points. Most importantly, the major cable and DTH operators in the huge U.S. market are finally promoting HDTV.

HD is also strongly positioned in

more processing power than MPEG-2, and there is now a dearth of ready-made silicon solutions for professional AVC compression applications. HD encoding compounds the challenge.

Despite the challenges, AVC products are being delivered. Look for SD products that can support full resolution processing and all the tools that make the standard efficient; including CABAC, macro block adaptive frame/field (MBAFF), de-blocking (loop) filter and multiple reference frames. **BE**

Neil Brydon is the director of product marketing for Modulus Video.

ATTENTION READERS!
 Sign up now for
BroadcastEngineering's
News Technology Update
 e-newsletter
 at www.broadcastengineering.com

The Optibase/ADI streaming platform

BY KOBI POVOLZKY

Transporting video content from one location to another has become a daily reality for broadcasters and networks as they seek to deliver live or non-live video to major news distribution points, provide ready-to-use material to affiliates, exchange footage from studio to studio or stadium to production center and distribute programming to several television channels.

The process, known as video contribution, or, in broadcast vernacular, video backhauling or video trunking, involves moving massive quantities as quickly and reliably as possible. Once at its destination, the content can go straight to air with no further post-production, or it can be edited, spliced for commercials and branded with logos or other overlays.

The problem

A typical transmission infrastructure for video contribution requires broadcasters to transfer their content using either satellite links or dedicated analog lines leased on an hourly basis. Because these links can be expensive, few broadcasters can afford to maintain them full time.

An end-to-end solution that uses broadband IP instead of a satellite or dedicated leased lines is one alternative that allows broadcasters to reduce video contribution expenses while gaining valuable new flexibility. A good example of such a solution that meets the needs and requirements of broadcasters and at the same time adheres to transmission and quality standards is the TV-over-IP streaming platform from Optibase and ADI.

The solution

In this scenario, digital or analog video footage at the broadcasting

headquarters is fed into an Optibase encoding and streaming platform. This platform encodes the streams and then transmits them over an IP network to the receiving station. Each encoding and streaming platform is equipped with a network interface card that connects directly to the IP network.

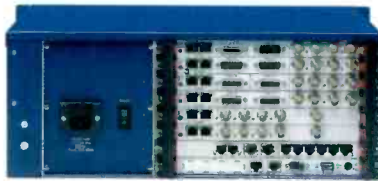

The MGW 1100TV streaming platform from Optibase is designed for broadcasters looking for carrier-grade stability and redundancy.

At the receiving end, an ADI MX decoder converts the signal back to its original form.

Optibase offers two TV streaming platforms; the MGW 2000e and the MGW 1100. The MGW 2000e can encode and transmit up to six analog or SDI signals, encode them in real time

chain. SDI is the most common video format. This standard provides lossless digital encoding of NTSC and PAL formats for use in broadcast-quality environments. The front end, therefore, necessitates 4:2:2 encoding in order to ensure high-color resolution for further editing, or MPEG-2 I-frame-only GOP structure for content that is re-edited and encoded more than once.

Also important for delivering video point-to-point via IP is minimal delay. Encoding and decoding delay is determined by the equipment used and has a strong impact on the overall quality of the transmission.

Jitter is another consideration. Broadcasters should look for an IP solution with an acceptable level of timing distortion. Too much intersymbol interference can introduce data and synchronization errors. Similarly, users will want optimum A/V synchronization between the transmitter and receiver. A suitable amount is typically less than five milliseconds difference between audio/video lip sync.

Key to the encoding and decoding process is the ability to maintain broadcast standards throughout the IP video contribution chain.

to MPEG-1 or MPEG-2, and then stream them over an IP network in multicast or unicast mode. The MGW 1100 can stream up to 30 channels with hot-swap support for all boards except the switch and host.

Key requirements

What should broadcasters look for in an IP-based link? Key to the encoding and decoding process is the ability to maintain broadcast standards throughout the IP video contribution

Finally, broadcasters should protect themselves against error and loss of information. This means choosing a system that ensures enough bandwidth during transmission to allow a continuous flow of data.

The benefits

Streaming delivery with Optibase and ADI provides several tangible advantages without compromising on quality or delivery. First, IP networks can help broadcasters save signifi-

cantly on expensive satellite links and dedicated lines. When using an IP network, the cost of sending 1Mb/s upwards of \$60 when using a satellite line — can be reduced to a little as \$3. IP is

A related benefit is that IP networks are accessible around the clock, whereas satellite links are usually leased on an hourly basis.

In terms of video fidelity, the

ing a broadcast-quality IP delivery system provides all the quality benefits of satellite at a lower cost plus 24/7 availability. **BE**

Kobi Povolozky is Manager, International Marketing & Business development, for Optibase.

Video contribution via IP streaming allows broadcasters and operators to manage bandwidth in a far more efficient way.

also more cost-effective and efficient when compared to other delivery methods, such as FTP or hand-delivery via courier.

Video contribution via IP streaming also allows broadcasters to manage bandwidth in a far more efficient way. Bandwidth capacity with IP corresponds to the bit rate of the streams being transmitted. In contrast, satellite links have a fixed capacity of 27Mb/s or 38Mb/s per transponder.

Optibase/ADI streaming platform uses MPEG-2 encoding to maintain top broadcast quality. A patent-pending eversync mechanism keeps audio and video in sync 24/7, while its traffic-shaping technology lets operators smooth bit-rate fluctuations and keep bit rates constant.

Finally, broadcasters should choose an IP network system that employs QoS technology so their video signal quality is preserved end-to-end. Us-

See the June issue of *BroadcastEngineering*.

Don't miss the 2005 Pick Hits

See the top 40 new products from this year's NAB convention

Selected by readers like you!



"Broadband Progress As Big As Texas"



SCTE's Cable-Tec Expo* hosts more than 400 manufacturers and service providers and is considered the broadband industry's premier engineering and hardware show of the year. With more than 10,000 annual attendees, this event provides hands-on, technology-focused exhibits, educational workshops, and numerous networking opportunities.



Society of Cable
Telecommunications
Engineers

Save \$100
when you register today
www.scte.org

KWTX speeds up with Quantel sQ

BY GEORGE LOVELESS

KWTX and its satellite station KBTX serve the towns of Waco, Bryan, Killeen and Temple in central Texas. The two stations have a potential audience of more than 310,000 households, with the world's largest military facility, Ft. Hood Army Base, on their doorstep, as well as more than 60,000 college students enrolled at nearby Texas A&M University and Baylor University.

By 2004, the technology KWTX and KBTX were relying on was becoming unreliable and uneconomical to maintain — and also, too slow in getting the news to air and keeping it fresh with every newscast. KWTX's existing system, based around Beta SP tape, was simply not up to the new challenges.

Specifying the system

One of the station's big objectives was to be able to quickly and efficiently fresh-en up video. The station wanted a system that would allow it to re-edit stories from show to show — simply and quickly. That means having faster access to material without cueing or loading. Tape is too slow to support the kind of show it wanted to put on, so its first requirement of the new system was to have nonlinear access to all material.

The station looked closely and critically at all the integrated news systems on the market, but most of them had too many separate boxes and too many jumps from one application to another. Close integration with KWTX's

ENPS newsroom system was also vital, and the system would need to be able to run under the control of the Sundance automation system.

KWTX visualized one big virtual newsroom across three locations in a

the company worked with the station on giving it a competitive price.

The system

To meet the 'single virtual newsroom' paradigm, the sQ system is spread across three locations, but it enables everyone everywhere to look at all material wherever it is held.

The station's headquarters in Waco, with upwards of 30 journalists, editors and photographers, has the biggest equipment roster. At its heart is a six-port sQ server with 90 hours of MPEG-2 storage. This supports eight sQView browse applications on journalists' desks in the newsroom, four of the powerful sQEdit applications in the craft edit rooms, an sQEdit Plus in the promos/ads suite and a new



Every journalist has access to every story on the server from their desktops with Quantel's sQView, which runs alongside ENPS.

non-discriminating environment that would provide equal access to all news video from everywhere.

Taking the plunge

The station chose the Quantel sQ system for a number of reasons. First, it was much closer to being a "newsroom system in a box" — an integrated news environment that would be easy for everyone to learn and use.

Second, the station's 20-year-long relationship with the company's still stores, DVEs and Paintbox proved the company's dependability. Third, KWTX felt that the company treats video the way it ought to be treated. Editors who had evaluated competing systems loved the intuitive simplicity of the company's editing and video handling. Cost was also a factor, but

Paintbox in graphics.

Alongside all the new Quantel systems in the equipment room are two Quantel Pictureboxes (installed in the early 90s), which are still in daily service fulfilling KWTX's stills presentation needs. The sQView applications share desktops with the journalists' ENPS workspaces, with Sundance Digital's NewsLink automation handling ingest, satellite scheduling and playout.

KBTX in Bryan has a four-port sQ server, with 20 hours of storage supporting four sQView and three sQEdit applications, while the Killeen bureau has just two sQEdit systems.

Connecting Waco, Bryan and Killeen in order to provide the seamless interchange of material, while containing costs, required the ingenuity of the

station's chief engineer, Larry Brown. The obvious way to go was to rent bandwidth on fibre, but the high cost of this option led Brown to look at the possibility of adapting their existing DS3 microwave infrastructure.

The station successfully managed to tie a new 5.8MHz carrier onto the existing 7GHz microwave system — particularly impressive because the microwave link is not line-of-sight, but a three-hop system.

Rounding out the new setup, archiving is done to videotape, with the Sundance Digital automation likely to be extended to provide asset management of the archive in the not-too-distant future.

It just works

So how's the new system doing? The first clue comes in the on-air control



The central apparatus room features legacy Quantel Picturebox still stores and a Paintbox Express (in the foreground) alongside the new sQ server, editing hardware and new-generation Paintbox.

room, where an air of calm, quiet and unhurried confidence reigns — even in the moments immediately prior to going on-air. Meanwhile, in the newsroom, it's clear that the Quantel interface has already become second nature

to the newsroom staff, and on any given day you are nearly as likely to see a news anchor or chief engineer sitting at the controls as the journalists or editors; everyone has been trained in the system's use.

But the real proof of the system is in the viewers' response. KWTX has begun to grow its audiences again — in particular, the young male viewers, with fast-moving video and lots more sports. KWTX has been able to turn around the important local college football highlights much more quickly and has been able to package

them more attractively on the new sQEdit Plus system. **BE**

George Loveless is a broadcast technology writer.

TRUST

The guy you want sitting next to you...



Broadcast Engineering is that guy.

Want information about what's going on at the FCC that might affect the way you do business? Say no more.

How about news regarding the ever-changing technical data, specs, interfaces, industry trends, and equipment needed to stay that crucial techno-step* ahead?

We'll look no further than **Broadcast Engineering's E-Newsletters:**

- RF Update • Digital Signage Update • News Technology Update
- Sports Technology Update • Strategic Content Management • Show Updates

And the great thing is, we'll never ask to borrow money for lunch.

Subscribe today and thrive tomorrow: <http://www.broadcastengineering.com>

**Testimonial courtesy of Kevin White, Independent Program Producer*

TRUSTED, Technology Industry Leader



Fiber-optic systems

BY JOHN LUFF

In a simpler time, video traversed systems on predictable (copper) circuits. Starting in the early days of monochrome systems, analog video exclusively used coaxial cable and connectors, which were intended for RF usage. Initially, many systems used UHF connectors, and beginning in the late 1970s, BNC connectors were increasingly used in manufactured products. The 75Ω nominal impedance was universal, and the bandwidth of under 6MHz made runs of more than 1000ft practical without amazing efforts to maintain equalization.

Complex systems were made practi-



Italian broadcaster Mediaset selected a network based on DWDM technology to connect its Rome production centers. Image courtesy of Cisco Systems.

cal by this universal interface. There was effectively no difference in the universal interface between systems in 525/30Hz and 625/50Hz countries. SMPTE and other standards organizations had a lot to do with establishing and maintaining effective standards for interchange based on these common elements, sometimes using MilSpec.

The transition to color somewhat modified the status quo, though not the physical layer of the interconnect. With the sensitivity of the subcarrier-based color systems of PAL and NTSC, it was important to establish tighter control over equalization, differential phase and differential gain on long circuits. In an effort to improve the quality of signals that were often degraded by long cables and microwave transmission, some manufacturers began to consider newly-developed fiber-optic technology to modulate video signals onto beams of light.

The first systems more than 20 years ago used strictly analog modulation and still required careful control of the same parameters to keep acceptable signal quality. Long fiber transmission suffers the same degradation as any other analog medium, including signal level caused by absorption of the light in the extended length of a circuit. Good modulators and demodulators had to be used to ensure the recovered signal was a good representation of the original. Audio was usually added as a modulated subcarrier above the visual spectrum. Some of this equipment is still in use today.

The advent of high-bandwidth HDTV signals at first seemed to require fiber interconnection for any reasonable interconnect distance. SMPTE worked on fiber interconnect standards for HDTV at the same time coax interconnections were developed. Manufacturers did an outstanding job of building interconnect hardware using SMPTE 292 transmitter and receiver chips for coax, making HDTV possible in reasonable facilities without fiber. But the march of technology in our industry to wider band-

widths continues to put increasing pressure on copper infrastructure and make fiber more attractive, for technical reasons at least.

Fiber interconnect has been ubiquitous in the IT and telephony industries. A major breakthrough was achieved in 1966 by Charles K. Kao at Standard Telecommunications Laboratories, when attenuation below 20dB per kilometer was first demonstrated. Kao correctly determined that the barrier to low attenuation was impurities in the glass itself. In the last 40 years, the capacity of fiber systems has grown to include deployments of Dense Wavelength Division Multiplexing (DWDM) fiber carrying multiple OC-192 rate (9.6Gb/s) signals. Using this approach, data rates currently extend to nearly 400Gb/s. In our industry, fiber is used for high bandwidth signals, such as SMPTE 292 (1.485Gb/s), as well as for a number of other important applications. These include:

- Extension of L-band satellite signals from teleports to receivers some distance away.
- Connections between two buildings where separate power sources could produce ground loops.
- Connection for HDTV cameras in remote and studio venues.
- ENG connections for remote cameras.
- Trunking of multiple video signals between two sites, or within one site when cabling space is at a premium.
- As a medium to connect stage boxes to audio mixers (and variants on that theme).

Each of these applications has a spectrum of variations. For instance, one manufacturer introduced a new type of patch panel last year with both op-

tical and electrical connections. A signal can be patched using conventional coax patch cords, but the signals are extended to their destination over multiple fibers, saving considerable weight and space. This was initially developed for mobile units, but it is

manufacturers. As our industry embraces telecom technology more, we will see more penetration of their industry-standard solutions.

The issue, as in almost everything in life, is the cost. The cost of the components for electrical connections is

technicians and installers skilled in terminating fiber is much lower than those skilled in coax termination. Much progress has been made, and system integration firms now train technicians in fiber termination routinely. With connections to video servers and transmission links requiring fiber, this can only grow over time.

It is reasonable to expect photonic routing to show up in broadcast in the next few years, with no conversion back to electrical signals necessary for switching. Currently, that is pretty pricey, but that has a way of healing itself in our business. At one time, very little fiber was used at all. Look around you today, and you will see loads of it installed in broadcast-related applications. **BE**

The march of technology to wider bandwidths continues to put increasing pressure on copper infrastructure and make fiber more attractive.

not hard to see how this might apply for large facilities needing to add HDTV infrastructure to crowded cable trays.

For optical interconnect to be ubiquitous in our industry, this kind of blurring of the distinction of what the interconnect is will need to proliferate. We are beginning to see digital routing switchers with fiber on the back plane, as well as a wide variety of other modular products from several

still cheaper than fiber. This is partially offset by the low cost of the actual fiber itself, with multiple strand fiber costing about the same as single runs of coax. At one time, the cost of termination was considerably higher due to the labor needed to cleave and polish the ends. New termination technology has reduced the handicap in labor cost considerably, though not completely.

It is also true that the number of

John Luff is senior vice president of business development at AZCAR.



Send questions and comments to:
john_luff@primediabusiness.com

TRUST



SUBSCRIBE

to the Trusted Technology Leader and Stay on Top of the Industry!

For over 45 years, readers have learned to **TRUST** *Broadcast Engineering* editors to bring them timely, reliable and indispensable technical information.

You can **TRUST** *Broadcast Engineering* to deliver the best: It is ranked #1 most authoritative global source of technology information in the industry.*

Stay on top of the latest technology developments, new players, products & decision-makers.

SUBSCRIBE to *Broadcast Engineering*.

To start your **FREE** subscription, go to www.broadcastengineering.com and click on **SUBSCRIBE NOW**.

*2003 Paramount Research Study



Celebrating 45 years
as the Technology Leader.

TRUSTED, Technology Industry Leader

BROADCAST VIDEO OVER IP

See us @ NAB 2005
Booth SL 3655

Streambox[®]
Power To Do More™

PROFESSIONAL QUALITY
ENCODERS FOR IP/T1/E1



ACT-L3 VIDEO TRANSPORT

Advanced Forward Error Correction
for wired/wireless/sat networks

HD Encoder
3Mbps - 9Mbps

SD Encoder
20Kbps - 7Mbps

ENG Portable Encoder
20Kbps - 7Mbps

Call or Visit Today! www.streambox.com • sales@streambox.com • 206/956-0544 x222

OTLighting

Tower Lighting Specialists

www.otlighting.com

OTL

**EXTRA LONG LIFE
TOWERS LAMPS**

**GUARANTEED
FOR
50,000 HOURS.**

**THE LAMPS
CAN SAVE YOU
THOUSANDS
OF DOLLARS.**

1-800-647-9110

43, Durkee Street, Office 719

Plattsburg, N.Y., 12901

Developed in conjunction with

OSRAM SYLVANIA

AP41-VP

TBC/Frame Synchronizer

The best filter is no digital comb filter
No vertical resolution loss
ideal for satellite feed

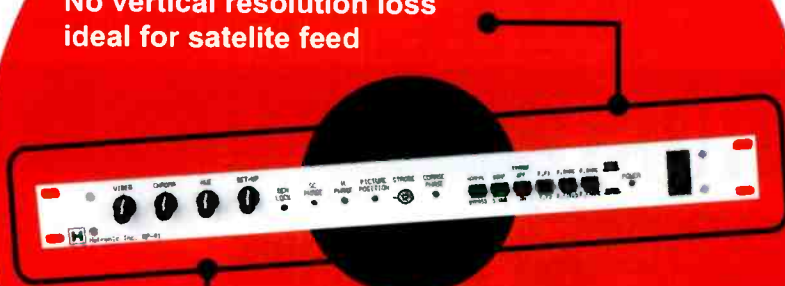

Automatically detects stable
NTSC signal or signal with
time base error

H HOTRONIC, INC.

1875 S. Winchester Blvd. Campbell • California 95008 U.S.A.

Tel: 408-378-3883 • Fax: 408-378-3888

Website: www.hotronics.com • Email: sales@hotronics.com



BROADCASTENGINEERING.COM

You'll find everything you need to know about advertising in 2005!

Choosing ERI with our dedication to **Quality** and **Innovation** coupled with the **Synergy** achieved through a complete ERI broadcast system gives you **The ERI Advantage**.

At NAB2005, visit us in
Booth N1306
of the Radio/ Audio Hall.



Innovation

STACKER® Optimized TV Antenna Structure

The STACKER™ offers a unique solution to the problem of diminishing tower top real estate. It offers high antenna density without the tradeoffs of inline stack designs or the expense of a candelabra or TBar.

ELECTRONICS RESEARCH, INC. ERI®

Your Single Source for Broadcast Solutions™

Call Toll-free at 877 - ERI - LINE • Visit Online at www.eriinc.com

HI DEF @ AFFORDABLE PRICE!

Precise image acquisition
Superb detail
Comprehensive functionality



The
NEW

SONY
HVR-ZU1
1080i HDV
CAMCORDER

WEST COAST LEADER
IN BROADCAST AND INDUSTRIAL
PRODUCTION PACKAGES

Studio Exchange



Authorized
Professional
Reseller

818.840.1351
studio-exchange.com

816 N. Victory Blvd. Burbank, CA 91502

The world's largest full-service

USED & NEW

pro video and audio
dealer on the planet!

LOGIN NOW
and start saving today!



**5% to
50%
DISCOUNTS!**

BROADCASTSTORE.COM
LA 818-551-5856 • NY 212-268-8800

See us at **NAB 2005** Booth #SU6358

NAB 2005
Booth C10120



BSG-50 \$349

Blackburst, Sync, & Audio Tone



"...Versatile and powerful performance."



"...Just what you've come to expect from Horita."

The **HORITA** BSG-50 takes center stage in the edit bay with multiple user-configurable outputs. Select from 6 blackburst, 4 sync, burst flag, and subcarrier *plus* audio tone.

Unconditionally Guaranteed!

HORITA

www.horita.com

(949)489-0240

horita@horita.com

TALLY MAPPER™

- ◆ Tally Routing & Mapping
- ◆ One Button Operation
- ◆ Store Maps Internally
- ◆ Edit From a PC/Laptop



A Compact Solution,
Ideal for Mobile Units and
Multiple Production Setups.

Videoframe™

Control System Solutions

Tel: 530-477-2000

www.videoframesystems.com

HD Encoding Workstation

Real-time, PC-based
High-resolution (1080i)



The HD Maestro

- Input HD-SDI, output DVB-ASI
- Based on the LSI Logic DoMiNo™ chipset
- Perfect for post production HD content distribution
- PC platform provides flexibility and connectivity

For more information on the HD Maestro or any DVEO products, call 858 613-1818. Or visit www.dveo.com

DVEO
Pro Broadcast Division
by CMI

NAB 2005
Booth SU 1119

Tests & Measurement

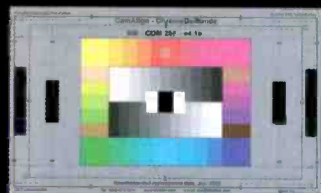

**Precision charts
the industry trusts**

From **dsc** Labs

For HD, SD and digital cinema

See *tech reports, papers
and user info* at:

www.dsclabs.com

'Better images through research' - since 1962

For Sale



AcousticsFirst™

Toll-Free
Number: **888-765-2900**

Full product line for sound control
and noise elimination.

Web: <http://www.acousticsfirst.com>

Help Wanted



TURNER STUDIOS

TURNER STUDIOS is the full service broadcast and post production division of Turner Entertainment Group, providing turnkey services for film, video and audio production. Turner Studios provides facilities and resources for all of the Turner Entertainment Networks worldwide from our state-of-the-art television complex in Atlanta Georgia.

We are seeking motivated, experienced, client-oriented Engineering professionals to join our expanding team. If your passion is cutting edge technology in a creative, fast-moving environment, Turner Studios Engineering is looking for you!

We're currently accepting resumes for:

ENGINEERING MANAGERS

Design, budget, plan, implement, support, project and personnel management

Data Systems - Digital Media, Render, Storage, Security, Server systems.

Projects - Live, Studio and Post Production systems, SD & HD

ENGINEERS IN CHARGE

Lead engineers in fast paced event environment

Studio - Live and Taped Event Engineering

Remote - EIC / Maintenance - HD Mobile units

PRODUCTION ENGINEERS

Design, install and maintain SD/HD production and post facilities

• Studio

• Audio

• Editorial

• Effects

• IT / Network

Workstation, application, OS, server support / MSCE, Cisco, Linux, SGI

Please send resumes to:

Jeff Sharpe

Director of Engineering

Fax - 404-878-4014

Email - jeff.sharpe@turner.com

For more information,
please visit:

<http://www.turnerstudios.com>

<http://www.turnerjobs.com>

BROADCASTENGINEERING.COM

Help Wanted

Satellite News Gathering Engineer



to operate vendor
C/KU Transportable Earth Station.

Expanding Rocky Mountain Region
SNG company looking for qualified
engineer to operate and maintain
SNG to cover live news and sporting
events for various networks.

- 2+ years experience •
- Clean driving record •

Peak Uplink
458 Silverhorn Drive
New Castle, CO 81647
peakuplinkinc@aol.com

**NEWSROOM IT SYSTEM ADMINIS-
TRATOR** WPVI-TV, the ABC O & O
Station in Philadelphia, is looking for
an IT professional to support the vari-
ous computer systems and new tech-
nology that is transforming our news
department & TV station. Candidate
must have several years of broadcast
IT experience, and work well under
the pressure of multiple daily dead-
lines. Television newsroom/non-linear
experience preferred. Proficient in
Microsoft Products (Windows,
Server2003, Office, Etc.) as well as
hardware troubleshooting and main-
tenance required. A degree in IT or
Computer Science/Engineering is
preferred, as well as hardware/soft-
ware certification. Schedule will en-
compass nights and weekends and
flexibility with hours will be required.
Send resume & cover letter (no calls/
faxes) John Chybinski, IT Manager,
WPVI-TV, 4100 City Ave., Suite 800,
Philadelphia, PA 19131 EOE

SENIOR SYSTEMS ADMINISTRATOR
Media General Broadcast Group,
www.mgbg.com, is seeking a Sr. Sys-
tems Administrator for our broadcast
systems. This position will develop,
install, and maintain master control
automation systems for a 26 station
group. The successful candidate will
have minimum 4 yrs. Experience in
broadcast television engineering with
additional experience in IT systems
(MS Windows, data networks, etc.).
Technical degree or college preferred.
Apply online at www.mediageneral.com/jobs ;
email resume to hr@mgbg.com ;
or by mail to MGBG HR, 111 N.
4th St., Richmond, VA 23219. Back-
ground check and drug test required.
EOE M/F/V/D.

Help Wanted

Fox Networks Engineering & Operations in Los Angeles, CA is searching for experienced professionals for the following positions:

Graphics Maintenance Technician

Macintosh/PC Tech Support Engineer to work in television graphics production environment. Will need expertise in setups, moves & configuring for both news/existing Macintoshes, XServers, PCs, & peripherals. In this role, you will also provide network administration & maintenance, network connections, file transfers & backups, as well as software/hardware installs, upgrades, troubleshooting & occasional user training.

Requires:

- 2-3 years experience in computer support or administration role, as well as in television graphics environment
- Hardware installation, configuration, backup & maintenance of Xserve G5 Servers & RAID's
- Provide end-user support for Macintosh OS X, Windows 2000 & XP clients
- Install, support & maintain computer hardware, software & peripherals
- Willing to work extended hours during peak periods
- Support for Final Cut Pro, Maya, After Effects, Photoshop & Illustrator applications
- BS/BA degree in technical field

Preferred:

- Writing scripts for UNIX and After Effects
- Maintenance of television graphics & post production equipment
- Troubleshoot & maintain Avid Editing systems

Help Wanted

Maintenance Engineer

This successful candidate will have excellent people skills & a strong electronic maintenance background with the ability to troubleshoot to the component level. Individual should be experienced in digital television system maintenance, including intercom systems, monitors, cameras, still stores, character generators, production & routing switchers, videotape & audio equipment. The candidate should also be familiar with LAN systems, TCP/IP, computer configuration & software installation.

The professional we seek will be a self-starter, well organized & willing to work flexible hours, including evenings, weekends & holidays. Must have an Associate's degree in electronics or a minimum of 4 years experience as a maintenance engineer in a broadcast or production facility.

To apply, interested candidates should visit:

www.FoxCareers.com



Fox is proud to be an Equal Opportunity Employer.

Maintenance Engineer - WESH-TV, Orlando's NBC affiliate and a Hearst-Argyle television station is seeking a talented Maintenance Engineer to join our staff of professionals. Successful applicant will be self-motivated, detail oriented and a team player. Job responsibilities include operation, repair and maintenance of broadcast equipment to the component level. VHF transmitter plant, tower and microwave maintenance experience is a strong plus. Knowledge of digital broadcasting equipment and computer skills are necessary. Requires at least 5 years experience in television studio and transmitter maintenance. Send resume to Richard Monn, Chief Engineer, WESH-TV, 1021 N. Wymore Road Winter Park, Florida 32789. email: rmonn@hearst.com. No Phone Calls, please! An Equal Opportunity Employer.

FIRST CALL UPLINKS is looking for an outstanding satellite truck operator to join our team of professionals in the Baltimore/Philly area covering network television news and sports. Minimum 2 years uplinking experience required with engineering background a definite plus. Benefits include great salary, health insurance, retirement plan and more. Excellent opportunity for a motivated, self-starter to join a growing company. Email cover letter and resume to Rob-in.Channell@firstcalluplinks.com

**Television Broadcast Transmitter/
Maintenance Engineer** - Successful candidate will have 5 years of solid work experience in the maintenance and repair of television broadcast transmitters, RF and DTV systems. The candidate will be responsible for maintaining complete and accurate documentation for all equipment at the transmitter facility. This is a hands-on position that will require a thorough knowledge of UHF/HDTV transmitters. Duties will also include technical training on remote transmitter monitoring to the station operations staff, repair of ENG equipment, support for live newscasts, and outside broadcast remotes. A strong news background is desirable along with the ability to lift a minimum of 25 lbs. and be willing to work nights, weekends and holidays. Two year Associates degree or electronic certification program preferred. FCC General Class license and/or SBE certification preferred. Drivers license with satisfactory driving record mandatory. Final candidate will be asked to submit to a drug screen. Deadline: Open. Salary: Open. Please submit resume and salary requirements to: KFTA-TV/KNWA-TV, Attn: Chief Engineer, 15 South Block St., Suite 101, Fayetteville, AR 72701. No phone calls please. EOE.

Editorial Director: Brad Dick, bdick@primediabusiness.com

Editor, World Edition: David Austabeny, editor@broadcastengineeringworld.com

Managing Editor: Susan Anderson, sanderson@primediabusiness.com

Assoc. Editor/Webmstr: Chevonn Payton, cpayton@primediabusiness.com

Asst. Editor: Angela Dauris, adauris@primediabusiness.com

Sr. Art Director: Michael J. Knust, mknust@primediabusiness.com

Art Director: Robin Morsbach, rmorsbach@primediabusiness.com

Technical Consultants: Computers & Networking – Brad Gilmer

Antennas/Radiation – John H. Battison

Digital Video – Michael Robin

Transmission Facilities – Donald L. Markley

Legal – Harry C. Martin

New Technology – John Luff

Industry Waicher – Paul McGoldrick

New Media – Craig Birkmaier

Sr. VP: Peter L. May, pmay@primediabusiness.com

Group Publisher: Dennis Triola, dtriola@primediabusiness.com

Marketing Dir.: Kirby Asplund, kasplund@primediabusiness.com

Online Sales & Marketing Dir.: Samantha Kahn, skahn@primediabusiness.com

Vice President of Production: Lisa Parks, lparks@primediabusiness.com

Sr. Ad Prod. Coord.: Kathy Daniels, kadaniels@primediabusiness.com

Classified Ad Coord.: Mary Corcoran, mcorcoran@primediabusiness.com

Dir., Audience Marketing: Barbara Kummer, bkummer@primediabusiness.com

Group Show Director/LDI: Sharon Morabito, smorabito@primediabusiness.com

PRIMEDIA

Business Magazines & Media

COO: Jack Condon, jcondon@primediabusiness.com

Executive Vice President: John French, jfrench@primediabusiness.com

Corp. Comm/Mkg.: Karen Garrison, kgarrison@primediabusiness.com

Primedia Inc.: 745 Fifth Ave., NY, New York 10151

Chairman: Dean Nelson, dean.nelson@primedia.com

President and CEO: Kelly Conlin, kelly.conlin@primedia.com

Vice Chairman & General Counsel: Beverly Chell, beverly.chell@primedia.com

MEMBER ORGANIZATIONS

Sustaining Member of:

• Society of Broadcast Engineers

Member, American Business Media; Member, BPA International



BROADCAST ENGINEERING, ISSN 0007-1394, is published monthly (except semi-monthly in June and December) by PRIMEDIA Business Magazines & Media Inc., 9800 Metcalf Ave., Overland Park, KS 66212 (primediabusiness.com). Current and back issues and additional resources, including subscription request forms and an editorial calendar, are available on the World Wide Web at broadcastengineering.com.

SUBSCRIPTION RATES: Free and controlled circulation to qualified subscribers. Non-qualified persons may subscribe at the following rates (Prices subject to change): USA and Canada, 1 year, \$70.00, 2 years, \$135.00, 3 years, \$200.00. Outside USA and Canada, 1 year, \$85.00, 2 years, \$165.00, 3 years, \$245.00 surface mail (1 year, \$55.00, 2 years, \$295.00, 3 years, \$440.00 airmail delivery). For subscriber services or to order single copies, write to Broadcast Engineering, 2104 Hanwell Circle, Bellevue, NE 68005 USA, call 866-505-7173 (USA) or 402-505-7173 (outside USA), or visit www.broadcastengineering.com.

ARCHIVES AND MICROFORM: This magazine is available for research and retrieval of selected archived articles from leading electronic databases and online search services including Factiva, LexisNexis and Proquest. Formicroform availability, contact ProQuest at 800-521-0600 or 734-761-4700, or search the Serials in Microform listings at proquest.com.

REPRINTS: Contact FosteReprints to purchase quality custom reprints or e-reprints of articles appearing in this publication at 866-436-8366 (219-879-8366 outside the U.S. and Canada). Instant reprints and permissions may be purchased directly from our Web site, look for the RS(Copyright tag appended to the end of each article.

PHOTOCOPIES: Authorization to photocopy articles for internal corporate, personal, or instructional use may be obtained from the Copyright Clearance Center (CCC) at 978-750-8400. Obtain further information at copyright.com.

PRIVACY POLICY: Your privacy is a priority to us. For a detailed policy statement about privacy and information dissemination practices related to Primedia Business Magazines and Media products, please visit our Web site at www.primediabusiness.com.

CORPORATE OFFICE: Primedia Business Magazines & Media, 9800 Metcalf, Overland Park, Kansas 66212 • 913-341-1300 • primediabusiness.com

Copyright 2005, PRIMEDIA Business Magazines & Media Inc. All rights reserved.

Ad Index

Broadcast Engineering is not responsible for errors in the Advertisers Index.

	Page #	Advertiser Hotline	Web site Address
Accom Inc.	19		accom.com
ADC Telecommunications Inc.	157-172	800-366-3891	adc.com/broadcast
Anton/Bauer	103	203-929-1100	antonbauer.com
Anystream	83	888-anystream	anystream.com
Ascent Media Network Service	69	201-767-1200	ascentmedia.com/systems
Avid Technology	4-5		avid.com/beimagine
Azden	93	516-328-7500	azdencorp.com
Barco Projection Systems Inc.	95	770-218-3200	barcocontrolrooms.com
Bogen Imaging	59	201-818-9500	bogenimaging.com
Broadcast Microwave Services	71	800-669-9667	bms-inc.com
Burst Communications	174	888-472-2820	burstvideo.com
Calrec Audio Ltd.	51	+44 1422 842159	calrec.com
Canare Cable Inc.	107	818-365-2446	canare.com
Canon USA Inc.	21		canondv.com
Canon USA Broadcast Lens	29	800-321-hdvt	canonbroadcast.com
Canopus Corporation	145	888-889-edit	canopus.com
Chyron Corporation	18		chyron.com
Clear-Com Communication Systems	49	510-496-6666	clearcom.com
Digital Transaction Group	189	800-243-2001	dtgtv.com
DMT USA	55	856-423-0010	dmtonline.usa
Dolby Laboratories Inc.	17		dolby.com/events/nab
Doremi Labs Inc.	91	818-562-1101	doremilabs.com
Eartec - Porta Phone	189	800-399-5994	eartec.com
Eastman Kodak Co.	113-116		kodak.com/go/filmthedifference
Echolab	31		echolab.com/identity4
Ensemble Designs	73-80	530-478-1830	ensembledesigns.com
ERG Ventures Co. Ltd.	53	949-263-1630	erg-ventures.com
ESE	85	310-322-2136	ese-web.com
Euphonix	33	650-855-0400	euphonix.com
Evertz Microsystems Ltd.	IBC	905-335-3700	evertz.com
Fischer Connectors	125	800-551-0121	fischerconnectors.com
Fission Software Inc.	101	888-644-8766	fission-sw.com
Floral Systems Inc.	84	352-372-8326	floral.com
Fluke Corporation / Pomona Electronics	34	800-490-2361	pomonaelectronics.com/sample
Focal Press	183		
For-A Corporation of America	143	+81 (0)3-3446-3936	for-a.com
Fujinon Inc.	121	973-633-5600	fujinon.com
GEPCO	56	800-966-0069	gepco.com
Hamlet Video International Ltd.	177	866-4-hamlet	hamlet.co.uk
Harris Broadcast	8-9		harris.com
Harris Broadcast	3	888-711-7295	intelligenttransmitter.com.harris
ICF - Interactive Content Factory	64		icf.tv
Inter BEE 2005	131		bee.jesa.or.jp
Kino Flo Inc.	52	818-767-6528	kinoflo.com
K-WILL Corporation	155	949-553-9701	kwillcorporation.com

	Page #	Advertiser Hotline	Web site Address
Laird Telemedia	66		lairdtelemedia.com
Leitch	BC, 133-140	800-231-9673	leitch.com
Leitch	87	800-231-9673	leitch.com/x75
Marshall Electronics Inc.	48	800-800-6608	lcdracks.com
Maxell Corp. of America	11	800-533-2836	maxellpromedia.com
MicroFirst Inc.	153		microfirst.com
Microwave Radio Communications	111	978-671-5700	mrcbroadcast.com
Middle Atlantic Products Inc.	43	800-266-7225	middleatlantic.com
Miranda Technologies Inc.	13	514-333-1772	miranda.com/xvp
MITEQ	123	630-759-9500	mcl.com
NAB HD	175		
Network Electronics	42	800-420-5909	network-electronics.com
NVision Inc.	97		nvision.tv
Omneon Video Networks	26		omneon.com
Omnibus Systems	65	303-237-4868	omnibus.tv
Panasonic Broadcast	7		panasonic.com/nab
Prime Image Inc.	25	408-867-6519	primeimageinc.com
Pro-Bel	32	631-549-5159	pro-bel.com
Quartz USA	82	888-638-8745	quartzus.com
Radyne	119	602-437-9620	radn.com
Riedel Communications Inc.	181	818-563-4100	riedel.net
Rohde & Schwarz	50	888-837-8772	rohde-schwarz.com/usa
Sachtler Corporation of America	27	516-867-4900	sachtler.com
Screen Service Italia	105	+39 030 3582225	screen.it
Sencore	127	800-736-2673	sencore.com
SES Americom	149	800-732-3273	ses-amicom.com
Snell & Wilcox Ltd.	35-40		snellwilcox.com
SCTE Cable-Tec Expo	193		scte.org
Sony Electronics - Business Systems	44-45		sony.com/hdselect1
Studer USA	67	866-406-2349	studer.ch
Sundance Digital	58	972-444-8442	sundancedigital.com
TBC Consoles Inc.	86	888-consocle	tbcconsoles.com
Telecast Fiber Systems Inc.	129	508-754-4858	telecast-fiber.com
Telemetrics Inc.	185		telemetricsinc.com
Terayon Communications	23		terayon.com
Thales Angenieux	57	973-812-3858	angenieux.com
Thomson/Grass Valley	15		thomsongrassvalley.com/newton
Triveni Digital	179	866-triveni	
T-Systems International	60-61		t-systems-mediabroadcast.com
Utah Scientific	151		utahscientific.com
VertigoXmedia	72	877-4-VERTIGO	vertigoxmedia.com/know
Videotek Inc.	99	800-800-5719	videotek.com
Wheatstone Corporation	IFC	252-638-7000	wheatstone.com
Zandar Technologies	147	321-939-0457	zandar.com
360 Systems	109	818-735-8821	360systems.com

US/CANADA

WEST

George Watts III
(360) 546-0379; Fax: (360) 546-0388

georgeww3@aol.com

EAST

Josh Gordon
(718) 802-0488; Fax: (718) 522-4751
jgordon5@bellatlantic.net

EAST/MIDWEST

Joanne Melton
(212) 462-3344; Fax: (913) 514-9249
jmelton@primediabusiness.com

INTERNATIONAL

EUROPE

Richard Woolley
+44-1295-278-407
Fax: +44-1295-278-408
richardwoolley@btclick.com

ISRAEL

Asa Talbar
Talbar Media
+972-3-5629565; Fax: +972-3-5629567
talbar@inter.net.il

JAPAN

Mashy Yoshikawa
Orient Echo, Inc.
+81-3-3235-5961; Fax: +81-3-3235-5852
mashy@fa2.so-net.ne.jp

CLASSIFIED ADVERTISING

Susan Schaefer
(484) 478-0154
Fax: (913) 514-6417
sschaefer@primediabusiness.com

REPRINTS

FosteReprints
(866) 436-8366;
International inquiries: (219) 879-8366

LIST RENTAL SERVICES

Marie Briganti, Statistics
(203) 778-8700 x146
(203) 778-4839
primedia@statistics.com

Customer Service: 913-967-1707 or 800-441-0294

BROADCAST ENGINEERING & World Edition
April 2005, Vol. 47, No.4 (ISSN 0007-1994) is published monthly and mailed free to qualified persons by Primedia Business, 9800 Metcalf Ave., Overland Park, KS 66212-2216. Periodicals postage paid at Shawnee Mission, KS, and additional mailing offices. Canadian Post Publications Mail Agreement No. 40597023. Canada return address: DHL Global Mail, 7496 Bath Road, Unit 2, Mississauga, ON L4T 1L2. POSTMASTER: Send address changes to *Broadcast Engineering*, P.O. Box 2100, Skokie, IL 60076-7800 USA. CORRESPONDENCE: Editorial and Advertising: 9800 Metcalf, Overland Park, KS 66212-2216 Phone: 913-341-1300; Edit. fax: 913-967-1905. Advert. fax: 913-967-1904. © 2005 by Primedia Business. All rights reserved.

Show your work

BY PAUL MCGOLDRICK

At college, or wherever the last place you studied mathematics was, you were probably told to show your work and not to jump to an analysis or a conclusion without explanation. The way that you tackled a problem was as important as whether you actually got the correct answer.

But it's not always true that is the best way to proceed. My father started driving a vehicle rather late in life and mercifully took himself out of the driving seat before his abilities were really impaired. He went the formal

you would not be able to tackle any repairs on it; repairing products down to the board level for all the equipment in the studio and transmitter was the norm, not the exception. Today that is no longer true for most equipment and most repairs are either at a higher, modular level, or equipment is completely chucked away.

What many engineers do not realize is how that also relates to the components that are used to achieve the results we want to see. When I came into the industry, a sync pulse generator was a rack-mounted unit (yes, with

cisco Bay area, it was a pleasure to be involved in giving out awards to a number of semiconductor companies. At one of the last stops, I was invited into a lab to see a prototype chip in operation; I was flabbergasted at what I was looking at. The IC was a software-configurable processor. In the demonstration, it was crunching an HDTV signal into other formats and sizes — in effect doing things that just a few years ago required rack-size boxes with mil-spec ICs, and a lot of them. Here was a \$100 IC, with a very small number of peripheral components, that could power a box that broadcast customers would pay tens of thousands for with a standards converter or video manipulation title attached to it.

So, if you see people at NAB wearing a badge with the company name Stretch, Inc., stop and ask them what they can do for your application. But don't ask them what is under the hood — you really don't need to know. **BE**

Paul McGoldrick is an industry consultant based on the West Coast.



Send questions and comments to:
paul_mcgoldrick@primediabusiness.com

We can see a similar pattern in broadcast engineering over the years in knowing, or not wanting to know, the internal workings.

driving school route in search of his license. During the first lesson, the instructor tried to explain the workings of the internal combustion engine and how speed and gears were all related to one another. My father cut him short and told him that he didn't care what was in front and below him, he just wanted to drive.

From an engineering perspective, we would probably insist that not understanding the relationship between engine speed, gearing and road speed would make it very difficult to understand how to use a gear box, but he wanted to learn to drive just by rote.

We can see a similar pattern in broadcast engineering over the years in knowing, or not wanting to know, the internal workings of products. There were days when you had to completely understand the circuit operation of a piece of equipment, or else

tubes!) and was unreliable, temperature-sensitive and always had a redundant backup. Then Ferranti produced an IC that was most of an SPG (it missed some broad pulses in the 50Hz version, as I remember), and there was a loud bell that went off in my head about what linear ICs might do in the future.

The broadcast industry has not been a prime target over the years for specialized ICs. Sure, there have been thousands of devices that have been used, but the main targets for the products have been in the much larger professional or consumer device arena. And that is probably not going to change in the foreseeable future, so we need to be careful not to ignore some advances in technology and technique that directly affect the way we design and use equipment.

During a recent trip to the San Fran-



See the June issue of BroadcastEngineering.

Don't miss the 2005 Pick Hits

See the top 40 new products from this year's NAB convention

Selected by readers like you!

PICK HIT

BroadcastEngineering

THE LEADER IN HDTV...

...and Multiviewers

...and Fiber Optics



...and Distribution & Conversion

...Closed Captioning

...Production & Post Production

...Time Code

and Much More...

U.S. West Coast Sales
818-558-3910
LAsales@evertz.com

U.S. & International Sales
Tele: 905-335-3700
sales@evertz.com

New York Sales
newyorksales@evertz.com

Washington Sales
dcsales@evertz.com

evertz®

www.evertz.com

UK Sales
uksales@evertz.com

Beijing Sales
beijingsales@evertz.com

Visit Us at NAB 2005 - Booth #SU6433
Order your new 2005 Catalog
from your Evertz Representative

[NEXIO™ Servers, More HD Dimensions]



HD SERVER

MTS SERVER

MPEG BRANDING



Winning Strategies
Master Your Move to HD with
Integrated Multi-dimensional
HD Servers and Shared Storage

High-Definition NEXIO™ Server Systems

Make the move onto integrated high-performance platforms running our flexible software architectures.

HD NEXIO™ — server integrates the first software-based agile codec for high-definition video, allowing baseband high-definition record and playback, while supporting up and down conversion of content for simulcast applications from the same shared storage file system.

Digital Turnaround Processor™ (DTP) — uses patented software for real-time compressed video processing, enabling broadcasters to overlay motion graphics and logos on pre-compressed high-definition and standard-definition streams.

MPEG-2 Transport Stream (MTS) — server provides ASI input/output interfaces with the ability to de-multiplex a multi-program transport stream (MPTS). Stores individual programs and re-multiplexes any new MPTS created by seamlessly splicing individual HD and SD clips, thereby bridging the gap in workflow between SD and HD broadcasting.

Master Your Move to HD with NEXIO Server Systems

Canada +1 (800) 387 0233
USA East +1 (800) 231 9673
USA West +1 (888) 843 7004
Latin America +1 (305) 512 0045

 **LEITCH**

www.leitch.com