

# The Bell System Technical Journal

July, 1928

---

## Precision Tool Making for the Manufacture of Telephone Apparatus

By J. H. KASLEY and F. P. HUTCHISON

THERE is probably no field of human endeavor in which hand labor has been more completely replaced by labor-saving devices than in the field of manufacturing. The design and employment of special tools together with semi- and full automatic machinery for operating them have reached a high stage of development and are probably more responsible than any other factors for the present age being generally referred to as the industrial age. The notable economies of present day manufacture result no more from the rapid production of parts thus made possible than from the interchangeability of these parts because of the accuracy with which they have been produced.

At the foundation of precision manufacture by machine lies the art of tool making. As a result of the impetus given it by the economic justification underlying the transition from hand labor to mechanical devices, it has grown steadily in importance and in refinement. In large measure, it is the art of tool making which insures the interchangeability of product.

There are probably few industries in which the refinements of the tool making art have been carried further than in the manufacture of telephone apparatus and equipment, especially when handled on a large production basis as by the Western Electric Company. The purpose of this article is to outline some of the refinements of the tool making art as practiced by this Company and to do this, illustrative material will be drawn from among the large number of punches and dies used for punch press methods of manufacture. The methods employed and precision necessary in building the tools discussed below can be considered as representative of the high class of workmanship required throughout the Company's tool rooms.

### PUNCHES AND DIES

*Tool Making for Telephone Apparatus Manufacture.* Briefly, a punch and die comprises a pair of individual tools so constructed

with respect to each other that, when properly guided and forced into engagement with sufficient pressure, they will produce a uniform permanent change on the material placed between them. Punches and dies are made to perform a variety of operations, such as cutting or shearing parts from strip stock, commonly termed blanking, perforating or piercing holes, drawing, forming or bending, stamping, embossing, etc. In many instances two or more operations are combined in one tool, as, for example, a perforating and blanking punch and die, which cuts the part to its required shape and also perforates the required holes. Multiple operation tools may be constructed in many different ways, depending on the particular requirements of the part to be made. Typical illustrations of punches and

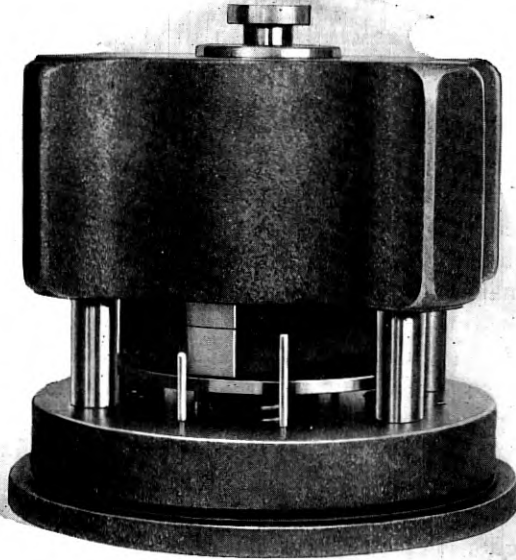

Fig. 1—Compound punch and die of the liner pin type assembled.

dies for accurate work are shown in Figs. 1 and 2. The former shows a compound punch and die of the liner or guide pin type assembled, and the latter shows a partially disassembled tool of the sub-press design, in which the moving member is completely enclosed and guided by the housing.

The compound type of construction mentioned in the preceding paragraph, which perforates and blanks the part complete in one die position and one stroke of the press, gets its name from this feature of performing a compound operation in one die position, and is generally used where very accurate parts, practically free from distortion and

with clean-cut edges, are to be produced, and particularly where thin stock is used. It is also preferable to other types of tool construction when the part is irregular in shape or is to be produced in large quantities, because of the uniformity of product, high speed at which it can be operated and because of its long life. Where small holes are to be perforated, the compound type is often advisable due to the fact that the perforators can be supported more substantially, with reduced breakage.

Fig. 3 is a cross-sectional view of one of the standard designs of sub-press compound tools illustrating this type of construction. As its name implies, the sub-press type is a practically self-contained press which is placed, assembled, in the power press. As will be noted from this figure, the compound type of tool has the perforating punches

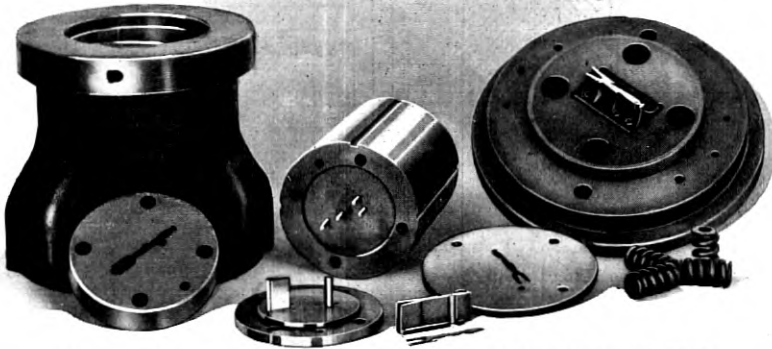

Fig. 2—Sub-press compound punch and die partially disassembled to show construction.

*L* located inside the blanking die *N*, and supported by the shedder *M*, and the die openings for the perforators inside punch *P*, which is fastened to the base *H* of the tool. In operation, the base *H* is mounted on the bed of the press and the cap adapter *A*, which is attached to the plunger *D*, is fastened to the slide or ram of the press. The stock is fed over the stripper *O* and the die *N* descends, thus depressing the stripper *O* and causing the shedder *M* to recede into the die *N*. As the shedder is backed up by a heavy spring *C*, the metal being blanked is held under pressure between the shedder and the punch *P* so that this type of construction fabricates thin sheet metal under conditions which insure the best results. As the downward movement progresses, the blank is cut from the stock and the holes perforated. The slugs forced out by perforators *L* drop through

the punch *P*, and as the die ascends on the up stroke of the press the blank is forced back into the stock by the action of the stripper and

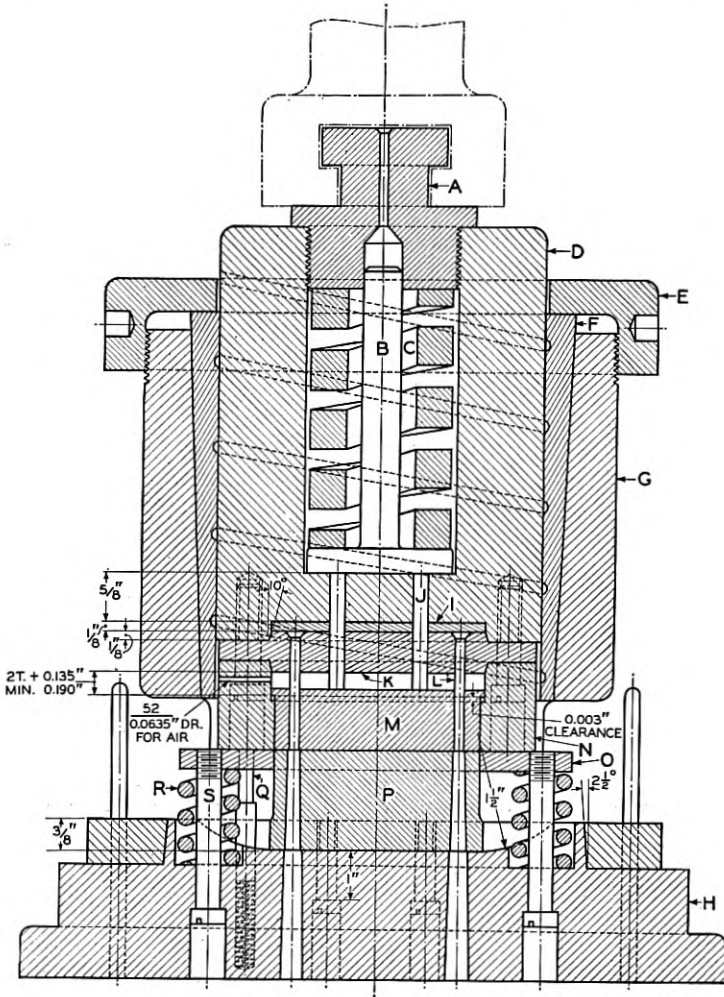

Fig. 3—Cross-sectional view of standard design for sub-press compound punch and die illustrating principal parts.

shedder. The material is then advanced to the next position and the operation repeated.

If no positive provision is provided in a punch and die for securing fixed alignment of the cutting members, considerable care and skill is required in order to adjust and set the tool in the press so as to bring

the die opening into its proper position with respect to the punch. Also, after the tool is set there is the possibility, especially in the case of the higher speed presses operating at about 300 strokes per minute, of the die shifting during operation and resulting in the "shearing" of the cutting edges of the die and punch. To overcome this difficulty the liner pin type of construction illustrated in Fig. 1, and the sub-press type shown in Figs. 2 and 3 are used in the better grade tools, and especially where a very small clearance must be maintained between the punch and die opening. In the former the arrangement consists of two or more round guide rods or liner pins fastened in the

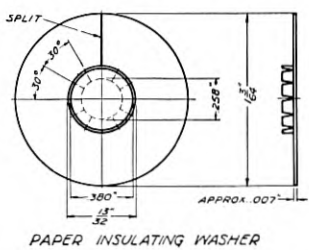
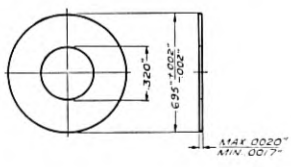
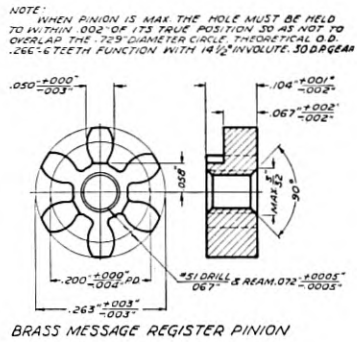
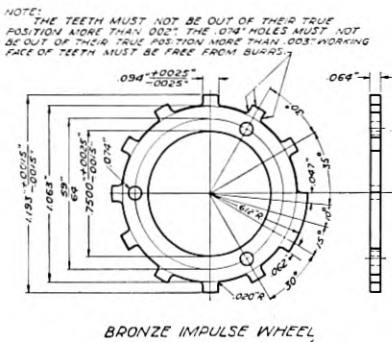

Fig. 4—Sketches of typical piece parts requiring accurately built punches and dies

bottom part of the tool and passing up through accurately bored holes in the top part, thus insuring that both members are always in their proper relative position. While the liner pin type of tool affords a very satisfactory alignment in most cases, the sub-press type is the better construction which, because of its "piston and cylinder" design, insures a more positive alignment. This is illustrated in Fig. 3. The plunger *D*, to which is attached the die *N*, perforators *L*, etc., slides in the bushing *F* in the housing *G*, and is therefore always in alignment with the base and the punch attached to it. This type of construction is followed largely where the part is small enough so

that it can be adapted to standardized housings, which are stocked, and especially where the tool is to be operated on high speed presses.

In order that a better appreciation may be obtained of some of the more exacting requirements which are being met in building tools of this kind, several of the important reasons for accurate workmanship to limits as close as a few ten-thousandths of an inch or less on some of the tool parts, together with typical examples, will first be considered.

*Meeting the Accuracy Required of Piece Part.* In order to obtain the correct functioning of the apparatus or equipment and also to insure interchangeability in assembly, many piece parts must be made with a

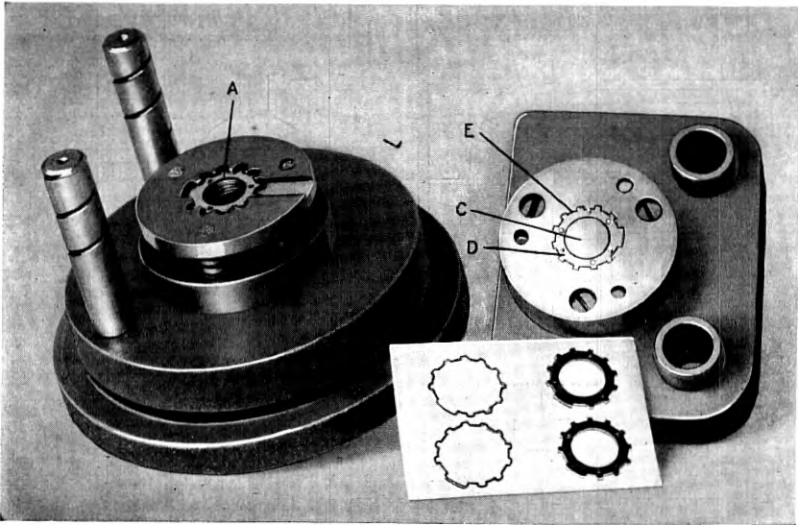

Fig. 5—Shaving and perforating punch and die for impulse wheel.

considerable degree of accuracy, often within limits of  $\pm .001$  in. or less for some of the dimensions. This is one of the most important and common reasons for accurately built tools, especially in the case of parts made in sufficiently large quantities to require a number of similar tools producing the same part, as the product of each tool must be interchangeable with that of any other provided for the same operation, and also for subsequent operations.

The bronze impulse wheel for No. 2 type dials and the pinion used in message registers, Fig. 4, are typical examples. Both of these parts are given shaving operations—the wheel after being blanked, and the pinion after being cut to length and swaged—in order to secure the required accuracy and smoothness of contour. Fig. 5

shows the shaving and perforating punch and die for the impulse wheel, together with an illustration of the part and the stock removed from the outer edge in the shaving operation which amounts to about .008 in. This tool is built to have a clearance between the shaving punch *A* and the die opening *B* of only two to four ten-thou-

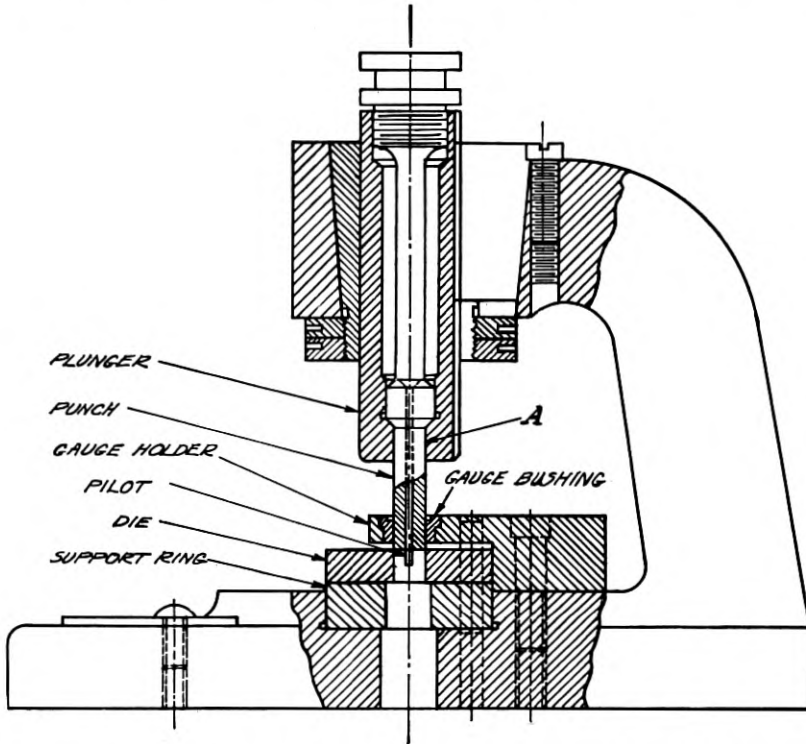

Fig. 6—Cross-section of second operation shaving punch and die for message register pinion.

sandths of an inch all around, and the punch must be located very accurately so that it will center in the die within this amount of clearance. The shaving perforator *C* for the center hole also has practically the same limit as has also the shedder *D*. Holes or openings in the die are held to as close as .0005 in. of their nominal dimensions and also with respect to each other. Fig. 6 is a partial cross-section of the second operation shaving punch and die for the message register pinion, which is made to similarly accurate limits. However, the close workmanship on parts of this tool is also necessary in order to insure interchangeability of tool parts, which will be referred to later.

One of the best examples of a high grade tool needed to make parts within close limits is the compound punch and die shown partially completed and disassembled in Fig. 7, for perforating and blanking complete in one operation the multiple bank terminal strip shown in front of the tool in the illustration. This terminal strip is  $36\frac{3}{4}$  in. long and has 30 common terminals on each side spaced on  $1\frac{1}{4}$  in. centers and 129 perforated holes. The design of the part requires that all terminals and some of the holes be held to within limits of  $\pm .004$  in.

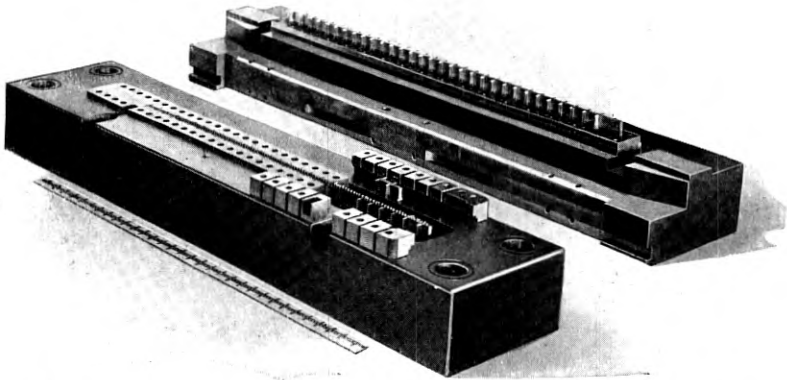

Fig. 7—Compound punch and die for blanking and perforating multiple bank terminal strip.

of their correct location with respect to a designated hole at one end of the strip. A limit of  $\pm .004$  in. for a single dimension is ordinarily not a difficult one to work to, but in this case the fact that any inaccuracies are accumulative makes it a very difficult limit to meet.

To make this tool with the required limits of accuracy, it is necessary to make the punch, die, shedder and punch plate sections, as shown in the illustration, so nearly to their exact dimensions that they are practically interchangeable. In fact, the variations are so small that if all the sections were removed from the tool and reassembled in different positions and combinations, the changed tool would not vary more than  $\pm .0002$  in. from the previous dimension over the entire length of the sections. In assembling the sections, it is necessary that they be carefully cleaned, as a slight amount of oil or dirt between them would throw the tool outside the desired limits. When it is considered that the tool must be made to much closer limits than the piece part, that all of the 103 sections, as well as the perforators, must



fit together within an overall limit of  $\pm .001 - .000$  in., that the punches and perforators must be accurately centered in the die openings with a clearance all around for the punches of  $.0003$  in. to

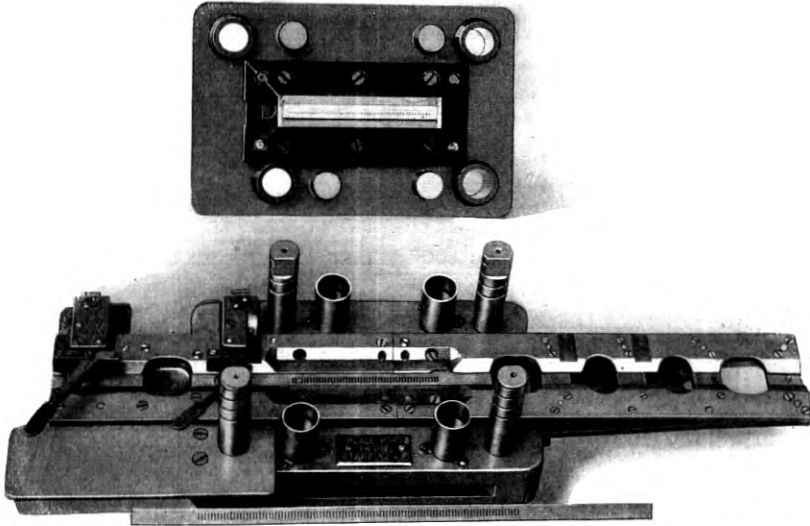

Fig. 8—Second operation punch and die for perforating holes in rack.

$.0005$  in. and for the perforators about  $.0001$  in., it is apparent why, with the possibility of the errors being accumulative, each individual section must be made very accurately, the majority not exceeding a

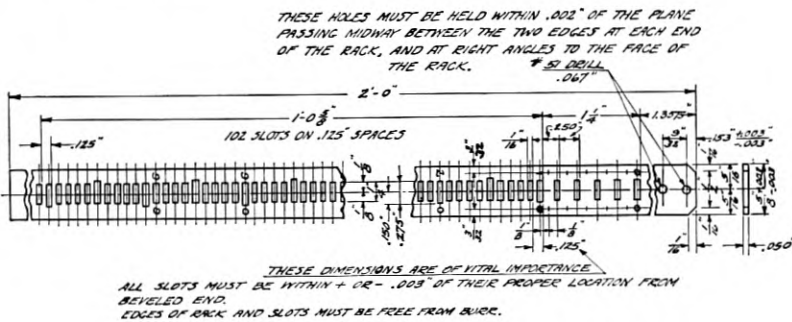

Fig. 9—Phosphor bronze rack for panel dial equipment.

limit of  $\pm .00001$  in. In addition, the slot in the die holder which holds the die, shedder, and punch plate sections, is made to almost exact dimensions and must have its sides parallel with each other and perpendicular to the bottom surface.

Another tool of this kind is the second operation perforating punch and die shown in Fig. 8, which perforates the slots in the rack for elevator apparatus shown in Fig. 9, and also in the illustration of the tool. The requirements of this part specify that all of the 107 slots  $1/16$  in. wide and spaced on  $.125$  in. centers must be within  $\pm .003$  in. of their proper location from the beveled end, which is a difficult requirement to meet on account of the nature and thickness of the stock, and, like the multiple bank strip, there must be practically no accumulated error. The tool has fifty perforators, fifty-one die and fifty-two shedder sections which are made with a degree of accuracy comparable to that of the multiple bank strip tool.

*Insuring Accurate Gaging in Subsequent Operations.* This is a reason which sometimes requires the tool maker to work to closer limits or to hold certain dimensions to closer limits than would be otherwise required. In such cases the tool must produce piece parts which are sufficiently accurate at certain gaging points used later in other tools or in the apparatus assembly fixtures, to insure the proper results from the subsequent tools and in assembly. This may require an accuracy of from  $.0005$  in. to  $.001$  in. An example is the bank contact for step-by-step type banks. In order that the parts may be made sufficiently accurate at certain points so that proper bank assembly may be obtained with the assembly fixtures, the blanking die openings are made to a limit of  $+.001$  in.  $-.000$  in. for the width at the ends, the length, and the offset dimension, although the apparatus requirements for the piece part do not necessitate this degree of accuracy.

*Production of Satisfactory Blanks from Thin Stock.* Typical piece parts of this kind are the mica diaphragm  $.0017$  in. to  $.002$  in. thick used in transmitters, and the oiled red rope paper insulator  $.007$  in. thick for coil spool assemblies which are shown in Fig. 4. In order to obtain clean-cut blanks, with practically no rough edges or burrs, from thin material of this kind, it is necessary that the clearance between the blanking punch and the die for the insulator does not exceed  $.0002$  in. and the diaphragm  $.0001$  in. all around, and the perforators nearly the same. In fact, these die parts are made to fit so closely that they will cut wet tissue paper. Accurate working fits are necessary between the other moving members, such as shedder, liner pins, etc., which mean that it must be possible to just push the parts together with no perceptible shake or clearance. The general construction of these tools is of the standard compound liner pin type similar to Fig. 1.

*Interchangeability of Tool Parts.* Some tools are so designed that certain parts, which on account of the design of the part being produced

are of fine construction, may be readily replaced in case of breakage or wear. In this case it is necessary that the parts be made accurately where they fit together, in order to insure interchangeability of the tool parts, without affecting the satisfactory operation of the tool or the accuracy of the parts being produced. The shaving punch and die for the message register pinion previously referred to and shown in Fig. 5 is a typical example, the construction and limits being so that parts such as the punch, die, gage bushing, and pilot may be easily replaced. For instance, in order to insure interchangeability of the punch, the dimensions of the plunger and punch at *A* are held within a limit of .0002 in., and other parts to correspondingly close limits.

*Feeding of Material and Properly Formed Part in "Tandem" or "Follow" Type of Dies.* In this type of tool the operation is a progressive one. While one part of the die notches, embosses, forms, or

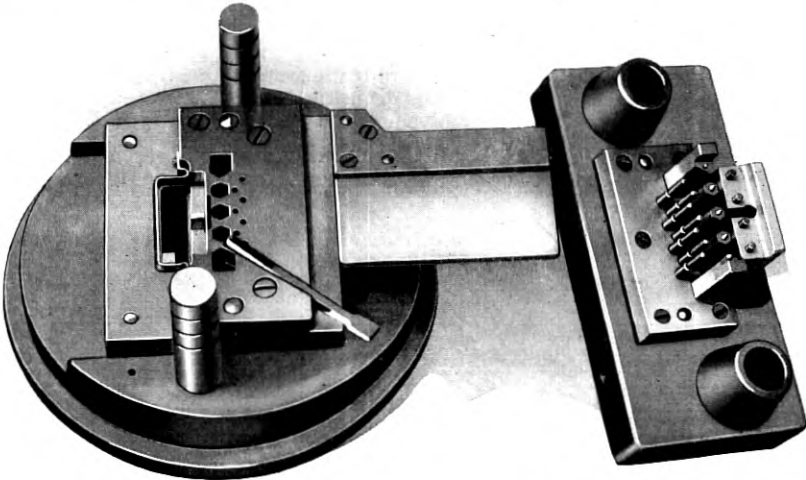

Fig. 10—Multiple perforating, blanking, and clipping punch and die for 3/8" brass hexagon nuts.

perforates the stock, another part blanks out the parts at a place where, at a former stroke, the preceding operations have been performed, so that complete parts result from each stroke of the press, although, of course, more than one operation has been performed on the parts before completion. This is illustrated in Fig. 10, which shows a multiple perforating, blanking, and clipping punch and die for making 3/8 in. brass hexagon nuts. As will be noted from the construction of the tool and the sequence of operations shown in Fig. 11, seven nuts are made with no scrap skeleton remaining at each stroke

of the press, three of the parts falling through the blanking openings and the others through the rectangular opening after being clipped off at the edge of the die.

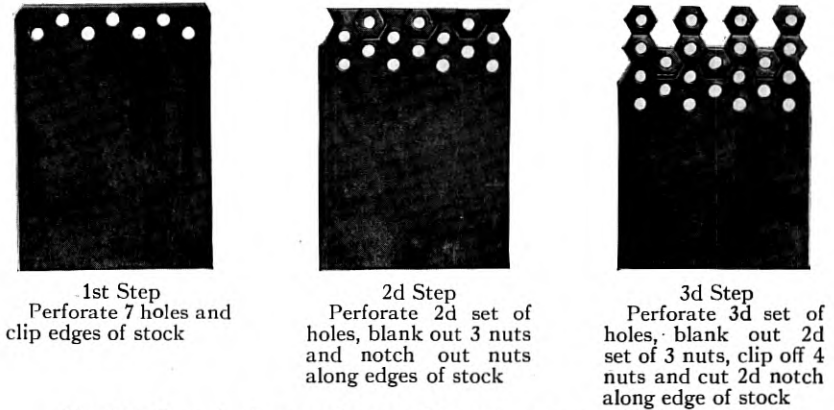

Fig. 11—Steps in the manufacture of brass hexagon nuts by scrapless punch and die method

On this tool, accuracy, from a tool making standpoint, is necessary in order to insure proper feeding of the material and an equal sided

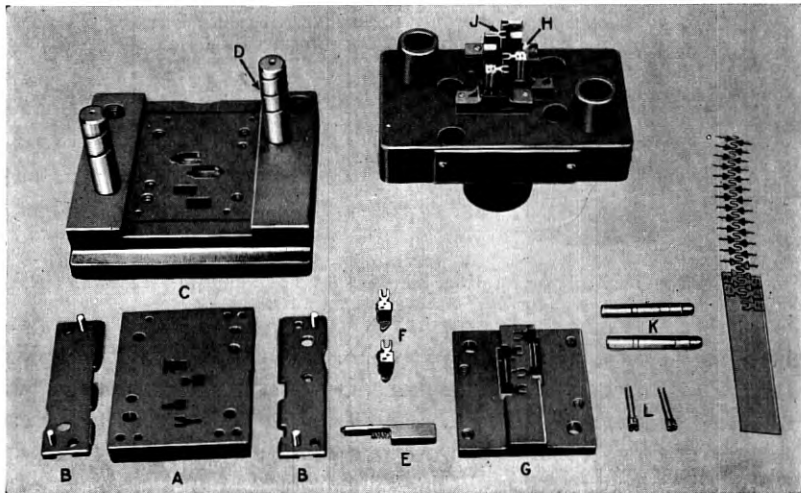

FIG. 12—Punch and die for shearing, blanking, and forming solderless cord tip

product. When the first tools were built, it was found necessary to develop very accurately the distance between the perforator and

blanking openings on account of the elongation or "creep" of the material. An error in a tool of this type is detected very easily in the product, and it requires only a very small amount to make the hexagon nut irregular in shape or "lop-sided" with respect to the center hole. It is therefore necessary that the tool maker work to close limits in maintaining the relationship between the perforator and the blanking openings and clipping edge, and the total variation between any of these is not more than .0008 in. to .001 in. It is not only necessary that this accuracy be held on the die section, but also on the punch plate and stripper, in order to insure the proper clearance between the punch members and die openings, which is .0015 in.

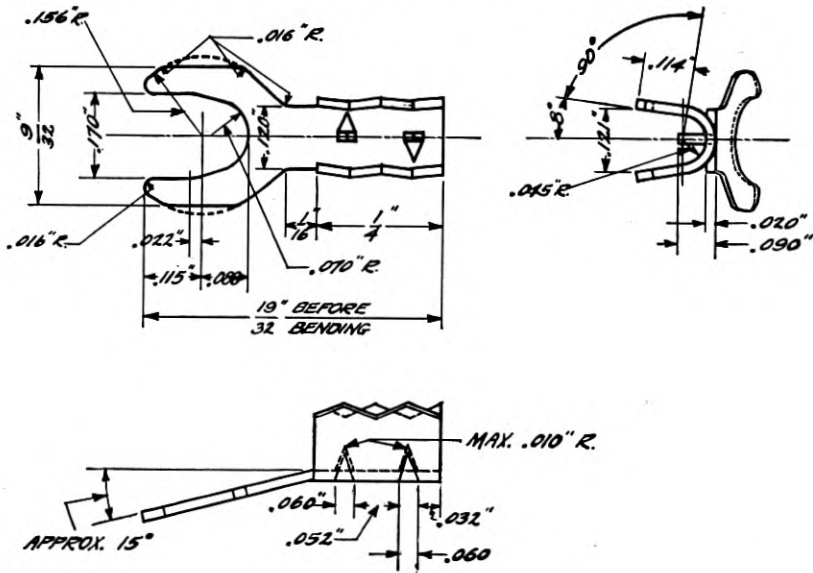

Fig. 13—No. 92 solderless cord tip.

Another example is the shearing, blanking, and forming punch and die shown partially dismantled in Fig. 12, which is used for making the solderless cord tip, Fig. 13. The parts of the tool, as shown in the figure, are *A* die, *B* stock guides, *C* die holder, *D* liner pins, *E* finger stop, *F* shedders, *G* stripper plate, *H* punch holder, *I* blanking punches, *J* forming punches, *K* dowel liner pins, *L* shearing or perforating punches. The blanked strip in the illustration shows the sequence of operations, the parts being first blanked and sheared two at a time with the blanks remaining in the scrap skeleton. The stock then advances until the blanks register with the forming die where the saw tooth

portion of the part is bent up, two complete parts being made with each stroke of the press. The location of the forming section with respect to the blanking section in this tool must be very accurate, as otherwise the blank will not register exactly under the forming punch and an incorrectly formed part will result. Also, the forming punches must be located accurately so they will center in the die openings. Other features

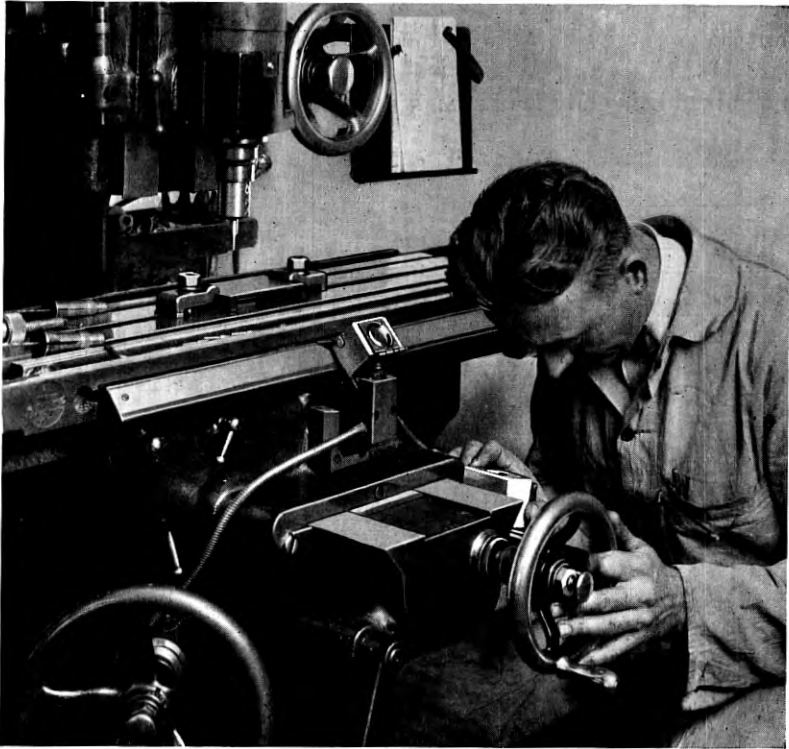

Fig. 14—Boring datum holes in master plate on veneer milling machine

regarding the workmanship required on this tool are included in the description of its construction given in the following paragraphs. Stock is fed to the punch and die by an automatic roll feed with an adjustment provided such that a precision feed within  $\pm .0005$  in. of the nominal may be obtained, which insures each part being located in the proper position for forming.

MAKING PUNCH AND DIE SECTIONS

Various methods may be used in the making of punch and die sections depending on the character of the work, accuracy required, etc. The use of templates and the vernier height gage in laying out work centers and outlines, the application of the master plate method, the use of micrometer heads and verniers on milling machines and various systems of end and distance gages are all found of value in this work. A brief description of several of the operations performed in making

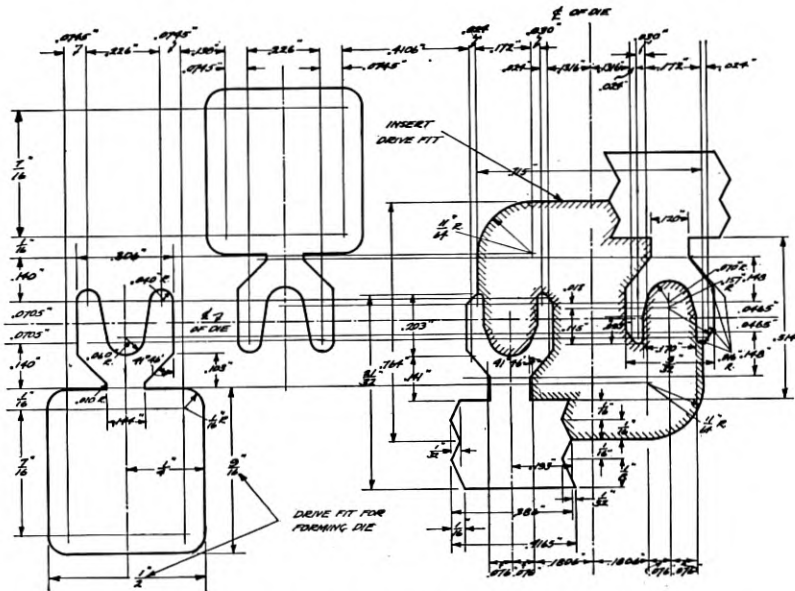

Fig. 15—Layout of die openings for solderless cord tip punch and die

the punch and die sections for the solderless cord tip punch and die previously described, will serve to illustrate the common practices followed in producing high grade work.

The first operation is the making of a tool steel master plate having all the datum or reference holes necessary for accurately locating the holes and contours of the openings in the die. The blank plate, after being squared and the sides finished parallel to each other, is mounted on the vernier milling machine shown in Fig. 14. This machine is equipped with magnifying lenses over the positioning vernier scales for adjusting the position of the table. The vernier scales read to .001 in. and by interpolation it is possible for an operator to adjust the table to within a few ten-thousandths of an inch. From the layout

of the die opening as shown on the tool drawing, Fig. 15, the required datum holes are then located by means of the vernier scales and bored to complete the master plate, as shown in Fig. 16. The

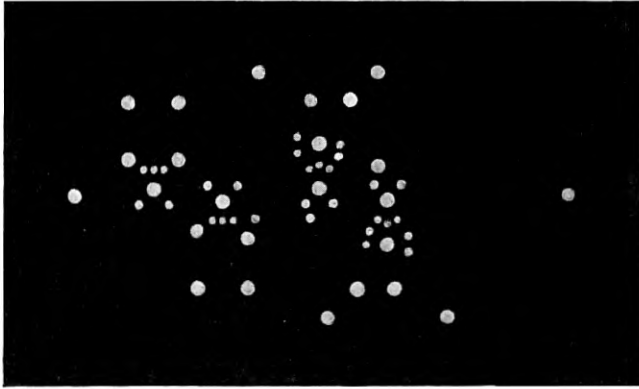

Fig. 16—Master plate for solderless cord tip die.

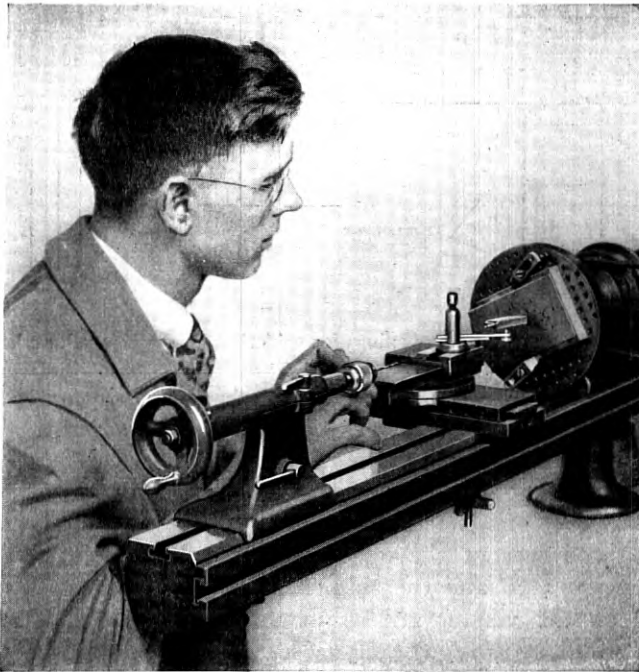

Fig. 17—Transferring datum holes from master plate to die block on bench lathe.

practice on master plates of this kind and other similar parts is to locate the various holes so that the error in any case is well within .001 in.



The master plate is mounted on the die block and located by means of two snug fitting pins driven into the block and projecting into the two aligning holes near each end of the plate. The die block and plate are then attached to the face plate of a bench lathe, as shown in Fig. 17. Each datum hole in turn is accurately centered with the lathe center by means of the indicator shown in the figure, the master plate removed, and the hole bored in the die block. In centering with



Fig. 18—Filing out die openings with filing attachment on bench lathe.

the indicator, the lathe is rotated and the master plate and die block shifted until the indicator pointer shows but little, if any, movement. With an indicator multiplying the movement 100 times, shifting the plate .0001 in. would move the pointer over the scale .010 in. or .0001 in. eccentricity of the hole would show a pointer movement of .020 in. The master plate gives a permanent precise outline of the important holes, radii, contours, etc., which can be utilized to considerable advantage in checking after heat treatment, and especially in making additional tools or replacement die sections.

After the boring of the holes in the die block is completed, the die openings are worked out roughly by drilling a series of holes corresponding to the shape required and brought to about .001 in. of the nominal by means of the lathe filing attachment, as shown in Fig. 18, or a standard bench filing machine. The perforating and blanking contour which is the one being filed in the illustration conforms only partially to the finished openings on the die as shown in Fig. 12, and the correct outline is obtained by means of an insert indicated on the die layout in Fig. 15. This construction is necessary because the two blanking openings are close together and could not be satisfactorily heat treated without considerable distortion. Also, it facilitates considerably the work of the tool maker in working out the die openings. The insert is heat treated before assembly in the die. The forming dies are also made separately and inserted in the square openings in the die block.

After the filing operation, the die block is heat treated and the upper and lower surfaces are then ground parallel. Although proper heat treatment is an important factor in the production of fine tools, it is too broad and extensive a subject to be considered in this paper, as the art has been developed to the point where it is now done on practically a scientific basis through the use of the most improved equipment and automatic temperature recording and control, with many different heating methods, etc., being employed for the various grades of steels and the different purposes for which they are used.

The next operation after heat treatment is the grinding of the die block openings, which is done on the bench lathe by means of the grinding attachment shown in Fig. 19. By this means the surfaces are brought to within .0003 in. to .0004 in., the most important dimensions as previously mentioned being those which affect the distance between corresponding surfaces of the blanking and forming die openings. The surfaces are then stoned or lapped by hand with about .0002 in. or less being removed as required, to give the final finish and accuracy, and the insert and forming dies, which are made with a similar degree of accuracy, fitted in place.

As can be seen from the foregoing, the highest precision work requiring the most expert workmanship comes in the final grinding, lapping, and fitting. The degree to which this must be carried, of course, depends on the requirements of the particular tool being made. In the case of the multiple bank strip and the rack tools previously described, the punch and die sections are ground to within .00005 in. of the required size and then lapped to the final dimensions, using a flat cast iron block or some other soft metal charged with an abrasive dust, such as emery, carborundum, or diamond.

An idea of what this class of workmanship means can be appreciated when it is considered that 10 degrees Fahrenheit difference in temperature will change the length of an inch block more than this .00005 in. limit. Since the change per inch in steel is about seven-millionths of an inch per degree Fahrenheit, the heat of the hands or machines may, in extremely accurate work, make sufficient difference so that

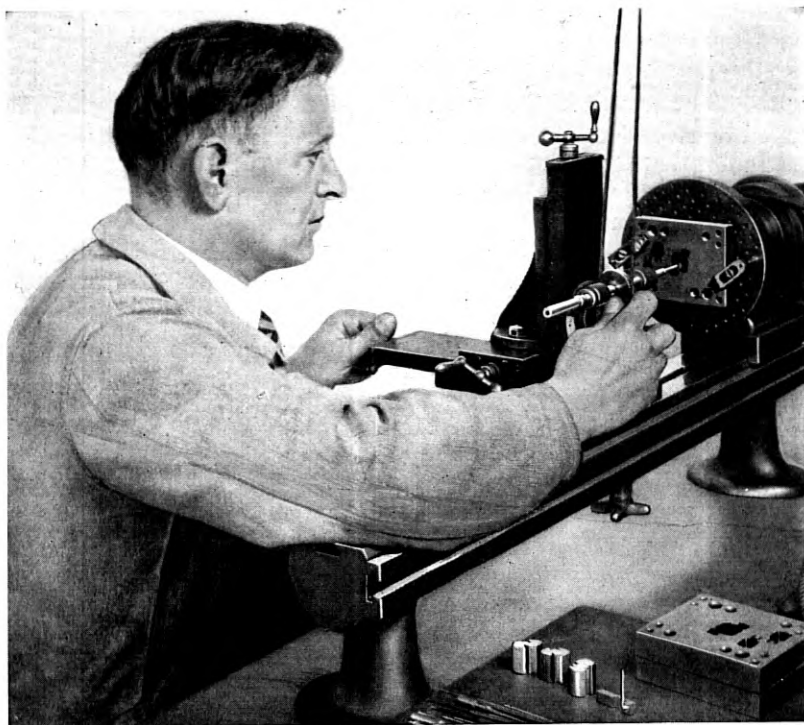

Fig. 19—Grinding die block openings after heat treatment.

parts have to be laid on steel blocks to attain room temperature before the dimensions are checked, in order that they will be of the same temperature as the master gages used. The temperature is also an important factor in producing accurate plane surfaces with a surface lap. Unless the temperature of the lap and the work is the same, a convex surface will usually be produced even though the lap itself is an accurate plane.

In making the blanking punch for the solderless cord tip tool, it is first rough milled to within  $1/64$  in. of the nominal dimensions,

as shown in Fig. 20. By means of a screw press, the punch is then forced into the die opening already completed, to a depth of approximately  $1/64$  in., and an accurate impression of the correct punch section obtained, as shown in the figure. The punch is then milled to form on the bench milling machine to within about .0005 in. to .001 in. of the nominal, the outline of the impression being used as a guide in this operation. The final shearing of the punch in the die, which amounts to practically a shaving operation, is accomplished in several steps, the excess metal being removed by filing after each operation, and the punch worked down until it enters the die to the required depth. The punch is then hardened, after which it is ground, and lapped or stoned to the exact clearance required between the punch and the die opening, which, in this case, is .0005 in. all around.

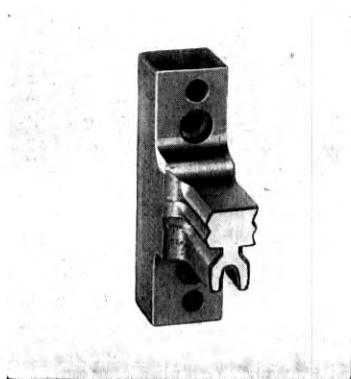

Fig. 20—Rough milled blanking punch, solderless cord tip punch and die

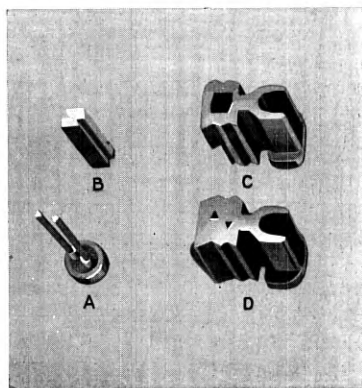

Fig. 21—Shedder, insert, and perforator punch for solderless cord tip punch and die

Fig. 21 shows "A" one set of the perforators for producing the two sharp projections in the cord tip stem, "B" the insert, and "C" and "D" the shedder before and after the insert is in place. The blanking punch also has die holes for the perforators, as can be observed from the general view of the tool in Fig. 12, and these are similarly formed by means of an insert. The perforators, which are working fits in the shedder, are .06 in. wide,  $1\frac{7}{16}$  in. long and of triangular cross-section. It would, therefore, be very difficult to work out the holes straight and accurate. To facilitate the tool making work, the shedder and punch are made as shown and the insert added. This is a good example of some of the means employed for overcoming difficult tool making problems.

## MAKING DIE BLOCKS FOR SHEATHING LEAD-COVERED CABLE

The making of the die blocks used in the hydraulic presses for sheathing lead-covered cable is of interest on account of the method used. The milling of the die contour, which is irregular in shape, is done on a die sinking machine shown in Fig. 22, the upper die being

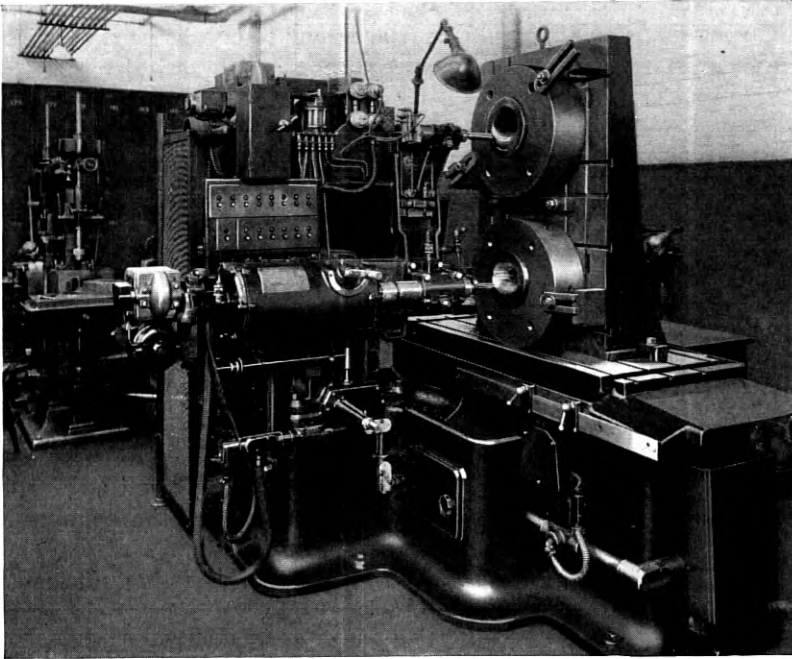

Fig. 22—Milling on die sinking machine the contour of die block for sheathing lead-covered cable

the master and the lower the die being profiled. The principle of the machine is that of having the cutter or milling tool automatically controlled and guided by means of a very sensitive tracer, which follows the contour of the master. This is accomplished by having individual motor drives and electrically operated clutches for each of the feeds, which are controlled by the movement of the tracer making and breaking the electrical circuits as it comes in contact with the surface of the master. This results in the feeds operating to move the table holding the dies and the slide holding the tracer and the cutting tool in such a manner that the tracer will follow the outline of the master die. The milling out of the opening is done by a series of either horizontal or vertical cuts, the machine automatically reversing at the

end of each cut. With this machine a set of die blocks, which would require approximately 300 hours to machine by the hand finishing method, can be completed in 80 hours. This machine was used for working out the openings of the moulding dies for the new hand set.

#### PRECISION MEASURING

One of the essential factors in high grade tool work is precision measuring instruments of sufficient accuracy to check the dimensions to the limits required. The most common and practical method of making precise measurements is by comparison with standard known dimensions and most of the instruments used on a commercial basis for measuring to limits of .0001 in. or less employ this principle.

The standards used for comparison are "Hoke" or "Johanssen" gage blocks made in 81 sizes as shown in Figs. 23 and 25. The blocks are arranged in four sets, the first consisting of four blocks 1 in., 2 in., 3 in. and 4 in. in length. The second set of 19 varies from .050 in. to .950 in. in .050 in. steps. The third set of 49 varies from .101 in. to .149 in. in .001 in. steps and the fourth set of 9 varies from .1001 in. to .1009 in. in .0001 in. increments. In combination any dimension may be obtained within the limit of the set in .0001 in. steps.

The surfaces of these gages are so flat and smooth that if two or more are wrung together so as to expel the air, they will adhere to each other and resist separation at right angles to the contacting surfaces with a force of over 20 pounds per sq. in. The precision of these gage blocks at 68° F. is within .00001 in. per inch of length of the dimensions stamped on the blocks for the larger sizes and .000005 in. for the smaller sizes under one inch. Although the gages are standard at 68° F., it is of course not necessary to use them at this temperature, or make corrections when measuring metal of the same coefficient of expansion. However, as previously mentioned, it is essential that the work to be measured be at the same temperature as the gages. In addition to being used as standards for checking parts in the different measuring instruments, a variety of other uses are made of the gage block in laying out and measuring the work directly. By the use of accessories and attachments, which are furnished for holding the blocks, they may be made into inside and outside calipers, shape and height gages, etc. One of the sets which has been checked and certified by the Bureau of Standards is maintained as a standard for checking the other sets and also other master gages.

One of the most frequently used measuring instruments is the upright dial indicator gage. The part to be measured is placed on the accu-

rately lapped surface plate of the instrument and brought into contact with the vertical plunger, which operates the universal dial indicator through a lever arrangement. The movement of the pointer is about  $1/16$  in. for each  $.0001$  in. vertical movement of the dial plunger. By noting the difference between the dial reading for a standard gage block of the size required and the part being measured, a comparison between the two may be made to within  $.0001$  in. and by interpolation between the calibration marks to within a few hundred-thousandths of an inch. The universal dial indicator is also frequently used by the tool maker with a standard surface plate, and a suitable arm for holding the indicator, when checking work in process.

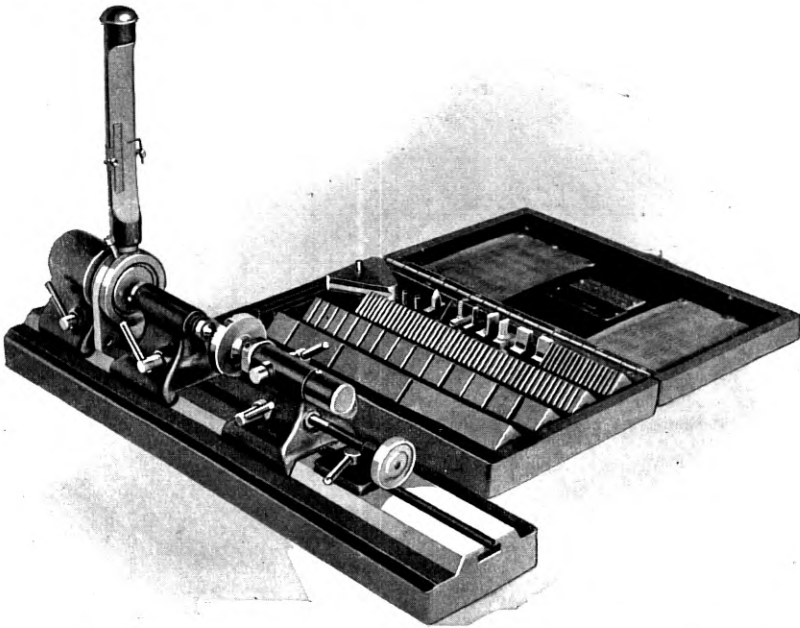

Fig. 23—Precision measuring instrument with fluid gage and "Hoke" gage block set.

If greater accuracy is required, parts are sometimes measured by comparison with the standards, using the liquid gages shown in Figs. 23 and 24. The instrument in Fig. 23, which has a multiplying ratio of 2200 to 1, was made in the Hawthorne Works Tool Room, while the other is a commercial liquid gage or prestometer. However, the comparator most generally used at present for this class of work is the optimeter shown in Fig. 25. This instrument makes use of an optical

system to magnify small measurements without the use of a vernier or other mechanical means, and due to its construction is dependable and probably less liable to variation than the liquid gage. Most of the errors due to play between mechanical parts such as gears,

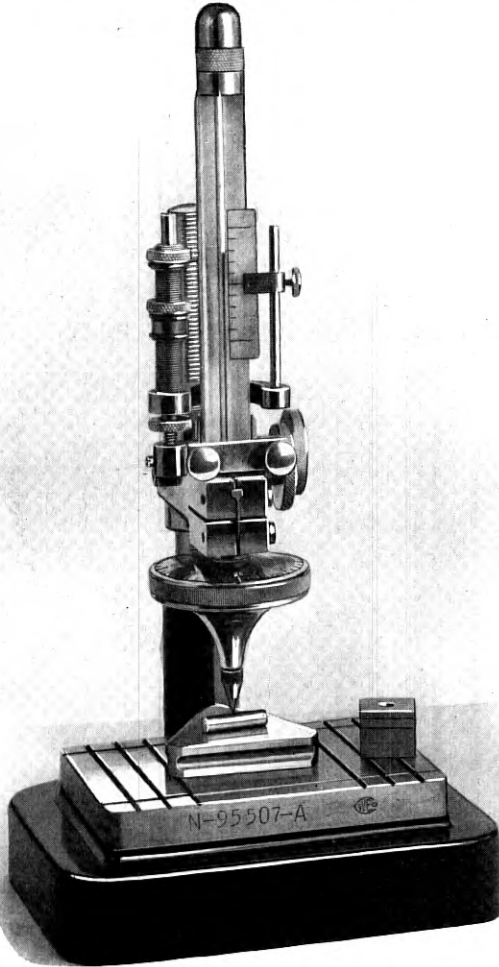

Fig. 24—Fluid gage or “prestometer” showing tool part in position for measuring

micrometer screws, knife edges, diaphragms, capillary tubes, etc., have been considerably reduced. The only moving part except the measuring feeler is a small mirror which is tilted by the upper end of the feeler and reflects the image of a stationary glass scale. The



feeler has a constant pressure of 7 or 8 ounces against the work, thus eliminating the "sense of touch" factor. Variations of the size of a part within a range of  $\pm .0035$  in. may be read directly to  $.00005$  in. and by interpolation to within one or two hundred-thousandths of an inch.

The instrument just described illustrates the use of light for making precise measurements by the optical lever method. Another method is by the use of a lens or projection system, whereby beams of light are controlled in such a manner as to form on a screen enlarged images of objects with a high degree of geometrical similarity between the

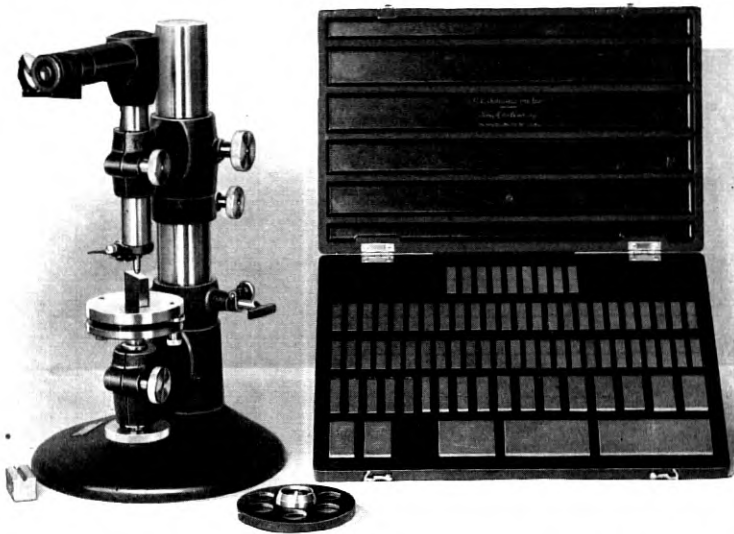

Fig. 25—Optimeter and "Johanssen" gage block set

image and the object. As the errors or variations in the object are magnified the same amount, they become correspondingly easier to observe and measure or check against a standard template, contour plate, limit chart, or accurately made scale drawing of the object. With a magnification of 250 diameters an error of only a thousandth of an inch will appear as a quarter of an inch and an error of one ten-thousandth can be readily observed. This method is particularly adaptable for measuring to close limits irregular shapes and contours, screw thread and profile gages, gear teeth, etc. The instrument used for this purpose is the contour measuring projector, the magnified image of an object being projected either on a vertical screen or the horizontal table attached to the instrument.

Two of the characteristics of light are the constancy of its wave length for a given color and its property of interference, which together establish the fact that each interference band produced by the reflection of light, as shown in Fig. 26, represents a very small definite separation

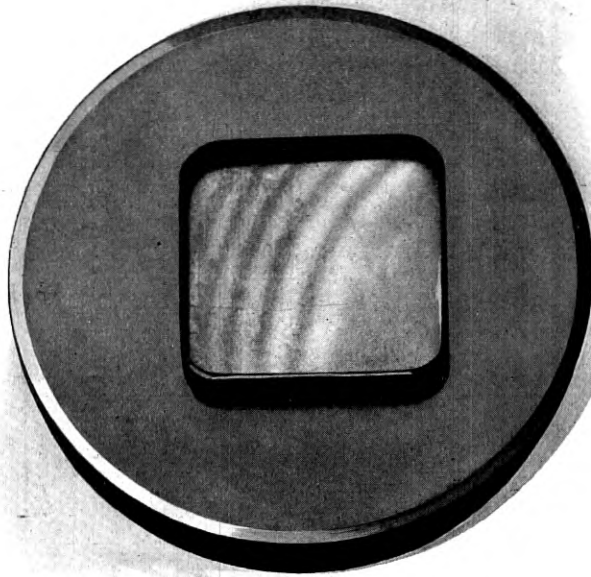

Fig. 26—Interference bands produced by the reflection of light waves

between the surfaces producing the reflections. As this separation or distance is a function of the wave length of the light used, the application of this principle permits extremely accurate measurements to within a few millionths of an inch.

Fig. 27 illustrates the application of this method in measuring a .375 in. plug, the equipment used being an optical glass flat, a metal flat on which the parts rest, a .375 in. master gage block, and a monochromatic light, usually red or green, having wave lengths of .000025 in. and .000020 in. respectively. In order to simplify calculations, the plug is placed so that its center is a distance from the gage block equal to the width of the latter. Unless the gage and the plug are exactly the same size, dark interference bands will appear across the gage block when the light falls upon it, due to the wedge-shaped air

space formed between the upper flat and the top surface of the gage block. In accordance with the theory of interference, the distance between the flat and the gage at the first band adjacent to the edge where contact between the two surfaces is made, is one half the wave length of the light used, which if red would be .0000125 in. The distance at the second band is then one wave length or .000025 in. If there are a total of three bands, the distance at the edge of the block

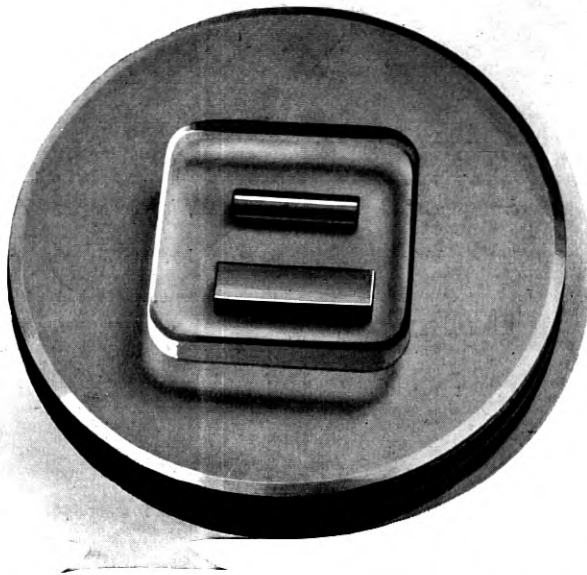

Fig. 27—Metal flat, optical glass flat, and gage block in position for measuring .375" plug by light wave interference method

is .000037 in. or the difference in size between the plug and the gage is .000074 in., since the distance between them is twice the width of the block. The interference method gives a reliable and permanent unit of measurement and is probably one of the greatest refinements in precision measuring. In addition to measuring lengths, it can be used for checking the accuracy of flat surfaces, tapers, etc.

For more precise comparisons of gages and for the direct measurements of gage blocks in terms of wave lengths of light there is available a special form of the Michelson interferometer made by Zeiss, having a monochromator for selecting the particular wave length to be used, Fig. 28. This instrument is a comparatively recent development and to

our knowledge there are only two in this country at present, the other one being in the Bureau of Standards.

The light is furnished by the helium tube "A." The particular wave length to be used is selected by rotating a glass prism inside the case by means of the cylinder "B" graduated to read the wave length directly. The gage block to be measured is located at "C" and the interference bands are observed through the eyepiece "E."

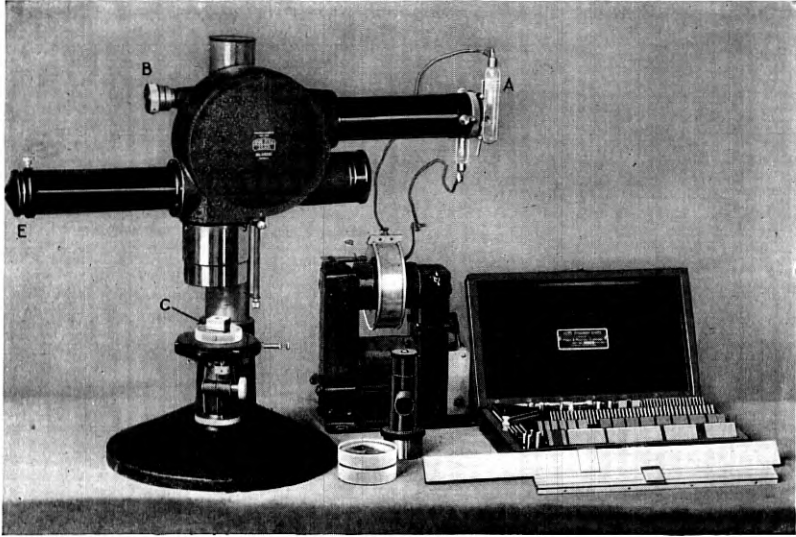

Fig. 28—Laboratory interferometer

To make a direct measurement of the length of a gage, observations are made using five wave lengths, and by computing the results obtained the length may be determined to an accuracy of about two millionths of an inch. In working with this degree of precision, the instrument is used in a constant temperature room and corrections made for temperature, humidity, and barometric pressure.

#### CONCLUSION

Tool making in all its branches as carried on in the tool rooms of the Western Electric Company is a comprehensive subject, regarding which several volumes might be written if covered in detail. In the foregoing description an effort has been made to give briefly, and by considering only one branch of the work, a general picture of the high grade workmanship required and some of the equipment and instruments employed. Similar precision is required on many classes

of tools, such as jigs, fixtures, screw machine tools, milling cutters, etc., and especially gages employed in interchangeable manufacture.

This paper would not be complete without mentioning the fact that the high degree of workmanship, technique, and precision found in the product and methods of the Western Electric Company's tool rooms and many of the novel features of tool design are in a large measure due to the Works Technical Organizations operating the tool rooms. The writer is indebted to these organizations, as well as to other groups in the Manufacturing Department, for much of the material presented in this paper.

## The Natural Period of Linear Conductors

By C. R. ENGLUND

**SYNOPSIS:** This paper describes the experimental determination of the frequency of free electrical oscillation of straight rods and circular loops. The results agree more closely with the formula of Abraham than with that of MacDonald. For three rods whose lengths were 300 cm., 250 cm. and 227.1 cm., the ratio of wave length at resonance to rod length had the values 2.11, 2.13 and 2.13, respectively. Measurements taken upon 250 cm. rods bent into circular arcs of different radii gave values of the ratio of resonant wave length to arc length which passed through a minimum value and were virtually independent of the radius of the arc over a wide range, deviating markedly only at the extreme value of minimum radius possible and infinite radius. The extreme measured range of the ratio was 2.05 to 2.166. The wave lengths were measured upon a pair of Lecher wires and a very satisfactory meter for the rapid comparison of waves of short length was found to be a quarter wave length Lecher frame. This frame showed a constant end correction so that  $\lambda = 4(d + 3.1)$ ,  $d$  being the length of the parallel rods.

IN 1898 Abraham<sup>1</sup> calculated the free period of an extended but relatively narrow metallic ellipsoid of revolution when excited by an electrical impulse. To a good approximation the fundamental natural period found was related to the major axis length by the expression  $\lambda/l = 2$ . Obviously a rectilinear conductor of circular cross-section cannot differ markedly from such an ellipsoid and Abraham concluded that the equation  $\lambda/l = 2$  was also valid for this.

In 1902 Macdonald<sup>2</sup> arrived, by a theoretical deduction quite different from that of Abraham, at the expression  $\lambda/l = 2.53$  for the fundamental free period of a linear conductor. Moreover Macdonald assigned the same value to the linear conductor when bent into a nearly closed circle. In the next twelve years a variety of papers were published<sup>3</sup> giving results which were aimed at clearing up this discrepancy without however definitely settling the matter one way or the other. The subject has in recent years become of interest again following the development of the short wave vacuum tube oscillator and the conjoint use of rectilinear conductors as radiators (or "reflectors")—particularly in grids of parabolic form.

Since the universal method of measuring wave length is that of determining the nodal distances for standing waves on parallel con-

<sup>1</sup> Abraham, *Ann. der Phys.*, 66, 435, 1898.

<sup>2</sup> Macdonald, "Electric Waves," pp. 111-112.

<sup>3</sup> See Bibliography at end.

ductor "Lecher" systems, and since further there are practical advantages in reducing the total length of these systems to a single or half a single nodal length ( $\lambda/2$  and  $\lambda/4$  "Lecher" frames), the problem of the natural period of a rectilinear conductor can be broadened to include a study of the shortest favorable shape of a linear conductor for use as a wave length standard. It is the purpose of this paper to give the results of some experimental work relating to both these questions. At the same time an examination of the operation of an

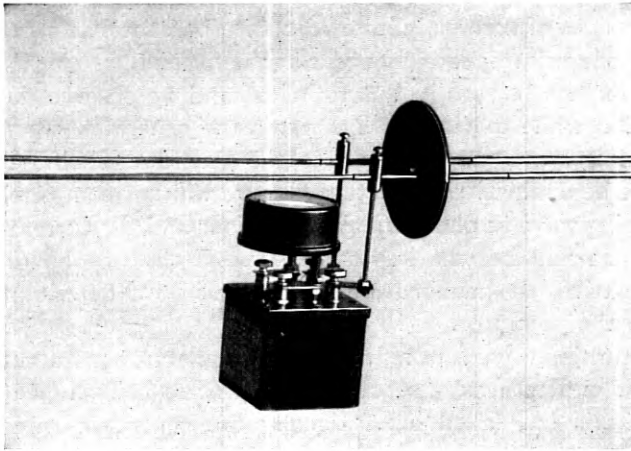

Fig. 1

extended Lecher system as a basic wave measuring apparatus was a necessary preliminary.

It was a matter of only a small amount of experimentation to demonstrate that the practical Lecher system for wave length measurement would necessarily consist of a pair of heavy uniformly spaced copper wires devoid of insulator spacers and at least a couple of wave lengths long. While the attenuation of Lecher systems made of ordinary wire is not great, as attenuations go, the accuracy with which the nodal points can be located, in the manner later described, depends markedly on the degree in which space resonance currents build up, and it is quite necessary to supply sufficient copper. The wire used here was No. 8 B. & S. gauge (3.26 mm. diam.) soft drawn copper and by "ironing" it with a slotted wood piece it was made as smooth as was necessary. It was stretched between two poles out of doors and kept tight with a turnbuckle. The spacing was fixed at 5.15 cms. by a metal bridge at one end and a micarta bridge at the other. The

total length was 15.4 meters. A photo of the sliding bridge unit is given in Fig. 1.

The method of using such a Lecher system requires consideration. If we set up a pair of parallel wires and feed energy from a generator into them, we shall have, unless the far end of the wires is terminated by the "surge" impedance of the line, a standing wave system set up. This standing wave will be most pronounced when the outer end is so terminated as to return all the energy arriving there and this requires that the terminating impedance be a pure reactance. If the extreme values of zero or infinite reactance be chosen, a current anti-node or node will respectively occur at the far end.

If the far end be reactively terminated and we observe the current distribution while moving back towards the generator, we shall find the standing wave persisting up to the generator itself. However, if the line be dissipative, the returned wave will not completely cancel the outgoing wave at phase equality locations and the current maxima and minima will become less contrasty. If the line be practically non-dissipative, the maxima and minima will not deteriorate as we approach the generator.

The returning wave is re-reflected at the generator end and traveling to the far end returns once more, this process being repeated until its amplitude has faded out. Usually the generator appears as a resistive impedance when viewed from the line so that not much energy survives reflection at this end. In any case, as the generator is the primary energy source, the generator voltage introduced into the line and the voltage of the re-reflected waves add vectorially to give a component just sufficient to maintain the standing wave line current. By an adjustment of the effective line length, either by changing the physical length, the far end reactance, or the generator impedance as viewed from the line, the power input to the line may be maximized for the particular generator used.

When this state of affairs has been attained, the standing wave may be observed by either a current or voltage operated device moved along the line. (If this device absorbs too much energy, it becomes a source of disturbing reflections itself, complicating matters by superposing on the original standing wave another pair of standing waves. It is not advisable to permit such secondary waves to exist in measurable amplitude.) Necessarily the standing wave is closely sinusoidal and at the maximum values  $\partial I/\partial l = 0$  so that locating these current extremes is not an accurate experimental process. The



accuracy of determination of the distance between two consecutive values of  $\partial I/\partial l = 0$  will not be sufficient unless very great care be taken, a large line current supplied, and an indicator responding well to  $\partial I/\partial l$  (such as a square law thermocouple) be used. For the attainment of greater accuracy an average over a number of nodal distances must be used. In short, this method of measurement requires a relatively long line for accuracy, up to the limit where a deterioration of the maxima and minima has become pronounced due to attenuation. At the current minima  $\partial I/\partial l$  is great enough for good settings but no meters of requisite sensitivity at the zero end of their scales exist.

Another and more sensitive method of observation of nodal distances is to make use of the variation of line current as the total line length is varied, particularly if both ends of the line be pure reactances and the line conductors have an adequate copper content and very good insulation. Coupling such a line weakly to a generator by merely placing the generator in the neighborhood makes it possible to build up very sharply resonant standing waves so that settings without any particular precautions can be made to one part in 3,500. Of course the point located is again one where  $\partial I/\partial l = 0$  but the value of  $\Delta I$ , for a given value of  $\Delta l$ , is very much larger. Moreover the accuracy is not decreased by shortening the line<sup>4</sup> and, since the resonance energy is then dissipated in a shorter length of line, the corresponding increase in the resonance current makes the antinode easier to locate. Although this method is very sensitive to energy losses it is by far the best method of using a Lecher system. Essentially it is nothing but a sharp "tune" observed and interpreted as space resonance. In the present work the length of the Lecher system was sufficient to observe four resonance maxima throughout the range of wave lengths used, giving, by difference, three wave length readings. These readings could readily be duplicated to one part in 3,500; it is improbable however that the velocity of propagation along the wires is within one part in 3,500 of that of free space so that this precision is unusable, though comforting. This accuracy of setting would be useful where small frequency differences or line constant changes are to be observed. Since the measurements checked admirably from day to day and the line attenuation was low, it was assumed that the line velocity was not affected by the adjacent ground (110 cms. at lowest point) and was near enough to that of the velocity of light to allow the line to be used as the basic wave length standard.

<sup>4</sup>A. Hund, Sci. Paper No. 491, Bureau of Standards, 1924, points out the same fact.

## RESONANCE PERIOD OF A STRAIGHT ROD

It was at first thought that it would be relatively simple to set up a vacuum tube generator together with a rectilinear rod and run resonance curves on the latter. This did not prove to be the case however. Working indoors was impossible and all the apparatus had to be moved out of doors. When the two antennas (the generator

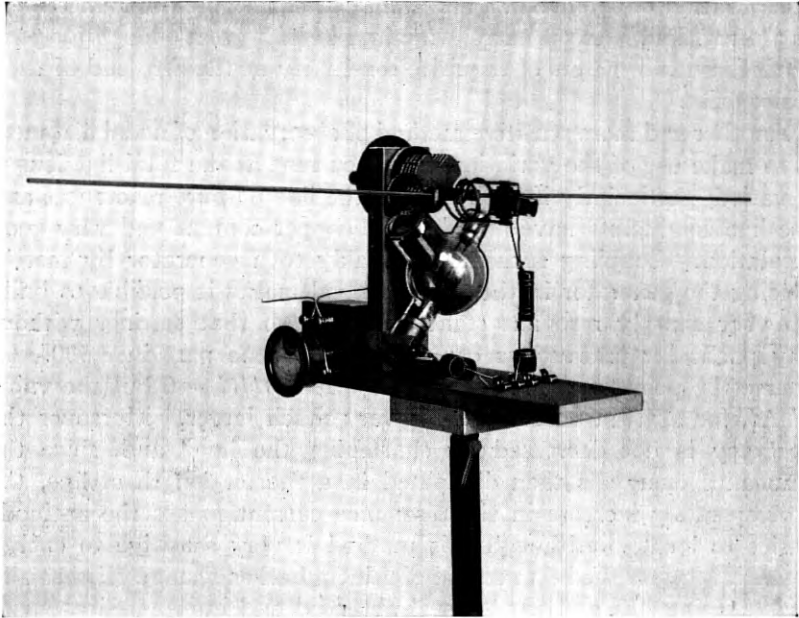

Fig. 2

antenna and resonant rod) were mounted vertically, the operator became a mobile reflector himself seriously disturbing the transmission. Moreover the ground was unsymmetrically disposed with respect to the two antenna ends and this was felt to be a disadvantage. With the antennas horizontal these objections vanished but the reflection from the ground had to be taken into account. This latter was the arrangement finally adopted and is shown in Fig. 3, the apparatus in question being mounted on the two tripods.

The attempt was made to get a generator whose radiation field was constant over a wide wave length range so that the rod resonance wave length could be obtained by observation while turning the generator tuning condenser. As a matter of fact, the generator output was apparently satisfactorily constant while actually not so,

and some time was wasted trying to get consistent results. Finally a control meter was placed on the generator and resonance curves run, observing by small steps wave length, rod meter deflection, and control meter deflection. Then by reducing the rod meter deflection to a standard control meter value satisfactory observations were obtained. As it turned out, the averaged value of all the unsatisfactory observations checked the resonance curve value very closely, but the individual observations scattered all over the rather broad resonance curve top. To avoid the reaction of antennas upon each other they must be separated by at least a wave length, and such a

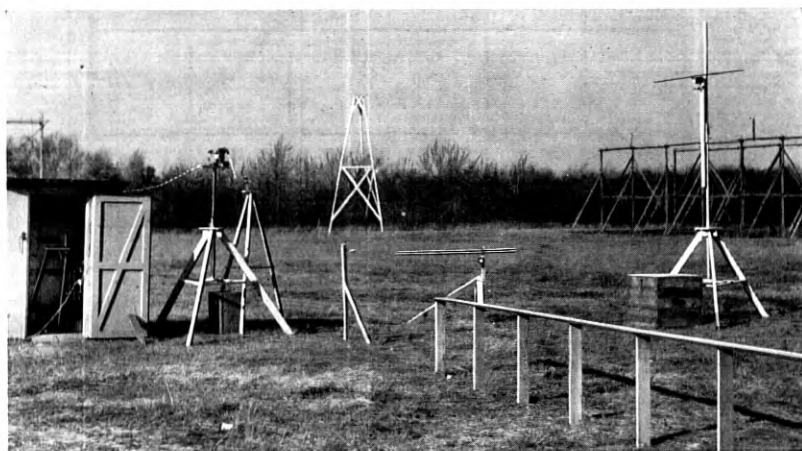
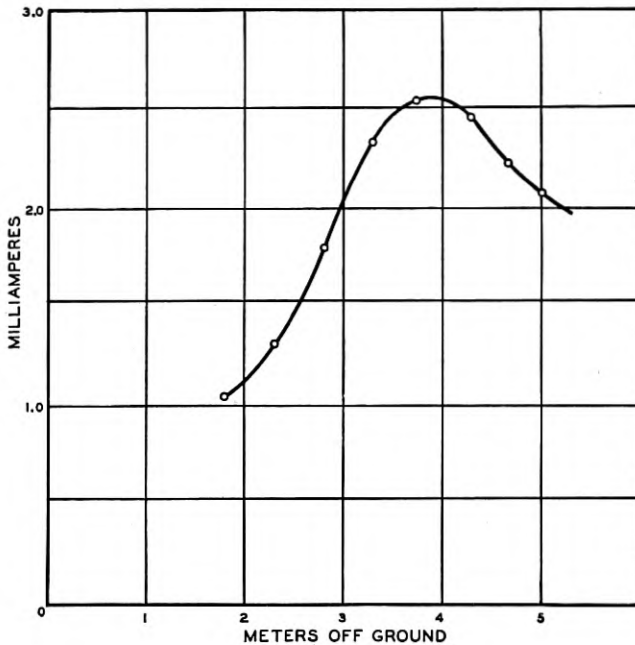

Fig. 3

separation here resulted in too low field strengths unless the antennas were off the ground sufficiently to get an additive combination of the direct and earth reflected radiations. The resonant rod should in any case be well off ground to make certain that its period is not affected by the ground. Check tests showed that at 4 meters distance the ground did not affect the free period markedly. It would be much simpler to observe the resonance curve of a variable length rod, at constant wave length, but it would not be permissible to use a rod of variable diameter and a telescoping arrangement is the only practical method of obtaining collapsibility.

The generator used was an UX852 tube connected as in Fig. 2. By means of the variable condenser shown a wave length range of 4.24 to 8.44 meters was obtained. This condenser is a cut down "Remmler," the oscillating coil is a three turn center-tapped unit

of 1/8 inch (0.32 cm.) copper tubing, the choke coils are 10 microhenry units resonant at 6.1 meters and the antenna rods are connected directly across the resonant circuit. This apparatus was finally set up on a tripod raising the antenna 2.55 meters above ground. The control meter consisted of a pair of 15 cm. wires connected to a thermocouple and Weston model 301 micro-ammeter combination. It was not resonant in the generator range and was fastened on the generator base permanently.



Curve I—300 cm. rod

The rods studied were ordinary 1/2 inch copper and brass tubes and were straightened and mounted in a bracket consisting of a pair of phosphor bronze knife edges spaced 27.5 cms. apart. These knife edges were attached to a micarta strip and connected to a 600 ohm thermocouple and Weston model 301 micro-ammeter combination as for the control meter. A tripod supported the rod mount and the meter was read with a field glass at the generator site. The wave length was determined by a  $\lambda/4$  Lecher "frame" (see Fig. 5) calibrated by means of the Lecher wires. This will be described later.

A full scale deflection of the resonant rod micro-ammeter corresponded to 4 milliamperes heater current and this was shown, by

means of experiment with two rods each equipped with a removable thermocouple, to have no effect on the resonant frequency. With two rods in proximity the resonance was much more sharp and definite than for one rod, and was also more sensitive to effects producing variations in the natural period.

Three separate rods were used, their specifications being,

Length	O.D.	I.D.	Material
300 cm.....	1.27 cm.	1.02 cm.	Copper
250 ".....	1.27	1.02	"
227.1 ".....	1.27	1.02	Brass

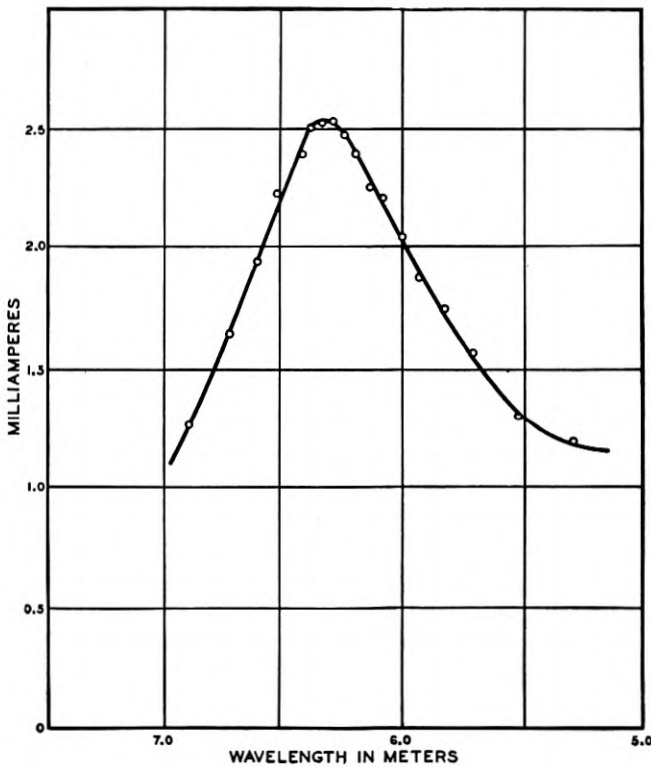

Curve II—300 cm. rod

Curve I shows the maximum current versus height above ground relation for the 300 cm. rod. The generator antenna was 2.55 meters above ground and the horizontal spacing between generator antenna and resonant rod always 7.7 meters, both antennas horizontal. The

curve thus needs correction for the fact that the air line distance varied as the rod was lowered and raised. This correction is small however.

It will be observed that the maximum current occurs at 3.85 meters and taking this value for determining the distance to the reflecting ground surface gives, if we assume a radiation field only,

$$(1.3 + 2h)^2 + (770)^2 = \left( \sqrt{130^2 + 770^2} + \frac{\lambda}{2} \right)^2$$

or with  $\lambda = 6.34$  meters,  $h = 3.26$  meters. The difference  $3.26 - 2.55 = 0.71$  meter is the apparent distance under ground of a metallic sheet equivalent to the ground itself.

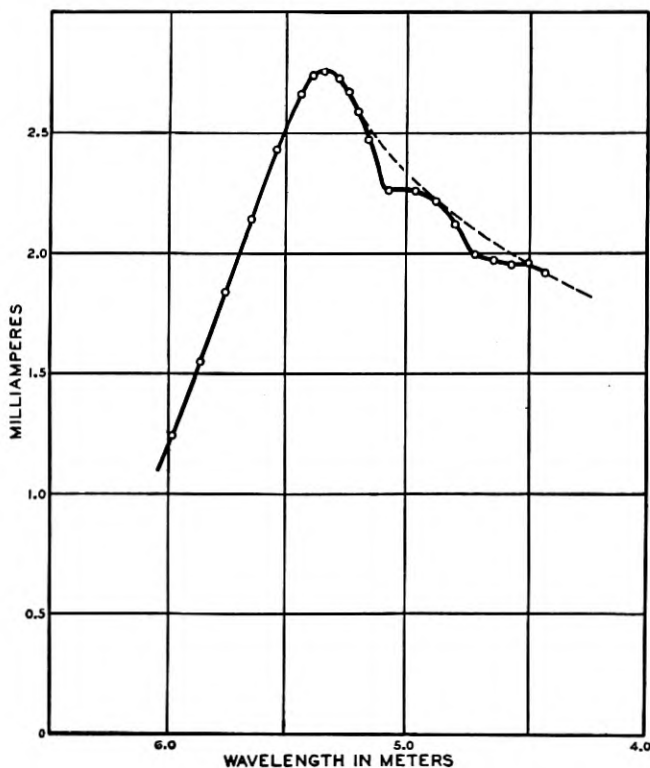

Curve III—250 cm. rod

Curves II and III give the resonance curves of the 300 and 250 cm. rods respectively, mounted horizontally and 4 meters above ground. The latter curve is complicated by two extraneous resonances

occurring somewhere in the generator circuit. With the advent of inclement weather the source of these resonances could not be looked for. These dips in the resonance curve are not evident to an observer watching the resonance rod meter as the generator wave length is varied; they become evident only on plotting a carefully taken resonance curve. The results both for preliminary eye settings and final resonance curve are:

Rod	By Res. Curve		By Eye Settings	
	$\lambda$	$\lambda/l$	$\lambda$	$\lambda/l$
300	6.34	2.11	6.33	2.11 (av. 10 settings)
250	5.36	2.14	5.32	2.13 (av. 13 " )
227.1	—	—	4.84	2.13 (av. 8 " )

A check eye setting on the 250 cm. rod mounted vertically agreed with the other eye settings. The eye settings, or eye estimates of the top of the rod resonance curve, were made first, the resonance curves were run last. On discovering the "dips" in the 250 cm. rod curve it became useless to run a 227.1 resonance curve before eliminating these dips, the preliminary curve being discarded. It is not certain however that these "dips" were present in most of the eye settings as these were chiefly made with the generator nearer ground and with shorter power leads. They are given for what they are worth.

Evidently experiment more nearly checks Abraham<sup>5</sup> than Macdonald, the rods operating as if their effective lengths were 6-7 per cent greater than their physical lengths. Whether this "end correction" varies with the rod diameter was not investigated owing to bad weather. Several rods were however bent into circles, cut to 250 cms. perimeter (outside length), and their natural periods determined. The results follow below. With the bending, the radiation resistance of the rods went down pronouncedly and the knife blade contacts were shortened to span a distance of 10.2 cms. A preliminary test showed the natural period of such rings to be independent of their orientations; they were therefore hung up in the knife edges with open gap downwards. The top edge of the ring was always

<sup>5</sup> Abraham gives a correction term of the form

$$\frac{\lambda}{l} = \frac{2}{n} \left[ 1 + C_n \cdot \left( \frac{1}{4 \log \frac{2l}{d}} \right)^2 \right],$$

where "n" is the order of the harmonic and  $C_n$  a complicated integral. For "n" = 1 and the 300 cm. rod,  $\lambda/l = 2.018$ , which is too small.

3.17 meters above ground, generator antenna horizontal and 2.55 meters above ground, horizontal separation between ring plane and transmitting antenna 7.2 meters. The results were:

RING SHAPED 250 CM. ROD WITH GAP

Gap Angle	Ring Radius	$\lambda$ Meters	$\lambda/l$
1.58°	40. cms.	5.414	2.166
10.8	41.1	5.228	2.09
21.8	42.4	5.178	2.07
56.4	47.2	5.128	2.05
99.8	55.1	5.148	2.06
360.0	$\infty$	5.36	2.14

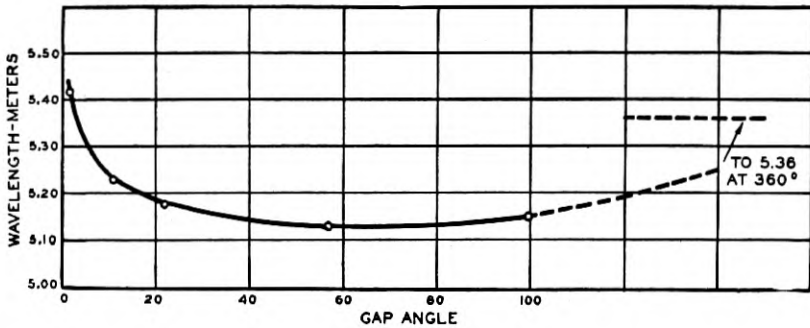

Curve IV

These values are plotted in Curve IV and do not check Macdonald's conclusion earlier referred to. In fact the first part of the curve is most simply explained by viewing the rod as a resonant inductance whose tuning capacity is decreased as the rod gap opens. The existence of a minimum resonant wave length is less easy to explain in this manner.

It was early observed that the current amplitude and sharpness of resonance of a rectilinear rod were greatly increased by the proximity of a second rod. Curves were therefore run with two parallel rods arranged both in horizontal and vertical planes, the spacing being changed while current magnitude and resonance wave length were observed. In each case the rods were symmetrically mounted about a central point held at the height of the generator antenna above ground (2.55 meters) and the short knife edge support, mentioned in connection with the rings, was used. All the antennas were horizontal and as accurately parallel as it was possible to set them. Fig. 4 shows one mounting and Curve V the current versus spacing relation, while Curve VI gives the resonance wave length versus spacing.



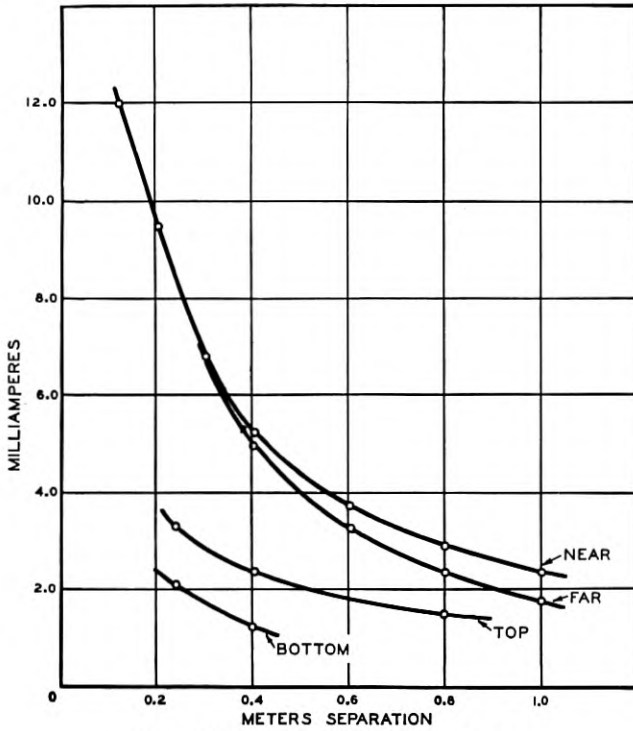

Curve V—Two rods each 250 cm. long

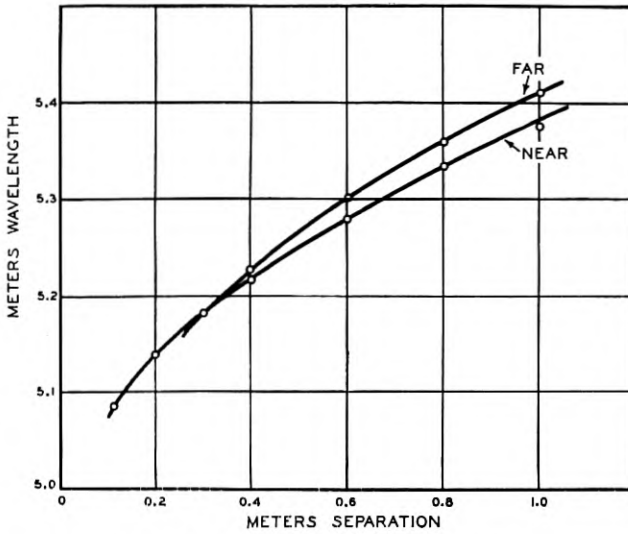

Curve VI—Two rods each 250 cm. long

It is unwise to attempt any critical conclusions from these curves as long as the standing wave pattern of the direct and earth reflected wave interference is not known. But two facts seem clear, viz.: a closely spaced rod pair gives a marked current step up over that of a single rod, and the natural period of a rod pair approaches the value  $\lambda = l/2$  as the spacing decreases. It is obvious that the currents

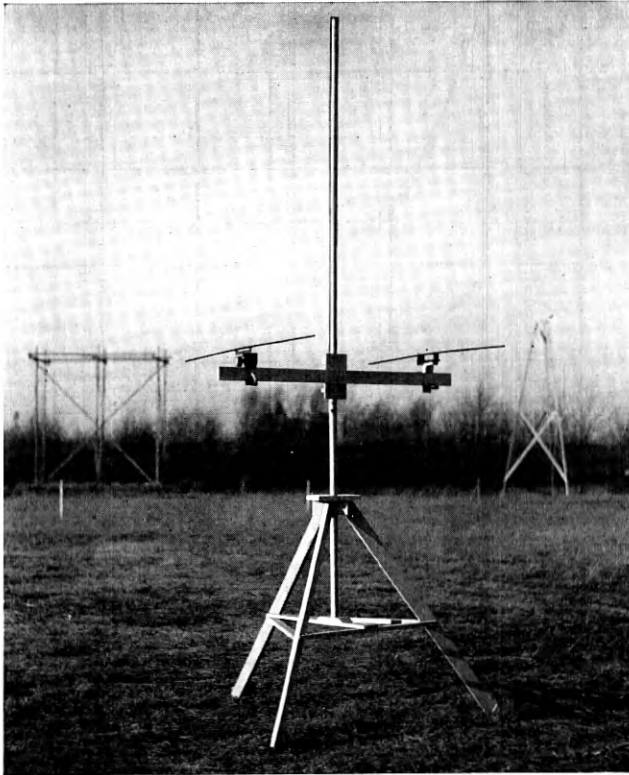

Fig. 4

in the two rods, at close spacing, are nearly anti-phased and that their vector sum must be nearly that current which an isolated rod would carry. The analogy with an anti-resonant circuit is evident, the "stepped up" current being limited only by the ohmic losses in the rods. Actually the tune, at close spacings, was excessively sharp and hard to set for with the generator condenser. The exigencies of the mounting of the rods and the observing of the meter prevented observations at close spacing for the "far," "top" and "bottom" meter positions.

## HIGH FREQUENCY WAVE METER

A pair of Lecher wires constitutes a wave measuring system much too awkward and extended for rapid use, and some apparatus much more portable and speedy in operation is necessary; especially when running resonance curves. Such an apparatus is a pair of heavy uniform and parallel conductors arranged with one or two sliding

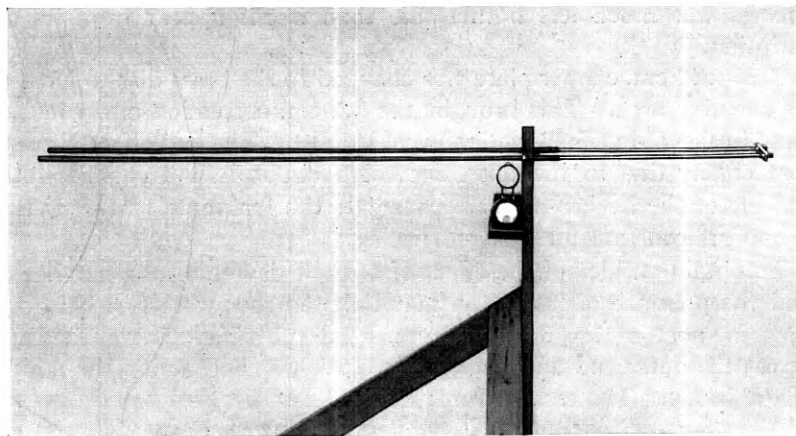

Fig. 5

metallic short-circuiting discs so as to constitute a quarter or a half wave length "Lecher frame" (see Fig. 5). Such a frame, if containing sufficient copper, is very sharply resonant, need only be a quarter wave length long, and after calibration becomes a wave length meter indicating to a precision of 1 part in 2,500 with the greatest ease. As an accessory apparatus such a wave frame was constructed, calibrated, tested for factors affecting its accuracy and used for most of the measurements reported above.

The Lecher frame shown in Fig. 5 was made of a pair of straight copper tubes 1.27 cms. diameter spaced 10.1 cms. center to center and sliding through a brass disc 15.5 cms. diameter, 0.3 cm. thick, with inserted guide tubes. It had a workable wave length range of 4 to 7.5 meters and the resonance setting was indicated by a three turn coil-thermocouple-microammeter combination placed with coil clearing one of the rods at the disc end by approximately two cms. It was ordinarily cleaned to make good contact at the disc guides but at no time was any indication noticed of an apparent lengthening of the frame due to a moving back inside of the guides of the contact point. It was calibrated over its whole range in terms of the Lecher

wire system already mentioned, calibrated not once but various times and unfailingly indicated 3.1 cms. too short. That is, the distance " $d$ " from open end to disc was 3.1 cms. short of  $\lambda/4$ , or  $\lambda = 4(d + 3.1)$ . It was not found possible to make a trombone slide which maintained its spacing accurately, and before each reading was completed a paper template was laid on the open end and the tubes given a slight bend to obtain parallelism. The setting was then completed. This process was much less bothersome than might appear from its description.

A 35 x 44 cm. copper plate was clamped to the brass disc to increase its effective area. This brought the 3.1 cm. correction down to 2.67 cms. (measured at 5.29 meters wave length). The end effect is therefore chiefly due to the open end. No doubt it will change if the spacing of the Lecher frame is changed; the fortunate feature is that it appears constant for a given spacing.

To obtain an idea of the effect of a slight degree of non-parallelism and the presence of insulation material, the rods were first bent out, then in, next a 1.3 x 3.8 x 12.7 cm. hard rubber block was laid flat across the outer end and finally this block was laid across the middle of the frame. The results were:

Lecher Frame Length	Condition	True $\lambda/4$ (Av. of Four Settings Each)	Deficiency in Frame
122 cms.	Parallel	125.07 cms.	3.07 cms.
"	Diverge 0.2 cm.	125.04	3.04
"	Converge 0.2 cm.	125.20	3.20
"	Rubber plate at end	126.21	4.21
"	Rubber plate at middle	125.58	3.58

Obviously a slight divergence is an advantage rather than otherwise, for an uncalibrated frame, and dielectric spacers at high potential points are sources of noticeable error.

#### BIBLIOGRAPHY

- ABRAHAM, M. *Ann.*, 2, 32, 1900. Elektrische Schwingungen in einem Frei Endigenden Draht.  
 KIEBITZ, F. *Ann.*, 5, 872, 1901. Über die Elektrischen Schwingungen eines Stabförmigen Leiters.  
 WILLARD AND WOODMAN. *Physical Rev.*, 18, 1, 1904. A study of the radiations emitted by a Right vibrator.  
 RAYLEIGH. *Phil. Mag.*, 8, 105, 1904. On the electrical vibrations associated within terminated conducting rods.  
 POLLOCK. *Phil. Mag.*, 7, 635, 1904. A comparison of the periods of the electrical vibrations associated with simple circuits.  
 COLE, A. D. *Phys. Rev.*, 20, 268, 1905. The tuning of Thermoelectric receivers for electric waves.  
 BLAKE AND FOUNTAIN. *Phys. Rev.*, 23, 257, 1906. Reflection of electric waves by screens of Resonators and by Grids.

- IVES, J. E. *Phys. Rev.*, 30, 199, 1910. The wave length and overtones of a linear electrical oscillator.
- BLAKE AND RUPPERSBERG. *Phys. Rev.*, 32, 449, 1911. On the free vibrations of a Lecher system using a Blondlot oscillator.
- BLAKE AND SHEARD. *Phys. Rev.*, 32, 533, 1911; 35, 1, 1912. On the free vibrations of a Lecher system using a Lecher oscillator.
- SEVERINGHAUS AND NELMS. *Phys. Rev.*, 1, 411, 1913. Multiple reflection of short waves from screens of metallic resonators.
- NELMS AND SEVERINGHAUS. *Phys. Rev.*, 1, 429, 1913. Resonators for short electrical waves.
- ARKADIEW, W. *Ann.*, 45, 133, 1915. Über die Reflexion Elektromagnetischen Wellen an Drahten.
- ABRAHAM. *Jahr. d. D. T. u. T.*, 14, 146, 1919. Die Strahlung von Antennen Systemen.
- DUNMORE AND ENGEL. *Bur. of Stand. Sci. Paper No. 469*, Apr. 11, 1923. Directional radio transmission on a wave-length of ten meters.
- TATARINOFF. *Jahr. d. D. T. u. T.*, 30 (Oct.), 1927.

# The Measurement of Capacitance in Terms of Resistance and Frequency

By J. G. FERGUSON and B. W. BARTLETT

**SYNOPSIS:** The adaptation of a bridge circuit due to M. Wien together with apparatus and procedure is described which permits measurement of capacitance in terms of resistance and frequency with an accuracy comparable to that of the primary standards. Among its advantages over the Maxwell method commonly employed are the use of a single frequency voltage and the fact that there is no general limitation placed on the type of condenser which may be measured or on the frequency at which the measurement may be made. The method is also applicable to the determination of inductance since its unit, like that of capacitance, may be derived from the units of resistance and frequency.

## INTRODUCTION

CONDENSERS are commonly measured by comparison with standard condensers of known value by means of one or another of the well-known bridge methods. The accuracy with which such measurements can be made depends upon the accuracy with which the capacitance of the standard is known.

The unit of capacitance is derivable from those of resistance and frequency and to obtain an absolute value for a standard of capacitance, some method is required for a precise determination of capacitance in terms of frequency and resistance. Of the methods which have been proposed, few yield the accuracy with which the primary standards of resistance and frequency are known and reproducible.

A generally accepted method for the absolute determination of capacitance in terms of resistance and frequency is to use a bridge, due to Maxwell,<sup>1</sup> employing the alternate charge and discharge of a condenser. This method has been used successfully by the Bureau of Standards,<sup>2</sup> which has obtained results of high accuracy. Several fundamental limitations, however, make it difficult for general use. Because of the operation of charge and discharge it is only applicable to the measurement of capacitances which are independent of frequency.<sup>3</sup> Practically this limits the method to the measurement of air condensers, which in large sizes are not very stable. Moreover the balance depends on the integration of successive charges and discharges of a condenser through a galvanometer and great care is required to insure that the galvanometer integrates correctly.

<sup>1</sup> J. Clark Maxwell, "Electricity and Magnetism," second edition, Volume 2, pp. 776-7.

<sup>2</sup> E. B. Rosa and N. E. Dorsey, *Bureau of Standards Bulletin*, Vol. 1, p. 153.

<sup>3</sup> H. L. Curtis, *Bureau of Standards Bulletin*, Vol. 6, 1910, p. 433.

The present paper describes the adaptation of a bridge circuit due to M. Wien,<sup>4</sup> together with apparatus and procedure, which permits a measurement of capacitance in terms of resistance and frequency with an accuracy comparable to that of the primary standards. To illustrate the possibilities of the method in practice the results of a specific determination are included. Among its advantages over Maxwell's method are the use of a single frequency voltage and the fact that there is no general limitation placed on the type of condenser which may be measured or on the frequency at which the measurement may be made.

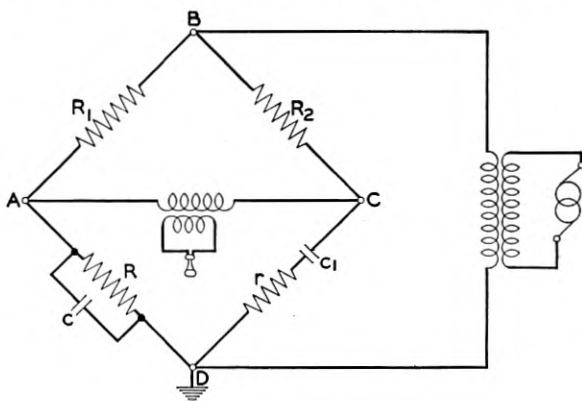

FIG. 1

The method described is also generally applicable to the determination of inductance, since its unit, like that of capacitance, may be derived from the units of resistance and frequency. The circuit and procedure to be described may be used with a change of only minor details.

In its simplest form the bridge, as shown in Fig. 1, consists of two equal resistance ratio arms, a third arm containing a capacitance and a resistance in series, and a fourth arm containing a capacitance and a resistance in parallel. A balance is easily made by varying any two of the five variables, viz., the two capacitances, the two resistances associated with them, and the frequency.

If, at balance, the frequency and any two of the other variables are known, the remaining two can be determined. Thus if the frequency, the resistance in the series arm, and the resistance in the parallel arm are known, the magnitude of both capacitances can be determined. However, the equations for balance, which are given below, are such that if the ratio of the capacitances and the value of the frequency are

<sup>4</sup> M. Wien, *Weid. Ann.*, 1891, p. 689.

known, the magnitudes of the capacitances can be determined from the knowledge of one only of the resistances, e.g., that in the series arm. Since the ratio of any two capacitances may be obtained with a high degree of precision by supplementary measurements, it therefore becomes possible to use the bridge just described without a knowledge of the parallel resistance, the measurement of which presents certain practical difficulties.

Although the Wien circuit is fundamentally simple, it is subject to many severe requirements when used to make an accurate determination of capacitance in terms of resistance and frequency, and must embody in its construction the refinements necessary for work of such high precision. In the Bell Telephone Laboratories there is available a capacitance bridge<sup>5</sup> of high precision, which is ordinarily used for the direct comparison of capacitances, and which, with slight modifications, is readily adapted to this purpose.

#### THEORY OF THE CIRCUIT

If in Fig. 1 the ratio arms are equal in resistance and phase angle, the equation of balance may be written

$$\left(\frac{1}{R} + j\omega C\right) \left(r + \frac{1}{j\omega C_1}\right) = 1,$$

and separating reals from imaginaries

$$\frac{C}{C_1} = 1 - \frac{r}{R} \quad (1)$$

and

$$CC_1 = \frac{1}{rR\omega^2}. \quad (2)$$

From these two equations it is obvious that, if the values of  $r$ ,  $R$  and  $\omega$ , are known, the true values of  $C$  and  $C_1$  can be determined.

However, the method of calibrating the capacitance bridge, which is described below and which is carried out irrespective of this determination gives the value of  $\frac{C}{C_1}$ , precisely, and this allows the reduction of the quantities to be determined to two,  $\omega$  and  $R$  or  $\omega$  and  $r$ .

Let  $C$  and  $C_1$  now be taken as the values of the two condensers as measured on the capacitance bridge to determine their ratios  $\frac{C}{C_1}$ .

<sup>5</sup> G. A. Campbell, *Elect. World and Engineer*, April 2, 1904; *Bell System Technical Journal*, July 1922; W. J. Shackelton and J. G. Ferguson, *Bell System Technical Journal*, Jan. 1928.



Since this ratio as measured is the true ratio, both of the measured values must be multiplied by the same factor to give the true values, and the following substitutions may be made in formulæ (1) and (2):

$$\begin{aligned} & KC_1 \text{ for } C_1 \\ \text{and} & KC \text{ for } C, \end{aligned}$$

where  $K$  is the correction factor necessary to reduce the values measured on the bridge to their true values. The formulæ now become

$$\frac{C}{C_1} = 1 - \frac{r}{R}$$

and

$$K^2 CC_1 = \frac{1}{rR\omega^2},$$

from which, eliminating  $R$  by the use of the ratio  $\frac{C}{C_1}$

$$K = \frac{1}{rC_1\omega} \sqrt{\frac{C_1 - C}{C}}.$$

In the foregoing  $C$  and  $C_1$  are assumed to be pure capacitances, and  $r$  and  $R$  pure resistances. Of course in practice neither pure capacitances nor pure resistances are obtainable. The former will have some slight conductance and the latter some slight reactance. It we use condensers having small losses, and resistances having small phase angles, the conductance of the condenser  $C$  (Fig. 1) may be considered as a resistance in parallel with  $R$ , and that of  $C_1$  as a resistance,  $r_1$ , in series with  $r$ . Similarly, the reactance of  $R$  may be considered as a capacitance  $C'$ , either positive or negative, in parallel with  $C$ , and the reactance of  $r$  as a capacitance,  $C_1'$ , in series with  $C_1$ . Of these quantities the conductance of  $C$  may be neglected, since the use of  $\omega$ ,  $r$ , and the ratio  $\frac{C}{C_1}$  as parameters eliminates  $R$  from the formula for  $K$ , and hence it is unnecessary to know it exactly. Including these second order quantities the formula for  $K$  becomes, using the notation above,

$$K = \frac{1}{(r + r_1) \left( \frac{C_1 C_1'}{C_1 + C_1'} \right) \omega} \sqrt{\frac{\frac{C_1 C_1'}{C_1 + C_1'} - (C + C')}{C + C'}}.$$

Now in the range of impedances actually used in the following determinations of  $K$  it was readily possible to obtain resistance units for  $r$  in

which the reactance was so small that  $\frac{C_1 C_1'}{C_1 + C_1'}$  was no different from  $C_1$  to the order of accuracy of the determinations. The parallel capacitance of  $R$  in the cases where single unit resistances only were used could also be made negligibly small compared with  $C$  in some cases, though the resistance values of  $R$  were in general considerably higher than those of  $r$ , and it was therefore more difficult to secure very small phase angles in the former. However, in a large number of the determinations a shielded resistance box was used for  $R$ , its phase angle was some 5 to 10 times that of the single units, and too large to neglect. Accordingly  $C_1'$  can be eliminated from the formula for  $K$  for the purpose of this investigation while  $C'$  cannot. The formula may then be written in the more simple form:

$$K = \frac{1}{(r + r_1)C_1\omega} \sqrt{\frac{C_1 - (C + C')}{C + C'}}. \quad (3)$$

The nominal values of the first order quantities used in the actual determinations are shown in Table 1. In this table  $Q$  is the ratio of reactance to resistance of either of the total arm impedances  $r$  and  $C_1$  or  $R$  and  $C$ .

TABLE I  
NOMINAL CAPACITANCE AND RESISTANCE COMBINATIONS USED IN  
DETERMINATION OF  $K$

$C_1$ $\mu f.$	$r$ ohms	$C$ $\mu f.$	$R$ ohms	$f$ cycles	$Q$
.4	690	.1	920	1000	.6
.2	800	.1	1600	1000	1.0
.4	400	.2	800	1000	1.0
.1	1000	.072	3520	1000	1.6
.2	1000	.078	1640	1000	.8
.3	1000	.066	1280	1000	.6
.4	1000	.055	1160	1000	.4
.1	1000	.039	1630	2000	.8
.2	1000	.027	1160	2000	.4
.3	1000	.020	1070	2000	.3
.4	1000	.015	1039	2000	.2
.1	500	.091	5500	1000	3.2
.2	500	.143	1750	1000	1.6
.3	500	.158	1055	1000	1.2
.4	500	.154	810	1000	.8
.1	500	.072	1760	2000	1.6
.2	500	.078	820	2000	.8
.3	500	.066	640	2000	.6
.4	500	.055	580	2000	.4

$$K = \frac{1}{\omega C_1 r} \sqrt{\frac{C_1 - C}{C}}.$$

As mentioned above the method of this paper may obviously be extended to the measurement of inductance in terms of resistance and frequency. If in the circuit of Fig. 1,  $C_1$  is replaced by an inductance  $L_1$  and  $C$  by an inductance  $L$ , at balance

$$L = \frac{r^2 + \omega^2 L_1^2}{L_1 \omega^2}. \quad (4)$$

If as before  $L_1$  is known in terms of  $L$ , i.e., if

$$L_1 = AL,$$

$L_1$  can be eliminated from (4) and

$$L = \frac{r}{\omega} \sqrt{\frac{1}{A(1-A)}}. \quad (5)$$

Expressing the relation (5) in terms of  $K$ , as in (3) above,

$$K = \frac{r}{\omega} \sqrt{\frac{1}{L_1(L - L_1)}}. \quad (6)$$

This formula neglects the effective resistance of  $L_1$ . The accuracy with which the value of  $K$  can be determined will in practice probably depend upon the accuracy with which the effective resistance of the inductance  $L_1$  can be determined, which in general will be somewhat less than the accuracy of determining the conductance of the corresponding capacitance.

#### DESCRIPTION OF APPARATUS

The bridge equipment was a completely shielded equal-ratio bridge built for the comparison of capacitance and including standard condensers in the bridge itself. In its adaptation to the Wien circuit the standard condensers were cut out leaving a pair of equal-ratio resistance arms, properly shielded. The two additional arms were made up of external resistances and the condensers being measured.

A description of the arrangement of the standards in the capacitance bridge, however, is necessary to explain the means of obtaining the precise value of the ratio of any two capacitances. The capacitance standards, self-contained in the bridge, are variable from 0 to 1  $\mu f$  and are arranged in decade form, first an air condenser with a range of slightly more than 10  $\mu\mu f$ , then fixed condensers up to 1  $\mu f$  in 5 additional decades, each consisting of unit condensers controlled by 10 point switches. An external capacitance is measured by turning the

dials of the standard capacitance until a balance is obtained and the value is then read from the dial settings and the reading of the air condenser, which has a minimum scale division of  $.2 \mu\mu f$ .

The bridge condensers cannot be made exactly direct reading, and for accurate work the bridge must be calibrated. This calibration may be made very simply due to the fact that the maximum setting on any dial is approximately equal to one step on the next higher dial. By the use of an auxiliary external condenser it is possible to get a balance with any desired setting of the bridge. Thus the maximum of one dial may be compared with each individual step of the next higher dial by balancing the bridge first with the maximum setting of the lower dial and then with that dial set at zero and the next higher dial moved up one step, no change being made in the auxiliary condenser. The change in capacitance required for balance, that is, the difference between the dial settings, is read on the air condenser. Since the condensers in each decade are completely shielded from those in the other decades this procedure gives an accurate comparison of the ten steps of any dial with one another, and with the maximum setting of the next lower dial. Evidently an extension of this method will furnish a precise comparison of any bridge setting with any other, although it gives no information as to the absolute values of any of the settings.

In practice after the above "step-up" calibration, as it is called, is performed the values of all the bridge condensers are computed in terms of an assumed value of a single one. This furnishes a bridge calibration of which the consistency is dependent only on the accuracy of the "step-up" and of which the accuracy is dependent only on the value of the single calibrating standard. In general the assumed value of the calibrating standard will be in error, its true value being a constant,  $K$ , times its assumed value. Any reading on the bridge using the calibration will, therefore, require a correction by this same factor  $K$ . Now let us suppose that this bridge has exactly equal ratio arms, is calibrated as described above and is used to measure successively two capacitances whose measured values are found to be  $C$  and  $C_1$ . Their true values will then be  $KC$  and  $KC_1$  and their ratio will be  $\frac{C}{C_1}$ , which is the true ratio between the capacitances irrespective of the value of  $K$ , that is, irrespective of the absolute accuracy of the measured values. By means of this type of precision capacitance bridge the ratio between any two capacitances may thus be obtained regardless of the absolute accuracy with which the capacitance of either is known.

Actually the best known value is always assumed for the capacitance used as the standard in computing the calibration of the bridge, and

accordingly the constant  $K$  by which the calibrated values of the bridge condensers must be multiplied to give their absolute values, is always very near unity. If the absolute value of the capacitance of a single condenser can be determined the factor  $K$  can readily be evaluated by measuring this known condenser on the capacitance bridge. If  $K$  is known the absolute value of any condenser can then be determined by measurement on the capacitance bridge because of the consistency of the bridge calibration. The practical reason, therefore, for determining the absolute value of a primary standard of capacitance in terms of resistance and frequency is to permit the determination of the error in the bridge calibration, i.e., to evaluate  $K$ . Accordingly, the actual measurements are carried out from the viewpoint of determining the value of  $K$  for the precision capacitance bridge rather than from the viewpoint of determining the absolute value of the capacitance of a single condenser. Of course, the latter determination is included in the former.

#### SPECIAL APPARATUS

Aside from the shielded capacitance bridge the following special apparatus employed in the determinations is worthy of mention. The unit standard condensers were dry stack mica condensers potted in an asphalt moisture-proofing compound and shielded by brass cans. They had been kept in the laboratory a number of years so that they were thoroughly aged and their values extremely stable. The phase difference of these condensers was very small, even for high grade mica condensers.

Unit resistances were made up especially for this series of tests and consisted of bifilar windings in 100 ohm sections connected in series on hard rubber spools  $\frac{3}{4}$  in. in diameter. No. 40 B. & S. gauge advance wire was used throughout. All the coils had phase angles less than .1 minute at 1,000 cycles. The 6 dial shielded resistance box used in some of the measurements was a laboratory standard variable from .01 to 10,000 ohms and calibrated for phase angle. The oscillator employed as a source of current was a specially constructed vacuum tube oscillator designed to maintain an extremely constant frequency, and to deliver a practically pure sine wave. The reference standard of frequency was a 100-cycle tuning fork surrounded by a constant temperature bath,<sup>6</sup> the average frequency of which from day to day was constant to .001 per cent. The reference standard of resistance against which the resistances of the units were calibrated was of the well-known

<sup>6</sup> J. W. Horton, N. H. Ricker, W. H. Marrison, "Frequency Measurement in Electrical Communication," *A. I. E. E. Transactions*, June, 1923.

National Bureau of Standards type,<sup>7</sup> calibrated by the Bureau of Standards.

#### EXPERIMENTAL PROCEDURE

The procedure used in the determination of  $K$ , was briefly as follows:

Separate unit mica condensers were selected for  $C$  and  $C_1$ . Each was measured on the capacitance bridge by itself to determine its value in terms of the bridge calibration, and in addition its series resistance was measured by comparison with the air condensers of the bridge, the series resistance of the bridge condensers being eliminated by virtue of the construction of the bridge,<sup>5</sup> and the method of making the measurement. At the same time the resistance of  $r$  and  $R$ , high quality resistance units, was determined by the customary Wheatstone bridge method, and their phase angles were measured by comparison with standards of which the phase angle was known to .02 minute at 1,000 cycles. The series impedance was then placed in one arm of the capacitance bridge which had previously been balanced at the frequency in question, and the parallel impedance in the other arm. The bridge was then rebalanced by varying slightly the small air condenser in the bridge and the frequency. The change in the bridge air condenser represents an algebraic addition to the capacitance  $C$  necessary because the quantities  $C$ ,  $C_1$ ,  $R$ , and  $r$  were not perfectly adjusted to their nominal values and because  $K$  is not exactly equal to 1. The change in frequency is necessary for the same reason. The true frequency was then determined by comparison with the laboratory standard by means of the cathode ray oscillograph.<sup>8</sup> For some of the determinations the bridge condensers were used for  $C$  instead of an external unit, and a shielded six dial resistance box, variable from .01 to 10,000 ohms instead of a unit resistance for  $R$ . In this case the final balance was obtained by varying the bridge condenser and  $R$  instead of the bridge condenser and the frequency. The vacuum tube oscillator used as a frequency source was capable of maintaining a frequency constant to better than .001 per cent for the duration of the tests. Sets of tests were made at three different times with an interval of about a month between them. The tests were made at frequencies of 1,000 and 2,000 cycles.

The results of the determination at each frequency are contained in Tables II and III respectively.

<sup>7</sup> E. B. Rosa, "A New Form of Standard Resistance," *Bulletin, Bureau of Standards*, Vol. 5, p. 413.

<sup>8</sup> F. J. Rasmussen, "Frequency Measurements with the Cathode Ray Oscillograph," *A. I. E. E. Journal*, January, 1927.

TABLE II

DETERMINATION OF *K* AT 1000 CYCLES

Those readings made on any given day are grouped together.

<i>C'</i> μμf	( <i>C</i> + <i>C'</i> ) μf	<i>r</i> <sub>1</sub> ohm	<i>r</i> <sub>1</sub> + <i>r</i> ohms	<i>C</i> <sub>1</sub> μf	<i>C</i> <sub>1</sub> - ( <i>C</i> + <i>C'</i> ) μf	<i>f</i> cycles	<i>K</i>	<i>d</i> × 10 <sup>5</sup>
+ 4	.100339	.15	687.08	.400130	.299791	1000.38	1.00030	+2
- 3	.100047	.15	793.53	.199133	.099086	1002.13	1.00023	-5
0	.199733	.15	397.29	.400130	.200397	1002.57	1.00025	-3
+ 4	.100336	.15	687.03	.400144	.299808	1000.49	1.00028	0
- 3	.100048	.15	793.45	.199142	.099094	1002.19	1.00028	0
0	.199725	.15	397.32	.400144	.200419	1002.61	1.00018	+10
+19	.071836	.35	998.44	.100297	.028461	1000.06	1.00031	+3
+20	.077748	.15	998.24	.199142	.121394	"	1.00036	+8
+15	.065825	.19	998.28	.301655	.235830	"	1.00032	+4
+13	.054783	.15	998.24	.400144	.345361	"	1.00036	+8
+19	.091217	.35	500.50	.100297	.009080	1000.00	1.00032	+4
+22	.143050	.15	500.30	.199142	.056092	±.05	1.00031	+3
+14	.158788	.19	500.34	.301655	.142867	"	1.00024	-4
+46	.154923	.15	500.30	.400144	.246221	"	1.00023	-5
+19	.071841	.35	998.42	.100294	.028453	"	1.00023	-5
+20	.077765	.15	998.22	.199135	.121370	"	1.00025	-3
+15	.065842	.19	998.26	.301644	.235802	"	1.00019	-9
+13	.054801	.15	998.22	.400124	.345323	"	1.00029	+1
+19	.071786	.35	998.42	.100294	.028508	1001.30	1.00031	+3
+20	.077638	.15	998.22	.199131	.121493	"	1.00031	+3
+15	.065703	.18	998.25	.301641	.235938	"	1.00033	+5
+13	.054673	.15	998.22	.400122	.345449	"	1.00031	+3
+22	.142942	.15	500.35	.199131	.056189	"	1.00022	-6
+14	.158586	.18	500.30	.301641	.143055	"	1.00022	-6
+46	.154661	.15	500.35	.400122	.245461	"	1.00026	-2
+40	.100209	.15	687.03	.400122	.299913	1001.30	1.00030	+2
+19	.100134	.15	793.47	.199131	.098997	"	1.00027	-1

*n* = no. of observations

*d* = deviation from mean

Av. 1.00028

$$\sigma = \sqrt{\frac{\sum d^2}{n}}$$

not defined until Table 6.

σ .000047

3σ .00014

Final Value of *K* 1.00034 ± .00003.\*

To determine the effect of any inequality in the ratio arms of the bridge tests were made first with the series circuit in one arm of the bridge and then in the other at the time of each series of tests. In each case the reversal was found to cause a change of +.008 per cent in the value of *K*. Hence, the error in the determinations caused by all bridge inequalities was assumed as -.004 per cent; i.e., .004 per cent should be added to all determinations.

\* The final value was obtained by adding .00002 for a known error in frequency and .00004 for the ratio arm error of the bridge to the average of the above determinations. The accuracy of the final value is equal to  $\pm \frac{3\sigma}{\sqrt{n}}$ .

TABLE III  
DETERMINATION OF  $K$  AT 2,000 CYCLES

$C'$ $\mu\mu f$	$(C + C')$ $\mu f$	$r_1$ ohm	$r_1 + r$ ohms	$C_1$ $\mu f$	$C_1 - (C + C')$ $\mu f$	$f$ Cycles	$K$	$d \times 10^6$
+20	.038819	.16	998.23	.100286	.061467	2000.00	1.00025	-1
+13	.027499	.06	998.13	.199108	.171609	2000.00	1.00028	+2
+14	.019687	.08	998.15	.301597	.281910	2000.00	1.00030	+4
+14	.015274	.06	998.13	.400064	.384790	2000.00	1.00025	-1
+22	.071752	.16	500.30	.100286	.028534	2000.00	1.00021	-5
+46	.077563	.06	500.20	.199108	.121545	2000.00	1.00023	-3
+43	.065626	.08	500.22	.301597	.235971	2000.00	1.00021	-5
+34	.054604	.06	500.20	.400064	.345460	2000.00	1.00025	-1
+20	.038778	.16	998.23	.100286	.061508	2001.66	1.00030	+4
+13	.027457	.06	998.13	.199116	.171659	2001.66	1.00032	+6
+22	.071712	.16	500.33	.100286	.028574	2001.66	1.00032	+6
+46	.077475	.06	500.23	.199116	.121641	2001.66	1.00025	-1
+43	.065529	.08	500.25	.301616	.236087	2001.66	1.00027	+1
+34	.054517	.06	500.23	.400082	.345565	2001.66	1.00026	0

$d$  = deviation from mean

Av. 1.00026

$$\sigma = \sqrt{\frac{\sum d^2}{n}}$$

$\sigma$  .000035

$3\sigma$  .00010

Final value of  $K$  1.00032  $\pm$  .00003.\*

The resistance of the coils used for  $r$  was determined before and after each set of tests. Although the best grade of commercial resistance wire was used in making up the resistance coils they were found to have an appreciable temperature coefficient for work of such high precision, and due allowance had to be made for temperature variations in the computation of the results. The temperature coefficients of the resistances used are contained in Table IV.

TABLE IV  
TEMPERATURE COEFFICIENTS OF RESISTANCE COILS USED AS  $r$

Nominal Resistance of Coil	Temp. Coeff. % per ° C. at 20° C.
500 ohms.....	-.0016
400 ".....	+.0083
690 ".....	+.0013
800 ".....	+.0013
1000 ".....	+.0013

The temperature of the room in which all the tests except the measurement of resistance, were made, was held within  $\pm 1^\circ$  C. As the condensers in the capacitance bridge and the special unit condensers

\* The final value was obtained by adding .00002 for a known error in frequency and .00004 for the ratio arm error of the bridge to the average of the above determinations. The accuracy of the final value is equal to  $\pm \frac{3\sigma}{\sqrt{n}}$ .



were all so selected as to have negligible temperature coefficients over this range no temperature correction in the capacitance values nor in the value of  $K$  was necessary.

A well aged 3 dial condenser box which had just been calibrated at the Bureau of Standards was checked on the bridge at the time of the second series of tests. In this way a comparison of the true capacitance of the bridge condensers as determined by the Bureau of Standards method and as determined by the present method is afforded. This comparison is shown in Table V.

TABLE V

COMPARISON OF ACCURACY OF PRIMARY STANDARDS BY DETERMINATION OF  $K$  AND BY BUREAU OF STANDARDS CALIBRATION

	K for Bridge at 1000 cycles by method of this paper:— 2/27/26 to 3/19/26	K for Bridge at 1000 cycles by comparison with Bureau of Stand- ards: 3/1/26
Average (27 determina- tions).....	1.00034	(18 values) . . 1.00038
$\sigma$ .....	.000047	.00005
$3\sigma$ .....	.00014	.00015
$\frac{3\sigma}{\sqrt{n}}$ .....	.000027	.000035
		K for Bridge at 2000 cycles by method of this paper:— 3/19/26
Average (14 determinations).....	1.00032	
$\sigma$ .....	.000035	
$3\sigma$ .....	.00010	
$\frac{3\sigma}{\sqrt{n}}$ .....	.000027	

Note:  $K$  by method of this paper was determined by the following bridge condensers .1, .2, .3, .4, .04, .06, .07, .08, .09.  $K$  by comparison with the Bureau of Standards values on condenser box No. 26962 was determined by all the settings of the .01 and .1 dials of the bridge.

DISCUSSION OF RESULTS

In the discussion which follows an attempt will be made to point out the various sources of error which may creep into such a determination and to state briefly what precautions were taken to guard against them.

1. Frequency Errors

The primary error in the values of frequency used was to be found in a variation of the standard fork from its nominal value. The average frequency of this fork integrated over 24 hours against the Arlington time signals can be held constant to  $\pm .001$  per cent. While this tells us little about the fluctuations from the mean value over short periods it is at least reasonable to assume that they will be of the same general order as the variation in the average. As a check on this

assumption the frequency of a very stable vacuum tube oscillator, specially constructed, when measured against the standard fork on the cathode ray oscillograph, can be shown not to vary with respect to the standard over a period of several hours by more than  $\pm .001$  per cent. Accordingly unless the standard fork and the special oscillator always fluctuate in exactly the same manner, which is very unlikely, we may conclude that both remain constant to better than  $\pm .001$  per cent. The use of the cathode ray oscillograph in checking the values of the oscillator used against the standard frequency introduces no error in the determination which is appreciable from the point of view of these tests.

### 2. Modulation Errors

Another type of error due to the source of frequency used was the masking of the true balance by oscillator harmonics affecting the detector system which consisted of the double-shielded output transformer of the bridge, a vacuum tube amplifier, a telephone receiver, and the human ear. The output characteristic of each of these elements is linear, or practically so, for small loads. Overloading of any one of them, however, results in a curved output characteristic which causes an appreciable amount of modulation. This is especially true of the vacuum tube amplifier. Now in a measurement of this type the bridge is balanced for the fundamental only, since the equations of balance contain the frequency as a parameter, and any harmonics present in the input will pass through into the detector circuit practically unattenuated. If they are appreciable in magnitude the elements of the detector, particularly the amplifier, become overloaded, more harmonics are generated, these harmonics are modulated in a succeeding element of the detector, and the fundamental may appear as a modulation product even though the bridge is actually balanced. Under such conditions the fundamental tone in the receiver can be eliminated only by unbalancing the bridge slightly. It was found during the tests that if the output of the oscillator was kept small no appreciable overloading occurred in the detector circuit, but that as the oscillator output was increased the amplitude of the harmonics also increased, the detector gradually became overloaded, and the bridge balance began to change as the oscillator output was varied. This effect was eliminated by the use of a filter to keep the harmonics from the oscillator out of the detector circuit.

### 3. Resistance Errors

Errors in the determination of  $K$  due to uncertainty in resistance values arose in four ways. The first source of error due to the resistance coils lay in their temperature coefficient. This coefficient was found to

be large enough to cause serious error in some of the values, one coil in particular having an extremely large temperature variation for resistances of this type. By determining the temperature coefficient of the coils used and making appropriate temperature corrections it was possible to reduce the uncertainty due to this cause to less than .001 per cent. The second source of error in resistance values resulted from the effect of humidity on the coils. They were impregnated with shellac, which absorbed moisture and swelled sufficiently to cause changes in resistance with humidity large enough to effect the results seriously. By measuring the coils both before and after each series of tests it was possible to keep the error due to this cause below .001 per cent. The use of potted coils would undoubtedly eliminate this difficulty completely. The third resistance error present arose from uncertainties as to the series resistance of the condensers  $C_1$ . These values were determined in terms of the bridge air condensers by the step-up method, on the assumption that the air condensers in the bridge have no conductance, it being eliminated by the method of measurement and by virtue of the special construction of the bridge.

In the fourth place the accuracy with which our primary standards of resistance are calibrated by the Bureau of Standards must be considered. These calibrations have been found consistent from year to year to about  $\pm .001$  per cent., and accordingly can probably be relied on to that value in the future. The results furnished by the Bureau are based on their primary standards, which agree with the primary standards of leading European nations to better than  $\pm .002$  per cent, hence there is little likelihood of their changing their values by the latter amount.

#### 4. *Capacitance Errors*

The accuracy with which the ratio of any two capacitances may be determined in such an investigation is dependent upon the consistency of the bridge calibration by the step-up method. A detailed discussion of the consistency of this calibration is beyond the scope of this paper. As an indication of the order of the precision with which it is possible to obtain a comparison between two condensers by this method, the results of measurements on a standard condenser box on three different bridges all calibrated by means of the step-up are shown in Table VI. The value of  $\pm 3\sigma$ , which is taken as the measure of the accuracy with which measurements can be reproduced, is  $\pm .004$  per cent as determined from 54 individual measurements. On this basis the error in the ratio of two condensers compared by this method will be less than  $\pm .0056$  per cent ( $\sqrt{2} \times .004$ ). Actually the error in the comparison of the values of two condensers by measurement on such a calibrated

TABLE VI

AGREEMENT BETWEEN MEASUREMENTS ON A STANDARD CONDENSER BOX ON THREE DIFFERENT BRIDGES, ALL CALIBRATED BY THE STEP-UP METHOD, USING THE SAME PRIMARY STANDARD

Setting $\mu f$	No. 2 Bridge		No. 8 Bridge		No. 9 Bridge	
	$d$	$d^2 \times 10^8$	$d$	$d^2 \times 10^8$	$d$	$d^2 \times 10^8$
.01	-.0013	169	+.0007	49	+.0007	49
2	+.0003	9	+.0013	169	-.0017	289
3	+.0017	289	+.0017	289	-.0033	1089
4	.0000	0	+.0010	100	-.0010	100
5	+.0003	9	-.0007	49	+.0003	9
6	+.0014	196	-.0006	36	-.0006	36
7	+.0010	100	.0000	0	-.0010	100
8	+.0010	100	.0000	0	-.0010	100
9	+.0010	100	-.0010	100	.0000	0
.1	+.0013	169	+.0003	9	-.0017	289
2	+.0023	529	.0000	0	-.0021	442
3	+.0033	1089	-.0017	289	-.0017	289
4	+.0028	784	-.0012	144	-.0017	289
5	+.0030	900	-.0010	100	-.0020	400
6	+.0010	100	.0000	0	-.0010	100
7	+.0013	169	-.0007	49	-.0007	49
8	+.0013	169	+.0003	9	-.0017	289
9	+.0020	400	-.0005	25	-.0010	100

$$\Sigma d^2 \times 10^8 = 11215,$$

$$\sigma = \sqrt{\frac{11215}{54}} \times 10^{-4},$$

$$\sigma = .0014\%,$$

$$3\sigma = .0042\%.$$

Note:  $d$  = per cent deviation from the mean value for any setting.  $\sigma = \sqrt{\frac{\Sigma d^2}{n}}$ , where  $n$  = the number of observations.

bridge was probably appreciably less than  $\pm .005$  per cent in all cases, as the values of Table VI were obtained in the course of the routine calibration of the several bridges, while in the determinations of  $K$  only the one bridge was used and special precautions were taken to make the consistency of the step-up as high as possible. In any event this value of  $\pm 3\sigma$  is appreciably less than that for a single determination of  $K$ , which ranges from  $\pm .010$  per cent to  $\pm .014$  per cent, as shown in Tables II and III. Accordingly the assumption that the consistency of the step-up method of calibration is sufficiently high for the purpose is well founded.

The accuracy of the capacitance values is also dependent upon the accuracy of the determination of the equivalent shunt capacitance of the resistance  $R$ . The phase angle of the series resistance  $r$  was

small enough to be neglected in all cases. The final determination of the shunt capacitance of  $R$  was accurate to  $\pm 1\mu\mu f$ , and hence in most of the cases under consideration the resulting uncertainty in  $K$  was less than  $\pm .001$  per cent.

4. Bridge Errors

The principal source of error in the bridge itself lies in the inequality of the ratio arms, both in magnitude and angle. Since this inequality may result from sources other than the ratio arms proper, it is best to

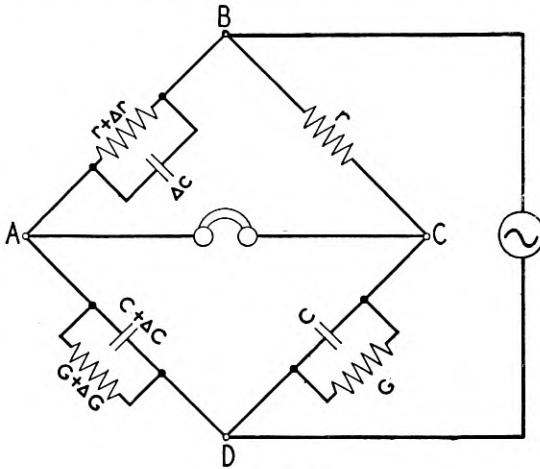

FIG. 2

ascertain it by interchanging the impedances being measured rather than by reversing the arms themselves. The following formulæ (see Fig. 2) show the errors in conductance and capacitance which may arise from ratio arm inequalities.

$$\frac{\Delta G}{2G} = -\frac{\Delta r}{r} - \frac{\omega^2 C \Delta cr}{G}, \tag{4}$$

$$\frac{\Delta C}{2C} = -\frac{\Delta r}{r} + \frac{\Delta cr G}{C}. \tag{5}$$

In the above,

$G$  = the conductance of the unknown.

$\Delta G$  = the change in conductance due to reversing the unknown and the standard arms.

$C$  = the capacitance of the unknown.

$\Delta C$  = the change in capacitance due to reversing the unknown and the standard arms.

- $r$  = the resistance of the ratio arms.  
 $\Delta r$  = the resistance unbalance of the ratio arms.  
 $\Delta c$  = the capacitance unbalance in the ratio arms.

These formulæ are not rigorous, as second order quantities have been neglected, but they are accurate to a close approximation provided the ratio arm capacitance is very small, the frequency is in the audible range, and the ratio of susceptance to conductance in the unknown is one or larger. All of these conditions obtain in the case in point.

By measuring direct and reversed an admittance having a  $Q$  (ratio of susceptance to conductance) of approximately 1 and solving the two equations simultaneously we may ascertain errors due to the differences in resistance and reactance of the ratio arms. The total change in capacitance of an admittance under test due to the resistance error of the ratio arms was found by the above method to be approximately .004 per cent; the capacitance error due to the reactance unbalance of the ratio arms was found to be  $\frac{.004\%}{Q}$ .

Thus the combined error in capacitance due to both types of unbalance is a function of the  $Q$  of the impedance being measured. In the case of the particular type of tests being made the combined error takes the form of an error in the capacitance  $C$ , i.e., the capacitance in the shunt circuit. Table I contains a column showing the  $Q$ 's of the impedances used for the tests, which range between .2 and 3.2. The corresponding error in  $C$  due to the total ratio arm unbalance varies between .014 per cent and .002 per cent (the error in  $C$  is obviously  $\frac{1}{2}$  of the total capacitance change resulting from the impedance arm reversal). It can easily be shown, however, from the relation between the capacitances  $C_1$  and  $C$  of Table I that the error in  $K$  resulting from the foregoing capacitance error will in general lie between limits of .003 per cent to .005 per cent except for one or two extreme cases for which the limits are .002 per cent and .008 per cent. Accordingly the total correction due to the bridge errors was lumped at .004 as noted under "Experimental Procedure," since the few cases for which the error reaches the extreme limits are those for which the accuracy of the test as a whole is a minimum, aside from this particular type of error.

#### *Final Accuracy of Result*

The standard deviation  $\sigma$  for the individual determinations of  $K$  has been worked out for the values in Tables II and III. The value of  $\sigma$  is significant in that, provided the distribution of errors is approxi-

mately normal, over 99 per cent of all determinations will fall within limits of  $\pm 3\sigma$  from the mean. In this discussion the accuracy of any measurement (exclusive of known consistent errors) will be defined as  $\pm 3\sigma$ . The standard deviation of the mean is given by the expression  $\frac{\sigma}{\sqrt{n}}$ , where  $n$  is the total number of observations. If the curve of errors is approximately normal (and we have no reason to assume otherwise), the error in the determination of  $K$  is given by  $\pm \frac{3\sigma}{\sqrt{n}}$ . In the

absence of any systematic errors, of which none have been detected of magnitude comparable with the final accuracy of the result, the limits of accuracy are therefore, from Table V,  $\pm .003$  per cent.

This limit was not exceeded in practice as is shown by the values for  $K$  at 1,000 and at 2,000 cycles in Table V. The difference between the two values of  $K$  is .002 per cent. Since the calibrations at both frequencies are based on the same original standard, namely, the 1,000-cycle value of the bridge .01 $\mu f$  air condenser, and the latter is assumed not to vary with frequency over the audio range, the final result for  $K$  in the two cases should be the same within the limits of accuracy of the result.

Table V contains a comparison of the values of  $K$  as determined by the method of this report and by comparing the Bureau of Standards calibrated values on a standard condenser box with the calibration of the capacitance bridge at 1,000 cycles. The agreement between these values, .004 per cent, is very close, in view of the accuracy which the Bureau certifies and the precision to which their results are given. Although the Bureau calibration is certified only to  $\pm .1$  per cent, the values are furnished to 5 significant figures and are apparently consistent to  $\pm .01$  per cent or better.

It will be noted that the values of capacitance chosen for these tests were all between .01 and .5 $\mu f$ . It is advisable that they be kept within these limits at the frequencies used in order that the resistance values required in the determination may be easily secured and easily capable of measurement with the required precision, and that errors in capacitance due to slight changes in the position of leads and units may not be appreciable.

# Distortion Correction in Electrical Circuits with Constant Resistance Recurrent Networks

By OTTO J. ZOBEL

SYNOPSIS: Constant resistance recurrent networks, that is, networks whose iterative impedances are a pure constant resistance at all frequencies, form here the basis of a method of distortion correction which is applicable to any electrical circuit. The paper takes up first the general problem of distortion correction, then this method of correction and its application in the following Parts and supplementary Appendices.

PART 1. *Ideal Circuit Characteristics.* Both ideal steady-state attenuation and phase characteristics are formulated and then verified as being necessary and sufficient for the preservation of signal-shape under transient conditions.

PART 2. *Constant Resistance Recurrent Networks.* These networks are of three general types and are made possible by the introduction of inverse networks of constant impedance product. Their propagation characteristics are considered in some detail and various methods of design are indicated.

PART 3. *Arbitrary Impedance Recurrent Networks.* These networks are a generalization of those in Part 2.

PART 4. *Applications.* The large variety of uses to which these networks may be put is illustrated by specific designs made for complementary distortion correcting networks, for a submarine cable circuit, a loaded-cable program transmission circuit, and an open-wire television circuit. In addition, networks are given for the equalization of variable attenuation in carrier telephone circuits, for phase correction in the transatlantic telephone system and for the simulation of a smooth line.

APPENDIX I. *Discussion of Linear Phase Intercept.*

APPENDIX II. *Linear Transducer Theorems.*

Three theorems are proved which relate to the variation with frequency over the entire frequency range of the propagation constants and iterative impedances of certain passive linear transducers.

APPENDIX III. *Propagation Constant and Iterative Impedance Formulæ for General Ladder, Lattice and Bridged-T Types.* This includes an improved formula for  $\cosh^{-1}(x + iy)$ .

APPENDIX IV. *Propagation Characteristics and Formulæ for Various Lattice Type Networks.* These results can be applied quite readily to many problems arising in the design of distortion correcting networks.



## INTRODUCTION

EVERY actual electrical circuit or transmission system distorts transmitted signals; that is to say, the received signal, regarded as a time-function, differs in shape from the impressed signal. Heaviside studied in detail the distorting action of the transmission line itself and indicated the necessary electrical properties of the distortionless line.<sup>1</sup> The distortionless line of Heaviside was approximately realized in the loaded line<sup>2</sup> in which similar lumped inductances are inserted in series with the line at uniform intervals. While this loading has the effect of partially correcting distortion of the lower frequency components of the signal, it also tends to increase the distortion of the higher frequency components and so limit somewhat the useful frequency range. More recently the transmission characteristics of some newly installed submarine cables have been greatly improved by means of continuous loading with the new magnetic material permalloy.<sup>3</sup>

The methods mentioned above are directed to rendering the line itself more nearly perfect. The method of distortion correction presented here may be used to supplement them and is that of passive *terminal* networks; more particularly networks whose iterative impedances are a pure constant resistance at all frequencies.<sup>4</sup> These networks are, however, not limited in their use to any particular type of transducer or transmission system but have general applicability. For this reason the general problem of distortion correction by this method resolves itself principally into a study of the transmission properties of these networks together with systematic methods of design to meet specified requirements.

This paper takes up first the characteristics necessary for no distortion in an electrical circuit; then, an extended study of constant resistance networks which can be used for distortion correction; finally, several applications to important practical problems. In addition, Appendix IV gives a considerable number of network structures and

<sup>1</sup> "Electrical Papers," Vol. II, p. 123, 1892; "Electromagnetic Theory," Vol. I, p. 445, 1893, Oliver Heaviside.

<sup>2</sup> U. S. Patent No. 652,230 to M. I. Pupin, dated June 19, 1900. See also "On Loaded Lines in Telephonic Transmission," G. A. Campbell, *Phil. Mag.*, March, 1903. Later a loading system more specifically directed to reducing distortion *per se* was disclosed in U. S. Patent No. 1,564,201 to J. R. Carson, A. B. Clark and J. Mills, dated December 8, 1925.

<sup>3</sup> "The Loaded Submarine Telegraph Cable," O. E. Buckley, *B. S. T. J.*, July, 1925.

<sup>4</sup> The equalization of the attenuation of certain transmission lines has for some time been obtained by means of comparatively simple series or shunt terminal networks. See, for example, U. S. Patent No. 1,453,980 to R. S. Hoyt, dated May 1, 1923. Such networks necessarily produce total terminal impedances which vary with frequency.

corresponding formulæ which will be found useful in further applications.

#### PART 1. IDEAL CIRCUIT CHARACTERISTICS

There is no distortion in the transmission of an impressed signal over an electrical circuit or network when the shape of the received signal, considered as a time-function with usually a time-of-transmission, is identical with that of the impressed signal. A uniform decrease in magnitude only is not distortion, and it can be restored to its original value by means of a distortionless amplifier.

Let us assume in the general case that the e.m.f. impressed on the circuit is  $E$ , and that the circuit is always terminated by a receiver of resistance,  $R$ , across which is the received voltage,  $v$ , in which we are interested. The received current is then directly proportional to the received voltage.

The necessary and sufficient conditions for distortionless transmission can be stated quite simply in terms of the steady-periodic transfer voltage ratio of the circuit which will be written as

$$\frac{v(i\omega)}{E(i\omega)} = e^{-a-ib}, \quad (1)$$

with the terminology  $a + ib =$  the transfer voltage exponent of the circuit, or concisely, the transfer exponent. Here  $a$  represents attenuation in napiers and  $b$  phase difference in radians, omitting in the latter any constant integral multiple of  $2\pi$ , and assuming the two voltages to have zero phase difference at zero frequency. That is, the origin of phase difference is so chosen that the phase intercept at zero frequency is zero.

*For ideal transmission characteristics the steady-periodic transfer exponent of the circuit should have an attenuation independent of frequency and a phase proportional to angular frequency,  $\omega$ , whose slope is the time-of-transmission of the circuit.*

In mathematical terms these ideal characteristics, represented by primes, are

$$a' = \text{constant (napiers)}, \quad (2)$$

and

$$b' = \tau\omega \text{ (radians)},$$

where

$$\tau = \text{time-of-transmission (seconds)}.$$

To show this, consider first what the indicial voltage,  $g(t)$ , would be under these assumptions. By *indicial voltage* is meant the received voltage as a time-function per unit constant e.m.f. impressed at the

sending end at time  $t = 0$ . With (1) and (2) in the integral equation of electric circuit theory<sup>5</sup> we obtain

$$\frac{e^{-a'-\tau p}}{p} = \int_0^{\infty} e^{-pt} g(t) dt, \quad (3)$$

whose solution is

$$g(t) = 0, \quad t < \tau, \quad (4)$$

and

$$g(t) = e^{-a'} = \text{constant}, \quad t > \tau.$$

Thus, a constant voltage, which has been attenuated by the circuit an amount  $a'$  napiers, arrives suddenly at the receiving end after a time  $\tau = (b'/\omega)$  seconds, and there is no distortion with respect to the unit constant e.m.f. impressed on the circuit at time  $t = 0$ .

If now any type of e.m.f.,  $E(t)$ , is impressed on this circuit which is specified by the steady-state characteristics (2) or the indicial voltage (4), we obtain through a general formula<sup>6</sup>

$$v(t) = \frac{d}{dt} \int_0^t E(t-y) g(y) dy = e^{-a'} E(t-\tau). \quad (5)$$

This received voltage has the same shape as the impressed e.m.f., there being an attenuation,  $a'$ , and a time-of-transmission,  $\tau$ . Hence, a circuit specified as above is distortionless to any type of impressed e.m.f. A further discussion involving the phase intercept is taken up in Appendix I.

It may be stated that Heaviside's theoretical distortionless smooth line was that in which the line constants  $R'$ ,  $L'$ ,  $G'$  and  $C'$  per unit length had the relation

$$R'/G' = L'/C', \quad (6)$$

giving attenuation and phase constants per unit length, respectively,

$$\alpha = \sqrt{R'G'} \text{ napiers,}$$

and

$$\beta = \sqrt{L'C'} \omega \text{ radians;}$$

also an iterative (or characteristic) impedance

$$k = \sqrt{\frac{R'}{G'}} = \sqrt{\frac{L'}{C'}} \text{ ohms,}$$

which is a constant resistance at all frequencies. A circuit made up

<sup>5</sup> "Electric Circuit Theory and the Operational Calculus," John R. Carson.

<sup>6</sup> L.c.

of such a line of length  $l$  terminated by a resistance  $R = k$  is readily seen to satisfy the conditions (2) above for no distortion. It would have an attenuation  $a' = \sqrt{R'G'}l$  nepiers and time-of-transmission  $\tau = \sqrt{L'C'}l$  seconds.

Having seen above what constitutes ideal transmission characteristics, the problem of distortion correction in any practical distorting circuit is that of altering the circuit in some way so as to approach this ideal. In most circuits it is impossible to obtain these ideal characteristics throughout the entire frequency range. More or less satisfactory transmission results will be had, however, if this ideal is approached over the range of frequencies most essential to the composition of the impressed e.m.f., as shown by its Fourier integral analysis.

How accurately an ideal attenuation characteristic has been met in any case depends upon how nearly constant the attenuation is in the frequency range. A simple practical measure of the degree of approach to an ideal phase characteristic at the frequencies in this range is furnished by a consideration of the time-of-phase-transmission in the steady state,

$$\tau_p = b/\omega \text{ seconds,} \quad (7)$$

in which  $b$  is defined as in (1) for the complete circuit. The more nearly constant  $\tau_p$  is in the frequency range, the closer it approaches equality with  $\tau$ , the time-of-transmission of the circuit for those frequencies.

In many cases approximately ideal phase characteristics already exist in the desired frequency ranges so that corrections need be made for attenuation only. In others, such as those in which the steady-periodic state is of most importance and where the phase relations between the components are immaterial, it is satisfactory to obtain uniform attenuation at the desired frequencies. The method of altering circuit transmission characteristics to be shown in this paper follows in Part 2.

## PART 2. CONSTANT RESISTANCE RECURRENT NETWORKS

### 2.1. *Fundamental Basis of Distortion Correction*

The general transmission circuit of Fig. 1 is shown as having a resistance,  $R$ , at the receiving end, as in the case where the energy is absorbed. Usually the circuit characteristics at this resistance with respect to the sending terminals show distortion in the required frequency range. If so, an ideal method of correcting the distortion

would appear to be that of interposing between the circuit and the receiving resistance a transducer having the requisite corrective propagation constant and an iterative impedance,  $R$ . By so doing, the transfer exponent at the end of the circuit proper would remain un-

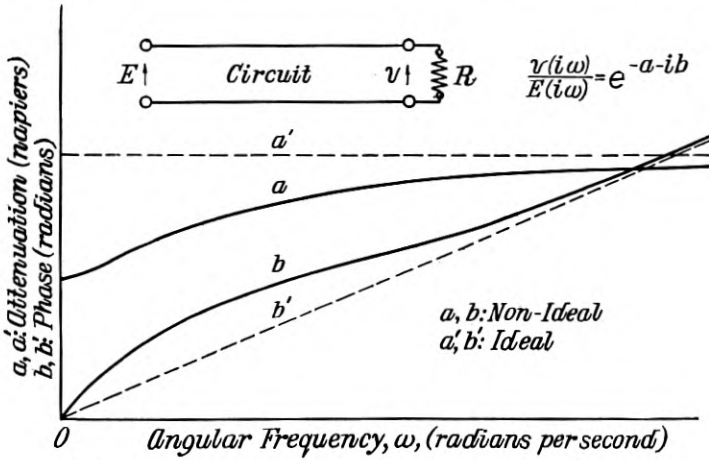

Fig. 1—Non-ideal and ideal transfer exponents of circuits.

altered, *irrespective of the exact nature of the network beyond*, since the latter has the impedance  $R$ ; but the total transfer exponent would become ideal through the addition of the complementary propagation constant of the transducer. Stated analytically,

let  $a + ib$  = transfer exponent of the distorting circuit at a terminating resistance  $R$ ,

$A + iB$  = propagation constant of the correcting transducer of iterative impedance  $R$ ,

and  $a' + ib'$  = resultant ideal transfer exponent at the receiving resistance  $R$ .

Then the correcting transducer must be so designed that  $A$  and  $B$  satisfy over the required frequency range the conditions

$$a' = a + A = \text{constant},$$

and

$$b' = b + B = \tau\omega,$$

where  $\tau$  is a positive constant. Or, explicitly,

$$A = a' - a, \text{ positive},$$

and

$$B = b' - b = \tau\omega - b. \tag{8}$$

The total attenuation,  $a'$ , and time-of-transmission,  $\tau$ , are somewhat at our disposal; it will be found that their best choice is usually guided by experience. The transducer will often consist of a number of sections, not necessarily alike. This distortion correcting process may be called "equalizing both the attenuation and the time-of-phase-transmission."

*The idea of altering circuit transmission characteristics by means of one or more sections of constant resistance recurrent networks forms the fundamental basis of the method of distortion correction presented here. It is, of course, dependent for its application upon the physical possibility of designing recurrent networks whose iterative impedances are a constant resistance at all frequencies and whose propagation constants have the desired characteristics.*

Another method by which distortion correction has sometimes been obtained is by means of terminal thermionic distortion circuits wherein networks of particular frequency characteristics are placed in the plate circuits of successive thermionic tubes. In it any reaction of one stage upon a preceding stage or upon the original circuit is prevented by the unilateral property of the tubes, whereas in the method given here this same result is obtained by the property of a constant resistance iterative impedance and the use of a resistance termination. While from the standpoint of the original circuit both methods give the resultant effect of a terminal unilateral device, one very practical advantage of the constant resistance method over the thermionic tube method appears to be that it corrects distortion before any amplification is added and hence with it there would be less tendency to cause tube distortion or modulation. Another advantage is that the distortion correcting networks can be designed independently of the amplifying device. A description of this other method appeared in the last number of the *Journal*.<sup>7</sup>

Before taking up specific types of constant resistance structures, let us consider some of the inherent limitations of certain transducers as are brought out by the following theorems.

## 2.2. Linear Transducer Theorems

These theorems relate to the variation with frequency over the entire frequency range of the iterative parameters, that is, the propagation constants and iterative impedances, of certain passive linear transducers. In symmetrical transducers we could as well employ the image parameters which are of such utility in a study of electric wave-

<sup>7</sup>"Phase Distortion and Phase Distortion Correction," Sallie Pero Mead. *B. S. T. J.*, April, 1928.

filters and which, together with iterative parameters, were discussed generally by the writer in a previous number of this *Journal*.<sup>8</sup> But since here in the ladder type networks some dissymmetrical sections are also considered, I shall use the iterative parameters throughout this paper.

*Theorem I: Any symmetrical transducer whose attenuation constant is zero at all frequencies has a phase constant which increases with frequency and an iterative impedance which is a constant resistance throughout the frequency range.*

*Theorem II: Any transducer whose iterative impedance is real at all frequencies has a constant resistance iterative impedance, and if in addition its phase constant is proportional to frequency, it has a uniform attenuation constant.*

*Theorem III: Any symmetrical transducer whose attenuation constant is independent of frequency and whose iterative impedance is a constant resistance at all frequencies has a phase constant which is zero or increases with frequency.*

The theorems, whose proofs are given in Appendix II, may be represented by the following table. The variations with frequency of the network parameters shown apply to the entire frequency range and in each theorem the parenthesis designates the dependent property, where *A* is the attenuation constant, *B* the phase constant, and *K* the iterative impedance.

TABLE I  
LINEAR TRANSDUCER THEOREMS

Theorem	<i>A</i>	<i>B</i>	<i>K</i>
I.....	0	(Increases)	(Constant)
II.....	(Constant)	$\tau\omega$	Real (Constant)
III.....	Constant	(Zero, or increases)	Constant

That part of Theorem I which relates to the iterative impedance explains why there is no physical ladder type network having zero attenuation throughout the frequency range. For, the ladder type, when non-dissipative and having zero attenuation, requires a mid-series or mid-shunt iterative impedance which varies with frequency.

<sup>8</sup> "Transmission Characteristics of Electric Wave-Filters," O. J. Zobel, *B. S. T. J.*, October, 1924. The term "characteristic impedance" used in that paper for a recurrent or iterative parameter with dissymmetrical transducers is replaced here by "iterative impedance." Thus, the same term "iterative" applies to the structure, to the corresponding impedances, and to the kind of parameters. The use of the term "characteristic impedance" will be limited to smooth lines, or sometimes to symmetrical recurrent structures. In symmetrical structures the "characteristic," "iterative," and "image" impedances are identical.

### 2.3. Inverse Networks of Constant Impedance Product

We have already seen that the fundamental advantage of using constant resistance networks for distortion correction lies in the fact that when they are placed ahead of the receiving resistance,  $R$ , they present this same impedance to the circuit proper and hence do not alter the transfer exponent at that point. They can be designed to have, in addition to the impedance  $R$ , a propagation constant which complements this exponent and produces a resultant transfer exponent at the receiving resistance which is approximately ideal.

The possibility of physically realizing recurrent networks having a constant resistance iterative impedance at all frequencies rests, as will be seen, upon that of obtaining pairs of two-terminal networks the product of whose impedances is constant, independent of frequency. Such pairs<sup>9</sup> I have defined as *inverse networks of impedance product*  $R^2$ , or more concisely, *inverse networks*.

In the paper just referred to it was pointed out that one elemental pair of such inverse networks is composed of two resistances  $R_1$  and  $R_2$ , and another is composed of an inductance  $L$  and a capacity  $C$  bearing the impedance product relations at all frequencies

$$R_1 R_2 = L/C = R^2. \quad (9)$$

The same paper gave a simple proof of the following theorem relating to series and parallel combinations of networks. *If  $z_1'$  and  $z_2'$  are any pair of inverse networks and if  $z_1''$  and  $z_2''$  are any other pair, such that  $z_1' z_2' = z_1'' z_2'' = R^2$ , then  $z_1'$  and  $z_1''$  in series and  $z_2'$  and  $z_2''$  in parallel are a pair; similarly  $z_1'$  and  $z_1''$  in parallel and  $z_2'$  and  $z_2''$  in series are another pair.*

Without much difficulty a theorem relating to simple networks having the form of a general Wheatstone bridge can also be obtained, as follows: *The inverse network corresponding to any given two-terminal bridge network of five distinct branches is also a bridge network, and may be derived by replacing the network in each branch of the given network by its inverse network and then interchanging the networks in either opposite pair of branches.* By successive applications of these relations, beginning with the elemental pairs, very complicated inverse networks can be built up. Only reactance networks were considered in the paper referred to above. Ordinarily the series and parallel

<sup>9</sup> An extensive use of inverse networks of pure reactance types was made in the paper, "Theory and Design of Uniform and Composite Electric Wave-Filters," O. J. Zobel, *B. S. T. J.*, January, 1923. Also in U. S. Patents No. 1,509,184, September 23, 1924; Nos. 1,557,229 and 1,557,230, October 13, 1925; and No. 1,644,004, October 4, 1927.



combinations are most useful, since the bridge structures require at least five elements in each network. Some networks may have other equivalent structures, as well.

If  $z_{11} = r_{11} + ix_{11}$  and  $z_{21} = r_{21} + ix_{21}$  are inverse networks such that

$$z_{11}z_{21} = R^2, \quad (10)$$

a number of simple relations exist among their impedance components; namely,

$$\frac{x_{21}}{r_{21}} = -\frac{x_{11}}{r_{11}},$$

$$\frac{r_{21}}{|z_{21}|^2} = \frac{r_{11}}{R^2}, \quad (11)$$

and

$$\frac{x_{21}}{|z_{21}|^2} = -\frac{x_{11}}{R^2}.$$

In a smooth line the condition (6) which makes it distortionless is actually the one making the series and shunt impedances per unit length inverse networks of impedance product  $R^2 = R'/G' = L'/C'$ .

#### 2.4. Types of Constant Resistance Recurrent Networks and Their Propagation Constants

The types of recurrent networks considered in this paper are the three simplest ones, the ladder, lattice, and bridged-T types whose general structures are shown in Fig. 2. Propagation constant and iterative impedance formulæ for these types in terms of general impedance elements are given in Appendix III for possible future reference.

By introducing in each of these types the use of inverse networks with  $z_{11}$  and  $z_{21}$  satisfying relation (10), and assuming various relations in the general formulæ, it is possible to derive general network structures whose iterative impedances are a constant resistance,  $R$ , at all frequencies.<sup>10</sup> The structures are of such general nature as to permit a very wide range of propagation constants. Any one of them when closed by a resistance,  $R$ , presents at the other terminals the impedance  $R$  at all frequencies. They will now be considered.

The networks of the *ladder type* are shown in Fig. 3 as six complete sections, each designated by the termination at which it has the iterative impedance  $R$ ; one at full-series, one at full-shunt, and two

<sup>10</sup> See U. S. Patent No. 1,603,305 to O. J. Zobel, dated October 19, 1926. Also British Patent Specification No. 236,189, dated July 8, 1926.

each at mid-series and mid-shunt. The first two sections are dissymmetrical as regards the two pairs of terminals. The two mid-series sections are symmetrical and identical except for the structure of their shunt branches, which, however, are equivalent impedances. Simi-

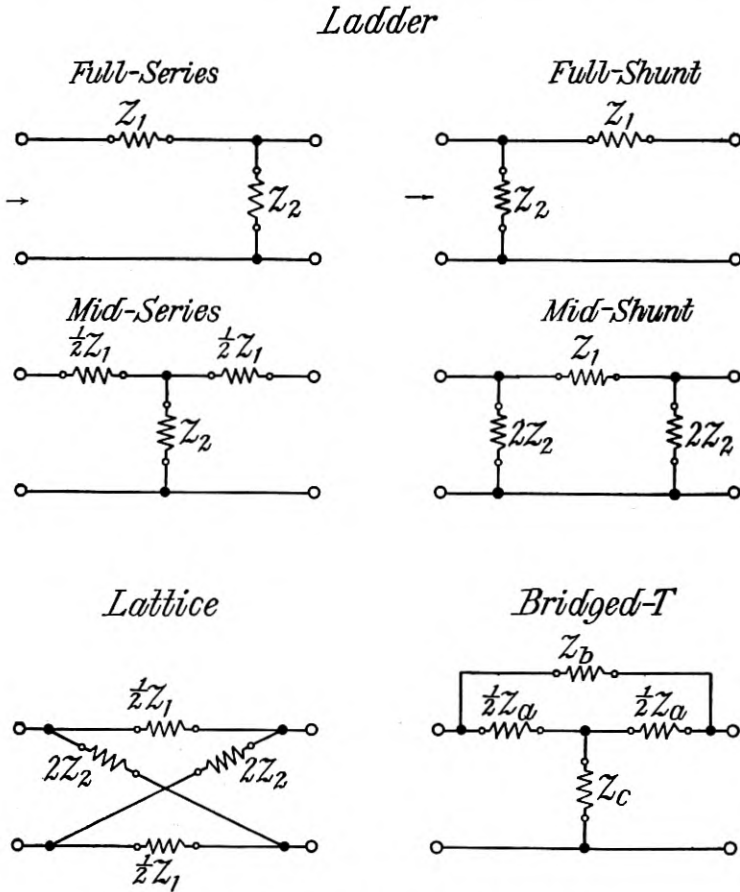

Fig. 2—Types of general recurrent network sections.

larly, the symmetrical mid-shunt pair have different series branches of equivalent impedance. It may be of interest to point out that if each of these sections is closed by a resistance,  $R$ , to form a two-terminal network, then three pairs of these networks are seen directly from series and parallel rules to be inverse networks; namely,

$$I_a, I_b; I_c, I_f; \text{ and } I_d, I_e.$$

If one has the impedance  $R$ , the other must also, as is the case. The propagation constant,  $\Gamma = A + iB$ , of each of these ladder type sections is the same and is given by the simple relation

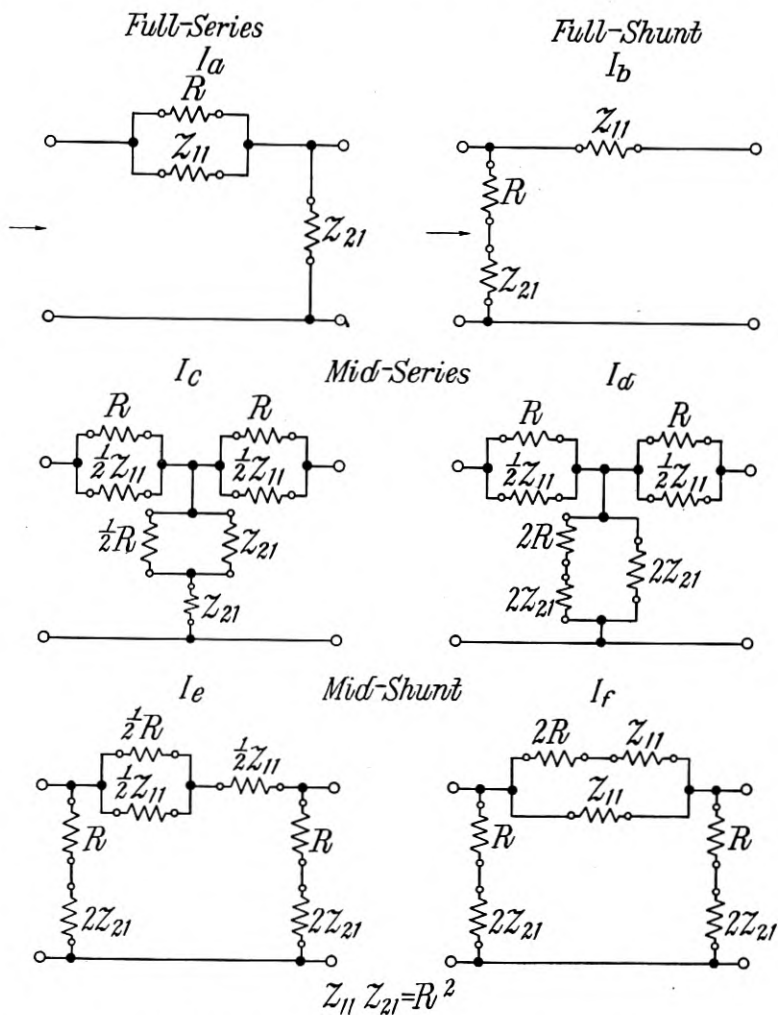

Fig. 3—Ladder type constant resistance sections.

$$e^{\Gamma} = 1 + z_{11}/R; \tag{12}$$

the particular iterative impedance is  $R$ . Here  $z_{11}$  is arbitrarily taken as the independent impedance determining the propagation constant

with  $z_{21}$  dependent through the inverse network relation  $z_{11}z_{21} = R^2$ . This relation, besides ensuring a constant resistance iterative impedance, reduces the network parameters at least one half. *Since resistances occur explicitly in the structures, these sections will all be dissipative.*

The network of the *lattice type*, shown in Fig. 4, is symmetrical and has a propagation constant determined by

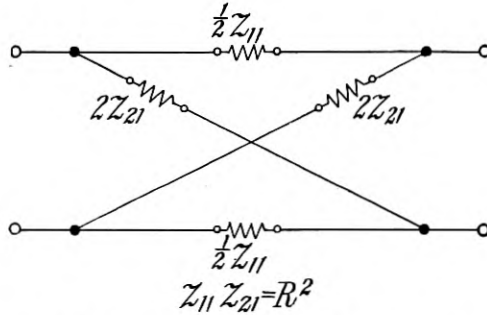

Fig. 4—Lattice type constant resistance section.

$$e^{\Gamma} = \frac{1 + z_{11}/2R}{1 - z_{11}/2R}, \tag{13}$$

where  $z_{11}z_{21} = R^2$ . *If  $z_{11}$  is a reactance, the network will introduce no attenuation, only phase difference.*

The networks of the *bridged-T type* are symmetrical and will be given in two groups, the members of each group having the same propagation constant. The two sections of the *first group* ( $I_a$  and  $I_b$ ) in Fig. 5

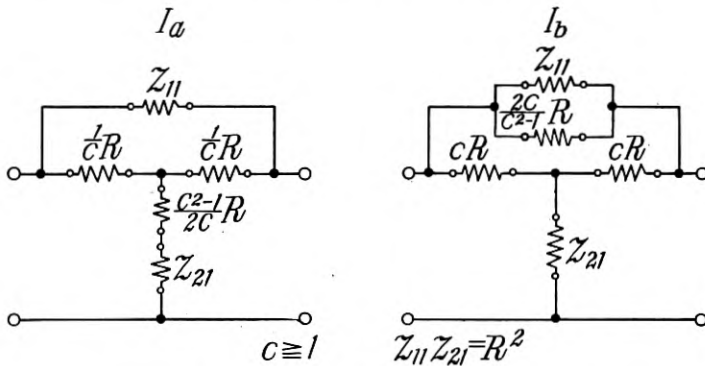

Fig. 5—Bridged-T(I) type constant resistance sections.

have a propagation constant formula

$$e^{\Gamma} = \frac{1 + (c + 1)z_{11}/2R}{1 + (c - 1)z_{11}/2R}, \tag{14}$$

where, besides the arbitrary impedance  $z_{11}$ , there is the arbitrary real  $c \cong 1$ . These sections will be dissipative owing to the ever present resistances. Utilizing directly the rule given for inverse bridge networks, it can be seen that when closed by  $R$  these two structures are inverse networks of impedance product  $R^2$ .

The four bridged-T sections of the *second group* (II<sub>a</sub>, II<sub>b</sub>, II<sub>c</sub>, and II<sub>d</sub>) in Fig. 6 have the formula

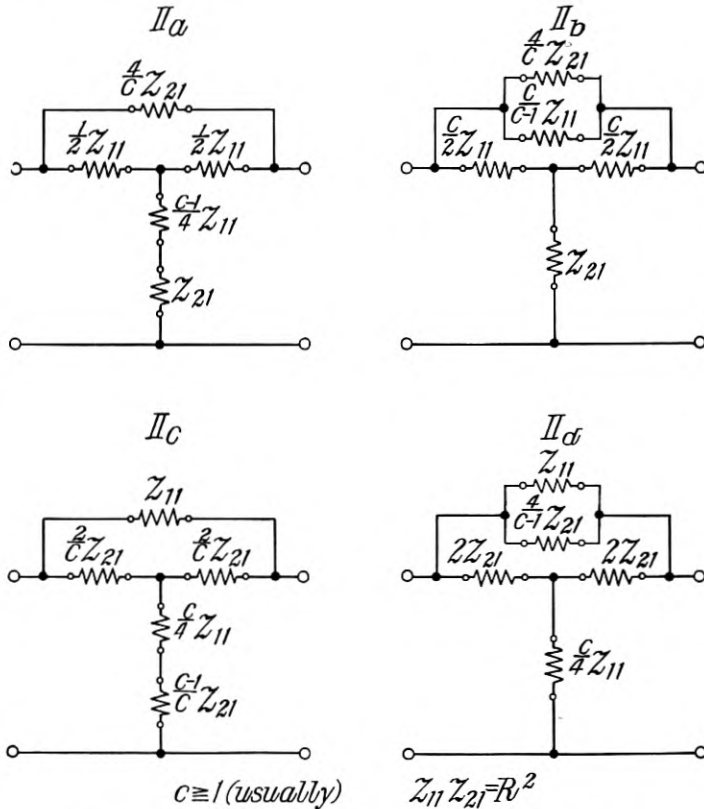

Fig. 6—Bridged-T(II) type constant resistance sections.

$$e^{\Gamma} = \frac{1 + z_{11}/2R + c(z_{11}/2R)^2}{1 - z_{11}/2R + c(z_{11}/2R)^2}, \tag{15}$$

where  $c \geq 1$ , usually. In the very special cases of networks  $\Pi_a$  and  $\Pi_b$ , wherein  $z_{11}$  is an inductance,  $c$  may be less than unity and approach zero as a limit. For the latter values the negative inductance may be obtained physically as a negative mutual between the series coils. When  $c = 1$ , networks  $\Pi_a$  and  $\Pi_b$  become physically identical, as do also networks  $\Pi_c$  and  $\Pi_d$ . If  $z_{11}$  is a reactance, there will be no attenuation. Again, we shall find by applying the proper rule directly that when the four general sections are closed by resistances  $R$  there will result two pairs of inverse networks of impedance product  $R^2$ , respectively  $\Pi_a, \Pi_d$  and  $\Pi_b, \Pi_c$ .

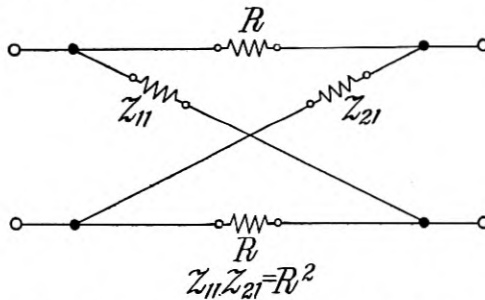

Fig. 7—Unbalanced lattice type constant resistance section.

A special network of the *unbalanced lattice type* may be mentioned briefly. This symmetrical structure as shown in Fig. 7 plays no direct part here as a distortion correcting network but is closely related to some of the other types and possesses interesting properties, among others that of conjugacy as in an ordinary balanced Wheatstone bridge. Its open-circuit impedance  $X$  and short-circuit impedance  $Y$  are both equal to  $R$ , hence its iterative impedance,  $\sqrt{XY}$ , is also  $R$ . Since  $\tanh \Gamma = \sqrt{Y/X} = 1$ ,  $\Gamma = \infty$ , which means that no current would flow in a terminating resistance  $R$  due to an e.m.f. applied through a sending resistance  $R$ , these two impedance branches being conjugate. The network containing four resistances  $R$ , which is obtained by terminating this section at each end by a resistance  $R$ , may likewise be derived directly from the limiting case ( $c = 1$ ) of the bridged-T (I) section which has similarly been terminated, merely by a rearrangement of form. It has these properties:

1. Opposite resistances are in conjugate branches.
2. Each of the four resistances is faced by a resistance  $R$ .

These properties can be seen as a result of the symmetry and also from a comparison with the full-series and full-shunt ladder type sections when terminated by resistances  $R$ . It is known that for one direction

of propagation these two ladder sections have the same iterative impedance and propagation constant. In the full-series section terminated by  $R$  the junction point between  $R$  of the section and  $z_{21}$  is short-circuited with the point at the receiving side of  $z_{11}$ , while in the corresponding full-shunt network the structure is the same except that these two points are open-circuited. Because of the identity of propagation constants this can be possible only if the two points are at the same potential whence they can be connected by any impedance without altering propagation in the one direction. This being the case, a branch of resistance  $R$ , conjugate with the sending branch, can be connected across these points, and this results in giving the symmetrical bridged-T (I) type (where  $c = 1$ ), or the equivalent network of Fig. 7 terminated by  $R$ . Thus the receiving-side series resistance  $R$  in the limiting case ( $c = 1$ ) of the bridged-T (I) section plays no rôle and is superfluous for this direction of transmission, but it makes the section symmetrical and ensures similar propagation and impedance characteristics when transmitting in the opposite direction.<sup>11</sup>

If, in the network of Fig. 7,  $z_{11}$  is made resonant and anti-resonant at different frequencies, selective *maximum* energy transmission can be obtained at these frequencies between pairs of the four different resistance branches which might also be considered as different lines. The propagation constant between any pair of resistances can be determined from the relationships established above.

As an aid in obtaining an approximate value of the propagation constant for any of these types when its impedance elements are known, a simple chart may be drawn up if desired. This could be obtained in the following manner. The formulæ (12) to (15) are all of the form

$$e^{\Gamma} = e^{A+iB} = m + in;$$

whence

$$e^A = \sqrt{m^2 + n^2}, \tag{16}$$

and

$$\tan B = n/m.$$

Thus, it is evident that any locus of uniform attenuation constant,  $A$ , is represented in the  $m, n$  plane by a circle of radius,  $e^A$ , with center at the origin. Also, any locus of uniform phase constant,  $B$ , is a straight line of slope,  $\tan B$ , starting from the origin.

<sup>11</sup> Another method of deriving the section having directly the form given by putting  $c = 1$  in the bridged-T (I) type was used by G. H. Stevenson, U. S. Patent No. 1,606,817, November 16, 1926.

## 2.5. Relations for Equivalence of Propagation Constants

All of the above networks have equivalent iterative impedances equal to  $R$ . It is sometimes useful to be able to transform readily from one type to another which has also an equivalent propagation constant, if that is physically possible. This may arise in an economic study of a final network design where account is taken of all practical factors, such as symmetry, line balance, number of the elements, their magnitudes, etc.

The structures which are important in this connection when dealing with both attenuation and phase characteristics comprise the ladder, lattice, and bridged-T (I) networks, whose propagation constant formulæ are given in (12), (13), and (14). For their propagation constants to be identical the impedance  $z_{11}$  in one type must bear a definite relation to that in another. In the following table, derived by equating these formulæ, a general impedance  $z$  is introduced. Each  $z_{11}$  may be expressed in terms of  $z$  and  $R$ . Here  $z$  is taken as the  $z_{11}$  for each type in succession. It then becomes a simple matter to transform from one type of structure to another having an equivalent propagation constant. The parameter  $c$  in a derived bridged-T (I) network would be taken such as to give the minimum number of elements.

TABLE II  
RELATIONS FOR EQUIVALENCE

Ladder $z_{11}$	Lattice $z_{11}$	Bridged-T (I) $z_{11}, c \geq 1$
$z$	$\frac{1}{\frac{1}{z} + \frac{1}{2R}}$	$\frac{1}{\frac{1}{z} + \frac{1}{-2R/(c-1)}}$
$\frac{1}{\frac{1}{z} + \frac{1}{-2R}}$	$z$	$\frac{1}{\frac{1}{z} + \frac{1}{-2R/c}}$
$\frac{1}{\frac{1}{z} + \frac{1}{2R/(c-1)}}$	$\frac{1}{\frac{1}{z} + \frac{1}{2R/c}}$	$z$

A transformation from the  $z_{11}$  of one type section to that of another equivalent one involves essentially only an alteration of the given impedance by a positive or negative resistance element in parallel with it. This will not always result in a physical network with



positive elements. The following statements can be made, however:

1. *The transformation of the ladder type to the equivalent bridged-T (I) type, and vice versa, is always possible.*

2. *The transformation of the ladder type, or the bridged-T (I) type, to the equivalent lattice type is always physically possible; the converse is not necessarily so.*

Those structures which are potentially phase networks, and thus useful when requiring a non-attenuating network with a phase characteristic only, are the lattice type again and the bridged-T (II) type. Such networks are used to introduce various characteristics for the time-of-phase-transmission. It will be sufficient to give the relations for equivalence between these two types, obtained from (13) and (15), as

$$(z_{11})_{\text{lattice}} = \left( \frac{1}{\frac{1}{z_{11}} + \frac{1}{4z_{21}/c}} \right)_{\text{bridged-T (II)}}, \quad (17)$$

which is always physically possible if the bridged-T (II) network exists. On the other hand

$$(z_{11})_{\text{bridged-T (II)}} = \frac{2}{c} (z_{21} \pm \sqrt{z_{21}^2 - cR^2})_{\text{lattice}}, \quad (18)$$

where the  $c$  which belongs to the bridged-T (II) type must necessarily be taken so as to make the radical a perfect square, if a physical equivalent is possible. It is to be pointed out that in the propagation constant formula (15), considered as a general form, the range of values for the parameter  $c$  which will give a physical bridged-T (II) network is  $c \geq 1$ , usually, while the range for a physical lattice network is  $c \geq 0$ , as seen from (17). Thus, the lattice type can give a greater variety of propagation constants.

From all the comparisons made above this conclusion may be drawn. *The lattice type has a greater range for its propagation constant characteristic than has either a ladder or a bridged-T type. Hence, the lattice type might well be considered as the fundamental one, when designing such networks, from which other equivalent types may be obtained by transformations, if such physical structures are possible.*

### 2.6. Propagation Constants Expressed as Frequency Functions

In Section 2.4 the propagation constant of any of these networks was given as varying with frequency only implicitly, according to some function of the impedance ratio,  $z_{11}/2R$ . To express it more explicitly as a frequency function, I shall sketch briefly a satisfactory general method to be followed.

For an impedance  $z_{11}$  which is made up of lumped elements of resistance, inductance, and capacity we may express the impedance ratio  $z_{11}/2R$  as the ratio of two frequency-polynomials in  $(if)$ , where  $i = \sqrt{-1}$  and  $f$  is frequency. Thus,

$$\frac{z_{11}}{2R} = \frac{a_0 + a_1(if) + a_2(if)^2 + \dots}{b_0 + b_1(if) + b_2(if)^2 + \dots} = s + iy. \quad (19)$$

The impedance coefficients  $a_0, b_0$ , etc., of which one is unity and some may be zero, are positive quantities and are algebraic combinations of the network elements. Their number is equal to, or greater than, the number of independent elements. For any given type of network the coefficients are fixed by the elements, and vice versa.

Putting this expression in any of the formulæ (12) to (15), there results for the propagation constant a form

$$e^{\Gamma} = \frac{g_0 + g_1(if) + g_2(if)^2 + \dots}{h_0 + h_1(if) + h_2(if)^2 + \dots}, \quad (20)$$

in which  $g_0, h_0$ , etc., are algebraic functions of  $a_0, b_0$ , etc., also of  $c$  if the network is a bridged-T type. From this the attenuation constant and phase constant can also be derived and expressed separately as functions of frequency.

For the attenuation constant, a form is obtained

$$F \equiv e^{2A} = 10^{\Gamma U/10} = \frac{P_0 + P_2 f^2 + \dots}{Q_0 + Q_2 f^2 + \dots}, \quad (21)$$

which is the ratio of two frequency-polynomials both in even powers of frequency. One of the attenuation coefficients is unity.

For the phase constant, a form

$$H \equiv \tan B = \frac{M_1 f + M_3 f^3 + \dots}{N_0 + N_2 f^2 + \dots}, \quad (22)$$

in which one of the phase coefficients is unity, is the ratio of two frequency-polynomials, odd powers of frequency in the numerator and even powers in the denominator. (It is sometimes convenient to use  $\tan (B/2)$ .) In (21) and (22) the attenuation coefficients  $P_0, Q_0$ , etc., and the phase coefficients  $M_1, N_0$ , etc., are expressible in terms of the impedance coefficients  $a_0, b_0$ , etc.

It should be mentioned here that in deriving the above expressions certain assumptions have been made; namely, invariable elements and non-dissipative inductances and capacities. These restrictions are well justified from the fact that such departures are usually small

and their effects in a network do not alter appreciably the general characteristics. However, to calculate accurate results for both the propagation constant and the iterative impedance of the final design of a physical network taking into account all factors, one should use the general formulæ given in Appendix III which have been simplified to give accurate results quite readily.

### 2.7. Network Solutions from Their Propagation Characteristics

It was assumed in the previous section that the recurrent network elements are invariable and that inductances and capacities are non-dissipative. On this basis general formulæ for the propagation characteristic were obtained in terms of these elements. The same assumptions are retained here but *reverse processes* will be carried through which derive the elements from the propagation characteristic of the recurrent network. Three methods will be outlined, necessarily in general terms.

#### Method 1. Solutions from the Attenuation Constant

Since attenuation is ordinarily of greatest importance, this method is the one most frequently used with networks having an attenuation characteristic and involves initially the determination of the attenuation coefficients  $P_0$ ,  $Q_0$ , etc., from this characteristic. Using these coefficients, one derives from algebraic relations, first, the impedance coefficients  $a_0$ ,  $b_0$ , etc., and finally the network elements in  $z_{11}$ . The elements of  $z_{21}$  follow from the inverse network relation (10).

The method is based upon the transformation of the attenuation formula (21) to a linear equation in  $P_0$ ,  $Q_0$ , etc., whose number is equal to or greater than the number of independent network parameters. If we multiply equation (21) by the  $Q$ -polynomial, we obtain formally the *attenuation linear equation* which holds at all frequencies,

$$P_0 + f^2 P_2 + \dots - F Q_0 - f^2 F Q_2 - \dots = 0. \quad (23)$$

Introducing in this the attenuation constant, and hence  $F$ , at a number of different frequencies equal to the number of independent network parameters, there results a system of independent simultaneous linear equations which can be solved for the coefficients. The simplest practical procedure is perhaps that of the *step-by-step elimination of the coefficients*.

When the number of coefficients and independent network parameters, hence equations, are the same, the solution of the latter offers no particular difficulty and results can readily be checked by substitution in the original equation (21).

When, as sometimes occurs, the number of coefficients is one greater than the number of independent network parameters, it means that one relation exists between the coefficients and hence any one of the latter may be assumed dependent. The dependent relation can be found from the formulæ for  $P_0$ ,  $Q_0$ , etc., in terms of  $a_0$ ,  $b_0$ , etc. However, in some such networks it is possible to use the attenuation constant at a particular frequency, say zero or infinite frequency, and thereby reduce the number of remaining coefficients and independent network parameters to equality, when the case is readily solvable. If this does not produce the desired reduction, it is usually best to first transfer the dependent coefficient to the right-hand member of (23) and after forming the set of linear equations solve them for the independent coefficients in terms of the dependent one. Substitution of these values in the dependent relation gives a polynomial in the dependent coefficient which can be solved by Horner's method. Its solution then determines the independent coefficients. This procedure might be extended similarly to cases where the number of coefficients is two or more greater than that of the linear equations, but obviously the process becomes quite involved.

The values of the attenuation coefficients  $P_0$ ,  $Q_0$ , etc., are unique when determined from linear equations. The impedance coefficients  $a_0$ ,  $b_0$ , etc., derived from them are also single-valued to give a physical solution in most types of networks, meaning that only one such physical network has the particular attenuation characteristic. However, in the *lattice type*, it has been found that there are usually possible *two or more physical solutions* for the impedance coefficients from the attenuation coefficients, which correspond to two or more similar appearing physical structures having identically the same attenuation characteristic but different phase constants.

#### *Method 2. Solutions from the Phase Constant*

This method is applicable particularly to phase networks which ideally have no attenuation and to other networks where the number of phase coefficients equals the number of independent network parameters. The procedure is the same as in the previous method where now we operate with the phase constant formula (22). Multiplying the latter by its  $N$ -polynomial, we obtain formally the *phase linear equation*, true at all frequencies,

$$fM_1 + f^3M_3 + \cdots - HN_0 - f^2HN_2 - \cdots = 0. \quad (24)$$

Fixing the phase constant, and hence  $H$ , in this equation at frequencies

equal in number to the phase coefficients gives us, if this number is equal to the number of independent network parameters, the desired set of linear equations to be solved by the usual methods. In a network where the number of phase coefficients is one less than the number of network parameters an additional relation will be needed to determine the network elements and this can be supplied from the attenuation characteristic. Here the attenuation characteristic can probably be lowered uniformly without altering the phase characteristic. (See Section 2.82.)

*Method 3. Solutions from the Propagation Constant*

Since it has been shown in Section 2.5 that any network of the type considered in this paper can always be represented physically by a lattice type having an equivalent propagation constant, we can simplify the discussion here by dealing entirely with the lattice network. From (13) the impedance ratio  $z_{11}/2R$  for this type is derived in terms of its propagation constant as

$$\frac{z_{11}}{2R} = \frac{e^{\Gamma} - 1}{e^{\Gamma} + 1} = \tanh(\Gamma/2), \quad (25)$$

which holds at all frequencies. Thus, a determination of the recurrent network from its propagation constant (attenuation and phase constants together) reduces to the solution of a two-terminal impedance network from its impedance characteristic. The impedance ratio components  $s$  and  $y$  in (19) will become definite known functions of frequency determined through (25) by the propagation constant of the given lattice network.

A method of solving for the impedance coefficients  $a_0, b_0$ , etc., and hence the network elements from the components  $s$  and  $y$ , follows. Instead of attempting to separate the impedance ratio expression into its real and imaginary parts which can then separately be equated to  $s$  and  $y$ , which is the usual method, let us multiply (19) by the  $b$ -polynomial. Now equating separately the real and imaginary parts we obtain a pair of equations which are linear in the coefficients and hold at all frequencies. This pair of *impedance linear equations* are formally

$$\begin{aligned} a_0 - f^2 a_2 + \cdots - s b_0 + f y b_1 + f^2 s b_2 + \cdots &= 0, \\ \text{and} \quad f a_1 - f^3 a_3 + \cdots - y b_0 - f s b_1 + f^2 y b_2 + \cdots &= 0. \end{aligned} \quad (26)$$

By this means the formulæ are put in a form such as to require in all cases the solution of a set of equations linear in the coefficients, obtained from (26) at different frequencies. A procedure for their solution

similar to that used in dealing with equation (23) can be applied and will not be repeated here. This process, apparently new, of obtaining linear equations for the impedance coefficients which contain powers of frequency and the impedance components, was applied by the writer to non-dissipative two-terminal networks in this *Journal*, January, 1923, p. 21, also in U. S. Patent No. 1,509,184, dated September 23, 1924; and to dissipative networks which simulate a smooth line impedance in U. S. Patent Application, Serial No. 134,515, filed September 9, 1926. It is merely outlined here.

### 2.8. Useful Properties and Relations

The following discussion covers a number of points concerning these networks which have been found quite useful. They can be verified readily from the fundamental formulæ and so need not be derived in detail.

#### 2.81. Analytical Simplifications

Let it be desired to design a given network from its attenuation characteristic in a frequency range when the number of attenuation coefficients is one greater than the number of independent network elements. As previously stated, it is usually possible in such cases to choose as part of the attenuation data the attenuation constant at a particular frequency, such as zero or infinite frequency, and make the resulting number of attenuation coefficients and independent elements equal in number, with consequent ease of solution. Another method of simplifying the analysis might be to slightly alter the form of the given  $z_{11}$  by adding to it, or subtracting from it, a resistance element in series or in parallel. This may have the effect of making the resulting attenuation coefficients and independent elements equal in number without appreciably altering the general attenuation characteristic in the desired frequency range.

#### 2.82. Uniform Attenuation Change

According to principles developed above, if the attenuation constant of a given network is changed uniformly over the entire frequency range without altering its phase constant, its distortion producing characteristics are not affected.

Let  $z_{11}$  correspond to a given *lattice type* network and  $z_{11}'$  to a derived one in which the attenuation only has been changed by a uniform amount  $A_0$  at all frequencies. Then one form of structure for  $z_{11}'$  is

$$z_{11}' = \frac{1}{\frac{1}{m_1 z_{11} + m_2 R} + \frac{1}{m_3 R}}, \quad (27)$$

where  $m_1 = \cosh^2 (A_0/2)$ ,

$$m_2 = \sinh A_0,$$

and  $m_3 = 2 \coth (A_0/2)$ ,

$m_1$  being greater than unity, while  $m_2$  and  $m_3$  have the sign of  $A_0$ . This relation for  $z_{11}'$  stated approximately in words is as follows: *To raise the attenuation, magnify the given  $z_{11}$  and add series resistance, then add parallel resistance to the whole; to lower the attenuation, magnify  $z_{11}$  and add such negative resistances.* An example is given by Networks 1a and 3a of Appendix IV.

An impedance equivalent form of structure for  $z_{11}'$  is

$$z_{11}' = \frac{1}{\frac{1}{m_1' z_{11}} + \frac{1}{m_2' R}} + m_3' R, \quad (28)$$

where  $m_1' = \operatorname{sech}^2 (A_0/2)$ ,

$$m_2' = 4 \operatorname{cosech} A_0,$$

and  $m_3' = 2 \tanh (A_0/2)$ ,

$m_1'$  being positive and less than unity, while  $m_2'$  and  $m_3'$  have the sign of  $A_0$ . Hence with this form, *to raise the attenuation, reduce the given  $z_{11}$  and add parallel resistance, then add series resistance to the whole; to lower the attenuation, reduce  $z_{11}$  and add such negative resistances.* An example is given by Networks 1b and 3b, Appendix IV.

It will be seen from these relations derived from a physical  $z_{11}$  that when  $A_0$  is positive a physical  $z_{11}'$  always results. When  $A_0$  is negative, however, physical impedances would be obtained only under certain conditions, depending upon the given  $z_{11}$  and upon  $A_0$ .

One practical utility of the relations would occur in the following situation. Suppose that a design was being attempted from assumed attenuation values with a network having such a general characteristic and that  $z_{11}$  consists of some structure in series or in parallel with a resistance element. The latter resistance as determined from the linear equations may come out to be negative and give  $z_{11}$  an unphysical structure. In such a case we could apply the above relations and raise all the attenuation values uniformly such an amount  $A_0$  that the resulting network  $z_{11}'$  would be physical.

Corresponding relations between two networks of the *ladder type* are

$$z_{11}' = e^{A_0} z_{11} + (e^{A_0} - 1)R; \quad (29)$$

and between two of the *bridged-T (I) type* are

$$z_{11}' = (c \sinh (A_0/2) + \cosh (A_0/2))^2 z_{11} + 2 \sinh (A_0/2) (c \sinh (A_0/2) + \cosh (A_0/2)) R, \quad (30)$$

and

$$c' = \frac{c + \tanh (A_0/2)}{c \tanh (A_0/2) + 1}.$$

In the above process we would generally be increasing the number of network parameters without changing the number or magnitude of the phase coefficients.

### 2.83. Phase Constant Comparisons of Certain Pairs of Lattice Type Networks

It has already been stated that there are usually two physical networks of the same structural lattice form which have identical attenuation constants but different phase constants. They are derivable as two physical solutions from the same attenuation coefficients. In the case of a limited class of these networks, an interesting relation exists between the phase constants of such a pair which may be stated as follows.

*Theorem.*—The two lattice type networks of every pair having the same attenuation characteristic in each of which the series impedance ( $z_{11}$ ) consists of a resistance in parallel with any pure reactance network, of different proportions in each, have phase constants such that their sum or difference is identical with that of a non-dissipative lattice phase network whose series impedance ( $z_{11}$ ) is a pure reactance network proportional to that in the series impedance of either of the pair.

A corollary results from this.

*One network of the pair is equivalent to the tandem combination of the other and the related phase network.*

It should be pointed out here that results for the case in which  $z_{11}$  is a resistance in series with a reactance network are similar, except for a phase change of  $\pi$ , since then the lattice impedance  $z_{21}$ , the inverse network of  $z_{11}$ , is a resistance in parallel with a reactance network.

A procedure for proving the theorem will be sketched briefly. Assume as given one network in which  $z_{11}$  is made up of a resistance in parallel with a pure reactance network whose impedance is  $imy$ , where  $m$  is a positive constant and  $y$  is a function of frequency. This gives a form

$$F = e^{2A} = \frac{1 + P_2 y^2}{1 + Q_2 y^2}. \quad (31)$$

Reversing the process, we obtain from the same coefficients  $P_2$  and  $Q_2$  a second similarly constructed network besides the original one. The



two physical networks differ in their phase constants but have the same attenuation constants. For one

$$\tan B' = \frac{(\sqrt{P_2} + \sqrt{Q_2})y}{-1 - \sqrt{P_2 Q_2} y^2}, \quad (32)$$

and for the other

$$\tan B'' = \frac{(\sqrt{P_2} - \sqrt{Q_2})y}{1 + \sqrt{P_2 Q_2} y^2}, \quad (33)$$

where  $B''$  has a maximum or minimum depending upon whether  $y$  is positive or negative. As a result for the *sum*

$$\tan \left( \frac{B' + B''}{2} \right) = \sqrt{P_2} y, \quad (34)$$

and for the *difference*

$$\tan \left( \frac{B' - B''}{2} \right) = \sqrt{Q_2} y. \quad (35)$$

Now a non-dissipative lattice type network in which  $z_{11}$  is a reactance proportional to  $y$  has a formula

$$\tan (B/2) = M_1 y, \quad (36)$$

where  $M_1$  is positive. Comparison of these latter formulæ indicates the proof of the theorem and its corollary.

A *simple and useful relation* exists between the maximum attenuation constant  $A_m$  occurring at  $y = \infty$  and the maximum or minimum phase constant  $B_m''$  of (33) occurring at  $y = \pm 1/(P_2 Q_2)^{1/4}$ . It is

$$\sinh (A_m/2) = \pm \tan B_m''. \quad (37)$$

An example is given by Networks 2a, Appendix IV, and a practical use of this relation will be made in Section 4.2.

#### 2.84. Composite Networks

The tandem combination of two or more different sections of constant resistance networks can generally give propagation characteristics which are unattainable in a single section. For this reason it is sometimes advantageous to treat such a composite network of two or three simple sections as a single unit. When this is done it will be found that the composite network has attenuation coefficients, if any, which in number may be equal to, greater than, or even less than the sum for the individual networks when considered separately.

An example of a case in which the number of attenuation coefficients

for the composite network equals the sum for the separate sections is furnished by two sections of Network 1a or of 2a, Appendix IV, both having four coefficients. On the other hand, a composite network of 1a and 2a, one of each, has five attenuation coefficients. Finally, a composite network of two sections of Network 3a has only five attenuation coefficients contrasted with a sum of six for the separate networks. In the latter case we can obtain only five linear equations from the attenuation characteristic which are not sufficient to determine the six series elements. This probably means that for the same attenuation characteristic the resistances in series with the two inductances can be given any ratio to each other from zero to infinity. A sixth relation can then be supplied by assuming the practical condition which makes the ratio of resistance to reactance the same in the inductance branches of both sections. This composite network can have an attenuation constant whose increase with frequency is approximately linear over a wide internal frequency range.

Composite phase networks of simple structure also lend themselves readily to such treatment as a single unit.

#### 2.85. Composite Lattice Networks Having Uniform Attenuation

To a lattice type network of a certain class having a finite non-uniform attenuation characteristic there corresponds a single infinity of complementary ones, such that when any one of the latter is combined with it, the composite network has a uniform total attenuation constant and a zero total phase constant over the entire frequency range. *The separate attenuation constants are complementary while the phase constants are equal, but opposite in sign.* Such a composite network we have seen would be *absolutely distortionless*. It is a relatively simple matter to obtain the necessary relations which such a complementary network must bear to the first if we impose these propagation conditions on the combination. Two sets of relations may be derived, each corresponding to a particular structure for the first network, with the following results.

If the given section ( $A, B$ ) has *series impedances*

$$z_{11} = R_s + z_s, \quad (38)$$

where  $R_s$  is a resistance and  $z_s$  is any impedance, any equivalent transformation of which does not contain series resistance, and if a complementary network ( $A', B'$ ) is added such as to give a composite network ( $A_c, B_c$ ) with the propagation constant

$$A_c = A + A' = \text{constant},$$

and

$$B_c = B + B' = 0, \tag{39}$$

then the complementary network is given by

$$z_{11}' = R_1 + \frac{1}{\frac{1}{z_2} + \frac{1}{R_3}}, \tag{40}$$

where  $R_1 = 2 \coth (A_c/2)R$ ,

$$z_2 = 4 \operatorname{cosech}^2 (A_c/2)R^2/z_s,$$

and  $R_3 = 4 \operatorname{cosech}^2 (A_c/2)R^2/(R_s - 2 \coth (A_c/2)R)$ .

Here  $z_2$  is the inverse network of  $z_s$  of impedance product  $4 \operatorname{cosech}^2 (A_c/2)R^2$ . The network in (40) is  $R_1$  in series with the parallel combination of  $z_2$  and  $R_3$ . An equivalent form for  $z_{11}'$  is

$$z_{11}' = \frac{1}{\frac{1}{R_1'} + \frac{1}{z_2'} + \frac{1}{R_3'}}, \tag{41}$$

where  $R_1' = \cosh^2 (A_c/2)(R_s - 2 \tanh (A_c/2)R)$ ,

$$z_2' = \cosh^2 (A_c/2)(R_s - 2 \tanh (A_c/2)R)^2/z_s,$$

and  $R_3' = \frac{2R(\coth (A_c/2)R_s - 2R)}{(R_s - 2 \coth (A_c/2)R)}$ .

It will be a *physical network* provided  $A_c$  satisfies the relation

$$1 < \coth (A_c/2) \leq R_s/2R. \tag{42}$$

At the *minimum*  $A_c$ ,  $R_1 = R_1'$ ,  $z_2 = z_2'$ , and  $R_3 = R_3' = \infty$ .

If, on the other hand, the given section has *parallel impedances* (similar to the preceding network of (38) whose output terminals are reversed),

$$z_{11} = \frac{1}{\frac{1}{R_p} + \frac{1}{z_p}}, \tag{43}$$

where  $R_p$  is a resistance and  $z_p$  is any impedance, any equivalent transformation of which does not contain parallel resistance, then a corresponding complementary network has one form given by

$$z_{11}' = \frac{1}{\frac{1}{R_1} + \frac{1}{z_2} + \frac{1}{R_3}}, \tag{44}$$

where  $R_1 = 2 \tanh (A_c/2)R$ ,

$$z_2 = 4 \sinh^2 (A_c/2)R^2/z_p,$$

and  $R_3 = 2 \sinh^2 (A_c/2)R(2R - \coth (A_c/2)R_p)/R_p$ .

An equivalent form is

$$z_{11}' = \frac{1}{\frac{1}{R_1'} + \frac{1}{z_2'}} + R_3', \quad (45)$$

where  $R_1' = 2 \operatorname{sech}^2 (A_c/2)RR_p/(2R - \tanh (A_c/2)R_p)$ ,

$$z_2' = 4 \operatorname{sech}^2 (A_c/2)R^2R_p^2/(2R - \tanh (A_c/2)R_p)^2z_p,$$

and  $R_3' = \frac{2R(2R - \coth (A_c/2)R_p)}{(2 \coth (A_c/2)R - R_p)}$ .

There will be a *physical network* provided

$$1 < \coth (A_c/2) \leq 2R/R_p. \quad (46)$$

At the *minimum*  $A_c$ ,  $R_1 = R_1'$ ,  $z_2 = z_2'$ , and  $R_3 = R_3' = 0$ .

It may be added that if (38) and (43) represent inverse networks of impedance product  $4R^2$ , then another such pair is given by (40) and (44), and still another by (41) and (45).

An extension of these results may now readily be made to give *two-section composite networks whose attenuation constants are uniform but whose phase constants are not zero*. It has been stated that to every lattice type network having finite attenuation there usually corresponds another one of the same structural form having the same attenuation but a different phase characteristic. Hence, in either case above where the two complementary sections giving a total uniform attenuation are known, we may derive by regular methods the alternative lattice sections, having, respectively, the same attenuation constants. Since we would then have two sections to give the one attenuation characteristic and two sections for the complementary characteristic, it would be possible to obtain *four composite networks* of similar structure, all of which give *the same uniform attenuation but four different phase characteristics*. One of these combinations would be the case in which the phase constant is zero. Four more phase characteristics, differing from the others by an amount  $\pi$ , can obviously be obtained by reversing the terminals of either section.

### 2.9. Procedure for the Design of Distortion Correcting Networks

It would be most gratifying to be able to obtain directly from a desired propagation characteristic the corresponding form of network.

This is generally a difficult problem and it becomes necessary to resort to simplifying methods somewhat similar to those employed in the design of electric wave-filters. One reason for this difficulty is that we are limited to physical resistance, inductance, and capacity elements, all of which must, in general, be positive. We would, therefore, begin with known forms of networks whose general propagation characteristics have been determined and choose from them one or more whose combination offers the possibility of giving a satisfactory desired result. A number of points which are applicable in the general case may be noted as follows:

1. First, determine the desired propagation characteristics of the distortion correcting network corresponding to formula (8).

2. If necessary, divide this propagation characteristic into several parts each of which has the approximate characteristic belonging to a known network structure.

3. Assume one of these networks physically capable of having such an allotted characteristic and attempt a design to approximately fit it according to one of the methods of Section 2.7. Where there is an attenuation characteristic, Method 1 is usually best, as attenuation is generally of more importance than phase and hence its simulation requires greater accuracy. The network will introduce a phase constant which will necessarily have to be taken into account. Of the two or more possible solutions for the lattice type network, the one with the most desirable phase constant would obviously be chosen and in some cases this may be close to requirements. Another reason for usually following this order of simulating the attenuation first and the resultant phase later is furnished as a consequence of Theorems I and II of Section 2.2. From them we see the physical possibility of introducing certain phase characteristics without attenuation (ideally), but not varying attenuation characteristics without phase. Method 3 imposes a rather severe requirement on a single network.

4. If the network design comes out to be unphysical with the particular characteristic values assumed, small variations from these values should be tried, since the natural varying curvatures in the propagation characteristic of the network must sometimes be allowed for. Otherwise, a different kind of network should be used, or a composite one, which has a similar characteristic.

5. In designing successive sections of the complete transducer, the effects of previous parts must be considered.

To facilitate the application of this method of distortion correction, general propagation characteristics together with formulæ have been derived for a representative number of lattice type structures. These

are given in Appendix IV. Any pair of the networks, such as 1a and 1b, differ only by an interchange of series and lattice elements with a corresponding difference in their phase constants of an amount  $\pi$ . In order to simplify computations for some networks the formulæ were derived so as to require attenuation data at a limiting frequency, but other formulæ may also be obtained. By means of the relations in Section 2.5, transformations can readily be made to any of the other general types, if they lead to physical structures.

The type of network which a final design is to assume will be suggested by economic and practical considerations. However, an approximate statement can be made in this connection. If the sections are to be dissymmetrical as regards the two pairs of terminals and unbalanced as regards the two sides of the line, use the full-series or full-shunt ladder types; if symmetrical and unbalanced, use the bridged-T types; if symmetrical and balanced, use the bridged-T or lattice types.

### PART 3. ARBITRARY IMPEDANCE RECURRENT NETWORKS

In Part 2 consideration was given entirely to recurrent networks whose iterative impedances are a constant resistance at all frequencies and which depend upon the use of inverse networks; that is,  $z_{11}z_{21} = R^2$ . It is intended here merely to point out briefly that all the types in Section 2.4 can be generalized to have iterative impedances of arbitrary value  $K$  provided in them

$R$  is generalized to  $K$ ,

and

$$z_{11}z_{21} = K^2; \quad (47)$$

that is,  $z_{11}$  and  $z_{21}$  are *inverse networks*<sup>12</sup> of impedance product  $K^2$ . The corresponding propagation constant formulæ hold also with these generalizations.

Where a recurrent network of arbitrary iterative impedance  $K$  is desirable, these structures would, theoretically at least, be applicable. Practically, however, considerable difficulties are usually encountered in physically realizing  $z_{11}$  and  $z_{21}$  to give a desired propagation constant, and perhaps even  $K$  when  $K$  is not a simple function of frequency. A few physical possibilities will be given here in which the structures for  $z_{11}$  and  $z_{21}$  are easily identified from the forms of the expressions. They may be used in the different types of networks, and, of course,  $z_{11}$  and  $z_{21}$  may be interchanged.

<sup>12</sup> The complete qualifying statement such as given is necessary here, not just simply "inverse networks."

1.

$$\begin{aligned} K &= R + iL\omega; \\ z_{11} &= iL_{11}\omega, \end{aligned} \tag{48}$$

and

$$z_{21} = (2RL/L_{11}) + i(L^2/L_{11})\omega + 1/i(L_{11}/R^2)\omega.$$

The impedance  $z_{21}$  is series resistance, inductance and capacity.

2.

$$\begin{aligned} K &= R + 1/iC\omega; \\ z_{11} &= 1/iC_{11}\omega, \end{aligned} \tag{49}$$

and

$$z_{21} = (2RC_{11}/C) + i(R^2C_{11})\omega + 1/i(C^2/C_{11})\omega.$$

Here  $z_{21}$  is the same type of structure as in (48).

3.

$$\begin{aligned} K &= R + 1/iC\omega; \\ z_{11} &= \frac{1}{\frac{R}{m_1} + \frac{1}{im_1C\omega}} + \frac{1}{\frac{R}{m_2} + \frac{1}{im_2C_{11}\omega}}, \end{aligned} \tag{50}$$

and

$$z_{21} = \frac{1}{\frac{1}{R_{21}} + \frac{1}{iL_{22}\omega}} + R_{23} + \frac{1}{iC_{24}\omega},$$

where  $R_{21} = m_2R(C - C_{11})^2/C^2$ ,

$$L_{22} = m_2R^2C_{11}(C - C_{11})^2/C^2,$$

$$R_{23} = R(m_1C^2 + m_2C_{11}(2C - C_{11}))/C^2,$$

and

$$C_{24} = C^2/(m_1C + m_2C_{11}).$$

The impedance  $z_{11}$  consists of two parallel branches each containing series resistance and capacity;  $z_{21}$  is made up of parallel resistance and inductance in series with both resistance and capacity. For certain values of the parameters  $m_1$ ,  $m_2$ , and  $C_{11}$ , even though positive, the resistance  $R_{23}$  can become negative and hence unphysical as a passive element.

A lattice or equivalent network made up of such impedances, in addition to having the assumed iterative impedance which approximates that of an open-wire line at the upper frequencies, can have an attenuation constant decreasing with frequency which tends to equalize that of a length of such line; the attenuation formula has the form

$$F = e^{2A} = \frac{P_0 + P_2f^2}{Q_0 + f^2}. \tag{51}$$

4.

$$K = \sqrt{\frac{R' + iL'\omega}{G' + iC'\omega}}, \quad (\text{smooth line});$$

$$z_{11} = mR' + imL'\omega, \tag{52}$$

and

$$z_{21} = \frac{1}{(mG' + imC'\omega)}.$$

Another possible simple pair is that in which  $z_{11}$  is a resistance and  $z_{21}$  is either series resistance and inductance in parallel with series resistance and capacity or parallel resistance and inductance in series with parallel resistance and capacity. These impedance elements may be used in the lattice or bridged-T (II) type structures where the impedance element  $K$  is not explicitly required. Extension to more complex structures can be made by the methods of Section 2.3. An application will be given in Section 4.7 which considers the simulation of a smooth line.

Owing to the much greater inherent difficulty of physically realizing inverse networks of impedance product  $K^2$  when  $K$  is not  $R$ , the generalization does not add much practically for our purpose, but some structures in which  $K$  is not  $R$  may be of utility under particular conditions.

PART 4. APPLICATIONS

4.1. Complementary Distortion Correcting Networks

The pair of networks in Fig. 8 illustrates in a very simple manner the general relations given in Section 2.85, as well as ideal distortion

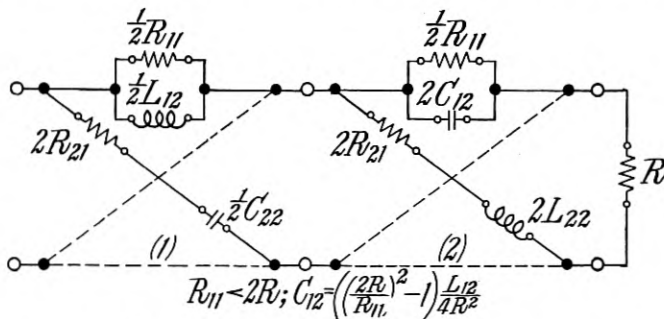

Fig. 8—Distortionless composite network. (Broken lines indicate the other series and lattice branches, respectively identical).

correction over the entire frequency range. When placed in tandem they represent a composite network whose attenuation constant is uniform at all frequencies and whose phase constant is zero, which are



characteristics for no distortion. Let us obtain the steady-state characteristics of each network and of the composite one; then consider transient conditions and obtain the indicial voltages of the corresponding networks to verify again by this illuminating example that the steady-state characteristics laid down for no distortion are quite sufficient when transient conditions exist.

The first section is Network *2a*, Appendix IV, wherein  $z_{11}$  is parallel resistance  $R_{11}$  and inductance  $L_{12}$ , with  $R_{11}$  less than  $2R$  and the characteristic 1. Let us put  $m = R_{11}/2R$ , and  $n = L_{12}/2R$ .

Then

$$\frac{z_{11}}{2R} = \frac{imn\omega}{m + in\omega}, \quad (53)$$

and the propagation constant formula becomes from (13)

$$e^{\Gamma_1} = \frac{m + i(1 + m)n\omega}{m + i(1 - m)n\omega}. \quad (54)$$

To obtain a complementary second section let us assume that the total attenuation constant,  $A_c$  nepiers, of the composite structure is to equal the maximum of the first section which occurs at infinite frequency. Then from the above

$$e^{A_c} = \frac{1 + m}{1 - m}$$

and  $\tanh(A_c/2) = m$ , giving as the correcting section by (44) one of Network *1b*, Appendix IV, with characteristic 1 in which

$$R_{11} = 2mR, \text{ as in (53),}$$

and

$$C_{12} = \frac{(1 - m^2)n}{2m^2R} = \left[ \left( \frac{2R}{R_{11}} \right)^2 - 1 \right] \frac{L_{12}}{4R^2}. \quad (55)$$

For this second section then

$$\frac{z_{11}}{2R} = \frac{m^2}{m + i(1 - m^2)n\omega},$$

and

$$e^{\Gamma_2} = \left( \frac{1 + m}{1 - m} \right) \left( \frac{m + i(1 - m)n\omega}{m + i(1 + m)n\omega} \right). \quad (56)$$

Obviously, from (54) and (56),

$$e^{\Gamma_1 + \Gamma_2} = \frac{1 + m}{1 - m} = e^{A_c},$$

as was assumed.

The attenuation and phase constants of each of these two sections and the combined structure are shown in Fig. 9, as a function of  $L_{12}\omega/2R$ , where  $R_{11} = R$ . It will be seen that  $A_1$  and  $A_2$  are complementary while  $B_1$  and  $B_2$  are equal but opposite. For the composite network  $A_c = \text{constant}$  and  $B_c = 0$ ; thus the latter phase constant

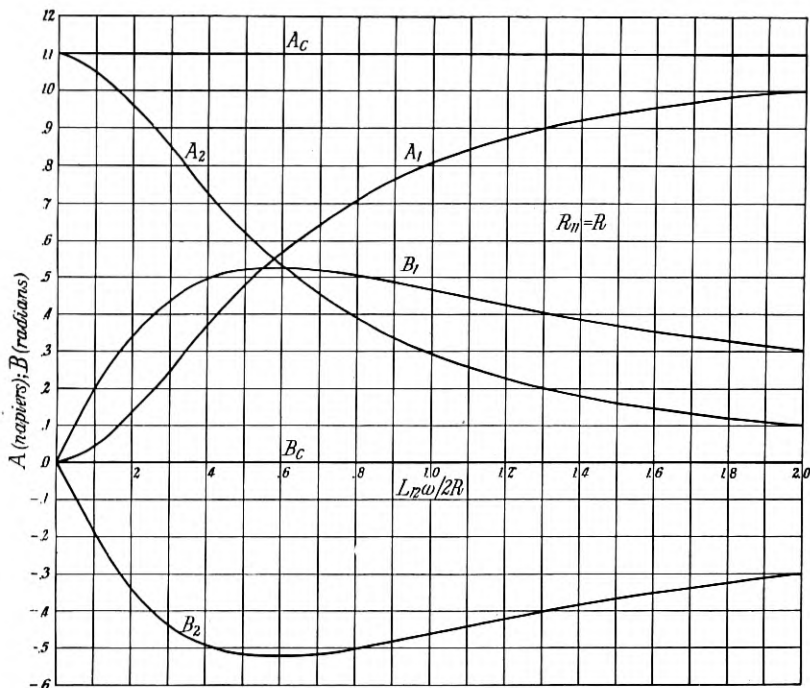

Fig. 9—Propagation constants in distortionless network.

has a zero slope with frequency. Whatever steady periodic voltage exists at one end would appear across the terminating resistance  $R$  in the same phase but attenuated by an amount  $A_c$  nepers. Since these conditions hold for the composite network at all frequencies, we should expect to obtain for it an indicial voltage and time-of-transmission, respectively,

$$g_c(t) = e^{-A_c}, \quad (57)$$

and

$$\tau = \frac{B_c}{\omega} = \frac{dB_c}{d\omega} = 0.$$

Let us next determine the indicial voltages of the individual sections when each is closed by a resistance  $R$ . Substitute the operator  $p$  for  $i\omega$  and obtain symbolically from (54) and (56)

$$e^{-\Gamma_1} = 1 - 2mn \left( \frac{p}{m + (1+m)n\dot{p}} \right), \quad (58)$$

and

$$e^{-\Gamma_2} = \frac{1-m}{1+m} + \frac{2mn(1-m)}{1+m} \left( \frac{p}{m + (1-m)n\dot{p}} \right). \quad (59)$$

Introducing these expressions in the general relation, where the network is terminated by  $R$ ,

$$\frac{e^{-\Gamma}}{p} = \int_0^{\infty} e^{-pt} g(t) dt, \quad (60)$$

there results for the indicial voltage of the first section, since

$$\frac{1}{u + v\dot{p}} = \int_0^{\infty} e^{-pt} \left( \frac{e^{-(ut/v)}}{v} \right) dt, \quad (61)$$

$$g_1(t) = 1 - \frac{2m}{1+m} e^{-[mt/(1+m)n]}; \quad (62)$$

and for the second section

$$g_2(t) = \frac{1-m}{1+m} + \frac{2m}{1+m} e^{-[mt/(1-m)n]}. \quad (63)$$

These functions are given in Fig. 10.

It will now be shown that, whereas the indicial voltage of each section alone is a varying function of time, that of the composite network is a constant, which represents the transient condition for no distortion with zero time-of-transmission.

For the composite network terminated by  $R$  the indicial voltage  $g_c(t)$  may be derived from the usual formula for such a combination, equivalent to (5),

$$g_c(t) = g_2(0)g_1(t) + \int_0^t g_1(t-y)g_2'(y)dy. \quad (64)$$

Upon carrying through the integration we get

$$g_c(t) = \frac{1-m}{1+m} = e^{-A_c} = \text{constant}, \quad (65)$$

which agrees with the prediction from the steady state and is so shown in Fig. 10.

Obviously the two sections can be interchanged.

The composite network appears at first hand to behave in a rather remarkable manner. For if a periodic voltage is suddenly impressed

at one end, the steady state will not be established within the network until after some lapse of time, whereas it occurs at the terminating resistance instantaneously. This property is, of course, to be expected from its steady-state characteristics.

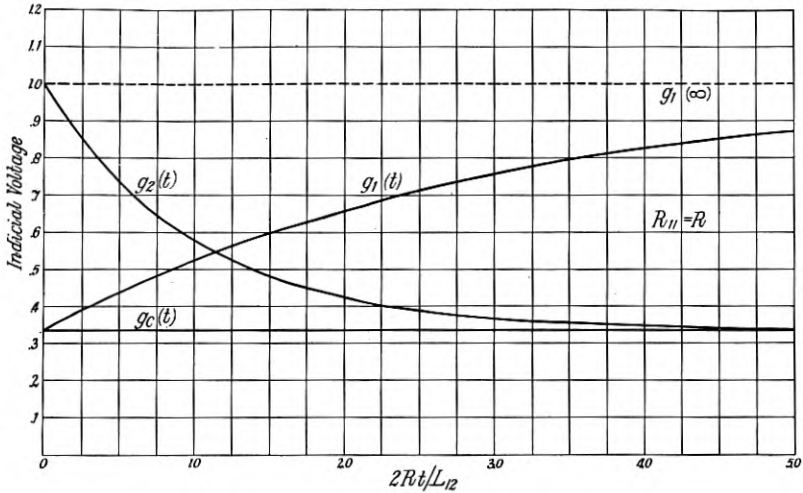

Fig. 10—Indicial voltages in distortionless network.

It may be added that such networks would still give complementary results if separated for any purpose by a symmetrical line in a circuit which is terminated at each end by a resistance  $R$  and which has an e.m.f. applied through one of the resistances. The separation of the two complementary networks under these conditions would result in the same current being received by the terminating resistance as when both networks are together at one end, where it is known the networks would produce no distortion. This follows immediately from the reciprocal theorem. For by it we readily see that the same current would be transmitted to the input terminals of the complementary receiving network whether the first network was at one end or the other. (These two cases are equivalent from the standpoint of received current to turning the combined transmission line and first network end for end.)

#### 4.2. Distortion Correction in Submarine Cable Circuit

The following illustration shows the improvement which can be made in the shape of the arrival voltage at the end of a long submarine cable circuit by distortion correction at the very low frequencies only. Such an improvement would increase the speed of building up of d-c. telegraph signals and hence allow a greater speed of signaling.

The circuit assumed is a submarine cable whose length,  $l$ , is 1700 miles and whose parameters are to have the constant values per mile

$$\begin{aligned} R' &= 2.74 \text{ ohms}; & L' &= .001 \text{ h.}; \\ G' &= 0 & ; & C' = .296 \text{ mf.} \end{aligned}$$

It is terminated at the receiving end only by a resistance  $R = \sqrt{L'/C'}$  = 58.12 ohms. The transfer exponent,  $a + ib$ , of this circuit at the terminal resistance is computed from the formula, easily derived,

$$e^{a+ib} = (k/R) \sinh \gamma l + \cosh \gamma l, \quad (66)$$

where

$$\gamma = \sqrt{(R' + iL'\omega)iC'\omega},$$

and

$$k = \sqrt{(R' + iL'\omega)/iC'\omega}.$$

These results are shown in Fig. 12.

It is desired to obtain distortion correction in this circuit from 0 to 25 cycles per second by introducing a terminal constant resistance transducer which will approximately equalize the attenuation over this range and make the resultant phase linear with frequency. Since in practice there is interference between different cables at higher frequencies, the correcting network should introduce increased attenuation above this range. Calculations gave

$$\text{at } f = 0, a = 4.40 \text{ napiers};$$

and

$$\text{at } f = 25\sim, a = 14.10 \text{ napiers.}$$

Assuming arbitrarily that the network will have at  $f = 25\sim$  an attenuation of only .30 napier, the ideal total attenuation for the frequency range is

$$a' = 14.10 + .30 = 14.40 \text{ napiers.} \quad (67)$$

The attenuation of the network should decrease from a maximum value of  $(14.40 - 4.40) = 10.00$  napiers at  $f = 0$  to a value of .30 napier at  $f = 25\sim$  and then increase with frequency. If a linear relation for the resultant phase is assumed so as to cross the  $b$  curve at about  $f = 25\sim$ , the phase which the network should give is negative in the range with a minimum of about  $-2.75$  radians, and is zero at  $f = 0$  and  $f = 25\sim$ .

A network having this desired general type of propagation constant is Network 8, Appendix IV, with the characteristic 1, but a single section will not be sufficient since its minimum phase is between 0

and  $-\pi/2$  radians. The best number of sections to use is determined by the total minimum phase required and can be found here quite readily, as follows. Because of the comparatively small amount of attenuation assumed for the total correcting network at  $f = 25\sim$ , this type of network is one in which  $z_{11}$  consists of a resistance in parallel with an approximate reactance so that we may apply for the present purpose the relation (37) between maximum attenuation and minimum phase of such a section. For a total maximum attenuation of 10.00 napiers this relation gives for two sections a total minimum phase of  $-2.81$  radians, which is close to the required value  $-2.75$  radians. Three sections give  $-3.59$  radians, showing the best number to be two. (If the result with two identical sections had been a negative phase considerably greater than the required value, it would have been possible to proportion the total maximum attenuation at zero frequency between two such different sections so as to give approximately the desired total minimum phase. In such a case each section could be designed from its corresponding proportion of the total attenuations at the other frequencies.)

Each of two such identical sections was designed by the formulæ given in Appendix IV, using attenuation data fixed by the values of  $(a' - a)/2$ . Allowances had to be made at  $f_1 = 5\sim$  and  $f_2 = 15\sim$  for necessary curvature in the attenuation characteristic so as to obtain a physical result. It was assumed that the phase constant would turn out to be satisfactory since it had already been given some consideration when determining the number of sections. The frequencies and corresponding attenuations used were

$$\begin{aligned} f_0 &= 0, & A_0 &= 5.00 \text{ napiers;} \\ f_1 &= 5\sim, & A_1 &= 3.25 \text{ napiers;} \\ f_2 &= 15\sim, & A_2 &= 1.78 \text{ napiers;} \\ f_3 &= 25\sim, & A_3 &= .15 \text{ napier.} \end{aligned}$$

The solution of the attenuation linear equations gave

$$P_2 = -68.737; \quad Q_2 = 1.1929; \quad Q_4 = 2.5537 \cdot 10^{-6}.$$

Whence

$$\begin{aligned} a_0 &= .98661 & ; & & a_1 &= 1.1854 \cdot 10^{-3}; \\ b_1 &= 15.829 \cdot 10^{-3}; & & & b_2 &= 1.5980 \cdot 10^{-3}. \end{aligned}$$

Also,

$$\begin{aligned} R_{11} &= 9.42 \text{ ohms;} & L_{12} &= 1.994 \text{ h.;} \\ C_{13} &= 20.30 \text{ mf.;} & R_{14} &= 114.68 \text{ ohms;} \end{aligned}$$

where  $R = 58.12$  ohms.

These results were transformed to give a ladder type network according to Section 2.5 and then incorporated in two of the dissymmetrical unbalanced full-shunt sections, as shown in Fig. 11.

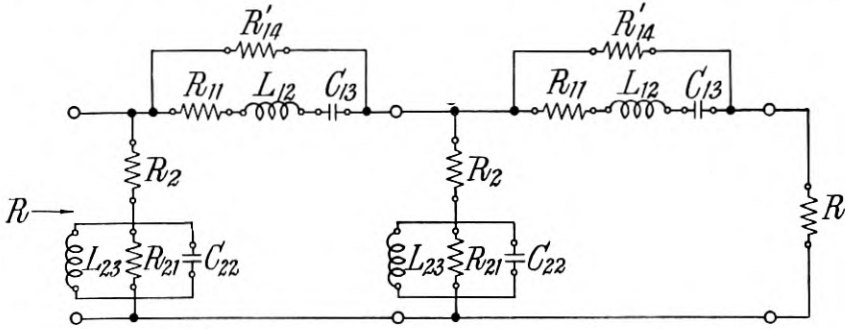

Fig. 11—Distortion correcting network for submarine cable circuit.

This transformation gives a different parallel resistance in the series branch, namely,

$$R_{14}' = 2a_0R/(1 - a_0). \tag{68}$$

Here  $R_{14}' = 8565$  ohms. The elements of  $z_{21}$  in the shunt branch of the ladder type were determined from the inverse network relations

$$R_{11}R_{21} = L_{12}/C_{22} = L_{23}/C_{13} = R_{14}'R_{24}' = R^2.$$

Finally combining two resistances which are in series,  $R_2 = R + R_{24}'$ , we have

$$\begin{aligned} R_{21} &= 359 \text{ ohms}; & C_{22} &= 590.3 \text{ mf.}; \\ L_{23} &= .0686 \text{ h.}; & R_{24}' &= .39 \text{ ohm}; \end{aligned}$$

and  $R_2 = 58.51$  ohms.

In Fig. 12 are shown the steady-state propagation characteristics of the uncorrected circuit, the correcting network, and the corrected circuit; the latter indicates approximately ideal conditions up to 25 cycles per second.

The improvement in shape of the arrival voltage due to this distortion correction can be seen from Fig. 13 which gives the ratio of initial to final voltage for both the uncorrected and corrected circuit, a constant e.m.f. being impressed at the sending end at time  $t = 0$ . (These were computed from the steady-state characteristics of the respective circuits, using formulæ based upon those given by J. R. Carson in *B. S. T. J.*, 1924, p. 563.) The building-up speed has been increased, perhaps fourfold. The arrival voltage for the corrected circuit is

within 3 per cent of its final value when that for the uncorrected circuit has reached but half value. The initial maximum in the former is similar to that in the case of a low-pass wave-filter<sup>13</sup> and may be

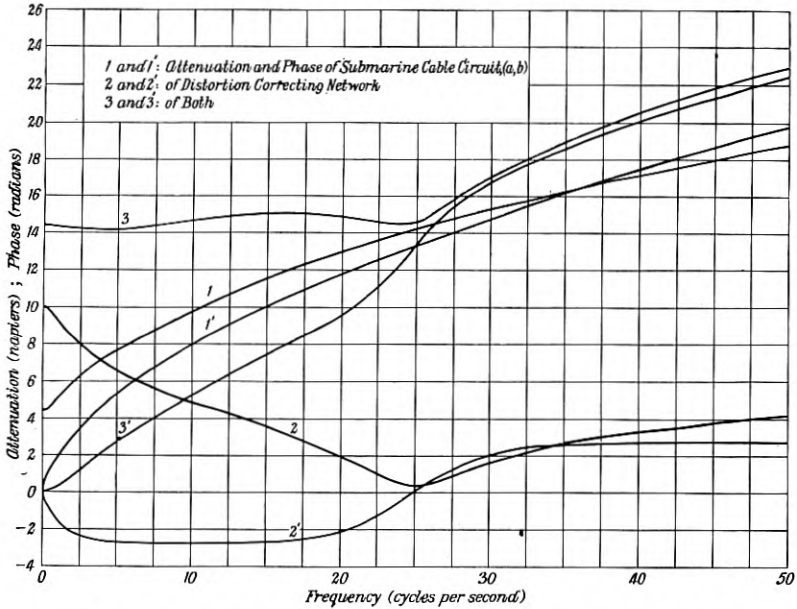

Fig. 12—Transmission characteristics of submarine cable circuit and distortion correcting network.

due to the increasing attenuation beyond the equalized range. It is probable that had but partial equalization been obtained without a

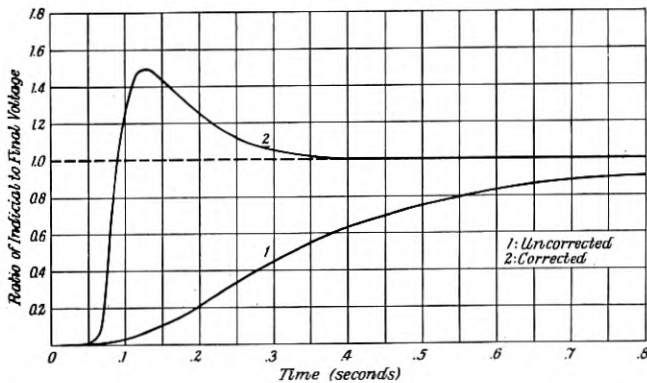

Fig. 13—Ratio of indicial to final voltage for (1) uncorrected and (2) corrected submarine cable circuit.

<sup>13</sup> "Transient Oscillations in Electric Wave-Filters," J. R. Carson and O. J. Zobel, *B. S. T. J.*, July, 1923.



sharp change in the attenuation, such a maximum would not have been produced. However, it is desirable to sharply attenuate the higher frequencies as has been done here, for the reason stated above. It is of interest to point out that the time-of-transmission which might be expected for the corrected circuit from the low-frequency slope with angular frequency of the steady-state phase, approximately  $\tau = .076$  second, is actually the time at which the indicial voltage increases most rapidly and has reached about .4 its final value, a quite satisfactory agreement.

#### 4.3. Distortion Correction in Loaded-Cable Program Transmission Circuits

Circuits which transmit programs originating at distant points to a radio broadcasting station need to be of considerably better quality over a wider frequency range than those used for ordinary telephone transmission and must be reliable under various weather conditions. Such circuits can be obtained economically with lightly loaded cable pairs which have been corrected by terminal networks for each repeater section.

The design of distortion correcting networks applicable to a 50-mile repeater section of 16-gauge H-44 cable follows. The section is terminated at *each end* by a resistance  $R = 600$  ohms, the generator which impresses the voltage  $E$  having an internal impedance  $R$ . Since the received voltage would be only  $.5E$  with the cable removed, in this case we are interested in the ratio

$$\frac{v}{.5E} = e^{-a-ib},$$

where  $a$  then represents the *insertion loss* in nepiers.

If  $\Gamma$  and  $K$  are the propagation constant and iterative impedance (here used at mid-section) of the loaded cable<sup>14</sup> of length,  $l$ , it can be shown that the transfer exponent is

$$a + ib = \Gamma l + M_1 + M_2, \quad (69)$$

where  $\Gamma l$  = propagation length,

$$e^{M_1} = \frac{1}{2} \left[ 1 + \frac{1}{2} \left( \frac{K}{R} + \frac{R}{K} \right) \right],$$

and

$$e^{M_2} = 1 - \left( \frac{K - R}{K + R} e^{-\Gamma l} \right)^2.$$

The above, of course, includes the effects of circuit terminations.

<sup>14</sup> Accurate computations for the propagation constant of the loaded cable were made readily by means of an improved formula for  $\cosh^{-1}(x + iy)$ , given in Appendix III.

It was desired to equalize the attenuation over a frequency range from zero to 4500 cycles per second and improve the time-of-phase-transmission at the lower frequencies. Computations for this 50-mile cable circuit gave values of attenuation ( $a$  in T.U.) and time-of-phase-transmission ( $b/2\pi f$ ) as shown in Fig. 15. These circuit characteristics suggested the use of two different networks in tandem shown separately in Fig. 14, one equalizing principally at the lower frequencies, the other at the higher frequencies of the required range.

*Low-Frequency Distortion Correcting Network*

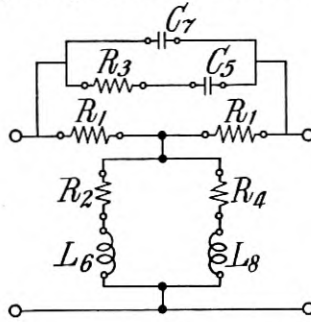

*High-Frequency Attenuation Equalizer*

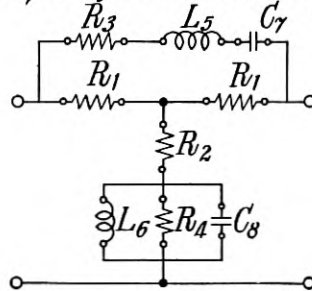

Fig. 14—Distortion correcting networks for program transmission circuit.

The low-frequency correcting network, shown as the upper section in Fig. 14, is of the symmetrical unbalanced bridged-T ( $Ia$ ) type and was transformed from Network 7, Appendix IV. In the design of the latter the attenuation data corresponding to (8) were

$$\begin{aligned}
 f_1 &= 40 \sim, & A_1 &= .536 \text{ napier;} \\
 f_2 &= 200 \sim, & A_2 &= .291 \text{ napier;} \\
 f_3 &= 800 \sim, & A_3 &= .176 \text{ napier;} \\
 f_4 &= 2000 \sim, & A_4 &= .100 \text{ napier.}
 \end{aligned}$$

Solution of the resulting four attenuation linear equations gave

$$P_0 = 102.007 \cdot 10^9; \quad P_2 = 5.06037 \cdot 10^6;$$

$$Q_0 = 32.200 \cdot 10^9; \quad Q_2 = 3.43087 \cdot 10^6;$$

from which

$$a_0 = .28054; \quad a_1 = .88319 \cdot 10^{-3};$$

$$b_1 = 8.6884 \cdot 10^{-3}; \quad b_2 = 4.0094 \cdot 10^{-6}.$$

Then, where  $R = 600$  ohms, the series elements in the lattice structures are

$$R_{11} = 248.40 \text{ ohms}; \quad C_{12} = 2.0171 \text{ mf.};$$

$$C_{13} = .6021 \text{ mf.}; \quad R_{14} = 336.65 \text{ ohms}.$$

Transforming from this lattice type to the equivalent bridged-T (Ia) type, we eliminate a parallel resistance in the bridged series branch (corresponding to  $R_{14}$ ) by letting

$$c = 1/a_0. \quad (70)$$

Then in Fig. 14, where  $c = 3.5645$ ,

$$R_1 = 168.3 \text{ ohms}; \quad R_3 = 248.4 \text{ ohms};$$

$$C_5 = 2.0171 \text{ mf.}; \quad C_7 = .6021 \text{ mf.};$$

and in the shunt branch

$$R_2 = 3037.4 \text{ ohms}; \quad R_4 = 1458.1 \text{ ohms};$$

$$L_6 = .243 \text{ h.}; \quad L_8 = 2.010 \text{ h.}$$

This latter useful form in which resistances are in series with inductances was obtained from the regular bridged-T (Ia) shunt elements by means of Transformation *C, B. S. T. J.*, January, 1923, p. 45.

The high-frequency network, shown as the lower section in Fig. 14, is well suited to extend the range of attenuation equalization above that so far considered and was derived from Network 8, Appendix IV. Allowing for both cable and low-frequency network attenuations, and arbitrarily assuming this network to have an attenuation of .300 napier at 4500 cycles per second, the data became (as from (8))

$$f_0 = 0, \quad A_0 = .796 \text{ napier};$$

$$f_1 = 3000 \sim, \quad A_1 = .747 \text{ napier};$$

$$f_2 = 4000 \sim, \quad A_2 = .530 \text{ napier};$$

$$f_3 = 4500 \sim, \quad A_3 = .300 \text{ napier}.$$

The solution is

$$P_2 = -46.207 \cdot 10^{-8}; \quad Q_2 = -9.0092 \cdot 10^{-8}; \quad Q_4 = 23.198 \cdot 10^{-16}.$$

Whence

$$\begin{aligned} a_0 &= .37824; & a_1 &= 8.4245 \cdot 10^{-6}; \\ b_1 &= 57.522 \cdot 10^{-6}; & b_2 &= 4.8164 \cdot 10^{-8}. \end{aligned}$$

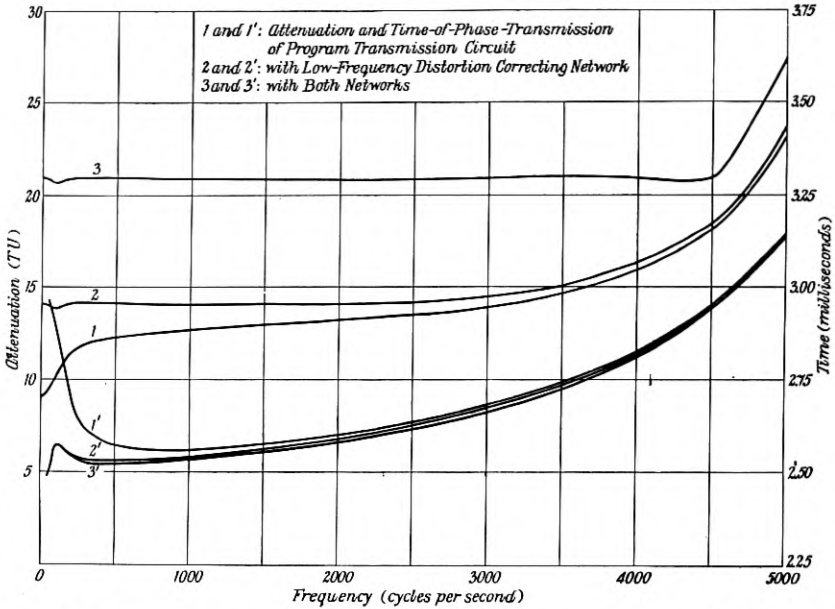

Fig. 15—Transmission characteristics of program transmission circuit with and without distortion correcting networks.

The series elements of the lattice structure are

$$\begin{aligned} R_{11} &= 286.8 \text{ ohms}; & L_{12} &= .0987 \text{ h.}; \\ C_{13} &= .01236 \text{ mf.}; & R_{14} &= 453.9 \text{ ohms.} \end{aligned}$$

Transforming to the equivalent bridged-T (Ia) type, we take  $c$  similarly as in (70); thus  $c = 2.6438$ . The series elements in Fig. 14 then become

$$\begin{aligned} R_1 &= 226.9 \text{ ohms}; & R_3 &= 286.8 \text{ ohms}; \\ L_5 &= .0987 \text{ h.}; & C_7 &= .01236 \text{ mf.}; \end{aligned}$$

and the shunt elements

$$\begin{aligned} R_2 &= 679.7 \text{ ohms}; & R_4 &= 1255.0 \text{ ohms}; \\ L_6 &= .00445 \text{ h.}; & C_8 &= .2741 \text{ mf.} \end{aligned}$$

The effect of adding these two sections successively to the cable circuit is shown in Fig. 15. It will be seen that the first section, besides equalizing the attenuation up to about 2000 cycles per second, produces as well approximately ideal results on the time-of-phase-transmission at the lower frequencies. The complete circuit attenuation departs less than .2 T.U. from a constant value everywhere over the assumed frequency range. If desired, the time-of-phase-transmission could be improved also at the upper frequencies by the addition of proper phase networks. Such a type of correction will be made in the following application.

#### 4.4. *Distortion Correction in Open-Wire Television Circuit*

The networks to be described here were designed by the writer especially for the particular open-wire circuit which was used for the television demonstrations from Washington, D. C., to New York City on April 7, 1927. They were designed entirely from calculated data, some of which had previously been derived from measurements on other similar lines, as the complete circuit was not available for measurements until later.

The circuit had a total length of about 285 miles, being made up principally of 276.4 miles of 165-mil open-wire pair together with 8.43 miles of necessary entrance, submarine and underground 13-gauge carrier-loaded cable (C-4.1). The iterative impedances of these two types of lines are very nearly the same in the frequency range considered and were so assumed in what follows. Hence, the propagation length of the circuit was taken as the sum of the propagation lengths of the parts. In order that such a circuit be suitable for television transmission it must be made to have extremely high quality over a very wide frequency range by means of distortion correcting networks. The requirements which the design of the present networks aimed to meet follow.

#### *Design Requirements*

1. An impedance of 600 ohms is to terminate the line at each end.
2. The attenuation, or insertion loss, of the corrected circuit is to be constant within  $\pm 1$  T.U. over the entire frequency range from 10 to 20,000 cycles per second.
3. The time-of-phase-transmission of the corrected circuit is to be constant within  $\pm 500$  microseconds ( $10^{-6}$ ) from 10 to 400 cycles per second, and to be the same constant within  $\pm 10$  microseconds from 400 to 20,000 cycles per second.
4. Provision is to be made for distortion correction under various

weather conditions of the open-wire line. Details of the process of arriving at some of these requirements, also measurements and performance of the complete television circuit, have been given in a previous number of this *Journal*.<sup>15</sup>

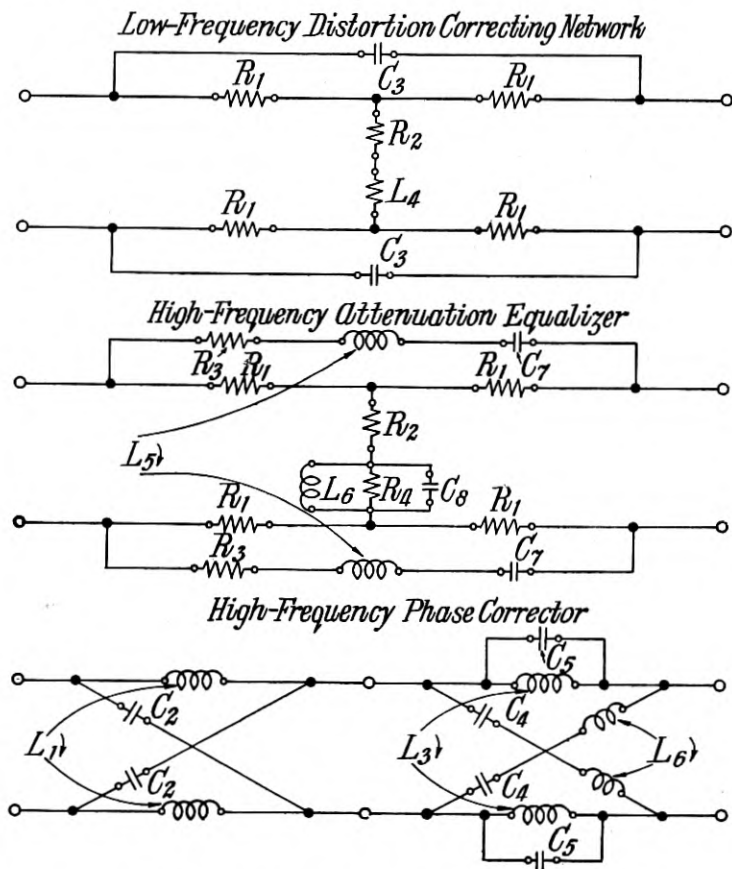

Fig. 16—Distortion correcting networks for television circuit. (Dry weather.)

Since the general circuit arrangement is here the same as in the previous problem, formula (69) is directly applicable. The transfer exponents,  $a + ib$ , were calculated from it for two weather conditions of the open-wire line, called dry weather and average-wet weather.

<sup>15</sup> "Wire Transmission System for Television," D. K. Gannett and E. I. Green, *B. S. T. J.*, October, 1927, pp. 616-632. See also "The Production and Utilization of Television Signals," Frank Gray, J. W. Horton, and R. C. Mathes, pp. 560-603. Three other papers on Television by H. E. Ives, by H. M. Stoller and E. R. Morton, and by E. L. Nelson are given in the same number of the *Journal*.

From a study of these characteristics and those of certain distortion correcting networks it appeared possible to obtain a base network design for the dry weather condition and supplementary networks for various degrees of wet weather.

The dry weather network consists of three parts in tandem, a low-frequency distortion correcting network, a high-frequency attenuation equalizer, and a high-frequency phase corrector, which were designed in the order given. The final structures are shown in Fig. 16, the first two being put in the form of balanced bridged-T (*Ia*) types. The low-frequency distortion correcting section corresponds to Network 1*b*, Appendix IV, and, while designed to approximately equalize the attenuation at low frequencies, it gave at the same time sufficient phase correction in that frequency range. The attenuation data used were

$$\begin{aligned} f_1 &= 50\sim, & A_1 &= .409 \text{ napier}; \\ f_2 &= 500\sim, & A_2 &= .060 \text{ napier}; \end{aligned}$$

from which, where  $R = 600$  ohms,

$$\begin{aligned} P_0 &= 60,307; & Q_0 &= 25,217; \\ a_0 &= .2145; & b_1 &= 4.945 \cdot 10^{-3}; \\ R_{11} &= 257.4 \text{ ohms}; & C_{12} &= 3.056 \text{ mf.} \end{aligned}$$

Transformation in the usual manner to the bridged-T (*Ia*) type, letting  $c = 1/a_0 = 4.662$ , gave the balanced structure of Fig. 16 in which

$$\begin{aligned} R_1 &= 64.35 \text{ ohms}; & R_2 &= 1334 \text{ ohms}; \\ C_3 &= 6.112 \text{ mf.}; & L_4 &= 1.100 \text{ h.} \end{aligned}$$

The high-frequency attenuation equalizer was derived from Network 8, Appendix IV, with this data, which followed formula (8) and allowed for the attenuation of the preceding network. The amount of attenuation at the highest frequency was arbitrarily assumed to be .400 napier.

$$\begin{aligned} f_0 &= 0, & A_0 &= 2.551 \text{ napiers}; \\ f_1 &= 5,000\sim, & A_1 &= 2.100 \text{ napiers}; \\ f_2 &= 10,000\sim, & A_2 &= 1.476 \text{ napiers}; \\ f_3 &= 20,000\sim, & A_3 &= .400 \text{ napier.} \end{aligned}$$

Solution of the linear equations gave

$$P_2 = -53.683 \cdot 10^{-8}; \quad Q_2 = 5.0669 \cdot 10^{-8}; \quad Q_4 = 3.7662 \cdot 10^{-18};$$

whence

$$\begin{aligned} a_0 &= .85529; & a_1 &= 6.1045 \cdot 10^{-6}; \\ b_1 &= 39.906 \cdot 10^{-6}; & b_2 &= 1.9407 \cdot 10^{-9}. \end{aligned}$$

Then in the lattice structure

$$\begin{aligned} R_{11} &= 223.8 \text{ ohms}; & L_{12} &= 9.668 \text{ mh.}; \\ C_{13} &= .005081 \text{ mf.}; & R_{14} &= 1026.3 \text{ ohms}. \end{aligned}$$

Transformation to the bridged-T (Ia) type, using as in (70)  $c = 1/a_0 = 1.1692$ , gave as the elements of the balanced structure of Fig. 16

$$\begin{aligned} R_1 &= 256.6 \text{ ohms}; & R_2 &= 94.20 \text{ ohms}; \\ R_3 &= 111.9 \text{ ohms}; & R_4 &= 1609 \text{ ohms}; \\ L_5 &= 9.668 \text{ mh.}; & L_6 &= 1.829 \text{ mh.}; \\ C_7 &= .010162 \text{ mf.}; & C_8 &= .02686 \text{ mf.} \end{aligned}$$

Having equalized the dry weather attenuation over the desired frequency range from 10 to 20,000 cycles per second and improved phase conditions at low frequencies, there remained the problem of total phase correction at the higher frequencies. It was found that the high-frequency attenuation equalizer introduced phase distortion at the higher frequencies which was of the same nature but more than twice as great as that due to the original circuit itself. Letting  $D$  be the departure from linearity to the value at 20,000 cycles per second of the total phase due to the circuit and the two networks above, the departures at three important frequencies were

$$\begin{aligned} f_1 &= 5,000\sim, & D_1 &= - .686 \text{ radian}; \\ f_2 &= 10,000\sim, & D_2 &= - 1.053 \text{ radians}; \\ f_3 &= 20,000\sim, & D_3 &= 0. \end{aligned}$$

A phase characteristic which when combined with these departures can give an approximate linear resultant phase in that frequency range is that of the composite phase Network 16, Appendix IV, containing three parameters. Its phase constant  $B$  was therefore taken to satisfy at these three frequencies the relation  $B + D = Cf$ , or explicitly

$$B = Cf - D. \quad (71)$$

The constant  $C$  was arbitrarily chosen so that the network became physical and satisfactory results were given at intermediate frequencies also. After a number of trials the final value taken was  $C = .370 \cdot 10^{-3}$ .



This then gave

$$M_1 = 2.8015 \cdot 10^{-4}; \quad M_3 = -1.3929 \cdot 10^{-12}; \quad N_2 = -2.4671 \cdot 10^{-8}.$$

Whence

$$a_1 = 1.8846 \cdot 10^{-4}; \quad a_1' = .9169 \cdot 10^{-4}; \quad b_2' = .7391 \cdot 10^{-8}.$$

These gave as the elements of the high-frequency phase corrector of Fig. 16

$$\begin{aligned} L_1 &= 35.99 \text{ mh.}; & C_2 &= .04999 \text{ mf.}; \\ L_3 &= 17.51 \text{ mh.}; & C_4 &= .02432 \text{ mf.}; \\ C_5 &= .02138 \text{ mf.}; & L_6 &= 15.40 \text{ mh.} \end{aligned}$$

The small attenuation effects of coil dissipation were not included in this design and they were later found to be negligible. An equivalent network, namely, Network 15, Appendix IV, might have been used instead of Network 16 for this phase corrector. But since it gives less uniform or practical magnitudes for the inductances and capacities, it would not be the simplest network to construct.

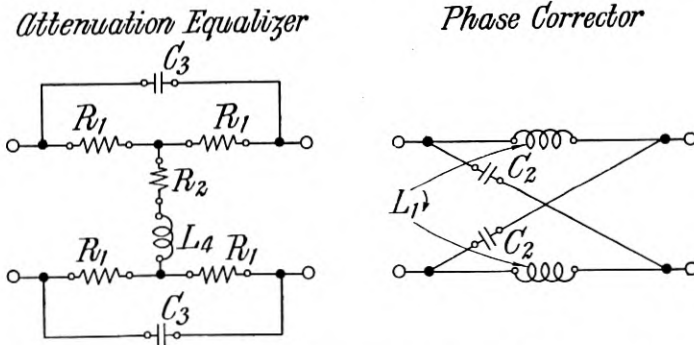

Fig. 17—Weather change distortion correcting networks for television circuit. (One step.)

To provide for wet weather effects on the open-wire part of the circuit, three identical weather change networks were designed each of which was capable of correcting one half the increase in circuit distortion caused by a change from dry weather to average-wet weather. With 0, 1, 2, or 3 of these supplementary networks added in tandem to the dry weather network, provision was thus made for a total of four assumed weather conditions which for convenience I have designated dry, semi-wet, wet, and extra-wet weather. These conditions differed by small equal steps and their number was later found to be

sufficient to cover the weather range ordinarily experienced. The increase,  $u + iv$ , in the transfer exponent due to a change of one step, such as from dry to semi-wet, was taken as one half the difference of these exponents computed for dry and average-wet weather conditions under which the circuit constants were known. Thus

$$u + iv = \frac{1}{2}[(a + ib)_{\text{av.-wet}} - (a + ib)_{\text{dry}}]. \quad (72)$$

The weather change network which corrected this consists of two parts shown in Fig. 17, an attenuation equalizer and a phase corrector, the latter being required primarily because of the phase constant necessarily introduced by the former.

This attenuation equalizer has the same form as the low-frequency network for dry weather and was designed similarly from the data (according to (8))

$$\begin{aligned} f_1 &= 0, & A_1 &= .466 \text{ napier}; \\ f_2 &= 20,000\sim, & A_2 &= .150 \text{ napier}. \end{aligned}$$

The assumption for the network of .150 napier at 20,000 cycles per second was found to result in a satisfactory attenuation characteristic over the entire frequency range. Then

$$\begin{aligned} P_0 &= 29,872 \cdot 10^4; & Q_0 &= 11,763 \cdot 10^4; \\ a_0 &= .22887; & b_1 &= .71099 \cdot 10^{-4}; \\ R_{11} &= 274.62 \text{ ohms}; & C_{12} &= .04120 \text{ mf.} \end{aligned}$$

Transforming to the bridged-T (Ia) structure,  $c = 1/a_0 = 4.369$  and the elements of Fig. 17 become

$$\begin{aligned} R_1 &= 68.65 \text{ ohms}; & R_2 &= 1242 \text{ ohms}; \\ C_3 &= .08240 \text{ mf.}; & L_4 &= 14.83 \text{ mh.} \end{aligned}$$

The phase corrector was Network 13, Appendix IV, designed in a manner somewhat different from that usually employed. If  $D$  again represents the phase departure of the uncorrected phase from linearity to the value at 20,000 cycles per second, it was found that

$$\begin{aligned} \text{at } f_1 &= 10,000\sim, & D_1 &= - .111 \text{ radian}; \\ \text{at } f_2 &= 20,000\sim, & D_2 &= 0. \end{aligned}$$

To give a satisfactory resultant phase which is linear through  $f_1$  and  $f_2$  irrespective of its slope, the phase corrector only needed to have a phase constant,  $B_1$  at  $f_1$  and  $B_2$  at  $f_2$ , such that

$$D_1 + B_1 = \frac{1}{2}B_2, \quad (73)$$

since  $f_1 = \frac{1}{2}f_2$ . Imposing this condition on the phase relation

$$H = \tan (B/2) = a_1 f, \tag{74}$$

there resulted

$$2 \tan^{-1} (H_2/2) - \tan^{-1} H_2 = - D_1,$$

which can be reduced to

$$\frac{H_2^3}{4 + 3H_2^2} = - \tan D_1,$$

and the cubic in  $H_2$ ,

$$H_2^3 + 3 \tan D_1 H_2^2 + 4 \tan D_1 = 0. \tag{75}$$

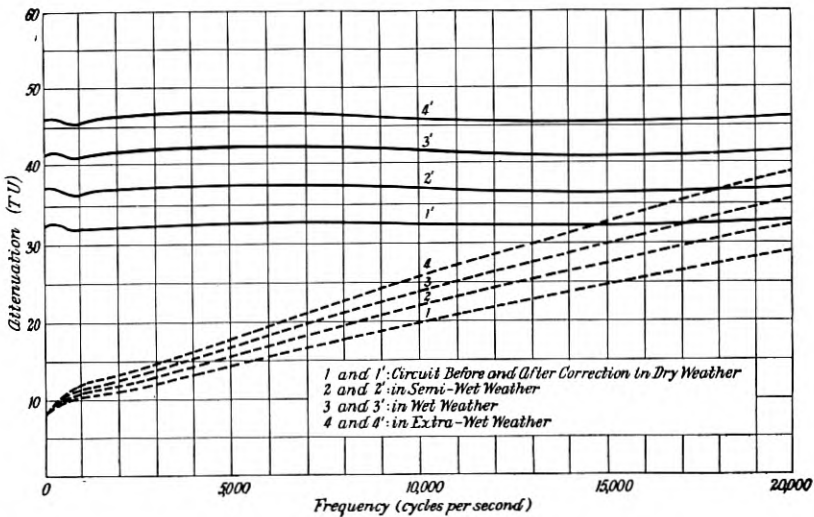

Fig. 18—Attenuation characteristics of television circuit before and after distortion correction.

The solution of the latter with  $D_1 = - .111$  radian gave here

$$H_2 = .89363, \quad \text{whence} \quad a_1 = H_2/f_2 = .44681 \cdot 10^{-4},$$

and in Fig. 17

$$L_1 = 8.533 \text{ mh.}; \quad C_2 = .01185 \text{ mf.}$$

For the purpose of showing the amount and precision of distortion correction produced by the addition of these various networks to the open-wire circuit under different weather conditions, attenuation and time-of-phase-transmission characteristics are given in Figs. 18 and 19, respectively. The final results indicate that the design require-

ments were fulfilled. (For measurements and performance of the complete line circuit see footnote 15.)

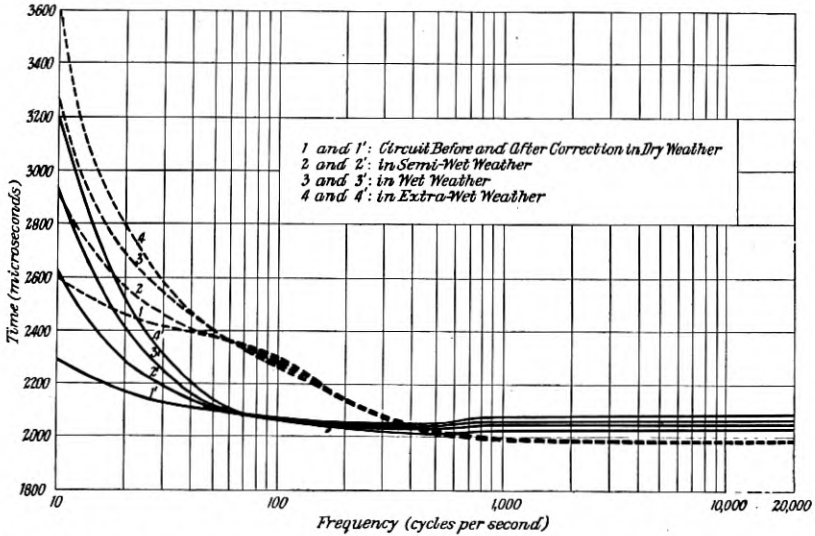

Fig. 19—Time-of-phase-transmission characteristics of television circuit before and after distortion correction.

#### 4.5. Equalization of Variable Attenuation in Carrier Telephone Circuits

An open-wire circuit, such as used in a carrier system, is exposed to various weather conditions along the line and consequently experiences considerable changes in its transmission characteristics, primarily its attenuation. For satisfactory operation of carrier circuits the total circuit attenuation must ordinarily be kept reasonably constant.

One practical and advantageous method of maintaining a constant circuit attenuation which takes into account weather changes as well as length differences in the successive repeater sections is the following. Each repeater section is built out and equalized with terminal networks such that at all times the total attenuation has the same uniform value in the desired frequency range. This is done by means of two kinds of networks, a *variable artificial line* and a *base attenuation equalizer*. The variable artificial line builds out any given section to correspond to what is effectively under wet weather conditions the maximum line section used, and the base attenuation equalizer makes this total attenuation of the section uniform in the frequency range under consideration. Then the total attenuation of any line section, artificial line, and attenuation equalizer has the same constant value over the frequency range and will thus be in proper adjustment with a repeater having a fixed gain.

Such an artificial line is made up of a number of different sections whose various tandem combinations can build up by small steps a considerable length of repeater section. A mechanism for switching the various sections of artificial line in and out of a repeater section might be operated by means of regulating apparatus which is automatically controlled from circuit conditions existing on a single-frequency pilot channel or channels. In Fig. 20 is shown a type of network suitable for a section of such artificial line. It is equivalent to Network 3a, Appendix IV, from which it can be transformed. The

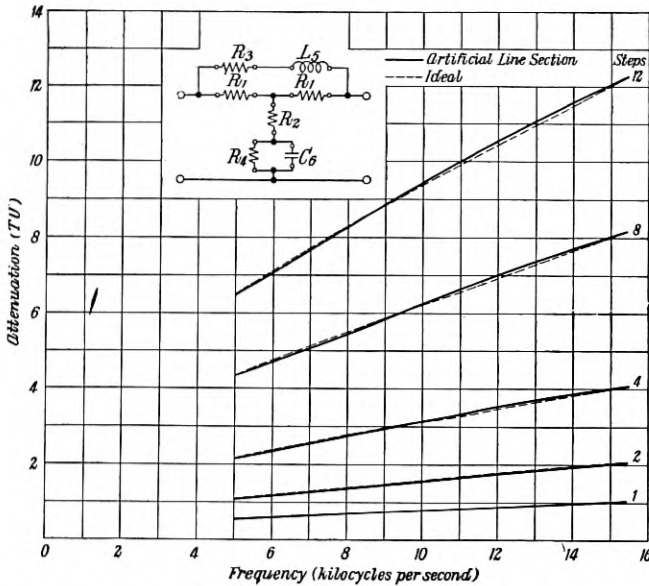

Fig. 20—Sections of variable artificial line and their attenuation characteristics for carrier telephone circuits.

following table gives the network elements for a group of such sections. I need not discuss any of the design details here but shall merely state that these sections were designed according to formulæ in Appendix IV from attenuation data which represent average requirements on the open-wire pairs used for carrier systems. The frequency range for these networks, 5.0–15.4 kilocycles per second, includes a lower group of adjacent carrier channels each having a band width of about 2500 cycles per second.

The attenuation characteristics of these individual sections are also given in Fig. 20. By properly combining them the desired maximum amount of artificial line can be obtained in equal steps, each step corresponding to approximately 1 T.U. at the highest frequency of the range.

TABLE III  
ARTIFICIAL LINE CONSTANTS (Fig. 20)  
(5.0–15.4 kilocycles per second)

	Steps				
	1	2	4	8	12
$R_1$ (ohms).....	54.2	108.2	212.9	401.4	605.0
$R_2$ .....	3348.	1637.	753.2	255.3	0
$R_3$ .....	40.2	80.5	160.9	318.4	445.3
$R_4$ .....	9108.	4544.	2275.	1150.	822.1
$L_5$ (mh.).....	1.62	3.24	6.57	13.83	23.13
$C_6$ (mf.).....	.004426	.008863	.01794	.03779	.06318

Iterative Impedance  $R = 605$  ohms.

A structure suitable for a base attenuation equalizer is that of Fig. 21, transformed from Network 11, Appendix IV. In designing it to simulate the required attenuation characteristic shown, the procedure

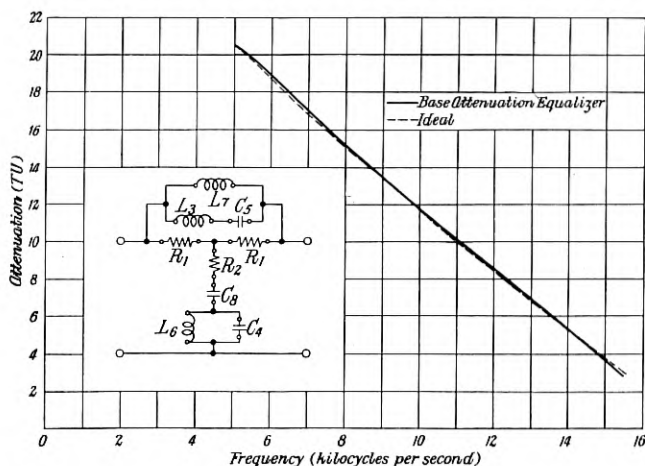

Fig. 21—Base attenuation equalizer and its attenuation characteristic for carrier telephone circuits.

was first to choose arbitrarily a plausible maximum attenuation for the network and then to use in the attenuation linear equations the three desired attenuation values at the mean and the extreme frequencies of the frequency range. At the highest frequency the attenuation was lowered slightly to allow for coil dissipation. Several such computations were made with different values of this maximum until a network was derived which gave a satisfactory result at all frequencies

within the range. The magnitudes of the elements corresponding to the partial attenuation characteristic shown in Fig. 21, where  $R = 605$  ohms, are

$$\begin{aligned} R_1 &= 508.4 \text{ ohms}; & R_2 &= 105.8 \text{ ohms}; \\ L_3 &= 12.69 \text{ mh.}; & C_4 &= .03469 \text{ mf.}; \\ C_5 &= .005852 \text{ mf.}; & L_6 &= 2.14 \text{ mh.}; \\ L_7 &= 238.8 \text{ mh.}; & C_8 &= .6525 \text{ mf.} \end{aligned}$$

The departures of the attenuation from the desired values are less than .2 T.U. At the highest frequencies small coil dissipation tends to improve this result.

#### 4.6. Phase Correction in Transatlantic Telephone System

At the receiving stations of the transatlantic telephone system it is necessary to use phase correctors in connection with the antenna arrays. These networks serve in two capacities, either (a) as artificial lines or delay networks which build out the phase characteristics of short transmission lines until they are equivalent to certain longer lines used elsewhere in the system, or (b) as phase correctors which secure adjustable and arbitrary phase characteristics when combining the outputs of the antennæ which form the array. For satisfactory operation the phase correctors had to meet these design requirements.

1. A constant iterative impedance of  $R = 600$  ohms.
2. A continuously variable phase change which is proportional to frequency over the frequency range from 50 to 65 kilocycles per second, the total phase change being from 0 to 250 degrees at 50 kilocycles per second.
3. Over any frequency band of 5 kilocycles per second in the range the variations should be less than .100 degree for the phase and less than .025 T.U. for the attenuation.
4. A balanced structure.

In making the design it was found that the continuously variable phase change to the desired maximum could be provided by means of one variable section having a small phase constant and five fixed sections of Networks 13, 14, and 16, Appendix IV. Designated in terms of their phase constants at 50 kilocycles per second as in Fig. 22, the variable section has a range of 0–15 degrees, while the fixed sections have phase constants of 10, 20, 40, 80, and 160 degrees, respectively. The variable section is normally required to give a maximum of only 10 degrees but an extension of its range to 15 degrees is provided so as to ensure phase overlapping at any transition point where a

section is put in or taken out of the circuit. By properly combining these sections it is seen that a continuous range from 0 to 325 degrees is obtainable.

The sections were designed from the formulæ of Appendix IV so as to give the desired individual linear phase characteristics shown in Fig. 22. It need only be stated that the data taken from the phase

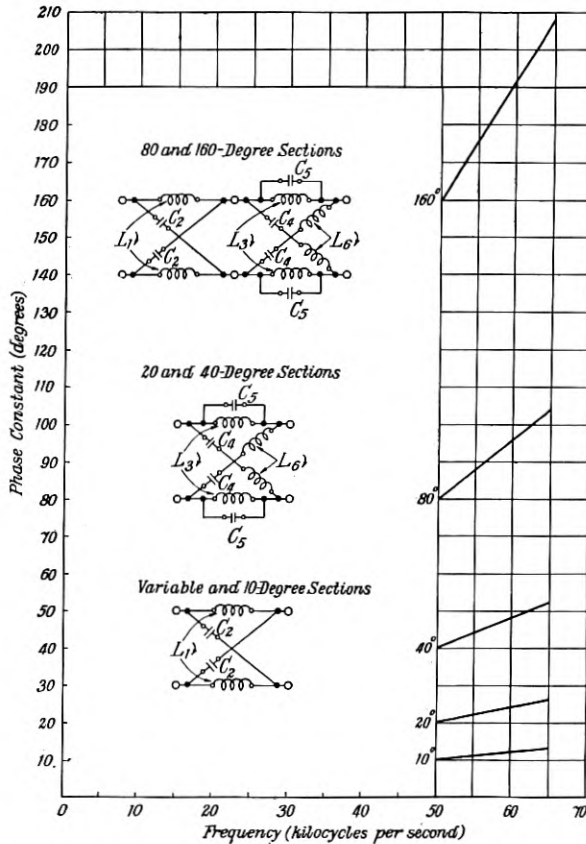

Fig. 22—Sections of variable phase corrector and their phase characteristics used in the transatlantic telephone system.

characteristics in the one-parameter sections were those at 50, in the two-parameter sections those at 50 and 65, and in the three-parameter composite sections those at 50, 57.5, and 65 kilocycles per second. The elements for the *variable section* in Fig. 22 are continuously variable and have their magnitudes given in terms of the variable phase constant  $B$  at 50 kilocycles per second as



$$L_1 = \frac{\tan (B/2)R}{50\pi} \text{ mh.}; \quad C_2 = \frac{10 \tan (B/2)}{\pi R} \text{ mf.}$$

The results for the fixed sections follow in Table IV.

TABLE IV  
PHASE CORRECTOR CONSTANTS  
(Fig. 22)

	Fixed Sections (Degrees at 50 kilocycles per second)				
	10	20	40	80	160
$L_1$ (mh.).....	.334			1.211	2.941
$C_2$ ( $10^{-3}$ mf.).....	.464			1.682	4.084
$L_3$ (mh.).....		.667	1.333	1.456	2.466
$C_4$ ( $10^{-3}$ mf.).....		.926	1.851	2.023	3.425
$C_5$ ( $10^{-3}$ mf.).....		.309	.631	1.051	2.408
$L_6$ (mh.).....		.223	.454	.756	1.734

In any one of these sections the computed departures of the phase constant from ideal proportionality to frequency in the frequency range 50 to 65 kilocycles per second was usually much less than .02 degree. The practical construction of the networks gave similar high precision, and by using coils of small dissipation constant,  $d =$  (resistance/reactance), the attenuation requirements were likewise satisfied. The frequency band now in use is from 58.5 to 61.5 kilocycles per second.

It may be added that these designs can readily be altered so as to apply to other frequency ranges. In order to translate the phase constants from the 50-kilocycle designation to any other frequency range with a minimum frequency,  $f_0$ , designation, multiply all inductances and capacities by the translation factor  $(50,000/f_0)$ .<sup>16</sup>

#### 4.7. Simulation of Smooth Line

This application is based upon and illustrates the general results of Part 3 which discusses recurrent networks having arbitrary iterative impedances. A network design will be given which has the following characteristics.

1. A propagation constant which simulates a moderate propagation length of any smooth line, or its equivalent.

<sup>16</sup> For a discussion of other applications of constant resistance networks see footnote 10; also "Transmission Circuits for Telephonic Communication," K. S. Johnson.

2. An iterative impedance which equals that of the smooth line at all frequencies.

Such a network could have a number of uses. For example, it could serve as a substitute for a small length of smooth line where approximately exact simulation is required as in certain laboratory tests, or as part of an artificial line in a balancing network. Leakage changes can be provided for by means of particular adjustable resistances. The design can represent the special case of a distortionless line at the lower frequencies and, if non-dissipative, give a phase network having a constant time-of-phase-transmission in this frequency range.

The method of solution differs considerably from those previously used for the other networks and so will be given here. To begin with let

$$\left. \begin{array}{l} z_a = \text{series} \\ z_b = \text{shunt} \end{array} \right\} \begin{array}{l} \text{impedance of any section of smooth line, or its equivalent,} \\ \text{of propagation constant } \gamma, \text{ iterative impedance } k, \text{ and} \\ \text{length } l. \end{array}$$

Also let

$$\left. \begin{array}{l} X = \text{open-circuit} \\ Y = \text{short-circuit} \end{array} \right\} \text{impedance of the smooth line section.}$$

Then

$$\gamma l = \sqrt{z_a/z_b} = \tanh^{-1} \sqrt{Y/X},$$

and

$$k = \sqrt{z_a z_b} = \sqrt{XY}.$$

(*B. S. T. J.*, October, 1924, p. 617.)

From these

$$z_a = k\gamma l = \sqrt{XY} \tanh^{-1} \sqrt{Y/X},$$

and

$$z_b = k/\gamma l = \sqrt{XY}/\tanh^{-1} \sqrt{Y/X};$$

thus  $z_a$  and  $z_b$  are inverse networks of impedance product  $k^2$ . In a physical smooth line  $z_a$  is simulated by series resistance and inductance and  $z_b$  by parallel resistance and capacity (assuming the line constants to be independent of frequency), both represented by simple physical networks. In other cases they may be realized in desired frequency ranges, more or less approximately, by physical networks. It will be assumed in what follows that  $z_a$  and  $z_b$  are given by the above formulæ.

The structure which is to simulate the smooth line is shown in its general form as Network 18, Appendix IV, wherein  $z_a$  and  $z_b$  are considered as two types of physical elements whose combinations in

different proportions make up the network. It consists of a composite lattice network of two sections having four real, positive parameters,  $m_1$ ,  $m_2$ ,  $m_1'$ , and  $m_2'$ , two in each section.

In the first section put for the series impedance

$$z_{11} = \frac{1}{\frac{1}{2m_1z_a} + \frac{1}{2z_b/m_2}}. \quad (78)$$

To satisfy the condition for the desired iterative impedance at all frequencies,

$$K = \sqrt{z_{11}z_{21}} = k = \sqrt{z_a z_b}, \quad (79)$$

it follows that the lattice impedance must be

$$z_{21} = \frac{m_2 z_a}{2} + \frac{z_b}{2m_1}. \quad (80)$$

That is,  $z_{11}$  and  $z_{21}$  are also inverse networks of impedance product  $k^2$ . The propagation constant, by generalized (13) (that is,  $R$  replaced by  $K$ ), is

$$e^\Gamma = \frac{1 + m_1 y + m_1 m_2 y^2}{1 - m_1 y + m_1 m_2 y^2}, \quad (81)$$

where for convenience  $y = \sqrt{z_a/z_b} = \gamma l =$  propagation length.

In the second section, similarly,

$$z_{11}' = \frac{1}{\frac{1}{2m_1'z_a} + \frac{1}{2z_b/m_2'}},$$

$$z_{21}' = \frac{m_2' z_a}{2} + \frac{z_b}{2m_1'}, \quad (82)$$

and

$$e^{\Gamma'} = \frac{1 + m_1' y + m_1' m_2' y^2}{1 - m_1' y + m_1' m_2' y^2}.$$

For the composite structure made up of these two sections in tandem, the iterative impedance condition is already fulfilled independently of the values of the coefficients, since (79) holds for each section. Its propagation constant is given from (81) and (82) by

$$e^{\Gamma_c} = e^{\Gamma + \Gamma'}$$

$$= \frac{1 + (m_1 + m_1')y + (m_1 m_2 + m_1 m_1' + m_1' m_2')y^2 + (m_1 m_2 m_1' + m_1 m_1' m_2')y^3 + m_1 m_2 m_1' m_2' y^4}{1 - (m_1 + m_1')y + (m_1 m_2 + m_1 m_1' + m_1' m_2')y^2 - (m_1 m_2 m_1' + m_1 m_1' m_2')y^3 + m_1 m_2 m_1' m_2' y^4}. \quad (83)$$

It remains to choose the coefficients  $m_1$ ,  $m_2$ ,  $m_1'$ , and  $m_2'$  so that for moderate propagation lengths,  $y = \gamma l$ , the composite network will give

$$\Gamma_c \text{ approximately } = y = \gamma l. \quad (84)$$

At this point let us introduce an important simplification by writing the function

$$e^y = \frac{e^{y/2}}{e^{-y/2}} = \frac{1 + \frac{1}{2}y + \frac{1}{8}y^2 + \frac{1}{48}y^3 + \frac{1}{384}y^4 + \frac{1}{3840}y^5 + \dots}{1 - \frac{1}{2}y + \frac{1}{8}y^2 - \frac{1}{48}y^3 + \frac{1}{384}y^4 - \frac{1}{3840}y^5 + \dots}. \quad (85)$$

Then upon comparing (83) and (85) we see that fortunately for small values of  $y$  we can satisfy (84) providing we identify the coefficients of powers of  $y$  in (83) as

$$\begin{aligned} m_1 + m_1' &= \frac{1}{2}, \\ m_1 m_2 + m_1 m_1' + m_1' m_2' &= \frac{1}{8}, \\ m_1 m_2 m_1' + m_1 m_1' m_2' &= \frac{1}{48}, \end{aligned} \quad (86)$$

and

$$m_1 m_2 m_1' m_2' = \frac{1}{384}.$$

The solution of the equations gives a sixth degree equation for  $m_1$ , namely,

$$m_1^6 - \frac{3}{2}m_1^5 + m_1^4 - \frac{3}{8}m_1^3 + \frac{5}{64}m_1^2 - \frac{1}{128}m_1 + \frac{1}{4608} = 0;$$

and for the others

$$m_2 = \frac{6m_1 - 48m_1^2 m_1' - 1}{48m_1(m_1 - m_1')},$$

$$m_1' = .5 - m_1,$$

and

$$m_2' = \frac{1 + 48m_1(m_1')^2 - 6m_1'}{48m_1'(m_1 - m_1')}.$$

From these we get this set of real positive coefficients, determined once for all, namely,

$$\begin{aligned} m_1 &= .45737; & m_2 &= .14456; \\ m_1' &= .04263; & m_2' &= .92403. \end{aligned} \quad (87)$$

With the above fixed values of the coefficients and formulæ (77), (78), (80), and (82), the network can be constructed which is to simulate any smooth line having physically realizable  $z_a$  and  $z_b$ . This simula-

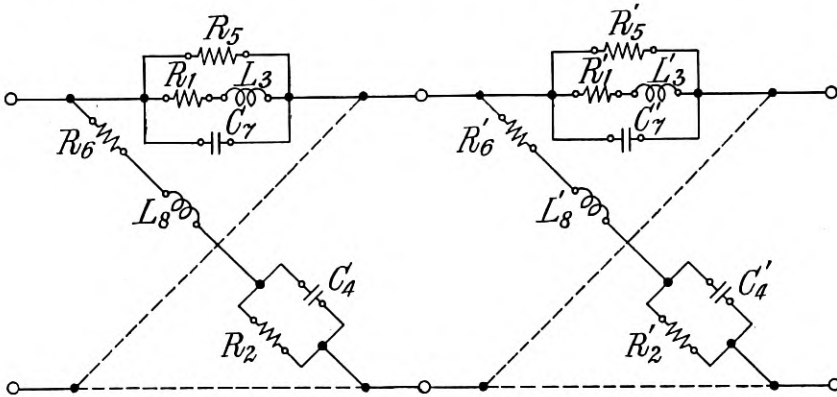

(Broken lines indicate the other series and lattice branches, respectively identical.)

$$\begin{array}{llll}
 R_1 = m_1 R'l, & R_2 = 1/m_1 G'l, & R'_1 = m'_1 R'l, & R'_2 = 1/m'_1 G'l, \\
 L_3 = m_1 L'l, & C_4 = m_1 C'l, & L'_3 = m'_1 L'l, & C'_4 = m'_1 C'l, \\
 R_5 = 1/m_2 G'l, & R_6 = m_2 R'l, & R'_5 = 1/m'_2 G'l, & R'_6 = m'_2 R'l, \\
 C_7 = m_2 C'l, & L_8 = m_2 L'l, & C'_7 = m'_2 C'l, & L'_8 = m'_2 L'l, \\
 m_1 = .45737, & m_2 = .14456, & m'_1 = .04263, & m'_2 = .92403.
 \end{array}$$

Fig. 23—Artificial smooth line which simulates a moderate length,  $l$ , of line having the primary constants  $R'$ ,  $L'$ ,  $G'$ , and  $C'$  per unit length. (If  $R' = G' = 0$ , it becomes a non-dissipative phase network whose time-of-phase-transmission at the lower frequencies has the constant value,  $\tau_p = \sqrt{L'C'l}$ .)

tion is very accurate for small values of  $y$ . As  $y$  increases, the departure of the network propagation characteristic from the smooth line values also increases, but it amounts to less than 1.4 per cent even at  $|y| = 3.0$ , as may be derived from a comparison of (83) and (85).

As an illustration of this type of design, these results were analytically applied to the case of a 104-mil open-wire smooth line having the constants per loop mile (for wet weather, and assumed independent of frequency),

$$\begin{array}{ll}
 R' = 10.12 \text{ ohms;} & L' = 3.66 \text{ mh.;} \\
 G' = 3.20 \text{ micromhos;} & C' = .00837 \text{ mf.}
 \end{array}$$

The corresponding simulating network for a length  $l$  is shown structurally in Fig. 23, where

and

$$\begin{aligned} z_a &= (R' + iL'\omega)l, \\ z_b &= 1/(G' + iC'\omega)l. \end{aligned} \quad (88)$$

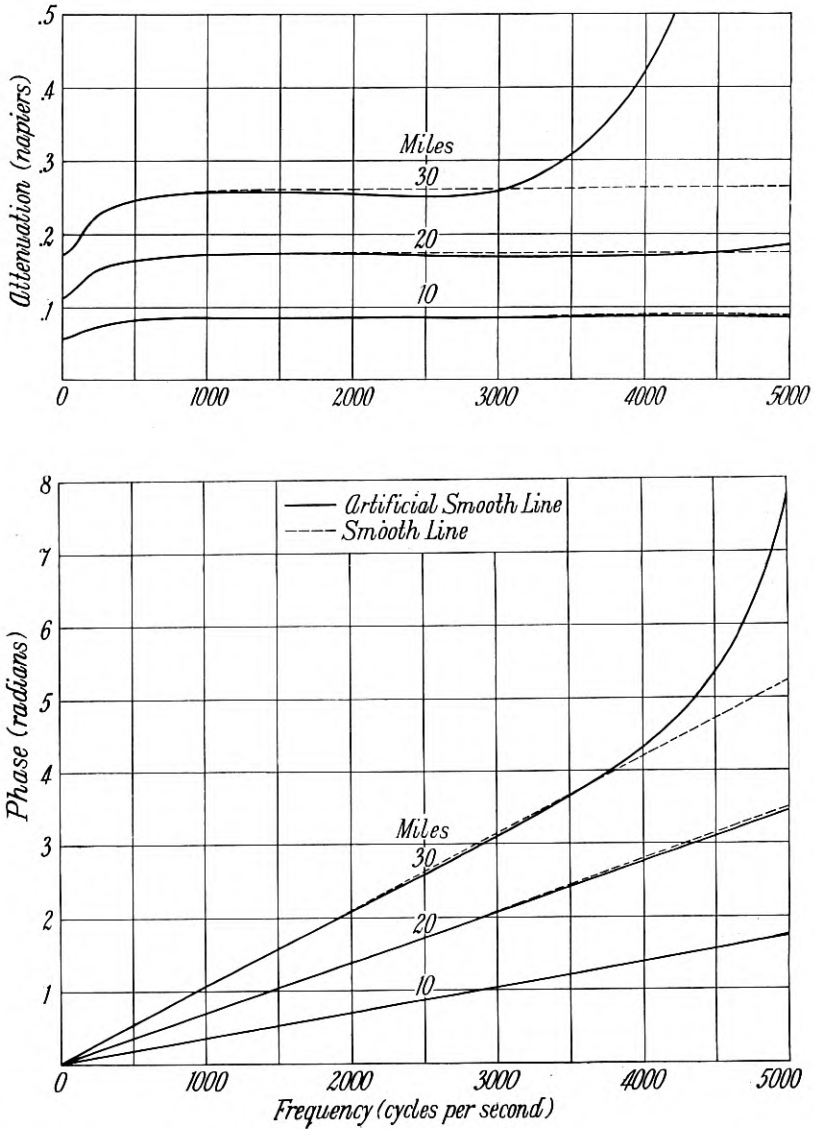

Fig. 24—Propagation characteristics of 10-, 20- and 30-mile lengths of 104-mil open-wire smooth line and of the simulating artificial smooth lines. ( $R' = 10.12$  ohms,  $L' = 3.66$  mh.,  $G' = 3.20$  micromhos (wet weather), and  $C' = .00837$  mf. per loop mile.)

A comparison of the propagation characteristic of a line section and that of its simulating network is shown in Fig. 24 for three different line lengths,  $l = 10, 20,$  and  $30$  miles. Even in the longest section the simulation is good up to 3000 cycles per second. The iterative impedances are, of course, identical as in Fig. 25.

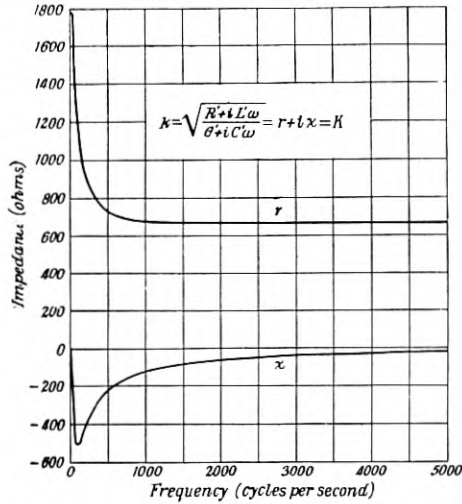

Fig. 25—Iterative impedance of 104-mil open-wire smooth line and of the simulating artificial smooth lines.

While the above general design considered four parameters, a similar procedure can be followed with other networks having a smaller or greater number of parameters. The structure can be obtained by building the series impedance of any section out of various combinations of the impedance elements  $z_a$  and  $z_b$ . However, several of the above four-parameter composite sections can perhaps meet most design requirements.

APPENDIX I

DISCUSSION OF LINEAR PHASE INTERCEPT

Let us first consider steady-state transmission over a circuit where the impressed e.m.f., consisting of simple sinusoids of any two angular frequencies  $\omega_1$  and  $\omega_2$ , is given by

$$\begin{aligned}
 E(t) &= \sin \omega_1 t + \sin \omega_2 t, \\
 &= 2 \cos \frac{1}{2}(\omega_1 - \omega_2)t \sin \frac{1}{2}(\omega_1 + \omega_2)t.
 \end{aligned}
 \tag{89}$$

Assume that the circuit has at these frequencies the transfer exponents  $a_1 + ib_1$  and  $a_2 + ib_2$  such that  $a_1 = a_2 = a'$ . A straight line drawn

through  $b_1$  and  $b_2$  in the  $\omega, b$  plane will have a slope  $\tau$ , say, and at  $\omega = 0$  a linear phase intercept  $b_0$  which may have any value. Hence, the transfer exponent may be expressed as a function of frequency at these two frequencies by the relations

$$a = a' = \text{constant}, \quad (90)$$

and

$$b = \tau\omega + b_0.$$

The received voltage across  $R$  will then be a periodic function which is attenuated by an amount  $a'$  napiers and is

$$\begin{aligned} v(t) &= e^{-a'} [\sin(\omega_1(t - \tau) - b_0) + \sin(\omega_2(t - \tau) - b_0)], \\ &= 2e^{-a'} \cos \frac{1}{2}(\omega_2 - \omega_1)(t - \tau) \sin \left( \frac{1}{2}(\omega_1 + \omega_2)(t - \tau) - b_0 \right). \end{aligned} \quad (91)$$

How the transmitting property of this circuit for the two frequencies depends upon the phase intercept can be seen from a comparison of (91) with (89). In order that the received voltage may be a time-function of identically the same shape as the impressed voltage, but with a time-of-transmission over the circuit of  $\tau$  seconds, it is necessary that  $b_0 = 2n\pi$  radians, where  $n$  is any positive or negative integer. This would mean no distortion of the impressed steady-state signal made up of the two frequency components. If  $b_0 = (2n \pm 1)\pi$ , there would be an apparent distortion only of a reversal in sign. However, if  $b_0 = (2n \pm \frac{1}{2})\pi$ , there would be maximum distortion in the transmitted voltage. These conclusions may be tabulated briefly as follows:

If  $b_0 = 2n\pi$ , no distortion;

If  $b_0 = (2n \pm 1)\pi$ , apparent distortion of sign reversal;

If  $b_0 = (2n \pm \frac{1}{2})\pi$ , maximum distortion.

The above discussion considered the case of any two frequencies. If now we assume that the circuit has the characteristics (90) for several or a range of frequencies, then the conclusions above obviously apply as well to the steady-state transmission of an impressed e.m.f. which is made up of any of those frequencies. Thus, *for distortionless steady-state transmission (without change of signal shape), the transfer exponent must have for the frequency components impressed not only a uniform attenuation and a linear phase relation, but also a proper linear phase intercept  $b_0 = 2n\pi$ .* If, in a physical system, (90) is satisfied over a frequency range which includes zero frequency, then  $\tau$  would necessarily be positive and  $b_0 = 0$  or a multiple of  $2\pi$ .

Proceeding next to the transmission of an e.m.f. impressed suddenly



at time  $t = 0$ , we note that since the e.m.f. can be expressed in terms of a Fourier integral representation from  $t = -\infty$  to  $t = +\infty$  we may regard it as made up of a distribution of steady-state components. For example, let the e.m.f. of (89) be impressed on a circuit at time  $t = 0$ . Then

$$\begin{aligned}
 E(t) &= \left( \frac{1}{2} + \frac{1}{\pi} \int_0^\infty \frac{\sin ty}{y} dy \right) (\sin \omega_1 t + \sin \omega_2 t), \\
 &= \frac{1}{2} (\sin \omega_1 t + \sin \omega_2 t) + \frac{1}{\pi} \int_0^\infty \left( \frac{\omega_1}{\omega_1^2 - \omega^2} + \frac{\omega_2}{\omega_2^2 - \omega^2} \right) \cos t\omega d\omega.
 \end{aligned} \tag{92}$$

This represents the impressed voltage for negative as well as positive values of  $t$  since in the first equation the factor of the sinusoids represents a function which is zero for all negative and unity for all positive values of  $t$ . We may then interpret the last equation as giving for all values of time the frequency distribution of steady-state components of all frequencies which give the same result as the sinusoids of (89) impressed suddenly at  $t = 0$ . This distribution extends over the entire frequency range and has the largest amplitudes about  $\omega = \omega_1$  and  $\omega = \omega_2$ .

Hence, if the initial part of the impressed e.m.f., as well as the final steady state, is to be transmitted without distortion, the circuit transfer voltage must have a characteristic which is distortionless not only with respect to  $\omega_1$  and  $\omega_2$  but also to all angular frequencies about them as obtained from the analysis. That is, since the steady state is only the limiting case of the transient state, an ideal circuit characteristic for its distortionless transmission is only a part of and is included in that for the transient state. Or, vice versa, ideal circuit characteristics for the steady state are at least the same as for the transient state.

These results are useful in studying a circuit whose attenuation is constant and whose phase characteristic is approximately linear over an internal frequency band. An extrapolation of this linear phase characteristic to zero frequency may give a phase intercept which is not ideal for preservation of wave-shape even in the steady state of frequencies within the band, as we have seen. Increasing the frequency range over which an ideal phase relation holds obviously improves the transmission of transient voltages. Practically, good results are obtained in a circuit wherein the attenuation is approximately constant and the phase is approximately proportional to frequency over the required internal band of frequencies; then the phase intercept,  $b_0$ , is zero and the time-of-phase-transmission,  $\tau_p = b/\omega$ , is approximately constant and represents the time-of-transmission of the circuit for those frequencies.

## APPENDIX II

## PROOFS OF LINEAR TRANSDUCER THEOREMS

*Theorem I:* Any passive network whose attenuation constant is zero at all frequencies is a limiting case of a physical wave-filter wherein the transmitting band extends over the entire frequency range. The proof that the phase constant increases with frequency in the transmitting band of any wave-filter has already been given by the writer in the paper, "Theory and Design of Uniform and Composite Electric Wave-Filters," *B. S. T. J.*, January, 1923, pages 37-38. In the present case, therefore, the phase constant increases throughout the frequency range.

The proof relating to the iterative impedance will be given in two steps which comprise essentially the proofs of two impedance theorems. From the first of these it will follow immediately that the transducer under consideration has everywhere a real iterative impedance because of symmetry and a transmitting band extending over the entire frequency range; from the second, this real iterative impedance is a constant resistance throughout the frequency range.

*Wave-Filter Impedance Theorem:* In all transmitting bands the iterative impedances of a recurrent section of any electric wave-filter are conjugate impedances. If the section is symmetrical, they are equal and real without a reactance component.

From the general formulæ on page 617 of *B. S. T. J.*, October, 1924, we may write the iterative impedances as:

$$\left. \begin{matrix} K_a \\ K_b \end{matrix} \right\} = \frac{1}{2}((X_a + X_b) \tanh \Gamma \pm (X_a - X_b)), \quad (93)$$

where  $X_a$  and  $X_b$  are the open-circuit driving-point impedances at the ends  $a$  and  $b$  of the transducer. In a wave-filter recurrent section which is made up of non-dissipative reactance elements the impedances  $X_a$  and  $X_b$  have only reactance components. Also, in a transmitting band the attenuation constant is zero, so that here  $\Gamma = iB$  and  $\tanh \Gamma = i \tan B$ . From this, it follows readily that in any transmitting band the first term of the right-hand member of (93) represents a positive resistance component and the second term a reactance component. Hence, the resistance components of  $K_a$  and  $K_b$  are identical while their reactance components differ only in sign; that is,  $K_a$  and  $K_b$  are conjugate impedances in all transmitting bands.

As results of the above we may state parenthetically:

*Corollary I:* The absolute values of the iterative impedances of a wave-filter recurrent section are equal at any frequency in all transmitting bands; and

*Corollary II:* The iterative impedances of a wave-filter recurrent section are such as to give maximum energy transfer from section to section in all transmitting bands.

When the section is symmetrical,  $X_a = X_b$ , and therefore  $K_a = K_b = r$ , a resistance in those frequency ranges.

*Non-Reactive Impedance Theorem:* The impedance of any two-terminal network whose reactance component is zero at all frequencies must have a resistance component which is constant, independent of frequency. To prove the theorem, let the impedance of any two-terminal network whose reactance component is zero at all frequencies be represented as:

$$Z = r, \quad (94)$$

where  $r$  is a real function of frequency.

The general relations between the components of the steady-state admittance,  $\alpha(\omega) + i\beta(\omega)$ , of a network and the corresponding indicial admittance,  $h(t)$ , are known from electric circuit theory to be:

$$\alpha(\omega) = h(0) + \int_0^{\infty} \cos \omega y h'(y) dy$$

and

$$\beta(\omega) = - \int_0^{\infty} \sin \omega y h'(y) dy; \quad (95)$$

also

$$h(t) = \alpha(0) + \frac{2}{\pi} \int_0^{\infty} \frac{\beta(\omega)}{\omega} \cos t\omega d\omega, \quad t > 0.$$

(See pages 18 and 180 of the reference in footnote 5.)

In the passive network under discussion here, the admittance components at all frequencies from (94) are

$$\alpha(\omega) = 1/r, \quad (96)$$

and

$$\beta(\omega) = 0.$$

Upon substituting them in (95) it is found that

$$h(t) = \alpha(0) = \text{a constant}, \quad t > 0,$$

$$h'(t) = 0 \quad (97)$$

and

$$\alpha(\omega) = 1/r = h(0) = \text{a constant}.$$

This relation demands that the resistance component  $r$  be constant, independent of frequency, as stated in the theorem.

*The converse of the above theorem does not follow, that is, if the resist-*

ance component of a two-terminal network impedance is constant, independent of frequency, it is not necessary that the reactance component be zero throughout the frequency range. This may be seen from the relations above. A simple example is series resistance and inductance.

*Theorem II:* If the iterative impedance of a network is real at all frequencies, it must be constant according to the latter impedance theorem above.

For the second part of Theorem II we have as assumptions regarding the propagation constant,  $\Gamma = A + iB$ , and iterative impedance,  $K$ , effectively

$$B = \tau\omega \quad (98)$$

and

$$K = \text{a constant} = R,$$

where  $\tau$  is some positive constant. The transfer admittance components with respect to a resistance  $R$  which terminates the transducer are then

$$\alpha(\omega) = \frac{e^{-A}}{R} \cos \tau\omega \quad (99)$$

and

$$\beta(\omega) = -\frac{e^{-A}}{R} \sin \tau\omega.$$

By means of these and (95) we shall prove that  $A$  is uniform at all frequencies.

To satisfy (95) with (99) at all frequencies the transducer must be such as to give the relations

$$h(0) = 0,$$

$$h'(l) = 0, \quad l \neq \tau,$$

and

$$\int_{\tau-}^{\tau+} h'(y) dy = \frac{e^{-A}}{R}. \quad (100)$$

Since the left-hand member of the last relation is independent of frequency, it follows necessarily that the attenuation constant,  $A$ , must be uniform. That uniform attenuation together with (98) is also sufficient to satisfy the other relations of (100) can be seen if the parameter characteristics at all frequencies are

$$A = \text{a constant},$$

$$B = \tau\omega \quad (101)$$

and

$$K = \text{a constant} = R.$$

From electric circuit theory, the fundamental integral equation for the indicial admittance  $h(t)$  becomes

$$\frac{1}{pZ(p)} = \frac{e^{-A-\tau p}}{pR} = \int_0^{\infty} e^{-py}h(y)dy, \quad (102)$$

where  $p$  replaces  $i\omega$ . Its solution is

$$h(t) = 0, \quad t < \tau$$

and

$$h(t) = \frac{e^{-A}}{R} = \text{a constant}, \quad t > \tau; \quad (103)$$

whence also  $h'(t) = 0$  for  $t \neq \tau$ , thus satisfying (100). These results hold as well for the limiting case of  $B = 0$ , meaning  $\tau = 0$ .

It may be pointed out here also that *the converse of the latter theorem does not follow*. That is, if the transducer has a uniform attenuation constant and a constant resistance iterative impedance, it is not necessary that the phase constant be proportional to frequency throughout the range. This is seen from the general equations or from the fact that we can alter the phase characteristic non-linearly by means of phase networks having zero attenuation and a constant resistance iterative impedance.

*Theorem III:* A symmetrical transducer made up entirely of resistances would have the characteristics

$$A = \text{a constant},$$

$$B = 0 \quad (104)$$

and

$$K = \text{a constant} = R.$$

Many other more complicated networks satisfying (104) are known to exist, as in Section 4.1. We need not, therefore, seek further to prove the possible existence of such a combination of parameters.

For networks in which  $B$  is not zero, but

$$A = \text{a constant}$$

$$K = \text{a constant} = R, \quad (105)$$

the transfer admittance components with respect to a terminating resistance  $R$  are given as

$$\alpha(\omega) = \frac{e^{-A}}{R} \cos B$$

and

$$\beta(\omega) = -\frac{e^{-A}}{R} \sin B. \quad (106)$$

Using these and the general relations (95), we can obtain

$$\frac{dB}{d\omega} = \frac{\int_0^{\infty} y \sin \omega y h'(y) dy}{\int_0^{\infty} \sin \omega y h'(y) dy}, \quad (107)$$

which is independent of  $A$ .

Since (if  $B$  is not everywhere zero)  $dB/d\omega$  is positive when  $A = 0$  according to Theorem I, and since by (107) it is independent of  $A$  (a constant), it will be positive whatever the value of  $A$ . Hence,  $B$  increases with frequency in such transducers.

### APPENDIX III

#### PROPAGATION CONSTANT AND ITERATIVE IMPEDANCE FORMULÆ FOR GENERAL LADDER, LATTICE AND BRIDGED-T TYPES

These formulæ apply to the general types of structures shown in Fig. 2 and should be used whenever it is desired to take into account accurately the actual physical impedances. Network designs which follow the methods given in this paper are made under the assumption of invariable lumped elements. In constructing physical networks according to such designs, however, certain departures from this assumption unavoidably make their appearance and must be taken into consideration whenever extreme accuracy is required. The departures include dissipation in coils and condensers, distributed capacity in coils, as well as inaccuracies due to manufacture.

Some of these formulæ have been given in previous papers but all can be derived readily either by the method given in *B. S. T. J.*, January, 1923, p. 34, or by that in *B. S. T. J.*, October, 1924, p. 617.

*Ladder Type:*

$$\cosh \Gamma = 1 + \frac{1}{2} \frac{z_1}{z_2}. \quad (108)$$

The iterative impedances at different terminations are:

$$\begin{aligned} \text{At full-series} &= K_1 + \frac{1}{2}z_1, \\ \text{At full-shunt} &= K_1 - \frac{1}{2}z_1, \\ \text{At mid-series} &= K_1 = \sqrt{z_1 z_2 + \frac{1}{4}z_1^2}, \\ \text{At mid-shunt} &= K_2 = z_1 z_2 / K_1. \end{aligned} \quad (109)$$

*Lattice Type:*

$$\cosh \Gamma = 1 + \frac{2z_1}{4z_2 - z_1} \quad (110)$$

and

$$K = \sqrt{z_1 z_2}. \quad (111)$$

*Bridged-T Type:*

$$\cosh \Gamma = 1 + \frac{2z_a z_b}{z_a(z_a + 4z_c) + 4z_b z_c} \tag{112}$$

and

$$K = \sqrt{\frac{z_a z_b (z_a + 4z_c)}{4(z_a + z_b)}} \tag{113}$$

As an aid in obtaining the propagation constant,  $\Gamma = A + iB$ , from any of the three hyperbolic cosine formulæ it will be found convenient to use the following formulæ.

*Computation Formulæ for the Complex Anti-Hyperbolic Cosine*

It is known that many formulæ have already been derived for such evaluations but those below appear to give accurate results more readily.

Let it be desired to obtain  $A$  and  $B$  from the formula

$$\cosh (A + iB) = x + iy, \tag{114}$$

wherein  $x$  and  $y$  are known. A transformation of the  $x$  and  $y$  variables is first made so as to use the form of substitution and formulæ given in *B. S. T. J.*, October, 1924, pages 577 and 578. A further substitution and the application of hyperbolic formulæ give the following results where

$$\begin{aligned} U &= \frac{1}{2}(x - 1), \\ V &= \frac{1}{2}y, \\ P &= 4(U + U^2 + V^2), \end{aligned} \tag{115}$$

and

$$Q = \frac{1}{2} \sinh^{-1} \left| \frac{V}{U + U^2 + V^2} \right|.$$

*When P is Positive:*

$$A = \sinh^{-1} (\sqrt{P} \cosh Q) \tag{116}$$

and

$$B = \pm \sin^{-1} (\sqrt{P} \sinh Q).$$

*When P is Negative:*

$$A = \sinh^{-1} (\sqrt{-P} \sinh Q) \tag{117}$$

and

$$B = \pm \sin^{-1} (\sqrt{-P} \cosh Q).$$

*When P is Zero, a Special Case:*

$$A = \sinh^{-1} \sqrt{2|V|} = \frac{1}{2} \cosh^{-1} (1 + 4|V|) \tag{118}$$

and

$$B = \pm \sin^{-1} \sqrt{2|V|} = \pm \frac{1}{2} \cos^{-1} (1 - 4|V|).$$

*In All Cases:*

$$B = \cos^{-1} \left( \frac{1 + 2U}{\cosh A} \right) = \sin^{-1} \left( \frac{2V}{\sinh A} \right). \quad (119)$$

The latter anti-cosine formula is particularly useful when  $B$  is in the neighborhood of  $(2n + 1)\pi/2$ , and both formulæ of (119) when considered together determine the sign of  $B$ .

The above formulæ give the solution of (114) which has a positive value for  $A$  (as in the propagation constant of a passive network). The other solution, since  $\cosh(-\Gamma) = \cosh \Gamma$ , would have values for both  $A$  and  $B$  which are the negative of those in the first solution (as may be possible in an active network).

It has been found that, when  $x$  and  $y$  are given to five or six decimals, it is possible to derive  $A$  and  $B$  to about this same degree of accuracy from these formulæ and the Smithsonian Mathematical Tables of Hyperbolic Functions. The formulæ may be used to advantage in accurately obtaining the propagation constant of a loaded line where  $x$  and  $y$  are calculated from the known circuit constants. (See footnote 2.)

#### APPENDIX IV

##### PROPAGATION CHARACTERISTICS AND FORMULÆ FOR VARIOUS LATTICE TYPE NETWORKS

Networks of the lattice type only are specifically considered here since they have more general propagation characteristics than ladder or bridged-T types. However, transformations of any lattice type design obtained can be made to equivalent networks of these other types, if physical, by means of the simple relations given in Table II and the corresponding Section 2.5.

The network drawings show only half of the elements so as to avoid confusion; it is to be understood that the broken lines indicate the other series and lattice branches, respectively identical. The double subscript notation adopted for the elements is to be interpreted as follows: the first subscript on any element denotes the general position of the element in the network, 1 for the series branch and 2 for the lattice branch; the second subscript denotes the serial number of the element in either branch. Elements in the two branches which have the same serial numbers for their second subscripts correspond to each other according to the inverse network relations.

This group of networks, while not exhaustive, includes the simpler and perhaps most useful structures, but it could readily be extended. The propagation characteristics shown for each structure and derived



from computed results are representative and serve to give an idea of the possibilities of the network for design purposes. All networks except the last have a constant resistance iterative impedance  $R$ . Networks 1a-12 have attenuation so that they will usually be designed from their attenuation characteristics in terms of which the formulæ are given. There is usually more than one physical solution from the same attenuation characteristic, and in Networks 9 and 10 as many as four have been found possible. These multiple solutions all have different phase constants. A possible practical advantage of one solution over another may lie either in its phase constant or the magnitudes of its elements. It is of interest to point out that if these networks were designed from the phase characteristic some of them might have multiple solutions with different attenuation characteristics. For example, Networks 3a and 3b corresponding to the phase characteristics 1' and 2' each can have two such solutions.

The Networks 1b, 2b, etc., with their output terminals interchanged are, respectively, identical with Networks 1a, 2a, etc. Hence, any pair of these networks have the same attenuation constants but phase constants differing by  $\pi$  radians. An extension of this list to include Networks 6b, 7b, etc., was not thought to be necessary.

Several networks may have the same form of frequency function for  $F$  or  $H$ . Some values of the attenuation or phase coefficients will give a physical structure to one network but not to another. Whether a network having a definite  $A$ - or  $B$ -characteristic is physical or not can be determined most readily by a direct substitution of the coefficients in the formulæ for the elements. In certain cases these latter formulæ show easily that one network may give a physical result where another cannot. For example, Networks 6 and 10 both have the same  $F$  formula, but when one network is physical the other is not; similarly with Networks 7 and 9. These particular results would be expected from the fact that those pairs of networks cannot have the same attenuation characteristics, as seen from their structures.

Networks 13-17 have no attenuation and are designed from their phase characteristics. Network 18 represents a somewhat general form of artificial line and has other types of formulæ.

Examples of networks which are potentially complementary are Networks 1a and 2b; 1b and 2a; 3a and 3b; 11 and 12.

Transformations of impedance branches to equivalent ones can be made in some of the networks by means of the general transformation formulæ given in *B. S. T. J.*, January, 1923, pages 45 and 46.

NETWORK 1a

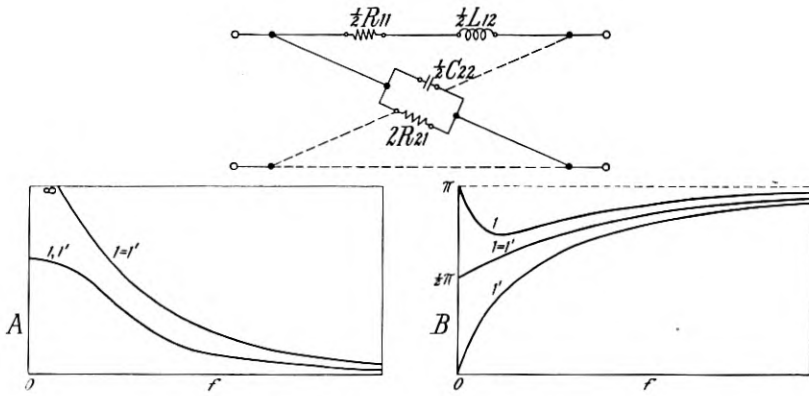

$$R_{11} = 2a_0R; \quad L_{12} = \frac{a_1R}{\pi}.$$

$$R_{11}R_{21} = L_{12}/C_{22} = R^2.$$

$$F = e^{2A} = 10^{\frac{TU}{10}} = \frac{P_0 + f^2}{Q_0 + f^2}.$$

Attenuation Linear Equation:

$$P_0 - FQ_0 = f^2(F - 1).$$

In physical solutions  $0 \leq Q_0 \leq P_0$ .

$$1. \quad a_0 = \frac{\sqrt{P_0} + \sqrt{Q_0}}{\sqrt{P_0} - \sqrt{Q_0}}; \quad a_1 = \frac{2}{\sqrt{P_0} - \sqrt{Q_0}}.$$

$$1'. \quad a_0 = \frac{\sqrt{P_0} - \sqrt{Q_0}}{\sqrt{P_0} + \sqrt{Q_0}}; \quad a_1 = \frac{2}{\sqrt{P_0} + \sqrt{Q_0}}.$$

$$H = \tan B = \frac{2a_1f}{(1 - a_0^2) - a_1^2f^2}.$$

NETWORK 1b

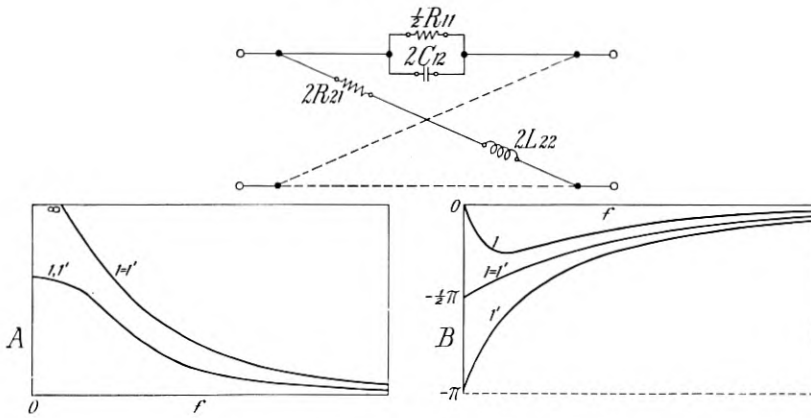

$$R_{11} = 2a_0R; \quad C_{12} = \frac{b_1}{4\pi a_0R}.$$

$$R_{11}R_{21} = L_{22}/C_{12} = R^2.$$

$$F = e^{2A} = 10^{\frac{2A}{10}} = \frac{P_0 + f^2}{Q_0 + f^2}.$$

Attenuation Linear Equation:

$$P_0 - FQ_0 = f^2(F - 1).$$

In physical solutions  $0 \leq Q_0 \leq P_0$ .

$$1. \quad a_0 = \frac{\sqrt{P_0} - \sqrt{Q_0}}{\sqrt{P_0} + \sqrt{Q_0}}; \quad b_1 = \frac{2}{\sqrt{P_0} + \sqrt{Q_0}}.$$

$$1'. \quad a_0 = \frac{\sqrt{P_0} + \sqrt{Q_0}}{\sqrt{P_0} - \sqrt{Q_0}}; \quad b_1 = \frac{2}{\sqrt{P_0} - \sqrt{Q_0}}.$$

$$H = \tan B = \frac{-2a_0b_1f}{(1 - a_0^2) + b_1^2f^2}.$$

NETWORK 2a

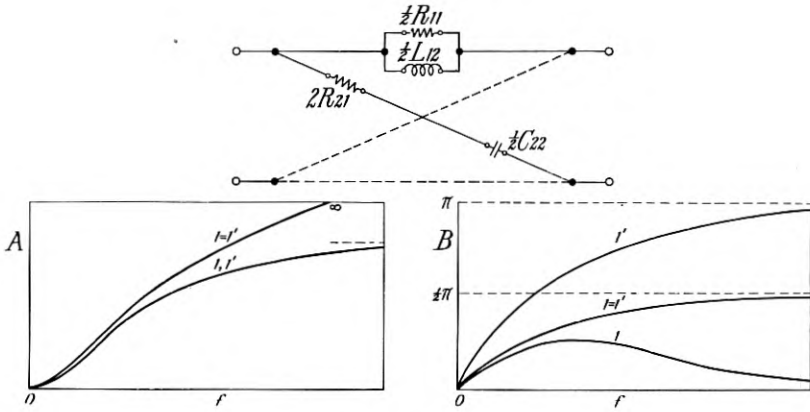

$$R_{11} = \frac{2a_1R}{b_1}; \quad L_{12} = \frac{a_1R}{\pi}.$$

$$R_{11}R_{21} = L_{12}/C_{22} = R^2.$$

$$F = e^{2A} = 10^{\frac{TU}{10}} = \frac{1 + P_2f^2}{1 + Q_2f^2}.$$

Attenuation Linear Equation:

$$P_2 - FQ_2 = (F - 1)/f^2.$$

In physical solutions  $0 \leq Q_2 \leq P_2$ .

$$1. \quad \left. \begin{matrix} a_1 \\ b_1 \end{matrix} \right\} = \frac{1}{2}(\sqrt{P_2} \mp \sqrt{Q_2}).$$

$$1'. \quad \left. \begin{matrix} a_1 \\ b_1 \end{matrix} \right\} = \frac{1}{2}(\sqrt{P_2} \pm \sqrt{Q_2}).$$

$$H = \tan B = \frac{2a_1f}{1 - (a_1^2 - b_1^2)f^2}.$$

NETWORK 2b

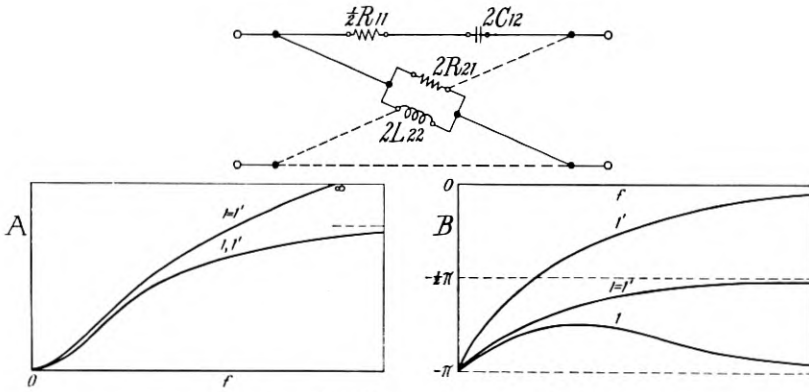

$$R_{11} = \frac{2a_1R}{b_1}; \quad C_{12} = \frac{b_1}{4\pi R}.$$

$$R_{11}R_{21} = L_{22}/C_{12} = R^2.$$

$$F = e^{2A} = 10^{\frac{TV}{10}} = \frac{1 + P_2f^2}{1 + Q_2f^2}.$$

Attenuation Linear Equation:

$$P_2 - FQ_2 = (F - 1)/f^2.$$

In physical solutions  $0 \leq Q_2 \leq P_2$ .

$$1. \left. \begin{matrix} a_1 \\ b_1 \end{matrix} \right\} = \frac{1}{2}(\sqrt{P_2} \pm \sqrt{Q_2}).$$

$$1'. \left. \begin{matrix} a_1 \\ b_1 \end{matrix} \right\} = \frac{1}{2}(\sqrt{P_2} \mp \sqrt{Q_2}).$$

$$H = \tan B = \frac{2b_1f}{1 + (a_1^2 - b_1^2)f^2}.$$

## NETWORK 3a

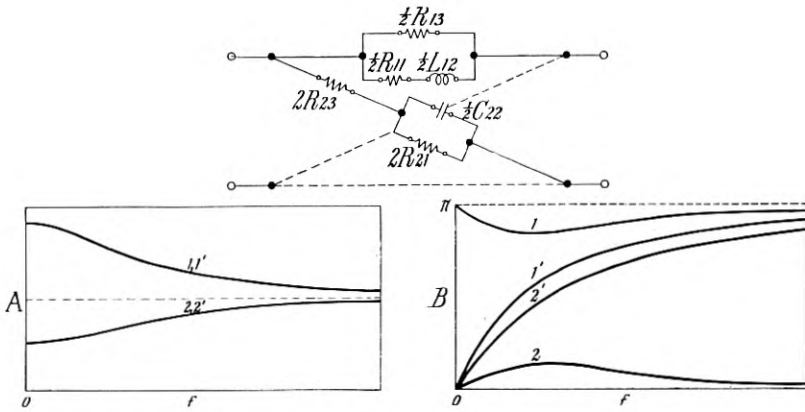

$$R_{11} = \frac{2a_0a_1R}{a_1b_0 - a_0}; \quad L_{12} = \frac{a_1^2R}{\pi(a_1b_0 - a_0)}; \quad R_{13} = 2a_1R.$$

$$R_{11}R_{21} = L_{12}/C_{22} = R_{13}R_{23} = R^2.$$

$$F = e^{2A} = 10^{\frac{TV}{10}} = \frac{P_0 + f^2}{Q_0 + Q_2f^2}.$$

Attenuation Linear Equation:

$$-P_0 + FQ_0 + f^2FQ_2 = f^2.$$

In physical solutions  $0 \leq Q_0 \leq P_0$ ;  $0 \leq Q_2 \leq 1$ .

If  $Q_0 < P_0Q_2$  ( $A$  decreases with frequency):

$$1. \left. \begin{array}{l} a_0 \\ b_0 \end{array} \right\} = \frac{\sqrt{P_0} \pm \sqrt{Q_0}}{1 - \sqrt{Q_2}}; \quad a_1 = \frac{1 + \sqrt{Q_2}}{1 - \sqrt{Q_2}}.$$

$$1'. \left. \begin{array}{l} a_0 \\ b_0 \end{array} \right\} = \frac{\sqrt{P_0} \mp \sqrt{Q_0}}{1 - \sqrt{Q_2}}; \quad a_1 = \frac{1 + \sqrt{Q_2}}{1 - \sqrt{Q_2}}.$$

If  $Q_0 > P_0Q_2$  ( $A$  increases with frequency):

$$2. \left. \begin{array}{l} a_0 \\ b_0 \end{array} \right\} = \frac{\sqrt{P_0} \mp \sqrt{Q_0}}{1 + \sqrt{Q_2}}; \quad a_1 = \frac{1 - \sqrt{Q_2}}{1 + \sqrt{Q_2}}.$$

2'. Same formulæ as in 1'.

If  $Q_0 = P_0Q_2$ ,  $F = 1/Q_2$  ( $A$  is constant).

$$H = \tan B = \frac{2(a_1b_0 - a_0)f}{(b_0^2 - a_0^2) + (1 - a_1^2)f^2}.$$

NETWORK 3b

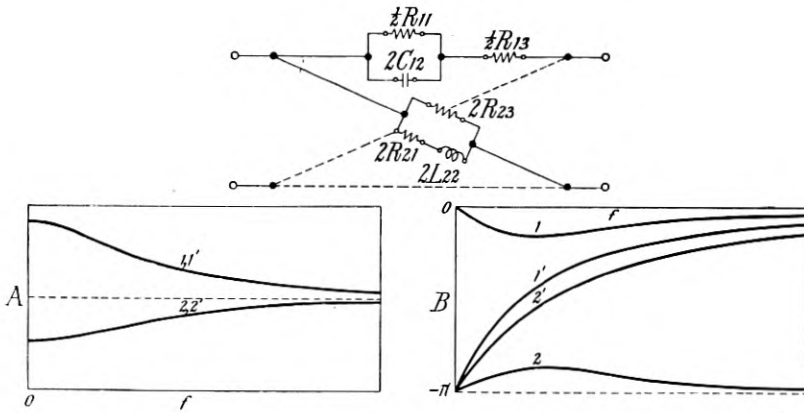

$$R_{11} = \frac{2(a_0 b_1 - a_1)R}{b_1}; \quad C_{12} = \frac{b_1^2}{4\pi(a_0 b_1 - a_1)R}; \quad R_{13} = \frac{2a_1 R}{b_1}.$$

$$R_{11}R_{21} = L_{22}/C_{12} = R_{13}R_{23} = R^2.$$

$$F = e^{2A} = 10^{\frac{20A}{10}} = \frac{P_0 + f^2}{Q_0 + Q_2 f^2}.$$

Attenuation Linear Equation:

$$-P_0 + FQ_0 + f^2 FQ_2 = f^2.$$

In physical solutions  $0 \leq Q_0 \leq P_0$ ;  $0 \leq Q_2 \leq 1$ .

If  $Q_0 < P_0 Q_2$  ( $A$  decreases with frequency):

$$1. \quad a_0 = \frac{\sqrt{P_0} - \sqrt{Q_0}}{\sqrt{P_0} + \sqrt{Q_0}}; \quad \left. \begin{matrix} a_1 \\ b_1 \end{matrix} \right\} = \frac{1 \mp \sqrt{Q_2}}{\sqrt{P_0} + \sqrt{Q_0}}.$$

$$1'. \quad a_0 = \frac{\sqrt{P_0} + \sqrt{Q_0}}{\sqrt{P_0} - \sqrt{Q_0}}; \quad \left. \begin{matrix} a_1 \\ b_1 \end{matrix} \right\} = \frac{1 \mp \sqrt{Q_2}}{\sqrt{P_0} - \sqrt{Q_0}}.$$

If  $Q_0 > P_0 Q_2$  ( $A$  increases with frequency):

$$2. \quad a_0 = \frac{\sqrt{P_0} + \sqrt{Q_0}}{\sqrt{P_0} - \sqrt{Q_0}}; \quad \left. \begin{matrix} a_1 \\ b_1 \end{matrix} \right\} = \frac{1 \pm \sqrt{Q_2}}{\sqrt{P_0} - \sqrt{Q_0}}.$$

2'. Same formulæ as in 1'.

If  $Q_0 = P_0 Q_2$ ,  $F = 1/Q_2$  ( $A$  is constant).

$$H = \tan B = \frac{-2(a_0 b_1 - a_1)f}{(1 - a_0^2) + (b_1^2 - a_1^2)f^2}.$$

NETWORK 4a

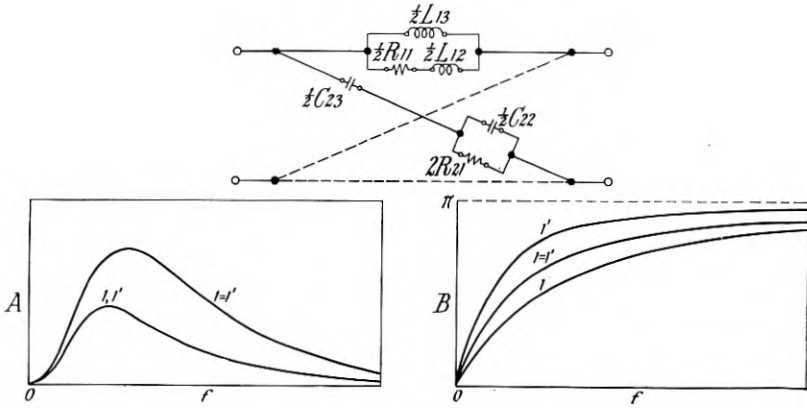

$$R_{11} = \frac{2a_1^2 R}{a_1 b_1 - a_2}; \quad L_{12} = \frac{a_1 a_2 R}{\pi(a_1 b_1 - a_2)}; \quad L_{13} = \frac{a_1 R}{\pi}.$$

$$R_{11} R_{21} = L_{12} / C_{22} = L_{13} / C_{23} = R^2.$$

$$F = e^{2A} = 10^{\frac{TU}{10}} = \frac{1 + P_2 f^2 + P_4 f^4}{1 + Q_2 f^2 + P_4 f^4}.$$

Attenuation Linear Equation:

$$P_2 - f^2(F - 1)P_4 - FQ_2 = (F - 1)/f^2.$$

In physical solutions  $0 \leq 2\sqrt{P_4} \leq Q_2 \leq P_2$ .

$$1. \left. \begin{matrix} a_1 \\ b_1 \end{matrix} \right\} = \frac{1}{2}(\sqrt{P_2 + 2\sqrt{P_4}} \mp \sqrt{Q_2 - 2\sqrt{P_4}}); \quad a_2 = \sqrt{P_4}.$$

1'. Same formulæ as in 1, but with  $a_1$  and  $b_1$  interchanged.

$$H = \tan B = \frac{2a_1 f + 2a_2 b_1 f^3}{1 - (a_1^2 - b_1^2)f^2 - a_2^2 f^4}.$$



NETWORK 4b

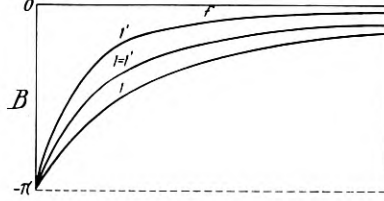
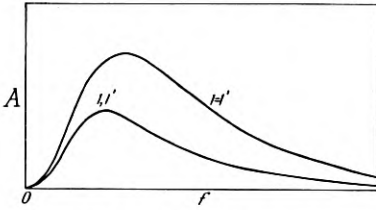
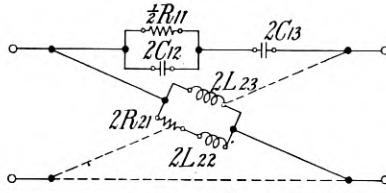

$$R_{11} = \frac{2(a_1 b_1 - b_2)R}{b_1^2}; \quad C_{12} = \frac{b_1 b_2}{4\pi(a_1 b_1 - b_2)R}; \quad C_{13} = \frac{b_1}{4\pi R}.$$

$$R_{11}R_{21} = L_{22}/C_{12} = L_{23}/C_{13} = R^2.$$

$$F = e^{2A} = 10^{\frac{TU}{10}} = \frac{1 + P_2 f^2 + P_4 f^4}{1 + Q_2 f^2 + P_4 f^4}.$$

Attenuation Linear Equation:

$$P_2 - f^2(F - 1)P_4 - FQ_2 = (F - 1)/f^2.$$

In physical solutions  $0 \leq 2\sqrt{P_4} \leq Q_2 \leq P_2$ .

$$1. \left. \begin{matrix} a_1 \\ b_1 \end{matrix} \right\} = \frac{1}{2}(\sqrt{P_2 + 2\sqrt{P_4}} \pm \sqrt{Q_2 - 2\sqrt{P_4}}); \quad b_2 = \sqrt{P_4}.$$

1'. Same formulæ as in 1, but with  $a_1$  and  $b_1$  interchanged.

$$H = \tan B = \frac{2b_1 f + 2a_1 b_2 f^3}{1 + (a_1^2 - b_1^2)f^2 - b_2^2 f^4}.$$

NETWORK 5a

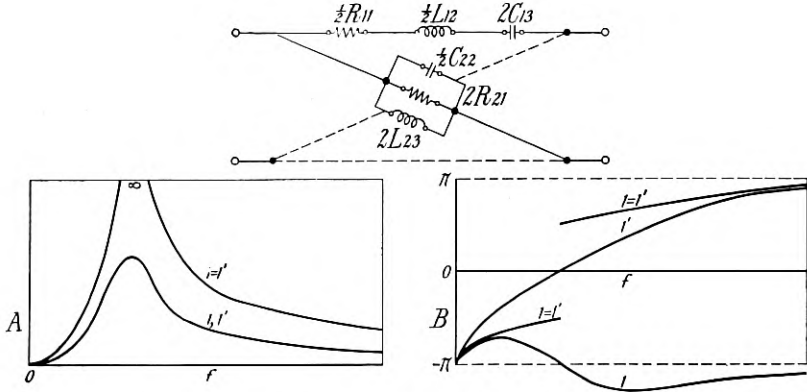

$$R_{11} = \frac{2a_1 R}{b_1}; \quad L_{12} = \frac{a_2 R}{\pi b_1}; \quad C_{13} = \frac{b_1}{4\pi R}.$$

$$R_{11}R_{21} = L_{12}/C_{22} = L_{23}/C_{13} = R^2.$$

$$F = e^{2A} = 10^{\frac{TU}{10}} = \frac{1 + P_2 f^2 + P_4 f^4}{1 + Q_2 f^2 + P_4 f^4}.$$

Attenuation Linear Equation:

$$P_2 - FQ_2 - f^2(F - 1)P_4 = (F - 1)/f^2.$$

In physical solutions  $-2\sqrt{P_4} \leq Q_2 \leq P_2$ .

$$1. \left. \begin{matrix} a_1 \\ b_1 \end{matrix} \right\} = \frac{1}{2}(\sqrt{P_2 + 2\sqrt{P_4}} \pm \sqrt{Q_2 + 2\sqrt{P_4}}); \quad a_2 = \sqrt{P_4}.$$

1'. Same formulæ as in 1, but with  $a_1$  and  $b_1$  interchanged.

$$H = \tan B = \frac{2b_1 f - 2a_2 b_1 f^3}{1 + (a_1^2 - 2a_2 - b_1^2)f^2 + a_2^2 f^4}.$$

NETWORK 5b

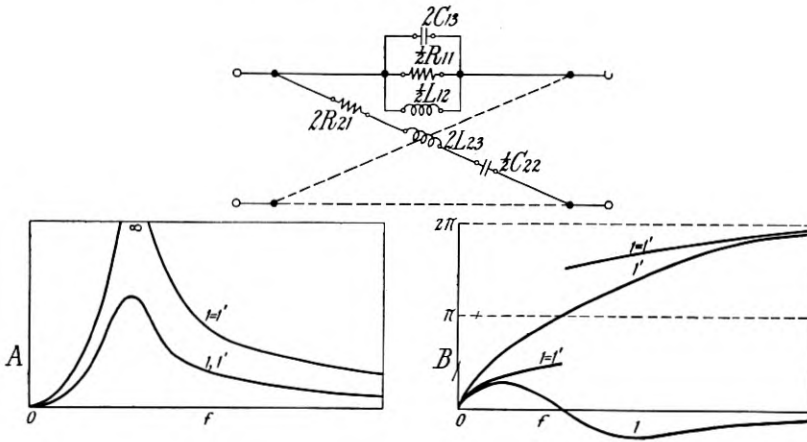

$$R_{11} = \frac{2a_1R}{b_1}; \quad L_{12} = \frac{a_1R}{\pi}; \quad C_{13} = \frac{b_2}{4\pi a_1R}.$$

$$R_{11}R_{21} = L_{12}/C_{22} = L_{23}/C_{13} = R^2.$$

$$F = e^{2A} = 10^{\frac{TU}{10}} = \frac{1 + P_2f^2 + P_4f^4}{1 + Q_2f^2 + P_4f^4}.$$

Attenuation Linear Equation:

$$P_2 - FQ_2 - f^2(F - 1)P_4 = (F - 1)/f^2.$$

In physical solutions  $-2\sqrt{P_4} \leq Q_2 \leq P_2$ .

$$1. \left. \begin{matrix} a_1 \\ b_1 \end{matrix} \right\} = \frac{1}{2}(\sqrt{P_2 + 2\sqrt{P_4}} \mp \sqrt{Q_2 + 2\sqrt{P_4}}); \quad b_2 = \sqrt{P_4}.$$

1'. Same formulæ as in 1, but with  $a_1$  and  $b_1$  interchanged.

$$H = \tan B = \frac{2a_1f - 2a_1b_2f^3}{1 - (a_1^2 - b_1^2 + 2b_2)f^2 + b_2^2f^4}.$$

NETWORK 6

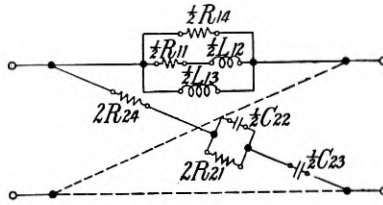

$A$ - and  $B$ -characteristics are similar to those of Networks 2a and 4a.

$$R_{11} = \frac{2a_1^2 a_2 R}{a_1 a_2 b_1 - a_1^2 b_2 - a_2^2}; \quad L_{12} = \frac{a_1 a_2^2 R}{\pi(a_1 a_2 b_1 - a_1^2 b_2 - a_2^2)};$$

$$L_{13} = \frac{a_1 R}{\pi}; \quad R_{14} = \frac{2a_2 R}{b_2}.$$

$$R_{11} R_{21} = L_{12} / C_{22} = L_{13} / C_{23} = R_{14} R_{24} = R^2.$$

$$F = e^{2A} = 10^{\frac{TV}{10}} = \frac{1 + P_2 f^2 + P_4 f^4}{1 + Q_2 f^2 + Q_4 f^4}.$$

Attenuation Linear Equation:

$$P_2 + f^2 P_4 - F Q_2 - f^2 F Q_4 = (F - 1) / f^2.$$

In unrestricted solutions, where  $0 \leq Q_4 \leq P_4$ :

$$\left. \begin{matrix} a_1 \\ b_1 \end{matrix} \right\} \text{ or } \left. \begin{matrix} b_1 \\ a_1 \end{matrix} \right\} = \frac{1}{2} (\sqrt{P_2 + 2\sqrt{P_4}} \pm \sqrt{Q_2 - 2\sqrt{Q_4}});$$

$$\left. \begin{matrix} a_2 \\ b_2 \end{matrix} \right\} = \frac{1}{2} (\sqrt{P_4} \pm \sqrt{Q_4}).$$

Also

$$\left. \begin{matrix} a_1 \\ b_1 \end{matrix} \right\} \text{ or } \left. \begin{matrix} b_1 \\ a_1 \end{matrix} \right\} = \frac{1}{2} (\sqrt{P_2 + 2\sqrt{P_4}} \pm \sqrt{Q_2 + 2\sqrt{Q_4}});$$

$$\left. \begin{matrix} a_2 \\ b_2 \end{matrix} \right\} = \frac{1}{2} (\sqrt{P_4} \mp \sqrt{Q_4}).$$

In physical solutions  $a_1, a_2, b_1, b_2$  are positive;

$$a_1^2 b_2 + a_2^2 \leq a_1 a_2 b_1.$$

$$H = \tan B = \frac{2a_1 f - 2(a_1 b_2 - a_2 b_1) f^3}{1 - (a_1^2 - b_1^2 + 2b_2) f^2 - (a_2^2 - b_2^2) f^4}.$$

NETWORK 7

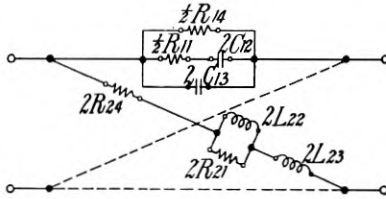

A- and B-characteristics are similar to those of Networks 1b and 4b.

$$R_{11} = \frac{2a_0 a_1^2 R}{a_0 a_1 b_1 - a_1^2 - a_0^2 b_2}; \quad C_{12} = \frac{a_0 a_1 b_1 - a_1^2 - a_0^2 b_2}{4\pi a_0^2 a_1 R};$$

$$C_{13} = \frac{b_2}{4\pi a_1 R}; \quad R_{14} = 2a_0 R.$$

$$R_{11} R_{21} = L_{22} / C_{12} = L_{23} / C_{13} = R_{14} R_{24} = R^2.$$

$$F = e^{2A} = 10^{\frac{TU}{10}} = \frac{P_0 + P_2 f^2 + f^4}{Q_0 + Q_2 f^2 + f^4}.$$

Attenuation Linear Equation:

$$P_0 + f^2 P_2 - F Q_0 - f^2 F Q_2 = f^4 (F - 1).$$

In unrestricted solutions, where  $0 \leq Q_0 \leq P_0$ :

$$a_0 = \frac{\sqrt{P_0} - \sqrt{Q_0}}{\sqrt{P_0} + \sqrt{Q_0}}; \quad b_2 = \frac{2}{\sqrt{P_0} + \sqrt{Q_0}};$$

$$\left. \begin{matrix} a_1 \\ b_1 \end{matrix} \right\} \text{ or } \left. \begin{matrix} b_1 \\ a_1 \end{matrix} \right\} = \frac{\sqrt{P_2 + 2\sqrt{P_0}} \pm \sqrt{Q_2 + 2\sqrt{Q_0}}}{\sqrt{P_0} + \sqrt{Q_0}}.$$

Also

$$a_0 = \frac{\sqrt{P_0} + \sqrt{Q_0}}{\sqrt{P_0} - \sqrt{Q_0}}; \quad b_2 = \frac{2}{\sqrt{P_0} - \sqrt{Q_0}};$$

$$\left. \begin{matrix} a_1 \\ b_1 \end{matrix} \right\} \text{ or } \left. \begin{matrix} b_1 \\ a_1 \end{matrix} \right\} = \frac{\sqrt{P_2 + 2\sqrt{P_0}} \pm \sqrt{Q_2 - 2\sqrt{Q_0}}}{\sqrt{P_0} - \sqrt{Q_0}}.$$

In physical solutions  $a_0, a_1, b_1, b_2$  are positive;

$$a_1^2 + a_0^2 b_2 \leq a_0 a_1 b_1.$$

$$H = \tan B = \frac{2(a_1 - a_0 b_1)f - 2a_1 b_2 f^3}{(1 - a_0^2) - (a_1^2 - b_1^2 + 2b_2)f^2 + b_2^2 f^4}.$$

NETWORK 8

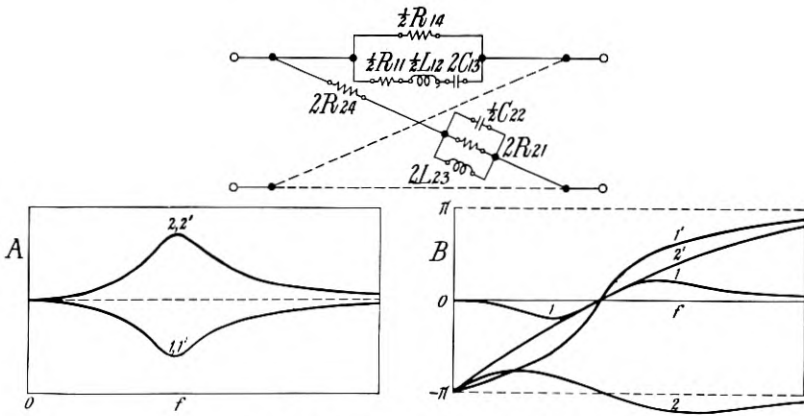

$$R_{11} = \frac{2a_0 a_1 R}{a_0 b_1 - a_1}; \quad L_{12} = \frac{a_0^2 b_2 R}{\pi(a_0 b_1 - a_1)};$$

$$C_{13} = \frac{a_0 b_1 - a_1}{4\pi a_0^2 R}; \quad R_{14} = 2a_0 R.$$

$$R_{11} R_{21} = L_{12} / C_{22} = L_{21} / C_{13} = R_{14} R_{24} = R^2.$$

$$F = e^{2A} = 10^{\frac{TV}{10}} = \frac{F_0 + P_2 f^2 + F_0 Q_4 f^4}{1 + Q_2 f^2 + Q_4 f^4}.$$

$$F_0(f = 0) = F_\infty(f = \infty); \quad A_0 = A_\infty.$$

Attenuation Linear Equation:

$$-P_2 + FQ_2 - f^2(F_0 - F)Q_4 = (F_0 - F)/f^2.$$

In physical solutions  $0 \leq Q_2 + 2\sqrt{Q_4} \equiv n \leq P_2 + 2F_0\sqrt{Q_4} \equiv m$ .

If  $P_2 < F_0 Q_2$  ( $A$  has a minimum):

$$1. \quad a_0 = \tanh(A_0/2); \quad b_2 = \sqrt{Q_4};$$

$$\left. \begin{matrix} a_1 \\ b_1 \end{matrix} \right\} = \frac{1}{2}(1 - \tanh(A_0/2))(\sqrt{m} \mp \sqrt{n}).$$

$$1'. \quad a_0 = \coth(A_0/2); \quad b_2 = \sqrt{Q_4};$$

$$\left. \begin{matrix} a_1 \\ b_1 \end{matrix} \right\} = \frac{1}{2}(\coth(A_0/2) - 1)(\sqrt{m} \mp \sqrt{n}).$$

If  $P_2 > F_0 Q_2$  ( $A$  has a maximum):

$$2. \quad a_0 = \coth(A_0/2); \quad b_2 = \sqrt{Q_4};$$

$$\left. \begin{matrix} a_1 \\ b_1 \end{matrix} \right\} = \frac{1}{2}(\coth(A_0/2) - 1)(\sqrt{m} \pm \sqrt{n}).$$

2'. The same formulæ as in 1'.

$$H = \tan B = \frac{2(a_0 b_1 - a_1)(-f + b_2 f^3)}{(1 - a_0^2) - (a_1^2 - b_1^2 + 2(1 - a_0^2)b_2)f^2 + (1 - a_0^2)b_2^2 f^4}.$$

NETWORK 9

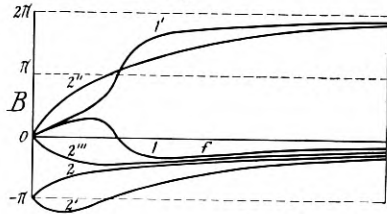
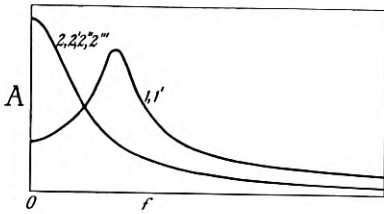
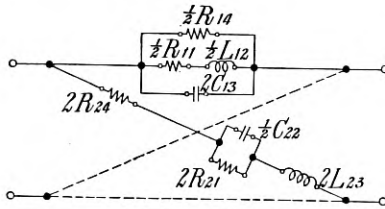

$$R_{11} = \frac{2a_0a_1^2R}{a_0^2b_2 + a_1^2 - a_0a_1b_1}; \quad L_{12} = \frac{a_1^3R}{\pi(a_0^2b_2 + a_1^2 - a_0a_1b_1)};$$

$$C_{13} = \frac{b_2}{4\pi a_1 R}; \quad R_{14} = \frac{2a_1^2R}{a_1b_1 - a_0b_2}.$$

$$R_{11}R_{21} = L_{12}/C_{22} = L_{23}/C_{13} = R_{14}R_{24} = R^2.$$

$$F = e^{2A} = 10^{\frac{TV}{10}} = \frac{P_0 + P_2f^2 + f^4}{Q_0 + Q_2f^2 + f^4}.$$

Attenuation Linear Equation:

$$P_0 + f^2P_2 - FQ_0 - f^2FQ_2 = f^4(F - 1).$$

In unrestricted solutions, where  $0 \leq Q_0 \leq P_0$ :

$$a_0 = \frac{\sqrt{P_0} - \sqrt{Q_0}}{\sqrt{P_0} + \sqrt{Q_0}}; \quad b_2 = \frac{2}{\sqrt{P_0} + \sqrt{Q_0}};$$

$$\left. \begin{matrix} a_1 \\ b_1 \end{matrix} \right\} \text{ or } \left. \begin{matrix} b_1 \\ a_1 \end{matrix} \right\} = \frac{\sqrt{P_2 + 2\sqrt{P_0}} \pm \sqrt{Q_2 + 2\sqrt{Q_0}}}{\sqrt{P_0} + \sqrt{Q_0}}.$$

Also

$$a_0 = \frac{\sqrt{P_0} + \sqrt{Q_0}}{\sqrt{P_0} - \sqrt{Q_0}}; \quad b_2 = \frac{2}{\sqrt{P_0} - \sqrt{Q_0}};$$

$$\left. \begin{matrix} a_1 \\ b_1 \end{matrix} \right\} \text{ or } \left. \begin{matrix} b_1 \\ a_1 \end{matrix} \right\} = \frac{\sqrt{P_2 + 2\sqrt{P_0}} \pm \sqrt{Q_2 - 2\sqrt{Q_0}}}{\sqrt{P_0} - \sqrt{Q_0}}.$$

In physical solutions  $Q_2 \leq P_2$ ;  $a_0a_1b_1 \leq a_0^2b_2 + a_1^2$ .

$$H = \tan B = \frac{2(a_1 - a_0b_1)f - 2a_1b_2f^3}{(1 - a_0^2) - (a_1^2 - b_1^2 + 2b_2)f^2 + b_2^2f^4}.$$

NETWORK 10

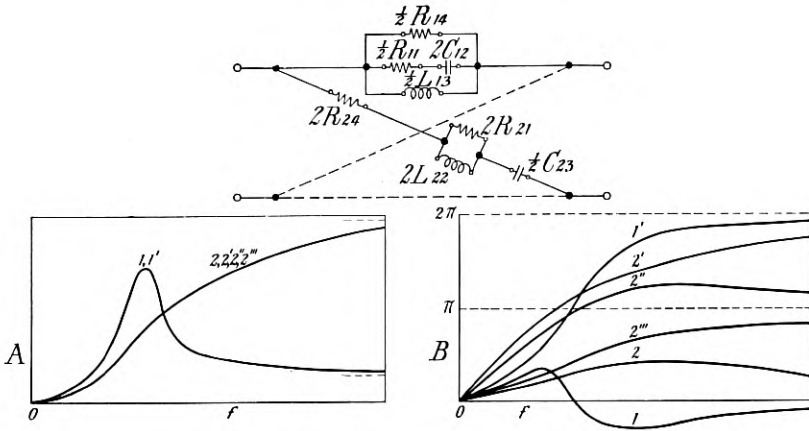

$$R_{11} = \frac{2a_1^2 a_2 R}{a_1^2 b_2 + a_2^2 - a_1 a_2 b_1}; \quad C_{12} = \frac{a_1^2 b_2 + a_2^2 - a_1 a_2 b_1}{4\pi a_1^3 R};$$

$$L_{13} = \frac{a_1 R}{\pi}; \quad R_{14} = \frac{2a_1^2 R}{a_1 b_1 - a_2}.$$

$$R_{11} R_{21} = L_{22} / C_{12} = L_{13} / C_{23} = R_{14} R_{24} = R^2.$$

$$F = e^{2A} = 10^{\frac{TU}{10}} = \frac{1 + P_2 f^2 + P_4 f^4}{1 + Q_2 f^2 + Q_4 f^4}.$$

Attenuation Linear Equation:

$$P_2 + f^2 P_4 - F Q_2 - f^2 F Q_4 = (F - 1) / f^2.$$

In unrestricted solutions, where  $0 \leq Q_4 \leq P_4$ :

$$\left. \begin{matrix} a_1 \\ b_1 \end{matrix} \right\} \text{ or } \left. \begin{matrix} b_1 \\ a_1 \end{matrix} \right\} = \frac{1}{2} (\sqrt{P_2 + 2\sqrt{P_4}} \pm \sqrt{Q_2 - 2\sqrt{Q_4}});$$

$$\left. \begin{matrix} a_2 \\ b_2 \end{matrix} \right\} = \frac{1}{2} (\sqrt{P_4} \pm \sqrt{Q_4}).$$

Also

$$\left. \begin{matrix} a_1 \\ b_1 \end{matrix} \right\} \text{ or } \left. \begin{matrix} b_1 \\ a_1 \end{matrix} \right\} = \frac{1}{2} (\sqrt{P_2 + 2\sqrt{P_4}} \pm \sqrt{Q_2 + 2\sqrt{Q_4}});$$

$$\left. \begin{matrix} a_2 \\ b_2 \end{matrix} \right\} = \frac{1}{2} (\sqrt{P_4} \mp \sqrt{Q_4}).$$

In physical solutions  $Q_2 \leq P_2$ ;  $a_1 a_2 b_1 \leq a_1^2 b_2 + a_2^2$ .

$$H = \tan B = \frac{2a_1 f - 2(a_1 b_2 - a_2 b_1) f^3}{1 - (a_1^2 - b_1^2 + 2b_2) f^2 - (a_2^2 - b_2^2) f^4}$$



NETWORK 11

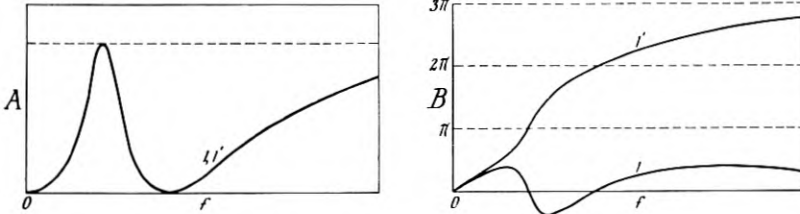
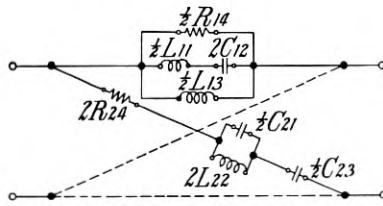

$$L_{11} = \frac{a_1 a_3 R}{\pi(a_1 b_2 - a_3)}; \quad C_{12} = \frac{a_1 b_2 - a_3}{4\pi a_1^2 R};$$

$$L_{13} = \frac{a_1 R}{\pi}; \quad R_{14} = \frac{2R}{m}.$$

$$L_{11}/C_{21} = L_{22}/C_{12} = L_{13}/C_{23} = R_{14}R_{24} = R^2.$$

$$F = e^{2A} = 10^{\frac{TU}{10}} = \frac{1 + (1 + m)^2 y^2}{1 + (1 - m)^2 y^2},$$

where

$$y = \frac{a_1 f - a_3 f^3}{1 - b_2 f^2}$$

is the total parallel reactance in  $z_{11}$  divided by  $2R$ .

- 1.  $m = \coth \frac{1}{2} A_\infty$ ;
- 1'.  $m = \tanh \frac{1}{2} A_\infty$ ;

where  $A_\infty$  is the maximum attenuation at  $f = \infty$  and at the internal frequency  $f = 1/\sqrt{b_2}$ .

Attenuation Linear Equation:

$$a_1 - f^2 a_3 + f y b_2 = y/f,$$

where

$$y = \pm \sqrt{\frac{F - 1}{(1 + m)^2 - (1 - m)^2 F}}$$

and the signs to be taken for  $y$  correspond to the particular reactance branches involved, whose signs in order on the frequency scale are +, -, and +.

In physical solutions  $a_3 \leq a_1 b_2$ .

$$H = \tan B = \frac{2y}{1 - (1 - m^2)y^2}.$$

NETWORK 12

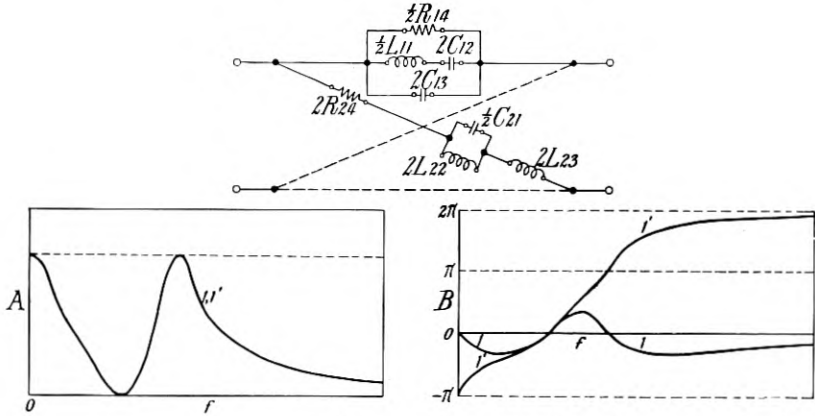

$$L_{11} = \frac{a_2^2 R}{\pi(a_2 b_1 - b_3)}; \quad C_{12} = \frac{a_2 b_1 - b_3}{4\pi a_2 R};$$

$$C_{13} = \frac{b_3}{4\pi a_2 R}; \quad R_{14} = \frac{2R}{m}.$$

$$L_{11}/C_{21} = L_{22}/C_{12} = L_{23}/C_{13} = R_{14}R_{24} = R^2.$$

$$F = e^{2A} = 10^{\frac{TU}{10}} = \frac{1 + (1 + m)^2 y^2}{1 + (1 - m)^2 y^2},$$

where

$$y = \frac{-1 + a_2 f^2}{b_1 f - b_3 f^3}$$

is the total parallel reactance in  $z_{11}$  divided by  $2R$ .

- 1.  $m = \coth \frac{1}{2} A_0$ ;
- 1'.  $m = \tanh \frac{1}{2} A_0$ ;

where  $A_0$  is the maximum attenuation at  $f = 0$  and at the internal frequency  $f = \sqrt{b_1/b_3}$ .

Attenuation Linear Equation:

$$a_2 - (y/f)b_1 + fyb_3 = 1/f^2,$$

where

$$y = \pm \sqrt{\frac{F - 1}{(1 + m)^2 - (1 - m)^2 F}}$$

and the signs to be taken for  $y$  correspond to the particular reactance branches involved, whose signs in order on the frequency scale are  $-$ ,  $+$ , and  $-$ .

In physical solutions  $b_3 \leq a_2 b_1$ .

$$H = \tan B = \frac{2y}{1 - (1 - m^2)y^2}.$$

NETWORK 13

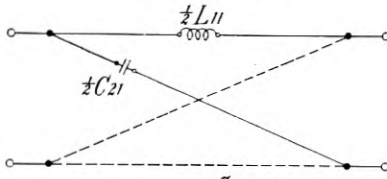

$A=0$

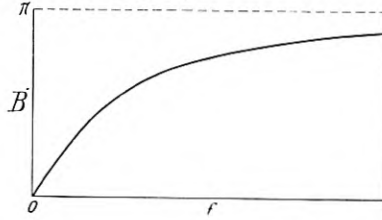

$$L_{11} = \frac{a_1 R}{\pi}; \quad L_{11}/C_{21} = R^2.$$

$$H = \tan \frac{1}{2} B = a_1 f.$$

Phase Linear Equation:

$$a_1 = H/f.$$

(See also formula (75).)

## NETWORK 14

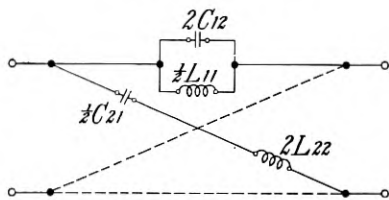
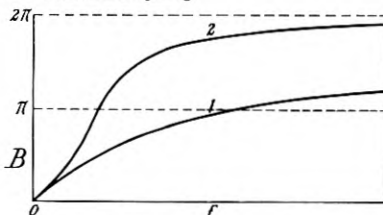
 $A=0$ 

$$L_{11} = \frac{a_1 R}{\pi}; \quad C_{12} = \frac{b_2}{4\pi a_1 R}.$$

$$L_{11}/C_{21} = L_{22}/C_{12} = R^2.$$

$$H = \tan \frac{1}{2}B = \frac{a_1 f}{1 - b_2 f^2}.$$

Phase Linear Equation:

$$a_1 + fHb_2 = H/f.$$

$$1. \quad b_2 < \frac{1}{3}a_1^2. \quad 2. \quad b_2 > \frac{1}{3}a_1^2.$$

Equivalent Network, if  $b_2 \leq \frac{1}{4}a_1^2$ :

Two sections ( $a_1'$  and  $a_1''$ ) of Network 13:

$$\left. \begin{array}{l} a_1' \\ a_1'' \end{array} \right\} = \frac{1}{2}(a_1 \pm \sqrt{a_1^2 - 4b_2}).$$

NETWORK 15

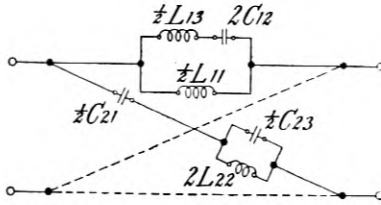

$A = 0.$

$B$ -characteristic is the sum of those for Networks 13 and 14.

$$L_{11} = \frac{a_1 R}{\pi}; \quad C_{12} = \frac{a_1 b_2 - a_3}{4\pi a_1^2 R}; \quad L_{13} = \frac{a_1 a_3 R}{\pi(a_1 b_2 - a_3)}.$$

$$L_{11}/C_{21} = L_{22}/C_{12} = L_{13}/C_{23} = R^2.$$

$$H = \tan \frac{1}{2} B = \frac{a_1 f - a_3 f^3}{1 - b_2 f^2}.$$

Phase Linear Equation:

$$a_1 - f^2 a_3 + f H b_2 = H/f.$$

In physical solutions  $a_3 \leq a_1 b_2$ .

Equivalent to Network 16.

## NETWORK 16

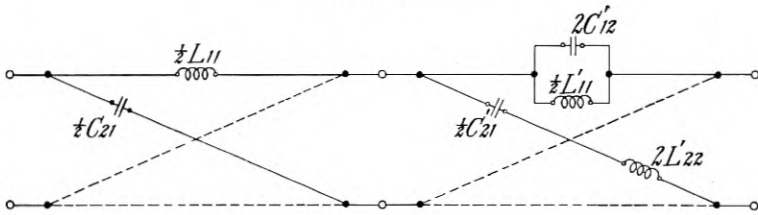

$A = 0.$

$B$ -characteristic is the sum of those for Networks 13 and 14.

$$L_{11} = \frac{a_1 R}{\pi}; \quad L_{11}' = \frac{a_1' R}{\pi}; \quad C_{12}' = \frac{b_2'}{4\pi a_1' R}.$$

$$L_{11}/C_{21} = L_{11}'/C_{21}' = L_{22}'/C_{12}' = R^2.$$

$$H = \tan \frac{1}{2}B = \frac{M_1 f + M_3 f^3}{1 + N_2 f^2}.$$

Phase Linear Equation:

$$M_1 + f^2 M_3 - f H N_2 = H/f.$$

$$a_1^3 - M_1 a_1^2 - N_2 a_1 + M_3 = 0;$$

$$a_1' = M_1 - a_1;$$

$$b_2' = -M_3/a_1.$$

Equivalent to Network 15.

NETWORK 17

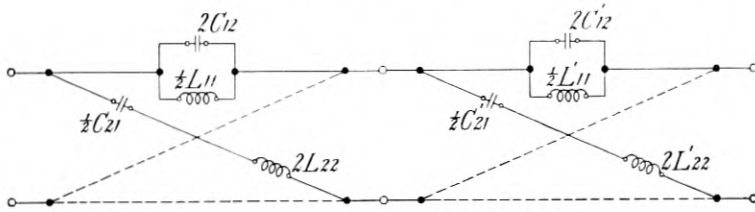

$A = 0.$

$B$ -characteristic is the sum of those for two sections of Network 14.

$$L_{11} = \frac{a_1 R}{\pi}; \quad C_{12} = \frac{b_2}{4\pi a_1 R}; \quad L_{11}' = \frac{a_1' R}{\pi}; \quad C_{12}' = \frac{b_2'}{4\pi a_1' R}.$$

$$L_{11}/C_{21} = L_{22}/C_{12} = L_{11}'/C_{21}' = L_{22}'/C_{12}' = R^2.$$

$$H = \tan \frac{1}{2}B = \frac{M_1 f + M_3 f^3}{1 + N_2 f^2 + N_4 f^4}.$$

Phase Linear Equation:

$$M_1 + f^2 M_3 - f H N_2 - f^3 H N_4 = H/f.$$

In physical solutions  $M_1$  and  $N_4$  are positive, as are also  $a_1, a_1', b_2,$  and  $b_2'$ .  $M_3$  and  $N_2$  are negative.

$$q^3 + 2N_2 q^2 + (-M_1 M_3 + N_2^2 - 4N_4)q + (M_1^2 N_4 - M_1 M_3 N_2 + M_3^2) = 0;$$

$$\left. \begin{matrix} a_1 \\ a_1' \end{matrix} \right\} = \frac{1}{2}(M_1 \pm \sqrt{M_1^2 - 4q});$$

$$\left. \begin{matrix} b_2 \\ b_2' \end{matrix} \right\} \text{ or } \left. \begin{matrix} b_2' \\ b_2 \end{matrix} \right\} = \frac{1}{2}(- (N_2 + q) \pm \sqrt{(N_2 + q)^2 - 4N_4}),$$

the determining condition being that  $a_1 b_2' + a_1' b_2 = -M_3.$

## NETWORK 18

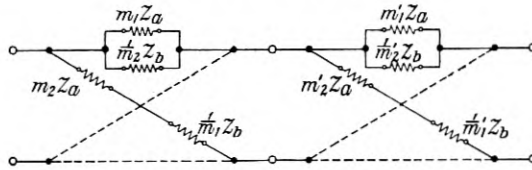

(To simulate a short symmetrical line or circuit)

Symmetrical Section of Line or Circuit:

$X$  = open-circuit impedance;

$Y$  = short-circuit impedance;

$\tanh^{-1} \sqrt{Y/X}$  = propagation length;

$\sqrt{XY}$  = iterative impedance.

Simulating Network:

$$z_a = \sqrt{XY} \tanh^{-1} \sqrt{Y/X};$$

$$z_b = \sqrt{XY} / \tanh^{-1} \sqrt{Y/X};$$

$$m_1 = .45737; \quad m_2 = .14456; \quad m_1' = .04263; \quad m_2' = .92403.$$

The impedances  $z_a$  and  $z_b$  are to be realized in desired frequency ranges, more or less approximately, by comparatively simple physical networks.



# Transmission of Information<sup>1</sup>

By R. V. L. HARTLEY

**SYNOPSIS:** A quantitative measure of "information" is developed which is based on physical as contrasted with psychological considerations. How the rate of transmission of this information over a system is limited by the distortion resulting from storage of energy is discussed from the transient viewpoint. The relation between the transient and steady state viewpoints is reviewed. It is shown that when the storage of energy is used to restrict the steady state transmission to a limited range of frequencies the amount of information that can be transmitted is proportional to the product of the width of the frequency-range by the time it is available. Several illustrations of the application of this principle to practical systems are included. In the case of picture transmission and television the spacial variation of intensity is analyzed by a steady state method analogous to that commonly used for variations with time.

WHILE the frequency relations involved in electrical communication are interesting in themselves, I should hardly be justified in discussing them on this occasion unless we could deduce from them something of fairly general practical application to the engineering of communication systems. What I hope to accomplish in this direction is to set up a quantitative measure whereby the capacities of various systems to transmit information may be compared. In doing this I shall discuss its application to systems of telegraphy, telephony, picture transmission and television over both wire and radio paths. It will, of course, be found that in very many cases it is not economically practical to make use of the full physical possibilities of a system. Such a criterion is, however, often useful for estimating the possible increase in performance which may be expected to result from improvements in apparatus or circuits, and also for detecting fallacies in the theory of operation of a proposed system.

Inasmuch as the results to be obtained are to represent the limits of what may be expected under rather idealized conditions, it will be permissible to simplify the discussion by neglecting certain factors which, while often important in practice, have the effect only of causing the performance to fall somewhat further short of the ideal. For example, external interference, which can never be entirely eliminated in practice, always reduces the effectiveness of the system. We may, however, arbitrarily assume it to be absent, and consider the limitations which still remain due to the transmission system itself.

In order to lay the groundwork for the more practical applications of these frequency relationships, it will first be necessary to discuss a few somewhat abstract considerations.

<sup>1</sup>Presented at the International Congress of Telegraphy and Telephony, Lake Como, Italy, September 1927.

## THE MEASUREMENT OF INFORMATION

When we speak of the capacity of a system to transmit information we imply some sort of quantitative measure of information. As commonly used, information is a very elastic term, and it will first be necessary to set up for it a more specific meaning as applied to the present discussion. As a starting place for this let us consider what factors are involved in communication; whether conducted by wire, direct speech, writing, or any other method. In the first place, there must be a group of physical symbols, such as words, dots and dashes or the like, which by general agreement convey certain meanings to the parties communicating. In any given communication the sender mentally selects a particular symbol and by some bodily motion, as of his vocal mechanism, causes the attention of the receiver to be directed to that particular symbol. By successive selections a sequence of symbols is brought to the listener's attention. At each selection there are eliminated all of the other symbols which might have been chosen. As the selections proceed more and more possible symbol sequences are eliminated, and we say that the information becomes more precise. For example, in the sentence, "Apples are red," the first word eliminates other kinds of fruit and all other objects in general. The second directs attention to some property or condition of apples, and the third eliminates other possible colors. It does not, however, eliminate possibilities regarding the size of apples, and this further information may be conveyed by subsequent selections.

Inasmuch as the precision of the information depends upon what other symbol sequences might have been chosen it would seem reasonable to hope to find in the number of these sequences the desired quantitative measure of information. The number of symbols available at any one selection obviously varies widely with the type of symbols used, with the particular communicators and with the degree of previous understanding existing between them. For two persons who speak different languages the number of symbols available is negligible as compared with that for persons who speak the same language. It is desirable therefore to eliminate the psychological factors involved and to establish a measure of information in terms of purely physical quantities.

*Elimination of Psychological Factors*

To illustrate how this may be done consider a hand-operated submarine telegraph cable system in which an oscillographic recorder traces the received message on a photosensitive tape. Suppose the

sending operator has at his disposal three positions of a sending key which correspond to applied voltages of the two polarities and to no applied voltage. In making a selection he decides to direct attention to one of the three voltage conditions or symbols by throwing the key to the position corresponding to that symbol. The disturbance transmitted over the cable is then the result of a series of conscious selections. However, a similar sequence of arbitrarily chosen symbols might have been sent by an automatic mechanism which controlled the position of the key in accordance with the results of a series of chance operations such as a ball rolling into one of three pockets.

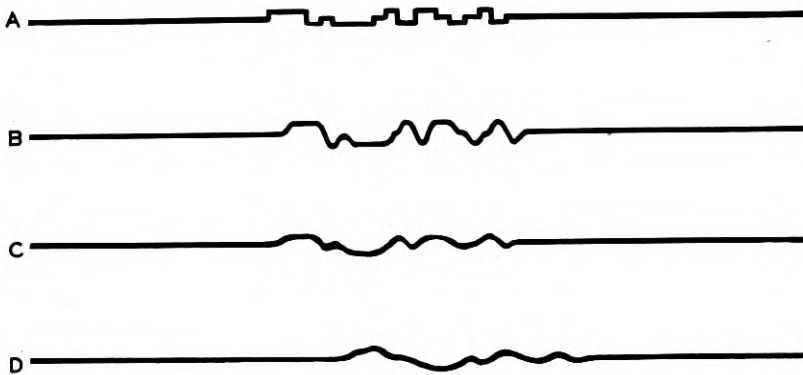

Fig. 1

Owing to the distortion of the cable the results of the various selections as exhibited to the receiver by the recorder trace are not as clearly distinguishable as they were in the positions of the sending key. Fig. 1 shows at *A* the sequence of key positions, and at *B*, *C* and *D* the traces made by the recorder when receiving over an artificial cable of progressively increasing length. For the shortest cable *B* the reconstruction of the original sequence is a simple matter. For the intermediate length *C*, however, more care is needed to distinguish just which key position a particular part of the record represents. In *D* the symbols have become hopelessly indistinguishable. The capacity of a system to transmit a particular sequence of symbols depends upon the possibility of distinguishing at the receiving end between the results of the various selections made at the sending end. The operation of recognizing from the received record the sequence of symbols selected at the sending end may be carried out by those of us who are not familiar with the Morse code. We would do this equally well for a sequence representing a consciously chosen message and for one sent out by the automatic selecting device already referred

to. A trained operator, however, would say that the sequence sent out by the automatic device was not intelligible. The reason for this is that only a limited number of the possible sequences have been assigned meanings common to him and the sending operator. Thus the number of symbols available to the sending operator at certain of his selections is here limited by psychological rather than physical considerations. Other operators using other codes might make other selections. Hence in estimating the capacity of the physical system to transmit information we should ignore the question of interpretation, make each selection perfectly arbitrary, and base our result on the possibility of the receiver's distinguishing the result of selecting any one symbol from that of selecting any other. By this means the psychological factors and their variations are eliminated and it becomes possible to set up a definite quantitative measure of information based on physical considerations alone.

#### *Quantitative Expression for Information*

At each selection there are available three possible symbols. Two successive selections make possible  $3^2$ , or 9, different permutations or symbol sequences. Similarly  $n$  selections make possible  $3^n$  different sequences. Suppose that instead of this system, in which three current values are used, one is provided in which any arbitrary number  $s$  of different current values can be applied to the line and distinguished from each other at the receiving end. Then the number of symbols available at each selection is  $s$  and the number of distinguishable sequences is  $s^n$ .

Consider the case of a printing telegraph system of the Baudot type, in which the operator selects letters or other characters each of which when transmitted consists of a sequence of symbols (usually five in number). We may think of the various current values as primary symbols and the various sequences of these which represent characters as secondary symbols. The selection may then be made at the sending end among either primary or secondary symbols. Let the operator select a sequence of  $n_2$  characters each made up of a sequence of  $n_1$  primary selections. At each selection he will have available as many different secondary symbols as there are different sequences that can result from making  $n_1$  selections from among the  $s$  primary symbols. If we call this number of secondary symbols  $s_2$ , then

$$s_2 = s^{n_1}. \quad (1)$$

For the Baudot System

$$s_2 = 2^5 = 32 \text{ characters.} \quad (2)$$

The number of possible sequences of secondary symbols that can result from  $n_2$  secondary selections is

$$s_2^{n_2} = s^{n_1 n_2}. \quad (3)$$

Now  $n_1 n_2$  is the number  $n$  of selections of primary symbols that would have been necessary to produce the same sequence had there been no mechanism for grouping the primary symbols into secondary symbols. Thus we see that the total number of possible sequences is  $s^n$  regardless of whether or not the primary symbols are grouped for purposes of interpretation.

This number  $s^n$  is then the number of possible sequences which we set out to find in the hope that it could be used as a measure of the information involved. Let us see how well it meets the requirements of such a measure.

For a particular system and mode of operation  $s$  may be assumed to be fixed and the number of selections  $n$  increases as the communication proceeds. Hence with this measure the amount of information transmitted would increase exponentially with the number of selections and the contribution of a single selection to the total information transmitted would progressively increase. Doubtless some such increase does often occur in communication as viewed from the psychological standpoint. For example, the single word "yes" or "no," when coming at the end of a protracted discussion, may have an extraordinarily great significance. However, such cases are the exception rather than the rule. The constant changing of the subject of discussion, and even of the individuals involved, has the effect in practice of confining the cumulative action of this exponential relation to comparatively short periods.

Moreover we are setting up a measure which is to be independent of psychological factors. When we consider a physical transmission system we find no such exponential increase in the facilities necessary for transmitting the results of successive selections. The various primary symbols involved are just as distinguishable at the receiving end for one primary selection as for another. A telegraph system finds one ten-word message no more difficult to transmit than the one which preceded it. A telephone system which transmits speech successfully now will continue to do so as long as the system remains unchanged. In order then for a measure of information to be of practical engineering value it should be of such a nature that the information is proportional to the number of selections. The number of possible sequences is therefore not suitable for use directly as a measure of information.

We may, however, use it as the basis for a derived measure which does meet the practical requirements. To do this we arbitrarily put the amount of information proportional to the number of selections and so choose the factor of proportionality as to make equal amounts of information correspond to equal numbers of possible sequences. For a particular system let the amount of information associated with  $n$  selections be

$$H = Kn, \quad (4)$$

where  $K$  is a constant which depends on the number  $s$  of symbols available at each selection. Take any two systems for which  $s$  has the values  $s_1$  and  $s_2$  and let the corresponding constants be  $K_1$  and  $K_2$ . We then define these constants by the condition that whenever the numbers of selections  $n_1$  and  $n_2$  for the two systems are such that the number of possible sequences is the same for both systems, then the amount of information is also the same for both; that is to say, when

$$s_1^{n_1} = s_2^{n_2}, \quad (5)$$

$$H = K_1 n_1 = K_2 n_2, \quad (6)$$

from which

$$\frac{K_1}{\log s_1} = \frac{K_2}{\log s_2}. \quad (7)$$

This relation will hold for all values of  $s$  only if  $K$  is connected with  $s$  by the relation

$$K = K_0 \log s, \quad (8)$$

where  $K_0$  is the same for all systems. Since  $K_0$  is arbitrary, we may omit it if we make the logarithmic base arbitrary. The particular base selected fixes the size of the unit of information. Putting this value of  $K$  in (4),

$$H = n \log s \quad (9)$$

$$= \log s^n. \quad (10)$$

What we have done then is to take as our practical measure of information the logarithm of the number of possible symbol sequences.

The situation is similar to that involved in measuring the transmission loss due to the insertion of a piece of apparatus in a telephone system. The effect of the insertion is to alter in a certain ratio the power delivered to the receiver. This ratio might be taken as a measure of the loss. It is found more convenient, however, to take the logarithm of the power ratio as a measure of the transmission loss.

If we put  $n$  equal to unity, we see that the information associated with a single selection is the logarithm of the number of symbols available; for example, in the Baudot System referred to above, the number  $s$  of primary symbols or current values is 2 and the information content of one selection is  $\log 2$ ; that of a character which involves 5 selections is  $5 \log 2$ . The same result is obtained if we regard a character as a secondary symbol and take the logarithm of the number of these symbols, that is,  $\log 2^5$ , or  $5 \log 2$ . The information associated with 100 characters will be  $500 \log 2$ . The numerical value of the information will depend upon the system of logarithms used. Increasing the number of current values from 2 to say 10, that is, in the ratio 5, would increase the information content of a given number of selections in the ratio  $\frac{\log 10}{\log 2}$ , or 3.3. Its effect on the rate of transmission will depend upon how the rate of making selections is affected. This will be discussed later.

When, as in the case just considered, the secondary symbols all involve the same number of primary selections, the relations are quite simple. When a telegraph system is used which employs a non-uniform code they are rather more complicated. A difficulty, more apparent than real, arises from the fact that a given number of secondary or character selections may necessitate widely different numbers of primary selections, depending on the particular characters chosen. This would seem to indicate that the values of information deduced from the primary and secondary symbols would be different. It may easily be shown, however, that this does not necessarily follow.

If the sender is at all times free to choose any secondary symbol, he may make all of his selections from among those containing the greatest number of primary symbols. The secondary symbols will then all be of equal length, and, just as for the uniform code, the number of primary symbols will be the product of the number of characters by the maximum number of primary selections per character. If the number of primary selections for a given number of characters is to be kept to some smaller value than this, some restriction must be placed on the freedom of selection of the secondary symbols. Such a restriction is imposed when, in computing the average number of dots per character for a non-uniform code, we take account of the average frequency of occurrence of the various characters in telegraph messages. If this allotted number of dots per character is not to be exceeded in sending a message, the operator must, on the average, refrain from selecting the longer characters more often than their average rate of occurrence. In the language

of the present discussion we would say that for certain of the  $n_2$  secondary selections the value of  $s_2$ , the number of secondary symbols, is so reduced that a summation of the information content over all the characters gives a value equal to that derived from the total number of primary selections involved. This may be written

$$\sum_1^{n_2} \log s_2 = n \log s, \quad (11)$$

where  $n$  is the total number of primary symbols or dot lengths assigned to  $n_2$  characters. This suggests that the primary symbols furnish the most convenient basis for evaluating information.

The discussion so far has dealt largely with telegraphy. When we attempt to extend this idea to other forms of communication certain generalizations need to be made. In speech, for example, we might assume the primary selections to represent the choice of successive words. On that basis  $s$  would represent the number of available words. For the first word of a conversation this would correspond to the number of words in the language. For subsequent selections the number would ordinarily be reduced because subsequent words would have to combine in intelligible fashion with those preceding. Such limitations, however, are limitations of interpretation only and the system would be just as capable of transmitting a communication in which all possible permutations of the words of the language were intelligible. Moreover, a telephone system may be just as capable of transmitting speech in one language as in another. Each word may be spoken in a variety of ways and sung in a still greater variety. This very large amount of information associated with the selection of a single spoken word suggests that the word may better be regarded as a secondary symbol, or sequence of primary symbols. Let us see where this point of view leads us.

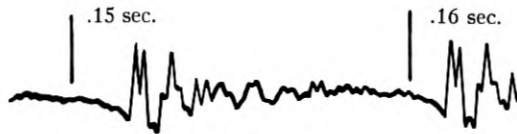

Fig. 2

The actual physical embodiment of the word consists of an acoustic or electrical disturbance which may be expressed as a magnitude-time function as in Fig. 2, which shows an oscillographic record of a speech sound. Such functions are also typical of other modes of communication, as will be discussed in more detail later. We have then to examine the ability of such a continuous function to convey informa-



tion. Obviously over any given time interval the magnitude may vary in accordance with an infinite number of such functions. This would mean an infinite number of possible secondary symbols, and hence an infinite amount of information. In practice, however, the information contained is finite for the reason that the sender is unable to control the form of the function with complete accuracy, and any distortion of its form tends to cause it to be confused with some other function.

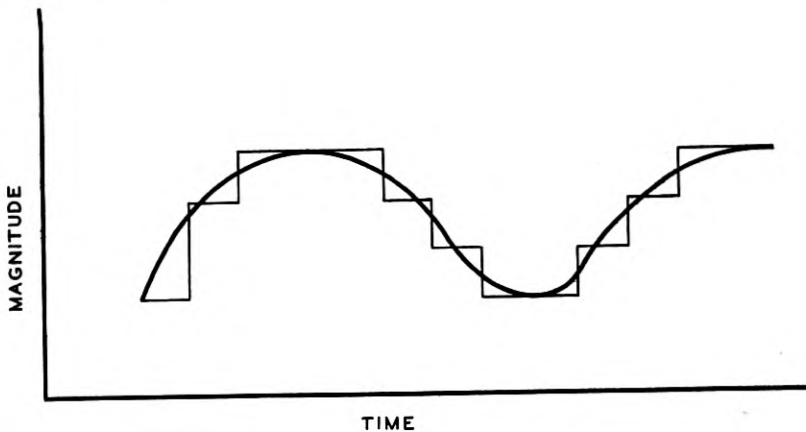

Fig. 3

A continuous curve may be thought of as the limit approached by a curve made up of successive steps, as shown in Fig. 3, when the interval between the steps is made infinitesimal. An imperfectly defined curve may then be thought of as one in which the interval between the steps is finite. The steps then represent primary selections. The number of selections in a finite time is finite. Also the change made at each step is to be thought of as limited to one of a finite number of values. This means that the number of available symbols is kept finite. If this were not the case, the curve would be defined with complete exactness at each of the steps, which would mean that an observation made at any one step would offer the possibility of distinguishing among an infinite number of possible values. The following illustration may serve to bring out the relation between the discrete selections and the corresponding continuous curve. We may think of a bicycle equipped with a peculiar type of steering device which permits the rider to set the front wheel in only a limited number of fixed positions. On such a machine he attempts to ride in such a manner that the front wheel shall follow an irregularly

curved line. The accuracy with which he is able to accomplish this will depend upon how far he goes between adjustments of the steering mechanism and upon the number of positions in which he is able to set it.

By this more or less artificial device the continuous magnitude-time function as used in telephony is made subject to the same type of treatment as the succession of discrete selections involved in telegraphy.

#### RATE OF COMMUNICATION

So far then we have derived an expression for the information content of the symbols at the sending end and have shown that we may evaluate a transmission system in terms of how well the wave as received over it permits distinguishing between the various possible symbols which are available for each selection. Let us consider next how the distortion of the system limits the rate of selection for which these distinctions between symbols may be made with certainty.

#### *Limitation by Intersymbol Interference*

We shall assume the system to be free from external interference and to be such that its current-voltage relations are linear. In such a system the form of the transmitted wave may be altered due to the storage of energy in reactive elements such as inductances and capacities, and its subsequent release. To evaluate the effect of such distortion in making it impossible to determine correctly which one of the available symbols had been selected, we may think of this distortion in terms of "intersymbol interference." In order to determine the result of any one selection an observation is made at such time that the disturbance resulting from that selection has its maximum effect at the receiving end. Superposed on this effect there will be a disturbance which is the resultant of the effects of all the other symbols as prolonged by the storage of energy in the system. This resultant superposed disturbance is what is meant by intersymbol interference. Obviously if this disturbance is greater than half the difference between the effects produced by two of the values available for selection at the sending end, the wave resulting from one of those values will be taken as representing the other. Thus a criterion for successful transmission is that in no case shall the intersymbol interference exceed half the difference between the values of the wave at the receiving end which correspond to the selection of different values at the sending end.

Obviously the magnitude of the intersymbol interference which affects any one symbol depends on the particular sequence of symbols

which precedes it. However, it is always possible for the sending operator so to make his selections that any one selection is preceded by that sequence which causes the maximum possible interference. Hence every selection must be separated from those preceding it by at least a certain interval which is determined by the worst condition of interference. If longer intervals than this are used, the transmission is unnecessarily retarded. Hence to secure the maximum rate of transmission the selection should be made at a constant rate. It might appear at first sight that the selections could be made at shorter intervals near the beginning of the message where there are fewer preceding symbols to cause interference. This assumes, however, that the system has previously been idle. Actually the previous user may have finished his message with that sequence which causes maximum intersymbol interference.

#### *Relation to Damping Constant*

How the intersymbol interference limits the rate of communication over the system depends upon the properties of the particular system. The relations involved are very complex, and no attempt will be made to obtain a complete or rigorous solution of the problem. We may, however, by treating a very simple case, arrive at an interesting relation. Consider a resistance in series with a capacity. Let one terminal be connected to one terminal of a battery made up of a very large number of cells of negligible internal resistance. Let the other terminal be connected to the battery through a switch. This switch is so arranged that by pressing any one of  $s$  keys the circuit terminal may be moved up along the battery by any number of cells from zero to  $s - 1$ . Let the sending operator make selections among the  $s$  keys at regular intervals, and let the receiving operator observe the current through the resistance. The most advantageous time for this observation is at the instant <sup>1</sup> at which the key is pressed, since the current has then its maximum value. The finest distinction to be made by the receiving operator is that between two currents which result from battery changes that differ from each other by one cell. The difference between two such currents is equal to the initial current which flows when one cell is introduced into the circuit. This is

$$i_s = \frac{E}{R}, \quad (12)$$

where  $E$  is the electromotive force of one cell and  $R$  the resistance of the circuit.

<sup>1</sup>Results identical with those which follow may be obtained if he observes the average current over a period beginning when the key is pressed and lasting not longer than the interval between selections.

The intersymbol interference will consist of currents resulting from all of the preceding symbols. The contribution of any one symbol will depend on its size, that is, on the number of added cells it represents, and on how long it preceded the symbol in question. For a given rate of selection the resultant of these contributions will be a maximum for that particular sequence of symbols for which at every selection preceding the one in question the operator had selected the largest

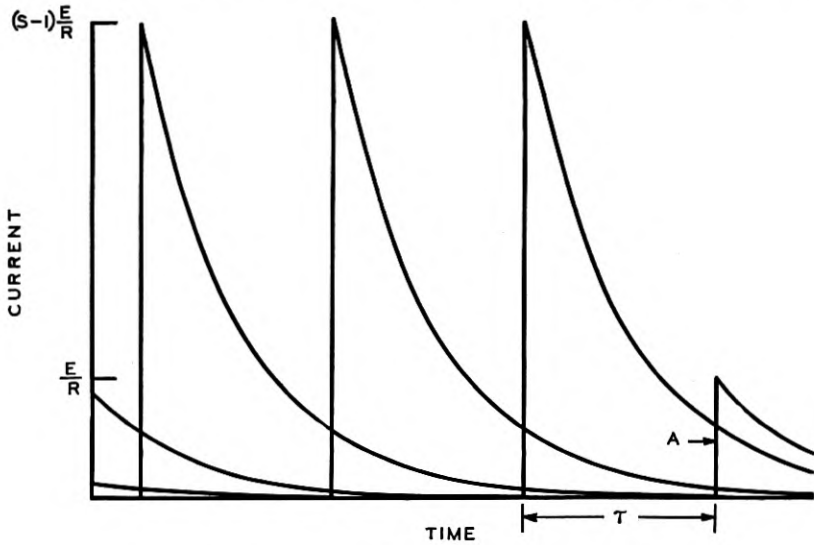

Fig. 4

possible symbol, that is, a voltage change of  $(s - 1)E$ . The form of the received current is then as shown on Fig. 4, where  $A$  represents the disturbed symbol. The curves are drawn for  $s$  equal to five. The current resulting from one such change occurring at time zero is

$$i = (s - 1) \frac{E}{R} e^{-\alpha t}, \quad (13)$$

where the damping constant,

$$\alpha = \frac{1}{RC}. \quad (14)$$

If the interval between selections is  $\tau$ , then the time during which any one interfering current is damped out before it makes its contribution to the interference with the disturbed symbol is  $q\tau$  where  $q$  is the number of selections by which it precedes the disturbed symbol. The magnitude of its contribution is therefore from (13)

$$i_q = (s - 1) \frac{E}{R} e^{-q\alpha\tau}. \quad (15)$$

If we sum this expression for all values of  $q$  from one to infinity, we get the combined effect of all the preceding symbols, that is, the intersymbol interference. Calling this  $i_i$ ,

$$i_i = (s - 1) \frac{E}{R} \sum_{q=1}^{q=\infty} e^{-q\alpha\tau} \quad (16)$$

$$= (s - 1) \frac{E}{R} \frac{1}{e^{\alpha\tau} - 1}. \quad (17)$$

This obviously increases as the interval  $\tau$  between selections is decreased. If this interval is made small enough, the intersymbol interference may cause confusion between symbols. Since the interference is here always of one sign it can cause confusion only when it becomes as large as the minimum difference,  $i_s$ , between symbols. Placing these two quantities equal, we get from (12) and (17) as the minimum permissible value of  $\tau$ ,

$$\tau_1 = \frac{\log s}{\alpha}. \quad (18)$$

The maximum number,  $n$ , of selections that may be made in  $t$  seconds is given by

$$n = \frac{t}{\tau_1}. \quad (19)$$

From (18) and (19)

$$\frac{n \log s}{t} = \alpha. \quad (20)$$

Here the numerator is, in accordance with our measure of information, the amount of information contained in  $n$  selections, so the left-hand member is the information per unit time or the rate of communication. This is equal to the damping constant of the circuit. We therefore conclude that for this particular case the possible rate of communication is fixed solely by the damping constant of the circuit and is independent of the number of symbols available at each selection. It is, of course, true that the larger this number the more susceptible will the system be to the effects of external interference.

Probably the practical system which most nearly approaches this idealized one is the non-loaded submarine telegraph cable when operated at such low speeds that its inductance may be neglected. It is of considerable historical interest to note that Lord Kelvin's

study of such cables led him to the conclusion that the extent to which the cable limited the dotting speed was given by  $KR$ , that is, the product of the total capacity and total resistance. Had he stated his results in terms of permissible speed he would have had the reciprocal of this quantity, which corresponds very closely to the damping constant which we arrived at as a measure of the rate of communication. It should be noted, however, that his consideration was limited to a fixed number of symbols, and did not involve the relation here developed between this number and the dotting speed.

The more complicated systems are similar to the simple case just treated in that the contribution of any one symbol,  $a$ , to the interference with any other symbol,  $b$ , is determined by the free vibration of the system which results from the change applied to it in the production of symbol  $a$ . This free vibration, instead of being expressible by a single exponential function as in the case just considered, may be the resultant of a large number of more or less damped oscillatory components corresponding to the various natural modes of the system. The total interference with any one symbol is the resultant of a series of these complex vibrations, one for each interfering symbol. The instantaneous values of the various components of the interference are so dependent upon their phases at the particular instant of observation that it is difficult to draw any general conclusions as to the magnitude of the total interference. It is equally difficult therefore to draw any general conclusions as to the relation between the rate of transmission over a particular circuit and the number of available symbols.

#### *Relation to Storage of Energy*

Even though for any one system there exists a number of available symbols for which the rate of communication is greater than for any other number, it is still possible to make a generalization with respect to the storage of energy in the system and its effect on the rate of transmission which is of considerable practical importance.

Each of the natural modes of vibration of a linear system has the general form

$$i = Ae^{-\alpha t} \cos (\omega t - \theta), \quad (21)$$

where the natural frequency  $\omega$  and damping constant  $\alpha$  are characteristic of the system and the amplitude  $A$  and phase  $\theta$  depend on the conditions of excitation. Wherever the time appears in this expression it is multiplied by either the damping constant  $\alpha$  or the frequency  $\omega$ . Consequently if both  $\alpha$  and  $\omega$  be changed, say in the ratio  $k$ , the instantaneous value of this mode of vibration in the new system will

be the same at a time  $t/k$  that it was at time  $t$  in the original system. If the same change is made in the damping constant and frequency of each one of the modes of free vibration, their resultant, or the wave set up by any one symbol, will also be so changed that any particular value occurs at time  $t/k$  instead of  $t$ . Suppose also that the interval  $\tau$  between selections be changed to  $\tau/k$ . Then any two symbols originally separated by a time  $t_1$  will be separated by  $t_1/k$ . The value of the interfering wave at the time  $t_1/k$  when the disturbed symbol occurs will be the same as it was at the corresponding time  $t_1$  when it occurred in the original system. Hence the contribution of this wave to the intersymbol interference is unchanged. Since this relation holds for all of the interfering symbols, the total intersymbol interference remains unchanged, and so the number of possible symbols that may be distinguished is unaltered. The rate of making selections is changed in the ratio  $k$ , and hence the maximum rate of communication is changed in the same ratio as the damping constants and natural frequencies.

Now let us consider what physical changes must be made in the system to bring about the assumed changes in the damping constants and natural frequencies of the various modes. Take the simple case of an inductance, capacity and resistance connected in series. Here we have the well-known relations

$$\alpha = \frac{R}{2L}, \quad (22)$$

$$\omega = \sqrt{\frac{1}{LC} - \left(\frac{R}{2L}\right)^2}. \quad (23)$$

If  $R$  remains fixed and  $L$  is changed to  $L/k$ ,  $\alpha$  becomes  $k\alpha$ . If, in addition,  $C$  is changed to  $C/k$ ,  $\omega$  becomes  $k\omega$ . What we have done is to leave the energy-dissipating element,  $R$ , unchanged and change both the energy-storing elements,  $L$  and  $C$ , in the inverse ratio in which the rate of communication is changed. For more complicated systems the expressions for  $\alpha$  and  $\omega$  are correspondingly complicated. In every case, however, it will be found that if all of the dissipating and storing elements are treated as in the simple case just considered all of the damping constants and natural frequencies will be similarly altered. Where mechanical systems are concerned we are to substitute for electrical resistances their mechanical equivalents, and for inductances and capacities, inertias and compliances. This generalization that a proportionate change in all of the energy-storing elements of the system with no accompanying change in the dissipating elements

produces an inverse change in the possible rate of transmission will be used later.

#### STEADY STATE AND TRANSIENT VIEWPOINTS

So far very little has been said about frequencies, and in fact nothing in the sense of the term in which our results are to be stated. By this I mean the use of the word "frequency" as applied to an alternating current or other sinusoidal disturbance in the so-called "steady state." The steady state viewpoint has proven very useful in certain branches of communication, notably telephony. During the past few years much progress has been made in establishing relations between steady state phenomena and what might be called transient phenomena of the sort which we have just been discussing. Before proceeding with the main argument I shall attempt to review in non-mathematical language the relationship of these two points of view to each other.

As its name implies, steady state analysis deals with continuing conditions. If a sustained sinusoidal electromotive force be applied at the sending end of a system, a sinusoidal current of the same frequency flows at the receiving end. The vector ratio of the received current to the sending electromotive force is known as the transfer admittance of the system at that frequency. It is assumed ideally that the driving electromotive force has been acting from the beginning of time, and practically that it has been acting so long that the results are indistinguishable from what would be obtained in the ideal case. The absolute magnitude of the transfer admittance gives the amplitude of the received current which results from a driving electromotive force of unit amplitude, and its phase angle gives the phase of the current relative to that of the driving electromotive force. The curves which represent this amplitude and phase as functions of the frequency constitute a steady state description of the transmission properties of the system. For a system which is free from energy storage such as a circuit containing resistances only, the transfer admittance is the same for all frequencies. The amplitude-frequency curve is a horizontal line whose position depends on the magnitude and arrangement of the resistances while the phase-frequency curve coincides with the frequency axis. The storage of energy in the system and its subsequent release cause the admittance-frequency curves to take other forms. If the only storage is that which occurs in a dissipationless medium, a condition which is approximated when a sound wave traverses the open air, the only effect is to make the phase-frequency curve a straight line passing through the origin and having a slope proportional to the time of transmission through the



medium. Other forms of energy storage give to the admittance-frequency curves shapes which are characteristic of the particular system. This alteration of these curves is commonly spoken of as frequency distortion. Their form may in most cases be deduced fairly readily from the values of the energy-storing and energy-dissipating elements of the system. This fact makes such a description of the system particularly useful for design purposes.

This physical description is, of course, useful as a criterion of performance only in so far as it can be related to the satisfactoriness with which the system performs its primary function of transmitting information. In the case of telephony it has been found practical to establish such a correlation by purely empirical means. Until fairly recently adequate results have been obtained by considering the amplitude-frequency function only. With the use of lines of increasing length and with increasingly severe standards of performance it is coming to be necessary to take account of the phase-frequency function as well.

In attempting to extend this method of treatment to telegraphy it was not found desirable to establish the correlation between steady state properties and overall performance by purely empirical methods. One reason for this was that a considerable fund of information has been accumulated with reference to the correlation between the overall performance and the transient properties of the system. A correlation therefore between steady state and transient properties would offer a means of bringing this empirical information to bear on the design of apparatus and systems on a steady state basis. For bridging this gap between steady state and transient phenomena there was already available one arch in the form of the Fourier Integral. This integral may be thought of as a mathematical fiction for expressing a transient phenomenon in terms of steady state phenomena. It permits the determination, for any magnitude-time function, of the relative amplitudes and the phases of an infinite succession of sustained sinusoids whose resultant is at any instant equal to the magnitude of the function at that instant. The amplitudes of the sinusoids are infinitesimal and the frequencies of successive components differ from each other by infinitesimal increments. The relative amplitudes and the phases of these components expressed as functions of the frequency constitute a steady state description of the magnitude-time function.

Suppose then we have given the magnitude-time function representing an impressed transient driving force and wish to obtain the magnitude-time function of the received current. We deduce the steady state description of the driving force, modify the amplitudes

and phases of its various components in accordance with the known admittance-frequency functions of the system, and obtain the amplitude- and phase-frequency curves which represent the steady state description of the received current. From these we deduce the magnitude-time function representing the received wave.

A slightly different point of view, however, leads to results which fit in better with our method of measuring information. We may apply the method just outlined to deduce the magnitude-time function which results when the applied wave consists merely of an instantaneous change in a steadily applied electromotive force from one value which may be zero to another value differing from it by one unit. The resulting wave form is characteristic of the system and has been called by J. R. Carson its indicial admittance. We may think of this as a transient description of the system. If we regard a continuously varying applied wave as being formed by a succession of steps, we may think of the received wave at any instant as being the resultant of a series of waves each corresponding to a single step. The wave form of each is that of the indicial admittance, its magnitude is proportional to the size of the particular step and its location on the time axis is determined by the time at which the particular step or selection was made. When the steps are made infinitely close together, a summation of these components becomes a process of integration whereby the resulting magnitude-time function may be accurately determined from the applied function. For the incompletely determined waves involved in communication where the separation of the steps is finite a corresponding summation of the indicial admittance curves resulting from all selections other than the one being observed gives a measure of the intersymbol interference.

Still another viewpoint, while it has, perhaps, less direct application to the present problem, is of interest in that it brings out the significance from the transient standpoint of the steady state characteristics of the system. If we take as the applied wave a mathematical impulse, that is to say, a disturbance which lasts for an infinitesimal time, we find that the amplitudes of its steady state components are the same for all frequencies. If the impulse occurs at zero time the phase-frequency curve coincides with the axis of frequency, and if not it is a straight line through the origin whose slope is proportional to the time of occurrence. In order to find the current resulting from such an impulse applied at zero time we multiply the constant amplitude-frequency curve of its steady state components by the amplitude-frequency curve of the system and obtain as the amplitude-frequency curve of the received wave a function of the same form as the ampli-

tude-frequency curve of the system. Similarly we add to the phase-frequency curve of the impressed wave, which is zero at all frequencies, the phase-frequency curve of the system and obtain for the received wave a phase-frequency curve identical with that of the system. The corresponding magnitude-time function gives the instantaneous value of the received current resulting from the impressed impulse. Thus we see that the steady state transfer admittance of a system is identical with the steady state description of the wave which is received over the system when it is subjected to an impulsive driving force. Once the form of this received wave is known the received wave resulting from any applied wave may be deduced by assuming the applied wave to consist of an infinite succession of impulses infinitesimally close together whose magnitudes vary with time in accordance with the given magnitude-time function. Methods for integrating the effect of this infinite succession of responses to impulses so as to obtain the transmitted wave have been developed.

From this review it is evident that the so-called frequency distortion and transient distortion are merely two methods of describing the same changes in wave form which result from the storage of energy in parts of the transmission system.

#### SIGNIFICANCE OF PRODUCT OF FREQUENCY-RANGE BY TIME

Distortion of this sort with its accompanying intersymbol interference may be unavoidable in the design of the system, or it may be deliberately introduced. The use of electrical filters to obtain multi-

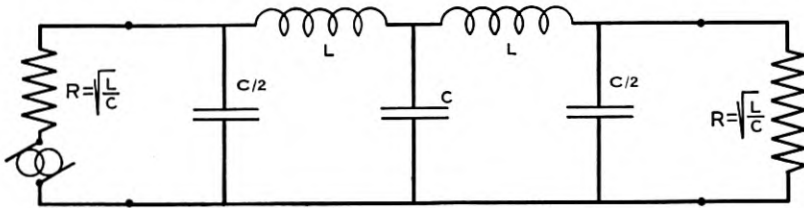

Fig. 5

plex operation, as in carrier systems, is an example of its deliberate use. Consider the effect of introducing a low pass filter, as shown in Fig. 5, into an otherwise distortionless transmission system. If the impedances of the circuits to which the filter is connected are approximately pure resistances of the values indicated in the figure, steady state frequencies above a critical value known as the cut-off frequency are so reduced as to be made practically negligible, while frequencies below this value are transmitted with very little distortion. The

transient distortion corresponding to this steady state distortion must result in intersymbol interference; hence it places a limit on the rate at which distinguishable symbols may be selected, that is, on the rate of transmitting information.

It does not necessarily follow, however, that the rate of transmission with such a system is the maximum attainable for systems whose transmission is limited to the frequency-range determined by the cut-off of the filter. It is conceivable that by the introduction of additional energy-storing elements the transfer admittance curves for frequencies within the transmitted range may be altered in such a way as to reduce the total intersymbol interference and so permit an increased rate of selection. The maximum rate of transmission of information which can be secured by such methods represents the maximum rate corresponding to that range of frequencies.

Let us consider next the way in which this possible rate of transmission varies with the cut-off frequency of the filter. The theory of filter design teaches us that the cut-off frequency may be changed without altering the required terminating resistances if we change all inductances and capacities in the inverse ratio of the desired change in cut-off frequency. Suppose this change in energy-storing elements, with no change in dissipative elements, is made not only for the filter but for the entire system. We have already seen that such a modification changes the rate of transmission in the inverse ratio of the change in energy-storing elements; that is, in the direct ratio of the change in cut-off frequency in the present case. That the new rate is the maximum for the new frequency-range is evident when we consider that the transfer admittance curves of the new system bear the same relation to its cut-off frequency as held in the original system.

This brings us to the important conclusion that the maximum rate at which information may be transmitted over a system whose transmission is limited to frequencies lying in a restricted range is proportional to the extent of this frequency-range. From this it follows that *the total amount of information which may be transmitted over such a system is proportional to the product of the frequency-range which it transmits by the time during which it is available for the transmission.* This product of transmitted frequency-range by time available is the quantitative criterion for comparing transmission systems to which I referred at the beginning of this discussion. The significance of this criterion can perhaps best be brought out by applying it to some typical situations.

*Fitting the Messages to the Lines*

To facilitate this discussion it seems desirable to introduce and explain a few terms. For transmitting a sequence of symbols various sorts of media may be available, such as a wire line, an air path, as in direct speech, or the ether, as in radio communication. For convenience we shall group all of these under the general name of "line." Each such medium is generally characterized by a range of frequencies over which transmission may be carried on with reasonable freedom from distortion and external interference. This will be called the "line-frequency-range." Similarly the symbol sequences corresponding to the various modes of communication such as telegraph and telephone, will be designated as "messages." Each of these will, in general, be characterized by a "message frequency-range." This may be thought of as being determined by the frequency-range of that line which will just transmit the type of message satisfactorily, or we may think of it as that part of the frequency scale within which it is necessary to preserve the steady state components of the message wave in order to permit distinguishing the various symbols as they appear in the transmitted wave.

When we set up practical communication systems it is often found that the message-frequency-range and the line-frequency-range do not coincide either in magnitude or in position on the frequency scale. If then we are to make use of the full transmission capacity of the line, or lines, we must introduce means for altering the frequency-ranges required by the messages. Two such means are available, which together offer the theoretical possibility of accomplishing the desired end of making the message-frequency-ranges fit the available line-frequency-ranges.

The process of modulation so widely used in radio systems and in carrier transmission over wires makes it possible to shift the frequency-range of any message to a new location on the frequency scale without altering the width of the range. This follows at once from the well-known fact that the steady state description of the wave which results from the modulation of a carrier wave by a symbol wave includes a pair of side-bands in each of which there is a component corresponding to each steady state component of the original wave. The frequency of each component of the side-band differs from the carrier frequency by the frequency of the corresponding component of the symbol wave. The elimination of one of these side-bands results in a wave which retains the information embodied in the original symbol wave and occupies a frequency-range of the same width

as the original but displaced to a new position on the frequency scale determined by the carrier frequency. The interval which must be allowed between these displaced messages in carrier operation is determined by the selectivity of the filters which are available for their separation. The imperfection of practical filters tends to make the message-frequency-range which may be transmitted less than the line-frequency-range which the messages occupy. The time for which the line is used to transmit a given amount of information is the same as the duration of the message conveying it. Thus the sum of the products of frequency-range by time for the messages is always equal to or less than the corresponding sum of the products of line-frequency-range by time.

In case the line-range available is less than the message-range, as would be the case in attempting to transmit speech over a submarine telegraph cable, it is still possible, if enough lines are available, to accomplish the transmission. The message wave may, by suitable filters, be separated into a plurality of waves each made up of those components of the original which lie in a portion of the message-range which is no wider than the line-range. Each of these portions of the message may then, by modulation, be transferred down to the frequency-range of the line and each transmitted over a separate line. A reversal of the process at the receiving end restores the original message.

While it is theoretically possible, if enough messages and lines are available, to fit the message-ranges to the line-ranges by modulation and subdivision of message-frequency-ranges, it is not always practical. It is sometimes more desirable to utilize the second method of transformation already referred to. This consists in making a record of the symbol sequence and reproducing it at a different speed in order to secure the wave used in transmission. The tape used in sending telegraph messages may be used in this manner. Here the symbol sequence represents a series of selections of secondary symbols. These selections are made at a rate at which it is convenient for the operator to manipulate the keys of the tape-punching machine. The electric wave impressed on the line by the holes in the tape represents a corresponding sequence of primary symbols. The rate at which these are applied to the line is determined by the velocity of the tape in reproduction. Since for a given number of different primary symbols the frequency-range required is proportional to the rate of making selections, it is obvious that the frequency-range of the message as reproduced from the tape may be made to fit whatever line-frequency-range is available, at least so far as width of the range is concerned.

Modulation may, of course, be necessary to bring the message-range to the proper part of the frequency scale. The time required for the reproduction of a message involving a given number of selections varies inversely as the velocity of the tape in reproduction, and therefore also inversely as the frequency-range required by the reproduced sequence. Thus the product of frequency-range by time for the reproduced message, which is also the required product for the line, is independent of the rate of reproduction, and depends only on the information content of the message in its original form.

In case the available line range calls for reproduction at a considerably increased speed a single operator cannot conveniently keep the sending apparatus supplied with tape. Multiplex operation may then be employed in which the line is used by the various operators in rotation. It is interesting to note that this distributor type of multiplex utilizes the frequency-range of the line as efficiently as would a single printing telegraph channel using the same dotting speed, and more efficiently than does the carrier multiplex method. By the distributor method each operator utilizes the full frequency-range of the line during the time allotted to him and there is no time wasted in separating the channels from each other. In the carrier multiplex, on the other hand, while each operator uses the line for the full time it is available, a part of the frequency-range is wasted in separating the channels because of the departure of physical filters from the ideal. Also both side-bands are generally transmitted in telegraphy, in which case a still greater line-frequency-range is required for the carrier method.

If the message is produced originally as a continuous time function, as in speech, the same method may be used by substituting for the tape a phonographic record. That here also the required line-frequency-range varies directly as the speed of reproduction and inversely as the time of reproduction is obvious when we consider an imperfectly defined wave as equivalent to a succession of finite steps or a perfectly defined wave as a succession of infinitesimal steps. From the steady state viewpoint, all of the component frequencies are altered in the ratio of the reproducing and recording velocities, and hence the range which they occupy is altered in the same ratio.

Thus we see that for all forms of communication which are carried on by means of magnitude-time functions an upper limit to the amount of information which may be transmitted is set by the sum for the various available lines of the product of the line-frequency-range of each by the time during which it is available for use.

*Application to Picture Transmission*

However, if in order to utilize fully the line-frequency-range we introduce the process of recording, our message no longer exists throughout its transmission as a magnitude-*time* function, but becomes a magnitude-*space* function. Also in the case of picture transmission the information to be transmitted exists originally as a magnitude-space function. We may, of course, regard either a phonograph record or a picture as a secondary symbol, and say that the information transmitted consists of the sender's selection of a particular record

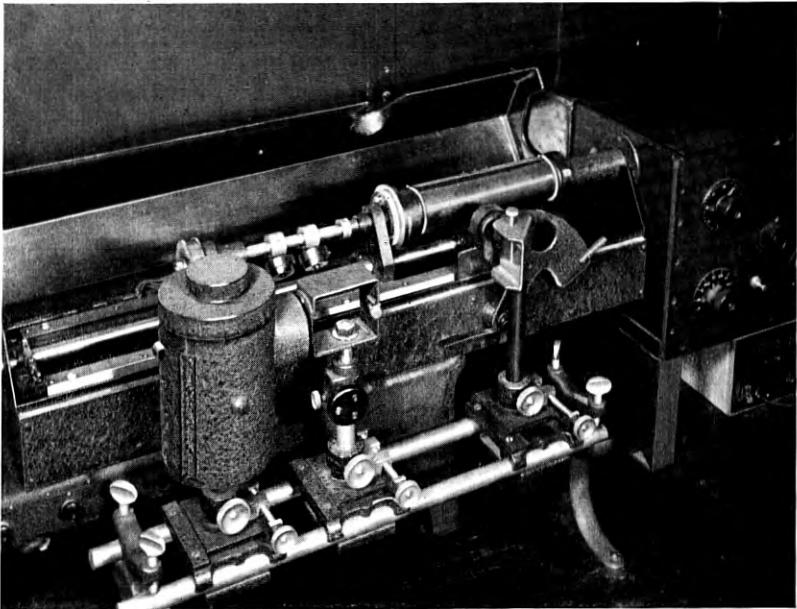

Fig. 6

or picture to which he desires to call the attention of the receiver. The information involved in such a selection is then measured by the logarithm of the number of different records or pictures which he might have selected. The problem then is to analyze the magnitude-space function which constitutes the secondary symbol into a sequence of primary symbols. This may be done in a manner similar to that already employed for magnitude-time functions.

The case of a phonograph record is directly analogous to those already considered in that the magnitude is a function of the distance along a single line. This distance is therefore analogous to time and



the information content may be found exactly as it would be from the pressure-time curve of the air vibration. In a picture, on the other hand, two dimensions are involved. We may, however, reduce this to a single dimension by dividing the area into a succession of strips of uniform width, as is done by the scanning aperture which is used in the electrical transmission of pictures. Figure 6 shows this scanning mechanism. The picture is mounted on a revolving cylinder which at each revolution is advanced by a spiral screw by the width of the desired strip. This scanning operation is equivalent to making an arbitrary number of selections in a direction at right angles to the strips. The number of these determines the degree of resolution in that direction. If the resolution is to be the same in both directions, we may consider the magnitude-distance function along the strip to be made up of the same number of selections per unit length. The total number of primary selections will then be equal to the number of elementary squares into which the picture is thus divided. These elementary areas differ from each other in their average intensity. The number of different intensities which may be correctly distinguished from each other in each elementary area of the reproduced picture represents the number of primary symbols available at each selection. Hence the total information content of the picture is given by the number of elementary areas times the logarithm of the number of distinguishable intensities.

In an actual picture the intensity as a function of distance along what we may call the line of scanning is a definite continuous function of the distance, but if there is any blurring of the picture as reproduced this function loses some of its definiteness. This blurring may be thought of as a form of intersymbol interference, since the intensity at one point in the distorted picture depends upon the original intensity at neighboring points. The similarity of this type of distortion to the intersymbol interference occurring in magnitude-time functions as a result of energy storage suggests that the picture distortion may also be treated on a steady state basis. We may think of the magnitude-distance function representing the picture as being analyzed into sustained components in each of which the intensity is a sinusoidal function of the distance. We may visualize such a single component in terms of the mechanism employed for recording and reproducing speech by means of a motion picture film. The intensity of the light transmitted by the developed film varies along its length in accordance with the magnitude of the electric wave resulting from the speech sound. If the speech wave be replaced by a sustained alternating current, there will result on the film a sinusoidal variation

in intensity with distance. The distance between successive maxima, or the wave-length, will vary inversely with the frequency of the applied alternating current. Figure 7 shows such a record of a speech wave and of sinusoidal waves of two different frequencies. The variations are superposed on a uniform component so as to avoid the difficulty of negative light.

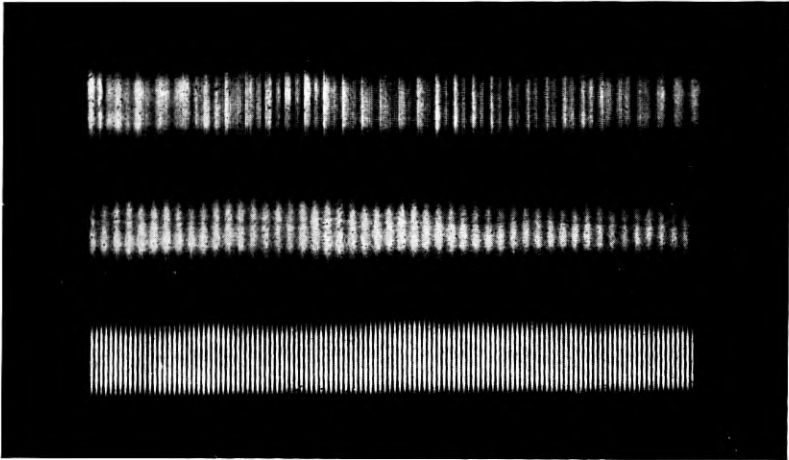

Fig. 7

The frequency of an alternating current is defined as the number of complete cycles which it executes in unit time. The analog of frequency in the corresponding alternating space wave is therefore the number of complete cycles or waves executed in unit distance. This is the reciprocal of the wave-length just as the frequency is the reciprocal of the period. Inasmuch as the term wave-number has been used by physicists to designate the reciprocal of wave-length, I shall use that term to designate the quantity corresponding to frequency in the steady state analysis of a magnitude-distance function. The distortion suffered by a picture in transmission may therefore be expressed in terms of the steady state amplitude and phase distortions as functions of wave number. Just as the transmission of a given amount of information requires a given product of frequency-range by time, so the preservation of a given amount of information in a picture requires a corresponding product of wave-number-range by distance. To illustrate, consider the effect of enlarging a picture without changing its detail or fineness of intensity discrimination. Suppose the enlargement to be made in two steps. In the first the

horizontal dimension is increased and the vertical dimension left unchanged. Let the scanning strips run in a horizontal direction. If we consider the magnitude-distance function representing the variation along any horizontal strip, the effect of the enlargement is to increase the wave-length of each steady state component in the ratio of the increase in linear dimension. The wave number of each component is therefore decreased in this ratio, and so the wave-number-range is also decreased in the same ratio. The product of the wave-number-range by the length of the strip remains constant, as does also the sum of the products for all of the strips, that is, for the entire picture. The second step consists in increasing the vertical dimensions with the horizontal dimensions fixed. By considering the scanning strips as running vertically in this case it follows at once that the product of wave-number-range by distance remains constant during this operation also.

Since the information transmitted is measured by the product of frequency-range by time when it is in electrical form and by the product of wave-number-range by distance when it is in graphic form, we should expect that when a record such as a picture or phonographic record is converted into an electric current, or vice versa, the corresponding products for the two should be equal regardless of the velocity of reproduction. That this is true may be easily shown. Let  $v$  be the velocity with which the recorder or reproducer is moved relative to the record. Let the wave-number-range of the record extend between the limits  $w_1$  and  $w_2$ . If we consider any one component of the distance function which has a wave-length  $\lambda$ , the time required for the reproducer to traverse a complete cycle is  $\lambda/v$ , or  $1/vw$ . This is the period of the resulting component of the time wave, so the frequency  $f$  of the latter is the reciprocal of this, or  $vw$ . The frequency-range is therefore given by

$$f_2 - f_1 = v(w_2 - w_1). \quad (24)$$

If  $D$  is the length of the record, then the time required to reproduce it is

$$T = \frac{D}{v}, \quad (25)$$

from which

$$(f_2 - f_1)T = (w_2 - w_1)D. \quad (26)$$

This shows that the two products are numerically equal regardless of the velocity.

*Application to Television*

As our first illustration was drawn from one of the earliest forms of electrical communication, the submarine cable, it may be fitting to use as the last what is probably the newest form, namely, television. Here the information to be transmitted exists originally in the form of a magnitude which is a continuous function of both space and time. In order to determine what line facilities are needed to maintain a constant view of the distant scene we wish to determine the line-frequency-range required. This we know to be measured by the total information to be transmitted per unit time.

In the systems of television which have been most successful the method has been similar to that of the motion picture in that a succession of separate representations of the scene is placed before the observer and the persistence of vision is relied upon to convert the intermittent illumination into an apparently continuous variation with time. The first step in determining the required frequency-range is to determine the information content of a single one of the successive views of the scene. This may be determined exactly as for a still picture. The required degree of resolution into elementary areas and the required accuracy of reproduction of the intensity within each area determine an effective number of selections and a number of primary symbols available at each selection. These determine a minimum product of wave-number-range by distance. This in turn is equal to the product of line-frequency-range by time which must be available for the transmission of a single view of the scene. The time available is set by the fact that flicker becomes objectionable if the interval between successive pictures exceeds about one sixteenth of a second. Thus we have only to divide the product of wave-number-range by distance for a single picture by one sixteenth to obtain the line-frequency-range necessary to maintain a continuous view.

In the result just obtained an important factor is the interval necessary to prevent flicker. The tendency to flicker is, however, the result of the particular method of transmission. If it were practical to eliminate this factor, the required frequency-range might be somewhat different. We might, for example, imagine a system more like that of direct vision in which the magnitude-time function representing the intensity variation of each individual elementary area is transmitted over an independent line and used to produce a continuously varying illumination of the corresponding area of the reproduced scene. The frequency-range required on any one of these individual

lines would then be determined by the extent to which the intensity at any one instant could be permitted to be distorted by the inter-symbol interference from the light intensities at neighboring times; that is to say, the frequency-range necessary would depend upon a blurring in time analogous to the blurring in space which is used to set the wave-number-range for a single picture. It seems probable that the total frequency-range required would be somewhat less for such a system than for one in which flicker is a factor.

#### CONCLUSION

At the opening of this discussion I proposed to set up a quantitative measure for comparing the capacities of various systems to transmit information. This measure has been shown to be the product of the width of the frequency-range over which steady state alternating currents are transmitted with sensibly uniform efficiency and the time during which the system is available. While the most convenient method of operation does not always make the fullest use of the frequency-range of the line, as is the case in double side-band transmission, a comparison of the frequency-range actually used with that which would be required on the basis of the actual information content of the material transmitted gives an idea of what may be gained in the cost of lines by making sacrifices in the convenience or cost of terminal equipment. Finally the point of view developed is useful in that it provides a ready means of checking whether or not claims made for the transmission possibilities of a complicated system lie within the range of physical possibility. To do this we determine, for each message which the system is said to handle, the necessary product of frequency-range by time and add together these products for whatever messages are involved. Similarly for each line we take the product of its transmission frequency-range by the time it is used and add together these products. If this sum is less than the corresponding sum for the messages, we may say at once that the system is inoperative.

# Carrier Systems on Long Distance Telephone Lines<sup>1</sup>

By H. A. AFFEL, C. S. DEMAREST and C. W. GREEN

**SYNOPSIS:** Two previous papers before the American Institute of Electrical Engineers discussed the activities of the Bell System in the development of multiplex telephone and telegraph systems using carrier current methods. The present paper describes developments which have resulted in improvements in the carrier telephone art during the past few years. A new, so-called type "C" system is described in detail, together with suitable repeaters and pilot channel apparatus for insuring the stability of operation; the line problems are considered and typical installations pictured. The growth of the application of carrier telephone systems and their increasingly important part in providing long distance telephone service on open-wire lines are shown.

## INTRODUCTION

AT the 1921 Midwinter Convention of the American Institute of Electrical Engineers, Messrs. Colpitts and Blackwell presented a paper entitled "Carrier Current Telephony and Telegraphy." This described the development work of the Bell System and the resulting commercial types of multiplex telephone and telegraph systems using carrier current methods. The paper also gave a brief historical summary and included a theoretical discussion of the methods involved.

The carrier current art had at that time emerged from the laboratory to play its part in meeting the practical requirements of telephone service in the field. This step was made possible largely by two tools, now indispensable to the communication engineer, the thermionic tube and the wave filter.

In an ordinary telephone circuit, each frequency component in the voice of the speaker is transmitted by an electrical current of the same frequency. In most cases the electrical equipment of the circuit is not called upon to transmit frequencies above about 3,000 cycles per second. In carrier current operation, however, the voice-frequency currents are caused to modulate a high-frequency current which thus serves as a "carrier" for the message. In this way, an additional telephone channel is obtained, using frequencies entirely above those transmitted in connection with the ordinary voice frequency channel. By using other high frequencies, several additional messages may be transmitted simultaneously on the same pair of wires. Each channel occupies a certain range of high frequencies. For example, the words of one speaker may be conveyed by a channel employing frequencies from about 23,500 to about 26,000 cycles per

<sup>1</sup> Presented before the Summer Convention of the American Institute of Electrical Engineers, June 29, 1928.

second. At the receiving terminal the various incoming ranges of high-frequency currents are separated by electrical filters. Then by demodulation the original voice-frequency currents are produced again and are transmitted over voice-frequency circuits, the transmission over each channel thus reaching the proper listener. In this way a telephone line already carrying direct-current telegraph and voice-frequency telephone services may be multiplexed so as to provide additional telephone facilities. In a somewhat similar manner the high-frequency range may be used instead to transmit telegraph messages. In the present paper, carrier telephony alone is considered.

The Colpitts-Blackwell paper described two carrier telephone systems which had been developed up to that time, a four-channel "carrier suppressed" system (type "A"), and a three-channel "carrier transmitted" system (type "B"). The initial installation of these systems was made about 1918 on the long lines of the Bell System.

These earlier systems were effective in bringing about economies by avoiding the stringing of additional wire on many long pole lines, but there remained many opportunities for further improvement in performance and simplification of equipment. New problems arose to be solved in connection with the desire to operate the largest possible number of systems on the same pole line. The result has been the development of a substantially improved technique and a new system (the type "C") which not only has provided much improved performance over its predecessors but which has led to further economies because of reduced costs.

*Carrier Telephone Growth in Bell System.* Whereas the use of the early types of systems was justified in competition with the alternative of additional wire stringing only for distances exceeding 250 to 300 miles, the new system proves economical for distances considerably less. This fact has naturally stimulated the application of carrier telephony in the Bell System. This is shown by Figure 1, which indicates the growth of these systems in terms of channel mileage afforded by their use. It will be noted that the rate of growth of the systems has increased greatly in the last two or three years, a result of the availability of the improved system.

At the end of 1927 there were in operation about 130,000 channel miles. By the end of 1928 the figure is expected to be about 230,000. This figure does not, of course, represent a very large proportion of the total toll mileage of the Bell System, which includes many circuits less than 100 miles in length. It is sufficient, however, to indicate that the carrier telephone systems are a substantial factor in the provision for the growth of the longer haul facilities, where they naturally

provide the greatest economies. Their use is, of course, restricted to sections of the country in which open-wire construction is chiefly employed.<sup>1</sup> They have contributed toward lowering the cost of service and in making possible the toll rate reductions which have been put into effect within the past year or so.

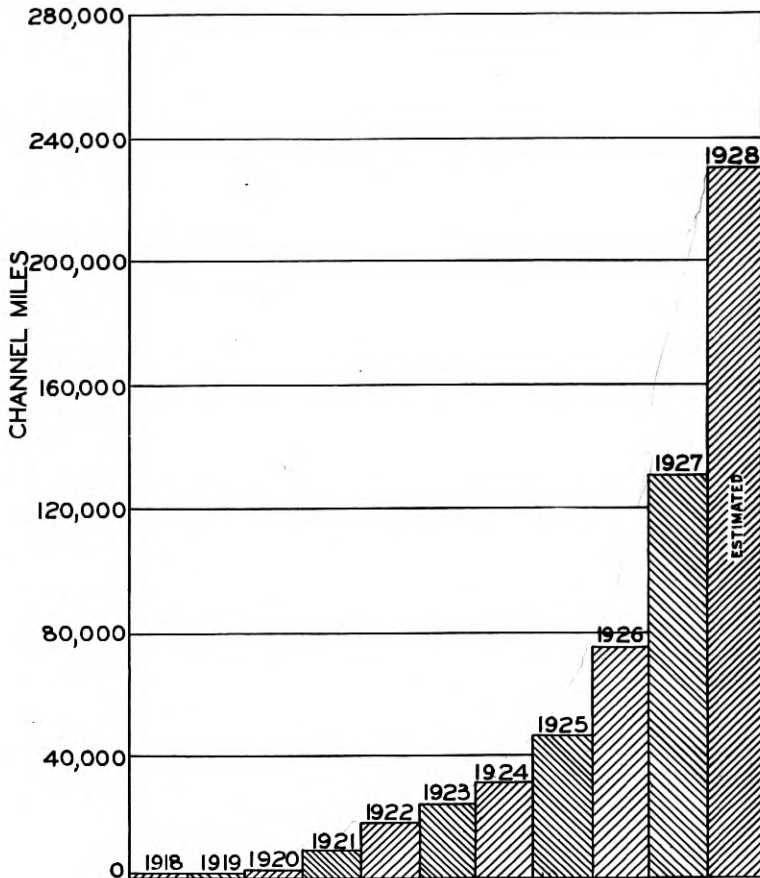

Figure 1—Growth of carrier telephony in Bell System

*New System Replacing Older Types.* The new type "C" system is essentially a long-haul, multi-channel system. It adds three high grade telephone circuits to the facilities normally afforded by a single pair of wires, and can be used over any distances likely to be encountered in the Bell System. Where repeaters are required they

<sup>1</sup> In localities having very heavy traffic requirements such as in the East, extensive use is made of toll cables.



are spaced at intervals of 150 to 300 miles depending upon particular transmission considerations. By means of a pilot channel, stability of transmission over the several carrier channels is assured, despite the relatively large inherent variations in high-frequency line transmission due to weather changes.

The service requirements which present themselves in the application of carrier methods are, of course, basically no different from those for commercial talking circuits obtained by other means. The problem is to establish a toll circuit between long distance offices which meets certain standards of transmission, including speech volume, stability and quality. The latter requires that there must be transmitted a certain band width of frequencies in the voice range. Furthermore, there must exist no appreciable load distortion effects. The circuit must also be relatively free from noise or crosstalk. A signaling system must be provided so that the operators at opposite terminals may call each other. In other respects the system must appear as a normal telephone circuit not distinguishable from an operating standpoint from the other circuits afforded by metallic wire connections. The apparatus installed in the telephone office must conform to certain physical standards of equipment, ruggedness, flexibility, etc. It must be capable of being maintained by trained office forces. Testing facilities must be provided, etc. It is believed that these objectives have been largely realized in the arrangements which are described in this paper.

#### THE TYPE "C" SYSTEM

The type "C" system embodies those major technical features which our experience with the older systems has indicated as most desirable. It is a carrier-suppressed, single sideband system, in which respect it is similar to the older type "A" system. However, it has been found possible to dispense with the equal frequency spacing of the channels which was characteristic of the type "A" system, and which involved the transmission of a synchronizing current between two terminals and the harmonic generation of higher frequencies from this synchronizing current. A simplification in apparatus has resulted. This non-harmonic arrangement of channels has further made possible a more efficient use of the frequency spectrum by the fact that the channel bands at lower frequencies can be squeezed together more closely than those of the higher frequencies where the band filters are less efficient due to decreasing ratio of band width to frequency.

The type "C" system requires for each modulator an oscillator as a source of carrier supply. Moreover, since a synchronizing current is not employed at the receiving terminal of the channel, an oscillator

of the same frequency is required for "demodulation." Advances in the art of designing vacuum tube oscillators of great frequency stability have made it possible to insure that these oscillators, which may be hundreds of miles apart, remain sufficiently close together in frequency so that no noticeable impairment in quality of transmission results.

In the matter of the frequency allocation of the channel bands, the type "C" system possesses one of the essential features of the older type "B" system, that is, the use of different carrier frequencies for transmission in opposite directions. Comparative experience with the type "A" system which, by means of high-frequency line and network balance, employed the same frequency band for the opposite directional paths of the channel led to the conclusion that the systems which avoided the high-frequency balance requirement were most desirable. Also the problem of intermediate repeater amplification is simplified where the opposite directional frequencies are thus separated and grouped. Furthermore, the crosstalk problem between different systems on the same pole line is greatly simplified for reasons which will be discussed later, and a greater total number of channels may usually be obtained on the same pole line.

The single sideband transmission employed reduces by about one half the frequency band that would otherwise be required for each channel. The carrier is not transmitted, as the presence in the system of carrier currents of the large magnitude required for a "carrier transmitted" system not only requires greater amplifier load capacity at the repeaters, but may increase the possibility of troublesome crosstalk and noise interference. The selectivity requirements of the band filters would also become more severe to keep the carrier of one channel out of the other channels in the system.

*A Complete System.* The simplified layout of a complete system is shown on Figure 2. It will be noted that it includes apparatus at a terminal, a line circuit, a repeater station, a second line circuit and apparatus at a second terminal. Obviously, the total line length between terminals may be extended by the use of a greater number of repeaters.

At each end there are the terminations of the three carrier channels 1, 2 and 3, and the regular voice circuit 4. These terminations appear, of course, at the long distance switchboard in the same office or in a different office from the carrier terminal. When a subscriber is connected to one of the terminations, for example, No. 1, speech currents pass through the three-winding hybrid coil, thence into the modulator circuit where they are caused to modulate high-frequency

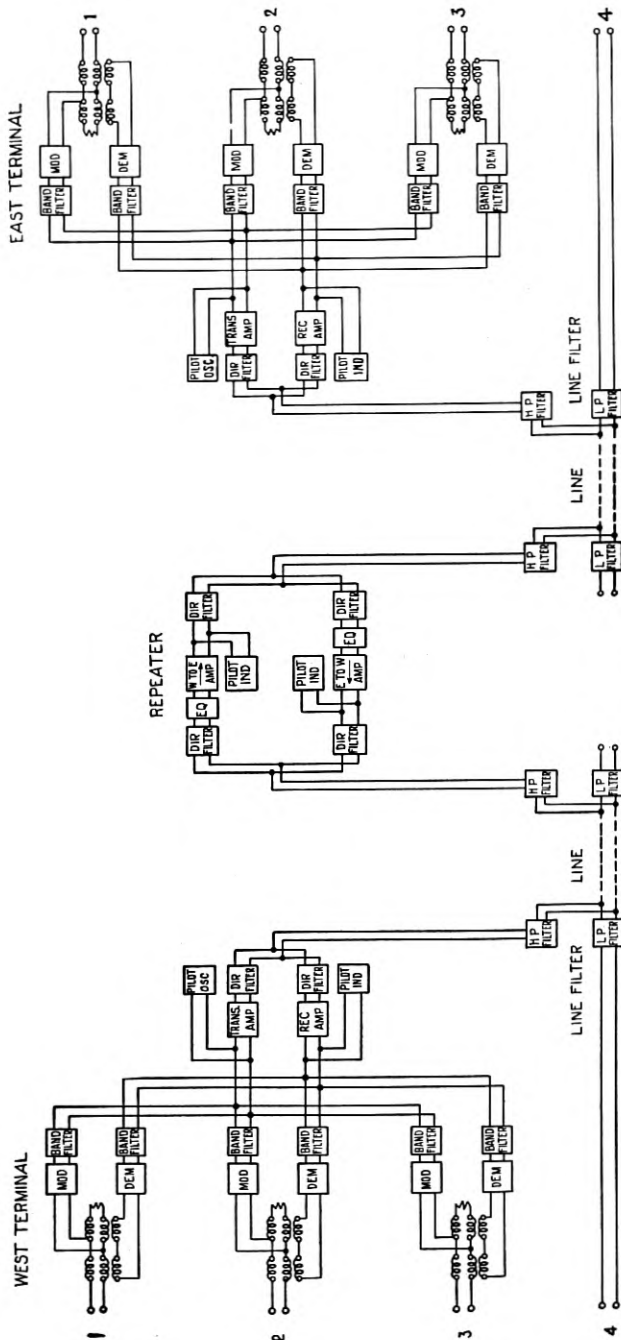

Figure 2—A complete carrier system schematic

carrier current. The resultant modulated bands<sup>2</sup> of frequencies pass through a band filter allowing only the desired band to pass to the transmitting amplifier, thence this band passes through a so-called directional filter and a high-pass filter to the line circuit. The high-pass filter last referred to, in association with its complementary low-pass filter, forms a so-called line filter set whereby the regular voice range currents are separated from the higher frequency carrier current at both terminal and repeater offices.

The other two carrier channels function similarly, and the several modulation bands of carrier frequencies join the first channel in passing through the common amplifier and directional filter circuit to the line. At the repeater point the group of bands comprising the three channels passes through the high-pass line filter circuit, thence through a directional filter and line equalizer to the amplifier circuit and outward through the directional and line filter circuit to the next line section. At the farther terminal the combined carrier currents pass through the directional filter and are again amplified in the receiving amplifier. At the output of the amplifier the different carrier channel bands of frequencies are selected one from another by the band filters, thence they pass to the demodulator circuit, are demodulated to their original form and then pass from the output connection of the hybrid coil to their respective terminations.

*Circuit Arrangements at Terminals.* Figure 3 shows diagrammatically in somewhat greater detail the terminal of the type "C" system. The modulator circuit consists of a two-tube "push-pull" grid-bias vacuum tube circuit in which the carrier frequency is balanced out. A separate oscillator tube circuit of exceptional frequency stability supplies the carrier. The frequency allocation requires the transmission of only the upper or lower sideband frequencies, and the band filter at the output selects the desired band, rejecting the other products of modulation as well as the amplified voice frequencies which are incidentally transmitted through the modulator unit. This sideband current in conjunction with the corresponding currents of the other two sidebands of the outgoing channels passes through the common amplifier. This is a two-stage vacuum tube unit having four tubes in the output circuit arranged in parallel push-pull connection to insure the required load carrying capacity.

The circuit then leads through a directional filter of either low-pass or high-pass type which distinguishes between the band groups of

<sup>2</sup> For a discussion of modulation see E. H. Colpitts and O. B. Blackwell, "Carrier Current Telephony and Telegraphy," *A. I. E. E. Transactions*, V. 40, 1921, pp. 205-300; R. V. L. Hartley, "Relation of Carrier and Side Bands in Radio Transmission," *Bell System Tech. J.*, V. 2, April 1923, pp. 90-112.

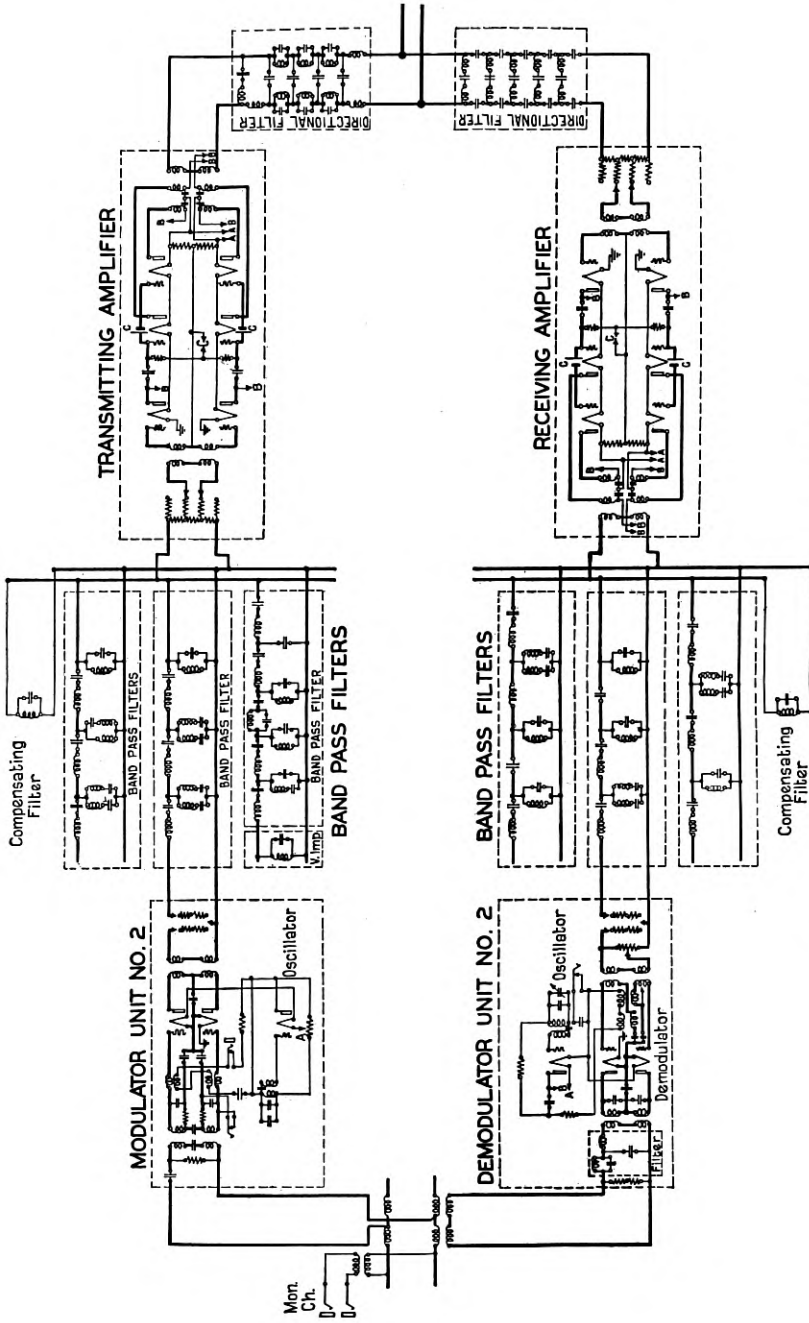

Figure 3—Schematic diagram of type "C" terminal circuit

the opposite directions of transmission as required by the allocation of frequencies. The amplified currents pass through the high-pass filter of the line filter set and thence to the line circuit.

In receiving, the sideband frequencies, after separation from the voice currents by the line filter set, pass through the directional filter and an amplifier similar to that used at the transmitting terminal. While the power output required at the receiving amplifier is usually small as compared to that required at the transmitting amplifier, the same unit is used for the two positions to provide flexibility in the adjustments of the receiving gains of the separate channels and for the purpose of economy in production. The different channel currents in the output of the amplifier are selected by the respective receiving band filters and thence pass into the demodulator circuits. In the demodulators the voice frequencies are derived by the modulation of the sideband currents with a carrier frequency supplied by a local oscillator whose frequency is adjusted accurately to agree with that of the corresponding transmitting modulator at the farther terminal. This important problem of synchronization of oscillators is further discussed later in the paper. It is, of course, obvious that if the carrier frequencies of the modulator and the corresponding demodulator of the same channel are not in sufficiently close agreement there will be a serious distortion of the speech currents received over the channel.

The output of the demodulator circuit includes a low-pass filter for suppressing the unwanted components of demodulation, and the circuit thence leads to the channel terminal through the hybrid coil. The function of the latter is to provide a two-wire termination of the channel and it prevents the output currents of the demodulator from reaching in any substantial magnitude the input of the modulator circuit, thus setting up a regenerative action which might result in "singing."

It may be noted that the circuit normally provides for a transmission "gain" or amplification of energy from the switchboard termination to the high-frequency line circuit of approximately 20 TU<sup>3</sup> corresponding to a current or voltage amplification of 10 to 1. In the receiving direction a gain of the same order of magnitude is also available. Of course, the exact amount utilized in a particular case depends on the line attenuation and the desired overall equivalent of the circuit. It is usually desirable at the transmitting terminal to maintain the level at the maximum possible for the system. The

<sup>3</sup> R. V. L. Hartley, "The Transmission Unit," *Electrical Communication*, V. 3, No. 1, July 1924, pp. 34-42. W. H. Martin, "Transmission Unit and Telephone Transmission Reference Systems," *A. I. E. E. Jl.*, V. 43, No. 6, June 1924, pp. 504-507, *Bell System Tech. Jl.*, V. 3, July 1924, pp. 400-408.

overall transmission afforded by a carrier system may be noted by the curve on Figure 4, which shows the relative speech frequency transmission characteristics of a typical channel. Where the carrier

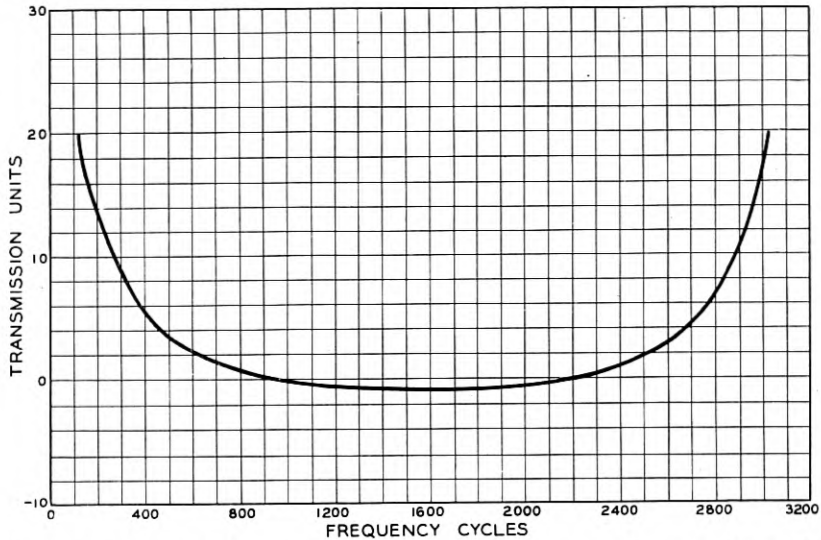

Figure 4—Representative overall transmission-frequency characteristic—type "C" carrier telephone system

channel is employed for terminal to terminal business the overall equivalent at 1,000 cycles is ordinarily adjusted to about 10 TU. The channels not infrequently form sections of much longer overall circuits, being connected to cable or perhaps open-wire circuits, in which case it is rather common to adjust the carrier section to a zero equivalent or even a gain of several TU.

*Line Considerations.* The passage of the carrier currents from the terminal apparatus over the line circuit which serves to connect the two terminals, or a terminal and repeater station, gives rise to several problems: the line loss or attenuation, the stability of transmission, the possibilities of crosstalk from other carrier systems on the same pole line and interference from currents from external sources. These factors must be considered not only in connection with the arrangement of the wires themselves but also in conjunction with the design of the terminal apparatus, repeaters, etc., so that satisfactory overall speech transmission may result.

As was brought out in the Colpitts-Blackwell paper, the line attenuation at the high frequencies is in accord with the recognized transmission theory. Because of skin effect in the wires and rising

losses in the insulators the attenuation increases steadily with frequency. Unfortunately the losses at the insulators are not constant and they increase greatly with the presence of moisture. This brings about an increase in attenuation in rainy weather. Fog, sleet and wet snow may greatly increase these attenuation changes. There is also a lesser source of variation due to temperature change and its effect on wire resistance.

If care is not observed, the carrier currents may be interfered with on the line circuits by crosstalk from other carrier systems and by miscellaneous currents which enter the circuit by induction from the outside. These latter manifest themselves as noise in the carrier channels. This makes it essential to use only the metallic circuit, i.e., two wires well balanced to ground for transmitting the carrier currents. The balance to ground must be maintained at a high degree by frequent transpositions in the wires. Even with these precautions unavoidable residual unbalances may permit a certain amount of interference to appear. The final remedy is to insure that the relations between the circuit length and the apparatus gains are properly considered in order that the speech currents may have ample margin above the noise currents at all points in the circuit.

In the matter of crosstalk between systems closely adjacent on the same line the situation is alleviated by providing two frequency allocations. (See Figure 5.) These are "staggered" with respect to

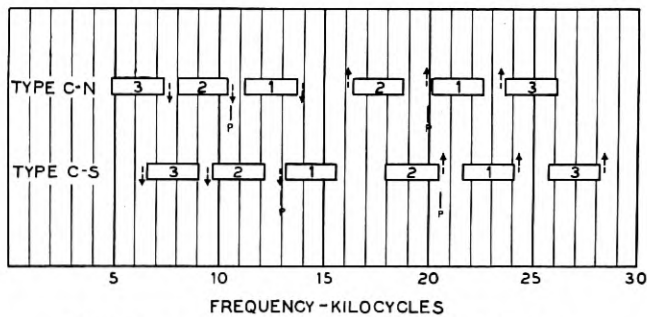

Figure 5—Frequency allocations of type "C" system

each other, so that a system installed on one pair using the so-called "N" frequency allocation has less crosstalk to and from a system installed and operating on an adjacent pair and using the so-called "S" frequency allocation than would be the case if both systems employed the same allocation. The maximum upper frequency required is raised only slightly by this arrangement.

*Repeaters.* Repeaters must be employed when the distance exceeds



that for which terminal transmitting apparatus is effective in maintaining the transmission level well above the line noise. The function of the repeater is, therefore, to amplify the carrier currents so that they pass on to the succeeding line section at a magnitude comparable to that sent out from the terminals. Obviously, the design of the repeater with respect to its gain and level carrying capacity, etc., presents a wide range of possibilities depending on the distance of transmission, frequency, etc.

It has been found most practical to install the repeaters along the route at approximately the spacing of the voice-frequency repeaters on the same wires. This means a spacing of from 150 to 300 miles, and occasionally slightly over 300. To have in the same office both voice-frequency and carrier repeaters reduces the equipment, simplifies the maintenance problem, and makes it possible to use the same sources of power supply. The gain and the load carrying capacity are, therefore, determined by this spacing, the gain being controlled by the attenuation loss between the repeaters, and the load carrying capacity by the output level desired because of noise considerations.

The higher attenuation of the line in the carrier range of frequencies means that the carrier repeaters must have a maximum gain of approximately four times that of the voice repeaters operated on the same wires. Whereas gains of the order of 8 to 15 TU may be readily supplied by voice repeaters using balance and so-called "two-wire" operation, the 30 to 45 TU gain required by the carrier repeaters necessitates non-balanced or "four-wire" operation or its equivalent, by using different frequencies in opposite directions and directional filters for the prevention of "singing."

Figure 6 is a schematic diagram of the circuits comprising a typical repeater station including loading, compositing apparatus and line filters. After passing through the high-pass line filter the carrier currents arrive at the high and low group directional filters which distinguish between the oppositely directed currents. These filters are substantially the same as those used for similar purposes at the terminal stations.

It is, of course, required in the design of the directional filters that in each direction the filters must pass a frequency band sufficient to transmit properly the three carrier channel bands. In addition to this the filters must present a loss outside of the transmission band which is sufficient to prevent the two-way amplifier circuit from "singing." This means that considering the closed loop circuit of the two amplifiers and the four directional filters the attenuation in this loop must be considerably greater than the sum of the gains or

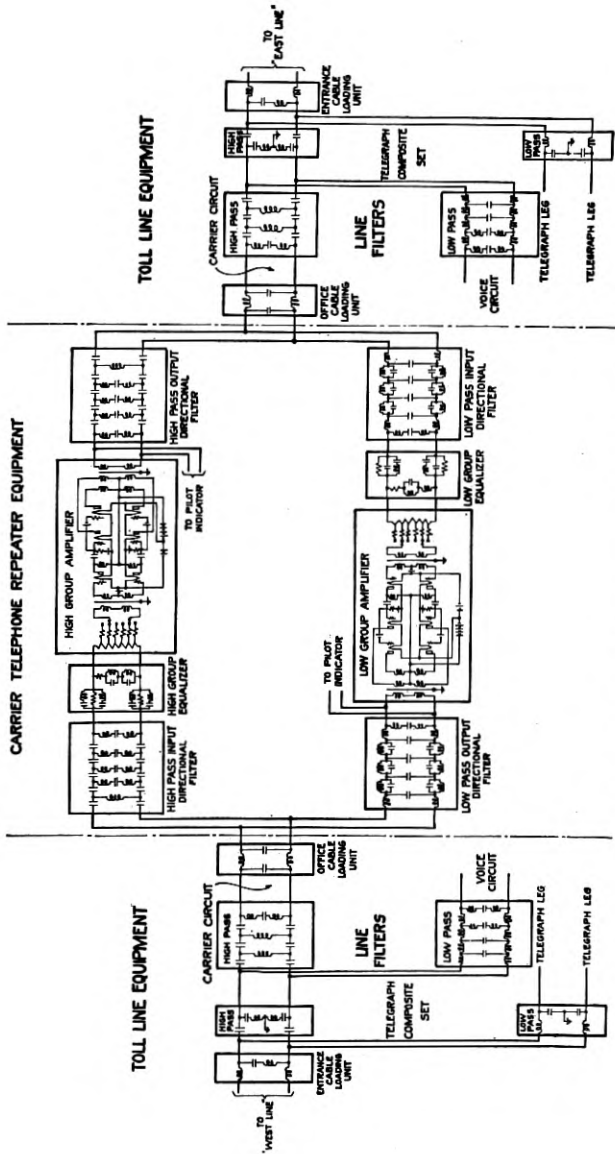

Figure 6—General schematic of carrier repeater circuit with associated line equipment

amplification of the two amplifiers. There are also other requirements which these filters must meet which are discussed later.

The amplifiers are the same as used for group amplification purposes at the terminals. Each consists of a two-stage reactance-coupled vacuum tube circuit having four tubes in parallel push-pull connection in the output circuit. The carrying capacity of this amplifier with the standard plate voltages is about one watt in the output, and the overall amplification or gain including incidental filter losses is about 30 TU. Where gains greater than 30 TU are necessary in the higher frequency group provision is made for the addition of an amplifier stage ahead of the unit shown, which adds approximately 15 TU gain. At the same time provision is made for the addition of greater directional filter selectivity.

An important feature of the repeater circuit is the equalizer which is connected ahead of the amplifier. Because the line circuit attenuation varies with frequency and is greatest at the higher frequencies it is necessary that the amplification introduced at a repeater point be varied with frequency. The amplification introduced by the amplifier unit itself is substantially uniform with frequency. The equalizer network, however, by introducing a loss which is a minimum at the highest frequency of transmission and which increases for the lower frequencies makes the overall repeater amplification a function of frequency and in general proportional to the line attenuation which it is designed to overcome.

A typical overall gain characteristic of the repeater is shown in Figure 7. The adjustment of the exact amount of gain desired at any time is made by the potentiometer at the input of the amplifier.

*Pilot Channel.* As noted previously, the attenuation of open-wire circuits of substantial length is affected by weather conditions. This makes it necessary to make occasional gain adjustments throughout the system. The extent of these adjustments is determined by means of the pilot channel, which provides a visual indication of the transmission levels of the carrier system in both directions of transmission without interfering with the speech currents over the channels themselves. It is, in effect, a separate constant frequency carrier channel allocated between certain speech channels in each transmission group.

The operation of the pilot is relatively simple. At each repeater point and receiving terminal there appears a meter for registering the output level of the amplifier. The pointer of the meter is expected normally to rest on the zero or normal level layout of the system. If a change in the attenuation of the line circuit causes a departure in the transmission level, the meter reading shows a corresponding

“up” or “down” indication and by adjustments of the repeater or terminal amplifier potentiometers the level may be returned to normal. An alarm circuit is furthermore provided at the receiving terminal

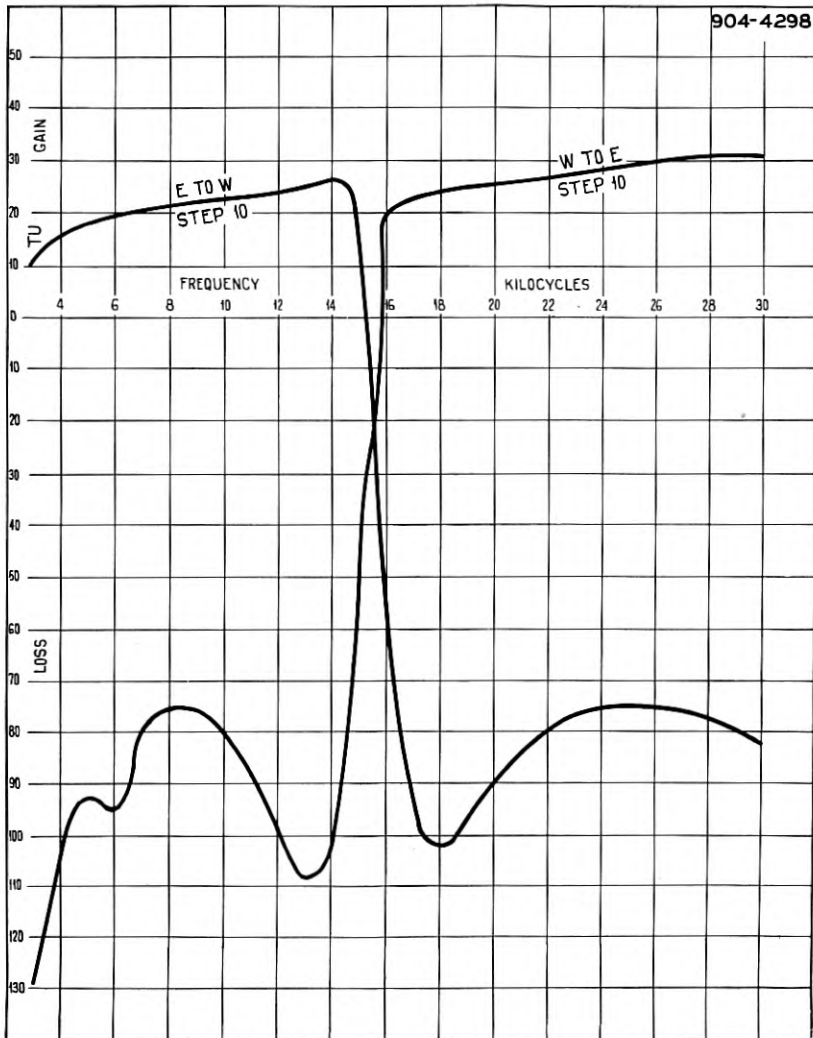

Figure 7—Overall transmission characteristics of carrier telephone repeater station

so that when the level has departed by more than a predetermined amount, say  $\pm 1.5$  TU, from the desired normal, the operating attendant is called in to make the adjustment.

A high-frequency current of constant amplitude is transmitted

from each end, and the meter indications are measurements of this current at the output of repeater amplifiers, and at the receiving terminal amplifiers (see Figure 2). A separate pilot frequency is utilized for each direction of transmission. Because no communication is carried on over this pilot carrier current, the band provided is extremely narrow, and no appreciable portion of the frequency spectrum is sacrificed.

The frequency selected for the pilot channel must coordinate with the other carrier system frequencies. The two frequency allocations of the type "C" system require different pilot channel frequencies, because their speech channels occupy different frequency bands. The apparatus has, therefore, been made so that the frequency of the pilot current can be adjusted to any value desired in the carrier range. The frequency selected for a given system may be determined by local conditions of crosstalk or interference, although in general the preferable location is between the channel bands as noted in Figure 5. The amount of current which is used is limited by its interfering effect into adjacent channels or into other carrier systems on the same line, and it is ordinarily of a low value, of the order of 2 to 6 milliamperes on the line.

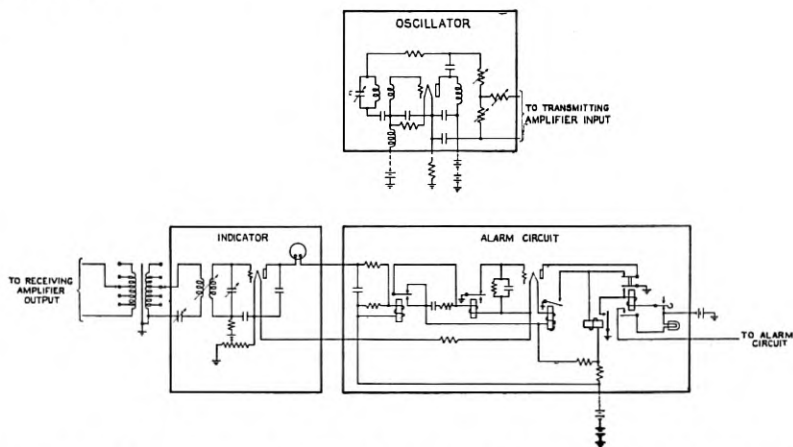

Figure 8—Schematic of pilot channel circuits. (The alarm circuit is used with terminals only)

Figure 8 shows schematically the principal features of the terminal pilot-channel circuit as a whole. The oscillator at each transmitting terminal which produces the pilot current is connected to the carrier circuit at the input to the transmitting amplifier, in parallel with the band filters. This current is amplified with the speech currents and

transmitted through the directional filter to the line. The attenuated pilot and sideband currents pass from the first section of the line into the receiving directional filter of the first repeater and enter the amplifier. The pilot channel indicator circuit is bridged across the output of the amplifier, and is tuned to discriminate very sharply against all but current of the pilot frequency. This circuit has a high impedance relative to the line, so that only a very small percentage of the pilot current is drawn from the line at a repeater point. The remainder is transmitted through the outgoing directional filter and over the subsequent section of the line.

That portion of the pilot current which enters the indicator circuit is amplified and rectified in the vacuum tube detector, and the output current is read on a d.-c. milliammeter. As stated above, this meter is calibrated to read in TU above and below a mid-scale position which represents a normal transmission level to which the system is initially adjusted.

Entering the receiving terminal of the carrier system, the pilot and speech currents pass through the directional filter and are amplified. As at the repeater, the pilot indicator circuit is bridged across the output of the amplifier. At this terminal, in addition to showing level, the output of the indicator actuates an alarm circuit which operates when the transmission level at this point varies from normal for a set interval of time by more than a prescribed amount. This delay action in the operation of the alarm provides selectivity against slight interference into the pilot channel from currents on the other channels of the system and thereby insures that the alarm indicates a definite level change.

The pilot channel thus insures that the high-frequency portion of the system is continuously checked with the exception of the individual channel band filters and modulator and demodulator units. These, however, are particularly stable in operation and require no unusual attention in maintenance. Of course, the overall check is made at only the pilot frequency in each direction. Variations of line equivalent caused by weather changes increase in magnitude with frequency. Therefore, corrections must be made in the gain relations of the individual channels whenever these weather changes are great. Fortunately the corrections follow a fairly definite relation with variations of pilot level and are ordinarily made by the terminal attendants on the channel potentiometers controlling the demodulator gain by reference to a table. This table shows the relations between the required gain changes at the three channel frequencies in terms of changes at the pilot frequency.

The type of oscillator is essentially the same as that used in the type "C" carrier systems for producing the carrier frequencies. It is controlled by condensers which include an adjustable air condenser for tuning to the particular frequency desired.

Two indicators are located at the repeater, one for each direction of transmission. Each indicator circuit consists of a vacuum tube rectifier operating from coupled tuned circuits into a d.-c. milliammeter having a special scale calibrated in transmission units. The filament and plate currents and bias potentials are obtained from the standard 130-volt battery. The advantage of using the same battery for the several functions is that it makes possible the stabilization of the rectifier output with power variations. An adjustable grid bias voltage is obtained from the negative drop of the filament circuit with an opposing 3-volt dry cell battery connected in series. With this arrangement normal variations in the 130-volt source cause only a negligible change in the indicator meter readings.

At the receiving terminal, in addition to the indicator circuit which is the same as at the repeater, an alarm circuit is provided as noted above. A sensitive marginal relay is connected in series with the indicator meter. When this relay operates, it starts the delay circuit by removing ground from the grid condensers of the alarm tube. The leakage through the grid resistances then causes the condenser potential, which is the grid potential of an auxiliary rectifier tube operating from the same power source, to decrease slowly, resulting eventually in a rise in the current of the plate circuit of the alarm rectifier tube. If the marginal relay remains operated for a given length of time, the alarm tube plate current will rise to a value necessary to operate the alarm relays. For shorter periods of operation, the normal highly negative grid potential of the rectifier tube is restored and no alarm is operated. The timing of the delay circuit is adjusted by the values of the grid leak resistances and condensers. A delay of about 15 seconds is usually employed, which effectually prevents false operation due to occasional transients such as speech interference. The adjustment of the contacts on the alarm relay is ordinarily such as to cause an alarm to be given at limits of  $\pm 1.5$  TU variation.

#### GENERAL TRANSMISSION CONSIDERATIONS

*Lines.* The typical open-wire telephone line consists of a number of 10-foot crossarms spaced two feet apart on poles whose height varies from 30 feet upward depending on local conditions. The poles are spaced at an average interval of 130 feet. Each crossarm carries 10 wires. The wires are normally spaced at 12-inch intervals, except

in the case of the so-called pole-pairs which straddle the pole and whose wires are about 18 inches apart. (See Figure 9.) The construction includes pins and glass insulators for supporting the wires.

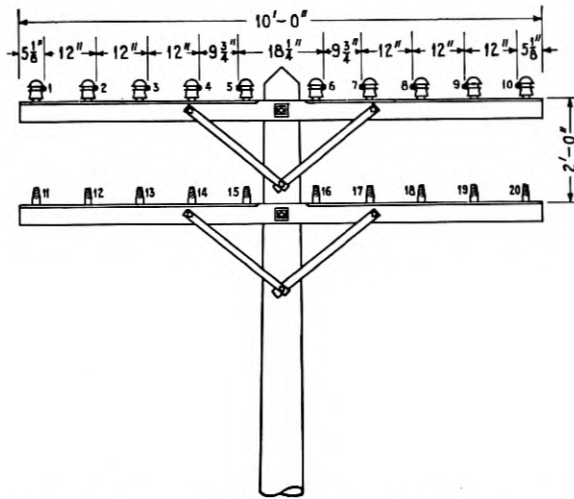

Figure 9—Showing arrangement of wires on telephone pole line

There are three gauges of wire in common use in the telephone plant, having diameters of 104, 128 and 165 mils,\* respectively. The largest gauge, 165-mil pairs naturally afford the lowest attenuation and have been generally used in connection with the application of the longer systems. The pairs of this sized conductor are, however, now fairly well used up for carrier purposes and new installations are being made more often on the smaller diameter circuits.

Typical attenuation curves for the three gauges of wire and the extremes of weather conditions are given in Figure 10. It will be noted that the wet weather attenuation may be as much as 40 per cent higher than the dry weather attenuation. Also, these variations are greater at the higher frequencies.

It is interesting in this connection to consider the effect of the possible variation in a practical case. Take, for example, a 165-mil pair 200 miles long with a carrier channel frequency at 25 kilocycles. This means a total attenuation of 20 TU in dry weather and 29 TU in extremely wet weather, a variation of 9 TU or a current ratio of about 3 to 1. In the case of a still longer line these possible variations present rather startling figures. For example, in a 1,000-mile circuit the variation would be five times the above or 45 TU, which would

\* The term "mil" as here used is equivalent to 0.001 inch.



mean that if the circuit were set up to have a proper volume of transmission in dry weather and rain occurred over the whole line it would cause the speech at the receiving end to drop to but 1/180 of the

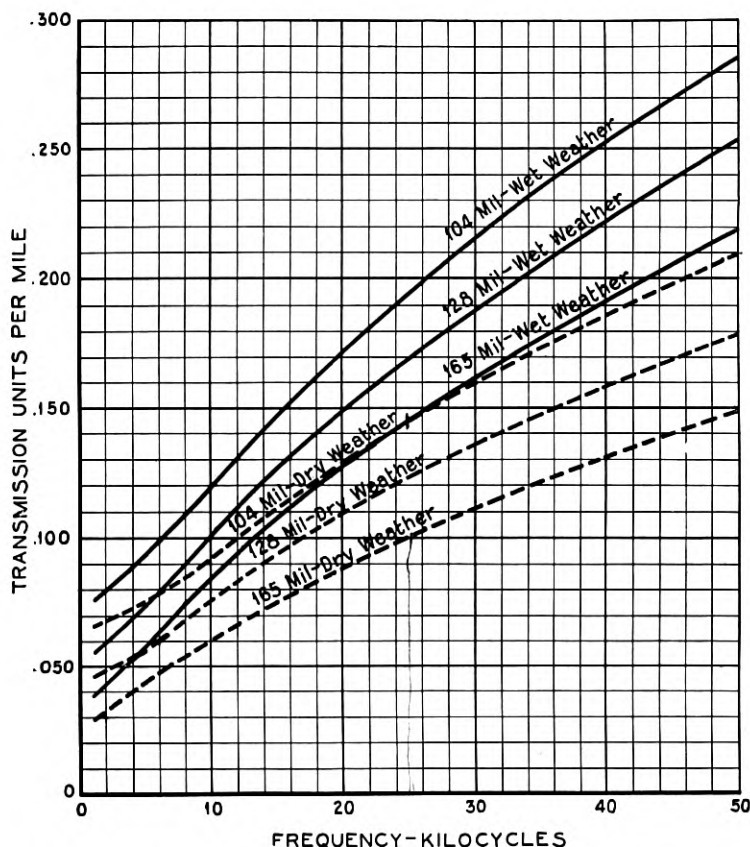

Figure 10—Attenuation curves for open-wire lines of different gauges at high frequencies

desired volume if the proper readjustments of gain at the repeaters and terminals were not made. Fortunately, these line variations occur gradually, at least in the case of the longer lines.

In connection with most carrier installations measurements are made<sup>4</sup> of line characteristics prior to the installation of the apparatus.

<sup>4</sup> Reference, "High-Frequency Measurements of Communication Lines," by H. A. Affel and J. T. O'Leary, *A. I. E. E. Transactions*, V. 44, 1927, pp. 504-513.

An interesting picture is presented in Figure 11 which shows the attenuation variations with time on a particular line (about 110 miles in length) during the period in which a storm arose to cause the attenuation to increase. Later, when the insulators dried, the corresponding drop in attenuation was that shown. From these variations it is quite obvious that means such as afforded by the pilot channel are needed to insure that the talking circuits provided by the carrier channels remain at substantially constant volume.

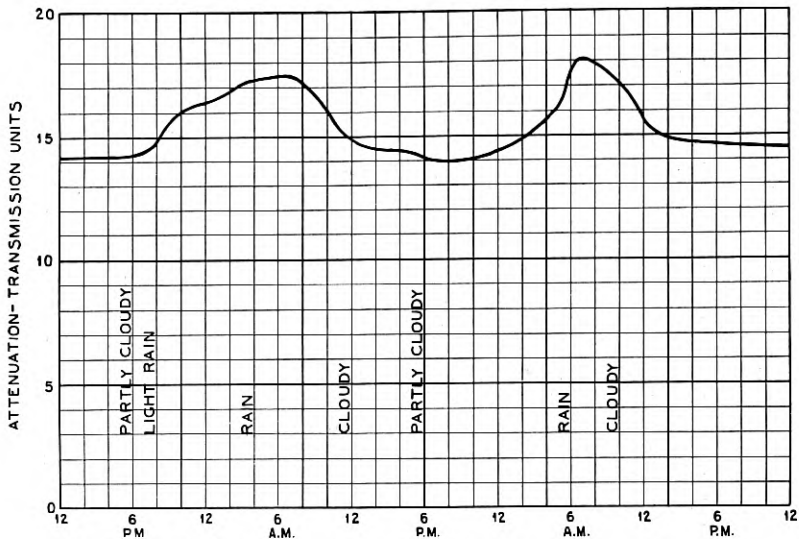

Figure 11—Variations in attenuation of a particular open-wire circuit

In addition to the improvement in stability effected by the use of pilot channel apparatus, substantial advances have been made in the design and application of special types of line insulators in which the high-frequency losses, particularly in wet weather, have been appreciably reduced, resulting in still further improvement in stability. The attenuation data given above are for the lines equipped with the older standard types of telephone insulators, which are still employed on the majority of circuits in the telephone plant. However, the newer types of improved insulators are now being applied and their use makes it possible to reduce the wet to dry weather attenuation variation by a factor of about 3 to 1 and to reduce the absolute value of attenuation at the higher frequencies by as much as 25 per cent. Further information describing the development

work which has made possible these improved insulators will be made available at a later date.

While the circuits employed for the transmission of carrier telephone systems as noted above are largely of open-wire construction, where these circuits pass through the more populated districts of the country it is frequently necessary to insert sections of cable. The smaller closely spaced wires of cables make the problem of attenuation at high frequencies more serious, even where the cables are relatively short, say a mile or so in length. Typical attenuation curves of non-loaded cable pairs are shown in Figure 12.

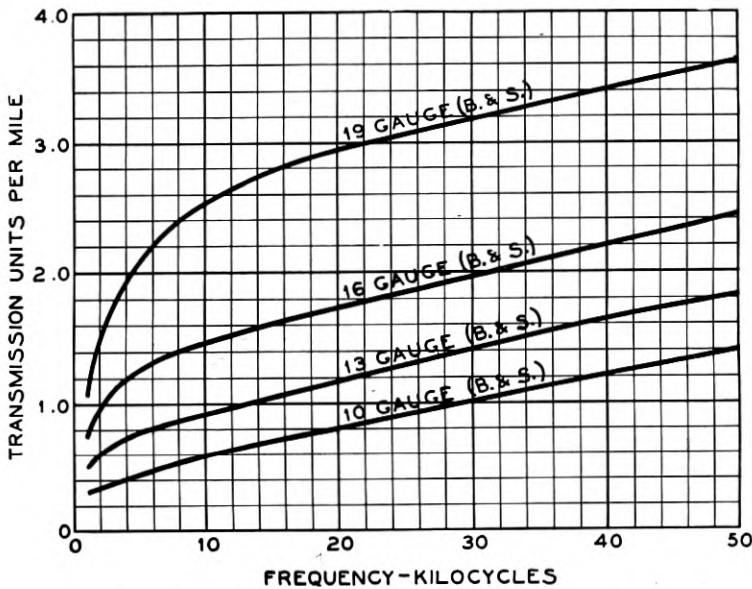

Figure 12—Attenuation of non-loaded cable circuits

This situation has led to the development of a special type of cable loading which permits making a substantial reduction in the attenuation for the higher frequencies and which also makes the characteristic impedance of the cable circuit more closely simulate that of the open-wire circuit so that the reflection effects discussed in detail later are thus greatly reduced. This is important, for, whereas the open-wire circuit characteristic impedance varies from 600 to 700 ohms, the non-loaded cable impedance is of the order of 130 to 150 ohms and the reflection losses and also certain resultant crosstalk effects as discussed later are, therefore, very substantial for even short lengths of non-

loaded cable. The present standard types of carrier cable loading systems<sup>5</sup> provide for the use of loading coils spaced at intervals of approximately 930 feet. When loaded, the cable circuits have a characteristic impedance closely approximating the open-wire impedance over the frequency range used in carrier transmission. This same carrier loading also greatly improves the characteristics of the voice circuit. The high-frequency attenuation is reduced to approximately one half the non-loaded condition. A special type of cable loading is also available for use in improving the transmission characteristics of office cable and wiring and very short intermediate and entrance cable.

*External Interference.* The carrier channels are unusually free from noise due to extraneous induced currents. However, this is the result of attention to this factor in the design of the apparatus and in laying out the installations rather than anything inherent in the high-frequency feature as such. Our experience has indicated that it is possible, if care is not taken, to have interference from the following external sources:

- a. Harmonics of power frequencies.
- b. Irregular frequencies produced by abnormal power line actions, such as arcing insulators, charging lightning arresters of certain types, electric railways, series street lighting, etc.
- c. Power line carrier systems.
- d. Powerful transoceanic radio transmitters.
- e. Lightning and other atmospheric disturbances.

In the matter of harmonics of the power line frequencies, the source of their generation normally limits them to very low magnitudes in the high-frequency range which has been employed for carrier systems on telephone lines. In this respect the carrier systems are, in general, affected to a lesser extent than the normal telephone circuits in the voice range. In the latter case, the power circuit harmonics frequently present serious interference problems because the harmonics in the power circuits are substantially greater at the lower frequencies.

Under particular conditions, however, such as, for example, in connection with a series street lighting system operated with individual series transformers or auto-transformers, where a burned-out lamp causes the saturation of the transformer magnetic circuit, induced harmonics of considerable magnitude, up to 30,000 cycles and over, have been measured in the carrier telephone circuits. Under the same

<sup>5</sup> Thomas Shaw and Wm. Fondiller, "Development and Application of Loading for Telephone Circuits," *Bell System Tech. Jl.*, April 1926, pp. 221-281.

conditions, however, much larger harmonics are present in the voice-frequency range, so that the induction in the normal telephone circuit is much more severe than the carrier circuit.

A much more severe source of carrier interference has been found to result from the abnormal actions of power line circuits in which arcing phenomena occur. Interference of this sort has been noted and traced to such sources as arcing insulators, tree leaks, pantograph and trolley collector sparking, charging lightning arresters, unusual commutator or slip ring sparking, switching, etc. In the early days of operation of carrier systems, interference of this type formed a not uncommon source of disturbance. The situation was remedied in some cases by cooperation with the power companies concerned. On the whole, this source of interference has been greatly reduced in the past few years.

On occasions the carrier telephone systems have been interfered with by power line carrier systems operating on near-by power lines. Considering the widespread use of power line carrier telephone systems and the fact that they normally involve a transmitting power many times that of the systems described in this paper, this would, no doubt, be a more common source of difficulty if it were not a fact that such power systems adjacent to the telephone systems are operated well above the frequency range of the telephone line carrier systems.

Energy picked up from the high-power transoceanic radio telegraph stations, transmitting at frequencies in the carrier range, is an occasional source of interference, particularly in the east where carrier systems are located relatively close to the radio stations. The open-wire telephone lines act as long-wave antennæ and intercept the radio energy. This, of course, enters initially on the longitudinal wire circuit to ground. Due to residual line unbalances, some energy is, however, unavoidably passed on to the metallic circuits on which the carrier systems are operated, and enters the speech channel in the form of a tone or note similar to a heterodyne signal at a radio telegraph receiver.

Lightning and general static disturbances form a substantial part of the background noise which is found on all carrier lines. Its general magnitude is ordinarily small, except under certain conditions such as the case of near-by storms.

*Transmission Levels.* In the design and laying out of type "C" installations, the transmission level of a system is ordinarily not permitted to fall below a certain figure, which, under particular circumstances might be about - 25 TU, with respect to the trans-

mitting terminal. A transmission level diagram will serve to explain this limitation.

Let it be assumed that it is desired to effect carrier transmission using a type C-N system between points A and B, 240 miles apart on 165-mil conductors. The highest frequency channel is normally considered, which in this case would be 26 kilocycles. The total attenuation of the line at this frequency, as determined from the line attenuation data already presented, would be 35 TU for wet weather conditions of operation. A level diagram would accordingly picture the situation as noted in Figure 13. At point A sufficient

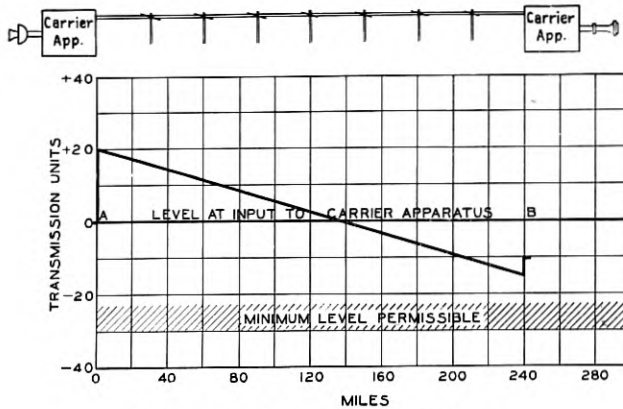

Figure 13—Transmission level diagram

transmitting gain would be provided by the equipment to bring the sending level to + 20 TU. The line attenuation in connection with transmission over the 240-mile circuit at point B would bring the level to - 15 TU. In order to obtain an overall talking circuit of, say, 10 TU., it would be necessary to operate with a receiving gain of 5 TU. It will be noted that in this particular layout the minimum line level is well above the limit set above. In fact, computations would indicate that the line circuit might be extended to the total length of about 300 miles, before the level limits would be exceeded. On longer lines, however, involving many repeater sections, the level limits are raised because of the cumulative effect of noise entering the circuit from a greater number of sources.

The line circuit illustrated is of the simplest type and in a practical case involving sections of intermediate and terminal cable construction the attenuation would be considerably greater and the effective geographical distance covered for a particular type of apparatus would, **therefore, be less.**

*Crosstalk.* Telephone circuits which are simultaneously operating in close proximity on a pole line are normally subject to crosstalk because of the mutual inductance and capacity relations between the wires. The problem which this presents in a pole line structure carrying many circuits requires careful consideration, even where the frequencies are no higher than the voice range. The problem is cared for by the application of transposition systems, i.e., arrangements whereby the effect of these relations between the circuits tends to be canceled out by transposing the wires constituting the two sides of a circuit in an orderly fashion. These transposition systems are carefully designed and the transpositions to be applied in each circuit specified.<sup>6</sup>

When using still higher frequencies for carrier purposes, this problem is correspondingly increased as the mutual relations tend to become greater at higher frequencies. The phase changes as the currents progress along the lines are more rapid for the higher frequencies. The design of the transposition system capable of permitting the simultaneous operation of a number of carrier systems on the same pole line is a difficult problem. The subject is one of great complexity and to give it complete consideration would require more space than is available here. It may be noted, however, that, by means of special transposition layouts installed in the circuits being used for carrier transmission, successful operation is being obtained with a large number of carrier systems on the same pole line, both telephone and telegraph. The locations of transpositions in circuits used for carrier transmission occur more frequently than in circuits restricted to operation at voice frequencies, in some cases as frequently as every other pole.

Several factors in the apparatus design have contributed to lessen the hardship imposed by the crosstalk problem:

1. The standardization of arrangements whereby the same frequencies are only employed in a given direction on systems on the same pole line.
2. The equalization of the transmission levels between paralleling systems.
3. The use of "staggered" frequency allocations for systems in closest proximity.
4. A careful consideration of impedance relations in the line circuits and apparatus.

<sup>6</sup>"The Design of Transpositions for Parallel Power and Telephone Circuits," H. S. Osborne, *A. I. E. E. Transactions*, V. 37, June 1918, pp. 897-936.

*Frequency Directions.* The importance of the use of a separate frequency for each direction of transmission may be considered by reference to Figure 14. If there are two paralleling telephone circuits

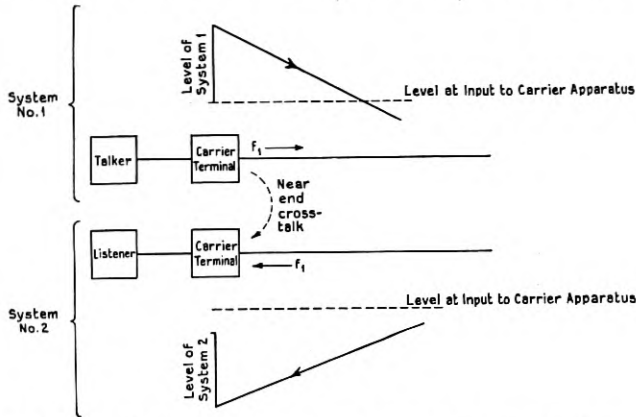

Figure 14—Diagram illustrating occurrence of near-end crosstalk between carrier systems employing the same frequency for opposite directions of transmission

employing frequencies ( $f_1$ ) in the same range, and if there exists between the two circuits a certain amount of crosstalk, when there is a talker at the terminal of one system (No. 1) and a listener at the same terminal of the other system (No. 2), then the speech from the talker at the high level will enter directly into the sensitive receiving circuit of the listener. This is commonly called "near-end" crosstalk. In the case of a carrier circuit, the transmitting terminal would involve a certain amount of amplification. The receiving circuit would likewise, so that the net effect would be that the crosstalk between the two circuits would be amplified by the combined amount of gain or amplification present in the sending and receiving circuits. In telephone parlance it would be stated that this is a situation in which substantial level differences exist between the two circuits.

On the other hand, in the case of two adjacent carrier systems employing the same frequencies for the same direction of transmission, a crosstalk situation involving only "far-end" crosstalk would exist, as illustrated in Figure 15. This assumes that near-end crosstalk by reflection as discussed later has been eliminated. In this case the talker and the listener would be situated at opposite terminals of the paralleling circuits and the crosstalk, while being amplified like the near-end crosstalk by the total gain in the transmitting and receiving circuits, suffers the attenuation of the line circuit which more than offsets the amplification. This is, therefore, a very substantial factor in favor of the two-frequency method of operation.



At the carrier frequencies, it has been found impracticable to design transposition arrangements providing for systems where the same frequencies are transmitted in opposite directions. It has been found that, while the two-frequency operation may mean fewer two-way

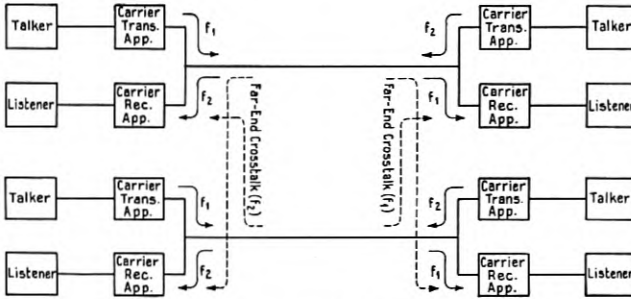

Figure 15—Diagram illustrating occurrence of far-end crosstalk only in carrier systems employing different frequencies for opposite directions of transmission

operating channels within the same frequency range on a single pair of wires than would be the case if the same frequency bands were provided for opposite directional transmission, the net result in the former case is to make it possible to obtain a greater number of channels on a pole line having many pairs of wires. The need for the directional coordination of frequencies has led to the general adoption of rules throughout the Bell System whereby the systems are all installed so that the low-frequency directional group of channels transmits east to west or north to south and the high-frequency directional group in the reverse direction, west to east or south to north.

*Level Equalization.* A situation involving an exaggeration of the crosstalk between two paralleling carrier systems may, of course, arise, even in the case of systems involving the transmission of the same frequency in the same direction for the two systems, if the transmission levels of the systems are not the same. If, for example, two systems operating between the same terminals are set up to have the same overall talking equivalent, and one system has a transmitting gain 10 TU higher than the other, the second system will have to have 10 TU greater receiving gain in order to provide the same overall equivalent. This would mean that this system would receive from the first system 10 TU higher crosstalk than if the levels of the two systems were alike. Efforts are, therefore, made in "lining up" the paralleling systems on a pole line so that as nearly as possible the same level relations are obtained for all systems, and the crosstalk tendencies are thus minimized.

*Staggering of Frequency Bands.* A substantial reduction of crosstalk is obtained through the staggering of an adjacent system frequency allocation as previously noted. Figure 5 shows the frequency allocations of the C-N and C-S systems. Because present standard types of telephone transmitters and receivers have response characteristics which exhibit the greatest sensitivity in the vicinity of 1,000 cycles, as the bands of two adjacent channels are shifted from an overlapping position, the crosstalk is appreciably reduced. In this case also the overlapping crosstalking points are always opposite sidebands and the intelligibility is completely lost even for the case of a substantial overlapping.

It is customary to install C-N and C-S systems on the two side circuits of a phantom group. The phantom group comprises four wires which are most closely associated electrically because they are employed not only to provide a telephone circuit on each pair of wires but a phantom telephone circuit each side of which is comprised of one pair of wires in parallel.

A typical arrangement of facilities afforded by one crossarm of the telephone line is illustrated by Figure 16. It will be noted that this

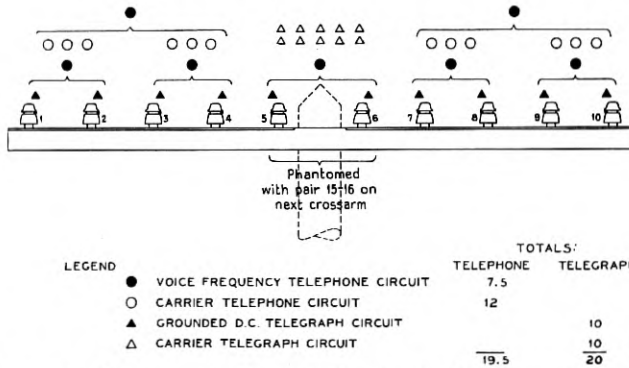

Figure 16—Arrangement of communication facilities on one crossarm

crossarm provides a total of twelve carrier telephone channels, five regular telephone circuits, two and one half phantom circuits, thus making a total of nineteen and one half telephone circuits. The telegraph facilities would total ten regular grounded d.-c. telegraph circuits, one for each wire, and ten carrier telegraph channels on the pole pair, thus affording a total of twenty duplex telegraph channels. This is, therefore, an average of approximately four telephone channels and four telegraph channels per pair of wires, which is obviously a fairly efficient use of the copper wire.

*Impedance.* It is found desirable in connection with communication circuits in general to match carefully the impedances of the various circuit and apparatus components if for no other reason than to insure the best transmission by keeping the reflection losses at a minimum. In connection with carrier systems the matter of crosstalk constitutes an additional important reason for doing this. As noted above, the crosstalk situation is simplified by the standardization of frequency arrangements by which only far-end crosstalk is normally received. This not only reduces the level differences at which crosstalk takes place as explained, but it simplifies the transposition design problem because near-end crosstalk is normally greater in magnitude than the far-end crosstalk. However, if the line circuit is irregular, i.e., if there are abrupt impedance differences in the circuit as it passes from point to point which bring about wave reflections, these may result in near-end crosstalk being reflected and appearing as far-end crosstalk, thus adding to the true far-end crosstalk and making it more difficult to keep within desirable limits. For this reason every effort is made in the layout of the carrier lines to avoid such reflection effects. This makes it desirable to load even relatively short cables including office cables and wiring. The apparatus terminal impedances are also carefully designed, so that their values simulate the characteristic impedance of the line circuits over which the systems are operated.

*Overall Line Circuit.* A situation sometimes occurs in a long carrier system where the line is made up of sections in which the wire pairs

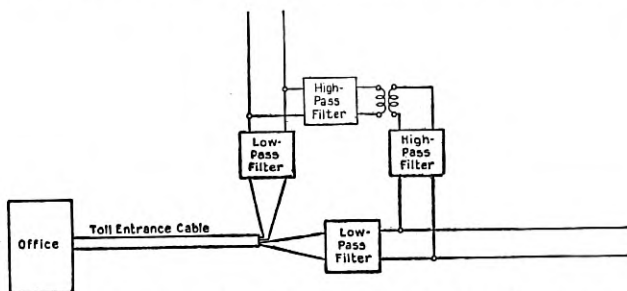

Figure 17—Schematic of high-pass transfer line filter circuit

occupy different pin positions in each section and the voice circuit on the pair in which the carrier system operates is terminated at different points or perhaps joins other lines. The use of line filter sets at the intermediate points makes this arrangement possible. Special transfer line filter sets have also been designed where it is desired to transfer the carrier currents from one pair of wires to another without affecting

the destination of the voice circuits and with a minimum impedance irregularity for either circuit. These line filters are sometimes mounted on poles, so that this transfer may take place where lines join at an outside point and where office equipment cannot be installed. A circuit arrangement illustrating the use of the pole-mounted high-pass transfer filter set is shown in Figure 17.

#### EQUIPMENT PROBLEMS AND TYPICAL INSTALLATIONS

The increasing use of carrier telephony as a substitute for line construction in providing toll facilities on long circuits has, like the development of toll cables, resulted in further increasing the proportion of the plant investment represented by the equipment within the offices. It has likewise required that a greater part of the maintenance effort involved in taking care of a given number of facilities be devoted to the equipment. These factors have made the design and arrangement of the carrier equipment matters of considerable importance. Recent developments in these respects have, therefore, been directed toward obtaining a high degree of adaptability of the carrier equipment to practical use in the telephone plant. Economies in design have also resulted which have been an important factor in extending the usefulness of the equipment.

The type "C" carrier telephone equipment is mounted on panels employing a uniform dimensional system in a manner similar to the other recent telephone developments. Arrangements have been devised so that in the future this mounting method will permit the desired close association between the carrier filters and other related apparatus in the lines in order to minimize high-frequency losses and impedance unbalances within the offices. Signaling arrangements flexibly adapted to present plant conditions have been provided.

The high frequencies and power levels used in carrier telephony and the frequency conversion functions of the system are the principal electrical factors which affect the arrangement and amount of equipment involved. The high frequencies necessitate careful wiring, shielding, and location of certain units with respect to others to avoid undesirable inductive and impedance effects. The modulation and demodulation processes and the high energy levels required necessitate the use of numerous vacuum tubes, with the consequent need of suitable sources of power.

*Typical System Equipments.* As noted previously, a long carrier telephone system involves equipment at a number of intermediate repeater stations in addition to that at the terminals. Figure 18

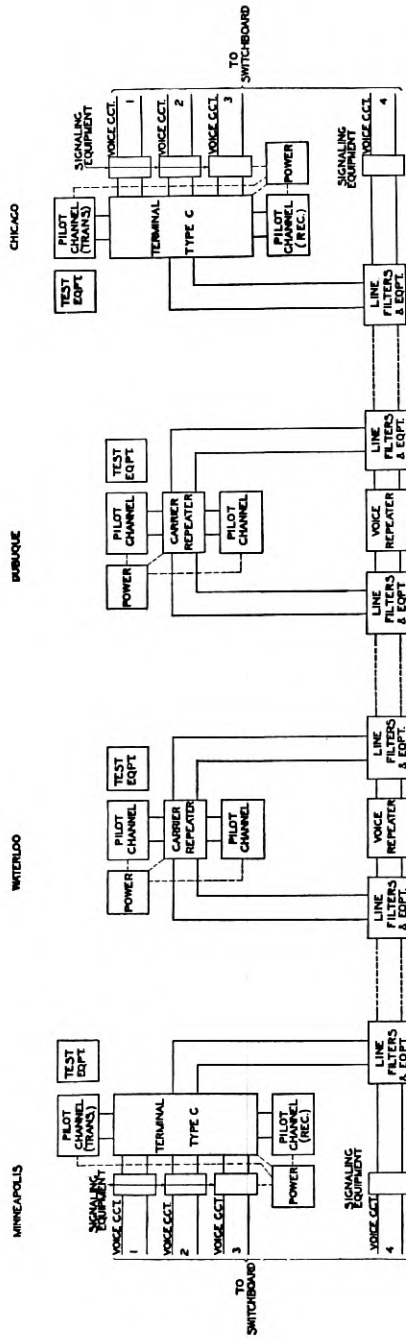

Figure 18—Elementary diagram showing principal equipment groups in typical type "C" carrier telephone system

shows the principal equipment groups involved in a typical long carrier system. The particular system illustrated is one of those between Minneapolis and Chicago, with repeater stations at Waterloo and Dubuque, Iowa. The carrier repeater equipment is ordinarily additional to voice-frequency repeater apparatus used in the wire line as mentioned above and is connected so that the high-frequency currents for the carrier pass around the voice-frequency repeater. The wires concerned are employed also for d.-c. telegraphy by the use of composite sets.

The principal groups of equipment involved in such a system include the carrier sending and receiving equipment and filters at the terminals, the repeater amplifiers and filters at the intermediate stations, and the line equipment and pilot channel equipment at all points. In addition, power supply equipment and testing equipment are required at all points, and voice-frequency and signaling apparatus at the terminals.

The total amount of equipment involved in a typical carrier telephone system shown in Figure 15, exclusive of the power supply, includes altogether about 188 panels assembled on racks equivalent to 14 bays<sup>7</sup> and occupying a total floor space, including aisle space, of about 84 square feet. If the three channels which the system ordinarily provides were obtained by regular wire circuits, the office equipment might amount altogether to about 36 panels and 1.7 bays, occupying about 10 square feet. Thus, in a typical case, about eight times as much office equipment, other than that for the power supply, might be required to furnish a given number of facilities by carrier telephony, in comparison with that needed for the equivalent number of ordinary wire circuits.

*Terminal Station Installations.* The principal equipment groups comprising a terminal of a type "C" system are indicated in Figure 19. A typical assembly showing a majority of these equipment groups is given in Figure 20. This does not include the signaling equipment, the pilot channel, or the power equipment. A rear view of this same assembly is shown in Figure 21.

Returning to Figure 20, the right-hand bay contains the apparatus comprising two channel terminals. The middle bay includes the third channel apparatus and the terminal transmitting and receiving amplifiers and directional filters which are mounted in the upper portion. The box-like units on both bays are the band filters and directional filters. On the right-hand bay the upper of the panels

<sup>7</sup> A bay consists of two channel or I beam uprights, ordinarily about  $11\frac{1}{2}$  feet high, and spaced so as to mount unit panels 19 inches wide and of varying height.

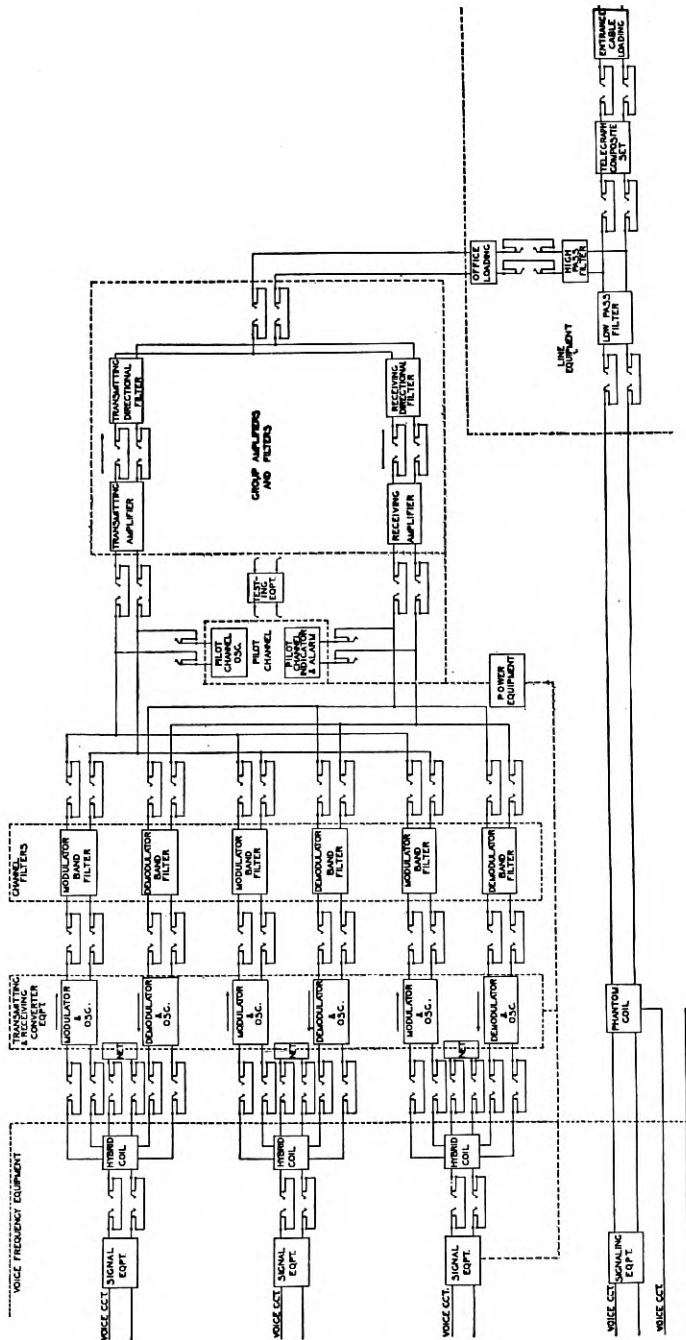

Figure 19—Schematic showing principal units comprising type "C" terminal equipment

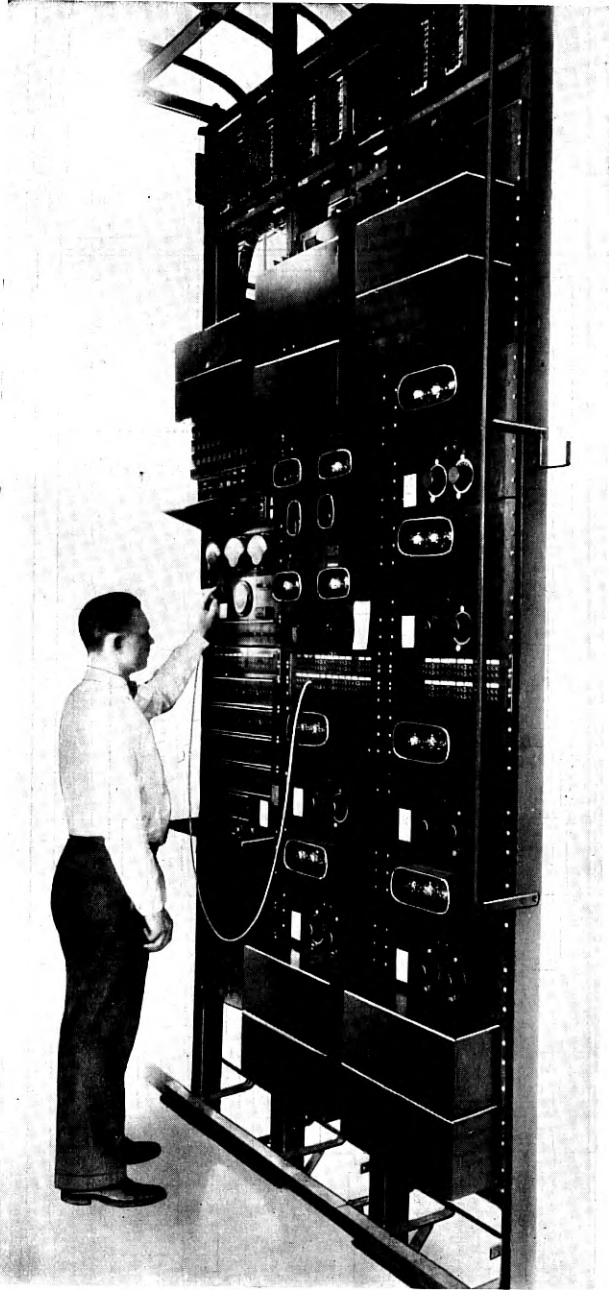

Figure 20—Type "C" carrier telephone terminal equipment, typical assembly of system. (Front)



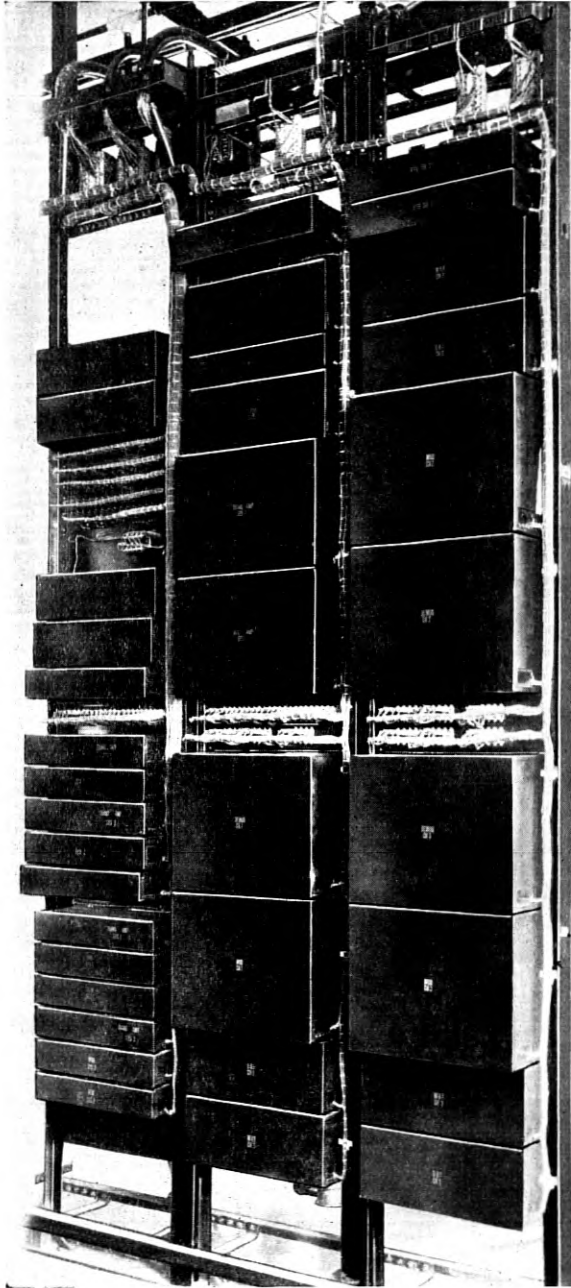

Figure 21—Type "C" carrier telephone terminal equipment, typical assembly of system. (Rear view)

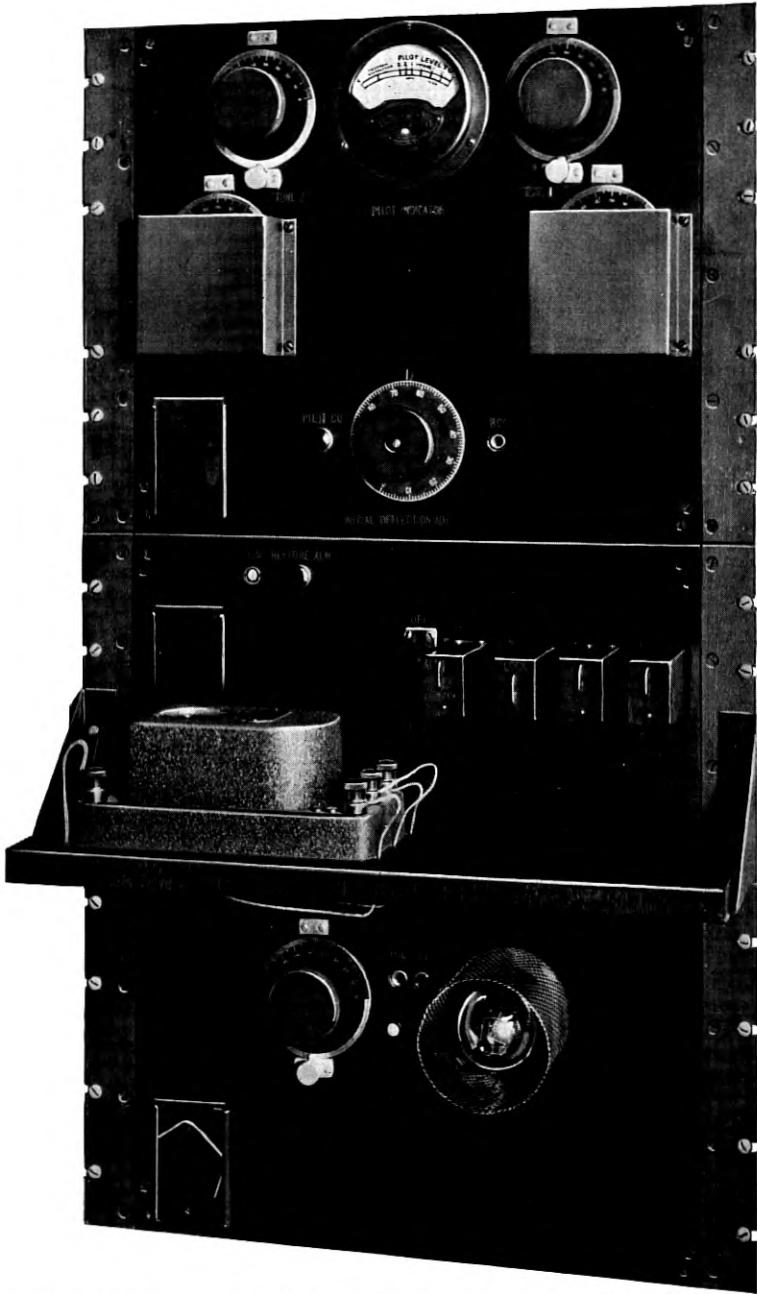

Figure 22—Typical assembly of pilot channel equipment in terminal installation

with three vacuum tubes is the modulator-oscillator panel of one channel. Below it is the demodulator-oscillator panel of the same channel. Below the latter and in the center of the bay is the jack mounting strip which makes it possible to disconnect, or switch for testing purposes, the various units of the complete equipment. The

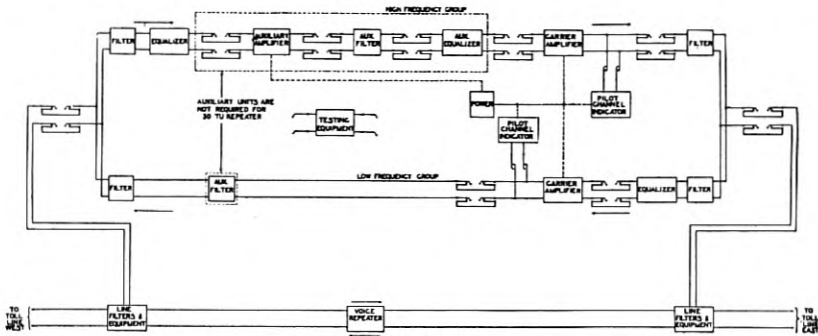

Figure 23—Schematic showing principal equipment units in carrier repeater circuit

demodulator-oscillator panel and modulator-oscillator panel, respectively, are the next two panels of the second channel. The terminal strips will be seen at the top of the bays. The metal shields surrounding the vacuum tubes are useful for mechanical protection only. The testing and power distribution equipment is located in the left-hand bay.

The pilot channel apparatus at the terminal station, which is employed in regulating the performance of the system to compensate for variations in the line equivalents, is assembled in a typical installation as shown in Figure 22. This apparatus may be located adjacent to the carrier terminal apparatus. The upper panel is the indicator unit with the indicator meter shown in the upper center of the panel. The panel immediately below this is the alarm panel with its voltmeter relay. On both of these panels the associated vacuum tubes are mounted in the rear. The lowest panel is the oscillator panel with its vacuum tube and frequency control.

*Typical Repeater Station Installations.* The equipment at each carrier repeater station consists mainly of the units indicated in Figure 23. It is seen from this figure that the principal items are the line filter equipment, the amplifiers, the equalizers, the directional filters, and the jacks provided for testing and patching the equipment. Pilot channel equipment, power supply equipment, and testing equipment are also included. The amplifier equipment in each carrier repeater,

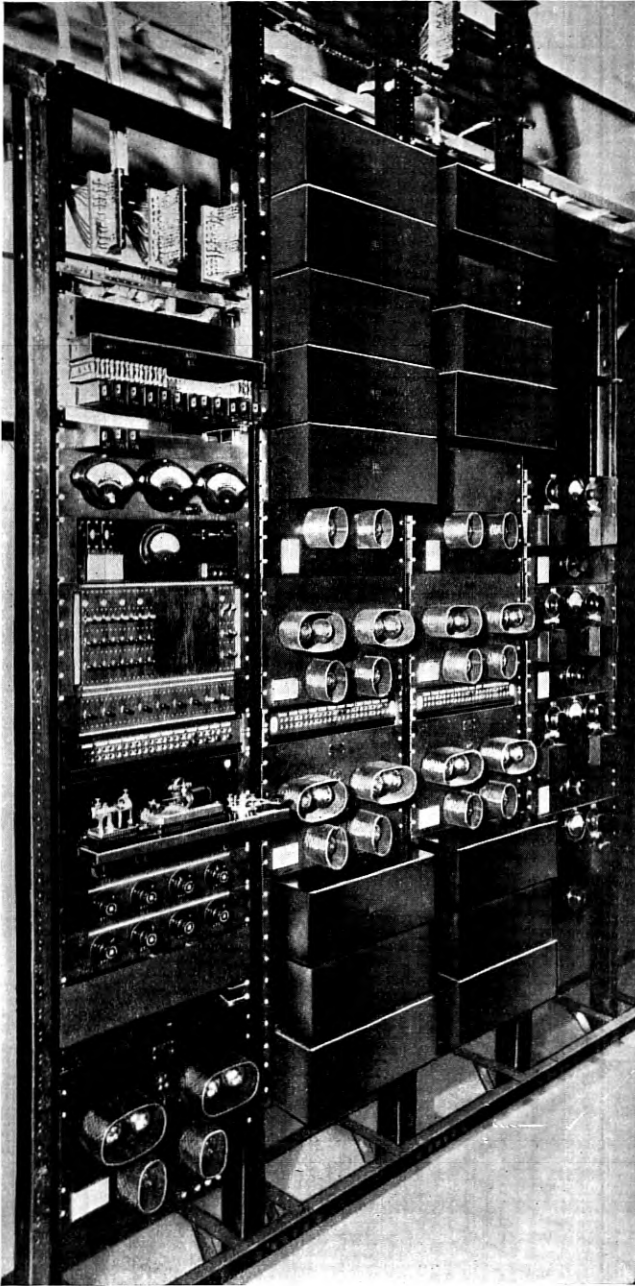

Figure 24—Typical installation of carrier telephone repeater equipment.  
(Front view.)

other than the 15 TU auxiliary amplifier, is identical to the group amplifiers employed in each terminal station. The filters are also identical in type, excepting that twice as many directional filters are required at each repeater station as at each terminal.

A typical complete installation of two carrier repeaters with testing and battery supply circuits located in the bay at the left is shown in Figure 24. The bottom panel on the left-hand bay is a reserve amplifier. Above this panel are the filament rheostats, telegraph instruments, jack panels, key panels for controlling the power supply, a panel containing a thermocouple and meter for testing, meters for reading currents and voltages, and finally the alarm relays. These last are operated by failure in the plate current in the amplifier tubes, thereby indicating when a tube burns out, or failure of either A or B battery supply.

Each repeater bay in this case, Figure 24, contains an auxiliary amplifier to increase the gain in the high-frequency group. From

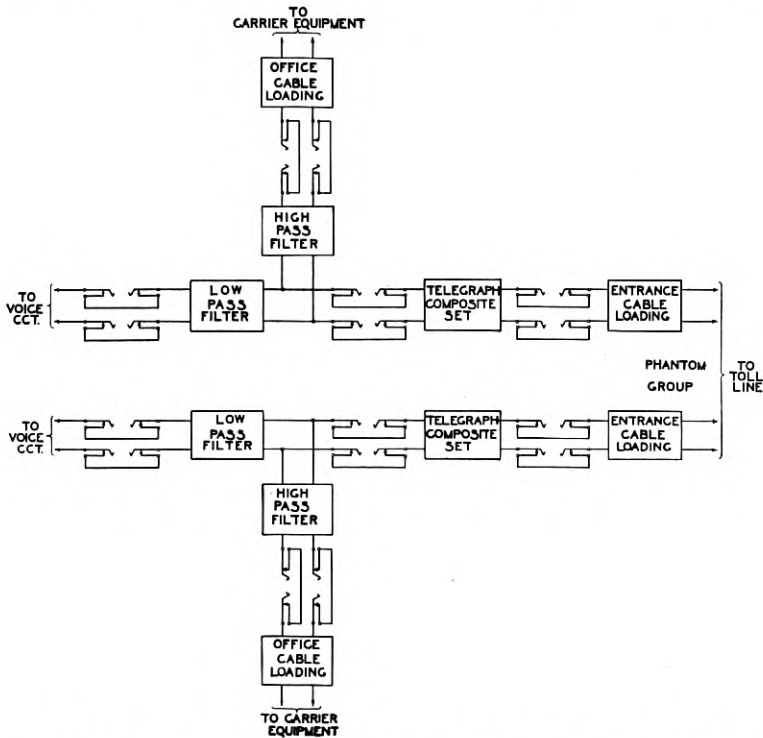

Figure 25—Schematic circuit showing line filter equipment for type "C" carrier telephone terminal. (Phantom group)

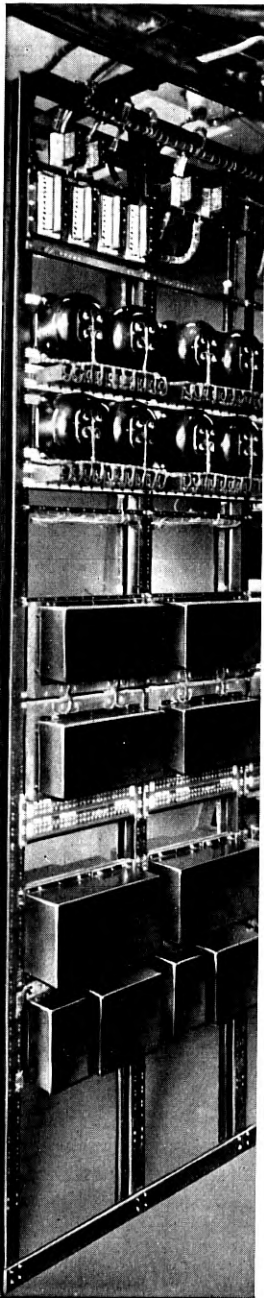

Figure 26—Arrangement of line equipment in one assembly for type "C" carrier telephone. (Front view)

top to bottom the panels are input filters, auxiliary filters, equalizers, auxiliary amplifier, two regular amplifiers separated by a jack panel, and output filters. The arrangement of filters and equalizers is chosen to minimize any tendency toward inductive feed-back effects between the output and input circuits of any one repeater as well as crosstalk between different repeaters on adjacent bays.

The pilot channel equipment at a carrier repeater station is similar to that employed at the terminal stations, excepting that the alarm and oscillator panels are not included. The alarm apparatus is omitted in this case, since it is not the practice to have the carrier repeater attendants readjust the carrier repeaters to take account of line changes, excepting when instructed to do so by the attendants at the terminal stations where the alarm apparatus is installed. The pilot channel equipment at each repeater station thus consists principally of an indicator panel associated with the transmission circuit in each direction, which is assembled with the other equipment as previously shown at the extreme right in Figure 24.

*Line Equipment.* Figure 25 shows the principal line equipment units which are closely associated in effecting connection between the high-frequency circuit of the carrier system and the voice-frequency line. This equipment, consisting of the line filters, composite sets, and entrance and office load coils, is mounted together in one assembly and located as near as practicable to the other carrier equipment. A method of assembly which is now under development is shown in Figure 26. The bay shown contains the line equipment for two phantom groups.

This compact method of assembling and wiring the line equipment reduces the amount of office cabling required for the carrier and,

therefore, reduces the possibility of inter-system crosstalk between carrier systems within the same office. The crosstalk requirements in an office may be more severe than on the pole lines because the level difference between circuits which operate on different pole lines terminating at the same office may be as much as 50 TU. As an aid in obtaining the required electrical separation all high-frequency wiring is reduced to a minimum by segregating and mounting together all line equipment associated with a single circuit. No high-frequency circuits appear at the toll testboard. The toll lines may be tested from the testboard by means of trunks between the testboard and the line equipment bays. All the carrier equipment is thoroughly shielded in such a manner that the separation between the equipment of any two systems is 120 to 135 TU.

The carrier line equipment at a carrier repeater station is generally similar to that at the terminal stations, as previously shown in Figure 26. At each repeater station, however, this equipment is provided in the lines in both directions. Two types of low-pass line filters are employed at the repeater station, one adapted to circuits in which both carrier and voice-frequency repeaters are used and the other, which is less commonly used, for circuits employing only carrier repeaters and where the voice circuit continues through without a repeater.

*Voice-Frequency and Signaling Equipment.* The general function of the voice-frequency terminating equipment is to associate, by means of a hybrid coil and network, the ordinary two-wire circuits in the tele-

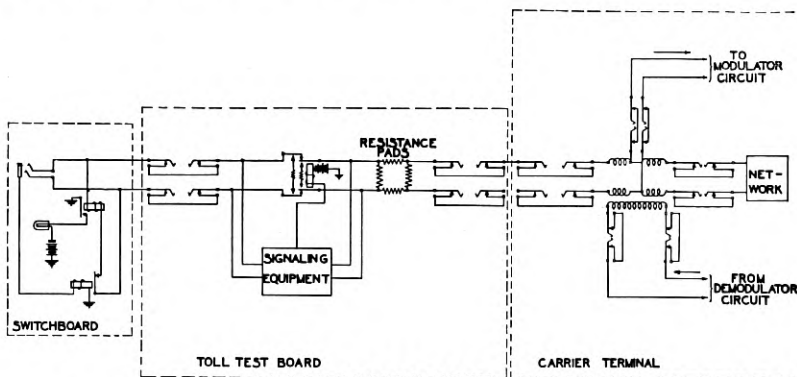

Figure 27—Schematic of voice-frequency circuit for type "C" carrier telephone system

phone switchboard, including both talking and signaling functions, with the sending and receiving branches of each of the different

carrier channels. The general arrangement of this equipment in the circuit is shown in further detail in Figure 27. This includes the signaling equipment and makes provision for the connection of a balancing network.

The use of a two-wire termination for the carrier system is necessary because ordinary telephone circuits at the switchboards, such as trunks, subscribers' lines, etc., are of the two-wire type and the cord circuits for interconnecting these are of this type. Hence, such a termination of the carrier system makes it possible to connect it to other circuits with the same apparatus and in the same manner as with ordinary telephone circuits.

The signaling apparatus consists of a 1,000-cycle ringer of the type which is employed on long voice-frequency lines. This is connected to the voice-frequency terminal of the carrier system in the same manner as to other voice circuits. The use of 1,000-cycle signaling with the carrier has been desirable in place of the more simple low-frequency signaling apparatus used on shorter lines, since frequencies less than 200 cycles are not efficiently transmitted.

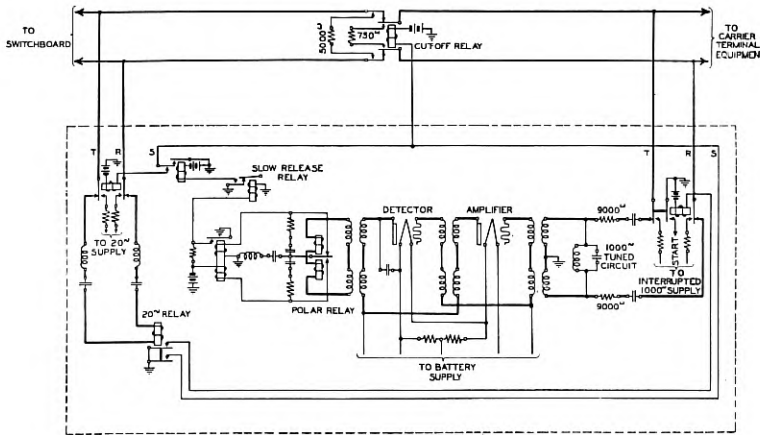

Figure 28—Schematic of 1,000-cycle ringing circuit

Figure 28 shows a simplified diagram of this type of ringer. The transmitted signaling currents as impressed upon the carrier channel are of 1,000-cycle frequency interrupted at a speed of 20 interruptions per second. This ringing current supply is obtained either from 1,000-cycle generators or vacuum tube oscillators. Such currents, while in the voice-frequency range and thus capable of being transmitted readily, form a signal of sufficiently distinctive character to permit separation from ordinary voice currents. Thus, practical



freedom from voice interference with the receiving apparatus is obtained, since this apparatus is designed to respond to very small currents of this character but to discriminate sharply against other currents.

*Tests and Adjustments of Apparatus.* For the purpose of testing and "patching" (i.e., interconnecting various equipment units in the carrier system), jacks are provided as previously shown in Figure 19. The equipment which is employed for testing and adjusting the carrier apparatus provides means for measuring gains and losses at the various frequencies encountered and includes a supply of testing current at these frequencies. The general arrangement of the testing apparatus provided for measuring gains and losses is shown in Figure 29. This is assembled with the other carrier equipment as previously shown in Figure 20. It consists chiefly of means for switching a known loss in the testing circuit, an attenuator, and a calibrated thermocouple type measuring instrument for determining the value of the current transmitted through this apparatus. The 1,000-cycle current is used for practically all testing of the terminal apparatus.

The testing equipment at a carrier repeater station is arranged in a manner similar to that at the terminal stations, as previously shown in a general way in Figure 29. It requires in addition, however, a

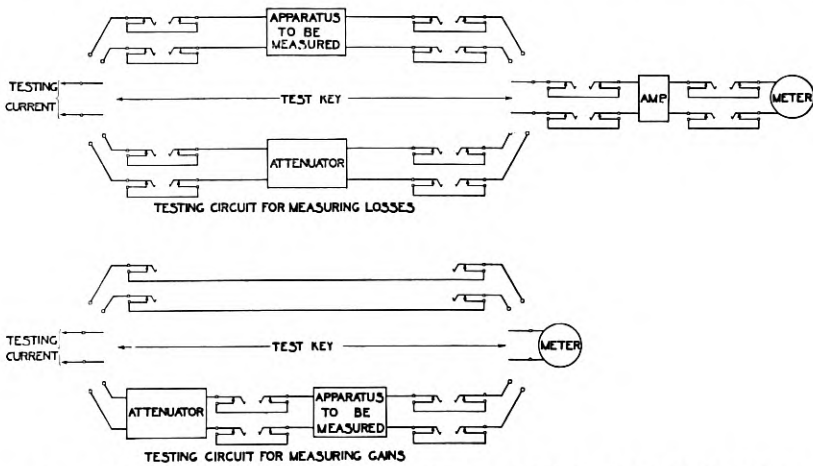

Figure 29—Schematic of testing circuit for type "C" carrier telephone system

carrier-frequency oscillator. Only high-frequency currents are transmitted through the carrier repeater, hence the 1,000-cycle supply employed at the terminals where modulation and demodulation of these carrier currents occur, is not useful in testing the repeater equipment.

It is customary to make periodic tests of the equipment. On the longer circuits<sup>8</sup> each day the channels are "lined up" for the required overall transmission equivalents. At less frequent intervals the vacuum tubes are checked for emission, the gains of the sending and receiving branches are measured, the carrier synchronism is checked, etc.

*Vacuum Tubes.* Two principal types of vacuum tubes are employed in this system. One of these is the so-called "L" tube. This tube has a filament circuit requiring a current of approximately 0.5 ampere with a voltage drop of 4.0. It has a  $\mu$  of 6.5, and a normal plate current, when used as an amplifier with a "B" voltage of 130 and a "C" biasing potential of 8, of about 6.5 milliamperes.

For the output stage of the amplifier a higher capacity tube is employed. This is a so-called "O" tube having a  $\mu$  of about 2.5, a filament current requirement of approximately one ampere at a voltage drop of 4.5. The normal plate current when used as an amplifier with a grid biasing potential of 22 and a plate potential of 130 volts is from 17 to 35 milliamperes.

In addition to the above the pilot channel uses a low-filament current tube. This tube has a  $\mu$  of 8, a filament current of .060 ampere, and a filament voltage drop of 3 volts. The normal plate current when used as an amplifier with a grid biasing potential of 7 volts and a plate potential of 130 volts is approximately .003 ampere.

The tubes employ oxide-coated filaments and have been designed to be especially long lived to meet daily 24-hour service requirements.

*Power Supply.* The power required for the carrier equipment is taken from the telephone office supply where this is adequate. Usually the 24-volt central office power plant is suitable for the purpose, and the 130-volt supply for the plate circuits of the tubes is taken from the same batteries provided for telephone repeaters if available. The carrier requirements, however, may amount to a substantial addition to the load on the power plant, particularly where several carrier systems are installed in a relatively small office.

The amount of power required for a typical carrier telephone system is substantially larger than the usual telephone power requirements for the same number of facilities. Each system terminal requires approximately 8 amperes at 24 volts and about 400 milliamperes at 130 volts. The power required for each carrier repeater amounts to about 4 amperes at 24 volts and 250 milliamperes at 130 volts. Thus, the total power required for one three-channel

<sup>8</sup> W. H. Harden, "Practices in Telephone Transmission Maintenance Work," *Bell System Tech. J.*, V. 4, Jan. 1925, pp. 26-51.

system with two intermediate repeater stations would be in the neighborhood of 24 amperes at 24 volts and 1.3 amperes at 130 volts, amounting altogether to about 750 watts. This corresponds roughly to the amount of power consumed by about 80 telephone repeaters, so that the total power required for three such carrier systems would be about equal to that required for a cable repeater station having between 200 and 300 repeaters. Assuming 2 or 3 repeaters in a typical voice circuit, the carrier systems are seen to require over ten times as much power as voice circuits in providing the same facilities.

The best results are obtained with the carrier systems when very close regulation of this power supply is maintained. About  $\pm 1$  volt for the 24-volt supply and  $\pm 5$  volts for the 130-volt supply are desirable limits of variation. Means for obtaining such regulation are added as required to the existing power plant. In the larger offices this may consist of a duplicate battery with full-floating operation. In the smaller installations, a relay regulating circuit may be added which controls the filament current as the voltage varies from 20 to 28 volts. This consists of a sensitive voltmeter relay arranged with accessory relays to cut resistance in and out of the individual filament supply circuits as the voltage varies.

#### DESIGN OF CARRIER APPARATUS

Many will, no doubt, be interested in the further technical details of some of the more important units of the carrier system.

In the development of the apparatus considerable preliminary work was necessary to determine the circuit requirements imposed upon the individual units. For example, preliminary to the design of the filters, laboratory studies were made to find what interfering frequencies might be expected in a channel and what attenuation the different filters must offer at various points in the frequency range, in order that the system should provide speech of satisfactory quality and freedom from interference. As a result of such work, it was possible to make the requirements of the filters no more stringent than absolutely necessary, thus keeping the cost down to a minimum while insuring adequate performance. Preliminary studies were also made on the other parts of the system such as modulator, demodulator, oscillator, etc. In the descriptions which follow, no attempt has been made to describe this preliminary work, the discussion being limited to the requirements imposed, and the circuits devised to meet these requirements.

*Modulator and Transmitting Oscillator.* A circuit drawing of the modulator is shown in Figure 30. It may be considered that the

function of the modulator is to translate the voice frequencies along a frequency scale to some assigned location in the band of frequencies to be occupied by the carrier system. The carrier frequency controls

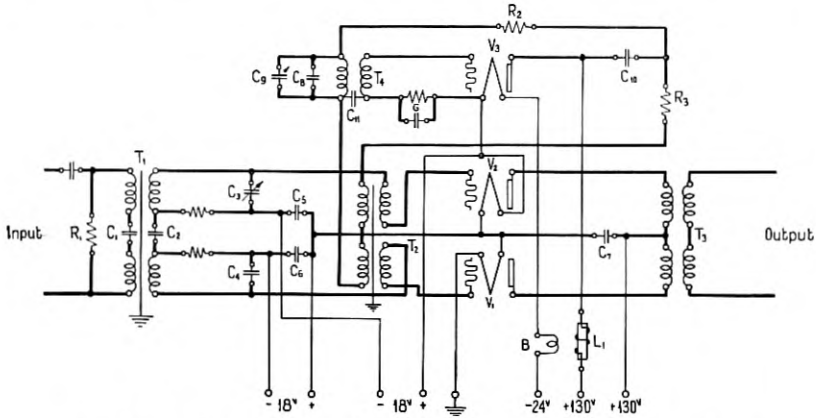

Figure 30—Schematic of modulator circuit and transmitting oscillator

the location of the shifted voice band or sideband, and the oscillator, which provides this frequency, is made an integral part of the modulator unit. The modulating process requires a circuit element having a non-linear response characteristic to produce the sideband from a combination of the carrier and voice frequencies. In this circuit the three-element vacuum tube is operated to give this required characteristic.

Since the carrier is not transmitted in the type "C" system, each modulator and demodulator becomes a complete and independent frequency changing unit. As previously noted, the frequency stability of each oscillator must be sufficiently good so that the carriers of the corresponding modulator and demodulator units will differ but slightly in frequency so as not to affect unfavorably the speech which is transmitted. In this connection both naturalness of the received speech and intelligibility must be considered. In the type "C" system satisfactory results have been obtained by holding the difference between the carrier frequencies of any two associated units due to all causes to within about 20 cycles.

The usual causes of frequency variation are fluctuations in the A and B battery supply and changes in temperature and humidity. Vacuum tubes have to be replaced periodically and differences in the tube characteristics may cause a slight variation in the frequency.

The type of oscillator circuit was chosen to furnish the greatest

frequency stability with variations in power supply, particularly in the plate battery. Fluctuations in the filament current are reduced by the use of ballast resistors to a point where they do not appreciably affect the oscillator frequency.

In order to maintain stability with temperature and humidity changes, it was necessary to develop circuit elements (primarily the inductance in the oscillating circuit) which were not greatly affected by these variables. As a result the oscillators vary less than 10 cycles per second at the highest carrier frequency with power variations within the limits of plant maintenance, and have a frequency temperature coefficient of approximately .002 per cent per degree Fahrenheit. This corresponds to about one cycle per second per degree Fahrenheit in the highest frequency units used in the type "C" system. The temperature difference between offices containing terminal equipment seldom exceeds 20 degrees Fahrenheit.

An extreme change in frequency of 20 cycles per second may be encountered with different tubes. Maintenance experience has shown that it is usually unnecessary to check the synchronization of the modulator and demodulator carrier frequencies more often than once a week, unless tubes are replaced or some other unusual circuit change occurs.

The modulating tubes are placed in a push-pull arrangement, and the carrier voltage is applied to both grids in phase and the suppression of the carrier frequency secured by a differential connection of the output transformer windings. It is difficult to completely suppress the carrier and a limit is set upon the amount which can be allowed on the high-frequency line without causing interference between systems. This limit requires that the carrier flowing out from the modulator should not exceed approximately 500 microamperes. With varying conditions of power, the balance of the modulator cannot be maintained absolutely constant, so that to insure meeting this requirement under the worst conditions it is necessary to adjust the balance under normal conditions to a point where the carrier has been reduced to about 150 microamperes at the output of the modulator. The side-band current flowing at this place in the circuit is ordinarily of the order of 2,000 microamperes. Adjustment of the carrier balance is made by changing the condenser across one half of the input circuit and by selecting tubes.

A further requirement imposed on the modulator unit is that of gain stability. In order to maintain sufficiently constant transmission over a circuit there must be a high degree of inherent stability in all those units whose variations are not included in the indications of

the pilot channel. The modulator and demodulator are the only units in this category.

In the modulator and demodulator the principal factors tending to cause instability of gain are the variations in plate and filament battery where these occur and changes in the tubes during their life. A characteristic behavior of the modulator described below has been used to advantage in minimizing this instability. The gain of the modulator for varying values of the carrier voltage passes through a maximum near the point where the grids of the modulator tubes are driven to a positive potential, with respect to the filament. The output from the carrier oscillator will increase with increasing plate potential, and due to the above characteristic may be made to compensate somewhat for the tendency of the gain of the modulating tubes to increase. Figure 31 shows the change in gain of the modu-

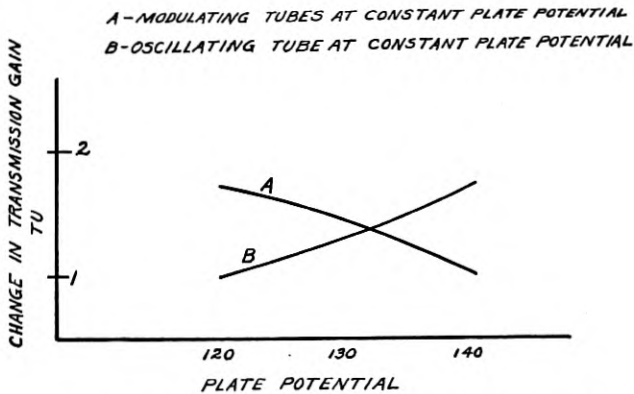

Figure 31—Modulator gain—relation to plate potential

lator circuit when the plate potential of either the oscillating or modulating tubes is changed independently. With these arrangements the total variation in the modulator or demodulator gain, due to the fluctuations of power supply, does not usually exceed  $\pm .25$  TU. The possible variation due to tube differences is somewhat larger, approximately  $\pm .7$  TU. This is not serious since tubes are ordinarily replaced when a system is out of service, and the gain can be readjusted before the system is restored to operation.

Another requirement which the modulator must meet is one of transmission quality or equality in transmission gain at various frequencies in the voice band. The modulator should not limit the band of frequencies which are to be transmitted over the system. In other words, the gain of the modulator should be substantially the

same for frequencies between 200 and 2,800 cycles per second. The characteristics of the transformers and the impedance in which the output of the modulator is terminated are the controlling factors in the quality of the modulator. A typical characteristic of modulator gain with frequency under ideal terminations is shown in Figure 32.

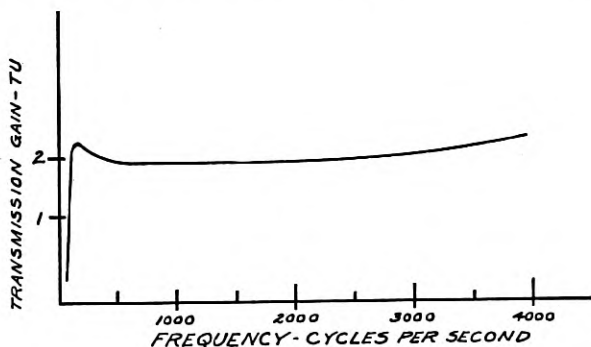

Figure 32—Modulator gain—relation to frequency

In the type "C" system the effect of the band filter impedance is to cause a variation in this characteristic of approximately 5 TU at 2,800 cycles.

The final requirement placed upon the modulator relates to the energy level which must be handled. It should not be possible to overload the modulator seriously with the amount of power produced by a subscriber's set at the transmitting toll testboard level. With a given modulator circuit, this requirement can be met by designing the input transformer with the proper turns ratio.

The following paragraphs give a more detailed description of the actual circuit which has been developed to meet the above requirements.

The voice-frequency circuit is through the hybrid coil to the terminals of the input transformer. The resistance placed across the input circuit is to improve the impedance terminating this branch of the hybrid coil, and thus improve the terminal impedance looking into the hybrid coil from the voice-frequency line. The condenser C-1 is inserted in series with the primary winding of the transformer to improve the transmission characteristic of the circuit at low frequency. This condenser resonates with the inductance of the primary winding, increasing the voltage across the primary at low frequencies where the modulator input circuit tends to become less efficient. The two windings of the secondary side of the transformer are separated

by by-pass condenser C-2, as they are at different potentials from ground, due to the series connection of the filaments of the vacuum tubes. The variable condenser C-3 affords a means of balancing the carrier frequency potentials. Condenser C-4 is one half the maximum capacity of C-3 in order that carrier frequency unbalance

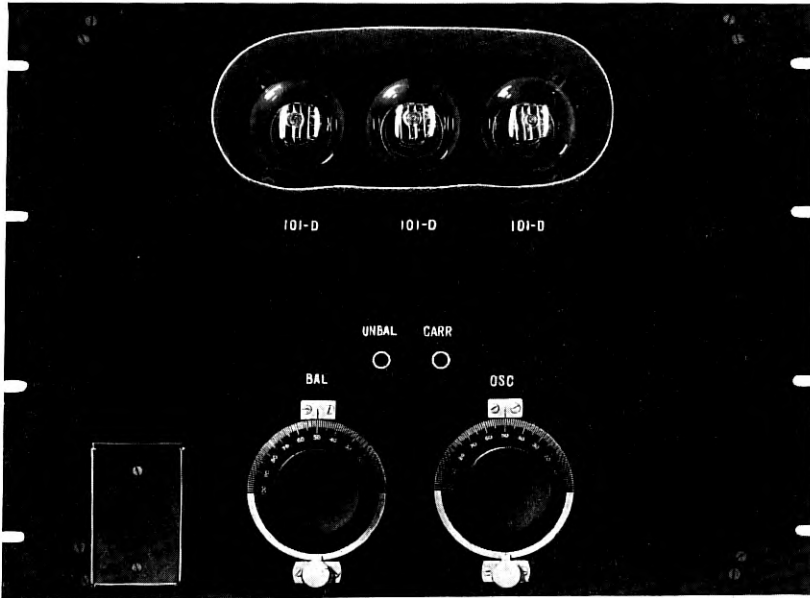

Figure 33—Assembly of modulator panel. (Front view)

in either side of the circuit may be compensated for to a sufficient degree by means of the one adjustable condenser C-3. The voltages,  $E_1$  and  $E_2$ , provide the grid bias for the modulating tubes V-1 and V-2. The condensers C-5 and C-6 provide a low impedance path around the source of biasing potentials for the carrier frequency, and condenser C-7 in the plate circuit performs the same function with respect to the plate battery.

In the oscillator, the condensers C-8 and C-9 together with the inductance of one winding of the transformer T-4 form the oscillating circuit. C-9 is made adjustable to compensate for manufacturing variations in the inductance, and to provide in addition a certain flexibility in frequency adjustment. A grid bias for the oscillating tube is provided by the grid leak-condenser combination C. The plate battery is connected through the retardation coil L-1, which presents a high impedance to the carrier frequencies, and prevents



them from flowing through the plate battery. The carrier current in the plate circuit divides between two paths, one through R-2, the feedback resistance to the grid circuit, and the other through R-3, the output resistance, and the transformer T-2 which impresses the carrier voltage on the grids of the modulating tubes. The filaments of the tubes in the modulator circuit are wired in series, and the current flow is regulated by a ballast resistor B.

Figures 33 and 34 show the front and rear views of the modulator panel. The adjustable condensers which control the carrier frequency

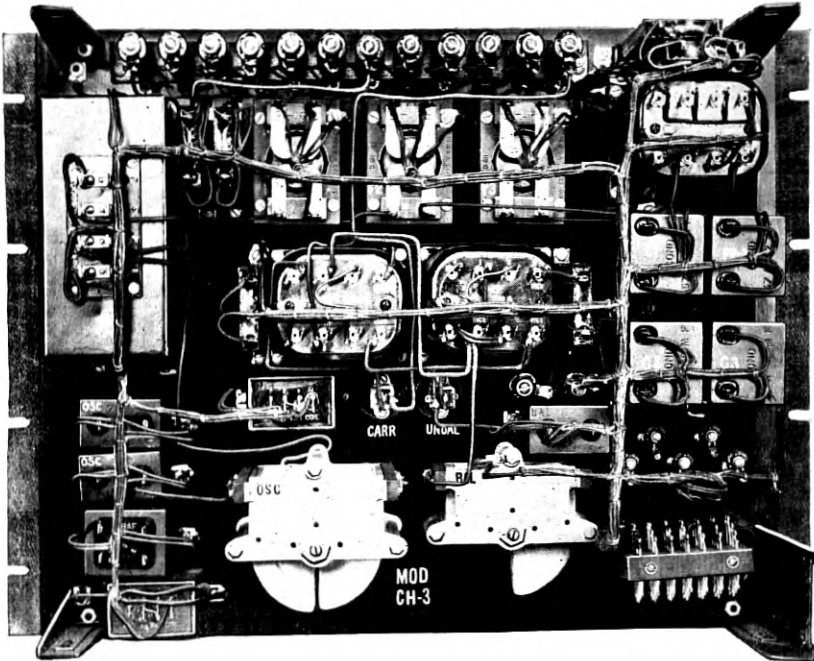

Figure 34—Assembly of modulator panel. (Rear view)

and the carrier balance are accessible from the front of the panel. In the rear view, the oscillator circuit occupies the left-hand side of the picture. The oscillating transformer is in the upper left-hand corner, with the oscillating condensers directly below it. The feedback and output resistances are connected across the top of the panel. The oscillating tube is left of the three tubes, and the carrier input transformer is below it. The voice input transformer is to the right of the carrier transformer, and the output transformer is located in the upper right-hand corner. A metal cover fits over the complete panel at the back to provide electrical shielding and mechanical

protection. All outside connections to the panel are made through the terminal block in the lower right-hand corner. Wires supplying power, together with those which are at a low a.-c. potential with respect to ground, are run in a cable, while wires at a high a.-c. potential are run directly from point to point in as short a path as possible in order to reduce losses resulting from the capacity of these wires to ground.

*Demodulator and Receiving Oscillator.* The circuit of the demodulator shown in Figure 35 is in many respects similar to that of the

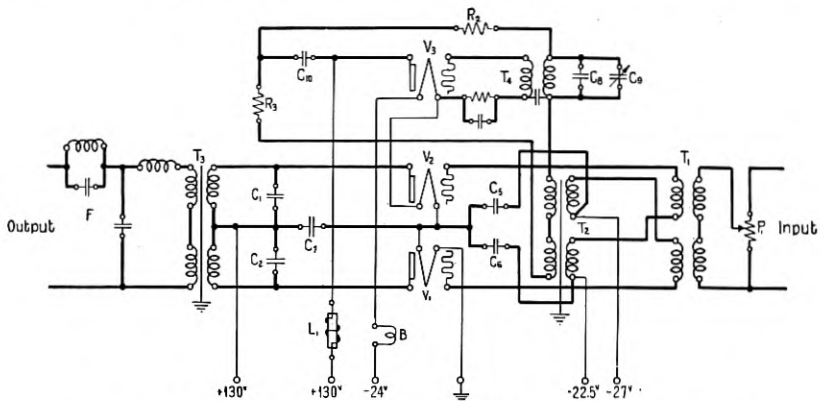

Figure 35—Schematic of demodulator circuit and receiving oscillator

modulator. The function performed by the demodulator is also similar, being a translation from a high-frequency band to a lower instead of the reverse.

The oscillator which supplies the carrier to the demodulator is of the same type as the modulator oscillator, and has been discussed in connection with that circuit. No adjustable feature for balancing the carrier is required in the demodulator circuit. The carrier suppression needed in addition to the suppression inherent in the balanced circuit is provided by the low-pass filter at the output. If the carrier is not sufficiently suppressed, it will pass into the voice circuit or across the hybrid coil into the associated modulator, causing in some channels an objectionable beat tone.

The transmission stability of the demodulator is obtained by the same methods used in the modulator since the performance of the two circuits is similar, and the transmission quality requirement is essentially the same for both units. A typical demodulator characteristic is shown in Figure 36. This characteristic at the higher frequencies is controlled by the low-pass filter.

One feature which is required with the demodulator, but not with the modulator, is a variable control of the transmission gain of the circuit. Due to the unequalized transmission of the line section

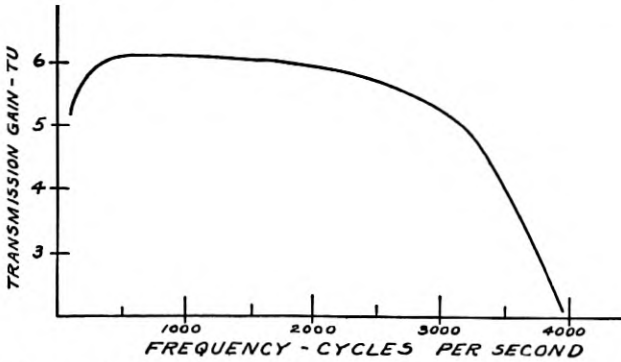

Figure 36—Demodulator characteristic—gain and frequency

adjacent to the terminal, or other differences in the channel equivalents, the three sideband currents normally arrive at a receiving terminal with unequal strength. A potentiometer controlling the gain of the demodulator permits of an equalization of the overall losses on the three channels.

In the following detailed description of the demodulator circuit other minor differences between it and the modulator may be pointed out:

The sideband frequencies enter the demodulator passing to the potentiometer P-1 which controls the amount of current to the input transformer T-1. The position of the carrier input transformer T-2 is somewhat different in the demodulator circuit as compared to the modulator circuit, due to the difference in the high-frequency characteristic of the T-1 transformers. In the modulator this transformer must be designed to transmit voice frequencies primarily. It has a comparatively large capacity to ground which would reduce the effective carrier voltage on the tube grids if it were placed in the same circuit position as is the demodulator transformer. The function of most of the circuit elements is evident from the previous description of the modulator. The C-1 and C-2 condensers provide a low impedance path for the carrier frequency. They are necessary here because the transformer T-3 designed for high efficiency at voice frequencies has considerable leakage inductance, which would present a high impedance to the carrier in the plate circuit if the condensers were not provided. For the maximum gain the impedance of this

circuit should, of course, be a minimum at carrier and sideband frequencies. At the output a low-pass filter structure F provides for the suppression of the unwanted products of demodulation.

A front view of the demodulator unit is shown in Figure 37. The

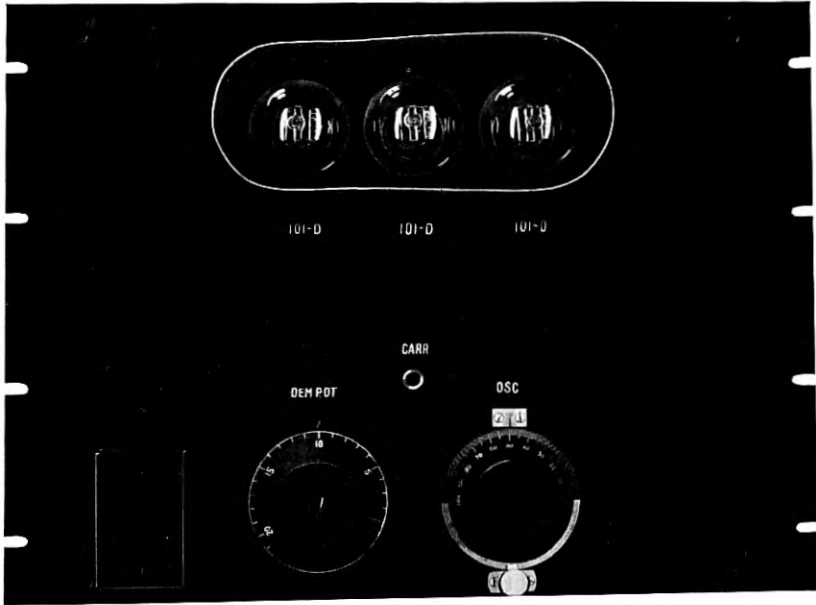

Figure 37—Assembly of demodulator panel. (Front view)

panel layout and general appearance is similar to that of the modulator. The two dials shown control the demodulator input and the oscillator frequency, respectively, as indicated in these figures.

*Filters.* The general function of a band filter is the selection of a band of frequencies, and the protection of this band from interfering frequencies located on either side. The filters determine what band width is transmitted, and thus to that extent they control the quality of speech which may be obtained through the carrier circuit. The type "C" system transmits a band corresponding to approximately 200 to 2,700 cycles per second in the voice range.

In considering the requirements imposed upon the band filters it is necessary to keep in mind<sup>9</sup> the fact that the modulator produces not only the particular sideband which is to be transmitted but also an unwanted sideband of the same volume as the wanted sideband and

<sup>9</sup> R. V. L. Hartley, "Relation of Carrier and Side Bands in Radio Transmission," *Bell System Tech. J.*, V. 2, April 1923, pp. 90-112.

equal to it in width, located on the opposite side of the carrier frequency. In addition to these products of modulation there are produced other frequency bands, the important ones occupying side-band positions about the harmonics of the carrier frequency. See Figure 38.

The first requirement on the band filters is imposed by the need of suppressing the unwanted sideband to prevent distortion when the

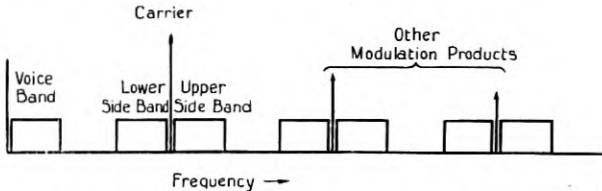

Figure 38—Frequency range of products of modulation

carriers are out of synchronism. The tests mentioned above in connection with the oscillator frequency stability were made with but one sideband transmitted. If both sidebands are transmitted, the carriers must be exactly in synchronism or a "wobble" due to the demodulation of both sidebands can be detected. One sideband must be suppressed by an increasing amount as this carrier difference increases. For a carrier frequency difference of about 20 cycles it is necessary to suppress the unwanted sideband about 40 TU, thus reducing it to about 1/100 of the strength of the wanted sideband in order to eliminate completely this type of distortion. This requirement can be met by providing the necessary attenuation in either the transmitting or the receiving band filter, or by making the sum of their attenuations equal to 40 TU.

The suppression of the unwanted sideband is necessary for another reason in a multi-channel system in which the transmitted sidebands are close together. The unwanted sideband from one channel overlaps the wanted sideband of an adjacent channel, and would be demodulated and appear as "crosstalk" into this channel if it were not suppressed by the transmitting band filter. The suppression needed is determined by the amount of interference which can be tolerated from one channel to another. It has been found that to meet this requirement the transmitting band filter must suppress the unwanted sideband about 60 TU. The other modulation products mentioned above must also be reduced by the transmitting band filter to a value which will not cause interference in any channel into which they might pass. The discrimination requirement for these frequencies is less severe because the magnitude of these modulator products is not so great.

A particular termination is required at the end of the filter which is connected to the modulator. In order to get the maximum sideband power out of the modulator used, the impedance of the associated band filter, seen from the modulator, must be made low over the range of voice frequencies.

With the channels placed closely together and with the coordination of different types of systems, depending upon the channel locations, it is important that the band filters remain constant after manufacturing, and that all filters of the same type be manufactured to meet close requirements. For proper coordination between systems it has been found desirable to keep all the channel bands within  $\pm 125$  cycles of an assigned location. This means in the higher frequency channels that the filters must be manufactured to a frequency accuracy of the order of  $1/2$  of 1 per cent.

The attenuation requirements for the receiving band filter are somewhat different from those of the transmitting band filter. The purpose of the receiving band filter is the suppression of the frequencies of the adjacent channels as they are received over the line. In contrast to the transmitting filter, which must suppress the unwanted frequencies produced in its own channel, a filter with somewhat different characteristics could, therefore, be used for a receiving filter. While the requirements were determined separately for the receiving and transmitting filters, it was desirable in the interest of manufacturing economy to build both alike, setting requirements on the basis of a double purpose filter. Thus, this filter had to provide attenuation at each frequency to meet the more severe of the requirements for either the transmitting or the receiving position. Figure 39 shows the transmitting characteristic of a typical filter designed to meet the requirements outlined above.

As has been explained, the grouping of the channel bands in opposite directions requires the use of so-called directional filters at terminal and repeater points. These filters occur in the circuit in pairs—each pair consisting of one high-pass and one low-pass filter. The “cut-off” point of the filters is determined by the type of system in use—C-S or C-N and its corresponding “grouping point.” At repeater points the filters are split for each direction in order to provide selectivity at both the output and input circuits of the amplifiers.

Considering the closed circuit through the two amplifiers and the four directional filters, the attenuation in this loop must be considerably greater than the sum of the gains of the two amplifiers at all frequencies. In the regions outside of the carrier frequencies, the margin between attenuation and gain is made about 10 T. U. For

frequencies in the carrier range this margin must be still greater to prevent distortion, which becomes objectionable when circulating currents of any size are allowed to exist. This "feed-back" effect

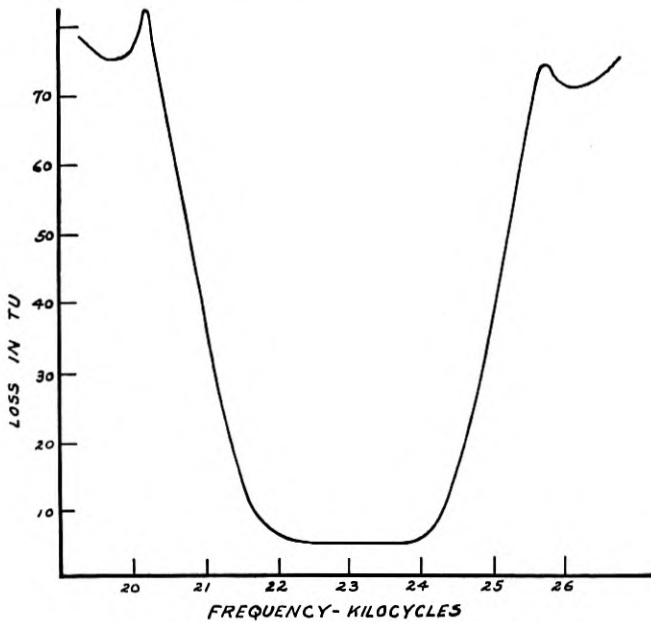

Figure 39—Typical band filter characteristic

will also affect the repeater input impedance, and because of the necessity for closely controlling this characteristic the margin between gain and attenuation is not permitted to be less than 25 T. U. at any frequency used for transmission in either direction. The impedance of these filters on the line side must match the line impedance closely in order that no considerable reflection of the carrier currents can take place at this junction point.

As was mentioned previously, the output of an amplifier contains, due to modulation, other frequencies in addition to those which compose the input, so that crosstalk is to be expected between some of the channels. The amount of this crosstalk, which will appear at the far end, depends on the ratio of the sideband currents to the interfering currents produced in the amplifier, the measurement being made at the repeater output. The near-end crosstalk, however, is dependent on the level difference between the strong output of the one amplifier and the weak input to the other. Those frequencies which may give trouble in the channels at the near end enter the

returning circuit at the amplifier input, a point where the sideband level is very low. To put the near-end crosstalk on the same basis as the far end, the output directional filter must introduce enough attenuation in its non-transmitting range to make up this level difference. This attenuation is increased until the near-end crosstalk due to this cause is appreciably less than the far end.

The output current of one amplifier may be 30 TU or more stronger than the input current to the amplifier for the opposite direction, and the directional filter at the input of this second amplifier must offer sufficient attenuation to the output currents of the first so that they will not contribute materially to its load.

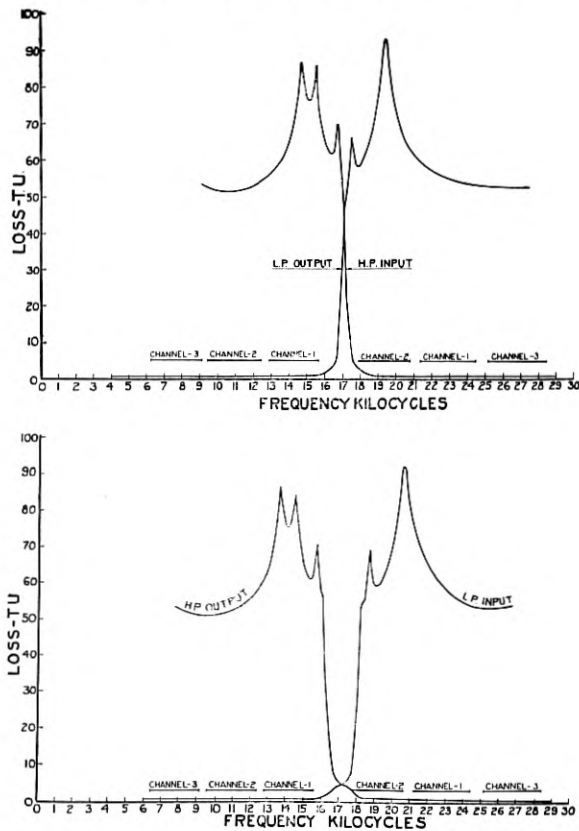

Figure 40—Typical directional filter characteristics

Figure 40 shows the selectivity characteristics of the two directional filters.

A pair of filters having important functions is the line filter set



which, as has been noted, acts to separate the carrier currents from the regular speech currents on the common line circuit. It consists of a high-pass and a low-pass filter paralleled on the line side. Currents entering these terminals from the line circuit pass through the high-pass circuit to the carrier apparatus or through the low-pass circuit to the circuit terminal or repeater. The transmission characteristics of these filters are shown on Figure 41. It will be noted that frequencies

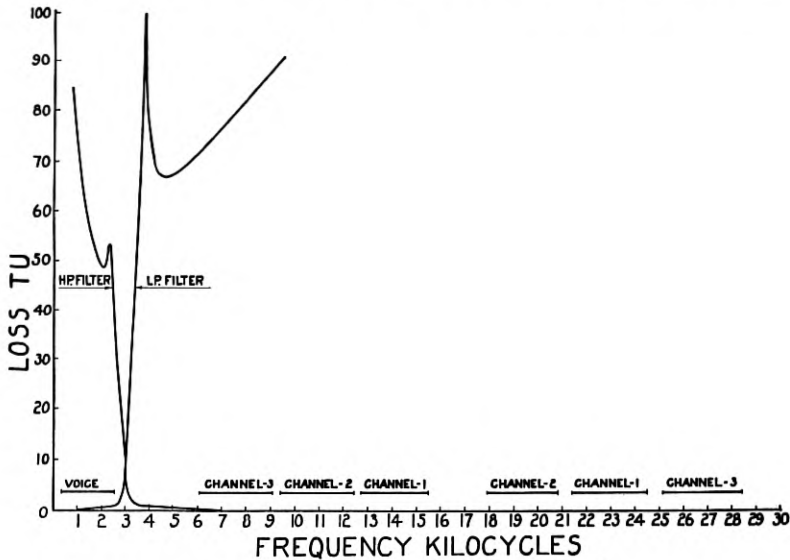

Figure 41—Typical line filter characteristics

above approximately 3,300 cycles are transmitted in the high-pass circuit and frequencies below about 2,800 cycles are transmitted through the low-pass circuit. It is common to equip a few line circuits with line filter sets, in addition to those which are normally in use for carrier transmission. This makes it readily possible in case of an emergency or for other reasons to use the spare wires thus equipped for carrier transmission.

Non-linear effects may be produced in the coils and condensers in the circuit. The design of the filter parts must be made so that these effects will be a minimum. This requires the use of non-magnetic cores in the coils, and also that the containers be of non-magnetic material. Condensers in magnetic containers must be located so that they will not lie in the field of the coils and thus contribute to the modulation products. The modulation in the line filters, telegraph composite sets, and office and cable loading units, must also be considered.

As already mentioned, care has to be exercised in the mounting of filters belonging to different systems in the same office, so that no crosstalk will be introduced from one system into another. A considerable level difference may exist between two filters of different systems, and it may be desired to mount these filters on adjacent bays. In order that the crosstalk between these two systems may be kept within desirable limits, the separation between the filters must, in some instances, correspond in attenuation loss to the order of 120 TU, or one part in a million. To meet this exacting requirement, the filters are totally incased in sealed copper boxes, the leads being brought out through small holes to terminal blocks.

*Amplifiers.* As previously mentioned, the amplifiers employed with the type "C" system at the terminals are identical with those used with the repeaters at intermediate stations. The following is, therefore, applicable to both cases:

The number and size of tubes needed to deliver the necessary output level or power are largely controlled by interchannel crosstalk requirements. With the grouping frequency arrangement, the three bands which transmit in the same direction are amplified in a common circuit. The different sideband frequencies in passing through the common amplifier must not react upon each other to produce other frequencies of sufficient magnitude to cause interference. For example, second harmonics of the lowest band frequencies lie within the range of the highest channel in the lower group. If these harmonics are permitted to become too great, troublesome noise will be present in the highest channel when speech currents flow in the lowest. In order that this interference or crosstalk may not become excessive the tubes used in this amplifier must be made of ample power capacity.

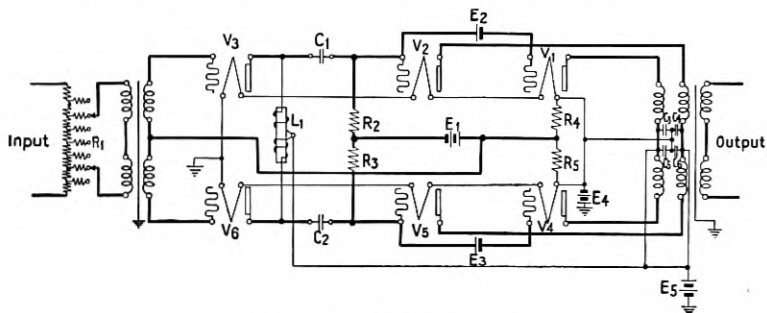

Figure 42—Amplifier circuit

This example of interference caused by the second harmonic shows the desirability of using a push-pull amplifier in carrier repeaters

because of its property of balancing out second order effects, which in a single tube or unbalanced circuit are the largest of all the modulation products at the usual loads.

The currents from the three channels enter the carrier amplifier shown in Figure 42. The circuit consists of two stages; the first stage of two tubes, the second of four of higher power rating. The gain is controlled in 2 TU steps by the adjustable potentiometer in the input. The gain frequency characteristics for different potentiometer settings are substantially flat within a small fraction of a TU over the range of any channel.

The amplifiers for the two directions are of slightly different design, each amplifier being arranged for a flat characteristic over its own group of frequencies. It has been stated that the load capacity of the amplifier is limited<sup>10</sup> by the modulation products which increase with the load. Figure 43 shows the amount of second and third

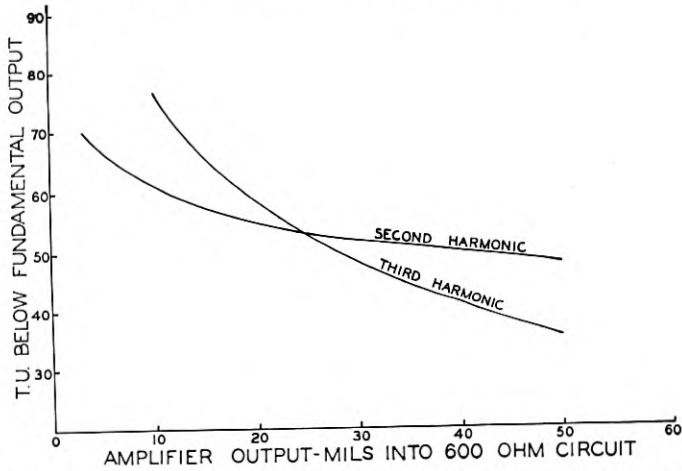

Figure 43—Amount of second and third harmonics as function of carrier repeater output

harmonics produced in a typical repeater with varying single frequency output. By connecting the tubes in push-pull instead of in parallel, the second harmonics have been reduced by about 15–20 TU. Other products of modulation as well as the second and third harmonics increase with the output and thus the power which can be taken from the amplifier under the operating conditions is limited as these effects are likely to result in interchannel interference.

When the alternating voltage applied to one grid is positive with

<sup>10</sup> F. C. Willis and L. E. Melhuish, "Load Carrying Capacity of Amplifiers," *Bell System Tech. J.*, V. 5, October 1926, pp. 573–592.

respect to the filament, that on the other grid is negative. Since the even order products are proportional to an even power of the input voltage, these currents will flow through the high side winding of the output transformer non-inductively producing no flux in the transformer, and hence no current in the low side windings. To realize this ideal condition, the two currents flowing in the output transformer windings must be equal in amplitude, and 180 degrees out of phase. Like amplitudes can be obtained in several ways since the plate current is a function of a number of tube constants. Tubes may, therefore, be selected which will give the same harmonic current, that is, tubes in which the net effect of the several factors is the same.

#### CONCLUSION

*Use in Telephone Plant.* The carrier systems are meeting successfully and economically the requirements of long distance telephone service. From what has already been written, it is evident, however, that the apparatus is by its nature complex and to a fair degree expensive, so that for the relatively short distances it is cheaper to string additional wire. The exact distance beyond which it is more economical to employ carrier methods is obviously dependent on the circumstances surrounding each particular case. Systems are operating for distances of 150 miles and upwards.

Traffic growth often requires additional circuits for the shorter distances, where there are longer haul continuous physical circuits on the same line. In this case it is not uncommon to break up the long haul physical circuits into sections to satisfy the short haul circuit growth and to install a carrier system to meet the long haul needs.

The growth of the use of carrier systems has already been pictured. How the systems are distributed over the lines of the Bell System is shown on Figure 44. The heaviest density of use occurs in the middle and western sections and in general where the circuit demand and growth have not reached the large figures required to justify the installation of toll cables. In particular, the section west of the Mississippi is a promising field for the application of carrier systems.

*Future.* While the type "C" system satisfies those circuit growth demands for moderate and long haul, there has remained undeveloped a considerable field for carrier methods over the shorter distances where only wire stringing has hitherto been economical. Very recent developments have resulted in the trial and early field applications of a simple single-channel carrier telephone system designed particularly to meet these shorter haul demands and thereby to secure the greatest practicable economy in providing facilities by carrier methods in the

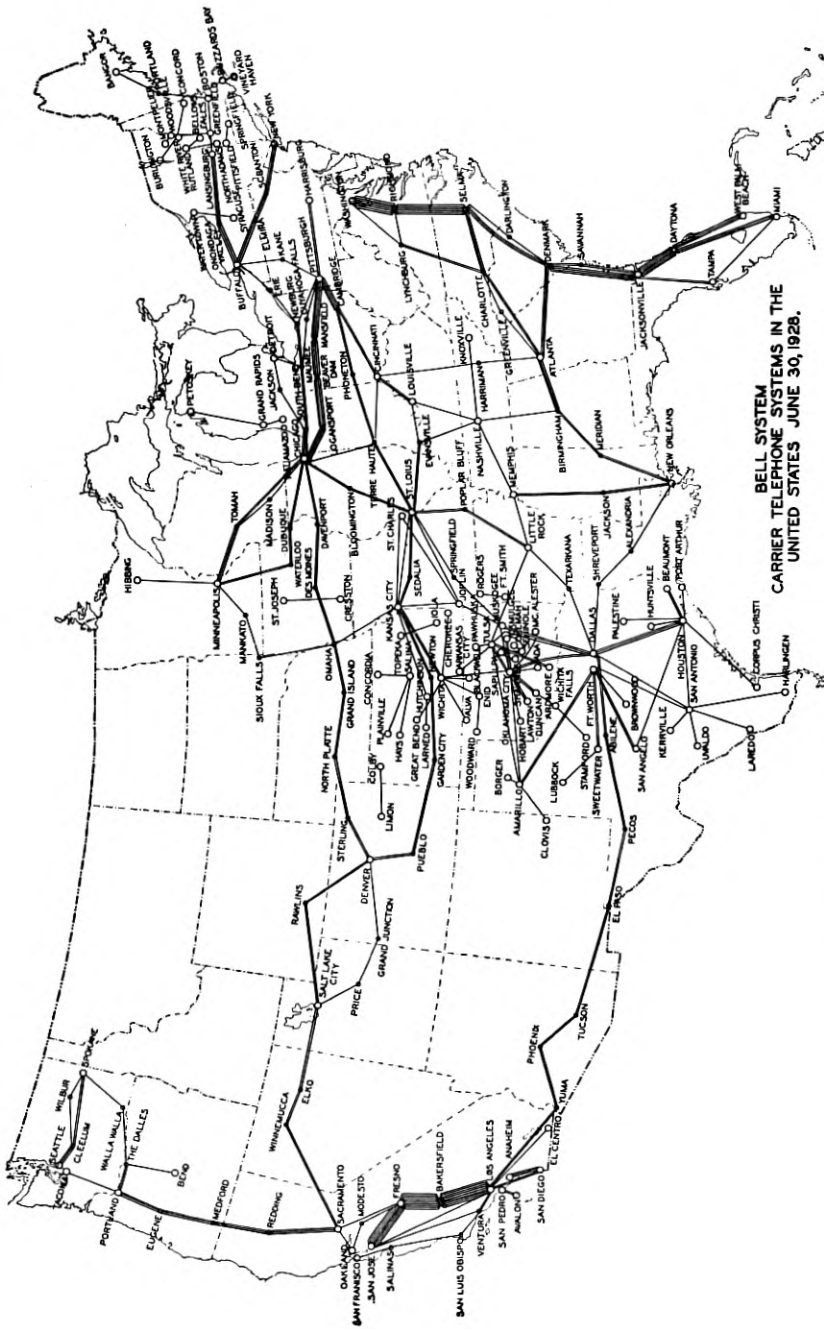

Figure 44—Map showing carrier telephone systems throughout Bell System

Bell System. It is naturally finding its most extensive use in the sections of the telephone plant where the shorter circuits predominate. Because of the fact that the type "D" system development is only now being completed it was thought desirable in the present paper to confine attention to the long haul system (type "C") and to defer the presentation of the detailed information on the short haul development until a somewhat later date.

While considerable progress has been made in the development and application of these carrier systems since the beginning of their use about ten years ago, there is still much to be done in the matter of simplifications and further use of the high-frequency spectrum. Automatic pilot channel arrangements are being tested whereby manual maintenance costs can be reduced. Further developments are anticipated in the matter of transposition arrangements to permit an open-wire line to carry multi-channel long haul carrier systems on most of its pairs. While the systems now in use in the field employ frequencies no higher than approximately 30,000 cycles, frequencies considerably higher than this can undoubtedly be economically employed.

#### BIBLIOGRAPHY

The following more important papers and articles relating to multiplex carrier telephony and telegraphy are offered, with no pretensions as to completeness, as an addition to the bibliography which forms part of the Colpitts-Blackwell paper. Reference should, therefore, be made to the latter for articles published prior to 1921.

- H. S. OSBORNE. The Design of Transpositions for Parallel Power and Telephone Circuits. *A. I. E. E. Transactions*, V. 37, June 1918, pp. 897-936.
- E. H. COLPITTS AND O. B. BLACKWELL. Carrier Current Telephony and Telegraphy. *A. I. E. E. Transactions*, V. 40, 1921, pp. 205-300.
- G. A. CULVER. Guided Wave Telephony. *Jl. of Franklin Institute*, V. 191, March 1921, pp. 301-328.
- R. A. HEISING. Modulation in Radio Telephony. *I. R. E. Proceedings*, V. 9, August 1921, pp. 305-352.
- G. A. CAMPBELL. Physical Theory of the Electric Wave-Filter. *Bell System Tech. Jl.*, V. 1, No. 2, November 1922, pp. 1-32.
- O. J. ZOBEL. Theory and Design of Uniform and Composite Electric Wave Filters. *Bell System Tech. Jl.*, V. 2, No. 1, January 1923, pp. 1-46.
- R. V. L. HARTLEY. Relation of Carrier and Side Bands in Radio Transmission. *Bell System Tech. Jl.*, V. 2, April 1923, pp. 90-112, and *Proceedings of I. R. E.*, V. 11, No. 1, February 1923, pp. 34-56.
- A. F. ROSE. Practical Application of Carrier Telephone and Telegraph in the Bell System. *Bell System Tech. Jl.*, V. 2, No. 2, April 1923, pp. 41-52.
- PAOLO BORGATTI. Telefonía e Telegrafía ad Alta-Frekuensi au Fili. *L'Elettrotecnica*, V. 10, August 16, 1923, pp. 531-541.
- H. S. OSBORNE. Telephone Transmission over Long Distances. *A. I. E. E. Jl.*, V. 42, No. 10, October 1923, pp. 1051-1062.
- RUDOLPH FIEDLER. Die Ruhmerschen Hochfrequenz Apparate für Mehrfachferusprechen auf Leitungen im Reichspostmuseum in Berlin. *Archiv f. Post u. Teleg.*, V. 52, 1924, pp. 123.
- RUDOLPH FIEDLER. Die Aussichten der Leitungsgerichteten Hochfrequenztelephonie u. -Telegraphie in Deutschland. *Teleg. u. Fernsprech*, V. 1, January 1924, pp. 5-8.
- HANS MUTH. Mehrfach Telephonie und Telegraphie Langs Leitungen. *Telef. Zeit.*, V. 6, No. 34, January 1924, pp. 27-44.
- N. H. SLAUGHTER AND W. V. WOLFE. Carrier Telephony on Power Lines. *A. I. E. E. Jl.*, V. 43, No. 4, April 1924, pp. 377-381.
- H. SCHULZ AND K. W. WAGNER. Der Drahtfunk. *E. T. Z.*, V. 45, May 15, 1924, pp. 485-489.
- R. V. L. HARTLEY. The Transmission Unit. *Electrical Communication*, V. 3, No. 1, July 1924, pp. 34-42.
- F. B. JEWETT. Making the Most of the Line. *Electrical Communication*, V. 3, July 1924, pp. 8-21.

- W. H. MARTIN. Transmission Unit and Telephone Transmission Reference Systems. *Bell System Tech. Jl.*, V. 3, July 1924, pp. 400-408, and *A. I. E. E. Jl.*, V. 43, No. 6, June 1924, pp. 504-507.
- LOUIS COHEN. Radio Sur Lignes. *L'Onde Elect.*, V. 3, No. 34, October 1924, pp. 477-490.
- N. H. SLAUGHTER. Carrier Telephone Equipment for High-Voltage Power Transmission Lines. *Electrical Communication*, V. 3, No. 2, October 1924, pp. 127-133.
- W. H. HARDEN. Practices in Telephone Transmission Maintenance Work. *Bell System Tech. Jl.*, V. 4, No. 1, January 1925, pp. 26-51.
- W. V. WOLFE. Carrier Telephony on High-Voltage Power Lines. *Bell System Tech. Jl.*, V. 4, No. 1, January 1925, pp. 152-177.
- B. P. HAMILTON, H. NYQUIST, M. B. LONG AND W. A. PHELPS. Voice Frequency Carrier Telegraph System for Cables. *A. I. E. E. Jl.*, V. 44, No. 3, March 1925, pp. 327-332, and *Electrical Communication*, V. 3, No. 4, April 1925, pp. 288-294.
- J. J. JAKOSKY AND D. H. ZELLERS. Line Radio and the Effects of Metallic Conductors on Underground Communication. Reports of Investigations, Department of the Interior—Bureau of Mines, Serial No. 2682, April 1925.
- R. A. HEISING. Production of Single Sideband for Transatlantic Radio Telephony. *I. R. E. Proceedings*, V. 13, No. 3, June 1925, pp. 291-312.
- W. H. CAPEN. Wire Telephone Communication in Theory and Practice. *Electrical Communication*, V. 4, January 1926, pp. 161-183.
- THOMAS SHAW AND WILLIAM FONDILLER. Development and Application of Loading for Telephone Circuits. *Bell System Tech. Jl.*, April 1926, pp. 221-281, and *A. I. E. E. Jl.*, V. 45, No. 3, March 1926, pp. 253-263.
- B. R. CUMMINGS. Carrier Current Communication. *General Electric Review*, V. 24, May 1926, pp. 365-367.
- H. W. HITCHCOCK. Carrier Current Communication on Submarine Cables. *A. I. E. E. Jl.*, V. 46, No. 10, October 1926, pp. 923-929, and *Bell System Tech. Jl.*, V. 5, October 1926, pp. 636-651.
- F. C. WILLIS AND L. E. MELHUISH. Load Carrying Capacity of Amplifiers. *Bell System Tech. Jl.*, V. 5, October 1926, pp. 573-592.
- H. A. AFFEL AND J. T. O'LEARY. High-Frequency Measurements of Communication Lines. *A. I. E. E. Transactions*, V. 44, 1927, pp. 504-513.
- E. I. GREEN. Methods of Measuring the Insulation of Telephone Lines at High Frequencies. *A. I. E. E. Transactions*, V. 44, 1927, pp. 514-518.
- W. J. SHACKELTON AND J. G. FERGUSON. High Frequency Measurements of Communication Apparatus. *A. I. E. E. Transactions*, V. 44, 1927, pp. 519.
- W. J. SHACKELTON. Shielding Bridge for Inductive Impedance Measurements at Speech and Carrier Frequencies. *A. I. E. E. Jl.*, V. 44, No. 2, February 1927, pp. 159-166.
- G. E. STEWART AND C. F. WHITNEY. Carrier Current Selector Supervisory Equipment. *A. I. E. E. Jl.*, V. 44, No. 6, June 1927, pp. 588-592.
- G. A. BODDIE. Telephone Communication over Power Lines by High-Frequency Currents. *Proceedings of I. R. E.*, V. 15, July 1927, pp. 559-640.
- G. A. BODDIE. Use of High-Frequency Currents for Control. *A. I. E. E. Jl.*, V. 44, No. 8, August 1927, pp. 763-769.

## Abstracts of Bell System Technical Papers Not Appearing in this Journal

*Effect of Grounding on Telephone Interference.*<sup>1</sup> J. J. PILLIOD. This paper, presented before the Pittsburgh Section of the Association of Iron and Steel Electrical Engineers in February 1928, is a rather complete although non-mathematical presentation of the inductive effects of power lines on nearby communication circuits. The production of noise on the latter circuits and the production of voltages sufficiently high to be prejudicial to the operators and users of these circuits are separately discussed. Comparisons are drawn between the inductive action of grounded and ungrounded power lines. Although free from mathematics, the paper gives a very good outline of the interference problem and points out the many opportunities presented for cooperative effort both in connection with original design and with reduction of interference on existing lines.

*A Modification of the Rayleigh Disk Method for Measuring Sound Intensities.*<sup>2</sup> L. J. SIVIAN. The usual procedure is to measure the deflexion of the disk under the influence of a steady sound-field. This paper outlines a procedure which has been found useful when the sound amplitude can be made a suitable function of time. The scheme depends on the fact that the torque which the sound-wave exerts on the disk is a non-linear function of the sound amplitude, being proportional to the square of the air particle velocity. The amplitude of the sound-wave to be measured is modulated with a frequency equal to that of the free vibration of the suspended disk. The measurement requires reading the amplitude of oscillations corresponding to the modulating frequency, rather than a steady deflexion of the disk. The disturbances caused by spurious air currents are largely reduced. In addition, in many practical cases at least, there is a gain in absolute sensitivity. Both theory and experimental verification are given.

*Reflection of Electrons by a Crystal of Nickel.*<sup>3</sup> C. J. DAVISSON and L. H. GERMER. This is a report of some preliminary results obtained in a new series of experiments in which a beam of electrons exhibits the properties of a beam of waves. In previous experiments (*Phys. Rev.*, 30, 705, 1927) a beam of electrons was directed at normal inci-

<sup>1</sup> *Iron and Steel Engineer*, Vol. V, pages 147-155, April 1928.

<sup>2</sup> *The London, Edinburgh, and Dublin Philosophical Magazine, and Journal of Science*, Vol. 5, No. 29, March 1928, pp. 615-620.

<sup>3</sup> *Proceedings of the National Academy of Sciences*, April 15, 1928, Vol. 14, No. 4, pp. 317-322.



dence against a face of a nickel crystal, and observations were made upon the diffraction beams which issued from the incidence side of the crystal at various critical speeds of bombardment. It was anticipated that if the angle of incidence were made other than zero a beam of electrons would be found issuing from the crystal at a series of critical speeds in the direction of regular reflection, and that the series of critical speeds would change with the incidence angle. This regularly and selectively reflected electron beam which is the analogue of the Bragg x-ray reflection beam has been found, and measurements have been made upon it. In the x-ray phenomenon the wave-length of the reflected beam at maximum intensity is related through a simple formula to the angle of incidence and a dimension of the reflecting crystal. This formula (Bragg's formula) does not obtain in the case of electron reflection because of the refraction of the electrons by the crystal. The departures from the Bragg relation are used to calculate indices of refraction of nickel for electrons of various speeds or wave-lengths.

*Introduction to Mathematics of Statistics.*<sup>1</sup> R. W. BURGESS. This book (282 pp.) discusses the best elementary methods of statistical analysis from the standpoint of a beginner who has had one year of college mathematics, or some practical statistical experience and the ordinary high school mathematics. "Statistical Analysis" is regarded in this book as the logical process by which large masses of quantitative facts may be classified, summarized, analyzed, and compared so as to yield reliable conclusions.

The topics treated include classification, formation of statistical series, use of ratios and percentages in statistical analysis, meaning and graphic discussion of frequency distributions, averages, index numbers, measures of dispersion, trend lines, analysis of seasonal variation, two-, three-, and four-variable correlation, and the elements of sampling and probability. Emphasis is placed on the type of statistical problems most common in the social sciences, in which the data are subject to a higher degree of variability than in the usual problems in physics or astronomy which require the use of the theory of least squares or the Gaussian "curve of error."

*The Use of a Moving Beam of Light to Scan a Scene for Television.*<sup>2</sup> F. GRAY. The paper is a discussion of a method of scanning employed in the television system demonstrated a year ago at the Bell Telephone Laboratories. A three-dimensional subject is scanned directly by a

<sup>1</sup>Houghton-Mifflin Company.

<sup>2</sup>*Journal of the Optical Society of America*, Vol. 16, pp. 177-190, March 1928.

moving beam of light to produce a picture current in photoelectric cells. This method permits the use of a very intense transient illumination and more than one large-aperture photoelectric cell to collect reflected light. These two factors give a highly efficient optical system for producing a picture current at a transmitting station. The image seen at a distant station is the same as if light came out of the photoelectric cells to illuminate the subject and a small aperture lens formed an image of the subject for transmission. The television system transmits only the spacial variations of brightness and not the absolute brightness of the view; consequently, an additional steady illumination of a subject does not affect the reproduced image.

*Maintaining High Standards in Products.*<sup>1</sup> E. D. HALL. This article presents briefly but clearly the essential features of a method of keeping before the management an accurate picture of the relative quality of manufactured products. Defects are grouped into four classes and given demerit grades that represent the seriousness of the fault. Defects found each month are added, reduced to an average value, and plotted on charts which as a reference base use the average quality of the preceding five years. A method of computing averages for an entire line of products is also given.

*Probability and Its Engineering Uses.*<sup>2</sup> THORNTON C. FRY. This book of 470 pages on the Theory of Probability is written from the standpoint of the engineer. Its earlier chapters deal with the fundamental mathematical concepts that underlie the theory, and its later chapters develop these concepts in the directions of their application to traffic and trunking problems, curve fitting, and atomic physics.

Among the subjects which receive especial emphasis are: the logical standing of attempts to determine the probability of an event by trial; the physical significance of the fundamental distribution laws, such as the Normal, the Binomial, and the Poisson Law; Pearson's criterion for "goodness of fit"; and trunking problems.

*Differential Intensity Sensitivity of the Ear for Pure Tones.*<sup>3</sup> R. R. RIESZ. The ratio of the minimum perceptible increment in sound intensity to the total intensity,  $\Delta E/E$ , which is called the differential sensitivity of the ear, was measured as a function of frequency and intensity. Measurements were made over practically the entire range of frequencies and intensities for which the ear is capable of sensation. The method used was that of beating tones, this method giving the

<sup>1</sup> "Manufacturing Industries," Vol. 16, No. 1, pp. 17-19, May 1928.

<sup>2</sup> D. Van Nostrand Company.

<sup>3</sup> *The Physical Review*, May 1928, Vol. 31, No. 5, pp. 867-875.

simplest transition from one intensity to another. The source of sound was a special moving coil telephone receiver having very little distortion, actuated by alternating currents from vacuum tube oscillators. Observations were made on twelve male observers. Average curves show that at any frequency  $\Delta E/E$  is practically constant for intensities greater than  $10^6$  times the threshold intensity; near the auditory threshold  $\Delta E/E$  increases. Weber's law holds above this intensity, the value of  $\Delta E/E = \text{constant}$  lying between 0.05 and 0.15, depending on the frequency. As a function of frequency  $\Delta E/E$  is a minimum at about 2500 c.p.s., the minimum being more sharply defined at low sound intensities than it is at high. This frequency corresponds to the region of greatest absolute sensitivity of the ear. Analytical expressions are given (Eqs. (2), (3), (4), and (5)) which represent  $\Delta E/E$ , within the error of observation, as a function of frequency and intensity. Using these equations, it is calculated that at about 1300 c.p.s. the ear can distinguish 370 separate tones between the threshold of audition and the threshold of feeling.

*Use of the Noble Metals for Electrical Contacts.*<sup>1</sup> E. F. KINGSBURY. The paper describes the results of an investigation of the behavior of gold, silver and the platinum metals as electrical contacts in communication circuits. Platinum has heretofore been considered the standard although some alloys of the platinum metals have been used in especially severe conditions. The economic situation has, however, encouraged the use of cheaper substitutes. Heretofore, accurate knowledge has not been available concerning the intrinsic merit of other materials. This problem is complicated by the various forms of discharges and mechanical conditions encountered in practice. The resistance, erosion, and transfer of contacts are discussed for a variety of materials under various circuit conditions and in different atmospheres.

*Economic Aspects of Engineering Applications of Statistical Methods.*<sup>2</sup> W. A. SHEWHART. This note calls attention to possible applications of modern mathematical statistical theory, to research, design, production, inspection, supply, and other engineering problems. Attention is given to certain general types of problems in the solution of which statistical applications have been made, and to the nature of the possible economies effected thereby. It is reasonable to believe that very definite economic advantages can be obtained in any large industry through such applications.

<sup>1</sup> Technical Publication No. 95, A. I. M. M. E., March 1928.

<sup>2</sup> *Journal of the Franklin Institute*, Vol. 205, March 1928, pp. 395-405.

*Evaluating Quality in Heat-Treated High-Speed Steel by Means of the Milling Cutter.*<sup>1</sup> J. B. MUDGE and F. E. COONEY. A test of heat-treated high-speed steel in the form of milling cutters, the variables having been reduced to a minimum, and the dulling point of the cutting edges of the tools determined by a recording wattmeter connected in the circuit of the motor of the milling machine. A "deadline" test resulted instead of the usual "breakdown" test.

It was found that:

Cutters of the same steel hardened by the same method check within limits that are sufficiently close for test purposes.

No cast cutter has been found to give results comparable to standard high-speed steel refined by suitable working. Cutters hardened by patented or salt bath processes have not given results comparable to standard high-speed steel hardened by the open fire method.

*A Bridge Method for the Measurement of Inter-Electrode Admittance in Vacuum Tubes.*<sup>2</sup> E. T. HOCH. A description is given of the Colpitts-Campbell bridge as applied specifically to the measurement of direct admittances in vacuum tubes. Data are given on several tubes.

*On Electrical Fields near Metallic Surfaces.*<sup>3</sup> JOSEPH A. BECKER and DONALD W. MUELLER. When an electron escapes from a metallic surface it passes through fields which tend to pull it back. Applied fields when properly directed partially neutralize the surface fields and hence reduce the work the electron has to do against these fields. That is why  $i$ , the thermionic current, increases steadily with  $F_a$ , the applied field. Quantitatively  $d(\log_{10} i)/dF_a = (11600/2.3T)Xs$ , where  $T$  is the temperature of the surface and  $s$  is the distance from the surface at which the surface field  $F_s$  is equal to  $F_a$ . Hence the slope of an experimental  $\log i$  vs  $F_a$  curve at any  $F_a$  yields the value of  $s$  corresponding to  $F_a$ . For clean or atomically homogeneous surfaces experiment shows that the only force opposing the escaping electron is due to its image field; for composite surfaces other fields, which are ascribed to the adsorbed ions, are superposed on the image field. For 70 per cent thoriated tungsten this "adsorption field" is very large close to the surface and in a direction to help electrons escape; it decreases rapidly in strength as  $s$  increases until it is zero at about 15 atom diameters; here it reverses its direction and then increases in strength till it attains a maximum value of 8000 volts/cm. at 75 atom

<sup>1</sup> *Transactions of the American Society for Steel Treating*, February 1928, Vol. 13, No. 2, pp. 221-239.

<sup>2</sup> *Proceedings of the I. R. E.*, April 1928, Vol. 16, No. 4, pp. 487-493.

<sup>3</sup> *Physical Review*, Vol. 31, No. 3, March 1928, pp. 431-440.

diameters; beyond this distance it decreases steadily. The intense field close to the surface accounts for the decreased work function while the reverse field farther out accounts for the poor saturation at ordinary applied potentials.

The photo-electric long wave-length limit should be shifted toward the red by applied fields. This shift should be particularly noticeable for composite surfaces.

*Direct Determination of Rubber in Soft Vulcanized Rubber.*<sup>1</sup> A. R. KEMP, W. S. BISHOP, and T. J. LACKNER. A modification of the Wijs method is shown to be suitable for determining the rubber content of vulcanized rubber. A procedure for the direct determination of sulfur combined with rubber is also outlined, and the effect of compounding ingredients is shown.

Results of analyses of four reclaimed rubbers by the proposed and difference methods are given for comparison.

*Photomicrography and Its Application to Mechanical Engineering.*<sup>2</sup> FRANCIS F. LUCAS. This paper was presented at the annual meeting of the American Society of Mechanical Engineers during the week of December fifth, 1927. It discusses the difference between magnification and resolution and stresses the difficulties in obtaining clear-cut photomicrographs at high magnifications. Until comparatively recently 1500 diameters was thought to be the limit.

The ultra-violet microscope should, theoretically, give about double the resolution of one using visible light because of the shorter wave-length, but until recently this has not been the case. The paper explains a mechanical focusing method used in Bell Telephone Laboratories by which a series of photographs are taken with a change in focus of one sixteenth micron between successive exposures. A typical set of four successive exposures at 1800 magnifications is shown.

The photomicrography of steel is gone into at some length, several photographs at 3500 magnifications being shown in illustration. Special importance is laid on the preparation of samples as well as on careful focusing.

<sup>1</sup> *Industrial and Engineering Chemistry*, Vol. 20, No. 4, April 1928, pp. 427-429.

<sup>2</sup> *Mechanical Engineering*, Vol. 50, No. 3, pp. 205-212, March 1928.

## Contributors to this Issue

J. H. KASLEY, Wheeling Technical College; Westinghouse Machine Company, 1898-1902; Western Electric Company, Inspection Branch, N. Y. C., 1905-07; Chief Process Inspector, New York and Hawthorne, 1908-09; Chief of Manufacturing Layout Department, 1913; Planning Engineer, 1915; Assistant Technical Superintendent, 1920; Superintendent of Manufacturing Planning, 1926; Hawthorne Works Operating Superintendent, 1927-.

F. P. HUTCHISON, B.S. in Mechanical Engineering, University of Missouri, 1916; Western Electric Company, Manufacturing and Installation Departments, 1916-. Mr. Hutchison has been engaged largely on manufacturing, planning, development, and design.

CARL R. ENGLUND, B.S. in Chemical Engineering, University of South Dakota, 1909; University of Chicago, 1910-12; professor of physics and geology, Western Maryland College, 1912-13; laboratory assistant, University of Michigan, 1913-14; Bell Telephone Laboratories, 1914-. Experimental work in radio communication is the field to which Mr. Englund has largely devoted himself since coming to the Laboratories.

J. G. FERGUSON, B.S., University of California, 1915; M.S., 1916; research assistant in physics, 1915-16; Bell Telephone Laboratories, 1917-. Mr. Ferguson's work has been in connection with the development of methods of electrical measurement.

B. W. BARTLETT, A.B., Bowdoin College, 1917; West Point, 1917-19; B.S., Massachusetts Institute of Technology, 1921; 1st Lieutenant, Engineers' Corps, 1919-22; M.A., Columbia, 1926. Mr. Bartlett was with the Bell Telephone Laboratories from 1922 to 1927, engaged in bridge development and measurement work. He returned to Bowdoin in 1927 as Professor of Physics.

O. J. ZOBEL, A.B., Ripon College, 1909; A.M., Wisconsin, 1910; Ph.D., 1914; instructor in physics, 1910-15; instructor in physics, Minnesota, 1915-16; Engineering Department, American Telephone and Telegraph Company, 1916-19; Department of Development and Research, 1919-. Mr. Zobel has made important contributions to circuit theory in branches other than the subject of wave filters.

R. V. L. HARTLEY, A.B., Utah, 1909; B.A., Oxford, 1912; B.Sc., 1913; instructor in physics, Nevada, 1909-10; Engineering Depart-

ment, Bell Telephone Laboratories, 1913-. Mr. Hartley is in charge of researches in the field of carrier current, telephone repeater, and telegraph systems.

H. A. AFFEL, S.B. in Electrical Engineering, Massachusetts Institute of Technology, 1914; research assistant in electrical engineering, 1914-16; Engineering Department and the Department of Development and Research, American Telephone and Telegraph Company, 1916-. Mr. Affel has been engaged chiefly in development work connected with carrier telephone and telegraph systems.

CHARLES S. DEMAREST, E.E., University of Minnesota, 1911; American Telephone and Telegraph Company, Engineering Department, 1911-19; Department of Development and Research, 1919-. Mr. Demarest's work has been connected with the development of equipment for toll telephone systems, including that for long distance cables, carrier and radio systems.

C. W. GREEN, B.S. in Electrical Engineering, University of Wisconsin, 1907; instructor and assistant professor, Massachusetts Institute of Technology, 1907-17; captain 1917, major 1918, U. S. Army; Bell Telephone Laboratories, 1919-. Mr. Green's work has had to do with the development of carrier telephone systems and voice frequency repeaters.