

May 1959

Bell Laboratories

# RECORD

The "Information" Problem

Line Scanning in ESS

A Portable Frequency Standard

Signaling in PI Carrier

Delay Equalization of TV Signals

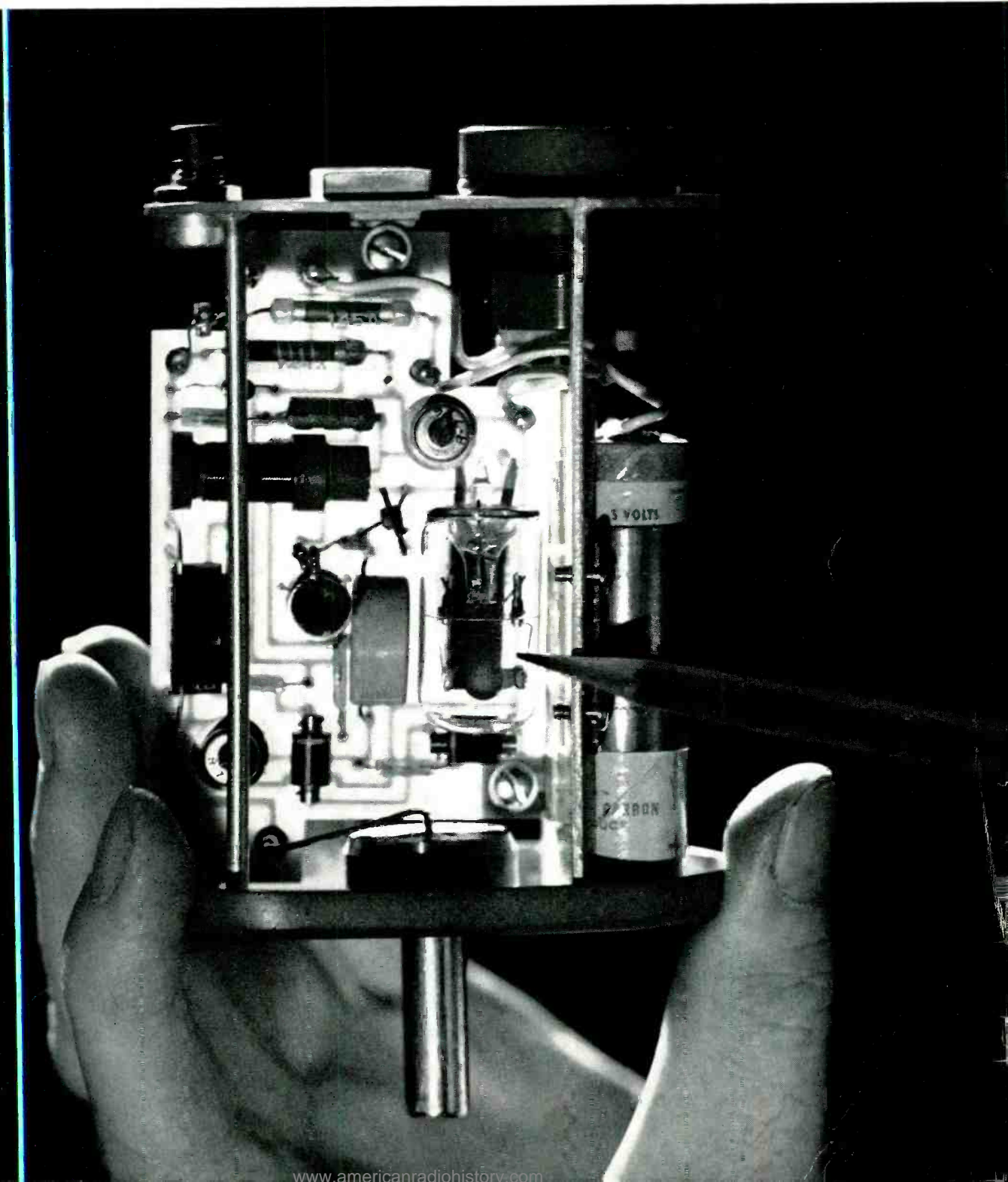

## Editorial Staff

G. E. Schindler, Jr., *Editor*  
W. W. Mines, *Associate Editor*  
A. G. Tressler, *Assistant Editor, Murray Hill*  
J. J. Gruesen, *Assistant Editor*  
R. F. Dear, *Design and Production*  
T. N. Pope, *Circulation Manager*

## Editorial Board

F. J. Singer, *Chairman*  
W. M. Bacon  
J. A. Burton  
J. W. Fitzwilliam  
E. T. Mottram  
R. J. Nossaman  
W. E. Reichle

THE BELL LABORATORIES RECORD is published monthly by Bell Telephone Laboratories, Incorporated, 463 West Street, New York 14, N. Y., J. B. FISK, President; W. C. TOOLE, Secretary; and T. J. MONTIGEL, Treasurer, Subscription: \$2.00 per year; Foreign, \$2.60 per year. Checks should be made payable to Bell Laboratories Record and addressed to the Circulation Manager. Printed in U. S. A. © Bell Telephone Laboratories, Incorporated, 1959.

## Contents

PAGE

- 162 The "Information" Problem *I. C. Osten-Sacken*
- 169 Line Scanning in ESS *A. Feiner*
- 173 A Portable Frequency Standard *L. F. Koerner*
- 177 Signaling in PI Carrier *D. C. Weller and J. C. Donaldson*
- 182 Equalization of Aural and Visual Delay  
*Idea Kerney and W. D. Mischler*
- 187 Jacketed Cords for Telephone Sets
- 189 Titan Guidance System Successfully Tested
- 190 A. T. & T. Annual Meeting
- 193 New Laboratories Building at Holmdel

Cover

*Compact printed-wiring board, the heart of a new portable frequency standard (see page 173). Pencil points to precision crystal used for high accuracy performance.*

*Information operators in big cities must have at their fingertips literally tons of records containing up-to-date directory listings. In seeking a way to overcome this problem of bulk, systems engineers at Bell Laboratories are currently testing a radically new and extremely compact method of storing and retrieving directory information and are experimenting with several other microphotograph techniques.*

I. C. Osten-Sacken

## **The “Information” Problem**

With a few simple turns of his dial, a Bell System customer can set in motion a chain of events that will connect his telephone to any one of millions of other telephones — provided, of course, he knows the number to dial. For while his own local directory contains reasonably up-to-date number information for most of his calls, there are some calls on which the customer needs the assistance of an “Information” operator.

Customer directories — the “telephone books” — are revised and reprinted once a year in most cities. These books start to get out-of-date the moment compilation stops and printing starts, and they become progressively more obsolete. For example, the Manhattan portion of the New York City directory is partially inaccurate the day it is published, because some three per cent of the listings are by then new or changed. By the end of the year, as many as thirty per cent of the listings may be out-of-date. More frequent printings and distribution would reduce this proportion, but at an excessive cost.

Even if the cost were not excessive, there would still be other difficulties in getting directory in-

formation to the customers. In large cities, for example, some customers receive directories for only part of their calling area; others lose or mutilate their books. Governmental and other special types of listings sometimes require a knowledge of the organization and functions of an agency to locate the desired number.

Another problem is to associate the telephone number of a service the customer wants with the actual listing in his directory. For example, he may want the 37th Street Bus Terminal, listed as “Metropolitan Bus Co.” Spelling also often causes trouble — the Smith he wants is listed as “Smyth” and Jones is sometimes spelled “Johnes.”

Telephone customers can get assistance with such problems, as well as on new listings, by calling “Information.” This puts them in personal contact with experienced operators who have before them printed directories that are reissued approximately every four weeks, and an accompanying file of “daily addenda.” In some cities, information operators have available both alphabetical and street-address directories. The street-address directory saves time on requests for in-

formation on names in wide usage — Smith, Cohen, Anderson, and the like. They also help when the customer seeking information isn't sure of the exact name, but has a definite address.

Each day, an average of nearly six million Bell System customers call "Information" for assistance. This is over two per cent of the more than 250 million calls originated daily. Information service is a big business, requiring the services of some 26,000 operators in about 650 cities and towns, and the production and distribution of an enormous quantity of records.

Operating costs for information service are over 100 million dollars a year. Each call for information, which is free to the customer, costs the Operating Company money. Anything that can be done to reduce this cost is an important consideration. But just as important is the problem of reducing the bulk of printed records in the larger information bureaus.

The amount of printed matter required for an efficient information bureau in New York City, for example, is so great that it is becoming difficult to find space to locate all of the necessary directories within easy reach of an operator. Handling the large books is awkward and is also somewhat of a physical chore. In the information bureau shown in the photograph above, there are twelve large directories, an aggregate of more than 10,000 pages with 5.5 million listings. The total thickness of these tomes is about 35 inches, and they weigh 95 pounds.

Further, the problem of directory size may become more widespread with the expansion of direct-distance-dialing. It is possible that central information bureaus may be established for each of the more than 100 numbering-plan areas, with information records for the entire dialing area located at each bureau.

### **The Experimental System**

Traffic people throughout the Bell System have been aware for some years of the increasing bulk of printed matter required for efficient information service. And in 1952, systems engineers at Bell Laboratories began an intensive study of the traffic-information problem. The goal of this study was the development of an experimental system for storing information records more compactly and for providing efficient access to these important records.

Such a system has been developed, and the storage portion of the experimental arrangement is based on microprint techniques for reducing the physical size of the required information listings. The access arrangement is contained in a



*A typical operator's position in a Manhattan information bureau. Operator is using alphabetical and street-address directory which contains about 4000 pages and weighs 25 pounds.*

new operator's position — essentially a desk — which has a built-in display system for enlarging the microprint records so that the operator can quickly and easily find a specific listing. A photograph of the experimental operator's position appears on page 165.

Briefly, the proposed system works like this. Each operator has a "deck" of 6-inch by 8-inch cards, which have microimages of a number of directory pages printed on one side. On the reverse of the cards are "visual aids," consisting of three-letter tabs which indicate the over-all contents of each card, and page indexes which define the listings on each page. Each page index is framed in a centering square that is accurately positioned over the associated micropage on the other side of the card.

The operator selects the proper card and then manually aligns the centering square of the page she wants under a square window that is located over the optical-pickup aperture. She then operates a foot switch, and the directory page is displayed lifesize on the illuminated reading screen before her.

Before exploring the design aspects of a new system, it seemed advisable to examine first the basic premise of the telephone-information task. Fundamentally, this is a problem of storing vast quantities of information, yet having quick access to an exact item of information. Two general techniques for storage and retrieval were available at the time the study was initiated.

inserting the microcards into a "reader." Investigations of electronic systems and an automatic roll-film plan indicated that a fully automatic card system would not be practical. Accordingly, two general plans were explored: (1) manual manipulation of the cards, and (2) a semi-automatic system for selection and insertion.

### Format of Card

Before either of these systems could be explored fully, however, some decisions had to be made concerning the format of the card. Many factors were involved here: the size, the material, visual aids for indexing, and the configuration and number of micropages to be placed on a card. The number of cards per directory and the number of pages per card were critical because of

their important bearing on search time. To help resolve this problem, a 60-page and a 28-page format were tried, with listings from the Manhattan directory. The 60-page format had an average of 50 pages per card, which reduced the directory to 30 cards, and the other had an average of 25 pages per card, which resulted in a 60-card directory.

Visual aids for seeing at a glance the scope of a page appear in the telephone book as "telltale" at the top of each page. Telltales generally consist of the first and last names on a page. In the information directories, groups of pages are indexed with tab inserts, usually containing from one to four letters. The same general pattern of telltales and tabs was applied to the cards. Each is identified by a three-letter tab index, and each page on a card has a telltale consisting of the first nine letters of the first listing on that page.

To gather data on the time required to select and position a card in a reader, a small trial of experimental manual and semi-automatic systems, using the two card formats, was conducted in a New York information bureau. No suitable reader was available to carry the test beyond selection and positioning, but this did not affect the time study. Opaque mock-up cards were used in the tests, merely because they were easy to produce.

The tests demonstrated that with both the manual and semi-automatic systems, a 28-page format very similar to the one shown at left resulted in the lower search time. Errors in locating pages were considerably greater with the semi-automatic access plan, and an information desk designed for semi-automatic operation would cost about twice that of a manual desk. It was logical, then, to proceed with the manual filing arrangement, using cards of the 28-page format.

### Materials for Microcards

The choice of a material (opaque or transparent) for the cards was considered next. Transparent cards require from 40 to 75 per cent less light for projection than opaque cards, and also require a reader that is relatively simple. On the other hand, film stock for making the transparencies stiff enough to permit manual manipulation, and rugged enough to withstand repeated use, costs much more than opaque stock.

Printing legible visual-aids on film was an additional problem, so opaque cards were used. Implicit in this choice was the knowledge that a fundamentally new reader would have to be developed because no available reader could meet the exacting display requirements.

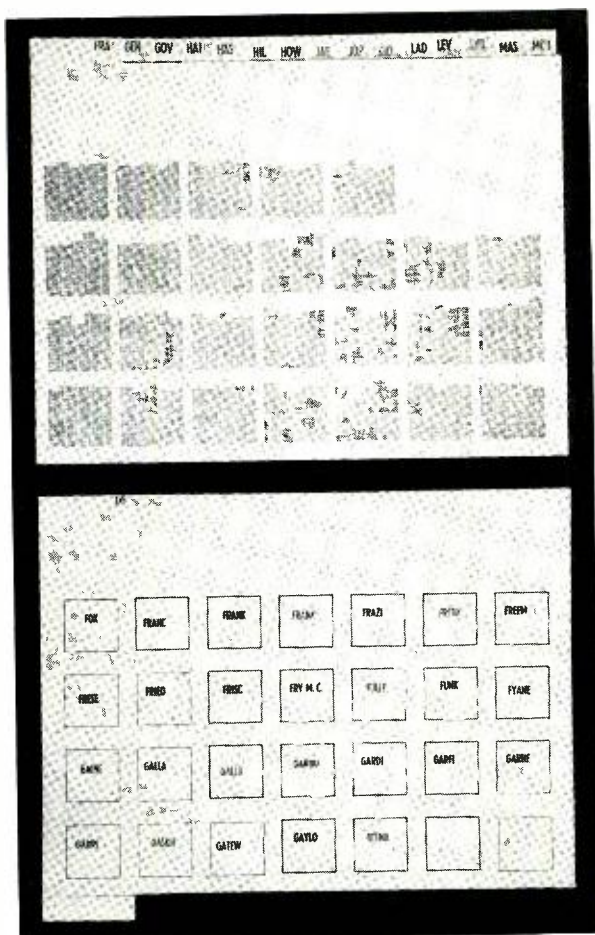

*Twenty-eight page card format used in field trial. Extra spaces give flexibility in revising cards. Front of card (top) has printed micropages and rear of card (below) has visual aids to show contents of micropages. "Tell-tales" on trial cards were later reduced to a maximum of five letters.*

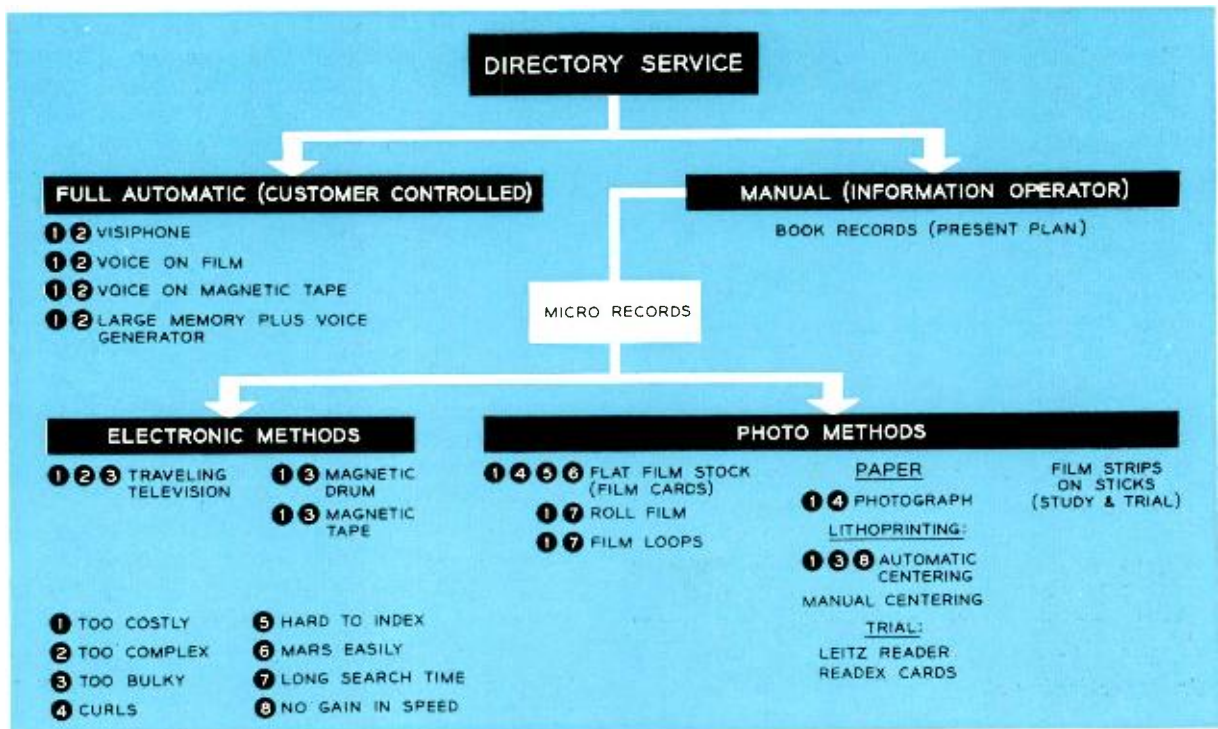

This table shows, in family-tree form, some of the various storage and access arrangements that

were explored in the course of the "Information" study program. Numbers refer to comments in key.

The opaque cards are positive prints at micro-size of a set of directory pages, printed on ceramic-coated paper. This paper does not curl and it costs less than one-fifth as much as the cheapest, suitable photographic paper. These microprints can be produced by a lithographic process at 3000 to 5000 impressions per hour.

There are special problems involved in using lithography for producing directory cards, however. Varying temperature and humidity affect the viscosity of the ink, and dust must be carefully excluded, because even a tiny speck of dust could obliterate several characters of a severely reduced line of type.

The specific requirements for microcard reproduction are unobtainable commercially. Mr. Albert Boni, of the Readex Microprint Corporation, took an active interest in this special problem, and was very instrumental in producing cards suitable for a trial.

These special lithographic problems, along with some data gathered in the positioning and selection trials, led to the design of the microcard format shown on page 166. The over-all size of the cards —  $7\frac{3}{8}$  by 6 inches — was established by the space required to print the index tabs and page telltales in large, easily read letters. With a card of this size, a relatively low reduction ratio

(11.5 to 1 diameters) could be used in micro-printing the originals of the printed directory pages. The micropages shown in the full-page, comparison photograph on page 164 are about one-inch square, including margins.

#### Design of Card Reader

To read these small pages, it was necessary to design a reader with a rather intricate optical system. This system, which was a major problem in the design of the reader, was designed by E. Leitz, Incorporated, to Laboratories' specifications. The size of the screen had the most direct bearing on the optical design. Because of an unavoidable loss of character definition, caused by optical transmission of the microimage, the projected image had to be about 22 per cent larger than the original page. This meant a fourteen-fold enlargement of the microimage of the page. A screen fifteen inches square was chosen to allow some tolerance in centering the projected page.

The level of brightness and uniformity of brightness over the screen posed one of the most difficult optical problems. An important part of this problem was the light source. After requirements for a new lamp were established, a special lamp was made available for the experimental reader by the General Electric Company.

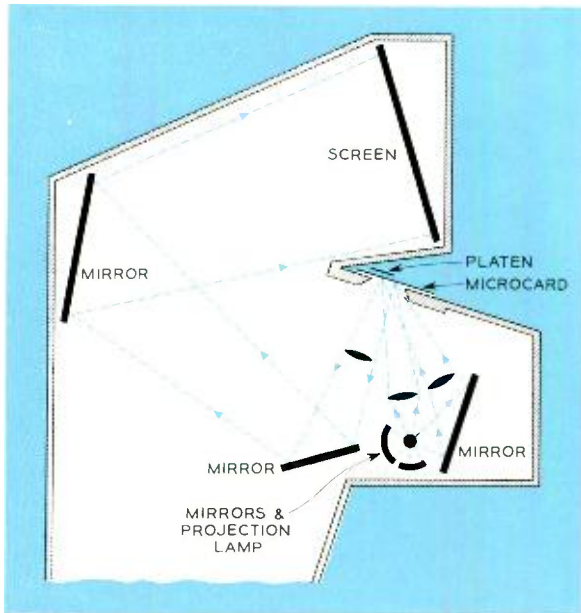

*Optical schematic of the experimental reader. Cross sectioning shows outline of reader cabinet.*

The reader has a unique light-concentration arrangement. With a series of mirrors, light that would otherwise be wasted is recaptured and directed into useful channels. The mirror arrangement and the general arrangement of the reader are shown in the line sketch above. With this arrangement, a 450-watt light source supplies what would ordinarily be equivalent to about 720 watts.

#### **Light Distribution on Screen**

The use of a high-intensity light source made it difficult to obtain an even distribution of light over the face of the screen. This difficulty was solved by incorporating a disc on the out-of-focus intermediate mirror, which diffused the light by reducing the intensity at the center of the screen, but not at the edges. The optical engineers got acceptable contrast by using a rear-projection screen inclined about 15 degrees away from the operator and partially shielded from the room's normal overhead light.

On this screen, only one micropage—actually, one directory page—is displayed at a time. Since each microcard has some 25 pages on it, the operator must position the card in the reader so that

the page she wants to read is displayed. And she must do this quickly and accurately.

The mechanism for positioning the pages in the reader includes a square frame under which the page-centering squares are aligned, and a metal platen to hold the microimage of the selected page in intimate contact with the glass window of the projection system. A foot-operated switch clamps the platen down on the card and simultaneously brings the lamps to full brightness.

#### **Service Trial**

As with any new system, a service trial under controlled conditions was the best way to test and evaluate this new approach to supplying directory information. The experimental system, as mentioned earlier, was designed with particular emphasis on reducing the bulk of information records in the largest cities. But the prodigious production of experimental microcards, which would be necessary for a thorough trial in New York City, was prohibitive, so the trial was held in Washington, D. C., where there are about a million listings. A directory of this size was considered large enough to provide a significant test of the reader and of the general operating method, though not of the bulk problem.

The data collected during this trial included an appraisal of the optical reader, including such factors as susceptibility of the optical system to dust, stability of the prefocusing adjustments, life and adjustments of the projection lamp, and effectiveness of the heat-dissipation measures. Data were also obtained on the durability, legibility and ease of handling of the microcards. Time-study data on the traffic-operating procedures, and an evaluation of the operators' reaction to the new arrangements, were also included.

The trial conducted at Washington produced considerable useful information, but does not necessarily represent a final solution. Additional trials will undoubtedly be necessary, using both microcard arrangements and other storage methods. Recent advances in electronic and mechanical storage techniques and in microphotography may suggest further improvements or new approaches. However, the present approach has demonstrated that it is feasible to compress the directory pages on individual microcards which can be handled separately. It may well be that microfilm, with its potentially greater capability for reduction, may make an attractive substitute for cards.



*An experimental telephone switching system using such new solid-state devices as the diode and transistor (in addition to tiny gas switching tubes) is now being developed at Bell Laboratories. One important component of this Electronic Switching System (ESS) is a "sensing" unit called the scanner; it gathers information from all telephone lines and trunks.*

A. Feiner

## Line Scanning in ESS

Scanning is a basic function common to many data-handling devices. In television, a scanning process is used in the camera to convert a space-pattern into a time sequence of impulses for transmission. A switchboard operator, in permitting her eye to rove over the array of lamps before her, is also performing a scanning activity. An analogous process is used in the experimental electronic switching system (ESS) to provide information to the central control on the state of all lines and trunks. This function is performed by the line scanner (RECORD, *October*, 1958) built at Bell Telephone Laboratories.

### **The Transmission Gate**

Most of the information which must be received, interpreted and acted upon reaches the telephone office in the form of dc current changes on lines and trunks. Because of the scanner, the central control of the electronic system possesses rapid means of access to all the lines and trunks, enabling the reception of supervisory and dial pulse information.

The telephone set for the experimental electronic switching system was designed to operate on relatively low dc currents ranging from 8 to 13 milliamperes (RECORD, *November*, 1958). This set presents to the telephone lines a nominal resistance of 1,500 ohms and requires that a resistance of 2,400 ohms appear in series with the 50-volt battery at the central office. As we shall see, the scanner distinguishes between the "on-hook" (idle) and "off-hook" (in use) states of the line by monitoring the voltage drops in the "battery-feed" resistors. These are the resistors labeled  $R_A$  and  $R_B$  shown in the line circuit (upper part of schematic on next page). In the scanner, these voltages are used to bias a diode in a transmission type of diode gate. If the telephone handset is on-hook, there is no back bias applied to the diode, and a short interrogation pulse will be transmitted to the output. With the receiver off-hook, a back bias of about one volt will block the pulse.

Similar voltage swings are developed in other circuits which the scanner interrogates — that



The author (right) with S. Bove test the scanner seen in the background; printed-wiring plug-in units can be seen in bottom part of the frame.

is, in the trunks and a number of test points throughout the system. The latter allow automatic testing for preventive maintenance and trouble diagnosis.

Once the transmission gate is adopted as a means for distinguishing between the two voltage levels, the next question is: How does the central control gain access to a particular gate out of a multitude? System and equipment considerations dictate that the scanner be constructed in blocks of some 1,000 lines. In ESS, the equipment numbers are handled internally in binary form. In other words, to specify one line in a thousand, the central control sends to the scanner over 10 pairs of leads a specific combination of high and low potentials. This is an electrical encoding of the ten-digit binary number ( $2^{10} = 1024$ ) corresponding to the address of a line in the scanner. It is then the function of the access circuitry of the electronic scanner to select, on the basis of this number, the appropriate line gate.

As shown in the first block diagram (lower part of drawing), the scanner gates are connected at the intersections of a square matrix of 32 vertical and 32 horizontal buses. A gate within this

square array is then selected by applying the interrogating pulse to one of the 32 vertical buses through a transistor "tree," using 5 binary digits of the line address. This leads to simultaneous interrogation of all the gate circuits connected to that vertical bus. Simultaneously, however, the remaining 5 binary digits are used to set up the output selector so that an output signal on the desired horizontal bus will be transmitted to central control. The combination of two selections uniquely determines the line circuit which the central control wishes to interrogate. The state of the interrogated circuit is then trans-

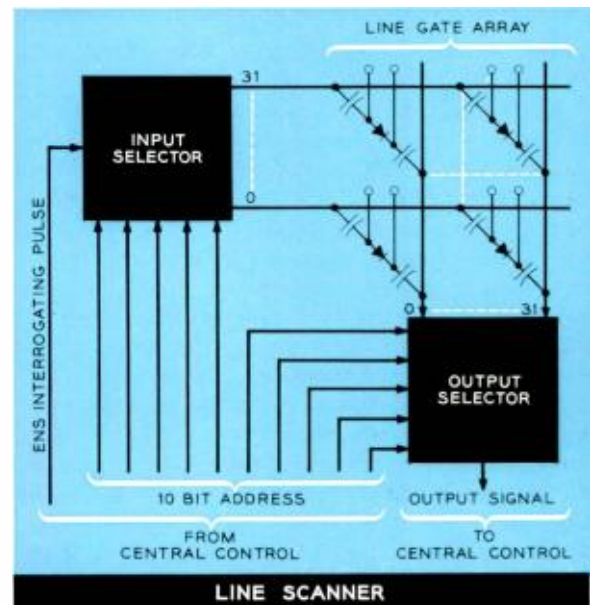
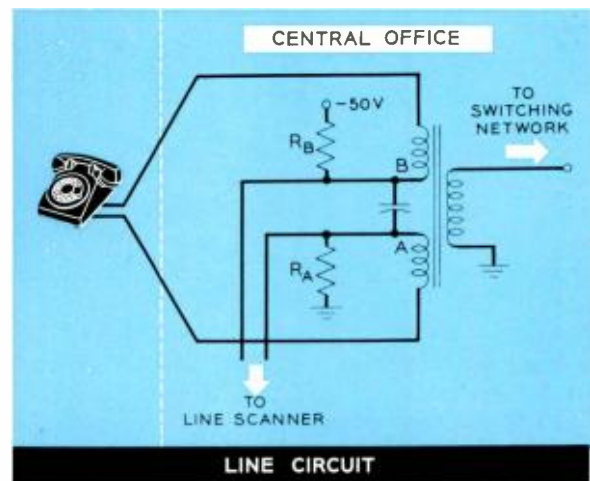

Block diagram of the scanner. A specific line gate is chosen out of the 32 by 32 array by the simultaneous selection of one vertical and one horizontal bus; the line circuit diagram is shown above.

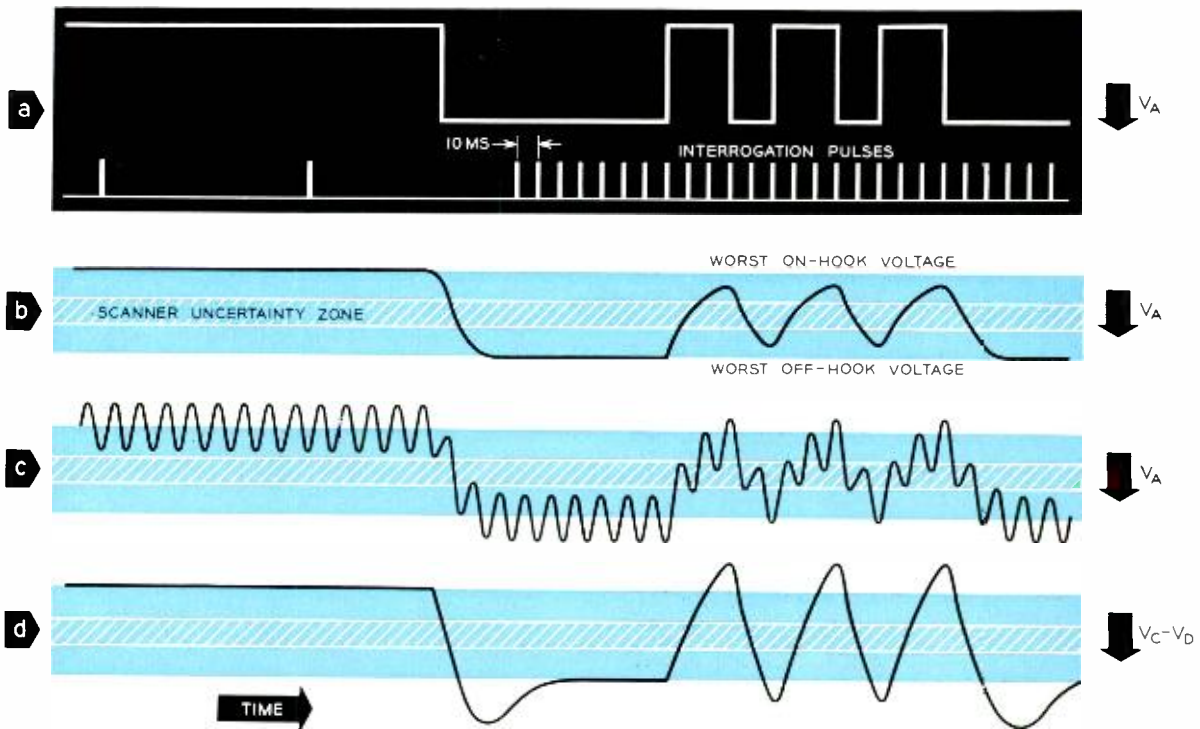

Line circuit waveforms: (a) shows the idealized voltage waveform at point A of the line circuit as the customer lifts the receiver and dials the digit "3". Note the fast scanning rate after the system discovers that customer has seized his

line and is going to dial. The effect of leakages, loop and station-set reactances on the waveform is seen at (b). Drawing (c) shows the added effect of 60-cycle induction; signal recovered by balanced scanner gate is shown in drawing (d).

mitted to the central control in the form of a binary one or zero.

Central control operates the scanner in two different modes to obtain, in the most efficient manner, all the information it needs. During the time a customer is not using his telephone, his line remains in a quiescent state, and central control would waste program time if the line were scanned too often. Similarly, when a customer is talking, his line is in another dc state which does not change rapidly. Rapid changes in the dc state occur only when the customer is dialing. Thus, all dialing lines must be scanned much more rapidly than idle or busy lines. Section (a) of the drawing on this page shows the idealized voltage at point A of the line circuit as the customer picks up his phone, dials a number, and carries on a conversation. A supervisory scan samples his line (and all other lines, trunks, and test points in the system) every tenth of a second. When off-hook is encountered, the central control is programmed to sample the line ten times faster (every 10 milliseconds) until all dial pulses have been registered.

When the connection is set up, central control reverts to the less frequent supervisory scan, which will detect hang-up when it occurs and will cause release of the connection.

It should be remembered that the central control operates in a time-division manner. After scanning a line and storing the results in an appropriate portion of the temporary memory, the central control proceeds to the scanning of other lines and to a multitude of other telephone functions such as timing, outpulsing, setting up connections in the network, and testing. The necessity of fitting all these functions into the allowable time imposes speed requirements on the components of the system. With this in mind, high-speed scanner circuitry was designed to limit the time required for scanning a line to 2.5 microseconds. This time figure includes the delays through the scanner circuitry and the transmission delay encountered in the cable linking the scanner and the central control.

If the idealized waveform shown on this page were available at the scanner input, the scanning problem would indeed be a very easy one, and the

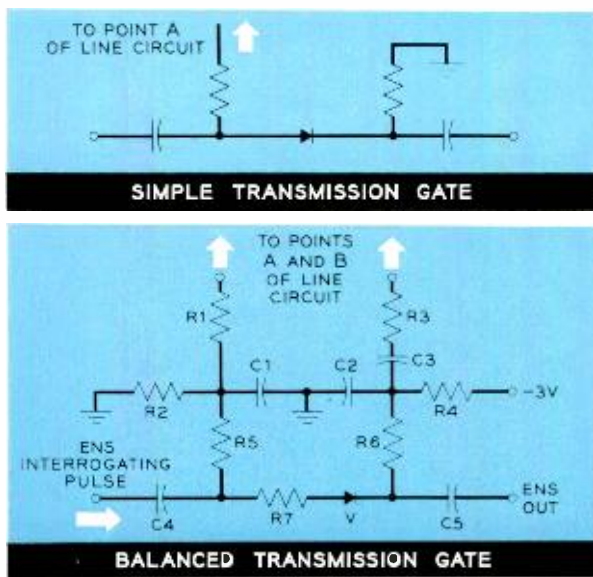

A simple transmission gate (above) and the balanced gate (below) which evolved from it; the latter permits dial-pulse scanning in the presence of pulse distortion and longitudinal induction.

simple transmission gate shown in the final drawing would be satisfactory. In reality, however, the transmission gate has to be designed to operate with satisfactory margins in the presence of such adverse factors as the leakage currents of customers' lines and telephones, induced power voltages, and high distortion of the arriving dial pulses caused by reactances in telephone sets and in telephone lines and cables. The (b) and (c) sections of the waveform drawings show the effect of these factors on a train of dial pulses, as observed at point A of the line circuit schematic drawing. The finite width of the "detection uncertainty" zone, which divides the recognizable on-hook and off-hook voltage regions, results from variations in the components and voltages of the scanner itself. It will be seen that longitudinal power induction might completely submerge the signal.

#### Balanced Gate

If in some way we were able to make use of the difference signal between points A and B of the line circuit, we would obtain a radical improvement which would help in two ways. Since the longitudinal interference appears in phase at points A and B, it will cancel in the difference signal; in addition, because of the direction of

the current through the battery-feed resistors, the dial-pulse voltages add. This doubles the useful dial pulse signal.

The balanced transmission gate in the last drawing is based on this observation. Longitudinal voltages are coupled in phase to both ends of the diode, leaving the net dc bias voltage unaffected. Capacitor  $C_3$  blocks the central office battery and prevents leakage drops across resistor  $R_1$  of the line circuit from affecting the dc operating margins of the gate. At the same time, it is a low impedance to both longitudinal voltages and dial pulses. An effective signal, which can be seen with a differential scope across the terminals of the line diode, is shown in the last of the four wave drawings. Capacitors  $C_4$  and  $C_5$  are very high impedances to low-frequency signals, but transmit the one microsecond interrogating pulse readily; these can be made to have large voltage ratings in small physical sizes and, coupled with hit (or protective) filters  $R_1C_1$  and  $R_3C_2$ , effectively protect other scanner circuits from lightning and additional noise voltages which may be picked up by the loop.

A skeletonized scanner is functioning satisfactorily as a part of the laboratory model of the experimental electronic switching system. Preliminary tests on a recently completed full-scale model of the scanner have given excellent results.



Author shown holding one of the line gate plug-in units which he has just removed from the scanner in the background. These key units permit the electronic "scanning" of lines and trunks.

*For the TH microwave system a small, lightweight unit has been designed as a frequency standard. Despite its small size, however, this unit delivers a test current at a frequency that is precise to one part in 1,000,000.*

L. F. Koerner

## **A Portable Frequency Standard**

Accurate sources of frequencies are very important to good communications. In the Bell System, such frequencies may range from a few kilocycles — for the lower-frequency channels of a carrier system, for example — to frequencies of thousands of megacycles used in radio-relay transmitters. And it is not sufficient, of course, merely to establish a frequency at the time of installation; it must be monitored to ensure accuracy despite aging, temperature changes, and a host of other factors that can affect oscillators.

For the new TH radio-relay system (RECORD, July, 1957) the various transmission frequencies are derived from an oscillator operating at a fixed frequency near 15 megacycles. The over-all accuracy of the system is one part in 100,000 — that is, the oscillator must not be more than about 150 cycles-per-second off the nominal value.

A portable frequency standard was developed for the periodic checking and readjustment required to maintain this oscillator. To minimize any inaccuracies of measurement due to the standard, and, accordingly, to reduce the number of maintenance checks, the standard has been made ten times more accurate than the unit to be tested, or one part in a million. In other words,

it is stable to within 15 cps out of 15 mc, an accuracy equivalent to a clock that does not lose or gain more than one second in about 11 days.

The unit seen in the accompanying photographs meets this requirement over a temperature range of 59° to 113°F. Further, it may hold this accuracy without adjustment for a considerable period of time — perhaps six months or longer. It is thus comparable with the best commercial fixed-station oscillators, even though the entire unit, including case, is hardly larger than a miniature camera.

This small size and high accuracy are a consequence of four developments at Bell Laboratories:

- (1) a new quartz crystal unit having a high precision,
- (2) a circuit to compensate for changes of frequency with temperature,
- (3) transistors, and
- (4) a voltage-reference diode which holds the operating voltage constant despite aging of the battery.

The contribution of transistors in attaining a small size is obvious. Transistors are small in themselves, and their low power drain means that the power supply can also be small. The

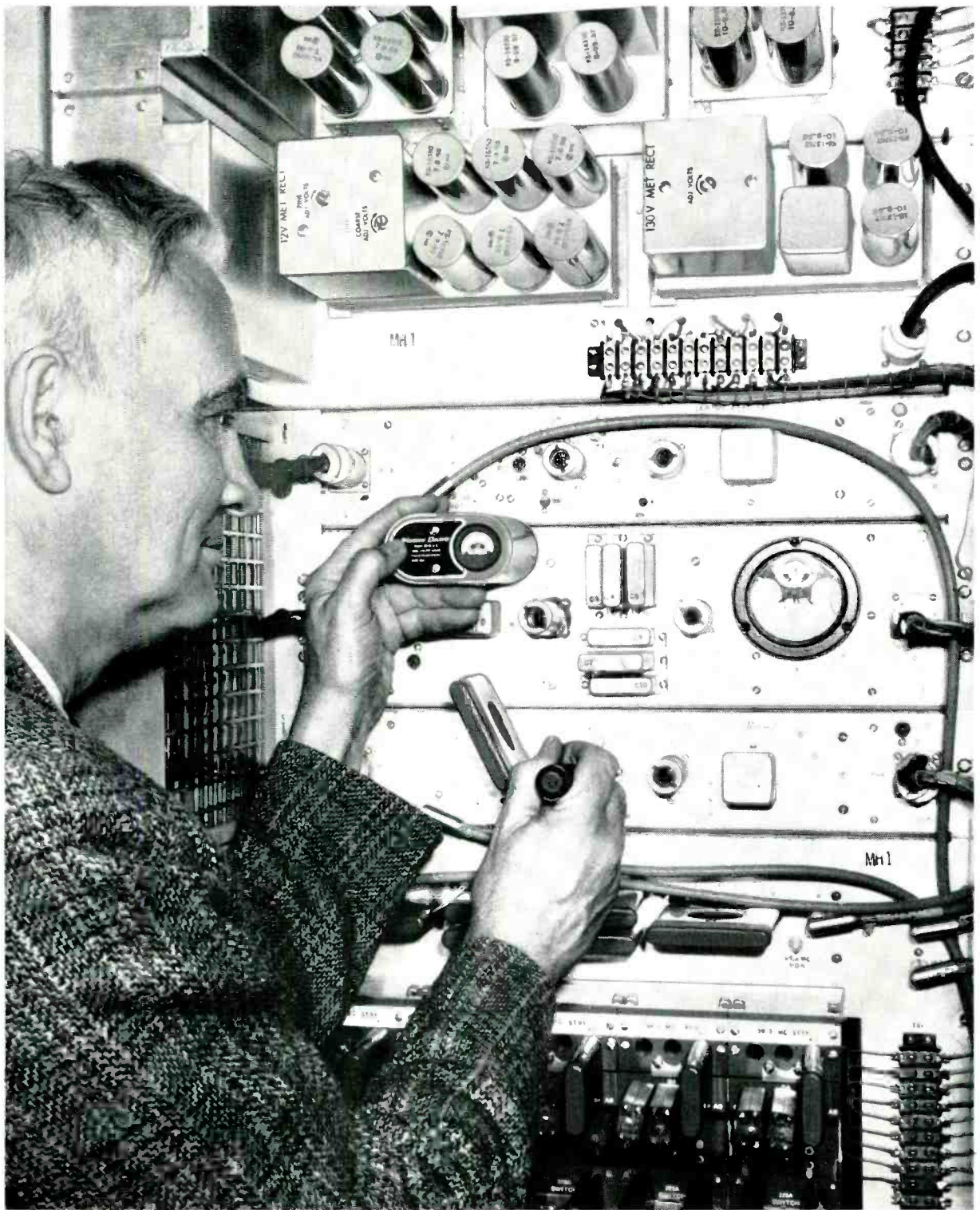

*The author making an adjustment in TH-system oscillator. Small frequency standard plugged into panel ensures accuracy to ten parts in million; the entire adjustment takes only a few minutes.*

temperature-compensation circuit and the reference diode also lend themselves to miniaturization. Their functions could be performed in other ways, but these would tend to result in bulky equipment that would be impracticable for this application.

The crystal unit is a descendant of the precision crystal units developed for a military navigation system. One of the critical problems of constructing such highly accurate crystal units is that the leads and metal plating always interfere, more or less, with what would otherwise be the free, unrestrained vibration of the crystal. For the primary standard units, a group in the Solid State Development Department at Bell Laboratories solved this problem by preparing a polished, lens-like crystal with a dense plating of pure gold, and by attaching the leads to the thin outer edge. The crystal vibrations are concentrated toward the center of the lens, and the leads have relatively little effect.

Extreme care in the machining and mounting of such crystals resulted in one of the most efficient and most accurate oscillator units ever made. In a temperature-controlled oven, these units can — for short periods of a day or so — achieve a stability of one part in ten billion: equivalent to one second in over 300 years. This accuracy, of course, is much greater than needed in a TH system standard; consequently, minor changes were made in the design to produce a suitable but more economical unit.

The crystal unit is glass enclosed. By itself, as is shown by the dashed line in the graph on this page, the unit has a maximum temperature coefficient of only about 0.5 part per million per degree C. With the inductor and thermistor, the temperature coefficient has been reduced about one tenth, as shown by the solid-line curve in the graph.

Individual crystals vary in their temperature coefficient from the maximum negative coefficient of 0.5 part per million per degree C as shown in the graph to a maximum positive coefficient of the same amount. During the fabrication of a standard, the coefficient of each crystal is measured and the appropriate series reactance is chosen. For a negative coefficient, as in the graph, this reactance is inductive; for a positive coefficient it is capacitive.

The thermistor is of the negative-coefficient type — that is, its resistance decreases as its temperature increases. At the higher temperatures it is essentially a short circuit across the reactance. With proper choice of values for the thermistor and reactance, the network forms the

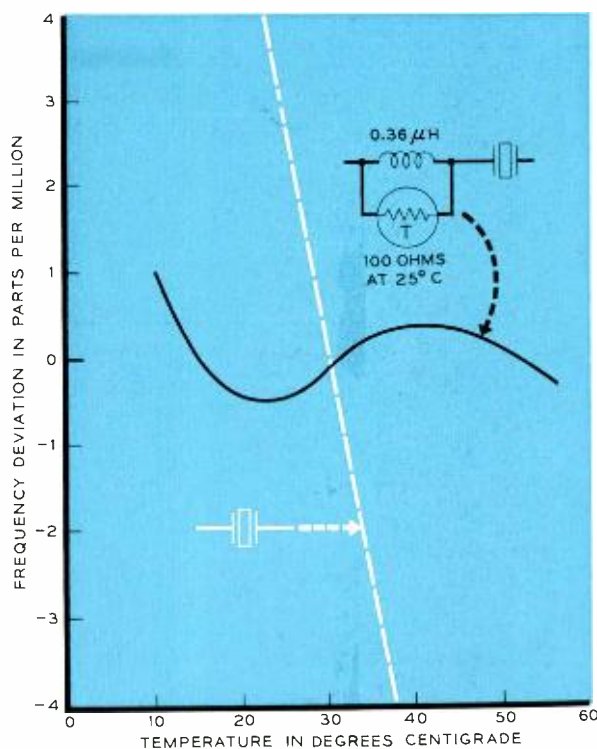

*Dashed line shows temperature characteristic of crystal unit alone; solid curve has "kink" which indicates improved performance over useful range.*

"kink" in the characteristic to produce the desired stability over a useful temperature range. Since the dashed curve for the crystal unit represents the maximum deviation to be expected, most units should have a smaller temperature coefficient. This reduces the value of the reactance in parallel with the thermistor and results in even better performance.

The change in frequency with supply voltage is quite small, and since the oscillator is operated only a minute or two for each measurement, long battery life is expected. The change of oscillator frequency with load is also small. If the load is resistive and is within 5 per cent of 75 ohms, the change will be less than one part in ten million.

The circuit of the frequency standard is shown in the diagram on the next page. The quartz crystal is indicated in the top center of the schematic, and the thermistor plus reactors  $L_1$  and  $L_2$  to its left comprise the calibration and temperature-compensation portion of the circuit. The essential parts are mounted on a printed-circuit board, as shown in the photograph on the front cover of this issue.

It can be seen that the circuit includes two

PRINTED CIRCUIT

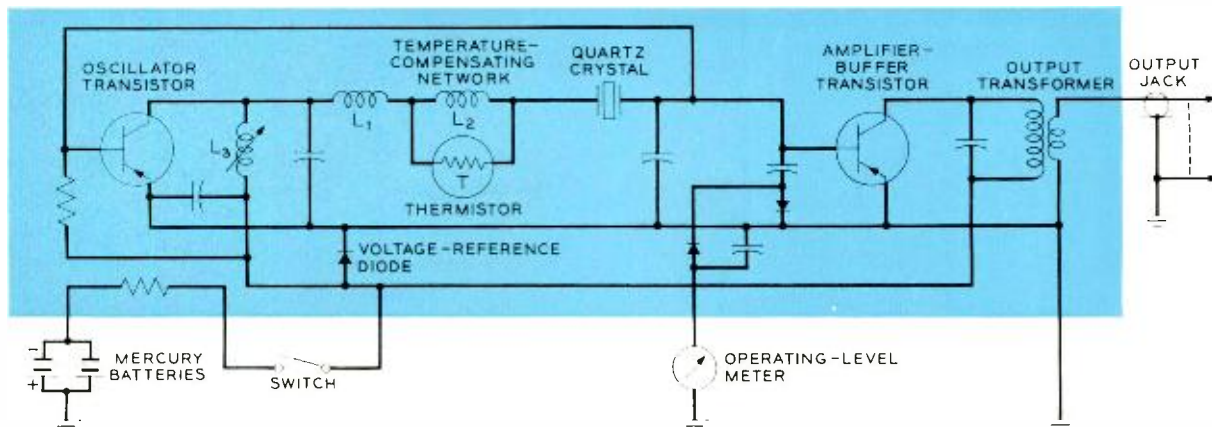

*Circuit of the portable frequency standard: two transistors, crystal unit and most other compo-*

*nents are mounted on small printed-circuit board. Accuracy compares with best commercial units.*

transistors. The one at the left in the schematic is the oscillator transistor, and inductor  $L_3$  in its circuit is tuned to permit exact adjustment to frequency. The second transistor, in the right part of the schematic, amplifies the signal and also serves as a buffer to isolate the oscillator section from the output load. The output circuit delivers about 2 milliwatts of power to a load of 75 ohms.

Part of the RF base voltage of the transistors is rectified and applied to the meter. This gives an indication of the unit's operating level—a value checked as part of the routine monitoring procedure. The two 5-volt mercury batteries connected in parallel supply power for the oscillator, and the voltage-reference diode stabilizes the input voltage to a nominal 4.5 volts.

The completely assembled standard is shown in the next photograph (*right*). The oscillator is disassembled by removing two screws holding the name plate. The cover may then be removed to expose all parts, to replace batteries and to make adjustments of frequency. To protect the oscillator from damage in shipment, it is enclosed in a felt-lined aluminum case.

The photograph on page 174 illustrates the use of the oscillator. The person checking the TH frequency carries the portable standard to the "frequency comparator" panel of the TH microwave carrier supply and plugs it into a jack provided for this purpose. He then depresses a push button on the standard and waits about fifteen seconds until the oscillator is sufficiently stable. He notes from the meter on the standard that the unit is operating at the proper level, and he then observes a "FREQ COMPR" (frequency comparison) meter installed on the panel. If "off fre-

quency" is indicated, a screwdriver adjustment will make the "FREQ COMPR" meter read zero. The accuracy of the adjustment is within about one-half part per million, and the entire operation should take only a couple of minutes.

The required accuracy of TH transmission can probably be maintained by checking it with the standard about once every three months. The standard itself will also have to be checked periodically against a precision source. When new, the standard will have to be checked frequently, but it is expected to become more stable as the crystal ages.

Although this oscillator was designed to operate at about 15 mc, it should be suitable over the range of 5 to 50 mc with appropriate crystal unit and circuit reactances. Quite possibly, therefore, it can find wide application for monitoring the operating frequencies of other systems.



*Portable standard with case in background.*



*The P1 System is the first carrier system that can furnish all of the ringing, dialing and supervisory signals normally provided for telephone service in rural areas. To incorporate these features, Laboratories engineers have used new, sensitive relays and transistor circuitry.*

D. C. Weller and J. C. Donaldson

## **SIGNALING IN P1 CARRIER**

The demand for telephone service for rural customers is constantly increasing. To supply this service, the Laboratories has designed a transistorized carrier-transmission system for rural areas, which is known as P1 Carrier (RECORD, August, 1956). The development has made it economically feasible to apply multi-channel-carrier operation to rural telephone service. At present, four carrier circuits can be furnished, in addition to the usual voice circuit, on a single pair of wires. Thus five simultaneous conversations can be conducted over the pair. A number of challenging problems were encountered in the signaling aspects of this system. This article explains how these problems have been overcome.

Flexibility, ease of installation and maintenance, and above all, low cost formed the framework of the transmission and signaling objectives of the P1 system. These objectives were met with new concepts in equipment (RECORD, April, 1957) and circuit design. Included were such innovations as printed-wiring boards for component assembly, and a molded wiregrid connector for interconnecting the various boards. Ultimately, these new features will result in reduced manufacturing costs and a more uniform product.

Newly developed components such as transis-

tors, foil-Mylar and dry-tantalum capacitors, and tunable ferrite inductors are used in the signaling circuits. Also used are new sensitive mercury-contact relays which help to reduce the complexity of the circuits. Transistors sufficiently lower the required "drain" of power to permit the remote terminal to operate economically from primary batteries in areas where ac power is not available. Where ac power is available, the power supply consists of a 22-volt rectifier with storage batteries to provide standby power in case an ac power failure occurs. These batteries can supply power to a remote terminal for four days.

Unlike most carrier systems, which operate between two central offices, the P1 Carrier operates between a central office and a pole-mounted remote terminal near the customers to be served. This results in added complexity because of the signaling which must be furnished.

On a normal rural line, the signaling functions are distinctly different for each direction of transmission. The central office signals the customer by ringing the bell in his telephone. (On multiparty lines this also involves the selection of the proper party.) The customer, in turn, controls the transmission of supervisory signals toward the central office which initiate or terminate calls.

In addition, he controls dialing signals which enable his call to be completed by automatic switches in the central office. A P1 Carrier System used on such a line must accept and reproduce these same central office and customer originated signals. Because the carrier system cannot transmit directly the low frequencies involved (dc to 30 cps), these signaling functions impose special requirements in the design of P1 Carrier.

In the P1 system, three in-band tones, in various on-off combinations, transmit ringing information from the central office to the remote terminal. At the remote terminal, these tones control the generation of power to ring the bells in the customer's telephones.

Two types of information travel in the opposite direction — from the remote terminal to the central office. One of these, supervisory information, tells the central office when the customer lifts the handset from his telephone. It is transmitted by the presence or absence of carrier-frequency voltage. The second piece of information comes from the dialing signals. These appear at the central-office terminal as successive trains of pulses of carrier voltage — in response to the number dialed by the customer.

Of the several items comprising the signaling circuits for P1 Carrier, ringing of the customer's bell or bells has posed the greatest single problem of design. There are a number of reasons for this.



*A. L. Bonner examines a tool-made sample of 805D Remote Signaling Network for P1 Carrier System.*

First, many different types of ringing must be handled. These include individual-line service and bridged ringing, divided code, four-party semi-selective and full-selective, and eight-party semi-selective. Of these types of ringing, the four party full-selective and eight-party semi-selective required the most attention. In both cases, not only must the system transmit the 20-cycle and "side-of-line" information, but it also must determine the polarity of dc bias that is superimposed on the 20 cycles. In P1 Carrier, two plug-in relay options at the remote terminal handle the several types of ringing involved. Thus, by the proper application of these options, the same signaling networks can be used for all types of ringing.

The second factor that complicates the design of the ringing circuits involves revertive calls. Revertive calls enable a customer served by a carrier channel to call another customer served by the same channel. This type of ringing requires that not only the called party receive a ring, but in addition a "guard" ring be received by the calling party. This guard ring enables the calling party to determine when the called party answers.

The customer makes such a call by dialing the wanted number (or in some cases, a special number) and then hanging up. He is alerted that the called party has answered when the ringing on his own telephone ceases. In this type of ringing, the signal may or may not be switched from one side of the line to the other, or in the case of selective ringing, the polarity of the bias may or may not be changed. The choices depend upon

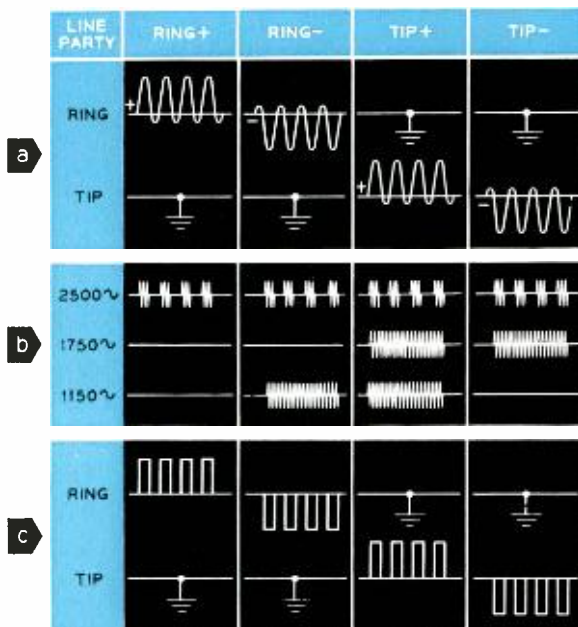

*Typical wave forms of the ringing signal as it is (a) applied to the central office terminal, (b) transmitted, (c) re-created at the remote terminal.*

which party originates the call and which party is being called. Because of these switching requirements, the timing and delay in the signaling circuits of the system have been important factors in the design.

The third aspect of ringing concerns the generation of 20-cycle ringing power at the remote terminal. In addition to being generated, this power must also be applied to the proper side of the line. And, in the case of selective ringing, the correct dc bias must be restored to the 20-cycle ringing current. Also, power required for ringing in comparison to that required by the transmission circuits is high. For example, it takes 2.5 times as much 20-cycle ac power to ring ten capacitor-coupled ringers as it does to power all of the transmission circuits of a remote terminal. These relatively high power requirements and the low frequency involved (20 cycles) lead to apparatus units of large physical size. The remote signaling circuits, for example, account for over half the weight and a third of the physical size of a remote terminal.

In solving the ringing problems, designers made compromises in circuit design and other features to keep the cost and physical size to a practicable minimum. For instance, one feature that does not appear in the P1 System is "ring

tripping" during ringing. This means that the ringing circuits continue to operate, even if the called party has picked up his handset, until a silent interval of the ringing code arrives. Circuit complexity, cost, and physical size are considerably reduced by providing ring tripping only during the silent intervals.

As previously mentioned, three in-band tones carry the ringing information from the central-office terminal to the remote terminal. Transmission of these tones — 2500, 1750 and 1150 cps — is controlled by three keyer circuits connected to the "ring" and "tip" conductors of the loop between the telephone equipment and the carrier terminal in the central office. The 20-cycle ringing and dc bias voltages applied to the loop operate these keyers. Ringing voltage pulses the 2500-cycle tone which carries the 20-cycle information over the system. The presence of this pulsed 2500-cycle tone indicates that ringing voltage is being applied to the loop. Transmission of the 1750-cycle tone indicates that the ringing is between the tip side of the line and ground, while absence of this tone indicates that ringing is between the ring side and ground. The 1150-cycle tone is transmitted when the dc bias accompanying the 20 cycles is either negative on the ring or positive on the tip. In other words, these last two tones (1750 and 1150 cps) determine which of the telephones on a multi-party line is to be rung.

At the central office terminal, the three in-band tones used for ringing are supplied by three two-stage transistor oscillators. Although placed in the first channel installed, these three oscillators can supply tones for as many as four channels on the same system. At the remote terminal, three tone-detector circuits separate, amplify and rectify the tones. The resulting dc signals (20-cycle pulses in the case of the 2500-cycle signal) then control sensitive mercury relays. Finally, the mercury relays control a ringing current supply which generates both the 20-cycle ringing and the bias voltage necessary for ringing the customers' bells, and applies this composite voltage to the proper side of the line.

A simplified schematic of the ringing-current generator in the remote terminal is shown in part (a) of the illustration on the next page. This generator supplies about 85 volts rms at 20 cycles. To do this, a transistor oscillator generates a 3000-cycle signal from the 22-volt supply, and this signal is stepped up by a transformer. Two full-wave rectifiers then rectify the 3000-cycle high voltage (200 volts) to produce both a positive and a negative output. Under control of the 2500-cycle tone, a relay contact, pulsing at a rate of

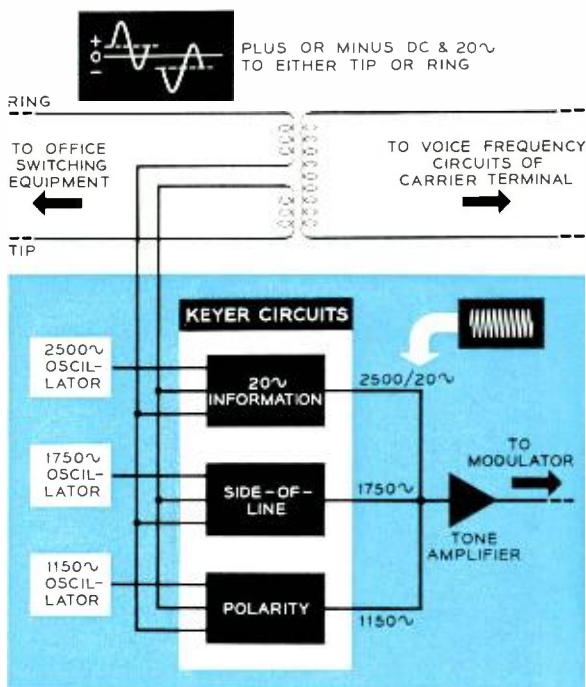

Three keyer circuits use ringing voltage to control the transmission of the three in-band tones. Two-stage transistor oscillators supply the tones.

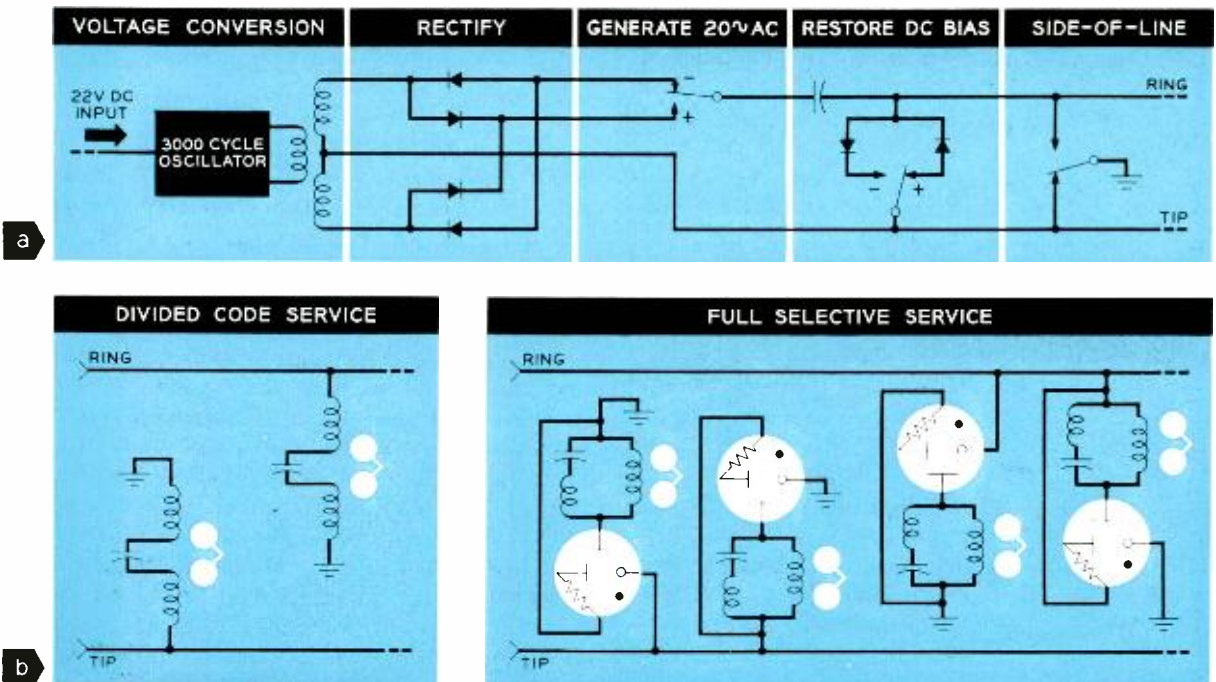

*A 3000-cycle signal and a step-up transformer solve the problem of supplying high voltage at*

*20 cycles. This circuit also makes individual filters adequate for filtering of the battery.*

20 cps, converts this high-voltage direct current to a 20-cycle ac square wave. This wave, when applied between ground and one side of the line, will ring capacitor-coupled ringers, as shown in part (b) of the figure.

Another relay, controlled by the 1750-cycle tone, determines the side of the line to which ringing voltage is applied. In the absence of this tone, the unoperated relay connects the tip side of the line to ground. The ringing voltage, which is applied between tip and ring, then operates the ringers connected between ring and ground. Similarly, operation of the relay by the tone connects the ring side to ground and operates the ringers connected between tip and ground.

Telephone sets used to furnish eight party semi-selective or four-party full-selective service have in their circuits a polarity-sensitive gas tube in series with the ringers. For ringing in this case, a dc bias, of controlled polarity, must be restored to the 20-cycle signal. The 1150-cycle tone operates a relay to control the polarity.

The ringing-current generator just described has a conversion efficiency (20-cycle power out divided by dc power in) of about 50 per cent. This generator has important advantages over types that generate 20 cycles directly from the 22-volt battery and then step up the 20 cycles to the proper voltage for ringing the bells. In the

P1 design, the step-up transformer operates at 3000 cycles instead of 20 cycles. This results in a 2.5-to-1 reduction in physical size of the transformer. In addition, the battery-filtering problem is reduced to a point where small, individual-circuit filters are sufficient to eliminate the cross-talk caused by the 3000 cycle signal.

This ringing circuit will ring ten capacitor-coupled or six gas-tube type ringers under the worst field conditions that may be expected. This will permit the use of extension ringers on rural lines served by the P1 Carrier.

The presence or absence of carrier-frequency voltage is responsible for supervisory and dialing information being transmitted from the remote terminal to the central-office terminal. At the remote terminal, the transmitting circuits are turned off during idle periods. When a customer lifts his handset, the terminal supplies loop current. Supervisory circuits in the remote terminal operate from this current to turn on the transmitting circuits and send a carrier signal to the central-office terminal. The central-office terminal recognizes the reception of carrier as a request for service and closes the dc loop between the carrier terminal and the central office.

In a manual office, closure of the loop lights a lamp on the operator's switchboard. The operator then proceeds to complete the call. In a dial office,

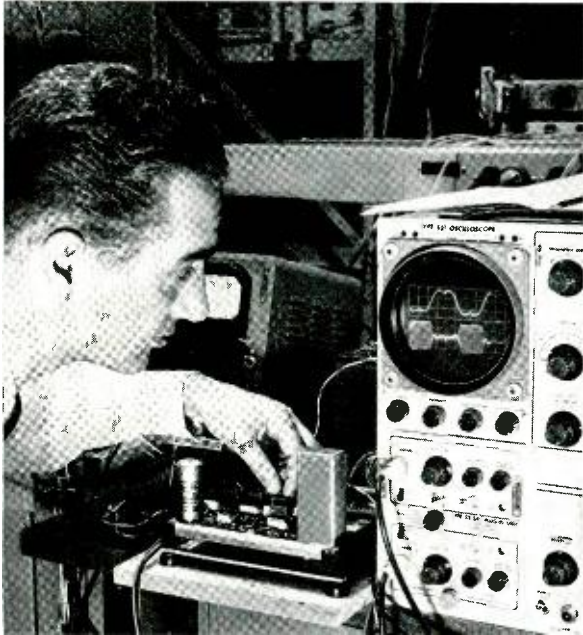

*G. H. Nosworthy compares the duty cycle of the 2500-cycle pulses with the 20-cycle ringing voltage on the telephone line using an oscilloscope.*

however, the central-office switching equipment recognizes the dc loop closure as a request for service and transmits dial tone back to the office terminal of the P1 channel. Dial tone is then transmitted over the system in the same manner as speech signals. When the customer begins to dial, the interruptions in loop current at the remote terminal turn the carrier voltage on and off. The central-office terminal converts the pulsing of the carrier to dc current pulses, and the switching equipment in the central office operates to complete the call as it would through any normal rural line.

The signaling circuits described permit P1 Carrier to be applied to rural lines with very few changes in existing central-office equipment. This holds true for all of the various ringing arrangements and the many different types of central-office switching and ringing equipment.

P1 Carrier has been in production for about three years and is now furnishing rural telephone service in many parts of the country. Operating Companies in some cases have used P1 to extend existing rural facilities. In other cases, they have used it for new service in areas where the installation of normal physical-wire plant would be economically unsound. The smallest installation made to date consists of a single channel serving 8 customers, while the largest installation uses 17 channels to serve 136 customers.

## Lightweight Aerial Platform

In recent years, there has been a trend toward equipment that one or two men can handle easily. For this reason, a number of such tools have been developed by Outside Plant Development.

One of these tools is an aerial platform to support a splicer while he is working aloft. It was necessary to design this platform to meet two very important requirements: strength and weight. It had to be strong enough to support safely a splicer with his equipment, yet light enough to be raised into position by one man.

A structure has therefore been designed which uses a sandwich-type construction developed by the Douglas Aircraft Company. The core of the sandwich consists of sheets of Kraft paper, impregnated with a phenolic-type resin and bonded

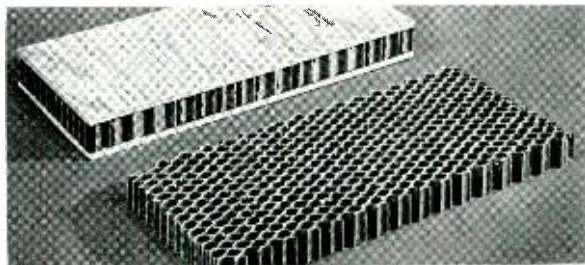

*Honeycomb construction used for the platform.*

together in such a manner as to form a cellular structure.

The core is faced both top and bottom with an exterior grade of Douglas fir plywood. With a waterproof adhesive, the plywood is bonded to the core perpendicular to the cell axes, and is cured at elevated temperatures in a press. The edges of this composite structure are sealed for protection against moisture, and the laminated panel is then equipped with hardware to accommodate four support and two guy ropes. A hook and ring bolt are supplied for raising or lowering.

The new design is about 20 pounds lighter than the old wood platform of the same size, and yet will support a distributed load of 3,600 pounds without deflecting more than 1 inch. It can be reversed if one side becomes excessively worn, thus increasing its service life.

The present cost of the lightweight aerial platform is only slightly higher than for the old type, and the differential in cost is more than offset by the usefulness of the laminated design.

A. T. JOHNSON *Outside Plant Development*

*In long-distance television transmission there may be an appreciable difference in time of arrival between the audio and the video signals. To overcome this problem, Bell Laboratories has developed a bypass arrangement to eliminate some of the causes of audio delay.*

Idea Kerney and W. D. Mischler

## **Equalization of Aural and Visual Delay**

Viewers of television programs expect to see a faithful reproduction of the studio performance. One requirement for such faithful reproduction is that the aural and visual signals arrive at the TV receiver at the same time. Often evident in the early days of sound motion pictures, lack of such close synchronization can seriously detract from the realism of a program. Especially annoying are close-up camera shots where a speaker or vocalist is obviously mouthing sounds not emerging from the loud-speaker at the same time.

Operation of present-day television networks over long distances can introduce serious differential time delay between aural and visual signals—the speech lags the action. Up to now, the remedy has meant placing severe restrictions on the flexibility of the transmission plant. This becomes particularly onerous as the Bell System is called upon to furnish longer and more complex networks to television broadcasters.

A prime contributor to the unwanted delay in the aural signals is the program terminal of the carrier wave. This unit converts the signal from its audio frequency to a carrier frequency and, at the proper time, back to audio. A second, and

considerably smaller, factor lies in the different transmission media generally used for the two components of a television program. The audio signals are usually transmitted over carrier-derived wire circuits, while, in most cases, the video signals are sent over microwave radio. The physical length between two given points is often greater, and the velocity of propagation is lower for the wire facilities than for the radio.

### **Program Terminal**

In television, it is expedient for the dual transmission media to be maintained for the aural and video signals. Therefore, to alleviate the delay problem, Laboratories engineers went to work on the major contributor—the program terminal. In the broadband carrier plant of the Bell System, frequency “space” for program facilities is obtained by disabling two or three of the normal speech channels in a standard twelve-channel group. For example, channels 6 and 7, when associated with a “C-1” program terminal, provide a five-kilocycle program band. This terminal translates the program signals from carrier to audio frequencies or audio to carrier frequencies, de-

pending upon whether the terminals are used as receiving or transmitting devices. It consists essentially of modulators, demodulators, band-pass filters and equalizers.

If program terminals were needed only at the initiating and receiving points of a television network, the delay introduced would be quite small. However, in the normal operation of carrier telephone, message circuits are "dropped" at many places along a route. To accomplish this, the circuits are brought down to base band—that is, the signal is demodulated to the audio frequency.

In the standard arrangements available up to now, the sound portion of a television program being transmitted along with regular telephone

messages also had to be brought to base band with a program terminal. Where the program was to be transmitted farther, a second terminal was required to re-translate the signal to carrier frequency. It is the accumulated delay of the many program terminals in a long network that makes impossible satisfactory operation of a carrier-derived program circuit when it forms the aural portion of a television network.

Some years ago Bell Laboratories carried out an investigation to determine the amounts of accumulated audio delay that could be tolerated in long-distance television transmission. These subjective tests resulted in an engineering requirement of 55 milliseconds as the maximum permissible differential delay. In addition, both

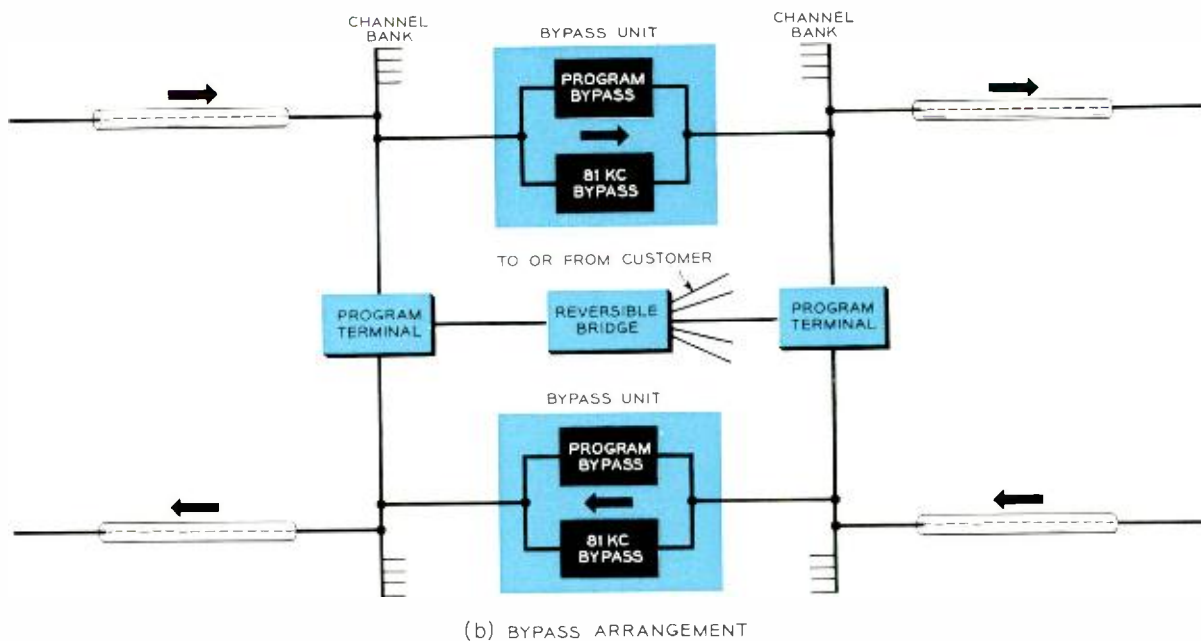
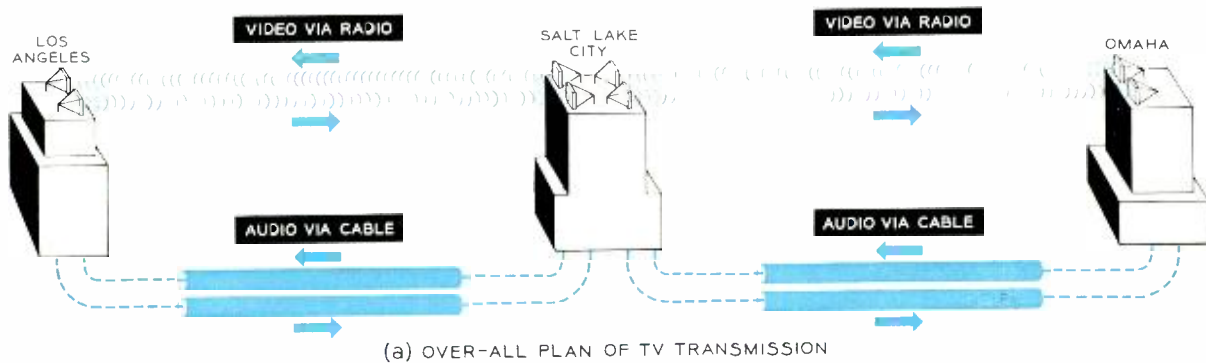

Transmission of audio signal over a telephone cable causes it to lag behind the visual signal.

Bypassing the former around telephone-message dropping points helps to limit this annoying delay.

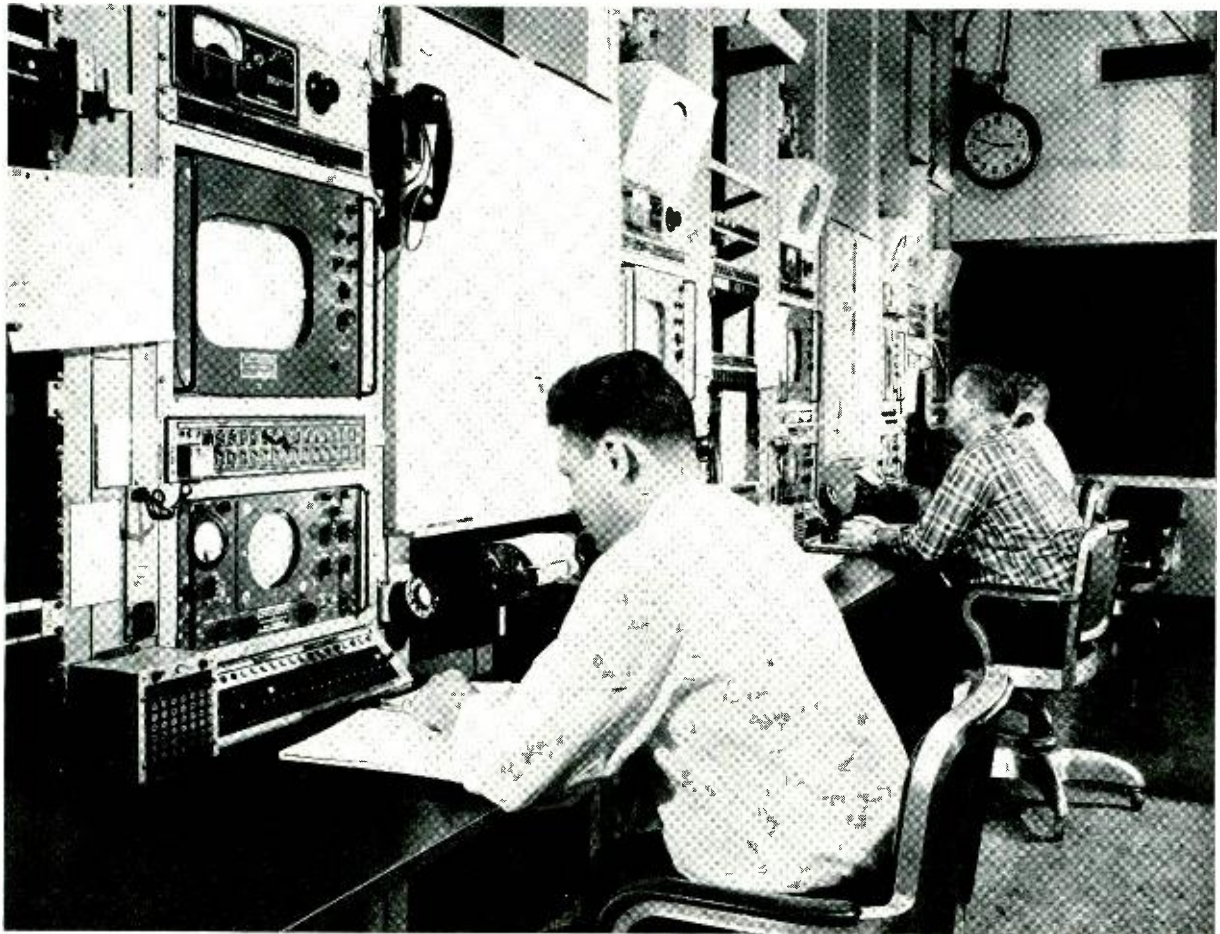

*Typical television monitoring center (Long Lines office in New York) where technicians keep close*

*check on synchronization of sight and sound. Bypass arrangement relieves much of this problem.*

laboratory measurements and field tests have indicated a limit of 15 milliseconds for the 100-cycle delay distortion; that is, the delay at 100 cycles compared to that at 1000 cycles — the reference frequency. The latter requirement is not unique to the aural signals associated with television transmission — it affects the fidelity of reception of any audio program.

Each pair of C-1 program terminals introduces an absolute delay of 9.4 milliseconds and a delay distortion of 1.2 milliseconds at 100 cycles. An example may help to explain the implications of these delays in the program terminals. Consider a television-network circuit 4000 miles long (roughly the equivalent of from Seattle, Washington to Key West, Florida) using program facilities derived from broadband carrier for the aural portion of the signal. Now, the differential delay between 4000 miles of broadband carrier circuit and 4000 miles of radio-relay circuit (which would provide the bulk of the transmis-

sion for the visual portion) is about 10 milliseconds, excluding the program terminals. Based on the over-all differential delay limit of 55 milliseconds, the maximum delay that can be accumulated by the program terminals and associated equipment is 45 milliseconds. Therefore, since each pair of C-1 program terminals presents a 9.4 millisecond delay, a limit of five pairs of terminals and five links of broadband carrier would be imposed on a circuit of this length.

Several years ago, engineers recognized that such a limit as this is not realistic for television network operations. For that reason the Laboratories has developed a way to increase the number of usable links in a carrier-derived program system. This is done by an arrangement that bypasses, at carrier frequencies, the aural portion of a television program around the telephone-message dropping point, with only a small increment of delay contributed at each point. This more nearly equalizes the transmission times



of aural and visual programs on the television circuit, and at the same time permits the telephone-message circuits to operate efficiently.

Four prototypes of the proposed by-pass unit were assembled at the Merrimack Valley Laboratory in Massachusetts, and were shipped to the program room at the A.T.&T. toll office in Salt Lake City. A field study of these units was conducted by Bell Laboratories personnel, assisted by engineers from the Operation and Engineering and Long Lines departments at A.T.&T.

### **Bypass Operation**

This bypass arrangement operates in the following manner. As shown in the illustration on page 183, the incoming band of carrier frequencies has a choice of two paths. One section of the bypass unit consists of a band-pass filter — with associated pads (fixed transmission-loss networks) — that transmits the 5 kc program at the group frequencies of from 83-88 kc. Another section of the bypass unit transmits a control frequency of 81 kc which when demodulated serves to activate the relay circuits that reverse the program direction. This branch consists of two filters in tandem, with associated pads and repeating coils. The tandem arrangement is needed because attenuation of a single filter is insufficient at frequencies other than 81 kc.

The bypass circuit transmits the 5-kc program (83-88 kc) and the 81 kc control tone, and suppresses the remainder of the group band. This suppression is necessary to prevent channel crosstalk which would otherwise take place between the receiving and transmitting channel groups connected by the bypass circuit.

The complete bypass arrangement consists of two reversible C-1 program terminals, each of which uses the frequency space allotted to two telephone-message channels, and two bypass circuits (one for each direction of transmission). This arrangement permits receiving from either direction alternately, transmitting an originating program in either direction alternately, or in both directions simultaneously.

The presence of 81 kc control tone in a particular program network conditions the program terminal to permit the proper direction of transmission. The toll office receives a television-sound program through the assigned C-1 program terminal. This program is also transmitted at carrier frequencies to the next repeater station through the associated bypass circuit without going through the receiving and transmitting program terminals. At the same time, the transmitting path between program terminals is open-

ed by relays in the bypass unit. Since, in normal program network operation, only one direction of transmission is used at a time in any one system, no provision has been made for receiving from both directions simultaneously.

A local broadcast station which originates a network program takes control of the network by transmitting a dc signal via a simplex circuit to the program terminals in the toll office. This puts both terminals in a transmitting condition and terminates the bypass circuits, so that transmission can take place in both directions simultaneously. It is sometimes desired to send a program in only one direction (as might be the case toward the beginning or end of a broadcast day due to time zone differences). In this case, the leg of the bridge that feeds the undesired direction can be terminated. Due to electrical interlocks in the program network, however, both the program terminals must remain in a transmitting condition or transmission in the desired direction will be lost.

At message-dropping points where there is no



*Radio-relay tower atop Buckhorn Mountain in Colorado on the Denver-Oakland relay route; the repeater point amplifies the television signal.*

requirement for either dropping or originating a program, a through program channel at carrier frequencies may be obtained by connecting a bypass circuit between hybrid coils of the channel banks. The circuit selects the program from the group frequencies of the receiving channel and reinserts it for transmission, also at group frequencies. It does this without either the absolute delay or delay distortion introduced by the program terminals.

Where a program drop is required, a high-impedance bridging circuit connects the bypass circuit to the program terminals. This circuit has negligible effect on the through transmission and does not appreciably change the power levels through the equipment. A group amplifier compensates for a 20-db loss introduced in each bridging circuit by this scheme.

### Relay Control

Under normal network operation, where the bypass circuit furnishes a path around the program terminals, relays are activated to disable the program terminals in the transmitting paths. On the other hand, where a program originates locally and is fed into the network, relays disable the bypass circuits in the transmitting path. The operation of both sets of these relays is controlled by spare contacts on another relay located in the reversing circuit of each of the program terminals.

When the program terminal is in a receiving condition, the bypass path it controls is closed through the circuit while the transmission path from the other program terminal is opened and terminated. When the program terminal is in a transmitting condition, the bypass path it controls is opened and terminated while the transmission path from the other program terminal is closed through the circuit.

To show the advantage of the bypass device, let us consider the case of a program circuit, composed of 13 broadband links, which is to be employed as the aural portion of a television circuit. The 13-link circuit is chosen for illustration because in the absence of any absolute delay considerations this is the greatest number of links that can be combined and still substantially meet our delay-distortion requirement for program transmission.

The accompanying table is a tabulation of two possible arrangements. Let us first assume, as tabulated in part A of the table, that the 13-link circuit is equipped with 13 pairs of C-1 program terminals with no bypass units. Then let us assume, as tabulated in part B, that bypass units

are used at 10 of the 13 locations, with three pairs of C-1 terminals operative in the remainder of the network.

Absolute delay is unimportant when a carrier-derived program circuit is used only as part of a radio network. This delay becomes a limiting factor, however, when the program circuit is employed as the aural portion of a television network. We use the figure of 45 milliseconds, arrived at earlier, as the maximum delay that can be accumulated by the program terminals and associated equipment. We see, however, that the total delay for 13 broadband links of carrier-derived program facilities (as shown in arrangement A of the table) is 122.2 milliseconds, or about 2.7 times the 45 milliseconds limit. Now, if the total delay is reduced to 33.2 milliseconds by the use of bypass units at ten of the thirteen terminals, (as indicated in arrangement B) the result is well within the 45 milliseconds limit. Also, the corresponding value of 12.6 milliseconds for the delay distortion, shown in arrangement B, more than meets the delay-distortion limit of 15 milliseconds.

The Laboratories is presently developing an arrangement which will use the program bypass technique with a single program terminal. This arrangement will permit the aural signal associated with a television network to be received from either direction and to be transmitted in both directions. Furthermore, it will probably effect substantial savings in cost of equipment for those networks requiring only one program terminal.

TABLE I  
Alternate Circuit-Terminal Arrangements

Arrangement A	
Total delay contributed by 13 pairs of C-1 terminals (9.4 ms per pair)	122.2ms
Total 100-cycle delay distortion contributed by 13 pairs of C-1 program terminals (1.2 ms per pair)	15.6 ms
Arrangement B	
Delay contributed by 3 pairs of C-1 program terminals (9.4 ms per pair)	28.2 ms
Delay contributed by 10 bypass units (0.5 ms per unit)	5.0 ms
Total delay when bypass units are employed at 10 of the 13 terminal locations	33.2 ms
100-cycle delay distortion contributed by 3 pairs of C-1 program terminals (1.2 ms per pair)	3.6 ms
100-cycle delay distortion contributed by 10 bypass units (0.9 ms per pair)	9.0 ms
Total delay distortion when bypass units are employed at 10 of the 13 terminal locations	12.6 ms

*New methods of telephone cord construction use a parallel conductor that eliminates the binder and filler threads of the older twisted cord method. A thinner, lighter, and easier to make cord is the result.*



## **Jacketed Cords for Telephone Sets**

Except in the very early days of telephony, almost all telephone sets have used cords of one type or another to connect the receiver or the handset to the rest of the set, and to connect the set either to a wall-mounted subset or to a connecting block. From the very beginning, every effort has been made to have these cords as light, flexible, and wear-resistant as possible. Although subjected to bending, twisting, kinking, rubbing, and pinching, in addition to pulling the conductors should not break, the insulation not fail, and the outer covering should not wear away.

For many years telephone-set cords were covered with a brown cotton braid, and some of these are still in use. Earlier, the conductors themselves were also insulated with cotton braid. Telephone sets, however, are often located where the cords are subject to moisture. The cotton braid was therefore given a water repellent treatment; even so, moisture often caused leakage currents between the conductors and also

accelerated corrosion of the conductors and rotting of the braid. Using rubber to insulate the conductors solved some of these problems, but before rubber-insulated cords could be made for general use, special rubber compounds had to be developed (RECORD, August, 1938).

Although insulating the conductors with rubber helped prevent many moisture troubles, the cotton outer braid was still subject to wear. In an effort to reduce troubles from worn-out cords, and to reduce the frequency with which the cords had to be replaced, the first rubber-jacketed cords for telephone sets were introduced for Bell System use in 1938. These cords were heavier and larger in diameter and — primarily because of the expensive finishing operations required — considerably more costly than the textile-covered cords. For these reasons, they were not considered desirable for general use but were restricted to sets that were subjected to unusually hard service or extreme moisture conditions.

Because of the rubber shortage, rubber-jacketed cords were not produced for civilian use during World War II; after the war, a survey indicated that neoprene would be more suitable than rubber for this purpose. Neoprene resists deterioration by oil and is less susceptible than rubber to ozone cracking. It was used, therefore, as the covering material when the production of jacketed cords was resumed. Otherwise, the construction of these cords was unchanged from that of the pre-war versions.

It was recognized that cord maintenance would be materially reduced and customer satisfaction increased if jacketed cords suitable for general use were available. This meant that both the weight and the thickness of the cords must be reduced — without, however, reducing the ability of the conductors to withstand bending and twisting. Laboratories' engineers and Western Electric accordingly undertook the development of new methods of cord construction. They developed a parallel conductor construction that eliminated the binder and filler threads which were characteristic of the older twisted construction. Laboratory tests showed that this parallel construction withstood bending and twisting just as well as the twisted construction, and that a thin paper wrapping would serve the function of the binder threads. The change in construction resulted not only in a thinner, lighter cord, but in a cord that was easier to manufacture.

Cords made by the new method and jacketed with neoprene were standardized in 1949 and essentially replaced those covered with textile braid for black telephone sets. By early 1954, cords of similar design — but using polyvinyl

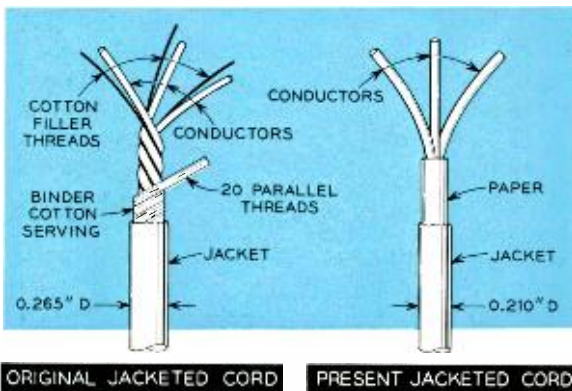

*Old jacketed cord design (left) had conductor and filler threads twisted and covered with a cotton binder. New cord (right) conductors are parallel.*

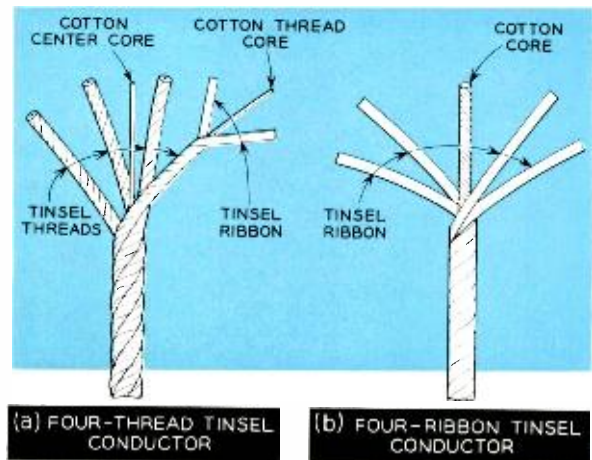

*Old telephone conductor (a) with a twisted cord design, versus new conductor (b) of less diameter, greater flexibility and simpler construction.*

chloride plastics for insulation and jacketing — were in production for color sets. Recently, improved polyvinyl chloride plastics have largely replaced neoprene, even for black set cords.

In addition to design changes in the methods of cord construction, a new type of tinsel conductor was developed. Formerly, tinsel conductors consisted of several tinsel threads wrapped around a cotton yarn core. Each tinsel thread, in turn, was made by wrapping one or two tinsel ribbons around a cotton yarn core. The new tinsel conductor has four tinsel ribbons wrapped in an overlapping manner around a single — but larger and stronger — cotton core. Smaller in diameter than the former tinsel conductor, the new tinsel conductor withstands bending and twisting better and is much more flexible than the older conductor. This new conductor is now being used in all vinyl-jacketed cords and in some neoprene-jacketed versions. Present plans call for its use for all conductors of station cords as soon as manufacturing facilities are available.

Laboratory tests and field experience with the jacketed cords indicate a marked lengthening of service life — with consequent lower maintenance costs — over that of the textile-braid covered cords. The search for improvement continues, however, in this as in other phases of the telephone art. New materials and manufacturing methods will lead to smaller and smaller cords with greater and greater resistance to wear.

C. A. WEBBER  
Outside Plant  
Development

## Titan Guidance System Successfully Tested

*A new system for missile guidance uses radio-inertial principles. Developed by Bell Laboratories, it is being tested in a series of launchings of Thor-Able missiles.*

On April 8 the nose cone from an Air Force Thor-Able II missile was quickly picked up in the South Atlantic, after having been fired earlier from Cape Canaveral, Florida. This rapid recovery was achieved through use of a new, highly-accurate system for missile guidance.

Developed by Bell Laboratories for the Ballistic Missile Division of the Air Force, this new radio-inertial system will be used for precise guidance of the first squadrons of the Titan intercontinental ballistic missile. The Laboratories is teamed with Remington Rand-Univac who developed the computer for the new system.

The April 8 recovery was the first for a Thor-Able II nose cone. In a previous test of the guidance system on March 21, the missile also successfully reached the selected impact area. But that nose cone was not picked up because of a malfunction in the recovery package.

The radio-inertial guidance system is being tested in a series of Thor-Able II missiles as a part of the Air Force program to accelerate the full capabilities of ICBM's. The Thor-Able II missiles assigned to the Air Force program are called "precisely guided re-entry test vehicles" (PGRTV). They are used for evaluating the performance of nose cones when they re-enter the earth's atmosphere as well as for early flight-testing of the guidance system.

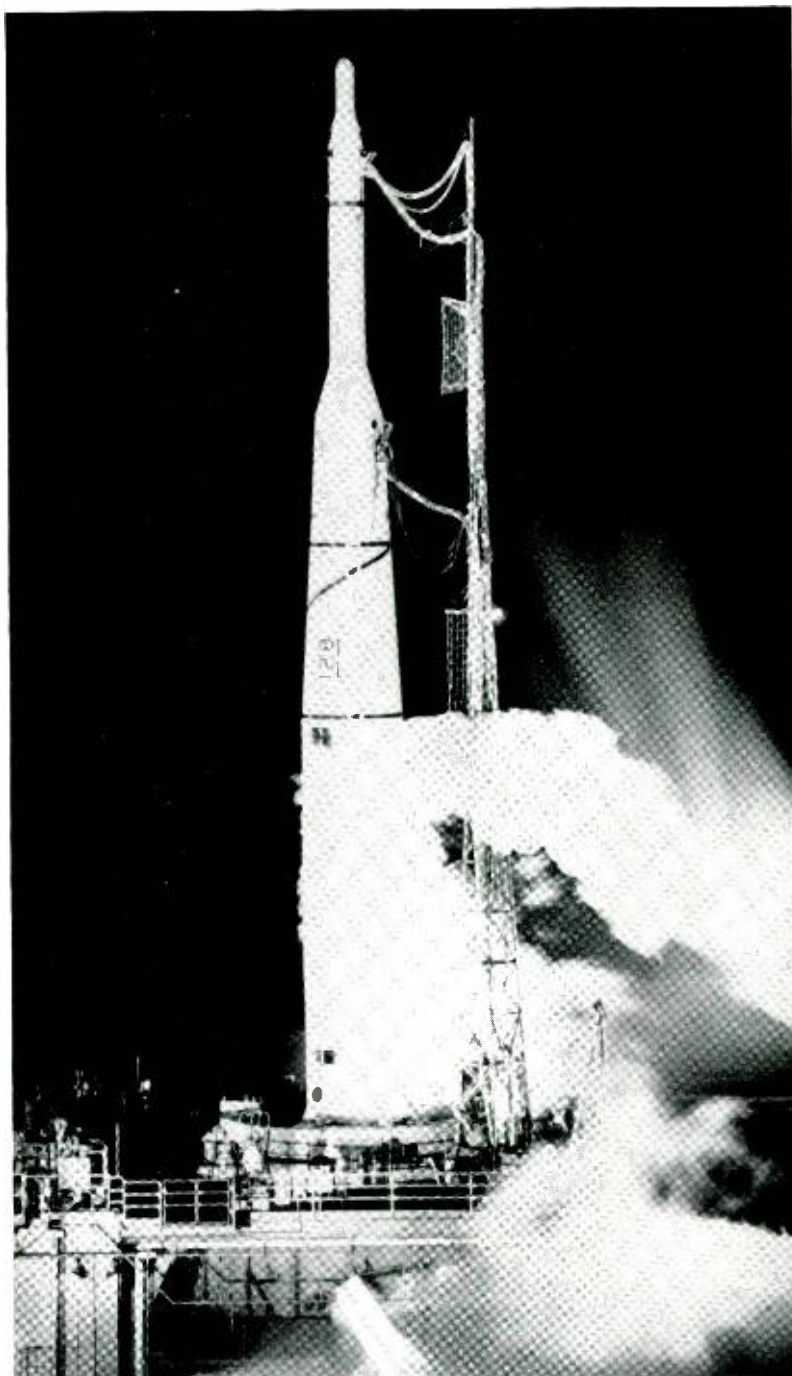

*A Thor-Able II missile on its launching pad at Cape Canaveral. Similar missiles were used in the test flights that successfully demonstrated the new, highly accurate guidance system for Titan.*

*Record number of share owners hear  
of continued improvement of business.  
First stock split overwhelmingly approved.*

## **A. T. & T. ANNUAL MEETING**



*Twelve thousand share owners, the largest number ever to attend an annual meeting of a U. S. corporation, filled the huge Kingsbridge Armory in New York City on April 15 to hear A. T. & T. President Frederick R. Kappel report on progress of the Bell System.*

"It deserves to be restated that we are in good shape and have good prospects ahead," A.T.&T. President Frederick R. Kappel told approximately 12,000 share owners attending the Company's 74th annual meeting in New York on April 15.

"In this growing country," Mr. Kappel added, "the services we provide are more and more wanted and more and more used; and they are wanted by more and more people. At the same time, we are continuing to improve existing services and develop new ones, and we are making our operations more efficient. All these factors hold promise for the future."

By an overwhelming vote, the share owners endorsed the three for one stock split. The vote for the split was 59,387,892 shares or 99.1 per cent; against the split, 542,809 shares or 0.9 per cent.

Referring to the proposed stock split Mr. Kappel said that there was "no thought whatsoever of changing the essential character of this business. We have never favored an up-and-down dividend policy and we are no more disposed to that now than we have ever been. Our responsibility is to do the best long-run job we can for every share owner, just as in providing service we are responsible to every customer. We shall continue to act on that principle."

The share owners re-elected the Board of Directors and the auditors of the company, and voted down proposals that would put a ceiling on officers' pensions and that would establish cumulative voting for the election of the directors.

Reporting further on Bell System progress, Mr. Kappel said, "we have also done a vast amount of work to make our communications system a strong bulwark of defense."

"The most difficult problem we have faced all through the post-war period has been the persistent rise in costs," he continued. "We have had to pay higher prices for raw materials. Construction costs have risen steadily, and so too have our operating expenses,



*President Kappel said, ". . . we are continuing to improve existing services and develop new ones, and we are making our operations more efficient. All these factors hold promise for the future."*

three-fifths of which are employment costs.

To meet this problem we have had to obtain increases in telephone rates, he said. We have also done a great deal to improve our methods of operation and "this process of innovation and improvement is continuous and it is vital to the success of the business."

Our anti-inflationary activity also includes discovery, development and introduction of new devices and systems that will provide better service and perform such services more economically, Mr. Kappel reported.

"Of course, research and technical development have always been vital elements in our business and I don't imply that we think of them as purely anti-inflationary measures. They are more than that. However, I can't refrain from pointing out that if it were not for this technical progress, our costs today would be far higher and our need for rate increases far greater."

Inflation eats up the dollar savings that come from technical gains, he said.

"If it were not for inflation, I'm sure that this kind of progress would take us far along the road to lower prices, better earnings—in fact better everything for

everyone. But inflation erases the economic gain and thereby puts a penalty on us all," Mr. Kappel said.

Showing slide films of the steps involved in introducing Direct Distance Dialing, Mr. Kappel cited the importance of three-way teamwork between the Bell System research, manufacturing and operating companies. "This teamwork has never been better and I am happy to pay tribute to the work that has been done by all of the men and women concerned."

Mr. Kappel also announced that a new \$20 million laboratory will be built by Bell Laboratories at Holmdel, N. J. It is expected that the new laboratory will house some 1,500 people (*see news item on page 193*).

At a press conference before the meeting he said that this year's construction program will be around \$2 billion.

Asked about federal legislation to eliminate the telephone excise tax, Mr. Kappel said the passage of the legislation would depend on the broad tax program that may develop. He expressed particular concern over proposals that would use telephone excise taxes to build sewage treatment facilities and for other state and local activities remote from telephone services.

## **Laying Begun for First Direct-to-Europe Cable**

Deep-sea operations recently got underway for the first submarine telephone cable system to link North America directly to the mainland of Europe. In mid-March, from a point just off Penmarch, France, the cables ship *Monarch* began paying out cable toward the western terminal at Clarenville, Newfoundland. The distance between the two terminals is 2,400 miles.

The twin-cable system will furnish at least 36 voice circuits between the U.S. and continental Europe. It will primarily serve France and Germany, with some circuits extended to Switzerland, Italy, Belgium, the Netherlands and Spain, and will supplement radiotelephone circuits now servicing Europe.

The new cable system will be owned jointly by the Long Lines Department of A.T.&T. Co., the French Ministry of Posts, Telegraph and Telephone, and the German Federal Ministry of Posts and Telecommunications. It is scheduled for public service in the Fall.

## **Vanguards I and II Success Aided by Laboratories Devices**

On March 17, the United States' Vanguard I satellite completed its first year in outer space, having circled the earth 3,918 times. Scientists have recently estimated the life of this satellite to be about 2,000 years.

Two developments at Bell Laboratories — the solar battery and the transistor — play major roles in the collection of information from Vanguard I. Signals are sent to earth by a transistorized

transmitter, which is powered by solar batteries. These signals are still as strong as those sent a year ago.

Vanguard II, a weather-observation satellite launched February 17, contains in its signaling equipment four diffused-base germanium transistors designed by the Laboratories.

During each orbit, photo cells in the weather satellite scan the sunlit side of the earth. The information obtained is fed into a tiny magnetic tape recorder and "spilled" to receivers as the satellite passes over one of the ground tracking stations.

To conserve the mercury battery powering the equipment, two silicon cells turn off the tape recorder when the satellite is in the earth's shadow.

With the recent launching of Discoverer II, the United States had five satellites up in the company of Russia's Sputnik III.

## **C. H. Townes Shares I.R.E.'s Morris Liebman Memorial Award**

Charles H. Townes, formerly in the Physical Research Department at Bell Laboratories, presently Professor of Physics at Columbia University and Consultant to the Laboratories, in March was co-recipient of the I.R.E.'s Morris Liebman Memorial Award. He was cited for "fundamental and original contributions to the maser."

At the Laboratories from 1939 to 1947, Professor Townes pursued the theory of sputtering of metals by bombarding them with ions, worked on radar bombsights and computers, and studied spectroscopy in microwave regions — the forerunner of his maser studies.

## **F. B. Llewellyn Speaks Before AMA Forum**

F. B. Llewellyn, assistant to the President, participated in the American Management Association's Forum on Capitalizing on European Science held March 30 — April 1 in New York City.

Speaking on the subject "Coordinating Research Efforts," Mr. Llewellyn explained how the Laboratories maintains liaison with research and development projects abroad.

## **Laboratories Announces Graduate Fellowships**

Bell Laboratories during April announced the names of the fifteen nationwide winners of its 1959-60 university graduate fellowships.

The fellowships are granted annually to outstanding students working toward the Doctor of Philosophy degree in sciences relating to communications. Each fellowship carries a minimum grant of \$2,000 to the student and an additional \$2,000 to the institution to cover tuition, fees and other costs. Four of this year's winners will study electrical engineering, four physics, four mathematics and three chemistry. They will be attending eight universities across the country.

## **Selection Committee**

The winners were selected by a Laboratories committee consisting of a S. A. Schelkunoff, Chairman, E. E. David, Jr., R. L. Dietzold, R. C. Fletcher, K. E. Gould, S. B. Ingram, W. D. Lewis, F. B. Llewellyn, H. E. Mendenhall, Sidney Millman and S. O. Morgan. One winner, Donald W. Tufts of Boston, is being honored a second time with a graduate study grant from the Laboratories. Mr. Tufts and another fellowship recipient, A. Dickson Hause of Rock Island, Ill., were at the Laboratories for six months as Massachusetts Institute of



Technology cooperative students. Their masters' theses were based on work done here. They are continuing their graduate work at M.I.T.

The 13 other fellowship winners, their home towns and the schools they have selected for their advanced studies are Francis A. Collins, Austin, Tex., Harvard University; Ya'akov Eckstein, Chicago, the University of Chicago; Robin T. M. Fraser, Wellington, New Zealand, University of Chicago; Herman R. Gluck, Princeton, N. J., Princeton University; James R. Guard, Princeton, N. J., Princeton University; Derek S. Henderson, Johannesburg, South Africa, Harvard University; Richard H. Jones, Ridley Park, Pa., Brown University; Bruce B. Lusignan, Palo Alto, Cal., Stanford University; Hiroshi Minato, Yamaguchi, Japan, Harvard University; Jan A. Norton, Toronto, Canada, Princeton University; Richard N. Porter, Texarkana, Tex., the University of Illinois; Daniel Weiner, Chicago, the University of Chicago; and Donald J. Williams, Jaffrey, N. H., Yale University.

### **Two Hold Office In Northern N. J. Section of the I.R.E**

Two members of Bell Laboratories, R. E. Lunney and J. G. Kreer, were elected to office at a recent meeting of the Northern New Jersey Section of the Institute of Radio Engineers. Mr. Lunney was elected Treasurer of the organization, and Mr. Kreer was elected Secretary.

A member of Bell Laboratories since 1954, Mr. Lunney is with the Military Power Apparatus Department, and is engaged in designing magnetic devices. Mr. Kreer has been a member of Bell Laboratories since 1925 and is currently engaged in military systems studies.

## **PLANS ANNOUNCED FOR NEW BELL LABORATORIES BUILDING AT HOLMDEL**

At the A. T. & T. Co. annual meeting on April 15 (*see page 190*), President Frederick R. Kappel announced plans for a new 20-million dollar laboratory in Holmdel, N. J. This new Bell Laboratories building, Mr. Kappel said, "will play its important part in helping the business to keep pace with the future." It will become part of the Bell System's research and development organization, at present employing nearly 11,000 people at eighteen locations in ten states.

The new building will be constructed on a 430-acre site owned by Bell Laboratories at Holmdel since 1929. Buildings presently on the property provide working space for about 150 scientists, engineers and staff studying high-frequency radio and electronics.

Over the past three decades, the present Holmdel laboratory has been the site of many historic communications developments in radio telephony and ultra short wave propagation. It was at Holmdel that K. G. Jansky performed his famous experiments that became the foundation of radio astronomy. Holmdel is also the site of important work on rhombic antennas, waveguide transmission and radar, and is the location where original work on microwave radio was carried out, leading to the development of transcontinental radio-relay systems.

The Board of Directors of Bell Laboratories has approved the first phase of a program for the Holmdel construction, created to meet the needs of the people who will be employed there and the kind of work they will do. The interior is functional in nature. The building was designed from the inside outwards, aiming toward utility, economy and attractiveness. It features over-all economy in first cost and maintenance, due to compact design with effective use of interior space for offices and laboratories. It provides complete flexibility for interchangeable use of space for either laboratory or office purposes. Laboratory services can be easily rearranged without disruption of other laboratories. Freedom from disturbances is provided for employees in work locations, with ease of movement around and between working areas. General services, such as restaurant, library, and so forth, are centralized to minimize employee travel time.

Working drawings for the initial construction will require about six months more for completion, with final bids from construction firms requiring about six additional weeks. Occupancy of the first portion of the building is expected in late 1961.

With this new laboratory, Bell System research and development at Bell Telephone Laboratories will be considerably strengthened in meeting its responsibilities for development and design of technical facilities for the most flexible and economic communications.

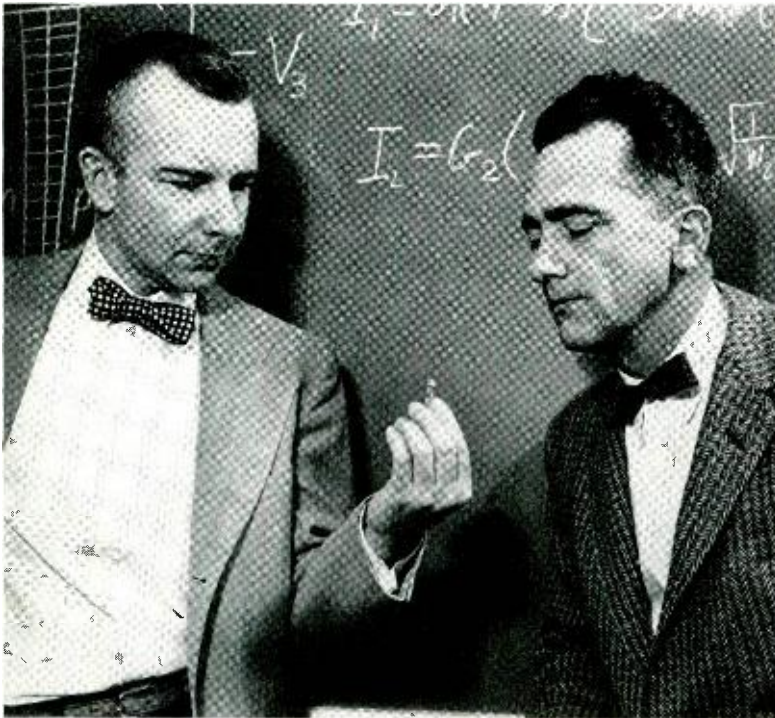

*R. M. Warner, Jr. (left) and H. A. Stone, Jr. examine a laboratory model of the recently developed field-effect tetrode.*

## **Field-Effect Tetrode A Multipurpose Device**

A new semiconductor device has recently been invented at Bell Laboratories by H. A. Stone, Jr., and R. M. Warner, Jr., of the Component Development Department. The device will perform a number of electronic functions that previously could not be obtained at all, or could be obtained only with extensive circuitry.

The four-terminal device, called the "field-effect tetrode," can function as a transformer, gyrator, non-distorting modulator, or a short-circuit stable negative resistance. The inventors have produced laboratory models which corroborate their theoretical predictions for operation of the device. This theory grew out of work previously reported on a field-effect current limiter (RECORD, April, 1958).

The tetrode is composed of a disk of semiconductor material having a diffused junction. The configuration may be pictured as two "slices" separated by the

junction.) A circular trench is cut into each face of the disk, to within about 1/1000th of an inch of the junction on either side. Two leads are then attached to each face, one inside the trench, the other outside.

A voltage applied across the junction produces a depletion layer, or space charge region, adjacent to it. This, in turn, increases the resistance of the thin "channels" flanking the junction.

The functions of the new device are unique; it has no analog either in electron tubes or in previous transistors. The tetrode can be either a transformer or a gyrator, depending on the polarity of the biasing voltage. As a transformer, it has a very decided size advantage for low-frequency use.

A gyrator is a non-reciprocal network with four terminals, which behaves similarly to a transformer. One function of the tetrode as a gyrator would be to

invert the impedance of an electrical circuit. For example, the new device might convert the reactance of a miniature capacitor into that of a highly efficient inductor.

According to its inventors, one of the most important applications for the new device may be as a distortionless modulator. In this use, a control voltage at a relatively low frequency varies the thickness of the depletion layer and thus the resistance of the device. Simple capacitors act as high-pass filters to isolate the control-voltage from the signal voltage, if the frequency ratio is maintained at a high level. Therefore, the signal voltage does not appear across the junction and has no effect on the depletion layer. For this reason, it can be much higher than the control voltage, without being distorted by self modulation. And for the same reason, it is not limited by the capacitance of the junction.

Directly connecting the inner lead on one face of the device and the outer lead on the other will result in a two-terminal device having negative resistance properties. In the experimental models produced at the Laboratories, this performance has been achieved over a range of about 30 to 250 volts, at 0.6 to 0.1 milli-ampere, in a silicon crystal doped with boron and having a phosphorous diffused junction.

Although still in the experimental stage, the field-effect tetrode is now being readied for a development program and eventual manufacture.

Following is a list of speakers, titles, and places of presentation for recent talks presented by members of Bell Laboratories.

**LONG-DISTANCE TRANSMISSION BY WAVEGUIDE CONVENTION, London, England**

Rowe, H. E., see Warters, W. D.

Unger, H. G., *Helix Waveguide Design*.

Warters, W. D., and Rowe, H. E., *Transmission Deviations in Waveguide Due to Mode Conversion—Theory and Experiment*.

Young, J. A., *Resonant Cavity Measurements of Circular-Electric Waveguide Characteristics*.

**STANDARDS ENGINEERS SOCIETY, New York Chapter**

Avedon, D. M., *Microfilm System for Engineering Drawings*.

Gallagher, W. J., *Microfilm System for Engineering Drawings*.

Locke, W. J., *Microfilm System for Engineering Drawings*.

**AMERICAN PHYSICAL SOCIETY, Cambridge, Mass.**

Anderson, P. W., *Theory of Very Imperfect Superconductors*.

Herring, C., *Transport Properties of Nearly Pure Semiconductors*.

Hopfield, J. J., *Theory of Exciton Fine-Structure in Hexagonal ZnO and CdS*.

Hrostowski, H. J., and Kaiser, R. H., *Absorption Spectra of MnF<sub>2</sub> and KMnF<sub>3</sub>*.

Kaiser, R. H., see Hrostowski, H. J.

Morin, F. J., *Some Electrical Properties of V<sub>2</sub>O<sub>5</sub>*.

Shulman, R. G., *Nuclear Magnetic Resonance in KMnF<sub>3</sub>*.

Thomas, D. G., *Exciton Spectrum of ZnO*.

**WESTERN JOINT COMPUTER CONFERENCE, San Francisco, Calif.**

Highleyman, W. H., *A Generalized Scanner for Pattern and Character Recognition Studies*.

Janik, J., Jr., *A Card Changeable Nondestructive Readout Twistor Store*.

Kamentsky, L. A., *Pattern and Character Recognition System—Picture Processing by a Net of Neuron-Like Elements*.

Looney, D. H., *A Twistor Matrix Memory for Semipermanent Information*.

McDonald, H. S., *A High-Speed Data Translator for Computer Simulation of Speech and Television Devices*.

**AMERICAN PHYSICS SOCIETY, Boston, Mass.**

Hopkins, I. L., and Wentz, R., *Stress Relaxation in Polystyrene Film*.

Kunzler, J. E., *Oscillatory Dependence of Temperature with Magnetic Field in Bismuth*.

Mandell, E. R., see Slichter, W. P.

Slichter, W. P., and Mandell, E. R., *Molecular Motion in Some Glassy Polymers*.

Wentz, R., see Hopkins, I. L.

**OTHER TALKS**

Anderson, O. L., *The Adhesion of Metals in Air at Room Temperatures*, A.S.M.E., Salt Lake City, Utah; Albuquerque, N. M.,

Phoenix, Arizona, San Francisco, Calif., Seattle, Wash., Portland, Oregon.

Benes, V. E., *Stochastic Processes and Communications*, Mathematics Dept., Dartmouth College, Hanover, N. H.

Dillon, J. F., *Domain Structure and Optical Properties of Transparent Ferrimagnetic Crystals*, Solid-State Colloquium, U. S. Naval Ordnance Laboratory, Silver Spring, Md.

Feher, G., *Electron Spin Resonance Experiments on Donors in Silicon*, Colloquium at Cornell University in Ithaca, N. Y.

Honaman, R. K., *Scientific Information in the U.S.S.R.*, A.I.E.E. Winter General Meeting, New York City.

Honaman, R. K., *The Forward Look in Electronics*, Seminar, Montclair State College and Bankers National Life Insurance Company, Montclair, N. J.

Jewett, W. E., *Semiconductor Devices and Their Application in the Power Switching Field*, Automatic Switch Company, Florham Park, N. J.

Miller, R. P., *Transistorized Class B Power Amplifiers*, Polytechnic Institute of Brooklyn, Brooklyn, N. Y.

Morrison, J., *Titanium in Vacuum Tubes*, M.I.T. Physical Electronics Conference, Cambridge, Mass.

Och, H. G., *Nike and the Air Defense of Our Country*, Professional Engineers of Spokane and Engineering Faculty and Students of Gonzaga University, Washington; Spokane Chamber of Commerce, Washington.

Pollak, H. O., *Mathematical Research in the Communications Industry*, Joint Mathematics Clubs of Chicago, Chicago, Ill.

## TALKS (CONTINUED)

---

- Rupprecht, E. G., *Transistor Circuits for Digital Computer*, Manhattan College, New York City.
- Slichter, W. P., *Nuclear Motion in Glassy Polymers*, Rohm & Haas Seminar, Philadelphia, Pa.
- Sobel, M., *Acceptance Sampling Using Life Tests*, New York University Life Testing Seminar, New York City.
- Stone, H. A., Jr., *The Field Effect Tetrode*, I.R.E. Convention, New York City.
- Sylwestrowicz, W. D., *Temperature Dependence of the Yield Stress and Stress Criteria for the Initiation of Neck in Copper and Aluminum Specimens*, M.I.T., Cambridge, Mass.
- Tanenbaum, M., *Diffusion in Semiconductors*, Diffusion Symposium, Maryland Institute of Metals, Baltimore, Md.
- Troe, J. L., *The Nike-Hercules Guided Missile System*, Seeing Eye, Inc., Morristown, N. J.
- Wilkinson, R. I., *Queuing Theory and Some of Its Industrial Uses*, New Jersey Chapter, American Institute of Industrial Engineers, East Orange, N. J.
- Young, J. A., *Waveguide As a Communication Medium*, I.R.E.-P.G.C.T., University of Washington, Seattle, Wash.

## PATENTS

---

Following is a list of the inventors, titles and patent numbers of patents recently issued to members of the Laboratories.

- Anderson, J. R. — *Electrical Circuits Employing Ferroelectric Condensers* — 2,876,435.
- Anderson, J. R. — *Electrical Circuits Employing Ferroelectric Capacitors* — 2,876,436.
- Becker, F. K. — *Two-Way Television Over Telephone Lines* — 2,878,310.
- Bender, H. P. — *Plugboard with Slidable Panel* — 2,879,493.
- Bjornson, B. G. and Bruce, E. — *Transistor Switching Network for Communication System* — 2,876,285.
- Bostwick, L. G. and Guncelle, R. L. — *Electromechanical Vibrator* — 2,877,319.
- Brooks, C. E., Fleckenstein, W. O., Lee, R. C. and Seckler, H. N. — *Magnetic Drum Auxiliary Sender for Telephone Switching System* — 2,876,288.
- Bruce, E., see Bjornson, B. G.
- Callaway, W. B. — *Multiline Answering Time Recorder for Use in Telephone Systems* — 2,876,282.
- Crawford, R. V. and Henneberg, F. J. — *Control Circuit for Indicator* — 2,879,460.
- Doherty, W. H. and Platow, R. C. — *Insulating Coatings and a Method for Their Production* — 2,879,183.
- Evans, J. B., Jr. — *Transmission Regulation* — 2,878,317.
- Fleckenstein, W. O., see Brooks, C. E.
- Gianola, U. F. and Wallace, R. L., Jr. — *Magnetostriction Devices* — 2,876,419.
- Guncelle, R. L., see Bostwick, L. G.
- Ham, J. H., Jr. and Kalin, W. — *Sound Output Controller for Signaling Devices* — 2,878,464.
- Henneberg, F. J., see Crawford, R. V.
- Hermance, H. W. — *Fountain Type Cleaner for Scrubbing Tools* — 2,877,479.
- Hussey, L. W. — *Semiconductor Switching Devices* — 2,876,366.
- Jakes, W. C., Jr. — *Microwave Passive Repeaters* — 2,880,310.
- Joel, A. E., Jr. — *Identification System* — 2,879,338.
- Kalin, W., see Ham, J. H., Jr.
- Keister, W. — *Automatic Game-Playing Machine* — 2,877,019.
- Kompfner, R. and Poole, K. M. — *Direct View Storage Tube* — 2,879,442.
- Lee, R. C., see Brooks, C. E.
- Linville, J. G. and Wallace, R. L., Jr. — *Nonsaturating Transistor Trigger Circuits* — 2,880,330.
- Logan, R. A., Peters, A. J. and Tanenbaum, M. — *Fabrication of Silicon Devices* — 2,879,190.
- Lundry, W. R. — *Transmission Regulation* — 2,876,283.
- Mason, W. P. — *Ferroelectric Torsional Transducer* — 2,880,334.
- McDowell, H. L. — *Traveling Wave Tubes* — 2,876,378.
- McSkimin, H. J. — *Temperature-Stable Ultrasonic Delay Lines* — 2,877,431.

## PATENTS (CONTINUED)

- Merrill, J. L., Jr. — *Negative Impedance Repeaters* — 2,878,325.
- Michal, W. C. and Tesche, W. J. — *Method of Making Copper Oxide Rectifiers* — 2,879,582.
- Miller, S. E. — *Branching Filter* — 2,879,484.
- Mitchell, D. — *Radiant Energy Communication System with Carrier Control* — 2,877,343.
- Nickerson, C. A. — *Sound Recording and Reproducing Apparatus* — 2,880,279.
- Oliver, J. W. — *Electromagnetic Relay* — 2,877,315.
- Pearsall, F. M., Jr. and Staehler, R. E. — *Transistor Circuits* — 2,877,357.
- Peek, R. L., Jr. — *Electromagnetic Relay* — 2,877,316.
- Peters, A. J., see Logan, R. A.
- Pfann, W. G. — *Semiconductor Translating Devices* — 2,875,505.
- Pierce, J. R. — *Multielectrode Traveling Wave Tube* — 2,876,380.
- Platow, R. C., see Doherty, W. H.
- Poole, K. M., see Kompfner, R.
- Ross, I. M. — *Semiconductive Pulse Translator* — 2,877,358.
- Ross, I. M. — *Semiconductor Signal Storage Device* — 2,877,359.
- Schneider, H. A. — *Self-Correcting Pulse Circuits* — 2,876,352.
- Seckler, H. N., see Brooks, C. E.
- Smith, H. J. — *Switching Device Mechanism* — 2,875,639.
- Staehler, R. E., see Pearsall, F. M., Jr.
- Straube, H. M. — *Shield for Electric Current Apparatus* — 2,879,318.
- Sumner, E. E. — *Monostable Transistor Circuit* — 2,876,367.
- Tanenbaum, M., see Logan, R. A.
- Tesche, W. J., see Michal, W. C.
- Thurmond, C. D. — *Alloyed Semiconductor Contacts* — 2,877,147.
- Vaughan, H. E. — *Electrical Circuits Employing Magnetic Cores* — 2,879,500.
- Vaughan, H. E. — *Electrical Impulse Responsive Network* — 2,880,317.
- Villars, C. P. — *Encoder for Pulse Code Modulation* — 2,876,418.
- Wallace, R. L., Jr., see Gianola, U. F.
- Wallace, R. L., Jr., see Linvill, J. G.

## PAPERS

Following is a list of the authors, titles, and places of publication of recent papers published by members of the Laboratories.

- Anderson, E. W., see Douglass, D. C.
- Anderson, P. W., *The Random Phase Approximation in the Theory of Superconductivity*, Phys. Rev., 112, pp. 1900-1916, Dec. 15, 1958.
- Ballhausen, C. J., and Liehr, A. D., *Some Comments on the Anomalous Magnetic Behavior of Certain Ni(II) Complexes*, J. Am. Chem. Soc., 81, pp. 538-542, Feb. 5, 1959.
- Benn, D. R., see Elkind, M. J.
- Benson, K. E., see Pfann, W. G.
- Birdsall, H. A., *Insulating Films — Digest of Literature on Dielectrics* (Published by National Academy of Sciences—National Research Council), 21, pp. 243-257, Mar., 1959.
- Bond, W. L., see Logan, R. A.
- Booth, Miss D. P., see Geller, S.
- Boyle, W. S., and Rodgers, K. F., Jr., *Performance Characteristics of a New Low-Temperature Bolometer*, J. Opt. Soc. Am., 49, pp. 66-69, Jan., 1959.
- Byrnes, J. J., see Wernick, J. H.
- Dorsi, D., see Wernick, J. H.
- Deutsch, Morton, *Trust and Suspicion*, J. of Conflict Resolution, 2, No. 4, pp. 265-279, Dec., 1958.
- Devlin, G. E., see Schawlow, A. L.
- Dillon, J. F., Jr., and Earl, H. E., Jr., *Domain Wall Motion and Ferrimagnetic Resonance in Manganese Ferrite*, J. Appl. Phys., 30, pp. 202-213, Feb., 1959.
- Douglass, D. C., see McCall, D. W.
- Earl, H. E., Jr., see Dillon, J. F.
- Elkind, M. J., and Benn, D. R., *Method of Analysis and Con-*

## PAPERS (CONTINUED)

- trol of Gas Atmospheres Used in the Processing of Electronic Parts and Devices*, ASTM Special Tech. Publication, 246, pp. 101-112, Mar., 1959.
- Frosch, C. J., see Spitzer, W. G.
- Flood, W. F., see Haynes, J. R.
- Geballe, T. H., Herring, C., and Kunzler, J. E., *Phonon Drag Thermomagnetic Effects in N-Germanium*, J. Phys. and Chem. of Solids, 8, pp. 347-353, Jan., 1959.
- Geller, S., and Booth, Miss D. P., *The Crystal Structure of Guanidinium Gallium Sulfate Hexahydrate, C(NH<sub>2</sub>)<sub>3</sub>Ga(SO<sub>4</sub>)<sub>2</sub>·6H<sub>2</sub>O*, Zeitschrift für Kristallographic, 111, No. 2, pp. 117-128, Mar., 1959.
- Hagelbarger, D. W., see Pfann, W. G.
- Hamming, R. W., see McCall, D. W.
- Haszko, S. E., Van Uitert, L. G.
- Haynes, J. R., Lax M., and Flood, *Analysis of Intrinsic Recombination Radiation from Silicon and Germanium*, J. Phys. Chem. of Solids, 8, pp. 392-396, Jan., 1959.
- Hellman, M. Y., see Lundberg, J. L.
- Herring, C., see Geballe, T. H.
- Isenberg, C. R., see Trumbore, F. A.
- Kleinman, D. A., see Spitzer, W. G.
- Kompfner, R., see Pierce, J. R.
- Kramer, H. P., *Symmetrizable Markov Matrices*, Annals of Mathematical Statistics, 30, No. 1, pp. 149-153, Mar., 1959.
- Kunzler, J. E., see Geballe, T. H.
- Lax, M., *Giant Traps*, J. Phys. and Chem. of Solids, 8, pp. 66-73, Jan., 1959.
- Lax, M., see Haynes, J. R.
- Liehr, A. D., and Ballhausen, C. J., *Complete Theory of Ni(II) and V(III) in Cubic Crystalline Fields*, Annals of Physics, 6, pp. 134-155, Feb., 1959.
- Liehr, A. D., see Ballhausen, C. J.
- Logan, R. A., and Bond, W. L., *Density Change in Silicon Upon Melting*, J. Appl. Phys., 30, p. 322, Mar., 1959.
- Lundberg, J. L., see Nelson, L. S. and Hellman, M. Y., *Carbon Formation by the Flash Illumination of Polymers*, Proc. Third Conference on Carbon, pp. 411-418, 1959 (Pergamon Press).
- Lundberg, J. L., see Nelson, L. S.
- MacWilliams, Mrs. F. J., *An Iterative Method for the Direct Hurwitz-Factorization of a Polynomial*, Transactions, I.R.E. Professional Group on Circuit Theory, CT5, No. 4, pp. 247-352, Dec. 1958.
- Matthias, B. T., and Zachariasen, W. H. (U. of Chicago), *Superconductivity of Rhenium Nitride*, J. Phys. and Chem. of Solids, 7, p. 276, Nov., 1958.
- McCall, D. W., Douglass, D. C., and Anderson, E. W., *Diffusion in Paraffin Hydrocarbons*, J. Physics of Fluids, 2, pp. 87-93, Jan.-Feb., 1959.
- McCall, D. W., Douglass, D. C., and Anderson, E. W., *Diffusion in Ethylene Polymers*, J. Chem. Phys., 30, pp. 771-773, Mar., 1959.
- McCall, D. W., and Hamming, R. W., *Nuclear Magnetic Resonance in Crystals*, Acta Cryst., 12, pp. 81-87, Feb. 10, 1959.
- Nelson, L. S., and Lundberg, J. L., *Heterogenous Flash Initiation of Thermal Reactions*, J. Phys. Chem., 63, pp. 433-436, Mar., 1959.
- Nelson, L. S., see Lundberg, J. L.
- Pfann, W. G., Benson, K. E., and Hagelbarger, D. W., *Improvement in Floating Zone Techniques*, J. Appl. Phys., 30 pp. 311-312, Mar., 1959.
- Pierce, J. R., and Kompfner, R., *Transoceanic Communication by Means of Satellites*, Proc. I.R.E., No. 3, pp. 372-380, Mar., 1959.
- Porbansky, E. M., see Trumbore, F. A.
- Schawlow, A. L., and Townes, C. H., *Infrared and Optical Masers*, Phys. Rev., 112, pp. 1940-1949, Dec. 15, 1958.
- Schawlow, A. L. and Delvin, G. E., *Effect of the Energy Gap on the Penetration Depth of Superconductors*, Phys. Rev., 113, pp. 120-126, Jan. 1, 1959.
- Spitzer, W. G., Kleinman, D. A., and Walsh, D., *Infrared Properties of Hexagonal Silicon Carbide*, Phys. R., 113, pp. 127-132, Jan. 1, 1959.
- Spitzer, W. G. Kleinman, D. A., and Frosch, C. J., *Infrared Properties of Cubic Silicon Carbide Films*, Phys. Rev., 113, pp. 133-136, Jan. 1, 1959.
- Townes, C. H., see Schawlow, A. L.
- Trumbore, F. A., Isenberg, C. R. and Porbansky, E. M., *On the Temperature Dependence of the Distribution Coefficient. The Solid Solubilities of Tin in Silicon and Germanium*, J. Phys. Chem. and Solids, 9, pp. 60-69, Jan., 1959.
- Walsh, D., see Spitzer, W. G.
- Wernick, J. H., Dorsi, D., and Byrnes, J. J., *Techniques and Results of Zone Refining Some Metals*, J. Electrochem. Soc., 106, pp. 245-248, Mar., 1959.
- Zachariasen, W. H. see Matthias, B. T.

## THE AUTHORS



I. C. Osten-Sacken

*I. C. Osten-Sacken*, a native of Rockville Centre, N. Y., joined the Development and Research Department of the A.T.&T. Company in 1925. There he was engaged in engineering studies of the panel switching system, and upon his transfer to the Laboratories in 1934 he continued in the field of dial switching. Mr. Osten-Sacken spent four years in World War II as a pilot in the Air Force, part of that time as commander of a geodetic control squadron engaged in making aerial maps of the various military theaters. He was also co-editor of the *Signal Corps Technical Manual on Electrical Communications Systems Engineering*. More recently, he has headed a group concerned with engineering studies on local switching systems. He is the author of "The Information Problem," in this issue.



A. Feiner

*A. Feiner*, a native of Vienna, Austria, attended the Technische Hochschule in Vienna, and then Columbia University where he received an M.S. degree in Electrical Engineering in 1952. After a further year of graduate study at Columbia he joined the Laboratories where, as a member of the Switching Development Department, he has been engaged in development work on electronic switching. At present he is supervising work on electronic remote line concentrators. He is a member of Sigma Xi. Mr. Feiner is the author of the article "Line Scanning in ESS," in this issue.



Lawrence F. Koerner

*Lawrence F. Koerner* was born in Niles, Michigan, and received the B.S. degree from Colorado College in 1923. In the following year, he received the M.S. degree from Harvard University, and joined the staff of Bell Telephone Laboratories in 1924. At the Laboratories, he has been concerned with the development of vacuum-tube oscillators, detectors, frequency-measuring equipment, and crystal units and crystal oscillator circuits for transmitters and receivers. Mr. Koerner holds several patents on crystal equipment and is the author of articles on the testing and calibration of quartz crystals. In this issue he



Iden Kerney

describes the portable frequency standard for the TH Microwave system. He is a member of Institute of Radio Engineers, the Harvard Engineering Society and Delta Epsilon and Pi Kappa Alpha.

*Iden Kerney* was born in Council Bluffs, Iowa. He joined the Development and Research Department of AT&T in 1923; he transferred to the Laboratories in 1934. Throughout most of his Bell System career he has been engaged in program transmission studies including the stereophonic transmission of music between Philadelphia and Washington in the first public demonstration in April 1933. During World War II he was concerned with classified communication projects for the Army and Navy. He is a member of the Acoustical Society of America, the Harvard Engineering Society, a senior member of the I.R.E. and was chairman of its Audio Technique Committees from 1956 to 1958, and a member of the Board of Directors of the American Symphony Orchestra League. Mr. Kerney received a B.S. in Communications Engineering from Harvard University in 1923. Mr. Kerney is the co-author of the article "Equalization of Aural and Visual Delay," in this issue.

## AUTHORS (CONTINUED)



W. D. Mischler

*W. D. Mischler* is a native of New York City. He joined the Western Electric Company Engineering Department, now Bell Telephone Laboratories, in 1920 as a technical assistant in the Local System Switching Department. He became a member of the technical staff in 1929 and transferred to the Toll Transmission Department to work on Telegraph Transmission and Switching in 1930. From 1932 to 1934 he attended the University of Wisconsin where he obtained a B.S. in Electrical Engineering in 1934. Mr. Mischler rejoined the Laboratories in 1936, and since then, has been active in the carrier telephone field—specializing in the development of broadband carrier terminals, their carrier supplies, and carrier derived program circuits. He is a member of Eta Kappa Nu, Tau Beta Pi and the I.R.E. Mr. Mischler is the co-

author of the article “Equalization of Aural and Visual Delay,” in this issue.

*J. C. Donaldson*, a native of Washington, Pa., is a graduate of Capitol Radio Engineering Institute. From 1947 to 1950 he served with the United States Air Force, part of this time being spent in Japan as wire chief for an Aircraft Control and Warning Squadron. He joined the Laboratories in 1952 and was assigned to the Transmission Systems Development Department to work on fundamental studies of a transistorized instantaneous compandor. In 1954 he became associated with the development of signaling circuits for the P1 Carrier System. Since his transfer to Merrimack Valley in 1954 Mr. Donaldson has continued the signaling development for P1 Carrier. At present he is attending the evening pro-



J. C. Donaldson

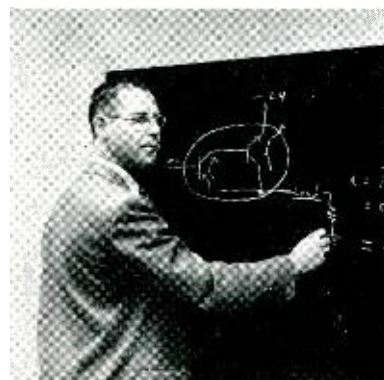

D. C. Weller

gram of the University of New Hampshire. Mr. Donaldson is co-author of the article, “Signaling in P1 Carrier” in this issue.

*D. C. Weller*, a native of Aurora, Illinois, received his A.B. degree from Kenyon College in 1946 and his M.S. degree in Electrical Engineering from the University of Illinois in 1948. He was a member of the first Communications Development Training class at the Laboratories and was active in the development of “N,” “O,” and “P” carrier systems. After the exploratory development phase of the P system he participated in the exploratory development of the PCM carrier system and has since been active in computer development. Mr. Weller is co-author of the article “Signaling in P1 Carrier” in this issue.