



Nobel Prize Awarded to Transistor Inventors

Vice President W. O. Baker congratulates W. H. Brattain in the Arnold Auditorium at the Murray Hill Laboratory shortly after news of the Nobel Prize award was received.

The Swedish Royal Academy of Sciences announced on November 1 that a Nobel Prize in Physics, most highly coveted award in the world of physics, had been awarded jointly to Dr. Walter H. Brattain of the Laboratories Physical Research Department, with Dr. John Bardeen and Dr. William Shockley, both former members of the Laboratories. The prize was awarded to these three men for "investigations on semi-conductors and the discovery of the transistor effect."

This marks the second time that work done at the Laboratories has been recognized by a Nobel Prize. The previous recipient was C. J. Davisson who shared in the 1937 prize for his discovery of electron diffraction as a result of experiments carried out with L. M. Germer, also of the Laboratories.

Each of the three winners of this year's prize will receive a gold medal, a diploma and a share of the \$38,633 prize money. When he was notified that he was one of these winners, Mr. Brattain said, "I certainly appreciate the honor. It is a great satisfaction to have done something in life and to have been recognized for it in this way. However, much of my good fortune comes from being in the right place, at the right time, and having the right sort of people to work with."

The principle of transistor action was discovered as a result of fundamental research directed toward gaining a better understanding of the surface properties of semiconductors. Following World War II, intensive programs on the properties of germanium and silicon were undertaken at the Laboratories under the direction of William Shockley and S. O. Morgan. One group in this program engaged in a

study of the body properties of semiconductors, and another on the surface properties. John Bardeen served as theoretical physicist and R. B. Gibney as chemist for both groups. These investigations, which resulted in the invention of the transistor, made extensive use of knowledge and techniques developed by scientists here and elsewhere, particularly by members of the Laboratories—R. S. Ohl, J. H. Scaff and H. C. Theuerer.

Since the transistor was announced, little more than eight years ago, it has become increasingly important in what has been called the "new electronics age." As new transistors and related semiconductor devices are developed and improved, the possible fields of application for these devices increase to such an extent that they may truly be said to have "revolutionized the electronics art."

The invention of the transistor, basis for the Nobel Prize award, represents an outstanding example of the combination of research teamwork and individual achievement in the Bell System that has meant so much to the rapid development of modern communications systems.

Dr. Brattain received a B.S. degree from Whitman College in 1924, an M.A. degree from the University of Oregon in 1926, and a Ph.D. degree from the University of Minnesota in 1928. He joined Bell Telephone Laboratories in 1929, and his early work was in the field of thermionics, particularly the study of electron emission from hot surfaces. He also studied frequency standards, magnetometers and infra-red phenomena.

Subsequently, Mr. Brattain engaged in the study of electrical conductivity and rectification phe-

nomena in semiconductors. During World War II, he was associated with the National Defense Research Committee at Columbia University where he worked on magnetic detection of submarines.

Mr. Brattain has received honorary Doctor of Science degrees from Whitman College, Union College and Portland University. His many awards include the John Scott Medal and the Stuart Ballantine Medal, both of which he received jointly with John Bardeen. Mr. Brattain is a Fellow of the American Academy of Arts and Sciences.

Dr. Bardeen received the B.S. in E.E. and M.S. in E.E. degrees from the University of Wisconsin in 1928 and 1929 respectively, and his Ph.D. degree in Mathematics and Physics from Princeton University in 1936. After serving as an Assistant Professor of Physics at the University of Minnesota from 1938 to 1941, he worked with the Naval Ordnance Laboratory as a physicist during World War II. In 1945 he joined the Laboratories as a research physicist, and was primarily concerned with theoretical problems in solid state physics, including studies of semiconductor materials.

Mr. Bardeen, whose honors include an honorary Doctor of Science degree from Union College, the Stuart Ballantine Medal, the John Scott Medal and the Buckley Prize, is a member of the National Academy of Sciences. He joined the University of Illinois in 1951.

Dr. Shockley received a B.Sc. degree from the California Institute of Technology in 1932, and a Ph.D. degree from the Massachusetts Institute of Technology in 1936. He joined the staff of Bell Telephone Laboratories in 1936. In addition to his many contributions to solid state physics and semiconduc-



W. H. Brattain, second from right, congratulated by members of the Laboratories. Left to right; H. S. Black, U. B. Thomas, Jr., J. A. Becker and J. T. Law.



***C. J. Davisson
Previous
Laboratories
Nobel
Laureate***

In December, 1937, Dr. Clinton J. Davisson of the Laboratories was awarded the Nobel Prize in Physics for his discovery of electron diffraction and the wave properties of electrons.

He shared the prize with Professor G. P. Thompson of London, who worked in the same field, though there was little in common between their techniques. Dr. Davisson's work on electron diffraction started as an attempt to understand the characteristics of secondary emission in multi-grid electron tubes. In this work, he discovered patterns of emission from the surface of single crystals of nickel. By studying these patterns, Dr. Davisson with Dr. L. H. Germer and their associates proved that reflected electrons have the properties of trains of waves.

Dr. Davisson received a B.S. degree in Physics from the University of Chicago in 1908 and the Ph.D. degree from Princeton in 1911. From September, 1911, until June, 1917, he was an instructor in physics at the Carnegie Institute of Technology, coming to the Laboratories on a wartime leave of absence. He found the climate of the Laboratories conducive to basic research, however, and remained until his retirement in 1946. Besides his work on electron diffraction, Dr. Davisson did much significant work in many other fields, particularly electron optics, magnetrons and crystal physics.

tors, Mr. Shockley has worked on electron tube and electron multiplier design, studies of various physical phenomena in alloys, radar development and magnetism.

His many awards include an honorary degree from the University of Pennsylvania, the Morris Liebmann Memorial Prize, the Buckley Prize, the Comstock Prize and membership in the National Academy. Dr. Shockley left the Laboratories to form the Shockley Semiconductor Laboratory at Beckman Instruments, Inc. in 1955.

Dislocations and Plastic Flow in Germanium

E. S. GREINER AND W. C. ELLIS

Metallurgical Research



In addition to its now well-known uses in devices such as transistors, the semiconductor germanium is being used at the Laboratories as a powerful aid toward gaining increased knowledge about the nature of solids. Germanium has a number of properties which make it almost ideally suited for the study of dislocations and plastic flow that may, in turn, lead to additional information concerning the strength of materials and the behavior of atoms in crystal structures.

Germanium, extensively used in semiconductor applications, is ordinarily considered to be a brittle element, as it is in fact at room temperature. Experiments have shown, however, that the brittleness disappears at higher temperatures. Germanium can then be bent, stretched, compressed or twisted by quite large amounts. A single crystal, after extensive twisting, is shown in Figure 1.

Deformation of solid germanium at high temperatures makes a new approach possible to fundamental questions concerning plastic flow.* This is because germanium has several properties that are of particular value in the study of crystal plasticity. First, crystals of germanium can easily be grown with relatively few dislocations compared to the numbers present in metal crystals. Second, these dislocations and others formed during deformation

can be made visible in the form of etch pits.† Since it is believed that plastic flow occurs by the multiplication and motion of dislocations,‡ the ability to see the distributions before and after deformation is a powerful aid to understanding this mechanism.

A third property of germanium, useful in this study, is that small amounts of plastic flow cause large changes in electrical conductivity. These changes are due primarily to large alterations in the number of available carriers of electric charge which result from structural imperfections introduced during plastic flow. Such imperfections include not only dislocations but also vacancies (unoccupied lattice sites) and interstitial defects (atoms not on crystal lattice sites). Since the mechanism of conduction in semiconductors is well understood, it is possible to relate the decrease or increase in conductivity to the numbers and kinds of these imperfections. Although this relationship can be used to study similar imperfections in metals, the changes in conductivity are much smaller.

A convenient method for deforming germanium is to compress it between platens. An apparatus for carrying out such compressions in an inert atmosphere and at an elevated temperature is shown above being operated by P. Broidt, Jr. Another con-

* RECORD, August, 1955, page 285. † March, 1955, page 104. ‡ April, 1956, page 133.



Fig. 1—Crystal of germanium twisted at 850°C.

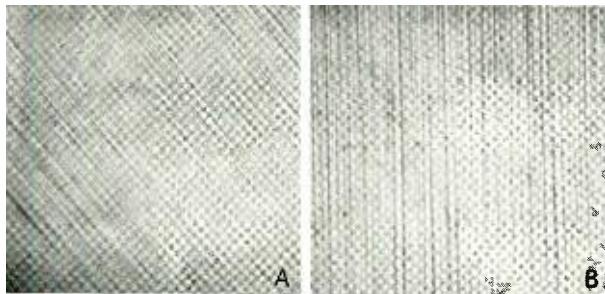

Fig. 2 — Slip lines on an exposed surface of (A) crystal compressed at 525°C and (B) crystal twisted at 600°C. Magnification 75 diameters.

venient method is to twist single crystals under similar conditions of temperature and atmosphere. Single crystals of germanium have been deformed by both of these methods and have been studied to obtain information on the mechanism of plastic flow. This knowledge, although obtained with germanium, is of general application to many crystalline substances.

When a germanium crystal is subjected to a compressive force or to a torque after it has been heated to a dull red color, the crystal does not rupture but flows plastically. If the crystal is prepared with smoothly polished surfaces and then moderately deformed, slip or glide lines will form on the exposed surfaces. These are shown in Figure 2A for compression and in Figure 2B for twisting. Two sets of parallel lines, the slip lines, are visible in each photograph. High resolution microscopic examination shows that these lines are steps in the surface. The displacements are manifestations of the movements of relatively large blocks of germanium sliding on definite planes.

A determination of the crystal orientation with X-rays, together with directions of slip traces, as in Figure 2, has established that slip occurs on the family of planes which crystallographers call the octahedral planes. One of a set of these octahedral planes is shaded in Figure 3.

The external slip markings on germanium deformed at elevated temperatures are the same as those on copper or aluminum when these metallic elements are deformed at room temperature. Slip occurs on the octahedral planes in all these cases.

There are additional similarities between germanium and the true metals. It has been found, for example, that a germanium crystal work-hardens, or becomes stronger, when it is being deformed. If it is then allowed to remain without stress at an elevated temperature, it partially recovers, or softens, just as do metallic elements — although metals have

this property to a greater degree. Work hardening and thermal softening are basically related to dislocation imperfections, and with germanium crystals, visible evidence for this can be obtained.

Since dislocations in germanium can be readily disclosed by etching, a method was available to ascertain whether the flow-produced displacements of Figure 2 were related to dislocations. Two specimens of germanium from the same single crystal ingot were prepared; the density of dislocations in one was measured in the undeformed crystal, and in the other after the crystal was compressed by 2.5 per cent at 625°C. Dislocations were detected by exposing and etching octahedral planes. For the compressed specimen, this plane contained the direction of compression. In the uncompressed crystal there were comparatively few dislocations; about sixty thousand dislocation etch pits per square centimeter were revealed on this plane, as shown in Figure 4A. After deformation, the number of dislocations increased to about fifteen million per square centimeter, as shown in Figure 4B. Also, Figure 4B shows that the pits tend to be arranged in parallel rows consistent with the idea that the dislocations lie on slip planes. Other types of deformation at these same temperatures have shown that the dislocations do lie on these planes.

The dislocations whose pits are shown in Figure 4B moved only a fraction of the way across the crys-

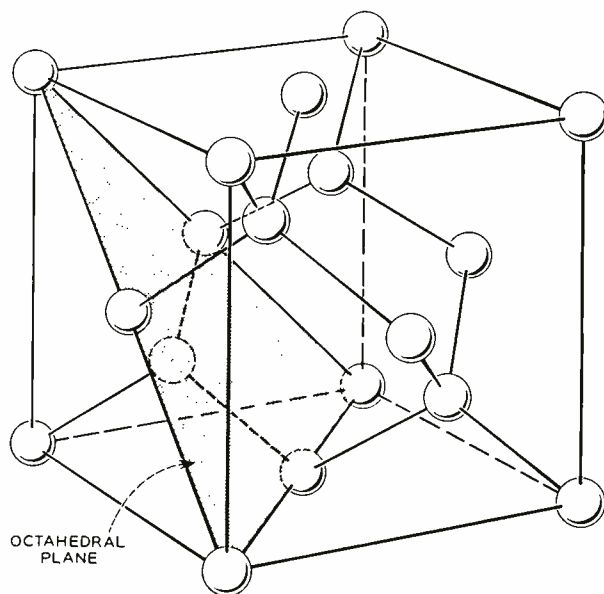

Fig. 3 — The unit cell of germanium. One of the octahedral planes, a slip plane, is cross hatched. Length of the cube edge is 5.658 angstroms (0.05658 millionths of a centimeter).

tal and stopped when the compressive stress was reduced to zero. The displacements, or slip lines, in Figure 2 have come from other dislocations which once existed on these same sets of planes, but, at least in part, moved out of the crystal during compression.

Two facts emerge from the evidence of these experiments. First, a large number of dislocations are generated in the crystal by plastic flow. One hundred to one thousand times more are present after deformation than before. It is believed that this increase occurs by the operation of Frank-Read sources.⁹ Second, some newly created dislocations are stored largely in slip planes, but others leave the crystal to produce displacements called slip lines.

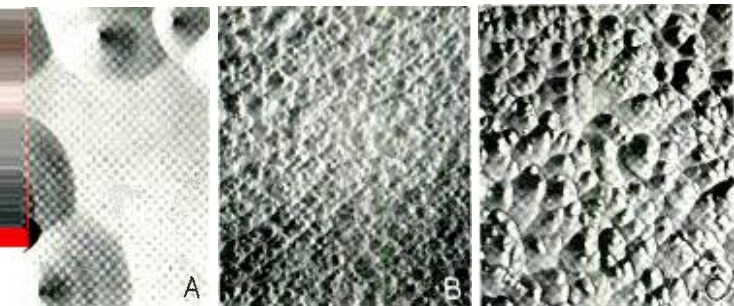

Fig. 4—Dislocation pit patterns in a germanium crystal on an octahedral face magnified 325 diameters. A—As grown—density is 60,000 per square centimeter. B—After compression of 2.5 per cent at 625°C. Density is 15,000,000 per square centimeter. C—After compression and thermal treatment at 825°C for 24 hours. Density is 3,000,000 per square centimeter.

Deformation by twisting also generates dislocations that are stored on slip planes, as shown by the parallel rows of pits in Figure 5A. The octahedral planes for slip in this case were perpendicular to the axis about which the specimen was twisted. Theoretical considerations show that twisting produces a grid of dislocations on the glide plane. For germanium, this grid consists of a hexagonal array shown edge-on in Figure 5A. The observed pattern of pits is consistent with such a grid, but an unequivocal demonstration of its existence has not as yet been made.

Annealing a cold-worked metal decreases its yield strength and hardness. The same softening occurs to a lesser extent when a plastically deformed and work-hardened crystal of germanium is thermally treated in the absence of external stress. In both cases, this softening is believed to be due, at least

⁹ RECORD, April, 1956, page 133.

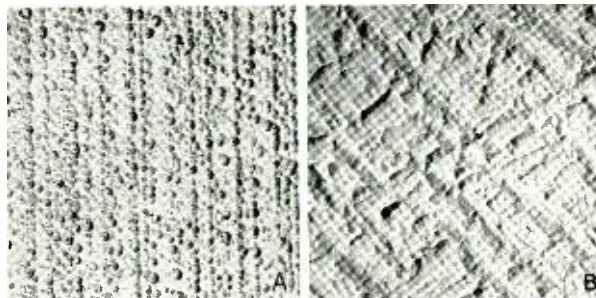

Fig. 5—A—dislocation pit patterns in a twisted crystal, magnification 125 diameters. Section is parallel to an octahedral plane inclined about twenty degrees to the torsion axis. B—deformation domains outlined by dislocation pits in a crystal heavily compressed at a high temperature, 23 per cent at 875°C. Magnification 250 diameters.

in part, to a decrease in the number of dislocations. It is possible to determine whether the number of dislocations has been decreased by thermally treating deformed germanium. This has been done, and the resulting dislocation pattern and density are shown in Figure 4C. This is the same deformed crystal shown in Figure 4B after it had been annealed for 24 hours at 825°C. This temperature is high enough to cause extensive motion of atoms in the crystal. As shown, many of the dislocations have disappeared; the density is now only about one-

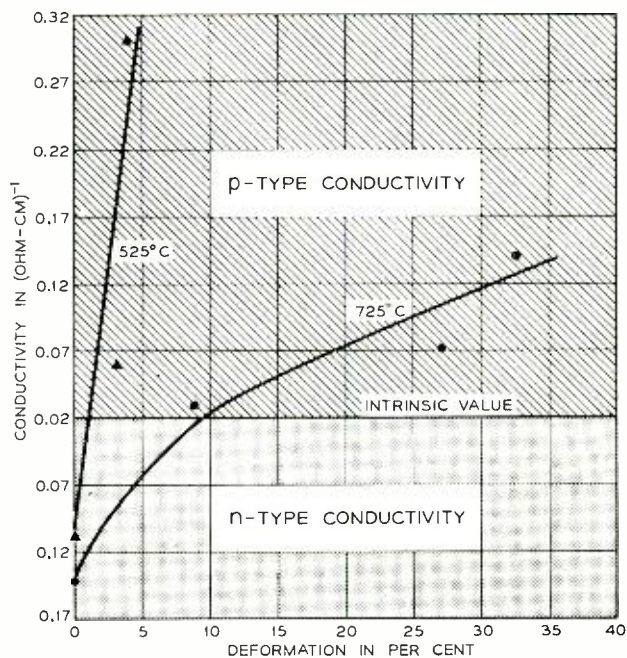

Fig. 6—Effect of deformation in compression, in the direction of a cube edge, on the conductivity of germanium crystals at room temperature.

fifth of that for the deformed state. This density is still fifty times that of the undeformed crystal.

Some dislocations have disappeared because, at the high temperature, they have either annihilated one another, or moved out of the crystal. Interstitial atoms and vacancies, both generated during plastic flow, diffuse through the crystal and help move the dislocations. Recrystallization in the solid, was not found in this crystal and has not been observed in any studies carried out at the Laboratories.

If germanium is compressed at a high temperature, the dislocations stored in plastic flow collect, for the most part, in walls outlining domains in the single crystal, as shown in Figure 5B. The chains of etch pits are the ends of dislocations bounding the individual domains. Further examination by X-rays shows that these walls of dislocations are small-angle boundaries; each domain differs in orientation from its neighbor by a small angle.

The structural changes in plastically deformed germanium are accompanied by large changes in electrical conductivity. Typical effects measured at room temperature for crystals of n-type germanium (germanium having an excess of donors) deformed at 525°C and 725°C are shown in Figure 6. The initial conductivity was approximately 0.1 (ohm-cm)⁻¹. Compression of about one per cent at 525°C converted the conductivity to p-type, in

which the charge carriers are holes rather than electrons. With further compression, the p-type conductivity increased. When the crystal is compressed at 725°C, the conductivity changes are more gradual, and a compression of about ten per cent is required to cause conversion.

Changes in the conductivity of germanium come about partly because distortion of the crystal structure changes the mobility of the charge carriers, electrons or holes. This is not the only effect, however, since the observed change of conductivity from n- to p-type can only be accounted for through the creation of new acceptor centers. These acceptor centers first neutralize the chemical donor centers of the crystal and then produce an increasing hole conductivity. Both dislocations and vacancies (produced during plastic flow) are believed to act as acceptor centers. The conductivity changes, Figure 6, are largely due to vacancies.

By study of plastic flow in germanium crystals, the association of dislocations with flow, and the generation of dislocations are demonstrated. The role of dislocations in hardening by deformation and softening on annealing is indicated. Conductivity studies demonstrate the introduction of other imperfections in plastic flow, and provide means for identifying the types of these imperfections and estimates of their concentrations.



THE AUTHORS

EARL S. GREINER received a B.S. degree from the Carnegie Institute of Technology in 1928 and an M.S. degree from Lehigh University in 1930. After joining the Laboratories in 1930, he studied at Columbia University and received the Ph.D. degree in 1944. His initial work at the Laboratories was concerned with investigations of magnetic materials for sound recording applications. Later, Mr. Greiner engaged in research on the structure and properties of titanium and chromium. More recently, his work has been on the plastic deformation of semiconductors and the growth of filamentary crystals (whiskers). He is a member of Sigma Xi and the American Institute of Mining, Metallurgical, and Petroleum Engineers.

WILLIAM C. ELLIS received the Ch.E. degree in 1924 and the Ph.D. degree in 1927 from Rensselaer Polytechnic Institute. He joined the Laboratories in 1927, and was first interested in conductor and spring materials. This was followed by studies of magnetic materials for loading coil cores, permanent magnets and magnetic recording. During World War II he was occupied principally with classified projects. Since 1945 Mr. Ellis has been head of a group engaged in fundamental studies of the metallic state. He is a member of the Institute of Metals Division of the American Institute of Mining, Metallurgical and Petroleum Engineers, and the British Institute of Metals.



Silicon Carbide Varistors: Properties and Construction

H. F. DIENEL *Electron Device Development*

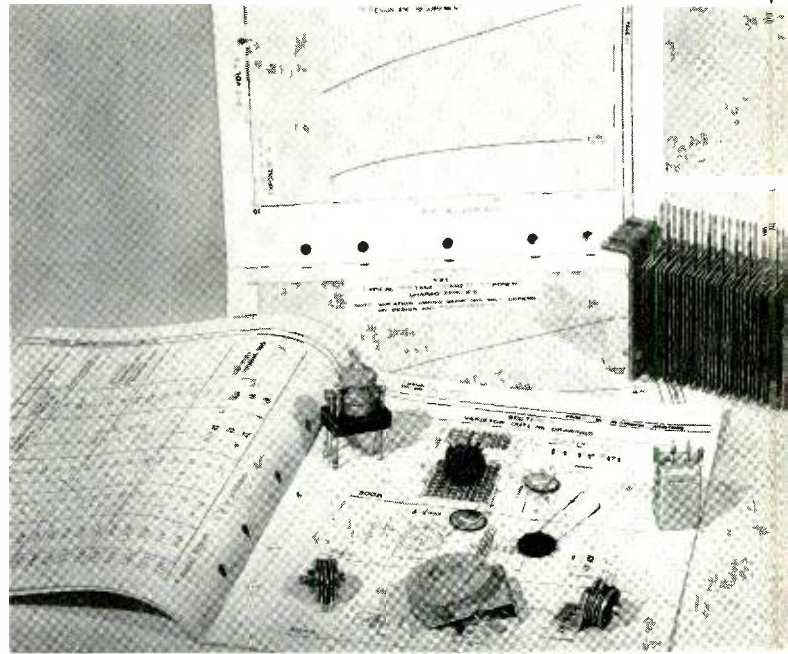

The “variable resistor” or varistor has developed into one of the most useful devices available to designers of modern electronic apparatus. Problems of performance, range and of reliability have been largely solved, and varistors can now be tailored to a great variety of circuit needs. Their use in large numbers in 500-type telephone sets is one indication of the Bell System’s confidence in their long life and efficient operation.

Of the many semiconducting devices used by the Bell System, silicon carbide varistors are among the oldest, having been introduced into the System in the early thirties. At present, the annual demand for these devices is over fifteen million, of which more than 95 per cent are made for use in the 500-type telephone set. Over the years, they have been the object of extensive research and development at Bell Laboratories,* with the result that silicon carbide varistors now have the desirable attributes of a high degree of design flexibility and manufacturing control, low cost, and reliability of operation.

A silicon carbide varistor is best described as a “symmetrical variable resistor.” First, it is a “variable resistor” in the sense that it does not obey Ohm’s law. The current-voltage graph for an ohmic resistor is a straight line, but a varistor’s characteristic departs from this elementary type of behavior. Second, a silicon carbide varistor is a “symmetrical” device in the sense that its current-voltage curve for one direction of current flow is

the same as the curve for the opposite direction of flow. That is, a silicon carbide varistor does not rectify. Such symmetrical varistors find diverse applications; they are used in dc circuits, for example, as voltage limiters for switchboard lamps, relay coils, key telephones and thermistors; and in ac circuits as voltage regulators for oscillators and bridges, and as variable resistors in feedback circuits. In the 500-type telephone set, they serve as equalizers to compensate for differences in transmission and reception levels caused by different lengths of line.

A graphical portrayal of the electrical characteristics of a typical silicon carbide varistor is shown in Figure 1, where dc voltage and resistance are plotted on logarithmic scales as functions of the current through the varistor. At very low currents, the varistor is ohmic, as shown by the straight voltage line with a 45-degree slope in the lower left part of Figure 1. With increasing current, the characteristic becomes increasingly non-ohmic. Then, at very high currents, the behavior becomes ohmic again. This latter region, shown by the dashed part of the voltage curve of Figure 1, is usually outside

* RECORD, September, 1954, page 336; July, 1940, page 322; October, 1940, page 46.

of the usable range, chiefly because of the need for dissipating relatively large amounts of power.

Similarly, the resistance curve in Figure 1 shows ohmic (constant) behavior at low direct currents, but with increasing current the resistance decreases rapidly until a limiting low-resistance region is obtained. These limiting resistance values are of the order of megohms at the low currents and ohms at the high currents. The shaded area in Figure 1 is the region in which most silicon carbide varistors are used in the Bell System.

For a simple ohmic resistor, current and voltage are related to resistance by the familiar equation $E = IR$, but the equations for curves like those in Figure 1 will of course be more complicated. The straight portions of the voltage curve are defined by $I = AE^n$, where I is the direct current in amperes, E is the dc potential in volts, and A is a constant. The exponent "n" in this equation is merely the reciprocal of the slope of the E-I curve in Figure 1. The value of "n" for each decade (multiple-of-ten interval on the current axis) is shown along the curve. This value increases from one (45° slope) to a maximum, and then decreases again to one.

The circuit designer deciding to use these varis-

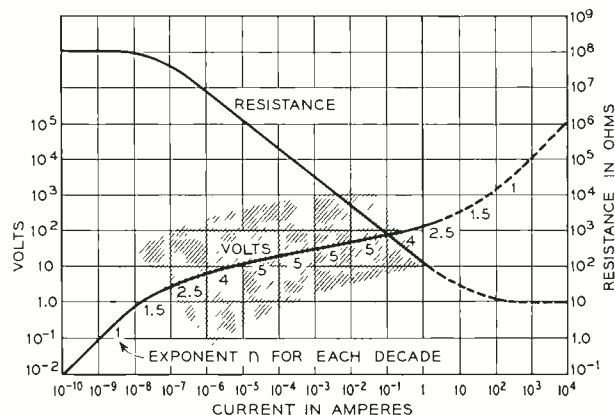

Fig. 1 — Typical characteristics of a silicon carbide varistor relating voltage and resistance to current.

tors usually has requirements which place a desired E-I curve within the shaded area in Figure 1. Many times an existing varistor will be satisfactory; at least its properties will be within the shaded area. For telephone-set varistors, however, it was desirable to have combinations of low voltage, low current, and high exponent — requirements which required extensive varistor development. In 1947, when one varistor was needed in the telephone set, a development program was initiated which suc-

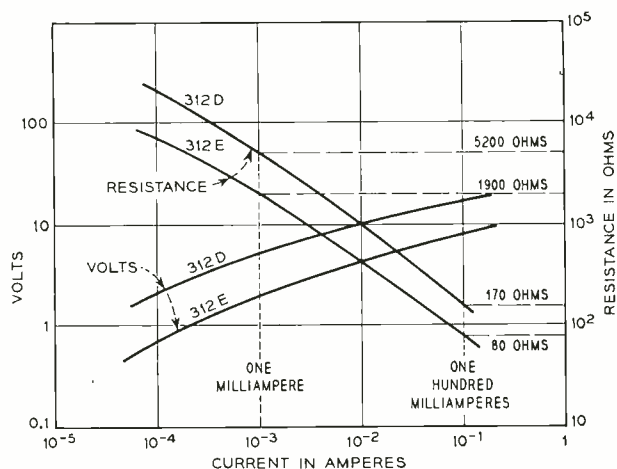

Fig. 2 — Electrical characteristics of the 312D and 312E varistors used in the 500-type telephone set.

ceeded in making such varistors realizable in production. In 1951, when two silicon carbide varistors were needed for the telephone set because of a new equalizer design, further reduction in voltage and increase in exponent were achieved. This came about as a result of extensive development in materials and processes.

Figure 2 shows the voltage-current and resistance-current characteristics of the two varistors (312D and 312E) used in the 500-type telephone set. It is observed that for the 312D, the resistance at 1 ma is 5,200 ohms, while at 100 ma it is only 170 ohms. The second type, the 312E, is the lowest resistance symmetrical varistor being produced by Western Electric. Its resistance at 1 ma is 1,900 ohms, while at 100 ma it is only 80 ohms. Thus, for an increase in the current by a factor of 100, the resistance of the 312D has decreased by a factor of about 30, and of the 312E by a factor of about 24.

The curves in Figures 1 and 2 were derived from direct-current measurements, but the alternating-current characteristics are also frequently important. Since the speech signal in a telephone set is made up of a small-amplitude alternating current superimposed on a relatively large direct current, the ac resistance must be considered as another variable. This resistance is very easily calculated; it is simply the dc resistance value divided by the value of the exponent "n" at the operating point on the E-I curve. A pair of ac resistance curves is thus obtained, similar to the curves in Figure 2 but displaced downward by a factor equal to the exponent "n." Because the ac resistance depends upon dc resistance, it is apparent that we can use a direct current to control the ac resistance.

Both the ac and dc resistance characteristics are used for equalization in the 500 set,^o where the varistors are essentially in parallel with the receiver and transmitter. When there is a long line between a central office and a telephone, the direct current from the office batteries will have a low value at the set. The speech signal also is considerably

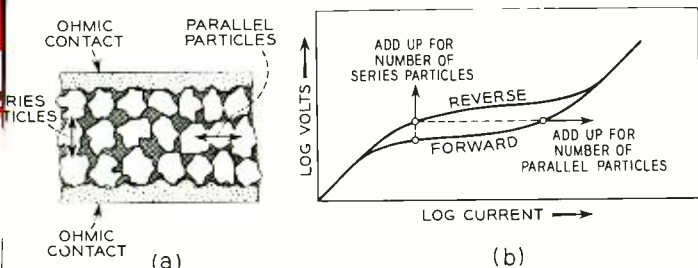

Fig. 3 — Simplified cross-section of a silicon carbide varistor (a) and a voltage-current characteristic of a contact to a single particle (b).

attenuated, but the lowered direct current causes the ac and dc resistances of the varistors to increase, which permits a stronger speech signal to be transmitted or received. The reason is that under these conditions less current is bypassed around the transmitter and receiver. As the line length decreases, the current to the telephone increases, and more current is bypassed by the varistors because their resistances are lower at higher currents. Consequently, more attenuation is provided for the stronger speech signals of the shorter loops.

A simplified cross-section of a silicon carbide varistor disc is shown in the left part of Figure 3. It is a compact of silicon carbide granules, which range in size from about one- to five-thousandths of an inch. The telephone-set varistors are made with five-thousandth-inch granules. The granules are held rigidly together by a bond of vitrified clay. To provide ohmic electrical contacts, the plane surfaces of the disc are sprayed with copper or tin. Copper is used when wire leads are to be attached for the "pig-tail" type of mounting, and tin is used for "washer-type" discs, which are mounted with brackets or screws. Because there are void spaces among the granules, the disc is also impregnated against effects of moisture with a silicone fluid. The amount of clay is purposely kept below the volume of the void space to insure contact among the granules.

The voltage-current characteristic of a single contact to a granule (right part of Figure 3) is similar to that shown in Figure 1, but is displaced

toward the lower left, and there are forward and reverse characteristics, that is to say, easy and difficult directions of current flow. For contacts made to individual granules, rectification ratios as high as about 1,000 are observed at constant voltage, but a considerable variation is found among the granules. The number of granules in a disc may range from about a hundred thousand to millions, depending upon the geometry of the disc and the size of granules. In the varistor disc, granules are randomly oriented in a complex series-parallel array, and the net result on the composite E-I curve is that the current is the same regardless of the polarity of the applied voltage. That is, there is no rectification.

The voltage-current characteristic of the silicon carbide granules is determined during manufacture by the supplier of these materials. Within wide limits, however, this characteristic may be controlled, as with other semiconductor materials. The material may be of the n-type, where conduction is by electrons, or of the p-type, where conduction is by holes. At present, the silicon carbide used for varistors is of the p-type.

When unbonded granules are arranged in a test cell with a geometry similar to that of a varistor, a voltage-current curve is obtained similar to that in Figure 1, but about one or two voltage decades higher. To bring the curve into the desirable region,

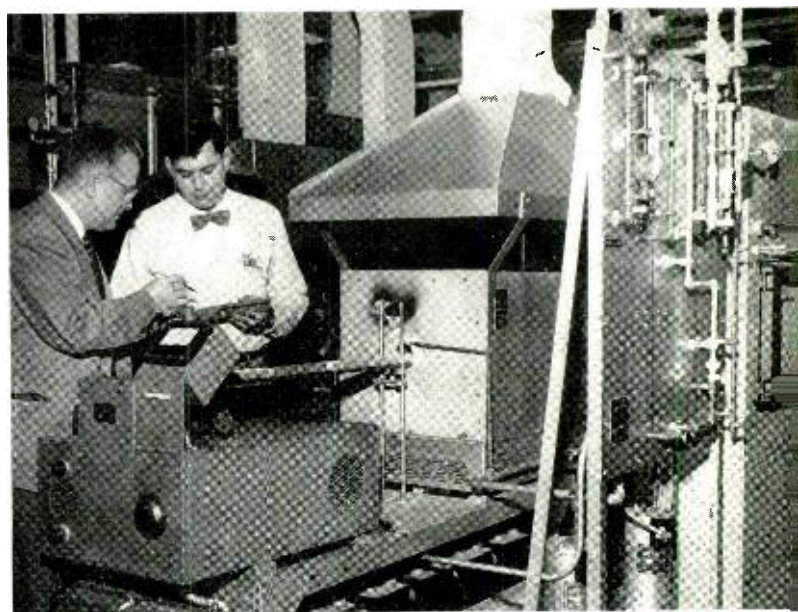

Fig. 4 — Varistor discs are placed on "boats" to travel through the furnace. Discs are fired for about one hour. The author (left) inspects a "boat" that is held by M. D. Patterson.

^o RECORD, September, 1951, page 414.

several variables must be considered. The E-I curve of the final varistor, for example, can be controlled by manipulating its geometry. More series granules increase the resistance, and more parallel granules decrease the resistance. If the geometry is fixed, an increase in the size of the granules results in a decrease in resistance, despite the fewer parallel paths. With larger granules, it turns out, the series elements predominate. So, one has available a simple and in part empirical means for shifting the E-I curve about.

Concurrent with these shifts of the E-I curve due to geometry and particle size, one also has to take into account the control of the exponent "n" at any particular level of current and voltage. This can be achieved by the proper combination of

the electrical properties of the varistor in both chemical and physical ways. The chemical constituents of the clay determine its plasticity and, hence, the adherence of the clay to the granules. Also, certain organic compounds in the clay probably react with the silicon carbide, giving effects similar to those of the carbon. Further, the electrical properties of the contacts between granules are pressure sensitive, and the physical properties of the fired-clay matrix are therefore important in determining both the initial and long-term characteristics of the varistor. The amount of clay is usually 40 parts and the silicon carbide 60 parts by weight. The water added for mixing is about equal to their combined weight.

In the mixing stage, the four materials are

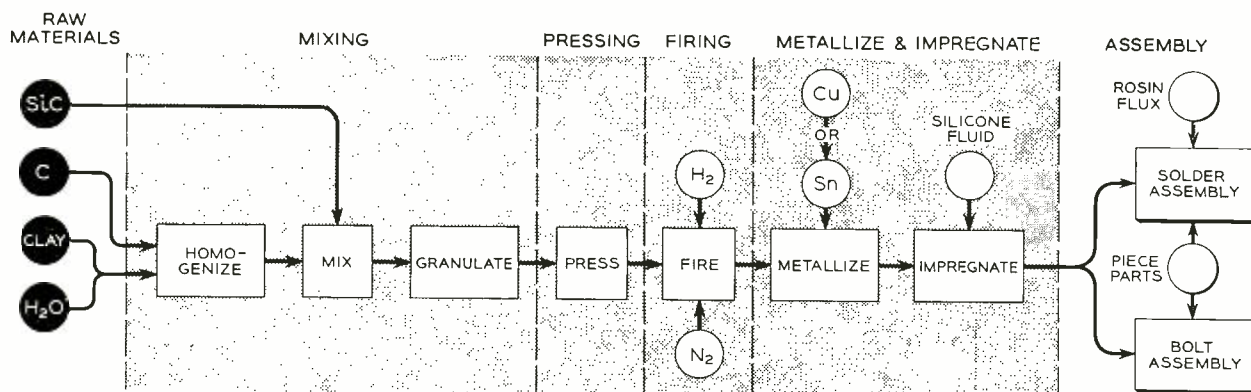

Fig. 5 — Flow chart of process for fabricating silicon carbide varistors.

geometry and particle size of the disc, and by processing the varistor disc. For example, with a fixed current and voltage, a numerical increase in "n" of as much as 0.8 can be achieved by reducing the varistor thickness by one-half.

The process for making silicon carbide varistors is closely allied to ceramic processes. A flow chart in Figure 5 outlines the major stages of the varistor process. The first stage concerns the raw materials: silicon carbide, carbon in the form of graphite, clay and water. The carbon content is one of the variables used to control the varistor's E-I curve — resistance decreases when the carbon content is increased. Carbon content may be as high as about 10 per cent of the total dry weight. At 1 ma, the sensitivity of the varistor voltage averages about 90 per cent change in voltage for a change in carbon content of one per cent of the total dry weight.

Clay is mixed with a temporary binder of water to make the matrix in which the silicon carbide granules are embedded. This clay contributes to

combined into a homogeneous mixture by making a slurry and gradually evaporating the excess water. This leaves a clay and carbon coating on the silicon carbide granules. The resulting granular material should have about 6 per cent moisture content to permit satisfactory pressing of the discs. Control of this moisture content is also important; in the electrical characteristics of the finished disc at 1 ma, it affects the varistor voltage about 20 per cent for each per cent of water present at the time the disc is pressed.

The granular mix is then pressed into discs as thin as 0.022 inch for the 312E varistor and 0.035 inch for the 312D varistor. The total pressure must be so adjusted that the pressure per particle is high enough to force the particles into contact with each other by pushing the clay out of the way. Washer-type varistor discs are pressed at about 14 tons per square inch and are made with granules about one- or two-thousandths inch in size. The solid discs of the 312D and E types

are pressed at about 6 tons per square inch, the lower pressure being used partly because the granules are larger.

In the firing process (see Figure 4), the clay is vitrified into a hard, stable matrix. The process also contributes significantly to the electrical properties of the varistor. Temperatures are in the 1100-1250°C region, and the furnace atmosphere consists of equal parts of highly purified hydrogen and nitrogen. At 1 ma. the temperature sensitivity of the varistor voltage ranges from no effect to several per cent change in voltage per 1°C change in temperature, depending upon the values of the other variables. The firing temperature itself is thus another variable used to obtain the appropriate E-I curve.

As shown in Figure 6, the discs are next metallized by spraying the plane surfaces with copper or tin. At this point, the electrical properties of the varistor can be measured for the first time. Finally, the discs are vacuum impregnated with a silicone fluid, and assembly is completed either by solder dipping to attach wire leads or, with the washer-type varistor, bolting together the discs, terminals, and brackets. By proper empirical control of the many variables, varistors can be made to cover the wide range of characteristics shown by the shaded area of Figure 1. Of course, still higher voltage values or greater power dissipation can be readily

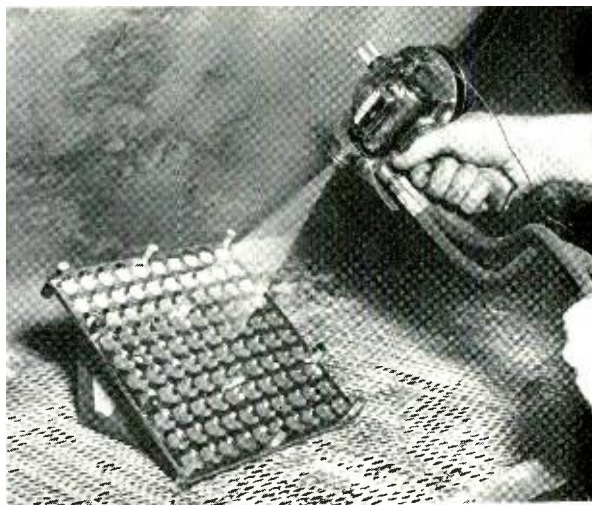

Fig. 6 — Metallizing gun in operation for applying electrodes of copper or tin to varistors.

achieved by increasing the size of the unit. The stability of the varistors' electrical characteristics with time can also be controlled; in fact, positive, negative, or zero aging over long periods of time can be achieved. By comparison with processes for fabricating other semiconductor devices, the degree of control is quite high. For the telephone-set varistors, approximately 95 per cent of the product lies within about ± 10 per cent of the average.

THE AUTHOR



H. F. DIENEL graduated from the University of Michigan in 1938, where he received the degree of B.S.E. in physics. After several years in the University of Michigan Engineering Research Laboratory and in industry, he joined the staff of Harvard University in 1941. At Harvard's Cruft Laboratory he was engaged in a project for the National Defense Research Committee in the field of electroacoustics. Mr. Dienel joined Bell Telephone Laboratories in 1947 and worked on the development, design and application of silicon carbide varistors. From 1955 to the present time he has been associated with a group studying the reliability of semiconductor devices at the Allentown Laboratory.

Dr. M. J. Kelly Delivers

Convocation Address at Cooper Union

Dr. M. J. Kelly delivered the convocation address at the Cooper Union Centennial in New York City on October 8. The title of his address was "The Nation's Need For Greater Scientific and Technical Strength and Means for its Attainment."

Early in his talk, Dr. Kelly pointed out that "science and technology provide the information necessary for industry to transform the basic materials and energies of our environment into facilities and services for our use and enjoyment. Without this knowledge, even though there be otherwise a most favorable climate, a strong industrial society cannot develop.

"Industrial strength makes possible increased time for our leisure and the cultural development of a

for those who are entering creative technology."

After describing the rapid growth of technology during the past 35 years, Dr. Kelly said, "Two somewhat related situations bring about the need for an increase and acceleration in the growth of our scientific and industrial strength. The effort providing this strength has undergone a huge expansion in the last fifteen years. This effort has produced a much larger volume of new scientific and technical knowledge than can be exploited with the available supply of scientists and engineers. At our present rate of education of scientists and engineers, the gap between opportunity and capacity to exploit it will surely widen.

"The world struggle between Russian Communism and the free western world also presents an urgency to the acceleration of our growth in science and technology," Dr. Kelly continued, "for Russia is making tremendous strides forward in its heavy industrial and military power, paced by an impressive expansion in its scientific manpower. The maintenance of our present superior position will only be insured by our marshalling to the full our innate capacities in science and technology.

"To meet this dual challenge successfully, we must educate more young people in science and engineering and raise the quality of that education. Greater depth of training in science – greater proficiency in mathematics and theoretical physics and chemistry – must be provided for those engineers who choose creative technology as a career. The period of academic training for these engineers must be lengthened and science and analytical engineering be made a large fraction of their present four-year program.

"It is my considered judgment that these changes in the preparatory program of our young engineers destined for careers in creative technology are fully as important as is their required increase in numbers," Dr. Kelly declared.

"To bring about this enlarged and more effective educational pattern, well planned, dynamic and sustained measures must be taken. They must be carried through at all levels of our government and social structure. Each secondary and high school; each preparatory school; each college, university, engineering and graduate school community and the legislative bodies of each state and of the nation must participate."



Harrison Tweed (right), Trustee of Cooper Union, introduced Dr. M. J. Kelly at the Convocation.

people. It can also make available an increasing amount and variety of material comforts and services to enrich the lives of a people. Strength in science and technology is essential to our protection and the preservation of our free society.

"Our strength resides primarily in the productive efforts of our scientists and engineers," Dr. Kelly continued. "To raise its level, we must increase their rate of supply; that is, there must be a larger number in each year who complete their academic preparation. The period of academic training must be increased beyond that of a large fraction of those now engaged in the effort. Not only is added time for training essential, but also our academic educational programs in engineering must be revised



Switchboards used by companies that provide telephone answering services have, for the most part, been restricted to operation in a single central-office area because of the charges for cable plant to clients in other areas. This, like other similar problems in the past, was substantially solved by the application of line concentration and identification techniques long used by the Bell System. This application of the concentrator-identifier now permits up to 100 lines to be concentrated onto two, three, or four trunks between a remote central office and an answering-service switchboard.

R. I. NOLAN *Switching Systems Development I*

Concentrator-Identifier for Telephone Answering Services

Telephone answering-service companies, for a monthly fee, will answer incoming calls to your telephone while you are away from your office or home. To provide for this service, the Telephone Companies bridge a pair of wires across each client's line at the central office and connect this pair to switchboard jacks and lamps at the answering-service location. The charge for this cable pair is usually based on the distance from the central office to the answering-service switchboard. Normally, 100 cable pairs are provided for one switchboard position. This method of operation becomes rather expensive when the answering-service switchboard is a substantial distance from the central office. Wherever possible, therefore, the switchboards are located near central offices to hold cable-pair charges to a minimum. The overhead involved in doing business at a number of branch offices, however, may often be costly.

To permit centralized operation by an answering-service company, a concentrator-identifier (CI) arrangement was developed. The CI is an application of long-used principles that effectively extends the reach of an answering-service switchboard without excessive cost, and thus eliminates the need for

branch switchboards. This is accomplished by concentrating calls from a large number of lines onto a few trunks for transmission to the answering-service bureau. The basic CI is arranged to serve 40 telephone lines, but additions may be made up to a maximum of 100 lines. At least two trunks must be provided between the central office and the switchboard, but one or two more trunks may be added as needed for increased traffic.

The arrangement, Figure 1, consists essentially of two major equipment units connected by the trunks. The originating equipment, or concentrator, is usually mounted on a single frame in the central office. It detects ringing on the clients' lines and transmits to the terminating equipment the identity of each client's line as it is being rung. It assigns the trunks for talking so that up to four calls can be answered by the switchboard simultaneously, thus concentrating all the traffic onto four trunks. The terminating equipment, or identifier, is mounted in a cabinet on the answering-service premises. As it receives the identity of each called line, it provides a momentary connection to the proper switchboard answering jack and flashes the associated lamp.

The block diagram of Figure 1 shows the over-all

concentrator-identifier system. The actual concentrating is done by crossbar switches under instructions from common-control circuits. Each client's line is multiplied to four positions on the switches of the originating circuit so that operation of the proper select and hold magnets can connect any line to any one of the trunks. In the terminating circuit, crossbar switches are again used to connect any of the incoming trunks to the jack and lamp associated with any particular client.

Each client's line is connected to the CI system in the central office by a ring-up circuit consisting of a 3-element gas tube and a relay, Figure 3. The gas tube ionizes when the proper ringing voltage is applied to the line and causes the relay to operate through one of its own contacts and lock operated through another contact. This method of operation is employed for two reasons. First, the gas tube is used for its polarization properties; that is, it pro-

Each line is assigned an arbitrary number, 00 to 99, which corresponds to its jack appearance in the switchboard. Operation of the ring-up relay starts the identification of the line, the selection of a trunk, and the selection of a controller. The ring-up relays are arranged in groups corresponding to the various units digits. Each group of ring-up relays, Figure 4, operates one of ten relays to identify the particular units digit. This array of ten relays, called the units identifier, is wired in a preference and lockout arrangement. Operation of the preferred units relay operates an associated lockout relay (not shown), which in turn locks operated to a timing circuit while opening the operating path for all ring-up relays having the same units digit. Because of the preference circuit, only one ring-up relay at a time can control the operation of the concentrator. Once all calls are served in a units group, that group cannot be served again until other groups with waiting

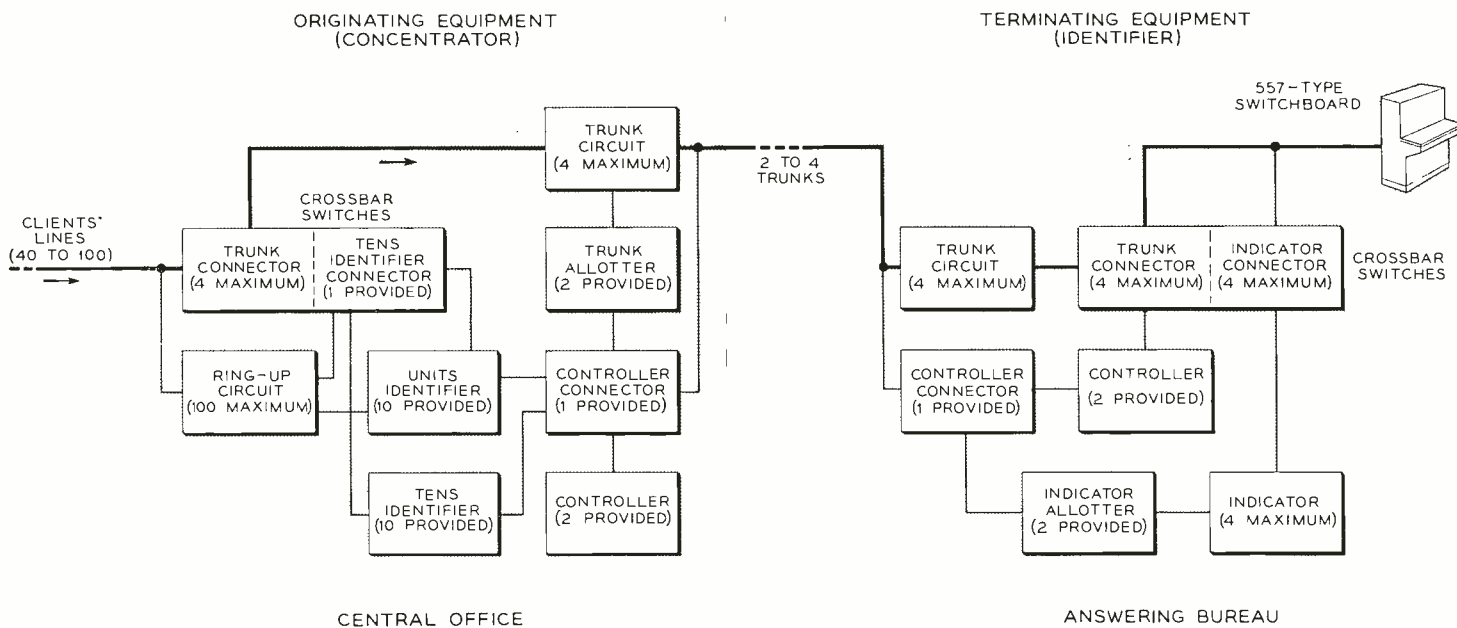

Fig. 1 — Block diagram of concentrator-identifier arrangement.

vides identification of the particular party being rung when a client is on a party line. Second, operating the relay through one of its own contacts causes it to be disconnected from the client's line as soon as it operates. If this were not done, the resistance of the auxiliary line relay in parallel with the client's telephones could be low enough to trip the ringing circuit falsely at the central office. Consequently, the number of allowable extension telephones on a client's premises would have to be reduced by one.

calls are served. The timing interval of the lockout circuit is such that a ring-up relay, once operated, is not reconnected to the line until ringing has stopped. This insures that the concentrator will respond only once per line during a ringing interval.

The tens identifier uses two vertical units of the crossbar switches and ten relays. A particular crosspoint of a crossbar switch is chosen by the operation of a select magnet followed by the operation of a hold magnet. The select magnet presets the switch so that any crosspoint in the selected horizon-



Fig. 2 — F. R. Lehman of the New York company tests relay operation in concentrator equipment.

tal level can be closed, and the hold magnet operates a vertical unit to close the desired crosspoint. Since only one contact is required to identify each line, the 120 contacts of the two identifying vertical units are ample for the maximum of 100 lines.

When the preferred relay in the units identifier is operated, it in turn operates the horizontal select magnet having the same numerical (units) designation. Ten of the twelve possible contacts at the selected level on the two identifying vertical units are used to connect between the ten ring-up relays of a units group and the associated tens relays in the tens identifier. When the crossbar hold magnets operate, the coil of the operated ring-up relay completes the operating path for one of the tens-identifier relays, which in turn connects ground to the trunk connector. Later, after the units digit has been outpulsed and while the tens digit is being outpulsed, the controller supplies ground to the tens-identifier relay. This releases the ring-up relay and all the other circuits it has been holding.

The selection of an idle trunk is also progressing as the call is being identified. If a trunk is available, the trunk connector connects it to the incoming line. Figure 5 (for simplicity only one side of the line is shown). Each trunk uses four verticals of the crossbar switches. Recalling that there can be as many as six wires per crosspoint and ten crosspoints per vertical, three clients' lines can be connected per crosspoint or 30 per vertical (both sides of the line must be switched). Since the horizontal already selected and operated by the units identifier extends across

these four verticals (called the trunk connector) it is only necessary for the tens identifier to operate one of four hold magnets to connect either two or three of 20 or 30 lines respectively to the trunk circuit. Relays in the trunk circuit, also under control of the tens identifier, connect the proper one of the two or three lines to the outgoing trunk.

While the line identification and trunk selection are progressing, a controller is being seized. When the controller is seized, it prepares another controller at the terminating end to receive the identity of the line. When the originating end has completely identified the line, its controller pulses forward, first the units digit, and then the tens digit of the line. A special code of positive and negative pulses is used, so that either one or three pulses identifies a digit. This code and the pulse rate of 20 pulses per second makes the controller holding time about 0.5 second. The dc pulsing is done on one side of one of the trunks,^o to avoid the need for an extra cable pair for signaling.

The terminating equipment at the answering service decodes the digit information as pulsed by the originating end and connects the incoming trunk to the appropriate client's jack in the switchboard. The decoded units digit causes a crossbar switch select magnet to operate, and the subsequent tens digit determines which hold magnet and trunk circuit relays will operate to connect the trunk to the client's jack. In addition, one of four indicator circuits is connected to the same jack position, through the crossbar switches, to light the associated line lamp. The indicator circuit remains connected to the line lamp for about one second and then drops off whether the line is answered or not. Even when all trunks are held busy by the answering-service attendant, the equipment continues to flash other

^o These are composite trunks on which dc signaling may be superimposed without interfering with the ac talking path.

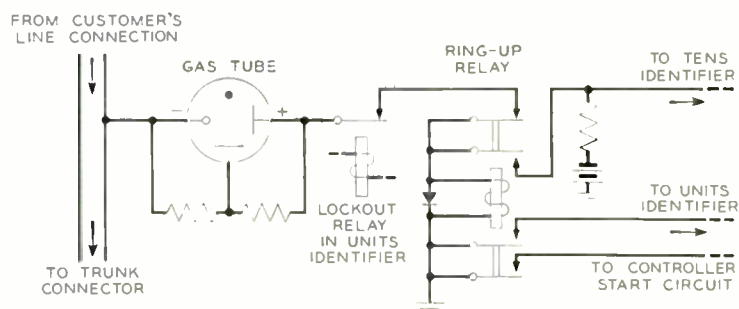

Fig. 3 — Ring-up circuit. Reversing gas tube or using the other wire of a pair provides for four-party ringing.

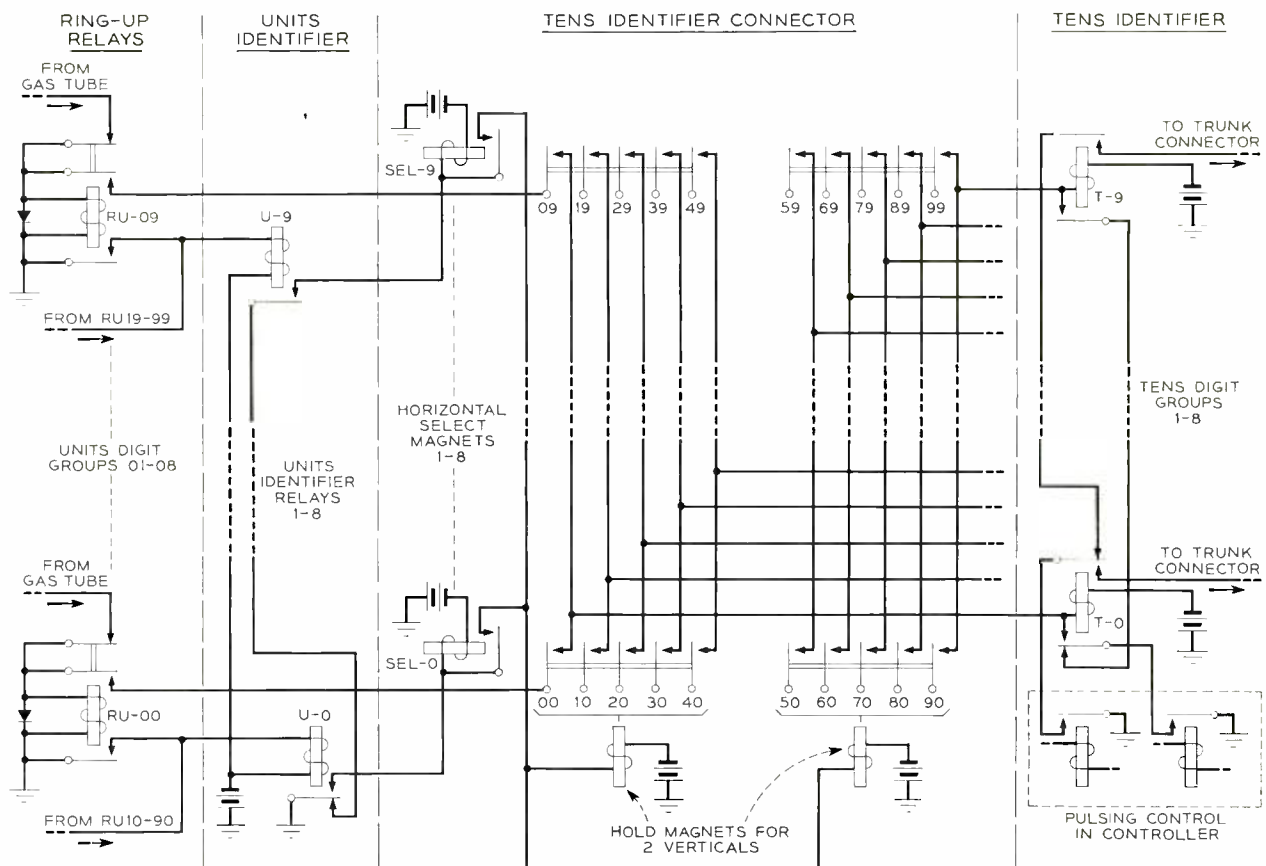

Fig. 4 — Basic plan of concentrator line-identification equipment.

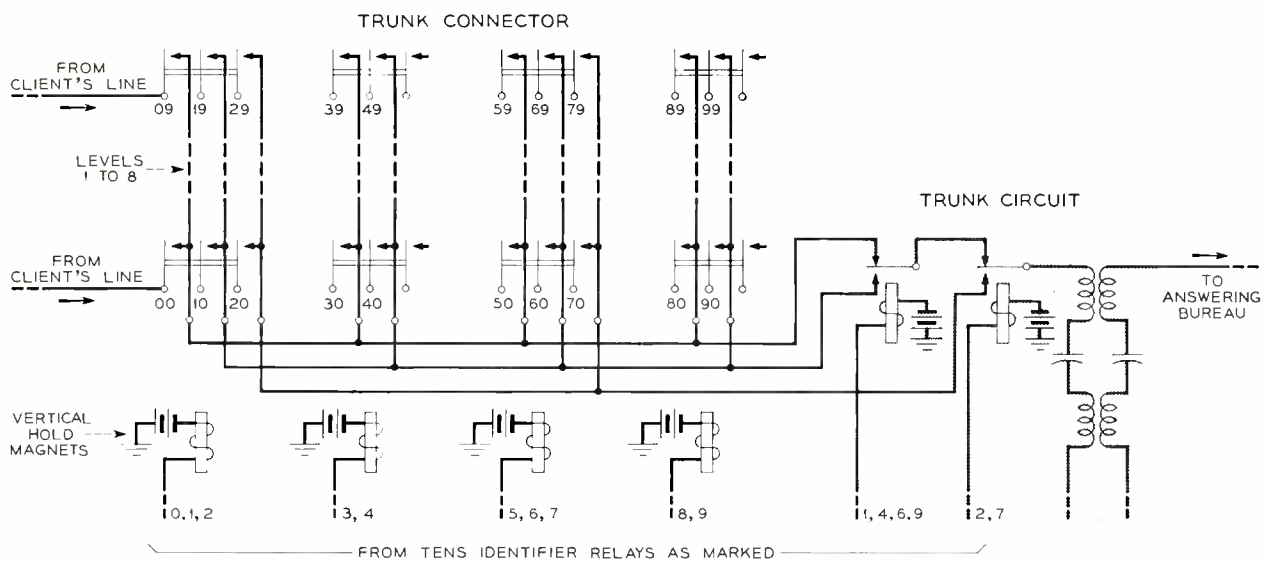

Fig. 5 — Actual concentration is done by the trunk connector.

client's switchboard lamps as their lines are rung.

With the trunk connected between the client's line and the switchboard, the common-control portions of the concentrator-identifier return to normal to await another call. After the attendant has disposed of the call and disconnects, the trunk returns to normal. If the attendant does not answer, the trunk returns to normal after about one second. The entire cycle is then repeated during the next ringing interval. The one-second lamp indication tells the answering-service operator that the line is being rung. Some clients instruct the answering service to answer calls only after a certain number of rings: the operator can count the lamp flashes and then answer. Although she can plug into the line jack between flashes, she can only be connected during the one second interval that the trunk is connected while the line is being rung, thus assuring privacy of the client's line.

The originating equipment is powered by the 48-volt office supply, the battery normally used for coin control (about 130 volts), and the ringing-current supply available in central offices. At the answering-service office, the terminating equipment uses PBX power-plant voltages of 18 to 24 volts dc. To care for locations where the PBX power supply is not sufficient, space has been provided in the terminat-

ing equipment cabinet to install a ten-cell storage battery, with charging facilities using either cable pairs from the central office or rectifiers operating on commercial power lines.

To guard against service failure, the CI common-control equipment is duplicated at both the central office and at the answering service. In addition, double-winding relays with separate fuses on each winding and paralleled contacts are used extensively. Progress lamps in the central office permit the maintenance force to determine the identity of a client's line being served, as well as the particular units serving the call. If trouble should develop, the office audible and visual alarms operate, the progress lamps lock in to indicate the equipment serving the call at the time, and the system automatically transfers to the alternate equipment. To insure that all circuits are in good working order, the equipment is used alternately on successive calls.

Development of this system was conducted in the switching laboratories where a model was made and tested. When all tests were completed, this model was shipped to Chicago and placed in service in July, 1953. The first production model built by Western Electric was installed in February, 1954, in Milwaukee. To date, over 300 units have been placed in service.

THE AUTHOR

R. I. NOLAN joined the Laboratories in 1941 as a technical assistant. Prior to World War II he was engaged in wiring and installing circuits in the switching laboratories. During the war he entered the Army and served in Europe. After the war he resumed his duties at the Laboratories, and in 1948 joined a group concerned with the maintenance and planning of the switching laboratories. Since 1951 he has been involved in the development and testing of No. 1 crossbar panel and common systems circuits.



Reducing Distortion in Mobile Radio Systems

W. C. BABCOCK AND R. V. CRAWFORD
Transmission Engineering I



Although component parts of some communication systems are purchased by the Western Electric Company from outside suppliers, Laboratories engineers and scientists are often called upon to help solve any problems that might arise with the use of these systems in the field. It was found, for example, that in some mobile radio systems for turnpikes and parkways, distortion or "hash" areas existed along short sections of the roads. The Laboratories cooperated closely with the operating companies to find and apply the best corrective measures to this problem.

In recent years numerous express highways have been built throughout the country. The Pennsylvania Turnpike, the New York Thruway, the New Jersey Turnpike and the Garden State Parkway in New Jersey are recent examples of such construction in the vicinity of New York. Before these express highways were opened to public use, the Associated Bell Telephone Companies and other interested concerns submitted bids for providing mobile telephone systems to operate along the entire length of the highways. Such two-way communication is usually required for use by police, vehicular service men and highway maintenance personnel.

Frequency space for this type of mobile service is allocated to highway authorities by the Federal Communications Commission around 150 mc or 460 mc. Although the Associated Companies have been in a position to provide systems in either range, most of those installed to date operate in the 150-mc band. The problem of satisfactory coverage in co-channel distortion areas is present in both bands, but it will be discussed with reference to the 150-mc band because of its greater usage.

A co-channel distortion area in a frequency- or phase-modulated system may be defined as an area in which radio-frequency signals from two or

more base stations, which transmit the same intelligence on the same nominal frequency, are received at approximately the same intensity so that the speech is distorted. Consider a two-base station co-channel system in open country having flat terrain; if each base station radiates the same amount of RF power from the same type antenna mounted at the same height above ground, the potential distortion area will be located about midway between the two. Figure 1 shows the relationship between RF carrier intensities at a mobile receiver for such base stations separated (a) by 16 miles, and (b) by 32 miles.

Laboratory measurements indicate that, with the same modulation applied to both transmitters, distortion can be expected if the RF carrier intensities are within 3 db of being equal. The potential distortion area for this condition is indicated on the figure by the solid black area. When different modulation is applied to the two base stations, an area of poor intelligibility, resulting when RF carrier intensities are within some 6 to 10 db of each other, can be expected to extend out to the boundaries indicated by A-A, B-B (6 db), A'-A', or B'-B' (10 db). As shown in Figure 1, the distortion area extends over a physically larger area

as the spacing between adjacent base stations is increased. When the same speech is transmitted from both base stations, the affected area is limited to about 10 per cent of the distance between stations.

Co-channel distortion areas result most frequently from the use of base stations on essentially the same frequency so spaced as to insure continuous field-strength coverage along a highway. In obtaining the desired coverage, with suitable margin, it is virtually impossible to avoid areas of overlapping. Sometimes adjacent base stations can be located along the highway in such a fashion that the terrain provides a natural barrier between their respective coverage areas. This is not always possible, however, and in many cases the barrier is insufficient to reduce the distortion to an acceptable limit.

Highways requiring this type of mobile service are seldom less than about 100 miles long and are often several times longer. To obtain suitable coverage from a single base station located near the central portion of a 200-mile highway, for example, without extravagant use of power, would require that the antenna be located on a site somewhat more than 5,000 feet above the level of the road. Even if such a site were available, transmitting from it would subject a considerable area of the country-side to potential interference from mobile system operation rather than concentrating the coverage area more or less along the highway. In practice this means that two or more base stations are required to obtain suitable coverage along express highways of moderate length.

Since at least two base stations are needed along a highway, the possibility of using somewhat different radio frequencies at these stations to avoid the distortion problem associated with co-channel operation may be considered. This would require additional radio equipment in the mobile units with provision for switching from one radio frequency to another whenever the unit passed from one base station coverage area into the next. Besides being costly, this type of operation would require the use of additional frequency assignments which would be difficult to justify. It would also complicate the problem of calling a particular car, since the driver might readily proceed from the coverage area of one base station into the next without switching to the frequency used by that station.

From the foregoing discussion, it appears that the use of co-channel stations is the best engineering approach. Ways of minimizing the distortion problem must therefore be devised. The problem of

controlling such distortion may be approached in two different ways: first, by arrangements at the mobile station, and second, by means applied to the base station. The first alternative may also be effective in controlling interference that results from the use of different modulations at adjacent co-channel base stations. The second method is applicable only to those systems which use the same modulation at all co-channel base stations.

The first method is based on the use of a switchable directive antenna on the mobile unit. The pattern of the antenna in the horizontal plane is preferably that of a cardioid (heart-shaped curve) in which a deep null is developed along the axis of travel opposite to the main lobe. In practice, when proceeding along the highway between two base stations, the operator of a vehicle generally adjusts the position of an antenna switch so that the main lobe is directed toward the nearer of the two stations. This is toward the rear of the car when it is starting out from a base station. As the car proceeds along the highway, the RF signal from this station becomes weaker while that from the next base station becomes stronger. As the two RF signal intensities approach equality in the receiver, with the antenna switch in its initial position, distortion will result. At this time, or preferably just before reaching the distortion area, the operator of the mobile unit should operate the antenna switch to the position in which the an-

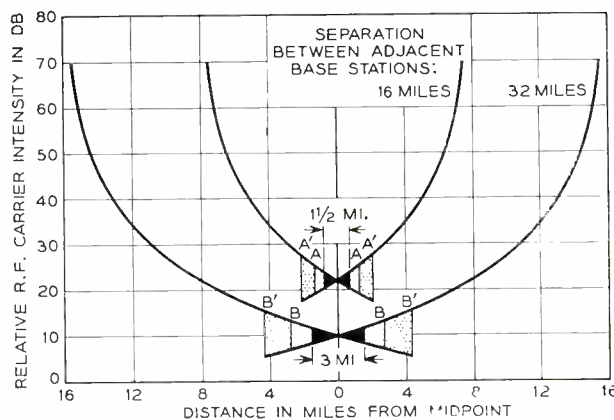

Fig. 1 — Carrier intensities versus base-station separation; shading indicates distortion areas.

tenna is directed toward the front of the car. The receiver will then be subject to "capture" by the new station while the signal from the initial station will be too weak to cause noticeable interference.

In preliminary tests of such a system, where the spacing between adjacent base stations was some 15 to 30 miles, distortion areas ranging from about

2½ miles to about 5 miles in extent were found to exist when the mobile unit was equipped with a single quarter-wave whip-type antenna. The sizes of these areas were substantially the same whether different or the same modulation was applied to the two transmitters. The use of different modulation, however, resulted in much more severe degradation of the service over about the same area. Satisfactory transmission was obtained throughout the length of the system with either the same or dif-

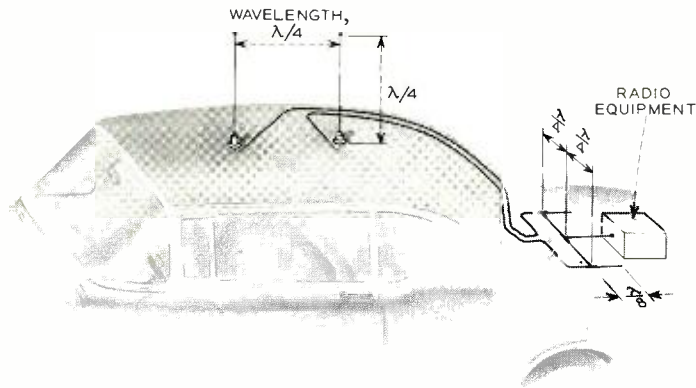

Fig. 2 — Mobile unit equipped with a switchable antenna.

ferent modulation when the mobile unit was equipped with a switchable antenna.

An antenna suitable for this purpose is shown schematically in Figure 2. Two quarter-wave whips are mounted a quarter wave-length apart along the fore-and-aft centerline of the car roof. Associated with each of these antennas is an eighth-wavelength stub of coaxial cable. In one position of the antenna switch, the stub associated with the forward antenna is short circuited whereas the other stub is effectively open. In the other switch position, the rear antenna stub is short circuited and the front stub is effectively open. This is accomplished by means of a coaxial relay under the control of the operator. When the stub associated with the forward antenna is open, the main lobe of the antenna pattern is directed forward as shown by the solid line curve of Figure 3. Conversely, when the stub associated with the rear antenna is open, the main lobe is toward the rear as shown by the dashed line curve in the figure. As these patterns indicate, operating the antenna switch reduces the magnitude of the radio frequency signal received at the mobile station from one of the base stations by approximately 20 db while increasing that received from the adjacent base station by a similar amount.

In a two-frequency system, however, where one frequency is used for transmitting and the other for receiving, it is not possible to obtain this much discrimination at both frequencies. Some compromise must be made to accommodate the two frequencies, which will result in a somewhat smaller discrimination at one of them. A model of the antenna shown in Figure 2 has been built. It provides about 10 db discrimination at one of two such frequencies (159 mc) and 20 db at the other (155 mc). This provides satisfactory performance in areas where no communication would be possible without some discrimination.

In hilly terrain, there may not be a single co-channel distortion area midway between transmitters, but many such areas where one transmitter or the other is partially blocked for short distances. In addition, there may be areas where the field strength will be alternately higher from one station and then from the other at such short intervals as to give a "picket-fence" effect as the mobile unit proceeds at moderate speed along the highway. Under these conditions, it may not be practicable to improve the quality by manual back-and-forth switching of the antenna direction.

In this case, the second method of reducing co-channel distortion effects may be desirable. This method requires that the factors which cause the speech distortion be more closely controlled. This, in turn, requires precise control of each RF signal transmitted by the base stations. Generally, a non-directive vehicular antenna is used.

A mobile receiver, located in the co-channel distortion area, is subjected to two signals that are similarly modulated, and are essentially equal in intensity. If the receiver is to deliver an undistorted output, it is necessary that the two signals appear as one, and therefore, that the incoming signals be modulated in phase at all times. This means that the two transmitters must not only be supplied with the same modulation, but further, that the modulation which originates from a single source must arrive at each transmitter at the same instant. Time delays in the entire transmission path, including wire line facilities and transmitters, must be equalized. In addition, it is desirable that the frequency of each transmitted carrier be accurately controlled to minimize background noise and audible "beats" (the heterodyne effect). Meeting these requirements will provide undistorted or non-degraded output from a mobile receiver located in a distortion area. In practice, however,

a limited amount of degradation from these two causes may be tolerated.

From the results of extensive listener tests conducted in the laboratory under controlled conditions, it has been found that a difference of even 1/6 millisecond in speech transmission time from two adjacent base stations produces noticeable degradation in quality. When the polarity of speech modulation applied to the two transmitters is the same, the quality of speech transmission continues to deteriorate as the delay difference increases from 1/6 ms up to 4 ms; falling off fairly rapidly between 1/6 and 1 ms and leveling off somewhat between 1 and 4 ms. The speech output from the mobile receiver is understandable throughout this range.

When the polarity of speech modulation applied to one of the transmitters is reversed, and the delay difference made zero, phase cancellation of speech is nearly complete. The resulting speech output from the mobile receiver is unintelligible except for an occasional word or part of a word. The introduction of 1/6 ms (or more) delay difference, however, produces speech output which, although degraded, is mostly understandable. As this delay difference is increased from 1/6 ms to 4 ms, the intelligibility improves somewhat and becomes essentially the same as that for the like polarity condition from about 1.2 ms to 4 ms. Differences in listener preferences are to be expected because of the altered frequency characteristics resulting from

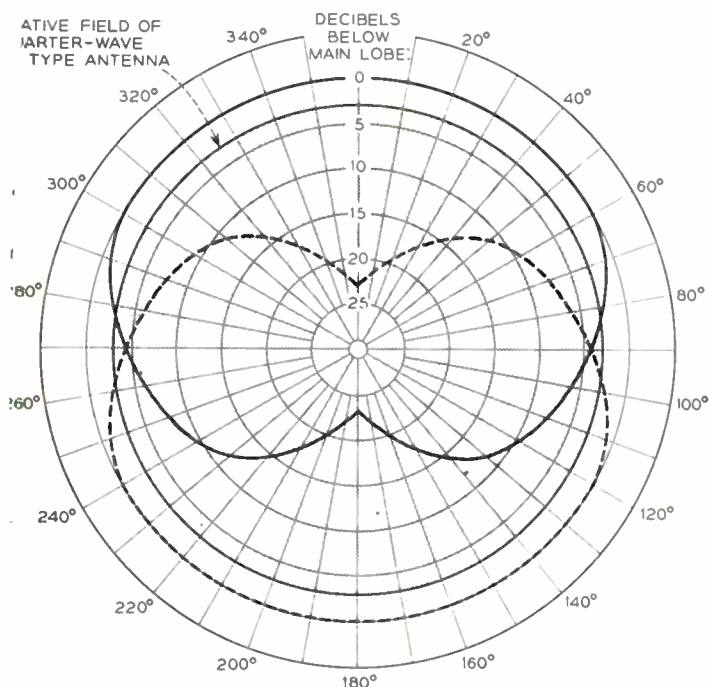

Fig. 3 — Pattern for switchable mobile antenna.

changes in delay difference and polarity. This effect also brings about a difference in intelligibility or circuit merit depending upon whether the speech is heard from a loudspeaker or from a handset.

Maximum degradation in the received speech, together with a maximum background noise, occurs

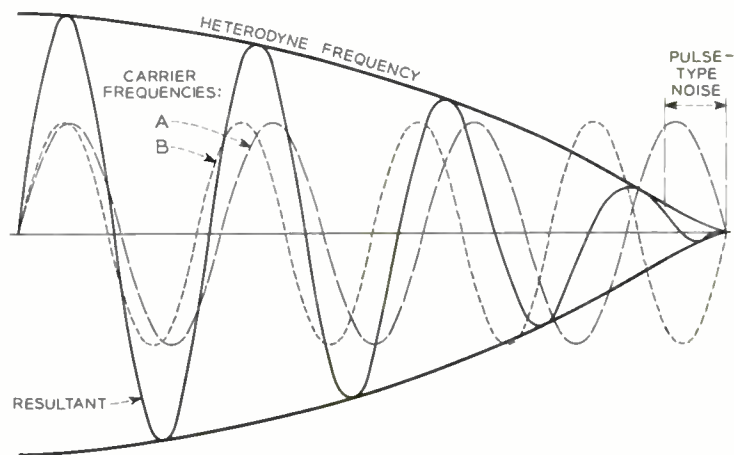

Fig. 4 — Heterodyning effect of two sine waves.

when the two RF carrier intensities are equal. Small changes in intensity of one RF signal with respect to the other (over a range of 0 to 3 db) result in an appreciable reduction in background noise and an improvement in intelligibility.

Background noise and heterodyne effects may be explained as follows: Simultaneous reception of the RF carriers from two base station transmitters produces a heterodyne beat note in the output of the mobile receiver when the carriers are of comparable intensity. When this produces a heterodyne frequency which falls within the voice range, a distracting tone results. This heterodyne tone is present when the intensities of two unmodulated RF carriers are within the range of 3 to some 15 or 20 db of each other. Thus, the heterodyne tone will be heard appreciably beyond the co-channel distortion area limits indicated on Figure 1. It is therefore desirable that this heterodyne frequency fall outside the voice band, especially the band between 500 and 2,500 cycles.

If the carrier frequency is offset so as to place the heterodyne tone slightly above the upper limit of frequencies used for communication, a disturbing high-frequency "noise" background will be produced when the two RF carrier levels are within 1 or 2 db of being equal.

The alternative is to control the frequencies of the adjacent base station transmitters so that the resulting heterodyne tone will be below the speech

frequencies. Since these systems operate in the vicinity of 150 mc, each carrier must have a stability of at least 0.0001 per cent to insure that the heterodyne frequency will be 300 cycles or less.

Normally, noise inherent in an FM system is masked by the carrier signal. When an FM receiver picks up two unmodulated carriers of equal intensity but having only a slight frequency difference, however, sharp, pulse-type noise results from the "unquieting" of the receiver during a short portion of each heterodyne cycle. In this situation, as shown in Figure 4, complete phase cancellation of the two carriers occurs once during each cycle of the heterodyne beat frequency. When the heterodyne frequency is between 50 and 150 cycles, noise which sounds like ignition-type interference will result. To minimize this effect, the frequencies of the base-station carriers must be kept as nearly identical as possible.

There is an additional factor due to the motion of the car which must be considered in establishing the permissible frequency separation of adjacent base-station carrier frequencies. Most of us are familiar with the apparent change in pitch of a locomotive whistle as the locomotive passes us when we are standing on a railroad platform. The pitch appears to be higher as the locomotive ap-

proaches us and lower as it goes away from us. This is known as the Doppler effect. It operates at radio frequencies in the same way it does at audible frequencies. Thus, two base stations, each emitting the same carrier frequency, will actually impress slightly different frequencies across a mobile receiver in a car that is traveling along a highway away from one base station and toward the other. If the car is traveling at a rate of 60 m.p.h. there will be a difference of 30 cycles between the two received carriers. If the base-station carriers are not alike but are displaced by 40 cycles, for example, then the received difference, or heterodyne beat, would be 70 cycles or 10 cycles, depending upon whether the mobile receiver approaches or departs from the base-station transmitter.

Although this article has described two general methods of reducing co-channel distortion effects, the latter method only aids in reducing these effects when the same modulation is transmitted simultaneously from both base-station transmitters. It does not afford any reduction of interference when different modulation is applied to the two transmitters. In this situation, the system dispatcher should be provided with manually operated key switches to disable or remove a transmitter from the system to avoid simultaneous reception.



THE AUTHORS

ROBERT V. CRAWFORD joined the Laboratories in 1930. In the Toll Development Department he was concerned with signaling problems and applications of ionic tubes. His work in the Transmission Engineering Department has been concerned mainly with mobile radio systems but it has also included HF propagation tests and long distance VHF transmission. During World War II his work in radio included tests with the proximity fuse, field tests for the NDRC and equipment for counter-measure work. Mr. Crawford attended Rensselaer Polytechnic Institute and New York University where he received a B.S. degree in Electrical Engineering. He is a member of I.R.E. and Radio Club of America.

WALLACE C. BABCOCK received his A.B. and B.S. degrees from Harvard University, and joined the Development and Research Department of A.T.&T. in 1922. He transferred with that department to the Laboratories in 1934. Prior to World War II, Mr. Babcock was engaged in crosstalk studies, and during the war, on radio countermeasures. Since then, he has been working on antenna development for mobile radio and point-to-point radio telephone systems, and military projects. He is a member of the I.R.E. and the Harvard Engineering Society.



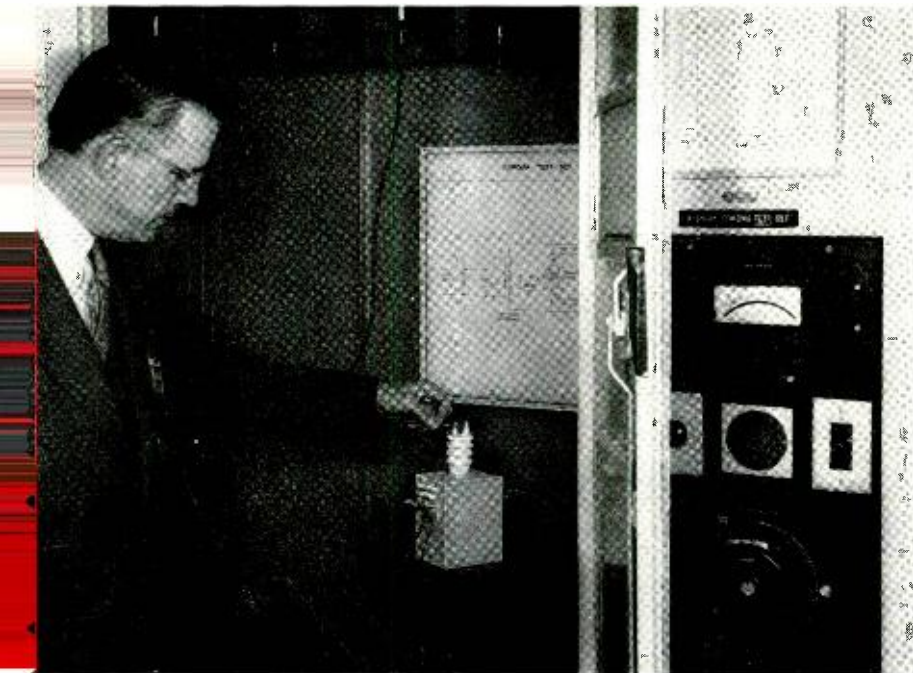

Terminals for Sealed Apparatus

R. F. SQUIRES *Component Development*

The successful operation of many present-day military and communications systems frequently depends on the highly stable and precise outputs of various electronic components. To help insure the required degree of stability and precision in these applications, it is often necessary to seal the components in containers which guard them against the adverse effects of such conditions as moisture and mechanical shock. A variety of sealed terminals have been developed to electrically connect such components into a system without materially reducing the effectiveness of the container.

To assure stable electrical characteristics, many circuit components, and even complete networks, must be sealed against the penetration of moisture and harmful atmospheres. Early units were impregnated with sealing compounds of rosin or wax. The impregnated units were then put into a can and sealed off by an asphaltic compound or a terminal plate fastened tightly to the can. In time, some potting and sealing compounds would develop cracks; others, at higher temperatures, would ooze out around the lead wires and terminal plates.

As the communications art developed, more stringent component requirements necessitated the use of better impregnants. Unfortunately, readily available and economical impregnants with suitable electrical characteristics were of low viscosity and thus leaked easily. To solve the problem, engineers formulated a new concept in apparatus packaging—individual sealed terminals. Each apparatus lead was to be brought outside a sealed can by a feed-through terminal that was insulated from, yet sealed

to, the can. Good design required that the terminal be leak-proof and occupy a minimum volume inside the can and a minimum surface area on the can cover. Since the first sealed terminal was developed well over twenty years ago, the constantly improving characteristics of components have required a corresponding improvement in terminal design. Military development during and since World War II provided added impetus to the development of improved sealed terminals. Several firms are now engaged solely in the manufacture of such terminals.

Several factors must be considered in the design of a sealed terminal for a given application: breakdown, flash-over, and corona-starting voltages under specific conditions of temperature, humidity, and atmospheric pressure; insulation resistance under the same conditions, with or without a dc polarizing voltage; current-carrying capacity; reliability of the seal; ability to withstand mechanical and thermal shock; space requirements; and both unit and installation costs. The increasingly widespread use

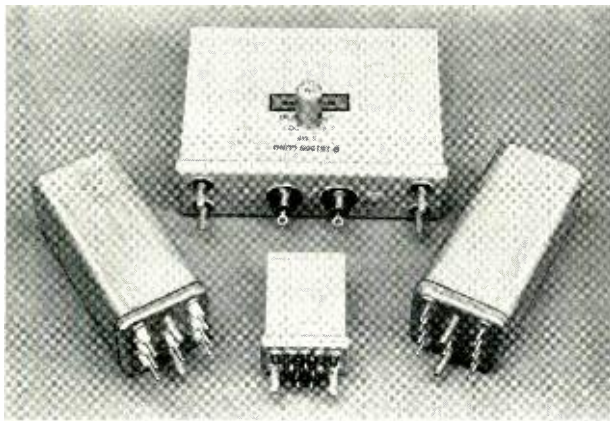

Fig. 1— Apparatus cans using various types of sealed terminals: left, solder-sealed ceramic; center foreground, rubber-sealed; center, molded phenolic; and right, glass-sealed. The small tubular can atop the large unit, center, shows the use of cold-compression fluorocarbon resin-sealed terminals.

of sealed terminals and their varied physical and electrical requirements have resulted in a large number of terminal types for specific purposes. Figure 1 shows several components using a variety of terminal types and sealing materials.

The first practical, low-cost sealed terminal developed by the Laboratories was the rubber-sealed terminal, Figure 2A. A tin-plated copper tube was slipped over a wire insulated with a specially-developed natural rubber compound and then compressed with the dies to reduce its diameter and squeeze it tightly onto the rubber. The tightly squeezed rubber formed the seal. When oil was substituted for wax as the impregnant, it deteriorated the rubber and this in turn affected the electrical characteristics of the oil. A special wire was then developed, using a neoprene jacket over the rubber insulation. Although neoprene is not materially affected by insulating oils, it does not provide as good a seal per unit length as the natural rubber. For this reason, natural rubber is still used in the shorter assemblies and their use is restricted to units not impregnated with oil or oily compounds.

Although their characteristics are generally very good, rubber-sealed terminals have been limited to applications where test voltages do not exceed about 6,000 volts dc or operating voltages do not exceed about 3,000 volts dc. Chlorinated impregnants used in capacitors to achieve higher capacitances for the same unit volume are harmful to rubber; molded phenolic terminals, Figure 2B, were designed for such applications. Phenolic material is molded between and around a metal lead-through and a con-

centric metal bushing; these parts are shaped for mechanical strength and a good seal. These terminals are used at voltages up to 10,000 volts dc at room temperature and up to 5,000 volts dc at 185 degrees Fahrenheit.

For units requiring apparatus to be sealed in a vacuum or a controlled atmosphere, another type of terminal was needed. With glass-sealing methods developed for making electron tubes, a glass bead was fused between a copper-coated alloy wire and the inside of one end of a copper tube. The other end of the tube was flared and spun over the flange of a hollow ceramic bushing. The lead-through was brought through the bushing and soldered to a terminal previously hollow-riveted to the bushing to complete the assembly. The metal tube could then be soldered to the apparatus can.

The trend toward miniaturization of components and the demands of the military during and after

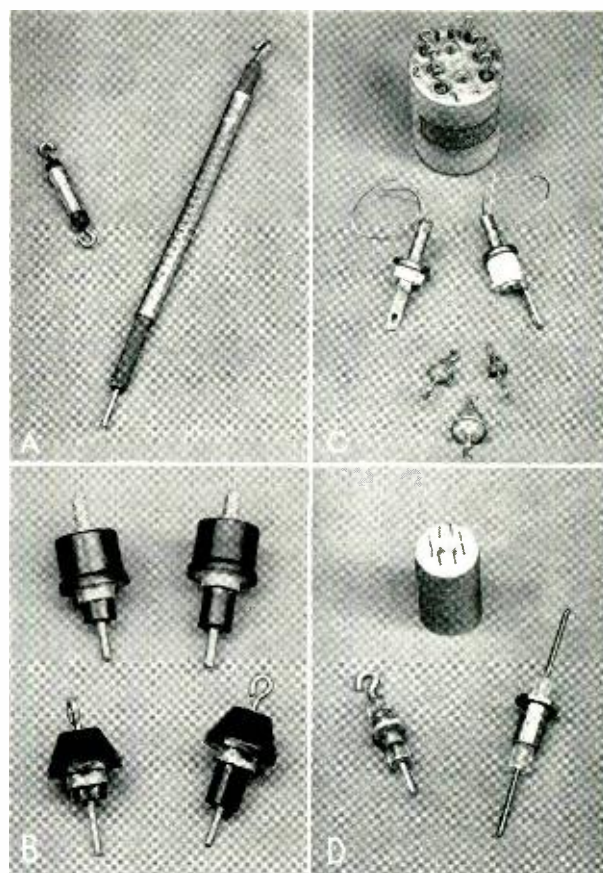

Fig. 2— A, large and small rubber-sealed terminals. B, short-shank (left) and long-shank molded phenolic terminals. C, copper-glass (center) and examples of glass-sealed terminals. D, molded plastic (left) and examples of cold-compression fluorocarbon resin-sealed terminals.

World War II led to further improvements in metal-glass terminals. Outside industry had developed glass-sealed terminals using a metal lead-through and bushing, separated by glass fused to the metal parts. The Laboratories undertook the design and development of smaller terminals using this process and the same materials — a special alloy, Kovar, and borosilicate glass. Several of these metal-glass terminal designs, some of which are shown in Figure 2C, are used in substantial quantities. They are somewhat restricted in their applications because of electrodeposition of metal over the glass surface when subjected to repeated temperature-humidity cycles with dc polarizing voltage across the terminal results in the lowering of insulation resistance, as indicated in Table I.

Further miniaturization of some components created a demand for sealed terminals that would meet more stringent requirements. Two designs using fluorocarbon resins were evolved at the Laboratories. These are illustrated in Figure 2D. One design consists of a fabricated wire lead-through and a concentric flanged metal bushing, separated and held in position by a fluorocarbon resin carefully molded to avoid internal air pockets that would affect the electrical characteristics of the terminal. These terminals use a resin (polychlorotrifluoroethylene) that can withstand fairly high temperatures and has particularly useful properties for miniaturized military equipment. Considerable care must

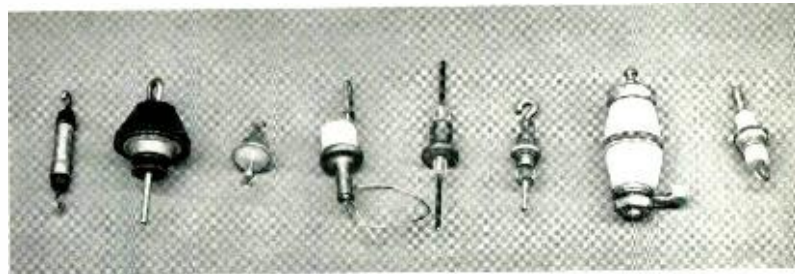

Fig. 3—An array of similar sizes of terminals. From left, they are: rubber-sealed, molded phenolic-sealed, glass-sealed, copper-glass, fluorocarbon resin-sealed, molded plastic-sealed, gasket-sealed ceramic, and solder-sealed high alumina ceramic.

be exercised in the fabrication and installation of these terminals to retain the desirable properties.

Usually, apparatus units are impregnated and filled with a potting compound after all soldering operations have been performed, including those on the terminals. Temperatures involved during impregnation are sometimes sufficiently high to jeopardize some types of terminal seals thus restricting the choice of seal materials. A second type of fluorocarbon resin terminal can be made directly on the apparatus can at room temperature after impregnation and potting have been done, eliminating this problem. In this process, a fairly heavy-walled bushing is fastened to the can cover or is formed as part of the can cover. The space between the bushing

TABLE I — TYPICAL ELECTRICAL CHARACTERISTICS OF TERMINALS FROM COMPONENT TEST DATA

Terminal	Voltages in KV Peak Room Conditions		Corona-Starting	Insulation Resistance in Megohms		Current Rating-Amps
	Maximum Test	Working		As Assembled	After Moisture Resistance Test With Polarizing Voltage	
RUBBER-SEALED						
Smallest Size	2.4	0.6	1.2	> 10 ⁵	> 10 ⁵	5
Longest Sleeve	6	3	3	> 10 ⁵	> 10 ⁵	5
MOLDED PHENOLIC						
Short Shank	5	2	1.2	> 10 ⁴	> 10 ⁵	10
Long Shank	10	5	1.2	> 10 ⁴	> 10 ⁵	10
METAL-GLASS						
Smallest Size	2.1	0.5	1.4	> 10 ⁵	< 1	5.5
Largest Size	5.6	1.4	3.7	> 10 ⁵	< 1	21.5
FLUOROCARBON RESIN (2 types)						
Compressed	6.5	2.5	3.7	> 10 ⁵	> 10 ⁵	5
Molded	7	2.8	2.8	> 10 ⁶	> 10 ⁵	15
GASKET-SEALED CERAMIC						
Smallest Size	5.6	2.1	4.2	> 10 ⁵	> 10 ⁴	15
Largest Size	100	50	60	> 10 ⁵	> 10 ⁴	15
SOLDER-SEALED CERAMIC						
Smallest Size	5	1.5	1.3	> 10 ⁵	> 10 ⁴	3
Largest Size	35	17	21	> 10 ⁵	> 10 ⁵	30

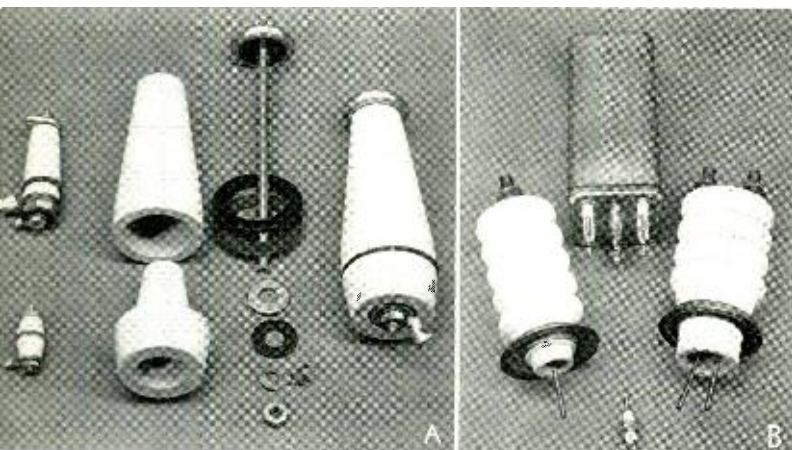

Fig. 4 — A, three sizes of gasket-sealed ceramic terminals with a large terminal disassembled. The terminal at upper left contains two coaxial feed-throughs. B, examples of solder-sealed high alumina ceramic terminals.

and a central wire lead-through acts as a filler hole for the drying, impregnating, and potting operations, and is then sealed with resin. A sleeve of either polychlorotrifluoroethylene or another plastic (polytetrafluoroethylene) is slipped over the lead-through into the bushing and is then compressed with a suitable tool. This gives a hermetic seal between sleeve and bushing and between sleeve and lead-through.

When still higher voltages are encountered, ceramic terminals are used. In compression-type ceramic terminals, Figure 4A, the insulator body consists of two parts, one inside and one outside the can, and a central lead-through threaded on one end to provide axial compression. Sealing is provided by special gaskets wherever the ceramic comes in contact with a metal surface. Two features are of interest: the hollow body permits the insulating oil of a unit to fill the insulator and improve the electrical

characteristics, and a terminal may be constructed with either a single or two coaxial lead-throughs.

Solder-sealed ceramic terminals fall into two classes, differing primarily in the glazed ceramic material of the bodies and the method of attaching the metal parts or "hardware" to the ceramic. One class uses steatite-type ceramic with specific areas of the bodies coated with metals; a paste of colloidal silver is fired onto the ceramic, and copper and then tin are electroplated onto the silver for better solderability. Soft (lead-tin) solder is used to attach the hardware as well as for mounting the terminal onto the apparatus can.

The other class, the so-called "high alumina" terminals, Figure 4B, are a more recent development. The ceramic material, chiefly recrystallized aluminum oxide, is more resistant to thermal shock and can withstand higher temperatures. Because of this, it is possible to apply a higher-temperature glaze that has superior non-wetting properties and surface resistivity; such terminals retain their high insulation resistance under extreme conditions of humidity and voltage. Also, by using special metallizing techniques, the hardware is attached to the ceramic with high-temperature brazing alloys. These terminals have superior electrical and mechanical properties and are replacing other types for the more critical applications. Soft solder or brazing can be used to attach these terminals to the can.

This wide variety of terminal types provides mechanical and electrical characteristics covering a considerable range of requirements. Table I shows typical electrical characteristics for various terminals in actual use on apparatus. Even such a wide variety of types, however, does not provide perfect terminals for present and future developments, and the Laboratories is continually searching for new and better ways of making sealed terminals.

THE AUTHOR

R. F. SQUIRES began his Bell System career in 1919 with the research group of the Engineering Department of the Western Electric Company, later Bell Telephone Laboratories. He spent several years with the magnetics research group, engaged in the development of continuously loaded submarine telegraph cable, and studying the heat treatment and properties of magnetic alloys. With the advent of World War II he transferred to the Apparatus Development Department where he has worked on precision resistors and inductors. After a survey and study of terminals for sealed apparatus, he returned to development work on components for submarine cable repeaters. He received a B.S. degree in E.E. from Cooper Union.



Type-ON: New Short-Haul Carrier



M. ARUCK *Transmission Engineering*

A very flexible and versatile carrier transmission system has recently been made available for short-haul service. This is the Type-ON system, which permits groups of channels from Type-O open-wire systems to be transmitted over Type-N cable without dropping down to voice frequencies at the junctions. In addition, the Type-ON system may be used as a twenty-channel system exclusively over cable.

In laying out short-haul toll circuits, it may be necessary to interconnect open-wire and cable circuits to provide through channels. These circuits may, in many cases, be provided by Type-O carrier systems* on open-wire lines and Type-N systems† on cable. The two systems may be joined by connecting Type-O and -N channels in tandem at voice frequencies. Thus, three 4-channel Type-O systems on open wire may be connected to a 12-channel Type-N system on cable at the junction point to provide 12 through circuits. This is wasteful of equipment, however, since two complete voice-frequency terminals are required at the junction for each channel. Where large numbers of channels are involved, substantial savings in equipment may be realized if the transition from open wire to cable and vice versa is made at carrier frequencies. The development of the Type-ON carrier system has achieved this end.

As its designation implies, the Type-ON system is essentially a method of applying Type-O frequencies over Type-N cable. This is accomplished with a minimum number of modifications of Type-O and Type-N equipment units and without interfering with Type-N signals that may be present in the same cable. This has minimized the development cost and

has permitted the system to be provided in a relatively short time to meet an urgent need in the field. It is also possible to use Type-ON systems over Type-N cable exclusively, and thus obtain a maximum of 20 channels as compared to 12 for Type-N carrier. This is possible because the Type-O system, from which the Type-ON signals are derived, is a single-sideband system, whereas the Type-N system employs double-sideband transmission.

The basic functions of the ON system can be explained with reference to Figures 1 and 2, which show the frequency arrangement of the ON system. Figure 1 illustrates several important facts about the grouping of channels in the ON spectrum. Five groups of four channels each (or a total of twenty channels) occupy the range of frequencies from 40 to 136 kc. These frequencies comprise the basic ON frequency band. It may be noted in Figure 1 that the five groups of four channels each in this band correspond to five of the O group frequencies, namely, OB low group, OB high group, OC low group, OC high group and OD low group. This frequency grouping was chosen so that existing O units could be used at the ON terminals and junctions.

In the ON system, unlike the O system, the same frequencies in each group in the 40-136 kc range are transmitted and received by the ON terminal or junction equipment. For instance, in an O ar-

* RECORD, June, 1954, page 215. † July, 1952, page 277.

rangement, an OB system transmits 40-56 kc (low group) and receives 60-76 kc (high group), or vice versa, on the same open-wire pair. In the ON system, on the other hand, group 5 of a terminal or junction would transmit 40-56 kc on one pair and receive the same frequencies on another pair.

On an N carrier line, however, low-group frequencies (40-136 kc) must be transmitted in one direction on one cable pair, and high-group frequencies (168-264 kc) in the opposite direction on the other cable pair. An ON repeater, used between an ON junction or terminal and the N line, provides this translation of frequencies where required. The low- and high-group ON bands are within the N carrier bands of 36 to 140 kc (low group) and 164-268 kc (high group), and can therefore be handled satisfactorily by the N repeaters and line.

Figure 2 illustrates how the O and ON frequency arrangements are translated from one to the other by the ON equipment at an open wire-cable junction point. In the left part of the diagram, the frequencies of the O systems range from 2 kc (bottom of the OA system, low group) to 156 kc (top of OD system, high group). Each of the five 4-channel O system groups received from the open-wire line (any one of which can be an OA, OB, OC, or OD

system, either high group or low group) is first translated or modulated to a 180-196 kc basic band. In the second step of modulation, each basic 4-channel group is then translated to a chosen position in the basic ON band (40-136 kc). An ON repeater then applies these frequencies to the N line unchanged, or modulates them with 304 kc to the high group band (168-264 kc) as required by the N line. In the reverse direction, the line frequencies of each ON group are modulated in reverse order in the ON repeater and ON junction equipment to the line frequencies of a particular O system used on the open-wire line. At an ON terminal, the same double modulation plan is also employed: that is, the carrier frequencies of each ON group are first modulated to the basic 180-196 kc band before demodulating to voice frequency.

Figure 3 shows a typical application of a 20-channel ON system on a combination of open wire and cable in block schematic form. This figure serves to illustrate the makeup and operation of the ON system. Five 4-channel O terminals of OA, OB, OC or OD type terminate the open-wire ends of the circuit in the left part of the figure. Each O system transmits and receives at its standard O line frequencies over open-wire equipped for O carrier transmission. The ON groups may be derived from any combination of O systems on two to five open-wire pairs on one or more routes of Type-O carrier systems.

At the open wire-cable junction, each O system group is connected to an ON junction unit. The junction equipment consists essentially of both standard and modified O plug-in units. Each ON junction unit separates and translates the O line frequencies of each O system to an ON group in the basic ON frequency allocation (40-136 kc) for application toward the cable. The two-wire arrangement of the open-wire systems is thus converted to the four-wire system used on the cable. The outputs of the plug-in units are combined for connection to the ON repeater. A level-control tone, which will be discussed in detail later, is added at this point when required.

The ON repeater provides amplification and, where required, as in the situation shown in Figure 3, frequency conversion from the basic ON low-group band (40-136 kc) to the ON high-group band (168-264 kc) to coordinate with the N carrier line. This repeater consists of a modified N repeater in which "frequency frogging" (shifting between high- and low-frequency groups) is omitted in one direction. The ON signals are transmitted over a cable quad (or two pairs) equipped with standard N repeaters. As in the N system, repeaters translate these

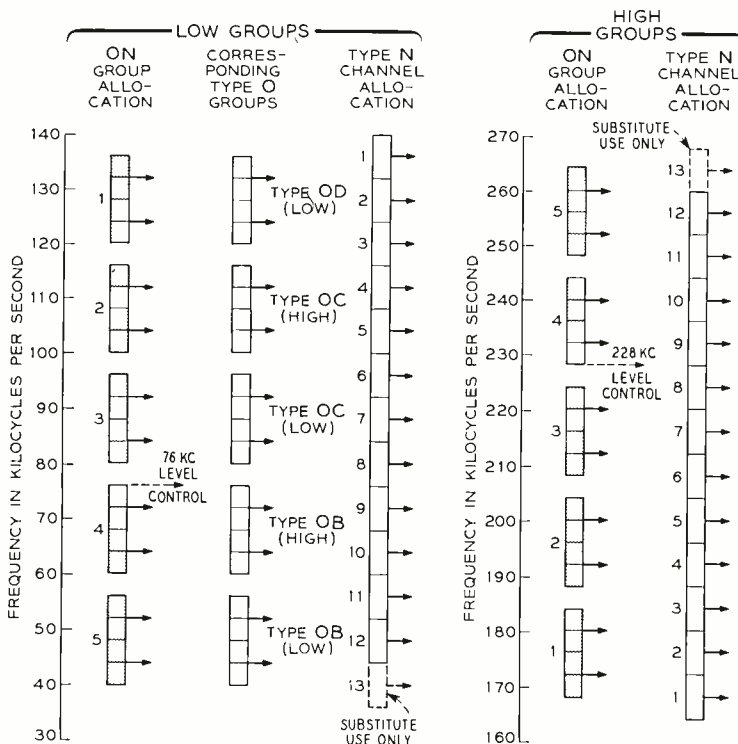

Fig. 1—Frequency allocations of the Type-ON system; Type-N frequencies and corresponding Type-O group-names are shown in the second column for comparison.

frequencies back and forth between low-group (40-136 kc) and high-group (168-264 kc) frequencies.

An ON repeater and terminal are used at the terminal end of the cable. Here again, the ON repeater

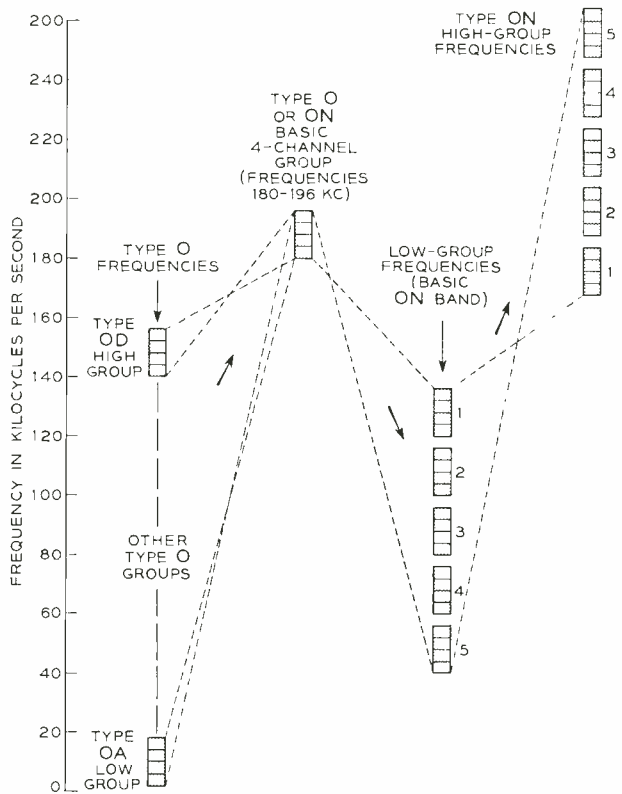

Fig. 2 — Frequency translation between Type-O and Type-ON systems; Type-O frequencies at left are translated to high and low group frequencies that can be handled by Type-N carrier cable.

provides amplification, but in this case frequency conversion is not necessary since the basic ON frequencies (40-136 kc) are received directly from the N line. The ON terminal provides voice-frequency termination of the 20 channels at the cable terminal of the circuit. It consists of five groups of 4-channel ON terminal units which receive and transmit the indicated ON frequency groups. Each ON terminal consists of a slightly modified O terminal. The principal change is to provide four-wire connections to the cable instead of two-wire, as is done in the O system. The type of O plug-in units used in the ON terminal — OD low group, OC high group, etc. — is determined by the frequency of each ON group, that is involved.

In the reverse direction in Figure 3, an ON terminal converts the voice-frequency channels on a 4-channel group basis to the basic ON group allocation (40-136 kc). These groups are then combined and applied to the ON repeater for amplification and, in this case, modulation to the high group band (168-264 kc) for transmission over the N line. At the cable-open wire junction in Figure 3, the ON repeater is only required to provide amplification. The ON junction equipment receives the ON frequencies from the ON repeater on a four-wire basis and converts each ON group to a particular O system line frequency for application on the open wire on a two-wire basis. As noted previously, any ON group may be translated to any O system allocation (OA, OB, OC, or OD, high group or low group transmitting). The O system groups are transmitted over the open-wire line in a standard manner to O system terminals at the terminal end of the open-

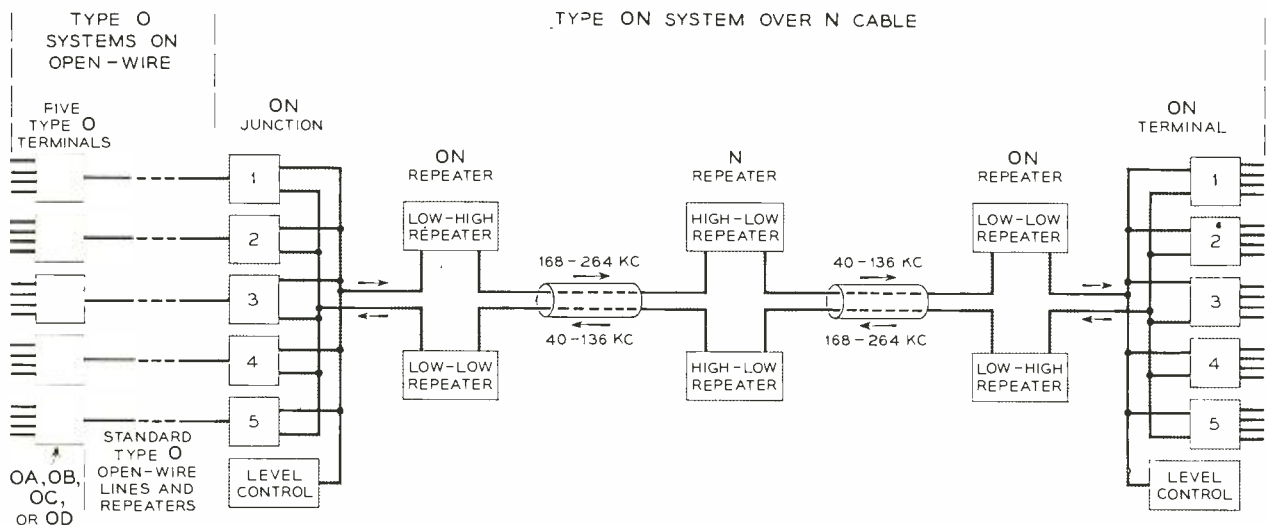

Fig. 3 — Typical Type-ON system on open-wire and cable.

wire line for conversion to voice-frequency channels.

Two principal features give the ON system its high degree of flexibility and wide field of application. The first is the use of the same double-modulation plan employed by the type-O system, in which

transmitted to maintain carrier levels at their normal values.

These advantages are illustrated in Figure 4, which shows another application of ON carrier on a combination of open wire and cable. This block sche-

Fig. 4—Twenty Type-ON channels arranged between cities B and C, showing various combinations of open-wire and terminations on either side.

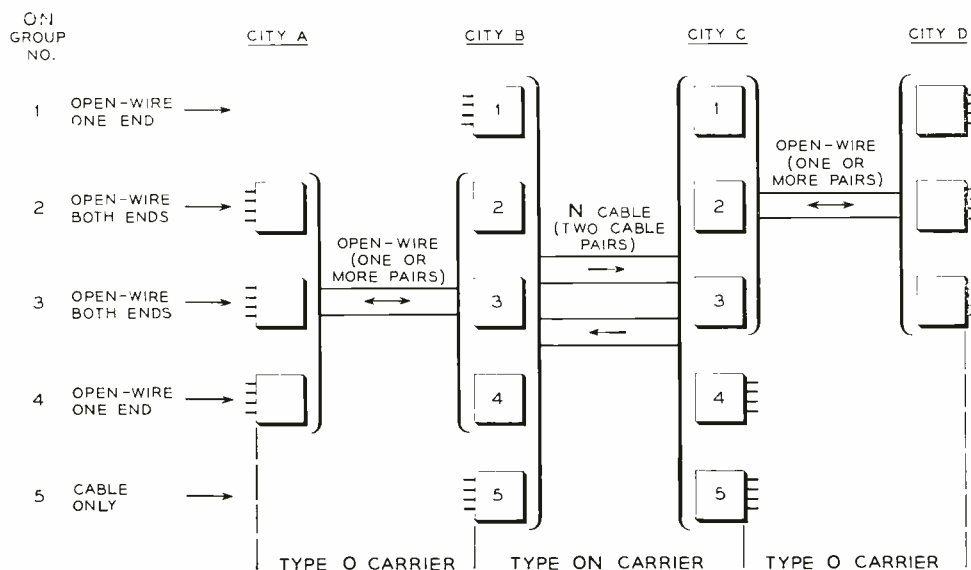

each group of 4 voice-frequency channels is translated to a basic 4-channel band of 180-196 kc. This double-modulation arrangement enables any O system on the open wire to be shifted to any ON group position on the cable. It also permits any one or more of the ON groups transmitted on the cable to be terminated at the cable-open wire junction, while the others are extended on open wire. Another result is that it permits the use of the ON as an all-cable system by terminating all ON groups at both ends.

The second feature is the use of a level-control oscillator to permit the operation of ON systems equipped with only one, two, or three groups without interference to other ON and N systems in the same cable. The output levels of N and ON repeaters are regulated by the total carrier power transmitted through the repeaters. The level-control oscillator supplies the missing carrier power when less than four ON groups are transmitted, so that the carriers are maintained close to their normal levels, regardless of the number of groups used. Thus, an ON system may be provided initially with only one or two 4-channel groups. As circuit growth and economic consideration warrant, additional groups may be added up to a total of five 4-channel groups or 20 channels. As each group is added, the output of the level-control oscillator is reduced accordingly until four groups are present, when it is removed completely. The ON system is thus more flexible than the N system, in which all 12 channels must be

matic represents an intermediate section of cable with open-wire lines at each end. The terminal ends and junction points are shown located at four cities, A, B, C, and D. A 20-channel ON system is involved in providing 4-channel circuit groups between the various cities. Two ON groups (numbers 2 and 3) provide circuits between cities A and D over two open-wire sections with an intermediate cable section. One ON group (number 1) provides circuits between cities B and D involving a cable section with an open-wire section at one end, while between cities A and C another ON group (number 4) involves the cable section with an open-wire section at the other end. The final ON group (number 5) provides circuits over the cable portion only between cities B and C. Standard O systems provide circuit groups over the open-wire sections. The use of similar arrangements would make it possible to operate the ON system over a cable with an intermediate open-wire section.

The ON system has found a wide field of use in combined open-wire and cable systems because the transition between open-wire and cable operation is relatively simple and can be made at substantially any point. For instance, the ON system may be used for operating O systems through long entrance or intermediate cable where the use of N repeaters offers an economic advantage over the use of O repeaters. It is not necessary that the cable terminate at a central office at either end, provided power is

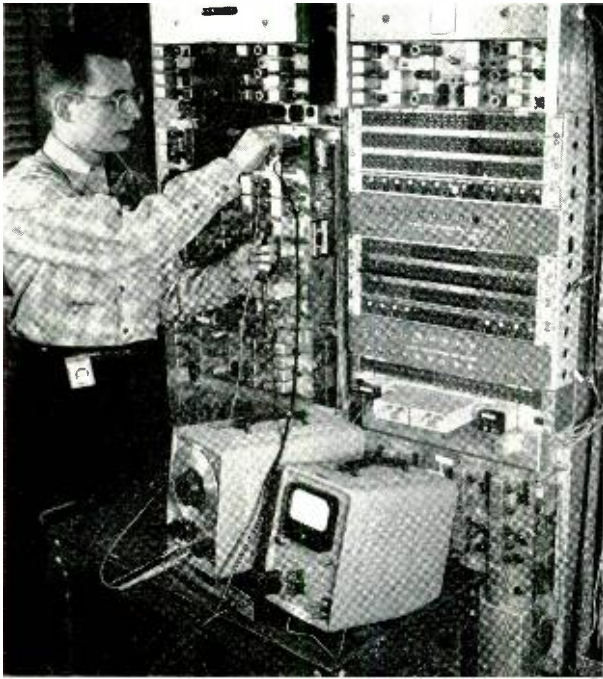

Fig. 5 — G. W. Carter performing a transmission test on Laboratories Type-ON terminal equipment.

available for operation of the junction equipment. The ON system also permits an O carrier open-wire route to be developed as a cable carrier route by periodic cable extensions as circuit growth and eco-

nomie considerations permit. As the ON system is extended to replace portions of the O system, the ON junction equipment is moved to the new open-wire cable junction.

In addition to these applications, the ON system has found considerable use as a 20-channel, all-cable system where N carrier has been used heretofore. Although ON terminals are higher in cost per channel than N terminals, ON systems are more economical for cable routes somewhat over 100 miles long. This results from the more economical use of cable pairs and N repeaters, since 20 channels are possible in comparison with only 12 channels for the N system over the same two cable pairs. In addition, ON may be employed in place of N to defer the installation of new cable. Or, it can be employed where all pairs in a cable suitable for N transmission are in use. This is done by replacing N terminals with ON terminal equipment and in this way deriving eight additional circuits on each cable quad, with no change in the line or repeaters.

Another important application of the ON system is in stacking or multiplexing channels for transmission over microwave radio. At present, up to 40 channels of ON carrier, consisting of two 20-channel ON systems, may be multiplexed. These systems may be extended over open wire or cable at either radio terminal.

THE AUTHOR

M. ARUCK joined Bell Telephone Laboratories in 1930, and for several years he was engaged in studies of noise and crosstalk on telephone circuits. During World War II, he worked on secrecy systems for speech and teletypewriter transmission for the Signal Corps, and on antenna and radio transmission studies on a project for the National Defense Research Committee. After the war he engaged in radio transmission studies for mobile radio telephone systems. In 1947 Mr. Aruck returned to work on noise problems, and since 1953 he has been engaged in systems engineering of short-haul carrier systems. Mr. Aruck received the degree of B.S. in E.E. from Cooper Union in 1936 and has attended New York University.





JAMES E. DINGMAN



RALPH L. HELMREICH

Ralph L. Helmreich Elected Vice President and General Manager of the Laboratories

Ralph L. Helmreich, Director of Operations of the Long Lines Department of the A. T. & T. Co., was elected Vice President and General Manager of the Laboratories at a recent meeting of the Board of Directors. Mr. Helmreich succeeds James E. Dingman, who has resigned to accept the position of Director of Operations of Long Lines. The moves were effective on November 1. Also on that date, Mr. Helmreich became a Director of the Laboratories, and Mr. Dingman succeeded him as a member of the Long Lines Board.

Mr. Helmreich is a native of Kansas City, Kansas, and received a degree in mechanical engineering from Kansas State College in 1928. In the same year he joined Southwestern Bell Telephone Company as a student engineer, Plant Department, Kansas City. He was transferred to Sedalia, Missouri, in 1932 as Wire Chief. During the next 16 years he continued to work in the Plant Department in various cities in Kansas and Missouri.

In 1949 Mr. Helmreich moved to the General Department of the A. T. & T. Co. in New York as Supply Practices Engineer. The following year he returned to Southwestern Bell as General Manager in Kansas City, Missouri. He was named Vice President in charge of Personnel for Mountain States Telephone and Telegraph Company, Denver, Colorado, in 1951 and was appointed Vice President – Operations a year later. In 1953 he returned to New York as Director of Operations, Long Lines. Mr. Helmreich is a member of the American Society of Mechanical Engineers and of Phi Delta Theta fraternity.

Mr. Dingman came to the Laboratories as Vice President and General Manager on December 1, 1952. Before that he had served for a number of

years as Vice President – Operations of the Bell Telephone Company of Pennsylvania.

After graduation from the University of Maryland with a degree in mechanical engineering, Mr. Dingman joined the Bell System in 1922 as a tester with Western Electric Company. In 1923 he transferred to Long Lines as equipment attendant in Lansingburg, N. Y. After successively filling a number of posts in the Long Lines Plant Department, he became Employee Relations Manager in New York in 1943 and Assistant to the General Manager of Long Lines in 1949. That same year he was elected Vice President – Personnel of the Bell Telephone Company of Pennsylvania and the Diamond State Telephone Company in April 1950 he became Vice President – Operations and a member of the Boards of Directors of those companies.

Paul A. Gorman Elected to Laboratories' Board of Directors

Paul A. Gorman, Vice President in charge of Manufacturing of Western Electric Company, was elected a Director of the Laboratories at a recent meeting of the Board. Mr. Gorman succeeded Frederick R. Kappel, President of A. T. & T. Co. A native of Missouri, Mr. Gorman joined Western Electric in Chicago in 1929 upon graduation from the University of Missouri. He has held several important Bell System positions, including those of Vice President – Finance, Vice President – Defense Projects, Personnel Director and Central Distribution Manager of Western Electric and Assistant Vice President of A. T. & T. He is a Director and a member of the Executive Committee of the Western Electric Company.

K. K. Darrow Completes Distinguished Laboratories Career

By retiring on November 30, Dr. K. K. Darrow will complete his long and distinguished association with Bell Telephone Laboratories. Dr. Darrow joined the Western Electric Company as a research physicist in 1917 and transferred to the Laboratories on its incorporation in 1925. He had previously completed extensive studies in mathematics and physics at the Universities of Chicago, Paris and Berlin. He received the B.S. and Ph.D. degrees from the University of Chicago in 1911 and 1917 respectively.

The influence of Dr. Darrow's work has extended beyond his immediate associates at the Laboratories to include almost the entire body of workers in the



K. K. DARROW

physical sciences here and abroad. Not a research specialist, he devotes a major portion of his time to the study and interpretation of current and historical scientific information for his colleagues, to keep them informed in fields related to their activities. He was a founder of and held several official positions in The Colloquium, a Laboratories organization which, between the two world wars, sponsored many talks for research personnel.

An accomplished lecturer and writer, Dr. Darrow has frequently been called upon to address fellow scientists on physics and related branches of research study. As an author, he has written eight books, among which are his *Introduction to Contemporary Physics*, *The Renaissance of Physics*, *Electrical Phenomena in Gases*, and *Atomic Energy*. He is also the author of over 200 scientific articles

which have appeared in Bell System publications and other journals. Dr. Darrow has, in addition, served as visiting professor at the University of Chicago, Columbia University, Smith College and Stanford University.

Beginning even before his student days, Dr. Darrow has been intimately acquainted with western Europe, and has met a considerable number of physicists in various countries, especially in France. He has had frequent occasion to attend scientific congresses and to visit laboratories in France and in other European countries. He has been a member of the French Physical Society for many years and served for a term on its Council.

In recognition of Dr. Darrow's activities both in the United States and abroad, the University of Lyons in 1949 granted him the honorary degree of Doctor of Science. In 1951, the French Legion of Honor awarded him the Legion's decoration, with the rank of Chevalier, for "services rendered to the international relations of Science and to the cultural relations between France and the United States."

Dr. Darrow has long been active in the American Physical Society and has served as Secretary since 1941. His many friends and associates in the Bell System will be glad to know that he plans to continue his work in the Society, with increasingly longer intervals of foreign travel, and that he also intends to continue through his writings and lectures to assess and interpret the latest discoveries in the physical sciences.

Dr. M. J. Kelly Reelected to M. I. T. Corporation Committees

Dr. M. J. Kelly was reelected to the Executive Committee of the Massachusetts Institute of Technology Corporation for a five-year term beginning Oct. 1, 1956. He has served as a member of this committee for the past year. Dr. Kelly was also re-elected chairman of the Visiting Committee to the Department of Physics for one year. A member of the visiting committee since 1953, he has served as chairman for the year 1955-56. He also continues as a member of the Visiting Committee to the Division of Defense Laboratories. Dr. Kelly was elected a Life Member of the Massachusetts Institute of Technology Corporation in June, 1953.



On the platform during opening ceremonies: left to right, Cleo F. Craig, Chairman of the Board of A.T.&T.; G. C. McConnaughey, Chairman of the Federal Communications Commission; Frederick R. Kappel, President of the A.T.&T. Co.; George L. Best, Vice President of the A.T.&T. Co.; W. E. Thompson, Assistant Vice President-Long Lines and President of Eastern Telephone and Telegraph; M. J. Kelly, President of the Laboratories; and H. T. Killingsworth, Vice President, Long Lines.

Ceremonies Mark Opening of Transatlantic Cable

The first transatlantic submarine telephone cable was opened for service on September 25 by the words "This is Cleo Craig in New York calling Dr. Charles Hill in London." The reply came from London, "This is Dr. Hill in London, Mr. Craig. I am delighted to hear your voice and join with you and our friends in Canada in inaugurating the first transatlantic cable telephone service."

This opening conversation between Cleo Craig, Chairman of the Board of A.T.&T. and Dr. Charles Hill, Her Majesty's Postmaster General, was part of simultaneous ceremonies in New York, London and Ottawa, Canada. George Marler, Minister of Transport, joined the conversation in behalf of Canada. After Mr. Craig, Frederick R. Kappel, President of A.T.&T., talked with both London and Ottawa, as did George C. McConnaughey, Chairman of the Federal Communications Commission.

When talking to Mr. Craig, Dr. Hill said, "This cable is a masterpiece of international cooperation into which has gone the best available from each country and only the best was good enough. We are sure that, as the people of our three countries use this new cable more and more to talk to one another, the ties of friendship and the understanding between us will grow ever stronger in the years to come."

In response Mr. Craig said, "We certainly share your feeling — and it seems to me that the building of the cable, all the planning and all the work of construction — these things in themselves are another fine example of the good spirit and cooperation which exist between our countries."

Ceremonies at the A.T.&T. Co. were attended by 300 people including Walter S. Gifford, former President of the A.T.&T. Co. and Dr. Oliver Buck-

Inaugural ceremonies were heard in the Arnold Auditorium at Murray Hill.

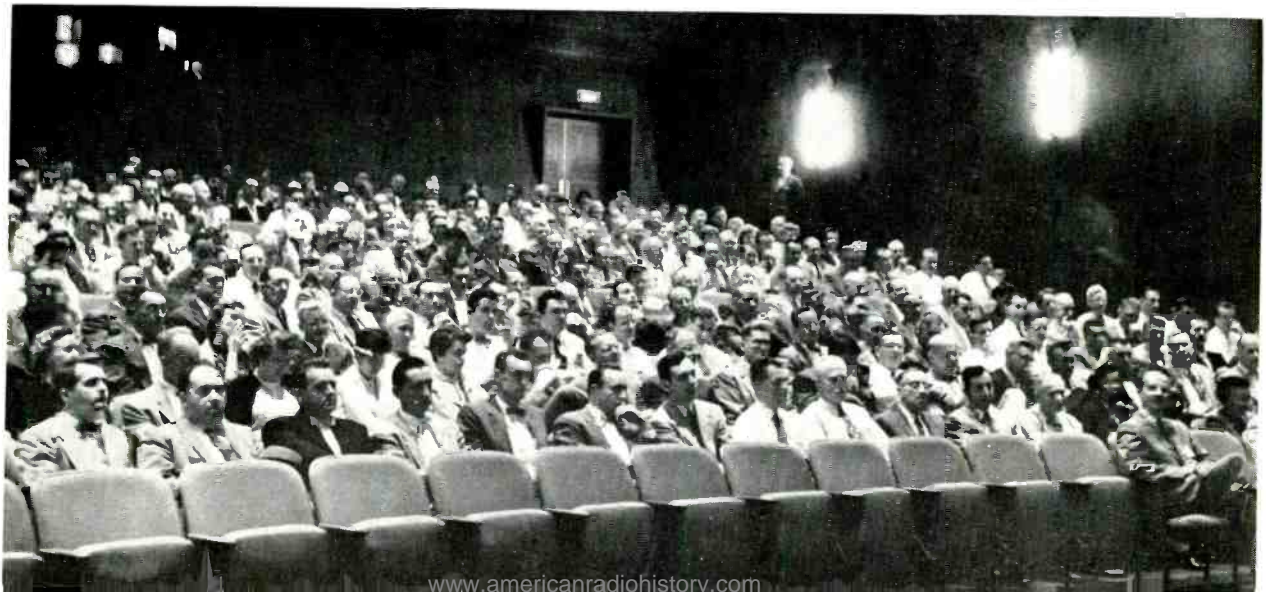



Cleo Craig makes the first call over the new transatlantic telephone cable to Dr. Charles Hill in London. Frederick R. Kappel is seated at the right, and George C. McConnaughey, at the left.

ley, former President of the Laboratories, both of whom made great contributions to the planning and development of the cable.

At a press conference following the inaugural ceremonies, Mr. Craig reported that the Bell System is already thinking of laying new transatlantic cables, but the time schedule depends on how fast the present cable is used to capacity. Following the formal ceremonies, members of the press were invited to talk to London over the new cable.

The transatlantic conversations were carried from New York to Portland, Maine, by cable, and from there to Sydney Mines, Nova Scotia, by radio relay. From Sydney Mines to Clarenville, Newfoundland, the path is over a shallow water cable. From Clarenville to Oban, Scotland, the path is over the deep water portion of the new cable, and from Oban to London, land cable circuits complete the route.

The telephone conversations between the United Kingdom and the United States and Canada were simultaneously broadcast at all the principal Laboratories locations. During the ceremonies, a new film "The Voice Beneath the Sea" was shown at the



Dr. M. J. Kelly addressed Laboratories people and their guests during an open-house held at the Murray Hill Laboratory on the evening of September 25.

A.T.&T. and Laboratories locations. This color film described the development and laying of the cable.

In addition to the Laboratories ceremonies during the inauguration of the cable, an open house was held at Murray Hill on the evening of September 25 for Laboratories people who worked on the cable, and their families. The guests were divided into three groups and each was addressed in the Arnold Auditorium; the first by Executive Vice President, J. B. Fisk, the second by Dr. M. J. Kelly, and the



At the Whippany Laboratory, first conversations over the new transatlantic telephone cable were broadcast to groups on the lawn.

third by Vice President W. A. MacNair. Dr. Kelly paid special tribute to the pioneer work in submarine cable development by Dr. Oliver Buckley. Dr. Buckley was in the audience as an honored guest, as was J. J. Gilbert, cable consultant who had worked with Dr. Buckley in early research and development on submarine cable systems.

During the evening, guests were invited to talk with several people in London from two telephone booths set up in the lounge at Murray Hill. The group in London included O. D. Grismore of the Laboratories, British workers who are making the Hawaiian Cable and several members of the Western Electric Company, the Long Lines Department, and the British Post Office.

The Murray Hill guests also heard a recording of the inaugural messages over the cable and saw the film "The Voice Beneath the Sea." Following the program they were invited to inspect the laboratories where many of the submarine cable developments took place.



“Our Mr. Sun” Introduces Bell System Science Series

Actor Eddie Albert checks a sequence in the film “Our Mr. Sun,” while Director Frank Capra (center) and Dr. Frank Baxter, narrator, look on.

The Bell System will sponsor a series of about three hour-long color telecasts a year devoted to a variety of scientific subjects. The first program in this series, to be carried over the Columbia Broadcasting System network, is called “Our Mr. Sun.” It will be telecast on Monday, Nov., 19 at 10:00 P.M. (EST).

The Bell System is sponsoring the Science Series because of its conviction of the increasing importance of science as a rich resource and vital element in the life of us all. In commenting on the series, Cleo F. Craig, Chairman of the Board of the American Telephone and Telegraph Company, said, “We of the Bell Telephone Companies hope that by showing the drama and excitement of science we can, in a modest way, help it to flourish and do even more for people, everywhere.”

The Bell System is one of the nation’s largest employers of scientific personnel, and has long been concerned about the increasing need for trained people in various scientific fields. One purpose of the television science series, therefore, is to interest young people in following scientific careers. To help further this aim, the science series will be made available, on film, for educational uses after the initial telecasts.

The programs in the science series dramatize the vital role of science in everyday life in the modern world through effective film techniques which are themselves as much a part of our technological age as they are of the art of our time. This has made it possible to bring home effectively, to a broad television audience of people with a wide variety of backgrounds and interests, the interrelation science and the whole endeavor and art of civilization.

Underlying all the planning and direction of the programs, however, has been the requirement that they be completely trustworthy. Meticulous care has been taken to make each production not only as entertaining and interesting as other types of films,

but above all to make it scientifically accurate.

To help insure that the telecasts are authoritative, an advisory board of experts in various fields has been engaged to work closely with the Bell System. Dr. Ralph Bown, formerly Vice President-Research of the Laboratories and now retired, is chairman of this board and the consultant on Engineering. Dr. Bown has been closely involved with the development of the series from its inception. Other members are: Dr. George W. Beadle, California Institute of Technology, Biology and Genetics; Dr. John Z. Bowers, University of Wisconsin, Medicine; Prof. Paul R. Burkholder, Brooklyn Botanic Garden, Microbiology and Bacteriology; Dr. Farrington Daniels, University of Wisconsin, Chemistry; Dr. Maurice Ewing, Columbia University, Earth Sciences; Dean George R. Harrison, Massachusetts Institute of Technology, Physics; Dr. Clyde Kluckhohn, Harvard University, Anthropology; and Dr. Warren Weaver, Rockefeller Foundation, Mathematics. Dr. John R. Pierce, Dr. A. G. Jensen and Dr. W. T. Wintringham, all of the Laboratories, are assisting the advisory board in various ways, including advice and assistance on color

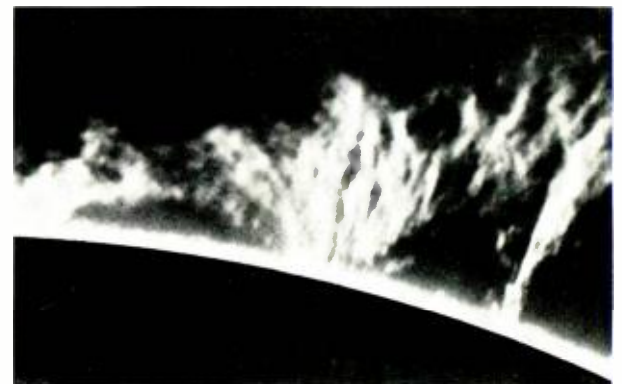

American Museum of Natural History.

Prominence activity on the surface of the sun is illustrated by film sequences.

television problems and the future of electronics.

Special scientific advisors on the production of "Our Mr. Sun" include Dr. Farrington Daniels, University of Wisconsin; Dr. Armin Deutsch, Mt. Wilson and Palomar Observatories; Dr. Donald Menzel, Harvard University; Dr. Walter Orr Roberts, University of Colorado High Altitude Observatory and Dr. Otto Struve, University of California.

Frank Capra, who has received wide acclaim for his ability to deal creatively with serious ideas, was chosen to direct the first program in the Science Series. He has made use of live actors, animation and special film sequences to make the informative content entertaining to the vast television audience. Solar pictures are included that were taken with telescopes and coronagraphs at Mt. Wilson and Palomar Observatories and the University of Colorado High Altitude Observatory. These films illustrate sunspots and activity on the surface of the sun.

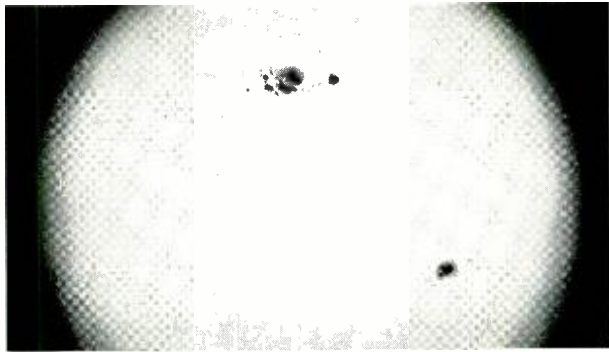

American Museum of Natural History.

Sunspots are illustrated in the telecast.

Eclipses of the sun and scenes from eclipse expeditions were obtained from other scientific organizations. Time-lapse pictures of the aurora borealis were furnished by Cornell University scientists working in the field. Abroad, camera crews photographed solar research in radio physics in Australia at Mount Louis, in France, in India and in Japan.

During the course of the program, "Our Mr. Sun" takes us from man's early picture of the sun as a beneficent god to the no less wonderful picture which science has given us of the physical nature of the sun and its relation to the planets of the solar system. We see the variety of ways in which the sun is vital to life on the earth, both in the growth of the food which sustains us, and as the source of the fuel which makes our science and technology possible. Films and animated sequences describe the corona, sunspots and sunspot cycles, and eruptions from the surface of the sun called "prominences." Other se-

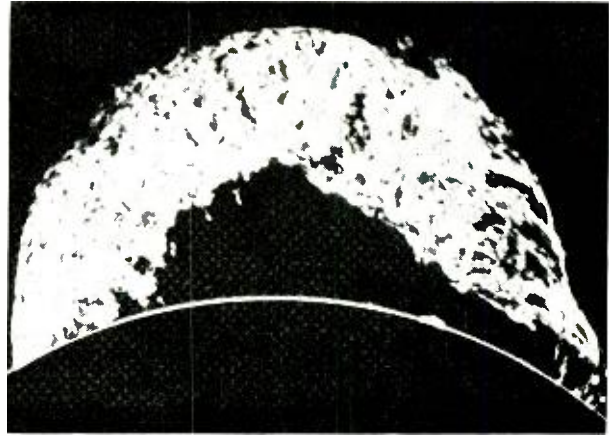

University of Colorado High-Altitude Observatory.

Spectacular prominence activity provides dramatic moment in "Our Mr. Sun."

quences describe current theories on the origin of solar energy including the "carbon cycle" theory proposed by Dr. Hans Bethe of Cornell University, and the hydrogen-helium fusion process. Still other parts show various attempts to use the energy of the sun directly to do the work now done by our decreasing resources of the fossil sunlight, which constitutes our present fuels — wood, coal, gas and oil. One sequence shows experiments on chlorella, and another, the development of the Bell Solar Battery.

The program brings out the fact that increased knowledge of the behavior and constitution of "our star — the sun" has been, and increasingly is, of value not only in such fields as chemistry and nuclear and atomic physics but in sociology, medicine and even in world politics. Recent developments, including the Bell Solar Battery and solar furnaces of many sorts, are shown in the film to have possible applications in the near future. The use of solar stoves is shown in areas where fuel is relatively scarce and expensive.

"Our Mr. Sun" indicates that, in the near future, solar energy, together with its partner, nuclear energy, may be the means whereby people in areas that are poor in other sources of power may be able to raise substantially their standards of living. The sun is shown in the telecast acting as a source of power that may provide the means of someday making many of the desert areas of the earth into food-producing fertile land.

"Our Mr. Sun" will be the only production in the science series to be telecast in 1956. Productions planned for next year will describe other branches of scientific knowledge. These include "Blood and the Human Circulating System," "Cosmic Rays," and "The Nature and Causes of Weather."

K. Bullington Awarded Stuart Ballantine Medal

K. Bullington of the Laboratories Systems Engineering Department was awarded the Stuart Ballantine Medal by The Franklin Institute at its annual Medal Day ceremonies on October 17.

The Institute honored Mr. Bullington for his ". . . advancement of space communications by means of beyond-the-horizon tropospheric wave propagation which resulted from his vision in recognizing the reliability of this means; his ability in planning and executing a broad experimental program; his engineering interpretation of the results which has led to effective design of communication systems employing this means."

After tests carried out at the Laboratories under Mr. Bullington's direction, he concluded that reliable beyond-the-horizon communication over the frequency range extending from 40 to 4,000 mega-

cycles is feasible at a distance up to 300 miles or more, but that high transmitter powers and large antennas will be required for reliable voice channels beyond 200 miles.

A graduate of the University of New Mexico with a B.S. degree in Electrical Engineering, Mr. Bullington received his Master of Science Degree from Massachusetts Institute of Technology in 1937. Until World War II, he was occupied with systems engineering work on wire transmission circuits. Since 1942, he has been concerned with transmission engineering on radio systems, especially with radio propagation studies.

Mr. Bullington received the Morris Liebmann Memorial Prize for 1956 for his work in tropospheric transmission beyond the horizon. He is the author of many published papers on radio propagation, a Fellow of the Institute of Radio Engineers and a member of Phi Kappa Phi, Sigma Tau and Kappa Mu Epsilon honorary fraternities.

Talks by Members of the Laboratories

During September, a number of Laboratories people gave talks before professional and educational groups. Following is a list of speakers, titles, and places of presentation.

THIRD NATIONAL CONFERENCE ON TUBE TECHNIQUES, NEW YORK, N. Y.

- Becker, E. J., see Pondy, P. R.
Craft, W. H., see Koontz, D. E.
Frost, H. B., *Measurement of the Total Cathode Resistance in Receiving Tubes.*
Helmke, G. E., see Pondy, P. R.
Koontz, D. E., and Craft, W. H., *Deposition and Stability of Transparent Conductive Coatings on Glass.*
Luckner, L. B., and Nielsen, R. J., *A Small Copper Radial Vane Grid for Reflex Klystrons* (presented by R. J. Nielsen).
Nielsen, R. J., see Luckner, L. B.
Olsen, E. G., *The Use of Powdered Glass as a Bonding Medium in Traveling Wave Tube Construction.*
Pondy, P. R., and Helmke, G. E., *Dust-Lint Evaluation and Control in Electron Device Assembly Areas.*
Pondy, P. R., Becker, E. J., and Robinson, H. J., *A Pressed Refractory Matrix Cathode System.*
Robinson, H. J., see Pondy, P. R.
Walsh, E. J., *Diffusion Welding, a Technique for Joining Metals.*

OTHER TALKS

- Biggs, B. S., see Lundberg, C. V.
Anderson, O. L., *A Review of Statistical Flaw Distribution Theories Applied to Glass Strength*, American Chemical Society, Palmerton, Pa.
Aspell, E. J., *Design of a 30-Watt Radio Telephone and Telegraph Transmitter for Use in Emergency Radio Networks*, Watchung Valley Radio Club, Westfield Municipal Center, Westfield, N. J.
Calbick, C. J., *Ejection of Particles During Evaporation of Carbon, and Thickness of Evaporated Carbon Films*, Electron Microscope Society of America, University of Wisconsin, Madison, Wis.
Darlington, S., *Digital Techniques in Missile Guidance Systems*, Advisory Group for Aeronautical Research and Development, Venice, Italy.
David, E. E., and McDonald, H. S., *Speech Communication*, Naval Reserve Unit, Princeton, N. J.
Dudley, H. W., *Synthesis of Speech*, Akron University Engineering School and Akron District of the Society of Professional Engineers, University Club, Akron, Ohio.
Dudley, H. W., *Review of Speech Synthesis*, I.R.E. Detroit Section, Detroit, Mich.
Garn, P. D., *An Automatic Recording Balance*, American Chemical Society, Atlantic City, N. J.
Geballe, T. H., see Kunzler, J. E.
Geyling, F. T., and Flugge, W. (Stanford University), *A General Theory of Deformations of Membrane Shells*, Université Libre, Brussels, Belgium.
Gibbons, D. F., *Acoustic Relaxation in Ferrite Single Crystals*, Conference on Ultrasonic Energy Losses in Crystalline Solids, Brown University, Providence, R. I.
Hull, G. W., see Kunzler, J. E.

- Kramer, H. P., and Mathews, M. V., *A Linear Coding for Transmitting a Set of Correlated Signals* (Presented by M. V. Mathews), Boston Symposium on Information Theory, Massachusetts Institute of Technology, Cambridge, Mass.
- Kretzmer, E. R., *Experiments on Favorable Encoding of Pictorial Information*, VDE/NTG Convention, Frankfurt, Germany.
- Kunzler, J. E., *A Semi-Adiabatic Heat Capacity Calorimeter for Measurements between 15 and 300° K*, Calorimetry Conference, Baltimore, Md.
- Kunzler, J. E., Geballe, T. H., and Hull, G. W., *Germanium Resistance Thermometers Suitable for Low Temperature Calorimetry*, Calorimetry Conference, Baltimore, Md.
- Lunsden, G. Q., *Wood Poles for Communication Lines*, Second Pacific Area National Meeting, ASTM, Los Angeles, Calif.
- Lundberg, C. V., Vacca, G. N., and Biggs, B. S., *Resistance of Rubber Compounds to Outdoor and Accelerated Ozone Attack*, Rubber Division, Am. Chemical Society, Atlantic City, N. J.
- Mason, W. P., *Internal Friction and Fatigue in Metals at Large Strain Amplitudes* (Presented by F. T. Geyling), International Congress of Applied Mechanics, Brussels, Belgium.
- Mason, W. P., *Internal Friction and Fatigue in Metals at Large Strain Amplitudes*, Conference on Ultrasonic Losses in Crystalline Materials, Brown University, Providence, R. I.
- Mathews, M. V., see Kramer, H. P.
- McDonald, H. S., see David, E. E.
- Mendizza, A., *The Standard Salt Spray Test — Is It a Valid Acceptance Test?*, Symp. Electrodeposited Coatings, ASTM Committee B-8, Los Angeles, Calif.
- Raisbeck, G., *Bell Solar Battery*, Illinois Bell Telephone Company Engineers, Chicago, Ill.
- Raisbeck, G., *Solar Electric Power Sources*, Central Illinois Section of the A.I.E.E., Springfield, Ill. and Joint Meeting of A.I.E.E., The American Institute of Architects, The Rock River Valley Chapter of Professional Engineers, The Rock River Valley Electric Association and The American Institute of Tool Engineers, Rockford, Ill.
- Ryder, R. M., *General Comments on Proving Component Reliability* (Presented by M. C. Waltz), Transistor Reliability Symp., New York City, N. Y.
- Savadelis, I. C., *Reliability Design of Grown Junction Transistors for P-Carrier System*, Transistor Reliability Symp. (sponsored by the Advisory Group on Electron Tubes), Western Union Telegraph Co., New York City, N. Y.
- Shannon, C. E., *Some Geometric Results in Channel Capacities* (Presented by E. R. Kretzmer) VDE/NTG Convention, Frankfurt, Germany.
- Siegmann, P. J., *Results of a Comparison of the Guttman Scaling Technique and Factor Analysis of Attitude Questions*, American Statistical Association, Detroit, Mich.
- Stansel, F. R., *Results of Transistor Reliability Studies During Type P Carrier Field Tests*, Transistor Reliability Symp. (sponsored by the Working Group on Semiconductor Devices), Western Union Telegraph Co., New York City, N. Y.
- Turnbull, W. G., *The Effect of Tolerances in Molded Plastic Parts on the End User*, Society of Plastic Engineers Meeting, New York City, N. Y.
- Vacca, G. N., see Lundberg, C. V.
- Van Horn, R. H., *Experimental Evaluation of the Reliability of Solderless Wrapped Connections*, Second RETMA Conference on Reliability of Electrical Connections, Philadelphia, Pa.
- Weiss, J. A., *A New Faraday Rotation Phenomenon and Its Application to Microwave Switching*, I.R.E., New Jersey Section, PCMTT, Arnold Auditorium, Murray Hill, N. J.
- White, P. R., *Industry Survey Question and Answer Session*, 2nd RETMA Conference, Philadelphia, Pa.
- Williams, J. C., *The Industrial Uses of Ceramics*, Drew University, Air Research and Development Command, Madison, N. J.

Papers Published by Members of the Laboratories

Following is a list of the authors, titles and places of publication of recent papers published by members of the Laboratories.

- Baldwin, M. W., Jr., and Nielsen, G., Jr., *Subjective Sharpness of Simulated Color Television Pictures*, Optical Soc. Am. J., **46**, pp. 681-685, Sept., 1956.
- Bemski, G., *Quenched-in Recombination Centers in Silicon*, Phys. Rev., **103**, pp. 567-569, Aug. 1, 1956.
- Bommel, H. E., see Mason, W. P.
- Brady, G. W., see Mays, J. M.
- Brown, W. L., see Montgomery, H. C.
- Cutler, C. C., *Instability in Hollow and Strip Beams*, J. Appl. Phys. Letter to the Editor, **27**, pp. 1028-1029, Sept., 1956.
- Dacey, G. C., see Thomas, D. E.
- Dail, H. W., Jr., see Galt, J. K.
- Feher, G., *Observation of Nuclear Magnetic Resonances Via the Electron Spin Resonance Line*, Phys. Rev., Letter to the Editor, **103**, pp. 834-835, Aug. 1, 1956.
- Ferrell, E. B., *A Terminal For Data Transmission Over Telephone Circuits*, Proc. Western Joint Computer Conf., pp. 31-33, Feb. 7-9, 1956.
- Galt, J. K., Yager, W. A. and Dail, H. W., Jr., *Cyclotron Resonance Effects in Graphite*, Phys. Rev., Letter to the Editor, **103**, pp. 1586-1587, Sept. 1, 1956.
- Garrett, C. G. B., *The Physics of Semiconductor Surfaces*, Nature, **178**, p. 396, Aug. 25, 1956.
- Goldey, J. M., see Moll, J. L.
- Goldstein, H. L., and Lowell, R. J., *Magnetic Amplifier Controlled Regulated Rectifiers*, Proc. Special Tech. Conf. on Magnetic Amplifiers, pp. 145-147, July, 1956.
- Guldner, W. G., *Application of Vacuum Techniques to Analytical Chemistry*, Vacuum Symp. Trans. pp. 1-6, 1955.
- Hittinger, W. C., see Warner, R. M., Jr.
- Holonyak, N., see Moll, J. L.
- Jaccarino, V., see Shulman, R. G.
- Lowell, R. J., see Goldstein, H. L.

Papers Published by Members of the Laboratories, (Continued)

- Luke, C. L., *Determination of Traces of Gallium and Indium in Germanium and Germanium Dioxide*, Anal. Chem., **28**, pp. 1340-1342, Aug., 1956.
- Luke, C. L., *Rapid Photometric Determination of Magnetism in Electronic Nickel*, Anal. Chem., **28**, pp. 1443-1445, Sept., 1956.
- Mason, W. P., and Bonnell, H. E., *Ultrasonic Attenuation at Low Temperatures for Metals in the Normal and Superconducting States*, J. Acous. Soc. Am., **28**, pp. 930-944, Sept., 1956.
- Mays, J. M., and Brady, G. W., *Nuclear Magnetic Resonance Absorption by H_2O on TiO_2* , J. Chem. Phys., **25**, p. 583, Sept., 1956.
- McLean, D. A., *Tantalum Capacitors Use Solid Electrolyte*, Electronics, **29**, pp. 176-177, Oct., 1956.
- Moll, J. L., Tanenbaum, M., Goldey, J. M., and Holonyak, N., *P-N-P-N Transistor Switches*, Proc. I.R.E., **44**, pp. 1174-1182, Sept., 1956.
- Montgomery, H. C., and Brown, W. L., *Field-Induced Conductivity Changes in Germanium*, Phys. Rev., **103**, pp. 865-870, Aug. 15, 1956.
- Moore, E. F., *Artificial Living Plants*, Sci. Am., **195**, pp. 118-126, Oct., 1956.
- Moshman, J., see Tien, P. K.
- Nelson, L. S., *Sapphire Lamp for Short Wavelength Photochemistry*, Optical Soc. Am. J., **46**, pp. 768-769, Sept., 1956.
- Nielsen, G., Jr., see Balwin, M. W., Jr.
- Phelps, J. W., *Protection Problems in Telephone Distribution Systems*, Telephony, **151**, pp. 20-22, 47-48, Sept. 1, 1956.
- Remeika, J. P., *Growth of Single Crystal Rare Earth Orthoferrites and Related Compounds*, Am. Chem. Soc. J., **78**, pp. 4259-4260, Sept. 5, 1956.
- Shulman, R. G., and Jaccarino, V., *Effects of Superexchange on the Nuclear Magnetic Resonance of MnF_2* , Phys. Rev., Letter to the Editor, **103**, pp. 1126-1127, Aug. 15, 1956.
- Shulman, R. G., and Wyluda, B. J., *Nuclear Magnetic Resonance of Si^{29} in n- and p-Type Silicon*, Phys. Rev., Letter to the Editor, **103**, pp. 1127-1129, Aug. 15, 1956.
- Slepian, D., *A Note on Two Binary Signaling Alphabets*, Trans. I.R.E., PGIT, IT-2, pp. 84-86, June, 1956.
- Snoke, L. R., and Richards, A. P., *Marine Borer Attack on Lead Cable Sheath*, Sci., Letter to the Editor, **124**, p. 443, Sept. 7, 1956.
- Tanenbaum, M., see Moll, J. L.
- Thomas, D. E., and Dacey, G. C., *Application Aspects of the Germanium Diffused Base Transistor*, Trans. I.R.E., PGCT, CT-3, pp. 22-25, Mar., 1956.
- Tien, P. K., and Moshman, J., *Monte Carlo Calculation of Noise Near the Potential Minimum of a High Frequency Diode*, J. Appl. Phys., **27**, pp. 1067-1078, Sept., 1956.
- Uhler, A., Jr., *Two-Terminal p-n Junction Devices for Frequency Conversion and Computation*, Proc. I.R.E., **44**, pp. 1183-1191, Sept., 1956.
- Warner, R. M., Jr., and Hittinger, W. C., *A Developmental Intrinsic-Barrier Transistor*, Trans. I.R.E., PGED, ED-3, pp. 157-160, July, 1956.
- Weinreich, G., *The Transit Time Transistor*, J. Appl. Phys., **27**, pp. 1025-1027, Sept., 1956.
- Wolff, P. A., *Theory of Plasma Resonance*, Phys. Rev., **103**, pp. 845-850, Aug. 15, 1956.
- Wyluda, B. J., see Shulman, R. G.
- Yager, W. A., see Galt, J. K.

Patents Issued to Members of Bell Telephone Laboratories During August

- Baker, W. O., and Winslow, F. H. — *Methods of Forming Bodies of Dehydrogenated Hydrocarbon Polymers* — 2,758,940.
- Belek, E. — *Wire Wrapping Tool for Stranded Wire* — 2,760,731.
- Brewer, S. T. — *Relay Circuits* — 2,759,130.
- Chaffee, J. G. — *Directive Antenna Systems* — 2,759,182.
- Collins, R. J., Reynolds, F. W., and Stilwell, G. R. — *Process of Making Photoconductive Compounds* — 2,759,861.
- Cutler, C. C. — *Traveling Wave Frequency Modulator* — 2,760,161.
- Felker, J. H. — *Serial Binary Digital Multiplier* — 2,758,787.
- Felker, J. H. — *Transistor Memory Circuits* — 2,760,087.
- Fletcher, R. C. — *Method and Apparatus for Determining Phase Angle and/or Coupling Sign in Measuring Microwave Impedances* — 2,760,156.
- Fox, A. G. — *Directional Phase Shifter* — 2,760,166.
- Graham, R. S., and Sperry, R. V. — *Equalizer* — 2,760,164.
- Hamilton, B. H. — *Transistor and Electromagnetic Control Apparatus* — 2,759,142.
- Kelly, H. P. — *Phase and Transmission Measuring System* — 2,760,155.
- King, A. P. — *Wave-Guide Mode Filter* — 2,760,171.
- Kircher, R. J. — *Ringling Circuit* — 2,759,179.
- Lozier, J. C. — *Two-Stage Transistor Feedback Amplifier* — 2,760,007.
- Mallina, R. F. — *Wrapped Electrical Connection* — 2,759,166.
- May, A. S. — *High Frequency Attenuator Means* — 2,760,170.
- Meacham, L. A. — *Pulse Transmission System and Regenerative Repeater Therefor* — 2,759,047.
- Oliver, B. M. — *Beam Aperture Correction in Horizontal and Vertical Direction* — 2,759,044.
- Reenstra, W. A. — *Number Group Circuit* — 2,760,004.
- Reynolds, F. W., see Collins, R. J.
- Schneider, H. A. — *Pulse Train Generator Circuits* — 2,760,089.
- Schneider, H. A. — *Direct Current Voltage Restoration Circuit* — 2,760,090.
- Shockley, W. — *Frequency Selective Semiconductor Circuit Elements* — 2,761,020.
- Sperry, R. V., see Graham, R. S.
- Stilwell, G. R., see Collins, R. J.
- Sullivan Miles V. — *Deposition of Metal Films from Carbonyls* — 2,759,848.
- White, H. A. — *Switching Device* — 2,759,371.
- Winslow, F. H., see Baker, W. O.
- Yaeger, R. E. — *Binary Code Translator, Adder and Register* — 2,758,788.