

# ELL LABORATORIES RECORD

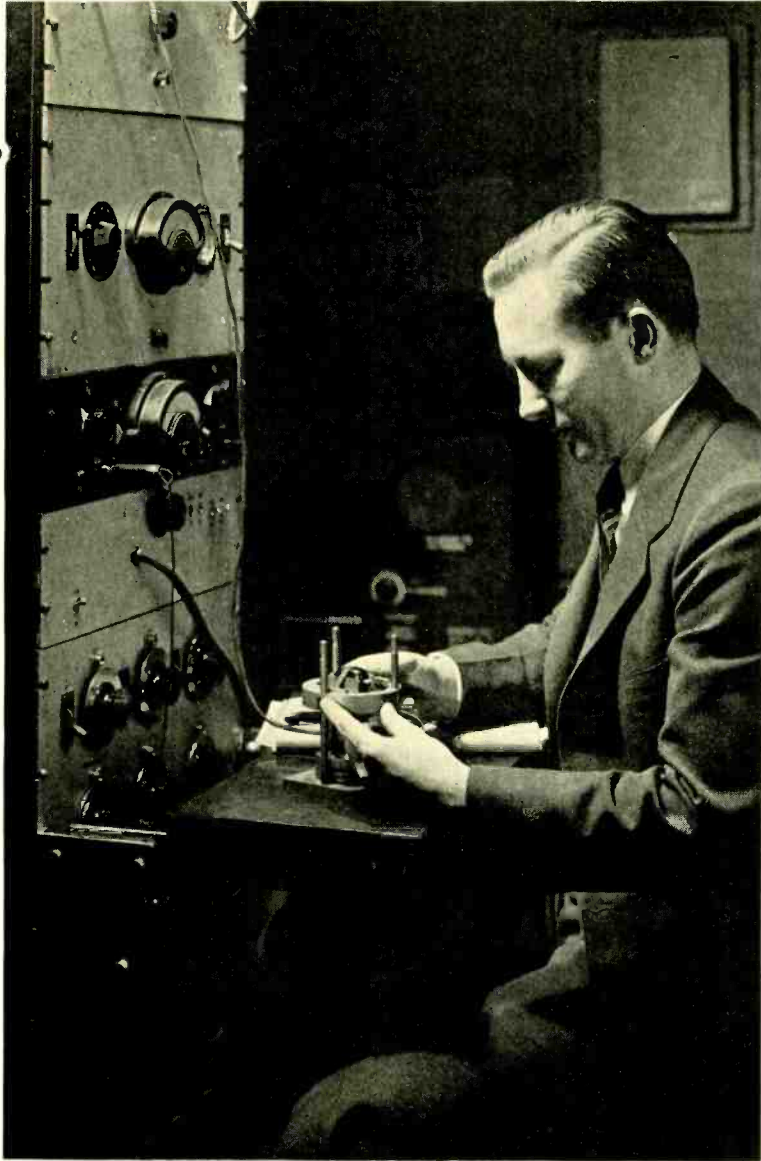

AUGUST  
1938

VOLUME XVI

NUMBER XII

*Testing a bone-conduction  
receiver*

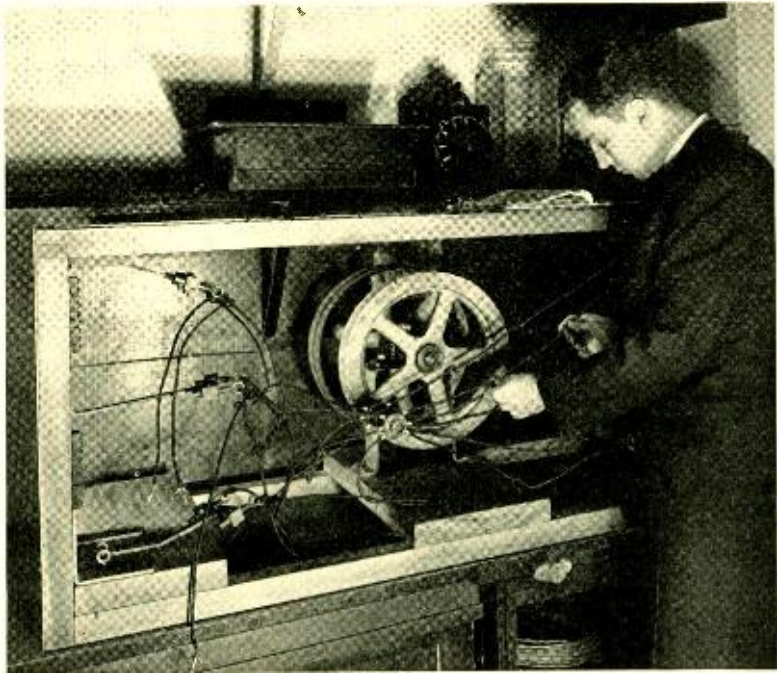

## Rubber-Insulated Station Cords

By H. H. STAEBNER  
*Telephone Apparatus Development*

**F**ROM the moment of its installation a telephone station cord is subject to a variety of forces tending to shorten or terminate its useful life. It is bent, twisted, kinked, rubbed, and strained day in and day out, and yet under these diverse destructive influences the conductors should not break, the insulation should not fail, and the outer braid should not fray. Besides these mechanical hazards, it must withstand contact with water, or excessive dampness, as well as perspiration from the hands. Rain may blow on it from an open window, wet umbrellas may be leaned against it, or in a large variety of ways water may gain access to the wires to cause leakage of current and in this manner accelerate

corrosion, or to rot the textile coverings.

For many years the insulation and outer covering of Bell System textile-insulated cords have been given a water repellent treatment similar in effect to that used in water-proofing woolen topcoats. While this treatment has been very effective in preventing trouble from casual wettings, field experience has shown that it does not afford complete protection under unusual conditions of wetting or under continued exposure to dampness. Under such conditions nothing less than a rubber insulation will serve, and because of this, for a number of years the Bell System has provided rubber-insulated cords that are available for use under these exceptional situations.

Although rubber-insulated cords

have been used in very damp locations, rubber of the kind commercially available has never been as satisfactory for general use in telephone cord insulation as the very carefully prepared textiles that have been usually employed. The rubber-insulated cords were necessarily larger and stiffer than the textile-insulated cords, and the rubber tended to deteriorate with time at a greater rate than the textile materials. Cords of this type were used, therefore, only under service conditions of exceptional severity; as a result the number made each year was comparatively small, and the cost correspondingly high.

In recent years a large amount of research has been conducted on rubber compounding,\* and much better rubber compounds are now available than could be obtained some years ago. In these Laboratories, work has been carried on with the particular objective of obtaining compounds suited for use in the telephone plant, as recounted in a past issue of the RECORD.† With these compounds, it seemed possible, therefore, to develop a more satisfactory type of rubber-insulated station cord that would be adaptable to large-scale production methods, and comparable in

cost with the textile-insulated type. The preliminary results were so satisfactory that it seemed desirable to extend the initial objective, and to develop a rubber-insulated station cord for universal use. This has been done,

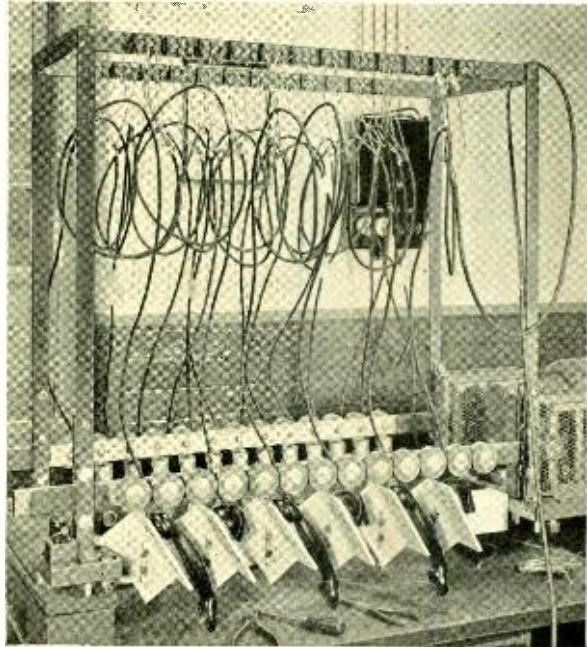

Fig. 2—A machine to study the effect of bending the cord back and forth over the entrance of the handset

and rubber-insulated station cords are now available for general use.

To the layman a station cord probably seems a commonplace thing, but as a matter of fact it is a complex structure, every part of which must be carefully chosen to secure a satisfactory service performance. In developing a new type of cord, therefore, every structural element must be duly considered, and every change must be justified by an adequate determination of its probable effect on the service that the product will give. The construction of the textile-insulated

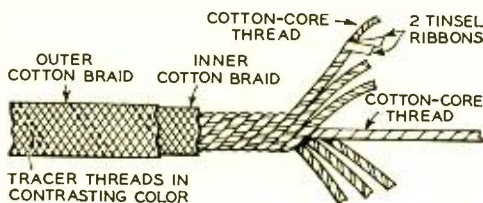

Fig. 1—Construction of the present textile-insulated cord conductor

\*RECORD, October, 1936, p. 34.

†RECORD, November, 1937, p. 85.

cord conductor that was previously standard is shown in Figure 1. It consists of six conducting elements, or tinsel threads, each made up of two tinsel ribbons wound around a cotton thread. These six tinsel threads are then in turn stranded around a core of cotton thread to form the complete conductor. A cotton braid is woven over this conductor, and then an outer braid. The outer braid carries the colored tracer threads used to identify the various conductors of the cord. A number of such conductors laid together in parallel and enclosed with a braided outer covering form the completed cord.

The former rubber cords used the same tinsel conductor structure as the textile cords, but over the conductors were placed two servings, or wrappings of cotton yarn, then the rubber insulation, and then an outer cotton braid carrying the tracer threads. As these insulated and braided conductors were larger and less flexible than the textile-insulated conductors they were generally twisted together, rather than laid parallel before the covering braid was put on, in order to provide cords of sufficient flexibility.

After an improved rubber compound had been developed, there remained the task of designing a cord structure. The individual conductors had to be small and flexible enough to allow them to be laid parallel in the cord and thus permit the use of the recently developed automatic braiding machines. To obtain estimates of the relative qualities of various cord constructions, a variety of testing machines have been developed and built which subjected the cords to the sort of wear they would receive in service, but at a greatly accelerated rate. In the machine shown in the photograph at the head of this article, for example, the cords are placed in position in an initially twisted condition which causes kinks to form near the middle of the cord. In the operation of the machine the cords are repeatedly pulled out from this twisted and kinked condition. At frequent intervals the cords are inspected for fraying of the braids and are tested electrically for breaks in the conductor. The cords are tested in pairs—each pair consisting of a standard and an experimental cord—and the results are obtained in terms of this com-

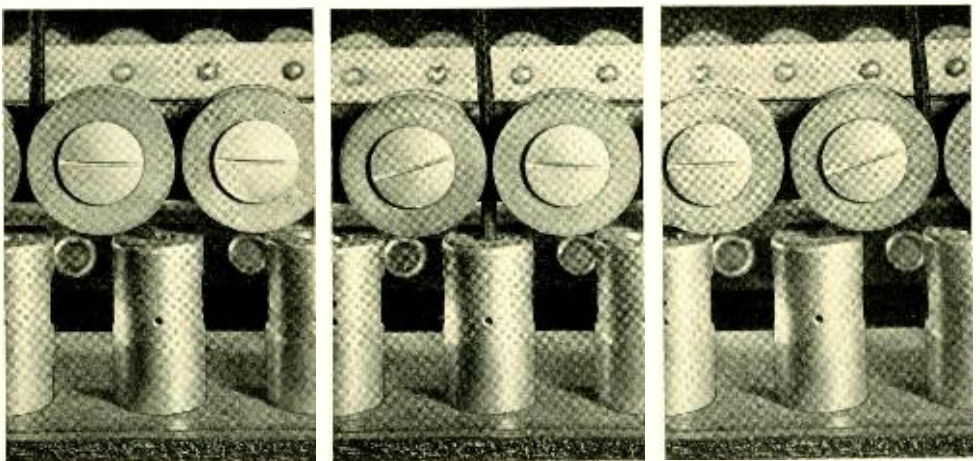

*Fig. 3—The cord is bent over the rounded edges of the cord holders between two rollers which are moved back and forth by a reciprocating bar*

parison rather than on an absolute measurement of cord durability.

In another machine, shown in Figure 2, the cords are bent back and forth across the entry hole of the handset handle, or across the top of cord holders shaped to simulate handset handles. This machine also is motor driven, and tests for conductor continuity are made periodically. The motion of the machine in bending the cord is shown in detail in Figure 3, which gives the two extreme positions and the mid-position as the crossbar carrying the rollers that flex the cords is moved back and forth by the motor drive. These two tests indicate the sort of treatment to which the experimental cords are subjected in the laboratory. They are supplemented by field trials of cords incorporating structural features of various materials which appear to be quite promising.

The conductor construction that has proven satisfactory, and is being used in the new rubber-insulated cords, consists of the standard tinsel conductor, covered first with a single fine cotton braid. Over this is placed the rubber insulation in colors corresponding to the tracer colors used in the textile braided conductors. These insulated conductors, placed parallel, are then covered with an outer braided covering of cotton.

One feature of this new type of cord that required consideration was the

design of a satisfactory cord tip for use with the rubber-insulated tinsel conductor. For the textile cords these have been of the solderless type already described.\* Such tips could not be used with the previous rubber cords because connections sufficiently stable in resistance could not be secured. However, the new type of tip that was

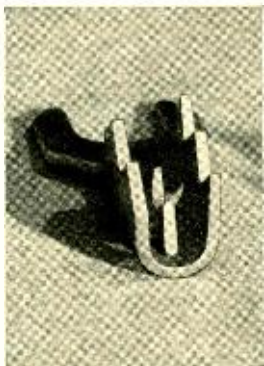

*Fig. 4—Conductor tip used for the new rubber-insulated cords*

developed has tangs so formed as to readily penetrate the rubber-insulated conductor and produce permanent low-resistance connections with the tinsel core. The penetration of the tangs was also aided materially by careful proportioning of the U-shaped portion of the tip relative to the diameter of the rubber-insulated conductor. In this way the conductor is held in position at the start of the closing operation until the tangs

have made their initial penetration of the rubber insulation.

The completion of the development work has made available an improved rubber-insulated cord, comparable both in manufacturing cost and service life to the textile-insulated cord, and having the additional advantage of being water-proof. Practically all of the station cords now being manufactured are rubber insulated, and are being used for most of the new stations and to replace the textile-insulated cords that become defective. Ultimately the new rubber-insulated cords will come into general use.

\*RECORD, July, 1926, p. 196.



# Acoustic Delay Circuits for Laboratory Use

By A. C. NORWINE  
*Circuit Research Department*

SPEECH energy takes about as long to travel through a hundred feet of pipe as an air wave as it does to travel electrically from New York to San Francisco over a regular telephone connection. This fact goes a long way toward explaining why a certain room in the Graybar-Varick building contains twenty-four large oblong boxes, each enclosing a coil of brass pipe with a loudspeaking receiver at each end. They are acoustic delay circuits, which in recent years have greatly expedited tests of voice-operated devices such as echo suppressors. To the casual observer their novelty lies in their form and their number, but to the engineer it lies in their large signal-to-noise ratio and negligible internal echoes.

It has been known for some time that the acoustic delay has much to recommend it for applications in which voice-frequency signals must be delayed for a considerable time. One

reason for this is its relative freedom from delay distortion. The velocity of sound within an acoustic unit is nearly the same for all voice frequencies. Delay distortion, arising from the different velocities of different frequencies, can therefore be made small more readily than in electric circuits. In addition, the signal-to-noise ratio for an acoustic delay circuit may be kept very large by careful design, and this gives it an advantage over the ordinary types of magnetic recorder, which might also be employed for obtaining long delays. The poorest delay circuit of the group of twenty-four has over 60 db margin between undistorted peak power and unweighted noise output, while for the majority the margin is over 75 db. Measured with message-circuit weighting already described in the RECORD,\* these margins are about 75 and 90 db, respectively.

Five sizes of delay from 23 to 150

\*RECORD, April, 1937, p. 252.

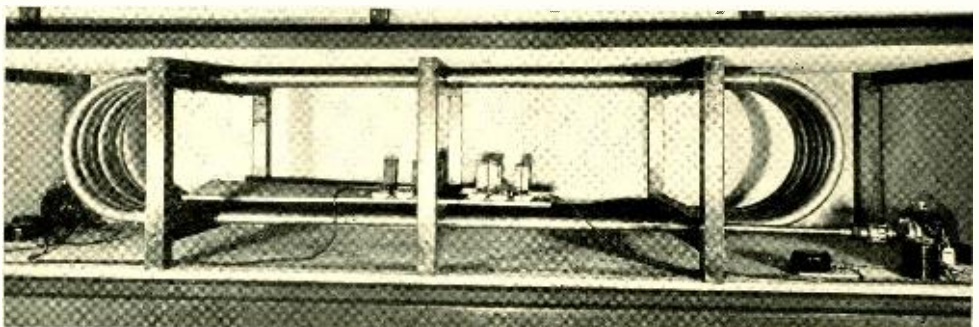
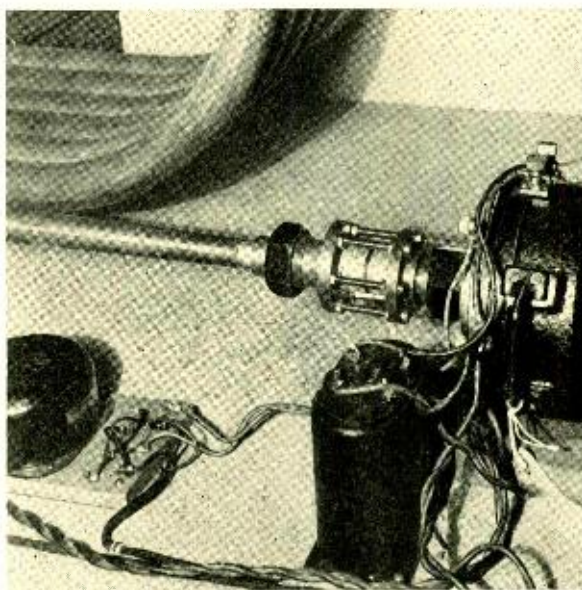

Fig. 1—An acoustic delay circuit showing the receivers and coupling transformers at each end, the equalizer in the center, and the attenuator between receiver and pipe at the right

milliseconds are included in this group, and since sound travels about 1100 feet a second in the brass pipes that comprise the delay paths, their lengths range from 25 to 165 feet. The pipes are curved into oblong loops, however, to produce more compact units; and at their ends are 555w receivers for converting the electrical speech signals to and from their acoustic form. Amplifiers are required to make up for the loss in the circuit, and these are mounted on bays in the same room. Equalizers also are needed to correct for the variation in loss at different frequencies, and these are installed on a board which, for convenience, is laid within the loop of the delay pipe. A typical delay circuit, showing receivers and equalizer, may be seen in Figure 1, which shows a one-hundred-millisecond delay circuit with one side of its housing removed.

Some of the studies of voice-operated devices require the perception of echoes which the devices should suppress, and it is important, therefore, that no additional echoes be produced by the delays included in the test circuit. In a delay circuit of this type, echoes are caused by the difference in acoustic impedance between the sound-carrying tube and the receivers, and the delay circuit must be so designed as to reduce them to negligible values. Since the loss in a pipe varies inversely with the diameter, echoes could be reduced to imperceptible values by employing small enough pipes. Unfortunately, however, the loss also varies with frequency, so that for very small pipes, the high frequencies as well as the echoes might



*Fig. 2—The transmitting end of a delay circuit*

be lost. This method of reducing echoes can thus be employed only to a limited extent. It is used as much as practicable and as a result the pipes range from 0.4 to 1.37 inches in inside diameter, depending on length.

Additional protection against echoes is secured by acoustic attenuators which were developed by P. B. Flanders, and are described in an accompanying article.\* Such an attenuator is mounted between the pipe and receiver at the transmitting end. An applied signal passes through the attenuator and proceeds to the receiver at the receiving end where partial reflection occurs. This echo passes back through the pipe, through the attenuator, is partially reflected at the sending receiver, and again passes through the attenuator to the receiver at the other end. While the signal passes through the attenuator only once, the echo passes through it three times, and thus suffers three times as much loss as the signal itself.

\*Page 403, this issue.

The attenuator may be seen in greater detail in Figure 2. The two flanges joined by long bolts are not part of the attenuator itself, but merely serve to secure it to the pipe and receiver in such a way as not to bring to bear on it mechanical pressure that would change its characteristics. The attenuator provides a  $\pi$ -type resistance network. Its inside diameter is 0.7 inch—the same as that of the throat of the receivers—and a tapered pipe is used as an acoustic transformer to connect it to the delay pipe. Attenuators having losses of 10, 15, and 20 db are now in use.

The narrow openings to the inside of the sound circuit, formed by annular slits which constitute shunt resistances in the attenuators, provide a path for the entrance of noise or crosstalk; it is for this reason that the net-

works are enclosed in individual celotex housings. In some instances, it is also necessary to wrap the attenuator in sound-absorbing material. To minimize possible "pick-up" from the outside, the attenuators are always installed at the sending end of the delay circuit, where the transmission level is highest. For the same reason these delay circuits, complete with their amplifiers, are wired to other parts of the laboratory, and the delay room itself is unoccupied.

Response curves of one of the longer delay circuits, with and without its equalizer, are shown in Figure 3. An attempt is made to keep the equalized output within  $\pm 2$  db for frequencies that range from 200 to 3000 cycles. The gains of a repeater following the delay and one preceding it are included in the curves that are shown.

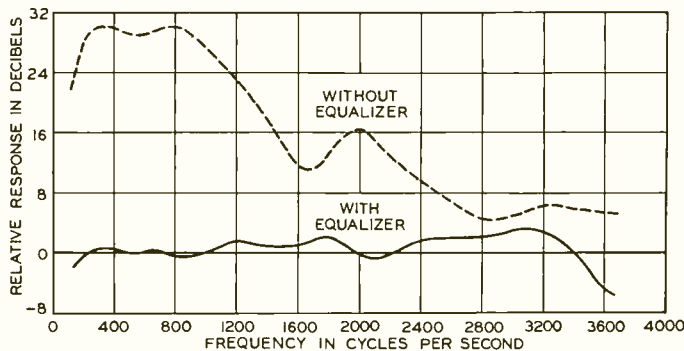
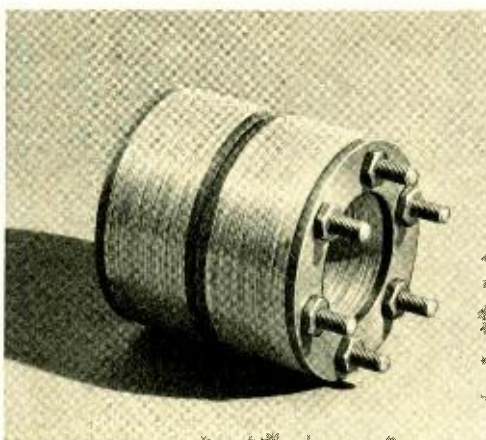

Fig. 3—Response curves of an acoustic delay circuit with and without equalizer. The curves that are given here include the input and output amplifiers





## Acoustic Attenuators

By P. B. FLANDERS  
*Acoustical Research Department*

**A**TTENUATION, as its name implies, is a process of thinning out or weakening. Familiar examples of attenuators are constrictions or throttles in pipes, thermal insulation in houses, smoked glass, and acoustic insulation for sound-proof rooms. Less familiar, perhaps, are electrical attenuators, which have been used for some time in telephony, and the newer acoustic attenuators used in the acoustic delay circuits described in an accompanying article.\* These different attenuators are all analogous, and function in one or both of two ways. The attenuation they produce may be due to obstructing or throttling, as in the case of a constricted pipe; or it may be due to absorption of energy within the attenuator, as in the case of smoked glass. Few attenuators are purely of one type or the other.

Despite the number of damping or sound-absorbing materials that are available in acoustics, there is no

\*Page 400, this issue.

natural material having the character of a substantially pure acoustic resistance of controllable magnitude. Since there is considerable need for such pure resistance attenuators in acoustical research it has been necessary to create them in the form of built-up units.

Acoustic resistance can be obtained by forcing air through a small hole. The resistance is due to internal viscosity, which may be visualized as friction between adjacent layers of air that are in relative motion. In the ordinary motion of air, all layers move with about the same velocity, so that frictional losses are small; but when air is forced to move through a small hole, friction causes the velocity of adjacent layers to vary from zero at the boundary to a maximum at the center. The smaller the hole, the higher will be the resistance because of the greater effect of the sides.

In addition to internal friction, air also has mass which, in response to the alternating pressure waves of sound,

must be accelerated first in one direction and then in the other. Thus time is required to attain a particular velocity in either direction. As the frequency is raised, this time for acceleration becomes shorter and consequently the maximum velocity reached in a half cycle becomes smaller. Such opposition to alternating forces is called mass reactance. It varies with frequency and is, therefore, undesirable in an attenuator, which should give the same loss for all frequencies.

This mass reactance increases as the size of the hole decreases, as does the resistance, but fortunately it increases at a slower rate. Because of this fact

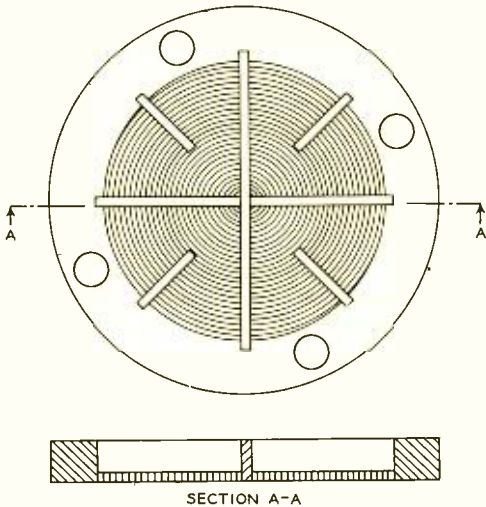

Fig. 1—One form of acoustic resistance consists of a spiral of narrow copper tape with adjacent turns very close together

the mass reactance becomes negligible compared to the resistance when the hole is made sufficiently small. With a round hole having a diameter of 0.0013 inch, for example, the reactance is only ten per cent of the resistance at 5000 cycles, and at 2500 cycles is only five per cent. The resistance of a single hole of this size would ordinarily be much too high,

but this can be corrected by using a sufficient number of holes to obtain the resistance desired. The reactance would also be decreased, but its relative value would remain the same.

A substantially pure acoustic resistance was first made by wrapping copper tape, about 0.02 inch wide and 0.0007 inch thick, into a spiral, with the turns spaced 0.0012 inch apart. Such a unit is shown in Figure 1. It is somewhat expensive to build, and as a result has had but occasional use. A less expensive form was developed by H. C. Harrison. Essentially it is a type of expanded metal. A thin sheet of metal is sheared in a number of closely spaced parallel lines, and then the sheet is expanded in a direction at right angles to these lines to form a series of narrow, closely spaced slots.

In one form, the metal is 0.007 inch thick with sheared slots 0.012 inch apart. The metal is then expanded until the slots are 0.0015 inch wide.

This form of resistance is primarily of the obstructing or throttling type if placed directly in the path of the

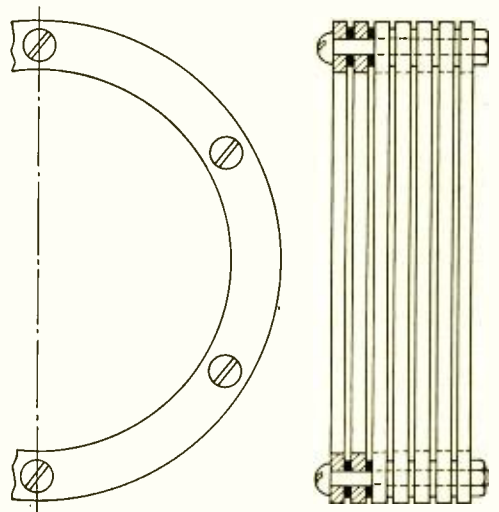

Fig. 2—A shunting or absorbing form of acoustic resistance can be built from a series of closely spaced washers

sound. A resistance of the absorbing type, for use where sound is being conducted through a tube, may be made by assembling a series of washers with thin spacers between them to form a series of circumferential slots of the same general magnitude as those of the expanded metal resistance. The inner diameter of the washers is the same as the diameter of the tube with



Fig. 3—The expanded metal form of acoustic resistance corresponds to a series electrical resistance as at "a," and the "washer" form corresponds to a shunt or absorbing resistance as at "b"

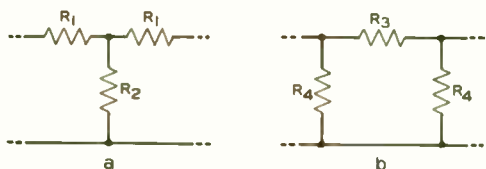

Fig. 4—To match the characteristic impedance of a circuit it is necessary to assemble three resistances to form either a T network as at "a" or a  $\pi$  network as at "b"

which the resistance is to be used, and the spacers take the form of small washers around the bolts that hold the assembly together. The general arrangement of the resistance is indicated in Figure 2.

Either of these types of resistances avoids distortion of the sound due to mass reactance. Distortion may also arise, however, due to reflection, which occurs whenever the characteristic impedance of the sound path changes its value. To be able to utilize such resistances satisfactorily in acoustic circuits, therefore, some

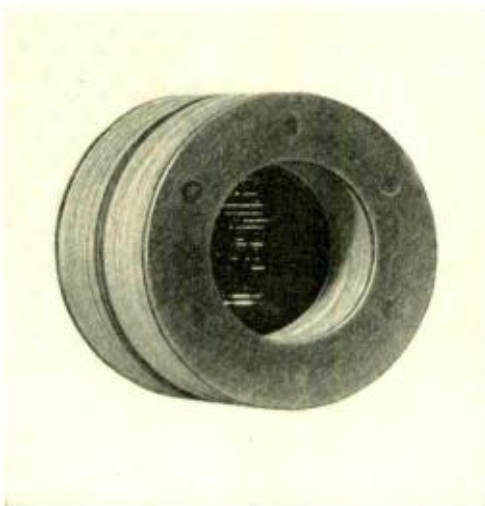
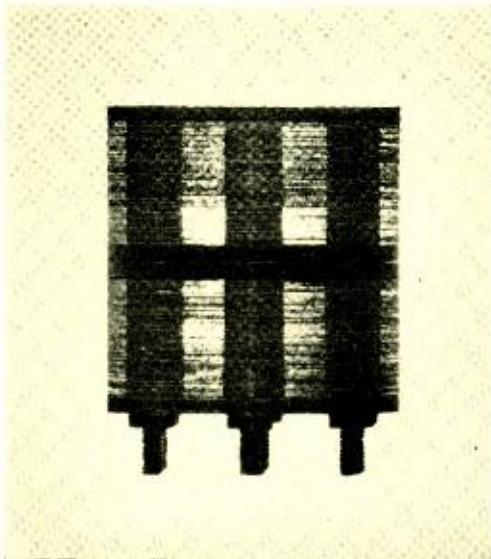

Fig. 5—The slots of the series resistance are too narrow to be seen except when light is allowed to shine through them

method must be devised of making the impedance of the attenuating element match, or equal, the impedance of the sound circuit in which it is connected.

The two types of acoustic resistances described above correspond to a series and shunt resistance in an electric circuit as shown at "a" and "b" in Figure 3. Either of these types of resistances placed in an electric circuit causes reflection because it causes a discontinuity, or sudden change, in the characteristic impedance of the circuit. It can be shown, however, that if two resistances of one type and one of the other are arranged as shown in Figure 4, and given certain values that are easily determined, there will be no reflection because the resistance of the three-element network will match the characteristic resistance of the circuit. This will also be true of acoustic resistances in an acoustic circuit, so that by assembling these acoustic resistances, two of one type and one of the other, a distortionless attenuation may be obtained.



*Fig. 6—By placing a strong light at one side of the attenuator the narrow space between the washers may be seen, and the bolts holding the assembly together are silhouetted*

The resistance assemblages of Figure 4 are known as  $\tau$  and  $\pi$  networks, respectively, because of the shape of the arrangement. For the same characteristic impedance and attenuation,

the resistances of the  $\pi$  network are of larger magnitude than those of the corresponding  $\tau$ , and since it is easier to build large acoustic resistances than small ones, a  $\pi$  network is preferable for acoustic work.

A unit of this type, used in the delay network described on page 400, is shown in the photograph at the head of this article. It consists of two shunting resistances of the washer and spacer type, and a series resistance of the expanded metal type between them. Figures 5 and 6, taken so that light shines through the two types of resistances, illustrate their construction. Limited adjustment of the resistances may be obtained after assembly by a parallel bending of the narrow strips of metal, as if they were slats in a Venetian blind. This effectively narrows the width of the slots. It may be accomplished by running the end of a pencil transversely across the resistance. This type of acoustic attenuator has proved very satisfactory and has found comparatively wide employment.

# Improvements in Relay Coil Insulation

By J. S. GARVIN  
*Telephone Apparatus Development*

A RELAY coil is a composite structure. While the wire itself is insulated, a variety of additional insulating components enter as essential parts of its make-up. With different functions to perform, these various insulating elements must have different mechanical properties, and yet all must have adequate dielectric strength and heat resistance, and they must not tend to promote coil corrosion. Studies and tests must therefore be continuously carried on to insure that the most suitable insulating materials available are employed in the almost countless relays required for the telephone plant.

The principal insulating parts are: the spool heads, spool-head washers, core cover, insulation between windings, and coil cover. These are indicated in Figure 1. In addition there is the insulation over lead-out wires and frequently a certain amount of insulation to smooth out the winding. The spool heads and spool-head washers form the end supports of the winding, and must be rigid and strong, while the core and coil covers must be tough and flexible.

This difference in mechanical properties and the chief electrical characteristics were recognized, of course, in the design of the very earliest relays, but the effect of the insulation on coil corrosion was hardly suspected. As a result available materials that met the known electrical and mechanical requirements were selected. For the most part they were jute manila

paper and bookbinder's cloth for the various wrappings, and vulcanized fibre for the spool heads. It was discovered before long, however, that a major cause of failure in relay windings was not of an electrical or mechanical nature but was rather a corrosion of the copper wires. The trouble was chiefly encountered with the smaller conductors, which can withstand less corrosion before they become open-circuited.

Studies revealed that this corrosion was mainly electrolytic in nature, and that as a result it was most severe when the winding was positive to the core. Tests were devised for studying the corrosion of windings under what were essentially accelerated condi-

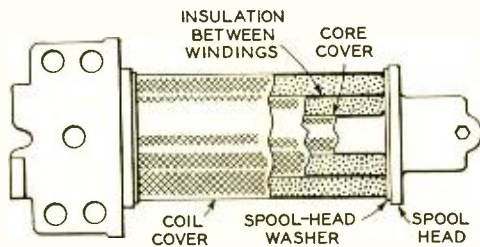
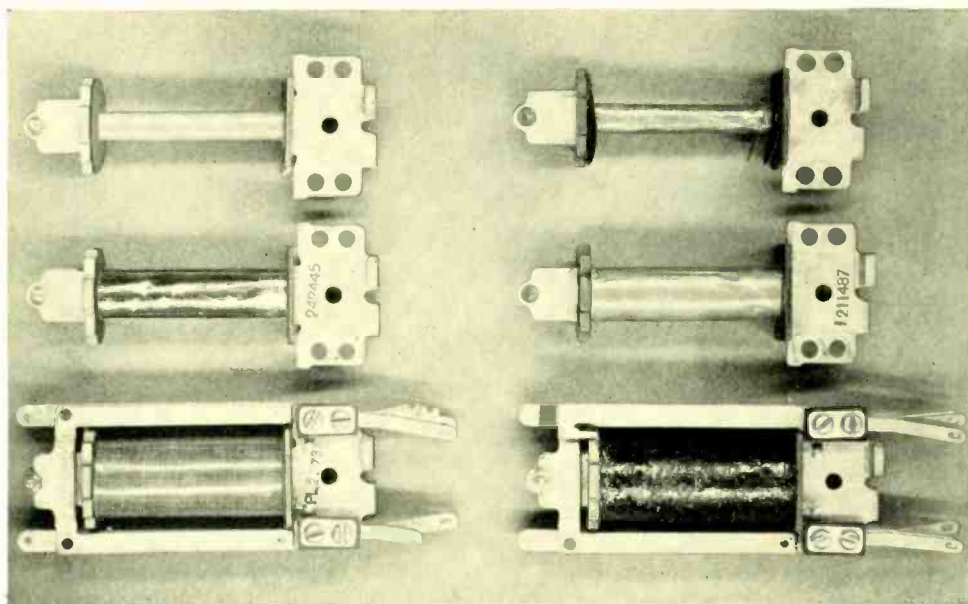

Fig. 1—Schematic cross-section of a typical relay showing major insulating parts

tions. Either moisture in the winding or low insulation resistance would accelerate the effect. A search was therefore made for materials with higher insulation resistance and which did not readily absorb moisture.

Waxed varnished Kraft paper was tried for core covers and insulation between windings, varnished red rope-



*Fig. 2—At left, relays employing cellulose acetate sheet throughout. At right, relays employing waxed paper for coil and inter-winding insulation and cotton serving coated with black shellac for coil cover*

paper for spool-head washers, phenol-fibre for spool heads, and bleached cotton serving for coil covers. While these materials proved much better than the ones they replaced, they did not result in satisfactory life with fine wires in humid climates. In an attempt to escape moisture absorption, impregnating the coils with beeswax and paraffin was tried. It was discovered, however, that the heat generated by the coils was sufficient to melt the wax, which would flow onto the moving parts of the relay and interfere with their proper functioning. Part of the wax was drained out in an effort to avoid this difficulty, but it was found that they were then little better than those without impregnation.

With the introduction of the dial system stricter requirements were placed on the operate and release times of relays. It was found that even waxed paper insulation caused uncertainty in the action of the relays be-

cause of small amounts of wax getting on the pole faces of the armature and core—either during manufacture or by flowing out later. It was seen, therefore, that not only would impregnation have to be given up, but that even the use of waxed paper was undesirable. In the search for more suitable insulation many materials were investigated. The most promising was cellulose acetate in one form or another. Corrosion was found to be due to a large extent to impurities in the form of salts and acids in the insulation. The advantage of cellulose acetate is that it is almost entirely free from such impurities. While previous efforts had been chiefly directed to keeping moisture out of the insulation, it was now found that with this very pure insulation, moisture had much less effect on corrosion. Efforts have been directed recently therefore to selecting the most suitable form of cellulose acetate for relay parts.

Phenol fibre is still employed for the spool heads, but cellulose acetate sheet is employed for the spool-head washers, replacing the red rope washers. Cellulose acetate yarn has been used for covering coils and cores and is entirely satisfactory with respect to corrosion. Something else was needed for insulation between windings, however, and cellulose acetate in both sheet and fabric forms was tried. The fabric was given a stiffening treatment to eliminate fraying and to facilitate punching and handling. It proved satisfactory so far as corrosion was concerned, but uniform stiffness was difficult to obtain, and because of the porosity of the fabric, the insulation to high voltages was lower than desired. Cellulose acetate in sheet form was much more satisfactory at high voltages, and is now being introduced throughout the coil for core covering, for insulation between windings, for spool washers, and for wrapping splices and lead-out wires. The spool-head washers of cellulose acetate sheet are formed where they fit over the core insulation to keep the wire from coming into contact with the core, and the cellulose acetate sheet between windings is corrugated at the ends to keep the wire of the outer winding from slipping down and crossing with the inner winding. The coil cover of cellulose acetate sheet is reinforced with muslin to give it strength, and the muslin is impregnated with vinsol. This cover is cheaper than the cellulose acetate thread, and equally good. In addition a cleaning step has been added to the manufacturing procedure to insure that the pole faces and all contacts and springs are free from wax or other substances that might later result in high contact resistance or failure of the relay to operate or release satisfactorily.

The comparative appearances of relays insulated with cellulose acetate sheet and with waxed paper are shown in Figure 2. The upper relays show just the core cover, spool head, and spool-head washers; the center illustrations show one winding in place and the between-winding insulation on; and the lower illustration, the completed relay with coil covering. The waxed paper relays are on the right, and their coil covering is cotton coated with black shellac. The improvement in corrosion failures brought about by these various changes is shown in Figure 3, where the per cent failures are plotted against days of test. No exact correlation between days of test and actual service life is

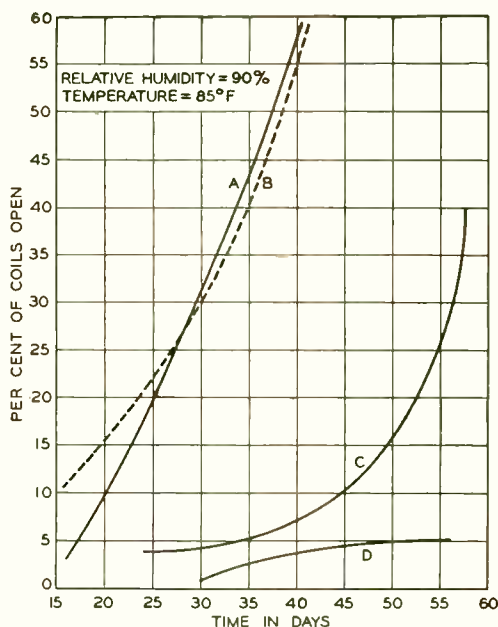

Fig. 3—Curves showing the effectiveness of various types of insulation in preventing failure due to wire corrosion: A—Waxed paper core cover and inter-winding insulation, with an outer cotton serving; B—Impregnated coils; C—Cellulose acetate yarn core and coil covers, waxed paper inter-winding insulation; D—Cellulose acetate sheet used throughout the relay assembly

possible, but an estimate may be obtained by assuming that one day of test is equivalent to one year of service.

The gain indicated by these curves is very considerable. With the coil insulated completely with cellulose acetate sheet, failure from corrosion is practically negligible. The improvement is a tribute to the effectiveness of continued research and development, and as frequently happens the

solution of the problem was of a somewhat unexpected nature. Having determined that the cause of the corrosion was chiefly electrolytic, one would expect that the corrosion would be decreased by preventing moisture from entering the winding; but it was not so easy to foresee that the elimination of small amounts of impurities in the insulating material would produce even greater beneficial effects.



*This Western Electric radio receiver, which is being installed on the giant Douglas DC-4 transport plane, is part of the most elaborate radio system yet developed for air service. It includes separate receivers for communication, beacon, weather and marker services, and a 250-watt transmitter. As the ship passes through the five radio zones of the transcontinental route, the transmitter and communication receiver to which it is geared are shifted progressively through five pairs of "day" and "night" frequencies, by means of a crank with an indicating dial on the transmitter panel*



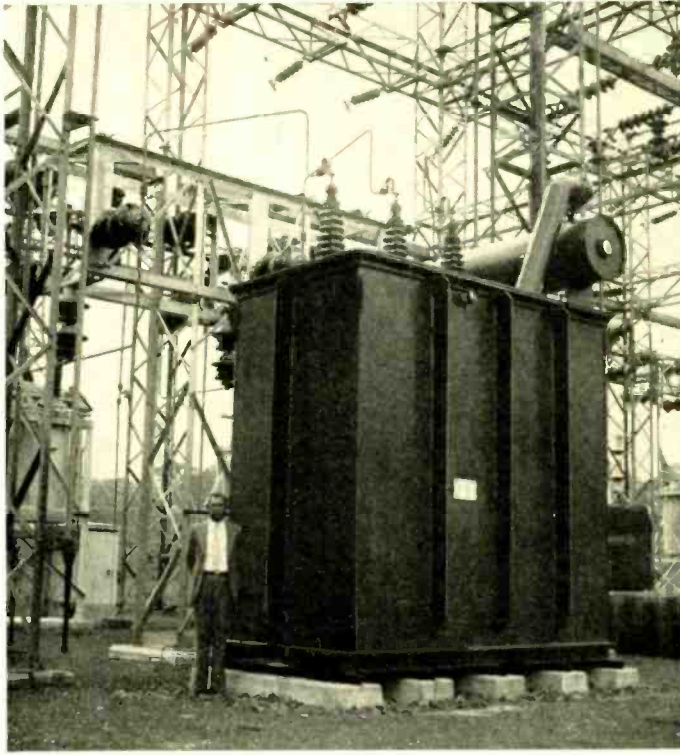

## Reducing Disturbances Produced on Telephone Circuits by Power Rectifiers

By P. W. BLYE

*Transmission Development Department*

THE increasing use of mercury-arc rectifiers for heavy duty power purposes and the accompanying wave-shape distortion on the power circuits with which they are associated have introduced an important problem of inductive coordination with paralleling telephone lines. New problems of this character, which are of mutual interest to the power and telephone industries, are usually referred for investigation to an organization known as the Joint Subcommittee on Development and Research, made up of representatives of the

Edison Electric Institute and the Bell System,\* and this organization has been studying the effects of rectifiers for several years. In addition to these general studies there have been a number of investigations of specific

---

\*The Joint Subcommittee on Development and Research is the part of the joint organization established by the Bell Telephone System and the Edison Electric Institute to consider problems of structural and inductive coordination, which is concerned with ascertaining the technical facts and the development of coordinative methods based on these facts. The joint work is under the general direction of the Joint General Committee and is carried out by the Joint Committee on Plant Coordination of which the Joint Subcommittee is a part.

field problems carried out in coöperation with the operating telephone and power or railway companies. The manufacturers of the rectifiers have participated extensively in practically all of these studies.

The results of the investigation of the wave-shape characteristics of rectifiers have been published in Engineering Reports of the Joint Subcommittee, and in papers before the American Institute of Electrical Engineers. They show that there is one inherent problem and problems involving the wave-shape characteristics of other types of power apparatus. With the more common types of apparatus,

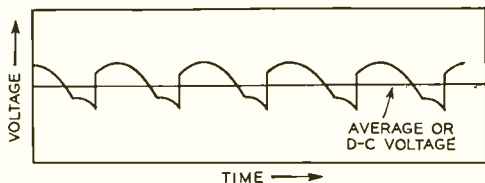

Fig. 1—Wave form of the output voltage of a typical six-phase rectifier under load conditions showing 360-cycle component

such as generators, motors, and transformers, the designer is able to control the generation of harmonics to a considerable extent, and it has been found commercially practicable to produce machinery of this character having relatively good wave shape. As a result of the coöperative efforts of the manufacturers and the power companies to this end, wave-shape conditions on power circuits employing these ordinary types of apparatus have usually been such that noise in exposed telephone lines could be maintained within satisfactory limits by the measures normally employed to limit the exposures and to restrict the influence of power circuits and the susceptibility of telephone circuits.

In the operation of rectifiers, however, the generation of harmonics in considerable magnitudes is inherent and, except for the choice of the number of phases, it has been found that the harmonics can be controlled to only a very limited extent in the design of the rectifier itself. As a result, the inductive influence of circuits with which rectifiers are associated may be from 5 to 10 times greater than that experienced with the more common types of machinery if adequate precautions are not taken. In a number of cases where the effect of rectifier installations was not anticipated, the ordinary coöordinative methods have therefore been found to be inadequate to cope with increased power system influence, and it has been found necessary to develop special devices for reducing the magnitudes of the harmonics on the power system to prevent their creating excessive disturbances on nearby telephone lines.

The studies have shown that, as might be expected, the design of frequency-selective devices for power systems is more complicated than the design of filters for accomplishing similar purposes on telephone lines. This results not only from the higher voltages and larger currents encountered, but also from the extreme range of impedances found on power systems. The impedance of a given system frequently exhibits series or

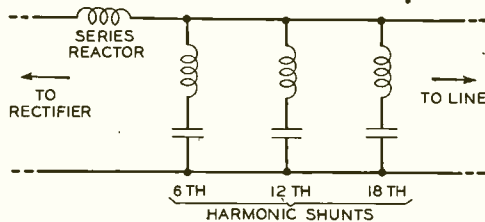

Fig. 2—Type of wave-shape corrective filter that is used in the output circuit of a six-phase power rectifier

parallel resonance points, or both, in the frequency range in which the more important harmonic frequencies lie. Furthermore it has been found necessary to consider carefully the impedance relations outside this range lest resonance be established between the filter and the line, thereby greatly amplifying harmonics not previously contributing to the noise.

The first rectifier problems studied involved induction between d-c trolley systems supplied by rectifiers and telephone systems. Figure 1 illustrates the wave form of the output voltage of a typical six-phase rectifier under load conditions. The fundamental frequency of the ripple superimposed on the d-c voltage is six times that of the

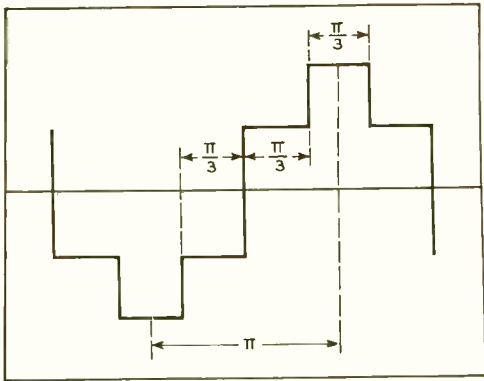

Fig. 3—Wave shape of input current to a six-phase rectifier

supply system frequency; when supplied from a sixty-cycle system, therefore, the frequency of this component is 360 cycles. All the harmonics of this ripple frequency are also present as indicated in Table I, which gives an analysis of the output voltage and current of a particular six-phase street railway rectifier. The table also gives the Telephone Influence Factor, abbreviated T.I.F., which is proportional to the weighted sum of all the

harmonic components, and is thus an index to the inductive influence of the particular power-system voltage or current on exposed telephone circuits. The T.I.F. of a sixty-cycle pure sine wave is unity, and for an average sixty-cycle power circuit is about

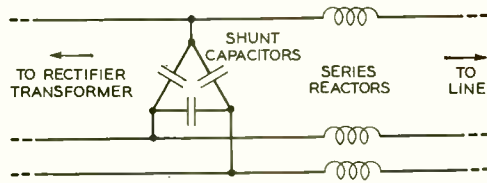

Fig. 4—Type of filter used in the a-c supply to a rectifier supplying a constant load

twenty. Because of their magnitudes and frequencies, the harmonic components in the range up to about 1500 cycles have usually been found of major importance from the coordination standpoint, although in particular cases the higher frequency components have also contributed materially to the noise.

The use of a twelve-phase rather than a six-phase connection has been found to reduce considerably the magnitudes of the sixth harmonic and its odd multiples in the d-c output, the twelfth harmonic becoming the fundamental component of the ripple. The use of twelve rather than six phases, therefore, has been found to reduce the severity of the coordination problem and consequently, where special remedial measures are necessary, to make them less expensive. However, it has usually not been sufficient to entirely eliminate the need for them. Theoretically, further increases in the number of phases would further reduce the number of harmonic components present and consequently the inductive influence. Because of the resulting complexity in the transformers, however, it has not to date

been found practicable to increase the number of phases in an individual rectifier unit beyond twelve.

The results of the extensive studies of frequency-selective devices suitable for use in the d-c output circuits of rectifiers are included in Engineer-

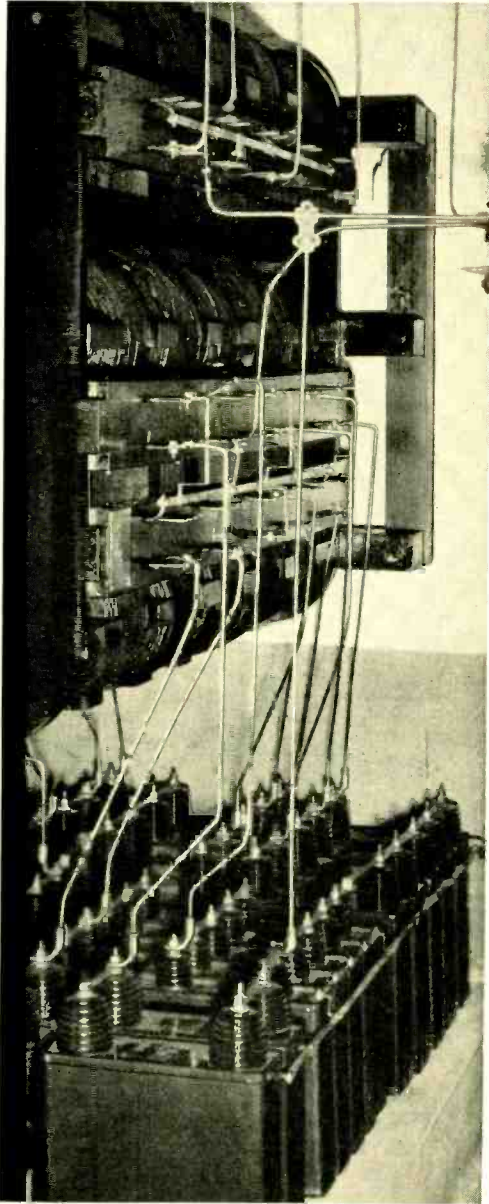

*Fig. 5—A five-element resonant-shunt filter for a 2300-volt supply bus*

ing Report No. 21 of the Joint Subcommittee on Development and Research. It was found that the type illustrated in Figure 2 was most practicable when wave-shape correction was required. This arrangement consists of a series reactor which carries the full output current of the rectifier, and a combination of resonant shunts tuned to the more important harmonic frequencies. Where a filter has been supplied with a six-phase rectifier, shunts for the sixth, twelfth, and eighteenth harmonics have always been provided, and sometimes an additional shunt for the 24th harmonic has been necessary. The series reactor is, of course, designed to have a low d-c resistance to prevent excessive d-c voltage drop. The shunt reactors are designed to have high ratios of reactance to resistance ( $Q$ ) at the tuned frequencies to minimize the amount of capacitance necessary for the low effective resistance required. The shunt capacitors must withstand the full d-c voltage and at the same time must carry safely the harmonic currents for which the capacitors are tuned.

It has been found practicable to secure reductions of the order of ten to one in the more important harmonic components and in the voltage T.I.F. in the output circuit of a rectifier by means of the type of filter illustrated. Since the impedance of the d-c system does not appreciably influence their effectiveness, particularly at the tuned frequencies, it has been found practicable to design filters of this type in advance of the installation of the rectifier, merely from a knowledge of the power rating of the rectifier and the voltage of the d-c system.

With the growth in the use of rectifiers not only for trolley systems but

for railway electrifications and in radio stations and industrial plants, problems arose due to harmonics on the a-c systems supplying the rectifiers, and the Joint Subcommittee turned its attention to these problems. The results of its studies of the a-c wave shape distortion associated with rectifiers are included in Engineering Report No. 22.

The theoretical wave form of the current in the a-c supply circuit to a six-phase rectifier, neglecting the impedance of the supply system, is as shown in Figure 3. An analysis of this current wave indicates the presence of all the odd harmonics except those such as the third, ninth, fifteenth, twenty-first, etc., that are odd harmonics of the third harmonic. The magnitude of a harmonic of the order  $N$  is equal to  $1/N$  times the current at the fundamental frequency. In practice, the wave form of the current and voltage on the a-c end has been found to depend to a considerable extent upon the impedance of the a-c supply system. With small rectifiers supplied from a large system of low impedance, the voltage wave-shape distortion has often been negligible. Conversely, a relatively large rectifier supplied from a system having appreciable impedance, has in some cases caused very considerable and widespread distortion of the voltage as well as of the current wave shape. An analysis of the current and voltage wave shape taken in a particular situation is illustrated in Table II. As in the d-c output circuit, a twelve-phase connection has been found to reduce considerably the magnitudes of cer-

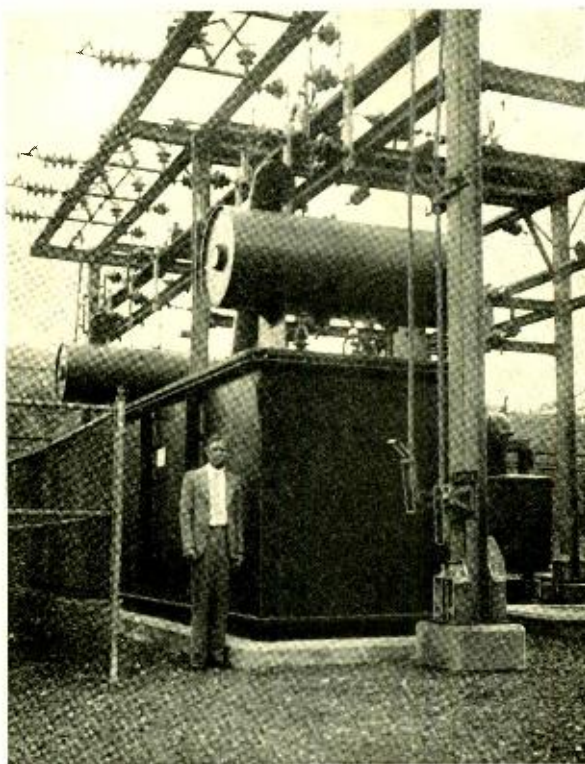

*Fig. 6—Resonant shunts on a 33,000-volt supply circuit to a 6000-kw rectifier*

tain of the harmonics present, but it has rarely been sufficient in itself to solve the problem entirely.

The development of suitable frequency-selective devices of reasonable cost for suppressing harmonics resulting from a rectifier has proved more difficult on the a-c than on the d-c end, because of the large number of harmonics present, the greater relative magnitudes of these harmonics, and the effects of the selective devices on the regulation and power factor. An additional difficulty has been that the rectifiers are supplied from a three-phase circuit, which considerably complicates the filter design. However, it has been found practicable to design such devices, and a number of them have been applied. Engineering Report No. 34 describes,

TABLE I—Magnitudes of Harmonic Currents and Voltages in Output of 6-Phase Rectifier Supplying Street Railway System

Frequency	Harmonic of A-C Supply Line Frequency	Volts	Amperes
d-c	..	608.0	1050.0
360	6	27.0	17.4
720	12	7.8	1.9
1080	18	5.2	0.50
1440	24	3.7	0.26
1800	30	3.5	0.19
2160	36	2.6	0.11
2520	42	2.7	0.06
2880	48	2.2	0.08
T.I.F.	..	150.0	.....

TABLE II—Harmonic Currents and Voltages in 33-Kv Supply Circuit to 1200-Kw Rectifier

Frequency	Harmonic of Line Frequency	Phase-Neutral Volts	Phase Amperes
60	1	18,300.0	24.9
300	5	610.0	2.12
420	7	257.0	1.28
660	11	246.0	.826
780	13	56.0	.544
1020	17	70.0	.212
1140	19	98.0	.161
1380	23	43.0	.107
1500	25	16.0	.10
1740	29	51.5	.097
1860	31	40.6	.085
2100	35	11.9	.048
2220	37	5.4	.032
2460	41	2.2	.033
T.I.F.	..	111.0	.....

in some detail, the results of the studies of the Joint Subcommittee in this field.

A schematic circuit diagram of a filter used in one particular application, involving a rectifier of about 200 kw supplying a constant load to a broadcast transmitter, is illustrated in Figure 4. This filtering circuit was installed in the 2300-volt circuit supplying the rectifier, and included series

reactors of about 13 mh each and shunt capacitors of 15 mf each. It successfully reduced the wave shape distortion, and because of the constant character of the load, the voltage drop resulting from the series reactors could be compensated by changing transformer taps.

With railroad rectifiers or rectifiers supplying broadcasting stations in which the load varies from moment to moment, the instantaneous regulation on the a-c supply circuit must be maintained at a minimum. This precludes the use of large series inductances in a wave-shape corrective filter. In such cases resonant shunts tuned to the more important harmonic frequencies have been found to provide a satisfactory type of frequency-selective device. Figure 5 illustrates a group of shunts applied in the 2300-volt circuit to a rectifier of about 1200-kw rating supplying a broadcasting station. Here the shunts were tuned to 660, 780, 1020, 1140, and 1380 cycles. With this filter the voltage T.I.F. on the 33-kv lines supplying the station was reduced from 111 to approximately 30.

A larger selective device applied directly in the 69,000-volt supply circuit to a 6000-kw railroad rectifier is illustrated in the photograph at the head of this article. Here the rectifier was of twelve-phase design, and it was necessary to provide shunts for the 660 and 780-cycle components only. In another instance, where adequate reductions of the 1020 and 1140-cycle components were not effected by the twelve-phase design, it was found necessary to include shunts for these frequencies as well as for the 660 and 780-cycle components. The latter installation was made on a 33,000-volt line supplying the rectifier, and is illustrated in Figure 6. In both these cases the selective devices reduced the

influence of the supply system to a degree that permitted the coördination of the power circuits with neighboring telephone lines by relatively simple supplementary methods.

It has been found that the design of a selective device for the a-c supply circuit to a rectifier depends to a considerable extent upon the supply

system impedance. In general, therefore, it has been necessary that these filters or resonant shunts be tailor-made to fit each individual situation. It has not been found practicable to provide such filters in advance except where the supply system was of a very simple type, the impedance of which could readily be calculated.

---

### *Telephone Statistics of the World*

*Of the 37,098,084 telephones in service on January 1, 1937, approximately one-half, or 18,433,400, were in the United States, according to a survey recently compiled by the American Telephone and Telegraph Company. By continents there were 19,952,423 in North America, 13,513,152 in Europe, 1,690,978 in Asia, 840,880 in Australia and other Pacific Islands, 765,435 in South America and 335,216 in Africa. Of the total number of telephones in use about 93 per cent could be reached by a subscriber in the Bell System. Private companies operated 22,538,753 or 61 per cent and government systems the balance. There were 18,300,000 automatic or dial telephones. Two American cities, Washington and San Francisco, lead the world's urban service with 37.43 and 37.00 telephones per 100 inhabitants, respectively, followed by Stockholm with 34.78 and Denver with 30.96.*

---

<i>Countries</i>	<i>Number of Telephones</i>	<i>Per Cent of Total</i>	<i>Telephones per 100 Population</i>	<i>Number of Telephone Conversations</i>
United States . . . . .	18,433,400	49.69	14.39	26,800,000,000
Germany . . . . .	3,431,074	9.25	5.08	2,562,000,000
Great Britain . . . . .	2,791,597	7.53	5.93	2,000,000,000
France . . . . .	1,481,788	4.00	3.51	941,000,000
Canada . . . . .	1,266,228	3.41	11.48	2,449,192,000
Japan . . . . .	1,197,129	3.23	1.70	4,772,000,000
Russia . . . . .	950,000	2.56	0.55	. . . . .
Sweden . . . . .	687,566	1.85	10.97	1,000,000,000
Australia . . . . .	562,868	1.52	8.31	514,000,000
Italy . . . . .	560,660	1.51	1.31	. . . . .
All others . . . . .	5,735,774	15.45	. . . . .	. . . . .
Total . . . . .	37,098,084	100.00	1.71	. . . . .

---



# Lifting a Finger Against Noise

By W. B. SNOW

*Acoustical Research*

**M**ANY a telephone user plugs his free ear with a finger when telephoning in a noisy place. This undoubtedly helps to reduce the distracting effect of sounds or nearby conversation; but experiment shows that it is the distraction, not the physical effect, which counts.

The effect of noise in reducing the intelligibility of speech is essentially the same as that of a reduction in loudness. This can be demonstrated by adjusting a radio receiving set to satisfactory loudness in the presence of a controllable noise, say that of an electric fan, and then shutting off the noise. The radio speech will immediately seem much louder and clearer. This experiment shows that noise which enters the ears with speech causes interference which makes the speech less intelligible.

When a noise, without interest value, is introduced into one ear, by

means of a rubber tube so that the head is not immersed in the noise, some sound is conducted across the head to the opposite ear but it is attenuated about 60 db. This experiment shows the interference caused by cross-conduction from the vibrating mechanism of the opposite ear—the interference which can be reduced by plugging that ear with a finger. On the other hand, when the head is immersed in noise, sound reaches the inner ear by transmission directly through the skull as well as through the normal path of the ear canals. For this reason, even when the canals are plugged or the ears are capped tightly by telephone receivers, the noise that the ears receive is attenuated only from 20 to 30 db.

Consequently, during a telephone conversation in a noisy place, the noise in the telephone ear picked up from outside by the head produces interference at least 30 db above that caused by the noise transmitted across the head from the free ear. Since tests have shown that adding two similar noises does not produce a change detectable by the ear if one is 25 db below the other, the noise from the free ear which is 30 db below that transmitted through the skull will cause no added interference. Therefore, stopping this ear will presumably be of no



physical benefit; but as previously stated it often helps by avoiding distraction when the interfering sound is of interest, as for example, a conversation between others who are in the same room.

The syllable articulation of a telephone circuit is a general indication of its value in transmitting speech. It is defined as the percentage of meaningless syllables which a crew of observers correctly understand after the syllables have been transmitted through the circuit. By employing the articulation test on an experimental telephone circuit it was possible to check directly the con-

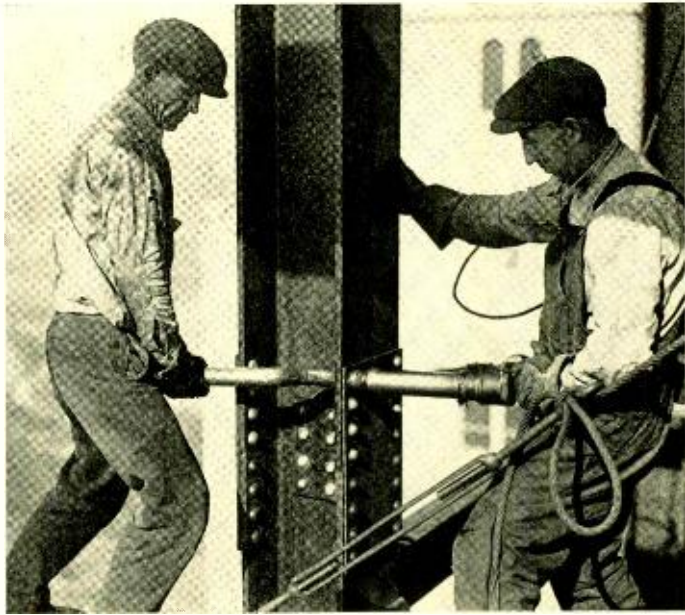

clusions of the last paragraph. Each observer wore a pair of receivers of which the left one carried the speech. Noise from a buzzer, which was used because it was steady and had no interest value, could be introduced into the observers' right ears by the auxiliary receivers, or into their left ears along with the speech. The syllable articulation was determined for various speech intensities from slightly above threshold to a high level for the three conditions indicated on the curves. The articulation rises rapidly to sensation levels of 50 to 60 db, which approximate the level of speech heard three feet from a speaker in a quiet place, and then remains relatively constant. Curves A and C show that the noise reduces speech at 70-db sensation level to the same intelligibility as speech without noise at 43-db level. But the noise introduced into the op-

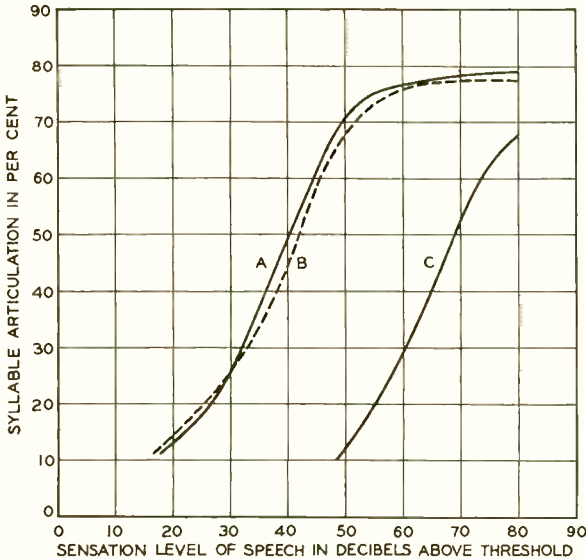
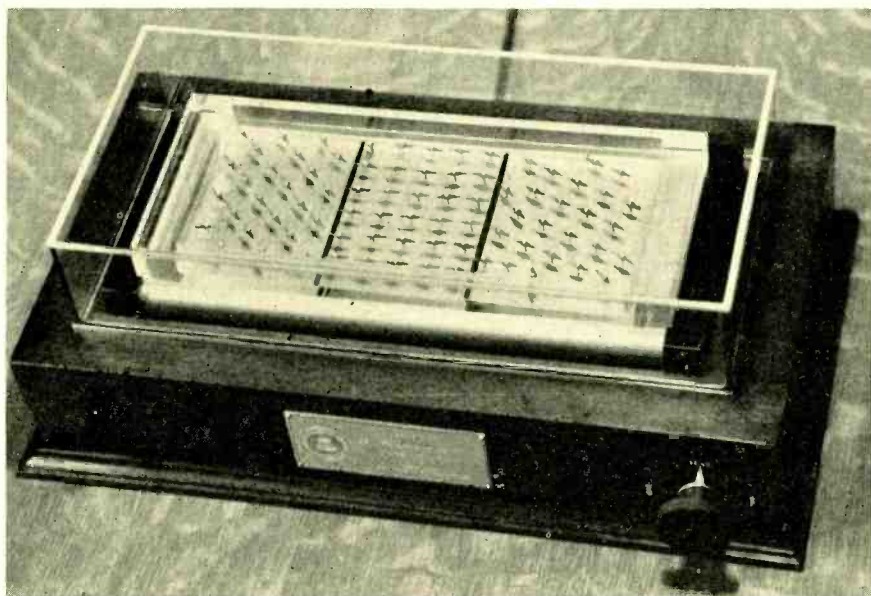

Fig. 1—The intelligibility of speech sounds applied to the left ear when nothing enters the right ear (A) is the same as when noise enters the right ear (B). But if both speech and noise enter the same ear (C) the speech has to be louder to be equally intelligible

posite ear caused negligible interference as was predicted by the indirect tests. This is confirmed by the fact that curves A and B, as shown in Figure 1, are practically identical.

Obviously the noise which enters the telephone ear with the sounds from the receiver causes the more serious physical interference with speech perception, although that which enters the free ear often distracts more by diverting attention

from the telephone conversation. These studies also indicate that even when the telephone is held tight to one ear and the other is stopped with a finger an appreciable amount of noise may reach the telephone ear. Improvement under these circumstances can be brought about by covering the transmitter opening with the hand but the most effective remedy for this situation is to provide less noisy surroundings for the telephone user.



*In this model demonstrating ferro-magnetic action, each magnet represents a "domain" or group of many atoms in a magnetic substance. The three groups of magnets, separated by black lines, represent three crystals each in turn consisting of many domains. A magnetic substance ordinarily shows no external magnetic field because its domains are magnetized in different directions and their effects cancel: each magnet (domain) points toward its nearest neighbor. In a weak field, applied to the model by turning the knob slightly, the magnets jump quickly into a partial line-up. The corresponding sudden motion of the domains causes the induced clicks or noise known as the Barkhausen effect. In a stronger field the magnets (domains) are pulled into closer alignment. Orientation of the domains depends not only on the magnitude of the applied field but also on the previous condition of magnetization. When residual magnetism is present, the domains present an ordered appearance, as shown in this photograph of a model loaned to The Franklin Institute at Philadelphia.*



# Pilot-Wire Regulators for Voice-Frequency Cable Circuits

By H. H. FEILDER  
*Toll Transmission Development*

WITH the introduction of cable for long toll lines, it became necessary to employ regulators to compensate for the change in loss of the cable conductors caused by variations in temperature. The greater part of the loss of a long toll line is offset by the gains of the repeaters; in a typical case only a small net loss of about 9 db is left. Whether or not regulation for temperature is needed, therefore, depends on whether or not the change in loss due to change in temperature is large in proportion to this net loss. Although other factors affect it, the major part of the change in loss is caused by the change in resistance of the conductor, which for copper wire is a little over 0.2 per cent per degree Fahrenheit. With open-wire lines the resistance change is small enough so that its effect can be compensated by occasional manual adjustment of the gain of the repeaters, but such a procedure is not generally adequate for cable circuits. On a four-wire cable circuit, for example, the conductor loss for a thousand miles may vary as much as 90 db over a year, and changes of 30 or 40 db in a day have been observed.

With loss changes of this magnitude, automatic regulation was obviously needed, and a suitable regulator was developed concurrently with the development of toll cable facilities for long four-wire circuits. This regulator,

already described in the RECORD,\* uses one pair of wires in the cable as a pilot circuit to determine the cable temperature change through the change in resistance of the pilot wire itself. The gains of the repeaters associated with the regulator are changed in accordance with the change in resistance of the pilot wire. The amount of gain adjustment provided by each regulating repeater must be restricted to keep the transmission level within the upper and lower limits set by crosstalk and noise consideration. The maximum range of each regulator, therefore, has been limited to about 19 db for long, four-wire circuits. This range is covered in twenty steps—ten steps in each direction from step zero.

With this limited range, a regulator can satisfactorily handle lengths of cable having loss variations with temperature not exceeding 19 db. The section of cable controlled by a regulator is known as a regulator section. Over such a section the net loss is held practically constant by the regulator insofar as temperature changes are concerned, but since the compensating gain is applied at one point, there will be a varying net loss to points within the section. A long toll circuit is made up of a number of such regulator sections, and it is desirable to have these sections terminate at large cities or cable junctions so that most

\*RECORD, *January, 1929, p. 183.*

of the circuits in a toll cable will include complete regulator sections. If this were not done, a great many circuits would include only a part of a regulator section, and would thus be subject to changes in loss as the temperature varied.

To meet these requirements, the regulator sections must vary in length, and to fit them to a given layout of toll centers and toll-line junctions requires considerable study. With sections in underground cable and with sections under about 140 miles in aerial cable, there is usually no question but that the regulator will have ample range to take care of the temperature changes on the section, but when a section of aerial cable is longer than this, the regulator range may not be adequate. Since the ability of the regulator to maintain the net loss of a section constant with respect to temperature depends on the total change in resistance due to temperature, it is

affected both by the length of the section and the maximum temperature range over it. Its regulating ability thus depends on the product of distance and temperature change, and is specified in degree-miles. The actual range of the regulator depends on the size of the pilot wire employed, and for 19-gauge conductors, for which the regulator was designed, it is about 18,100 degree-miles. This value was set during its development, and is based on such factors as the effect of the transmission level on distortion, noise, and crosstalk interference. In determining whether the regulator is adequate for a proposed section, therefore, both the length of the section and the maximum temperature range must be considered in relation to the regulator range.

The major part of the toll cable of the United States is located in the northeastern part of the country, where the mean temperature generally lies between fifty and sixty degrees Fahrenheit. For this reason the regulator was designed to be on its middle step when the temperature is fifty-five degrees. In considering the ability of the regulator to handle a proposed section, therefore, it is necessary to determine both the maximum and the minimum cable temperatures over its route, and from this to determine whether the regulator is adequate both for the total temperature range and for the ranges above and be-

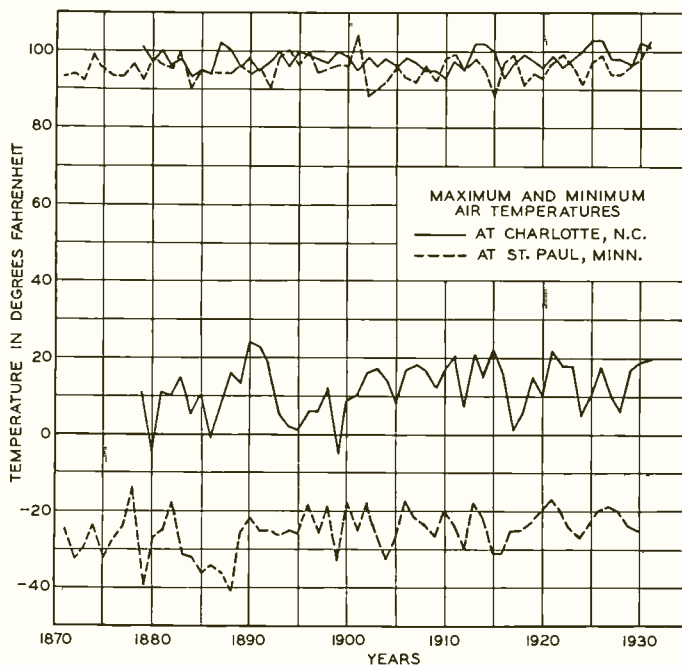

Fig. 1—Air temperature data for St. Paul and Charlotte

low the nominal mean of the fifty-five-degree base temperature.

The maximum and minimum air temperatures over the section are determined from Weather Bureau records. Since the temperature extremes are not the same year after year, however, an attempt is made to estimate the extremes which will be reached or exceeded once per year on the average. A statistical study for a number of points has indicated that sufficiently accurate once-per-year maximum values may be obtained by averaging the yearly maximums. Similarly, the once-per-year minimum values may be obtained by averaging the yearly minimums. The cable absorbs heat more readily than air in direct sunlight, with the result that maximum cable temperature is appreciably higher than maximum air temperature. For the average amount of exposure to direct sunlight in a regulator section, the maximum cable temperature is about twenty degrees higher than maximum air temperature. Also the cable radiates heat more readily than air with the result that its minimum temperature may become slightly lower than minimum air temperature, but it is assumed to be substantially the same. The temperature of aerial cable, therefore, is assumed to vary from average minimum air temperature in winter to twenty degrees higher than average maximum air temperature in summer.

There is a considerable variation in the yearly extreme temperatures as is indicated in Figure 1, which shows air temperature data for St. Paul and Charlotte for a number of years. The values used for engineering purposes will not be reached every year. On the other hand, they will be exceeded in some years, and occasionally the excess will be sufficient to require

special action on regulator sections that are near the limiting length.

The algebraic difference between the two extreme cable temperatures multiplied by the length of the section gives at once the degree-miles of regulation required. If this is less than 18,100, the regulator will be adequate so far as the overall range is concerned. Since with normal adjustment the regulator provides half of its total gain change on each side of fifty-five degrees, it is necessary next to see whether the maximum temperature minus fifty-five degrees multiplied by the length, and fifty-five degrees minus the minimum temperature multiplied by the length are each equal to or less than half the total degree-miles. If they are found to be, the regulator will satisfactorily take care of the section with its normal adjustment, and no further consideration is required.

Where it is found that the total degree-miles of the proposed section, or its range above or below the fifty-five-degree mid-point, exceeds the range of the regulator, the length of the section is decreased if practicable. If this is not practicable, adjustment of the regulator itself, or of the operating procedure, is required. These modifications may take several forms. Frequently, it is found that the overall degree-miles of the section is satisfactory, but that the range above or below the fifty-five-degree mid-point is inadequate. Under these conditions, an "offset" adjustment is made. This is accomplished by electrical changes in the circuit, which have the effect of shifting the mid-position of the regulator so that instead of having ten steps above and ten below the fifty-five-degree point, there are perhaps twelve above and eight below, or any other combination that most nearly meets the actual conditions, although the

mid-point is not usually offset by more than two steps. So long as the overall degree-miles of the section is not greater than 18,100, this offset adjustment will be permanent, and once made the regulator will satisfactorily control the section.

Where the overall degree-mile range of the section is greater than 18,100, temporary offset adjustments may be made to permit the satisfactory employment of the regulator. Thus one

offset adjustment might be made for the winter months and another for the summer; or one offset adjustment might serve for part of the year and the normal adjustment for the rest.

The occasional excesses in temperature variations at either the cold or hot extreme will usually be of short duration. For this reason, special adjustments for excess variations are not made until the excess amounts to about two regulator steps.

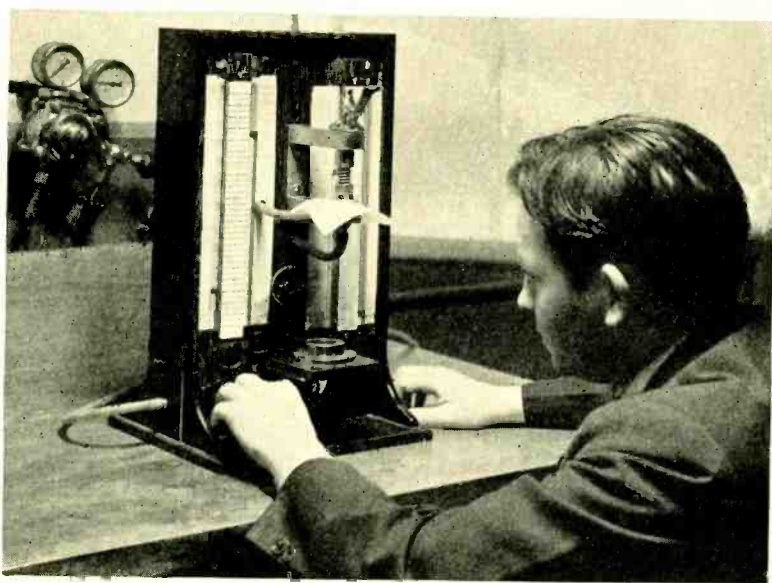

*An acoustic resistance, useful in controlling the response, is provided in certain types of telephone receivers by a bit of silk cloth which checks the flow of air through a small hole back of the diaphragm. The laboratory set-up shown above gives information on the porosity of various kinds of silk by measuring the resistance of the material at zero frequency—that is, to a steady stream of air. The measuring device embodies one manometer (left) to measure the pressure of the air against the silk and another (right) to measure the rate of air flow through a small orifice*



## Contributors to this Issue

P. W. BLYE joined the American Telephone and Telegraph Company in March, 1919, after receiving the degree of S.B. in electrical engineering from Massachusetts Institute of Technology. As a member of the transmission division of the Department of Development and Research he was engaged for several years in the development of special testing apparatus and methods required in inductive coordination studies. He was subsequently assigned to developmental studies dealing with the wave-shape and inductive influence of power systems, including methods for their control. As Noise Coördination Engineer he is now in charge of development work on the inductive coordination of power and telephone systems at noise frequencies. He is Bell System chairman of Project Committee 1A on Noise Induction, of the Joint Subcommittee on Development

and Research of the Edison Electric Institute and the Bell System.

P. B. FLANDERS received the A.B. degree from Harvard in 1920, and the S.B. degree in electrical engineering in 1922. He then joined the technical staff of the Laboratories where, with the Transmission Department, he worked on the development of horns and other acoustic devices until 1935. The acoustic attenuator described in this issue was developed during this period. Since 1935 he has been engaged in relay investigations and contact studies.

H. H. FELDER was graduated from Clemson A. and M. College in 1918 with a B.S. degree in electrical and mechanical engineering. After some months in the U. S. Signal Corps he joined the Engineering Department of the A. T. and T. Company in January, 1919, and became a member of the Department of Development



*P. W. Blye*



*P. B. Flanders*



*H. H. Felder*



*A. C. Norwine*



*H. H. Staebner*



*W. B. Snow*

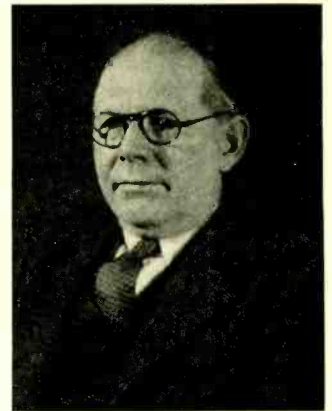

*J. S. Garvin*

ment and Research upon its formation later that year. He has been engaged in general transmission problems in connection with telephone repeater development and toll circuit layout and switching. Recently he has been engaged also in work on some of the phases of cable loading as applied to entrance cables for Type-J open-wire carrier systems.

In 1925 A. C. Norwine became a member of the Laboratories after having received the degrees of A.B., B.S. in electrical engineering and E.E. from the University of Missouri. His work has been entirely in the Research Department. Following two years on carrier broadcasting he has been concerned with the development of new types of voice-operated devices, of volume control apparatus for application to toll circuits, and with the evaluation of the transmission effects of such devices.

H. H. STAEBNER received the B.S. degree in electro-chemical engineering from Massachusetts Institute of Technology in 1927 and joined the Technical Staff of the Laboratories in August of the same year. His work has been concerned with the development of central office wire insulation, switchboard and telephone cords of various types and enamel-insulated wire for winding coils and for use in cable.

W. B. SNOW came to the Laboratories in 1923 after receiving the degree of A.B. in mechanical engineering from Stanford University. A year later he returned to Stanford for further studies and received his E.E. degree in 1925. After this he again joined the Laboratories as a member of the acoustical research group. Since that time he has been engaged primarily on fundamental studies of speech and music.

J. S. GARVIN graduated from the University of Kentucky in 1910, receiving the degree of B.M.E., and shortly after joined the student course of the Western Electric Company at Hawthorne. After less than one year in the Manufacturing and Installation Departments, he was transferred to the Transmission Branch of the Western Electric Engineering Department in New York. For the next six years he participated in the development of telephone transmitters, receivers, induction coils, loud-speaking apparatus; recording and reproducing apparatus; and in the investigation of telephone apparatus made by manufacturers other than the Western Electric Company. In 1917 he became associated with the apparatus group in the development of electromagnetic apparatus, and has continued this work to the present time.



# Index to Authors

## A

- ALMQUIST, M. L. . . . Broad-Band Carrier System for Cables . . . . . 260  
ATKINS, G. E. . . . New Magnetic Telephone . . . . . 282

## B

- BACON, W. M. . . . Tool Kit for Teletypewriter Maintenance . . . . . 391  
BAILEY, AUSTIN . . . An Ultra-Short-Wave Circuit for Palomar Observatory . . . . . 48  
BAYLES, J. C. . . . Making Broadcast Synchronization Easy . . . . . 347  
BESCHERER, E. A. . . . A Multi-Frequency Transmitter for the Private Plane . . . . . 271  
BIDWELL, C. H. . . . Carrier Supply for Type-K Systems . . . . . 364  
BLYE, P. W. . . . . Reducing Disturbances Produced on Telephone Circuits  
from Power Rectifiers . . . . . 411  
BOGHOSIAN, W. H. . . A Filter for Airway Range Systems . . . . . 88  
BOWER, M. M. . . . The Carrier Telephone Alphabet . . . . . 208  
BOZORTH, R. M. . . . Higher Magnetic Permeabilities . . . . . 229  
BURGESS, A. A. . . . The 1A Teletypewriter Switchboard . . . . . 34

## C

- CORBIN, J. E. . . . An Anti-Static Loop for Aircraft . . . . . 201  
CRANE, R. E. . . . Channel-Terminal Equipment for Broad-Band Carrier  
Systems . . . . . 315

## D

- DECINO, A. . . . . Stability of Reception at Two Meters . . . . . 244  
DE KAY, R. D. . . . Permanent Magnet Machines for Telephone Offices . . . . . 236  
DICKIESON, A. C. . . . The Type-H Carrier Telephone System . . . . . 76  
DIETZOLD, R. L. . . . The Isograph—A Mechanical Root-Finder . . . . . 130  
DOBA, JR., S. . . . . Higher Volume without Overloading . . . . . 174  
DOWNES, G. H. . . . Pressure Cleaning . . . . . 122  
DURKEE, A. L. . . . Forecasting Sunspots and Radio Transmission  
Conditions . . . . . 127

## E

- EDWARDS, C. F. . . . Experimental Results from the Musa . . . . . 232  
ELLIOTT, J. S. . . . Precise Measurement of Insertion Phase Shift . . . . . 285

## F

- FARMER, W. J. . . . Aluminum Alloy Structural Materials . . . . . 164  
FELDER, H. H. . . . Pilot-Wire Regulators for Voice-Frequency  
Cable Circuits . . . . . 421

FELDMAN, C. B. . . . .	Principles of the Musa . . . . .	148
FLANDERS, P. B. . . . .	Acoustic Attenuators . . . . .	403
FLETCHER, HARVEY . . . . .	Noise Measurements and the International Conference on Acoustics . . . . .	213

## G

GARDNER, L. A. . . . .	A Teletypewriter Switchboard for Private-Line or PBX Service . . . . .	379
GARDNER, M. B. . . . .	Hearing Impairment and Sound Intensity . . . . .	224
GARVIN, J. S. . . . .	Improvements in Relay Coil Insulation . . . . .	407
GLASS, M. S. . . . .	New Cathode-Ray Tubes . . . . .	110
GRAY, C. R. . . . .	The 755 PBX . . . . .	336

## H

HAWORTH, F. E. . . . .	High Dispersion X-Ray Spectrometer . . . . .	66
HEBBERT, C. M. . . . .	Variation of Cable Loss with Temperature . . . . .	114
HERBORN, L. E. . . . .	An Inexpensive Bridge for Capacitance and Conductance Measurements . . . . .	91
HERMANCE, H. W. . . . .	Paper as a Medium in Microanalysis . . . . .	370
HERRIOTT, W. . . . .	High-Speed Motion-Picture Photography . . . . .	279
HICKMAN, C. N. . . . .	Magnetic Recording and Reproducing . . . . .	2
HIGHT, S. C. . . . .	Quartz Plates for Frequency Sub-Standards . . . . .	21
HILL, H. E. . . . .	Vibration Studies with the Rapid-Record Oscillograph . . . . .	26
HOVGAARD, O. M. . . . .	A Volume-Limiting Amplifier . . . . .	179
HUBBARD, F. A. . . . .	A Multi-Channel Radio Monitoring System . . . . .	62

## I

INGMANSON, J. H. . . . .	Non-Corroding Rubber Insulation for Telephone Cords . . . . .	85
--------------------------	---------------------------------------------------------------	----

## J

JONES, P. F. . . . .	A Recording System for Transmission Measurements . . . . .	289
----------------------	------------------------------------------------------------	-----

## K

KOOS, P. V. . . . .	The 5 Teletypewriter Switchboard . . . . .	171
KUEBLER, R. E. . . . .	The 281A Program Line Panel . . . . .	383

## L

LANE, C. E. . . . .	Limitations in High-Frequency Band-Filter Design . . . . .	56
LANGABEER, H. T. . . . .	Supplying Power to Central Offices . . . . .	43
LAREW, J. L. . . . .	Power Supply for the Coaxial Repeaters . . . . .	239
LEUTRITZ, JOHN . . . . .	Laboratory Tests of Wood Preservatives . . . . .	324

LEVIN, S. A. . . . .	High-Frequency Attenuator . . . . .	99
LIVINGSTON, F. B. . . . .	Conductance in Telephone Cables . . . . .	141
LLEWELLYN, F. B. . . . .	Equivalent Networks for Negative-Grid Triodes . . . . .	39
LOWRY, L. R. . . . .	The Musa from the Outside . . . . .	203

## M

MARSHALL, R. N. . . . .	Low-Cost Microphone for Varied Application . . . . .	80
MASON, W. P. . . . .	Transmission Line Structures as High-Frequency Networks . . . . .	118
M McNALLY, J. O. . . . .	New Tubes for Carrier Systems . . . . .	17
MERCNER, R. O. . . . .	The Mechanism of the Isograph . . . . .	135
MINER, R. C. . . . .	Diphonic Loudspeaker for Mirrophonic Sound Systems . . . . .	53
MITCHELL, D. . . . .	Automatic Adjustments in Radio-Telephone Control Terminals . . . . .	157
MITCHELL, D. . . . .	A Voice-Operated Return-Loss Measuring Set . . . . .	375

## N

NORWINE, A. C. . . . .	Acoustic Delay Circuits for Laboratory Use . . . . .	400
------------------------	------------------------------------------------------	-----

## O

O'LEARY, J. T. . . . .	Applying the Type-H Carrier Telephone System to Railroads . . . . .	220
ONG, F. C. . . . .	Protective Circuits for Antenna-Coupling Networks . . . . .	254
OSGOOD, D. T. . . . .	Short-Circuiting Relay Protectors . . . . .	350

## P

PIERCE, J. R. . . . .	Electron Multiplier Design . . . . .	305
-----------------------	--------------------------------------	-----

## R

REYNOLDS, J. N. . . . .	The Crossbar Switch in the 755 PBX . . . . .	332
-------------------------	----------------------------------------------	-----

## S

SHARPLESS, W. M. . . . .	Musa Apparatus . . . . .	153
SINGER, F. J. . . . .	The Teletypewriter Exchange Network . . . . .	167
SKELLETT, A. M. . . . .	Time Lag in Gas-Filled Photoelectric Cells . . . . .	321
SNOW, W. B. . . . .	Lifting a Finger against Noise . . . . .	418
STAEBNER, H. H. . . . .	Rubber-Insulated Station Cords . . . . .	396
STRIEBY, M. E. . . . .	Television over the Coaxial Cable . . . . .	188
SWART, L. K. . . . .	Gas-Tube Voltage Recorders . . . . .	387

## T

TEBO, J. D. . . . .	Design Features of Short-Circuiting Relay Protectors . . . . .	353
THOMAS, JR., U. B. . . . .	Lead-Calcium for Storage Batteries . . . . .	12

## W

WAGAR, H. W. . . .	The U-Type Relay . . . . .	300
WEGMAN, E. C. . . .	Improved Methods in Cable Testing . . . . .	275
WENTZ, J. F. . . .	Transmission Characteristics of the Coaxial Structure . . . . .	196
WERRING, W. W. . . .	A New Micrometer Ratchet . . . . .	162
WILLIAMS, I. V. . . .	Steel in the Telephone Plant . . . . .	266
WILSON, L. T. . . .	Open-Wire Line Losses . . . . .	95
WOOD, E. B. . . .	Vapor-Pressure Humidostat and Thermostat . . . . .	102
WOODWORTH, F. B. . . .	A New Coastal Marine Radio Telephone Set . . . . .	358
WRATHALL, L. R. . . .	Eddy-Current Shielding in Laminated Cores . . . . .	7
WRIGHT, S. B. . . .	Noise Protection for Voice-Operated Devices . . . . .	248

## Z

ZAMMATARO, S. J. . . .	An Inductance and Capacitance Bridge . . . . .	341
ZUPA, F. A. . . .	The Y-Type Relay . . . . .	310

# Index of Subjects, Volume XV

(Roman numerals refer to Picture Sections)

## A

Accounting Department, Tabulating Machines in (Picture) . . . . .	228
Acoustics (see Sound, Speech, Hearing and Acoustics)	
Aircraft (see Radio)	
Aluminum Alloy Structural Materials . . . . .	<i>Farmer</i> . . . . . 164
Amplifiers	
Higher Volumes Without Overloading . . . . .	<i>Doba</i> . . . . . 174
Volume-Limiting Amplifier . . . . .	<i>Hovgaard</i> . . . . . 179
Antennas (see Radio)	
Attenuators	
Acoustic . . . . .	<i>Flanders</i> . . . . . 403
Acoustic Delay Circuits for Laboratory Use . . . . .	<i>Norwine</i> . . . . . 400
High-Frequency . . . . .	<i>Levin</i> . . . . . 99
Awards (see Prizes and Other Honors)	

## B

Batteries	
253 Relay for Charging (Picture) . . . . .	<i>Thomas</i> . . . . . 12
Lead-Calcium for Storage Batteries . . . . .	Nov.—111
Biographies and Personalities	
Davisson, C. J., Awarded Nobel Prize in Physics . . . . .	108, 152, 216
Ives, H. E., Honored by Optical Society . . . . .	84
Jewett, F. B., Receives Washington Award . . . . .	207
Southworth, G. C., Awarded Morris Liebmann Prize . . . . .	346
Williams, R. R., Awarded Willard Gibbs Medal . . . . .	231, 352
Bridges	
For Capacitance and Conductance Measurements . . . . .	<i>Herborn</i> . . . . . 91
Inductance and Capacitance Bridge . . . . .	<i>Zammataro</i> . . . . . 341
Precise Measurement of Insertion Phase Shift . . . . .	<i>Elliott</i> . . . . . 285
Broadcast (see Radio)	

## C

Cables	
Coaxial System	
Coaxial Structures as High-Frequency Filters . . . . .	<i>Mason</i> . . . . . 118
New York - Philadelphia Demonstration . . . . .	108
Power Supply for Coaxial Repeaters . . . . .	<i>Larew</i> . . . . . 239
Television Over the Coaxial Cable . . . . .	<i>Strieby</i> . . . . . 188
Transmission Characteristics of the Coaxial Structure . . . . .	<i>Wentz</i> . . . . . 196
Conductance of Telephone Cables . . . . .	<i>Livingston</i> . . . . . 141
Loss Due to Temperature Variations . . . . .	<i>Hebbert</i> . . . . . 114

Cables (Continued)		
Sheath, Effect of Compression on Cable (Picture) . . . . .		Sept.—111
Test Plot at Chester (Picture) . . . . .		65
Testing Methods . . . . .	<i>Wegman</i> . . . . .	275
Calcium, Lead-, for Storage Batteries . . . . .	<i>Thomas</i> . . . . .	12
Calculating Machines		
The Isograph—A Mechanical Root-Finder . . . . .	<i>Dietzold</i> . . . . .	130
The Mechanism of the Isograph . . . . .	<i>Mercner</i> . . . . .	135
Carrier Systems		
Alphabet of Carrier Systems (Types A to K) . . . . .	<i>Bower</i> . . . . .	208
Attenuator, High-Frequency, for Transmission Studies . . . . .	<i>Levin</i> . . . . .	99
Channel-Terminal Equipment for Broad-Band Systems . . . . .	<i>Crane</i> . . . . .	315
D-99739 Relay (Picture) . . . . .		Nov.—11
Limitations in High-Frequency Band-Filter Design . . . . .	<i>Lane</i> . . . . .	56
New York - Philadelphia Coaxial Demonstration . . . . .		108
Open-Wire Line Losses . . . . .	<i>Wilson</i> . . . . .	91
Type-H System . . . . .	<i>Dickieson</i> . . . . .	76
Type-H System for Railroad Applications . . . . .	<i>O'Leary</i> . . . . .	220
Type-K Broad-Band System . . . . .	<i>Almquist</i> . . . . .	260
Type-K System, Carrier Supply for . . . . .	<i>Bidwell</i> . . . . .	364
Vacuum Tubes for (310, 311, 328 and 329 Types) . . . . .	<i>McNally</i> . . . . .	17
Cathode-Ray Tubes (325 and 326 Types) . . . . .	<i>Glass</i> . . . . .	110
Central Office Equipment		
Cabling a Power Board (Picture) . . . . .		Feb.—IV
Carrier Supply for Type-K Systems . . . . .	<i>Bidwell</i> . . . . .	364
Cleaning, Pressure . . . . .	<i>Downes</i> . . . . .	122
Permanent Magnet Machines for Telephone Offices . . . . .	<i>de Kay</i> . . . . .	236
Supplying Power to Central Offices . . . . .	<i>Langabeer</i> . . . . .	43
Testing Crossbar Circuits (Pictures) . . . . .		223, 363
Chemical Research		
Laboratory Tests of Wood Preservatives . . . . .	<i>Leutritz</i> . . . . .	324
Non-Corroding Rubber Insulation for Telephone Cords . . . . .	<i>Ingmanson</i> . . . . .	85
Paper as a Medium in Microanalysis . . . . .	<i>Hermance</i> . . . . .	370
Chester, N. J.		
Cable Test Plot (Picture) . . . . .		65
Cleaning, Pressure . . . . .	<i>Downes</i> . . . . .	122
Contacts, Experiments on Talking . . . . .		374
Cords		
Rubber-Insulated Station Cords . . . . .	<i>Staebner</i> . . . . .	396
Rubber Insulation for Cords . . . . .	<i>Ingmanson</i> . . . . .	85
Coaxial System (see Cables)		
Crossbar System		
755 PBX . . . . .	<i>Gray</i> . . . . .	336
Cabling a Power Board (Picture) . . . . .		Feb.—IV
Crossbar Switch in 755 PBX . . . . .	<i>Reynolds</i> . . . . .	332
Testing Line-Link Circuits (Pictures) . . . . .		223, 363
Crystals (see Quartz Crystals)		

## D

Delay Circuits, Acoustic . . . . .	<i>Norwine</i> . . . . .	400
Development Shop, Band Saw in (Picture) . . . . .		178
Drafting Room (Picture) . . . . .		188
Dry Batteries (see Batteries)		

## E

Eddy-Current Shielding in Laminated Cores . . . . .	<i>Wrathall</i> . . . . .	7
Electron Multiplier Design . . . . .	<i>Pierce</i> . . . . .	305

## F

Ferro-Magnetic Action Demonstration (Picture) . . . . .		420
Filters		
Coaxial Structures as High-Frequency Filters . . . . .	<i>Mason</i> . . . . .	118
For Airway Range Systems . . . . .	<i>Boghosian</i> . . . . .	88
Limitations in High-Frequency Band-Filter Design . . . . .	<i>Lane</i> . . . . .	56

## G

Generators		
Permanent Magnet Machines for Telephone Offices . . . . .	<i>de Kay</i> . . . . .	236
Wind-Driven (Picture) . . . . .		219

## H

Hearing (see Sound, Speech, Hearing and Acoustics)		
Honors (see Prizes and Other Honors)		
Humidostat and Thermostat, Vapor-Pressure . . . . .	<i>Wood</i> . . . . .	102

## I

Insulation		
Improvements in Relay Coil Insulation . . . . .	<i>Garvin</i> . . . . .	407
Rubber-Insulated Station Cords . . . . .	<i>Staebner</i> . . . . .	396
Rubber Insulation for Cords . . . . .	<i>Ingmanson</i> . . . . .	85
Vapor-Pressure Humidostat and Thermostat . . . . .	<i>Wood</i> . . . . .	102
International Conference on Acoustics . . . . .	<i>Fletcher</i> . . . . .	213
Isograph		
A Mechanical Root-Finder . . . . .	<i>Dietzold</i> . . . . .	130
The Mechanism of the Isograph . . . . .	<i>Mercner</i> . . . . .	135

## L

Lead-Calcium for Storage Batteries . . . . .	<i>Thomas</i> . . . . .	12
Loudspeakers (see Public Address Systems)		

## M

Magnetic Recording and Reproducing . . . . .	<i>Hickman</i> . . . . .	2
Magnetic Telephones . . . . .	<i>Atkins</i> . . . . .	282

Magnetization	
Casting a Magnetic Alloy (Picture) . . . . .	259
Eddy-Current Shielding in Laminated Cores . . . . . <i>Wrathall</i> . . . . .	7
Ferro-Magnetic Action Demonstration (Picture) . . . . .	420
Higher Magnetic Permeabilities . . . . . <i>Bozorth</i> . . . . .	229
Maintenance and Adjustment	
Automatic Adjustments in Radio-Telephone Control	
Terminals . . . . . <i>Mitchell</i> . . . . .	157
Pressure Cleaning . . . . . <i>Downes</i> . . . . .	122
Tool Kit for Teletypewriter Maintenance . . . . . <i>Bacon</i> . . . . .	391
Materials	
Aluminum Alloy Structural . . . . . <i>Farmer</i> . . . . .	164
High-Speed Motion-Picture Studies of . . . . . <i>Herriott</i> . . . . .	279
Steel in the Telephone Plant . . . . . <i>Williams</i> . . . . .	266
Measurements and Testing	
Attenuator, High-Frequency . . . . . <i>Levin</i> . . . . .	99
Bridges	
For Capacitance and Conductance Measurements . . . . . <i>Herborn</i> . . . . .	91
For Capacitance and Inductance Measurements . . . . . <i>Zammataro</i> . . . . .	341
Cables	
Conductance of Telephone Cables . . . . . <i>Livingston</i> . . . . .	141
Loss Due to Temperature Variations . . . . . <i>Hebbert</i> . . . . .	114
Effect of Compression on Sheath (Picture) . . . . .	Sept.-III
Effect of Stretching on Sheath (Picture) . . . . .	382
Test Plot at Chester, N. J. (Picture) . . . . .	65
Testing Methods for Cables . . . . . <i>Wegman</i> . . . . .	275
Contacts, Experiments on Talking . . . . .	374
Eddy-Current Shielding in Laminated Cores . . . . . <i>Wrathall</i> . . . . .	7
Fatigue in Wire Ties (Picture) . . . . .	Sept.-II
Humidostat and Thermostat, Vapor-Pressure . . . . . <i>Wood</i> . . . . .	102
Insertion Phase Shift, Precise Measurement of . . . . . <i>Elliott</i> . . . . .	285
Line Losses, Open-Wire . . . . . <i>Wilson</i> . . . . .	91
Micrometer Ratchet . . . . . <i>Werring</i> . . . . .	162
Optical Apparatus Measures to 0.00005 inch (Picture) . . . . .	147
Quartz Plates for Frequency Sub-Standards . . . . . <i>Hight</i> . . . . .	21
Receivers	
Calibration of Standard Comparison (Picture) . . . . .	May-I
Measuring Flux Density in (Picture) . . . . .	Sept.-III
Separation between Pole Pieces and Diaphragm (Picture) . . . . .	May-II
Testing a Bone-Conduction Receiver (Picture) . . . . .	395
Recording System for Transmission Measurements . . . . . <i>Jones</i> . . . . .	289
Standing Waves in Concentric Line (Picture) . . . . .	Sept.-I
Silk, Acoustic Resistance of (Picture) . . . . .	424
Transmitters	
Dynamic Characteristics of Carbon (Picture) . . . . .	331
Measuring Handset Carbon (Picture) . . . . .	104
Thickness of Paper Damping Ring (Picture) . . . . .	Sept.-IV



Measurements and Testing (Continued)

Vibration Studies with Oscillograph . . . . .	<i>Hill</i> . . . . .	26
Voice-Operated Return-Loss Measuring Set . . . . .	<i>Mitchell</i> . . . . .	375
Voltage Indicator for Recording Transient Voltages on Telephone Lines (Picture) . . . . .		Feb.-111
Voltage Recorders, Gas-Tube . . . . .	<i>Swart</i> . . . . .	387
X-Ray Spectrometer . . . . .	<i>Haworth</i> . . . . .	66
Microanalysis, Paper as a Medium in . . . . .	<i>Hermance</i> . . . . .	370
Micrometer Calipers . . . . .	<i>Werring</i> . . . . .	162
Microphones		
633A . . . . .	<i>Marshall</i> . . . . .	80
Directional (Picture) . . . . .		52
Microphonic Sound System . . . . .	<i>Miner</i> . . . . .	53
Motion-Picture Studies of Materials, High-Speed . . . . .	<i>Herriott</i> . . . . .	279
Motion Pictures Transmitted Over Coaxial Cable . . . . .	<i>Strieby</i> . . . . .	188
Musa (see Radio, Transoceanic)		

N

Networks, Transmission Line Structures as High-Frequency	<i>Mason</i> . . . . .	118
New York World's Fair (Picture) . . . . .		299
Noise, Lifting a Finger Against . . . . .	<i>Snow</i> . . . . .	418
Noise Measurements and the International Conference on Acoustics . . . . .	<i>Fletcher</i> . . . . .	213
Noise Protection for Voice-Operated Devices . . . . .	<i>Wright</i> . . . . .	248

O

Oscillators		
For Voice-Frequency Carrier Telegraph (Picture) . . . . .		Feb.-1
Oscillating Crystal . . . . .		357
Test Oscillator at Deal (Picture) . . . . .		75
Oscillographs, Vibration Studies with . . . . .	<i>Hill</i> . . . . .	26
Outside Plant		
Cable Test Plot at Chester, N. J. (Picture) . . . . .		65
Fatigue in Wire Ties (Picture) . . . . .		Sept.-11
Measuring the Stretching of Cable Sheath (Picture) . . . . .		382
Short-Circuiting Relay Protectors		
Applications . . . . .	<i>Osgood</i> . . . . .	350
Design Features . . . . .	<i>Tebo</i> . . . . .	353

P

Palomar Observatory, Ultra-Short-Wave Circuit for . . . . .	<i>Bailey</i> . . . . .	48
Paper as a Medium in Microanalysis . . . . .	<i>Hermance</i> . . . . .	370
Permeabilities, Higher Magnetic . . . . .	<i>Bozorth</i> . . . . .	229
Photoelectric Cells, Time Lag in Gas-Filled . . . . .	<i>Skellett</i> . . . . .	321
Physical Research		
Acoustic Delay Circuits for Laboratory Use . . . . .	<i>Norwine</i> . . . . .	400

Physical Research (Continued)

Electron Multiplier Design . . . . .	<i>Pierce</i> . . . . .	305
Ferro-Magnetic Action Demonstration (Picture) . . . . .		420
Hearing Impairment and Sound Intensity . . . . .	<i>Gardner</i> . . . . .	224
High Dispersion X-Ray Spectrometer . . . . .	<i>Haworth</i> . . . . .	66
Higher Magnetic Permeabilities . . . . .	<i>Bozorth</i> . . . . .	229
Lifting a Finger Against Noise . . . . .	<i>Snow</i> . . . . .	418
Noise Measurements and the International Conference on Acoustics . . . . .	<i>Fletcher</i> . . . . .	213
Relationship Between Current and Potential in Space Between Grid and Plate in Vacuum Tube (Picture) . . . . .		335
Talking Contacts, Experiments on . . . . .		374
Time Lag in Gas-Filled Photoelectric Cells . . . . .	<i>Skellett</i> . . . . .	321
Pilot-Wire Regulators for Voice-Frequency Cable Circuits . . . . .	<i>Felder</i> . . . . .	421
Preservatives, Laboratory Tests of Wood . . . . .	<i>Leutritz</i> . . . . .	324
Private Branch Exchanges		
755 PBX . . . . .	<i>Gray</i> . . . . .	336
Crossbar Switch in the 755 PBX . . . . .	<i>Reynolds</i> . . . . .	332
Prizes and Other Honors		
Morris Liebmann Prize to G. C. Southworth . . . . .		346
Nobel Prize in Physics to C. J. Davison . . . . .	108, 152,	216
Optical Society Honors H. E. Ives . . . . .		84
Washington Award to F. B. Jewett . . . . .		207
Willard Gibbs Medal to R. R. Williams . . . . .		231, 352
Power Rectifiers, Reducing Disturbances from . . . . .	<i>Blye</i> . . . . .	411
Power-Supply Systems		
253A Relay for Battery Charging (Picture) . . . . .		Nov.—III
Cabling a Power Board (Picture) . . . . .		Feb.—IV
For Coaxial Repeaters . . . . .	<i>Larew</i> . . . . .	239
Permanent Magnet Machines for Telephone Offices . . . . .	<i>de Kay</i> . . . . .	236
Supplying Power to Central Offices . . . . .	<i>Langabeer</i> . . . . .	43
Wind-Driven Generator (Picture) . . . . .		219
Protectors, Short-Circuiting Relay		
Applications . . . . .	<i>Osgood</i> . . . . .	350
Design Features . . . . .	<i>Tebo</i> . . . . .	353
Public Address Systems		
Diphonic Loudspeaker for Mirrophonic Sound Systems . . . . .	<i>Miner</i> . . . . .	53

Q

Quartz Crystals		
Limitations in High-Frequency Band-Filter Design . . . . .	<i>Lane</i> . . . . .	56
Oscillating Crystals . . . . .		357
Plates for Frequency Sub-Standards . . . . .	<i>Hight</i> . . . . .	21

R

Radio		
Aircraft		
Anti-Static Loop for Aircraft . . . . .	<i>Corbin</i> . . . . .	201

Radio (Continued)

Douglas DC-4 Airliner (Picture) . . . . .		410
Filters for Airway Range Systems . . . . .	<i>Boghosian</i>	88
Multi-Frequency (25A) Transmitter for Private Plane . . . . .	<i>Bescherer</i>	271
Antennas		
Anti-Static Loop for Aircraft . . . . .	<i>Corbin</i>	201
Musa		
Antenna System . . . . .	<i>Lowry</i>	203
Apparatus . . . . .	<i>Sharpless</i>	153
Experimental Results . . . . .	<i>Edwards</i>	232
Principles . . . . .	<i>Feldman</i>	148
Protective Circuits for Antenna-Coupling Networks . . . . .	<i>Ong</i>	254
Broadcast		
281A Program Line Panel . . . . .	<i>Kuebler</i>	383
Console-Type Speech-Input Equipment . . . . .		295
Directional Microphone (Picture) . . . . .		52
Higher Volumes Without Overloading . . . . .	<i>Doba</i>	174
Making Broadcast Synchronization Easy . . . . .	<i>Bayles</i>	347
Protective Circuits for Antenna-Coupling Networks . . . . .	<i>Ong</i>	254
Volume-Limiting Amplifier . . . . .	<i>Hovgaard</i>	179
General		
Forecasting Sunspots and Radio Transmission Conditions . . . . .	<i>Durkee</i>	127
Line Structures as High-Frequency Networks . . . . .	<i>Mason</i>	118
Measuring Standing Waves in Concentric Line (Picture) . . . . .		Sept.—I
Stability of Reception at Two Meters . . . . .	<i>Decino</i>	244
Sunspot Activity . . . . .		373
Test Oscillator at Deal (Picture) . . . . .		75
Marine		
Costal Radio-Telephone Set . . . . .	<i>Woodworth</i>	358
Point-to-Point		
Ultra-Short-Wave Circuit for Palomar Observatory . . . . .	<i>Bailey</i>	48
Receivers		
D-99167 Radio Receiver . . . . .	<i>Hubbard</i>	62
Ship-to-Shore		
S.S. Washington Installation (Picture) . . . . .		215
Transmitters		
25A Multi-Frequency Transmitter . . . . .	<i>Bescherer</i>	271
Transoceanic		
Automatic Adjustment at Control Terminals . . . . .	<i>Mitchell</i>	157
Multi-Channel Radio Monitoring System . . . . .	<i>Hubbard</i>	62
Musa (see Radio, Antennas)		
Railroads, Applying Type-H System to . . . . .	<i>O'Leary</i>	220
Receivers		
Measuring Flux Density (Picture) . . . . .		Sept.—III
Open-Field Calibration of Standard Comparison (Picture) . . . . .		May—I
Separation Between Pole Pieces and Diaphragm (Picture) . . . . .		May—II
Testing a Bone-Conduction Receiver (Picture) . . . . .		395

Recording Systems	
Gas-Tube Voltage Recorders . . . . .	<i>Swart</i> . . . . . 387
Magnetic Recording . . . . .	<i>Hickman</i> . . . . . 2
Transmission Measurement Recording System . . . . .	<i>Jones</i> . . . . . 289
Rectifiers, Reducing Disturbances from Power . . . . .	<i>Blye</i> . . . . . 411
Regulators, Pilot-Wire, for Voice-Frequency Cable Circuits . . . . .	<i>Felder</i> . . . . . 421
Relays	
253A for Battery Charging (Picture) . . . . .	Nov.-III
Adjusting Telegraph Relays (Picture) . . . . .	Feb.-II
D-81431 for Submarine Cable Telegraph (Picture) . . . . .	Nov.-IV
D-99739 for Voice-Operated Circuits (Picture) . . . . .	Nov.-II
Improvements in Relay Coil Insulation . . . . .	<i>Garvin</i> . . . . . 407
Miscellaneous Group for Communication Circuits (Picture) . . . . .	Nov.-I
Short-Circuiting Relay Protectors	
Applications . . . . .	<i>Osgood</i> . . . . . 350
Design Features . . . . .	<i>Tebo</i> . . . . . 353
U-Type . . . . .	<i>Wagner</i> . . . . . 300
Vibration Studies with Oscillograph . . . . .	<i>Hill</i> . . . . . 26
Y-Type . . . . .	<i>Zupa</i> . . . . . 310
Reproducing, Magnetic . . . . .	<i>Hickman</i> . . . . . 2
Return-Loss Measuring Set, Voice-Operated . . . . .	<i>Mitchell</i> . . . . . 375
Rubber-Insulated Station Cords . . . . .	<i>Staubner</i> . . . . . 396
Rubber Insulation for Telephone Cords . . . . .	<i>Ingmanson</i> . . . . . 85

S

Silk, Acoustic Resistance of (Picture) . . . . .	424
Sound, Speech, Hearing and Acoustics	
Acoustic Attenuators . . . . .	<i>Flanders</i> . . . . . 403
Acoustic Delay Circuits for Laboratory Use . . . . .	<i>Norwine</i> . . . . . 400
Acoustic Resistance of Silk (Picture) . . . . .	424
Hearing Impairment and Sound Intensity . . . . .	<i>Gardner</i> . . . . . 224
Lifting a Finger Against Noise . . . . .	<i>Snow</i> . . . . . 418
Noise Measurements and the International Conference on Acoustics . . . . .	<i>Fletcher</i> . . . . . 213
Spectrometer, High-Dispersion X-Ray . . . . .	<i>Haworth</i> . . . . . 66
Standards, Quartz Plates for Frequency Sub- . . . . .	<i>Hight</i> . . . . . 21
Statistics of World Telephones . . . . .	417
Steel in the Telephone Plant . . . . .	<i>Williams</i> . . . . . 266
Storage Batteries (see Batteries)	
Subscriber Station Equipment	
755 PBX . . . . .	<i>Gray</i> . . . . . 336
Magnetic Telephone . . . . .	<i>Atkins</i> . . . . . 282
Rubber-Insulated Station Cords . . . . .	<i>Staubner</i> . . . . . 396
Rubber Insulation for Telephone Cords . . . . .	<i>Ingmanson</i> . . . . . 85
Sunspots	
Activity of . . . . .	373
Forecasting . . . . .	<i>Durkee</i> . . . . . 127

## T

Tabulating Machines in Accounting Department (Picture) . . . . .	228
Talking Contacts, Experiments on . . . . .	374
Telegraph Systems and Equipment . . . . .	
1A Teletypewriter Switchboard . . . . . <i>Burgess</i> . . . . .	34
5 Teletypewriter Switchboard . . . . . <i>Koos</i> . . . . .	171
Adjusting Relays (Picture) . . . . .	Feb.—11
D-81431 Relay (Picture) . . . . .	Nov.—1V
Oscillators for Voice-Frequency System (Picture) . . . . .	Feb.—1
Sloping Keyshelf for 1A Teletypewriter Switchboard (Picture) . . . . .	33
Teletypewriter Switchboard for Private-Line or PBX Service . . . . . <i>Gardner</i> . . . . .	379
Teletypewriter Exchange System . . . . . <i>Singer</i> . . . . .	167
Tool Kit for Teletypewriter Maintenance . . . . . <i>Bacon</i> . . . . .	391
Telephone, Magnetic . . . . . <i>Atkins</i> . . . . .	282
Telephones, Statistics of the World . . . . .	417
Teletypewriter Systems (see Telegraph Systems and Equipment)	
Television	
Coaxial Cable System Transmits Motion Pictures . . . . .	108
Over Coaxial Cable . . . . . <i>Strieby</i> . . . . .	188
Testing (see Measurements and Testing)	
Thermostat and Humidostat, Vapor-Pressure . . . . . <i>Wood</i> . . . . .	102
Toll Systems and Equipment	
Carrier Supply for Type-K System . . . . . <i>Bidwell</i> . . . . .	364
Carrier Systems, General Description of (Types A to K) . . . . . <i>Bower</i> . . . . .	208
Channel-Terminal Equipment for Broad-Band Systems . . . . . <i>Crane</i> . . . . .	315
Noise Protection for Voice-Operated Devices . . . . . <i>Wright</i> . . . . .	248
Open-Wire Line Losses . . . . . <i>Wilson</i> . . . . .	95
Pilot-Wire Regulators for Voice-Frequency Cable Circuits . . . . . <i>Felder</i> . . . . .	421
Type-H Carrier System . . . . . <i>Dickieson</i> . . . . .	76
Type-K Carrier System . . . . . <i>Almquist</i> . . . . .	260
Voice-Operated Return-Loss Measuring Set . . . . . <i>Mitchell</i> . . . . .	375
Tool Kit for Teletypewriter Maintenance . . . . . <i>Bacon</i> . . . . .	391
Transformers	
Eddy-Current Shielding in Laminated Cores . . . . . <i>W'rathall</i> . . . . .	7
Transmission Measurements, Recording System for . . . . . <i>Jones</i> . . . . .	289
Transmitters	
Dynamic Characteristics of Carbon Transmitters (Picture) . . . . .	331
Measuring Thickness of Paper Damping Ring (Picture) . . . . .	Sept.—1V

## V

### Vacuum Tubes

310, 311, 328 and 329 Types for Carrier Systems . . . . . <i>McNally</i> . . . . .	17
325 and 326 Cathode-Ray Tubes . . . . . <i>Glass</i> . . . . .	110
Electron Multiplier Design . . . . . <i>Pierce</i> . . . . .	305

Vacuum Tubes (Continued)

Equivalent Networks for Negative-Grid Triodes . . . . .	<i>Llewellyn</i> . . . . .	39
Negative-Grid Short-Wave (Picture) . . . . .		38
Relationship Between Current and Potential in Space		
Between Grid and Plate (Picture) . . . . .		335
Time Lag in Gas-Filled Photoelectric Cells . . . . .	<i>Skellett</i> . . . . .	321
Vibration Studies with Oscillograph . . . . .	<i>Hill</i> . . . . .	26
Voice-Operated Devices, Noise Protection for . . . . .	<i>Wright</i> . . . . .	248
Voltage-Recorders, Gas-Tube . . . . .	<i>Swart</i> . . . . .	387

W

Wind-Driven Generators (Picture) . . . . .		219
Wires		
Fatigue in Wire Ties (Picture) . . . . .		Sept.-11
Open-Wire Line Losses . . . . .	<i>Wilson</i> . . . . .	95
Wood Preservatives, Laboratory Test of . . . . .	<i>Leutritz</i> . . . . .	324
World's Fair, Bell System Building in New York . . . . .		299

X

X-Ray		
High Dispersion Spectrometer . . . . .	<i>Haworth</i> . . . . .	66
Photograph of 23A Equalizer (Picture) . . . . .		212