

NAVY ELECTRONICS
LIBRARY
LABORATORY

BELL

LABORATORIES
RECORD

INDEX

VOLUME 16

*from September 1937 to
August 1938*

BELL LABORATORIES RECORD

PAUL B. FINDLEY, *Managing Editor*

PHILLIP C. JONES, *Associate Editor*

GEORGE F. FOWLER, *Circulation*

Board of Editorial Advisers:

E. W. ADAMS	HARVEY FLETCHER	JOHN MILLS
H. A. AFFEL	W. FONDILLER	D. A. QUARLES
H. M. BASCOM	H. A. FREDERICK	G. B. THOMAS
B. C. BELLOWS	O. M. GLUNT	H. M. TRUEBLOOD
RALPH BOWN	W. H. MARTIN	R. R. WILLIAMS
	W. H. MATTHIES	

BELL TELEPHONE LABORATORIES, INCORPORATED

463 West Street, New York, N. Y.

LIST OF ISSUES IN VOLUME XVI

No. 1	September, 1937	Pages 1- 32
" 2	October, 1937	33- 72
" 3	November, 1937	73-106
" 4	December, 1937	107-146
" 5	January, 1938	147-186
" 6	February, 1938	187-218
" 7	March, 1938	219-258
" 8	April, 1938	259-298
" 9	May, 1938	299-330
" 10	June, 1938	331-362
" 11	July, 1938	363-394
" 12	August, 1938	395-426



BELL LABORATORIES RECORD

SEPTEMBER

1937

VOLUME XVI

NUMBER 1



Final radio frequency amplifiers in a single-sideband short-wave transmitter



Magnetic Recording and Reproducing

By C. N. HICKMAN
Acoustical Research Department

ABOUT thirty years ago a Danish professor named Poulsen invented a system of recording speech on a steel wire. The wire was drawn rapidly past the iron cores of a set of coils, and speech current in the coils caused a magnetic pattern to be left in the wire. When the wire thus treated magnetically was drawn past a set of reproducing poles, a current was induced in the surrounding coils, which was similar to that used for recording. The system offered a number of desirable characteristics. The record could be kept indefinitely and yet could readily be wiped out by a strong steady field if it were wanted only

temporarily. In addition no processing was required, and no precautions had to be taken to avoid external vibration in the recording mechanism. In spite of these advantages, however, and the many attempts to commercialize it, no practical results were obtained until recent years.

There were several reasons for this failure, which only recent developments have been able to overcome. In general, it arose from the use of round wire, from the establishment in the wire of magnetic elements that had large components along their length, and from the lack of satisfactory magnet materials. Another

shortcoming was the lack of suitable amplifiers, which at the present time are easily procured. The developments which have changed this situation were carried on largely in these Laboratories and consist chiefly of improved magnetic material, the use of a very thin and narrow tape instead of a round wire, and the use of perpendicular magnetization—that is, the magnetic elements in the tape have no appreciable component along the length of the tape.

At the time of Poulsen, although he had suggested its use, steel tape of suitable magnetic characteristics was not available so that a wire had to be used. A wire, however, is bound to twist around its axis, and if its magnetic elements were transverse, a twist of ninety degrees would result in no currents being induced in the reproducing coils. To avoid this, it was necessary to produce in the wire magnetic elements that were chiefly parallel to the axis, so that their effective strength was not seriously changed by axial twisting of the wire. The highest frequency that can be reproduced is a function of the axial length of the magnetic elements in the wire and the speed with which the wire is moved. With comparatively long magnetic elements, which is necessary where their length is mainly along the axis of the wire, high speeds are necessary, and these high speeds produce excessive wear on the pole-pieces and have other disadvantages.

Besides possessing these objectionable features the longitudinal method of magnetization produces a certain distortion in the signals that is inherent. To produce magnetic elements in the wire or tape that have large axial components, it is necessary to offset the poles with respect to each other, and this results in a leakage

flux that causes the distortion. This may be seen in Figure 1, which is a schematic cross-section at the recording magnets, drawn somewhat out of scale to illustrate better the factors that are involved.

Before reaching the recording magnets, the wire or tape has been strongly magnetized in a direction opposite to the magnetization to be given by the recording magnets. Because the two poles on opposite sides of the wire are offset with respect to each other, the flux from each pole does not all follow a straight line from pole to pole, but rather is distributed as indicated by the flux lines numbered from 1 to 7 in the diagram. The flux represented by line 1, since it is approximately parallel to and in the same direction as the magnetization already in the medium, produces little or no effect. The flux represented by line 2, however, is approximately at right angles to this flux and thus dis-

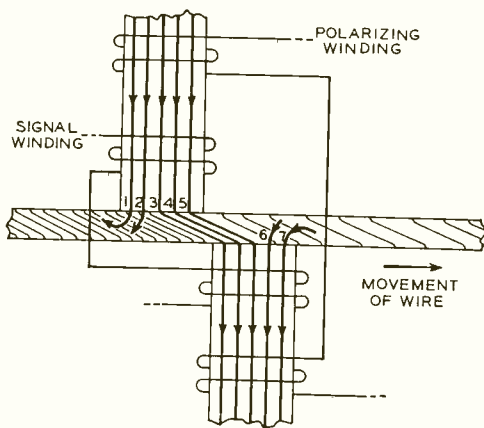

Fig. 1—Cross-section of iron-wire recording method at the recording magnets

torts it. Flux represented by lines 3, 4, and 5 runs diagonally across the wire from pole to pole, and would produce correct flux modulation in the wire if it were not for the distorting flux rep-

represented by line 2, already mentioned, and that represented by lines 6 and 7. The flux represented by line 6, instead of running across the wire as does that represented by lines from 3 to 5, is essentially at right angles to the established signal flux and thus produces a distortion in the flux pattern. Flux represented by line 7, although

tape, and thus permits lower speeds, but avoids the distortion inherent with staggered pole-pieces. As indicated in Figure 2, the flux is essentially at right angles to the axis of the tape throughout, so that no appreciable distortion occurs.

To reduce possible distortion due to the non-linearity of the magnetization characteristics of the steel tape, the section of the magnetization curve over which modulation occurs should be as nearly straight as possible. In the system developed by the Laboratories this is secured by properly proportioning the winding on the polarizing poles and the biasing and signal windings on the recording poles. The action of these windings may be followed

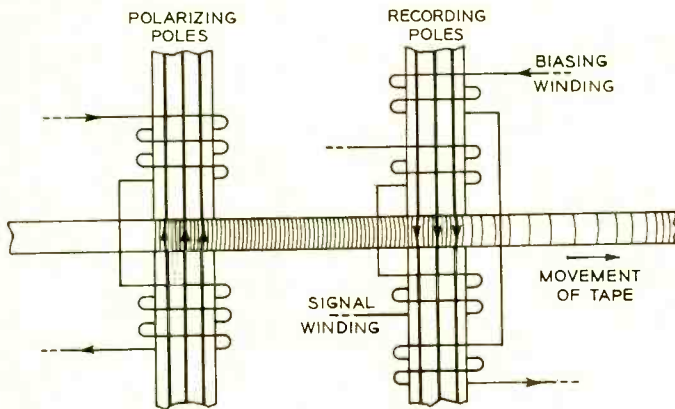

Fig. 2—Cross-section of the perpendicular-magnetization method, showing polarizing and recording magnets

essentially parallel to the main modulating flux, is opposite to it in direction, and thus distorts by tending to destroy the recorded signal. Instead of the true flux pattern, as would have been recorded by fluxes from 3 to 5 alone, therefore, the final magnetic pattern is distorted because of fluxes 2, 6, and 7, and with the staggered pole-pieces no way has been found of avoiding distortion of this type.

One great improvement brought about by the developments of these Laboratories consists in providing a better magnetic material, in rolling it into a thin tape, and in properly heat-treating it. With a tape, the twisting tendency is avoided so that perpendicular magnetization can be employed, with the two poles placed directly opposite each other. This not only gives a shorter magnetic wave-length in the

from Figure 3 in conjunction with Figure 2. The magnetizing force of the polarizing poles is great enough to magnetize the tape to the saturation point in the positive direction—point P of Figure 3—while the tape is directly between the pole-pieces. As the tape passes out from between the pole-pieces, the magnetization decreases along curve B until, when it is completely away from the influence of the poles, it reaches point R—corresponding to zero magnetizing force.

The biasing windings on the recording magnets provide a magnetizing force opposite to that of the polarizing magnets, and, if there is no signal current in the recording windings it will carry the magnetization of the tape, when directly between the pole-pieces, to point N of Figure 3. As the tape moves out from the influence of these

poles, the magnetization of the tape will follow curve 1 to zero, and the tape will be in the unmagnetized condition. With current in the recording winding, the flux in the recording magnets will be carried from R to some point above N on one-half of each cycle and to some point an equal amount below N on the other half cycle. Depending on the volume of the signal, the flux will range between points A and C while the tape is immediately between the pole-pieces. As the tape moves out from the pole-pieces the corresponding magnetization points will be A' and C'. In this way, the magnetization is made to vary over the largest possible straight section of the magnetization curve, and distortion is minimized.

The voltage induced in the reproducing winding is proportional to the rate of change of flux in its core, and this, in turn, is approximately proportional to the rate of change of magnetization in the tape. With a constant speed of the tape, this rate of change in magnetization is proportional to the frequency of the recorded signal. As a result the response for the same voltage of input signal increases directly with frequency. As a frequency is reached where the width of the pole faces approaches a

full wavelength of the recorded sound, however, the response falls off rapidly. The frequency at which this falling off occurs will, of course, be directly proportioned to the speed of the tape. The actual response curve will thus consist of two parts: a rising characteristic at the lower frequencies and then a rapid falling off. Two response

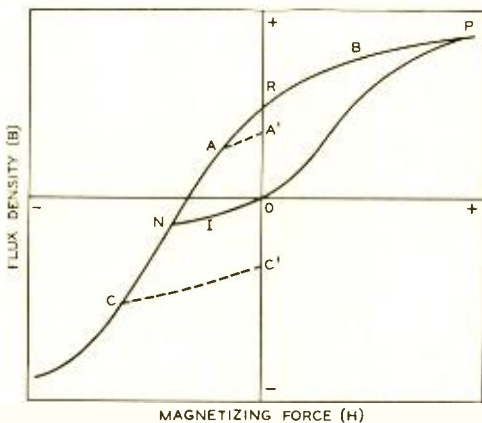

Fig. 3—Magnetization curve of steel tape showing section used in recording

curves—one for a speed of eight and the other of sixteen inches per second—are shown by the upper curves on Figure 4. The reproducing circuit, however, may be equipped with an equalizer to make the response essentially constant for all frequencies, and such an equalized response curve is also shown in Figure 4 for a tape speed of sixteen inches per second.

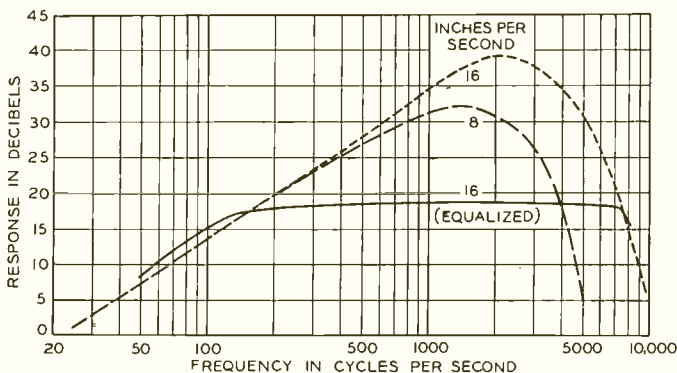

Fig. 4—Response curves for magnetic recording

makes the record available immediately after the recording, and this advantage, coupled with the possibility of providing very long records in very small compass, and the fact that no appreciable deterioration occurs with repeated playing, should make it useful for a wide variety of applications. The photograph shown in the headpiece of this article illustrates an experimental use of the apparatus to give up-to-the-minute announcements

of potato prices and car movements, loadings and holdings over the local telephone system at Hightstown, New Jersey. The men shown in this photograph are, from left to right, C. C. Towne of the Laboratories, C. L. Schoch, equipment investigation engineer of the New Jersey Bell Telephone Company, W. W. Oley, chief of the Bureau of Markets of the New Jersey State Department of Agriculture and W. B. Duryee, Secretary.

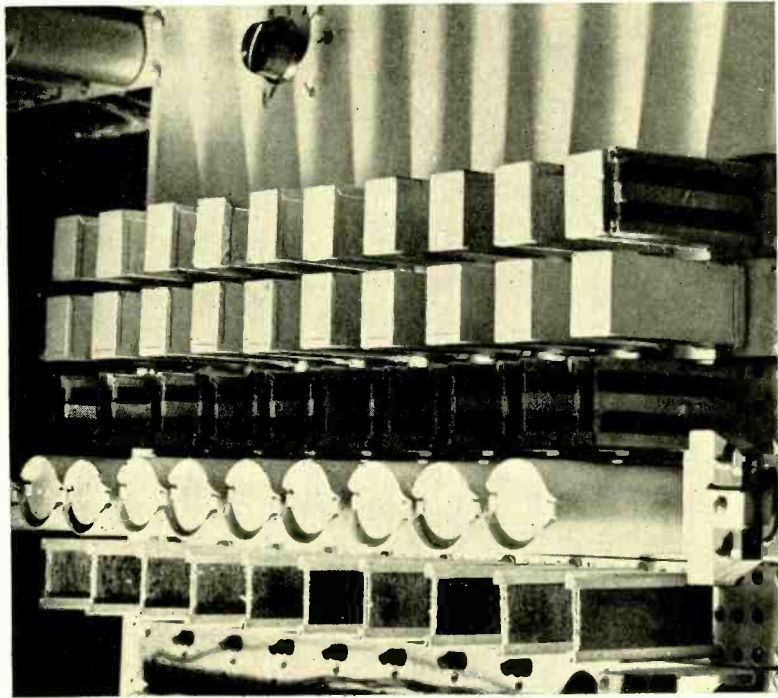
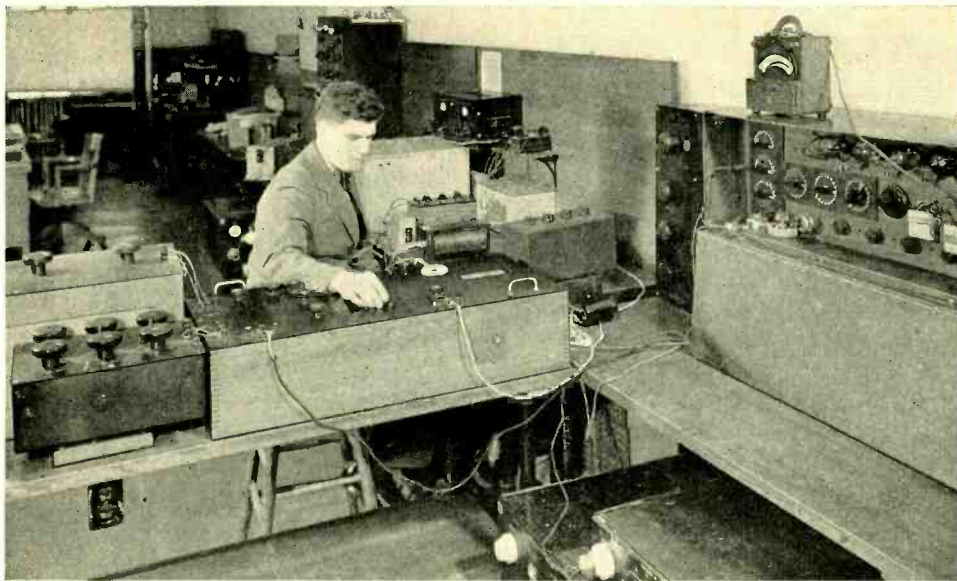

Fig. 5—Section of distributing panel at the Hightstown central office showing the branching networks which permit as many as ten incoming calls to be connected simultaneously to the announcing circuit



Eddy Current Shielding in Laminated Cores

By L. R. WRATHALL
Wire Transmission Research

EDDY currents cause energy losses in wires, transformer cores and other electrical conductors and are often a serious obstacle to increasing the range of usefulness of electrical equipment. On the other hand they can also be used to shield apparatus or cables against outside electromagnetic interference.

When an electric conductor is placed in an alternating magnetic field, the distribution of the magnetic field within the conductor will not be uniform, but will vary both in magnitude and phase from one part of the conductor to another. This phenomenon, which is called eddy current shielding, is due to eddy currents that are induced in the conductor by the alternating magnetic flux.

The effects of eddy currents depend on many factors such as the electric

and magnetic properties of the conductor and its shape and size; also, on the direction, frequency and distribution of the magnetic field. In many cases the effects of eddy current shielding may be readily calculated. This is true of the special case shown in Figure 1, where a plane laminated conductor, whose width (a) is large compared to its thickness (b), is used as the core of a long coil.* When an alternating current flows through the windings of the coil an alternating magnetic field of the same frequency will be produced within the coil windings. This field will be directed parallel to the Z axis of Figure 1 and consequently will also be parallel to the surface of the lamination.

*In the case of a lamination that is made in the form of a ring its width must be small compared to the radius of the ring.

If there were no eddy currents in the core of the coil this field would distribute itself uniformly over the area within the windings but actually the alternating field will induce eddy currents in the lamination. These currents flow in the xy plane and tend to follow paths parallel to the surface of the conductor. Figure 1 shows the direction of the eddy currents in a small cross-section of the lamination. They tend to go in the opposite direction to the current in the coil windings and the magnetic field produced by

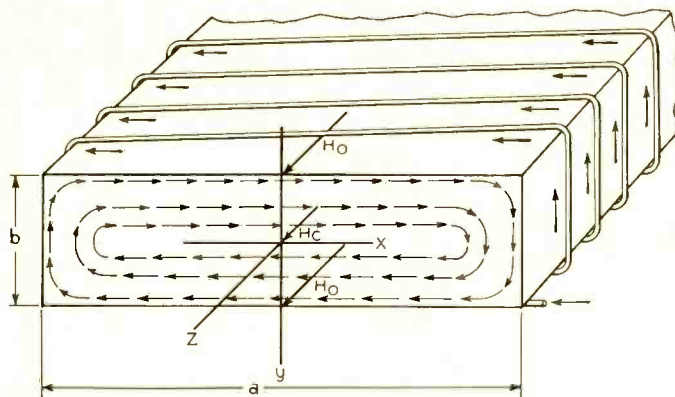

Fig. 1—Cross-section of a thin lamination showing eddy currents generated by an electric current in the windings

them within the area about which they flow will tend to oppose the field H_0 produced by the current in the windings. The resultant field is smallest at the center of the lamination and equal to H_0 at the surface.

The distribution of this field from the surface to the center of the lamination has been shown to be analogous to the distribution of current along a certain type of transmission line. This comparison has proved to be very effective in making eddy current shielding more readily understandable. Many investigators have reported that measured values obtained with ferromagnetic materials

check this theory very well but others have found deviations. These deviations are relatively small generally but in some cases, especially in chromium permalloy cores, variations of the order of tenfold have been observed. Investigations show that these discrepancies are caused by a thin surface layer on the lamination, the permeability of which is much lower than that of the inner material.

The transmission line analogy is illustrated in Figure 2 where I , the current at any point in the line, is analogous

to the magnetic field H at the corresponding point in the lamination; I_0 , the current entering the line, simulates the magnetizing force at the surface of the lamination; and I_c , the current leaving the line, is analogous to the magnetizing force at the center of the lamination. It will be observed that a differential section of this infinite line has only one series element, an inductance l , and one shunt element, a resistance r .

The inductance l is proportional to the permeability and the resistance r to the specific resistance of the core material. The total length of the line is equal to half the thickness of the lamination while the impressed voltage E_0 is the voltage across the width, a , of the lamination.

This analogy may be used in many types of problems which deal with eddy current shielding but will be applied here to the effects on the inductance and resistance of a coil with a core composed of thin laminated conductors of constant

permeability.* In this case the analogous line not only gives the distribution of the magnetic field within the lamination but it can be shown that at a given frequency the impedance of the coil will be proportional to the impedance of the line both in phase and amplitude, if the copper and hysteresis losses are neglected. This affords an easy means of determining the changes of the coil impedance caused by eddy currents.

Attenuation in this analogous line corresponds to the condition where eddy currents are flowing in the lamination. To reduce the attenuation in the line several things may be done. The value of r , the differential shunt element, can be increased; the series element l may be decreased; or the length of the line may be shortened. In terms of the lamination these things mean an increase of the resistivity, a reduction of the permeability of the material, and the use of thinner laminations, respectively.

If there is no attenuation along the line the impedance looking into it will be the sum of all the series elements which will be an inductance, designated by L_0 . The impedance then will be ωL_0 where ω is the product of 2π and the frequency. However, if there is attenuation along the line some cur-

*If the coil core is composed of a ferromagnetic material, H_0 must be kept small to have a permeability that may be considered constant.

rent will flow through the shunt resistances, r , which means that energy is being dissipated within the line. Then a resistive component R must be added to the impedance.

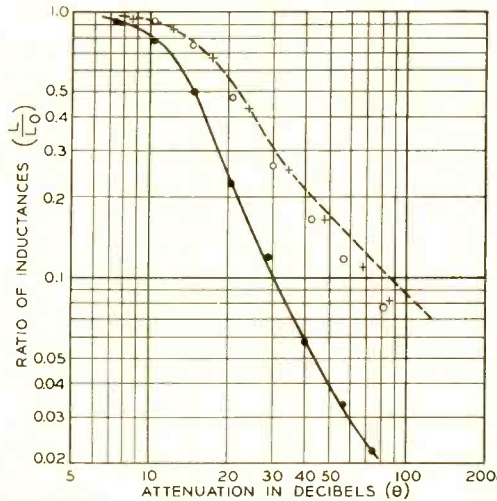

Fig. 3—The experimental and calculated values of L/L_0 are in accord when a thin surface of low permeability has been etched from the laminations

A comparison of results calculated by transmission line theory with those obtained experimentally is shown in Figure 3 by plotting the ratio L/L_0 for the coil and analogous line against the attenuation, θ . Here L is the inductance of the coil or line when there are eddy currents in the laminations; and L_0 is the inductance when eddy currents are absent. The full line gives

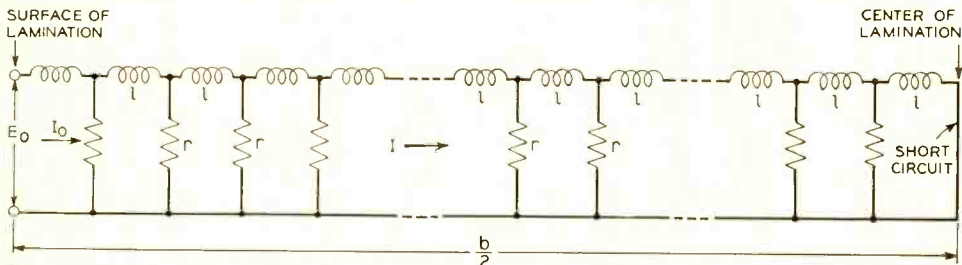

Fig. 2—Transmission line in which the current distribution is analogous to that of the magnetic field across the lamination shown in Figure 1

the measured values of L/L_0 for the coil, as first obtained, and the dashed ones those computed from transmission line theory. The discrepancy between the curves disappears when the thin surface layer of low permeability has been etched away from the laminations. The circles show the results after two mils have been removed and the crosses when an additional half mil has been taken off.

This non-homogeneous lamination may be represented by the analogous line as shown in Figure 4. Here the surface layer of thickness c is represented by the section of line of the same length. Suppose the ratio of the permeability of the inner material to the surface layer is n , but that the resistivity is constant throughout the lamination. If the differential series inductance which represents the inner material is l then the corresponding inductance for the surface layer will be l/n . At very low frequencies where there is no attenuation along the line the impedance of the composite line will be the sum of the inductive elements. The only effect of the surface layer is to decrease the average inductance per unit length along the line which in the lamination means that the average permeability of the lamination will be decreased. However, at frequencies where appreciable attenuation begins to appear in the inner

line, sizable reflections take place at the junction with a corresponding change of phase and input voltage for a constant input current. Here the

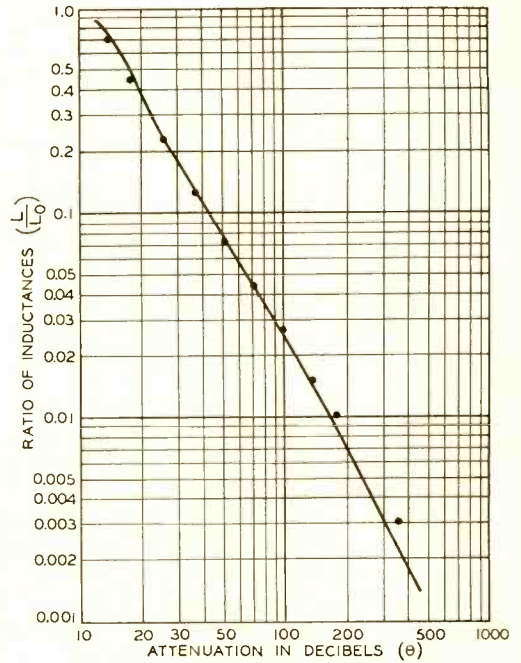

Fig. 5—Theory and measurements agree when the analogous line is made to simulate a non-uniform lamination

impedance of the line may drop rapidly to a very low value and the phase angle may greatly exceed that found in the homogeneous lamination. If the frequency becomes high enough so that a large amount of attenuation

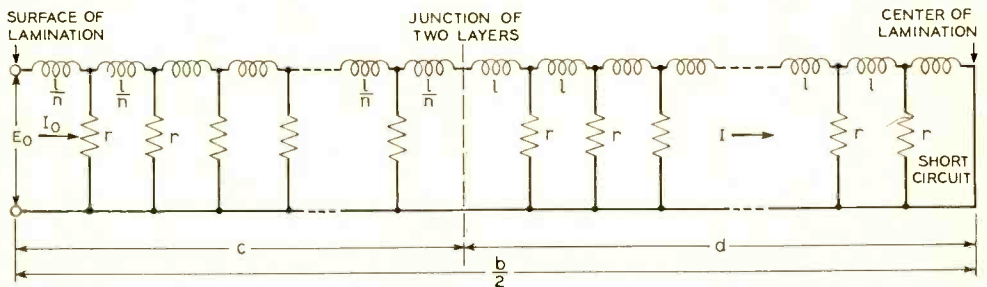

Fig. 4—Transmission line in which the current distribution is analogous to that of the magnetic field across a lamination with a low permeability surface layer

is found in the outer line or surface layer, the impedance of the line will be the same as if it were composed entirely of the line representing the low permeability material. The inductance of the coil will decrease for this condition until it reaches the value that it would have if the lamination were composed entirely of the low permeability material found in the surface layer. This treatment of the subject neglects the possibility of a gradual transition between surface and body materials.

By the use of existing transmission theory the theoretical effects of a low

permeability layer were obtained and by plausible assumptions as to the thickness and permeability of the surface layer in a chromium permalloy coil that showed large deviations from the simple theory, an attempt was made to check the observed values of L/L_0 . The results were very gratifying as indicated on Figure 5, which shows how well the calculated and measured values check. This not only confirms the correctness of the assumption of a low permeability surface layer but it justifies the use of existing transmission line theory to extend our knowledge of eddy current shielding.

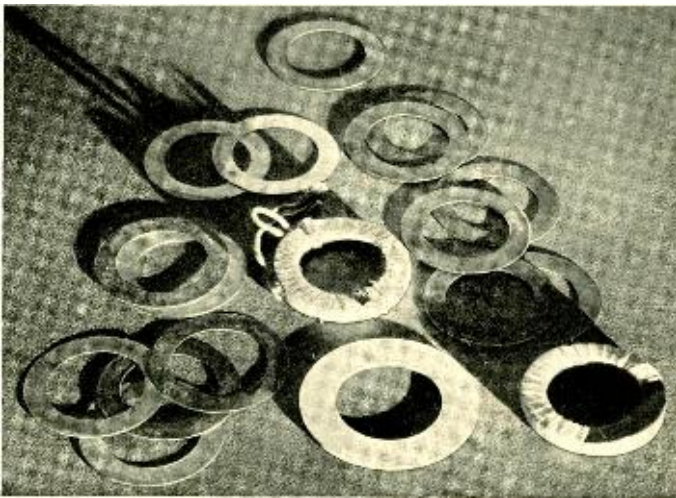

Fig. 6—Coil and laminations used in eddy current studies

When lead or one of its alloys is made cathode in sulfuric acid, as in the charging of a battery, hydrogen is evolved as soon as most of the sulfate has been reduced. Experiment shows that this takes place on lead-antimony at a potential of nearly 0.4 volts more positive than on either lead-calcium or pure lead. This means that during the latter portion of the charge of a battery made of lead-calcium, less current will be wasted in the evolution of hydrogen on the plate, and that a greater proportion of it will fulfill its proper purpose of changing lead sulfate to sponge lead. In terms of battery behavior for one particular type of cell on constant potential charge at 2.6 volts, more than twice as much current would be required near the end of the charge by the lead-antimony as by the lead-calcium. This extra current is all used for the evolution of hydrogen. As the charging potential is raised, even greater differences in efficiencies will occur.

The metallurgical work, which paralleled the electrochemical studies, was equally important. Antimony was originally incorporated in the lead battery grid to give the material the necessary strength. Accordingly, alloys of lead and calcium in varying proportions were made and heat

treated. The tensile strength of specimens cast from these alloys was determined. Figure 2 shows that the maximum strength is obtained with about 0.1 per cent calcium. This maximum value of 8000 pounds per square inch is comparable to that of the commonly used nine per cent antimony alloy when similarly cast.

Entirely satisfactory grid castings have been made experimentally from lead-calcium, some of them only 0.070 inch thick. Figure 5 shows a grid for a standard starting and lighting battery, such as was used for the experimental cells. Lead-calcium can be fabricated by drawing, extrusion, stamping, machining, welding, and burning. The electrical conductivity of lead-calcium (0.1 per cent calcium) is about twenty per cent higher than that of lead-antimony (nine per cent antimony), a factor of importance in securing a uniform current distribution throughout the grid when large currents are drawn.

The realization in a commercial way of the advantages which are indicated by the foregoing studies will require a considerable manufacturing development and a long term service trial of the resulting batteries in order to uncover and correct difficulties which may be introduced in practice.

STANDING WAVES:
*detected by measuring the
voltage at several points
along this concentric
transmission line*

FATIGUE:
*present and experimental
wire ties under vibration*

COMPRESSION:
*a study of its effect on
cable sheath*

VIBRATION:
*its reactions on relay con-
tacts shown by a rapid-
record oscillograph*

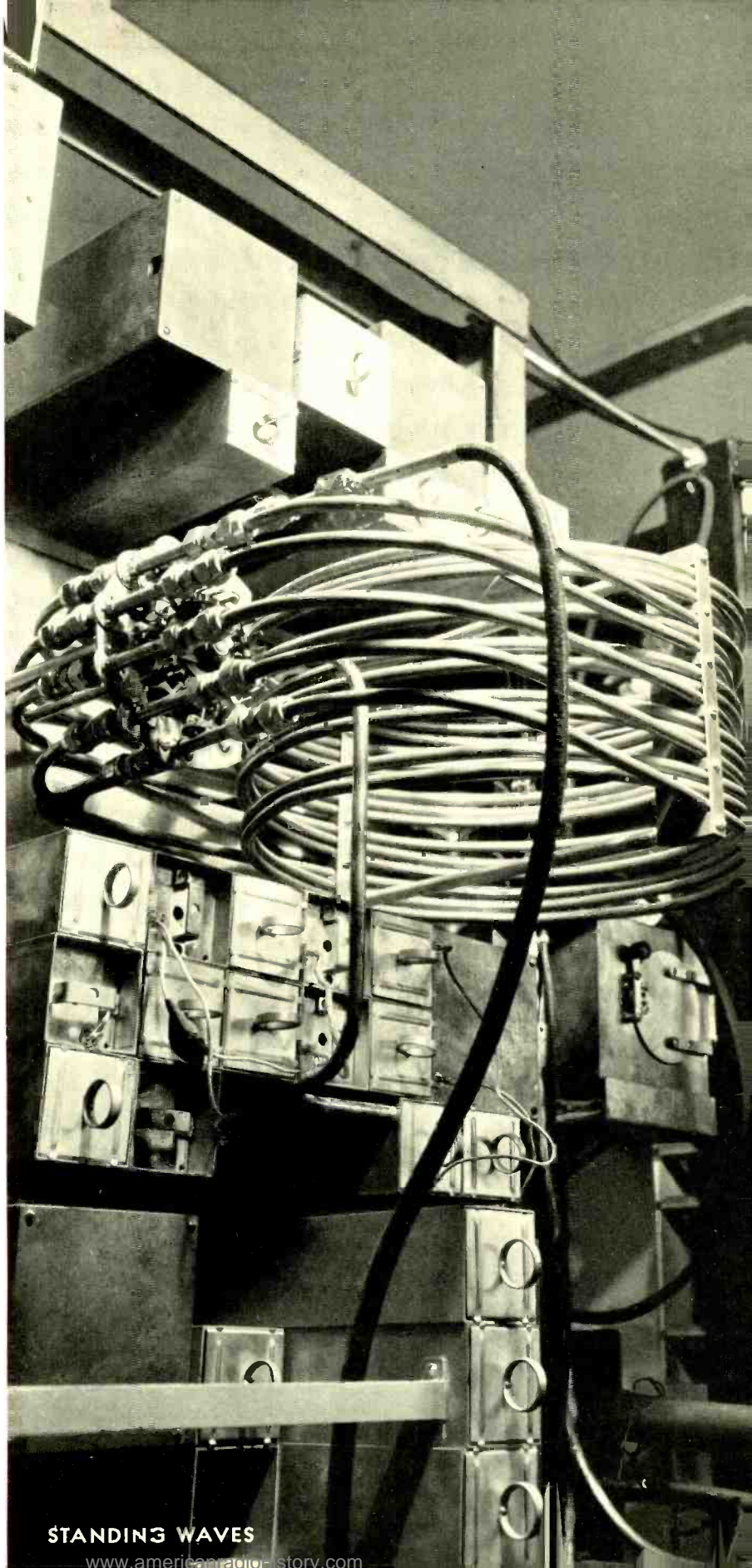

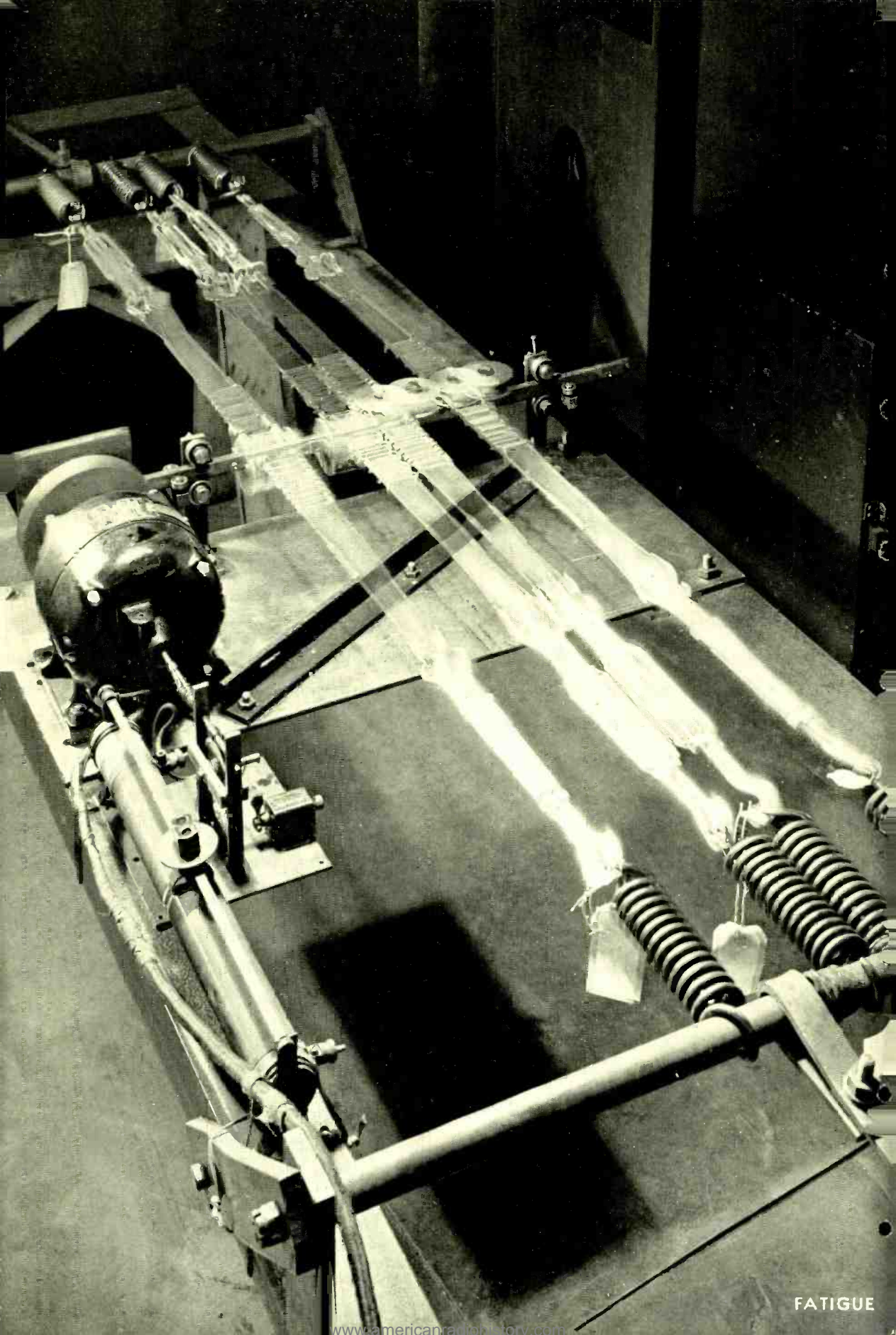

FATIGUE

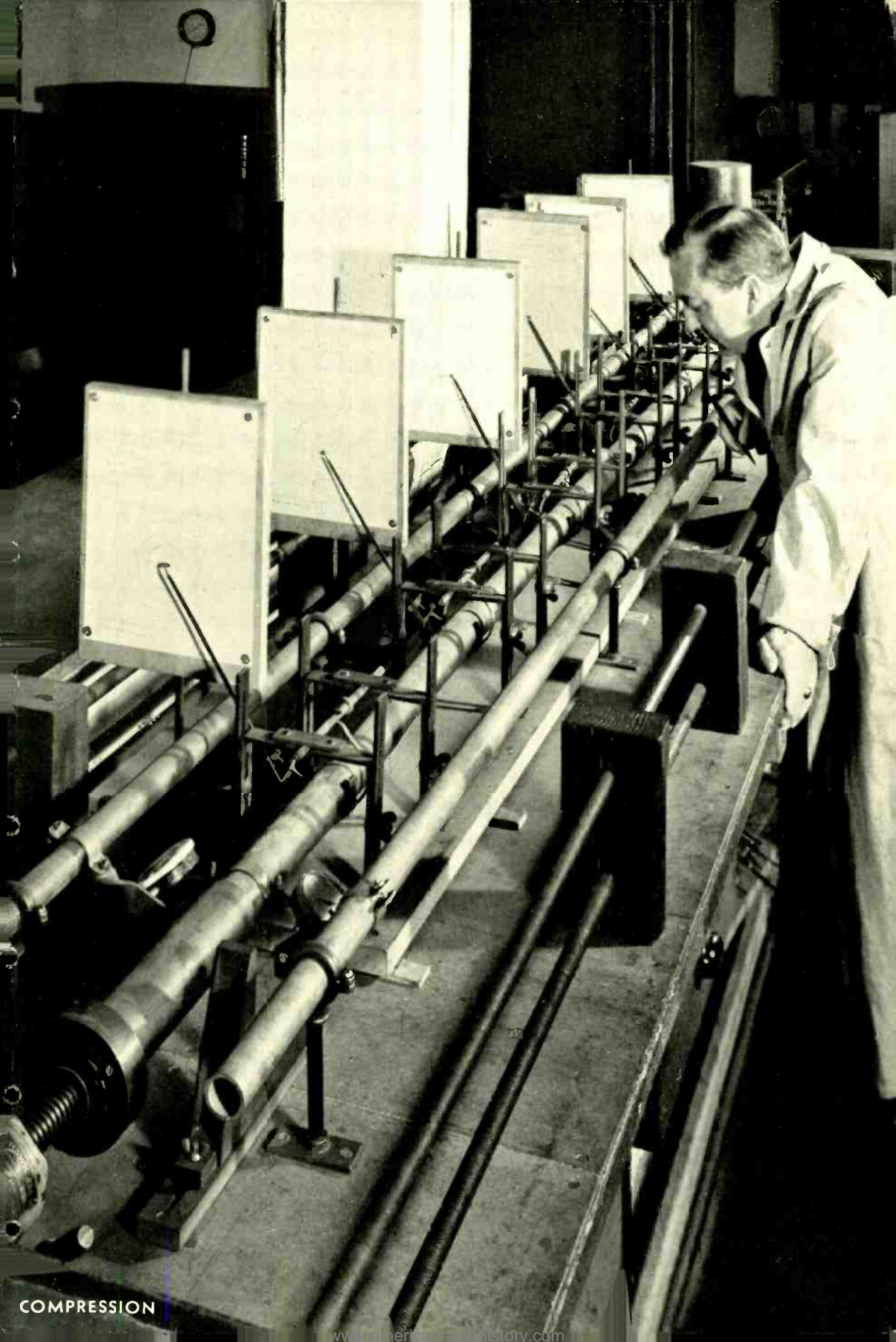

COMPRESSION

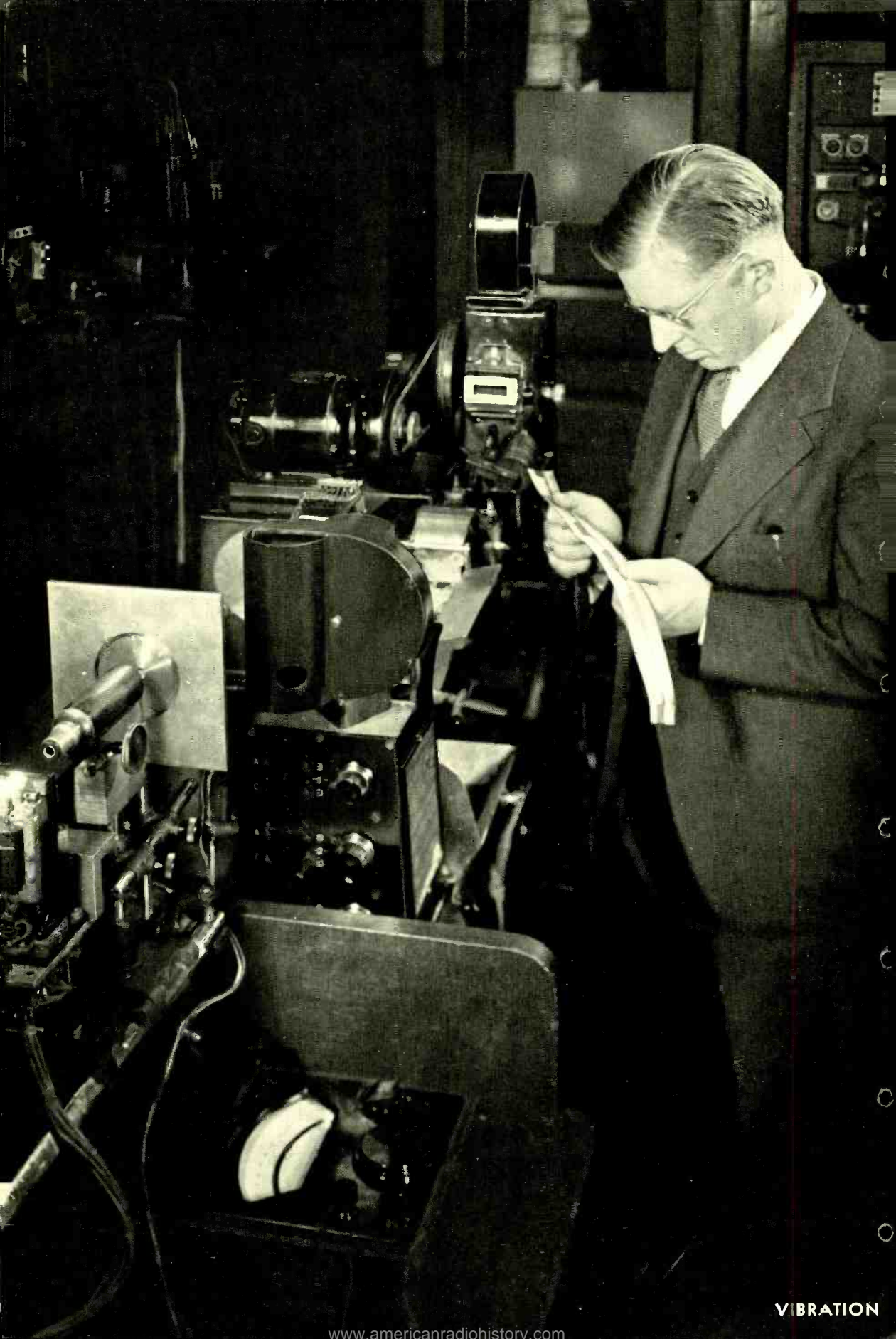



New Tubes for Carrier Systems

By J. O. McNALLY
Vacuum Tube Development

WIDER frequency ranges and the use of repeaters and terminal amplifiers stabilized by feedback are being planned for new carrier systems. These features have placed special and exacting requirements on the vacuum tubes used, with the result that it has been necessary to develop four new types, which differ from the familiar repeater tubes now used throughout the telephone system in that they all contain indirectly heated or equipotential cathodes and are of the pentode rather than the triode type. Two of the tubes have been designed as high-gain voltage amplifiers. They are

identical in electrical characteristics except for the operating heater voltages and currents. The other two tubes are of the power output type and are also identical electrically, except for heater voltages and currents.

The use of equipotential cathodes overcomes some circuit difficulties because it is no longer necessary to maintain the cathodes at the potential of the filament or cathode supply battery. The more compact structure of the equipotential cathode tube is also an advantage where the physical size of the tube has to be maintained at a minimum, which is desirable in the carrier services. The rigid cathode also

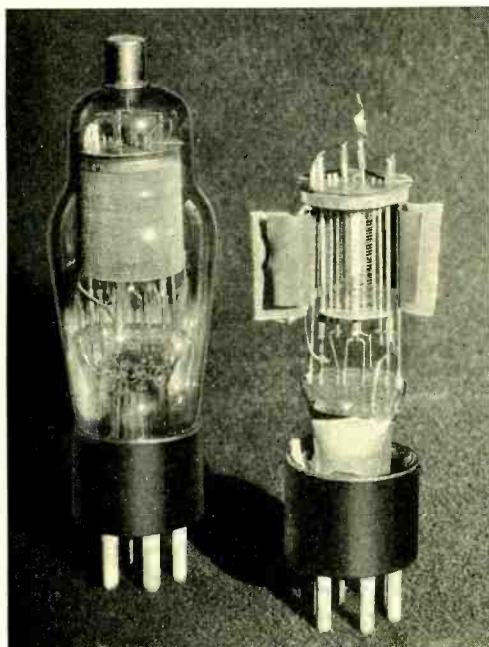

Fig. 1—The 310A amplifier tube complete and also dissected by folding back the outer screen and plate to expose inner elements

permits the use of smaller spacings between the cathode surface and the innermost grid. This inherently means that the equipotential cathode structure may be made to have a high mutual conductance and therefore a high gain. The equipotential cathode has the additional advantage that electrostatic shielding may be simplified and the inter-electrode capacities made smaller than in the filamentary type. Although this type of cathode is generally heated by alternating current, direct current will be used for the majority of applications in the telephone plant.

The elements in the two high-gain voltage-amplifying tubes, coded 310A and 328A, are normally obscured from view by the outer screen, which provides electrostatic shielding of the plate from the control grid. In Figure 1, however, they are shown by cutting

part of the outer screen and the plate away. Next to the cathode is the control grid, on which the signal is applied. This grid normally operates at a potential of three volts negative with respect to the cathode. The next grid outside of the control grid is the screen, which is operated with a fixed positive voltage of approximately 135 volts to accelerate the electrons toward it from the cathode. Only about twenty per cent of the electrons, however, are intercepted by this screen grid and the remainder pass through to the plate.

The screen of the tube also provides electrostatic shielding between the control grid and the plate. This is accomplished by tying the screen grid to the cathode through a condenser, thereby effectively grounding this grid at voice and carrier frequencies. Additional shielding of the control grid is provided by the upper and lower shields and the cylindrical shield external to the plate. Between the screen and the plate is the suppressor grid which is held at approximately the potential of the cathode. The purpose

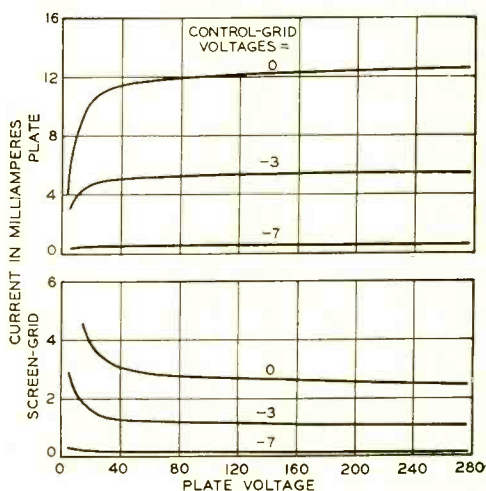

Fig. 2—Static characteristics of the 310A and 328A repeater tubes

of this grid is to prevent secondary electrons, knocked out of the plate by the impact of the arriving electrons, from being carried to the screen when the plate is at a lower potential than the screen.

When the above voltages are applied on the grids of the 310A and 328A tubes, and when the plate voltage is 135 volts, the plate current is about 5.5 milliamperes. Under these conditions the mutual conductance is approximately 1800 micromhos. A resistance load of 100,000 ohms gives a ratio of output voltage across the load to signal voltage on the grid of about 159 or a voltage gain of 44 db. It is of interest to compare this value with that for the 102F type at present used as a voltage amplifier tube in voice frequency repeaters. A load resistance of 100,000 ohms for the 102F tube gives a voltage step-up of 19.5 fold and increasing the resistance load to several hundred thousand ohms gives a maximum possible step-up of only 30 times. With a single-frequency power output twice that of the 102F the harmonics of all three tubes constitute approximately the same percentage of the output. The inputs necessary to give these outputs are about three and one-half times as great in the 102F as in the other two tubes. Static characteristic curves for the 310A and 328A are given in Figure 2.

The power tubes, coded 311A and 329A, when working with a control grid bias of -15 volts and a plate and screen voltage of 135 volts give an average plate current of approximately thirty milliamperes. Characteristic curves for these tubes are shown in Figure 4. The mutual conductance is approximately 2800 micromhos and the power output obtained with a resistance load of 4000 ohms and an input of fifteen peak

volts is approximately 1.8 watts. This is approximately nine times the output of the 104D type which is the power tube used in existing carrier systems. The third harmonic is about thirty-five db greater in the new

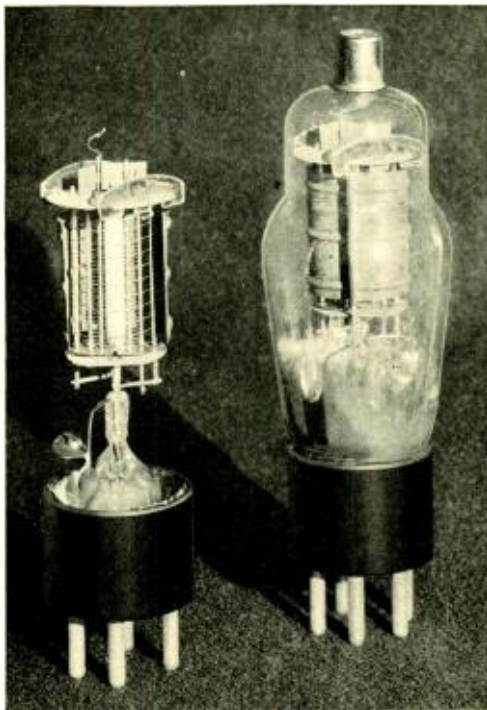

Fig. 3—The 311A power tube

tubes but this is permissible since the new carrier systems use feedback and the third harmonic is thereby reduced to an acceptable value.

The normal heater voltage for the 310A tube is ten volts and the average heater current is 0.32 amperes. The 328A tube has a 7.5 volt heater which takes 0.425 ampere. In the 311A tube the heater requires ten volts at 0.64 amperes and in the 329A tube, 7.5 volts at 0.85 amperes. This particular arrangement of heater voltages and currents was decided upon so that two 310A heaters, connected in parallel, could be operated in series with the

heater of one 311A tube. The group, which requires twenty volts, can then be operated economically in "regulated" offices where the battery voltage is maintained close to twenty-four volts. The heater voltages of the 328A and 329A tubes were selected as the most economical for operation in "un-

a ceramic material to further improve the insulation, and the small metal plates used for electrostatic shielding are formed to act as baffles to prevent material sprayed from the surface of the cathode from being deposited on the insulators and causing leaks.

Inter-electrode capacities are usually not considered of great importance in a tube of the general type of the 311A and 329A. However, for carrier uses it has been necessary to reduce the capacities, particularly that between control grid and plate, to a minimum. In these tubes the average value is 0.07 micromicrofarads instead of approximately 1.0 as it is in the more usual tube of this size. It has been necessary moreover to reduce the variations in this capacity from tube to tube. During the development of the tubes too wide a variation was traced to a peculiar and curious "island" effect caused by a capacitance-resistance network across the mica insulators between control grid and plate. The effect was eliminated by removing the plate supports entirely from the mica insulators.

It is necessary to have the longest possible life for tubes in this type of service. With this in view a series of experiments has been undertaken to try various types of active material on the cathode and different means of processing the parts and pumping. Already there are indications that the adoption of some of these methods may greatly increase the useful life of the tubes.

These new tubes not only fulfill the more exacting requirements imposed by new carrier systems but they are more effective than those now in use and give promise of reducing appreciably the cost of maintenance.

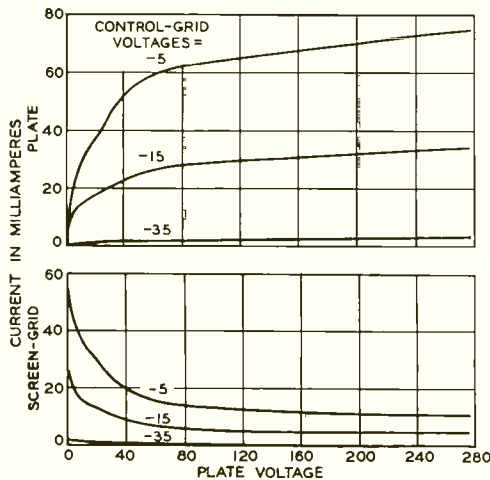

Fig. 4—Static characteristics of the 311A and 329A repeater tubes

regulated" offices where the battery voltage may vary from twenty to twenty-eight volts and where it is necessary to use ballast lamps in series with the heaters to maintain currents within sufficiently narrow limits.

All of these tubes have been designed to meet the severe demands of telephone service. Since insulation leaks between the control grid and any of the other elements could cause trouble the mica insulators at the top and bottom of the structure contain slots between the mounting holes for the control grid and other elements, to make the insulation paths longer across the surface of the mica. In addition the insulators are sprayed with



Quartz Plates for Frequency Sub-Standards

By S. C. HIGHT
Radio Research Department

THE need for a rugged portable sub-standard of frequency has led to the development of a new type of quartz plate with low temperature-coefficient, and a stabilized circuit in which the crystal has complete control of the frequency. This makes the sub-standard independent of variations in the supplied voltage and of circuit reactances.

The essential element of the frequency standard is a quartz plate which, because of its piezo-electric properties, vibrates when an alternating current is applied across its face. Although of electric origin this vibration is mechanical and the fundamental frequency like that of all

vibrating plates depends on the size, and the density and elasticity of the material of which the plate is made. The elasticity and hence the frequency of vibration changes with the temperature and, in the case of quartz, also with the direction in which the crystal is cut relative to the natural axes of the crystal.

It has been found that quartz plates of low temperature-coefficient can be made by cutting the crystal in certain directions with reference to the crystal axes.* These cuts are related to the electric axis (x), the mechanical axis (y) and the optic axis (z) as illustrated in Figure 1.

*RECORD, Vol. 14, April, 1936, p. 250.

The manner in which these plates vibrate is illustrated in Figure 2. If a static electric field is applied between the upper and lower faces two shear stresses result which tend to deform the crystal. One distorts the crystal as illustrated in Figure 2b and the other as in Figure 2c. If the applied field alternates, these deformations vary periodically and, if the frequency of the field corresponds to the natural period of either mode, the plate vibrates. The frequency of each of these modes depends on the dimensions of the crystal. That of the mode illustrated in Figure 2b is inversely proportional to the thickness of the crystal while that shown in Figure 2c depends on the length and width of the crystal and has the lower frequency of the two. Vibrations of these two types occur in both of the plates illustrated in Figure 1.

The possibility of making plates with low temperature-coefficients to operate at frequencies below the broadcast band has recently been in-

vestigated by the Laboratories. The results disclosed two new types of quartz crystal elements which operate at frequencies below five hundred kilocycles. They are cut parallel to the electric axis as shown in Figure 1 and employ the mode of vibration illustrated in Figure 2c. Their frequency depends on the dimensions of the large face of the plates.

The new plates which are designated by the letters CT and DT have many unique advantages over their predecessors. The frequency may be lowered as well as raised by a simple abrasion. Also, the temperature-co-

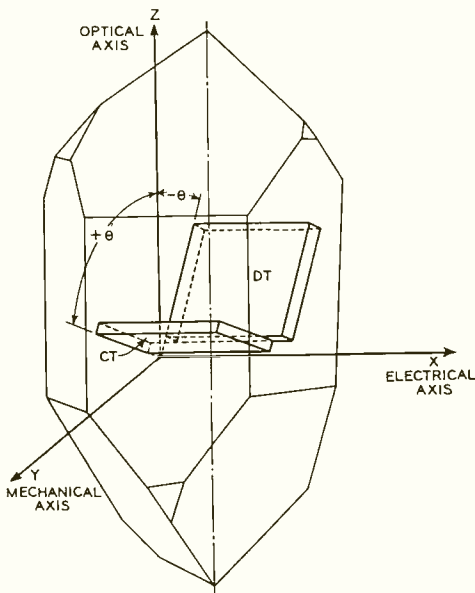

Fig. 1—Orientations of the zero temperature-coefficient plates

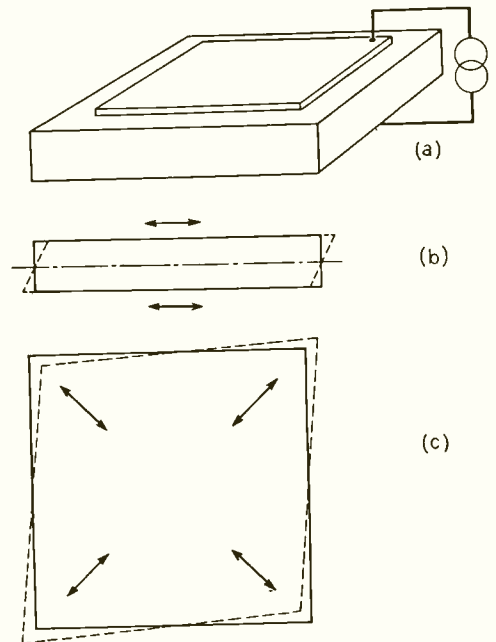

Fig. 2—Vibrations of these types are obtained by applying an alternating electric field across the faces of quartz plates

efficient may be changed in either a positive or negative direction by abrading the faces so as effectively to alter the orientation a slight amount. These two adjustments produce a plate precisely adjusted to frequency and temperature-coefficient, thus

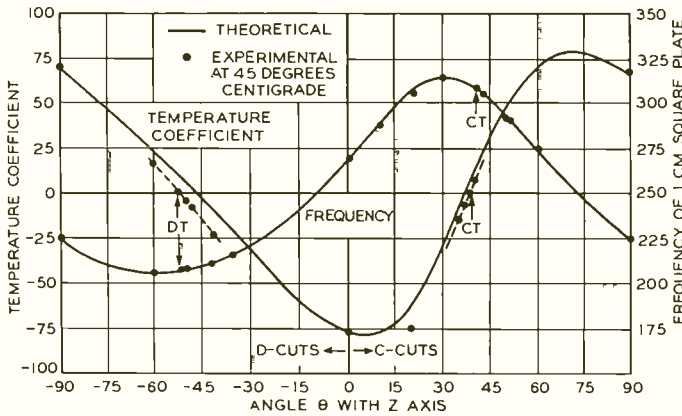

Fig. 3—The wide range of temperature-coefficient and frequency-constant obtainable in C and D cut plates results from variations of rigidity. Orientations which give zero coefficient are marked CT and DT and occur near the maximum and minimum frequency of oscillation

eliminating at once the errors of shop-production tolerances, and the penalties of over-adjustment which are inherent in the usual one-way adjustment of frequency.

The mode of vibration is simple and the amplitude is so large that the motion can be studied in a microscope. The geometrical center of the large square area is a node while the corners move along the diagonals. This deforms the periphery into a rhombus as shown in Figure 2c. Neither the frequency, temperature-coefficient nor vibrational pattern is affected by couplings to neighboring frequencies or harmonics of lower frequencies, since they do not exist.

Plates cut out of a crystal at any angle about the axis will vibrate in the low frequency mode illustrated in Figure 2c but the frequency and temperature coefficient will depend upon the angle.

Figure 3 shows theoretical curves and experimental check points for these quantities for all orientations with the z crystal axis. At the points on the curves corresponding to the CT and DT plates the effects of temperature on the modulus of rigidity, the density, and the linear dimensions are so balanced that the frequency remains constant. It is interesting to note that at the orientations which give

zero temperature coefficient, the crystalline planes in which the vibrations take place are nearly the same as those used in the better known high-frequency AT and BT plates.

A more detailed analysis of the relations between temperature, orientation, and frequency is shown in Figure 4. The zero coefficient occurs only at a certain temperature which is dependent on the orientation of the plate. For operation at room temperature the angle of cutting for the CT plate should be +37 degrees 30

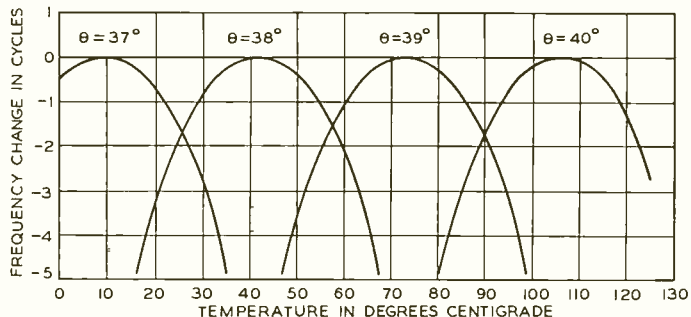

Fig. 4—Temperature-frequency curves of several 100-kilocycle plates oriented at angles from +37 to +40 degrees in respect to the Z axis. The actual zero coefficient of these crystal plates occurs only at the peaks of the curves

minutes with the z axis. This will allow the temperature to vary from 20 degrees to 30 degrees Centigrade, and still keep the frequency within one part in a million of the desired value. A similar set of relations exists for DT plates which exhibit even less variation of frequency than those shown.

circuit used in conjunction with the new crystals for this sub-standard must also be precise and simple. Such a circuit which takes full advantage of the characteristics of the CT plate, is shown in Figure 5.

In general, the major frequency instabilities of oscillator circuits are as-

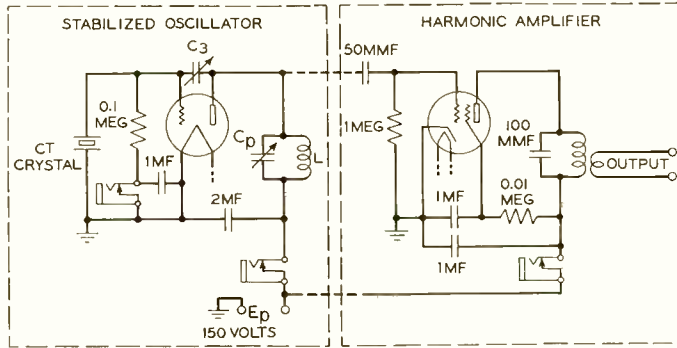

Fig. 5—The frequency of this stabilized oscillator is not affected by variations of the reactances or applied voltage. The output contains useful multiples of one hundred kilocycles at frequencies as high as thirty megacycles

An important factor in the practical application of these plates is the method of mounting them. The ordinary crystal holders have been found unsuited for sub-standards of frequency. The one used supports the crystal without clamping by resting it on a slightly convex electrode where it is kept from moving about by a retainer fitted very closely to the crystal around the edges. The upper electrode is spaced from the crystal by a small air gap.

One of the principal uses in prospect for the new low temperature-coefficient plates is that of frequency sub-standards for measuring purposes. Such sub-standards must be better than the frequency control elements in radio transmitters, but do not need to be so elaborate, accurate, nor delicate as the standards used for the most precise scientific work. The cir-

cuit used in conjunction with the new crystals for this sub-standard must also be precise and simple. Such a circuit which takes full advantage of the characteristics of the CT plate, is shown in Figure 5.

In general, the major frequency instabilities of oscillator circuits are associated with reactance, temperature, and voltage changes. Variations in temperature or applied voltage may be considered as equivalent reactance changes, since it is through reactance changes that they affect the frequency. Temperature changes cause reactance changes by acting directly on the coils and condensers external to the vacuum tube, while variations

in the applied voltage have the effect of changing the amplification factor and internal impedances of the tube. Hence, if a circuit can be so adjusted that the frequency is independent of small changes in the reactances it is also independent of small temperature and voltage variations. Such an adjustment has been found attainable, and this makes it possible to stabilize the relatively simple circuit of Figure 5. Its novelty lies in the values chosen for the reactances, and the manner in which adjustment for stability is made by successive approximations.

This stability is brought about by operating at the peaks of the curves 1 and 2 shown in Figure 6. Under this condition, small changes in either the feedback capacity, Curve 1, or the plate reactance, Curve 2, cause no change in frequency; and the fre-

quency is also independent of variations in the applied voltage, Curve 3. A practical advantage of this stabilized circuit over previous and more complex ones lies in its simplicity of adjustment, which is complete when the two condensers c_p and c_3 are set to produce their maximum frequency.

Both the CT crystal and the stabi-

lized circuit have already found several applications in radio frequency control and frequency sub-standardization. The results of this development of crystal and circuit provide an excellent example of the fruitful results of simultaneous research into the piezo-elastic properties of quartz and the associated electrical networks.

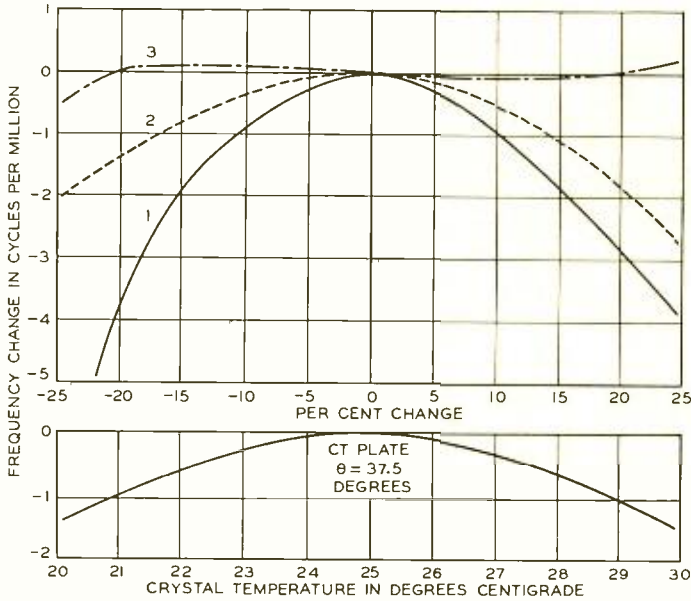
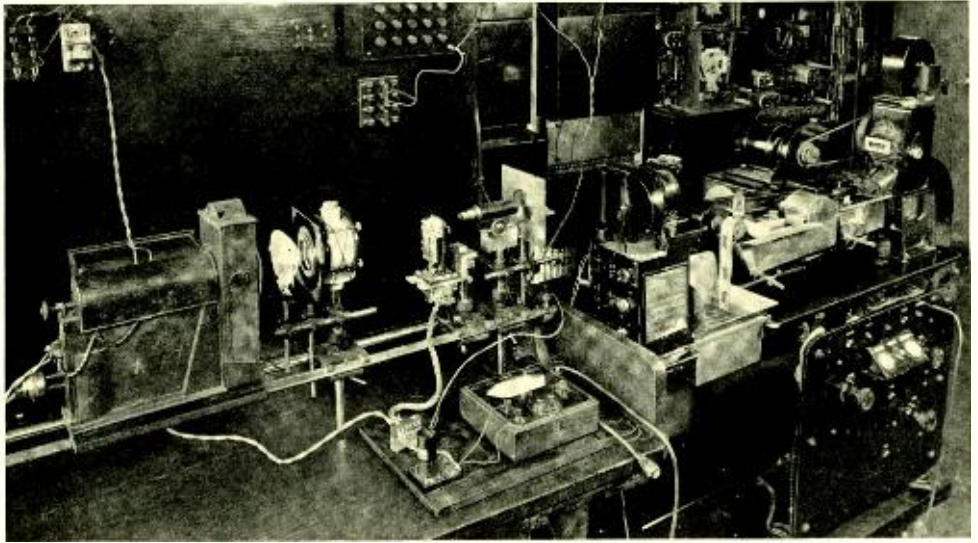

Fig. 6—These overall stability curves of the crystal and circuit show how the frequency is maintained within one part in a million of its mean value with normal variations in reactances, voltage, and temperature



Vibration Studies With the Rapid Oscillograph

By H. E. HILL.
Research Department

RELAYS and bells play an important part in telephone equipment and with increasing service requirements the demands on these devices have become very severe. The technique of measuring their electrical characteristics has progressed with the communication art but little advance has been made, heretofore, in determining the dynamic behavior of the mechanical structures involved. A method of measuring the motion of such parts directly and of correlating the magnitude, velocity and phase of that motion with the current in the electrical circuit has recently been developed by H. N. Wager of the Laboratories. Improvements particularly in the magnification attainable have been made in the equipment used in making these studies and the results are described in the present article.

The method involves projecting the shadow image of an edge of the moving part onto the recording paper of a high speed oscillograph, and making a graphic record of the deflection of that part as a function of time. If the device is electro-mechanical, part of the recording paper may also be used to make an oscillographic record of the current which caused the motion, or that which was caused by the motion, or both. In this manner, the amplitude, frequency, and waveshape of the motion may be obtained as well as the phase relationship across the magneto-mechanical coupling.

The equipment necessary to make such composite shadow-oscillograms consists essentially of a brilliant light source, a condensing lens, a projection lens, and a high-speed oscillograph. This equipment has been used to ex-

amine such things as the motion of the armature and contacts of the polarized telegraph relay, that of the clapper and gongs of a telephone ringer, that of certain cams in the teletypewriter and a plunger in the spring pileup of a "U" type relay. The ratio of the amplitude of the shadow movement as recorded on the paper tape to the amplitude of motion of the moving part has ranged in value from two or three in studying the cam movement of the teletypewriter to about 100 when investigating the contact action of the polarized telegraph relay. The term "magnification" is used in this connection to denote this ratio.

A few composite shadow-oscillograms are illustrated in Figures 1 and 2. Those in Figure 3 show graphically at relatively high magnification the operation of the telegraph relay on two different currents and at two frequencies. The shadowgrams indicate the movement of the armature between the pole-pieces, and also that of one of the armature contacts. The motions recorded are those at point *a*, Figure 3, on the armature and at *b* on the contact spring respectively. Point *b* lies on the center line between the contacts, hence the motion of the contact spring at *b* is the same as the motion of the armature contact. The

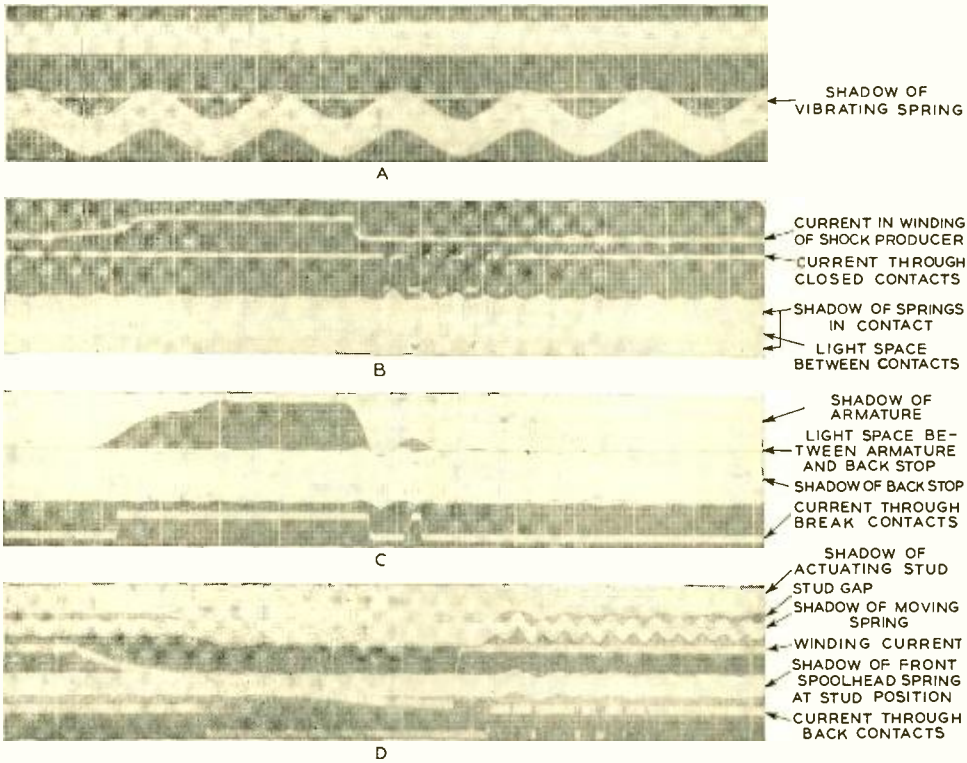

Fig. 1—These shadowgrams were made with the earlier apparatus designed by H. N. Wager. A—measurements of the natural frequency of a spring; B—contact chatter caused by shocks applied to the frame supporting the contacts; C—the correlation between mechanical rebound of a relay armature and the reopening of contacts under its control; and D—the combined action of armature rebound and spring vibration in causing contact chatter

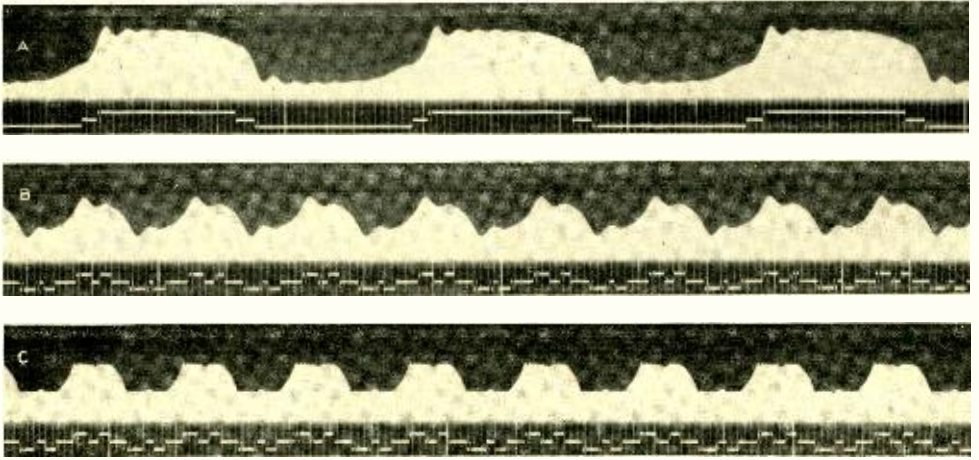

Fig. 2—Shadow oscillograms of a telegraph relay showing the motion of moving parts and the operation of the contact. A—Armature motion between the pole-pieces (above) with operating current of four milliamperes at 20 cycles (below); B—Armature motion between pole-pieces with operating current of one milliampere at 60 cycles; and C—Motion of armature contacts with operating current of one milliampere at 60 cycles

oscillogram records the time when an electrical connection is made between the armature and the stationary contacts as the armature and the armature contacts move in the manner indicated by their respective shadows. The oscillograms also provide a time scale on which the distance between two adjacent vertical lines represents one millisecond.

A few composite shadow-oscillograms in which a low as well as a high magnification was used are shown in Figure 4. These shadow-oscillograms indicate graphically the operation of a telephone ringer. The movement of the clapper is illustrated by record A in which the height of the dark area represents the space between the clapper and the gong. This same movement is shown at B at very much greater magnification. In this case, the vibration of the edge of the gong appears very distinctly. The edge vibration at a point on the periphery 90 degrees from the place where the gong is struck by the clapper is shown

at c. The oscillograms also record the current which operates the ringer.

The arrangement of the equipment for making these graphic records of motion and of current on the same recording medium so that the time abscissa is common to both is illus-

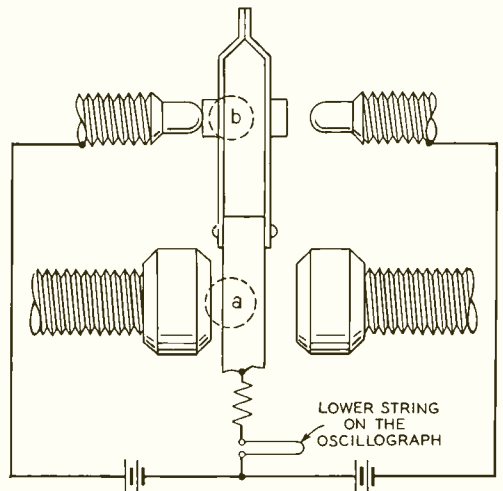

Fig. 3—Diagram showing the contacts and pole-pieces of a telegraph relay. The parts illuminated for shadowgraph records are indicated by the dotted circles

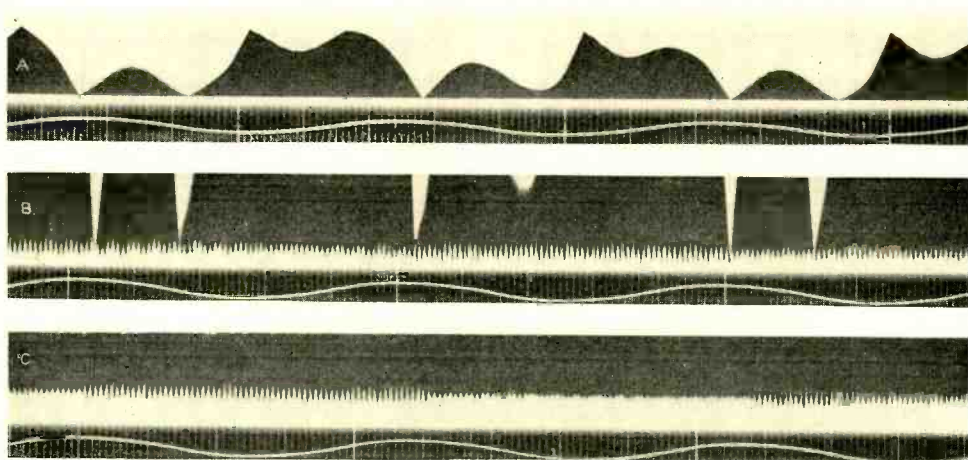

Fig. 4—Shadow oscillogram of a telephone ringer showing the motion of the clapper (above), one of the gongs (center), and the operating current (below). A—motion magnified 5.5 times; B—Same magnified 67 times; and C—Motion of the edge of the gong 90 degrees from the point struck by the clapper, magnified 67 times

trated in Figure 6. For low magnifications a filament lamp may be used as a source of illumination, and the best results seem to be obtained by imaging the light in the projection lens. With high magnifications an arc lamp is required and a water cell has to be interposed in the light path to remove excessive heat. If the object has a definite edge whose movement corresponds to that of the object, it is advantageous to focus the light source on this edge. An image of the edge is formed on that portion of the recording paper which is shielded from the

oscillograph illumination. A piece of paper pasted over a portion of the hole from which the light emerges in passing through the front pole-piece shields a portion of the recording paper from the oscillograph illumination and thus provides part of the paper for the oscillograph record of the shadow movement.

The shadowgraph image and that of the oscillograph must fall in the same horizontal line on the record paper. If there is a slight displacement between these two images, events that occur simultaneously in the mechanical structure and in the electrical circuit will appear to have occurred at different times.

Some devices can not be made to function correctly if they are orientated so that the edge of the shadow of the part whose motion is to be studied is parallel to the direction in which the recording paper moves. This difficulty can be overcome by placing a right-angle prism with the hypotenuse and end bases parallel to the optic axis in the light path be-

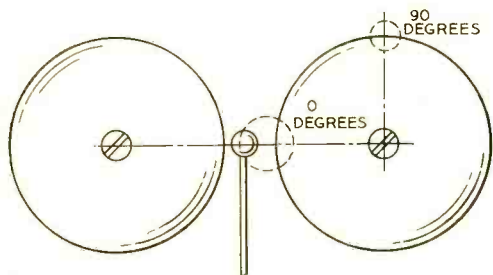

Fig. 5—Diagram of the gongs and clapper of a ringer showing, as a dotted circle, the region illuminated to obtain a shadow record of the motion of these parts

tween the projection lens and the recording paper. Rotating this prism around the optic axis rotates the projected image. In this manner, the shadow of a part inclined at any angle may be made parallel to the shadows cast by the galvanometer strings.

For convenience the equipment is mounted on an optical bench as shown in the photograph. From left to right are the arc lamp, condensing lens, iris diaphragm, water cell, telegraph relay, projection lens mounted in a microscope tube, and right-angle prism mounted on its holder. This arrangement of the equipment makes it adaptable for making measurements on different pieces of apparatus and at different magnifications. The magni-

fication may be changed by moving the oscillograph away from the projection lens as well as by using projection lenses of different focal lengths.

This method of measuring the motion of small moving parts has the advantage over some others that a graphic record of the motion of the part in question is obtained directly, on the same recording medium as the oscillographic record of the current with which the motion is magneto-mechanically coupled. The abscissa of time is also common to both records and nothing is attached to the moving part to affect its motion. The procedure that is involved is simple, flexible, and adaptable to a great variety of types of apparatus.

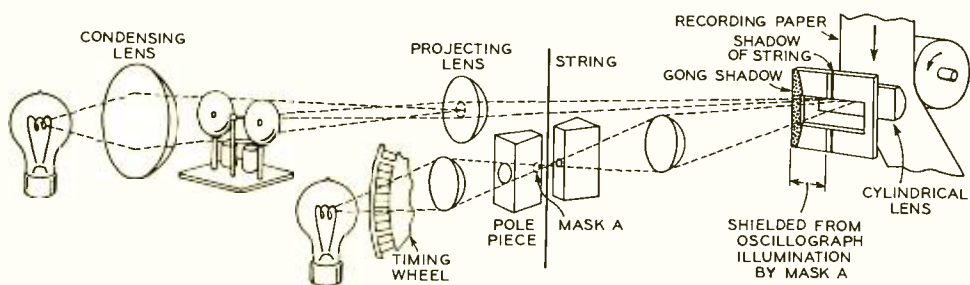

Fig. 6—Shadow-oscillograms are made by condensing light from a brilliant source onto the moving part being studied and projecting the image onto the record tape

Contributors to this Issue

C. N. HICKMAN received the A.M. degree at Clark University in 1917, and then engaged in ballistic research for the U. S. Government. At the close of the war he was employed at the Bureau of Standards in the Inductance and Capacitance Laboratory. He then returned to Clark University and received the Ph.D. degree in 1922 under Dr. A. G. Webster. Following a short period of service with the Navy Department designing submarine mines, he was employed in the Research Department of the American Piano Company. In 1930 he joined the Technical Staff of the Laboratories where he has had charge of a group engaged in investigating magnetic recording and in designing special acoustical instruments.



C. N. Hickman

L. R. WRATHALL obtained a B.S. degree from the University of Utah in 1927 and returned the following year for graduate work. In 1929 he joined the Laboratories' Research Department. Since that time the major part of his work has been devoted to the study of the non-linear properties of coils and condensers.

H. E. HILL graduated from Stanford University in 1929. After receiving an E.E. degree in 1930 he came to the Laboratories. He was first concerned with the early development of tone operated and voice operated devices for use on long transmission lines. At present, he is engaged in studying the operation of electromechanical devices, and in this connection has made use of the oscillographic method



L. R. Wrathall

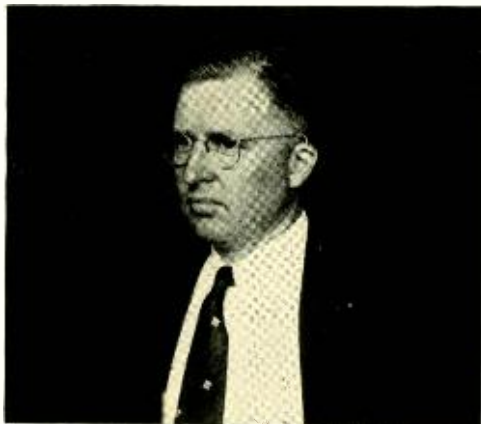

H. E. Hill



J. O. McNally



U. B. Thomas, Jr.

that is described in the present issue of the RECORD.

J. O. McNALLY graduated from the University of New Brunswick, Canada, in 1924 with the degree of B.Sc. in Electrical Engineering. Coming at once to New York, he joined the vacuum tube development group of the Laboratories' Research Department. Since that time he has been associated with the development of many of the different types of small high-vacuum tubes used in the sound-picture and radio fields as well as in repeaters employed extensively throughout the Bell System.

S. C. HIGHT joined the Laboratories in 1930 after he had received the B.S. degree in Electrical Engineering from the University of California. He has been en-

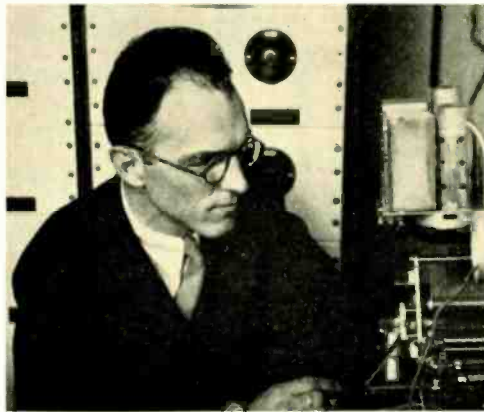

S. C. Hight

gaged here with the radio research group in investigations of quartz crystal oscillators and their associated circuits. These studies have resulted in the development of more precise methods for controlling the effects of temperature changes on the frequency of crystal oscillators. In 1934 Mr. Hight received the A.M. degree in physics from Columbia University.

UPTON B. THOMAS, JR., received the B.S. degree in chemistry at the College of William and Mary in 1929 and joined the Technical Staff of the Laboratories in July of that year. Since that time he has been engaged in extensive fundamental studies on storage batteries and on the contact resistance characteristics of clean and tarnished metal surfaces.