

BELL

LABORATORIES

RECORD

INDEX

VOLUME 15

*from September 1936 to
August 1937*

BELL LABORATORIES RECORD

Edited by the Bureau of Publications:

PAUL B. FINDLEY, *Managing Editor*

PHILIP C. JONES, *Associate Editor*

GEORGE F. FOWLER, *Circulation*

Board of Editorial Advisers:

E. W. ADAMS	H. A. FREDERICK	W. H. MATTHIES
H. A. AFFEL	O. M. GLUNT	JOHN MILLS
H. M. BASCOM	M. J. KELLY	D. A. QUARLES
B. C. BELLOWS	W. H. MARTIN	G. B. THOMAS
W. FONDILLER		R. R. WILLIAMS

BELL TELEPHONE LABORATORIES, INCORPORATED

463 West Street, New York, N. Y.

LIST OF ISSUES IN VOLUME XV

No. 1	September, 1936	Pages 1- 32
" 2	October, 1936	33- 64
" 3	November, 1936	65- 96
" 4	December, 1936	97-136
" 5	January, 1937	137-176
" 6	February, 1937	177-208
" 7	March, 1937	209-240
" 8	April, 1937	241-272
" 9	May, 1937	273-304
" 10	June, 1937	305-336
" 11	July, 1937	337-368
" 12	August, 1937	369-400

BELL LABORATORIES RECORD

WILMINGTON
(INSTITUTION)

SEP 11 1936

FREE LIBRARY



TELETYPEWRITER
EXCHANGES

G. A. LOCKE

ROTATION OF MOLE-
CULES IN CRYSTALS

A. H. WHITE

TELEPHONE
HAND TOOLS

C. R. MOORE

SEPTEMBER 1936 Vol. XV No. 1

BELL LABORATORIES RECORD

Published Monthly by BELL TELEPHONE LABORATORIES, INC.

PAUL B. FINDLEY, *Managing Editor* PHILIP C. JONES, *Associate Editor*

Board of Editorial Advisors

B. C. BELLOWS	W. FONDILLER	H. A. FREDERICK	O. M. GLUNT
H. H. LOWRY	W. H. MARTIN	W. H. MATTHIES	JOHN MILLS
D. A. QUARLES	J. G. ROBERTS	G. B. THOMAS	R. R. WILLIAMS

SINGLE COPIES \$0.25; subscriptions are accepted at \$2.00 per year; foreign postage \$0.60 extra per year. Subscriptions should be addressed to Bell Laboratories Record, 463 West Street, New York City

In this Issue

An All-Purpose Radio Receiver for Mobile Applications	2
<i>K. O. Thorpe</i>	
Teletypewriter Exchange Systems	7
<i>G. A. Locke</i>	
Molecular Rotation in Organic Crystals	11
<i>A. H. White</i>	
Out-of-Block Protector	15
<i>A. W. Dring</i>	
Directive Antenna Solves Coverage Problem	17
<i>J. F. Morrison</i>	
Telephone Hand Tools	21
<i>C. R. Moore</i>	
New Reproducer System for Small Theatres	25
<i>G. Puller</i>	
The Impinger	30

Volume 15—Number 1—September, 1936

BELL LABORATORIES RECORD

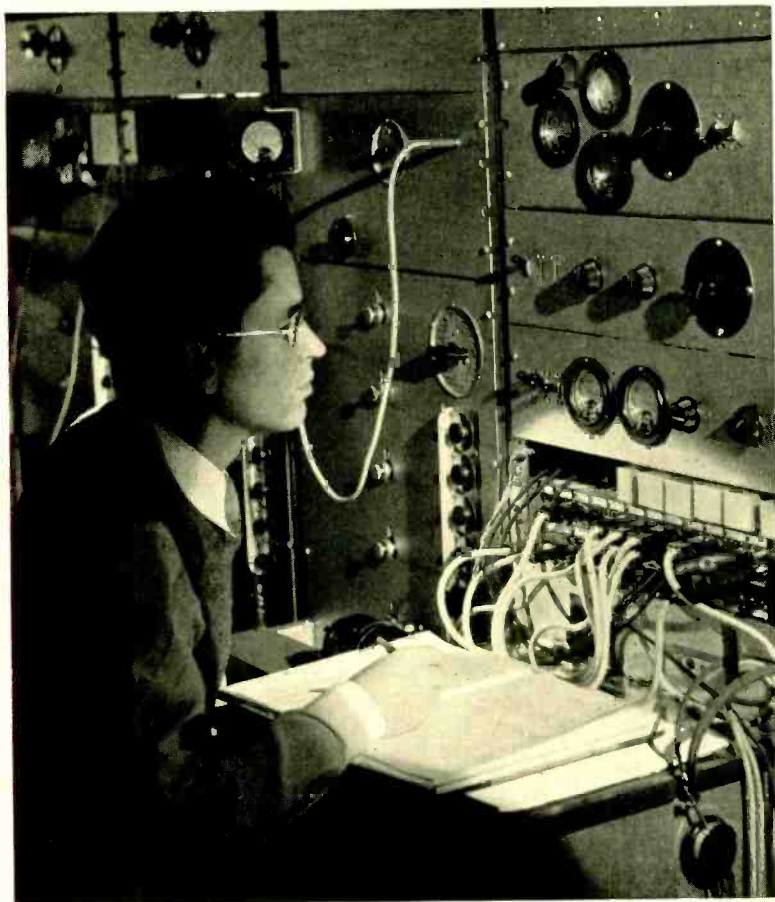

Control panels for a directional antenna at Holmdel

SEPTEMBER, 1936

VOLUME FIFTEEN—NUMBER ONE



An All-Purpose Radio Receiver for Mobile Applications

By K. O. THORP

Radio Development Department

WITH the recognition of its convenience and utility, the radio telephone has become an essential part of the equipment not only of commercial transport and mail planes but also of the steadily increasing number of privately operated aircraft. On large transport planes it is common practice to have one receiver for beacon and weather service, and another for two-way telephone communication with ground stations. Sometimes a broadcast receiver is also provided for the entertainment of the passengers. The more limited space in the smaller planes generally makes any such multiplicity of radio units impractic-

able, but the need for these various services exists nevertheless. The development of the 17A* receiver, providing reception for both beacon and broadcast bands, went a long way toward supplying the private flyer with the services he needed.

The recent development of the Western Electric 20-type receiver now makes available in a single small receiver not only the beacon and broadcast bands but the short-wave bands employed for communication with ground stations. It thus provides a radio receiver that is suitable either for the private flyer or for emergency service in transport planes.

*RECORD, *January, 1936, p. 161.*

The adaptability of the 20-type receiver to a wide variety of services makes it also suitable for marine use, particularly on yachts, harbor craft, and other vessels navigating coastal waters. Besides permitting them to pick up the various broadcast programs, it would also allow them to receive weather reports, storm warnings, and the accurate time signals transmitted for chronometer rating.

This new receiver employs the superheterodyne principle, and contains one stage of tuned radio-frequency amplification, two stages of intermediate-frequency amplification, and two stages of audio-frequency amplification. Four frequency bands are provided, and the one desired is selected by a four-position switch on the front of the receiver. One band is from 200 to 400 kilocycles, covering the beacon and weather-broadcast bands; one is from 550 to 1500 kilocycles, covering the broadcast band; and the other two are high-frequency bands covering the aviation channels, and police, amateur, and foreign broadcast bands—one from 1500 to 4000 kilocycles, and the other from 4000 to 10,000 kilocycles.

Automatic volume control is incorporated and is normally used for all except beacon reception, where its use might interfere with course indication. A switch on the front of the receiver permits this automatic volume control to be cut in or out as desired. Manual gain control is provided

for both the radio and audio-frequency amplifiers, but when the automatic volume control is in use, the manual radio-frequency control is turned to the position of maximum gain to give full range to the automatic control. Any adjustment in volume is then made with the audio control. For beacon reception, with the automatic volume control off, this procedure is generally reversed, and what volume adjustment is needed is obtained with the manual radio-frequency control.

Provision is made for converting the new receiver for crystal-controlled reception in either or both of the high-frequency bands. When this is desired a two-crystal frequency-control unit is incorporated. One of the crystals may be used in each of the high-frequency bands, or both may be used in the same band. This feature is useful when the receivers are used by commercial air lines, who have defi-

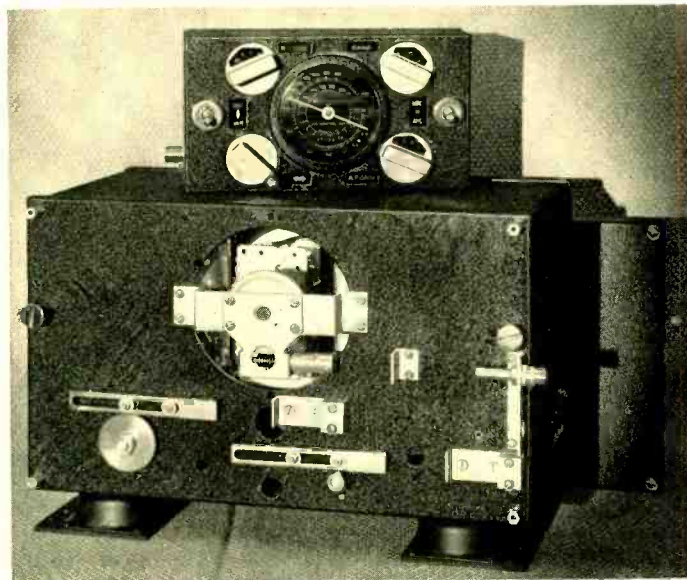

Fig. 1—The 20B receiver is totally enclosed and may be placed in any convenient location. It is controlled by the 27A control unit (shown above the receiver) placed within reach of the pilot

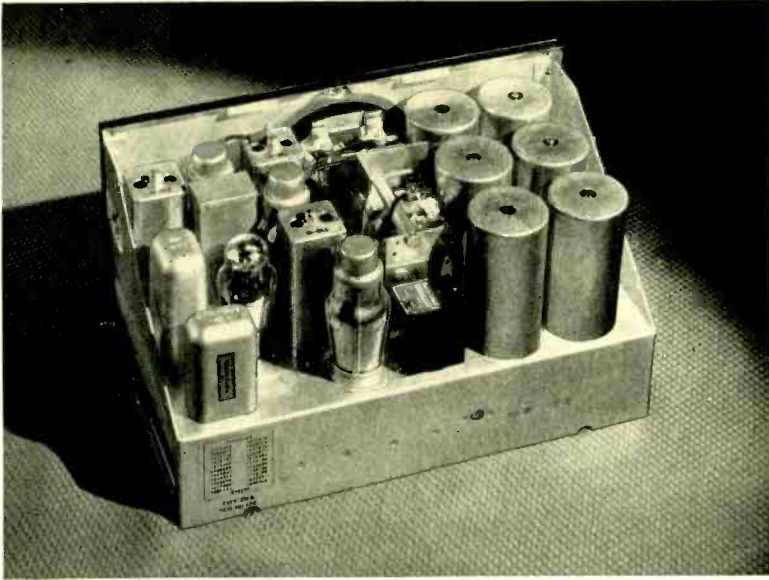

Fig. 2—A metal chassis carries all the apparatus in a compact arrangement with all wiring in the lower compartment

nite day and night frequencies for communication between air and ground, and who are not interested in receiving signals at other frequencies in the high-frequency bands. It has also valuable marine applications. Such crystal control simplifies the operation of the receiver, since only the pre-selector circuits need to be tuned, and for this accuracy of setting is not necessary. Tuning in other bands is not affected by this modification, but the band, or bands, converted for crystal control cannot be used for receiving except on the one fixed channel. Only a slight wiring change is required for this conversion to crystal control.

This new receiver is available in two basic forms, known as the 20A and the 20B. The former is arranged for local control and must be mounted within easy reach of the pilot. A view of this type, installed for test in the Laboratories' Fairchild plane, is shown in the headpiece. The dial, marked

with scales for the four bands, is in the center, with its high-ratio tuning drive immediately below it. Just beneath the latter is the switch for turning on or off the automatic volume control. At the extreme left side is the four-position band-selecting switch; the two manual volume controls are at the right of the automatic vol-

ume-control switch. The switch at the left of the automatic volume-control switch is used, with the receiver wired for crystal control, for switching from one to the other of the two crystals when both are used in the same band. When one crystal is in each band, the band-selecting switch is used to transfer from one to the other. A switch for cutting a varistor in or out, for reducing loud static crashes when receiving very weak signals, is installed on the right of the cabinet.

The 20B receiver may be installed at some distance from the pilot, and is then operated from the 27A control unit, which is quite small and may be mounted within easy reach. It incorporates all the controls that are on the front of the 20A receiver, but they are grouped compactly around the dial. A worm-gear drive with flexible shaft is used for the tuning control, while push-pull shafts, operating racks and pinions, control the band selector switch and the audio gain. The radio-

frequency gain, the varistor, and the automatic volume control are operated electrically. No provision is made in the 20B receiver for switching crystals, and thus two crystals may not be used in the same band. To turn the receiver off, in either the 20A or 20B type, the audio-frequency gain control is turned to its extreme left.

The mechanical construction of the receiver is, in general, similar to that of the 17A receiver, with all of the apparatus mounted on a metal chassis that slides into a cabinet provided with a shock-absorbing base. The compact arrangement of the apparatus is shown in Figure 2. Power connections are made through a detachable plug on the right-hand side of the receiver. Adjacent to the power connection is a headphone jack; and an audio-frequency output circuit is also brought to additional terminals on the power receptacle so that it may be extended to other parts of the plane. For heater supply about 0.9 ampere is required at 12 volts, and for

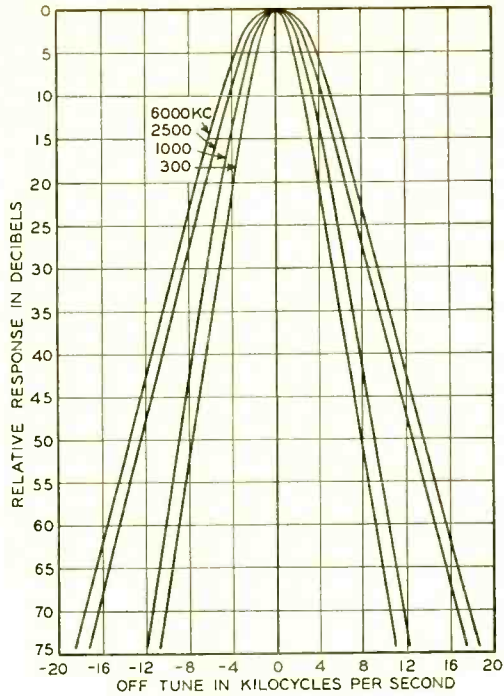

Fig. 4—Selectivity characteristic curves

plate supply, about 55 milliamperes at 200 volts. Either a small dynamotor or batteries may be employed

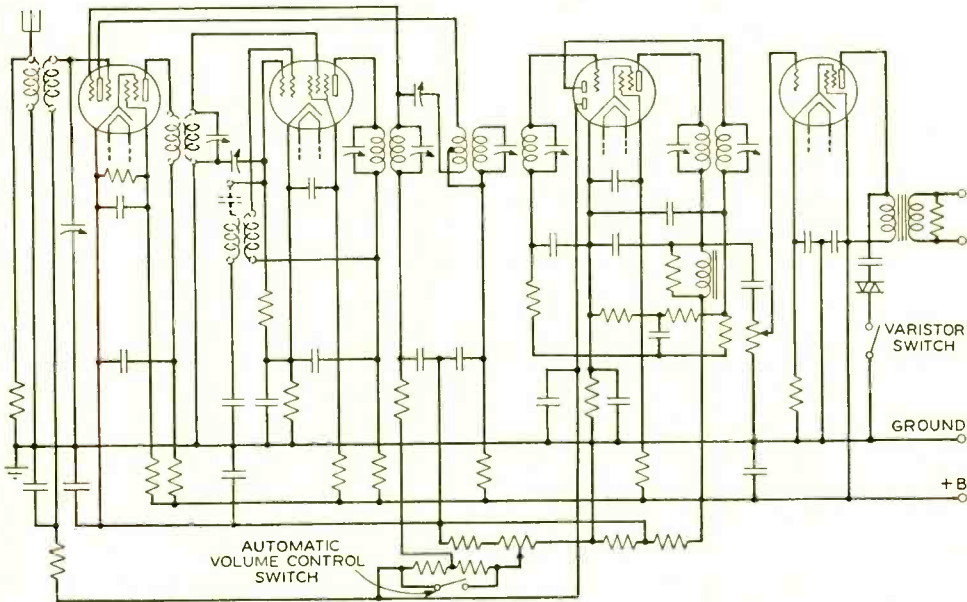

Fig. 3—Simplified schematic diagram of the Western Electric 20 type radio receiver

for the latter, while the regular plane battery supplies the heaters.

To conserve space, weight, and power, all vacuum tubes except that in the last audio-frequency stage are made to serve a variety of purposes. In this way only four tubes are required. Their arrangement in the circuit is indicated on the simplified schematic of Figure 3. In each case the coupling coil shown in dotted lines is only one of a set of four, the one selected depending on the position of the band-selecting switch. The first tube is a triode-pentode—the pentode section being used as a radio-frequency amplifier, and the triode section as a neutralized intermediate-frequency amplifier. The second tube is a pentagrid converter, and serves as an oscillator and modulator. The third tube, which is a duplex diode-pentode, serves four purposes. The pentode section serves both as the second intermediate-frequency amplifier and as a reflexed audio-frequency

amplifier, while one diode serves as a second detector, and the other as the automatic volume control. The final tube, which is a power pentode, is the second audio-frequency amplifier, and serves as the output tube.

Two antenna terminals are provided so that two antennas may be employed—one for the beacon and broadcast bands, and one for the two high-frequency bands. When only one antenna is provided these two terminals are connected together.

Selectivity of the new receivers is indicated by the four curves of Figure 4. The sensitivity is sufficient to permit reception of very weak signals with satisfactory volume of audio-output. An input signal of from one to five microvolts at the antenna terminals will result in an audio-frequency output of fifty milliwatts. Sufficient power is provided in the output stage, however, so that six or more headphones may be used where these are required.



Two-Way Radio for Tugboats

Preparatory to establishing regular two-way radio telephone service for commercial craft in New York Harbor and nearby waters, the New York Telephone Company has been conducting an operating trial of equipment on seven boats engaged in freight transportation in the harbor. The tests are being made under experimental licenses issued by the Federal Communications Commission. When the service is opened to the public, after the trials conducted jointly by the telephone company and the transportation enterprises, it is expected to be widely used by various classes of harbor vessels. It may also be used by vessels operating in Long Island Sound and on the Hudson River.

The shore station, on Staten Island, is similar to that at Green Harbor, Mass., described in the RECORD for November, 1932. On the harbor vessels it is proposed to adopt standard Western Electric aircraft apparatus. The transmitter will be of the 19 type, described on page 136 in December, 1935, RECORD, and the receiver will be the 20A, described on page 2 of this issue.



Teletypewriter Exchange Systems

By G. A. LOCKE
Telegraph Development

TELETYPEWRITERS were first employed in conjunction with leased lines for communication between two or more stations on a full-time basis. The advantages of this means of communication were quickly recognized and the size of the leased networks grew rapidly. It then became evident that it would be desirable to be able to switch a teletypewriter to any of a number of stations. A considerable amount of this switching, done for the most part at the toll office, soon became necessary, but it was not until the inauguration of the Bell System teletypewriter exchange service, in November, 1931, that a teletypewriter subscriber could signal an operator and be connected to any other subscriber. This date marked

the beginning of another nation-wide communication service. In the five years since its inauguration, teletypewriter exchange service has grown rapidly until on April 1, 1936, there were over 8,200 subscribers served by the group of central offices indicated in Figure 1.

To provide facilities for this new type of service, teletypewriter switchboards had to be devised in several forms so as to meet the needs of communities of different sizes. The most pressing need was for facilities for the larger cities, and as a result the No. 1 board, already described in the *RECORD*,* was developed. Boards of this type are now installed in Boston, Chicago, Cleveland, Detroit, Los An-

**RECORD*, January, 1932, p. 145.

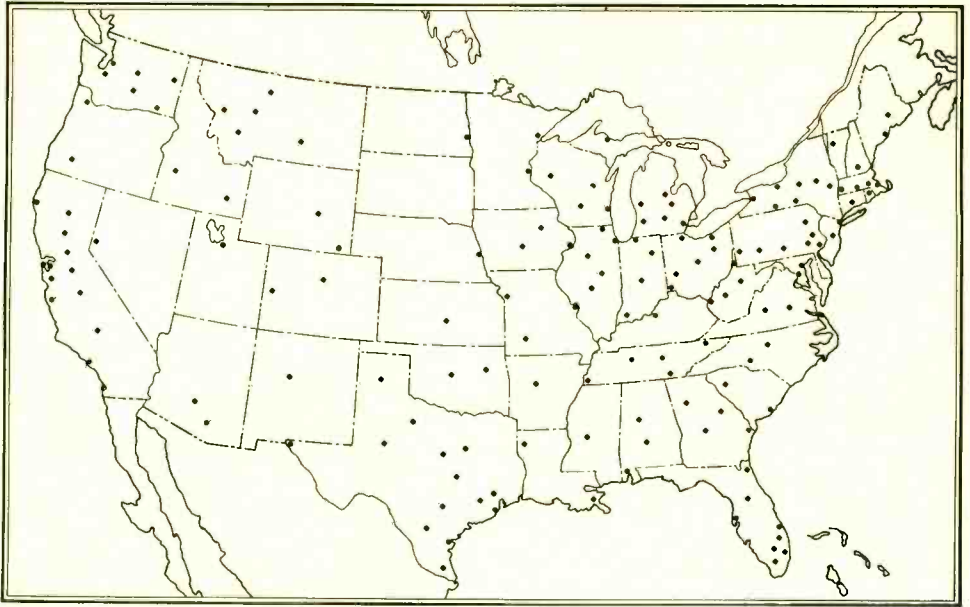

Fig. 1—Teletypewriter exchanges now span the entire continent to form a national teletypewriter system serving over eighty-two hundred subscribers

geles, New York, Philadelphia, San Francisco, and Washington. The New York installation is shown in the photograph at the head of this article.

The needs of this rapidly growing system, however, could not be satisfactorily met by the large No. 1 board alone. Smaller boards had to be improvised as rapidly as possible, and at the present time five sizes are in use. For the smallest communities, where not more than 40 lines are to be expected in the immediate future, the Nos. 4, 5, and 9 test boards* are utilized. With a few modifications these boards lend themselves quite readily to this use. Such an installation in Portland, Maine, is shown in Figure 2.

For somewhat larger communities, where as many as eighty lines may be needed, the 65B1 board was pressed into service. This board was originally designed as a teletypewriter P.B.X. for police systems,† but could easily

be modified for use at small teletypewriter central offices. Its normal capacity is forty, but by employing two

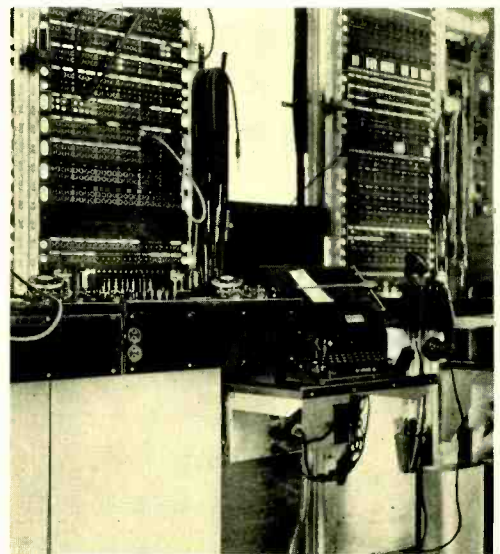

Fig. 2—A No. 9 test board modified to provide teletypewriter exchange service in Portland, Maine

*RECORD, October, 1935, p. 45.

†RECORD, October, 1931, p. 58.



Fig. 3—A 65B1 teletypewriter board installed in Denver, Colorado

positions, eighty lines are made available. Some modification has been made in the field to increase this capacity. A single-position installation is shown in Figure 3.

The No. 3 teletypewriter switchboard was developed to handle some-

what larger communities, and accommodates 360 subscriber lines and 80 toll lines. An installation of such a board in Akron, Ohio, is shown in Figure 4. This is a multiple board but the individual positions are separated. For still larger districts the 3A board, which has already been described in the RECORD,* is employed. It has facilities for 1230 subscriber lines and

*RECORD, January, 1936, p. 146.



Fig. 4—An installation of the No. 3 teletypewriter switchboard in Akron, Ohio

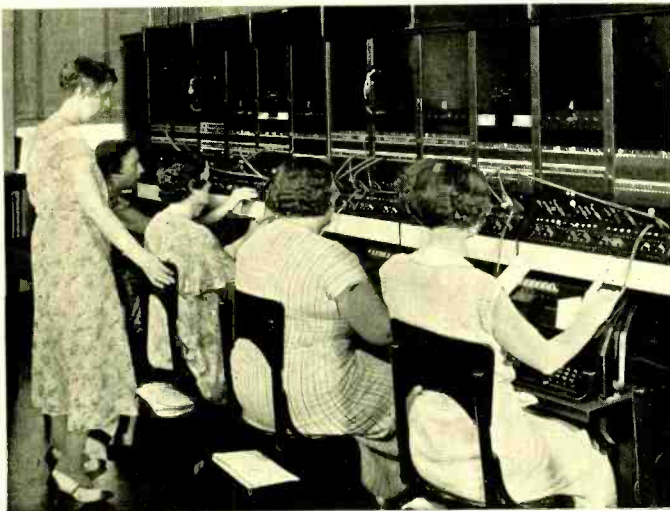

Fig. 5—A 3A teletypewriter switchboard in Pittsburgh
September 1936

240 toll lines, and incorporates a number of novel features. An installation of this board in Pittsburgh is shown in Figure 5. This is the largest board except the No. 1, already mentioned, which provides a capacity of 3600 subscriber lines and 840 toll lines.

As may be seen from Figure 1, the central offices now established are quite far apart in many cases, and as a result some of the sub-

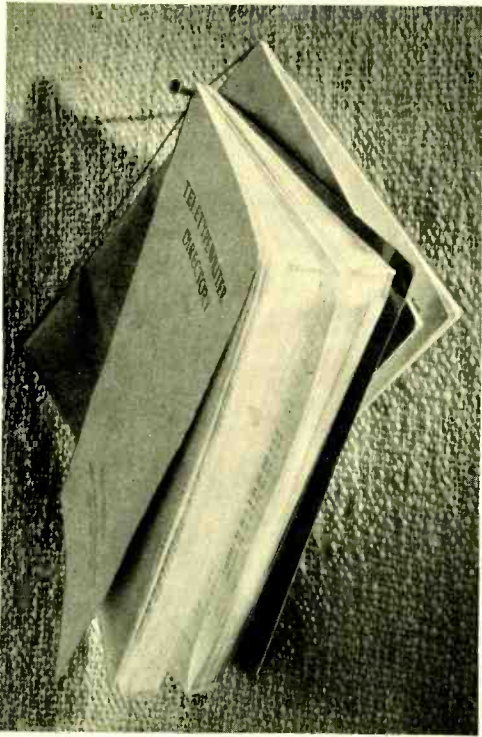

Fig. 6—The relative thicknesses of the 1931 and 1935 teletypewriter directories clearly indicate the rapid growth that has taken place in this comparatively new service

scribers served by any one office may be at a considerable distance from it, while others will be very close. Such a situation is now ordinarily encountered in telephone practice, and to provide for it satisfactorily the teletypewriter subscribers have been grouped into four classes of service, depending on their distance from the central office.

One class includes all those in the same city as the central office and generally not more than twelve miles route-of-cable from it. These are known as local subscribers, and are served by a pair of wires as in telephone practice. A subscriber within the twelve-mile limit but in a different city is designated as an SL subscriber. He is served in the same way as the

local subscriber, but his name is listed in the directory under the town in which he is located.

If a subscriber is more than twelve but less than thirty-eight miles, route-of-cable, from the central office, special loading networks are provided in the loop to give satisfactory transmission. These are called SLX subscribers, and like the SL subscribers are listed in the directory under their own town rather than that of the central office.

When a subscriber is more than thirty-eight miles from the central office, he is known as a TLX subscriber and must be served by regular toll telegraph facilities. For this class of subscribers the distance from the central office is a matter of economics only, since standard toll facilities are employed. Occasionally there are no standard telegraph facilities anywhere near the subscriber, and to provide for such conditions a method has been worked out for handling the subscriber over a single carrier channel on regular telephone lines.

By these various methods of serving subscribers, even when they are at considerable distances from the central office, and by a judicious location of the central offices themselves, a country-wide teletypewriter system has been provided, which—even during the depression—has steadily expanded. National teletypewriter directories are provided in which the subscribers are listed under their cities and towns. The increasing popularity of this type of service is well illustrated by the relative sizes of the directories of 1931 and 1935 respectively, shown in Figure 6. This has now been enlarged by the addition of a classified directory. As the advantages of the system are more fully recognized, and industrial activity increases, a more extensive growth may be expected.



Molecular Rotation in Organic Crystals

By A. H. WHITE
Chemical Laboratories

UNTIL recently it was believed that the rotation of molecules which occurs in any liquid ceased when the liquid solidified. Experimental evidence now points to the conclusion that camphor molecules and those of certain other complex organic compounds are rotating in the solid as well as in the liquid state.* This conclusion rests on the theory that the camphor molecules are polar,† that is that they have centers of positive and negative charge which are permanently separated. This polarity of the molecules causes them to orient themselves when in an electric field, provided they are able to rotate, and this orientation increases the dielectric capacity of the material. Since the dielectric constant of camphor does not decrease abruptly on solidification, as would be expected if the molecules ceased rotation, it is reasonable to suppose that camphor molecules are rotating in the solid state as well as in the liquid. The dielectric constant decreases only at some temperature below the solidifying point and it is at this lower temperature that the molecules cease to rotate.

The reason why the molecules of camphor and two or three closely related compounds should be able to rotate in the crystal while most other molecules of similar shape and chemical composition do not, is not immediately obvious, but heat capacity measurements lead to the conclusion

that this rotation is found in crystals whose molecules have a structure which permits unusually free vibration of the component atoms. This, in turn, allows the molecules to rotate as units even in the solid state as long as this structure is maintained.

When the specific heat of d-camphor was measured at temperatures just below and just above that at which rotation of the molecules ceases it was found that the rotating molecules gave the higher heat capacity. This was an unexpected result, because molecules which rotate end for end should absorb less energy with increasing temperature than molecules which do not turn in this manner but instead oscillate about a fixed position. The reason is that with increasing temperature both the kinetic and the potential energy of the oscillatory motion should increase. But when free rotation occurs there can be no further increase of potential energy with temperature and only the kinetic energy should contribute to the heat capacity. In other words, the transition of the molecules from a condition of restrained oscillation to that of rotation end for end should require according to theory a drop in the heat capacity instead of an increase.

Since the observed increase of heat capacity could not be explained in terms of motion of the unit molecules in the crystal lattice it became necessary to suppose that it must be due to the rise of some new kind of motion within the molecule. This pointed

*RECORD, *September*, 1935, p. 22.

†RECORD, *June*, 1931, p. 463; *July*, 1931, p. 535.

immediately to a greatly increased freedom of vibration of the atoms of the molecule with respect to each other at the transition temperature as the most plausible explanation of the difference in the values of the specific heat. A change apparently occurs within the molecule which loosens the atomic binding forces and permits a freer atomic vibration with the consequent absorption of more heat. Since the thermal data indicate that this change within the molecule occurs at the same temperature as the transition which permits the molecules to

crudely put by saying that a vibrating atom may be considered to occupy all the positions between its extremes of motion at once, in the sense that an airplane propeller in motion is a disk as far as the observer is concerned. The rise of vigorous atomic vibration would therefore tend to reduce the irregularities in the time-average shape of the molecule and make rotation easier since a perfectly symmetrical distribution of electrical charge would have no difficulty rotating, no matter how irregular the external field.

If this picture is the right one, it is apparent that molecular rotation should be most frequently found in those crystals whose molecules are most likely for one reason or another to exhibit pronounced atomic motion, allowing of course for the requirement that the molecule must be fairly spherical in shape before it can rotate under any circumstances. In this connection the fact that the

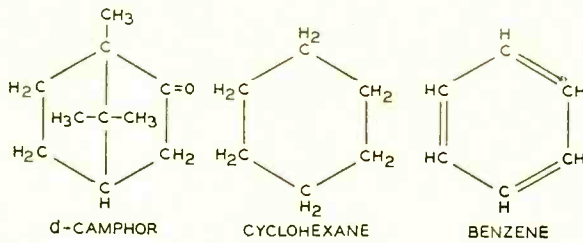

Fig. 1—The carbon atoms of *d*-camphor and cyclohexane are held by single valence bonds while those of benzene have double bonds

rotate as units, as shown by the change in dielectric capacity, it is probable that one of the transitions is instrumental in producing the other. To say definitely which is cause and which is effect is not easy but there are theoretical reasons for believing that the onset of vigorous atomic vibration within a molecule should make it easier for that molecule to rotate, while it is not obvious why rotation of the whole molecule should facilitate atomic vibration within it. The theory may be

structure of camphor involves only single valence bonds between the carbon atoms of the ring is significant, since it is well known that single bonds

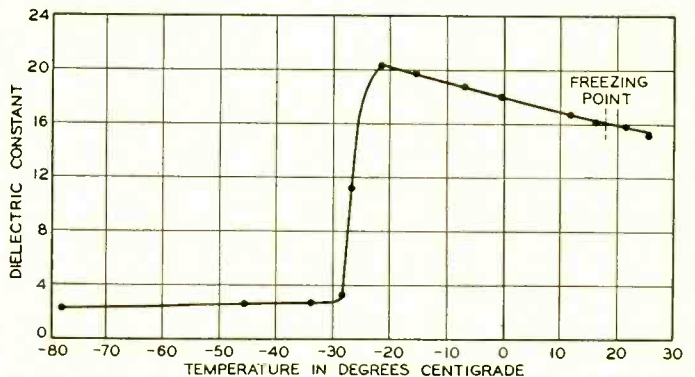

Fig. 2—The dielectric constant cyclohexanol does not decrease abruptly at the freezing point. This indicates that the molecules are free to rotate in the solid state

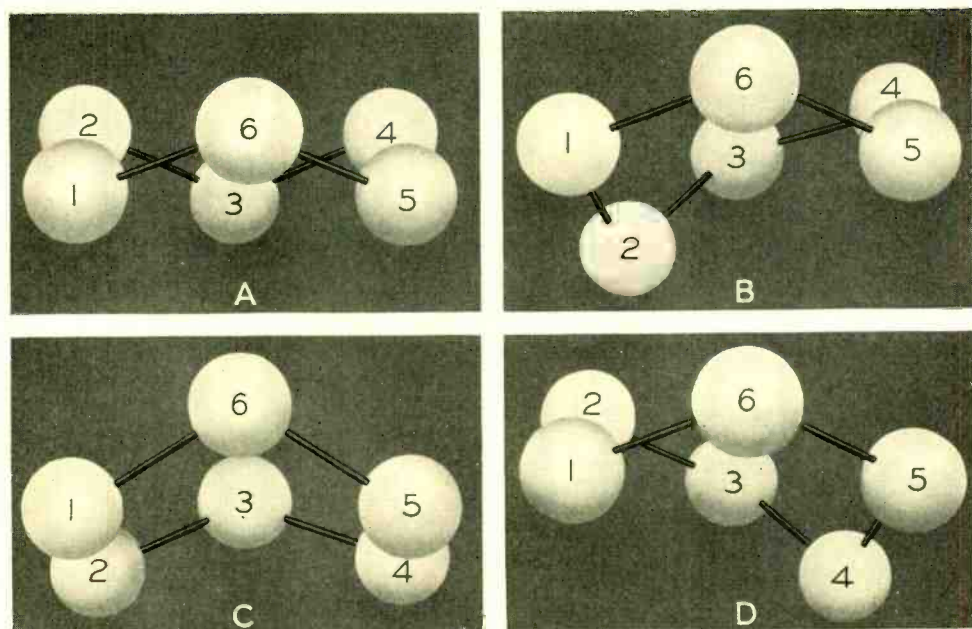

Fig. 3—The carbon atoms of cyclohexane can be arranged in a relatively rigid configuration, A, or in the more pliable forms shown in B, C and D, where, within limits, the valence forces do not act to restrain the atomic motion

exert less restraint on atomic vibration than do double bonds.

Another large class of compact molecules characterized by single bonds in the ring appears in the derivatives of cyclohexane, which are all based on the structure shown in Figure 1. According to the theory proposed above the derivatives of cyclohexane should exhibit molecular rotation in the crystal more frequently than any other class of organic compounds outside of the camphor group. Since this rotation can be observed in the case of polar derivatives by dielectric measurements, several such compounds have been studied in the laboratory. The results for cyclohexanol are shown in Figure 2 and are typical of those for cyclohexanone, chlorocyclohexane, and cyclohexene. The expected continuity of dielectric constant at the freezing point is observed, instead of the drop

which would occur if molecular rotation stopped when the material was solidified.

The occurrence of molecular rotation in solid cyclohexane derivatives is especially interesting because chemical theory has provided a possible mechanism for a transition which would permit freer atomic vibration. According to this theory the four valence bonds of the carbon atom should make equal angles with each other, and when carbon atoms are joined together in a compound they should tend to assume positions which will permit the bonds to maintain this so-called tetrahedral angle. Now two such strainless forms of the cyclohexane ring are possible, as indicated in Figure 3, which shows the carbon atoms of the molecule. One of these forms, that shown in Figure 3A, is relatively rigid; no vibration of the carbon atoms is possible without

bending or stretching the valence bonds. The other form is extremely pliable; it may assume the configurations shown in Figures 3B, 3C and 3D, in succession, without at any time bending or stretching any of the valence bonds to the slightest degree. The wide amplitude of atomic vibration involved in such a series of changes may be noted from the successive positions of carbon atom No. 2 with respect to its neighbors 1 and 3. It is apparent that a transition of the molecule from the first to the second of these forms should greatly reduce the forces restraining atomic vibration, thus permitting a rate of absorption of heat energy sufficient to account for a large increase of heat capacity. At the same time the effective symmetry of the molecule is increased greatly and its rotation in the crystal lattice made much less difficult. The energy required to produce such a transition by moving atomic group No. 2 from its position in Figure 3A to that in Figure 3B should not be excessive, even though such a change would be resisted by the tendency of the valence bonds to remain straight and strainless.

It is not at present possible to prove that such a change actually does occur within the cyclohexanol molecule when

it starts to rotate in the crystal lattice; the point is that chemical theory provides a possible mechanism for just such a change in cyclohexanol as has been assumed to explain the dielectric and thermal measurements on the derivatives of cyclohexane. It must be said that chemical theory provides no picture as to how such a transition could occur in the camphor molecule.

This explanation of the rotation of saturated cyclic molecules in the solid crystal is also confirmed by the fact that very few if any aromatic compounds show molecular rotation in the crystal; they are characterized by the maximum number of double bonds in their rings, which would be expected to cut down the chances of vigorous atomic vibration. The molecular structure of benzene, the parent of all such compounds, is illustrated in Figure 1. All measurements of the pure polar crystals of such compounds which have so far been made in these laboratories or reported in the literature show that molecular rotation ceases when they are solidified. So they also fit into the picture and confirm the idea that the rotation of the molecules of certain organic compounds in the solid state is associated with a chemical structure which permits unusually free vibration of the constituent atoms.

Out-of-Block Protector

By A. W. DRING
Outside Plant Development

ONE of the many problems involved in supplying telephone service is that of protecting the customer and property against possible damage due to abnormal potentials induced in the telephone lines during electrical storms or from contact with power lines. To this end the telephone system is divided into areas which are classified as exposed or unexposed. Every subscriber station served by aerial cables or open wires which are exposed to lightning or to aerial power lines operated at potentials above 250 volts must be protected at the subscriber's premises by a station protector having open space cutouts and fuses.

There are, however, many locations where it is economical to serve a limited number of subscribers in an exposed area by drop wire connections to a cable which is entirely in an unexposed area. When this is done, a protector is installed at the junction of the unexposed cable and the exposed wires. Unless such protection is provided the entire cable must be classified as exposed and all subscribers' stations served by it have to be equipped with protectors.

The protector available in the past for this type of service has been the standard station protector used in an outside protector mounting. This

is satisfactory for locations where only one exposed circuit is involved, but when protection must be provided for more than one circuit at the same location the installation on building walls of several station protectors in addition to the cable terminal may introduce difficulties, largely because of appearance. Also where the distribution is from poles it is difficult to obtain satisfactory locations for two or more protectors, especially on the small poles employed within blocks.

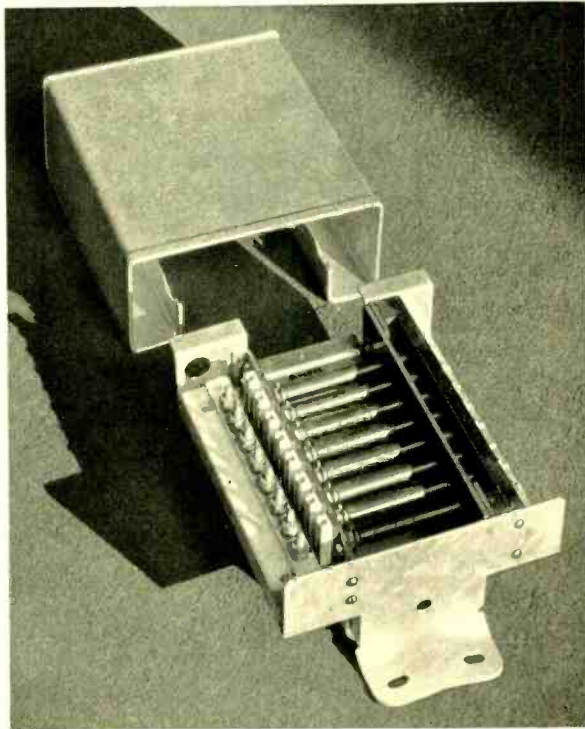

Fig. 1—The out-of-block protector provides cut-out and fuse protection for four pairs of drop wires

A new device called the "Out-of-Block Protector" has been developed for such situations. It is equipped with protector blocks and fuses for four pairs of drop wires. The blocks are held by clamping springs as in the regular station protectors. The fuses are attached at one end to fuse clips and the other ends, which are supported in wooden guides, serve as terminal connections for the exposed wires. There are binding posts for the wire connections to the cable terminal of the unexposed cable. The protector is housed in a galvanized sheet metal box which is provided with a binding post to attach the connection for grounding the protector unit and the housing to the cable sheath.

When a fuse operates, ionized gases may be expelled by the fuse into the protector housing. If, during violent operation, these gases should envelope the exposed line end of the fuse, a sustained power arc from that point to the grounded housing might result. To minimize this possibility the exposed ends of the fuses are shielded in such a manner that the gases pass upward, through an opening in the drop wire channel and thence out to the open air without passing over the exposed ends of the fuses. There is also an air space between the shield and

fuse guide which serves as a further barrier against the passage of gas to the line ends of the fuses. With the cover of the protector in the open position the outer plate of the shield may be moved sufficiently to permit fuses to be removed or inserted.

The protector is detachable from a mounting plate which is permanently fastened to a pole or wall. The cover is held in the open position by a spring catch attached to the upper part of the base and when closed it fits snugly over the shield and around the base so that the entrance of dust and moisture is retarded.

The wires enter the protector at the bottom through two rear channels formed by the cover and two side flanges of the base. The unexposed wires are dressed through the left channel of the housing to the binding posts and the exposed wires are brought from the right channel to the fuse ends.

Situations where the use of such a protector may be advantageous exist not only in the one or two large eastern cities, which were studied in connection with the development, but, no doubt, in other localities throughout the country. For all of these, this protector is now available through the Western Electric Company.

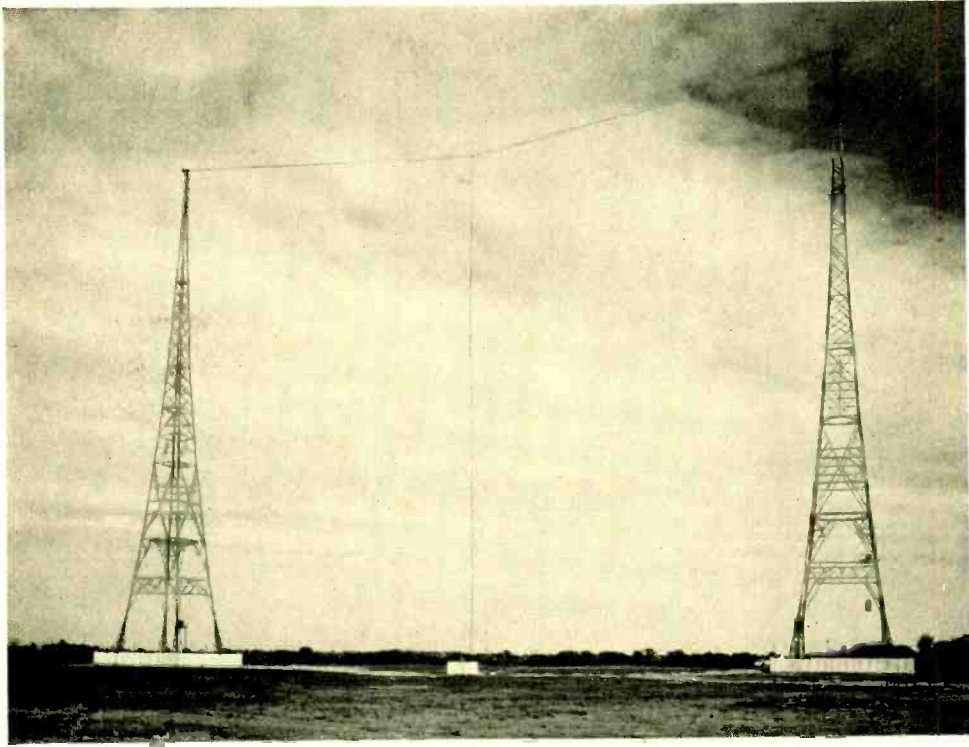

Directive Antenna Solves Coverage Problem

By J. F. MORRISON
Radio Development

THE dry, rocky soil of New England proves a considerable handicap to the operators of broadcast stations. The effect on broadcast transmission is to produce a very rapid attenuation, so that greater power is required to attain a given coverage than would be necessary in most other parts of the country. Station WJAR, of the Outlet Company of Providence, Rhode Island, has been operating at 500 watts from a site in the business district of Providence. It has been found that because of this high attenuation, WJAR is not adequately covering the two neighboring cities of Woonsocket

and Fall River—distant only twelve and fifteen miles respectively.

To remedy this situation WJAR proposed to move to a more favorable site on the outskirts of Providence, and to erect a vertical half-wave antenna. This would have greatly increased their effective radiation, and would have enabled them to cover the two outlying cities in a more satisfactory manner. This proposal, however, required an antenna structure over 600 feet high and because of the closeness of commercial airways, it was felt that a structure of that height would be a hazard to air navigation. For this reason it became neces-

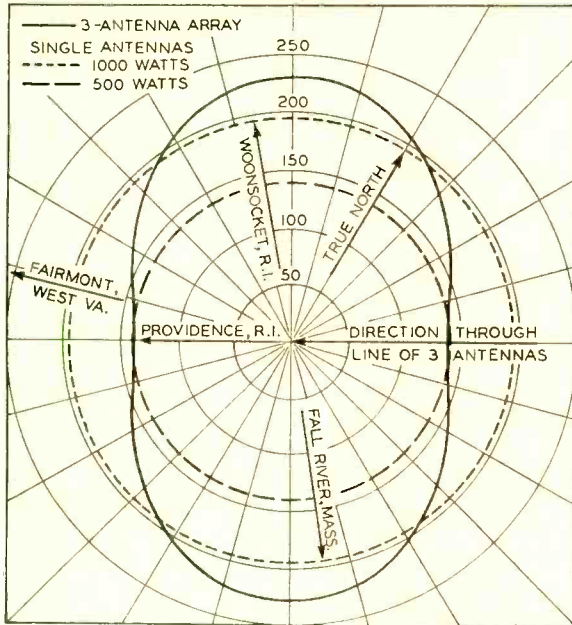

Fig. 1—Ground-wave radiation pattern of the antenna array for WJAR

sary to limit the antenna height to about 320 feet, or slightly over a quarter wave-length, but with such an antenna Woonsocket and Fall River would not be adequately covered with power limited to 500 watts.

If it were merely a matter of laying down an adequate field intensity in these two cities, a simple solution could be found by increasing the power of the transmitter. Permits for increase in power, however, are granted only when it can be shown that the increase will not result in interference with already existing stations.

The engineers of station WJAR saw a possible solution to the problem of providing improved coverage without causing interference in the same or adjacent channels by the use of controlled radiation, and the Laboratories were consulted on a directive antenna

design to meet that objective. A study of the problem indicated that an array of three vertical antennas giving an oval-shaped radiation pattern would offer a satisfactory solution and with this pattern the Federal Communications Commission has authorized the use of 1000 watts power.

The nearest station to Providence operating on the same frequency as WJAR is located at Fairmont, West Virginia. The bearing of this station from the new site of WJAR is approximately the same as that of the center of Providence, and is at right angles to the line joining Woonsocket and Fall River, which passes approximately through the site of the new station. It was

thus possible to orient the antenna array so as to give minimum radiation toward Fairmont, and maximum radiation toward Fall River and Woonsocket. Although the city of Providence lies in a sector of reduced radiation, the distance between the site and the center of that city is only a few miles so that good coverage can be obtained with much less signal emitted in that direction.

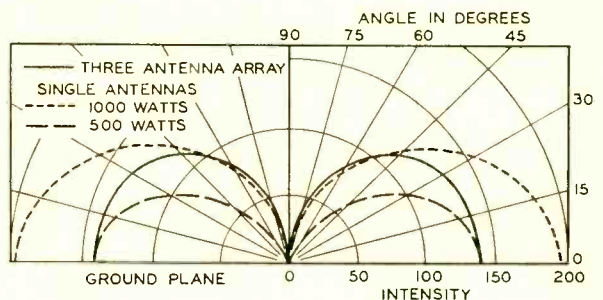

Fig. 2—Radiation from the WJAR antenna at angles above the horizontal for a plane passing through the three antennas

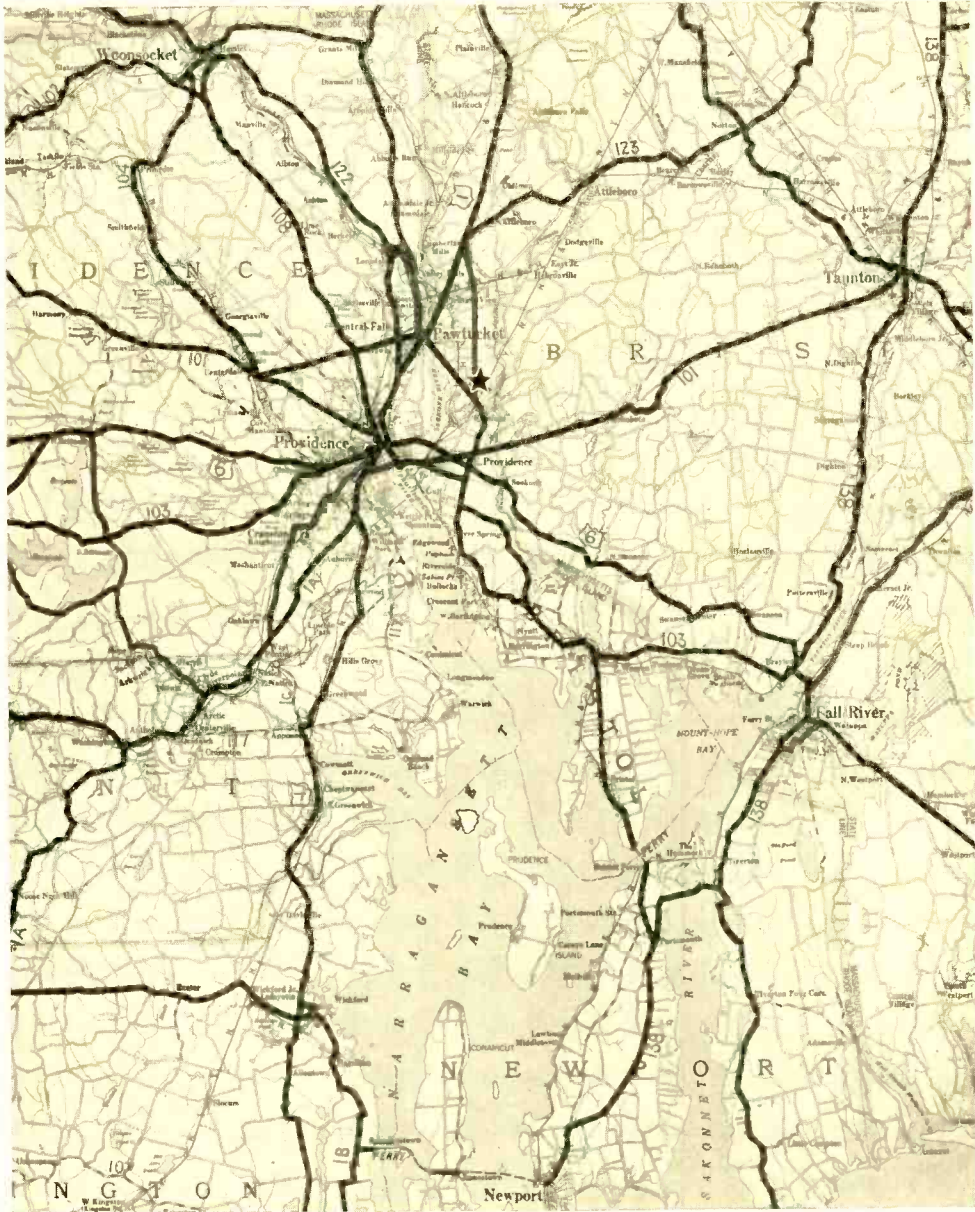

Fig. 3—Map of the area covered by WJAR

The estimated radiation pattern of the array is shown in Figure 1, on which are marked the directions of the cities that determined its design. On this graph are marked the estimated patterns for a single antenna with power outputs of 500 and 1000

watts, and for the array with 1000 watts. It will be noticed that the radiation in the direction of Providence and Fairmont is about the same as would have been obtained from a single antenna radiating 500 watts, while in the direction of Fall River

and Woonsocket the radiation is greater than would have been produced by 1000 watts and a single antenna of the limited height. Actually it is about the same as would be obtained with 1400 watts and the single antenna. These patterns show the intensity of the ground wave.

Since the attenuation of this ground wave is rapid and the distance to Fairmont is nearly 500 miles, the day time field strength there due to WJAR is negligible. At night, however, due to a refraction phenomenon in the ionosphere, the radio waves have a much greater range, and radiation at angles above the horizontal becomes of great importance. The three-antenna array designed for WJAR, however, provides controlled radiation at angles above the horizontal as well as along the ground. The radiation from the antenna at various vertical angles in the direction of Providence and Fairmont is shown in Figure 2. Radiation reaching Fairmont would be that emitted at lower angles, and for these angles it will be

noticed that the array provides for substantially the same field intensity that would be obtained from a single antenna radiating 500 watts, and considerably less than from a single antenna radiating 1000 watts.

The antenna system provided, shown in Figure 4, consists of two 320-foot steel towers spaced 410 feet apart on a line running 60° east of true north. These towers are insulated and serve as the two end antennas. The center antenna is formed by a vertical wire suspended from an insulated steel messenger cable strung between the tops of the towers. A concentric transmission line connects the radio transmitter to a line-branching transformer and phase-control network at the base of the central antenna. Antenna coupling units are required, in addition, to match the impedance of the individual radiators to the transmission lines and phase-control networks. A ground system is also provided which consists of copper wire buried to form a grid in the earth as indicated in the diagram below.

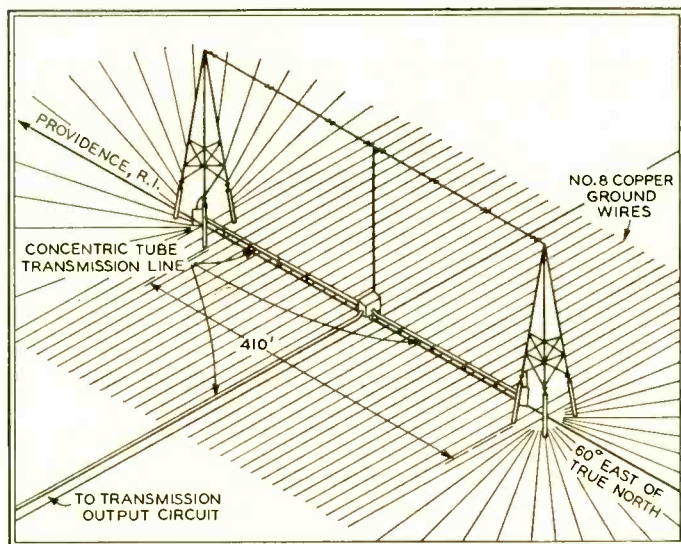
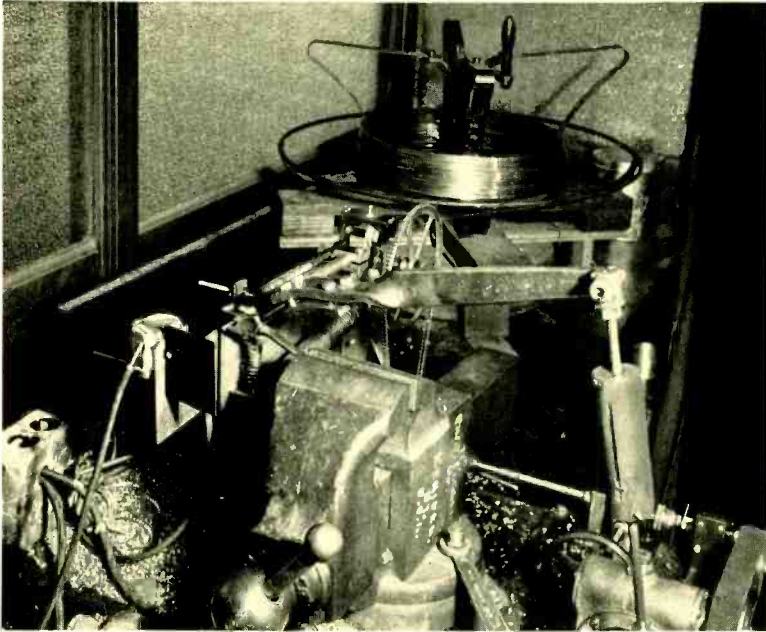

Fig. 4—Antenna array for station WJAR



Telephone Hand Tools

By C. R. MOORE

Outside Plant Development

TO build and keep in order a plant as complicated as that of the Bell System, a great variety of tools is required. For outside plant use alone, several hundred different hand tools are needed, not to mention automotive and power-driven tools, and the System's investment runs into large figures. Many of these hand tools are of familiar design but they differ from the ordinary commercial grades which can be bought in any hardware store, in being the result of careful study from the standpoint of serviceability and efficiency and with the needs of telephone work in mind. Laboratory tests are checked in most cases by field trials and the combined results are embodied in specification requirements of such a

nature that they can be readily checked by inspection during or after manufacture. This procedure is justified from the point of view of efficiency and economy by the large investment of the Bell System in hand tools.

Pliers are representative examples of commercially available tools. In the development of specification requirements, samples are tested in our Outside Plant Laboratory for characteristics that have been found to be significant, such as hardness, ductility and service life. For the life test of side-cutting pliers, for example, the lower handle of the sample is clamped securely in a large vise and the upper end is attached to a long horizontal bar. A small motor is connected to this bar by a crank

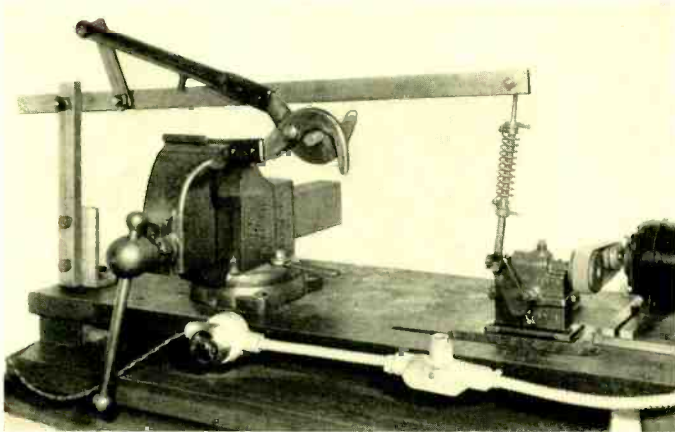

Fig. 1—Cable cutters are used to shear off lead cable. They are tested to destruction by making them bite repeatedly into a large brass rod at the rate of forty times a minute

mechanism which operates the plier handle about forty times per minute. Hard-drawn copper wire is fed automatically to the cutting edge of the pliers. When the plier breaks, or the cutting edges become dulled to the point where the wire is not cut through, the motor is automatically stopped. A counter indicates the number of operations.

The cable cutter, which is a shear used to cut lead cables ranging up to $2\frac{5}{8}$ inches in diameter, is another instance of a tool that must be designed to withstand repeated severe stresses. To insure proper choice of materials and design, sample cutters are tested in the machine shown in Figure 1. In the test, the cutter is required to bite into a brass rod forty times per minute until failure of the cutting blade or other part occurs. With comparative results from such tests, suitable grades of steel and shapes of parts can be specified.

To obtain a measure of the service life of the leg iron of linemen's climbers, a special testing machine has been designed. It applies repeatedly a downward force to the stirrup, thus simu-

lating the weight of the lineman, while the climber is supported at the top of the leg iron and the gaff. The machine is operated by a motor until the climber breaks, when the motor switch is automatically tripped. The number of repetitions is read on a counter. The leg iron is tested for ductility by bending it half-way around a cylinder two inches in diameter. This severe treatment must be withstood

without fracture. The gaff also must be sufficiently ductile to permit hammering the point half an inch toward the leg iron without signs of breaking. The hardness of both the leg iron and gaff is determined by the Rockwell test. This consists of pressing a

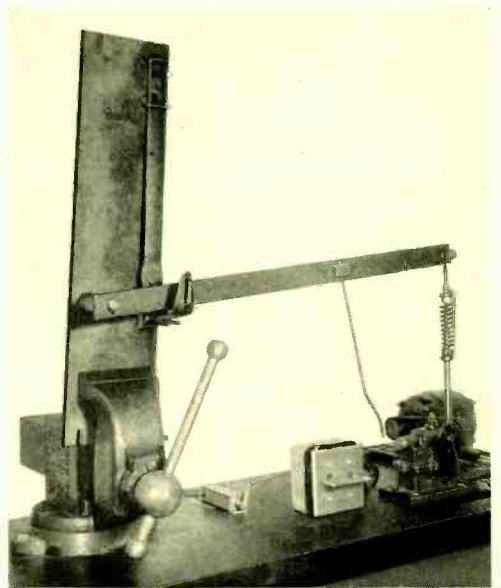

Fig. 2—Linemen's climbers are tested by subjecting the stirrup to a repeated downward thrust in this testing machine

diamond point of definite size and shape against the surface by a known force and measuring the depth of the depression which results.

Problems of a different character are encountered in the development of special tools to fulfill specific needs. The shunt dynamometer and the cable car fall in this category. The shunt dynamometer measures the tension in the stranded steel wire used for such purposes as guying poles and as a "messenger" to support telephone cables. It is important that the tension in this "messenger strand" be held between fairly definite limits. While the tension must be adequate to limit sag and maintain clearances, excessive tension would aggravate bowing of the cable caused by the difference in the expansion, with rising temperature, of the cable and the supporting strand. The dynamometer operates on the principle that the force required to thrust a given length of supporting strand aside may be used as a measure of the tension in the strand. The instrument consists of a rectangular steel bar split lengthwise to the center and provided with a

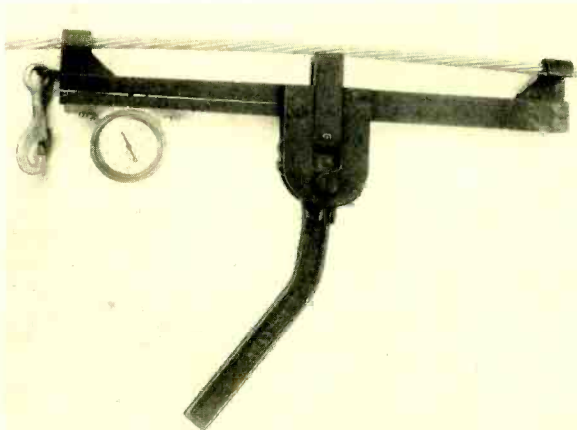

Fig. 3—The tension of the stranded steel wire used as a messenger to support aerial cable or for guying poles is measured with the strand dynamometer

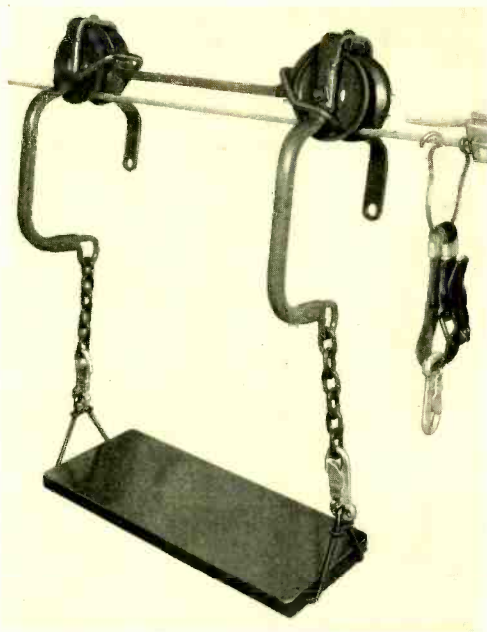

Fig. 4—The construction and maintenance of aerial cable frequently requires that workmen ride a cable car

hook at each end to fit over the strand. At the mid-point, there is a cam handle which operates a plunger. This applies lateral pressure and bows both the strand and the upper bar of the dynamometer an amount which depends on the tension of the strand. The bowing of the dynamometer bar is measured by the dial gauge attached to the lower bar. A calibration is made by noting the readings of the gauge for each size of strand under measured tensions. These data are plotted and supplied with the instrument to enable the operator to convert the dial readings into tension in pounds.

In the construction and maintenance of aerial cable, it is necessary to work along the supporting strand. For this purpose, a small trolley-like

vehicle called a "cable car" is provided. In its latest form, it consists of a light steel frame mounted on two rubber-tired wheels and supporting a wooden seat by means of short chains and snap hooks. The height of the seat may be adjusted to suit the workman and a strap which is threaded through the D ring in the workman's belt is attached to the eyelets below the wheels to protect him from falling. Rubber-tired wheels are provided so that the cable rings will not be pushed along the strand, experience having shown that the relatively soft rubber will yield to the ring and ride over it. In addition to these more obvious points, great care was exercised to embody in the design safety features that are only apparent on detailed

study. For example, the snap hook had to be redesigned in relation to the chain link it engages so as to make it impossible for the chain to be accidentally disengaged from the hook. As the cable car must be manipulated aloft by the lineman, weight is an important consideration and every effort was made to reduce the weight to a minimum consistent with strength and safety.

The care taken in working out these details in special tools and the thoroughness of the tests made on commercial types is indicated by the few examples given here. That these efforts are justified is shown by the notable improvement in the efficiency and life of many telephone plant tools which have resulted from this work.



Fig. 5—Riding the strand

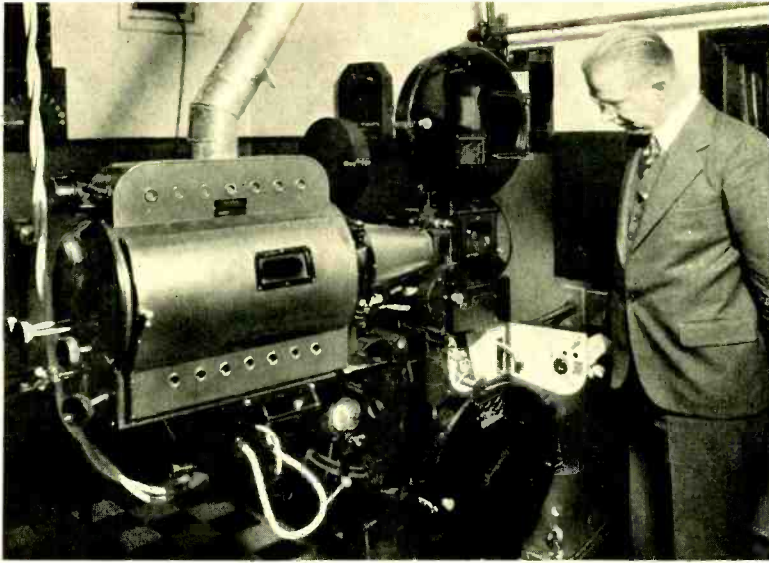

New Reproducer System for Small Theatres

By G. PULLER

Special Products Development

TWO-THIRDS of the 17,000 motion picture theatres in this country which are equipped for sound have less than six hundred seats and of these about two thousand can accommodate less than two hundred people. A large portion of these small theatres have sound reproducing systems of inferior quality caused partly by the fact that when installed only expensive large theatre systems were available. To provide up-to-date equipment for these theatres a new low-cost reproducing system has been developed for Electrical Research Products Incorporated.

The complete installation consists of a reproducing set for each picture projector; a control unit which provides switching means for the power and voice circuits, and the exciter lamps; a main amplifier, power supply

unit and monitoring loud speaker all in a single cabinet; and the stage loud speakers. The equipment is entirely operated from a 105-125 volt 50 or 60 cycle power supply. It reproduces both variable density and variable width 35 mm. film records.

For distortionless reproduction of sound-on-film, the film speed at the point where the sound record is scanned must be uniform. To attain this requirement, the film speed control mechanism in this reproducer is equipped with an inertia controlled scanning drum called a kinetic scanner. It is mounted on precision ball bearings to reduce friction to a minimum, and is housed in a single compartment frame casting, Figure 1. Extra precautions have been taken to effectively seal the ball bearings against the entrance of dust since this would

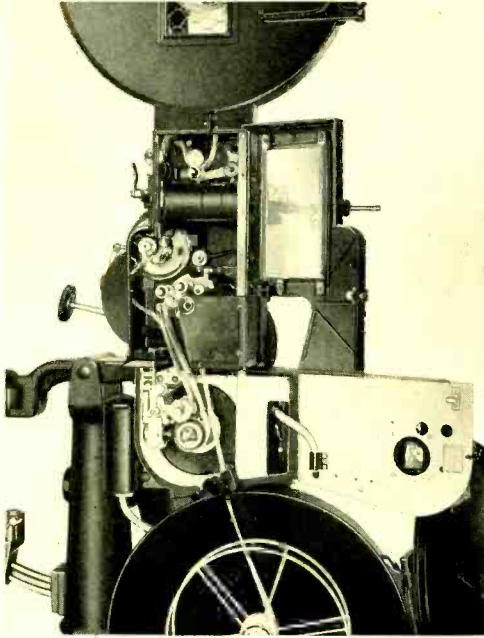

Fig. 1—The sound reproducer apparatus is made to fit between the projector mechanism and the lower film magazine

interfere with the smooth rotation of the scanning drum and introduce disturbances in the reproduced sound. The construction is such that the initial lubrication should last for an indefinite period. The kinetic scanner and its associated parts are manufactured to the highest degree of precision and the final assembly is accurately balanced in order to insure uniform travel of the film past the scanning point and to prevent the film from weaving in and out of its proper focal plane. Constant speed of the scanning drum is maintained by means of the specially designed double flywheel of the kinetic scanner. One flywheel is integral with the scanning drum which effectively prevents high frequency oscillations of the film; the other is free floating and is coupled to the first one by means of a mechanical filter which effectively suppresses

slow oscillations. The kinetic scanner is so stabilized that a sudden change in the film speed or a disturbance in the film loop, such as the passage of a film splice, has no appreciable effect on its uniformity of rotation. During the acceleration period of the scanning drum the two flywheels are coupled together by means of a centrifugal

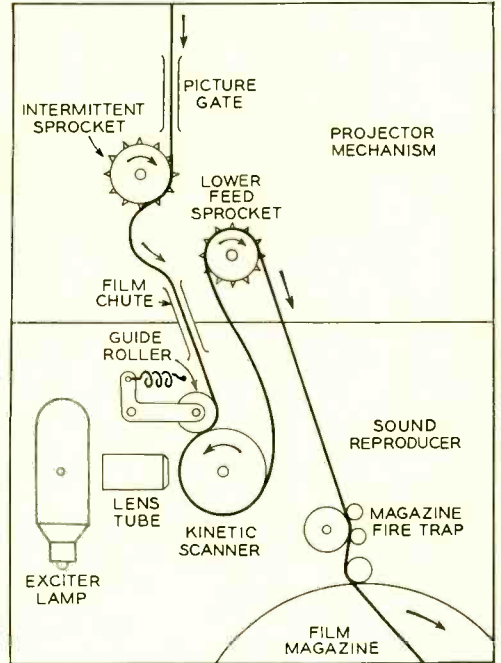

Fig. 2—The film passes from the intermittent sprocket around the drum where the sound track is scanned and then over the lower feed sprocket

clutch. This phase of the development was greatly aided by methods recently devised by the Laboratories for measuring changes in the motion of the film quantitatively.

The film is threaded into the projector mechanism, Figure 2, in the usual manner up to the intermittent sprocket from which it passes directly through a film chute into the sound reproducer which fits between the projector mechanism and the lower

magazine. Here it is guided by a pivoted guide roller onto the scanning drum of the kinetic scanner around which the film is wrapped. From this point it passes up to the lower feed sprocket in the projector mechanism and thence down to the lower film magazine. The extremely low friction of the kinetic scanner allows the film to rotate it without being subjected to appreciable tension. This results in the formation of an elastic film loop between the scanning drum and the feed sprocket. This loop introduces a compliance between the feed sprocket and the scanning drum and prevents the sprocket tooth impulses from being transmitted to the scanning point. The film chute can be readily dismantled for cleaning. Film scratching and abuse is eliminated by the use of highly polished film guides. The pivoted guide roller is supported be-

tween bronze bearings lubricated through covered oil cups. This roller is provided with chromium-plated flanges to resist wear and positions the center of the sound track at the center of the optical system. Its adjustment is accomplished by a slotted knob which is accessible through an opening in the closed door. It is thus seen that no film sprocket or sprocket drive mechanisms are employed in the sound reproducer as has been the practice heretofore. This results in a much less expensive and simpler construction. The location of the lower film magazine is such that the usual

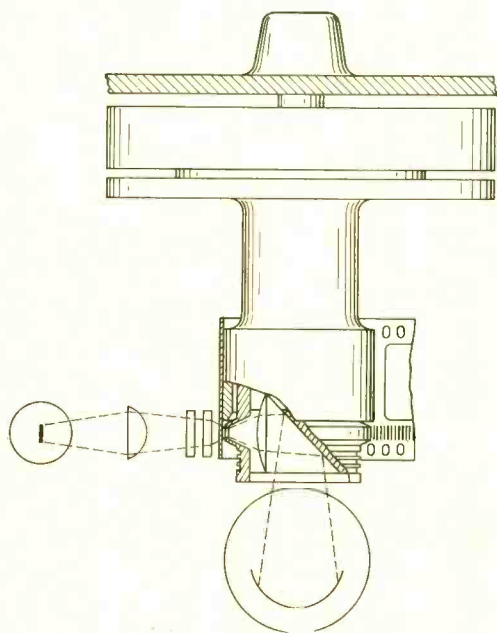

Fig. 3—A total reflecting prism is located within the scanning drum to deflect the light which has passed through the sound track out at right angles into the photoelectric cell

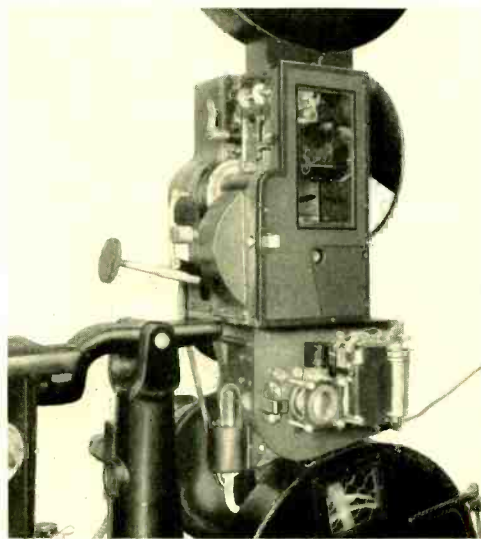

Fig. 4—The photoelectric cell, with its associated transformer and condenser, is mounted on the door of the film compartment

projection angles are readily attained.

The exciter lamp, which is the light source, is mounted in a separate holder external to the sound reproducer. To eliminate adjustments and to facilitate replacements in case of a lamp failure, a new type of lamp provided with a pre-focus skirt on its base is employed. This permits the use of a low cost automobile type of

pre-focus socket which may be obtained from any commercial dealer.

The lens tube assembly is hermetically sealed and is exceptionally efficient in terms of light output. It differs from earlier designs in that it images the incandescent filament of the high intensity exciter lamp as a concentrated line of light directly on the sound track of the film by means of cylindrical lenses without the use of a mechanical slit. The lens tube assembly may be adjusted with the compartment door closed by removing a latch plate. This exposes an opening through which the focus adjustment at the back of the lens tube may be made and also a screw and lock nut for adjusting the light beam azimuth. A total reflecting prism with one convex surface, shown in Figure 3, is located within the scanning drum to

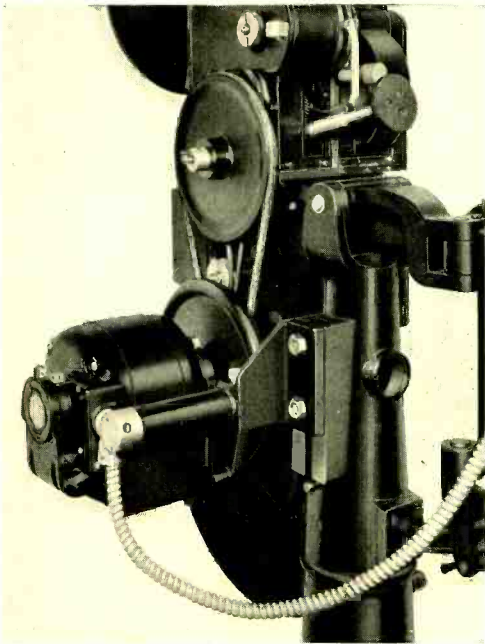

Fig. 5—The projector mechanism is driven by a round endless belt. A $\frac{1}{8}$ HP induction motor, pivoted so that its weight keeps the belt taut, is the source of power

deflect and focus the light rays, which have passed through the photographic recordings on the sound track of the film, out at right angles into the photoelectric cell. Here the modulated light beam is transformed into electrical vibrations which are subsequently amplified and finally converted into audible sound by the stage loud speakers. The prism is mounted in a holder which can be removed readily for inspection and cleaning without disturbing its adjustment. The prism holder incorporates an aperture which is introduced immediately behind the point where the film is scanned to limit the length of the effective scanning line and to prevent stray light from entering and affecting the sound reproduction.

The photoelectric cell, Figure 4, is a new type which has a higher gas amplification factor than was formerly obtainable. This cell, together with its associated transformer, which is cushion suspended to reduce microphonic disturbances to a minimum, and a condenser are mounted on the door of the film compartment. The entire assembly is protected by a sheet metal cover, which also acts as a shield against external electrical disturbances. When the door is opened a clear path is presented for threading the film and easy accessibility of the parts of the mechanism inside the sound reproducer is attained.

A flexible armored cable is employed to bring the photoelectric cell circuit from the door to the terminal compartment at the front end of the sound reproducer. From here the sound circuit extends through the main amplifier and thence to the stage and monitor loud speakers.

The projector mechanism is driven by means of a round endless belt, Figure 5. A $\frac{1}{8}$ horsepower induction

motor is used to drive the projector and is mounted upon a pivoted bracket secured to the projector pedestal so that its weight supplies the necessary tension to the driving belt. The bracket is provided with means for adjusting and maintaining just sufficient tension in the belt to drive the projector mechanism reliably.

The driven pulley is equipped with a gear which meshes with the projector gearing. This pulley and gear rotate on a stationary shaft supported from the projector. Lubrication is provided through an oil cup conveniently located. A combination flywheel and handwheel is attached to the driving motor to prevent too rapid starting of the projector mechanism which might result in film damage and to facilitate turning the machine over by hand during the film threading operation. The take-up drive of the lower film magazine is connected by a belt directly to the projector mechanism in the conventional manner.

The three-stage amplifier, Figure 6, is resistance coupled and has negative feedback. There are two suppressor-grid pentode tubes in the preliminary stages, one high-transconductance triode in the output stage and one full-wave vacuum rectifier tube. The amplifier also furnishes polarizing potential for the photoelectric cells and field energy for the monitoring speaker. It has an undistorted power output of 8 watts. A separate rectifier unit supplies rectified and filtered current for the fields of the loud speakers located on the stage and for

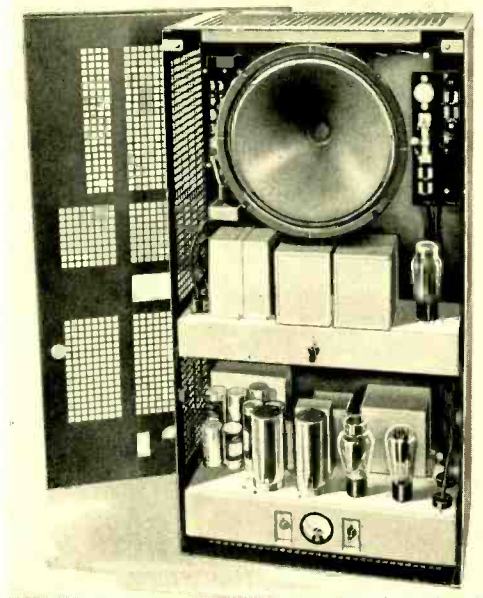

Fig. 6—The main amplifier, power supply unit and monitoring loud speaker are installed in a single cabinet

the photoelectric-cell exciter lamps.

A control cabinet intended to be mounted on the front wall of the projection booth between the two projectors is used to provide means for connecting the output of either one of the two reproducer sets to the amplifier, to control the volume, to switch from one exciter lamp to the other and to equalize the exciter lamps.

The new system is compact, easy to operate and as simple and economical in construction as is consistent with the maintenance of high quality sound reproduction. These features should appeal to the exhibitor in the small theatre field.



The Impinger

IN studying the effect of dust particles on contacts in telephone circuits, the dust itself must be caught and examined. An ingenious device called the impinger, designed particularly to remove particles from very small areas, has been made by Bell Telephone Laboratories for this purpose. It collects the dust particles by sucking them into a glass tube and then hurling them against a microscope cover glass, shown at the rear of the apparatus. The suction tube is constricted to a fine point at the outer end so that it can be brought

accurately to the desired spot and the cover glass is coated with petrolatum to assure that the dust adheres. Surrounding the suction tube at the other end is a glass jacket which is connected to a small pump through the side arm. This arm also carries a handle and provides support for the spring clamp which holds the micro-

scope slide air-tight against the jacket. The flow of air through the device is controlled by opening or closing the port in the side arm with the finger.

In using the apparatus the suction

orifice is guided as closely as possible, if necessary with the aid of a hand lens, to the point from which the dust sample is to be taken. Suction is not applied until after the orifice is in place to avoid picking up dust from other than the desired source. This device gives promise of great usefulness for its intended purpose, especially because it provides



certain removal and automatic transfer of the particles in question and eliminates the danger of contamination from other sources. In the accompanying illustration H. V. Wadlow of the Chemical Laboratories shows how the impinger is used to gather dust particles from a sequence switch of the panel-dial system.



Contributors to This Issue

G. A. LOCKE entered the Bell System in 1908 by way of the New York Telephone Company. In 1915, he transferred to the engineering department of the Western Electric Company where he engaged in the development of printing-telegraph apparatus. During the war he went to France as a member of the Signal Corps in a special unit dealing with printing and other telegraphic communication circuits. On returning to this country in 1919, he again became associated with the Laboratories, spending three years on printing-telegraph development in the Systems Department, and then transferred to the Research Department, where he worked on apparatus for high - speed transatlantic telegraph cables. During this period he received both a B.S. and an E.E. degree from Cooper Union. In 1928 he joined the toll development group where he has

since been engaged in the design of telephone-typewriter systems.

K. O. THORP graduated from Purdue University in 1924 with the degree of B.S. in Electrical Engineering and immediately joined the Technical Staff of the Laboratories. With the Special Products Department, the development and installation of power line carrier telephone equipment received the greater part of his attention until 1932. Since that time he has been engaged in the development of radio receiving and direction finding equipment.

C. R. MOORE received the degree of B.S. in both mechanical and electrical engineering from Purdue in 1907 and that of E.E. from the same university in 1910. He also did graduate work at the University of Illinois. From 1907 to 1913 he was associated with Purdue first as instructor and later as Assistant Professor of Elec-



G. A. Locke



K. O. Thorp



C. R. Moore



G. Puller



J. F. Morrison



A. W. Dring



A. H. White

trical Engineering and he served in the latter capacity at the University of Illinois from 1913 to 1916. In 1916 he joined the Laboratories to take charge of transmitter development. This work subsequently led to the development of the handset transmitter. During the World War he directed work on submarine signalling. Recently he has been in charge of tool development in the Outside Plant Department where he was responsible for the single sleeve rolled joint now standard in the Bell System and the tool used in making such joints. He has about thirty-five patents, including those covering the barrier and H-type microphones, the sleeve rolling tool and the application of abrasive material to single-tube sleeves to increase their strength.

G. PULLER joined the Laboratories staff in 1920 after receiving the degree of B.S. in both mechanical and electrical engineering and also that of M.E. from Cooper Union. His work has involved a variety of projects including the design of household appliances, radio receivers and power line carrier apparatus. Since 1926 he has been engaged in the design of sound picture reproducing equipment of which the low-priced projector described in this RECORD is the latest example.

J. F. MORRISON joined the radio development department of these Laboratories in 1929. His work has included the

supervising of radio broadcast transmitter installations, radio transmission studies, and broadcast antenna design. An account of Mr. Morrison's professional career before joining the Laboratories will be found on page 412 of the August issue of the RECORD.

A. W. DRING joined the Apparatus Development Department of the Western Electric Company in 1916 after having had three years' experience elsewhere in tool design. During the war he served two years in France with the Research and Inspection Division of the Signal Corps. On returning to the Laboratories he entered the Specification Group and supervised the issuance of specifications on machine switching apparatus. In 1928 he transferred to the Outside Plant Department, where he has since been interested in the development of cable terminals and various types of protection apparatus.

A. H. WHITE has been a member of the Chemical Department since he entered the Laboratories following his graduation from Occidental College in 1930. His work on the relationship between the electrical properties and chemical structure of dielectric materials led to an experimental and theoretical investigation of the causes of molecular rotation in solids, which are discussed in his article in this issue of the RECORD.